



# 2014 JAY FEATHER TOWABLES

0196624.2014



PRINTED ON RECYCLED PAPER





**THE JAYCO ECOADVANTAGE IS OUR COMPANY'S  
COMMITMENT TO PROTECTING THE ENVIRONMENT.**

Through Jayco's company-wide sustainability program, we're creating better ways to build better RVs using fewer natural resources.

Already, our initiative has created significant impact. **In 2011, our company recycled 5,438 tons of wood, 1,332 tons of scrap metal and 793 tons of cardboard and paper.** We're

proud of our results, and we know those numbers show that a little initiative can go a long way. The Jayco EcoAdvantage is our way of making sure endless generations can enjoy the Great Outdoors.





**WARNING: READ ALL INSTRUCTIONS IN THIS MANUAL AND COMPONENT MANUFACTURER SUPPLIED INFORMATION BEFORE USING YOUR RV.**

This manual has been provided by Jayco, Inc. for the sole purpose of providing instructions concerning the operation and maintenance of this vehicle and its components. Nothing in this manual creates any warranty, either expressed or implied. The only warranty offered by Jayco, Inc. is as set forth in the limited warranty applicable to this vehicle.

The owner's failure to provide required service and/or maintenance could result in the loss of warranty. The owner should review Jayco's limited warranty and the limited warranties that apply to specific components that are offered with this vehicle.

Instructions are included in the manual for operating various components which are optional on some vehicles or may not be available on your particular model. "If so equipped" does not indicate or imply that the component(s) or option(s) were at any time available, or can be retrofitted to your model. In addition, the owner should refer to individual manufacturer's operating instructions contained in the owner's packet.

**Section 1: WARRANTY & SERVICE**

About This Manual ..... 1-1

Customer Relations..... 1-4

Customer Responsibility ..... 1-3

Dealer Responsibility ..... 1-3

Jayco Customer First Emergency Roadside Assistance..... 1-6

JayPlus™ Extended Service Contract ..... 1-5

Jayco Travel Club ..... 1-5

Manufacturing Process ..... 1-3

Jayco Towable Rental Limited Warranty..... 1-15

A Notice To Jayco Dealers..... 1-14

Obtaining Emergency Warranty Repair..... 1-6

Obtaining Service At Jayco ..... 1-7

Obtaining Service For Separately Warranted Items..... 1-7

Replacement Parts..... 1-7

Reporting Safety Defects ..... 1-2

Safety Alerts..... 1-1

Suggestions For Obtaining Service..... 1-4

Towable Limited Warranty ..... 1-8

Towable Limited Tent Warranty ..... 1-12

Update Your Contact Information..... 1-5

Warranty Packet..... 1-1

**Section 2: OCCUPANT SAFETY**

Combination Carbon Monoxide/Propane Alarm..... 2-4

Cold Weather Usage..... 2-7

Condensation ..... 2-8

Extended Dry Camping ..... 2-7

Fire Extinguisher ..... 2-1

Fire Safety..... 2-1

Formaldehyde ..... 2-7

Other Fire Safety Information..... 2-1

Secondary Means Of Escape ..... 2-9

Smoke Alarm..... 2-2

**SECTION 3: PRE-TRAVEL INFORMATION**

Brake System..... 3-1

Hitch-Travel Trailer (Customer Supplied)..... 3-6

Loading Your RV..... 3-3

Sway Control-Travel Trailer (Customer Supplied)..... 3-7

Tow Vehicle ..... 3-1

Vehicle Labels..... 3-2

Weighing Your Tow Vehicle & RV..... 3-4

Weight Distributing System-Travel Trailer (Customer Supplied) ..... 3-7

Weight Labels ..... 3-2

**SECTION 4: TOWING & SET-UP**

Breakaway Switch-Travel Trailer..... 4-14

Changing A Tire ..... 4-4

Emergency Stopping..... 4-8

Emergency Towing ..... 4-8

Entrance Door ..... 4-9

Expandable Models..... 4-16

Hitching Procedure-Travel Trailer ..... 4-14

Keyless Entry (If So Equipped) ..... 4-9

Keys/Locks ..... 4-9

Leveling The RV ..... 4-8

Safety Chains-Travel Trailer ..... 4-14

Seasoning The New Tent (Expandable Models Only) ..... 4-16

Set Up-Travel Trailer ..... 4-15

Setting Up The Front & Rear Beds (Expandable Models Only) ..... 4-17

Spare Tire Carrier (If So Equipped) ..... 4-5

Stabilizer Jacks ..... 4-8

Tent Maintenance ..... 4-20

Tires ..... 4-3

Towing ..... 4-1

Towing Behind Your RV – Travel Trailers ..... 4-15

Wheel Lugs ..... 4-6

Wire Harness/Connector Plug ..... 4-1

**SECTION 5: SLIDEOUT SYSTEMS**

Operating the Slideout ..... 5-1

Troubleshooting the Slideout ..... 5-2

**SECTION 6: 30 AMP ELECTRICAL SYSTEM**

120-volt Circuit Breakers ..... 6-2

120-volt AC System ..... 6-1

12-volt DC Outlet (If So Equipped) ..... 6-5

12-volt DC System ..... 6-3

12-volt Fuse Panel ..... 6-4

30 AMP System ..... 6-6

Approximate Electrical Load Ratings ..... 6-8

Auxiliary Battery (Customer Supplied) ..... 6-3

Battery Isolator For Your Tow Vehicle (Customer Supplied) ..... 6-4

Calculating Electrical Load ..... 6-7

Converter ..... 6-2

DC Fuse Panel Layout ..... 6-5

Electrical System Maintenance ..... 6-1

GFCI Receptacle Outlet ..... 6-3

In Case Of An Electrical Fire ..... 6-1

Power Cord ..... 6-6

Replacing Light Bulbs ..... 6-5

**SECTION 7: FUEL SYSTEMS**

Calculating Propane Usage ..... 7-10

Cooking With Propane Gas ..... 7-9

Hoses, Pipes, Tubes & Fittings ..... 7-8

Installing Propane Cylinder(s) ..... 7-5

Propane Gas Container ..... 7-2

Propane Gas System ..... 7-1

Propane Leak Test ..... 7-1

Propane Regulator ..... 7-7

Propane Safety Procedures ..... 7-2

Traveling With Propane ..... 7-10

Using The Propane System ..... 7-8

**SECTION 8: PLUMBING SYSTEM**

12-volt Water Pump & Switch ..... 8-3  
 Bathroom Tub/Shower ..... 8-8  
 Black & Grey Tank Drains ..... 8-13  
 Black/Grey Water Holding Tanks ..... 8-13  
 Black/Grey Water System ..... 8-11  
 Draining the Fresh Water System ..... 8-9  
 Faucets ..... 8-7  
 Fresh Water Connections ..... 8-2  
 Fresh Water Holding Tank ..... 8-2  
 Fresh Water System ..... 8-1  
 Hardware & Sink or Shower Fixtures ..... 8-8  
 Monitor Panel ..... 8-1  
 Outside Shower ..... 8-7  
 Plumbing System Maintenance ..... 8-1  
 Sanitizing the Plumbing System ..... 8-10  
 Toilet ..... 8-14  
 Water Heater ..... 8-4  
 Water Pressure Regulator (Customer Supplied) ..... 8-3  
 Water Purification System ..... 8-8  
 Winterizing the Plumbing System ..... 8-10

**SECTION 9: HEATING & COOLING**

Air Conditioner – Roof Mount (If So Equipped) ..... 9-2  
 Attic Fan ..... 9-1  
 Ceiling Fan (If So Equipped) ..... 9-1  
 Ducting & Return Air ..... 9-1  
 Fireplace (If So Equipped) ..... 9-2  
 Furnace ..... 9-1  
 Thermostat ..... 9-1

**SECTION 10: APPLIANCES**

Central Vacuum (If So Equipped) ..... 10-2  
 Cooking With Propane ..... 10-1  
 In Case of Grease Fire ..... 10-1  
 Kitchen Range & Oven (If So Equipped) ..... 10-1  
 Microwave (If So Equipped) ..... 10-1  
 Refrigerator ..... 10-1  
 Washer/Dryer Prep (If So Equipped) ..... 10-2

**SECTION 11: ELECTRONICS**

Satellite (If So Equipped) ..... 11-2  
 Television Power Supply ..... 11-1  
 Television Roof Antenna ..... 11-1

**SECTION 12: INTERIOR**

ABS Plastics ..... 12-3  
 Booth Dinette (If So Equipped) ..... 12-4  
 Cabinetry & Tables ..... 12-2  
 Cleaning The Interior ..... 12-1  
 Countertops ..... 12-2  
 Décor Items ..... 12-1  
 Floor Safe (If So Equipped) ..... 12-3



Flooring..... 12-2  
 Free-Standing Table & Chairs (If So Equipped) ..... 12-4  
 Furniture Upholstery ..... 12-1  
 Heated Bed Mats (If So Equipped) ..... 12-5  
 Hide-A-Bed (If So Equipped) ..... 12-3  
 J-Steel Sofa (If So Equipped) ..... 12-4  
 Paneling..... 12-1  
 Pantry (If So Equipped) ..... 12-3

**SECTION 13: EXTERIOR**

BBQ Grill (If So Equipped) ..... 13-1  
 Cleaning The Exterior ..... 13-2  
 Exterior Roof & Sidewall Vents ..... 13-5  
 E-Z Lube Axle ..... 13-5  
 Frame ..... 13-5  
 Outside Kitchen (If So Equipped) ..... 13-8  
 Patio Awning ..... 13-7  
 Rear Bumper ..... 13-5  
 Roof Ladder (If So Equipped) ..... 13-8  
 Sealants..... 13-6  
 Windows ..... 13-7

**SECTION 14: TRAVEL/CAMPING/STORAGE CHECKLISTS**

Maintenance Checklist..... 14-4  
 Ready to Leave Checklist ..... 14-1  
 RV Start-Up ..... 14-1  
 RV Storage ..... 14-2

**SECTION 15: ADDITIONAL INFORMATION**

Featured Components Quick Reference Chart ..... 15-1  
 Change of Address/Ownership Form..... 15-2

Revision A – added water heater note (8-11) 6/20/13

*Congratulations!* Thank you for selecting a Jayco RV. We are excited to welcome you to our growing RV family. Jayco is the largest privately held manufacturer of recreation vehicles in the world. We are committed to being the most respected name in RVs. We invite you to drop by our Visitors Center located in Middlebury, Indiana. To book a group tour or check our scheduled factory tour times (free admission, closed holidays) please call 1-800-RV-JAYCO.

## ABOUT THIS MANUAL

This manual is a guide to the operation and maintenance of your RV. Jayco RVs are available in several sizes and models, so accessories and components may differ. Some equipment described in this manual may not apply to your RV. If you find the components vary significantly from what is described, contact your dealer to ensure you have the correct information. Nothing in this manual creates any warranty, either expressed or implied, nor does it cover every possible detail of equipment, standard or option, installed on or in your RV.

*Information, illustrations and specifications in this manual reflect the most current available at the time of publication approval, are subject to change and not intended to indicate actual size.*

## WARRANTY PACKET

The Warranty Packet contains original equipment manufacturer operator manuals, warranty cards and/or registrations. It is important you complete and mail the warranty cards and registrations within the prescribed time limits to avoid loss of warranty coverage. This manual and the Warranty Packet should be considered a permanent part of the RV. If the RV is sold, they should remain with the RV for the next owner.

## SAFETY ALERTS

Your safety, and the safety of others, is very important. To help you make informed decisions, we have provided operating procedures and other information on safety labels affixed to your RV and in this manual. Please call your dealer or Jayco Customer Service if you are unsure how to proceed. Always use the appropriate safety gear when servicing or maintaining your RV.



This is the safety alert symbol. It is issued to alert you to potential personal injury hazards. Obey all safety messages that follow this symbol to avoid possible injury or death.



### DANGER

This indicates an imminently hazardous situation which, if not avoided, will result in death or serious injury.



### WARNING

This indicates a potentially hazardous situation which, if not avoided, will result in death or serious injury.

**CAUTION**

This indicates a potentially hazardous situation which, if not avoided, will result in minor or moderate injury.

**CAUTION**

This indicates a potentially hazardous situation which, if not avoided, may result in property damage.

**REPORTING SAFETY DEFECTS****In the United States**

If you believe that your RV has an alleged defect that could cause a crash or cause injury or death, you should immediately inform the National Highway Traffic Safety Administration (NHTSA) and Jayco.

If NHTSA receives similar complaints, it may open an investigation, and if it finds that a safety defect exists in a group of vehicles it may order a recall and remedy campaign. However, NHTSA cannot become involved in individual problems between you, your dealer or Jayco.

For additional information, please refer to the NHTSA website at [www.safercar.gov](http://www.safercar.gov).

*To contact NHTSA by phone:*

Call the Department of Transportation (DOT) Vehicle Safety Hotline at 1-888- 327-4236 and a NHTSA representative will record your complaint information (TTY: 1-800-424-9153 or 1-202-484-5238).

*To contact NHTSA by mail:*

Office of Defects Investigations/CRD  
NVS-216  
1200 New Jersey Ave SE  
Washington, DC 20590

**In Canada**

If you believe your RV has an alleged safety defect, you should contact Transport Canada and Jayco. Transport Canada prefers to be called instead of posted mail or email as it enables their investigators to confirm that your information is correct, and to answer your questions accurately. For additional information, please refer to the Transport Canada website at [www.tc.gc.ca](http://www.tc.gc.ca).

*To contact Transport Canada by phone:*

Call 1-800-333-0510 (or 1-613-993-9851 if you are calling from the Ottawa region) and ask to speak to a defect investigator.

*To contact Transport Canada by mail:*

Road Safety and Motor Vehicle  
Regulation Directorate  
Transport Canada  
Tower C, Place de Ville  
330 Sparks Street  
Ottawa, Ontario K1A 0N5

## MANUFACTURING PROCESS



Jayco recreation vehicles are manufactured for use as temporary living quarters for recreation, camping and travel uses, all as defined by the bylaws of the Recreation Vehicle Industry Association (RVIA).

This recreation vehicle is not intended for use as a full-time residence or for commercial use.

Commercial use means using the RV as a business asset such as a mobile office or using the RV for lease or rental purposes.

Jayco reserves the right to discontinue or change specifications or design at any time without notice and without incurring any obligation whatsoever. RV's built for sale in Canada may differ to conform to Canadian Codes.

## CUSTOMER RESPONSIBILITY

It is important you read and understand the information in this manual and your Warranty Packet using your RV.

Familiarize yourself with the applicable warranties. You are responsible for ensuring the procedures for obtaining warranty repair are followed properly. It is your responsibility and obligation to return your RV to your dealer for warranty service repair.

As the owner of the RV, you are responsible for regular and proper maintenance performed in accordance with this manual and the OEM manuals. Regular and proper maintenance will help prevent conditions arising from neglect that are not covered by warranty.

As with your other personal belongings, it is important to protect yourself and others with insurance coverage. Your insurance agent can assist you in obtaining the appropriate insurance coverage for personal liability, theft, collision, property damage, etc.

## DEALER RESPONSIBILITY

At the time of sale of the new RV, your dealer is expected to:

- Deliver your RV in the best condition possible. Your RV must pass the dealer's pre-delivery inspection (PDI), including all systems tests.
- Provide orientation of the RV, its systems, components and operation.
- Request that you read all warranty information and explain any provision not clearly understood.
- Ensure you receive the Warranty Packet. Your dealer can assist you in completing the OEM warranty cards or registrations, and locate any required component model or serial numbers.
- Complete and return the "Warranty Registration and Customer Delivery Form" to Jayco within 10 days of delivery to activate the applicable warranty coverage.

The **Towable Limited Warranty** is activated only after Jayco receives a signed and dated "Warranty Registration and Customer Delivery Form" from your dealer.

---

## SUGGESTIONS FOR OBTAINING SERVICE

---

The independent dealers authorized to sell Jayco RVs are also there to provide service after the sale. We work closely with them in an effort to keep you satisfied. To help ensure your dealer provides the level of service you expect, here are some suggestions we would like to make:

**Contact your dealer at once...** Do not wait until you are ready to use your RV. Your dealer may not be able to service it immediately and/or the repair may require parts be ordered.

The dealer's service department is busiest on Mondays, Fridays and before the holidays.

**Prepare for the appointment...** If you are having warranty work performed, be sure to have the right papers with you. Take your warranty folder and have your vehicle information available. Not all the work to be performed may be covered by the warranty; discuss additional charges with the dealer's service management.

**Prepare a list...** Provide your dealer with a written list of specific repairs needed. It is important that you provide any vehicle repair history to the dealer's service manager. Keep a maintenance log of your RV service history. This can often provide a clue to the current issue.

**Be reasonable with your requests...** If you leave a list with several items and you need your RV returned back by a specific time, discuss the situation with the dealer's service management and list your items in order of priority. This may include making a second appointment for work not completed or parts that the dealer may need to order.

**Don't expect to look over the technician's shoulder...** Please do not be offended if you are told you cannot watch the work being done. Some insurance requirements forbid admission of customers to the service area.

**Inspect the work performed...** Finally, check out the service or repair job when you pick up your RV. Notify the dealer's service management immediately of any dissatisfaction. If you cannot return your RV immediately for repair, make an appointment as soon as possible.

Please be aware that all repair businesses require notification of any issues with their repairs within a specified time limit. Make sure you are familiar with your dealer or RV repair center's repair policies.

---

## CUSTOMER RELATIONS

---

Jayco, has empowered its dealers to make warranty and repair decisions. If a special circumstance occurs that requires information from Jayco, we have asked your dealer's service management to make the contact on your behalf. **This is why you should always talk to your dealer's service management first.**

When making contact with your dealer, please provide the following information:

- Your name, location and phone number.
- Your RV 17-digit vehicle identification number (VIN).
- Your date of purchase.
- The name of your selling dealer.
  - If different from above, the contact information for the RV repair facility you are contacting Jayco to discuss.
- A detailed description of the concern.
- If applicable, the component description, serial number and model number.

**Mailing address**

Jayco, Inc.  
 Customer Service  
 P.O. Box 460  
 903 S. Main Street  
 Middlebury IN 46540

Phone (toll-free)  
 Phone (local)  
 Fax (toll-free)

Brochure request info@Jayco.com

Service email service@Jayco.com

Website www.Jayco.com

**Shipping address**

Jayco, Inc.  
 Customer Service  
 100 Bontrager Drive  
 Bldg 42 Door 4220  
 Middlebury IN 46540

(800) 283-8267  
 (574) 825-0608  
 (866) 709-9139

**An important note about alterations and warranties**

Installations or alterations to the original equipment vehicle as distributed by Jayco are not covered by the Towable Limited Warranty. The special body company, assembler, equipment installer or upfitter is solely responsible for warranties on the body or equipment and any alterations (or any effect of the alterations) to any of the parts, components, systems or assemblies installed by Jayco. Jayco is not responsible for the safety or quality of design features, materials or workmanship of any alterations by such suppliers.

**UPDATE YOUR CONTACT INFORMATION**

Help keep your contact information current so that, in the event of a recall or customer notification letter, you are notified. Please copy and mail your completed “Change of Address or Ownership, Stolen, Totaled or Destroyed” form to Jayco.

If you purchased your RV as “used,” include proof of ownership (i.e., a copy of your bill of sale, insurance policy, etc.).

**JAYCO TRAVEL CLUB**

All owners of Jayco RVs are eligible for membership in the Jayco Travel Club. The club promotes family camping and the active use of your RV with others who have similar interests in the RV lifestyle.



One “International Rally” is held each year in various locations around the United States and Canada. In addition, the club offers a variety of local and regional activities throughout the year.

By belonging to the Jayco Travel Club, you will find new ways to enjoy your RV and make friends all across the country. For more information please visit www.Jaycorvclub.com or call 1-800-262-5178.

**JAYPLUS™ EXTENDED SERVICE CONTRACT**

Don't let unexpected repair costs keep you from traveling toward your dreams.



Protect yourself with a JayPlus™ Extended Service Agreement. For more information, contact your dealer or call 1-800-527-3426.

Your dealer can help you obtain a JayPlus™ insurance quote from GMAC Insurance or call 1-877-484-2261 (Savings Code: GL 2A).

## **JAYCO CUSTOMER FIRST EMERGENCY ROADSIDE ASSISTANCE**

---

Jayco has teamed up with Coach-Net to offer 24/7 motorist assistance. We are offering this free of charge for the first year of ownership (certain restrictions apply\*). You may continue your emergency roadside assistance benefits in the following years by contacting Coach-Net to discuss terms and rates for this independently continued coverage.

For details on accessing your emergency roadside assistance benefits, please refer to your Member Benefit Guide that is sent out 6-8 weeks after your completed “Warranty Registration and Customer Delivery Form” is received by Jayco, or contact Coach-Net ([www.coach-net.com](http://www.coach-net.com)) at 1-877-801-0333.

*\*To qualify for coverage, your RV must be eligible as set forth under the terms of the **Towable Limited Warranty**.*

## **OBTAINING EMERGENCY WARRANTY REPAIR**

---

A roadside emergency can happen at any time, whether your RV is new or old. If you are traveling, using the following guidelines can help get you back on the road faster.

1. Call 1-800-RV-JAYCO or use our website dealer locator to find an authorized Jayco dealer in your area. Contact them for an appointment; they will handle all warranty repair billing and returned parts for you.
2. If you cannot locate an authorized Jayco dealer near you, ask the campground staff for referrals or check the local telephone yellow pages. Or contact Jayco Customer Service or your selling dealer for assistance in locating a repair facility.
  - a. Contact the RV repair facility to discuss your situation and make an appointment. Ask how their billing will be handled. They may choose to bill Jayco directly; otherwise, you are expected to pay them.
  - b. Have the RV repair facility inspect your RV. Either they or you must call Jayco Customer Service to discuss applicable warranty coverage prior to any repair work being performed.
  - c. Jayco Customer Service will issue an authorization number upon warranty repair approval and advise if any original parts need to be returned.
  - d. Once Jayco Customer Service has issued an authorization number, the RV repair facility may begin actual repair to your RV.
  - e. Inspect the completed repair work thoroughly. If you are not satisfied, communicate that immediately to the RV repair facility management. Make sure you are satisfied with the repair before you pay or leave the premises.
  - f. For reimbursement, either you or the RV repair facility must send a copy of your itemized repair bill and all requested return parts by UPS (regular ground, freight pre-paid) within 60 days of the completed repair date.

To expedite processing your warranty claim, include your name, address, phone number, RV 17-digit VIN and authorization number. If returning parts, include a copy of your return freight bill.



**Obtaining weekend or after business hours repair assistance**

If an authorized Jayco dealer is not located nearby, contact your selling dealer for assistance. If your dealer is closed, check with the campground staff or telephone yellow pages for an RV repair facility. Have the item repaired and contact Jayco Customer Service immediately the following business day.

Failure to contact Jayco Customer Service, unauthorized or improper warranty repairs, or failure to return requested original parts may result in loss of reimbursements and/or loss of warranty.

**OBTAINING SERVICE FOR SEPARATELY WARRANTED ITEMS**

Your selling dealer is responsible for servicing your RV before delivery, and has an interest in your continued satisfaction. We recommend your dealer perform all inspection, warranty and maintenance services. Some dealers may be authorized service centers for those OEMs whose products are warranted separately and excluded from the **Towable Limited Warranty**.

**OBTAINING SERVICE AT JAYCO**

Should your RV be in need of service, and your dealer recommend that the repairs be made at the Jayco Factory Service Center, your RV may be returned to us with the following guidelines\*:

- You or your dealer must make a confirmed appointment a minimum of 60 days prior to dropping off your RV at the Jayco Factory Service Center.
- The holding tanks must be emptied and rinsed. We have a dumping station available for customer use.
- The propane system and all electrical systems must be shut down and turned off. We are not responsible for discharged batteries or propane tanks.
- During the appropriate season, please ensure your RV is winterized.
- Unless prior approval has been obtained from the Jayco Factory Service Center, all personal items must be removed from the area where you are requesting service repair and the refrigerator emptied. We are not responsible for loss of food items.
- You are responsible for all transportation costs. You may need to arrange for alternative accommodations for some types of repairs. Please be prepared accordingly.

*\*Jayco Customer Service occasionally utilizes local independent repair facilities. Your RV may be referred to or repaired by one of these local repair facilities.*

**REPLACEMENT PARTS**

Parts for Jayco RVs are distributed exclusively by authorized Jayco dealers. Jayco does not sell parts retail direct or to non-authorized dealers. If an original part is no longer available, Jayco will try to provide an appropriate substitute.

**TOWABLE LIMITED WARRANTY****WHAT AND WHO IS COVERED**

The Jayco warranty covers this recreational vehicle ("RV"), when used only for its intended purpose of recreational travel and camping, for two (2) years. It covers RV's that are sold in, and remain in, the United States, U.S. Territories and Canada, only. The warranty period begins on the date that the RV is delivered to the first retail purchaser by an independent, authorized dealer of Jayco, or, if the dealer places the vehicle in service prior to retail sale, on the date the RV is first placed in such service. In the event that a substantial defect in material or workmanship, attributable to Jayco, is found to exist during the warranty period, it will be repaired or replaced, at Jayco's option, without charge to the RV owner, in accordance with the terms, conditions and limitations of this limited warranty.

This limited warranty applies to the first consumer purchaser only. All rights and limitations within this warranty are applicable to the original owner of the RV only. Jayco's limited warranty only covers substantial defects in materials, components, or parts of the RV attributable to Jayco. It does not replace, modify, or apply to the warranties provided by the manufacturers that supply the products used by Jayco to assemble the RV, like the frame. You may contact an independent, authorized dealer for details.

Jayco's obligation to repair or replace defective materials or workmanship is the sole obligation of Jayco under this limited warranty. Jayco reserves the right to use new or remanufactured parts of similar quality to complete any work, and to make parts and design changes from time to time without notice to anyone. Jayco reserves the right to make changes in the design or material of its products without incurring any obligation to incorporate such changes in any product previously manufactured. Jayco makes no warranty as to the future performance of this RV, and this limited warranty is not intended to extend to the future performance of this RV, or any of its materials, components or parts. In addition, the RV owner's obligation to notify Jayco, or one of its independent, authorized dealers, of a claimed defect does not modify any obligation placed on the RV owner to contact Jayco directly when attempting to pursue remedies under state or federal law.

**LIMITATIONS, EXCLUSIONS AND DISCLAIMER OF IMPLIED WARRANTIES**

**ANY IMPLIED WARRANTY THAT IS FOUND TO ARISE BY WAY OF STATE OR FEDERAL LAW, INCLUDING ANY IMPLIED WARRANTY OF MERCHANTABILITY OR ANY IMPLIED WARRANTY OF FITNESS, IS LIMITED IN DURATION TO THE DURATION SET FORTH IN THIS LIMITED WARRANTY AND IS LIMITED IN SCOPE OF COVERAGE TO THE SCOPE OF COVERAGE OF THIS LIMITED WARRANTY.**

Jayco makes no warranty of any nature beyond that contained in this limited warranty. Jayco does not authorize any person to create any other obligation or liability for it regarding this RV, and Jayco is not responsible for any representation, promise or warranty made by any dealer or other person beyond what is expressly stated in this limited warranty, and no one has the authority to enlarge, amend or modify this limited warranty. Any selling or servicing dealer is not Jayco's agent, but an independent entity.

**JAYCO SHALL NOT BE LIABLE FOR ANY INCIDENTAL OR CONSEQUENTIAL DAMAGES THAT MAY RESULT FROM BREACH OF THIS LIMITED WARRANTY OR ANY IMPLIED WARRANTY. THIS EXCLUSION OF CONSEQUENTIAL AND INCIDENTAL DAMAGES SHALL BE INDEPENDENT OF ANY FAILURE OF THE ESSENTIAL PURPOSE OF ANY WARRANTY, AND**

**THIS EXCLUSION SHALL SURVIVE ANY DETERMINATION THAT THIS LIMITED WARRANTY OR ANY IMPLIED WARRANTY HAS FAILED OF ITS ESSENTIAL PURPOSE.**

Some states do not allow limitations on how long an implied warranty lasts, or the exclusion or limitation of incidental or consequential damages, so the above limitations or exclusions may not apply to you.

**HOW TO GET SERVICE**

To obtain warranty service the owner must do all of the following:

1. Notify an independent, authorized dealer of Jayco, or Jayco, of the substantial defect in material or workmanship attributable to Jayco, within the warranty coverage period designated above;
2. Provide the notification mentioned in (1), above, within ten (10) days of when the owner discovered, or should have discovered, the substantial defect in material or workmanship attributable to Jayco;
3. Promptly schedule an appointment with and take the RV to an independent, authorized dealer of Jayco, or Jayco, for repairs; and
4. Pay any freight or transportation costs, import duties, fees and all incidental expenses associated with obtaining warranty service.

For warranty service simply contact one of Jayco's independent, authorized service centers for an appointment and then deliver your RV to the service center on the specified appointment date. If you need assistance you may contact Jayco, at 903 S. Main Street, P.O. Box 460, Middlebury, Indiana 46540, Attn: Customer Service, (574) 825-5861, (800) 283-8267 or [www.jayco.com](http://www.jayco.com).

NOTE: Jayco does not control the scheduling of service work at the independent, authorized dealerships. You may encounter some delay in scheduling or completion of work. Also, you must notify the selling dealer at time of delivery to have work performed on any defect that occurred at the factory during manufacture at no cost to you as provided by this limited warranty. (See below under WHAT IS NOT COVERED).

If two (2) or more service attempts have been made to correct any covered defect that you believe impairs the value, use or safety of the RV, or if it has taken longer than thirty (30) days for those types of repairs to be completed, you must, to the extent permitted by law, notify Jayco directly, in writing, at the above address, of the unsuccessful repair(s) of the alleged defect(s) so that Jayco can become directly involved in making sure that you are provided service pursuant to the terms of this limited warranty.

**WHAT IS NOT COVERED**

By way of example only, this limited warranty does not cover any of the following: defects in materials, components or parts of the RV not attributable to Jayco; items that are added or changed after the RV leaves the possession of Jayco; additional equipment or accessories installed at any dealership, or other place of business, or by any other party, other than Jayco; any RV used for rental or other commercial purposes (Note: It shall be concluded that the RV has been used for commercial and/or business purposes if the RV owner or user files a tax form claiming any business or commercial tax benefit related to the RV, or if the RV is purchased, registered or titled in a business name); any RV sold or used outside the United States, U.S. Territories or Canada; any RV not used solely for recreational travel and camping; any RV purchased through auction or wholesale; any RV purchased from a dealer that is not an authorized dealer of Jayco; normal wear, tear or usage, such as tears, punctures, soiling, mildew, fading, or

discoloration of exterior plastic or fiberglass, or soft goods, such as upholstery, drapes, carpet, vinyl, screens, cushions, mattresses and fabrics; the effects of condensation or moisture from condensation inside the RV or failure to provide adequate ventilation; mold or any damage caused by mold to the inside or outside of the RV; imperfections that do not affect the suitability of the RV for its intended purpose of recreational use or items that are working as designed but that you are unhappy with; problems, including water leaks, related to misuse, mishandling, neglect or abuse, including failure to maintain the RV in accordance with the owner's manual, or other routine maintenance such as inspections, lubricating, adjustments, tightening of screws and fittings, tightening of lug nuts, sealing, rotating tires; damage due to accident, whether or not foreseeable, including any acts of weather or damage or corrosion due to the environment, theft, vandalism, fire, or other intervening acts not attributable to Jayco; service items such as windshield wiper blades, lubricants, fluids, filters, etc.; damage resulting from tire wear or tire failure; defacing, scratches, dents, chips on any surface or fabric of the RV; damage caused by off road use, overloading the RV or alteration of the RV, or any of its components or parts; wheel alignment or adjustments to axles when caused by improper maintenance, loading or damage from road hazards, including off road travel, wheel damage or balancing or damage from tire failures. Also, any costs associated with obtaining service, including by way of example, travel costs, are specifically excluded from the coverage of this warranty.

In addition, this limited warranty does not cover any material, component or part of the RV that is warranted by another entity, including, by way of example, handling, braking, wheel balance, muffler, tires, tubes, batteries, gauges, generator, hydraulic jacks, inverter, converter, microwave, television, DVD/CD player, radio, speakers, television, refrigerator, range, hot water heater, water pump, stove, carbon monoxide detector, smoke detector, propane detector, furnace or any air conditioner. (Note: The written warranty provided by the manufacturer of the component part is the direct responsibility of that manufacturer).

Defects and/or damage to interior and exterior surfaces, trim, upholstery and other appearance items may occur at the factory. These items are usually detected and corrected at the factory or by the selling dealer prior to delivery to the retail customer. You must inspect your RV for this type of damage when you take delivery. If you find any such defect or damage you must notify the selling dealer at time of delivery to have these items covered by this limited warranty and to have work performed on the items at no cost to you as provided by this limited warranty.

### **EVENTS DISCHARGING JAYCO FROM OBLIGATION UNDER WARRANTY**

Certain things completely discharge Jayco from any obligation under this warranty and void it. By way of example, the following shall discharge Jayco from any express or implied warranty obligation to repair or replace any defect that results from: any rental or other commercial use or purchase of the RV (as defined in this warranty), any RV sold outside of, or used outside of, the United States, U.S. Territories or Canada, through an auction or wholesale or by a non-authorized dealer, any defect in a separately manufactured component part, owner neglect or failure to provide routine maintenance (See Owner's Manual), unauthorized alteration, off road use, collision or accident, whether or not foreseeable, including any acts of weather or damage or corrosion due to the

environment, theft, vandalism, fire, explosions, overloading in excess of weight ratings, and tampering with any portion of the RV, or any use of the RV as a semi-permanent or permanent home.

### **LEGAL REMEDIES**

Any action to enforce any portion of this limited warranty, or any implied warranty, shall be commenced within six (6) months after expiration of the warranty coverage period designated above. Any performance of repairs shall not suspend this limitation period from expiring. Any performance of repairs after the warranty coverage period has expired, or performance of repairs regarding anything excluded from coverage under this limited warranty shall be considered “good will” repairs, and they will not alter the express terms of this limited warranty, or extend the warranty coverage period or this limitation period. In addition, this warranty is not intended to extend to future performance, and nothing in this warranty, or any action of Jayco, or any agent of Jayco, shall be interpreted as an extension of the warranty period or this limitation period. Some states do not allow a reduction in the statute of limitations, so this reduction may not apply to you.

### **WARRANTY REGISTRATIONS**

Your warranty registration records should be completed and delivered to the manufacturers of component parts. The selling dealership will assist you in completing and submitting the Jayco product warranty registration form. That form must be returned to Jayco within ten (10) days of your taking delivery of the RV. Your Jayco warranty will not be registered unless this warranty registration is completed and received by Jayco. Failure to file this warranty registration with Jayco will not affect your rights under this limited warranty as long as you can present proof of purchase, but it can cause delays in obtaining the benefits of this limited warranty, and it may inhibit any servicing facility’s ability to provide proper repairs and/or part replacement.

### **CARE AND MAINTENANCE**

It is the owner’s responsibility to perform proper care and maintenance of the RV, and to assure correct load distribution. For details regarding this, please see your Jayco owner’s manual and the owner’s manuals of the chassis manufacturer and other component part manufacturers. These outline various care and maintenance that is required to maintain your RV. Please review all manuals supplied with your RV, and contact your selling dealership or supplier of the component part if you have questions. Note: Failure to maintain the RV as noted in those manuals voids this limited warranty, and any damage to the RV as a result of your failure to perform such care, is not covered by this limited warranty.

**THIS WARRANTY GIVES YOU SPECIFIC LEGAL RIGHTS, AND YOU MAY ALSO HAVE OTHER RIGHTS THAT VARY FROM STATE TO STATE.**

#### **JAYCO, INC.**

903 S. Main Street \* P.O. Box 460 \* Middlebury, IN 46540  
Telephone: 574-825-5861 or 800-283-8267

**TOWABLE LIMITED TENT WARRANTY**  
**(Travel Trailers with Bunk Ends with Tents, Only)**

**WHAT AND WHO IS COVERED**

The Jayco limited tent warranty covers the tents on the bunk ends of the slide rooms of this travel trailer, when the RV is used only for its intended purpose of recreational travel and camping. This warranty covers parts, labor and freight for the first two (2) years and parts, Jayco factory labor and return freight from Jayco for an additional three (3) years. It covers RV's sold in, and remain in, the United States, U.S. Territories and Canada, only. The warranty period begins on the date that the RV is delivered to the first retail purchaser by an independent, authorized dealer of Jayco, or, if the dealer places the vehicle in service prior to retail sale, on the date the RV is first placed in such service. In the event that a substantial, functional defect with the material or workmanship of the tents, attributable to Jayco, is found to exist during the warranty period, it will be repaired or replaced, at Jayco's option, without charge to the RV owner, in accordance with the terms, conditions and limitations of the Jayco, Towable Limited Warranty and this limited warranty. The cost of parts, labor and shipping are covered by Jayco for the first two (2) years. The cost of parts, Jayco factory labor and return freight from Jayco are covered by Jayco for an additional three (3) years.

This limited tent warranty applies to the first consumer purchaser only. All rights and limitations within this warranty and the Jayco, Towable Limited Warranty are applicable to the original owner of the RV only. You may contact an independent, authorized dealer for details.

Jayco's obligation to repair or replace defective materials or workmanship is the sole obligation of Jayco under this limited warranty. Jayco reserves the right to use new or remanufactured parts of similar quality to complete any work, and to make parts and design changes from time to time without notice to anyone. Jayco reserves the right to make changes in the design or material of its products without incurring any obligation to incorporate such changes in any product previously manufactured. Jayco makes no warranty as to the future performance of this RV, or the tents, and this limited warranty is not intended to extend to the future performance of this RV, or the tents, or any of its materials, components or parts. In addition, the RV owner's obligation to notify Jayco, or one of its independent, authorized dealers, of a claimed defect does not modify any obligation placed on the RV owner to contact Jayco directly when attempting to pursue remedies under state or federal law.

**LIMITATIONS, EXCLUSIONS AND DISCLAIMER OF IMPLIED WARRANTIES**

**ANY IMPLIED WARRANTY THAT IS FOUND TO ARISE BY WAY OF STATE OR FEDERAL LAW, INCLUDING ANY IMPLIED WARRANTY OF MERCHANTABILITY OR ANY IMPLIED WARRANTY OF FITNESS, IS LIMITED IN DURATION TO THE DURATION SET FORTH IN THIS LIMITED WARRANTY AND IS LIMITED IN SCOPE OF COVERAGE TO THE SCOPE OF COVERAGE OF THIS LIMITED WARRANTY.** Jayco makes no warranty of any nature beyond that contained in this limited warranty. Jayco does not authorize any person to create any other obligation or liability for it regarding this RV, and Jayco is not responsible for any representation, promise or warranty made by any dealer or other person beyond what is expressly stated in this limited warranty, and no one has the authority to enlarge, amend or modify this limited warranty. Any selling or servicing dealer is not Jayco's agent, but an independent entity.

**JAYCO SHALL NOT BE LIABLE FOR ANY INCIDENTAL OR CONSEQUENTIAL DAMAGES THAT MAY RESULT FROM BREACH OF THIS LIMITED WARRANTY OR ANY IMPLIED WARRANTY. THIS EXCLUSION OF CONSEQUENTIAL AND INCIDENTAL DAMAGES SHALL BE INDEPENDENT OF ANY FAILURE OF THE ESSENTIAL PURPOSE OF ANY WARRANTY, AND THIS EXCLUSION SHALL SURVIVE ANY DETERMINATION THAT THIS LIMITED WARRANTY OR ANY IMPLIED WARRANTY HAS FAILED OF ITS ESSENTIAL PURPOSE.**

Some states do not allow limitations on how long an implied warranty lasts, or the exclusion or limitation of incidental or consequential damages, so the above limitations or exclusions may not apply to you.

### **RELATION TO JAYCO TOWABLE LIMITED WARRANTY**

This limited tent warranty applies to tents on the bunk ends of the slide rooms of this travel trailer, only. It does not apply to any other RV, or any other portion of this RV. In addition, this warranty does not change, alter or modify the limited warranty that Jayco provides with the RV in any fashion. It only supplements the Jayco limited warranty to provide for a limited, five (5) year tent warranty (covering parts, labor and freight for the first two (2) years and parts, Jayco labor and return freight from Jayco for an additional three (3) years).

For additional information regarding the relationship between the warranties, please see the Jayco Limited Warranty you received with your RV. It contains information on What and Who is Covered, Limitations, Exclusions And Disclaimers, How To Get Service, What Is Not Covered, Events Discharging Jayco From Obligations, Legal Remedies, Warranty Registrations and Care and Maintenance. The information in those sections of the Jayco warranty provided with your RV is applicable to this warranty as well.

---

**NOTICE TO JAYCO DEALERS**

---

Pages 8-13 of this Owner's Manual contains the warranty that applies to this RV.

However, if the Jayco dealer decides to use this RV for rental purposes, then the warranty contained in pages 8-13 will not apply to this RV. The rental warranty, located on pages 15-18, applies in that situation.

If, on the other hand, the Jayco dealer sells this RV to a retail customer then the rental warranty would not be applicable. **The rental warranty does not apply to retail consumers.**

Jayco's rental program is applicable to the following product lines:

- Jay Series Camping Trailers
- Baja Camping Trailers
- Jay Feather Ultra Lite Travel Trailers
- Jay Feather Ultra Lite EXP Travel Trailers
- Jay Feather Ultra Lite SLX
- White Hawk Travel Trailers
- Jay Flight Travel Trailers
- Jay Flight Swift Travel Trailers
- Jay Flight Bungalow Park Trailers
- Jay Flight Destination
- Eagle Travel Trailers
- Eagle Fifth Wheels
- Eagle HT Fifth Wheels
- Eagle Premier FW
- Pinnacle Fifth Wheels
- Octane ZX Lite Weight Toy Haulers

If you have any questions regarding this, please contact Jayco Customer Service at (800) 283-8267 or (574) 825-0608.



**JAYCO TOWABLE RENTAL LIMITED WARRANTY****WHAT AND WHO IS COVERED**

The Jayco warranty covers this recreational vehicle (“RV”), when used only for recreational travel and camping, including recreational travel and camping by renters of the Dealer, for one (1) year. This limited warranty applies to the original Dealer only, and it is not transferable. The warranty period begins on the date that Dealer first places the RV in rental service. In the event that a substantial defect in material or workmanship, attributable to Jayco, is found to exist during the warranty period, Jayco will reimburse the Dealer either the reasonable costs of repair or the reasonable costs of replacement of the defect, (Jayco’s option), in accordance with the terms, conditions and limitations of this limited warranty.

Jayco’s obligation to reimburse Dealer for the reasonable costs of repair or replacement of defective materials or workmanship is the sole obligation of Jayco under this limited warranty. Jayco reserves the right to use new or remanufactured parts of similar quality to complete any work, and to make parts and design changes from time to time without notice to anyone. Jayco reserves the right to make changes in the design or material or its products without incurring any obligation to incorporate such changes in any product previously manufactured. Jayco makes no warranty as to the future performance of this RV, and this limited warranty is not intended to extend to the future performance of this RV, or any of its materials, components or parts. In addition, the Dealer’s obligation to notify Jayco, of a claimed defect does not modify any obligation placed on the Dealer to contact Jayco directly when attempting to pursue remedies under state or federal law.

**LIMITATIONS, EXCLUSIONS AND DISCLAIMER OF IMPLIED WARRANTIES**

**ANY IMPLIED WARRANTY THAT IS FOUND TO ARISE BY WAY OF STATE OR FEDERAL LAW, INCLUDING ANY IMPLIED WARRANTY OF MERCHANTABILITY OR ANY IMPLIED WARRANTY OF FITNESS, IS LIMITED IN DURATION TO THE DURATION OF THIS LIMITED WARRANTY AND IS LIMITED IN SCOPE OF COVERAGE TO THE SCOPE OF COVERAGE OF THIS LIMITED WARRANTY.** Jayco makes no warranty of any nature beyond that contained in this limited warranty. Jayco does not authorize any person to create any other obligation or liability for it regarding this RV, and Jayco is not responsible for representation, promise or warranty made by any dealer or other person beyond what is expressly stated in this limited warranty, and no one has the authority to enlarge, amend or modify this limited warranty. Any selling or servicing dealer is not Jayco’s agent, but an independent entity.

**JAYCO SHALL NOT BE LIABLE FOR ANY INCIDENTAL OR CONSEQUENTIAL DAMAGES THAT MAY RESULT FROM BREACH OF THIS LIMITED WARRANTY OR ANY IMPLIED WARRANTY. THIS EXCLUSION OF CONSEQUENTIAL AND INCIDENTAL DAMAGES SHALL BE INDEPENDENT OF ANY FAILURE OF THE ESSENTIAL PURPOSE OF ANY WARRANTY, AND THIS EXCLUSION SHALL SURVIVE ANY DETERMINATION THAT THIS LIMITED WARRANTY OR ANY IMPLIED WARRANTY HAS FAILED OF ITS ESSENTIAL PURPOSE.**

Some states do not allow limitations on how long an implied warranty lasts, or the exclusion or limitation of incidental or consequential damages, so the above limitations or exclusions may not apply to you.

## HOW TO GET SERVICE

To obtain reimbursement of warranty service the owner must do all of the following:

1. Notify Jayco of the substantial defect in material or workmanship attributable to Jayco, within the warranty coverage period;
2. Provide the notification mentioned in (1), above, within ten (10) days of when the owner discovered, or should have discovered, the substantial defect in material or workmanship attributable to Jayco;
3. Promptly and appropriately make the necessary repairs; and
4. Pay any freight or transportation costs, import duties, fees and all incidental expenses associated with obtaining warranty service.

If you need assistance you may contact Jayco, at 903 S. Main Street, P. O. Box 460, Middlebury, Indiana, 46540, Attn: Customer Service (574) 825-5861, (800) 283-8267 or [www.jayco.com](http://www.jayco.com). Also, you must notify Jayco within three (3) days of delivery to you to have work performed on any defect or damage to appearance items that occurred at the factory during manufacturer or during delivery at no cost to you as provided by this limited warranty. (See below under WHAT IS NOT COVERED).

If two (2) or more service attempts have been made to correct any covered defect that you believe impairs the value, use or safety of the RV, or if it has taken longer than thirty (30) days for those types of repairs to be completed, you must, to the extent permitted by law, notify Jayco directly, in writing, at the above address, of the unsuccessful repair(s) of the alleged defect(s) so that Jayco can become directly involved in making sure that you are provided service pursuant to the terms of this limited warranty.

## WHAT IS NOT COVERED

By way of example, only, this Limited Warranty does not cover any of the following: defects in materials, components or parts of the RV not attributable to Jayco; items that are added or changed after the RV leaves the possession of Jayco; additional equipment or accessories installed at any dealership, or other place of business, or by any other party, other than Jayco; any RV not used solely for recreational travel and camping; all soft goods, normal wear, tear or usage, such as tears, punctures, soiling, mildew, fading, or discoloration of exterior plastic, fiberglass, upholstery, drapes, carpet, vinyl, screens, cushions, mattresses and fabrics; the effects of condensation or moisture from condensation inside the RV and failure to provide adequate ventilation; mold or any damage caused by mold to the inside or outside of the RV; imperfections that do not affect the suitability of the RV for its intended purpose of recreational use or items that are working as designed but that you are unhappy with; problems related to misuse, mishandling, neglect or abuse, including failure to maintain the RV in accordance with the owner's manual, or other routine maintenance such as inspections, lubricating, adjustments, tightening of screws, tightening of lug nuts, sealing, rotating tires; damage due to accident, whether or not foreseeable, including any acts of weather or damage or corrosion due to the environment, theft, vandalism, fire, or other intervening acts not attributable to Jayco; service items such as windshield wiper blades, lubricants, fluids, filters, etc.; damage resulting from tire wear or tire failure; defacing, scratches, dents, chips on any surface or fabric of the RV; damage caused by off road use, overloading the RV or alteration of the RV, or any of its components or parts.

In addition, this limited warranty does not cover any material, component or part of the RV that is warranted by another entity, including, by way of example, handling, braking, wheel balance, muffler, tires, tubes, batteries, gauges, generator, hydraulic jacks, inverter, converter, microwave, television, DVD/CD player, radio, speakers, television, refrigerator, range, hot water heater, water pump, stove, carbon monoxide detector, smoke detector, propane detector, furnace or any air conditioner. (Note: the written warranty provided by the manufacturer of the component part is the direct responsibility of that manufacturer).

Defects and/or damage to interior and exterior surfaces, trim, upholstery and other appearance items may occur at the factory or during delivery of the RV to you. These items are usually detected and corrected at the factory. You must inspect the RV for this type of damage when you take delivery from Jayco. If you find any such defect or damage you must notify Jayco within three (3) days of delivery of the RV to you to have these items covered by this limited warranty and to have work performed on the items covered by this limited warranty.

### **EVENTS DISCHARGING JAYCO FROM OBLIGATION UNDER WARRANTY**

Certain things completely discharge Jayco from any obligation under this warranty and void it. By way of example, the following shall discharge Jayco from any express or implied warranty obligation to repair or replace any defect that results from: any defect in a separately manufactured component part, any neglect or failure to provide routine maintenance by you or anyone you rent the RV to (See Owner's Manual), unauthorized alteration, off road use, collision or accident, whether or not foreseeable, including any acts of weather or damage or corrosion due to the environment, theft, vandalism, fire, explosions, overloading in excess of weight ratings, and tampering with any portion of the RV.

### **LEGAL REMEDIES**

Any action to enforce any portion of this limited warranty, or any implied warranty, shall be commenced within six (6) months after expiration of the warranty coverage period designated above. Any performance of repairs shall not suspend this limitation period from expiring. Any performance of repairs after the warranty coverage period has expired, or performance of repairs regarding any thing excluded from coverage under this limited warranty shall be considered "good will" repairs, and they will not alter the express terms of this limited warranty, or extend the warranty coverage period or this limitation period. In addition, this warranty is not intended to extend to future performance, and nothing in this warranty, or any action of Jayco, or any agent of Jayco, shall be interpreted as an extension of the warranty or this limitation period. Some states do not allow a reduction in the statute of limitations, so this reduction may not apply to you.

### **WARRANTY REGISTRATIONS**

Your warranty registration records should be completed and delivered to the manufacturers of component parts. The Jayco product warranty registration form must be returned to Jayco within ten (10) days of your taking delivery of the RV. Your Jayco warranty will not be registered unless this warranty registration is completed and received by Jayco. Failure to file this warranty registration with Jayco will not affect your rights under this limited warranty as long as you can present proof of purchase, but it can cause delays in obtaining the benefits of this limited warranty, and it may inhibit any servicing facilities' ability to provide proper repairs and/or part replacement.

**CARE AND MAINTENANCE**

It is your responsibility to perform proper care and maintenance of the RV, and to assure correct load distribution. For details regarding this, please see your Jayco owner's manual and other component part manufacturers. These outline various care and maintenance that is required to maintain your RV. Please review all manuals supplied with the RV, and contact Jayco or the supplier of the component part if you have questions. Note: failure to maintain the RV as noted in those manuals voids this limited warranty, and any damage to the RV as a result of your failure to perform such care, is not covered by this limited warranty.

**THIS WARRANTY GIVES YOU SPECIFIC LEGAL RIGHTS, AND YOU MAY ALSO HAVE OTHER RIGHTS THAT VARY FROM STATE TO STATE.**

**JAYCO, INC.**

903 S. Main Street \* P.O. Box 460 \* Middlebury, IN 46540  
Telephone: 574-825-5861 or 800-283-8267

## FIRE SAFETY

If a fire does start, follow these basic safety rules:

1. Have everyone evacuate the RV immediately.
2. After everyone is clear and accounted for, check the fire to see if you can attempt to put it out.
3. If it is large, or the fire is fuel-fed, get clear of the RV and have the Fire Department handle the emergency.
4. Do not attempt to use water to put out the fire. Water can spread some types of fire, and electrocution is possible with an electrical fire.

## OTHER FIRE SAFETY INFORMATION

Refer to the following sections for additional fire safety information.

- See the Electrical Systems Section**, in case of an electrical fire.
- See the Appliance Section**, in case of a grease fire.

## FIRE EXTINGUISHER

Fire extinguishers are classified and rated by fire types, A, B, and C. These classifications identify the kinds of fires or burning materials they are designed to fight.

**Class A** – Solid materials such as wood, paper, cloth, rubber and some plastics.

**Class B** – Liquids such as grease, cooking oils, gasoline, kerosene or other flammable liquids.

**Class C** – Electrical such as electrical wires or other live electrical equipment.

A dry chemical fire extinguisher has been installed in your RV. It is suitable for extinguishing small fires of the Class B or C type only. We suggest you become thoroughly familiar with the operating instructions displayed on the side of the fire extinguisher.

**NOTE:** For information on how to use your fire extinguisher, refer to the fire extinguisher user's manual provided in your Warranty Packet.

### Inspection and Maintenance

Read and follow all instructions on the label and owner's manual provided by the fire extinguisher manufacturer.



### WARNING

Do not check the pressure, test or practice using the fire extinguisher by squeezing the trigger, even briefly. The fire extinguisher is not rechargeable or refillable. Once used, it will gradually lose pressure and will not be fully charged for use in an emergency.



### DANGER

Do not turn the electrical power back on or plug in any appliances after the use of a fire extinguisher. Please refer to the fire extinguisher's user manual for further instructions on maintenance and clean up.

## SMOKE ALARM

Some of the most common fire safety issues are burning candles, smoking in bed, leaving children unattended and cleaning with flammable fluids. The smoke detector is intended to help reduce those risks.

Your RV is equipped with a smoke alarm that is listed for use in a recreation vehicle. They are not fool proof. Smoke alarms only work if they are operational and maintained. Be sure to read, understand and follow the owner's information from the manufacturer of the smoke alarm included in your Warranty Packet, including information regarding the limited life of smoke alarms.

Please be aware the smoke alarm cannot detect fires if the smoke does not reach it. Anything preventing smoke from reaching the alarm may delay or prevent an alarm (i.e., a closed door may prevent smoke from reaching an alarm on the other side of the door, etc.).

There are instances when the smoke detector alarm may not be heard. Though the alarm horn in this detector meets or exceeds current UL standards, it may not be heard for many reasons.

These include (but not limited to): a closed or partially closed door, the alarm may be drowned out by other noise like the TV, stereo, traffic, weather, air conditioner or other appliances.



### WARNING

This smoke alarm will not alert hearing impaired residents. Special alarms with flashing strobe lights are recommended for the hearing impaired.

### Operation

The smoke alarm is operational once the battery is correctly installed. The LED light will indicate the battery is functioning properly. When the production of combustion is sensed, the smoke detector sounds a loud alarm that continues until the air is cleared.

The LED light will also give a visual indication of a sounding alarm.

### How to test

Stand at arm's length from the smoke alarm when testing as the alarm horn may be harmful to your hearing. The alarm horn is loud to alert you to an emergency. The test button will accurately test all functions. Never use an open flame from a match or lighter to test this smoke alarm.



### WARNING

Test the smoke alarm operation after the vehicle has been in storage, before each trip and at least once per week during use. Do not disconnect the battery or the alarm.

A warning label is located near the smoke alarm (Fig. 2.1). Please do not remove the following label from your RV.

Fig. 2.1 Test smoke alarm



**Maintenance**

Gently vacuum off any dust on the cover of the smoke alarm with your vacuum’s soft brush attachment. Test the smoke alarm once you have vacuumed. Never use water, cleaners or solvents to clean the smoke alarm as they may damage the smoke alarm. Do not paint the smoke detector. For information on how to maintain your smoke detector, refer to the smoke detector user’s manual provided in the Warranty Packet.

**Battery**

The smoke alarm will not function if the battery is missing, disconnected, dead, the wrong type of battery is used or the battery is not installed correctly. The smoke detector requires one standard 9V battery.

When the battery becomes weak, the smoke alarm will “beep” about once a minute (the low battery warning). The low battery warning should last for 30 days, but you should replace the battery immediately to continue your protection.

When the battery is removed from the alarm, the battery flag in the compartment will pop up; therefore, the alarm cannot be installed to the mounting bracket without a battery.



Regardless of the manufacturer’s suggested battery life, you MUST replace the battery once the smoke alarm starts “beeping” (the low battery warning).

For information on the correct battery and battery installation for your smoke detector, refer to the smoke detector user’s manual provided in the Warranty Packet.

**Replacement**

Smoke alarms have a limited life and are not foolproof. Smoke alarms will wear out over time like any appliance. Always replace the detector immediately if it is not working properly, it displays any type of problem, or within five years of use. Refer to the smoke detector manufacturer’s information in your Warranty Packet for additional information.

**COMBINATION CARBON MONOXIDE/ PROPANE ALARM**

Your RV is equipped with a combination carbon monoxide (CO)/propane alarm that is listed for use in recreation vehicles. The combination carbon monoxide/propane alarm will only work if it is operational and maintained.

The alarm is wired directly to the RV 12-volt electrical system, with continual power being supplied by the RV battery. There is no 9-volt battery power supply in the carbon monoxide/propane alarm. If the battery cable is disconnected at the battery terminals, the combination alarm will not work.

Be sure to read, understand and follow the owner's information from the manufacturer of the combination CO/propane alarm that has been supplied in your Warranty Packet. This includes information regarding the limited life of the alarm.

Carbon monoxide (CO) is an insidious poison. It is a colorless, odorless and tasteless gas. Many cases of reported carbon monoxide poisoning indicate while victims are aware they are not feeling well, they become so disoriented they are unable to save themselves by either exiting the vehicle or calling for assistance. Young children and household pets may be the first affected.

**WARNING**

The following symptoms are related to carbon monoxide poisoning and should be discussed with all members of the household:

**Mild exposure:** Slight headache, nausea, vomiting, fatigue (often described as "flu-like" symptoms).

**Medium exposure:** Severe throbbing headaches, drowsiness, confusion, fast heart rate.

**Extreme exposure:** Unconsciousness, convulsions, cardio-respiratory failure, death.

Your combination carbon monoxide/propane alarm is designed to detect the toxic carbon monoxide fumes that result from incomplete combustion, such as those emitted from appliances, furnaces, fireplaces and auto exhaust. A carbon monoxide/propane alarm is **NOT A SUBSTITUTE** for other combustible gas, fire or smoke alarms. This carbon monoxide alarm is designed to detect carbon monoxide gas from ANY source of combustion. It is not designed to detect smoke, fire or any other gas. Please note that there are hazards against which carbon monoxide detection may not be effective, such as natural gas leaks or explosions.

This alarm is designed to sense the presence of carbon monoxide/propane gas, however there are other combustible fumes or vapors that may be detected by the sensor including (but not limited to ): acetone, alcohol, butane and gasoline.

These chemicals can be found in commonly used items such as deodorants, colognes, perfumes, adhesives, lacquer, kerosene, glues, wine, liquor, most cleaning agents and the propellants of aerosol cans.

High temperatures can activate glue and adhesive vapors. If you close up a recreation vehicle on a hot day, the chemicals used in its construction may be detected for months after the vehicle was constructed (for more information, refer to Section 2, Formaldehyde).





## WARNING

The carbon monoxide detector installed is intended for use in ordinary indoor locations of recreation vehicles. It is not designed to comply with Occupational Safety and Health Administration (OSHA) commercial or industrial standards.

Do not disconnect the battery or the alarm.

Individuals with medical problems may consider using warning devices that provide audible and visual signals for carbon monoxide concentrations under 30 PPM.

This alarm will only indicate the presence of carbon monoxide gas at the sensor. Carbon monoxide gas may be present in other areas.

The ultimate responsibility for protection against toxic carbon monoxide fumes rests solely on you. Installing a carbon monoxide/propane alarm is just the first step in protecting your family from toxic carbon monoxide poisoning



## WARNING

Actuation of this detector indicates the presence of carbon monoxide which can kill you.

1. Operate the RESET/SILENCE button.
2. Call your emergency services (fire department or 911).
3. Immediately move to fresh air (outdoors or by an open door or window)
4. Do not re-enter the premises or move away from the open door or window until the emergency service responders have arrived, the premises have been aired out, and your alarm remains in its normal condition.

If your alarm reactivates within a 24-hour period, repeat steps 1-4 and call a qualified appliance technician to investigate for sources of carbon monoxide from fuel burning equipment and appliances, and inspect for proper operation of this equipment. Make sure that motor vehicle(s) are not, and have not been, operating in an attached garage or adjacent to the RV.

If problems are identified during this inspection, have the alarm serviced immediately. Note any combustion equipment not inspected by the technician and consult the manufacturer's instructions or contact the manufacturer directly for more information about carbon monoxide safety and this alarm.

### Alarm Signals

- Normal Operation:** The LED will maintain a steady green light, indicating that the alarm is powered.
- CO alarm condition:** The red LED light will remain steady and the alarm will sound 4 "BEEPS" then silent for 5 seconds. These signals indicate immediate action is required.
- Propane gas alarm:** The red LED light will flash and the alarm will sound a steady tone. These signals indicate immediate action is required.

- ❑ **Alarm malfunction/low battery:** The gas LED will remain off and the Operational/CO LED will alternate re/green and the alarm will sound once every 15 seconds.
- ❑ **End of life alarm:** The LED will flash red/red, green/green and the alarm will “BEEP every 25-30 seconds. The alarm should be immediately replaced.

**WARNING**

Never turn the 12-volt battery disconnect control to the off position and disconnect the battery cable to silence the alarm.

**WARNING**

The alarm will automatically sense when the level of carbon monoxide in the air reaches below dangerous levels. You should stay outside the vehicle in fresh air until the alarm is silenced. When the alarm sounds, do not stand too close to the alarm. The sound produced by the alarm is loud because it is designed to wake a person in an emergency. Prolonged exposure to the alarm at a close distance may be harmful to your hearing.

**Maintenance**

Vacuum the alarm cover at least once a year. Clean the cover by hand using a cloth dampened in clean water. Dry with a soft cloth. Do not spray the front panel of the alarm with cleaning agents or waxes. This action may damage the sensor causing an alarm or cause the alarm to malfunction. Do not paint the face of the alarm.

**Testing the combination carbon monoxide/ propane alarm****WARNING**

Test the alarm operation after the RV has been in storage, before each trip and at least once per week during use.

The TEST/RESET button tests all ELECTRICAL functions of the alarm. The TEST/Mute switch is located on the front of the alarm. Press and hold the test button for 1 second. The alarm is working properly if the GREEN indicator light changes color to RED and the horn beeps 4 times. The Gas LED should also blink red.

⊗**NOTE:** Pressing the test button does not check the sensor operation. Refer to the carbon monoxide/propane alarm manufacturers user’s manual provided in the Warranty Packet for additional information on testing the sensors.

Repair or replace the combination carbon monoxide/propane alarm when the alarm no longer functions. As with any electronic product, it has a limited life. Alarms that do not work cannot protect you.

⊗**NOTE:** The carbon monoxide/propane alarm manufacturer strongly recommends replacement of the detector five years after the date of purchase.

**Further Information**

Refer to the Warranty Packet for more information from the carbon monoxide/propane alarm manufacturer.

## FORMALDEHYDE

Some components in the RV contain formaldehyde-based adhesives that may release formaldehyde fumes into the air for an unknown period of time. Individuals who are allergic to formaldehyde gas fumes may experience irritation to eyes, ears, nose and throat.

Indoor air quality may also be affected by leaving your RV closed for a period of time.

To aide in dissipation, ventilate the RV by opening all windows and circulate the air with a fan. The following label is located inside the RV near the entry door. This label should be left permanently affixed to the RV.

Fig. 2.2 Formaldehyde warning label

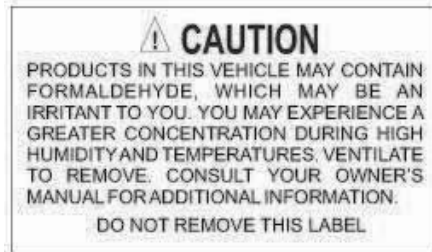

## EXTENDED DRY CAMPING



Your RV has been built for enjoyment in a recreational manner. It is not intended to be used as full-time living quarters.

## COLD WEATHER USAGE

Proper care should be taken when planning to use your RV in cold weather. Please keep in mind that your RV was not designed for use during sub-freezing weather. When used in freezing or below freezing temperatures, the following precautions need to be taken:

- More protection will be needed to protect the fresh water and drainage systems to avoid freezing problems (see **Winterizing the Plumbing System**).
- Propane and sufficient power is needed for protection from possible freeze-ups on the propane regulator. Keep in mind that more frequent furnace operation will substantially increase battery draw and propane use.
- During cool weather usage, ventilation or the addition of a dehumidifier may be required to reduce condensation (see **Condensation**).
- Check outside extrusions on compartment doors, locks, slide outs, windows, vents, etc., for frozen moisture before operating to avoid damage to parts.

---

**CONDENSATION**

---

**WARNING**

Condensation should be taken seriously. Ignoring it can damage the motor home (damage caused by condensation is not warrantable), and more importantly could lead to mold or mildew issues which could be a health hazard.

Condensation is a natural phenomenon. The amount of condensation will vary with climate conditions, particularly the relative humidity.

**To reduce condensation**

Proper ventilation and, if needed, the use of a dehumidifier (customer supplied) will assist in controlling condensation. Many RV and marine dealers carry small dehumidifiers sized for RV use. Other suggestions are:

- Crack open windows and roof vents to allow warm moist air to escape.
- When taking a shower open the bath roof vent (if so equipped) approximately ½" allowing the moisture to escape.
- Use the range hood fan (if so equipped) when cooking or washing dishes.
- Avoid hanging wet towels (or clothes) inside the RV to dry.
- If condensation is found in cabinets or closets, open those doors slightly to equalize the temperature and provide ventilation.

Uncontrolled condensation can cause dampness, mildew, etc., inside your RV. Be sure to make strong effort to control condensation. Repairs due to condensation are not covered under the terms of the **Towable Limited Warranty** or the **Extended Limited Warranty**.

- ❑ When camping leave a small opening using each bunk zipper to permit air flow and allow the tent to “breathe”. This will help minimize moisture gathering above the bunk area on the vinyl.

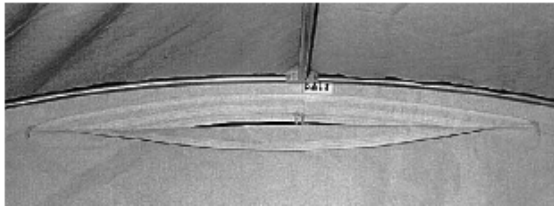

Tent Usage

**SECONDARY MEANS OF ESCAPE (EXIT WINDOW)**

The emergency egress window is designed to allow quick exit from the RV during an emergency if access to the main entrance door is not available.

- Make sure all occupants know how to open and operate the egress window before an emergency occurs.
- When pulling into your campsite, make sure the egress is not blocked by trees or other obstacles. Make sure the ground below the window is solid and can be used as an escape path.

The emergency exit is located next to the bunk area in your camping trailer. To exit, unzip the lifter post cover until the Velcro separates and exit the RV.

⊗ **NOTE: The privacy curtain strings are not designed to provide support when exiting the RV.**

Do not remove the following label from your RV:



Fig. 2.4 Emergency exit label



Fig. 2.3 Emergency exit

**THIS PAGE IS INTENTIONALLY BLANK**

---

## Tow VEHICLE

If you plan to tow your RV with a tow vehicle you already own, contact your automotive dealer to find out your vehicle towing capacity. If you plan to purchase a new tow vehicle, be certain to tell your automotive dealer the GVWR, size and type of RV that you will be towing (some tow vehicles can be purchased with an optional tow package). As a minimum requirement, the Gross Vehicle Weight Rating (GVWR) of your RV must not exceed your tow vehicle's towing rating.

Some automotive manufacturers publish brochures that discuss towing considerations. Ask your automotive dealer how to obtain a copy of this information. If applicable, verify if the brochure ratings are listed "with" or "without" an optional tow package.

## RV BRAKE SYSTEM



### WARNING

Failure to maintain the brakes in proper working condition as specified in the operator's manual supplied by the axle OEM will cause property damage, personal injury and possibly death. Consult with your dealer for assistance.

The electric brakes are designed to work with the tow vehicle brakes. To maintain proper braking performance, both the RV and tow vehicle brakes must be used together. Separate use of the braking systems will cause accelerated wear and damage.

**When your RV is new, it is impossible to adjust the brake shoes precisely. It takes approximately 1,000 miles and/or 50 medium to heavy stops to "burnish" fit or "seat" the shoes to the brake drum. After the initial break-in period your brake shoes must be adjusted accurately for best performance and increased durability.**

Braking system components include:

- Tow vehicle battery
- Brake controller
- Wire harness/connector plug
- Trailer battery
- Breakaway switch

### Hydraulic brakes (if so equipped)

Your camping trailer may be equipped with hydraulic surge brakes. These brakes operate automatically as the tow vehicle's brakes are applied. When the tow vehicle operator begins to decrease speed and apply the brakes, the weight of the moving trailer pushes forward and the coupler moved downward. This pressure moves the plunger, which in turn pushes the piston and rubber cup inside the master cylinder. Brake fluid presses inside of the wheel cylinder and activates the brake shoes against the drum.

As designed, the weight of a trailer pushing forward will activate the surge brake system. When backing a trailer up hill, the trailer weight may activate the surge brake system, making it difficult to continue to reverse.

1. Prior to backing up a slope or through soft ground, pull the RV forward slightly to assure that the actuator socket is in the forward position.

2. Move the lever on the side of the actuator downward from the “towing position” along the curved slot in the actuator frame to the “backup position.” The slot has a notch at the bottom of its travel. Push the lever down to engage the locking notch.
3. The RV will now back up. This lever will slide into the correct position when pulling forward.

It is extremely important to keep the master cylinder full at all times. An empty cylinder invites moisture.

**Tow vehicle battery**

The tow vehicle battery is the primary source of power for your RV's electric brake operation. To ensure available power when needed, keep your tow vehicle battery and charging system working properly.

**Brake controller (customer supplied)**

The brake controller should be installed in the tow vehicle to work in conjunction with the RV electric brakes. Consult with your dealer or the brake controller OEM to decide what is right for your towing combination.

**VEHICLE LABELS**

Decals and data plates used throughout the RV aid in its safe and efficient operation; others give service instructions.

Read all decals, data and instruction plates before operating your RV. If any decal, data or instruction plate is painted over, damaged or removed, it should be replaced.

Keep a record of the 17-digit vehicle identification number (VIN) and your license number in the event theft or vandalism requires you to supply this information to the authorities.

**WEIGHT LABELS**



## WARNING

The factory-installed weight labels are specific to the recreation vehicle for which they are supplied and are not interchangeable.

Vehicle weight labels are posted on Jayco manufactured RVs so you can make an informed decision before your purchase. Do not remove these labels from your RV. If the labels are missing, contact your dealer or Jayco Customer Service for replacements.

TIRE AND LOADING INFORMATION			
			SEE OWNER'S MANUAL FOR ADDITIONAL INFORMATION <small>10-323</small>
TIRE	SIZE	COLD TIRE PRESSURE	
FRONT			
REAR			
SPARE			

MANUFACTURED BY: JAYCO, INC.		DATE: _____
FABRIQUE PAR: _____		
INC. VEHICULE MFG BY: _____	VEHICULE	FRENCH/CANADIAN
VEHICULE FABRIQUE PAR: _____	TYPE	PROCESO COMPLETO
CHASSIS/PNEU: KG _____	CHASSIS/PNEU	PNEU
	FRONT/AVANT	FRONT
	REAR/ARRIERE	ARRIERE
TYPE OF VEHICLE: (1) RECREATION (2) TOURING (3) MULTIPLE USES		
THIS VEHICLE CONFORMS TO ALL APPLICABLE U.S. FEDERAL MOTOR VEHICLE SAFETY STANDARDS AND STANDARDS PRESCRIBED UNDER THE CANADIAN MOTOR VEHICLE SAFETY REGULATIONS EFFECTIVE ON THE DATE OF MANUFACTURE/HOMOLOGATION.		
CE VEHICULE CONFORME A TOUTES LES NORMES QUE LES SONT APPLICABLES EN VERTU DU REGLEMENT SUR LA SECURITE DES VEHICULES AUTOMOBILES DU CANADA EN VIGUEUR A LA DATE DE SA FABRICATION/OMOLOGATION.		

Fig. 3.1 Tire and Loading Information

Fig. 3.2 Federal Certification label



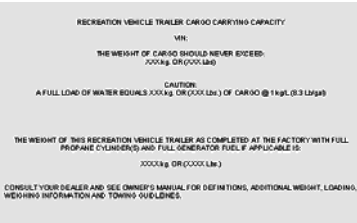



Fig 3.3 Trailer Weight Information label

You may question the total weight capacity of the tires on your RV being less than the GVWR; this is correct. In order to calculate the actual weight on the RV tires, it is necessary to include the tongue weight. The tongue weight is actually being carried by your tow vehicle, not the RV tires.

For example: If the tires are rated at 2,000 lbs. each x 4 tires = 8,000 lbs. and the RV has a GVWR of 9,000 lbs. with a tongue weight of 1,200 lbs. The actual weight on the RV tires is 7,800 lbs. which is within the weight rating of the tires.

If you have further questions, please contact your dealer or Jayco Customer Service.

**LOADING YOUR RV**

 **WARNING**

---

Never load the RV in excess of the GAWR for either axle. Overloading your RV may result in adverse handling characteristics and damage to the chassis.

 **WARNING**

---

Your recreation vehicle's load capacity is designated by weight, not by volume, so you cannot necessarily use all available space when loading the vehicle. Do not exceed your GVWR and ensure you are loading the vehicle as evenly as you can for the best possible handling. Ensure heavy items are secured so they do not shift during travel.

 **WARNING**

---

**DO NOT EXCEED YOUR GVWR!** This means you should weigh your RV as loaded for your normal travel to determine the actual weight. If you exceed the GVWR, you **MUST** remove items from the RV, or drain liquids, then re-weigh the vehicle to ensure you have achieved a safe weight. Do not travel with full grey/black holding tanks. This not only wastes gas but, depending upon the location of the grey or black holding tanks, can affect handling characteristics.

 **WARNING**

---

Store items in areas designated for storage. Do not store anything in the areas reserved for the converter, electrical panels or the furnace or water heater, etc.

Store and secure all loose items inside the RV before traveling. Overlooked items such as canned goods, or small appliances on the countertop, cooking pans on the range or free-standing furniture items can become dangerous projectiles during a sudden stop.

Distribute cargo side-to-side so the weight on each tire does not exceed one-half of the GAWR for either axle. For traveling safety, it is important to make sure any tie down straps (if so equipped) on appliances or furniture are secured.

### WEIGHING YOUR TOW VEHICLE & RV



#### WARNING

The actual weight of the vehicle, all options, liquids, the hitch weight, and your personal cargo is important for you to know so you do not exceed the Gross Vehicle Weight Rating (GVWR) of the recreation vehicle. The volume of space available for storage may exceed the amount of available cargo capacity. Large storage compartments have been designed to accommodate normal camping items, which are bulky, but not necessarily heavy.



#### WARNING

**DO NOT EXCEED YOUR GVWR!** This means you should weigh your RV as loaded for your normal travel to determine the actual weight.



#### WARNING

If you exceed the GVWR, you **MUST** remove items from the RV, or drain liquids, then re-weigh the vehicle to ensure you have achieved a safe weight. Weight labels are posted inside your recreation vehicle so you can make a decision before you buy about how much cargo capacity is important for you personally.

There are two important factors when loading your RV, total weight and balance. It is imperative that you verify compliance within all applicable weight ratings. Overloading your RV will void the **Towable Limited Warranty** and the warranties of many component part manufacturers.

**Have your RV weighed periodically at a public scale to determine the proper load distribution.** Keep in mind that individual scales will operate differently.

The surroundings of the scale need to be adequate to accommodate weighing each side of your RV.

#### To weigh your tow vehicle and RV



#### WARNING

**Total weight of your tow vehicle and RV must not exceed the GCWR.** Do not assume that you can tow a RV that happens to be within the capacity of the tow vehicle hitch. By doing so, you may exceed the total GCWR of your tow vehicle and RV towing combination.

**WARNING**

It is important to redistribute the load to avoid component failure as well as to improve the handling characteristics of the vehicle.

Read through all the weighing instructions before you begin. If you have further questions, consult with your dealer or the scale operator. Your RV must be weighed fully loaded (that is with food, clothing, fuel, water, propane, supplies, etc).

1. Weigh the RV including the tongue weight, while detached from the tow vehicle. This actual overall weight must be less than or equal to the GVWR for safe operation. If the overall weight is greater than the GVWR, some contents must be removed until the actual overall weight is less than or equal to GVWR.
2. Hitch the RV to your tow vehicle. Weigh the RV and the tow vehicle to determine the GCW. Make sure that this rating is less than or equal to the GCWR as specified by the manufacturer of your tow vehicle. If this overall weight is greater than the GCWR, some contents must be removed to bring the combination into compliance with the listed ratings.
3. Weigh the RV while attached to but excluding the tow vehicle. This will result in the actual weight that is exerted on all of the RV tires. This weight may be subtracted from the overall RV GVWR to determine the actual "tongue" weight.
4. With the RV still attached to the tow vehicle, weigh each wheel position separately to ensure each tire is not overloaded.

**To determine the wheel position weight:**

5. Pull the RV onto the scale so only one tire is on the scale. Record the weight. Your RV must remain as level as possible on the scale (even though an axle or side is not physically on the scale). Obviously, to obtain the side-to-side weights, there must be enough space on either side of the scale to accommodate the RV being partially off the scale.
6. To calculate the opposite side of the RV wheel position weight, subtract the first side's weight from the weight determined in step #3.

If there is a difference in the weights on one side of the vehicle as compared to weights on the other side, components (tires, wheels, brakes, springs, etc.) on the heavier side could be overloaded, even though the total axle load is within the GAWR.

It is important to redistribute the load to avoid component failure, improve the handling characteristics of the tow vehicle and not void the **Towable Limited**

**Warranty.**

With these actual weights, it is now possible to compare them against the Trailer Weight Information label weight ratings to ensure you are below the posted minimum ratings.

**TRAVEL TRAILER HITCH (CUSTOMER SUPPLIED)**

Hitch selection is important because it affects the towing and handling characteristics of your RV. There are many kinds of hitches available for various uses and assuring that you have the correct hitch installed is critical to a safe towing experience.

Ask your dealer about the proper class and type of hitch you need to purchase for your individual tow vehicle/RV combination. A travel trailer requires a frame mounted hitch.

The hitch manufacturer assigns a hitch class rating based on the capacity that hitch has for towing and a weight classification.

The weight classification is determined from the hitch's weight carrying capacity (also known as the tongue weight on a travel trailer). Before selecting a hitch, you must know your GVWR and tongue weight.

**The rating of the hitch package purchased should be equal to or greater than the RV's GVWR and the hitch weight.**

**CAUTION**

Using an oversized or undersized hitch can cause damage to the RV frame. Jayco cannot be responsible for the tow vehicle suspension system. The final ball height after the tow vehicle/travel trailer combination is completely hooked up is a factor that must be considered. To avoid overloading your trailer axles and minimize possible handling difficulties, your trailer should be level when hooked to your tow vehicle. Do not overload your tow vehicle.

Equipment that sometimes gives autos, trucks and sport utility vehicles a softer ride can accentuate swaying when pulling a RV; conversely, suspension that is too stiff will increase vibration, bounce and accelerate wear of your tow vehicle and RV combination.

**Jayco cannot be responsible for the suspension system of any tow vehicle. There are a variety of tow vehicle suspension systems available that will affect the ball height, stability and levelness of a hooked up RV.**

Make sure your dealer is aware of the tow vehicle you are using so a compatible hookup is achieved.

**Travel trailer hitch weight**

Maintain the proper tongue weight of the trailer. Stay within the target range of 10%-15% of the overall gross weight (travel trailer weight plus contents).

**Travel trailer hitch height & hitch ball**

This unit hitch height is:

To determine the hitch height for your model, make sure that the trailer is level. When the loaded RV is hitched to the tow vehicle, check the hitch ball height. This can be determined by measuring the distance from the center of the hitch ball to the ground. Record this number in the box for future reference.

Adjust the equalizing bars of the hitch assembly so that the tow vehicle and the trailer are essentially level. A high hitch will transfer weight behind the axles and cause the vehicle to fishtail. A low hitch will transfer additional weight to the hitch. Refer to the hitch manufacturer instructions to adjust the weight-distributing hitch to the proper height.

If you have additional questions, consult with your dealer. Make certain your Dealer is aware of the tow vehicle you are using so a compatible hookup is achieved. Depending on the model, your required travel trailer hitch ball diameter is either 2" or 2-5/16" (consult your dealer for assistance).

### **TRAVEL TRAILER SWAY CONTROL (CUSTOMER SUPPLIED)**



#### **WARNING**

A sway control device (customer supplied) should be used with your tow vehicle/travel trailer combination. Consult with your Dealer to obtain the proper equipment for your needs.

Sway control devices are available to reduce the sway produced by crosswinds, air displacement caused by other vehicles passing you in transit, incorrect weight distribution, excessive speed, the RV tires dropping onto the shoulder of the road, etc. You will also want to discuss this purchase with your Dealer.

The use of a sway control device will help to control the side-to-side movement and keep sway in check.

Suggestions for sway situations:

- Slowly ease your foot off the accelerator.
- Turn the steering wheel as little as possible. Natural lag time reaction when counter-steering to correct sway could possibly make it worse.
- If the trailer is equipped with electric brakes, using the hand control will help to keep the vehicles aligned.
- As soon as possible, stop to determine the cause of the sway. Check all equipment and load distribution. If the problem cannot be solved immediately, contact your Dealer for a service appointment (travel at a much reduced speed on your way there).

### **TRAVEL TRAILER WEIGHT DISTRIBUTING SYSTEM (CUSTOMER SUPPLIED)**

A weight distributing hitch system provides a more stable tow vehicle/RV combination. This system will spread the weight evenly to distribute it to the tow vehicle front and rear axles and the trailer axle. Consult with your dealer to familiarize yourself with the operation and requirements of the weight distributing hitch system. Be certain your tow vehicle can carry the hitch weight.

**THIS PAGE IS INTENTIONALLY BLANK**

---

Driving safety and protection against injury cannot be fully ensured. However, we recommend you pay special attention to the following:

- ❑ Keep the tires inflated to the specified levels. Replace the tires before they are excessively worn.
- ❑ The propane cylinder(s) should be turned off when traveling. Most refrigerators will keep food cold or frozen for eight hours without running while you travel.
- ❑ Adverse weather conditions and extremes in terrain may affect the performance and handling of your tow vehicle. Do not operate the tow vehicle cruise control on icy or extremely wet roads, winding roads, in heavy traffic or in any other traffic situation where a constant speed cannot be maintained.

**WIRE HARNESS/CONNECTOR PLUG**

A 7-way wire harness/connector plug is wired into your trailer to connect electrical power from the tow vehicle for travel. This supplies power to the RV brakes, tail lights, clearance lights, turn signals, brake lights, etc. Wiring to operate your brakes must be the same size in both the tow vehicle and RV (the RV brake wiring is 12-gauge wire).

When attaching wires to your tow vehicle, carefully and tightly tape all the connections for moisture protection.

White	1	Ground
Blue	2	Brakes
Green	3	Running lights
Black	4	Auxiliary battery charge line
Red	5	Stop & left turn
Brown	6	Stop & right turn
Yellow	7	Back up

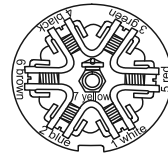

**Fig. 4.1**  
7-way trailer plug - Car end, rear view

The connector plug may build up corrosion with extended use and should be cleaned periodically to insure good electrical contact. Make sure the connector plug is kept clean and protected from road elements as you travel.

**TOWING**

 **WARNING**

---

**Your RV braking system is rated for operation at GVWR not GCWR.**

 **WARNING**

---

Whenever possible, do not travel with waste in the holding tanks. Liquid or debris in the holding tank(s) may affect the towing characteristics and may result in property damage or personal injury.

You will find that your RV will travel safely and comfortably at most posted trailer highway speed limits. However, it will take longer than a passenger automobile to reach that speed. Keep this in mind when overtaking and passing another vehicle. Allow more time to go around the vehicle you are passing.

You cannot cut back into the traffic lane as quickly due to the longer length of your tow vehicle/RV combination. Drive with caution to avoid situations that might require quick momentum changes.

Even though your RV is equipped with brakes designed for GVWR, we suggest practicing stopping away from traffic until you become accustomed to your RV's stopping distance. A good way to practice is at a large parking lot (where it is permissible). Easing to a stop and starting smoothly saves wear and tear on your tow vehicle/RV combination.

Be aware of road surface conditions. Slow down well in advance of dips and bumps to reduce the jolting to your tow vehicle/RV combination.

Drive over them slowly and let the trailer tires pass over them before accelerating. Cross railroad tracks slowly (always release your brakes before crossing).

When descending a long hill, drop down into a lower gear (or lower range if you have automatic transmission). Avoid conditions that require excessive and prolonged use of your brakes. Apply and release brakes at short intervals to give them a chance to cool. The tow vehicle transmission and engine will help in controlling downhill speed and can lengthen brake life. The distance required to stop the RV is greater than an automobile's. Use care when accelerating or decelerating on a slippery surface. Abrupt speed changes can cause skidding and loss of control.

Driving through water deep enough to wet the brakes may affect stopping distance or cause the vehicle to pull to one side. Check the RV's brake operation in a safe area to be sure they have not been affected. **Never operate any vehicle if a difference in braking efficiency is noticeable.**

### **Vehicle Clearance**

Remember some bridges, older ones in particular, may not support the weight of your tow vehicle/RV combination. Know the weight and size of your towing combination and observe any posted weight and clearance limits. The added height of roof air conditioners, TV antennas or floodlights may cause clearance problems around some tunnels, canopies and hanging signs.

### **Turning Corners**

When turning, the tires do not follow the path of your tow vehicle tires. The RV will make a tighter turn than the tow vehicle.

You must compensate for this action by carefully pulling the tow vehicle out into the intersection further than you would normally so that the RV clears the curb (or any parked vehicles along the curb).

When making a turn, check the road clearance and be aware of others. Have someone help guide you out of a difficult parking space or traffic pattern. Swerves and sharp turns, especially at high speeds, could result in loss of control of the RV.

### **Backing up**

If your camping destination does not have pull through sites, pick a level site and back in carefully. We suggest you stop near the site, get out of the RV and observe the surrounding area. Check to ensure there are no obstacles in your path and that you have plenty of vehicle clearance. Check for low-hanging tree limbs, posts, large rocks or other obstacles.

Try to choose a site that is on the driver's side, so you can see what the rear of the RV is doing. With the site on the passenger side, you would be backing into the site on your blind side, which is more difficult.



When you determine the site conditions are satisfactory, maneuver the RV into position for backing up into the site space. Back the RV up slowly using your tow vehicle mirrors as a guide. Have another person outside the RV assist you until the RV is parked in the desired position.

### **Parking**

After the RV is in the desired location, set the tow vehicle parking brake and place the transmission in park. Turn OFF the ignition switch. Go outside the RV and block all wheels securely with wheel chocks. The wheel chocks can be wood blocks or purchased items as long as they prevent the RV from rolling.

## **TIRES**

### **Read and understand the following before taking your first trip in your RV!**

Proper care and maintenance of your tires is essential to ensure your safety, as well as the safety of others, as you travel.

Taking time to become educated on the special qualities of RV tires and care they require will enhance your travel enjoyment.

Routine maintenance on your RV is important, but it cannot be overstated just how critical proper tire maintenance is to the safety, operation and durability of your new RV.

You must follow the manufacturer's inflation guidelines for maximum load capacity; under-inflation is just as dangerous as over-inflation.

To insure your tires are operating safely, regular inspection of your tires and checking tire pressures is absolutely mandatory.

Examine your tires frequently for unusual wear. Alignment, balance and bearing wear will affect tire wear. Make sure to look for cracking, bulging, uneven tread wear, etc.

When you are using your RV, check inflation pressure weekly to insure maximum tire life and travel wear. Pressure should be checked when the tires are cold. During travel, tires heat up and pressure increases. **Do not bleed air from hot tires or your tires may then be under-inflated.**

**⊗ NOTE:** Cold tire inflation pressure is defined as a tire that has not been used for three or more hours, or has been driven less than one mile. Tire inflation pressure of a hot tire may show an increase of as much as 6 psi over a cold tire.

Tire pressure is the most important factor in the life and performance of your tires. Proper inflation should be monitored closely. Failure to do so could result in the overheating of a tire, which could result in a blowout. Inflation pressure should be as recommended by the tire manufacturer or as the federal label for the RV indicates.



### **WARNING**

It is recommended that the tire pressure be checked at the beginning of each journey to obtain the maximum life of the tire. Follow the instructions listed on the Federal Certification label, affixed to the roadside front corner of your trailer, to determine the correct tire pressure. Under-inflation may cause tire failures and swaying; this may result in loss of control, injury, death or property damage.

**DANGER**

Failure to follow proper inflation guidelines may result in tire failure, which, under certain circumstances can cause loss of vehicle control or accidents that may result in property damage, bodily injury and/or death.

**CHANGING A TIRE****WARNING**

Do not use the stabilizer jacks to support the RV while under the vehicle or changing tires. The stabilizer jacks are designed as a stabilizing system only. Do not use the stabilizer jacks as a jack or in conjunction with a jack. Attempts to change tires while supporting the RV with the stabilizer jacks could result in damage to the RV and risk causing serious injury or death.

**WARNING**

Never raise the RV by placing the jack under the axle, springs or any attachment parts. Failure to comply could result in property damage, personal injury or death.

1. Keep the RV attached to the tow vehicle. Block the tire on the opposite side of the RV from the tire you are changing.
2. Loosen the wheel lug on the tire you are changing before jacking up the RV. DO NOT remove the lug nuts; only loosen them for ease of removal when the tire is off the ground.
3. Locate the main frame rail of the trailer (it spans from front-to-back just inside the tires).
4. To raise the RV, place the jack (hydraulic or screw) under the main frame rail. It must be just ahead of the front tire or just behind the rear tire.

**WARNING**

Be sure to use only tires that are rated for RV use. The use of passenger tires should be avoided. The load rating/range embossed on the sidewall of passenger tires must be de-rated accordingly; they do not have the same load capability as tires that are specifically identified for RV use. Failure to use tires that are properly matched to your recreation vehicle could lead to premature tire wear or less than optimum trailer handling.

**Replacement**

If you experience a flat tire on your RV while driving, gradually decrease your vehicle speed (if possible). Hold the steering wheel firmly and move the RV to a safe place on the side of the road.

Any service or warranty coverage on tires is to be handled by the tire store representing the brand installed on your RV. They are not to be returned to your dealer or Jayco.



**WARNING**

When replacing a tire make sure to replace it with a tire of the same size and specifications (refer to the Federal Certification label.)

If you have questions regarding your tires, contact the tire manufacturer or Jayco Customer Service.

**SPARE TIRE CARRIER (IF SO EQUIPPED)**

If your RV is equipped with a spare tire, it will either be mounted under the unit (hoist) or on the rear bumper.

**Under the unit (hoist) mounted**



**WARNING**

DO NOT exceed the maximum load capacities of 100 lbs. for the hoist. DO NOT use air driven guns or impact wrenches to lift the spare tire to the travel position.

The following diagram illustrates the travel position of the spare tire (the spare tire must contact the brackets as shown).

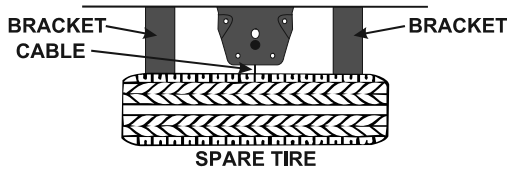

**Fig. 4.2 Hoist mount spare tire position**

To secure the spare tire in the travel position:



**Fig. 4.3**



**Fig. 4.4**

1. Put the steel hoist lift support located on the end of the cable through the rim of the tire. The hoist lift support clips need to seat inside the center hole of the tire rim. The valve stem of the tire **MUST** be pointed in the up position or toward the bottom of the trailer.
2. Insert the crank handle into the hole located in the center of the rear "bumper." Turn the crank handle to lift the tire to the travel position.
3. Two crisp breaks must be heard and felt to insure proper seating of the tire for travel.

Reverse this process to release the spare tire for usage.

**Bumper mounted**

The spare tire bracket can be released and extended down to access a storage compartment at the rear of the trailer without removing the tire.

**To extend the tire down**

1. Remove the cotter key from the pin holding the tire carrier in place.
2. Remove the pin and extend the tire carrier away from the trailer.
3. Always return the tire carrier to the upright position and lock it in place while traveling.

**To remove the tire from the tire carrier**

1. Remove the lug nuts holding the tire in place.
2. Remove the support bracket from the bottom lug.
3. Pull the tire from the tire carrier.



**Fig. 4.5 Bumper mount**

**To install the tire on the tire carrier**

1. Place the tire on the carrier with the top lug bolt inserted into one of the holes in the tire rim and the bottom lug bolt in the center of the rim.
2. Install the top lug nut.
3. Place the support bracket over the bottom lug bolt across the center of the rim.
4. Install the bottom lug nut over the support bracket.
5. Make sure the lug nuts are tightened securely before returning to travel.

**WHEEL LUGS**

After your first trip, check the wheel lug torque periodically for safety. Check the wheel lugs after winter storage, after a wheel removal, before starting a trip or following extensive braking. Use the correct star pattern sequence to attach the RV wheels (see **Wheel Lug Torque Chart**.)

1. Start all nuts by hand to prevent cross threading.
2. Tighten the nuts in the sequence shown.
3. Tighten the lug nuts equally in stages as indicated for your trailer's wheels (see **Wheel Lug Torque Chart**).

**Check and re-torque after the first 10, 25 and 50 miles (16, 40 and 80 kilometers). Thereafter, check and maintain the torque according to the listed torque values (see Wheel Lug Torque Chart.)**

**⊗ NOTE:** The proper method of tightening wheel lug nuts is with a properly calibrated torque wrench and socket, not with an impact wrench or by hand. Do not use a 4-way lug wrench or any other type of wrench that does not measure the actual pressure applied to the lug nut.

Because of the importance of having proper torque on the wheel lug nuts, you should always have the wheels mounted and properly torqued by a qualified technician using the proper tools.

**WHEEL LUG NUT DIAGRAMS:**

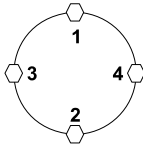

4-Lug Nuts

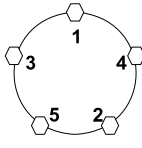

5-Lug Nuts

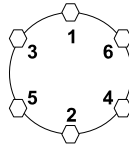

6-Lug Nuts

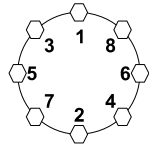

8-Lug Nuts

**WHEEL TORQUE INSTRUCTIONS:**

1. Start lug nuts with fingers on studs to avoid cross threading.
2. Stage 1, Torque: Impact lug nuts in a star pattern\* until snug to rim. -- See *Wheel Lug Nut Diagram*
3. Stage 2, Torque: Use calibrated torque wrench to torque each lug nut, in a star pattern, to the values indicated. Wheels must remain stationary during torquing process for control purposes. --See *Wheel Lug Nut Torque Chart* and *Wheel Lug Nut Diagram*
4. Stage 3, Torque: Use calibrated torque wrench to torque each lug nut, in a star pattern, to the values indicated. Wheels must remain stationary during torquing process for control purposes. --See *Wheel Lug Nut Torque Chart* and *Wheel Lug Nut Diagram*

**WHEEL LUG NUT TORQUE CHART:**

Lug Nut	Stud Dia.	Rim	Type	Stage 1 Impact Gun	Stage 2 Clicker Setting (+/-3ft/lbs)	Stage 3 Clicker Setting (+/-3ft/lbs)	Acceptable Torque Range
4-Lug Nuts	1/2"	12"	Steel	40-50 ft/lbs	60 ft/lbs	70 ft/lbs	50-75 ft/lbs
5-Lug Nuts	1/2"	13"	Chrm/Steel	40-50 ft/lbs	60 ft/lbs	70 ft/lbs	50-75 ft/lbs
5-Lug Nuts	1/2"	14"	Chrm/Steel/Alum	40-50 ft/lbs	95 ft/lbs	115 ft/lbs	90-120 ft/lbs
5-Lug Nuts	1/2"	15"	Chrm/Steel/Alum	40-50 ft/lbs	95 ft/lbs	115 ft/lbs	90-120 ft/lbs
6-Lug Nuts	1/2"	15"	Chrm/Steel/Alum	40-50 ft/lbs	95 ft/lbs	115 ft/lbs	90-120 ft/lbs
6-Lug Nuts	1/2"	16"	Chrm/Steel	40-50 ft/lbs	95 ft/lbs	115 ft/lbs	90-120 ft/lbs
8-Lug Nuts	1/2"	16"	Steel/Aluminum	40-50 ft/lbs	95 ft/lbs	115 ft/lbs	90-120 ft/lbs

**TRANSPORTATION INSTRUCTIONS:**

1. Prior to travel and after excessive braking, all wheel lug nuts must be checked for torque.  
\*This also applies to any service involving wheel or lug removal, during the life of the recreational vehicle.
2. Torque readings must fall within the Acceptable Torque Range. --See *Wheel Lug Nut Torque Chart*
3. Torque specifications, must be checked by using a torque wrench.  
\*Digital or Dial Torque Wrenches are recommended.
4. If Torque falls below the Acceptable Torque Range, additional torque is required.  
-- See *Wheel Torque Instructions* and *Wheel Lug Nut Diagram* for the correct pattern and recommended final torque value.
5. During travel, wheel lug nuts must be checked and re-torqued, as required, after the first, 10 miles, 25 miles, 50 miles, then periodically during travel (16 kilometers, 40 kilometers, 80 kilometers, then periodically during travel).  
-- See *Wheel Torque Instructions* and *Wheel Lug Nut Diagram* for the correct pattern and recommended final torque value.
6. Failure to follow these instructions may result in wheel loss, an accident, or loss of control, resulting in death or serious injury.



**WARNING**

Check and tighten wheel lug nuts regularly to make sure they did not loosen during travel. Wheel lug nuts must be applied and maintained at the proper torque levels to prevent loose wheels, broken studs and possible separation of the wheel(s) from your trailer. The lug nuts on the wheels of your RV must be maintained according to listed torque values (see **Wheel Lug Torque Chart**.) Over-torqued and/or under-torqued wheels may result in component failure.



**WARNING**

Failure to maintain proper torque of the wheel lug nuts could lead to separation of the tire and wheel while driving, possibly resulting in property damage or personal injury.

## EMERGENCY STOPPING

---

Always carry road flares or reflective warning signs to display if necessary. Pull off the roadway as far as possible for emergency stopping or tire changing. Turn ON your RV hazard warning flashers. If traveling at night, use three red warning indicators such as flares, reflectors or lanterns, as follows:

1. Place the first warning indicator on the traffic side of the RV, directed at the nearest approaching traffic.
2. Place the second warning indicator 100 feet behind the RV in the center of the lane and toward approaching traffic.
3. Place the third warning indicator 100 feet in front of the RV in the center of the lane and away from the traffic approaching from behind.

The hazard-warning flasher provides additional safety if the RV is stopped on the side of the roadway and presents a possible hazard to other motorists. When the flasher is on, it serves as a warning to others to approach and overtake your vehicle with caution.

**For personal safety, always stand off the road and out of the way of traffic. Curves and/or hills may affect the safe placement of warning indicators**

## EMERGENCY TOWING

---



### WARNING

**Never allow anyone to go under the RV while it is being lifted and/or being towed.**

If your RV needs to be towed, please contact an emergency road service provider or a qualified service facility for assistance.

## LEVELING THE RV

---

Now that you have parked your RV, you need to ensure it is level. Leveling is very important. A level RV is more comfortable for sleeping and walking.

The refrigerator is designed to operate when level for best performance due to the absorption system. The water drainage systems are designed with proper slope and must be level for proper operation. The appliances perform best when level.

## STABILIZER JACKS

---

1. Each stabilizer jack can be individually adjusted to stabilize the trailer for use.
2. When setting your RV up on soft ground, you may wish to place a wood pad or the equivalent under each stabilizer jack foot. This will help keep the stabilizer jack from sinking into the ground.

### Manual stabilizer jacks (if so equipped)

To lower each jack, insert the jack crank onto the applicable stabilizer jack shaft.

1. To lower each jack, insert the jack crank onto the applicable stabilizer jack shaft.
2. Turn the crank clockwise to lower each leg until it contacts the ground and stabilizes the trailer.

To raise each jack, insert the jack crank onto the applicable stabilizer jack shaft and turn the crank counter-clockwise.

**Electric stabilizer jacks (if so equipped)**

Control switches for the stabilizer jacks are located on the (door) side of the unit above the stabilizer jack(s).

To lower each jack, press the control switch until each leg contacts the ground and stabilizes the unit.

To raise the jack, press the control switch until the jack is returned to the retracted position.

**⊗ NOTE:** The stabilizer jacks must be fully retracted before moving or towing the RV to prevent stabilizer jack damage.

**WARNING**

**DO NOT USE THE STABILIZER JACKS TO LEVEL THE RV.** It is important to remember that the stabilizer jacks are to be used only for support while occupying and moving around the RV. They are not designed to bear the weight of the RV.

**ENTRANCE DOOR WITH SCREEN DOOR****CAUTION**

Make sure the entrance door is completely closed and locked when traveling. Locking the door helps prevent it from opening unintentionally.

The entrance door is located on the curbside of the RV. Always hold onto the entrance door when opening or closing it as damage caused because you failed to do so is not covered by the **Towable Limited Warranty**.

**KEYS/LOCKS**

Several keys are provided when you purchase your RV. Most keys have an individual key number stamped on the plate. Record these key numbers and keep the information in safe place. You can order a key blank from your RV dealer to have duplicate keys made. If you lose the keys, contact your RV dealer or a locksmith for assistance.

**⊗ NOTE:** Locks on entrance and baggage doors need biannual lubrication using a light coat of silicone spray. Conditions such as rain, salt, dust and pollution may increase the maintenance needs.

**KEYLESS ENTRY (IF SO EQUIPPED)**

If your RV is equipped with a keyless entry system, it will be powered by the RV electrical system, or by batteries. If the entrance door frame is equipped with power contact buttons, your entry system is powered by the electrical system. If there are no contact buttons on the door frame, your entry system is battery powered. The following is an overview of both systems.

For detailed instructions, please refer to the manufacturer's operators manual included in your warranty packet.

**Electric powered keyless entry system:**

To prevent unauthorized access to your RV unique **Authority** and **Access** codes must be programmed into the keyless entry keypad. Failure to do so allows access by those with knowledge of the default code settings.

**Definitions**

- ❑ **Authority code:** A unique 5 digit pass code that gives the system administrator (or owner) the ability to program keypad access codes. The default **Authority** code is 7-7-7-7-7.
- ❑ **Access code:** A unique 5 digit pass code that is input into the entry keypad to unlock the main entry door. Up to 5 separate access codes can be programmed into the keyless entry system. The default **Access** code is 1-3-5-7-9.

To lock the main entry door press the 1/2 button on the keypad for two seconds.

To unlock the main entry door enter the 5-digit **Access** code.

**Prior to programming keyless entry keypads:**

1. Retrieve the keypad **authority** code from the keyless entry owner's manual. If the keyless entry **authority** code is still set to the factory default of 5 presses of the 7/8 button it must be changed for security purposes. Failure to create a unique authority code specific to your RV will allow access to your RV by anyone knowing the factory default **authority** code.
2. If a unique keypad **authority** code has already been assigned, and is known, skip to programming processes "**B**" below.

If a unique keypad **authority** code has not been assigned, or if it is not known, proceed to process "**A**".

**Keypad programming - Process "A"**

1. Gain access to the back side of the keyless entry keypad.
2. Plug the RV into 120-volt shore power and verify that the power converter is operational (interior lights will be operational).
3. Connect the yellow wire exiting the back side of the keyless entry keypad to chassis ground (B-) until the keypad beeps approximately 5 seconds). Note: The black wire exiting the rear of the keypad always goes to chassis ground.
4. Disconnect the yellow wire exiting the back side of the keyless entry keypad from chassis ground after the beep in step #3 occurs.
5. Enter a unique 5 digit **authority** code into the keypad. The keypad will beep twice to confirm each button press and 3 times after the 5<sup>th</sup> button press.
6. Re-enter the same unique 5 digit **authority** code into the keypad. The keypad will beep 3 times to confirm successful programming. A long beep indicates programming failure.
7. Record the new **authority** code in a safe place for future reference. Note: The authority code and the access code should never be the same for security purposes.
8. Proceed to **process "B"**.

**Keypad programming - Process "B"** (use only after a unique **authority** code has been assigned and is known).

1. Press and hold down the keypad 5/6 button for 5 seconds. The keypad will beep indicating that learning mode has been entered.



2. Enter the 5 digit **authority** code assigned in process "A" above. Once input the keypad will emit a long beep.
3. You can define up to 5 different keypad **access** codes. The next button pressed and released determines which access code you are programming. If you press and release button #1 you are indicating that you want to program access code #1. If you press and release button #2 you are indicating that you want to program access code #2. This process also applies to access codes #3, #4, and #5. The keypad will emit a single confirmation beep after this single button press.
4. Enter a unique 5 digit **access** code into the keypad. The keypad will beep twice to confirm each button press.
5. Re-enter the same unique 5 digit **access** code into the keypad. The keypad will beep 3 times to confirm successful programming. A long beep indicates programming failure.
6. Record the new 5 digit **access** code in a safe place for future reference.
7. Repeat the 6 steps above to program additional **access** codes.

For detailed instructions refer to the manufacturer's user guide included in the Warranty Packet.

### **Battery powered keyless entry system:**

The battery powered entry system is a 4 touch pad button programmable deadbolt lock. The 4 buttons are labeled "1|2", "3|4", "5|6", "7|8". The button labeled "1|2" is the same button whether the number 1 or 2 is desired. Please note this handle uses touch technology. The buttons are activated by touch and does not require pressing the buttons. Touch the button and lift finger from button for proper code entry.

### **Operation**

The entry system incorporates proximity sensing to determine when you want to activate the lock. To operate the lock you first must "wake up" the lock. To "wake up" the lock you must touch the area next to the buttons. The buttons will illuminate once the Touch Pad is awakened. This indicates that the touch pad is ready for the code to be entered.

### **Preset Factory Code**

The entry system has a factory set code of 3,7,1,5 followed by the Enter button. The Enter button is required to be touched after the code is entered. The factory code resets every time the batteries are removed for at least 10 seconds.

### **Programming New Code**

To set a new code, touch and hold the "3|4" button and the Enter Buttons for 2 seconds. The system will provide three short beeps, indicating it is ready to accept a new code. Enter the new 4 digit code followed by the "\*". The system will provide four short beeps to indicate new code acceptance. This new code will now activate the lock.

To reset the code, remove the batteries for at least 10 seconds. Re-install the batteries; and follow the steps to **Programming New Code**.

**Please Enter Personal Code upon Installation of Lock to prevent inadvertent programming.**

**System Fault Logic:****Action**

Ready to Accept New Code  
 New Code Entered  
 Wrong Code Entered  
 Dead Bolt Locks  
 Dead Bolt Unlocks  
 Dead Bolt fails to Lock  
 Dead Bolt fails to Unlock  
 Low Battery

**Response**

Three short beeps  
 Four short beeps  
 One long beep  
 Two short beeps  
 Two short beeps  
 One long beep  
 One long beep  
 One Long beep after the Lock/Unlock beeps

The lock will cycle up to 10 more times once the low battery indication occurs. After this the final electric function in a low battery condition will be unlock and not lock until the batteries have been replaced. Please note that if the deadbolt is in the locked position and the batteries die the deadbolt will remain locked. The key will always be able to activate the deadbolt lock.

**IMPORTANT:**  
**The Touch Pad only**  
**activates the Dead Bolt.**  
**The Paddle Lock is**  
**Master Keyed for Dealer**  
**and Service Center use.**  
**The Dead Bolt provides**  
**Maximum Security.**

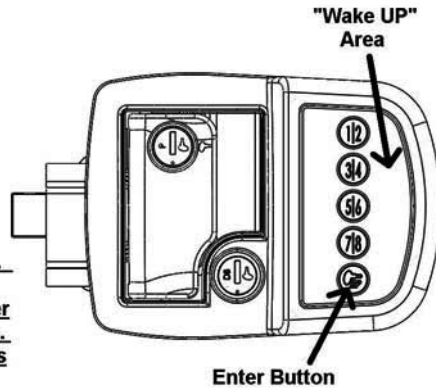

1. Touch the area next to the Buttons to "Wake Up" the lock.

2. The Buttons will illuminate when the lock is "awake" and ready to accept the code.

3. The factory default code is 3,7,1,5 is followed by the Enter Button.

4. Touch and hold "3/4" Button and Enter Button for 2 seconds. The lock will be 3 times to accept a new code. Enter a 4 digit code followed by the Enter Button. The lock will beep 4 times to indicate new code acceptance. This is now your new code.

**Please enter your Personal Code upon Installation of lock to prevent inadvertent programming.**

**General Maintenance and Operating Guidelines**

- ❑ Install fresh batteries as necessary. The Bauer NE is designed to function for months of normal usage with fresh, high quality AA batteries. Battery life is highly dependent upon battery quality, usage, and environment (temperature).
- ❑ Make sure there are no obstructions in the door frame to prevent Dead Bolt extension.
- ❑ Do not wash with power washer or high pressure cleaner. The Bauer NE is designed to resist water intrusion to protect its electrical components from normal water encounter such as rain.
- ❑ The Bauer NE uses Touch Technology. The buttons are activated by touching not pressing.
- ❑ Remove batteries when storing or not using this lock for extended periods of time.

### Trouble shooting

After installation the touch pad does not work

- Batteries are dead
- Batteries are not installed properly
- Plug not engaged properly

Dead Bolt not engaging into Door Frame

- Obstruction in Door Frame

Code not working

- Remove Batteries for 10 seconds then Program New Code

Inside Paddle not Opening Latch

- Inside screws are not secured to the Housing.

If the problem is not found on this list, please refer to the manufacturer's operators manual.

### Battery Installation:

The entry system uses 4 AA batteries for operation. We do not recommend zinc carbon batteries for this application

Fresh batteries should be installed as necessary. Battery Life is highly dependent upon battery quality, usage, and environment (temperature). Remove batteries if the lock will not be used for extended periods of time.

The following steps are shown on the enclosed Battery Installation schematic.

1. Remove (2) 4x40 screws from Battery Compartment Lid. These screws are very small so please take care in removal and installation.
2. Install the AA batteries in accordance with the orientation shown in the Battery Compartment. The batteries will fit tightly.
3. Install Battery Compartment Lid by aligning the (3) tabs on the lid with the (3) slots on the Inside Plate Assembly. These tabs act as a hinge for closing the Battery Compartment Lid.
4. Install the (2) 4x40 screws back to attach the Battery Compartment Lid to the Inside Plate Assembly.

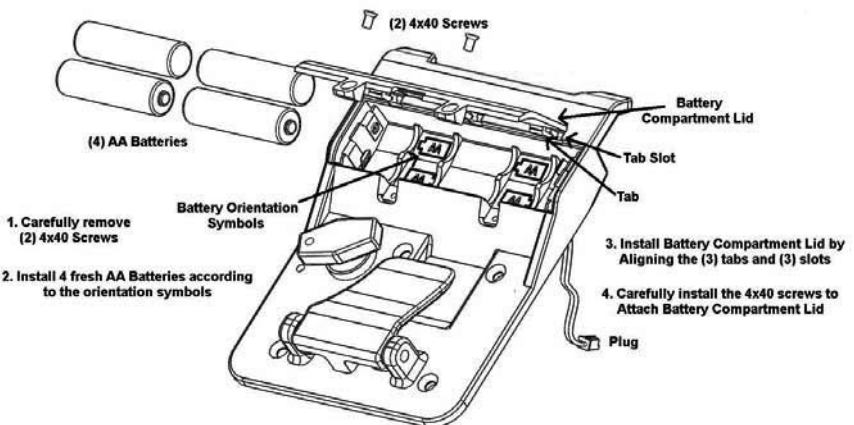

### TRAVEL TRAILER HITCHING PROCEDURE

The following procedure will help to assist you in securely hooking up your RV to your tow vehicle.

1. Make sure the trailer wheels are blocked.
2. Turn the tongue jack crank to raise the travel trailer tongue above the hitch ball.
3. Open the coupler latch on the travel trailer hitch.
4. Back the tow vehicle into the proper position.
5. Turn the tongue jack crank to lower the coupler onto the hitch ball.
6. Close the coupler latch after it is completely seated.
7. Install the (customer supplied) weight distributing bars (equalizers) as directed by the OEM.
8. Remove the dolly wheel or platform and retract the tongue jack to its maximum height.
9. Attach the breakaway switch cable to the tow vehicle.
10. Attach the safety chains.
11. Plug in your wire harness/connector plug from the tow vehicle to the travel trailer.
12. Walk around the RV to verify exterior lights are working correctly.
13. Remove the trailer wheel blocks.

**⊗ NOTE:** If an Atwood brake actuator is used with an equalizing hitch, be sure the hanger chains hang between straight down and forward up to 34°. Do not use less than 6-1/2" hanger chain length. For optimum brake performance, hang chains forward 34°. Refer to the manufacturer's owner's manual for more information.

### TRAVEL TRAILER BREAKAWAY SWITCH



#### CAUTION

NEVER use the breakaway switch and trailer brake system as a parking brake. Doing so would create a high amp draw on the battery and converter. This can cause damage to wiring, connectors and the breakaway switch.

The breakaway switch is a crucial part of the RV braking system. Located on the travel trailer A-frame, this switch will apply the trailer brakes if the trailer becomes detached from the tow vehicle. Attach the breakaway switch lanyard to a permanent part of the tow vehicle (on a travel trailer do not attach it to the hitch ball or similar removable parts) when hitching the trailer. If the RV becomes detached from the tow vehicle, the pull pin will be pulled from the switch. This automatically causes the switch to "close" and activates the RV brakes.

**A battery (customer supplied) must be installed to activate the breakaway switch.**

### TRAVEL TRAILER SAFETY CHAINS

Safety chain requirements vary from state to state. Your RV is equipped with chains to meet SAE standard requirements for maximum gross trailer weight.

Always have the safety chains attached when towing. Install them as shown below so they do not restrict sharp turns, but tight enough so they do not drag on the ground.

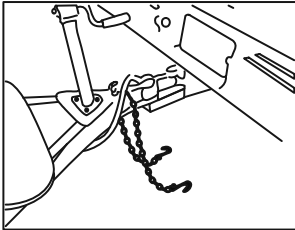

1. Inspect chains to determine if they are properly attached to trailer frame.

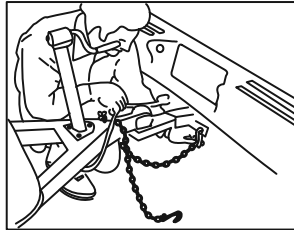

2. Criss-cross left chain and attach to right mounting slot in tow vehicle hitch.

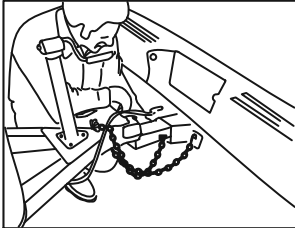

3. Repeat Step 2 with right chain. Slack for each length should be the same but not more than necessary to permit the vehicle to turn at the minimum radius.

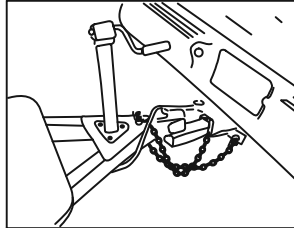

4. Properly mounted safety chains. Note that the jack is fully raised and dolly wheel removed.

**Fig. 4.6 Safety chain installation**

Crisscross the left safety chain under the coupler and attach to the right mounting slot in the trailer hitch; repeat with the right safety chain. Slack for each length should be the same but not more than necessary to permit the vehicle to turn at its minimum radius.

### TOWING BEHIND YOUR RV – TRAVEL TRAILERS



#### **WARNING**

Towing items behind your Jayco trailer, or overloading the rear, will void the warranty and may result in: damage to the trailer or add-on items, towing difficulties, property damage and/or personal injury.

**DO NOT tow anything behind your RV. The RV frame and bumper are not designed for towing.**

### TRAVEL TRAILER SET UP

1. Position the RV as desired.
2. Level the RV (side-to-side).
3. Block the wheels securely to prevent the RV from moving.
4. Unhook the wire harness/connector plug, safety chains and breakaway switch lanyard.
5. Install the dolly wheel or platform.
6. Release the weight distributing bars (customer supplied).

7. Open the tongue jack coupler latch.
8. Turn the tongue jack crank to raise the coupler above the hitch ball.
9. Level the RV (front-to-back) with the tongue jack crank.
10. If applicable, lower the stabilizer jacks.
11. Pull the tow vehicle away, as desired.

### --EXPANDABLE MODELS ONLY--



#### CAUTION

The tent canvas is a mildew resistant fabric; however, this does not mean that it is mildew proof. Taking proper care of your tent canvas will help to prolong its life. For warranty coverage, it is imperative that you read, understand and follow the listed recommendations in this owner's manual and all related literature.

Proper care and maintenance are important for the life of your tent canvas. If the tent must be stored wet, open the camping trailer and allow the tent to dry thoroughly as soon as possible. Be aware that the canvas portion of the tent will take longer to dry than the vinyl. Make sure the entire tent is completely dry before refolding it and storing the camping trailer.

Assure that your canvas and trailer have good ventilation, especially after a rainy period. The most common cause of a damaged canvas is mildew, which is the result of storing your RV for any period of time with a damp or wet canvas, even for short periods. This is even more important in humid climates.

Touching the tent canvas when it is wet can cause leakage. During periods of rain, avoid contact with the tent. The natural body oils in skin will neutralize the tent waterproofing and cause the rain to soak through. If leakage persists, please contact your dealer for assistance.

### SEASONING THE NEW TENT



#### CAUTION

It is very important to "season" your new tent. If you do not follow this procedure, you may experience some water seepage during the first few exposures to rain.

Well in advance of your first trip, set up your new RV. Use a garden hose and thoroughly soak the tent with a light spray of water (do not spray directly on the tent with a high pressure hose). After the tent dries, repeat the soaking process three additional times.

If you note any water seepage or leaks after seasoning your tent let the tent dry, then spray water repellent using the instructions provided on the product container. One or more applications of seam sealer may be necessary to stop water seepage in seams where thread enters the fabric. Water repellent products and tent seam sealers are usually available where tent or camping supplies are sold. Once performed, the new tent seasoning process does not need to be repeated unless a section of your tent is replaced.

## SETTING UP THE FRONT &amp; REAR BEDS

**CAUTION**

Dropping the bed board could cause undo pressure on the RV, cable and bed board.

1. Unlock and release the exterior locks that hold the bed board in place.
2. The bed board is supported by cables attached to the RV and the corners of the bed board. Slowly lower the bed board (DO NOT drop the bed board) into position. Maintain pressure on the bed board until the cables are fully extended. Pull the tent canvas out and over the edges of the bed board.



**Fig. 4.8** Tent canvas, exterior side view (rear)

3. From the interior, place the C-shaped end of the bed bow brace onto the bed bow connector (Fig. A). Push the bed bow brace outward and upward while pressing the second button from the curved end of the bed bow brace. Insert the end of the brace into the bracket mounted on the shelf, just past the first button (Fig. B). Release the button.

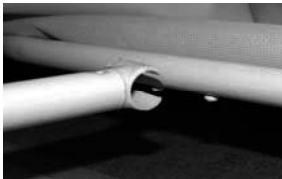

**4.9 Fig. A**



**4.9 Fig. B**

4. Attach the hinge cover to the bed board by placing the Velcro strip on the hinge cover onto the Velcro strip on the bed board and pressing firmly.
5. Push the bed mats onto the bed board. Unfold the hinged mat and slide on to the bed platform. Fold the canvas straps under the front edge of the small bed mat.

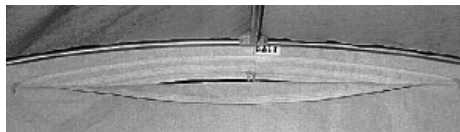

Condensation can be prevalent if proper ventilation is not used. It can exist whether or not a heater is used. We recommend that you leave a small opening in each bunk zipper to permit air to flow through and allow the tent to “breathe.” This will help minimize moisture gathering above the bunk area on the vinyl (see Condensation).

### Closing the beds

**⊗NOTE:** The front bed mat will be the easiest place to store the side and rear bed bow braces. Starting with the front bed will enable you to take the bed bow braces off of the rear and side and immediately store them. Caution should be taken to place the bed bow braces in the mat with the curved part down to prevent the bed bow brace ends from damaging the mat.

#### Front bed

1. Remove the bunk mat from the front bed platform, set aside. Make sure all loose items have been removed from the bunk mat and bed platform. Items left in these areas may cause damage to the mats and tent.
2. Loosen the hinge cover by lifting up on the Velcro side. Lay the cover back on the bed shelf.
3. Remove the bed bow brace from the ceiling by pushing in on the exposed button and pulling down. Pull the bed bow towards you and remove the C-shaped connector from the bed bow. Set the bed bow brace aside.
4. From the exterior, lift the bottom of the tent up exposing the bed platform. Fold the tent in towards the center of the bed platform.



5. Make sure the bed tent is pushed in at least 1” above the side bulb seal.



6. Lift the bed up and hold it in a vertical position. Tuck the tent in on both sides. Make sure the top of the door is clear from obstructions.
7. Latch one side of the door.
8. From the interior, inspect the perimeter of the door making sure there is nothing obstructing the top and sides of the door. Make sure the hinge cover is clear of the door.



If the tent or hinge cover is not clear of the door edges, the door will not close and seal tightly, and/or damage to the bulb seal may occur. Either circumstance may result in water leaks.



9. From the exterior, latch the other side of the door.

**⊗NOTE:** If the bed does not close easily, inspect the bed cushion from the sides looking for obstructions. Once the obstruction is located, lower the bed board, correct the obstruction and try again.

10. Place the bed bow brace inside the folded front bed mat.

11. Place the front bed mat against the closed front bed platform. Secure it in place by hooking the canvas straps to the D-ring hasp located above the bed shelf. You may need to adjust the straps to assure the mat is firmly secure against the bed platform

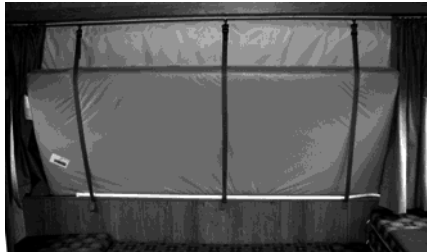

### Side Bed (if so equipped)

Repeat steps 1 -9.

10. Place the side bed bow brace in the folded FRONT bed mat for storage.

### Rear Bed

Repeat steps 1 -9.

10. Place the rear bed bow brace in the folded FRONT bed mat for storage.

Store the bunk mat between bed platform and the interior wall. You will need to slide one end in first and bend the mat to secure it in place.



## CAUTION

Heated bed mats (if so equipped) should not be stored between the wall and bed platform. Storing them in a tight space or in a twist or bind may result in damage to the heating elements. **See Section 12; Heated Bed Mats for more information.**

**TENT MAINTENANCE****CAUTION**

Do not use any cleaner which contains abrasives, solvents, citrus or chlorine bleach. Damage to the fabric will result.

**Exterior or vinyl side**

For minor stains, dirt, etc., the vinyl or outside of the material can be cleaned with mild liquid detergent and water, using a sponge or soft cloth. **Do not use a brush on the vinyl side of material!** Rinse well and air or wipe dry.

For more stubborn stains, dirt, etc., the tent fabric manufacturer recommends:

- OxiClean®
- Fantastick® (must state it can be used on vinyl)
- Star Brite® Vinyl Cleaner / Shampoo, #80216
- Meguiar's® 57 Vinyl & Rubber Cleaner / Conditioner, #5716
- Marine Specialties Group® Vinyl Finish Vinyl Cleaner #990917
- West Marine® Vinyl Cleaner, #2669323

**Interior or Fabric Side**

For minor stains, dirt, etc., dry brush with a soft bristle brush or use clean tap water with a sponge or soft bristle brush.

For more stubborn stains, the following products are recommended by the tent fabric manufacturer using either a sponge, soft cloth or soft bristle brush:

- OxiClean®
- Mild liquid detergent
- Resolve® Carpet Cleaner

**When using any of the above products, please follow the cleaning product manufacturer's directions! If practical, use a wet/dry vacuum to remove all moisture or excess cleaning product. Do not fold up tent while fabric is still wet or damp!**

Most of the above items can be purchased at local hardware stores, and RV or Marine dealers or supply stores.

**WARNING**

Ensure that the trailer is level before operating the slideout room. Water leaks and other problems could result if the slideout is operated without leveling the trailer.

Ensure there are no people or obstructions blocking the path of the room when it is moving. Keep away from the slide rails when the room is in motion. The gear assembly may pinch or catch on loose clothing causing personal injury.

Ensure the slideout is in the closed position prior to hooking the unit to the tow vehicle.

**FAILURE TO FOLLOW THESE INSTRUCTIONS COULD RESULT IN SERIOUS INJURY OR DEATH.**

**CAUTION**

Do not place excessive weight in the slideout room. It can cause the slideout room to malfunction and cause damage to the slideout.

The slideout room system is designed for additional floor space and comfort. The mechanical components are gear driven. Electric powered slideout room systems have a manual override to allow you to extend or retract the slideout room(s) in case of a power loss. Make sure you have sufficient power available before operating your slideout system.

**OPERATING THE SLIDEOUT****CAUTION**

Additional support jacks are not needed under the slideout. Damage can occur to your slideout room from improper use of aftermarket support jacks.

1. The auxiliary battery (customer supplied) must be fully charged and connected. If possible, the RV should be hooked up to 120-volt AC power so the converter operates.
2. The RV must be level and the stabilizer jacks in the extended position.
3. Locate the slideout control switch.



**Fig. 5.1 slideout control switch**

4. To move the room out, press the OUT section of the switch and hold it until the motor stops (travel time is approx. 25 seconds). Operating the switch after the room is fully extended will damage the switch and motor.

After the slideout is extended, verify that the corners of the black rubber seal are set up correctly. The corners of this seal are cut at a 45° angle. The top of the seal must overlap the side of the seal to avoid the possibility of water penetration.

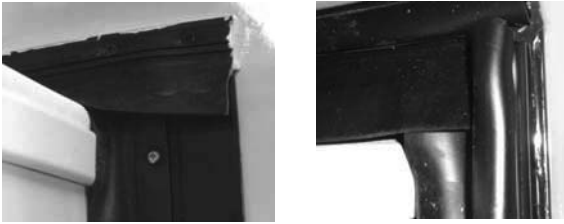

**Fig. 5.2 Slideout overlap**

### **Retracting slideout room**

Press the IN section of the slideout control switch and hold it until the motor stops.

Operating the switch after the room is fully retracted will damage the switch and motor.

### **Maintenance**



### **WARNING**

Do not work on your system unless the 12-volt DC (auxiliary battery, customer supplied) and 120-volt AC electrical systems (shore line power cord) have been disconnected.

Your slideout system has been designed to require very little maintenance. To ensure a long life of your slideout system, read, understand and follow these simple instructions. This system contains a pre-lubed bearing that is lubricated when the room is moved in and out. Do not spray oil or grease on the rails while the room is extended.

### **TROUBLESHOOTING THE SLIDEOUT**

**If the slideout does not move when the slideout switch is depressed, follow these steps.**

- Check the auxiliary battery (customer supplied) for a full charge and good wire connections.
- Check the 12-volt fuse or circuit breaker.
- Check for loose connections at the slideout motor.

**If the slideout still will not operate, follow these steps.**

- If the slideout is extended, refer to the following section on overriding the specific slideout system installed on your RV.
- If the slideout is retracted, leave it in that position.
- Contact your dealer or customer service for repair assistance.

**Dexter Chassis Group (DCG) Center Drive Slide override (flush floor models)**

Disconnect the slideout motor brake wires from the power wires. Connect a 9 volt battery harness to the motor brake wires. Locate the manual advance crank nut on the backside of the motor.

Crank the nut on the slideout motor with a 5/8" socket. With the 9 volt battery connected to the motor brake crank the nut on the motor until the room is sealed. Once the slide is in a closed position remove the 9 volt battery and harness.

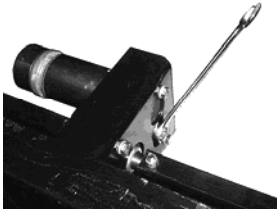

**Fig. 5.3 DCG manual advance crank nut**

**M-Tec rear bed/flush floor slideout override**

In the event of a power failure or low battery, the slideout may be operated manually using the manufacturer's crank handle provided with your RV. The manual crank shaft is located on the motor transmission housing. **USE ONLY THE MANUFACTURER'S CRANK HANDLE PROVIDED.** Turn the crank clockwise to move the room "in", counter-clockwise to move the room "out".



**Fig. 5.4 M-Tec crank handle inserted to override the slideout motor**

The following decal should remain permanently affixed to your RV. If you have any questions regarding the rear wall slideout system please contact your dealer or our customer service department.

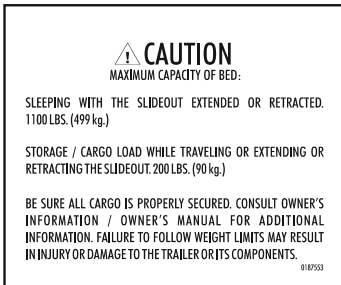

**Fig. 5.5 Rear bed slideout label**

**M-Tec sofa slideout override**

In the event of a power failure or low battery, the slide-out room may be operated manually with a 5/8" ratchet wrench (not supplied). The manual crank shaft is located on the motor-transmission housing. Turn the crank clockwise to move the room "in", counter-clockwise to move the room "out".

**THIS PAGE IS INTENTIONALLY BLANK**

---

**The** RV electrical system is comprised of two independent electrical systems. One operates off of 12-volt DC power and the other off of 120-volt 60hz AC power. All installations have been made in compliance with industry standards applicable on the date of manufacture. Because the electrical equipment and associated circuitry are engineered into a dedicated system specific to your RV, we recommend you do not make unauthorized changes or add fixed appliances to it. **Changes or additions made after delivery may result in a hazardous condition.**

Service and/or modification of the electrical system should only be performed by qualified electrical technicians using approved materials, components, and methods meeting current safety and code requirements. Please consult your dealer's service department for assistance.

To read more about the various components incorporated into the RV electrical system, please refer to the information contained in your Warranty Packet.

### ELECTRICAL SYSTEM MAINTENANCE

Always disconnect the shore power cord and disconnect the negative 12-volt DC battery terminal before working on the electrical system. Always make sure the power converter, is turned "off" before disconnecting the battery.



#### WARNING

Use caution when using metal tools. If a tool contacts a battery terminal or metal connected to it, a short circuit could occur which could cause personal injury, explosion or fire.

### IN CASE OF AN ELECTRICAL FIRE



#### WARNING

Do not attempt to use water to put out an electrical fire. Water can spread some types of fire, and electrocution is possible with an electrical fire.

1. Have everyone evacuate the RV immediately.
2. Switch the 120-volt main circuit breaker in the trailer to the "off" position.
3. Disconnect the negative battery cable(s) at the battery.
4. Disconnect the power cord from the shore power receptacle.
5. Always have faulty or damaged wiring and electrical components repaired immediately.

**⊗ NOTE:** It is important that everyone knows where to find the 120-volt main circuit breaker and how it operates.

### 120-VOLT AC SYSTEM

The following electrical components (if so equipped) will only operate when your RV is connected to shore power: 120 to 12-volt power converter, air conditioner, 120-volt refrigerator, microwave oven, television(s), fireplace and appliances plugged into convenience receptacles.

## 120-VOLT CIRCUIT BREAKERS

The 120-volt AC circuit breakers located inside the main load center protect all 120-volt wiring and components in the RV from circuit overloads and short circuits. Should a circuit overload or short circuit occur the circuit breaker protecting the affected circuit will “trip” preventing the flow of electricity through that circuit.

If a circuit breaker trips, shut “off” the appliance on that circuit (i.e., power converter etc.) and allow the circuit breaker to cool down for a brief period of time. After the cooling down period, reset the circuit breaker by moving its lever “off” and then back to the “on” position. If the circuit breaker re-trips or frequently trips, contact your dealer to have the electrical problem diagnosed and repaired.

A circuit breaker identification label is permanently attached to the inside surface of the 120-volt load center.



### CAUTION

Circuit breakers and fuses will not offer complete protection of the electrical system in the event of power surge or voltage spike.

## Maintenance and Replacement

At the beginning of camping season, inspect the circuit breakers and replace as needed. Test by turning each circuit breaker “off” and back “on”. Circuit breakers are wearable parts and must be replaced as needed, as part of your RV maintenance. If you have any questions, consult your dealer.



### WARNING

Replacement circuit breakers must be of the same voltage, amperage rating and type. Never use a higher rated replacement circuit breaker; doing so may cause a fire by overheating the RV wiring.

Please contact your dealer for repair assistance when replacing circuit breakers.

## CONVERTER

The power converter converts 120-volt AC power to useable 12-volt DC power when the shore power cord is connected to an external power source.

The converter has a built-in protective thermal breaker that will shut it down should overheating occur. Overheating can be caused by operating the converter above its maximum power output for an extended period of time, or by an obstruction to its ventilation air flow. To reduce converter heat build keep unnecessary 12-volt lights and motors turned “off”. Keep the converter cooling fins and fan clear of obstructions.

## Inspection and maintenance

If the 12-volt power converter is not working (auxiliary battery not being charged) check the reverse polarity fuse(s) in the converter fuse panel. **There are no customer serviceable parts inside the converter case and the manufacturer’s warranty will be void if the case has been removed.** If you have further concerns contact your dealer.



## **GFCI RECEPTACLE OUTLET**

---

Grounding is your personal protection from electrical shock. Each RV has a ground fault current interrupter (GFCI) engineered into the electrical system. This device has been designed to reduce the possible injury caused by electric shock. The GFCI will not protect against short circuits or circuit overloads.

Test all GFCI receptacles monthly

- ❑ Push in the GFCI “TEST” button. The GFCI “RESET” button should pop out indicating the GFCI receptacle has been “tripped” and interrupted 120-volt power.
- ❑ Push in the GFCI “RESET” button to restore 120-volt power. Contact your independent dealer for assistance if the GFCI “RESET” button does not restore 120-volt power and pops back out.

A “tripped” GFCI receptacle indicates that abnormally high 120-volt current flow (a ground fault) was detected through the electrical system grounding circuit. A fault condition can be caused by faulty wire insulation, wet wiring inside an appliance, or faulty electrical equipment connected to the circuit, etc. All ground faults must be repaired before use of the RV.

## **12-VOLT DC SYSTEM**

---

The majority of your RV lighting is powered by 12-volt electricity. The 12-volt DC system is composed of components that will operate when the following conditions are met:

- ❑ Power is supplied by the tow vehicle alternator when the engine is running and the 7-way trailer plug is connected. This powers the RV’s running lights, brake lights, turn signals and brakes. In addition, the 7-way trailer plug provides a common ground and a 12-volt charge line to charge the auxiliary battery.
- ❑ The converter will supply interior 12-volt DC power when the power cord is plugged into campground power. The converter will also charge the RV battery in most situations.
- ❑ The auxiliary battery powers many interior 12-volt components including the lighting fixtures, water pump, 12-volt motors, 12-volt appliances, etc. It also powers the breakaway switch.

## **AUXILIARY BATTERY (CUSTOMER SUPPLIED)**

---

Your RV has many 12-volt DC loads. When combined, their total is more than the converter can produce. High demands for 12-volt power can be met by an auxiliary battery for limited periods of time. The 12-volt DC electrical system is designed for usage with a Group 27, deep cycle battery.

### **Dry camping**

Consider the charge condition of the auxiliary battery when dry camping. If the auxiliary battery is not being recharged and power is being drawn from it, it will eventually discharge. A battery will discharge at a faster rate as its energy level becomes depleted. It is recommended you plan your electrical usage accordingly. For accuracy, test the auxiliary battery voltage using a volt-ohm meter (customer supplied).

A fully charged auxiliary battery will read 12.7 volts DC and 1.265 specific gravity at 80°F (32°C). The auxiliary battery is considered discharged at 11.8 volts, and dead at 11.65 volts.

When voltage drops below those levels, permanent damage may occur. Typically, a deep cycle battery has an amp-hour rating of 75-100 amps.

If you run the furnace and refrigerator simultaneously, you will be using approximately (12.0 + 3.0) 15.0 amps per hour. This does not include any 12-volt lights, water pump or any other 12-volt component.

If the furnace and refrigerator in the above example operated constantly, a 75 amp-hour battery would become fully discharged in 5 hours (75ah / 15a = 5h).

The auxiliary battery should be installed in parallel with the battery in your tow vehicle. When the 7-way trailer plug is connected, both batteries power the RV so it is important not to discharge your tow vehicle battery below the level required to start the engine. To prevent this from occurring, disconnect the 7-way trailer plug or install a battery isolator. When the tow vehicle engine is operating with the RV connected, the tow vehicle charging system will charge both batteries.

### **Replacement and maintenance**

Some equipment in your RV will draw small amounts of current even when turned OFF. To prevent the auxiliary battery from being discharged when your RV is not connected to shore line power, disconnect the auxiliary battery negative cable at the battery. During storage, it is important to check the voltage monthly and recharge the auxiliary battery as needed. If you remove the auxiliary battery from your RV, store it in a dry, cool area per the manufacturer's instructions.

When it is time to replace the auxiliary battery, replace it with a Group 27 deep cycle battery only. Contact the battery manufacturer for further information. Do not reverse the positive and negative battery cables (doing so will blow the reverse polarity fuse(s) that protect the converter).

### **BATTERY ISOLATOR FOR YOUR TOW VEHICLE (CUSTOMER SUPPLIED)**

You may want to consider the installation of a battery isolator on your tow vehicle as a convenience feature:

- It receives current from the tow vehicle alternator and controls distribution of energy to both the RV auxiliary battery and the tow vehicle battery.
- It serves as a check valve to prevent energy from being drawn from your tow vehicle chassis battery (so you can start your tow vehicle engine).

Your dealer can assist you with the selection, purchase and installation of this aftermarket part.

### **12-VOLT FUSE PANEL**

The 12-volt fuse panel is labeled to indicate fuse sizes, positions and the components powered. At the beginning of camping season, inspect all the 12-volt fuses and replace as needed.

#### **Replacing a fuse**

Before replacing a fuse, always turn off electrical component(s) protected by it.

1. Disconnect the shore power cord.
2. Disconnect the RV auxiliary battery main negative battery cable.
3. Remove the fuse panel cover to check fuses.
4. Pull the fuse straight out of the fuse block. If the fuse is not blown, something else must be causing the problem. Please contact your dealer for further assistance.

5. Insert a new fuse of the same specified voltage, amperage rating and type in the original location. **Never use a higher rated replacement fuse.**

The fuse panel label should be kept permanently affixed to your RV. The fuses will not offer complete protection of the RV electrical system in the event of a power surge or spike.



## WARNING

Replacement fuses must be of the same voltage, amperage rating and type. Never use a higher rated replacement fuse; doing so may cause a fire by overheating the RV wiring.

### DC FUSE PANEL LAYOUT

Below is a typical wiring layout. Your individual RV may be different.

#	Size	Function
1	—	Open
2	15 amp fuse	Bathroom Lights & Vent
3	15 amp fuse	Pump/Monitor Panel/Range Hood/Sink Lights
4	15 amp fuse	Refrigerator/Furnace
5	15 amp fuse	Bedroom
6	15 amp fuse	TV/Radio/Propane Detector
7	15 amp fuse	Ceiling Lights
8	15 amp fuse	Bunk Lights
9	15 amp fuse	Slideout Lights
10	15 amp fuse	Option
11	15 amp fuse	Option
12	20 amp auto	Slideout Motor

### 12-VOLT DC OUTLET (IF SO EQUIPPED)

There may be a 12-volt DC outlet (not applicable on all models) in your RV. When the 12-volt DC outlet is used as a power source for an electric appliance, make sure that the appliance operates on 12-volt DC power and that it consumes less than 60 watts (5 amps) of 12-volt power. To prevent short circuits do not allow metallic foreign matter to get into the 12-volt DC outlet.

### REPLACING LIGHT BULBS

Before replacing a bulb, be sure the light is off. Do not touch the glass part of the new bulb with your bare fingers. The skin oil left on the glass will evaporate when the bulb gets hot, the vapor will condense on the reflector and it will dim the surface.

Replacement light bulbs must be of the type, voltage and wattage listed on the lamp fixture. Use of incorrectly sized bulbs can overload lam circuits and may create a fire hazard by overheating the fixture.

Interior	Ceiling, Bunk Lights	#921
Exterior	Porch Light	#922
Exterior	Tail Light / Signal	#3157
Exterior	Clearance	#194

### 30 AMP SYSTEM



#### WARNING

Make very certain the external power source (30 amp systems only) you connect the power cord to is a **30 amp/120-volt AC** RV receptacle and not 240 volt AC.

Your RV is equipped with a 30 amp 120-volt 60hz AC electrical system. The entire system is designed to operate on 1 leg of 120-volt power at a maximum current flow of 30 amperes. Exposure to voltages higher or lower than a nominal 120-volts will damage or shorten the service life of the electrical system and appliances. The 30 amp 120-volt 60hz AC electrical system can be powered by the 120-volt 60hz utilities found in RV campgrounds or by 120-volt 60hz generator power.

### 30 AMP POWER CORD

The power cord is also commonly referred to as the "shore power cord." This power cord is designed to ground the RV electrical system through the external power source receptacle. It is also designed to carry the voltage and current output from 30 amp campground power receptacles.

Occasionally the electrical service provided by a campground may experience low or high voltage (i.e., surges or spikes). Any prolonged exposure will shorten the life of the electrical system and appliances. Consult your dealer for recommendations on power surge protection.



#### WARNING

##### **PLUG INTO 30-AMP SERVICE ONLY.**

- ❑ Do not hook up the 30-amp power cord to any receptacle until you have verified proper polarity and grounding. Polarity indicators can be purchased in most electrical and hardware stores.
- ❑ Do not use any cheater plug, adapter or extension cord to reduce incoming AC power or break the continuity of the circuit connected to the grounding pin.
- ❑ Do not connect the power cord into an outlet that is not grounded, or adapt the 30 amp power cord plug to connect it to a receptacle for which it is not designed.
- ❑ Do not remove the grounding pin to connect to a non-grounded receptacle. Removal of the ground pin disables an important safety feature designed to prevent shock and electrocution hazards.
- ❑ Do not connect the power cord to an extension cord. Use of an improper extension cord will cause overheating of the cord as well as potentially causing premature failure of the AC equipment.

It is the responsibility of the owner of the electrical receptacle to ensure that the receptacle is properly wired and grounded. Reverse polarity and/or improper grounding of your RV can cause personal injury or death.

**WARNING**

**PLUG INTO 30-AMP SERVICE ONLY.**

**WARNING**

Plugging the shoreline power cord into an incorrectly wired power source could damage the RV electrical system and result in severe or fatal injury.

**WARNING**

The power cord must be fully extended when in use and not left coiled in the electrical compartment or on the ground. If the power cord is left coiled, it may potentially create enough heat to melt its protective casing.

**Connecting the power cord**

Always test the 30 amp external power source (i.e., the campsite power receptacle or electrical box) with a ground monitor before connecting your power cord to it. If the ground monitor indicates 'reverse polarity' or an 'open ground' **DO NOT** connect the power cord.

1. Turn "off" the load center main 30 amp 120-volt circuit breaker.
2. Carefully extend the entire length of the power cord (approximately 25'-35') from the electric cable hatch to the external power source.
3. Plug the power cord into the receptacle. Be sure all the power cord prongs are properly plugged into the receptacle.
4. Return to your RV and turn "on" the load center main circuit breaker.
5. To help prevent power surges from damaging the connected loads, please follow these instructions when hooking up to the external power source:

**The shore line power cord should be unplugged when the RV is left unattended. If something would happen to the electrical system, this may help limit potential damage.**

When you are ready to leave, reverse the power cord connection process. Use care to prevent damaging the power cord electrical connection pins when connecting or disconnecting the shore line power cord. Grasp the plug to remove the power cord from the outlet; do not unplug it by pulling on the cord.

**Maintenance**

Inspect the power cord for cuts, cracks and worn insulation. Have the power cord replaced immediately if these symptoms are noticed.

**CALCULATING ELECTRICAL LOAD**

When connecting appliances to the electrical system, remember that 120-volt power usage is limited to a total of 30 amps. Be mindful of the fact that each operating appliance collectively places an added load on your 120-volt electrical system.

An unintentional "trip" of a circuit breaker may occur if you overload the RV's and/or campground's electrical system. The amperage rating of individual

appliances can be calculated by dividing appliance wattage consumed (normally listed on the appliance) by nominal design voltage (120 for a 120-volt appliance). For example: 1200 watts divided by 120-volts equals 10 amps.



## WARNING

To help prevent power surges from damaging the electrical system and its connected devices, please follow the instructions listing below when connecting to shore power.

- ❑ Only connect the shore power cord to properly wired 30 amp NEMA TT30 120 volt power receptacles.
- ❑ Do not connect the shore power cord to any power receptacle until you have contacted the campground owner and/or premise attendant to verify proper shore receptacle polarity and grounding. Polarity indicators can be purchased in most electrical and hardware stores.
- ❑ Do not use a cheater plug, adapter or extension cord to reduce incoming AC power or to break the continuity of the power cord grounding circuit.
- ❑ Do not connect the power cord to an outlet that is not grounded or adapt the 30 amp power cord plug to connect to a receptacle for which it is not designed.

## APPROXIMATE ELECTRICAL LOAD RATINGS

<b>120 Volt System</b>	
Air Conditioner	18 AMPS
Coffee Maker	6-12 AMPS
Converter (each)	8 AMPS
Curling Iron or Hair Dryer	10-14 AMPS
DVD System	3 AMPS
Microwave	12 AMPS
Refrigerator	6 AMPS
Satellite Receiver	2 AMPS
TV	2-4 AMPS
Vacuum Cleaner	8 AMPS
Washer/Dryer	12 AMPS
Water Heater	12 AMPS

120 Volts: Labeled watts divided by 120 = Power consumed in AMPS

12 Volt System	
Aisle Lights	1.0 AMP
Baggage Compartment Lights	1.4 AMPS
Decorative Wall Lights	1.5 AMPS
Dinette Light	4.5 AMPS
Exterior Entertainment Center	5-7 AMPS
Fantastic Fan	1.5 AMPS
Fluorescent Double Lights -12"	2.0 AMPS
Fluorescent Double Lights -18"	2.5 AMPS
Furnace	12.0 AMPS
Generator Start	95.0 AMPS*
Halogen Light	1.7 AMPS
Illuminated Switch	.125 AMP
Inverter	variable
Leveling System	95.0 AMPS*
LP Detector	.125 AMP
Map Light	1.5 AMPS
Porch Light	1.5 AMPS
Power Awning	10.0 AMPS
Power Vent	5.0 AMPS
Refrigerator	3.0 AMPS
Shower Light	1.4 AMPS
Step Cover	10.0 AMPS
TV Plate/Antenna Booster	1.0 AMP
Vanity Light	4.2 AMPS
Water Heater	6.0 AMPS
Water Pump	7.0 AMPS

\*Momentary Load

12 Volts: Labeled watts divided by 12 = Power consumed in AMPS

**THIS PAGE IS INTENTIONALLY BLANK**

---



## PROPANE GAS SYSTEM

Propane or LP (liquefied petroleum) gas is a clean and efficient form of energy when proper handling and safety precautions are observed. The propane system in your RV furnishes the fuel for cooking, heating and hot water. Propane can also be used as an alternative energy source for refrigeration

**The propane fuel system is comprised of numerous components such as the propane container, hoses, the propane gas regulator, piping and copper tubing lines to each appliance.**

Propane is heavier than air; the gas tends to flow to lower areas and will sometimes pocket in these low areas, such as the floor. Your RV is equipped with a propane alarm (refer to **Sec. 2 Safety Precautions**, Combination Carbon Monoxide (CO)/Propane Alarm.)



### WARNING

Propane cylinders should not be placed or stored inside RV. LP-gas cylinders are equipped with safety devices that relieve pressure by discharging gas into the atmosphere.

## Maintenance

Although both Jayco and your selling dealer carefully test for leakage, travel vibrations can loosen fittings. Have the propane system checked at all connections soon after the purchase of your RV, and after the initial filling of the propane tanks.

**⊗NOTE:** All propane lines have been checked with air pressure at the time of manufacture. Dealers are required to recheck and adjust pressure before retail delivery.

Continued periodic checks of the propane system at 5,000 miles of travel (or at least once a year), by a qualified propane service representative as part of your normal maintenance is recommended.

Hand tighten the LP gas system valves only, do not use a wrench or pliers as over tightening may damage the valve seals and cause them to leak.

## PROPANE LEAK TEST

Leaks may be found easily with a soapy water solution. Do not use a solution containing ammonia or chlorine when locating leaks. These products are corrosive to copper gas lines and brass fittings, which could result in deterioration of the copper and brass components.

Apply the soapy solution to the outside of the gas piping fittings. If a leak is present, the soapy solution will "bubble" at the leak point.

If a leak is indicated, shut off the propane system valve(s) and contact an independent Jayco dealer or qualified propane service representative immediately.



### DANGER

**Never use an open flame to test for a propane leak.** Do not check for leaks using products that contain ammonia or chlorine; these products can cause cracks to form on the metal tubing and brass fittings

## PROPANE SAFETY PROCEDURE

Propane is a colorless and odorless gas that, in the liquefied state, resembles water. An odorant (mercaptan that is described, by many people, as having an odor similar to “rotten eggs”) is added as a warning agent. If you smell propane within the vehicle, quickly and carefully perform the procedure listed on the label below.

This label has been placed in the RV near the range, for models equipped with a propane system.



**Fig. 7.1 “If you smell propane” label**

When propane container is low, occasionally there may be a concentration of an onion or garlic-like odor, which can be mistaken for a propane gas leak.

After the propane container has been refueled, the odor will usually disappear. If not, turn off the valve(s) and have the propane system inspected by an independent Jayco dealer or qualified propane service representative.

## PROPANE GAS CONTAINER

Propane “container” is a general all inclusive term used to describe a vessel that is used for storage and delivery of propane gas. The most common of these are:

DOT (Department of Transportation) cylinders are transportable and are commonly used on RV trailers. The capacity of DOT propane cylinders is expressed in pounds. DOT propane cylinders are required to be removed from the RV for filling and must be filled by weight by a qualified propane facility. DOT Propane cylinders are equipped with an OPD or Over Fill Protection Device designed to reduce the potential of overfilling. DOT propane cylinders are also equipped with an ACME service valve that is for connection of the TYPE 1 ACME pigtail hose assembly to the RV two-stage regulator.

The TYPE 1 ACME pigtail hose assembly is a wrenchless, user friendly, right hand threaded connector that features a thermally sensitive sleeve and excess flow device. Max output is 200,000 BTU/hr. It is used to connect propane cylinders to regulators, hoses and other fittings. It is not for use on gas grills and other low pressure devices. DOT cylinders equipped with an OPD and ACME type 1 service valve are identified by the triangular service valve knob.

DOT cylinders are typically marked with “top” or an arrow to indicate the correct orientation of the cylinder(s). Do not mount, store or transport any cylinder other than the in proper position indicated. Be sure to securely re-install DOT cylinder(s) to the RV after they have been removed for filling or replacement. Always close the service valve and install a dust cap or plug when transporting or storing disconnected containers whether full or empty.

ASME tanks are permanently mounted to the RV and are commonly used on RV motor homes.

The capacity of ASME tanks is expressed in gallons. ASME tanks are filled while the tank is attached to the motor home by a qualified propane facility. ASME tanks are equipped with an automatic stop fill valve designed to reduce the potential of overfilling. ASME propane tanks are also equipped with a P.O.L. service valve that is for connection of the supply hose with a left hand threaded brass P.O.L. fitting from the tank service valve to the two-stage regulator. Not for use on gas grills and other low pressure devices.



## WARNING

---

DOT propane cylinders must be transported and stored in an upright position so the pressure relief device will function properly. Laying a DOT propane cylinder on its side may potentially create a very dangerous situation.

**⊗NOTE: Tanks are to be installed, fueled and maintained in accordance to State and Local codes, rules, regulations or laws.**

Propane is a true gas compressed into a liquid form. As the fuel is released from the container, it changes to vapor which is then used for the operation of the appliances. Propane will not run through the appliances in the liquid state.

Propane expands 1½ percent for every ten degrees of increase in temperature. It is imperative to leave sufficient space inside the container to allow for natural expansion of gas during warmer weather.

The main shut off valve must be kept closed at all times unless you are using the propane system or filling the propane cylinder. When the cylinder is disconnected from the hose, install the valve cover that is attached to the container.

Close the propane cylinder main shut off valve by hand tightening only. Use of tools creates a potential to over tighten the valve (damaging the interior seals on the cylinder valve seat). If this type of damage occurs, the cylinder will not close properly.

The following label should be kept permanently affixed to your RV.

**WARNING**

THIS SYSTEM IS DESIGNED FOR USE WITH PROPANE ONLY.  
DO NOT CONNECT NATURAL GAS TO THIS SYSTEM.

**BEFORE TURNING ON PROPANE:**

- (1) ALL CERTAIN APPLIANCES ARE CERTIFIED FOR PROPANE AND ARE EQUIPPED WITH CORRECT BURNER ORIFICES.
- (2) MAKE CERTAIN ALL PROPANE CONNECTIONS ARE TIGHT BY TESTING WITH SOAPY WATER. ALL APPLIANCE VALVES ARE TURNED OFF, AND ANY UNCONNECTED OUTLETS ARE CAPPED.

**AFTER TURNING ON PROPANE:**

- (3) LIGHT ALL PIPIERS.
- (4) ALL CONNECTIONS, INCLUDING THOSE AT THE APPLIANCES, REGULATORS, AND CONNECTIONS, SHOULD BE LEAK TESTED PERIODICALLY WITH SOAPY WATER BY THE OCCUPANT. NEVER USE A LIGHTED MATCH OR OTHER FLAME WHEN CHECKING FOR LEAKS.
- (5) DO NOT LEAVE SYSTEM TURNED ON OR CONTAINERS CONNECTED UNTIL THE SYSTEM HAS BEEN PROVEN TO BE FREE OF ANY LEAKS.
- (6) COOKING APPLIANCES SHOULD NOT BE USED FOR SPACE HEATING.
- (7) WHEN THE CONTAINERS ARE DISCONNECTED, THE PROPANE SUPPLY LINE SHOULD BE CAPPED OR PLUGGED.

**AVERTISSEMENT**

CETTE INSTALLATION EST CONÇUE POUR LE PROPANE SEULEMENT.  
NE PAS L'ALIMENTER EN GAZ NATUREL.

**AVANT LA MISE EN SERVICE:**

- (1) S'ASSURER QUE LES APPAREILS SONT CERTIFIÉS POUR LE PROPANE ET MUNIS D'ORIFICES DE BRÛLEUR APPROPRIÉS.
- (2) VÉRIFIER L'ÉTANCHÉITÉ DE TOUTES LES RACCORDEMENTS AU PROPANE, LA FERMETURE DE TOUTS LES ROBINETS D'APPAREILS ET L'OBSTRUCTION DE TOUTES LES SORTIES NON RACCORDEES.

**APRÈS LA MISE EN SERVICE:**

- (3) ALLUMER TOUTES LES VÉLLEUSES.
- (4) L'OCCUPANT DOIT ÉProuver PÉRIODIQUement L'ÉTANCHÉITÉ DE TOUTS LES RACCORDEMENTS, Y COMPRIS CELUX AUX APPAREILS, AUX INTÉRIEURS ET AUX SORTIES, EN Y AJOUTANT DE L'EAU SAVONNEUSE. NE JAMAIS SE SERVIR D'UNE ALLUMÈTE OU D'UNE FLAMME POUR LA DÉTECTION DES FUITES.
- (5) NE PAS LAISSER L'ALIMENTATION OUVERTE, NI LES RÉGÉNÉRS RACCORDEES, SAUF SI DEVRAIT COMPLÈTE L'ÉPREUVE D'ÉTANCHÉITÉ AU PROPANE DE L'INSTALLATION.
- (6) LES APPAREILS DE CUISINE NE DOIVENT PAS ÊTRE UTILISÉS POUR LE CHAUFFAGE DES LOCALS.
- (7) LORSQUE LES RÉGÉNÉRS SONT DÉCONNECTÉS, L'ALIMENTATION DE PROPANE DOIT ÊTRE OBTURÉE OU SCÉLÉE.

JA-105

Fig. 7.2 "Use propane only" label (Canada only)

### Servicing or filling

Have the RV checked for leaks at the connections on the propane system soon after the purchase and the initial filling of each propane cylinder. When you have a new cylinder filled for the first time, make sure your propane supplier purges your new cylinder of trapped air. Otherwise, an improper mixture of gas and air will make it impossible to light your propane appliances.

**WARNING**

Before entering a propane or fuel service station make sure all pilot lights are extinguished. Shut off gas to all appliances by closing the propane gas main shut off valve. Always shut OFF any engine before refueling. Do not smoke and do not operate other ignition sources while refueling.

No one should be inside and only the qualified propane service technician should be near the RV while the propane tank is being filled. The new propane container must be carefully purged for best performance and must **NEVER BE OVERFILLED**. The following label should be kept permanently affixed to your RV.



Fig. 7.3 “Shut off during re-fueling” label

The position of the propane container(s) and the hoses are critical to proper operation and propane flow. Follow these instructions to make sure your propane container(s) are connected properly.

**WARNING**

The pigtail hose must be installed to avoid tension or pulling stress at either end of the hose. Keep the pigtail hose away from sharp edges of the cylinder collar, rigid corners, walls, doors or other compartment structures including the cover.

**LP gas container overflow**

Never allow your propane tank to be filled above the maximum safe level as indicated by the fixed liquid level gauge. Do not allow the visible gauge to be used for filling. Overfilling the propane container above the liquid capacity indicated on the container, could allow liquid propane to enter the system that is designed for vapor only creating a hazardous condition.

**WARNING**

If you suspect your propane container has been overfilled, contact your independent Jayco dealer or a qualified propane technician for assistance immediately. Do not attempt to service a propane container overflow yourself.

The following label should be kept permanently affixed to your RV.



Fig. 7.4 “Do not fill to more than 80%” label

Refer to your Warranty Packet for more information on the LP gas system components.

## INSTALLING PROPANE CYLINDER(S)



### WARNING

Ensure that all fasteners are secured before traveling.

### Single Cylinder Mounted On A-Frame (if so equipped)

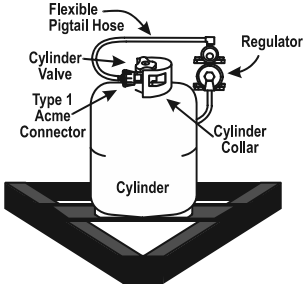

Fig. 7.5 Single cylinder

1. Connect the 3/8" low pressure hose to the outlet of the two stage regulator.
2. Attach the regulator with the "Z" bracket on the center of the front wall with the vent pointing down.
3. Attach the protective plastic cover to the regulator.
4. The regulator has a 90° elbow that directs the inlet toward the trailer curbside.
5. Place the cylinder on the bracket provided on the A-frame and position it so the outlet of the cylinder valve is pointed directly outward to the curbside wall.
6. If a vinyl cylinder cover is provided, slip it over the cylinder and leave the zipper open (if so equipped).
7. Attach the 1/4" inverted flare x 24" Type 1 pigtail hose to the regulator inlet and the right hand swivel nut to the cylinder valve.
8. If applicable, close the cylinder cover zipper (if so equipped) up to the hose.
9. Secure the cylinder to the A-frame bracket using the bolts, nuts and washers provided.

### Double Cylinder Mounted On A-Frame (if so equipped)

When a second cylinder is installed, a tee check valve is used to replace the 90° elbow at the top of the regulator and another 1/4" inverted flare x 24" Type 1 pigtail is added. The regulator stays in the original position.

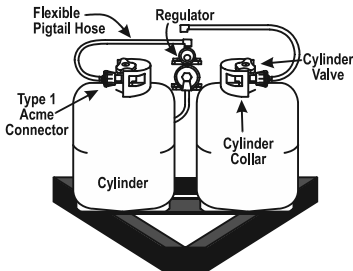

Fig. 7.6 Double cylinder

1. Place the second cylinder on the A-frame bracket so the cylinder valve is pointed to the roadside of the folding camping trailer.
2. Secure the second cylinder to the A-frame using the bolts, nuts and washers provided.
3. If a vinyl cylinder cover is used, slip it over the new single cylinder, or a double cylinder cover may be used in lieu of single covers.
4. Attach the second 24" hose to the tee check valve on the regulator and the right handed swivel nut to the cylinder valve.

#### Located in a recessed compartment or housing (if so equipped)

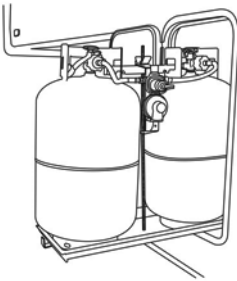

Fig 7.7 Two propane cylinders

1. Connect the 3/8" low-pressure hose to the outlet of the two-stage regulator.
2. Place the cylinder on the bracket in the recess compartment or housing and secure them so the outlets of the cylinder valves are facing the "sidewalls" of the compartment or housing (opposite of each other).
3. Mount the regulator on the center back wall of the compartment or housing so the vent is pointed downward.
4. Attach the 1/4" inverted flare x 18" Type-1 pigtail hose to the regulator inlet and the right hand swivel nut to the cylinder valve.

#### Main Supply Hose – Low Pressure

Attach the main supply hose from the regulator to the brass manifold fitting in the frame of the trailer. The swivel brass nut on the main hose will be your final attachment.



3/8" MPT x 1/2" Female  
Flare Swivel

Fig. 7.8 Main supply  
hose

Several things to remember each time the propane container is removed:

1. Check that ALL fittings are tight.
2. Check that ALL connections are tested with a propane leak detector (or soapy water) solution.
3. Open the main valve slowly to avoid a fast rush of propane to the excess flow valve causing propane freeze up. If you experience a propane "freeze-up," close the main valve and wait at least fifteen (15) minutes before trying again. Refer to the regulator manufacturer's operator manual.
4. Listen carefully - a "hissing" sound longer than one second may indicate a propane leak. If you feel there may be a leak present, close the valve and contact your dealer or qualified propane technician for repair assistance.

Replace all protective covers and caps on the propane system after filling. Make sure the valve is closed and the compartment door is securely latched.

**Maintenance**

Propane gas is normally non-corrosive - you need not worry about the inside of your container. However, the outside should be kept free from rust by a periodic coat of paint in a light reflective color. Rust, scratches and/or dents can affect the safety of the cylinder. Inspect the cylinder at regular intervals.

If there is a problem, have it evaluated by a qualified technician and discard it. DOT requires that a visual inspection be made prior to each filling.

Any cylinder that has been exposed to fire, leaks or seems damaged should not be refilled.

Do not attempt to repair any containers, container valves, regulator or appliances by yourself. Use only trained certified propane gas service technicians to perform repairs.

**Propane cylinder recertification**

If you have an older RV you should know that, according to Federal law, DOT cylinders may only be used for 12 years after their manufacture date (the number of years for certification may vary in your area). After that, the cylinders must be "recertified" which provides another five years of use.

The cylinders can be recertified every five years thereafter. Federal DOT (Department of Transportation) regulations require periodic inspections and re-qualifications of the propane cylinders. DO NOT USE damaged or rusted containers.

Verify with your local propane dealer that all required inspections and certifications have been completed on the propane cylinder within the correct time period before refilling the cylinder.

Have the LP system checked for leakage each time a cylinder is refilled or after any part of the propane system has been disconnected.

**PROPANE REGULATOR****WARNING**

Propane regulators must always be installed with the regulator vent facing downward. Regulators that are not located in baggage compartments have been equipped with a protective cover. Make sure the regulator vent faces downward and (if applicable) the cover is in place to minimize vent blockage that could result in excessive gas pressure causing fire or explosion.

**Single stage regulator**

Some models are equipped with a single stage regulator.

**Two stage regulator**

The two-stage regulator has the only moving components in the propane system. Its sole function is to reduce the pressure from the propane containers to a safe and consistent low operating pressure. The first stage reduces the container pressure to 10-13 lbs. The second stage reduces the 10-13 lbs. of pressure further to an operating pressure of 11" W.C. (water column) or 6.35 oz. of outlet pressure to your appliances.

The second stage is adjustable and will need to be adjusted by your dealer or qualified propane service technician for optimum performance (this adjustment should always be made with a properly calibrated manometer).

If the pressure is too high, it affects performance and safety; if the pressure is too low, your appliances will not operate correctly.

If your RV is equipped with the “automatic” two-stage regulator, with both cylinders full of propane, turn the lever on the regulator towards the cylinder you wish to use first. This will now be the “supply” cylinder and the other the “reserve.” Slowly open both cylinder valves. The indicator on top of the regulator will turn bright green. When the cylinder becomes empty, the indicator will change to bright orange. Now turn the regulator lever to the side of the “reserve” cylinder and the green signal should return. You may now remove the empty cylinder to have it refilled without interrupting the flow from the full bottle. After filling the cylinder, connect the pigtail hose and slowly open the bottle valve.

## **HOSES, PIPES, TUBES & FITTINGS**

The hoses, pipes, tubes and fittings used in your propane system are designed to withstand pressures exceeding those of the propane system. However, because environment and time can both contribute to the deterioration of these components, they must be inspected for wear at regular intervals.

Be sure to inspect the hose before each season and when having the tank refilled. Look for signs of deterioration such as cracks or loss of flexibility. When replacing the hose or other propane components, make sure to always replace them with components of the same type and rating (check with your dealer).

Fittings are used to connect the various system components to each other. The P.O.L. fitting at the end of the propane supply hose is made of brass so that pipe sealants are not necessary to prevent leaking. It also has a left-handed thread, which means that it is turned clockwise to remove, and counter-clockwise to tighten. The P.O.L. fitting has been designed to help restrict the flow of LP gas in the event of a regulator failure or hose malfunction.

## **USING THE PROPANE SYSTEM**



### **WARNING**

Do not use portable fuel-burning equipment, including wood and charcoal grills and stoves, inside the RV. The use of these items inside a RV may cause fires or asphyxiation (inability to breathe).

After the RV is completely set up and you are prepared for camping enjoyment, use the following steps for propane operation:

1. Close ALL burner valves, controls and pilot light valves.
2. Open the main valve in the propane container slowly to avoid a fast rush of propane vapor through the excess flow valve causing propane “freeze-up.” Should you experience propane “freeze-up,” close the main valve and wait 15 minutes before trying again.
3. Listen carefully as propane begins to flow. If a hissing noise is heard for more than one or two seconds, close the main valve and contact your dealer to have the propane system tested.
4. Light the appliances as needed and directed in the appropriate appliance manufacturer’s owner manual located in the Warranty Packet.



Make sure that you read and fully understand ALL safety requirements for handling and operation of the propane system.

The Warranty Packet contains operator's manuals for the various appliances hooked to your propane system. The propane system provides added benefits to your camping enjoyment; however, it must be handled with care. If you have any questions or concerns, consult with your dealer and/or the specific manufacturer.

If you have double cylinders on your RV, use only one at a time. Otherwise, the propane supply will be drawn equally from both cylinders until the supply has been totally exhausted.

Using one cylinder until it is empty, then using the second cylinder will allow you to fill the empty cylinder at your convenience without running totally out of propane.

**COOKING WITH PROPANE**

Unlike homes, the amount of oxygen supply is limited due to the size of the recreation vehicle. Proper ventilation when using the cooking appliance(s) will help you avoid the danger of asphyxiation. **It is especially important that cooking appliances not be used for comfort heating, as the danger of asphyxiation is greater when the appliance is used for long periods of time. FAILURE TO COMPLY MAY RESULT IN DEATH OR SERIOUS INJURY.**



The following warning labels are located in the cooking area to remind the user to provide an adequate supply of fresh air for combustion.

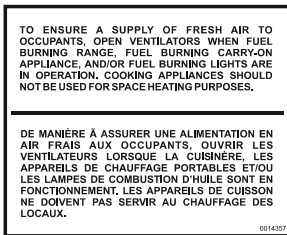

**Fig. 7.9 Ensure a supply of fresh air**



**Fig. 7.10 Cooking / comfort heating fresh air label (Canada Units only) label**

## CALCULATING PROPANE USAGE

It is important to remember that (if applicable) your furnace, refrigerator, water heater and range all may use propane to operate. Each has a different BTU rating, and you will need to consider them to determine how long your propane supply will last. Most RV gas appliances are operated intermittently.

Propane consumption depends on individual use of appliances and the length of time operated. Unless there is heavy use of hot water, the water heater consumption of propane is minimal.

During cool temperature or high wind conditions, furnace consumption can be extremely high.

To calculate your propane supply, take the BTU ratings for your propane appliances and divide that into the BTU availability. Each gallon of propane (3.86 liters) produces about 91,500 BTU's (46,514 kilojoules) of heat energy.

The following chart provides average propane consumption information.

Appliance	Average BTU Consumption/Hr.	Kilojoules/Hr.
Water Heater	8800	9280
Refrigerator	640-1200	680-1270
Furnace	16,000 - 35,000	16,880 - 36,930
Range w/Oven	7100	7490
Range – Rear Burner	6500	6860
Range – Front Burner	9000	9490
Outside Grill	10,000	10,550

## TRAVELING WITH PROPANE

Use care when fueling your tow vehicle. Make certain your propane container is properly fastened in place.

Some states prohibit propane appliances to be operated during travel, especially in underground tunnels. Make sure you know the laws for the areas where you travel.

The label listed below should be kept permanently affixed to your RV:

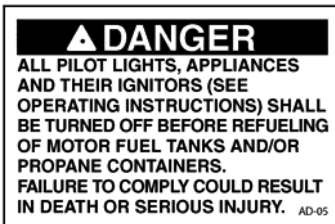

Fig. 7.11 Refueling warning label

There are two different water systems in your RV: the fresh water system and the waste water system. The fresh water system consists of the fresh water holding tank, fresh water connections, water pump, outside shower assembly (if so equipped), water heater, faucets, shower or tub, and water purification system (if so equipped). The waste water system consists of the waste water holding tank, sewage holding tank, drains and toilet.

### **PLUMBING SYSTEM MAINTENANCE**

- Check all fittings, pressure and waste, for leaks before each trip or before vehicle storage as part of your normal maintenance.
- Inspect all faucets, the water purification system (if so equipped) and sink connections (including drain baskets or filters).
- Inspect connections at the water pump and water heater.
- At the end of every trip, you should drain any unused water from the fresh water system.
- The fresh water (or potable water) system needs periodic sanitization and winterization to take care of all the components within the plumbing system and help discourage the growth of bacteria and other organisms that can contaminate the water supply.

There are labels affixed to the exterior of the RV's sidewall that indicate the locations of the water system drains and fills. Be aware some drains may be located inside the RV (once the exterior label is found, go inside to find the drain corresponding location).

### **FRESH WATER SYSTEM**



#### **WARNING**

DO NOT drink water deemed microbiologically unsafe or of unknown quality.

All water contains contaminant and mineral particles that can cause fresh water system odors. Untreated well water is a major source of water system odors. The fresh water (or potable water) system needs periodic sanitization and winterization to take care of all the components within the plumbing system and help discourage the growth of bacteria and other organisms that can contaminate the water supply.

### **MONITOR PANEL (IF SO EQUIPPED)**

The interior wall-mounted monitor panel allows you to monitor the fresh water, grey water, black water and auxiliary battery levels. These functions are controlled using the "tact" switches located on the monitor panel faceplate. The monitor panel operates on 12-volt DC power supplied by either the converter or auxiliary battery. Sensors installed in the holding tanks connect to a resistor assembly (relaying an electronic message to the display board). No power is drawn from the battery unless a switch is pushed or turned ON. Fuses for the monitor panel are located in the load center. Refer to the manufacturer's operators manual for further information.

**Operation**

Press only one "fact" switch at a time. As you push either the "FRESH", "BLACK" or "GREY1" switch, one or more LED lights will illuminate indicating that holding tank content level. When pushing the "BATT" switch, the highest LED light illuminated indicates the estimated auxiliary battery condition.

C	=	charge at 12.7 volts
G	=	good at 12.1 volts
F	=	fair at 11.6 volts
L	=	low at 6.0 volts.

**Water pump switch (if so equipped)**

When the water pump switch is ON the water pump runs until 45 pounds of pressure has been achieved. The red light will stay ON. Turn the water pump switch OFF when it is not in use.

**Water heater switch (if so equipped)**

The "propane GAS" water heater switch enables propane operation of the water heater. The "ELECTRIC" water heater switch enables electric operation of the water heater.

**FRESH WATER HOLDING TANK**

The fresh water tank can be gravity filled or pressure filled using the fresh water inlet (called city water). Plastic overflow tubes are plumbed into the fresh water holding tank to allow water to flow out of the water tank. Occasionally, you may see water coming from the overflow tubes (located underneath the RV) when the fresh water holding tank is filled. This is normal, and is caused by external circumstances, including the RV being parked on an incline, or the motion caused by starting or stopping the RV during travel.

**CAUTION**

Be careful not to overfill the fresh water holding tank. It can pressurize the tank, causing leakage and water damage and void the warranty. DO NOT leave the tank unattended while filling.

**Do not cap, block or modify the fresh water tank overflow tubes in any way. Enough water pressure can build up during the filling process to damage the plumbing system if the overflow tubes are obstructed.**

**FRESH WATER CONNECTIONS**

There are two types of direct exterior fresh water connections in your RV: city water and gravity fill.



**Fig. 8.1 Fresh water connections**

**City Water Fill**

**Gravity Water Fill**

**To use the city water fill**

1. If needed, sanitize the water system.
2. Remove the connection cap and attach a non-toxic drinking water hose to the inlet.

3. Turn ON the water at the water source. Enter the RV and open the cold water supply faucets to bleed air from the water lines. When the water lines are nearly full, you may experience some "air pockets." Allow them to escape before closing the cold water supply faucets.
4. The water heater will fill first, followed by the supply lines and faucets.

**The fresh water connection should be unplugged (i.e., the non-toxic drinking water hose disconnected) when the RV is left unattended for any amount of time. If something would happen to the water system, this may help limit water damage to a smaller area.**

#### **To disconnect the city water fill**

5. Shut OFF the water at the water source.
6. Disconnect the non-toxic drinking water hose and reinstall the connection cap. Reinstall the connection cap when the fresh water connection is not being used. Do not remove the following label from your RV:

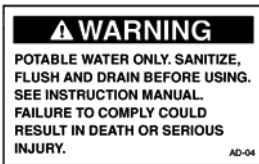

Fig. 8.2 Potable water only label

#### **Dry camping**

You can gravity fill the fresh water system if you do not have access to city water; however, allow extra time to fill the fresh water system if you are using this method.

Follow the steps listed above; however, at step 3 put the other end of the non-toxic drinking water hose into your container of fresh water, and turn ON the water pump (instead of turning ON the water at the water source.) When the fresh water tank is full, shut OFF the water pump and disconnect the non-toxic drinking water hose.

#### **WATER PRESSURE REGULATOR (CUSTOMER SUPPLIED)**

Excessive pressure from water supply systems may be encountered in some parks, especially in mountain regions. Water pressure regulators are available to protect your system against such high pressure. Water pressure regulators (customer supplied) are available from your RV dealer to protect the plumbing system against such high pressure.

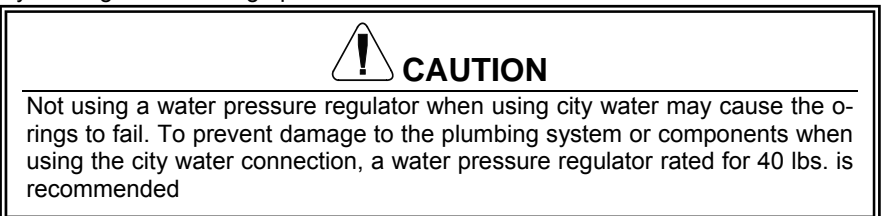

#### **12-VOLT WATER PUMP & SWITCH (IF SO EQUIPPED)**

Once activated, the water pump (also known as the on-demand pump) will self-prime, and provide water. The water pump continues to run until approximately 45 lbs. of pressure is achieved and shut off.

The water pump will automatically re-start when pressure drops. Some cycling may occur, depending on the volume of water being released. The water pump has a built-in check valve to prevent water from back flowing.

Periodically check the in-line water pump strainer for accumulated debris. To clean, shut off the water pump, unscrew the clear cap, remove the re-useable metal strainer and clear any debris, then reinstall.



Fig. 8.3 Water pump strainer

### Water pump switch (if so equipped)

When the water pump switch is ON the water pump runs until 45 pounds of pressure has been achieved. The red light will stay ON. Turn the water pump switch OFF when it is not in use.

**The water pump switch should be in the OFF position when the RV is left unattended for any amount of time. If something would happen to the water system, this may help limit water damage to a smaller area.**

⊗ **NOTE:** When you want to use water in your RV and the RV is not hooked up to city water, you will need sufficient 12-volt DC power to run the water pump.

## WATER HEATER

The water heater is designed to heat water quickly and efficiently. The water heater manufacturer has preset the sensing limit to maintain the water temperature when the water heater is activated.



### WARNING

Hydrogen gas may result if you have not used the water heater for two weeks or more. **HYDROGEN GAS IS EXTREMELY FLAMMABLE.** To reduce the risk of injury under these conditions, open the hot water faucet for several minutes at the kitchen sink before you use any electrical appliance connected to the hot water system. If hydrogen is present, you may hear what sounds like air escaping through the pipe as the water begins to flow. Hydrogen gas may be present even after water has been drained from the water heater tank. Open the faucet at the sink and allow the system to vent for five to ten minutes. Do not smoke or have any open flame near the open faucet while venting. On DSI water heater models, make sure the switch is OFF.



### WARNING

Do not replace any component part with an accessory part that is not authorized by the water heater manufacturer, such as an “add-on” electric heating element. Such items are not approved to be installed and could create an unsafe condition and will void all warranties.

Read the safety and operating information provided in the manufacturer’s manual before attempting to activate the water heater. Make sure the water heater is filled with water before use; even momentary operation of the water heater without water in it may result in damage to the tank and/or controls.

Always open both the hot and cold water faucets when filling the fresh water tank to allow air pockets to be forced out of the water heater.

**Operating instructions**



**WARNING**

If you smell propane gas then STOP! and follow the procedures listed in the Propane System section of this manual before attempting to operate the water heater.

Read the safety and operating information provided in the manufacturer’s user guide before attempting to activate the water heater.

Make sure the water heater is filled with water before use; even momentary operation of the water heater without water in it may result in damage to the tank and/or controls.

**Draining and winterization**

If the RV is to be stored over the winter months, the water heater must be drained to prevent damage from freezing. It is recommended the water heater be drained and bypassed during the winterization process particularly if introducing RV antifreeze into the plumbing system.

**Water heater bypass**

Use the factory installed water heater bypass, available in most floor plans, to avoid filling the entire water heater with RV antifreeze.

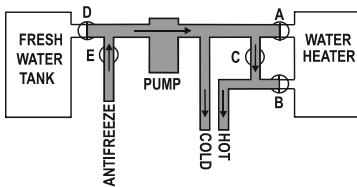

**Fig. 8.4 Water heater bypass**

To bypass the water heater close valves A and B, and open the mixer valve (valve C). For normal camping usage of the water heater, reverse these instructions.

**Water heater switch (if so equipped)**

The "propane GAS" water heater switch enables propane operation of the water heater. The "ELECTRIC" water heater switch enables electric operation of the water heater

**Odor from the hot water system**

Many water supplies contain sufficient amounts of sulfur to produce an odor, often called "sulfur water." Sulfur water can be caused by a chemical action or by bacteria. Generally, sulfur water is not harmful, only unpleasant to smell. Refer to the water heater manufacturer’s owners manual for details on eliminating the odor from sulfur water. Odor from sulfur water is not a service problem.



## WARNING

Do not replace anode rod or any other component with an accessory part that is not authorized by the water heater manufacturer, such as an “add-on electric heating element. Such items are not approved to be installed and could create an unsafe condition and will void all warranties

### Anode rod protection

The tank in the water heater is protected by a magnesium or aluminum anode to prolong the life of the tank by absorbing the corrosive action of hot water.

Under normal use, the anode rod will deteriorate and because of this, the water heater manufacturer recommends the anode rod be replaced yearly. Water with high levels of iron and/or sulfate will increase the rate of deterioration; therefore, more frequent replacements may be required.

If an anode rod is mostly eaten away, replace it with a new one.

The water heater manufacturer recommends replacement of the anode rod when consumption or weight loss is greater than 75 percent.

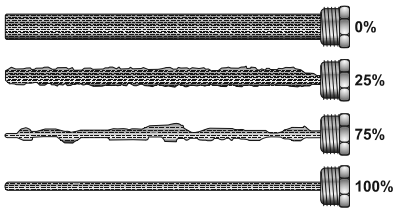

Fig. 8.5 Anode rod replacement chart

Operating the water heater without the proper anode rod protection will decrease tank life and will void the tank manufacturer’s warranty on the tank. To extend the anode life, drain the water from the water heater tank whenever the RV is not being used. Avoid any extended time of non-use with water in the tank.

To prevent a water leak when replacing the anode rod, a pipe thread sealant approved for potable water (such as Teflon Tape) must be applied to the threads of the anode rod. Proper application of a thread sealant will not interfere with the anode’s

### High altitude deration

Operation of the water heater at high altitudes may require derating. If the water heater is not properly derated, lack of sufficient oxygen for combustion may produce improper burner operation. Pilot outage caused by burner lift-off or sooting from a yellow burner may occur, indicating the possibility of carbon monoxide.

You may also notice a lack of efficiency in heating the water because of incomplete combustion of the burner at these higher altitudes.

Consult with the local propane company, your dealer or the water heater manufacturer for proper derating of the water heater. Change out of the orifice (derating) should be done by the dealer or a qualified service agency.

⊗ **NOTE:** It is important that once the RV has returned to lower elevation (below 4500 feet) any high altitude deration or other adjustments be reversed for proper operation of the water heater.



**Pressure & temperature relief valve**

When cold water is heated in the water heater tank, the water pressure will rise. For this reason, a pressure and temperature (P&T) relief valve is required for safety in all water heaters. It is normal for the P&T relief valve to release a small quantity of water during the heating cycle and does not indicate a defective P&T relief valve. One way to reduce the frequency of the water weeping or dripping from the P&T relief valve is to maintain an air pocket at the top of the water heater. This air pocket will form in the tank by design; however, it will be reduced over time by the everyday use of your water heater (refer to the manufacturer's manual); If the weeping persists, consult your dealer or a service agency authorized by the water heater manufacturer.

**OUTSIDE SHOWER (IF SO EQUIPPED)**

A handheld shower assembly with both hot and cold water is available for washing or rinsing outside the RV.

1. Be sure the water heater is ON and had sufficient time to heat the water.
2. If dry camping, be sure the 12-volt water pump is ON.
3. Open the outside shower compartment door.
4. Remove the hand held showerhead and hose from its holder.
5. Turn ON the hot and cold faucet knobs, and adjust the water temperature as desired.
6. To activate the hand held shower turn ON the sprayer head attachment (some models. Open the faucet knobs and adjust them to the desired temperature.

To cease operation, close the faucet knobs. After the water has been allowed to drain from the shower head, replace it in the outside shower compartment. Any remaining water in the shower hose will drip or run out; this is not a leak but performs as intended.

The showerhead can be removed to drain the hose faster. If you choose to remove the showerhead to drain the hose, reassemble it for storage. Coil the hose and arrange it with the showerhead inside the faucet assembly. Make sure that the hose is not being pinched and the showerhead is not being damaged when the door is closed.

**FAUCETS****WARNING**

Water temperatures over 125°F (49°C) can cause severe burns instantly or death from scalds; therefore, be careful when using hot water. Always test the water temperature before showering or washing.

The faucets operate much the same way as the faucets in your home. Make sure there is sufficient water available and, if dry camping, the 12-volt water pump is turned ON before operating. To open the faucets, turn the hot and cold knobs ON and adjust the temperature to your comfort level. Close the faucets when a sufficient amount of water is released.

---

**BATHROOM SHOWER OR TUB**

---

The shower faucet (if so equipped) requires a vacuum breaker when the shower hose and head are used. There are two purposes for this breaker:

- To prevent siphoning water through the hose from another fixture.
- To prevent water from being contained in the hose.

The showerhead DOES NOT have a complete shut-off valve (the complete shut-off is at the faucet). The showerhead may drip slightly in the OFF position after use; this is normal and does not indicate a leak or defect. There may be air in the plumbing lines that will need to be bled out before a steady stream of water comes from the faucet.

The bathing facilities in your RV function similar to those in your home. Prepare the bath or shower curtains (if so equipped) to prevent water from spilling onto the floor. Keep the water heater and holding tank capacities in mind when using the fresh water system. The used water will drain through the plumbing pipes into the grey water holding tank.

1. Be sure the water heater is ON and had sufficient time to heat the water.
2. If dry camping, be sure your 12-volt water pump is ON.
3. Adjust the hot and cold faucets to the desired temperature before bathing.
4. To conserve water while showering, wet down and turn the water OFF while you use soap, then rinse.
5. When you are finished, shut the water faucets OFF.

Unlike your home, the RV does not contain a water pressure balance valve. If someone is using the shower, it is recommended that the fresh water system NOT BE USED until they are finished.

**Maintenance**

Read the manufacturer's operator manual. The tub and shower walls (if applicable) in your RV are made of ABS plastic material.

Use a mild detergent soap and warm water to clean (these cleaning instructions are similar to those recommended for fiberglass tubs and shower walls). Contact your RV dealer for repair or replacement.

DO NOT use gritty or abrasive particle soaps or scouring compound to clean ABS plastic.

Avoid using "Citrus" or biodegradable cleaners which contain "D-Limonene." They will damage plastic materials.

---

**HARDWARE & SINK OR SHOWER FIXTURES**

---

Use mild dish soap and water to clean these fixtures.

Do not use harsh chemicals or sprays. A mild solution of vinegar and water works well to remove hard water spots and stains from the sink or shower fixtures.

---

**WATER PURIFICATION SYSTEM (IF SO EQUIPPED)**

---

The water purification system is located under the kitchen sink. If the water supply has not been used for some time, allow the water to flow for several minutes to flush the system. When not in use, the water filter cartridge should be stored out of freezing temperatures. RV antifreeze will damage the water filter cartridge. The manufacturer has supplied a clear plastic bypass hose with fittings on either end to replace the water filter cartridge when the RV is being winterized. This clear plastic bypass hose is re-usable; store it when it is not in use.

Each new RV is winterized with RV antifreeze before it is shipped to the dealer. To use the water purification system the clear plastic bypass hose must be removed and the water filter cartridge installed.

### Replacing the water filter cartridge

Replace the water filter cartridge at least once a year.

1. Drain the fresh water system.
2. Place a container beneath the water cartridge filter to catch any spillage.
3. Unscrew the fittings at the top and bottom of the water filter cartridge. Pull the water filter cartridge down and out of the fittings.

Insert the new water filter cartridge and tighten the fittings securely by hand. Dispose of the used water cartridge filter.

### For more information

Refer to the manufacturer's owners manual and the label on the water filter cartridge.

## DRAINING THE FRESH WATER SYSTEM

Permanent water tanks may be drained through a valve located near the tank. A RV with a demand pressure pump system will have low-point drains attached to the water lines (normally located near the water tank).

These low-point drains will release water in the supply lines by opening the valves and all faucets. The water heater has its own drain plug. To drain the permanent fresh water holding tank and supply lines:

1. Open all faucets, including the outside shower faucet (if so equipped).
2. Open the "exterior fresh tank drain" valve on the permanent fresh water holding tank. This knob turns 45° to open or close.
3. Open the "low point drains" by turning, then pulling the handles up. As their name indicates, the valves will be at the lowest point of water lines. As their name indicates, the valves will be at the lowest point of water lines. A label may be placed on the outside of the RV to indicate where the drains are located. The drains will typically need to be opened from inside the trailer. Once the label is found on the outside of the trailer, go inside to find the corresponding location of the drains.
4. Drain the sink by removing the drain cap.
5. Turn ON the water pump and allow it to run as needed.
6. Open all faucets, including the outside shower faucet. Make sure the "water heater bypass" valve is open.
7. Relieve the water pressure using the water heater P&T valve BEFORE removing the water heater drain plug. Otherwise, if there is any water pressure present the water will spray out of the opening when the drain plug is removed.



**Fig. 8.6**  
Exterior  
fresh water  
drain

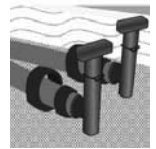

**Fig. 8.7**  
Low point  
drains

When you are finished draining the fresh water system, reverse these steps and, dump the grey and black water holding tanks at an appropriate facility or according to local public codes. It is normal for some liquid to remain in the fresh water tank after drainage procedure.

**SANITIZING THE PLUMBING SYSTEM****When to sanitize**

- When your RV is new.
- At the beginning and end of each season.
- When the water system becomes contaminated or every three months of use.

**How to sanitize with a water pump**

1. Level the RV and drain the fresh water system. (see **Draining the fresh water system**).
2. Close the drain valves.
3. Prepare a chlorine solution using 1/4 cup of household bleach (sodium hypochlorite solution) to one gallon (3.785 liters) of water in a container. Prepare one gallon of solution for every 15 gallons of tank capacity. This will result in a residual chlorine concentration of 50 ppm in the water system. If a 100-ppm concentration is required as discussed in step 10, use 1/2 cup of household bleach with one gallon of water to prepare the chlorine solution. One gallon of the solution should be used for each 15 gallons of tank capacity.
4. Pour the chlorine solution in at the gravity fill connection.
5. Continue filling the fresh water tank with potable water until it is full.
6. Turn the water pump ON.
7. After the recommended amount of solution is in the tank, turn OFF the water pump.
8. Open the hot water line on all the faucets until water begins to flow continuously and a chlorine smell is noticeable.
9. Close the hot water lines and repeat with the cold water lines on the faucets.
10. Let the solution remain in the system for at least four hours when disinfecting with 50-PPM residual chlorine. If a shorter time period is desired, then a 100-PPM chlorine concentration should be permitted to sit in the system for at least one hour.
11. After the required period, drain the chlorine solution from the fresh water system (see **Draining the fresh water system**).

**Some solution may remain in the water heater and will be flushed in the following steps:**

12. Fill the fresh water system completely full using clean (potable) water.
  13. Then, drain the fresh water system (see **Draining the fresh water system**).
- NOTE:** If a chlorine taste lingers in the water, flush the water system with a solution consisting of one-quart vinegar to five gallons of clean water. Re-flush as necessary.

**WINTERIZING THE PLUMBING SYSTEM****WARNING**

Automotive antifreeze (ethylene glycol) and windshield washer antifreeze (methanol) are poisonous. Never use these products in your fresh water system. These products are harmful and may be fatal if swallowed.

Preparing your RV for colder weather or storage is very important for most states and Canada. Failure to prepare your RV may cause water supply lines and the water heater to freeze.

No commodity or product should be added to the fresh water system to ensure freeze protection other than RV antifreeze.

The RV should be winterized at the end of the camping season or when the RV will be exposed to temperatures that will fall at or below 32°F (0°C). Repairs due to freezing are not covered under the terms of the **Towable Limited Warranty**.

⊗**NOTE:** **The water heater must be drained to prevent damage from freezing.** It is recommended the water heater be drained and bypassed during the winterization process particularly if introducing RV antifreeze into the plumbing system (Revision A).

There are two methods of winterizing your trailer based upon your model. Please read, understand and follow all instructions before beginning.

### **Air pressure**

This method will utilize an air hose to blow excess water from the water lines.

1. Make sure all holding tanks are empty and drain valves OPEN.
2. Run the water pump until it is dry, this will take approximately 15-20 seconds.
3. OPEN all faucets and drains, and the toilet.
4. Using an air hose and adapter (customer supplied), blow air through the city water connection. Any remaining water will blow out in five to ten minutes.
5. Pour one cup of non-toxic RV antifreeze into all drain P-traps.

### **Demand or power plumbing system**

It may be easier to winterize the RV with another person to assist you.

1. Level the RV and drain the fresh water plumbing system.
2. Replace the water filter cartridge with the clear plastic bypass hose (if so equipped).
3. Make sure the water heater 12-volt and 120-volt interior control switches are OFF.
4. Turn the water heater bypass valves to the BYPASS position.
5. Make sure the “fresh tank drain” and “low point drains” are closed.
6. Open the clear hose valve to the water pump and insert the clear hose into a water container of RV antifreeze solution. (Rev. A – 7/2/12)
7. Turn the water pump ON.
8. Open the hot water line on all the faucets (kitchen, lavatory, shower and outside shower) until RV antifreeze begins to flow continuously.
9. Close the faucet hot water lines and repeat with the cold water lines on all the faucets. Do not forget to run RV antifreeze through the toilet.

### **When you are done adding RV antifreeze**

10. Remove the garden hose from the container of RV antifreeze.
11. To prevent staining, wipe the RV antifreeze out of the sinks, shower (or tub) and toilet using a soft, dry cloth.

If needed, contact your RV dealer for assistance.

### **BLACK/GREY WATER SYSTEM**

Water from the sinks and shower flow into the gray water (or waste water) holding tank. Water from the toilet will flow into the sewage (or black water) holding tank.

**WARNING**

Never travel with full black or grey water holding tanks. This not only wastes your fuel but depending on the location of the tank(s), it can affect your tow vehicle handling characteristics.

The weight of the holding tank contents is not calculated into the RV cargo carrying capacity (this extra weight would reduce your available cargo capacity). Traveling with full holding tank(s) could possibly cause you to exceed the individual tire ratings and/or the RV GAWR or RV GVWR. Potential damage to suspension components, such as springs, tires and axles, could result.

If your RV holding tank(s) are located behind the axles, the weight of the full tank(s) will reduce the hitch weight. Trailer sway and other handling difficulties can be the result of the hitch weight being too light.

Dump the gray and black water holding tanks before traveling to avoid carrying unnecessary weight. If you are dry camping and cannot immediately empty your holding tanks, reduce your vehicle speed until you reach a dumping station.

Before using the RV or after dumping the grey and black water holding tanks, always add the proper amount of deodorant to the black water tank to prevent malodors and help break down holding tank contents (unless winterizing). Follow the deodorant bottle or package instructions. Driving to a disposal site will normally loosen any accumulated waste debris or solids from the sides of the holding tanks.

**WARNING**

Do not add automotive antifreeze or caustic chemicals such as laundry detergents into the holding tanks. Although these products may have a deodorizing effect, they may damage the plastic and rubber parts of the plumbing system or the components.

**Drain pipes With P-Trap (If So Equipped)**

The drain pipes may be equipped with a "P-trap" installed to help prevent odors from escaping into the RV. During travel, water from the P-traps may spill and permit odors into the RV. By adding water and using a RV approved deodorizing agent you will dissolve the contents faster and will keep the drain lines and tanks clean and free flowing.

These chemicals are available at an RV supply store or your dealer.

**Drain pipes With Dry Sealing Valve (If So Equipped)**

Your RV may be equipped with a dry sealing valve that prevents the escape of odors from your waste system and eliminates the need for P-traps.

Should the RV drain piping system become clogged and a mechanical cleanout tool is used to open the drain pipe, it is important that the dry valve be removed before passing the cleanout tool through the piping.

Passing a mechanical cleanout tool through the waterless valve may cause damage to the internal seal that may potentially allow sewer gases to escape to the RV interior

A label has been placed near the location of the waste valve that reads as follows:

REMOVE WATERLESS TRAP BEFORE  
USING MECHANICAL DRAIN-CLEANING DEVICES.

### Vents

Another important part of this system is the vent pipes and vents that release air from the grey and black water holding tanks. The exterior vent cap is attached to the roof and must be kept clear of obstructions to perform as intended. On some models, the vent pipe may be part of the drainage system referred to as a "wet vent" (water flows downward as air flows upward in the same pipe).

### BLACK/GREY WATER HOLDING TANKS

When connected to the sewer drain line at a campground, keep the "black tank drain" valve closed until the holding tank is at least  $\frac{3}{4}$  full. This should provide sufficient water to assist in complete draining of the black water holding tank. Repeat as needed.

Never leave the black tank drain in the open position continuously when connected to the campground sewer system.

### BLACK & GREY TANK DRAINS

There are labels on the exterior of the RV indicating the location of the grey tank drain and black tank drain (also called dump valves). Always drain the black water holding tank first so the following grey tank waste water can help rinse any solids or debris from the dump outlet and sewer hose.

1. To make drainage easier, level the RV.
2. Remove the sewer hose housing dust cap, and attach the sewer hose (customer supplied).
3. Place the end of the sewer hose into the approved dump station.
4. Open the black tank dump valve (close the dump valve when the black water holding tank is emptied).
5. Open the grey tank dump valve (close the dump valve when the grey holding tank is emptied).
6. Remove, clean and store the sewer hose.
7. Close the sewer hose housing dust cap.



**Fig 8.8 Black/Grey tank dump valves**

You can locate many dump stations throughout the United States and Canada in Woodall's, Rand McNally Camp Guide, Good Sam Camp Guide, KOA Campgrounds Camp Guide and various other publications. Some fuel stations also have dump stations.

Please contact your RV dealer for assistance in the purchase and installation of a sewer hose or sewer hose extension (if needed).

**TOILET****WARNING**

It is important to prevent solid waste buildup. Follow the toilet manufacturer's recommended instructions each time after emptying the black water holding tank

The toilet is efficient and easy to operate. Generally, more water is required only when flushing solids. Prior to using the sanitation system, it is strongly recommended to flush the toilet several times to release sufficient water into the holding tank. If there is not a sufficient amount of water used during flushing, the waste materials may not evacuate properly from the drain line to the tank. Clogged tanks and pipes could eventually occur.

The toilet system will perform better when water is run for ten to fifteen seconds after flushing to ensure that the waste will proceed to the bottom of the tank. Unlike a toilet in a home, which uses four to seven gallons (18 - 32 liters) of water per flush, the average recreation vehicle system uses one to three quarts (1 - 3 liters). For added convenience and better sanitation system performance, it is advisable to always have four to six inches (10 - 15 cm) of water in the toilet.

To prevent help toilet blockage, always use RV grade single-ply toilet paper. Do not flush paper towels, diapers, sanitary napkins or other foreign objects down the RV toilet.

**Sewage (black) tank preparation****WARNING**

It is important to add enough water to prevent solid waste buildup. Follow the directions listed below and in the manufacturer's operator manual

1. Release one to two quarts (1 or 2 liters) of water into the toilet bowl.
2. Follow the directions on your toilet chemical bottle (customer supplied), by placing the recommended quantity of holding tank chemical into the toilet bowl.
3. Flush the toilet and allow at least two gallons (8 liters) of water to flow into the holding tank.

**Waste (grey) holding tank preparation**

No special preparation is required, however, placing a small quantity of chemicals into this tank, such as baking soda or an approved RV chemical, will reduce odors from food particles in the system.

**Cleaning & Maintenance**

The toilet should be cleaned regularly for maximum sanitation and operational efficiency. Do not use chlorine (undiluted) or caustic chemicals, such as laundry bleach or drain opening types, in the toilet system. These products damage the seals in toilets and dump valves.



## DUCTING & RETURN AIR

---

All heat discharges, registers and return air grills must be free and clear of obstructions. This includes all closeable registers that are intended to reduce airflow, not shut it off completely.

## ATTIC FAN

---

The 12-volt DC attic fan (or powered roof vent) allows fresh air to circulate through the RV. Do not leave the attic fan open when the RV is stored or unattended for long periods.

High winds, other unusual conditions or obstructions may prevent the dome from closing; the resulting leakage could cause non-warrantable damage.

## CEILING FAN (IF SO EQUIPPED)

---



### WARNING

Be careful to avoid placing any object in the path of the ceiling fan blades!

Ceiling fans are both functional and decorative. Turn the ceiling fan ON/OFF using the interior wall switch. The 3-speed ceiling fan is controlled by the pull chain switch. The sequence of operation for the pull chain switch is: OFF, High, Medium, Low, OFF. The slide switch (located on the fan) controls the direction of operation (down for forward, up for reverse). Stop the fan first before reversing the operation direction!

**☒ NOTE:** During cooler temperatures, set your fan settings to "low," and set the fan to turn clockwise to pull warm air from the ceiling back towards the floor. In the summer, the fan should turn counterclockwise to keep air moving.

**For additional information** refer to the manufacturer's owner's manual included in your warranty packet.

## THERMOSTAT

---

There are may be up to two 12-volt DC thermostats in your RV. Use the controls to set the temperature to your comfort setting.

## FURNACE

---



### WARNING

The furnace should be inspected periodically (monthly during the heating season) for presence of soot on the vent. Soot is formed whenever combustion is incomplete. This is a visual warning that the furnace is operating in an unsafe manner. If soot is observed on the vent, immediately shut the furnace OFF and contact a qualified service agency. Operating the furnace under this condition could lead to serious property damage, personal injury or loss of life.

**WARNING**

To ensure your personal safety, do not obstruct or alter the furnace in any manner. Do not install screens over the vent for any reason. Screens will become restricted and cause unsafe furnace operation. For your safety, only the manufacturer's factory authorized parts are to be used on your furnace.

The furnace installed in your RV is controlled by a thermostat. The furnace requires both 12-volt power and propane gas for full operation.

Make sure you have sufficient power available before operating your furnace.

If you have any questions contact your dealer or our customer service department.

A qualified RV technician should perform all furnace maintenance at least once a year (more often depending on furnace usage). Never attempt to repair the furnace yourself.

**FIREPLACE (If So Equipped)**

You may have a fireplace installed in your RV. Refer to the manufacturer's owner's manual. If you have further questions, please contact your dealer or Jayco Customer Service.

**AIR CONDITIONER – ROOF MOUNT (If So Equipped)**

The roof mounted air conditioning system is controlled by a thermostat. Cooled air enters the RV through the adjustable "chill grill." Make sure you have sufficient power available before operating the air conditioner. Do not operate the air conditioner without the return air filter. Operating the system without the filter allows the lint and dirt that is normally stopped by the filter to accumulate on the cooling coil of the air conditioner. This also will lead to a loss of air volume, possible equipment damage and an expensive cleaning process.

A special foam gasket is placed between the roof material and the subframe of the air conditioner to guard against water leakage. The air conditioner is subjected to wind pressures along with motor vibration during normal operation.

Inspect the mounting bolts for tightness to ensure there is no leakage or looseness at least annually. Re-tighten bolts when they are loose.

DO NOT over tighten these bolts as it may damage this gasket. The air conditioner gasket is a wearable part that eventually will need to be replaced as maintenance. To gain access to the bolts, remove the filtered panel cover on central air systems or the entire air box on non-central air conditioners. Consult the manufacturer's operators manual or your RV dealer for more information.

**For additional information** refer to the manufacturer's owner's manual included in your warranty packet.

## REFRIGERATOR



### WARNING

If you smell propane gas **STOP!** Follow the directions located in the manufacturer's operators manual and in this manual.

The refrigerator is not intended for quick freezing or cooling. We recommend stocking it with pre-frozen or pre-cooled food when possible. The shelves should not be covered with paper or plastic and the food items should be arranged so air can circulate freely. Keep the area at the back of the refrigerator clean and free of debris. Check for obstructions in the exterior refrigerator vent area (i.e., spider webs, bird nests, etc). Use a soft cloth to dust off the debris.

For optimum efficiency and performance, it is recommended the refrigerator be checked at least twice a year as part of the routine maintenance.

## MICROWAVE (IF SO EQUIPPED)

Make sure there is sufficient 120-volt power available before operating the microwave. Ensure the microwave turntable (if so equipped) is secured prior to traveling.

## IN CASE OF A GREASE FIRE



### WARNING

Do not attempt to use water to put out the fire. Water can spread some types of fire, and electrocution is possible with an electrical fire.

Grease is flammable. Never allow grease to collect around top burners or on the cook top surface. Wipe spills immediately. **Refer to Section 2 for fire safety and fire extinguisher information.**

## COOKING WITH PROPANE

**See the Propane System Section for important safety instructions.** Refer to the manufacturer's owners manual for detailed operating and safety instructions for all propane appliances.

## KITCHEN STOVE, RANGE OR OVEN (IF SO EQUIPPED)

To prevent damage, always use the manufacturer's recommended size flat bottom pan(s). Generally, the pan should be large enough to cover the burner, but not be more than one inch larger than the burner grate.

Do not use a broiler pan, griddle or any other large utensil that covers more than one burner at a time. This will create excessive heat that may cause melting, sooting or discoloration.

In addition, the use of undersized pans could expose a portion of the heating element to direct contact and may result in ignition of clothing.

Proper relationship of pans to burner will improve efficiency.

**WARNING**

During and after use, do not touch or let clothing or other flammable material come in contact with the top burners (or heating elements), burner grates or other areas near the top burners or oven until they have had sufficient time to cool. These areas can get hot enough to cause burns.

Never leave cooking food unattended. Turn pan handles inward, but not over the tops of the other range burners. Ensure that pans used are large enough to contain the food and avoid boil-overs. Heavy splattering or spills left on the cook top can ignite and cause burns.

If using glass, glass/ceramic, ceramic, earthenware or other glazed utensils (or cookware) verify it is safe for use on the top burners. Only certain types of utensils (or cookware) are suitable for surface or top burner use.

**Oven (if so equipped)****WARNING**

Do not cover the oven vent openings while the oven is in operation. Restricting the flow of combustion air will create an asphyxiation hazard.

The propane gas oven must have 12-volt power to operate. If you have any questions contact your dealer or our customer service department. Do not use the oven as a storage area.

**For additional information** refer to the manufacturer's owners' manual included in the warranty packet.

**WASHER/DRYER PREP (IF SO EQUIPPED)**

If your RV was built with this feature, be aware the cabinet space provided is intended for the installation of an aftermarket washer/dryer combo unit (customer supplied) only. Please consult your dealer or the manufacturer for installation assistance.

**CENTRAL VACUUM (IF SO EQUIPPED)**

The RV must be hooked up to (and be operating on) 120-volt AC power for the central vacuum system to be operational. The vacuum will automatically begin to operate when the hose wall fitting is inserted into the central vacuum wall port. The vacuum will automatically cease to operate when the hose wall fitting is extracted from the central vacuum wall port.

Change the vacuum filter bags regularly to maintain maximum vacuuming power. The filter is located inside the central vacuum assembly that is in turn located inside the front storage compartment.

**WARNING**

**DO NOT PICK UP ANYTHING THAT IS BURNING OR SMOKING, SUCH AS CIGARETTES, MATCHES, OR HOT ASHES.** RV damage, personal injury, or death may result from vacuuming up burning or smoking material.

**WARNING**

**DO NOT PICK UP FLAMMABLE OR COMBUSTIBLE LIQUIDS SUCH AS GASOLINE, OR USE IN AREAS WHERE THEY MAY BE PRESENT.** RV damage, personal injury, or death may result from vacuuming up flammable or combustible material.

**THIS PAGE IS INTENTIONALLY BLANK**

---

## TELEVISION POWER SUPPLY

For good station reception, the TV power supply must be turned ON to view local television stations. Turning the TV power supply ON sends 12-volt DC through the cable to the TV roof antenna. The voltage energizes the transistors in the antenna head amplifier.

Turn the TV power supply OFF to view cable or satellite television, or to use a VCR or DVD.



**Fig. 11.1 TV  
Power  
Supply**

## TELEVISION ROOF ANTENNA

To view local stations at either (or both) the front or bedroom television sets using the television antenna, make sure the TV power supply is ON and the TV roof antenna is raised to the operating position.

The following is an overview of the antenna operation. Refer to the manufacturer's user guide included in your Warranty Packet for detailed operating instructions, or visit the manufacturer's website.

### Raising the antenna

To raise the TV antenna to the operating position turn the antenna elevating crank clockwise in the UP direction (approximately 13 turns) until some resistance to turning is noted (Fig. 9.2).

On amplified models, 12-volt DC power is required. After the antenna is in the full UP position, pull down on the round knob with both hands until it disengages from the ceiling plate. Rotate the knob for best picture (Fig. 9.3).

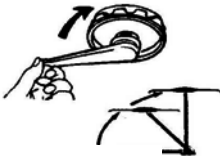

**Fig. 11.2**



**Fig. 11.3**

### To Test

1. Make sure the television set is working properly.
2. Switch the power supply ON and OFF to see if there is a difference in the picture quality while watching TV. If there is no difference, refer to manufacturer's manual for further testing procedures.



### CAUTION

The TV power supply should be turned OFF when connecting/disconnecting the cables to the power supply and antenna, but should be turned ON when testing for voltage.

**Lowering the antenna**

Rotate the antenna until the pointer on the directional handle aligns with the pointer on the ceiling plate. Turn the elevating crank counterclockwise in the DOWN direction until resistance is noted. The antenna is now locked in the travel position.

**CAUTION**

Make sure the television antenna is in the travel position (cranked down) before moving the motor home. Failure to lower the antenna into the travel position before traveling may damage the antenna.

**SATELLITE (IF SO EQUIPPED)**

Please refer to the manufacturer's instructions for setup, care and maintenance.



---

## CLEANING THE INTERIOR

---

To keep the value of your RV, perform regular maintenance using the proper materials and procedures. Using the wrong cleaner may result in damage to the surfaces in your RV. Check with the manufacturer's information for the recommended cleaning agent. If in doubt, check to see if the cleaner will cause damage by testing a small area out of sight or contact your independent dealer for assistance. Do not use flammable liquids or sprays to clean your RV.

---

## FURNITURE UPHOLSTERY

---

To retain the value of your RV, maintain the furniture upholstery carefully and keep the interior clean. Vacuum the furniture regularly using a soft brush attachment to remove any loose dirt or debris.

### **Fabric (if so equipped)**

It is recommended the fabric be professionally cleaned if it becomes stained or soiled. For more information, refer to the specific furniture manufacturer's care instructions.

### **Suede Upholstery (if so equipped)**

It is recommended the suede be professionally cleaned if it becomes stained or soiled.

### **Vinyl Upholstery (if so equipped)**

Do not dry clean vinyl components. If they are dry cleaned, the vinyl on the reverse side will shrink, become hard and crack. If a spill does occur water base cleaners are recommended (solvents are not recommended as they may have an adverse reaction to the specific backing of your upholstery fabric). Blot up the spot, but do not rub it in or saturate the area. Use a professional furniture cleaning service for an overall cleaning.

Clean the suede or vinyl upholstery only as recommended. Using other processes than those listed may produce undesired results and possibly damage the upholstery. This type of damage is not warrantable.

---

## DÉCOR ITEMS

---

Décor items should be cared for as follows:

### **Window treatments, curtains, blinds and shades**

Dust occasionally with a vacuum and soft brush attachment. Professionally clean only.

### **Shower Curtain (if so equipped)**

To help prevent mildew or mold, clean the shower curtain.

### **Décor Glass (if so equipped)**

Use a glass cleaner to remove smudges, smears and spots. If there is any decorative etching on the décor glass, use care when cleaning around that area.

---

## PANELING

---

To clean, use a mild solution of soap and lukewarm water with a soft sponge or cloth. Do not use abrasive cleaners as they could cause the vinyl to scratch and turn dull. Grease spots and stubborn dirt can be cleaned off with an all-purpose spray cleaner. Harsh cleaners and organic solvents can attack the printed vinyl; they are not recommended.

---

## CABINETRY & TABLES

---

To keep hardwood doors, cabinet fronts and hardwood tables looking like new regularly dust with a soft cloth dampened with a cleaning polish or mild detergent solution. Avoid using ammonia based products or silicone oils as they may cause damage if used over a long period of time.

The finish is durable and resistant to most household spills. However, spills should be wiped up promptly to avoid potential problems. Excessive prolonged exposure to direct sunlight, high temperatures and high humidity can cause damage to both the finish and the wood itself. These should be avoided.

---

## COUNTERTOPS

---

### To prevent permanent damage

- Always use hot pads or trivets under hot pans, dishes, or heat producing appliances such as frying pans.
- Always use a cutting board; never use a knife on the countertop.
- Avoid harsh chemicals such as drain cleaners, oven cleaners, etc.
- Do not let cleaners with bleach set on the top. Wipe them off promptly.

### Laminate countertops (if so equipped)

Glass rings, food spills, water spots and smudges usually wipe off with a damp sponge. Stubborn stains can be removed with a general-purpose spray cleaner. Some stains can be removed by squeezing fresh lemon juice over the stain and allowing the juice to soak for approximately forty-five minutes. After 45 minutes, sprinkle baking soda over the lemon juice and rub with a soft cloth.

### Solid surface countertops (if so equipped)

Solid surface materials are easy to care for. Soapy water, ammonia based cleaners (not window cleaners as they can leave a waxy build up that may dull the surface) or commercially available solid surface cleaners will remove most dirt and residue from all types of finishes. A damp cloth followed by a dry towel will remove watermarks. Disinfect the surface periodically with diluted household bleach (one part water to one part bleach).

For additional information on the removal of difficult stains or surface damage repair, refer to the countertop manufacturer's user guide.

---

## FLOORING

---

Always test a cleaning agent in an inconspicuous area for colorfastness.

### Carpet (if so equipped)

Vacuum regularly using a vacuum cleaner with a revolving brush or beater bar. Be sure the vacuum does not have teeth, combs or rough edges as they may damage the carpet. It is important to remove loose soil and debris while it is on the surface. Heavily traveled areas (i.e., walkways, areas in front of the furniture) may be protected with small throw rugs to prolong the life of the carpet.

Some spills contain chemicals that will destroy carpet fibers and dyes. If you have doubts about what caused the spot, contact a professional carpet cleaner.

Because of the additional dirt typically associated with camping, we recommend that you vacuum the carpet frequently.

Have tough and deep stains professionally steam cleaned. Use spot removers for minor spills. Always test the carpet for color fastness in an inconspicuous area before using any product.

### **Vinyl flooring (if so equipped)**

Periodically vacuum or sweep to remove dirt and gritty particles. Although most common spills will not permanently stain the vinyl floors, they are usually easier to remove if wiped up before they set. Simply blot with a paper towel and wipe clean with a damp cloth. As part of a regular maintenance program, sponge mop the entire floor. Do not use dish detergents or vinegar and water because they will dull your floor. To avoid problems of “yellowing” linoleum, the flooring manufacturer recommends avoiding cleaners that contain oil based solvents (i.e. cleaners containing lemon oil, Murphy’s Oil Soap, etc).

To care for the vinyl floor covering, use a damp mop with water and a mild cleaner. **DO NOT SOAK THE FLOORING.** Use care to avoid wetting the carpet edges.

### **ABS PLASTICS**

---

ABS plastic components will retain their original beauty with reasonable care. Dust and wipe clean with soft, damp cloth or chamois, wiping gently. Do not use gritty or abrasive particle soaps or scouring compound to clean ABS plastic. Avoid using “Citrus” or biodegradable cleaners which contain “D-Limonene” as they may damage plastic materials.

### **PANTRY (IF SO EQUIPPED)**

---

Depending on the kitchen layout of your RV, you may have a pantry that you can use to store items you wish to take with you as you travel and camp. Ensure items stored in the pantry are secured so they do not shift during travel. The cabinetry has been designed to accommodate the normal camping items (i.e., paper plates, flatware, cookware, etc.) which are bulky but not necessarily heavy.

**Remember your RV’s load capacity is designed by weight, not volume, so you cannot necessarily use all available space**

### **FLOOR SAFE (IF SO EQUIPPED)**

---

Your RV may have a safe mounted on the floor of the closet or under the bed. The safe is intended to help to safeguard valuable items. Jayco cannot be held liable for loss of personal property that is placed within the safe.

To secure items in the safe, utilize the key provided with the safe and lock it after placing items in the box. Store the key in a location away from the safe.

### **HIDE-A-BED (IF SO EQUIPPED)**

---

The hide-a-bed sofa functions much the same as a regular residential hide-a-bed sofa. To make the hide-a-bed sofa into a bed, remove the seat cushions and pull the sofa back towards you firmly and gently. Activate (or deflate) the air mattress (if so equipped) using the supplied furniture manufacturer’s instructions. To convert the hide-a-bed back into the upright sofa position, reverse the process.

### **J-STEEL SOFA (IF SO EQUIPPED)**

The J-steel sofa functions much the same as a residential futon. To make the J-steel sofa in to a bed, lift up on the bottom seat cushion and pull it towards you.

The sofa back will drop down to provide a sleeping surface. For additional comfort and to reduce fabric damage, you may want to place a cover or air mattress (customer supplied) over the J-steel sofa when it is in the sleeping position.

### **FREE-STANDING TABLE & CHAIRS (IF SO EQUIPPED)**

The free-standing dinette table can be positioned to seat up to four people. To prevent damage, the standard free-standing dinette chairs should be fastened securely at the dinette table when you are traveling

### **BOOTH DINETTE (IF SO EQUIPPED)**

The dinette is designed to seat up to four adults. You can access the dinette bench storage by removing all the cushions and lifting the bottom seat supports. If the dinette bottom seat support is screwed shut, it is to protect factory-installed equipment (do not use that area for storage). To convert back to a booth dinette, reverse the process.

The booth dinette can be converted into a bed. To convert, remove all the cushions from the booth dinette. Lift the tabletop, remove the detachable table legs and place the tabletop on the ledges provided between the booth dinette benches.

Lay the seat back cushions against the back of the booth dinette bench. Lay the dinette seat bottom cushions in between the seat back cushions. The area where the cushions meet should be slightly raised. Push the raised cushion ends down gently. The cushions are designed to fit snugly. Reverse this process when converting back to the booth dinette.

### **Extendable dinette (if so equipped)**

Your travel trailer may be equipped with side extensions on the dinette benches that can be used only when the slideout is extended.

1. Remove the snap strap (located at the back of the dinette bench) that secures the extensions in the travel position.
2. Pull out the dinette bench extension until it hits the factory-installed stops.
3. Remove the seat, seat back cushion and plywood seat extender from the revealed storage compartment (put the cushions off to the side).
4. Position the plywood seat extender across the dinette bench extension brackets. The plywood seat extender **MUST** be in place to use the extendable dinette.
5. Place the seat and seat back cushions on the extensions and repeat the process for the other dinette bench extension.



**Fig. 12.1 Extendable dinette**

To close the extendable dinette, reverse the process. The extendable dinette must be closed, the snap strap secured and the tabletop put in the bed position **BEFORE** the slideout room is retracted for transit.

**HEATED BED MATS (IF SO EQUIPPED)**

The heated bed mats are manufactured to reach gentle, soothing heat warmth, NOT the pain relieving heat of a heating pad. At first touch it may seem only slightly warm because it is conserving energy. As your body weight presses onto the bedding, and a blanket covers you, it will feel considerably warmer and comfortable.

**WARNING**

Be sure to read all instructions carefully before using the heated bed mats. **YOUR BEDDING SHOULD ALWAYS REMAIN FLAT, NEVER FOLDED, ROLLED OR BUNCHED. EXCESSIVE HEATING MAY OCCUR FROM MISUSE.**

- Ensure the heated bed mats are on the bed board with the label and connector pointed up.
- The cord should be at the head of the bed.
- Do not tuck in the wired area of the heated bed mats.
- Let the cord hang free. Do not route electrical cords between the heated bed mats and the bed boards. Do not allow the cords to be pinched. NEVER pull a heated bed mat by its cord.
- Keep the heated bed mat control away from an open window.
- Do not use pins or any heavy, sharp pointed objects on the heated bed mats. They may damage the heating elements.
- Be sure the heated bed mats are used on a 120 volt AC circuit.
- Turn off the electric current when this bedding is not in actual use.

**Maintenance****WARNING**

Do not use dry cleaning fluid on the heated bed mats. Cleaning solvents may have a deteriorating effect on the insulation of the heating element.

Unplug the bed mats first. Wipe gently or blot the soiled area, using a damp cloth treated with a mild detergent. DO NOT IMMERGE the heated bed mats; allow them to dry thoroughly before plugging them in for use.

**THIS PAGE IS INTENTIONALLY BLANK**

---

**BBQ GRILL (IF SO EQUIPPED)****WARNING**

Make sure that you read, understand and follow all information supplied with your RV about propane before operating the BBQ grill. The propane hose must be correctly connected before lighting the grill. Failure to follow instructions supplied by the grill manufacturer with your RV or to use any other components than those originally supplied with the grill could lead to death or serious injury from fire or explosion.

**WARNING**

The maximum weight limit for the bracket on the side of your trailer is 50 lbs. This limit includes the weight placed on the BBQ grill. Exceeding this weight limit could cause damage to the unit and possibly cause personal injury from hot equipment.

The BBQ grill is for use outside of the RV. Never use this grill inside a compartment or the RV. Before operating the BBQ grill, make sure that it is securely placed on the support bracket.

The BBQ grill must be **COMPLETELY** cooled before storing to avoid damaging the carrying case (if so equipped) and causing injury from handling the grill when it is hot. Wait until the grill is completely cooled, then store it.

**Setting up the grill (bumper mount grill only – if so equipped)**

Insert the grill mounting bar into the bracket (mounting tube) on the rear bumper of the RV. Insert the pin through the hole in the bracket and mounting bar. The pin must be installed to insure the mounting bar is secure during use. Set the BBQ grill on the mounting bar by inserting the (2) pegs on the bar into the grill mounting bracket. Make sure the mounting bar and the grill are securely in place before proceeding with the propane connection.

**Attaching the “quick coupler” connection**

The “quick coupler” is directly connected to the RV propane system.

The “quick-coupler” connection has a positive shut-off valve as required by code and standards.

1. Place the “quick coupler handle in the OFF position and push back the sleeve. The valve handle must be OFF to make the connection.
2. Insert the plug and release the sleeve.
3. Push the plug until the sleeve snaps forward, locking the plug into the socket.

Turn the handle ON to allow propane to flow to the drop in stove.

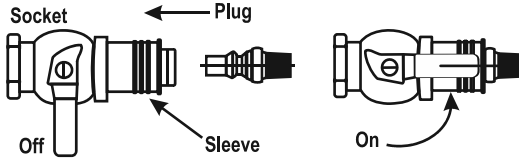

Fig. 13.1 Quick connect coupler

## CLEANING THE EXTERIOR

To protect your RV's exterior finish, wash it often and thoroughly. Regular cleaning and waxing will help protect the exterior. If chalking occurs, wash and try to wax a small area to see if the luster returns. If the exterior becomes scratched, nicked or cracked have your dealer inspect the RV.

Your RV is exposed to many environmental conditions that have an adverse affect on the paint finish:

- Road Salt and Sodium Chloride
- Road Tar / Bugs
- Bird Droppings / Tree Sap
- Industrial Fallout / Acid Rain /Pollution
- UV Exposure and Moisture

The most common problems resulting from these conditions are corrosion, staining, and chemical spotting. Generally, the longer the foreign material remains in contact with the exterior finish, the more extensive the damage. These problems can be minimized by regularly scheduled washing and polishing. Wash your RV as soon as possible if it becomes contaminated with foreign material. Avoid parking under trees or near ocean sea salt. Ice or snow should not be scraped from the painted surface: Brush off!

Anti-freeze, gasoline or washer solvents if spilled on the painted surface should be rinsed off with water immediately. Bugs and bird droppings should be rinsed off daily.

We recommend that you do not take your RV through automatic car washes. Extreme caution should be used if utilizing any type of pressure sprayer around all attachments, doors, windows, appliance vents, etc.

Avoid forcing water inside the RV, which could possibly damage component parts.

Some types of hot water washing equipment apply high pressure and heat to the RV. They may cause heat distortion and damage to the resin parts and may flood the RV's interior. Therefore, be sure to observe the following:

1. Keep the washing nozzle about 16 inches (40 cm) or more away from the RV body.
2. When washing around the door, vent and glass areas, hold the nozzle at right angles to the surface.

Depending on your model, the exterior is constructed of aluminum or fiberglass. Refer to the general instructions that follow for care information.



**Washing**

Chemicals contained in dirt and dust picked up from the road surface can cause damage if left on the RV for a long time.

Frequent washing and waxing is the best way to protect your RV from this damage. Frequent washings also protect your RV from environmental elements, such as rain, snow and salt air.

Do not wash the RV when it is in direct sunlight. Park the RV in the shade and spray it with water to remove dust. Next, using an ample amount of clean water and a car-washing mitt or sponge, wash the RV from top to bottom.

Use a mild car-washing soap if necessary. Rinse thoroughly and wipe dry with a chamois or soft cloth.

Carefully clean the joints and flanges of the slideout (if so equipped), doors, hood, etc., where dirt is likely to remain.

Some types of hot water washing equipment apply high pressure and heat to the RV. They may cause heat distortion and damage to the resin parts and may flood the RV's interior. Therefore, be sure to observe the following:

1. Keep the washing nozzle about 16 inches (40 cm) or more away from the RV body.
2. When washing around the glass areas, hold the nozzle at right angles to the glass surface.

**During cold weather**

Salt and other chemicals that are spread on winter roads in some geographical areas can have a detrimental effect on the RV's underbody. If your RV is exposed to these conditions, spray the underbody with a high-pressure hose every time you wash the exterior of your RV. Take special care to remove mud or other debris that could trap and hold salt or moisture. After washing your RV, wipe off all water drops from the rubber parts around the slideout and doors.

If the slideout or door is frozen, opening it by force may tear off or crack the rubber gasket that is installed around the slideout or door. Pour warm water on the gasket to melt the ice (wipe off the water thoroughly after opening the slideout or door). To prevent the weather stripping from freezing, treat it with a silicone spray.

**Waxing your RV**

Wax your RV once or twice a year, or when painted surfaces do not shed water well.

Use a soft cloth to apply a small amount of wax to the painted surfaces. After the wax has dried, polish the RV with a dry, soft cloth.

Do not wax your RV in direct sunlight. Wax it after the surfaces have cooled. Do not apply wax to any area having a flat black finish as it can cause discoloration. If the finish has been stained with wax, wipe off the area with a soft cloth and warm water.

When waxing the area around the various openings, do not apply any wax on the weatherstrip. If it is stained with wax, the weatherstrip cannot maintain a weatherproof seal around the opening.

**CAUTION**

Do not use waxes containing high-abrasive compounds. Such waxes remove rust and stains effectively, but they are also harmful to the luster of the surface, since they may scrape off the coating. Further, they are detrimental to glossy surfaces, such as the grille, garnish, moldings, etc. Do not use gasoline or paint thinners to remove road tar or other contamination to the painted surface.

**Polishing your RV**

If painted surfaces have been severely damaged and have lost their original luster and color tone, polish the surface lightly with a fine polishing compound. Avoid limiting your polishing to the damaged surface only; polish a somewhat wider area, moving the polishing cloth in one direction. After polishing, flush the compound from the surface and apply a coat of wax to regain a beautiful luster.

**CAUTION**

Do not use a buffer and a buffing compound as it may damage the exterior surface. Please contact a professional paint body shop for assistance.

**Damaged paint**

To prevent corrosion, touch up small cracks and scratches in the paint coat as soon as possible with touch-up film or paint. Carefully check the body areas facing the road and the tires for damage to the paint coat caused by flying stones, etc. To purchase touch-up paint, use the closest automotive paint (available locally) match possible.

**Cleaning plastic parts**

Use a sponge or chamois to clean plastic parts. Use warm water and a soft cloth or chamois to remove any white residue from dark colored plastic surfaces.

Do not use a scrubbing brush or other hard tools as they may damage the plastic surface. Do not use wax containing abrasives that may damage the plastic surface.

**CAUTION**

Do not allow plastic to come into contact with brake fluid, engine oil, grease, paint thinner, or battery acid. These will damage plastic. Use a soft cloth and a mild detergent solution to wipe away any such contact.

**Chrome parts (if so equipped)**

To prevent chrome parts from spotting or corroding, wash with water, dry thoroughly, and apply a non-abrasive automotive wax. If the chrome is severely damaged or pitted, use a commercially available chrome polish product.

**Stone Guard (if so equipped)**

Wash the stone guard with mild liquid dishwashing soap or liquid car washing soap and water. Do not use powdered detergent, powdered soap, liquid and spray cleaners or pressure washing. Wax frequently to protect the surface and make cleaning easier.

## EXTERIOR ROOF & SIDEWALL VENTS

---

While you are cleaning the exterior roof, also inspect the roof vents (including sealants) for cracks and keep them clean. Inspect the refrigerator and holding tank vents for blockages from bird nests, spider webs, leaves, etc.

Water heater, furnace and refrigerator exterior doors need to be kept clean and free of obstructions (i.e., insect nests, mud daubers, etc.) while the appliances (if so equipped) are in use.

## TRAILER FRAME

---

Sand, pebbles, objects on the highway, climate (salt air exposure) or ice inhibiting chemicals used during the winter months will damage the paint, inviting rust and other deterioration. Periodically inspect the exterior exposed areas, clean and repaint the steel members occasionally and whenever you notice rust or paint chipped away, to insure protection.

## E-Z LUBE AXLE (IF SO EQUIPPED)

---

The E-Z lube feature on your axles provides the ability for the bearings to be periodically lubricated without removing the hubs from the axle. This feature consists of axle spindles that have been specially drilled and fitted with grease zerks in their ends. When grease is pumped into the zerk, it is channeled to the inner bearing and then flows back to the outer bearing and eventually back out the grease cap hole. If you have further questions, consult with your dealer.

**⊗NOTE:** The convenient lubrication provisions of the E-Z lube must not replace periodic inspection and maintenance of the bearings. Use a hand-operated grease gun; improper use of a commercial grease gun may damage the seals.

## REAR BUMPER

---



### CAUTION

Do not add items to the RV rear bumper. Add-on items will eventually damage your bumper. Damage caused by such aftermarket equipment installation or improper loading voids the **Towable Limited Warranty**.

The rear bumper of your RV is not designed to carry cargo. Items that extend beyond the bumper OR weigh over 100 lbs. (45kg) will place undo strain on the bumper.

The 100 lb. bumper capacity includes the weight of the spare tire that may have been attached at the factory.

**⊗NOTE:** Some items may fall within the given weight range, however, can still cause damage. Over time, weight added to the bumper will cause damage from the motion created while traveling. In addition, extra weight behind the axle may reduce the hitch weight (leading to adverse handling conditions from wind gusts and/or passing traffic).

---

**SEALANTS**

---

**CAUTION**

Failure to properly maintain or reseal your RV may result in serious water damage to the roof and other parts of the RV. This damage is not covered by the **Towable Limited Warranty**.

Sealants perform a very important function and should be inspected closely and regularly maintained. We incorporate many different types of sealants, including butyl/putty, black butyl-encapsulated foam, silicone (clear and colored), roof sealant and foam. In general, sealants do not have "set" lifetimes. Varying environmental factors affect the pliability and adhesiveness of sealants. You or your dealer must:

- Inspect all sealants, a minimum of every six months. Make sure to check the roof and all four sides of the RV including all moldings, doors, vents and exterior attachments. A quick walk around the RV before leaving may help prevent potential problems during trips and vacations.
- Have the sealant replaced if you notice any cracks, peeling, voids, gaps, breaks, looseness or any sign of physical deterioration. Reseal at least one time each year as preventative maintenance.
- Always use the same type of sealant that was removed. Your dealer service or parts manager can help you obtain the correct sealant(s).

The sealants may become damaged due to ultraviolet exposure, air pollution, freezing temperatures and exposure to other elements. If deteriorated, repair immediately to prevent damage.

If you notice water inside the RV, immediately have the dealer check for the source of the leak. Failure to correct the leak may result in serious damage to your RV; this damage may not be warrantable.

Although the diagrams below may not accurately reflect the exact model of your RV, make sure you inspect all sealants as indicated in the text. If you have questions and/or need assistance with sealing your RV, consult with your RV dealer.

**Travel Trailers**

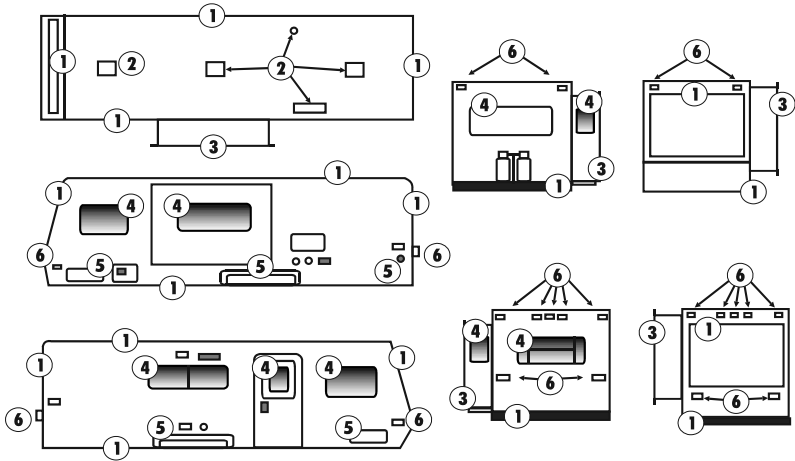

- 1. Trim Edges**
- 2. Roof items**
- 3. Slideout Roof/Floor**
- 4. Windows/Doors**
- 5. Storage Compartments/ Access Doors/Wheel Wells**
- 6. Lights**

**WINDOWS**

Any ventilating window may permit water inside, especially during heavy rainstorms. Condensation will also cause water to accumulate on windows and in the tracks.

The window “glass” can normally be cleaned with a sponge and water. Use glass cleaner to remove wax, oil, grease, dead insects, etc. After washing the glass, wipe it dry with a clean, soft cloth.

**PATIO AWNING (IF SO EQUIPPED)**

Please refer to the awning manufacturer’s operators manual. Keep your awning in good condition to prevent costly repairs. It is very important to keep the awning clean. If weather conditions are windy or stormy, close the awning into the travel mode position. Shut the awning in the travel position if you will be away from the RV for an extended period of time.

The 12-volt power awning may need to be adjusted (retracted) to operate the entry door (some models)



**CAUTION**

---

Awnings must be closed (and locked if applicable) while the RV is in transit.

### ROOF LADDER (IF SO EQUIPPED)

Your RV may be equipped with an optional roof ladder. The RV roof has decking under the rubber roof membrane to allow you to walk on the roof (with caution) to do maintenance.



#### WARNING

If your RV is equipped with a roof ladder, do not leave items attached to it while traveling. The ladder has a weight limit of 350# when using it to access the roof. DO NOT exceed this weight limit.

### OUTSIDE KITCHEN (IF SO EQUIPPED)

The outside kitchen unit consists of a 2-burner cooktop, refrigerator and sink. See the manufacturer's user guide for detailed cooktop and refrigerator operation information.

To access the kitchen unit, open the exterior door by lifting it up until the door struts are fully extended. The struts will hold the door in the open position.

Lift up the countertop extension and secure it in place by pulling the (2) wooden supports forward. Make sure the supports are pulled completely forward to insure proper support of the extension.



Fig. 13.2 Wood Support

Locate the black locking lever at the base of the swing arm. Push in on the lever while pulling forward on the swing arm. Swing the cooktop unit open as far as the swing arm will allow.



Fig. 13.3 Locking Lever

Locate the support leg on the back side of the cooktop unit. Push in and hold the release button on the support leg while pushing the bottom of the leg extension in allowing it to drop from the stowed position to the support position. Push in and hold the release button once again to allow the extension portion of the support leg to drop down to the appropriate height to support the cooktop unit. Make sure the support leg is setting on a stable solid surface.

**NOTE:** The cooktop will function more efficiently when level. The support leg should be adjusted to ensure to cooktop is as level as possible.



#### WARNING

The support leg must be down and in the support position prior to using the cooktop. Be sure the support leg is on a stable solid surface. Using the cooktop without the support leg or not having the leg on a stable solid surface may increase the risk of hot food or utensils falling off the cooking surface resulting in serious injury.



## WARNING

**The maximum capacity of the cooktop with the support leg down is 50 lbs. / 23kg.** Never use the cooktop without the supporting leg, or lean on the cooktop or swing out assembly. Setting items on the cooktop that exceed the weight limit, using the cooktop without the support leg or leaning on the cooktop could cause damage to the unit or result in personal injury.

### Attaching the “quick coupler” connection

The “quick coupler” is directly connected to the RV propane system. The “quick-coupler” connection has a positive shut-off valve as required by code and standards.

1. Place the “quick coupler handle in the OFF position and push back the sleeve. The valve handle must be OFF to make the connection.
2. Insert the plug and release the sleeve.
3. Push the plug until the sleeve snaps forward, locking the plug into the socket.
4. Turn the handle ON to allow propane to flow to the drop in stove.

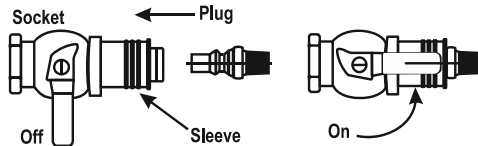

**Fig. 13.1 Quick connect coupler**

To return the kitchen unit to the stowed position, first disconnect the propane connection. Hold in the release button on the support leg and retract the lower portion of the leg. Swing the leg up into the stowed position and extend the leg into the storage bracket. Swing the cooktop back into the stowed position until it locks into place. Pull down on the exterior door until it is in the closed position. Make sure all exterior door locks are in the locked position prior to travel.

**THIS PAGE IS INTENTIONALLY BLANK**

---



## RV START-UP

---

The following checklist will help ensure a trouble-free camping season:

- Inspect and work all interior and exterior latches and locks (lube if necessary).
- Make sure the batteries are fully charged and installed correctly.
- Inspect the power cord and carefully clean the contacts if necessary. Plug in the power cord to an appropriate power source.
- Turn on the interior lights and check outlets for polarity. If needed, replace any blown fuses. Check the circuit breakers and test the GFCI.
- Inspect and test all safety detectors. If needed, replace any drained or discharged batteries. If you have a defective or damaged safety detector, replace it immediately.
- Inspect and turn on the propane system. If you have any questions, contact your dealer or a qualified propane service representative for assistance.
- If the propane system is functioning properly, test the pilot lights on range, refrigerator, furnace and water heater (if so equipped).
- Inspect the leveling jacks (if so equipped) for operation. If needed, perform maintenance as specified by the leveling jack manufacturer.
- Test all exterior and interior lights. Replace any bulbs if they are burnt out.
- Inspect the tires for wear, cracks and inflation pressure.
- Wash the exterior of the RV. Do a sealant inspection and repair as necessary.
- De-winterize and sanitize the fresh water system.
- Connect your tow vehicle to the RV and test all connections and lights.

## READY TO LEAVE CHECKLIST

---

Before leaving or returning home, it is critical that you complete the necessary procedures to ensure a safe trip. As you develop a routine, it is possible that a checklist will be helpful. This is a general list, which you may want to customize as you determine your own needs

- Make sure you follow all safety precautions noted in this owner's manual and in any manufacturer's operators manual when preparing to travel.
- Check the area under the RV after overnight parking and look for water or other fluid leaks. If leaks are detected, find the cause and correct it immediately.
- Make sure all tow vehicle fluids are at proper levels. Check the engine oil, transmission fluid, engine coolant, power steering fluid and wind shield washer fluid.
- Check the lights on the RV. Have someone observe the operation of all exterior lights while you activate the controls. Check the turn signals and brake lights.
- Examine the tires for excessive tread wear or uneven wear patterns. Check for stones, nails, glass or other objects lodged in the tread. Inspect for tread cuts or sidewall cracks.
- Check wheel lug nuts for tightness and tires for proper air inflation pressure.
- Check the propane cylinder gauge to make sure there is propane available. Make sure the propane cylinder is in place and secure for transport.

**Interior**

- Close roof vents.
- Close windows & latch blinds.
- Counter items put away or tied down.
- Furnace turned off.
- Latch drawers, cabinets & doors.
- Turn off the interior lights and appliances.
- Disconnect any cable TV or phone hookups and lower the TV antenna (if so equipped).
- Move slideout (if so equipped) in and lock it in place.
- Fasten and secure the furniture for travel (if so equipped).
- Refrigerator door locked (if so equipped).
- Set refrigerator to 12-volt (if so equipped).
- Water heater turned off (if so equipped).
- Water pump turned off (if so equipped).

**Exterior**

- Empty black holding tank, rinse as needed (if so equipped).
- Empty gray holding tank (if so equipped).
- Pack equipment into compartments and secure it.
- Propane turned off.
- Retract awning and secure in place for transport (if so equipped).
- Retract step.
- Retract leveling jacks to the travel position (if so equipped)
- Water hose & electric cord unhooked and stored.
- Check tire pressure-include inner wheel and spare (if so equipped).
- Check wheel lugs.
- Test brakes for proper operation.
- Secure any loose, heavy or sharp objects in the RV or exterior compartments.
- Disconnect the shore line power cord and ensure it is stored correctly.
- Fasten all interior and exterior doors securely. Lock them (if so equipped).
- Secure and lock the entrance door.
- Walk around your RV one last time to make sure everything is stored away and the baggage compartments are closed and locked.

**RV STORAGE**

---

Properly preparing your RV for storage during periods of non-usage will prevent problems from arising. It will also make it easier to get started again for the following camping trip or season. To prevent costly freeze-ups, winterize the plumbing system when it will not be in use for an extended period of time, especially if it is stored in colder climates.

Periodically inspect your RV for damage during storage, and seal off any area that can offer an entry point for rodents, birds or insects. **Damage from birds, rodents, insect, etc., is not covered under the "Towable Limited Warranty" applicable to your RV.**

When storing your RV, it is recommended that the auxiliary battery (customer supplied) be disconnected to avoid battery discharge.

### **Prior to Storage**

If storing for the winter, be sure the RV is winterized (refer to **Sec. 8 Plumbing System**, Winterizing the plumbing system).

- Check your roof and other surfaces to ensure there is no damage and potential leakage that might otherwise go unnoticed until it is too late.
- Close all windows and roof vents.
- Close the propane cylinder valve(s). If you do not have a propane cylinder cover, we recommend purchasing one to make sure the regulator is covered.
- Cover all external outlets, such as furnace, exhaust, etc. to prevent mice or other rodents from entering.
- Cover the roof air conditioner (if so equipped).
- Disconnect 120-volt AC power to the RV.
- Do not use the stabilizing jacks during storage.
- Drain all water lines.
- Drain and flush all holding tanks (fresh water, gray water, black water and/or hot water tanks).
- Remove all batteries from the RV and store in a place where they won't freeze. Batteries that have been frozen will never hold a proper charge.
- Store your RV indoors, under a roof or purchase a "breathable" cover for use during storage.
- Thoroughly wash the interior and the exterior of your RV.
- To prevent weather checking and other UV damage, cover tires that are exposed to sunlight.
- Turn all cushions on edge to prevent the moisture/mildew buildup during storage.
- Turn off 12-volt DC/120-volt AC/propane to the refrigerator; defrost and clean (if so equipped). Prop (or block) the doors open so air can circulate and prevent mildew or use crumpled newspaper or open boxes of baking soda in the refrigerator to eliminate odors during storage.
- Remove all perishables from the cabinets. Leave the cabinets and doors ajar to allow air circulation and prevent mildew and musty odors.
- Remove all perishables from the cabinets. Leave the cabinets and doors ajar to allow air circulation and prevent mildew and musty odors.
- Lubricate locks and hinges on exterior doors.

### **During Storage Period**

Remove snow from the top of your RV to prevent damage to the unit's structure.

**CAUTION**

Excessive snow, 8" or more, or ice, 2" or more, places excessive weight on the RV roof. Remove excessive snow or ice as needed. Care **MUST** be exercised to not damage the roof material when removing snow & ice. Excessive weight can damage the roof, seals, etc. Water leaks and poor fit or operation are the results of this damage.

**MAINTENANCE CHECKLIST**

This list is a quick reference sheet for suggested areas of regular maintenance. Review all manufacturer's operators manuals supplied with your RV to perform these listed maintenance items.

**Prior to First Trip**

- Inspect and reseal as needed.
- Have the propane system checked for leaks by your dealer.
- Check wheel lug nuts at specified intervals to listed torque specifications, re-torque as needed.
- Sanitize the fresh water system.
- Test the safety alarms.

**First Two-Hundred Miles**

- Check wheel nuts at specified intervals to listed torque values. Re-torque as needed.
- Have brakes adjusted by a qualified service technician.

**Each Trip**

- Inspect and reseal as needed.
- Check the auxiliary battery (If so equipped).
- Have the propane system checked for leaks by your dealer.
- Check running lights.
- Check tire pressure and wear, including spare (if so equipped). Make sure the tires are cold when checking the tire pressure.
- Flush out water heater tank.
- Inspect safety chains for signs of wear (if so equipped).
- Test brakes.
- Test safety alarms.

**FEATURED COMPONENTS QUICK REFERENCE CHART**

Your RV may be equipped with some of the items listed below. This is a partial listing and it is not intended to cover all components in your RV. All information is the latest available at the time of publication. Jayco reserves the right to change any of the following information without notice.

COMPONENT	MANUFACTURER	WEBSITE	PHONE NO.
AIR CONDITIONER	RV PRODUCTS	<a href="http://www.rvcomfort.com">www.rvcomfort.com</a>	(316) 832-4357
AWNING	CAREFREE OF COLORADO	<a href="http://www.carefreeofcolorado.com">www.carefreeofcolorado.com</a>	(800) 622-3230
AXLE	Dexter Axle	<a href="http://www.dexteraxle.com">www.dexteraxle.com</a>	(574) 295-7888
DVD/CD	CONTACT YOUR RV DEALER		
ENTRANCE STEP	Hickory Springs	<a href="http://www.hickorysprings.com">www.hickorysprings.com</a>	(800) 438-5341
FAN, EXHAUST 12V	VENTLINE	<a href="http://www.ventline.com">www.ventline.com</a>	(574) 848-4491
FIRE EXTINGUISHER	CONTACT YOUR DEALER		
FURNACE	ATWOOD/ HYDROFLAME	<a href="http://www.atwoodmobile.com">www.atwoodmobile.com</a>	(800) 546-8759
MICROWAVE	CONTACT YOUR DEALER		
MONITOR PANEL	KIB ENTERPRISES	<a href="http://www.kibenterprises.com">www.kibenterprises.com</a>	(800) 250-7051
OUTSIDE SHOWER	B & B MOLDERS	<a href="http://www.bandbmolders.com">www.bandbmolders.com</a>	(574) 259-7838
PROPANE TANK	MANCHESTER TANK	<a href="http://www.mantank.com">www.mantank.com</a>	(800) 877-8265
PROPANE/CARBON MONOXIDE ALARM	CONTACT YOUR DEALER		
PROPANE REGULATOR	Marshall Brass	<a href="http://www.marshallbrass.com">www.marshallbrass.com</a>	(800) 447-9513
Range	Atwood	<a href="http://www.atwoodmobile.com">www.atwoodmobile.com</a>	(815)877-5700
RANGEHOOD	VENTLINE INC.	<a href="http://www.ventline.co">www.ventline.co</a> ,	(574) 848-4491
REFRIGERATOR, NORCOLD	NORCOLD	<a href="http://www.norcold.com">www.norcold.com</a>	(800) 543-1219
SMOKE ALARM	CONTACT YOUR DEALER		
TANK SPRAYER/BLK	B & B MOLDERS	<a href="http://www.bandbmolders.com">www.bandbmolders.com</a>	(574) 259-7838
THERMOSTAT	RV PRODUCTS	<a href="http://www.rvcomfort.com/rvp">www.rvcomfort.com/rvp</a>	(316) 832-4357
TOILET	THETFORD CORP	<a href="http://www.thetford.com">www.thetford.com</a>	(800) 521-3032
TV	CONTACT YOUR DEALER		
TV ANTENNA	WINEGARD COMPANY	<a href="http://www.winegard.com">www.winegard.com</a>	(800) 788-4417
WATER HEATER, TANK DSI	ATWOOD GREENBRIER OPERATIONS	<a href="http://www.atwoodmobile.com">www.atwoodmobile.com</a>	(800) 546-8759
WATER HEATER, TANKLESS	GIRARD SYSTEMS	<a href="http://www.girardsystems.com">www.girardsystems.com</a>	(800) 382-8442
WATER PUMKP, 12V	SHURFLO EAST	<a href="http://www.shurflo.com">www.shurflo.com</a>	(800) 854-3218

## Jayco Ownership Notification

Fax Form To: (800) 825-7876

**ATTENTION!**

Federal record keeping laws require that we maintain a file of owners of our product. Your cooperation in filling out this form will be appreciated.

Change of Owner       Transfer of Limited Warranty (see limited warranty for details)

**Model Information:**

Serial #: \_\_\_\_\_

Chassis #: \_\_\_\_\_

Odometer Reading: \_\_\_\_\_  
(Motorized Only)**New Owner Information:**

Purchased Date : \_\_\_\_\_

Name: \_\_\_\_\_

Address: \_\_\_\_\_

City: \_\_\_\_\_ State/Province: \_\_\_\_\_ Zip Code: \_\_\_\_\_

Phone #: \_\_\_\_\_ E-Mail Address \_\_\_\_\_

**Previous Owner Information**

Purchased Date: \_\_\_\_\_

Name: \_\_\_\_\_

Address: \_\_\_\_\_

City: \_\_\_\_\_ State/Province: \_\_\_\_\_ Zip Code: \_\_\_\_\_

Phone #: \_\_\_\_\_ E-Mail Address: \_\_\_\_\_