



water GARDENING

2016
product catalog





Your Paradise

Our Passion

TABLE OF CONTENTS

10	Pond Kits	56	Water Treatment	80	Liner & Underlayment
12	Pondless® Kits	66	Seasonal	82	Decorative
16	Filtration	70	Fish Care	98	Installation Tools
36	Pumps	76	Plant Care	102	RainXchange®
50	Lighting	78	Hose & Pipe		



Is Your Yard Ready for THE POND SQUAD?

For over 20 years, Ed Beaulieu (The Scientist), Brian Helfrich (The Foreman) and Greg Wittstock (The Pond Guy) have been working and playing together creating some of the most beautiful water features in the world! In the fall of 2014, National Geographic recognized their unique talents and featured their exploits in their own Reality Series, the Pond Stars on the Nat Geo Wild channel.

Today, Ed, Brian, Greg, and their newest teammate, Chris Hanson (The New Guy), bring you a brand new show, the Aquascape Pond Squad. Each month, the team tackles new projects and streams their creations with their show directly to YouTube at www.youtube.com/AquascapePondSquad for the world to enjoy. Whether you're a hobbyist living the water feature lifestyle or someone looking for inspiration for your yard, you are going to love what you see with the Aquascape Pond Squad.

The best part of this new show is we are coming to you! Whether you're ready for your first water feature or your old one is ready for a facelift, you just might have exactly what we are looking for! Tell us your story and you might find your yard transformed by the Aquascape Pond Squad.

To have your yard considered for filming please fill out an application at www.aquascapeinc.com/pondsquad/show-ideas. Who knows, you might just end up with the yard of your dreams and make a lot more than your neighbors envious with the Aquascape Pond Squad doing all the work! Apply, tune-in and live the water feature lifestyle!



MEET THE POND SQUAD



Greg Wittstock
"The Pond Guy™"

Also known as The Pond Guy™, Greg Wittstock is Founder and CEO of Aquascape Inc. Since its inception in 1991, Aquascape, Inc. has experienced incredible growth, appearing on Inc. Magazine's list of 500 Fastest-Growing, Privately-Held Companies in North America 4 years in a row (1999-2002).

Greg is a highly sought-after motivational speaker, having conducted seminars nationwide for contractors, retailers, and distributors. He authored The Pond Guy on Marketing, and his company has produced numerous publications for contractors, retailers, and consumers. Greg has appeared on HGTV and is a member of the Aquascape Pond Squad, as seen on YouTube.



Ed Beaulieu
"The Scientist"

Ed came to Aquascape in 1993 as a construction laborer, but a little creativity and a positive outlook on life and business helped catapult Ed to the position of Vice President of Field Research. Ed specializes in all aspects of pond design, construction, maintenance, biology, water quality, and filtration for residential and commercial water features. His favorite things about working at Aquascape include the eco-friendly headquarters and helping customers create unique water features. Ed co-authored the Pond Builder's Bible and is a member of the Aquascape Pond Squad on YouTube.



Brian Helfrich
"The Foreman"

Brian Helfrich has been with Aquascape, Inc. since 1995, starting out in the warehouse and working his way up to construction manager. He's given hundreds of pond construction seminars across the country and is considered to be the premier waterfall builder in the nation. Brian's pond designs have been featured in numerous publications, including Better Homes and Gardens special interest publications, and Nature's Garden. Brian has extended his pond artistry to several impressive, public water feature designs including Epcot® International Flower and Garden Show, Chicago Lincoln Park Zoo, John G. Shedd Aquarium in Chicago, and more. Brian co-authored the Pond Builder's Bible and is a member of the Aquascape Pond Squad.



Chris Hanson
"The New Guy"

Although Chris is dubbed "The New Guy," he's been working in the landscape industry for 15 years and decided to turn his green thumb blue when he took on the role of construction manager for Aquascape. Chris' background as landscape designer comes in handy when creating custom-designed water features. Chris has a horticulture degree from Kisuwaukee College and is an ISA-certified arborist. Chris has worked on impressive water features, such as the ones you'll find at Chicago's famed Lincoln Park Zoo and those you see on the Aquascape Pond Squad show. Chris claims he now has the best job on Earth!

AQUASCAPE POND SQUAD



What happens when four passionate pond builders, aka the Aquascape Pond Squad, meet a barren stretch of landscape? They work their artistic magic to create an inspiring and refreshing oasis with ponds, waterfalls, and fountains. You'll be amazed and entertained as you watch this talented crew carve a piece of paradise into landscapes across North America!

Tune into the Aquascape Pond Squad on YouTube where you'll learn more about nature and the wonders of the water feature lifestyle!



www.youtube.com/AquascapePondSquad



WATERFALLS OF FUN

Improving the quality of life for others is one of the many great benefits of being a pond builder. That couldn't be any truer than when the Aquascape Pond Squad installed a unique Pondless® Waterfall for an incredibly worthy organization, Casa Hogar home, on the top of the Baja in beautiful Cabo San Lucas, Mexico. The results of the efforts speak for themselves in the smiles for the thirty to forty boys who call Casa Hogar home. The Aquasape Pond Squad couldn't have done it without the help of several Certified Aquascape Contractors. Watch the inspiring story!



OVER THE TOP FOUNTAINSCAPE

The Aquascape Pond Squad takes on Brian's vision for an "over the top" display at the 2015 Chicago Flower and Garden Show, the oldest flower show in the country. Included in this display is an impressive signature fountainscape water feature. Reinforcements are needed so the Aquascape Pond Squad calls in their Certified Aquascape Contractors from New Jersey to lend a hand. When all is said and done, the full display shows a diverse collection of water features including fountainscapes, Pondless® Waterfalls, a large water garden, as well as a formal style pond. Watch this amazing transformation completed in just 9 days at Chicago's Navy Pier.



WATER FEATURE OASIS IN THE DESERT

The kids at Sunshine Acres Children's Home in Arizona become the happy recipients of a new pond and waterfall donated by Texas Roadhouse, installed by the Aquascape Pond Squad and the crew at Pondscapes AZ. See how a barren space is transformed into a refreshing water feature that serves as a home to 6 ducks on the property and an outdoor classroom for the kids who will take care of the pond.

Living The Water Feature LIFESTYLE



TODAY MORE THAN EVER, TIME IS A COVETED POSSESSION.

At Aquascape, our passion is helping people transform their yards and subsequently how they spend their time. When you own a water feature you transform a house into a home. You create an escape from the stress of the world right where you live. How important is that in today's world?! We have dubbed this trend "Living The Water Feature Lifestyle." The Water Feature Lifestyle is what you experience owning and living with a water feature. It is how you interact with it, but even more descriptively, it's how it interacts with you! When you live with a water garden, a waterfall, or even a decorative fountainscape, you will be seduced outside, away from the T.V., the computer, and the rat-race. People simply don't sit in their yards for hours on end watching their flowers grow. When you're feeding the fish, watching the birds splash in your waterfall or simply gazing hypnotically and listening to the beautiful sounds of a babbling brook, you're experiencing "The Water Feature Lifestyle" right where you live ... at home! From this catalog to our website, www.aquascapeinc.com, to our YouTube videos (www.youtube.com/Aquascape4), you can learn about and decide what feature is best for your property, lifestyle, and budget.

Your Paradise, Our Passion®



**VIDEO ON
THE LIFESTYLE**





WHO WE ARE

The best way for us to answer who we are, is to ask who you are. Are you someone who works hard, or worked hard for your money? Do you like to relax? Get your hands dirty? Love fish? Love nature? Love the outdoors? Do you like to entertain? "Living the Water Feature Lifestyle," encapsulates all those things PLUS so much more! Living the Water Feature Lifestyle is about having an escape at home. A place that beckons you outdoors where the stress

melts away. It's about creating a feature that draws your eyes to it that sets a mood, all while making a statement.

Throughout the pages of this catalog you can see who we are by seeing how we live with the water features we own. What we aren't, is like any other manufacturer of water feature products in the world. We are hobbyists who are passionate about the products we produce, because as you will

see, we live with them ourselves. We have many unique products, designs, and features that we've created to expand the enjoyment, improve the performance, or reduce the cost of owning a water feature. For you, that means "Living the Water Feature Lifestyle" should be simpler, and more economical than ever with Aquascape. "Your Paradise, Our Passion."



TRULY A WORKPLACE UTOPIA

In less than 15 years, Aquascape has morphed from a tiny basement and garage to a 256,000 square foot state-of-the-art green office building. Aqualand started as The Pond Guy's™ pie-in-the-sky dream and is now the pride and joy of employees and customers alike. Aqualand is truly a workplace utopia and the embodiment of Aquascape spirit and culture - building a balance in life that stimulates the mind, challenges the body, and nurtures the spirit. Visit www.aquascapeinc.com to learn more.

THE CULTURE OF BUILDING A BALANCE

Culture is a way of living that is most often associated with artistic and intellectual pursuits. It can be found in a variety of socio-environments: family, religion, education, sports teams, business, and more. When used in business, culture becomes a powerful tool that can set a company apart from its competitors. Aquascape, Inc. has created an entrepreneurial culture that is creative, fun, healthy, innovative, competitive, dynamic, and fast-paced. Aquascape is the industry leader in all things water gardening: from pond kits to seminars, special events to marketing materials, fish food to books, water treatments to fountains, and more. Due to the rapid growth of the water garden market, Aquascape embraces a cultural philosophy of building a balance in life.



**VIDEO ON
AQUALAND**



Aquascape Ecosystem Pond Approach

Filtration System

Includes the use of both a biological and a mechanical filter.

- A BioFalls® provides surface area for beneficial bacteria to colonize and remove excess nutrients from the water.
- A Skimmer will pre-filter the water and house the pump, collecting surface debris and reducing pond maintenance.

Rocks and Gravel

Rocks and gravel not only protect pond liners, they also provide tremendous surface area for beneficial bacteria to break down excess nutrients in the water.

Recirculation System

The proper size pump is important for the aesthetics of a water feature. More importantly, an efficient circulation system will keep the water moving and provide the necessary oxygen levels for healthy fish and plants.

Fish

Fish are an integral part of any ecosystem, grazing on string algae and bottom feed from the pond floor. They also make very enjoyable pets, providing hours of natural entertainment.

Aquatic Plants

Mother Nature's true filters, plants are great for adding character to a pond by providing color and texture. Aquatic plants are critical for the overall health of the ecosystem, thriving from excess nutrients in a pond and depriving algae of its food source.

Aquascape ecosystem pond kits create a complete low-maintenance system that works with Mother Nature.



**VIDEO ON
THE AQUASCAPE
ECOSYSTEM**





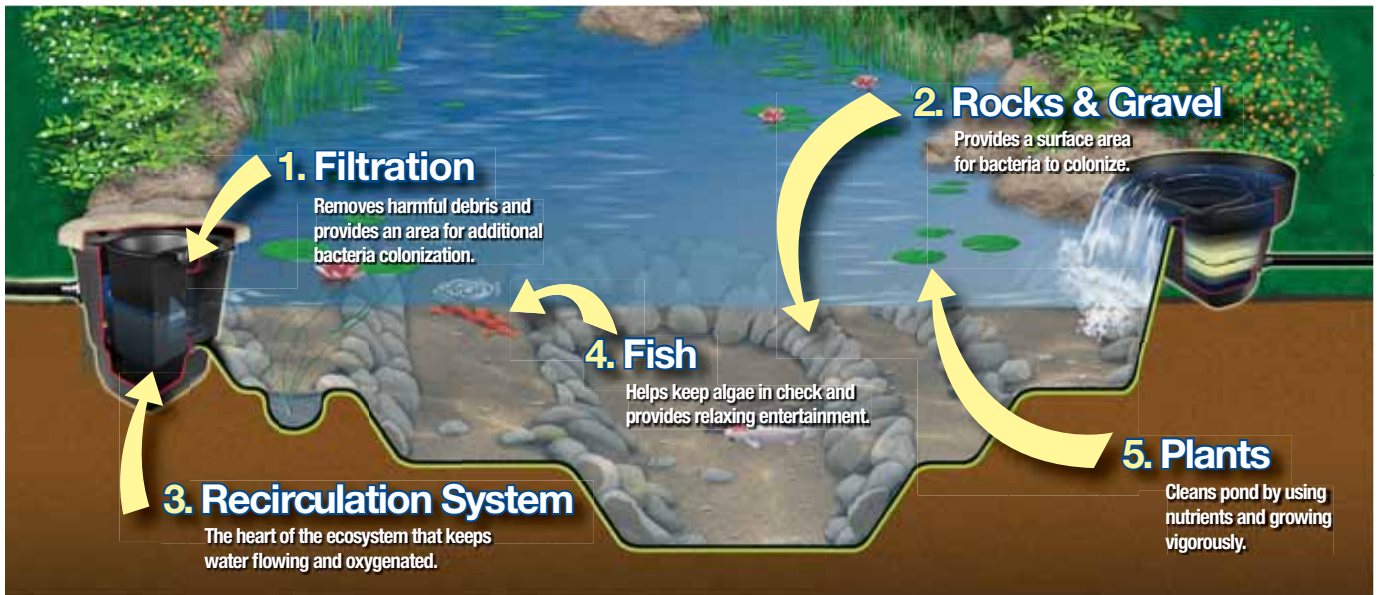







**VIDEO ON
HOW TO BUILD
A POND**



A pond is made up of many different parts and when those parts are assembled together correctly, they form a beautiful and naturalistic work of art that changes personality with the time of day, the change of the seasons, and the moods of Mother Nature.

Step-By-Step

<p>1</p> <p>Carefully remove contents from box.</p> 	<p>2</p> <p>Select your location.</p> 	<p>3</p> <p>Use garden hose to outline.</p> 	<p>4</p> <p>Position the filters.</p> 	<p>5</p> <p>Dig the hole.</p> 
<p>6</p> <p>Level the excavation.</p> 	<p>7</p> <p>Install underlayment and liner.</p> 	<p>8</p> <p>Add rock and gravel.</p> 	<p>9</p> <p>Fill the pond.</p> 	<p>ENJOY!</p> 

Aquascape Pond Kits

An Aquascape ecosystem pond kit comes complete with all the necessary components assembled together in a convenient, all-in-one kit that takes the guesswork out of purchasing necessary components separately.



DIY Backyard Pond Kits

Our most popular DIY pond kit takes the guesswork out of trying to assemble the perfect combination of equipment and liner.

Kit Includes:

- Signature Series™ 200 Pond Skimmer- Removes leaves and debris from the surface of the pond and provides protection for your pump
- Signature Series™ 1000 BioFalls® Filter and BioBalls™ - Provides complete biological filtration
- AquaSurge® 2000 waterfall pump
- 25 feet of 1½" quality kink-free hose
- Pond Liner made from quality EPDM 45 mil fish safe rubber - 20-year guarantee!
- Geotextile underlayment - Protects liner from sharp objects
- All necessary fittings and silicone sealants
- Welcome Kit - Staple Fish Food Pellets, printed material, USB manual, video and instructions

4' x 6' Pond Kit

#99763 MSRP \$899.98

(Unit Weight: 73 lbs.)

Includes 8' x 10' Liner

6' x 8' Pond Kit

#99764 MSRP \$949.98

(Unit Weight: 85 lbs.)

Includes 10' x 12' Liner

8' x 11' Pond Kit

#99765 MSRP \$999.98

(Unit Weight: 105 lbs.)

Includes 12' x 15' Liner



**VIDEO ON
HOW TO BUILD A POND**

New
Now Includes
Automatic
Dosing System



Small Pond Kit

#53033 MSRP \$1,566.04

(Unit Weight: 140 lbs.)

with AquaSurge® 3000 Pump

Our most popular professionally installed pond kit.

Kit Includes:

- 12' x 15' Liner and 180 sq. ft. Underlayment
- Signature Series™ 1000 BioFalls® Filter w/Rock Tray and BioBalls™
- Signature Series™ 400 Pond Skimmer
- AquaSurge® 3000 Pump
- 1½" x 25' Flexible PVC Pipe
- Pump Check Valve Assembly and Installation Kit
- Automatic Water Treatment Dosing System for Ponds
- Welcome Kit - Staple Fish Food Pellets, printed material, USB manual, video and instructions



New
Now Includes
Automatic
Dosing System



Medium Pond Kit 11' X 16'

#53034 MSRP \$2,536.00
(Unit Weight: 215 lbs.)

with AquaSurge® PRO 2000-4000 Pump

#53035 MSRP \$2,509.00
(Unit Weight: 218 lbs.)

with 3PL - 3000 Pump

**Two Pump
Model
Choices**

The 11' x 16' pond is small enough to fit into tight spaces yet big enough to make a design impact in any landscape setting.

Kit Includes:

- 15' x 20' Liner and 300 sq. ft. Underlayment
- Signature Series™ 2500 BioFalls® Filter w/BioBalls™
- Signature Series™ 1000 Pond Skimmer
- AquaSurge® PRO 2000-4000 **OR** 3PL - 3000 Pump
- 2" x 25' Flexible PVC Pipe
- Pump Check Valve Assembly and Installation Kit
- LED Lighting Package
 - (2) 3-Watt 12V LED Spotlights
 - 1-Watt 12V LED Waterfall Light
 - 60-Watt Transformer w/photocell
 - 3-Way Splitter and 25' LVL Extension Cable
- Automatic Water Treatment Dosing System for Ponds
- Welcome Kit - Staple Fish Food Pellets, printed material, USB manual, video and instructions



New
Now Includes
Automatic
Dosing System



Large Pond Kit 21' X 26'

#53036 MSRP \$3,724.42
(Unit Weight: 405 lbs.)

with AquaSurge® PRO 4000-8000 Pump

#53037 MSRP \$3,877.42
(Unit Weight: 409 lbs.)

with 9PL - 7000 Pump

**Two Pump
Model
Choices**

Don't let larger ponds intimidate you. Our largest pre-packaged kit ensures you have all of the right products for the job.

Kit Includes:

- 25' x 30' Liner and 750 sq. ft. Underlayment
- Signature Series™ 6000 BioFalls® Filter w/BioBalls™
- Signature Series™ 1000 Pond Skimmer
- AquaSurge® PRO 4000-8000 **OR** 9PL - 7000 Pump
- 2" x 50' Flexible PVC Pipe
- Pump Check Valve Assembly and Installation Kit
- LED Lighting Package
 - (2) 3-Watt 12V LED Spotlights
 - 1-Watt 12V LED Waterfall Light
 - 60-Watt Transformer w/photocell
 - 3-Way Splitter and 25' LVL Extension Cable
- Automatic Water Treatment Dosing System for Ponds
- Welcome Kit - Staple Fish Food Pellets, printed material, USB manual, video and instructions

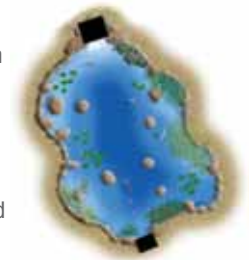

don't forget

Add-On Stream and Waterfall Liners (Note: When adding a stream, additional pipe lengths and coupling fitting may be required.)

45 mil EPDM Boxed Liner

#29607 MSRP \$129.00
(Unit Weight: 29 lbs.)

10' x 10'

#29612 MSRP \$258.00
(Unit Weight: 58 lbs.)

10' x 20'

#29616 MSRP \$387.00
(Unit Weight: 87 lbs.)

10' x 30'



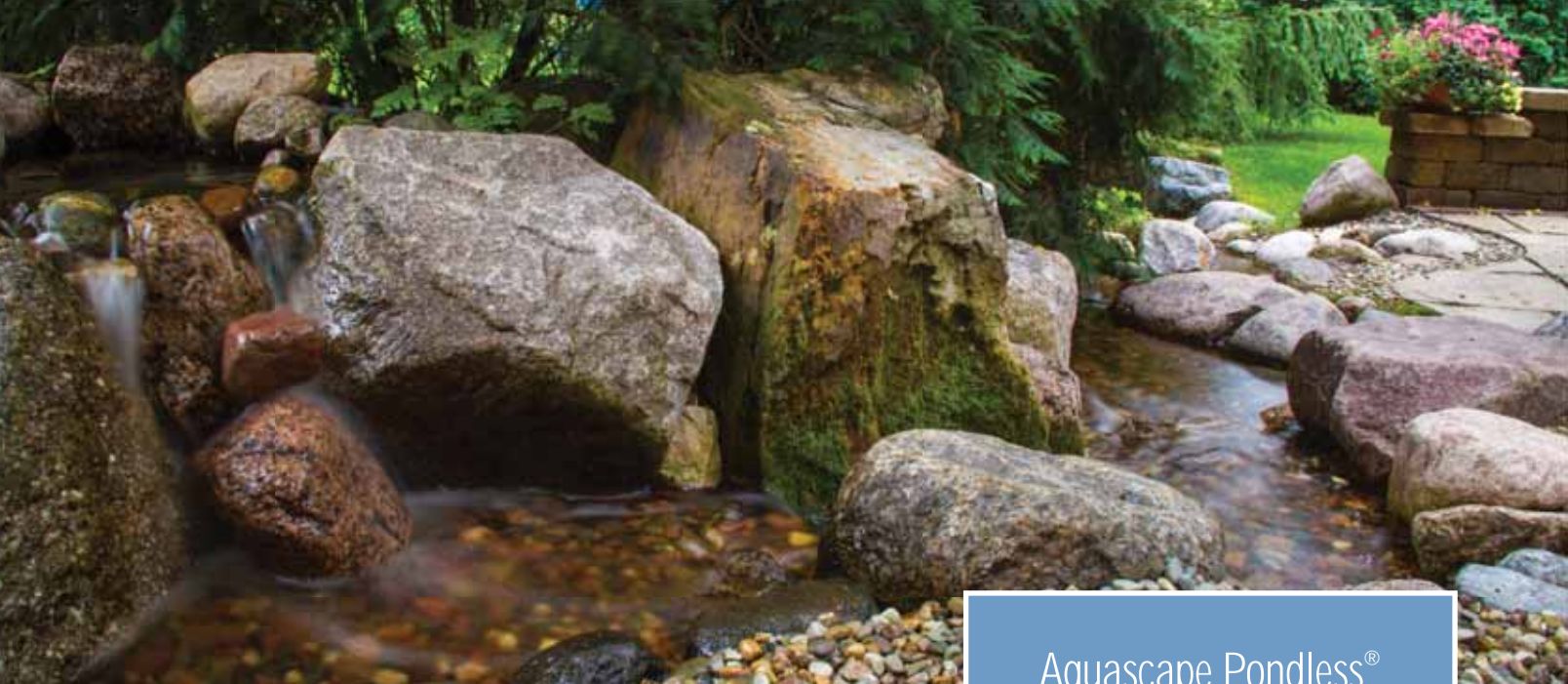

Aquascape Pondless®
Disappearing Waterfall
provides the sights and
sounds of water without
having a traditional pond
or water garden.

What is a Pondless® or Disappearing Waterfall

Pondless® Waterfalls are simply a re-circulating waterfall and/or stream without the presence of a pond. You can enjoy the sight and sound of running water without the maintenance of a pond.

The waterfall is undoubtedly the most beautiful and favored feature in a water garden. If space is limited in your yard or you have safety concerns with a pond, why not build a Pondless® or disappearing waterfall? The name basically explains it all. It's a waterfall and stream, without the pond. So why would you want a waterfall without a pond?

Safety

Because there is no pool of water, a Pondless® Waterfall is a great option for small children that want to play and splash in the water without the concern of safety.

Cost

Cost can be a big factor when considering the type of water feature you want to build. In most cases, the price of a Pondless® Waterfall will be less than a pond, as it often requires less rock and materials.

Space

The small size of the Pondless® Waterfall means you can build and enjoy a beautiful waterfall anywhere in your yard.

Maintenance

Taking care of your Pondless® Waterfall is easy. Filling the reservoir every few weeks to compensate for water loss due to evaporation is all that is required.

Flexibility

Perhaps the best part of the Pondless® Waterfall is the possibility for the future. If you change your mind later, wishing you had built a pond, that's ok! If you leave enough room around the base of the waterfall, it's easy to add a pond onto a Pondless® Waterfall.

The Aquascape Pondless® Waterfall has made many water-lovers who were previously unable to indulge in the sweet sounds of falling water, very happy. It's a great alternative for those who are trying to get their feet wet, or looking to fit a little bit of paradise into their own backyard.



**VIDEO ON
HOW TO BUILD
A PONDLESS®**





How the Aquascape Pondless® Disappearing Waterfall Works:

1. Water held within the reservoir or void space below a decorative layer of gravel flows from a submersible water pump contained within a protective waterfall vault; the waterfall vault protects the pump from being clogged and reduces pump maintenance.
2. The water flows to a waterfall spillway that creates the start of a beautiful waterfall.
3. The water then flows over the rock that creates the waterfall and the process is restarted.

Step-By-Step

1
Carefully remove contents from box.

2
Select your location.

3
Position equipment and outline area.

4
Excavate the area.

5
Install underlayment and liner.

6
Add filter equipment.

7
Build waterfall.

8
Install spillway at top of waterfall.

9
Fill basin.

ENJOY!



Aquascape Pondless® Disappearing Waterfall Kits



DIY Backyard Waterfall Kit

#83001 MSRP \$999.98

(Unit Weight: 80 lbs.)

A Pondless® Waterfall is simply a waterfall without the pond.

The perfect DIY solution for small spaces includes enough liner to create a small 3' long waterfall.

Kit Includes:

- Waterfall Spillway - This is the starting point of your waterfall
- Pondless® Waterfall Vault - Provides access to your pump and allows you to check the water level in the system
- (2) Small AquaBlox® - provides water storage for reservoir
- AquaSurge® 2000 waterfall pump
- 25 feet of 1.5" quality Kink-Free Hose
- 10' x 12' Pond Liner made from quality EPDM 45 mil fish safe rubber - 20-year guarantee!
- 105 sq. ft. of Geotextile Underlayment - protects liner from sharp objects
- Welcome Kit - printed material, USB manual, video and instructions



**VIDEO ON
DISAPPEARING
WATERFALL KIT**

New
Now Includes
Automatic
Dosing System



Small Pondless® Waterfall With Up To 6' Stream

#53038 MSRP \$1,537.10

(Unit Weight: 149 lbs.)

with AquaSurge® PRO 2000-4000 Pump

Provide the sight and sound of cascading water into any landscape setting with our small entry-level professional Pondless® Waterfall Kit. Includes enough liner to create a 6' waterfall and stream.

Kit Includes:

- 10' x 10' Liner and 100 sq. ft. Underlayment
- 10' x 8' Stream Liner
- Pondless® Waterfall Vault
- Waterfall Spillway
- (3) Small AquaBlox®
- AquaSurge® PRO 2000-4000 Pump (comes with Remote and Receiver)
- 1.5" x 25' Flexible PVC Pipe
- Pump Check Valve Assembly and Installation Kit
- Automatic Water Treatment Dosing System for Fountains
- Welcome Kit - printed material, USB manual, video and instructions



New
Now Includes
Automatic
Dosing System



Medium Pondless® Waterfall With Up To 16' Stream

#53039 MSRP \$2,027.93
(Unit Weight: 212 lbs.)

with AquaSurge® PRO 2000-4000 Pump

#53040 MSRP \$2,000.93
(Unit Weight: 215 lbs.)

with 3PL - 3000 Pump

**Two Pump
Model
Choices**

Have the flexibility to create longer waterfalls and streams with the Medium Pondless® Waterfall Kit. Includes a stream liner long enough for you to install up to a 16' stream and waterfall.

Kit Includes:

- 10' x 12' Liner and 120 sq. ft. Underlayment
- 10' x 20' Stream Liner
- Pondless® Waterfall Vault
- Waterfall Spillway
- (5) Small AquaBlox®
- AquaSurge® PRO 2000-4000 **OR** 3PL - 3000 Pump
- 2" x 25' Flexible PVC Pipe
- Pump Check Valve Assembly and Installation Kit
- LED Lighting Package
 - (2) 1-Watt 12V LED Waterfall Lights
 - 60-Watt Transformer w/photocell
 - 3-Way Splitter and 25' LVL Extension Cable
- Automatic Water Treatment Dosing System for Fountains
- Welcome Kit - printed material, USB manual, video and instructions



New
Now Includes
Automatic
Dosing System



Large Pondless® Waterfall With Up To 26' Stream

#53041 MSRP \$2,572.77
(Unit Weight: 309 lbs.)

with AquaSurge® PRO 4000-8000 Pump

#53042 MSRP \$2,590.77
(Unit Weight: 313 lbs.)

with 5PL - 5000 Pump

**Two Pump
Model
Choices**

Our largest pre-packaged Large Pondless® Waterfall Kit uses the Pondless® Vault with the Vault Extension allowing you to store more water and create longer stream and waterfall runs.

Kit Includes:

- 12' x 15' Liner and 180 sq. ft. Underlayment
- 10' x 30' Stream Liner
- Pondless® Waterfall Vault
- Pondless® Waterfall Vault Extension
- Waterfall Spillway
- (5) Large AquaBlox®
- AquaSurge® PRO 4000-8000 **OR** 5PL - 5000 Pump
- 2" x 50' Flexible PVC Pipe
- Pump Check Valve Assembly and Installation Kit
- LED Lighting Package
 - (3) 1-Watt 12V LED Waterfall Lights
 - 60-Watt Transformer w/photocell
 - 3-Way Splitter and 25' LVL Extension Cable
- Automatic Water Treatment Dosing System for Fountains
- Welcome Kit - printed material, USB manual, video and instructions





The Science Behind Filtration

There are two forms of filtration that are critical to maintaining a successful ecosystem pond: mechanical and biological. Through biological and mechanical filtration, the water garden will process a variety of nutrients found in the system, including fish waste, uneaten fish food, leaves, and runoff from lawns.

An important role of proper filtration is avoiding high levels of ammonia (a form of nitrogen). High ammonia levels can be toxic to fish as well as contribute to prolific algae growth. Biological filtration utilizes nitrogen more than any other nutrient in these systems, and therefore plays a crucial role in the success of maintaining a healthy water feature.

So, how does biological filtration work? Biological filtration begins as nitrifying bacteria absorb ammonia and turn nitrites into nitrates. Nitrates are less dangerous and act as excellent fertilizer, as they are absorbed by aquatic plants and algae during their growth processes.

After nitrites are converted into nitrates, the nitrates are removed from the pond by denitrification, another biological filtration method. This process occurs only in anaerobic areas of the pond (areas without oxygen). One area that experiences minimal water flow and oxygen is below the surface of the gravel at the bottom of the pond. The anaerobic bacteria that live in these areas of the pond turn nitrates into nitrogen gas, which is released into the atmosphere.

There literally needs to be billions of bacteria at work in order for the biological filtration to work successfully to purify the water. These bacteria prefer to anchor themselves to a surface, which is why surface area is so important in constructing a successful ecosystem. More surface area means more bacteria, which maximizes the effectiveness of biological filtration. Surface area in a water feature is provided by filter media (BioBalls™), rocks, and gravel. A pond with gravel on the bottom will contain more surface area compared to a pond with exposed liner at the bottom, providing more space for bacteria to colonize!

Aquascape offers a wide selection of premium pond filtration products to suit any budget or water garden.



How to Choose the Right Filter for Your Pond

Choosing the right filter for your pond/water garden can be an intimidating and daunting task, so let us break up the task into easier-to-digest categories and desired functionality. There are advantages and disadvantages to every type of filter so we will list the features and benefits of each filter, making the choice of correct filter for your application easier.

New Ponds

The advantage of choosing the right filter before you get started should not be underestimated. Aquascape takes an ecosystem approach to water gardening. This approach uses a Skimmer and BioFalls®. The skimmer removes leaves and debris from the surface of the pond optimizing water quality. A BioFalls® Filter performs two very important functions; it supports mechanical and biological filtration and is also a great start to any waterfall.

Existing Ponds

In some circumstances it is difficult to add a Skimmer and/or BioFalls® to an existing system, maybe the shape and/or building technique makes it prohibitive. In this situation we would normally recommend the use of a UltraKlean™ Pressure Filter, Submersible Pond Filter or Pond Filter Urn. These filters will retrofit quickly into existing systems and provide efficient biological and mechanical filtration.

						
	BioFalls® Filter	Skimmer Filter	UltraKlean™ Pressure Filter	Submersible Pond Filter	Pond Filter Urn	IonGen™
Mechanical Filtration	√	√	√	√	√	
Biological Filtration	√		√	√	√	
UV Clarifier			√			
Lifetime Warranty	√	√				
Easy to Maintain	√	√	√	√	√	√
Energy-efficient	NA	NA	√	NA	NA	√
Ideal for New Pond	√	√	√	√	√	√
Controls String Algae						√
Controls Green Water			√			
Ideal for Existing Ponds	√		√	√	√	√





Aquascape Skimmer Filters

U.S. Patent 7,144,501

Can I have a pond without a skimmer?

Yes, of course you can have a pond without a Skimmer. However, skimmers are designed to eliminate water quality problems and reduce maintenance by removing debris before it sinks to the bottom of the pond, allowing a pond to be installed anywhere, even beneath trees. Because the skimmer removes debris before it gets to the pump, it acts as a pre-filter reducing pump maintenance, and makes accessing the pump quick and easy.

New

Signature Series™ 200 Pond Skimmer

#43020 MSRP \$199.98

(Unit Weight: 15.9 lbs.)

20"L x 17.5"W x 17.5"H



New

Signature Series™ 400 Pond Skimmer

#43021 MSRP \$319.99

(Unit Weight: 21 lbs.)

21.5"L x 18"W x 21"H



New

Signature Series™ 1000 Pond Skimmer

#43022 MSRP \$499.99

(Unit Weight: 27 lbs.)

21"L x 22"W x 26.5"H



Step-By-Step

1
Select the location for Skimmer placement.



2
Level the Skimmer and check for correct water level.



3
Mark the liner for installation.



4
Use silicone and screws to adhere Skimmer door.

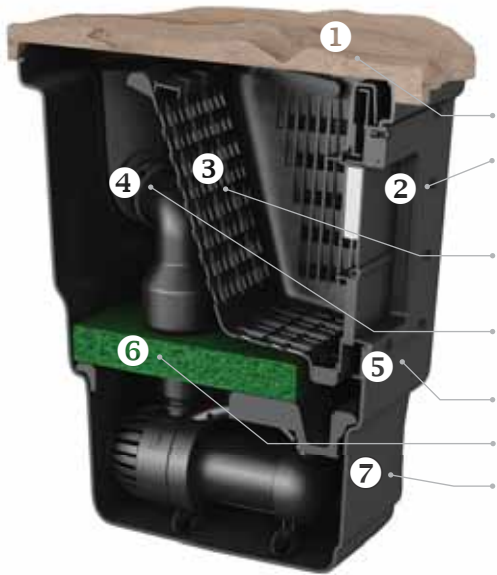

5
Trim liner and complete installation.

Features found on the Signature Series™ 400 and 1000 Pond Skimmers

- ① Natural Looking Faux-Rock Lid: Grooves designed into lid provide space for gravel or mulch
- ② Patented Adjustable Faceplate: Have you ever messed up your transit measurement when setting your pond's water level? Forget about it! Three inches of travel enable you to tweak out the perfect water level (Signature 1000 only)
- ③ Easy Maintenance: We are making it as easy as possible for the pond owner to maintain their filter with a large-volume, rigid debris basket (Signature Series™ 400 and 1000)
- ④ Injection Molded Fittings: Check valve threads into skimmer wall providing a professional watertight seal along the back of the filter
- ⑤ Corrosion-resistant non-cross-threading hardware stands up to the elements
- ⑥ Filter mat removes smaller sediment and debris
- ⑦ Rounded shape provides maximum strength



**VIDEO ON
SKIMMER FILTERS**

Aquascape Skimmer Specification Chart

Model	Signature Series™ 200 Pond Skimmer	Signature Series™ 400 Pond Skimmer	Signature Series™ 1000 Pond Skimmer
Pond Size	up to 200 sq. ft.	up to 400 sq. ft.	up to 1,000 sq. ft.
Pump Flow Rate	up to 3,000 GPH / 11,360 LPH	up to 4,000 GPH / 15,140 LPH	up to 10,000 GPH* / 37,850 LPH
Recommended Pumps	AquaSurge®	AquaSurge®, AquaSurge® PRO & PL's	AquaSurge®, AquaSurge® PRO & PL's*
Weir Size	6"	6"	8"
Adjustable Height Face Plate	-	Included	Included
Leaf & Debris Net	Included	-	-
Leaf & Debris Rigid Basket	-	Included	Included
Filter Brush Cartridge	Optional	-	-
Filter Mat	-	Included	Included
Dimensions	20"L x 17.5"W x 17.5"H	21.5"L x 18"W x 21"H	21"L x 22"W x 26.5"H
Warranty	Limited Lifetime	Limited Lifetime	Limited Lifetime

* Note: 12PN-10,000 and AquascapePRO® 10,000 pumps are too large to fit in these skimmers. Multiple pumps can be used to achieve up to 10,000 gallons per hour.



Aquascape BioFalls® Filters

Aquascape professional-grade BioFalls® Filters provide the most filtration and highest water flows in the market. Durable rotationally-molded polyethylene ensures maximum strength and withstands whatever Mother Nature can dish out. All Aquascape BioFalls® Filters include a lifetime warranty!

- Circular shape maximizes structural strength
- Fully-attachable lip with patented non-cross threading screws make it easy to install



Signature Series™ 1000 BioFalls® Filter

(2" Bulkhead)

#99774 MSRP \$279.98

(Unit Weight: 11 lbs.)

17.5"L x 20.5"W x 17"H



Signature Series™ 2500 BioFalls® Filter

(2" Bulkhead)

#09020 MSRP \$479.99

(Unit Weight: 23 lbs.)

24"L x 29.5"W x 20"H



Signature Series™ 6000 BioFalls® Filter

(2" Bulkhead)

#29319 MSRP \$759.99

(Unit Weight: 55 lbs.)

40"L x 45"W x 29.5"H



Signature Series™ 6000 BioFalls® Filter

(3" Bulkhead)

#29384 MSRP \$799.99

(Unit Weight: 57 lbs.)

40"L x 45"W x 29.5"H

Step-By-Step

1
Select the location for the BioFalls® placement.



2
Level the BioFalls®.



3
Prepare liner for installation.



4
Use silicone and screws to attach liner to filter.



5
Trim liner and complete installation.



Features found on the BioFalls® Filter 2500 & 6000



- ① More advanced installers will love the reversible waterfall lip option, which provides the flexibility of using a natural stone spillway and large accent boulders along the front of the unit (for 2500 and 6000 model filters)
- ② Removable upper tray can hold rocks, plants, and gravel, helping to naturalize the BioFalls® Filter into the surrounding landscape
- ③ Media net (BioBalls™ sold separately)
- ④ Corrosion resistant non-cross-threading hardware stands up to the elements
- ⑤ Two Poly-Flo ESA biological Filter Mats provide 50% more surface area than traditional filter mats
- ⑥ Two bulkhead ports provide plumbing options
- ⑦ Filter support rack ensures evenly distributed waterflow through filter mats and provides structural strength to the walls of the filter
- ⑧ Circular shape provides maximum strength and makes it easy to camouflage into the landscape

See page 33 for more information on BioBalls™

rp replacement parts available



VIDEO ON BIOFALLS® FILTERS

Aquascape BioFalls® Specification Chart

Model	BioFalls® 1000 Filter	Signature Series™ 2500 BioFalls® Filter	Signature Series™ 6000 BioFalls® Filter	Signature Series™ 6000 BioFalls® Filter
Filters Pond up to	1,000 gallons / 3,800 liters	2,500 gallons / 9,500 liters	6,000 gallons / 22,700 liters	6,000 gallons / 22,700 liters
Pump Flow Rate	up to 3,000 GPH / 11,400 LPH	up to 5,000 GPH / 18,900 LPH	up to 15,000 GPH / 56,800 LPH	up to 15,000 GPH / 56,800 LPH
Spillway Width	15"	21.5"	28"	28"
Bulkhead Port	Single 2"	Dual 2"	Dual 2"	Dual 3"
Fittings Included	1.5" PVC slip & 1.5" kink-free insert	Two 2" PVC slip	Two 2" PVC slip	Two 3" PVC slip
Rock Tray	Optional	Included	Included	Included
Filter Mats	Two Included	Two Included	Two Included	Two Included
BioBalls™	100 Included*	200 Included*	400 Included*	400 Included*
Media Nets	One Included	Two Included	Three Included	Three Included
Dimensions	17.5"L x 20.5"W x 17"H	24"L x 29.5"W x 20"H	40"L x 45"W x 29.5"H	40"L x 45"W x 29.5"H
Warranty	Limited Lifetime	Limited Lifetime	Limited Lifetime	Limited Lifetime

* Note: BioBalls™ only included as part of Pond Kits. See Kits starting on page 10. To buy BioBalls™ separately see page 33.

Pondless® Waterfall Vault

U.S. Patent 7,754,072

#49000 MSRP \$269.99

(Unit Weight: 14 lbs.)

Not too big and not too small, the expandability of the Pondless® Waterfall Vault makes this filter perfectly sized to meet the need of any Pondless® Waterfall or RainXchange® project.

- Simple to install and maintain
- Large interior fits a wide range of pump sizes up to 12,500 gallons per hour
- Expandable height allows the Pondless® Waterfall Vault to be used on any size project
- Comes standard for use with the Small AquaBlox®
- Optional Pondless® Waterfall Extensions can be used when creating deeper basins using the Large AquaBlox®
- Made from durable rotationally molded polyethylene



Pondless® Waterfall Vault



Pondless® Waterfall Extension

Pondless® Waterfall Extension

#49001 MSRP \$74.99

(Unit Weight: 5.4 lbs.)

- Slides onto the Pondless® Waterfall Vault increasing the height for deeper basins using the Large AquaBlox®
- Required when using larger and/or taller pumps with 3-inch plumbing to ensure the height of the vault is tall enough to accommodate the large pump

Pondless® Waterfall Vault & Extension Specification Chart

	Vault	Vault Extension
Dimensions	23"L x 17"W x 25.5"H	16"L x 16"W x 9"H
Access Opening Dimensions	16"L x 16"W	16"L x 16"W
Pump Sizes	up to 12,500 GPH / 47,300 LPH	up to 12,500 GPH / 47,300 LPH



**VIDEO ON
PONDLESS®
WATERFALL VAULT**



Designed to integrate with the AquaBlox® making excavation and installation a snap!



Built in water level inspection port allows lid to be buried out of sight.



- ① Extra wide opening provides easy pump access
- ② Excellent water circulation through horizontal and vertical water intakes
- ③ Large interior fits a wide range of pump sizes

Pondless® Waterfall Vault Application

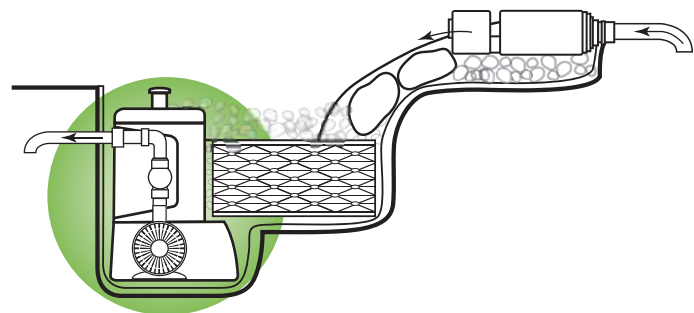

Waterfall Spillway

#77000 MSRP \$139.99

(Unit Weight: 9 lbs.)

17.5"L x 24"W x 5"H

The Waterfall Spillway is a cost-effective solution to help create the starting point of a beautiful waterfall and stream.

- Creates smooth, consistent, leak-free water flow
- Handles flow rates up to 7,500 GPH / 28,000 LPH
- The durable design makes it easy to disguise by allowing soil, rocks or logs to be placed directly on top of the unit
- Comes complete with a 2-inch PVC slip fitting, 1.5-inch barbed hose fitting and pre-installed bulk head

When to use the Waterfall Spillway - The Waterfall Spillway is a versatile tool that can be used in a wide variety of water feature applications. You may find that your imagination is the only limitation to what you can create with the Waterfall Spillway.

- The Waterfall Spillway is an ideal solution for starting waterfalls on Pondless® Waterfall systems, where, due to the absence of fish, more expensive biological filters aren't necessary.
- The Waterfall Spillway is also an excellent choice for designing additional waterfalls and streams onto new or existing ponds that already have a biological filter.
- With the Waterfall Spillway you can build behind hardscape walls to provide a more formal waterfall design.
- You can use multiple Waterfall Spillways to design larger, more creative waterfall configurations.



- ① Strong design allows boulders, logs, gravel, soil or other creative landscape material to be set directly on top of the Waterfall Spillway, helping to camouflage it into the surrounding landscape
- ② Watertight connection is made using the fitting on the back of the Waterfall Spillway
- ③ Wide 22-inch spillway handles flow rates up to 7,500 gallons per hour
- ④ Internal barriers dam the incoming flow of water, providing a smooth-flowing waterfall



**VIDEO ON
WATERFALL SPILLWAY**

Waterfall Spillway Specification Chart

Spillway Width	22"
Bulkhead Port	Single 2"
Fittings Included	2" PVC slip, 1.5" barbed hose fitting and pre-installed bulkhead
Flow Rates Handled	7,500 GPH / 28,000 LPH

Waterfall Spillway Application

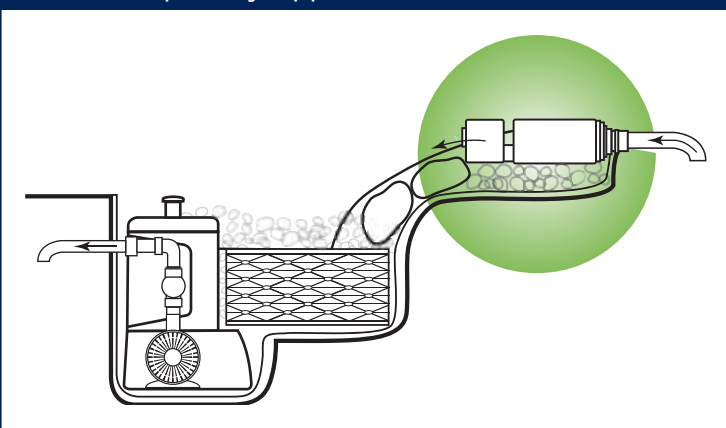

UltraKlean™ Biological Pressure Filter

Guaranteed to clear pond water

The Aquascape UltraKlean™ Biological Pressure Filter with a high output ultraviolet clarifier/sterilizer and an integrated electronic bulb-saver option, provides pond owners with optimum water conditions and crystal clear pond water. The unique sponge-free design minimizes maintenance and maximizes efficient mechanical and biological filtration. Simple-to-use cleaning feature allows for the unit to be backwashed in less than five minutes without opening the canister or getting hands dirty.

- Provides optimal filtration for ponds up to 3,500 gallons / 13,000 liters
- Efficiently traps dirt and debris and eliminates green water
- Includes Aquascape UltraKlean™ Bio-Media and T5 high-output ultraviolet clarifier/sterilizer
- Easily integrated into new or existing ponds

UltraKlean™ 2000

#95053 MSRP \$369.98

(Unit Weight: 12 lbs.)

UltraKlean™ 3500

#95054 MSRP \$449.98

(Unit Weight: 15 lbs.)



UltraKlean™ 3500

UltraKlean™ 2000



Fittings Included

6x 1", 1.25", 1.5" Multi-Hose Adapters, 1x Backwash Cap



For ponds larger than 3,500 gallons, or ponds containing large fish loads, we recommend using a larger unit or multiple units. Multiple UltraKlean™ units can be easily plumbed in line with one pump using an Aquascape Two-Way Control Valve (sold separately).

UltraKlean™ Product Specification Chart

Model	2000	3500
Average Pond Size Recommendation	2,000 US gallons / 7,600 liters	3,500 US gallons / 13,000 liters
Maximum Flow Rate (GPH)	2,700 GPH / 10,200 LPH	5,200 GPH / 19,800 LPH
Wattage	14 Watts	28 Watts
Power Cord Length	20'	20'
Discharge Hose Diameter	1", 1.25", 1.50"	1", 1.25", 1.50"
Dimensions	13"L x 13"W x 17"H	13"L x 13"W x 21.5"H
Warranty	3-Year Limited	3-Year Limited

Aquascape UltraKlean™ Filtration Kits

Aquascape UltraKlean™ Filtration Kits take the guesswork out of selecting the correct pump and filtration combination for any new or existing pond. Available in three sizes and two configurations, there is an UltraKlean™ Filtration Kit for almost any pond configuration. Buying a filtration kit is simple and provides the best overall value. Components are selected by Aquascape not only for size of pond, but also matched components that will work well together as a team.



UltraKlean™ 1500 Filtration Kit

#95058 MSRP \$599.98
(Unit Weight: 38 lbs.)

Pressure Filter and Pump Kit

Includes the following components:

- UltraKlean™ 2000 Pressure Filter with Integrated 14-Watt UV Clarifier/Sterilizer
- AquaForce® 1000 Solids Handling Waterfall Pump
- 25 Feet of 1.5" Quality Kink Free Pipe
- Stainless Steel Hose Clamps
- Provides filtration for ponds up to 1,500 gallons / 5,678 liters



UltraKlean™ 2500 Filtration Kit

#95059 MSRP \$649.98
(Unit Weight: 40 lbs.)

Pressure Filter and Pump Kit

Includes the following components:

- UltraKlean™ 2000 Pressure Filter with Integrated 14-Watt UV Clarifier/Sterilizer
- AquaForce® 2700 Solids Handling Waterfall Pump
- 25 Feet of 1.5" Quality Kink Free Pipe
- Stainless Steel Hose Clamps
- Provides filtration for ponds up to 2,500 gallons / 9,464 liters



UltraKlean™ 3500 Filtration Kit

#95060 MSRP \$799.98
(Unit Weight: 45 lbs.)

Pressure Filter and Pump Kit

Includes the following components:

- UltraKlean™ 3500 Pressure Filter with Integrated 28-Watt UV Clarifier/Sterilizer
- AquaForce® 5200 Solids Handling Waterfall Pump
- 25 Feet of 1.5" Quality Kink Free Pipe
- Stainless Steel Hose Clamps
- 2 Way control valve
- Provides filtration for ponds up to 3,500 gallons / 13,249 liters



UltraKlean™ 1000 Filtration Kit

#77014 MSRP \$519.98
(Unit Weight: 32 lbs.)

BioFalls® Filter and Pump Kit

Includes the following components:

- Signature Series™ 1000 BioFalls® Filter
- AquaForce® 2700 Solids Handling Waterfall Pump
- 25 Feet of 1.5" Quality Kink Free Pipe
- Stainless Steel Hose Clamps
- Allows spillway for waterfall creation





Submersible Pond Filter (for ponds up to 800 gallons)

#95110 MSRP \$64.98

(Unit Weight: 4.5 lbs.)

New

Low-profile in-line pump filter

The Aquascape Submersible Pond Filter provides pond owners with efficient mechanical and biological filtration. This unobtrusive filter can be added to the intake of almost any submersible water pump resulting in crystal clear water and maintenance-free pumps.

- Provides additional filtration
- Pre-filters pumps for reduced maintenance
- Removable cage for easy cleaning
- Keeps pond water clean, clear and healthy



Fitting Included

2x 3/4", 1", 1.25" Multi-Hose Fitting



**Ideal for use
with Ultra pumps
up to 1100
will handle
flow rates up to
1300 GPH**



Step-By-Step

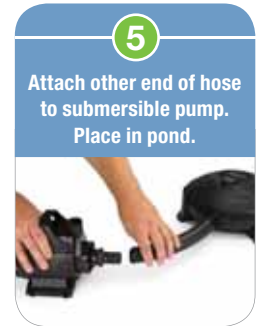
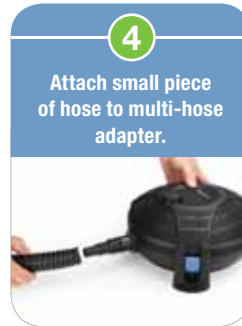
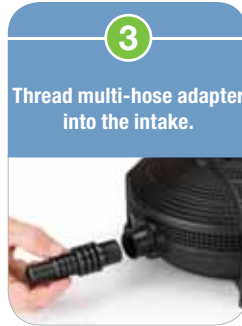
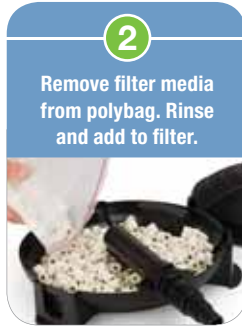
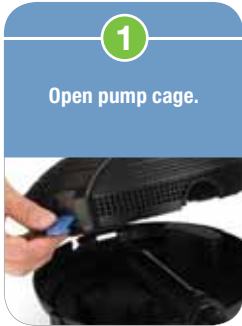

- ① The large surface area of the cage and small openings prevents large debris from clogging the filter
- ② The pre-filtration sponge pack is a mechanical/biological filter media preventing small debris from clogging or damaging pump impeller, dramatically reducing pump maintenance
- ③ The included threaded intake and multi-hose adapter makes this filter easily adapt to most pond pumps with a small piece of kink free hose or 3/4" threaded fitting
- ④ The ceramic filtration rings provide a huge surface area for beneficial bacteria to colonize, providing efficient biological filtration

Submersible Pond Filter Application

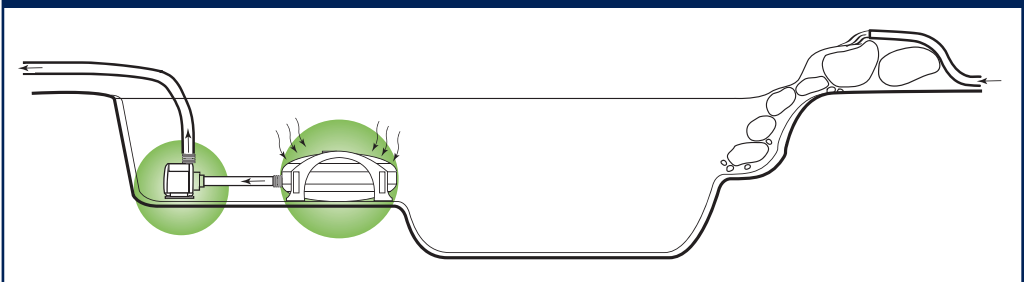

IonGen™ System G2

#95027 MSRP \$379.98

(Unit Weight: 3.3 lbs.)

4.25" L x 1" W x 3.25" H (Control Panel)

6.25" L x 2.75" W x 4.75" H (Flow Chamber)

The IonGen™ System G2 Electronic Algae Controller allows you to spend your time relaxing next to your water feature instead of trying to maintain it! The IonGen™ effectively kills algae without the use of traditional liquid chemicals and is designed with a microprocessor that sends a signal to its ion producing probe helping to control algae throughout the entire water feature.

- Drastically reduces pond maintenance
- Helps to control unsightly algae without the use of liquid chemicals
- Simple to install
- Compatible with water containing fish and plants
- Energy efficient (less than \$1 per month in electrical costs)
- Treats ponds up to 25,000 gallons
- Probe typically lasts 1-3 seasons depending on the ionization level, volume of water in the pond, and the algae conditions you are trying to control
- Complete with electronic control panel, outdoor-rated transformer, flow chamber, probe fittings, probe holder, copper test kit, alkalinity test kit and owner's manual



EPA Registration #83739-1

How does the Aquascape IonGen™ System G2 Help Control String Algae?

The Aquascape IonGen™ System releases a calculated mixture of copper ions into the path of flowing water. The IonGen™ Control Panel sends signals that slowly dissolve the replaceable probe. The ions produced by the probe treat the water and reduce string algae, as well as drastically reduce maintenance and the need for liquid pond chemicals.



VIDEO ON
IONGEN™

IonGen™ Pond Application

- Option 1:** Probe can be installed directly into the water feature plumbing
Option 2: Probe can be placed in an area with good water circulation

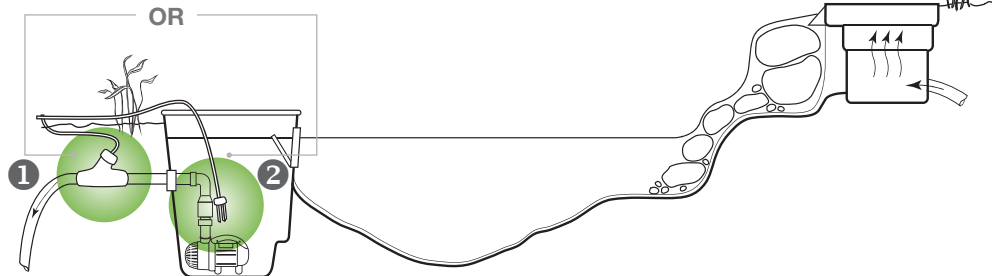

Step-By-Step

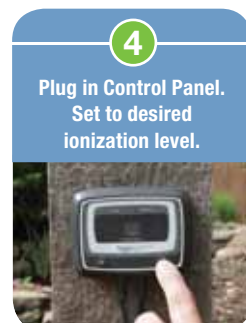
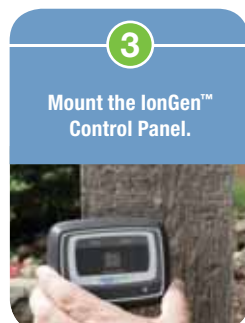
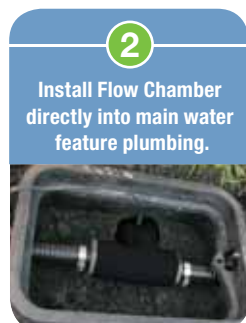
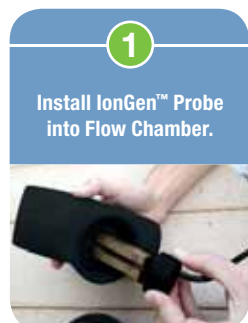



- ① Weatherproof Control Panel
- ② Easy-to-read digital display
- ③ Indicator notifies you when the probe needs to be replaced
- ④ Adjustable ionization level
- ⑤ Durable quick-connect electrical connections - cable to transformer (12' long) and probe (15' long)



- ⑤ durable quick-connect electrical connections



Fittings Included

1", 1.25", 1.5" Multi-Hose Fitting, 2" PVC Slip Fitting

Complete with electronic control panel, outdoor-rated transformer, flow chamber, probe fittings, probe holder, copper test kit, alkalinity test kit and owner's manual

IonGen™ Probe Holder

#95077 MSRP \$9.98

(Unit Weight: .5 lbs.)

- Allows for installation of G2 Probe without Flow Chamber
- Can be used in a filter, such as a Skimmer or Pondless® Waterfall Vault
- Straps onto any pipe from 1 - 4 inches in diameter
- Works great attached to the AquascapePRO® Check Valve



IonGen™ Probe for the G2 System

#95028 MSRP \$119.98

(Unit Weight: .5 lbs.)

1.5"L x 1.5"W x 3.25"H

- For 2nd Generation Flow Chamber
- Includes 5 ft. Quick-Connect cable



IonGen™ Probe for the G1.5 System

#95075 MSRP \$119.98

(Unit Weight: 1 lb.)

- For 1st Generation PVC tee-style Flow Chamber and the G2 control panel
- Includes 5 ft. Quick-Connect cable



Copper Test Kit

#96020 MSRP \$19.98

(Unit Weight: .2 lbs.)

- Measures residual copper
- 25 tests per kit



KH/Alkalinity Test Kit

#96019 MSRP \$19.98

(Unit Weight: .2 lbs.)

- Measures KH/Alkalinity
- 60 tests per kit





UltraKlear® UV Clarifier/Sterilizer

In a pond, algae blooms, or "green water", can be a difficult issue to address safely and effectively. Not anymore! The Aquascape UltraKlear® UV Clarifier/Sterilizer uses a technologically-advanced T5 high output UVC bulb, making it more efficient than traditional UV clarifiers. The Aquascape UltraKlear® UV Clarifier/Sterilizer features a swirl sleeve that helps direct the water around the UV bulb, creating more contact time and increasing UV efficiency up to 50% over traditional UV clarifiers.

- Effectively clears unsightly green (pea soup) water algae blooms
- Simple to use, install and easy to maintain
- Features a swirl sleeve that optimizes UV efficiency
- High-output UV bulb maximizes performance
- Easy-to-remove bulb and quartz sleeve
- Can be mounted horizontally or vertically

3-Year
Limited
Warranty

UltraKlear® 1000

#95036 MSRP \$189.98
(Unit Weight: 6.5 lbs.)

UltraKlear® 2500

#95037 MSRP \$239.98
(Unit Weight: 8 lbs.)

UltraKlear® 5000

#95038 MSRP \$309.98
(Unit Weight: 10 lbs.)



Step-By-Step

1
Select a location near the pond.



2
Attach the tubing from the pump.



3
Attach the tubing to the remaining fitting for return to the pond.

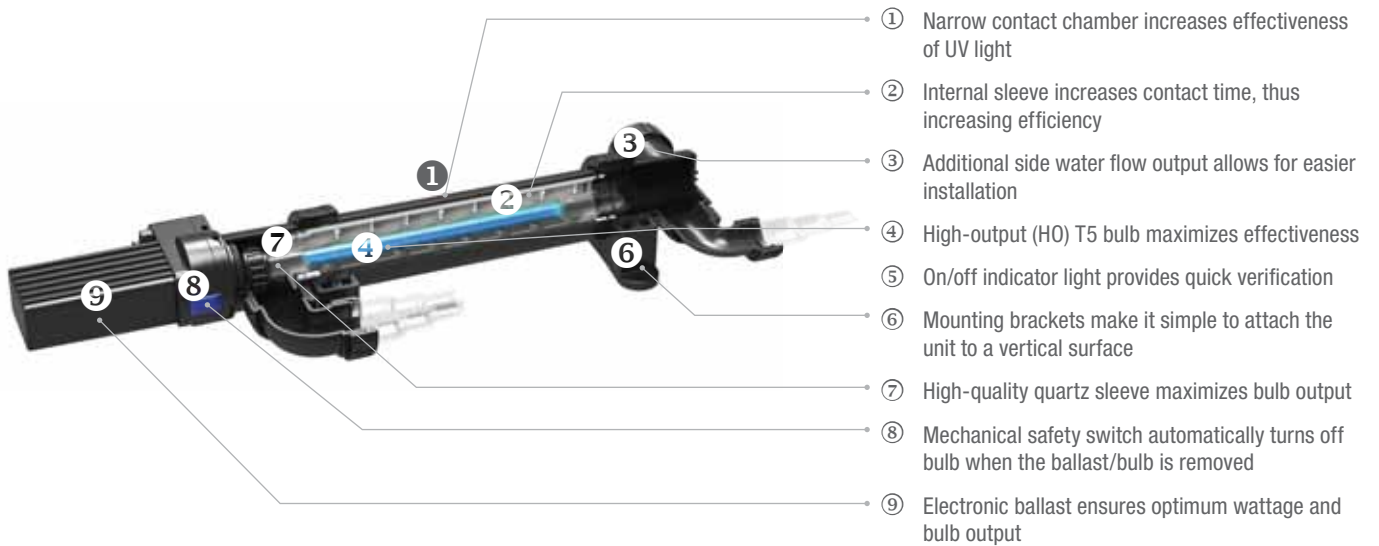
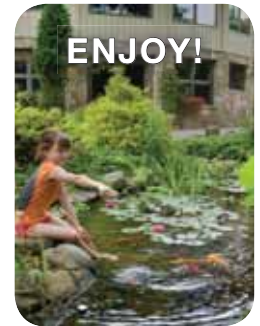

4
Route tubing back to the pond.

Fittings Included

2x Locking Rotational Ball Fittings, 4x 1", 1.25", 1.5" Multi-Hose Fittings, 2x Elbows, 2x Adapters, 2x Mounting Brackets



For ponds larger than 5,000 gallons or ponds containing large fish loads, we recommend using a larger unit, or multiple UltraKlear® UV units. Multiple units can be easily plumbed in line with an UltraKlear® UV Adapter Kit or the Aquascape Two-way Control Valve.

UltraKlear® Product Specification Chart			
Model	1000	2500	5000
Average Pond Size Recommendation	1,000 US gallons / 3,800 liters	2,500 US gallons / 9,500 liters	5,000 US gallons / 19,000 liters
Maximum Flow Rate	500 GPH / 1,900 LPH	1,000 GPH / 3,800 LPH	1,500 GPH / 5,700 LPH
Wattage	14 Watts	28 Watts	55 Watts
Power Cord Length	20'	20'	20'
Discharge Hose Diameter	1", 1.25", 1.50"	1", 1.25", 1.50"	1", 1.25", 1.50"
Dimensions	23.5"L x 5.5"W x 3.75"H	33.5"L x 5.5"W x 3.75"H	43"L x 5.5"W x 3.75"H
Warranty	3-Year Limited	3-Year Limited	3-Year Limited

Pond Filter Urn

The Aquascape Pond Filter Urn is ideal for smaller ponds, including preformed ponds or container water gardens. The Aquascape Pond Filter Urn can easily be incorporated into existing ponds. Ideal for use with Aquascape Ultra™, AquaForce® or AquaJet™ Water Pumps.

Pond Filter Urn

#77006 MSRP \$159.98
(Unit Weight: 16.1 lbs.)



Pond Filter Urn - Lg

#77011 MSRP \$299.98
(Unit Weight: 25 lbs.)



Pond Filter Urn Filtration Replacement Kit

#77007 MSRP \$39.98
(Unit Weight: 5 lbs.)



Pond Filter Urn Filtration Replacement Kit - Lg

77012 MSRP \$79.98
(Unit Weight: 8 lbs.)



- ① The removable filter lid allows easy access for cleaning
- ② The decorative filter housing can be easily incorporated into most any setting
- ③ Inlet hose will accommodate most small pumps
- ④ Mechanical filtration filters out debris
- ⑤ Ceramic filtration rings provide bacteria with a large surface area for colonization

Aquascape Pond Filter Urn

Product	Max Flow Rate	Pond Volume	Inlet Fitting Dimensions	Filter Dimensions
Pond Filter Urn	400 GPH	500 gal	1/2"	20"L x 11"W x 11"H
Pond Filter Urn - Lg	1,100 GPH	1,500 gal	3/4"	28"L x 15.5"W x 15.5"H



**VIDEO ON
FILTER URN**

Container Water Garden Filter

#77005 MSRP \$27.98
(Unit Weight: .8 lbs.)

Ideal for all container water gardens holding up to 50 gallons of water

The Aquascape Container Water Garden Filter is a complete solution for small to medium-size container water gardens or any containers with stagnant or non-moving water including birdbaths, or water containers holding specimen pond plants like lotus or waterlilies.

- Provides ideal filtration when adding goldfish to a container water garden
- Magnetically driven, or "mag drive" motor technology, is simple and easy to maintain
- Extremely energy-efficient
- Durable pre-filter water intake design prevents clogging and reduces pump maintenance
- Provides years of trouble-free operation



- ① Adjustable spray bar allows for surface movement and adds oxygen to the water
- ② Integrated suction cups help adhere the Container Water Garden Filter to the integrated shelf found in the Aquascape Patio Pond
- ③ Mechanical and biological filter sponge and filter carbon reduces maintenance and provides excellent filtration
- ④ Protective pump cage and large mechanical and biological pre-filter prevents debris from clogging or damaging pump



BioBalls™ (100 pcs.)

#98464 MSRP \$44.98

(Unit Weight: 2.8 lbs.)

1.5" diameter

Aquascape BioBalls™ provide a textured surface area (19 sq. inches per BioBall™) for beneficial bacteria to colonize and grow. Aquascape BioBalls™ are the ideal filtration media for use in all biological filtration. Each box contains 100 balls, and media bag with drawstring.

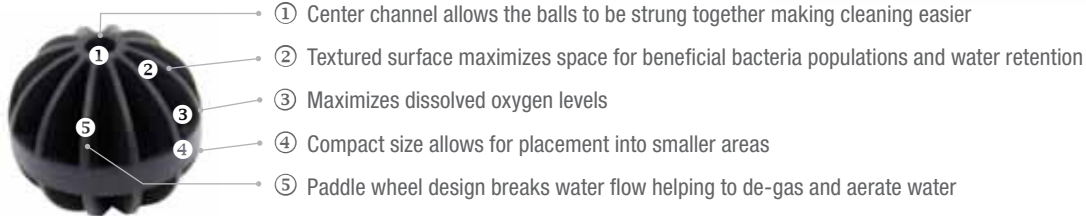

Filter Media Rolls

Bulk roll provides the ability to cut the filter mat to the shape and size of any pond filter. The 2" coarse material is the most popular material used in skimmers and biological filters.

1.25" x 10' Coarse 56" wide

#99321 MSRP \$229.98

(Unit Weight: 8.4 lbs.)

2" x 10' Coarse 56" wide

#99323 MSRP \$279.98

(Unit Weight: 11.9 lbs.)

1" x 10' Dense 56" wide

#99325 MSRP \$189.98

(Unit Weight: 8.8 lbs.)



Coarse Filter Mat



Dense Filter Mat



Aquascape Filter Media Mats

Aquascape Filter Media Mats can be easily cut to desired size using a serrated knife. Aquascape Filter Media Mats are easy to maintain and only need to be cleaned periodically. For best results we recommend combining different densities maximizing mechanical and biological filtration.

New



Low Density Filter (Black)

#80003 MSRP \$49.98

(Unit Weight: 3.1 lbs.)

24"L x 39"W x 1.5" Thick



Medium Density Filter (Green)

#80004 MSRP \$49.98

(Unit Weight: 3.1 lbs.)

24"L x 39"W x 1.5" Thick



High Density Filter (Blue)

#80005 MSRP \$49.98

(Unit Weight: 3.1 lbs.)

24"L x 39"W x 1.5" Thick

AquaBlox®

Aquascape's AquaBlox® modular water storage system, also known as the D-Raintank® by Atlantis®, is an efficient way to maximize your water storage capacity in Pondless® Waterfall reservoirs.

- Over 3 times more water storage capacity than gravel
- Holds approximately 7.4 gallons of water per cubic foot, as compared to gravel, which holds approximately 2.2 gallons of water per cubic foot
- Extra water storage capacity means less time topping off reservoir due to evaporation
- Easier to clean and less prone to clogging than traditional gravel basins
- The ability to hold more water per cubic foot allows for smaller reservoir footprint
- Less labor required to excavate and move gravel for basin
- Uses less liner and geotextile underlayment than reservoirs constructed with gravel



Modular Design

The lightweight design of AquaBlox® makes installation quick, safer and less expensive.

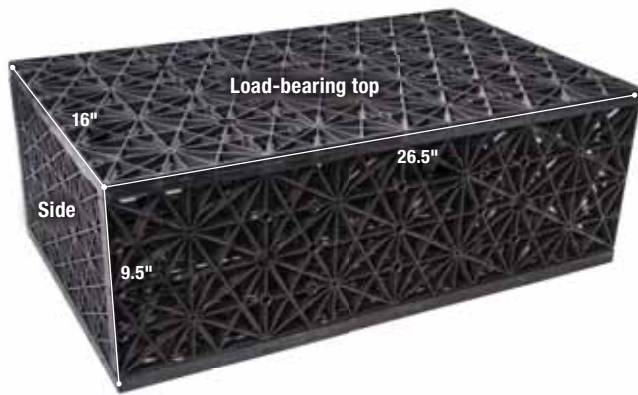

Small AquaBlox®

#29491 MSRP \$42.99
(Unit Weight: 11 lbs.)

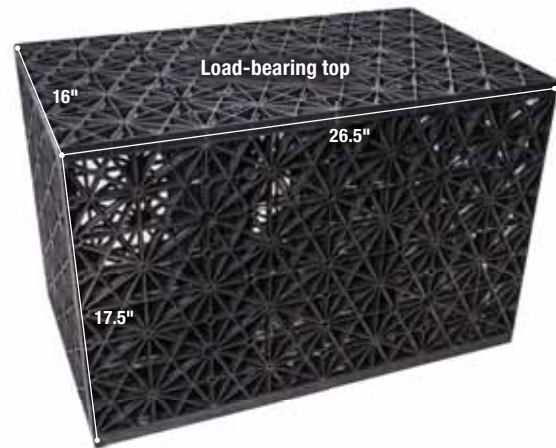

Large AquaBlox®

#29492 MSRP \$52.99
(Unit Weight: 16 lbs.)

AquaBlox® Specification Chart

AquaBlox® Size	Dimensions	Volume	Load Bearing Weight
Small	26.5"L x 16"W x 9.5"H	17 gallons	5,472 lbs./sq. ft.
Large	26.5"L x 16"W x 17.5"H	32 gallons	5,472 lbs./sq. ft.

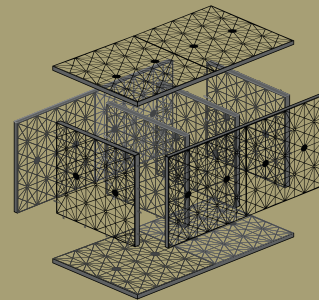

takes 1 minute
to assemble!

AquaBlox are assembled on site, making transporting and installation extremely efficient

Wetland Filter

U.S. Patent 6,740,232 and 7,114,668

A Field-Tested, Field-Proven System for Filtering Large Bodies of Water

Our patented Snorkel™ Vault and Centipede® Module were specifically designed to tackle any number of the common issues that plague large scale water features. They are modular in design, allowing builders and designers the flexibility to expand the system to meet their needs.

- Highly effective at removing sediment (suspended solids) from the pond
- Easily access collected sediment with the Snorkel™ Vault, reducing the need for costly and invasive dredging
- Improves water clarity
- Works on earth bottom and liner membrane ponds
- Strips excess nutrients from the water column, reducing algae and the physical and chemical maintenance that goes along with removing algae
- Easily retrofitted onto existing ponds
- Create a waterfall and stream by designing the wetland filter system off the perimeter of the pond

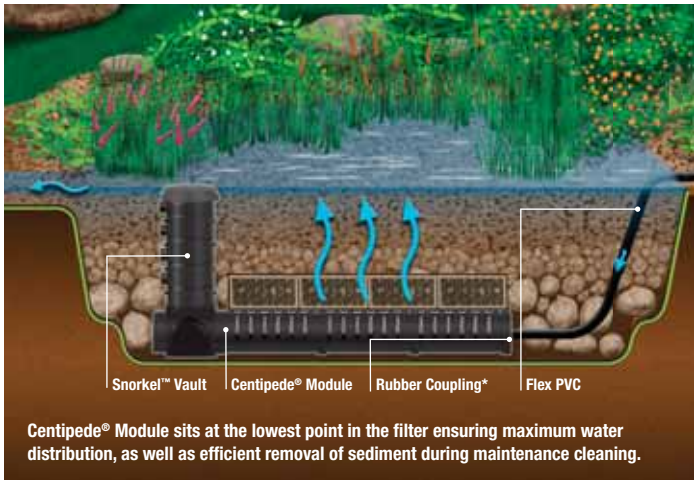

Constructed Wetland Filter System Requirements

Pond Size (in sq. ft.)	Actual Filter Size	Number of Centipede® Modules	Liner, Basic Configurations Minimum Sizes	Pump Flow GPH
600	8' x 10'	1	15' x 20'	3,000
2,400	8' x 15'	2	15' x 25'	4,500
7,200	8' x 20'	3	15' x 30'	7,500
10,000	8' x 25'	4	15' x 35'	10,000
20,000	8' x 50'	8	15' x 70'	20,000
40,000	25' x 50'	12	35' x 70'	30,000
80,000	50' x 50'	16	70' x 70'	40,000

Step 1: The layout of the Snorkel™ Vault and Centipede® Modules for the first shoreline wetland filter

Step 2: The excavated wetland is lined with EPDM rubber liner and the Snorkel™ Vault and Centipede® Modules are set in place

Step 3: The Centipede® Modules are covered with several layers of stones. The larger voids found between these stones allow the incoming water to flow throughout the wetland and provides ample room for the deposition of sediments

Step 4: A section of the finished wetland

Large Snorkel™ Vault and Cap

#29064 MSRP \$459.99
(Unit Weight: 27 lbs.)

- Allows pump to be dropped in for easy cleaning
- 4 ports for Large Centipede® Module attachment

Snorkel™ Vault Extension

#29068 MSRP \$169.99
(Unit Weight: 10 lbs.)

- For use when creating deeper basins. Also required when using the AquascapePRO 10,000 or 12PN pump
- For use with Large Snorkel™ Vault

Large Centipede® Module

#29065 MSRP \$329.99
(Unit Weight: 29 lbs.)

- Modular design
- For use with Large Snorkel™ Vault



Aquascape Pumps

Choosing the right water pump for your pond or fountain can be difficult and time consuming. With so many options to choose from it's often difficult to make a decision. The rising cost of electricity could also be a deciding factor. There are three basic types of water pumps available in the ornamental pond industry: motor driven, asynchronous, and magnetically driven pumps also known as mag drive. We hope the explanation and chart helps you make the right decision. If you are still having trouble making a decision please feel free to visit our website or contact us.

Motor Driven

Motor driven water pumps provide consumers with a high torque, high head height option with good solids handling ability. Motor driven pumps are generally easier to maintain because of their solids handling ability. One of the few downsides of using a motor driven pump is that the pump needs to be operated within a specific performance curve to optimize lifespan. They are also more expensive to run and consume more electricity when compared to asynchronous and mag drive pumps.

Asynchronous

Asynchronous water pumps are a hybrid between a motor driven and mag drive pump. They are easy to maintain and only have one moving part, making it less expensive and easy to repair if something goes wrong. One of the other advantages is that the pump is extremely energy-efficient, choosing this pump over a traditional motor driven pump often pays for itself quickly in power consumption. The only disadvantage of an asynchronous water pump is maintenance; the filter screen may need to be cleaned more often than a motor driven pump to prevent clogging.

Mag Drive

Mag drive water pumps are a simple and easy-to-use solution for small water features including small waterfalls. These pumps are easy to retrofit into existing water features and simple to maintain. Mag drive pumps only have one moving part making them inexpensive and easy to repair. Mag drive pumps are also extremely quiet and energy efficient.

Aquascape makes a complete range of energy efficient water pumps designed for all water gardening applications.



How to Choose the Right Pump for Your Water Feature

Ideal for Ponds and Waterfalls

	AquaSurge®	AquaSurge® PRO	PL and PN	AquascapePRO®	AquaForce®	AquaForce® PRO
Flow Range	2,000 to 5,000 GPH	up to 8,000 GPH	up to 10,000 GPH	up to 10,000 GPH	1,000 to 5,000 GPH	up to 8,000 GPH
Mag Drive						
Asynchronous	√	√			√	√
Motor Driven			√	√		
Comes with Fittings	√	√			√	√
Adjustable Flow Remote Control		√				√
Warranty Years	3	3	2	2	3	3
Large Solids Handling			√	√	√	√
Needs to be Pre-filtered with Skimmer or Vault	√	√	√	√		
Energy Efficient			√	√		
Extremely Energy-efficient	√	√			√	√
Ideal for Ponds	√	√	√	√	√	√
Ideal for Pondless® Waterfalls	√	√	√	√		

Ideal for Statuary and Decorative Fountains

	Ultra™ Pump	Statuary / Fountain Pump
Flow Range	up to 2,000 GPH	up to 320 GPH
Mag Drive	√	√
Asynchronous		
Comes with Fittings	√	√
Fountainheads Available (sold separately)	√	
Electronic Flow Remote Control		
Large Solids Handling		
Needs to be Pre-filtered with Skimmer or Vault		
Warranty Years	3	3
Ideal for Small Statuary	√	√
Ideal for Large Statuary	√	
Extremely Energy-efficient	√	√

Ideal for General Water Circulation

	AquaForce®	AquaJet™	Ultra™ Pump
Flow Range	up to 5,000 GPH	up to 2,000 GPH	up to 2,000 GPH
Mag Drive		√	√
Asynchronous	√		
Motor Driven			
Comes with Fittings	√	√	√
Comes with a Fountainhead		√	
Fountainhead Sold Separately			√
Warranty Years	3	3	3
Needs to be Pre-filtered with Skimmer or Vault			
Extremely Energy-efficient	√	√	√



AquaSurge® Skimmer and Pondless® Waterfall Vault Pump

Submersible Waterfall and Filter Pump Made For Use in Skimmer Style Filter Systems (available in flow rates from 2,000 to 5,000 GPH / 7,570 to 18,927 LPH)

AquaSurge® asynchronous skimmer, waterfall and filter pumps combine energy efficient performance, high flow rates and ease of maintenance making this pump the ideal choice for discriminating pond owners. AquaSurge® pumps are ideal for use in Aquascape and other skimmer and falls filter systems as well as Pondless® Waterfall filter vaults.

- Extremely energy-efficient, saving hundreds of dollars over traditional water pumps
- Asynchronous motor technology provides high torque, trouble-free performance at higher head heights
- Designed for use in skimmer and falls filter systems
- Oil-free design prevents pond contamination
- Provides years of trouble-free operation
- Made for continuous use
- Will not corrode or rust
- Rubber feet reduce noise and vibration
- Can be used vertically or horizontally
- Plumbing adapter fittings included



AquaSurge® 2000

#91017 MSRP \$349.98
(Unit Weight: 9.3 lbs.)

AquaSurge® 3000

#91018 MSRP \$399.98
(Unit Weight: 9.7 lbs.)

AquaSurge® 4000

#91019 MSRP \$459.98
(Unit Weight: 12.1 lbs.)

AquaSurge® 5000

#91020 MSRP \$509.98
(Unit Weight: 13.7 lbs.)

AquaSurge® PRO Adjustable Flow Pumps

- Allows you to customize and fine-tune the flow of waterfalls and streams
- Ability to wirelessly adjust the flow makes it easy to select the right pump for any application
- Pump can be turned on or off with remote
- Ideal for use in Pondless® Waterfall applications, allowing the falls to be adjusted or turned on and off when desired
- Each remote and receiver are paired together with a unique frequency

Pro Pump Remote and Receiver (G2)

Features include:

- Numeric flow indicator
- Remote control holster allowing for permanent mounting
- Receiver includes mounting hardware
- Sleek and ergonomic design

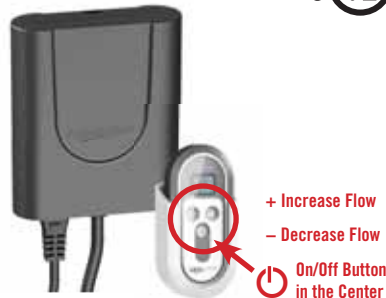

AquaSurge® PRO 2000-4000

#45009 MSRP \$549.99
(Unit Weight: 10.5 lbs.)

AquaSurge® PRO 4000-8000

#45010 MSRP \$679.99
(Unit Weight: 13 lbs.)

AquaSurge® Pond and Pondless® Waterfall Application

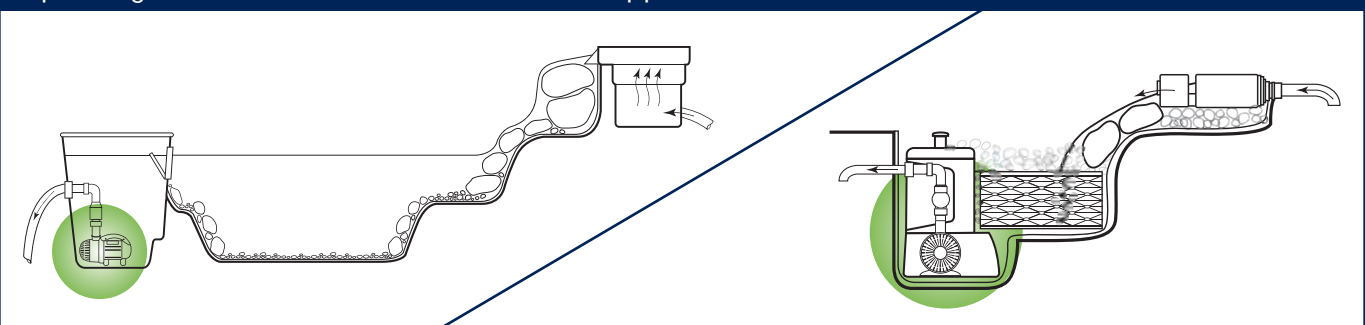

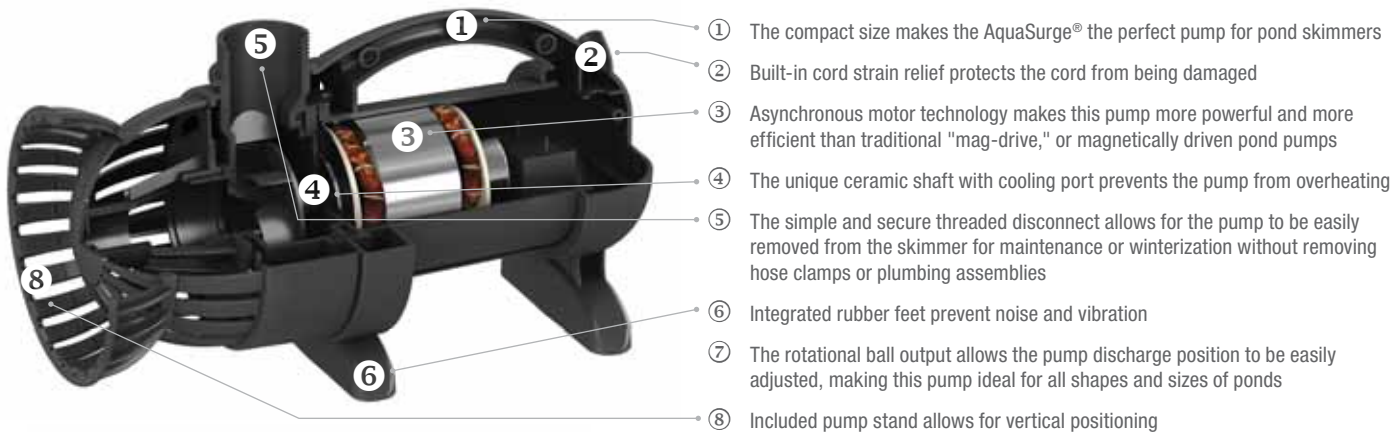

- ① The compact size makes the AquaSurge® the perfect pump for pond skimmers
- ② Built-in cord strain relief protects the cord from being damaged
- ③ Asynchronous motor technology makes this pump more powerful and more efficient than traditional "mag-drive," or magnetically driven pond pumps
- ④ The unique ceramic shaft with cooling port prevents the pump from overheating
- ⑤ The simple and secure threaded disconnect allows for the pump to be easily removed from the skimmer for maintenance or winterization without removing hose clamps or plumbing assemblies
- ⑥ Integrated rubber feet prevent noise and vibration
- ⑦ The rotational ball output allows the pump discharge position to be easily adjusted, making this pump ideal for all shapes and sizes of ponds
- ⑧ Included pump stand allows for vertical positioning



rp replacement parts available



Fittings Included

3x 1.25", 1.50", 2" Multi-Hose Fitting, 2", 1.50" Multi-Hose Fitting, 1.50" Rotational Ball Output, 1.50" Female Fitting

Please Note: many of the fittings included with your Aquascape product may look similar in size and shape. We include fittings specific to Aquascape kink-free tubing as well as fittings that will allow you to adapt to many competitors products. We recommend that you simply test fit the included fittings to determine what fitting best suits your needs.

AquaSurge® and AquaSurge® PRO Pump Specs

Model	2000	3000	4000**	5000**	2000-4000**	4000-8000**
Maximum Flow Rate (GPH)	2,193	3,196	3,947	5,284	3,947	7,793
Maximum Head Height	12.5'	15'	18.5'	24'	18.5'	28'
Motor Type	Asynchronous	Asynchronous	Asynchronous	Asynchronous	Asynchronous	Asynchronous
Wattage	160	165	215	360	180 - 215*	500 - 660*
Amperage	1.3	1.4	1.82	3	1.82	5.5
Power Cord Length	20'	20'	20'	20'	20'	20'
Pump Discharge Diameter	1.5" MPT	1.5" MPT	1.5" MPT	1.5" MPT	1.5" MPT	1.5" MPT
Dimensions Pump	12"L x 5.5"W x 7"H	12"L x 5.5"W x 7"H	14"L x 6"W x 7.5"H	14"L x 6"W x 7.5"H	14"L x 6"W x 7.5"H	14"L x 6"W x 7.5"H
Dimensions Remote					2.5"L x 1.5"W x .75"H	
Dimensions Receiver					4.5"L x 1.5"W x 5"H	
Warranty	3-Year Limited	3-Year Limited	3-Year Limited	3-Year Limited	3-Year Limited	3-Year Limited

* Wattage range depending on remote control flow setting. ** Not for use with MicroSkim®. For an in-pond application please use the Aquascape AquaForce® pump

AquaSurge® and AquaSurge® PRO Pump Flow Chart (GPH)

Model	Max Head Ft.	0' (0 psi)	5' (2.16 psi)	10' (4.33 psi)	15' (6.49 psi)	20' (8.66 psi)	25' (10.82 psi)	30' (12.99 psi)
2000	12.5	2193	1850	1465	0			
3000	15	3196	2700	2350	0			
4000	18.5	3947	3750	3350	2250	0		
5000	24	5284	5000	4750	3250	1750	0	
2000-4000	18.5	3947	3750	3350	2250	0		
4000-8000	28	7793	7350	7000	5850	4300	2000	0

BEST Operating Zone MAXIMUM Operating Zone

PL and PN Solids Handling Pond, Pondless® Waterfall, and Vault Water Pump

The PL and PN Series pumps are known for durability, performance and value. The semi-vortex impeller design enables the pump to efficiently and effectively handle solids resulting in less maintenance and trouble-free performance. The built in thermal overload protects the pump from damage if ever run in low water conditions. Ideal for use in Aquascape and other skimmer and falls filter systems as well as Pondless® Waterfall filter vaults.

- Ideal for use in skimmer filters and Pondless® Waterfall applications
- Semi-vortex solids handling impeller reduces clogging and decreases maintenance
- Energy efficient, continuous duty motor operates at lower temperatures which extends pump life
- Constructed of stainless steel and composite resin for strength and corrosion resistance



3PL - 3000 Pump

#29975 MSRP \$519.99
(Unit Weight: 17 lbs.)

5PL - 5000 Pump

#29976 MSRP \$699.99
(Unit Weight: 19 lbs.)

9PL - 7000 Pump

#29977 MSRP \$849.99
(Unit Weight: 23 lbs.)

8PN - 5500 Pump

#29495 MSRP \$799.99
(Unit Weight: 29 lbs.)

12PN - 10,000 Pump

#30391 MSRP \$999.99
(Unit Weight: 31.9 lbs.)



3PL, 5PL, 9PL Pumps

8PN, 12PN Pumps

PL and PN Pump Specs



Model	3PL	5PL	9PL	8PN	12PN
Maximum Flow Rate (GPH)	3,000	5,300	7,300	5,548	10,000
Maximum Head Height	14'	23'	35'	56'	23'
Motor Type	Direct Drive	Direct Drive	Direct Drive	Direct Drive	Direct Drive
Wattage	320	620	1000	1000	900
Amperage	3.1	5.6	8.6	9.1	9.1
Power Cord Length	20'	20'	20'	20'	20'
Pump Discharge Diameter	2"	2"	2"	2"	3"
Dimensions	12.2"L x 5.6"W x 7.1"H	13.2"L x 5.9"W x 7.3"H	14"L x 5.9"W x 7.3"H	9.3"L x 6.4"W x 15"H	11.7"L x 7.7"W x 15.1"H
Warranty	2-Year Limited	2-Year Limited	2-Year Limited	2-Year Limited	2-Year Limited

PL and PN Pump Flow Chart (GPH)

Model	Max Head Ft.	0' (0 psi)	5' (2.16 psi)	10' (4.33 psi)	15' (6.49 psi)	20' (8.66 psi)	25' (10.82 psi)	30' (12.99 psi)	35' (15.15 psi)	40' (17.32 psi)	45' (19.48 psi)	50' (21.65 psi)	55' (23.81 psi)
3PL	14	3,000	1,700	0									
5PL	23	5,300	4,500	3,500	1,800	0							
9PL	35	7,300	6,400	5,600	4,900	4,100	3,000	0					
8PN	56		5,500	5,200	4,800	4,300	3,600	2,800	2,000	1,200	600	0	
12PN	23	10,000	7,600	4,600	1,500	0							

BEST Operating Zone

MAXIMUM Operating Zone

DO NOT Operate Zone

AquascapePRO® Solids Handling Pond, Pondless® Waterfall, and Vault Water Pump

Available in flow rates from 3,000 to 10,000 gallons per hour (11,350 to 37,800 liters per hour)

AquascapePRO® pumps are ideal for use in Aquascape and other skimmer and falls filters systems as well as Pondless® Waterfall filter vaults.

Aquascape's horizontal pond pumps, from the AquascapePRO® line, are energy efficient and low maintenance. Quiet and efficient, these pumps have stainless steel construction, along with rubber feet to reduce vibration. With high head heights and a wide variety of flow rates to choose from there is sure to be an AquascapePRO® pump that fits your water gardens requirements.

AquascapePRO® 3000

#20002 MSRP \$569.99
(Unit Weight: 16 lbs.)

AquascapePRO® 4500

#20003 MSRP \$759.99
(Unit Weight: 17 lbs.)

AquascapePRO® 7500

#20004 MSRP \$929.99
(Unit Weight: 22 lbs.)

AquascapePRO® 10,000

#20006 MSRP \$1,049.99
(Unit Weight: 39 lbs.)



AquascapePRO® 10,000

AquascapePRO® 7500

AquascapePRO® 4500

AquascapePRO® 3000

AquascapePRO® Pump Specs				
Model	3000	4500	7500	10,000
Maximum Flow Rate (GPH)	2,900	4,500	6,700	10,600
Maximum Head Height	20'	33'	42'	28'
Motor Type	Direct Drive	Direct Drive	Direct Drive	Direct Drive
Wattage	280	625	1200	1240
Amperage	2.6	5.4	10	11
Power Cord Length	20'	20'	20'	20'
Pump Discharge Diameter	2"	2"	2"	3"
Dimensions Pump	12"L x 6"W x 7"H	13"L x 6.5"W x 7"H	13"L x 6.5"W x 7"H	12.5"L x 9"W x 17"H
Warranty	2-Year Limited	2-Year Limited	2-Year Limited	2-Year Limited

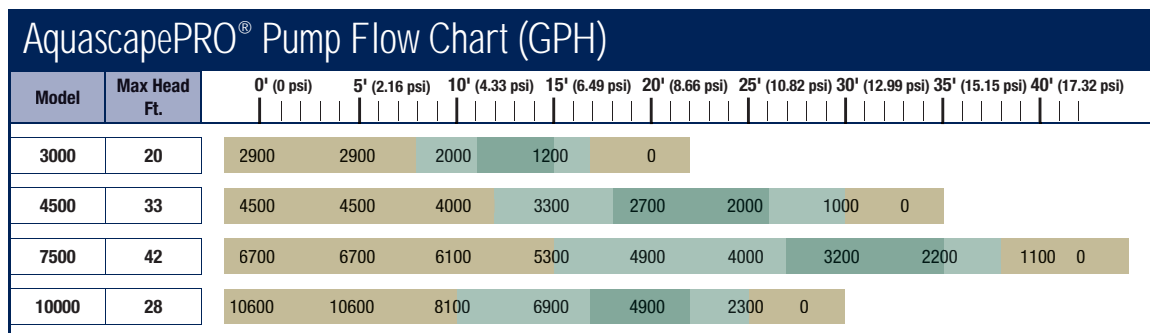

BEST Operating Zone
 MAXIMUM Operating Zone
 DO NOT Operate Zone

AquaForce® Solids-Handling Waterfall Pump

Submersible, solids-handling waterfall and filter pump (available in flow rates from 1,000 to 5,200 GPH / 3,785 to 19,684 LPH)

AquaForce® asynchronous, solids-handling waterfall and filter pumps combine energy efficient performance, high flow rates and ease of maintenance making this pump the ideal choice for discriminating pond owners. The AquaForce® protective pre-filter cage allows the pump to be placed directly into the pond. AquaForce® pumps are able to pump solids up to one quarter of an inch, making it ideal for use with external pressure filters or Aquascape waterfalls type filter systems.

- Extremely energy-efficient, saving hundreds of dollars over traditional water pumps
- Asynchronous motor technology provides high torque, trouble-free performance at higher head heights
- Easy to maintain
- Durable prefilter cage design prevents clogging and reduces pump maintenance
- Oil-free design prevents pond contamination
- Plumbing adapter fittings included
- Provides years of trouble-free operation

AquaForce® 1000 Solids Handling Pump

#91011 MSRP \$219.98
(Unit Weight: 10.6 lbs.)

AquaForce® 1800 Solids Handling Pump



#91112 MSRP \$239.98

AquaForce® 2700 Solids Handling Pump

#91012 MSRP \$269.98
(Unit Weight: 11.5 lbs.)



AquaForce® 3600 Solids Handling Pump



#91113 MSRP \$309.98

AquaForce® 5200 Solids Handling Pump

#91013 MSRP \$429.98
(Unit Weight: 15.4 lbs.)

AquaForce® PRO 4000-8000 Adjustable Flow Solids Handling Waterfall Pump

#91104 MSRP \$669.99
(Unit Weight: 16.5 lbs.)

- Allows you to customize and fine-tune the flow of waterfalls and streams
- Ability to adjust the flow makes it easy to select the right pump for any application
- Pump can be turned on or off with remote
- Each remote and receiver are paired together with a unique frequency

Pro Pump Remote and Receiver (G2)

Features include:

- Numeric flow indicator
- Remote control holster allowing for permanent mounting
- Receiver includes mounting hardware
- Sleek and ergonomic design

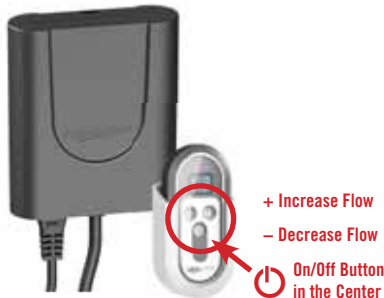

AquaForce® Pond Application

The AquaForce® protective pre-filter cage allows the pump to be placed directly into the pond.

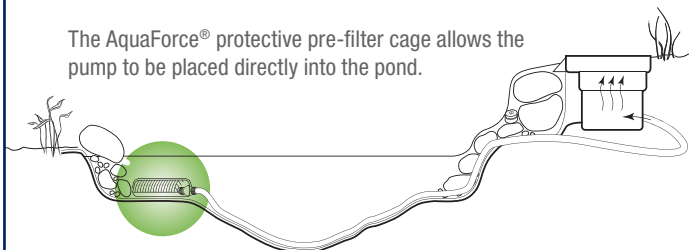



- ① Protective pump cage prevents large debris from clogging or damaging pump, thereby reducing maintenance
- ② Large cage openings allow for solids to be easily processed by pump, allowing debris to be passed and filtered, preventing the pump from being clogged or damaged
- ③ Asynchronous motor technology makes this pump more powerful and more efficient than traditional "mag drive," or magnetically driven pond pumps
- ④ The simple and secure threaded disconnect allows for the pump to be easily removed from the pond for maintenance or winterization without removing hose clamps or plumbing assembly
- ⑤ The wide, flat shape of the pump cage makes it stable and easy to place in the pond
- ⑥ The rotational ball output allows the pump discharge position to be easily adjusted, making this pump ideal for all shapes and sizes of ponds



Fittings Included

1.25", 1.50", 2" Multi-Hose Fitting, Locking Rotational Ball Fitting, 2", 1.50" Multi-Hose Fitting

Please Note: many of the fittings included with your Aquascape product may look similar in size and shape. We include fittings specific to Aquascape kink-free tubing as well as fittings that will allow you to adapt to many competitors products. We recommend that you simply test fit the included fittings to determine what fitting best suits your needs.



The Aquascape AquaForce® doubles as a great winterizing pump

AquaForce® and AquaForce® PRO Pump Specs

Model	1000	1800	2700	3600	5200	4000-8000
Maximum Flow Rate (GPH)	1,070	2,149	2,695	3,868	5,284	7,793
Maximum Head Height	10'	16.5'	14'	18'	24'	28'
Motor Type	Asynchronous	Asynchronous	Asynchronous	Asynchronous	Asynchronous	Asynchronous
Wattage	55	160	147	215	360	500-660*
Amperage	0.51	1.33	1.25	1.8	3	5.5
Power Cord Length	25'	25'	25'	25'	25'	20'
Pump Discharge Diameter	1.5" MPT	1.5" MPT	1.5" MPT	1.5" MPT	1.5" MPT	1.5" MPT
Dimensions Pump	14"L x 14"W x 6.5"H	14"L x 14"W x 6.5"H	14"L x 14"W x 6.5"H	14"L x 14"W x 6.5"H	14"L x 14"W x 6.5"H	14"L x 14"W x 6.5"H
Dimensions Remote						2.5" L x 1.5" W x .75" H
Dimensions Receiver						4.5" L x 1.5" W x 5" H
Warranty	3-Year Limited	3-Year Limited	3-Year Limited	3-Year Limited	3-Year Limited	3-Year Limited

* Wattage range depending on remote control flow setting.

AquaForce® and AquaForce® PRO Pump Flow Chart (GPH)

Model	Max Head Ft.	Head (psi)						
		0' (0 psi)	5' (2.16 psi)	10' (4.33 psi)	15' (6.49 psi)	20' (8.66 psi)	25' (10.82 psi)	30' (12.99 psi)
1000	10	1070	850	0				
1800	16.5	2149	1806	1320	260	0		
2700	14	2695	2425	1840	0			
3600	18	3868	3613	3254	2100	0		
5200	24	5284	5116	4250	3186	1500	0	
4000-8000	28	7794	7150	6440	5320	3950	1800	0

BEST Operating Zone

MAXIMUM Operating Zone



VIDEO ON
AQUAFORCE®

Ultra™ Pumps

Submersible fountain, waterfall and filter pump (available in flow rates from 400 to 2,000 GPH / 1,514 to 7,570 LPH)

Ultra™ Pumps are the complete solution for small ponds, fountains and water features. This all-in-one kit includes a three-way or single valve and multi-size hose connection making it adaptable to almost any hose or tubing size. Ultra™ Pumps are ideal for supplying water to run fountains, water features, external filters and spitting ornaments.



- Extremely energy-efficient, saving hundreds of dollars over traditional water pumps
- Magnetically driven or "mag-drive" motor technology is simple and easy to maintain
- Durable prefilter cage design protects pump and reduces pump maintenance
- Oil-free design prevents pond contamination
- Provides years of trouble-free operation



400 GPH Ultra™ Pump

#91005 MSRP \$84.98

(Unit Weight: 2.9 lbs.)

1100 GPH Ultra™ Pump

#91008 MSRP \$189.98

(Unit Weight: 4.6 lbs.)

550 GPH Ultra™ Pump

#91006 MSRP \$104.98

(Unit Weight: 3.3 lbs.)

1500 GPH Ultra™ Pump

#91009 MSRP \$209.98

(Unit Weight: 8.4 lbs.)

800 GPH Ultra™ Pump

#91007 MSRP \$129.98

(Unit Weight: 4.4 lbs.)

2000 GPH Ultra™ Pump

#91010 MSRP \$239.98

(Unit Weight: 8.8 lbs.)



Ultra™ Pump Fountain Head Kit

Add a new dimension to the Ultra™ Pump with the simple addition of the Ultra™ Pump Fountain Head Kit.

Comes complete with three fountain heads and diverter valve to adjust the fountain height, as well as allows for the diversion of water to an external filter or waterfall.

Foaming Jet Fountain



Daisy Fountain



Waterbell Fountain



Small - for the Ultra™
400, 550 & 800 Pump

#91045 MSRP \$16.98
(Unit Weight: .7 lbs.)

Large - for the Ultra™
1100, 1500 & 2000 Pump

#91046 MSRP \$21.98
(Unit Weight: .7 lbs.)

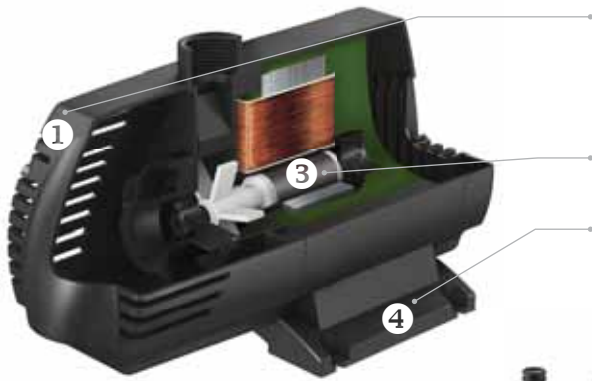

- ① Protective pump input strainer cover and sponge filter prevents debris from damaging pump, thereby reducing maintenance and prolonging pump life
- ② Included three-way splitter with valve and multi-hose adapter makes the pump simple to connect almost all hose sizes
- ③ "Mag-drive" motor technology makes this pump energy efficient and simple to maintain
- ④ The wide, flat base and rubber feet make the pump stable and reduce vibration



Fittings Included in the Ultra 400, 550 and 800
3/4", 1", 1.25" Multi-Hose Fitting, 1/2" Valve



Fittings Included in the Ultra 1100, 1500 and 2000
3/4", 1", 1.25" Multi-Hose Fitting, 3/4" 3-Way Valve



The Aquascape Ultra™ Pump will provide years of trouble-free operation when properly maintained. If your Ultra™ Pump stops working try cleaning the protective input strainer and sponge. Another tip is to remove and clean the impeller and impeller housing with a mild acid-like white vinegar and toothbrush. This will remove any white scale build-up and allow the pump to run like new again. Note: replacement impeller kits are available.



replacement parts available



**VIDEO ON
ULTRA™ PUMP**

Ultra™ Pump Specs

Model	400	550	800	1100	1500	2000
Maximum Flow Rate (GPH)	370	528	793	1,110	1,480	1,982
Maximum Head Height	7.5'	8'	9'	12'	16.5'	20'
Motor Type	Mag-Drive	Mag-Drive	Mag-Drive	Mag-Drive	Mag-Drive	Mag-Drive
Wattage	24	33	58	92	153	250
Amperage	.40	.55	.80	.85	1.46	2.60
Power Cord Length	12'	12'	25'	25'	25'	25'
Discharge Hose Diameter	1/2", 3/4", 1", 1.25"	1/2", 3/4", 1", 1.25"	1/2", 3/4", 1", 1.25"	3/4", 1", 1.25"	3/4", 1", 1.25"	3/4", 1", 1.25"
Dimensions	5.5"L x 4"W x 3.5"H	6"L x 4"W x 4"H	6"L x 4"W x 4"H	9"L x 5"W x 6"H	9.5"L x 6"W x 7"H	9.5"L x 6"W x 7"H
Warranty	3-Year Limited	3-Year Limited	3-Year Limited	3-Year Limited	3-Year Limited	3-Year Limited

Ultra™ Pump Flow Chart (GPH)

Model	Max Head Ft.	0' (0 psi)	5' (2.16 psi)	10' (4.33 psi)	15' (6.49 psi)	20' (8.66 psi)				
400	7.5	370	300	200	0					
550	8	528	425	300	75	0				
800	9	793	675	500	275	0				
1100	12	1110	1000	800	600	300	0			
1500	16.5	1480	1350	1200	1050	825	575	200	0	
2000	20	1982	1875	1750	1600	1375	1125	800	450	0

BEST Operating Zone

Statuary and Fountain Pumps

Submersible fountain, waterfall and filter pump (available in flow rates from 70 to 320 GPH / 265 to 1,211 LPH)

Aquascape Statuary and Fountain Pumps are perfect for running smaller decorative fountains. These high quality, "mag-drive" or magnetically driven water pumps are ideal for supplying water to run fountains, water features, external filters, spitting ornaments and indoor or outdoor water fountains. This combination of energy-efficient, mag-drive performance, and flow and ease of maintenance make this pump the ideal choice for discriminating water feature owners.



- Extremely energy-efficient
- Magnetically driven or mag-drive motor technology is simple and easy to maintain
- Durable pre-filter cage design prevents clogging and reduces pump maintenance
- Oil-free design prevents pond contamination
- Provides years of trouble-free operation



320 GPH Water Pump

#91026 MSRP \$34.98
(Unit Weight: 1.25 lbs.)

180 GPH Water Pump

#91025 MSRP \$24.98
(Unit Weight: 1.5 lbs.)

90 GPH Water Pump

#91024 MSRP \$17.98
(Unit Weight: .75 lbs.)

70 GPH Water Pump

#91023 MSRP \$14.98
(Unit Weight: .75 lbs.)



- ① "Mag-drive" motor technology makes this pump energy efficient and simple to maintain
- ② Included flow control valve allows you to create a customized water flow
- ③ The wide, flat base of the pump makes it stable and easy to place in the pond or fountain
- ④ Protective pump input strainer cover prevents debris from clogging or damaging pump, thereby reducing maintenance
- ⑤ Intake strainer on the bottom of the pump prevents the pump from running dry or pulling in air in shallow applications



Aquascape Statuary and Fountain Pumps will provide years of trouble-free operation when properly maintained. If your Statuary and Fountain Pump stops working, try cleaning the protective input strainer and sponge. Another tip is to remove and clean the impeller and impeller housing with a mild acid-like white vinegar and a toothbrush. This will remove any white scale build-up and allow the pump to run like new again. Note: Replacement impeller kits are available

Statuary and Fountain Pump Specs

Model	70 GPH	90 GPH	180 GPH	320 GPH
Maximum Flow Rate (GPH)	70 GPH	90 GPH	180 GPH	320 GPH
Maximum Head Height	2'	3'	4'	5.5'
Motor Type	Mag-Drive	Mag-Drive	Mag-Drive	Mag-Drive
Wattage	3.0	4.3	9.3	17.6
Amperage	.037	.061	.175	.339
Power Cord Length	6'	6'	6'	6'
Discharge Hose Diameter	1/2"	1/2"	1/2"	1/2", 5/8"
Dimensions	2"L x 1.5"W x 1.25"H	2.5"L x 1.75"W x 2"H	3"L x 2.5"W x 2"H	4"L x 3.25"W x 2.5"H
Warranty	3-Year Limited	3-Year Limited	3-Year Limited	3-Year Limited

AquaJet™ Pumps



Submersible fountain, waterfall and filter pump (available in flow rates from 600 to 2,000 GPH / 2,271 to 7,570 LPH)

AquaJet™ fountain and filter pumps are ideal for small to medium-size ponds or ponds up to 4,000 gallons. This all-in-one kit provides a stunning water fountain with the choice of three included fountain heads. An integrated diverter valve supplies water to a small waterfall, external filters or spitting ornaments. Extremely energy-efficient, saving hundreds of dollars over traditional water pumps

- Magnetically driven or "mag-drive" motor technology is easy to maintain
- Durable pre-filter cage design prevents clogging and reduces pump maintenance

AquaJet™ 600 Pump

#91014 MSRP \$209.98
(Unit Weight: 5.5 lbs.)

AquaJet™ 1300 Pump

#91015 MSRP \$239.98
(Unit Weight: 8.8 lbs.)

AquaJet™ 2000 Pump

#91016 MSRP \$319.98
(Unit Weight: 9.7 lbs.)



- ① The adjustable riser stem makes it simple to adjust the fountain head to different heights (10" to 20") and/or depths
- ② Adjustable diverter and flow control allows water to be used for fountainhead
- ③ The rotational riser stem fitting allows for simple adjustment or leveling of fountain heads
- ④ Protective pump cage prevents debris from clogging or damaging pump, thereby reducing maintenance
- ⑤ Mag-drive motor technology makes this pump energy efficient and simple to maintain
- ⑥ Fine cage openings prevents fountain heads from becoming clogged
- ⑦ Simple pump cage clips make it easy to open the protective pump cage to perform pump maintenance or remove debris



Fittings Included in the AquaJet™ 600, 1300 and 2000
AquaJet Foaming Jet, Waterbell, Daisy, Riser Stems, Multi-Hose Fitting, Divert Valve

AquaJet™ Pump Specs

Model	600	1300	2000
Average Pond Size Recommendation	1,200 US gallons	1,300 US gallons	2,000 US gallons
Maximum Fountain Height (Daisy Fountain)	up to 47"	up to 62"	up to 65"
Motor Type	Mag-Drive	Mag-Drive	Mag-Drive
Wattage	33	110	250
Amperage	.55	1.00	2.60
Power Cord Length	25'	25'	25'
Discharge Hose Diameter	with nozzle fountain heads	with nozzle fountain heads	with nozzle fountain heads
Discharge Hose Diameter on Divertter	1/2", 3/4"	1/2", 3/4"	1/2", 3/4", 1"
Dimensions	12"L x 12"W x 6"H	12"L x 12"W x 6"H	12"L x 12"W x 6"H
Warranty	3-Year Limited	3-Year Limited	3-Year Limited

AquaJet™ Pump Flow Chart (GPH)

Model	Max Head Ft.	Head (psi)				
		0' (0 psi)	5' (2.16 psi)	10' (4.33 psi)	15' (6.49 psi)	20' (8.66 psi)
600	7.5	525	300	0		
1300	13.5	1350	1050	625	0	
2000	20	2000	1800	1525	1075	0

BEST Operating Zone



VIDEO ON
AQUAJET™



replacement parts available

2-Outlet and 4-Outlet Pond Aerators

Every process that happens in the pond is dependent on oxygen. This is especially important at night when plants are not converting sunlight into oxygen. Dissolved oxygen levels are also generally lower in warmer water temperatures. Pond aerators oxygenate your pond, helping all biological processes and create a more stable environment, resulting in healthier fish and plants. Aeration is also very important during winter months in colder climates, as aeration helps to keep a small hole open in the surface of the pond to aid in degassing.

- Extremely energy-efficient
- Quiet
- Simple to use and maintain
- Durable outer housing prevents damage
- Comes complete with winter resistant air line, preassembled check valves and air discs
- Provides years of trouble-free operation



2-Outlet Pond Aerator

#75000 MSRP \$59.98
(Unit Weight: 3.2 lbs.)



4-Outlet Pond Aerator

#75001 MSRP \$109.98
(Unit Weight: 5.2 lbs.)







**VIDEO ON
POND AERATOR**

- ① The strong outer housing protects the pump from becoming damaged
- ② A thick rubber gasket separates the two halves of the air pump, reducing noise and preventing vibration
- ③ The wide, flat base of the pump makes it stable and easy to place
- ④ The integrated rubber feet prevent noise and vibration keeping the pump stable so there is no movement from its intended position
- ⑤ The replaceable diaphragm and assembly cartridge makes this pump simple and inexpensive to service

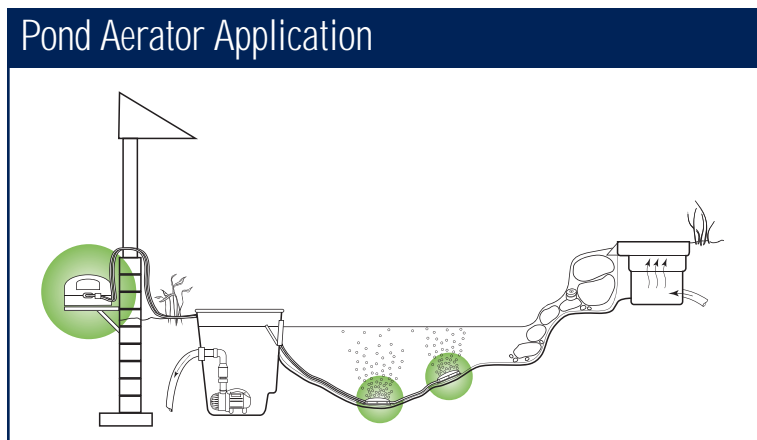

Pond Aerator Replacement Aeration Disc (qty. 1)

#75005 MSRP \$4.98
(Unit Weight: 0.3 lbs.)



The 2-outlet and 4-outlet aerator pump should be placed in an indoor location dry and free from airborne dust and debris. If you notice that your pump is losing air pressure or simply doesn't work as well as when you purchased it, a simple, inexpensive renew kit is available. After installing the renew kit your pond aerator should be as good as new.

Pond Aerator PRO 60

#61000 MSRP \$289.99

(Unit Weight: 18 lbs.)

7.75"L x 6"W x 6.25"H



Aquascape professional-grade aeration system is designed to help improve water circulation and increase oxygen throughout the pond. The Pond Aerator PRO system can also be used during the winter months where the bubbles created at the surface will keep a small hole open in the ice for oxygenation and the removal of possible harmful gases from the water.

- Comes complete with a weather-proof, outdoor-rated, energy-efficient 45-watt air pump
- High volume 2.1 CFM of air
- For ponds up to 10,000 gallons
- Includes one large 8-inch diameter aeration disc and 30-feet of 3/8" braided aeration tubing



Winter Application

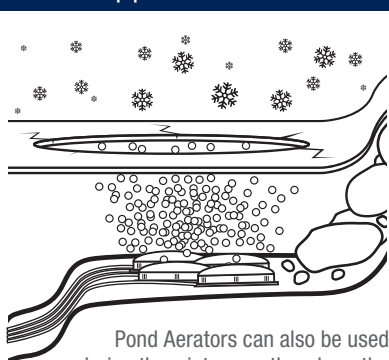

Pond Aerators can also be used during the winter months where the bubbles created at the surface can help keep a small hole open in the ice for oxygenation.

Pond Aerator PRO 8" Aeration Disc

#61001 MSRP \$44.99

(Unit Weight: 2.5 lbs.)



Remember to not place the air diffusers on the bottom of the pond during the winter, which may disrupt the natural thermocline found in the deeper portions of the pond where the fish are overwintering. Instead place the air diffusers about 1 to 1 1/2 ft. below the surface of the water.

Pond Aerator Pump Specs

Model	2-Outlet	4-Outlet	Pond Aerator PRO 60
Maximum Air Flow Rate (Loaded)	0.28 CFM (8 L/min)	0.49 CFM (14 L/min)	2.1 CFM (60 L/min)
Maximum Air Depth (Loaded)	3.70 psi (0.26 kgf/cm ²)	3.98 psi (0.28 kgf/cm ²)	5.08 psi (0.36 kgf/cm ²)
Number of Outlets	2	4	1
Wattage	6W	11W	45W
Power Cord Length	6'	6'	6'
Pump Dimensions	5.25"L x 4.75"W x 3.5"H	7.75"L x 7.25"W x 6.25"H	7.75"L x 7.25"W x 4"H
Aeration Disc	2 x 4" disc	4 x 4" disc	1 x 8" disc
Length of Airline	(2) 25 ft. Rolls 3/16" Silicone	(4) 25 ft. Rolls 3/16" Silicone	30 ft. Roll 3/8" Braided Vinyl
Check Valve	Included and Preinstalled	Included and Preinstalled	Included and Preinstalled
Warranty	3-Year Limited	3-Year Limited	3-Year Limited
Pond Size	Up to 2,000 gallons	Up to 3,500 gallons	Up to 10,000 gallons
Max Recommended Pond Depth	8.5'	9'	10'

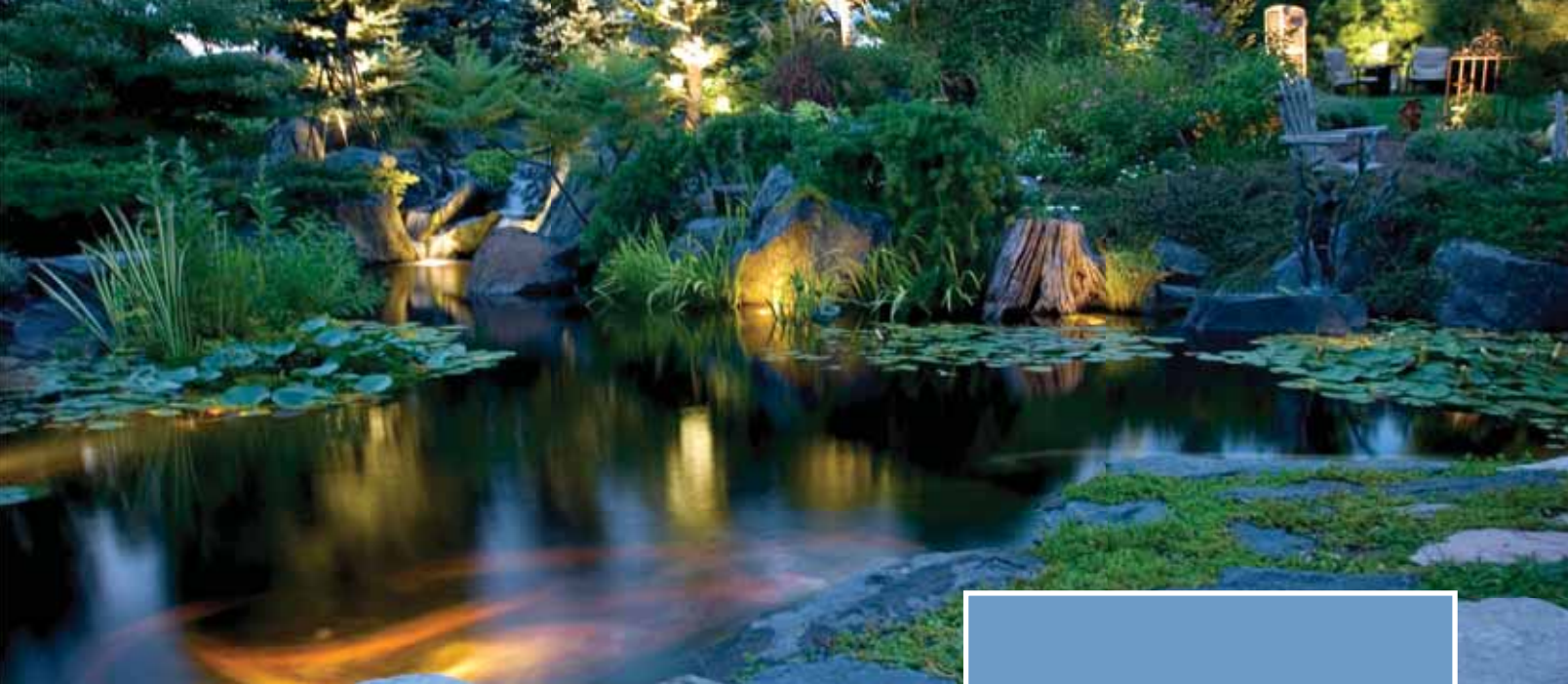

Aquascape LED Garden and Pond Lighting

Add a new dimension to your water feature by bringing it to life at night. With today's busy lifestyle, it is often difficult to enjoy your pond or landscape during the day. With Aquascape's complete line of garden and pond lighting, enjoying your garden is easy - day or night.

Aquascape LED Garden and Pond Lighting combines style and simplicity. Our newest component fixtures feature a die-cast metal housing finished with a coating providing a durable finish that will hold up in all weather conditions. Aquascape LED Garden and Pond Lighting can be used fully submersed, or in traditional landscapes. Aquascape LED lights consist of permanently sealed watertight fixtures and are backed by a limited five-year full replacement warranty.

Aquascape LED Garden and Pond Lighting can be used fully submersed, or in traditional landscapes.



**VIDEO ON
LED LIGHTS**

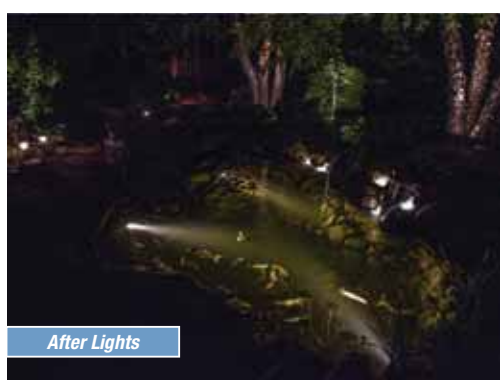

Design Your Own Aquascape LED Garden and Pond Lighting System

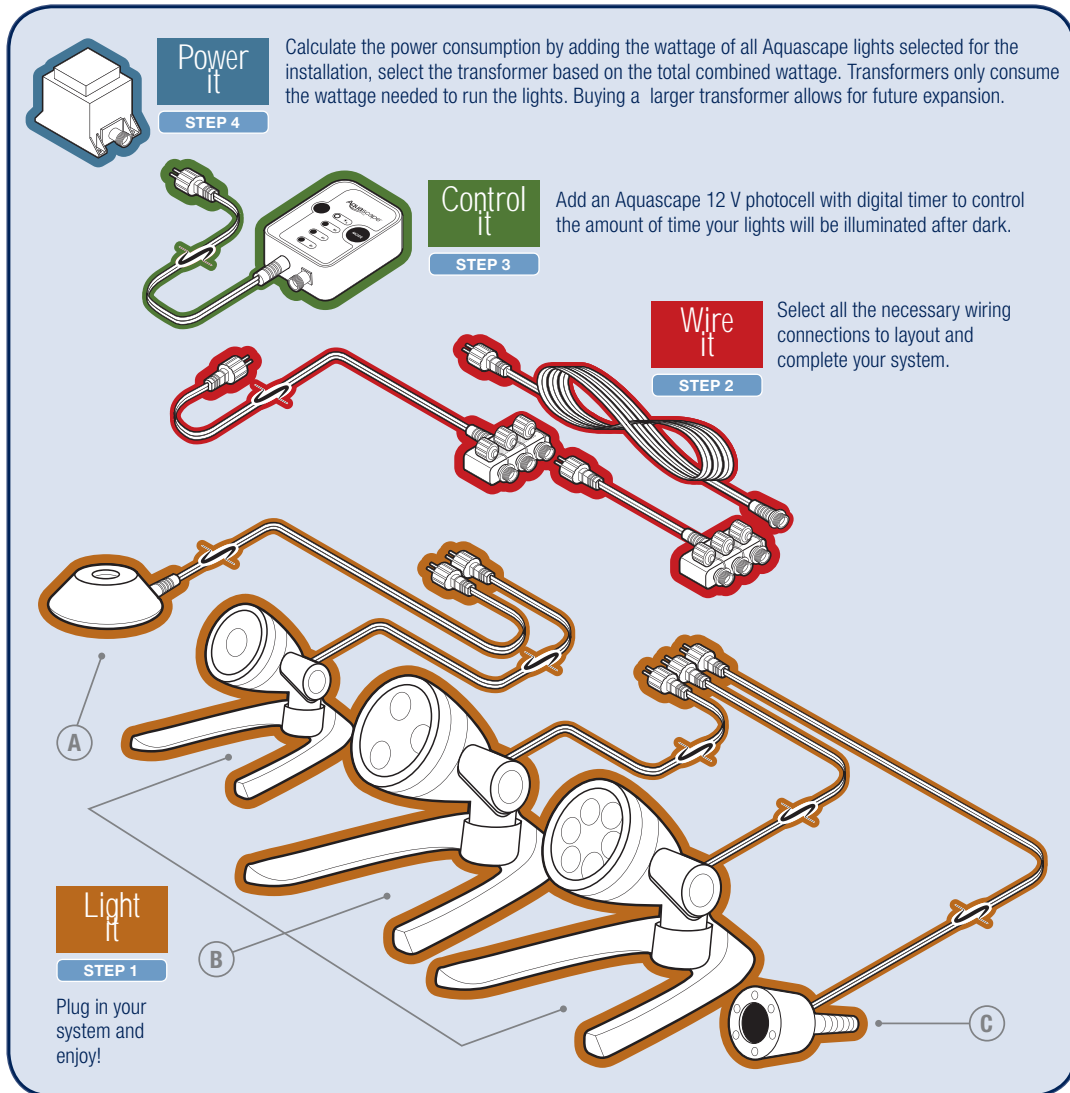

STEP 1

Choose an LED Lighting Option that Best Suits Your Needs



A Waterfall & Up Light



B Garden and Pond Spotlight



C Fountain Accent Light

STEP 2

Calculate the power consumption by adding the wattage of all the Aquascape lights selected.

EXAMPLE: 2 x 3-Watt Lights = 6 Total Watts of power consumed

Wire it
LED 6W
See package for wattage.

STEP 3

Take total wattage and add 10% to compensate for voltage fluctuations.

EXAMPLE: 6 Total Watts + 10% = 6.6 Watts

STEP 4

Select the appropriate wattage transformer, accessories, and lighting components.





Aquascape LED Garden and Pond Waterfall and Up Light 1-Watt

#84032 MSRP \$49.98

(Unit Weight: 1.1 lbs.)

- Light output is equivalent to a 10-watt halogen light
- 40,000 hour bulb life
- Features a powerful 1-watt LED diode
- Natural warm color light output 3000K
- Integrates easily with other quick-connect 12 volt components
- Limited five-year full replacement warranty

*Transformer sold separately



Aquascape LED Garden and Pond Spotlight 1-Watt

#84031 MSRP \$49.98

(Unit Weight: .9 lbs.)

- Light output is equivalent to a 10-watt halogen light
- 40,000 hour bulb life
- Features a powerful 1-watt LED diode
- Natural warm color light output 3000K
- Integrates easily with other quick-connect 12 volt components
- Limited five-year full replacement warranty

*Transformer sold separately



Aquascape LED Garden and Pond Spotlight 3-Watt

#84033 MSRP \$109.98

(Unit Weight: 1.75 lbs.)

- Light output is equivalent to a 20-watt halogen light
- 40,000 hour bulb life
- Features 3 powerful 1-watt LED diodes
- Natural warm color light output 3000K
- Integrates easily with other quick-connect 12 volt components
- Limited five-year full replacement warranty

*Transformer sold separately



Aquascape LED Garden and Pond Spotlight 6-Watt

#84034 MSRP \$149.98

(Unit Weight: 2 lbs.)

- Light output is equivalent to a 50-watt halogen light
- 40,000 hour bulb life
- Features 6 powerful 1-watt LED diodes
- Natural warm color light output 3000K
- Integrates easily with other quick-connect 12 volt components
- Limited five-year full replacement warranty

*Transformer sold separately



*Durable Quick-Connect
Electrical Connections*



included

Aquascape LED Lights include two different mounting platforms - an adjustable stand, and a stake.

Aquascape LED Garden and Pond Spotlight Kit 3-Watt

#84030 MSRP \$119.98

(Unit Weight: 4 lbs.)

Aquascape Garden and Pond Light Kit includes everything needed to create a beautiful nighttime focal point in any water garden or traditional landscape. The small compact design allows for installation in even the tightest spaces.

Kit Includes:

- Three pre-wired 1-watt LED injected molded lighting fixtures
- 6-watt /12 V transformer
- Automatic on/off photo cell with integrated timer
- Limited five-year full replacement warranty

Features and Benefits:

- Light output is equivalent to a 10-watt halogen light
- 40,000 hour bulb life
- Features a powerful 1-watt LED diode
- Natural warm color light output 3000K



Aquascape LED Garden and Pond Lighting Contractor Pack

Designed for quicker and easier installation of Aquascape lighting components, Aquascape Lighting Contractor Packs take up less space, reduce the amount of packaging, and are ideal for installations requiring multiple lights.



1-Watt (6-pack)

#84045 MSRP \$249.98

(Unit Weight: 7 lbs.)



3-Watt (6-pack)

#84047 MSRP \$549.98

(Unit Weight: 13 lbs.)



6-Watt (6-pack)

#84048 MSRP \$749.98

(Unit Weight: 13 lbs.)



1-Watt Waterfall and Up Light (6-pack)

#84046 MSRP \$249.98

(Unit Weight: 7 lbs.)

Aquascape LED Fountain Accent Light 2.5-Watt

- Light output is equivalent to a 10-watt halogen light
- 40,000 hour bulb life
- Features a powerful 2.5-watt light output LED diode

- Natural warm color light output 3000K
- Integrates easily with other quick-connect 12 volt components
- Limited five-year full replacement warranty



LED Fountain Accent Light

#84008 MSRP \$39.98

(Unit Weight: .6 lbs.)



LED Fountain Accent Light with Transformer

#84009 MSRP \$49.98

(Unit Weight: 1.9 lbs.)



Garden and Pond 12 Volt Photocell with Digital Timer

#84039 MSRP \$24.98
(Unit Weight: .4 lbs.)



- Repeats programmed schedule daily
- Auto On at dusk / Off at dawn or 4-6-8 hour timer option
- Built-in memory setting in case of power loss
- Integrates easily with other quick-connect 12 volt components
- Up to 60-Watt capacity
- 36" cord
- Limited five-year full replacement warranty



Garden and Pond Manual Quick-Connect 12 Volt Transformers

Simple plug-in transformers provide an economical solution for operating low voltage lighting fixtures. Transformer includes a single quick-connect cable port for adding a light. Multiple light fixtures can be added by using the 3-Way Splitter.



60-Watt

#98486 MSRP \$49.98
(Unit Weight: 3.1 lbs.)

20-Watt

#98485 MSRP \$39.98
(Unit Weight: 1.5 lbs.)

6-Watt

#98375 MSRP \$19.98
(Unit Weight: .5 lbs.)



Garden and Pond 150-Watt Transformer With Photocell

#01002 MSRP \$99.99
(Unit Weight: 8 lbs.)

Includes 4, 6, 8 hour photo cell intervals options, as well as manual on/off override.



Garden and Pond 60-Watt Transformer With Photocell

#99070 MSRP \$69.98
(Unit Weight: 5 lbs.)

Includes 4, 6, 8 hour photo cell interval options.

Aquascape Garden and Pond Quick-Connect 12 Volt Accessories

- Integrates easily with other quick-connect 12 volt components
- No need to cut wires
- Simple weatherproof connections
- Weatherproof caps protect unused connections



**Durable Quick-Connect
Electrical Connections**



Splitters For 12 Volt Lighting

Provides a simple connection of 3 or 6 light fixtures to a single transformer. Multiple 3-way and 6-way quick-connect adaptors can be chained together to attach additional fixtures.



3-Way Splitter

#98489 MSRP \$10.98

(Unit Weight: .2 lbs.)

6" cord length



6-Way Splitter

#84022 MSRP \$17.98

(Unit Weight: 0.5 lbs.)

36" cord length



25' Lighting Cables W/Quick-Connects

This extension cable allows for simple extension of Aquascape lighting up to 25 feet. Ideal for use with our manual 12 Volt transformers and 3-way splitters.

- For use with Aquascape LED lighting system
- No need to cut wires
- Quick-connect system provides weatherproof seal



25' LVL Extension Cable w/Quick-Connects

#98998 MSRP \$16.98

(Unit Weight: 1 lb.)



25' Lighting Cable w/5 Quick-Connects

#84023 MSRP \$24.98

(Unit Weight: 1 lb.)



Aquascape Water Treatments

Combining science with simplicity, Aquascape makes it simple to maintain a healthy, well-balanced water garden. Aquascape's pump-top liquid bottles and bubble tabs make dosing simple and affordable. Put away your calculators and enjoy a clean, clear, healthy pond with the complete line of Aquascape water treatment products.

Aquascape's complete line of water treatments make it simple to maintain a healthy, well-balanced water garden.

Aquascape



Aquascape Pro



See page 64-65 for professional line of water treatments

Automatic Dosing System

Eliminate the guesswork and routine of adding water treatments to your pond, Pondless® Waterfall, fountain, or water feature.

In order for water treatments to work correctly, or to maintain optimum water quality, water treatments should be added consistently and on a regular basis. The Aquascape Automatic Dosing System accurately and consistently applies your choice of water treatment.

- Helps maintain optimum water quality
- Easy to use and fully programmable
- Can be used on almost any pond, fountain, or water feature
- Dependable and quiet operation



Drastically Reduces Pond Maintenance

Each type of water feature has its own set of challenges to maintain optimal water quality. In order to provide optimum results we have created two separate categories of treatment outlined below.



Automatic Dosing System for Ponds

#96030 MSRP \$129.98
(Unit Weight: 4 lbs.)

9"L (with hoses connected) x 4.25"W x 14"H (Install Dimensions)
7.5"L (canister top) x 4.25"W x 14"H (Canister Dimensions)

Includes a FREE Maintain treatment - a \$29.98 MSRP value

Includes a FREE Water Treatment!

Automatic Dosing System for Fountains

#96031 MSRP \$129.98
(Unit Weight: 4 lbs.)

9"L (with hoses connected) x 4.25"W x 14"H (Install Dimensions)
7.5"L (canister top) x 4.25"W x 14"H (Canister Dimensions)

Includes a FREE Prevent treatment - a \$29.98 MSRP value

Pond Water Treatments for Automatic Dosing System

For Ponds

Formulated specifically for systems that contain fish and plants, Aquascape Pond Water Treatments are the ideal way of maintaining optimum water quality, clarity and an overall healthy pond.

Each water treatment will treat a 2000 gallon pond for up to 30 days.



1 Maintain

#96032 MSRP \$29.98
(Unit Weight: 2.7 lbs.)

- Reduces maintenance
- Helps prevent fish loss

3 Clear

#96033 MSRP \$29.98
(Unit Weight: 2.7 lbs.)

- Clears discolored water
- Helps maintain crystal clear water

2 Clean

#96034 MSRP \$29.98
(Unit Weight: 2.7 lbs.)

- Contains a powerful combination of sludge eating bacteria and enzymes

4 Protect

#96035 MSRP \$29.98
(Unit Weight: 2.7 lbs.)

- Reduces fish stress in spring or after a cleanout

Fountain Water Treatments for Automatic Dosing System

For Fountains

Formulated for water features that don't contain fish and that may or may not be filtered. Aquascape Fountain Water Treatments help to maintain the original beauty of self-contained AquaBasin® fountains, Pondless® Waterfalls or traditional stand-alone fountains.

Self-contained water features often evaporate quickly and need to be topped off leaving a large concentration of minerals that will leave unsightly deposits on the surface of the fountain and will over time damage pumps. Aquascape Fountain Water Treatments prevent scale before it happens without the use of acids that may damage the surface of the fountain.



Each water treatment will treat most water fountains for up to one full season.

1 Prevent

#96042 MSRP \$29.98
(Unit Weight: 2.7 lbs.)

- Prevents stains, scale and unsightly water conditions
- Safe for birds and animals that may drink from the feature

2 Clean

#96037 MSRP \$29.98
(Unit Weight: 2.7 lbs.)

- Cleans existing growth and debris
- Will not damage the surface of the feature
- Safe for birds and animals

Aquascape Beneficial Bacteria for Ponds provides clean, clear and healthy water conditions and reduces pond maintenance.

- Contains eight pure strains of concentrated beneficial bacteria.
- Effective at reducing sludge, uneaten fish food, fish waste, dead and decaying plant material and excess nutrients that cause poor water quality and clarity
- Safe for fish, plants, pets and wildlife



**VIDEO ON
BENEFICIAL BACTERIA**



Beneficial Bacteria For Ponds (Liquid)

#98886 MSRP \$13.98

(Unit Weight: .6 lbs.)

8 oz./236 ml.

1 pump treats 100 gal./378 liters

1 bottle treats 5,000 gal./18,900 liters

#98887 MSRP \$19.98

(Unit Weight: 1.2 lbs.)

16 oz./473 ml.

1 pump treats 100 gal./378 liters

1 bottle treats 10,000 gal./37,800 liters

#98888 MSRP \$34.98

(Unit Weight: 2.3 lbs.)

32 oz./946 ml.

1 pump treats 100 gal./378 liters

1 bottle treats 20,000 gal./75,600 liters

#40002 MSRP \$19.98

(Unit Weight: 2.2 lbs.)

Refill Pouch 32 oz./946 ml. Liquid

1 oz. treats 600 gal./2,268 liters

1 pouch treats 20,000 gal./75,600 liters

#98885 MSRP \$79.98

(Unit Weight: 9.2 lbs.)

1 gal./3.78 liters

1 pump treats 600 gal./2,268 liters

1 bottle treats 80,000 gal./302,400 liters

- Contains 8 strains of bacteria including Photo Synthetic
- 1.5 billion CFU per ounce potency
- Contains marigold and vitamin B



Beneficial Bacteria For Ponds (Dry)

#98925 MSRP \$12.98

(Unit Weight: .3 lbs.)

4.4 oz./125 grams

1 scoop treats 1,300 gal./4,914 liters

1 container treats 26,000 gal./98,280 liters

#98948 MSRP \$19.98

(Unit Weight: .6 lbs.)

8.8 oz./250 grams

1 scoop treats 1,300 gal./4,914 liters

1 container treats 52,000 gal./196,560 liters

#98949 MSRP \$34.98

(Unit Weight: 1.2 lbs.)

1.1 lb./500 grams

1 scoop treats 1,300 gal./4,914 liters

1 container treats 104,000 gal./393,120 liters

#98950 MSRP \$149.98

(Unit Weight: 7.8 lbs.)

7 lb./3.2 kg.

1 scoop treats 1,300 gal./4,914 liters

1 container treats 665,600 gal./2,515,968 liters

- Contains 8 strains of bacteria including Photo Synthetic
- 3 billion CFU per gram potency
- Contains marigold and vitamin B
- Ideal for larger ponds



Cold Water Beneficial Bacteria (Liquid)

#98892 MSRP \$14.98

(Unit Weight: .6 lbs.)

8 oz./236 ml.

1 pump treats 100 gal./378 liters

1 bottle treats 5,000 gal./18,900 liters

#98893 MSRP \$24.98

(Unit Weight: 1.2 lbs.)

16 oz./473 ml.

1 pump treats 100 gal./378 liters

1 bottle treats 10,000 gal./37,800 liters

#98894 MSRP \$39.98

(Unit Weight: 2.3 lbs.)

32 oz./946 ml.

1 pump treats 100 gal./378 liters

1 bottle treats 20,000 gal./75,600 liters

#96021 MSRP \$99.98

(Unit Weight: 9.2 lbs.)

1 gal./3.78 liters

1 pump treats 600 gal./2,268 liters

1 bottle treats 80,000 gal./302,400 liters

- Reduces ammonia, nitrite and organic debris
- 1.5 billion CFU per ounce
- Works in very cold water, as cold as 35°F/2°C
- Safe for fish, plants and animals



Sludge & Filter Cleaner

#98889 MSRP \$13.98
(Unit Weight: .6 lbs.)

8 oz./236 ml.

1 pump treats 100 gal./378 liters
1 bottle treats 5,000 gal./18,900 liters

#98891 MSRP \$34.98
(Unit Weight: 2.3 lbs.)

32 oz./946 ml.

1 pump treats 100 gal./378 liters
1 bottle treats 20,000 gal./75,600 liters

Biological Pond and Filter Cleaner

- Contains 5 strains of heterotrophic bacteria
- 1.5 billion CFU per ounce potency

#98890 MSRP \$19.98
(Unit Weight: 1.2 lbs.)

16 oz./473 ml.

1 pump treats 100 gal./378 liters
1 bottle treats 10,000 gal./37,800 liters

#98883 MSRP \$89.98
(Unit Weight: 9.2 lbs.)

1 gal./3.78 liters

1 pump treats 600 gal./2,268 liters
1 bottle treats 80,000 gal./302,400 liters

- Contains marigold and humic acid
- Safe for fish, plants and animals



Pond Starter Bacteria

#96013 MSRP \$15.98
(Unit Weight: .6 lbs.)

8 oz./236 ml.

1 pump treats 100 gal./378 liters
1 bottle treats 5,000 gal./18,900 liters

#96015 MSRP \$39.98
(Unit Weight: 2.3 lbs.)

32 oz./946 ml.

1 pump treats 100 gal./378 liters
1 bottle treats 20,000 gal./75,600 liters

Establishes Biological Ecosystem

- Quickly establishes biological ecosystem
- Great for spring start-ups and new ponds
- Safe for fish, plants and animals

#96014 MSRP \$24.98
(Unit Weight: 1.2 lbs.)

16 oz./473 ml.

1 pump treats 100 gal./378 liters
1 bottle treats 10,000 gal./37,800 liters

#96008 MSRP \$89.98
(Unit Weight: 9.2 lbs.)

1 gal./3.78 liters

1 pump treats 600 gal./2,268 liters
1 bottle treats 80,000 gal./302,400 liters



New

Ammonia Neutralizer

#96050 MSRP \$19.98
(Unit Weight: 1.2 lbs.)

16 oz./473 ml.

1 pump treats 100 gal./378 liters
1 bottle treats 10,000 gal./37,800 liters

#96051 MSRP \$34.98
(Unit Weight: 2.3 lbs.)

32 oz./946 ml.

1 pump treats 100 gal./378 liters
1 bottle treats 20,000 gal./75,600 liters

#96052 MSRP \$79.98
(Unit Weight: 9.2 lbs.)

1 gal./3.78 liters

1 pump treats 600 gal./2,268 liters
1 bottle treats 80,000 gal./302,400 liters

- Makes pond water safe for fish and plants
- Detoxifies chloramine in tap water
- Neutralizes large concentrations of toxic ammonia



Bacteria Bubble Tabs

#98951 MSRP \$14.98
(Unit Weight: .3 lbs.)

36 Tabs

1 tablet treats 100 gal./378 liters
1 container treats 3,600 gal./13,608 liters

#98930 MSRP \$24.98
(Unit Weight: .6 lbs.)

72 Tabs

1 tablet treats 100 gal./378 liters
1 container treats 7,200 gal./27,216 liters

- Keeps pond water clean and clear
- Maintains a balanced ecosystem
- Reduces pond maintenance



Sludge Cleaner Bubble Tabs

#98901 MSRP \$15.98
(Unit Weight: .3 lbs.)

36 Tabs

1 tablet treats 100 gal./378 liters
1 container treats 3,600 gal./13,608 liters

#98902 MSRP \$24.98
(Unit Weight: .6 lbs.)

72 Tabs

1 tablet treats 100 gal./378 liters
1 container treats 7,200 gal./27,216 liters

Pond Bottom and Filter Cleaner

- Bubble Tabs help disperse sludge-eating bacteria quickly
- Safe for fish, plants or animals that may drink pond water
- Over 500 million CFU bacteria count per tablet



Algaecide

#96022 MSRP \$8.98

(Unit Weight: .7 lbs.)

8 oz./236 ml.

1 tsp. treats 50 gal./189 liters

1 bottle treats 2,500 gal./9,450 liters

#96024 MSRP \$19.98

(Unit Weight: 2.3 lbs.)

32 oz./946 ml.

1 tsp. treats 50 gal./189 liters

1 bottle treats 10,000 gal./37,800 liters

#96023 MSRP \$12.98

(Unit Weight: 1.2 lbs.)

16 oz./473 ml.

1 tsp. treats 50 gal./189 liters

1 bottle treats 5,000 gal./18,900 liters

#96026 MSRP \$69.98

(Unit Weight: 9 lbs.)

1 gal./3.78 liters

1 tsp. treats 50 gal./189 liters

1 bottle treats 40,000 gal./151,400 liters

No More Algae Growth

- Controls string algae
- Clears green water
- Can be used on ponds with fish and plants



SAB™ Stream & Pond Cleaner

#98898 MSRP \$12.98

(Unit Weight: .3 lbs.)

4.4 oz./125 grams

1 scoop treats 120 gal./454 liters

1 container treats 1,200 gal./4,536 liters

#98900 MSRP \$34.98

(Unit Weight: 1.2 lbs.)

1.1 lb./500 grams

1 scoop treats 120 gal./454 liters

1 container treats 4,920 gal./18,597 liters

#98899 MSRP \$19.98

(Unit Weight: .6 lbs.)

8.8 oz./250 grams

1 scoop treats 120 gal./454 liters

1 container treats 2,400 gal./9,072 liters

#98896 MSRP \$149.98

(Unit Weight: 7.8 lbs.)

7 lbs./3.2 kg.

1 scoop treats 1,420 gal./5,368 liters

1 container treats 31,240 gal./118,087 liters

Breaks Down Debris in Ponds, Streams, and Waterfalls

- Maintains a balanced ecosystem
- Reduces pond maintenance
- Reduces ammonia, nitrite and phosphate
- Phosphate binder



EcoBlast™

#29311 MSRP \$14.98

(Unit Weight: 1 lb.)

8.8 oz./250 grams

1 container treats up to 200 square feet

#29313 MSRP \$69.98

(Unit Weight: 7 lbs.)

7 lbs./3.2 kg.

1 container treats up to 2,275 square feet

#29312 MSRP \$34.98

(Unit Weight: 3 lbs.)

38.4 oz./1.1 kg.

1 container treats up to 780 square feet

Fastest Way to Eliminate Algae

- Eliminates algae from waterfalls, streams, fountains and water features on contact
- Can be used at any water temperature
- Product available in U.S. only



**VIDEO ON
ECOBLAST™**



Pond Detoxifier

#98876 MSRP \$10.98

(Unit Weight: .6 lbs.)

8 oz./236 ml.

1 pump treats 100 gal./378 liters

1 bottle treats 5,000 gal./18,900 liters

#40005 MSRP \$24.98

(Unit Weight: 2.2 lbs.)

Refill Pouch 32 oz./946 ml. Liquid

1 oz. treats 600 gal./2,268 liters

1 pouch treats 20,000 gal./75,600 liters

#98877 MSRP \$15.98

(Unit Weight: 1.2 lbs.)

16 oz./473 ml.

1 pump treats 100 gal./378 liters

1 bottle treats 10,000 gal./37,800 liters

#96010 MSRP \$89.98

(Unit Weight: 9.2 lbs.)

1 gal./3.78 liters

1 pump treats 600 gal./2,268 liters

1 bottle treats 80,000 gal./302,400 liters

Makes Tap Water Safe for Fish and Plants

- Removes and detoxifies chlorine
- Neutralizes ammonia
- Detoxifies and chelates copper and heavy metals



**VIDEO ON
POND DETOXIFIER**



Rapid Clear Flocculant

#98879 MSRP \$15.98
(Unit Weight: .6 lbs.)

8 oz./236 ml.

1 pump treats 100 gal./378 liters
1 bottle treats 5,000 gal./18,900 liters

#40006 MSRP \$24.98
(Unit Weight: 2.2 lbs.)

Refill Pouch 32 oz./946 ml. Liquid

1 oz. treats 600 gal./2,268 liters
1 pouch treats 20,000 gal./75,600 liters

#96049 MSRP \$19.98
(Unit Weight: 1.2 lbs.)

16 oz./473 ml.

1 pump treats 100 gal./378 liters
1 bottle treats 10,000 gal./37,800 liters

#96007 MSRP \$89.98
(Unit Weight: 9.2 lbs.)

1 gal./3.78 liters

1 pump treats 600 gal./2,268 liters
1 bottle treats 80,000 gal./302,400 liters

Quickly Clears Cloudy Pond Water by Clumping Suspended Debris

- Safe for fish, plants or animals that may drink pond water
- Works within 24 hours
- For best results use in combination with a Rapid Clear Fine Filter Pad (#80001).



Rapid Clear Fine Filter Pad (3-pack)

#80001 MSRP \$11.98
(Unit Weight: .6 lbs.)

Speeds-Up Filtering of Flocculated Particles

- For best results use in combination with Rapid Clear Liquid water treatment
- Enhances water quality
- Includes three 12" x 24" filter pads



Barley Straw Extract

#98903 MSRP \$10.98
(Unit Weight: .6 lbs.)

8 oz./236 ml.

1 pump treats 100 gal./378 liters
1 bottle treats 5,000 gal./18,900 liters

#98904 MSRP \$15.98
(Unit Weight: 1.2 lbs.)

16 oz./473 ml.

1 pump treats 100 gal./378 liters
1 bottle treats 10,000 gal./37,800 liters

#98905 MSRP \$28.98
(Unit Weight: 2.3 lbs.)

32 oz./946 ml.

1 pump treats 100 gal./378 liters
1 bottle treats 20,000 gal./75,600 liters

#96012 MSRP \$99.98
(Unit Weight: 9.2 lbs.)

1 gal./3.78 liters

1 pump treats 600 gal./2,268 liters
1 bottle treats 80,000 gal./302,400 liters

Natural Way to Clarify Pond Water

Barley straw has been used for hundreds of years to promote clean clear water conditions in ponds and streams.

- Provides clear, clean pond conditions
- Starts working instantly
- Concentrated formulation with added enzymes



Quick Start Concentrated Barley Straw Pellets

#96029 MSRP \$24.98
(Unit Weight: 5.7 lbs.)

5 lbs./2.3 kg.

1 container treats 1,000 gal./3,780 liters

Fast-acting, Long-term Natural Way to Clarify Pond Water

- Concentrated barley straw pellets
- Comes in a resealable mesh bag
- Contains a blend of bacteria and enzymes





Alkalinity Booster with Phosphate Binder

#96027 MSRP \$19.98

(Unit Weight: 3 lbs.)

1.1 lb./500 grams

1 scoop treats 125 gal./472 liters

1 container treats 5,000 gal./18,900 liters

#96028 MSRP \$34.98

(Unit Weight: 9.8 lbs.)

9 lbs./4.08 kg.

1 scoop treats 125 gal./472 liters

1 container treats 40,750 gal./154,035 liters

Increases Overall KH/pH and Alkalinity

- Lab tested and pharmaceutical grade
- Dissolves completely and easily in pond water
- Phosphate and ammonia free



Pond Salt

#99416 MSRP \$12.98

(Unit Weight: 2 lbs.)

2 lbs./0.9 kg.

1 scoop treats 190 gal./718 liters

1 container treats up to 1,520 gal./5,745 liters

#99417 MSRP \$34.98

(Unit Weight: 9 lbs.)

9 lbs./4.08 kg.

1 scoop treats 190 gal./718 liters

1 container treats up to 6,840 gal./25,835 liters

#40003 MSRP \$49.98

(Unit Weight: 40 lbs.)

40 lbs./18.16 kg.

1 scoop treats 190 gal./718 liters

1 container treats up to 30,400 gal./114,912 liters

Reduces the Effects of Nitrite Levels Toxic to Fish

- Helps restore natural electrolytes
- Repairs natural slime coat
- Prevents disease



Pond Foam Free

#98909 MSRP \$15.98

(Unit Weight: .6 lbs.)

8 oz./236 ml.

1 pump treats 100 gal./378 liters

1 bottle treats 5,000 gal./18,900 liters

Safely Eliminates Foam Near Waterfalls

- Helps maintain the beauty of your pond
- Helps keep water clean and clear of foam
- Non-toxic, safe for birds, fish, plants or animals that may drink pond water



Natural Pond Tint

#98884 MSRP \$15.98

(Unit Weight: .6 lbs.)

8 oz./236 ml.

1 pump treats 100 gal./378 liters

1 bottle treats 5,000 gal./18,900 liters

Tints Water a Natural Tea Color

- Contains humic acid and enzymes to help balance the pond ecosystem
- Creates a shimmering effect
- One dosage lasts up to 6 weeks



Blue Pond Tint

#98882 MSRP \$16.98

(Unit Weight: .6 lbs.)

8 oz./236 ml.

1 pump treats 100 gal./378 liters

1 bottle treats 5,000 gal./18,900 liters

Reformulated EcoShade™ Safely Colors Pond Water

- Filters sunlight and helps cool water
- Added enzymes help balance the pond ecosystem
- One dosage lasts up to 6 weeks



Activated Pond Carbon

#80000 MSRP \$19.98

(Unit Weight: 2.2 lbs.)

1 scoop treats 25 gal./95 liters

1 container treats up to 800 gal./3,024 liters

Removes Discoloration and Odors

Now made with bamboo carbon, a sustainable natural resource with exceptional discoloration removal capacity.

- Clarifies pond water
- Quickly reduces pond odor
- Removes discolorations



Container Water Garden Maintenance Tabs

#40004 MSRP \$14.98

(Unit Weight: .3 lbs.)

36 Tabs

1 tablet treats 100 gal./378 liters

1 container treats 3,600 gal./13,608 liters

Targeted Treatment for Container Water Gardens

- Contains 8 pure strains of beneficial bacteria
- Helps optimize water quality
- Safe for fish, plants or animals that may drink from container water gardens



Fountain Maintenance

#40007 MSRP \$19.98

(Unit Weight: .6 lbs.)

8 oz./236 ml.

1 pump treats 10 gal./37.8 liters

1 bottle treats 500 gal./1,890 liters

Safely Eliminates Scale and Debris Build up from Water Features

- Helps maintain the beauty of your water feature
- Helps maintain perfect water quality
- Prevents white scale build-up without damaging feature
- Non-toxic, safe for birds and animals



Fountain Foam Free

#98908 MSRP \$15.98

(Unit Weight: .6 lbs.)

8 oz./236 ml.

1 pump treats 10 gal./37.8 liters

1 bottle treats 500 gal./1,890 liters

Safely Eliminates Foam from Water Features

- Helps maintain the beauty of your water feature
- Helps keep water clean and clear of foam
- Non-toxic, safe for birds and animals



Fountain Scale Free

#98907 MSRP \$15.98

(Unit Weight: .6 lbs.)

8 oz./236 ml.

1 pump treats 10 gal./37.8 liters

1 bottle treats 500 gal./1,890 liters

Safely Removes Calcium and Scale from Water Fountains

- Helps keep water clean and clear of hard water deposits, white scale and foam
- Adds the fresh clean scent of lavender
- Non-toxic, safe for birds and animals

AquascapePRO® Water Treatments

- 25% more concentrated than the consumer equivalent product
- Measuring cups make it easy to apply larger doses
- Dosage guide on measuring cup for easy application



Beneficial Bacteria For Ponds (Liquid)

#30406 MSRP \$99.99

(Unit Weight: 9 lbs.)

1 gal./3.78 liters

1 scoop treats 6,000 gal./22,680 liters

1 bottle treats 96,000 gal./362,880 liters

Provides Clean, Clear and Healthy Water Conditions

- Contains Photo-Synthetic Bacteria
- 4.5 billion CFU per ounce potency
- Contains marigold and vitamin B



Beneficial Bacteria For Ponds (Dry)

#30407 MSRP \$199.99

(Unit Weight: 9.3 lbs.)

9 lb./4.08 kg.

1 scoop treats 48,000 gal./181,440 liters

1 container treats 672,000 gal./

2,540,160 liters

Provides Clean, Clear and Healthy Water Conditions

- Contains 8 strains of bacteria
- Contains Photo-Synthetic Bacteria
- 5 billion CFU per gram potency



Cold Water Beneficial Bacteria (Liquid)

#98895 MSRP \$99.99

(Unit Weight: 9 lbs.)

1 gal./3.78 liters

1 scoop treats 6,000 gal./22,680 liters

1 bottle treats 96,000 gal./362,880 liters

Provides Clean, Clear and Healthy Water Conditions

- Reduces ammonia, nitrite and organic debris
- 4.5 billion CFU per ounce potency
- Works in very cold water, as cold as 35°F/2°C



Ammonia Neutralizer Pro

#40012 MSRP \$99.99

(Unit Weight: 9 lbs.)

1 gal./3.78 liters

1 scoop treats 6,000 gal./22,680 liters

1 bottle treats 96,000 gal./362,880 liters

Protects the Biological Balance of Your Pond

- Makes pond water safe for fish and plants
- Detoxifies chloramine in tap water
- Instantly neutralizes large concentrations of toxic ammonia



New

Barley Straw Extract

#98906 MSRP \$99.99

(Unit Weight: 9 lbs.)

1 gal./3.78 liters

1 scoop treats 6,000 gal./22,680 liters

1 bottle treats 96,000 gal./362,880 liters

Natural Way to Clarify Water

- Provides clear, clean pond conditions
- Starts working instantly
- Concentrated formulation with added enzymes



SAB™ Stream & Pond Cleaner



#30409 MSRP \$199.99

(Unit Weight: 9.3 lbs.)

9 lbs./4.08 kg.

1 scoop treats 3,000 gal./11,340 liters

1 container treats 45,000 gal./170,100 liters

Keeps Ponds Clean and Crystal Clear

- Reduces pond maintenance
- Now contains more phosphate binder
- Reduces ammonia, nitrite and phosphate

Wetland Pond & Lake Bacteria



#98897 MSRP \$159.99

(Unit Weight: 9.2 lbs.)

1 gal./3.78 liters

1 scoop treats 48,000 gal./181,440 liters

1 bottle treats 768,000 gal./2,903,040 liters

Reformulated AquaClearer™ Extreme Wetland Pond & Lake Formula Beneficial Bacteria Maintenance

- Includes 8 pure strains of beneficial bacteria, including PSB (Photo-Synthetic Bacteria)
- Maintains a balanced ecosystem
- Naturally reduces ammonia, nitrite and excess nutrients like phosphate

Waterfall & Rock Cleaner



#30413 MSRP \$79.99

(Unit Weight: 9.3 lbs.)

9 lbs./4.08 kg.

1 scoop treats 151-200 sq. feet/46-60 meters

1 container treats 3,650 sq. feet/339 sq.meters

Spot-Treat the Trouble Areas on Water Features

- Quickly dissolves debris from waterfalls and rocks
- Reduces pond maintenance
- Goes to work instantly

Pond Detoxifier



#30410 MSRP \$99.99

(Unit Weight: 9 lbs.)

1 gal./3.78 liters

1 scoop treats 6,000 gal./22,680 liters

1 bottle treats 96,000 gal./362,880 liters

Makes Tap Water Safe for Fish and Plants

- Removes and detoxifies chlorine and chloramines
- Neutralizes ammonia
- Detoxifies and chelates copper and heavy metals

Natural Pond Tint



#30411 MSRP \$99.99

(Unit Weight: 9 lbs.)

1 gal./3.78 liters

1 scoop treats 6,000 gal./22,680 liters

1 bottle treats 96,000 gal./362,880 liters

Tints Water a Natural Tea Color

- Contains humic acid and enzymes
- Added enzymes help balance the pond ecosystem
- One dosage lasts up to 6 weeks

Sludge & Filter Cleaner



#30408 MSRP \$99.99

(Unit Weight: 9 lbs.)

1 gal./3.78 liters

1 scoop treats 6,000 gal./22,680 liters

1 bottle treats 96,000 gal./362,880 liters

Biological Pond and Filter Cleaner

- Contains 5 strains of heterotrophic bacteria
- 4.5 billion CFU per ounce potency
- Contains marigold and humic acid

Pond Starter Bacteria



#40011 MSRP \$99.99

(Unit Weight: 9 lbs.)

1 gal./3.78 liters

1 scoop treats 6,000 gal./22,680 liters

1 bottle treats 96,000 gal./362,880 liters

Establishes Biological Ecosystem

- Establishes biological ecosystem
- Great for spring start-up and new ponds
- Safe for fish, plants and animals

Rapid Clear



#30412 MSRP \$99.99

(Unit Weight: 9 lbs.)

1 gal./3.78 liters

1 scoop treats 6,000 gal./22,680 liters

1 bottle treats 96,000 gal./362,880 liters

Clears Discolored or Cloudy Water

- Clumps suspended debris (flocculation)
- Clears most ponds in 24 hours

Pond & Debris Clarifier



#40010 MSRP \$79.99

(Unit Weight: 9 lbs.)

1 gal./3.78 liters

1 scoop treats 6,000 gal./22,680 liters

1 bottle treats 96,000 gal./362,880 liters

Quickly Cleans Unsightly Debris

- Restores water quality
- Reduces pond maintenance



Selecting Your Seasonal Care Products

Below are the vital components for ensuring that your water feature is properly maintained and your fish are cared for over the colder months of the year.

Cold Water Bacteria (For spring and fall) – see page 58 for more information

Beneficial bacteria living in the biological filter and throughout the rocks and gravel in the pond are another key component to achieving crystal clear water and reducing pond maintenance. The bacteria, similar to aquatic plants, consume excess nutrients but are also capable of breaking down organic debris. It is important to the pond's ecosystem for these maintenance microbes to become established as early in the spring as possible. Aquascape's Cold Water Bacteria is perfect for both spring and fall because it works at temperatures below 50°F and contains 7 pure strains of concentrated beneficial bacteria that go to work quickly, cleaning and balancing your ornamental pond.



Coldwater Fish Food (For spring and fall) – see page 71 for more information

In the colder months of the year when the water temperature is below 60 degrees, your fish's metabolism slows down in preparation for hibernation. It is important during these times to either eliminate fish feeding from your daily regimen or switch to a food that is formulated for low water temperatures. Aquascape's Premium Cold Water Fish Food has been scientifically formulated to provide quality nutrition to all pond fish, including goldfish and koi. The inclusion of spirulina and wheat germ helps make the food easier to digest at colder water temperatures.



"Being prepared for every different season Mother Nature throws our way helps us help our ponds cope with the changes."



Protective Pond Netting

When fall comes and the leaves start turning a multitude of colors, it's an absolutely dazzling time of the year. But when the colors begin to fade, your pond will become a magnet for falling leaves. One way to minimize the leaves that accumulate at the bottom of your pond, along with the work required in spring clean-out, is to drop Aquascape's Protective Pond Netting over the pond. If you do this, life will be much easier in the spring.



300-Watt Pond De-Icer

If you are located in a region that experiences long periods of extremely cold weather you will also want to consider adding our 300-Watt Pond De-Icer in combination with the Aquaforce® recirculating pump. The de-icer ensure that there is always a hole open in the ice for oxygenation...even during extreme weather conditions. The Aquascape 300-Watt Pond De-Icer also comes equipped with a built-in LED light that indicates when the heater is in use.



AquaForce® – see page 42 for more information

In the colder months, it is important to start thinking about protecting your fish by ensuring that there's a hole open in the ice all winter long. Our AquaForce® pump is a recirculating bubbler pump designed to sit in the pond and oxygenate the water. The flow from the pump will bubble at the surface of the pond and maintain an opening in the ice. By keeping a hole open in the ice, you keep the water oxygenated and also allow the harmful gases to escape.



300-Watt Pond De-Icer

#39000 MSRP \$129.98

(Unit Weight: 3 lbs.)

Now comes with a 3-year limited warranty

Aquascape stainless steel Pond De-icer is ideal for keeping a small hole opening in the ice during cold winter months, and ensures proper gas exchange helping keep fish alive during the winter.

- Prevents winter fish loss
- Keeps a small hole in the ice during winter months
- Helps increase pond oxygen levels
- Stainless steel construction prevents corrosion and cracking
- Low cost to operate
- Built-in LED light indicates when heater is in use



- ① High quality stainless steel housing
- ② LED light indicates when the unit is operating



VIDEO ON
POND DE-ICER

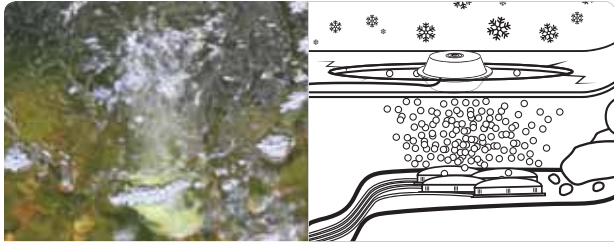

2 and 4-Outlet Pond Aerators



Pond Aerator PRO 60

Pond Aeration

Pond aerators can also be used during the winter months where the bubbles created at the surface can help keep a small hole open in the ice for oxygenation.

See pages 42 and 49 for more information on the Pond Aerators



AquaForce® Pumps Great for Winter De-icing

The fact that the AquaForce® can be submerged directly in the pond also makes it a great pump to be used as a winter de-icer. The AquaForce's powerful flow of water positioned just below the surface of the pond will keep a hole open in the ice and ensure critical oxygen levels are maintained in the pond during the cold winter months.

See pages 42 and 43 for more information on the AquaForce®

Protective Pond Netting

Aquascape Protective Pond Netting keeps predators out while also catching leaves and falling debris before they enter the pond. The reusable netting is easy to install and resists tearing. Complete with 14 stakes to secure netting in place.

- Keeps falling leaves and debris from entering the pond
- Protects fish by keeping predators out
- Comes complete with stakes to secure netting into place
- Quality woven poly material resists tearing
- Reusable

7' x 10'

#98000 MSRP \$9.98
(Unit Weight: .6 lbs.)

14' x 20'

#98001 MSRP \$19.98
(Unit Weight: 1.1 lbs.)

28' x 30'

#98002 MSRP \$49.98
(Unit Weight: 2.3 lbs.)



**VIDEO ON
WINTERIZATION**



Step-By-Step

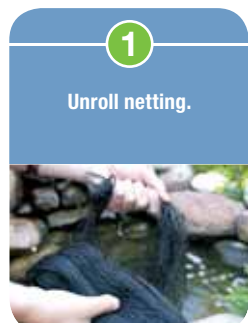

1

Unroll netting.

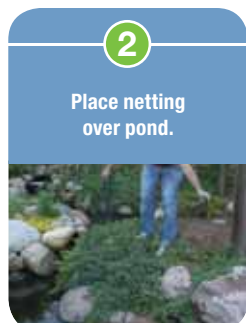

2

Place netting
over pond.

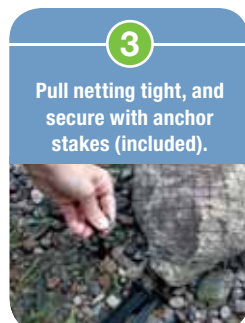

3

Pull netting tight, and
secure with anchor
stakes (included).

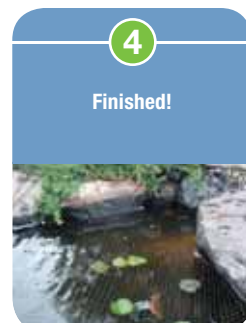

4

Finished!



Actual Size

Submersible Pond Thermometer

#74000 MSRP \$7.98

(Unit Weight: 0.2 lbs.)

Monitor pond temperature throughout the year to help adjust fish feeding and water treatment applications during seasonal changes.



Floating Alligator Decoy

#93000 MSRP \$44.98

(Unit Weight: 2.7 lbs.)

Add a little fun to your pond while protecting your valuable fish. The natural body movement will deter herons and other predators from visiting your pond.

- Three hinged body parts allow gator to float freely and appear lifelike deterring pond predators
- Detailed in non-fading, no-glare, all-weather paint



Blue Heron Decoy

#81030 MSRP \$49.98

(Unit Weight: 3 lbs.)

25"L x 7"W x 26.5"H

Deter herons from coming to your pond by tricking them into thinking another heron is already there.

- Looks life-like!
- Quick and easy set-up
- Hand-painted with non-fading, no-glare, all-weather paint
- Surface treated to prevent paint flaking
- Molded from durable, lightweight polymer





Aquascape Fish Care

Fish, like all creatures, need food to survive. All Aquascape fish foods contain probiotics that aid in digestion, optimize growth rates and reduce fish waste. Quality ingredients, including multivitamins and stabilized vitamin C, provide superior nutrition and will not pollute pond water. Aquascape fish foods are scientifically formulated to provide all pond fish, including koi and goldfish with premium quality nutrition at an affordable price.

- Floating pellet ideal for all pond fish
- Keeps pond water clean and clear
- Includes stabilized multivitamin
- Will not break apart and cloud water
- Contains high quality protein



Small
(pellet size)
2.5 - 3.5mm



Medium
(pellet size)
4.5 - 5.5mm



Large
(pellet size)
6.5 - 7.5mm

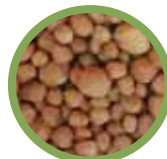

Mixed Pellet
(pellet size)
2.5 - 7.5mm

VIDEO ON
FISH FOOD



Aquascape fish foods are scientifically formulated to provide premium quality nutrition at an affordable price.





Premium Staple Fish Food Pellets

#98867 MSRP \$9.98

1.1 lbs. /500g

Medium Pellet

#98868 MSRP \$14.98

2.2 lbs. /1kg

Medium Pellet

#98869 MSRP \$27.98

4.4 lbs. /2kg

Large Pellet

#81049 MSRP \$54.98

11 lbs. /5kg

Large Pellet

#81007 MSRP \$89.98

22 lbs. /10kg

Large Pellet

#50003 MSRP \$169.98

44 lbs. /20kg

Large Pellet



Mixed Pellet

#81050 MSRP \$9.98

1.1 lbs. /500g

Mixed Pellet (small, med, large)

#81051 MSRP \$14.98

2.2 lbs. /1kg

Mixed Pellet (small, med, large)

#81052 MSRP \$27.98

4.4 lbs. /2kg

Mixed Pellet (small, med, large)

#81053 MSRP \$54.98

11 lbs. /5kg

Mixed Pellet (small, med, large)

Aquascape Premium Staple Fish Food Pellets are formulated for everyday use.



Premium Cold Water Fish Food Pellets

#98870 MSRP \$14.98

1.1 lbs. /500g

Medium Pellet

#98871 MSRP \$21.98

2.2 lbs. /1kg

Medium Pellet

#98872 MSRP \$32.98

4.4 lbs. /2kg

Large Pellet

#81047 MSRP \$69.98

11 lbs. /5kg

Large Pellet

#81003 MSRP \$129.98

22 lbs. /10kg

Large Pellet

#81004 MSRP \$229.98

44 lbs. /20kg

Large Pellet

Aquascape Premium Cold Water Fish Food Pellets can be fed at temperatures as low as 50°F/10°C.



Premium Color Enhancing Fish Food Pellets

#98873 MSRP \$14.98

1.1 lbs. /500g

Medium Pellet

#98874 MSRP \$22.98

2.2 lbs. /1kg

Medium Pellet

#98875 MSRP \$32.98

4.4 lbs. /2kg

Large Pellet

#81048 MSRP \$69.98

11 lbs. /5kg

Large Pellet

#81005 MSRP \$129.98

22 lbs. /10kg

Large Pellet

#81006 MSRP \$249.98

44 lbs. /20kg

Large Pellet

Aquascape Premium Color Enhancing Fish Food Pellets will promote brilliant colors on all pond fish.

Aquascape Premium Fish Food Pellets

Size	Recommendation
Small Pellet	Ideal for small fish from 3" (8cm) and above
Medium Pellet	Ideal for medium fish from 7" (18cm) and above
Large Pellet	Ideal for large fish from 8" (20cm) and above
Bulk (Large) Pellet	Ideal for large fish 8" (20cm) and above
Mixed Pellet	Ideal for all size fish from 3" (8cm) and above





Koi Krunchies

#81000 MSRP \$14.98

(Unit Weight: 1.1 lbs.)



Made With Natural Citrus Flavors

Aquascape Koi Krunchies are a wonderful addition to your fish's regular diet. Koi Krunchies are ideal for hand feeding goldfish, koi and other pond fish. Aquascape Koi Krunchies contain real fruit flavors and are a great source of vitamin C, which is linked to proper tissue formation, proper digestion and disease resistance.

- Great for hand feeding all pond fish
- Contains quality natural ingredients
- Great source of vitamin C
- Low waste



- Always feed koi from the same place so that fish start to recognize who you are and that you are about to feed them
- Make sure not to make sudden movements when hand feeding, as this may frighten koi
- When hand feeding, slowly place half of the food into the pond to get the fish used to coming to the surface to feed, this will also get the fish used to the smell and taste of their new treat
- Remember, whenever offering a new food, fish need a chance to recognize new shapes and smells as something to eat. Be patient and before you know it your fish will come rushing towards you to receive their delicious Aquascape Koi Krunchies treat or food

Aquascape Premium Flake Fish Food

Ideal For Small Pond Fish

Aquascape Premium Flake Fish Food has been scientifically formulated to provide premium nutrition to all pond fish including goldfish and koi. The inclusion of plankton and shrimp meal help make this food irresistible to all pond fish and can be easily consumed by smaller fish including babies known as fry.



- Flake food ideal for all pond fish
- Keeps pond water clean and clear
- Includes stabilized multivitamin
- Will not break apart and cloud water
- Contains high quality protein
- Will promote brilliant colors on all pond fish



#98878 MSRP \$14.98

(Unit Weight: .4 lbs.)

4.2 oz. /119g



#81016 MSRP \$24.98

(Unit Weight: .7 lbs.)

7.2 oz. /200g



#81017 MSRP \$39.98

(Unit Weight: 1.7 lbs.)

15 oz. /450g

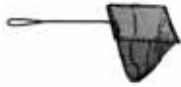

Mini Pond Net

#98556 MSRP \$7.98

(Unit Weight: .2 lbs.)

10" x 7" with 12" Handle

This net is best suited for small ponds or container water gardens.



Pond Net With Extendable Handle (Small)

#98558 MSRP \$15.98

(Unit Weight: .6 lbs.)

32" handle, extends to 63"

This small 12" x 7" net is great for tight spaces or ideal for children to lend a helping hand.



Pond Skimmer Net With Extendable Handle (Small)

#98559 MSRP \$15.98

(Unit Weight: .6 lbs.)

32" handle, extends to 63"

This small 12" x 7" net is great for scooping up small debris in tight spaces.



Pond Net With Extendable Handle (Heavy Duty)

#98560 MSRP \$29.98

(Unit Weight: 1.4 lbs.)

36" handle, extends to 69"

Our Best Value Pond Net

This heavy duty pond net is great for general maintenance as well as the addition and removal of larger pond fish. The strength of this quality net allows for the removal of large amounts of debris, cutting down on maintenance time.



Pond Skimmer Net With Extendable Handle (Heavy Duty)

#98562 MSRP \$29.98

(Unit Weight: 1.4 lbs.)

36" handle, extends to 63"

Our Best Value Pond Skimmer Net

This heavy duty skimmer net is great for general maintenance. The strength of this quality net allows for the removal of large amounts of debris, cutting down on maintenance time.



Pro Fish Net With Extendable Handle

#98561 MSRP \$34.98

(Unit Weight: 2.1 lbs.)

22" diameter head, 36" handle, extends to 69"

This net is specifically designed to handle and cradle larger pond fish including koi. The super soft netting and shallow design prevents fish from being snagged in the mesh. This style of net is a must for the pond owner with larger fish.



Professional Grade Pond Nets

AquascapePRO® pond nets are designed and built for professional pond maintenance crews. Nets include a heavy-duty, 3-foot handle that collapses for storage, allowing for safe transport from one pond to the next.

Pond Net

#50000 MSRP \$59.99

(Unit Weight: 2 lbs.)

- great for removal of large fish and a variety of debris

Pond Skimmer Net

#50001 MSRP \$59.99

(Unit Weight: 2 lbs.)

- ideal for removing small floating and suspended debris from the pond water



Collapsible Pond Nets

The Collapsible Fish and Skimmer Nets include quick-latch, telescoping handles that extend to 35" and completely fold down for compact storage.

Collapsible Pond and Fish Net 17" Black Coarse Mesh

#81031 MSRP \$29.98

(Unit Weight: 1.1 lbs.)

- ideal net for catching and handling fish

Collapsible Pond Skimmer Net 17" White Fine Mesh

#81032 MSRP \$29.98

(Unit Weight: 1.1 lbs.)

- ideal for quick and easy removal of leaves and other debris

Ulcer & Bacterial Treatment (Dry)

#81038 MSRP \$14.98

(Unit Weight: 0.6 lbs.)

8.8 oz./250 grams

1 scoop treats 125 gal./472 liters

1 bottle treats 4,875 gal./18,427 liters



Used For the Treatment of Bacterial Infections, Fin Rot, Open Sores and Ulcers

Bacterial infections and ulcerations are primarily a secondary infection resulting from external damage caused by parasites, physical damage caused by improper netting or rough handling. Most disease problems or issues may be linked back to poor water quality or introduction of sick or stressed fish. Before adding any medication to your pond or holding system, make sure and verify all water parameters and rectify any issues before treatment.

Praziquantel Treatment (Liquid)

#81041 MSRP \$24.98

(Unit Weight: 0.6 lbs.)

8 oz./236 ml

5 ml. treats 25 gal./94 liters

1 bottle treats 1,250 gal./4,725 liters



Used For the Treatment of External and Internal Parasites, Flukes, Flatworms and Tapeworms

Praziquantel is known to be one of the safest most effective pond fish medications available for treating a vast array of external and internal parasites. It will not stress pond fish, damage filtration systems, or negatively affect the balance of your pond. One of the biggest advantages in large ponds is that water changes are not necessary and it only takes one treatment.

Fungus Treatment (Liquid)

#81040 MSRP \$14.98

(Unit Weight: 0.6 lbs.)

8 oz./236 ml

5 ml. treats 25 gal./94 liters

1 bottle treats 1,250 gal./4,725 liters



Used For the Treatment of Fungus External Protozoan Parasites Including, Freshwater / Saltwater Ich, Costia and Trichodinella

It is important to treat immediately after noticing the first signs of fungus or a parasite problem on your pond fish. Common symptoms include white, green or grey cottony looking patches, fish quickly rubbing or flashing against surfaces within the pond. White spots that look like grains of salt or larger stuck to the surface of the fish.

Common issues that should be avoided include water temperature fluctuation, poor water quality and/or fish stress.

Parasite & Ich Treatment (Liquid)

#81039 MSRP \$14.98

(Unit Weight: 0.6 lbs.)

8 oz./236 ml

5 ml. treats 25 gal./94 liters

1 bottle treats 1,250 gal./4,725 liters



Used For the Treatment of External Protozoan Parasites Including, Freshwater / Saltwater Ich, Costia and Trichodinella

It is important to treat immediately after noticing the first signs of a parasite problem on your pond fish. Common symptoms include fish quickly rubbing or flashing against surfaces within the pond. White spots that look like grains of salt or larger stuck to the surface of the fish.

Common issues that should be avoided include water temperature fluctuation, poor water quality and/or fish stress.

Pond Salt

Reduces the Effects of Nitrite Levels Toxic to Fish

- Helps restore natural electrolytes
- Repairs natural slime coat
- Prevents disease



#99416 MSRP \$12.98

(Unit Weight: 2 lbs.)

2 lbs./0.9 kg.

1 scoop treats 190 gal./718 liters

1 container treats up to 1,520 gal./5,745 liters

#99417 MSRP \$34.98

(Unit Weight: 9 lbs.)

9 lbs./4.08 kg.

1 scoop treats 190 gal./718 liters

1 container treats up to 6,840 gal./25,835 liters

#40003 MSRP \$49.98

(Unit Weight: 40 lbs.)

40 lbs./18.16 kg.

1 scoop treats 190 gal./718 liters

1 container treats up to 30,400 gal./114,912 liters

Fish Symptom	Possible Problems	Treatment
Erratic movement, flashing or rubbing on rocks and surfaces throughout the pond	– Parasite Problem	<ul style="list-style-type: none"> • Aquascape Parasite & Ich Treatment • Aquascape Praziquantel Treatment • Aquascape Pond Salt
Growths that look like “cotton balls”	– Fungal Infection	<ul style="list-style-type: none"> • Aquascape Fungus Treatment
Open wounds or ulcers	– Bacterial Infection	<ul style="list-style-type: none"> • Aquascape Ulcer & Bacterial Infection Treatment • Aquascape Medicated Fish Food
Fins appear to be rotting away	<ul style="list-style-type: none"> – Fin Rot – Bacterial Infection 	<ul style="list-style-type: none"> • Aquascape Ulcer & Bacterial Infection Treatment • Aquascape Medicated Fish Food • Aquascape Pond Salt
Red streaks in the fins	<ul style="list-style-type: none"> – Bacterial Infection – Parasite Problem – Ammonia Poisoning 	<ul style="list-style-type: none"> • Aquascape Parasite & Ich Treatment • Aquascape Praziquantel Treatment • Aquascape Medicated Fish Food • Aquascape Pond Salt and water change using Aquascape Pond Detoxifier • Aquascape Ammonia Neutralizer
Small, white spots that look like salt stuck to the body of the fish	<ul style="list-style-type: none"> – Ich – Parasite problem 	<ul style="list-style-type: none"> • Aquascape Parasite & Ich Treatment • Aquascape Pond Salt
Gasping at the surface of the water	– Oxygen Depletion	<ul style="list-style-type: none"> • Aerate the pond and agitate the pond surface • Reduce fish load
Bulging eyes	– Bacterial Infection	<ul style="list-style-type: none"> • Aquascape Ulcer & Bacterial Infection Treatment • Aquascape Medicated Fish Food
Scales protruding from a swollen body like a pine cone	<ul style="list-style-type: none"> – Dropsy – Bacterial Infection 	<ul style="list-style-type: none"> • Difficult to treat; treat the pond as a preventative measure • Aquascape Ulcer & Bacterial Infection Treatment
Difficulty swimming underwater floating at the surface upright	– Swim Bladder Disease	<ul style="list-style-type: none"> • If the fish is still feeding, feed fish with canned peas or a Spirulina-based fish food
Red or swollen gills	– Parasite Problem	<ul style="list-style-type: none"> • Aquascape Parasite & Ich Treatment • Aquascape Praziquantel Treatment • Aquascape Pond Salt



Most fish issues can be avoided by following a few simple, preventative measures:

- Understand Your Water Quality** - The majority of issues are caused by poor water quality. Make sure that the fish population is under control and don't be afraid to do partial water changes often and consistently. Make sure when adding water, or when doing a partial water change, that you treat the water with Pond Detoxifier to eliminate chlorine/chloramines and chelate heavy metals. Aerating pond water is also something that can potentially increase water quality dramatically.
- Buy Your Fish From a Responsible Retailer** - Never buy sick fish and, if possible, quarantine fish for a few days before adding them to your pond. Always ask how long the retailer has had the fish. If they have just received them in, ask the retailer to hold the fish for a few days to make sure the fish recovers from stress related to transport and new water chemistry.
- Keep a Close Eye on Your Fish** - If any signs of disease are seen, start using Pond Salt immediately and start feeding with medicated fish food. If things look like they are getting worse, immediately treat the pond with the appropriate treatment. The longer you wait to treat the problem, the less chance you have of saving your fish.
- Test Your Water** - Test it yourself or have your local retailer test it for any signs of a problem. It is also important to test the water coming directly from your tap as it is increasingly common to have issues including ammonia coming directly from your source water.
- Feed Your Fish a High-Quality Food** - Feeding a high-quality food will not affect water quality and will ensure that your fish are getting all the vitamins and nutrients they need to maintain proper health. Be sure to feed often and consistently.

Before treating any potential problem with your fish, it is important to make sure that you are using the correct treatment, dosage or treatment rate to prevent any reoccurrence.

Remember, prevention is the best cure. The easiest way to avoid disease problems is to maintain optimum water conditions. Feeding a quality diet and adding beneficial bacteria on a regular basis will help maintain a balanced Ecosystem. Disease problems must be addressed in the early stages to be successful.



Aquascape Aquatic Plant Care

Aquatic plants are the foundation of every water garden. Not only do they provide beauty, but they also help to balance the pond ecosystem. Aquatic plants will quickly naturalize the pond while at the same time provide shelter and shade for aquatic creatures. Aquascape offers a full line of products to help you care for your aquatic plants.

Regardless of why you got into this hobby, adding aquatic plants to the pond is an important part of the water garden. They provide beauty and naturalization with a huge array of plant choices. Most importantly, they help balance the pond's ecosystem and provide valuable biological filtration that removes nitrogen, ammonia, nitrates and other minerals from pond water. These excess nutrients are often the cause of unsightly water conditions. The end result helps to minimize pond maintenance, leaving more time to enjoy your pond. Without aquatic plants, your pond would not be able to function as a complete ecosystem.

Aquatic Pond Plants can be classified into a few main categories: Water Lilies, Marginal Plants, Floaters and Oxygenators. Plants can also be put into two basic types known as "tropical" and "hardy." Hardy plants will over-winter in colder climates and tropical plants are more suited to warmer climates, although tropical plants are often used as annuals in colder climate zones.

Aquatic plants
are the foundation
of every
water garden.

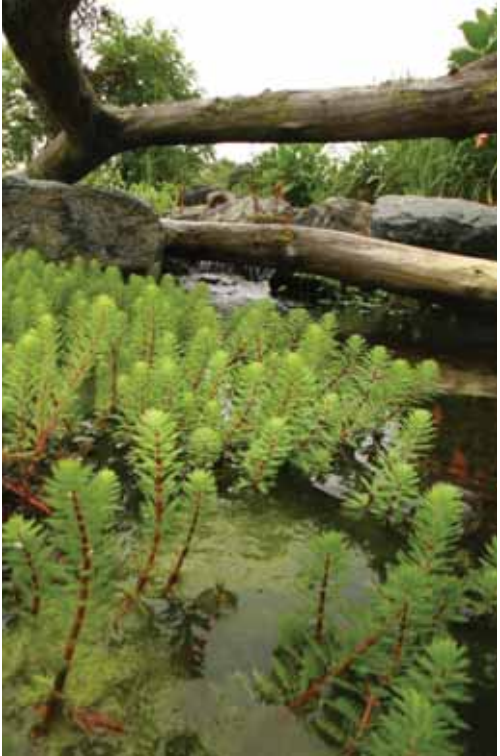



Floating Plant Island

#89006 MSRP \$27.98

(Unit Weight: .4 lbs.)

15"L x 11"W x 4"H

Display plants in deeper areas of the pond where there are no plant shelves

Aquascape's Floating Plant Island is ideal for displaying plants in deeper areas of the pond or where there are no plant shelves. The floating planter keeps the soil intact and lets water in while protecting plants from fish. Constructed to stay afloat at the surface of the pond, the Aquascape Floating Plant Island provides stunning options for displaying plants within the pond.

Aquatic Planters

Aquascape Aquatic Planters are ideal for all pond plants. Made from fine, porous material, the planters allow water in while preventing soil from entering your pond. The flexibility of Aquatic Planters makes it simple to place plants between rocks and other form-fitting areas. Aquatic Planters blend into their surrounding and will not break or crack like traditional plastic planters.

- Can be molded to fit in tight spaces
- Will not break or crack
- Keeps soil from escaping



Aquatic Plant Pot 6" x 6" (2 Pk.)

#98501 MSRP \$3.98

(Unit Weight: .1 lbs.)

Aquatic Plant Pot 8" x 6" (2 Pk.)

#98502 MSRP \$4.98

(Unit Weight: .1 lbs.)

Aquatic Plant Pot 12" x 8" (2 Pk.)

#98500 MSRP \$7.98

(Unit Weight: .1 lbs.)



Aquatic Lily Pot 14" x 7" (2 Pk.)

#98929 MSRP \$8.98

(Unit Weight: .1 lbs.)



Pond Plant Fertilizer 10-14-8

#98918 MSRP \$14.98

(Unit Weight: .4 lbs.)

36 Tabs/7 oz.

#98919 MSRP \$24.98

(Unit Weight: .8 lbs.)

72 Tabs/14 oz.

Aquascape Pond Plant Fertilizer feeds all types of aquatic plants including waterlilies. Unlike other pond tablets that feed for only two weeks, Aquascape Pond Plant Fertilizer provides an initial quick-release of nutrients that ensures proper growth and longer lasting blooms for up to 45 days.



*Not for sale in the state of California or Florida.



Once-A-Year Plant Fertilizer 13-13-13

#98916 MSRP \$19.98

(Unit Weight: 1.2 lbs.)

500 grams/1.1 lb.

#98917 MSRP \$109.98

(Unit Weight: 7.8 lbs.)

3.2 kg/7 lb.

Aquascape Once-A-Year Plant Fertilizer contains a complete time-released fertilizer that will help maximize plant growth and increase flower production all in a single application. Why fertilize every few weeks when you can do it once a year?

*Not for sale in the state of California or Florida.

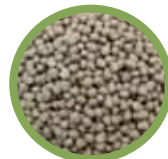

Pond Plant Potting Media

#89002 MSRP \$9.98

(Unit Weight: 10 lbs.)

This all-natural, non-toxic alluvial planting media is fine-grained and perfect for supporting the growth of your aquatic plants. Our premium potting media contains no peat moss or compost and is safe for fish.





Flexible PVC Pipe

Aquascape high quality Flexible PVC Pipe makes installations quick and easy. The main advantage of this type of pipe is durability and the ability to be glued into standard Schedule 40 PVC fittings. But it can simplify your install saving you time and money.

Features

- Simplifies plumbing layouts and installations
- Works with all Schedule 40 PVC fittings
- Sun, ozone, and mildew resistant - Note: we do not recommend placing flexible PVC pipe in continuous sunlight
- Made in USA

Kink-Free Pipe

Aquascape high quality Kink-Free Pipe is an excellent choice for quick and easy installations without the use of PVC cement. Kink-Free Pipe is extremely flexible and resistant to crimping or collapsing around tight curves. Works best when used with traditional stainless steel hose clamps and barbed fittings.

Features

- Simplifies plumbing layouts and installations
- Internal spiral prevents crushing
- Smooth inner wall reduces friction and maximizes water flow
- Made in USA

Aquascape will indicate size by color coding the internal spiral or structure located inside the tubing to a color coded system making finding fittings and matching hose sizes easier.

- ¾ inch (Dark Blue Spiral)
- 1 inch (Green Spiral)
- 1.25 inch (Red Spiral)
- 1.5 inch (Light Blue Spiral)

Aquascape's color coded kink-free pipe makes finding fittings and matching hose sizes easier.





Flexible PVC Piping

#48015 MSRP \$69.99

(Unit Weight: 14.5 lbs.)

1" x 50'

#29021 MSRP \$49.99

(Unit Weight: 12 lbs.)

1 1/2" x 25'

#29022 MSRP \$94.99

(Unit Weight: 24 lbs.)

1 1/2" x 50'

#29023 MSRP \$69.99

(Unit Weight: 16 lbs.)

2" x 25'

#29024 MSRP \$129.99

(Unit Weight: 32 lbs.)

2" x 50'

#29025 MSRP \$299.99

(Unit Weight: 65 lbs.)

3" x 50'

#29026 MSRP \$549.99

(Unit Weight: 130 lbs.)

3" x 100'



Kink-Free Pipe

#94002 MSRP \$34.98

(Unit Weight: 3.5 lbs.)

3/4" x 25'

#94001 MSRP \$39.98

(Unit Weight: 4 lbs.)

1" x 25'

#94000 MSRP \$44.98

(Unit Weight: 6 lbs.)

1 1/4" x 25'

#94006 MSRP \$59.98

(Unit Weight: 8.4 lbs.)

1 1/2" x 25'

#98288 MSRP \$99.98

(Unit Weight: 8.4 lbs.)

1/2" x 100'

#94003 MSRP \$129.98

(Unit Weight: 14 lbs.)

3/4" x 100'

#94004 MSRP \$149.98

(Unit Weight: 17.2 lbs.)

1" x 100'

#94005 MSRP \$179.98

(Unit Weight: 24.5 lbs.)

1 1/4" x 100'

#94007 MSRP \$199.98

(Unit Weight: 34.5 lbs.)

1 1/2" x 100'



Black Vinyl Tubing

#94008 MSRP \$79.98

(Unit Weight: 5 lbs.)

3/8" x 100'

#94009 MSRP \$89.98

(Unit Weight: 6 lbs.)

1/2" x 100'

#94010 MSRP \$129.98

(Unit Weight: 10.9 lbs.)

3/4" x 50'

#94011 MSRP \$159.98

(Unit Weight: 13.6 lbs.)

1" x 50'

Pre-Cut Kink-Free Pipe

#88003 MSRP \$11.98

(Unit Weight: 0.85 lbs.)

6' x 1/2"

#98404 MSRP \$12.98

(Unit Weight: 1 lb.)

6' x 3/4"

Aquascape's Kink-Free Pipe cut into 6-foot sections and packaged for convenience. Great for plumbing basalt and other natural stone fountains.



AquascapePRO® Check Valve Assembly

An AquascapePRO® Check Valve Assembly is needed to connect your pump to the pond plumbing. Aquascape dual union check valves have a removable connection underneath the check valve which allows you to disconnect the pump and plumbing without draining the water in your BioFalls® Filter (not included in #29500 Plumbing Assembly). See descriptions and chart below to determine which check valve assembly fits your project.

AquascapePRO® Check Valves

Item #	Check Valve Assembly (CVA)	For Use in the Following Filter	For Use with the Following Pump	MSRP	Weight
29500	Plumbing Assembly	Signature Series™ 200 Skimmer	AquaSurge® 2000 & 3000	\$39.99	1.4 lbs
29501	CVA Signature Series™ Skimmer & Pondless® Vault	Signature Series™ Skimmer 400 & 1000 Pondless® Vault	3PL, 5PL, 9PL & 8PN AquascapePRO 3000, 4500 & 7500	\$79.99	2.3 lbs
29108	CVA Signature Series™ Skimmer & Pondless® Vault AquaSurge®	Signature Series™ Skimmer 400 & 1000 Pondless® Vault & MicroSnorkel™ Vault	All AquaSurge® Pumps	\$79.99	1.5 lbs
29099	CVA 2" Large Pondless® Waterfall	Pondless® Waterfall Vault w/Extension Large Snorkel™ Vault	All AquaSurge® Pumps 3PL, 5PL, 9PL & 8PN AquascapePRO 3000, 4500 & 7500	\$89.99	4 lbs
29098	CVA 3"	Pondless® Waterfall Vault w/Extension Large Snorkel™ Vault Grande Skimmer	12PN AquascapePRO 10,000	\$109.99	5.5 lbs

Refer to our Pricing and Program Guide for more information on the: 2-Way Flow Control Valve, Check Valve Assembly 2-3 Conversion Kit and the Check Valve 2" Aquasurge® Adapter



Liner & Underlayment

The liner is the pond's foundation. Choosing an inferior liner can lead to a leaky pond. Educate yourself on the selection of liners that are available. Don't even consider using a liner if it doesn't come with a long-term warranty. It is important to also determine whether the liner you choose is safe for any fish that may inhabit the pond.

Underlayment is installed before the liner in order to prevent any punctures that may occur from rough or rocky ground. The underlayment actually serves a couple of purposes. It not only provides protection for the liner against rocky soils and roots, but it also allows the ground to breathe from underneath. The earth releases gases and the fabric allows the gases to escape from underneath the liner rather than becoming trapped, causing gas bubbles to push the liner up into the pond.

Don't even consider using a liner if it doesn't come with a long-term warranty.



EPDM Pond Liner

Aquascape 45 mil fish-safe EPDM pond liner leads the industry in quality and reliability. Backed by an industry leading 20 year guarantee, Aquascape is the choice of discriminating pond professionals.

- Superior elongation and lay-flat characteristics
- Exceptional resistance to solar UV, ozone and oxidation
- Ease of installation with no special tools required

#42002 MSRP \$645.00

(Unit Weight: 162 lbs.)

5' x 100' Liner

#29188 MSRP \$645.00

(Unit Weight: 162 lbs.)

10' x 50' Liner

#29189 MSRP \$1,290.00

(Unit Weight: 324 lbs.)

10' x 100' Liner

#29192 MSRP \$967.50

(Unit Weight: 243 lbs.)

15' x 50' Liner

#29193 MSRP \$1,935.00

(Unit Weight: 486 lbs.)

15' x 100' Liner

#29196 MSRP \$1,290.00

(Unit Weight: 324 lbs.)

20' x 50' Liner

#29197 MSRP \$2,580.00

(Unit Weight: 648 lbs.)

20' x 100' Liner

#29200 MSRP \$1,612.50

(Unit Weight: 405 lbs.)

25' x 50' Liner

#29201 MSRP \$3,225.00

(Unit Weight: 810 lbs.)

25' x 100' Liner

#29202 MSRP \$1,935.00

(Unit Weight: 486 lbs.)

30' x 50' Liner

#29203 MSRP \$3,870.00

(Unit Weight: 972 lbs.)

30' x 100' Liner

#29206 MSRP \$2,580.00

(Unit Weight: 678 lbs.)

40' x 50' Liner

#29207 MSRP \$5,160.00

(Unit Weight: 1295 lbs.)

40' x 100' Liner

#29210 MSRP \$3,225.00

(Unit Weight: 810 lbs.)

50' x 50' Liner

#29211 MSRP \$6,450.00

(Unit Weight: 1,619 lbs.)

50' x 100' Liner

**Larger roll lengths of 150' and 200' available. Call for availability!*

EPDM Pond Liner - Mini Roll

#42018 MSRP \$645.00

(Unit Weight: 162 lbs.)

20' x 25'

#42019 MSRP \$774.00

(Unit Weight: 195 lbs.)

20' x 30'

#42020 MSRP \$967.50

(Unit Weight: 243 lbs.)

25' x 30'

#42021 MSRP \$1,161.00

(Unit Weight: 292 lbs.)

30' x 30'

Liner For Large Projects *SPECIAL ORDER ITEM

#30336 PLEASE CALL FOR PRICE

(Unit Weight: .15 lbs./ft.²)

Aquascape 36 Mil Reinforced Polypropylene Liner

Ultra strong liner of choice for large projects. Minimum size 50 ft. x 100 ft.*

Non-Woven Geotextile Underlayment Rolls

This soft polyethylene fabric helps protect pond liner from rocks and other sharp objects. The underlayment spreads easily and allows gases to escape.

#29227 MSRP \$.40 (Per sq.ft.)

(Unit Weight: .04 lbs./ft.² over 900 sq.ft.)

Cut to Size

#30300 MSRP \$329.99

(Unit Weight: 59 lbs.)

5' x 300'

#29169 MSRP \$899.99

(Unit Weight: 200 lbs.)

15' x 300

#29170 MSRP \$899.99

(Unit Weight: 175 lbs.)

7.5' x 600'

Boxed EPDM Pond and Stream Liner

Aquascape 45 mil fish safe EPDM Pond Liner boxed for convenience.

#85009 MSRP \$103.20

(Unit Weight: 23 lbs.)

8' x 10'

#29607 MSRP \$129.00

(Unit Weight: 29 lbs.)

10' x 10'

#85000 MSRP \$154.80

(Unit Weight: 35 lbs.)

10' x 12'

#29612 MSRP \$258.00

(Unit Weight: 58 lbs.)

10' x 20'

#29616 MSRP \$387.00

(Unit Weight: 87 lbs.)

10' x 30'

#85001 MSRP \$232.20

(Unit Weight: 52 lbs.)

12' x 15'

#85002 MSRP \$290.25

(Unit Weight: 65 lbs.)

15' x 15'

#85003 MSRP \$387.00

(Unit Weight: 87 lbs.)

15' x 20'

#85004 MSRP \$645.00

(Unit Weight: 145 lbs.)

20' x 25'

Boxed Non-Woven Geotextile Underlayment

#85010 MSRP \$49.00

(Unit Weight: 5.7 lbs.)

10' x 15'

Aquascape underlayment boxed for convenience. Multiple sections can be laid out for larger applications.

Rock Pad

#25000 MSRP \$26.99

(Unit Weight: 1.1 lbs.)

The rock pad is an extra thick 3' x 3' nonwoven polypropylene fabric that can be laid down on the liner before placing those large rocks.

Also available in rolls!

Rock Pad Roll (15' x 150' Roll)

#25001 MSRP \$1,749.99

(Unit Weight: 260 lbs.)

Woven Microgrid Geotextile

A specialty woven geotextile recommended for use on top of the AquaBlox® when using permeable pavers. This woven geotextile keeps the base aggregate bed on top of the AquaBlox®, while allowing water to infiltrate into the water storage basin.

#42016 MSRP \$999.99

(Unit Weight: 65 lbs.)

8' x 225' Roll

#42015 MSRP \$14.99

(Unit Weight: 0.5 lbs.)

4' x 4'



Aquascape Decorative Water Features

What is a Fountainscape?

Fountainscapes are decorative water features such as container water gardens, stand-alone fountains, bubbling stone, decorative spitters including fountains that incorporate an in-ground reservoir.

Container Water Gardens

If you're interested in "testing the waters" of the water gardening hobby, a container water garden or Patio Pond is a great place to start! They are generally used to add the sound of water to a deck or patio, but they also look great greeting visitors by the front door. But they don't just add beauty; they also give kids a fun way to learn about nature.

Standalone Fountains

Standalone Fountains are gaining popularity due to their ease of set-up and maintenance, all you need to do is add water, plug it in, and enjoy. A great example of a standalone fountain is the New Aquascape Fire Fountain that combines the beauty of water and fire in a quick and easy plug and play format.

Bubbling Stone Fountains and Spillway Bowls

These larger water features are typically set atop an underground reservoir also known as an AquaBasin®, a water pump contained within the AquaBasin® keeps circulating the water over the feature. An AquaBasin® can easily be installed within just a few hours if you like to tackle home projects on your own, or you can hire a Certified Aquascape Contractor to do the job for you.

Decorative Spitters

Decorative Spitters are often used to add a whimsical touch or create a focal point and water movement to existing ponds or container water gardens. Decorative Spitters can also be incorporated into traditional landscapes when combined with a small reservoir or mini AquaBasin®.

Aquascape handcrafted decorative items provide a unique and creative way to decorate your outdoor living space.



Spillway Bowl, Basin and Stand

Inspired by our own construction crew, the Aquascape Spillway Bowl, Basin and Stand allows for an unlimited amount of installation possibilities. The Aquascape Spillway Bowl and Basin can be installed as a standalone disappearing water feature, or several spillway bowls can be linked together for an amazing display. Aquascape Spillway Bowls can also be used in combination with the Aquascape Large AquaBasin®.

- Made from durable GFRC
- Unique and beautiful patina finish
- Light weight and easy to install



Spillway Bowl

#78204 MSRP \$299.98

(Unit Weight: 71 lbs.)

32"

The Aquascape Spillway Bowl creates a beautiful spilling water feature that can be added to any pond or pool creating an instant waterfall. Spillway Bowls can also easily be linked together creating a unique modern standalone water feature.



Spillway Basin

#78205 MSRP \$449.98

(Unit Weight: 141 lbs.)

40"

The Aquascape Spillway Basin is an ideal standalone overflowing water feature that will create a beautiful, tranquil focal point in almost any setting.



Spillway Bowl Stand (2 Pack)

#78206 MSRP \$79.98

(Unit Weight: 13 lbs.)

The Aquascape Spillway Bowl Stand provides the ideal pedestal to showcase The Aquascape Spillway Basin or Spillway Bowl. Ideal when installing Spillway Bowls or Basins on a patio, deck or as a stand-alone water feature. The Spillway Bowl Stand creates the ideal elevation between Spillway Bowls.

Fire Fountain

Self-contained water and fire features have been gaining in popularity over the last few years. The Aquascape Fire Fountain provides the beauty and elegance of fire and flowing water in a bowl-shaped GFRC or glass fiber reinforced concrete water feature. The self-contained feature is a simple plug-and-play water feature with a fire feature in the center making it an ideal focal point or centerpiece to any outdoor setting.

- Sets up in minutes
- Made from durable GFRC material
- Pump included, fire fuel and decorative stones not included

#78201 MSRP \$349.98

(Unit Weight: 56 lbs.)

24" diameter 12"H

#78202 MSRP \$449.98

(Unit Weight: 72 lbs.)

28" diameter 14"H

#78203 MSRP \$549.98

(Unit Weight: 96 lbs.)

32" diameter 16"H



Step-By-Step

1

Unpack, rinse and position Fire Fountain in desired location.



2

Attach pump to plumbing.



3

Add water to fountain portion of the Fire Fountain.



4

Add paraffin fuel to fuel canister. Add gravel.



5

Plug in pump, light fire source.

ENJOY!



We recommend the use of paraffin fuel (sold separately) readily available for use in outdoor torches etc.

Aquascape Aquatic Patio Ponds

Aquascape Aquatic Patio Ponds make it simple to have a complete water garden in almost any setting. Creating a beautifully planted water bowl or container water garden has never been easier. Aquascape Aquatic Patio Ponds have all the natural beauty of real rock with the added durability and light weight of fiberglass. Create a natural paradise in your backyard with Aquascape Aquatic Patio Ponds!

- Light weight and durable
- Can be used indoors or outdoors
- Never fade or chips
- Natural rock veneer
- Ages like real stone
- Integrated plant shelves



**VIDEO ON
PATIO POND**



Green Slate

#98853 MSRP \$179.98
(Unit Weight: 10.1 lbs.)

24" (10 gal.) 24" diameter 12"H

#98856 MSRP \$289.98
(Unit Weight: 15 lbs.)

32" (20 gal.) 32" diameter 14"H

#98859 MSRP \$399.98
(Unit Weight: 19.6 lbs.)

40" (30 gal.) 40" diameter 16"H



Desert Granite

#98854 MSRP \$179.98
(Unit Weight: 13.6 lbs.)

24" (10 gal.) 24" diameter 12"H

#98857 MSRP \$289.98
(Unit Weight: 18.9 lbs.)

32" (20 gal.) 32" diameter 14"H

#98860 MSRP \$399.98
(Unit Weight: 23.5 lbs.)

40" (30 gal.) 40" diameter 16"H



European Terra Cotta

#98855 MSRP \$179.98
(Unit Weight: 12.6 lbs.)

24" (10 gal.) 24" diameter 12"H

#98858 MSRP \$289.98
(Unit Weight: 17.2 lbs.)

32" (20 gal.) 32" diameter 14"H

#98861 MSRP \$399.98
(Unit Weight: 21.7 lbs.)

40" (30 gal.) 40" diameter 16"H



Textured Gray Slate

#78049 MSRP \$179.98
(Unit Weight: 14.1 lbs.)

Small (15 gal.) 24"L x 24"W x 12"H

#78050 MSRP \$289.98
(Unit Weight: 18.7 lbs.)

Medium (27 gal.) 27"L x 27"W x 14.5"H

#78051 MSRP \$399.98
(Unit Weight: 22.5 lbs.)

Large (45 gal.) 33"L x 33"W x 16"H



Aquatic Patio Pond Kit

#78197 MSRP \$149.98
(Unit Weight: 9 lbs.)

Add the beauty of water to your garden, deck, patio or balcony.

Kit Includes:

- 16" Square Textured Gray Slate Patio Pond
- Pouring Bamboo Fountain with pump
(Marginal Plants Not Included in Kit)



Step-By-Step

1
Rinse pond with a garden hose.



2
Position pond and fill with water.



3
Place plants on integrated shelf.



4
Add small fish for color and movement.



Aquatic Patio Ponds Basic Planting Guide

24" Aquatic Patio Pond



32" Aquatic Patio Pond



40" Aquatic Patio Pond

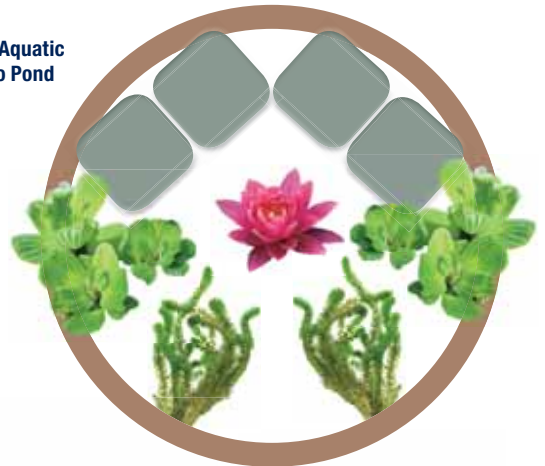

Step One: Choose your Aquatic Patio Pond



24" dia. (10 gal.)



32" dia. (20 gal.)



40" dia. (30 gal.)



24" sq. (15 gal.)
27" sq. (27 gal.)
33" sq. (45 gal.)

Step Two: Add your plants

8" Square Marginal



Waterlily



Floater



Oxygenator



Step Three: Enjoy!



Aquascape Poly-Resin Spitters

Made from high quality poly-resin, this sturdy material is light weight, UV and heat resistant. Poly-resin is also ideal for taking on the texture, shape, and finish of real brass and stone at a fraction of the cost and maintenance of natural materials. All Aquascape poly-resin spitters come complete with water pump taking the guesswork out of matching the correct pump to run your spitter.



Alligator Spitter

#78208 MSRP \$149.98

(Unit Weight: 11 lbs.)

19"L x 11"W x 12"H

Includes a 180 GPH pump



Dragonfly Spitter

#78209 MSRP \$179.98

(Unit Weight: 12 lbs.)

12"L x 11"W x 25"H

Includes a 180 GPH pump



Double Frog with Cattail Spitter

#78210 MSRP \$149.98

(Unit Weight: 10 lbs.)

10"L x 10"W x 18"H

Includes a 180 GPH pump



Frog on Reed Spitter

#78211 MSRP \$149.98

(Unit Weight: 9 lbs.)

12"L x 9"W x 18"H

Includes a 180 GPH pump



Ideal for use with the Aquascape Patio Pond



Deer Scarer Bamboo Fountain

#78013 MSRP \$79.98

(Unit Weight: 2.6 lbs.)

5"L x 5"W x 15"H

Includes a 90 GPH pump



Pouring Three-Tier Bamboo Fountain

#78015 MSRP \$79.98

(Unit Weight: 2.6 lbs.)

5"L x 5"W x 15"H

Includes a 90 GPH pump



Adjustable Pouring Bamboo Fountain

#78014 MSRP \$79.98

(Unit Weight: 3.5 lbs.)

Extends from 18" - 30" 5"L x 5"W x 15"H

Includes a 90 GPH pump



Toucan Spitter

#78011 MSRP \$149.98

(Unit Weight: 7.3 lbs.)

9"L x 18"W x 18"H

Includes a 90 GPH pump



Naughty Dog Spitter

#78012 MSRP \$119.98

(Unit Weight: 5.3 lbs.)

18.5"L x 10"W x 10.5"H

Includes a 90 GPH pump



Lazy Frog on Lily Pad Spitter

#78017 MSRP \$79.98

(Unit Weight: 2.6 lbs.)

12"L x 10"W x 5"H

Includes a 90 GPH pump



Crazy Legs Frog Spitter

#78010 MSRP \$149.98

(Unit Weight: 5.5 lbs.)

37"L x 8"W x 20"H

Includes a 90 GPH pump



Man In Barrel Spitter

#78016 MSRP \$79.98

(Unit Weight: 3 lbs.)

4"L x 9"W x 5"H

Head - 8.5"L x 11"W x 8"H Hands - 4.5"L x 5"W x 3"H

*Barrel not included

Includes a 90 GPH pump

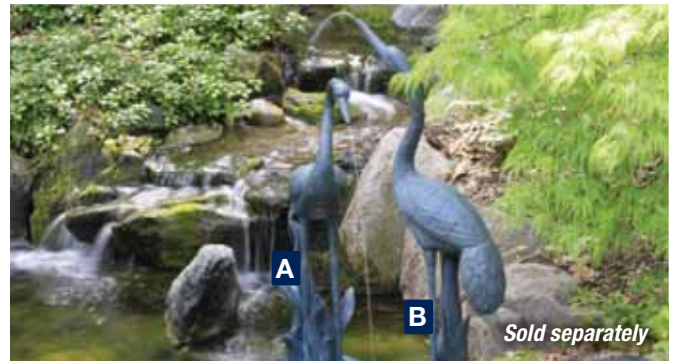

A. Crane with Lowered Head Spitter

#78009 MSRP \$229.98

(Unit Weight: 11 lbs.)

32"H

Includes a 180 GPH pump

B. Standing Crane Spitter

#78008 MSRP \$229.98

(Unit Weight: 11 lbs.)

25"H

Includes a 320 GPH pump

Sold separately

Aquascape Stone Fountains

Since each piece is handcrafted from natural Stone, some variations in size, color, weight, and texture will occur. Fountains darken when wet.



Mongolian Basalt Kit

#58065 MSRP \$786.34
(Approx. Unit Weight: 388 lbs.)

Kit Includes:

- Natural Mongolian Basalt Column - 30"
- AquaBasin® Large
- Ultra™ 800 Pump
- 6' of 3/4" Kink-Free Pipe



Natural Mongolian Basalt Column



#58038 MSRP \$319.98
(Approx. Unit Weight: 200 lbs.)

24"H x 10" dia.

To complete your system:

- #98469** AquaBasin® Small
- #91005** 400 GPH Ultra™ Pump
- #98404** 6' of 3/4" Kink-Free Pipe



#98503 MSRP \$369.98
(Approx. Unit Weight: 335 lbs.)

30"H x 10" dia.

To complete your system:

- #98134** AquaBasin® Large
- #91007** 800 GPH Ultra™ Pump
- #98404** 6' of 3/4" Kink-Free Pipe



#98969 MSRP \$419.98
(Approx. Unit Weight: 375 lbs.)

36"H x 10" dia.

To complete your system:

- #98134** AquaBasin® Large
- #91007** 800 GPH Ultra™ Pump
- #98404** 6' of 3/4" Kink-Free Pipe



Set of 3 Natural Mongolian Basalt Columns

#58062 MSRP \$999.98
(Approx. Unit Weight: 850 lbs.)

Includes:

- (1) - 24"H x 10" dia.
- (1) - 30"H x 10" dia.
- (1) - 36"H x 10" dia.

To complete your system:

- #98134** AquaBasin® Large
- #91010** 2,000 GPH Ultra™ Pump
- #98404** 6' of 3/4" Kink-Free Pipe



Set of 3 Semi-Polished Stone Basalt Columns

#98264 MSRP \$799.98
(Approx. Unit Weight: 289 lbs.)

Includes:

- (1) - 12"H x 7.5" dia.
- (1) - 20"H x 7.5" dia.
- (1) - 27"H x 10" dia.

To complete your system:

- #98134** AquaBasin® Large
- #91010** 2,000 GPH Ultra™ Pump
- #98404** 6' of 3/4" Kink-Free Pipe



Double-Textured Basalt Cored Water Columns

#98548 MSRP \$499.98
(Approx. Unit Weight: 276 lbs.)

Includes:

- (1) - 20"H x 9" dia.
- (1) - 13"H x 7" dia.
- (1) - 8"H x 8" dia.

To complete your system:

- #98469** AquaBasin® Small
- #91010** 2,000 GPH Ultra™ Pump
- #98404** 6' of 3/4" Kink-Free Pipe



Set of 3 Keyed Basalt Columns

#98552 MSRP \$499.98
(Approx. Unit Weight: 246 lbs.)

Includes:

- (1) - 18"H x 11" dia.
- (1) - 12"H x 11" dia.
- (1) - 6"H x 10" dia.

To complete your system:

- #98469** AquaBasin® Small
- #91005** 400 GPH Ultra™ Pump
- #98404** 6' of 3/4" Kink-Free Pipe



Aquascape Fiberglass Resin Composite

Aquascape Fiberglass Resin Composite has all the natural beauty of real rock with the added durability and light weight of fiberglass. Aquascape fiberglass stone finish creates the soothing sound of trickling water making it the focal point of any setting. Create a natural paradise in your back yard.

- Lightweight and durable
- Can be used indoors or outdoors
- Never fades or chips
- Natural rock veneer
- Ages like real stone



Small Stacked Slate Urn

#98939 MSRP \$349.98

(Approx. Unit Weight: 27.2 lbs.)

25" diameter x 32"H

Recommended pump size - 550 GPH Ultra Pump

Medium Stacked Slate Urn

#78207 MSRP \$599.98

(Approx. Unit Weight: 53 lbs.)

27" diameter x 45"H

Recommended pump size - 800 GPH Ultra Pump

Large Stacked Slate Urn

#98940 MSRP \$949.98

(Approx. Unit Weight: 116 lbs.)

38" diameter x 56.5"H

Recommended pump size - 2,000 GPH Ultra Pump

Small Stacked Slate Urn Fountain Kit

#58064 MSRP \$459.98

(Approx. Unit Weight: 39.2 lbs.)

Kit Includes:

- Small Stacked Slate Urn - 32"
- DecoBasin
- Ultra™ 550 Pump
- 6' of 3/4" Kink-Free Pipe



Fire Fountain Add-on Kit

#78221 MSRP \$79.98

(Approx. Unit Weight: 4.5 lbs.)

New

Prepare to be amazed at the difference fire can make for your new Aquascape Stacked Slate Urn. The Aquascape Fire Fountain Add-on Kit is made from durable GFRC and high-quality stainless steel, providing a long-lasting sturdy construction. This 'hot' new item includes a long-lasting wick that will provide hours of enjoyment. Simply add paraffin or citronella fuel (sold separately) to transform any outdoor space into a cozy backyard paradise.



Please Note: The Aquascape Fire Fountain Add-on Kit can only be used on the 2016 production of the Small, Medium and Large Stacked Slate Urns. Item numbers 98939, 78207 and 98940.

Step-By-Step

1

Place fire pot holder in position.



2

Remove plastic. Place into fire pot holder.



3

Set wick into fire pot. Push to the bottom.



4

Set wick ring inside fire pot, directly on top of wick.



5

Add paraffin oil to top of wick until pot is full.



6

Light wick using a long handled lighter or match.



7

Extinguish flame by placing pot cover on fire pot.



Aquascape AquaBasin® Mini Fountain Kits

The AquaBasin® Mini Fountain Kits come complete with water pump, basin & fountain.



Leaning Vase Fountain

#98920 MSRP \$69.98
(Approx. Unit Weight: 5.5 lbs.)
11"L x 11"W x 16"H



Amphora Vase Fountain

#98922 MSRP \$69.98
(Approx. Unit Weight: 4.3 lbs.)
11"L x 11"W x 16"H



Swirly Vase Fountain

#58019 MSRP \$69.98
(Approx. Unit Weight: 6 lbs.)
12.75"L x 12.75"W x 18.5"H



Mini Stacked Slate Urn Fountain

#58014 MSRP \$69.98
(Approx. Unit Weight: 5 lbs.)
12.75"L x 12.75"W x 18.5"H

Fountain Kit

#98921 MSRP \$149.98
(Approx. Unit Weight: 12.7 lbs.)

Fountain Kit

#98923 MSRP \$149.98
(Approx. Unit Weight: 11.6 lbs.)

Fountain Kit

#58054 MSRP \$149.98
(Approx. Unit Weight: 13 lbs.)

Fountain Kit

#58060 MSRP \$149.98
(Approx. Unit Weight: 12 lbs.)



**VIDEO ON
MINI FOUNTAIN**



Step-By-Step

1

Prepare hole in ground.



2

Insert basin, fill surrounding space.



3

Attach pump to fountain.



4

Add decorative pebbles and water.



ENJOY!





Aquascape AquaRock Fountain Kit

Incorporate the sight and sound of water into your garden or home. The Aquascape AquaRock Fountain Kit is available in two colors and comes complete with everything needed to install a beautiful water fountain.

- Simple to install and maintain (most installations take less than 1 hr.)
- Integrates easily into existing landscapes
- Comes complete with all necessary components
- Fountain is made from real rock (stone size and quantity may vary)
- Hand crafted and made in the USA

Kit Components:

1. Five gallon bucket (water basin) and perforated lid
2. Lid liner skirt
3. Water pump with 6' power cord
4. Water hose
5. Drilled rock stack

AquaRock Sandstone Kit

#97068 MSRP \$59.98

(Approx. Unit Weight: 45 lbs.)

14.5"H x 12" dia.



AquaRock Blue Stone Kit

#97067 MSRP \$59.98

(Approx. Unit Weight: 45 lbs.)

14.5"H x 12" dia.



Step-By-Step

1

Dig out soil to bury bucket.



2

Place bucket into hole you have created.



3

Add gravel or decorative pebbles.



4

Fill with water, plug in pump and ENJOY!

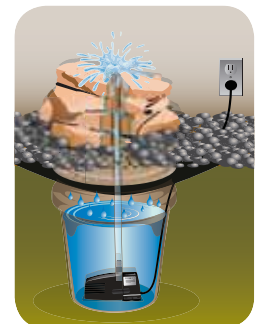

Please Note: The AquaRock Fountain Kit does not include decorative gravel or pebbles.

Aquascape Paver Fountain Kits

Aquascape Paver Fountain Kits make it simple to add a splash of water to almost any traditional paver application including patios, driveways and walkways

- Can easily be installed in new or existing paver applications
- Creates an oxygenated water source for birds and other wildlife
- The sound of bubbling water can be used to mask unpleasant noise pollution

Choose from the pre-designed Mosaic Fountain Stone or create your own design with the solid granite Bubbling Fountain Stone

Kit includes:

- Solid granite Bubbling Fountain Stone or Bubbling Formal Mosaic Fountain Stones
- Fountain Accent Light with 12V Transformer
- Medium AquaBasin® Water Reservoir
- Ultra™ Water Pump
- All Necessary Plumbing Components and Microgrid Geotextile



**VIDEO ON
PAVER BUBBLER
FOUNTAIN KITS**



Bubbling Fountain Stone Kit

#58069 MSRP \$379.98
(Unit Weight: 65 lbs.)

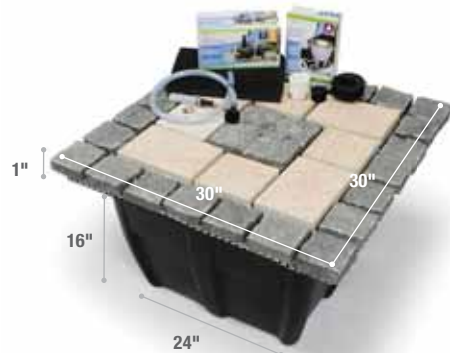

Bubbling Formal Mosaic Fountain Kit

#58070 MSRP \$499.98
(Unit Weight: 110 lbs.)

Step-By-Step

1

Dig the hole and position the AquaBasin®.



2

Add the included pump, plumbing and lighting.



3

Fill the AquaBasin with water.



4

Install the fountain stones and complete with pavers of your choice.



ENJOY!





Aquascape's Stainless Steel WaterWall Spillway

Incorporate beautiful, low-maintenance formal waterfalls into any design using the Aquascape Stainless Steel WaterWall Spillway.



Stainless Steel WaterWall Spillway

#58066 MSRP \$219.99

(Unit Weight: 9 lbs.)

- Stainless steel construction for strength and corrosion resistance
- Clog-free, open-top design reduces maintenance
- 16" wide spillway and 1" plumbing port handles pumps up to 2,000 gallons per hour

WaterWall Spillway Kit

#58080 MSRP \$569.99

(Unit Weight: 40 lbs.)

The WaterWall Spillway Kit combines all of the required components into a convenient kit that saves you time and money.

Kit includes:

- 16" Stainless Steel Waterfall Spillway
- Medium AquaBasin[®] with Splash Pad
- Ultra™ Pump with Plumbing Components
- 1-Watt 12V LED Waterfall Up Light with 12V Transformer
- Compact Water Fill Valve



Step-By-Step

1

Connect the plumbing.



2

Position the spillway in the wall.



3

Level the unit and finish the wall.



4

Fill the basin with water and plug in the pump.

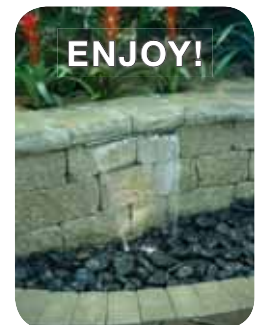

Aquascape AquaBasin®

Designed to take the guesswork out of installing fountain rocks, hand-carved stone, brass fountains, and bubbling urns. The AquaBasin® is a great way for anyone to quickly and easily install these popular styles of water features. Can accommodate all Ultra™ Pumps.

AquaBasin® Features:

- Professional grade, high-density polyethylene, double walled structure gives it superior strength and weight distribution
- Extra large water capacity means less maintenance
- Pump access panels allow access for maintenance
- Pre-drilled hole in the center makes it easy to hook up plumbing
- Designed for maximum strength when backfilling and positioning decorative pieces



VIDEO ON
AQUABASIN®



AquaBasin® Large

#98134 MSRP \$479.98

(Unit Weight: 46.5 lbs.)

45"L x 45"W x 14"H

- 75-gallon water storage capacity
- 18-inch diameter recess allows for larger pieces to be backfilled in order to increase stability
- Maximum weight capacity - 1,200 lbs.
- Two 9" x 16" pump access panels
- Can accommodate Magnetic Driven Ultra™ Pumps totaling up to 4,000 GPH



AquaBasin® Medium

#76004 MSRP \$279.98

(Unit Weight: 20 lbs.)

24"L x 24"W x 16"H

- 40-gallon water storage capacity
- Ideal reservoir for Aquascape's Paver Fountains and WaterWall Spillway
- 8.5" diameter pump access opening with lid
- Maximum weight capacity - 1,200 lbs.
- Can accommodate pumps up to 2,000 GPH



AquaBasin® Small

#98469 MSRP \$279.98

(Unit Weight: 17 lbs.)

30"L x 30"W x 10"H

- 40-gallon water storage capacity
- Maximum weight capacity - 350 lbs.
- One 9" x 16" pump access panel
- Can accommodate pumps up to 2,000 GPH



change the look

LED Fountain Accent Light (Item #84008)

Why only appreciate your water feature during the day? Adding lights can dramatically change the look of any fountain. See page 51.



Patio Basin

#76000 MSRP \$349.98

(Unit Weight: 122 lbs.)

Natural Limestone

#78191 MSRP \$349.98

(Unit Weight: 122 lbs.)

Burnt Umber



Allows for a decorative fountain installation above the ground.

The Aquascape Decorative Patio Basin allows for the above ground installation of decorative fountains that normally require a reservoir that would need to be dug into the ground. The above ground application allows for DIY placement into decks, patios or indoors in minutes. The low maintenance decorative deck can accommodate pebbles or rocks to add a decorative touch and create a contrasting focal point.

- 18-gallon water storage capacity
- Maximum weight capacity 100 lbs.
- Can accommodate magnetic driven Ultra Pumps up to 550 GPH

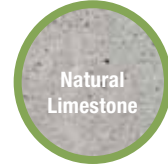

Fountain Shims

(set of 6)



#78159 MSRP \$5.98

(Unit Weight: 2.1 oz.)

4.5"L x .75"W

Ideal for leveling resin, concrete stone or GFRC water fountains or features.

Decorative River Pebbles

#78160 MSRP \$19.98

(Unit Weight: 22 lbs.)

Black Pebbles 10 kg. – 3"-5"

#78161 MSRP \$19.98

(Unit Weight: 22 lbs.)

Mixed River Pebbles 10 kg. – 3"-5"



- Pre-washed and polished
- Easy to carry 22 lb. bags are ideal for decorative fountain applications
- Each 22 lb. bag covers approximately 1.5 sq. ft. of surface

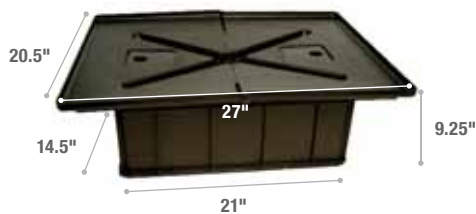

AquaBasin® Mini

#98924 MSRP \$39.98

(Unit Weight: 6.5 lbs.)

Aquascape AquaBasin® Mini makes it simple to have a water feature in almost any setting. Can accommodate pumps up to 350 GPH.

AquaBasin® Mini Features:

- Light weight and durable
- Can be used indoors or outdoors
- Basin holds 8 gallons of water
- Quick and easy to install
- Provides easy pump access
- Maximum weight capacity: 50 lbs.



**VIDEO ON
AQUABASIN® MINI**



DecoBasin

#60000 MSRP \$89.98

(Unit Weight: 9 lbs.)

Aquascape DecoBasin comes complete with water reservoir and splash skirt. Can accommodate pumps up to 1,500 GPH.

DecoBasin Features:

- Light weight and durable basin
- 54" splash skirt prevents leakage or over splash
- Basin holds 15 gallons of water
- Quick and easy installation
- Large center hole provides easy pump access
- Maximum weight capacity: 50 lbs.



Installation Tools

Whether you are a do-it-yourselfer or professional water feature contractor, Aquascape has all of the pieces and parts that you need for successful installation or repair. Installation tools, spare parts and accessories are often available individually or as part of a kit. Installation tools located within this section of the catalog include the following.

- Water Fill Valves
- Water Fill Valve Accessories
- Black Waterfall Foam, Tools and Accessories
- Black Silicone Sealant
- EPDM Rubber Liner Installation and Repair Accessories

Aquascape has all the pieces and parts that you need for successful installation or repair.



Aquascape Water Fill Valves

Aquascape Water Fill Valves automatically add water to features when needed.

- Reduces time-consuming maintenance versus manually filling with a hose
- Helps protect pump from running dry
- Better for pond ecosystems by adding small amounts of water as needed, eliminating large water chemistry swings (including chlorine/chloramine levels) that occur during manual top-offs



Compact Water Fill Valve

#88006 MSRP \$29.99

(Unit Weight: .3 lbs.)

- Up to 1.5 gallons per minute flow rate at a working pressure of 0-100 PSI
- Small size allows it to fit into any skimmer filter, Pondless® Waterfall Vault or decorative water feature application
- Includes fittings to connect to a standard garden hose, 1/4" poly-pipe, 1/2" poly-pipe, 1/2" pvc pipe (**pipe sold separately**)

Water Fill Valve 200

#29272 MSRP \$49.98

(Unit Weight: .7 lbs.)

- Up to 3 gallons per minute flow rate at a working pressure of 0-100 PSI
- Reliable mechanical arm style fill valve
- Brass hardware with poly float
- Includes fittings to connect to 1/2" poly-pipe or 1/2" pvc pipe (**pipe sold separately**)

Hudson Water Fill Valve

#29469 MSRP \$79.99

(Unit Weight: 1.2 lbs.)

- Up to 1.5 gallons per minute flow rate at a working pressure of 8-65 PSI
- Works great in the Signature Series™ Pond Skimmers and the Pondless® Waterfall Vault
- Mounting plate allows 4-inch setting adjustments
- Includes quick-connect fitting for 1/4" poly pipe
- Can also be used with 1/2" poly or 1/2" pvc by using the Fill Valve Irrigation Conversion Kit (Item #01008)

Aquascape Water Fill Valves Specs

Item #	Model	Flow Rate	Plumbing Size	Working PSI	Dimensions
88006	Compact Water Fill Valve	0 - 1.5 GPM	1/2" PVC, 1/2" Poly, 1/4" Poly or Garden Hose	0 - 100 PSI	7.5" x 1.5" diameter
29272	Water Fill Valve 200	0 - 3 GPM	1/2" Poly or 1/2" PVC	0 - 100 PSI	12"L x 3.25"W x 2.25"H
29469	Hudson Water Fill Valve /slide plate	0 - 1.5 GPM	1/4" Poly	8 - 65 PSI	5" x 2.5" diameter

Water Fill Valve Accessories



Fitting Fill Valve Spigot 1/4" Quick Connect

#07000 MSRP \$17.99

(Unit Weight: .2 lbs.)

Connects 1/4" Poly Pipe to Garden Spigot.



Garden Hose Adapter Assembly

#29517 MSRP \$8.99

(Unit Weight: .2 lbs.)

Connects 1/2" Poly Pipe to Garden Spigot.



Fill Valve Irrigation Conversion Kit

#01008 MSRP \$7.99

(Unit Weight: .05 lbs.)

1/2" X 1/4"

Converts the 1/4" Hudson Water Fill Valve up to 1/2" Poly Pipe or PVC.



WFV Poly Pipe

#29350 MSRP \$19.99

(Unit Weight: 1.3 lbs.)

1/4" x 100'

#29470 MSRP \$49.99

(Unit Weight: 6.1 lbs.)

1/2" x 100'



Economy Foam Gun Applicator

#54003 MSRP \$42.99
(Unit Weight: 1.1 lb.)

We've added an economy model of our popular professional-grade Foam Gun. This lower-priced Foam Gun provides an attractive price point so that all contractors, no matter how many features they build, can afford to add a foam gun to their pond-building tool kit. To be used with Black Waterfall Foam cans.



Pro Foam Gun Applicator

#29268 MSRP \$219.99
(Unit Weight: 0.8 lb.)

Aquascape PRO Series foam gun applicator guns are designed to create an air and moisture-tight seal between the gun and the can allowing for maximum foam yield and minimal waste.



Installation Kit

#22008 MSRP \$32.99
(Unit Weight: 2.2 lbs.)

Kit includes:

- (1) Liner Patch
- (1) Christy's Red Hot Blue Glue
- (1) Tube of Black Silicone Sealant
- (1) 16 oz. Can of Do-it-Yourself Black Waterfall Foam

Individual kit items may be purchased separately. See items on these pages for details.



Professional Foam Gun Kit

#22013 MSRP \$359.99
(Unit Weight: 13.5 lbs.)

Includes everything needed for Professional Waterfall Foam application in a durable custom fit toolbox. Professional Foam Gun applicator allows exact dispersion of expanding black foam for sealing waterfalls.

Kit includes:

- (1) Case
- (3) 24 oz. Cans Black Waterfall Foam
- (1) Professional Grade Foam Gun
- (1) Can Cleaner

Replacement Gun available



DIY Black Waterfall Foam

#21053 MSRP \$19.98
(Unit Weight: 1.2 lbs.)

Easy to use for the beginner or do-it-yourselfer. Convenient and economical for the quick touch-up on a larger project. Also sold as part of our installation kit. No gun needed!



Foam Gun Cleaner

#22011 MSRP \$29.99
(Unit Weight: 1.1 lbs.)

A handy cleaner to flush the foam gun clean if it is not working properly. It will also remove uncured foam.



Aquascape Pro Black Waterfall Foam

#30096 MSRP \$29.99
(Unit Weight: 2.2 lbs.)

24 oz. can of expandable Black Waterfall Foam. Equivalent to 5 Do-it-Yourself Black Waterfall Foam cans. To be used with foam guns (sold separately).

Christy's Red Hot Blue Glue



#29969 MSRP \$7.99
(Unit Weight: .4 lbs.)

4 fl. oz.

The original all-weather, wet or dry PVC cement.



EPDM Liner Patch

#22018 MSRP \$9.98
(Unit Weight: .1 lb.)

This 6" self adhesive patch quickly repairs holes, tears and cuts in liner.



EPDM Liner Cover Tape One Sided

#22003 MSRP \$129.99
(Unit Weight: 5.8 lbs.)

6" x 25'

#22005 MSRP \$249.99
(Unit Weight: 20 lbs.)

6" x 100'



EPDM Liner Seam Tape Double Sided

#22017 MSRP \$52.99
(Unit Weight: 1.5 lbs.)

3" x 25'

#22020 MSRP \$129.99
(Unit Weight: 7.8 lbs.)

3" x 100'

New

Cleanout Pump

#45033 MSRP \$379.99
(Unit Weight: 25 lbs.)

- Great for pond cleanouts and installation wash-downs
- 4200 gallons per hour for fast pump-outs!
- Pumps water down to 1/4 inch off the bottom



New

Cleanout Pump Discharge Hose

#48019 MSRP \$99.99
(Unit Weight: 14.75 lbs.)

- Heavy duty Cleanout Discharge Hose engineered for flexibility and optimal flow
- Swivel cuff fitting prevents kinking or tangling allowing easy movement around the water feature
- 50 foot roll



Firestone® QuickPrime Plus- EPDM Liner Seaming Tape Primer

#54008 MSRP \$49.99
(Unit Weight: 1 lb.)

1 quart/0.95 liters

QuickPrime Plus is designed to clean and prime EPDM liner prior to seaming.



Firestone® QuickScrubber Kit

#54009 MSRP \$39.99
(Unit Weight: .75 lbs.)

Kit consists of 30 scrub pads and 4 holders designed for the application of QuickPrime Plus seaming tape primer.



Black Silicone Sealant

#22010 MSRP \$5.98
(Unit Weight: .4 lbs.)

4.7 oz. tube

#29186 MSRP \$9.99
(Unit Weight: .6 lbs.)

10.1 oz. tube

- Used for sealing joints where liner attaches to biofilter snout and the skimmer faceplate
- Fish Safe



Firestone® QuickSeam Pond Liner Repair Kit

#42023 MSRP \$34.99
(Unit Weight: .5 lbs.)

Allows easy repair of up to two holes in EPDM liner.

Kit includes:

- (2) 6" x 6" QuickSeam patches
- (1) Bottle of LVOC Primer (2 oz./57 ml.)
- (1) Scrubber pad
- (1) Patch roller
- (1) Pair disposable gloves



The Aquascape RainXchange® System is a revolutionary design that combines a recirculating decorative water feature with a subsurface rainwater harvest storage system.

How The RainXchange System Works:

- Downspout Filter** – Captures and removes pollutants flushed into the system during a rain event
- Connecting Pipe** – Carries the water, via gravity, to the modular storage basin
- Modular Storage Basin** – Modular design can be configured to fit a wide variety of applications and settings. EPDM rubber membrane creates a water-tight basin
- Snorkel™ Vault & Centipede® Module** – Optimum water utilization within the system and a convenient access point for yearly maintenance and cleaning

- Overflow Infiltration** – Excess rainwater is sent to a storage area that facilitates the infiltration of water into deeper soils and aquifers
- Biological Filtration** – Beneficial bacteria and enzymes reduce organic waste and pollutants to less toxic substances that can be absorbed by plants
- Aquatic Plants** – Providing food and shelter for a great number of birds, insects and amphibians and the cornerstone for maintaining biodiversity
- Irrigation System** – Natural water is loaded with micronutrients and compounds that will make plants flourish



VIDEO ON RAINWATER HARVESTING 

For more information on opportunities with the RainXchange® System or to receive a FREE COPY of the RainXchange® Product & Applications Guide call **1.877.766.3489** or visit **www.aquascapeinc.com**



What is the Aquascape Foundation?

The Aquascape Foundation is a not for profit 501 3C organization established in 2008. The mission of The Foundation is to create sustainable solutions for the world-wide water crisis. The purpose of The Foundation is to promote awareness of water as our most precious resource through environmental, educational and philanthropic efforts. One of the ways that we will accomplish this mission is by utilizing the Aquascape RainXchange® System as a solution to bring clean drinking water to places where people currently have no access.

The Aquascape Foundation is utilizing its core technology to end this needless suffering. With this technology we can capture, purify and store thousands of gallons of rainwater, making it accessible and potable. Our technology will not only bring health and wellness to a community, but with an accessible water source, children can focus on education and adults can focus on employment. It's a smart and sustainable solution to a complex problem.

water

IS LIFE



Get involved today!

Visit our website at www.aquascapefoundation.org to learn more about our next trip or to make a donation.



**MORE ON
THE FOUNDATION**

The 
Aquascape™
Foundation



Prsrt Std
U.S. Postage
PAID
Aquascape
Designs, Inc.

901 Aqualand Way • St. Charles, IL 60174
Toll Free: (866) US-PONDS or (866) 877-6637
Customer Service Fax: (877) 329-2340
Technical Support Fax: (877) 329-2348
www.support.aquascapeinc.com

©2015 Aquascape Inc. (5)
All Worldwide Rights Reserved

The new Aquascape Automatic Dosing System for Ponds and Fountains

Includes a
**FREE Water
Treatment**

valued at
\$29.98 USD

Maintaining optimum water quality is easy as 1-2-3

1. Choose the appropriate Automatic Dosing System for your application Pond/Fountain
2. Install the Automatic Dosing System (typical installation takes less than 15 minutes)
3. Set it and forget it. Sit back and enjoy a new level of maintenance free water quality

The Aquascape Automatic Dosing System

- Can be used on almost any pond/fountain
- Helps maintain optimum water quality
- Is easy to use and fully programmable
- Is dependable and extremely quiet



See page
57 for more
information



For Ponds



For Fountains



www.aquascapeinc.com