

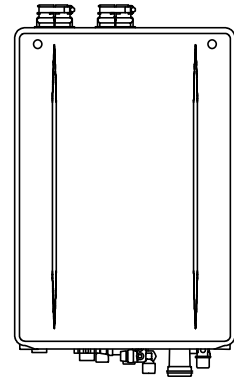

CONDENSING TANKLESS GAS WATER HEATER

Installation Manual

Models : NRCR111DV (GQ-C3260WXQ-FF US)
NRCR92DV (GQ-C2660WXQ-FF US)



⚠ WARNING

If the information in these instructions is not followed exactly, a fire or explosion may result causing property damage, personal injury or death.

- Do not store or use gasoline or other flammable vapors and liquids in the vicinity of this or any other appliance.
- WHAT TO DO IF YOU SMELL GAS
 - Do not try to light any appliance.
 - Do not touch any electrical switch; do not use any phone in your building.
 - Immediately call your gas supplier from a neighbor's phone. Follow the gas supplier's instructions.
 - If you cannot reach your gas supplier, call the fire department.
- Installation and service must be performed by a qualified installer, service agency or the gas supplier.

⚠ CAUTION

Requests to Installers

- In order to use the Water Heater safely, read this installation manual carefully, and follow the installation instructions.
- Failures and damage caused by erroneous work or work not as instructed in this manual are not covered by the Noritz America Limited Warranty.
- Check that the installation was done properly in accordance with this Installation Manual upon completion.
- After completing installation, either place this Installation Manual in a plastic pouch and attach it to the side of the Water Heater (or the inside of the pipe cover or recess box if applicable), or hand it to the customer to retain for future reference. Also, be sure to fill in all of the required items on the warranty and to hand the warranty to the customer along with the Owner's Guide.

FOR USE IN RESIDENTIAL OR MANUFACTURED HOME APPLICATIONS.

Installation must conform with local codes, or in the absence of local codes, the National Fuel Gas Code, ANSI Z223.1 / NFPA 54- latest edition and/or the Natural Gas and Propane Installation Code CSA B149.1- latest edition.

When applicable, installation must conform with the Manufactured Home Construction and Safety Standard, Title 24 CFR, Part 3280 or the Canadian Standard CAN/CSA-Z240 MH Mobile Homes, Series M86.

Noritz America reserves the right to discontinue, or change at any time, the designs and/or specifications of its products without notice.

Contact Noritz America at 1-866-766-7489, if you have any questions or concerns.



Low NOx Approved by SCAQMD
14 ng/l or 20 ppm
(Natural Gas Only)

NORITZ America Corporation

SBB8168
Rev. 05/19



Contents

1	Before Installation	3	8	Connecting the Water Supply	41
			8.1	Overview of the Recirculation System.....	41
			8.2	Installation	42
			8.3	Water treatment.....	45
2	About the Water Heater	5	9	Connecting the Condensate Drain	47
2.1	Included Accessories	5	10	Connecting Electricity	49
2.2	Optional Accessories	5	10.1	Water Heater	49
2.3	Specifications	7	10.2	Remote Controller	49
2.4	Dimensions	8	10.3	Recirculation	50
2.5	External View	10	10.4	Quick Connect Cord-2	51
3	Choosing an Installation Location	11	11	Installation of the Remote Controller	52
4	Installation Clearances	13	11.1	General Requirements.....	52
4.1	Indoor Installation	13	11.2	RC-7651M-A	52
4.2	Outdoor Installation	14	11.3	RC-9018M	54
4.3	For Quick Connect Multi-System.....	14	12	Setting the DIP Switches	58
5	Installation of the Water Heater	15	13	Setting for Recirculation	59
5.1	Mounting the Water Heater to the wall	15	14	Trial Operation	60
5.2	Elevation Adjustment Above 2,000 ft.....	16	15	Checklist After Installation	63
5.3	Filling the condensate container with water	16	16	Plumbing Applications	65
6	Venting the Water Heater	17	17	Installation of the Quick Connect Multi-System	66
6.1	Venting Installation Sequence	17	18	Maintenance	68
6.2	General Requirements.....	17	18.1	Periodic Check	68
6.3	Select a Vent Type.....	23	18.2	Procedure for Flushing the Heat Exchanger	69
6.4	Vent Pipe Installation (Direct Vent)..	24			
6.5	Vent Pipe Installation (Non-Direct Vent)	30			
6.6	Outdoor Installation	36			
7	Connecting the Gas Supply	37			

1 Before Installation

▲ DANGER

▲ WARNING

▲ CAUTION

NOTICE

▲ DANGER

Checkup

Check the fixing brackets and vent pipe yearly for damage or wear. Replace if necessary.

▲ WARNING

Precautions on Vent Pipe Replacement

The vent system will almost certainly need to be replaced when this appliance is being installed. Only use vent materials that are specified in this Installation Manual for use on this appliance. Refer to the “Venting the Water Heater” section for details. If PVC, CPVC, or Category IV listed pipe is already installed, check for punctures, cracks, or blockages and consult with the vent pipe manufacturer before reusing. If the flexible polypropylene pipe is already installed, replace to the new flexible polypropylene pipe. Improper venting may result in fires, property damage or exposure to Carbon Monoxide.

Snow Precaution

If this product will be installed in an area where snow is known to accumulate, protect the vent termination from blockage by snow drifts or damage from snow falling off of roofs.

Check the Gas

- Check that the rating plate indicates the correct type of gas.
- Check that the gas supply line is sized for 199,900 Btu/h or 165,000 Btu/h.
199,900 Btu/h:
NRCR111DV (GQ-C3260WXQ-FF US)
165,000 Btu/h:
NRCR92DV (GQ-C2660WXQ-FF US)

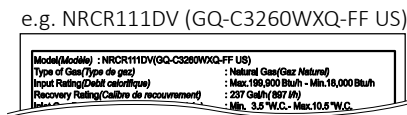

Check the Power

The power supply required is 120 VAC, at 60 Hz. Using the incorrect voltage may result in fire or electric shock.

Use Extreme Caution if Using With a Solar Pre-Heater

Using this appliance with a solar pre-heater can lead to unpredictable output temperatures and possibly scalding. If absolutely necessary, use mixing valves to ensure output temperatures do not get to scalding levels. Do not use a solar pre-heater with the Quick Connect Multi-System because the system may not operate properly.

Precautions for Mobile Home Installation

- Verify that the gas supply type matches the gas type listed on the rating plate. If a gas conversion must be done, follow the instructions listed in the gas conversion kit manual.
- If this product will be installed indoors, usage of the SV conversion kit (SV-CK-2) and the Flex Vent 2 in. Conversion Kit (EZ2-CK) are prohibited. Make sure to follow all clearance and venting requirements outlined in this manual.

Chemicals

This product can expose you to chemicals including lead, lead compounds and carbon bisulfide which are known to the State of California to cause cancer, birth defects or other reproductive harm. For more information go to www.P65Warnings.ca.gov.

⚠ CAUTION

Do Not Use Appliance for Purposes Other Than Those Specified

Do not use for other than increasing the temperature of the water supply, as unexpected accidents may occur as a result.

Check Water Supply Quality

If the water supply is in excess of 12 grains per gallon (200 mg/L) of hardness, acidic or otherwise impure, treat the water with approved methods in order to ensure full warranty coverage.

NOTICE

- This appliance is suitable for combination potable water and space heating applications. It cannot be used for space heating applications only.
- Do not use this appliance if any part has been underwater. Immediately call a qualified service technician to inspect the appliance and replace any part of the control system and gas control which has been under water.

2 About the Water Heater

The following accessories are included with the Water Heater. Check for any missing items before starting installation.

Anchoring Screw (× 7)



Remote Controller (× 1) (See page 52)
[RC-7651M-A]

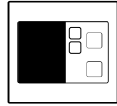

Owner's Guide, Warranty card,
Installation Manual (this document) (1 each)

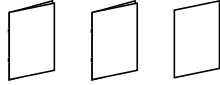

Remote Controller Cord (6 ft (1.8 m)) (× 1)



Wall Mounting Bracket (× 1)

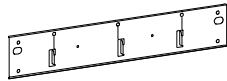

The accessories listed below are not included with the Water Heater, but may be necessary for installation.

NOTE Additional vent pieces are available; consult the latest product catalogue for details.

Quick Connect Cord (× 1)
[QC-2]



Remote Controller Cord (26 ft (7.9 m)) (× 1)
[RC-CORD26]



Isolation Valves (1 each)
(includes pressure relief valve)

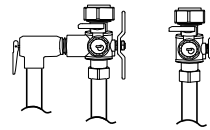

Isolation valves are necessary for flushing the Heat Exchanger. They allow for easy flushing and troubleshooting of the system.

Cross Over Valve Kit (× 1)
[cCS-V]

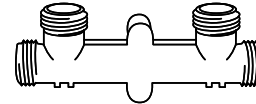

PVC Concentric Termination (× 1)
2 in. (50 mm) : [PVC-2CT]
3 in. (75 mm) : [PVC-3CT]

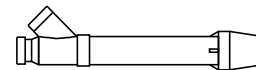

2 in. SV Conversion Kit (× 1)
[SV-CK-2]

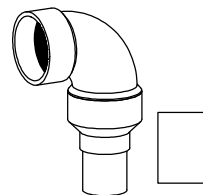

- 90° Elbow (With Inlet Screen)
- 2 in. × 3 in. Increaser coupling
- 2 in. Pipe
- Installation Manual (Check List)

Outdoor Vent Cap (× 1)
[VC-6]

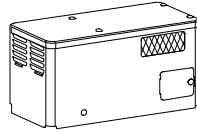

Bird Screen for 2 in. (50 mm) PVC
[VT2-PVCS]



Bird Screen for 3 in. (75 mm) PVC
[VT3-PVCS]



3 in. (75 mm) Horizontal Hood Termination
[PVT-HL]



Universal Concentric Vent Kit
[PVC-UCVK]

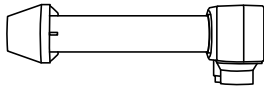

Low Profile Termination Kit
2 in.: [PVC-2LPT]
3 in.: [PVC-3LPT]



ULC S636 / UL 1738
certified for use in both
Canada and USA

Plastic Rain Cap
[PRC-1]



Not approved for use in
Canada.

Noritz Connect Wireless Adapter
NWC-ADAPTER (× 1)
[NAW-1 US]

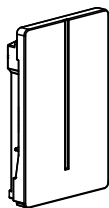

Noritz Connect Wireless
Adapter enables users to:

- Remote control (Power ON/OFF, Adjust set temperature, Operating for recirculation)

For more information, visit
the Noritz America website
(<http://wifi.noritz.com/>).

Neutralizer (× 1)
[NC-1S]
(For 1 Water Heater)

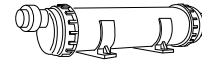

Flex Vent 2 in. Conversion Kit
[EZ2-CK]

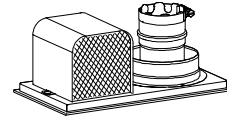

Flex Vent 2 in. Kit – 25 ft
[EZ2FVK-1]

Flex Vent 2 in. Kit – 35 ft
[EZ2FVP35-3]

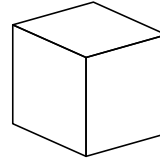

During the installation of
Flex Vent 2 in. Kit (EZ2FVK-1
and EZ2FVP35-3), ambient
temperatures must be
greater than 40°F (5°C).
Afterwards, installation
site ambient temperature
must be greater than -4°F
(-20°C). Flex vent pipe
breakage may occur if these
temperature requirements
are not observed.

Remote Controller (× 1) (See page 54)
[RC-9018M]

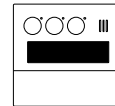

- Specifications may be changed without prior notice.
- The capacity may differ slightly, depending on the water pressure, water supply, piping conditions, and water temperature.

Item		Specification	
Model Name		NRCR111DV (GQ-C3260WXQ-FF US) NRCR92DV (GQ-C2660WXQ-FF US)	
Type	Installation	Indoor / Outdoor Wall mounted	
	Air Supply / Exhaust	Power Vented	
Ignition		Direct Ignition	
Operating Pressure		15-150 psi (Recommended 50 to 80 psi for maximum performance)	
Minimum Activation Flow Rate*		0.5 GPM (2.0 L/min)	
Minimum Operating Flow Rate*		0.29 GPM (1.1 L/min)	
Dimensions (Height) × (Width) × (Depth)		27.0 in. (687 mm) × 18.5 in. (471 mm) × 14.1 in. (359 mm)	
Weight		73 lbs. (33 kg)	
Water Holding Capacity		0.85 Gallon (3.2 L)	
Connection Sizes	Water Inlet	NPT 3/4 in.	
	Hot Water Outlet	NPT 3/4 in.	
	Hot Water Return	NPT 3/4 in.	
	Gas Inlet	NPT 3/4 in.	
	Condensate Drain	NPT 1/2 in.	
Power Supply	Supply	120 VAC (60 Hz)	
	Consumption	NG: 218 W LP: 202 W Freeze Prevention: 114 W	NG: 185 W LP: 175 W Freeze Prevention: 114 W
	Maximum Current	4 Amps	
Materials	Casing	<ul style="list-style-type: none"> •Front Cover: Hot-dipped zinc-aluminum-magnesium-alloy-coated steel w/ Polyester Coating •Casing: Zincified Steel Plate / Polyester Coating 	
	Flue Collar	PP	
	Primary Heat Exchanger	Stainless Steel Sheeting, Stainless Steel Tubing	
	Secondary Heat Exchanger	Stainless Steel Sheeting, Stainless Steel Tubing	
Safety Devices		Flame Rod, High Limit Switch, Lightning Protection Device (ZNR), Freezing Prevention Device, Fan Rotation Detector	
Included Accessories		Remote Controller, Remote Controller Cord, Anchoring Screws, Wall Mounting Bracket	

* Minimum flow rate may change by setting temperature and water temperature.

Performances

Item	Performance				
	NRCR111DV (GQ-C3260WXQ-FF US)		NRCR92DV (GQ-C2660WXQ-FF US)		
		Maximum	Minimum	Maximum	Minimum
Gas Consumption	NG	199,900 Btu/h	18,000 Btu/h	165,000 Btu/h	18,000 Btu/h
	LP	199,900 Btu/h	18,000 Btu/h	165,000 Btu/h	18,000 Btu/h
Maximum Hot Water Capacity (45°F (25°C) Rise)		8.7 GPM (33 L/min)		7.1 GPM (27 L/min)	
Capacity Range		0.5-11.1 GPM (2-42 L/min)		0.5-9.2 GPM (2-35 L/min)	
Temperature Settings	°F Mode	100-140°F (In 5°F intervals) (9 Options)			
	°C Mode	37-48°C (In 1°C intervals), 50-60°C (In 5°C intervals) (15 Options)			

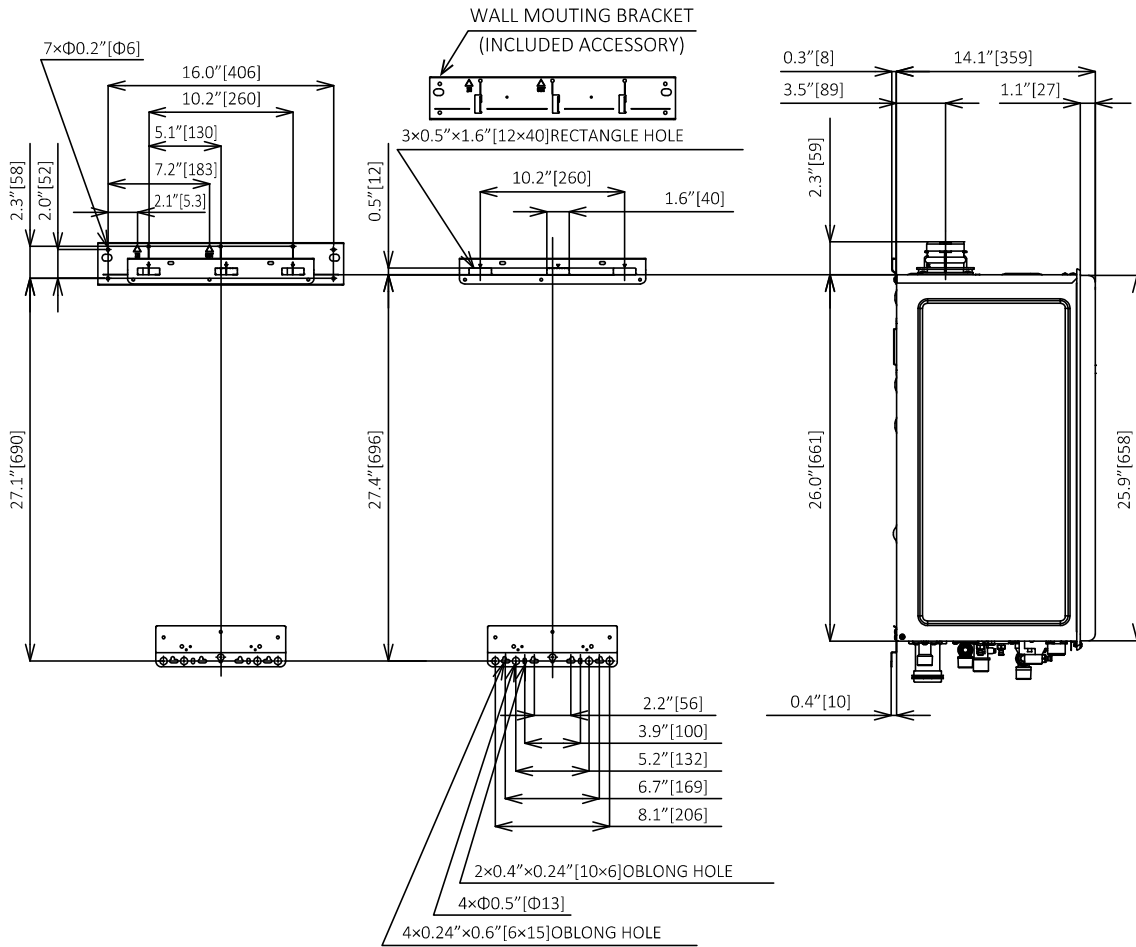

<inch [mm]>

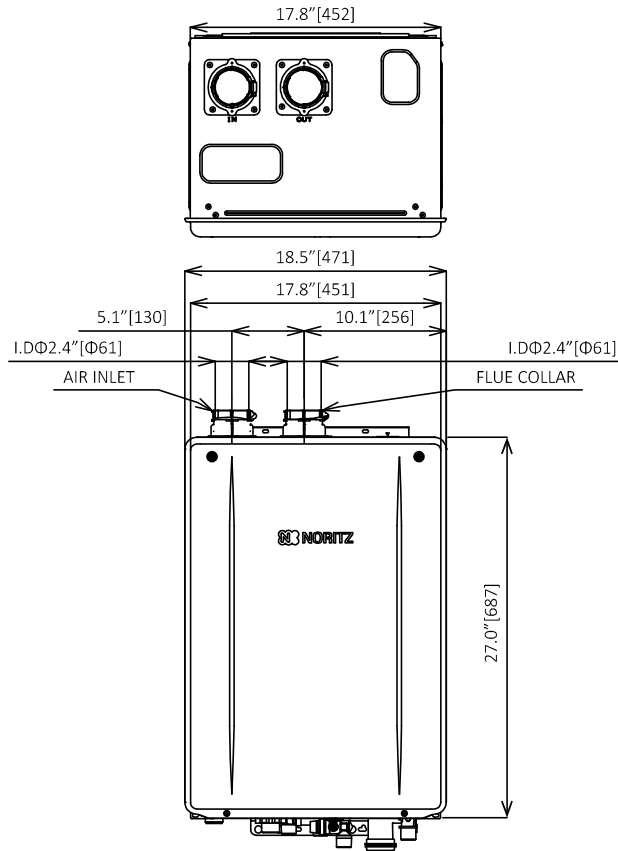

(VIEW FROM BOTTOM)

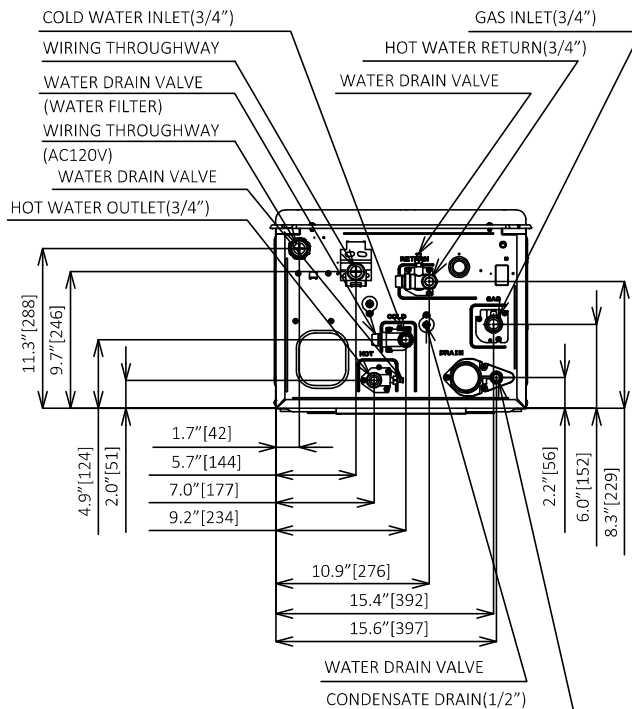

HEIGHT OF EACH FITTING FROM BOTTOM OF CASE

HOT WATER OUTLET	1.8" [45]
COLD WATER INLET	1.9" [49]
CONDENSATE DRAIN	1.7" [42]
HOT WATER RETURN	2.7" [69]
GAS INLET	2.2" [56]

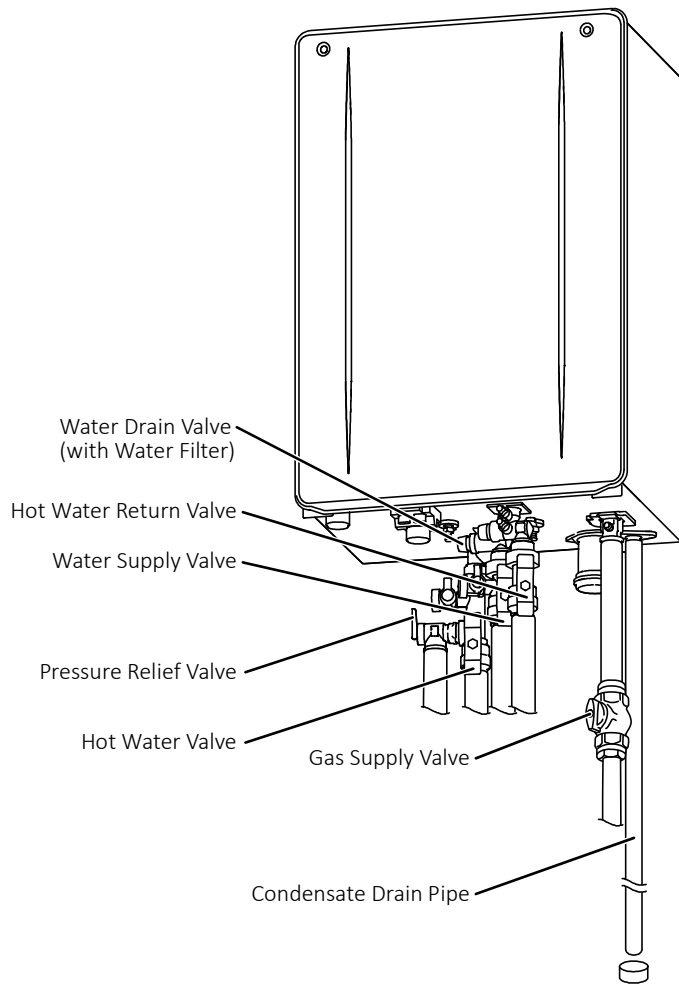

Indoor Installation

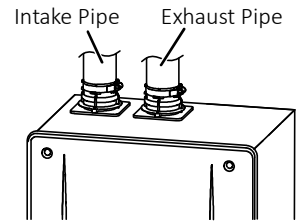

Outdoor Installation

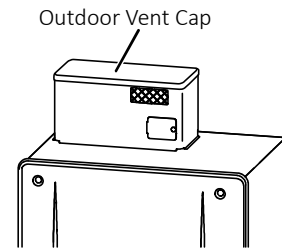

3 Choosing an Installation Location

⚠ DANGER

Locate the vent terminal and make sure there are no obstacles around the termination for exhaust to accumulate or be obstructed. Do not enclose the termination with corrugated metal or other materials. Carbon monoxide poisoning or fire may occur as a result.

⚠ WARNING

- Avoid places where fires are common, such as those where gasoline, benzene and adhesives are handled, or places in which corrosive gases (ammonia, chlorine, sulfur, ethylene compounds, acids) are present. If you do not follow the above, a fire or explosion may result causing property damage, personal injury or death.
- Avoid installation in places where dust or debris will accumulate. Dust may accumulate and reduce the performance of the fan of the appliance. This can result in incomplete combustion.
- Avoid installation in places where special chemical agents (e.g. hair spray or spray detergent) are used. Ignition failures and malfunctions may occur as a result.
- Do not install this Water Heater in a recreational vehicle or on a boat as this may be a Carbon Monoxide Poisoning Hazard.
- The manufacturer does not recommend installing the Water Heater in an attic due to safety issues.
If you install the Water Heater in an attic:
 - Make sure the appliance will have enough combustion air and proper ventilation.
 - Keep the area around the Water Heater clean. Dust may accumulate and reduce the performance of the fan of the appliance. This can result in incomplete combustion.
 - A drain pan, or other means of protection against water damage, is required to be installed under the Water Heater in case of leaks.

⚠ CAUTION

Do not install in the following places

- A location where it is not free from obstacles and stagnant air.
- Near staircases or emergency exits.
- A place where it may be threatened by falling objects, such as under shelves.
- On common walls as the appliance will make some operational noises while it is running.

Consideration to the surroundings

- Do not install the Water Heater where the exhaust will blow on outer walls, other walls or material not resistant to heat. Also consider the surrounding trees and animals. The heat and moisture from the Water Heater may cause discoloration of walls and resinous materials, or corrosion of aluminum materials.
- Do not locate the vent termination directed towards a window or any other structure which has glass or wired glass facing the termination.
- Take care that noise and exhaust gas will not affect neighbors.
- If the appliance is installed in a location with very high humidity, condensate may form inside the appliance and/or cause incomplete combustion, damage to the electrical components, or electric leakage.

Install according to regulations and manual

- Install the Water Heater in an area that allows for the proper clearances to combustible and non-combustible construction. Consult the rating plate on the appliance for proper clearances.
- The Water Heater must be installed according to manual.
- Before installing, make sure that the exhaust flue termination will have the proper clearances according to the National Fuel Gas Code (ANSI Z223.1- latest edition) or the Natural Gas and Propane Installation Code (CSA B149.1).

⚠ CAUTION

Installation in the vicinity of gas ranges, stoves, fans, and range hoods

- Avoid installation above gas ranges or stoves.
- Avoid installation between the kitchen fan and stove. If oily fumes or a large amount of steam are present in the installation location, take measures to prevent the fumes and steam from entering in the appliance.

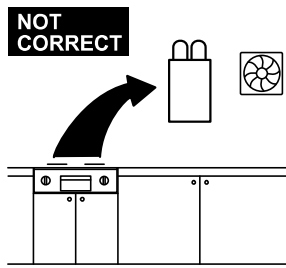

- Install in a location where the exhaust gas flow will not be affected by fans or range hoods.

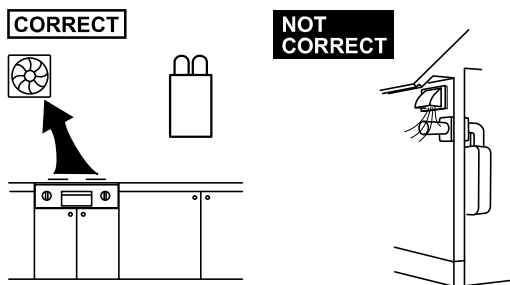

NOTICE

- Place the appliance for easy access for maintenance and repair.
- Do not install the Water Heater in a location where the appliance will be exposed to excessive winds.
- Locate the appliance in an area where leakage from the appliance or connections will not result in damage to the area adjacent to the appliance or to the lower floors of the structure. When such installation locations cannot be avoided, a suitable drain pan, adequately drained, must be installed under the appliance. The pan must not restrict combustion air flow.
- As with any water heating appliance, the potential for leakage at some time in the life of the product does exist. The manufacturer will not be responsible for any water damage that may occur.
- Water quality:
If this Water Heater will be installed in a location where the hardness of the supply water is high, scale Build-up may cause damage to the Heat Exchanger. Perform suggested treatment and maintenance measures in reference to “8.3 Water Treatment”.
Damage to the Water Heater as a result of the below is not covered by the Noritz America Limited Warranty.
 - Water in excess of 12 gpg (200 mg/L) of hardness
 - Poor water quality (see the following table)

Total Hardness*	200 mg/L (12 gpg) or less
Aluminum	0.05 to 0.2 mg/L or less
Chloride	250 mg/L or less
Copper	1.0 mg/L or less
Iron	0.3 mg/L or less
Manganese	0.05 mg/L or less
pH	6.5-8.5
Total Dissolved Solids	500 mg/L or less
Zinc	5 mg/L or less
Sulfate	250 mg/L or less
Residual chlorine*	4 mg/L or less

Source: EPA National Secondary Drinking Water Regulations (40 CFR Part 143.3)

* Maximum limit suggested by Noritz.

NOTE Consult with the customer concerning the location of installation.

State of California: The Water Heater must be braced, anchored or strapped to avoid moving during an earthquake. Contact local utilities for code requirements in your area or call 1-866-766-7489 and request instructions.

The Commonwealth of Massachusetts:

- 1) This Water Heater can only be used in outdoor applications if the usage is restricted to summertime usage exclusively.
- 2) The Water Heater can be used for hot water only and not in a combination of domestic and space heating.

For Venting Manufacturers Requirements, see the Noritz America website (www.noritz.com).

4 Installation Clearances

⚠ WARNING

Before installing, check for the following:

Install in accordance with relevant building and mechanical codes, as well as any local, state or national regulations, or in the absence of local and state codes, refer to National Fuel Gas Code ANSI Z223.1 / NFPA 54- latest edition. In Canada, see the Natural Gas and Propane Installation Code CSA B149.1- latest edition for detailed requirements.

Required Clearances From the Water Heater

Maintain the clearances from both combustible and non-combustible materials.

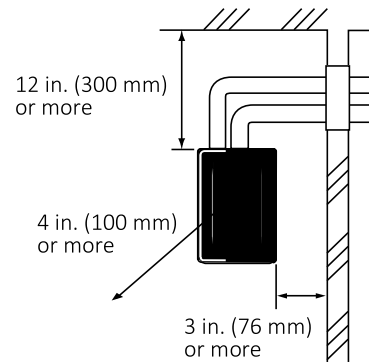

Securing of space for inspection/repair

In order to facilitate inspection and repair, the minimum clearances should be met.

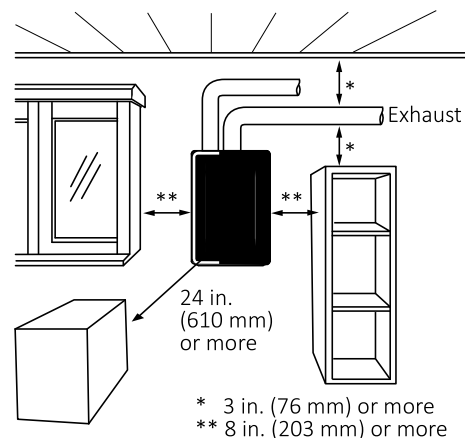

Cooking Equipment

When utilizing an indoor air supply, if the Water Heater will be installed in the vicinity of a permanent kitchen range or stove that has the possibility of generating steam that contains fats or oils, use a dividing plate or other measure to ensure that the Water Heater is not exposed to air containing such impurities.

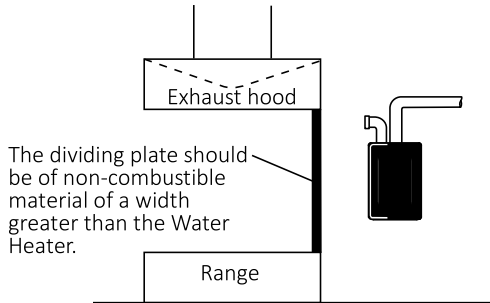

Surrounding the area of installation

[When installing the Water Heater in a common side corridor]

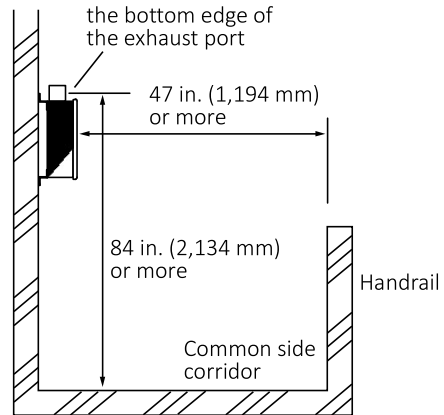

Required Clearances From the Water Heater

Maintain the clearances from both combustible and non-combustible materials.

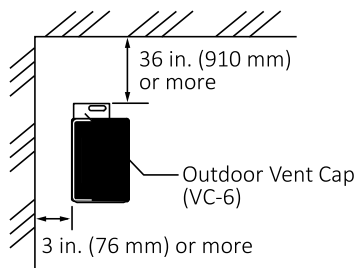
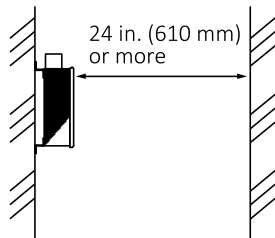

The Quick Connect Cord is 6 ft (1.8 m) long. Install the Water Heaters 3-18 in. (76-457 mm) apart from each other to ensure the cord will be able to reach between the Water Heaters.

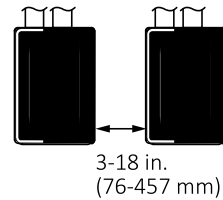

5 Installation of the Water Heater

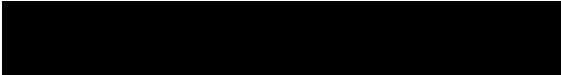

⚠ WARNING
Do not drop or apply unnecessary force to the appliance when installing. Internal parts may be damaged and may become highly dangerous.

⚠ CAUTION

- Protect your hands with gloves and take caution to not inflict injury.
- Be careful not to hit electrical wiring, gas, or water piping while drilling holes.

NOTICE

- The weight of the appliance will be applied to the wall. If the strength of the wall is not sufficient, reinforcement must be done to prevent the transfer of vibration.
- Install the appliance on a vertical wall and ensure that it is level.

1. Ensure that the Wall Mounting Bracket is leveled.
Drill holes for the Wall Mounting Bracket and affix the Wall Mounting Bracket securely to the wall by 5 screws.
Finally, make sure the bracket can support the weight of the Water Heater.

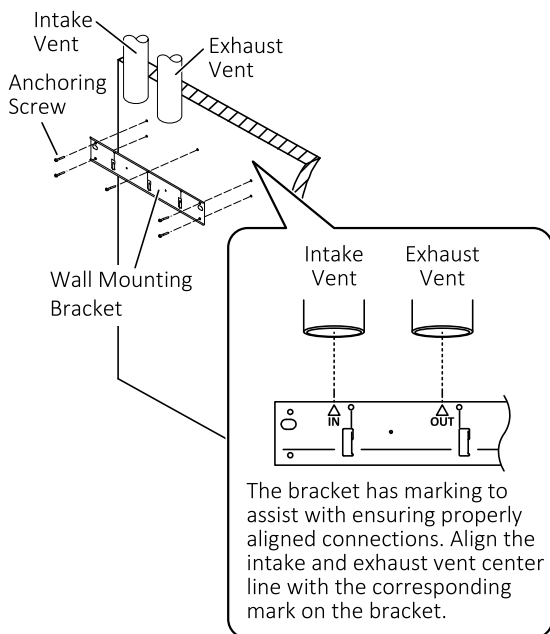

2. Hang the Water Heater on the Wall Mounting Bracket.

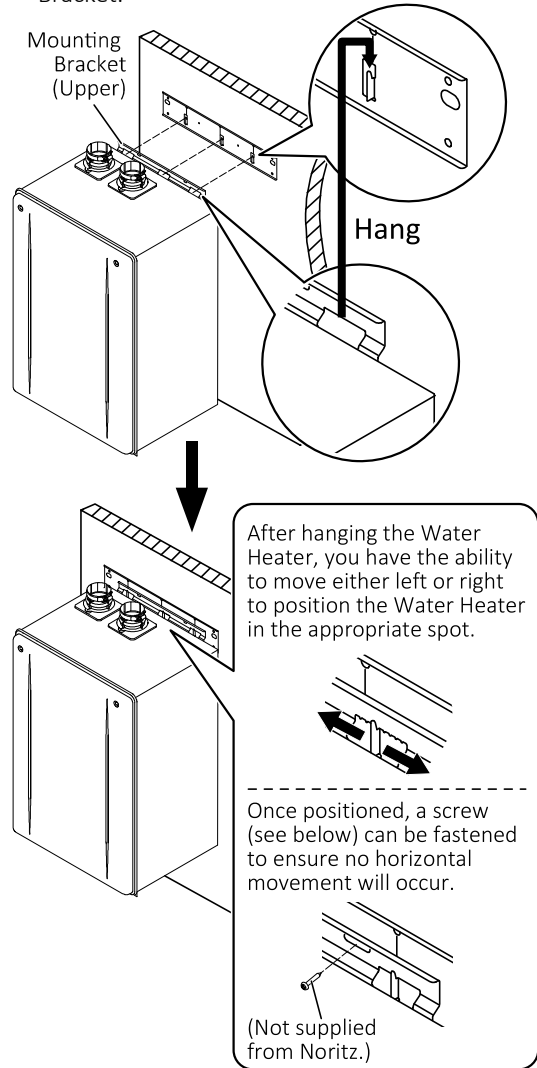

3. Affix the Mounting Bracket (Lower) to the wall by 2 screws.

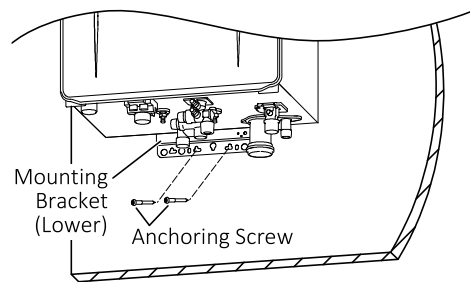

- Adjust the DIP switches as illustrated in the table below, if this Water Heater is installed at an altitude of 2,000 ft (610 m) or higher.
- Disconnect the electrical power and then adjust the DIP switches.
Refer to page 58 for the location of the DIP switch bank and how to change the DIP switches. Failure to perform this step will result a “73” code displayed on the Remote Controller and a cease in operation.
If this occurs, disconnect, then reconnect the electrical power to the Water Heater to reset the system.

NOTE Do not change any other DIP switches.

ON = ● / OFF = ○

High elevation adjustment	DIP switches	
	#5	#6
0-2,000 ft (0-610 m)	○	○
2,001-4,000 ft (611-1,219 m)	●	○
4,001-7,000 ft (1,220-2,134 m)	○	●
7,001-10,000 ft (2,135-3,048 m)	●	●

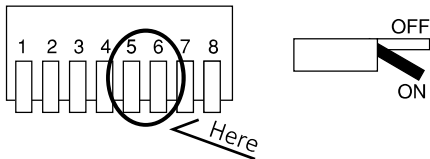

⚠ DANGER

Prior to initial start up, make sure that you fill the condensate container with water. This is to prevent dangerous exhaust gases from entering the building. Failure to fill the condensate container could result in severe personal injury or death.

Follow the procedure described below to ensure that the condensate container is filled with water.

Fill the condensate container by pouring approx. 10 oz. (280 mL) of water into the exhaust flue on the top of the Water Heater as illustrated below.

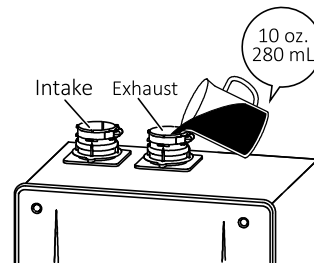

If the vent pipe has already been installed:
After installing the condensate drain pipe, make sure that the area around the Water Heater is well ventilated; open a window or a door if necessary. Then, operate the Water Heater and verify that condensate is coming out of the condensate drain pipe.
(During normal use of the Water Heater, condensate will begin to discharge from the condensate drain pipe within 15 minutes of use. However, depending on the season and/or installation site conditions, it may take longer.)

6 Venting the Water Heater

⚠ WARNING
CARBON MONOXIDE POISONING
 Follow all vent system requirements in accordance with relevant local or state regulation, or, in the absence of local or state code, if in the U.S., refer to the National Fuel Gas Code ANSI Z223.1 / NFPA 54- latest edition, and if in Canada, in accordance with the Natural Gas and Propane Installation Code CSA B149.1 - latest edition.



1. Install the Water Heater.
2. Determine the termination method—horizontal or vertical, etc.
3. Determine proper location for wall or roof penetration for each termination.

NOTE Do not exceed maximum allowed vent lengths as described in this manual.

4. Install termination assembly as described in this manual or in the vent manufacturer's installation instructions. If necessary, install Bird Screen (not supplied with Water Heater).
5. Install combustion air and exhaust vent piping from Water Heater to termination.
6. Slope the horizontal vent 1/4 in. upwards for every 12 in. (305 mm) toward the termination.
7. Install supports and hanger straps allowing for movement from expansion, or as per vent pipe manufacturer's instructions or local code requirements.



6.2.1 Vent Piping Material

- **This is a Category IV appliance.** Only vent materials approved for use with Category IV appliances shall be used.
- Under normal conditions, this Water Heater will not produce an exhaust flue temperature in excess of 149°F (65°C).

For PVC/CPVC/PP material

- Schedule 40 PVC pipe may be used as the vent material. **If required by local code, use schedule 40/80 CPVC or PP.**

- This Water Heater must be vented with plastic pipe materials as specified in the table below. Vent installations in Canada which utilize plastic vent systems must comply with ULC S636.

[Exhaust Vent / Air Intake]

Material	United States		Canada	
	Exhaust	Air Intake	Exhaust	Air Intake
Schedule 40 PVC	ANSI/ASTM D1785		ULC S636 Certified Materials Only	CSA B137.3
PVC-DWV	ANSI/ASTM D2665			CSA B181.2
Schedule 40 CPVC	ANSI/ASTM F441			CSA B137.3
Polypropylene (PP)*	Centrotherm- InnoFlue® (certified ULC S636), DuraVent PolyPro® (certified ULC S636)			
System 1738™ PVC Fuel Gas Venting	IPEX Management Inc. (certified UL 1738)			

- * Only listed manufacture specified vent parts may be used for this Water Heater. Refer to the manufacture's literature for detailed information.

- Approved Vent Manufacture:
 - Centrotherm- InnoFlue® PP

	Parts #
Single Wall Pipe (2 in. / 3 in.)	ISVL02xx(UV)/03xx(UV), ISEP02xx/03xx, ISIA0203
Elbow	ISELLO287(UV)/0387(UV), ISELLO245/0345
Termination**	ISELLO287UV/0387UV, ISTT0220/0320
Bird Screen	IASPP02/03

- DuraVent PolyPro®

	Parts #
Single Wall Pipe (2 in. / 3 in.)	2PPS-xxBL/3PPS-xxBL, 2PPS-xxL/3PPS-xxL
Elbow	2PPS-E90(B)L/3PPS-E90(B)L, 2PPS-E45(B)L/3PPS-E45(B)L
Termination**	2PPS-E90(B)L/3PPS-E90(B)L, 2PPS-T(B)L/3PPS-T(B)L
Bird Screen	2PPS-BG/3PPS-BG

- ** Applicable vent termination are "90° elbow" or "Tee type". Concentric vent termination of polypropylene are prohibited.

[Pipe Cement / Primer]

Material	United States	Canada
PVC	ANSI/ASTM D2564	ULC S636 Certified Materials Only
CPVC	ANSI/ASTM F493	

NOTE Use of cellular core PVC (ASTM F891), cellular core CPVC, or Radel® (polyphenylsulfone) in non-metallic venting system is prohibited.

- Use only solid PVC / CPVC (schedule 40) or PP pipe.
- 2 in. or 3 in. schedule 80 pipe may also be used on this Water Heater, however the Btu/h input of the Water Heater will be reduced by up to 9%.
- Maintain the same vent pipe diameter from the Water Heater flue to the termination.
- In Canada, plastic vent systems must be certified to ULC S636. The components of the certified vent system must not be interchanged with other vent systems or unlisted pipe/fittings.
- In Canada, specified primers and glues of the ULC S636 certified vent system must be from a single system manufacturer and not intermixed with other system manufacturer's vent system parts.

NOTE Covering non-metallic vent pipe and fittings with thermal insulation is prohibited.

For 2 in. flexible PP material

- Flex Vent 2 in. Conversion Kit (EZ2-CK) must be used when using 2 in. flexible PP pipe for vent pipe installation. Refer to the instructions provided with Flex Vent 2 in. Conversion Kit for additional detail.
- During the installation of Flex Vent 2 in. Kit (EZ2FVK-1 and EZ2FVK-2), ambient temperatures must be greater than 40°F (5°C). Afterwards, installation site ambient temperature must be greater than -4°F (-20°C). Flex vent pipe breakage may occur if these temperature requirements are not observed.
- Only listed manufacturer specified vent parts may be used for this Water Heater.

[Information regarding certified "Flexible vent pipe and connections"]

- Flex Vent 2 in. Kit – 25 ft (EZ2FVK-1)
- Flex Vent 2 in. Kit – 35 ft (EZ2FVP35-3)

Standard(s)	ULC-S636-08 Standards for type BH Gas Venting Systems
Product	25 ft- Flex Pipe 2 in.- LE, Flex Vent 2 in. Rigid 45 Elbow Set- LE, 35 ft- Flex Pipe 2 in.- LE
Brand name	Living Engineering Co,Ltd.

- Do not intermingle any other venting material with allowable polypropylene venting mentioned.
- The Btu/h input of the Water Heater will be reduced by up to 9% when maximum vent length.

For flexible pipe for chimney

- During the installation, ambient temperatures must be greater than 40 °F (5 °C). Afterwards, installation site ambient temperature must be greater than -4 °F (-20 °C). Flexible vent pipe breakage may occur if these temperature requirements are not observed.
- Only listed manufacture specified vent parts may be used for this appliance. Refer to the manufacture's literature for detailed information.

- DuraVent®- Flex Through Chimney w/ Air Intake

Exhaust	Flex Chimney Lining Kit (3 in.): 3PPS-FKL, Flex Length (3 in.): 3PPS-FLEXxx
Intake	Aluminum Flex Length (3 in.): 3DFA-xx, Coupler (3 in.): 3DFA-FCP
Exhaust & Intake*	Elbow (3 in.): 3PPS-E45L, 3PPS-E90L, Single-Wall Pipe (3 in.): 3PPS-xxL Appliance Adapter for PVC Coupler (2 in.): 2PPS-ADL, Increaser: 2PPS-X3L

- Centrotherm- InnoFlue® PP

Exhaust	Chimney Kit (3 in.): IFCK03xx, Flexible Pipe PP (3 in.): IFVL03xxx
Intake	Termination**: ISELLO387UV, ISTT0320, Bird Screen: IASPP03
Exhaust & Intake*	Single Wall Pipe (3 in.): ISVL03xx(UV), ISEP03xx Elbow (3 in.): ISELLO387UV, ISELLO345UV, ISEL0387, ISEL0345, Increaser: ISIA0203

* Recommended items.

** Applicable vent termination are "87° elbow" or "Tee type".

Concentric vent termination of polypropylene are prohibited.

6.2.2 Installation Instructions

⚠ WARNING

CARBON MONOXIDE POISONING

- Failure to properly seal the vent system could cause flue products to enter the living space.
- (For flexible pipe for chimney)
Handle the flexible vent carefully.
Dropping, Crushing and Stacking may cause damage, and may result in fires, property damage or exposure to Carbon Monoxide.

- Follow all general venting guidelines as outlined in this manual.
- Clearance described in this document is the minimum recommendation/required distance. Take appropriate clearance according to the situations of the site.
- Make sure the vent system is gas tight and will not leak.
- Support the vent pipe with hangers at regular intervals as specified by these instructions or the instructions of the vent manufacturer.
- All piping must be fully supported. Use pipe hangers at a minimum of 3 ft (0.9 m) intervals.

NOTE Do not use the Water Heater to support the vent piping.

- Ensure at least 3 ft (0.9 m) or more distance between the near edge of the air intake pipe or exhaust pipe to the inside corner of a wall.

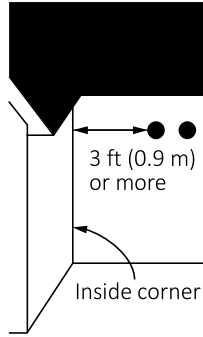

For PVC/CPVC/PP material

- When preparing and assembling the pipe, follow instructions as provided by the pipe manufacturer. In general, the following practices must be observed:
 - Squarely cut all pieces of pipe.
 - Remove all burrs and debris from joints and fittings.
 - All joints must be properly cleaned, primed, and cemented. Use only cement and primer approved for use with the pipe material as outlined on page 17.
- PVC, CPVC or PP pipe has been approved for use on this Water Heater with zero clearance to combustibles.
- The pipe shall be installed so that the first 3 ft (0.9 m) of pipe from the Water Heater flue outlet is readily accessible for visual inspection.
- When attaching the piping to the Water Heater, use the appropriate primer and cement to ensure a proper seal.

[How to tighten the Vent Pipe]

1. Continue to insert the Vent Pipe until it reaches to the base of the Water Heater Exhaust and Intake Flue.
 - The Vent Pipe will be inserted approximately 2.3 in. (60 mm).
2. Secure the Vent Pipe by tightening the band using a screwdriver.
 - The tightening torque shall be the following:
 - For PVC/CPVC pipe: between 16 and 20 in lb
 - For PP pipe: between 12 and 15 in lb

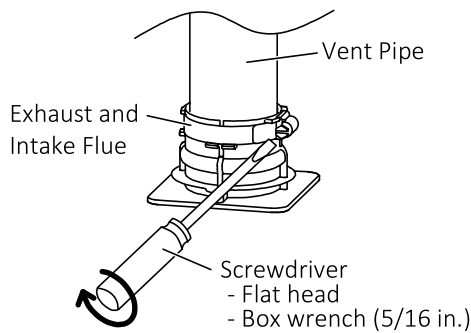

For 2 in. flexible PP material

- **Flex Vent 2 in. Kit may be used only in accordance with the installation manual included with the kit.**
- Flex Vent 2 in. Kit can be installed at zero clearance to combustibles.
- The Water Heater can be started up immediately after Flex Vent 2 in. Kit is installed and inspected.
- Flex Vent 2 in. Kit systems expand and contract slightly during heating cycles and must be installed following included instructions.
- Flex Vent 2 in. Kit cannot be painted.
- When installing N-Flex vent, pitch is required as detailed in Flex Vent 2 in. Kit installation manual.

For flexible pipe for chimney

- Every venting system must be properly planned and installed for optimum performance and safety. A flexible pipe installation always begins with an inspection of the existing masonry chimney (Chimney must be clean, sized correctly, properly constructed and in good condition, if being installed in a chimney as a liner). Inspect chimney to make certain it is constructed according to the latest revision of the NFPA211. Local codes may differ from this code and should be checked. Where there is a conflict, the local code will prevail. In Canada refer to the National Building Code or CSA-A405 as applicable.
- Refer to manufacturer's instructions for assembly of all flexible components including the chimney cap and adaptor to rigid pipe at base of masonry Chimney.
- Ensure none of the vent pipes and chimneys are damaged or blocked.
- Do not use an existing chimney as a raceway for a flue pipe if another appliance or fireplace is vented through the chimney, and do not have any connections inside the chimney chase.
- When using an inoperative chimney as a means of a chase for the vent system, the surrounding space within the chimney cannot be used to draw combustion air or vent another appliance.
- The remaining space surrounding a chimney liner, the flexible pipe within a masonry, metal or factory-built flue shall not be used to supply combustion air to the Water Heater. A separate combustion air intake pipe routed back to the Water Heater can be used in the remaining space if required, the Water Heater venting system is approved for zero clearance, and can be run directly beside the combustion air intake pipe. Bolt or screw joints together to avoid sag.
- Flexible pipe vertical offsets must not exceed 45° and are limited to a maximum number of 2.
- Connect flue pipe to the chimney with the shortest possible length of flue pipe.
- Slope the horizontal vent 1/4 in. upwards for every 12 in. (300 mm) toward the chimney from the Water Heater.

- Check and confirm that there is no tension to the flexible pipe by hanging or suspending of anything.
- Check vent piping at least once a season. Verify vent pipe connections to chimney are secure and no obstructions are present. If vent piping shows sign of leaking, replace it immediately.

6.2.3 Termination Considerations

- Do not store hazardous or flammable substances near the vent termination and check that the termination is not blocked in any way.
- Steam or condensed water may come out from the vent termination. Select the location for the termination as to prevent injury or property damage.
- If snow is expected to accumulate, make sure the termination will not be covered with snow or hit by falling lumps of snow.
- (For PVC/CPVC/PP material) A bird screen must be installed on the vent terminations to prevent debris or animals from entering the piping. These screens are not supplied with the Water Heater and must be purchased separately.

Vent Material	Bird Screen Parts #
2 in. (50 mm) PVC or CPVC	VT2-PVCS
3 in. (75 mm) PVC or CPVC	VT3-PVCS
Centrotherm- 2 in. (50 mm) PP	IASPP02
Centrotherm- 3 in. (75 mm) PP	IASPP03
DuraVent- 2 in. (60 mm) PP	2PPS-BG
DuraVent- 3 in. (80 mm) PP	3PPS-BG

- The following termination can also be used.
 - Termination Manufacturer: IPEX Management Inc.
 - Item description

Item	Item #
Universal Concentric Vent Kit (UCVK)* (PVC ULC S636/UL 1738- Certified for use in both Canada and USA)	PVC-UCVK (397007)
IPEX Low Profile Termination Kit** (PVC ULC S636/UL 1738- Certified for use in both Canada and USA)	2 in. PVC-2LPT (397100)
	3 in. PVC-3LPT (397101)

NOTE Below are additional models approved for use by Noritz and supplied by IPEX. Refer to the IPEX literature or web site for additional details.

* Universal Concentric Vent Kit :
 <USA> #397256- PVC System 1738
 <Canada> #196256- PVC System 636
 #197256- CPVC System 636

** Low Profile Termination Kit :
 <USA> #397984- 2" PVC System 1738
 #397985- 3" PVC System 1738
 <Canada> #196984- 2" PVC System 636
 #196985- 3" PVC System 636

6.2.4 Maximum Vent Length

- This Water Heater has been designed to be vented with either 2 in. (50 mm) or 3 in. (75 mm) PVC, CPVC, PP, or 3 in. (75 mm) flexible pipe for chimney. If you use Flex Vent 2 in. Conversion Kit, you must use 2 in. flexible PP.
- The minimum total vent length including horizontal and vertical vent runs should not be less than:
 - PVC/CPVC/PP, 3 in. (75 mm) flexible pipe for chimney: 3 ft (0.9 m)
 - 2 in. flexible PP: 5 ft (1.5 m)
- The Water Heater can be adjusted to accommodate longer vent runs; refer to the table below. Do not exceed the maximum vent length.
- Disconnect the electrical power and then adjust the DIP switches according to the vent condition noted in the tables below.
 Refer to page 58 for the location of the DIP switch bank and how to change the DIP switches.
 Failure to perform this step will result a "73" code displayed on the Remote Controller and a cease in operation.
 If this occurs, disconnect, then reconnect the electrical power to the Water Heater to reset the system.

- NOTE**
- When adjusting the DIP switches for longer vent runs, the Btu/h input of the Water Heater will be reduced by up to 9%.
 - Do not change any other DIP switches.

Maximum Vent Length Configurations (For PVC/CPVC/PP material)

- The maximum vent length when using 2 in. (50 mm) pipe is 65 ft.
- The maximum vent length when using 3 in. (75 mm) pipe is 150 ft.

Both maximum lengths are reduced by the number of elbows used, as shown in the following table:

Vent diameter	Maximum equivalent vent length* ¹ V (Vertical) + H (Horizontal)	Maximum # of elbows* ²	Equivalent length
2 in.	65 ft (20 m)	6	90° elbow: 5 ft (1.5 m)
3 in.	150 ft (46 m)	15	45° elbow: 3 ft (0.9 m)

*1 The maximum vent length includes elbows.

*2 Not including the termination.

[DIP Switch Adjustment]

ON = ● / OFF = ○

Vent length condition	DIP switches	
	#7	#8
① Less than 33 ft using 2 in. (50 mm) pipe	○	○
② 33 ft or more using 2 in. (50 mm) pipe	●	○
③ Less than 75 ft using 3 in. (75 mm) pipe	○	●
④ 75 ft or more using 3 in. (75 mm) pipe	●	●

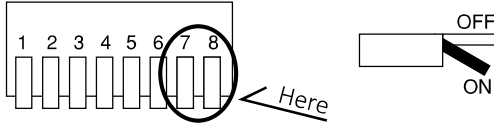

[Vent length Calculation example]

Step 1:

Vent Diameter
2 in.

Step 2:

Straight pipe length
(Vertical length + Horizontal length)
17 ft

Step 3:

Number of elbows
90° elbows: 2
45° elbows: 2

Step 4:

Calculate equivalent length
90° elbows: 2 × 5 ft = 10 ft
45° elbows: 2 × 3 ft = 6 ft

Step 5:

Total vent length
(Add Step 2 and Step 4 together)
17 ft + 16 ft = 33 ft

Step 6:

Check [DIP Switch Adjustment] and select DIP switch settings.
② [33 ft or more using 2 in. (50 mm) pipe] (i.e., turn ON DIP switch #7)

Maximum Vent Length Configurations (For Flex Vent 2 in. Conversion Kit)

Maximum Vent Length Example:

- Actual Vent Length = 13 ft (3.9 m) (with DIP switch set at "Short length" condition)
- Actual Vent Length = 25 ft (7.5 m) (with DIP switch set at "Long length" condition)

ON = ● / OFF = ○

	Vent length	DIP switches	
		#7	#8
Short length	5 ft (1.5 m) - 15 ft (4.5 m)	○	○
Long length	15 ft (4.5 m) - 35 ft (10.5 m)	●	○

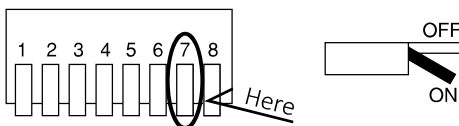

Maximum Vent Length Configurations (For flexible pipe for chimney)

[DuraVent® - Flex Through Chimney w/ Air Intake (Only 3 in.)]

The vent length condition setting depends on the flexible pipe length, the rigid pipe length and number of elbows. Calculate an each ventilation system equivalent length, then adjust the DIP switch.

ON = ● / OFF = ○

Vent length condition	DIP switch #7	Maximum equivalent vent length* V (Vertical) + H (Horizontal)	Equivalent length
Short length	○	< 50 ft (15 m)	Flexible pipe: 1 ft (0.3 m) Rigid pipe: 1 ft (0.3 m) 90° elbow: 5 ft (1.5 m) 45° elbow: 3 ft (0.9 m)
Long length	●	50 ft (15 m)–75 ft (22.5 m)	

* The maximum vent length includes elbows.

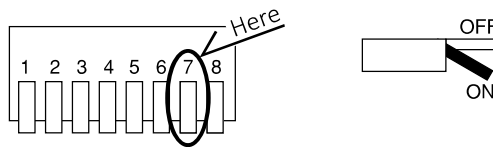

- Equivalent vent length calculation example:

[Example 1]

- Vent Size: 3 in.
- V (Vertical length): 20 ft
- H (Horizontal length): 6 ft
- 90° elbow: 2

1 ft × 20 + 1 ft × 6 + 5 ft × 2 = 36 ft
Total equivalent length ≤ 50 ft

Select "Short length"

[Example 2]

- Vent Size: 3 in.
- V (Vertical length): 35 ft
- H (Horizontal length): 10 ft
- 90° elbow: 3

1 ft × 35 + 1 ft × 10 + 5 ft × 3 = 60 ft
50 ft < Total equivalent length ≤ 75 ft

Select "Long length"

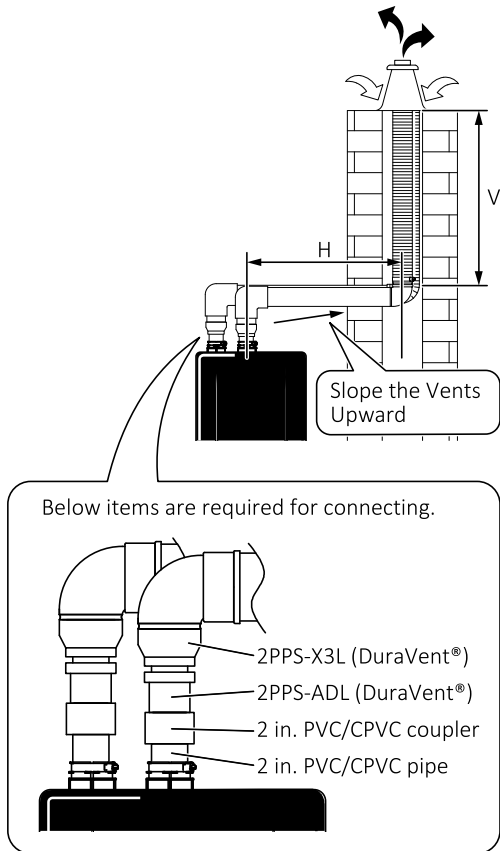

[Centrotherm® - Flex Through Chimney w/ Air Intake (Only 3 in.)]

The vent length condition setting depends on the flexible pipe length, the rigid pipe length and number of elbows. Calculate an each ventilation system equivalent length, then adjust the DIP switch.

ON = ● / OFF = ○

Vent length condition	DIP switch #7	Maximum equivalent vent length*	Equivalent length
Short length	○	Exhaust vent V (Vertical) + H (Horizontal): < 50 ft (15 m) Air Intake: < 50 ft (15 m)	Flexible pipe: 1 ft (0.3 m) Rigid pipe: 1 ft (0.3 m)
Long length	●	Exhaust vent V (Vertical) + H (Horizontal): 50 ft (15 m)–75 ft (22.5 m) Air Intake: 50 ft (15 m)–75 ft (22.5 m)	90° elbow: 5 ft (1.5 m) 45° elbow: 3 ft (0.9 m)

* The maximum vent length includes elbows.

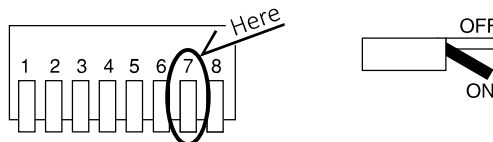

- Equivalent vent length calculation example:

[Example 1]

- Vent Size: 3 in.
- V (Vertical length): 25 ft
- H (Horizontal length): 5 ft
- 87° elbow: 2

$$1 \text{ ft} \times 25 + 1 \text{ ft} \times 5 + 5 \text{ ft} \times 2 = 40 \text{ ft}$$

$$\text{Total equivalent length} \leq 50 \text{ ft}$$

Select "Short length"

[Example 2]

- Vent Size: 3 in.
- V (Vertical length): 30 ft
- H (Horizontal length): 10 ft
- 87° elbow: 3

$$1 \text{ ft} \times 30 + 1 \text{ ft} \times 10 + 5 \text{ ft} \times 3 = 55 \text{ ft}$$

$$50 \text{ ft} < \text{Total equivalent length} \leq 75 \text{ ft}$$

Select "Long length"

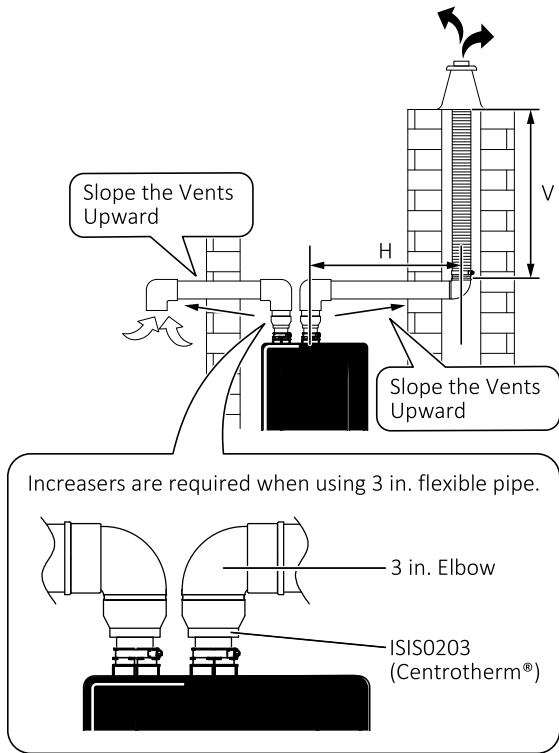

Non-Direct Vent (with Flex Vent 2 in. Conversion Kit EZ2-CK)

Combustion air is supplied from the surrounding indoor air.

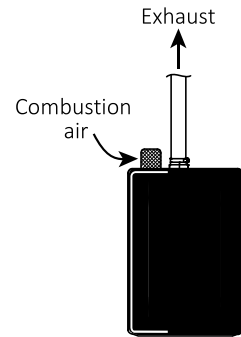

Outdoor (with Outdoor Vent Cap VC-6)

The Water Heater can be installed outside using the Outdoor Vent Cap (VC-6).

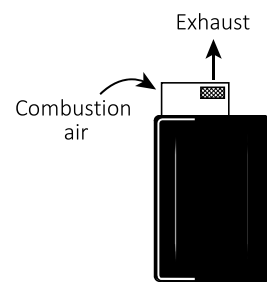

Common Vent

This Water Heater is suitable for Common Vent System. To make a Common Vent System, refer to the Common Vent installation manual or contact Noritz America at <http://support.noritz.com/> or 1-866-766-7489 for details.

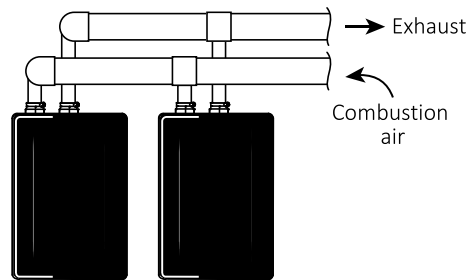

Direct Vent

Combustion air is supplied from the outdoors. Combustion air and exhaust are separate vent pipes.

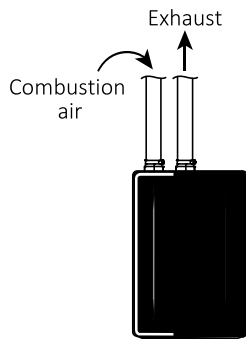

Non-Direct Vent (with SV Conversion Kit SV-CK-2)

Combustion air is supplied from the surrounding indoor air.

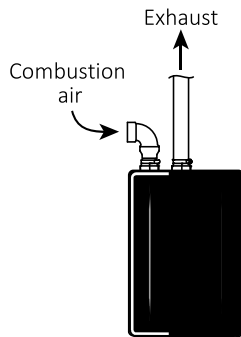

⚠ WARNING

Exhaust gasses and combustion air must not be combined into a single PVC pipe using a "Y" fitting.

Single Pipe

Combustion air

Exhaust

6.4.1 Clearance Requirements from Vent Terminations to Building Openings [When supplying combustion air from the outdoors]

- All clearance requirements are in accordance with ANSI Z21.10.3 and the National Fuel Gas Code, ANSI Z223.1 and in Canada, in accordance with the Natural Gas and Propane Installation Code CSA B149.1.

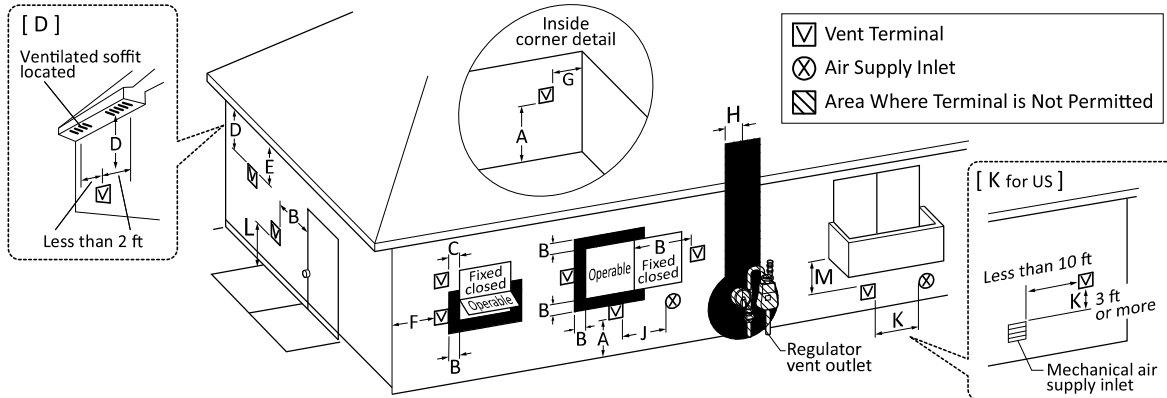

Ref	Description	Canadian Direct Vent Installations ¹	US Direct Vent Installations ²
A	Clearance above grade, veranda, porch, deck, or balcony	12 in. (30 cm)	12 in. (30 cm)
B	Clearance to window or door that may be opened	6 in. (15 cm) for appliances ≤ 10,000 Btuh (3kW), 12 in. (30 cm) for appliances > 10,000 Btuh (3kW) and ≤ 100,000 Btuh (30 kW), 36 in. (91 cm) for appliances > 100,000 Btuh (30 kW)	6 in. (15 cm) for appliances ≤ 10,000 Btuh (3kW), 9 in. (23 cm) for appliances > 10,000 Btuh (3kW) and ≤ 50,000 Btuh (15 kW), 12 in. (30 cm) for appliances > 50,000 Btuh (15 kW)
C	Clearance to permanently closed window	*	*
D	Vertical clearance to ventilated soffit located above the terminal within a horizontal distance of 2 feet (61 cm) from the center line of the terminal	*	*
E	Clearance to unventilated soffit	*	*
F	Clearance to outside corner	*	*
G	Clearance to inside corner	*	*
H	Clearance to each side of center line extended above meter/regulator assembly	*	*
I	Clearance to service regulator vent outlet	Above a regulator within 3 ft (91 cm) horizontally of the vertical center line of the regulator vent outlet to a maximum vertical distance of 15 ft (4.5 m)	*
J	Clearance to non-mechanical air supply inlet to building or the combustion air inlet to any other appliance	6 in. (15 cm) for appliances ≤ 10,000 Btuh (3kW), 12 in. (30 cm) for appliances > 10,000 Btuh (3kW) and ≤ 100,000 Btuh (30 kW), 36 in. (91 cm) for appliances > 100,000 Btuh (30 kW)	6 in. (15 cm) for appliances ≤ 10,000 Btuh (3kW), 9 in. (23 cm) for appliances > 10,000 Btuh (3kW) and ≤ 50,000 Btuh (15 kW), 12 in. (30 cm) for appliances > 50,000 Btuh (15 kW)
K	Clearance to a mechanical air supply inlet	6 ft (1.83 m)	3 ft (91 cm) above if within 10 ft (3 m) horizontally
L	Clearance above paved sidewalk or paved driveway located on public property	7 ft (2.13 m)†	*
M	Clearance under veranda, porch, deck, or balcony	12 in. (30 cm)‡	*

¹ In accordance with the current CSA B149.1 Natural Gas and Propane Installation Code

² In accordance with the current ANSI Z223.1 / NFPA 54 National Fuel Gas Code

† A vent shall not terminate directly above a sidewalk or paved driveway that is located between two single family dwellings and serves both dwellings.

‡ Permitted only if veranda, porch, deck, or balcony is fully open on a minimum of two sides beneath the floor.

* Clearance in accordance with local installation codes and the requirements of the gas supplier. Clearance to opposite wall is 24 in. (60 cm).

6.4.2 Horizontal Vent Termination

For Horizontal Vent Termination - PVC/CPVC Material Only

- Use a condensation drain if necessary.
- In the Commonwealth of Massachusetts a carbon monoxide detector is required for all side wall horizontally vented gas fuel equipment. Refer to Technical Bulletin TB 010606 for full installation instructions.

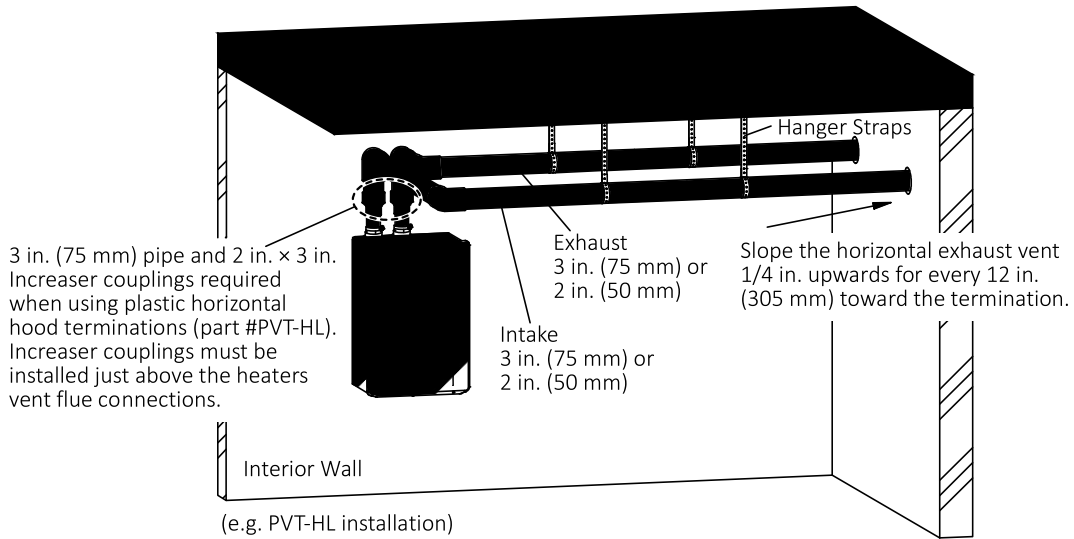

(e.g. PVT-HL installation)

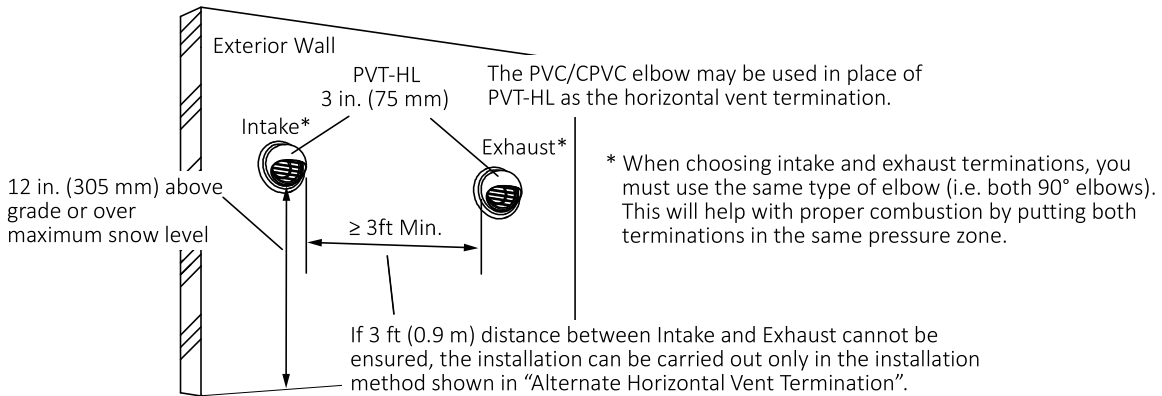

(e.g. PVT-2LPT installation)

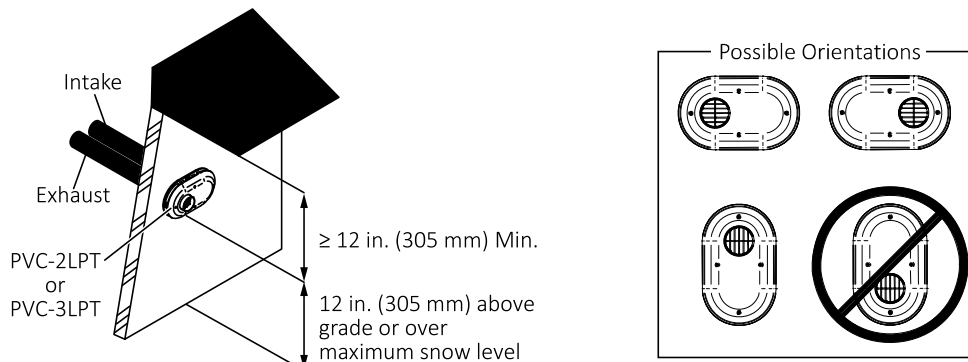

Alternate Horizontal Vent Termination- PVC, CPVC or PP Material

(When 3 ft (0.9 m) distance between Intake and Exhaust cannot be ensured.)

⚠ WARNING

- If the distance between the air inlet and exhaust vent terminations is too short, the Water Heater will draw in the exhaust gases through the intake. There is a risk of inadequate combustion air for the Water Heater, thus increasing Carbon Monoxide (CO) emissions and noise due to vibration.
- Termination elbows must be oriented vertically, pointing directly downward. Attempts to prevent exhaust air from entering the air inlet by angling termination elbows in directions other than directly downward will increase the risk of freezing.
- Reversing the air intake and exhaust pipes is not allowed. Carbon Monoxide (CO) emissions and noise due to vibration will increase.

- Insert the bird screen into the 90° elbow installed vertically downward.
- Intake and exhaust should face the same direction. Intake and exhaust should keep the same pressure zone.

NOTE Do not use Hood termination (PVT-HL).

[Interior View]

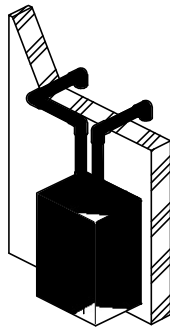

[Exterior View]

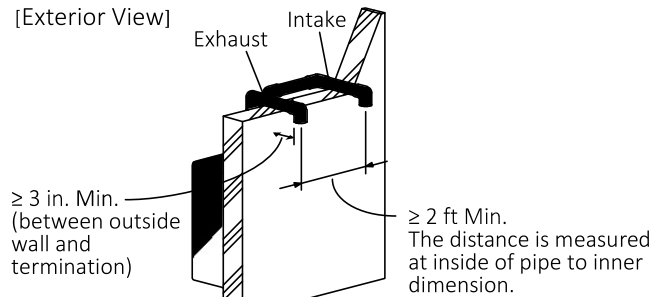

[Interior View]

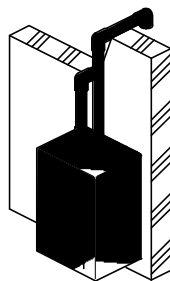

[Exterior View]

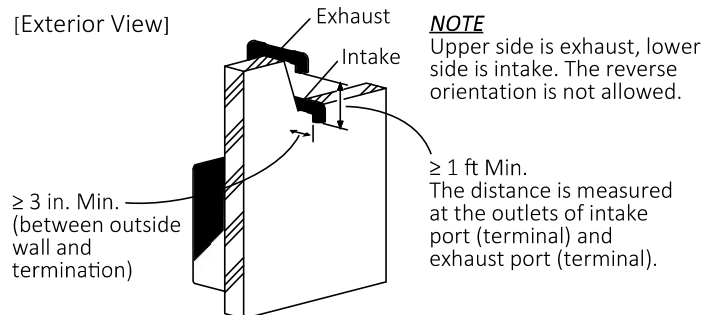

[Interior View]

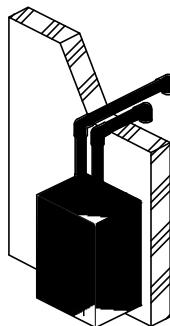

[Exterior View]

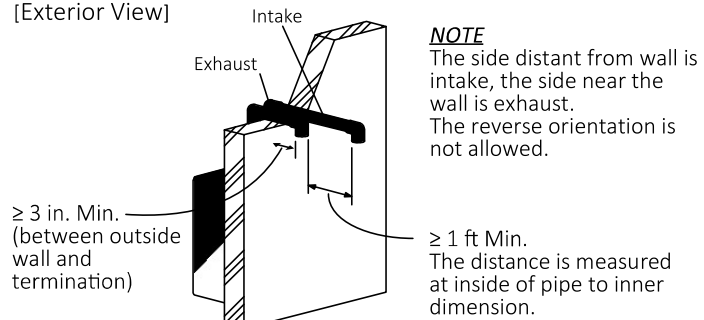

For Horizontal PVC Concentric Termination - PVC/CPVC Material Only

- The concentric termination may be shortened, but not lengthened from its original factory supplied length.
- 2 in. (50 mm) or 3 in. (75 mm) PVC or CPVC pipe may be used with the concentric termination. Maintain the same vent pipe diameter from the Water Heater flue to the termination.
- Use a condensation drain if necessary.
- In the Commonwealth of Massachusetts a carbon monoxide detector is required for all side wall horizontally vented gas fuel equipment. Refer to Technical Bulletin TB 010606 for full installation instructions.

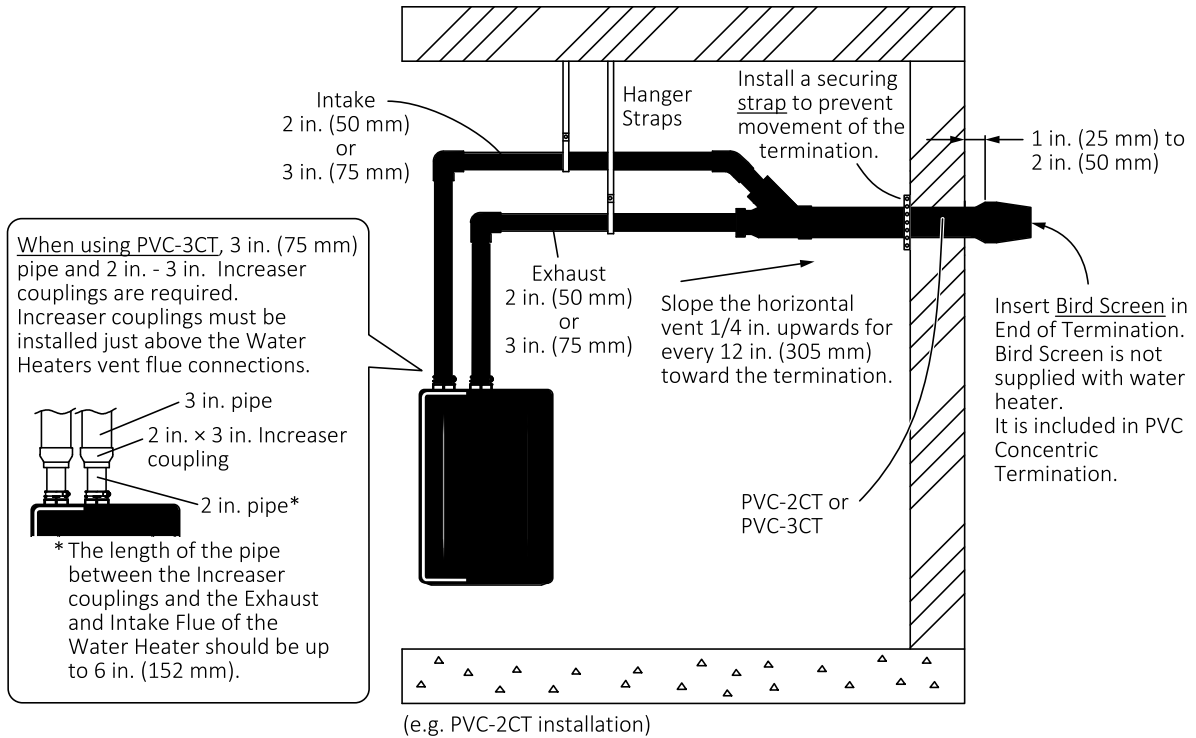

For Universal Concentric Vent Kit

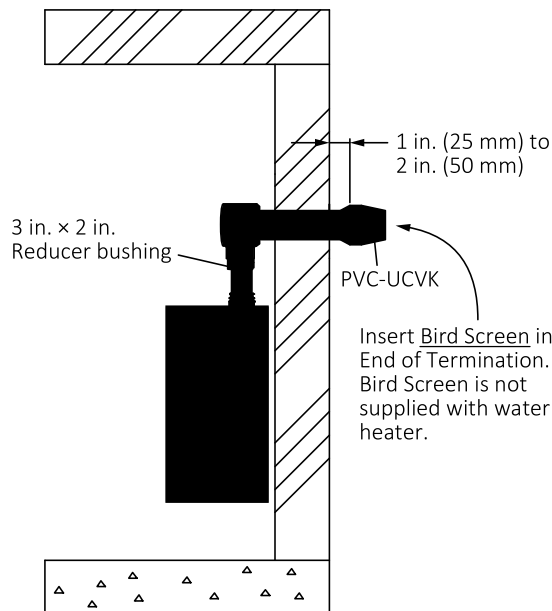

6.4.3 Vertical Vent Termination

For Vertical Vent Termination - PVC, CPVC or PP Material

***About the termination**

- When choosing intake and exhaust terminations, you must use the same type of elbow (i.e. both 90° elbows). This will help with proper combustion by putting both terminations in the same pressure zone.
- Insert Bird Screen in End of 90° Elbow. Bird Screen is not supplied with water heater, order separately.
- To prevent excessive condensation formation, only the vent termination should be located on the exterior of the building.

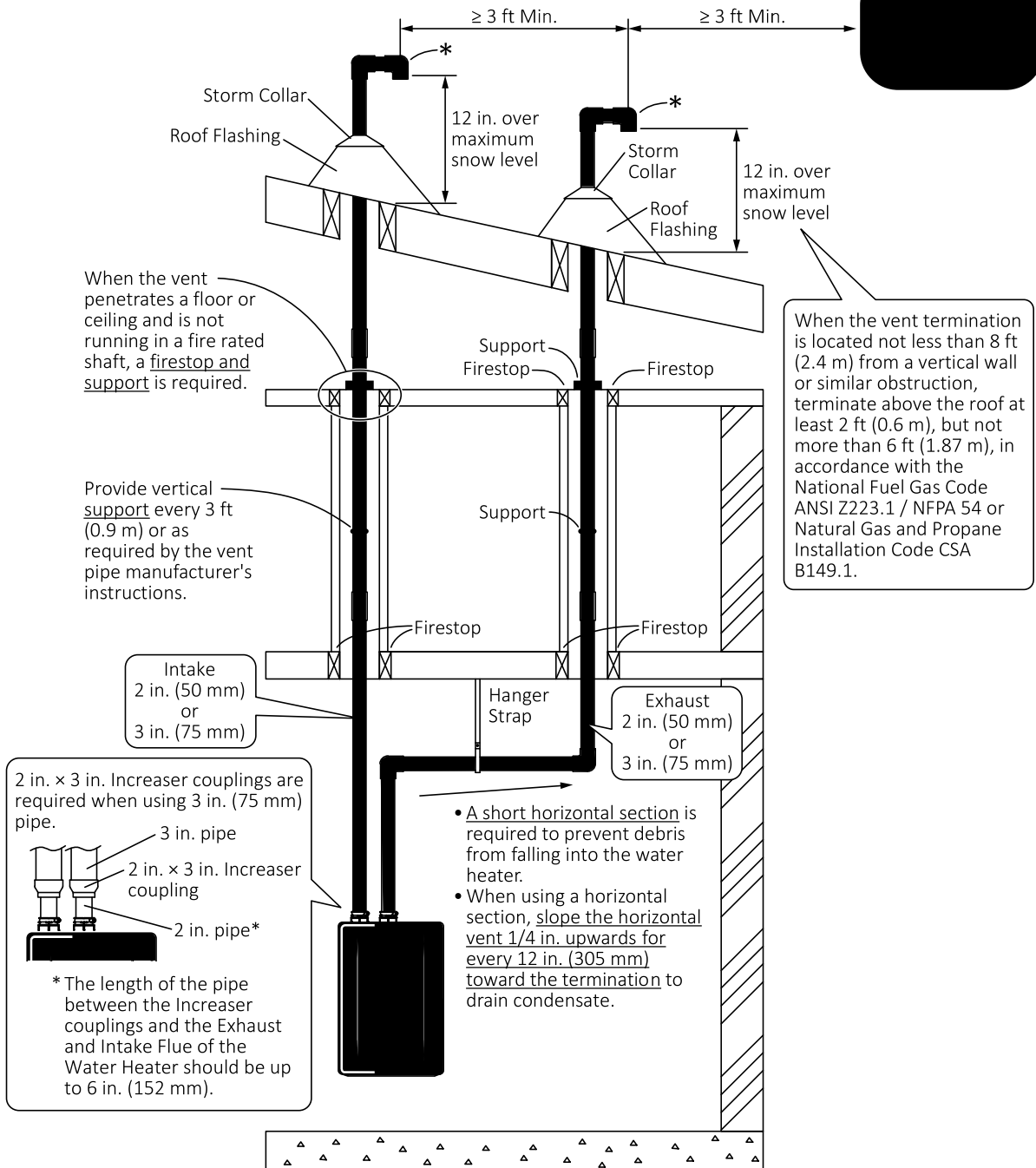

For Vertical PVC Concentric Termination - PVC/CPVC Material Only

- The concentric termination may be shortened, but not lengthened from its original factory supplied length.
- 2 in. (50 mm) or 3 in. (75 mm) PVC or CPVC pipe may be used with the concentric termination. Maintain the same vent pipe diameter from the Water Heater flue to the termination.
- Use a condensation drain if necessary.
- In the Commonwealth of Massachusetts a carbon monoxide detector is required for all side wall horizontally vented gas fuel equipment. Refer to Technical Bulletin TB 010606 for full installation instructions.

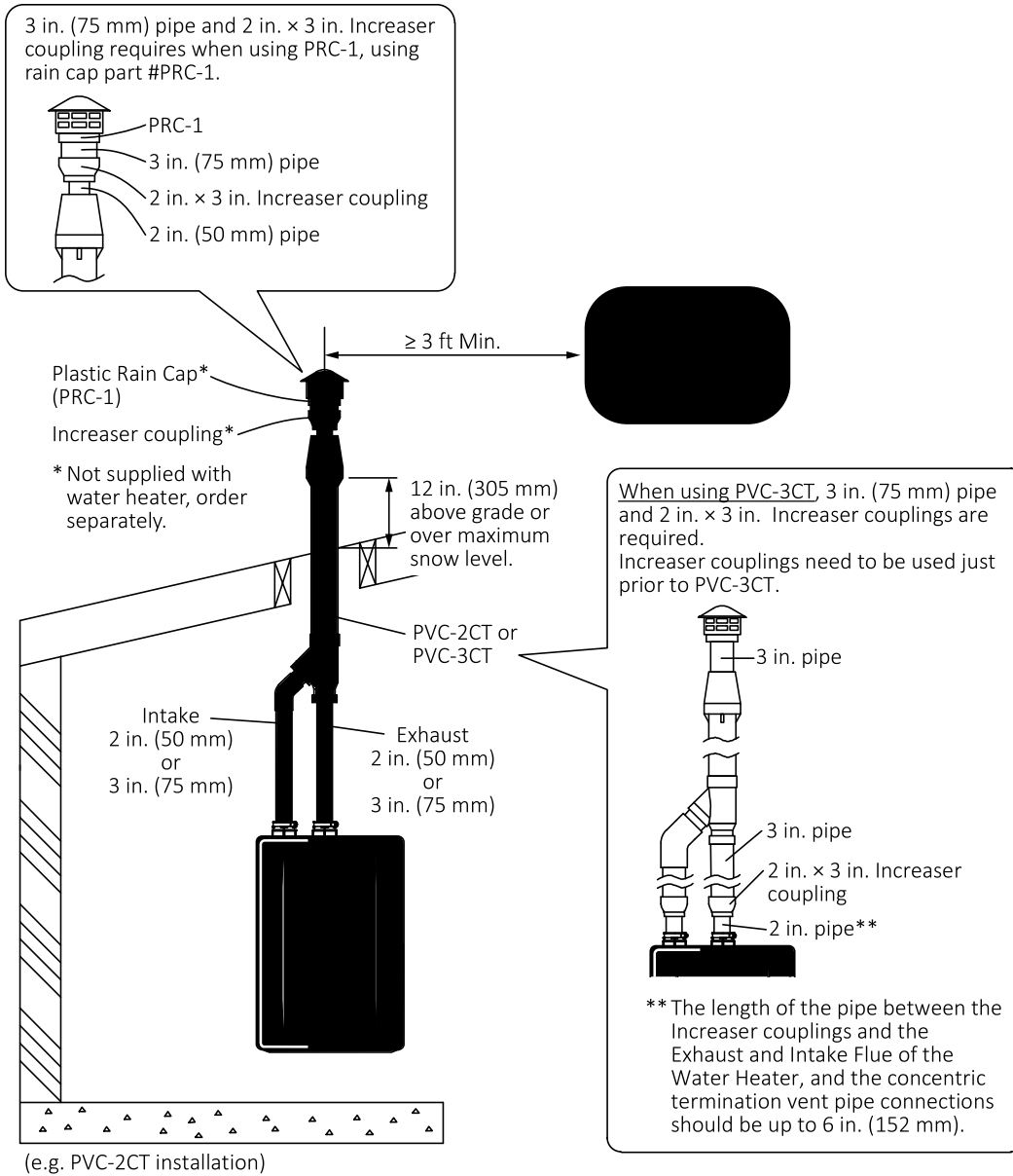

6.5.1 Clearance Requirements from Vent Terminations to Building Openings [Other than Direct Vent]

- All clearance requirements are in accordance with ANSI Z21.10.3 and the National Fuel Gas Code, ANSI Z223.1 and in Canada, in accordance with the Natural Gas and Propane Installation Code CSA B149.1.

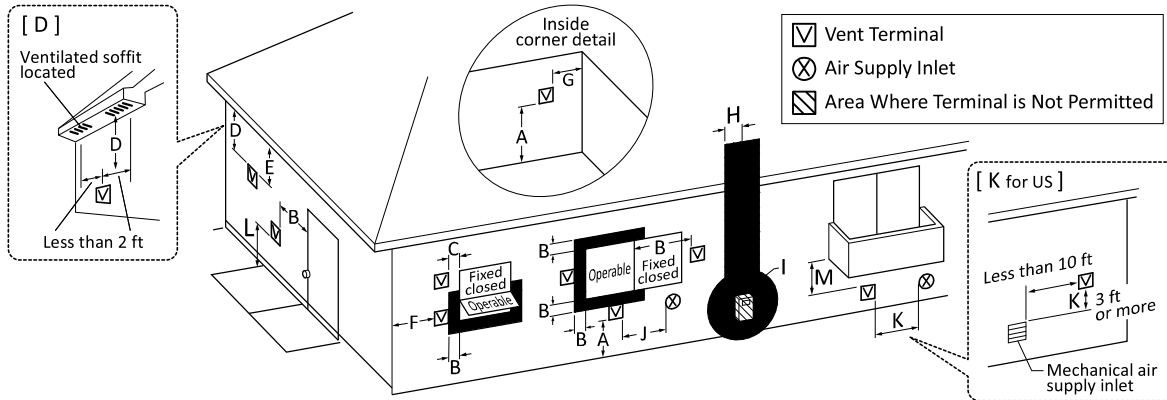

Ref	Description	Canadian Non-Direct Vent Installations ¹	US Non-Direct Vent Installations ²
A	Clearance above grade, veranda, porch, deck, or balcony	12 in. (30 cm)	12 in. (30 cm)
B	Clearance to window or door that may be opened	6 in. (15 cm) for appliances ≤ 10,000 Btuh (3kW), 12 in. (30 cm) for appliances > 10,000 Btuh (3kW) and ≤ 100,000 Btuh (30 kW), 36 in. (91 cm) for appliances > 100,000 Btuh (30 kW)	4 ft (1.2 m) below or to side of opening; 1 ft (300 mm) above opening
C	Clearance to permanently closed window	*	*
D	Vertical clearance to ventilated soffit located above the terminal within a horizontal distance of 2 feet (61 cm) from the center line of the terminal	*	*
E	Clearance to unventilated soffit	*	*
F	Clearance to outside corner	*	*
G	Clearance to inside corner	*	*
H	Clearance to each side of center line extended above meter/regulator assembly	*	*
I	Clearance to service regulator vent outlet	Above a regulator within 3 ft (91 cm) horizontally of the vertical center line of the regulator vent outlet to a maximum vertical distance of 15 ft (4.5 m)	*
J	Clearance to non-mechanical air supply inlet to building or the combustion air inlet to any other appliance	6 in. (15 cm) for appliances ≤ 10,000 Btuh (3kW), 12 in. (30 cm) for appliances > 10,000 Btuh (3kW) and ≤ 100,000 Btuh (30 kW), 36 in. (91 cm) for appliances > 100,000 Btuh (30 kW)	4 ft (1.2 m) below or to side of opening; 1 ft (300 mm) above opening
K	Clearance to a mechanical air supply inlet	6 ft (1.83 m)	3 ft (91 cm) above if within 10 ft (3 m) horizontally
L	Clearance above paved sidewalk or paved driveway located on public property	7 ft (2.13 m)†	*
M	Clearance under veranda, porch, deck, or balcony	12 in. (30 cm)‡	*

¹ In accordance with the current CSA B149.1 Natural Gas and Propane Installation Code

² In accordance with the current ANSI Z223.1 / NFPA 54 National Fuel Gas Code

† A vent shall not terminate directly above a sidewalk or paved driveway that is located between two single family dwellings and serves both dwellings.

‡ Permitted only if veranda, porch, deck, or balcony is fully open on a minimum of two sides beneath the floor.

* Clearance in accordance with local installation codes and the requirements of the gas supplier. Clearance to opposite wall is 24 in. (60 cm).

6.5.2 Consideration for Installation

⚠ DANGER

- When installing this Water Heater in an area with a large amount of lint such as a commercial Laundromat, direct vent (“-DV”) system must be used. The “-SV” configuration (using SV Conversion Kit) and Flex Vent 2 in. Conversion Kit are prohibited.
- When installing this Water Heater in a mobile home, all combustion must be drawn directly from the outdoors. The “-SV” configuration (using SV Conversion Kit) and Flex Vent 2 in. Conversion Kit are prohibited.

For SV Conversion Kit

⚠ WARNING

Failure to change DIP switch #3 and use SV Conversion Kit SV-CK-2 could result in a fire or explosion causing property damage, personal injury or death. Refer to the instructions provided with the conversion kit for additional details.

- Disconnect the electrical power and then turn ON DIP switch #3 if combustion air will be supplied from the indoors. Refer to page 58 for the location of the DIP switch bank and how to change the DIP switch. Failure to perform this step will result a “73” code displayed on the Remote Controller and a cease in operation. If this occurs, disconnect, then reconnect the electrical power to the Water Heater to reset the system.

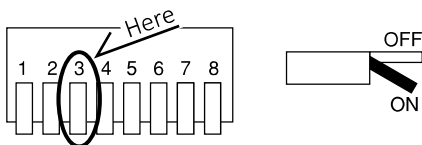

- SV Conversion Kit SV-CK-2 is required for the air intake.
- Noritz recommends a carbon monoxide alarm installed in same room space as Water Heater when supplying combustion air from the indoors.

⚠ WARNING

To prevent possible personal injury or death due to asphyxiation, common venting with other manufacturer’s induced draft appliances is not allowed.

For Flex Vent 2 in. Conversion Kit

Flex Vent 2 in. Conversion Kit

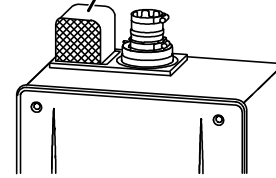

1. Secure the “Flex Vent 2 in. Conversion Kit” to top of the Water Heater. (Refer to the instructions provided with “Flex Vent 2 in. Conversion Kit” for additional detail.)

NOTE Flex Vent 2 in. Conversion Kit must be installed in the proper direction as shown above.

2. Disconnect the electrical power and then turn ON DIP switch #2 and #3. Refer to page 58 for the location of the DIP switch bank and how to change the DIP switches. Failure to perform this step will result a “73” code displayed on the Remote Controller and a cease in operation. If this occurs, disconnect, then reconnect the electrical power to the Water Heater to reset the system.

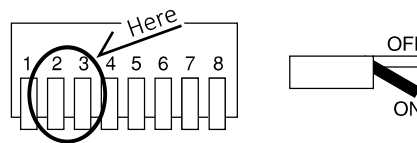

6.5.3 Combustion Air

NOTE Provide adequate combustion air so as to not create negative pressure within the building.

- Supply combustion air to the Water Heater as per the National Fuel Gas Code, ANSI Z223.1- latest edition and in Canada, in accordance with the Natural Gas and Propane Installation Code CSA B149.1 - latest edition.
- A minimum free area of each opening:

[NRCR111DV (GQ-C3260WXQ-FF US)]

Indoor make up air is provided		200 in. ²
	example	20 in. (W) × 10 in. (H)
Outdoor make up air is provided	Direct or Vertical ducts	50 in. ²
	example	10 in. (W) × 5 in. (H)
	Horizontal ducts	100 in. ²
	example	20 in. (W) × 5 in. (H)

[NRCR92DV (GQ-C2660WXQ-FF US)]

Indoor make up air is provided		165 in. ²
	example	20 in. (W) × 8 1/4 in. (H)
Outdoor make up air is provided	Direct or Vertical ducts	41 in. ²
	example	10 in. (W) × 4 1/10 in. (H)
	Horizontal ducts	82 in. ²
	example	20 in. (W) × 4 1/10 in. (H)

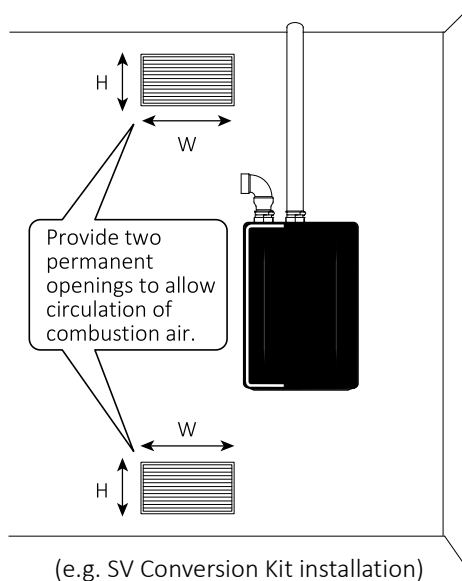

- If the Water Heater is installed in a mechanical closet, a minimum of permanent clearance of 4 in. or more in front of the Water Heater is required. In order to facilitate maintenance and repair, a minimum clearance (24 in. or more) should be met.
- If combustion air will be provided through a duct, size the duct to provide as below.
 - NRCR111DV (GQ-C3260WXQ-FF US):
70 ft³ of fresh air per minute
 - NRCR92DV (GQ-C2660WXQ-FF US):
58 ft³ of fresh air per minute

6.5.4 Horizontal Vent Termination

- Use a condensation drain if necessary.
- In the Commonwealth of Massachusetts a carbon monoxide detector is required for all side wall horizontally vented gas fuel equipment. Refer to Technical Bulletin TB 010606 for full installation instructions.

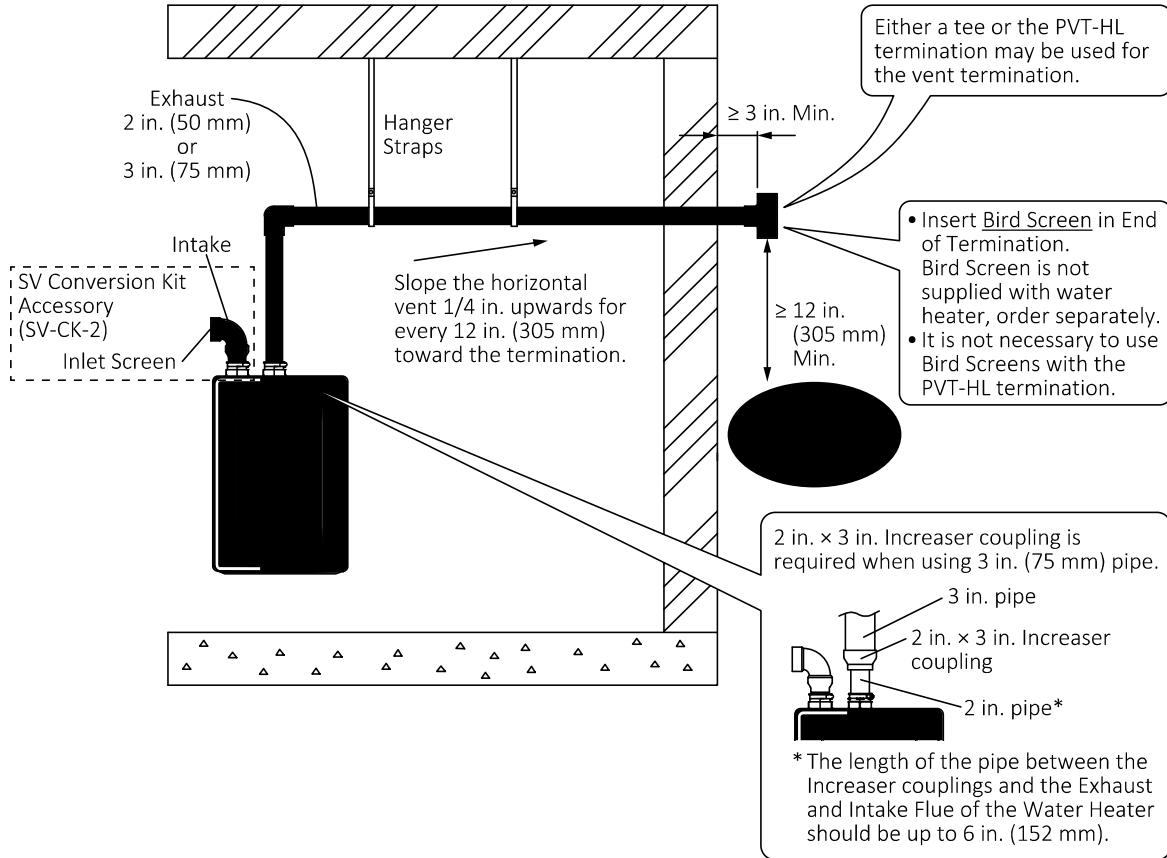

6.5.5 Vertical Vent Termination

For SV Conversion Kit

***About the termination**

- Insert Bird Screen in End of 90° Elbow.
- Bird Screen is not supplied with water heater, order separately.
- To prevent excessive condensation formation, only the vent termination should be located on the exterior of the building.

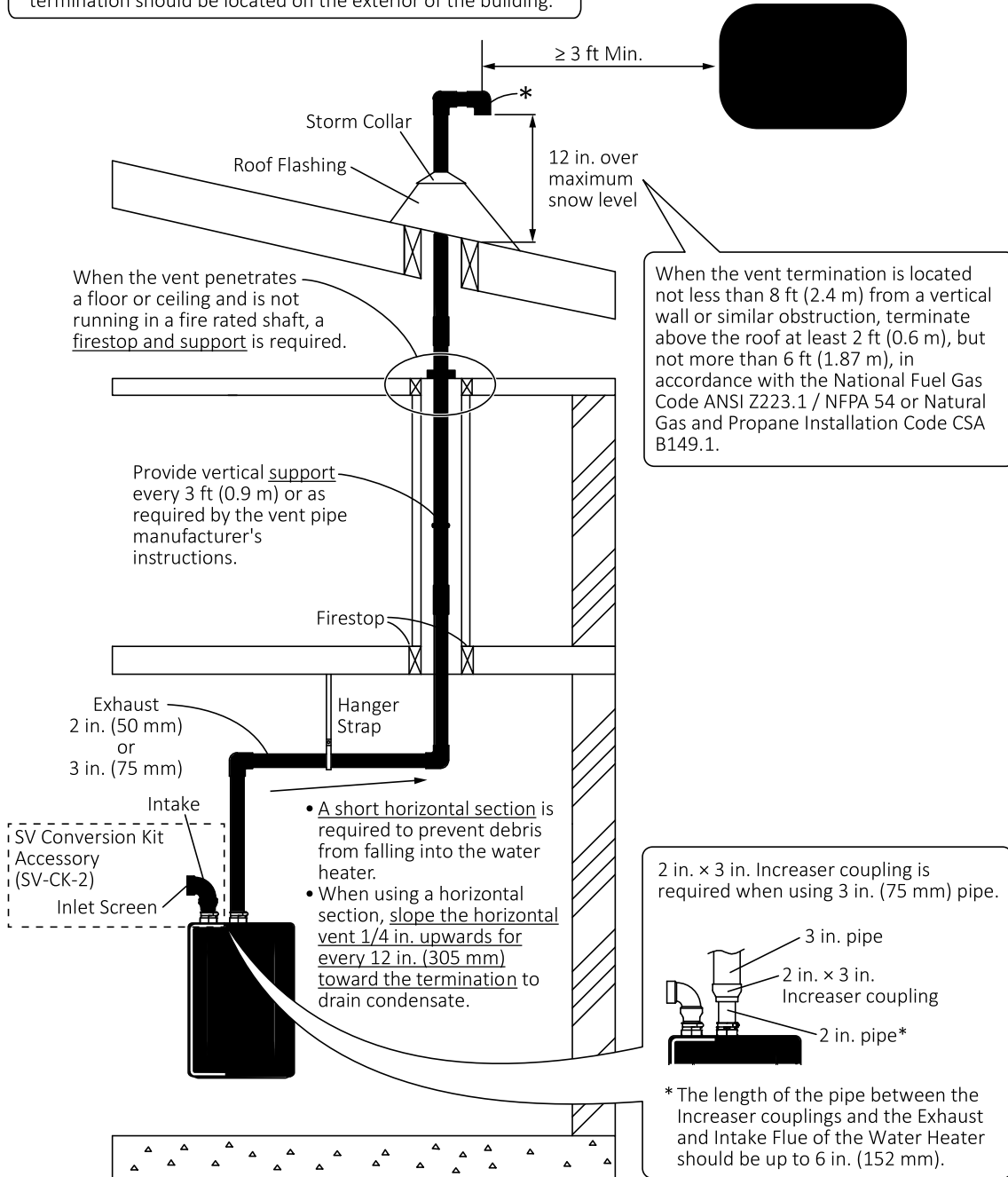

For Flex Vent 2 in. Conversion Kit

⚠ WARNING
 This Water Heater is suitable only for vertical vent.

***About the termination**
 To prevent excessive condensation formation, only the vent termination should be located on the exterior of the building.

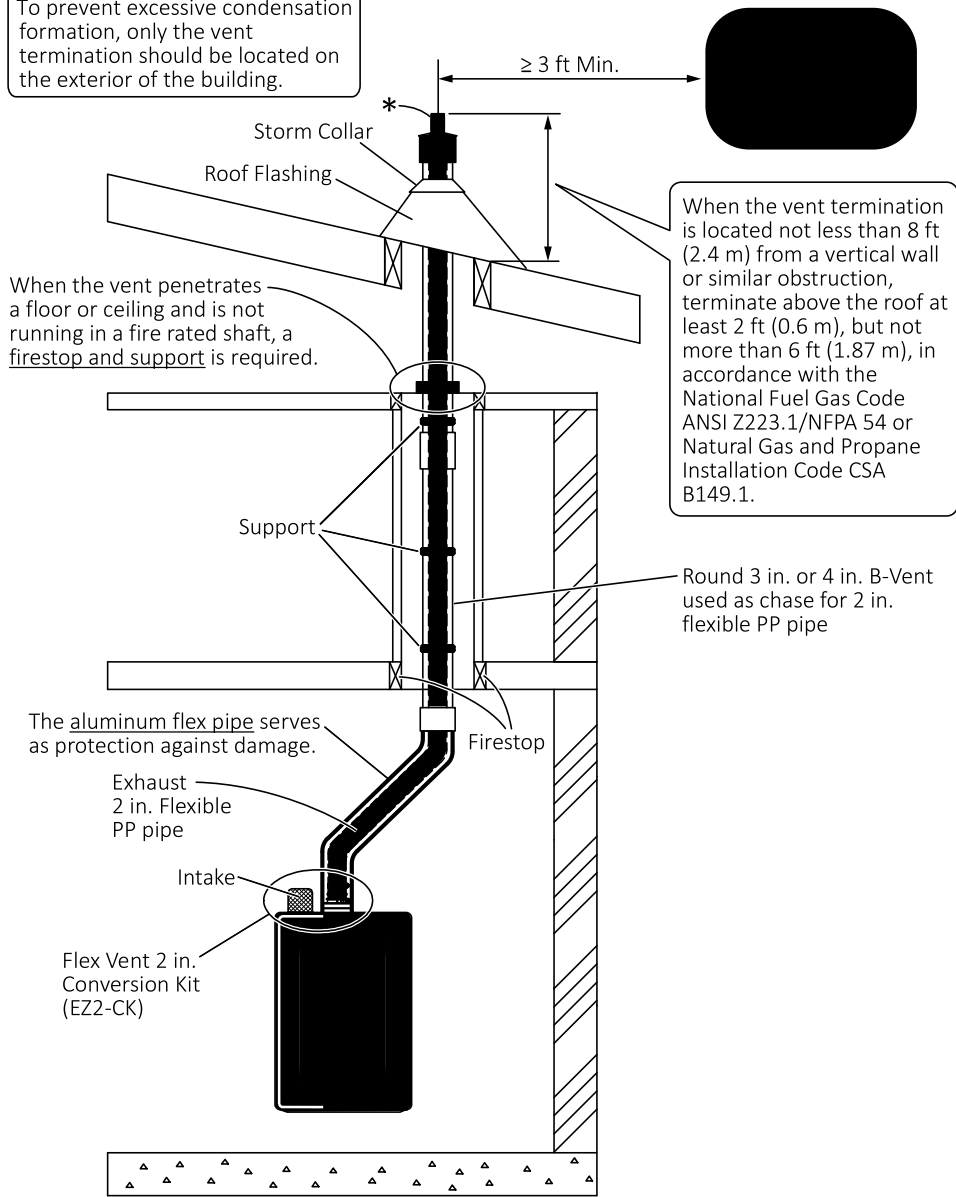

- When installing this Water Heater outdoors, the “Outdoor Vent Cap (VC-6)” must be used.
- Refer to the instructions provided with Outdoor Vent Cap for additional detail.

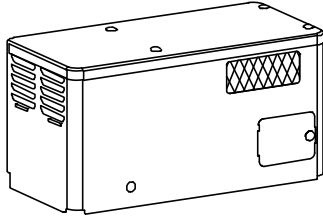

- Disconnect the electrical power and then turn ON DIP switch #2 if outdoor installation. Refer to page 58 for the location of the DIP switch bank and how to change the DIP switch. Failure to perform this step will result a “73” code displayed on the Remote Controller and a cease in operation. If this occurs, disconnect, then reconnect the electrical power to the Water Heater to reset the system.

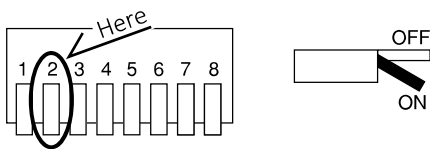

7 Connecting the Gas Supply

Follow the instructions from the gas supplier.

⚠ WARNING

The sizing and installation of the gas system for this Water Heater, as with any gas appliance, is the sole responsibility of the installer. The installer must be professionally trained to do such work and must always follow all local and national codes and regulations.

Gas Type

The gas type indicated on the Water Heater's rating plate (NG or LP) must match the type of gas being supplied to the Water Heater.

Gas Conversions

- If the supplied gas does not match the gas type on the rating plate, contact your water heater supplier for a replacement Water Heater with the proper gas type.
- If a gas conversion is needed, there are conversion kits available for some models.
- The conversion kit shall be installed by a qualified service agency in accordance with the manufacturer's instructions and all applicable codes and requirements of the authority having jurisdiction. The qualified service agency is responsible for the proper installation of this kit. Improper installation of this kit will void the Noritz America Limited Warranty. Conversion kits will only be shipped directly to the Distributor or Agency performing the conversion.

Meter

- The gas meter must be sized properly for the Water Heater and other gas appliances to operate properly.
- Select a gas meter capable of supplying the entire Btu/h demand of all gas appliances in the building.

Regulators

⚠ WARNING

- Ensure that all gas regulators used are operating properly and providing gas pressures within the specified range of the Water Heater being installed.
- Excess gas inlet pressure may cause serious accidents.

Pressure

- Check the gas supply pressure immediately upstream at a location provided by the gas company.
- Supplied gas pressure must be within the limits shown in the specifications section with all gas appliances operating.

⚠ WARNING

The inlet gas pressure must be within the range specified. This is for the purposes of input adjustment. Low gas pressure may cause a loss of flame or ignition failure at other appliances in the home, which may result in unburned gas in the home. Serious accidents such as fire or explosion may result.

Pressure Test

The appliance and its gas connections must be leak tested before placing the appliance in operation.

- Test at test pressures equal to or less than ½ psi (3.5 kPa).
- The appliance must be isolated from the gas supply piping system by closing its individual manual shut off valve during any pressure testing of the gas supply piping system.
- If test pressures are in excess of 1/2 psi (3.5 kPa), the appliance and its individual shut off valve must be completely disconnected from the gas supply piping system during the test process.

Measuring Gas Pressure

In order to check the gas supply pressure to the Water Heater, a tap is provided on the gas inlet.

1. Remove the **9/32 in. hex head /Philips screw** from the tap.

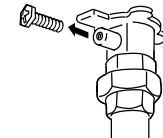

2. Connect a manometer using a silicon tube.
3. Open up at least two fixtures with hot water side fully.
4. Hold in the "Maximum Burner Set Button" on the circuit board.

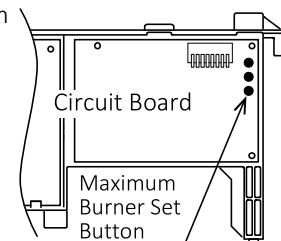

Pipe Sizing

- A gas shut off valve must be installed on the supply line.
- Gas piping shall be in accordance with local utility company requirements and/or in the absence of local codes, use the latest edition of National Fuel Gas Code (NFPA54GC), ANSI Z223.1. In Canada, use the latest edition of CSA B149.1, Natural Gas and Propane installation code.
- Size the gas line according to total Btu/h demand of the building and length from the meter or regulator so that the following supply pressures are available even at maximum demand.

	Supply Pressure	
	Natural Gas	LP Gas
Min	3.5 in. W.C.	8 in. W.C.
Max	10.5 in. W.C.	14 in. W.C.

⚠ WARNING

Gas pressures below the required minimum pressure may result in ignition failure, personal injury or death.

Flexible Connectors

Flexible gas lines are not recommended unless the minimum inside diameter is $\frac{3}{4}$ in. or greater and the rated capacity of the connector is equal to or greater than the Btu/h demand of the Water Heater.

Reference Tools & Sample Calculations

NOTICE

The tables and samples below are for reference only. The professional sizing and installing the gas line should always run the appropriate calculations before all installations.

[Calculation Example]

A partial set of sizing tables are printed on page 40. In cases where these tables are not appropriate, refer to the NFPA.

1. Draw a sketch of a piping system. Enter the system information.

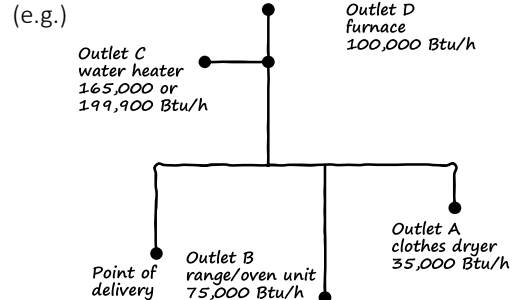

2.
 - Determine the gas type used and supply gas Pressure, and enter it.
 - Determine the piping material and enter it to the below.
 - Select the appropriate pipe sizing table from page 40 and enter it to the below.

(e.g.)

Gas type: Natural
 Supply gas pressure: 6 in. W.C.
 Piping material: Sch 40 steel
 Table used: 2
 Pressure drop: 1.0 in. W.C.

Gas type: _____
 Supply gas pressure: _____
 Piping material: _____
 Table used: _____
 Pressure drop: _____

3.
 - On the sketch, label the section of pipe from the point of delivery (meter or regulator) to the first tee as Section 1.
 - Label the section from the first tee to the second tee as Section 2, and label the section from the first tee to the third tee as Section 3. Use similar section numbers for additional sections.

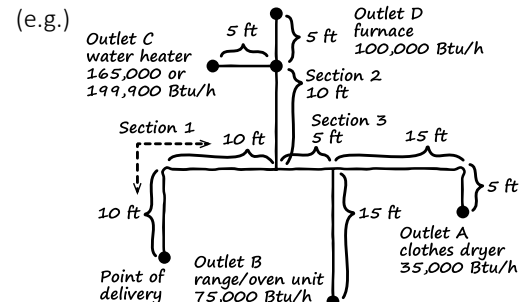

4.
 - Enter the demand is the amount of gas flowing through a section of pipe in the table below.
 - For natural gas, use total Btu/h rating/1000 (ft³/h).
 - For propane, use total Btu/h.
 - For each section, determine the longest piping from the point of delivery to the furthest appliance through each section. Enter this length for all pipe sections in the table below.
 - Round up to the lengths in the appropriate table on page 40. Read across until a capacity equal to or greater than the required demand for the section is found. Read up to find the size. Repeat for each section of piping. Enter this size in the table below.

(e.g.)

Section	Demand	The longest length	Size
1	409.9	45 ft	1 in.
2	299.9	35 ft	1 in.
3	110	45 ft	3/4 in.
4			
5			

Section	Demand	The longest length	Size
1			
2			
3			
4			
5			

5.
 - Enter the input rating for each appliance in the table below.
 - For natural gas appliances, enter the input rating in Btu/h/1000 (ft³/h).
 - For propane appliances, enter the input rating in Btu/h.
 - Enter the outlet length from each appliance to the point of delivery in the table below.
 - Round up to the lengths in the appropriate table on page 40. Read across until a capacity equal to or greater than the required demand for the section is found. Read up to find the size. Repeat for each appliance. Enter this size in the table below.

(e.g.)

Appliance	Demand	Outlet length	Size
Outlet A	35	45 ft	1/2 in.
Outlet B	75	40 ft	1/2 in.
Outlet C	199.9	35 ft	3/4 in.
Outlet D	100	35 ft	1/2 in.

Appliance	Demand	Outlet length	Size
Outlet A			
Outlet B			
Outlet C			
Outlet D			

Final Check

1. Turn on and operate all gas appliances including the Water Heater.
2. Check the inlet pressure at each appliance shall be such that the supply pressure at the appliance is greater than or equal to the minimum pressure required by the appliance.

NOTE If all appliances are not receiving the minimum inlet pressure, the gas piping system may need to be changed.

[Gas pipe sizing tables]

- These tables are for reference only. Consult gas pipe manufacturer for actual pipe capacities.
- It is an example of Schedule 40 Metallic Pipe.
- (Only Table 1- 4) Values in Table are in ft³ of Gas per Hour. Contact your gas supplier for Btu/ft³ ratings. For simplification of your calculations, 1 ft³ of Gas is approximately equivalent to 1,000 Btu.

1. Maximum Natural Gas Delivery Capacity (For Less than 6 in. W.C. initial supply pressure)														
Pipe Size	Length (including fittings)													
	10 ft (3 m)	20 ft (6 m)	30 ft (9 m)	40 ft (12 m)	50 ft (15 m)	60 ft (18 m)	70 ft (21 m)	80 ft (24 m)	90 ft (27 m)	100 ft (30 m)	125 ft (38 m)	150 ft (45 m)	175 ft (53 m)	200 ft (60 m)
1/2 in.	172	118	95	81	72	65	60	56	52	50	44	40	37	34
3/4 in.	360	247	199	170	151	137	126	117	110	104	92	83	77	71
1 in.	678	466	374	320	284	257	237	220	207	195	173	157	144	134
1 1/4 in.	1,390	957	768	657	583	528	486	452	424	400	355	322	296	275
1 1/2 in.	2,090	1,430	1,150	985	873	791	728	677	635	600	532	482	443	412
2 in.	4,020	2,760	2,220	1,900	1,680	1,520	1,400	1,300	1,220	1,160	1,020	928	854	794
2 1/2 in.	6,400	4,400	3,530	3,020	2,680	2,430	2,230	2,080	1,950	1,840	1,630	1,480	1,360	1,270

2. Maximum Natural Gas Delivery Capacity (For 6 - 7 in. W.C. initial supply pressure)														
Pipe Size	Length (including fittings)													
	10 ft (3 m)	20 ft (6 m)	30 ft (9 m)	40 ft (12 m)	50 ft (15 m)	60 ft (18 m)	70 ft (21 m)	80 ft (24 m)	90 ft (27 m)	100 ft (30 m)	125 ft (38 m)	150 ft (45 m)	175 ft (53 m)	200 ft (60 m)
1/2 in.	250	172	138	118	105	95	87	81	76	72	64	58	53	50
3/4 in.	524	360	289	247	219	199	183	170	160	151	134	121	111	104
1 in.	986	678	544	466	413	374	344	320	300	284	252	228	210	195
1 1/4 in.	2,030	1,390	1,120	957	848	768	707	657	617	583	516	468	430	400
1 1/2 in.	3,030	2,090	1,680	1,430	1,270	1,150	1,060	985	924	873	774	701	645	600
2 in.	5,840	4,020	3,230	2,760	2,450	2,220	2,040	1,900	1,780	1,680	1,490	1,350	1,240	1,160
2 1/2 in.	9,310	6,400	5,140	4,400	3,900	3,530	3,250	3,020	2,840	2,680	2,380	2,150	1,980	1,840

3. Maximum Natural Gas Delivery Capacity (For 7 - 8 in. W.C. initial supply pressure)														
Pipe Size	Length (including fittings)													
	10 ft (3 m)	20 ft (6 m)	30 ft (9 m)	40 ft (12 m)	50 ft (15 m)	60 ft (18 m)	70 ft (21 m)	80 ft (24 m)	90 ft (27 m)	100 ft (30 m)	125 ft (38 m)	150 ft (45 m)	175 ft (53 m)	200 ft (60 m)
1/2 in.	364	250	201	172	153	138	127	118	111	105	93	84	77	72
3/4 in.	762	524	420	360	319	289	266	247	232	219	194	176	162	151
1 in.	1,440	986	792	678	601	544	501	466	437	413	366	332	305	284
1 1/4 in.	2,950	2,030	1,630	1,390	1,230	1,120	1,030	957	898	848	751	681	626	583
1 1/2 in.	4,420	3,030	2,440	2,090	1,850	1,680	1,540	1,430	1,350	1,270	1,130	1,020	938	873
2 in.	8,500	5,840	4,690	4,020	3,560	3,230	2,970	2,760	2,590	2,450	2,170	1,970	1,810	1,680
2 1/2 in.	13,600	9,310	7,480	6,400	5,670	5,140	4,730	4,400	4,130	3,900	3,460	3,130	2,880	2,680

4. Maximum Natural Gas Delivery Capacity (For 8 - 10.5 in. W.C. initial supply pressure)														
Pipe Size	Length (including fittings)													
	10 ft (3 m)	20 ft (6 m)	30 ft (9 m)	40 ft (12 m)	50 ft (15 m)	60 ft (18 m)	70 ft (21 m)	80 ft (24 m)	90 ft (27 m)	100 ft (30 m)	125 ft (38 m)	150 ft (45 m)	175 ft (53 m)	200 ft (60 m)
1/2 in.	454	312	250	214	190	172	158	147	138	131	116	105	96	90
3/4 in.	949	652	524	448	397	360	331	308	289	273	242	219	202	188
1 in.	1,790	1,230	986	844	748	678	624	580	544	514	456	413	380	353
1 1/4 in.	3,670	2,520	2,030	1,730	1,540	1,390	1,280	1,190	1,120	1,060	936	848	780	726
1 1/2 in.	5,500	3,780	3,030	2,600	2,300	2,090	1,920	1,790	1,680	1,580	1,400	1,270	1,170	1,090
2 in.	10,600	7,280	5,840	5,000	4,430	4,020	3,700	3,440	3,230	3,050	2,700	2,450	2,250	2,090
2 1/2 in.	16,900	11,600	9,310	7,970	7,070	6,400	5,890	5,480	5,140	4,860	4,300	3,900	3,590	3,340

5. Maximum Undiluted Propane (LP) Delivery Capacity in Thousands of Btu/h														
Pipe Size	Length (including fittings)													
	10 ft (3 m)	20 ft (6 m)	30 ft (9 m)	40 ft (12 m)	50 ft (15 m)	60 ft (18 m)	80 ft (24 m)	100 ft (30 m)	125 ft (38 m)	150 ft (45 m)	175 ft (53 m)	200 ft (60 m)		
1/2 in.	291	200	160	137	122	110	101	94	89	84	74	67		
3/4 in.	608	418	336	287	255	231	212	197	185	175	155	140		
1 in.	1,150	787	632	541	480	434	400	372	349	330	292	265		
1 1/4 in.	2,350	1,620	1,300	1,110	985	892	821	763	716	677	600	543		
1 1/2 in.	3,520	2,420	1,940	1,660	1,480	1,340	1,230	1,140	1,070	1,010	899	814		
2 in.	6,790	4,660	3,750	3,210	2,840	2,570	2,370	2,200	2,070	1,950	1,730	1,570		

8 Connecting the Water Supply

- Installation and service must be performed by a qualified plumber.
- In the Commonwealth of Massachusetts, this product must be installed by a licensed plumber or gas fitter in accordance with the Massachusetts Plumbing and Fuel Gas Code 248 CMR Sections 2.00 and 5.00.
- Observe all applicable codes.
- Noritz recommends to install insulation to the hot water line and the hot water return line for comfort and energy saving.

- With a Recirculation System, the water from the Water Heater to the fixtures can be warmed up in advance. You can get hot water to your fixtures more quickly with less waste of water.
- See the Owner's Guide for more information about what you can do.
- Perform water treatment properly because Scale build-up is more likely to occur in a Recirculation System.
- (Only when conforming to California Code of Regulations Title 24 Part 6)
Install the plumbing in accordance with the regulation.
- Only one recirculation loop shall be installed in the recirculation system.

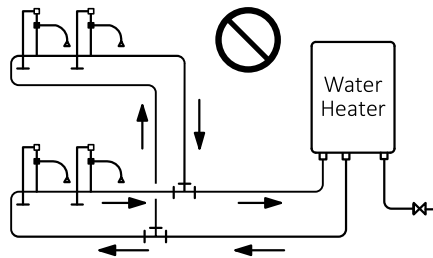

[With a dedicated return line]

- (Only when conforming to California Code of Regulations Title 24 Part 6)
 - Change the Recirculation setting. (See page 59)
 - Install On-demand Switch and Thermo-sensor. (See page 50)

Isolation Kit

Noritz recommends the use of an Isolation Kit with the installation. These kits include an integrated shut-off and service valve with unions and a pressure relief valve.

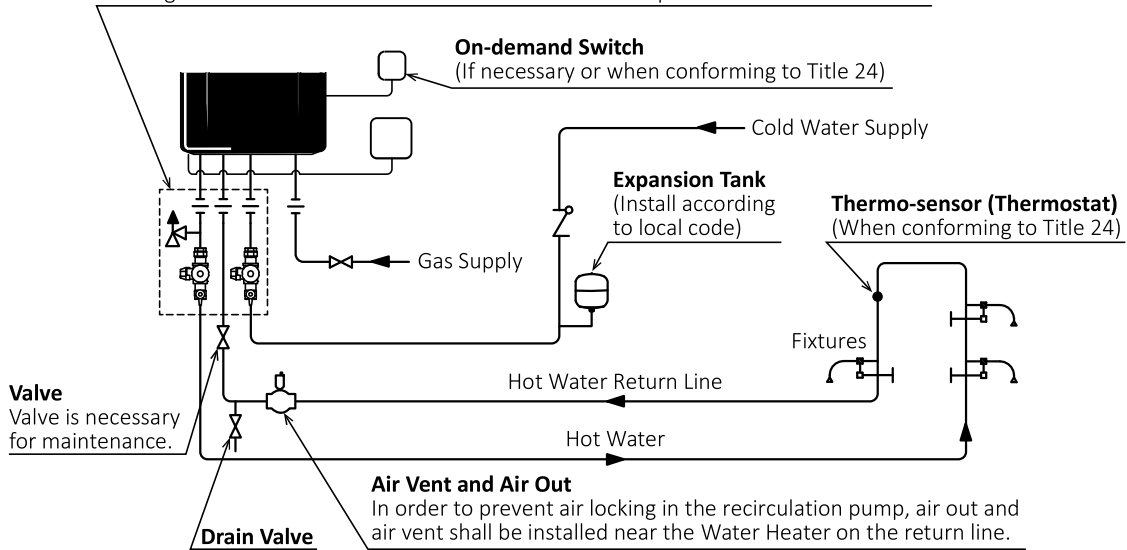

[With the Crossover Valve]

- Connect the connector marked “Crossover”. Refer to page 51 for the location of the connector.
- Minimum setting temperature is 120°F (49°C)
- Noritz recommends using Watts product. (Sensor Valve Kit : 596816)
Model number or specification subject to change at manufacturer’s discretion. Be sure to contact the manufacturer.

NOTE Crossover valve passes cold water, therefore Water Heater will operate and recirculate automatically even without direct hot water usage.

Isolation Kit

Noritz recommends the use of an Isolation Kit with the installation. These kits include an integrated shut-off and service valve with unions and a pressure relief valve.

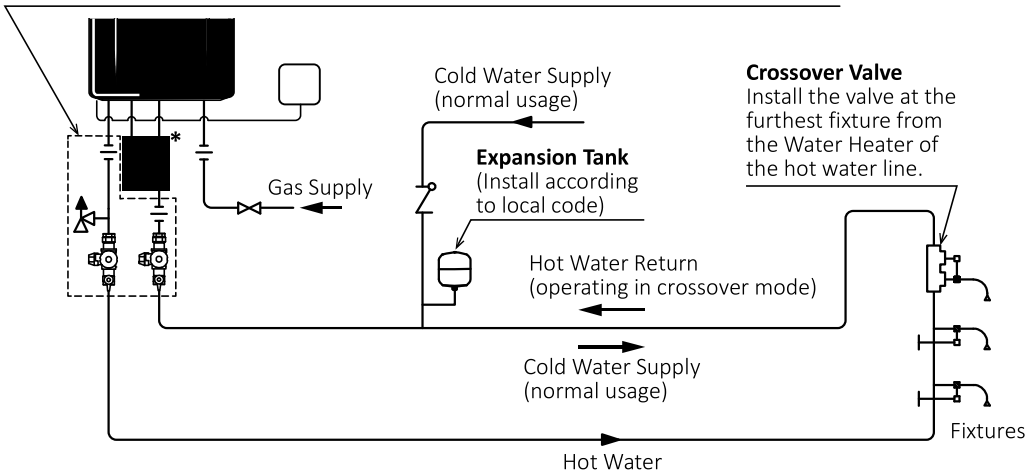

* The cold water supply line must be branched to the hot water return line.

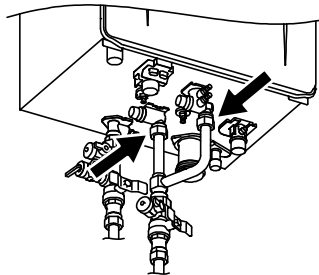

8.2.1 Guidelines

Installation location

- If the Water Heater is installed in a closed water supply system, such as one having a backflow preventer on the cold water supply line, means shall be provided to control thermal expansion. Contact the water supplier or a local plumbing inspector on how to control this situation..

- If installing the Water Heater on a roof: If the Water Heater is installed on a roof to supply water to the levels below, make sure that the water pressure supplied to the Water Heater does not drop below 29 psi. It may be necessary to install a pump system to ensure that the water pressure is maintained at this level or to decrease the flow rate by adjusting the water fixture. Check the pressure before putting the Water Heater into operation. Failure to supply the proper pressure to the Water Heater may result in noisy operation, shorter lifetime of the Water Heater, and may cause the Water Heater to shut down frequently.

Potable water

- Piping and components connected to the Water Heater shall be suitable for use with potable water.
- Toxic chemicals, such as those used for boiler treatment, shall not be introduced into the potable water.
- A Water Heater used to supply potable water may not be connected to any heating system or components previously used with a nonpotable water heating appliance.

Maximum accept length for recirc.

Pipe length of hot water supply line and hot water return line and fittings should be within following table.

	3/4 in.	1/2 in.
	500 ft (152 m)	200 ft (61 m)

Valve

- A pressure relief valve must be installed near the hot water outlet that is rated in accordance with and complying with either The Standard for Relief Valves and Automatic Shutoff Devices for Hot Water Supply Systems, ANSI Z21.22, or The ANSI/ASME Boiler and Pressure Vessel Code, Section IV (Heating Boilers).
- A pressure relief valve must be capable of an hourly Btu rated temperature steam discharge capacity of 199,900 Btu/h. Multiple valves may be used. The pressure relief capacity must not exceed 150 psi.
- Do not install a shutoff valve between a relief valve and the Water Heater. The relief valve must be installed such that the discharge will be conducted to a suitable place for disposal when relief occurs.
- No reducing coupling or other restriction may be installed in the discharge line. The discharge line must be installed to allow complete drainage of both the valve and the line.
- If this Water Heater is installed with a separate storage vessel, the separate vessel must have its own temperature and pressure relief valve.
- Temperature and pressure relief valve must also comply with The Standard for Relief Valves and Automatic Gas Shutoff Devices for Hot Water Supply Systems, ANSI Z21.22 (in the U.S. only).
- A temperature relief valve is not required, but if one is used, do not install the valve with the probe directly in the flow of water. This may cause unwarranted discharge of the valve.
- When the system requires water for space heating at temperatures higher than required for other uses, a means such as a mixing valve shall be installed to temper the water for those uses in order to reduce scald hazard potential.

Connecting water supply

- Flush water through the pipe to clean out metal powder, sand and dirt before connecting it.
- Use a union coupling or flexible pipe for connecting the pipes to reduce the force applied to the piping.

- NOTE**
- Do not use piping with a diameter smaller than the coupling.
 - Avoid using joints as much as possible to keep the piping simple.
 - Avoid piping in which an air holdup can occur.

Cold water supply

- Be sure to check the water pressure.
 - In order for the client to use the Water Heater comfortably, 15 to 150 psi* (103.4 to 1034 kPa) of pressure is needed from the water supply.
 - * Recommended 50 to 80 psi for maximum performance.
 - If the water pressure is low, the Water Heater cannot perform to its full capability, and may become a source of trouble for the client.
 - If the water pressure is low, local boiling will occur inside the Water Heater causing abnormal sounds and decreasing the durability of the Heat Exchanger.
 - If the water pressure is too high, use a Pressure Reducing Valve and a Water Hammer Arrester.
- Recommend installing a pressure meter on the inlet.
- Mount a check valve (near the inlet) when required by local code.
- Mount a shut off valve (near the inlet).

- NOTE** Do not use PVC, iron, or any piping which has been treated with chromates, boiler seal or other chemicals.

Hot water supply

- Try to make the piping as short as possible. The longer the piping, the greater the heat loss.
- Use mixing valves with low water flow resistance.
- Use shower heads with low pressure loss.
- If the Maximum flow of water cannot be obtained with the supplied water pressure and/or the water supply pressure is below the recommended pressure, use a pump to increase the pressure and water flow.
- Noritz recommends the installation of a wye pattern strainer downstream on the hot water supply to prevent loose scale from accumulating and clogging fixtures.

- NOTE** Do not use lead, PVC, iron or any piping which has been treated with chromates, boiler seal or other chemicals.

8.2.2 Freeze Prevention

Perform the following insulation measures for prevention of freezing.

- Take appropriate heat insulation measures (e.g. wrapping with heat insulation materials, using heat tape, electric heaters, solenoids, or pipe covers) according to the climate of the region to prevent the plumbing external to the Water Heater from freezing.
The freeze prevention heaters will not prevent this plumbing from freezing.
- Make sure that there are no water leaks from the cold and hot water supply lines and the hot water return line, then insulate the pipes completely.
- Be sure to also completely insulate the water supply valve and the cold water, hot water and hot water return connections on the Water Heater.
- For temporary freeze protection measures, refer to the Owner's Guide.

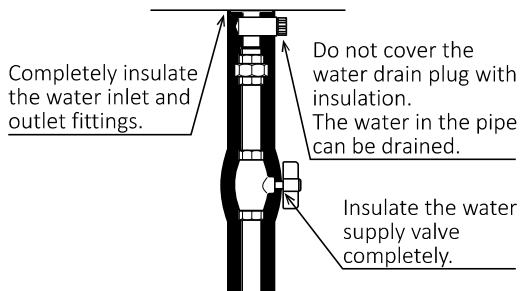

NOTE In order for the freeze prevention heaters to operate, the Water Heater must connect the electrical power at all times.

Indoor Installation

- Freezing is prevented within the Water Heater automatically unless the outside temperature without wind is below -30°F (-35°C).
- If this model is installed in an area where the outside temperature can approach freezing conditions of -30°F (-35°C) or below, then additional freeze protection measures must be used.

NOTE The room temperature must be greater than 32°F (0°C) to prevent freezing and the room inside must not have negative pressure.

Outdoor Installation

- Freezing is prevented within the Water Heater automatically unless the outside temperature without wind is below -4°F (-20°C).
- If this model is installed in an area where the outside temperature can approach freezing conditions of -4°F (-20°C) or below, then additional freeze protection measures must be used.

If this Water Heater will be installed in a location where the hardness of the supply water is high, scale Build-up may cause damage to the Heat Exchanger. Perform suggested treatment and maintenance measures to be taken based on the water hardness level according to the below table.

Treatment Guidelines

Soft	0-1 gpg (0-17 mg/L)	None	None
Slightly Hard	1-3 gpg (17-51 mg/L)		
Moderately Hard	3-7 gpg (51-120 mg/L)	Scale Shield or Water Softener	Once a Year***
Hard	7-10 gpg (120-171 mg/L)		
Very Hard	10-12 gpg (171-200 mg/L)		
Extremely Hard	> 12 gpg (> 200 mg/L)		

- * When selecting a treatment device, you must consult with the device's spec sheet and installation manual for guidelines and limitations. Not all water supplies are compatible. A water test may be required.
- ** Install Noritz Isolation Valves to allow for flushing.
- *** Flushing is required if a water treatment device is not installed.

NOTE Damage to the Water Heater as a result of the items below is not covered by the Noritz America Limited Warranty.

- Water in excess of 12 gpg (200 mg/L) of hardness
- Poor water quality (See the Water Quality List on page 12.)
- The Remote Controller has displayed a "C1# (Service Reminder)" indicating Scale Build-up, but the Heat Exchanger has not been flushed.

Water treatment device

- The water must be treated with either the Noritz Scale Shield or a water softener.
- Water softeners may be regulated by the local water jurisdiction, consult with the manufacturer for code, sizing, and installation guidelines.

The below diagram is for reference only. For more information about Scale Shield, contact Noritz America at <http://support.noritz.com/> or 1-866-766-7489.

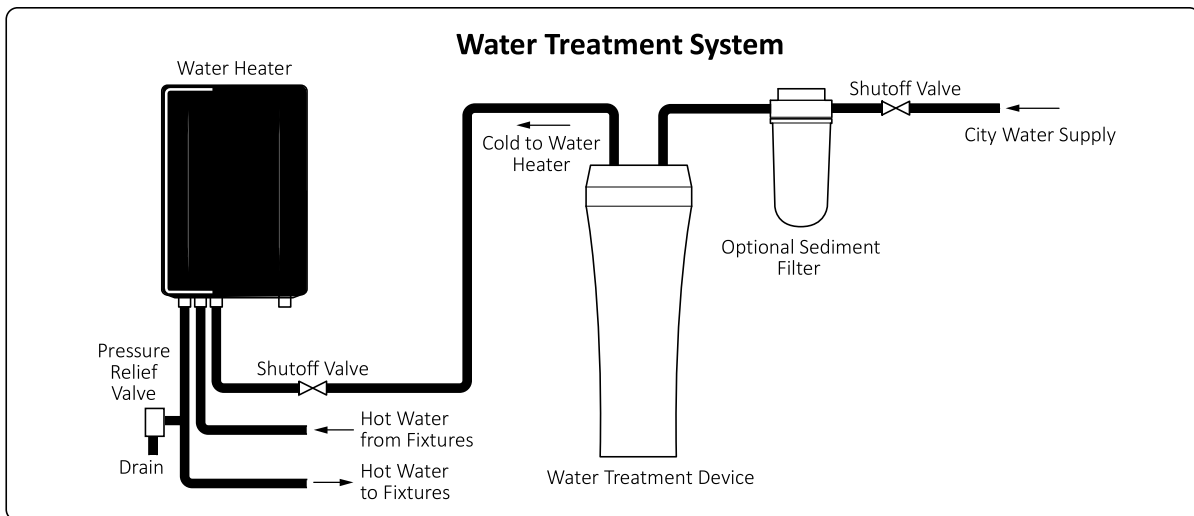

The illustration is an example. Check with the actual Water Heater about the position of piping, and form.

Flushing the Heat Exchanger

- The Heat Exchanger regularly needs to be flushed to prevent damage from Scale Build-up. Refer to the “Procedure for flushing the Heat Exchanger” on page 69 or contact Noritz America for more information. (<http://support.noritz.com/> or 1-866-766-7489)

About the Service Reminder

- This Water Heater is equipped with an automatic service reminder to announce for flushing the Heat Exchanger.
- If the service reminder is selected to ON, the code “C1#*” will displayed on the Remote Controller after the set time period has been reached. When the code is displayed, the Heat Exchanger needs to be flushed to prevent damage from Scale Build-up.
 - * Noritz recommends to flush the Heat Exchanger when the code “C1#” appears.
 - # = 1, 2, 3, 4 ... 9
- The factory default of this service reminder is disable. If desired, the customer or installer needs to enable the service reminder (connect the red connector marked “SERVICE REMINDER”).

[Procedure when turning the service reminder ON]

1. Remove the front cover (4 screws).
2. Connect the red connector marked “SERVICE REMINDER” near the Circuit Board.

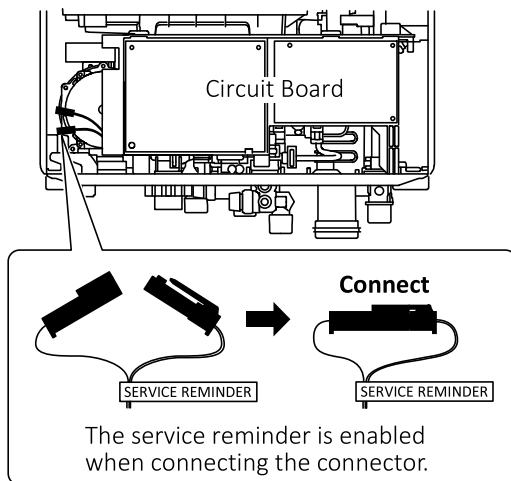

3. Reattach the front cover (4 screws).

[When the code “C1#” appears:]

Flush the Heat Exchanger.

Refer to the “Procedure for flushing the Heat Exchanger” on page 69.

After completing the flushing, the code will be reset.

To deactivate the code “C1#”, disconnect the red connector marked “SERVICE REMINDER”. The service reminder will be disabled.

NOTE Need to be flushed the Heat Exchanger in this case.