



**VR3® Hip Abduction  
Owner's Manual  
Strength Systems  
Part Number 12200-999-4 K**

# Table of Contents

## Safety

Safety Guidelines and Practices . . . . .	3
Anchoring Equipment . . . . .	3
Facility Safety Precautions . . . . .	3
User Safety Precautions . . . . .	4
Warnings and Cautions . . . . .	6
Label Placement . . . . .	7

## Assembly

Machine Specifications . . . . .	8
Choosing and Preparing a Site . . . . .	8
Tools Required . . . . .	9
Assembly Procedure . . . . .	9

## Exercise

Intended Use . . . . .	14
Instructions . . . . .	14

## Maintenance

Warnings . . . . .	15
Daily Procedures . . . . .	15
Weekly Procedures . . . . .	17
Yearly Procedures . . . . .	20
Cable Adjustment . . . . .	21
Belt Adjustment . . . . .	22

## Customer Service

Product Registration . . . . .	23
Contacting Service . . . . .	23
Ordering Parts . . . . .	23
Return Material Authorization (RMA) . . . . .	24
Damaged Parts . . . . .	24

Cybox® and the Cybox logo are registered trademarks of Cybox International, Inc.  
VR3® and its mark are registered trademarks of Cybox International, Inc.

DISCLAIMER: Cybox International, Inc., makes no representations or warranties regarding the contents of this manual. We reserve the right to revise this document at any time or to make changes to the product described within it without notice or obligation to notify any person of such revisions or changes.

© Copyright 2013, Cybox International, Inc. All rights reserved. Printed in the United States of America.

10 Trotter Drive Medway, MA 02053 • 508-533-4300 • FAX 508-533-5183 [www.cyboxintl.com](http://www.cyboxintl.com) • 12200-999-4 K • May 2013

# Safety

## Safety Guidelines and Practices

 Read the Owner's Manual carefully before assembling, servicing, or using the equipment. Owner must comply with all safety guidelines in this manual. It is also the owner's responsibility to instruct users on the safe and proper operation of the equipment and to properly display any and all warning labels and instructional placards. All users should read these labels and placards before using equipment.

### **WARNING**

Death or serious injury could occur if the following safety precautions and instructions are not followed.

## Anchoring Equipment



- Owner should not allow equipment to be used until it is properly anchored as described below.
- To maximize stability and eliminate rocking, tipping, or falling over, equipment must be anchored to a solid, level surface, utilizing all anchoring holes provided.
- Fasteners must have a minimum of 500 lbs. tensile capacity. Cybox recommends .3/8" grade 2 bolts or better. A minimum pull force of 220 lbs/100 kgs is required for each anchor position.
- If leg frames do not contact surface, **DO NOT** pull down with anchors. Shim any leg or frame not in contact with surface using flat washers.
- Due to the wide variation of flooring on which machines may be anchored or installed, consult with a qualified and licensed contractor to ensure proper anchoring and installation.

## Facility Safety Precautions

Do not allow anyone, including trainers, to use equipment in a manner other than that shown on the warning labels and instructional placards located on every machine.

Do not install equipment on an uneven surface. The solid, level surface should not deviate more than 1/8" over a 10' distance or as defined and required by local building and architectural codes.

It is the responsibility of the facility owner/owner of the equipment to ensure that there is appropriate clearance around each machine to allow for safe use and passage.

In compliance with the ADA (American Disabilities Act) there must be clear floor space of at least 30 by 48 inches and be served by an accessible route for at least one of each type of exercise equipment. If the clear space is enclosed on three sides (e.g., by walls or the equipment itself), the clear space must be 36 by 48 inches.

All other machines must have a clear floor space of 23" for all access point on the machine, unless shown in the Owner's Manual.

The dimensions stated in the assembly instructions of this manual include the maximum foot print (in use) dimensions.

All equipment should be used in a supervised, access-controlled area.

Do not allow equipment to be used by children 12 and under. Supervise disabled and children 13 and older.

The owner should ensure that regular inspection and maintenance checks as detailed in this manual are performed. Keep a log of all maintenance and repair activities.

Each day before use, the owner should inspect the equipment. If there are any loose or worn components such as belts, cables, grips, pulleys, or any missing, damaged labels, or placards, the owner should fix any deficiencies before they allow the equipment to be used.

Use only Cybex components to maintain and repair the equipment.

Display the Facility Safety Sign so it is visible and prominent.

### ***User Safety Precautions***

Owners must instruct users to **DO** the following:

- Follow all warning labels and instructional placards when using equipment.
- Insert weight pin completely before using selectorized equipment.
- Consult a physician prior to commencing an exercise program. If at any time during exercise you feel faint, dizzy or experience pain, stop and consult your physician.
- Use a spotter for Free Weight equipment.

Owners must instruct users to **NOT DO** the following:

- **DO NOT** pin weights on selectorized equipment in an elevated position or use the machine if found in this position.
- **DO NOT** increase weight resistance on equipment by any means other than those provided by Cybex.
- **DO NOT** wear loose or dangling clothing or jewelry while using equipment. Stay clear of moving parts.

- **DO NOT** lean or pull on machine
- **DO NOT** use machine for support during stretching.
- **DO NOT** attach resistance straps, ropes or other means to equipment, except those provided by the manufacturer for intended use on the equipment.
- **DO NOT** exceed the maximum specified user weight.
- **DO NOT** use if equipment appears damaged or inoperable upon inspection.
- **DO NOT** use if guards are missing or damaged.
- **DO NOT** remove any labeling from equipment.

## Warnings and Cautions

Warning decals indicate a potentially hazardous situation that could result in death or serious injury if the precautions are not observed.

Caution decals indicate a potentially hazardous situation that could result in minor or moderate injury if the precautions are not observed.

The diagram following the decals show where each decal is located.

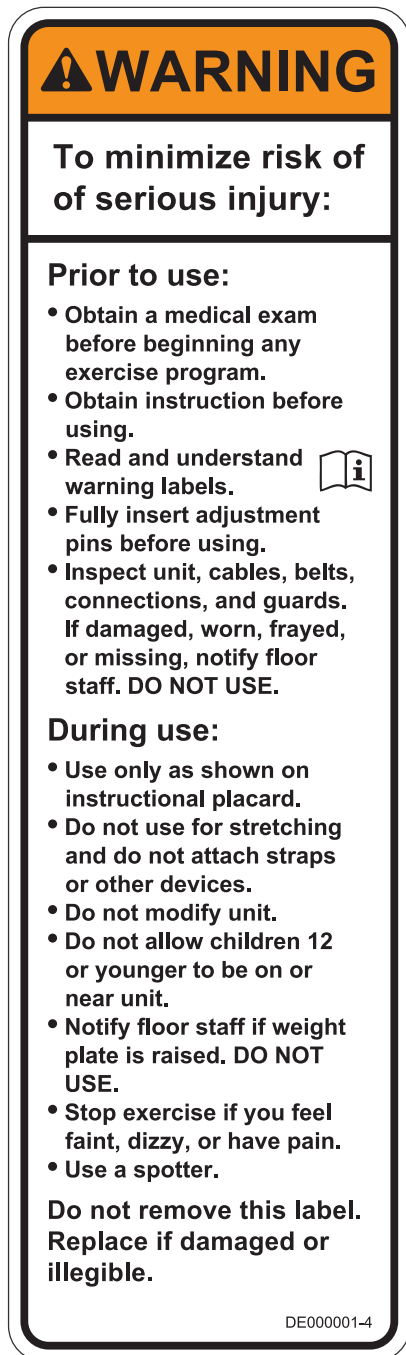

**Label Placement**

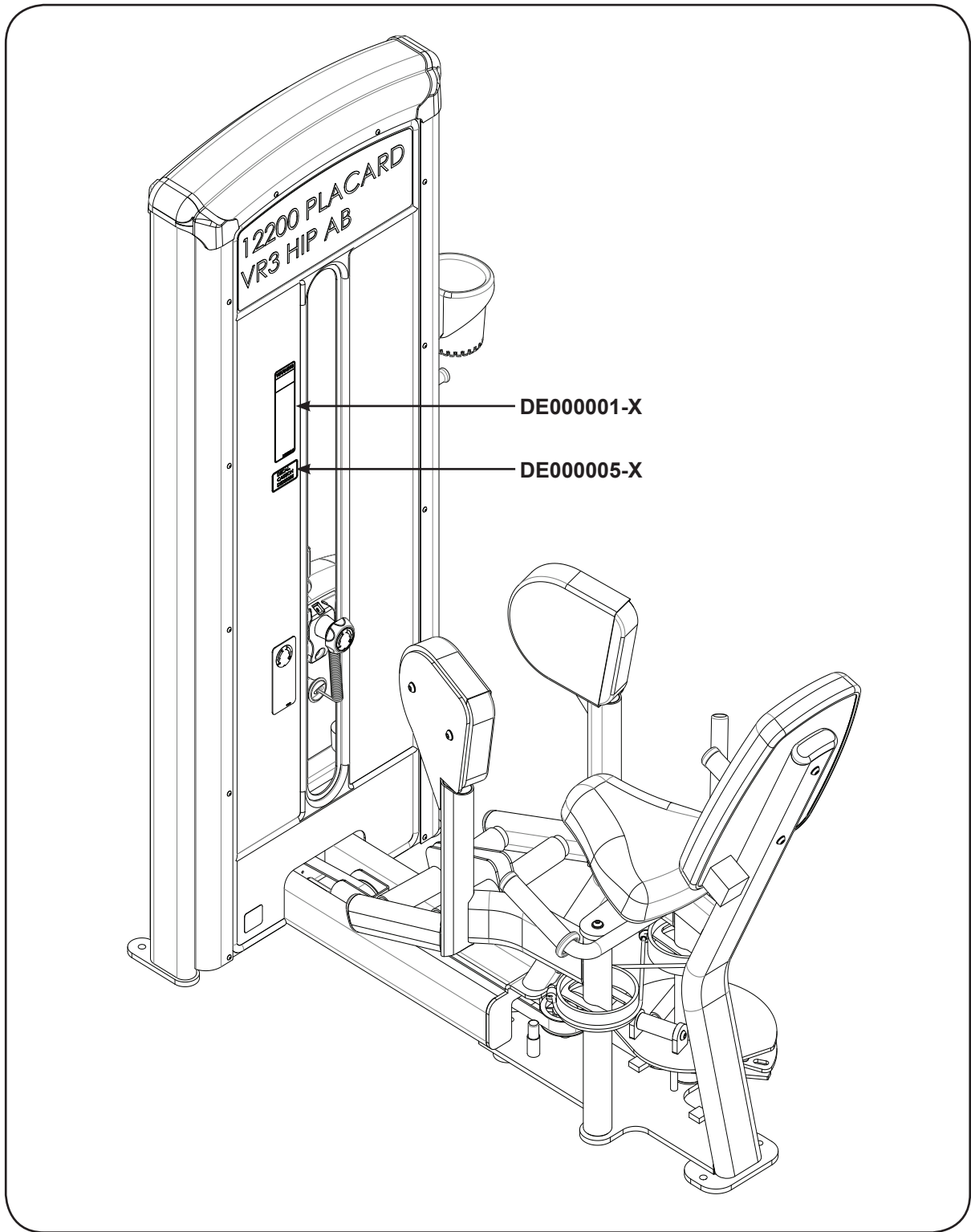

# Assembly

## Machine Specifications

### Total Weight and Size VR3 Hip Abduction 12200 Standard Stack

Weight	Machine Dimensions at Rest	Machine Dimensions in Use
435 Lbs	56" L x 27" W x 64" H	56" L x 54" W x 64" H
198 Kg	143 cm L x 70 cm W x 162 cm H	143 cm L x 137 cm W x 162 cm H

### Total Weight and Size VR3 Hip Abduction 12200 Heavy Stack

Weight	Machine Dimensions at Rest	Machine Dimensions in Use
475 Lbs	56" L x 27" W x 64" H	56" L x 54" W x 64" H
216 Kg	143 cm L x 70 cm W x 162 cm H	143 cm L x 137 cm W x 162 cm H

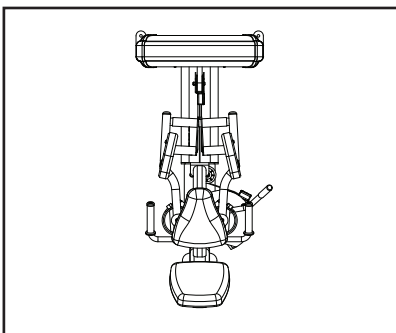

Maximum User Weight	Maximum Training Weight
300 lbs/135 kg	205lbs/93kg

## Choosing and Preparing a Site

Before assembling the unit, verify the chosen site meets the following criteria:

- Area is well lit and well ventilated.
- Surface is structurally sound and properly leveled.
- Free area for access to unit and emergency dismount. Minimum clearance is 23.6 inches (0.6 meters).
- Adjacent units may share the free area.

It is the responsibility of the facility owner/owner of the equipment to ensure that there is appropriate clearance around each machine to allow for safe use and passage.



In compliance with the ADA (American Disabilities Act) there must be clear floor space of at least 30 by 48 inches and be served by an accessible route for at least one of each type of exercise equipment. If the clear space is enclosed on three sides (e.g., by walls or the equipment itself), the clear space must be 36 by 48 inches.

All other machines must have a clear floor space of 23" for all access point on the machine, unless shown in the Owner's Manual.

The dimensions stated in the assembly instructions of this manual include the maximum foot print (in use) dimensions.

- Area is not in the vicinity of high humidity, such as in the vicinity of a steam room, sauna, indoor pool or outdoors. This unit is designed to function normally in an environment with a relative humidity range of 30% to 75%.

Exposure to extensive water vapor, chlorine and/or bromine could adversely affect the electronics as well as other parts of the unit.

- Area maintains an ambient temperature range of 50° F (10° C) to 104° F (40° C) degrees.

### Tools Required



- 7/32" Allen wrench
- 1/8" Allen wrench
- Medium weight automotive engine oil
- Torque wrench
- 3/4" Wrench



### Assembly Procedure

Two people will be required for this procedure.

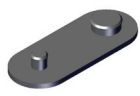
 Read and understand all instructions thoroughly before assembling this unit. Check all items carefully. If there is damage, see the Customer Service section of this manual for proper procedure to return, replace, or reorder parts.

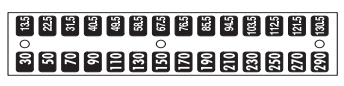
Verify parts list shown below

Qty	Part Number	Description	Diagram
3	12090-322	Foot Pad	
1	12000-345	Foot Pad	
1	12000-560	Decal, Weight Plate (30-290)	

Qty	Part Number	Description	Diagram
7	4000C101	Weight Stack Plate (Standard)	
9	4000C101	Weight Stack Plate (Heavy)	

**Move to desired location**

If	Then
<b>If machine can be moved without adding or removing weight stacks.</b>	<p><b>Two people will be required for this procedure</b></p> <ol style="list-style-type: none"> <li>1. Move to desired location.</li> <li>2. Remove the four shipping cones using a 3/4" socket or wrench.</li> <li>3. Attach foot pads to each foot of frame.</li> </ol>

If	Then
<b>If machine needs weight stacks removed before moving to desired location.</b>	<p><b>Two people will be required for this procedure</b></p> <ol style="list-style-type: none"> <li>1. Do not remove middle BHSCS securing shroud to bottom bracket</li> <li>2. Remove the two Button Head Socket Cap Screws (BHSCS) securing the bottom bracket to the frame using a 1/8" Allen wrench.</li> <li>3. Remove the remaining BHSCS securing the back shroud to the frame.</li> <li>4. After the final BHSCS is removed shroud will slide down to the floor with bottom bracket attached.</li> <li>5. Slide shroud out of machine.</li> <li>6. Slide spring loaded top guide rod cap down guide rod until cap is clear of frame.</li> </ol>

If	Then
<b>If machine needs weight stacks removed before moving to desired location.</b>	<ol style="list-style-type: none"> <li>7. Slowly release grasp of guide rod cap.</li> <li>8. Guide rod cap contains a compression spring that will fly if grasp is not released slowly.</li> <li>9. Remove guide rod cap and spring and set aside.</li> <li>10. Repeat above steps for opposite guide rod.</li> <li>11. Lean guide rods slightly outward, away from machine to clear pulley. DO NOT put excessive pressure on guide rods, it will damage rod caps</li> <li>12. Slide top weight up and out of the machine and set aside.</li> </ol>

## Move to machine to the desired location

1. Remove the four shipping cones using a 3/4" socket or wrench.
2. Attach foot pads to each foot of frame.

## Securely anchor machine to the floor

Cybox strongly recommends to maximize stability, equipment must be secured to a solid level surface.



### **WARNING: Anchoring equipment:**

- *Cybox is not responsible for the actual anchoring of equipment. Consult with a professional contractor.*
- *Use fasteners having a minimum of 500 lbs. tensile capacity (3/8" grade 2 bolts or better).*
- *If legs/frame does not contact surface, DO NOT pull down with anchors. Shim any leg or frame not in contact with surface using flat washers.*

## Install weight plates

1. Install individual weight plates one at a time.
2. Position each weight plate so wide edges of bushings face upward and narrow edges of bushings face downward.

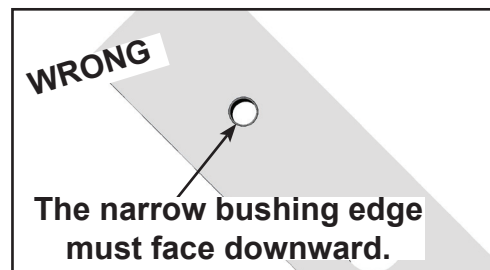
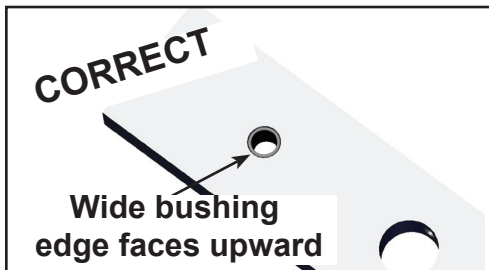

3. Install lifting post.
4. Place springs and guide rod caps on guide rods.
5. Compress guide rod caps and align guide rod caps with weight frame holes and secure in place.
6. Guide rod caps must snap or lock into weight frame holes.

## Belt routing

1. Verify belt is routed through top of pulley bracket and then route end of belt down to the top weight.
2. Lift top weight and verify that the position of the belt clamp (on the top weight) is aligned properly with the top pulley bracket.
3. Slide belt through slot in belt clamp.

4. Verify belt and insert are installed properly. Do not install the insert backwards.

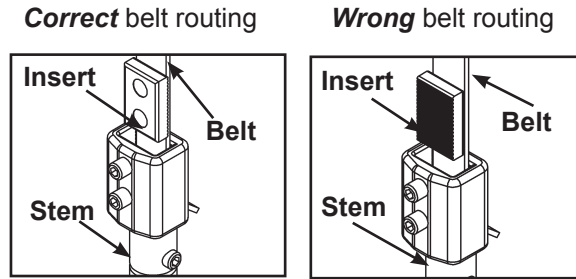

5. Pull belt tight and secure belt to clamp with the two set screws.
6. Torque set screws 300-350 lb-in.
7. Place weight stack pin in each plate to verify proper installation.
8. Simulate normal operation by lifting top weight up and down with out selecting any resistance.
9. Place weight stack pin in each plate to verify proper installation.
10. Lift top weight up and down simulating normal operation (without selecting any resistance).
11. Verify that the belt is moving smoothly and is routed straight from the top pulley bracket to the the weight belt clamp.
12. Turn the Increment Weight Adjusting Knob to select 0 lbs or 0 kg.

### Install back shroud

1. Place shroud into position.
2. Starting at the bottom replace the two BHSCS to secure bottom support bracket to the shroud.
3. Install but do not tighten remaining BHSCS securing shroud.
4. Tighten all BHSCS.

### Install weight plate decals

1. Peel off back side of decal making sure that the decals remain attached to the front sticker.

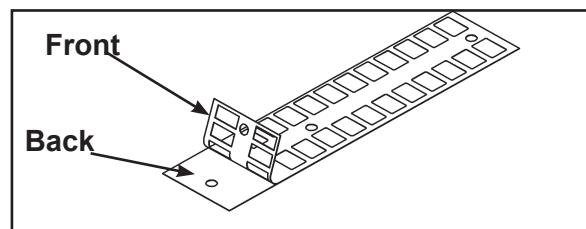

2. Insert a guide pin through each hole of the template. A guide pin can be anything that fits through the weight stack hole, such as a weight stack selector pin.

3. Align decal and rub it onto weight plates.
4. Remove front side, leaving decals adhering to weight plates.

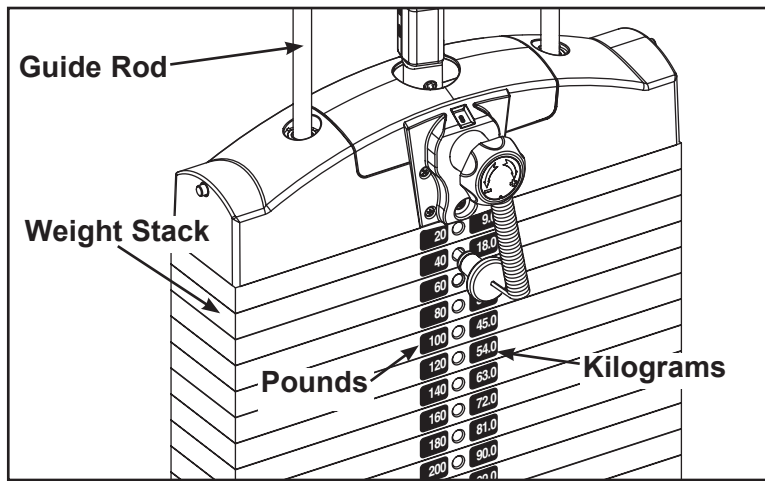

**Verify proper operation**

# Exercise

## Intended Use

The intended commercial use of this machine is to aid exercise and improve general physical fitness.

## Instructions

 Read and understand all instructions and warnings prior to using this machine in the Safety section of the Owner's Manual.

All adjustment points on the machine have yellow handles or knobs.

### Set Up

1. Adjust knee pads to bring the knees together.

### Movement

1. Push out against the knee pads, forming a wide "V" with your legs.



**CAUTION:** Use only in manner depicted

To avoid serious injury, use equipment only as describe in placards located on each machine.

## Hip Abduction

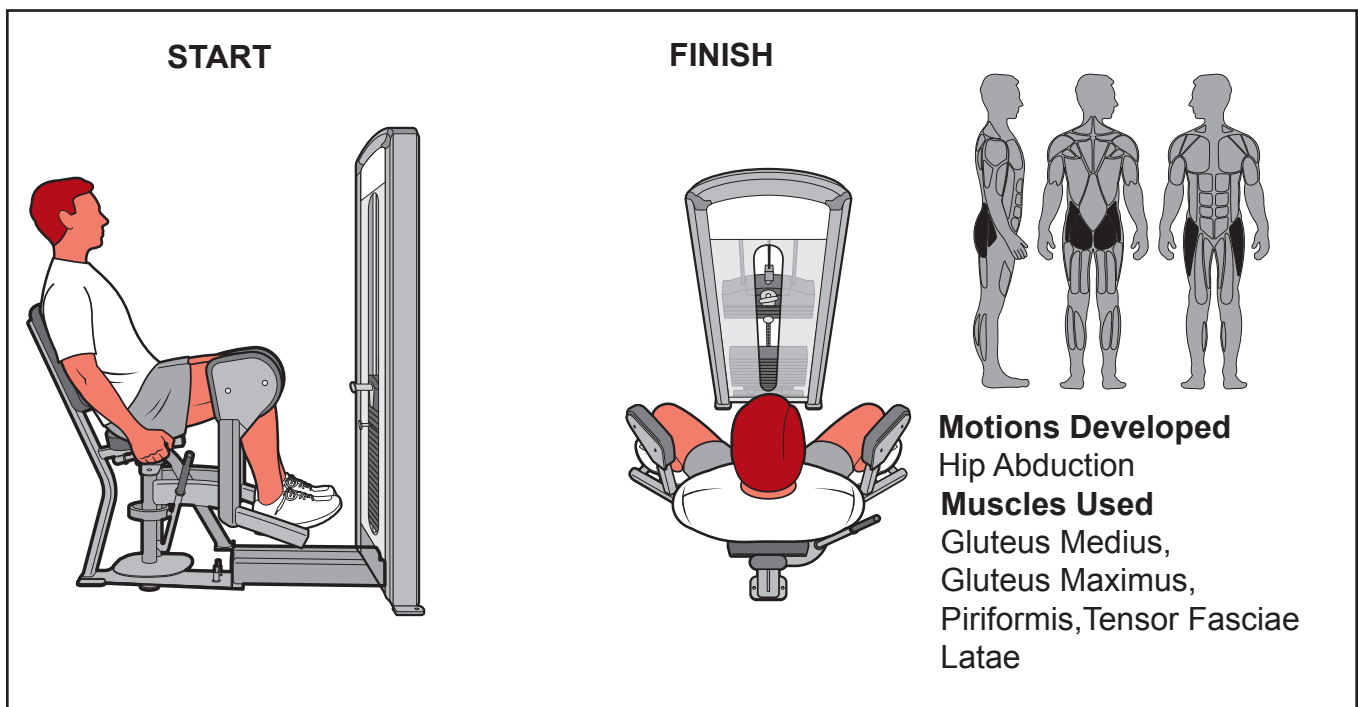

# Maintenance

All preventive maintenance activities must be performed on a regular basis. Performing routine preventive maintenance actions can aid in providing safe, trouble-free operation of all Cybex equipment.

Cybex is not responsible for performing regular inspection and maintenance actions for your machines. Instruct all personnel in equipment inspection and maintenance actions and also in accident reporting/recording. Cybex representatives are available to answer any questions that you may have.

## Warnings

 Read all warnings in this chapter.



**WARNING:** *For maintenance, service and repair:*

- *Must be performed by trained service personnel only*
- *Use only Cybex replacement parts.*

Observe the following warnings:



**WARNING:** *Equipment hazard.*

*To avoid serious injury or death replace worn or damaged components immediately and keep the equipment out of use until repair is completed.*

## Daily Procedures

When using strong cleaning agents such as rubbing alcohol or bleach, it is advisable to first test in an inconspicuous area. Other cleaning agents may contain harsh or unknown solvents and are subject to formula changes by the product manufacturer without notice. Should you desire to use other cleaning agents, carefully try them in an inconspicuous area to determine potential damage to the material. Never use harsh solvents or cleaners which are intended for industrial applications. To clean stained or soiled areas, a soft white cloth is recommended. Avoid use of paper towels.

Cleaning products may be harmful/irritating to your skin, eyes, etc. Use protective gloves and eye protection. **Do Not** inhale or swallow any cleaning product. Protect surrounding area/clothing from exposure. Use in well ventilated area. Follow all product manufacturer's warnings. Cybex and its vendors cannot be held responsible for damage or injuries resulting from the use or misuse of cleaning products.

## Clean Upholstery

If	Then
<b>Light Soiling</b>	<ol style="list-style-type: none"> <li>1. Prepare a solution of 10% household liquid soap and warm water.</li> <li>2. Apply with a soft damp cloth.</li> <li>3. If necessary, apply a solution of liquid cleanser with a soft bristle brush.</li> <li>4. Dampen a clean soft cloth in water and wipe residue away.</li> </ol>
<b>More Difficult Stains</b>	<ol style="list-style-type: none"> <li>1. Prepare a solution of 10% household bleach (sodium hypochlorite) and 90% water. Dampen a soft white cloth in the solution.</li> <li>2. Rub gently on the stained area.</li> <li>3. Dampen a clean soft cloth in water and rinse area.</li> <li>4. If stains are still present, a full strength household bleach may be used. Allow bleach to puddle on the affected area or apply with a bleached-soaked cloth for approximately 30 minutes. Dampen a clean soft cloth in water, and rinse area to remove any remaining bleach concentration.</li> </ol>
<b>More Difficult Stains (Alternative Method)</b>	<ol style="list-style-type: none"> <li>1. Dampen a soft white cloth with rubbing alcohol.</li> <li>2. Gently rub stained area.</li> <li>3. Dampen a clean soft cloth in water and rinse area.</li> </ol>
<b>Restoring Luster</b>	<ol style="list-style-type: none"> <li>1. Apply a light coat of furniture wax for 30 seconds.</li> <li>2. Lightly rub area using a clean white cloth.</li> </ol>

## Clean Frames

Wipe down all frames using a mild solution of warm water and car wash soap. Be sure to dry thoroughly. **AVOID** acid or chlorine based cleaners and also cleaners containing abrasives as these could scratch or damage the equipment.

## Clean Chrome

Clean chrome tubes, first using chrome polish and then using a car wax seal. Neutral cleaners with a pH between 5.5 and 8.5 are recommended. Be sure to dry thoroughly. **AVOID** acid or chlorine based cleaners and also cleaners containing abrasives as these could scratch or damage the equipment.



### **Guidelines for cleaning front panel:**

Use clean soft cloths or sponges for application of cleaners and again for washing and rinsing. Follow up each application with warm water rinse.

- **DO NOT** use abrasives or high alkaline cleaners.
- **DO NOT** leave cleaners on for long periods, wash immediately.
- **DO NOT** apply cleaners in direct sunlight or at elevated temperatures.
- **DO NOT** use scrapers, squeegees, or razors.
- **DO NOT** clean with gasoline.

### **Compatible Cleaners and Detergents:**

- Formula 409
- Top Job
- Joy
- Palmolive
- Windex with Ammonia D

### **To Minimize Fine or Hairline Scratches:**

Mild automotive polish applied and removed with a soft clean cloth will help fill scratches.

### **Suggested Polishes:**

- Johnson Paste Wax
- Mirror Glaze #10 Plastic Polish (by Mirror Bright Polish Co.)
- Novus Plastics Polish #1, #2 (By Novus Inc.)

## ***Weekly Procedures***

### **Inspect All Nuts and Bolts**

Tighten all loose nuts and bolts as required.



**! WARNING: Equipment hazard.**

*To avoid serious injury or death replace worn or damaged components immediately and keep the equipment out of use until repair is completed.*





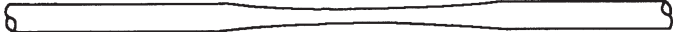

**Inspect cables and belts**

Inspect all cables and belts for wear or damage and proper tension. When inspecting cables and belts, run fingers on the cable or belt, paying particular attention to bends in cables and attachment points. The following conditions may indicate a worn cable:

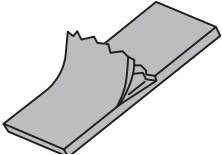
**Cables**

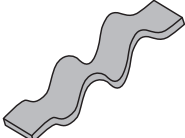
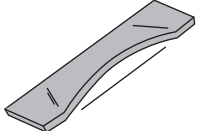
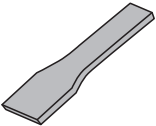
Condition of Cable	Diagram
A tear or crack in the cable sheath that exposes the cable	
A kink in the cable	
A curled sheath	
Necking - A stretched cable sheath	

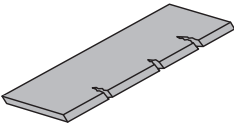
**Belts**

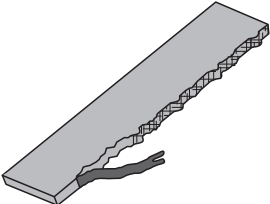
Condition of Belt	3D View	3D or Side View
Peeling of the belt's skin.		
Wave in belt		
Belt is necked down (narrow section)	<p data-bbox="654 627 984 772">Replace belt if any section is over 1/32" (.03) narrower than the rest of belt</p> 	<p data-bbox="1000 627 1498 737">Examine edge of belt (both sides). Replace belt if any section is narrower than the rest.</p> 
Cracks or splits		
One or more strands of kevlar is hanging out, or if there is a significant amount of frayed kevlar.		



**CAUTION: Worn handles**

- Do not use handles if less than 1/8" of material remains on edge.
- Replace all worn handles immediately.

Inspect bars and handles for wear, paying particular attention to tab area connection points.

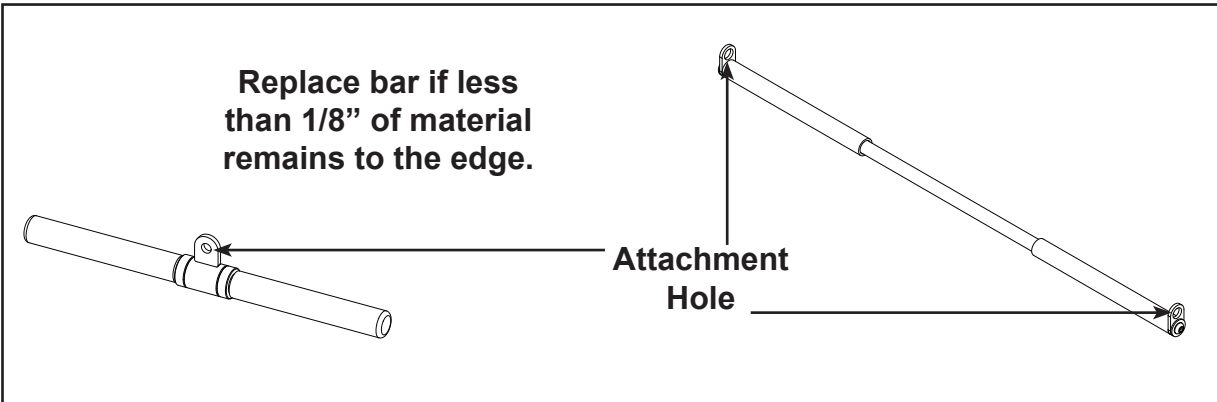

Inspection	Action
Inspect bars and handles for wear, paying particular attention to tab area connection points.	Replace all worn handles immediately.
Inspect snap links for proper latching (indicates wear).	Replace all loose or worn grips immediately.
Inspect all labeling for readability, including instructional placards, warning and caution decals.	Replace all worn labeling immediately.
Inspect all weight stacks for proper alignment and operation.	Correct all improper alignment and operation issues immediately.
Inspect guide rods for lubrication.	Wipe Weight Stack Guide Rods clean over entire length. Lubricate with a light coat of medium weight automotive engine oil.

**Yearly Procedures**

Replace all cables and belts annually

## Cable Adjustment

### Tools Required

9/16" Wrench (2)

Four types of cable tension adjustment are used on Cybox Strength Systems:

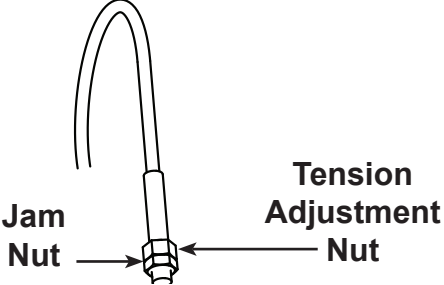
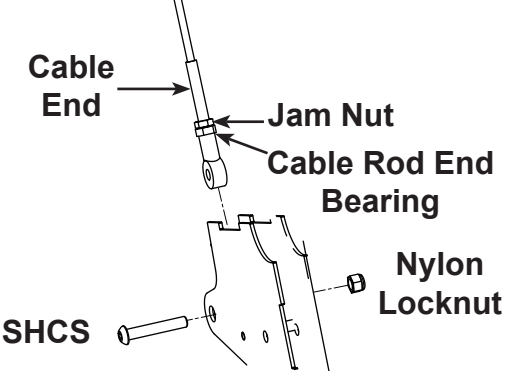
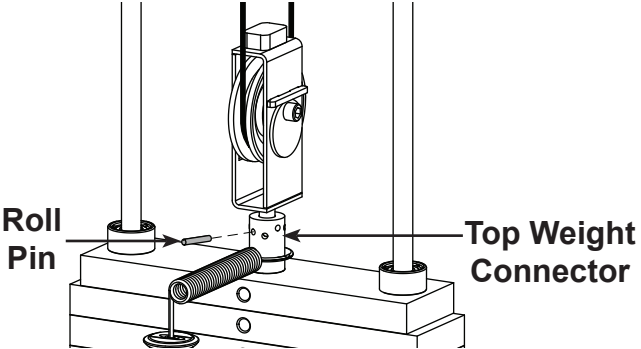
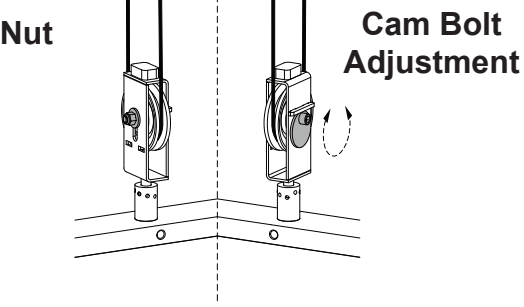
Cable Adjustment	Description	Diagram
Jam Nut Adjustment	This type of adjustment uses a jam nut and a tension adjustment nut at the cable cam end as the primary adjustment. The other end of the cable usually contains a roll pin adjustment.	 <p>The diagram shows a cable with a curved end. A 'Jam Nut' is positioned on the cable, and a 'Tension Adjustment Nut' is positioned further down the cable. Arrows point from the labels to the respective nuts.</p>
Rod End Adjustment	This type of adjustment uses a socket head cap screw (SHCS) securing a cable rod end bearing to the machine. Primary adjustment is by turning the rod end bearing. The other end of the cable usually contains a roll pin cable adjustment.	 <p>The diagram shows a cable rod end bearing assembly. Labels include 'Cable End', 'Jam Nut', 'Cable Rod End Bearing', 'SHCS' (socket head cap screw), and 'Nylon Locknut'. Arrows point from the labels to the corresponding parts of the assembly.</p>
Roll Pin Adjustment	This type of adjustment uses a roll pin and series of holes in the weight stack top weight connector.	 <p>The diagram shows a weight stack with a 'Top Weight Connector'. A 'Roll Pin' is shown being inserted into one of the holes in the connector. Arrows point from the labels to the roll pin and the connector.</p>
Cam End Adjustment	This type of adjustment uses an adjustment bolt on the pulley bracket. Loosen nut and rotate cam bolt to adjust cable.	 <p>The diagram shows a pulley bracket with a 'Nut' and a 'Cam Bolt Adjustment'. The cam bolt is shown being rotated to adjust the cable. Arrows point from the labels to the nut and the cam bolt.</p>

## Belt Adjustment

### Tools Required

- 7/32" Wrench
- Torque wrench (lbs-in)

Belt Adjustment	Action
Loose Belt	<ol style="list-style-type: none"> <li>1. Using a 7/32" Allen wrench loose set screws.</li> <li>2. Pull belt tight.</li> <li>3. Secure belt in place with set screws.</li> <li>4. Torque set screws to 300-350 lb-in.</li> <li>5. Verify that the belt is moving smoothly and is routed straight from the top pulley bracket to the to weight belt clamp</li> </ol>

# Customer Service

## Product Registration

To register product do the following:

1. Visit [www.cybexintl.com](http://www.cybexintl.com).
2. Locate Product Registration in the Support section.
3. Fill out form completely.
4. Click the Submit button to register product.

## Contacting Service

Hours of phone service are Monday through Friday from 8:30 a.m. to 6:00 p.m. Eastern Standard Time.

For Cybex customers living in the USA, contact Cybex Customer Service at 888-462-9239.

For Cybex customers living outside the USA, contact Cybex Customer Service at 508-533-4300 or fax 508-533-5183. Email address [internationaltechhelp@cybexintl.com](mailto:internationaltechhelp@cybexintl.com)

Find information on the web at [www.cybexintl.com](http://www.cybexintl.com).

To contact us online go to [www.cybexintl.com](http://www.cybexintl.com).

## Ordering Parts

To order parts online go to [www.cybexintl.com](http://www.cybexintl.com).

To speak with a customer service representative, call 888-462-9239 (for customers living within the USA) or 508-533-4300 (for customers outside the USA).

The following information located on the serial number decal will assist our Cybex representatives in serving you.

- Unit Serial Number, Product Name and Model Number
- Part Description and Part Number if you have it. All parts can be found on the web at [www.cybexintl.com](http://www.cybexintl.com)
- Shipping Address
- Contact Name
- Include a description of the problem.

In addition to your shipping address and contact name, your account number is helpful but not required. You may also fax orders to 508-533-5183.

## **Return Material Authorization (RMA)**

The Return Material Authorization (RMA) system is used when returning material for placement, repair or credit. The system assures that returned materials are properly handled and analyzed. Follow the following procedures carefully.

Contact your authorized Cybex dealer on all warranty-related matters. Your local Cybex dealer will request a RMA from Cybex, if applicable. Under no circumstances will defective parts or equipment be accepted by Cybex without proper RMA and an Automated Return Service (ARS) label.

Please contact Cybex Customer Service for the return of any item that is defective.

Provide the technician with a detailed description of the problem you are having or the defect in the item you wish to return. Provide the model and serial number of your Cybex equipment.

At Cybex's discretion, the technician may request that you return the problem part(s) to Cybex for evaluation and repair or replacement. The technician will assign you a RMA number and will send you an ARS label. The ARS label and the RMA numbers must be clearly displayed on the outside of the package that contains the item(s) to be returned. Include the description of the problem, the serial number of the equipment and the name and address of the owner in the package along with the part(s).

Merchandise returned without an RMA number on the outside of the package or shipments sent COD will not be accepted by the Cybex receiving department.

## **Damaged Parts**

Materials damaged in shipment should not be returned for credit. Shipping damages are the responsibility of the carrier (UPS, Federal Express, trucking companies, etc.)

### **Apparent Damage**

Upon receipt of your shipment, check all items carefully. Any damage seen with a visual check must be noted on the freight bill and signed by the carrier's agent. Failure to do so will result in the carriers refusal to honor your damage claim. The carrier will provide you with the required forms for filing such claims.

### **Concealed Damage**

Damage not seen with a visual check upon receipt of a shipment but notices later must be reported to the carrier as soon as possible. Upon discovery of the damage, a written or phone request to the carrier asking them to perform an inspection of the materials must be made within ten days of the delivery date. Keep all shipping containers and packing materials as they will be needed in the inspection process. The carrier will provide you with an inspection report and the necessary forms for filing a concealed damage claim. Concealed damage claim is the carrier's responsibility.







10 Trotter Drive Medway, MA 02053 • 508-533-4300 • FAX 508-533-5183

[www.cybexintl.com](http://www.cybexintl.com)