

Welch Allyn[®]
Surveyor[™] S12/S19
SURVEYOR PATIENT MONITORS
SERVICE MANUAL

Manufactured by Welch Allyn, Inc., Skaneateles Falls, NY U.S.A.



CAUTION: *Federal law restricts this device to sale by or on the order of a physician.*

©2019 Welch Allyn This document contains confidential information that belongs to Welch Allyn, Inc. No part of this document may be transmitted, reproduced, used, or disclosed outside of the receiving organization without the express written consent of Welch Allyn, Inc.

Welch Allyn is a registered trademark of Welch Allyn, Inc. Surveyor™, AM12M™, and VERITAS™ are trademarks of Welch Allyn, Inc.

Nellcor™, Covidien™, C-LOCK™, SatSeconds™, OxiMax™, MAX™, Max-Fast™, SoftCare™, Oxiband™, Dura-Y™, PediCheck™, OxiCliq™, and Durasensor™ are trademarks of Nellcor Puritan Bennett Inc.

Smart Capnography™, Smart Breath Detection Algorithm™ (BDA™), Smart Alarm Respiratory Analysis™ (SARA), Integrated Pulmonary Index™ (IPI), Microstream®, Filterline® and Capnoline® are trademarks or registered trademarks of Oridion Medical Ltd.

Edwards® is a registered trademark of Edwards Lifesciences Corporation.

Oridion CO2 License Information -- NO IMPLIED LICENSE – Possession or purchase of this bedside monitor does not convey any express or implied license to use the bedside monitor with unauthorized consumable CO2 sampling products which would, alone, or in combination with this bedside monitor, fall within the scope of one or more patents relating to this bedside monitor and/or CO2 sampling consumable products.

The capnography component of this product is covered by one or more of the following US patents: 6,428,483; 6,997,880; 6,437,316; 7,488,229; 7,726,954 and their foreign equivalents. Additional patent applications pending.

All other trademarks and registered trademarks are the property of their respective owners.

For patent information, please visit www.welchallyn.com/patents

For information about any Welch Allyn product, visit: <https://www.welchallyn.com/en/about-us/locations.html>

Customer Service and Technical Support: <https://www.welchallyn.com/en/other/contact-us.html>

1.888.667.8272, mor_tech.support@hillrom.com



9516-183-50-ENG Rev S (also refer to TDR pages when making revision changes)

Revision Date: 2021-01



901138 PATIENT MONITOR



Welch Allyn, Inc.
4341 State Street Road
Skaneateles Falls, NY 13153 USA

www.welchallyn.com

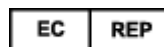

EU IMPORTER

Welch Allyn Limited
Navan Business Park, Dublin Road,
Navan, Co. Meath C15 AW22
Ireland

TABLE OF CONTENTS

1. NOTICES	4
MANUFACTURER’S RESPONSIBILITY	4
RESPONSIBILITY OF THE CUSTOMER	4
EQUIPMENT IDENTIFICATION	4
COPYRIGHT AND TRADEMARK NOTICES.....	4
OTHER IMPORTANT INFORMATION.....	4
NOTICE TO EU USERS AND/OR PATIENTS.....	4
2. WARRANTY INFORMATION	5
YOUR WELCH ALLYN WARRANTY.....	5
3. USERSAFETY INFORMATION	7
SAFETY REGULATIONS.....	7
WARNING(S)	7
POWER WARNINGS	8
ACCESSORIES, CABLES, AND EXTERNAL CONNECTIONS WARNINGS	10
USE WITH ELECTRO SURGERY DEVICES WARNINGS.....	11
INSTALLATION AND MOUNTING WARNINGS.....	11
ECG WARNINGS.....	11
ECG CALCULATED HEART RATE WARNINGS.....	12
WARNINGS FOR PATIENTS WITH PACEMAKERS	13
RESPIRATION WARNINGS.....	13
SpO2 WARNINGS	13
NIBP WARNINGS.....	15
INVASIVE PRESSURE WARNINGS	16
CO2 WARNINGS.....	16
CARDIAC OUTPUT WARNINGS.....	17
CAUTIONS	18
NOTES.....	19
4. EQUIPMENT SYMBOLS AND MARKINGS	21
SYMBOL DELINEATION	21
5. ELECTROMAGNETIC COMPATABILITY (EMC)	23
TABLE X-1 GUIDANCE AND MANUFACTURER’S DECLARATION: ELECTROMAGNETIC EMISSIONS	24
TABLE X-2 GUIDANCE AND MANUFACTURER’S DECLARATION: ELECTROMAGNETIC IMMUNITY	24
TABLE X-3 GUIDANCE AND MANUFACTURER’S DECLARATION: ELECTROMAGNETIC IMMUNITY	25
TABLE X-4 RECOMMENDED SEPARATION DISTANCES BETWEEN PORTABLE AND MOBILE RF COMMUNICATIONS EQUIPMENT AND THE EQUIPMENT.....	26
6. GENERAL CARE AND MAINTENANCE	27
PRECAUTIONS.....	27
INSPECTION.....	27
CLEANING	27
DISPOSAL.....	29
MAINTENANCE.....	30
SAFETY TESTING	32
BATTERY REPLACEMENT	35

BATTERY LIFE AND CHARGE TIME.....	35
BATTERY CONDITIONS	36
DECOMMISSIONING AND DISPOSAL	36
CALIBRATION	36
CO2 CALIBRATION	36
INVASIVE PRESSURE CALIBRATION	37
NIBP CALIBRATION	37
S12/S19 PREVENTATIVE MAINTENANCE RECORD.....	38
8. DEVICES SETUP	40
OVERVIEW	40
PATIENT INFORMATION.....	40
PARAMETERS.....	40
WAVEFORMS.....	41
RECORDER	43
ARRHYTHMIA.....	44
ALARM SUSPEND.....	45
ALARMS	45
AUDIO	47
RESTORE DEPARTMENTAL DEFAULTS	48
ADMINISTRATION	48
CONFIGURATION.....	49
COMMUNICATIONS	49
SCREEN CLEANING.....	50
ADMINISTRATION SETUP ALARMS DIALOGUE	50
ADMINISTRATION SETUP SYSTEM DIALOGUE	52
ADMINISTRATION SETUP SERVICE DIALOGUE.....	53
ADMINISTRATION SETUP FACTORY DIALOGUE	53
9. UNIT DISSASSEMBLY.....	54
BATTERY REMOVAL & REPLACEMENT.....	57
REAR HOUSING REMOVAL & REPLACEMENT	58
PROCESSOR BOARD REMOVAL & REPLACEMENT	61
MAIN BOARD REMOVAL & REPLACEMENT	62
LCD REMOVAL & REPLACEMENT S12	64
LCD REMOVAL & REPLACEMENT S19	65
REMOVAL AND REPLACEMENT OF THE OPTIONAL THERMAL WRITER (S12 ONLY)	67
OPTIONAL THERMAL WRITER FOR THE S19	70
10. CONFORMANCE TESTING.....	82
REQUIRED EQUIPMENT:.....	82
1.0 POWER TESTING	83
2.0 FUNCTIONAL TESTING	83
3.0 DEVICE CLEANING	111
4.0 SAFETY TESTING.....	112
11. PRODUCT SPECIFICATIONS.....	116
GENERAL SPECIFICATIONS	116
ENVIRONMENTAL CONDITIONS.....	116
POWER REQUIREMENTS & BATTERY.....	117
DISPLAY SPECIFICATIONS	117
RECORDER SPECIFICATIONS.....	117
MOUNTING SPECIFICATIONS	118

TRENDING.....	118
12. PARAMETER SPECIFICATIONS.....	119
PATIENT POPULATION	119
WAVEFORMS.....	119
ECG	119
ARRHYTHMIA ANALYSIS.....	120
ST ANALYSIS.....	121
NON-INVASIVE BLOOD PRESSURE (NIBP)	122
PULSE OXIMETRY (SPO2).....	122
TEMPERATURE	123
RESPIRATIONS: VIA ECG IMPEDANCE.....	123
CAPNOGRAPHY (CO2)	123
INVASIVE PRESSURES.....	124
CARDIAC OUTPUT.....	125
13. PARAMETER ALARM LIMIT RANGES.....	127
ADULT PATIENT MODE.....	127
PEDIATRIC PATIENT MODE.....	129
14. ALARM SPECIFICATIONS	131
GENERAL ALARMS.....	131
ECG AND HR MESSAGES	131
NON-INVASIVE BLOOD PRESSURE (NIBP) MESSAGES	132
PULSE OXIMETRY (SPO2) MESSAGES.....	134
TEMPERATURE MESSAGES.....	135
RESPIRATION MESSAGES	136
CAPNOGRAPHY (CO2) MESSAGES.....	137
INVASIVE PRESSURE MESSAGES	138
CARDIAC OUTPUT MESSAGES.....	139
NETWORK MESSAGES.....	139
15. TROUBLESHOOTING	140
POWER AND BATTERY.....	140
DISPLAY AND TOUCH SCREEN	140
ECG, ARRHYTHMIA, AND ST.....	141
NON-INVASIVE BLOOD PRESSURE (NIBP)	141
PULSE OXIMETRY (SPO2).....	142
TEMPERATURE	142
RESPIRATIONS: VIA ECG THORACIC IMPEDANCE	142
CAPNOGRAPHY (CO2)	142
INVASIVE PRESSURES.....	143
CARDIAC OUTPUT.....	143
WLAN CONNECTIVITY	144
16. MOUNTING ACCESSORIES	148
QUICK DISCONNECT (M-SERIES) WALL MOUNTING COMPONENTS	148
VALUE (VESA M-SERIES) WALL MOUNTING COMPONENTS.....	148
PREMIUM (VHM-25) WALL MOUNT COMPONENTS.....	149
SURVEYORS12 ROLL STAND COMPONENTS (NOT TO BE USED WITH S19)	150

1. NOTICES

Manufacturer's Responsibility

Welch Allyn, Inc. is responsible for the effects on safety and performance of the patient monitor, as indicated by the  label, only if article 2 of 93/42/EEC directive is applied, in particular:

-  **WARNING:** System installation and assembly operations, extensions, readjustments, modifications or repairs are carried out by personnel authorized by Welch Allyn, Inc. only.
- The patient monitor is used in accordance with the instructions for use.
- The patient monitor is correctly maintained according to the standards authorized by Welch Allyn, Inc. using original spare parts.
- The patient monitor is used with original accessories and supplies that are in compliance with the standard specifications described in this manual.
- The electrical installation of the relevant room complies with the requirements of appropriate regulations.

Responsibility of the Customer

The user of this patient monitor is responsible for ensuring the implementation of a satisfactory maintenance schedule. Failure to do so may cause undue failure and possible health hazards. This manual must be kept in a safe place to prevent its deterioration and/or alteration. The user and Welch Allyn, Inc. authorized personnel must have access to this manual at any time.

The user of this patient monitor must periodically check the accessories, their functionality and integrity.

Equipment Identification

Welch Allyn, Inc. equipment is identified by a serial and reference number on the back of the patient monitor. Care should be taken so that these numbers are not defaced.

Copyright and Trademark Notices

This document contains information that is protected by copyright. All rights are reserved. No part of this document may be photocopied, reproduced, or translated into another language without prior written consent of Welch Allyn, Inc.

Other Important Information

The information in this document is subject to change without notice.

Welch Allyn, Inc. makes no warranty of any kind with regard to this material including, but not limited to, implied warranties of merchantability and fitness for a particular purpose. Welch Allyn, Inc. assumes no responsibility for any errors or omissions that may appear in this document. Welch Allyn, Inc. makes no commitment to update or to keep current the information contained in this document.

Notice to EU Users and/or Patients

Any serious incident that has occurred in relation to the device, should be reported to the manufacturer and the competent authority of the Member State in which the user and/or patient is established.

2. WARRANTY INFORMATION

Your Welch Allyn Warranty

WELCH ALLYN, INC. (hereafter referred to as “Welch Allyn”) warrants that components within Welch Allyn products (hereafter referred to as “Product/s”) will be free from defects in workmanship and materials for the number of years specified on documentation accompanying the product, or previously agreed to by the purchaser and Welch Allyn, or if not otherwise noted, for a period of twelve (12) months from the date of shipment.

Consumable, disposable or single use products such as, but not limited to, PAPER or ELECTRODES are warranted to be free from defects in workmanship and materials for a period of 90 days from the date of shipment or the date of first use, whichever is sooner.

Reusable product such as, but not limited to, BATTERIES, BLOOD PRESSURE CUFFS, BLOOD PRESSURE HOSES, TRANSDUCER CABLES, Y-CABLES, PATIENT CABLES, LEAD WIRES, MAGNETIC STORAGE MEDIUMS, CARRY CASES or MOUNTS, are warranted to be free from defects in workmanship and materials for a period of 90 days. This warranty does not apply to damage to the Product/s caused by any or all of the following circumstances or conditions:

- a) Freight damage;
- b) Supplies, accessories and internal parts NOT approved by Welch Allyn;
- c) Misapplication, misuse, abuse, and/or failure to follow the Product/s instruction sheets and/or information guides;
- d) Accident;
- e) A disaster affecting the Product/s;
- f) Alterations and/or modifications to the Product/s not authorized by Welch Allyn;
- g) Other events outside of Welch Allyn’s reasonable control or not arising under normal operating conditions.

THE REMEDY UNDER THIS WARRANTY IS LIMITED TO THE REPAIR OR REPLACEMENT WITHOUT CHARGE FOR LABOR OR MATERIALS, OR ANY PRODUCT/S FOUND UPON EXAMINATION BY WELCH ALLYN TO HAVE BEEN DEFECTIVE. This remedy shall be conditioned upon receipt of notice by Welch Allyn of any alleged defects promptly after discovery thereof within the warranty period. Welch Allyn’s obligations under the foregoing warranty will further be conditioned upon the assumption by the purchaser of the Product/s (i) of all carrier charges with respect to any Product/s returned to Welch Allyn’s principal place or any other place as specifically designated by Welch Allyn or an authorized distributor or representative of Welch Allyn, and (ii) all risk of loss in transit. It is expressly agreed that the liability of Welch Allyn is limited and that Welch Allyn does not function as an insurer. A purchaser of a Product/s, by its acceptance and purchase thereof, acknowledges and agrees that Welch Allyn is not liable for loss, harm, or damage due directly or indirectly to an occurrence or consequence there from relating to the Product/s. If Welch Allyn should be found liable to anyone under any theory (except the expressed warranty set forth herein) for loss, harm, or damage, the liability of Welch Allyn shall be limited to the lesser of the actual loss, harm, or damage, or the original purchase price of the Product/s when sold.

EXCEPT AS SET FORTH HEREIN WITH RESPECT TO REIMBURSEMENT OF LABOR CHARGES, A PURCHASER'S SOLE EXCLUSIVE REMEDY AGAINST WELCH ALLYN FOR CLAIMS RELATING TO THE PRODUCT/S FOR ANY AND ALL LOSSES AND DAMAGES RESULTING FROM ANY CAUSE SHALL BE THE REPAIR OR REPLACEMENT OF DEFECTIVE PRODUCT/S TO THE EXTENT THAT THE DEFECT IS NOTICED AND WELCH ALLYN IS NOTIFIED WITHIN THE WARRANTY PERIOD. IN NO EVENT, INCLUDING THE CLAIM FOR NEGLIGENCE, SHALL WELCH ALLYN BE LIABLE FOR INCIDENTAL, SPECIAL, OR CONSEQUENTIAL DAMAGES, OR FOR ANY OTHER LOSS, DAMAGE, OR EXPENSE OF ANY KIND, INCLUDING LOSS OF PROFITS, WHETHER UNDER TORT, NEGLIGENCE OR STRICT LIABILITY THEORIES OF LAW, OR OTHERWISE. THIS WARRANTY IS EXPRESSLY IN LIEU OF ANY OTHER WARRANTIES, EXPRESS OR IMPLIED, INCLUDING, BUT NOT LIMITED TO THE IMPLIED WARRANTY OF MERCHANTABILITY AND THE WARRANTY OF FITNESS FOR A PARTICULAR PURPOSE.

3. USER SAFETY INFORMATION



WARNING: Means there is the possibility of personal injury to you or others.



Caution: Means there is the possibility of damage to the patient monitor.

Note: Provides information to further assist in the use of the patient monitor.

***NOTE:** This manual may contain screen shots and pictures. Any screen shots and pictures are provided for reference only and are not intended to convey actual operating techniques. Consult the actual screen in the host language for specific wording.*

Safety Regulations

- Surveyor is a medical patient monitor.
- Surveyor and its accessories are  labeled, according to European directive 93/42/EEC (MDD), as a class IIb patient monitor, and class I medical patient monitors respectively.
- Surveyor with all accessories that have a physical or logical connection with it, forms part of a Medical Electrical System. Surveyor complies with various safety and performance regulations as mentioned in this manual (Applied Standards).



WARNING(S)

- This manual gives important information about the use and safety of this patient monitor. Deviating from operating procedures, misuse or misapplication of the patient monitor, or ignoring specifications and recommendations could result in increased risk of harm to users, patients and bystanders, or damage to the patient monitor.
- Users are expected to be licensed clinical professionals knowledgeable about medical procedures and patient care, and adequately trained in the use of this patient monitor. Patient monitor captures and presents data reflecting a patient's physiological condition that when reviewed by a trained physician or clinician can be useful in determining a diagnosis; however, the data should not be used as a sole means for determining a patient's diagnosis.
- Before attempting to use this device for clinical applications, the operator must read and understand the contents of the user manual and other accompanying documents. Inadequate knowledge or training could result in increased risk of harm to users, patients and bystanders, or damage to the patient monitor. Contact Welch Allyn Technical Service for additional training options.
- The patient monitor provides the possibility to monitor multiple functions, but is not intended to be connected to more than one patient.
- Operation of the equipment beyond its specified ranges, or beyond normal physiological conditions of human subjects, may cause inaccurate results.
- To ensure the safety of both the patient and the device, 1.5 meters (5') of open area should surround the patient.

- A possible explosion hazard exists. Do not use the device in the presence of a flammable anesthetic mixture. Do not mount any part of the device closer than 25 cm from outlets of flammable gases, including oxygen.
- For proper operation and the safety of users or patients and bystanders, equipment and accessories must be connected only as described in this manual.
- Repairs and modification must be made by authorized and trained technical personnel. Unauthorized modifications and repairs will void the Surveyor warranty and may pose a danger to patients and users.
- If additional devices beyond Surveyor are connected to the patient, leakage currents through the patient might add up and should be accounted for.
- The Surveyor, as all medical equipment or systems, needs special precautions regarding EMC and needs to be installed and put into service according to the EMC information provided in the installation procedure in order to obtain a sufficient degree of immunity as well as not to create disturbance to other equipment. Refer to the specific EMC instructions in this manual.
- The quality of the signal produced by the device may be adversely affected by the use of other medical equipment, including but not limited to electrosurgery and ultrasound machines. Do not use the system in the presence of imaging equipment such as magnetic resonance imaging (MRI) and tomography systems. Simultaneous operation may damage the device or lead to erroneous results.
- Portable and mobile RF communications equipment may affect medical electrical equipment or systems as well as the Surveyor and its accessories. Do not operate the Surveyor near high frequency emissions (e.g. microwaves).
- Various alarm conditions require operator to adjust alarm configurations individualized according to patient condition and demographics. Surveyor supports the selection of appropriate alarm profiles when a patient is admitted. The operator should check these settings with each patient admission to ensure the alarm settings are appropriate for the individual patient. Inappropriate alarm configuration settings may render the alarm system useless.
- Surveyor alarms can only be silenced and not reset. This means that visual representation of an alarm condition remains present after an operator-silenced action until the alarm condition disappears (unless obscured by another, higher level, alarm). The auditory alarm signal does not re-activate after a silence action if the alarm condition remains the same. As soon as the alarm condition of a silenced alarm goes away, the alarm can be reactivated. Always respond promptly to alarms.
- A patient monitor is an addition to monitoring patient status and is not intended to replace clinical assessments and clinical judgments. It is important that a qualified individual regularly supervise the patient.
- In an environment where multiple systems, whether Surveyor and/or other systems, are utilized for monitoring patients, use of different alarm presets on each system may pose a safety risk. Be careful in using different alarm conditions on different systems.

Power Warnings

- Only use the Welch Allyn-provided external power adapter with the Surveyor. Ensure that the power adapter is connected to a properly grounded power terminal and the electrical installation complies with local safety requirements for the environment where it is used.
- To ensure that electrical safety is maintained during operation from AC power, the Surveyor external power adapter must be plugged into a hospital-grade outlet.
- Where the integrity of external protective earth conductor arrangement is in doubt, the device shall be operated from its internal battery power source.
- Do not use the Surveyor power supply to power other devices, because of the risk of additional leakage currents

and of transformer overload.

- The device is not operative if no image appears on the screen. If the device becomes inoperative during monitoring, a medium level type alarm sounds and the system resets automatically.
- Regularly check all mains power cables for damage and proper connection. Do not use equipment with a damaged power cord.
- The Surveyor contains a lithium ion battery. The following precautions should be taken regarding the battery:
 - Do not immerse the device in water.
 - Do not heat or throw the device in fire.
 - Do not leave the in conditions over 60 °C or in a heated car.
 - Do not attempt to crush or drop the device.
 - Only use the approved Welch Allyn battery pack with the Surveyor monitor.
 - Follow the instructions in the disposal section of this manual when the Surveyor monitor is taken out of service.
- The Surveyor battery must be initially fully charged prior to use. Ideally, the battery must be fully charged and fully discharged several times to allow for optimal performance.
- The Surveyor produces audible startup tones when powered on (two tones followed by two higher beeps). If a patient monitor does not sound the startup tones when it is powered on, remove the patient monitor from service and contact Welch Allyn Technical Support.
- If the AC power supply is interrupted or disconnected during monitoring, the Surveyor switches to battery backup if the battery is properly installed and has sufficient charge. If power is completely interrupted, including exhausting the battery supply, monitoring will cease until AC power supply has been restored or a fresh battery is installed, and the monitor's power switch is recycled.
- For continued operation, always connect the Surveyor to a wall outlet when a Low Battery alarm indication occurs. Failure to do this can lead to an interruption of monitoring.
- Ensure the battery has sufficient charge prior to disconnecting the external power supply. To disconnect from the AC power, disconnect the external power adapter from AC power first, then disconnect the power connection from the back of the monitor.
- Always reconnect the power cord to AC power after operating the patient monitor using battery power. This ensures that the batteries are recharged for the next time the patient monitor is operated on battery power. A light next to the on/off switch will illuminate indicating that the patient monitor is connected to mains power and charging. The battery icon on the main display indicates when the battery is fully charged.

Accessories, Cables, and External Connections Warnings

- The patient monitor is designed to meet applicable specifications when using Welch Allyn-approved patient cables and accessories. Use of non-approved cables and accessories may result in reduced performance and may pose possible patient and user safety concerns.
- It is the user's responsibility to use only approved supplies, accessories and internal parts available through Welch Allyn, Inc. Product performance and patient safety require the use of supplies, accessories and internal parts that comply with applicable standards. To maintain designed operator and patient safety, peripheral equipment and accessories used that can come in direct patient contact must be in compliance with applicable standards including IEC 60601-1, or other IEC standards (e.g., IEC 60950) as appropriate to the patient monitor. Additionally, cables and accessories must comply with all EMC regulations. In Europe, cables and accessories should bear the CE Mark. Only use parts and accessories supplied with the patient monitor and available through Welch Allyn, Inc.
- Connected devices must stay outside of the patient environment, and must be electrically insulated from the Surveyor by a separation device, or alternatively a permanent additional safety ground must be attached to the Surveyor using the appropriate terminal at the back of the unit. Connecting additional devices to the patient monitor may increase chassis and/or patient leakage currents. To maintain operator and patient safety, consideration should be given to the requirements of IEC 60601-1-1, and leakage currents should be measured to confirm no electric shock hazard exists.
- Do not use excessive force on any of the connection cables and handle all accessories with care.
- Proper clinical procedure must be employed to prep the electrode and sensor sites and to monitor the patient for excessive skin irritation, inflammation, or other adverse reactions. Electrodes and other sensors are intended for short-term use and should be removed from the patient promptly following testing.
- Conductive parts of the ECG patient cables, electrodes, and associated connections of type CF applied parts, including the neutral conductor of the patient cable and electrode should not come into contact with other conductive parts including earth ground.
- To avoid the possibility of serious injury or death during patient defibrillation, do not come into contact with patient monitor or patient cables. Additionally, proper placement of defibrillator paddles in relation to the ECG electrodes is required to minimize harm to the patient.
- To avoid potential for spread of disease or infection, single-use disposable components (e.g., electrodes, IBP catheters, disposable SpO₂ sensors, disposable temperature sensors, single-use blood pressure cuffs, etc.) must not be reused.
- Welch Allyn-approved manufacturers of accessories provide separate user manuals (e.g., patient cables, electrodes, etc.). Read these manuals thoroughly and refer to them for specific functions. It is recommended to keep all manuals together.
- To maintain safety and effectiveness, reusable sensors and cables - such as ECG electrodes and SpO₂ sensors - must not be used beyond their expiration date or useful life.
- All accessories including hoses, cables, connectors, hoses and other patient-applied parts supplied with the Surveyor do NOT contain any Latex. If the patient develops an allergic reaction or rashes, immediately remove the accessory and inform Welch Allyn Technical Support.
- Check the date and integrity of the packing of all accessories that need to be sterilized before use.
- Do not attach unauthorized devices such as a mouse or keyboard to the USB port.
- Do not attach unauthorized patient cable for use with AM12M. Patient cable should provide locking mechanism to mating device.

Use with Electro Surgery Devices Warnings

- The Surveyor is approved for use in the presence of electrosurgical (ESU) equipment providing the following precautions are taken:
 - To minimize the risk of patient burns, only use ESU equipment that monitors the impedance of the ESU return wires.
 - Users should be properly trained in the operation of the ESU equipment.
 - The AM12M 12-Lead ECG Acquisition Module should NOT be used when operating ESU equipment.
 - Keep patient-applied cables (e.g., ECG lead wires) off of earth ground and away from the ESU knife and return wires to prevent burns to measurement sites.
 - To prevent burns to the patient in the event of a defective neutral ECG electrode of the device, it is necessary to place ECG electrodes far from the neutral electrode, and as equidistant as possible from the blade-neutral axis of the surgical patient monitor.
 - When activating the ESU device, the ECG signals may be distorted or may disappear, and Lead Fail or Noise alarms might be present. The signal should return once the ESU activation stops.
 - When activating the ESU device, using the SpO2 parameter as the heart rate source rather than the ECG parameter to determine heart rate may be clinically preferred.

Installation and Mounting Warnings

- Place the Surveyor on a flat and leveled surface or mount it according to the manufacturer's instructions. Place the Surveyor in a well-ventilated place. Keep the Surveyor away from overly hot, cold or humid places, places directly under sunlight, or dusty surroundings.
- Ensure that the Surveyor is securely placed or mounted such that it does not tip or drop which may damage the monitor and potentially create a hazard to patients and hospital personnel.
- Only approved rolling stands and wall-mount fixtures should be used with the Surveyor.
- A VESA-standard adapter is available on the back of the Surveyor system for wall, swivel-arm or rolling-stand mounting. The user is responsible for correct installation of the system.
- Do not mount the S12 on a rolling stand at a height exceeding 110 cm (43").
- The S19 should NOT be mounted on a rolling stand.

ECG Warnings

- Excessive patient movement could interfere with the operation of the system.
- Proper patient preparation is important to proper application of ECG electrodes and operation of the patient monitor.
- If the ECG amplifier input is out of normal operating range, the display will indicate a lead fail for the lead(s) where this condition is present and if the signal is being displayed or printed, the respective lead(s) will print out as blank. A lead fail alarm is generated on the Surveyor Central monitoring station
- The AM12M acquisition module automatically calibrates when it is connected to the monitor or when the monitor powers up. If there is a very high amount of electrical interference present at that time (usually because electrodes make spurious contact with earth ground), the calibration may fail. The monitor is aware of the failure and will not display the ECG waveforms. If this happens, the user should attempt to recalibrate by reconnecting the AM12M to the monitor, making sure that there are no spurious contacts between electrodes and earth ground.
- Patient cables intended for use with the patient monitor include series resistance (9 Kilo Ohm minimum) in each lead for defibrillation protection. Patient cables should be checked for cracks or breakage prior to use.
- ECG electrodes could cause skin irritation; patients should be examined for signs of irritation or inflammation.

- Defibrillation protection is guaranteed when the original Welch Allyn ECG patient cables are used.
- The system captures and presents data reflecting a patient's physiological condition that when reviewed by a trained physician or clinician can be useful in determining a diagnosis. However, the data should not be used as a sole means for determining a patient's diagnosis. The system is equipped with Welch Allyn's VERITAS™ 12-lead resting ECG interpretation algorithm. The VERITAS ECG algorithm can provide an over-reading physician with a silent second opinion through diagnostic statements output on the ECG report.
- 12-lead ECGs acquired through Surveyor will normally use a modified lead system with the limb electrodes positioned on the torso. Although this is a generally accepted practice (e.g., in stress testing), the different electrode positions can cause morphology changes on the ECG, thus influencing their interpretation. Most frequently seen differences are a vertical and rightward axis shift, minor changes of evidence of old inferior infarction and changes in the T-wave in the limb leads. All 12-lead ECGs printed with Surveyor have a warning message that alerts the physician that the ECG might have been acquired with torso positioned limb leads. It is recommended that you place the electrodes as close as possible to the normal limb positions avoiding the possibility of causing artifact. The right arm and left arm electrodes should be placed on the clavicles as close as possible to the arms. The left leg electrode should be placed as close as possible to the left leg without subjecting it to the possibility of motion artifact.
- During periods of lead fail and when a reduced lead set is used for patient monitoring, 12-lead resting ECG interpretation cannot be reliably used in determining a diagnosis.
- For full diagnostic quality, the resting ECG should be printed on the Surveyor Central Station printer and not on the S12 or S19 strip chart recorder.

ECG Calculated Heart Rate Warnings

- Heart rate indication is usually not affected by pacemakers with direct cardiac application, ventricular or supraventricular arrhythmias or irregular heart rates; however, in some conditions a pacemaker pulse can give rise to double QRS detections. Also, not activating the "Analyze Pacers" field in the signals menu in the presence of a pacemaker might lead to beat detections without a QRS complex due to the detection of the pacemaker spike.
- Heart rate is calculated over 16 beats at rates over 40 bpm and 4 beats at lower heart rates. This results in a response time of 9 seconds or less when the heart rate changes suddenly from 80 bpm to 40 or 120 bpm, as measured according to ANSI/AAMI EC13 and IEC 60601-2-27.
- Tall and peaked T-waves may affect QRS detection resulting in doubled heart rates. Surveyor rejects tall T-Waves less than or equal to 240% of a 1mV QRS in diagnostic mode, and 70% of a 1mV QRS in monitoring mode, as well as a Q-T interval of 350 ms measured for both diagnostic and monitoring modes according to ANSI/AAMI EC13 and IEC 60601-2-27.
- The heart rate meter correctly detects all beats of the alternating beat type waveforms considered in ANSI/AAMI EC 13 and IEC 60601-2-27 Figure 201.101 patterns A1-A4 if the QRS amplitudes exceed the minimum detection threshold set by the user.
- Time to tachycardia, as measured according to ANSI/AAMI EC13 and IEC 60601-2-27 Figure 201.101 patterns B1-B2 is less than 8 seconds.
- Heart rate indication is not reliable during episodes of ventricular fibrillation.
- The summarized performance of the QRS recognition and classification algorithm on standard databases, as defined by ANSI/AAMI EC 57, is as follows:

MIT Database	
Performance Measures	Welch Allyn
QRS Detection Sensitivity %	99.94
QRS Detection Positive Predictivity %	99.87
PVC Detection Sensitivity %	95.49
PVC Detection Positive Predictivity %	97.05
PVC Detection False Positive Rate %	0.220
AHA Database	
Performance Measures	Welch
QRS Detection Sensitivity %	99.86
QRS Detection Positive Predictivity %	99.90
PVC Detection Sensitivity %	93.49
PVC Detection Positive Predictivity %	98.32
PVC Detection False Positive Rate %	0.162

- Because of noise, artifact and the many different physiological manifestations of the ECG signal, it is inevitable that some beats are not detected or correctly classified by the system. The user is advised not to rely completely on automatic alarm systems for the monitoring of critical patients.

Warnings for Patients with Pacemakers

- Rate meters may continue to count the pacemaker rate during occurrences of cardiac arrest or some arrhythmias. Do not rely entirely upon rate meter alarms. Keep pacemaker patients under close surveillance.
- When using the 3/5 lead ECG cable, pacemaker spikes are normally recognized and rejected by the software. Signals are recognized as pacemaker spikes when they have a slew rate over 1.4 V/s, as measured according to the ANSI/AAMI EC 13 and IEC 60601-2-27 standards.
- When using the AM12M 12-lead ECG Acquisition Module, pacemaker spikes in the range of 0.3 to 1.3 mS, +/- 2 to +/-700 mV are recognized and rejected according to the ANSI/AAMI EC13 and IEC 60601-2-27:2011 standards.
- The pacemaker rejection software can be deactivated by the user. This should not be done for patients with a pacemaker or suspected to have a pacemaker implanted because this can lead to a heart rate indication and failure to alarm for cardiac arrest.
- Other than the influence on beat detection as stated above, there is no known safety hazard if other equipment, such as pacemakers or other stimulators, is used simultaneously with the system.

Respiration Warnings

- When using an ECG electrode to calculate respiration rate via the thorax impedance method, movement artifacts may create inaccurate results. Respiration rates derived from CO₂ parameter is not subject to such movement artifacts.

SpO₂ Warnings

- Use only approved pulse oximetry sensors specifically intended for use with the patient monitor. Unapproved components can result in degraded performance and/or device malfunction.
- Use pulse oximetry sensors specified for the correct patient mode and for the correct application position.
- Pulse oximetry sensors must be checked a minimum of every 4 hours and moved to a new site as necessary. Reposition the sensor at least once every 24 hours to allow the patient's skin to breathe.

- Tissue damage or inaccurate measurements may be caused by incorrect SpO₂ sensor application or use, such as wrapping too tightly, applying supplemental tape, failing to inspect periodically, or failing to position appropriately. Read the Instructions for Use provided with the SpO₂ sensor carefully prior to use.
- Do not sterilize or immerse pulse oximetry sensors in liquid. Clean and/or disinfect re-usable sensors between patients.
- Pulse oximetry sensors are susceptible to high ambient light interference including surgical lights, especially xenon light sources, ambient photodynamic therapy (e.g., Bilirubin lamps), fluorescent lights, infrared heating lamps, direct sunlight. Shield the sensor area as necessary.
- SpO₂ measurement may be adversely affected by dyes (e.g., methylene blue, indocyanine green, indigo, carmine, fluorescein) introduced into the bloodstream
- That factors that may cause inaccurate readings and alarms, decreased perfusion, and or low signal strength include:

Interfering substances:

- Carboxyhemoglobin may erroneously increase SpO₂ reading.
- Methemoglobin (MetHb) usually represents less than 1% of the total Hgb, but in the case of methemoglobinemia that can be congenital or induced by some IV dyes, antibiotics (such as sulphas,) inhaled gases etc. this level increases sharply and thus can confound the SpO₂ reading.
- Intravascular dyes (such as indocyanine green, methylene blue, etc.).

Physiological conditions:

- Cardiac arrest
- Hypotension
- Shock
- Severe vasoconstriction
- Severe anemia
- Hypothermia
- Venous pulsations
- Ventricular septal defects (VSDs)

Sensor placement:

- Incorrect sensor placement
- Poor sensor fit
- Any condition that restricts blood flow such as the use of a blood pressure cuff or supplemental tape, or extremes in systemic vascular resistance may cause inability to determine accurate SpO₂ readings.
- Certain conditions such as physical movement (patient and imposed motion); diagnostic testing; low perfusion; electromagnetic interference; electrosurgical patient monitors; dysfunctional hemoglobin; and inappropriate positioning of the pulse oximeter sensor may result in pulse oximetry readings that are unreliable.
- SpO₂ signal inadequacy is indicated by error messages or alarms generated at the Surveyor patient monitors.
- If the accuracy of any measurement does not seem reasonable, first check the patient's vital signs, and then check for conditions that may cause inaccurate SpO₂ readings. If the problem is still not resolved, check the monitor and the SpO₂ module, cable, or sensor for proper functioning.
- A pulse oximeter is not an apnea monitor. A pulse oximeter should be considered an early warning device. As a trend toward patient deoxygenation is indicated, blood samples should be analyzed by a laboratory CO-oximeter to completely understand the patient's condition. Check that the pulse oximetry waveform is physiological in shape.
- To prevent erroneous readings, do not use physically damaged sensors, cables or modules. Discard a damaged sensor or cable immediately.

- The performance of the pulse oximetry may be compromised by excessive motion including tremors or shivering.
- Nail polish and/or artificial fingernails can affect the accuracy of pulse oximetry and should be removed.
- Pulse rate measurement is based on the optical detection of a peripheral flow pulse. While a pulse rate does assist with the detection or absence of a peripheral pulse, the pulse oximeter should not be used as a replacement or substitute for ECG-based arrhythmia analysis.
- In certain situations such as low perfusion or weak signal strength, such as with patients who have pigmented or thick skin, inaccurate SpO₂ measurements may be reported. Verification of oxygenation should be made through other means, particularly in preterm infants, and patients with chronic lung disease, prior to instituting any therapy or intervention.
- Always monitor ECG for arrhythmia detection purposes. HR calculated from pulsatile SpO₂ waveform may differ significantly from ECG HR measured values.

NIBP Warnings

- Use only approved blood pressure (BP) cuffs specifically intended for use with the Surveyor patient monitors.
- Use the correct size cuff for the intended limb (see indication of cuff size in cm printed on cuff) of the patient. The terminology printed on some BP cuffs like “child,” “adult,” “thigh,” etc., is only an indication of the size of the cuff and should not be used to determine if the cuff is suitable for the limb. Use the range markers on the BP cuffs to determine whether a particular cuff fits the patient’s arm or not.
- The Surveyor patient monitor is not intended for use with neonates.
- Do not fold, clamp, cut, or alter the pressure hose of the cuff or the monitor.
- Periodically check the limb connected to the cuff for adequate perfusion, circulation, and function. Repeated NIBP measurements can lead to hematomas, limb ischemia, and other limb injuries. Kinked or blocked hoses can lead to prolonged impairment of blood circulation and lead to injury.
- Educate the patient to relax, rest, and lie still during inflation and pressure measurements. Patient movement can lead to artifacts or errors.
- The pressure measurement might be influenced by patient position, physical conditions, and other factors.
- Avoid placing the blood pressure cuff on the arm next to where a patient has had a mastectomy.
- Avoid applying the cuff to a wounded limb as this can cause further injury. Use with caution in patients with dermatological disease, subcutaneous laceration, or other integumentary compromise as there may exist a skin damage hazard during electronic NIBP measurements. Follow prudent evidence-based clinical practice to determine if an electronic blood pressure is safe for these patients.
- There may be an increased risk of hematomas in patients with serious coagulation problems.
- Avoid applying the cuff to a limb with a catheter, arterio-venous shunt or infusion pump applied. The cuff pressure could produce damage to the tissues surrounding the catheter, shunt or the infusion needle, or compromise the infusion flow.
- To avoid the potential for spread of disease or infection, reusable blood pressure cuffs should be cleaned after each patient use. Disposable blood pressure cuffs should not be used with multiple patients.
- Inflation of the NIBP cuff can cause a temporary degradation of monitoring of other parameters derived from the same limb, including invasive pressure and SpO₂ measurements. If applicable, place the SpO₂ sensor and the NIBP cuff on different limbs.

- An irregular heart beat (arrhythmia) causes beat-to-beat blood pressure variations and may therefore disturb the NIBP measurement, which may fail or be inaccurate. It is advisable to confirm automatic NIBP measurements periodically for patients with frequent premature beats or a very irregular heart rate, for example caused by atrial fibrillation.
- NIBP measurements may be inaccurate or fail in the presence of excessive movement, shivering, or trembling. Advise patients to relax and avoid moving when a blood pressure measurement is made.
- NIBP cuffs and hoses supplied with the Surveyor do NOT contain any Latex. If the patient develops an allergic reaction or rashes, immediately remove the cuff.

Invasive Pressure Warnings

- All invasive procedures involve risks to the patient. Use aseptic technique. Follow catheter manufacturer's instructions and established hospital guidelines.
- Ensure that no part of the patient connections touches any electrically conductive material including earth.
- Only use invasive pressures transducers that can withstand defibrillation as required by ANSI/AAMI BP22 standard.
- Mechanical shock to the invasive blood pressure transducer may cause severe shifts in zero balance and calibration, and cause erroneous readings.

CO2 Warnings

- Always inspect the airway adapter for a tight connection and proper operation before attaching it to the patient.
- Remove the airway sampling line from the patient's airway while nebulized medications are being delivered.
- Route all tubing away from the patient's throat to avoid strangulation.
- Do not apply pressurized air to any outlet or tubing connected to the monitor. Pressure may destroy sensitive elements.
- When monitoring an anesthetized patient in an operating room environment, it is recommended to connect the CO2 exhaust port of the Surveyor to the hospital's waste gas scavenging system so as to prevent exposure for other patients and hospital personnel to the patient's respiratory sample. Ensure that sampled gases are not returned from the exhaust port to a breathing system such as a ventilator. Use standard clinical guidelines and/or hospital procedures. Scavenge vacuum greater than 1 mmHg may result in damage to the Surveyor.
- When using a sampling line for intubated patients with a closed suction system, do not place the airway adapter between the suction catheter and endotracheal tube. This is to ensure that the airway adapter does not interfere with the functioning of the suction catheter.
- Loose or damaged connections may compromise ventilation or cause an inaccurate measurement of respiratory gases. Securely connect all components and check connections for leaks according to standard clinical procedures.
- Do not cut or remove any part of the sample line. Cutting the sample line could lead to erroneous readings.
- If too much moisture enters the sampling line (i.e., from ambient humidity or breathing of unusually humid air), the message CO2 Purging Line will appear in the message area. If the sampling line cannot be cleared, the message CO2 occluded line will appear in the message area. Replace the sampling line once the CO2 occluded line message appears.

Cardiac Output Warnings

- Refer to the catheter package insert provided with each PA catheter for the appropriate computation constant, specific instructions on catheter placement and use, warnings, cautions, and specifications.

- Inaccurate Cardiac Output measurements may be caused by:
 - Incorrect placement or position of the catheter.
 - Excessive variation in pulmonary artery blood temperature, perhaps caused by bolus drug administration.
 - Clot formation on the thermistorport.
 - Anatomical abnormalities, (for example, cardiac shunts).
 - Excessive patient movement.
 - Repeated intermittent flushes of cold fluid through the fluid lumens of the catheter.
 - Electrocautery or electrosurgical device interference.
 - Rapid changes in cardiac output.
 - Using an incorrect computation constant.



Cautions

- Cleaning must be performed with the system turned off. Let all parts dry well before turning the power back on.
- Prevent liquids from penetrating the system, components, and transmitters. Do not spray the system with liquid cleaning agents. If liquids have penetrated the system, open by authorized personnel for inspection and let dry completely.
- Do not attempt to clean the patient monitor or patient cables by submersing into a liquid, autoclaving, or steam cleaning as this may damage equipment or reduce its usable life. Wipe the exterior surfaces with a warm water and mild detergent solution and then dry with a clean cloth. Use of unspecified cleaning/disinfecting agents, failure to follow recommended procedures, or contact with unspecified materials could result in increased risk of harm to users, patients and bystanders, or damage to the patient monitor.
- No user-serviceable parts inside. Screw removal by authorized service personnel only. Damaged or suspected inoperative equipment must be immediately removed from use and must be checked/repared by authorized service personnel prior to continued use.
- The rechargeable internal battery is a sealed lithium ion type. If the battery appears to become defective, refer to Welch Allyn Technical Support.
- Do not pull or stretch patient cables as this could result in mechanical and/or electrical failures. When not in use, patient cables can be stored. Keep patient cables should be stored off of the floor away from bedrails and wheels to avoid cable damage. Roll the patient cables into a loose loop prior to hanging for storage.
- When necessary, dispose of the patient monitor, its components and accessories (e.g., batteries, cables, electrodes), and/or packing materials in accordance with local regulations.
- Do not connect the patient monitor to any unauthorized patient monitors or use any third-party accessories. This may cause inaccurate measurements or harm the patient. Installation and connection to data networks must be performed by properly trained personnel, authorized by Welch Allyn.
- Check that all operating and environment conditions such as ambient temperature meet the specifications of the Surveyor.
- Do not exert excessive pressure on the touch panel LCD. Excessive pressure may permanently damage the display.
- During MRI scanning, the module must be placed outside the MRI suite. When the module is used outside the MRI suite, EtCO₂ monitoring can be implemented using the FilterLine XL.
- Use of a CO₂ sampling line with H in its name (indicating that it is for use in humidified environments) during MRI scanning may cause interference. The use of non H sampling lines is advised.

- Microstream® etCO₂ sampling lines are designed for single patient use, and are not to be reprocessed. Do not attempt to clean, disinfect, sterilize or flush any part of the sampling line as this can cause damage to the monitor.
- Dispose of sampling lines according to standard operating procedures or local regulations for the disposal of contaminated medical waste.
- Before use, carefully read the Microstream® etCO₂ sampling lines Directions for Use.
- Only use Microstream® etCO₂ sampling lines to ensure the monitor functions properly.

Notes

- The Surveyor's NIBP parameter is indicated for use with pregnant patients, including those with pre-eclamptic or eclamptic conditions.
- Patient movements may generate excessive noise that may affect the quality of signals and derived parameters and waveforms.
- Proper patient preparation is important to proper application of sensors and electrodes to ensure the correct operation of the patient monitor.
- There is no known safety hazard if other equipment, such as pacemakers or other stimulators, is used simultaneously with the patient monitor; however, disturbance to the signal may occur.
- If an ECG electrode is not connected properly to the patient, or one or more of the patient cable lead wires are damaged, the display will indicate a lead fault for the lead(s) where the condition is present and if the signal is being printed, the respective lead(s) will print out as blank.
- This patient monitor is intended to be used in a hospital or doctor's office setting, and should be used and stored according to the environmental conditions specified.
- During nebulization or suction for intubated patients, in order to avoid moisture buildup and sampling line occlusion, remove the sampling line luer connector from the monitor.
- Replace the sampling line according to hospital protocol or when a blockage is indicated by the device. Excessive patient secretions or a build-up of liquids in the airway tubing may occlude the sampling line, requiring more frequent replacement.
- When the caution message "Blockage" appears on the screen, indicating that the FilterLine which is attached to the monitor is blocked, the monitor's CO₂ pump will stop pumping the patient's breath into the monitor for testing. Follow the instructions that appear in the Troubleshooting section of this manual: First disconnect and reconnect the FilterLine. If the message still appears, disconnect and replace the FilterLine. Once a working FilterLine is attached to the monitor, the pump will automatically resume operation.
- Following connection of the CO₂ sampling line to the monitor and patient, check that CO₂ values appear on the monitor display.

- The device is ETL listed:























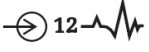



ETL-Listed device in the USA and Canada.

- Upon request, Welch Allyn can supply a Service Manual that includes additional calibration and test instructions as well as list of spare parts and accessories that must be used with the Surveyor patient monitors.

4. EQUIPMENT SYMBOLS AND MARKINGS

Symbol Delineation

	WARNING The warning statements in this manual identify conditions or practices that could lead to illness, injury, or death. In addition, when used on a patient applied part, this symbol indicates defibrillation protection is in the cables. Warning symbols will appear with a grey background in a black and white document.	
	CAUTION The caution statements in this manual identify conditions or practices that could result in damage to the equipment or other property, or loss of data.	
	Indicates compliance to applicable European Union directives	 Do not dispose as unsorted municipal waste. Requires separate handling for waste disposal according to local requirements
IPX1	Indicates device has been tested for safety from vertically dripping water; specifically, it indicates DRIP PROOF, a higher than ordinary level of protection from drips, leaks, and spills	 Defibrillator-proof type CF applied part
	Tested for safety by the Intertek according to applicable U.S. and Canadian standards and requirements	REF 4101-012  External power AC/DC power supply; use only Welch Allyn Power Supply; REF 4101-012
	Power On/Off switch	 7d welchallyn.com Follow instructions/directions (DFU) – mandatory action. A copy of the DFU is available on this website. A printed copy of the DFU can be ordered from Welch Allyn for delivery within 7 calendar days.
	Local Area Network interface	 External alarm interface
IOIOI	Interface to external devices – Reserved for future use	 Connector for 3/5 lead ECG parameter
	Connector for 12-lead ECG parameter using Welch Allyn AM12M	NIBP Connector for non-invasive blood pressure parameter
SpO ₂	Connector for oxygen saturation parameter	CO Connector for cardiac output parameter
P 1 & 2	Connector for invasive pressure 1 & 2 parameters	P 3 & 4 Connector for invasive pressure 3 & 4 parameters
T1	Connector for temperature 1 parameter	T2 Connector for temperature 2 parameter

 <p>Connector for CO₂ parameter</p>	 <p>Connector for CO₂ parameter exhaust port</p>
 <p>This end up</p>	 <p>Keep away from sunlight</p>
 <p>Fragile, handle with care</p>	 <p>Keep dry</p>
 <p>Storage temperature range</p>	 <p>10 rolls of recorder paper per case</p>
 <p>Recorder interface (S19 only)</p>	 <p>Medical Device</p>
 <p>Model Identifier</p>	 <p>Reorder Number</p>

5. **ELECTROMAGNETIC COMPATABILITY**

(EMC)

When using the patient monitor, assess the electromagnetic compatibility with surrounding devices.

An electronic device may either generate or receive electromagnetic interference. Testing for electromagnetic compatibility (EMC) has been performed on the bedside monitor according to the international standard for EMC for medical bedside monitors (IEC 60601-1-2). This IEC standard has been adopted in Europe as the European Norm (EN 60601-1-2).

The patient monitor should not be used adjacent to or stacked with other equipment. If the patient monitor is used in this manner, verify the patient monitor operates in an acceptable manner in the configuration in which it will be used.

Fixed, portable, and mobile radio frequency communications equipment may affect the performance of medical equipment. See Table X-4 for recommended separation distances between the radio equipment and the patient monitor.

The use of accessories, transducers, and cables other than those specified by Welch Allyn may result in increased emissions or decreased immunity of the equipment.

Table X-1 Guidance and Manufacturer's Declaration: Electromagnetic Emissions

The equipment is intended for use in the electromagnetic environment specified in the table below. The customer or the user of the equipment should ensure that it is used in such an environment.

Emissions Test	Compliance	Electromagnetic Environment: Guidance
RF Emissions CISPR 11	Group 1	The Surveyor patient monitor uses RF energy only for its internal function. Therefore, its RF emissions are very low and not likely to cause any interference in nearby electronic equipment.
RF Emissions CISPR 11	Class A	
Harmonic Emissions IEC 61000-3-2	Not Applicable	
Voltage Fluctuations/ Flicker Emissions IEC 61000-3-3	Not Applicable	

Table X-2 Guidance and Manufacturer's Declaration: Electromagnetic Immunity

The equipment is intended for use in the electromagnetic environment specified in the table below. The customer or the user of the equipment should ensure that it is used in such an environment.

Immunity Test	IEC 60601 Test Level	Compliance Level	Electromagnetic Environment: Guidance
Electrostatic discharge (ESD) EN 61000-4-2	+/- 6 kV contact +/- 8 kV air	+/- 6 kV contact +/- 8 kV air	Floors should be wood, concrete, or ceramic tile. If floors are covered with synthetic material, the relative humidity should be at least 30%.
Electrical fast transient/burst EN 61000-4-4	+/- 2 kV for power supply lines +/- 1 kV for input/output lines	+/- 2 kV for power supply lines +/- 1 kV for input/output lines	Mains power quality should be that of a typical commercial or hospital environment.
Surge IEC 61000-4-5	+/- 1 kV differential mode +/- 2 kV common mode	+/- 1 kV differential mode +/- 2 kV common mode	Mains power quality should be that of a typical commercial or hospital environment.
Voltage fluctuations and interruptions	<5% UT for 0.5 cycles 40% UT for 5 cycles 70% UT for 25 cycles <5% UT for 5s	<5% UT for 0.5 cycles 40% UT for 5 cycles 70% UT for 25 cycles <5% UT for 5s	Note that monitoring is interrupted at the level "<5% UT for 5s", but equipment remains safe (as specified in EN 60601-1-2).
Power frequency (50/60 Hz) magnetic field IEC 61000-4-8	3 A/m	3 A/m	Power frequency magnetic fields should be at levels characteristic of a typical location in a typical commercial or hospital environment.

NOTE: *UT is the AC Mains voltage prior to application of the test level.*

Table X-3 Guidance and Manufacturer’s Declaration: Electromagnetic Immunity

The equipment is intended for use in the electromagnetic environment specified in the table below. The customer or the user of the equipment should ensure that it is used in such an environment.

Immunity Test	IEC 60601 Test Level	Compliance Level	Electromagnetic Environment: Guidance
Conducted RF EN 61000-4-6	3 Vrms 150 kHz to 80 MHz	3 Vrms 150 kHz to 80 MHz	<p>Portable and mobile RF communications equipment should be used no closer to any part of the equipment, including cables, than the recommended separation distance calculated from the equation applicable to the frequency of the transmitter.</p> <p>Recommended separation distance</p> $d = 1.2 \sqrt{P}$ $d = 1.2 \sqrt{P} \quad 80 \text{ MHz to } 800 \text{ MHz}$
Radiated RF IEC 61000-4-3	3 V/m 80 MHz to 2.5 GHz	3 V/m 80 MHz to 2.5 GHz	$d = \sqrt{P} \quad 800 \text{ MHz to } 2.5 \text{ GHz}$ <p>Where P is the maximum output power rating of the transmitter in watts (W) according to the transmitter manufacturer and d is the recommended separation distance in meters (m).</p> <p>Field strengths from fixed RF transmitters, as determined by an electromagnetic site survey^a, should be less than the compliance level in each frequency range^b.</p> <p>Interference may occur in the vicinity of equipment marked with the following symbol:</p> 

a. Field strengths from fixed transmitters, such as base stations for radio (cellular/cordless) telephones and land mobile radios, amateur radios, AM and FM radio broadcast, and TV broadcast cannot be predicted theoretically with accuracy. To assess the electromagnetic environment due to fixed RF transmitters, an electromagnetic site survey should be considered. If the measured field strength in the location in which the equipment is used exceeds the applicable RF compliance level above, the equipment should be observed to verify normal operation. If abnormal performance is observed, additional measures may be necessary, such as reorienting or relocating the equipment.

b. Over the frequency range 150 kHz to 80 MHz, field strengths should be less than [3] V/m.

Table X-4 Recommended Separation Distances Between Portable and Mobile RF Communications Equipment and the Equipment

The equipment is intended for use in the electromagnetic environment in which radiated RF disturbances are controlled. The customer or the user of the equipment can help to prevent electromagnetic interference by maintaining a minimum distance between portable and mobile RF communications equipment (transmitters) and the equipment as recommended in the table below, according to the maximum output power of the communications equipment.

Rated Maximum Output Power of Transmitter (W)	Separation Distance According to Frequency of Transmitter (m)		
	150 KHz to 80 MHz	80 MHz to 800 MHz	800 MHz to 2.5 GHz
	$d = 1.2 \sqrt{P}$	$d = 1.2 \sqrt{P}$	$d = 2.3 \sqrt{P}$
0.01	0.12 m	0.12 m	0.23 m
0.1	0.38 m	0.38 m	0.73 m
1	1.2 m	1.2 m	2.3 m
10	3.8 m	3.8 m	7.3 m
100	12.0 m	12.0 m	23.0 m

For transmitters rated at a maximum output power not listed above, the recommended separation distance d in meters (m) can be estimated using the equation applicable to the frequency of the transmitter, where P is the maximum output power rating of the transmitter in watts (W) according to the transmitter manufacturer.

NOTE: At 80 MHz and 800 MHz, the separation distance for the higher frequency range applies.

NOTE: These guidelines may not apply in all situations. Electromagnetic propagation is affected by absorption and reflection from structures, objects, and people.

6. GENERAL CARE AND MAINTENANCE

Precautions

- Power off the patient monitor before inspecting or cleaning.
- Protect the patient monitor from liquids.
- Never immerse the patient monitor in water.
- Do not drop the patient monitor or subject to shock and/or vibration.
- Do not use organic solvents, ammonia-based solutions, or abrasive cleaning agents that may damage equipment surfaces.

Inspection

Inspect your equipment daily prior to clinical operation. Do not use the equipment and contact an authorized service representative for servicing if there are concerns about integrity of the system.

- Verify that all cords and connectors are securely seated.
- Check the case and chassis for any visible damage.
- Inspect cables, cords, and connectors for any visible damage.
- Inspect keys and controls for proper function and appearance.
- Check for neat and well balanced screen images.
- Inspect patient accessories such as cuffs, sensors, and wires for any visual damage.
- Ensure that auditory and visual alarms are available and working appropriately.

Cleaning

The following section provides information on proper cleaning directions for the Surveyor patient monitor and patient accessories. Accessories should be cleaned before they are applied to a new patient. The patient monitor should be cleaned as per facility standard of care. Before cleaning, please refer to the cautions listed below.



CAUTION: Always disconnect the Surveyor patient monitor from AC (wall) mains power before cleaning.



CAUTION: Do not use harsh chemicals for cleaning. Do not use disinfectants that contain phenol as they can spot plastics. Do not steam autoclave, gas sterilize, irradiate, subject to intense vacuum, or immerse in water or cleaning solution. Be careful to avoid getting cleaning liquids into connectors or the patient monitor. If this occurs, allow the patient monitor to dry in warm air for 2 hours, then check to make sure all monitoring functions are working properly.



CAUTION: Take particular care when cleaning the NIBP cuff, NIBP hose, and NIBP connector on the Surveyor patient monitor to prevent fluid from entering the connectors or cuff. Fluid in the NIBP system may affect blood pressure determination accuracy and damage the monitor.



CAUTION: Keep the patient accessories off of the floor. Accessories that fall on the floor should be inspected for defects, contamination, proper functionality, and cleaned or discarded according to the approved recommendations.



CAUTION: The user has the responsibility to validate any deviations from the recommended method of cleaning and disinfection.

GENERAL CARE AND MAINTENANCE	
Touch screen Display	<p><u>Approved Cleaning Agents</u></p> <ul style="list-style-type: none"> • Clean the touch screen with a soft cloth moistened with either a solution of 70% isopropyl alcohol in distilled water or soapy water. <p>Do not spray cleaner directly onto the touch screen. Spray the cleaner onto a lint-free cloth and then wipe the monitor.</p> <p>To clean the touch screen display,</p> <ol style="list-style-type: none"> 1. Select the Settings sidebar button. 2. Select the Administrative menu. 3. Select the Screen Cleaning mode. This action disables the monitor’s touch screen for 15 seconds for cleaning purposes. After the 15 seconds expires, the touch screen controls are reactivated.
ECG Cables TEMP Cable SpO2 Cable NIBP Hose External Power Supply Power Cord	<p><u>Approved Cleaning Agents</u></p> <ul style="list-style-type: none"> • Enzymatic detergent such as ENZOL (US) or CIDEZYME (outside the US) • Distilled water • Disinfectant solution (such as CIDEX OPA, or a 10% solution of household bleach (5.25% sodium hypochlorite) in distilled water) • Soft, lint-free cloths and/or soft-bristled brushes • Protective gloves and eyewear <p><u>Procedure</u></p> <ol style="list-style-type: none"> 1. Disconnect the patient monitor from the wall outlet. 2. Put on gloves and protective eyewear. 3. Prepare the enzymatic detergent according to the manufacturer's instructions, and also the disinfectant solution, in separate containers. 4. Apply detergent to product using a soft, lint-free cloth. If material is dried on, allow to sit for 1 minute. Do not immerse cable ends or lead wires in liquid as it can cause corrosion. 5. Wipe smooth surfaces with the cloth. 6. Use a soft-bristle brush on visibly soiled areas and irregular surfaces. 7. Remove detergent from product using cloth dampened in distilled water. 8. Repeat as necessary. 9. Apply disinfectant solution on affected area using a soft cloth. Allow product to sit for 5 minutes. 10. Wipe excess solution and clean product again with cloth dampened in distilled water. 11. Allow 2 hours for drying.

Reusable NIBP Cuffs	<p><u>Approved Cleaning Agents</u></p> <ul style="list-style-type: none"> • Mild detergent and water • Non-chlorine bleach <p><u>Procedure</u></p> <ol style="list-style-type: none"> 1. Prior to washing, remove any internal cuff bladders and engage the Velcro hook and loop fasteners to prevent lint from collecting in the hooks. 2. For general cleaning of cuffs, use a soft, lint-free cloth lightly moistened with a mild soap and water solution. Be careful not to get liquid inside the tubes. Allow to air dry. 3. For excessive perspiration marks or odor, the exterior of the cuff can be hand-washed under running water with a mild detergent. Do not allow water to enter the cuff. Allow to air dry. 4. If required, the use of non-chlorine bleach is acceptable. Using chlorine bleach solutions will shorten the service life of the cuff. 5. Sterilize the cuff using commercially available disinfectants. Using dark colored disinfectants may stain the cuff material. Test a single cuff to ensure that no damage or staining occurs. Follow the manufacturer's instructions. Thoroughly rinse each component to remove any residual disinfectants. Once cleaned, wash off all disinfectant material using a cloth dampened with a mild detergent. Failure to remove disinfectants may lead to mild skin irritation on some patients. Allow the components to air dry for a minimum of 2 hours. 6. Cuffs may be sterilized with Ethylene Oxide. Do not autoclave or iron the cuff as the hook and loop fasteners will melt at temperatures above 325°F (162°C). 7. Use caution with excess liquid. 8. Do not use excessive drying techniques such as forced heat. 9. Prevent liquid from penetrating the cuff and do not attempt to clean/disinfect the cuff by submerging into liquid, autoclaving, or steam cleaning.
SpO2 Reusable Sensor	<p><u>Approved Cleaning Agents</u></p> <ul style="list-style-type: none"> • 70% isopropyl alcohol <p><u>Procedure</u></p> <ol style="list-style-type: none"> 1. Remove sensor from patient and disconnect from sensor cable. Wipe off with alcohol pad. 2. Allow sensor to dry before placing it on a patient.
Disposable: SpO2 Sensors Temperature Probes CO2 Lines	<p>These items are intended for use with a single-patient and must be properly disposed of after use. Refer to the sensor/probe manufacturer instructions for further details.</p>

Disposal

This product and its accessories must be disposed of according to the local laws and regulations. Do not dispose of this product as unsorted municipal waste. For more specific disposal information see www.welchallyn.com/weee.

Maintenance

The following table shows the recommended maintenance procedures for the Surveyor patient monitor and its accessories. The Surveyor S12 and S19 patient monitors should be serviced and calibrated once a year by a Welch Allyn authorized service technician. However, it is good practice to periodically ensure the patient monitor is in proper working order. Perform these checks at least every 12 months by a qualified biomedical engineer or other trained service personnel. To accomplish these steps in their entirety and verify the correct operation of the system, appropriate patient simulators or other equipment may be required.

Functionality	Procedure
Mechanical Integrity	Check for cracks, abrasive edges and other signs of damage.
Power LED	Verify that the green power LED is illuminated when the patient monitor is ON or charging.
Speaker	Power-cycle the Surveyor patient monitor and verify that the power-up speaker test tones are generated.
Second Speaker	Power-cycle the Surveyor patient monitor and verify that the power-up second speaker test tones are generated.
ECG / Respiration	<ul style="list-style-type: none"> • Connect ECG leads to Patient Simulator. • Verify proper heart rate at 30 and 300 bpm (+/- 2 bpm or +/- 1%). • Verify 1 mV test pulse (Lead II). • Verify proper respiration rate at 15 and 120 bpm (+/- 3 bpm).
SpO ₂	<ul style="list-style-type: none"> • Connect to Patient Simulator (select appropriate sensor type). • Verify proper SpO₂ value at 84% and 96% (+/- 2%). • Verify proper PR value at 30 and 240 bpm (+/- 5%).
CO ₂	<p>NOTE: Use only certified calibration gas apparatus [See “CO₂ Calibration” section below] that has not reached its expiration date. This cal gas can be applied to the Surveyor patient monitor in pulses that simulate patient breaths.</p> <ol style="list-style-type: none"> 1. NOTE: Between calibrations, the ETCO₂ performance parameters and tolerance can be verified as needed as well as during preventive maintenance. The calibration gas should be applied to the Surveyor patient monitor in pulses of 5 seconds on and 5 seconds off, to simulate patient breaths of 5-6 RR. Continue long enough for the ETCO₂ to stabilize in both inhale and exhale states. The ETCO₂ value should read 38 ± 2 mmHg. The FICO₂ value should read 0 ± 2 mmHg and a ± 0.05 correction factor for every 100 mmHg ambient pressure above or below sea level, respectively. Connect an Oridion Microstream FilterLine single-use capnography sample line to the Surveyor monitor’s gas inlet port. 2. Connect with a tight fit, the other end of the Oridion sample line to one of the two open ports on the Cal Gas tubing apparatus. 3. Pulse the calibration gas actuator, holding it depressed for 5 seconds and released for 5 seconds (5-6 RR). This will allow enough time for the ETCO₂ to stabilize in both inhaled and exhaled states. 4. Verify that the EtCO₂ value reads the CO₂ concentration stated on the canister \pm the accuracy tolerance stated in the product specifications. 5. Verify the FiCO₂ value reads 0 ± 2 mmHg. <p>NOTE: Factor a ± 0.05 correction for every 100mmHg of ambient barometric pressure above or below sea level respectively.</p> <p>NOTE: The monitor should be returned to the manufacturer for periodic servicing of the CO₂ system after 30,000 hours of CO₂ use.</p>

Functionality	Procedure
NIBP	<p>NOTE: Do not allow system to remain pressurized and stable below 20 mmHg. The monitor will remove this pressure as a zero offset and this will affect the validity of the calibration check.</p> <p>NOTE: The following are required to perform this test: NIBP simulator or sphygmomanometer along with a Y-cable and a hand inflation bulb.</p> <p>Pressure Accuracy Test: Via the Service settings, put the NIBP in to calibration mode. Set the pressure to 25 mmHg and 225 mmHg respectively and verify that the pressure values reported by the Surveyor patient monitor matches (± 2 mmHg) of that reported on the simulator or sphygmomanometer. Release pressure.</p> <p>Overpressure Test: Inflate cuff to 300 mmHg. Verify that the pressure is automatically dumped at 300 +/- 30 mmHg.</p> <p>Leak Test: Inflate a cuff to 150 mmHg. Allow cuff pressure to settle (thermal effect). Verify that the pressure drops less than 4 mmHg in 1 minute. Verify that the pressure is automatically dumped after 180 seconds.</p> <p>Set the NIBP back to normal mode. Power cycle the monitor.</p> <p>Measurement Accuracy Test: Connect to Patient Simulator and take a NIBP measurement. Verify proper NIBP value at 120/80 (+/- 5 mmHg).</p>
Invasive Pressures (P1-P4)	<ul style="list-style-type: none"> • Connect static pressure sources at 20 and later at 100 mmHg to IBP sensors P1-P4. Verify correct pressure is displayed for each (+/- 2mmHg). • Connect a patient simulator with dynamic IBP waveform for radial artery of 120/80. • Verify correct pressure waveform and values are displayed (+/- 2 mmHg).
Temperature	None (self-checking).

Safety Testing

If the monitor housing was opened for repair or inspection work, the following safety tests should be performed in accordance with the IEC 60601-1 or IEC 62353 methods and limits.

The S12 and S19 are considered a Class 1 Type CF devices, intended to be utilized with the Welch Allyn specified patient modules and product accessories.

DC Hi-pot Testing

Applies to all of the following optional patient inputs (applied parts) installed on the monitor being tested. Test connectors are required to properly connect test equipment to the applied part inputs to perform Hi-pot testing. The negative (black) connection of the tester should be connected to the DC Power Input via TF0571 (or equivalent). The positive (red) lead wire is connected to the connection defined below.

The ECG input should be tested separately, and the other applied parts (SpO2, Temp, CO) can be connected together via a shorting bar (as shown in the diagram below) to expedite the testing process. *This is not a requirement and the tests can be performed separately.*

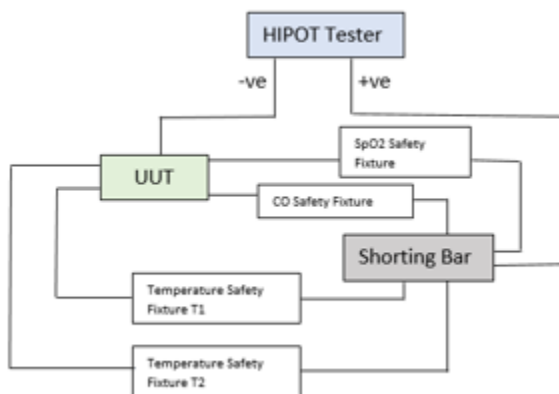

Connection	Test Connector/Method
ECG	Patient cable 9293-050-60 and shorting bar
SpO2	TF0281
Temp 1, Temp 2	TF0559
Cardiac Output	TF0558

Item	Value	Unit of Measure	Boundary
Applied Potential	5000	Volts DC	Minimum
Ramp Time	3.0	Seconds	Minimum
Dwell Time	1.0	Seconds	Minimum
Current High	0.500 (500 uA)	mA	Maximum
Current Low	0.0	mA	Minimum

Nurse call / Ethernet Test: The ports on the back of the device (nurse call/ethernet) are tested at a different voltage as defined below. The negative (black) connection of the tester should be connected to the DC Power Input via TF0571 (or equivalent). The positive (red) lead wire is connected to TF0570.

Connection	Test Connector/Method
Nurse Call/Ethernet	TF0570

Item	Value	Unit of Measure	Boundary
Applied Potential	1000	Volts DC	Minimum
Ramp Time	3.0	Seconds	Minimum
Dwell Time	1.0	Seconds	Minimum
Current High	0.500 (500 uA)	mA	Maximum
Current Low	0.0	mA	Minimum

AC Hi-pot Testing

Applies to all of the following optional patient inputs (applied parts) installed on the monitor being tested. Test connectors are required to properly connect test equipment to the applied part inputs to perform Hi-pot testing. The negative (black) connection of the tester should be connected to both the Line and Neutral on the AC side of the external AC/DC Power Module (Item # 4101-012), typically by utilizing tool TF-0107. The positive (red) lead wire is connected to the connection defined below.

The ECG input should be tested separately, and the other applied parts (SpO₂, Temp, CO) can be connected together via a shorting bar (as shown in the diagram below) to expedite the testing process. *This is not a requirement and the tests can be performed separately.*

Connection	Test Connector/Method
ECG	Patient cable 9293-050-60 and shorting bar
SpO ₂	TF0281
Temp 1, Temp 2	TF0559
Cardiac Output	TF0558

Item	Value	Unit of Measure	Boundary
Applied Potential	3000	Volts AC	Minimum
Ramp Time	3.0	Seconds	Minimum
Dwell Time	1.0	Seconds	Minimum
Current High	0.500 (500 uA)	mA	Maximum
Current Low	0.0	mA	Minimum

For Brazil testing, dwell time is increased to 60 seconds.

ECG Input Connection Diagram:

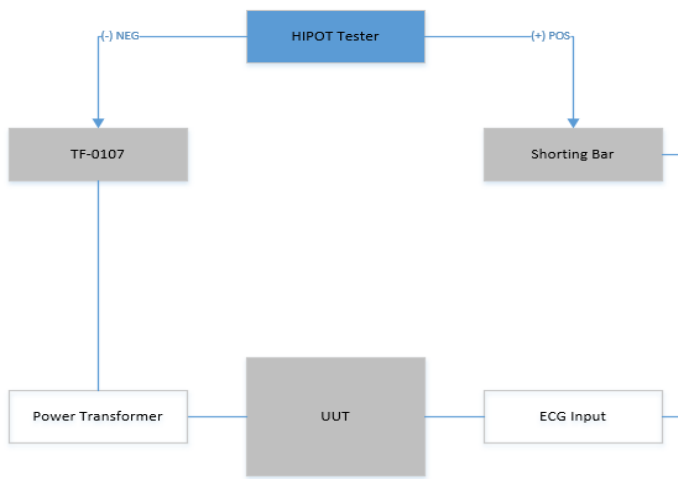

Applied Part Connection Diagram:

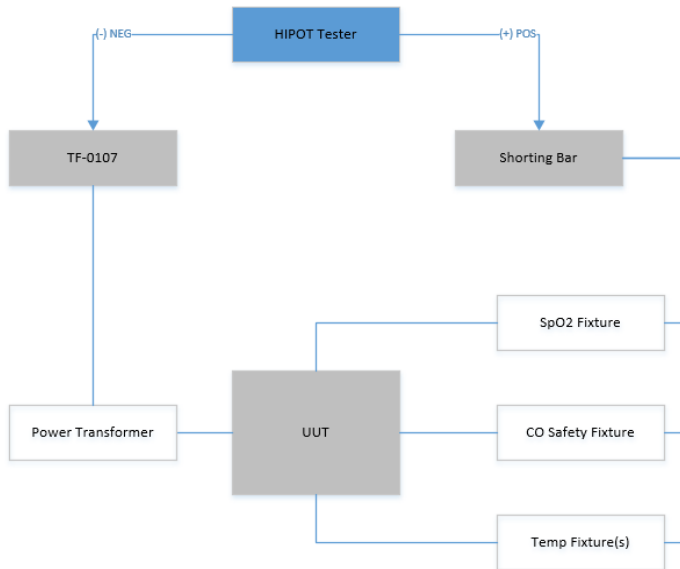
**Leakage Testing**

The factory External AC/DC Power Module (Item # 4101-012) and appropriate regional AC power cord should be used to perform the leakage tests defined below.

- Earth Leakage
- Enclosure Leakage
 - Non-conductive (fully insulated) chassis testing should be performed utilizing 200 cm² conductive foil or equivalent.
- Patient Leakage
 - Applied part – patient input (utilize Welch Allyn patient cable 9293-050-60 or -61)
- Patient Leakage (mains on applied part)
 - Applied part – patient input (utilize Welch Allyn patient cable 9293-050-60 or -61)

Battery Replacement



CAUTION: The battery should be removed from the monitor if the monitor is to be stored for an extended period of time.

The battery may need to be replaced if it is no longer holding a charge. Under optimum conditions, the battery lifetime is approximately two years. Replacing the battery should only be done by qualified service personnel.



WARNING: Use only APPROVED BATTERIES as listed in the Accessories section. Use of unapproved batteries may cause a hazard and will void the warranty.



CAUTION: Batteries should only be replaced by trained service personnel.

To replace the battery:

1. Obtain a replacement battery from Welch Allyn (see Accessories section for part number).
2. Power-off the Surveyor patient monitor.
3. On the back of the Surveyor patient monitor, disconnect the external power supply from the monitor.
4. Remove the battery cover with the VESA mounting plate by removing the four screws holding the cover as shown in the picture below.
5. Remove the battery by pulling on the top side of the battery as shown in Figure 1.
6. Insert new battery ensuring that the connector is properly engaged.
7. Carefully reinstall back cover and screws.
8. Properly dispose of the old battery (see Disposal section).

Figure 1 Battery Replacement



Battery Life and Charge Time

Estimated Battery Life

S12: 3 hours*

S19: 2 hours*

*Fully charged new batteries at 25 °C for the following conditions: continuous ECG and SpO₂, as well as NIBP measurements at every 15 minute interval.

Estimated Battery Charge Time

When OFF, 5 hours

When ON, S12: 7 hours

When ON, S19: 20 hours

Battery Conditions

When the Surveyor S12 and S19 monitor's battery has less than 5 minutes of power remaining, the battery icon flashes, a battery alert message displays, and an audio technical tone is sounded.

When the battery power is too low to continue normal operation, the Surveyor S12 and S19 monitor's screen clears, a Battery Nearly Depleted message displays in the center of the screen, and monitoring is discontinued. When AC power is restored, the battery begins the recharge process and monitoring can resume once the clinician has powered on the monitor.

Decommissioning and Disposal

Dispose of the patient monitor, its components and accessories (e.g., batteries, cables, electrodes), and/or packing materials in accordance with local regulations. Do NOT incinerate or throw the battery in garbage.

Calibration

Welch Allyn recommends Surveyor S12 and S19 patient monitors be serviced annually by an authorized service technician.

Please read the calibration section in its entirety before beginning service.

CO2 Calibration

The CO2 module is calibrated by the manufacturer, therefore a new patient monitor can be put into clinical use without the need of calibration. The Surveyor patient monitor displays a "CO2 Calibration Due" message when the manufacturer's suggested number of operating hours has been reached. In the first calibration cycle, the CO2 module should be calibrated after 1200 hours of use. Subsequent calibration cycles are alerted after 4000 hours of use. The number of hours until calibration is due may be found in the Surveyor patient monitor's event log, which is accessed via the "Administration – System – Show Event Log" menu.

NOTE: Calibration should be performed by a trained technician.

NOTE: Verify the calibration gas has not expired.

NOTE: After calibration, the device's next-calibration timer automatically resets to 4000 hours, unless the calibration was done prematurely (less than 720 hours after the last calibration), in which case it is reset to 1200 hours. It is therefore recommended to perform calibration only when the device has been displaying the "CO2 Calibration Due" message.

NOTE: Calibration of the CO2 module will require a calibrated gas mixture of 5% CO2, 21% O2, with the balance N2. The calibration kit available from Air Liquide (Scott Medical); Part Number T4653ORF-CD contains a canister of the above gas mixture, a T-piece connector and a Calibration Filterline.

To calibrate the CO2 module:

1. Prepare the gas apparatus by attaching the sample line to the calibration gas canister. Mate the shorter of the two orange connectors of the sample line with the clear connector found on the larger tubing, all supplied with the calibration kit. Verify that the gas apparatus is functioning properly by very briefly depressing the actuator and listening for gas expulsion. Set aside.
2. Power on the S12/19 device and verify the ETCO2 function is enabled by navigating through the following menus: Setup > Parameters > ETCO2 Enabled = Yes > OK > Close.
3. Connect the CO2 sampling line to the S12/19 device by inserting the orange connector into the Microstream receptacle and turning clockwise half a turn. Do not over tighten.
4. Navigate through the following menus: Setup > Administration > Service > Code Entry 53, 51, 54 > OK > Calibration.
5. Select Start CO2 Calibration on the screen while immediately depressing and holding the gas canister actuator/trigger for approximately 1 minute. The Surveyor patient monitor will display “CO2 Calibrating” at the bottom of the screen.
6. Once completed, the Surveyor patient monitor displays “CO2 Calibration Okay” or “CO2 Calibration Failed”.
7. If the calibration fails, determine the cause of the failure appropriate to the displayed error message given. Repeat the CO2 procedure. If the calibration is unsuccessful after 3 attempts, contact Welch Allyn Technical Support.
8. Upon successful completion, disconnect the calibration gas and hold the power button to power down the S12/19 device. It is not necessary to exit out of the calibration menus.
9. Turn monitor on and reconnect the CO2 sampling line to the S12/19 device in preparation for verifying ETCO2 performance is within specified tolerances.
10. Apply the calibration gas to the Surveyor patient monitor in pulses of 5 seconds on, 5 seconds off, to simulate patient breaths of 5-6 RR. Continue long enough for the ETCO2 to stabilize in both inhale and exhale states, or approximately 1.5-2 sweeps across the screen. The ETCO2 value should read 38 ± 2 mmHg. The FICO2 value should read 0 ± 2 mmHg and a ± 0.05 correction factor for every 100 mmHg ambient pressure above or below sea level, respectively.

Invasive Pressure Calibration

The Invasive Pressure interfaces are calibrated by the manufacturer therefore a new patient monitor can be put into clinical use without the need of calibration. Annual Invasive Pressure calibration is recommended after the first year of use.

In order to calibrate the Invasive Pressure interfaces, perform the following steps:

1. Connect a static pressure source, such as ambient air, to pressure transducer that is connected to the P1 invasive pressure interface.
2. Select “Start P1 Calibration” via the “Administration - Service – Calibration” screen (password required to access this screen).
3. Await “P1 Calibration OK” message, or similar if the interface is labeled something other than P1.
4. Repeat for interfaces P2 through P4.

NIBP Calibration

The NIBP module is calibrated by the manufacturer therefore a new patient monitor can be put into clinical use without the need of calibration. The accuracy of the NIBP pressure sensor and overall functionality of the NIBP interface can be verified as detailed in the Maintenance section in this manual. Based on the results of the verification testing, calibration may be required.

If further calibration is required, contact Welch Allyn Technical Support or your authorized service personnel.

S12/S19 Preventative Maintenance Record

Unit Serial #: _____

1.0 Mechanical Integrity

2.0 Device Cleaning

3.1 Functional Testing

Power LED	PASS / FAIL	(circle)
Speaker Test	PASS / FAIL	(circle)
Second Speaker Test	PASS / FAIL	(circle)
ECG/Respiration	PASS / FAIL	(circle)
SpO2	PASS / FAIL / N/A	(circle)
CO2	PASS / FAIL / N/A	(circle)
NIBP	PASS / FAIL / N/A	(circle)

Pressure Accuracy (+/- 2mmHg)	25, _____ mmHg	225, _____ mmHg
Overpressure	_____ mmHg	(300 +/- 30 mmHg)
Leak Test	_____ mmHg drop	(<4mmHg after 1 min)
Measurement Accuracy	_____/_____ mmHg	(monitor reading)

IBP (P1-P4)	PASS / FAIL / N/A	(circle)
Temperature	PASS / FAIL / N/A	(circle)

4.0 Calibration

CO2	Cal performed / Not performed	(circle one)
IBP (P1-P4)	Cal performed / Not performed	(circle one)
NIBP	Cal performed / Not performed	(circle one)

If calibration was performed, a second test record should be completed to verify proper operation.

5.0 Safety Testing

DC Hi-pot Testing (ECG and applied parts)	PASS / FAIL
DC Hi-pot Testing (nurse call/ethernet)	PASS / FAIL
AC Hi-pot Testing (ECG and applied parts)	PASS / FAIL
Leakage Testing (attach test report)	PASS / FAIL

Overall Testing Results PASS / FAIL (circle)

Performed by: _____ Date: ____/____/____

8. DEVICE SETUP

Overview

The Setup quick action key provides access to advanced functions such as arrhythmia settings, alarm settings, and other monitor configuration menus.

Example Setup Dialogue

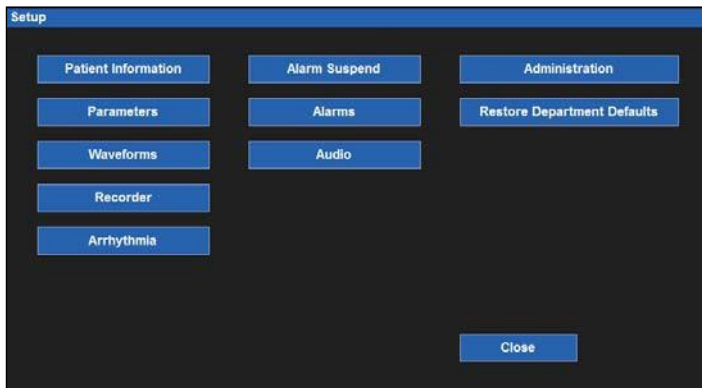

Patient Information

The Patient Information button provides access to the Patient Information dialogue. Access to this dialogue can also be obtained by selecting the black patient information area located above the system date and time.

Information that can be entered includes Last Name, Middle Initial, First Name, ID, Room number, Mode, Gender, Ethnicity, Date of Birth, Height and Weight.

Refer to the Patient Information dialogue section in this manual for further details.

To access the Patient Information dialogue from the Setup dialogue:

1. Select the Setup quick action key on the main screen to access the Setup dialogue.
2. Select the Patient Information button to access the Patient Information dialogue.

Parameters

The Setup Parameters dialogue is where the clinician can enable and disable the monitoring of certain parameters. Disabling a parameter removes that parameter from the patient monitor's main screen.

Example Setup Parameters Dialogue

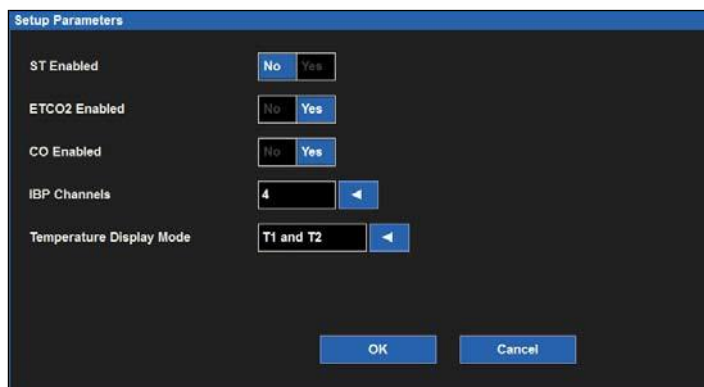

To enable/disable a parameter:

1. Select the Setup quick action key on the main screen to access the Setup dialogue.
2. Select the Parameters button to access the Setup Parameters dialogue.
3. Locate the parameter label.
4. For ST Enabled, ETCO2 Enabled, and CO Enabled:
 - a. Select Yes to enable the parameter.
 - b. Select No to disable the parameter.
5. For IBP Channels, select the arrow to display the drop-down list box:
 - a. Select 2 to enable P1 and P2.
 - b. Select 4 to enable P1, P2, P3, and P4.
 - c. Select None to disable all invasive pressure channels.
6. For Temperature Display Mode, select the arrow to display the drop-down list box:
 - a. Select T1 only to display only T1 on the main screen.
 - b. Select T1 and T2 to display both temperatures on the main screen.
 - c. Select T1 and L'T to display T1 and L'T on the main screen.
7. Select the OK button to enter that change OR select the Cancel button to cancel the changes.

Waveforms

The Setup Waveform Area dialogue is where the clinician can choose which waveforms are displayed on the main screen, the size of those waveforms, and the sweep speed of those waveforms. This dialogue is also where the clinician can choose to overlap the invasive pressures on the main screen.

Example Setup Waveform Area Dialogue

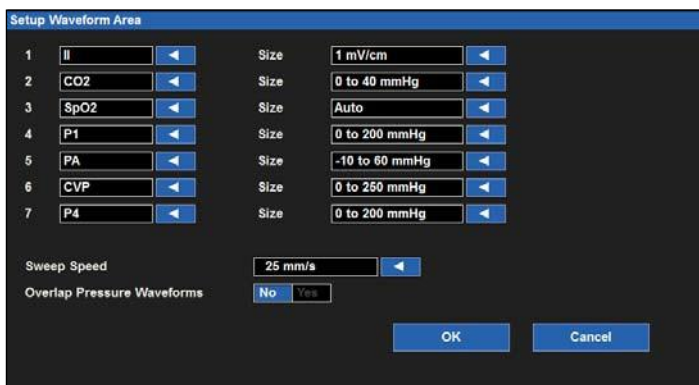

To select a waveform for display on the main screen:

1. Select the Setup quick action key on the main screen to access the Setup dialogue.
2. Select the Waveforms button to access the Setup Waveform Area dialogue.
3. The numbers 1-7 indicate waveform position on the main screen.
 - a. Waveform position #1 is always reserved for an ECG tracing.
 - b. Waveform positions #4-7 are always reserved for an invasive pressure tracing
 - c. The waveform selections are based on monitor options, ECG lead set, and the parameters that have been enabled/disabled in the Setup Parameters dialogue.
4. Choose the desired waveform position.
5. Select the arrow to display the drop-down list box of available waveform choices.
6. Select the OK button to enter that change OR select the Cancel button to cancel the changes.

To select a waveform size for display on the main screen:

1. Select the Setup quick action key on the main screen to access the Setup dialogue.
2. Select the Waveforms button to access the Setup Waveform Area dialogue.
3. Locate the Size label next to the parameter requiring adjustment.
4. Select the arrow to display the drop-down list box of available waveform size choices.
 - a. The choices available are based on the specific waveform parameter.
 - b. Select the desired waveform size.
5. Select the OK button to enter that change OR select the Cancel button to cancel the changes.

To select the sweep speed for waveforms displayed on the main screen:

1. Select the Setup quick action key on the main screen to access the Setup dialogue.
2. Select the Waveforms button to access the Setup Waveform Area dialogue.
3. Locate the Sweep Speed label.
4. Select the arrow to display the drop-down list box (Choices include 6.25 mm/s, 12 mm/s, and 25 mm/s).
5. Select the sweep speed desired.
6. Select the OK button to enter that change OR select the Cancel button to cancel the changes.

To enable/disable overlap invasive pressure waveforms:

1. Select the Setup quick action key on the main screen to access the Setup dialogue.
2. Select the Waveforms button to access the Setup Waveform Area dialogue.
3. Locate the Overlap Invasive Pressure label:
 - a. Select Yes to overlap all available invasive pressure.
 - b. The invasive pressures will occupy the space of four waveform slots.
 - c. The overlapped invasive pressure have independent waveform sizes.
 - d. Select No to keep the invasive pressure waveforms in separate waveform parameter tiles.
4. Select the OK button to enter that change OR select the Cancel button to cancel the changes.

Recorder

The Surveyor S12 and S19 patient monitors may have a two-channel thermal bedside recorder as a purchasable option. The Recorder dialogue provides configuration for which two waveforms print, the length of the recording strip, and the recording delay.

Example Setup Recorder Dialogue

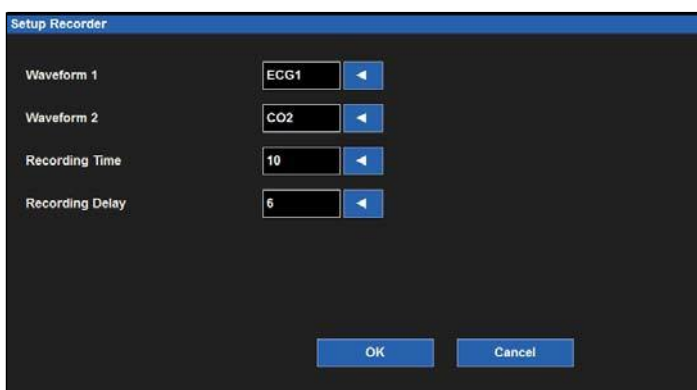

To select the two waveforms to print on the bedside recorder (optional):

1. Select the Setup quick action key on the main screen to access the Setup dialogue.
2. Select the Recorder button to access the Setup Recorder dialogue.
3. Locate the Waveform 1 (prints in top waveform position of the thermal recorder printout) label.
4. Locate the Waveform 2 (prints in the bottom waveform position of the thermal recorder printout) label.
5. Select the arrow to display the drop-down list box (Choices are dependent upon monitor configurations).
6. Select the waveform desired.
7. Select the OK button to enter that change OR select the Cancel button to cancel the changes.

To select the recording length to print on the bedside recorder (optional):

1. Select the Setup quick action key on the main screen to access the Setup dialogue.
2. Select the Recorder button to access the Setup Recorder dialogue.
3. Locate the Recording Time label.
4. Select the arrow to display the drop-down list box (Choices are 5 seconds, 10 seconds, and 16 seconds).
5. Select the recording time desired.
6. Select the OK button to enter that change OR select the Cancel button to cancel the changes.

To select the recording delay for the bedside recorder (optional):

1. Select the Setup quick action key on the main screen to access the Setup dialogue.
2. Select the Recorder button to access the Setup Recorder dialogue.
3. Locate the Recording Delay label.
4. Select the arrow to display the drop-down list box (Choices are 0 seconds, 6 seconds, and 10 seconds).
5. Select the recording delay desired.
6. Select the OK button to enter that change OR select the Cancel button to cancel the changes.

Arrhythmia

Setup Arrhythmia Dialogue

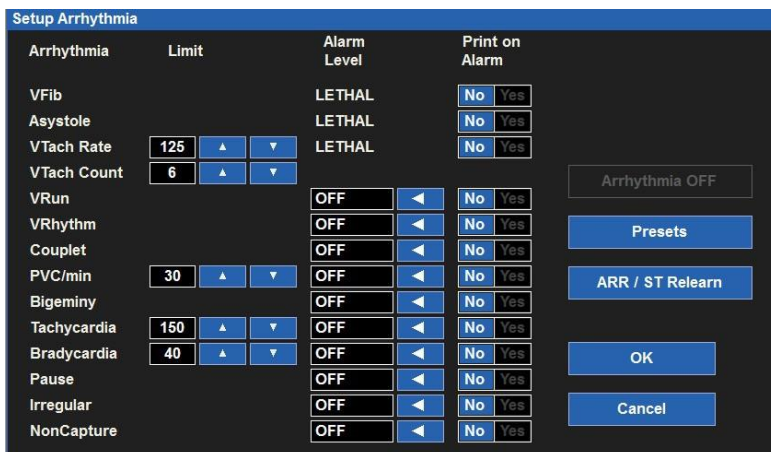

To adjust Arrhythmia alarm settings:

1. Select the Setup quick action key on the main screen.
2. Select the Arrhythmia button in the Setup menu.
3. Adjust the Arrhythmia alarm settings as desired.
 - a. To adjust the Alarm Level:
 - Locate the Alarm Level button.
 - Select the arrow to display the drop-down list box with choices.
 - Select the appropriate choice.
 - b. To adjust the Print on Alarm:
 - Locate the Print On Alarm button.
 - Select Yes to enable the Print On Alarm.
 - Select No to disable the Print On Alarm.
 - c. Select No to disable the Print On Alarm.
4. Select the OK button to enter that change OR select the Cancel button to cancel the changes.

VFib, Asystole and VTach may not be turned off in this dialogue, are only available as high level alarms, and are labeled as LETHAL.

To disable all the non-lethal arrhythmias with one action:

1. Select the Setup quick action key on the main screen.
2. Select the Arrhythmia button in the Setup menu.
3. Select the Arrhythmia OFF button.
4. This action disables all the non-lethal arrhythmia alarms.
5. To re-enable a non-lethal arrhythmia, select the individual non-lethal arrhythmia and configure.

Alarm Suspend

The ability to suspend all alarms is a configurable feature determined by the system administration and is protected behind a password in the Administration Setup Alarms dialogue. Contact the system administrator for further details.



WARNING: *IF this feature is enabled, suspending all alarms suspends ALL alarm conditions **including** the lethal arrhythmias (VFib, VTach, and Asystole). Use this feature with extreme caution as alarm checking is suspended for **all** alarm conditions **including** the lethal arrhythmias (VFib, VTach, and Asystole). Patients must be closely observed if all alarms are suspended.*

NOTE: *Follow hospital standard of care for the use of this feature. This feature is only intended to be used during end of life situations and only based on the hospital standard of care.*

NOTE: *This feature can be enabled/disable by the system administrator.*

When this feature is enabled, during an Alarm Suspend mode, an Alarm Suspend message appears in the messaging area of the main screen. Once the Alarm Suspend period ends the audio and visual alarm notifications automatically resume.

When this feature is enabled, to enter the All Alarms Suspended Mode and suspend **all** alarm notifications (**including VFib, Vtach, and Asystole**):

1. Select the Setup quick action key on the main screen.
2. Select the Alarm Suspend button in the Setup menu.
 - This displays the “Alarms Suspended” message in the message area on the main screen.
 - **ALL** alarms are now suspended including the lethal arrhythmias (VFib, Vtach, and Asystole).
3. Select the Close button to close the Setup menu.

When this feature is enabled, to exit the All Alarms Suspended Mode and resume alarm notifications:

1. Select the Setup quick action key on the main screen.
2. Select the Alarm Resume button in the Setup menu.
 - This removes the “Alarms Suspended” message in the message area on the main screen.
 - All configured alarms are now active.
3. Select the Close button to close the Setup menu.

Alarms

The Setup Alarms dialogue is where the clinician can make changes to several parameters are one time as opposed to making changes through each individual numeric parameter’s tile.

The Alarm section is pass code protected. The Pass code is:

- Dial 1 49
- Dial 2 48
- Dial 3 46

Example Setup Alarms Dialogue

	Lower Limit	Upper Limit	Alarms On	Print on Alarm
HR	50 ▲ ▼	120 ▲ ▼	Auto	No Yes
ETCO2	25 ▲ ▼	60 ▲ ▼	Auto	No Yes
RR	5 ▲ ▼	30 ▲ ▼	Auto	No Yes
FICO2		5 ▲ ▼	Auto	No Yes
IPI	4 ▲ ▼		Auto	No Yes
SpO2	90 ▲ ▼	100 ▲ ▼	Auto	No Yes

Previous Page Next Page OK Cancel

To adjust numeric parameter alarm settings:

1. Select the Setup quick action key on the main screen.
2. Select the Alarms button in the Setup menu.
3. Locate the numeric parameter to adjust. Select the Next Page button to scroll to see more numeric parameters (based on monitor configuration).
4. Adjust the numeric alarm settings as desired.
 - a. To adjust the Lower and High alarm limits:
 - Adjust the Lower alarm limit by selecting the up/down arrows to move the lower alarm limit box until the desired value is reached.
 - Adjust the Upper alarm limit by selecting the up/down arrows to move the upper alarm limit box until the desired value is reached.
 - b. To Auto adjust the alarm limit values:
 - Select the Auto button.
 - c. To adjust the Alarm On/Off:
 - Select Yes to enable that parameters' alarms.
 - Select No to disable that parameters' alarms.
 - The Alarm Off icon displays in that numeric parameter tile.



WARNING: Disabling the parameters' alarm limits means that NO low or high alarm conditions for that parameter will produce alarm notifications. Use this feature with extreme caution.

NOTE: The Lower Limit and Higher Limit windows in this dialogue may contain limit values but these alarms ARE disabled if that numeric parameters' Alarms on button is set to NO.

- d. To adjust the Print on Alarm:
 - Locate the Print On Alarm button.
 - Select Yes to enable the Print On Alarm.
 - Select No to disable the Print On Alarm.
5. Select the OK button to enter that change OR select the Cancel button to cancel the changes.

Audio

The Setup Audio dialogue is where the speaker volume and the HR/PR tone volume are configured. This area is also where the HR/PR systole beep tone can be enabled and disabled.

Example Setup Audio Dialogue

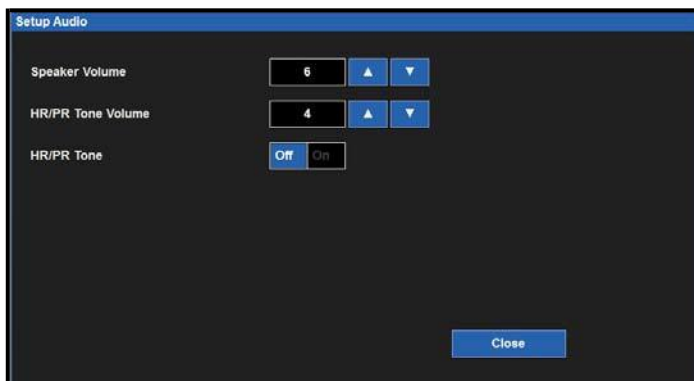

To adjust the speaker volume:

1. Select the Setup quick action key on the main screen.
2. Select the Audio button in the Setup menu.
3. Locate the Speaker Volume label.
4. The Speaker Volume choices are 1 to 10 in increments of 1.
 - a. Select the Up arrow to increase the speaker volume.
 - b. Select the Down arrow to lower the speaker volume.
 - c. As the volume is adjusted, an audible tone is played to indicate the volume of the speaker.
5. Select the OK button to enter that change OR select the Cancel button to cancel the changes.

To adjust the HR/PR systole beep tone volume:

1. Select the Setup quick action key on the main screen.
2. Select the Audio button in the Setup menu.
3. Locate the HR/PR Tone Volume label.
4. The HR/PR Tone Volume choices are 1 to 10 in increments of 1.
 - a. Select the Up arrow to increase the HR/PR systole beep volume.
 - b. Select the Down arrow to lower the HR/PR systole beep volume.
 - c. As the volume is adjusted, an audible tone is played to indicate the volume of the HR/PR systole beep.
5. Select the OK button to enter that change OR select the Cancel button to cancel the changes.

To enable/disable the HR/PR systole beep tone:

1. Select the Setup quick action key on the main screen.
2. Select the Audio button in the Setup menu.
3. Locate the HR/PR Tone label.
 - a. Select Yes to enable the HR/PR systole beep tone.
 - b. Select No to disable the HR/PR systole beep tone.
4. Select the OK button to enter that change OR select the Cancel button to cancel the changes.

Restore Departmental Defaults

Restore Departmental Defaults

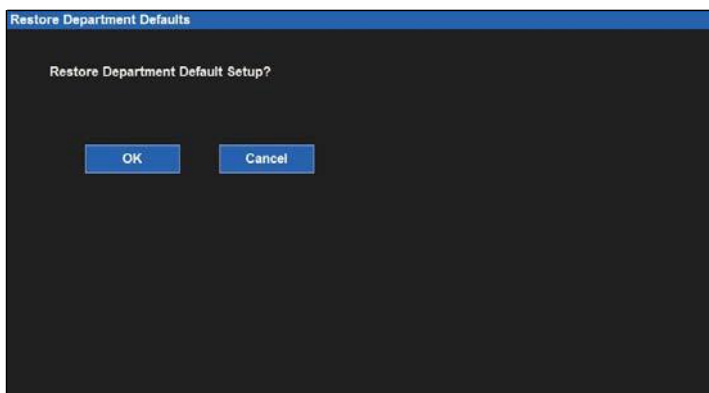

To restore the patient monitor back to the departmental default configuration:

1. Select the Setup quick action key on the main screen to access the Setup dialogue.
2. Select the Restore Departmental Defaults button.
3. Select the OK button to enter OR select the Cancel button to cancel the changes.

Administration

The Administration dialogue contains service and configuration related functions. The functions located on the left of this dialogue do not require a password. The functions located on the right of this dialogue are password-protected. Contact the system administration for further details.

Example Administration Dialogue

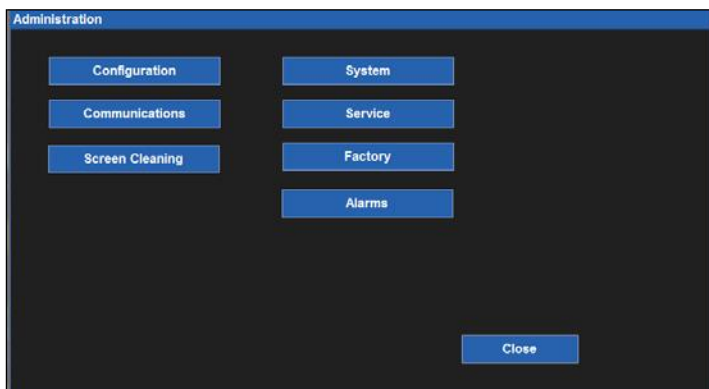

Configuration

Selecting this item displays the setup of this Surveyor including its serial number, Ethernet MAC address, internal software version as well as those of accessories and modules integrated with this system. There are no configuration options here but this information is helpful for service personnel when analyzing the system for issues.

Example Setup Configuration Dialogue

Setup Configuration	
Serial number	PFD1010
Ethernet MAC	
MAIN	1.0.555 X Jul 11 2012
PRESS	--
ACQUIRE	--
ECGACQ	--
CF	--
ZAC	1.0
SpO2	
CO2	
Recorder	

Close

Communications

Use this dialogue to configure the communication parameters of the Surveyor including the Bed ID, Unit ID as well as the network parameters for both the Surveyor Central and this Surveyor patient monitor. This information is typically defined by authorized installation and service personnel.

The communications are pass code protected. The pass code is:

Dial 1	53
Dial 2	51
Dial 3	54

Specific configuration parameters include:

- Bed ID and Unit ID for interfacing with Surveyor Central.
- TCP/IP network parameters including host name, IP address, and port number for Surveyor Central.
- Whether dynamic host control protocol (DHCP) is utilized by the Surveyor to obtain IP address information for the bedside monitor. If not, the user can define specific static IP addresses including IP address, subnet mask, gateway address and Domain Name System (DNS) address information.

Example Setup Communications Dialogue

Setup Communications			
Bed ID		Use DHCP	<input type="radio"/> No <input type="radio"/> Yes
Unit ID			
Central Host Name			
Central IP Address	10.0.1.10		
Central Port Number	5005		
IP Address	192.168.10.242		
Subnet	255.255.255.0		
Gateway	192.168.10.78		
DNS	192.168.10.78		

OK Cancel

Screen Cleaning

Based on the clinician's discretion, the bedside monitor's touch screen may require occasional cleaning. The touch screen may be cleaned with a soft, lint-free cloth and a non-abrasive, gentle cleaner such as plain soap and water. Avoid spraying cleaning agents directly onto the monitor's touch screen. Spray the cleaning agent onto the lint-free cloth first and then wipe the touch screen. Do not use any cleaning agents that may leave a film.

To clean the touch screen:

1. Select the Setup quick action key on the main screen to access the Setup dialogue.
2. Select the Administration button.
3. Select the Screen Cleaning button.
4. The "Screen Cleaning Mode" message displays in the alarm messaging area of the main screen.
5. During this 15 seconds, patient monitoring and alarm notifications continue.
6. After the 15 seconds has expired, the touch screen activates.

Administration Setup Alarms Dialogue

The Administration Setup Alarms dialogue is a pass code protected feature. The pass code is:

- Dial 1 49
- Dial 2 48
- Dial 3 46.

Administration Setup Alarms Dialogue

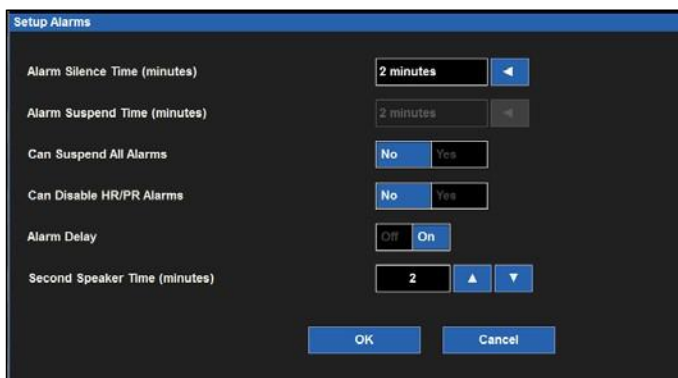

The screenshot shows the "Setup Alarms" dialogue box with the following settings:

Setting	Value
Alarm Silence Time (minutes)	2 minutes
Alarm Suspend Time (minutes)	2 minutes
Can Suspend All Alarms	No
Can Disable HR/PR Alarms	No
Alarm Delay	Off
Second Speaker Time (minutes)	2

Buttons: OK, Cancel

Alarm Silence Time

This setting controls the length of silence time for the Alarm Silence quick action key on the main screen. To select the Alarm Silence Time:

1. Select the Setup quick action key on the main screen to access the Setup dialogue.
2. Select the Administration button.
3. Select the Alarms button to access the Administration: Setup Alarms dialogue.
4. Locate the Alarm Silence Time label.
5. Select the arrow to display the drop-down list box (Choices are 1 minute, 1.5 minutes, 2 minutes, 5 minutes and 10 minutes).
6. Select the alarm silence time desired.
7. Select the OK button to enter that change OR select the Cancel button to cancel the changes.

Alarm Suspend Time

This setting controls the length of silence time for the Alarm Suspend function.

To select the Alarm Suspend Time:

1. Select the Setup quick action key on the main screen to access the Setup dialogue.
2. Select the Administration button.
3. Select the Alarms button to access the Administration: Setup Alarms dialogue.
4. Locate the Alarm Suspend Time label.
5. Select the arrow to display the drop-down list box (Choices are 1 minute, 1.5 minutes, 2 minutes, 5 minutes and 10 minutes).
6. Select the alarm silence time desired.
7. Select the OK button to enter that change OR select the Cancel button to cancel the changes.

Can Suspend All Alarms

This setting controls if the clinician has the ability to suspend all alarms including the lethal arrhythmias (Asystole, VTach, and VFib).

To configure:

1. Select the Setup quick action key on the main screen to access the Setup dialogue.
2. Select the Administration button.
3. Select the Alarms button to access the Administration: Setup Alarms dialogue.
4. Locate the Can Suspend All Alarms label.
 - a. Selecting Enabled means the clinician can suspend all alarms including the lethal arrhythmias.
 - b. Selecting Disabled means the clinician cannot disable all alarms. If this choice is selected, the Suspend All Alarms button will be hidden from the Setup dialogue.
5. Select the OK button to enter that change OR select the Cancel button to cancel the changes.

Can Disable HR/PR Alarms

This setting controls if the clinician has the ability to disable the HR/PR alarms.

To configure:

1. Select the Setup quick action key on the main screen to access the Setup dialogue.
2. Select the Administration button.
3. Select the Alarms button to access the Administration: Setup Alarms dialogue.
4. Locate the Can Disable HR/PR Alarms label.
 - a. Selecting Enabled means the clinician can disable the HR/PR alarms.
 - b. Selecting Disabled means the clinician cannot disable the HR/PR alarms.
5. Select the OK button to enter that change OR select the Cancel button to cancel the changes.

Alarm Delay

This setting determines if the monitor uses a delay before providing alarm notifications. This feature is intended to reduce erroneous alarm notifications.

To configure:

1. Select the Setup quick action key on the main screen to access the Setup dialogue.
2. Select the Administration button.
3. Select the Alarms button to access the Administration: Setup Alarms dialogue.
4. Locate the Alarm Delay label.
 - a. Select Yes to enable the alarm delay.
 - b. Select No to disable the alarm delay.
5. Select the OK button to enter that change OR select the Cancel button to cancel the changes.

If enabled, the alarm delay values are based on the specific parameter and as follows:

Parameter	Lower limit violation delay	Upper limit violation delay
HR, PR (from SpO2), PR (from IBP)	3 seconds	3 seconds
RR	5 seconds	5 seconds
Welch Allyn SpO2, Nellcor SpO2 (SatSeconds disabled)	10 seconds	10 seconds
IPI	10 seconds	0 seconds
Nellcor SpO2(SatSeconds enabled), all other parameters	0	0

Second Speaker Time (Minutes)

The Surveyor has a second speaker that provides additional audible notification when the initial audible alarm is not acknowledged and silenced. The second speaker begins sounding approximately 1 second after a pre-defined amount of time has passed if the initial alarm sound has not been silenced.

To configure the second speaker alarm time:

1. Select the Setup quick action key on the main screen to access the Setup dialogue.
2. Select the Administration button.
3. Select the Alarms button to access the Administration: Setup Alarms dialogue.
4. Locate the Second Speaker Time (Minutes) label.
 - Select the Up/Down arrow to rotate through the choices (Choices include 0 minutes, 1 minute, 2 minutes, and 3 minutes).
5. Select the OK button to enter that change OR select the Cancel button to cancel the changes.

Administration Setup System Dialogue

The System dialogue is a password protected area intended for use by service and system administrative personnel only. The Setup System dialogue is where the units of measure are configured for height, weight, and temperature. This dialogue is also used to configure the print location, set the date and time, and to save departmental default settings. Contact service or system administrator for further details.

The following table lists specific reports and where they may be printed based on system configuration.

Recording type	Prints at
Strip chart (initiated by pressing the Print soft key on monitor)	Print location setting (Bedside, Central, or both)
12 lead report	Print location setting (Bedside, Central, or both)
Alarm report	Print location setting (Bedside, Central, or both)
Trend report	Bedside
ST averages	Bedside

Administration Setup Service Dialogue

The Service dialogue is a password protected area intended for use by service and system administrative personnel only. The Setup Service dialogue is where the demonstration mode for simulated data on the patient monitor is enabled and disabled. This dialogue is also where the monitor settings can be transferred to and from a USB thumb stick when configuring multiple monitors. The monitor can be returned to the factory default configuration settings in this dialogue. Restore the factory defaults to the unit by tapping the “Setup” icon, select “Administration”, select “service” enter the passwords, Dial 1 = 53, Dial 2 = 51, Dial 3 =54. Press “OK”, tap the ‘Restore Factory Defaults’ icon and press “Ok”. You will see an on screen message that says “Please restart monitor for changes to take effect”. Power cycle the unit, and start a monitoring session with a new patient. If required, refer to S12/S19 User Manual, 9515-183-50-xxx for that process.

Administration Setup Factory Dialogue

The Factory dialogue is a password protected area intended for use by service and administrative personnel only. Contact service or system administrator for further details.

9. UNIT DISSASSEMBLY

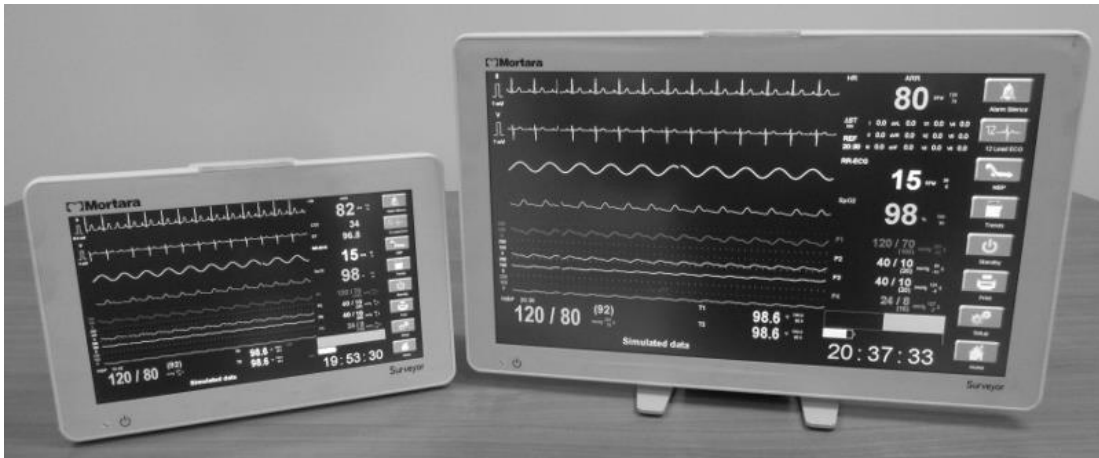

S12 and S19 Patient Monitors

Unit disassembly and repair activities are to be performed by Authorized Welch Allyn Service Representatives.

S12 Monitor

Mechanical Overview

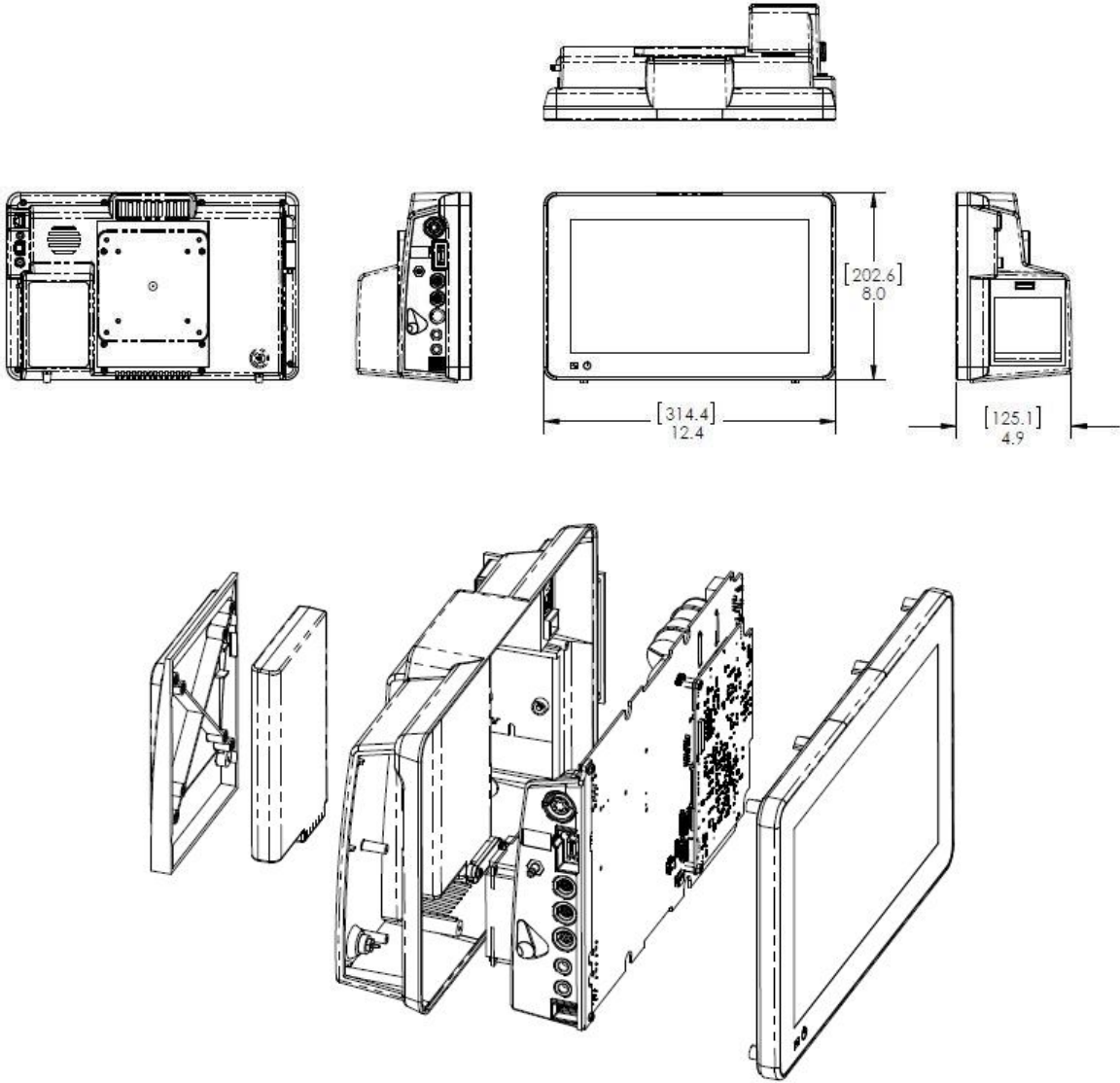

S19 Monitor

Mechanical Overview

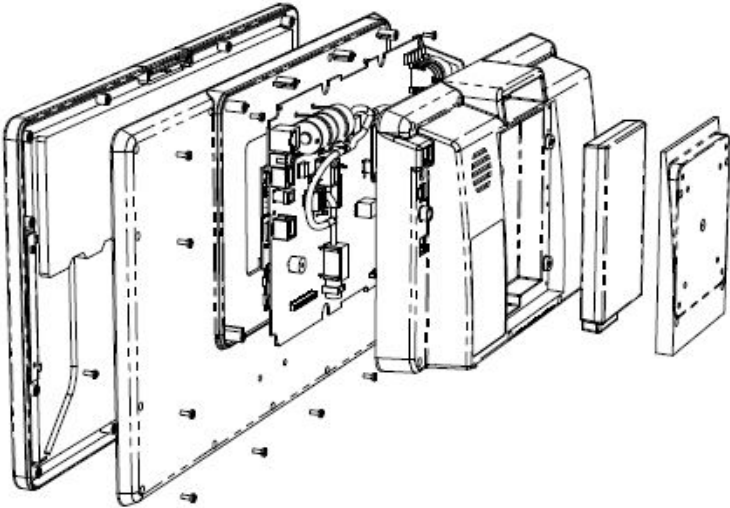
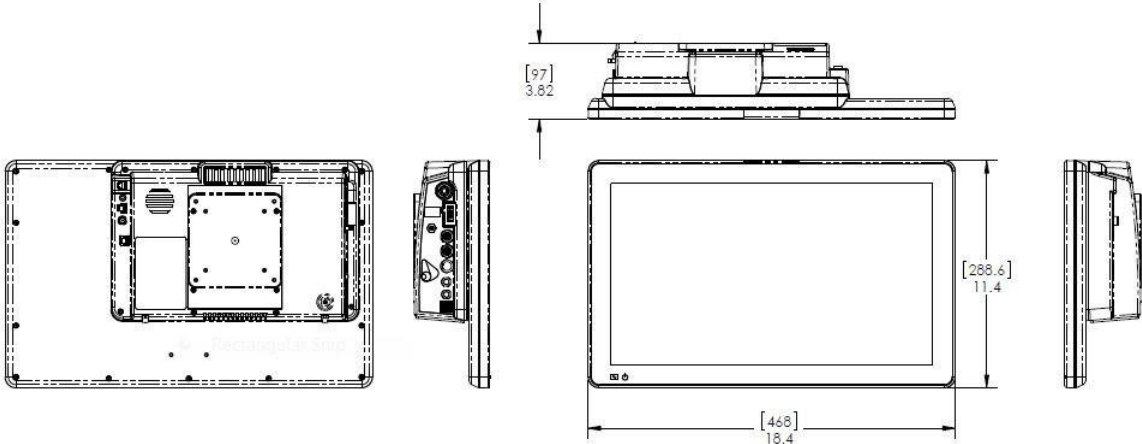

Battery Removal & Replacement

1. Dismount the unit and remove any mounting assembly on the unit.
2. Locate the 4 screws (item 11) that retain the battery door (Item 45) and remove them.

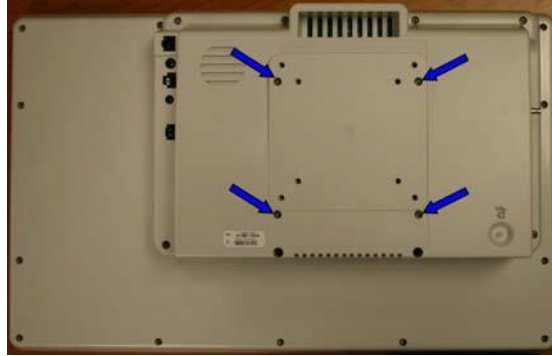

S19 picture above, the location of the screws on the S12 are identical.

3. Remove the battery door (Item 45) to access the battery (Item 7)



4. Turn the unit over to allow gravity releases the battery from the unit.
5. Install the battery in reverse order.

Rear Housing Removal & Replacement

1. Dismount the unit and remove any mounting assembly attached to the device.
2. Lay the unit face down on a flat surface with the top of the unit facing you (*S19 shown*).



3. Remove the battery (see Battery Removal and Replacement).
4. Locate the eight (8) mounting screws (Item 11) for the Rear Housing and remove them.

(S19 shown – locations are identical for the S12)



5. Once the screws are removed, carefully lift the Rear Housing assembly straight up approx 3 to 4 inches (7 to 10cm).

6. Locate the 4 wire cable to the Beacon board (closest cable to top of the unit, Item 36) and remove the cable from the connection to the main board.

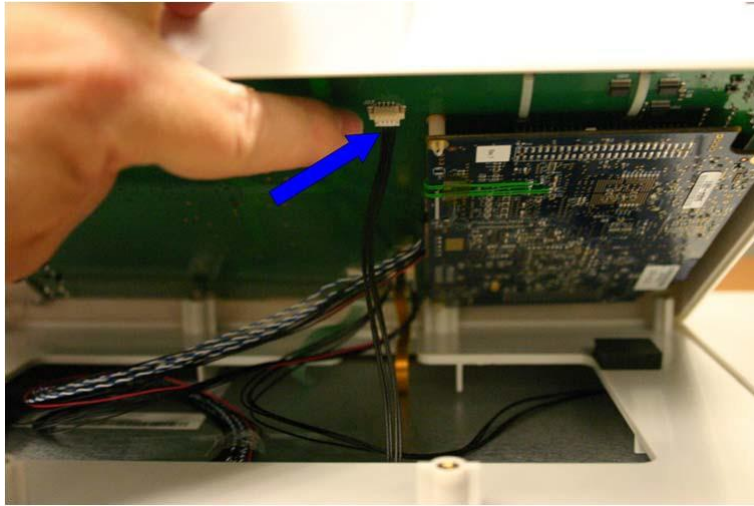

7. Once the Beacon Board cable is disconnected from the main board, the Rear Housing can be raised for easier access to the remaining cables.

Note: For the S12 monitor the Beacon Board and cable will now be loose and can be removed from the LCD housing.

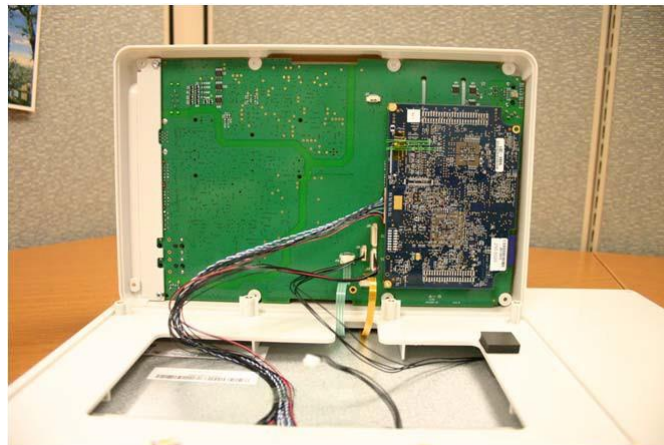

8. Remove the remaining cables form the circuit boards, noting the cable size and location.

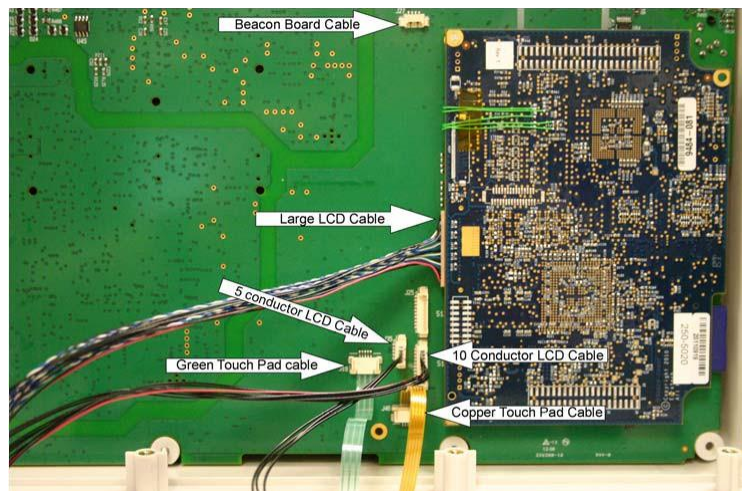

S19 Cable Connections

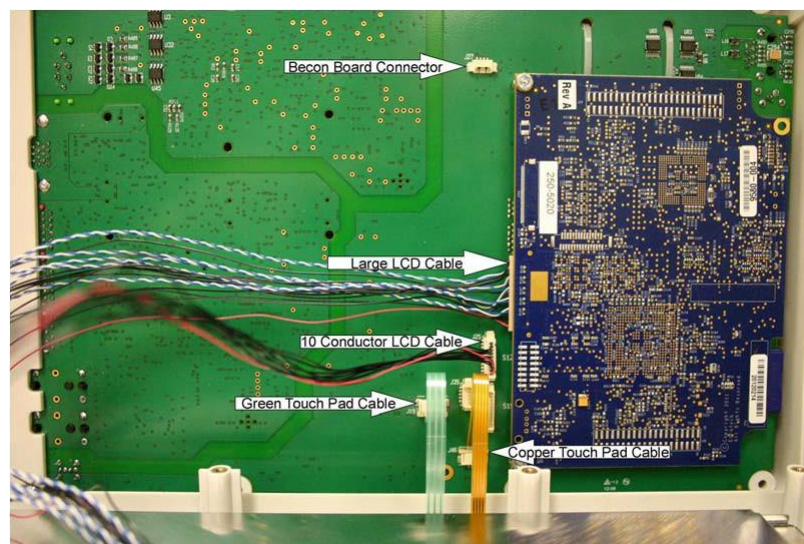

S12 Cable Connections

Table of Cable Connections

Unit	Cable	Board Connection	Item #
S12 & S19	Main LCD (large Cable)	Processor/Bitsy board connector JJ8	46
S12& S19	Beacon Board Cable	Main Board – J27	36
S12 & S19	Copper colored Touch Pad Cable	Main Board - J46	
S12 & S19	Green colored Touch Pad cable	Main Board – J46	
S19	Small LCD cable (5 conductor cable)	Main Board - J35	
S19	Large LCD cable (10 conductor cable)	Main Board - J18	
S12	Large LCD cable (10 conductor cable)	Main Board - J25	

Processor Board Removal & Replacement

1. With the battery and the Rear Housing removed locate the 2 nuts (Item 44) retaining the processor board (Item 41) to the Main Board and remove them.

NOTE: Earlier models used item 41a (S12/S19), later models used a Gen2 board 41b (S12) or 41c (S19). Refer to the item identification table for correct part number information.

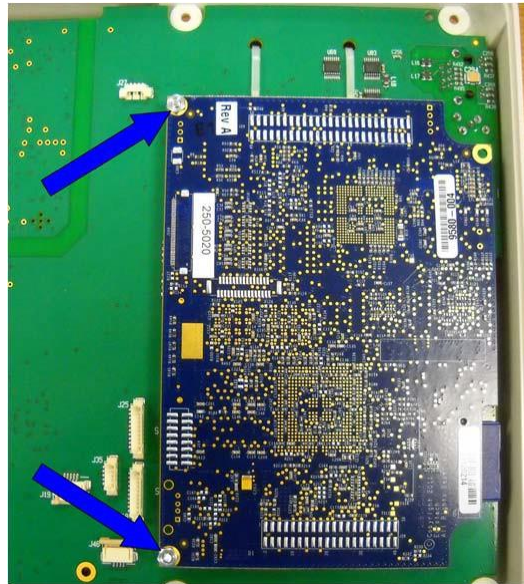

2. Lift gently straight up on both ends of the processor board (Item 41) as shown to remove the PCA from the two connector sockets on either end of the board.



3. Reassemble in reverse order

Main Board Removal & Replacement

If the main PCBA requires replacement, the conformance testing section will need to be performed. In addition, the unit serial number will need to be entered into system memory by navigating to the following password protected factory menu screen: Setup, Administration, Factory.

1. Locate the three (3) mounting screws and remove them. Item #10 for the two screws shown on the left and one item #9 screw shown on the right.

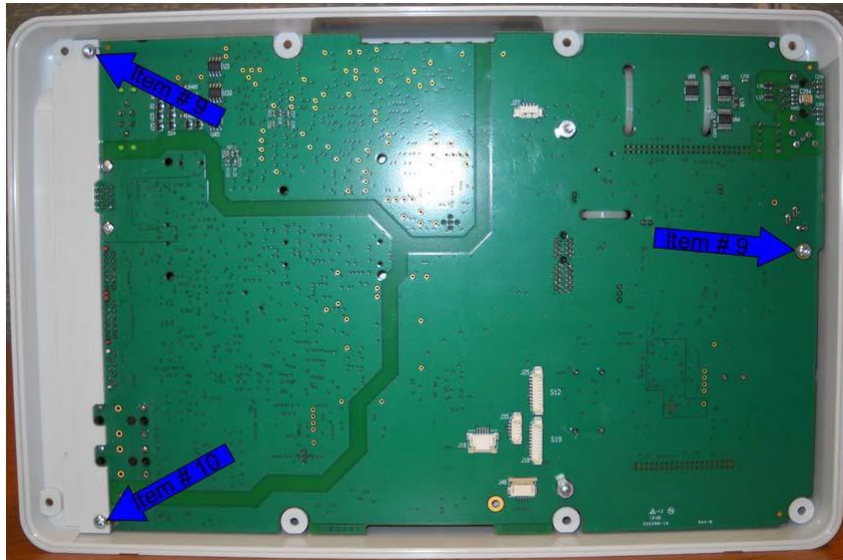

2. Gently lift up on the NIBP nozzle (item 34) to lift the board out of the Rear Housing



- Carefully lift the main board out of the Rear Housing, there will be at least 2 cables that will need to be removed, the Battery Interconnect Cable (Item 4) and the Speaker Cable (Item 1).

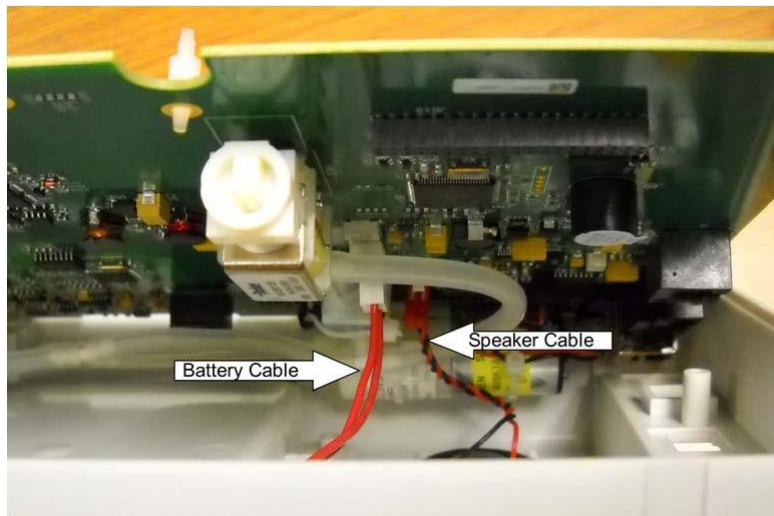

- Reach between the Rear Housing and the Main board and remove the Battery Interconnect Cable (Item 4) and Speaker Cables (Item 1).



NOTE: Earlier models used item 2a (GEN 1), later models used a Gen2 board item 2b. Refer to the item identification table for correct part number information.

Note - There may be other cables connected to the Main Board (based on the optional equipment) before it can be removed from the Rear Housing.

- Reassemble in reverse order



CAUTION: Ensure the hoses are not pinched during reassembly of the unit.

LCD Removal & Replacement S12

Please note that the LCD and front bezel for the S12 comes as a complete assembly (Item 23). If the LCD requires replacement Welch Allyn recommends replacing the entire assembly. If the LCD is OK, but the touch screen or bezel require replacement, Welch Allyn recommends replacing the Bezel/Touchscreen assembly (Item 25).

1. Remove the Rear Housing from the unit.
2. Locate the 4 screws holding the LCD to the front bezel and remove them.



3. Lift the LCD out of the Front bezel



LCD Removal & Replacement S19

Please note that the LCD and front bezel for the S19 comes as a complete assembly (Item 24). If the LCD requires replacement Welch Allyn recommends replacing the entire assembly. If the LCD is OK, but the touch screen or bezel require replacement, Welch Allyn recommends replacing the Bezel/Touchscreen assembly (Item 26).

1. Remove the Rear Housing from the unit.
2. Locate the 13 screws (Item 11) holding the Back LCD Bezel (Item 42) and remove them.

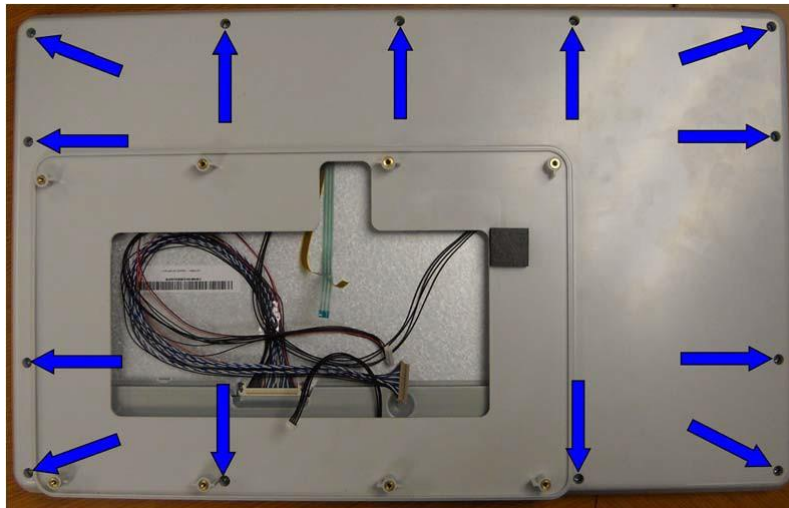

3. Lift the Back Bezel off the LCD assembly (no cables are attached)

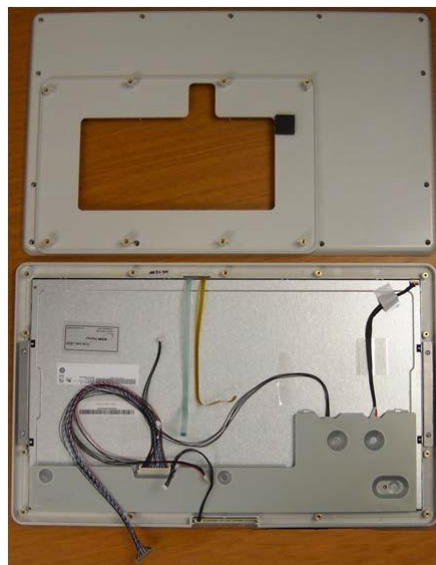

4. Locate the 4 screws that hold the LCD to the front LCD Bezel.

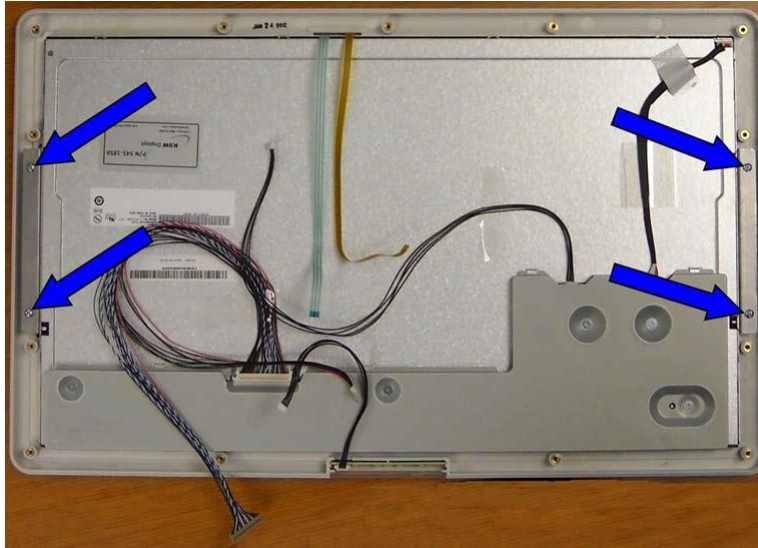

5. Lift the LCD out of the Front bezel

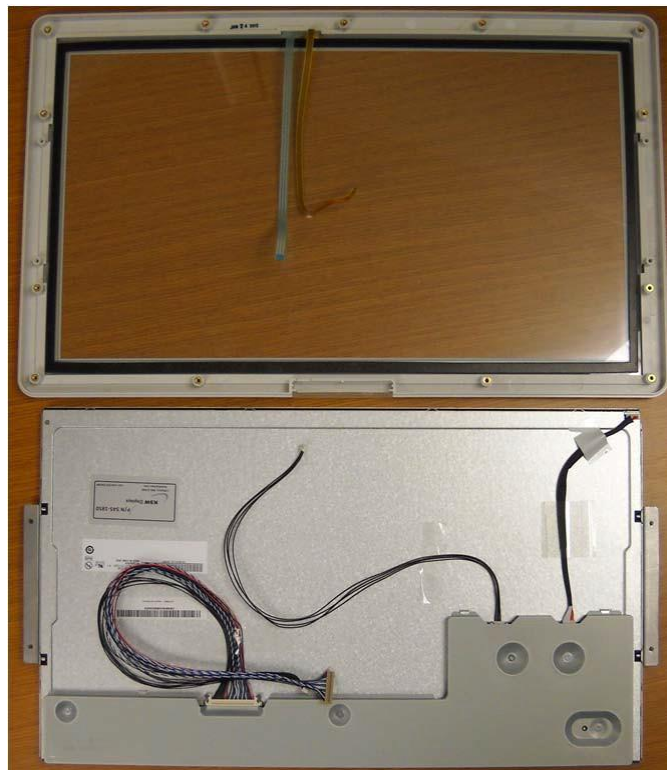

6. Reassemble in reverse order
Ensure that the cables do not get pinched when reassembling.

Removal and Replacement of the Optional Thermal Writer (S12 ONLY)



The S12 has an optional single channel thermal writer (Bedside Recorder, Item 8). S12 monitors with this option have a different Rear Housing however removal of the Rear Housing removal procedure is identical.

1. Open the writer door by sliding down the latch release button.



2. Remove the paper roll from the writer assembly.



3. Locate the mounting screws for the writer.

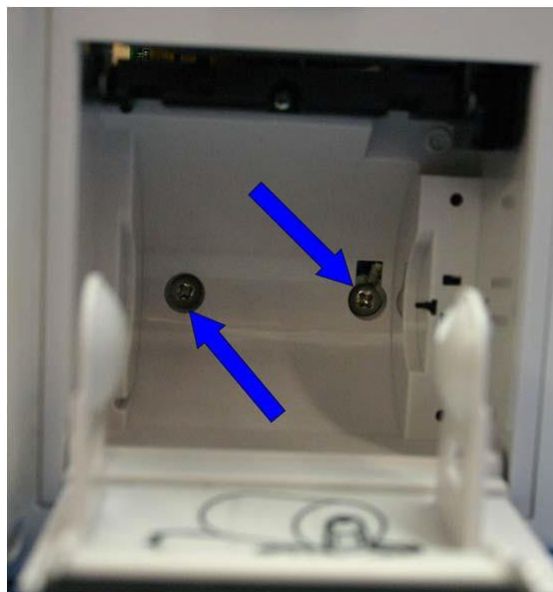

Note: These screws are captive screws and they will remain attached to the writer assembly.

1. Slide the writer (Item 8) out of the Rear Housing being careful of the attached data cable.



2. Follow the writer data cable into the unit to reach the snap in RJ45 connector. Remove the cable from the Main Board by unlatching the cable from the connector.

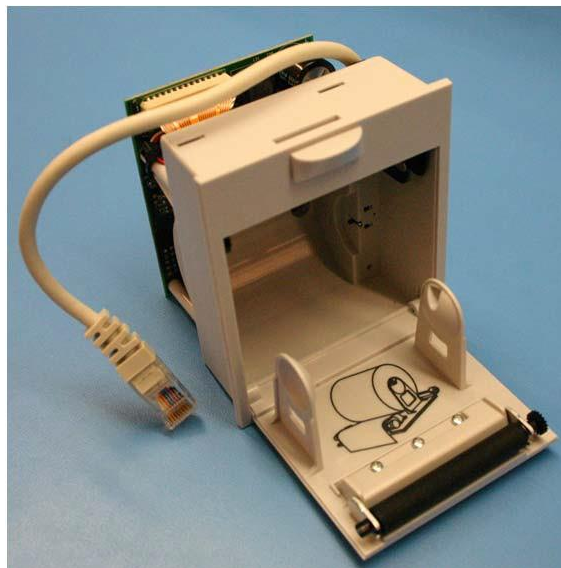

3. Reinstall the writer (Item 8) in the reverse order.

Note: The writer can also be removed by removing the Rear Housing and the main board. This method allows for easier access to the cable.



Optional Thermal Writer for the S19



The optional thermal writer for the S19 monitor comes as a completed assembly (Item 43). Service parts for this item are not sold separately.



The items listed in the S12/S19 Item Identification Table identify the serviceable level of the device.

Subcomponents of assemblies listed are not available as individual service items from Welch Allyn, the assembly level item must be used for servicing purposes.

S12/S19 Item Identification Table			
Item #	Part #	Description	Item
1	25020-053-53	SPEAKER LEADS & CONNECTOR ASSY	
2a	SERV-26025-115-150	SURVEYOR SpO2, 4IBP+CO, GEN 1, S12 PRINTER CONN	 (26025-115-61 pictured)
	SERV-26025-115-151	SURVEYOR SpO2, 4 IBP+CO, GEN1, S19 PRINTER CONN	
	SERV-26025-115-152	SURVEYOR SpO2, 4IBP+No CO, GEN 1, S12 PRINTER CONN	
	SERV-26025-115-153	SURVEYOR SpO2, 4 IBP+No CO, GEN 1, S19 PRINTER CONN	
	SERV-26025-115-160	OEM SpO2, 4 IBP+CO, GEN 1, S12 PRINTER CONN	
	SERV-26025-115-161	OEM SpO2, 4 IBP+CO, GEN 1, S19 PRINTER CONN	
	SERV-26025-115-162	OEM SpO2, 4 IBP+No CO, GEN 1, S12 PRINTER CONN	
	SERV-26025-115-163	OEM SpO2, 4 IBP+No CO, GEN 1, S19 PRINTER CONN	





2b	36025-155-150	SURVEYOR SpO2, 4IBP+CO, GEN 2, S12 PRINTER CONN	 <p>(36025-155-152 pictured)</p>
	36025-155-151	SURVEYOR SpO2, 4 IBP+CO, GEN 2, S19 PRINTER CONN	
	36025-155-152	SURVEYOR SpO2, 4IBP+No CO, GEN 2, S12 PRINTER CONN	
	36025-155-153	SURVEYOR SpO2, 4 IBP+No CO, GEN 2, S19 PRINTER CONN	
	36025-155-160	OEM SpO2, 4 IBP+CO, GEN 2, S12 PRINTER CONN	
	36025-155-161	OEM SpO2, 4 IBP+CO, GEN 2, S19 PRINTER CONN	
	36025-155-162	OEM SpO2, 4 IBP+No CO, GEN 2, S12 PRINTER CONN	
	36025-155-163	OEM SpO2, 4 IBP+No CO, S19, Gen 2, PRINTER CONN	
3	26025-116-151	BEACON BOARD PCB ASSY S12/S19	

S12/S19 Item Identification Table

Item #	Part #	Description	Item
4	26025-118-50	PCB ASSY BATTERY CONNECTOR & CABLE	
5	3181-008	POWER CORD US/CAN HOSPITAL 5-15P+320-C13	
6	4101-012	POWER SUPPLY 100-240VAC 15VDC 40W	
7	4800-017	BATTERY RECHARGEABLE LITHIUM ION	
8	5450-006-50	THERMAL PRINTER 50mm ROLL	
	SERV PART 183-01	S12/S19 PLATEN ROLLER ASSEMBLY (For use in 5450-006-50)	

S12/S19 Item Identification Table

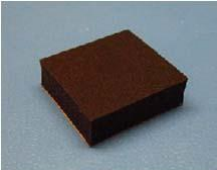
Item #	Part #	Description	Item
9	6020-060	SCREW THD-FORM PAN HD TORX 4-20x1/4"	
10	6020-065	SCREW THD-FORM PAN HD TORX 4-20x5/16"	
11	6020-836	SCREW PAN HD TORX M3x8 SS	
12	6140-006	E-RING 4mm ID	
13	6140-007	C-RING 5mm ID	
14	6160-009	STANDOFF NYLON HEX 6MM W/ 3MM TAP THRU	
15	6320-006	FOOT PAD 2.5 X 0.30 X 0.125 THK BLACK	
16	6320-007	FOOT PAD 4.25 X 0.30 X 0.125 THK BLACK	
17	6901-016-01	MODULE CO2 ORIDION MICROMEDI	

S12/S19 Item Identification Table			
Item #	Part #	Description	Item
18	6901-017-01	MODULE SpO2 EXT CABLE SENSOR NELLCOR	 (Front)  (Back)
19	6901-019	FITTING PANEL MNT CONN NYLON 3/32" & 1/16" (CO2 EXHAUST FITTING)	
20	8363-033-50	PAD PROCESSOR BD SUPPORT	
21	8363-001-50	HOUSING REAR S12 W/RECORDER	

S12/S19 Item Identification Table

Item #	Part #	Description	Item
22	8363-002-50	HOUSING REAR SURVEYOR S12 / S19	
23	8363-003-53	BEZEL S12 FINAL ASSY W/ LCD AND TOUCH	
24	8363-004-53	BEZEL S19 FINAL ASSY W/ LCD AND TOUCH	
25	8363-003-52	BEZEL S12 WITH TOUCH SCREEN ASSY	
26	8363-004-52	BEZEL S19 WITH TOUCH SCREEN ASSY	
27	N/A		
28	8363-011-50	BATTERY CONN RETAINER S12 / S19	

S12/S19 Item Identification Table

Item #	Part #	Description	Item
29	8363-013-50	RETAINER CONN S12 / S19	
30	8363-016-50	BRACKET RECORDER MTG S12 INTERNAL	
31	8363-017-50	SPRING INPUT PANEL SPRING RETAINER ORIDION INLET	
32	8363-018-50	DOOR ETCO2 SURVEYOR S12 / S19	
33	8363-024-50	WASHER SPEAKER MOUNT	
34	8363-025-50	COUPLER NIBP SLIP-IN	
35	8363-028-50	CABLE ASSY MICROMEDI ETCO2	
36	8363-034-50	CABLE ASSY BEACON BOARD S12/S19	

S12/S19 Item Identification Table

Item #	Part #	Descripti	Item
--------	--------	-----------	------

37	9042-080-03	LABEL NELLCOR OXIMAX	
38	9050-090-01	LABEL NAMEPLATE SURV S12 PATIENT MONITOR	
39	9050-090-02	LABEL NAMEPLATE SURV S19 PATIENT MONITOR	
41a	SERV-9960-066-03	PROCESSOR BOARD S12/S19 (Bitzy Board)	
41b	413350	G2 Processor Board S12 (Tested)	
41c	413351	G2 Processor Board S19 (Tested)	
42	8363-005-50	REAR COVER BEZEL S19	

S12/S19 Item Identification Table

Item #	Part #	Description	Item
43	5450-007-50	External Writer Kit S19	
	SERV PART 183-01	S12/S19 PLATEN ROLLER ASSEMBLY (For use in 5450-007-50)	
44	6150-003	NUT M3	
45	8363-038-50	COVER BATTERY S12 / S19	
46	25020-085-50	VIDEO CABLE	
47	25020-084-50	BACKLIGHT CABLE	
48	8363-029-50	MANIFOLD ASSEMBLY NIBP	

S12/S19 Item Identification Table

Item #	Part #	Description	Item
49	9042-080-01	LABEL WELCH ALLYN SpO2	
50	9042-080-03	LABEL NELLCOR OXIMAX	
51	6301-001	MUFFLER-FILTER NIBP PUMP INTAKE	
52	8363-027-50	PUMP & WIRE ASSY	
53	7495-018	CABLE TIE 8"	
54	8363-026-50	VALVE ASSEMBLY .050 IN ORIFICE	
55	7400-022	TAPE KAPTON DISC 3/8" DIA (used to hold SD card)	
56	8363-030-50	BATTERY CABLE ASSY	

S12/S19 Item Identification Table

Item #	Part #	Description	Item
57	8363-007-50	INPUT PANEL w-etCO2 Printed, 4p CO	 <p data-bbox="1024 596 1382 625">8363-009-50 shown as example</p>
	8363-008-50	INPUT PANEL w-etCO2 Printed, 2p no CO	
	8363-009-50	INPUT PANEL wo-etCO2 Printed, 4p CO	
	8363-010-50	INPUT PANEL wo-etCO2 Printed, 2p no CO	

10. CONFORMANCE TESTING

Conformance Testing

Conformance testing is to be performed by Authorized Welch Allyn Service Representatives to verify the device is functioning correctly after repair operations have been performed. Testing results should be documented on the test data record at the end of this section of the manual.

Required Equipment:

Qty	Part Number	Description
1	EL400 or equivalent	Vital Sign Simulator
1	N/A	NIBP Cuff
1	EL275	DMM
1	N/A	Power Driver 3.5 inch-pounds
1	N/A	Power Driver 5.0 inch-pounds
1	N/A	Nut Driver (7/32)
1	9293-052-50	CO2 Test Cable Filter Line Set
1	9293-050-60	5 Lead ECG Cable
1	9293-057-60	Finger Clip SpO2 Sensor (Welch Allyn SpO2)
1	9293-057-51	Cable SpO2 Adaptor & Extension
1	6901-017-03	Finger Clip SpO2 Sensor Nellcor (SpO2)
1	6901-017-02	Cable SpO2 Adaptor & Extension Nellcor
1	TF-0567	AM12M Acquisition Module
2	TF-0560	IBP Test Cable
1	TF-0561	Temperature Test Cable
1	TF-0562	Cardiac Output Test Cable
1	TF-0563	USB Production Dongle
1	TF-0564	USB Test Harness Drive
1	TF-0565	Nurse Call Fixture
1	TF-0568	S12/S19 Power Test Fixture
2	N/A	Shorting Bar (applied parts)

Required to perform NIBP calibration (not required to perform preventive maintenance or conformance testing).

Qty	Part Number	Description
1	6901-011	Hose fitting
1	6901-022-01	Extension hose
1	N/A	Hand pump
1	TF0419	Alloy NIBP Rigid Vessel
1	N/A	Pressure measurement device

1.0 Power Testing

- 1.1 Unscrew the battery cover from the UUT and remove the lithium ion battery.
- 1.2 Connect **TF-0568** to the battery terminals of the UUT, with a current meter in series to measure current flow.
- 1.3 Insert the battery removed from the monitor into **TF-0568**.
- 1.4 With the monitor in the off state, the current draw (**off current**) should **read < 350uA**. Record the test result.
- 1.5 Configure the current meter to the **10A** range and press the “**on**” button on the monitor to power up the device.
- 1.6 Once the monitor powers up and enters the main screen, the current draw (on current) should read as follows (depending on the model). Record the test result.

S12 Patient Monitor <1.6A
S19 Patient Monitor <2.3A

- 1.7 Verify the battery icon appears in the lower right section of the monitor.
- 1.8 Connect the external power supply (15 VDC) to the DC power input located on the right side of the monitor. The current flow should reverse polarity and begin to charge the battery at a rate of **2000mA** or less (depending on the condition of the battery).

The charging current will be less when the monitor is in the on state versus the off state, particularly for the S19 model.

- 1.9 Verify the AC Power LED, located in the lower left corner of the monitor is illuminated.

2.0 Functional Testing

2.1 Touch Screen calibration

- 2.1.1 Insert **TF-0564** USB Test Harness Drive into the USB patient connector port of the UUT as shown below:



- 2.1.2 Plug in the **Power Cord** into the back of the UUT and then press the Power button to power up the UUT as shown below:



- 2.1.3 In the UUT screen select “**Recalibrate Touch Panel**”.

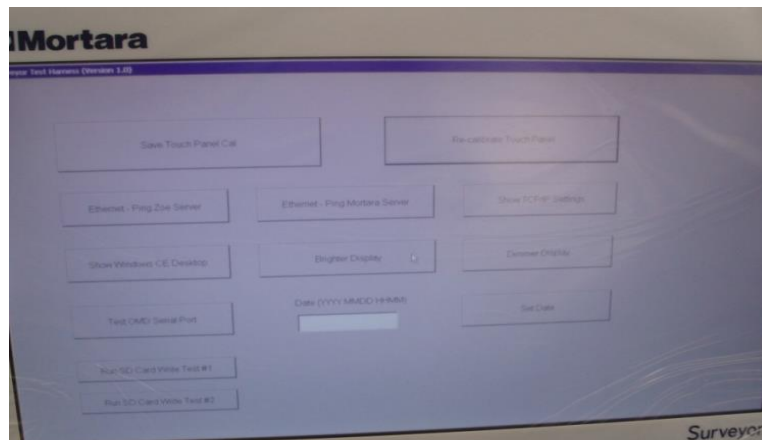

- 2.1.4 Use a pen to touch the intersection of the two lines in the middle of the screen.
NOTE: The software will move the lines to a new location.



- 2.1.5 In the UUT select the “**Save Touch Panel Cal**” button after the touch screen calibration is complete as shown below:



2.2 Monitor Brightness Adjustment Check

- 2.2.1 On the UUT display, tap the “**Dimmer Display**” button to verify the screen changes accordingly.

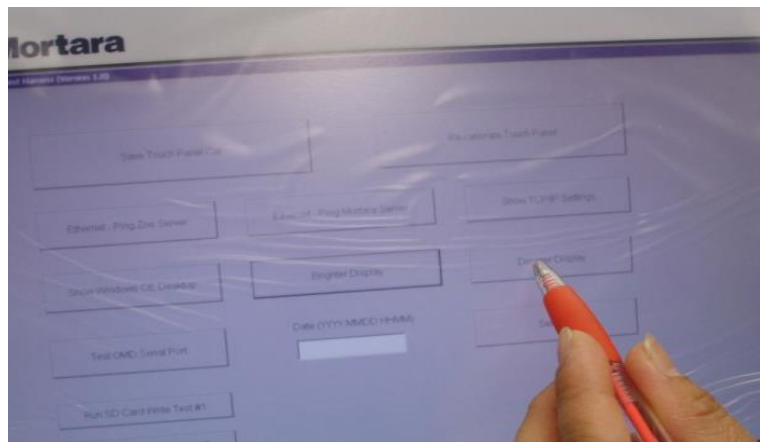

- 2.2.2 On the UUT display, tap the “**Brighter Display**” button to verify the screen changes accordingly.

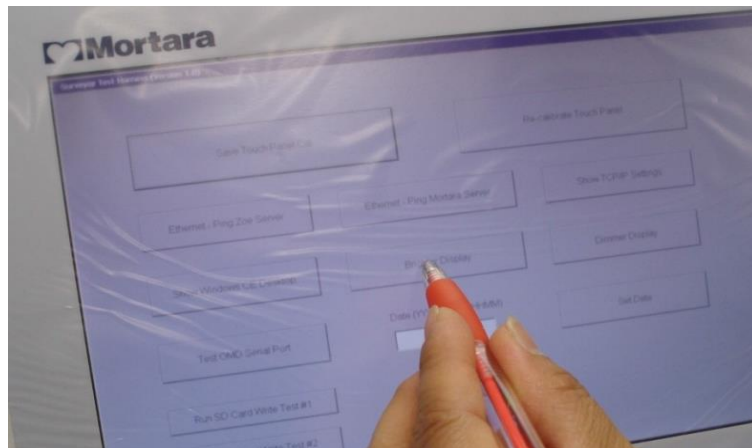

2.2.3 On the UUT press and hold the **power button** to turn off the UUT.

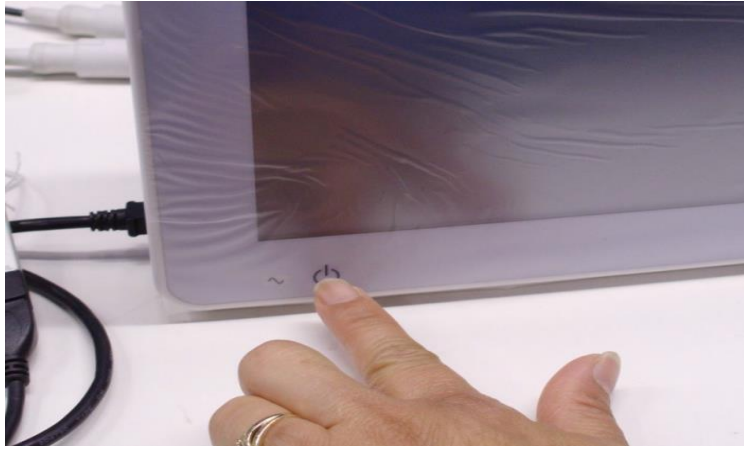

2.2.4 On the UUT, remove **TF-0564** USB test drive.



2.3 Speaker Volume and Date/Time Verify

2.3.1 Insert **TF-0563** USB Production Dongle.



2.3.2 Power on UUT by pressing the **power button**.



2.3.3 Select **“No”** to the New Patient screen when UUT powers on.



2.3.4 Perform Audio Check.

Select "**Setup**" button from lower right of the UUT. Select "**Audio**". Run a **speaker volume** and **HR/ PR Tone** volume check: pressing the Up/Down arrows while verifying the volume increases as the numbers get higher, and decreases as the numbers get smaller (1-9). Then Press "**OK**" Button. (See **Setup Audio Below**).

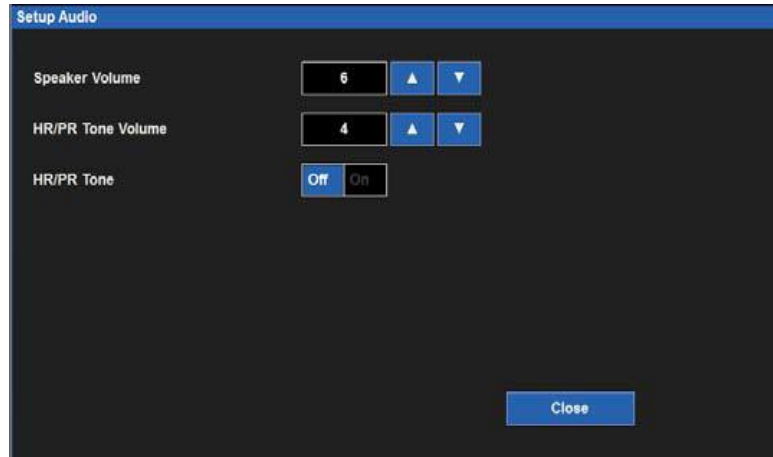

2.3.5 Date/Time Verify

From UUT setup screen, select **Administration>System>Set Date & Time**. Verify date and time settings, adjust to current date and time if necessary. Then press "**OK**" twice to return to the main screen.



2.4 Ethernet Connectivity Check

- 2.4.1 Connect the **LAN Cable** into the **Ethernet Port** in the back of the UUT. Make sure the cable clicks into place.
- 2.4.2 Verify the **Yellow and Green LEDs** are **ON** at the LAN connector.



- 2.4.3 On the UUT go to **Setup>Administration>Communications** to open the **“Communications”** menu and change the **Use DHCP** box to **“Yes”**. Then press **“OK”**. The UUT will reboot.
- 2.4.4 On the UUT go to **Setup>Administration>Communications** to open the **“Communications”** menu. Verify the Ethernet connection **IP Address** has been populated with an IP address other than 0.0.0.0. Press **“Cancel”** and reopen the **Communications** menu if the IP address does not populate right away.
- 2.4.5 After the Ethernet connection is verified, set the **Use DHCP** box to **“NO”**. Then press **“OK”**. The UUT will reboot.

Setup Communications		Use DHCP
Bed ID		<input type="radio"/> No <input type="radio"/> Yes
Unit ID		
Central Host Name		
Central IP Address	10.0.1.10	
Central Port Number	5005	
IP Address	192.168.10.242	
Subnet	255.255.255.0	
Gateway	192.168.10.78	
DNS	192.168.10.78	
		<input type="button" value="OK"/> <input type="button" value="Cancel"/>

- 2.4.6 Disconnect the **LAN** cable.

2.5 Thermal Writer Check

- 2.5.1 Verify paper is installed in the thermal writer.
- 2.5.2 Select the **“Print”** icon from the Main Screen to print a test strip.

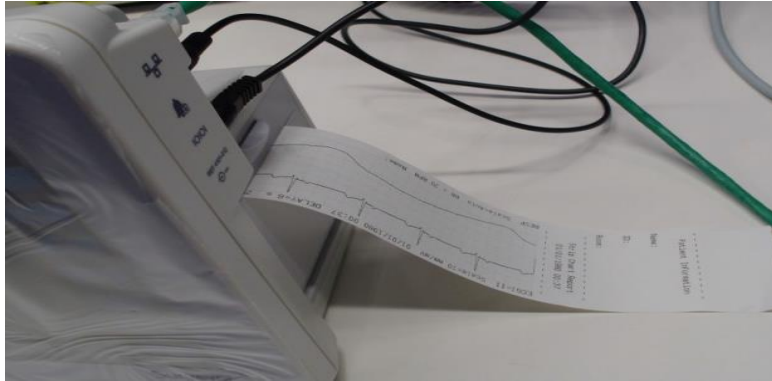

- 2.5.3 Verify a full test strip prints including: a patient information section, strip chart report section, and parameter snapshot section.

2.6 Nurse Call Functional Check

- 2.6.1 Insert **TF-0565** nurse call test fixture into the right side panel of the UUT next to the **Bell Icon**.
- 2.6.2 Open the **Recorder Door** and verify the door open alarm sounds.



- 2.6.3 Verify a **Blue Alarm Light** on top of the UUT and an audible tone.
- 2.6.4 Verify the LED of the **Nurse Call Fixture** illuminates in the same manner as the alarm light.
- 2.6.5 Verify the error message **“Recorder Door is Open”** appears on the bottom of the Main Screen.
- 2.6.6 Close the **Recorder Door**, the alarming should stop and the alarm light should also turn off. Remove **TF-0565** from the UUT.

2.7 NIBP Testing

NOTE: Do not allow system to remain pressurized and stable below 20 mmHg. The monitor will remove this pressure as a zero offset and this will affect the validity of the calibration check.

NOTE: The following are required to perform this test: NIBP simulator or sphygmomanometer along with a Y-cable and an NIBP cuff.

Pressure Accuracy Test: Via the Service settings, put the NIBP in to calibration mode. Set the pressure to 25mmHg and 225 mmHg respectively and verify that the pressure values reported by the Surveyor patient monitor matches (± 2 mmHg) of that reported on the simulator or sphygmomanometer. Release pressure.

Measurement Accuracy Test: Connect to Patient Simulator and take a NIBP measurement. Verify proper NIBP value at 120/80 (+/- 5 mmHg).

Leak Test: Inflate a cuff to 150-170 mmHg. Allow cuff pressure to settle (thermal effect). Verify that the pressure (once stable) drops less than 4 mmHg in 1 minute. Verify that the pressure is automatically discharged through the overpressure valve 150 seconds +/- 5 seconds after the pressure exceeds 15mmHg.

Overpressure Test: Power cycle the UUT and put the NIBP in to calibration mode. Inflate cuff to 300 mmHg. Verify that the pressure is automatically discharged through the overpressure valve at 300 +/- 30 mmHg.

Set the NIBP back to normal mode. Power cycle the monitor.

NIBP Calibration – (ONLY PERFORMED IF NIBP OUT OF ACCEPTABLE RANGE)

Place Surveyor into Test by powering on UUT with Dongle installed in USB port.

Place Surveyor into NIBP cal mode by selecting the Stand By button on main screen.

Initial Setup:

- Connect 6901-011 Hose Fittings, 6901-022-01 extension hose, hand pump, and TF0419 ALLOY NIBP RIGID VESSEL to Pressure Standard.
 - Connect end of extension hose to transducer located at U44 of UUT.
 - Turn on Pressure Standard and select F2 (units of measure).
- Inflate to 250mmHg using hand pump or equivalent.
 - Set pot R74 so NIBP cuff pressure on Surveyor display matches the pressure gauge reading.
 - Release pressure completely so simulator display indicates zero.
 - Re-inflate to 250mmHg and verify accuracy.
 - Power off unit by holding down the on/off button on front of display.

If calibration was performed to restore to specification, perform all conformance tests defined above to ensure proper operation.

2.8 ECG Input Test

- 2.8.1 Remove the USB production dongle **TF-0563** from the UUT.



- 2.8.2 Connect the **AM12M** USB cable to the UUT port. Verify the 12 patient leads are connected to the **EL400** simulator.



- 2.8.3 From the main screen of the UUT, touch the **HR** menu in the upper right corner (usually displaying the heart rate reading) to open the **Setup HR/PR** menu.



2.8.4 In the **Setup HR/PR** menu set the **12-Lead Enabled** setting to “YES”.



2.8.5 Select “OK”.



2.8.6 From the main screen select “12 Lead ECG”.



2.8.7 Verify that all 12 ECG waveforms are displayed and show no signs of distortion.



2.8.8 Select “Close” to return to the main screen.



2.8.9 From the main screen, verify the UUT reads **60 +/- 1 bpm**. Record the test result.

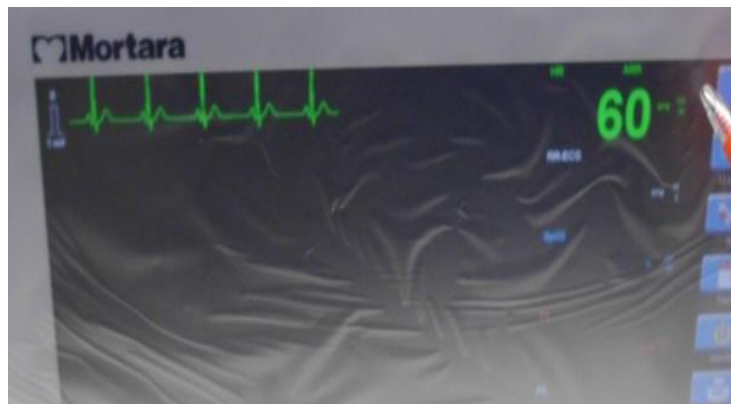

2.8.10 Disconnect the AM12M from the UUT and verify a **Lead Off** alarm sounds. Reconnect the AM12M USB to the UUT. Verify the **Lead Off** alarm turns off.

- 2.8.11 From the main screen of the UUT, touch the **HR** menu in the upper right corner (usually displaying the heart rate reading to open the **Setup HR/PR** menu.

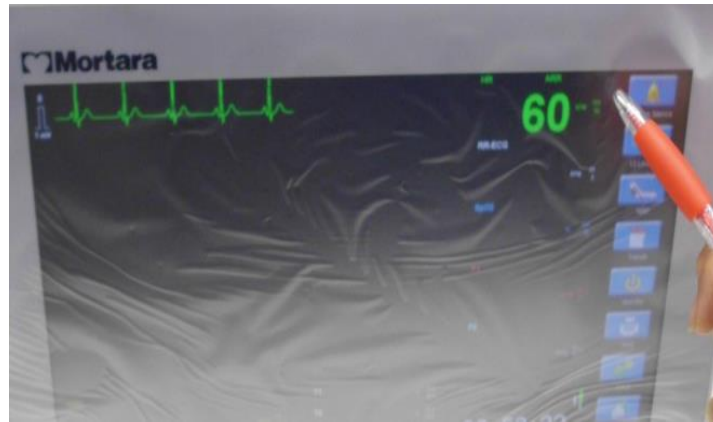

- 2.8.12 In the **Setup HR/PR** menu set the **12-Lead Enabled** setting to “NO”.



- 2.8.13 Select “OK”.



- 2.8.14 The **Lead Off** alarm will sound. Select the “**Alarm Silence**” icon to turn off the alarm.

- 2.8.15 Disconnect the **AM12M** USB cable from the UUT.



- 2.8.16 Connect the green **ECG (5) lead** patient cable to the appropriate side port. Verify the 5 patient leads are connected to the **EL400** simulator.



- 2.8.17 Verify on the UUT main screen that the **ECG waveform** and the **RR-ECG waveform** appear.
Note: If the UUT does not display the RR-ECG waveform, select Setup>Parameters and set ETCO2 Enabled to "NO". Select "OK" and "Close" to return to the main screen.



2.8.18 Verify the UUT reads **60 +/- 1 bpm** and the **RR-ECG** reads **20 +/- 1 rpm**.



2.8.19 From the main screen, select “All ECG”.



2.8.20 Verify the UUT displays **Leads II, V, and I** and no traces show any sign of distortion.
Note: If the UUT only displays Lead I, select the “HR” in the top right corner to enter the Setup HR/PR menu. Set the ECG Lead Set menu to 5 wires and then select “OK”.



- 2.8.21 Select the “HR” in the top right corner to enter the **Setup HR/PR** menu and verify the “**Analyze Pacers**” setting is set to “**Yes**”. Press “**OK**” to return to the ECG screen.

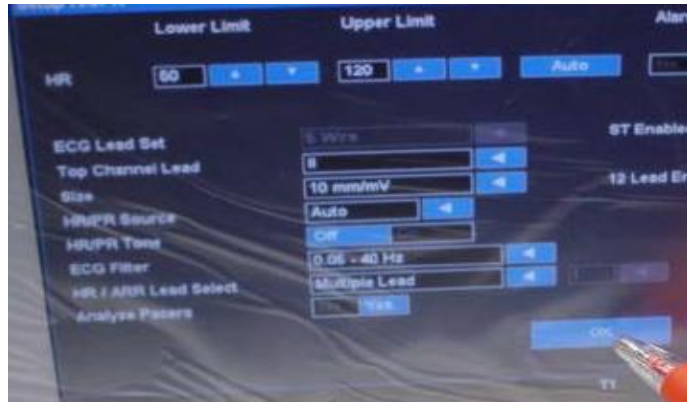

- 2.8.22 Set the patient simulator **EL400** to input a **Paced Beat**. On the simulator press “**ECG**”. Go to the **Wave Group: NSR (Adult)** setting press **Enter** and scroll down to the **TV Paced** wave group. Press **Enter** to select this wave group. Verify that white pace marks appear above **Pacemaker Spikes** on the ECG display of the UUT.

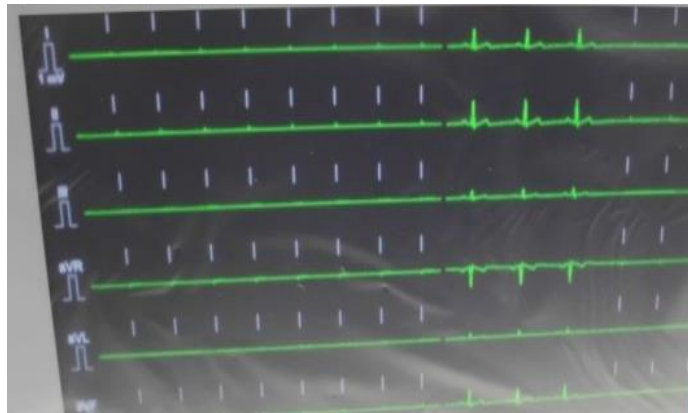

- 2.8.23 Turn off the patient simulator **EL400**. Verify that all wave forms become flat lines. Verify that the “**ARR Asystole**” alarm sounds and the beacon light is **Red**. Select the “**Alarm Silence**” button to turn off the alarm.

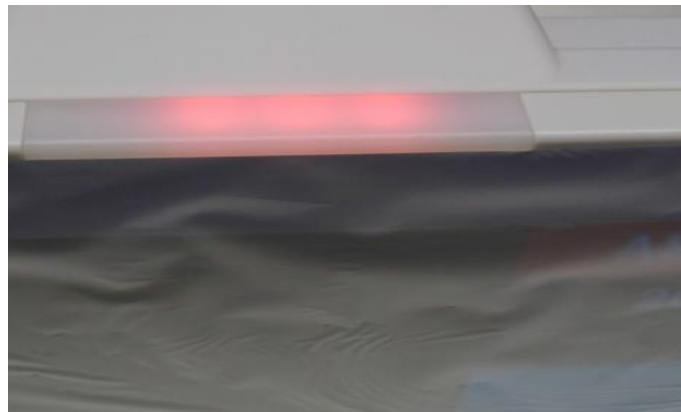

- 2.8.24 Unplug the green **5 Lead ECG** cable from the UUT. With the “**ARR Asystole**” alarms silenced, verify the “**Lead Off**” alarm appears.



- 2.8.25 Reconnect the **5 Lead ECG** cable to the UUT and turn on the patient simulator. Select the “**Normal ECG**” button to return to the main screen.

2.9 Impedance RR

- 2.9.1 From the main screen of the UUT, verify the **RR-ECG** is reading **20 +/- 1 rpm**. Record the test result.

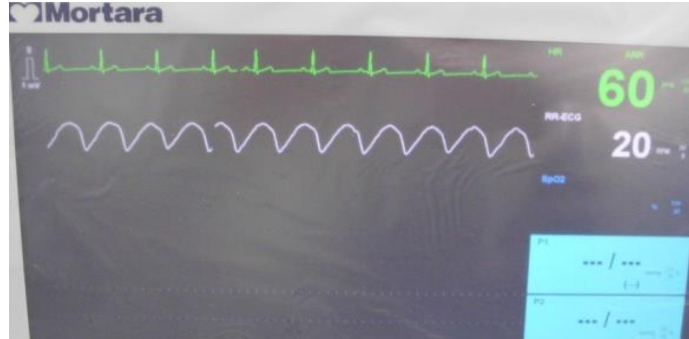

- 2.9.2 On the patient simulator **EL400**, press the “**SPECIAL FUNC**” button. Select the **Respiration** setting and press “**Enter**”. Select the **Rate** setting and decrease the rate to **15 brpm**. Verify the UUT displays **15 +/- 1 rpm**.
- 2.9.3 In the **Respiration** setting, select the **Rate** setting and decrease the rate to **30 brpm**. Verify the UUT displays **30 +/- 1 rpm**.
- 2.9.4 Reset the **Rate** to **20 brpm**. Remove the **5 Lead ECG** cable from the UUT and turn off the “**Lead Off**” alarm using the “**Silence Alarm**” button.

2.10 SpO2 Check

- 2.10.1 Connect the appropriate **SpO2 cable** (Welch Allyn or Nelcor) to the UUT port.



- 2.10.2 Verify that the **RED LED** light is ON in the finger clip.



- 2.10.3 On the **EL400** simulator press the “**SpO2**” button. Verify that the **SpO2 Test Value** is set to **96%**.
(Note: Bottom signal bar on the simulator screen is blank)
- 2.10.4 Connect the **SpO2 Finger Clip** to the **EL400** patient simulator.
(Note: the signal bar on the simulator should be green. If not, adjust the finger clip until the signal bar is green.)
- 2.10.5 Verify the UUT SpO2 value is reading **96% +/- 2%** and the waveform shows no signs of distortion. Record the test value.
- 2.10.6 On the **EL400** patient simulator, change the **SpO2 Test Value** to **84%**. Verify the UUT displays a **SpO2** reading of **84% +/- 2%** and the waveform shows no signs of distortion. Verify the UUT alarms and displays **SpO2<90**. Change the **SpO2 Test Value** back to **96%**. Verify that the alarm turns off.
- 2.10.7 On the **EL400** patient simulator, scroll down to the **Heart Rate** setting in the SpO2 menu. Set the **Heart Rate** to **30 bpm** and press “**Enter**” Verify that the **PR** value on the UUT reads **30 bpm +/- 5 bpm**. Verify that the UUT alarms and displays **PR<50**.
- 2.10.8 On the **EL400** patient simulator, scroll down to the **Heart Rate** setting in the SpO2 menu. Set the **Heart Rate** to **240 bpm** and press “**Enter**” Verify that the **PR** value on the UUT reads **240 bpm +/- 5 bpm**. Verify that the UUT alarms and displays **PR<120**.
- 2.10.9 On the **EL400** patient simulator, scroll down to the **Heart Rate** setting in the SpO2 menu. Set the **Heart Rate** to **60 bpm** and press “**Enter**” Verify that the **PR** value on the UUT reads **60 bpm +/- 5 bpm**. Verify that the UUT alarm turns off.
- 2.10.10 Unplug the **SpO2 cable** from the UUT and verify that the UUT alarms and displays **SpO2 Unplugged**. Press the “**Alarm Silence**” button to turn off the alarm.

2.11 IBP Calibration and Check

- 2.11.1 Connect **TF-0560 IBP “Y”** cable to the **EL400** patient simulator ports **IBP Channel 1 & IBP Channel 2**.



- 2.11.2 Connect **TF-0560 IBP “Y”** cable to the UUT IBP side panel connection.



- 2.11.3 The UUT will show flat lines on the 2 IBP channels and alarm **“P1 and P2 Needs Calibration”**.
 (Note: If the waveforms are not present select **Setup>Parameters>IBP Channels** and then select **2 (or 4 if 4 IBP channels are present)** from the drop-down menu. Press **“OK”** and **“Close”** to return to the main screen.)





2.11.4 On the **EL400** patient simulator press the “**IBP**” button.
(NOTE: If the Screen displayed as i below, change the setting to ii below).

- i. **Channel 1**
 Chamber: Arterial
 Pressure: 120/80 mmHg
 Artifact: Off
Channel 2
 Chamber: Arterial
 Pressure: 120/80 mmHg
 Artifact: Off
- ii. **Press “F1 & F2” on the Simulator to zero Channels 1 & 2.**
Channel 1
 Chamber: Static
 Pressure: 0 mmHg
Channel 2
 Chamber: Static
 Pressure: 0 mmHg

2.11.5 Perform calibration for **P1 & P2** or **P3 & P4**.

- i. On the UUT select **Setup>Administration>Service>Calibration**
- ii. On the UUT, select “**Start PX Calibration**”.



- iii. Verify **“PX Calibration OK”** shows at the bottom of the UUT display. Perform this calibration step for all available **PX** channels.

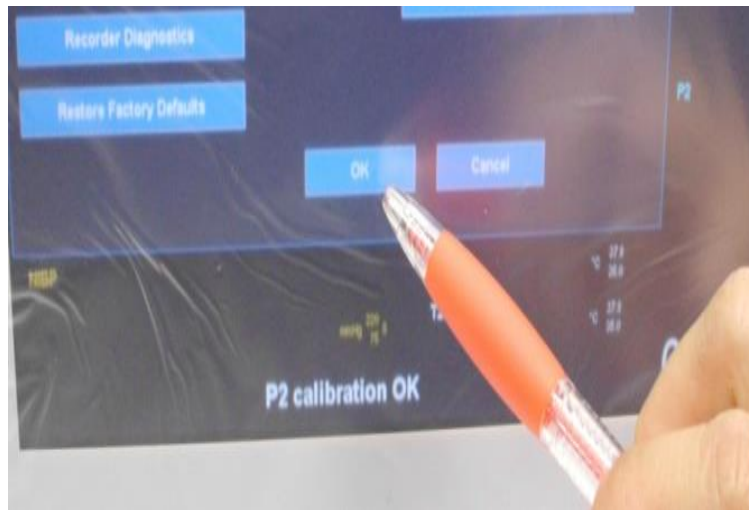

- iv. On the UUT, select **OK>OK>Close>Close** to return to the main screen.

2.11.6 Zero the **PX** channels.

- i. On the UUT, select one of the **PX** readings to open the **Setup PX** menu. Select the **“Zero All”** button.

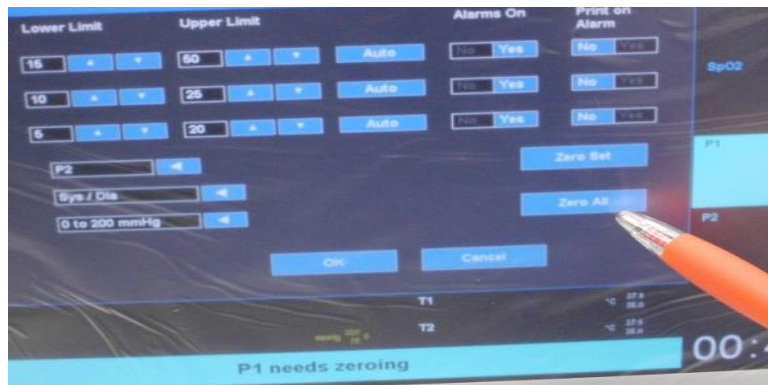

- ii. Verify the **“PX Zero OK”** message appears at the bottom of the UUT display.



- iii. Verify that both **PX** channels read 0/0 mmHg.

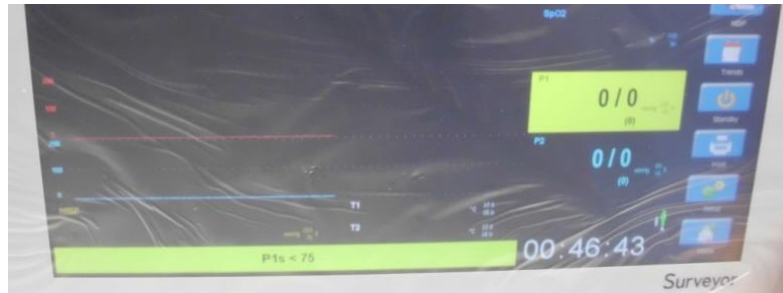

- 2.11.7 On the **EL400** patient simulator press the “**IBP**” button. Set channel 1 & 2 to the settings displayed below.

- i. **Channel 1**
 Chamber: Arterial
 Pressure: 120/80 mmHg
 Artifact: Off
- Channel 2**
 Chamber: Arterial
 Pressure: 120/80 mmHg
 Artifact: Off

- 2.11.8 On the UUT, verify that the **IBP** readings show **120/80 +/- 1mmHg** for both channels and the waveforms show no sign of distortion. Verify an alarm goes off for one or both **PX** channels. Press the “**Silence Alarm**” button to turn off the alarm.

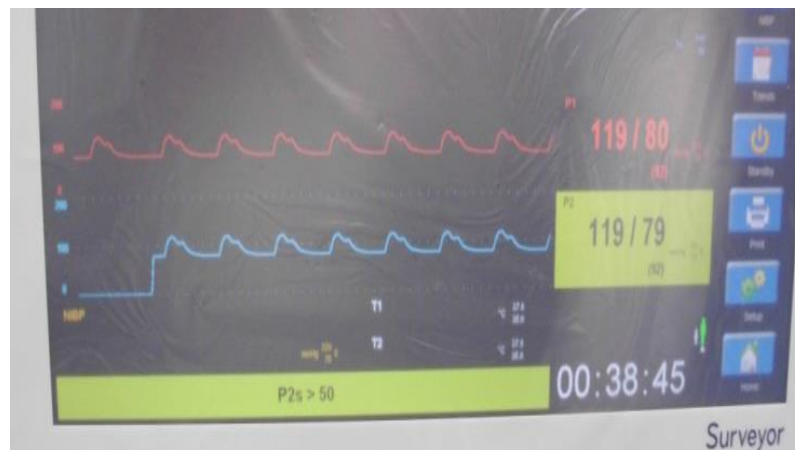

- 2.11.9 For **IBP channels 3 & 4** repeat testing from step 2.11.4 for those 2 IBP channels with **TF-0560** connected to **P3 & 4** port.
- 2.11.10 Once testing is complete on all channels, disconnect **TF-0560**. Verify UUT alarms and displays “**PX unplugged**”. Press the “**Alarm Silence**” button to turn off the alarm.

2.12 Temperature Verification

- 2.12.1 On the **EL400** patient simulator, press “**Special Func**” and select “**Temperature**”. Press “**Enter**”. Press “**Enter**” to set the **Temperature** to **37° C**.
- 2.12.2 Connect the **TF-0561** temperature cable to the **EL400** patient simulator.

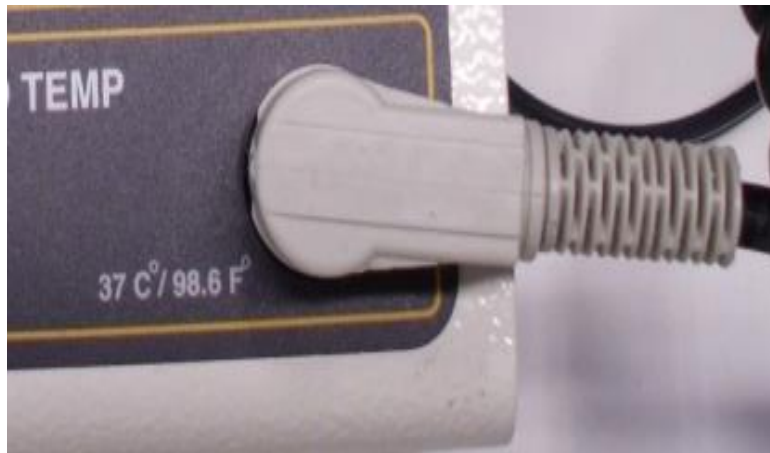

- 2.12.3 Connect the other end of the **TF-0561** temperature cable to the **T1** temperature port of the UUT.



- 2.12.3 Verify the UUT **T1** reading is $37^{\circ} \pm 1^{\circ} \text{C}$.
(Note: If the **T1** and **T2** reading does not appear on the UUT display, select **Setup>Parameters** and set the **Temperature Display Mode** to **T1 and T2** from the drop-down menu. Press **“OK”** and **“Close”** to return to the main screen.)

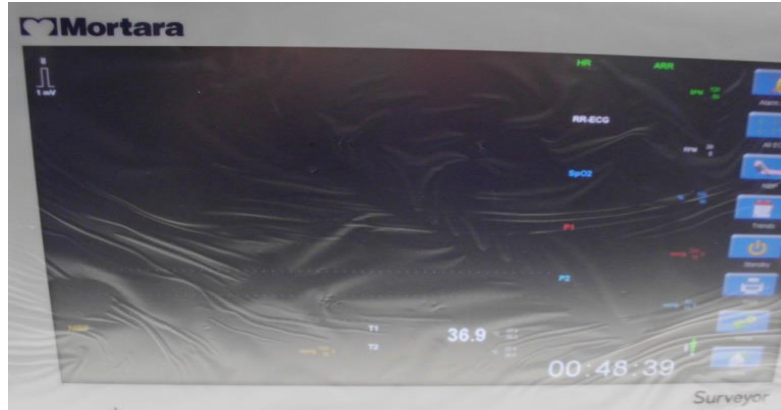

- 2.12.4 Disconnect the **TF-0561** temperature cable from **T1** of the UUT. Verify the UUT alarms and displays **“T1 unplugged”**. Press the **“Alarm Silence”** button to turn off the alarm. Connect the **TF-0561** temperature cable to the **T2** temperature port of the UUT.



- 2.12.5 Verify the UUT **T2** reading is $37^{\circ} \pm 1^{\circ} \text{C}$.



- 2.15.6 Disconnect the **TF-0561** temperature cable from **T2** of the UUT. Verify the UUT alarms and displays **“T1 unplugged”**. Press the **“Alarm Silence”** button to turn off the alarm.



2.13 Cardiac Output

2.13.1 Connect **TF-0562** CO cable to the **Cardiac Output** of the **EL400** patient simulator.



- 2.13.2 Connect the other end of the **TF-0562** CO cable to the CO port of the UUT.
- 2.13.3 On the UUT, select the **CO** reading on the display to open the “**Setup CO**” menu.
(Note: If the UUT does not display CO and CI select Setup>Parameters and then set the CO Enabled setting to YES. Then press OK>Close to return to the main screen.)
- 2.13.4 In the **Setup CO** menu, press the up/down arrow keys to set the **Computation Constant** to **.501**.
- 2.13.5 Set the “**Injectate probe type**” to **In-line** from the drop-down menu.
- 2.13.6 From the **Setup CO** menu, select “**Begin CO Measurement**”.
- 2.13.7 In the **Measure CO** menu, set the **Mode** to **Manual** from the drop-down menu.
- 2.13.8 On the **EL400** patient simulator press the “**SPECIAL FUNC**” button. Select “**Cardiac Output**” and the press “**Enter**”. Verify that the following settings:
- Wave: 5.0 L/min**
Baseline Temp: 37 degree C
Injectate Temp: 0 degree C
- 2.13.9 Adjust the **TF-0562** dial so that the **IT** reading on the UUT **Measure CO** menu reads **28 +/- 0.2**. Verify the UUT **BT** reading shows **37 +/- 2**.
- 2.13.10 On the UUT, press “**Start**” to start a CO measurement.
- 2.13.11 Wait for the UUT to display “**Ready**”. Press “**F1**” on the **EL400** patient simulator to begin the CO measurement.
- 2.13.12 Verify the UUT displays **1.1 +/- 0.1 l/min**. Repeat steps 2.13.10 through 2.13.12 three times.
- 2.13.13 When done, press “**Exit**”. Press “**OK**” when asked to exit without saving average.
- 2.13.14 In the **Setup CO** menu, set the “**Injectate probe type**” to **Bath** from the drop-down menu.
- 2.13.15 From the **Setup CO** menu, select “**Begin CO Measurement**”.

- 2.13.16 In the **Measure CO** menu, set the **Mode** to **Manual** from the drop-down menu.
- 2.13.17 Adjust the **TF-0562** dial so that the **IT** reading on the **UUT Measure CO** menu reads **10 +/- 0.2**. Verify the **UUT BT** reading shows **37 +/- 2**.
- 2.13.18 On the UUT, press **“Start”** to start a CO measurement.
- 2.13.19 Wait for the UUT to display **“Ready”**. Press **“F1”** on the **EL400** patient simulator to begin the CO measurement.
- 2.13.20 Verify the UUT displays **3.2 +/- 0.1 l/min**. Repeat steps 2.13.18 through 2.13.20 three times.
- 2.13.21 When done, press **“Exit”**. Press **“OK”** when asked to exit without saving average. Press **“OK”** in the **Setup CO** menu to return to the main screen.
- 2.13.22 Remove the **TF-0562** CO cable from the UUT.

2.14 etCO₂

- 2.14.1 Insert the **CO₂ Filter Line Set (pn: 9293-062-50)** into the UUT CO₂ port.



- 2.14.2 Verify the UUT displays a flat yellow line on the **ETCO₂** reading.
(Note: If the **ETCO₂** measurement is not displayed, select **Setup>Parameters** and set **ETCO₂ Enabled** to **Yes**. Press **OK>Close** to return to the main screen)



- 2.14.3 Lightly blow into the open plastic cylinder and verify that the UUT displays any reading in **mmHg**.

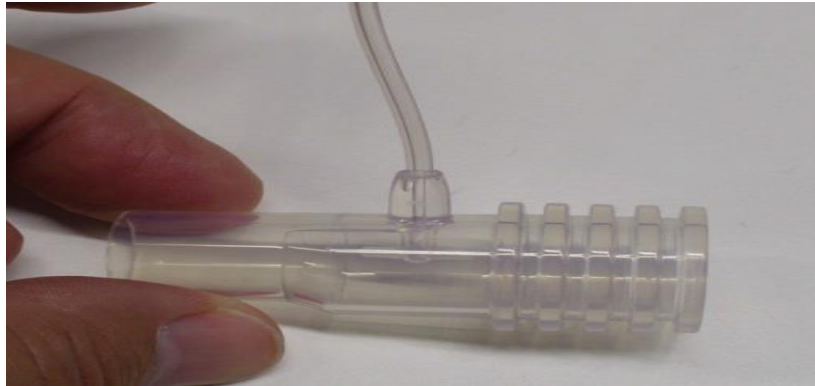

- 2.14.4 Disconnect the **CO2 Filter Line Set** from the UUT. Verify the UUT alarms and shows “**CO2 unplugged**” on the display. Verify the LED alarm on the UUT lights up.

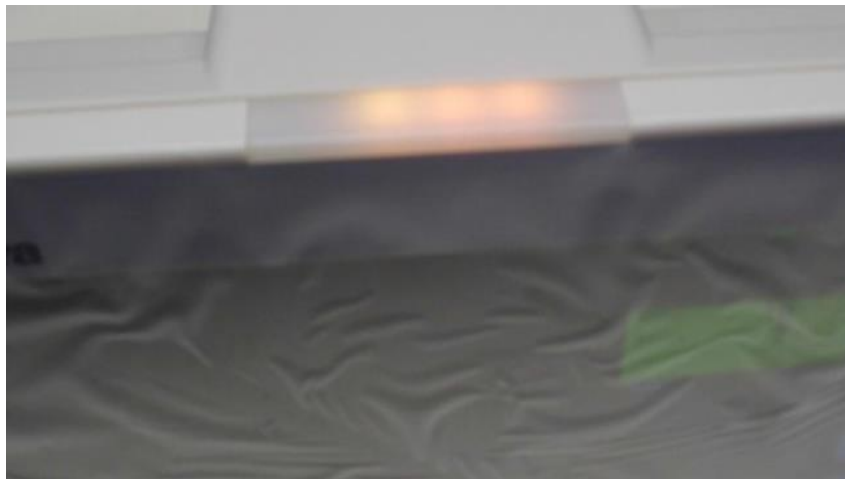

- 2.14.5 On the UUT, select the “**Alarm Silence**” button to turn off the alarm. Press and hold the **Power Button** to turn off the UUT. Disconnect the power cord on the back of the UUT.

3.0 Device Cleaning

Clean unit per the instructions provided in the Maintenance & Cleaning section of the service manual.

4.0 Safety Testing

If the monitor housing was opened for repair or inspection work, the following safety tests should be performed in accordance with the IEC 60601-1 or IEC 62353 methods and limits.

The S12 and S19 are considered a Class 1 Type CF devices, intended to be utilized with the Welch Allyn specified patient modules and product accessories.

DC Hi-pot Testing

Applies to all of the following optional patient inputs (applied parts) installed on the monitor being tested. Test connectors are required to properly connect test equipment to the applied part inputs to perform Hi-pot testing. The negative (black) connection of the tester should be connected to the DC Power Input via TF0571 (or equivalent). The positive (red) lead wire is connected to the connection defined below.

The ECG input should be tested separately, and the other applied parts (SpO2, Temp, CO) can be connected together via a shorting bar (as shown in the diagram below) to expedite the testing process. *This is not a requirement and the tests can be performed separately.*

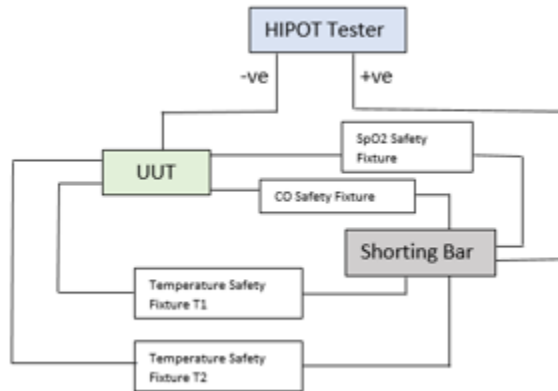

Connection	Test Connector/Method
ECG	Patient cable 9293-050-60 and shorting bar
SpO2	TF0281
Temp 1, Temp 2	TF0559
Cardiac Output	TF0558

Item	Value	Unit of Measure	Boundary
Applied Potential	5000	Volts DC	Minimum
Ramp Time	3.0	Seconds	Minimum
Dwell Time	1.0	Seconds	Minimum
Current High	0.500 (500 uA)	mA	Maximum
Current Low	0.0	mA	Minimum

Nurse call / Ethernet Test: The ports on the back of the device (nurse call/ethernet) are tested at a different voltage as defined below. The negative (black) connection of the tester should be connected to the DC Power Input via TF0571 (or equivalent). The positive (red) lead wire is connected to TF0570.

Connection	Test Connector/Method
Nurse Call/Ethernet	TF0570

Item	Value	Unit of Measure	Boundary
Applied Potential	1000	Volts DC	Minimum
Ramp Time	3.0	Seconds	Minimum
Dwell Time	1.0	Seconds	Minimum
Current High	0.500 (500 uA)	mA	Maximum
Current Low	0.0	mA	Minimum

AC Hi-pot Testing

Applies to all of the following optional patient inputs (applied parts) installed on the monitor being tested. Test connectors are required to properly connect test equipment to the applied part inputs to perform Hi-pot testing. The negative (black) connection of the tester should be connected to both the Line and Neutral on the AC side of the external AC/DC Power Module (Item # 4101-012), typically by utilizing tool TF-0107. The positive (red) lead wire is connected to the connection defined below.

The ECG input should be tested separately, and the other applied parts (SpO2, Temp, CO) can be connected together via a shorting bar (as shown in the diagram below) to expedite the testing process. *This is not a requirement and the tests can be performed separately.*

Connection	Test Connector/Method
ECG	Patient cable 9293-050-60 and shorting bar
SpO2	TF0281
Temp 1, Temp 2	TF0559
Cardiac Output	TF0558

Item	Value	Unit of Measure	Boundary
Applied Potential	3000	Volts AC	Minimum
Ramp Time	3.0	Seconds	Minimum
Dwell Time	1.0	Seconds	Minimum
Current High	0.500 (500 uA)	mA	Maximum
Current Low	0.0	mA	Minimum

For Brazil testing, dwell time is increased to 60 seconds.

ECG Input Connection Diagram:

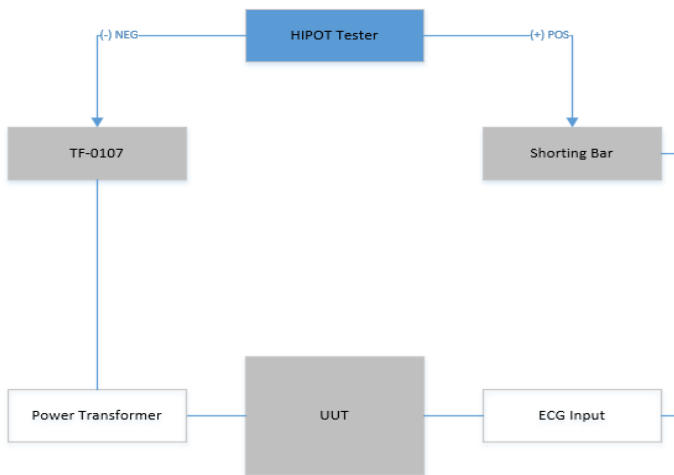

Applied Part Connection Diagram:

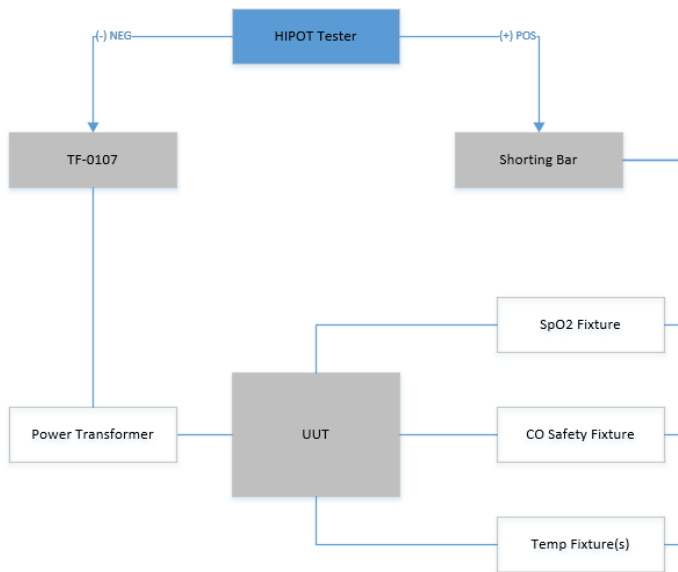

Leakage Testing

The factory External AC/DC Power Module (Item # 4101-012) and appropriate regional AC power cord should be used to perform the leakage tests defined below.

- Earth Leakage
- Enclosure Leakage
 - Non-conductive (fully insulated) chassis testing should be performed utilizing 200 cm² conductive foil or equivalent.
- Patient Leakage
 - Applied part – patient input (utilize Welch Allyn patient cable 9293-050-60 or -61)
- Patient Leakage (mains on applied part)
 - Applied part – patient input (utilize Welch Allyn patient cable 9293-050-60 or -61)

S12/S19 Conformance Test Data Record

Unit Serial #: _____

1.1	Power Testing		
Complete	Test		PASS / FAIL (Circle)
<input type="checkbox"/>	Off Current	_____ uA (< 350uA)	PASS / FAIL
<input type="checkbox"/>	On Current	_____ A (S12 < 1.6A, S19 < 2.3A)	PASS / FAIL
<input type="checkbox"/>	Charging Current / AC Power LED		PASS / FAIL

2.1 Functional Testing

N/A	Complete	Test		PASS / FAIL (Circle)
<input type="checkbox"/>	<input type="checkbox"/>	Touch Screen Calibration		PASS / FAIL
<input type="checkbox"/>	<input type="checkbox"/>	Monitor Brightness		PASS / FAIL
<input type="checkbox"/>	<input type="checkbox"/>	Speaker Volume		PASS / FAIL
<input type="checkbox"/>	<input type="checkbox"/>	Date/Time		PASS / FAIL
<input type="checkbox"/>	<input type="checkbox"/>	Ethernet Connectivity		PASS / FAIL
<input type="checkbox"/>	<input type="checkbox"/>	Thermal Writer		PASS / FAIL
<input type="checkbox"/>	<input type="checkbox"/>	Nurse Call Function		PASS / FAIL
<input type="checkbox"/>	<input type="checkbox"/>	Pressure Accuracy (+/- 2mmHg)	Actuals = _____, _____ mmHg	PASS / FAIL
<input type="checkbox"/>	<input type="checkbox"/>	Overpressure (300 +/- 30 mmHg)	Actual = _____ mmHg	PASS / FAIL
<input type="checkbox"/>	<input type="checkbox"/>	Leak Test (< 4mmHg after 1 min)	Actual drop = _____ mmHg	PASS / FAIL
<input type="checkbox"/>	<input type="checkbox"/>	Measurement Accuracy	Actual = _____ / _____ mmHg	PASS / FAIL
<input type="checkbox"/>	<input type="checkbox"/>	ECG Input (60 +/- 1 bpm)	Actual = _____ bpm	PASS / FAIL
<input type="checkbox"/>	<input type="checkbox"/>	Impedance RR (20 +/- 1 rpm)	Actual = _____ bpm	PASS / FAIL
<input type="checkbox"/>	<input type="checkbox"/>	SpO2	Actual = _____ %	PASS / FAIL
<input type="checkbox"/>	<input type="checkbox"/>	IBP		PASS / FAIL
<input type="checkbox"/>	<input type="checkbox"/>	Temperature		PASS / FAIL
<input type="checkbox"/>	<input type="checkbox"/>	Cardiac Output		PASS / FAIL
<input type="checkbox"/>	<input type="checkbox"/>	etCO2		PASS / FAIL

3.0	<input type="checkbox"/>	Device Cleaning	
4.0		DC Hi-pot Testing (ECG and applied parts)	PASS / FAIL
		DC Hi-pot Testing (nurse call/ethernet)	PASS / FAIL
		AC Hi-pot Testing (ECG and applied parts)	PASS / FAIL
		Leakage Testing (attach test report)	PASS / FAIL

Performed by: _____ Date: _____/_____/_____

11. PRODUCT SPECIFICATIONS

General Specifications

Dimensions	S12: 315 W x 203 H x 125 D mm (12.4 W x 8.0 H x 4.9 D inches) S19: 468 W x 289 H x 97 D mm (18.4 W x 11.4 H x 3.8 D inches)
Weight	S12: 3 Kg (6.6 lbs) Standard configuration; including battery and built-in recorder S19: 5 Kg (11.2 lbs) Standard configuration, including battery; excluding recorder
Type of Protection (Electrical)	Class I
Degree of Protection (Electrical)	ECG: Type CF Applied Part SPO2: Type BF Applied Part IBP: Type BF Applied Part CO: Type BF Applied Part Temperature: Type BF Applied Part
Degree of Protection (Water)	Drip Proof (IPX1)
Disinfecting Method	Per the instructions in the General Care & Maintenance section
Degree of Safety (Flammable Anesthetic Mixture)	Not suitable for use in the presence of a Flammable Anesthetic Mixture including O ₂ or N ₂ O
Mode of Operation	Continuous
Languages	English, Italian, German, Spanish, Portuguese, French, Dutch
Units of measure (each set independently)	English (inches, lbs, °F, mmHg) Metric (cm, kg, °C)
Network Interface	IEEE 802.3 100 Ethernet 10/100 RJ45 or optional IEEE 802.11 a/b/g/n WiFi networking module (currently not available); with static or dynamic IP for interface to Surveyor Central monitoring station.
Patient Risk Current	Complies with IEC 60601-1 Leakage Current Requirements
Casing Material	PC-ABS

Environmental Conditions

Temperature	Operating temperature: +0° to +40° C (+32° to +104° F) Storage temperature: -20° to +60° C (-4° to +140° F)
Humidity	Operating humidity: 15% to 90% RH, non-condensing Storage humidity: 15% to 95% RH, non-condensing
Altitude	Operating: 0 to 4572 m (0 to 15,000') : Storage: 0 to 12192 m (0 to 40,000')
Cooling	Convection (no fan)
Shock	Per IEC 60068-2-27
Vibration	Per IEC 60068-2-64

Power Requirements & Battery

Power Source	AC Power / Battery
AC Power Source	External AC Power Adapter (Welch Allyn REF: 4101-012) 100 – 240 VAC; 1.2 A max; 50 – 60 Hz Class I, Continuous Use
Power Consumption	S12: 18W nominal, 29W (when charging battery) S19: 27W nominal, 29W (when charging battery)
Startup Time	Less than 46 seconds
Battery Type	Internal Lithium-Ion Rechargeable 8700 mAh (Welch Allyn REF: 4800-017)
Battery Life	S12: 3 hours* S19: 2 hours*
Battery Charging Time	When off: 5 hours When On: S12: 7 hours S19: 20 hours

Display Specifications

Type	High definition, antiglare 16:9 Color TFT-LCD with LED backlight and resistive touch panel controls
Size & Resolution	S12: 11.6 inches diagonal; 256mm x 144 mm active area; 1366 x 768 pixels S19: 18.5 inches diagonal; 410mm x 230 mm active area; 1366 x 768 pixels

Recorder Specifications

Type	Thermal
Patient Monitors	S12: Optional, configured S19: Optional, modular
Print Width	48 mm
Paper Width	50 mm
Recording	Strip chart printing of two selectable waveforms
Recorder Speed	25 mm/sec
Recorder Resolution	200 dpi (v) x 400 (h) dpi
Waveform Recording	Any two of <ul style="list-style-type: none"> • ECG (I, II, III, avR, avL, avF, or V) • SpO2 • CO2 • IBP (P1, P2, P3 or P4)
Recording Time (Total duration of recording)	5, 10 & 15 seconds
Recording Delay (Recorded data prior to Alarm/Print condition)	0, 6 & 10 seconds

Mounting Specifications

Per the Flat Display Mounting Interface (FDMI), also known as VESA Mounting Interface Standard (MIS), of the Video Electronics Standards Association.

Conforms to MIS-D 75 (75 mm × 75 mm) and MIS-D 100 (100 mm × 100 mm) standards for optional mounting on a rolling stand (max. height 100 cm or 43 inches), wall mount or articulating wall mount using Welch Allyn specified accessories.

Trending

Trending	Up to 72 hours of numeric parameter information
----------	---

12. PARAMETER SPECIFICATIONS

Patient Population

Monitoring Capabilities	Adult or Pediatric
-------------------------	--------------------

Waveforms

Waveform Slots	<p>8 total slots available</p> <p>Top waveform (Position #1) always reserved for an ECG tracing</p> <p>Bottom four waveforms (Position #5, 6, 7, and 8) always reserved for invasive pressures.</p> <p>Configurable based on available parameters</p> <ul style="list-style-type: none"> • ECG any of I, II, III, V, aVL, aVR or aVF • SpO2 • CO2 or impedance respiration • IBP P1, P2, P3 or P4
Waveform Sweep Speed	6.25 ms, 12.5 ms, 25 ms & 50 ms
Waveform Delay	0.5 seconds on all parameters

ECG

ECG	3/5 Lead Cable or Welch Allyn AM12M 12-Lead ECG Acquisition Module
ECG Interpretation	Available with AM12M only
ECG Modes	Adult / Pediatric
Simultaneous Leads Available	<p>3 Lead Cable: I, II, III</p> <p>5 Lead Cable: I, II, III, aVR, aVL, aVF, V</p> <p>AM12M: I, II, III, aVR, aVL, aVF, V1, V2, V3, V4, V5, V6</p>
Acquisition Rate:	<p>3/5 Lead Cable: 250 samples/s</p> <p>AM12M: 40,000 samples/s initially, reduced to 500 s/s for analysis</p>
Resolution:	<p>3/5 Lead Cable: 2.5μV</p> <p>AM12M: 1.17μV reduced to 2.5μV for analysis</p>
Dynamic Range/Offset Tolerance:	\pm 300mV
ECG Gain	2.5, 5, 10, or 20 mm/mV
CMRR:	According to AAMI EC13 and IEC60601-2-27
Max. Auxiliary Patient Current:	< 10 μ A
Frequency Response Filtering:	<p>3/5 Lead Cable: Diagnostic or ST Monitoring: 0.05 to 40 Hz</p> <p>Monitoring: 0.67 to 40 Hz</p> <p>AM12M: Diagnostic: 0.05 to 150 Hz</p>
Input Impedance:	>2.5 MOhm at 10 Hz
Electrodes:	Must be compatible with EN 60601-2-27
Beat Detection:	Sensitivity 99.90%, positive predictivity 99.88% (AHA/MIT database)

Beat Recognition:	Normal, Ventricular, Paced, Unknown
HR Averaging	<p>The algorithm calculates the heart rate from its available source.</p> <p>If the heart rate from the last four R to R intervals is greater than 48 beats per minute, the average heart rate is determined by averaging the last 16 R to R intervals.</p> <p>If the heart rate from the last four R to R intervals is less than or equal to 48 beats per minute, then this rate is used.</p> <p>Paced beats and PVCs are included in the heart rate calculation.</p>
HR Range:	15 to 300 bpm Adult and Pediatric
HR Resolution	1 beat per minute
HR Availability:	Within 6 s after appearance of traces
HR Measurement Accuracy	Measurement error (RMS) as measured according to ANSI/AAMI EC57: 2.8% AHA database, 1.7% MIT database
HR Report Interval	1 second
Minimum QRS Amplitude:	300 μ V
Notch AC-Filter:	50, 60 Hz
Pacer Display/Analysis	Clinician selectable

Arrhythmia Analysis

Arrhythmia Detection	VFib, Asystole, VTach, PVC Run, VRhythm, Couplet, Bigeminy, Sustained Tachycardia, Sustained Bradycardia, Irregular, PVC/m too high, Pause, Pacer Non-Capture
VFib Detection: ECG Leads Used	3 lead: Displayed ECG vector 5 lead and AM12M: II, V1, and V5.
Beat Detection: ECG Leads Used	<p>3 lead: Displayed ECG vector</p> <p>5 lead:</p> <ul style="list-style-type: none"> When configured to Auto, the ECG leads used for HR and ARR processing start with II and V for detection and III for confirmation while allowing the algorithm to switch to other available leads based on signal quality. When configured to Single Lead, the ECG lead used for HR and ARR processing is the one specified by the user from the set I, II, III, or V. When configured to Multiple Leads, the ECG leads used for HR and ARR processing are selected internally from the set II and V for detection, and III for confirmation.
	<p>AM12M:</p> <ul style="list-style-type: none"> When configured to Auto, the ECG leads used for HR and ARR processing start with II and V5 for detection and V1 for confirmation while allowing the algorithm to switch to other available leads based on signal quality. When configured to Single Lead, the ECG lead used for HR and ARR processing is the one specified by the user from the set I, II, III, or V (V1). When configured to Multiple Leads, the ECG leads used for HR and ARR

	processing are selected internally from the set II and V5 for detection, and V1 for confirmation.
Beat Typing: ECG Leads Used	<p>3 lead: Displayed ECG vector</p> <p>5 lead:</p> <ul style="list-style-type: none"> When configured to Auto, the ECG leads used for HR and ARR processing start with II and V for detection and III for confirmation while allowing the algorithm to switch to other available leads based on signal quality. When configured to Single Lead, the ECG lead used for HR and ARR processing is the one specified by the user from the set I, II, III, or V. When configured to Multiple Leads, the ECG leads used for HR and ARR processing are selected internally from the set II and V for detection, and III for confirmation. <p>AM12M:</p> <ul style="list-style-type: none"> When configured to Auto, the ECG leads used for HR and ARR processing start with II and V5 for detection and V1 for confirmation while allowing the algorithm to switch to other available leads based on signal quality. When configured to Single Lead, the ECG lead used for HR and ARR processing is the one specified by the user from the set I, II, III, or V (V1). When configured to Multiple Leads, the ECG leads used for HR and ARR processing are selected internally from the set II and V5 for detection, and V1 for confirmation.
VTach Rate Threshold	Configurable from 100-200 beats per minute. For a VTach condition to be considered, the rate of the ventricular rate must be greater than the configured VTach rate.
VTach Count (PVC Run)	Configurable from 1-6 consecutive ventricular beats. For a VTach condition to be considered, the length of the ventricular waveform must be greater than the configured VTach length.

ST Analysis

ST Segment Analysis	Sensing leads: Any ECG lead available based on lead set used
ST Measurement Accuracy	Range: 2500 to +2500 μ V, Mean Error = 7 μ V (Std Dev = 63 μ V) per EC57 on ESC-ST database
Averaging	Over rolling 32 beats
Alarm Delay	60 seconds

Non-Invasive Blood Pressure (NIBP)

Type:	Oscillometric
Input Connector	Single Lumen Hose (Quick-Disconnect fitting)
Cuffs	Child, Small Adult, Regular Adult, Large Adult, Thigh
Rated Cuff Pressure Range	0 to 270 mmHg
Derived Parameters	Systolic, Mean, Diastolic
Resolution	1 mmHg
Measurement Range	Systolic: 30 to 250 mmHg Mean: 20 to 230 mmHg Diastolic: 10 to 210 mmHg
Measurement Accuracy	Sys: ± 5 mmHg (<i>std. dev.</i> < 8 mmHg) Mean: ± 5 mmHg (<i>std. dev.</i> < 8 mmHg) Dia: ± 5 mmHg (<i>std. dev.</i> < 8 mmHg)
Pulse Rate Range	30 to 240 bpm
Pulse Rate Accuracy	$\pm 5\%$ or ± 2 bpm, whichever is greater
Update Interval	Upon measurement completion
Measurement Time	30 seconds (typical) < 135 seconds (maximum)
Initial Cuff Pressure	Adults: 160 mmHg (clinician-selectable) Pediatrics: 120 mmHg (clinician-selectable)
Repeated Cuff Pressure	Previous systolic + 40 mmHg
Static Cuff Pressure Accuracy	± 3 mmHg
Overpressure Cutoff	290 ± 3 mmHg (normal means), 300 ± 30 mmHg (back-up)
Measurement Modes	Single Measurement or Auto (Interval) Measurement
Auto Measurement Settings	OFF, 2, 3, 5, 10, 15, 30, 60 minutes

Pulse Oximetry (SpO₂)

Module	Nellcor or Welch Allyn
Application	Adult / Pediatric
Method	Absorption – Spectrophotometric (dual wavelength) (Functional oxygen saturation of arterial hemoglobin)
Parameters	Plethysmogram (trace), % SpO ₂ , Pulse rate
Resolution	SpO ₂ : 1% O ₂ PR: 1 bpm (beat per minute)
Measurement Range	SpO ₂ : 30 – 100 %, calibrated range 70-100% PR: 30 – 240 bpm (Welch Allyn) PR: 25 – 250 bpm (Nellcor)

Measurement Accuracy	SpO ₂ : from 70 to 100%: $\pm 2\%$ (O ₂ %), < 70%: unspecified PR: ± 3 bpm
Measurement Test Method	Per ISO9919 Clause 50 (Welch Allyn SpO ₂ A _{RMS} = 1.73%) (Nellcor SpO ₂ A _{RMS} = 1.66%)
Report Interval	1 second. Numeric values held < 30 seconds
Pulse Tone	Yes (pulse tone pitch tied to SpO ₂ parameter value)

Temperature

Parameters	T1, T2 or ΔT ; Direct-Mode
Compatibility	YSI 400-series probes
Input Connector	2-pin connector
Display Patient monitors	$^{\circ}\text{F}$ and $^{\circ}\text{C}$ (clinician-selectable)
Measurement Resolution	0.1 $^{\circ}\text{C}$ (0.1 $^{\circ}\text{F}$)
Measurement Range	T1 & T2: 5.0 to 50.0 $^{\circ}\text{C}$ (41.0 to 122.0 $^{\circ}\text{F}$) ΔT : 0.0 to 50.0 $^{\circ}\text{C}$ (32.0 to 122.0 $^{\circ}\text{F}$)
Measurement Accuracy	± 0.1 $^{\circ}\text{C}$ plus probe tolerance
Transient Response	Within 30 seconds from 25 to 27 $^{\circ}\text{C}$

Respirations: Via ECG Impedance

Method	Impedance Pneumography
Input Connector	Available via 3/5 ECG Cable only
Sensing Lead	II
RR Resolution	1 bpm (breaths per minute)
Measurement Range	2 to 120 bpm
Measurement Accuracy	± 3 bpm
Measurement Sensitivity	0.25 ohms (minimum)
Report Interval	1 second
Bandwidth	0.17 to 3.3 Hz (-3dB)
Impedance Measuring Current	40 μA @ 28 kHz square wave across Lead II

Capnography (CO₂)

Method	Side-stream (Non-dispersive IR absorption)
Input Connector	Oridion Microstream FilterLine®. See Accessories chapter.
Displayed Parameters	End Tidal CO ₂ , Respiration Rate, FiCO ₂ and Integrated Pulmonary Index (IPI)
Displayable Waveform	Continuous CO ₂

Measurement Resolution	EtCO ₂ + FiCO ₂ : 1 mmHg Respiration: 1 bpm (breath per minute)
Measurement Range	etCO ₂ : + FiCO ₂ : 0 to 150 mmHg Respiration: 0 to 150 bpm
Measurement Accuracy (at sea level)	EtCO ₂ : + FiCO ₂ : 0 to 38 mmHg: ± 2 mmHg 38 to 150 mmHg: ± (5% or reading + 0.08% for every 1 mmHg > 38 mmHg) Accuracy applies for breath rates of up to 80 bpm. For breath rates above 80 bpm, accuracy is 4 mmHg or ±12 % of reading whichever is greater, for EtCO ₂ values exceeding 18 mmHg. This is tested according to and is compliant with ISO 21647. To achieve the specified accuracies for breath rates above 60 breaths/minute, the Microstream FilterLine H Set for Infant/Neonatal (p/n 006324) must be used. Above 55°C module temperature, ± 1mmHg or ± 2.5% (whichever is greater) has to be added to the tolerance of the accuracy specs. Respiration: 0 to 70 bpm: ± 1 bpm 71 to 120 bpm: ± 2 bpm 121 to 150 bpm: ± 3 bpm ETCO ₂ , FICO ₂ and Respiration accuracy tested according to ISO21647 using a mixture of gases (5% CO ₂ , 21% O ₂ , N ₂ balance) supplied via function generator and breath simulator application. Respiration rates from 10-60 bpm for adults/pediatrics and 60-110 bpm for infants as measured in 10 bpm discrete steps were tested for 1 minute before moving forward to the next value and at the end of this one minute period modules readings were taken.
Report Interval	1 second
Flow Rate	50 ml / min (-7.5 to +15 ml / min), flow measured by volume
Warm-up Time required to meet accuracy specifications	Typical: 30 seconds Max: 180 seconds (Readings are not reported until warm-up has completed)
Barometric Pressure Range	430 to 795 mmHg
Automatic Barometric Compensation	Yes
Total System Response Time	3.5 seconds (typical) using standard Microstream FilterLine®
Drift of measurement Accuracy	Meets accuracy specifications when the calibration schedule is followed in the General Care & Maintenance section.
Measurement Accuracy for Gas Mixture	Meets ISO 21647 Clause 51.101.3 (Tables 101 and 103): ± (volume fraction of 0.43% + 8% of gas level)
Measurement Accuracy in the Presence of Interfering Gases	Meets ISO 21647 Clause 101.1 (Tables 101 and 105): ± (volume fraction of 0.43% + 8% of gas level)

Invasive Pressures

Number of channels	P1, P2 (standard) and P3 or P4 (optional)
Sensitivity:	5μV/V/mmHg
Transducer Excitation Voltage	5V DC

Resolution:	1 mmHg
Measurement Range	-50 to 300 mmHg
Measurement Accuracy	± 1 mmHg or $\pm 1\%$, whichever is greater
Report Interval	Every 3 seconds
PR Range	30 – 250 bpm
PR Accuracy	± 2 bpm or $\pm 2\%$, whichever is greater
PR Resolution	1 bpm
Frequency Response:	0 – 12 Hz
Linearity Error:	< 1% or 1 mmHg
Measurement Patient monitors:	mmHg
Parameters:	Diastolic, Systolic, Mean for all types except Mean-only for CVP, RA, LA & ICP
Defibrillator Protection:	Requires transducers that withstand defibrillation as required by ANSI/AAMI BP 22
Zero Setting:	At connection of transducer, over complete pressure range, within 0.1 mmHg Manual

Cardiac Output

Method	Thermodilution
CO Resolution	0.1 liters per minute
CO Measurement Range	0.3 to 20.0 liters per minute
CO Measurement Accuracy	$\pm 5\%$ at 0 °C injectate
Update Interval	After each measurement
Measurement Start	Automatic, Manual
CO Averaging Support	Yes
Blood Temperature Probe Compatibility	3 pin thermistor (Edwards)
Blood Temperature Patient monitors	°C, °F
Blood Temperature Resolution	0.01 °C
Blood Temperature Measurement Range	33.0 to 40.0 °C
Injectate Temperature Probe Compatibility	In-line (Edwards), Bath (YSI)
Injectate Temperature Units of Measure	°C, °F
Injectate Temperature Resolution	0.1 °C
Injectate Temperature Measurement Range	0.0 to 40.0 °C

PARAMETER SPECIFICATIONS

Computation Constant Resolution	0.001
Computation Constant Range	0.000 to 0.999
Hemodynamic Calculations:	CO, CI, BSA, SV, SVI, SVR, SVRI, PVR, PVRI, LVSW, LVSWI, RCW, RCWI, RVSW, RVSWI, PAWP

13. PARAMETER ALARM LIMIT RANGES

The high and low alarm limit ranges are as per the tables below.

Adult Patient Mode

Parameter	Lower Limit Range (Factory Default)	Upper Limit Range (Factory Default)	Alarm Level (Factory Default)	Alarms On Choices (Factory Default)	Print on Alarm Choices	
Heart Rate	Off, 20 – 269 (50)	50 – 270, Off (120)	*Med	No, *Yes	No*	Yes
Bradycardia	10 – 90 (40)		Off* , Low, Med, High	(Non Applicable)	No*	Yes
Tachycardia	80 – 280 (150)		Off* , Low, Med, High	(Non Applicable)	No*	Yes
ST Increase	(Non Applicable)		Off* , Low, Med,	(Non Applicable)	No*	Yes
ST Decrease	(Non Applicable)		Off* , Low, Med,	(Non Applicable)	No*	Yes
ST Change	1.0 – 9.0 (2.0)		(Non Applicable)	(Non Applicable)	(Non Applicable)	
NIBP Systolic	Off, 30 – 258 (75)	32 – 260, Off (220)	*Med	No, *Yes	No*	Yes
NIBP Mean	Off, 20 – 253 (50)	22 – 255, Off (120)	*Med	No, *Yes	No*	Yes
NIBP Diastolic	Off, 10 – 233 (35)	12 – 235, Off (110)	*Med	No, *Yes	No*	Yes
SpO2	Off, 50 – 98 (90)	52 – 100, Off (100)	*Med	No, *Yes	No*	Yes
T1	°C : Off, 15.0– 44.9 (35.0) °F: Off, 59.0 – 112.8 (95.0)	°C : 15.1 – 45, Off (37.8) °F : 59.2 – 113.0, Off (100.0)	*Med	No, *Yes	No*	Yes
T2	°C : Off, 15.0– 44.9 (35.0) °F: Off, 59.0 – 112.8 (95.0)	°C: 15.1 – 45, Off (37.8) °F : 59.2 – 113.0, Off (100.0)	*Med	No, *Yes	No*	Yes
ΔT	°C: Off, 0.0 – 29.9 (0.0) °F: Off, 0.0 – 53.8 (0.0)	°C : Off, 0.1 – 30.0 (2.8) °F : 0.2 – 54, Off (5.0)	*Med	No, *Yes	No*	Yes
Resp Rate	Off, 2 – 118 (5)	4 – 120, Off (30)	*Med	No, *Yes	No*	Yes)
ETCO2	Off, 0 – 97 (25)	2 – 99, Off (60)	*Med	No, *Yes	No*	Yes
FICO2	(Non Applicable)	1 – 25, OFF (5)	*Med	No, *Yes	No*	Yes
IPI	Off, 1 – 9 (4)	(Non Applicable)	*Med	No, *Yes	No*	Yes

*Factory Default Settings

PARAMETER ALARM LIMIT RANGES

Parameter	Lower Limit Range	Upper Limit Range	Alarm Level	Alarms On Choices	Print on Alarm Choices
P1 Systolic	Off, -30 – 298 (*75)	-28 – 300, Off (*220)	*Med	No, *Yes	No* , Yes
P1 Mean	Off, -30 – 298 (*50)	-28 – 300, Off (*120)	*Med	No, *Yes	No* , Yes
P1 Diastolic	Off, -30 – 298 (*35)	-28 – 300, Off (*110)	*Med	No, *Yes	No* , Yes
P2 Systolic	Off, -30 – 298 (*15)	-28 – 300, Off (*50)	*Med	No, *Yes	No* , Yes
P2 Mean	Off, -30 – 298 (*10)	-28 – 300, Off (*25)	*Med	No, *Yes	No* , Yes
P2 Diastolic	Off, -30 – 298 (*5)	-28 – 300, Off (*20)	*Med	No, *Yes	No* , Yes
P3 Systolic	Off, -30 – 298 (*35)	-28 – 300, Off (*110)	*Med	No, *Yes	No* , Yes
P3 Mean	Off, -30 – 298 (*15)	-28 – 300, Off (*50)	*Med	No, *Yes	No* , Yes
P3 Diastolic	Off, -30 – 298 (*10)	-28 – 300, Off (*25)	*Med	No, *Yes	No* , Yes
P4 Systolic	Off, -30 – 298 (*35)	-28 – 300, Off (*110)	*Med	No, *Yes	No* , Yes
P4 Mean	Off, -30 – 298 (*15)	-28 – 300, Off (*50)	*Med	No, *Yes	No* , Yes
P4 Diastolic	Off, -30 – 298 (*10)	-28 – 300, Off (*25)	*Med	No, *Yes	No* , Yes

*Factory Default Settings

Pediatric Patient Mode

Parameter	Lower Limit Range	Upper Limit Range	Alarm Level	Alarms On Choices	Print on Alarm Choices
Heart Rate	Off, 20 – 100 (50)	50 – 250, Off (150)	*Med	No, *Yes	No* , Yes
Bradycardia	10 – 90 (40)		Off, Low, Med, High (Off)		No, Yes (No)
Tachycardia	80 – 280 (180)		Off, Low, Med, High (Off)		No, Yes (No)
ST Increase	(Non Applicable)		Off, Low, Med (Med)	(Non Applicable)	No, Yes (No)
ST Decrease	(Non Applicable)		Off, Low, Med (Med)	(Non Applicable)	No, Yes (No)
ST Change	1.0 – 9.0 (2.0)		(Non Applicable)	(Non Applicable)	(Non Applicable)
NIBP Systolic	Off, 30 – 158 (75)	32 – 160, Off (145)	*Med	No, *Yes	No* , Yes
NIBP Mean	Off, 15 – 138 (50)	17 – 140, Off (110)	*Med	No, *Yes	No* , Yes
NIBP Diastolic	Off, 10 – 128 (35)	12 – 130, Off (100)	*Med	No, *Yes	No* , Yes
SpO2	Off, 50 – 98 (90)	52 – 100, Off (100)	*Med	No, *Yes	No* , Yes
T1	°C : Off, 15.0 – 44.9 (35.0) °F : Off, 59.0 – 112.8 (95.0)	°C : 15.1 – 45, Off (37.8) °F : 59.2 – 113.0, Off (100.0)	*Med	No, *Yes	No* , Yes
T2	°C : Off, 15.0 – 44.9 (35.0) °F : Off, 59.0 – 112.8 (95.0)	°C : 15.1 – 45, Off (37.8) °F : 59.2 – 113.0, Off (100.0)	*Med	No, *Yes	No* , Yes
ΔT	°C : Off, 0.0 – 29.9 (0.0) °F : Off, 0.0 – 53.8 (0.0)	°C : Off, 0.1 – 30.0 (2.8) °F : 0.2 – 54, Off (5.0)	*Med	No, *Yes	No* , Yes
Resp Rate	Off, 2 – 118 (10)	4 – 120, Off (45)	*Med	No, *Yes	No* , Yes
ETCO2	Off, 0 – 97 (25)	2 – 99, Off (60)	*Med	No, *Yes	No* , Yes
FICO2	(Non Applicable)	1 – 25, OFF (5)	*Med	No, *Yes	No* , Yes
IPI	Off, 1 – 9 (4)	(Non Applicable)	*Med	No, *Yes	No* , Yes

*Factory Default Settings

Parameter	Lower Limit Range	Upper Limit Range	Alarm Level	Alarms On Choices	Print on Alarm Choices
P1 Systolic	Off, -30 – 298 (75)	-28 – 300, Off (145)	*Med	No, *Yes	No* , Yes
P1 Mean	Off, -30 – 298 (50)	-28 – 300, Off (110)	*Med	No, *Yes	No* , Yes
P1 Diastolic	Off, -30 – 298 (35)	-28 – 300, Off (100)	*Med	No, *Yes	No* , Yes
P2 Systolic	Off, -30 – 298 (15)	-28 – 300, Off (50)	*Med	No, *Yes	No* , Yes
P2 Mean	Off, -30 – 298 (10)	-28 – 300, Off (25)	*Med	No, *Yes	No* , Yes
P2 Diastolic	Off, -30 – 298 (5)	-28 – 300, Off (20)	*Med	No, *Yes	No* , Yes
P3 Systolic	Off, -30 – 298 (35)	-28 – 300, Off (110)	*Med	No, *Yes	No* , Yes
P3 Mean	Off, -30 – 298 (15)	-28 – 300, Off (50)	*Med	No, *Yes	No* , Yes
P3 Diastolic	Off, -30 – 298 (10)	-28 – 300, Off (25)	*Med	No, *Yes	No* , Yes
P4 Systolic	Off, -30 – 298 (35)	-28 – 300, Off (110)	*Med	No, *Yes	No* , Yes
P4 Mean	Off, -30 – 298 (15)	-28 – 300, Off (50)	*Med	No, *Yes	No* , Yes
P4 Diastolic	Off, -30 – 298 (10)	-28 – 300, Off (25)	*Med	No, *Yes	No* , Yes

*Factory Default Settings

14. ALARM SPECIFICATIONS

General Alarms

Alarms	Audible & visible alarm indication + external nurse call interface Alarm levels: High, Medium & Low Alarm Volume: 45 - 85 dB(A)
Visual Alarm Light	Color coded: Red, Yellow, Cyan Complies with IEC60601-1-8
Audible:	High, medium, low level, no sound Clinician adjustable volume control from 1 to 10 (45 – 85 dB) Complies with IEC60601-1-8
Alarm Silence / Suspend Times	Configurable: 1, 1.5 or 2 minutes

ECG and HR Messages

Message	Parameter Value	Possible Causes	Suggested Actions
HR asystole	ASY	No QRS detected for last 4 seconds	<p>Check the patient and provide any necessary clinical care.</p> <p>Check the ECG lead being used to calculate the heart rate (the top displayed lead) -- make sure that the QRS amplitude on this lead is at least 0.5 mV.</p> <p>Change to another ECG lead to get adequate QRS amplitude.</p> <p>Reposition or change electrodes if no lead gives adequate QRS amplitudes. Remember the importance of good skin preparation techniques.</p>
HR ventricular fibrillation	VF	No organized ventricular rhythm detected	<p>Check the patient and provide any necessary clinical care.</p> <p>Check the ECG lead being used to calculate the heart rate (the top displayed lead) -- make sure that the QRS amplitude on this lead is at least 0.5 mV.</p> <p>Change to another ECG lead to get adequate QRS amplitude.</p> <p>Reposition or change electrodes if no lead gives adequate QRS amplitudes. Remember the importance of good skin preparation techniques.</p>

Message	Parameter Value	Possible Causes	Suggested Actions
HR lead off	[blank]	<ul style="list-style-type: none"> Unplugged cable Broken cable Loose lead wire Faulty lead wire Dried out electrode Inoperable ECG circuit 	<p>Check to make sure electrodes are still securely attached to the patient, and reattach if necessary. Remember the importance of good skin preparation techniques.</p> <p>Check to make sure all the lead wires are still connected to the electrodes.</p> <p>Check to make sure the lead wires are securely connected to the Surveyor patient monitor.</p> <p>Check to make sure there are no broken lead wires.</p> <p>Turn monitor off, then back on</p> <p>If message persists, contact Welch Allyn technical</p>
HR artifact	---	<ul style="list-style-type: none"> Patient movement Electrical noise from auxiliary equipment Bad electrode contact 	<p>Calm the patient.</p> <p>Isolate the patient from auxiliary equipment, if possible.</p> <p>Check to make sure electrodes are still securely attached to the patient, and reattach if necessary. Remember the importance of good skin preparation techniques.</p>
HR < [lower limit]	[number]	The patient's heart rate has fallen below the current lower alarm limit.	<p>Check the patient and provide any necessary clinical care.</p> <p>Change the alarm limit if it is no longer clinically appropriate.</p>
HR > [upper limit]	[number]	The patient's heart rate has risen above the current upper alarm limit.	<p>Check the patient and provide any necessary clinical care.</p> <p>Change the alarm limit if it is no longer clinically appropriate.</p>
ECG Unable to Calibration		The AM12M 12-Lead ECG Acquisition Module has failed its calibration	Disconnect and reconnect the AM12M, while making sure that there are no spurious contacts between electrodes and earth ground.

Non-Invasive Blood Pressure (NIBP) Messages

Message	Parameter Value	Possible Causes	Suggested Actions
NIBP weak signal	---	<ul style="list-style-type: none"> Poor limb perfusion Improper cuff placement Cuff size too large for the patient 	<p>Check the patient and provide any necessary clinical care</p> <p>Check to make sure the cuff is wrapped properly, with the "artery" mark lined up over the brachial artery</p> <p>Check the limb circumference against the recommended range as printed on the cuff, to insure the cuff is not too big</p>

Message	Parameter Value	Possible Causes	Suggested Actions
NIBP artifact	---	Persistent patient movement or coughing Hemodynamic interference (varying pulse amplitudes due to breathing or cardiac valve defects) Hose is clogged or leaking	Check the patient and provide any necessary clinical care Calm the patient Move the cuff to another limb with less movement If no obvious patient motion, switching to the other limb may still help in the case of hemodynamic interference Check the cuff and hose for signs of damage
NIBP cuff leak	---	Leaky cuff or hose Cuff not applied to patient	Check for leaks in the cuff or hose and replace if necessary Check that cuff and hose are connected to the monitor Check that cuff is applied to patient
NIBP blocked hose -- check patient	---	Pinched Hose	Check the patient and insure that the cuff is deflated Check for kinks or obstructions in the hose Replace hose if necessary
NIBP measurement time exceeded	---	The measurement time limit (2¼ minutes) was exceeded, usually due to motion artifact	See suggestions for “NIBP artifact” Repeat the measurement
NIBP needs service	---	Monitor has detected a hardware problem	Check the patient and insure that the cuff is deflated Turn the monitor off, then on. If message persists, contact Welch Allyn technical
NIBP cannot measure	---	Initial inflation pressure may not have been high enough (if patient’s systolic pressure is above 200 mmHg) Patient movement	Repeat the measurement (monitor will automatically adjust to using a higher initial inflation pressure if needed)
NIBPs < [lower limit]	[number]	The patient's systolic pressure has fallen below the current lower alarm limit.	Check the patient and provide any necessary clinical care. Change the alarm limit if it is no longer clinically appropriate.

Message	Parameter Value	Possible Causes	Suggested Actions
NIBPs > [upper limit]	[number]	The patient's systolic pressure has risen above the current upper alarm limit.	Check the patient and provide any necessary clinical care. Change the alarm limit if it is no longer clinically appropriate.
NIBPd < [lower limit]	[number]	The patient's diastolic pressure has fallen below the current lower alarm limit.	Check the patient and provide any necessary clinical care. Change the alarm limit if it is no longer clinically appropriate.

NIBPd > [upper limit]	[number]	The patient's diastolic pressure has risen above the current upper alarm limit.	Check the patient and provide any necessary clinical care. Change the alarm limit if it is no longer clinically appropriate.
NIBPm < [lower limit]	[number]	The patient's mean pressure has fallen below the current lower alarm limit.	Check the patient and provide any necessary clinical care. Change the alarm limit if it is no longer clinically appropriate.
NIBPm > [upper limit]	[number]	The patient's mean pressure has risen above the current upper alarm limit.	Check the patient and provide any necessary clinical care. Change the alarm limit if it is no longer clinically appropriate.

Pulse Oximetry (SpO₂) Messages

Message	Parameter Value	Possible Causes	Suggested Actions
SpO ₂ replace sensor	---	Bad SpO ₂ sensor Incorrect set-up within the Surveyor patient monitor.	Replace the SpO ₂ sensor. Contact Welch Allyn Technical Support.
SpO ₂ check sensor placement	---	Sensor has become detached from patient Sensor not fully inserted on patient's finger Excessive ambient light Bad sensor (no red light coming from sensor)	Check to make sure the sensor is attached fully and securely to the patient Cover the sensor with opaque material, such as a towel, to reduce ambient light Reattach the sensor, possibly on a smaller or larger finger Replace sensor if there is no red light coming from it.
SpO ₂ weak signal	---	Poor perfusion Large tissue mass Nail polish Bad SpO ₂ sensor	Check the patient and provide any necessary clinical care Warm the patient's extremities if needed Reattach the sensor on a smaller finger Remove any nail polish that may be interfering with the red light Replace the SpO ₂ sensor
SpO ₂ unplugged	[blank]	SpO ₂ sensor not connected to SpO ₂ cable	Check to make sure the SpO ₂ sensor is securely connected to the SpO ₂ cable on the monitor
SpO ₂ artifact	---	Patient movement or coughing Hemodynamic interference	Calm the patient Reattach the sensor on another finger with less movement Reattach the sensor on a larger finger

SpO2 < [lower limit]	[number]	The patient's oxygen saturation has fallen below the current lower alarm limit.	Check the patient and provide any necessary clinical care Change the alarm limit if it is no longer clinically appropriate
SpO2 > [upper limit]	[number]	The patient's oxygen saturation has risen above the current upper alarm limit.	Check the patient and provide any necessary clinical care Change the alarm limit if it is no longer clinically appropriate

Message	Parameter Value	Possible Causes	Suggested Actions
PR < [lower limit]	[number]	The patient's pulse rate has fallen below the current lower alarm limit.	Check the patient and provide any necessary clinical care Change the alarm limit if it is no longer clinically appropriate
PR > [upper limit]	[number]	The patient's pulse rate has risen above the current upper alarm limit.	Check the patient and provide any necessary clinical care Change the alarm limit if it is no longer clinically appropriate

Temperature Messages

Message	Parameter Value	Possible Causes	Suggested Actions
T1 < [lower limit] T2 < [lower limit] L'T < [lower limit]	[number]	The patient's temperature or different between the two temperature probes has fallen below the current lower alarm limit.	Check the patient and provide any necessary clinical care. Verify that the values are not due to artifact by checking the position of the patient and cables as well as the placement of the probe. Change the alarm limit if it is no longer clinically appropriate.
T1 > [higher limit] T2 > [higher limit] L'T > [higher limit]	[number]	The patient's temperature or different between the two temperature probes has risen above the current higher alarm limit.	Check the patient and provide any necessary clinical care. Verify that the values are not due to artifact by checking the position of the patient and cables as well as placement of the probe. Change the alarm limit if it is no longer clinically appropriate.
T1 probe disconnected T2 probe disconnected	--	Probe is not connected to the Surveyor patient monitor	Connect the probe to the Surveyor patient monitor and the patient per clinical guidelines.

Respiration Messages

Message	Parameter Value	Possible Causes	Suggested Actions
RR out of range (too high)	---	<p>The patient's respiration rate has risen above the maximum value the monitor can accurately detect.</p> <p>Electrical noise from auxiliary equipment</p> <p>Monitor confused by signal artifact</p>	<p>Check the patient and provide any necessary clinical care.</p> <p>Isolate the patient from auxiliary equipment, if possible.</p> <p>Check to make sure electrodes are still securely attached to the patient, and reattach if necessary. Remember the importance of good skin preparation techniques.</p>
RR lead off	[blank]	<p>Unplugged cable</p> <p>Broken cable</p> <p>Loose lead wire</p> <p>Faulty lead wire</p> <p>Dried out electrode</p> <p>Inoperable respiration detection circuit</p>	<p>Check to make sure electrodes are still securely attached to the patient, and reattach if necessary. Remember the importance of good skin preparation techniques.</p> <p>Check to make sure all the lead wires are still connected to the electrodes.</p> <p>Check to make sure the lead wires are securely connected to the Surveyor patient monitor.</p> <p>Check to make sure there are no broken lead wires.</p> <p>Turn monitor off, then back on</p> <p>If message persists, contact Welch Allyn technical</p>
RR artifact	---	<p>Patient movement</p> <p>Electrical noise from auxiliary equipment</p> <p>Bad electrode contact</p>	<p>Calm the patient.</p> <p>Isolate the patient from auxiliary equipment, if possible.</p> <p>Check to make sure electrodes are still securely attached to the patient, and reattach if necessary. Remember the importance of good skin preparation techniques.</p>
RR < [lower limit]	[number]	<p>The patient's respiration rate has fallen below the current lower alarm limit.</p> <p>No breath has been detected for 30 seconds.</p>	<p>Check the patient and provide any necessary clinical care.</p> <p>Change the alarm limit if it is no longer clinically appropriate.</p>
RR > [upper limit]	[number]	<p>The patient's respiration rate has risen above the current upper alarm limit.</p>	<p>Check the patient and provide any necessary clinical care.</p> <p>Change the alarm limit if it is no longer clinically appropriate.</p>

Capnography (CO₂) Messages

Message	Parameter Value	Possible Causes	Suggested Actions
ETCO ₂ < [lower limit]	[number]	The patient's ETCO ₂ parameter value has fallen below the current lower alarm limit.	Check the patient and provide any necessary clinical care. Change the alarm limit if it is no longer clinically appropriate.
ETCO ₂ > [upper limit]	[number]	The patient's ETCO ₂ parameter value has risen above the current upper alarm limit.	Check the patient and provide any necessary clinical care. Change the alarm limit if it is no longer clinically appropriate.
FICO ₂ > [upper limit]	[number]	The patient's FICO ₂ parameter value has risen above the current upper alarm limit.	Check the patient and provide any necessary clinical care. Change the alarm limit if it is no longer clinically appropriate.
IPI < [lower limit]	[number]	The patient's IPI parameter value has fallen below the current lower alarm limit.	Check the patient and provide any necessary clinical care. Change the alarm limit if it is no longer clinically appropriate.
RR out of range (too high)	---	The patient's respiration rate has risen above the maximum value the monitor can accurately detect. Electrical noise from auxiliary equipment Monitor confused by signal artifact	Check the patient and provide any necessary clinical care. Isolate the patient from auxiliary equipment, if possible. Check to make sure electrodes are still securely attached to the patient, and reattach if necessary. Remember the importance of good skin preparation techniques.
RR < [lower limit]	[number]	The patient's respiration rate has fallen below the current lower alarm limit. No breath has been detected for 30 seconds.	Check the patient and provide any necessary clinical care. Change the alarm limit if it is no longer clinically appropriate.
RR > [upper limit]	[number]	The patient's respiration rate has risen above the current upper alarm limit.	Check the patient and provide any necessary clinical care. Change the alarm limit if it is no longer clinically appropriate.

Message	Parameter Value	Possible Causes	Suggested Actions
Note: Changing patient mode will change current setting values to saved default values.	--	The patient mode has changed. The patient age has changed.	Verify that the correct patient mode (Adult/Pediatrics) is being applied. Save or Purge patient data as appropriate, or cancel selection. Verify that the patient age is correctly entered. Clear IPI trend data and continue, or cancel selection.

Note: Changing patient mode will clear IPI trend data, even if other patient data is saved.	--	The patient mode has changed. The patient age has changed.	Verify that the correct patient mode (Adult/Pediatrics) is being applied. Save or Purge patient monitoring data as appropriate, or cancel selection. Verify that the patient age is correctly entered. Clear IPI trend data and continue, or cancel selection.
IPI age range not set	--	For pediatric patients, the age range must be set to correctly determine IPI.	Set the age range in the CO2 setup screen.
CO2 Occluded Line	--	CO2 sampling line cannot be cleared due to moisture or other obstruction.	Replace the sampling line. If connected to scavenging system, remove to see if the message disappears.
CO2 Warming Up	--	CO2 module is preparing to acquire data.	Allow more time.
CO2 unplugged	--	CO2 interface is not connected.	Connect the CO2 sample line to the monitor and patient.
CO2 Problem Detected	-	CO2 interface has encountered a problem	Check the CO2 subsystem including sampling line and exhaust port. Verify that the exhaust port is not blocked.

Invasive Pressure Messages

Message	Parameter Value	Possible Causes	Suggested Actions
IBPs < [lower limit] IBPm < [lower limit] IBPd < [lower limit]	[number]	The patient's invasive systolic/diastolic/mean pressure has fallen below the current lower alarm limit.	Check the patient and provide any necessary clinical care. Verify that the values are not due to artifact by checking the position of the patient, cables and transducer. Zero set the pressure if necessary. Change the alarm limit if it is no longer clinically appropriate.
IBPs > [higher limit] IBPm > [higher limit] IBPd > [higher limit]	[number]	The patient's invasive systolic/diastolic/mean pressure has risen above the current higher alarm limit.	Check the patient and provide any necessary clinical care. Verify that the values are not due to artifact by checking the position of the patient, cables and transducer. Zero set the pressure if necessary. Change the alarm limit if it is no longer clinically appropriate.
IBP signal out of range [low] IBP signal out of range [high]	--	The invasive signal is out of range.	Verify the position of the patient, cables and transducer. Zero set the pressure if necessary.
IBP unplugged	--	IBP cable or transducer not plugged	Verify that the cable and transducer are properly connected.
Unable to zero	--	Stopcock is not open	Open the stopcock and check tubing and cables.
Needs zeroing	--	IBP channel not zeroed	Zero the IBP channel

Needs zeroing after 60 seconds	--	IBP channel not zeroed	Zero the IBP channel
Needs calibration	--	IBP channel requires calibration	Arrange for calibration service of the IBP channel
Calibrating	--	IBP channel calibration is in progress	Wait until the calibration process is completed
Unable to calibrate	--	Calibration failed	Contact Welch Allyn Technical Support
ART: Check Transducer	--	ART IBP pressure below 10mmHg	Check ART catheter to ensure that it is properly positioned and connected.

Cardiac Output Messages

Message	Parameter Value	Possible Causes	Suggested Actions
BT signal out of range (high)	N/A	BT out of range (too high)	Check the BT transducer
BT signal out of range (low)	N/A	BT out of range (too low)	Check BT transducer
IT signal out of range (high)	N/A	IT out of range (too high)	Check IT transducer
IT signal out of range (low)	N/A	IT out of range (too low)	Check IT transducer
CO measurement time exceeded	N/A	CO measurement timeout	Restart the CO
BT unplugged	N/A	BT unplugged	Plug in the BT transducer
IT unplugged	N/A	IT unplugged	Plug in the IT transducer

Network Messages

Message	Parameter Value	Possible Causes	Suggested Actions
Network Connection Lost	N/A	LAN cable unplugged. Network failure. Monitor out of WIFI coverage.	Check the LAN cable to ensure that it is properly connected into the patient monitor. Ensure that the monitor is under the WIFI coverage.

15. TROUBLESHOOTING

The following table provides guidance for investigating issues that may occur during operation of the Surveyor patient monitors. Contact Welch Allyn Technical Service for further assistance.

Power and Battery

Symptom	Possible Causes	Suggested Resolution
The Surveyor patient monitor is not working and displays an error message.	Internal system failure	Power cycle the Surveyor patient monitor and try again. If problems persist, stop using the Surveyor patient monitor and contact Welch Allyn Technical Support.
The patient monitor is plugged in but does not start up.	No AC power from outlet	Verify that the power outlet is working; verify the green LED on the front panel is illuminated.
	The monitor is powered off	Press the power switch to power on the patient monitor.
	Internal system error	Power cycle the Surveyor patient monitor. If problem persists, stop using the Surveyor patient monitor and contact Welch Allyn Technical Support.
The patient monitor will not run once on battery power.	Battery needs charging	Connect the Surveyor patient monitor to AC power. Verify that the green LED is illuminated and the Surveyor patient monitor powers up.
	Battery will not hold charge	Replace the battery according to instructions in the General Care & Maintenance section.

Display and Touch Screen

Symptom	Possible Causes	Suggested Resolution
The touch screen is not working properly.	Touch screen failure	Power cycle the Surveyor patient monitor and try again. If problems persist, stop using the Surveyor patient monitor and contact Welch Allyn Technical Support.
	Touch screen may need calibrating	Attempt to calibrate the touch panel from the Service menu.
The display is not working properly.	Display failure	Power cycle the Surveyor patient monitor and try again. If problems persist, stop using the Surveyor patient monitor and contact Welch Allyn Technical Support.

ECG, Arrhythmia, and ST

Symptom	Possible Causes	Suggested Resolution
ECG signal is noisy.	Notch filter selection may not be appropriate for local settings.	Change the notch filter setting in the Service menu based on local power frequency (50 or 60 Hz). Check the proximity of the ECG lead cables to power cable or high frequency noise sources.
	Patient movement Electrical noise from auxiliary equipment Bad electrode contact	Confirm electrode site preparation; confirm correct ECG placement; instruct the patient to not move. Calm the patient. Isolate the patient from auxiliary equipment, if possible. Check to make sure electrodes are still securely attached to the patient, and reattach if necessary. Remember the importance of good skin preparation techniques.
No ST numeric values displayed	ST is not enabled in the Setup HR dialogue AND/OR ST is not enabled in the Setup>Parameters dialogue	Enable ST in the Setup HR dialogue AND/OR Enable ST in the Setup>Parameters dialogue
AM12M connected but no ECG traces are displayed	12-lead is not enabled in the Setup HR dialogue AND/OR AM12M encountered an error during power-up auto calibration	Enable 12-lead in the Setup HR dialogue AND/OR Unplug the AM12M from the device and plug it back in.

Non-Invasive Blood Pressure (NIBP)

Symptom	Possible Causes	Suggested Resolution
NIBP measurement fails or inaccurate.	Cuff selection or placement, or patient movement	Confirm the selection and placement of the NIBP cuff; instruct the patient to not move during the measurement cycle; confirm appropriate initial inflation pressure settings. Re-attempt the measurement. If problems persist, contact Welch Allyn Technical Support.
Audible beep heard	Successful completion of NIBP measurement	No action. This is as per design. The NIBP End Tone signifies to the clinician that the NIBP measurement has completed.
Cannot obtain BP measurement	Patient moving during BP acquisition Improper cuff size Cuff or tubing not properly connected BP out of range Improperly configured NIBP inflation pressure	Use comfort measures to encourage patient to keep NIBP limb still Ensure proper BP cuff size Check all NIBP connections Use a manual or alternative BP acquisition mode Adjust the NIBP inflation pressure based on the patient's systolic BP

BP values higher or lower than clinically anticipated	Improper cuff size or placement Patient moving during BP acquisition	Ensure proper BP cuff size and placement Use comfort measures to encourage patient to keep NIBP limb still
---	---	---

Pulse Oximetry (SpO2)

Symptom	Possible Causes	Suggested Resolution
Pulse oximetry measurement fails or inaccurate	Sensor placement or patient movement	Confirm the selection and placement of the pulse oximetry sensor; instruct the patient to not move the SpO2 sensor extremity; remove dark finger nail polish.
Cannot obtain SpO2	SpO2 sensor not connected to patient Sensor/cable not properly connected Patient moving Overhead lighting interference Patient has poor perfusion, slow HR, low BP	Connect SpO2 sensor to patient Check all SpO2 connections Use comfort measures to encourage patient to keep SpO2 limb still Place SpO2 limb under the top sheet or blanket, for example Switch SpO2 to another limb
SpO2 waveform is erratic, low amplitude	Patient moving SpO2 sensor on same limb as NIBP cuff	Use comfort measures to encourage patient to keep SpO2 limb still Move SpO2 and NIBP to different patient limbs

Temperature

Symptom	Possible Causes	Suggested Resolution
No T1, T2, or L'T numeric values displayed	Incorrect display format	Select the temperature parameters to display via the Setup Temperature dialogue

Respirations: Via ECG Thoracic Impedance

Symptom	Possible Causes	Suggested Resolution
No respiration waveform displayed	3 or 5 lead cable: Cable not connected Electrodes not connected AM12M in use Resp disabled	Check that the ECG cable is properly connected into the patient monitor. Ensure ECG electrodes have good connection with the patient's skin. The AM12M 12-Lead ECG Acquisition Module does not support respirations. Alternative: Use 3 or 5 lead cable, capnography. Enable Respirations via Setup Resp dialogue

Capnography (CO2)

Symptom	Possible Causes	Suggested Resolution
No CO2 waveform and numeric values displayed	CO2 is not enabled in the Setup>Parameters dialogue	Enable CO2 in the Setup>Parameters dialogue

Invasive Pressures

Symptom	Possible Causes	Suggested Resolution
No Invasive pressure waveform and numerics displayed	<p>Improper manifold setup Loose pressure tubing connections Pressure cable not connected into monitor Stopcock not in correct position Transducer requires zeroing</p> <p>Invasive pressure are not enabled in the Setup>Parameters dialogue</p>	<p>Ensure the pressure manifold is properly connected, the invasive cable is inserted into the correct invasive pressure channel of the patient monitor, and the transducer is intact. Zero the invasive pressure</p> <p>Enable invasive pressures in the Setup>Parameters dialogue</p>
Invasive pressure waveform is dampened	Air in invasive pressure tubing Kinked or occluded patient catheter	<p>Check patient Check invasive pressure tubing for patency Follow hospital standard of care</p>
Cannot zero the invasive pressure	Stopcock not in correct position	<p>Open stopcock to atmosphere Check pressure manifold patency</p>
Invasive pressure numerics higher or lower than clinically anticipated	Improperly leveled transducer- either too high or too low	Re-level the transducer as per hospital standard of care
The PAWP dialogue is hidden	Invasive pressure not labeled as PA	Label the appropriate invasive pressure as PA

Cardiac Output

Symptom	Possible Causes	Suggested Resolution
No CO tile displayed	CO is not enabled in the Setup>Parameters dialogue	Enable CO in the Setup>Parameters dialogue
No CO numerics displayed	<p>CO curves not yet performed CO average not saved</p> <p>CO is not enabled in the Setup>Parameters dialogue</p>	<p>Perform CO measurements Save CO average</p> <p>Enable CO in the Setup>Parameters dialogue</p>
CO numerics higher or lower than clinically anticipated	Computation constant incorrect for catheter and injectate volume	Enter computation constant as per PA catheter manufacturers recommendation
Irregular CO curve	<p>Improper CO injection technique Patient movement during CO injection</p>	<p>Reattempt CO bolus as per hospital standard of care Use comfort measures to encourage patient to keep still during CO procedure</p>
CO curves not drawn	Monitor is in Manual CO mode	When in Manual CO mode, select START when injecting the CO bolus to begin the CO curve drawing Switch to Auto CO mode

WLAN connectivity

Symptom	Possible Causes	Suggested Resolution
The patient monitor stops working and a popup window with an error message appears on screen. The patient monitor then begins rebooting within 2 or 3 minutes from startup, after having displayed the popup with the error message.	Internal system error	Stop using the Surveyor patient monitor and contact Welch Allyn Technical Support.

Surveyor S12 and S19 Software Block Diagram

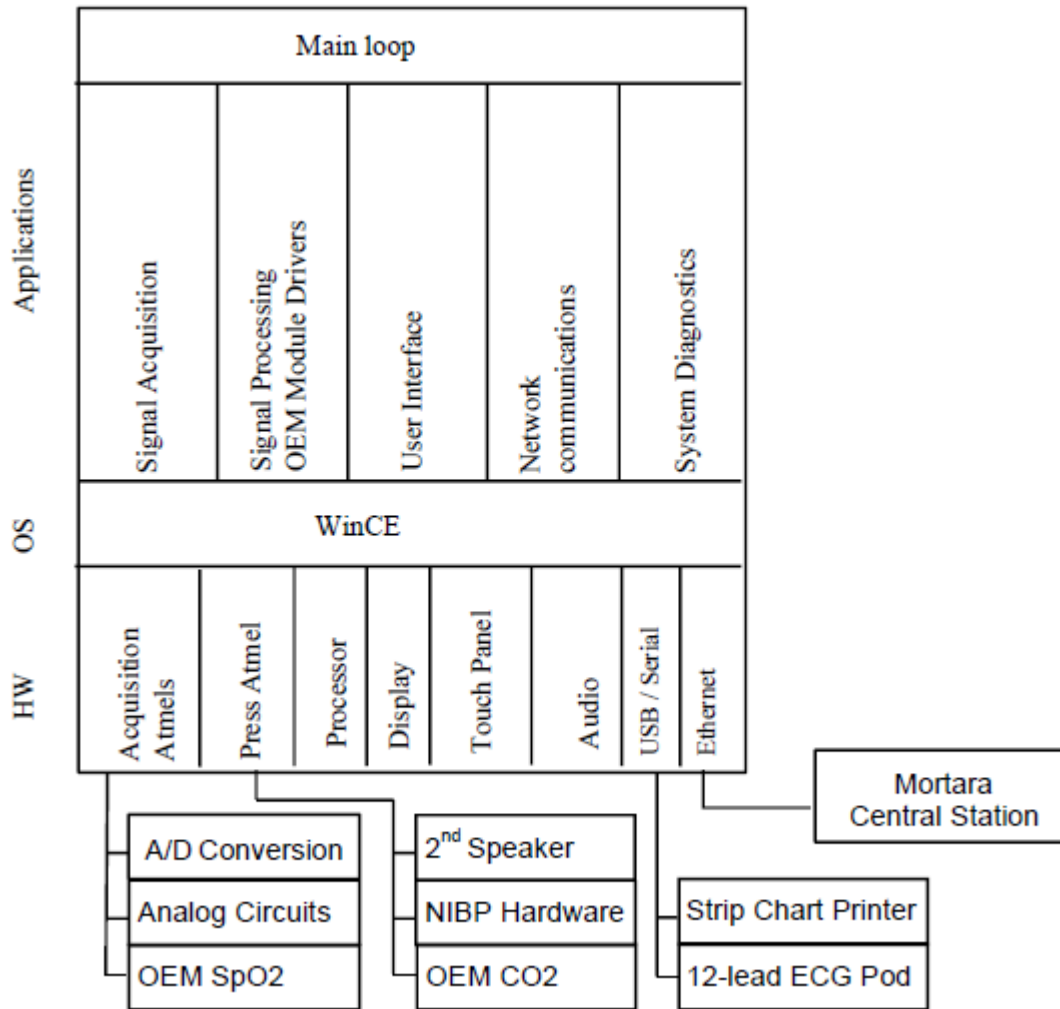

Surveyor S12 and S19 Hardware Block Diagram

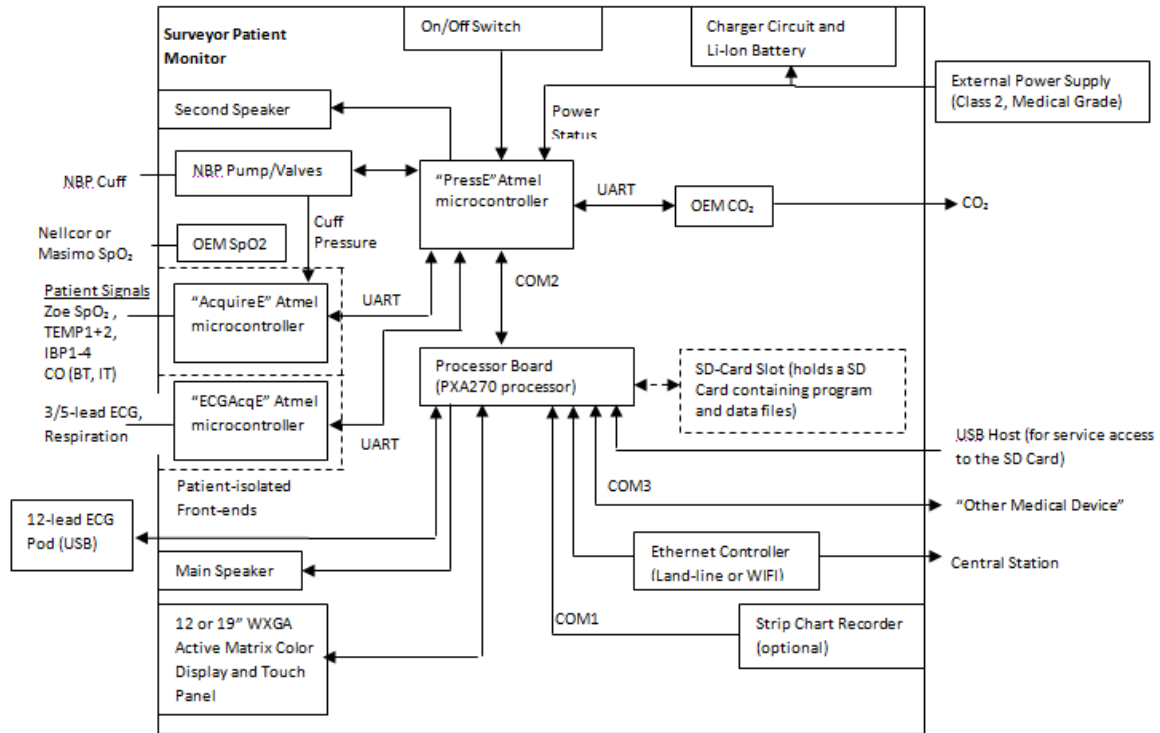

Serial Number and Revision Information

To access the “Setup Configuration” screen press Setup, Administration, Configuration.

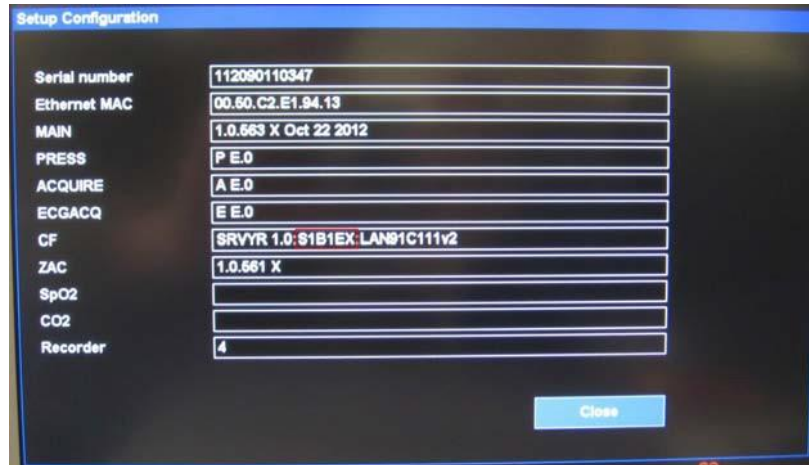

Field Name	Definition
Serial Number	Factory Serial Number of the Patient Monitor
Ethernet MAC	MAC Address of the onboard LAN
MAIN	<p>Main is the program that drives the Surveyor device (e.g., user interface, signal processing). It is loaded at start-up from the SD Card by the WinCE OS and runs on the Processor Board.</p> <p>The Main program includes the following DLL's and Libraries:</p> <ul style="list-style-type: none"> • ZAC (DLL) • ArrhyLib (Library) - ECG / Arrhythmia / ST analysis software • RestInterp (Library) - Rest-ECG Interpretation software • USB_DRV (DLL) - WinCE USB Driver for the AM12MPod • Ethernet Driver (DLL) - WinCE Ethernet Driver - controlled by Zoe
PRESS	The “PressE” program manages the system power, NIBP pneumatic control, safety buzzer and backlight control. It runs on the Main Board’s ATmega640 microcontroller.
ACQUIRE	The “AcquireE” program manages the acquisition and control of the non-ECG physiological waveforms. It runs on one of the Main Board’s ATmega162 microcontrollers.
ECGACQ	The “ECGAcqE” program manages the acquisition and control of the 5-lead ECG physiological waveforms. It runs on one of the Main Board’s ATmega162 microcontrollers.
CF (part 1 of 3)	Revision of the Surveyor Patient Monitor Software
(part 2 of 3)	BIOS Revision: The “BIOS” is a collection of files that are stored in the Processor Board’s flash memory. These include the boot loader, boot-time splash screen, hardware configuration table, initial WinCE registry settings, and the WinCE OS.
(part 3 of 3)	Ethernet Driver Revision
ZAC	ZAC (DLL) – Surveyor Central Station interface software revision.
SpO2	The “SpO2 (Nellcor)” program manages the acquisition and analysis of the pulse oximetry physiological waveforms. It runs on the Covidien Nell-1 board.
CO2	The “CO2” program manages the acquisition and analysis of CO2 physiological waveforms. It runs in the Oridion MiniMediCO2 module.
Recorder	The “Recorder” program manages the rendering of recordings on thermal paper, including the associated motor and printer-dot management. It runs on the processor in the recorder component.

16. MOUNTING ACCESSORIES

Quick Disconnect (M-Series) Wall Mounting Components

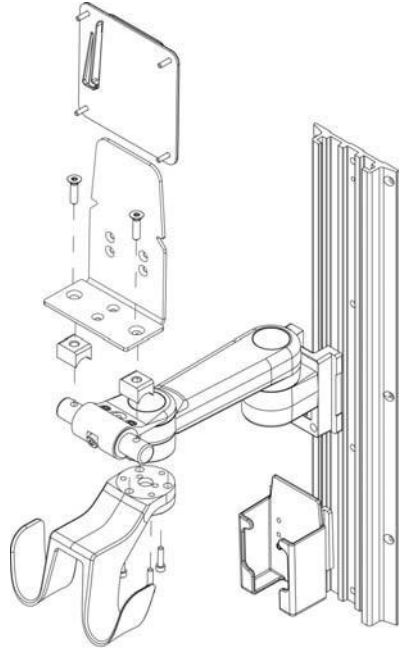

Value (Vesa M-Series) Wall Mounting Components

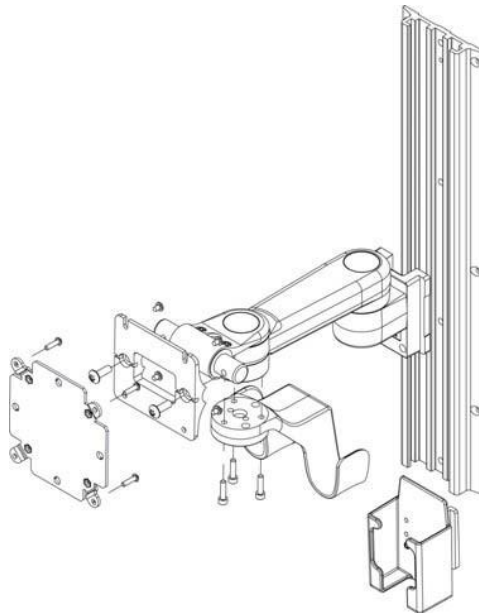

Premium (VHM-25) Wall Mount Components

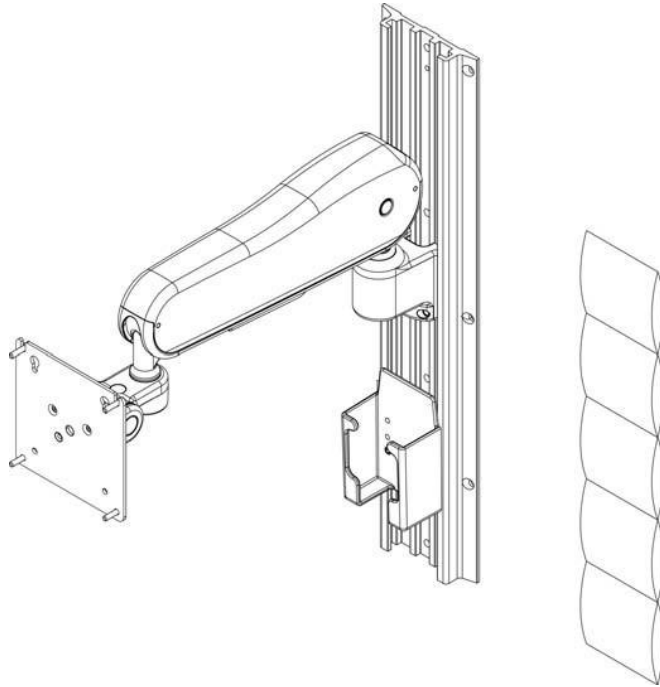

Surveyor S12 Roll Stand Components (not to be used with S19)

