

Wire Connectors

Terminals & Wire

Switches

Conduit Bending

Conduit Fishing

Hole Making

Hand Tools

Test Instruments

Cable Ties

Staples

Wire Management

Voice • Data • Video

Full Line Product Catalog



New Products

NEW Flex Straps

152



NEW
Beadle Wraps

152



NEW
Wireless Inspection Camera

138



NEW
Xtreme Ties



152

NEW
Bundle Boss

151



<i>Wire Connectors</i>	5
<i>Terminals & Wire</i>	15
<i>Switches</i>	25
<i>Conduit Bending</i>	33
<i>Conduit Fishing</i>	65
<i>Hole Making</i>	101
<i>Hand Tools</i>	115
<i>Test Instruments</i>	131
<i>Cable Ties</i>	145
<i>Staples</i>	153
<i>Wire Management</i>	161
<i>Voice • Data • Video</i>	173
<i>Index</i>	189

Wire Connectors

Crimp Connectors 12
Copper Lugs 14
Twist-on Connectors 7-10
Grounding Accessories 14
Hi-Temp Black Connectors 8
Mechanical Lugs 12-13
Nylon Pigtail Connectors 11
Push-In Connectors (PushGard™) 11
Winged Connectors (WingGard™) 8

Terminals & Wire

Clips & Clamps 23
Butt Splices & Kits 17, 20
Disconnects 19
Ring Terminals 17, 18
Spade Terminals 17, 18
GB Xtreme™ Terminals 17
Tap Splices 20
Terminal Blocks 20
Underground UF Splice Kits 22
Wire 23

Switches

Door Switch 32
Pull Chain Switches 30, 31
Push Button Switches 29, 30
Rocker Switches 31
Rotary Switches 32
Toggle Switches 28, 29
Toggle Switch Cover 29

Conduit Bending

Cyclone™ Electric Bender (B2000) 36
Hand Benders (including Big Ben™) 58-60
Hydraulic Benders / Accessories 40-53
Pumps 49-51
PVC Benders & Plug Sets 61-63
Sidewinder® Electric Bender (B2555) 37
Sidewinder® Mechanical Benders 54-57
Ultra Egor™ Hydraulic Bender 40-41
Storage Cases (Tool-Guard™) 64

Conduit Fishing

Blower Systems 68-69
CO2 Systems 71-72
Fish Sticks 81
Fish Tapes (including UpperHand™) 76-80
Lubricants 91-93
Pull Line/Line Carriers 73-75
Pullers & Accessories 82-90
Reel Rollers & Jacks 96
Rope 93-94
Ultra Brutus™ 88-89
Wire Caddies & Carts 97-98

Hole Making

35-Ton Hydraulic Punch 108
Drawstuds 110-111
Step Bits 112
Slug-Out™ Sets for Mild & Stainless Steel 103-107
Stud Punch 113

Hand Tools

Circuit Alert™ 117-119
Cutters 122-123
Datacom/VDV 124-125

Knives 117, 130
Pliers 119, 126-128
Screwdrivers 119, 129
Wire Strippers 118, 120-124

Test Instruments

Battery Tester (analog) 142
Continuity Testers 135
Multimeters (analog, digital, clamp-on) 139-141
Non-Contact Voltage Testers 136
Receptacle Testers/Analyzers 137
Tester Parts 142
Tone & Trace 138
Voltage Testers 133-136

Cable Ties

Colored 150
Grip Strip™ 151
Heavy Duty 148
Miniature 147
Mounting Bases & Ties 149, 151
Releasable 149
Standard 147
Tensioning Tools 151

Staples

Category 3 & 5 Data 159
Coaxial 158, 160
Conduit Straps 158
Fiber-Insulated 160
Insulated Metal 156
Low Voltage 156, 159
Masonry 159, 160
MultiCable 157
Metal 156
Plastic 157
Roofing 160
Service Entrance 157, 158
Staple Gun 155-156

Wire Management

Electrical Reference Books 172
Anchor Kit 171
Box Supports/Spacers 170, 172
Bushings/Insulators 178
Cable Clamps 167
Duct Seal Compound 169
Hanger Strap 169
Heat-Shrink Tubing 165-166
Knockout Seals 168
Screw Kits 171
Seals 168-169
Split Flex Tubing/Spiral Wrap 166
Stud Insulators 168
Tape 163-164
Wire Marking 170

Voice • Data • Video

Cable Boss™ Staple Gun 181
Cable Staples 181, 183
Coaxial Strippers/Cutters 177, 178
F-Series Connectors 177
Punch-down Tools 175
TelCom RJ-45 Modular Plugs 180
UTP/STP Cable Stripper 179
Wire Tracker™ Wire Tracer 176
Accessories 181-183

Wire Connectors

Gardner Bender™ wire connectors are engineered to exceed the expectations of professional electricians. Perfect for commercial or residential applications, GB® wire connectors offer world-class quality, performance and application versatility.

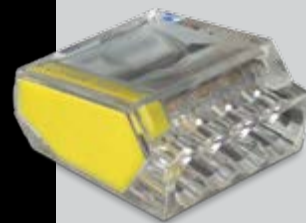

page 11



page 7



page 12



page 13

Aluminum Mechanical Lugs.....	13
Aluminum Splicer-Reducers	13
Aluminum Split Bolt Connectors.....	12
Anti-Oxidant Compound (Ox-Gard™)	14
Copper Mechanical Lugs	13
Copper Split Bolt Connectors.....	12
Crimp Connectors.....	12
Grounding Connectors (GreenGard™)	10
Grounding Accessories.....	14
Hi-Temp Black Connectors	8
Multi-Range Connectors (Hex-Lok®)	9
Pigtail Connectors.....	11
Push-In Connectors (PushGard™).....	11
Straight-Sided Connectors (WireGard™)	7
Universal Connectors (Uni-Lok®).....	10
Winged Connectors (WingGard®).....	8

WireGard™ Color-Coded Screw-On Wire Connectors

The industry standard twist-on connector with top quality, performance and durability.

- Color-coded for easy size selection.
- Tight, square-wire spring makes quick, secure connections for positive continuity.
- Tough, thermoplastic shell shields against environmental extremes.
- Resists chemical action from hydrocarbons, diluted acid or alkaline solutions.
- Flame-retardant properties resist heat distortion up to 105 °C (221 °F).
- High-dielectric shell features deep skirt design to prevent exposure of bare wire.
- Copper-to-copper connections only.
- All wire nuts are made with Polypropylene.



	Color	Part #	Pkg Qty	Wire Range	Min	Max
GB-1 (71B)		10-001	100/box	#22 - #16 AWG (connections rated at 300 V Max.)	1 #20 w/1 #22	2 #16
		12-001	25,000/bulk keg			
		12-001BU	150,000/bulk barrel			
		16-001	150/jar			
		19-001	14/card			
		25-001	25/resealable bag			
GB-2 (72B)		10-002	100/box	#22 - #16 AWG (connections rated at 300 V Max.)	3 #22	3 #16
		12-002	10,000/bulk keg			
		12-002BU	96,000/bulk barrel			
		16-002	150/jar			
		19-002	14/card			
		25-002	25/resealable bag			
GB-3 (73B)		10-003	100/box	#22 - #14 AWG (connections rated at 300 V Max. and 600 V Max.) ²	3 #20	4 #16 w/1 #20
		12-003BU	53,000/bulk barrel			
		13-003	500/bag			
		16-003	100/jar			
		16-003M	300/jar			
		17-003	50/bag			
		19-003	12/card			
		25-003	25/resealable bag			
GB-4 (74B)		10-004	100/box	#18 - #10 AWG (connections rated at 300 V Max. and 600 V Max.) ²	1 #14 w/1 #18	3 #12
		12-004BU	32,400/bulk barrel			
		13-004	500/bag			
		16-004	200/jar			
		17-004	50/bag			
		19-004	9/card			
25-004	25/resealable bag					
GB-6 (76B)		10-006	100/box	#18 - #10 AWG (connections rated at 300 V Max. and 600 V Max.) ²	2 #14	2 #10 w/2 #12
		12-006BU	21,000/bulk barrel			
		13-006	250/bag			
		16-006	125/jar			
		17-006	50/bag			
		19-006	6/card			
25-006	25/resealable bag					

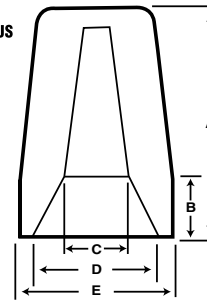

Dimensions

	A	B	C	D	E
GB-1	37/64"	11/64"	1/8"	1/4"	21/64"
GB-2	45/64"	11/64"	3/16"	5/16"	25/64"
GB-3	27/32"	21/64"	13/64"	11/32"	7/16"
GB-4	15/16"	17/64"	15/64"	7/16"	35/64"
GB-6	11/16"	17/64"	21/64"	17/32"	21/32"

² Note: Connection rated at 600 V Max. for building wiring and rated at 1000 V Max. in lighting fixtures/luminaries and signs. See carton for detailed wire combination ratings or www.gardnerbender.com.

Assortments

Part #	Pkg Qty	Description
19-AWC	9/card	2 gray, 2 orange, 3 yellow, 3 red
25-AWC	25/resealable bag	3 gray, 4 blue, 6 orange, 6 yellow, 6 red

Hi-Temp Black Connectors for Tough Environments

Connectors manufactured with high-temperature-rated plastic to withstand extreme temperatures.

- Temperature-rated to 150 °C (302 °F).
- Available in two standard models.
- Copper-to-copper connections only.



GB-4 GB-3

Model	(Size)	Part #	Pkg Qty	Wire Range	Min	Max
GB-3	(73B)	10-003HT	100/box	#22 - #14 AWG ¹	3 #20	4 #16 w/1 #20
		27-003	10,000/bulk keg			
GB-4	(74B)	10-004HT	100/box	#18 - #10 AWG ¹	1 #14 w/1 #18	4 #14
		27-004	10,000/bulk keg			



¹ Connections rated at 300 V Max. and 600 V Max.



Note: Connection rated at 600 V Max. for building wiring and rated at 1000 V Max. in lighting fixtures/luminaries and signs. See carton for detailed wire combination ratings or www.gardnerbender.com.

WingGard® Color-Coded Twist-On Wire Connectors

Unsurpassed quality and durability in a high-leverage, easy-on wing-type design.

- Wings are knurled for a sure grip and offset from centerline for greater twisting leverage.
- Square-wire plated spring instantly adjusts to the shape and size of the splice.
- Flame-retardant properties resist heat distortion up to 105 °C (221 °F).
- High-dielectric shell features deep skirt design to prevent exposure of bare wire.
- Copper-to-copper connections only.



	Color	Part #	Pkg Qty	Wire Range	Min	Max
#84™		10-084	100/box	#22 - #10 AWG (connections rated at 300 V Max. and 600 V Max.)	2 #22	3 #12
		12-084BU	42,000/bulk barrel			
		13-084	500/bag			
		16-084	100/jar			
		16-084M	225/jar			
		17-084	50/bag			
		19-084	6/card			
		25-084	25/resealable bag			
#86™		10-086	100/box	#22 - #6 AWG (connections rated at 300 V Max. and 600 V Max.)	2 #20	4 #10
		12-086BU	22,500/bulk barrel			
		13-086	500/bag			
		16-086	125/jar			
		16-086L	325/jar			
		17-086	50/bag			
		19-086	6/card			
		25-086	25/resealable bag			
#89™		10-089	50/box	#14 - #6 AWG (connections rated at 300 V Max. and 600 V Max.)	1 #10 w/1 #12	1 #6 Str w/2 #8 Str
		13-089	100/bag			
		19-089	2/card			
		25-089	10/resealable bag			

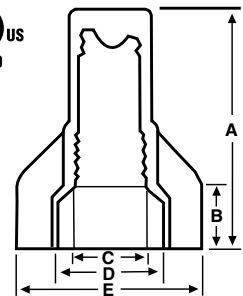

Dimensions

	A	B	C	D	E
#84™	1 1/32"	5/16"	7/32"	1/4"	23/32"
#86™	1 1/4"	5/16"	9/32"	7/16"	29/32"
#89™	1 1/2"	7/16"	3/8"	3/4"	1 1/4"

Note: Connection rated at 600 V Max. for building wiring and rated at 1000 V Max. in lighting fixtures/luminaries and signs. See carton for detailed wire combination ratings or www.gardnerbender.com.

Assortments

Part #	Pkg Qty	Description
16-8486M	160/jar	80 red, 80 yellow
19-AWW	5/card	2 yellow, 2 red, 1 large gray
25-AWW	25/resealable bag	8 yellow, 8 red, 7 tan, 2 blue

Gardner Bender™ Twist-On Wire Connectors

Engineered to exceed the expectations of professional electricians.

All GB® Twist-On Wire Connectors:

- Are designed to make wiring jobs fast, easy, safe and reliable.
- Provide maximum application flexibility by offering contractors myriad packaging options, ergonomic designs and wire ranges.
- Exceed UL standards for dielectric strength, wire pullout force and static heat resistance.
- Are manufactured of top-quality materials.
- Meet the requirements of nearly all budgets.
- Are continually evaluated for improvements and enhancements.

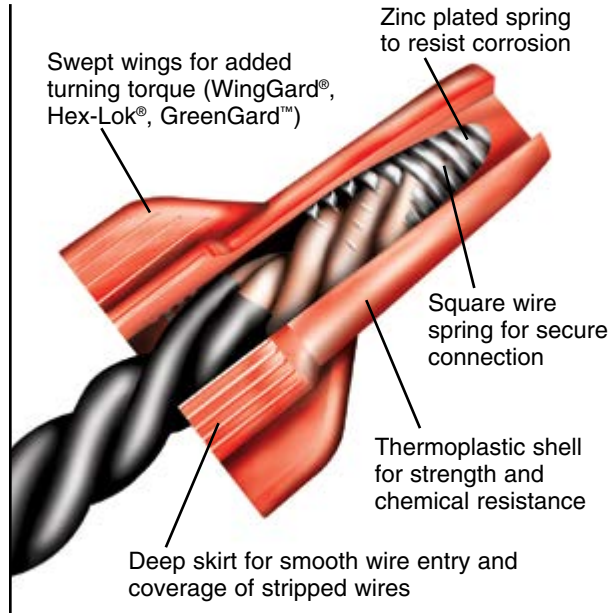



Hex-Lok® Multi-Range Wire Connectors

Multi-range, hex-head copper-to-copper connector covers 95% of everyday applications.

- Streamlined design for compact installations.
- Square-wire spring grabs and holds wires for secure connections.
- Long skirt covers stripped wires.
- Rated at 600 V Max. in building wire and at 1000 V Max. in lighting fixtures/luminaries and signs.
- Copper-to-copper connections only.



Patented

	Color	Part #	Pkg Qty	Wire Range	Min	Max
H1		10-1H1	100/box	#22 - #8 AWG	3 #22	3 #10
		12-1H1BU	28,000/bulk barrel			
		12-1H1BX	33,000/bulk barrel			
		13-1H1	500/bag			
		16-1H1	175/jar			
		16-1H1L	400/jar			
		17-1H1	50/bag			
		19-1H1	6/card			
		25-1H1	25/resealable bag			
H2		10-2H2	50/box	#14 - #6 AWG	3 #14	1 #6 w/1 #8
		12-2H2BU	16,000/bulk barrel			
		13-2H2	250/bag			
		19-2H2	6/card			
		25-2H2	25/resealable bag			

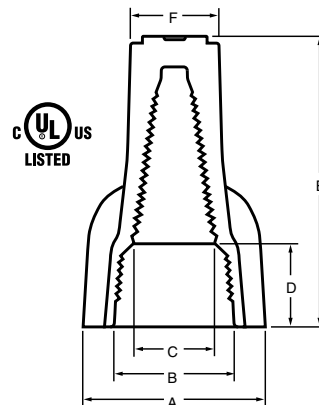

Dimensions



	A	B	C	D	E	F
H1	47/64"	9/16"	5/16"	21/61"	15/32"	5/16"
H2	1"	15/32"	25/64"	13/32"	1 21/64"	7/16"

Uni-Lok® Universal Wire Connectors

Versatile and cost-effective, Uni-Lok® connectors are designed to accept a wide range of wire combinations.

- Swept mini-wings provide additional torque.
- Square-wire spring grabs and holds wires for secure connections.
- Long skirt covers stripped wires.
- Rated at 600 V Max. in building wire and at 1000 V Max. in lighting fixtures/luminaries and signs.
- Copper-to-copper connections only.



	Color	Part #	Pkg Qty	Wire Range	Min	Max
G1		10-1G1	100/box	#22 - #12 AWG	4 #22	3 #12
		12-1G1BU	40,000/bulk barrel			
		13-1G1	500/bag			
		19-1G1	6/card			
G2		10-2G2	100/box	#22 - #10 AWG	3 #20	5 #12
		13-2G2	500/bag			
		19-2G2	6/card			
		25-2G2	25/resealable bag			

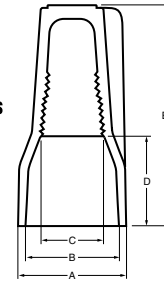

Dimensions

	A	B	C	D	E
G1	31/64"	27/64"	9/32"	13/32"	63/64"
G2	37/64"	33/64"	23/64"	27/64"	111/64"

GreenGard™ Grounding Wire Connectors

Specifically designed for making positive ground connections, GreenGard™ connectors feature the same live-action as GB® WingGard® connectors with the added plating protection for corrosion resistance in grounding applications.

- Easier to use — New design enables torque-up with improved grip.
- Contoured, offset wings enable firm ground connections.
- Flame retardant, thermoplastic shell resists punctures, cuts, abrasion and corrosion.
- Connectors have a hole in the tip for ground wire.
- Solid copper-to-copper connections only.

	Color	Part #	Pkg Qty	Wire Range	Min	Max
#95™		10-095	100/box	#14 - #10 AWG <i>(connections rated at 600 V Max.)</i>	2 #14	4 #12
		13-095	500/bag			
		16-095	125/jar			
		19-095	6/card			
		25-095	25/resealable bag			

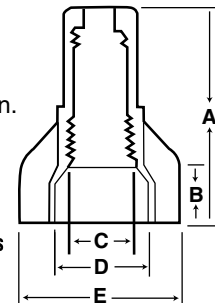

Dimensions

	A	B	C	D	E
#95™	1 1/4"	5/16"	9/32"	7/16"	29/32"



INNOVATION

PushGard™ Push-in Wire Connectors

Easy and fast to use, just strip and push conductors into PushGard™ connectors to make reliable, secure connections.

- Simplified insertion and compact size helps in tight locations.
- Clear polycarbonate housings have color-coded side panels for connection verification and identification.
- With corrosion-resistant stainless steel springs, PushGard™ connectors restrict wire pullout, yet corrections are possible with a simple left-right twist and pull.
- Continuity test point for easy voltage checks.
- Available in 2-,3-,4 and 8-port configurations.
- Rated at 600 V Max. in building wire and at 1000 V Max. in lighting fixtures/luminaries.
- Copper-to-copper connections only.



	Color	Ports	Part #	Pkg Qty	Wire Range
PC2		2	10-PC2	100/box	#22 - #12
			19-PC2	10/clam	AWG Solid (connections rated at 600 V Max.)
PC3		3	10-PC3	100/box	#22 - #12
			19-PC3	10/clam	AWG Solid (connections rated at 600 V Max.)
PC4		4	10-PC4	100/box	#22 - #12
			19-PC4	10/clam	AWG Solid (connections rated at 600 V Max.)
PC8		8	10-PC8	50/box	#22 - #12
			19-PC8	10/clam	AWG Solid (connections rated at 600 V Max.)

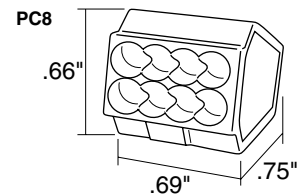
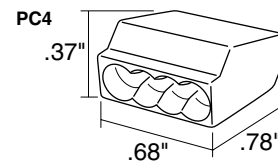
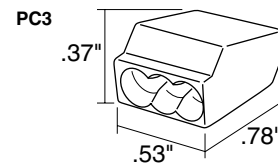
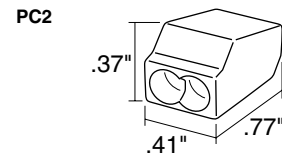

Nylon Pigtail Connectors

Closed-end crimp connector designed for use with solid or stranded wire.

- Vibration resistant.
- Tin-plated seamless copper.
- Corrosion and chemical resistant.



Part #	Pkg Qty	Wire Range	Min	Max
20-089	10/clam	#22 - #14 AWG	2 #22	1 #14 w/1 #18
15-090	15/clam	#22 - #10 AWG	3 #18	1 #10 w/1 #20
20-090	10/clam	#22 - #10 AWG	3 #18	1 #10 w/1 #20



Crimp Connectors

Use GB® crimp connectors for strong, vibration-resistant permanent connections in branch circuit and fixture wiring.

- Two styles and sizes available.
- Copper or zinc-plated steel.



Copper

Part #	Model	Pkg Qty	Wire Range	Min	Max
10-310C	310	100/clam	#18 - #10 AWG	2 #16	2 #10 w/1 #12
10-311C	311	50/clam	#14 - #8 AWG	3 #12	4 #10

Zinc-plated Steel

Part #	Model	Pkg Qty	Wire Range	Min	Max
10-410	410	100/box	#18 - #10 AWG	2 #16	2 #10 w/1 #12
10-410C	410	100/clam			
13-410	410	500/bag			
20-410	410	12/clam			
10-411	411	50/box	#14 - #8 AWG	3 #12	4 #10
20-411	411	8/clam			

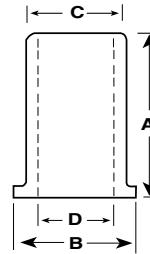

Dimensions				
Model	A	B	C	D
310/410	3/8"	19/64"	1/4"	13/64"
311/411	5/8"	23/64"	21/64"	17/64"

Copper Split Bolt Connectors

All-copper alloy construction for high mechanical strength, maximum conductivity and low resistance.

- Accept a wide range of solid and stranded conductors from 16 AWG – 3/0 AWG.
- Can be torqued with standard wrenches.



Part #	Pkg Qty	Wire Gauge
GSBC-8	2/clam	#16 - #10 AWG Stranded, #16 - #8 AWG Solid
GSBC-6	2/clam	#10 AWG Stranded, #10 - #8 AWG Solid
GSBC-4	2/clam	#8 - #4 AWG Solid
GSBC-2	2/clam	#6 - #2 AWG Solid

Part #	Pkg Qty	Wire Gauge
GSBC-1/0	1/clam	#4 - #0 AWG Solid
GSBC-2/0	1/clam	#2 - #00 AWG Solid
GSBC-3/0	1/clam	#2 - #000 AWG Solid

Plated Aluminum Split Bolt Connectors*

Constructed of high-strength aluminum with oxide-displacing jaws to prevent galvanic corrosion.

- Accept conductors from 10 AWG – 4/0 AWG.
- Use GB® OX-GARD™ anti-oxidant treatment on Al-Al and Al-Cu to prevent corrosion and permit cooler connections.



Part #	Pkg Qty	Wire Gauge
GAK-2	1/clam	#8 - #2 AWG Solid
GAK-1/0	1/clam	#8 - #0 AWG Solid
GAK-2/0	1/clam	#10 AWG Stranded, #10 - #00 AWG Solid
GAK-4/0	1/clam	#6 - #0000 AWG Solid

*Not UL listed for Aluminum Conductor Applications.

Aluminum Mechanical Lugs

- Feature high-strength, low-resistance aluminum construction.
- Accepts conductors from 14 AWG - 2/0 AWG.
- For 3/8" stud.
- Use GB® OX-GARD™ anti-oxidant treatment on Al-Al and Al-Cu to prevent corrosion and permit cooler connections.



1 Conductor

Part #	Pkg Qty	Wire Gauge
GTA-2	2/clam	#14 - #10 AWG Stranded, #14 - #2 AWG Solid
GTA-2/0	2/clam	#14 - #10 AWG Stranded, #14 - #00 AWG Solid

Copper Mechanical Lugs

Provide maximum mechanical strength and minimum resistance.

- All-copper alloy construction features a compact design that is reusable.
- Accept a wide range of solid and stranded conductors from 14 AWG – 0 AWG.
- For 3/8" stud.



Part #	Pkg Qty	Wire Gauge	Part #	Pkg Qty	Wire Gauge
GSLU-25	2/clam	#14 - #10 AWG Stranded	GSLU-70	2/clam	#8 - #2 AWG Solid
GSLU-35	2/clam	#14 - #10 AWG Stranded, #14 - #6 AWG Solid	GSLU-125	2/clam	#6 - #0 AWG Solid

Aluminum Splicer-Reducers

Designed to splice similar-gauge conductors or reduce the gauge from a larger wire diameter to a smaller one.

- Galvanic corrosion is limited by an internal wire stop, preventing direct contact of dissimilar metals inside.
- Use GB® OX-GARD™ anti-oxidant treatment on Al-Al and Al-Cu to prevent corrosion and permit cooler connections.



Part #	Pkg Qty	Wire Gauge
GSPA-2	2/clam	#14 - #10 AWG Stranded, #14 - #2 AWG Solid
GSPA-0	1/clam	#14 - #10 AWG Stranded, #14 - #0 AWG Solid
GSPA-4/0	1/clam	#6 - #0000 AWG Solid



SEE PG
14

FOR MORE INFO ON
Ox-Gard™

Copper Lugs

Heavy-duty lugs made from pure copper for maximum current flow.

- Tinned for corrosion resistance.
- Seamless barrel for maximum strength.
- Closed ends seal out moisture.



Part #	Pkg Qty	Wire Gauge	Stud Size
AML-200	2/clam	#6 AWG	1/4"
AML-201	2/clam	#6 AWG	5/16"
AML-202	2/clam	#6 AWG	3/8"
AML-203	2/clam	#4 AWG	5/16"
AML-204	2/clam	#4 AWG	3/8"

Part #	Pkg Qty	Wire Gauge	Stud Size
AML-205	2/clam	#2 AWG	5/16"
AML-206	2/clam	#2 AWG	3/8"
AML-207	2/clam	#1/0 AWG	3/8"
AML-208	2/clam	#2/0 AWG	3/8"

Grounding Accessories

Convenient grounding accessories include products suitable for most job requirements.

- Zinc-plated grounding clips provide positive grounding to switch, outlet or junction boxes for #10, 12, 14 AWG copper grounding wire.
- Hex-head grounding screws secure ground wires to circuit box.
- Grounding clamps listed for connection of ground wire to ground rod.
- Fork terminals for 8–10 stud.

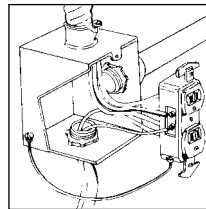

14-GRC



GGP-1502



GGG-1032HC

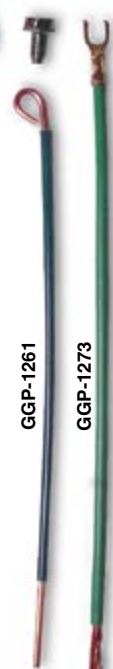

GGP-1261

GGP-1273



Part #	Pkg Qty	Description	Length	Ends
GGP-1261	25/bag	Grounding Pigtail; #12 AWG Solid	6 1/2"	Captured screw/stripped
GGP-1273	25/bag	Grounding Pigtail; #12 AWG Str	7"	Stripped/bare fork terminal
GGP-1282	25/bag	Grounding Pigtail; #12 AWG Str	8"	Captured screw/bare fork terminal
GGP-1461	25/bag	Grounding Pigtail; #14 AWG Solid	6 1/2"	Captured screw/stripped
GGP-1502	2/card	Grounding Pigtail; #12 AWG Str	8"	Captured screw/bare fork terminal
14-GRC	1/card	Grounding Clamp for 1/2" - 1" pipe		
GGC-1508	8/card	Grounding Clip for Aluminum or Copper; Grounding wire; Zinc plated		
GGG-1032HC	100/clam	Hex-Head Ground Screw 10–32 x 1/2"		
GGG-1512R	12/card	Green Round Washer Head Screw for Switch and Outlet Boxes -10-32 x 3/8"		

Ox-Gard™ Anti-Oxidant Compound

The perfect safeguard for aluminum-to-aluminum, aluminum-to-copper wire connections and aluminum conduit joints and copper-to-copper.

- Guards against oxidation.
- Improves conductivity; penetrates aluminum oxide to maintain inter-strand and inter-conductor current paths.
- Produces a cooler connection.

Part #	Pkg Qty	Description
OX-100B	1/tube	1 oz Squeeze Tube (blister pack)
OX-800	1/tube	8 oz Squeeze Tube





Terminals & Wire

Dependable and easy to use, Gardner Bender™ terminals and wiring accessories offer the high quality and application flexibility that professionals demand. Available in a variety of packaging options, look to Gardner Bender™ for secure wire connection options.

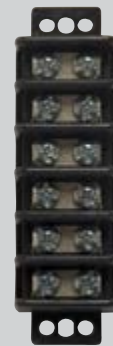

page 20



page 17



page 22



page 23

Alligator Clips.....	23
Battery Charging Clips, Clamps	23
Bullet Splices	19
Butt Splices & Kits.....	19,20,21
Disconnects	19
GB Xtreme® Terminals	17
Ring Terminals.....	17,18
Spade Terminals	17,18
Terminal Adapters.....	20
Terminal Kits.....	21
Tap Splices	20
Underground UF Splice Kit	22
Wire	23

GB Xtreme®

GB Xtreme® Terminals

Constructed with Heat Shrink insulation – adhesive lined to waterproof and environmentally seal electrical connections when crimped and heated.

- Insulates and protects connections from wire pullout, moisture intrusion and abrasion.
- Heat-activated adhesive melts and flows to create a seal.
- Resists salt water, oil, gasoline and other environmental contaminants.
- Rated at 600 Volt Max.
- Temperature rating: -67°–221°F (-55°–105°C).
- 2.5:1 shrink ratio.
- *AMT-51 & XTM/GBX Series are solder heat shrink.
- Heat to 135°C / 275°F.



Ring Terminals

22-18 Gauge



Part #	Pkg Qty	Stud Size
AMT-100	3/clam	8 to 10
AMT-4100	6/clam	8 to 10
*AMT-5102	4/clam	10

16-14 Gauge



Part #	Pkg Qty	Stud Size
AMT-103	3/clam	8 to 10
AMT-4103	6/clam	8 to 10
*AMT-5104	4/clam	10
*XTM-260	6/clam	10

12-10 Gauge



Part #	Pkg Qty	Stud Size
AMT-106	3/clam	8 to 10
AMT-108	3/clam	1/4"
AMT-4106	5/clam	8 to 10
*AMT-5106	3/clam	10
*XTM-265	4/clam	10

Disconnects

GB Xtreme



Part #	Pkg Qty	Stud Size
*XTM-220	3/clam	22-18 AWG
*XTM-225	3/clam	16-14 AWG
*XTM-230	2/clam	12-10 AWG

Spade Terminals

22-18 Gauge



Part #	Pkg Qty	Stud Size
AMT-110	3/clam	8 to 10
AMT-4110	16/clam	8 to 10

16-14 Gauge



Part #	Pkg Qty	Stud Size
AMT-113	3/clam	8 to 10
AMT-4113	6/clam	8 to 10

12-10 Gauge



Part #	Pkg Qty	Stud Size
AMT-116	3/clam	8 to 10
AMT-4116	5/clam	8 to 10

Butt Splices

22-18 Gauge



Part #	Pkg Qty
AMT-120	3/clam
AMT-121	25/clam
AMT-4120	8/clam
*AMT-5121	5/clam
*XTM-240	6/clam

16-14 Gauge



Part #	Pkg Qty
AMT-123	3/clam
AMT-124	25/clam
AMT-4123	7/clam
*AMT-5123	5/clam
*XTM-245	6/clam

12-10 Gauge



Part #	Pkg Qty
AMT-126	3/clam
AMT-127	25/clam
AMT-4126	5/clam
AMT-5126	4/clam
*XTM-250	4/clam

Assortment



Part #	Pkg Qty	Description
*GBX-TK	24/card	22-10 AWG assorted butt splices



General Purpose Terminals

Quick and reliable crimp-type wire connections.

- Color-coded by wire gauge size.
- Available in a variety of packaging options and stud sizes.
- Includes Spade and Ring Terminals, Disconnects, and Bullet, Butt & Tap Splices (p.17-19)

Spade Terminals - Vinyl-Insulated Barrel

- Rated at 600 Volt Max.
- Temperature rating: 167 °F (75 °C).



22-18 Gauge	Part #	Pkg Qty	Stud Size
	20-111	20/clam	4 to 6
	20-112	20/clam	8 to 10
	75-111	75/clam	4 to 6

16-14 Gauge	Part #	Pkg Qty	Stud Size
	10-113	100/clam	4 to 6
	10-114	100/clam	8 to 10
	15-114	15/clam	8 to 10
	20-113	20/clam	4 to 6
	20-114	20/clam	8 to 10
	75-113	75/clam	4 to 6

12-10 Gauge	Part #	Pkg Qty	Stud Size
	10-116	50/clam	8 to 10
	15-116	15/clam	8 to 10
	75-116	5/clam	8 to 10

SEE PG
122





FOR MORE INFO ON
Crimp Tools

Ring Terminals - Vinyl-Insulated Barrel

- Rated at 600 Volt Max.
- Temperature rating: 167 °F (75 °C).



22-18 Gauge	Part #	Pkg Qty	Stud Size
	20-101	22/clam	4 to 6
	20-102	22/clam	8 to 10
	21-101	10/clam	4 to 6
	21-102	10/clam	8 to 10

16-14 Gauge	Part #	Pkg Qty	Stud Size
	10-104	100/clam	8 to 10
	10-105	100/clam	12 to 1/4"
	15-104	15/clam	8 to 10
	15-105	15/clam	12 to 1/4"
	20-103	22/clam	4 to 6
	20-104	22/clam	8 to 10
	20-105	17/clam	12 to 1/4"
	21-1055	7/clam	5/16" to 3/8"
	75-104	75/clam	8 to 10

12-10 Gauge	Part #	Pkg Qty	Stud Size
	10-106	50/clam	8 to 10
	10-107	50/clam	12 to 1/4"
	10-108	50/clam	1/4" to 3/8"
	15-106	15/clam	8 to 10
	15-107	15/clam	12 to 1/4"
	15-108	15/clam	5/16" to 3/8"
	20-106	14/clam	8 to 10
	20-107	14/clam	12 to 1/4"
	20-108	13/clam	1/4" to 3/8"
	21-106	8/clam	8 to 10
	21-109	7/clam	7/16" to 1/2"
	75-106	50/clam	8 to 10



6 Gauge	Part #	Pkg Qty	Stud Size
	14-095	4/card	1/4"
	14-097	4/card	1/2"
	15-096	4/card	3/8"



4 Gauge	Part #	Pkg Qty	Stud Size
	14-099	4/card	1/2"
	15-098	4/card	3/8"



Disconnects - Vinyl-Insulated Barrel

- Rated at 600 Volt Max.
- Temperature rating: 167 °F (75 °C).



22-16 Gauge	Part #	Pkg Qty	Tab	Type
	10-141F	100/clam	0.250"	Female
	10-141M	100/clam	0.250"	Male
	20-141F	21/clam	0.250"	Female
	20-141M	18/clam	0.250"	Male
	21-146F	10/clam	0.187"	Female
	21-146M	10/clam	0.187"	Male



16-14 Gauge	Part #	Pkg Qty	Tab	Type
	10-143F	100/clam	0.250"	Female
	15-143F	15/clam	0.250"	Female
	15-143M	14/clam	0.250"	Male
	20-143F	20/clam	0.250"	Female
	20-143M	18/clam	0.250"	Male
	21-143F	10/clam	0.250"	Female
	75-143F	75/clam	0.250"	Female



12-10 Gauge	Part #	Pkg Qty	Tab	Type
	10-145F	100/clam	0.250"	Female
	10-145M	100/clam	0.250"	Male
	15-145F	15/clam	0.250"	Female
	20-145F	16/clam	0.250"	Female
	20-145M	16/clam	0.250"	Male
	21-145F	8/clam	0.250"	Female
	75-145F	50/clam	0.250"	Female



Disconnects - Fully-Insulated

- Rated at 600 Volt Max.
- Temperature rating: 167 °F (75 °C).



22-16 Gauge	Part #	Pkg Qty	Tab	Type
	10-151F	100/clam	0.250"	Female
	15-151F	15/clam	0.250"	Female
	15-151M	15/clam	0.250"	Male
	20-151P	20/clam	0.250"	F/M Pairs

16-14 Gauge	Part #	Pkg Qty	Tab	Type
	10-153F	100/clam	0.250"	Female
	10-153P	100/clam	0.250"	F/M Pairs
	15-153F	15/clam	0.250"	Female
	15-153M	15/clam	0.250"	Male
	20-153F	20/clam	0.250"	Female
	20-153P	20/clam	0.250"	F/M Pairs



12-10 Gauge	Part #	Pkg Qty	Tab	Type
	10-155F	50/clam	0.250"	Female
	21-155F	4/clam	0.250"	Female
	21-155M	4/clam	0.250"	Male



22-10 Gauge	Part #	Pkg Qty	Tab	Type
	15-152P	12/clam	0.250"	F/M Pairs

Bullet Splice - Fully Insulated

- Rated at 600 Volt Max.
- Temperature rating: 167 °F (75 °C).



22-18 Gauge	Part #	Pkg Qty	Tab	Type
	20-161P	10/clam	0.156"	F/M Pairs
	21-161F	6/clam	0.156"	Female
	21-161M	6/clam	0.156"	Male

16-14 Gauge	Part #	Pkg Qty	Tab	Type
	20-163F	20/clam	0.156"	Female
	20-163M	20/clam	0.156"	Male
	20-163P	20/clam	0.156"	F/M Pairs

Butt Splices



- Rated at 600 Volt Max.
- Temperature rating: 167 °F (75 °C).

22-18 Gauge	Part #	Pkg Qty
	10-121	100/clam
	15-121	15/clam
	20-121	22/clam
	75-121	75/clam

16-14 Gauge	Part #	Pkg Qty
	10-123	100/clam
	15-123	15/clam
	20-123	21/clam
	75-123	75/clam

12-10 Gauge	Part #	Pkg Qty
	10-126	50/clam
	15-126	15/clam
	20-126	15/clam
	75-126	50/clam

Tap Splices

- Secure connections without stripping wire.
- Rated at 600 Volt Max.
- Temperature rating: 221 °F (105 °C).

22-18 Gauge	Part #	Pkg Qty
	15-2218	5/clam ¹²
	20-2218	5/clam ¹²

18-14 Gauge	Part #	Pkg Qty
	10-100	25/clam
	20-100	5/clam ¹²
	21-100	5/clam ¹³

12-10 Gauge	Part #	Pkg Qty
	20-1210	4/clam ¹²

¹²10 clams/master ¹³5 clams/master

Terminal Blocks



- Rated at 30 Amp/600 Volt max.
- Temperature rating: -40 °F (-40 °C) to 260 °F (130 °C).
- Wire range 22-10 AWG.
- Accepts #8 stud size.

Part #	No. of Poles	Pkg Qty
GTB-406	6	1/clam
GTB-408	8	1/clam
GTB-410	10	1/clam

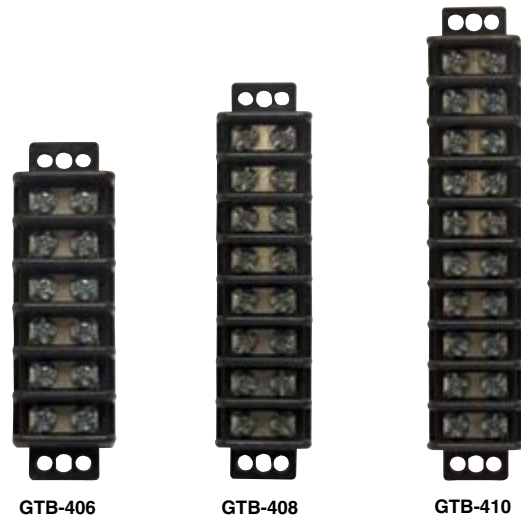

GTB-406

GTB-408

GTB-410

Terminal and Connector Kits and Assortments

- Large selection of popular terminals and connectors.
- Assorted wire ranges, terminal and connector types.

SEE PG
122



FOR MORE INFO ON
Crimp Tools

Part #	Pkg Qty	Description
10-170	100/clam	Ring and spade terminals, disconnects and butt splices, 22-14 AWG
15-120	15/clam	Fully insulated butt splice assortment, 22-10 AWG
15-2210	10/clam	Tap splice assortment, 22-10 AWG
15-2214	14/clam	Ring terminal assortment, 4-6 stud, 22-14 AWG
15-2216	14/clam	Spade terminal assortment, 8-10 stud, 22-14 AWG
CK-570	570/kit	WireGard™ and WingGard® connector kit, 22-6 AWG
GS-67K	25/clam	Stripper and crimper tool with ring and spade terminals, butt splices, female disconnects, 22-14 AWG
TK-32	32/card	WireGard™ and nylon pigtail connectors, 22-10 AWG
TK-40	40/card	Ring and spade terminals, butt splices, female disconnects, 22-10 AWG
TK-100	80/reusable case	WireGard™ connectors, ring and spade terminals, butt and tap splices, female disconnects, 22-10 AWG
TK-175	175/reusable case	Ring and spade terminals, butt splices, male and female disconnects, 22-10 AWG
TK-500	500/card	WireGard™ and nylon pigtail connectors, ring and spade terminals, butt and tap splices, male and female disconnects, 22-10 AWG
TK-806	100/case	Ring and spade terminals, butt splices, male and female disconnects, 22-10 AWG
TK-1210	28/card	Ring and spade terminals, butt splices, male and female disconnects, 12-10 AWG
TK-1614	48/card	Ring and spade terminals, butt splices, male and female disconnects, 16-14 AWG
TK-1822	46/card	Ring and spade terminals, butt splices, male and female disconnects, 22-18 AWG
TK-QC	18/clam	Tap splice kit, 22-10 AWG

**For more detailed information,
 please visit our website.**

www.gardnerbender.com



TK-806

15-120

Underground UF Splice Kit

Accommodates waterproof splicing of #14 - #8 AWG UF copper wire.

- Connector set screws engage each wire securely for a solid splice.
- Minimum conductor size 14/2 with ground.
- Maximum conductor size 8/3 with ground.
- Rated at 600 V max.

Part #	Pkg Qty	Description
HST-1300	1 kit	Underground UF Splice Kit



Kit Contains:

Qty	Description
4	Screw Splice Connectors
1	8" Heavy-Wall Polyolefin Heat-Shrink Tubing with Watertight Adhesive Liner

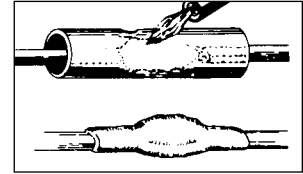

Underground Butt Splice Kit (#8 - #2 AWG)

Used for waterproof installation or repair of #8 - #2 AWG copper cable.

- 3/4" ID heat shrink tube
- 1/2" Ø x 1 1/2" brass butt splice
- Eliminates messy epoxies, tapes or mastics.
- Rated at 600 V max.

Part #	Pkg Qty	Description
HSB-28	1 kit	Butt Splice Kit



Kit Contains:

Qty	Description
1	Screw Splice Connectors
1	4" Heavy-Wall Polyolefin Heat-Shrink Tubing with Watertight Adhesive Liner

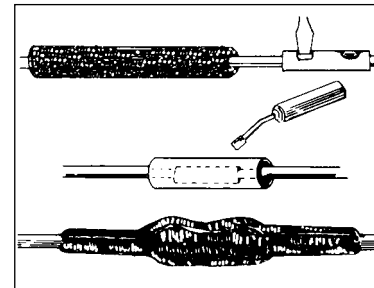

Underground Butt Splice Kit (#14 - #8 AWG)

Used for waterproof repair of well pipe cables and splices of stranded cable #14 - #8 AWG.

- .4" ID heat shrink tube
- 1/4" Ø x 1 1/4" brass butt splice
- Rated at 600 V max.

Part #	Pkg Qty	Description
HST-WP	1 kit	Butt Splice Connector Kit



Kit Contains:

Qty	Description
1	Screw Splice Connectors
1	4" Heavy-Wall Polyolefin Heat-Shrink Tubing with Watertight Adhesive Liner



Battery Charging Clips

Designed specifically for battery and testing equipment applications, 5 - 50 Amp.

- Available in versatile sizes.



Part #	Pkg Qty	Description	Part #	Pkg Qty	Description
14-505	4/card	5 Amp	14-530	2/card	30 Amp
14-510	4/card	10 Amp	14-550	1/card	50 Amp
14-520	2/card	20 Amp			

Insulated Battery Clamps

For battery, battery charger and testing equipment applications.

- Copper-clad clamp.
- Handle grips are insulated and color-coded for easy identification.



Part #	Pkg Qty	Description
14-610	2/card (1 red & 1 black)	10 Amp Copper Clad
14-630	2/card (1 red & 1 black)	30 Amp Copper Clad

Alligator Clips

Multi-purpose alligator clips for home, auto and marine applications.

- Available with insulating sleeve.

Part #	Pkg Qty	Description
14-075	4/card	Non-Ins. #22 - #14 AWG 1 1/4"
14-076	4/card	Non-Ins. #22 - #14 AWG 2"
14-077	2/card	Barrel-Ins. #22 - #14 AWG 2"
14-078	2/card	Fully-Ins. #22 - #14 AWG 2"

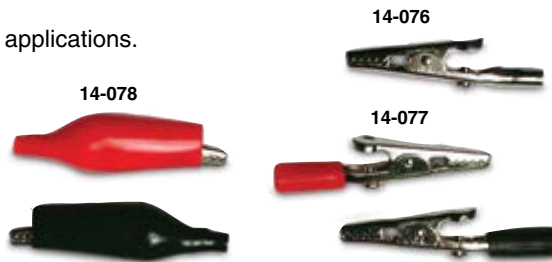

GB Xtreme® Primary Wire

Tinned copper wire provides maximum protection against corrosion and electrolysis.

- Ultra-flexible (Type 3) stranding.
- Resists salt water, battery acid, oil, gasoline and UV radiation.
- Insulation is heat and abrasion-resistant.
- Packaged in small spools.
- Rated to 600 V and 105 °C (221 °F) maximum.

	Part #	Pkg Qty	Wire Gauge	Length
	AMW-312	1/clam	12 AWG	12 FT
	AMW-314	1/clam	14 AWG	18 FT
	AMW-316	1/clam	16 AWG	25 FT
	AMW-318	1/clam	18 AWG	35 FT
	AMW-322	1/clam	12 AWG	12 FT
	AMW-324	1/clam	14 AWG	18 FT
	AMW-326	1/clam	16 AWG	25 FT
	AMW-328	1/clam	18 AWG	35

	Part #	Pkg Qty	Wire Gauge	Length
	AMW-332	1/clam	12 AWG	12 FT
	AMW-334	1/clam	14 AWG	18 FT
	AMW-336	1/clam	16 AWG	25 FT
	AMW-338	1/clam	18 AWG	35 FT

NOTES



Switches

Gardner Bender™ switches are available in many different styles and sizes. They are used in countless applications, from basic on-off to multifunction applications.



page 30



page 28



page 31



page 30

Door Switch	32
Pull-Chain Switches	30,31
Push-Button Switches	29,30
Rocker Switches	31
Rotary Switches	32
Toggle Switches.....	28,29
Toggle Switch Cover	29

Switch Terminology

Single Pole (SP): A switch device that opens, closes or changes connections in a single conductor of an electrical circuit

Double Pole (DP): A switch device that opens, closes or changes connections in both conductors of the same circuit.

Two Circuit (2 CIR): A switch device that opens, closes or changes connections in a single conductor of two independent circuits.

Single Throw (ST): A switch device that opens, closes or completes a circuit at only one of the extreme positions of its actuator.

Double Throw (DT): A switch device that opens, closes or completes a circuit at both extreme positions of its actuator.

Actuator: A lever, push-button, slide, trigger or other means by which an external force is applied to operate a switch mechanism.

Normally Open (NO): A momentary type switch in which one or more circuits are open when the switch actuator is at its normal or rest position.

Normally Closed (NC): A momentary type switch in which one or more circuits are closed when the switch actuator is at its normal or rest position.

Alternate Action (Double Action Push): Push to make, then push to break, a circuit.

Power Ratings for Switches: The current handling capability of a switch measured in amperes, horsepower, lamp load or combinations of these with applicable voltages.

UL/CSA Rated Switches

A **UL/CSA-marked rating** in amperes indicates that the switch meets or exceeds test house performance requirements of 6000 make-and-break cycles at the rated current, preceded by 50 make-and-break cycles at 150% switch current rating. 125% is used when switch ratings exceed 10 amperes.

A **UL/CSA horsepower-only rated device** meets minimum test requirements of 50 make-and-break cycles at the appropriate locked rotor current, followed by 6000 cycles at one-sixth the AC-locked rotor current and 10% of the DC-locked rotor current.

AC ampere ratings are resistive or inductive, with the inductive rating tested at 75% to 80% power factor.

AC horsepower ratings are inductive and tested at 40% to 50% power factor.

“L” Rating denotes ability of an AC-only switch to handle the initial high in-rush characteristics of a tungsten filament lamp on AC voltage only.

“T” Rating denotes ability of an AC/DC switch to handle the initial high in-rush characteristics of a tungsten filament lamp on either AC or DC voltage.

All **DC ratings** are 100% resistive only (non-inductive).

Many **AC-only rated** switches can be used in applications where less than 30 volts DC is required, provided current does not exceed full current rating of the switch.

Ampere-rated switches will *not* automatically handle in-rush characteristics of five to six times switch rating.

Toggle Switches



Versatile toggle switch family with multiple position configurations.



- Available in single or double pole.
- Perfect for industrial equipment or emergency lighting.
- 1/2" mounting hole required.
- **Specifications:** 10 A, 277 V AC / 20 A, 125 V AC; 75°C max. temp rating.
- Standard nut size (15/32"-32").

tip: All switches must be installed with a hex nut (provided) behind panel to prevent damage during installation.



Part Number	GSW-10	GSW-11*	GSW-110	GSW-121
Poles	SPST			
Pkg Qty	1/card	1/card	1/card	1/card
Toggle Position	ON-OFF	ON-OFF	ON-OFF	ON-OFF
Terminal Type	Screw	Screw	"O" Ring & Screw	Spade
Rating	1½ HP 125-250 V AC	¾ HP 125-250 V AC	¾ HP 125-250 V AC	¾ HP 125-250 V AC

*GSW-11 has an ON-OFF faceplate.



Part Number	GSW-12	GSW-13	GSW-120	GSW-117
Poles	SPDT			
Pkg Qty	1/card	1/card	1/card	1/card
Toggle Position	ON-ON	ON-OFF-ON	ON-OFF-ON	(ON)-OFF-(ON)
Terminal Type	Screw	Screw	Spade	Screw
Rating	¾ HP 125-250 V AC	¾ HP 125-250 V AC	¾ HP 125-250 V AC	¾ HP 125-250 V AC

() Indicates momentary action



Part Number	GSW-14	GSW-15	GSW-16	GSW-123
Poles	DPST		DPDT	
Pkg Qty	1/card	1/card	1/card	1/card
Toggle Position	ON-OFF	ON-ON	ON-OFF-ON	(ON)-OFF-(ON)
Terminal Type	Screw	Screw	Screw	Screw
Rating	1½ HP 125-250 V AC	1½ HP 125-250 V AC	1½ HP 125-250 V AC	1½ HP 125-250 V AC

() Indicates momentary action



Part Number	GSW-17*	GSW-18*	GSW-124	GSW-125	GSW-125BP
Poles	SPST				
Pkg Qty	1/card	1/card	1/card	1/card	10/box
Toggle Position	ON-OFF	ON-OFF	ON-OFF	ON-OFF	ON-OFF
Terminal Type	Screw	6" wire leads	screw	6" wire leads	6" wire leads
Actuator	bat lever	bat lever	short ball	short ball	short ball
Rating	3 A/240 V AC, 6 A/120 V AC	8 A/125 V, 4 A/250 V, 1/3 HP/125 V AC, 10 A/125 V AC	3 A/240 V AC, 6 A/120 V AC	3 A/250 V, 6 A/125 V	3 A/250 V, 6 A/125 V

() Indicates momentary action *GSW-17 & 18 have an ON-OFF faceplate.

Toggle Switch Cover

Tough EDPM rubber covers to protect switches from moisture, dust and dirt.

- Built-in hex nut base screws onto all GB® toggle switches.



Part #	Pkg Qty	Description
GSW-20	2/card	Toggle Switch Cover



Double Insulated, Plastic Toggle Switches



Double insulated for moisture protection in all environments.



- Internal "O" ring design for moisture and dust resistance.
- Perfect for marine/recreational equipment and weather-resistant applications.
- **Specifications:** 10 A, 277 V AC / 20 A, 125 V AC; 75°C max. temp rating.
- Standard nut size (¹⁵/₃₂"-32").

		
Part Number	GWS-19	GWS-114
Poles	SPST	SPDT
Pkg Qty	1/card	1/card
Toggle Position	ON-OFF	(ON)-OFF-(ON)
Terminal Type	Screw	Spade



Momentary Contact Push-Button Switches



Basic push-button switch family utilized in applications requiring intermittent continuity contacts.



- Normally OFF or normally ON models.
- Screw terminals.
- Mounts in standard 1/2" diameter hole.
- Mounting nut included.

		
Part Number	GWS-22	GWS-23
Poles	SPST	
Pkg Qty	1/card	1/card
Toggle Position	OFF (ON)	ON (OFF)
Terminal Type	screw	screw
Plating	Black	Red
Rating	6 A/120 V AC, 3 A/240 V AC	3 A/120 V AC, 1.5 A/277 V AC

() Indicates momentary action

Maintained Contact Push-Button Switch - Motor Rated



Maintained push-button switch rugged and versatile enough to be utilized in many applications.



- Push on, push off switch with #18 AWG, 6" stripped wire leads.
- Mounting nut included.



Part #	Pkg Qty	Poles	Toggle Position	Terminal Type	Rated
GSW-21	1/card	SPST	Push ON-Push OFF	Wire Leads	10 A/125 V AC, 8 A/125 V, 4 A/250 V, 1/3 HP 125 V AC

Maintained Contact Push-Button Switches



Double insulated for moisture protection in all environments.



- Internal "O" ring design for moisture and dust resistance.
- Perfect for marine/recreational equipment and weather-resistant applications.
- **Specifications:** 1 A, 125 VT / 6 A, 125 VL / 6 A, 125 V AC / 3 A, 250 V AC; 75°C max. temp rating.

tip:

Horsepower Rating: AC horsepower ratings are inductive and tested at 40% to 50% power rating.



Part Number	GSW-24	GSW-24BP	GSW-25
Poles	SPST		
Pkg Qty	1/card	10/box	1/card
Toggle Position	ON-OFF	ON-OFF	ON-OFF
Terminal Type	6" wire leads	6" wire leads	6" wire leads
Plating	Nickel	Nickel	Brass
Circuit	2 pos. 2 wire	2 pos. 2 wire	2 pos. 2 wire

Single Circuit Pull-Chain Switches



Basic ON-OFF switch family with pull-chain feature.



- ON-OFF switch with #18 AWG, 6" stripped wire leads.
- Mounts in 1 3/32" diameter hole (GSW-35 mounts in 1/2" diameter hole).
- Color coordinated nickel or brass plated.
- **Specifications:** 3 A/125 VL, 6 A/125 V AC, 3 A/250 V AC; 75°C max. temp rating.

tip:

"L" Rating Example: 3A/125VL means the switch is rated to handle the high in-rush from 3 amp incandescent AC loads.



Part Number	GSW-31	GSW-31BP	GSW-32	GSW-32BP	GSW-35*
Poles	SPST				
Pkg Qty	1/card	10/box	1/card	10/box	1/card
Toggle Position	ON-OFF	ON-OFF	ON-OFF	ON-OFF	ON-OFF
Terminal Type	6" wire leads	6" wire leads	6" wire leads	6" wire leads	wire leads
Plating	Nickel	Nickel	Brass	Brass	Nickel
Circuit	2 Pos. 2 Wire	2 Pos. 2 Wire	2 Pos. 2 Wire	2 Pos. 2 Wire	2 Pos. 2 Wire

*All angle

Variable Speed & Two Circuit Pull-Chain Switches



Pull chain switches for multifunction applications.



- Two and three speed switching.
- Push-in connections for #18 AWG wire.
- Mounts in 1 $\frac{1}{32}$ " diameter hole.
- **Specifications:** 6 A/125 V AC, 3 A/250 V AC, 6 A/125 VL; 75°C max. temp rating.

Part Number	GSW-33	GSW-34	GSW-39
Poles	SPDT	SP3T	DP3T
Pkg Qty	1/card	10/box	1/card
Toggle Position	OFF-ON-ON	OFF-ON-ON-ON	OFF-ON(A)-ON(B) -ON(A+B)
Terminal Type	wire leads	wire leads	6" wire leads
Plating	Brass	Brass	Brass
Circuit	3 Pos. 3 Wire	4 Pos. 4 Wire	4 Pos. 3 Wire

Standard Rocker Switches



Heavy-duty rocker switches that fit .830" X 1.45" panel cutouts.



- Frame and rocker are black glass-filled nylon.
- Lighted or unlighted versions available.
- **Specifications:** 10 A/277 V AC, 20 A/125 V AC; 75°C max. temp rating.
- Switches with solder terminals come in a phenolic case and do not have a moisture and dust resistant seal.

Part Number	GSW-45	GSW-49*
Poles	SPST	
Pkg Qty	1/card	1/card
Toggle Position	ON-OFF	ON-OFF
Terminal Type	spade	spade
Rating	$\frac{1}{2}$ HP 125 - 250 V AC	$\frac{1}{2}$ HP 125 - 250 V AC

*Red lighted

Appliance Rocker Switches



Economy rocker switches that fit standard .550" X 1.125" panel cutouts.



- Perfect for machinery or appliances.
- Lighted or unlighted versions available.
- **Specifications:** 16 A/125 V AC, 8 A/250 V AC; 75°C max. temp rating.



Part Number	GSW-41	GSW-42*
Poles	SPST	
Pkg Qty	1/card	1/card
Toggle Position	ON-OFF	ON-OFF
Terminal Type	spade	spade

*Red lighted

Mini Rocker Switch



Miniature rocker switch that fits .520" X .776" panel cutouts.



- Perfect for small machinery or appliances.
- **Specifications:** 13 A/125 V AC, 10 A/250 V AC, $\frac{1}{2}$ HP 125 - 250 V AC; 75°C max. temp rating.



Part #	Pkg Qty	Poles	Toggle Position	Terminal Type	Rated
GSW-48*	1/card	SPST	ON-OFF	spade	10 A/125 - 250 V AC, $\frac{1}{2}$ HP 250 V AC, $\frac{1}{2}$ HP 125 V AC

*Red lighted







Rotary Switches



Single or three position switches in various fan and lighting applications.



- #18 AWG, 6" stripped wire leads.
- Brass terminals.
- Nut size (3/8" - 27").

						
Part Number	GWS-61	GWS-63B	GWS-69	GWS-69BP	GWS-62	GWS-68
Poles	SPST			DP3T		SPTT
Pkg Qty	1/card	1/card	1/card	10/box	1/card	1/card
Toggle Position	ON-OFF	ON-OFF	ON-OFF	ON-OFF	OFF-ON(P)-ON(N) -ON(N+P)	OFF-ON(P)-ON(N) -ON(N+P)
Plating / Color	Brass	Black Button	Black Plastic	Black Plastic	Brass	Brass
Rating	6 A/125 V AC, 3 A/250 V AC	1.5 A/250 V AC	6 A/125 V AC, 3 A/250 V AC	6 A/125 V AC, 3 A/250 V AC	6 A/125 V AC, 3 A/250 V AC	6 A/125 V AC, 3 A/250 V AC
Mounting Hole	.406"	.513"	.513"	.513"	.406"	.513"



Door Switch



Push button switch with metal box, cover plate and mounting hardware to operate lights when door is opened.



- Mounts in door jam.
- Fits in 1.25" X 2.75" X 2.0" deep approximate mounting hole.
- **Specifications:** 16 A/125 V AC, 10 A/250 V AC, 10 A/277 V AC, 1/2 HP 125 - 277 V AC; 75°C max. temp rating.

		
Part Number	GWS-SK	GWS-26
Poles	SPST	
Pkg Qty	1/card	1/card
Toggle Position	Normally ON -Mom Contact	Normally ON -Mom Contact
Description	Door Switch	Replacement for GWS-SK



Conduit Bending

Gardner Bender™ innovations have delivered the ultimate in job-site performance, durability and reliability since 1959. Gardner Bender™ provides a complete line of products to bend EMT, Rigid, IMC and PVC coated conduit.



page 56



page 36



page 58



page 63

Guide to Bending Booklet	64	One-Shot Hydraulic Benders	42-48
Benders – Aluminum Rigid Conduit		Sidewinder® Electric Bender (B2555)	37
Cyclone® Electric Bender (B2000)	36	Sidewinder™ Mechanical Benders	54-57
Gardner™ EMT Hand Benders.....	59	Sweep/Segmental Hydraulic Benders	46, 48
One-Shot Hydraulic Benders	42-48	Ultra Eegor™ Hydraulic Bender.....	40
Sidewinder® Electric Bender (B2555)	37	Bender Shoe Groups	
Sidewinder™ Mechanical Benders	54-57	Sidewinder® Electric Bender	
Sweep/Segmental Benders	46, 48	(B2555) - IMC.....	38
Ultra Eegor™ Hydraulic Bender.....	40	Sidewinder® Electric Bender	
Benders – EMT Conduit		(B2555) - Rigid.....	37
Big Ben® Hand Benders	58	Sidewinder® Electric Bender	
Cyclone® Electric Bender (B2000)	36	(B2555) - EMT	38
Gardner™ EMT Hand Benders.....	59	Sidewinder® Electric Bender	
Iron Hand Benders	60	(B2555) - PVC-Coated	38
Sidewinder® Electric Bender (B2555)	37	Hand Benders	
Sidewinder™ Mechanical Benders	54-57	Big Ben® Hand Benders	58
Ultra Eegor™ Hydraulic Bender.....	40	Gardner™ Thinwall Hand Benders.....	59
Benders – IMC Conduit		Iron Hand Benders	60
Cyclone® Electric Bender (B2000)	36	Handles.....	61
Sidewinder® Electric Bender (B2555)	37	Hickey Bending Heads.....	61
Sidewinder™ Mechanical Benders	54-57	Hydraulic Bender Accessories	52
Ultra Eegor™ Hydraulic Bender.....	40	Hydraulic Cylinder Specifications.....	53
Benders – PVC Conduit		PVC Plug Sets.....	63
HotBlanket™ Benders.....	63	Pumps	
HotBox™ Benders	62-63	Economy Electric.....	50
HotTube™ Bender	61	Manual Hydraulic.....	51
Benders – PVC-Coated Rigid Conduit		Submerged Electric	50
Cyclone® Electric Bender (B2000)	36	Z-Class™ Electric	49
Sidewinder® Electric Bender (B2555)	37	Table (Bend-Mate™ Bender	
Sidewinder™ Mechanical Benders.....	54, 56-57	Table for Ultra Eegor™)	41
Benders – Rigid Steel Conduit		Storage Cases (Tool-Guard™).....	64
Rigid Bender Capacities Chart	39		
Big Ben® Hand Benders	58		
Cyclone® Electric Bender (B2000)	36		
Gardner™ EMT Hand Benders.....	59		
Iron Hand Benders	60		

Bending Selection Guide

Part # & Description

Combination Bending-Rigid, IMC, EMT Conduit	Page #	½"	¾"	1"	1¼"	1½"	2"	2½"	3"	3½"	4"	5"
B2000 Cyclone® Bender	36	✓	✓	✓	✓	✓	✓					
B2555 Sidewinder® Bender & BRIG-52	37	✓	✓	✓	✓	✓	✓					
B2555 Sidewinder® Bender & BEMT-52	37	✓	✓	✓	✓	✓	✓					
B2555 Sidewinder® Bender & IMC-52	37	✓	✓	✓	✓	✓	✓					
B2555 Sidewinder® Bender & BPVC-152	37	✓	✓	✓	✓	✓	✓					
B400L & DL Ultra Eegor™	40							✓	✓	✓	✓	
BW Series - Mechanical Sidewinder™ Bender (EMT)	56-57	✓	✓	✓	✓	✓	✓					
BW Series - Mechanical Sidewinder™ Bender (IMC)	55-57	✓	✓	✓	✓	✓						
BW Series - Mechanical Sidewinder™ Bender (Rigid)	55-57	✓	✓	✓	✓	✓						
Rigid Conduit Bending	Page #	½"	¾"	1"	1¼"	1½"	2"	2½"	3"	3½"	4"	5"
B2000 Cyclone® Bender	36	✓	✓	✓	✓	✓	✓					
B2555 Sidewinder® Bender & BRIG-52	37	✓	✓	✓	✓	✓	✓					
B400L & DL Ultra Eegor™	40							✓	✓	✓	✓	
B316S One-Shot Bender	42	✓	✓	✓	✓	✓	✓					
B308S Combination One-Shot/Sweep Bender	43			✓	✓	✓	✓	✓	✓	✓	✓	
B340S One-Shot Bender	44				✓	✓	✓	✓	✓	✓	✓	
B359S Combination One-Shot/Sweep Bender	45				✓	✓	✓	✓	✓	✓	✓	✓
B306S Sweep/Segmental Bender	46				✓	✓	✓	✓	✓	✓	✓	
B343S One-Shot Eject-O-Matic® Bender	47				✓	✓	✓	✓	✓	✓	✓	
B351S Combination Eject-O-Matic® Bender	48				✓	✓	✓	✓	✓	✓	✓	✓
Mechanical Sidewinder™ Bender BW11,12,15, 20,30, 27	54-57	✓	✓	✓	✓	✓						
Hand Benders - Gardner™ Bender	59	931B	932	933								
Hand Benders - Big Ben®	58	961	962									
Hand Benders - Malleable Iron	60	921	922	923								
Hand Benders - Hickeys	61	820	821	822								
EMT Conduit Bending	Page #	½"	¾"	1"	1¼"	1½"	2"	2½"	3"	3½"	4"	5"
B2000 Cyclone® Bender	36	✓	✓	✓	✓	✓	✓					
B2555 Sidewinder® Bender & BEMT-52	37	✓	✓	✓	✓	✓	✓					
B400L & DL Ultra Eegor™	40							✓	✓	✓	✓	
Mechanical Sidewinder™ Bender BW30, 27, 201, 221	54-57	✓	✓	✓	✓	✓	✓					
Hand Benders - Gardner™ Bender	59	930B	931B	932								
Hand Benders - Big Ben®	58	960	961	962								
Hand Benders - Malleable Iron	60	920	921	922	923							
IMC Conduit Bending	Page #	½"	¾"	1"	1¼"	1½"	2"	2½"	3"	3½"	4"	5"
B2000 Cyclone® Bender	36	✓	✓	✓	✓	✓	✓					
B2555 Sidewinder® Bender & IMC-52	37-38	✓	✓	✓	✓	✓	✓					
B400L & DL Ultra Eegor™	40							✓	✓	✓	✓	
Mechanical Sidewinder™ Bender BW11,12,15, 20,30, 27	54-57	✓	✓	✓	✓	✓						
PVC-Coated Rigid Conduit Bending	Page #	½"	¾"	1"	1¼"	1½"	2"	2½"	3"	3½"	4"	5"
B2000 Cyclone® Bender	36	✓	✓	✓	✓	✓						
B2555 Sidewinder® Bender & BPVC-152	37-38	✓	✓	✓	✓	✓	✓					
Mechanical Sidewinder™ Bender BW30,27,201, 221	54-57	✓	✓	✓	✓	✓						



IMPROVED Cyclone®
Electric-Powered Conduit Bender

One shoe bends 1/2" - 2" conduit with no loose parts:

- Rigid
- Rigid aluminum
- EMT
- IMC
- PVC-coated rigid (1/2" to 1 1/2")
- Ability to make repeatable bends at the same degree.
- Horizontal and vertical positions allow the unit to create accurate offset bends.
- Four-wheels increases mobility.
- Low-volt (95), high-volt (132) automatic shut-off helps protect electrical components from voltage fluctuations.
- Resetting circuit breaker eliminates down time changing fuses.
- On/Off switch allows user to shut machine down for extended periods of time.
- Hook attachment on pendant control frees hands while working with conduit.
- Minimal training time.
- Weather-resistant cover included.
- 110/115 V AC, 15 AMP 1 HP DC Motor.
- Dimensions: 47" x 33" x 43".
- Weight 408 lbs.



B2000

Features:

- | | |
|---|--|
| 1. STRONG LEGS
Increased durability (10x life test) | 4. FORK LIFT TUBES
Allows lifting and transport capability—built into base |
| 2. LARGE TIRES/WHEELS
Increased mobility | 5. LIFT HOOK
Security (job-site) tethering |
| 3. STRONG UPRIGHT HANDLE
Ease of use | 6. STORAGE AREA
Storage for tools, etc. while in use |



Can be performed in the horizontal or vertical position.



Easy dial settings—makes training time virtually non-existent.

Part #	Description	Weight
B2000	Cyclone® Electric-Powered Production Bender, 115 V / 15 A	408 lbs
B2005	Cover	
LK15	Decal Kit	

Centerline Radius Chart:

Conduit Size	PVC-Coated			
	IMC	Rigid	EMT	Rigid
1/2"	4 3/8"	5 3/8"	4 1/4"	4 3/8"
3/4"	5 5/16"	6 1/2"	5 3/8"	5 5/16"
1"	6 7/32"	7 27/32"	6 1/2"	6 7/32"
1 1/4"	7 23/32"	8 3/8"	7 27/32"	7 23/32"
1 1/2"	8 7/32"	N/A	8 3/8"	8 15/64"
2"	9 15/32"	N/A	9 21/32"	9 29/64"

One-Shot Bender Capacities Chart

One Shot / Sweep / Segmental

This chart is meant as a guide for bending capabilities only.
 For those instances where doubt exists, a trial bend is recommended.

Pipe Size	Outside Dia.	Wall Thick.	Sched. Pipe*	Part #			
				B316S	B308S	B306S B340S B343S	B351S B359S
1/2"	.840"	.108"	40	✓	✓	WS	WS
		.147"	80	✓	✓	WS	WS
		.187"	160	WS	WS	WS	WS
		.294"	DEH	WS	WS	WS	WS
3/4"	1.050"	.113"	40	✓	✓	WS	WS
		.154"	80	✓	✓	WS	WS
		.218"	160	WS	WS	WS	WS
		.308"	DEH	WS	WS	WS	WS
1"	1.315"	.133"	40	✓	✓	WS	WS
		.179"	80	✓	✓	WS	WS
		.250"	160	WS	WS	WS	WS
		.358"	DEH	NR	WS	WS	WS
1 1/4"	1.660"	.140"	40	✓	✓	✓	✓
		.191"	80	✓	✓	✓	✓
		.250"	160	WS	WS	✓	✓
		.342"	DEH	NR	WS	WS	WS
1 1/2"	1.900"	.145"	40	✓	✓	✓	✓
		.200"	80	✓	✓	✓	✓
		.281"	160	WS	WS	✓	✓
		.400"	DEH	NR	WS	WS	WS
2"	2.375"	.154"	40	✓	✓	✓	✓
		.218"	80	NR	✓	✓	✓
		.343"	160	NR	WS	✓	✓
2 1/2"	2.875"	.203"	40	NR	✓	✓	✓
		.276"	80	NR	WS	✓	✓
		.375"	160	NR	WS	✓	✓
3"	3.500"	.216"	40	NR	✓	✓	✓
		.300"	80	NR	WS	✓	✓
3 1/2"	4.000"	.226"	40	NR	✓	✓	✓
		.318"	80	NR	WS	✓	✓
4"	4.500"	.237"	40	NR	✓	✓	✓
		.337"	80	NR	NR	✓	✓
5"	5.563"	.258"	40	NR	NR	NR	✓
		.375"	80	NR	NR	NR	✓

***Schedule Pipe:**

- 40 = Standard
- 80 = Extra Duty
- 160 = Double Extra Duty
- DEH = Double Extra Heavy (slightly thicker than 160)

Other:

- NR = Not Recommended
- WS = Can be bent using wider spacing for swivel shoes

Electric Sidewinder® Bender

Bends ½" to 2" conduit:

- Rigid
- IMC
- PVC-coated rigid (40 mil)
- Rigid aluminum (schedule 40 max.)
- EMT conduit
- Up to 180 degree one-shot bends in ½" through 2" conduit.
- The handle detaches and pivots out of the way for offset bending.
- Competitor shoes are interchangeable (Greenlee, Current, etc.).
- 110/115 V AC
- 20 AMP

Centerline Radius Chart:

Conduit Size	EMT	IMC	Rigid
½"	4¼"	4¾"	4¾"
¾"	5¾"	4½"	4½"
1"	6¾"	5¾"	5¾"
1¼"	8¾"	7¼"	7¼"
1½"	8¾"	8¾"	8¼"
2"	9¾"	9¾"	9½"



B2555

note: Bender & Shoe Groups can be purchased as a kit or individually.

Part #	Description	Capacity/Range	Weight
B2555	Electric Sidewinder® w/o Shoes	—	270 lbs
B2555RIG	Electric Sidewinder® w/ Rigid Shoe Group	½"-2" Rigid & ½"-1¼" IMC conduit	365 lbs
B2555EMT	Electric Sidewinder® w/ EMT Shoe Group	½" - 2" EMT conduit	430 lbs
B2555PVC	Electric Sidewinder® w/ PVC Shoe Group	½" - 2" 40 mil PVC-Coated conduit	365 lbs

Electric Sidewinder® Shoe Groups

Rigid Shoe Group (½" to 2")

BRIG-52

Part #	Conduit	Description	Weight	I.D. #
RS-5125	½" & 1¼"	Rigid and IMC Bending Shoe	43 lbs	1
RSR-5125	½" & 1¼"	Rigid and IMC Support Roller	8 lbs	2
RS-152	1½" & 2"	Rigid Bending Shoe	36 lbs	3
RSR-152	1½" & 2"	Rigid Support Roller	6 lbs	4
BX-1	—	Metal Storage Box	36 lbs	—

Total Weight: 129 lbs

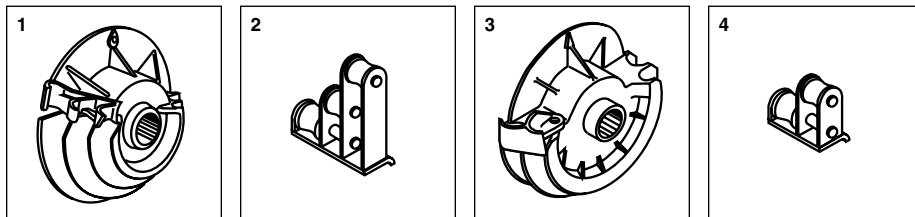

More Shoe Sets available on following page...

Electric Sidewinder® Shoe Groups (cont.)

EMT Shoe Group (½" to 2")

BEMT-52

Part #	Conduit	Description	Weight	I.D. #
ES-5125	½" & 1¼"	EMT Bending Shoe	24 lbs	1
ESR-5125	½" & 1¼"	EMT Support Unit	6 lbs	2
ES15	1½"	EMT Bending Shoe	23 lbs	3
ES-2	2"	EMT Bending Shoe	31 lbs	4
ESR-152	1½" & 2"	EMT Support Roller Unit	40 lbs	5
BX-1	—	Metal Storage Box	36 lbs	—

Total Weight: 160 lbs

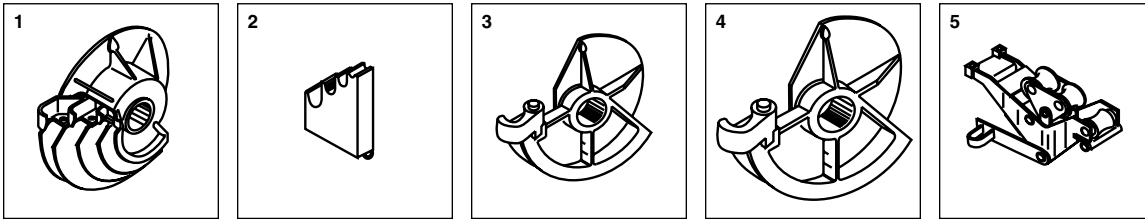

IMC Shoe Group (1½" to 2")

BIMC-152

Part #	Conduit	Description	Weight	I.D. #
IS-15	1½"	IMC Bending Shoe	22 lbs	1
IS-2	2"	IMC Bending Shoe	29 lbs	2
ISR-152	1½" & 2"	IMC Support Roller Unit	40 lbs	3
BX-1	—	Metal Storage Box	36 lbs	—

Total Weight: 127 lbs

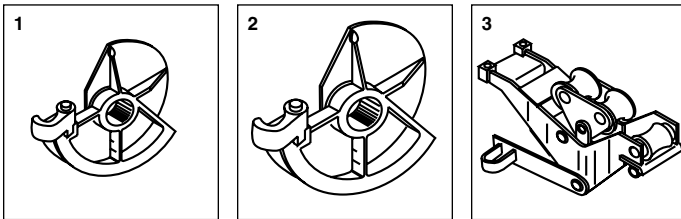

PVC-Coated Rigid Shoe Group (½" to 2" or 40 mil)

BPVC-52

Part #	Conduit	Description	Weight	I.D. #
PVS-5125	½" & 1¼"	PVC-Coated Rigid Bending Shoe	43 lbs	1
PVR-5125	½" & 1¼"	PVC-Coated Rigid Support Roller	8 lbs	2
PVS-152	1½" & 2"	PVC-Coated Rigid Bending Shoe	36 lbs	3
PVR-152	1½" & 2"	PVC-Coated Rigid Support Roller	6 lbs	4
BX-1	—	Metal Storage Box	36 lbs	—

Total Weight: 132 lbs

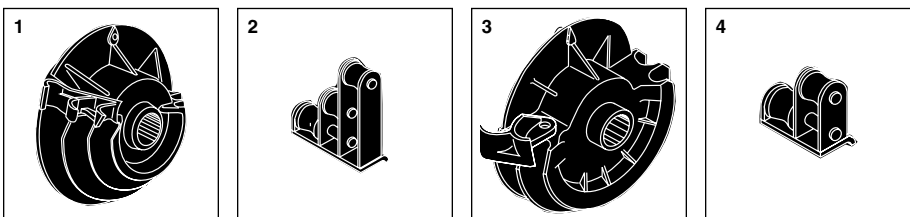

GB **INNOVATION**

IMPROVED Ultra Eegor™ Hydraulic Bender

Bends 2½" to 4" conduit:

- Rigid
- Rigid aluminum (schedule 40 max)
- EMT
- IMC

No additional attachment sets required to change per pipe or conduit type.

- 30 ton, 28" stroke cylinder can make a 90° bend with one pass.
- Double-acting cylinder for rapid retraction, regardless of hose lengths and system losses.
- Improved shoes and follow bars to reduce conduit kinking during bending.
- Hydraulic power ensures the smoothest bends without deformations to the conduit.
- Constant radii follow bars eliminate the need for special calculations.
- Conduit is automatically stripped free from the shoe during the return cycle-which ensures no extra labor or damaged conduit.
- Angle markings on frame ensure easy and accurate bending.

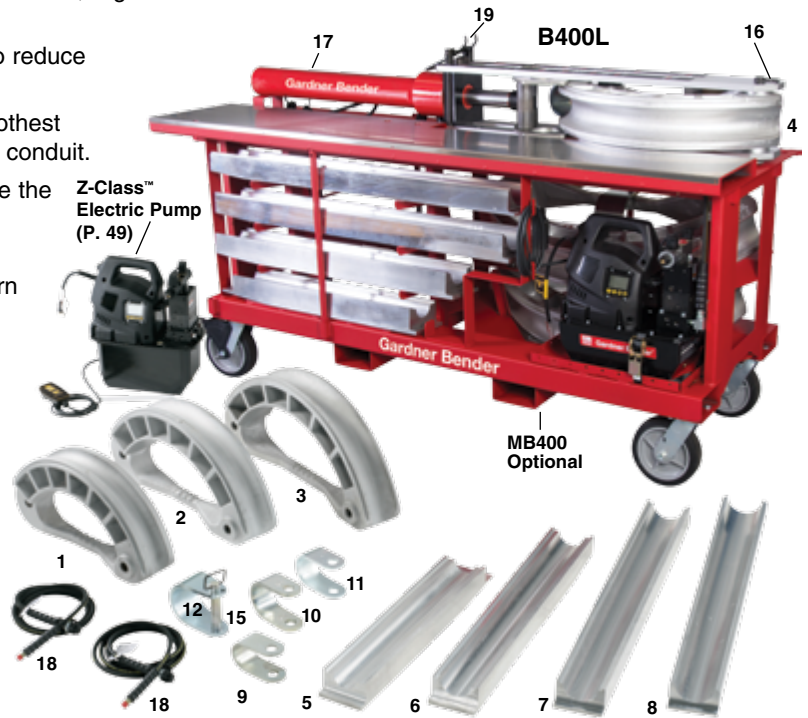

B400L with BE400 Table, CS400 Cylinder Support & Z-Class™ Pump

Centerline Radius Chart:

Nominal Size	IMC	EMT	Rigid
2½"	13½"	13½"	13½"
3"	15⅞"	15⅞"	15⅞"
3½"	18½"	18½"	18½"
4"	21"	21"	21"

Part #	Description	Pump	Weight
B400L	Long-stroke Ultra Eegor™	—	770 lbs
B400LP408S	Long-stroke Ultra Eegor™	P408S Electric	870 lbs
B400DL	Long-stroke Ultra Eegor™ w/o 3½" shoe group	—	770 lbs
B400DLP408S	Long-stroke Ultra Eegor™ w/o 3½" shoe group	P408S Electric	795 lbs
CD3028KT*	Eegor® Conversion Kit, 28" Stroke Cylinder		105 lbs
ZDC404	Bend Angle Decal		1 lb

SEE PG
49



FOR MORE INFO ON
Electric Pumps

tip:

*To convert older B400 or B400D to Long-stroke Cylinder, use CD3028KT Kit, which includes Long-stroke Cylinder, CS400 Cylinder Support and DC404 Decal.

Components Included with the Long-stroke Ultra Eegor™ Bender

Part #	Conduit	Description	Weight	I.D. #	Part #	Conduit	Description	Weight	I.D. #
BS2500	2½"	Bending Shoe	44 lbs	1	BZ34	3"	U-strap	5 lbs	10
BS3000	3"	Bending Shoe	50 lbs	2	BZ39*	3½"	U-strap	8 lbs	11
BS3500	3½"	Bending Shoe	75 lbs	3	BZ44	4"	U-strap	10 lbs	12
BS4000	4"	Bending Shoe	90 lbs	4	BZ76	-	U-strap Pin	4 lbs	15
BFB2500	2½"	Follow Bar	34 lbs	5	BZ78	-	Bend Shoe Pin	4 lbs	16
BFB3000	3"	Follow Bar	35 lbs	6	ZCD3028	-	30-Ton, Double-Acting Hyd. Cyl.	95 lbs	17
BFB3500	3½"	Follow Bar	42 lbs	7	HC927	-	(2) 10' Hose w/High-Flow Coupler	4 lbs	18
BFB4000	4"	Follow Bar	40 lbs	8	BZ74	-	Double Anchor Frame Pin	66 lbs	19
BZ28	2½"	U-strap	5 lbs	9	CM20	-	Metal Case for Ultra Eegor™	182 lbs	-

*These parts are not included with B400DL and B400DLP408S.

Replacement Components for Egor® Roller Assembly BZ72:

Part #	# Req'd	Description	I.D. #
CK211950	1	Plate assembly (top)	1
CK212950	1	Plate assembly (bottom)	2
CF860013	1	Pilot keyway	4
CF862281	2	Roller (short)	6
CF861108	2	Roller insert (short)	7
CK579281	1	Roller	8
CF863104	1	Roller axle	9
CM191044	1	Retaining ring	10
CM194900	1	Roller assembly	11
B1021028	1	Roller cam cap screw	13
CH819044	AR	Wire, retaining	14
CH951044	1	Ring, retaining	15

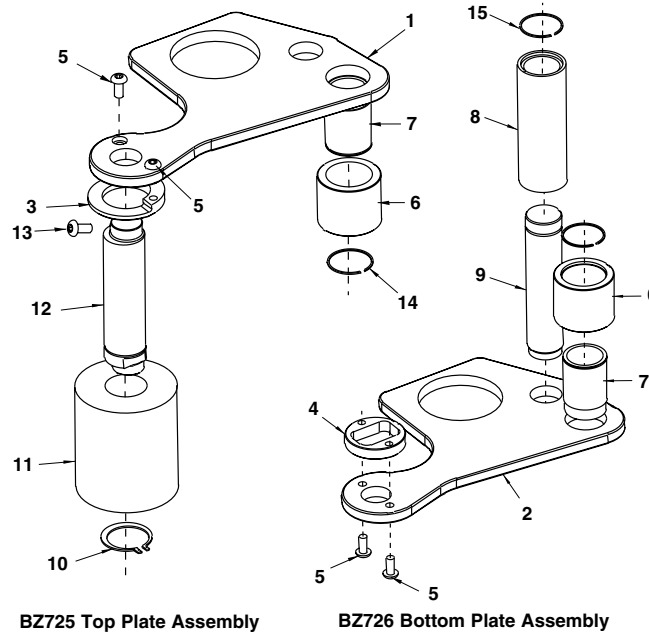

The New Mobile Bend-Mate™ system empowers one person to setup, operate and finish a job faster than ever. As soon as you're ready, lock down the wheels and get to work. You have everything you need at your fingertips. All bending shoes, follow bars and pump are integrated into a unique design - even the hydraulic hoses are pre-installed and routed - to optimize setup and teardown time on the job site. When one job is complete, the Mobile Bend-Mate™ makes it easy to move from one location to the next. Four heavy duty swivel casters pivot in any direction to help you wheel the entire system just about anywhere since it fits through a standard 32" doorway. Built-in forklife pockets are available for lifting on all four sides. And the end of the work day, the Mobile Bend-Mate™ is designed so you can easily secure shoes, follow bars, pump and bender for overnight storage on the job site.

- Eliminates need for Job Box
- Extermely fast setup time.
- To be used with Ultra Egor Conduit Bender
- Backward compatible with all Ultra Egor Benders
- Includes: Table only



Part #	Description	Weight
MB400	Mobile Bend-Mate™ Table Only	308 lbs
MB400L	Ultra Egor™ with Mobile Bend-Mate™ Table with Complete Shoe Groups - w/o Pump	1093 lbs
MB400LP	Ultra Egor™ with Mobile Bend-Mate™ Table with Complete Shoe Groups & Pump	1178 lbs
MB400DL	Ultra Egor™ with Mobile Bend-Mate™ Table w/o Pump & 3.5" shoe group	968 lbs
MB400DLP	Ultra Egor™ with Mobile Bend-Mate™ Table & Pump w/o 3.5" shoe group	1053 lbs

tip: Using MB400 table with an Egor® Hydraulic Bender will help reduce labor costs, and physical strain.

tip: When ordering the optional MB400 Table for use with the Ultra Egor™, you must order the MB400L Cylinder Support.

1/2" - 2" One-shot Rigid Hydraulic Benders

Gardner Bender™ Rigid Benders are made with high-grade aluminum for durability, and interchangeable shoes that allow quick and precise bends.

- Bends 1/2" to 2" rigid steel or rigid aluminum conduit.
- Portable hand pump or economical electric pump options.
- Durable metal job box included.
- Optic angle gauge for quick references of bend progression.
- Ability to be powered by manual or electric pumps.

note: These benders are for use on Rigid conduit only.



Part #	Description	Weight
B316S	1/2" - 2" One-shot Rigid Bender	104 lbs
B316SPH39	1/2" - 2" One-shot Rigid Bender w/ PH39 Hand Pump	114 lbs
B316SPE22J	1/2" - 2" One-shot Rigid Bender w/ PE22J Electric Pump	160 lbs



Centerline Radius Chart:

Nominal Size	Rigid Radius	Bending Shoe	Nominal Size	Rigid Radius	Bending Shoe
1/2"	3 9/16"	BZ12011	1 1/4"	7 1/4"	BZ12041
3/4"	4 1/2"	BZ12021	1 1/2"	8 1/4"	BZ12051
1"	5 13/16"	BZ12031	2"	9 1/2"	BZ12061



Components Included with B316S Models:

Part #	Conduit	Description	Weight	I.D. #	Part #	Conduit	Description	Weight	I.D. #
BZ12011	1/2"	Bending Shoe	1 lb	1	BZ12071	-	(2) Pivot Shoes	1 lb	8
BZ12021	3/4"	Bending Shoe	1 lb	2	BZ12091	-	Angle Gauge	.5 lb	9
BZ12031	1"	Bending Shoe	2 lbs	3	BZ12375	-	(2) Pivot Pins	1 lb	10
BZ12041	1 1/4"	Bending Shoe	4 lbs	4	BZ12371	-	Bender Frame	25 lbs	11
BZ12051	1 1/2"	Bending Shoe	5 lbs	5	BZ12377	-	Shoe Lock Pin	.25 lb	12
BZ12061	2"	Bending Shoe	7 lbs	6	HC913	-	6' Hose	3 lbs	13
CS1010	-	10-ton Single-Acting Cylinder*	13 lbs	7	CM4	-	Metal Case	56 lbs	14

*Must order A12 Smooth Saddle, see p. 52

1" - 2" Combination One-shot / 2 1/2" - 4" Sweep Rigid Hydraulic Benders

Bends 1" to 2" rigid steel or aluminum conduit in one shot. Includes 2 1/2" to 4" sweep bend shoes.

- Capability of one-shoe bending for elbows.
- Ability to produce sweep bends where several bending stages are necessary.
- Durable metal job box included.
- Ability to be powered by manual or electric pumps.



Part #	Description	Weight
B308S	1" - 2" One-shot / 2 1/2" - 4" Sweep Combination	225 lbs
B308SPH80	1" - 2" One-shot / 2 1/2" - 4" Sweep Combo w/ PH80 Hand Pump	253 lbs
B308SPE22J	1" - 2" One-shot / 2 1/2" - 4" Sweep Combo w/ PE22J Elec. Pump	340 lbs

Centerline Radius Chart:

Nominal Size	Rigid Radius	Bending Shoe	Nominal Size	Smallest Radius	Bending Shoe
1"	5 ¹³ / ₁₆ "	BZ12031	2 1/2"	10 1/2"	BZ12382
1 1/4"	7 1/4"	BZ12041	3"	13"	BZ12383
1 1/2"	8 1/4"	BZ12051	3 1/2"	17 1/2"	BZ12384
2"	9 1/2"	BZ12061	4"	20"	BZ12385



Components Included with B308S Models:

Part #	Conduit	Description	Weight	I.D. #	Part #	Conduit	Description	Weight	I.D. #
BZ12031	1"	Bending Shoe	2 lbs	1	CS2510	-	25-ton Single-Acting Cylinder*	31 lbs	9
BZ12041	1 1/4"	Bending Shoe	4 lbs	2	BZ13401	-	(2) Pivot Shoes	4 lbs	10
BZ12051	1 1/2"	Bending Shoe	5 lbs	3	BZ12091	-	Angle Gauge	.5 lb	11
BZ12061	2"	Bending Shoe	7 lbs	4	BZ12376	-	(2) Pivot Pins	4 lbs	12
BZ12382	2 1/2"	Sweep Bending Shoe	4 lbs	5	BZ12372	-	Bender Frame	54 lbs	13
BZ12383	3"	Sweep Bending Shoe	5 lbs	6	BZ12377	-	Shoe Lock Pin	.25 lb	14
BZ12384	3 1/2"	Sweep Bending Shoe	9 lbs	7	HC913	-	6' Hose	3 lbs	15
BZ12385	4"	Sweep Bending Shoe	12 lbs	8	CM7	-	Metal Case	98 lbs	16

*Must order A29 Smooth Saddle, see p. 52

1¼" - 4" One-shot Rigid Hydraulic Benders

Bends 1¼" to 4" rigid steel or rigid aluminum conduit.

- Choice of hand or electric pumps.
- Durable metal job box included.
- Ability to be powered by manual or electric pumps.



Part #	Description	Weight
B340S	1¼" - 4" One-shot Rigid Bender	334 lbs
B340SPH80	1¼" - 4" One-shot Rigid Bender w/ PH80 Hand Pump	350 lbs
B340SPE22J	1¼" - 4" One-shot Rigid Bender w/ PE22J Electric Pump	390 lbs
B340SP208J	1¼" - 4" One-shot Rigid Bender w/ P208J Electric Pump	325 lbs

Centerline Radius Chart:

Nominal Size	Rigid Radius	Bending Shoe	Nominal Size	Rigid Radius	Bending Shoe
1¼"	7¼"	BZ12041	3"	13"	BZ12351
1½"	8¼"	BZ12051	3½"	17½"	BZ12391
2"	9½"	BZ12061	4"	20"	BZ12392
2½"	10½"	BZ12341			



Components Included with B340S Models:

Part #	Conduit	Description	Weight	I.D. #	Part #	Conduit	Description	Weight	I.D. #
BZ12041	1¼"	Bending Shoe	4 lbs	1	BZ13401	-	(2) Pivot Shoes	4 lbs	9
BZ12051	1½"	Bending Shoe	5 lbs	2	BZ12091	-	Angle Gauge	.5 lb	10
BZ12061	2"	Bending Shoe	7 lbs	3	BZ12376	-	(2) Pivot Pins	4 lbs	11
BZ12341	2½"	Bending Shoe	15 lbs	4	BZ12374	-	Bender Frame	63 lbs	12
BZ12351	3"	Bending Shoe	15 lbs	5	BZ12377	-	Shoe Lock Pin	.25 lb	13
BZ12391	3½"	Bending Shoe	40 lbs	6	HC913	-	6' Hose	3 lbs	14
BZ12392	4"	Bending Shoe	41 lbs	7	CM7	-	Metal Case	98 lbs	15
CS2514	-	25-ton Single-Acting Cylinder*	31 lbs	8	B350	-	5" Conversion Kit (optional)	63 lbs	-

*Must order A29 Smooth Saddle, see p. 52

1¼" - 5" One-shot Sweep Combination Rigid Hydraulic Benders

Bends 1¼" to 4" rigid steel or rigid aluminum conduit.

- Choice of hand or electric pumps.
- Durable metal job box included.
- Ability to be powered by manual or electric pumps.

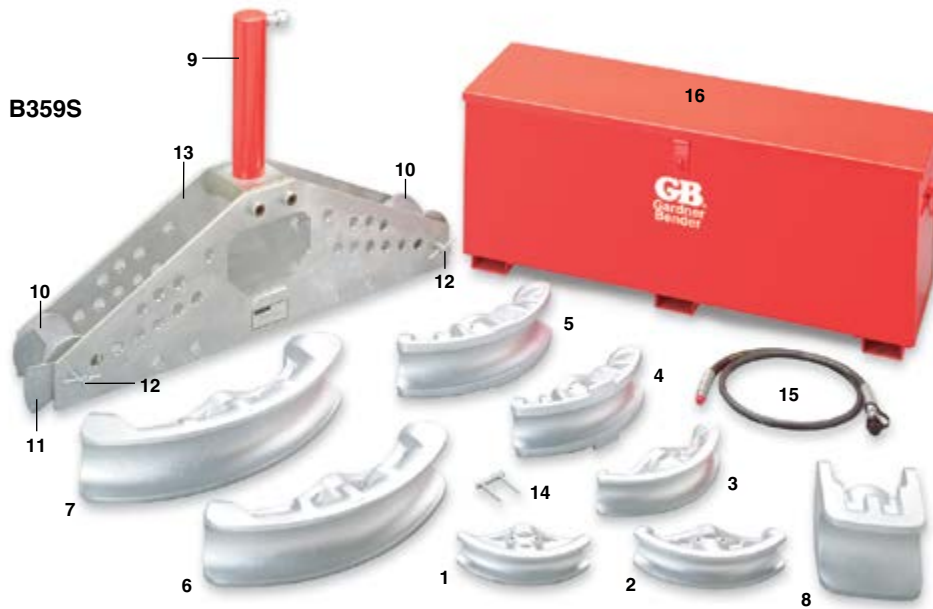

Part #	Description	Weight
B359S	1¼" - 4" One-shot / 5" Sweep Combination	225 lbs
B359SPH80	1¼" - 4" One-shot / 5" Sweep Combo w/ PH80 Hand Pump	253 lbs
B359SP208J	1¼" - 4" One-shot / 5" Sweep Combo w/ P208J Elec. Pump	340 lbs

SEE PG **49**  FOR MORE INFO ON **Electric Pumps**

SEE PG **51**  FOR MORE INFO ON **Manual Pumps**

SEE PG **53**  FOR MORE INFO ON **Cylinders**

Centerline Radius Chart:

Nominal Size	Rigid Radius	Bending Shoe	Nominal Size	Rigid Radius	Bending Shoe
1¼"	7¼"	BZ12041	3"	13"	BZ12351
1½"	8¼"	BZ12051	3½"	17½"	BZ12391
2"	9½"	BZ12061	4"	20"	BZ12392
2½"	10½"	BZ12341			

Components Included with B359S Models:

Part #	Conduit	Description	Weight	I.D. #	Part #	Conduit	Description	Weight	I.D. #
BZ12041	1¼"	Bending Shoe	4 lbs	1	CS2514*	-	25 ton Single Acting Cylinder	31 lbs	9
BZ12051	1½"	Bending Shoe	5 lbs	2	BZ12388	-	(2) Pivot Shoes	4 lbs	10
BZ12061	2"	Bending Shoe	7 lbs	3	BZ12091	-	Angle Gauge	.25 lb	11
BZ12341	2½"	Bending Shoe	14 lbs	4	BZ12390	-	(2) Pivot Pins	4 lbs	12
BZ12351	3"	Bending Shoe	15 lbs	5	BZ12389	-	Bender Frame	85 lbs	13
BZ12391	3½"	Bending Shoe	40 lbs	6	BZ12377	-	Shoe Lock Pin	.25 lb	14
BZ12392	4"	Bending Shoe	41 lbs	7	HC913	-	6' Hose	3 lbs	15
BZ12386	5"	Sweep Bending Shoe	18 lbs	8	CM7	-	Metal Case	98 lbs	16

*Must order A29 Smooth Saddle, see p. 52

1 1/4" - 4" Sweep/Segmental Rigid Hydraulic Benders

Bends 1 1/4" to 4" rigid steel or rigid aluminum conduit sweep/segmental.

- Choice of hand or electric pumps.
- Durable metal job box included.
- Ability to be powered by manual or electric pumps.

tip: For a quick reference guide, order GB® part #E507 at no charge.



Part #	Description	Weight
B306S	1 1/4" - 4" Sweep	216 lbs
B306SPH80	1 1/4" - 4" Sweep w/ PH80 Hand Pump	243 lbs
B306SPE22J	1 1/4" - 4" Sweep w/ PE22J Electric Pump	230 lbs

SEE PG **49**  FOR MORE INFO ON **Electric Pumps**

Centerline Radius Chart:

Nominal Size	Smallest Radius	Bending Shoe	Nominal Size	Smallest Radius	Bending Shoe
1 1/4"	7 1/4"	BZ12397	3"	13"	BZ12383
1 1/2"	8 1/4"	BZ12380	3 1/2"	17 1/2"	BZ12384
2"	9 1/2"	BZ12381	4"	20"	BZ12385
2 1/2"	10 1/2"	BZ12382			

SEE PG **51**  FOR MORE INFO ON **Manual Pumps**

SEE PG **53**  FOR MORE INFO ON **Cylinders**

Components Included with B306S Models:

Part #	Conduit	Description	Weight	I.D. #	Part #	Conduit	Description	Weight	I.D. #
BZ12379	1 1/4"	Sweep Bending Shoe	2 lbs	1	CS2510*	-	25 ton Action Cylinder	31 lbs	8
BZ12380	1 1/2"	Sweep Bending Shoe	2 lbs	2	BZ13401	-	(2) Pivot Shoes	4 lbs	9
BZ12381	2"	Sweep Bending Shoe	3 lbs	3	BZ12376	-	(2) Pivot Pins	4 lbs	10
BZ12382	2 1/2"	Sweep Bending Shoe	4 lbs	4	BZ12372	-	Bender Frame	54 lbs	11
BZ12383	3"	Sweep Bending Shoe	5 lbs	5	BZ12377	-	Shoe Lock Pin	.25 lb	12
BZ12384	3 1/2"	Sweep Bending Shoe	9 lbs	6	HC913	-	6' Hose	3 lbs	13
BZ12385	4"	Sweep Bending Shoe	12 lbs	7	CM7	-	Metal Case	98 lbs	14

*Must order A29 Smooth Saddle, see p. 52

1 1/4" - 4" One-shot Eject-O-Matic® Rigid Hydraulic Benders

Bends 1 1/4" to 4" rigid steel and rigid aluminum conduit. Eject-O-Matic® feature retains conduit with a T-pin while bending shoe is hydraulically retracted. Once complete, the conduit automatically pops free.

- Optional 5" conversion kit available (B350) - segment only.
- Automatic ejection saves time and money.
- Ability to be powered by manual or electric pumps.

tip: Double Acting (two hose) cylinders provide controlled and powerful bending and return functions.



Part #	Description	Weight
B343S	1 1/4" - 4" One-shot	330 lbs
B343SPH84	1 1/4" - 4" One-shot w/ PH84 Hand Pump	380 lbs
B343SP408J	1 1/4" - 4" One-shot w/ P408J Electric Pump	430 lbs
B343SP408S	1 1/4" - 4" One-shot w/ P408S Electric Pump	432 lbs

Centerline Radius Chart:

Nominal Size	Smallest Radius	Bending Shoe	Nominal Size	Smallest Radius	Bending Shoe
1 1/4"	7 1/4"	BZ12041	3"	13"	BZ12351
1 1/2"	8 1/4"	BZ12051	3 1/2"	17 1/2"	BZ12391
2"	9 1/2"	BZ12061	4"	20"	BZ12392
2 1/2"	10 1/2"	BZ12341			

SEE PG **49** FOR MORE INFO ON **Electric Pumps**

SEE PG **51** FOR MORE INFO ON **Manual Pumps**

SEE PG **53** FOR MORE INFO ON **Cylinders**

Components Included with B343S Models:

Part #	Conduit	Description	Weight	I.D. #	Part #	Conduit	Description	Weight	I.D. #
BZ12041	1 1/4"	Bending Shoe	4 lbs	1	BZ13401	-	(2) Pivot Shoes	4 lbs	9
BZ12051	1 1/2"	Bending Shoe	5 lbs	2	BZ12091	-	Angle Gauge	.5 lb	10
BZ12061	2"	Bending Shoe	7 lbs	3	BZ12376	-	(2) Pivot Pins	4 lbs	11
BZ12341	2 1/2"	Bending Shoe	14 lbs	4	BZ12374	-	Bender Frame	78 lbs	12
BZ12351	3"	Bending Shoe	15 lbs	5	BZ12377	-	Shoe Lock Pin	.25 lb	13
BZ12391	3 1/2"	Bending Shoe	40 lbs	6	HC913	-	(2) 6' Hoses	6 lbs	14
BZ12392	4"	Bending Shoe	41 lbs	7	CM7	-	Metal Case	98 lbs	15
CD3014	-	30-ton Double-Acting Cylinder*	31 lbs	8	B350	-	5" Conversion Kit (optional)	63 lbs	-

*Must order A29 Smooth Saddle, see p. 52

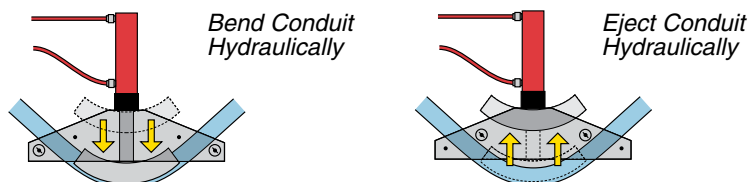

1 1/4" One-shot Eject-O-Matic® Rigid Hydraulic Benders - 5" Sweep

Bends 1 1/4" to 4" rigid steel and rigid aluminum conduit in one shot and 5" sweep.

- Choice of hand or electric pumps.
- Durable metal job box included.
- Eject conduit hydraulically by moving one pivot pin.
- Ability to be powered by manual or electric pumps.



Part #	Description	Weight
B351S	1 1/4" - 4" One-shot / 5" Sweep Combination	377 lbs
B351SPH84	1 1/4" - 4" One-shot / 5" Sweep Combo w/ PH84 Hand Pump	410 lbs
B351SP408S	1 1/4" - 4" One-shot / 5" Sweep Combo w/ P408S Elec. Pump	460 lbs



Centerline Radius Chart:

Nominal Size	Rigid Radius	Bending Shoe	Nominal Size	Rigid Radius	Bending Shoe
1 1/4"	7 1/4"	BZ12041	3"	13"	BZ12351
1 1/2"	8 3/4"	BZ12051	3 1/2"	17 1/2"	BZ12391
2"	9 1/2"	BZ12061	4"	20"	BZ12392
2 1/2"	10 1/2"	BZ12341			



Components Included with B351S Models:

Part #	Conduit	Description	Weight	I.D. #	Part #	Conduit	Description	Weight	I.D. #
BZ12041	1 1/4"	Bending Shoe	4 lbs	1	CD3014*	-	30 ton Double Acting Cylinder	31 lbs	9
BZ12051	1 1/2"	Bending Shoe	5 lbs	2	BZ12388	-	(2) Pivot Shoes	10 lbs	10
BZ12061	2"	Bending Shoe	7 lbs	3	BZ12091	-	Angle Gauge	.5 lb	11
BZ12341	2 1/2"	Bending Shoe	14 lbs	4	BZ12390	-	(2) Pivot Pins	4 lbs	12
BZ12351	3"	Bending Shoe	15 lbs	5	BZ12389	-	Bender Frame	85 lbs	13
BZ12391	3 1/2"	Bending Shoe	40 lbs	6	BZ12377	-	Shoe Lock Pin	.25 lb	14
BZ12392	4"	Bending Shoe	41 lbs	7	HC913	-	(2) 6' Hoses	13 lbs	15
BZ12386	5"	Sweep Bending Shoe	18 lbs	8	CM7	-	Metal Case	98 lbs	16

*Must order A29 Smooth Saddle, see p. 52

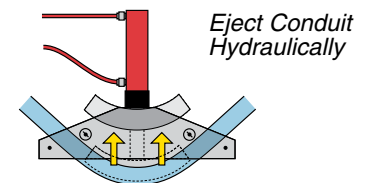
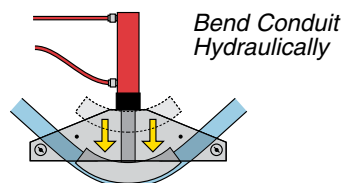

Z-Class™ Electric Pumps

Introducing Gardner Bender™ Z-Class™ hydraulic pumps—pumps that run cooler, use less electricity and are easier to service than conventional pumps. Gardner Bender™ has used the latest metallurgical, bearing and seal technologies to produce a pump whose features and benefits far surpass the electric pumps that are available today. By reducing the number of moving parts, improving flow dynamics and decreasing friction, Z-Class™ pumps will stay on the job longer, require less energy to operate and when needed, have lower service costs.

- Two-speed high-efficiency pumps.
- Self-priming, high-flow 1st stage pump.
- Large, heavy-duty bearings and balanced rotating components.
- Replaceable piston check-valves.
- Powerful universal motor and excellent low-voltage operating.
- Brush design lasts 4-times longer.
- Ergonomic high strength composite.

Double-Acting Pump
 P408S
 1.7 HP Pump



Single-Acting Pump
 P208K
 1.7 HP Pump



	P208J	P408S	P408J	P408K
Motor Size	1.7hp	1.7hp	1.7hp	1.7hp
Type	Z-Class™	Z-Class™	Z-Class™	Z-Class™
Reservoir Capacity	1 gallon	1 gallon	1 gallon	2 gallon
LCD Display	Yes	Yes	No	No
Pendant Control	Yes	Yes	No	No
Valve Operation	Manual	Solenoid	Manual	Manual
Pump Type	single-acting	double-acting	double-acting	double-acting
Pressure Rating				
1st stage (psi)	100	100	100	100
2nd stage (psi)	10,000	10,000	10,000	10,000
Output Flow Rate				
1st stage (in ³ /min)	700	700	700	700
2nd stage (in ³ /min)	60	60	60	60
Valve Type	3 way/2 pos.	4 way/3 pos.	4 way/3 pos.	4 way/3 pos.
Current Draw (max) (Amps)	20	20	20	20
Motor Voltage (VAC)	115	115	115	115
Sound (dba)	85-90	85-90	85-90	85-90
Weight (lbs)	70	85	71	71
Relief Valve Adj. Range (psi)	2,000-10,000	2,000-10,000	2,000-10,000	2,000-10,000



Back-lit LCD

Provides essential information:

- Hour & cycle counts
- Low voltage warning
- Self-test, diagnostic and read-out capabilities
- Pressure read-out and adjustable trigger pressure settings
- Information displayed in 6 languages

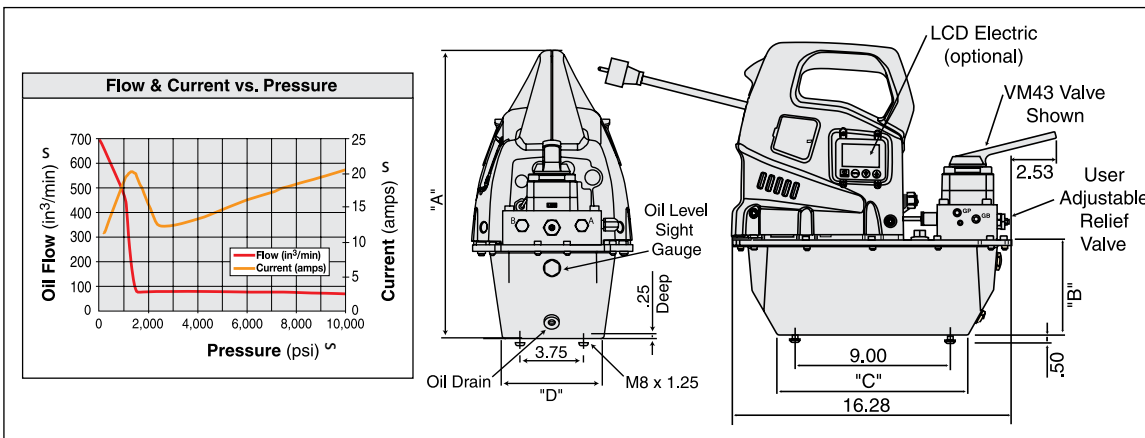

Economy Electric Pumps

PE20D & PE22J

- Lightweight - 22 - 41 lbs.
- 115 V AC 50/60 cycle universal motor works well with long extension cords or generator-driven power.
- Long 10' remote control for operator safety.
- Great for medium-sized cylinders.

	PE20D	PE22J
Motor Size	1/2 hp	1/2 hp
Type	Economy	Economy
Reservoir Capacity	1 gallon	1 gallon
Pump Type	Single-Acting	Single-Acting
Pressure Rating		
1st stage (psi)	200	200
2nd stage (psi)	10,000	10,000
Output Flow Rate		
1st stage (in ³ /min)	200	200
2nd stage (in ³ /min)	20	20
Valve Type	Dump	3-way, 2 pos.
Current Draw (Amps)	9.5	9.5
Motor Voltage (VAC)	115	115
Sound (dba)	85	85
Weight	29 lbs	27 lbs

Single-Acting Pump

PE20D
1/2 HP Pump



Single-Acting Pump

PE22J
1/2 HP Pump



PE20D or PE22J Economy Electric Pumps

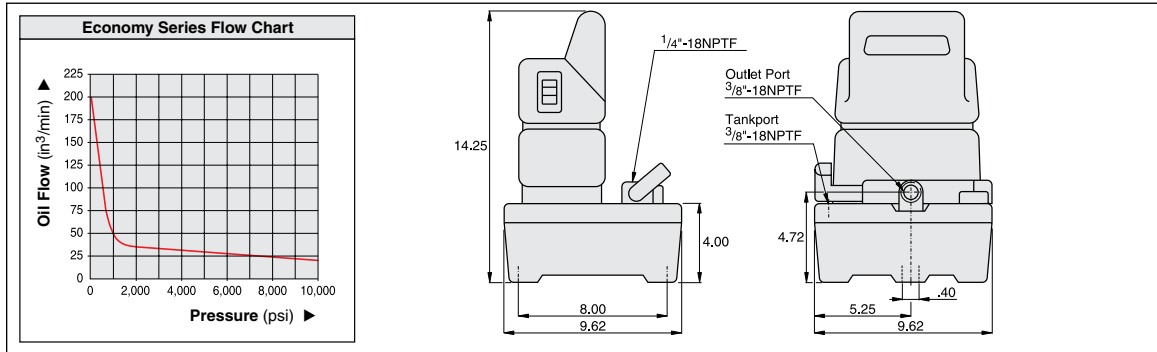

Manual Hydraulic Pumps

Durable manual pumps utilized with Gardner Bender™ hydraulic bender sets.

- PH80 model feature two-speed action for faster cylinder cycle time.
- PH39 has economical single-speed design.
- All pumps contain internal high-pressure relief overload protection.

	PH20	PH39	PH80	PF65
Pump Type	Single-Speed	Single-Speed	Two-Speed	Single-Speed
Usable Oil Capacity (in³)	20	40	134	22
Pressure Rating				
1st stage (psi)	N/A	N/A	350	N/A
2nd stage (psi)	10,000	10,000	10,000	6,500
Oil Displ. per Stroke				
1st stage (in ³)	N/A	N/A	.99	N/A
2nd stage (in ³)	.055	.16	.15	.16
Max. Handle Effort	72 lbs	111 lbs	104 lbs	125 lbs
Piston Stroke (in)	.50	.81	1.00	.81
Piston Diameter				
1st stage (in)	.75	.94	1.13	.50
2nd stage (in)	.38	.44	.44	N/A
Dimensions (in)				
A	7.31	15.50	16.75	8.25
B	13.25	20.47	21.22	12.88
C	1.13	1.28	1.00	1.28
D	3.37	1.50	1.75	1.5
E	1.13	1.25	2.13	1.88
F	-	-	-	-
H	12.56	18.25	20.75	8.5
J	.75	1.18	1.14	1.18
L	5.63	4.69	6.88	4.38
M	-	2.56	.75	.51
N	3.75	5.25	5.75	5.25
P	3.18	-	4.76	-
Q	-	-	-	-
R	-	-	.83	-
S	-	-	.31	-
T	-	-	-	-
Weight	4.5 lbs	13 lbs	24 lbs	12 lbs



PH20
Manual Pump



PH39
Manual Pump



PH80
Manual Pump



PH84
Manual Pump



PF65
Manual
Foot Pump

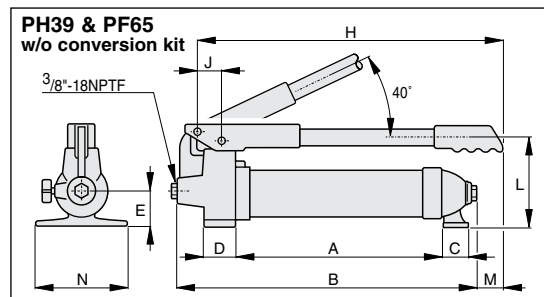
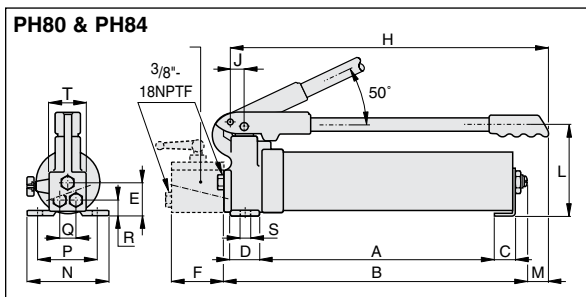
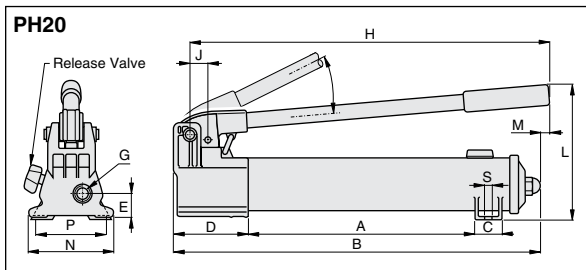

Hydraulic Bender Accessories

Quality accessories to increase bending efficiency.

See following page for Hydraulic Cylinder Specifications.

Hoses and Oil

Part #	Description	Weight
H8210	10' Rubber Hydraulic Hose w/ AH630 coupler	4 lbs
H864	6' Rubber Hydraulic Hose w/ AH630 coupler	2 lbs
HC913	6' Rubber Hydraulic Hose w/ CH604 coupler	3 lbs
HC927	10' Rubber Hydraulic Hose w/ CH604 coupler	4 lbs
HF100	Hydraulic Oil, Quart—ISO Grade 32	2 lbs
HF101	Hydraulic Oil, Gallon—ISO Grade 32	8 lbs

Couplers

Part #	Description	Weight
A630	Hydraulic Coupler: 1/4" Female Half	.5 lb
	Hydraulic Coupler: 1/4" Male Half	.5 lb
C604	Hydraulic Coupler: 3/8" High-flow Female Half	.5 lb
	Hydraulic Coupler: 3/8" High-flow Male Half	.5 lb

Smooth Saddles

Part #	For Use With	2A Thread	Weight
A12	10-ton Cylinders	1 - 8 UNC	5 lbs
A29	25 ton Cylinders	1 1/2 - 16 UNC	7 lbs

tip: When ordering a replacement hydraulic cylinder for your bender you must also order a new smooth saddle. See chart above.

note: When installing a new saddle, apply LOCTITE® thread locker to threads prior to installation.



HF101



H864



A630

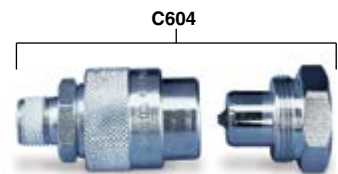

C604

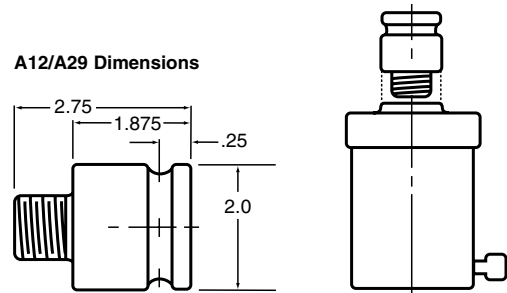

Hydraulic Cylinder Specifications

		CH1211	CS106	CS1010	CS2510	CS2514	CD3014
Cylinder Capacity (tons)		12.00	10.00	10.00	25.00	25.00	30.00
Stroke (in)		1.63	6.13	10.13	10.25	14.25	14.50
Max Cylinder Capacity (tons)	Push						30.00
Max Cylinder Capacity (tons)	Pull						5.00
Cylinder Effective Area (in ²)		2.77	2.23	2.23	5.15	5.15	
Cylinder Effective Area (in ²)	Push						6.51
Cylinder Effective Area (in ²)	Pull						3.00
Oil Capacity (in ³)		4.52	13.67	22.59	52.79	73.39	
Oil Capacity (in ³)	Push						92.70
Oil Capacity (in ³)	Pull						43.00
Collapsed Height (in)	A	4.75	9.75	13.75	14.75	18.75	21.63
Extended Height (in)	B	6.38	15.88	23.88	25.00	33.00	36.13
Outside Diameter (in)	D	2.75	2.25	2.25	3.38	3.38	4.00
Cylinder Bore Diameter (in)	E	2.13	1.69	1.69	2.56	2.56	2.88
Plunger Diameter (in)	F	1.38	1.50	1.50	2.25	2.25	2.13
Cyl. Base to Advance Port (in)	H	0.75	0.75	0.75	1.00	1.00	1.56
Top to Ret. Port (in)	I						3.19
Saddle Diameter (in)	J	–	1.38	1.38	2.00	2.00	2.00
Saddle Protr. from Plunger (in)	K	–	0.25	0.25	0.41	0.41	0.41
Plunger Internal Thread (in)	O	3/4-16	1-8	1-8	1 1/2-16	1 1/2-16	1 1/2-16
Plunger Thread Length (in)	P	0.63	0.75	0.75	1.00	1.00	1.00
Base Mounting Holes							
Bolt Circle Diameter (in)	U		1.56	1.56	2.31	2.31	–
Thread (in)	V		5/16-18	5/16-18	1/2-13	1/2-13	–
Thread Depth (in)	Z		.50	.50	.75	.75	–
Collar Thread (in)	W	2 3/4-16	2 1/4-14	2 1/4-14	3 5/16-12	3 5/16-12	3 5/16-12
Collar Thread Length (in)	X	1.19	1.13	1.13	1.94	1.94	1.94
Center Hole Diameter (in)	Y	0.77					
Weight (lbs)		6.20	9.80	14.00	31.00	39.00	64.00
Rating (tons)		12	10	10	25	25	30
Saddle (sold separately) (tons)		12	10	10	25	25	30



CH1211 has a 1.88" diameter base that protrudes .25" from base.

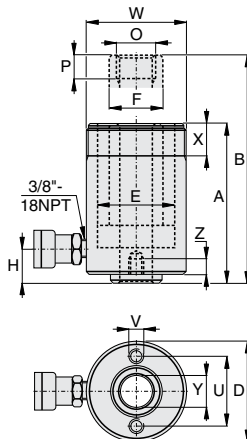

CH1211 model

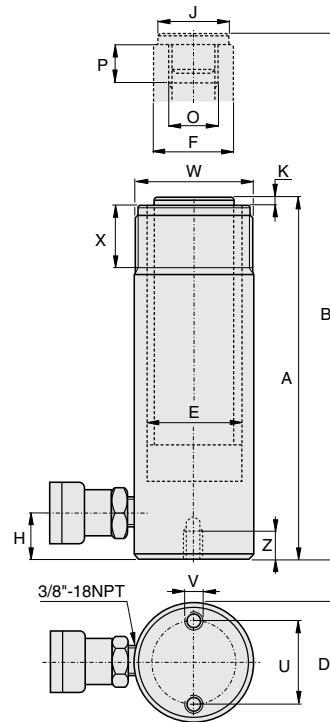

CS106, CS1010,
 CS2510, CS2514 models

Mechanical Sidewinder™ Benders

A fully portable system that bends:

- 1/2" to 1 1/2" rigid steel, rigid aluminum, PVC-Coated rigid and IMC conduit.
- 1/2" to 2" EMT conduit.
- Removable bender can be bolted onto workbench or truck bed for unparalleled flexibility.
- 0° to 90° bend indicator built into the frame shows bend angle while bending.
- Double-dog ratchet prevents shoe spring-back during bends; allows fast release after bending.
- Interchangeable shoes adapt single bender frame to cover widest range of conduit types.

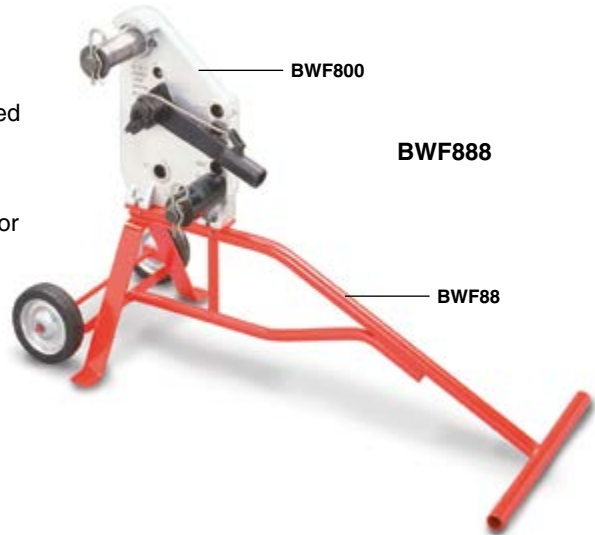

BWF800 Bender Head Assembly

Part #	Description	Weight
BWF888	Sidewinder™ Bender w/ out Shoe Groups	64 lbs
BF41	Urethane Roller Assembly & Shaft Assembly	3 lbs
BF42	2" EMT Strap	8 lbs
BF47	Shaft Assembly	3 lbs
BF48	2" Steel Sleeve and Strap Kit	4 lbs
BF49	Ratchet Assembly	9 lbs
BT112520	Insert Teeth (for 1 1/4" - 1 1/2" and 2" shoes)	1 lb
CM260281	Urethane Roller Only	1 lb

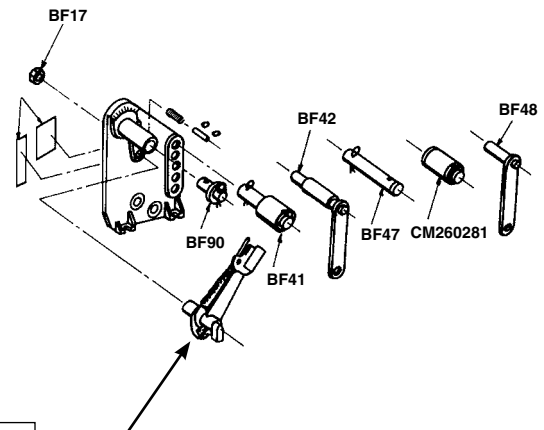

Jaws attach to shoes with chain.

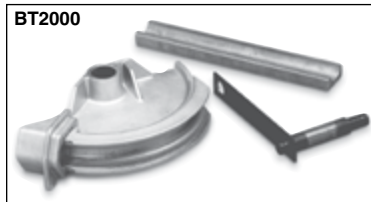

Repair Kits for BF49

Part #	Description
BW72	Lever and Washer Kit
BW74	Drive Pawl and Spring Kit
BW75	Hold Pawl and Spring Kit
BW76	Pin and Spring Kit

See Repair Parts Sheet for a detailed breakdown of these kits.

tip: A bend handle is not included with these units. A 6 ft. piece of 1" Dia. Rigid conduit can be used.

Bending Shoes

Part #	Clamping Jaw Range	Conduit	Weight	Clamping Jaw Part #	Weight
BT57510	1/2", 3/4" & 1"	EMT	15 lbs	BZ1306	2 lbs
BT12515	1 1/4" - 1 1/2"	1 1/2" EMT	34 lbs	BZ1307	4 lbs
BT2000*	2"	EMT	39 lbs	BZ13081	4 lbs
BR57510	1/2", 3/4" & 1"	Rigid & IMC	18 lbs	BZ1306	2 lbs
BR12515	1 1/4" - 1 1/2"	Rigid & IMC	28 lbs	BZ1307	4 lbs
BR20000	2"	Aluminum Rigid	33 lbs	BZ1308	3 lbs

*Shoe includes BZ1345 follow bar and strap.

Sidewinder™ ½" - 1" Rigid / IMC Bender

Bends ½", ¾" and 1" rigid steel and IMC conduit.

- Shoe lock slips into place and removes easily for quick change-outs.
- Fully portable.



Part #	Weight	Contains		Weight
		Part #	Description	
BW11	78 lbs	BWF888	Sidewinder™ Bender Frame	64 lbs
		BR57510	½", ¾" & 1" Rigid & IMC Shoe	18 lbs

Sidewinder™ 1¼" - 1½" Rigid / IMC Bender

Bends 1¼" and 1½" rigid steel and IMC conduit.

- Shoe tooth inserts can be replaced in the field which allows extended service life.
- Order part number BT112520.



Part #	Weight	Contains		Weight
		Part #	Description	
BW12	88 lbs	BWF888	Sidewinder™ Bender Frame	64 lbs
		BR12515	1¼" & 1½" Rigid & IMC Shoe	28 lbs

Sidewinder™ ½" - 1½" Rigid / IMC Bender

Bends ½" to 1½" rigid steel and IMC conduit.

- Combines features and bending capabilities of BW11 and BW12.
- Able to handle the most commonly used rigid and IMC conduit sizes.



Part #	Weight	Contains		Weight
		Part #	Description	
BW15	106 lbs	BWF888	Sidewinder™ Bender Frame	64 lbs
		BR57510	½", ¾" & 1" Rigid & IMC Shoe	18 lbs
		BR12515	1¼" & 1½" Rigid & IMC Shoe	28 lbs

Sidewinder™ Rigid / IMC & Rigid Aluminum Conduit Bender

Bends 1/2" to 1 1/2" rigid and IMC and 2" rigid aluminum conduit. Adds 2" rigid aluminum conduit bending capability to 1/2" to 1 1/2" rigid and IMC capacity of BW15 Sidewinder™.

- Larger shoes feature field-replaceable tooth inserts for extended service life.
- Set includes metal storage box.



Part #	Weight	Contains		
		Part #	Description	Weight
BW20	175 lbs	BWF888	Sidewinder™ Bender Frame	64 lbs
		BW20S (Shoe Set)	BR57510 1/2", 3/4" & 1" Rigid & IMC Shoe	18 lbs
			BR12515 1 1/4" & 1 1/2" Rigid & IMC Shoe	28 lbs
			BR20000 2" Rigid Aluminum Shoe	33 lbs
		CM4 4-cubic-foot Case	26 lbs	

Shoes available separately or as a BW20S Set

Sidewinder™ Bender for All Conduit Types

Bends 1/2" to 1 1/2" rigid and IMC, 1/2" to 2" EMT, 1/2" to 2" rigid aluminum and 1/2" to 1 1/2" PVC-coated rigid conduit.

- The most comprehensive Sidewinder™ set for every job.
- Larger shoes feature filed-replacement-tooth inserts for extended service life.
- Set includes metal storage box.



Part #	Weight	Contains		
		Part #	Range	Weight
BW30	290 lbs	BWF888	Sidewinder™ Bender Frame	64 lbs
		BW30S (Shoe Set)	BT57510 1/2", 3/4", & 1" EMT Shoe	18 lbs
			BT12515 1 1/4" & 1 1/2" EMT Shoe	34 lbs
			BT2000 2" EMT Shoe	39 lbs
		BR57510 1/2", 3/4" & 1" Rigid & IMC Shoe	18 lbs	
		BR12515 1 1/4" & 1 1/2" Rigid & IMC Shoe	28 lbs	
		BR20000 2" Rigid Aluminum	33 lbs	
		CM7 7-cubic-foot Case	51 lbs	

Sidewinder™ Bender for Most Conduit Types

Bends 1/2" to 1 1/2" rigid and IMC, 1 1/4" to 2" EMT and 1" to 1 1/2" PVC-coated rigid conduit.

- The economical choice for bending the most popular sizes of rigid/IMC and larger EMT conduit.
- Set includes metal storage box.



Part #	Weight	Contains		Weight
		Part #	Description	
BW27	210 lbs	BWF888	Sidewinder™ Bender Frame	64 lbs
		BW27S	BT12515 1 1/4" & 1 1/2" EMT Shoe	28 lbs
		(Shoe Set)	BT2000 2" EMT Shoe	39 lbs
			BR57510 1/2", 3/4" & 1" Rigid & IMC Shoe	18 lbs
			BR12515 1 1/4" & 1 1/2" Rigid & IMC Shoe	28 lbs
			CM4 4-cubic-foot Case	26 lbs

Shoes available separately or as a BW27S Set

Sidewinder™ EMT & PVC-Coated Rigid Conduit Bender

Bends 2" EMT and 1 1/2" PVC-coated rigid conduit.

- Field-replaceable shoe-tooth inserts extend service life.
- Order part number BT112520.



Part #	Weight	Contains		Weight
		Part #	Description	
BW201	99 lbs	BWF888	Sidewinder™ Bender Frame	64 lbs
		BT2000	2" EMT Shoe	39 lbs

Sidewinder™ EMT & PVC-Coated Rigid Conduit Bender

Bends 1/2" to 2" EMT and 1/2" to 1 1/2" PVC-coated rigid conduit.

- Larger shoes feature filed-replacement-tooth inserts for extended service life.
- Set includes metal storage box.



Part #	Weight	Contains		Weight
		Part #	Description	
BW221	184 lbs	BWF888	Sidewinder™ Bender Frame	64 lbs
		BW221S	BT57510 1/2", 3/4" & 1" EMT Shoe	18 lbs
		(Shoe Set)	BT12515 1 1/4" & 1 1/2" EMT Shoe	28 lbs
			BT2000 2" EMT Shoe	39 lbs
			CM4 4-cubic-foot Case	26 lbs



Big Ben® Conduit Hand Bender

GB's new series of Big Ben® aluminum hand benders has improved traditional hand benders by enlarging the hook, increasing the foot pedal size and clearance, highlighting the markings and incorporating a dual sight-line system for bending on the floor or in the air. GB's new Big Ben® series offers industry standard markings to simplify the contractor's job. Made of rugged, heat-treated aluminum, the Big Ben® series is backed by a lifetime warranty and is available in the most common sizes of ½", ¾" and 1".

- All models include embossed sight lines for 10°, 22°, 30°, 45°, 60° and 90°.
- Industry-standard markings– 30° bend when handle is straight up.
- Bigger hook with a 5x durability factor.
- Bigger foot pedal– 40% larger.
- More foot room allows for a booted foot.
- Bend-back channel easily corrects conduit over-bends.
- Vise-Mate™ holds conduit while cutting or reaming.



These benders available with or without high-strength steel handle

						
Part Number	960	960H	961	961H	962	962H
Description	Head Only	Head & Handle	Head Only	Head & Handle	Head Only	Head & Handle
Application	½" EMT		¾" EMT / ½" Rigid		1" EMT / ¾" Rigid	
Fits Handle #	BH-75	Included	BH-75	Included	BH-100	Included
Material	Aluminum	Aluminum	Aluminum	Aluminum	Aluminum	Aluminum
Weight	1.34 lbs	5.06 lbs	1.58 lbs	5.34 lbs	3.16 lbs	7.01 lbs
Bend Radius	3.69"	3.69"	4.74"	4.74"	5.81"	5.81"
EMT Size	½"	½"	¾"	¾"	1"	1"
Rigid Size	—	—	½"	½"	¾"	¾"



Industry Standard Style
30° bend when handle is straight up



Bigger Hook
With a 5x durability factor



Bigger Foot Pedal
40% larger



More Foot Room
Allows for a booted foot



Bend-Back Channel
Easily corrects conduit over-bends



Vise-Mate™
Holds conduit while cutting or reaming

GB EXCLUSIVE! Gardner™ EMT / Rigid Aluminum Hand Benders (Series 930B)

Bends 1/2" to 1 1/4" EMT, and 1/2" to 1" rigid and rigid aluminum conduit.

- Built-in acrylic level gauge helps make precise bends in half the time.
- All models include embossed sight lines for 10°, 22.5°, 30°, 45°, 60° and 90°.
- Patented Vise-Mate™ holds conduit steady as it is cut to appropriate size.



These benders are available with or without high-strength steel handle

SEE PG **61** FOR MORE INFO ON Handles



Part Number	930B	930H	931B	931H
Description	Head Only	Head & Handle	Head Only	Head & Handle
Application	1/2" EMT		3/4" EMT / 1/2" Rigid	
Fits Handle #	BH-75	Included	BH-75	Included
Material	Aluminum	Aluminum	Aluminum	Aluminum
Weight	.8 lbs	5.3 lbs	2.3 lbs	6.4 lbs
Bend Radius	5"	5"	6"	6"
EMT Size	1/2"	1/2"	3/4"	3/4"
Rigid Size	—	—	1/2"	1/2"

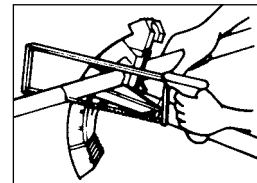

Insert conduit through Vise-Mate™ opening and cut to desired length.

Iron Hand Benders (Series 920-923)

Bends 1/2" to 1 1/4" EMT and 1/2" to 1" rigid and rigid aluminum conduit.

- Cast-in-place degree marks facilitate accurate bends.
- Constructed of rugged-malleable iron for strength and durability.
- Arrow and diamond indicate beginning and back-of-bend locations.



These benders are available with or without high-strength steel handle



Part Number	920		921	
	Head Only	Head & Handle	Head Only	Head & Handle
Description	1/2" EMT		3/4" EMT / 1/2" Rigid	
Application	1/2" EMT		3/4" EMT / 1/2" Rigid	
Fits Handle #	BH-75	Included	BH-75	Included
Material	Iron	Iron	Iron	Iron
Weight	2.7 lbs	7.2 lbs	5 lbs	9.6 lbs
Bend Radius	5"	5"	6"	6"
EMT Size	1/2"	1/2"	3/4"	3/4"
Rigid Size	—	—	1/2"	1/2"

Part Number	922		923	
	Head Only	Head & Handle	Head Only	
Description	1" EMT / 3/4" Rigid		1 1/4" EMT / 1" Rigid	
Application	1" EMT / 3/4" Rigid		1 1/4" EMT / 1" Rigid	
Fits Handle #	BH-100	Included	BH-125	
Material	Iron	Iron	Iron	
Weight	4.9 lbs	14.5 lbs	14 lbs	
Bend Radius	8"	8"	11"	
EMT Size	1"	1"	1 1/4"	
Rigid Size	3/4"	3/4"	1"	

Hand Bender Handles

High quality, pre-threaded bender handles for all Gardner Bender™ bender heads.

- Constructed of high-strength steel.
- Powder painted for increased durability.
- Comfort grip design ensures increased grasping capabilities.

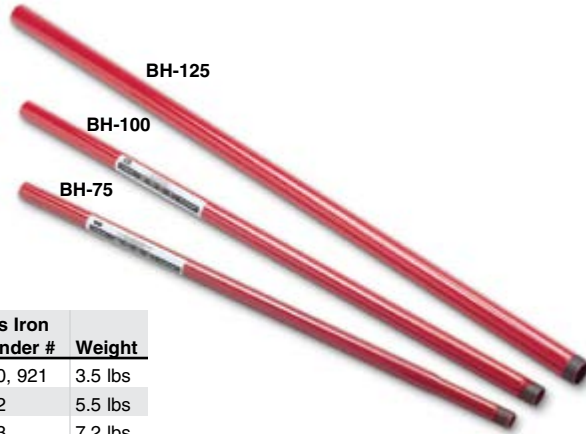

Part #	Size	Fits Aluminum Bender #	Fits Iron Bender #	Weight
BH-75*	3/4" NPT x 38" long	930B, 931B, 960, 961	920, 921	3.5 lbs
BH-100*	1" NPT x 44" long	932, 962, 820, 821	922	5.5 lbs
BH-125	1 1/4" NPT x 54" long	933, 822	923	7.2 lbs

* Patented

Hickey Bending Heads

For 1/2" to 1" rigid conduit.

- Manufactured using permanent mold process with high-strength, heat-treated aluminum.
- Lightweight and extremely durable.



Part #	Rigid Size	Fits Bender Handle #	Weight
820	1/2"	BH-100	.9 lb
821	3/4"	BH-100	1.2 lbs
822	1"	BH-125	2.2 lbs

GB EXCLUSIVE! HotTube™ PVC Bender for 1/2" to 2" Conduit (schedule 40-80)

This high-production bender can simultaneously heat up to five lengths of 1/2" conduit and up to three lengths of 3/4" conduit, without rotating.

- Adjustable thermostatic control heats conduit fast and maintains perfect bending temperature.
- Patented technology enables HotTube™ to maintain temperature in wide range of ambient temperatures and wind conditions.
- No need to rotate conduit. Won't burn or scorch.
- Insulated, weatherproof housing provides safe, cool operation—unit is portable immediately after use.
- Dimensions: 27 3/8" x 5 1/2" x 8 1/2".
- Temperature Range: 0 °F - 265 °F.

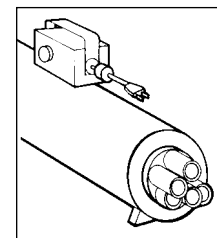

Part #	Description	Power Requirements			Weight
		Watts	Volts	Amps	
BHT-520A	1/2" - 2" HotTube™	1440	115/120	12	24 lbs

HotBox™ PVC Bender for ½" to 2" Conduit (schedule 40-80)

Complete PVC bending system includes Bend-Guide™ bending gauge.

- Highly polished reflector surfaces heat conduit quickly and evenly.
- Low power consumption.
- Lightweight with convenient carrying handle and cover clasp.
- Bending guide adjusts for 0° to 90° bend segments in any radius from 6" to 12" (Not sold separately).
- Dimensions: 29½" x 7" x 7⅛".
- Temperature Range: 0 °F - 450 °F.



Part #	Description	Power Requirements			Weight
		Watts	Volts	Amps	
BHB-520D	½" - 2" HotBox™	1450	115/120	12	17 lbs
BHE-50K	Replacement Heating Element	1450	115/120	12	1 lb

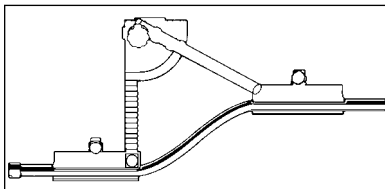
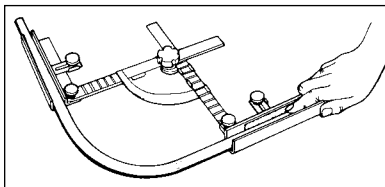

Convenient Bend-Guide™ is included with every BHB-520D.

HotBox™ PVC Bender for ½" to 4" Conduit (schedule 40-80)

Meets most PVC bending needs. Accommodates conduit range from ½" to 4".

- Highly polished reflector surfaces heat conduit quickly and evenly.
- Large wheels provide job-site portability.
- Allows conduit to be reheated and reformed.
- Dimensions: 54½" x 8½" x 11½".
- Temperature Range: 0 °F - 400 °F.



Part #	Description	Power Requirements			Weight
		Watts	Volts	Amps	
BHB-540A	½" - 4" HotBox™	2400	115/120	20	34 lbs
BHE-540	Replacement Heating Element	2400	115/120	20	3.5 lbs

HotBox™ PVC Bender for ½" to 6" Conduit (schedule 40-80)

Accommodates conduit range from ½" to 6". Specially designed covers and heat flow system allow heating of shorter lengths as well as lengths sufficient for 48" radius, 90° elbows.

- Highly polished reflector surfaces heat conduit quickly and evenly.
- Power drive model automatically rotates conduit 5–6 RPM for faster bends.
- Large wheels provide job-site portability.
- Allows conduit to be reheated and reformed.
- Dimensions: 74" x 11½" x 14".
- Temperature Range: 0 °F - 400 °F.



Part #	Description	Power Requirements			Weight
		Watts	Volts	Amps	
BHB-560	½" - 6" HotBox™	5500	230	24	60 lbs
BHB-560P	½" - 6" HotBox™ w/ Power Rotator	5500	230	24	68 lbs
BHE-560	Replacement Heating Element	5500	230	24	8.5 lbs

HotBlanket™ PVC Benders for ½" to 4" Conduit (all schedules)

New improvements have made this family of conduit benders the most durable and economical bending system in the industry.

- Internal thermostatic control will not scorch or burn conduit.
- Use in any in-place position.
- Thermostatic control heats pipe fast, even in cold or windy conditions.
- Multiple circuit design extends the life of the blankets.
- Multiple wound heavy-gauge wire ensures the longest life of any bending blanket.

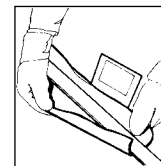

Wrap

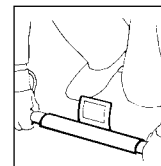

Heat

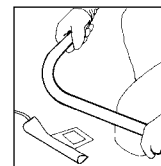

Bend

Part #	Conduit Size	Dimensions (L x W)	Power Requirements			Weight
			Watts	Volts	Amps	
BB5150	½" - 1½"	16" x 7½"	310	120	2.6	2 lbs
BB2030	2" - 3"	25" x 11¼"	690	120	6.3	3 lbs
BB3040	3" - 4"	36" x 14¾"	1120	120	10.2	6 lbs

PVC Plug Set

Prevents conduit from collapsing or deforming by supporting the inside surface during heating and bending.

- Decreases heating time by trapping hot air in the conduit.
- Use with 2" and larger conduit.
- Includes durable storage case.

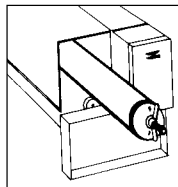

Part #	Description	Weight	Components	
			Description	Weight
BVS-240	2" - 4" PVC Plug Set	6 lbs	2" PVC Plug	.32 lb
			2½" PVC Plug	.38 lb
			3" PVC Plug	.44 lb
			4" PVC Plug	.44 lb

Guide to Bending Booklet

Easy-to-use instructions for completing multiple types of conduit bends.

- Contains quick reference charts and guides.
- Easy to carry.
- Provided at no charge.

Part #	Description
E507	Guide to Profitable Bending Booklet

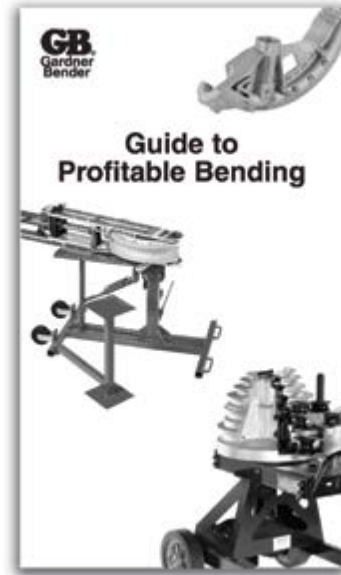

Tool-Guard™ Metal Storage Cases

Shelter equipment from dust, grease, dirt or loss on the jobsite, maintenance area or shop.

- Constructed of durable 16-gauge steel with quality arc-welded seams.
- Dual rolled-lip design resists sprung hinges, keeps cover aligned, adds rigidity and strength.
- Continuous heavy-duty hinges stand up to rugged use.
- Water-resistant design retards leakage.
- Bottom skids enhance protection and permit easy forklift movement.
- Recessed closure shields padlock from cutting and prying attempts. (lock not included).
- Painted with rust-resistant primer and finished in durable red enamel.



CM7



CM20

tip: Use #5 Master Lock® lock when locking boxes.

Part #	Size cu. in.	Inside Dimensions				Shelf Dimensions		Weight
		Length	Width	Rear Height	Front Height	Length	Width	
CM4	4½	31"	14"	14"	14"	–	–	56 lbs
CM7	8	36"	19"	18"	18"	–	–	98 lbs
CM20	28	60"	24"	28"	28"	59½"	5¼"	182 lbs



Conduit Fishing

Gardner Bender™ offers a complete range of solutions for conduit fishing and cable pulling, with the contractor in mind. From fish tapes to powered cable pullers, our products are designed around durability, innovation and ease of use.



page 76



page 69



page 75

page 88

Blower Systems	
JetLine® Super Blower™ (Electric)	68
Super Blo-Vac™ System (Blower/Vacuum)...	69
Cable Pullers and Accessories	
2,000 lb Mini-Brutus™ Powered Puller	82
8,000 lb Brutus™ Powered Puller	83
10,000 lb Ultra Brutus™ Powered Puller .	88-89
Sub-Assembly Kits.....	84
Brutus™ Powered Puller	
Application Instructions	85-87
Hook Sheaves.....	91
Pulling Grips.....	90
Tension Meter.....	91
Conduit Measuring Tape.....	75
CO2 Systems	
Air Compressor Seal-Off.....	73
CO2 Refill Connector	72
Powr House™ Conduit Fishing Systems	71
Powr-Pak I™ 5 lb. Portable System	72
Fish Tapes and Accessories	
Cable Snake™ Steel Fish Tapes.....	77-78
Economy Fish Tape	79
Fiberline™ Non-Conductive	
Fiberglass Fish Tapes.....	79
Fish Tape Ball	80
Fish Tape Leader	80
Nylo-Flex™ Non-Conductive	
Nylon Fish Tapes.....	80
Replacement Tapes - Steel	79
Rewind™ Fish Tape Winder	77
Streamline™ Steel Fish Tapes	78
UpperHand™ Steel Fish Tapes	76
UpperHand™ Non-Conductive	
Fiberglass Fish Tapes.....	76
Fish Sticks	
12' Fish Ease™	81
15' Glo Fish™	81
Material Handling	
Reel Rollers	
30" Reel Roller	96
Handy-Saver™ Reel Roller.....	96
Reel Jacks - Telescoping	96
Wire Caddies & Carts	
Deluxe Spool Cart & Caddy Combo	98
Hand Wire Caddy	97
Heavy-Duty Spool Cart &	
Caddy Expander Combo	98
Portable Wire Caddy	97
Portable Wire Dispenser	99
Replacement Parts	99
Spool Caddy Cart	97
Wire Dispenser.....	98
Lubricants	
Wire-Aide™	91
Poly-Gel™	92
Super-Slick™	93
Pull Line / Line Carriers	
Foam Line Carriers	74
Heavy-Duty Bulk Nylon Line	75
The Inflatables® Line Carriers	73
Missile Line Carriers.....	73
Poly-Pull™ Line.....	75
Power Saver™ Line Packages	74
Tag-Along™ Line Packages.....	74
Rope	
Rope Selection Guide	95
Poly-Pro™ General Purpose Rope	94
Super Tuff-Pull™ Double Braided Rope	93
Tuff-Pull™ Single Braided Rope.....	94
Vacuum / Blowers	
Super Blo-Vac™ System	69

Conduit Installation Chart

- **JetLine® Super Blower™ System (B60)** Page 68
- **Super Blo-Vac™ System (BV208DA)** Page 69

The following chart illustrates typical conduit installation. Fewer bends and lighter pull lines can increase the maximum distances obtainable. The chart below refers to a typical run with (4) 90° bends and no obstructions or leaks, using JetLine® PL232 Pull Line (200lb test) and foam line carriers.

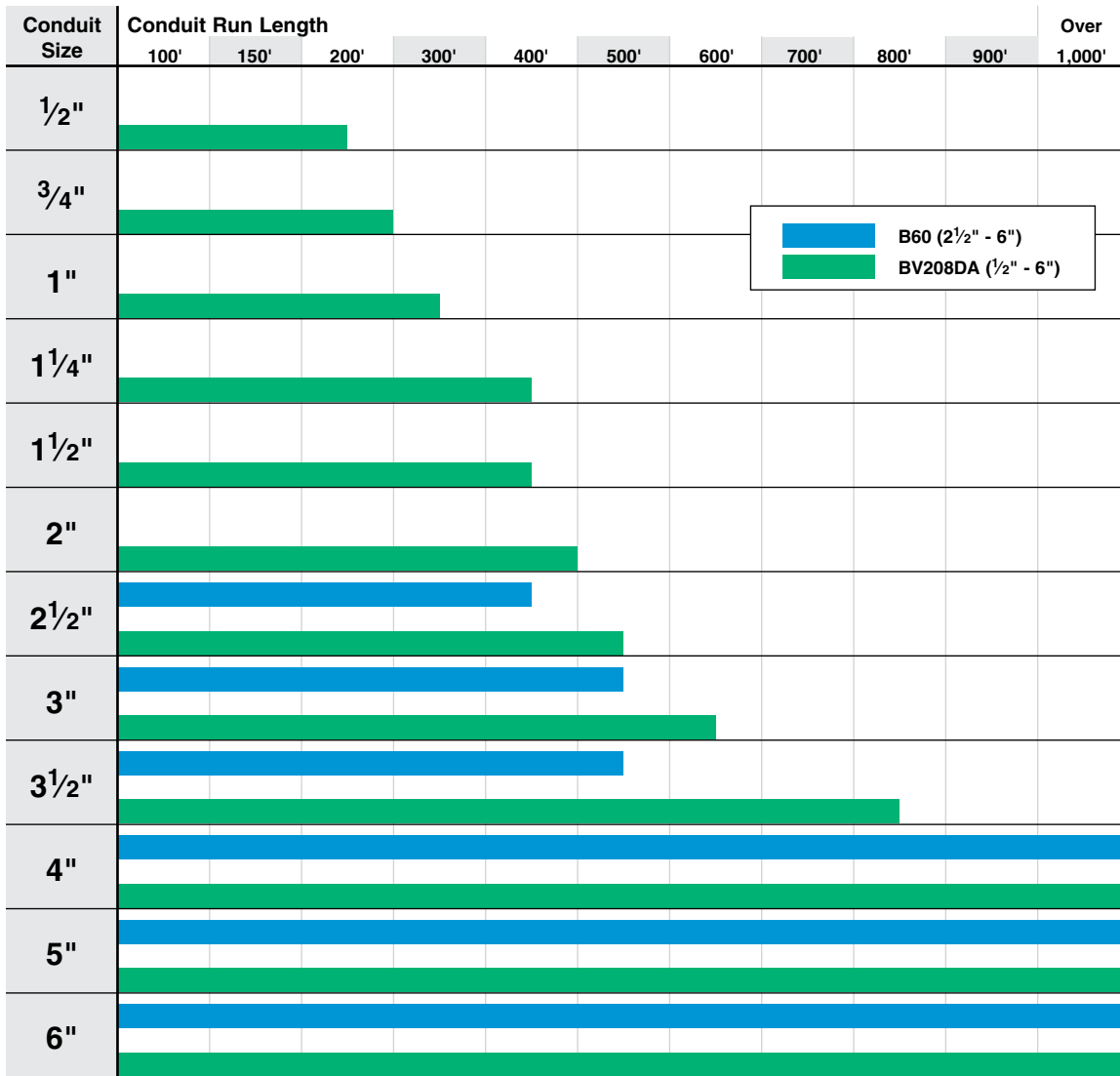

GB
Gardner
Bender **INNOVATION**

JetLine® Super Blower™ System

The most powerful blower system in the market.

- Blower unit delivers 275 cfm at 3 psi – more than enough to blow ½" Poly-Pull™ rope 1000' or more through conduit up to 6" diameter.
- Lightweight (35 lbs) and compact (24" x 7½" x 8¼") power unit can be hand-carried to the work area.
- Extra-long 25' hose allows power unit to be located outside the manhole or vault.
- All work is done from one end of the conduit, permitting one-person operation. Works on 115 V AC power.
- System includes Dial-A-Line™ Seal-Off System; eliminates extra steps by allowing simple "dial" selection of feed-thru opening size for up to ½" pull rope.
- Can use pull rope and True Tape® conduit measuring tape simultaneously.
- 115 V AC, 23 A; Power Consumption 2.65 kw.
- Specifications: max. 4 psi; 150 cfm; 3 motors (1½ hp each).

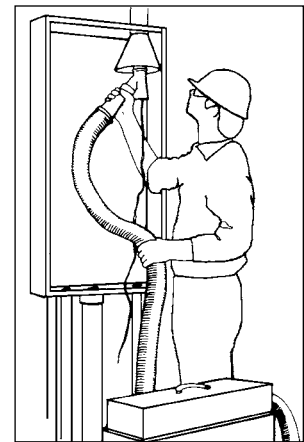

Part #	Description	Weight
B60	JetLine® Super Blower™ Conduit Fishing System	56 lbs

System Includes:

Part #	Description	Weight	I.D. #
B3000	Power Unit	34 lbs	1
126025*	25' x 2½" Heavy-duty Hose	12 lbs	2
B26	Large Dial-A-Line™ Seal-Off Body	.7 lb	3
BV24	Seal-Off for 2½" - 6" conduit	3.3 lbs	4
M5000	5" Plastic Line Carrier	.4 lb	6
M6000	6" Plastic Line Carrier	.5 lb	7

*Order catalog number 901152 to replace hose cuff end as necessary.

Super Blo-Vac™ System

This rugged blower/vacuum system handles 1/2" to 6" conduit.

- Blows or vacuums most debris and water from conduit runs.
- High-impact, lightweight polypropylene construction will not rust or dent.
- Compartments can be unlatched and separated. Recovery compartment capacity expandable to 9 gallons by using bottom tool storage compartment.
- 10" diameter metal hubbed wheels allow mobility.
- Complete package includes Dial-A-Line™ Seal-offs, The Inflatables® line carriers, foam line carriers, Power Saver™ and Tag-Along™ line packages. All accessories store neatly in self-contained tool storage compartment.
- Three-stage blower/vacuum motor delivers up to 25% more power for longer runs and faster operation.
- 115 V AC, 13 A, 14 1/4" x 16 1/2" x 39 3/4"
- Specifications: max. 5 psi; 95 cfm; 2 1/4 hp; 134" vacuum.



Part #	Description	Weight
BV208DA	Super Blo-Vac™ Power Conduit Fishing System	63 lbs

System Includes:

Part #	Description	Weight I.D. #	Part #	Description	Weight I.D. #	
1525	Cart	25 lbs	1	JV09	Long Seal-off for 1/2" - 1 1/4" conduit .1 lb	12
JV12	Seal-off for 1 1/4" - 2 1/2" conduit	.3 lb	2	B26	Large Dial-A-Line™ Seal-off Body .7 lb	13
LP3300	(5) 300' Line Pkgs for 3/4" conduit	.9 lb	3	BV23	Seal-off for 1 1/4" - 2 1/2" conduit .3 lb	14
LP2206T	(2) 400' Line Pkgs for 1 1/4" or larger conduit	.6 lb	5	BV24	Seal-off for 2 1/2" - 6" conduit 3.3 lbs	15
LP2207T	(2) 800' Line Pkgs for 1 1/4" or larger conduit	1 lb	6	BV1281	Crevice Tool (for clean-up) .1 lb	16
JV210	Filter Bag (for vacuuming)	.1 lb	7	LP2150	(10) 150' Line Pkgs for 1/2" conduit .8 lb	17
12568	8' x 1 1/2" Heavy-duty Hose*	3.3 lbs	8	LP3450	(5) 450' Line Pkgs for 3/4" conduit 1.4 lbs	18
BV12	Hose Adapter (to Dial-A-Line™ body)	.1 lb	9	LP4450	(5) 450' Line Pkgs for 1" conduit .8 lb	19
JV07	Dial-A-Line™ Seal-off Body	.2 lb	10	FC1-10	(1 ea) Foam Line Carriers for 1/2" - 4" conduit 1 lb	20
JV08	Short Seal-off for 1/2" - 1 1/4" conduit	.1 lb	11			

*15' x 1 1/2" heavy-duty hose not sold separately. Order Part #125615.

Super Blo-Vac™ Specifications

Vacuum* (inches of waterlift)	134"
Maximum Air Pressure*	5 psi
Electrical Rating	120 V AC, 13.8 A
Type of Motor	By-pass
Number of Impeller Stages	3
Recovery Capacity**	9 gallons
Net Weight	55 lbs
Height w/Cart	41"
Motor Brush Life	750 hours

* Will vary with voltage and atmospheric conditions @ sealed vacuum.

** When using Recovery Compartment and Tool Storage Compartment together.

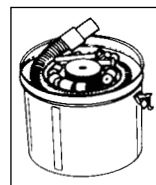



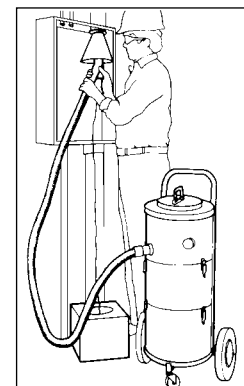

Tool Storage Compartment

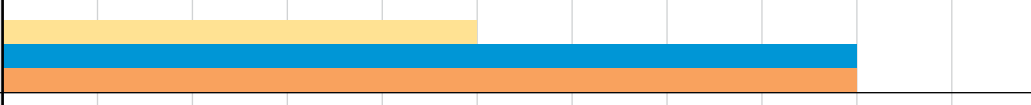
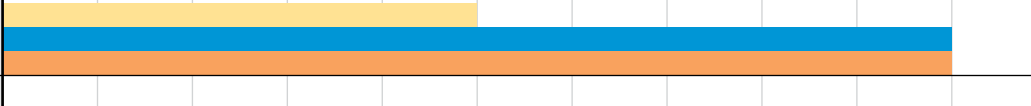
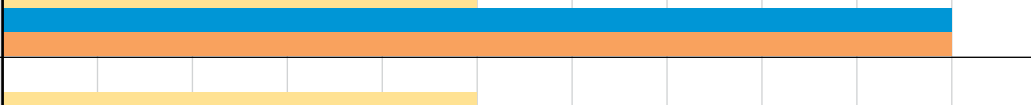
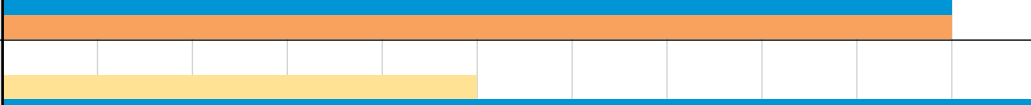

Conduit Installation Guide

- **Powr-Pak I™ 5-lb Portable System (J025)** Page 72
- **Powr House™ System with 20-lb CO₂ (J0225LC + 1208)** Page 71
- **Powr House™ System with 50-lb CO₂ (J0225LC + 950)** Page 71

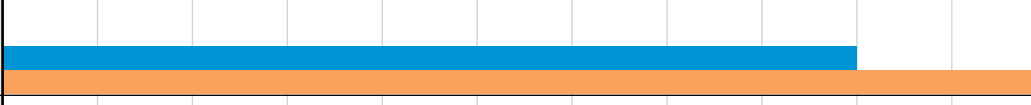
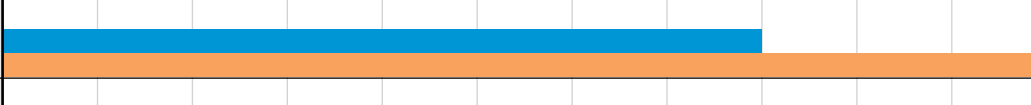
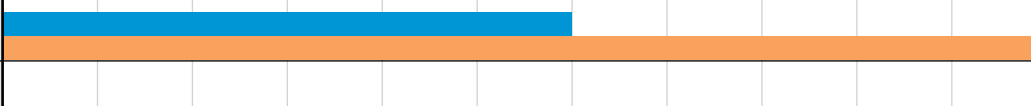
The following chart illustrates typical conduit installation. Fewer bends and lighter pull lines can increase the maximum distances obtainable. The chart below refers to a typical run with (4) 90° bends and no obstructions or leaks, using JetLine® PL232 Pull Line (200-lb test) and foam line carriers.

Conduit Size	Conduit Run Length										Over 1,000'
	100'	150'	200'	300'	400'	500'	600'	700'	800'	900'	
1/2"											
3/4"											
1"											
1 1/4"											
1 1/2"											
2"											
2 1/2"											
3"											
3 1/2"											
4"											
5"											
6"											

GB EXCLUSIVE! Powr House™ Conduit Fishing Systems

For 1/2" to 6" conduit.

- Completely self-contained with no electrical power source required. Use 50 lb cylinder as source for refilling smaller cylinders (requires RV5 refill connector).
- Quick, easy setup.
- Metered operating valve controls CO₂ volume to minimize waste and maximize safety.
- Locking pull ring prevents accidental discharge.
- 1" tank thread.
- Specifications: 840 psi @ 70 °F.

Accessories included with JO225LC

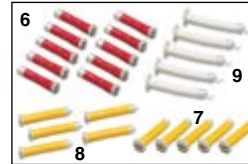
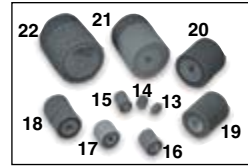

Part #	Description	Weight
JO225LC	Powr House™ Conduit Fishing System without CO ₂ Cylinder	40 lbs
950	50 lb CO ₂ Cylinder (full) (JO250 only)	161 lbs
1208	20 lb CO ₂ Cylinder (full) (JO220 only)	58 lbs



JO225LC & 950
 (50 lb Cylinder)



JO225LC & 1208
 (20 lb Cylinder)



JO225LC Powr House™
CO₂ System w/o Cylinder

Contents Included in JO225LC:

Part #	Description	Weight	I.D. #	Part #	Description	Weight	I.D. #
1105A*	12" Valve Assembly with hose	3.6 lbs	1	FC1	Foam Line Carrier for 1/2" conduit	.1 lb	13
1215	Seal-off for 1/2" - 1" conduit with 2' hose	.4 lb	2	FC2	Foam Line Carrier for 3/4" conduit	.1 lb	14
1142	Angle Adapter (for 1215 Seal-off)	.1 lb	3	FC3	Foam Line Carrier for 1" conduit	.1 lb	15
1216	Seal-off for 1 1/4" - 2 1/2" conduit with 2' hose	.8 lb	4	FC4	Foam Line Carrier for 1 1/4" conduit	.1 lb	16
1206	Seal-off for 1 1/2" - 6" conduit	5.2 lbs	5	FC5	Foam Line Carrier for 1 1/2" conduit	.1 lb	17
LP2150	(10) 150' Line Pkgs for 1/2" conduit	1.3 lbs	6	FC6	Foam Line Carrier for 2" conduit	.1 lb	18
LP3300	(10) 300' Line Pkgs for 3/4" conduit	1.1 lbs	8	FC7	Foam Line Carrier for 2 1/2" conduit	.1 lb	19
LP4300	(5) 300' Line Pkgs for 1" conduit	1.1 lbs	9	FC8	Foam Line Carrier for 3" conduit	.1 lb	20
LP2206T	(3) 400' Line Pkgs for 1 1/4" or larger conduit	.6 lb	10	FC9	Foam Line Carrier for 3 1/2" conduit	.1 lb	21
LP2207T	(3) 800' Line Pkgs for 1 1/4" or larger conduit	.6 lb	11	FC10	Foam Line Carrier for 4" conduit	.1 lb	22
LP2208T	(3) 600' Line Pkgs for 1 1/4" or larger conduit	.9 lb	12	FC11	Foam Line Carrier for 5" conduit	.1 lb	NS
				FC12	Foam Line Carrier for 6" conduit	.1 lb	NS

*Order UG121112 for hose and coupling assembly.

NS=Not Shown

Powr-Pak I™ 5-lb Portable System

For 1/2" to 2 1/2" conduit.

- Exclusive from Gardner Bender.
- Lightweight, portable system requires no electrical power.
- Metered operating valve controls volume, preventing waste.
- 5 lb cylinder can be refilled from larger cylinder using #RV5 refill connector.
- Locking pull ring prevents accidental discharge.
- 3/4" NGA tank thread.
- Specifications: 840 psi @ 70 °F.



Part #	Description	Weight
J025	Powr-Pak I™ Portable CO ₂ Conduit Fishing System	16 lbs
J025A	Powr-Pak I™ Portable CO ₂ Conduit Fishing System w/out Cylinder	10 lbs

System Includes:

Part #	Description	Weight	I.D. #	Part #	Description	Weight	I.D. #
1103N	5-lb-capacity CO ₂ Cylinder w/valve (full)	18 lbs	1	LP2150	(10) 150' Line Pkgs for 1/2" conduit	1.3 lbs	11
1102*	Shoulder Strap	.4 lb	2	LP3300	(5) 300' Line Pkgs for 3/4" conduit	.8 lb	12
1215	2' hose seal-off for 1/2" - 1" conduit	.4 lb	4	LP4300	(5) 300' Line Pkgs for 1" conduit	1.1 lbs	13
1142	Angle Adapter (for 1215 Seal-off)	.1 lb	5	LP1701	1000' Nylon Bulk Line	1 lb	14
1216	2' hose seal-off for 1 1/4" - 2 1/2" conduit	.8 lb	6	LP1702	2000' Nylon Bulk Line	1 lb	15
RV5	Refill Connector (with 1137 Cone)	.8 lb	7				
FC1	(5) Foam Line Carriers for 1/2" conduit	.1 lb	8				

* Not sold separately.

CO₂ Refill Connector

Connection for refilling CO₂ cylinders.

- Flexible urethane hose with quick disconnects.
- Saves time.



Part #	Description	Weight
RV5	CO ₂ Cylinder Refill Connector	.8 lb

Air Compressor Seal-Off

Use with most commercial air compressors to blow pull line into conduit or duct. For use with 2½" to 6" conduit sizes.

- The Dial-A-Line™ feature is incorporated into the compressor fitting.
- Maximum 200 cfm rating.
- Shut-off valve.

CAUTION

Use in 2½" - 6" conduit only. To avoid rapid pressure build-up, do not use on smaller sizes of conduit.

Part #	Description	Weight
CB21V	Air Compressor Seal-off	6 lbs

Sold as complete assembly only.



½" N.P.T.
 (AM-2)
 Air Coupler

The Inflatables® Line Carriers

For ¾" to 6" conduit.

- Each inflatable line carrier adjusts to fit the conduit; four items cover a range of eleven diameters of rigid, IMC, EMT, PVC or flexible conduit, or single-bore duct.
- Heavy-gauge waterproof woven nylon assures long life.

Part #	Qty	Description	Weight
F125	5/bx	The Inflatables® Line Carrier for ¾", 1" & 1¼" conduit	.6 lb
F250	5/bx	The Inflatables® Line Carrier for 1½", 2" & 2½" conduit	.6 lb
F400	2/bx	The Inflatables® Line Carrier for 3", 3½" & 4" conduit	.3 lb
F600	2/bx	The Inflatables® Line Carrier for 5" & 6" conduit	.3 lb



Missile Line Carriers

For 2" to 6" conduit.

- Fast blowing and vacuuming of 2" to 6" diameter conduit by low-friction plastic carriers.
- Easily removed from conduit if stuck or jammed.

Part #	Qty	Description	Weight
M2000	1/bg	Missile Line Carrier for 2" conduit (w/rope eye)	.1 lb
M3000	1/bg	Missile Line Carrier for 3" conduit (w/rope eye)	.3 lb
M4000	1/bg	Missile Line Carrier for 4" conduit (w/rope eye)	.3 lb
M5000	1/bg	Missile Line Carrier for 5" conduit (w/rope eye)	.4 lb
M6000	1/bg	Missile Line Carrier for 6" conduit (w/rope eye)	.5 lb



Foam Line Carriers

For 1/2" to 6" conduit.

- Cleans water and debris from most conduit – rigid, EMT, IMC, PVC or flexible.
- Durable for indefinite re-use.

Part #	Qty	Description	Weight
FC1	10/bx	Foam Line Carrier for 1/2" conduit	.3 lb
FC2	10/bx	Foam Line Carrier for 3/4" conduit	.3 lb
FC3	10/bx	Foam Line Carrier for 1" conduit	.4 lb
FC4	10/bx	Foam Line Carrier for 1 1/4" conduit	.4 lb
FC5	5/bx	Foam Line Carrier for 1 1/2" conduit	.3 lb
FC6	5/bx	Foam Line Carrier for 2" conduit	.4 lb
FC7	5/bx	Foam Line Carrier for 2 1/2" conduit	.6 lb
FC8	5/bx	Foam Line Carrier for 3" conduit	.6 lb
FC9	2/bx	Foam Line Carrier for 3 1/2" conduit	.5 lb
FC10	2/bx	Foam Line Carrier for 4" conduit	.6 lb
FC11	2/bx	Foam Line Carrier for 5" conduit	.8 lb
FC12	2/bx	Foam Line Carrier for 6" conduit	.8 lb



Power Saver™ Line Packages

For 1/2" to 1" conduit.

- Carrier and pull line included in a single, handy package. Line is dispensed smoothly and quickly as line carrier moves through conduit.
- No knots to tie, no foam carriers to retrieve.
- Color coded packages indicate line diameter.



Part #	Qty	Description	Length	Color	Breaking Strength	Weight
LP2150	50/bx	Power Saver™ Line Package for 1/2" conduit	150'	Red	17 lbs	.8 lb
LP3300	25/bx	Power Saver™ Line Package for 3/4" conduit	300'	Yellow	17 lbs	.8 lb
LP3450	25/bx	Power Saver™ Line Package for 3/4" conduit	450'	Yellow	17 lbs	.8 lb
LP4300	25/bx	Power Saver™ Line Package for 1" conduit	300'	White	17 lbs	.8 lb
LP4450	25/bx	Power Saver™ Line Package for 1" conduit	450'	White	17 lbs	.8 lb

Tag-Along™ Line Packages

For 1 1/4" to 6" conduit.

- Handles longer runs with less energy.
- Line is dispensed as package moves through conduit attached to line carrier.
- Works with foam or inflatable line carriers.
- While supplies last.



Part #	Qty	Description	Length	Breaking Strength	Weight
LP2206T	10/bx	Tag-Along™ Pull Line Package	400'	22 lbs	.6 lb
LP2207T	10/bx	Tag-Along™ Pull Line Package	800'	22 lbs	1.1 lbs
LP2208T	10/bx	Tag-Along™ Pull Line Package	600'	22 lbs	.9 lb

Heavy-Duty Bulk Nylon Line

Doubles as general-purpose line for layout of suspended ceilings, plumb-lines and masonry construction.

- Use with line carriers for any size conduit.
- All packages are center-dispensing (except #LP1707).

Part #	Qty	Description	Length	Breaking Strength	Weight
LP1701	6/bx	Heavy-duty Bulk Nylon Line	1000'	85 lbs	2.5 lbs
LP1722	6/bx	Heavy-duty Bulk Nylon Line	2200'	85 lbs	6.3 lbs



LP1722



LP1701

Poly-Pull™ Series Pull Line

Super high strength – up to 500 lbs breaking strength.

- Self-lubricated polyolefin line lasts for years; will not rust, rot or mildew.
- Center-dispensing box pays out line smoothly.
- Blow directly into conduit using Dial-A-Line™ Seal-off bodies.

PL235



PL232B

Part #	Description	Length	Breaking Strength	Outside Diameter	Color	Weight
PL232B	Poly-Pull™ Line in bucket	6500'	210 lbs	1/8"	Blue tracer	11 lbs
PL235	Poly-Pull™ Line in dispenser box	2200'	500 lbs	3/16"	Red tracer	15 lbs
PL235B	Poly-Pull™ Line in bucket	2200'	500 lbs	3/16"	Red tracer	16 lbs

Conduit Measuring Tape

Blow or vacuum through the run to estimate wire length or to locate obstructions.

- Strong and durable.
- Breaking strength of 165 lbs.
- Mildew and rot-resistant.
- Measured in feet.

Part #	Description	Dimensions	Weight
ST40	Super True Tape® Measuring Tape	2750' Roll x 1/4" wide	3.6 lbs



GB **INNOVATION**
Gardner Bender

GB EXCLUSIVE! UpperHand™ Fish Tape

GB's series of UpperHand™ fish tapes has improved traditional hand fishing with the first ergonomic fish tape in the industry. The improved design is manufactured with impact-resistant ABS and nylon resins and includes a full, wrap-around interior ring to increase durability. The UpperHand™ series is backed by an industry leading 5-year limited warranty.

- Exclusive **Ergonomic Handle** reduces wrist strain.
- Exclusive **Comfort Formed Grip** reduces forearm strain.
- Exclusive cushioned **Rubber Hand Grips** for ease of operation and comfort (certain models).
- **Impact Modified Handle and Housing** that exceeds the 25 ft drop-test.
- **Plated Steel Wire** resists corrosion (certain models).



Patented

A Tape for Every Job



Standard Carbon Steel

Tried-and-true, tough and economical solution for wire pulling.



Corrosion-Resistant Plated Carbon Steel (R series)

The toughest, most durable tape for long-lasting use.



Non-Conductive Fiberglass Core with Nylon Jacket

Exclusive non-conductive tip and unique flat shape is easier to feed yet able to pull up to 500 lbs.

SEE PG **77**  FOR MORE INFO ON **Fish Tape Winder**

Five Year Warranty

	FTN-100R	FTS-65R	FTS-125R	FTS-250R
Tape Length	100'	65'	125'	250'
Tape Material	Fiberglass Core w/ Nylon Jacket	Corrosion-Resistant Plated Carbon Steel		
Pkg Qty	1/card	1/card	1/card	1/card
Handle / Housing Material	Nylon / ABS w/ rubber grips	Nylon / ABS w/ rubber grips	Nylon / ABS w/ rubber grips	Nylon / ABS w/ rubber grips
Tape Dimensions	1/8" W	1/8" W	1/8" W	1/8" W
Weight	2.99 lbs	3.0 lbs	5.2 lbs	8.2 lbs
Internal / External Ring Dia.	5½" / 12"	4" / 8½"	5½" / 12"	5½" / 12"



Ergonomic Handle

Reduces fatigue and wrist strain by allowing the user to keep their wrist in a natural position



INNOVATION

Cable Snake™ Steel Fish Tape

Rugged, ergonomically-designed steel fish tape.

- Comfortable handle made of impact-resistant plastic.
- Handle will not pop-out.
- Largest opening and gripping surface in the industry.
- GB exclusive trigger design cleans tape and provides constant tension during retrieval.
- Tape is wound directly into housing. No need to “snap” retaining tapes.
- Wire has clean lubricating properties to prevent rust.
- Maximum design strength 500 lbs.
- Fish tape ball helps guide through tricky bends.
- Patented.



Patented

Part #	Description	Weight
FTS-100GR	120' x 1/8" x .0625" Cable Snake™	4.6 lbs
FTS-200GR	240' x 1/8" x .0625" Cable Snake™	7.2 lbs

Streamline™ Steel Fish Tape

Setting the industry standard for quality and dependability.

- Tape is wound directly into housing; no need to “snap” retaining tapes; no sticky residue inside housing.
- Form-fitting finger grips around reel fit the hand comfortably.
- Shatter-proof reel stands up to on-the-job abuse.
- Four viewing ports on reel show how much tape remains.
- Easy disassembly for fast replacement of tape.
- Maximum design strength 500 lbs.



Part #	Description	End Type	Reel Dia.	Weight
FTS-50B	50' x 1/8" x .045" Fish Tape	Curled	8 1/2"	2.3 lbs

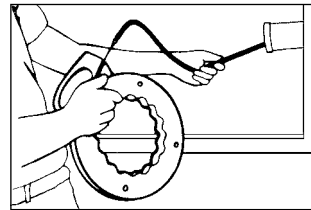

Cable Snake™ Steel Fish Tape

Perfect for short runs installing electrical boxes, outlets, lighting fixtures, doorbells and security systems.

- Compact design houses 25' of tape and fits in tool box or on tool belt.
- Flat wire steel tape fishes down walls, under carpets and over ceilings.
- Wedge-shaped tip prevents hang-up.
- Low-memory tape does not curl during extension - perfect for non-conduit situations.
- Formed handle fits easily in hand.
- Compact tape rewind knob for quick wind-up.
- Tape is 1/4" wide x .03" thick.



Patented

Part #	Description	Weight
EFT-21PN	25' Cable Snake™ Fish Tape	1.10 lbs



Standard fish tape used for conduit

High memory tape curls when extended not allowing fishing through walls



25' Cable Snake™

Low memory tape does not curl when extended, making it ideal for fishing overhead or through walls

Replacement Fish Tape

Replacement tape FTS series.

- Durable flat steel tapes in 1/8" and 1/4" widths.

Part #	Description	Fits Housing Number	Weight
RTS-50B	50' x 1/8" x .045" Steel	FTS-50B	1.2 lbs
RTS-100	100' x 1/8" x .060" Steel	FTS-100CE, FTS-100GR	3.0 lbs
RTS-200	200' x 1/8" x .060" Steel	FTS-200CE, FTS-200GR	5.6 lbs



Economy Fish Tape

Economical 50' tape.

- Standard steel material.
- View port in reel allows user to see amount of tape used.

Part #	Description	Reel Dia.	Weight
EFT-50B	50' x 1/8" x .045" Fish Tape	7"	1.8 lbs



Nylo-Flex™ Non-Conductive Nylon Fish Tape

Non-conductive fish tape – light and flexible.

- Designed for use in conduit with existing wires or cables.
- Glides through ½" to 4" conduit.
- High-strength nylon tape tested at 300 lbs average tensile strength.
- Shatterproof reel is virtually indestructible; features no-slip, form-fitting finger grips.
- Four viewing ports on reel show how much tape remains.
- 6-inch spiral wound metal leader with pulling eyelet included (attached).
- Tape diameter is 3/16".

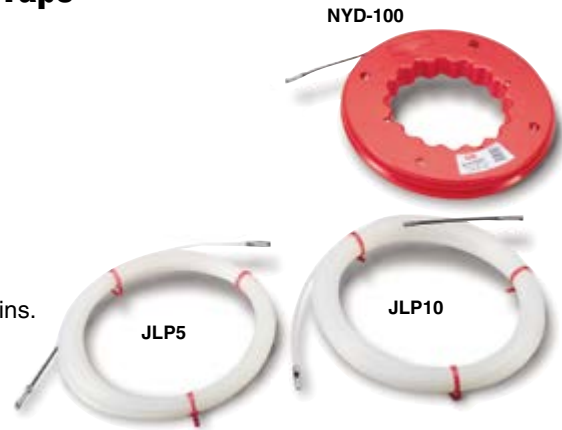

Part #	Description	Weight
NYD-100	100' Nylo-Flex™ Non-conductive Fish Tape Housing	2.2 lbs
JLP5	50' Non-conductive Replacement Tape (coil only)	1 lb
JLP10	100' Non-conductive Replacement Tape (coil only)	1.5 lbs

Fish Tape Ball

Eye holds 7 #10, 12 #12 or 19 #14 bare wires.

- Attaches directly to most 1/8" x .0625" steel fish tapes.
- Maximum design strength 500 lbs.

Part #	Description	Weight
FTB-10	Fish Tape Ball	.06 lb



Fish Tape Leader

Multi-Flex™ is a flexible, non-kink, round metallic leader perfect—for flat steel tapes.

- Double-sheathed to prevent unraveling. Brass plated for corrosion resistance.
- Spring Coil easily curves around bends, yet is rigid enough to fish smoothly through conduit with existing wire.
- High strength – tested at 400 lb tensile strength.
- Attaches directly to 1/8" tapes.

Part #	Description	Weight
FTL-5	Fish Tape Leader, Multi-Flex™	.5 lb

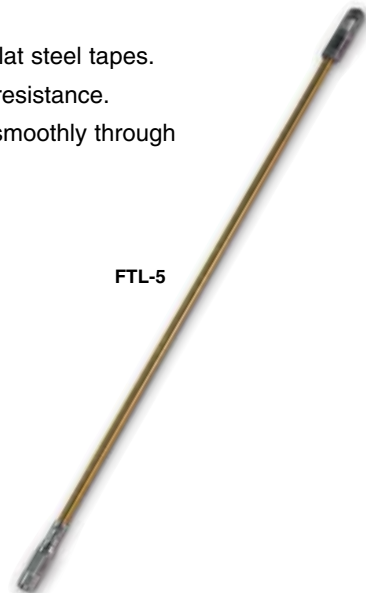

FTL-5

Fish Ease™ 12' Fish Sticks

- 3 durable interlocking fiberglass rods extend up to 12'. (4' sections).
- 1/4" diameter ensures rigidity when extended.
- 2 different threading tips provided for a variety of applications.

Part #	Description	Dimensions	Weight
FTX-12L	Fish Ease™ 12' Fish Sticks	(3) 4' sections x 1/4"	1 lb



Glo Fish™ 15' Glow in the Dark Fish Sticks

- 3 interlocking fiberglass rods extend up to 15'.
- Made from luminescent fiberglass to make fishing through walls or over ceilings easier.
- 1/4" diameter ensures rigidity when extended.

Part #	Description	Dimensions	Weight
FTX-15GL	Glo Fish™ 15' Fish Sticks	(3) 5' sections x 1/4"	1 lb



Brutus™ Powered Puller

Pulls up to 8,000 lbs.

- Exclusive planetary gear design lets powerhead deliver smooth, sure power without breakage.
- 30% more pulling force than competitors' models.
- Versatile frame mounts power head almost anywhere.
- Frame assembles in numerous configurations.
- No chains or sprockets to break.
- Powerful 1½ hp motor starts under full load. Capstan is non-reversing with backstop brake. Will not reverse when power is shut off.
- Load read-out meter indicates pulling load at all times; alerts operator to hung-up cable or other excessive conditions.
- Two-way power head mounting adapts to tight corners.
- Pulls 10 feet/minute without buckling or bending.
- Heavy-duty metal case included.
- Min 15 A, Max 30 A.

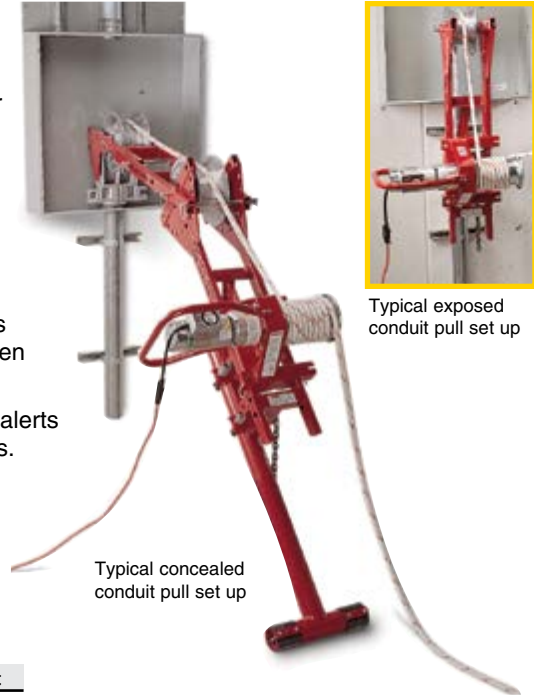

Typical exposed conduit pull set up

Typical concealed conduit pull set up

Part #	Description	Weight
CP8000	Brutus™ Powered Puller for exposed or concealed conduit	355 lbs

CP8000 Includes:

Part #	Qty	Description	Weight	I.D. #
CP800	1	Power Head	60 lbs	1
CP503	3	2' Chain Assembly	3 lbs	4
CP505	5	8" Lock Pins	7 lbs	5
CP601	1	Conduit Frame Adapter	55 lbs	6
S-8512	3	12" Sheave	7 lbs	7
CP622	3	10" Lock Pins	3 lbs	8
CP631	1	Boom Extension	18 lbs	9
CP701	1	Puller Base Extension	25 lbs	10
CP702	1	Coupling Clamp	8 lbs	11
CP703	1	Adjustable Pipe Adapter	22 lbs	12
CP706	1	3" Conduit Coupling	5 lbs	13
CP707	1	3½" Conduit Coupling	4 lbs	14
CP708	1	4" Conduit Coupling	3 lbs	15
CP709	1	6" Lock Pin	2 lbs	16
HS-8512	1	12" Cable Sheave with Hook	20 lbs	17
CM20	1	Metal Case with CM44 Casters	133 lbs	18



CP8000

CP8001 Includes:

Part #	Qty	Description	Weight	I.D. #
CP800	1	Power Head	60 lbs	1
CP80*	1	Floor Mount Kit (on following page)	33 lbs	3

*Complete with qty. 4, ¾" x 5½" concrete wedge anchors and lockpins.



Brutus™ Powered Puller Sub-Assembly Kits

May be purchased as additions to existing cable-puller sets.

Part #	Description	Weight	Part #	Qty	Description	Weight	I.D. #
CP800	Power Assembly	110 lbs	CP801	1	Power Head	60 lbs	1
				1	Base Mounting Bracket	50 lbs	2
CP80*	Floor Mount Kit	33 lbs	CP80	1	Floor Mount w/ Anchors	65 lbs	3
CP600	Conduit Frame & Sheave Adapter Assembly	72 lbs	CP503	2	2' Chain Assembly	3 lbs	4
			CP505	3	8" Lock Pins	7 lbs	5
			CP601	1	Conduit Frame Adapter	55 lbs	6
			S-8512	1	12" Sheave	7 lbs	7
CP630	Boom Extension Kit	22 lbs	CP622	3	10" Lock Pins	3 lbs	8
			CP631	1	Boom Extension	18 lbs	9
CP700	Puller Base Extension Kit	94 lbs	CP503	1	2' Chain Assembly	3 lbs	10
			CP505	2	8" Lock Pins	7 lbs	11
			S-8512	1	12" Sheave	7 lbs	12
			CP701	1	Puller Base Extension	25 lbs	13
			CP702	1	Coupling Clam	8 lbs	14
			CP703	1	Adjustable Pipe Adapter	22 lbs	15
			CP706	1	3" Conduit Coupling	5 lbs	16
			CP707	1	3½" Conduit Coupling	4 lbs	17
			CP708	1	4" Conduit Coupling	3 lbs	18

*Complete with 1¾" x 5½" concrete wedge anchors.

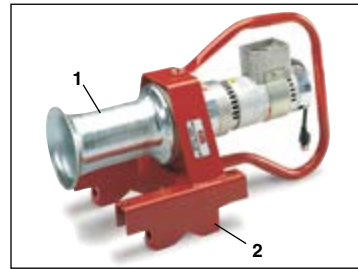

CP800

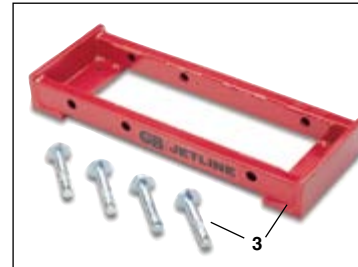

CP80

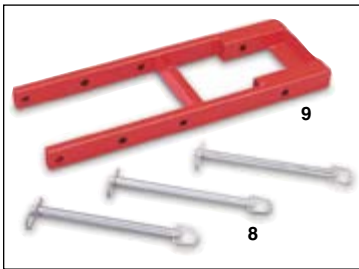

CP630



CP700

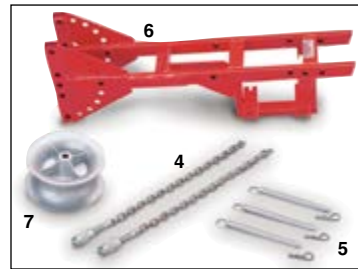

CP600

Optional Equipment

May be purchased as additions to existing cable-puller sets.

Part #	Description	Weight	I.D. #
CP709	6" Lock Pin	2 lbs	1
HS-8512	12" Cable Sheave with Hook	20 lbs	3
RST-7530	Double Braided Rope (¾" x 300' spool)	54 lbs	-
RST-7560	Double Braided Rope (¾" x 600' spool)	109 lbs	-
CP10	Load Readout (meter only CA1064001)	3 lbs	4
CP15	Foot Switch for Remote Operation	4 lbs	5
CP504	6' Chain Assembly	6 lbs	6
CP704	2" Conduit Coupling	7 lbs	7
CP705	2½" Conduit Coupling	6 lbs	8
CP806	Capstan (standard) 10'/min.	7 lbs	-



tip: For maximum performance and safety, use only original GB® rope.



Brutus™ Puller Application Instructions

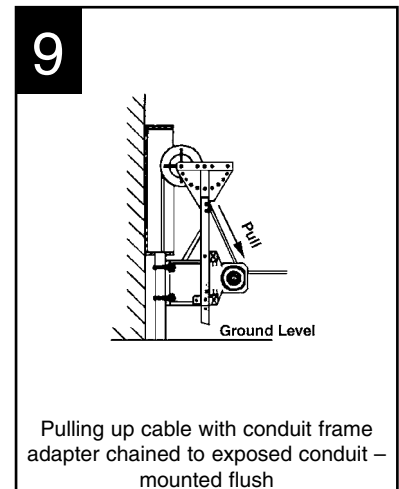
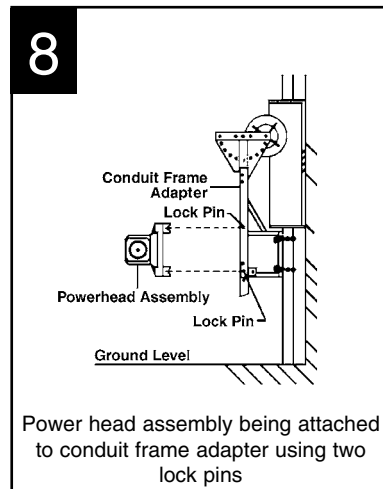
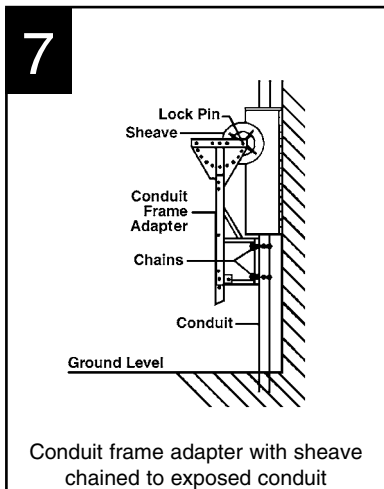
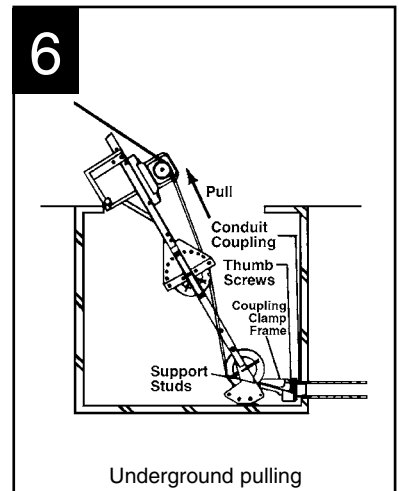
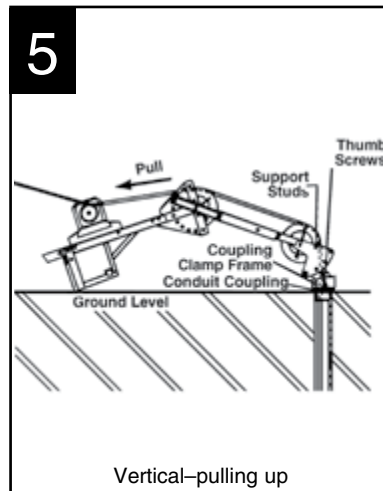
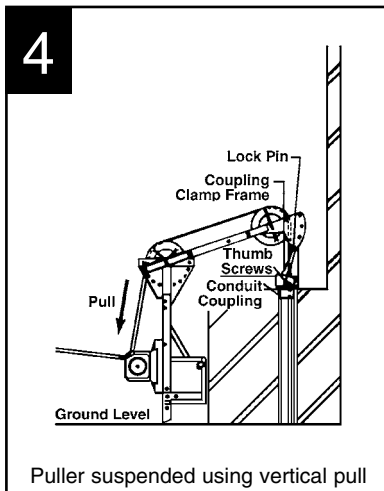
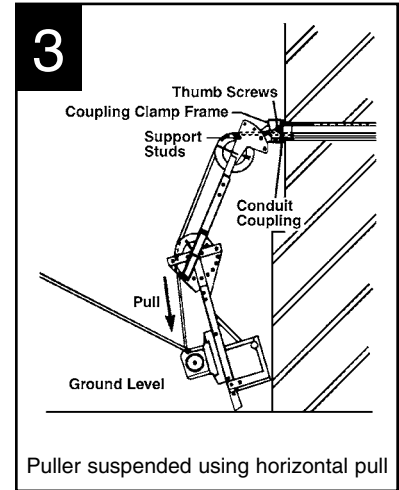
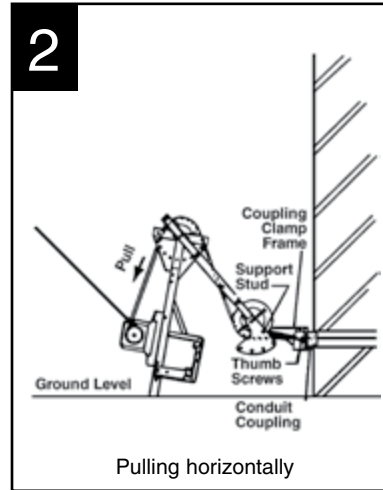
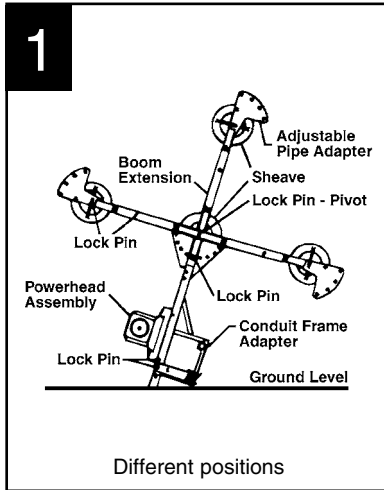

Brutus™ Puller Application Instructions

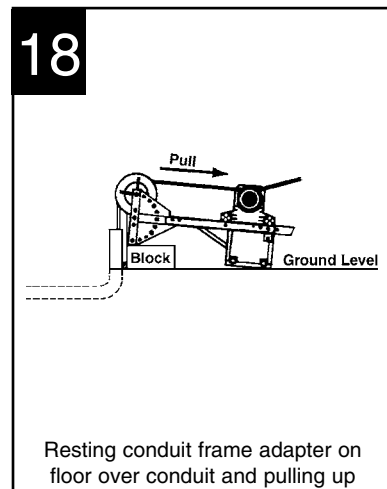
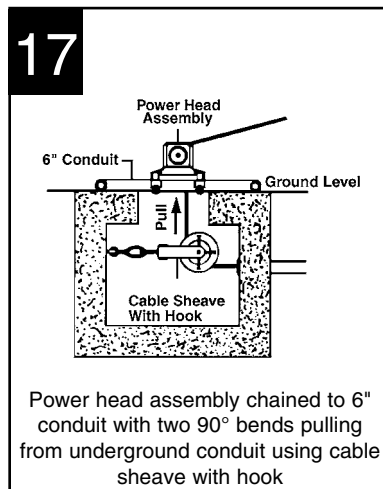
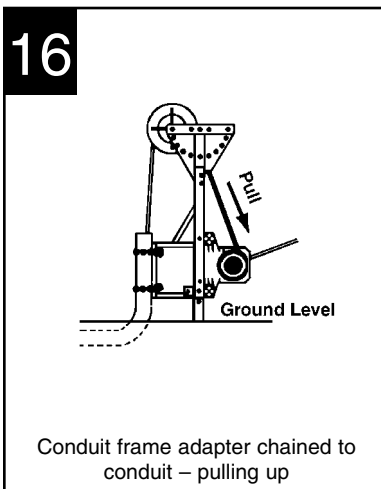
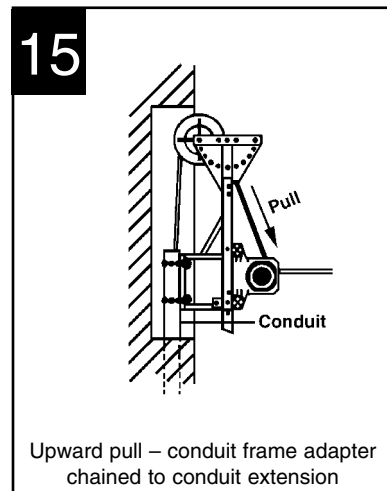
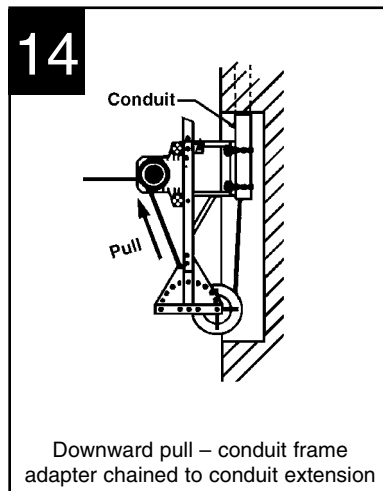
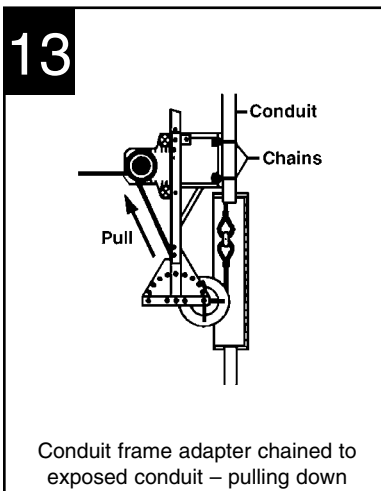
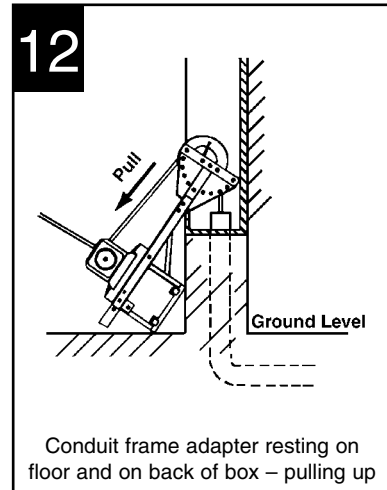
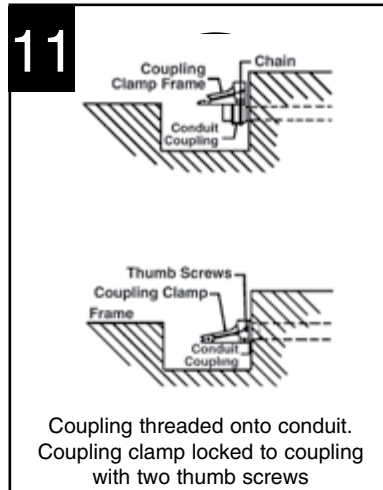
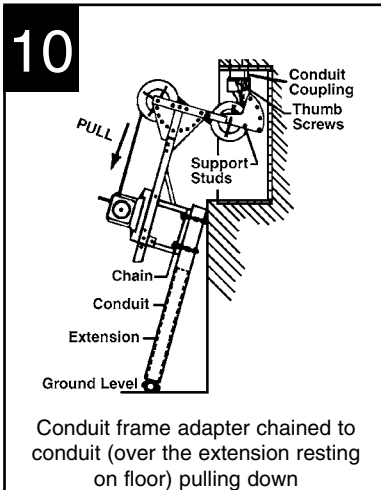

Brutus™ Puller Application Instructions

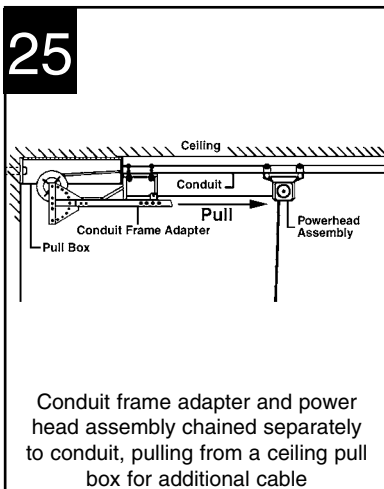
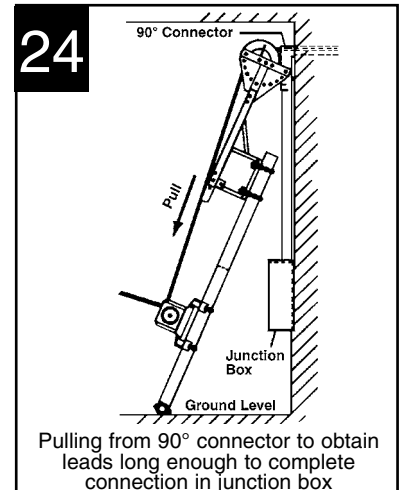
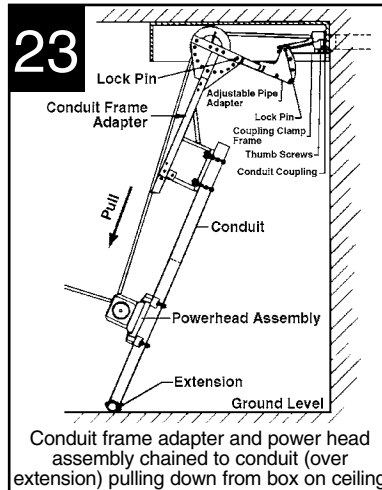
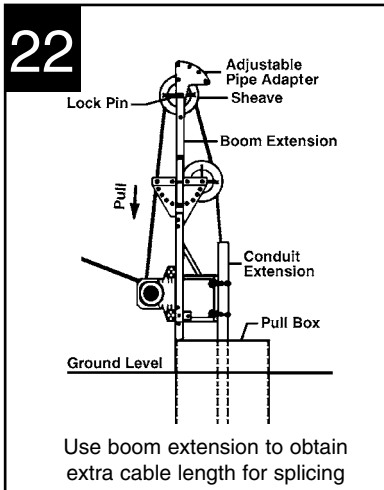
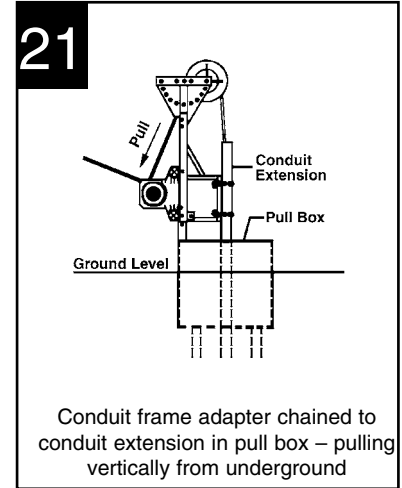
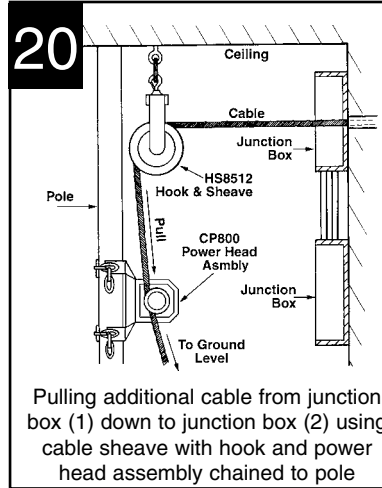
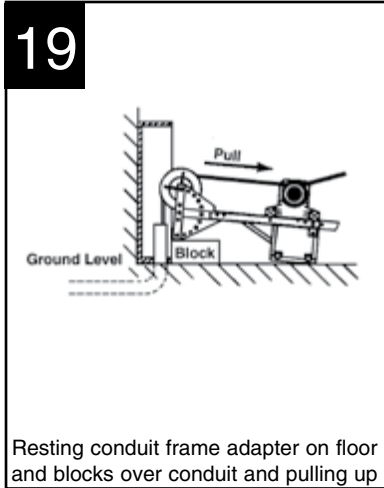

NOTES

Ultra Brutus™ Cable Puller

Leading the heavy-duty class, the new Ultra Brutus™ 10,000 lb Cable Puller takes both the labor and the labor cost out of cable pulls. Commercial electrical contractors that need both equipment and operator to be ready at all times will appreciate its flexible operation, mobility and labor saving features.

Engineered for heavy-duty use on commercial, industrial and utility electrical jobsites, the Ultra Brutus™ stands out from the crowd with its one-person, 2-minute set-up. Unlike any other cable puller, the Ultra Brutus™ comes fully assembled from the factory and can be completely set-up by one person. This set-up and tear down takes one-tenth of the time that competitive pullers require.



The Other Brand

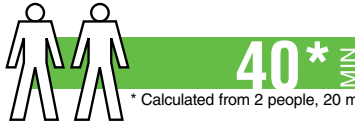

* Calculated from 2 people, 20 minutes each

The Gardner Bender Ultra Brutus™ 10,000 lb. puller has an innovative design that features a one person set-up in under two minutes and the ability to run at max capacity for short bursts of power.

Part #	Description	Weight	Recommended Rope	Pulling Force	Motor
CP10K	Ultra Brutus™ Cable Puller	385 lbs	RST-7830/ RST-7860	10,000 lbs	1.7 Hp



Patent Pending

Conduit Adapters

Gardner Bender offers extra conduit adaptors for smaller jobs.

Part #	Description
CP10-242	Conduit Adapter, 1-1/4"
CP10-243	Conduit Adapter, 1-1/2"



Fast 1 person set-up



1 Pump main boom to 30°



2 Flip booms into position and lock



3 Align with conduit, properly adjust booms



4 Place in conduit



Requires no assembly
Space saving design

- Folds to 61" L x 28" W x 39" H
- Footswitch included



- A**
- 5 conduit adapters**
- 2" - 4" adapters stored conveniently onboard
 - Doesn't need to be fastened to conduit



- B**
- Extended boom**
- Allows 12' of cable to be pulled from the conduit to the capstan



- C**
- Quick toolless angle adjustment**
- Spring loaded pin reduces risk of loss
 - Faster positioning saves time
 - Adjusts up to 300°



- D**
- Easily change pulling direction**
- Only requires one person
 - Doesn't require disassembly
 - Speeds up and simplifies set-up
 - Safer for the user
 - No tools required

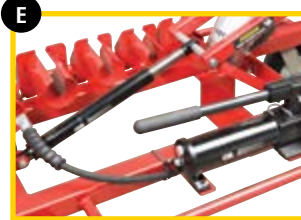

- E**
- Hydraulic assisted boom lift/ one person setup**
- Set-up in 2 minutes with 1 person
 - Designed for optimal safety
 - Adjust boom to any angle



- F**
- 10,000 lb. pulling capacity**
- Non-reversing planetary gear motor for consistent pulling power up to 10,000 lbs for short bursts of pulling power.



- G**
- Swiveling casters/ mobility**
- Moves easily on dirt and gravel
 - Flat-free wheels



- No assembly required/ fast setup**
- No loose parts
 - No tools required
 - Includes footswitch

Junior Basket-Type Pulling Grips

- 340–820 lbs maximum rated capacity
- Ideal for small job requirements
- Single weave of galvanized steel mesh
- For use in conduit or cable tray
- Flexible pulling eye
- Light duty pulling (80–780 lbs)



Part #	Description	Max Rated Capacity (lbs)
PGJ-025	.25–.36" (6.4–9.1 mm)	340
PGJ-037	.37–.49" (9.4–12.4 mm)	340
PGJ-050	.50–.61" (12.7–15.5 mm)	340
PGJ-062	.62–.74" (15.7–18.8 mm)	560
PGJ-075	.75–.99" (19.1–25.1 mm)	820
PGJ-100	1.00–1.24" (25.4–31.5 mm)	820

K-Basket-Type Pulling Grips

- 1,120–9,600 lbs maximum rated capacity
- Ideal for long, heady-duty cable pulls
- Double weave of galvanized steel mesh
- For use in conduit, tray, overhead, or underground
- Forged steel compact rotating eye
- Heavy duty pulling, long runs, swivel head (1,120–9,600 lbs)



Part #	Description	Max Rated Capacity (lbs)
PGK-075	.75–.99" (19.1–25.1 mm)	1,920
PGK-100	1.00–1.49" (25.4–37.8 mm)	3,280
PGK-150	1.50–1.99" (38.1–50.0 mm)	3,280
PGK-250	2.50–2.99" (63.5–75.9 mm)	6,600
PGK-300	3.00–3.49" (76.2–88.6 mm)	8,200
PGK-350	3.50–3.99" (88.9–101.3 mm)	9,600
PGK-400	4.00–4.49" (101.6–114.0 mm)	9,600

T-Basket-Type Pulling Grips (short mesh length)

- 900–6,200 lbs maximum rated capacity
- Ideal for medium-duty applications
- Double weave of galvanized steel mesh
- For use in conduit, tray, overhead, or underground
- Flexible pulling eye
- Medium duty pulling, short mesh length (900–6,200 lbs)



Part #	Description	Max Rated Capacity (lbs)
PGTS-100	1.00–1.49" (25.4–37.8 mm)	1,920
PGTS-150	1.50–1.99" (38.1–50.0 mm)	3,280
PGTS-200	2.00–2.49" (50.8–63.2 mm)	3,700
PGTS-250	2.50–2.99" (63.5–75.9 mm)	4,900
PGTS-300	3.00–3.49" (76.2–88.6 mm)	4,900
PGTS-350	3.50–3.99" (88.9–101.3 mm)	6,200

Hook Sheaves

Suspends cable overhead and reduces strain on pulling equipment.

- Keeps cable together for easier manageability and enables direction of cable to be changed.
- Sheave made of rugged aluminum alloy. Hook frame made of welded steel.
- Rated at 8,000-lb capacity.



HS-8512

Part #	Description	Width	Dia.	Weight	Hook Only Weight	Sheave Only Weight
HS-8512	Hook Sheave	5"	12"	20 lbs	H-8512 13 lbs	S-8512 7 lbs

Wire & Cable-Pulling Tension Meter

Monitors tension throughout the pull to prevent over-stressing cable. Perfect for use with powered pullers.

- Self-contained hydraulically-operated meter measures in 200-lb increments up to 10,000 lbs maximum capacity.
- Maximum-indicating pointer helps read pre-selected loads.
- ± 2% accuracy.
- Comes with certificate of calibration.
- Minimum Reading 1,000 lbs; Increments 200 lbs.

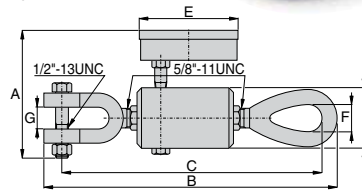

Part #	Description	Capacity	A	B	C	D	E	F	G	Weight
TM5	Tension Meter	10,000 lbs	4.75"	9.75"	9.29"	2.00"	3.69"	.88"	.75"	9 lbs

Wire-Aide™ Wire-Pulling Lubricant

Slides on smoothly and clings throughout the pull. Modified wax-base formula dries to a slippery film.

- Greaseless, non-toxic compound will not stain skin, clothing or construction trim; cleans up quickly with soap and water.
- Stable and safe to use. Withstands normal temperature extremes and will not dry out in the container. Non-combustible, non-conductive and non-corrosive.
- Will not damage conduit or insulation.
- Remains stable with multiple freeze-thaw cycles.
- Suitable for fiber-optic wire.



79-006

79-003

79-002

Part #	Container Size	Weight
79-002	1 gal. Pail	9 lbs
79-003	5 gal. Pail	42 lbs
79-006	1 qt. Squeeze Bottle	2 lbs

Wire-Aide™ Specifications

Base	Wax, modified	Staining Properties	Non-staining to hard surfaces
Color	Yellow	Removal	Soap and hot water
Viscosity	Heavy cream-like paste	Abrasion Protection	Excellent
pH	Approx. 6.5 - 7.0	Cling Ability	Excellent
Freezing Point	28° F	Water Resistance	Repels water to some extent
Freeze-Thaw Stability	OK/3 cycles	Hardening Charac.	Non-hardening
Lubricity	Excellent	Condition on Drying	Waxy-film
Shelf Life	Indefinite	Flash Point	Non-combustible
Corrosion Test	Non-corrosive to metals		

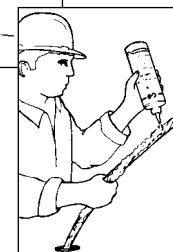
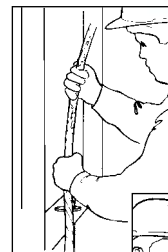

Poly-Gel™ Cable-Pulling Lubricant

Perfect for all types of insulation and conduit, including fiber-optic cable, cable with low-density, linear low-density polyethylene, polyurethane and semi-conducting jackets.

- Clean, clear gel, water-based for easy cleanup. Non-staining and non-toxic.
- Dries to a clear, non-conductive film for easy handling, stripping and terminating of cable. Will not gum up or harden on conduit.
- Easy and versatile to use. Apply manually or with pump.
- Workable over wide temperature range:
 - Poly-Gel™ +28 °F to +200 °F
 - All Season Poly-Gel™ -10 °F to +180 °F



Part #	Description	Container Size	Weight
79-201	Poly-Gel™	1 qt. Squeeze Bottle	2.5 lbs
79-202	Poly-Gel™	1 gal. Pail	8.75 lbs
79-203	Poly-Gel™	5 gal. Pail	42 lbs
79-301	All Season Poly-Gel™	1 qt. Squeeze Bottle	2.5 lbs

Poly-Gel™ Specifications

Base	Poly-oxyethylene/Water
Color	Blue
Viscosity	Thick Clear Gel
pH	7.2 - 8.2
Freezing Point	28 °F
Freeze-Thaw Stability	Excellent
Lubricity	Excellent
Shelf Life	Indefinite
Corrosion Test	Non-corrosive
Staining Properties	Non-staining
Removal	Soap and water
Cling Ability	Excellent
Condition on Drying	Semi-fluid film
Flash Point	Non-combustible

All Season Poly-Gel™ Specifications

Base	Polyethylene polymer
Color	Lime Green
Viscosity	Heavy gel-like paste
pH	Approx. 6.5 - 7.5
Freezing Point	-10 °F
Freeze-Thaw Stability	OK/3 cycles
Lubricity	Excellent
Shelf Life	Indefinite
Corrosion Test	Non-corrosive to metals
Staining Properties	Non-staining to hard surfaces
Removal	Soap and Water
Cling Ability	Excellent
Condition on Drying	Lubricious film
Flash Point	Non-combustible

Super-Slick™ Cable-Pulling Lubricant

Exclusive GB® Micro Bead Formula rolls cable through the longest pulls.

- Lowest pulling tension. This GB® lubricant innovation combines a lubricating agent with microbeads that act as miniature ball bearings to raise the cable off the conduit surface. Cable literally rolls through the run, reducing friction by an additional 30% compared to regular lubricants.
- Adheres throughout long pulls. Creates a slick film that will not rub off or dry out on long pulls or re-pulls.
- Requires up to 45% less lubricant per foot than regular lubricants, actually reducing cable-pulling costs.
- Stable under temperature extremes of 28 °F to 200 °F and withstands repeated freeze-thaw cycles.
- Harmless to skin and safe for the environment. Non-toxic, non-flammable and non-corrosive to all conduit types. Easily cleans up with water and will not stain clothing.
- Universally compatible with all cable types and jacket materials, including low-density and linear low density polyethylene, polyurethane and semi-conducting jackets.



Part #	Container Size	Weight
79-401	1 qt. Squeeze Bottle	2.5 lbs
79-402	1 gal. Jug	8.75 lbs
79-403	5 gal. Pail	42 lbs

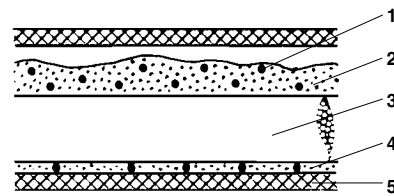

1. Micro Beads
2. Shear-sensitive carrying agent with suspended lubricating oil
3. Cable
4. Thin film of lubricating oil
5. Conduit wall

Super-Slick™ Specifications

Base	Water	Staining Properties	Non-staining
Color	White	Removal	Water Rinse
Viscosity	2100 cps@ 50 rpm	Abrasion Protection	Excellent
pH	6.0 - 8.0	Cling Ability	Excellent
Freezing Point	30.2 °F	Hardening Charac.	Non-Hardening
Freeze-Thaw Stability	Excellent	Condition on Drying	Slick Film
Lubricity	Excellent	Flash Point	Non-Combustible
Shelf Life	Indefinite		

Super Tuff-Pull™ Double Braided Rope

The toughest, strongest pulling rope available. Double-braided 100% polyester construction, delivers the highest working loads and tensile strength at every diameter.

- Super abrasion resistance for longer life.
- Low stretch, high strength characteristics result from exclusive manufacturing process which carefully controls yarn tension during braiding. Torque-free, non-rotating, non-kinking performance due to double-braided construction for ease of handling—wet or dry.
- Weather resistant. Will not rot or mildew.
- The 3/4" diameter rope includes a factory-spliced eye on both ends.



Super Tuff-Pull™ is constructed of a jacket braided over a braided core. Double braided construction entirely shields one of the two ropes from abrasion.

Part #	Size	Working Load*	Weight
RST-5030	1/2" x 300'	3,500 lbs	30 lbs
RST-5060	1/2" x 600'	3,500 lbs	61 lbs
RST-7530**	3/4" x 300'	8,000 lbs	54 lbs
RST-7560**	3/4" x 600'	8,000 lbs	109 lbs
RST-7830***	7/8" x 300'	10,000 lbs	97 lbs
RST-7860***	7/8" x 600'	10,000 lbs	202 lbs

* Working loads are based on use with GB® Cable Pullers and for the purpose of pulling wire through conduit.

** Preferred for Brutus™ 8,000-lb Cable Puller.

*** Preferred for Ultra Brutus™ 10,000-lb Cable Puller.

Tuff-Pull™ Single Braided Rope

Toughest, strongest single-braided rope available. Constructed of 12 strands of 100% polyester fibers braided over and under each other in a circular pattern.

- Non-rotating, non-kinking performance due to braided construction (unlike ordinary twisted rope) makes handling easy.
- Low stretch, high strength characteristics result from tension-controlled braiding process.
- Weather-resistant. Will not rot or mildew.
- The 3/4" diameter rope includes a factory-spliced eye on both ends.



Part #	Size	Working Load	Weight
RTP-3830	3/8" x 300'	1125 lbs	14 lbs
RTP-7530	3/4" x 300'	4500 lbs	58 lbs

tip:

Vary rope application. Reverse the rope, end-for-end. Alternate the lay of the rope around capstan and sheaves.

Store rope in clean dry area, preferably on well-ventilated racks.

Keep rope away from chemical contact or fumes.

Avoid exposing rope to extreme heat in excess of 140 °F.



Tuff-Pull™ is constructed of 12 strands of polyfibers braided over and under each other in a circular direction.

Poly-Pro™ General Purpose Rope

Strong, durable, lightweight polypropylene general purpose rope for manual wire pulling and general construction applications (barrier rope, tie downs, tow rope, etc.).

- Resistant to mildew, rot and chemical action.

Part #	Size	Working Load	Weight
RGP-2525	1/4" x 250'	113 lbs	4 lbs
RGP-2560	1/4" x 600'	113 lbs	9 lbs
RGP-3825	3/8" x 250'	243 lbs	10 lbs
RGP-3860	3/8" x 600'	243 lbs	23 lbs
RGP-5025	1/2" x 250'	420 lbs	18 lbs
RGP-5060	1/2" x 600'	420 lbs	37 lbs
RGP-7560	3/4" x 600'	850 lbs	81 lbs



⚠ WARNING

Not recommended for powered cable pulling.

Rope Selection

1. Select the proper rope for the job.

CAUTION

Always choose a strong, durable rope with limited elasticity and long service life. The material, tensile strength and recommended working load are critical factors.

- a. **Working Load Rating** represents the maximum pulling load to which the rope should be subjected. It increases with rope diameter and is calculated for rope in good condition with appropriate splices under normal service.
Note: Working load guidelines are void under conditions of rapid or sudden load changes.

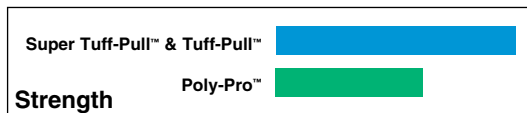

- b. **Tensile Strength** is the average breaking point of new, unused rope. It gives some indication of the rope's ability to withstand sudden or shock loads. Tensile strength decreases over time as the rope is used and should not be relied upon as an indication of working strength.

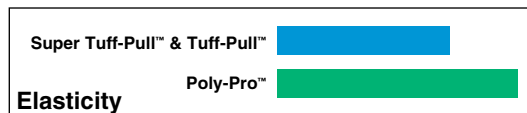

tip: Polyester ropes such as Tuff-Pull™ and Super Tuff-Pull™ are preferred for cable pulling because of their low elasticity, high strength and endurance.

2. Inspect the rope thoroughly before each use.

CAUTION

Avoid using rope that shows signs of wear, such as frayed ends, broken yarns or pulled strands.

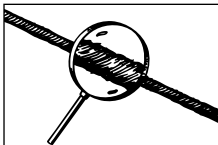

Rope Usage

1. Always check all fittings, splices, connectors, etc. before using rope.
2. Do not stand directly in line with rope under tension.

WARNING

All synthetic rope under load will recoil if it, or a fitting (chain, hook, bolt, etc.) fails. The snap-back action will propel the rope - and any still attached metal fittings - at high speed. Serious injury to persons or property in the vicinity is possible.

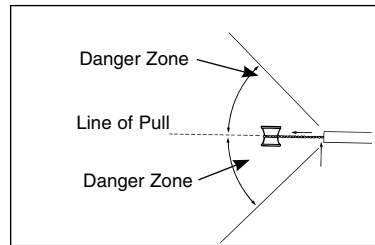

3. Do not overload the rope.

CAUTION

Handle loads slowly and smoothly to avoid sudden strains or shock loads which can exceed the rope's breaking strength. Such dynamic loading occurs when a load is picked up, stopped, moved or swung and may subject the rope to two or three times its normal working load.

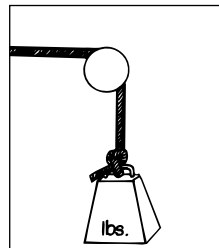

4. Avoid abrasive conditions.

CAUTION

Rough surfaces and sharp edges can severely damage rope. Do not pull rope over sharp bends or angles. Make sure chocks, capstans, sheaves and pulleys are free of burrs and rust and rotate freely. Keep rope surface clean. Do not drag it over rough ground; dirt and grit will work into and cut inner fibers.

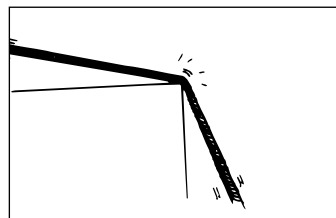

Handy-Saver™ Reel Roller

Durable roller base that permits fast, easy loading and re-loading.

- 3000 lb capacity per pair.
- Slanted ramp permits fast, easy loading and unloading.
- Five roller slot adjustments set for wide range of reel diameters; no limit on reel widths.
- Epoxy-coated solid steel platform withstands heavy use.
- For 15" to 30" diameter reels.
- Dimensions: 26" L x 11¼" W x 4½" H.

Part #	Description	Weight
WRR-100	Handy-Saver™ Reel Roller (1 ea.)	48 lbs

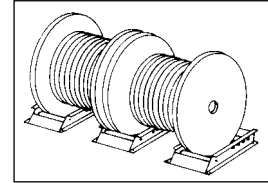

30" Reel Roller

Holds reels up to 30" diameter; 2000 lb capacity.

- Five roller slot adjustments to fit reel diameter.
- Epoxy-coated solid steel platform with handy loading/unloading ramp.
- Dimensions: 33½" L x 26½" W x 4½" H.

Part #	Description	Weight
WRR-300	30" Reel Roller	50 lbs

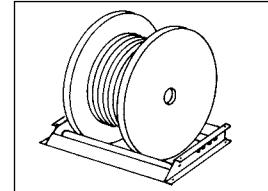

Telescoping Reel Jacks

Easily set up in minutes to dispense or take up wire, cable, rope or hose.

- Adjustable jack height accommodates various reel sizes.
- Roller bearings on jack permit smooth reel rotation.
- High-strength steel construction holds up to 5000-lb reel.

Part #	Dimensions	Jack Height Range	Reel Capacity		Weight
			Size	Weight	
TRJ-56	14½" L x 15" W	13" to 28"	28" to 56"	2500 lbs. (ea.)	25 lbs
TRJ-96	24" L x 16" W	22" to 54"	46" to 96"	2500 lbs. (ea.)	49 lbs

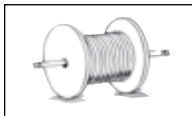

Insert spindle through center of reel.

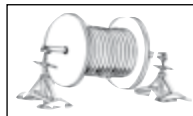

Place reel jacks under each end of spindle, aligning roller bearings with spindle grooves, and raise one jack until reel end clears floor.

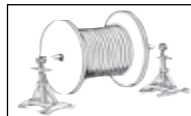

Raise opposite jack until spindle is level.

Hand Wire Caddy

Convenient hand carrying or dispensing of small quantities of reeled wire.

- Rugged construction from $\frac{5}{8}$ " .083 steel tubing, epoxy-coated to reduce chipping and peeling.
- Holds up to eight reels, each 7" diameter by 5" wide, or four reels, each 7" diameter by 6" to 10" wide.

Part #	Description	Dimensions	Weight
WSP-100E	Hand Caddy	22½" L x 13½" W x 9½" H	6 lbs

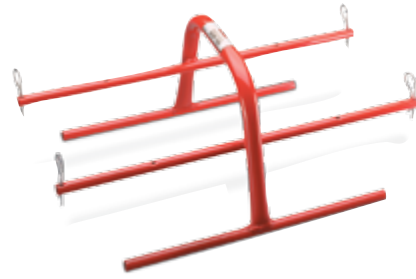

Portable Wire Caddy

Maximum flexibility to dispense six 500' spools of #6 to #10 AWG or twelve 7" diameter by 5" wide wire reels at the same time.

- Durable welded square-tube steel frame to stand up to tough job-site applications.
- WSP-115 model comes with wire guide and casters.

Part #	Description	Dimensions	Weight
WSP-115	Wire Caddy with Casters	16" L x 26" W x 20½" H	8 lbs



WSP-115

Spool Caddy Cart

Transport and dispense reels of building wire, coaxial and multi-conductor cables.

- Hand Caddy WSP-100E is included. The caddy is easily attached to and detached from cart for maximum capacity and flexibility.
- Constructed of heavy-duty, steel tubing holds up to 300 lbs.
- Semi-pneumatic steel wheels are much more durable than plastic wheels.
- Special channel allows up to two hand caddies to attach to cart.

Part #	Description	Dimensions	Weight
WSP-140	Spool Caddy w/ WSP-100E	22" L x 16" W x 43" H	27 lbs



WSP-140 Assembled

WSP-140 Unassembled

Deluxe Spool Cart & Caddy Combo

- Holds up to 23 500' spools or two 2,500' spools.
- Constructed of heavy-duty steel tubing holds up to 400 lbs. Durable semi-pneumatic wheels.
- WSP-144 offers five spool holders that attach in six positions to hold reel/spool combinations:
 - Ten - 23 reels, each 5" - 7" diameter and 5" - 10" wide
 - Four reels, each 10" - 12" diameter, 7" wide
 - Two reels, each 15" - 18" diameter, 14" wide
- Hand Caddy (WSP-100E) is easily attached to and detached from cart using a special channel.

Part #	Description	Dimensions	Weight
WSP-144	Deluxe Spool Caddy	22" L x 18½" W x 43" H	28 lbs



WSP-144

Heavy-Duty Spool Caddy

- Constructed of heavy-duty steel tubing, holds up to 700 lbs.
- Shock-absorbing, semi-pneumatic wheels mounted on ball bearing steel rims with easy-service grease fittings.
- Dispenses THHN, THW, Romex® and other materials from horizontal or vertical position.
- Two wire guide feeders permit wire feed in any direction.
- WSP-150 has a versatile carrying capacity. Holds four reels each 10" diameter x 15" wide, or three reels, each 12" - 14" diameter, or two reels each 12" - 15" diameter x 15" wide or one 24" diameter reel 15" wide.

Part #	Description	Dimensions	Weight
WSP-150	Heavy-Duty Spool Caddy	22" L x 18½" W x 45" H	60 lbs



WSP-150

Wire Dispenser

Capacity to handle ten 2500' spools up to 18" diameter.

- Swivels a full 360° on the base.
- All-steel construction.
- Base has two fixed and two swivel locking casters.
- Spindles are mounted at an angle to keep wire reels in proper payout position.
- Easily rolls through standard 36" door opening.

Part #	Description	Dimensions	Weight
WCM-10	Wire Dispenser	36¾" L x 31¾" W x 59¼" H	155 lbs



Wire Caddy Replacement Parts

- Replacement parts for Gardner Bender™ wire caddies.

WSP144050



WSP144251



WSP144253

Part #	Description	For Wire Cart:	Qty	Weight
WSP144050	Spool Caddy Bars 18" L	WSP-144, WSP-140	5	1.5 lbs
WSP144251	R-Clips	All Caddies	10	.5 lb
WSP144253	Wheels	WSP-144	2	5 lbs

NOTES



Hole Making

From single parts to complete kits, Gardner Bender™ has versatile, durable hole-making products that contractors depend on. If you need to knockout, punch, notch, drill or insulate, Gardner Bender™ has the right tool for the job.



page 107



page 109



page 112

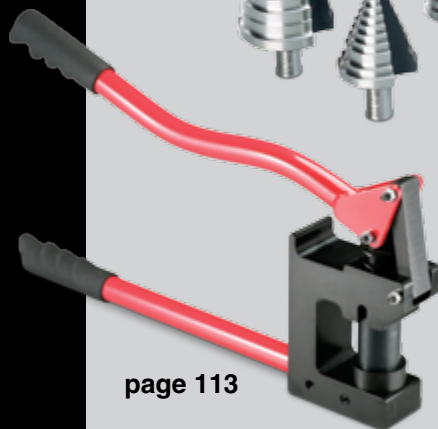

page 113

Slug-Out™ Knockouts	
35 Ton Hydraulic Punch	108
Draw Studs.....	110-111
Hydraulic Slug-Out™ Sets.....	103-104
Individual Components.....	107, 110-111
Mechanical Slug-Out™ Sets.....	105-106, 112
Notching Pliers	108
Super Stainless Steel	
Slug-Out™ Sets	109, 112
Stud Punch	113
Step Bits	112

Slug-Out™ Hydraulic Knockout Sets

Punches holes for 1/2" to 4" conduit in distribution boxes, electrical panels or troughs.

- Four point design allows slug to drop automatically without splitting.
- Punches up to 10-gauge mild steel and 12-gauge stainless steel.
- Hand or foot operation; choose hand or foot-powered hydraulic pump.
- Assortment of punches, dies and accessories.
- Includes metal storage case (11 1/8" x 18 3/4" x 6 1/4").
- Competitors' punches and dies are interchangeable.



Part #	Description	Weight
KOH14A	Hydraulic Slug-Out™ Set w/o punches and dies and with PH20 Hand Pump	27 lbs
KOF520	1/2" - 2" Hydraulic Slug-Out™ Set with PF65 Foot Pump	40 lbs
KOH520A	1/2" - 2" Hydraulic Slug-Out™ Set with PH20 Hand Pump	31 lbs
KOF540	1/2" - 4" Hydraulic Slug-Out™ Set with PF65 Foot Pump	59 lbs
KOH540A	1/2" - 4" Hydraulic Slug-Out™ Set with PH20 Hand Pump	50 lbs

KOH14A Set Includes:

Part #	Description	Hole	Weight	I.D. #	Part #	Description	Hole	Weight	I.D. #
PH20	Hand Pump - 2 speed	-	5 lbs	22	CH1211	12-ton Hydraulic Cylinder	-	6 lbs	26
KPR7540	Drawstud for 3/4" - 4" Punches & Dies	-	2.5 lbs	23	H864	6' Rubber Hose Coupler	-	2 lbs	27
KPS50*	Stainless Steel Pull Rod, 3/8" dia.	-	.2 lb	24	CM5	Metal Case	-	11 lbs	28
KC3540**	Converter	-	.4 lb	25					

KOF520 & KOH520A Sets Include:

Part #	Description	Hole	Weight	I.D. #	Part #	Description	Hole	Weight	I.D. #
KP500B	1/2" Punch	7/8"	.4 lb	1	KP2000B	2" Punch	2 3/8"	2 lbs	11
KD500B	1/2" Die	7/8"	1 lb	2	KD2000B	2" Die	2 3/8"	2 lbs	12
KP750B	3/4" Punch	1 3/32"	.4 lb	3	PF65	Foot Pump (KOF520 only)	-	12 lbs	21
KD750B	3/4" Die	1 3/32"	1 lb	4	PH20	Hand Pump - 2 speed (KOH520A only)	-	5 lbs	22
KP1000B	1" Punch	1 11/32"	1 lb	5	KPR7540	Drawstud for 3/4" - 4" Punches & Dies	-	2.5 lbs	23
KD1000B	1" Die	1 11/32"	1 lb	6	KPS50*	Stainless Steel Drawstud, 3/8" dia.	-	.2 lb	24
KP1250B	1 1/4" Punch	1 11/16"	2 lbs	7	KC3540**	Converter	-	.4 lb	25
KD1250B	1 1/4" Die	1 11/16"	2 lbs	8	CH1211	12-ton Hydraulic Cylinder	-	6 lbs	26
KP1500B	1 1/2" Punch	1 15/16"	2 lbs	9	H864	6' Rubber Hose Coupler	-	2 lbs	27
KD1500B	1 1/2" Die	1 15/16"	2 lbs	10	CM5	Metal Case	-	11 lbs	28

KOF540 & KOH540A Sets Include:

Part #	Description	Hole	Weight	I.D. #	Part #	Description	Hole	Weight	I.D. #
KP500B	1/2" Punch	7/8"	.4 lb	1	KP3000	3" Punch	3 1/2"	4 lbs	15
KD500B	1/2" Die	7/8"	1 lb	2	KD3000	3" Die	3 1/2"	4 lbs	16
KP750B	3/4" Punch	1 3/32"	.4 lb	3	KP3500	3 1/2" Punch	4"	4 lbs	17
KD750B	3/4" Die	1 3/32"	1 lb	4	KD3500	3 1/2" Die	4"	4 lbs	18
KP1000B	1" Punch	1 11/32"	1 lb	5	KP4000	4" Punch	4 1/2"	4 lbs	19
KD1000B	1" Die	1 11/32"	1 lb	6	KD4000	4" Die	4 1/2"	4 lbs	20
KP1250B	1 1/4" Punch	1 11/16"	2 lbs	7	PF65	Foot Pump (KOF540 only)	-	12 lbs	21
KD1250B	1 1/4" Die	1 11/16"	2 lbs	8	PH20	Hand Pump - 2 speed (KOH540A only)	-	5 lbs	22
KP1500B	1 1/2" Punch	1 15/16"	2 lbs	9	KPR7540	Drawstud for 3/4" - 4" Punches & Dies	-	2.5 lbs	23
KD1500B	1 1/2" Die	1 15/16"	2 lbs	10	KPS50*	Stainless Steel Drawstud, 3/8" dia.	-	.2 lb	24
KP2000B	2" Punch	2 3/8"	2 lbs	11	KC3540**	Converter	-	.4 lb	25
KD2000B	2" Die	2 3/8"	2 lbs	12	CH1211	12-ton Hydraulic Cylinder	-	6 lbs	26
KP2500	2 1/2" Punch	2 7/8"	3 lbs	13	H864	6' Rubber Hose Coupler	-	2 lbs	27
KD2500	2 1/2" Die	2 7/8"	3 lbs	14	CM5	Metal Case	-	11 lbs	28

* Must be used with 1/2" punch and die. ** Must be used with 3 1/2" - 4" punch and die.

Slug-Out 90™ Set

1/2" to 2" conduit size.

- Right-angle head swivels 360° for flexible punching in tight work spaces.
- Punches up to 2 1/2" conduit sizes, up to 10-gauge mild steel and 12-gauge stainless steel.
- No cumbersome "spacers" required.
- Compact, lightweight size: 7 1/2 pounds and 13" in length.
- Operating pressure rated at 10,000 psi.
- Set includes the most popular draw studs, punches, and dies for punching holes for 1/2" to 2" conduit all packed in a sturdy storage case.

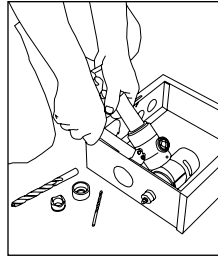

Part #	Description	Weight
KOS5290	Self-contained Hydraulic Slug-Out 90™ Set	15 lbs

Set Includes:

Part #	Description	Hole	Weight	I.D. #	Part #	Description	Hole	Weight	I.D. #
KP500B	1/2" Punch	7/8"	.4 lb	1	KP1500B	1 1/2" Punch	1 15/16"	2 lbs	9
KD500B	1/2" Die	7/8"	1 lb	2	KD1500B	1 1/2" Die	1 15/16"	2 lbs	10
KP750B	3/4" Punch	1 3/32"	.4 lb	3	KP2000B	2" Punch	2 3/8"	2 lbs	11
KD750B	3/4" Die	1 3/32"	1 lb	4	KD2000B	2" Die	2 3/8"	2 lbs	12
KP1000B	1" Punch	1 11/32"	1 lb	5	KLP6	Hydraulic Driver	-	10 lbs	13
KD1000B	1" Die	1 11/32"	1 lb	6	KPR7520	Drawstud	-	1 lb	14
KP1250B	1 1/4" Punch	1 11/16"	2 lbs	7	KPS50	Drawstud	-	.2 lb	15
KD1250B	1 1/4" Die	1 11/16"	2 lbs	8	KSA50	Drawstud Adapter	-	.3 lb	16

Seal Repair Kit KLP6K1

Slug-Out™ Self-Contained Hydraulic Knockout Set

1/2" to 2" conduit size.

- Hydraulic driver punches up to 10-gauge mild steel and up to 12-gauge stainless steel.
- Four-point design allows slug to drop automatically without splitting.
- Lightweight and easy to use.
- Hydraulic driver operates in any position.

Optional 2 1/2" and 3" punch and die available.



Part #	Description	Weight
KOS520	Slug-Out™ Self-contained Hydraulic Set	14 lbs

*Set Includes:

Part #	Description	Hole	Weight	I.D. #	Part #	Description	Hole	Weight	I.D. #
KP500B	1/2" Punch	7/8"	.4 lb	1	KD1500B	1 1/2" Die	1 15/16"	2 lbs	10
KD500B	1/2" Die	7/8"	1 lb	2	KP2000B	2" Punch	2 3/8"	2 lbs	11
KP750B	3/4" Punch	1 3/32"	.4 lb	3	KD2000B	2" Die	2 3/8"	2 lbs	12
KD750B	3/4" Die	1 3/32"	1 lb	4	KLP2	Hydraulic Driver	-	10 lbs	13
KP1000B	1" Punch	1 11/32"	1 lb	5	KPR7520	Drawstud	-	1 lb	14
KD1000B	1" Die	1 11/32"	1 lb	6	KPS50	Drawstud	-	.2 lb	15
KP1250B	1 1/4" Punch	1 11/16"	2 lbs	7	KSA50	Drawstud Adapter	-	.3 lb	16
KD1250B	1 1/4" Die	1 11/16"	2 lbs	8					
KP1500B	1 1/2" Punch	1 15/16"	2 lbs	9					

* Storage Case not sold separately.

Slug-Out™ Quick Hand Ratchet

1/2" to 2" conduit size.

- Four-point design allows slug to drop automatically without splitting.
- Smooth operating ratchet handles up to 10-gauge mild steel and 12-gauge stainless steel.

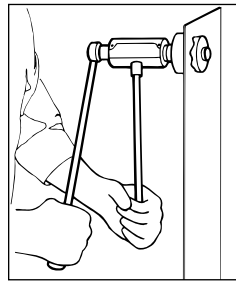

Part #	Description	Weight
KOR520	Slug-Out™ Ratchet Set	16 lbs
KOR14	Ratchet (without punch and dies)	12 lbs

*KOR520 Set Includes:

Part #	Description	Hole	Weight	I.D. #	Part #	Description	Hole	Weight	I.D. #
KP500B	1/2" Punch	7/8"	.4 lb	1	KD1500B	1 1/2" Die	1 15/16"	2 lbs	10
KD500B	1/2" Die	7/8"	1 lb	2	KP2000B	2" Punch	2 3/8"	2 lbs	11
KP750B	3/4" Punch	1 3/32"	.4 lb	3	KD2000B	2" Die	2 3/8"	2 lbs	12
KD750B	3/4" Die	1 3/32"	1 lb	4	KOR14	Ratchet	-	12 lbs	13
KP1000B	1" Punch	1 11/32"	1 lb	5	KOR50	1/2" Screw Adapter	-	.4 lb	14
KD1000B	1" Die	1 11/32"	1 lb	6	KOR75125	3/4" - 1 1/4" Screw Adapter	-	1 lb	15
KP1250B	1 1/4" Punch	1 11/16"	2 lbs	7	KOR152	1 1/2" - 2" Screw Adapter	-	1 lb	16
KD1250B	1 1/4" Die	1 11/16"	2 lbs	8					
KP1500B	1 1/2" Punch	1 15/16"	2 lbs	9					

* Storage Case not sold separately.

Slug-Out™ Set With Ratchet Wrench

1/2" to 2" conduit size.

- Four-point design allows slug to drop automatically without splitting.
- Punches up to 10-gauge mild steel and 12-gauge stainless steel.
- Set includes ratchet wrench, six sizes of punches and dies, and two drive screws all packaged in a rugged storage case.

Part #	Description	Weight
KOW520	Mechanical Slug-Out™ Set w/ KW52 Wrench	12 lbs



Set Includes:

Part #	Description	Hole	Weight	I.D. #	Part #	Description	Hole	Weight	I.D. #
KP500B	1/2" Punch	7/8"	.4 lb	1	KP1500B	1 1/2" Punch	1 15/16"	2 lbs	9
KD500B	1/2" Die	7/8"	1 lb	2	KD1500B	1 1/2" Die	1 15/16"	2 lbs	10
KP750B	3/4" Punch	1 3/32"	.4 lb	3	KP2000B	2" Punch	2 3/8"	2 lbs	11
KD750B	3/4" Die	1 3/32"	1 lb	4	KD2000B	2" Die	2 3/8"	2 lbs	12
KP1000B	1" Punch	1 11/32"	1 lb	5	KW52	Hand Ratchet Wrench	-	1 lb	13
KD1000B	1" Die	1 11/32"	1 lb	6	KSB50B	1/2" Bearing & Drive Screw	-	1 lb	14
KP1250B	1 1/4" Punch	1 11/16"	2 lbs	7	KS752B	3/4" - 2" Bearing & Drive Screw	-	1 lb	15
KD1250B	1 1/4" Die	1 11/16"	2 lbs	8	K88007	Storage Case	-	1.5 lbs	16

Slug-Out™ Set for 1/2" to 1 1/4" conduit size

Four-point design allows slug to drop automatically without splitting.

- Punches up to 10-gauge mild steel and 12-gauge stainless steel.
- Set includes the four most popular sizes of punches and dies packed in a sturdy storage case.



Part #	Description	Weight
KOM50125	Mechanical Slug-Out™ Set	3 lbs

Set Includes:

Part #	Description	Hole	Weight	I.D. #	Part #	Description	Hole	Weight	I.D. #
KP500B	1/2" Punch	7/8"	.4 lb	1	KP1250B	1 1/4" Punch	1 11/16"	2 lbs	7
KD500B	1/2" Die	7/8"	1 lb	2	KD1250B	1 1/4" Die	1 11/16"	2 lbs	8
KP750B	3/4" Punch	1 3/32"	.4 lb	3	KSB50B	1/2" Bearing & Drive Screw	-	1 lb	9
KD750B	3/4" Die	1 3/32"	1 lb	4	KS752B	3/4" - 2" Bearing & Drive Screw	-	1 lb	10
KP1000B	1" Punch	1 11/32"	1 lb	5	K88004	Storage Case	-	1.5 lbs	11
KD1000B	1" Die	1 11/32"	1 lb	6					

Slug-Out™ Set for 1 1/2" to 2" conduit size

Four-point design allows slug to drop automatically without splitting.

- Punches up to 10-gauge mild steel and 12-gauge stainless steel.
- Durable storage case.



Part #	Description	Weight
KOM152	Mechanical Slug-Out™ Set	4 lbs

Set Includes:

Part #	Description	Hole	Weight	I.D. #	Part #	Description	Hole	Weight	I.D. #
KP1500B	1 1/2" Punch	1 5/8"	2 lbs	1	KD2000B	2" Die	2 3/8"	2 lbs	4
KD1500B	1 1/2" Die	1 5/8"	2 lbs	2	KS752B	3/4" - 2" Bearing & Drive Screw	-	1 lb	5
KP2000B	2" Punch	2 3/8"	2 lbs	3	K88001	Storage Case	-	1.5 lbs	6

Slug-Out™ Assortment Kit for 2 1/2" to 4" conduit size

Expand capability of 1/2" - 2" sets.

- Four-point design allows slug to drop automatically without splitting.
- Punches up to 10-gauge mild steel and 12-gauge stainless steel.
- Packed in metal storage case.



Part #	Description	Weight
KOH2540	Slug-Out™ Set in Metal Case	22 lbs

Set Includes:

Part #	Description	Hole	Weight	I.D. #	Part #	Description	Hole	Weight	I.D. #
KP2500	2 1/2" Punch	2 7/8"	3 lbs	1	KD3500	3 1/2" Die	4"	4 lbs	6
KD2500	2 1/2" Die	2 7/8"	3 lbs	2	KP4000	4" Punch	4 1/2"	4 lbs	7
KP3000	3" Punch	3 1/2"	4 lbs	3	KD4000	4" Die	4 1/2"	4 lbs	8
KD3000	3" Die	3 1/2"	4 lbs	4	K88008	Metal Storage Case	-	5 lbs	9
KP3500	3 1/2" Punch	4"	4 lbs	5					

Slug-Out™ Individual Punch & Die

1/2" to 4" conduit size.

- A complete selection of 11 individual punch, die and drive screw sets from 1/2" - 4".
- Four-point design allows slug to drop automatically without splitting.
- Punches up to 10-gauge mild steel and 12-gauge stainless steel.

KOM300 Apart



KOM300 Assembled

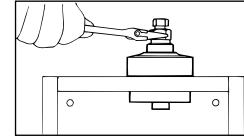

Part #	Weight	Pipe Size	Hole Size	Punch #	Weight	Die #	Weight	Drive Screw #	Weight	Drive Nut #
KOS-500B	1.5 lbs	1/2"	7/8"	KP500B	.4 lb	KD500B	1 lb	KSB50B	1 lb	-
KOS-750B	1.5 lbs	3/4"	1 3/32"	KP750B	.4 lb	KD750B	1 lb	KS752B	1 lb	-
KOS-1000B	1.8 lbs	1"	1 11/32"	KP1000B	1 lb	KD1000B	1 lb	KS752B	1 lb	-
KOS-1250B	1.75 lbs	1 1/4"	1 11/16"	KP1250B	2 lbs	KD1250B	2 lbs	-	-	-
KOS-1250DS	1.8 lbs	1 1/4"	1 11/16"	KP1250B	2 lbs	KD1250B	2 lbs	KS752B	1 lb	-
KOS-1500B	1.8 lbs	1 1/2"	1 15/16"	KP1500B	2 lbs	KD1500B	2 lbs	-	-	-
KOS-1500DS	1.9 lbs	1 1/2"	1 15/16"	KP1500B	2 lbs	KD1500B	2 lbs	KS752B	1 lb	-
KOM1732	3 lbs	-	1 7/32"	KP1732B	.3 lb	KD1732B	.3 lb	KS752B	1 lb	-
KOM200	2 lbs	2"	2 3/8"	KP2000B	2 lbs	KD2000B	2 lbs	KS752B	1 lb	-
KOM250	4 lbs	2 1/2"	2 7/8"	KP2500	3 lbs	KD2500	3 lbs	KSN2530	1.5 lb	KSN2530
KOM300	5 lbs	3"	3 1/2"	KP3000	4 lbs	KD3000	4 lbs	KSN2530	1.5 lb	KSN2530
KOM350	10 lbs	3 1/2"	4"	KP3500	4 lbs	KD3500	4 lbs	KS3540	4 lbs	KSN3540
KOM400	11 lbs	4"	4 1/2"	KP4000	4 lbs	KD4000	4 lbs	KS3540	4 lbs	KSN3540
KKT316	Keyway Tool (for use with KOM1732)									

*KSN2530 is the complete Drive Screw & Nut.

Individual Slug-Out™ Components

1/2" to 4" conduit size.

- Four-point design allows slug to drop automatically without splitting.
- Punches up to 10-gauge mild steel and 12-gauge stainless steel.

Part #	Description	Hole Size	Weight
KP500B	1/2" Punch	7/8"	.4 lb
KD500B	1/2" Die	7/8"	1 lb
KSB50B	Drive Screw for 1/2" Punch & Die	-	1 lb
KP750B	3/4" Punch	1 3/32"	.4 lb
KD750B	3/4" Die	1 3/32"	1 lb
KS752B	Drive Screw for 3/4" thru 2" Punch & Die	-	1 lb
KP1000B	1" Punch	1 11/32"	1 lb
KD1000B	1" Die	1 11/32"	1 lb
KP1250B	1 1/4" Punch	1 11/16"	2 lbs
KD1250B	1 1/4" Die	1 11/16"	2 lbs
KP1500B	1 1/2" Punch	1 15/16"	2 lbs
KD1500B	1 1/2" Die	1 15/16"	2 lbs
KP1732B	1 7/32" Punch	1 7/32"	2 lbs
KD1732B	1 7/32" Die	1 7/32"	2 lbs
KP2000B	2" Punch	2 3/8"	2 lbs
KD2000B	2" Die	2 3/8"	2 lbs
KP2500	2 1/2" Punch	2 7/8"	3 lbs
KD2500	2 1/2" Die	2 7/8"	3 lbs
KSN2530	Drive Screw for 2 1/2" & 3" Punch & Die	-	1.5 lbs
KP3000	3" Punch	3 1/2"	4 lbs
KD3000	3" Die	3 1/2"	4 lbs
KP3500	3 1/2" Punch	4"	4 lbs
KD3500	3 1/2" Die	4"	4 lbs
KSN3540	Drive Screw for 3 1/2" & 4" Punch & Die	-	4 lbs
KP4000	4" Punch	4 1/2"	4 lbs
KD4000	4" Die	4 1/2"	4 lbs



KEYWAY TOOL

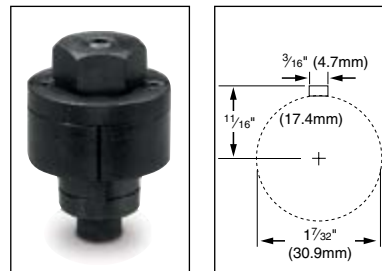

Punches holes for oil-tight electrical switches. Keyway tool (Part # KKT316) forms 3/16" notch in punched hole to prevent rotary movement of switch.

35-Ton Hydraulic Punch

Punches clean, burr-free bolt and small conduit holes in mild steel plates, beams, railings, bus bars or angle iron up to 1/2" thick.

- Portable or fixed applications. Lift and position with easy-carry handle or mount for production setups. Height 13 3/4", weight 35 lbs.
- Four punch and die sets included for round holes 7/16" - 1 3/16" diameter (gives clearance for 3/8", 1/2", 5/8" or 3/4" bolts or conduit) plus die changeover tool set. Throat depth 3".
- Holding plates grip work while punching to prevent binding and clamp punch in place to free operator's hands.



Part #	Description	Weight
SP3500	35-ton Steel Punch Set	40 lbs

Set Includes:

Part #	Description	Weight
SPD-438	3/8" Punch & Die Set	1 lb
SPD-563	1/2" Punch & Die Set	1 lb
SPD-688	5/8" Punch & Die Set	1 lb
SPD-813	3/4" Punch & Die Set	1 lb
SPK10	Installation Kit	5 lbs

tip: Hydraulic Pumps and Hoses recommended for use with SP-3500 Punch:

- PE20D Electric Pump
- HC913 6' Hose
- PH39 Manual Pump
- HC927 10' Hose
- PH80 Manual Pump

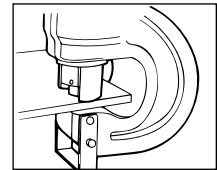

SEE PG **49** FOR MORE INFO ON **Electric Pumps**

SEE PG **51** FOR MORE INFO ON **Manual Pumps**

Notching Pliers

Creates clean notches for making keyways for push button switches.

- Ergonomically paddled handles for easy use.
- Accommodates up to 10-gauge mild steel.

Part #	Description	Weight
NP-1	Notching Pliers	3.3 lbs

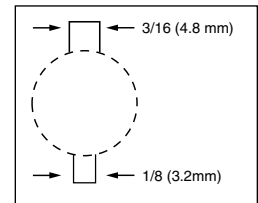

Hydraulic Super Stainless Steel Slug-Out™ Set

1/2" - 2" conduit size.

- Punches stainless steel up to 10-gauge (3.5 mm).
- Exclusive three-knife design splits slug into three pieces.
- Easy-to-use portable pump.
- Includes durable steel case.



Part #	Description	Weight
KSS520A	Hydraulic Super Slug-Out™ Set	35 lbs

Set Includes:

Part #	Description	Hole	Weight	I.D. #	Part #	Description	Hole	Weight	I.D. #
KPS500	1/2" Punch	7/8"	.4 lb	1	KDS1500	1 1/2" Die	1 15/16"	2.5 lbs	10
KDS500	1/2" Die	7/8"	1 lb	2	KPS2000	2" Punch	2 3/8"	5 lbs	11
KPS750	3/4" Punch	1 3/32"	.4 lb	3	KDS2000	2" Die	2 3/8"	4.5 lbs	12
KDS750	3/4" Die	1 3/32"	1 lb	4	PH20	Hand Pump	-	5 lbs	13
KPS1000	1" Punch	1 11/32"	1 lb	5	KPR7540	Drawstud for 3/4" - 2"	-	2.5 lbs	14
KDS1000	1" Die	1 11/32"	1 lb	6	KPS50	Drawstud for 1/2"	-	.2 lb	15
KPS1250	1 1/4" Punch	1 11/16"	2 lbs	7	CH1211	12 ton Hydraulic Cylinder	-	6 lbs	16
KDS1250	1 1/4" Die	1 11/16"	2 lbs	8	H864	6' Rubber Hose Coupler	-	2 lbs	17
KPS1500	1 1/2" Punch	1 15/16"	3 lbs	9					

Super Stainless Steel Slug-Out™ Set

1/2" - 2" conduit size.

- Punches stainless steel up to 10-gauge (3.5 mm).
- Exclusive three-knife design splits slug into three pieces.
- Rugged storage case.
- Extended punch life.



Part #	Description	Weight
KSS520	1/2" - 2" Super Stainless Steel Knockout Set	4 lbs

*Set Includes:

Part #	Description	Hole	Weight	I.D. #	Part #	Description	Hole	Weight	I.D. #
KPS500	1/2" Punch	7/8"	.4 lb	1	KPS1500	1 1/2" Punch	1 15/16"	3.5 lbs	9
KDS500	1/2" Die	7/8"	1 lb	2	KDS1500	1 1/2" Die	1 15/16"	2.5 lbs	10
KPS750	3/4" Punch	1 3/32"	.4 lb	3	KPS2000	2" Punch	2 3/8"	5 lbs	11
KDS750	3/4" Die	1 3/32"	1 lb	4	KDS2000	2" Die	2 3/8"	4.5 lbs	12
KPS1000	1" Punch	1 11/32"	1 lb	5	KPR7520	3/4" - 2" Drawstud for Hydraulic Driver	-	1 lb	13
KDS1000	1" Die	1 11/32"	1 lb	6	KSA50	1/2" Adapter	-	.3 lb	14
KPS1250	1 1/4" Punch	1 11/16"	2 lbs	7	KPS50	1/2" Drawstud	-	.2 lb	15
KDS1250	1 1/4" Die	1 11/16"	2 lbs	8					

* Storage Case not sold separately.

tip: Use this set to expand your KOS5290 or KOS520.



Drawstuds

Shown Actual Size



KPS50 2½" x ⅜"



KSA50 1⅜" x ¾"



KOR75125 3⅜" x ¾"



KOR152 4¾" x ¾"



KPR7520 4⅓" x ¾"



KC3540 2⅝" x 1⅛"



KOR50 3" x ⅜"

KPR7540 10⅝" x ¾"



Drawstuds

Shown Actual Size



KS3540 Stud 7⁵/₈" x 1¹/₈"



KSN3540 Hex Drive Nut 2¹/₂" x 1³/₈"



KS752B Drawstud & Bearing 4¹/₄" x 3³/₄"



KSB50B Drawstud & Bearing 2³/₄" x 3³/₈"



KSN2530 Stud 6" x 3³/₄" and Hex Drive Nut 1¹/₂" x 1"



Mechanical Super Stainless Steel Slug-Out™ Set

1/2" - 1 1/4" conduit size.

- Punches stainless steel up to 10-gauge (3.5 mm).
- Exclusive three-knife design splits slug into three pieces.
- Constructed of high-alloy tool steel.
- Rugged storage case.



Part #	Description	Weight
KSS50125	1/2" - 1 1/4" Super Slug-Out™ for Stainless Steel	4 lbs

Set Includes:

Part #	Description	Hole	Weight	I.D. #	Part #	Description	Hole	Weight	I.D. #
KPS500	1/2" Punch	7/8"	.4 lb	1	KPS1250	1 1/4" Punch	1 11/16"	2 lbs	7
KDS500	1/2" Die	7/8"	1 lb	2	KDS1250	1 1/4" Die	1 11/16"	2 lbs	8
KPS750	3/4" Punch	1 3/32"	.4 lb	3	KSB50B	Bearing and Drawstud for 1/2"	-	.5 lb	9
KDS750	3/4" Die	1 3/32"	1 lb	4	KS752B	Bearing and Drawstud for 3/4" - 2"	-	1 lb	10
KPS1000	1" Punch	1 11/32"	1 lb	5	K88007	Storage case	-	1.5 lbs	11
KDS1000	1" Die	1 11/32"	1 lb	6					

Step Bits

Drills large holes in confined spaces.

- Self-starting, self-centering drill tip. No pilot hole required.
- For accurate step-by-step drilling in sheet metals. Drills through 10-gauge mild steel or stainless steel.
- Double flute cutting action drills clean, round holes quickly and safely with minimum effort.
- Exclusive three-lobed shank for positive, non-slip grip in drill chucks.
- Made of high-speed steel for faster drilling and longer life.
- Applications include junction boxes, switch boxes, metal studs, electrical appliances, lighting fixtures and many other uses.



Part #	Sizes	Increments	No. of Sizes	Shank Size	Step Thickness	Weight
SB-205	1/4" - 3/4"	1/16"	9	3/8"	1/8"	1 lb
SB-207	3/16" - 7/8"	1/16"	12	3/8"	1/8"	1.3 lbs
SB-209	7/16" - 1 1/8"	-	12	1/2"	1/8"	1.5 lbs
SB-210	1/4" - 1 1/2"	1/16"	11	3/8"	1/8"	1.8 lbs

Stud Punch

Punches 7/8" holes for 1/2" conduit or pipe and 1 1/32" holes for 3/4" to 1" conduit or pipe.

- Features a spring loaded sleeve that increases the life and accuracy of the punch while providing a smoother cutting action.
- Easily punches "H" studs without damaging flanges.
- Automatic stripper.
- High-leverage design permits punching holes in aluminum studs and mild steel (up to 20-gauge) with minimum effort.
- From the center of the punch to the back of the housing measures 2".



Part #	Description	Weight	Punch #	Weight	Die #	Weight
*SP-7	Stud Punch w/spring release and 7/8" (22.2mm) or 1 1/32" (34.1mm) size punch.	6 lbs	43-52	1 lb	43-95	1 lb

* Carrying Case Included.



Stud Insulators

One piece design insulating 360° protection for cable runs through metal studs.

- Fits all pre-punched and field punched hole sizes and configurations.
- Unique folding tabs for fast, one-handed installations.
- Meets NEC article 300-4(b) and CEC rule 12-516.



Part #	Pkg Qty	Description
SI-25N	25/bag	Metal Stud Insulators

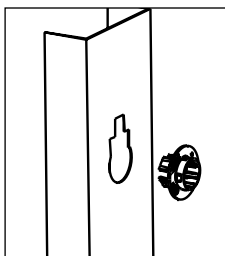

Slug-Out Knockout Mechanical Driver

Turn your ordinary everyday cordless drill into a powerful knockout driver. You win—with the versatile dual drive, durable all metal construction and powerful gear design! Save time, hassle and money, with Gardner Bender.

Versatile: ready to use quickly in any environment with dual-drive functionality

Durable: with precision gearing and an all metal housing, this driver was made with heavy-use in mind... Jobsite STRONG!

Powerful: as an addition to your drill, it puts all the power to make clean holes right in your hands

FEATURES:

- All metal construction—Provides maximum durability in tough job site conditions.
- Tactile grip—Allows for better control when in use.
- Dual drive—Allows unit to be driven from both sides and any angle.
- Universal draw stud design—works with most competitive draw studs to provide maximum jobsite versatility.



Part #	Includes:
KOMD1	Mechanical driver, adapter, case and draw studs
KOM520A	Mechanical driver, ½"-2" knockout set, adapter, step bit, case and draw studs
KOM540A	Mechanical driver, ½"-4" knockout set, adapter, step bit, case and draw studs



Tactile grip



3/8" Dual square drive



Great for tight spaces



Multiple angles



Self-centering punch and dies



Total time to make a hole*

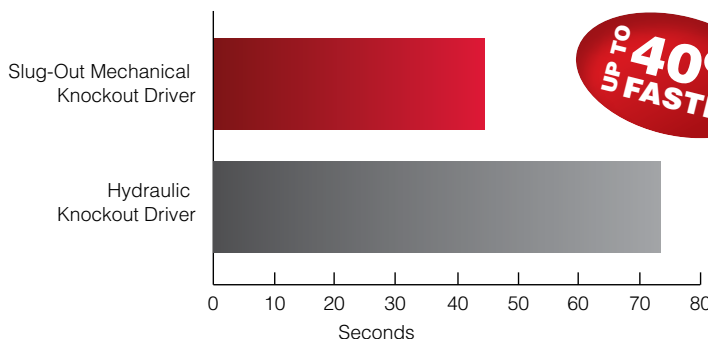

* internal testing



Hand Tools

Hand tools are a part of every tool box. With exclusive features for safety, durability, reliability and life strength, Gardner Bender™ hand tools offer superior performance on every job.



page 118



page 123



page 127



page 129

Circuit Alert® Tools	
Circuit Alert® Tester	117
Circuit Alert® Knife	117
Circuit Alert® Wire Strippers	118
Circuit Alert® Work Lights	118
Circuit Alert® Pliers	119
Circuit Alert® Screwdrivers	119
Cable Rippers	123
Cutters	
BX cutter	128
Ratcheting	129
PVC	129
Datacom/ VDV	
Cable strippers	124
Punch-down	125
Crimpers	125
Fuse Puller	130
Knives	117, 130
Multi-tools	122
Pliers	
Long Nose	126
Linemen's	127
Screwdrivers	129
Wire Strippers	120-122

CIRCUIT ALERT®

Safe & Convenient

This patented line of tools with Snap-in sensor detects AC voltage without contacting live wires

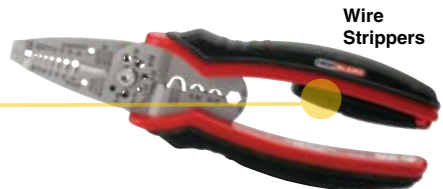

Wire Strippers

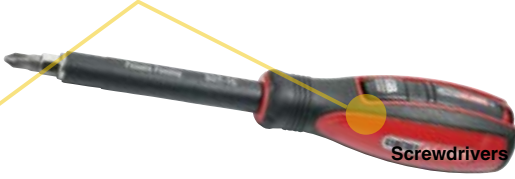

Screwdrivers



Pliers

BE SAFE. WORK SMART.

Circuit Alert® Voltage Sensing Module

The Circuit Alert® voltage sensing module fits in a whole variety of Circuit Alert® tools.

- Non-contact AC voltage detection.
- Audio and visual alerts.
- Pocket clip.
- Tri-directional momentary on/off switch.

Patented

Part #	Description
CAM-10	Voltage-sensing module



www.circuitalert.com



CAM-10 Pocket Clip

Circuit Alert® Voltage Sensing Wire Strippers

- Audible and visual alerts indicate the presence of voltage.
- Cuts and strips solid and stranded wire.
- Stainless steel body for maximum corrosion resistance.
- Ergonomic, cushioned handles for ultimate comfort and control.
- Double bevel cutting blades for superior nick resistance.
- Dual gripping positions for traditional or forward hand positions.
- Easy-to-read stamped markings.
- Cuts and rethreads bolt sizes 6-32, 8-32 and 10-32.
- Wire looping holes form wire to fit on screw terminals.
- Plier nose for gripping and pulling.
- cULus listed tester.
- Durable, drop resistant construction.

Patented

CIRCUIT ALERT

www.circuitalert.com



GST-55M



GST-70M



GST-224M

Part #	Description	Wire Gauge	Length
GST-55M	Circuit Alert® Voltage Sensing Wire Stripper	#10 - #18 AWG	7"
GST-70M	Circuit Alert® Voltage Sensing Crimper/Stripper	#8 - #20 AWG & Multi Crimping Stations	7"
GST-224M	Circuit Alert® Voltage Sensing NM Cable Stripper	12/2 & 14/2 NM Cable	7½"

Limited
Lifetime
Warranty

Patents Pending



Wire Stripping



Volt Sensing (50-600 VAC)



Bolt Cutting and Rethreading

Circuit Alert® Pliers

Circuit Alert® pliers combine common electrician's needs with Gardner Bender's over-molded, comfort grip.



www.circuitalert.com

- Crimp terminals.
- Cut wire and cable up to 10 AWG.
- Strip wire.
- Hammer head.
- Forged steel construction for long life.
- Precision hardened cutting blades

Patented

Part #	Description	Size
GPT-80	Circuit Alert® Voltage Sensing Long Nose Pliers	8"
GPT-90	Circuit Alert® Voltage Sensing Linesmens	8"



GPT-80



GPT-90



Testing



GPT-80 – Wire Stripping



GPT-90 – Hammer Head

Circuit Alert® Screwdriver

The Circuit Alert® screwdrivers deliver up to 10-in-1 bits and insulated comfort grip handles.



www.circuitalert.com

- Use with Hex-Lok® connectors.

Patented

SEE PG **9** FOR MORE INFO ON **Hex-Lok® Wire Connector**

Part #	Description	Bits
SDT-10	Circuit Alert® Voltage Sensing Screwdriver 10-in-1	See diagram

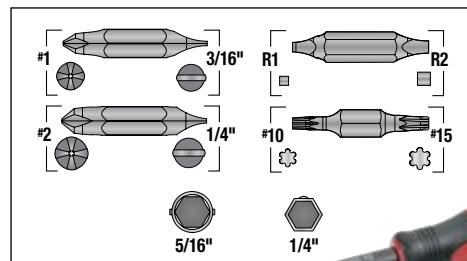

SDT-10

10-in-1

Wire Strippers

Comparison Chart

Feature	GS-40	GS-355	GS-360	GS-361	GES-55	GES-55	GES-55	GES-224	GES-224	GST-70M	GST-55M	GST-224M
Voltage Sensing										✓	✓	✓
Spring Action Return	✓	✓	✓	✓	✓	✓	✓	✓	✓	✓	✓	✓
Pliers Nose		✓	✓	✓	✓	✓	✓	✓	✓	✓	✓	✓
Loop Hole	✓	✓	✓	✓	✓	✓	✓	✓	✓	✓	✓	✓
Deluxe Cushion Grip				✓	✓	✓	✓	✓	✓	✓	✓	✓
Locking Handle	✓		✓									
Wire Stripping Range												
Solid	#10 - #24	#10 - #20	#10 - #20	#16 - #30	#10 - #18	#10 - #18	#12 & #14	#12 & #14	#8 - #20	#10 - #18	#12 & #14	
Stranded	#10 - #24	#10 - #20	#10 - #20	#16 - #30	#12 - #20	#12 - #20	—	—	#10 - #22	#12 - #20	—	
NM Cable	—	—	—	—	—	—	14/2 & 12/2	14/2 & 12/2	—	—	14/2 & 12/2	

ArmorEDGE® Wire Stripper

Strips and cuts solid and stranded wire.

- Stainless steel body for maximum corrosion resistance.
- Ergonomic, cushioned handles for ultimate comfort and control.
- Double bevel cutting blades for superior nick resistance.
- Dual gripping positions for traditional or forward hand positions.
- Easy-to-read laser-etched markings.
- Cuts and rethreads bolt sizes 6-32, 8-32 and 10-32.
- Wire looping holes form wire to fit on screw terminals.
- Plier nose for gripping and pulling.
- Limited Lifetime Warranty.
- GES-70 crimps insulated and non-insulated terminals, crimps coaxial "F" connectors, cuts bolt sizes 4-40, 5-40, 6-32, 8-32, 10-24 and 10-32.



GES-55



GES-55



GES-70

Part #	Description	Handle	Wire Gauge	Length
GES-55	ArmorEDGE® Wire Stripper	Curved	#10 - #18 AWG	6"
GES-55	ArmorEDGE® Wire Stripper	Symmetric	#10 - #18 AWG	6"
GES-70	ArmorEDGE® Multi-Tool Stripper/Crimper	Symmetric	#10 - #22 AWG	8"
GES-224	ArmorEDGE® NM Cable Stripper	Curved	12/2 & 14/2 NM Cable	7"
GES-224	ArmorEDGE® NM Cable Stripper	Symmetric	12/2 & 14/2 NM Cable	7"

Limited Lifetime Warranty



12/2 and 14/2 NM Cable Stripper



10-18 AWG Wire Stripper



GES-224



GES-224

Clipper™ Strippers

Strips solid or stranded wire.

- Compact tool adjusts quickly to any of eight wire sizes.
- Hardened spring steel provides strength and durability.
- Looping hole bends and loops wire for termination on screws.
- Vinyl grips for added comfort.
- GS-40 includes spring return for easy handling.

Part #	Description	Wire Gauge	Length
GS-40	Clipper™ Stripper w/spring	#10 - #24 AWG	5"



Wire Strippers

Strips solid or stranded wire.

- Precision stripping stations.
- Laser-etched markings.
- Pliers nose and curved cutting blade aid in pulling and cutting wire.
- Power spring return reduces hand fatigue.
- Curved handles for added comfort.
- Looping hole forms wire to fit on screw terminal.
- Comfortable high-leverage handles.

Part #	Description	Wire Gauge	Length
GS-355	Stripper	#10 - #20 AWG	6¼"
GS-360	Stripper with lock	#10 - #20 AWG	6"
GS-361	Small Gauge Stripper	#16 - #30 AWG	6¼"



GS-355



GS-360



GS-361

Strip-Easy™ Stripper

Strips solid or stranded wire.

- Strips wires clean with one easy squeeze, up to a full 7/8".
- Blades cut insulation without nicking conductor. Jaws open automatically to remove wire without crushing ends.
- AWG size clearly marked at each cutting hole.
- Comfortable no-slip handles.

Part #	Description	Wire Gauge	Length
SE-92	Automatic Wire Stripper	#8 - #22 AWG	8"



Automatic Stripper & Crimper

Strips solid or stranded wire.

- Automatic jaw-loaded wire stripper self-adjusts.
- Crimps insulated, and non-insulated terminals.
- Comfort high-leverage handles.

Part #	Description	Wire Gauge	Length
GS-394	Automatic Wire Stripper	#10 - #26 AWG	8"



Multi-Tools

Comparison Chart

Feature	GS-365	GS-370	GESP-70
Spring Action Return	✓		
Pliers Nose	✓	✓	✓
Conduit Reamer Nose	✓		
Loop Hole	✓	✓	✓
Deluxe Cushion Grip	✓	✓	✓
Locking Handle	✓		
Cutter Blade	✓	✓	✓
Cuts & Rethreads Bolts	✓	✓	✓
Crimps Insulated Terminals	✓	✓	✓
Crimps Non-insulated Terminals	✓	✓	✓
Copper & Steel Crimp Sleeves	✓	✓	✓
Coaxial Connectors	✓	✓	✓
Wire Stripping Range	#6 - #16	#10 - #22	#10 - #22



Multi-Tool Stripper, Cutter & Crimper

Strips and cuts wire.

- Strips copper and aluminum wire, solid or stranded.
- Cuts and rethreads bolt sizes 4-40, 5-40, 6-32, 8-32, 10-24 and 10-32.
- Pliers nose for pulling and looping wire.
- Crimps insulated & non-insulated terminals.
- Crimps coaxial "F" connectors.
- Curved cutting blade.
- Comfort high-leverage handles.
- Precision ground-stripping stations prevent nicking conductor while stripping.

Part #	Description	Wire Gauge	Length
GS-370	Multi-Tool	#10 - #22 AWG	8½"



Multi-Tool Stripper, Cutter & Crimper

Strips #6 - #16 AWG solid, #8 - #18 AWG stranded.

- Strips copper and aluminum wire, solid or stranded.
- Cuts and rethreads bolt sizes 4-40, 5-40, 6-32, 8-32,
- Crimps #310, 311, 410 and 411 crimp sleeves, solderless terminals and coaxial connectors.
- Pliers nose for pulling and looping wire.
- Snub nose for reaming ½" and 1" conduit.
- Precision ground-stripping stations prevent nicking conductor while stripping.
- Lock for compact storage.

Part #	Description	Wire Gauge	Length
GS-365	Multi-Tool Stripper and Cutter	#6 - #16 AWG, Solid #8 - #18 AWG, Stranded	8½"



Multi-Tool Cable Strippers

Strips, crimps and cuts bolts.

- Crimps terminals.
- Strips 10-22 AWG wire.



Part #	Description	Wire Gauge	Length
GS-366	Multi-tool crimper & stripper	#10 - #22 AWG	9 1/4"

Romex® Strippers

Comparison Chart

Feature	CR-100	CRC-100	CR-1000	GRX-3224
Spring-Action Return				✓
Pliers Nose				✓
Loop Hole				✓
Wire Stripper			✓	✓
Locking Handle				✓
Cutter Blade			✓	✓
Cuts & Rethreads Bolts				✓
Cable Ripping Range	12/2 & 14/2 NM cable	12/2 & 14/2 NM cable	10/2 & 14/2 NM Cable	12/2 & 14/2 NM cable



* See ArmorEDGE® and Circuit Alert® sections for additional Romex® / NM cable strippers.

Dual Romex® Stripper

Strips outer sheath of #12/2 or #14/2 cable in one tool.

- Strips single conductor #12 or #14 AWG.
- Power spring return reduces hand fatigue.
- Curved cutting blade.
- Pliers nose.
- Wire looping hole.
- Cuts and rethreads bolt sizes 6-32 and 8-32.
- Locking handle for compact storage.



Part #	Description	Wire Gauge	Length
GRX-3224	NM Cable Stripper	12/2 & 14/2 NM Cable and #12 AWG and #14 AWG single conductor	7 5/8"

Cable Ripper

Slits outer covering of Romex® (all sizes, both old and new) and other non-metallic (type NM) sheathed cable.

- Wire gauge on handle checks and strips #6 to #14 AWG.
- Nickel-plated finish resists corrosion.

Part #	Description	Wire Gauge	Length
CR-100	Cable Ripper	12/2 & 14/2 NM Cable	4"
CRC-100	Curved Cable Ripper	12/2 & 14/2 NM Cable	4"
CR-1000	Premium Cable Ripper	12/2 & 14/2 NM Cable	4"



1. Rip open cable jacket 2. Cut off cable jacket 3. Strip wire ends

Romex® is a registered trademark of Southwire Company, Carrollton, GA

Datacom Strippers

Comparison Chart

Feature	GTPS-100	GS-359	SE-98	GTPS-3200
Strips RG-58		✓	✓	
Strips RG-59		✓	✓	
Strips RG-6		✓	✓	
Strips CAT 3 Cable	✓			✓
Strips CAT 5 Cable	✓			✓
Strips Flat Telephone Wire				✓
Cutter Blade to Cut Cable		✓		✓

UTP/STP Cable Stripper

Strips UTP and STP cable up to .24" (6.2mm) diameter.

- Tension release lever for easy positioning and release of cable.
- Compact design for easy handling.
- For use on CAT 3 and CAT 5 cable.

Part #	Description	Wire Gauge	Length
GTPS-100	UTP/STP Round Cable Stripper	UTP/STP	3¼"
GTPS-3200	Premium Cable Stripper	UTP, STP, flat, round from 1/8" to 3/8" in diameter and silver satin and other flat cables	4½"



GTPS-100



GTPS-3200

Coaxial Stripper

Cuts and strips RG-59 and RG-6 coaxial cable.

- Can be used with both standard and quad shield cable.
- Multiple size stripping stations strip both the outer jacket and inner conductor.
- Exclusive hex-shaped slot helps push "F" connectors onto cable.
- Curved cutting blade.

Patented



Part #	Description	Wire Gauge	Length
GS-359	Coaxial Stripper	RG-59 & RG-6	6¼"

Coaxial Cutter & Stripper

Cuts and strips coaxial cable (RG-58, RG-59 and RG-6).

- Easily adjusts to various cable thickness.
- One-squeeze cutting action.
- Includes replacement blade model #SERB-25.



Part #	Description	Wire Gauge	Length
SE-98	Coaxial Cable Cutter & Stripper	RG-58, RG-59 & RG-6	4¾"

Punch-Down Tools

High-impact design assures good quality terminations.

- Inserts and cuts cable in termination blocks.
- Constructed of durable ABS resin.
- Impact adjustment with high/low setting accommodates multiple applications.
- Extra blade can be stored in handle.
- Spring-loaded design quickly and easily inserts and trims terminations.
- 110-style blade used in CAT 3 and CAT 5 terminations.
- 66-style blade used to terminate phone wiring.



PDT-110

Part #	Description	Network	Length
PDT-110	Type-110 Terminal Punch-Down Tool with Blade	Data	7½"

Replacement Blades:

Part #	Description
PDB-66110	Type-66 Replacement Blade
PDB-110	Type-110 Replacement Blade



PDB-66110



PDB-110

RJ45/RJ11 Modular Plug Crimp Tool

Used to produce patch cable and handset cables, cut, strip and crimp.

- Heat-treated steel frame provides strength and durability.
- Replacement cutting blade extends the life of the tool.
- Slip-resistant handles.



GMC-1145

Part #	Description	Plugs	Pins
GMC-1145	Telephone Crimp Tool, RJ-11/12 and RJ-45	RJ-11, RJ-12 RJ-45	2, 4, 6 8



Long Nose Pliers

Long Nose Pliers

Multi-function pliers – cuts, strips and crimps.

- Use needle nose to form wire or grip small parts.
- Strips #14 - #16 AWG solid or stranded wire.
- Crimps insulated terminals up to #10 AWG.
- Cutting blade cuts solid or stranded wire.



Part #	Description	Length
GS-385	Long Nose w/ Cutter and Crimper	6½"

Long Nose Pliers with Side Cutter

Long nose design for forming and looping wire and handling small parts.

- Forged from high-carbon steel for durability and strength.
- Knurling on jaws grips work tightly.
- Cutting edges are heat treated to hold their edge.
- Comfort-grip handles.



Part #	Description	Length
GPS-3238	Long Nose Pliers	8½"

Cutting Pliers

Cutting Pliers, Box Joint

Tapered nose allows cutting in tight locations.

- Dual cutting edge and high-leverage handle design for optimal gripping and cutting performance.
- Precision-machined and induction-hardened knives strengthen cutters and provide consistent performance when cutting aluminum, copper and medium-hard steel wire.
- Comfort-grip handles.



GPS-3220



GS-386

Part #	Description	Length
GPS-3220	Cutting Pliers, Box Joint	8"
GS-386	Diagonal Cutting Pliers	6 ¾"

Cutting Pliers, Curved Diagonal

Angled head allows cutting in tight locations.

- Dual cutting edges and high-leverage handle design for optimal gripping and cutting performance.
- Precision-machined and induction-hardened knives strengthen cutters and provide consistent performance when cutting aluminum, copper and medium-hard steel wire.
- Flared handles for added comfort.



Part #	Description	Length
GPS-3228	Cutting Pliers, Curved Diagonal	8"

Linemen's Pliers

Linemen's Pliers

Medium-duty side-cutting pliers.

- Cuts copper or aluminum wire.
- Serrated, square tip jaw for extra grip on bolts.
- Hardened-steel construction for long life.
- Comfort-grip handles.



Part #	Description	Length
GS-387	Linemen's Pliers	7½"

Linemen's Pliers with Fish Tape Puller

Built-in groove designed for gripping and pulling flat fish tape.

- Forged from high-carbon steel for durability and strength.
- Precision-machined and induction-hardened knives strengthen cutters and provide consistent performance when cutting aluminum, copper and medium-hard steel wire.
- Comfort-grip handles.



Built-in groove designed for gripping and pulling flat fish tape

Part #	Description	Length
GPS-3214	Linemen's Pliers w/ Fish Tape Puller	9½"

SEE PG **76** FOR MORE INFO ON **Fish Tapes**

Linemen's Pliers, Round Nose

Standard pliers cut aluminum, copper and medium-hard steel wire.

- Forged from high-carbon steel for durability and strength.
- Dual cutting edges and high-leverage handle design for optimal gripping and cutting performance.
- Precision-machined and induction-hardened knives strengthen cutters and provide consistent performance.
- Comfort-grip handles.



Part #	Description	Length
GPS-3219	Linemen's Pliers, Round Nose	9¼"

Linemen's Pliers with Cutter & Crimper

High-leverage tool with crimping die and side cutters.

- Comfort-grip handles.



Part #	Description	Length
GCP-3400	Linemen's Pliers and Crimping Tool	9½"

Crimping Pliers

8" Crimping Pliers

Crimp insulated or non-insulated terminals.

- Cuts copper and aluminum wire.
- Tapered nose for cutting in tight locations.



Part #	Description	Length
GS-388	Crimping Pliers	8"

BX & Flexible Cable Cutter

Cuts BX, MC, AC, and liquid tight 3/8".

- High durability blade provides 2X normal wear characteristics.
- Includes storage space for replacement blades.
- Pivot shaft is reinforced with high strength steel sleeve.
- 25 foot drop test.
- Thumbwheel for easy blade change, no tooling required.
- Quick-clamp feature automatically adjusts to cable size and secures it for splitting.
- Automatic release ejects cable.
- Cutting depth adjustment ensures clean cuts without nicking cable.



Extra blade storage



Part #	Description	Length
GBX-300	BX Armor Cutter	7 1/4"

Cable Cutter

Cable-cutting tool designed to cut cleanly with high-leverage one-hand operation.

- Cuts soft copper & aluminum cable.



Part #	Description	Cut Size	Length
GC-375	Cable Cutter	2/0	8"

High-Leverage Cutters

Cuts soft copper and aluminum cable up to 1000 MCM.

- Heat-treated alloy steel jaws make fast, sharp cuts.
- Lightweight fiberglass handles on GC-500 and GC-1000 feature comfortable rubber grips.



GC-1000

GC-500

Part #	Description	Cut Size	Length
GC-500	Cable Cutter	500 MCM max	24"
GC-1000	Cable Cutter	1000 MCM max	33"

Ratcheting Cable Cutter

Cut copper and aluminum cable up to 750 MCM.

- Ratcheting mechanism for increased leverage.
- Variable-force cutting action permits choice between high force and speed.
- Dual-action handles cut from either direction; easy to use in tight spots.
- Hardened alloy-steel blades are easily sharpened without removing them from tool.
- Rubber hand grips permit firm grip control.



Part #	Description	Jaw Opening	Length
GRC-750	Ratcheting Cable Cutter	1 9/16"	15 3/4"

Cut-A-Way® PVC Conduit Cutter

Cuts flexible, watertight flexible and schedule 40 PVC conduit 1/2" to 2".

- Design makes fast, clean cuts.
- Tough, lightweight nylon handles.
- Compact 8" tool fits neatly and safely into pocket or tool pouch.



GPC-200



GKC-100A

Part #	Description	Length
GPC-200	Cut-A-Way® PVC Cutter (2")	17"
GKC-100A	Cut-A-Way® PVC Cutter (1")	8"

Insulated Screwdriver Set

Part #	Description	Length	Set Contains:	
			Qty	Description
SCE-3262	Insulated Screwdriver Set, 2 pc.	8"	1	No. 2 Phillips® tip
			1	3/16" Slotted tip



Reversible Insulated Screwdriver

Reversible tip combines two tools into one.

- Molded shaft insulation provides secondary protection against accidental electrical shock.
- Ergonomic grip is engineered for maximum torque with minimum effort.

SEE PG 119 FOR MORE INFO ON Circuit Alert® Screwdrivers



Part #	Description	Reverse from	Reverses to
SCE-3260	Insulated Screwdriver, Reversible tip	No. 2 Phillips®	3/16" Slotted

Triple Tap

Three-in-one tapping tool designed for electrical work.

- Cleans and rethreads holes.
- Made of top-grade steel.

Tap Sizes
 6-32 8-32 10-24



Part #	Description	Length
TT-10B	3 Size Tapping Tool	6 1/8"

Fuse Puller

Part #	Description	Fuse Size	Length
FPE-20	Fuse Puller	0-200A/250V and 0-100A/600V	8"



Electrician's Knife

Two-in-one tool has sharpened blade for skinning wire and screwdriver tip for screws.

- Tempered carbon-steel blades sharpen easily and hold their edge.
- Compact 3¾" size.

Part #	Description
KF-200	Two-in-one Electrician's Knife





Testing equipment can be put to good use ensuring that electrical equipment is properly installed and safe to operate. Faulty installations can be lethal; the condition of electrical installations can be established when contractors use test equipment. Gardner Bender™ is pleased to offer this innovative, full featured line of test equipment designed to make electrical work faster and safer.



page 136

page 137



page 140

page 141

Battery Tester (Analog).....	142	Reference Books	
Continuity Tester		“Wiring Simplified”.....	143
Heavy-Duty.....	135	“Ugly’s Electrical References”.....	143
Multimeters - Analog		“How to Use Your Multimeter”.....	143
Analog Multimeters Comparison Chart....	139	Voltage Testers	
Five Function, 12-Range	139	Voltage Testers Comparison Chart.....	133
Six Function, 14-Range	139	6-way Circuit.....	134
Seven Function, 19-Range	139	Heavy-Duty 3-way	134
Multimeters - Clamp-On		Low Voltage Twin Probe.....	133
Clamp-On Comparison Chart.....	141	Screwdriver, Voltage Probe &	
AC Clamp Meter with Lockjaw.....	141	Continuity Tester.....	134
Auto-Ranging Digital	141	Solenoid	135
Multimeters - Digital		Tester Leads	142
Digital Multimeters Comparison Chart....	140	Tester Replacement Parts	
Three Function, 13-Range	140	(fuses, batteries)	143
Four Function, 14-Range	140		
Seven Function, 7-Range Auto-Ranging	140		
Non-Contact Voltage Testers			
Non-Contact Voltage Testers			
Comparison Chart.....	136		
Circuit Alert®.....	136		
Live-Wire™.....	136		
Receptacle Testers/Analyzers			
Receptacle Testers/Analyzers			
Comparison Chart.....	137		
Lan Tracker™.....	138		
Receptacle Tester & Circuit Analyzer.....	137		
GFCI & Circuit Analyzer.....	137		

Voltage Testers

Selection Chart

Feature	GET-3202	GET-3100	GET-3213	GET-3206	GCV-3206	GVT-392	GCT-3304	GAT-3400	GVD-3504	GVD-3505
Voltage Range										
AC Voltage	5-50V	80-250V	80-300V	120-300V	12-250V	120-480V			50-600V	12-600V
DC Voltage	5-50V	80-250V	80-300V	150-380V	12-250V	120-480V		6-12V		
Functions										
Polarity						✓				
Continuity					✓		✓			
Tracing										
Indication										
Audible									✓	✓
Visual	✓	✓	✓	✓	✓	✓	✓	✓	✓	✓
Vibration						✓				
General										
Lead Length	5.5"	2"	24"	30"	30"	26"	36"	36"		
Pocket Clip	✓	✓	✓		✓		✓	✓	✓	✓
Agency Approvals	(ETL)	(UL)	(ETL)	(ETL)	(ETL)	(ETL)			(ETL)	(ETL)
Drop Rating	6'	6'	6'	6'	6'	6'	6'	6'	6'	6'
Crush Rating	150 lb	150 lb	150 lb	150 lb	150 lb	150 lb	150 lb	150 lb	150 lb	150 lb
CAT Rating	I 50V	II 300V	II 300V				III 600V		III 600V	III 600V
Warranty	1 year	1 year	1 year	1 year	1 year	1 year	1 year	1 year	1 year	1 year

Low Voltage Twin Probe Circuit Tester

Tests AC/DC Voltage from 5 - 50 V AC/DC, 50-60 Hz.

- Indicator glows when voltage is present and brightens as voltage increases.
- Insulated alligator clip test leads.
- Pocket clip for added convenience.
- Dual Insulated, durable ABS housing.

TESTS

- ✓ Low volt outdoor lighting
- ✓ Low volt control panels
- ✓ Doorbells
- ✓ Alarm systems
- ✓ Automotive 12 V DC and 36 V DC

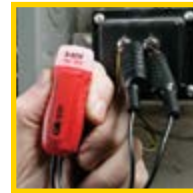

No batteries required

Part #	Description
GET-3202	Low Voltage Twin Probe Circuit Tester



Twin Probe Circuit Tester

Tests AC/DC Voltage from 80-250 V AC/DC.

- Neon indicator glows when voltage is present and brightens as voltage increases.
- Insulated housing.
- Insulated test leads.
- Pocket clip for added convenience.
- 2" test lead.

TESTS

- ✓ DC motors
- ✓ Switches
- ✓ Outlets



No batteries required

Part #	Description
GET-3100	Twin Probe Circuit Tester



Heavy-Duty 3-way Voltage Tester

Tests AC/DC Voltage at 120, 240 and 277 V.

- Individual indicators for each voltage range assures reliability.
- Functional, lightweight design features twin flexible leads and convenient pocket clip.
- 24" test lead.
- Dual insulated, durable ABS housing.

TESTS

- ✓ Outlets
- ✓ Panels
- ✓ Light fixtures
- ✓ Switches
- ✓ Circuit Breakers

Part #	Description
GET-3213	Heavy-Duty 3-way Voltage Tester



6-Way Circuit Tester

Tests AC Voltage at 120, 240, 480 V and DC Voltage at 150, 300 and 500 V.

- 30" test lead.
- Bright neon indicators.
- Rugged twin-probe design features heavy-duty test lead insulators.

TESTS

- ✓ Outlets
- ✓ Light Fixtures
- ✓ Switches
- ✓ Circuit Breakers
- ✓ Motors
- ✓ Appliances
- ✓ Fuses

Part #	Description
GET-3206	6-Way Circuit Tester



Combination Screwdriver, Voltage Probe & Continuity Tester

Tests for Continuity and 12 - 250 AC/DC Voltages.

- LED indicator glows when voltage or continuity exists.
- Operates from (2) LR-44 batteries, included.
- Convenient screwdriver tip and pocket clip.

TESTS

- ✓ Outlets
- ✓ Fuses
- ✓ Switches
- ✓ Extension cords
- ✓ Light fixtures
- ✓ Low Voltage Lighting Circuits

Part #	Description
GCV-3206	Combination Screwdriver, Voltage Probe & Continuity Tester



Solenoid Voltage Tester

Test AC/DC Voltage from 120 - 480 V and DC Polarity.

- Dual voltage indication: solenoid vibration and neon bulb.
- Neon bulb indicates DC polarity.
- Built-in slots in probe housing hold probes for one-hand testing and storage.
- 4' reach from probe to probe with probes unlocked.
- High-impact, dual insulated, case stands up to rugged service.

TESTS

- ✓ Outlets
- ✓ Panels
- ✓ Light fixtures
- ✓ Switches
- ✓ Circuit Breakers
- ✓ Extension Cords



Probes lock together to enable one handed testing of standard outlet

Part #	Description
GVT-392	Solenoid Voltage Tester



Heavy-Duty Continuity Tester

Tests for continuity in non-energized circuits.

- 36" insulated test lead with alligator clip.
- Bright indicator bulb lights if continuity exists.
- Operates from (2) AAA batteries.
- Pocket clip for added convenience.

TESTS

- ✓ Extension cords
- ✓ Fuses
- ✓ Switches
- ✓ Water heater coils
- ✓ Unenergized low voltage wiring



Part #	Description
GCT-3304	Heavy-Duty Continuity Tester



Automotive Voltage Tester

Used to test DC Voltage in automotive applications.

- DC Voltage from 6-12 V.
- Durable ABS Housing w/pocket clip.
- 3' test lead with alligator clamp.
- Pocket clip for added convenience.

TESTS

- ✓ Fuses in junction block
- ✓ Automotive circuits for voltage
- ✓ Back probe connectors & sockets

Part #	Description
GAT-3400	Automotive Voltage Testers



Non-Contact Voltage Testers

Comparison Chart

Feature	GVD-3504	GVD-3505
Detection Range	50-600 V AC	12-600 V AC
Visual	✓	✓
Audible	✓	✓
Adjustable Sensitivity	✓	✓
Pocket Clip	✓	✓
Agency Approvals	(ETL)	(ETL)
Warranty	1 year	1 year
Batteries (included)	1 AAA	(2) Button Cells



Circuit Alert® Non-Contact Voltage Detector

Indicates the presence of AC Voltage from 50 - 600 V.

- Visual (flashing) and audible (beeping) indicators signal presence of voltage.
- Built-in "safe test" feature assures batteries are operating properly.
- Compact design fits in shirt pocket.
- Operates from 1-AAA battery.

TESTS

- ✓ Outlets
- ✓ Switches
- ✓ Circuit breaker panels
- ✓ Wiring
- ✓ Light fixtures



Patented

Part #	Description
GVD-3504	Circuit Alert™ Non-Contact Voltage Detector



Live-Wire™

Adjustable sensitivity detects the presence of AC Voltage from 12 - 600 V without contacting wires.

- Visual (flashing) and audible (beeping) indicators signal presence of voltage.
- Adjustable sensing levels.
- Built-in "safe test" feature assures batteries are operating properly.
- Operates from 2-LR44 1.5 Volt batteries (included).

TESTS

- ✓ Doorbells
- ✓ Low voltage lighting
- ✓ Outlets
- ✓ Switches
- ✓ Electrical panels
- ✓ Light fixtures



Patented

Part #	Description
GVD-3505	Live-Wire™



Receptacle Testers / Analyzers

Comparison Chart

Tests for:	GRT-3500	GFI-3501
Open Ground	✓	✓
Open Neutral	✓	✓
Open Hot	✓	✓
Hot / Ground Reversed	✓	✓
Hot / Neutral Reversed	✓	✓
Correct Wiring	✓	✓
GFCI Test Function		✓
Agency Approvals	ETL	ETL
Warranty	1 year	1 year

Receptacle Tester & Circuit Analyzer

Tests standard receptacles to ensure proper wiring.

- Neon indicators give positive indication of circuit status.
- Compact unit simply plugs into any standard 3-wire/grounded receptacle (110 - 125 V AC circuits).
- Tests for six circuit conditions: open ground, open neutral, open hot, hot/ground reverse, hot/neutral reverse, and correct wiring.
- Succession of yellow and red lights provides indication of circuit status or specifies wiring errors.
- Easy-to-read three views – top, side and bottom.

TESTS

- ✓ Standard outlets
- ✓ Extension cords



Tests standard outlets

Part #	Description
GRT-3500	Receptacle Tester & Circuit Analyzer

One Year
 Warranty



Ground Fault Receptacle Tester & Circuit Analyzer

Tests ground fault receptacles by overloading circuit and tripping GFCI.

- Easy to use. Simply plug tester into any circuit protected by a ground fault receptacle (110 - 125 V AC) and press black button to overload circuit.
- Tests for seven conditions: ground fault interruption, open ground, open neutral, open hot, hot/ground reverse, hot/neutral reverse, and correct wiring.
- Succession of yellow and red lights provides indication of circuit status or specifies wiring errors.
- Tester trips GFCI between 6 - 9 mA.

TESTS

- ✓ Standard outlets
- ✓ GFCI outlets
- ✓ Extension cords



Tests standard outlets



Tests outlets protected by GFCIs

Part #	Description
GFI-3501	Ground Fault Receptacle Tester & Circuit Analyzer

One Year
 Warranty



NEW Wireless Inspection Camera

See behind walls, through pipes, and into ductwork to inspect wiring, appliances, and infrastructure in the safest, quickest and most cost-effective manner possible with the WiFi Inspection Camera. This value priced device features a water-resistant and non-conductive (up to 500 volts), 3ft flexible tube with a dustproof/water-resistant 9mm camera and adjustable LED lighting at the tip allowing the user to view into spaces they cannot reach due to structural obstructions (like the inside of a wall or above a ceiling). The device creates and utilizes its own private WiFi network — no need for a modem or internet connection — to transmit images from the camera to any iOS™ or Android™ enabled smart device via a free downloadable app. The resulting images are projected in full color and can be captured as still images or video for sending to other devices or people via email. Powered by 4 AA batteries (not included) so you never need to wait to recharge or figure out how to dispose of and/or replace expensive lithium ion batteries.

- Creates its own WiFi signal to connect to user's smart-phone or tablet using the free application available for iOS™ or Android™ devices – NO INTERNET NEEDED!
- Water-resistant 3 ft flexible camera shaft is non-conductive up to 500 volts.
- Capture live full color video and/or E-mail video or pictures directly from app.
- Lens mounted LEDs with adjustable brightness.
- Transmits up to 30ft.
- Only takes 4 AA batteries (not included).

Part #	Description
WIC-100	Wireless Inspection Camera

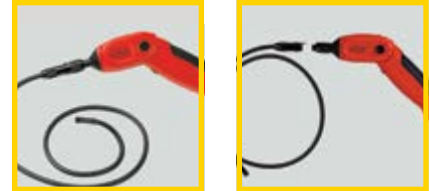

Key Features:

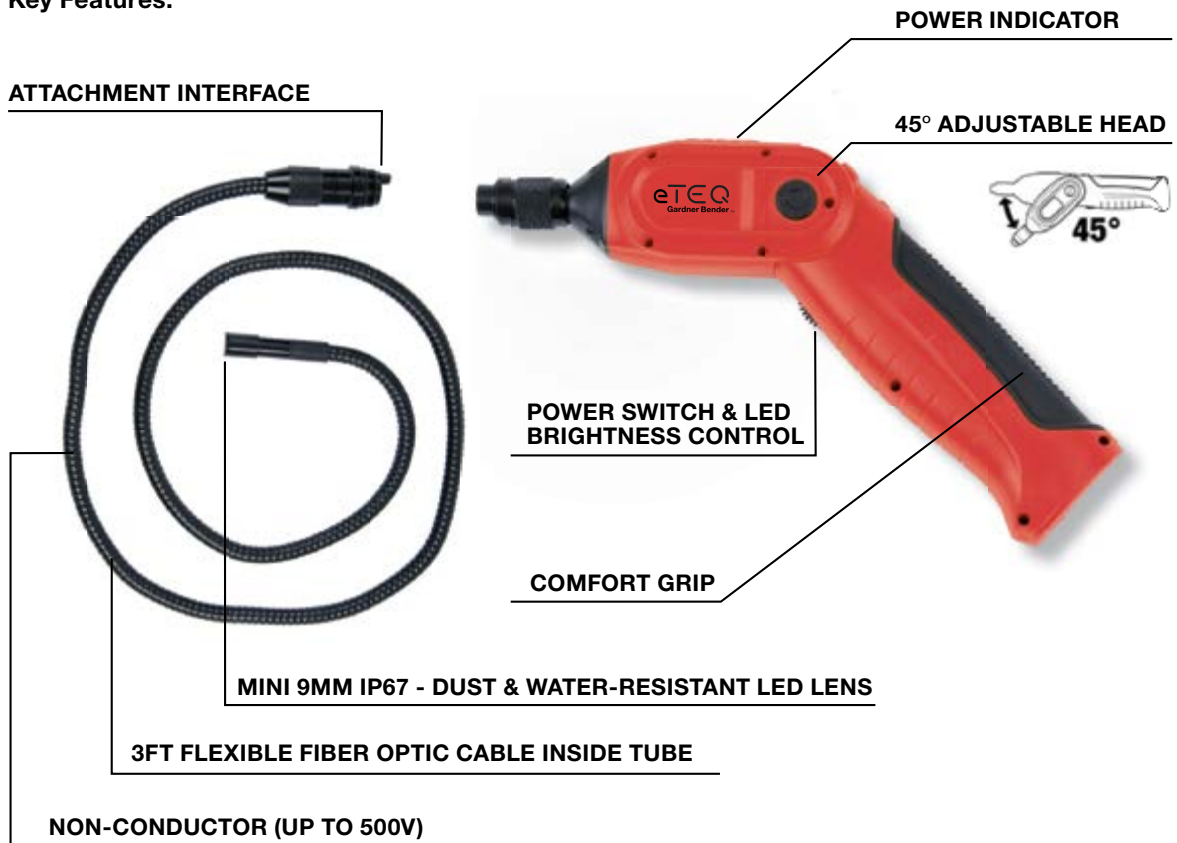

Water-resistant



Transmits up to 30 ft



Still image & video



iOS™ & Android™



FREE APP

Analog Multimeters

Full family of analog multimeters test AC Voltage, DC Voltage, DC Current, Resistance, Continuity, and batteries.

- Manual range selection.
- Easy to read, color-coded analog displays.
- All testers include test leads and operating instructions.
- All are Agency approved and incorporate fuse overload protection circuitry.



GMT-312



GMT-318



GMT-319



Feature	GMT-312	GMT-318	GMT-319
Voltage Range			
AC Voltage	300V	500V	1000V
DC Voltage	300V	500V	1000V
Current Range			
AC Current			
DC Current	250 mA	250 mA	10 A
Functions			
Resistance	1 Meg	50K	10 Meg
Decibels (on AC voltage ranges)	-20 to +56dB	-20 to +56dB	-8 to +62dB
Continuity (Audible)			✓
Battery Testing	Internal	✓ 1.5 & 9V	✓ 1.5 & 9V
Specifications			
Manual Range Selection	✓	✓	✓
Total Functions	5	6	7
Total Ranges	12	14	19
Fuse	250 mA	250 mA	500 mA & 10A
Accuracy	±5%	±4%	±4%
General			
Agency Approval	ETL CE	ETL CE	ETL CE
CAT Rating	II 300V	II 500V	II 1000V
Warranty	1 year	1 year	1 year

Digital Multimeters

Full family of digital multimeters test AC Voltage, DC Voltage, Resistance, Continuity, Temperature, Diodes, and Batteries.

- Manual and auto ranging styles.
- Easy to read digital displays.
- All testers include test leads and operating instructions.
- Conforms to UL 61010-1 standards and certified to CAN/CSA C22.2.



Circuit Breakers



Batteries



Back-Lit Display



Magnetic Attachment

GDT-311



GDT-3190



GDT-3200



Feature	GDT-311	GDT-3190	GDT-3200
Voltage Range			
AC Voltage	500V	500V	500V
DC Voltage	600V	600V	600V
Functions			
Resistance	2 meg Ω	2 meg Ω	20 meg Ω
Diode Test			✓
Continuity (Audible)			✓
Temperature (Probe type)			✓ -40 to 1832°F
Battery Testing		✓ 1.5 & 9V	✓ 1.5V
Specifications			
Manual or Auto Ranging	Manual	Manual	Auto
Total Functions	3	4	7
Total Ranges	13	14	7
Display Count	2000	2000	2000
Low Battery Indicator	✓	✓	✓
Auto Off		✓	✓
Rubber Boot		✓	✓
Magnet Strap			✓
Backlit LCD			✓
General			
Agency Approval	ETL CE	ETL CE	ETL CE
Drop Rating	3'	6'	6'
Crush Rating	150 lb	150 lb	150 lb
CAT Rating	III 600V	III 600V	III 600V
Warranty	1 year	1 year	1 year

Clamp-On Multimeters

Gardner Bender™ clamp meters test AC Current, AC Voltage, DC Voltage, Resistance and Continuity.

- Manual and autoranging styles.
- Easy-to-read displays.
- All testers include test leads and operating instructions.

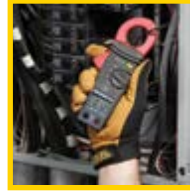

Current (GCM-221)



Voltage (GCM-221)

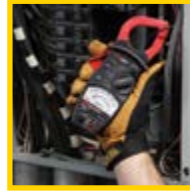

Current (GCM-500)

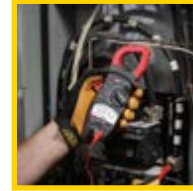

Voltage (GCM-500)



Feature	GCM-500	GCM-221
Voltage Range		
AC Voltage	600V	600V
DC Voltage	60V	
Current Range		
AC Current	600A	600A
Functions		
Resistance	1000 Ω	200 Ω
Continuity		✓
Audible Buzzer		✓
Specifications		
Manual or Auto Ranging	Manual	Auto
Total Functions	4	3
Total Ranges	8	3
Display Count		1000
Data Hold	✓	✓
Jaw Size	1/2"	1/4"
Fuse	500 mA	
Accuracy	±5%	AC V: ±1.5% AC A: ±2.0% Ω : ±1.0%
General		
Agency Approval	(ETL)	CE
Drop Rating	3'	6'
Crush Rating	150 lb	150 lb
CAT Rating		II 600V, III 300V
Warranty	1 year	1 year

Analog Battery Tester

Tests all common batteries to determine if they are charged or need replacement.

- Tests from 1.5 V button cells to 22.5 V photo cells.
- Includes test leads for easy testing.

TESTS

- ✓ AA, AAA, C, D, N
- ✓ 1.5 V button cells
- ✓ 1.25 V Ni-Cad rechargeable
- ✓ 3 V lithium
- ✓ 22.5 V photo & lantern cells
- ✓ 6 V lantern
- ✓ 12 V, 15 V Photo cells
- ✓ 9 Volt

Part #	Description
GBT-500A	Analog Battery Tester



One Year
Warranty

Analog Battery Tester

Tests most common household battery types to determine existing charge.

- Moveable contact arm fits multiple battery sizes.
- Simple "Low/Good" indicator.

TESTS

- ✓ AA
- ✓ AAA
- ✓ C
- ✓ D
- ✓ 9 V
- ✓ 1.5 V button cells
- ✓ N

Part #	Description
GBT-3502	Analog Battery Tester



Movable contact arm fits multiple battery sizes

One Year
Warranty

Test Leads

Replacement leads for Gardner Bender™ meters.

- Tough ABS construction.
- Flexible cords for easy use.

Part #	Description	Models
RTL-103	Small Test Leads	GDT-11, GDT-190
RTL-107	Push-on Alligator Clips	RTL-103, RTL-108, RTL-200
RTL-108	Mid-size Test Leads	GMT-312, GMT-318
RTL-200	Large Test Leads	GDT-292A, GDT-293A, GDT-294A, GDT-295A, GCM-500, GCM-221



RTL-103



RTL-107



RTL-200



RTL-108

Replacement Parts and Accessories

Test Instruments

Model	FUSES					Batteries
	10A/250V	0.5A/250V	2.0A/250V	0.2A/250V	0.25A/250V	
Analog Multimeters						
GMT-312		✓				(1) AA
GMT-318		✓				(1) AA
GMT-319		✓				(2) AAA
Digital Multimeters						
GDT-311						(1) 9 Volt
GDT-3190			✓			(1) 9 Volt
GDT-3200			✓			(1) 9 Volt
Clamp Meters						
GCM-221				✓	✓	(2) AAA
GCM-500	✓					(1) AA
Probe Testers						
GAT-3400					✓	
GBT-500A	✓					
GBT-3502	✓				✓	
GCT-3304						(2) AAA
GCV-3206						(2) LR44
GET-3100						
GET-3202						
GET-3206						
GET-3213						
GVD-3504						(1) AAA
GVD-3505						(2) 1.5 V LR44
GVT-392						

Electrical Reference Books

Reference books that outline safe wiring recommendations based on the National Electric Code.

Part #	Pkg Qty	Description
ERB-UG	1	<i>Ugly's Electrical References - Revised 2011 Edition.</i> A quick, on-the-job reference guide for the most commonly required information in an easy-to-read format.
ERB-WS	1	<i>Wiring Simplified 43rd Edition</i> A comprehensive book that translates the NEC rules into easy-to-understand explanations on how to complete safe wiring installs in homes.
GMT-BK	1	<i>Multimeter Handbook</i> Make measurements and solve electrical problems around the home, in the workshop, at the office, and on the job.



NOTES



Cable Ties

Gardner Bender™ offers a broad range of cable ties in a wide variety of materials, color, style and size options to meet your specific needs. A patented design and high quality construction make Gardner Bender™ ties a great solution for bundling wire, cable, hoses, ducts and in countless other applications.



page 151



page 147



page 151



page 151

Cable Ties	
Colored	150
Grip-Strip™ Hook-and-Loop Fasteners	151
Heavy Duty (Natural & Ultraviolet Black).....	148
Miniature (Natural & Ultraviolet Black).....	147
Releasable (Natural & Ultraviolet Black).....	149
Standard (Natural & Ultraviolet Black).....	147
Mounting Bases and Ties	
(Natural & Ultraviolet Black).....	149, 151
Tensioning Tools	151
Bundle Boss	151



INNOVATION



Miniature & Standard Cable Ties

Gardner Bender offers a broad range of cable ties, great for bundling wire, cable, hoses, ducts and countless other applications.

- Made from durable nylon 6/6 material.
- Black ties contain UVB - Ultra Violet Black
- Serviceable through temperatures 0 to 85 °C (32 to 185 °F).
- UL recognized component listing E125869.
- Meets UL 94 V-2 flammability classification.
- Patented DoubleLock® design has teeth on both sides of the tie, ensuring 50% greater strength than industry standards.

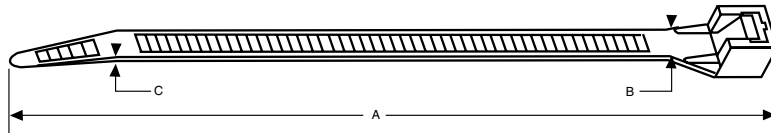

Miniature

Length A	Part #	Pkg Qty	DoubleLock®	Tensile Strength	Width B	Thickness C	Bundle Dia. Max.	UL	Color
4"	45-104	40/bag	—	18 lb	0.095"	0.035"	13/16"	UR	Natural
	46-104	100/bag	—	18 lb	0.095"	0.035"	13/16"	UR	Natural
	46-104MN	1,000/bag	—	18 lb	0.095"	0.035"	13/16"	UR	Natural
	45-104UVB	30/bag	—	18 lb	0.095"	0.035"	13/16"	UR	Black
	46-104UVB	100/bag	—	18 lb	0.095"	0.035"	13/16"	UR	Black
	46-104UVBMN	1,000/bag	—	18 lb	0.095"	0.035"	13/16"	UR	Black

Standard

Length A	Part #	Pkg Qty	DoubleLock®	Tensile Strength	Width B	Thickness C	Bundle Dia. Max.	UL	Color
6"	46-206	100/bag	✓	45 lb	0.13"	0.055"	13/8"	—	Natural
	46-206M	1,000/bag	—	45 lb	0.13"	0.055"	13/8"	—	Natural
	46-206UVB	100/bag	✓	45 lb	0.13"	0.055"	13/8"	—	Black
8"	45-308	20/bag	✓	75 lb	0.17"	0.055"	2"	UR	Natural
	46-308	100/bag	✓	75 lb	0.17"	0.055"	2"	UR	Natural
	46-308MN	1,000/bag	✓	75 lb	0.17"	0.055"	2"	UR	Natural
	46-507N	500/bag	✓	75 lb	0.17"	0.055"	2"	UR	Natural
	45-308UVB	15/bag	✓	75 lb	0.17"	0.055"	2"	UR	Black
	46-308UVB	100/bag	✓	75 lb	0.17"	0.055"	2"	UR	Black
	46-308UVBMN	1,000/bag	✓	75 lb	0.17"	0.055"	2"	UR	Black
11"	45-312	12/bag	✓	75 lb	0.17"	0.055"	3"	UR	Natural
	46-310	100/bag	✓	75 lb	0.17"	0.055"	3"	UR	Natural
	46-310M	1,000/bag	✓	75 lb	0.17"	0.055"	3"	UR	Natural
	46-311	300/bag	✓	75 lb	0.17"	0.055"	3"	UR	Natural
	46-210	100/bag	✓	45 lb	0.13"	0.055"	3"	—	Natural
	45-312UVB	8/bag	✓	75 lb	0.17"	0.055"	3"	UR	Black
	46-210UVB	100/bag	✓	45 lb	0.13"	0.055"	3"	—	Black
	46-310UVB	100/bag	✓	75 lb	0.17"	0.055"	3"	UR	Black
46-310UVBM	1,000/bag	✓	75 lb	0.17"	0.055"	3"	UR	Black	
14"	45-315	8/bag	✓	75 lb	0.17"	0.055"	4"	UR	Natural
	46-315	100/bag	✓	75 lb	0.17"	0.055"	4"	UR	Natural
	46-315M	1,000/bag	✓	75 lb	0.17"	0.055"	4"	UR	Natural
	45-315UVB	8/bag	✓	75 lb	0.17"	0.055"	4"	UR	Black
	46-315UVB	100/bag	✓	75 lb	0.17"	0.055"	4"	UR	Black
	46-315UVBM	1,000/bag	✓	75 lb	0.17"	0.055"	4"	UR	Black



Heavy-Duty Cable Ties

Heavy-duty design offers 120 and 175 lbs of tensile strength.

- Patented DoubleLock® design (on 120 lb) ensures 50% greater tensile strength.
- Ultraviolet black (UVB) ties resist harmful light rays – primarily for outdoor use.

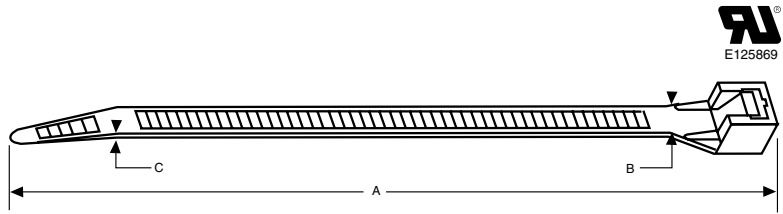

Length A	Part #	Pkg Qty	DoubleLock®	Tensile Strength	Width B	Thickness C	Bundle Dia. Max.	UL	Color
8"	46-408	100/bag	✓	120 lb	0.25"	.072"	2"	UR	Natural
	46-408UVB	100/bag	✓	120 lb	0.25"	.072"	2"	UR	Black
12"	46-412	100/bag	✓	120 lb	0.25"	.072"	3"	UR	Natural
	46-412UVB	100/bag	✓	120 lb	0.25"	.072"	3"	UR	Black
15"	45-515	10/bag	✓	120 lb	0.25"	.072"	4"	UR	Natural
	46-415	50/bag	✓	120 lb	0.25"	.072"	4"	UR	Natural
	45-515UVB	10/bag	✓	120 lb	0.25"	.072"	4"	UR	Black
	46-415UVB	50/bag	✓	120 lb	0.25"	.072"	4"	UR	Black
17"	45-518N	10/bag	—	175 lb	0.35"	.07"	4.90"	UR	Natural
	46-418	50/bag	—	175 lb	0.35"	.07"	4.90"	UR	Natural
	45-518UVBN	10/bag	—	175 lb	0.35"	.07"	4.90"	UR	Black
	46-418UVB	50/bag	—	175 lb	0.35"	.07"	4.90"	UR	Black
21"	45-521	10/bag	—	175 lb	0.35"	.07"	5.5"	UR	Natural
	46-421	50/bag	—	175 lb	0.35"	.07"	5.51"	UR	Natural
	45-521UVB	10/bag	—	175 lb	0.35"	.07"	5.51"	UR	Black
	46-421UVB	50/bag	—	175 lb	0.35"	.07"	5.5"	UR	Black
24"	45-524	10/bag	—	175 lb	0.35"	.07"	7"	UR	Natural
	46-424	50/bag	—	175 lb	0.35"	.07"	7"	UR	Natural
	45-524UVB	10/bag	—	175 lb	0.35"	.07"	7"	UR	Black
	46-424UVB	50/bag	—	175 lb	0.35"	.07"	7"	UR	Black
30"	46-330	25/bag	—	175 lb	0.35"	.07"	9"	UR	Natural
	46-330UVB	25/bag	—	175 lb	0.35"	.07"	9"	UR	Black
36"	45-536	10/bag	—	175 lb	0.35"	.07"	10.30"	UR	Natural
	46-436	50/bag	—	175 lb	0.35"	.07"	10.30"	UR	Natural
	45-536UVB	10/bag	—	175 lb	0.35"	.07"	10.30"	UR	Black
	46-436UVB	50/bag	—	175 lb	0.35"	.07"	10.30"	UR	Black
48"	45-548	10/bag	—	175 lb	0.35"	.07"	14.30"	UR	Natural
	46-448	50/bag	—	175 lb	0.35"	.07"	14.30"	UR	Natural
	45-548UVB	10/bag	—	175 lb	0.35"	.07"	14.30"	UR	Black
	46-448UVB	50/bag	—	175 lb	0.35"	.07"	14.30"	UR	Black

Releasable Cable Ties

Temporarily fastens wires, cables and hoses.

- Extended releasable tab in the head makes for easy release and reusability.
- Great for temporary work or where frequent servicing is required.
- Ultraviolet black (UVB) ties resist harmful light rays – primarily for outdoor use.

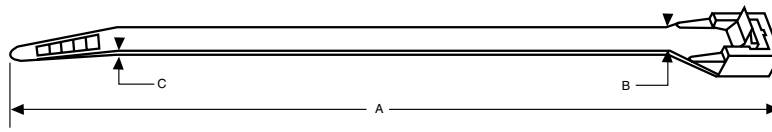
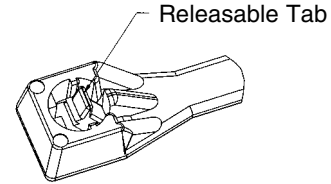

Length A	Part #	Pkg Qty	DoubleLock®	Tensile Strength	Width B	Thickness C	Bundle Dia. Max.	UL	Color
8"	47-108	25/bag	—	50 lb	0.17"	0.05"	1.75"	UR	Natural
	47-108UVB	25/bag	—	50 lb	0.17"	0.05"	1.75"	UR	Black
16"	47-115UVB	4/bag	—	175 lb	0.52"	0.09"	4"	UR	Black
22"	47-121UVB	3/bag	—	175 lb	0.52"	0.09"	6"	UR	Black
28"	47-127UVB	3/bag	—	175 lb	0.52"	0.09"	8"	UR	Black

Mounting Cable Ties

Secures bundles to walls, studs or other surfaces easily.

- Accepts #10 screws.
- Ultraviolet black (UVB) ties resist harmful light rays – primarily for outdoor use.

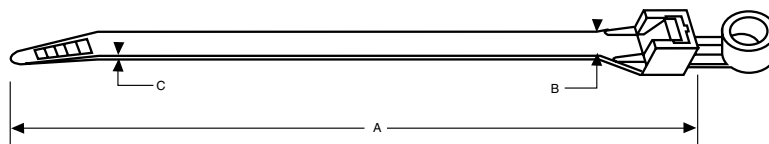

Length A	Part #	Pkg Qty	DoubleLock®	Tensile Strength	Width B	Thickness C	Bundle Dia. Max.	UL	Color
8"	45-308MT	20/bag	—	50 lb	0.17"	0.055"	2"	UR	Natural
	48-308	100/bag	—	50 lb	0.17"	0.050"	2"	UR	Natural
	45-308MTUVB	15/bag	—	50 lb	0.17"	0.055"	2"	UR	Black
	48-308UVB	100/bag	—	50 lb	0.17"	0.055"	2"	UR	Black
	45-308MTG	15/bag	—	50 lb	0.17"	0.055"	2"	UR	Gray

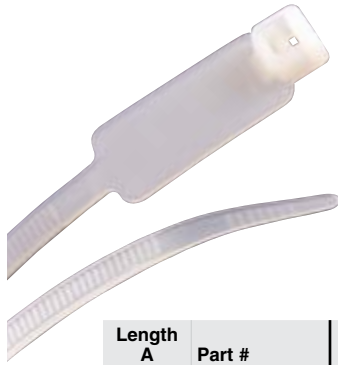

ID Cable Ties

- ID tab allows for easy identification.
- For indoor use.

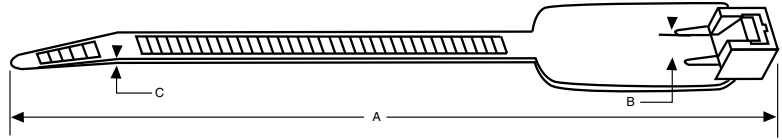

Length A	Part #	Pkg Qty	DoubleLock®	Tensile Strength	Width B	Thickness C	Bundle Dia. Max.	UL	Color
8"	45-308ID	25/bag	—	50 lb	0.17"	0.05"	2"	—	Natural



Colored Cable Ties

Colored cable ties fasten wire for easy bundle identification.

- Patented DoubleLock® design ensures 50% more tensile strength than industry standards.
- Flexible nylon material allows cable ties to remain serviceable through temperature ranges of -40 to 185 °F (-40 to 85 °C).
- Recognized under component program of UL, E125869.
- Meets flammability classification UL 94 V-2.

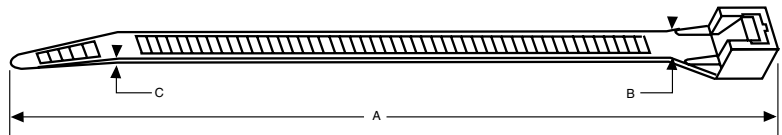

Length A	Part #	Pkg Qty	DoubleLock®	Tensile Strength	Width B	Thickness C	Bundle Dia. Max.	UL	Color
8"	45-308FB	20/bag	✓	75 lb	0.17"	0.055"	2"	UR	Flr Blue
	45-308FG	20/bag	✓	75 lb	0.17"	0.055"	2"	UR	Flr Green
	45-308FY	20/bag	✓	75 lb	0.17"	0.055"	2"	UR	Flr Yellow
	45-308G	20/bag	✓	75 lb	0.17"	0.055"	2"	UR	Green
	46-308G	100/bag	✓	75 lb	0.17"	0.055"	2"	UR	Green
	46-308FST	100/bag	✓	75 lb	0.17"	0.055"	2"	UR	Asst.
	46-ACL	120/bag	✓	75 lb	0.17"	0.055"	2"	UR	Asst.
	46-ACT	100/bag	✓	75 lb	0.17"	0.055"	2"	UR	Asst.



Stainless Steel Cable Ties

- 304 Stainless Steel design for harsh, corrosive, and salt-water environments.
- Resists chemicals and radiation exposure as well as enduring extreme temperatures.
- Stainless steel is great for clean environments such as food processing areas.
- Self-locking ball mechanism meets low insertion force requirements while maintaining high tensile strength.

Length	Part #	Pkg Qty	Tensile Strength	Bundle Dia. Max
6"	45-306SS	10/bag	100 lb	1.5"
11"	45-312SS	10/bag	100 lb	3.75"



Metal Pawl Ties

- Metal Pawl ensures a firm and lasting closure.
- Strong pawl design for infinite locking points on the body of the tie.
- Made from durable Nylon 6/6.
- Smooth notchless outside reduces stress under tension.

Length	Part #	Pkg Qty	DoubleLock®	Tensile Strength	UL	Color
7"	46-308MP	20/bag	—	50 lb	—	Natural
	46-308UVBMP	20/bag	—	50 lb	—	Black
11"	46-310MP	10/bag	—	50 lb	—	Natural
	46-310UVBMP	10/bag	—	50 lb	—	Black



Mounting Bases

- Adhesive-backed mounting bases for securing wire and cable bundles.
- Center screw hole for extra holding power.
- Molded with durable nylon 6/6 material.
- Four-sided insertion design for mounting flexibility.

Part #	Pkg Qty	Size	Fits Widths	UR	Recommended Cable Ties	Color
45-MB	5/bag	1" x 1"	.10" - .17"	UR	18 lbs to 75 lbs	Natural
45-MBUVB	5/bag	1" x 1"	.10" - .17"	UR	18 lbs to 75 lbs	Black
MB-20	100/bag	1" x 1"	.10" - .17"	UR	18 lbs to 75 lbs	Natural
MB-20UVB	100/bag	1" x 1"	.10" - .17"	UR	18 lbs to 75 lbs	Black



Grip-Strip™ Hook-and-Loop Fasteners

- Reusable strip fastens wires and cables.
- Wrap excess around bundle – no waste.
- Great for home/office, tools and electronics.
- Cinch tab allows attachment to cable or cord.

Length	Part #	Pkg Qty	Color
8"	45-V8BKV	5/bag	Black
	45-V15FBK	50/bag	Black
11"	45-V11BKW	5/bag	Black



Economy Cable Tie Tensioning Tool

Tightens and cuts off cable ties.

- Quick twist snaps off excess length.
- Use for all cable ties up to 75 lbs tensile strength.
- Lightweight, economical.

Part #	Description
CTT-45	Economy Cable Tie Tensioning Tool

NEW Bundle Boss

The Bundle Boss can handle small sizes up to 45" without all the wasted cable tie material. The Bundle Boss saves time and space-allowing you to use one tool instead of carrying multiple sizes of cable ties.

- Bundling data cables
- Electrical cords
- Industrial applications



Part #	Pkg Qty	Description	Color
BB-K01	4/pcs	Cable Tie Bundler Tool, 39.4' cable, 4 replacement Cartridges	Natural
BB-B01	1/pc	39.4' Spool of Replacement Cable	Natural
BB-C01	1/pc	Replacement Clip Cartridge	Natural
BB-B01UVB	1/pc	39.4' Spool of Replacement Cable	Black
BB-C01UVB	1/pc	Replacement Clip Cartridge	Black

NEW Flex Strap

Cable Wraptor® Flexible Straps offer a reusable, versatile, lightweight organizational solution without a wasted "tail". Just wrap, tighten, then cut and wrap again! Stretchable, flexible material won't damage delicate cables and cords.

- Re-usable. Thread the tail backward through the last slot used, and pull to release the strap.
- 12" long strap with finger grips on the end and tail.
- Malleable material will stretch up to 300%.
- Thread 2 slots for a stronger hold on bundle.
- Interlinkable - thread multiple straps together for greater lengths.

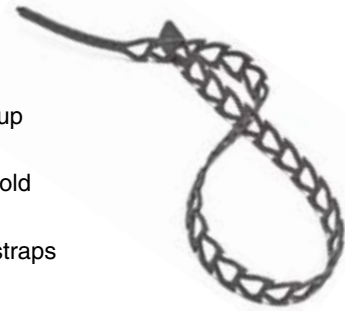

Length	Part #	Pkg Qty	Tensile Strength	Description	Bundle Dia. Min.	Bundle Dia. Max.	Color
12"	45-812UVB	10/bag	20 lb	Flexstrap	0.25"	3¼"	Black
	45-824UVB	24/bag	20 lb	Flexstrap	0.25"	3¼"	Black
	45-812GN	12/bag	20 lb	Flexstrap	0.25"	3¼"	Green
	45-824GN	24/bag	20 lb	Flexstrap	0.25"	3¼"	Green
	45-812N	12/bag	20 lb	Flexstrap	0.25"	3¼"	Natural
	45-824N	24/bag	20 lb	Flexstrap	0.25"	3¼"	Natural



NEW Xtreme Ties

Xtreme Ties save the day in harsh environment applications. Specifically designed to perform under intense UV and cold weather conditions.

- Enhanced UV protection.
- UL Listed for indoor and outdoor applications from -4°F - 185°F (-20°C - 85°C). UL Type 21.

Engineered from improved Nylon 66 - ISO certified to maintain its properties to -40°F/C.

Length	Part #	Pkg Qty	Tensile Strength	Description	Bundle Dia. Max.	Color
8"	45-308UVBFZ	20	50 lb	Flexstrap	2"	Black
11"	45-311UVBFZ	20	50 lb	Flexstrap	3"	Black
14"	45-314UVBFZ	20	50 lb	Flexstrap	4"	Black
8"	46-308UVBFZ	100	50 lb	Flexstrap	2"	Black
11"	46-311UVBFZ	100	50 lb	Flexstrap	3"	Black
14"	46-314UVBFZ	100	50 lb	Flexstrap	4"	Black



NEW Beadle Wraps™

Finally, a re-usable cable tie that offers the heavy duty tensile strength you need. Easier than a twist tie, more versatile than a cable tie, and stronger than hook and loop fasteners.

- Releaseable: Use & re-use. Beads lock and release through key-hole slots.
- Heavy Duty: 70 lb and 140 lb tensile strength.
- Adjustable: Bundle capacities from ¼" to 7" diameters or string together for greater capacity.
- Secure: Bundle and secure with double lock through 2 convenient keyhole slots to bind, hook, and secure.
- Flexible: Bundle and create a loop to hang.

Length A	Part #	Pkg Qty	Tensile Strength	Description	Color
8"	45-8BEADGN	15/bag	70lb	Cable Tie, Beaded	Green
	45-8BEADYW	15/bag	70lb	Cable Tie, Beaded	Yellow
	46-8BEADBK	40/bag	70lb	Cable Tie, Beaded	Black
	45-8BEADBK	15/bag	70lb	Cable Tie, Beaded	Black
12"	45-12BEADGN	15/bag	70lb	Cable Tie, Beaded	Green
	45-12BEADYW	15/bag	70lb	Cable Tie, Beaded	Yellow
	45-12BEADBK	15/bag	70lb	Cable Tie, Beaded	Black
	46-12BEADBK	40/bag	70lb	Cable Tie, Beaded	Black
18"	45-18BEADGN	10/bag	140lb	Cable Tie, Beaded	Green
	45-18BEADYW	10/bag	140lb	Cable Tie, Beaded	Yellow
	45-18BEADBK	10/bag	140lb	Cable Tie, Beaded	Black
	46-18BEADBK	25/bag	140lb	Cable Tie, Beaded	Black
24"	45-24BEADYW	5/bag	140lb	Cable Tie, Beaded	Yellow
	45-24BEADBK	5/bag	140lb	Cable Tie, Beaded	Black
	46-24BEADBK	20/bag	140lb	Cable Tie, Beaded	Black





Staples

Gardner Bender™ provides a complete line of staple and fastening solutions for all industries, including industrial, residential, construction, or manufacturing. From low voltage wire to service entrance cables, professionals rely on Gardner Bender™ for quality fastening products.



page 156



page 158



page 158



page 157

Category 3 & 5 Data Staples.....	159
Coaxial Cable Staples.....	159
Conduit Straps.....	158
Fiber-Insulated Staples	160
Insulated Metal Staples.....	156
Low Voltage Wire Staples.....	158, 160
Masonry Staples	159, 160
Metal Staples	156
MultiCable Staples	157
Plastic Staples	157
Roofing Staples	160
Service Entrance Staples	157
Service Entrance Straps.....	158
Staple Gun	155



INNOVATION

Cable Boss® Staple Gun

- Secures 120V & low-volt cable: Romex®, Coaxial & CAT 5 from the same tool.
- Comfort grip areas for 2-handed operation.
- Easy trigger force.
- Ergonomic handle.
- Secures round and flat cable.
- 3 sizes covering: NM, Coax, Voice/Data, Low Volt.
- Requires 55 lbs of pressure.

Patented



Reversible cable guide for easy cable stapling change over



Part #	Pkg Qty
MSG-501	1/clam



Size	Part #	Pkg Qty	Color	Application
5/16"	MPS-2080	250/box	Blue	Voice/Data: CAT 5e Speaker Wire: 16/2, 16/4, 12/2 (standard and in-wall styles) Security Wire: 18/4
3/8"	MPS-2100	200/box	White	Coax: RG-6 Voice/Data: CAT 6 NM Cable: 14/2, 14/3, 12/2
1/2"	MPS-2125	200/box	Black	Coax: RG-6 Quad Shield NM Cable: 10/2, 12/3 Structured Cabling: Siamese CAT 5e, Siamese CAT 5e and 16/4 Speaker wire



Low-Volt Staple Gun

- Heavy-duty stainless steel design.
- Safety handle for compact storage.
- Staples cover wide range of wire applications.
- Easy loading.



Part #	Pkg Qty
MSG-301	1/clam



Size	Part #	Pkg Qty	Application
5/32"	MMS-3101	625/box	Use with alarm, bell, intercom, security, speaker, and thermostat wires
1/4"	MMS-3102	625/box	Use with television, CAT 5e, CAT 6, RG-59, and computer wires

IMPROVED Metal Staples

Secures Romex® wire and other types of non-metallic (NM) cable.

- Recessed head drives faster and protects cable insulation.
- Pointed legs drive in straight; will not split wood.
- Preferred length.
- Virtually "Oil-Free" for cleaner handling.
- Sharper tips for easy starting.



Dims W x L	Part #	Pkg Qty	Application
1/2"	MS-1550T	24/card	14/2, 12/2, 10/2
	MS-1555	50/card	
	MS-150	100/box	
	MS-500J	500/jar	
	MS-550	500/box	
	MS-950B	5,000/bucket	
	MS-950BU	10,000/bucket	

Dims W x L	Part #	Pkg Qty	Conductor
9/16"	MS-1575T	18/card	14/3, 12/3, 10/3
	MS-1577	50/card	
	MS-175	100/box	
	MS-450J	450/jar	
	MS-575	500/box	
	MS-975B	5,000/bucket	

Insulated Metal Staples

Secures and protects non-metallic (NM), BX, MC, AC and UF cable.

- Insulator made from durable polyethylene.
- Plastic insulator protects cables and helps prevent arc faults.



Dims W x L	Part #	Pkg Qty	Application
1/2"	MSI-1525T	15/card	14/2 & 12/2 cable
	MSI-50B	50/bag	
	MSI-150	100/box	
	MSI-200JT	200/jar	
	MSI-550	500/box	
	MSI-950B	4,000/bucket	

Dims W x L	Part #	Pkg Qty	Application
9/16"	MSI-1575	15/card	14/3, 12/3,
	MSI-75	50/bag	10/3 cable



Service Entrance Staples

Secures service entrance cables.

- Pointed offset legs drive in straight.
- Will not split wood.



Dims W x L	Part #	Pkg Qty	Application
1 3/16" x 1 3/8"	GSE-15310	10/card	SEU #6/3 with ground
	GSE-5310	25/box	
	GSE-310	100/box	
1 1/8" x 1 1/2"	GSE-15410	10/card	4/3 and 2/3 SE cable
	GSE-4310	25/box	
	GSE-410	100/box	
1 5/8" x 2 1/8"	GSE-710	100/box	4/0 SE, Large BX, Romex®, Greenfield



Plastic Staples

Secures Romex®, UF and other types of non-metallic (NM) cable.

- Fast and easy to install – both zinc-plated nails drive together without splitting wood.
- Nail heads are recessed for minimum exposure.
- Smooth saddles prevent damage to insulation.
- UV-resistant polyethylene saddles will not rust, rot or deteriorate.



14 Gauge

Size	Part #	Pkg Qty	Color	Application
1/2"	PS-50	50/bag	White	14/2, 12/2, 10/2
	PS-150	100/box	White	
	PS-150Z	100/bag	White	
	PS-225J	225/jar	White	
	PS-250N	250/bag	White	
	PS-550	500/box	White	
	PS-750B	2,000/bucket	White	

Size	Part #	Pkg Qty	Color	Application
3/4"	PS-1575T2	15/card	White	14/3, 12/3, 10/3
	PS-75	50/bag	White	
	PS-175	100/box	White	
	PS-175ZN	100/bag	White	
	PS-175J	175/jar	White	
	PS-275N	250/bag	White	
	PS-575	500/box	White	



MultiCable Staples

Organizes and secures multiple cable runs on a stud.

- Secures NM/Romex®, coaxial and CAT 5 all on the same st
- Snap lock gate quickly and easily secures all cables.
- Self-centering tab guides perfect placement on the stud.
- Secures with a nail or staple for wood studs, a screw for metal studs.



Patented

Part #	Pkg Qty	Stud Type	Cable Combinations
MCS-20W	20/box	Wood/Metal	(8) NM-B Flat 14-2
MCS-100W	100/box	Wood/Metal	(8) NM-B Flat 12-2
			(4) NM-B Flat 10-2
			(2) NM-B Round 14-3
			(2) NM-B Round 12-3
			(10) RG-59
			(8) RG-6
			(10) CAT-5



Clip-on Plastic Staples

Secures Romex®, UF and other type-NM cable.

- Fast and easy to install – both zinc-plated nails drive together.
- Hardened nails can penetrate cement block, mortar or plaster surfaces.
- Nail heads are recessed for minimum exposure.
- Smooth saddles prevent damage to cable insulation.
- UV-protected polyethylene saddle resists rot, rust and deterioration.



Size	Part #	Pkg Qty	Type	Application	Size	Part #	Pkg Qty	Type	Application
1/2"	PSM-1550T	25/clam			3/4"	PS-75M	50/bag	Masonry	14/3, 12/3, 10/3
	PS-50M	50/bag	Masonry	14/2, 12/2, 10/2		PS-175JM	175/jar		
	PS-225JM	225/jar							



Service Entrance Cable Straps

Plastic insulated straps quickly and easily secure service entrance cable.

- Electro-zinc plated nails provide strength and durability.
- Polyethylene straps stabilized against UV rays and extreme cold; withstand deterioration and breakage.



Part #	Pkg Qty	Application	Part #	Pkg Qty	Application
GSE-105	5/card		GSE-304	4/card	
GSE-115	10/box	#6 SEU	GSE-314	10/box	#2 SER
GSE-170	70/box		GSE-330	30/box	
GSE-205	5/card		GSE-402	2/card	#4/0 SEU
GSE-215	10/box	#2 SEU	GSE-505	5/card	#6 SER
GSE-250	50/box		GSE-515	10/box	



Conduit Plastic Straps

Enables secure fastening of plastic electrical conduit, schedule 40 PVC, copper tubing, etc.

- Heavy-duty polyethylene resists deterioration from UV rays and breakage from extreme cold.



Size Dia.	Part #	Pkg Qty	Application	Size Dia.	Part #	Pkg Qty	Application
.840"	GCC-120	6/card	1/2" conduit	1.66"	GCC-410	10/bag	1 1/4" conduit
1.05"	GCC-220	20/bag	3/4" conduit	1.9"	GCC-510	10/bag	1 1/2" conduit
1.315"	GCC-310	10/bag	1" conduit	2.375"	GCC-610	10/bag	2" conduit

Coaxial Cable Staples - Low Voltage

Secures RG-59 and RG-6 coaxial cables.

- UV-resistant polyethylene saddle.
- For indoor and outdoor applications.
- Zinc-plated nails resist rust and corrosion.



Size	Part #	Pkg Qty	Color
1/4"	PSB-1650T	25/card	Black
	PSW-1650T	25/card	White
	PSB-165	50/card	Black
	PSW-165	50/card	White
	PSB-100	100/box	Black
	PSW-100	100/card	White
	PSW-200JN	200/jar	White

Size	Part #	Pkg Qty	Color
1/4"	PCC-1525	25/clam	Black
	PSG-15	15/card	Gray
7/16"*	PSG-50	50/box	Gray
	PSG-100	100/bag	Gray
	PR-50	50/bag	White

*For RG-8, triaxial and up to 25 pairs UTP cable



Plastic Staples - Low Voltage

Secures bell, speaker, thermostat and telephone wire.

- For inside and outside applications.
- UV-resistant polyethylene saddles will not rust, rot or deteriorate.
- Zinc-plated nails resist rust and corrosion.



Size	Part #	Pkg Qty	Color
3/16"	PLW-1525L1	25/clam	White*
	PMB-1525	25/card	Black*
3/16"	PMW-100	100/box	White*
	PSB-1600T	25/card	Black
	PSW-1600T	25/card	White
	PSB-160	100/card	Black
	PSW-160	100/card	White

*Indicates clip on staples



Masonry Staples - Low Voltage

Secures bell, speaker, thermostat and telephone wire.

- Hardened nails can penetrate cement block, mortar or plaster surfaces.
- UV-resistant polyethylene saddles will not rust, rot or deteriorate.
- Zinc-plated nails resist rust and corrosion.



Size	Part #	Pkg Qty	Color
3/16"	PMC-1525WT	25/clam	White



Category 3 & 5 Data Staples Low Voltage

Secures RJ-11, RJ-12, RJ-45, Category 3 and Category 5 wire.

- UV-resistant polyethylene saddles will not rust, rot or deteriorate.
- Zinc-plated nails resist rust and corrosion.
- 1/4" wide opening



Part #	Pkg Qty	Color
PTP-25T	25/clam	Blue
PTP-100	100/bag	Blue
PTP-250JT	300/jar	Blue



Masonry Category 3 & 5 Data Staples - Low Voltage

Secures and protects RJ-11, RJ-12, RJ-45, Category 3 and Category 5 wire.

- Hardened nails can penetrate cement block, mortar or plaster surfaces.
- UV-resistant polyethylene saddles will not rust, rot or deteriorate.
- Zinc-plated nails resist rust and corrosion.
- 1/4" wide opening



Part #	Pkg Qty	Color
PTM-25	25/clam	Blue
PTP-100M	100/bag	Blue



Coaxial Masonry Staples - Low Voltage

Secures RG-59 and RG-6 coaxial cables.

- Hardened nails can penetrate cement block, mortar or plaster surfaces.
- UV-Protected.



Size	Part #	Pkg Qty	Color
1/4"	PCS-1525	25/card	Black
	PCS-100	100/box	Black
	PCS-100B	100/bag	Black
	PCS-1600T	25/clam	Black



Coaxial Roofing Staples - Low Voltage

Secures RG-59 and RG-6 coaxial cables

- Extra-long nail accommodates roofing applications.
- UV-resistant polyethylene saddles will not rust, rot or deteriorate.
- Zinc-plated nails resist rust and corrosion.



Size	Part #	Pkg Qty	Color
1/4"	PSR-25	25/card	Black



Double Coaxial Staples - Low Voltage

Secures multiple RG-59, RG-59 quad shield, RG-6 and RG-6 quad shield wire.

- UV-resistant polyethylene saddles will not rust, rot or deteriorate.
- Zinc-plated nails resist rust and corrosion.



Size	Part #	Pkg Qty	Color
1/4"	PDS-1525BT	25/clam	Black



Double Coaxial Masonry Staples - Low Voltage

Secures multiple RG-59, RG-59 quad shield, RG-6 and RG-6 quad shield wire.

- Hardened nails can penetrate cement block, mortar and plaster surfaces.
- UV-resistant polyethylene saddles will not rust, rot or deteriorate.



Size	Part #	Pkg Qty	Color
1/4"	PDC-1525BT	25/clam	Black



Fiber Insulated Staples - Low Voltage

Secures bell, speaker, telephone and thermostat wire.

- Insulates and protects cable.



Size	Part #	Pkg Qty	Color
1/8"	MSB-1540	40/card	Brown
	MSW-1540	40/card	White

Kwik Mount Staples - Low Voltage

Fastens and guides wires.

- Wires easily snap in or out of two usable sides.
- Accommodates Category 5 wire.
- Use to secure holiday light sets, sound system wires, etc.



Size	Part #	Pkg Qty
7/8" X 3/16" X 1/4"	PWS-1525	25/card





Wire Management

When wires become entangled they are safety hazards, for both the equipment and the owner. Gardner Bender™ offers a variety of products for protection and neatness. As the needs of professional electricians change in managing wire and cable, Gardner Bender™ continues to deliver innovative solutions.

page 163



page 167



page 165



page 168



Anchor Kit - Plastic Conical	171
Box Supports/Spacers	170, 172
Cable Clamps - Plastic	167
Cable Clamps - Rubber Insulated	167
Cable Wraptor™	163
Duct Seal Compound	169
Grommets	168
Hanger Strap	169
Heat-Shrink Gun	164
Heat-Shrink Tubing	
Thin Wall Polyolefin	165
Colored PVC	165
Heavy-Wall	166
Knockout Seals	168
Reference Books	
“Wiring Simplified”	172
“Ugly’s Electrical References”	172
“How to Use Your Multimeter”	172
Screw Kits	171
Seals	169
Spiral Wrap	166
Split Flex Tubing	166
Stud Insulators	168
Tape	
Electrical	163
Friction	164
Silicone Self-Sealing	164
Liquid Electrical	164
Wire Markers - Pocket Pack	170

CABLE WRAPTOR™

Simple design, endless solutions.

- "T" handle feature allows for easy carrying from one job to the next.
- Large hang hole is perfect to store and hang.
- Stainless steel hinge and spring to prevent rusting.
- Large teeth design for secure locking system.
- Easy release trigger.
- Cable tie looping hole for permanent attachment.
- Spring-loaded hinge helps close tail.

Part #	Pkg Qty	Bundle Dia. Max.	Size
CW-T1RR50	50/box	1 1/8"	small
CW-T2RR25	25/box	2"	medium
CW-T3RR25	25/box	3"	large
CW-T4RR20	20/box	4"	x-large
CW-MULTI1L2M3S	15/box		1lg 2md 3sm



Patent Protected
 8246095 D608, 191



Product # CW-MULTI1L2M3S

Electrical Tape

Quality electrical tape designed for general purpose electrical applications.

- Made from low-lead PVC material.
- For applications up to 600 V.
- Temp rating up to 80 °C (176 °F).

Part #	Pkg Qty	Sleeve Qty	Width	Length	Color
GTP-307	1/roll	10/sleeve	3/4"	30'	Black
GTP-307D	1/card	—	3/4"	30'	Black (w/Dispenser)
GTP-307WD	1/card	—	3/4"	30'	Black - Weather Resistant (w/Dispenser)
GTP-607	1/roll	10/sleeve	3/4"	60'	Black
GTP-607P	1/puck	—	3/4"	60'	Black
GTB-667P	1/puck	—	3/4"	60'	Blue
GTN-667P	1/puck	—	3/4"	66'	Brown
GTO-667P	1/puck	—	3/4"	66'	Orange
GTG-667P	1/puck	—	3/4"	66'	Green
GTR-667P	1/puck	—	3/4"	66'	Red
GTW-667P	1/puck	—	3/4"	66'	White
GTY-667P	1/puck	—	3/4"	66'	Yellow
GTPC-512	5/card	—	3/4"	12'	Assorted (Red, White, Blue, Green, Yellow)
GTPC-550	5/clam	—	1/2"	20'	Assorted (Red, White, Blue, Green, Yellow)



Friction Tape

Black friction tape with matted finish, available in two lengths.

- Matted finish provides the best gripping surface available.
- Use over electrical splices, wrapping grips or sporting goods.
- Available in two lengths: 30' or 60'.

Part #	Pkg Qty	Description
GTF-300	1/roll	¾" wide, 30' long
GTF-600	1/roll	¾" wide, 60' long

Self Sealing Tape

High quality tape to insulate many conductor shapes.

- Insulates and seals surfaces
- Fuses to itself during application to stay watertight
- Silicone Tape provides permanent mold in 24 hrs, or in minutes with application of heat



RTP-3422

Part #	Pkg Qty	Description	Material	Max Voltage	Max Temp	Min Temp
RTP-3422	1/roll	¾" wide, 22' long, .031 mil thick	Rubber	600V	176°F/80°C	—

Repair Tape

Repair Tape fuses only to itself when applied under tension. No sticky residue remains on wrapped surfaces.

- Operates and remains flexible from -60°F (-51°C) to 500°F (260°C).
- Stretches up to 300% its original length with 60 ppi tear strength.
- A permanent air and water tight seal, Repair Tape has excellent UV Resistance.
- Repair Tape begins to bond immediately on contact with itself.

Part #	Pkg Qty	Length	Color	Part #	Pkg Qty	Length	Color
HTP-1010	1/roll	1"x10'	Black	HTP-1010GRY	1/roll	1"x10'	Gray
HTP-1010BLU	1/roll	1"x10'	Blue	HTP-1010RED	1/roll	1"x10'	Red
HTP-1010CLR	1/roll	1"x10'	Clear	HTP-1010WHT	1/roll	1"x10'	White
HTP-1010GRN	1/roll	1"x10'	Green	HTP-1010YLW	1/roll	1"x10'	Yellow

HTP-1010

Liquid Tape

A liquid coating used to insulate and protect electrical splices and connections.

- Waterproof, will not unravel or deteriorate like traditional tape.
- Great for home, auto/marine and electrical applications.
- Indoor/outdoor.
- Brush-on applicator included.

Part #	Pkg Qty	Color	Part #	Pkg Qty	Color
LTB-400	4 oz/bottle	Black	LTW-400	4 oz/bottle	White
LTR-400	4 oz/bottle	Red	LTS-400	6 oz/spray	Black
LTG-400	4 oz/bottle	Green			

Spray Liquid Tape

- Waterproof, will not unravel.
- Great for home, auto/marine and electrical applications.
- Indoor/outdoor.
- Spray can application.

Part #	Pkg Qty	Color
LTS-400	6 oz/can English/Spanish	Black
LTS-600BLU	6 oz/can	Blue
LTS-600ORG	6 oz/can	Orange

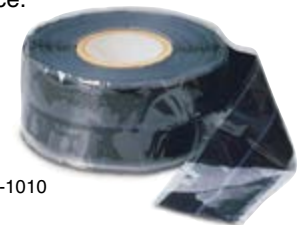

Heavy-Wall Heat-Shrink Tubing

Provides maximum reliability for insulating and protecting wire, cables and terminations.

- High impact, abrasion and corrosion resistance.
- Submersible and great for direct burial installations.
- Inner adhesive bonds to plastics, rubber, neoprene, steel, polyethylene.
- Continuous operating temperature: -55 °C (-67 °F) - 125 °C (257 °F).
- Shrink temperature: 125 °C (257 °F) - 250 °C (480 °F).
- 3:1 shrink ratio.



Part #	Pkg Qty	Inside Diameter		Length
		Before	Finished	
HWT-0722	1/bag	3/4"	7/32"	6"
HWT-1138	1/bag	1 3/32"	3/8"	6"
HWT-1550	1/bag	1 1/2"	1/2"	6"

Heat Shrink Gun

- Use with heat shrink tubing or terminals.
- Refillable butane can included.

Part #	Pkg Qty
MSTR-TORCH	1/clam



Split Flex Tubing

Protects hoses, wire and cables from cuts, abrasions and UV wear.

- Excellent for managing cords for electronics, under hood or trailer wiring.
- Corrugated for added flexibility.
- Split down the center for wire breakout where needed.

Part #	Inside Dia.	Length	Color	Pkg Qty
FLX-757GR	3/4"	5'	Gray	1/bag
*XTM-450	3/8"	10"	Black	Each

NEW

GB Xtreme

* Flame retardant, self-extinguishing split loom permits flexible routing of cable harnesses while providing an extra layer of abrasion protection for wire and cable.



Spiral Wrap

Manages wire and cable neatly and allows for cable to break out at desired locations.

- Made from flexible polyethylene.
- Protects cables from cuts, abrasions and UV wear.

Part #	Description	Color	Includes:		
			Qty	Description	Inside Dia.
FSP-AST2	Assorted	Clear	1	4' length	3/8"
			1	4' length	1/8"
FSP-BlackT		Black	2	3.5' length	1/2"
FSP-ClearT		Clear	2	3.5' length	1/2"



Plastic Cable Clamps

Polypropylene clamps hold harnesses, cables and tubing.

- Used for construction, maintenance and assembly-line operations.
- Use in control cabinets, panels and general applications.
- Tough, durable, yet extremely lightweight.
- Working temperature range: -54 °C (-66 °F) to 170 °C (340 °F).
- Clean, smooth edges for easy handling.
- Fast installation.



Part #	Pkg Qty	Dimensions					Color
		A dia.	B	C	D	E width	
PPC-1525	18/card	1/4"	29/64"	1/32"	3/64"	3/8"	Natural
PPC-1525UVB	18/card	1/4"	29/64"	1/32"	3/64"	3/8"	Black
PPC-1538	15/card	3/8"	31/64"	1/32"	3/64"	3/8"	Natural
PPC-1538UVB	15/card	3/8"	31/64"	1/32"	3/64"	3/8"	Black
PPC-1550	12/card	1/2"	35/64"	3/64"	3/64"	3/8"	Natural
PPC-1550UVB	12/card	1/2"	35/64"	3/64"	3/64"	3/8"	Black
PPC-1575	6/card	3/4"	3/64"	3/32"	3/64"	1/2"	Natural
PPC-1575UVB	6/card	3/4"	3/64"	3/32"	3/64"	1/2"	Black
PPC-1600	4/card	1"	51/64"	3/32"	3/64"	1/2"	Natural

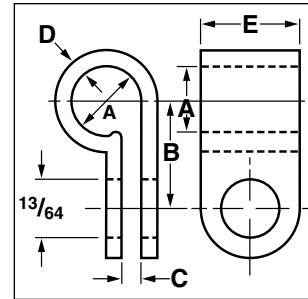

NEW EZ-Cable Clips

EZ-Cable Clips are designed to secure low voltage cables and tubing.

- Flexible to accommodate different cable sizes.
- Made from aluminum, will not rust, crack or deteriorate.

Part #	Qty	Size	Clamp Dia.	Color
PAW-1525L1	15/clam	S	1/4"	White
PAW-1525T	15/clam	S	1/4"	White
PAW-1550L1	15/clam	L	1/2"	White



Rubber Insulated Clamps

Secures wire and cable in industrial, auto/marine and where vibrations may occur.

- Corrosive-resistant plated steel clamp.
- Flexible 1/2" wide body.
- Secure with 1/4" screw.
- XTM are stainless steel.

Part #	Size	Pkg Qty
PPR-1550	1/2"	2 pcs
PPR-1575	3/4"	2 pcs
PPR-1600	1"	1 pc

GB Xtreme

Part #	Qty	Size	Country
XTM-401	2	3/8"	US
XTM-405	2	1/2"	US

These corrosive-resistant stainless steel clamps secure wire and cable wherever vibrations may occur. The controlled "squeeze" fastener allows fastening to desired tightness.



Plastic Kwik Clips

Mount bundles, cables, cords, tools etc. to drywall, wood and painted surfaces.

- Ratcheting/releasable feature allows adjustment to a range of bundle diameters.
- Adhesive backed.

Part #	Pkg Qty	Description	Color
GKK-1538	6/card	Holds 3/8" Cable	Natural
GKK-1538UVB	6/card	Holds 3/8" Cable	Black
GKK-1550	4/card	Holds 1/2" Cable	Natural
GKK-1575	2/card	Holds 3/4" Cable	Natural



Stud Insulators

One piece design insulating 360° protection for cable runs through metal studs.

- Fits all pre-punched and field punched hole sizes and configurations.
- Unique folding tabs for fast, one-handed installations.
- Meets NEC article 300-4(b) and CEC rule 12-516.

Part #	Pkg Qty	Description
SI-25N	25/bag	Metal Stud Insulators

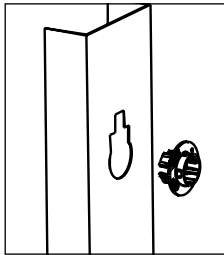

Patented

SEE PG
113



FOR MORE INFO ON
Stud Punch

Grommets

Protect wires from chafing against drilled holes.

Part #	Pkg Qty	Inside Dimensions
GHG-1525	6/card	1/4"
GHG-1538	5/card	3/8"
GHG-1550	4/card	1/2"
GHG-1575	3/card	3/4"
GHG-AST	8/clam	1/4", 3/8", 1/2", 3/4"



Knockout Seals (1/2" to 4")

Easy-to-use metal knockout seal.

- Fast and easy to install from inside or outside of box.
- Embossed for quick self-centering in unused knockouts. One screw holds seal in place.
- Made of rust-proofed, cold-rolled galvanized steel. Screw and bar are zinc-plated.
- Marked for size and catalog number for easy identification.
- 16-gauge steel; 3/8" thread.
- Not waterproof.



Part #	Pkg Qty	For Knockout Dia	Part #	Pkg Qty	For Knockout Dia
KO701	100/box	1/2"	KO705	10/box	1 1/2"
KO701C	5/clam	1/2"	KO706	10/box	2"
KO702	50/box	3/4"	KO707	10/box	2 1/2"
KO702C	3/clam	3/4"	KO708	10/box	3"
KO703	25/box	1"	KO709	10/box	3 1/2"
KO704	25/box	1 1/4"	KO710	10/box	4"

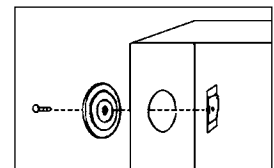

SEE PG
104



FOR MORE INFO ON
Hydraulic Drivers & Pull Studs

Snap-In Seals (1/2" to 2")

Convenient snap-in feature for quick installation.

- Zinc-plated to resist corrosion.
- Not waterproof.

Part #	Pkg Qty	For Knockout Dia.
601	100/box	1/2"
602	100/box	3/4"
603	50/box	1"



SEE PG 107 FOR MORE INFO ON Knockouts

Galvanized Hanger Strap

For hanging or fastening conduit, pipe or cables.

- Flexible for easy use.



Part #	Pkg Qty	Description
GHS-1510	1/card	10' x 3/4" x 26 gauge

Saf-Te-Plate™ Protectors

Protects cable and plastic pipe from nail punctures.

- Plate attaches to wood studs with a single hammer blow.
- Required for compliance with NEC 1990 Article 300-4A.

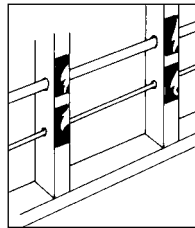

Part #	Pkg Qty	Description
FP159-3	100/box	1 1/2" x 3" x 16 gauge Metal Safety Plate
FP159-6	50/box	1 1/2" x 6" x 16 gauge Metal Safety Plate

Duct Seal Compound

Seals conduit openings against drafts, dust, moisture and noise.

- Protects terminal boxes, pot heads and bushings from corrosive elements.
- Deadens switch gear panel noise.
- Dough-like compound is easily "thumbed" over holes and gaps.
- Will not harden or form a skin under normal conditions.
- Not for use outdoors.
- No Silicone.
- Specifications:
 - Viscosity: ASTM D-217 300-gram load - 7.0 -11.0; ASTM DS-S2 100-gram load - 9.0 -15.0
 - Temperature Range: Adheres at -20 °F (-29 °C). Will not slump after 1 hr. at 350 °F (175 °C).
 - Flash Point: Over 550 °F (285 °C).
 - Other Properties: Non-conducting, non-deteriorating, non-toxic, non-corrosive, non-staining, non-curable; 99% solid, coil-based.



Part #	Pkg Qty	Description
DS-130	30 pugs	1 lb Pugs
DS-530	6 pugs	5 lb Pugs

Pocket Pack Wire Markers

Pocket-sized booklets of cloth wire markers and matching terminal markers.

- Saves time and money during all on-site and in-plant initial hookup, troubleshooting, maintenance and repair.
- Nylon-impregnated cloth resists moisture, dirt and oil.
- Non-smear legends assure high visibility for instant, positive identification.
- Matching terminal marker with every wire marker, plus an extra page of blank write-on wire and terminal markers for special legends.



Part #	Marker Legends	Qty
42-027	0 - 9	45/ea
42-028	A - Z	10/ea
	0 - 15	10/ea
	Symbols: +, -, /	10/ea
42-029	1 - 45	10/ea
42-030	46 - 90	10/ea
42-035	1 - 15	6/ea
	16 - 90	4/ea
	A - Z	2/ea
	Symbols: +, -, /, 0	2/ea
42-ALPHA	Circuit Breaker Box Marker Book	

Box Supports

Saves time for installing outlet or switch boxes.

- Screwless support for ease of use.
- Simple to use:
 1. Mark corners of box position and drill four 1/2" holes.
 2. Saw between holes to make box opening.
 3. Place box into opening.
 4. Slip box supports into openings alongside box; one with long end up, the other down.
 5. Bend fingers of box supports into box while firmly pressing box against wall.

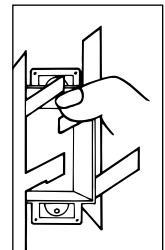

Part #	Pkg Qty	Description
800	25 sets/box	Box Support Set (pair)



Electrician's Screw Kits

Assorted sizes & lengths of commonly used electrical machine screws.

- Slotted round-head screws for switches, receptacles and outlet applications.
- Slotted flat-head screws for all-purpose electrical fastening.

Part #	Pkg Qty	Type	Contents
SK-832WP	135 pcs	8-32 Round Head	1/2", 3/4", 1", 1 1/4", 1 1/2", 2" wall plate screws (white, ivory & almond)
14-WPI	10/card	Wall Plate Screws	Ivory
14-WPW	10/card	Wall Plate Screws	White



SK-832WP

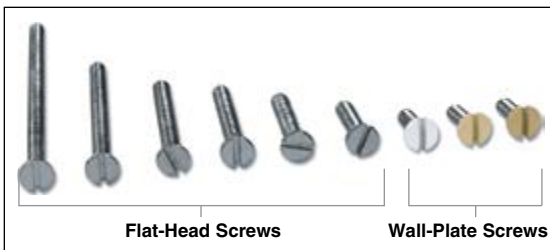

Flat-Head Screws

Wall-Plate Screws

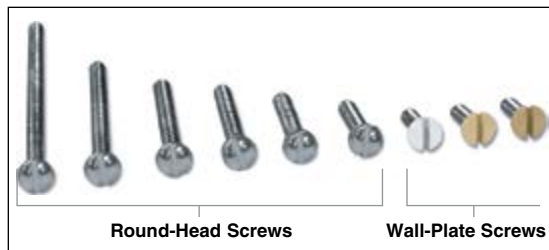

Round-Head Screws

Wall-Plate Screws

Big Red™ Plastic Conical Anchor Kit

Perfect multi-purpose kit for professionals and end-users.

- Tapered end for easy installation.
- Flanged ribs prevent turning or twisting in hole.
- Carbide drill bit included with each kit.

Part #	Pkg Qty	Description
AP4-K100	1 kit	Plastic Anchor Kit

Kit Contains:

Qty	Description
100	1/4" x 1" Anchors
100	#10 x 1" Slot/Phillips Combo Head Sheet-Metal Screws
1	1/4" Carbide Drill Bit

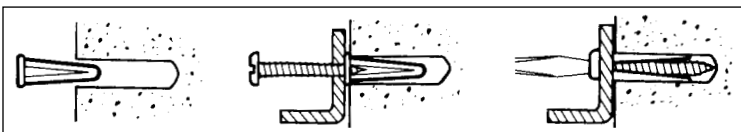

Quick Fix Spacers

Adjusts length of receptacle or switches for proper fit of face plates.

- Four-inch stack of spacers twists apart easily for desired thickness.

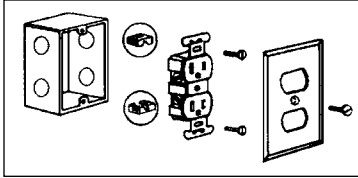

Part #	Pkg Qty	Description
GSP-04	4 strips	Spacers
GSP-24	24 strips	Spacers

Electrical Reference Books

Reference books that outline safe wiring recommendations based on the National Electric Code.

Part #	Pkg Qty	Description
ERB-UG	1	<i>Ugly's Electrical References - Revised 2011 Edition.</i> A quick, on-the-job reference guide for the most commonly required information in an easy-to-read format.
ERB-WS	1	<i>Wiring Simplified 43rd Edition</i> A comprehensive book that translates the NEC rules into easy-to-understand explanations on how to complete safe wiring installs in homes.
GMT-BK	1	<i>Multimeter Handbook</i> Make measurements and solve electrical problems around the home, in the workshop, at the office, and on the job.

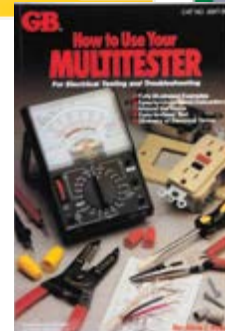



Voice • Data • Video

As home and work becomes more automated with technology there is a need in the market for innovations and better solutions for professionals and for homeowners installing home theaters, and networks.

The Gardner Bender™ Voice Data Video program includes tools, testers, connectors, and fasteners that will support both coax and data installations.



page 178



page 176



page 180



page 176

Coax Cable Products

Coax Cable Stripper/Cutter.....	177
Coaxial Cutter/Crimp RG-59 RG-6	178
Coaxial Cutter & Stripper	178
Compression Crimp Tool	178
Compression F-Series Connector, RG-6 bulk	177
F-Series Coax Connector, Female Adapter	177
Splitter Satellite/Digital TV 5 MHz-2 GHz	177
Tool-Less F-Series Coax & UTP/STP Cable Tester	176
Wire Tracker™ Wire Tracer	176

Twisted Pair Products

Cable-Test™ Plus Coax & UTP/STP Cable Tester....	176
Combo Blade 66/110 (Cut Style)	175
Non-Impact Punch-Down Tool	175
Premium Electrician Scissors/Cutters.....	180
Punch-Down Blade	175
Punch-down Tool.....	175
RJ-45 / RJ-11 Modular Plug Crimp Tool.....	179
TelCom RJ-45 Cat 5 Modular Plug	180
TelCom RJ-45 Cat 6 Modular Plug	180
UTP/STP Cable Stripper	179

Accessories

Cable Boss® Staple Gun	181
Cable Boss™ Staples.....	181
Cable Snake™ Steel Fish Tape.....	181
Cable Ties	182
Cat 3 & 5 Data Staples.....	183
Coaxial Cable Clamp for RG-6	183
Coax Staple.....	183
Fish Ease™ 12' Fish Sticks.....	182
Grip Strip™ Hook-and-Loop Fasteners.....	182
Split-Flex Tubing	183

Combo Blade 66/110 (Cut Style)

- 110-style blade used in CAT 3 and CAT 5 terminations (Cut).
- 66-style blade used to terminate phone wiring (Cut).



Part #	Description
PDB-66110	Combo Blade 66/110

Non-Impact Punch-Down Tool

- Non-impact punch-down.
- Non-cut blade.
- 110-style blade used in CAT 3 and CAT 5 terminations.



Part #	Description	Network	Length
PDTL-3110	Non-Impact Punch Down Tool	Data	7½"

Tool-Less F-Series Connector, RG-6

- Cable termination is easy with our ITC (Instant Tool-less Connectors) products.
- Strip your cable with our GB® SE-398, fold braid back.
- JUST PUSH into ITC Connector.

Part #	Description	Wire Gauge	Pkg Qty
ITC-RG-6	Tool-Less Connector	RG-6	2
ITC-RG-6C	Tool-Less Connector	RG-6	6



ITC-RG-6 /
 ITC-RG-6C

Cable-Test™ Plus Coax & UTP/STP Cable Tester

- Tests all coax and Cat 3-6 patch cords and installed cables for proper wiring.
- Test for opens, shorts, miswires, reversals, and shield continuity.

Part #	Description	Pkg Qty
TT64202	Cable Tester	1/clam, 2/clams/mstr



Wire Tracker™ Wire Tracer

A must-have tester for audio visual installers and data com technicians.

- Multi-purpose wire tracer for identifying wires such as coax, CAT 5, speaker, phone, or any non-energized (non-live) wires
- Adapter plugs include: RJ-45, RJ-11, Coax, Automotive fuse blade, and Insulated clamps
- Adjustable sensitivity positively identifies a single wire when multiple wires are routed in close proximity
- Audible and visual indication
- Operates from (2) AAA batteries (transmitter) and 4-LR44 batteries (receiver) (included).

Part #	Description	Pkg Qty
ET64220	Cable Tester	1/clam, 2/clams/mstr



Splitter Satellite/Digital TV 5 MHz-2 GHz

- Bandwidth: 5 MHz - 1 GHz
- Impedance: 75 Ohm
- Over 120 dB of RFI Shielding
- Low insertion loss
- PCB Printed circuit board design
- Nickel plated housing
- Splits signals up to 2, 3, or 4 outlets

Part #	Description
GDC-2W2G	Splitter Satellite 2-Way
GDC-3W2G	Splitter Satellite 3-Way
GDC-4W2G	Splitter Satellite 4-Way

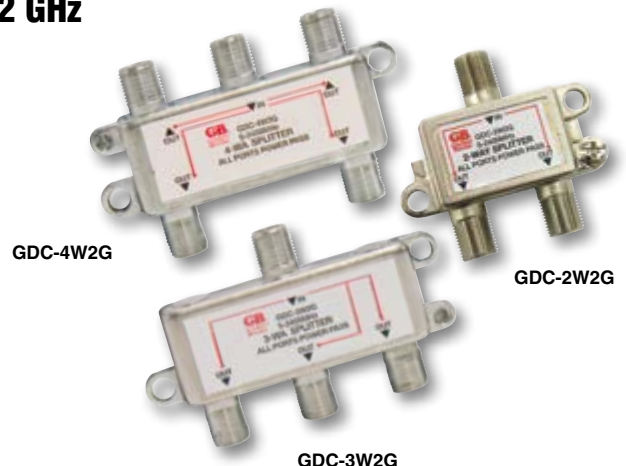

Compression F-Series Connector, RG-6 bulk

F-Type Coaxial Connector

- For use with RG-6/Quad Coaxial Cable.
- Nickel plated to resist corrosion.

Part #	Description	Pkg Qty	Type
GDC-6C	Compression Connector	50/Bag	RG-6/Quad
GDC-6CM	Compression Connector	4/Bag	RG-6/Quad



GDC-6C / GDC-6CM

F-Series Coax Connector, Female Adapter

- To combine two lengths of coaxial cable.
- To connect cables through wall.

Part #	Description	Wire Gauge	Pkg Qty
GDC-FAM	Coax Connector	RG-6	2



Compression Crimp Tool (Universal)

- Permanent connection.
- Works with most brands.
- Compression connectors add a water tight seal.

Part #	Description	Range
COM-320	Crimp Tool	Universal



Compression Crimp Tool

- Permanent connection.
- Works with most brands.
- Compression connectors add a water tight seal.
- Compact size.

Part #	Description	Range
COM-310	Crimp Tool	RG-6, RG-6 Quad, RG-59

Part #	BNC	F-Type	Mini Coax	RCA	RG11
COM-310		✓			
COM-320	✓	✓	✓	✓	✓



Coaxial Cutter & Stripper

- Cuts and strips coaxial cable (RG-58, RG-59, RG-6, and RG-6 quad).
- Easily adjusts to various cable thickness.

Part #	Description	Wire Gauge	Length
SE-398	Coaxial Cable Cutter & Stripper	RG-59 & RG-6	6¼"



Coaxial Cutter/Crimp RG-59 RG-6

- Crimps RG-59 and RG-6 "F" Connectors.
- Machined black blade cuts coaxial cable.
- Cushioned handles.

Part #	Description	Pkg Qty
GS-389	Coaxial Cutter/Crimp	1/Cd, 5 Cds/mstr



Coax Cable Stripper/Cutter

- Cuts and strips RG-59 and RG-6 coaxial cable.
- Can be used with both standard and quad shield cable.
- Multiple size stripping stations strip both the outer jacket and inner conductor.
- Exclusive hex-shaped slot helps push "F" connectors onto cable.
- Curved cutting blade.

Patented

Part #	Description	Wire Gauge	Length
GS-359D	Coaxial Stripper	RG-59 & RG-6	6¼"



RJ-45 / RJ-11 Modular Plug Crimp Tool

Used to produce patch cable and handset cables, cut, strip, and crimp.

- Heat-treated steel frame provides strength and durability.
- Comfort grip handles.
- RJ-11 and RJ-45 Plugs.

Part #	Description	Plugs	Pins
GMC-1145D	Telephone Crimp Tool, RJ-11 and RJ-45	RJ-11, RJ-12, RJ-45	2, 4, 8



RJ-45 / RJ-11 Modular Plug Crimp Tool

Used to produce patch cable and handset cables, cut, strip, and crimp.

- RJ-11 and RJ-45m 8 Port.

Part #	Description	Plugs	Pins
GMC-2000D	Module Crimp Tool	RJ-11, RJ-45	2, 4, 8



UTP/STP Cable Stripper

Strips UTP and STP cable up to 0.24" (6.2 mm) diameter.

- Tension release lever for easy positioning and release of cable.
- Compact design for easy handling.
- For use on CAT 3 and CAT 5 cable.

Part #	Description	Wire Gauge	Length
GTPS-3100	UTP/STP Round Cable Stripper	UTP-STP	3 1/4"



UTP/STP Cable Stripper

Strips UTP and STP cable up to 0.24" (6.2 mm) diameter.

- Tension release lever for easy positioning and release of cable.
- Compact design for easy handling.
- For use on CAT 3 and CAT 5 cable.

Part #	Description	Wire Gauge	Pins
GTPS-3200	Premium Cable Stripper	UTP, STP, flat, round from 1/8" to 3/8" in diameter and silver satin and other flat cables	4 1/2"



Premium Electrician Scissors/Cutters

Stainless steel with precision hollow-ground and hardened for long-lasting edge.

- One micro-serration blade reduces slippage.
- Extension tang to get extra tough.
- Right and Left handed users.
- Full Length: 5 1/2" (138 mm), Cutting Length: 1 5/8" (42 mm)
- For Shearing: Soft cable, up to 22 mm dia., Insulation materials, Electrical tape, many other materials, and stripping insulation.

Part #	Description	Length
ES-360	Scissors/Cutters	5 1/2"



TelCom RJ-45 Cat 5 Modular Plug, 8-Position, 8-Contact, Rounded Cable, Solid Wire

- RJ45 Modular Connectors
- Use with network/twisted pair cable CAT-5E

Part #	Description	Pkg Qty	Type
GMC-88C5	Modular Plug	50/Bag	CAT-5e
GMC-88M5	Modular Plug	8/Bag	CAT-5e

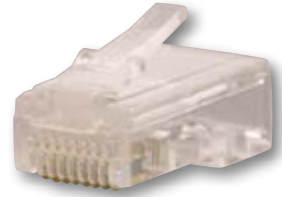

TelCom RJ-45 Cat 6 Modular Plug, 8-Position, 8-Contact, Rounded Cable, Solid Wire

- RJ45 Modular Connectors
- Use with network/twisted pair cable CAT-6

Part #	Description	Pkg Qty	Type
GMC-88M6	Modular Plug	50	CAT-6
GMC-88C6	Modular Plug	8	CAT-6



Cable Snake™ Steel Fish Tape

- Perfect for short runs installing electrical boxes, outlets, lighting fixtures, doorbells and security systems.
- Compact design houses 25' of tape and fits in tool box or on tool belt.
- Flat wire steel tape fishes down walls, under carpets and over ceilings.
- Wedge-shaped tip prevents hang-up.
- Low-memory tape does not curl during extension—perfect for non-conduit situations.
- Formed handle fits easily in hand.
- Compact tape rewind knob for quick wind-up.
- Tape is 1/4" W x .03" thick



Patented

Part #	Description	Weight
EFT-321PN	25' Cable Snake™ Fish Tape	1.10 lbs.

Romex® is a registered trademark of Southwire Company, Carrollton, GA

Fish Ease™ 12' Fish Sticks

- 3 durable interlocking fiberglass rods extend up to 12'. (4' sections).
- 1/4" diameter ensures rigidity when extended.
- 2 different threading tips provided for a variety of applications.

Part #	Description	Dimensions	Weight
FTX-312	Fish Ease™ 12' Fish Sticks	3-4' sections x 1/4"	1 lb.



Cable Boss® Staple Gun

- Secures 120 V & low-volt cable: Romex®, Coaxial & CAT 5 from the same tool.
- Comfort grip areas for 2-handed operation.
- Easy trigger force.
- Ergonomic handle.
- Secures round and flat cable.
- 3 sizes covering: NM, Coax, Voice/Data, Low Volt.

Part #	Description
MSG-501	Cable Boss® Staple Gun



Patented

Cable Boss™ 5/16" Blue Staples

- Insulated staple.
- Barbed leg design for superior holding power.
- Secures flat and round cable.

Part #	Size	Pkg Qty	Color	Application
MPS-2080	5/16"	250/box	Blue	Voice/Data: CAT 5e Speaker wire: 16/2, 16/4, 12/2 (standard and in-wall styles) Security Wire: 18/4 Thermostat: 18/7 Telephone Wire: 24/8



Cable Boss™ 1/2" Black Staples

- Insulated staple.
- Barbed leg design for superior holding power.
- Secures flat and round cables.

Part #	Size	Pkg Qty	Color	Application
MPS-2125	1/2"	200/box	Black	Coax: RG-6 Quad Shield NM Cable: 10/2, 12/3 Structured Cabling: Siamese CAT 5e, Siamese CAT 5e and 16/4 Speaker Wire



Assorted Cable Ties

- Colored cable ties fasten wire for easy bundle identification.
- Patented DoubleLock® design ensures 50% more tensile strength than industry standards.
- Flexible nylon material allows cable ties to remain serviceable through temperature ranges of -40 to 185 °F (-40 to 85 °C).
- Recognized under component program of UL, E125869.
- Meets flammability classification UL 94 V-2.

Part #	Color	Pkg Qty	Tensile Strength	Lengths
10095VDV	Assorted	20 Blue / 20 Yellow / 60 Grey	18-75 lbs.	4" and 6"



8" Mounting Tie

- 8" Cable Ties
- Tensile Strength: 50 lb.
- Bundle Diameter: 2"

Part #	Color	Pkg Qty	Double Lock™	Tensile Strength	Length	Width	Thickness	Bundle Dia. Max.	UL
45-308MTG	Grey	15/pk	DLOCK	50 lb	8"	0.17"	0.055"	2"	UR



Grip-Strip™ Hook-and-Loop Fasteners

Reusable strip fastens wires and cables.

- Wrap excess around bundle—no waste.
- Great for home/office, tools and electronics.
- Cinch tab allows attachment to cable or cord.

Part #	Description	Pkg Qty	Length
45-V8BK	Grip-Strip™	5/Bag	8"



1/4" Coaxial Cable Clamp for RG-6

- Secures RG-59, RG-6 coaxial and other.
- Combo screw for safer installs.
- Screw-in depth 1/2".



Part #	Description	Pkg Qty	Size
PEC-31525	Cable Clamp	25/Bag	1/4"

Coax Staple 1/4"

- Black masonry staple.
- Secures RG-59, RG-6 and RG-6Q cables to cement, block, mortar or plaster.
- Hardened nail penetrates cement block, plaster and mortar.
- Zinc plated nails resist corrosion.
- UV protected.
- Clip-on strap permits hands free installation.



Part #	Description	Pkg Qty	Size	Color
PCS-3600	Coax Staple	50/Bag	1/4"	Black

Coax Staple 1/4"

- Secure 1/4" coaxial cable including RG-59 and RG-6 types.
- Corrosion resistant zinc plated nail for indoor/outdoor use.
- UV resistant saddle.



Part #	Description	Pkg Qty	Size	Color
PSW-3650	Coax Staple	50/Bag	1/4"	White

Cat 3 & 5 Data Staples (RJ-11; RJ-12; RJ-45; Cat 3 & 5)

- Secures CAT 3, CAT 5, and other datacom wires.
- Easy nailing.
- Protects wire insulation.
- Will not rust, crack or deteriorate.



Part #	Description	Pkg Qty	Size	Color
PTP-325	Data Staple	50/Bag	1/4"	Blue

Terminating Coaxial Cable – Terminology

Parts of the Cable



Jacket

Placed on the outside of the cable to protect all of the other internal components of the wire from the environment.

Foil

A thin foil shield is wrapped over the dielectric which helps to prevent high frequency noise from interfering with the data signal.

Dielectric

Usually constructed out of solid plastic or a foam plastic, this is used to separate the Center Conductor from the shielding.

Center Conductor

This is the part of the cable that the data travels on. RG-6 and RG-6 Quad have 18 AWG copper coated steel wire, while RG-59 has a smaller 22 AWG center conductor.

Braid

The second part of the shielding on coaxial cables, braiding is typically made from a number of copper or aluminum wires

woven together to form a conductor around the dielectric core. The braiding prevents lower frequency noise from interfering with the data signal.

Cable Types

RG-6 is the recommended standard cable for use in satellite and cable television networks. RG-6 loses only about 50% of the signal every 100 ft., due to its 18 AWG center conductor and combination aluminum foil/aluminum braid shield.

RG-6 Quad has the same center conductor and signal loss ratio as the RG-6, but features an extra layer of shielding. This cable is optimal for use where extra protection from outside interference is needed.

RG-59 is no longer the recommended standard for cable or satellite television networks, due to its smaller center conductor and less shielding. This combination results in an 80-90% data loss over 100 ft. span.



Connectors

The most common type of coaxial cable connector.

Compression (Professional)

The compression connector is approved by cable and satellite providers because of the permanent and water tight connection it makes with the cable. Although this connector creates a professional quality connection it is easy enough for anyone to install.

(Part #: GDC-6CM)



Push On (Best)

This connector provides the same permanent install as the compression connector, but does not need a compression tool to install. (Part #: ITC-6)



Crimp On (Better)

This connector works by pushing the connector over the stripped end of the RG-6 or RG-6 Quad coaxial cable and using a special crimping tool the connector is squeezed or crimped onto the cable.

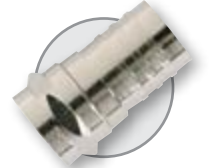

Twist On (Good)

The twist on connector threads onto the stripped end of the coaxial connector until it is fully seated on the cable, this connector requires no other tools.



Creating a Coax Cable

Step 1 – Connector Selection

Select the type of connector that will be needed for your application from the connector selection guide.



Step 2 – Cut Cable

Note: It is important that you use a round cutter to maintain the cable geometry.



Step 3 – Strip Cable

Note: F-Connectors require a two step 1/4" x 1/4" strip, make sure you are using an F-connector wire stripper. (Part #: SE-398)

To strip the cable place the cable in the blade end of the stripper, press down on the stripper handle, and while applying pressure rotate the stripper multiple times.

Before placing the connector over the stripped end of the wire the metal braiding needs to be pushed back over the jacket of the cable, then push on the connector until the white dielectric is even with the center hole of the connector.



Step 4 – Terminate

Compression

Insert the cable, with the compression connector placed on the end, into the compression tool and squeeze the handle until the handle is flush with the tool.

(Part #: COM-310 or COM-320 Pro)

Crimp

Strip cable, fold braid back. Insert the cable, push white dielectric until flush with center hole. Place connector in tool. Squeeze and crimp. *(Part #: GS-389)*

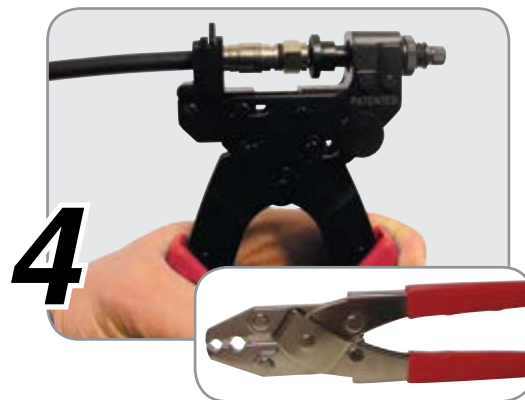

Step 5 – Testing

Test the cable with a continuity tester to make sure cable is properly terminated with no opens or shorts.

(Part #: TT64202)



Terminating Twisted Pair Cables Terminology



Twisted Pair Cable

is given this name because of how the pairs of conductors from a single circuit are twisted together for the purpose of cancelling out electromagnetic interference.

Cable Types

Category 3 Cable (Cat 3) is the FCC recommended cable for phone use, but can also be used for data networks that are limited to 10 Mbs.

Category 5e and 6 Cable (Cat 5e and Cat 6) both of these cables are used for computer data networking. Both of these cables will support 10/100/1000 Mbs network speeds, the only difference being that Cat 6 cables will have lower transmission errors in a 1000 Mbs environment.

Data Jack

is used when more than one connection is going to be used in a fixed location. Most commonly the cables will be run through the wall to a data jack in an office or at a work station.

Connectors

RJ-11 Modular Plug is a 2 pair or 4 wire connector that is used when creating phone line patch cords. Each connector can support up to two phone lines.

RJ-45 Modular Plug is a 4 pair or 8 wire connector that is used when creating patch cables for computer data networks.

Creating a Twisted Pair Patch Cable (RJ-45)

Step 1

Strip back 2 inches of outer jacket.
(Part #: GTPS-3200)



Step 2

Separate pairs into proper sequence based on type of cable being made:

Straight Thru (most commonly used):

Wire both ends of the cable as noted in the diagram.
(Dashed Orange, Orange, Dashed Green, Blue, Dashed Blue, Green, Dashed Brown, Brown)

Crossover Cable (used to connect like devices (ie. router to router):

Wire one end as shown above and wire the other end as shown in below diagram.

(Dashed Green, Green, Dashed Orange, Blue, Dashed Blue, Orange, Dashed Brown, Brown)

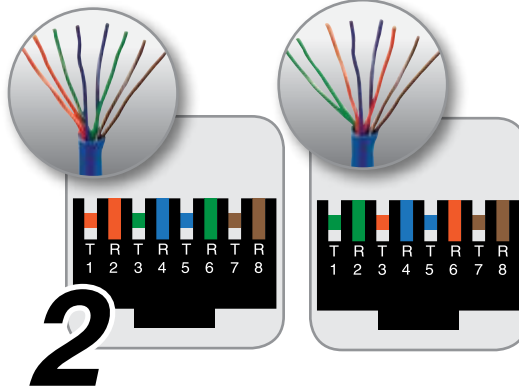

Step 3

Now group and flatten the wires so they are laying side by side and trim them to 1/2" from the outer jacket. Slide the RJ-45 Plug onto the trimmed wires with the release down (brown pair should be on the right).

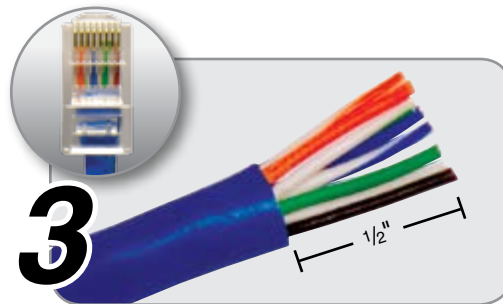

Step 4

Terminate the plug using a modular plug crimping tool by inserting the plug into the RJ-45 die and squeeze the handles. (Part #: GMC-1145D)



Step 5

Test the cable with a continuity tester to make sure the cable is properly terminated. (Part #: TT64202)



Terminating into a Data Jack

Step 1

Strip back 2 inches of outer jacketing. Avoid damaging or nicking the pairs. (Part #: *GTPS-3200*)

Step 2

Place the wires into the data jack based on the color diagram printed on the wiring jack (T568B is most common). Leave no more than 1/2" of the wire untwisted.

Step 3

Terminate the wires in the jack using a punch down tool, making sure the cutting edge is on the outside of the jack. For easy termination use GB® impact punchdown tool. (Part #: *PDT-3110*)

Step 4

Test the connections by using a wiremap tester. (Part #: *TT64202*)

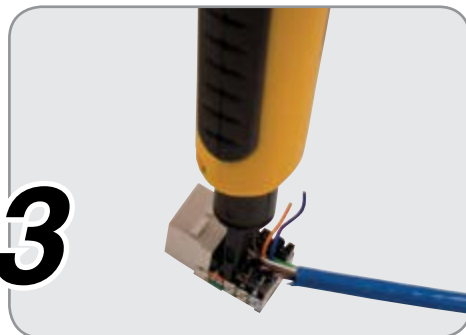
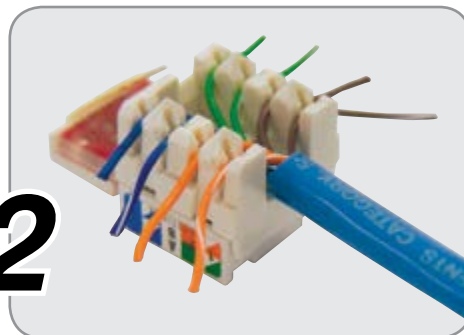

NAME	PG	NAME	PG	NAME	PG
Alligator Clips.....	23	Cable Boss® Staple Gun.....	181	Fish Tapes and Accessories	
Aluminum Mechanical Lugs.....	13	Cable Boss® Staples.....	181	Cable Snake™ Steel Fish Tapes.....	77-78
Aluminum Splicer-Reducers.....	13	Cable Clamps - Plastic.....	167	Economy Fish Tape.....	79
Aluminum Split Bolt Connectors.....	12	Cable Clamps - Rubber Insulated.....	167	Fiberline™ Non-Conductive	
Anchor Kit - Plastic Conical.....	171	Cable Pullers and Accessories		Fiberglass Fish Tapes.....	79
Anti-Oxidant Compound (Ox-Gard™).....	14	8,000 lb Brutus™ Powered Puller.....	82	Fish Tape Ball.....	80
Battery Charging Clips, Clamps.....	23	Sub-Assembly Kits.....	83-84	Fish Tape Leader.....	80
Battery Tester (Analog).....	142	10,000 lb Ultra Brutus™ Powered Puller... ..	88-89	Nylon-Flex™ Non-Conductive Nylon Fish Tapes... ..	80
Beadle Wraps.....	152	Brutus™ Powered Puller		Replacement Tapes - Steel.....	79
Benders – Aluminum Rigid Conduit		Application Instructions.....	85-87	Rewind™ Fish Tape Winder.....	77
Cyclone® Electric Bender (B2000).....	36	Hook Sheaves.....	91	Streamline™ Steel Fish Tapes.....	78
Gardner™ EMT Hand Benders.....	59	Tension Meter.....	91	UpperHand™ Steel Fish Tapes.....	76
One-Shot Hydraulic Benders.....	42-48	Conduit Measuring Tape.....	75	UpperHand™ Non-Conductive	
Sidewinder® Electric Bender (B2555).....	37	Conduit Adapter.....	88	Fiberglass Fish Tapes.....	76
Sidewinder™ Mechanical Benders.....	54-57	Cable Snake™ Steel Fish Tape.....	181	Flex Strap.....	152
Sweep/Segmental Benders.....	46	Cable-Test™ Plus Coax & UTP/STP		F-Series Coax Connector,	
Ultra Eeigor™ Hydraulic Bender.....	40-41	Cable Tester.....	176	Female Adapter.....	177
Benders – EMT Conduit		Cable Ties.....	147-150	Fuse Puller.....	130
Big Ben® Hand Benders.....	58	Cable Wraptor™.....	163	GB Xtreme™ Terminals.....	17
Cyclone® Electric Bender (B2000).....	36	Category 3 & 5 Data Staples.....	159, 183	Grip-Strip™	
Gardner™ EMT Hand Benders.....	59	Circuit Alert®		Hook-and-Loop Fasteners.....	151, 182
Iron Hand Benders.....	60	Circuit Alert® Tester.....	117	Grounding Accessories.....	14
Sidewinder® Electric Bender (B2555).....	37	Circuit Alert® Knife.....	117	Grounding Connectors (GreenGard™).....	10
Sidewinder® Mechanical Benders.....	54-57	Circuit Alert® Wire Strippers.....	118	Guide to Bending Booklet.....	64
Ultra Eeigor™ Hydraulic Bender.....	40-41	Circuit Alert® Work Lights.....	118	Hand Benders	
Benders – IMC Conduit		Circuit Alert® Pliers.....	119	Big Ben® Hand Benders.....	58
Cyclone® Electric Bender (B2000).....	36	Circuit Alert® Screwdrivers.....	119	Gardner™ Thinwall Hand Benders.....	59
Sidewinder® Electric Bender (B2555).....	37	CO2 Systems		Iron Hand Benders.....	60
Sidewinder™ Mechanical Benders.....	54-59	Air Compressor Seal-Off.....	73	Handles.....	61
Ultra Eeigor™ Hydraulic Bender.....	40-41	CO2 Refill Connector.....	72	Hickey Bending Heads.....	61
Benders – PVC Conduit		Powr House™ Conduit Fishing Systems.....	71	Hanger Strap.....	169
HotBlanket™ Benders.....	63	Powr-Pak I™ 5 lb. Portable System.....	72	Heat-Shrink Tubing - Colored PVC.....	165
HotBox™ Benders.....	62-63	Coaxial Cable Staples.....	159	Heat-Shrink Tubing - Heavy-Wall.....	166
HotTube™ Bender.....	61	Coaxial Cable Clamp for RG-6.....	183	Heat-Shrink Tubing - Thin Wall Polyolefin..	165
Benders – PVC-Coated Rigid Conduit		Coaxial Cable Stripper/Cutter.....	177	Heavy Duty Cable Ties	
Cyclone® Electric Bender (B2000).....	36	Colored Cable Ties.....	150	(Natural & Ultraviolet Black).....	148
Sidewinder® Electric Bender (B2555).....	37	Compression Crimp Tool.....	178	Hi-Temp Black Connectors.....	8
Sidewinder™ Mechanical Benders.....	54-57	Compression F-Series Connector,		Hydraulic Bender Accessories.....	52
Benders – Rigid Steel Conduit		RG-6 Bulk.....	177	Hydraulic Cylinder Specifications.....	53
Rigid Bender Capacities Chart.....	39	Conduit Straps.....	158	Insulated Metal Staples.....	156
Big Ben® Hand Benders.....	58	Continuity Tester		Knives.....	130
Cyclone® Electric Bender (B2000).....	36	Heavy-Duty.....	135	Knockout Seals.....	168
Gardner™ EMT Hand Benders.....	59	Copper Mechanical Lugs.....	13	Low Voltage Wire Staples.....	158, 160
Iron Hand Benders.....	60	Copper Split Bolt Connectors.....	12	Lubricants	
One-Shot Hydraulic Benders.....	42-48	Crimp Connectors.....	12	Wire-Aide™.....	91
Sidewinder® Electric Bender (B2555).....	37	Cutters		Poly-Gel™.....	92
Sidewinder™ Mechanical Benders.....	54-57	BX cutter.....	128	Super-Slick™.....	93
Sweep/Segmental Hydraulic Benders.....	46	Ratcheting.....	129	Masonry Staples.....	159, 160
Ultra Eeigor™ Hydraulic Bender.....	40-41	PVC.....	129	Material Handling	
Bender Shoe Groups		Datacom/ VDV		Reel Rollers	
Sidewinder® Electric Bender (B2555) - IMC.....	38	Coax Cable Products.....	176-178	30" Reel Roller.....	96
Sidewinder® Electric Bender (B2555) - Rigid.....	38	Twisted Pair Products.....	176-180	Handy-Saver™ Reel Roller.....	96
Sidewinder® Electric Bender (B2555) - EMT.....	38	Accessories.....	181-183	Reel Jacks - Telescoping.....	96
Sidewinder® Electric Bender		Disconnects.....	19	Wire Caddies & Carts	
(B2555) - PVC-Coated.....	38	Door Switch.....	32	Deluxe Spool Cart & Caddy Combo.....	98
Blower Systems		Duct Seal Compound.....	169	Hand Wire Caddy.....	97
JetLine® Super Blower™ (Electric).....	68	Electrician Scissors/Cutters.....	180	Heavy-Duty Spool Cart &	
Super Blo-Vac™ System (Blower/Vacuum).....	69	EZ Cable Clips.....	167	Caddy Expander Combo.....	98
Box Supports/Spacers.....	170, 172	Fiber-Insulated Staples.....	160	Portable Wire Caddy.....	97
Bullet Splices.....	19	Fish Sticks		Portable Wire Dispenser.....	99
Bundle Boss.....	151	12' Fish Ease™.....	81	Replacement Parts.....	99
Butt Splices & Kits.....	17, 20, 21	15' Glo Fish™.....	81	Spool Caddy Cart.....	97

<u>NAME</u>	<u>PG</u>	<u>NAME</u>	<u>PG</u>	<u>NAME</u>	<u>PG</u>
Wire Dispenser.....	98	Reference Book - "How To Use Your Multimeter"	143, 172	UTP/STP Cable Stripper.....	179
Metal Staples	156	Releaseable Cable Ties (Natural & Ultraviolet Black).....	149	Vacuum / Blowers Super Blo-Vac™ System	69
Miniature Cable Ties (Natural & Ultraviolet Black).....	147	Ring Terminals.....	17, 18	Voltage Testers Voltage Testers Comparison Chart.....	133
Mounting Bases and Ties (Natural & Ultraviolet Black).....	149, 151	RJ-45 / RJ-11 Modular Plug Crimp Tool.....	179	6-way Circuit.....	134
MultiCable Staples	157	Rocker Switches	31	Heavy-Duty 3-way	134
Multimeters - Analog Analog Multimeters Comparison Chart	139	Roofing Staples	160	Low Voltage Twin Probe.....	133
Five Function, 12-Range	139	Rope Rope Selection Guide	95	Screwdriver, Voltage Probe & Continuity Tester	134
Six Function, 14-Range	139	Poly-Pro™ General Purpose Rope	94	Solenoid	135
Seven Function, 19-Range	139	Super Tuff-Pull™ Double Braided Rope.....	93	Winged Connectors (WingGard®)	8
Multimeters - Clamp-On Clamp-On Comparison Chart	141	Tuff-Pull™ Single Braided Rope	94	Wire	23
AC Clamp Meter with Lockjaw	141	Rotary Switches.....	32	Wire Markers - Pocket Pack	170
Auto-Ranging Digital	141	Screwdrivers.....	129	Wire Strippers.....	120-122
Multimeters - Digital Digital Multimeters Comparison Chart	140	Screw Kits.....	171	Multi-tool.....	122
Three Function, 13-Range	140	Seals	169	Cable Rippers.....	123
Four Function, 14-Range	140	Service Entrance Staples	157	Wire Tracker™ Wire Tracer	176
Seven Function, 7-Range Auto-Ranging.....	140	Service Entrance Straps.....	158	Wireless Inspection Camera	138
Multi-Range Connectors (Hex-Lok®).....	9	Slug-Out™ Knockouts 35 Ton Hydraulic Punch	108	Xtreme Ties.....	152
Non-Contact Voltage Testers Non-Contact Voltage Testers Comparison Chart	136	Draw Studs.....	110-111		
Circuit Alert®	136	Hydraulic Slug-Out™ Sets	103-104		
Live-Wire™	136	Individual Components.....	107, 110-111		
Pigtail Connectors.....	11	Mechanical Slug-Out™ Sets.....	105-106, 112		
Plastic Staples	157	Notching Pliers	108		
Pliers Long Nose	126	Super Stainless Steel Slug-Out™ Sets.....	109, 112		
Linemen's	127	Spade Terminals.....	17, 18		
Pull-Chain Switches	30, 31	Spiral Wrap	166		
Pull Line / Line Carriers Foam Line Carriers	74	Split Flex Tubing.....	166, 183		
Heavy-Duty Bulk Nylon Line	75	Splitter Satellite/Digital TV 5MHz-2 GHz	177		
The Inflatables® Line Carriers.....	73	Standard Cable Ties (Natural & Ultraviolet Black).....	147		
Missile Line Carriers	73	Staple Gun	155, 156		
Poly-Pull™ Line	75	Step Bits	112		
Power Saver™ Line Packages.....	74	Storage Cases (Tool-Guard™).....	64		
Tag-Along™ Line Packages	74	Straight-Sided Connectors (WireGard™)....	7		
Pumps Economy Electric.....	50	Stud Insulators	168		
Manual Hydraulic.....	51	Stud Punch	113		
Submerged Electric	50	Table (Bend-Mate™ Bender Table for Ultra Egor™)	41		
Z-Class™ Electric	49	Tape - Electrical	163		
Punch-Down Blade	175	Tape - Friction.....	164		
Punch-Down Tool	175	Tape - Liquid Electrical	164		
Push-Button Switches	29, 30	Tape - Silicone Self-Sealing	164		
Push-In Connectors (PushGard™)	11	Tap Splices	20		
PVC Plug Sets.....	63	TelCom RJ-45 Cat 5 Modular Plug	180		
Receptacle Testers/Analyzers Receptacle Testers/Analyzers Comparison Chart	137	TelCom RJ-45 Cat 6 Modular Plug	180		
Lan Tracker™	138	Tensioning Tool	151		
Receptacle Tester & Circuit Analyzer.....	137	Terminal Adapters.....	20		
GFCI & Circuit Analyzer	137	Terminal Kits.....	21		
Reference Book - "Ugly's Electrical References"	143, 172	Tester Leads	142		
Reference Book - "Wiring Simplified"	143, 172	Tester Replacement Parts (fuses, batteries)	143		
		Toggle Switch Cover.....	29		
		Toggle Switches.....	28, 29		
		Underground UF Splice Kit	22		
		Universal Connectors (Uni-Lok®).....	10		

Romex® is a registered trademark of the Southwire Company, Carrollton, GA

PART #	PG	PART #	PG	PART #	PG	PART #	PG	PART #	PG
601.....	169	1103N.....	72	16-003M.....	7	21-101.....	18	46-104UVB.....	147
602.....	169	1105A.....	71	16-004.....	7	21-1055.....	18	46-104UVBMN... 147	
603.....	169	12-001.....	7	16-006.....	7	21-106.....	18	46-206.....	147
800.....	170	12-001BU.....	7	16-084.....	8	21-109.....	18	46-206M.....	147
820.....	61	12-002.....	7	16-084M.....	8	21-143F.....	19	46-206UVB.....	147
821.....	61	12-002BU.....	7	16-086.....	8	21-145F.....	19	46-210.....	147
822.....	61	12-003BU.....	7	16-086L.....	8	21-146F.....	19	46-210UVB.....	147
920.....	60	12-004BU.....	7	16-095.....	10	21-146M.....	19	46-308.....	147
921.....	60	12-006BU.....	7	16-1H1.....	9	21-155F.....	19	46-308FST.....	150
922.....	60	12-084BU.....	8	16-1H1L.....	9	21-155M.....	19	46-308G.....	150
923.....	60	12-086BU.....	8	16-8486M.....	8	21-161F.....	19	46-308MN.....	147
950.....	71	12-1G1BU.....	10	17-003.....	7	21-161M.....	19	46-308MP.....	151
960.....	58	12-1H1BU.....	9	17-004.....	7	25-001.....	7	46-308UVB.....	147
961.....	58	12-2H2BU.....	9	17-006.....	7	25-002.....	7	46-308UVBMN... 147	
962.....	58	13-003.....	7	17-084.....	8	25-003.....	7	46-308UVBMP... 151	
1102.....	72	13-004.....	7	17-086.....	8	25-004.....	7	46-310.....	147
1142.....	71, 72	13-006.....	7	17-1H1.....	9	25-006.....	7	46-310M.....	147
1206.....	71	13-084.....	8	19-001.....	7	25-084.....	8	46-310MP.....	151
1208.....	71	13-086.....	8	19-002.....	7	25-086.....	8	46-310UVB.....	147
1215.....	71, 72	13-089.....	8	19-003.....	7	25-089.....	8	46-310UVBM..... 147	
1216.....	71, 72	13-095.....	10	19-004.....	7	25-095.....	10	46-310UVBMP... 151	
1525.....	69	13-1G1.....	10	19-006.....	7	25-1G1.....	10	46-311.....	147
12568.....	69	13-1H1.....	9	19-084.....	8	25-1H1.....	9	46-315.....	147
125615.....	69	13-2G2.....	10	19-086.....	8	25-2G2.....	10	46-315M.....	147
126025.....	68	13-2H2.....	9	19-089.....	8	25-2H2.....	9	46-315UVB.....	147
10-001.....	7	13-410.....	12	19-095.....	10	25-AWC.....	7	46-315UVBM..... 147	
10-002.....	7	14-075.....	23	19-1G1.....	10	25-AWW.....	8	46-330.....	148
10-003.....	7	14-076.....	23	19-1H1.....	9	27-003.....	8	46-330UVB.....	148
10-003HT.....	8	14-077.....	23	19-2G2.....	10	27-004.....	8	46-408.....	148
10-004.....	7	14-078.....	23	19-2H2.....	9	42-027.....	170	46-408UVB.....	148
10-004HT.....	8	14-095.....	18	19-AWC.....	7	42-028.....	170	46-412.....	148
10-006.....	7	14-097.....	18	19-AWW.....	8	42-029.....	170	46-412UVB.....	148
10-084.....	8	14-099.....	18	19-PC2.....	11	42-030.....	170	46-415.....	148
10-086.....	8	14-505.....	23	19-PC3.....	11	42-035.....	170	46-415UVB.....	148
10-089.....	8	14-510.....	23	19-PC4.....	11	42-ALPHA.....	170	46-418.....	148
10-095.....	10	14-520.....	23	19-PC8.....	11	45-104.....	147	46-418UVB.....	148
10095VDV.....	182	14-530.....	23	20-089.....	11	45-104UVB.....	147	46-421.....	148
10-100.....	20	14-550.....	23	20-090.....	11	45-306SS.....	150	46-421UVB.....	148
10-104.....	18	14-610.....	23	20-100.....	20	45-308.....	147	46-424.....	148
10-105.....	18	14-630.....	23	20-101.....	18	45-308FB.....	150	46-424UVB.....	148
10-106.....	18	14-GRC.....	14	20-102.....	18	45-308FG.....	150	46-436.....	148
10-107.....	18	14-WPI.....	171	20-103.....	18	45-308FY.....	150	46-436UVB.....	148
10-108.....	18	14-WPW.....	171	20-104.....	18	45-308G.....	150	46-448.....	148
10-113.....	18	15-090.....	11	20-105.....	18	45-308ID.....	150	46-448UVB.....	148
10-114.....	18	15-096.....	18	20-106.....	18	45-308MT.....	143	46-507N.....	147
10-116.....	18	15-098.....	18	20-107.....	18	45-308MTG . 149,182		46-ACL.....	150
10-121.....	20	15-104.....	18	20-108.....	18	45-308MTUVB... 143		46-ACT.....	150
10-123.....	20	15-105.....	18	20-111.....	18	45-308UVB.....	147	47-108.....	149
10-126.....	20	15-106.....	18	20-112.....	18	45-312.....	147	47-108UVB.....	149
10-141F.....	19	15-107.....	18	20-113.....	18	45-312SS.....	150	47-115UVB.....	149
10-141M.....	19	15-108.....	18	20-114.....	18	45-312UVB.....	147	47-121UVB.....	149
10-143F.....	19	15-114.....	18	20-121.....	20	45-315.....	147	47-127UVB.....	149
10-145F.....	19	15-116.....	18	20-1210.....	20	45-315UVB.....	147	48-308.....	149
10-145M.....	19	15-120.....	21	20-123.....	20	45-515.....	148	48-308UVB.....	149
10-151F.....	19	15-121.....	20	20-126.....	20	45-515UVB.....	148	75-104.....	18
10-153F.....	19	15-123.....	20	20-141F.....	19	45-518N.....	148	75-106.....	18
10-153P.....	19	15-126.....	20	20-141M.....	19	45-518UVBN.....	148	75-111.....	18
10-155F.....	19	15-143F.....	19	20-143F.....	19	45-521.....	148	75-113.....	18
10-170.....	21	15-143M.....	19	20-143M.....	19	45-521UVB.....	148	75-116.....	18
10-1G1.....	10	15-145F.....	19	20-145F.....	19	45-524.....	148	75-121.....	20
10-1H1.....	9	15-151F.....	19	20-145M.....	19	45-524UVB.....	148	75-123.....	20
10-2G2.....	10	15-151M.....	19	20-151P.....	19	45-536.....	148	75-126.....	20
10-2H2.....	9	15-152P.....	19	20-153F.....	19	45-536UVB.....	148	75-143F.....	19
10-310C.....	12	15-153F.....	19	20-153P.....	19	45-548.....	148	75-145F.....	19
10-311C.....	12	15-153M.....	19	20-161P.....	19	45-548UVB.....	148	79-002.....	91
10-410.....	12	15-2210.....	21	20-163F.....	19	45-MB.....	151	79-003.....	91
10-410C.....	12	15-2214.....	21	20-163M.....	19	45-MBUVB.....	151	79-006N.....	91
10-411.....	12	15-2216.....	21	20-163P.....	19	45-V11BKW.....	151	79-201.....	92
10-PC2.....	11	15-2218.....	20	20-2218.....	20	45-V15FBK.....	151	79-202.....	92
10-PC3.....	11	16-001.....	7	20-410.....	12	45-V8BKV... 151, 182		79-203.....	92
10-PC4.....	11	16-002.....	7	20-411.....	12	46-104.....	147	79-301.....	92
10-PC8.....	11	16-003.....	7	21-100.....	20	46-104MN.....	147	79-401.....	93

PART #	PG	PART #	PG	PART #	PG	PART #	PG	PART #	PG
45-812UVB.....	152	AMT-5126.....	17	BHB-520D.....	62	BZ12383.....	43, 46	CP8000.....	82
45-824UVB.....	152	AMW-312.....	23	BHB-540A.....	62	BZ12384.....	43, 46	CP8001.....	83
45-812GN.....	152	AMW-314.....	23	BHB-560.....	63	BZ12385.....	43, 46	CP801.....	83
45-824GN.....	152	AMW-316.....	23	BHB-560P.....	63	BZ12386.....	45, 48	CP806.....	83
45-812N.....	152	AMW-318.....	23	BHE-50K.....	62	BZ12388.....	45, 48	CR-100.....	123
45-824N.....	152	AMW-322.....	23	BHE-540.....	62	BZ12389.....	45, 48	CR-1000.....	123
45-8Beadgn.....	152	AMW-324.....	23	BHE-560.....	63	BZ12390.....	45, 48	CRC-100.....	123
45-8Beadyw.....	152	AMW-326.....	23	BHT-520A.....	61	BZ12391.....	44-45,	CS1010.....	42, 53
46-8beadbk.....	152	AMW-328.....	23	BIMC-152.....	38	47-48	CS106.....	53
45-8beadbk.....	152	AMW-332.....	23	BPVC-52.....	38	BZ12392.....	44-45,	CS2510.....	43, 46, 53
45-12beadgn.....	152	AMW-334.....	23	BR12515.....	54, 55	47-48	CS2514.....	44, 45, 53
45-12beadyw.....	152	AMW-336.....	23	BR20000.....	54	BZ13401.....	43,	CTT-45.....	151
45-12beadbk.....	152	AMW-338.....	23	BR57510.....	54, 55	44, 46, 47	CW-MULTI1L2M3S	
46-12beadgn.....	152	AP4-K100.....	171	BRIG-52.....	37	BZ28.....	40	163
45-18beadgn.....	152	B1021028.....	41	BS2500.....	40	BZ34.....	40	CW-T1RR50.....	163
45-18beadyw.....	152	B2000.....	36	BS3000.....	40	BZ39.....	40	CW-T2RR25.....	163
45-18beadbk.....	152	B2555.....	38	BS3500.....	40	BZ44.....	40	CW-T3RR25.....	163
46-18beadbk.....	152	B2555EMT.....	38	BS4000.....	40	BZ72.....	41	CW-T4RR20.....	163
45-24beadyw.....	152	B2555PVC.....	38	BT12515.....	54	BZ725.....	41	DS-130.....	169
45-24beadbk.....	152	B2555RIG.....	38	BT2000.....	54, 57	BZ726.....	41	DS-530.....	169
46-24beadbk.....	152	B26.....	68, 69	BT57510.....	54	BZ74.....	40	EFT-21PN.....	78, 180
79-402.....	93	B3000.....	68	BTI12520.....	54	BZ76.....	40	EFT-50B.....	79
79-403.....	93	B306S.....	37, 46	BV12.....	69	BZ78.....	40	ERB-UG.....	172
920H.....	60	B306SPE22J.....	46	BV1281.....	69	C604.....	52	ERB-WS.....	172
921H.....	60	B306SPH80.....	46	BV208DA.....	69	CAM-10.....	117	ES15.....	39
922H.....	60	B308S.....	37, 43	BV23.....	69	CB21V.....	73	ES-2.....	39
930B.....	59	B308SPE22J.....	43	BV24.....	68, 69	CD3014.....	47, 48, 53	ES-360.....	179
930H.....	59	B308SPH80.....	43	BVP25.....	63	CD3028KT.....	40	ES-5125.....	39
931B.....	59	B316S.....	37, 42	BVS-240.....	63	CF860013.....	41	ESR-152.....	39
931H.....	59	B316SPE22J.....	42	BW11.....	55	CF861108.....	41	ESR-5125.....	39
960H.....	58	B316SPH39.....	42	BW12.....	55	CF862281.....	41	ET64220.....	176
961H.....	58	B340S.....	37, 44	BW15.....	55	CF863104.....	41	F125.....	73
962H.....	58	B340SP208J.....	44	BW20.....	56	CH1211.....	53, 103, 109	F250.....	73
A12.....	52	B340SPE22J.....	44	BW201.....	57	CH819044.....	41	F400.....	73
A29.....	52	B340SPH80.....	44	BW20S.....	56	CH951044.....	41	F400B.....	68
A630.....	52	B343S.....	37, 47	BW221.....	57	CK211950.....	41	F600.....	73
AML-200.....	14	B343SP408J.....	47	BW221S.....	57	CK212950.....	41	FC1.....	71, 72, 74
AML-201.....	14	B343SP408S.....	47	BW27.....	57	CK-570.....	21	FC10.....	71, 74
AML-202.....	14	B343SPH84.....	47	BW27S.....	57	CK579281.....	41	FC11.....	71, 74
AML-203.....	14	B350.....	44, 47	BW30.....	56	CM191044.....	41	FC1-10.....	69
AML-204.....	14	B351S.....	37, 48	BW30S.....	56	CM194900.....	41	FC12.....	71, 74
AML-205.....	14	B351SP408S.....	48	BW72.....	54	CM20.....	40, 64, 82	FC2.....	71, 74
AML-206.....	14	B351SPH84.....	48	BW74.....	54	CM260281.....	54	FC3.....	71, 74
AML-207.....	14	B359S.....	37, 45	BW75.....	54	CM4.....	42, 64	FC4.....	71, 74
AML-208.....	14	B359SP208J.....	45	BW76.....	54	CM5.....	103	FC5.....	71, 74
AMT-100.....	17	B359SPH80.....	45	BWF888.....	54-57	CM7.....	43-48, 64	FC6.....	71, 74
AMT-103.....	17	B400DL.....	40	BX-1.....	38, 39	COM-310.....	177	FC7.....	71, 74
AMT-106.....	17	B400DLP408S.....	40	BZ12011.....	42	COM-320.....	177	FC8.....	71, 74
AMT-108.....	17	B400L.....	40	BZ12021.....	42	CP10.....	83	FC9.....	71, 74
AMT-110.....	17	B400LP408S.....	40	BZ12031.....	42, 43	CP10-242.....	88	FLX-757GR.....	166
AMT-113.....	17	B60.....	68	BZ12041.....	42-45, 47-48	CP10-243.....	88	FP159-3.....	169
AMT-116.....	17	BB2030.....	63	BZ12051.....	42-45,	CP10K.....	88	FP159-6.....	169
AMT-120.....	17	BB3040.....	63	47-48	CP15.....	83	FPE-20.....	130
AMT-121.....	17	BB5150.....	63	BZ12061.....	42-45,	CP503.....	82, 83	FSP-AST2.....	166
AMT-123.....	17	BB-K01.....	151	47-48	CP504.....	83	FSP-BLACKT.....	166
AMT-124.....	17	BB-B01.....	151	BZ12071.....	42	CP505.....	82, 83	FSP-CLEAR.....	166
AMT-126.....	17	BB-C01.....	151	BZ12091.....	42-45,	CP600.....	83	FTB-10.....	80
AMT-127.....	17	BB-B01UVB.....	151	47-48	CP601.....	82, 83	FTL-5.....	80
AMT-4100.....	17	BB-C01UVB.....	151	BZ12341.....	44-45,	CP622.....	82, 83	FTN-100R.....	76
AMT-4103.....	17	BEMT-52.....	38	47-48	CP630.....	83	FTS-100GR.....	77
AMT-4106.....	17	BF41.....	54	BZ12351.....	44-45,	CP631.....	82, 83	FTS-125R.....	76
AMT-4110.....	17	BF42.....	54	47-48	CP700.....	83	FTS-200GR.....	77
AMT-4113.....	17	BF47.....	54	BZ12371.....	42	CP701.....	82, 83	FTS-250R.....	76
AMT-4116.....	17	BF48.....	54	BZ12372.....	43, 46	CP702.....	82, 83	FTS-50B.....	78
AMT-4120.....	17	BF49.....	54	BZ12375.....	42	CP703.....	82, 83	FTS-65R.....	76
AMT-4123.....	17	BFB2500.....	40	BZ12376.....	43-44,	CP704.....	83	FTX-12L.....	81
AMT-4126.....	17	BFB3000.....	40	46-47	CP705.....	83	FTX-15GL.....	81
AMT-5102.....	17	BFB3500.....	40	BZ12377.....	42-44,	CP706.....	82, 83	FTX-312.....	180
AMT-5104.....	17	BFB4000.....	40	46-48	CP707.....	82, 83	GAK-1/0.....	12
AMT-5106.....	17	BH-100.....	61	BZ12379.....	46	CP708.....	82, 83	GAK-2.....	12
AMT-5121.....	17	BH-125.....	61	BZ12380.....	46	CP709.....	82, 83	GAK-2/0.....	12
AMT-5123.....	17	BH-75.....	61	BZ12381.....	46	CP80.....	82, 83	GAK-4/0.....	12
				BZ12382.....	43, 46	CP800.....	82, 83		

PART #	PG	PART #	PG	PART #	PG	PART #	PG	PART #	PG
GAT-3400	133,	GPC-200	129	GSW-121	28	HC927	40, 52	KD1000B	103-107
.....	135, 143	GPS-3214	127	GSW-123	28	HF100	52	KD1250B	103-107
GBT-3502	142, 143	GPS-3219	127	GSW-124	28	HF101	52	KD1500B	103-107
GBT-500A	142, 143	GPS-3220	126	GSW-125	28	HS-8512	82, 83, 91	KD1732B	107
GBX-300	128	GPS-3228	126	GSW-125BP	28	HSB-28	22	KD2000B	103-107
GBX-TK	17	GPS-3238	126	GSW-13	28	HST-093	165	KD2500	103,
GC-1000	128	GPT-80	119	GSW-14	28	HST-093B	165	106, 107
GC-375	128	GPT-90	119	GSW-15	28	HST-093W	165	KD3000	103,
GC-500	128	GRC-750	129	GSW-16	28	HST-093R	165	106, 107
GCC-120	158	GRT-3500	137	GSW-17	28	HST-100	165	KD3500	103,
GCC-220	158	GRX-3224	123	GSW-18	28	HST-101	165	106, 107
GCC-310	158	GS-355	121	GSW-19	29	HST-101B	165	KD4000	103,
GCC-410	158	GS-359	124	GSW-20	29	HST-102	165	106, 107
GCC-510	158	GS-359D	178	GSW-21	30	HST-107	165	KD500B	103-107
GCC-610	158	GS-360	121	GSW-22	29	HST-125	165	KD750B	103-107
GCM-221	141, 143	GS-361	121	GSW-23	29	HST-125B	165	KDS1000	109, 112
GCM-500	141, 143	GS-365	122	GSW-24	30	HST-125B6	165	KDS1250	109, 112
GCP-3400	127	GS-366	123	GSW-24BP	30	HST-125R	165	KDS1500	109
GCT-3304	133,	GS-370	122	GSW-25	30	HST-125W6	165	KDS2000	109
.....	135, 143	GS-385	126	GSW-26	32	HST-187	165	KDS500	109, 112
GCV-3206	133,	GS-386	126	GSW-31	30	HST-250	165	KDS750	109, 112
.....	134, 143	GS-387	127	GSW-31BP	30	HST-250B	165	KF-200	130
GDC-2W2G	176	GS-388	128	GSW-32	30	HST-250R	165	KKT316	107
GDC-3W2G	176	GS-389	178	GSW-32BP	30	HST-250W	165	KLP2	104
GDC-4W2G	176	GS-394	122	GSW-33	31	HST-375	165	KLP6	104
GDC-6C	177	GS-40	121	GSW-34	31	HST-500	165	KO701	168
GDC-6CM	177	GS-67K	21	GSW-35	30	HST-750	165	KO701C	168
GDC-FAM	177	GSBC-1/0	12	GSW-39	31	HST-999	165	KO702	168
GDT-311	140, 143	GSBC-2	12	GSW-41	31	HST-187W	165	KO702C	168
GDT-3190	140, 143	GSBC-2/0	12	GSW-42	31	HST-750B	165	KO703	168
GDT-3200	140, 143	GSBC-3/0	12	GSW-45	31	HST-750B6	165	KO704	168
GES-224	120	GSBC-4	12	GSW-48	31	HST-750R	165	KO705	168
GES-55	120	GSBC-6	12	GSW-49	31	HST-999B	165	KO706	168
GESP-224	120	GSBC-8	12	GSW-61	32	HST-999R	165	KO707	168
GESP-55	120	GSE-105	158	GSW-62	32	HST-999W	165	KO708	168
GESP-70	120	GSE-115	158	GSW-63B	32	HST-1300	22	KO709	168
GET-3100	133, 143	GSE-15310	157	GSW-68	32	HST-AST	165	KO710	168
GET-3202	133, 143	GSE-15410	157	GSW-69	32	HST-ASTA	165	KOF520	103
GET-3206	133,	GSE-170	158	GSW-69BP	32	HST-ASTB	165	KOF540	103
.....	134, 143	GSE-205	158	GSW-SK	32	HST-WP	22	KOH14A	103
GET-3213	133,	GSE-215	158	GTA-2/0	13	HTP-1010	164	KOH2540	106
.....	134, 143	GSE-250	158	GTA-2/0	13	HTP-1010BLU	164	KOH520A	103
GFI-3501	137	GSE-304	158	GTB-406	20	HTP-1010CLR	164	KOH540A	103
GGC-1508	14	GSE-310	157	GTB-408	20	HTP-1010GRN	164	KOM152	106
GGP-1261	14	GSE-314	158	GTB-410	20	HTP-1010GRY	164	KOM1732	107
GGP-1273	14	GSE-330	158	GTB-667P	163	HTP-1010RED	164	KOM200	107
GGP-1282	14	GSE-402	158	GTF-300	164	HTP-1010WHT	164	KOM250	107
GGP-1461	14	GSE-410	157	GTF-600	164	HTP-1010YLW	164	KOM300	107
GGP-1502	14	GSE-4310	157	GTG-667P	163	HWT-0722	166	KOM350	107
GGG-1032HC	14	GSE-505	158	GTN-667P	163	HWT-1138	166	KOM400	107
GGG-1512R	14	GSE-515	158	GTO-667P	163	HWT-1550	166	KOM50125	106
GHG-1525	168	GSE-5310	157	GTP-307	163	IS-15	39	KOM520A	114
GHG-1538	168	GSLU-125	13	GTP-307D	163	IS-2	39	KOM540A	114
GHG-1550	168	GSLU-25	13	GTP-307WD	163	ISR-152	39	KOMD1	114
GHG-1575	168	GSLU-35	13	GTP-607	163	ITC-RG-6	175	KOR14	105
GHG-AST	168	GSLU-70	13	GTP-607P	163	ITC-RG-6C	175	KOR152	105, 110
GHS-1510	169	GSP-04	172	GTPC-512	163	JLP10	80	KOR50	105, 110
GKC-100A	129	GSP-24	172	GTPC-550	163	JLP5	80	KOR520	105
GKK-1538	167	GSPA-0	13	GTPS-100	124	JO225LC	71	KOR75125	105, 110
GKK-1538UVB	167	GSPA-2	13	GTPS-3100	179	JO25	72	KOS-1000B	107
GKK-1550	167	GSPA-4/0	13	GTR-667P	163	JO25A	72	KOS-1250B	107
GKK-1575	167	GST-224M	118	GTW-667P	163	JV07	69	KOS-1250DS	107
GMC-1145	125	GST-55M	118	GTY-667P	163	JV08	69	KOS-1500B	107
GMC-1145D	178	GST-70M	118	GVD-3504	133,	JV09	69	KOS-1500DS	107
GMC-2000D	179	GSW-10	28	136, 143	JV12	69	KOS-500B	107
GMC-88C5	180	GSW-11	28	GVD-3505	133,	JV210	69	KOS520	104
GMC-88C6	180	GSW-110	28	136, 143	K88001	106	KOS5290	104
GMC-88M5	180	GSW-114	29	GVT-392	133,	K88004	106	KOS-750B	107
GMC-88M6	180	GSW-117	28	135, 143	K88007	105, 122	KOW520	105
GMT-312	139, 143	GSW-12	28	H8210	52	K88008	106	KP1000B	103-107
GMT-318	139, 143	GSW-120	28	H864	52, 103, 109	K88020	105, 109	KP1250B	103-107
GMT-319	139, 143	HC913	42-48, 52	KC3540	103, 110	KP1500B	103-107
GMT-BK	143	KP1732B	107

PART #	PG	PART #	PG	PART #	PG	PART #	PG	PART #	PG
KP2000B	103-107	MB400L	41	PE22J	50	PSB-100	158	SB-210	112
KP2500	103, 106, 107	MB400LP	41	PEC-31525	183	PSB-160	159	SCE-3260	129
KP3000	103, 106, 107	MB400DL	41	PF65	51, 103	PSB-1600T	159	SCE-3262	129
KP3500	103, 106, 107	MB400DLP	41	PGJ-025	90	PSB-165	158	SDT-10	119
KP4000	103, 106, 107	MCS-100W	157	PGJ-037	90	PSB-1650T	158	SE-398	178
KP500B	103-107	MCS-20W	157	PGJ-050	90	PSG-100	158	SE-92	121
KP750B	103-107	MMS-3101	156	PGJ-062	90	PSG-15	158	SE-98	124
KPR7520	104, 109, 110	MMS-3102	156	PGJ-075	90	PSG-50	158	SI-25	113, 168
KPR7540	103, 109, 110	MPS-2080	155, 181	PGJ-100	90	PSM-1550T	158	SK-832WP	171
KPS1000	109, 112	MPS-2100	155	PGK-075	90	PSR-25	160	SP3500	108
KPS1250	109, 112	MPS-2125	155, 181	PGK-100	90	PSW-100	158	SP-7	113
KPS1500	109	MS-150	156	PGK-150	90	PSW-160	159	SPD-438	108
KPS2000	109	MS-1550T	156	PGK-250	90	PSW-1600T	159	SPD-563	108
KPS50	103, 104, 109, 110	MS-1555	156	PGK-300	90	PSW-165	158	SPD-688	108
KPS500	109, 112	MS-1575T	156	PGK-350	90	PSW-1650T	158	SPD-813	108
KPS750	109, 112	MS-1577	156	PGK-400	90	PSW-200JN	158	SPK10	108
KS752B	105, 106, 107, 111-112	MS-175	156	PGTS-100	90	PSW-3650	183	ST40	75
KSA50	104, 109, 110	MS-450J	156	PGTS-150	90	PTM-25	159	TK-100	21
KSB50B	105-107, 111-112	MS-500J	156	PGTS-200	90	PTP-100	159	TK-1210	21
KSN2530	107, 111	MS-550	156	PGTS-250	90	PTP-100M	159	TK-1614	21
KSN3540	107, 111	MS-575	156	PGTS-300	90	PTP-25T	159	TK-175	21
KSS50125	112	MS-950B	156	PGTS-350	90	PTP-250JT	159	TK-1822	21
KSS520	109	MS-950BU	156	PH20	51, 103, 109	PTP-325	183	TK-32	21
KSS520A	109	MS-975B	156	PH39	51	PVR-152	39	TK-40	21
KW52	105	MSB-1540	160	PH80	51	PVR-5125	39	TK-500	21
LP1701	75	MSG-301	156	PL102B	75	PVS-152	39	TK-806	21
LP1701B	72	MSG-501	155, 181	PL232B	75	PVS-5125	39	TK-QC	21
LP1722	75	MSI-150	156	PL235	75	PWS-1525	160	TM5	91
LP2150	69, 71, 72, 74	MSI-1525T	156	PL235B	75	RGP-2525	94	TRJ-56	96
LP2206T	69, 71, 74	MSI-1575	156	PMB-1525	159	RGP-2560	94	TRJ-96	96
LP2207T	69, 71, 74	MSI-200JT	156	PMC-1525WT	159	RGP-3825	94	TT-10B	129
LP2208T	71, 74	MSI-50B	156	PMW-100	159	RGP-3860	94	TT64202	176, 180
LP3300	71, 74	MSI-550	156	PPC-1525	167	RGP-5025	94	UG121112	71
LP3450	69, 74	MSI-75	156	PPC-1525UVB	167	RGP-5060	94	WCM-10	98
LP4300	71, 72, 74	MSI-950B	156	PPC-1538	167	RGP-7560	94	WIC-100	138
LP4450	69, 74	MSTR-TORCH	17, 164	PPC-1538UVB	167	RKT-21	117	WRR-100	96
LTB-400	164	MSW-1540	160	PPC-1550	167	RS-152	38	WRR-300	96
LTG-400	164	NP-1	108	PPC-1550UVB	167	RS-5125	38	WSP-100E	97
LTR-400	164	NYD-100	80	PPC-1575	167	RSR-152	38	WSP-115	97
LTS-400	164	OX-100B	14	PPC-1575UVB	167	RSR-5125	38	WSP-140	97
LTS-600BLU	164	OX-800	14	PPR-1550	167	RST-5030	93	WSP-144	98
LTS-600ORG	164	P208J	49	PPR-1575	167	RST-5060	93	WSP144050	99
LTS-400	164	P408J	49	PPR-1600	167	RST-7530	83, 93	WSP144251	99
LTW-400	164	P408K	49	PS-150	157	RST-7560	83, 93	WSP144253	99
M2000	73	P408S	49	PS-150Z	157	RST-7830	93	WSP-150	98
M3000	73	PAW-1525L1	167	PS-1550T	157	RST-7860	93	XTM-220	17
M4000	73	PAW-1525T	167	PS-1575T2	157	RTL-103	142	XTM-225	17
M5000	68, 73	PAW-1550L1	167	PS-175	157	RTL-107	142	XTM-230	17
M6000	68, 73	PCC-1525	158	PS-175JM	158	RTL-108	142	XTM-240	17
MB-20	151	PCS-100	160	PS-225J	157	RTL-200	142	XTM-245	17
MB-20UVB	151	PCS-100B	160	PS-225JM	158	RTP-3422	164	XTM-250	17
MB400	41	PCS-1525	160	PS-250N	157	RTP-3830	94	XTM-260	17
		PCS-1600T	160	PS-275N	157	RTP-7530	94	XTM-265	17
		PCS-3600	183	PS-50	157	RTS-100	79	XTM-301	165
		PDB-110	125	PS-50M	158	RTS-200	79	XTM-305	165
		PDB-66110	125, 175	PS-550	157	RTS-50B	79	XTM-401	167
		PDC-1525BT	160	PS-575	157	RV5	72	XTM-405	167
		PDS-1525BT	160	PS-75	157	S-8512	82, 83	XTM-450	166
		PDT-110	125	PS-75M	158	SB-205	112	ZCD3028	40
		PDTL-3110	175	PS-750B	157	SB-207	112	ZDC404	40
		PE20D	50			SB-209	112		



USA

PO Box 3241
Milwaukee, WI 53201-3241
800.624.4320
Fax 800.799.3779

www.gardnerbender.com

CANADA

6615 Ordan Drive, Units 14-15
Mississauga, Ontario
L5T 1X2 Canada
905.564.5749
Fax 905.564.0305



Catalog # GAR_CAT_008_0914
©2014 Gardner Bender™