

PRACTICAL WIRELESS

MAY
1970

3/6

**DECODER for
STEREO
f.m. transmissions**



**also:
AERIALS FOR MOBILES
3 BAND RECEIVER
GOING HI-FI**

COMPLETE STEREO SYSTEM

FOR ONLY **39 GNS**
CARRIAGE 35/-



The Premier Stereo System "ONE" consists of an all transistor stereo amplifier. Garrard 2025 T/C auto manual record player unit fitted stereo mono cartridge and mounted in teak finish plinth with perspex cover and two matching teak finish loudspeaker systems. Absolutely complete and supplied ready to plug in and play. The 10 transistor amplifier has an output of 5 watts per channel with inputs for pick-up, tape and tuner also tape output socket. Controls: Bass, Treble, Volume, Balance, Selector. Power on off, stereo mono switch. Brushed aluminium front panel. Black metal case with teakwood ends: Size 12 x 5½ x 3½ in. high (Amplifier available separately if required £14.19.6 Carr. 7/6.)

TELETON SAQ203E STEREO AMPLIFIER



oiled walnut cabinet with brushed aluminium front panel. List Price £28.7.0

A small but powerful amplifier designed for stereo hi-fi reproduction. Incorporates 16 transistors and diodes. 10 watts per channel music power. Inputs for Gram (Magnetic and Crystal), Tuner and Auxiliary. Tape Record output. Controls: Volume, Balance, Bass, Treble, Stereo/Mono slide switch. Stereo headphone socket. Attractive

OUR PRICE **22 Gns.** P. & P. 10/-

"NOVA" 505 TRANSISTOR STEREO AMPLIFIER

A superb stereo amplifier offering every facility for the hi-fi enthusiast. Output 5 watts per channel. Frequency response 40-20,000 Hz ± 3dB. Inputs for radio, P.U., Ceramic, P.U., Magnetic Tape. Separate bass and treble controls. Volume and Balance controls. Mono Stereo Switch. Also features headphone socket and tape output. Teak case with attractive illuminated front panel. Size 14½ x 9½ x 3½ in. A.C. 200/250V.



WONDERFUL VALUE AT **18 Gns.** Carr. 10/-

PREMIER STEREO SYSTEM "FOUR"

Teleton SAQ203E Amplifier (as above)	£28.7.0
Garrard SP25	£11.19.6
Shure M3D	£6.19.6
Teak base and cover	£5.10.0
Pair of Hi-Fi Enclosures fitted E.M.I. Speakers	£26.5.0
Total cost if purchased separately	£78.16.0

PREMIER PRICE **65 Gns.** Carr. 35/-

ALBA UA100D ALL TRANSISTOR STEREO TUNER AMPLIFIER

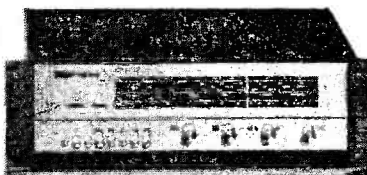

Covers Long, Medium and Short Waves plus VHF/BM with built in stereo decoder and A.F.C. Output 15 watts r.m.s. per channel into 8 ohms (distortion less than 0.3%). Response 20Hz-20KHz. Inputs for Magnetic and ceramic p.u. and Tape. Tape outlet socket. Tuning Volume, Bass, Treble and Balance controls. Push button selector. Black leatherette top, teak ends and brushed aluminium front panel.

PREMIER PRICE **£67.11.6** Carriage 12/6.

PREMIER STEREO SYSTEM "TWO"

As system 'ONE' above but with Garrard SP25.

PREMIER PRICE **45 Gns.** Carr. 35/-

VERITAS V-149 MIXER

Battery operated 4-channel audio mixer providing four separate inputs. Size 6 x 3 x 2½ in. suitable for crystal microphone low impedance microphone, with transformer, radio, tape, etc. Max. input 1.5v. Max. output 2.5v. Gain 6 dB. Standard jack plug socket inputs, phono plugs output. Attractive teak wood grain finish case.



MONO MODEL **59/6** STEREO MODEL **69/6** P. & P. 2/6.

PREMIER STEREO SYSTEM "FIVE"

Alba UA100D Tuner/Amplifier	£67.11.6
Garrard Sp25	£11.19.6
Shure M3D	£6.19.6
Teak base and cover	£5.10.0
Pair of Hi Fi Enclosures fitted E.M.I. Speakers	£26.5.0
Total cost if purchased separately	£118.5.6

PREMIER PRICE **£110** Carr. 35/-

PREMIER STEREO SYSTEM "THREE"

Nova 505 Amplifier (as above)	£18.18.0
Garrard SP25	£11.19.6
Sonotone 9TAHCD	£2.15.0
Teak base and cover	£5.10.0
Pair of Hi-Fi Enclosures fitted E.M.I. Speakers	£26.5.0
Total cost if purchased separately	£65.7.6

PREMIER PRICE **55 Gns.** Carr. 35/-

VERITAS V-313 TAPE HEAD DEFLUXER



A must for all tape users! Tape heads become permanently magnetized with constant use: this leads to background noise that prevents perfect recordings. Simply applied to recording head the V313 leaves head free of magnetism. Cleans any tape head in seconds.

34/6 P. & P. 1/6.

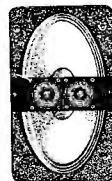

E.M.I. 13 x 8 in HI-FI SPEAKERS

Fitted two 2½ in tweeters and crossover network. Impedance 8 & 15 ohms. Handling capacity 10W. Brand new.

99/6 P. & P. 7/6

Also available without tweeters.

49/6 P. & P. 7/6

TAPE CASSETTES



C60 (60 min.) **7/6**

THREE FOR 21/-

C90 (90 min.) **12/6**

THREE FOR 36/-

C120 (120 min.) **17/6**

THREE FOR 51/- P. & P. 1/-.



CASSETTE HEAD CLEANER

Removes unwanted deposits from delicate tape heads. Fits all cassette recorders.

11/6 P. & P. 1/-.

"VERITONE" RECORDING TAPE

SPECIALLY MANUFACTURED IN U.S.A. FROM EXTRA STRONG PRE-STRETCHED MATERIAL. THE QUALITY IS UNEQUALLED. TENSILISED to ensure the most permanent base. Highly resistant to breakage, moisture, heat, cold or humidity. High polished splice free finish. Smooth output throughout the entire audio range. Double wrapped-attractively boxed.

LP3 3" 250' P.V.C.	5/8	LP6 5½" 1800' P.V.C.	12/8
TT3 3" 450' POLYESTER	7/6	DT6 5½" 1800' POLYESTER	22/6
DT3 3½" 600' POLYESTER	11/6	TF6 5½" 2400' POLYESTER	37/6
SP5 5" 600' P.V.C.	8/6	SP7 7" 1200' P.V.C.	12/6
LP5 5" 300' P.V.C.	10/-	LP7 7" 1800' P.V.C.	15/-
DT5 5" 1200' POLYESTER	15/-	DT7 7" 2400' POLYESTER	25/-
		TT7 7" 3600' POLYESTER	50/-

TAPE SPOOLS 3" 1/-, 5", 5½", 7" 1/9, Post and Packing 3" 1/-, 5", 5½", 1/6, 7" 2/- (3 reels and over Post Free).



PREMIER RADIO

23, TOTTENHAM COURT ROAD, LONDON, W.1 Tel: 01-636 3451



Laskys

SCOOP Garrard 3000

CUSTOM UNIT by Famous British manufacturer

The unit incorporates the renowned Garrard 300 four speed autochanger with lightweight tubular pick-up arm fitted with SONOTONE 9TA STEREO CARTRIDGE with diamond stylus. The beautifully made plinth in finished in richly figured teak veneer with tinted perspex panels in the lid and with attractive charcoal grey "mirror" insert panel on front. All metal trim parts are satin chrome. Black leather grain unci" side. The lid allows the player to operate fully automatically when closed and has snap action "stay" when raised. Mains socket and DIN audio output socket are at rear. Overall size 15 1/2 x 7 1/2 x 14 in.

LASKY'S SPECIAL PRICE £16.15.0 Post 15/-



SKYROVER Mk II Garrard

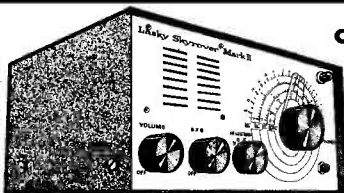

COMMUNICATION RECEIVER

A short wave receiver, exclusive to Lasky's, at a real economy price. Four valve line up using one each 6BE6, 6BA6, 6AV6 and 6AR5 valves, gives highly sensitive reception and powerful gain. Switch selected SW frequency range covers: 1.6 to 30MHz in three separate bandspread ranges and full AM medium wave-band cover in one range 550-

1,600kHz. Reduction drive tuning with hair line cursor. Controls include volume on/off BFO, Band selector. Power on indicator lamp. External antenna connections and mains fuse at rear. Internal speaker plus standard 5mm jack socket for phones on front. For 220/240V a.c. mains operation. Strong metal cabinet finished in grey crackle with anodised silver front panel. Size 9 1/2 x 5 1/2 x 5 1/2 in. Complete with mains lead and full instructions. IDEAL BEGINNERS RECEIVER.

LASKY'S PRICE £13.13.0 Post 5/-

TRIO 9R-59DE

- 8 valve plus 7 diode circuit continuous coverage from 550kHz to 30MHz with Calibrated Bandspread on 10, 15, 20, 40 and 80 metre bands
- Clear SSB reception is achieved through the use of a product detector.
- Finished in light grey with dark grey case. Fully guaranteed, complete with instruction manual and service data.

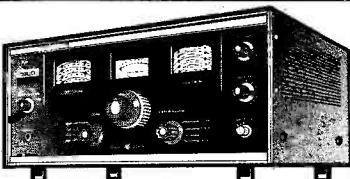

SPECIFICATION: Frequency Ranges: 550-1600kHz; 1.6-4.8MHz; 4.8-14.5MHz; 10.5-30MHz. Bandspread: (Direct Reading on Ham Bands) 3.5MHz 80m; 7MHz 40m; 14MHz 20m; 21MHz 15m; 28MHz 10m. Sensitivity: A, B, C, Bands—Less than 6dB (for 10dB S/N ratio); D Band—13MHz; Less than 18dB (for 10dB S/N ratio); 28MHz; Less than 10dB (for 10dB S/N ratio). Selectivity: ± 5kHz at -50dB. Audio Output: 1.5w. Power Requirements: AC 115/230V, 50/60Hz. Recommended Speaker Type: 4 or 8 ohm. Built-in Circuits: Bandspread; Automatic Noise Limiter (ANL); Automatic Volume Control (AVC); Headphone Jack. Dimensions: 7in. H 15in. W, 10in. D.

LASKY'S PRICE £42.0.0 Carriage free

TRIO SP-5D Communications speaker unit—matching all the TRIO receivers in both style and size. Contains 5 x 3 in. elliptical 8 ohms speaker specially designed to give extremely crisp reproduction of voice frequencies. Dark grey metal cabinet—size 7 x 3 1/2 x 5 1/2 in.

LASKY'S PRICE 87/6 post 5/-

TRIO HS-4 HEADPHONES

Rugged construction plus comfort make these a must for the Ham. Dynamic headset, input impedance 8 ohms, matching 4-16 ohms. Max. power 3w. Frequency range 300-3000Hz.

LASKY'S PRICE £5.19.6 post 3/6



TTC B-1016

A handy microphone for communications 6ft retractable lead, special hanger bracket built in "talk" switch! imp: 50,000 ohms. Size: 3 1/2 x 2 1/2 x 1 1/2 in.

67/6 post 3/6

AUTOCHANGERS

SL 72B £25 0 0
2025 TC complete with stereo cart. £8 17 6
3000 complete with 9TA HC stereo cart. £9 19 6
SL 65B £15 19 6
1025 complete with stereo cart. £6 19 6
SL 95B £40 0 0
SL 75B £32 0 0

SINGLE PLAYERS
AP 75 £18 10 0
AP 75 with AD 76K mag. cart. £21 10 0
SP 25 Mk II £11 19 6
SP 25 Mk. II complete AD76K stereo cart £15 10 0
401 Transcription unit £28 0 0

BASES AND COVERS FOR GARRARD UNITS
Type WB1 and WB5 for models 2025TC, 3000, SL65B, 1025, SP25 Mk. II. Price WB1 £3 16 6. WB5 £5 12 6. Type WB4 for models SL72B, SL75B. SL95B Price £5 12 6. Perspex covers: SPC1 for WB1 £3 14 1. SPC4 for WB4 and WB5 (allows unit to be played with the cover in place—Price £4 8 0.

PACKAGE DEALS

AP 75 complete with AD 76K Stereo magnetic cart., teak plinth and perspex cover (illustrated), **£30.0.0** Post 10/-
SP 25 Mk II complete with AD 76K magnetic cartridge teak plinth and perspex cover. **£19.0.0** Post 7/6
1025 complete with J2105 stereo crystal cart., teak plinth and perspex cover. **£11.19.6** Post 7/6
Post on Garrard units: 6/- extra—except AP 75, SL 75B, SL 95B and 401 7/6 extra. Post on bases and covers 5/- extra.

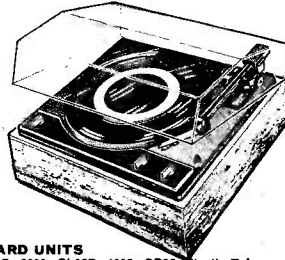

AUDIO DEVELOPMENT AD-76K

Stereo magnetic cartridge with diamond stylus. Frequency response 20-20,000Hz. 5mV output.

LASKY'S PRICE £4.10.0 Post Free

THE AMAZING

Astrad ORION

THE WORLD'S SMALLEST 6 TRANSISTOR TWO WAVEBAND RADIO OVER 50,000 SOLD

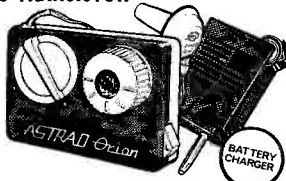

Made to the highest space-age standards—this remarkable micro-size set measures only 1 1/2 x 1 1/2 x 1 1/2 in. yet it contains 6 transistors and other components combined in a photo etched circuit, only 1/2 x 1/2 in. tuning capacitor, ferrite rod aerial, battery, wave band selection switch etc. Output to a high impedance crystal earpiece, giving ample volume (automatically adjusted) and clear tone. Brief tech. spec.: Waveband coverage—Medium wave 525 to 160kHz, Long wave 150kHz to 480kHz. Sensitivity: 35mV max. Selectivity—10dB (at 30kHz de-tuning). Power source: 1 x 1.4V Mercury battery.

The Orion is supplied fully built and tested complete with battery, left and right fitting earphone supports and attractive black and ivory plastic presentation/carrying case (matching the Orion). Never miss your favourite music, sport, news—the Orion is an ideal gift for all, providing a constant source of enjoyment without disturbing others.

LASKY'S PRICE ONLY 39/6 Post 2/6 Extra rechargeable battery 3/6

*NOTE: The battery we supply with the Orion is a rechargeable type. Charger units are available enabling you to re-charge the battery from AC Mains 220/240V supply.

PRICE 19/6 extra. Post free with radio—otherwise 2/-

Audio Tronics 70

The 1970 edition of Lasky's famous Audio-Tronics catalogue is now available—FREE on request. The 28 tabloid pages—many in full colour are packed with 1000's of items from the largest stocks in Great Britain of everything for the Radio and Hi-Fi enthusiast. Electronics Hobbyist, Servicemen and Communications Ham. Over half the pages are devoted exclusively to every aspect of Hi-Fi (including Lasky's budget Stereo Systems and Package Deals), Tape recording and Audio accessories. All the goods shown are available from any of our branches or by Mail Order to any address in the U.K. or Overseas—bringing the benefits of shopping at Lasky's to you in the comfort of your home.

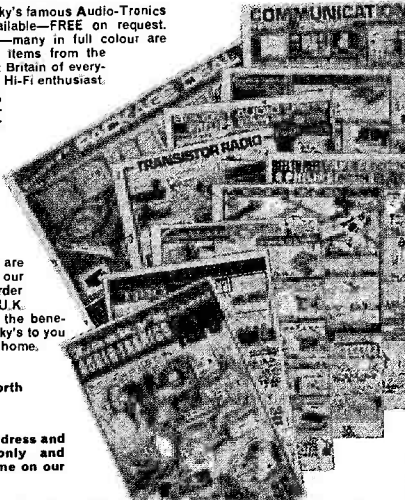

plus Lasky's amazing money saving vouchers worth over £25 0s. 0.

SEND TODAY

Send: Your name, address and 2/6 for the post only and inclusion of your name on our regular mailing list

THIS MONTHS

VOUCHERS WORTH 40/-!

EXCLUSIVE

DENSHI BOARD KITS

EDUCATIONAL AND EXPERIMENTAL CIRCUIT SYSTEM

The DENSHI BOARD system enables the young experimenter and electronics hobbyist to produce a wide range of transistor circuits of increasing sophistication—without soldering or the use of any tools at all! Basically the system comprises a slotted circuit board into which plug-in components and bridge pieces are set to produce up to 30 different circuits. The components are encapsulated in transparent plastic blocks bearing the appropriate circuit symbol and value thus enabling even the complete novice to visually grasp the fundamentals of circuitry after only a few moments study. Each DENSHI BOARD KIT comes complete with 80-page manual of circuits and data. **THESE ARE JUST A FEW OF THE CIRCUITS YOU CAN BUILD IN MINUTES:** VARIOUS RADIO RECEIVERS, AMPLIFIERS, MORSE CODE PRACTICE DEVICE, SIGNAL INJECTOR, SIGNAL TRACER, WIRELESS MICROPHONE, ETC. **DENSHI BOARD KIT SR-1A comprises:** Base board; tuner block; 4 resistors; choke coil transformer; 2SA transistor for RF; 2 diodes; 3 capacitors; battery block; Morse key; antenna lead; crystal earphone; various bridge and connecting pieces and manual. This kit permits the building of 16 basic circuits.

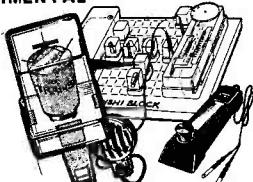

LASKY'S PRICE 87/6 Post 3/6

MODEL SR-2A with extra components—builds 30 basic circuits £6.2.6.

IC-403 INTEGRATED CIRCUIT

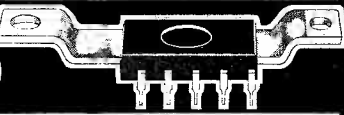

Originally developed for computer and space projects—these tiny modules—size only 25 x 10 x 5 millimetres—represent the most amazing breakthrough in circuit design since the introduction of the transistor. The IC-403 is an integrated power and pre-amplifier requiring only the addition of tone and volume controls, power source and speaker to form a complete audio amplifier of 3W output. **SPECIFICATIONS** (ratings at 25°C): Output power typically 3W from 250mV input. Frequency response 20Hz to 80kHz + 3dB. Max. operating voltage 21V. Min. operating load 7.5 ohms. Pre-amp. input imp. 2M/ohms. Pre-amp. D.C. input current 50nA. **THE IC-403 IS AVAILABLE EXCLUSIVELY FROM LASKY'S—COMPLETE WITH INSTRUCTION DATA AND SUGGESTED CIRCUIT APPLICATIONS.**

LASKY'S PRICE 49/6 Post 1/6 **2 for 95/-** post free

JUST ARRIVED DIGITAL CLOCK SCOOP!

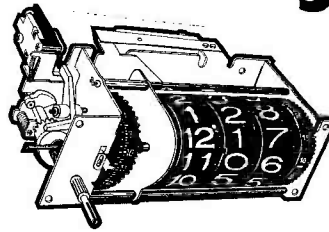

- MADE ESPECIALLY FOR LASKY'S BY FAMOUS MAKER
- MAINS OPERATION
- 12 HOUR ALARM
- AUTO "SLEEP" SWITCH
- HOURS - MINUTES AND SECONDS READ-OFF
- FORWARD AND BACKWARD TIME ADJUSTMENT
- SHOCK AND VIBRATION PROOF
- BUILT IN ALARM BUZZER

● SILENT OPERATION SYNCHRONOUS MOTOR

This unique DIGITAL CLOCK is now available EXCLUSIVELY FROM LASKY'S in chassis form for you to mount in any housing that you choose. All settings are achieved by two dual-concentric controls at the front including: ON-OFF-AUTO and AUTO ALARM, "sleep" switch, 10 minute division "click" set alarm (up to 12 hour delay), time adjustment. Ultra simple mechanism and high quality manufacture guarantee reliable operation and long life. The sleep switch will automatically turn off any appliance—radio, TV, light etc. at any pre-set time up to 60 min. and in conjunction with the AUTO setting will switch on the appliance again next morning. The clock measures 4 1/4" x 1 1/4" x 3/8" (overall from front of drum to back of switch). SPEC: 210/240V AC, 50Hz operation; switch rating 250V. 3A. Complete with instructions. HUNDREDS OF APPLICATIONS FOR THE ELECTRONICS HOBBYIST.

LASKY'S PRICE £5.19.6 POST 3/6

SPECIAL QUOTATIONS FOR QUANTITIES

WIEN FMX-1917 AM/FM STEREO TUNER AMP

A solid state AM/FM Multiplex tuner Amplifier offering excellent quality and pleasing design at a price you can afford. Brief spec: 18 transistors, 9 germanium diodes, 1 variable diode and 1 silicon rectifier. Single ended push pull amplifier—output 5W RMS per channel into 8 ohms. Frequency response 30Hz to 12kHz. Frequency range: FM—88 to 108MHz. AM—535 to 1605 kHz. Stereo separation 15dB at 100µV input. External FM aerial; built-in ferrite rod antenna for AM. Controls: Balance, Mode, Tone, Vol./on-off, tuning. Input for ceramic phono pick-up. Powered by 220/250V a.c. 50/60Hz. Extremely well made oiled walnut cabinet with large clear tuning dial (black/grey/silver trim). Size 14 x 8 1/2 x 5 1/2in.

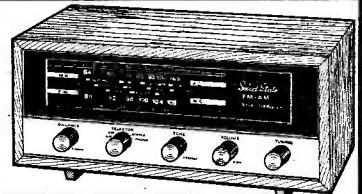

LASKY'S PRICE £29.0.0 Carriage FREE

WIEN PACKAGE DEAL

WIEN FMX-1917 + 2 ATOMIX SA-1003 Bookshelf speakers + GARRARD 1025 auto change with stereo cartridge + Lasky's Base and cover for 1025. **SPECIAL PACKAGE PRICE £51** post 45/-

TTC C-1051 METER

A completely new design 20,000 O.P.V. pocket multimeter with mirror scale and built-in thermal protection. Exceptionally large easy to read meter with D'Arsonval movement. Colour coded scales. Single positive click-in, recessed selection switch for all ranges. Ohms zero adjustment. Range spec. a.c. volts: 0-6-30-300-1,200V at 10K/ohms/V. DC volts: 0-3-15-150-300-1,2KV at 20K/ohms/V. Resistance: 0-60K-6megs. DC current: 0-60µA-300 mA. Decibels: —20dB to 17 dB. Extremely high standards of accuracy on all ranges. Uses one 1 1/2V penlight battery. Strong impact resistant plastic cabinet—size only 4 1/2 x 3 1/4 x 1 1/2in. Two colour buff/green finish. Complete with test leads and battery.

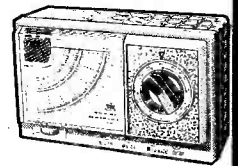

LASKY'S PRICE 75/- Post 2/6

Lasky's Radio Limited

207 EDGWARE ROAD, LONDON, W.2. Tel: 01-723 3271
33 TOTTENHAM CT. RD, LONDON, W1P 9RB. Tel: 01-636 2605

Open all day, 9 a.m. - 6 p.m. Monday to Saturday
109 FLEET STREET, LONDON, E.C.4. Tel: 01-353 5812
152/3 FLEET STREET, LONDON, E.C.4. Tel: 01-353 2833

HIGH FIDELITY AUDIO CENTRES
42-45 TOTTENHAM CT. RD, LONDON, W1P 9RD. Tel: 01-580 2573
Open all day, 9 a.m. - 6 p.m. Monday to Saturday

118 EDGWARE ROAD, LONDON, W.2. Tel: 01-723 9789
Open all day Saturday early closing 1 p.m. Thursday



ALL MAIL ORDERS AND CORRESPONDENCE TO: 3-15 CAVELL STREET, TOWER HAMLETS, LONDON, E1 2BN Tel: 01-790 4821

BOOKS BY G. A. BRIGGS

OVER A QUARTER OF A MILLION COPIES SOLD SINCE 1946

AERIAL HANDBOOK (second edition)

176 pages, 144 illustrations.
PRICE (semi-stiff cover) 15/- (16/6 post free).
Cloth bound 22/6 (24/- post free).



CABINET HANDBOOK

112 pages, 90 illustrations.
PRICE (semi-stiff cover) 7/6 (8/6 post free).
Cloth bound 15/- (16/6 post free).



AUDIO BIOGRAPHIES

344 pages, 64 contributions from pioneers and leaders in Audio. Cloth bound.
PRICE 25/- (27/- post free).



MUSICAL INSTRUMENTS AND AUDIO

240 pages, 212 illustrations. Cloth bound.
PRICE 32/6 (34/6 post free).



LOUDSPEAKERS

Fifth edition—336 pages, 230 illustrations
Cloth bound.
PRICE 30/- (32/6 post free).



A TO Z IN AUDIO

224 pages, 160 illustrations. Cloth bound.
PRICE 15/6 (17/- post free).



PIANOS, PIANISTS AND SONICS

190 pages, 102 illustrations. Cloth bound.
PRICE 18/6 (20/- post free).



ABOUT YOUR HEARING

132 pages, 112 illustrations
PRICE (semi-stiff cover) 15/6 (16/6 post free)
Cloth bound 22/6 (24/- post free).



READERS OPINIONS

I have recently been going through eight of your books and they have been a feast of information. I have been like a dog with eight tasty dishes, not knowing which one to tackle first but nipping about and sampling each one.
Somerset, Sept. 69

Having read the majority of your 'Bibles on Hi Fi', of such a remarkably 'hi' standard, I eagerly await a copy of your Cabinet Handbook.

London N22, Nov. 69

Please send orders and enquiries to:—

RANK WHARFEDALE BOOK DEPT. B.W.S.
13 WELLS ROAD ILKLEY YORKS

Telephone: ILKLEY 4246

Published by:

RANK WHARFEDALE LTD IDLE BRADFORD YORKSHIRE



for fast, easy, reliable soldering

Contains 5 cores of non-corrosive flux, instantly cleaning heavily oxidised surfaces. No extra flux required.

SAVBIT ALLOY ALSO REDUCES COPPER BIT WEAR.

Economically packed for general electrical and electronic soldering. 75ft. 18 gauge on plastic reel. Recommended retail price 15/-



THIN GAUGE SOLDER, ESSENTIAL FOR

soldering small components and thin wires. High tin content, low melting point, 60/40 alloy, 170ft. 22 gauge on plastic reel. Recommended retail price 15/-



A RANGE OF SOLDERS IN HANDY DISPENSERS.

REF. ALLOY SWG

4A	60/40	18	3/-*
Size 5 (ill-ustrated)	Savbit	18	3/-*
15	60/40	22	4/-*

*Recommended Price



INVALUABLE FOR STRIPPING FLEX, THE NEW AUTOMATIC OPENING BIB WIRE STRIPPER AND CUTTER,

easily adjustable for all standard diameters. Plastic covered handles can also be used as wire cutter. Recommended retail price 8/6



From Electrical and Hardware shops. If unobtainable, write to: Multicore Solders Ltd., Hemel Hempstead, Herts.



AMAZING MINI-DRILL

FOR PRECISION MODEL WORK

ABRASIVE
SPEAR DRILL
BURR
MHP
BRUSH

+ 6 TOOLS

Indispensable for precision drilling, grinding, polishing, etching, gouging, shaping. Precision power for the enthusiast. Shockproof. Completely portable power from 4½ volt external battery. So much more scope with MINI-DRILL. Super Kit (extra power, interchangeable chuck) 79/6, p.p. 2/6. De Luxe Professional Kit with 17 tools 130/- p.p. 4/6. Money ref. g'tee.

MERLIN SUPPLY CO.

Dept. PW5D, Nailsea, Bristol BS19 2LP

BUILD YOUR CIRCUITS

ON

VEROBOARD

—the Universal Wiring Board—
obtainable from your local Retailer

Trade enquiries to:

NORMAN ROSE (ELECTRICAL) LTD.

8 St. Chad's Place, Gray's Inn Road, London, W.C.1

Technical enquiries to:

VERO ELECTRONICS LTD.

Industrial Estate, Chandler's Ford, Hants

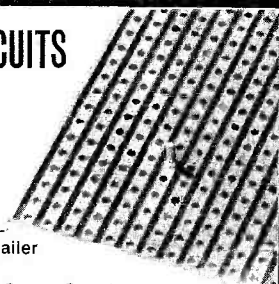

Complete stereo system — £29-10

The new Duo general-purpose 2-way speaker system is beautifully finished in polished teak veneer, with matching vynair grille. It is ideal for wall or shelf mounting either upright or horizontally.

Type 1 SPECIFICATION:—

Impedance 3, 8 or 10 ohms (please state requirement) high flux 6" x 4" speaker and 2 1/4" tweeter. Teak finish 12" x 6 3/4" x 5 3/4". 4 guineas each. 7/6d. p. & p.

Type 2 as type 1. Size 17 1/2" x 10 3/4" x 6 3/4". Incorporating 10 1/2" x 6 1/4" speaker and 2 1/4" high frequency speaker 3 ohms impedance £6-6-0 plus 15/- p. & p.

Garrard Changers from £7.19.6d. p. & p. 7/6d.

Cover and Teak finish Plinth £4.15.0d. 7/6d p. & p.

The items illustrated can be purchased together for £29-10.

The Duetto is a good quality amplifier, attractively styled and finished. It gives superb reproduction previously associated with amplifiers costing far more.

SPECIFICATION:—

R.M.S. power output: 3 watts per channel into 10 ohms speakers. INPUT SENSITIVITY. Suitable for medium or high output crystal cartridges and tuners. Cross-talk better than 30dB at 1Kc/s.

CONTROLS: 4-position selector switch (2 pos. mono and 2 pos. stereo) dual ganged volume control.

TONE CONTROL: Treble lift and cut. Separate on/off switch. A preset balance control.

£9-10

Integrated Transistor Stereo Amplifier plus 7/6d. p. & p.



The above 5 items can be purchased together for £29.10 + £1.10.0 p. & p.

The Classic

£9 plus 7/6 p. & p.

Controls: Selector switch Tape speed equalisation switch (3 1/2 and 7 1/2 i.p.s.). Volume. Treble. Bass. 2 position scratch filter and 2 position rumble filter.

Specification: Sensitivities for 10 watt output at 1KHz into 3 ohms. Tape head: 3mV (at 3 1/2 i.p.s.). Mag. P.U.: 2mV. Cer. P.U.: 80 mV. Tuner: 100mV. Aux.: 100mV. Tape/Rec. output: Equalisation for each input is correct to within ± 2dB (R.I.A.A.) from 20Hz to 20KHz. Tone control range: Bass ± 13dB at 60Hz. Treble ± 14dB at 15KHz. Total distortion: (for 10 watt output) < 1-5%. Signal noise: < -60dB. A.C. mains 200-250V. Built and tested. Size 12 1/2 in. long, 4 1/2 in. deep, 2 1/2 in. high. Teak finished case.

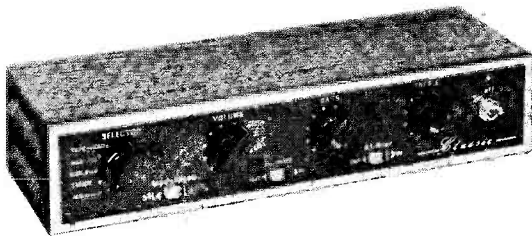

The Viscount

£14.5 plus 7/6 p. & p.

Integrated High Fidelity Transistor Stereo Amplifier. Specification—Output: 10 watts per channel into 3 to 4 ohms speakers (20 watts monaural). Input: 6 position rotary selector switch (3 pos. mono and 3 pos. stereo), P.U., Tuner, Tape and Tape Rec. out. Sensitivities: All inputs 100mV into 1.8M ohm. Frequency Response: 40Hz-20KHz ± 2dB. Tone Controls: Separate bass and treble controls; treble, 13dB lift and cut (at 15KHz); Bass, 15dB lift and 25dB cut (at 60Hz). Volume Controls: Separate for each channel. A.C. Mains Input: 200-240V, 50-60Hz. Size, 12 1/2" x 6" x 2 3/4" in teak finished case. Built and tested. **VISCOUNT MARK II** for use with magnetic pick-ups specification as above. Fully equalised for magnetic pick-ups. Suitable for cartridges with minimum output of 4mV/cm/sec. at 1kc. Input impedance 47k. £15.15 plus 7/6 p. & p.



also see opposite page



SPECIAL OFFER!

Complete stereo system comprising BALFOUR 4-speed autoplayer with stereo head, 2 Duo speaker systems, size 12in. x 6 1/2 in. x 5 1/2 in. Plinth (less cover) and the DUETTO stereo amplifier. All above items

£25 plus £2 p. & p.

NEW COMPLETE HI-FI STEREO SYSTEM - £41

comprising SP 25 Garrard Mk II with diamond cartridge, or 2025 TC, Viscount Mk I amplifier, two type 2 speakers, plinth and cover

£41 plus £2-10-0 p. & p.

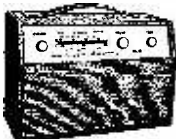

The ELEGANT SEVEN Mk. III (350mW Output)

7 transistor fully tunable M.W.-L.W. superhet portable. Set of parts. Complete with all components, including ready etched and drilled printed circuit board—back printed for foolproof construction.
MAINS POWER PACK KIT: 9/6 extra.
Price **£5.5.0** plus 7/6 P. & P.

Circuit 2/6
FREE WITH PARTS.

The DORSET (600mW Output)

7-transistor fully tunable M.W.-L.E. superhet portable—with baby alarm facility. Set of parts. The latest modulated and pre-alignment techniques makes this simple to build. Sizes: 12 x 8 x 3in.

Price **£5.5.0** plus 7/6 P. & P.

MAINS POWER PACK KIT: 9/6 extra

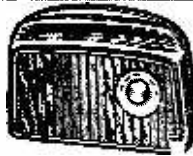

Circuit 2/6
FREE WITH PARTS

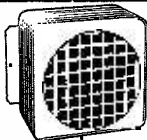

EXTRACTOR FAN

A.C. mains 230/250v. complete with pull switch. Size: 6 x 6 x 4in.

Price **27/6** plus 7/6 P. & P.

X101 10W SOLID-STATE HI-FI AMP WITH INTEGRAL PRE-AMP

Specifications: Power Output (into 3 ohms speaker) 10 watts. Sensitivity (for rated output): 1mV into 3K ohms (0.33 microamp).

Total Distortion at 1KHz at 5 watts, 0.35%, at rated output 1.3%.

Frequency Response: Minus 3dB points 20Hz and 40KHz. Speaker: 3-4 ohms (3-15 ohms may be used). Supply voltage: 24V. DC. at 800mA (6-24V. may be used).

Price **69/6** plus 2/6 P. & P.

Control assembly: including resistors and capacitors. 1. Volume: PRICE 5/-, 2. Treble: PRICE 5/-. 3. Comprehensive bass and treble: PRICE 10/-. The above 3 items can be purchased for use with the X101

Power Supplies for the X101:
P101 M (for mono) 35/- plus 4/6 p. & p.
P101 S (for stereo) 42/6 plus 4/6 p. & p.



CAR TRANSISTOR IGNITION SYSTEM

by famous manufacturer

For 6 volt or 12 volt positive earth systems, Comprising: special high voltage working hermetically sealed silicon transistor mounted in finned heat-sink, high output ignition coil, ballast resistor and hardware (screws, washers, etc.).

Price **£4.19.6** plus 5/- P. & P.

50 WATT AMPLIFIER

A.C. Mains 200-250V

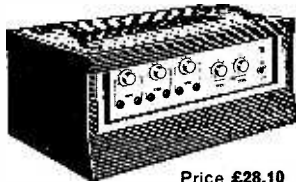

Price **£28.10**
plus 20/- p. & p.

1m. Suitable for most high output instruments (gram, tuner, organ, etc.). Input sensitivity relative to 10w output. TONE CONTROLS ARE COMMON TO ALL INPUTS. Bass Boost +12dB at 60Hz. Bass Cut -13dB at 60Hz. Treble Boost +11dB at 15 KHz. Treble Cut -12dB at 15 KHz. With bass and treble controls central -3dB points are 30 Hz and 20 KHz. POWER OUTPUT: For speech and music 50 watts rms. 100 watts peak. For sustained music 45 watts rms. 90 watts peak. For sine wave 38.5 watts rms. Nearly 80 watts peak. Total distortion at rated output 3.2% at 1KHz. Total distortion at 20 watts 0.15% at 1KHz. Output to match into 8 or 15 ohms speaker system. NEGATIVE FEEDBACK 20dB at 1KHz. SIGNAL TO NOISE RATIO 60dB. MAINS VOLTAGES adjustable from 200-250V. A.C. 50-60Hz. A protective fuse is located at the rear of unit. Output impedance, 3, 8 and 15 ohms.

B.S.R. TD-2 TAPE DECK

Takes 5 1/2in. spools, fitted with B.S.R. 1/2 Track Heads. Size 13 1/2in. long by 8 1/2in. wide.

Price **£8.19.6** plus 7/6 P. & P.

TERMS C.W.O.
All enquiries S.A.E.

The RELIANT

SOLID-STATE
GENERAL
PURPOSE
AMPLIFIER

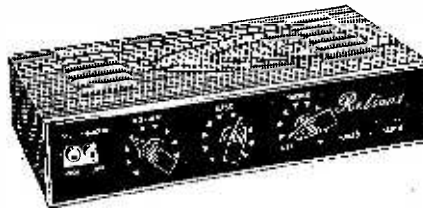

SPECIFICATIONS

Output—10 watts
Inputs—1. xtal mic 10mV Tone Controls—Treble control range ±13dB at 10KHz. 2. gram/radio 250mV Base control range ±13dB at 100Hz
Frequency Response—(with tone controls central) Minus 3dB points at 20Hz and 40KHz. Signal to Noise Ratio—better than -60dB. Transistors—4 silicon Planar type and 3 Germanium type. Mains input—220/250V. A.C. Size of chassis—10 1/2" x 4 1/2" x 2 1/2". For use with Std. or L.P. records, musical instruments, all makes of pick-ups and mikes. Separate bass and treble lift control. Two inputs with control from gram, and mike. Built and tested.

RELIANT Mk. I

As above less teak case
£5.15 plus 7/6 P. & P.

RELIANT Mk. II

In teak finished case.
£6.16 plus 7/6 P. & P.

RECORD PLAYER SNIP

A.C. Mains 240V

The "Princess", 4-speed automatic record changer and player engineered with the utmost precision for beauty, long life, and trouble free service. Will take up to ten records which may be mixed 7" to 10" or 12". Patent stylus brush cleans stylus after each playing and at shut off, the pick-up locks itself into its recess. A most useful feature with portable equipment—other features include pick-up height adjustment and stylus pressure adjustment. This truly is a fine instrument which you can purchase this month at only **£5.19.6** complete with cartridge and ready to play. Post and ins. 7/6 extra.

ONLY **£5.19.6** plus 7/6 P. & P.

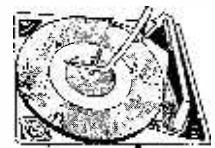

POCKET MULTI-METER



Size 3 1/2" x 2 1/2" x 1 1/2in. Meter size 2 1/2 x 1 1/2in. Sensitivity 1,000 O.P.V. on both A.C. and D.C. volts 0-15, 0-150, 0-1,000 D.C. current 0-150mA Resistance 0-100K Ohm Complete with test prods, battery and full instructions.

42/6 plus 3/6 P. & P.

FREE GIFT to limited period only, 30 watt Electric Soldering Iron value 15/- for every purchaser of the Pocket Multi-Meter

40W FLUORESCENT LIGHT KIT



Incorporating GEC Choke size 8 1/2 x 1 1/2 x 1 1/2in, 2 bi-pin holders, starter and starter-holder. P. & P. 5/6.

11/6

Similar to above: 80W. Fluorescent Light Kit incorporating GEC choke size 11 1/2 x 1 1/2 x 1 1/2in. 2 bi-pin holders, start and starter holder. P. & P. 6/6

17/6

THREE-IN-ONE HI-FI 10 WATT SPEAKER

A complete Loud Speaker system on one frame, combining three matched ceramic magnet speakers with a low loss crossover network. Peak handling power 10 watts. Impedance 15 ohms. Flux density 11,000 gauss. Resonance 40-60 c/s. Frequency range 50c/s to 20Kc/s. Size 13 1/2 x 8 1/2 x 4 1/2in. By famous manufacturer.

List price **£7** OUR PRICE **74/6** plus 5/- P. & P.

Similar speaker to the above without tweeters in 3 and 15 ohms **44/6** plus 5/- p. & p.

PYE CAR RADIO

Push Button Tuning Heart

This PRESTOLOK 5 station Push-Button Tuner Heart with Manual Over-ride is an ideal basis for a quality AM car radio. Size 6 1/2" x 4" x 2".

As illustrated but without knobs.

25/- plus 3/- P. & P.

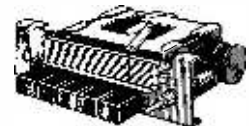

QUALITY MAINS TRANSFORMER

Input 250 volts. OUTPUT (All RMS values) 4 windings of 11.5 volts connected in series total 46 volts at 4.5 amps (conservatively rated). The following combinations may be used. 1.23-0-23 volts. 2.46 volts.

Both of these above voltages are commonly used in medium to high powered transistor amplifiers, power supplies, etc.

Price **35/-** plus 7/6 P. & P.



Goods not despatched outside UK

RADIO & T.V. COMPONENTS (ACTON) LTD.
21c High Street, Acton, London W.3.

Also at 323 Edgware Road, London, W.2.

ALL ORDERS BY POST TO OUR ACTON ADDRESS

RADIO & TV COMPONENTS
R+TV
(ACTON) LIMITED

HENRY'S RADIO LTD.

ELECTRONIC COMPONENTS AND EQUIPMENT
303 EDGWARE ROAD, LONDON W.2. 01-723 1008.9
Open Monday to Saturday 9am to 6pm (Thurs 1pm)
Open all day Saturday.



★ EXPERIMENTERS MODULE

Brand new STC time delay electronic units. Relay output. Adjustable 3-15 secs. 9-12V operated. Supplied complete with uses and circuits STC Module Price 35/-, or 3 for 90/-

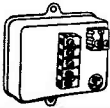

★ MULTIMETER

Return of a popular model. 2,000 ohms/V 0/10/50/500/1,000V a.c./d.c. 0/500μA, 0/10/250mA d.c., 0/10/100kΩ/1MΩ resistance. dB and capacitance scales. Size 5in. 3 1/2in. 1 1/2in. Robust and easy to use. Complete with leads, batteries and instructions. THL33a. Price 82/6, p.p. 2/6. Leather case. Price 22/6



★ GRID DIP METER

All transistor grid dip meter, absorption and osc. detector. Frequency range 440 kc/s to 280Mc/s in 6 coils. Uses 3 transistors plus diode with 500μA meter. Internal battery. TE15 Price £11.10.0. p.p. 3/6.



★ RF SIGNAL GENERATOR

Accurate wide range signal generator covering 120 Kc/s-500Mc/s on 6 bands. Directly calibrated. Variable RF attenuator, audio output. Xtal socket for calibration. 220/240V. a.c. Brand new with instructions. Size 140 215 170mm. TE20D Price £15 p.p. 7/6



★ MULTIMETER 20Ω/V

Popular model but with extra scale range 20,000 ohms per volt. 0/5/25/50/250/500/2,500V d.c. 0/10/50/100/500/1,000V a.c. 0/50μA, 0/2 1/2/250mA, Resistance 0-6KΩ and 6MΩ. Also dB scales and capacitance. 200H, Price 77/6 p.p. 2/-. Leather case, Price 15/-



★ 50,000 OHMS PER VOLT MULTIMETER

Recommended quality instrument with mirror scale and overload protection. 0/0-3/3/12/60/120/300/600/1,200V d.c. 50kΩ/V; 0/6/30/120/300/600/1,200V a.c. 10kΩ/V; 0/30μA/6/60/300mA, 0/12A; resistance 0/10kΩ/10/100MΩ. Meter movement 20μA. Polarity reversing switch. Complete with batteries, leads and instructions. AF105, Price £8.10.0. p.p. 2/6. Leather case 28/6

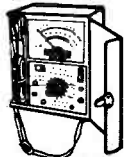

FREE 16 PAGE BROCHURE COVERING LOW COST TEST EQUIPMENT FULLY DETAILED AND ILLUSTRATED. OVER 50 UNITS DETAILED ASK FOR PUBLICATION 'T' - REMEMBER IT'S FREE!

★ SINE/SQUARE WAVE AUDIO GENERATOR

Provides audio output on 4 bands. Sine wave 20c/s to 200kc/s, output up to 7V; square wave 60c/s to 30kc/s, 7V p-p Distortion under 2%. Output impedance 1kΩ. Variable output amplitude control. Supplied with leads and instructions. A.C. mains operated. TE22, Price £16.10.0. Carriage, etc. Also TE22D (matching TE20D) Price £17. p.p. 10/-

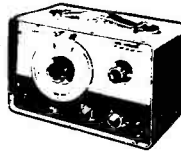

★ LOW COST VACUUM TUBE VALVE VOLTMETER

New model Multi-Range and easy to use; d.c. and a.c. Volts 0/1 1/5/15/50/150/500/1,500, a.c. p-p 0/4 1/2/14/42/140/420/1,400/4,200. Resistance 0-2 ohm to 1,000 Meg-ohm-7 ranges. dBm scales -20 to +25dBm. Input impedance: d.c. 11 Meg, a.c. ±5 Meg. Response: ±1dB 20c/s to 5Kc/s. Complete with probe and handbook. (Size 10 1/2in. 5 1/2in. 4 3/4in. VT650 Price £16.10.0. p.p. 7/6

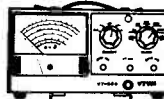

New printed circuit design with full power output. Fully tuneable on both MW/LW bands. 7 Mullard transistors. Fitted 5in. speaker. Room filling power. Easy to build with terrific results. Two colour leathercloth cabinet with silvered front. All local and continental stations. Complete detailed instructions. Total cost £6.19.6. p.p. 4/6. Ask for Leaflet No. 1.

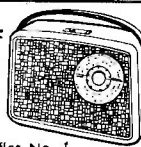

★ SCOOPI! STAAR RECORD PLAYER

Deck plays 33, 45, 78, r.p.m. records, 9V operated, with mono cartridge. BRAND NEW... as illustrated.

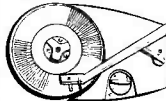

Price 59/6 p.p. 3/6. Send for leaflet No. 2.



MULLARD 1 WATT AMPLIFIER Portable Transistor Unit. Ideal for intercoms, Baby Alarms, Telephone, Record Players or Guitar Practice. 9V 5 transistors with volume control, output 3 ohms. Ideal for use with Staar Record Deck. Price 45/-, p.p. 2/6

★ QUALITY PANEL METERS (D.C. RANGES)

38 Series, Face size 42mm x 42mm (1 1/2in. x 1 1/2in.), 50μA, 37/6; 100μA, 35/1; 200μA, 32/6; 500μA, 27/6; 1mA, 5M/A, 10mA, 50mA, 100mA, 500mA, 25/- each; 10V, 20V, 50V, 100V, 300V, and 500V, 25/- each; 1A and 5A, 25/- each "S" meter, 1mA, 29/6 VUmeter, 37/6. 65 Series, Face size 86mm x 78mm (3 3/8in. x 3 1/8in.), 50μA, 42/6; 100μA, 52/6; 200μA, 47/6; 500μA, 44/6; 1mA, 5M/A, 10mA, 50mA, 37/6 each. "S" meter, 1mA, 42/6. Other ranges and sizes in stock. Ask for list.

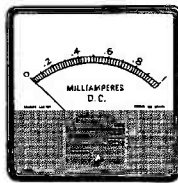

★ FIELD STRENGTH METERS

5-ranges 1-250Mc/s. Fitted 200A meter. Earphone output. Calibrated tuning scales. FL30HA Price 72/6 p.p. 2/- Also non calibrated type peaking F/S Meter. FSI Price 45/- p.p. 2/6



★ TRANSISTOR CHECKER

Complete capacity for checking all transistors npn and pnp for alpha, beta and Leakage. Also diodes complete with leads and instructions. ZQM-2. Price £5.19.6. p.p. 3/6



★ SIGNAL INJECTOR AND TRACER

Pocket, speed model for checking all audio and RF up to VHF. Simple to use. Battery operated. Output approx. 1kc/s, 1.4V Harmonics up to VHF. SE250B Price 35/- p.p. 1/6 *Matching Signal tracer SE500 Price 27/6 p.p. 1/-



● All parts in stock to build the integrated circuit and other designs appearing in Practical Wireless and Electronics. Ask for quotations—see latest catalogue editions.

★ 10 in 1 TEST UNIT

A new design tests most circuits. Model SE400 Price £9.10.0. *A.c./d.c. Volts (4K/Volt) 0/15/50/150/500 *Resistance 0/10K/100K/1 Meg. *Five values resistance and capacitance substitution. *RF F/S Meter 1 to 140Mc/s. *455/700kc/s RF Generator Size 7 1/2in. x 3 1/2in. x 1 1/2in. *D.C. Ammeter 0/500mA. *400c/s Audio Generator.



COMPONENTS UK's LARGEST STOCKISTS ASK FOR QUOTES—SEE LATEST CATALOGUE

HENRY'S FAMOUS CATALOGUES—SEE BACK COVER FOR DETAILS

GARRARD TURNTABLES ★ NOTE THESE SPECIAL PRICES WITH DIAMOND STYLUS CARTRIDGES ★

GOLDRING - BSR - GARRARD

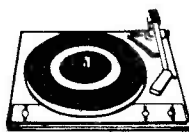

BSR UA25 mono £5 19 6
2025 GK525 stereo £7 19 6
2025 TC 9TAHC £8 19 6
3000 LM DIAM £9 15 0
3500 Ceramic £12 19 6
Deccadec Deram £18 10 0

Cartridge Model	Less Cartridge	9TAHC Diam.	AT21 or M3DM	AT66 AT21X*	AT33 Deram*	G800	J203 800SE*	CS91E Ceramic
	£ s d	£ s d	£ s d	£ s d	£ s d	£ s d	£ s d	£ s d
SP25 Mk II	11 9 6	13 12 6	19 0 0	10 15 0	16 10 0*	21 0 0	15 10 0	19 0 0
AP75	17 15 0	19 15 0	25 10 0	23 0 0	27 0 0	27 0 0	21 17 6	25 10 0
GL75P	46 0 0	46 0 0	42 10 0	60 0 0*	55 10 0	53 0 0	70 0 0*	53 10 0
GL69P	35 0 0	37 0 0	40 0 0	40 0 0	44 10 0	42 0 0	48 0 0	46 10 0
MA70	12 10 0	14 10 0	20 0 0	17 12 6	—	—	16 10 0	20 0 0
AT60 Mk II	13 10 0	15 15 0	21 7 6	19 0 0	18 0 0*	—	17 12 6	21 10 0
GL75	33 0 0	35 0 0	40 10 0	47 0 0*	42 10 0	40 0 0	57 0 0*	40 10 0
SL72B	25 0 0	27 0 0	32 10 0	30 10 0	34 10 0	34 0 0	29 0 0	32 10 0
SL75B	31 0 0	33 0 0	33 10 0	36 10 0	40 10 0	40 0 0	35 0 0	38 10 0
SL95B	39 0 0	41 0 0	46 10 0	53 10 0*	48 10 0	48 0 0	59 0 0	42 10 0
SL65B	15 19 6	18 0 0	23 10 0	21 10 0	20 10 0*	25 0 0	18 15 0	23 10 0
GL69	23 0 0	25 0 0	30 10 0	28 0 0	32 10 0*	30 0 0	47 0 0*	30 10 0

Plinth/covers 2025, 3000, 3500, SP25 95/-, p.p. 6/- (Note GL69P and GL75P complete with plinth/covers) 2025, 3000, 3500, SP25, SL65B, SL72B, SL75B, SL95B Deluxe type—plays with top on (state model) £8.10.0. p.p. 7/6.

● SPECIAL Sinclair Stereo 60 Preamp. Two Z30 AD PZ5 Power Pack (usually £23.18.0) £19

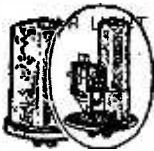

FLASHERS

Heavy duty light flasher employs a condenser discharge principle operating on electro mechanical relay (As inset). Housed in strong plastic case. Flashing rate between 60-120 per minute. 12V DC operation. Maximum load 6 amps. Size 2 1/2" dia. x 4 1/2". Supplied brand new at a fraction of original cost. 6/8 each. P. P. 2/6. (3 for 17/6. P. P. 4/0).

CLASS D WAVEMETERS

A crystal controlled heterodyne frequency meter covering 1-7.8 Mc/s. Operation on 6 volts D.C. Ideal for amateur use. Available in good used condition. £5.19.6. Carr. 7/6. Or brand new with accessories. £7.19.6. Carr. 7/6.

CLASS D WAVEMETERS No. 2
Crystal controlled. 1.2-19 Mc/s. Mains or 12V. D.C. operation. Complete with calibration charts. Excellent condition. £12.10.0. Carr. 30/-.

R209 MK II COMMUNICATION RECEIVER

11 valve high grade communication receiver suitable for tropical use. 1-20 Mc/s on 4 bands. AM/CW/FM operation. Incorporates precision vernier driver, 1 F.O., aerial transformer internal speaker and 12V. D.C. internal power supply. Supplied in excellent condition, fully tested and checked. £15.0.0. Carr. 20/-.

TYPE 13A DOUBLE BEAM OSCILLOSCOPES

An excellent general purpose D/B oscilloscope. T.B. 2 cps-150 Kc/s. Bandwidth 5.5 Mc/s. Sensitivity 33mV/CM. Operating voltage 0/110/200/250V. A.C. Supplied in excellent working condition. £22.10.0. Or complete with all accessories, probe, leads, lid, etc. £25. Carriage 30/-.

MARCONI T/44/TF956 AF Absorption Wattmeter

1 μ watt to 6 watts. £20. Carr. 10/-.

SOLARTRON CD 711S2 Double Beam Oscilloscopes

D.C. to 9 Mc/s. Perfect order £53. Carr. 50/- (Few available less C.R.T.) £25 Carr. 50/-

TO-3 PORTABLE OSCILLOSCOPE

3in. tube. Y amp. Sensitivity 0.1V p-p/CM. Bandwidth 1.5 cps-1.5 MHz. Input imp. 2 meg Ω 20pF. X amp. sensitivity 0.9V p-p/CM. Bandwidth 1.5 cps-800KHz. Input imp. 2 meg Ω 20pF. Time base. 3 ranges 10 cps-300 KHz. Synchronization. Internal/external. Illuminated scale 140 x 215 x 330 mm. Weight 15 1/2 lb. 220/240V. A.C. Supplied brand new with handbook. £37.10.0. Carr. 10/-.

TRANSISTORISED L.C.R. AC MEASURING BRIDGE

A new portable bridge offering excellent range and accuracy at low cost. Ranges: R. 1Ω-11.1 meg Ω. 6 Ranges ± 1%. L. 1 μ H - 111 HENRYS. 6 Ranges ± 2%. C. 10pF - 1110nFD. 6 Ranges ± 2%. TURNS RATIO 1:1/1000-1:11100. 6 Ranges ± 1%. Bridge voltage at 1,000 cps. Operated from 9 volts. 100μA. Meter indication. Attractive 2 tone metal case. Size 7 1/2 x 5 x 3in. £20. P. & P. 5/-.

UNR-30 4-BAND COMMUNICATION RECEIVER

Covering 550 Kcs-30 Mc/s. Incorporates BFO. Built in speaker and phone jack. Metal cabinet. Operation 230/240V. A.C. Supplied brand new, guaranteed with instructions. Carr. 7/6. **13 gns.**

TRIO JR.310 New Amateur Band 10-80 Metre Receiver in stock. £77.10.0.

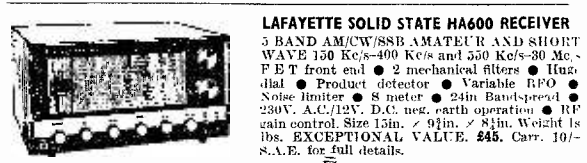

LAFAYETTE SOLID STATE HA600 RECEIVER

5 BAND AM/CW/SSB AMATEUR and SHORT WAVE 150 Kcs-400 Kcs and 500 Kcs-30 Mc/s. FET front end ● 2 mechanical filters ● Ifug. dial ● Product detector ● Variable BFO ● Noise limiter ● 8 meter ● 24in Bandspread ● 230V. A.C./12V. D.C. neg. earth operation ● HF gain control. Size 15in. x 9 1/2in. x 8 1/2in. Weight 15 lbs. EXCEPTIONAL VALUE. £45. Carr. 10/- S.A.E. for full details.

LAFAYETTE HA-800 SOLID STATE AMATEUR COMMUNICATION RECEIVER

Six bands 3-5.4, 7-7.5, 14-14.35, 21-21.45, 28-29.7, 50-54Mc/s. Dual conversion on all bands. 2 x 455 Kcs mechanical filters. FET front end, product detector, variable BFO, 100Kc/s crystal calibrator. 'S' Meter. Huge slide rule dial. Operation 230V AC or 12V DC. Size 15 x 9 1/2 x 8 1/2 in. Complete with instruction manual. £57.10.0 Carr. Paid. 100Kc/s crystal 39/6 extra.

UR-1A SOLID STATE COMMUNICATION RECEIVER

4 bands covering 550 Kcs-30 mc/s continuous. Special features are use of FET transistors. S meter, built in speaker and telescopic aerial, variable BFO for SSB reception, noise limiter, bandspread control, sensitivity control. Output for low impedance headphones. Operation 220/240 volt A.C. or 12 volt D.C. Size 12 1/2in. x 4 1/2in. x 7in. Excellent value ONLY £24. Carr. 7/6.

TRIO COMMUNICATION RECEIVER MODEL 9R-59DE

4 band receiver covering 550 Kcs to 30 Mc/s continuous and electrical bandspread on 10, 15, 20, 40 and 80 metres. 8 valve plus 7 diode circuit, 4.8 ohm output and phone jack. SSB-CW ● ANL ● Variable BFO ● S meter ● Sep. bandspread dial ● 1F 455 Kc/s ● Audio output 1.5 W. ● Variable BF and AF gain controls. 115/250V. A.C. Mains. Beautifully designed. Size 7 x 15 x 10in. With instruction manual and service data. £42. carriage paid. TRIO COMMUNICATION TYPE HEADPHONES. Normally £5.19.6. OUR PRICE: £3.15.0 if purchased with above receiver.

TRIO TS 510 AMATEUR TRANSCEIVER with speaker and mains P.S.U. £180 IN STOCK!

RCA COMMUNICATIONS RECEIVERS AR88D

Latest release by industry BRAND NEW in original cases. 110-250V. A.C. operation. Frequency in 6 Bands. 553 Kcs-32 Mc/s continuous. Output impedance 2-5-600 ohms. Incorporating crystal filter, noise limiter, variable BFO, variable selectivity, etc. Price £87.10.0. Carr. £2.

LAFAYETTE PF-60 SOLID STATE VHF FM RECEIVER

A completely new transistorised receiver covering 152-174 Mc/s. Fully tunable or crystal controlled (not supplied) for fixed frequency operation. Incorporates 4 INTEGRATED CIRCUITS. Built in speaker and illuminated dial. Squelch and volume controls. Tape recorder output. 75 Ω aerial input. Headphone jack. Operation 230V. A.C./12V. D.C. Neg. earth. £87.10.0. Carr. 10/-.

TELETON CR-10T AM/FM STEREO TUNER AMPLIFIER

A new model from Teleton. 31 solid state devices. 4 + 4 watt output. Inputs for ceramic/crystal cartridge. Frequency range AM 540-1600KHz. FM 88-108MHz. Automatic FM Stereo reception. Stereo Indicator. Controls: Tuning, function selector, Tone and R & L volume controls. AFC switch. Stereo headphone socket. Size 13 1/2" x 3 1/2" x 9 1/2" approx. PRICE £34.0.0. Carr. 7/6.

CLEAR PLASTIC PANEL METERS

First grade quality Moving Coil panel meters. Type MR 38P. 1 1/2 in. square fronts.

500-0-500μA	27/6	50mA	27/6	150V. D.C.	27/6
1mA	27/6	100mA	27/6	300V. D.C.	27/6
1-0-1mA	27/6	150mA	27/6	500V. D.C.	27/6
2mA	27/6	200mA	27/6	750V. D.C.	27/6
5mA	27/6	300mA	27/6	15V. A.C.	27/6
10mA	27/6	500mA	27/6	50V. A.C.	27/6
30μA	40/-	750mA	27/6	150V. A.C.	27/6
100μA	37/6	1 amp.	27/6	3V. D.C.	27/6
100-0-100μA	35/-	2 amp.	27/6	10V. D.C.	27/6
200μA	35/-	5 amp.	27/6	20V. D.C.	27/6
500μA	40/-	10mA	27/6	100V. D.C.	27/6

FULL RANGE OF OTHER SIZES IN STOCK SEND S.A.F. FOR LEAFLET

Variable Voltage TRANSFORMERS

Brand new, quality, 1 and 2 watt, 50-60 cycles. High quality construction. Input 230V. 50-60 cycles. Output full variable from 0-260 volts. Bulk quantities available. 1 amp. -£5.10.0; 2 1/2 amp. -£6.15.0; 5 amp. -£9.15.0; 8 amp. -£14.10.0; 10 amp. -£18.10.0; 12 amp. -£21.0.0; 20 amp. -£37.0.0.

CRYSTAL CALIBRATORS NO. 10

Small portable crystal controlled wavemeter. Size 7 x 7 1/2 x 4in. Frequency range 500 Kcs-10 Mc/s (up to 30 Mc/s on harmonics). Calibrated dial. Power requirements 300V. D.C. 15mA and 12V. D.C. 0.3A. Excellent condition. 89/6. Carr. 7/6.

TE-40 HIGH SENSITIVITY A.C. VOLTMETER

10 meg. input 10 ranges: 0/1-003/1-31/3/10/30/100/300V. R.N.S. 4cps-1.2 Mc/s. Decibels -40 to +50dB. Supplied brand new complete with leads and instructions. Operation 230V. A.C. £17.10.0 Carr. 5/-.

LELAND MODEL 27 BEAT FREQUENCY OSCILLATORS

Frequency 0-20 Kcs. on 2 ranges. Output 500 Ω or 5k Ω. Operation 200/250V. A.C. Supplied in perfect order. £12.10.0 Carr. 10/-.

TE-65 VALVE VOLTMETER

High quality instrument with 28 ranges. D.C. volts 1.5-1,500V. A.C. volts 1.5-1,500V. Resistance up to 1,000 megohms. 200/240V. A.C. operation. Complete with probe and instructions. £17.10.0. P. & P. 6/- Additional probes available: R.F. 35/-, H.V. 42/6.

COSSOR 1049 DOUBLE BEAM OSCILLOSCOPES

D.C. coupled. Band width 1Kc/s. Perfect order. £25. Carr. 30/-.

AM/FM SIGNAL GENERATORS

Oscillator Test No. 2. A high quality precision instrument made for the industry by Airmecc. Frequency coverage 20-80 Mc/s. AM CW/FM. Incorporates pre-tuned dial, level meter, precision attenuator 1μV-100μV. Operation from 12 volt D.C. or 0/110/200/250 volt A.C. Size 12 x 8 1/2 x 9in. Supplied in brand new condition complete with all connectors fully tested. £45. Carr. 20/-.

EDDYSTONE VHF RECEIVERS Model 770R. 19-165 Mc/s. Excellent condition. £150.

PLESSEY SL405A 3 watt Integrated Amplifier Circuit 49/6. Post paid.

TE-16A Transistorised Signal Generator. 5 ranges 400Hz-30MHz. An inexpensive instrument for the handyman. Operates on 9v battery. Wide easy to read scale. 800KHz modulation. 1/2 x 2 1/2 x 3 1/2 in. Complete with instructions and leads. £7.19.6. P. & P. 4/-.

HOSIDEN'DH-08S DE-LUXE STEREO HEADPHONES

Features unique mechanical 2-way units and fitted adjustable level controls. 8 ohm impedance. 20-20,000cps. Complete with spring lead and stereo jack plug £7.19.6. P. & P. 2/6.

AUTO TRANSFORMERS

0/115/230V. Step up or step down. Fully shrouded.

150 W.	£2.2.6.	P. & P. 3/6.
300 W.	£2.19.6.	P. & P. 4/6.
500 W.	£4.10.0.	P. & P. 6/6.
1,000 W.	£5.10.0.	P. & P. 7/6.
1,500 W.	£7.19.6.	P. & P. 8/6.
2,500 W.	£15.10.0.	P. & P. 20/-.

G. W. SMITH & CO (RADIO) LTD. Also see oppo. page

No soldering

-circuits work first time. Build and learn about electronics with these exciting kits

Build a radio set in an evening with a Radionic radio kit. Construct a digital computer that adds, subtracts, divides and multiplies. Make electronic music with the simple yet highly effective electronic organ.

Special 'Radionic mounted' components require no soldering and can be used time and time again. You can build 26 circuits with just one kit. And you can learn as you build.

Suitable for study towards G.C.E., City and Guilds, National Certificate, or even higher qualifications.

Write to the address below for free details of Radionic radio and electronics construction kits.

Radionic Products Ltd

St. Lawrence House, Broad Street, Bristol BS1 2HF.

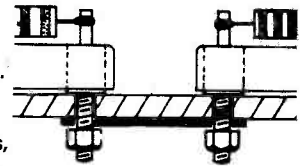

NEW FOR THE HOME CONSTRUCTOR

BRITISH MADE

L&M PLINTH

TO FIT MOST MAKES OF

GARRARD

TURNTABLES

85/- Carr. Paid

Complete and ready for easy assembly with perspex cover of Neutral Smoke tint. Spindle can be left in position with cover on.



Full current range offered brand new and fully guaranteed

AND Enormous Savings

ALSO AVAILABLE

L & M Plinth & Cover

Fully Assembled 95/- Carr. Paid

Most makes of audio equipment available

1025 Stereo/Cart	£7 10 0
2025 Stereo/Cart	£7 19 6
2025 TC	£8 17 6
3500 Stereo/Cart	£9 19 6
SP25 Mk II	£11 19 6
AP75	£17 17 0
SL75	£28 10 0

SHORTLY AVAILABLE

5/100	5/200
40B	CC10
SL65B	SL72B
SL75B	SL95B

L&M SUPPLIES

37B HIGH ST. CHISLEHURST,
KENT Tel. 01-467-0934

CALLERS WELCOME

Listen to the world with Eddystone

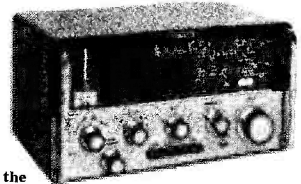

When you own an Eddystone communications receiver, you have the broadcasting world at your finger tips - wherever you happen to be - on land or at sea. The reputation these sets have attained is proof of their excellence and reliability and at Imhofs, there is a special Eddystone department, where you can see, hear and compare all models listed here. Same day despatch to any part of the world; free delivery in the U.K.; plus after sales service for which Imhofs and Eddystone are world famous.

EDDYSTONE EB35 Mark II broadcast receiver AM/FM transistorised. A high performance all-band receiver, can also be used as a 'Hi-Fi' tuner. Powered by 6 SP2 torch cells, or, with Type 924 power supply unit, from AC mains. £82.4.9d.

EDDYSTONE 940 (13 valve) communications receiver. A connoisseur's instrument combining 'Professional' appearance with performance; has a world-wide reputation, two RF stages ensure high-sensitivity. £158.0.0d.

EDDYSTONE EC10 transistorised communications receiver. An enthusiast's receiver at a modest price. Embodies features usually only found in much more expensive designs. Powered by 6 SP2 torch cells or Type 924 power unit (AC). £59.10.0d.

EDDYSTONE EC10 Mark II transistorised communications receiver. A de-luxe version of this famous design now incorporating 'S' meter and limited fine tuner. £69.10.0d.

EDDYSTONE EA12 'Ham Band' receiver. Built to professional standards but specifically for the amateur enthusiast. High sensitivity for all reception modes CW, MCW, AM and SSB. FSK adaptor available as ancillary £195.0.0d.

There is an Eddystone Communications receiver for any frequency between 10kHz and 870 MHz full details from Imhofs or your local Eddystone agent.

IMHOFS

MAIN EDDYSTONE
DISTRIBUTORS



Dept: PW5

112-116 New Oxford Street, London, WC1 Tel: 01-636 7878

R36C

Never Built a Kit Before?

Why not prove how easy it is the HEATHKIT way.
Build one of these beginner kits.



Stereo Record Player
Exciting Sound — Budget Price
Kit: K/SRP-1 - - £27.6.0
Carr. 11/-



Automobile Tune-up Meter
For D.I.Y. Car Mechanics
Kit: K/ID-29 - - £17.8.0
Carr. 5/-



108-136 MHz
Portable
Aircraft Monitor Receiver
Kit: K/GR-98 - - £27.12.0
Carr. 5/-



Economy SW Receiver
World-wide Reception
1 to 30 MHz plus 550-1620 KHz
Kit: K/GR-64 - - £24.16.0
Carr. 9/-



Deluxe Car Radio
Heathkit Value—Powerful Output
Kit: K/CR-1 (Less Speakers) £12.12.0
Carr. 5/-

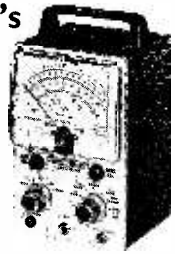

Technician's Versatile 'VVM'
7AC, 7DC,
7 ohm ranges
Kit: K/IM-18U - - £16.14.0
Carr. 5/-

'SEVERN' AM/FM Radio
Beautiful Looks — Luxury Sound



Kit: K/SEVERN - - £18.18.0
Carr. 5/-

Portable 'VVM'
For Hobbyists — Householders



Kit: K/IM-17 - - £14.8.0
Carr. 6/-



Modellers Low-cost Tachometer
Uses reflected ambient light
Kit: K/GD-69 - - £11.0.0
Carr. Paid

Many more kits to choose from in the 1970 Catalogue

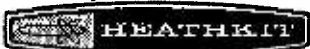

A Schlumberger Company

DAYSTROM LTD.
GLOUCESTER GL2 6EE

★ Please rush me a copy of your Free Catalogue

NAME.....

ADDRESS..... POST CODE.....

51/5

R.S.C. SENSATIONAL HIGH FIDELITY STEREO 'PACKAGE' OFFERS

★ Super 30 Amplifier (30 watt) in veneered housing
★ Goldring Transcription Turntable on Plinth
★ Shure or Goldring Magnetic Pick-up Cartridge
★ Pair of Stanway II Loudspeaker Units
Special total price. Four fully wired units ready to "plug-in". Carr. 30/-.

86 Gns.

TA12 Amplifier (13 watt) in veneered housing Garrard 3000 4 sp. Autochanger unit on plinth Sonotone 9TA P.U. cartridge. Pair of Dorchester Loudspeaker units.
Special Total Price **47 1/2 Gns.**
Carr. 25/-

Matching as recommended for optimum performance. Send for coloured brochure showing other money-saving offers.

Package prices apply providing all individual units are purchased from any branch within 3 months. See leaflet.

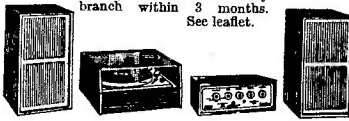

EXTREMELY ATTRACTIVE PLINTHS finished in Teak or Afrormosia veneer. Trans plastic cover.

★ Super 30 amplifier (15 + 15 watt) in veneered housing
★ Garrard SP25 Mk II Turntable on Plinth
★ Goldring CS90 Ceramic P.U. Cartridge with diamond stylus
★ Pair Stanway II Speaker Units
Four fully wired units ready to "plug-in". Special total price **76 Gns.** Carr. 30/-.

● TA12 Amplifier (13 watt) in veneered housing
● Garrard SP25 Mk II 4 sp. player unit on plinth
● Goldring CS90 Ceramic P.U. Cartridge with diamond stylus
● Pair of Dorchester Loudspeaker Units.
Special total price **£51.5** (Total 59 gns.). Transparent plastic cover 3 gns. extra.

Or Dep. £10.03 and 9 monthly payments £2.15. TERMS AVAILABLE ALL PACKAGE OFFERS

AUDIOTRINE HIGH FIDELITY LOUDSPEAKERS



Heavy construction. Latest high efficiency ceramic magnets. Treated cone surround. "D" indicates Tweeter Cone providing extended frequency range up to 15,000 c.p.s. 'L' indicates Roll Rubber cone surround. Impedance 3 or 16 ohms. Please state choice. Exceptional performance at low cost.

HF510L 5" 10W	49/9	HF120 12" 15W	79/9
HF801D 8" 8W	49/6	HF120D 12" 15W	89/9
HF102D 10" 10W	62/6	HF126 12" 15W	25.5.0
HF100D 10" 15W	£4.19.9	HF126D 12" 15W	25.5.0
HF105DL 10" 10W	6gns.		

HIGH FIDELITY LOUDSPEAKER UNITS
Cabinets latest style Satin Teak or Afrormosia veneer. Acoustically lined or fitted acoustic damping. Ported where appropriate. credit terms available.

DORCHESTER Size 16 x 11 x 9in. approx. Range 45-15,000 c.p.s. Rating 8-10 watts. Fitted High flux 1838in. Dual Cone spkr. Imp. 3 or 16 ohms. **£8.19.9**

STANWAY II Size 20x10x9 1/2 in. approx. Rating 10 watts. Inc. Fane 13x5in. speaker with highly flexible cone surround, long throw voice coil and 11,000 line magnet. High flux tweeter. Handsome Scandinavian design cabinet. Range 35-20,000 c.p.s. Imp. 15 ohms. Gives smooth realistic sound output. **16 Gns.**

R.S.C. TA6 6 Watt HIGH FIDELITY SOLID STATE AMPLIFIER



200-250v. AC mains operated. Frequency Response 30-20,000 c.p.s. -2dB. Harmonic Distortion 0.3% at 1,000 c.p.s. Separate Bass and Treble. "lift" and "cut" controls. 3 input sockets for Mike, Gram, Radio or Tape. Input selector switch. Output for 3-15 ohm spkrs. Max. sensitivity 6mV. Output rating 1H.F.M. Fully enclosed enamelled case. 9 1/2 x 7 1/2 in. Attractive brushed silver finish facia plate 10 1/2 x 9 1/2 in. and matching knobs. Complete kit of parts with full wiring diagrams and instructions. **7 Gns.** Carr. 7/6

Or factory built with 12 months' guarantee. **£8.19.9**

RECORD PLAYING UNITS

Money saving units. Mounted on Plinth. Supplied with transparent plastic cover. Ready to plug into Amplifier or Tape recorder.

RP2C Garrard SP25 Mk II (with heavy turntable) fitted Goldring CS90 high compliance ceramic Stereo/Mono cartridge with diamond stylus. Carr. 9/6 **23 Gns.**

RP5C Garrard 2025 Auto Unit fitted Garrard GCS 23 Stereo Cartridge with diamond tip, Plinth & Cover as RP2C **15 Gns.**

Other types available with Magnetic cartridges and with alternative design plinths.

Limited Number of CLEARANCE LINES in leading makes of Hi-Fi equipment at Branches only

R.S.C. PLINTHS



for Record Playing units, cut for Garrard 1025, 2025, 3000, AT60, SP25 etc.

Available **3 gns.** with trans. plastic cover. **6 gns.**

INTEREST CHARGES REFUNDED
On Credit Sales settled in 3 months.

LINEAR L10 HIGH FIDELITY IOW AMPLIFIER 10 Gns.

with separate Pre-amp Magnetic P.U. matching. To clear

R.S.C. TA12 MKII 13 WATT STEREO AMPLIFIER

FULLY TRANSISTORISED. SOLID STATE CONSTRUCTION HIGH FIDELITY OUTPUT OF 6.5 WATTS PER CHANNEL
Designed for optimum performance with any crystal or ceramic Gram P.U. cartridge, Ram or tuner. Tape recorder, 'Mike' etc. ★ 3 separate switched input sockets on each channel ★ Separate Bass and Treble controls ★ Slide Switch for mono use ★ Speaker Output 3-16 ohms ★ For 200-250v. A.C. mains ★ Frequency Response 30-20,000 c.p.s. -2dB ★ Harmonic Distortion 0.3% at 1000 c.p.s. Hum and Noise -70dB ★ Sensitivities (1) 300mV (2) 50mV (3) 100mV (4) 2mV. Output rating 1H.F.M. ★ Handsome brushed silver finish Facia and Knobs. Complete kit of parts with full wiring diagrams & instructions. Factory built with 12mth gntee **17 Gns** or Deposit **£5.2.6** and 9 mthly pymts **34/-** (Total £20.8.0). Or in Teak or Afrormosia veneer housing **20 1/2 Gns.** Dep. £5.10.6 and 9 monthly payments **£2.1.7** (Total £24.4.9).

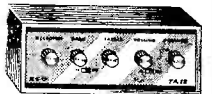

AUDIOTRINE HI-FI SPEAKER SYSTEMS

Consisting of matched 12in. 11,000 line 15 Watt 15 ohm high quality speaker, cross-over unit and tweeter. Smooth response and extended frequency range ensure surprisingly realistic reproduction. Or Senior 15 Watt inc. HF126 Carr. 5/9 15,000 line Speaker **£6.15.0** Carr. 6/6

HI-FI SPEAKER ENCLOSURE

Teak or Afrormosia veneer finish. Modern design. Acoustically lined. All sizes approx. Carr. 5/- per enclosure
ESB Size 16 x 11 x 9in. Presurised. Gives pleasing results with any 8in. Hi-Fi speaker. **£4.15.0**
SE8 For optimum performance with any 8in. Hi-Fi speaker. Size 22 x 15 x 9in. Ported **£5.15.0**
SE10 For outstanding results SE12 For exchnt prfmrnce with 12in. with 10in. Hi-Fi 'spkr **£19.6** Hi-Fi speaker and Tweeter. **£6.19.9** Size 24x16x10in. P'd. Size 26 x 18 x 10in.

THE 'YORK' HIGH FIDELITY 3 SPEAKER SYSTEM

★ Moderate size, only 25 1/4 x 10in. COMPLETE KIT **20 Gns**
★ Response 30-20,000 c.p.s. Impedance 15 ohms Carr. 12/6
★ Performance comparable with units costing considerably more. Consists of (1) 12in. 15 watt Bass unit with cast chassis. Roll rubber cone surround for ultra low resonance, and ceramic magnet. (2) 3-way quarter section series cross-over system. (3) 8 x 5in. high flux middle range speaker. (4) High efficiency tweeter. (5) Appropriate quality acoustic damping material (6) Teak veneered cabinet. (7) Circuit and full instructions. Terms: Dep. £5.10.6 and 9 monthly payments 39/- (Total £23.1.0)



R.S.C. TFM1 SOLID STATE VHF/FM RADIO TUNER

★ 200-250v. A.C. Mains operation. ★ High-sensitivity. ★ Sharp A.M. Rejection ★ Drift-free reception. ★ Output ample for any amplifier approx. 500 m.v.v. ★ Output for feeding Stereo Multiplier ★ Tuner head using silicon Planar Transistor. ★ Designed for standard 80 ohm aerial input. Visually matching our Super 16 and 30 amplifiers and of the same high standard of performance and reliability. Printed circuitry. A quality product at considerably less than the cost of comparable units. Factory built 18 gns. Or in Teak finished cabinet as illustrated **£1 gns.** Terms: Deposit **£61.0** and 9 monthly payments. 2mth. Total **£24.19.0**. Stereo version, 23 1/2 gns. Carr. 10/6

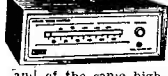

R.S.C. SUPER 30 MK II HIGH FIDELITY STEREO AMPLIFIER

High Grade Components
Specifications comparable with units costing considerably more.

TRANSISTORS 9 high quality types in each channel.

OUTPUT 10 Watts R.M.S. continuous into 15 Ω (per channel). 15 Watts R.M.S. continuous into 3 Ω.

INPUT SENSITIVITIES Mag. P.U. 4 mV. Ceramic P.U. 35 mV. Tape Amp. 400 mV. Aux. 100 mV. Mic. 5 mV. Tape Head 2.5 mV.

FREQUENCY RESPONSE ± 2 dB. 10-20,000 c.p.s.

TREBLE CONTROL +17 dB to -14 dB at 10 Kc/s.

BASS CONTROL +17 dB to -15 dB at 60 c/s.

HUM LEVEL -80 dB.

HARMONIC DISTORTION 0.1% at 10 watts 1,000 c.p.s.

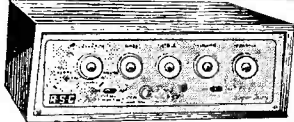

Employing Twin Printed Circuits. 200/250v. A.C. mains operation. CROSS TALK 52 dB at 1,000 c.p.s. CONTROLS 5 Position Input Selector. Bass, Treble, Vol. Bal., Stereo/Mono Switch, Tape Monitor Switch, Mains Switch. INPUT SOCKETS (1) P.U. (2) Tape Amp. (3) Radio, (4) Mic. or Tape Head. (Operation of Input Selector assures appropriate equalisation).

CHASSIS Strong Steel construction. Approx. 12 x 3 x 8in.

FACIA PLATE Attractive design in rigid Perspex. Silver finish matching control knobs as available.

Eminently suitable for use with any make of pick-up or Mic. (Ceramic or Magnetic, Moving Coil, Ribbon or Crystal) currently available. Superb sound output quality can be obtained by use with first rate ancillary equipment.

COMPLETE KIT OF PARTS 22 gns.
Point to point wiring diagrams Carr. 15/- and detailed instructions.

UNIT FACTORY BUILT 29 gns.
With 12 months guarantee. or Deposit **£7.5.0** and 9 monthly payments **58/9** (Total **£33.13.9**) or in Teak or Afrormosia veneer housing **32 Gns.** Carr. 15/- Terms: Deposit **£7.5.0** and 9 monthly payments of **66/6** (Total **£37.2.0**). Send S.A.E. for leaflet.

R.S.C. BATTERY/MAINS CONVERSION UNITS

Type BMI
An all-dry battery eliminator.
Size 5 1/4 x 4 1/4 x 2 1/2 in. approx.
Completely replaces batteries supplying 1.5v. and 90v. where A.C. mains 200/250v. 30c/s is available. Complete kit with diagram 52/6 or assembled 3 Gns.

SUPER 15 HIGH FIDELITY SOLID STATE AMPLIFIER

Approx as Super 30 but single channel. Complete kit with full constructional details and point to point wiring diagrams. **12 1/2 gns.** Carr. 12/6
OR FACTORY BUILT **15 1/2 Gns.** Carr. 12/6. Terms: Deposit 4 Gns. and 9 monthly payments 31/1 (Total **£18.3.9**) or in Teak or Afrormosia veneered housing. **18 Gns.**

PARTRIDGE "JOYSTICK" SHORT WAVE AERIALS AND TUNERS AT ALL BRANCHES (S.A.E. for full list)

- BRADFORD 10 North Parade. (Half-day Wed.) Tel. 25349
- BLACKPOOL (Agent) O. & C. Electronics, 227 Church Street
- BIRMINGHAM 30/31 Gt. Western Arcade 021-236-1279 (Half-day Wed.)
- DERBY 26 Osaston Rd., The Spot (Half-day Wed.) Tel. 41361
- DARLINGTON 18 Priestgate (Half-day Wed.) Tel. 68043
- EDINBURGH 133 Leith St. (Half-day Wed.) Tel. Waverley 5766
- GLASGOW 326 Argyle St. (Half-day Tues.) Tel. CITY 4158
- HULL 91 Paragon Street (Half-day Thursday) Tel. 20505



- 32 High Street (Half-day Thurs.) Tel. 56420 LEICESTER
- 5-7 County (Mecca) Arcade, Briggate (Half-day Wed.) LEEDS Tel. 28252
- 73 Dale St. (Half-day Wed.) Tel. CENTRAL 3573 LIVERPOOL
- 238 Edgware Road, W2 (Half-day Thurs.) Tel. LONDON PAD 1629
- 60A Oldham Street (Half-day Wed.) Tel. CENTRAL 2778 MANCHESTER
- 106 Newport Rd. (Half-day Wed.) Tel. 47096 MIDDLESBROUGH
- 41 Blackett Street (Opp Fenwicks Store) (Half-day Wed.) Tel. 21469 NEWCASTLE UPON TYNE
- 13 Exchange Street (Castle Market Bldgs.) (Half-day Thurs.) Tel. 20716 SHEFFIELD

MAIL ORDERS TO: 102 Hancocner Lane, Bramley, Leeds 13. No C.O.D. unless C.W.O. or C.O.D. Postage 4/6 extra under £2 5/9 extra under £5. Trade supplied. S.A.E. with enquiries. Branches open all day Sats. MAIL ORDERS MUST NOT BE SENT TO SHOPS

R.S.C. A10 30 WATT ULTRA LINEAR HI-FI AMPLIFIER



Highly sensitive. Push-Pull high output, with Pre-amp. Tone Control Stages. Performance figures of factory built units: Hum level—70dB. Frequency response $\pm 3dB$ 30-20,000c/s. Sectionally wound output transformer. All high grade components. Valves: 6X6, 6Y6, ECC83, 807, 807, GZ34. Separate Bass and Treble Controls. Sensitivity 30mV. Suitable for high impedance microphones. Crystal or Ceramic P.U.'s. Designed for Clubs, Schools, Theatres, Dance Halls or Outdoor Functions, etc. For use with Electronic Organ, Guitar, String Bass, etc. Gram, Radio or Tape. Reserve L.T. and H.T. for Radio Tuner. Two inputs with associated volume controls so that two separate inputs such as Gram and "Mike" can be mixed. 200-250v. 50c/s A.C. mains. For 3 and 15 ohm speakers. Complete kit of parts with point-to-point wiring diagrams and instructions. **15 Gns.** Carr. 12/6

R.S.C. A11 HIGH FIDELITY 12-14 WATT AMPLIFIER

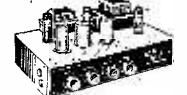

PUSH-PULL ULTRA LINEAR OUTPUT "BUILT-IN" TONE CONTROL PRE-AMP. Two input sockets with mixing facilities High sensitivity, 5 valves, Independent Bass and treble controls. Frequency response $\pm 3dB$ 30-20,000 c/s. Hum level—60dB. Sensitivity 40 millivolts. For Crystal or Ceramic P.U.'s. High Impedance "mikes". For Musical Instruments etc. Std. A.C. mains. For 3 & 15 ohm spkrs. SAE for leaflet. Complete kit. Full instructions and point-to-point wiring diagrams. Carr. 11/6. Twin handled metal cover 27/6. Price Factory built 12/4 gns. or Deposit 9/0 and 9 monthly payments of 25/- (Total £16.13.6). **RSC A11 TRANSISTORISED VERSION** of above complete kit 9 Gns. (Assembled 13 Gns.)

30 WATT HI-FI AMPLIFIER

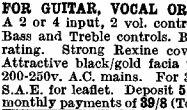

FOR GUITAR, VOCAL OR INSTRUMENTAL GROUP A 2 or 4 input, 2 vol. control Hi-Fi unit with Separate Bass and Treble controls. B.V.A. valves. Peak output rating. Strong Rexine covered cabinet with handles. Attractive black/gold fascia panel Neon indicator. For 200-250v. A.C. mains. For 3 or 15 ohm speakers. Send S.A.E. for leaflet. Deposit 5 gns. and 9 monthly payments of 39/8 (Total £22 gns.) **19 Gns.** Carr. 12/6

FANE ULTRA HIGH POWER LOUSPEAKERS

All power ratings are R.M.S. continuous. 2 years' guarantee. High flux ceramic magnets. Heavy cast chassis. All prices carr. free			
'POP' 100 18" 100 Watt 14,500 gauss 8/15/2	'POP' 60 15" 60 Watt 14,000 gauss 15/2	'POP' 50 12" 50 Watt 14,000 gauss 15/2	'POP' 30C 12" 25 Watt Dual cone 15/2 £5-19-9 Carr. free
21 GNS.	12 GNS.	10 GNS.	

F.A.L. P.A. AMPLIFIERS PHASE 50 **29 GNS.** PHASE 100 **59 GNS.** S.A.E. for leaflets.

R.S.C. COLUMN SPEAKERS

Covered in two-tone Rexine/Vynal, ideal for vocalists and Public Address. 15 ohm matching. C57 15 watts inc. five 7 x 4in. speakers £7.19.11.

TYPE C48S 25/30 WATTS. Fitted four 8in. high flux 8 watt speakers. Overall size approx 42 x 10 x 5in.

16 Gns. Carr. 10/-
Or deposit 87/- and 9 monthly payments 34/9 (Total £18.19.9)

TYPE C412S, 50 WATTS. Fitted four 12in. 11,000 line 15 watt speakers. Overall size 56 x 14 x 9in. approx.

26 Gns. Or Deposit 15/- **£5.17.6** and 9 monthly payments of 54/6 (Total £30.7.0)

HIGH QUALITY LOUSPEAKERS

In Teak or Afrormosia veneered Cabinets
L13 13" x 8" 10 Watt 10,000 lines 3 or 15 ohms. **£4-19-9** Carr. 7/6
Type L12 12" 20 Watt 10,000 lines 15 ohms. Carr. 8/9 **£8-19-9**

R.S.C. BASS-REGENT 50 WATT AMPLIFIER

A powerful high quality all-purpose unit for vocal, rhythm, bass guitar, lead, lists, gram. radio, tape. Peak C rating.
Two extra heavy duty 12in. Loudspeakers. Four Jack inputs and two Volume Controls for simultaneous use of up to four pick-ups or "mikes". Bass and Treble controls.
55 Gns. Carr. 30/- or dep. £13.4.9 and 9 monthly payments of £5.11.9. (Total 60/- gns.) Send S.A.E. for leaflet.
G100 100 watt peak output with Pr. speaker column and a Bass Unit (Six 12" and Two 15" Speakers). 99/- gns.



R.S.C. MAINS TRANSFORMERS

FULLY GUARANTEED. Interleaved and Impregnated. Primarys 200-250v. 50c/s. Screened MIDGE CLAMPED TYPE 2 1/2 x 2 1/2 x 2 1/2in.
250-0-250v. 60mA, 6.3v. 2a. 17/11
250-0-250v. 60mA 6.3v. 2a. 18/11
FULLY SROUDED UPRIGHT MOUNTING
250-0-250v. 60mA, 6.3v. 2a., 0-5-6.3v. 2a. 24/9
250-0-250v. 100mA, 6.3v. 4a., 0-5-6.3v. 3a. 39/9
300-0-300v. 100mA, 6.3v. 4a., 0-5-6.3v. 3a. 39/9
300-0-300v. 130mA, 6.3v. 4a., c.t., 6.3v. 1a. 39/9
For Mullard 510 Amplifier. 47/11
350-0-350v. 100mA, 6.3v. 4a., 0-5-6.3v. 3a. 39/9
350-0-350v. 150mA, 6.3v. 4a., 0-5-6.3v. 3a. 47/8
425-0-425v. 200mA, 6.3v. 4a., c.t., 5v. 2a. 89/9
425-0-425v. 200mA, 6.3v. 4a., 6.3v. 3a., 5v. 2a. 89/9
450-0-450v. 250mA, 6.3v. 4a., c.t., 5v. 3a. 99/9
TOP SROUDED DROP-TREBO TYPE
250-0-250v. 70mA, 6.3v. 2a., 0-5-6.3v. 2a. 28/9
250-0-250v. 100mA, 6.3v. 3.5a. 27/9
250-0-250v. 100mA, 6.3v. 2a., 6.3v. 1a. 28/9
350-0-350v. 80mA, 6.3v. 2a., 0-5-6.3v. 2a. 29/11
350-0-350v. 100mA, 6.3v. 4a., 0-5-6.3v. 3a. 39/9
300-0-300v. 100mA, 6.3v. 4a., 0-5-6.3v. 3a. 39/9
300-0-300v. 130mA, 6.3v. 4a., 0-5-6.3v. 1a. 39/9
Suitable for Mullard 510 Amplifier 46/9
350-0-350v. 100mA, 6.3v. 4a., 0-5-6.3v. 3a. 39/9
350-0-350v. 150mA, 6.3v. 4a., 0-5-6.3v. 3a. 46/11
FILAMENT or TRANSISTOR POWER PACK
Types 6.3v. 1.5a. 8/9; 6.3v. 2a. 9/9; 6.3v. 3a. 13/9;
6.3v. 6a. 22/9; 12v. 1a. 9/11; 12v. 3a. or 24v. 1.5a. 23/9; 0.9-18v. 1.2a. 19/11; 0-12-25-42v. 2a. 31/9
CHARGER TRANSFORMERS 0-9-15v. 1.2a. 18/9; 2.1a. 19/11; 3a. 21/11; 5a. 25/11; 6a. 29/9; 8a. 36/9
AUTO (Step UP/step DOWN) TRANSFORMERS
0-110/120v. 200-250-250v., 6-50 watts 19/9;
150 watts, 33/6 250 watts 49/9; 500 watts 105/-
OUTPUT TRANSFORMERS
Standard Pentode 5,000 Ω or 7,000 Ω to 3 Ω 8/9
Push-Pull 8 watts EL84 to 3 Ω or 15 Ω 14/9
Push-Pull 10 watts 6V6, ECL86 to 3, 5, 8 or 15 Ω 24/9
Push-Pull EL84 to 3 or 15 Ω 0-15-15 watts 23/9
Push-Pull Ultra Linear for Mullard 510, etc. 39/9
Push-Pull 15-18 watts, sectionally wound 6L6, KT66, etc. for 3 or 15 Ω 85/9
Push-Pull 20 watt high quality sectionally wound EL34, 6L6, KT66 etc. to 3 or 15 Ω 59/9
SMOOTHING CHOKES 150mA, 7-10H, 250 Ω 12/8; 100mA, 10H, 200 Ω 19/8; 80MA, 10H, 350 Ω 8/8; 60mA, 10H, 400 Ω 4/11.
SELENIUM RECTIFIERS F.W. (Bridged) All 6/12v. D.C. output. Max. A.C. input 18v. 1a. 4/3. 2a. 6/11. 3a. 9/8. 4a. 12/8. 6a. 15/9.

YOURS FREE FOR 7 DAYS

The 'New Picture-Book' way of learning

BASIC ELECTRICITY (5 VOLS.)

BASIC ELECTRONICS (6 VOLS.)

You'll find it easy to learn with this outstandingly successful NEW PICTORIAL METHOD—the essential facts are explained in the simplest language, one at a time, and each is illustrated by an accurate, cartoon-type drawing. The books are based on the latest research into simplified learning techniques. This has proved that the PICTORIAL APPROACH to learning is the quickest and soundest way of gaining mastery over these subjects.

TO TRY IT, IS TO PROVE IT

To The SELRAY BOOK CO., 60 HAYES HILL, HAYES, BROMLEY, KENT BR2 7HP

Please send me WITHOUT OBLIGATION TO PURCHASE, one of the above sets on 7 DAYS FREE TRIAL, I will either return set, carriage paid, in good condition within 7 days or send the following amounts. BASIC ELECTRICITY 75/- Cash Price, or Down Payment of 20/- followed by 3 fortnightly payments of 20/- each. BASIC ELECTRONICS 90/- Cash Price, or Down Payment of 20/- followed by 4 fortnightly payments of 20/- each. This offer applies to UNITED KINGDOM ONLY. Overseas customers cash with order, prices as above.

Tick Set required (Only one set allowed on free trial)

BASIC ELECTRICITY BASIC ELECTRONICS

Prices include Postage and Packing.

Signature _____
(If under 21 signature required of parent or guardian)

NAME _____
BLOCK LETTERS

FULL POSTAL ADDRESS _____

WHAT READERS SAY

'Everything is clearly set out ...'
... I am well pleased with this pictorial system. Everything is clearly set out in diagrams, ... L.P., Co. Armagh.

'... very pleased with the set ...'
... I was very pleased with the set of Basic Electronics. Please send Basic Electricity ... D.W., Margate.

'... how understandable your books are ...'
... Pleased to say how understandable your books are, I now have a sound knowledge of the subject ... A.A., Hull.

A TECH-PRESS PUBLICATION

POST NOW FOR THIS OFFER!!

LOOK!

PRACTICAL!
VISUAL!
EXCITING!

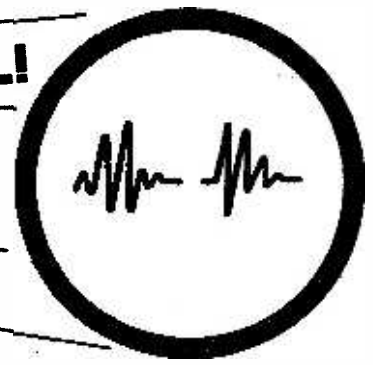

a new 4-way method of mastering

ELECTRONICS

by doing — and — seeing . . .

1 ▶ OWN and HANDLE a

complete range of present-day **ELECTRONIC PARTS** and **COMPONENTS**

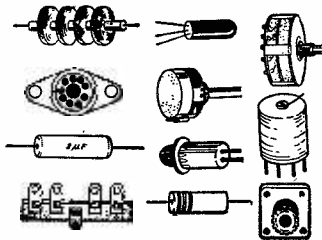

2 ▶ BUILD and USE

a modern and professional **CATHODE RAY OSCILLOSCOPE**

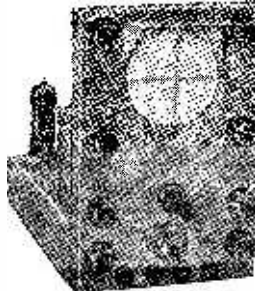

3 ▶ READ and DRAW and

UNDERSTAND **CIRCUIT DIAGRAMS**

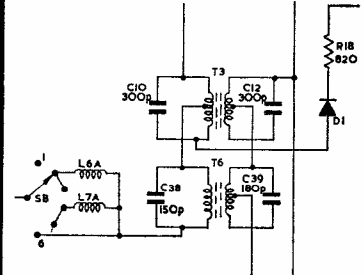

4 ▶ CARRY OUT OVER **40** EXPERIMENTS ON BASIC ELECTRONIC CIRCUITS AND SEE HOW THEY WORK . . . INCLUDING . . .

- VALVE EXPERIMENTS
 - TRANSISTOR EXPERIMENTS
 - AMPLIFIERS
 - OSCILLATORS
 - SIGNAL TRACER
- PHOTO ELECTRIC CIRCUIT
 - COMPUTER CIRCUIT
 - BASIC RADIO RECEIVER
 - ELECTRONIC SWITCH
 - SIMPLE TRANSMITTER
- A.C. EXPERIMENTS
 - D.C. EXPERIMENTS
 - SIMPLE COUNTER
 - TIME DELAY CIRCUIT
 - SERVICING PROCEDURES

This new style course will enable anyone to really understand electronics by a modern, practical and visual method—no maths, and a minimum of theory—no previous knowledge required. It will also enable anyone to understand how to test, service and maintain all types of Electronic equipment, Radio and TV receivers, etc.

FREE POST NOW
for
BROCHURE

or write if you prefer not to cut page

To: **BRITISH NATIONAL RADIO SCHOOL, READING, BERKS.** Please send your free Brochure, without obligation, to: *we do not employ representatives*

NAME.....BLOCK CAPS

ADDRESS.....PLEASE PW5

PRACTICAL WIRELESS

VOL 46 NO 1

Issue 759

MAY 1970

TOPIC OF THE MONTH

The Vintage Years

SOMETIMES in this column, certain elements are berated for not being as up-to-date as we think they should be. This month, with that special perversity of editors, the clock is going to be turned backwards—not, exactly, to the dawn of time but to those days when radio was a crude, exciting newcomer.

It has become clear from correspondence that there is a growing interest in those early days. So many readers have written to us on the subject that it has not been possible to answer everyone individually. These interesting letters have been greatly appreciated and, for those who have not had an acknowledgement, a grateful thank-you. Those who have asked for a feature on the history of radio will be pleased to know that something *will* be done about this as soon as possible. In the meantime, historically-minded readers might care to ponder on a couple of points.

Quite a few enthusiasts have added a useful sideline to their hobby by collecting pieces of vintage radio equipment, either components or complete models. In this way, some useful little private collections have been formed, quite apart from specimens in museums or owned by radio companies. These pieces of equipment are quickly passing from the phase of being 'junk' to becoming respectable 'antiques'. We think it important that readers keep a weather eye open for anything in this line which might otherwise end up in the dustbin—a good home can always be found for such items.

The second point is that, although there are vintage car organisations, vintage record societies, vintage gramophone clubs and vintage-practically-everything-else-clubs, there is to our knowledge no vintage radio equipment organisation. The need obviously exists and such an organisation could do much to collate information and put fellow enthusiasts in touch with each other. We would be pleased to give space to any readers wishing to start such an enterprise.

W. N. STEVENS—*Editor*.

JUNE ISSUE WILL BE PUBLISHED ON MAY 5

NEWS AND COMMENT

Leader	19
News and Comment	20, 21
Practically Wireless by Henry	30
MW Column by C. Molloy	41
On the Short Waves by Malcolm Connah and David Gibson, G3JDG	57

CONSTRUCTIONAL

FM Stereo Decoder by W. Cameron	22
Direct Reading Frequency Meter by T. J. Melville	26
3-Band TRF 4 Receiver by F. G. Rayer	38
Take 20, Two Transistor Radio by Julian Anderson	48
Beginners' AF Amplifier by A. S. Ellis	51
Electronic Receiver Switch for Transmit-Receive by F. G. Rayer, G3OGR	54
I.C. of the Month, R.C.A. CA 3052 by L. A. J. Ireland	61

OTHER FEATURES

Sums plus Circuits equals Understanding Part 2 by Leslie Moore	33
Miniaturisation, Making Printed Circuit Boards by R. A. Yates	42
Aerials for Mobiles by F. Judd, G2BCX	44
What do you know about Meter Shunts? Part 2 by H. A. Cole	49
P.W. Guide to Components, Part 17 by M. K. Titman, B.Sc.	65
P.W. Pedal Steel Guitar, Alternative Construction for Preamplifier by H. G. Middleton	70

©IPC Magazines Limited 1969. Copyright in all drawings, photographs and articles published in "Practical Wireless" is fully protected, and reproduction or imitations in whole or in part are expressly forbidden. All reasonable precautions are taken by "Practical Wireless" to ensure that the advice and data given to readers are reliable. We cannot, however, guarantee it, and we cannot accept legal responsibility for it. Prices are those current as we go to press. All correspondence intended for the Editor should be addressed to Fleetway House, Farringdon Street, London, E.C.4. Address correspondence regarding advertisements to Advertisement Manager, Fleetway House, Farringdon Street, London, E.C.4. Orders for back numbers should be addressed to IPC Magazines Ltd., Back Numbers Department, Carlton House, Gt. Queen Street, London W.C.2.

Marconiphone 1970

First new models for 1970 announced by British Radio Corporation are three Marconiphone sets, a portable radio and two tape recorders.

The Marconiphone model 4170 is a a.m./f.m. transistor radio with a recommended retail price of £32 10s.

Waveband coverage includes long, medium, short and v.h.f., with built-in a.m. and f.m. aerials. There is a permeability-tuned aerial circuit for matching a car aerial on long and medium wavebands. The receiver has automatic frequency control on v.h.f. with push button on/off switch.

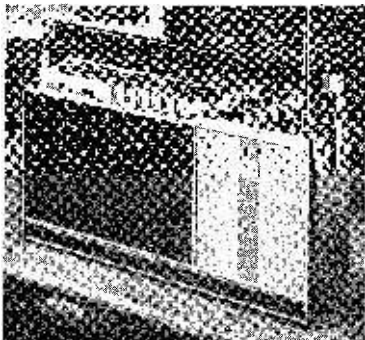

Model 4170 receiver.

Output is approximately 1W, at less than 5% harmonic distortion through a 6 x 4in. loudspeaker. Sockets are included for a car aerial, tape recorder, earphone and an external power unit; when this latter socket is used the internal battery is switched out.

The Marconiphone tape recorder model 4245 is a twin-track single-speed machine with 5½in.

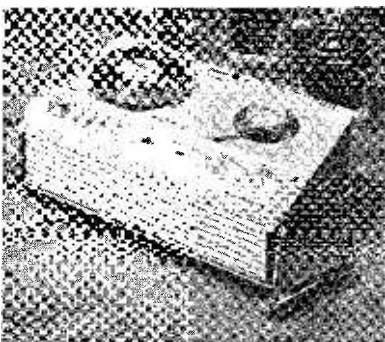

Model 4245 tape recorder.

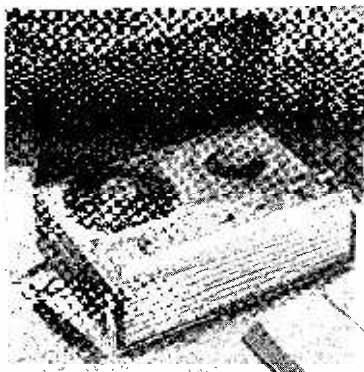

Model 4246 tape recorder.

spools. With lid removed it will accommodate spools up to 7in. diameter. Tape speed is 3¾i.p.s.

Incorporating an entirely new BRC tape deck, model 4245 has automatic recording level control, switched for either speech or music. Other facilities include a combined input and output socket for recording and playback, automatic end stop, pause control and 4-digit tape position indicator with reset button.

Solid state, model 4245 has an amplifier output of 3W, speech and music rating at 5% distortion; speaker size is 5½ x 2½in. elliptical.

Supplied with a moving coil microphone, 900 feet of LP tape on a 5½in. spool, a DIN 2-pin speaker plug and connecting lead in a plastic wallet, model 4245 has a recommended retail price of £35 19s.

Marconiphone model 4246 is a 4-track single speed tape recorder running at 3¾i.p.s. Of very similar specification to the 4245, the model 4246 has a switched automatic recording level control for the more advanced recording enthusiast to go on to manual when required. Recommended retail price of Marconiphone model 4246 is £41 14s.

Rastra Catalogue

Rastra Electronics Ltd. announce the issue of a new 17-page loose-leaf catalogue of i.c.'s, transistors, triacs, thyristors, rectifiers, computer diodes, breadboards, sockets etc. *Rastra Electronics Ltd., 275 King Street, Hammersmith, London, W.6.*

Local Radio on MW

The BBC local radio stations, soon numbering 20, can use the Medium Wave in the future. The Minister of Posts and Telecommunications (GPO) John Stonehouse recently released the necessary frequencies and freed the BBC from its restrictive v.h.f. allocation.

The reason for this move is that while v.h.f. gives superior reception only a limited number of listeners have or can afford suitable receivers. Local stations will in future use the "opt-out" channels used for local radio.

These stations will, of course, be best received during the daytime as at night the Continentals come up and make local reception on m.w. virtually useless. V.H.F. will still however be used.

ITT Power Supply

ITT Components Group Europe now offer a new MP range of stabilised power supplies.

The MP range is available in output d.c. current ratings of 0.5, 1, 2, 3, 5 and 10A. Each current rating may be specified in stabilised output voltage ranges of 0-16, 0-30 and 0-50V.

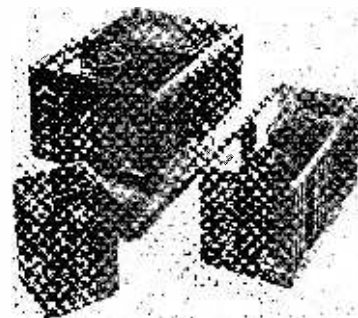

A key feature of the MP range is that two versions of each unit are offered. The "industrial" version meets the majority of normal industrial requirements.

Stability ratio of the industrial version is 1000:1 above 6V output and 250:1 below, compared with 10000:1 for the professional version at all voltages. *ITT Components Group, Europe, Standard Telephones and Cables Limited, Edinburgh Way, Harlow, Essex.*

IC FM tuner kit

We have been informed by General Avionic Associates Ltd. that they have changed their address to: 2 Cheam Court, Station Way, Cheam, Sutton, Surrey. They apologise for any inconvenience caused to readers and ask that if they sent cheques and postal orders to the old address (9 Wimpole Street, London, W.1) would they be kind enough to cancel them and re-order from the Sutton address.

Amateur radio network links 'shut-in' operators

In an age when satellites make communications swifter and more extensive than ever before, it can be surprising to discover that some people are still cut off from their fellow men by physical handicaps. For the deaf and the blind there are hearing aids, Braille printing and similar devices to help overcome disabilities. Yet other ailments can shut in the victim from the world—unless he is determined not to be left out, and some physically sound friends respond to that determination.

That is what happened in San Ysidro, a city in California close to the Mexican border, where two young men, victims of a crippling disease, have become amateur radio operators, able to communicate with the world. The identical twin brothers, Henry and Jack Johnson, are only able to talk, move their eyeballs and control a capillary nerve in one arm. But now, thanks to the efforts of a group of dedicated amateur radio "hams," they are able to talk to the four corners of the earth.

As a result, there is now a radio network linking handicapped operators around the world. The organisation, called International Handicappers' Net (IHN), grew out of a conversation with the disabled twins and a Lieutenant Commander Ray E. Meyers, a retired Navy communications officer. Soon other amateurs joined the group and an exotic control system was developed for operating the radio

Practical Wireless and Practical Television Filmshow—1970

The meeting was opened by the Chairman, W. N. Stevens, Editor of *P.W.* and *P.T.V.* He paid tribute to Mr. A. T. Collins, the recently retired Managing Editor of the Practical Group magazines who had been with the firm 40 years, and who had worked with F. J. Camm in the early days of *P.W.* When Mr. Camm died, Mr. Collins took over as Managing Editor. Referring to the subject of the evening, the Chairman said that the integrated circuit was not the end of the Home Constructor by any means and that it should stimulate ideas and open up new fields. He said that *Practical Wireless* tried to keep up to date as far as it possibly could and that it was one of the first magazines to publish regular articles on integrated circuit projects in each issue.

Two films were shown, the first entitled "Mullard-ability" and was described as a profile of Mullard Ltd, the largest manufacturer of electronic components in the U.K. The second film, entitled "Something Big in Microcircuits" was set against a background of a $\frac{1}{4}$ -million square feet of production space, years of scientific work in research labs and millions of pounds of invested capital.

The film showed how hundreds of components are created on a tiny chip of silicon less than three square millimetres in area and described why modern technological progress has made this process necessary. Also shown, were some of the ways in which microcircuits are already being used and outlined the future of these devices in the 1970s.

After the films, there was the usual break for refreshments and when the audience had returned, Philip Hunt deputising for Ian Nicholson gave a talk entitled "The Integrated Circuit". He said that integrated circuits had necessitated an entirely new approach to the whole subject of circuitry and circuit design. He discussed the reasons for and the results of this and told of their development and manufacture by Mullard Ltd.

After the talk, the meeting was opened to questions and some interesting points of view were brought forward.

equipment within the limited abilities of Henry and Jack.

It was the Johnson brothers who suggested starting a radio network of handicapped amateurs along with the possibility of listing the members so that others might immediately recognise fellow members. The result would be "on the air" contact, discussion, or relaying of messages.

Members are classified as operators or honorary—the honorary members are unhandicapped persons who help the handicapped to learn to operate their sets and solve problems of managing transmission and reception. Membership is also graded according to the operator's skills, as novice, technician, general and extra. The net has more than 3,000 members in all the states and in almost all countries. Many operators were

"hams" before they became handicapped; the others learned their skills after illness made them shut-ins.

Because the physical handicaps include a wide range of crippling conditions, the honorary members have resorted to a variety of systems of instruction in addition to creating ingenious devices to meet individual difficulties in handling transmission and reception of messages.

Some helpful amateurs developed voice-controlled relays permitting an armless or paralyzed operator to send intelligible code. Others have perfected radio controls which can be turned on and off by the flick of an eyelid. Another device enables a bed-ridden operator to manage his controls by air pressure blown through a flexible hose.

F.M. STEREO DECODER

W. CAMERON

SINCE publication of the Author's "Transistor FM Tuner" (P.W. Feb.-Mar. 1969) there has been a considerable call from constructors for a stereo decoder unit suitable for use with this tuner. The tuner unit itself was designed for use with a decoder, so it requires no modification. The decoder may be used with other tuners which have an output which by-passes, or otherwise renders inoperative, the de-emphasis network.

This or any other decoder will not work satisfactorily from a tuner which has inadequate i.f. bandwidth, poor a.f. response, or is verging on instability, which may cause lack of bandwidth or a poor frequency/phase relationship. It is also very desirable, if not essential, that the tuner have a.f.c. or be crystal controlled, as channel separation depends largely on the signal being always correctly tuned.

A signal which is of just sufficient strength to provide acceptable mono reception is likely to be inadequate for stereo. Similarly, at some sites or beyond the service area of the v.h.f. station concerned, the change from mono to stereo reception may introduce additional background noise. This is an unavoidable consequence of the decoding process which can only be overcome by improving the signal into the tuner by means of a better aerial system.

In any case the aerial should be in a fixed position and not just a flying lead hanging from the receiver's aerial socket.

With these points already in mind, it is as well to have some idea of how stereo broadcasting works.

The system the BBC is using is the pilot tone (Zenith G-E) system, which is a method of transmitting both left (A) and right (B) channels on a single wavelength, coded at the transmitter by a multiplexing process.

At the receiver, the decoder converts the multiplexed signal back into the A and B signals for the two channels. The system is compatible, so that on a mono only receiver the stereo signal is reproduced only as mono, being the sum of the A and B signals.

For stereo reception however, additional information is necessary to enable the decoder to separate the A and B signals. This extra information consists of a "difference" signal (A-B) which is transmitted

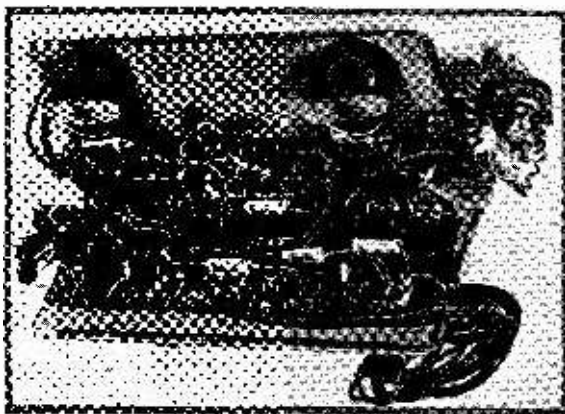

as the upper and lower sidebands of a 38kHz suppressed sub-carrier.

A simple way to envisage this operation, and which would give the same result, is as a process of alternately switching the signal to left and right hand channels at a rate of 38,000 times per second.

The same sort of switching process in the decoder extracts the A and B channels for feeding to the respective left and right amplifiers and loudspeakers.

This rate of switching is synchronised between the transmitter and receiver by means of a 19kHz pilot tone, which is doubled to 38kHz for the switching operation. The two frequencies are phase coherent.

The block diagram (Fig.1) should explain the operation of the decoder.

CIRCUIT DESCRIPTION

The first stage, Tr1, has unity gain and serves only to provide an inverted audio signal from the collector with respect to the emitter. The 19kHz pilot tone is taken off by the tuned circuit L1-C5 via R5 and C3, and amplified by Tr2. Tr3 is directly coupled to the collector of Tr2 and its base bias is set (by adjustment of VR1) to or beyond cut-off to ensure efficient frequency doubling in the 38kHz tuned circuit L2-C8. The silicon diode D1, holding the emitter at 0.6V, ensures that the transistor will turn on only when the pilot tone reaches a sufficient amplitude to operate the transistor switches Tr4 and Tr5. The diode therefore also ensures that Tr3 remains cut off when no pilot tone is received (mono) so that the switches will not be spuriously operated by high level audio signals, which may otherwise shock L1 and hence T1 into excitation.

The transistors Tr4 and Tr5 are shunt gates, driven by the anti-phase voltages appearing at each end of the centre-tapped L3. Outputs A and B will be left and right channels

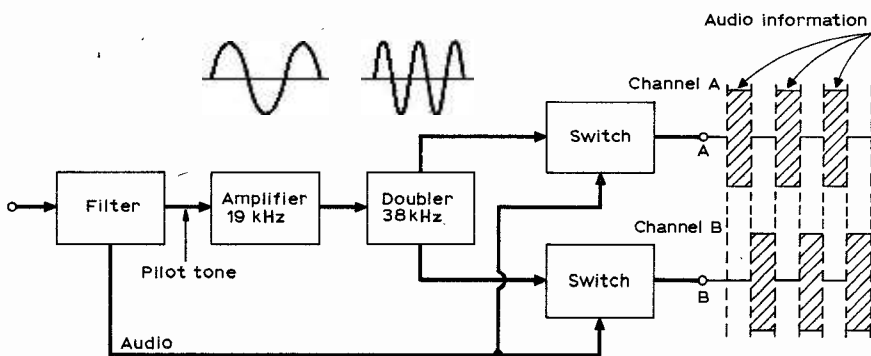

Fig. 1: Block diagram showing operation of decoder

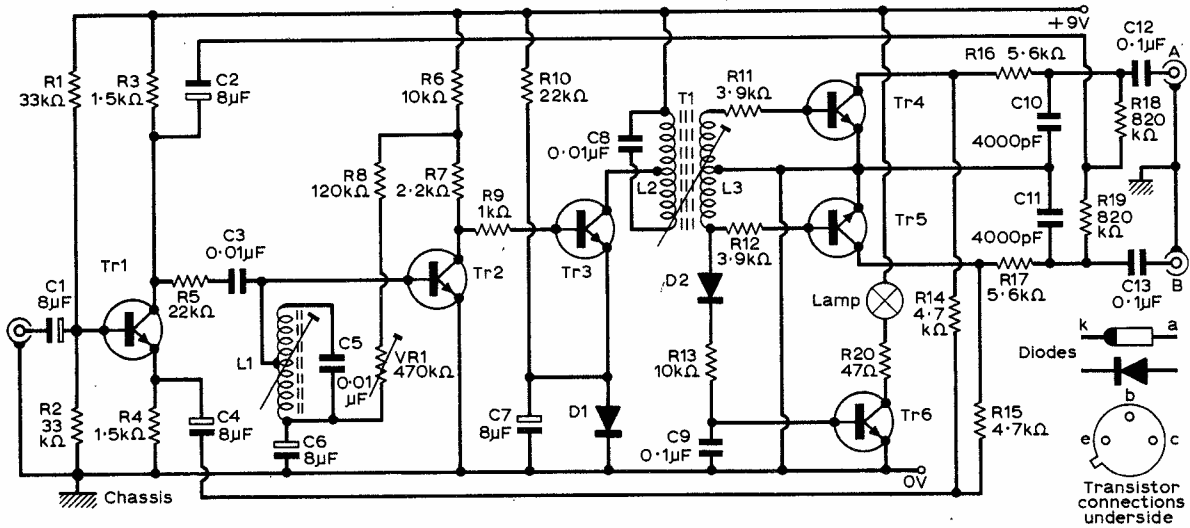

Fig. 2: Circuit shown is for -ve earth. For +ve earth, chassis connection is made to + rail and C1 reversed in polarity.

respectively when the phasing of T1 is as shown in the circuit diagram (Fig.2). Reversing the connections of L3 will invert the channels.

Series gate systems were tried, but were found to have the disadvantage that a large switching rate signal was present in the output, sufficient to overload the following amplifier if its response extended to over 38kHz, unless rather elaborate filtering was used.

Although a transistor switch can never be like a perfect switch, the shunt gate system is very efficient. Crosstalk (measured at 1kHz) due to inefficiency is -26dB, which is improved to better than 40dB by applying an out of phase signal via

R18 and R19 to each channel. These resistors may be adjusted to improve overall separation as mentioned later. The potential of the switching signal in the output is very small and is almost completely removed by the de-emphasis capacitors C10 and C11.

The germanium diode D2 and transistor Tr6 and associated components are optional, and are to provide an indication by means of a light when a stereo programme is being transmitted. The power supply for the decoder will dictate whether or not it can be used.

Without the pilot light circuit, the decoder requires a supply of 9V at only 11mA, but with the light and Tr6 etc., requires a supply of 9V at 70mA.

In the Author's case, both tuner and decoder are powered from the amplifier supply, (Low Cost Hi-Fi, P.W. Jan.-Feb. 1968) the tuner from the negative supply line and the decoder from the positive line, the chassis or earths all being common. Figure 3 shows the additional components required when the decoder is powered from a 12V source. The decoupling capacitor should be 1000µF if audio is present on the 12V line.

The input impedance to the decoder is 10kΩ and is suitable for direct connection to a transistor tuner with an output of 600mV to 1V peak to peak

★ components list

Resistors:

R1 33kΩ	R12 3.9kΩ
R2 33kΩ	R13 10kΩ
R3 1.5kΩ	R14 4.7kΩ
R4 1.5kΩ	R15 4.7kΩ
R5 22kΩ	R16 5.6kΩ
R6 10kΩ	R17 5.6kΩ
R7 2.2kΩ	R18 820kΩ
R8 120kΩ	R19 820kΩ
R9 1kΩ	R20 47Ω for 60mA bulb
R10 22kΩ	68Ω for 40mA bulb
R11 3.9kΩ	

All resistors ½ watt, 10% miniature types
VR1 470kΩ 1in. miniature preset

Capacitors:

C1 8µF 12V	C8 0.01µF 2% polyester
C2 8µF 12V	C9 0.1µF ceramic
C3 0.01µF ceramic	C10 4,000pF ceramic
C4 8µF 12V	C11 4,000pF ceramic
C5 0.01µF 2% p'ster	C12 0.1µF ceramic
C6 8µF 12V	C13 0.1µF ceramic
C7 8µF 12V	

Semiconductors:

Tr1-Tr6 BC108 or BC109
D1 Silicon diode BA100, OA202, etc.
D2 Germanium diode AA119, OA91, etc.

Miscellaneous:

Pot Core assemblies, STC 10D/WR Type A1;
Miniature 18-way group board; 13-way tag strip;
Aluminium panel 5in x 5in; Bulb 6V 60mA (or 40mA);
Bulb holder; 40 s.w.g. enamelled wire for coils.

TRANSISTOR VOLTAGE READINGS

	MONO			STEREO		
	E	B	C	E	B	C
Tr 1	3.8	4.2	5.0	3.8	4.2	5.0
Tr 2*	0	0.4	0.3	0	0.15	0.2
Tr 3*	0.6	0.3	9.0	0.6	0.2	9.0
Tr 4	0	0	0	0	1.5	0
Tr 5	0	0	0	0	1.5	0
Tr 6	0	0	9.0	0	0.7	0.9

* Depends upon setting of VR1.

Readings may vary slightly. Measured using a 20kΩ/V meter; 9V battery supply.

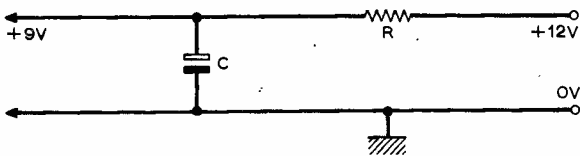

Fig. 3: Additional components required when using a 12V supply.

(approx. 200 to 300mV r.m.s.).

With a valve tuner, it may be necessary to fit a resistor in series with the input (typically 10kΩ to 47kΩ) to provide the correct input level to the decoder and also to reduce the tuner discriminator loading to an acceptable value. It may be necessary to shunt the resistor with a capacitor of 300-1000pF to maintain the h.f. response.

The amplifier input impedance should be not less than 50kΩ for the de-emphasis to be effective, and so that the decoder shall not give an insertion loss.

Allowance must be made for the fact that on stereo, as the audio modulation is shared at the transmitter between the A and B channels, the output per channel will be approximately halved compared to mono.

CONSTRUCTION

Layout is not critical provided the coils L1 and T1 are not too close to each other. They should be about 3in. apart to avoid mutual coupling.

The layout shown (Fig.4) is preferred as it results in a rigid as well as a compact unit, while the aluminium chassis gives a useful degree of screening and provides a good earth connection for the ferrite pot cores.

Coil winding details are given in Fig.5. The capacitors C5 and C8 may be either polystyrene or silver mica types with a tolerance of 2 per cent or better.

To allow for winding and capacitor tolerances, it is wise to wind the tuned windings L1 and L2 with a few extra turns, which can be removed later if necessary depending on how the coils tune. (It is not important that the centre tap be exact except for L3).

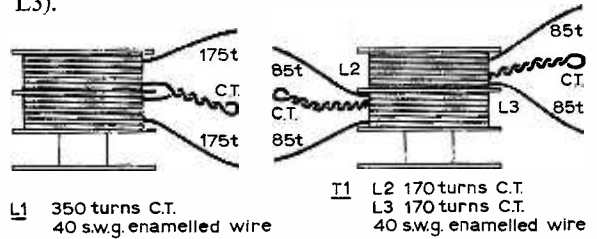

Fig. 5: Coil winding details.

The coils and the length of tag strip with its associated components are mounted first. Only the end lugs on the strip are used for mounting, the remainder being cut off. The completed group board is then put into position, taking care that the transistor cases (which are internally connected to the collector) do not come into contact with any metal part. The board is secured to the chassis with a couple of 6BA screws; nuts between the board and chassis serve as spacers to hold the board clear of the chassis.

A solder tag on each screw provides the screen connection for the input and output screened leads. A single lead from the chassis to the negative line

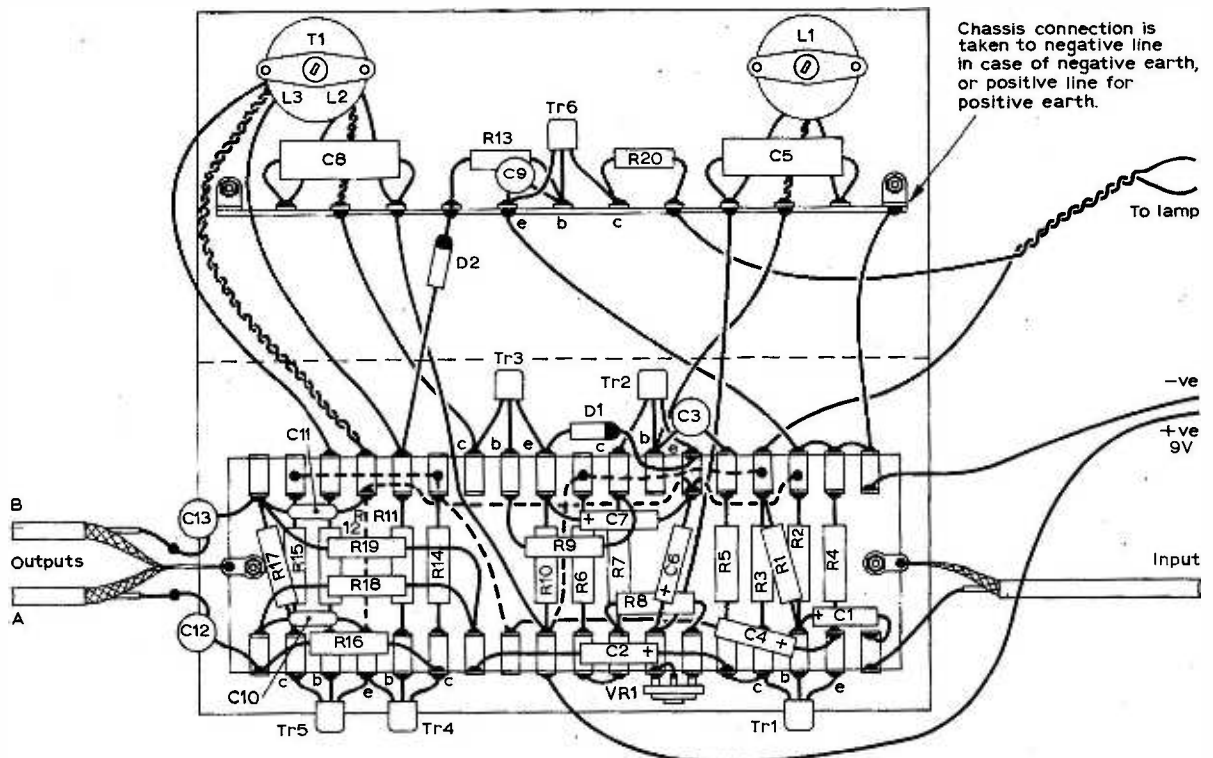

Fig. 4: Component layout and wiring details.

TEST TONE TRANSMISSIONS, BBC RADIO 3 WEDNESDAYS AND SATURDAYS

TIME	LEFT CHANNEL(A)	RIGHT CHANNEL(B)	NOTES
2330	250Hz at zero level	440Hz at zero level	1 This schedule is subject to variation to accord with programme requirements and essential transmission tests.
2332	440Hz at zero level	440Hz at zero level, antiphase to left channel	
2335	440Hz at +8dB	440Hz at +8dB, antiphase to left channel	2 The zero level reference corresponds to 40 per cent of the maximum level of modulation applied to either stereophonic channel before pre-emphasis. All tests are transmitted with pre-emphasis.
2337	440Hz at +8dB	440Hz at +8dB, in phase with left channel	
2339	250Hz at +8dB	440Hz at +8dB	3 Periods of tone lasting several minutes are interrupted momentarily at one-minute intervals.
2340	250Hz at zero level	Nothing	
2344	Nothing	440Hz at zero level	
2347.20 approx.	Tone sequence at -4dB: 60Hz, 900Hz, 5kHz, 10kHz. This sequence is repeated.	Nothing	
2348.20 approx.	Nothing	Tone sequences as for left channel at 2347.20	
2351 approx.	250Hz at zero level	Nothing	Every day except Wednesday and Saturday To facilitate channel identification and adjustment of channel cross-talk, 250Hz tone is transmitted in the left channel only from about four minutes after the end of the Third Programme until 2355. This test may be interrupted from time to time.
2352	Nothing	Nothing	
2353	Reversion to monophonic transmission		

completes the earth line when the unit is to be powered from a negative earth supply. This lead will be taken to the positive line in the case of a positive earth supply, and C1 reversed in polarity.

When operating from a 12V supply the dropping/decoupling resistor will be in the positive line in the case of negative earth, or in the negative line for positive earth. (Fig.3).

SETTING UP

The unit can be set up on any BBC stereo transmission, and checked finally with the BBC test transmissions, details of which are given in this article.

It is first necessary to set VR1 to its approximate operating position. This is done by adjusting VR1 until the voltage at the collector of Tr2 is 1V.

Temporarily connect a potentiometer (any value between 50kΩ and 250kΩ will do) across the tuner output, with the slider connected to the decoder input. Turn the control to maximum and tune the receiver to a stereo broadcast. Connect a meter (2.5V scale) between the negative line and the base of Tr4 (or Tr5), negative probe to base, and adjust the cores of L1 and T1 for maximum, when the reading will be about 1.5V. Limiting occurs at this point and it will not be possible to tune the coils accurately, so the input signal must be reduced to below the point of limiting by means of the potentiometer so that the reading at Tr4 base is 1V or less and the coils adjusted again for maximum. Repeat as necessary always keeping the input low enough below the point of limiting to obtain a definite peak.

The stereo indicator lamp itself can serve as an indication of correct tuning if desired, with only slightly less accuracy than a meter, by reducing the input as above so that the lamp glows at half brilliance and adjusting the cores for maximum brightness.

It is desirable that when correctly tuned, the screw cores of L1 and T1 should be neither right out of nor

right into the coils. If right out, turns should be removed as necessary. If right in, it is rather difficult to add more turns, but it is permissible to shunt the 0.01μF capacitor with a small capacitor of 100-200pF. Now remove the potentiometer and connect the decoder direct.

The pre-set VR1 must now be set correctly. Turn the pre-set to minimum so that only R8 is in circuit. At this point there will be no voltage at the bases of Tr4 and Tr5 and the indicator lamp will be out. Gradually increase the value of VR1 when the voltage on the bases will rise and the lamp will light. The correct point of adjustment of VR1 is where the voltage at the base of Tr4 just reaches maximum (maximum brilliance). Further adjustment will cause the voltage (and bulb brightness) to fall again as Tr3 is driven beyond limiting and produces a distorted waveform.

When the decoder is set up as described, it should require little or no further adjustment, as in this unit when L1 and T1 are correctly peaked, maximum output coincides with correct phase.

The unit can now be checked with the BBC test transmission, but if it has been carefully set up on a normal stereo broadcast, it is likely that only marginal improvement can be made for channel separation, by slight adjustment of T1 and VR1.

As resistors R18 and R19 are fixed and are about optimum for cancelling crosstalk due to switch inefficiency, it is possible to improve overall separation by making these resistors variable.

The procedure would be to identify the left channel while a tone is being transmitted, and then disconnect this channel from the amplifier. The resistor in the right hand channel should then be adjusted for minimum crosstalk. The procedure is repeated in the other channel.

Messrs. C. and D. Electronics, who advertise elsewhere in this issue have agreed to wind the coil bobbins at a nominal fee for those constructors who may hesitate to wind their own. ■



A Direct Reading FREQUENCY METER

T. J. MELVILLE

The design incorporates a device known as a "diode-transistor pump", which was originally developed a few years ago to operate as an f.m. discriminator, frequency divider or, as used in this meter, a linear frequency to voltage converter. The basic design and theoretical operation of the system have been described by D. E. O'N. Waddington (*Wireless World*, July 1966); so the author claims no particular credit for the present design.

Operation

Figure 1 illustrates schematically the various stages of the circuit, and Fig. 2 shows the circuit in component form. The pre-amplifier is a straightforward single transistor stage (Tr1 of Fig. 2), using a silicon npn transistor in the common emitter mode, and enabling the instrument to test low-level signals. The *mark/space ratio standardiser* is D1 of Fig. 2. This diode comprises the base-emitter junction of an npn transistor connected in reverse across the base-emitter junction of Tr2. The negative-going portion of the waveform reaching D1 will therefore be earthed, leaving only the positive going pulses to be amplified by TR2. In practice D1 will

A RELIABLE direct-reading frequency meter has various uses in the home workshop. It can, for example, check the frequency of oscilloscope timebases, bias oscillators in tape recorders, and, of course, the output from signal generators. To be of any value, such an instrument should be capable of giving accurate readings regardless of the waveform and amplitude of the signal presented to it, and the meter to be described is, in fact, capable of a high level of accuracy from 10Hz to 200kHz, providing the input signal is above a certain minimum level, typically 50mV r.m.s. (for sine waves) at the extreme frequencies, and somewhat less for those in between.

Readers with little or no other test gear should have few difficulties in building or using this meter, since setting-up requires the adjustment of only one pre-set potentiometer, and the microammeter retains its linear 0-200 calibration.

maintain the mark/space ratio of the waveform at a constant 1:1.

Since a square wave is needed to drive the diode-transistor pump part of the circuit, the next stage required is the *waveform standardiser*, or square-wave converter, which is, in effect, an overdriven amplifier stage consisting of Tr2. Assuming for the moment that sinusoidal pulses are being fed into Tr2's base, the collector current available for the transistor in its given circuit reaches the maximum well before the input pulses reach their peak. Hence the corresponding pulses appearing at the collector of Tr2 will have their tops clipped, and if the input pulses are of sufficient amplitude, a square-wave output will be obtained. Clearly, sawtooth waveforms will be modified in the same way as sine waves, and square waves, not requiring modification, will come out as they went in. It also follows that once full limiting of Tr2 has been reached, any

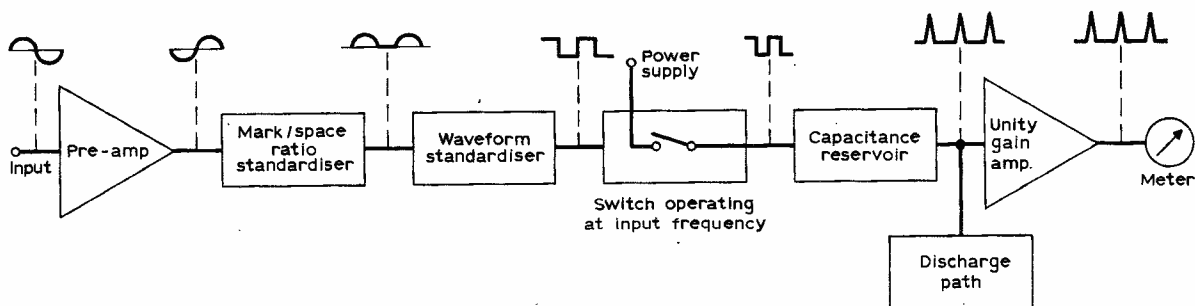

Fig. 1 : Block diagram showing stages of the Frequency Meter

increase in signal input amplitude cannot affect the pulses appearing at the collector.

Although Tr2 has been described as an overdriven amplifier, it could just as well be thought of as an electronic switch, especially as the box labelled *switch operating at input frequency* in Fig. 1 is operated by this transistor. Tr2's bias resistor, R4, provides only a small amount of base current, and the transistor is, in practice, switched on and off by the pulses reaching it from the previous stage. When the transistor is "off", very little current passes through R5, enabling whichever of the capacitors C3-6 that is in circuit to charge up to almost the full supply voltage. However, with Tr2 in the "on" state, current in R5 increases, and a larger voltage is dropped across it. Hence, the voltage charge available for C3-6 varies square-wave fashion, and is directly related to the square wave of the original signal that reaches Tr2's collector.

As the supply voltage is the nominal reference level for the charge stored in C3-6, the resistor R5 must have a low value. Ideally, there should be no resistance at all in between the power supply and the capacitor to be charged, but obviously the circuit could not function if this were the case. If the author had the inclination (or more likely the wit!) to produce pages of theoretical calculations on the effect of different time constants for the combinations R5/C3-6, it could no doubt be shown mathematically that R5 must be well under 500Ω for measurements at different frequencies to be reasonably accurate. Experimentally, it was found that 470Ω was the maximum permissible value of R5 before non-linearity of readings on the meter became apparent. To put it simply, since capacitors C3-6 draw current initially on charging up (Tr2 off), a large blocking resistor would prevent them from attaining their full charge before Tr2 switched on again. To allow for "experimental error", the value chosen for R5 is 270Ω, as indicated in Fig. 2. This value allows for more than an adequate output to drive the pump, which comprises the reservoir capacitors, D2 and Tr3. These two semiconductors also constitute the discharge path for the reservoir, and D1 the resistive emitter load for Tr3.

The charging and discharging of a capacitor is momentary of course; so although the switching voltage available for charging C3-6 would look like a square wave on a graph, the actual current flow in and out of these reservoirs would graphically look like a row of spikes. The spikes or pulses reaching D2 and Tr3 switch from a positive potential to zero and back again. When positive, D2 conducts and prevents current flowing in Tr3; when zero, Tr3 conducts, and a proportion of the average collector current is registered on the scale of the meter M1.

As indicated in the block diagram, Tr3 operates as a common-base amplifier with a current gain of almost unity. In fact, the gain is slightly under that, as the collector current includes base as well as emitter current. The power gain of the final stage is however much greater than unity, enabling a pulsed d.c. voltage to appear across the transistor's

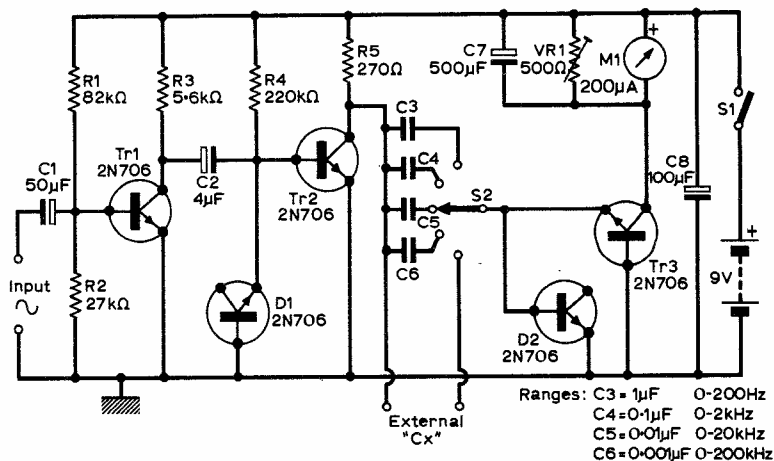

Fig. 2 : Circuit of the Frequency Meter

collector load. The meter M1 can thus be considered to be either a voltmeter measuring the voltage drop across VR1, or as a current meter sharing the collector load with the pre-set potentiometer. In either case, the current flow and output voltage of Tr3 are linearly related to the number and size of the pulses at its emitter.

Increasing the frequency of the input signal obviously increases the number of pulses reaching Tr3, and if only one reservoir capacitor, say 1µF, were used, the meter's pointer would reach full scale at 200Hz, and the instrument would be unable to check higher frequencies. Fortunately, the substitution of different value capacitors for the reservoir is quite straightforward, since the average current flow in Tr3's collector remains unchanged when the pulse count at the emitter is increased, provided that the amplitude of the pulse is reduced by the same amount. So, if our 1µF reservoir is reduced by a factor of ten to 0.1µF, pulse size will be similarly reduced, and f.s.d. will be achieved with an input signal of 2kHz.

Practical Considerations

The accuracy of readings obtainable on the meter over the four ranges depends on the absolute values of the reservoir capacitors C3-6. These should have a tolerance of ±1%, or better. Polyester or silver mica types are preferable, though old-fashioned, large paper types with a high voltage rating may be suitable if they can be tested for low leakage. But on this score, most modern miniature paper capacitors have to be ruled out, and miniature disc ceramics are equally suspect. 1% 1µF polyester types are usually unobtainable, and if they were they would be inordinately expensive. The usual solution to this problem is to select a capacitor with a nominal tolerance of 10% or 20%, which turns out to be slightly under 1µF, and then wire an extra small capacitor in parallel, using a capacitance bridge as a check. Alternatively, the frequency meter can be used to test its own 1µF capacitor, preferably with a suitable signal generator, and this process will be described below.

The accuracy of the meter also depends on the semiconductors used. Transistors with a high cut-off frequency are essential (the F_T of the types specified

is 200MHz), but their current gain is relatively unimportant, and so almost any silicon planar epitaxial transistors would do. A high-gain type for Tr1 will improve sensitivity somewhat, but little advantage is to be gained by using high-gain transistors for Tr2 and Tr3. The reverse-connected diode pairs (D1/Tr2 base-emitter and D2/Tr3 base-emitter) must be fairly accurately matched, not only for different V_f's at different currents, but also for frequency-dependent characteristics; the easiest way to achieve this is to use the base-emitter junctions of transistors of the same type as Tr2 and Tr3. In any case, general purpose diodes, such as the germanium OA81 and silicon OA200 have been found to be unsuitable. The 2N706's used in the final version of the prototype were "untested" types obtained from advertisers in this journal at very low prices. Providing some preliminary testing (for short and open circuits) is undertaken, these types appear to be eminently suitable for this design.

The capacitor connected across the meter M1 needs to be large, certainly at least 100 μ F. The waveform at Tr3's collector is pulsed d.c., and so the varying inductive reactance of the meter winding will produce inaccurate readings if this current is not smoothed. Further, at very low frequencies, the vibration of the meter's pointer would make readings impossible without a large amount of smoothing.

★ components list

Resistors:

R1	82k Ω	All $\frac{1}{2}$ watt 10%
R2	27k Ω	
R3	5.6k Ω	
R4	220k Ω	
R5	270 Ω	

Capacitors:

C1	50 μ F 6V electrolytic
C2	4 μ F 6V electrolytic
C3	1 μ F 1%
C4	0.1 μ F 1%
C5	0.01 μ F 1%
C6	0.001 μ F 1%
C7	500 μ F 4V electrolytic
C8	100 μ F 12V electrolytic

Semiconductors:

Tr1, Tr2, Tr3, D1 and D2
all Type 2N706

Miscellaneous:

VR1 500 Ω pre-set, panel mounting
S1 s.p.s.t. toggle switch
S2 1-pole 5 way rotary switch
M1 200 μ A moving coil meter
Battery, Veroboard, terminals, metal case.

Two holes are provided in the module for fixing purposes. C3-6 are connected directly to the tags on S2 and to a thick copper busbar (eg. 16s.w.g. wire) secured to one of the Cx terminals. C7 is wired directly across M1, and C8 in the prototype is a largish type requiring a separate securing clip.

The power supply is a small battery mounted inside the metal case housing the instrument. The minimum supply voltage has been found to be 4V and the maximum 9V. It should be noted that higher voltages increase the collector current of Tr3 to the point where linearity is not maintained. A battery of 6 to 9V (PP3, PP4 types, etc.) is quite suitable, and should have a long life, since the quiescent current drain is only 1.5mA. This, however, will increase to up to 20mA when a hefty input signal is applied. Incidentally, the maximum input signal should be limited to about 4V r.m.s. or 6V peak. The maximum can be roughly determined from the maximum reverse voltage that can be applied to Tr1's base-emitter junction; in the case of the 2N706, this is 3V. With the prototype, signals of up to 10V r.m.s. have been applied without any ill effects, apart from Tr1 getting rather warm, but such experimenting is inadvisable.

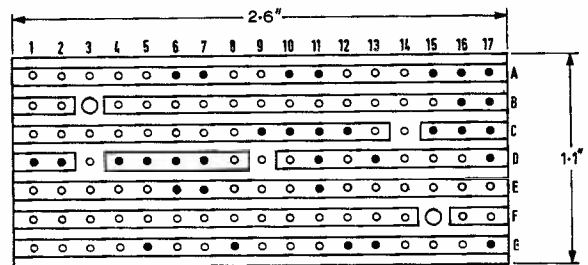

Fig. 3: Basic circuit board

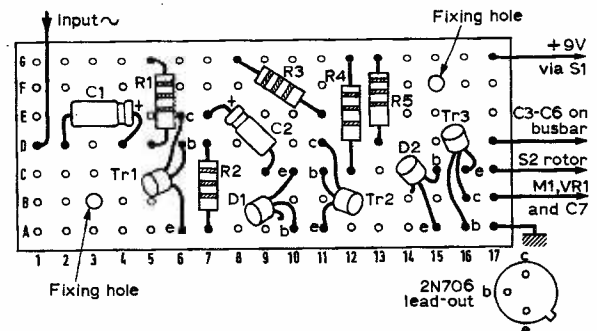

Fig. 4: Top of circuit board

It is strongly recommended that the whole instrument is housed in a metal box, since powerful magnetic fields from domestic mains wiring will otherwise affect the instrument's performance. Far less than the nominal limiting voltage is needed at the input terminals for "things to happen", and if a length of unshielded wire is connected up and allowed to float around near a mains cable or an unscreened oscillator, the behaviour of the meter's pointer can only be described as berserk. This will in fact tell the user without access to a millivoltmeter when full limiting has occurred. In the latter condi-

Construction

Most of the components in the prototype are accommodated on a small piece of 0.15in. matrix Veroboard (normally advertised as 2.5x1in.), and the layout is shown in Figs. 3 and 4. Note the breaks in the copper strip at holes D9, D15 and E4. Layout is not particularly critical, and the author more or less followed the "layout" of the circuit diagram.

tion, the needle will stay motionless at some point on the scale; just below limiting, a higher reading will be indicated, but the pointer tends to waver about, and at lower input levels still, the meter movement becomes more erratic until it finally settles at zero when the input is removed.

Providing suitable components have been used, the pre-set pot VR1 need only be adjusted on one range. An accurate signal generator can of course be used to check all four ranges, but with the prototype it is sufficient to set VR1 for a reading of 50Hz on the lowest range with a mains-derived input; the author then gets an accurate reading of 200kHz on the top range on connecting the instrument up to a signal generator tuned to Radio 2.

Since a 1 pole 12-way switch will normally have to be purchased for S2, the constructor can add extra ranges if desired; eg. a 0.2 μ F capacitor will give a f.s.d. of 1kHz. A 20Hz range could theoretically be provided if a close tolerance 10 μ F capacitor could be acquired. But electrolytic capacitors are quite unsuitable as a rule, since they have a poor leakage factor, a typical +100-20% tolerance, and frequently do not assume their maximum capacitance until an unpredictable fraction of the stated working voltage is applied to them. Unfortunately, a 2MHz range seems to be an equally unlikely possibility from extensive experiments carried out by the author. The a.c. gain of most "r.f." and "fast-switching" transistors (F_T 100-300MHz) falls quite rapidly above 100kHz, so that the input signal level required for limiting of Tr2 increases to several volts even at 1MHz.

The main reason, in fact, why a 200 μ A meter was chosen for M1 instead of a more standard 100 μ A type, was because the useful response of the instrument with a 50mV or so input almost abruptly stopped at about 300kHz. A claimed response of up to 200kHz might therefore seem rather presumptuous. Certainly no "guarantee" is offered, but various types of high F_T silicon transistors have been tried, and the equipment demolished and rebuilt several times without affecting the response at this frequency. An additional reason for making 200kHz the top frequency was that even with an uncalibrated home-made signal generator, an accurate check can be made using a radio tuned to Radio 2 to check the signal generator.

Capacitance Meter

This is merely a logical refinement to the basic frequency meter design. If a wide-range low-frequency signal generator is available, the "standard" capacitors incorporated in the frequency meter may as well be put to good use. The only extra cost incurred is that of buying four instead of two connecting terminals. The extra two are marked Cx in Fig. 2. The unknown capacitor is simply connected across them, and the range selector S2 switched to the appropriate position. The signal generator is connected to the input terminals of the meter, and the test frequency increased from the lowest available up to 200Hz, 2kHz, 20kHz or 200kHz, the frequency selected being the one at which a reading somewhere between 20 and 200 is obtained on the meter. One of the capacitors C3-6 is then switched into circuit as appropriate, and the

signal generator adjusted, if necessary, to obtain an exact reading of 200. The reading given by "Cx" is then rechecked. If, for example, "Cx" gives a reading of 100 on the 20kHz range, the value of the capacitor can be readily calculated as $\frac{100}{2}$ % of 0.01 μ F or 0.005 μ F. Suspect capacitors can be checked against any other close-tolerance types in a similar fashion of course, not only against the four in the meter.

As mentioned earlier, it is possible to use a non-descript capacitor fished out of the junk box for the 1 μ F standard in the meter, using the 0.1 μ F $\pm 1\%$ already acquired as a reference, and using furthermore only a 50Hz input, if no signal generator is available. If a mains-derived input is to be used, a higher resistance pot should be temporarily substituted for VR1 (1.5k Ω should do). With a 9V supply, adjust this so that the meter reads 20 (instead of 5) on the 2kHz range, and then "pad up" a capacitor slightly under 1 μ F connected to the Cx terminals so that a reading of 200 is obtained with S2 in the Cx position.

The reliability of this procedure depends on the meter's being accurately calibrated and having a hairline pointer (and the constructor having good eyesight!). A somewhat more dependable but more laborious or expensive method would be to use ten close-tolerance 0.1 μ F capacitors—each one could be an ordinary type checked against C4, if necessary. The tolerance of this cumulative capacitor would still be $\pm 1\%$, if C4 was of that rating. A less bulky 1 μ F could then be assembled and checked against this. ■

CORRIGENDA

Noise limiter—December 1969. In Fig. 2; the component layout, R2 should be shown connected between 9-k and 7-k and not between 9-k and 8-k as shown.

A Stereo Decoder—December 1969. In the circuit diagram Fig. 1: the base of Tr1 should go direct to the bottom end of R3. C3 should be between R1 and the junction of R3/Tr1 base.

The Chelmer Six—February 1970. In the Component List the three i.f.t.'s should be types P51/1, P51/2 and P50/3v respectively. The output transformer T2 used in the prototype was a Weyrad OPT1.

Vox Control Unit—March 1970. In the circuit diagram the value of the potentiometer should be shown as 470k Ω and marked VR1. The capacitor CX should be shown as C1.

A Versatile Power Supply Stabiliser—March 1970. If the stabilised output current is to be of the order of several amperes the Zener diode Z2 must be capable of handling this current and not of a low power rating as indicated in the text. Stabilised currents up to the limit set by Tr3 may however be taken from point Vx and earth.

practically wireless commentary by HENRY

Four-Eared Monsters

AUDIO again—and what better subject, with Sonex 70 soon to be ringing in our ears? Will the arguments ever cease? What is better, the intimacy of the hotel room or the garish fair of an open exhibition? About the same number that thought last year's jamboree at Olympia an audio success have decried it in the trade and specialist magazines as an expensive waste. Very soon we shall know their opinion of the Skyways venture.

That is the trouble with audio; its progress has been strewn with the besoms of criticism rather than the psalms of praise. Gimmickry! cries a weary public at the news of each fresh development. Now it is Quadraphonics that stands on trial.

Four-channel stereo is not all that new, despite the hysterical ranting of some advertisements. We had multi-channel stereo in 1933, and when Bell Telephones settled for 3-channel systems it was to fill the 'hole in the middle' of a two-channel frontal stage, and the Philadelphia and Washington DC experiments at that time included four, five and more channels. It was only on grounds of economy that a two-channel system was used when stereo tape was launched. Twenty years ago, believe it or not.

Six-channel stereo systems were

used for Cinerama and only Mickey Mouse knows how many channels Disney's 'Fantasia' was planned for. But these were aural gimmicks, unashamedly. Serious multi-channel work included a 12-channel system by one of tape recording's pioneers, Martin Camras, an eight-channel recording of the Boston Symphony Orchestra by Prof. Bose and those complicated hundred speaker systems with circuits like a telephone exchange that EMI and Philips used for their 'ambiphonic' experiments.

Four-channel stereo is supposed to fill the room, not just the hole in the middle. One of the complaints of the audiophile has been the added reverberation of his listening room (not solved by using phones, merely altered) and the unfaithful rendering of the reverberation of concert hall or studio where the recording originated. Quadraphonics puts this lost ambience back by using the rear two speakers of a four-speaker system for the reverberation, and delayed direct sound, as it would be in the concert hall—or, mark the term, for 'special purposes'.

O.K. so you would like to hear the Berlioz *Requiem* played properly, with a brass band in each corner of the lounge. Me, I prefer to keep the peace with my neighbours.

Edward Tatnall Canby—who is Associate Editor of the American magazine 'Audio'—started the controversial ball rolling over here with a report in the December 1969 *Hi-Fi News*, 'Four-channel Stereo'. He reported on the venture by Vanguard Recording Society in New York, who were bringing out four-channel recordings on $\frac{1}{4}$ -inch tape, and then on an experimental series of stereo broadcasts from Boston which had commenced on September 27th, 1969.

PW readers will be interested in knowing that while so many of us are fretting busily over the continued inability of the BBC to comply with their charter and give



My transatlantic spies.

us even two-channel stereo, the Acoustical Research Company was able to sponsor two simultaneous broadcasts from Boston stations of Boston Symphony Orchestra concerts. The programmes are picked up on two f.m. multiplex receivers. The series of demonstrations should have finished in April, and to judge by the reports of my transatlantic spies, initial reception will have been maintained and the four-channel stereo boom is decidedly on.

The other experiments, with Vanguard tape and the 'surround stereo' system, were less encouraging. Henry was tickled by Ed Canby's comment that 'the lady who sang out in front of us seemed about forty foot tall'.

A four-channel multiplex broadcasting licence is being petitioned for, and the FCC are reported to be wilting. The sponsors want to use the 'Halstead System'. That is normal stereo for the two front channels and two additional f.m. modulated subcarriers in a left-right configuration at 72kHz and 92kHz for the rear two channels. Len Feldman (who already has the hardware on the shelf at \$89.95) claims that 'using Panoramic Spectrum Analyser' no problem of side-band spillage is encountered.

You know, that comforts Henry, with his single channel, unmultiplied, wavering f.m. noisebox. The only thing multi about his reception are the paths along which the mono signal bounces.



Will the arguments never cease?

Two new Build-it-yourself speaker kits from Wharfedale

"Why don't you produce kits for bigger speakers?" people asked us when Unit 3 proved such a success. We hope you'll like our answer—Unit 4 (2-speaker floor

standing system) and Unit 5 (3-speaker monitor system). So if you're a high fidelity enthusiast who enjoys building his own equipment, send for details.

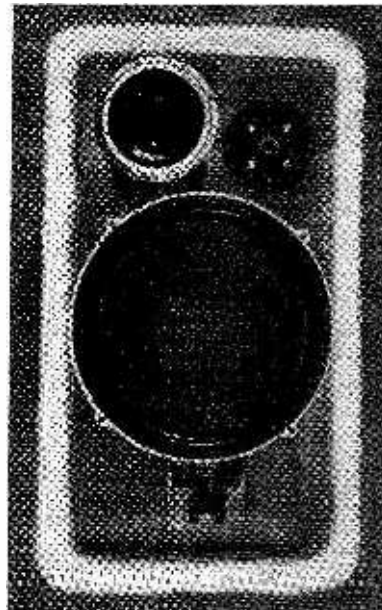
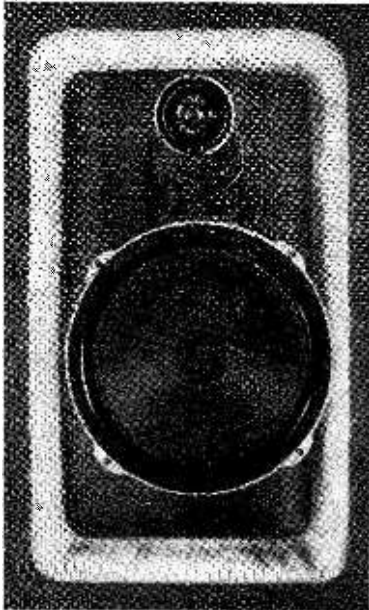

Unit 4 full range floor standing system.

2 speakers (12" Bass and 3" Treble) to give full range, balanced reproduction.

Frequency response of 45-17,000 Hz. when housed in suitable cabinet.

Superior 4-element crossover unit ensures optimum performance from each speaker.

Rec. Retail Price £16-0-0

All kits include speakers, crossover network, acoustic wadding, mounting bolts and connecting wire, together with full assembly instructions. No expert technical knowledge needed.



Unit 5 the monitor system you can build yourself.

3 speakers (12" Bass, 5" Mid-Range unit, and 1" Treble) give clean, smooth performance.

Frequency response of 40-20,000 Hz. when housed in suitable cabinet.

Unique mechanical/electrical 6 element crossover unit.

Rec. Retail Price £23-10-0.



the true sound in High Fidelity



Rank Wharfedale Ltd.,
Idle · Bradford · Yorkshire

CUT HERE

To: Rank Wharfedale Ltd., Idle, Bradford.

Please send me leaflets describing your speaker kits.

Name (Block capitals, please)

Address

.....

.....

.....

P.W.4/7

SUMS**plus****CIRCUITS****equals****UNDERSTANDING****PART 2****LESLIE MOORE****GRAPHS**

OF all mathematical techniques available to circuit designers, graphs often prove to be the most useful; they conveniently display much information which would otherwise be contained in complicated formulae or be widely dispersed in leaflets giving technical data; they provide a practical approach to circuit design and eliminate many possible sources of error. It is often thought that graphs provide approximate solutions only, and that results obtained from them will most likely be in error. This leads to an important point which should be understood from the outset.

If the component tolerances with which one is working are large, then of course results will be approximate. Allowances should be made for spreads in component characteristics, for instance; although modern production techniques have improved the possibility of being able to interchange field-effect transistors, without altering other circuit parameters to compensate for characteristics spreads, field-effect transistors of the same type number can still vary by as much as $\pm 30\%$ in drain current for the same value of gate current.

Conversely, many high precision voltmeters etc are provided with calibration graphs allowing voltage measurements to within a $\pm 0.05\%$ accuracy. Graphs will give the result to a problem as accurate as associated factors (tolerances, graph scale etc) will allow.

The most basic graphs show a mathematical relationship between one variable and another. The simplest of these are:—

$$\begin{array}{ll} y = a & y = cx \\ y = x & y = dx^2 \\ y = x + b & \end{array}$$

(where x^2 is x multiplied by x).

The graphs these equations described are shown in Fig. 2.1.

In the equations the letters a , b , c & d , represent constant values whereas the letters x and y represent variables. The graphs show how y will vary as x varies for the different equations.

$y = a$ means that for all values of x , y will have the value a . When $y = x$, y will have the value of x at all times. Obvious perhaps, but the simplest of facts can prove awkward in much more complicated equations.

The equation $y = cx$ has a direct application to our work as it is in a similar form to that derived from Ohm's law: $V = RI$.

Assuming that the resistance R is held constant, then the relationship between voltage V and current I , is the resistance.

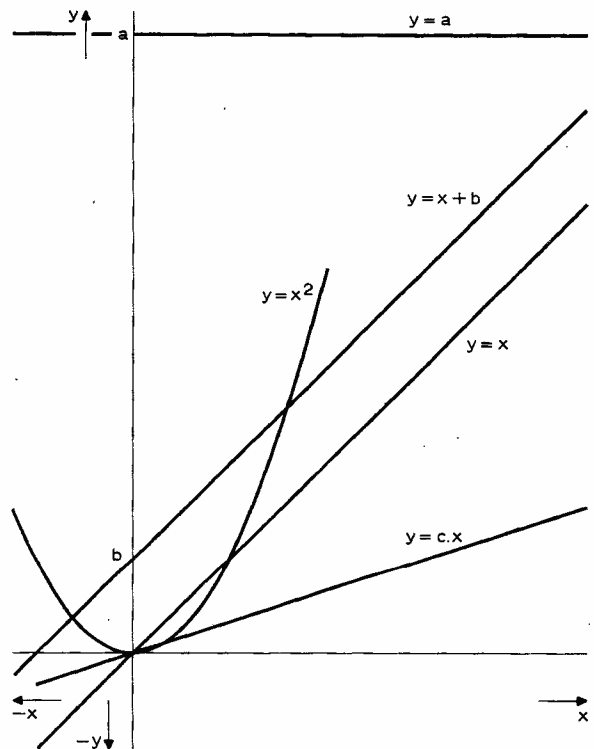

Fig. 2.1: Basic graphs

Simple relationships can be useful in graphical analysis in determining the operation or limits of operation of a component or circuit.

The load line drawn on a set of transistor characteristics to determine operation limits etc is a straight line determined by $V = RI$.

A further example is the maximum power limit of a transistor or similar device.

Suppose a transistor is rated at 25 mW (or 0.025 Watts). Power is related to voltage and current in the manner:

$$\text{power} = VI$$

Due to transistor operation it is convenient to use units of volts and milliamperes (mA), and we can write that

$$1\text{mW} = 1 \text{ Volt} \times 1\text{mA}$$

To draw a graph of the maximum power we must treat the maximum power limit as a constant and therefore:

$$VI = 25 \text{ therefore } I = \frac{25}{V}$$

From this simple equation we can form a table of different values of current flow obtained by varying the voltage value.

e.g. when $V = 1$ volt, $I = 25$ mA.

V volts	..	1	2	5	10	12.5	25
I mA	..	25	12.5	5	2.5	2	1

This may be plotted as shown in Fig. 2.2. Such curves are usually given, or must be plotted, where a maximum power limit is an important consideration as for all semi-conductor components.

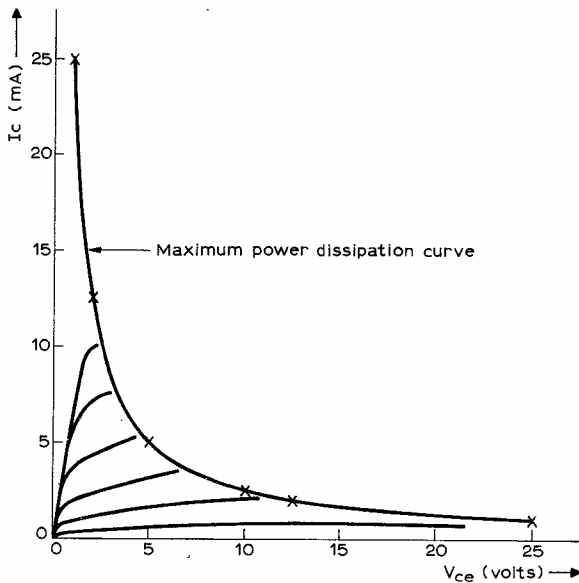

Fig. 2.2: Plot of maximum power dissipation

Graphs and Amplifiers

Graphs have particular use in electronic and radio circuitry for describing the characteristics of a circuit.

For an amplifier several relationships are important:

(i) Between output and input: showing the limits which must be placed on the input signal to prevent saturation of the output, and it indicates the amplifier's linearity.

(ii) Between gain and frequency: showing the useful range of frequencies for which the amplifier can be operated.

(iii) Distortion level and frequency: this plot can indicate an amplifier's usefulness for specific applications.

(iv) Output voltage and supply voltage for constant levels of input signal: This will indicate the variation of power supply voltage allowable for good performance.

Examples of these graphs are given in Fig. 2.3.

Waveforms are a form of graph often taken for granted. These show how a voltage or current magnitude varies with time. A few common waveforms are shown in Fig. 2.4.

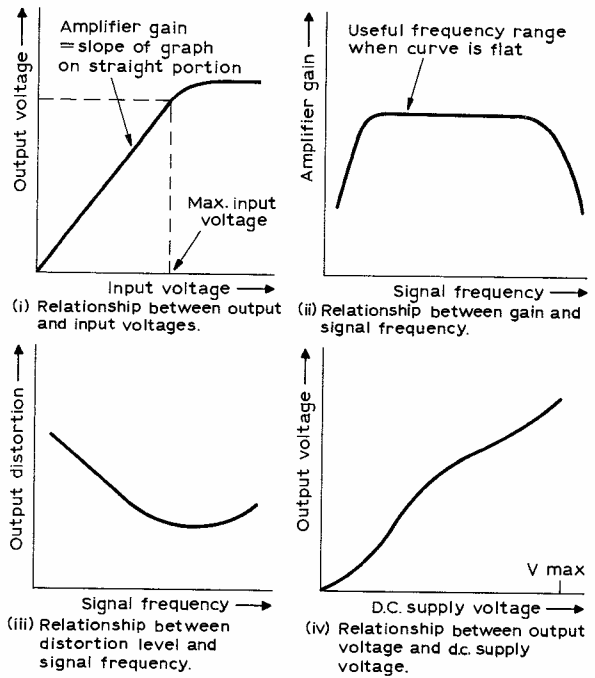

Fig. 2.3: Examples of graphs showing amplifier characteristics

Waveforms

An ability to understand the formation of these waveforms and how and where they are used in electronic circuitry is essential in practice, especially when oscilloscopes are used.

The waveforms with which we are concerned are periodic functions of time, that is, they produce a pattern which repeats at regular intervals. The time taken for the waveform to completely pass through one cycle of operation is known as "periodic time". The number of repeats in one second is called the waveform "frequency" whose units are Hertz (Hz), although called "cycles per second" until recently.

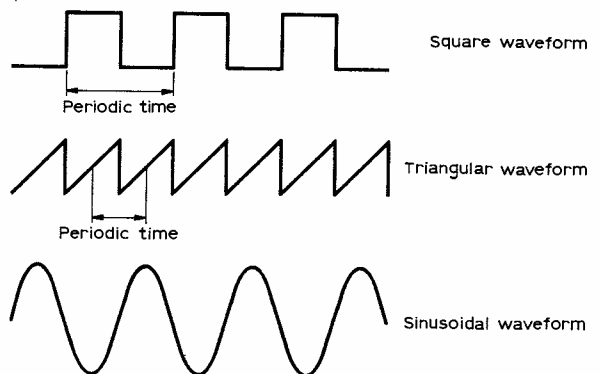

Fig. 2.4: Examples of waveforms

It can be shown mathematically that all waveforms which are not sinusoidal are, in fact, composed of a number of sinusoidal waveforms having different frequencies. A square waveform is made up of a fundamental frequency and all its odd harmonics.

—continued on page 37



Sign here..!

**for your
miniature
soldering
iron.**

CN 15 Watts. Ideal for miniature and micro miniature soldering. 18 interchangeable spare bits available from .040" (1mm) up to 3/16" from **32/6** For 240, 220, 110, 50 or 24 volts.



G18 watts. Fitted 3/32" bit for miniature work on production lines. Interchangeable spare bits, 1/8", 3/16" and 1/4" available. For 240, 220 or 110 volts: 32/6.



E20 watts. Fitted with 1/4" bit. Interchangeable spare bits 3/32", 1/8", 3/16" available. For 240, 220, 110 volts. From 35/-



E325 watts. Fitted with 1/8" bit. Interchangeable bits 3/32", 3/16" and 1/4" available. Ideal for high speed production lines. For 240, 220, 110, 24 or 12 volts. From 35/-



F40 watts. Fitted 5/16" bit. Interchangeable bits 1/4", 3/16", 1/8" and 3/32" available. Very high temperature iron. For 240, 220, 110, 24 or 20 volts. From 42/6 Spare bits and elements for all models, and manuals immediately available from

Complete precision soldering kit

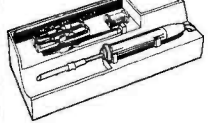

PLUS 36-page booklet on "How-to-Solder"—a mine of information for amateur and professional.

- This kit—in a rigid plastic "tool-box" — contains
- Model CN 15 watts miniature iron, fitted 3/32" bit. Interchangeable spare bits 1/8", 3/16"
 - Reel of resin-cored solder
 - Felt cleaning pad
 - Stand for soldering iron

From Electrical and Radio Shops or send cash to Antex. **49/6**



Model CN 240/2
15 watts - 240 volts
Fitted with nickel plated bit (3/32") and in handy transparent pack. From Electrical and Radio Shops or send cash to Antex. **31/-**



PRECISION MINIATURE SOLDERING IRONS

Antex, Mayflower House, Plymouth, Devon. Telephone: Plymouth 67377/8. Telex: 45296. Giro No. 2581000.

- Please send me the Antex colour catalogue
- Please send me the following irons

Quantity	Model	Bit Size	Volts	Price
.....
.....
.....

I enclose cheque/P.O./cash value

NAME

ADDRESS

PW5

BI-PRE-PAK LTD

DEPT. D, 222-224 WEST ROAD, WESTCLIFF-ON-SEA, ESSEX
TELEPHONE: SOUTHEND (0702) 46344

FULLY TESTED AND MARKED

AC107	3/-	OC170	3/-
AC126	2/6	OC171	3/6
AC127	3/6	OC200	3/6
AC128	2/6	OC201	7/-
AC176	5/-	2G301	2/6
ACY17	3/-	2G303	2/6
AF114	4/-	2N1302-3	4/-
AF115	3/6	2N1304-5	5/-
AF116	3/6	2N1306-7	5/-
AF117	3/6	2N1308-9	9/-
AF239	12/6	2N3819 FET.	9/-
AF186	10/-	2N3844A	5/-
AF139	10/-	Power Transistors	10/-
BFY50	4/-	OC20	10/-
BSY25	7/6	OC23	10/-
BSY26	3/-	OC25	8/-
BSY27	3/-	OC26	5/-
BSY28	3/-	OC28	7/6
BSY29	3/-	OC35	5/-
BSY95A	3/-	OC36	7/6
OC41	2/6	AD149	10/-
OC44	2/6	AUY 10	30/-
OC45	2/6	2N3055	15/-
OC71	2/6	2S034	10/-
OC72	2/6	Diodes	2/-
OC73	3/6	AAY42	2/-
OC81	2/6	OA91	2/-
OC81D	2/6	OA79	1/9
OC83	4/-	OA81	1/9
OC139	2/6	IN914	1/6
OC140	3/6		

NEW UNMARKED UNTESTED PAKS

B78	12	Integrated Circuits, Data and Circuits of types, supplied with orders.	10/-
B80	8	Dual Trans. Matched O/P pairs NPN. Sil. in TO-5 can.	10/-
B82	10	OC45, OC81D and OC81 Trans Mullard glass type.	10/-
B83	200	Trans. Makers rejects. NPN/ PNP, Sil. and Germ.	10/-
B84	100	Silicon Diodes DO-7 glass equiv. to OA200, OA202.	10/-
B66	150	High quality Germ. Diodes. Min. glass type.	10/-
B86	50	Sil. Diodes sub. min. IN914 and IN916 types.	10/-
B87	100	Germ. PNP Trans. equiv. to OC44, OC45, OC81, etc.	10/-
B88	50	Sil. Trans. NPN, PNP, equivalent to OC200/1, 2N706A, BSY95A, etc.	10/-
B60	10	7 Watt Zener Diodes. Mixed voltages.	10/-
H5	16	1 Amp. Plastic Diodes, 50-1,000 Volts. 6 large, 10 small	10/-
H6	40	250mW. Zener Diodes DO-7 min. Glass Type. AV. 40% Good.	10/-

NEW TESTED & GUARANTEED PAKS

B2	4	Photo Cells, Sun Batteries .3 to .5 volt., .5 to 2 ma.	10/-
B77	2	AD161-AD162 NPN/PNP Trans Comp. Output, Pair.	10/-
B79	4	1N4007 Sil. Rec. Diodes. 1,000 P.I.V. 1 amp. Plastic.	10/-
B81	10	Reed Switches, mixed types, large and small.	10/-
B89	2	5SP5 Light Sensitive Cells. Light Res. 400Ω Dark 1MΩ	10/-
B91	8	NKT163/164 PNP Germ. TO-5 equivalent to OC44, OC45.	10/-
B92	4	NPN, Sil. Trans. AO6 BSX20 2N2369 500 MHz, 360mW.	10/-
B93	5	GET113 Trans. equiv. to ACY17 to ACY21 PNP Germ.	10/-
B96	5	2N3136 PNP Sil. Trans. TO-18. HFE 100-300 I.C. 600mA. 200MHz.	10/-
B98	10	XB112 and XB102 equiv. to AC126, AC156, OC81/2, OC71/2, NK271, etc.	10/-
B99	200	Capacitors, Electrolytics, paper silver mica, etc. Post and packing, this Pak 2/6.	10/-
H4	250	Mixed Resistors, Post and packing 2/-.	10/-
H7	40	Wirewound Resistors. Mixed Values. Postage 1/6.	10/-

FREE! Packs of your own choice up to the value of 10/- with orders over £4.

RETURN OF THE UNBEATABLE P.I. PAK. NOW GREATER VALUE THAN EVER

Full of short lead semiconductors and electronic components, approx. 170. We guarantee at least 30 really high quality factory marked Transistors PNP and NPN, and a host of diodes and rectifiers. Mounted on printed circuit panels. Identification chart supplied to give some information on the transistors.

P1 PLEASE ASK FOR PAK P.I. 2/- P. & P. on this Pak **ONLY 10/-**

Complementary Set. NPN/PNP Germ. trans., Pak F.3. **2/6 PAIR**

P.O. RELAYS 8 FOR 20/-
Various Contacts and Coil Resistances.
Post & Packaging 5/-

★ ALL OUR TESTED SEMICONDUCTORS HAVE A WRITTEN GUARANTEE ★

SEND FOR OUR FREE LISTS AND CATALOGUE OF ALL OUR PRODUCTS. CHECK YOUR OWN EQUIVALENT WITH OUR FREE SUBSTITUTION CHART.

NO CONNECTION WITH ANY OTHER FIRM. MINIMUM ORDER 10/-. CASH WITH ORDER PLEASE. Add 1/- post and packing per order OVERSEAS AND EXTRA FOR AIRMAIL.

HOME RADIO (Components) LTD. Dept. PW, 234-240 London Rd., Mitcham, CR4 3HD. Phone 01-648 8422

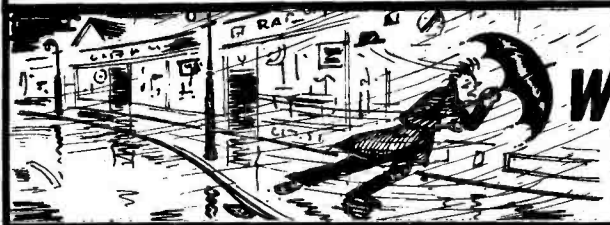

Why live the **HARD** way?

We're making life **EASY** for you!



We've never seen the sense in wasting time and energy tramping round the shops trying to locate components for radio and electronic projects—especially when the British weather turns it into a battle worse than a lone journey across Antarctica! That's why we issue the Home Radio Components Catalogue which for many years has enabled thousands of enthusiasts to order by post. We've built up a mail-order service which for speed and efficiency is second to none. But recently we've gone a step further in making life easy for you. Now you need not even walk round the post box. With our Credit Account Service you can just telephone—any time of day or night, week-ends included! If your call comes out of shop hours a recording machine takes your message for us to deal with when we open next day.

For full details just drop us a line or phone 01-648 8422. After you have availed yourself of the service for 12 months we regularly send an up-to-date catalogue—FREE.

If you've not already got a Home Radio Catalogue, send the coupon with cheque or P.O. for 12/6 (8/6 plus 4/- P. & P.). Even if you don't intend to use our Credit Account Service you certainly need the catalogue—it has 350 pages, lists over 8,000 components and has over 1,500 illustrations!

The price of 12/6 applies only to catalogues purchased by customers residing in the U.K.

Please write Name and Address in block capitals



NAME

ADDRESS

HOME RADIO (COMPONENTS) LTD., Dept. PW,
234-240 London Road, Mitcham, Surrey, CR4 3HD

—continued from page 34

A square wave of 1 Volt peak to peak amplitude and 1 Hz frequency will have the following sinusoidal components.

	peak-peak Amplitude	Frequency
Fundamental	1 Volt	1 Hz
3rd harmonic	$1/3$ Volt	3 Hz
5th harmonic	$1/5$ Volt	5 Hz
7th harmonic etc. ..	$1/7$ Volt	7 Hz

so that the very high harmonic frequencies have little effect on the waveform amplitude.

This fact is used in a technique called "pulse testing" which, simply, is the application of a square waveform to the input of an amplifier and comparing it against the output waveform. In doing this, the amplifier is subjected to a complete range of frequencies so the output waveform can yield much valuable information. Fig. 2.5 gives examples of waveforms obtained from pulse testing.

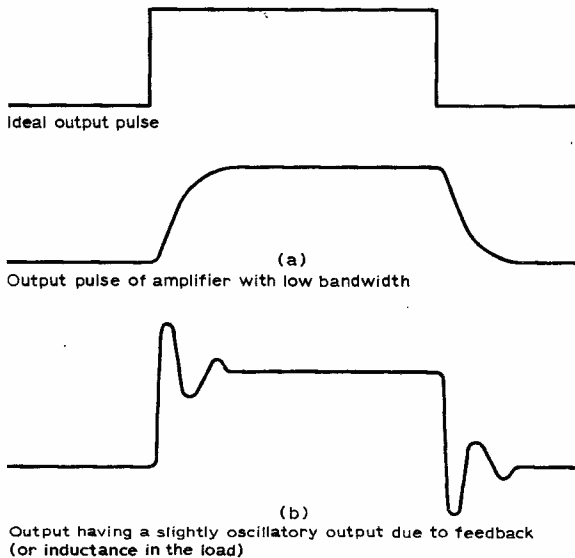

Fig. 2.5: Pulse testing

Graphs and Bandwidth

Due to reactive components inherently contained in semi-conductor devices, thermionic devices and other necessary circuit components, amplifiers do not reproduce input signals as might be expected. Those illustrated indicate (a) an amplifier with low bandwidth i.e. only suitable for fairly low frequency work and, (b) an unstable amplifier due to some sort of feedback within the amplifier circuit.

Amplifiers which amplify one frequency only are called tuned amplifiers. It would be desirable, if in practice, we could amplify only one frequency. We are, however, able to reach a good approximation to a perfect tuned amplifier. The reasons for capacitance and inductance in an amplifier circuit affecting gain at different frequencies will become more apparent later in the series, here we shall discuss the use of graphs in tuned amplifier design.

The factors which govern the design of a tuned amplifier are, required amplifier bandwidth, power output, signal frequency and gain at that signal frequency. A typical tuned amplifier stage is shown in Fig. 2.6.

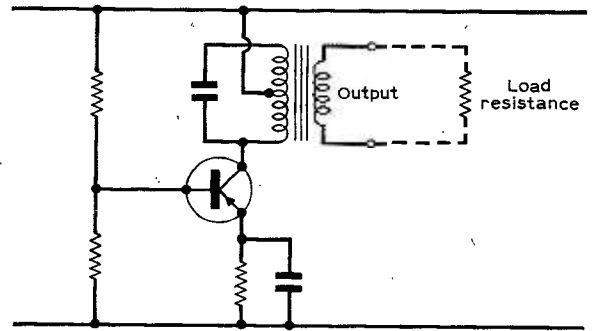
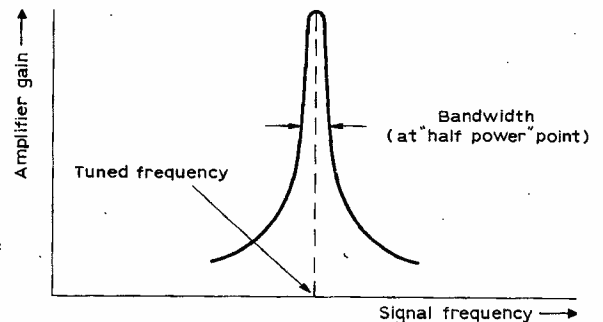
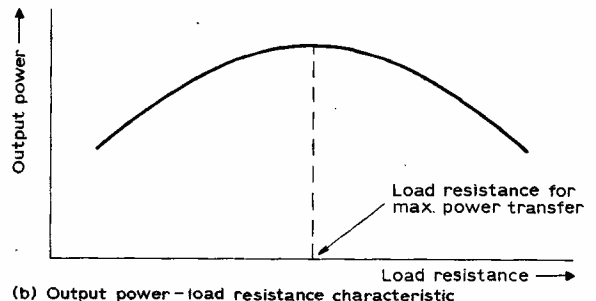

Fig. 2.6: Typical tuned amplifier stage

Bandwidth is dependent on transistor characteristics, Q factor of the tuned circuit (or its "goodness"), transformer turns ratio and the amplifier load resistance. Often a compromise must be made between one or other of these factors as the amplifier's tuned frequency also depends on tuned circuit characteristics and loading.



(a) Gain-frequency characteristic of a tuned amplifier



(b) Output power-load resistance characteristic

Fig. 2.7: Useful graphs for a tuned amplifier

Often maximum power output is required. This means that the transistor output resistance must be equal to the load multiplied by the transformer turns ratio. The frequency response of the amplifier and the output power/load curve are shown in Fig. 2.7.

Graphs can be shown to give far more assistance to the electronics engineer or enthusiast. However, to understand them and their uses further basic mathematical concepts must be understood. We shall begin to cover some of these in the next article.

TO BE CONTINUED

3 BAND T.R.F. 4 RECEIVER

F.G. RAYER

FOUR transistors in a reflex type t.r.f. circuit will give good loudspeaker volume from quite a large selection of stations, and a receiver of this kind is easy to assemble and wire. The receiver shown here has a main tuning range of about 2,000-480kHz, or 150-620 metres. Tuning at the h.f. end of the medium wave band is usually rather critical so the band selection switch brings into use a "bandspread" type of circuit, similar to that in some superhets, covering approximately 2.2-1.7MHz, or 140-185 metres, with the full rotation of the tuning capacitor. To avoid switching inductors, the third switch position loads the ferrite aerial so that a band of about 190-210kHz is obtained, for reception of the 200kHz or 1500 metre BBC transmission.

These ranges, and particularly that in the bandspread position, can be easily changed. The 2.2-1.7MHz range was used because it was found that quite a number of interesting amateur and other signals could be received.

The actual receiver is 5 x 2½ x 2½ in., the ferrite rod increasing the width to 6 in. To this must be added space for the battery and loudspeaker. Headphones may be plugged in when wanted.

CIRCUIT

This is shown in Fig. 1 and the ferrite aerial L1 is tuned by VC1 with the switch in the "M" (Medium Wave) position. Moving the switch to

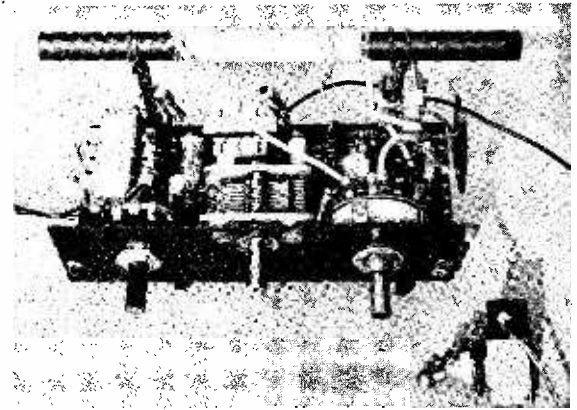

"BS" (Bandspread) brings the small capacitor TC1 in series with VC1, so that only a narrow band near the h.f. end of the range is tuned. The highest frequency reached is slightly increased because the minimum capacity is lower. When the switch is at "L" (Long Wave) VC1, C1 and TC2 are in parallel across the tuned portion of L1, and TC2 is adjusted so that 200kHz will be reached with VC1 about half closed. This arrangement does not give full long wave frequency coverage, but allows a narrow band around 1500m or 200kHz to be tuned.

Feedback from Tr1 collector is through TC3, and regeneration is controlled by VR1. R.F. is blocked

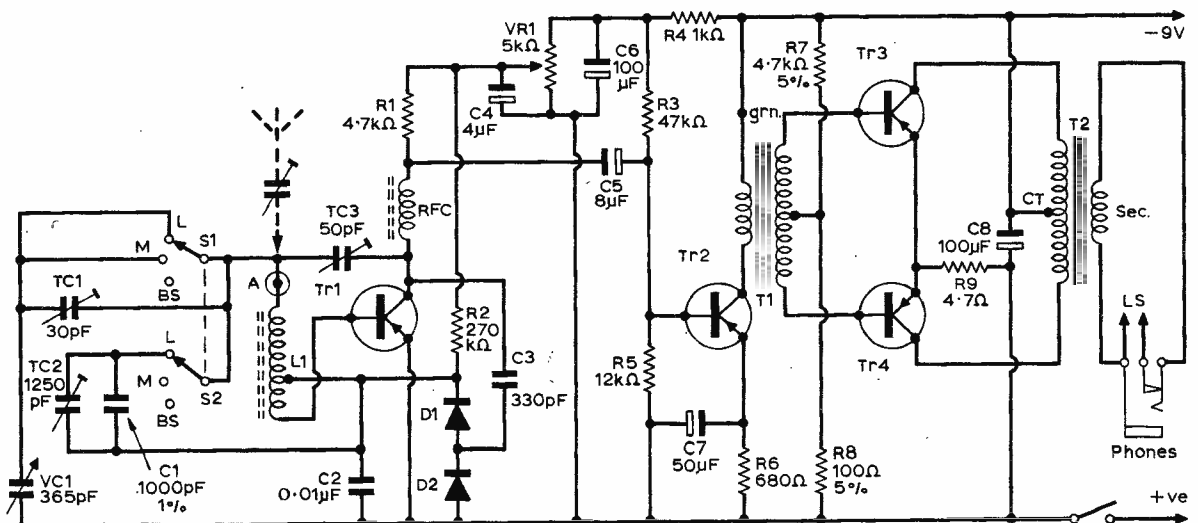

Fig. 1: Circuit of complete receiver

by the r.f. choke, but reaches diodes D1 and D2 through C3. The audio obtained by detection passes through L1 to Tr1 base, and after amplification signals reach Tr2 from C5, R1 being Tr1 collector audio frequency load.

Tr2 is an audio amplifier, driving the push-pull transistors Tr3 and Tr4 through the driver transformer T1 and T2 is the output transformer.

CIRCUIT BOARD

Construction is on a ready-perforated board $2\frac{1}{2} \times 5$ in. and having holes at 0.2 in. intervals but plain $\frac{1}{8}$ in. thick paxolin can be drilled to suit.

The receiver panel is $5 \times 1\frac{1}{2}$ in. and $\frac{1}{8}$ in. thick, and is fixed with two brackets, Fig. 2. A lead is soldered to the frame tag of VC1 and passed down through the board. VC1 is mounted with very short 4BA bolts. When the completed receiver is put in a cabinet it is held by the fixing nuts of VR1 and the band switch so bolt heads on the panel should be countersunk.

Two pieces of paxolin $2 \times \frac{1}{2}$ in. are shaped at the top to fit the ferrite rod, and are drilled for elastic and mounting brackets, so that they can be fitted as in Figs. 2 and 4.

CONSTRUCTION

The resistors and other items can now be inserted in the positions shown in Fig. 2. Place diodes D1 and D2, and the electrolytic capacitors with the positive ends as indicated. The wire ends are spread slightly, to prevent the components falling out.

The board can then be turned over, and wired as in Fig. 3. A wire between the two tags forms the positive line. Bend and shape the leads, solder them, and cut off excess. Sleeving should be put on wires which cross other leads.

★ components list

Resistors:

R1	4.7k Ω	R6	680 Ω
R2	270k Ω	R7	4.7k Ω 5% $\frac{1}{2}$ watt
R3	47k Ω	R8	100 Ω 5% $\frac{1}{2}$ watt
R4	1k Ω	R9	4.7 Ω
R5	12k Ω		

10% $\frac{1}{2}$ watt unless otherwise stated.

Capacitors:

C1	1000pF 1% s.m.	C5	8 μ F 6V
C2	0.01 μ F 150V	C6	100 μ F 12V
C3	330pF mica	C7	50 μ F 6V
C4	4 μ F 12V	C8	100 μ F 12V

VC1 365pF Jackson Type 01
 TC1 3-30pF Type VC29C (Home Radio)
 TC2 40-1250pF Type VC29SA (Home Radio)
 TC3 4-50pF pre-set

Semiconductors:

D1	OA81
D1	OA81
Tr1	OC44
Tr2	OC81D
Tr3/4	OC81's (matched pair)

Miscellaneous:

T1	Weyrad LFDT4
T2	Weyrad OPT1

Paxolin panels $\frac{1}{16}$ in: 2 off $2 \times \frac{1}{2}$ in. 1 off $5 \times 1\frac{1}{2}$ in.
 Paxolin or eyelet board BTS33 (Home Radio)
 Opening circuit miniature jack plug and socket
 On/off toggle switch
 2 pole 3-way rotary switch
 3 Ω speaker
 Ferrite rod 6 in \times $\frac{3}{8}$ in
 26 s.w.g. DCC wire

The receiver is intended to use the internal ferrite aerial but a short external aerial (rod or wire) can be connected to A on L1, Fig. 1, a very small capacitor (such as 30pF pre-set) being put in series with the lead.

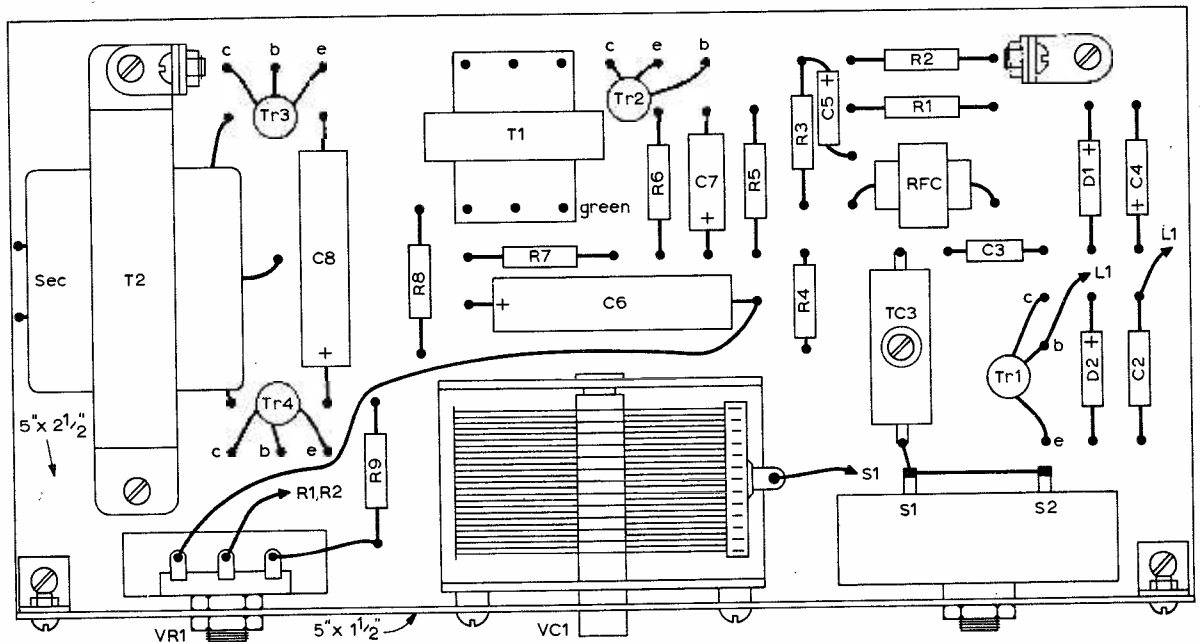

Fig. 2: Top of circuit board with panel attached

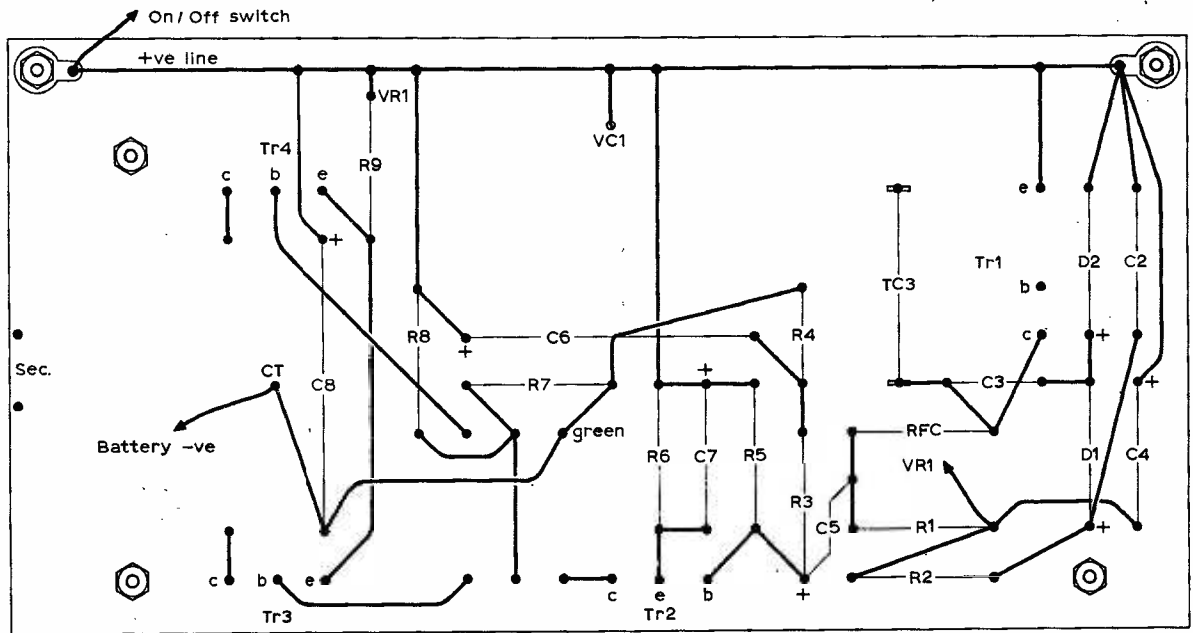

Fig. 3: Reverse side of circuit board

TRANSISTORS AND DIODES

The wire ends of these can be at least $\frac{1}{4}$ in. to $\frac{3}{4}$ in. long. It should only be necessary to keep the iron in contact with the joint to be made for a second or two, and this will normally cause no damage but a heat shunt can be used. Place sleeving on the transistor wires, or shape them so that they cannot touch each other. The transistor type given for Tr1 is recommended. If any alternatives are tried, it may be necessary to change R1 and R2.

If diodes D1 and D2 are not as given in the component list, R2 may have to be changed, for best results and will generally lie between about 100k Ω and 470k Ω . If totally different types are used for Tr2, and Tr3/4, the values of R3, R5 and R6 may need changing, or R7 and R8. If other transistors are to hand resistors R3 to R9 should be of the values recommended for the actual transistors fitted. T1 and T2 may also have to be changed.

AERIAL

The ferrite rod is 6 \times $\frac{1}{4}$ in. and the winding is 26 s.w.g. double cotton-covered wire, 76 turns wound side by side, with a tapping at 11 turns, Fig. 4, which also shows the switch wiring.

In both long and medium wave positions S1 shorts out trimmer TC1 but this is in series with VC1 for bandspread. S2 connects C1 and TC2 across the 65 turn position of the rod, for 1500m reception. TC2 is mounted in a hole in the paxolin support but TC1 is soldered directly to the switch tags.

TESTING

A meter may be placed in one battery lead, and should indicate about 10-12mA with no signal or moderate volume. A much lower current, with distortion, may indicate that R7 and R8 are of unsuitable values for Tr3 and Tr4. With good volume, current peaks will be about 25-40mA.

Unscrew TC3, switch to medium waves, and rotate VR1 clockwise for about two-thirds of its travel. Tune in a signal with VC1, screwing TC3 down, until oscillation just commences. Switch to long waves, set VC1 half closed, and adjust TC2 until the 200kHz BBC transmission is tuned in. With the switch at bandspread, coverage is adjusted with TC1, which is slightly unscrewed. Screwing down TC1 increases coverage at the l.f. end of this band.

For all but strong signals, VR1 must be advanced just enough to bring the receiver near oscillation giving best sensitivity. Turning

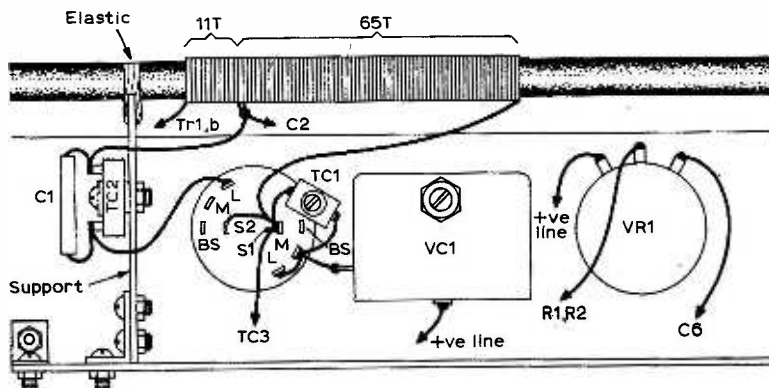

Fig. 4: Details of ferrite aerial and associated wiring

VR1 too far will worsen reception. If necessary, adjust TC3 slightly, so that smooth regeneration is possible on all three bands, controlled by VR1. With a t.r.f. receiver results depend very much indeed on the correct control of regeneration, and this circuit can give a smooth build up of volume on all bands.

If bandspreading is to cover the bottom of the medium wave band, a 50pF trimmer can be connected across the tuned portion of L1, or the number of turns on the ferrite rod can be increased. In each case, frequencies which occupied only a few degrees rotation of VC1, at the high frequency end of the band, are opened out to occupy the full 180 degrees. Reception on these frequencies will normally be greatly improved as darkness falls, though 160m amateurs are often active during daylight hours, especially at weekends.

CABINET

A suitable size, inside dimensions, is 6½in. wide, 6in. high, and 3in. deep. Work is greatly simplified by using ready-planed wood 3×¼in. Top and bottom are then 7×3in., and the sides are 6×3in. and the front can be ½in. hardboard, 7×6½in. Put adhesive on all meeting surfaces and fix them together with a few small panel pins. When the adhesive is dry, smooth joints and edges with a glasspaper block. The case shown was covered with self-adhesive material but the wood must be smooth and free of dust beforehand. Place the cabinet front down upon a piece about 9×8½in., smooth out wrinkles, and cut each corner, so that about 1in. folds over on to top, sides and bottom. A strip about 4in. wide is then cut, long enough to go round and overlap. This is put on, tightly stretched, and the corners cut so that excess can be folded over inside.

With the cabinet shown, the front was cut to clear all the control knobs, and a panel was glued behind this opening for the receiver. Silk was placed over the speaker aperture in the cabinet front before covering the case, and a hole cut in the covering material.

The headphone outlet and switch are fixed directly to the cabinet. If headphones are not required, connect the speaker directly to the secondary of T2. When the headphone plug is inserted, this opens contacts which silence the speaker. ■

**THE APRIL ISSUE OF
PRACTICAL WIRELESS
WAS THE LAST OF
VOL. 45
—
WHY NOT BIND YOUR
VOLUME?**

THE MW COLUMN

THERE are a few countries that do not broadcast on the short waves, consequently the DXer who would like to add them to his list of countries heard and verified, will have to turn to the medium waves. The listener in the UK is fortunate that a number of these 'medium wave only' countries can be logged without too much difficulty.

The nearest and easiest is Andorra which currently is broadcasting on two frequencies only, both on the medium waves. *Radio Andorra* 701kHz has programmes in Spanish while *Radio Sud* 818 is in French: both verify. Further south and more difficult is Gibraltar on 1484kHz which is an international common frequency also used by Radio 4. Try in summer before the BBC signs-on. The BBC relay in Malta is now on 1546kHz and is audible as a background to Radio 3 during the evening. It has been heard clear of interference at 0430hrs GMT. Spanish Sahara has two medium wave transmitters, *Radio Sahara* EAJ103 654kHz in El Aaiun is usually logged in the late evening with programmes in Spanish and EAJ203 *Radio Villa Cisneros* on 998kHz is sometimes audible about 2100hrs GMT broadcasting in Hausa and Spanish. The Portuguese island of Madeira has CSB91 on 1529kHz which can be recognised by its fluttery signal during the hour before closedown at midnight GMT.

The Faroe Islands have a single 5kW transmitter at Torshaven on 584kHz. This is a difficult station but it was logged several times last winter shortly after sunrise. A loop aerial is essential to combat interference on this channel. Nearby Iceland is much easier: Hofn 665kHz is usually strong after midnight. *Radio St. Pierre* 1375kHz on the French islands of St. Pierre and Miquelon near Newfoundland is fairly easy but be careful not to confuse it with Lille on 1376kHz which closes down at 2300hrs GMT. There are three MW stations in Bermuda the easiest being ZBM1 on 1235kHz which is usually heard when the path to North America is open. The other two, ZFB1 960 and ZBM2 1340 are more difficult but can sometimes be heard amid North American QRM. There are a number of 'MW countries' in the Caribbean. Listen after midnight for Point Galina 750kHz in Jamaica; WIVI 970 and WBNB 1000 in the U.S. Virgin Islands; WKVM 810, WBMJ 1190 and WMDD 1480 in Puerto Rico; Trinidad on 730 ZNS 1540 in Nassau, Bahamas. ZNS is usually logged at sunrise during the summer when European QRM is light.

Mediumwave DXers now have their own radio programme from *Radio Nederland*. Included in 'DX Juke Box' on the 5th Thursday of the month, the next is on April 30th, is a feature on medium-wave DXing run by the National Radio Club of America. It is broadcast on two frequencies in the 49m band at 2000hrs GMT and at other times from the relay in Bonaire. Full information is available from Radio Nederland, Postbox 222, Hilversum, Holland.

CHARLES MOLLOY

MINIATURISATION R.A. YATES

MAKING PRINTED CIRCUIT BOARDS

THE "art" of miniaturisation is within the reach of everyone and made possible by the use of printed circuits and suitable for small current circuits such as radio tuners, pre-amps, multivibrators and electronic switches.

The process of miniaturisation is relatively simple but it can become tedious if one is not experienced in printed circuit techniques.

CHOICE OF COMPONENTS

The choice of components is very critical and will dictate the final size of the device. Sub-miniature components are available but they tend to be too expensive for the ordinary constructor.

Resistors are no worry at all as there are relatively cheap types on the market which are small enough for our needs. The normal Radiospares 1/4W resistor measures 0.12in diameter and 0.25in long. The 1/4W carbon film resistor measures 0.12in in diameter and 0.32in long. Both types are excellent, the difference being that the latter is more stable and reliable but is slightly more expensive.

Capacitors are available small enough for miniature circuits but they are expensive, compared to resistors. Electrolytic capacitors are quite reasonable, especially the Mullard C426 range, which are available up to 400 μ F in the 4V working range. Other suitable types of capacitor are ceramic, polystyrene, polyester and silver mica. Polystyrene capacitors are quite suitable as they are tubular but at least one centimetre of the leads must be left. Ceramic capacitors can be obtained in either disc or tubular form and they are both suitable for printed circuits. For the person who puts size above cost there are extremely small capacitors available. These "tantalum bead" capacitors, are expensive, costing about 4s each.

Transistors can be quite large when compared with the rest of the miniature components. Transistors like OC71's tend to stand well above the rest of the circuit, their leads having to be left quite long so that a heat sink can be used between the encapsulation and the soldered ends.

The coils in a circuit are usually a problem. I.F. coils (Japanese) can be obtained quite small—measuring only 0.4 \times 0.4 \times 0.5in. Aerial coils can be made quite small by using a suitable former and radio frequency chokes can be obtained in miniature form. These are quite expensive but can be made by using a resistor as a former.

PRELIMINARY DESIGN

By means of a scaled-up drawing the components are positioned so that the device is made as small as possible. The positioning of the components can be done in either of two ways; first, so that the final device is relatively thick (all the components standing up—Fig. 1) and a small area of copper

laminated board used; secondly, so that the device is relatively thin (all the components lying flat—Fig. 2), and a large area of copper laminated board used. The former of these two ways is usually the more compact as some components when laid flat take up too much space.

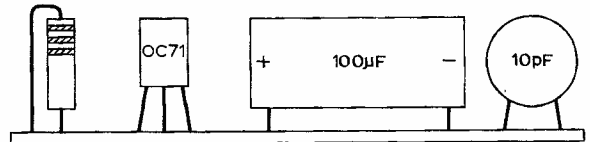

Fig. 1: 'Vertical' mounting of components

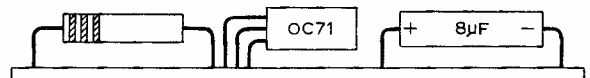

Fig. 2: 'Horizontal' mounting of components

FINAL DESIGN

Once the position of the components has been decided the job of interconnecting the components can begin. The components are drawn in plain view about four times actual size. This is best done in rough as more than one sketch will have to be made. The distances between the components should be exaggerated as this will make the interconnections clearer. These are seen better if they are represented by a thick line made with a soft pencil.

The components should be rearranged slightly until none of the interconnections cross. If this is impossible to do without waste of space an external connection should be made by means of an insulated jumper lead.

MAKING THE PRINTED CIRCUIT

Once the design has been finalised a life size drawing is made (graph paper is a boon at this stage). The outline of the components should be drawn in lightly and the holes for their leads and the interconnections shown clearly. The copper laminated board is now cut to size with the copper side facing upwards so that the copper foil (which is only about 0.002in. thick) is not forced off the laminated board.

The "patina" on the surface of the copper is now removed by means of a damp cloth and a domestic cleansing powder which acts as an abrasive and therefore a good electrical contact is ensured.

A tracing of the holes for the leads is now taken from the life size drawing and this is reversed (the original drawing was done as if one was looking

down on the component side of the printed circuit board and the holes are to be transferred on to the copper side of the printed circuit board) and accurately located on the copper side of the printed circuit board.

With a pointed bradawl the positions of the holes are transferred to the copper foil. The holes can now be drilled with a $\frac{1}{32}$ in. drill. As the drill bit is very fine a special brace, for use with small bits, should be used. If one of these special braces is not obtainable an electric drill can be used, but very carefully as these bits are very easily broken.

The masking of the copper laminate board can now be done. The design is painted on to the copper, using a suitable medium such as nail varnish, but gloss, cellulose, or enamel paint can be used with equally good results.

The masking of the copper laminate board can be done by either of two ways depending on the size of the copper laminate board.

By the first method the interconnections are painted directly on to the copper using a fine brush. This method is suitable for large printed circuits where there is enough room to use a brush.

By the second method the copper is painted with the medium and then the paint around the interconnections scraped away using a pin or a fine pointed bradawl. This method is suitable for small printed circuit boards where a brush is too large to use.

Both these methods have the same effect but the latter is more suitable for miniaturisation as it is possible to put the interconnections closer together than if they were directly painted on.

Now that the "resist" has been applied the excess copper can be etched away. There are several solutions that can be used but one of the quickest acting solutions is 50% concentrated nitric acid and 50% water. A good solution for those afraid of handling concentrated acids is ferric chloride (FeCl_3). It is much slower acting than nitric acid but just as effective. A suitable solution of ferric chloride is 920 grams of ferric chloride in one litre of water.

NOTE!—apart from the fact that nitric acid is extremely corrosive it is also dangerous giving off poisonous brown fumes when reacting with copper.

The solution is poured into a suitable glass or plastic vessel and the copper laminate board immersed copper side up, and left for a while. If nitric acid is used the etching process will be finished when no more brown fumes are given off. If ferric chloride solution is used the way to find out whether or not the etching process has been completed is to look at the copper itself. When the etching process has been completed any remaining unwanted pieces of copper can be removed with a knife. The "resist" can now be removed with a cloth and a suitable solvent.

FINAL ASSEMBLY

The components are now prepared for soldering to the copper laminate board by bending the leads into the correct shape (Fig.3), and then tinning the ends, care being taken not to enlarge the ends of the leads too much, by tinning, because the enlarged leads might not fit into the holes previously drilled.

The transistors are soldered in place after as many

as possible of the other components have been fitted. The leads are pushed through the appropriate holes with about $\frac{1}{16}$ in. protruding out of the copper foil. These leads are now bent over (Fig. 4) and carefully soldered to the copper. It is advisable, when soldering a printed circuit board, to use a miniature soldering iron of not more than fifteen watts rating with a one millimetre bit, so that the joints can be made closer together.

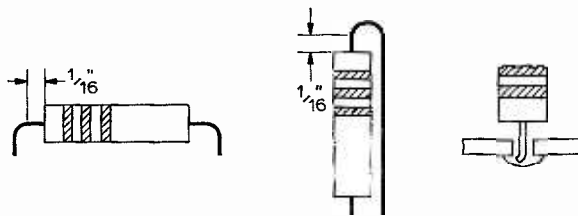

Fig. 3: Left and centre: preparation of component leads

Fig. 3: Right: Position of leads in circuit board

When soldering transistors special care has to be taken so as not to permanently damage them a heat-sink being used between the encapsulation and the joint. A pair of long nosed pliers is suitable but surgical forceps are better as they grip the lead leaving both hands free. 22 s.w.g., 60/40 (60% tin and 40% lead) solder should be used with a quick, firm application of the soldering iron directly on the tinned lead, making sure that none of the solder flows on to an adjacent joint and therefore producing a short-circuit. If a short-circuit is produced in this manner it can be rectified by either scraping away the offending solder with a pointed bradawl or by quick and careful use of the soldering iron.

When all the components are soldered in place the printed circuits should be checked against the circuit diagram, and that there are no short circuits, and that all the joints are good. This may be done by moving the components slightly and if any joint is worked lose it will not be electrically sound.

These printed circuit techniques described may not be the same as those that other printed circuit makers use but they are tried and tested and work well and give good results. ■

BLUEPRINT SERVICE

We would like to draw readers' attention to the fact that the BLUEPRINT SERVICE has been discontinued and therefore no further BLUEPRINTS are available.

QUERY COUPON

This coupon is available until 8th May 1970 and must accompany all queries in accordance with the rules of our Query Service.

PRACTICAL WIRELESS, MAY 1970

AERIALS FOR MOBILES

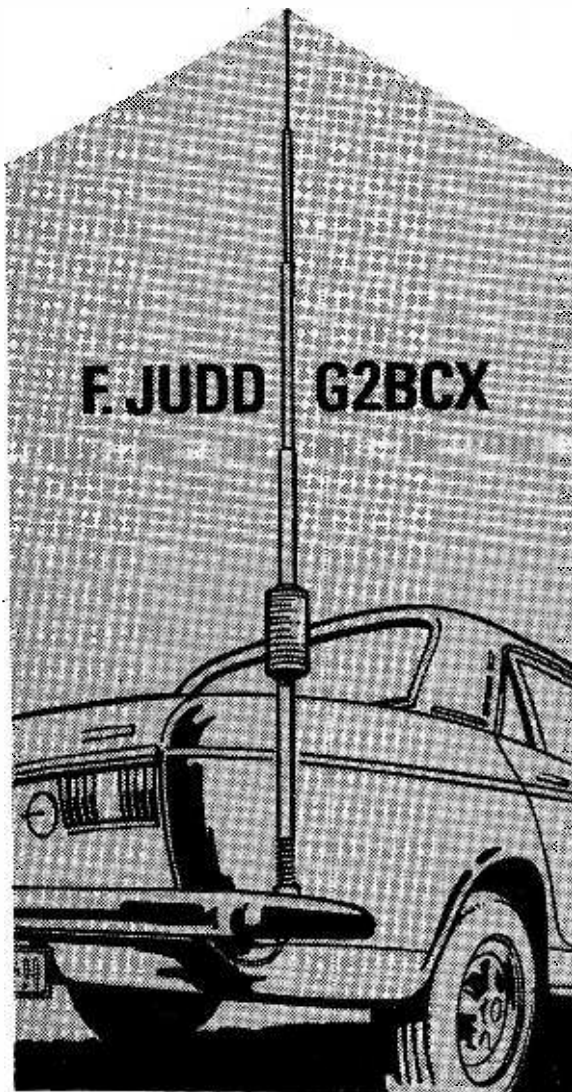

AERIALS for mobile operation in the h.f. amateur bands between 1.8 and 28 MHz are normally short vertical types with inductive loading, especially those operating at the lower frequencies. Short vertical aerials produce a vertically polarised wave which is radiated in the horizontal plane equally well in all directions, i.e., the aerial is omni-directional. Assuming the ground to be flat and perfectly conducting and that the current distribution in the aerial is sinusoidal, the radiated power in the vertical plane of an aerial less than $\frac{1}{4}$ th of a wavelength is approximately as shown in Fig. 1.

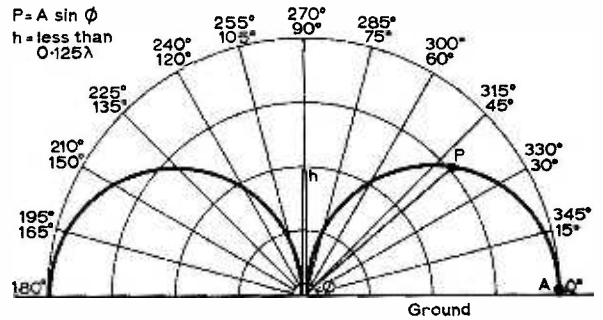

Fig. 1 : Radiation pattern of a short vertical aerial.

As the aerial length is increased, the pattern of the vertical radiation (as in Fig. 1) tends to flatten with a resultant increase in energy along the ground and a reduction of energy skywards. Mobile aerials for the lower frequency bands (1.8, 3.5 and 7MHz etc) must, for obvious reasons, be much smaller physically than even $\frac{1}{4}$ th of a wavelength and although they may be tuned to resonance they can not radiate with the same efficiency as a resonant aerial a $\frac{1}{4}$ wavelength long.

The main reason for the high efficiency of a $\frac{1}{4}$ wavelength aerial is that an aerial of this length being resonant behaves as an almost pure resistance. This resistance is known as the *radiation resistance* and is equivalent to the impedance at the feed point of the aerial as in Fig. 2. Almost all the power fed into the aerial will be radiated. As the aerial length is reduced to fractions of a wavelength less than a quarter the aerial will show an increasing capacitive reactance and a decreasing radiation resistance. For an

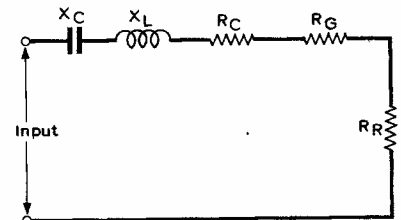
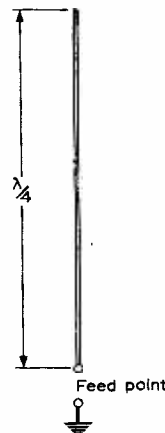

Fig. 2 : (Left) Feedpoint of short vertical aerial

Fig. 3 : (Above) Equivalent circuit of loaded vertical aerial

average 6 to 8ft. long mobile whip aerial the capacitive reactance may range from about 150Ω at 21MHz to as high as $8,000\Omega$ at 1.8MHz resulting in a radiation resistance of about 15Ω at 21MHz to as low as 0.1Ω at 1.8MHz.

If the radiation resistance is low a large current must flow in the circuit if any power is to be radiated at all. By cancelling out the capacitive reactance with an equivalent inductive reactance the aerial can be made resonant resulting in a higher and much more useful radiation resistance. This does not, however, produce an aerial of high efficiency, i.e., one equal to a truly self resonant aerial of a quarter-wavelength or more in physical length.

Radiation resistance is also reduced as the effective height of the aerial is reduced and physically small mobile aerials particularly those for 1.8, 3.5, 7 and 14MHz have a very small effective height. Inductively loaded aerials of small dimensions are, therefore, something of a compromise and the only way of preserving efficiency is to keep all other possible losses to a minimum, for example, in mobile operation there are losses due to ground resistance which at the lower frequencies may be quite high. Coils used for loading also introduce resistance loss and although the coil may radiate some energy, thus adding to the all important radiation resistance, this will usually be small compared to the coil resistance loss.

The equivalent circuit of a loaded whip is shown in Fig. 3. The reactance due to the self capacity of the aerial X_c is of course cancelled by the inductive reactance of the loading coil X_l . This still leaves the coil resistance R_c and the ground loss resistance R_g in series with the radiation resistance R_r . Only the power flowing in R_r is radiated. That in R_c and R_g is dissipated in heat! A resonant mobile aerial for 1.8MHz and about 8ft overall is by comparison with its full quarter-wave counterpart (132ft) only approximately 4% as efficient.

Mobile Aerials for the HF Bands

Any amateur radio mobile rally will reveal a wide assortment of loaded aerials, some unusual, some dangerous, some efficient and some not so efficient. They range from base loaded types to helical coil arrangements with or without 'capacity' hats but which will all add up to the same thing—a resonant aerial, i.e., one tuned by inductive loading to simulate $\frac{1}{4}$ wavelength resonance.

The 28 to 29.7MHz band is the only one for which inductive loading will not be required providing the physical length of the aerial is a quarter-wavelength. If the aerial is to be of fixed length, i.e., non telescopic, this should be 8ft. 3in. which allows for series tuning to resonance over the whole of the band by means of a 500F variable capacitor in series with the co-axial feed cable as shown in Fig. 4. With this system a co-axial cable of 70-80 Ω can be used to couple the aerial to the transmitter even though the feed point impedance is only about 40Ω . The capacitor should be adjusted for maximum current into the aerial at point X.

If a telescopic aerial is used the overall length should be that required for the lowest frequency (2.8MHz). This is 8ft. 5in. and the aerial can be adjusted to resonance by sliding in the top section of the whip. In this case the co-axial feeder should be 50Ω but it may be worthwhile using an impedance

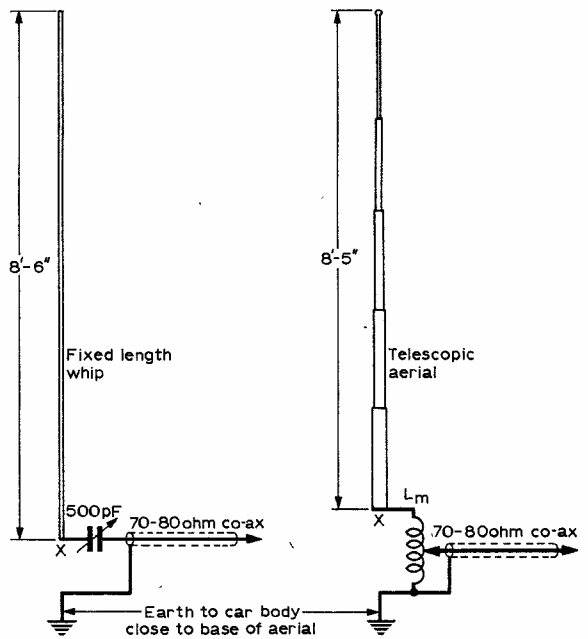

Fig. 4 : (Left) Capacity tuned aerial for the 10 metre band.
Fig. 5 : (Right) Alternative version with inductance loading.

matching arrangement similar to that shown in Fig. 5. The amount of inductance required for L_m will be very small and is best determined experimentally. Five or six turns of 16 or 14 s.w.g. wire on a 2in. diameter former with $\frac{1}{4}$ in. spacing between turns should be ample. The aerial should first be adjusted to resonance at a midband frequency with a grid dip oscillator but with the co-axial feed line disconnected. The line is then connected to a point along the coil which produces maximum current into the aerial at point X.

It is worthwhile keeping in mind that the top of an aerial 8ft. or so in length may well be 11 or 12ft. above the ground if it is mounted on the rear of a car body. This should be regarded as a reasonably safe height limit even for a whip of fairly rigid but otherwise lightweight material. At 21MHz a quarter-wavelength is a little over 11ft. and just a bit too long for safety. Reduction of the overall aerial length to 8ft. or so means using inductive loading for 21MHz and of course for the 14, 7, 3.5 and 1.8MHz bands, in fact aerials for all these bands should be restricted to an overall length not exceeding 8ft. It may be necessary to make the aerial even shorter depending on the size of the car and the point where the aerial can be safely mounted.

The proximity of the loading coil and the whip section to the car body must also be given consideration. It is not possible therefore to give precise dimensions and constructional details for any given types of aerial. The inductance of the loading coil for instance will vary with the length of aerial above it and to some extent its own proximity to the car body. For this reason final adjustment of coils and aerial lengths for resonance should be carried out with the aerial mounted on the car.

The two most efficient forms of loaded mobile aerials are the base loaded and centre loaded types. The base loaded aerial has the advantage of greater physical stability and the fact that the coil resistance

loss is lower because a smaller value of inductance is required. The centre loaded aerial, having a smaller whip section above it, requires a larger inductance which may result in a higher coil resistance loss. The use of a capacity hat above the coil does help to reduce the inductance required and therefore the coil resistance losses but it is generally believed that because the largest proportion of current will be flowing in the section of aerial beneath the loading coil the radiation resistance of the aerial will be greater. Measurements have shown a gain of 3dB or so over a base loaded aerial of the same physical length and height. There is little that can be done about ground loss resistance except good earth contact between the transmitter and the car body. The screening braid of the co-axial feed line to the aerial should be earthed at the transmitter and to the car body at a point as close to the feed point of the aerial as possible.

Loading Coils

The inductance of the loading coil depends very largely on the capacity of the aerial section above it which, for an aerial approximately 8ft long and averagely a $\frac{1}{4}$ in. diameter, will be about 25pF. This means a fairly large inductance for a 1.8MHz base loading coil and if the Q is to be kept high and the coil resistance losses low, the coil itself will be quite big. As the length of the aerial section above the coil becomes smaller the coil inductance must be increased. This applies also to centre loaded aerials where the inductance may be as much as twice that required for base loading.

Tables 1 and 2 give approximate inductance values and winding details for base loaded and centre loaded aerials of about 8ft. total length including the coil. It must be noted that the coil winding will have to be adjusted to bring the whole aerial to resonance when it is mounted on the car.

In order to keep the Q of the coil as high as possible it is recommended that low loss formers are used but these must, however, be strong enough to support the aerial section above. Paxolin tube with a $\frac{1}{8}$ th to $\frac{1}{4}$ in. wall thickness is ideal. Plastic drain pipe with a wall thickness of $\frac{1}{8}$ ths to a $\frac{1}{4}$ in. is also suitable. Solid wood formers should be avoided, for despite coats of varnish, water can seep in and will not only lower the coil Q but also detune it. Plugs at each end of the former for attaching a supporting stub and/or the whip section can be of hard wood or metal but if metal is used the ends of the coil windings should finish at least 1in. from the plugs because the plugs can behave as short circuited turns and lower the Q of the coil.

When the loading coil has been finally adjusted it may be given two or three coats of good quality varnish which will not effect the Q. Plastic containers also make good rain covers but never use a metal cover.

Mounting the Aerial on the Car

The exact place on the car at which the aerial is to be mounted may have some bearing on the construction of the aerial as a whole. Some mobile operators favour the offside of the rear bumper

TABLE 1
BASE LOADING COILS
for 8ft aerials

Band MHz	Inductance μ H	Wire Turns	Wire Size s.w.g.	Coil Dia (inch)	Approx winding length (inch)
1.8	345	135	18	3	10
3.5	77	75	14	2 $\frac{1}{2}$	10
3.5	77	29	12	5	4 $\frac{1}{2}$
7	20	17	16	2 $\frac{1}{2}$	1 $\frac{1}{4}$
7	20	22	12	2 $\frac{1}{2}$	2 $\frac{3}{4}$
14	4.5	10	14	2	1 $\frac{1}{4}$
14	4.5	12	12	2 $\frac{1}{2}$	4
21	1.25	6	12	1 $\frac{3}{4}$	2

TABLE 2
CENTRE LOADING COILS
for 8ft aerials

Band MHz	Inductance μ H	Wire Turns	Wire Size s.w.g.	Coil Dia (inch)	aprox. winding length (inch)
1.8	700	190	22	3	10
3.5	150	100	16	2 $\frac{1}{2}$	10
7	40	28	16	2 $\frac{1}{2}$	2
7	40	34	12	2 $\frac{1}{2}$	4 $\frac{1}{4}$
14	8.6	16	14	2	2
14	8.6	15	12	2 $\frac{1}{2}$	3
21	2.5	8	12	2	2

bracket provided this projects far enough from the rear of the car body. On most small modern cars the bumpers seem to have become part of the body and offer no safe area for supporting a long aerial. If a bumper or bumper bracket is used be sure that the aerial remains fairly rigid when the car is in

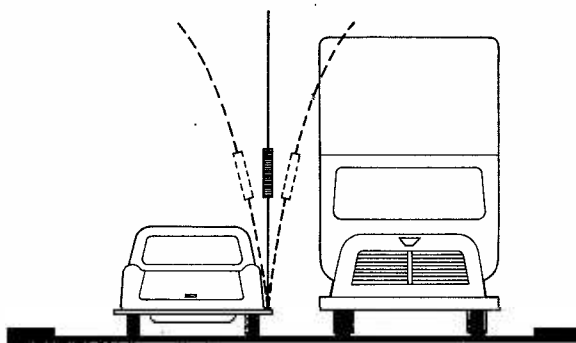

Fig. 6 : Importance of adequate rigidity in aerial mountings.

motion. Long, thin and very flexible aerials with heavy centre loading coils can be dangerous as illustrated in Fig. 6. An alternative to bumper bracket mounting is a flat bracket extending from beneath the chassis as in Fig. 7. This form of mounting is suitable for cars where the rear comes down directly from the roof. A centre loaded aerial would be advantageous here to keep the loading coil away

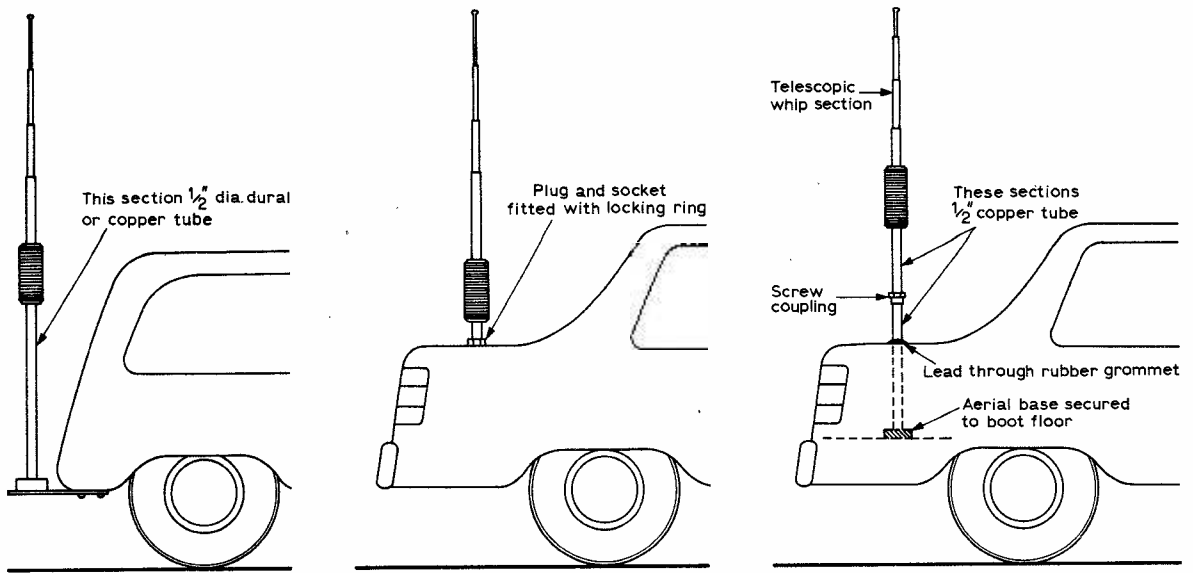

Fig. 7 : 8 : 9 : Three possible methods of mounting whip aerials

from the vertical part of the car body. For cars where the boot extends back from the rear window the offside bodywork might be found suitable for direct mounting of base loaded aerials as in Fig. 8. The method suggested is suitable for a centre loaded aerial and is used by the writer on a Triumph Herald Fig. 9. Note that the drawing is not to scale

and the section of aerial rod inside the boot is only a few inches long. This has no effect on the efficiency of the aerial. Aerials should always be mounted on the offside of the car so as to remain clear of overhanging trees and hedges on country roads. Also remember that the aerial must either be demountable or can be telescoped to get the car into a garage. A demountable type is best and for this purpose $\frac{1}{2}$ in. diameter copper water pipe is useful for making mounting stubs as these can be fitted with screwed couplers. Large co-axial type sockets can also be used for demountable base loaded aerials the plug being fitted to the bottom of the loading coil.

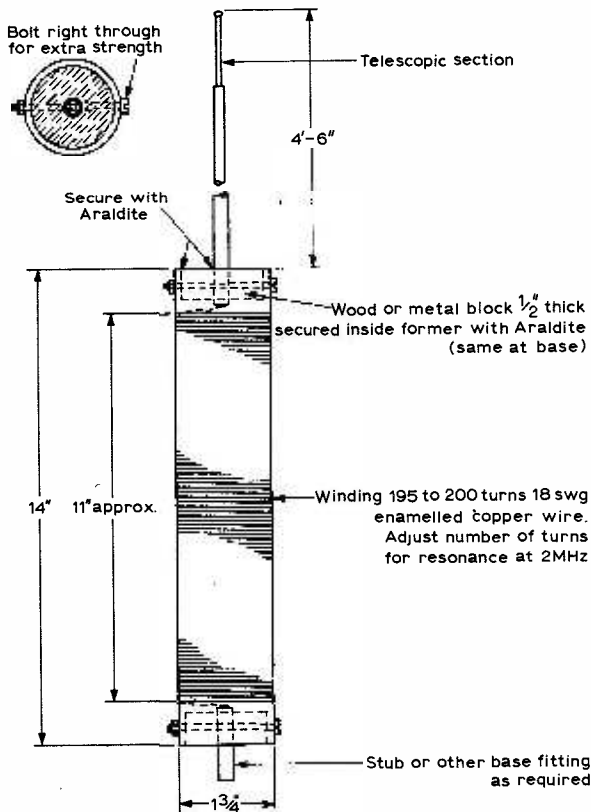

Fig. 10 : Base loaded aerial for Top Band.

Aerial Construction

For centre loaded aerials the coil should not be too large in diameter or the former made of too heavy material. Plastic piping 2 to 3 in. in diameter is very suitable and plastic rolling pins have been used with success. The lower section of a centre loaded aerial should be either copper, brass or dural of at least $\frac{1}{2}$ in. diameter. Lengths, up to about 4ft. will support a loading coil and top whip section without swaying. The whip section above the coil may be a telescopic receiving aerial but use a heavy duty type that will not telescope of its own accord. Base loaded aerials require a long whip section and most of the receiving type telescopic aerials are too short. A section of copper or dural tube plus a telescopic section will make up height and copper-plated steel whips can be used successfully as they have nothing to support but their own weight.

Methods of joining whip sections to coil formers must be left to the reader but such joins must be secure and able to withstand vibration. As long as the aerial is fairly rigid it will not be affected very much when the car is in motion. A typical method of assembly is shown in Fig. 10.

TO BE CONTINUED

TAKE 20

JULIAN ANDERSON

A series of simple transistor projects, each using less than twenty components and costing less than twenty shillings to build

FROM the letters we receive it would seem that there are thousands of readers continually constructing simple radios using one, two or three transistors. I can well understand these people since I belong in their ranks and must have built over fifty of these in various sizes and to different designs in the last few years.

I make no apology for describing yet another radio; if you follow this series you will remember that a one transistor and a three transistor design have already been described. The circuit described here is particularly suitable for miniaturisation and although no direct constructional details are given, several comments are made later regarding component choice etc.

The problem with most published designs is that to achieve the high gains necessary for such sets very accurate biasing etc. is required, and since transistors have appreciable spreads in their characteristics the published circuits will only work well with ones used in the prototype. The circuit shown here has been thoroughly tested and over thirty transistors were tried. All worked well and only one resistance has to be chosen with care for the complete circuit to be sensitive and stable.

The supply voltage can vary between 3V and 15V with no circuit modifications though performance is, of course, better using the higher supply voltages. The circuit has very high gain and so the ferrite rod aerial—which is a problem when miniaturisation is the aim—can be very small. The prototype uses a 1½ in. x ¾ in. size cut from a longer length.

The Circuit

VC1, L1 and C1 comprise the tuned circuit and the overwind on L1 auto-transforms the r.f. picked up and feeds this to the base of Tr1. The collector of Tr1 is connected directly to the base of Tr2 whose emitter voltage is raised to the necessary level by R3 smoothed by C2. Detection takes place in Tr2 and the rectified r.f. is smoothed by C3 connected between the negative and the collector of Tr2. R2 acts as the collector load of Tr1 and provides the bias for Tr2.

The base bias for Tr1 is provided by R1 which is connected through the aerial coil. This gives a measure of regeneration to the first stage and has the advantage over capacitively coupled feedback in that it is not frequency selective and gives smooth regeneration over the complete m.w. band. It is this resistor that has to be chosen with care. Stray capacitance will contribute to the regenerative process and so the value will depend not only on the actual transistor used but on the physical layout. The values in the prototypes varied between 56kΩ and 1MΩ.

The earpiece used should be a high impedance

No. 13

TWO TRANSISTOR RADIO

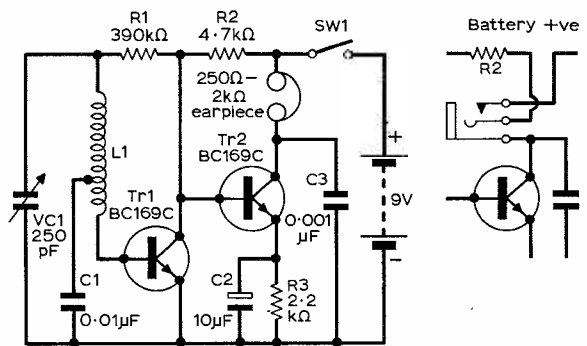

Fig. 1: The circuit of the two transistor radio. If the jack socket is connected as shown a switch is unnecessary.

magnetic type between 250Ω and 2000Ω. These earpieces seem to be fairly widely available (they're all made in Japan of course) but if these are difficult to obtain in your area a crystal earpiece connected across a 3.3kΩ resistor will work just as well.

★ components list

Resistors:

R1 390kΩ—see text R3 2.2kΩ
R2 4.7kΩ
All ¼th watt

Capacitors:

C1 0.01μF C3 0.001μF
C2 10μF 10V VC1 250pF trimmer

Transistors:

Tr1 BC169C Tr2 BC169C
Available from Electrovalve Ltd of Egham.

Miscellaneous:

L1—see text; 250Ω or 2000Ω magnetic earpiece—see text; miniature jack socket; 4.5V–15V battery—see text.

Construction

The aerial rod is easily made and about 80 turns on a ¾ in. ferrite rod tapped at 8 turns will do. Enamelled copper wire of almost any gauge will suffice.

The cheapest and smallest tuning capacitors are the Radiospares 250pF or 500pF trimmers and these are ideal for miniature radios. The 250pF is quite adequate for this set and using the aerial coil described above will give a coverage from about 600kHz to 1.5MHz.

The components can be mounted on Veroboard or on paxolin sheet. The battery switch can easily be incorporated in the earphone socket by bending the contacts so that the jack socket makes rather than breaks the switch contacts.

The finished set draws only about 1.5mA and so all resistors can be ¼th watt types and the battery will last a long while. ■

WHAT DO YOU KNOW ABOUT METER SHUNTS?

H.A. COLE, C. ENG., M. I. E. R. E.

PART 2

THE principle of the **universal shunt method** for multi-range current measurement is illustrated in Fig. 5. A single shunt (R_{st}) consisting of a number of series-connected resistors ($R_{s1} - R_{s5}$), is permanently connected in parallel with the meter. The interconnections between the constituent resistors which make up the total shunt (R_{st}) are taken to a number of input sockets or to a single pair of sockets by way of a range selection switch.

The main advantage of the universal shunt is that contact resistance of the switch, if used, has a negligible effect on the measurement accuracy. This is because the shunts are always positively connected across the meter whereas in the separate shunt method they are connected through the contact resistance of the switch. The contact resistance is still present, of course, but it is now in series with the resistance of the external circuit which is producing the current where its comparatively low value will have little effect.

The first thing which has to be considered when designing a multi-range universal shunt, is the choice of an overall resistance (R_{st}) for the shunt. The major factor influencing this decision is the maximum effective resistance which can be accepted for the testmeter. The larger this resistance, the greater will its effect be on the total resistance of the external circuit supplying the current to be measured; and hence the greater will be its influence on the measurement accuracy. For good accuracy it is necessary to keep the effective resistance of the testmeter as low as possible. One can now develop a design procedure for the same current ranges previously catered for in the separate shunt method. The same type of meter will be used, $50\mu A$ f.s.d. (I_m) and $1,000\Omega$ internal resistance (R_m).

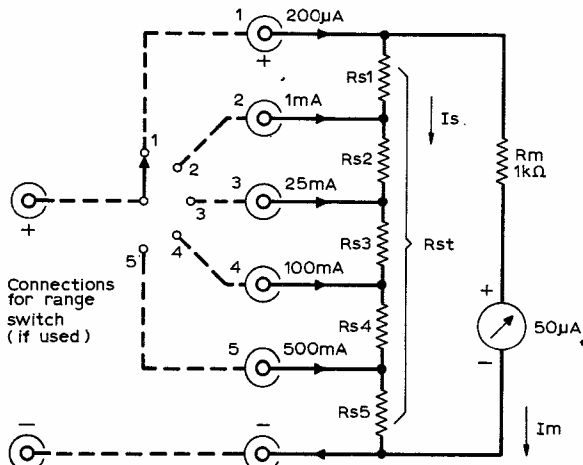

Fig. 5 Universal shunt method.

Firstly, to derive a simple formula which will then be used to determine the individual sections of the universal shunt, consider the meter circuit for the lowest current range (range 1). This range uses the total value of the shunt (R_{st}), and the simplified circuit looks like that shown in Fig. 6. ' I_t ' is the total current flowing in the testmeter; I_s is the current in the shunt, and I_m is the current in the meter. Determine the value of R_{st} by

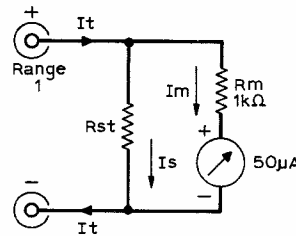

Fig. 6 Single range shunt.

using equation (iii) i.e., $R_{st} = \frac{R_m}{N-1}$ (where N is the

f.s.d. magnification factor). The next step is to draw the circuit showing the next higher current range i.e., range 2. This has been done in Fig. 7 where the same circuit has been drawn in two different ways in order to make the explanation clearer. The total shunt resistance (R_{st}) is the same value as shown in Fig. 6 but it is now split into the two sections formed by R_{s1} and R_{s2} (Fig. 7a).

When the input current (I_t) is applied to the range 2 socket, some flows into the shunt section R_{s2} , and the remainder (I_m) flows into the shunt section R_{s1} , now in series with the meter resistance (R_m). The value of R_{st} has been calculated using equation (iii). The problem is to determine the value of R_{s2} . It is known that $R_{s1} + R_{s2} = R_{st}$, and also that $I_s + I_m = I_t$. From these two facts is derived the equation needed.

The voltage developed across R_{s2} , due to the current I_s , equals that developed across $R_{s1} + R_m$, due to I_m . From Ohm's law:

$$I_s R_{s2} = I_m (R_{s1} + R_m).$$

But $R_{s1} = R_{st} - R_{s2}$, therefore substituting for R_{s1} in the above equation:

$$I_s R_{s2} = I_m (R_{st} - R_{s2} + R_m).$$

multiplying the terms within the brackets by I_m ,

$$I_s R_{s2} = I_m R_{st} - I_m R_{s2} + I_m R_m.$$

Collecting the terms containing R_{s2} :

$$I_s R_{s2} + I_m R_{s2} = I_m R_{st} + I_m R_m$$

Factorising both sides:

$$R_{s2}(I_s + I_m) = I_m (R_{st} + R_m)$$

But $I_s + I_m = I_t$, therefore:

$$R_{s2} I_t = I_m (R_{st} + R_m)$$

$$\text{or, } R_{s2} = \frac{I_m (R_{st} + R_m)}{I_t}$$

Now, the f.s.d. current range factor

$$'N' = \frac{I_t}{I_m}, \text{ therefore } \frac{I_t}{I_m} = \frac{1}{N}$$

Substituting $\frac{1}{N}$ for $\frac{I_m}{I_t}$ in the above equation:

$$R_{s2} = \frac{R_{st} + R_m}{N} \dots\dots\dots (iv)$$

(this is the same value of N as used in equation (iii), and it means exactly the same).

This equation can be used to determine any sectional value of R_{st} , having first selected the value of R_{st} using equation (iii).

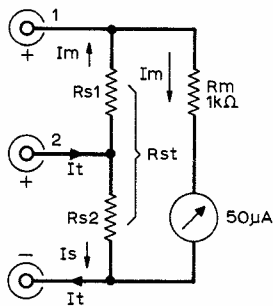

Fig. 7(a) Two range shunt.

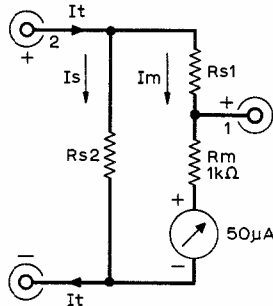

Fig. 7(b) Equivalent circuit.

Now use these two equations to derive the values of the shunt sections shown in Fig. 5. First determine R_{st} for range 1 (200µA), using equation (iii).

$$R_{st} = \frac{1,000}{\left(\frac{200}{50} - 1\right)} = \frac{1,000}{3}$$

Therefore $R_{st} = 333\Omega$

Now derive the shunt section required for range 2 (1mA), using equation (iv); (note that this section of R_{st} is composed of $R_{s2} + R_{s3} + R_{s4} + R_{s5}$, which we will label R_{s2-5}).

$$R_{s2-5} = \frac{333 + 1,000}{\left(\frac{1,000}{50}\right)} = \frac{1,333}{20} = 66.66$$

$$R_{s2-5} = 66.66\Omega$$

Similarly, for range 3 (25mA),

$$R_{s3-5} = \frac{333 + 1,000}{\left(\frac{25,000}{50}\right)} = \frac{1,333}{500} = 2.666$$

$$R_{s3-5} = 2.666\Omega$$

For range 4 (100mA),

$$R_{s4-5} = \frac{333 + 1,000}{\left(\frac{100,000}{50}\right)} = \frac{1,333}{2,000} = 0.666$$

$$R_{s4-5} = 0.666\Omega$$

Lastly, for range 5 (500mA),

$$R_{s5} = \frac{333 + 1,000}{\left(\frac{500,000}{50}\right)} = \frac{1,333}{10,000} = 0.1333$$

$$R_{s5} = 0.1333\Omega$$

With this data now work out the individual values for $R_{s1}, R_{s2} \dots R_{s5}$, as follows:

$$R_{st} = 333\Omega$$

$$\therefore R_{s1} = R_{st} - R_{s2-5} = 333 - 66.66 = 266.4\Omega$$

$$R_{s2} = R_{s2-5} - R_{s3-5} = 66.66 - 2.666 = 64\Omega$$

$$R_{s3} = R_{s3-5} - R_{s4-5} = 2.666 - 0.666 = 2\Omega$$

$$R_{s4} = R_{s4-5} - R_{s5} = 0.666 - 0.133 = 0.533\Omega$$

$$R_{s5} = 0.133\Omega$$

Check for $R_{s1} + R_{s2} + R_{s3} + R_{s4} + R_{s5} = R_{st} = 333\Omega$.

$$266.4 + 64 + 2 + 0.533 + 0.133 = 333.06$$

(satisfactory).

Substituting these values in Fig. 5, the testmeter circuit will now look like that shown in Fig. 8; the range selection switch could be replaced by individual sockets, as shown in Fig. 5.

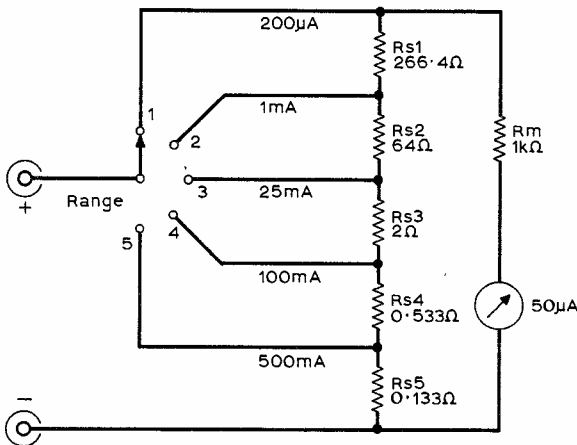

Fig. 8 Final circuit using Universal shunt.

By deliberately working out each shunt section familiarity with the working of equation (iv) is obtained. It is, after all, nice to know what one is doing, and why one is doing it. As many will have noticed from the results, however, a much simpler procedure is possible, once having determined R_{st} using equation (iii). For example, requiring a shunt section of 66.66Ω for 1mA, will require a shunt section equal to one hundredth of this value (0.666Ω) for a range 100 times as great i.e., 100mA. Similarly, if 2.666Ω is required for 25mA, then $\frac{25}{500} = \frac{1}{20}$ th of 2.666Ω i.e., 0.133Ω, is required for 500mA.

This is a very simple procedure but its simplicity is not readily appreciated without having first understood the derivation of equation (iv). The bit that puzzles most people when using the simple approach is "what happens to the unwanted sections of R_{st} i.e., those sections which end up in series with R_m !

To end this discussion, one very important point should be noted about the universal shunt method of measuring current, and that is the fact that the minimum current range can never be made equal to the f.s.d. of the meter, as it could in the separate shunt method. This is because the presence of R_{st} being permanently connected in parallel with the meter, will always bypass some of the current applied to the meter, even though this can be made very small by using a large value of R_{st} . It can now be seen why 100µA and not 50µA was selected for the minimum current range of our hypothetical testmeter. ■

Beginners

A.F. AMPLIFIER

A.S. ELLIS

The low cost and simplicity of this little amplifier make it eminently suitable as a beginner's project. Despite this simplicity, however, the unit is capable of a fairly high standard of reproduction, albeit at very modest output levels, and is ideal for boosting the output from a phones-only transistor radio to loudspeaker strength.

In the prototype, the frequency response is exceptionally good, (-2dB at 15Hz and 40kHz).

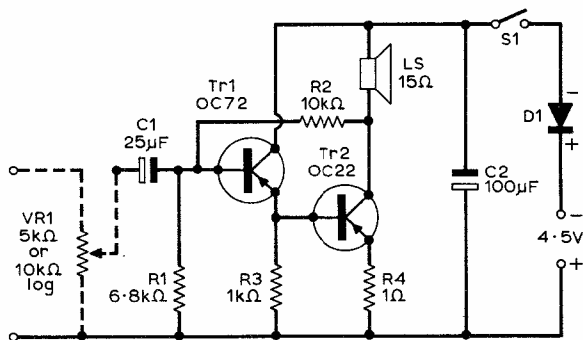

Fig. 1: Circuit of amplifier

CIRCUIT

The circuit diagram is shown in Fig. 1. It will be noted that direct coupling has been used between the two stages: this makes for simplicity and minimises the number of circuit components. Tr1 operates in common collector mode, feeding the common emitter amplifier Tr2. The $10\text{k}\Omega$ resistor R2 is part of the base-bias network for Tr1, and incidentally also introduces negative feedback, so contributing to the stability of the configuration. The base bias current for Tr2 is derived from the standing emitter current of Tr1. The emitter resistor R4 introduces a small amount of negative feedback, in addition to that already provided by R2. The overall effect of the total feedback shows up in the extremely good frequency response of the unit. (See Fig. 2).

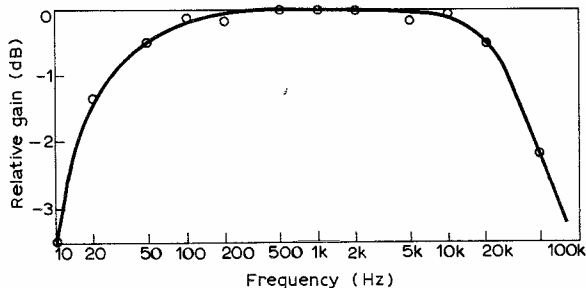
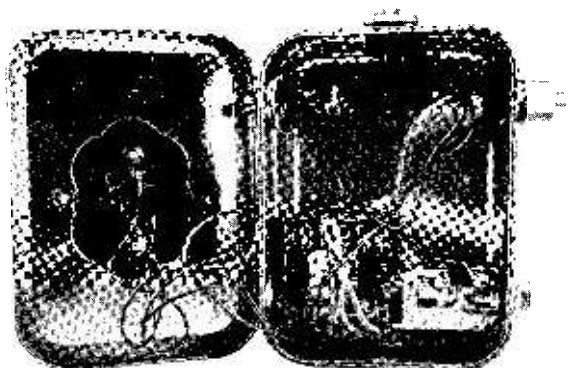

Fig. 2: Response curve of amplifier



CONSTRUCTION

All small components, including Tr1, are mounted on a miniature 6-way groupboard as in Fig. 3. The power transistor, however, is mounted on a suitable flat surface (ideally paxolin) and is connected to the groupboard by flying leads. Fig. 4 gives drilling details for the paxolin mount. The unit is small

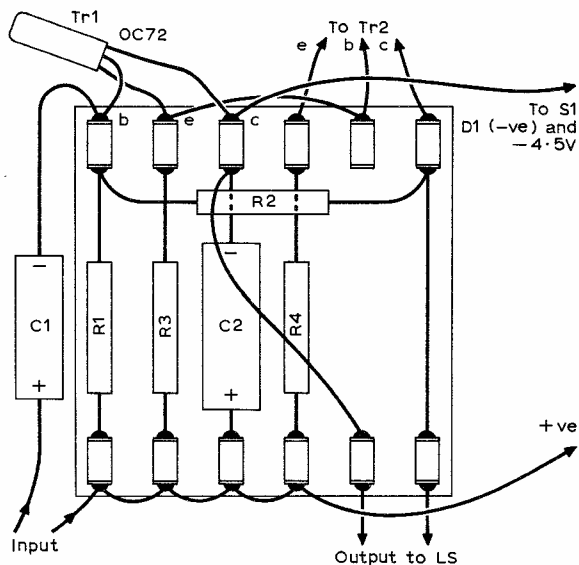

Fig. 3: Component board

enough to be constructed inside a 2 oz. tobacco tin, complete with input and output jacks. But note that if general practice were followed, using the tin as earth (+VE supply) the output jack would need to be of the insulated variety. Neither would it be permissible to mount Tr2 directly on the tin, since the transistor collector is directly connected to its casing. In this event, a suitably large hole would need

to be cut in (say) the lid of the tin, and the paxolin sheet carrying Tr2 bolted over it. In circumstances where such a transistor was running at full power, it would need to be bolted to a metal plate heatsink. In the circuit here however, the device operates well within its power rating, and remains cold at all times: a heatsink is therefore unnecessary.

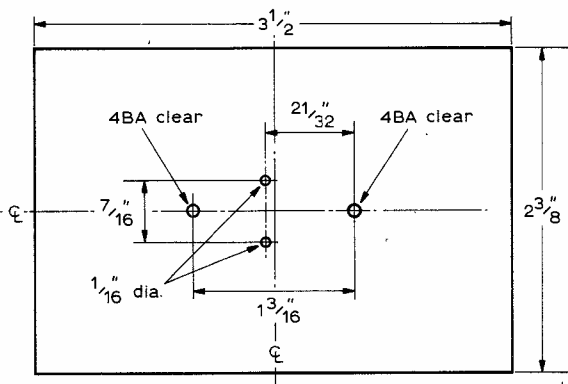

Fig. 4: Mounting board for power transistor

Although an OC72 has been specified for Tr1, an OC81 will do just as well, and the author has even used some of the more robust specimens of a batch of unmarked, untested transistors, all with equal success. Alternative transistors have not been tried in place of Tr2, although it is probable that other types could be used, provided that one is prepared to juggle a little with component values.

★ components list

Resistors:

- R1 6.8k Ω
- R2 10k Ω
- R3 1k Ω
- R4 1 Ω
- All resistors $\frac{1}{2}$ watt 20%
- VR1 5k Ω or 10k Ω Log.

Capacitors:

- C1 25 μ F 12V wkg.
- C2 100 μ F 12V wkg.

Semiconductors:

- Tr1 OC72 (see text)
- Tr2 OC22
- D1 10 p.i.v. 250mA

Miscellaneous:

- Groupboard (6 way); Input and output sockets;
- Piece of paxolin $2\frac{3}{8} \times 3\frac{1}{2}$ "; 4BA nuts & bolts; Switch, single pole on/off; Battery, 4.5V.

Finally, a word about power supplies: unlike the more commonly encountered class B transistor amplifiers, this unit draws a steady high current all the time it is switched on (class A), regardless of whether or not a signal is applied. The prototype has an appetite which requires about 110mA at 4.5V to satisfy it. Correspondingly, the battery needs to be as large as convenience allows. The prototype draws its nourishment from a 4.5V Bell-battery Type 126. A couple of these in parallel or a PP11 might be a better idea.

Damage resulting from incorrect connection of the power supply is prevented by the inclusion of diode D, in the negative supply line. ■

NEXT MONTH IN

PRACTICAL WIRELESS

LIGHT BEAM TELEPHONE

The light beam telephone provides a convenient method of short range point-to-point communication without the use of wires, which does not involve transmission and reception on frequencies requiring a Post and Telecommunications Licence. Basically, the transmitter consists of a lamp which is amplitude (brightness) modulated by the voice signal to be transmitted. The lamp is mounted in an optical system, so as to produce a parallel beam of light, which is directed at the receiver. The receiver consists of a phototransistor mounted in a similar optical system, plus an amplifying system to operate an ear-phone.

WIDE RANGE L.F. GENERATOR

The frequency coverage of this signal generator is 15Hz to 1.5MHz in five ranges. The circuit uses a minimum of components, consistent with reliable operation and is easy to build and use. The basic unit is built on a Veroboard panel and operates from a built-in mains unit.

L.F. BANDS TRANSMITTER-RECEIVER

This equipment incorporating all the required circuitry for transmission and reception and with an internal power pack and loudspeaker, offers a neat "one box" station for regular use, or for /A working. The transmitter runs the full permitted power (10 watts) on the 160 metre band, and can easily be modified to cover 80 metres.

PLUS THE REGULAR "TAKE 20" AND "I.C. OF THE MONTH" FEATURES AND OTHER CONSTRUCTIONAL ARTICLES AND FEATURES

Don't miss your copy of the June issue of Practical Wireless —on sale 8th May—price 3s. 6d.

CODAR CR.70A

Communications Receiver 540-10 metres



The Codar CR.70A is an excellent general coverage communications receiver for the keen short wave listener. Very reasonably priced at just £21 the CR.70A is outstanding value for money. In four stable ranges, the receiver covers from 540 metres medium wave, right through the shipping and coastguard frequencies all the short wave and international amateur bands up to and including 10 metres, where the rapidly improving conditions that now prevail allow the regular reception of world-wide call-signs!

The CR.70A has a high 'Q' aerial input stage using exclusive CODAR COIL air space inductor. Double tuned, iron cored I.F. transformers produce high selectivity. Ready to plug into 200-250 volt AC mains, the CR.70A needs only your aerial and a 2-3 ohm loudspeaker. The cabinet measures only 13" x 5 1/2" x 7 1/2" and the control panel is finished in black and white with chrome trim knobs. Fully guaranteed for 12 months!

New model has separate direct output socket for feeding tape recorder, Hi-Fi equipment, etc.

20 gns.

- *Ideal for SWLs
- *5 valves (inc. two twin triodes) giving 7 valve line-up
- *Excellent on amateur and shipping frequencies
- *Calibrated signal strength meter (illuminated)
- *Automatic volume control
- *Separate B.F. oscillator for morse and S.S.B. signals
- *Two speed vernier tuning
- *Separate output for recording etc.

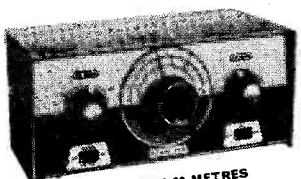

T22 RECEIVER FOR 160 & 80 METRES AMATEUR BANDS
 9 translators, bandspread 1.8-2Mc/s and 3.5-4Mc/s 12 volts, only 8" x 4" x 3 1/2". Ideal portable, mobile or home receiver. Efficient BFO, printed circuits. ONLY £15.17.6. Carr. 4/6.

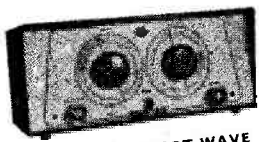

CR45 MAINS T.R.F. SHORT-WAVE RECEIVER
 World wide reception. * Separate electrical band-spread. * 3 slow motion drives. * Output 3 watts for 23 ohm speaker. * Valves ECC81, FL84, EZ80. Size 12" x 5 1/2" x 7". CODAR-KIT CR.45K with 3 coils 10-28, 25-75, 60-176 metres). £10.10.0 Carr. 10/- Extra coils 6/3 each. Built £13.10.0.

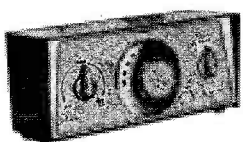

R.F. PRE-SELECTOR MODEL P.R.30
 1.5-30Mc/s Provides up to 20dB gain plus substantial image rejection. Improved signal/noise ratio and selectivity. Power requirements 180-250 volts 12mA H.T. 6.3 volts, 3 amp L.T. Size 8 1/2" x 5" x 4". Ready built complete with cables, plugs and instructions. £5.19.6. Carr. 4/6. Self-powered P.R.30X £7.19.6. Carr. 4/6.

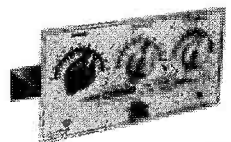

MINI-CLIPPER—OUR FAMOUS SHORT-WAVE RECEIVER
 * Can be built in one evening. * Complete with valve, one coil 25-75 metres and 4 page instruction manual. Price £2.9.0. Carr. 3/- Extra coils 6/3.

CRC CODAR RADIO COMPANY
 UNIT 1, MEADOW ROAD, INDUSTRIAL ESTATE, EAST WORTHING, SUSSEX. WORTHING 37315
 World-wide Mail Order Service

Please supply... (tick as required)

I enclose cheque/M.O./P.O. value of £.....

Ad stamp enclosed for leaflets

NAME _____

ADDRESS _____

POST ORDER FORM TODAY

ELECTRONIC RECEIVER SWITCH

TRANSMIT FOR RECEIVE

F.G. RAYER G30GR

IT is usual to employ the same aerial for transmission and reception, and to have an aerial change-over switch, change-over relay, or switching in the transmitter to transfer the aerial from the transmitter output socket to the receiver aerial input socket. As the receiver speaker generally needs to be muted while transmitting, this makes necessary some inter-connection of units, which may be found a nuisance when using two or more transmitters.

The circuit in Fig. 1 avoids the need for such switching, and is permanently connected to the aerial, which will also be used for transmission. During reception, V1 acts as a cathode follower, with bias and output developed across R4. C3 couples signals to the receiver.

V2 is the first audio amplifier of the receiver, in this case with contact potential bias from R5 and R2. C4 is coupled to the volume control, and C6 provides signals for the output stage and speaker.

When the transmitter is on, a high r.f. voltage appears at V1 control grid, and rectification develops bias across R1 and R2, thus virtually cutting off V1 so that the signal is not applied to the receiver aerial circuit. The bias voltage developed across R2 is beyond the cut-off value for V2, thus muting the audio section and speaker.

Stray coupling through V1 and elsewhere allows the receiver a.g.c. circuit to cut down the sensitivity of i.f. and other controlled stages while transmitting. When the r.f. signal from the transmitter is removed, the receiver returns almost instantly to its usual condition.

CONSTRUCTIONAL POINTS

As the circuit was fitted in a home-built receiver, V1 was mounted on the chassis between aerial socket and aerial coils. This stage should be assembled on a small sub-chassis, and fully screened as far as possible. The voltage across C1 depends on the type of aerial and transmitter power, so a 1kV mica component was fitted. For Top band, moderate power, or feeding from a 75Ω or similar line, 500V would suffice. The r.f. voltage across C1 is greatest with end-fed half-wave systems where the receiver is operated from the aerial without a tuner but this is not recommended.

R4 suits the general medium impedance receiver aerial input circuit. For a receiver with 300Ω or 75Ω input, signal strength would be improved by reducing R4 and increasing C3. The h.t. voltage is not very important, and can be about 150-250V, taken from the receiver supply.

The speed of recovery of the whole circuit depends largely on the receiver a.g.c. component values. Re-

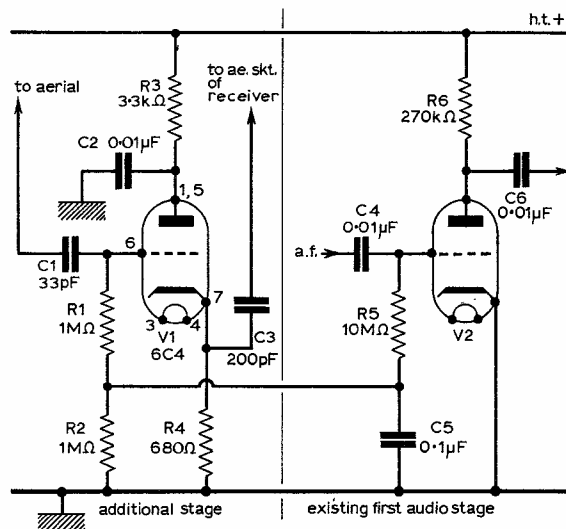

Fig. 1: Circuit of switch.

covery of the cathode follower and audio stage is practically instantaneous. If the receiver has a very sluggish a.g.c. circuit, the effects of this can be reduced by decreasing the capacitor and resistor values in the a.g.c. circuit.

With the circuit in use, omit all inter-connection of receiver and transmitter, and any aerial change-over relay or similar device. The aerial is permanently connected to the receiver by a single lead, or preferably by co-axial cable, to suit the type of aerial feed. The transmitter is connected to the aerial directly, or through a tuner, as usual. If desired the tuner may be in circuit for reception.

The transmitter is normally switched on by closing a switch in the main h.t. circuits, where low voltages are involved, or a switch or relay in the supply to a transformer which provides h.t. current in other cases.

The circuit was intended for use in conjunction with a.m. transmitters. Where high power is used, the voltage rating of C1 should at least be equal to that of the p.a. anode circuit coupling capacitor.

The circuit was found to be satisfactory with an s.s.b. transmitter, for automatic receiver muting, but not suitable for c.w., due to the long time constant of the receiver a.g.c. circuits.

It is not recommended that this switch be used with receivers having transistorised r.f. stages as the transistors could be damaged by the high r.f. voltages that exist around V1 in the transit mode. ■

Heathkit for the new "Compact" Sound of the 70's



'COMPACT' AD27

The fabulous stereo "Compacts" Models AD-17 and AD-27 are setting the pace in hi-fi for the 1970's. They offer outstanding value and performance. The AD-17 comprises a BSR MA-65 turntable/Shure M44-MB magnetic cartridge and a 10 watt (RMS) per channel stereo amplifier all mounted on a Teak or Walnut plinth.
Kit Price £54. Carr. 13/-

The AD-27 is similar but uses the MA-70 turntable and includes an FM stereo tuner. In this case the "plinth" is better described as a small cabinet. It has the additional features of a "Roller Shutter" lid and is available in Teak or Walnut.
Kit Price £82. Carr 13/-

Heathkit offer many excellent loudspeaker systems the new "Ambassador" Hi-Fi loudspeaker is winning many friends. Its cabinet is supplied ready assembled and finished in selected Teak or Walnut veneers to harmonise with other current Heathkit hi-fi equipment. It uses three loudspeaker units a 12in. bass, 5in. mid range and a 1in. Dome Pressure Tweeter.
Kit Price £29.16.0 Carr. 15/-

The complete Heathkit hi-fi range of stereo amplifiers, tuner/amplifiers, FM tuners, Stereo "Compacts", loudspeaker systems and ancilliary hi-fi equipment are all described and illustrated, many in full colour. In a wonderful free catalogue.

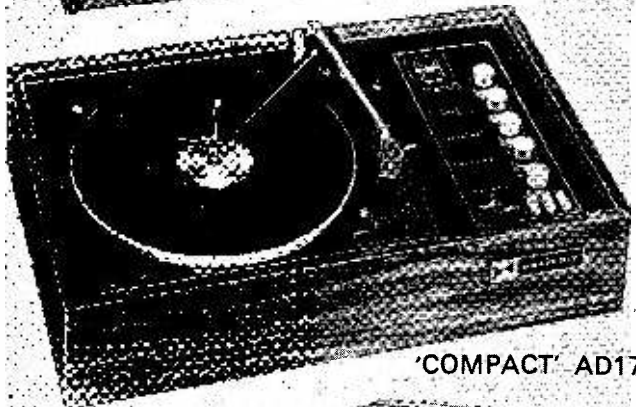

'COMPACT' AD17

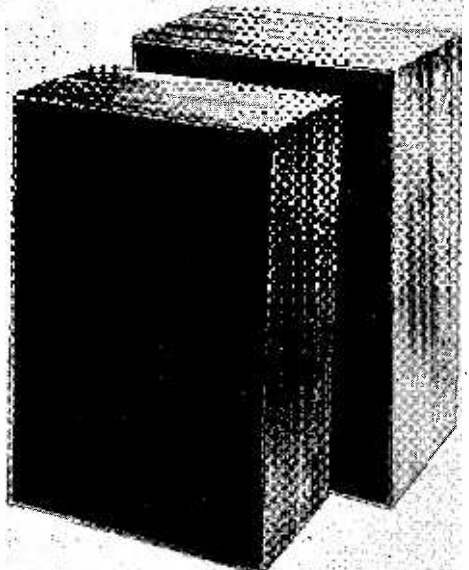

AMBASSADOR SPEAKERS

**Send for the
 FREE Catalogue
 and see for
 yourself . . .
 Today !**

TO DAYSTROM LTD., GLOUCESTER, GL2-6EE

Please rush me details of the latest Heathkit Hi-Fi Models

NAME
 ADDRESS

51/5

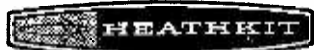

A Schlumberger Company

DAYSTROM LTD
 GLOUCESTER
 GL2-6EE

THE STICK THAT DOES THE TRICK!!!

JUST LISTEN TO THE SIGNAL FROM THE

JOYSTICK

REGD.

VARIABLE FREQUENCY ANTENNA

ALL BAND - WORLD RECORD AWARD WINNING AERIAL - JUST 7 ft. 6 ins. LONG!

Obtainable from :-

R.S.C. HI-FI CENTRES at :
BIRMINGHAM, Gt. Western Arcade
BRADFORD, 10 N. Parade
DARLINGTON, 18 Priestgate
DERBY, 16 Osmaston Rd.
EDINBURGH, 133 Leith St.
GLASGOW, 326 Argyle St.
HULL, 91 Paragon St.
LEEDS, 5-7 County Pde.
LEICESTER, 32 High St.
LIVERPOOL, 73 Dale St.
MANCHESTER, 60a Oldham St.
MIDDLESBROUGH, 106 Newport Rd.
NEWCASTLE/TYNE, 41 Blackett St.
SHEFFIELD, 13 Exchange St.
LONDON, 288 Edgware Rd.
LASKY'S RADIO at :
LONDON, 207 Edgware Rd.
 33 Tottenham Ct. Rd.
 152-3 Fleet St.
G. W. SMITH & CO. at :
LONDON, 3 & 34 Lisle St. WC2
 311 Edgware Rd. W2
IMHOF'S (Eddystone Dist.) at :
LONDON, New Oxford St. WC1
AND AT :
ABERDEEN, L. Hanlie, 542 George St.

ASHFORD (MIDDX), Echelford Conns.
BATH, Rivland Huntley, 15 Old Bond St.
BIRMINGHAM, Amateur Electronics
 Chas. H. Young Ltd.
BOURNEMOUTH, Forresters Nat. Radio
BRADFORD, Radio Ham Shack, Godwin St.
BRIGHTON, Arthur Sallis, Gardener St.
BURNLEY, Trafalgar Supplies
CARDIFF, Vesek Radio, Cathays
CEILMSFORD, Radio Service, New St.
CHESTERFIELD, J. & A. Tweedy Ltd.
EDINBURGH, F. Brown & Co. Geo. V. Bdge.
EXETER, Electrosure Ltd. Fore St.
FRASERBURGH, Murray Mackie
GLASGOW, RME Surplus Supplies
GOODMAYES, Unique Radio, Foxtote
GT. YARMOUTH, The Record Shop
HALIFAX, Albert Hind Ltd.
HARTLEPOOL, Specialist Radio
HERNE BAY, Purday's
HUDDERSFIELD, Radio Craft Ltd.
HULL, Short Wave, Newland Ave.
ILFORD, Radio Dev. Clayhall Ave.
IPSWICH, Eagle Elect. (Dunslac).
LEEDS, Henry Elect. Harrogate Rd.
LEICESTER, S. May, 12-14 Church Gate
LIVERPOOL, Stephens-James, Priory Rd.
 Super Radio (Whitechapel)

LONDON, City Radio, Ealing W5.
 Newbury Radio, Forest Gate
 R.T. & I. Elect. Ashville Rd. E11.
LUTON, Coventry Rdo. Dunstable Rd.
NEWARK, Geo. Francis, Balderton Gate
NEWCASTLE/LYME, Sydney T. Chadwick
NEWCASTLE/TYNE, Richey & Freeman
NEWPORT (MON), K. P. Paull, Dock St.
NEWQUAY, R. V. Heming Ltd.
NORWICH, Radiomatics, St. Benedicts St.
NOTTINGHAM, Pete's Elect. Arkwright St.
OLDHAM, The Electronic Centre, The Mumps
PLYMOUTH, Radioparts, 5 Market Way
PRESTON, Croftlin, 46 Priargate
ROMFORD, Newbury Rdo. 120 North St.
SCARBOROUGH, Derwent Rdo. Hillcrest Ave.
SOUTHAMPTON, Frank Victor, Northam
S. SHIELDS, J. R. Gough Fleet. Imeary St.
SUNDELAND, Red Radio Shop, Cowtree Rd.
SWANSEA, W. J. Holt, Oxford St.
WESTCLIFF-ON-SEA, Radio Const. Co.
WEYMOUTH, Dorset Radio Electronic
WORCESTER, Jack Porter, College St.
WOLVERHAMPTON, Lings Rdo. Snow Hill
WORTHING, (G.W.M. Rdo. Portland Rd. or from :
PARTRIDGE ELECTRONICS LTD., (PWA),
BROADSTAIRS, KENT. Tel: Thanet 62836

H.A.C. Electronic Kits

DID YOU KNOW?

That we have specialized in the supply of kits for the Amateur Constructor for over 35 years. (Established 1934.)

That we now have available a full range of Complete transistor kits with comprehensive instruction manual, for constructing—Radios—Resistance Bridge—Lightmeter—Electronic Counter—Voltmeter—80 metre Converter, etc. etc. (Details for 40 different electronic circuits are available.) Complete kits from 54/-. Fully guaranteed. Illustrated brochure upon application, send S.A.E. please.

H.A.C. Products. 29 Old Bond Street. London W.1.

FREE LIST!
 SEND S.A.E.
 FOR BUMPER FLOG
 LIST

TECHNICAL TRADING

BARGAIN SPRING
 SALES AT ALL
 BRANCHES

- ★ LONDON (MUS 2639)
- ★ 10 Tottenham Court Road
- ★ PORTSMOUTH (Tel. 22034)
- ★ 350-352 Fratton Road
- ★ SOUTHAMPTON
- ★ 72 East Street (Tel. 25851)
- ★ BRIGHTON (Tel. 23975)
- ★ Queen's Road

FANTASTICALLY POPULAR

JASON TAPE ★

We offer you fully tensilised polyester mylar and P.V.C. tapes of identical quality hi-fi, wide range recording characteristics as top grade tapes. Quality control manufacture. They are truly worth a few more coppers than acetate, sub-standard, jointed or cheap imports. TRY ONE AND PROVE IT YOURSELF.

Standard Play		Long Play	
3in. 150ft.	2/3	3in. 225ft.	2/9
4in. 300ft.	4/6	4in. 450ft.	5/6
5in. 600ft.	7/6	5in. 900ft.	10/6
5 1/2 in. 900ft.	10/6	5 1/2 in. 1,200ft.	13/-
7in. 1,200ft.	12/6	7in. 1,800ft.	18/6
Double Play		Triple Play	
5in. 300ft.	4/-	4in. 900ft.	13/-
4in. 600ft.	8/-	5in. 1,800ft.	23/-
5in. 1,200ft.	15/-	5 1/2 in. 2,400ft.	34/-
5 1/2 in. 1,800ft.	19/6	7in. 3,600ft.	44/-
7in. 2,100ft.	27/-	3in. 600ft.	8/6

Postages 1/- reel.
 Post Free less 5% on three reels.
 Quantity and Trade enquiries invited.
 All mail orders to DEVONIAN COURT, PK. CRES. PLACE, BRIGHTON (Tel. 680722)

SYLVANIA MAGNETIC SWITCH—a magnetically activated switch operating in a vacuum. Switch speed—4ms. temperature—54 to +200° C. Silver contacts normally closed rated 8 amps. at 120v. 1.5 amp. at 240v. 10/- each. £4.10.0 per dozen. Special quotations for 100 or over. Reference Magnets available 1/6 each.

SYLVANIA CIRCUAL BREAKERS gas filled providing a fast thermal response between 80° and 180°C. Will withstand pressures up to 2,000 lb. sq.in. rated 10 amp. at 240v. continuous. Fault currents of 28 amps. at 120v. or 13 amp. at 240v. silver contacts. Supplied in any of the following opening temperatures (degs. cent.) 80, 85, 95, 100, 105, 110, 120, 125, 130, 135, 140, 145, 150, 155, 160, 170, 175, 180, 10/- each or £4.10.0 per dozen.

MINIATURE "LATCHMASTER" RELAY 6, 12, or 24v. DC operation. One make one break, contacts rated 5 amps. at 30v. Once current is applied, relay remains latched until input polarity is reversed. Manufactured for high acceleration requirements by Sperry Gyroscope Co. Size: 7/16 in. dia. 7/16 in. high (including mount). Please state vertical or horizontal mount and voltage, £2.5.0 each.

"Parvalux" Reversible 100 RPM Geared Motor
 Type S.D. 14, 230/250v. AC 22lb/in. Standard foot mounted, variable speed, angle final drive. Removable 8-tooth chain spigot on 3/16 in. spindle. 1st class condition. £7.10.0 each. P. & P. 10/-

Transistor (U.S.A.) Tantalum, Wet Sintered Anode Polarised Capacitors: 200 UF. 25v. D.C. size: 3/16 in. long x 3/16 in. dia. 180 UF. 24v. D.C. size: 3/16 in. long x 3/16 in. dia. 150 UF. 30v. D.C. 3/16 in. long x 3/16 in. dia. 33TF. 75v. D.C. size: 3/16 in. long x 9/32 in. dia. One wire each end. All types 5/- each. Also few only Transistor "MICRO-MODULE" capacitors 0.2 Mfd. 15v. wire-ended, size: 3/32 in. dia (disc) 5/- each.

Ernest Turner 5in. x 4in. 0-1 Ma. Meters calibrated 0-10 in 50 divisions mirrored scale, handsome chrome escutcheon for flush mounting. A quality instrument. £6.10.0.

New 75-0-75 Micro-ammeter by Sifam. 750 ohm movement, clear reading, 52a divisions x 3/16 in.; plastic front, angle final drive. Removable 8-tooth chain spigot 3/16 in. (tapering forward). size: 4 1/2 in. x 3 1/2 in. 57/6 each.

Welwyn high value Resistors Type GA 36501. Values between 9.4 and 10.9 kilo-ohms ± 1%, glass encapsulated 15/-.

MINIATURE B.P.L. 500-0/500 Micro-Ammeter. 13/16 in. diam. scale. Through-Panel mounting, 45/-.

Bereo Rotary "Regavolk" variable voltage transformers input 240v. 50/60 cps., output 0-240v. C.T. at 6 amps. Not new, but in 1st class condition. Few only, £8.10.0. P. & C. 10/-.

Isolation Transformers. 1 to 1 ratio, 240v. input 240v. centre tapped out, at 2 K.V.A., mounted in metal case measuring 8 1/2 in. x 8 1/2 in. x 1 1/2 in. high. Weight 65lbs. £18.10.0, carr. £1.

Motor Driven Variable Voltage Transformers by Ohmite (U.S.A.). Input 120/240v., 50/60 c.p.s. Output 0-240v. at 480 v.a. A reversible 115v. a.c. geared motor drives the contact sweep arm in the direction required. There is a micro switch mounted at each end of the track which is cam-operated and intended to be connected as a safety-stop. First class condition. £8.15.0 P. & P. 10/-.

ELECTRO-TECH. SALES 264 PENTONVILLE ROAD, LONDON, N.1
 (ONE MIN. FROM KINGS X STATION) Tel. 01-837 7401

Where no carriage charge is indicated price is inclusive. Personal callers welcome.
 9.30-6.0 p.m. 1 p.m. Sats.

SHORT WAVES

MONTHLY NEWS FOR DX LISTENERS

Times in GMT • Frequencies in kHz

THE BROADCAST BANDS

Malcolm Connah

FOR the second month in a row I have received enough information to fill several pages. I would like to thank all those who have reported to this column and to apologise for the fact that I have had to severely edit their reports in order to include the maximum amount of information.

Reader's logs and news

Alexander Lex-Arnold of Hemel Hempstead uses a Heathkit Mohican Mk. II and a 16 foot indoor wire which enabled him to hear:

11795 WINB, Red Lion, Pa., 2115-2200 SINPO, 52533. 11855 Saudi Arabia 1935-2000 in English, 53444. 15110 WIBS, Grenada, 2005-2045 in English, 55434. 21480 RSA, S. Africa, 1800-1850 in English, 43433.

Geoffrey Gilham of London SE12 heard my plea for l.f. logs and used his Eddystone EC10 and Trio 9R59D to send in some of the best DX this month:

4680 *R. Nacional Espizo*, Ecuador 0437, 44333. 4690 *R. Reloj*, Costa Rica at 0535, 44444. 4720 *R. Clube Mindelo*, Cape Verde at 2200, 33333. 4850 *R. Mauritania* at 2030, 43443. 4865 *Ponta Delgada*, Azores at 2035, 43443. 4965 *R. Sante Fe*, Colombia at 0737, 43443. 15110 XERR, Mexico at 2339, 54444.

Mr. N. Colton of Ventnor, I.o.W. reports hearing *Radio RSA*, S. Africa on 21480 as above but also on 15250 at the same time. He has also heard *Radio Kiev* in English to West Europe at 1930-2000 on 7120 and 5920; *Radio Ghana* in English at 1445-1530 on 13930, 16790, 17870 and 21505; WNYW, *Radio New York World Wide* at 2200 on 15440. His equipment consists of a 4 valve domestic superhet and a longwire antenna.

Maurice Williams of Sleaford, Lincs. is yet another reader who has a Trio 9R59DE this time with a 20 foot base loaded vertical or a 70 foot long wire:

4967 KBS, Kuwait at 2100, 34233. 11765 HCJB, Ecuador at 2210-2300 in English, 32332. 11855 Saudi Arabia at 1830-2000, 44444. 15115 WIBS, Grenada at 2110, 45444.

Chris Stacey of Tunbridge Wells has a Lafayette HA700 and a Joystick antenna yielding:

3295 *R. Zambia* at 2009, unreadable. 4040 *R. Yerevan*, Armenia, Domestic Service at 1644. 4500 Urumchi, China with poor reception at 1552. 4775 Afghanistan in Pustu/Dari at 1611, poor. 4880 *R.TV Congolaise* at 1810, poor. 7255 VOA, Okinawa in Chinese at 1628, poor.

Richard Ellis of Stroud has a 1944 vintage Hammarlund receiver and a 49 metre 'V' dipole and heard:

11710 *R. Nacional*, Argentina at 2300-2352, 55445. 15125 ELWA, Liberia in Arabic with Eng. ID. every 15 minutes from 2130 to 2200, 54555. 17705 *Radio Havana*, Cuba at 2010-2030, 54344. 17825 NHK, Japan at 0800-0830, 33233.

Nigel Pope of Chesterfield does not seem to have much luck with his Codar CR70A and Joystick, the only station he reported was:

17705 *Radio Havana*, Cuba at 2047, 44444.

The station asked for reports and suggestions to be sent to P.O.Box 7026, Havana, Cuba.

C. Williams of London SW18 had more luck with his Codar CR45 and 40 foot end-fed antenna and heard:

11710 *Radio Australia* at 0645-0745, poor. 15185 *Radio Finland* in English at 1800-1830, strong, 21690 *UN Radio* with news in English at 1800 & 1825.

Roy Patrick of Derby reports that *HCJB, Ecuador* has placed a new 100kW transmitter into service on s.w. They plan to introduce two further 100kW transmitters in the future.

Radio Brazzaville, Congo has been heard on a new frequency of 4800, at 1915 they relay Paris with an English programme, reception is good apart from the c.w. QRM.

John Adams of Sheffield does not let us know what equipment he has but he managed to hear:

9600 approx. *R. Vilnius*, Lithuania at 2240, 55545. 17720 WINB, Red Lion, P.a., at 1800.

John W. Smith of Anstruther, Fife used his Eddystone 840C and Joystick to send in a very interesting log of Brazilian stations:

9610 *R. Tamois* at 2035-2100. 11875 *R. Soc. de Bahia*, Brazil. 15125 *R. Dif. de Soc. de Bahia*, Brazil. 15145 *R. Journal do Comercio* at 2035-2100. 15155 *R. Dif de Sao Paulo* at 2035-2100. 15370 *R. Tamois & Tupi* at 2035-2100.

News from the Clubs

The Pathfinder Radio Group (PRG) is now a special section of Euradio and has an observer on the European DX Council. Euradio accounts are via the PRG and all communications should be sent to them at 13 Little Road, Hemel Hempstead, Herts.

The International Shortwave League (ISWL), 60 White Street, Derby, DE3 1HA, now offers a reduced subscription rate of 25s. to members under the age of 18 years. It is hoped that this move will encourage young people to take an interest in the hobby at a time when they may be unable to afford the full subscription.

All reports, preferably in frequency order, should arrive at 58, Kensington Gardens, Ilford, Essex by the 17th of each month.

THE AMATEUR BANDS

David Gibson, G3JDG

THERE have been so many logs this month that it seems a good idea to get in as many as possible and let readers draw their own conclusions about the amateur bands. One or two letters have pointed out that two metres is far from dead and that the souls of long lost carriers do roam about in the 144MHz region. A few more point out that the Codar CR70A is a superhet and not a t.r.f.

D. Robbins (Warks.), draws attention to the prefix game and confesses confusion. He says that YU is now YT, UA and RA are the same, II is IØ to commemorate the founding of Rome, VK is AX and HT1HSM lives in Nicaragua but so does YN1HSM. Heard during the A.R.R.L. contest, 9E3USA who became ET3USA the following day.

J. Leaver (Lancs.), has a BC348L, a 100ft. long wire round the attic and the mains earth. Goodies bagged on topband c.w. include—DL9KRA, GD3SVK, GI3JEX, GI3RNY, GM3TMK, HB9ANW, HB9NL, K1PBW, K2GNC, OE3AX, OI3NQ, seventeen OL stations, nine OK stations, PAØNF, PAØPN, VO1FB, VO1HN, W1BB, W8ANO, WB2OZW, YU3TMX, ZB2BO, 5Z4LE/HZ. James notes hearing VO1HN coming through at 2200 calling CQ and ZB2BO at 2355 also calling CQ but getting no replies.

W. Waldron (Mon.), 840C, a.t.u. fed by a three-wire folded dipole, claims this bunch for 80 metres—CO2DR, CO2FA, CR4BC, HS5ABD, HV3SJ, K3UZE, KV4FZ, KZ5AG, MP4BFO, OA8V, OY5NS, PJ7JC, PZ1DF, TA3MQ, VO1FB, VP5TH, WB2LWH/P/VP9, W5KUC, W8KYD, 4S7PB, 4X4UF, 6Y5EM, 9H1CB, TG9EP.

D. Henbry (Sussex), KW77, 7ft. vertical at 30ft., (that could be dangerous to a low-flying gull), skewered these on 80 s.s.b.—CP1GN, CT2AC, CT2AK, EA8HA, FP8AP, HK3WO, HV3SJ, KG4AS, KP4CL, MP4BFO, OD5FA, TG9EP, VP2SY, VP2VI, VS6DO, W5GC, WB2LWH/VP9, XE1KS, XW8BP, YV5BPG, ZB2BX, 4X4UF, 5Z4KL. On 40, David hooked—CT2AC, HC2HM, HK6BRK, YV1PW, YV4YC, XE1RRK.

G. Jones (Ayrshire), GR64, 88ft. end-fed, went s.s.b.-ing on 80. Rewards include—CT1BH, CT2AK, GB2DX (?), PZ1DF, TA3MQ, VE1IE, VO1BD, VO1DE, VP1AAW, VP2VI, VP5TH, W1FRR, W5AEQ, XW8BP, 4S7PB, 4X4UH, 5Z4KL, 9H1BI, 3Z5BT.

S. Ireland (Kent), PW Clubman Mk II, 19-set variometer, 67ft. end-fed is also an l.f. enthusiast. Eighty produced—CT1VY, CO2FA, CR4BC, EA6BC, HC1RF, HK3BQM, HK3WO, HL1HN, HL1LLA, IS1DF, KG4AS, KP4CL, KZ5AE, LX1BW, OX5BJ, OA3KD, OA4ABK, TI9CE, TF5TP, scores of VE/VO/W including VE2BUP/P/VE1 on Prince Edward Is., VP2VI, VP2SY (St. Vincent), XE1KS, XE2IH, ZL4NH, ZM3LE, 9Y4MM.

No doubts about the l.f. end and v.h.f. sleuths are enthusiastic about the coming summer days, so it could be a bumper DX year.

S. Cole (Mon.), tells that ON4UN has worked over 200 countries since January 1969. Stephen claims 111 countries which include 9M, ZF, PY, 3V8 and VP9.

A. Mercer (Lancs.), no mention of a receiver or aerial so he must have mighty sensitive headphones. Twenty metres yielded—AC3DK, CN8MC, CR8AF, CRØRL, EP7BST, FG7US, KC4AA, LX1CV, MP4DDI, OA7AC, OX2EY/MM, PJ1HT, PY1AY, PZ1BC, SV1DK, TN2TJ, VK2XQ, VK7AV, VK7PN, VKØAN (Heard Is.), VP9VV, YA8RMO, YA5ZAR, YV5VX, ZS6SR, 4X4PZ, 6W8DY.

A. Crooks (Leics.), RA1 plus PR30, 45ft. end-fed, invaded twenty to discover—AC3PT (Sikkim), AX7DK, ET3USA, FP8CS (Miquelon Is.), HI8LA, JX3MN, OA4LM, OX3BE, OY3B, PY7AEW, SU1MA, TA2SC, VO1CU, W7EQB, YV5CRZ, ZB2BV, ZL3BQ.

On fifteen, Andy bagged—AX1JL, AX2AU, AX3ADO, AX4FD, AX6NM, C31AP (Andorra ?), EA8DZ, EP2JP, FG7TD, HT1HSM, IRØIJ, JW7UH, JX3MN, MP4TDA, SV1BX, TF2WKI, UAØBP, VE5TM, VP2MA, VP5GM (South Caicos Is.), VP7CG, VU2DK, W6LZV, YA1GNT, ZM3NS, 9N1RA.

M. Bayes (Surrey), 9R59DE, TV aerial (Cor, Peyton Place and ZLs), reports signals on fifteen from—AX2ADJ, AX2BAS, AX4UL, CE3FA, CT1UV, EA6BK, EA8HB, EA9EA, EL9BVZ, ET3RU, HC2GG/1, HR1WSG, IRØWRP, IT1SPI, JA1ISG, JA2GAR, JA3MNR, JA6DGN, JA7ECH, JA8ADJ, K2MKD/MM, KP4BCM, KZ5IT, LU3JS, LX1BW, OY1WP, SVØWII, TI2MGM, VE2DFY, VE3GEC, VE5TM, VE8EQI, VK2ASS, VK2FU, WA5ZUB, W61YK, 9G1GD, 9H1BH.

P. Starling (Essex), had a quick look around ten metres. His best include—K6UDR, OD5BZ, SVØWII, VE1ATJ, VE1QJ, VP2VI, YL9APB, 3V8AL, 9J2RQ.

D. Robbins (Warks.), CR70A superhet. plus 60ft. end-fed listened to s.s.b. from—HC2KF, HR2WTA, KZ5EK, LU2AHI, LU6DRB, SV1AB, VP9BK, W5NMF, W5RER, W6DLN, YV3AQ, ZC4JW, 6W8DY, 9H1BP.

G. Richards pens some strong words disagreeing with my comments about two metres. His best on this band to date are PAØCML and PAØWTE at distances of 300 and 410 miles respectively. Glyn uses a GC-1U, a JJK converter with an i.f. tuning 28-30MHz, and the aerial is a 120ft. long wire. He now has a four-over-four slot-fed yagi so things should improve. A listen on ten produced—K7TEG, VP7CG, WA6BVY/P/W6, WA6DLI, WA6GRQ, WA6UAG, WAØTOF, 9J2DT all s.s.b. On a.m.—UA9KMK, VE5VV, W7RSP, YV3MC.

“What about some six metre logs?” queries **F. Smales** (Yorks). This band is used by American amateurs and ranges from 50-54MHz. Using a National NC155 with a four-element broad-band beam, the following were logged on six metres—WA1BSR, W2ERV, W3FAU, W3FET, W4OGX, W4OSJ, W9EKP, W9BGX.

Still a large proportion of mail received asks about the various prefixes and where can a list be found. So, for all those who are thinking about asking the question, here's the answer. Send 1s 4d to the Radio Society of Great Britain, 35 Doughty Street, London, W.C.1., and ask for a “Countries List”. Incidentally, it pays to get a new one each year, just to try to keep track of all the changes.

Goings on in April include: April 5th., 80 metre low power contest; 11-12th., 4 metre open contest; 19th., North Midlands Mobile Rally; 26th., DF qualifying event (good fun these if you like streaking about the countryside with a small d.f. portable).

DISCOSOUND

NEW DISCOSOUND PRE-4

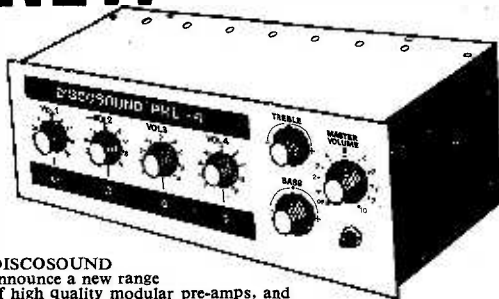

DISCOSOUND announce a new range of high quality modular pre-amps, and main amplifiers which offer a wide range of facilities to suit all types of applications.

Model Pre-4. This is a four channel fully mixable pre-amp, with separate treble, bass and master volume controls, and is completely self powered. All four inputs are by standard jack socket on the front panel with the addition of inputs 3 and 4 being duplicated on the back panel, with two paralleled outputs also featured for versatility in use.

Specification:

Inputs.	Vol. 1.	10 mv at 50k Ohms	} Other Impedances can be made to special order.
	Vol. 2.	10 mv at 50k Ohms	
	Vol. 3.	50 mv at 500k Ohms	
	Vol. 4.	50 mv at 500k Ohms	

Frequency Response: 30—20,000 HZ \pm 3db.

Signal/Noise Ratio: -65db.

Bass: continuously variable 20db. at 100 HZ.

Treble: continuously variable 20db. at 10 KHZ.

Output: variable up to 1 volt RMS at 25k Ohms.

Size: front panel 12 $\frac{1}{2}$ x 5 $\frac{1}{2}$ cut out required 11 $\frac{1}{2}$ x 4 $\frac{1}{2}$.

Completely built and tested.

PRICE £18.0.0 inc. P. & P.

NEW DISCOSOUND 70 MAIN AMPLIFIER

This is a 70 watts RMS (8 Ohms) High Fidelity power Amplifier which utilises all silicon transistors of modular construction and features, full automatic overload protection against short or open circuits. The High output is ideally suited for discotheques, groups, clubs, etc., or anywhere where reliability and quality are required. This unit is the companion model for use with our control pre-amp Discosound PRE-4, or can be used with any other high quality pre-amp control unit.

Specification:

Power Output: 70 watts RMS into 8 Ohms.

Frequency response: 20—20,000 Hz \pm 2db.

Harmonic distortion: less than 0.5% at 70 watts RMS.

Input Impedance and Sensitivity: 700 mv at 20-30k Ohms.

Size: 7" x 9" x 6".

Completely built and tested on steel Chassis.

PRICE £30.0.0 inc. P. & P.

DJ 30L PSYCHEDELIC LIGHT CONTROL UNIT

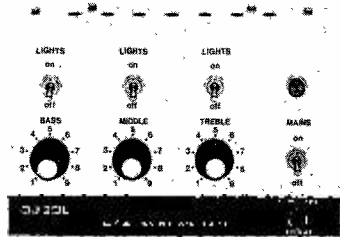

3 channel light control unit that handles up to 1,000 watts per channel. Separate bass, middle and treble controls for full frequency separation.

Completely built and tested.

PRICE £37.10.0 inc. P. & P.

NEW DJ 70S INTEGRATED MIXER-AMPLIFIER

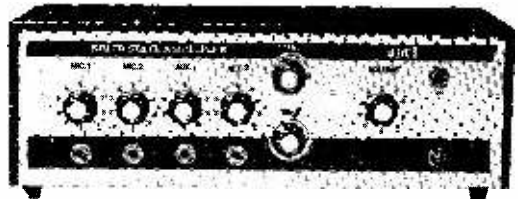

One of the finest units available on the market today, regardless of price. The front end of the unit consists of a four channel mixer with separate inputs and volume controls, plus a separate bass, treble and master volume control. One of the main features of this remarkable amplifier is its elaborate protection against short and open circuit and we can guarantee that it is virtually indestructible. Allied to this is its very high power output, a frequency response that is superb, and distortion that is well below 1% even at full output. The unit is suitable for use with discotheques, groups, P.A., clubs etc., or anywhere that high quality high output is required.

SPECIFICATION

Power output 70 watts R.M.S. \pm 1db at 8 ohms

Frequency response 30-20,000 HZ \pm 3db.

Signal/noise ratio Better than -65db at full output.

Harmonic distortion Less than 1% at full output.

Inputs 1 & 2 -MIC 8 mV at 50k ohms.

3 & 4 -AUX 50 mV at 1 meg ohm.

50 or 600 ohm mic Inputs can be ordered at extra cost to special order.

Bass Continuously variable 20db at 100HZ

Treble Continuously variable 20db at 10KHZ

Size 15 $\frac{1}{2}$ in x 5in x 6in.

PRICE £55.0.0 inc. P. & P.

Also available DJ105S 30 watt P.A. Amplifier. Similar specification to above.

PRICE £35.0.0 inc. P. & P.

For full details of these and all Discosound Products write direct to:—

DISCOSOUND, 122 BALLS POND ROAD, LONDON, N.1. Tel: 01-254 5779

Full money back guarantee if returned within 10 days.

All Discosound Products are guaranteed for 12 months.

Demonstrations given at any time.

AUDIO AMPLIFIERS



16 Transistor and Valve Designs for the Home Constructor

Amplifiers for Tuner Units, Record Players, Tape Recorders, Public Address, etc., etc.

Includes contributions by such well-known authors as

A. S. Carpenter, A. Kinloch, E. Govier, G. A. French, F. G. Rayer, P. F. Bretherick, K. Jones, D. Aldous, R. Murray-Shelley, C. Swires, G. A. Stevens and V. E. Holley.

Edited by J. R. Davies

124 pages

PRICE 10s. 6d.

Postage 8d.

To: **DATA PUBLICATIONS LTD.,**
57 Maida Vale London W9

Please supply copy(ies) of
"Audio Amplifiers", Data Book No. 18

I enclose cheque/crossed postal order
for

NAME

ADDRESS

BLOCK LETTERS PLEASE

AUDIO EFFECTS

5 SHAW LANE, HALIFAX YORKS

Buy with confidence and obtain the right results. Refunds without question if any of our products fail to give 100% satisfaction.

AMATEUR BAND ALL TRANSISTOR SUPERHET RECEIVER KIT. No fuss, no drilling. Just fit the components on our printed circuit. Slow Motion tuning. Simple IF alignment. Perspex front panel. Push pull AF amp drives your 8-15 ohm speaker. Amp can be used separately. Designed to accept a BFO signal. Uses Denco plug in coils 2T. 0.5 to 1.54 Mhz 3T. 1.67 to 5.3 Mhz 4T. 5.0 to 15 Mhz 5T. 10.5 to 31.5 Mhz Range 3T normally supplied with kit. Uses 9 volt battery. Easy step by step instructions. Complete Kit. £8.19.6 plus 5/6 P. P. & Ins. Extra ranges 12/- per range.

POWER CONTROLLER. Power at your finger tips. Not merely half watt control over full wave. A single variable control gives zero to full power. Uses latest 15 amp 3kW triac and special triggering device. Ideal for all types of lighting, fires, motors, drills, etc. Complete with box, power socket, cables, etc. In kit form with easy to follow instructions £6.9.6. Ready built £9.4.6 plus 5/6 P. P. & Ins. **REVERBERATION AMPLIFIER.** Self contained transistorized, battery operated. An entirely different approach to sound reproduction. Normally, sound reproduction from a single source, has a flat one dimensional effect. With this unit, proper sound delay through reverberation, ones, are created with a truly third dimension for concert hall originality. Two controls adjust volume and reverberation. Simply plug microphone, guitar, etc., in, and the output into your amplifier. Supplied in a beautiful walnut cabinet 7 1/2in x 3in x 4 1/2in. £10.4.0 plus 6/- P. P. & Ins.

VOX SWITCH. This sound operated switch is ideal for mobile TX work, tape recorder switching, etc. You speak, it switches. High and medium imp. inputs. AF take off point. Drives your 12 volt relay. In kit form with full instructions 42/6. Ready built, tested and guaranteed. 62/6, plus 2/6 P. P. & Ins. **METRONOME UNIT.** Variable beat. Listen while you play and keep in time. Easily built, pocket size with personal mini earphone. In kit form 27/6, post paid. Ready built in an attractive black and white polystyrene case. 37/6 post paid.

MORSE OSCILLATOR. PC board, transistors, high stab. components, battery carrier, ear piece. Adjustable tone. Just attach your key. Drives phones or speaker. In kit form 17/6 post paid. Ready built in similar case as above 25/- post paid.

STRAIGHT FROM THE PRESS. Latest Mullard manual: Audio Amps, FM tuners. Stereo decoder. Receiver circuits, Hi Fi Tape, etc. etc. 32/6 post paid. **JUST ARRIVED IN STOCK.** Texas transistors. Complementary symmetry. Driver. NPN. PNP output. The set of three **ONLY 6/6 post paid.** Free lists with every order. For lists only send 1/6 (deductible from first order).

NEW VALVES!

Guaranteed and Tested
24-HOUR SERVICE

1R5	5/6	DL04	5/9	EL84	4/9	PL504	13/3
1R5	4/3	DL66	7/-	EY61	7/-	PY32	10/-
1T4	2/9	DY86	5/3	EY86	6/3	PY33	10/-
3B4	5/9	DY87	5/3	EZ80	4/3	PY81	5/-
3V4	5/9	EABC80	5/9	EZ81	4/6	PY82	5/-
6/20L2	11/6	EBC33	7/8	KT81	9/8	PY83	6/6
6A45	4/2	EB241	9/3	KT86	16/8	PY88	6/6
6V6G	3/-	EBF80	6/-	N78	17/-	PY800	7/-
25L6GT	4/6	EBF89	5/9	PABC80	6/9	PY801	6/9
30FL1	13/9	ECC81	3/6	PC86	10/3	R19	6/3
30FL12	14/8	ECC82	4/-	PC88	10/3	U25	12/9
30P4	11/6	ECC83	4/9	PC900	7/-	U26	11/6
30P19	11/6	ECC85	5/-	PC84	8/9	U191	12/-
30PL1	14/6	ECH85	5/6	PCO89	8/11	U193	8/6
30PL13	16/9	ECH81	5/9	PCF90	5/11	U251	14/-
CCH35	13/-	ECL80	6/6	PCF801	6/6	U301	10/-
CL33	17/6	ECL82	6/3	PCF802	8/9	U329	14/-
DAC32	6/9	ECL83	8/-	PCL82	6/9	UABC80	6/-
DAF91	4/3	ECL86	7/6	PCL83	11/9	UB41	8/3
DAF96	6/9	EF87A	6/-	PCL84	7/-	UBF89	8/3
DF33	7/6	EF89	4/6	PCL85	8/6	UC85	7/3
DF91	2/8	EF80	4/6	PCL86	8/-	UCH81	6/6
DF96	6/9	EF85	5/9	PFL20011/-	-	UCL82	6/9
DK32	6/9	EF86	6/3	PL36	9/3	UF41	10/6
DK91	5/8	EF89	4/9	PL51	8/-	UF89	6/-
DK92	5/8	EF83	7/6	PL82	5/9	UL11	11/9
DK96	7/3	EF184	5/3	PL83	6/3	UL84	6/3
DL55	4/9	EH90	6/-	PL84	6/-	UY41	7/-
DL92	5/9	EL33	9/3	PL500	12/9	UY85	5/3

Postage on 1 valve 9d. extra. On 2 valves or more, postage 6d. per valve extra. Any insured parcel against damage in transit 6d. extra. Office address, no callers.

GERALD BERNARD

83 OSBALDESTON ROAD
STOKE NEWINGTON.
LONDON, N16

MARCONI CR 150/2 DOUBLE CONVERSION SHORT WAVE RECEIVERS, frequency 1.5-22 mc/s. Features are as follows: Fitted 's' meter, geared tuning with no backlash, 2 speed motion, slide rule dial, calibrated in M/Gs, logging scales for accuracy. 500 Kc/s Xtal Calibrator, mechanical bandspread. Technical description. 1st LF is 1.6 Mc/s 2nd LF 465 with Xtal filter giving a passband from 100 c.p.s. to 10,000 c.p.s. BFO Variable 3-3 Kc/s. Reheats 1F0/p, DF input, split teleprinter 8/p; output 600 ohms and 3 ohms for LS Front end has 2 R.F. stages of amplification giving a sensitivity of 2-4 µv depending on band in use. Separate mixer/oscillator. 2nd oscillator is also variable 5-0.5 Kc/s bandspread. A separate power supply is needed to power the above set at 300v at 100 MA and 6.3v 4 amps Lr. AC/DC circuit connection supplied to purchasers of this very fine receiver. These RXs are not new but are in quite good condition and tested on despatch. Unrepeatable offer. Circuit supplied. Price **£22.10.0** plus 50/- p.p.

RE99 RECEIVER AM/GW/FM 1-20 Mc/s Four bands. Vernier tuning, 12 volt DC input. Tested and working. Price **£13.0.0** plus £1 p.p.

COMPUTER BOARDS Min 30 transistors and diodes and res. etc. 10 boards at 10/- plus 2/6 p.p.; 25 boards at £2/6 plus 4/6 p.p.

HEADPHONES Chamois padded, low impedance. Moving coil, magnetic microphone new, ex W.D., rare type, limited stock. 25/- per pair plus 3/6 p.p. Also used and checked DLR5 headphones, balanced armature type. 12/6 per pair plus 2/6 p.p.

AERIALS new condition, extending to 11 ft. fully open: whip type: 12/6 each plus 3/6 p.p. Whip aerials, 12ft. collapsible type; used condition: 10/- each plus 3/6 p.p. Bases for above 5/- each plus 2/6 p.p.

BARGAIN PARCELS 14lb at 29/- plus 6/6 p.p.: 28lb at 55/- plus 12/6 p.p.; 56lb at 90/- plus 25/- p.p. Contain pots, Res. Valves, Diodes, Tagboards, Chassis, Valveholders, etc. Good value save £££. Lucky Dip Service.

FURZHILL BEAT FREQUENCY OSCILLATOR 0-10 kc/s. 110/250 volt. Good condition complete with spares. **£25.10.0** plus 25/- p.p.

VHF Receiver, Type 715, less crystal 60-100 Mc/s can be operated on 2 or 4 meters or made tunable 12 volt input, not tested; complete with valves and speaker. **£30.0.0** plus £1 p.p.

VIBRATOR POWER SUPPLY TYPE 69 for BCC for 69T/R. Small compact 12V input gives 250V DC at 80MA and 12V output. Good condition. 25/- plus 7/6 p.p.

MOBILE POWER UNITS by PVE for the G12 T/R. Power output is 400V DC at 140MA and 300V DC at 100 MA Good condition. **£3.10.0** plus £1 p.p.

INSULATION TESTERS. Bench or fieldwork; speed clutch, new condition, complete with leather case; 500V, 500 megohms. **£20.0.0** plus 12/6 p.p. Also 1000V 1000 megohms with case. **£23.0.0** plus 12/6 p.p.

CRYSTALS AS NEW: Hc 6u, 5,345; 5,055; 5,030; 5,005; 4,945; 4,875; 4,840; 4,795; 4,680; 4,660; 4,520; 4,510; 2,300; 2,295 Kc/s and 10 x 3465 Kc/s.

10/- each plus 1/6 p.p. **METERS MOVING COIL EX-EQUIPMENT** Good condition; all from 0.10 ma 30mA 50mA., 100mA, 500mA, All 2 1/2in. round. 10/- each plus 1/6 p.p. From 15 amp D.C., 20 amp D.C., 40 amp D.C., All 2in. round. 10/- each plus 1/6 p.p.

SCOOP PURCHASE OF BRAND NEW CARBON RESISTORS 10% tolerance 1/2 & 1 watt. Preferred values in packets of 10. Our price 10/- per 100, 18/- per 200, 27/- per 300, 500 at 42/6. Our selection. Pp. 1/6 per 100 and 6d. per extra 100.

TRIMMER BARGAINS. These are 10PF sub-min. airspaced trimmers on board with min. wire ended Xtal. Brand new. No details; Contents 12 trimmers, some ceramic caps. Xtal frequency 3RD overtone 249 mc/s - 250 Mc/s, 255 Mc/s. No choice. Trimmers without Xtal 12/- per doz plus 3/6 p.p. Trimmers with Xtal 15/- per doz plus 3/6 p.p. Also 20 PF min. brand new air spaced. 10/- per doz plus 3/6 p.p.

SIGNAL GENERATORS OSCILLATOR NO. 2. Size 12in. x 8 1/2in. x 9in. Ideal for VHF work. 20-80 Mc/s. Functions are AM/CW. Deviation up to 40 Kc/s RF meter. Measuring levels; RF output 1 µ microvolt to 100 microvolts set. Mod-set carrier controls. Good condition with accessories; 230V AC 12V DC. **£20.0.0** plus 15/- p.p.

TF 144 G Signal Generators 85 Kc/s to 25 Mc/s Good condition and complete with accessories. **£22.0.0** plus 30/- p.p.

Rf Thermo Couple Meters. New and boxed. 0-1 amp. 2in. diameter. **17/6** plus 4/- p.p.

MAINS MOTOR 250 volt AC; 1/40th H.P. at 1,500 R.P.M. Ex W/D type; Size 6in x 4in. Tested and in good condition. **85/-** plus 7/6 p.p.

TELESCOPIC MASTS. New condition, 20ft closes to 5ft 9in 90/-, cartage 15/-, 34ft closes to 5ft 9in 120/-, cartage 15/-. Used condition, 20ft 70/-, 34ft 80/-, cartage 15/-, Base for same 20/-, cartage 7/6.

VIBRATORS - 4 pin, 12 volt DC in good condition. Non Syncr Type N8 12 **5/-** each plus 1/- p.p.

A. H. THACKER,

Radio Dept.

HIGH STREET, CHESLYN HAY.
Nr. Walsall, Staffs.

C.W.O. Carriage charges to Mainland only.

Callers welcome at anytime during the week and on Saturdays from 9 a.m. till 3 p.m. and Sundays 11 a.m. - 12.30 p.m.

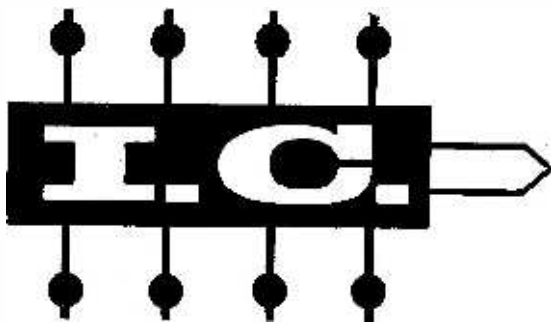

OF THE MONTH

L.A.J. IRELAND

Number 7 The R.C.A. CA3052 with 4 Amplifiers

There are many quality high power audio amplifiers on the market nowadays such as the Sanken SI-1020A model with a power output of 25 watts which may be purchased at a fairly reasonable price but they nearly all require an external preamplifier stage before they can be driven to their full output power. Very few microphones or pick-ups are capable of producing an output signal in the region of 300mV which is the usual level required for such amplifiers and so the constructor is faced with the problem of building a suitable preamplifier. Another consideration is the necessity for having more than one input facility

and this together with the associated volume and tone controls very often make the preamplifier and mixer unit more expensive than the main amplifier.

One of the newer types of IC's recently released by RCA, CA3052, provides in a 16 lead dual-in-line package four independent A.C. amplifiers. A schematic diagram showing one of the amplifiers is given in Fig. 1 together with a block diagram indicating the pin configuration of the various amplifiers. It can be seen by referring to Fig. 1 that a choice of input impedances is provided. By feeding the input signal to the Darlington pair Tr1, Tr2 via pin 9, a medium input impedance of about 90kΩ is obtained while alternately pin 10 offers an input impedance in the region of 50Ω. The amplified signal appearing at the collector of Tr2 is further amplified by Tr4, Tr5 and Tr6 with the output taken from pin 11, the collector of Tr6, via an external capacitor. A degree of negative feedback is applied to the base of Tr3 by the resistor chain from pin 11.

Tone Control Unit

Ideally tone control circuits should be placed, electronically speaking, as close to the loudspeaker as possible but in actual practice this is impossible as the main amplifier would need to handle all input signals without overloading. Most quality amplifiers compromise and place volume and tone control circuits after the preamplifier stage. The CA3052 provides this facility for the constructor who wishes to make a high quality stereo preamplifier with a signal to noise ratio greater than 70dB. Fig. 2 gives the theoretical diagram and component values for one channel. Two amplifiers are used in each channel since the equalisation and tone control circuits reduce the overall gain of the first stage by about 30dB.

Mixer Unit

The average constructor, however, is not concerned with looking for such high quality reproduction and would consider the use of the two preamplifiers as rather wasteful. To locate the volume and tone controls at the input to the amplifier will be quite adequate and a signal to noise ratio of about 50dB obtainable by this mode of operation is acceptable. Consequently, each amplifier can then be utilised separately to provide a four-channel mixer. Used in this way only a handful of passive components

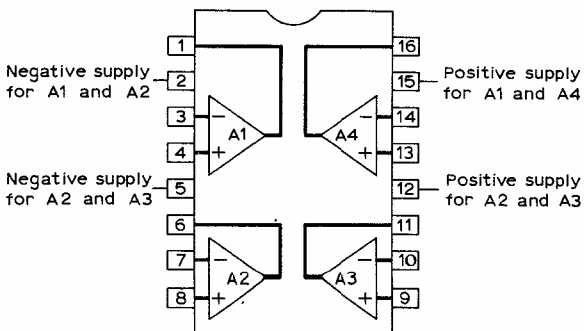
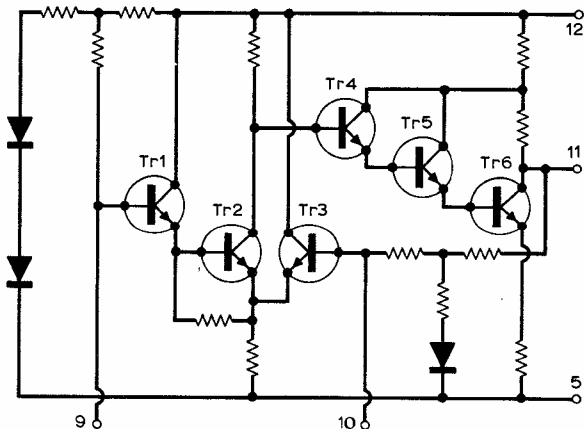
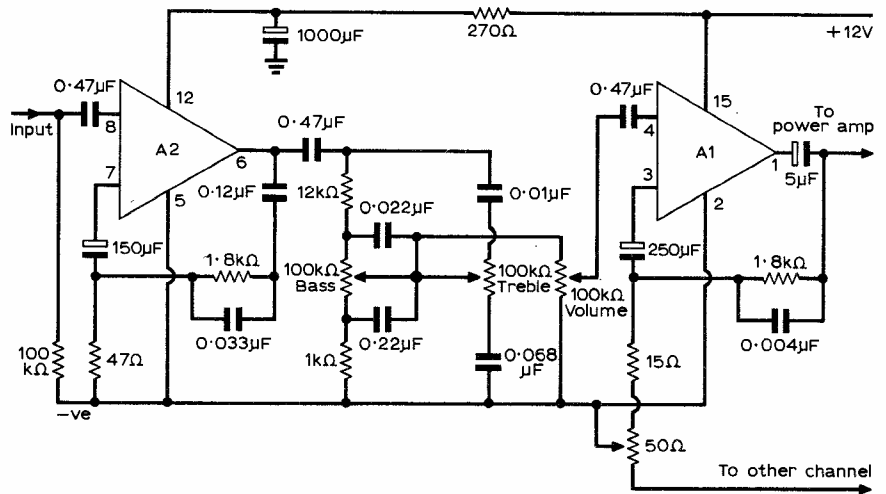

Fig. 1 : top : Schematic diagram of a single amplifier.
bottom : Pin connections for the four amplifiers.

Fig. 2: Circuit for a tone control unit utilising two of the amplifiers for one channel of a stereo preamplifier.



is required for each amplifier and a reasonable quality four-channel mixer can be built for under £4. Fig. 3.

Another interesting feature of the CA3052 is its use as a tremolo unit as shown in Fig.4. The tremolo effect is obtained by amplitude modulating

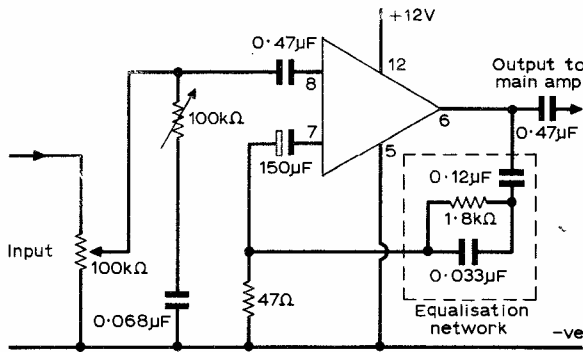

Fig. 3 : One channel of a four channel mixer.

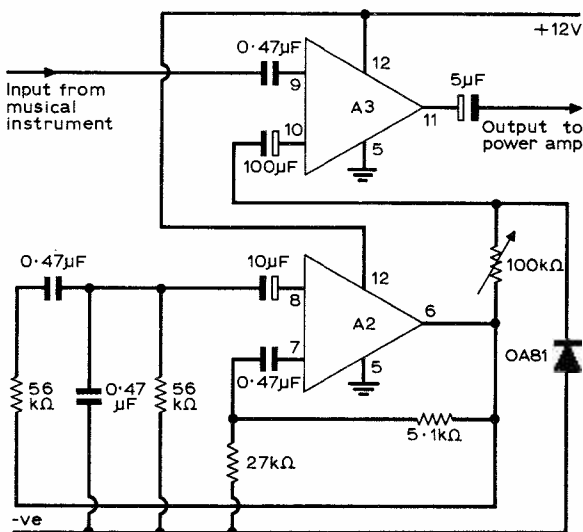

Fig. 4 : Circuit for a tremolo unit.

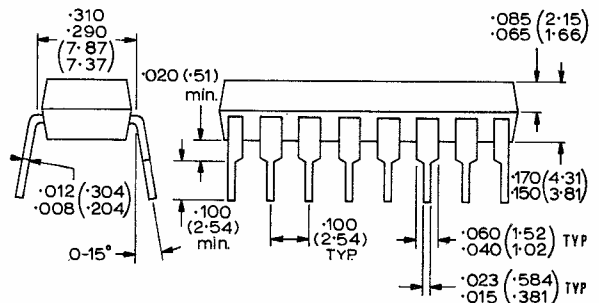

Fig. 5 : Outline dimensions of the i.c.

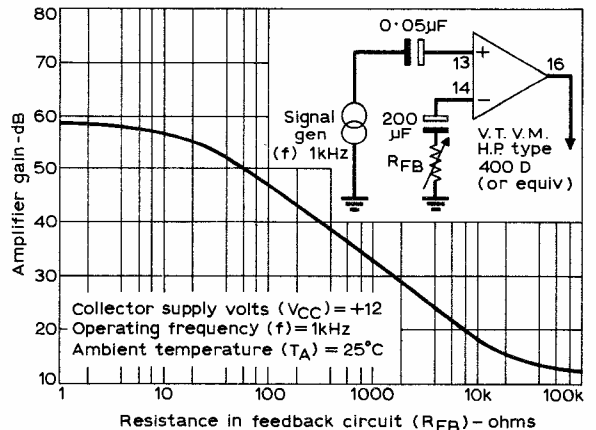

Fig. 6 : Graph showing variation of gain with change in feedback resistance.

the signal from a musical instrument at a very low frequency, typically under 10Hz. In the diagram amplifier No. 2 is used as a Wien bridge oscillator running at a frequency of 5Hz. Its output is fed through a 100kΩ variable resistor acting as a modulation depth control, to the preamplifier stage No. 3. The output is taken to the power amplifier through the 5μF capacitor. This arrangement can, of course, be duplicated with the other two amplifiers in the IC or they can be used as two independent amplifiers.

4! brings you a mountain of components at manufacturers' prices

The serious amateur should never be without this comprehensive price list and guide to semiconductors and electronic components from RCA, IR, SGS, Emihus, Semitron, Keyswitch, Plessey, Morganite, Litesold and others (together with manufacturers' application data) which you can buy direct from us at *manufacturers' prices* e.g. IN914 1/3d.
 IN916 1/11d. 2N697 4/5d. 2N706 2/3d. 2N706A 2/9d. 2N929 5/8d.
 2N1613 4/8d. 2N3011 9/1d. 2N3053 6/2d. 2N3055 15/9d. 3N140 15/3d. BFY50 4/8d. BFY51 3/9d. BSY27 18/- BSY95A 3/3d. C407 4/6d. CA3012 18/3d. CA3014 25/6d. CA3020 25/9d. OA200 1/9d. OA202 1/11d.



Build the NEW Mainline Audio Amplifier kits - UP TO 70 WATTS

The result of the combined resources of SGS and RCA, these quasi circuits set new standards in quality and performance. Each kit is complete with circuit diagram, all semiconductors, resistors, capacitors and printed circuit board.

12A	£7. 0. 0.
25A	£8. 5. 0.
40A	£9. 0. 0.
70A	£10.10. 0.

Any two will make an outstanding stereo equipment.



To: Mainline Electronics Limited, Thames Avenue, Windsor, Berkshire

I enclose 4/-. Please send me your price list and guide

I am interested in Amp Mainline Audio Amplifier Kits. Please send me full data

I am interested in receiving data on preamplifier & power supply kits

NAME _____ ADDRESS _____

(A member of the ECS Group of Companies)

PW5

R.S.T. VALVE MAIL ORDER CO.

BLACKWOOD HALL, 16a WELLFIELD ROAD, STREATHAM, S.W. 16

Mon.—Sat. 9 a.m.—5.30 p.m.
Closed Sat. 1.30—2.30 p.m.
Open Daily to Callers

Tel. 769-0199/1649

1A7	7/9	6BR8	12/6	6K7GT	4/6	10C1	12/6	2SL8GT	7/-	1502B	11/6	DK39	7/9	ECH85	11/6	EY61	8/-	PCC189	10/6	R2	7/6	UF41	10/6
1D5	7/6	6BR7	25/-	6R8	2/6	10C2	12/6	25Y5	6/-	150C4	4/6	DK91	6/-	ECH42	12/6	EY86	7/-	PCB80	6/6	R19	7/9	UT89	7/6
1H5	7/-	6BW6	14/6	6K8M	11/6	10F1	14/6	25Z4	6/3	801	9/-	DK92	9/-	ECH51	5/9	EZ35	6/-	PCF82	6/6	RG5/500	80/-	UL41	12/-
1LD5	6/-	6BW7	13/-	6K8G	3/-	10F3	13/-	26Z5	8/-	807	9/-	DK96	7/-	ECH83	8/6	EZ40	8/6	PCF84	8/-	S130	40/0	UL84	7/-
1N5GT	8/-	6C4	5/-	6K8GT	7/-	10F9	10/6	25Z6	7/8	813USA	8/6	DL66	25/-	ECL80	5/9	EZ41	9/6	PCF86	9/-	SP4	3/0	UM80	5/6
1E5	6/-	6C5G	5/-	6K25	15/-	10F18	8/-	28D7	9/3	813	120/-	DL92	6/-	ECL82	7/-	EZ80	5/6	PCF801	9/9	SP41	5/6	UT8	21/-
1S4	5/6	6C8	3/8	6L1	12/-	10G1	8/6	30C1	6/3	813	75/-	DL93	4/-	ECL83	10/8	EZ81	5/6	PCF802	9/0	SP61	5/7	UT8	21/-
1S5	4/6	6C8G	6/-	6L6G	7/9	10LD11	13/6	30C15	15/-	866A	8/6	DL94	6/9	ECL86	9/-	EZ501	10/-	PCF808	12/-	STV280/80	6/0	UT8	21/-
1T4	4/6	6CD6G	24/-	6L18	6/-	10P13	13/6	30C17	16/-	954	5/3	DL95	7/8	PCF800	30/-	EZ32	10/-	PCF1088	15/6	SU25	19/6	UY21	9/6
3A4	4/-	6CH6	7/6	6Q7G	6/-	11E3	7/9	30C18	15/-	1625	6/6	DL96	7/8	EF9	20/-	EZ34	11/-	PCL82	7/9	SU2150	12/6	UY41	8/6
3Q4	7/9	6COW4	12/-	6Q7GT	8/6	12AT6	4/9	30F5	17/-	4022AR	8/6	DM70	6/-	EF9	20/-	EZ37A	7/-	HN809	22/6	PCL83	10/8	T41	17/6
3Q5	7/-	6D6	3/9	68A7M	7/-	12AT7	6/-	30FL1	18/-	5763	12/-	DY86	6/-	EF37A	7/-	KT36	18/-	PCL84	8/8	TDD4	8/6	VMP4G	17/6
3S4	6/3	6E5	7/9	68C7	7/-	12AT8	5/9	30FL12	16/8	7198	2/-	DY87	12/-	EF41	12/-	KT63	17/6	PCL85	9/3	U10	7/6	VP4B	25/-
3V4	6/9	6F1	12/6	68G7	6/-	12AU7	5/9	30FL14	15/8	7475	14/-	E88C	6/6	EAF50	3/6	KT66	21/-	PCL86	9/8	U14	7/6	VB105/30	6/6
5B4GY	10/6	6F5G	5/-	68H7	3/3	12AX7	6/3	30L15	17/-	A61	8/6	EAF50	3/6	EF80	4/3	KT81	35/-	PD500	29/19	U19	35/-	VR150/30	6/6
5U4G	5/6	6F6G	6/-	68J7	6/-	12BA6	6/3	30L17	17/-	ATP4	2/3	EABCS0	6/6	EF80	4/3	KT81	35/-	PD500	29/19	U19	35/-	VR150/30	6/6
5V4G	8/-	6F8G	5/6	68K7GT	4/9	12BA6	6/3	30P4	15/-	ATP5	15/-	EAF42	10/-	EF85	7/-	KT81	(7C5)	PEN4A	20/-	U25	15/6	VT25	15/-
5Y3GT	6/-	6F11	6/6	68L7GT	6/-	12C8GT	5/-	30P12	16/-	ATP7	2/6	EAF41	10/-	EF86	6/6	KT85	22/6	PENB4	20/-	U26	15/6	VT31	80/-
5Z4G	7/-	6F13	6/6	68N7GT	5/6	12E1	20/-	30P19	15/-	AU2	8/9	EB91	3/6	EF89	5/6	KT88	34/-	PEN46	7/-	U78	4/6	VU111	8/9
6/301L2	15/6	6F14	12/6	68Q7	7/6	12J5GT	2/6	30P11	19/-	AU5	8/9	EB93	3/6	EF91	2/9	KTW61	8/6	PEN46	4/6	U191	13/9	VU120	12/6
6A7	15/6	6F23	16/-	6U4GT	12/-	12J7GT	2/6	30P13	18/6	AZ1	8/6	EB94	10/6	EF92	2/8	KTZ41	6/-	PL36	10/9	U251	16/3	VU508	35/-
6A8G	12/6	6F24	14/-	6U5G	7/6	12K7GT	7/-	30PL14	15/-	AZ31	10/-	EBF90	4/9	EF98	15/-	ML4	17/8	PL81	8/6	U301	12/6	W81M	13/6
6A07	4/-	6F25	15/-	6V6M	12/6	12K8GT	7/-	35A5	11/6	EBL31	16/-	EBF90	7/8	EF183	6/6	ML6	7/6	PL82	8/6	U403	6/6	XH1-5	5/-
6AK5	4/-	6F28	14/-	6V6G	4/6	12Q7GT	6/-	35L6	9/6	OCB35	15/-	EBF83	9/-	EF184	7/-	MSP4	10/-	PL83	7/6	U404	7/6	XPI-5	5/-
6AM5	4/6	6F32	2/9	6V6GT	6/6	19S47	8/-	35W4	4/6	CL33	20/-	EBF89	6/6	EL32	3/6	MU14	7/6	PL84	7/6	U801	23/6	XSG1-5	110/-
6AM6	3/6	6G6	2/6	6X4	4/6	19S67	6/6	35Z4	10/-	CV450	25/-	EBL1	14/-	EL38	12/6	MX40	12/6	PL500	14/6	UABC80	6/6	Y63	7/6
6AQ3	6/3	6H6	3/-	6X6G	4/6	19SHT	3/6	35Z4GT	8/6	CY30	12/6	EBL21	12/6	EL34	10/8	N78	19/-	PL508	22/6	UAF42	10/6	Tubes	7/6
6A87G	16/-	6J5M	9/-	6X5GT	6/-	19S7	3/9	35Z5	6/-	CY31	8/6	EBL31	27/6	EL38	22/6	N108	25/-	PL509	29/-	UBC41	9/6	SBGI	65/-
6AT6	4/9	6J5G	4/-	7B6	11/6	19S7K	4/9	37	6/6	DAC32	7/-	EC90	5/-	EL41	10/6	NGT1	3/6	PL802	16/6	UBCR1	9/3	3FP7	29/-
6AU6	5/-	6J5GT	5/6	7B7	7/6	19S87	5/-	42	6/-	DAP91	4/6	ECC81	6/-	EL42	10/6	NGT7	55/-	PX4	14/6	UBF80	7/6	5CP1	65/-
6B4G	20/-	6J6	3/6	7C5	22/6	14H7	9/6	50B5	6/6	DAP96	7/6	ECC82	5/8	EL84	4/9	OA2	6/-	PY33	10/9	UBF89	7/6	CV1528	40/-
6B5G	2/-	6J7M	8/6	7C6	15/-	19A95	5/-	50C5	6/3	DCC90	10/6	ECC83	6/8	EL85	6/8	OC3	5/-	PY81	5/9	UCC84	8/6	ACR131	100/-
6B45	5/-	6J7G	6/-	7D3	8/6	50D1	10/-	50DG	31/-	DF39	8/6	ECC84	5/6	EL88	20/-	OZ4	4/6	EY82	4/9	UCC85	7/6	VT65	100/-
6B8E	5/-	6J7GT	7/6	7H7	6/6	20P2	14/-	50L6GT	5/-	DF70	9/-	ECC85	5/-	EM34	21/-	PC88	11/8	PY33	7/-	UCF80	8/6	VCR97	85/-
6BH6	9/-	6K5GT	5/-	7H7	13/-	20L1	20/-	75	9/8	DF91	4/6	ECC88	7/8	PC88	11/8	PY500	18/6	UCH42	10/6	UCH42	10/6	VCR517B	46/-
6BJ6	9/-	6K7	1/9	787	45/-	20P4	20/-	78	5/-	DF92	3/6	ECC90	6/6	EM81	8/8	PC97	8/9	PY500	29/-	UCH81	7/-	46/-	46/-
6BQ7A	7/-	6K7M	6/6	7Y4	8/6	20P5	20/-	80	7/8	DF96	7/6	PCF82	6/6	EM84	7/6	PC84	6/6	PY800	9/6	UCL82	8/9	VCR517C	46/-
6BR7	17/-	6K7G	2/-	93W6	7/-	25A6	5/9	86A2	7/8	DH77	4/6	ECHR21	12/6	ESU160	20/-	PC89	10/9	PY801	9/6	UCL83	10/-	46/-	46/-

Manufacturers and Export Inquiries Welcome

OBSOLETE TYPES A SPECIALITY

QUOTATIONS FOR ANY VALVE NOT LISTED

Express postage 9d. per valve.

Ordinary postage 6d. per valve. C.W.O. No C.O.D.

Tube postage 7/6 each

Special Express Mail Order Service

TUBES			
14 inch	..	24	0 0
17 inch	..	24	5 0
19 inch	..	26	0 0
21 inch	..	26	10 0
23 inch	..	212	0 0
27 inch	..	28	0 0

SETS OF VALVES
DAF91, DF91, DK91, DL92 or DL94 19/- plus postage
DAF96, DF96, DK96, DL96 27/6 plus postage

TRANSISTORS									
AC127	5/-	OC25	7/8	OC71	3/0	OC81	4/-	OC83	4/6
AF114	5/-	OC28	12/6	OC72	4/6	OC81D	3/0	OC170	5/6
AF115	5/-	OC35	6/3	OC75	4/6	OC81DM	3/0	OC171	6/-
AF116	4/8	OC44	4/6	OC76	3/0	OC82	3/0	OC200	5/6
AF117	4/6	OC45	2/6	OC77	4/6	OC82D	3/0		

SEND S.A.E. FOR LIST OF 3,000 TYPES

TAPE AMPLIFIER FOR MAGNAVOX TAPE DECKS - 4 TRACK

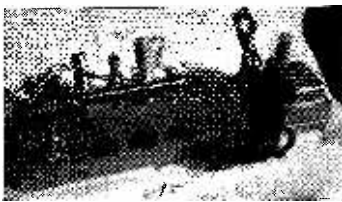

Chassis 12½ x 5½ x 4¼ in. high. Plastic front panel finished in Black and "Silver". 200-250 A.C. Record/Playback amp. switch: Off/On-Tone; Vol./Mc.; Vol./Gram; Mic. Input; Gram. Input; Valves 6BR7, 12AX7, EM54, EL84 and EZ80. Separate Output Transformer (Already wired to amp). PRICE £12 (10/- P. & P.). 3-ohm speaker 7" x 4" 16/- extra.

STEREO AMPLIFIER type HV— 2 x 3 Watts

Fully built. On off. sep. vol. and tone each channel 12 x 4½ x 6 in. high. EZ80, 2 x ECL86; for 3 ohm speakers, double wound main trans; fixing flanges and base plate, suitable for crystal cart, tuner etc. £6.10.0 (8/- p. x p.)



STEREO AMPLIFIER type RC— 2 x 3 Watts

Fully built. 2 x UCL82, metal rect; sanged vol. and tone cont; on-off. balance. 11 x 3½ x 4 in. high. Double wound mains trans, with supporting brackets. For 3-ohm speakers. £6 (8/- p. & p.).



MONO GRAM CHASSIS 3 WATT

3 Wave band long-med-short. Gram., 200-250v AC Ferrite aerial. Chassis 13 x 7 x 5 in. Dial 13 x 4 in. Double wound mains transformer 5 valves ECH81 EF89, EBC81, EL84, EZ80. Price £10.12.6. (7/6 p. & p.) Output trans. for 3-ohm speaker.

NEW TAPE AMPLIFIER for 4 track B.S.R. Deck TD2. Mains and output Trans. 10" x 6" x 4" overall. Rect; ECC83, EL84. Mike and Gram inputs. £7.5.0 (10/- P. & P.). For 3-ohm speaker. £27.5.0 (10/- P. & P.).

GLADSTONE RADIO

66 ELMS ROAD, ALDERSHOT, Hants.

(2 mins. from Station and Buses) FULL GUARANTEE. Aldershot 22240 CLOSED WEDNESDAY. S.A.E. for enquiries please.

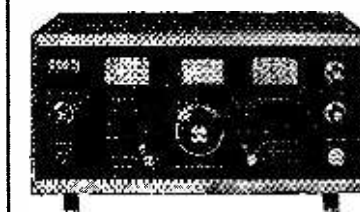

SWOP your camera or hi fi for a TRIO

TRIO JR-500-SE
Crystal controlled 1Kc Divisions—very stable £69.10.0. Carriage free. Full twelve month guarantee
TRIO JR-DE
500 Kc/s to 30 Mc/s. Full ham band spread—free voltage stabilizer supplied

S.W. Receiver at

HOLDINGS PHOTO-AUDIO
Mincing Lane/Darwen St. BLACKBURN
Tel: 59595 Closed Thurs.

If you have difficulty in obtaining
PRACTICAL WIRELESS
Please place a regular order with your newsagent or send 1 year's subscription (£2-5-0) to Subscription Department, Practical Wireless, Tower House, Southampton St., London, W.C.2.

P.W. GUIDE TO COMPONENTS

PART 17

M.K. TITMAN, B.Sc. (Eng)

INTEGRATED CIRCUITS

(continued)

Design Limitations

MOST active devices can be produced in integrated circuit form and indeed many integrated circuit f.e.t. and m.o.s.t. devices are on the market. All the specialist devices discussed in parts 5, 6, 11, 12, 13 and 14 of this series can be fabricated and many are.

Monolithic circuits have resulted in new design techniques due in part to the method of isolating components which automatically incorporate parasitic resistors and capacitors. Also the limitations in component values—particularly inductors—considerably reduce design flexibility. Initially design is carried out from basic, known circuits with parasitic elements included. Very often this design is analysed by computers and studied at a breadboard stage. In order to give cost effectiveness a minimum die size must result in order to give maximum yield per wafer.

Now die size depends largely on component values since a high value capacitor requires a large surface area, as does a high value resistor. In fact the area required for one transistor is roughly equivalent to that required for a resistor of 500Ω to $1.5k\Omega$ or a capacitor of 3 to $6pF$. A typical discrete circuit may require, say, 27Ω for base bias and $100pF$ for feedback etc. In terms of die size required these components would occupy the area equivalent to 25-30 and 20 transistors respectively. In consequence design is regulated by a primary requirement to use active components as much as possible. A circuit containing two low value resistors and 20 transistors is therefore considerably smaller than one containing one high value resistor and one or two transistors. It is for this reason that seemingly complicated multi-transistor circuits—such as the JK flip flop discussed later—are produced.

Two further basic design rules are followed: resistor ratios are used in preference to single resistors in order to reduce tolerances from $\pm 10\%$ to $\pm 3\%$ as discussed earlier; also matched pairs of transistors are used since true matching can be achieved and hence temperature and other effects

can be minimised. These design principles are illustrated in the circuit for an operational amplifier discussed later.

Parasitic Components

Parasitic components are also fundamental in design consideration. As illustrated in Fig. 8 isolation is achieved by reverse biased diodes which have associated capacitance and leakage resistance paths. In this case each capacitance is directly across the output and can considerably reduce the overall frequency response. In addition feedback and modulation effects can occur through the capacitance varying with changing bias levels.

Figure 11 illustrates the parasitic elements associated with the diffused resistor structure shown in Fig. 9. Again capacitance will reduce frequency response and must be carefully taken into account in the basic design. Other design limitations include crosstalk from interconnecting leads and p-n-p-n (Thyristor) switching action. However, good design and layout can usually reduce all these effects at least to the levels associated with discrete component circuits.

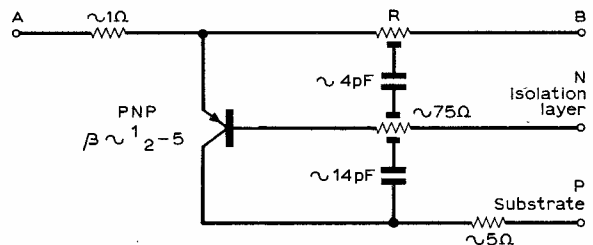

Fig. 11: Parasitic elements of diffused resistor structure.

Using Monolithic IC's

The previous discussion has shown how monolithic integrated circuits are fabricated and some of the reasons for the seemingly peculiar circuits which result. In the light of this knowledge let us examine the rules associated with the use of such components.

Initially it will be appreciated that they are essentially low power, low dissipation assemblies. At no stage should the loads to such circuits be exceeded since localised overheating could result. Generally the supply voltages are limited to around 6V and the reason for this relatively low voltage is generally the breakdown characteristics of the isolation diodes

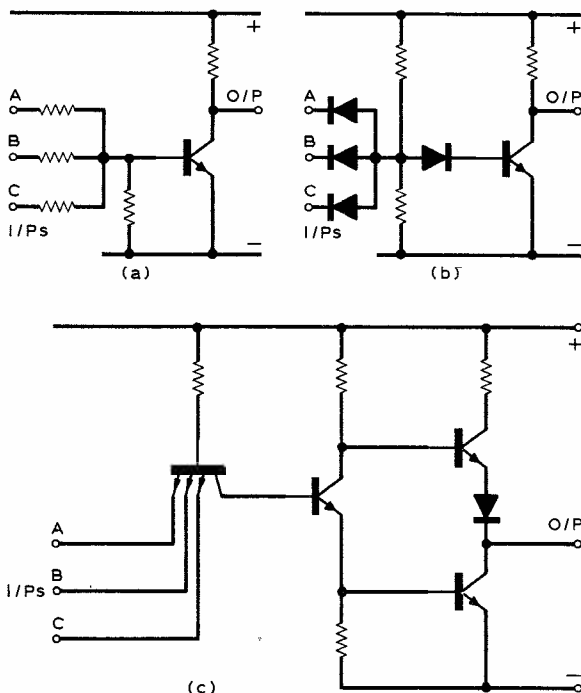

Fig. 12: Three typical logic systems.

—coupled with maximum power dissipation in resistive elements. Commonly the supply voltage is directly connected to the substrate but, if not, care should be taken to ensure that it is connected to the highest supply potential in order to eliminate loss of isolation or p-n-p-n switching action taking place. Interfaces between integrated circuits and other mechanisms or circuits should always be within the voltage and current ratings of the device.

Having emphasised the limitations let us consider the advantages of using integrated circuits. They are small—but this is not an advantage to everyone. They are extremely reliable, and this is a very considerable advantage in many fields. They are complete, in that they can perform the entire specification of some requirements. They are cheap—this at first seems rather hasty but relative to the cost of design and development or even the construction of equivalent circuits they are very often cheaper substitutes.

Digital Devices

Digital devices are designed to operate in switching logic circuits. Generally they are derived from transistors operating in two stable states, “off” and “on” (fully saturated). They are many ways of applying potentials to a transistor in order to change its state from fully on to off and as a result there

are many forms of logic available. The three most common logic systems are illustrated in Fig. 12 and each of these circuits represents what is known as a three input gate.

Figure 12(a) shows the schematic of a resistor transistor logic (RTL) gate and the circuit is often referred to as a NOR (NOT OR) gate. The NOR terminology is derived from its operation—since if input A or B or C is connected to the positive rail then the transistor conducts and produces a negative (i.e. NOT positive) potential at the output. Fig. 12(b) illustrates a different bias system known as diode transistor logic (DTL) and this circuit is commonly referred to as a NAND gate. Again the terminology is derived from its operation since if inputs A and B and C are connected to the positive rail the output is negative (NOT +). Fig. 12(c) shows a transistor transistor logic (TTL or T²L) circuit which is also a NAND gate. It follows therefore that only DTL and TTL circuits are interchangeable.

Many other logic forms are available but these three are by far the most common. RTL was the first system and is generally a direct replacement of discrete component modules used in computers. DTL was produced at roughly the same time but TTL is relatively new and is superior in speed of operation over DTL. At present it would seem that TTL is the form most likely to be used in the future.

A typical family of gates is shown in Table 1 together with costs for the three logic systems. Most of us will continue to think of these gates in terms of the basic circuit but for complex circuits logic symbols are used and these are illustrated in the table. Many other digital circuits are available such as monostables, normal or Set Reset (RS) bistables, expanding circuits, driver units, etc. Most can how-

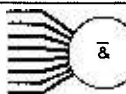
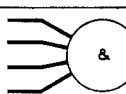
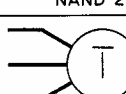
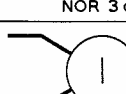
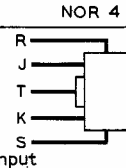
Function	Symbol	Costs		
		RTL	DTL	TTL
Single 8 input gate	 NAND 1 off	20/- to 35/-	15/- to 30/-	20/- to 40/-
Dual 4 input gate	 NAND 2 off			
Triple 3 input gate	 NOR 3 off			
Quad 2 input gate	 NOR 4 off			
JK Flip flop	 Input Output	40/- to 60/-	25/- to 50/-	15/- to 40/-

Note All RTL gates are NOR symbol and all DTL or TTL gates are NAND

Table 1: Typical gates and their average costs.

—continued on page 69

FLUORESCENT CONTROL KITS

Each kit comprises seven items—Choke, 2 tube ends, starter, starter holder and 2 tube clips, with wiring instructions. Suitable for normal fluorescent tubes or the new "Grotlux" tubes for fish tanks and indoor plants. Chokes are superior, mostly resin filled. Kit A—15-20 w. 19/6. Kit B—30-40 w. 19/6. Kit C—50 w. 22/6. Kit E—65 w. 19/6. Kit MF1 is for 6in., 9 in. and 12in. miniature tubes. 16/6. Postage on Kits A and B 4/6 for one or two kits then 4/6 for each two kits ordered. Kits C, D and E 4/6 on first kit then 3/6 for each kit ordered. Kit MF1 3/6 on first kit then 3/6 on each two kits ordered.

REED SWITCHES

Glass encased, switches operated by external magnet—gold plated contacts. We can now offer 3 types:

Miniature. 1in. long x approximately 1/4in. diameter. Will make and break up to 1/2 up to 300 volts. Price 2/6 each, 24/- dozen.
Standard. 2in long x 3/16in. diameter. This will break currents of up to 1A, voltages up to 250 volts. Price 3/- each, 18/- per dozen.
Flat. Flat type, 3in. long, just over 1/16in. thick, approximately 1/4in. wide. The Standard Type flattened out, so that it can be fitted into a smaller space or a larger quantity may be packed into a square solenoid. Rating 1 amp 200 volts. Price 6/- each. 23/- per dozen.
Small ceramic magnets to operate these reed switches 1/6 each. 18/- dozen.

TELESCOPIC AERIAL

For portable, car radio or transmitter. Chrome plated—six sections, extends from 7 1/2 to 4in. Hole in bottom for 9BA screw. 7/6



TOGGLE SWITCH

3 amp 250v, with fixing ring, 1/6 each, 15/- doz.



MINIATURE EAR PIECE

As used with imported pocket radios 1/6 each, 15/- doz.

ISOLATION SWITCH

20 Amp D.P. 250 volts. Ideal to control Water Heater or any other appliance. Neon indicator shows when current is on, 4/6. 48/- per dozen.



15/20 AMP CONNECTORS

Polythene insulated 12-wire strip, 2/6 each, 24/- doz.



13 AMP FUSED SWITCH

Made by G.E.C. For connecting water heater etc., into 13 amp ring main. Flush type 3/6 each, 30/- doz. Metal boxes for surface mounting 1/6 each, 15/- doz.



MICRO SWITCH

5 amp, changover contacts, 1/9 each, 18/- doz. 15 Amp Model 2/- each or 21/- doz.



SUPPRESSOR CONDENSER TCC

1 mfd., 250V A.C. working, metal case with fixing lug. 1/9 each 18/- doz.

REED RELAY

Glass encapsulated reed switch in 24-volt solenoid, neatly enclosed in neat metal case, size 2 1/2in. x 1/2in. x 3/8in. Operates from 24 volts D.C. or from A.C. mains using rectifier, resistor and condenser (3/6 extra).

SHEET PAXOLIN

Ideal for transistor projects, panels 12in. x 6in. 1/9 each, 15/- per dozen.

G.E.C. MULTIPLE SWITCHES

Metal boxes (with cable knockouts) sprayed silver with cover and switch mounting grid. For 12 switches 6/6, 6 switches 5/4, 4 switches 4/6, 2 switches 3/6.



G.E.C. Clipper Switches

For the above boxes, 5 amp A.C. rating, one-way 1/6, 2-way 2/-, Bell push 2/-, intermediate 2/6, secret 2/6, 15 amp one-way 2/6.

THERMOSTAT

Continuously variable 30°-90°C. Has sensor bulb connected by 33in. of flexible tubing. On operation 15 amp 250 volt switch is opened and in addition a plunger moves through approx. 1/2in. This could be used to open valve on ventilator etc. 29/6 plus 4/6 p. & ins.

RING MAIN JUNCTION BOXES

Made by Rock. This won designs award for making quick and neat junctions in 9/23 twin and earthed cable as used for ring main circuits. Our price 1/6 each, 15/- per dozen.

15, 30 & 100 WATT HI-FI SPEAKERS

FULL FL 12 INCH LOUDSPEAKER. This is undoubtedly one of the finest loudspeakers that we have ever offered, produced by one of the country's most famous makers. It has a die-cast metal frame and is originally recommended for Hi-Fi load and Rhythm Guitar and public address. Flux Density 11,000 gauss—Total Flux 44,000 Maxwells—Power Handling 15 watts R.M.S. Cone Moulded fibre—Freq. response 30-10,000 c.p.s.—Specify 3 or 15 ohms—Mains resonance 60 c.p.s.—Chassis Diam. 12in.—12in. over mounting lugs—Baffle hole 1 1/2in. diam.—Mounting holes 4, holes—1/2in. diam. on pitch circle 1 1/2in. diam.—Overall height 5 1/4in. A 66 speaker offered for only £2.19.6 plus 7/6 p. & p. Don't miss this offer. 15in. 25 watt £7.19.6 18in. 100 watt £19.10.0.



MINIATURE EXTRACTOR FAN

Beautifully made by famous German Company. PAPST System, 230/240 A.C. Mains operated, size 3 1/2in. x 3 1/4in. x 2in. Made for instrument cooling but ideal to incorporate in a cooker hood, etc. 65/- P. & p. 2/9.



DISTRIBUTION PANELS

Just what you need for work bench or lab. 4 x 1 1/2 amp sockets in metal box to take 4 x 13 amp fused plugs and 4 or 4 1/2 1/2 switch with neon warning light. Supplier complete with 7 feet of heavy cable wired up, ready to work 39/6 less plug, 45/- with fitted 13 amp plug. 47/6 with fitted 15 amp plug, plus 4/6 post & insurance.



STANDARD WAFER SWITCHES

Standard Size 1 1/2 wafer—silver plated 5 amp contact standard 1/2" spindle—2", long—with locking washer and nut.

No of Poles	2 way	3 way	4 way	5 way	6 way	8 way	10 way	12 way
1 pole	6/6	6/6	6/6	6/6	6/6	6/6	6/6	6/6
2 poles	6/6	6/6	6/6	6/6	6/6	6/6	6/6	6/6
3 poles	6/6	6/6	6/6	6/6	6/6	6/6	6/6	6/6
4 poles	6/6	6/6	6/6	6/6	6/6	6/6	6/6	6/6
5 poles	6/6	6/6	6/6	6/6	6/6	6/6	6/6	6/6
6 poles	6/6	6/6	6/6	6/6	6/6	6/6	6/6	6/6
7 poles	6/6	6/6	6/6	6/6	6/6	6/6	6/6	6/6
8 poles	6/6	6/6	6/6	6/6	6/6	6/6	6/6	6/6
9 poles	6/6	6/6	6/6	6/6	6/6	6/6	6/6	6/6
10 poles	6/6	6/6	6/6	6/6	6/6	6/6	6/6	6/6
11 poles	6/6	6/6	6/6	6/6	6/6	6/6	6/6	6/6
12 poles	6/6	6/6	6/6	6/6	6/6	6/6	6/6	6/6

THIS MONTH'S SNIP

A parcel of integrated circuits made by the famous Plessey Company. A once in a lifetime offer of Micro-electronic devices well below cost of manufacture. The parcel contains 5 ICs all new and perfect, first grade device definitely not sub-standard or seconds. The ICs are all single silicon chip General Purpose Amplifiers. Regular price of which is well over £1 each. Full circuit details of the ICs are included and in addition you will receive a list of 50 different ICs available at bargain prices 5s. upwards with circuits and technical data of each. Complete parcel only £1 post paid or List and all technical data.

1 WATT AMPLIFIER & PRE-AMP

5 transistors—highly efficient, made for use with tapehead G4 but equally suitable for microphone or pick up—limited quantity 29/6 Full circuit diag. also shows tape controls 5/-



VARIAC CONTROLLERS

With these you can vary the voltage applied to your circuit from zero to full mains without generating undue heat. One obvious application therefore is to dim lighting. We offer a range of these, ex-equipment but little used and in every way as good as new. Any not so, will be exchanged or cash refunded. 2 amp £4.19.6. 5 amp £7.19.6. 8 amp £12.19.6. 10 amp £15.19.6.



HOUR COUNTERS

If you wish to know how long your equipment has been switched on then this is what you need. Counts running time up to 999 hours. Resettable 3in. dial. 10 c/s mains operation. 49/6 plus 3/6 post and insurance. Resettable type 69/6 plus 3/6 p. & i.

THE PECTRON HEATING/VENTILATING CONTROL

This neat unit contains all the controls needed for a gas-fired central heating system as follows:—
(a) A clock switch giving 2 on/off periods per 24 hours.
(b) A thermal delay switch to prevent cold air being blown while fire warms up.
(c) Auto transformer to vary voltage and thus control fan speed.
(d) A 24-volt transformer to provide the low voltage necessary to operate solenoid of gas valve.
(e) A changeover switch to bypass the clock.
(f) Changeover switch to cut off heat so allowing cold air to be blown for Summer ventilation.
(g) Neon indicator and fuses.
The unit has a circuit diagram and five leads labelled "Mains," "Fan," "Thermostat 1," "Thermostat 2," "Gas Valve," £5.19.6 plus 4/6 postage and insurance.



INFRA RED MONOSCOPE

This equipment is complete and portable. Basically it consists of an infra red image converter tube with optical lenses for focusing the image and a Zambini pile to provide the necessary E.H.T. The monoscope is housed in a hi case size 9 x 8 x 4in. approx. Made originally for the army for night observations, sniping etc., this equipment has many scientific and practical applications; a limited quantity only is available in original sealed carton. Price £9.19.6.

NOTE: Although unused in fact still in original sealed cartons. The equipment is approx. 25 years old and consequently the Zambini pile may not be operating. Drying out might help but a better idea might be to replace it with a battery operated power unit; there is plenty of room



MINIATURE WAFER SWITCHES

2 pole, 2 way—4 pole, 2 way—3 pole, 3 way—4 pole, 3 way—2 pole, 4 way—3 pole, 4 way—2 pole 6 way—1 pole, 12 way. All at 3/6 each. 39/- dozen, your assortment.



WATERPROOF HEATING ELEMENT

26 yards length 70W. Self-regulating temperature control. 10/- post free.

DRILL CONTROLLER

Electronically changes speed from approximately 10 revs. to maximum. Full power at all speeds by finger-tip control. Kit includes all parts, case, everything and full instructions. Made up model also available 37/6 plus 2/6 p. & p.



MAINS MOTOR

Precision made—as used in record decks and tape recorders—ideal also for extractor fans, blower, heater, etc. New and perfect. Snip at 9/6. Postage 2/6 for first one then 1/6 for each one ordered. 12 and over post free.

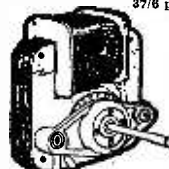

ELECTRIC CLOCK WITH 25 AMP SWITCH

Made by Smith's, these units are as fitted to many top quality cookers to control the oven. The clock is mains driven and frequency controlled so it is extremely accurate. The two small dials enable switch on and off times to be accurately set. Ideal for switching on tape recorders. Offered at only a fraction of the regular price—new and unused only 39/6, less than the value of the clock alone—post and insurance 2/9.



COOKER CLOCK

Cooker clock with temperature controller. This is as the clockswitch described above but with additional panel which incorporates oven thermometer and thermostat switch. The thermostat switch may be set anywhere between 50°C and 90°C. Made for high-class continental cooker. This is a very fine instrument. £4.19.6, plus £1.10.0 for oven sensor unit.



0.605mFd TUNING CONDENSER

Proved design, ideal for straight or reflex circuits 2/6 each, 24/- doz.



SUB-MINIATURE MOVING COIL MICROPHONE

as used in behind the ear deaf aids Acts also as earphone size only 3/4in. x 3/4in. x 3/4in. Regular price probably £3 or more. Our price 19/6. Note these are ex-equipment but if not in perfect working order they will be exchanged.



MAINS TRANSISTOR POWER PACK

Designed to operate transistor sets and amplifiers. Adjustable output 6v., 9v., 12 volts for up to 500mA (class B working). Takes the place of any of the following batteries: PP1, PP3, PP4, PP6, PP7, PP9, and others. Kit comprises: mains transformer rectifier, smoothing and load resistor, condensers and instructions. Real snip at only 16/6, plus 3/6 postage.

PP3 BATTERY ELIMINATOR

Run your small transistor radio from the mains—full wave circuit—made up ready to wire into your set and adjustable high or low current. 3/6 each.



85 Watt Tubular Element. Very well made unit.

The element is wound on a porcelain former then encased in a brass tube terminated with beaded leads 12in. long. Normal mains voltage. Price 8/- each or 54/- per doz.

250V AC working condensers for power factor correction, motor starting etc. 3.5 mfd. 6/6 ea. 6.5 mfd. 8/6 ea. 8 mfd. 9/6 ea. 3 amp battery charger kit comprises copper backed circuit board, 3 amp mains transformer, regulator resistors and smoothing condenser 29/6 inc. wiring diagram, post 2 in. 4/6

BALANCED ARMATURE UNIT

500 ohm operates speaker or microphone, so useful in intercom or similar circuits. 6/6 ea., £3.10.0 doz.



ELECTRONICS (GROYDON) LTD
Dept. PW, 266 London Rd., Croydon CP0-2TH
Also 102/3 Tamworth Road, Croydon

BI-PAK SEMICONDUCTORS

500 CHESHAM HOUSE, REGENT STREET, LONDON W.1.

NEW LOW PRICE TESTED S.C.R.'s.

TO-5	3A	7A	16A	30A
PIV each case	5/-	5/-	10/6	25/20/-
100	5/-	6/6	10/6	50 23/-
200	7/-	7/6	11/6	15/- 100 28/-
400	8/6	9/6	13/6	18/- 200 32/-
600	10/6	11/6	15/6	25/- 400 35/-
800	12/6	14/-	18/-	30/- 800 80/-

PRINTED CIRCUITS EX-COMPUTER

Packed with semiconductors and components, 10 boards give a guaranteed 30 trans. and 30 diodes. Our price 10 boards 10/-. Plus 2/- p. & p.

TRANSISTOR EQVT. & SPECIFICATION BOOK

(German publication). A complete cross reference and equivalent book for European, American and Japanese Transistors. Exclusive to BI-PAK. 15/- ea.

2N2060 NPN SIL. DUAL TRANS. CODE D1699 TEXAS. Our price 5/- ea.
120VCB NIXIE DRIVER TRANSISTOR. Sim. BSX21 & C67, 2N693 FULLY TESTED AND CODED ND120, 1-24, 3/6 each. TO-5 NPN 25 up 3/- each.

PLEASE NOTE. To avoid any further increased Postal Charges to our Customers and enable us to keep our "By Return Postal service" which is second to none, we have re-organized and streamlined our Despatch Order Department and we now request you to send all your orders together with your remittance, direct to our Warehouse and Despatch Department, postal address: BI-PAK SEMICON. BOX 6, WARE, HERTS. Postage and packing still 1/- per order. Minimum order 10/-.

SIL. RECTS. TESTED

PIV	750mA	3A	10A	30A
50	10/-	2/9	4/3	9/6
100	1/3	3/3	4/6	15/-
200	1/9	4/-	4/9	20/-
300	2/3	4/6	6/6	22/-
400	2/6	5/6	7/6	25/-
500	3/-	6/-	8/6	30/-
600	3/3	6/9	9/-	37/-
800	3/6	7/6	11/-	40/-
1000	4/-	9/3	12/3	50/-
1200	6/6	11/6	15/-	

TRIACS

VBOM	2A	6A	10A
(TO-18)	(TO-66)	(TO-8)	
100	14/-	15/-	22/6
200	17/6	30/-	38/-
400	20/-	25/-	35/-

VBOM=Blocking voltage in either direction.

2N3055

115 WATT SIL. POWER. NPN. OUR PRICE 12/6 EACH.
FULL RANGE OF ZENER DIODES. VOLTAGE RANGE 2-16V. 400mW (DO-7 Case) 2/6 ea. 1-5W (Top-Hat) 3/6 ea. 10W (SO-10 Stud) 5/- ea. All fully tested 5% tol. and marked. State voltage required.

BRAND NEW TEXAS GERM. TRANSISTORS Coded and Guaranteed.
Pak No. EOVT
T1 8 2G371A OC71
T2 8 2G374 OC75
T3 8 2G374A OC81D
T4 8 2G381A OC78
T5 8 2G382T OC82
T6 8 2G344A OC44
T7 8 2G345A OC45
T8 8 2G376 OC78
T9 8 2G399A 2N1302
T10 8 2G417 AF117
All 10/- each pack

SUPER PAKS

NEW BI-PAK UNTESTED SEMICONDUCTORS

Unequaled Value and Quality

Satisfaction GUARANTEED in Every Pak. or money back.

- Pak No.
- U1 120 Glass Sub-min. General Purpose Germanium Diodes 10/-
 - U2 60 Mixed Germanium Transistors AF/RF 10/-
 - U3 75 Germanium Gold Bonded Diodes sim. OA5, OA47 10/-
 - U4 40 Germanium Transistors like OC81, AC128 10/-
 - U5 60 200mA Sub-min. Sil. Diodes 10/-
 - U6 40 Silicon Planar Transistors NPN sim. BSY95A, 2N706 10/-
 - U7 16 Silicon Rectifiers Top-Hat 750mA up to 1,000V .. 10/-
 - U8 50 Sil. Planar Diodes 250mA OA/200/202 10/-
 - U9 20 Mixed Volts 1 watt Zener Diodes 10/-
 - U11 30 PNP Silicon Planar Transistors TO-5 sim. 2N1132 10/-
 - U13 30 PNP-PNP Sil. Transistors OC200 & 2S104 10/-
 - U14 150 Mixed Silicon and Germanium Diodes 10/-
 - U15 30 NPN Silicon Planar Transistors TO-5 sim. 2N697 .. 10/-
 - U16 10 3-Amp Silicon Rectifiers Stud Type up to 1000 PIV 10/-
 - U17 30 Germanium PNP AF Transistors TO-5 like ACY17-22 10/-
 - U18 8 6-Amp Silicon Rectifiers BY213 Type up to 600 PIV 10/-
 - U19 30 Silicon NPN Transistors like BC108 10/-
 - U20 12 1.5 amp Silicon Rectifiers Top-Hat up to 1,000 PIV 10/-
 - U21 30 AD Germanium alloy Transistors 2G300 Ser. & OC71 10/-
 - U23 30 MAF like MAT Series PNP Transistors 10/-
 - U24 20 Germanium 1-amp Rectifiers GJM up to 300 PIV .. 10/-
 - U25 25 300Mc/s NPN Silicon Transistors 2N708, BSY27 .. 10/-
 - U26 30 Fast Switching Silicon Diodes like IN914 Micro-min. 10/-
 - U28 Experimenters' Assortment of Integrated Circuits, untested. Gates, Flip-Flops, Registers, etc. 8 Assorted Pieces 20/-
 - U29 10 1-amp SCR's TO-5 can up to 600 PIV CR51/25-600 20/-
 - U31 20 Sil. Planar NPN trans. low noise Amp 2N3707 10/-
 - U32 25 Zener diodes 400mW DO7 case mixed Volts. 3-18 .. 10/-
 - U33 15 Plastic case 1 amp Silicon Rectifiers IN4000 series 10/-
 - U34 30 Sil. PNP alloy trans. TO-5 BCY26, 2S302/4 10/-
 - U35 25 Sil. Planar trans. PNP TO-18 2N2906 10/-
 - U36 25 Sil. Planar NPN trans. TO-5 BFY 50/51/52 10/-
 - U37 30 Sil. alloy trans. SO-2 PNP, OC200 2S322 10/-
 - U38 20 Fast Switching Sil. trans. NPN, 40 Mc/s 2N3011 10/-
 - U39 30 RF Germ. PNP trans. 2N1303/5 TO-5 10/-
 - U40 10 Dual trans. 6 lead TO-5 2N2060 10/-
 - U41 30 RF Germ. trans. TO-1 OC45 NKT72 10/-
 - U42 10 VHF Germ. PNP trans. TO-1 NKT667 AF117 10/-

Code Nos. mentioned above are given as a guide to the type of device in the Pak. The devices themselves are normally unmarked.

I.C. AMPLIFIER



Identical encapsulation and pin configuration to the following: SL402-3, 1C10 and 1C403. Each circuit incorporates a Pre-amp and class A/B. Power amp stage capable of delivering up to 3 watts RMS. Fully tested and guaranteed. Supplied complete with circuit details and data CODED BP110. OUR LOWEST PRICE 30/- each. 10 up 25/- each.

AD161 NPN

AD162 PNP
MATCHED COMPLEMENTARY PAIRS OF GERMPower TRANSISTORS. For mains driven output stages of Amplifiers and Radio receivers. OUR LOWEST PRICE OF 12/6 PER PAIR.

UNIJUNCTION

UT46. Evt. 2N2646, Evt. 71543, BEN3000-25-99 5/- 100 up 4/-

NPN Silicon PLANAR BC107/8/9, 2/- each 50-99, 1/10 100 up, 1/8 each, 1,000 off, 1/8 each. Fully tested and coded TO-18 case.

NPN DIFFUSED SILICON PHOTODIODE TYPE 1S701 (2N2175), or Tape Readout, high switching and measurement indicators. 50V, 250mW. OUR PRICE 10/- EACH. 50 OR OVER 8/6. EACH. FULL DETAILS.

FET'S

2N 3819 8/-
2N 8820 25/-
MPP105 8/-

YOUR CAREER in RADIO & ELECTRONICS ?

Big opportunities and big money await the qualified man in every field of Electronics today—both in the U.K. and throughout the world. We offer the finest home study training for all subjects in radio, television, etc., especially for the CITY & GUILDS EXAMS (Technicians' Certificates); the Grad. Brit. I.E.R. Exam.; the RADIO AMATEUR'S LICENCE; P.M.G. Certificates; the R.T.E.B. Servicing Certificates; etc. Also courses in Television; Transistors; Radar; Computers; Servo-mechanisms; Mathematics and Practical Transistor Radio course with equipment. We have OVER 20 YEARS' experience in teaching radio subjects and an unbroken record of exam. successes. We are the only privately run British home study College specialising in electronics subjects only. Full details will be gladly sent without any obligation.

To: British National Radio School, Reading, Berks.

Please send FREE BROCHURE to

NAME Block

ADDRESS Caps.

..... Please

1/70

BRITISH NATIONAL RADIO SCHOOL

Kinver for Components

LINEAR INTEGRATED CIRCUITS

High Performance operational Amplifiers. Texas Type SN72709N 21/- each
This device is electronically similar to MIC709, MC709C, µA709C, NS709A etc. supplied complete with specification sheet.

Also in stock:

PA234	23/-	CA3012	26/3	TAA293	21/8
CA3020	27/6	TAA310	32/-		
PA246	34/-	CA3028A	20/-	TAA320	13/6
CA3000	47/-	CA3028B	37/6	SL403A	49/6 net
CA3001	54/6	CA3029	26/3	1C10	59/6 net
CA3011	20/6	CA3035	30/-	1D3T1	10/8
		TAA231	56/8	2N5306	11/6

Add 1/- to the above i.g.s. for data sheets if required (1/9 with SL403A, free with 1C10). Other data sheets (apart from 1C10) may be purchased separately at 1/6 per sheet, post free.

1 WATT AMPLIFIER MODULE TYPE PCM1

This amplifier unit is a printed circuit module incorporating the popular and well tried PA234 i.c. amplifier. The unit is a complete AUDIO AMPLIFIER and requires no external components. You simply connect an 18 volt power supply and a 15 or 16 ohm speaker or head phone, even the supply smoothing capacitor and the output capacitor are included! The overall dimensions, including capacitors, are 2 1/2" x 3 1/2" x 1 1/2". The input for 1 watt output at 1 kHz is typically 300mV into 100 kohms. This unit is available at only 36/- net, complete with descriptive leaflet or 70/- net per pair. Send for free leaflet.

SILICON TRANSISTORS FOR HIGH QUALITY EQUIPMENT

BC107	3/3	BD123	24/3	T1P32A	23/-	2N3055	15/9
BC108	3/-	BDY20	24/3	T1S44	18/-	2N 1702	3/6
BC109	3/3	BF184	7/6	T1S49	3/6	2N 1703	3/3
BC158	7/6	BF194	7/-	T1S50	3/6	2N 1704	3/6
BC182L	3/2	BFX29	10/4	2N696	4/9	2N 1705	2/9
BC183L	2/5	BFX84	6/8	2N697	3/-	2N 3707	4/-
BC184L	2/2	BFX85	8/8	2N706	3/3	2N 3708	2/5
BC212L	2/9	BLY50	5/-	2N1132	10/9	2N 3819	9/-
BC213L	3/9	BLY51	4/6	2N2906	13/-	2N 3820	18/9
BC141L	4/-	BFY52	5/-	2N2924	4/4	2N 3826	5/11
BCY70	5/4	BSY95A	3/11	2N2925	5/3	2N4058	5/6
BCY71	10/4	MJ481	27/3	2N2926	3/-	2N4059	2/5
BCY72	4/6	MJ481	32/11	2N3053	6/8	2N4577	9/9
BD121	17/3	T1P31A	17/-				

COMPONENTS CATALOGUE—2/- post free (Inland)

P & P 1/6 inland, overseas at cost (min. 10/-). Cash with order please, discounts may be deducted as follows: order over £5—10%; order over £10—15%. Trade orders—net 30 days.

Please send SAE with enquiries. CALLERS WELCOME. Open 9.00 a.m.—12.50 p.m., 2.00 p.m. to 5.00 p.m. Weekdays and Saturday mornings 9.00 a.m.—12.50 p.m.



STONE LANE KINVER
STURBOROUGH WORS
Telephone: KINVER 2099

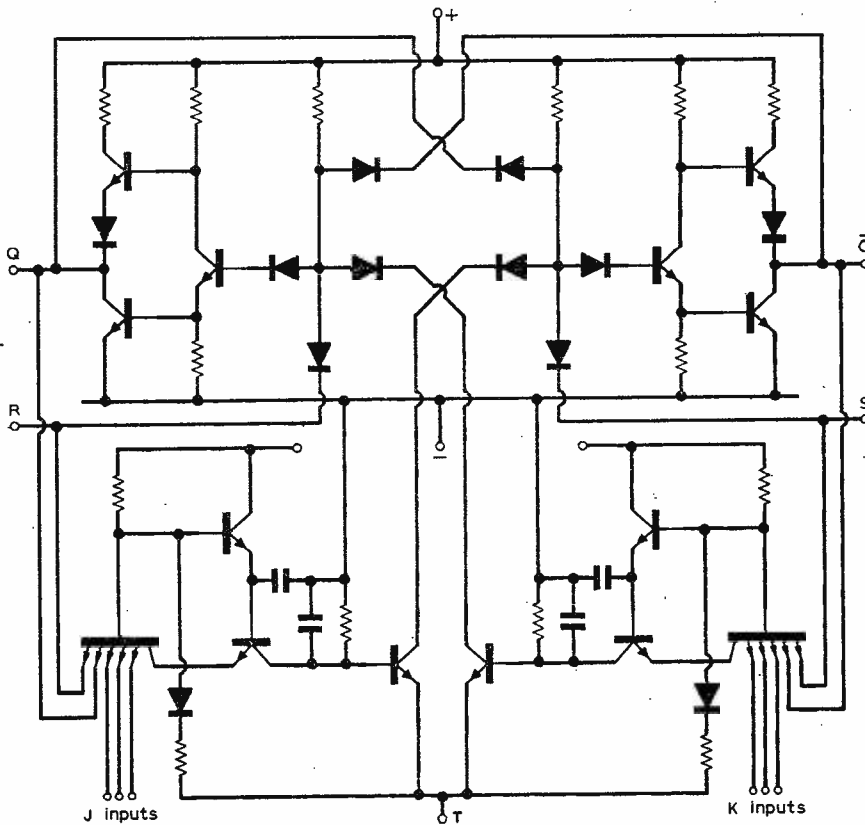

Fig. 13: Left: Circuit of a JK flip-flop. Note the number of components contained in this relatively inexpensive device.

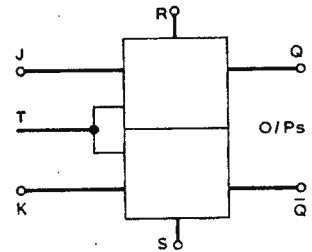

Fig. 14: Block diagram of Fig. 13: to facilitate understanding the operation of the flip-flop circuit.

—continued from page 66

ever be built up from the basic gate units and additional discrete components.

Currently, very much more sophisticated binary circuits have appeared such as complete decade counters, code changing circuits, shift registers and half adders. Although at present they are expensive the space saving and reliability very often outweigh this consideration. In addition f.e.t. and m.o.s.t. binary elements are now available and although expensive they have advantages in terms of noise immunity; power requirements, speed of operation and feedback.

In order to illustrate the circuit complexity which can be achieved in a relatively inexpensive device the circuit of a JK flip flop is shown in Fig. 13. This device illustrates the advantages derived from using many active elements in preference to passive components. It is also a device which is often misunderstood because of the terminology (JK) used to describe it. Because of the circuit complexity—which contains two cross connected bistables—it is preferable to refer to the block diagram shown in Fig. 14. The circuit has five inputs T, J, K, R and S as well as the two outputs Q and Q-bar.

T is the trigger or clock pulse input whilst the other inputs inhibit or direct the bistable. If the R or S inputs are activated then the bistable is held in a fixed state until the input is released. If the J or K inputs are operated then the bistable will change when the clock pulse occurs. Hence a delayed pulse on the J or K inputs can be retimed at the bistable output by the system timing sequence at T. The JK flip flop can therefore be used as a divide by two binary or a retiming circuit.

Encapsulations

Unlike a great many other semiconductor devices the encapsulations used for integrated circuits have been standardised. The three main encapsulations are: the 10- or 12-terminal TO-5 casing shown in Fig. 15; the flat pack illustrated in Fig. 16; and the dual in-line package shown in Fig. 17. Fig. 15 also shows a typical chip with interconnections. In all cases the numbering is standard and in a very large number of cases the terminals used for supply

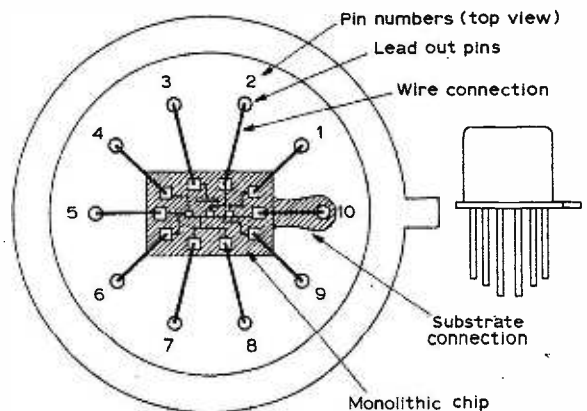

Fig. 15: TO-5 encapsulation and typical chip interconnections.

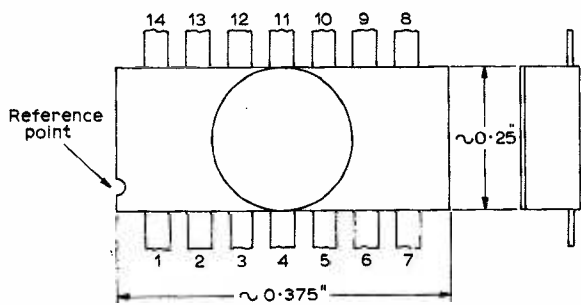

Fig. 16: Flat pack outline.

voltages and polarities are common.

Both the flat pack and dual in-line packages are available with ceramic mouldings when used for high frequency circuits, but in general epoxy resin is used. Although the TO-5 can still be the most widely used encapsulation it is rapidly being superseded by the plastic dual in-line package. The plastic

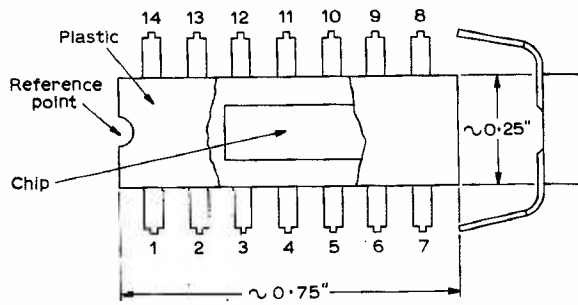

Fig. 17: Dual in-line package outline.

package has resulted in a cheaper encapsulation and the dual in-line structure has the added advantage that it can be plugged directly into a socket. As a word of warning however it must be emphasised that dual in-line sockets are expensive (about 30/-) and are in consequence often dearer than the integrated circuit. **TO BE CONTINUED**

**PW
STEEL
GUITAR**

—

**Alternative
Construction
for
Pre-amplifier**

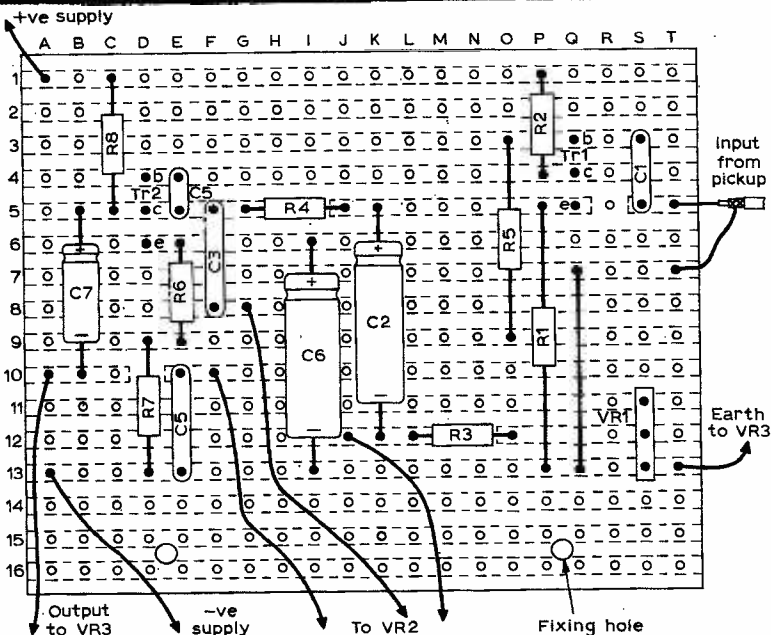

READERS building the *Practical Wireless* Pedal Steel Guitar described in the November, December (1969) and January (1970) issues may prefer to assemble the pre-amplifier on Veroboard rather than plain pin-board, which makes for a tidier layout and some simplification of construction. A prototype Veroboard pre-amplifier has been built and the layout is given in the accompanying diagram.

A sheet of 0.15in. matrix Veroboard with copper strips, 20 holes long by 16 holes wide (2½in.) is required, and any larger size can easily be cut to size with sidecutters. To ensure that everything will fit into the space shown it is suggested that constructors endeavour to obtain the following components, which are described a little more fully than in the Components and Materials table (Part 2), and in most cases differ.

All resistors are ¼th watt hi-stabs, which are quite

freely available from the larger suppliers. C1 is a 0.05µF Mylar (Japanese, green), while C3 and C4 are 0.01µF and 0.022µF Mullard polyester ("candy-stripe"). The electrolytics are Mullard (blue): C2, 100µF 4V; C6, 80µF 16V; C7, 10µF 16V; C5 is an ultra-miniature ceramic with side leads. VR2 and VR3 are not critical, but VR1 is a miniature 5kΩ skeleton preset with 0.15in. lead spacings. Tr1 and Tr2 are BC169s, which is the cheaper plastic encapsulated version of the BC109. They are not, however, physically interchangeable, because the lead order is different.

Construction is very easy, only four strips needing to be broken. One bridging wire is needed from Q7 to Q13, so that the braid from the pickup coax can be anchored close to the input point. The board will mount straight onto the original board fixing holes if the drilling positions on the layout drawing are followed.

Published approximately on the 7th of each month by IPC Magazines Limited, Fleetway House, Farringdon Street, London, E.C.4. Tel: 01-236 8080. Printed in England by Index Printers, Dunstable, Beds. Sole Agents for Australia and New Zealand—Gordon and Gotch (A/asia) Ltd.; South Africa—Central News Agency Ltd.; Rhodesia, Malawi and Zambia—Kingston Ltd.; East Africa—Stationery and Office Supplies Ltd. Subscription rate (including postage): For one year to any part of the world £2 5s 0d.

PRACTICAL WIRELESS is sold subject to the following conditions, namely, that it shall not, without the written consent of the Publishers first given, be lent, resold, hired out or otherwise disposed of by way of Trade at more than the recommended selling price shown on the cover, and that it shall not be lent, resold or hired out or otherwise disposed of in a mutilated condition or any unauthorised cover by way of Trade, or affixed to as part of any publication or advertising, literary or pictorial matter whatsoever.

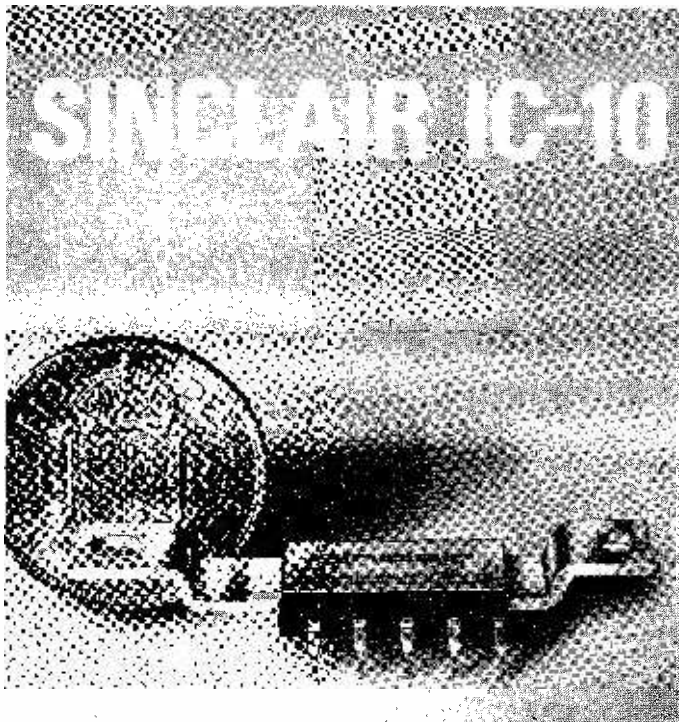

MONOLITHIC INTEGRATED CIRCUIT HIGH FIDELITY AMPLIFIER AND PRE-AMP

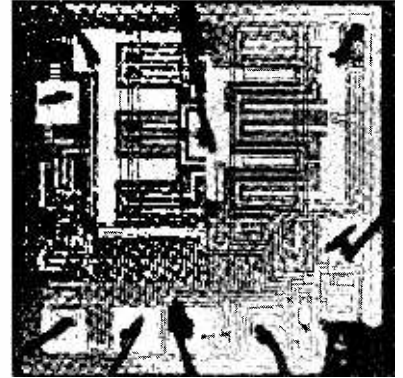

the world's most advanced high fidelity amplifier

The Sinclair IC-10 is the world's first monolithic integrated circuit high fidelity power amplifier and pre-amplifier. The circuit itself, a chip of silicon only a twentieth of an inch square by a hundredth of an inch thick, has an output of 5 watts R.M.S. (10 watts peak). It contains 13 transistors (including two power types), 2 diodes, 1 Zener diode and 18 resistors, formed simultaneously in the silicon by a series of diffusions. The chip is encapsulated in a solid plastic package which holds the metal heat sink and connecting pins. This exciting device is not only more rugged and reliable than any previous amplifier, it also has considerable performance advantages. The most important are complete freedom from thermal runaway due to the close thermal coupling between the output transistors and the bias diodes and very low level of distortion.

The IC-10 is primarily intended as a full performance high fidelity power and pre-amplifier, for which application it only requires the addition of such components as tone and volume controls and a battery or mains power supply. However, it is so designed that it may be used simply in many other applications including car radios, electronic organs, servo amplifiers (it is d.c. coupled throughout) etc. The photographic masks required as part of the process of producing monolithic I.C.s are expensive but once made, the circuits can be produced with complete uniformity and at very low cost. This enables us to cover every IC-10 with the Sinclair guarantee of reliability.

■ SPECIFICATIONS

Output	10 Watts peak, 5 Watts R.M.S. continuous.
Frequency response	5 Hz to 100 KHz \pm 1dB.
Total harmonic distortion	Less than 1% at full output.
Load impedance	3 to 15 ohms.
Power gain	110dB (100,000,000,000 times) total.
Supply voltage	8 to 18 volts.
Size	1 x 0.4 x 0.2 inches.
Sensitivity	5mV.
Input impedance	Adjustable externally up to 2.5 M ohms.

■ CIRCUIT DESCRIPTION

The first three transistors are used in the pre-amp and the remaining 10 in the power amplifier. Class AB output is used with closely controlled quiescent current which is independent of temperature. Generous negative feedback is used round both sections and the amplifier is completely free from crossover distortion at all supply voltages, making battery operation eminently satisfactory.

■ APPLICATIONS

Each IC-10 is sold with a very comprehensive manual giving circuit and wiring diagrams for a large number of applications in addition to high fidelity. These include stabilised power supplies, oscillators, etc. The pre-amp section can be used as an R.F. or I.F. amplifier without any additional transistors.

SINCLAIR

IC.10 with *IC.10 manual* **59/6**

POST FREE

sinclair

SINCLAIR RADIONICS LIMITED
22 NEWMARKET ROAD · CAMBRIDGE

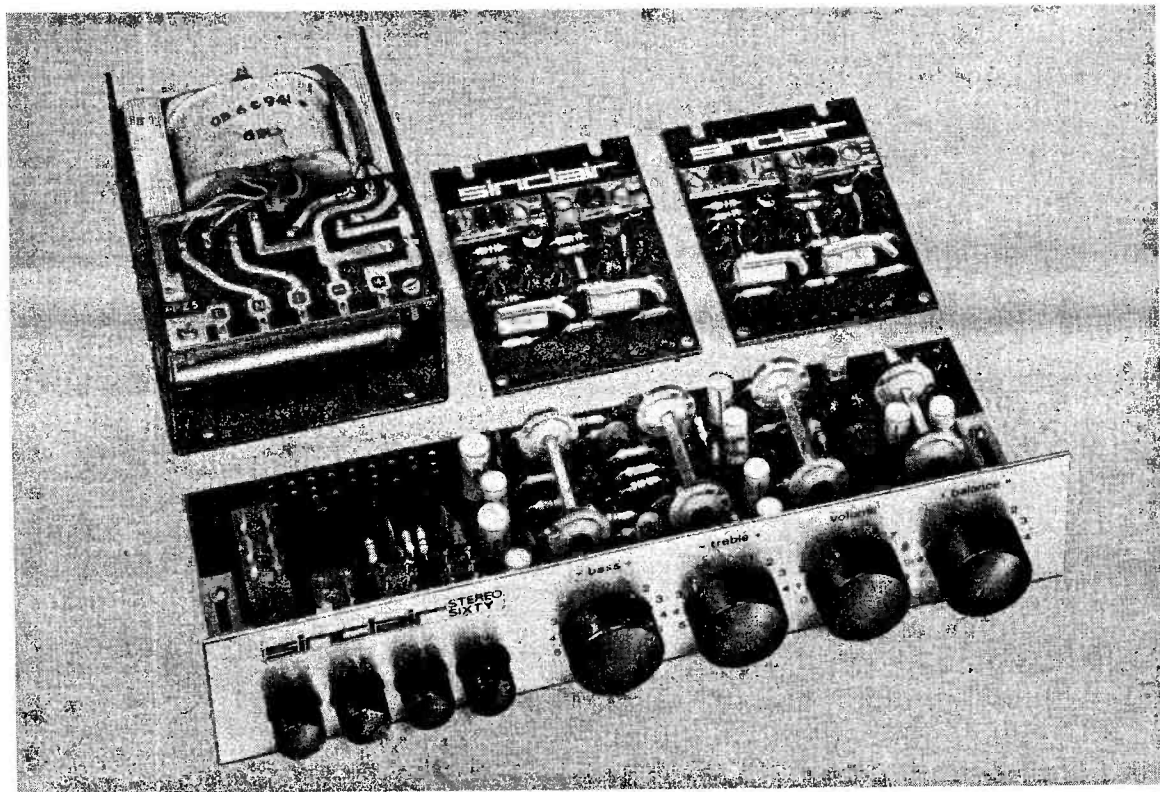

Project 60 an exciting alternative

The buyer of an amplifier, today has a remarkably wide variety to choose from. It is unlikely that a purchaser would have real difficulty in finding a unit that met all his requirements, although the price might not be as low as could be wished. The only snags are that one's needs can change and that the technically correct amplifier may be physically inconvenient. If you are confident that there is an amplifier available, of the right size and price, which will meet all your needs for the foreseeable future, then that is your best buy. If not, however, we can offer you another possibility which we believe to be an exciting alternative approach. That alternative is **Project 60**.

Project 60 is a range of modules which connect together simply to form a complete stereo amplifier with really excellent performance. So good, in fact, that only 2 or 3 amplifiers in the world can compare with it in overall performance.

The modules are: **1.** The Z-30 high gain power amplifier, which is an immensely flexible unit in its own right. **2.** The Stereo 60 preamplifier and control unit. **3.** The PZ.5 and PZ.6 power supplies. A complete system comprises two Z-30's, one Stereo-60 and a PZ-5 or PZ-6. The power supplies differ in that the PZ-6 is stabilised whilst the PZ-5 is not. This means that the former should be used where the highest possible continuous sine wave rating is required. In a normal domestic application there will not be a significant difference between using either power unit unless loudspeakers of very low efficiency are being used.

In view of the very high performance of an amplifier system built with Project 60 modules, the cost may seem surprisingly low. There are two reasons for this: Firstly, we are the largest producers of this type of module in Europe and we are able therefore to use highly efficient production methods. Secondly, you are not paying for a cabinet which you may not require anyway.

All you need to assemble your system is a screwdriver and a soldering iron. No technical skill or knowledge whatsoever is required and, in the unlikely event of you hitting a problem, our customer service and advice department will put the matter right promptly and willingly.

Project 60 modules have been carefully designed to fit easily into virtually every type of plinth or cabinet to provide a complete unit of great compactness. Only holes have to be drilled into the wood of the plinth and any slight slips here will be covered completely by the aluminium front panel of the Stereo 60. The Project 60 manual gives all the instructions you can possibly want clearly and concisely.

Perhaps the greatest beauty of the system is that it is not only flexible now but will remain so in the future. We shall shortly be introducing additional modules which will include a comprehensive filter unit, a stereo F.M. tuner and an even more powerful amplifier for very large systems. These and all other modules we introduce will be compatible with those shown here and may be added to your system at any time.

sinclair

SINCLAIR RADIONICS
22 NEWMARKET ROAD, CAMBRIDGE

LIMITED
Tel: 0223 52731

Z.30 TWENTY WATT R.M.S. (40 WATT PEAK) HIGH FIDELITY POWER AMPLIFIER

The Z.30 is a complete power amplifier of very advanced design employing 9 silicon epitaxial planar transistors. Total harmonic distortion is incredibly low being only 0.02% at full output and all lower outputs. As far as we know, no other high fidelity amplifier made can match this specification, no matter what the price. Thus you can be utterly certain that your Project 60 system will do full justice to your other equipment however good it may be. The Z.30 is unique in that it will operate perfectly, without adjustment, from any power supply from 8 to 35 volts. It also has sufficient gain to operate directly from a crystal pickup. So in addition to its use in a high fidelity system you can use a Z.30 to advantage in your car or a battery operated gramophone for your children, for example. These, and many other applications of the Z.30 are covered in the manual of circuits and instructions supplied with every Z.30 high fidelity power amplifier.

SPECIFICATIONS

Power output—15 watts R.M.S. into 8 ohms using a 35 volt supply; 20 watts R.M.S. into 3 ohms using a 30 volt supply.

Output—Class AB.

Frequency response: 30 to 300,000 Hz \pm 1dB.

Distortion: 0.02% total harmonic distortion at full output into 8 ohms and at all lower output levels.

Signal-to-noise ratio: better than 70dB unweighted.

Input sensitivity: 250mV into 100Kohms.

Damping factor: > 500.

Loudspeaker Impedances: 3 to 15 ohms.

Power requirements: From 8 to 35 V.d.c. (The Z.30 will operate ideally from batteries if required.)

Size: 3 1/2 x 2 1/4 x 1/2 inches.

APPLICATIONS

Hi-fi amplifier; car radio amplifier; record player amplifier fed directly from pick-up; intercom; electronic music and instruments; P.A.; laboratory work etc. Full details for these and many other applications are given in the manual supplied with the Z.30.

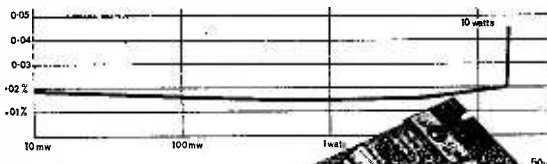

Power versus distortion curve of Sinclair Z.30 amplifier

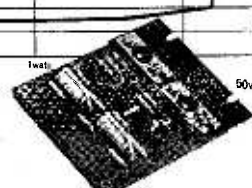

Z.30
Built, tested and guaranteed, with circuits and instructions manual

89/6

STEREO SIXTY PREAMPLIFIER AND CONTROL UNIT

The Stereo 60 is a stereo preamplifier and control unit designed for the Project 60 range but suitable for use with any high quality power amplifier. Again silicon epitaxial planar transistors are used throughout and great attention has been paid to achieving a really high signal-to-noise ratio and excellent tracking between the two channels. Input selection is by means of push buttons and accurate equalisation is provided for all the usual inputs. The tone controls are also very carefully designed and tested.

SPECIFICATIONS

● Input sensitivities—Radio—up to 3mV Magnetic Pickup—3mV: correct to R.I.A.A. curve \pm 1dB; 20 to 25,000 Hz. Ceramic Pickup—up to 3mV; Auxiliary—up to 3mV.

● Output—250mV

● Signal-to-noise ratio—better than 70dB.

● Channel matching—within 1dB.

● Tone controls—TREBLE + 15 to -15dB. at 10 KHz; BASS + 15 to -15dB at 100Hz.

● Power consumption 5mA.

● Front panel—brushed aluminium with black knobs and controls.

● Size 8 1/4 x 4 ins.

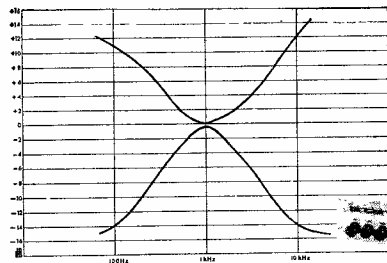

Treble and bass cut and boost curves of Sinclair Stereo Sixty



Ready for immediate installation **£9. 19s. 6d.**

SINCLAIR POWER SUPPLIES

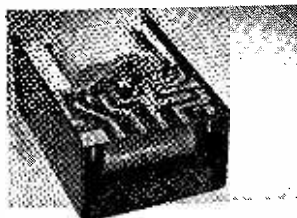

PZ-5

30 volts un stabilised—sufficient to drive two Z.30's and a Stereo 60 for the majority of domestic applications.

Price: **£4. 19s. 6d.**

PZ-6

35 volts stabilised—ideal for driving two Z.30's and a Stereo 60 when very low efficiency speakers are employed.

Price: **£7. 19s. 6d.**

GUARANTEE

If at any time within 3 months of purchasing Project 60 modules from us, you are dissatisfied with them, we will refund your money at once. Each module is guaranteed to work perfectly and should any defect arise in normal use we will service it at once and without any cost to you whatsoever provided that it is returned to us within 2 years of the purchase date. There will be a small charge for services thereafter. No charge for postage by surface mail. Air-mail charged at cost.

SINCLAIR RADIONICS LIMITED
22 NEWMARKET ROAD, CAMBRIDGE

Telephone 0223 5273;

sinclair

To: SINCLAIR RADIONICS LTD., 22 NEWMARKET RD., CAMBRIDGE
Please send

NAME

ADDRESS

For which I enclose cash/cheque/
money order

PW 570

SINCLAIR Q.16

new elegance in an
outstanding loudspeaker

All the superb features which went to make the Sinclair Q.14 have been incorporated in the new Q.16 which gives an exciting new opportunity for you to match your Sinclair equipment with modern decor. Employing the same well proven acoustic system in which materials, processing and styling are used in such a radical and successful departure from conventional design, the new Q.16 presents an entirely new appearance with its attractive teak surround and all-over special cellular foam front chosen as much for its appearance as for its ability to pass all audio frequencies without loss. The Q.16 is compact and slim. Its new styling makes it eminently suitable for shelf mounting, but it is no less versatile than its famous predecessor. Listen to a pair of Q.16s in stereo and marvel at the standards of quality and clarity they give.

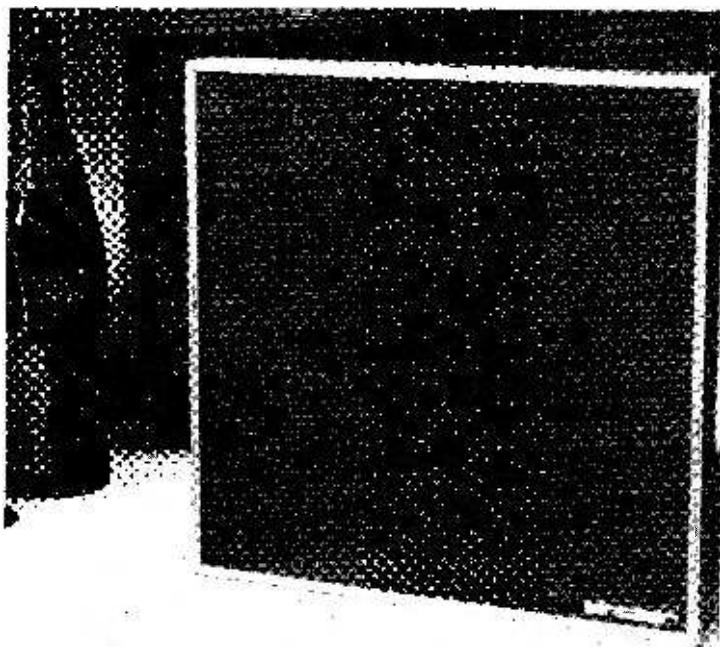

The Q.16 will handle loading up to 14 watts R.M.S. and presents an 8 ohm impedance to the amplifier output. Frequency response extends from 60 to 16,000Hz with exceptional smoothness. A specially designed driver system is used in a sealed and contoured pressure chamber to ensure good transient response at all frequencies. Size: 9 $\frac{3}{4}$ " square \times 4 $\frac{3}{4}$ " deep from front to back.

£8.19.6

POST FREE

SINCLAIR MICROMATIC

The world's most
successful miniature
radio

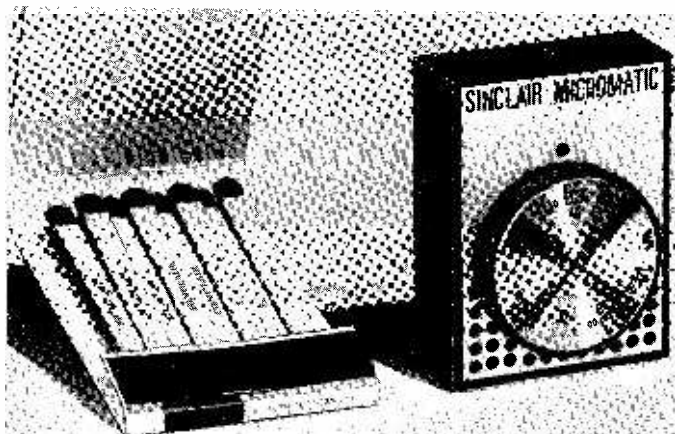

SPECIFICATIONS—Size: 1 $\frac{13}{16}$ " \times 1 $\frac{7}{16}$ " \times $\frac{1}{2}$ " (46 \times 33 \times 13mm). **Weight incl. batteries:** 1 oz. (28.35gm) approx. **Tuning:** Medium wave band with bandspread at higher frequency end. **Earpiece:** Magnetic type. **Case:** Black plastic with anodized aluminium front panel, spun aluminium dial.

Complete kit incl. earpiece, case, solder and instructions in fitted pack.
Ready built, tested and guaranteed, with earpiece.

49/6

59/6

Mallory Mercury Cell RM675 (2 req.) 2/9 each

Considerably smaller than an ordinary box of matches, this is a multi-stage A.M. receiver meticulously designed to provide remarkable standards of selectivity, power and quality. Powerful A.G.C. is incorporated to counteract fading from distant stations; bandspread at higher frequencies makes reception of Radio 1 easy at all times. Vernier type tuning plus the directional properties of the self-contained special ferrite rod aerial makes station separation much easier than with many larger sets. The plug-in magnetic earpiece which matches exactly with the output provides wonderful standards of reproduction.

Everything including the batteries is contained within the attractively designed case. Whether you build your Micromatic or buy it ready built and tested, you will find it as easy to take with you as your wrist-watch, and dependable under the severest listening conditions.

SINCLAIR GENERAL GUARANTEE

Should you not be completely satisfied with your purchase when you receive it from us, return the goods without delay and your money will be refunded in full, including cost of return postage, at once and without question. Full service facilities are available to all Sinclair customers.

sinclair

SINCLAIR RADIONICS LIMITED

22 NEWMARKET ROAD, CAMBRIDGE

Tel: 0223 52731

To: SINCLAIR RADIONICS LTD., 22 NEWMARKET RD., CAMBRIDGE
Please send

NAME

ADDRESS

For which I enclose cash/cheque/
money order

PW 570

A GUIDE TO AMATEUR RADIO

By Pat Hawker, G3VA

Fourteenth edition. 100 pages.

The new edition of this indispensable aid to all who want to know more about amateur radio. Designed to assist the newcomer to this unique hobby. Revised and expanded.

8s 10d post paid

RADIO COMMUNICATION HANDBOOK

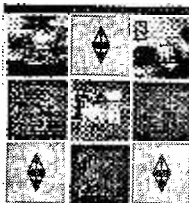

over
20,000

copies sold

Now in its
second printing

Radio Communication Handbook

832 pages of everything in the science of radio communication. The Handbook's U.K. origin ensures easy availability of components. The standard work in its field.

69s post paid

THE VHF-UHF MANUAL

By George Jessop, G6JP

A complete manual for frequencies above 30 MHz. Covers aerials, receivers, transmitters and test equipment. The first book of its kind outside the USA.

23s post paid

Obtainable from:

RADIO SOCIETY of GREAT BRITAIN
35 DOUGHTY STREET, LONDON, WC1

PHOTOELECTRIC KIT

CONTENTS: 2 P.C. Chassis Boards, Chemicals, Etching Manual, Infra-Red Phototransistor, Latching Relay, 2 Transistors, 3 Diodes, Resistors, Gain Control, Terminal Block, Elegant Case, Screws, etc. In fact everything you need to build a Steady-Light Photo-Switch/Counter/Burglar Alarm, etc. (Project No. 1) which can be modified for modulated-light operation.

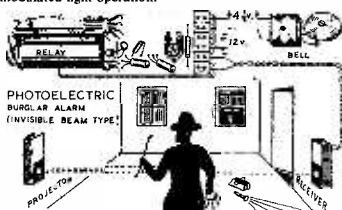

PHOTOELECTRIC KIT

39/6

Postage and Pack. 2/6 (UK)

Commonwealth:

SURFACE MAIL 3/6

AIR MAIL £1.00

Australia, New Zealand,

S. Africa, Canada and U.S.A.

Also Essential Data Circuits

and Plans for Building

10 Advanced Designs

INVISIBLE BEAM OPTICAL KIT

Everything needed (except plywood) for building: 1 Invisible-Beam Projector and 1 Photocell Receiver (as illustrated). Suitable for all Photoelectric Burglar Alarms, Counters, Door Openers, etc.

CONTENTS: 2 lenses, 2 mirrors, 2 45-degree wooden blocks, Infra-red filter, projector lamp holder, building plans, etc. Price 19/6. Postage and Pack. 1/6 (U.K.). Commonwealth: Surface Mail 2/-; Air Mail 8/-.

LONG RANGE INVISIBLE BEAM OPTICAL KIT

CONTENTS: As above. Twice the range of standard kit. Larger Lenses, Filter, etc. Price 29/6. Postage and Pack. 1/6 (U.K.). Commonwealth: Surface Mail 2/6; Air Mail 10/-.

JUNIOR PHOTOELECTRIC KIT

Versatile invisible-beam, Relay-less, Steady-light Photo-Switch, Burglar Alarm, Door Opener, Counter, etc., for the Experimenter.

CONTENTS: Infra-Red Sensitive Phototransistor, 3 Transistors, Chassis, Plastic Case, Resistors, Screws, etc. Full Size Plans, Instructions, Data Sheet "10 Advanced Photoelectric Designs". Price 19/6. Postage and Pack. 1/6 (U.K.). Commonwealth 2/-; Air Mail 4/-.

JUNIOR OPTICAL KIT

CONTENTS: 2 Lenses, Infra-Red Filter, Lampholder, Bracket, Plans, etc. Everything (except plywood) to build 1 miniature invisible beam projector, and photocell receiver for use with Junior Photoelectric Kit. Price 10/6. Post and Pack. 1/6 (U.K.). Commonwealth: Surface Mail 2/-; Air Mail 4/-.

YORK ELECTRICS

335 BATTERSEA PARK RD., LONDON S.W.11

Send a S.A.E. for full details, a brief description and Photographs of all Kits and all 52 Radio, Electronic and Photoelectric Projects Assembled.

TECHNICAL TRAINING

in radio television and electronics

Whether you are a newcomer to radio and electronics, or are engaged in the industry and wish to prepare for a recognized examination, ICS can further your technical knowledge and provide the specialized training so essential to success. ICS have helped thousands of ambitious men to move up into higher paid jobs—they can help you too! Why not fill in the coupon below and find out how?

Many diploma and examination courses available, including expert coaching for:

- C. & G. Telecommunication Techns'. Certs.
- C. & G. Electronic Servicing
- R.T.E.B. Radio/T.V. Servicing Certificate
- Radio Amateurs' Examination
- P.M.G. Certs. in Radiotelegraphy
- General Certificate of Education, etc.

Examination Students coached until successful

NEW SELF-BUILD RADIO COURSES

Learn as you build. You can learn both the theory and practice of valve and transistor circuits, and servicing work while building your own 5-valve receiver, transistor portable, and high-grade test instruments, incl. professional-type valve volt meter—all under expert tuition. Transistor Portable available as separate course.

POST THIS COUPON TODAY

for full details of ICS courses in Radio, T.V. and Electronics.



EST. 1891

INTERNATIONAL CORRESPONDENCE SCHOOLS

Dept. 171, Intertext House, Stewart's Road, London, S.W.8.

Please send me the ICS prospectus—free and without obligation.

(state Subject or Exam).....

.....

NAME

ADDRESS.....

.....

..... 5/70

INTERNATIONAL CORRESPONDENCE SCHOOLS

TRANSISTORS etc.

AC107	3/-	OC35	9/-
AC126	2/-	OC44	2/-
AF115	3/-	OC45	2/-
AF116	3/-	OC70	2/3
*AF117	4/-	OC71	2/-
BFY18	4/6	OC72	2/2
BFY61	4/6	OC73	2/2
GET113	2/6	OC75	2/2
OA5	1/6	OC81	2/-
OA9	1/8	OC81D	2/-
OA47	1/9	OC82D	2/3
OA81	1/6	OC140	5/-
OA85	1/6	OC169	3/6
OC23	6/6	OC170	2/6
OC25	6/-	*OC170	4/-
OC26	7/6	OC171	2/2
OC28	8/6	OC202	4/6

* With 4 leads

Crystal Diodes—6 for 2/6 (74d.)

SILICON DIODE RECTIFIERS

BY 100 800 pV	2/10
500mA 250 pV	1/9
Avalanche 1 1/4	
1200 pV	4/-
Six Amp Series	
BY213 300 pV	3/6
BY216 600 pV	4/6
BY211 900 pV	5/6
BY210 1200 pV	5/6
Mullard Stack FW	
Bridge	
12A 100 pV	39/6 (3/-)
THYRISTORS	
5 amp series	
100 pV	7/6
200 pV	9/6
300 pV	10/6
400 pV	11/6
800 pV	25/-
10 amp series	
50 pV	10/-
100 pV	12/-
100 amp series prices available on request.	

Midjet Electrolytic Conds. Wire Ends

4uF	150 volt
At 9d. each	
0.9uF	25 volt
2uF	350 volt
4uF	12 volt
8uF	12 volt
16uF	16 volt
30uF	10 volt
100uF	6 volt
125uF	10 volt
640uF	2.5 volt
At 1/- each	
50uF	10 volt
100uF	12 volt
200uF	10 volt
320uF	10 volt
If exact voltage shown is not available, nearest is sent.	
2000 MFD. 30V	5/6
1500 MFD. 30V	4/6

M. & B. RADIO

38 BRIDGE END, LEEDS 1

Telephone: 0532-35649

STEREO CABINETS. A beautifully finished polished wood cabinet supplied in original carton. Size approx. 22 x 16 x 8in. New 47/6 plus 6/6 carriage.



TELEMETERS. A well finished cabinet containing lots of useful items for the constructor. Endless tape unit and tape head, 2 motors, auto and mains transformers, miniature valve I.F. strip etc. Ideal for modifying or stripping. 77/6 plus 7/6 carr.



STETHOSCOPE HEADSETS. Brand New. Ideal for stereo or mono. Low impedance. 27/6 plus 3/6 pp.

MICROPHONES. Radiotelephone type, used. 5/- plus 2/- pp.

TRANSISTORISED 2 METER CONVERTERS. Please state preference of I.F. frequency when ordering. £7.15.0 plus 5/- pp. 4 metre models available at the same price. VHF Marine band model £8.5.0 plus 5/- pp.

12V TRANSISTOR INVERTERS. 12vdc input. 275vdc at 150mA output. Size of aluminium case 1 1/2" x 2 1/4" x 4" approx. Size of transformer approx. 1 1/2" x 2" x 2". £3.5.0 plus 5/- pp.

2 to 3 WATTS INTEGRATED CIRCUITS. Tested c/w circuit. £1 plus 1/- pp.

60 UNTESTED TRANSISTORS 5/- plus 1/- pp.

60 UNTESTED DIODES 2/6 plus 1/- pp.

BYX25 800R Silicon diodes 800 pV 16amps on heat sink 5/- plus 1/- pp. 455Kc/s F.M. Transistorised I.F. Strips. Facility usually low in gain but new. 6 transistors. 12/6 plus 1/- pp.

USED TESTED VALVES. OQVO3/10 6/-, 6AQ5/EL90/3/-, 6B16 1/6, 6B16 1/6, 12AX7/ECC83 2/6, 5U4 6/-, ECF80 2/-. All plus 1/6 pp.

AERIAL CHANGE OVER RELAYS 6v, 12v or 50v 4/- plus 1/6 pp. UHF Coaxial AERIAL CHANGE OVER RELAYS. BNC Sockets. 27/6 plus 2/6 pp.

BRAND NEW HEADPHONES. A well known make of headset which combines quality with comfort. Mono or Stereo. 54/- plus 4/- pp.

PLEASE NOTE NEW ADDRESS. NO CONNECTION WITH FIRM PREVIOUSLY AT THIS ADDRESS

LIST OF OTHER EQUIPMENT PLEASE SEND 6d. PLUS S.A.E.

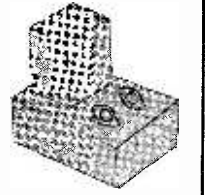

Also 8uF 350V 1/2, 25uF 25V 1/2 and 30uF 50V 1/8. Other electrolytics in current list. Postage, Packing and Insurance all above 1/- up to 11.12 and over charges paid. **2 GANG VAR. CONDENSER:** Mol. air-spaced, .0005 ca. sec. 5/- (1/-). **3 GANG. 7/6 (1/6).** **SUB-MIN. TRANSFORMER:** Output (3Ω for OC72 etc) 2/9 (Up to six 1/-). **MULTIMETER:** 20,000 Ω/V D.C., 10,000 Ω/V A.C. 0-5/25/50/100/1K volts D.C. ●-10/50/100/500/1K volts A.C. ●-0-50μA 2.5mA/250mA D.C. ●-0-6K Ω/250 meg Ω. ●-10uF-.001mfd/1mfd. ●-20 to ×23dB. ●Complete with test leads and instructions. ●Over-load protected 790 model with above refinement. £21.0 (2/6). **JUNIOR MODEL** at 47/6 (2/6). 1000 Ω/V described in free list. Spec. subject to slight variation. **SOLDERING IRON.** Slim Mod. British High speed, 8 1/2in., all parts replaceable, fully guaranteed for professional, radio and general D.I.Y. use. 19/6 (1/6).

DIAMOND STYL. Replacements for BSE TC8LP, TC8/8 and TC8LP/STEREO; and GC8LP: ACOS GP85/87; all at 7/6 each (1/-). ACOS GP72 and Standard fittings. Mono GP67/2, 47/6 (2/6). ACOS ST/AT: ST/AT: PHILIPS AC6306, 3060, (3063, 3066, 3301, 3302, 3304), all at 13/6 (1/6). Double diamond types omitting 78 r.p.m., out shortly at lowest prices.

SAPPHIRE all the above 7/6 types only, also ACOS GP37 at 3/3 each (1/-). ACOS GP91 at 7/6 (1/-). No other types at present, and no 78 r.p.m available in any type.

PICK-UP CARTRIDGES All fitted Styl and Standard fittings. Mono GP67/2, 15/-. ●Stereo compatible—Mono which also plays Stereo records monaurally with min. wear. GP91/SC, 21/-. ●latest Stereo GP93, 24/6. ●Ceramic Stereo, top quality for expensive outfits, GP94, 38/6 (all 1/-).

PP3 ELIMINATOR (A.C.) 17/6 (1/6). **TWO STATION TRANS. INTER-COM.** Excellent baby alarm. Instant, easy fitting with leads, plugs and battery. All you require 52/6 (3/-).

TRANSISTORISED AMPLIFIERS. 3 watt, 9V operation. 45/6 (1/6); 7 1/2 watt, 6 trans. 24V operation. 67/6 (2/6).

Extra High Torque MINI-MOTOR, 4 1/2 to 12V. 1 1/2 x 1/2 x 3/16 in. 9,000 r.p.m.

SUBSTITUTION BOXES. Capacitance 26/6 (1/6). Resistance 32/6 (1/6). Both full range and complete. Full details in list.

TEST PRODS: Flexible, unbreakable 24in. Red and Black leads, thin 4 1/2in. rods, 14in. plugs 4/9 (1/-). **CROC. CLIPS:** Plated with screw, or with red/black hn dies. 6d. each. 5/- doz. (1/-).

RECORDING TAPE Finest quality British Mylar. **STANDARD:** 5in. 600ft. 7/3. 5 1/2in. 850ft. 8/9. 7in. 1200ft. 11/3. **LONG PLAY** 5in. 900ft. 10/-, 5 1/2in. 1200ft. 11/3, 7in. 1800ft. 13/- (1/3 reel). Still the finest quality and value obtainable.

MICROPHONES—CRYSTAL: MIC91, Desk, 16/3; MIC45, curved hand grip 17/6; Stick "300" 20/6; Stick "300" 20/6 (1/6 each type). Clear plastic hand grip type 7/6, or with "strut" stand, swivel and 2 leads with 2.5 and 3.5 plugs/12/6 (1/3). Lapel (or hand) with clip 6/6 (1/1-). Machined metal tapered stick type with neck cord and adaptor to fit standard floor stands, 25/- (1/6). **DYNAMIC:** Cream hand/table 15/6 (1/6). **MS10** 50K Ω, 3 1/4 x 1 1/4 in. with Base. Adaptor 37/6 (2/6). **MS11**, similar but fixed on flexible Swan neck to switch-fitted base 42/6 (2/6).

CARDIOD DYNAMIC OMNI-DIRECTIONAL: Two highly successful makes "SQUARE" 208. £5.10.0. "BALL" type, 209, with 50K/600 ohms imp., £5.17.6 (either type 5/-).

MICROPHONE INSERTS: Diameter 1.75in. or 0.9in., either size 5/6 (1/-).

SPEAKERS: 12in. round, fitted Tweeter, 6W, 3 or 15 Ω (state which), 37/6 (5/6); or for stereo, 80/- per pair (charges paid), 2 1/2in. 3 Ω (6/6) (1/-); 6 x 4 heavy duty 3 Ω 14/8 (3/6) or for Stereo 34/6 pair (charges paid). Limited quantity powerful 2 1/2in. PM transistor replacement speakers, high ohms, excellent 8/6 (1/-). **HEADPHONES:** High Res. 2000 Ω ea. earpiece 18/6 (1/6); Stereo Dyn 8-16 Ω 8/6 (3/-). **EARPIECES** with lead and min. jack plug, magnetic 1/8. Crystal 4/9 (up to 3 for 1/- on either). State if 2.5 mm. or 3.5mm. plug required. (Crystal 3.5mm. only).

AERIALS, Car Types: Telescopic, vandal proof, locks retracted, 2 keys and all fittings, 22/6 (2/6). Motor driven, 12V, 5 section, complete £7.10.0 (3/-).

FOR ALL PORTABLES AND F.M. SETS: 7-section 9 1/2-32in. no swivel, screw hole in base, 6/6. 10-section 6 1/2-47in. no swivel, screw hole in base, 12/6.

DISAPPEARING 8 section, no swivel, screw hole in base, 6 1/2-33in. 10/- . New 6 section 5 1/2-25 1/2in., screw hole in base, no swivel 4/- (1/- all sizes).

SWITCHES: Standard toggle, metal, 250V 2A. One hole fixing: SPST 2/3, SPDT 2/9, DPST 3/- DPDT 3/3. Slide type, Sub-min. DPDT 1/6 each. Small DPDT 3 way, centre "off" 1/9. Reed magnetic on/off 1/9 (up to three, 1/-; 1d each all additional). Rotary Switches etc. in list.

VIBRATORS: Famous makes only, 12 volt 4 pin non-synch, 4/6. 12 volt 7 pin synch. 12/6 (1/- each either type). No other types available.

MAINS NEON TESTER: Fly leads 2/- . Pocket screwdriver type 3/6. **PLUGS:** Std. Jack, plastic body 2/3. Screened 3/- . **VALVE HOLDERS:** B7G or B9A, Moulded 6d. (all above 1/- up to three).

CONNECTING WIRE: 5 coils asstd. coils, each 5 yds. Solid Core 2/6. Flexible 3/- . Super thin for transistor wiring etc. 3/- (1/- all types per 5 coils). **PICK-UP WIRE:** Twin Super thin Flex, Screened, Sheathed, 1 1/3 yd. (6d. up to 6 yds., over 6 yds. post free). **TWIN MIKE CABLE:** 1 1/3 yd. **SINGLE MIKE CABLE:** 8d. yd. Both flexible, screened and sheathed. (E.P. to 3 yds. 8d., each additional yard 1d. extra).

U.F. FIELD INDICATOR: 5-battery with antenna, monitoring crystal earpiece, visible indicator etc. 35/6 (1/6). Details in list.

RETRACTABLE FLEXIBLE LEADS. Space saving "Curly", many uses in car and home: with phono plug each end, 6ft., 4/6; 12ft., 7/8; With phono plug one end, phono socket at other, 6ft., 5/-, 12ft., 8/6 (1/- each all types).

CAR RADIO: Splendid new All-British dash-mounting radio using Mullard transistors and circuit M. and L. wave. Separate speaker and badge. Absolutely complete for + or - chassis, £11.11.0 (6/9). A huge success since introduction.

CURRENT LIST: With many more items sent with all orders or Free. For S.A.E. This advertisement cancels all previous ones and lists supplied prior to March 31st 1970.

ANNUAL HOLIDAYS No orders or correspondence received after May 23rd will be dealt with until June 8th.

Build your own Hi-Fi Record Player with the Sereade fully transistorised amplifier which comes complete with 2-10" x 6" speakers and the latest BSR 4 Speed Stereo/Mono Record Changer.

Advanced solid state amplifier only 4 1/2" deep, 14 transistors plus 4 diodes, separate Bass and Treble—10 watts total power. Frequency response 50-15,000 c/s.

EASY TO INSTALL NO TECHNICAL KNOWLEDGE REQUIRED

Only 28 Gns. + P & P 17/6

Credit terms available, first monthly payment £3.6.2 followed by 9 monthly payments of £3.6.2. (Total "Credit Sale" Price £41.1.8.) Send £4.3.8 today.

Build your own Hi-Fi Record Player with the Sereade fully transistorised amplifier which comes complete with 2-10" x 6" speakers and the latest BSR 4 Speed Stereo/Mono Record Changer.

Advanced solid state amplifier only 4 1/2" deep, 14 transistors plus 4 diodes, separate Bass and Treble—10 watts total power. Frequency response 50-15,000 c/s.

EASY TO INSTALL NO TECHNICAL KNOWLEDGE REQUIRED

Only 28 Gns. + P & P 17/6

Credit terms available, first monthly payment £3.6.2 followed by 9 monthly payments of £3.6.2. (Total "Credit Sale" Price £41.1.8.) Send £4.3.8 today.

Build your own Hi-Fi Record Player with the Sereade fully transistorised amplifier which comes complete with 2-10" x 6" speakers and the latest BSR 4 Speed Stereo/Mono Record Changer.

Advanced solid state amplifier only 4 1/2" deep, 14 transistors plus 4 diodes, separate Bass and Treble—10 watts total power. Frequency response 50-15,000 c/s.

EASY TO INSTALL NO TECHNICAL KNOWLEDGE REQUIRED

Only 28 Gns. + P & P 17/6

Credit terms available, first monthly payment £3.6.2 followed by 9 monthly payments of £3.6.2. (Total "Credit Sale" Price £41.1.8.) Send £4.3.8 today.

Build your own Hi-Fi Record Player with the Sereade fully transistorised amplifier which comes complete with 2-10" x 6" speakers and the latest BSR 4 Speed Stereo/Mono Record Changer.

Advanced solid state amplifier only 4 1/2" deep, 14 transistors plus 4 diodes, separate Bass and Treble—10 watts total power. Frequency response 50-15,000 c/s.

EASY TO INSTALL NO TECHNICAL KNOWLEDGE REQUIRED

Only 28 Gns. + P & P 17/6

Credit terms available, first monthly payment £3.6.2 followed by 9 monthly payments of £3.6.2. (Total "Credit Sale" Price £41.1.8.) Send £4.3.8 today.

Build your own Hi-Fi Record Player with the Sereade fully transistorised amplifier which comes complete with 2-10" x 6" speakers and the latest BSR 4 Speed Stereo/Mono Record Changer.

Advanced solid state amplifier only 4 1/2" deep, 14 transistors plus 4 diodes, separate Bass and Treble—10 watts total power. Frequency response 50-15,000 c/s.

EASY TO INSTALL NO TECHNICAL KNOWLEDGE REQUIRED

Only 28 Gns. + P & P 17/6

Credit terms available, first monthly payment £3.6.2 followed by 9 monthly payments of £3.6.2. (Total "Credit Sale" Price £41.1.8.) Send £4.3.8 today.

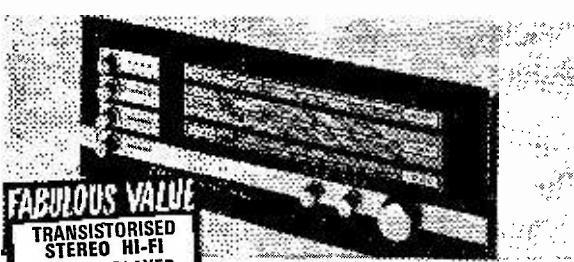

FANTASTIC VALUE

TRANSISTORISED STEREO HI-FI RECORD PLAYER

Build your own Hi-Fi Record Player with the Sereade fully transistorised amplifier which comes complete with 2-10" x 6" speakers and the latest BSR 4 Speed Stereo/Mono Record Changer. Advanced solid state amplifier only 4 1/2" deep, 14 transistors plus 4 diodes, separate Bass and Treble—10 watts total power. Frequency response 50-15,000 c/s. EASY TO INSTALL NO TECHNICAL KNOWLEDGE REQUIRED Only 28 Gns. + P & P 17/6 Credit terms available, first monthly payment £3.6.2 followed by 9 monthly payments of £3.6.2. (Total "Credit Sale" Price £41.1.8.) Send £4.3.8 today.

FANTASTIC BARGAIN OFFER!

"TRANSCONTINENTAL"

FULLY TRANSISTORISED STEREO PHONIC RADIOGRAM CHASSIS

Complete with 2-10" x 6" speakers and the latest BSR Mono/Stereo Record Changer—a complete radiogram at half normal price ONLY

10 Watts Total output **£36.10.0** P & P 17/6

17 Transistors & 10 diodes

EASILY FITTED NO TECHNICAL KNOWLEDGE NECESSARY

Credit Terms available. First monthly payment £4.2.2 followed by 9 monthly payments of £4.2.2. (Total "Credit Sale" Price £41.1.8.) Send £4.18.8 today

Callers Welcome

PLEASE SEND ME FREE DETAILS OF YOUR RANGE

Name _____ Address _____

LEWIS radio 100 CHASE SIDE, SOUTHGATE, DEP. P570 LONDON, N.14. TELEPHONE 886 3733/19666

peak sound englefield

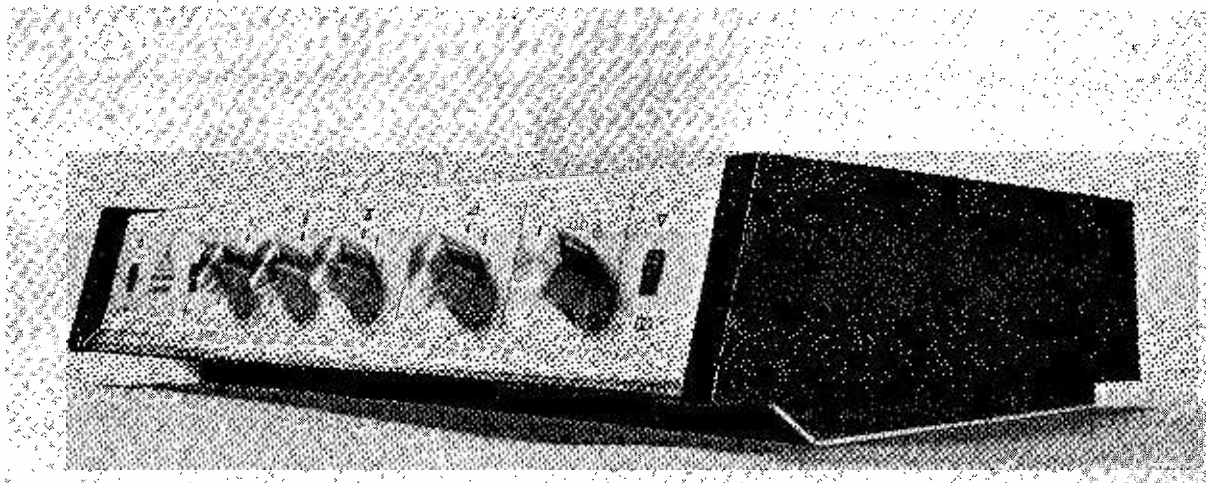

developed out of the highly successful PW. 12+12 and now in complete kit form to save you still more

The Peak Sound Englefield is a system offering great flexibility whilst providing cost-performance ratios which have never been bettered in high fidelity. Here top-flight circuitry is housed in a cabinet of elegantly original styling which is both beautiful and completely practical front and back. Now we carry design standards further by offering a 12+12 watt version completely in kit form. The resultant specification surpasses that even of the original PW.12+12 which again was based on Peak Sound design. In this Englefield kit, printed circuit boards are supplied for you to mount the components on. Standards of input sensitivity and overload factor on all channels as well as filter performance are all improved. By giving you the satisfaction of building the Englefield this way, you save considerably and finish with a completely professionally styled instrument. Go to your dealer and start building now, or send direct for delivery by return in case of difficulty.

and this is the Peak Sound Specification Guarantee

Peak Sound guarantee that their equipment meets all specifications as published by them and that these are written in the same terms as used in equipment reviews appearing in this and other leading British hi-fi journals. Audio output powers are quoted at continuous sine wave power in terms of Root Mean Square values (R.M.S.) into stated loads at stated frequencies.

The specification that tells you everything (See guarantee)

Using two Peak Sound PA. 12-15's, driven simultaneously at 1 KHz from 240 V. mains supply.

Output per channel: 11 watts into 15Ω; 14 watts into 8Ω.

Frequency bandwidth: 10Hz to 45 KHz for 1dB at 1 watt.

Total Harmonic Distortion at 1 KHz at 10 watt into 15Ω—0.1%.

Input sensitivities: Mag. PU.3.5 mV. R.I.A.A. equalized into 68KΩ; Tape, 100mV linear into 100KΩ; Radio, 100mV linear into 100KΩ.

Overload factor: 29dB on all input channels. Signal/noise ratio: —65dB on all inputs.

Vol. control at max. Controls: Volume, Treble, Bass, Low-pass Filter. Mono/Stereo: On/off; Balance.

Complete kit of parts including cabinet assembly, knobs, transistors, well-prepared instructions and wire to length, colour coded and stripped at ends as well as built-in mains power supply. (Post free in U.K.)

£33.2.0

Englefield assembly as above, but in easy-to-put-together modules. (Post free in U.K.)

£38.9.0

Peak Sound ES.10-15 BAXANDALL LOUD-SPEAKER. Fantastic performance and value. Ideal with your Englefield. Cabinet 18"x12"x10" natural teak finish. Ready built—18½ gns. Parts available separately for building yourself with appreciable saving. Leaflet on request.

peak sound

PEAK SOUND (HARROW) LTD., SAINT JUDES ROAD, ENGLEFIELD GREEN, EGHAM, SURREY. Egham 5316

To Peak Sound, Saint Judes Road, Englefield Green, Egham, Surrey
 Details of Englefield systems, please and.....
 Name
 Address
 PW5
 Write your stockist's name and address in margin below and cut out with coupon if necessary

WEYRAD

COILS & TRANSFORMERS FOR CONSTRUCTORS

Special versions of our P50 Series are now available for AF117 or OC45 Transistors. They can be used in the standard superhet circuit with slight changes in component values.

Oscillator Coil	P50/1AC (For OC45)	P50/1AC (For AF117)	5/4
1st I.F. Transformer	P50/2CC (For OC45)	P51/1 (For AF117)	5/7
2nd I.F. Transformer	P50/2CC (For OC45)	P51/2 (For AF117)	5/7
3rd I.F. Transformer	P50/3CC (For OC45)	P50/3V (For AF117)	6/-
Rod Aerial	RA2W	12/6	
Driver Transformer	LFDT4/1	9/6	
Output Transformer	OPT1	10/6	
Printed Circuit	PCA1	9/6	

I.F. TRANSFORMERS FOR "PRACTICAL WIRELESS" CIRCUITS

Components for several receivers are available, including the following for the "Clubman".

T41/1E	1st I.F. Transformer	7/6
T41/2E	2nd I.F. Transformer	7/6
T41/3T	3rd I.F. Transformer	10/6
T41/3T	B.F.O. Coil	10/6

Details of these and our other components are given in an illustrated folder which will be supplied on request with 4d. postage please.

WEYRAD (ELECTRONICS) LIMITED

SCHOOL STREET, WEYMOUTH, DORSET

H.A.C. SHORT-WAVE KITS

WORLD-WIDE RECEPTION

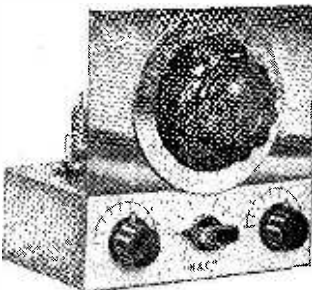

Famous for over 35 years for Short-Wave Equipment of quality, "H.A.C." were the Original suppliers of Short-Wave Receiver Kits for the amateur constructor. Over 10,000 satisfied customers—including Technical Colleges, Hospitals, Public Schools, R.A.F., Army, Hams, etc.

IMPROVED 1970 RANGE

One-valve model "DX", complete kit—price 56/6 (Postage and packing 3/6).

Customer writes:—"Definitely the best one-valve S.W. Kit available at any price. America and Australia received clearly at good volume." This kit contains all genuine short-wave components, drilled chassis, valve, accessories and full instructions. Ready to assemble, and of course, as all our products—fully guaranteed. Full range of other S.W. kits including the famous model "K" and "K plus" (illustrated above.) All orders despatched by return. (Mail order only.) Send now for a descriptive catalogue, order form.

"H.A.C." SHORT-WAVE PRODUCTS
29 Old Bond Street, London W.1

4-STATION INTERCOM



£7/15/0

Solve your communication problems with this 4-Station Transistor Intercom system (1 Master and 3 Subs), in de-luxe plastic cabinets for desk or wall mounting. Call/talk/listen from Master to Subs and Subs to Master. Ideally suitable for Business, Surgery, Schools, Hospital, Office and Home. Operates on one 9V battery. On/off switch. Volume control. Complete with 3 connecting wires each 66ft. and other accessories. P. & P. 7/6.

MAINS INTERCOM

No batteries—no wires. Just plug in the mains for instant two-way, loud and clear communication. On/off switch and volume control. Price £11.19.6. P. & P. 8.6 extra.

INTERCOM/BABY ALARM



OUR PRICE ONLY 3 gns.

Same as 4-Station Intercom for two-way instant communication. Ideal as Baby Alarm and Door Phone. Complete with 66ft. connecting wire. Battery 2/6. P. & P. 4/6.

TRANSISTOR TELEPHONE AMPLIFIER



59/6

Why not boost business efficiency with this incredible De-luxe Telephone Amplifier. Take down long telephone messages or converse without holding the handset. A useful office aid. On/off switch. Volume Control. Battery 2/6 extra. P. & P. 3/6. Full price refunded if not satisfied in 7 days. WEST LONDON DIRECT SUPPLIES (P.W.) 189 KENSINGTON HIGH STREET, LONDON, W.8.

NEW RANGE U.H.F. TV AERIALS

All U.H.F. aerials now fitted with tilting bracket and 4 element grid reflectors. Loft Mounting Arrays, 7 element, 40/-, 11 element, 47/6. 14 element, 55/-, 18 element, 62/6. Wall Mounting with Cranked Arm, 7 element, 60/-, 11 element, 67/-, 14 element, 75/-, 18 element, 82/6. Mast Mounting with 2in. clamp, 7 element, 42/6, 11 element, 55/-, 14 element, 62/-, 18 element, 70/-. Chimney Mounting Arrays, Complete. 7 element, 72/6. 11 element, 80/-, 14 element, 87/6. 18 element, 95/-. Complete assembly instructions with every unit. Low Loss Cable, 1/6 yd. U.H.F. Preamps from 75/- State clearly channel number required on all orders.

BBC - ITV AERIALS

BBC (Band 1). Loft, 25/-, External S/D, 30/-. "H" £2.15.0. ITV (Band 3). 3 element loft array, 30/-, 5 element, 40/-, 7 element, 50/-, Wall mounting, 3 element, 50/-, 5 element, 55/-, Combined BBC/ITV. Loft 1 + 3, 40/-; 1 + 5, 50/-; 1 + 7, 60/-; Wall mounting 1 + 3, 60/-; 1 + 5, 70/-; Chimney 1 + 3, 70/-; 1 + 5, 80/-, VHF transistor pre-amps, 75/-.

COMBINED BBC1 - ITV - BBC2 AERIALS 1 + 3 + 9, 70/-, 1 + 5 + 9, 80/-, 1 + 5 + 14, 90/-, 1 + 7 + 14, 100/-, Loft mounting only.

F.M. (Band 2). Loft S/D, 17/6. "H", 35/-, 3 element, 57/6. External units available. Co-ax cable 8d. yd. Co-ax. plugs 1/6. Outlet boxes, 5/-. Diplexer Crossover Boxes, 17/6. C.W.O. or C.O.D. P. & P. 6/6. Send 6d. stamps for illustrated lists.

Callers welcomed — open all day Saturday

K.V.A. ELECTRONICS (Dept. P.W.)
40-41 MONARCH PARADE
LONDON ROAD, MITCHAM,
SURREY 01-648 4884

HERE'S A MARVELLOUS ANNUAL FOR YOUR CAR!

Just like the children, your car will appreciate being treated to its very own annual! It will enjoy your new-found confidence in putting right any minor troubles, keeping it all tricked out in the best accessories, and your ability to keep both the bodywork and machinery in mint condition!

ROUTINE MAINTENANCE

advice on the cooling system, de-coking, brakes, clutch, etc.

TROUBLE-SHOOTING SECTION

A peculiar noise? Here's how to diagnose and correct typical faults.

FAULT-DIAGNOSING CHART

A 'family tree' of the working parts of your car.
50 GET-YOU-HOME TIPS

Could save you a lot of trouble and embarrassment!
OVERHAUL

The complete A-Z of all that needs to be done and how to do it including starter, dynamos, suspension.

RENOVATION

Repairing bodywork, tidying interior and exterior trims, 'touching up' with crude equipment.

PRESERVATION

Cleaning your car, anti-rust precautions, sorting out water leaks.

ALSO: A-Z Car Electrics, Motoring Holidays (9 pages) Workshop Hints, Accessories.

Surely your car deserves this good book? Get it today, price 3/6



PADGETTS RADIO STORE

OLD TOWN HALL, LIVERSEDGE, YORKS

Telephone: Heckmondwike 4285

AW48-80 TV Tubes good picture—no guarantee £1 plus 12/- carriage.

Aircraft Sighting Head with Gyro Unit. Condition Fair 18/6, carriage B.R.S. 12/-.

Small 12-way Plug and Socket, 1/6 each p. & p. 1/-, 15/- per doz. p. & p. 3/6. Ex unit.

Panel of 19 mixed pots, 5/- post paid. Ex unit.

Panels of Resistors and Condensers 8/- per doz., post paid. Ex unit.

Bombsight-Computers containing a large selection of gears. A delight for The Model Maker. 55/- carriage paid.

Complete untested 17 inch TV Sets 12 channel 50/-, 15/- carriage.

Small Sub Chassis containing small 12-way plug and socket. Few Resistors and Condensers 5/-, p. & p. 1/6.

Speakers removed from T.V. Sets. All FM and 3 ohm. 6in. round 3/-, p. & p. 3/-; 6 for 24/-, post paid 6 x 4in. 3/-, p. & p. 3/-; 6 for 24/-, post paid. 5in. round 3/-; p. & p. 3/-; 6 for 24/-, post paid. 7 x 4in. 5/-, p. & p. 3/-; 6 for 24/-, post paid. Slot Speakers 8 x 2 1/2 in. 5/-, p. & p. 3/-; 6 for 30/- post paid.

Reclaimed T.V. Tubes, with 6 months' guarantee 17in. Type AW43/80. AW43/88 40/-, MW43/69 30/-, 14in. Type 17-. All Tubes 12/- carriage.

Silicon Rectifier 500mA 800 PIV. 2/6, post paid. 24/- per dozen, post paid.

Tap Earpiece. Magnetic 8 ohm. Small and Large Plug 1/11, post paid.

G.P. Diodes 3/6 per dozen, post paid.

Top Grade Mylar Tapes, 7in. Standard 11/6. 7in. Long Play 14/-, 5in. Standard 7/9. 5in. Long Play 10/-, plus post on any tape 1/9.

VALVE LIST

Ex Equipment, 3 months' guarantee

Single Valves Post 7d., over 3 Valves, p. & p. paid.

ARP12	1/6	PCL82	4/-	6B8	1/8
EB91	9d	PCL83	5/-	6BW7	2/6
EF85	3/-	PL36	5/-	6K7	1/9
EBF80	3/-	PL38	6/-	6U4	5/-
ECC81	3/-	PL81	4/-	6P28	5/-
ECC82	3/-	PY33	5/-	10F13	2/8
		PY31	1/6	185BT	3/6
ECC83	4/-	PY82	1/6	20D1	3/-
ECL80	1/6	PZ30	5/-	20F1	5/-
EF50	1/-	U191	5/-	20P3	2/6
EF80	1/6	U281	5/-	30PL1	5/-
EF91	9d	U282	5/-	30P12	5/-
EY86	5/-	U301	5/-	30E3	2/6
PCC84	2/-	U329	5/-	30FL1	5/-
PCF80	2/-	U251	5/-	6/80L2	5/-

BAKER 12in. MAJOR £8



The remarkable quality and performance of the "Major" makes possible truly brilliant and rich sound from a single loudspeaker. It recreates the entire musical spectrum from 30 to 14,500 c.p.s. The unit consists of the latest double cone, woofer and tweeter cone together with a special Baker magnet assembly Alcomax II having a flux density of 14,000 gauss and a total flux of 145,000 Maxwells. Bass resonance 45 c.p.s. For Hi-Fi or P.A. Rated 20 watts. Voice coils available 3 or 8 or 15 ohms.

Major Module 30-17,000 cps with tweeter, crossover, baffle. £10.19.6
19" 12 1/2 in. and instructions.

Send 4d Stamp for Further Details

Baker Reproducers Ltd

Bensham Manor Road Passage, Thornton Heath, Surrey. 01-684-1665.

LARGE SCALE MULTIMETER YOU CAN AFFORD!

WITH ALL THESE FEATURES

- ★ 20,000 ohm/volt ★ Overload protection
- ★ Mirror Scale ★ Free batteries
- ★ D.C. volts: 0.6, 3, 12, 30, 120, 300.
- ★ A.C. volts: 3, 30, 120, 600
- ★ D.C. amps: 50 μ A, 600 μ A, 60mA, 600mA.
- ★ Resistance: 10k, 100k, 1 meg, 10 megs. Half scale reading: 60 Ω , 600 Ω , 6000 Ω , 60k Ω .
- ★ Decibels: -20 to +46db.
- ★ Size: 6" x 4 1/2" x 2 1/2".

Money back if not delighted

ONLY SPECIAL £6.50 OFFER The famous 'GOSCU' CUTTER & SHAPER

The easy way to cut & shape metals, plastics, hardboard, laminates, plywood etc. 3 blades for different uses. Never need re-sharpening. List price, 37/6.

OUR PRICE ONLY 28/6, p. & p. 2/6.

Dept. PW5,31 Albert Rd., Hendon, London, N.W.4.



TRANSISTOR RADIOS TO BUILD YOURSELF

Backed by after sales service

NEW! roamer eight mk1 WITH VARIABLE TONE CONTROL

7 Tunable Wavebands: Medium Wave 1, Medium Wave 2, Long Wave, SW1, SW2, SW3 and Trawler Band. Built in Ferrite Rod Aerial for Medium and Long Waves. Five section 22in. chrome plated Telescopic aerial for Short Waves can be angled and rotated for maximum performance. Push pull output using 600 mW transistors. Socket for car aerial. Tape record socket. Selectivity switch. Switched earpiece socket complete with earpiece for private listening. Eight transistors plus 3 diodes. Famous make 7in. x 4in. Speaker. Air spaced ganged tuning condenser. On/Off switch volume control. Wave change switch and tuning control. Attractive case in rich chestnut shade with gold blocking. Size 9 x 7 x 4in. approx. Easy to follow instructions and diagrams make the Roamer Eight a pleasure to build. Total Building Costs

£6.19.6

Parts Price List and Easy Build Plans 5/- (FREE with parts).

P & P 7/6.



roamer seven mkIV

SEVEN FULLY TUNABLE WAVEBANDS—MW1, MW2, LW, SW1, SW2, SW3 and Trawler Band. Extra Medium waveband provides easier tuning of Radio Luxembourg, etc. Built in ferrite rod aerial for Medium and Long Waves. Five Section 22in. chrome plated telescopic aerial for Short Waves—can be angled and rotated for peak S.W. listening. Socket for Car Aerial. Powerful push-pull output. Seven transistors and two diodes including Micro-Alloy R.F. Transistors. Famous make 7 x 4in. P.M. speaker. Air spaced ganged tuning condenser. Volume/on/off control, wave change switches and tuning control. Attractive case with carrying handle. Size 9 x 7 x 4in. approx. Easy to follow instructions and diagrams make the Roamer 7 a pleasure to build. Parts price list and easy build plans 3/- (FREE with parts). Personal Earpiece with switched socket for private listening, 3/- extra.

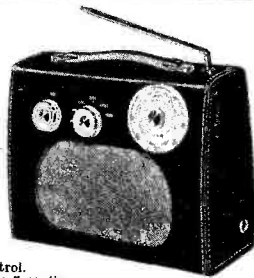

Total building costs
£5.19.6

P. & P. 7/6

NEW! trans eight

SIX WAVEBAND PORTABLE WITH 3in. SPEAKER

Attractive case in black with red grille and cream knobs and dial with polished brass inserts. Size 9 x 5 1/2 x 2 1/2 in. approx. Tunable on Medium and Long Waves; three Short Waves and Trawler Band. Sensitive ferrite rod aerial for M.W. and L.W. Telescopic aerial for Short Waves. Eight improved type transistors plus 3 diodes. Push pull output. Ample power to drive a larger speaker. Parts price list and easy build plans 5/- (FREE with parts). Earpiece with switched socket for private listening 5/- extra.



Total building costs **89'6**

P & P 5/6

pocket five

MEDIUM WAVE, LONG WAVE AND TRAWLER BAND PORTABLE WITH SPEAKER

Attractive black and gold case. Size 5 1/2 x 1 1/2 x 3 1/2 in. Tunable over both Medium and Long Waves with extended M.W. band for easier tuning of Luxembourg, etc. 7 stages—5 transistors and 2 diodes, super-sensitive ferrite rod aerial, fine tone moving coil speaker. Easy build plans and parts price list 1/6 (FREE with parts).

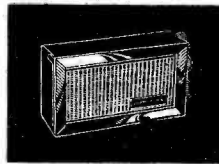

Total building costs
44'6

P. & P. 3/6

transona five

MEDIUM WAVE, LONG WAVE AND TRAWLER BAND PORTABLE WITH SPEAKER AND EARPIECE

Attractive case with red speaker grille. Size 6 1/2 x 4 1/2 x 1 1/2 in. 7 stage—5 transistors and 2 diodes, ferrite rod aerial, tuning condenser, volume control, fine tone moving coil speaker also Personal Earpiece with switched socket for private listening. Easy build plans and parts price list 1/6 (FREE with parts).



Total building costs
47'6

P. & P. 3/9

roamer six

SIX WAVEBAND PORTABLE WITH 3in. SPEAKER

Attractive case with gilt fittings. Size 7 1/2 x 5 1/2 x 1 1/2 in. Tunable on Medium and Long waves, two short waves, Trawler Band Plus an extra M.W. band for easier tuning of Luxembourg, etc. Sensitive ferrite rod aerial and telescopic aerial for Short waves. 8 stages—5 transistors and 2 diodes including Micro-Alloy R.F. Transistors etc. (Carrying strap 1/6 extra). Easy build plans and parts price list 2/-. (FREE with parts).



Total building costs
79'6

P. & P. 4/6

RADIO EXCHANGE CO

61 HIGH STREET, BEDFORD. Tel. 0234 52367

I enclose £..... please send items marked

ROAMER EIGHT	<input type="checkbox"/>	ROAMER SEVEN	<input type="checkbox"/>
TRANSONA FIVE	<input type="checkbox"/>	TRANS EIGHT	<input type="checkbox"/>
POCKET FIVE	<input type="checkbox"/>	ROAMER SIX	<input type="checkbox"/>

Parts price list and plans for

Name

Address

PW.17

* Callers side entrance Stylo Shoe Shop

* Open 10-1, 2.30-4.30 Mon-Fri. 9-12 Sat

ELECTROVALUE

Everything brand new and to specification • Large stocks • Good service

RESISTORS :

Code	Power	Tolerance	Range	Values available	1 to 9	10 to 99	100 up
C	1/20W	5%	82 Ω-220K Ω	E12	18	16	15
C	1/8W	5%	4.7 Ω-830K Ω	E24	2.5	2	1.75
C	1/4W	10%	4.7 Ω-10M Ω	E12	2.5	2	1.75
C	1/2W	5%	4.7 Ω-10M Ω	E24	3	2.5	2.25
MO	1/2W	2%	10 Ω-1M Ω	E24	9	8	7
C	1W	10%	4.2 Ω-10M Ω	E12	6	5	4.5
WW	1W	10%+1/20 Ω	0.22 Ω-3.3 Ω	E12	15d all quantities		
WW	3W	5%	12 Ω-10K Ω	E12	15d all quantities		
WW	7W	5%	12 Ω-10K Ω	E12	18d all quantities		

Codes : C = carbon film, high stability, low noise.
MO = metal oxide, Electrois TR5, ultra low noise.
WW = wire wound, Plessey.

Values : E12 denotes series: 1, 1.2, 1.5, 1.8, 2.2, 2.7, 3.3, 3.9, 4.7, 5.6, 6.8, 8.2 and their decades.
E24 denotes series: as E12 plus 1.1, 1.3, 1.6, 2, 2.4, 3, 3.6, 4.3, 5.1, 6.2, 7.5, 9.1 and their decades.
Prices are in pence each for quantities of resistors of same ohmic value and power rating NOT mixed values.
(Ignore fractions of one penny on total resistor order.)

COLVERN 3 WATT WIRE-WOUND POTENTIOMETERS :

10 Ω, 15 Ω, 25 Ω, 50 Ω, 100 Ω, 150 Ω, 250 Ω, 500 Ω, 1K Ω, 1.5K Ω, 2.5K Ω, 5K Ω, 10K Ω, 15K Ω, 25K Ω, 50K Ω.
Price only 5/6 each.

CARBON TRACK POTENTIOMETERS : Double wiper ensures minimum noise level.

Long plastic spindles each
Single gang linear: 220 Ω, 470 Ω, 1K etc. to 2.2M Ω 2/6 Log/Anti-log: 10K, 47K, 1M Ω only 8/6
Single gang log: 4K7, 10K, 22K etc. to 2.2M Ω 2/6 Dual anti-log: 10K only 8/6
Dual gang linear: 4K7, 10K, 22K etc. to 1M Ω 8/6 Any type with 1/2 amp. double pole mains
Dual gang log: 4K7, 10K, 22K etc. to 2.2M Ω 8/6 switch extra 2/3

FETS n-channel low cost general purpose 2N5163, 25 volt, only 5/- each.
Audio/r.f. Texas 2N3819 8/6, Motorola 2N5459 (MPP105) 9/9 each.
Motorola 2N5457 (MPP105) 9/9 each.

NEW PLESSEY INTEGRATED CIRCUIT POWER AMPLIFIER
TYPE 6L40SA. Only 48/6 nett. Operates with 18V power supply.
Sensitivity 20mV/mov 20M Ω, 3 watts into 7.5 Ω. Applications data with two or more. PE Nov. 69 Stereo Amplifier kit less metal work £11/8- NET complete.

30 WATT BAILEY AMPLIFIER COMPONENTS:

Transistors for one channel £7/5/6 list, with 10% discount only £6/11/0.
Transistors for two channels £14/11/0 list, with 15% discount only £12/7/5.
Capacitors and resistors for one channel list £2.
Printed circuit board free with each transistor set.
Complete unregulated power supply kit £4/17/6 mono or stereo, subject to discount.
Complete regulated power supply kit £9/5/- subject to discount. Further details on application.

SINCLAIR IC10 Integrated Circuit Amplifier and Pre-amplifier.
This remarkable monolithic integrated circuit amplifier and pre-amp now available from stock. The equivalent of 13 transistor/18 resistor circuit plus 3 diodes and the first of its kind ever. It is d.c. coupled and applicable to an unusually wide range of uses as detailed in the manual provided with it. As advertised, post free 59/6 NET.

CARBON SKELETON PRE-SETS.
Small high quality, type PR. Linear only: 100 Ω, 220 Ω, 470 Ω, 1K Ω, 2.2K Ω, 4K7, 10K, 22K, 47K, 100K, 220K, 470K, 1M Ω, 2M Ω, 5M, 10M Ω vertical or horizontal mounting, 1/- each.

S-DeCs put an end to "birdsnesting". Components just plug in. Saves valuable time. Use components again and again. S-DeC only 30/6 post free. Compact T-DeC, increased capacity, may be temperature-cycled T-DeC only 51/- post free. Full range available.

CAPACITORS: All new stock

Ripple current types:
2000μF 25V 7/4; 2000μF 50V 11/4; 5000μF 25V 12/8; 5000μF 50V 21/11; 1000μF 100V 18/3; 2000μF 100V 25/9; 5000μF 70V 36/-; 5000μF 100V 58/3; 1000μF 50V 8/2; 2500μF 64V 15/5; 2500μF 70V 19/6.

Medium electrolytics

Axial leads: Values (μF/V):
50/50 2/-; 100/25 2/-; 100/50 2/8; 250/25 2/8; 250/50 3/9; 500/25 3/9; 1000/10 3/3; 500/50 4/8; 1000/25 4/-; 1000/50 6/-; 2000/25 6/-; 3030/25 2/6.

Small electrolytics

Axial leads: 5/10, 10/10, 25/10, 50/10 1/- each, 25/25, 47/25, 100/10, 220/10 1/8 each.

PEAK SOUND ENGLEFIELD KITS

Brilliant new styling and available in two forms:
Stereo 15 watts per channel in kit form with complete amplifier and pre-amplifier modules and power supply. Build it 12 + 12 or 25 + 25 Output per channel into 15 Ω 12 watts R.M.S. Price £38/9/- net



25 WATTS PER CHANNEL. As above but Output per channel into 15 Ω 25 watts R.M.S. Price £58/15/- Net
Brief specification: Total harmonic distortion 0.1%.
Inputs: Magnetic, Ceramic, Tape, Radio, Signal to noise ratios: Better than 60dB all inputs. O/load factor 20dB all channels.

ENGLEFIELD CABINET to house either above assemblies (as illustrated) £8 Net. OTHER PEAK SOUND PRODUCTS AS ADVERTISED.

MULLARD Sub-min electrolytic G426

Range: Price 1/3 each. Axial leads: Values (μF/V): 0.64/64; 1/40; 1.8/25; 2.5/16; 2.5/64; 4/10; 4/40; 5/64; 6.4/6.4; 6.4/25; 8/4; 8/40; 10/2.5; 10/16; 10/64; 12.5/25; 16/40; 20/16; 20/64; 25/6.4; 25/25; 32/4; 32/10; 32/40; 32/64; 40/16; 40/2.5; 50/6.4; 50/25; 50/40; 64/4; 64/10; 80/2.5; 80/16; 80/25; 100/6.4; 125/4; 125/10; 125/16; 160/2.5; 200/6.4; 200/10; 250/4; 320/2.5; 320/6.4; 400/4; 500/2.5μF/V.

Wavechange switches: 1P 12W; 2P 6W; 3P 4W; 4P 3W long spindles, 4/9 each.

Slider switches, double pole double throw 3/- each.

BARGAINS IN NEW TRANSISTORS

All power types supplied with free insulating sets

2N696	5/6	2N5192	25/-
2N697	5/6	2N5195	28/3
2N706	2/9	4036	12/6
2N1132	9/9	40362	16/-
2N1302	4/-	AC126	6/6
2N1303	4/-	AC127	6/-
2N1304	4/6	AC128	6/-
2N1305	4/6	AC176	11/-
2N1306	6/9	ACY22	3/9
2N1307	6/9	ACY40	4/-
2N1308	8/9	AD140	19/-
2N1309	8/9	AD149	17/6
2N1613	6/-	AD161	16/-
2N1711	7/-	AD162	comp. pr.
2N2218	9/3	AF118	16/6
2N2147	18/9	AF124	7/6
2N2369A	5/3	AF127	7/-
2N2646	10/9	BA102	9/-
2N2924	4/-	BC107	2/9
2N2925	4/6	BC108	2/6
2N2926R	2/3	BC109	2/9
2N2926G	2/3	BC147	3/6
2N2926Y	2/3	BC148	3/3
2N2926G	2/3	BC149	3/6
2N3053	5/6	BC153	10/-
2N3054	14/3	BC154	11/-
2N3055	16/-	BC157	3/9
2N3391A	6/3	BC158	3/6
2N3702	3/6	BC159	3/9
2N3703	3/3	BC167	2/6
2N3704	3/9	BC168	2/3
2N3705	3/5	BC169	2/6
2N3706	3/3	BC177	6/3
2N3707	4/-	BC178	5/8
2N3708	3/-	BC179	6/-
2N3709	3/-	BD121	17K
2N3710	3/6	BD123	24/3
2N3711	3/11	BF178	10/6
2N3904	7/6	BFX29	10/9
2N3906	7/6	BFX85	8/3
2N3731	24/-	BFX88	6/9
2N4058	5/3	BSX20	3/9
2N3325	10/9	BFY50	4/6
2N3794	3/3	BFY51	4/3
2N4284	3/3	MJ480	21/-
2N4286	3/3	MJ481	27/-
2N4289	3/3	MJ491	30/-
2N4291	3/3	P346A	4/6
2N4292	3/3	V405A	7/9
2N4410	4/9	NKP403	15/6
		NKP405	15/-

MAIN LINE AMPLIFIER KITS as advertised. Prices Net. Authorised dealer.

COMPONENT DISCOUNTS :
10% on orders for components for £5 or more.
15% on orders for components for £15 or more.
(No discount on net items.)

POSTAGE AND PACKING :
Free on orders over £2.
Please add 1/6 if order is under £2.
Overseas orders welcome; carriage charged at cost.

ELECTROVALUE

(Dept. PW. 4) 28 ST. JUDES ROAD. ENGLEFIELD GREEN, EGHAM, SURREY.

Telephone: Egham 5533 (STD 0784-3)

Open 9-5.30 Sats. 1 p.m.

EX-RENTAL TELEVISIONS

TWO-YEAR GUARANTEE

17" SLIMLINE 405 only
£11 10 0

19" SLIMLINE 405/625
39 Gns.

Carriage and Insurance 30/-

FREE ILLUSTRATED LIST OF
TELEVISIONS

17"-19"-21"-23"

WIDE RANGE OF MODELS,
SIZES AND PRICES

DEMONSTRATIONS DAILY

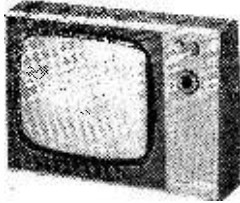

TWO-YEAR GUARANTEED TUBES 100% REGUNNED

Slim Line Tubes 110" 17" and 19" 109/6, 21" and 23" 129/6.

Normal Tubes 70" and 90" 17" 99/6, 21" 119/6, 14" and other sizes 79/6.

SPEAKERS 10/-, 24" 8Ω, 3 1/2" 25Ω,
4" 10Ω, 3" x 5" 8Ω, 7" x 4" 3Ω, 8" x
3" 3Ω. BRAND NEW. P. & P. 2/-.

RECORD PLAYER CABINET
49/6

Transistors: Mullard matched output
kit 7/6, OC81D-2 OC81's. P. & P.
FREE.

Transistor Radio Cases: 4 for £1.
Size 9 1/2" x 6 1/2" x 3 1/2". P. & P. 9/6.

Ferrite Rods 3/6: 6" and 8" complete
with LW/MW Coils. P. & P. FREE.

STRIP LIGHT TUBES 3/9 each.
1 1/2" (284mm), 230/240 volts, 30 watts.
Ideal for cocktail cabinets, illuminating
pictures, diffused lighting, etc.
6 for £1. P. & P. free.

Cloth covered. Size 16 1/2" x 14 1/2" x
7 1/2". Takes any modern auto-
changer. P. & P. 7/6.



(DUKE & CO. LONDON) LTD.

£21/3 Romford Road, London, E12

Tel. 01-478 6001/2/3

VALVES

SAME DAY SERVICE NEW! TESTED! GUARANTEED

SETS 1R5, 1B5, 1T4, 3B4, 3V4, DAF91, DF91, DK91, DL92, DL94.
Set of 4 for 18/6, DAF96, DF 96, DK96, DL96, 4 FOR 27/-.

0Z4	4/6	12K8GT 7/3	DK91 5/6	EF184 5/6	PCL82 7/3	UBP80 5/6
1A7GT	7/6	18B6G17/6	DK92 8/6	EH90 6/3	PCL83 12/-	UBF89 6/6
1H5GT	7/8	20F2 13/6	DK96 7/3	EL33 9/6	PCL84 7/6	UCC84 7/3
1N3GT	7/9	20P3 11/9	DL35 5/-	EL34 9/6	PCL85 9/-	UCC85 7/3
1R5	5/6	20P4 13/6	DL32 5/9	EL41 11/-	PCL86 8/3	UCF80 7/3
1R5	4/8	28L6GT 5/-	DL94- 6/8	EL64 4/9	PEN44 13/6	UCH42 12/6
1T4	2/9	25UAGT11/6	DL96 7/3	EL90 4/6	PFL20011/9	UCR81 6/6
3B4	5/9	30C1 6/6	DY86 5/9	EL500 12/6	PL36 9/9	UCL82 7/-
3V4	6/3	30C15 12/-	DY87 5/9	EM30 7/6	PL81 8/9	UCL83 11/9
6Y3GT	5/9	30C17 16/-	EABC80 6/6	EM81 7/6	PL81A 10/6	UF41 10/6
6Z4C	7/6	30C18 14/-	EAF42 10/-	EM84 6/9	PL82 6/6	UF80 7/-
6/30L2	13/-	30F5 16/-	EB91 2/9	EM87 7/6	PL83 7/6	UF85 6/9
6AL5	2/3	30FL1 14/-	EBC33 8/6	EY81 7/3	PL84 6/6	UF89 6/9
6AM6	2/9	30FL12 14/6	EBC41 9/6	EY86 6/6	PL500 13/-	UL41 11/9
6AQ5	4/6	30FL14 14/9	EBF80 6/9	EZ40 8/-	PL504 13/6	UL44 20/-
6AT6	4/-	30L1 6/6	EBF89 6/3	EZ41 8/-	PL508 23/6	UL84 7/-
6AU6	4/6	30L15 14/-	ECC81 3/9	EZ80 4/6	PM84 7/6	UM84 6/6
6BA6	4/6	30L17 15/6	ECC82 4/9	EZ81 4/9	PX25 12/-	UY41 7/6
6BE6	4/9	30P4 12/-	ECC83 7/-	GZ39 8/9	PY32 10/-	UY85 5/9
6BJ6	8/6	30P12 13/9	ECC85 5/-	GZ34 9/9	PY33 10/-	VP4B 10/-
6BW6	13/-	30P19 12/-	ECC91 3/-	KT61 9/9	PY81 5/3	W77 3/6
6CG6	4/9	30PL1 14/9	ECC804 12/-	KT66 16/9	PY82 5/3	W119 7/-
6F13	3/6	30PL13 17/6	ECP80 6/6	N78 17/6	PY83 5/9	Z77 2/9
6F14	9/-	30PL14 16/6	ECP82 6/6	PABC80 7/-	PY88 6/9	Transistors
6F23	14/3	35L6GT 8/6	ECH85 6/-	PC86 10/3	PY800 7/6	AC107 3/6
6F25	13/-	35W4 4/6	ECH42 13/6	PC88 10/3	PY901 7/6	AC127 2/6
6J9G	4/9	35Z4GT 5/-	ECH81 5/9	PC96 8/6	R19 6/6	AD140 7/6
6J6	3/-	6063 12/6	ECH83 8/3	PC97 8/6	R20 12/6	AF115 3/-
6K7G	2/8	807 9/-	ECH84 7/6	PC900 7/6	U25 13/-	AF116 3/-
6K8G	2/9	AC/VP210/-	ECL80 7/-	PC884 6/6	U26 12/-	AF117 4/-
6L18	6/-	AZ91 9/6	ECL82 6/9	PC885 6/-	U47 13/6	AF125 3/6
6SN7GT	4/3	B729 12/6	ECL83 8/6	PC888 9/-	U49 13/6	AR127 3/6
6V6G	3/3	CCH35 13/6	ECL86 8/-	PC889 10/6	U78 4/3	OC26 5/-
6V6GT	6/6	CL33 13/6	EF37A 6/6	PCC189 11/6	U191 12/6	OC44 2/6
6X4	4/3	CY31 6/9	EF39 4/9	PCF80 6/6	U193 8/6	OC45 2/3
6X5GT	5/9	DAC32 7/3	EF41 10/9	PCF82 6/6	U251 14/6	OC71 2/6
10F1	14/-	DAF91 4/6	EF90 4/6	PC886 10/6	U301 10/6	OC72 2/6
10F18	7/-	DAF96 7/3	EF95 6/3	PC890 13/6	U329 14/6	OC75 2/6
10F13	12/-	DF33 7/9	EF86 6/3	PCF801 6/9	U801 19/6	OC81 2/6
12AT7	3/9	DF91 2/9	EF89 5/3	PCF802 9/-	UABC80 6/6	OC81D 2/6
12AU6	4/9	DF96 7/3	EF91 2/9	PCF805 14/-	UAF42 10/3	OC82 2/3
12AU7	4/9	DH77 4/-	RF94 4/6	PC896 12/9	UB41 6/6	OC82D 2/3
12AX7	4/9	DK32 7/6	RF183 5/9	PCF808 14/9	UBC41 9/-	OC170 4/6

READERS RADIO

85 TORQUAY GARDENS, REDBRIDGE, ILFORD,
ESSEX. Tel. 01-550 7441.

Postage on 1 valve 9d. extra. On 2 valves or more, postage 6d. per
valve extra. Any Parcel Insured against Damage in Transit 6d. extra

Opportunities with Redifon in Radio Communications

Experienced Test Engineers are invited to write to Redifon with regard to vacancies in our Test Department at Wandsworth.

The Company is engaged in the design and manufacture of a wide range of radio communications and allied equipment from military pack-set to broadcast transmitter, including communications receivers, M.F. beacons, teleprinter terminals, complete radio office installations for the Merchant Marine and mobile H.F. S.S.B. Stations. Our Test Engineers have sound technical knowledge coupled with good practical experience in the alignment and test of H.F. and V.H.F. Communications equipment. The work is varied and interesting and offers excellent opportunity to broaden experience in semiconductors, S.S.B. and Frequency synthesis.

Limited vacancies also exist for engineers experienced in Test gear maintenance.

Please write in the first instance to:

The Personnel Officer,

REDIFON LTD.,

Broomhill Road, Wandsworth, SW18.

REDIFON

A Member Company of the Rediffusion Organisation

Suppliers of Radio Communications equipment to Home, Commonwealth, and foreign governments. Contractors to B.B.C., G.P.O., Crown Agents, Cable and Wireless, leading shipping companies of the world, etc.

Practical Wireless Classified Advertisements

The pre-paid rate for classified advertisements is 1/8d. per word (minimum order 20/-), box number 1/6d. extra. Semi-displayed setting £5 10s. 0d. per single column inch. All cheques, postal orders, etc., to be made payable to PRACTICAL WIRELESS and crossed "Lloyds Bank Ltd." Treasury notes should always be sent *registered post*. Advertisements, together with remittance, should be sent to the Classified Advertisement Manager, PRACTICAL WIRELESS, IPC Magazines Ltd., Fleetway House, Farringdon Street, London, E.C.4 for insertion in the next available issue.

MISCELLANEOUS

THE NEW ELECTRONIC MUSIC FOR YOU

Then how about making yourself an electric organ? Constructional data available—full circuits, drawings and notes! It has 5 octaves, 2 manuals and pedals with 24 stops—uses 41 valves. With its variable attack you can play Classics and Swing. Write NOW for free leaflet and further details to C. & S., 20 Maude Street, Darlington, Durham. Send 4d. stamp.

NOTES ON USE of TV for UFO Detection. Optical Detector Circuits, 8s 6d. Radar & Electronic Publications, "Highlands," Needham Market, Suffolk.

EXPRESS ROTARY SWITCHES. Switches for Mullard audio circuits, also switches made to customers own specifications. For details and price list, write or phone to 189 Edgware Road., London W.2. Tel. 01-723 4455.

6 OR 12 VOLT FLUORESCENT LIGHTS

12 ins. 8 Watt tube ample light for caravan, tent etc. Fully transistorised, low battery drain. Unbeatable at **£2.19.6**

or in kit form **50/-**

4 WATT GRAM AMPS.

Volume and tone controls, mains operation, 3Ω output, new and boxed **65/- POST PAID**

SALOP ELECTRONICS Callers welcome
23 Wyle Cop, Shrewsbury,
Shropshire S.A.E. for list

MUSICAL MIRACLES. Send S.A.E. for details of Rythm Modules, versatile bass-pedal unit, self-contained with unique effects, kits for waa-waa pedals. Also new 50μA meters, 25/- post paid. HURRY. D.E.W. Ltd., 254 Ringwood Road, Ferndown, Dorset.

TOP TRANSISTORS

High Stability 5% ½ watt Resistors
12/6 for 50. 10Ω to 1MΩ your selection.

ACY22 1/9	OC45 1/9	ZTX300 1/9
BC108 1/9	OC71 1/9	2N2926 1/9
BFY52 1/9	OC202 1/9	2N3708 1/9

All the above types are available at 16 for £1. Brand New. Individually Tested. MONEY BACK GUARANTEE. P. & P. 1/-

J. M. KING.

17 Buckridge, Portpool Lane, E.C.1

SERVICE MANUALS for Pre 1958 H.M.V. and E.M.I. MODELS. Radio and Record Player Manuals 5/- each. Television Manuals 7/6 each. Send C.W.O. stating model required. Also limited range of components and spares. Send details of your requirements. R.D.I. Ltd., Chilton Works, Garden Road, Richmond, Surrey.

MISCELLANEOUS

(continued)

Be well-equipped

You need not worry about the painful and lingering minor burns that occur from time to time in leisure pursuits if you keep BURNZEZE close to hand. This unique new scientific aerosol cools and anaesthetizes. BURNZEZE takes the heat out of a burn in just 8 seconds, then controls the blistering and pain that steal skill from nimble fingers. Be well-equipped—buy BURNZEZE, from chemists.

Potter & Clarke Ltd Croydon
CR9 3LP



BUILD IT in a DEWBOX quality cabinet. 2in. x 2½in. x any length. D.E.W. Ltd., Ringwood Road, FERNDOWN, Dorset. S.A.E. for leaflet. Write now—Right now.

BOOKS & PUBLICATIONS

SURPLUS HANDBOOKS

19 set Circuit and Notes ..	7/0 p/p 9d.
1155 set Circuit and Notes ..	7/0 p/p 9d.
H.R.O. Technical Instructions ..	6/0 p/p 9d.
38 set Technical Instructions ..	6/0 p/p 9d.
46 set Working Instructions ..	6/0 p/p 9d.
88 set Technical Instructions ..	7/6 p/p 9d.
BC.221 Circuit and Notes ..	6/0 p/p 9d.
Wavemeter Class D Tech. Instr ..	6/0 p/p 9d.
18 set Circuit and Notes ..	6/0 p/p 9d.
BC.1000 (31 set) Circuit and Notes ..	6/0 p/p 9d.
CR.100/B.28 Circuit and Notes ..	10/6 p/p 1/-
R.107 Circuit and Notes ..	7/6 p/p 9d.
AR.88D Instruction Manual ..	18/6 p/p 9d.
62 set Circuit and Notes ..	7/0 p/p 9d.
Circuit Diagram 5/6 each post free, R.1116/A, R.1224/A, R.1355, R.F. 24, 25 and 26, A.1134, T.1154, CR.300, BC.312, BC.342, BC.348J, BC.348 (E.M.P.), BC.624, 22 set.	
52 set Sender and Receiver circuits 8/- post free	

Colour code indicator 2/6 p/p 6d.

S.A.E. with all enquiries please.

Postage rates apply to U.K. only.

Mail order only to:

INSTRUCTIONAL HANDBOOK SUPPLIES

DEPT. PW, TALBOT HOUSE,
28 TALBOT GARDENS, LEEDS 8

TAPE RECORDING YEAR BOOK

COMPLETELY NEW NINTH EDITION
WITH COMPREHENSIVE CATALOGUE
SECTION AND ARTICLES BY EXPERTS

PRICE 10/6d. from
7 ALVERSTONE AVENUE,
EAST BARNET, HERTS.

FOR SALE

MORSE MADE !!

FACT NOT FICTION. If you start RIGHT you will be reading amateur and commercial Morse within a month. (Normal progress to be expected.)

(Using scientifically prepared 8-speed records you automatically learn to recognise the code RHYTHM without translating. You can't help it, it's easy as learning a tune. 18 W.P.M. in 4 weeks guaranteed.)

For details and course C.O.D. ring, s.t.d. 01-660 2896 send 8d. stamp for explanatory booklet to:
686HS (BOX 11), 45 GREEN LANE, PURLEY, SURREY

SEEN MY CAT? 5,000 items. Mechanical & Electrical Gear, and materials. S.A.E. K. R. WHISTON, Dept. PW, NEW MILLS, Stockport.

YUKAN SELF-SPRAY

Get these *air-drying* **GREY HAMMER** *OR* **BLACK WRINKLE** *(CRACKLE)* Finishes

NOW!

Yukan Aerosol spraykit contains 16 ozs. fine quality durable easy instant spray. No stove baking required. Hammers available in grey, blue, gold, bronze. Modern Eggshell Black Vynilite (Crackle) all at 15/11 at our counter or 16/11 carriage paid, per push-button self-spray can. Also Durable, heat and water resistant Black Matt finish (12 ozs. self-spray cans only) 13/11 carriage paid.

SPECIAL OFFER: 1 can plus optional transferable snap-on trigger-handle (value 5/3) for 18/11, carriage paid. Choice of 13 self-spray plain colours and primer (Motor car quality) also available. Please enclose cheque or crossed P.O. for total amount direct to:

Dept M - YUKAN, 307A, EDGWARE ROAD, LONDON, W.2.

We supply many Government Departments, Municipal Authorities, Institutes and Leading Industrial Organisations—We can supply you too.

Open all day Saturday. Closed Thursday afternoons.

WANTED

CASH PAID for New Valves. Payment by return. WILLOW VALE, ELECTRONICS, 4 The Broadway, Hanwell, London, W.7. 01-567/5400-2971.

WANTED NEW VALVES ONLY

Must be new and boxed
Payment by return

WILLIAM CARVIS LTD.
103 North Street, Leeds 7

WE BUY New Valves and Transistors. State price. A.D.A. MANUFACTURING CO., 116 Alfreton Road, Nottingham.

WANTED NEW VALVES. televisions, radiograms, transistors, etc. STAN WILL-ETTS, 37 High Street, West Bromwich, Staffs. Tel.: WES 0186.

WE BUY New Valves, Transistors and clean new components, large or small quantities, all details, quotation by return. WALTON'S WIRELESS STORES, 55 Worcester Street, Wolverhampton.

WANTED
(continued)

SERVICE SHEETS AND MANUALS PURCHASED. Highest prices paid. Sultan Radio, 29 Church Road, Tunbridge Wells, Kent. Phone T.W. 22093.

ELECTRICAL

**240 VOLT
ELECTRICITY
ANYWHERE**



BEST EVER 200/240 VOLTS "MAINS" SUPPLY FROM 12 VOLT CAR BATTERY
Exclusive World Scoop Purchase. The fabulous Mk. 2D American Heavy Duty Dynamotor Unit with a Massive 220 watt output and giving the most brilliant 200/240 volt performance of all time. Marvellous for Television, Drills, Power Tools, Mains Lighting, AC Fluorescent Lighting and all 200/240 volt Universal AC/DC mains equipment. Made at tremendous cost for U.S.A. Govt. by Delco-Remy. This magnificent machine is unobtainable elsewhere. Brand New and Fully Tested, only £4.19.6, plus 10/6 postage. C.O.D. with pleasure. Money back if not delighted. Please send s.a.e. for interesting illus. details. Dept. PW STANFORD ELECTRONICS, Rear Derby Road, North Promenade, Blackpool, Lancashire.

SERVICE SHEETS

SERVICE SHEETS (1925-1970) for Televisions, Radios, Transistors, Tape Recorders, Record Players, etc., by return post, with free Fault-Finding Guide. Prices from 1/-. Over 8,000 models available. Catalogue 2/6. Please send S.A.E. with all orders/enquiries. Hamilton Radio, 54 London Road, Bexhill, Sussex.

SERVICE SHEETS. Radio, TV etc. 8,000 models. List 2/-. S.A.E. enquiries. TEL-RAY, 11 Maudland Bank, Preston.

RADIO, TELEVISION over 3,000 models. JOHN GILBERT TELEVISION, 1b Shepherds Bush Rd., London W.6. SHE 8441.

LARGE SUPPLIER OF SERVICE SHEETS
(T.V., RADIO, TAPE RECORDERS, RECORD PLAYERS, TRANSISTORS, STEREOGRAMS, RADIOGRAMS, CAR RADIOS)

Only 10/- each, plus large S.A.E.

(Uncrossed P.O. s please, original returned if service sheets not available.)

C. CARANNA
71 BEAUFORT PARK
LONDON, N.W.11

We have the largest supplies of Service Sheets (strictly by return of post). Please state make and model number alternative.

Free TV fault tracing chart or TV list on request with order.
Mail order only.

SERVICE SHEETS
(continued)

TRADER SERVICE SHEETS

5/- each plus postage

We can supply Trader Service Sheets for most makes and types of Radios, Tape Recorders and Televisions—Manuals for some.

Cheques and open P.O.s returned if sheets not available.

OAKFIELD ENTERPRISES LIMITED

30 CRAVEN STREET, STRAND
LONDON WC2

Make	Model	Radio/TV

1970 List now available at 2/- plus postage

If list is required indicate with X

From
Address

enclose remittance of.....
(and a stamped addressed envelope)
s.a.e. with enquiries please

MAIL ORDER ONLY (February PW)
RECEIVERS & COMPONENTS

RECEIVERS & COMPONENTS
(continued)

TRANSISTOR METRONOME ready built on printed circuit board with control for variable beat. This useful unit is complete with ear-piece and battery, but will drive any loud-speaker. Fully tested and guaranteed. Compare our price 22/8 + 2/6 P.P. **BRAND NEW HEADPHONES** complete with heavy duty hand-mike. Our best seller, only 15/- + 5/- P.P. **CARBON MICROPHONE INSERTS** 3 for 3/- + 1/- P.P., 6 for 6/- post free. 12 for 10/- post free. **NEW AIRP12 VALVES**, 8 for 6/- post free, 12 for 10/- post free.
MEPPEN-WALTER MAIL ORDER.
12 Gledhow Park View, Leeds LS7 4JQ.

COMPLETE RANGE of Amateur Aircraft, Communications receivers. Chassis, panels, meters, cabinets, microphones, etc. Stephens-James Ltd., 70 Priory Road, Liverpool 4. Tel. 051-263-7829.

TO HELP THE HOME CONSTRUCTOR. Heathkit now make available our surplus Resistors, Capacitors, etc. at Bargain prices. Send for lists. E. Moyle, Daystrom Ltd., Gloucester.

AUDIOSCAN-HI-FI loudspeaker systems for the home constructor, cabinet kits, new range of Peerless speakers, speaker kit systems and cross-over networks. BAF wadding and all necessary components. Free speaker fabric samples on request. Send 9d in stamps to: **AUDIOSCAN**, Dept. P.W., 4 Princes Square, Harrogate, Yorks.

COMMUNICATIONS RECEIVERS: Ex-Govt. bargains in the £10 to £20 range, including: R209, PCR2, CR300, B40, B41, Murphy HF/MF, and others. Write or phone for details. P. R. GOLLEDGE, G3EDW, Glen Tor, Torrington, Devon. 08-052 2411.

A CORNUCOPIA OF COMPONENTS! Scarce valve, selected T.V. components, Speakers, Cabinets, Computer panels—long leads NOT printed circuits. Transistors, resistors—new and recovered. State requirements. S.A.E. (F.S.) for details. **MAIL-MART**, 6 Eastbourne Road, Pevensey Bay, Sussex.

LOW PRICE, HIGH QUALITY SPEAKER SYSTEMS

All cabinets are new and carefully designed acoustically with speakers mounted on 1/4 in. chipboard baffles. All speakers are ex-TV high quality with hi-flux magnets carefully matched and tested.



CAXTON COLUMN. This is a column cabinet 23 1/2 x 5 1/2 x 5 1/2 in. deep finished in black or wood grain cloth with blue Vynair front. Key-hole slot for wall mounting. Fitted with three speaker units, 9 ohms impedance. Handles 8 watts. Makes all the difference in quality and volume of tape recorders and record players. Real bargain at 59/6d. P. & P. 10/6d. each.

SPEAKERS: Elac Heavy duty Ceramic Magnets 11,000 line, 10in. round, 10 x 6in, 3 ohm or 15 ohm, 48/6. P. & P. 3/6. 8in. round 15, 42/6. P. & P. 3/6. E.M.I. 13 1/2 x 8in. 3 ohm, 45/-, 15 ohm 48/6. P. & P. 1/6. E.M.I. 3in. tweeter 17/6. P. & P. 1/6. E.M.I. 13 x 8in. fitted two 2 1/2in. tweeters. 15 ohm 77/6. P. & P. 4/6. E.M.I. 13 1/2 x 8in. (15 ohm) Hi-Fi quality £5.19.6. P. & P. 4/6. E.M.I. Woofers, 6 1/2 x 6 1/2 in. square, 8 ohm, 59/6. P. & P. 4/6. E.M.I. Crossover, 16/6. P. & P. 1/-. **EAGLE** Crossover units 3 or 16 ohms. 17/4. P. & P. 1/-. Bakers 12in. 25 watt 15 ohm £6.6.0. P. & P. 3/6.

VYNAIR Widths from 40 to 54in., 15/- yd. off roll. P. & P. 1/9. 1/2 yard, 8/-, P. & P. 1/9. Send 1/- stamps for samples.

SPEAKER MATCHING TRANSFORMERS. 3, 7, 15 ohms, 8 watt, 13/6. P. & P. 1/6.

CARTRIDGES. Stereo: Sonotone 9TA H/C Diamond, 47/6. Ronette S105 Medium Output, 28/6. S106 High Output 28/6. Acos GP93 1 Sapphire, 37/6. GP94 1 Sapphire, 39/6. GP81 Diamond, 42/- GP91 Stereo Compatible (High, Medium or Low Output), 25/-. TA800 converts Philips AG3001, AG3006 to B.S.R. SX14. Plug-in head complete with cartridge, 50/-. TA700 equivalent to B.S.R. SX1M, 35/-. Japanese equivalent to B.S.R. TC8s, 35/- P. & P. 1/6.
Mono: Acos GP67/2 will replace Collaro and Garrard Mono cartridges, 18/6. T.T.C. Crystal High Gain, 15/-. B.S.R. YC8H Jap. equivalent, 26/- Sonotone 2TS5, 15/- P. & P. 1/6.

EARPIECES WITH CORD and 3.5mm. plug, 8 ohm magnetic, 3/-, 250 ohm, 4/-, 180 ohm with clip, 6/6. Xtal. P. & P. 6d.

PIANO KEY PUSH BUTTON SWITCHES. 7 button inc. mains on off. 6 banks of 6 P.C.O.s. 8/6. P. & P. 1/-.

INSTANT HEAT. Soldering gun!
Save £ £ 2's by tackling intricate soldering jobs yourself! All-purpose soldering gun gives **INSTANT HEAT**
Save electricity.



Automatic spotlight makes work easier. Spare solder bits only 2/6 each (P. & P. 5d.). Money ref. guarantee.

Only 32/6 5/- p.d.p.

BROADWAY ELECTRONICS (Nr. Tooting Broadway Underground Stn)
92 MITCHAM ROAD, TOOTING BROADWAY, LONDON, S.W.17 01-672 3984 (Closed all day Wed.)

RECEIVERS & COMPONENTS
(continued)

EX COMPUTER PRINTED CIRCUIT PANELS 2in x 4in packed with semi-conductors and top quality resistors, capacitors, diodes, etc. Our price, 10 boards 10/- P. & P. 1/6. With a guaranteed minimum of 35 transistors. Transistor data included.

SPECIAL BARGAIN PACK. 25 boards for £1. P. & P. 3/6. With a guaranteed minimum of 85 transistors. Transistor data included.

PANELS with 2 power transistors sim. to OC28 on each board + components. 2 boards (4 x OC 28) 10/- P. & P. 1/6d.

9 OAs, 3 OA10, 3 Pot Cores, 26 Resistors, 14 Capacitors, 3 GET 872, 3 GET 872B, 1 GET 875. All long leaded on panels 13" x 4"
4 for 20/- P. & P. 5/-.

EX COMPUTER "MEMORY" CORE STORE PLANES

160 BITS £1 P. & P. 2/-
4,000 BITS £4 P. & P. 4/-
10,000 BITS £8 P. & P. 8/-

250 MIXED RESISTORS
½ & ¼ watt 12/6 P. & P. 1/6

DIODES EX. EQPT SILICON

10 AMP 150 PIV 4 for 10/-
20 AMP 150 PIV 4 for £1
35 AMP 150 PIV 4 for 45/- P. & P. 1/-

EXTRACTOR / BLOWER

FANS (Papst)

100 c.f.m. 4½" x 4½" x 2"
2800 r.p.m.
50/- ea. P. & P. 5/-

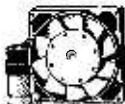

RELAY OFFER

Single pole changeover silver contacts 2" x 6" x 7" 2.5 KΩ coil operates on 25 to 50v 8 for 10/- P. & P. 1/6

KEYTRONICS

LT/STEP DOWN TRANSFORMER

PR10, 200, 215, 230, 245v
SEC 1, 0.10 25v 4A
SEC 2, 0.115v 2A
30/- P. & P. 6/- Quantity available

12V 4A POWER SUPPLY

Extremely well made by Frako GMBH in West Germany with constant voltage mains transformer, tapped input from 115 to 240V full wave rectification and capacitor smoothing. Size 9 x 6 x 5. Weight 11lbs. These units are brand new unused and fully guaranteed. Makers price believed to be around £80.

OUR PRICE £9.10.0 Carr. 10/-

150 HIGH STABS ½, ¼ and 1 Watt
5% and Better 12/6d. P. & P. 1/6

LARGE CAPACITY ELECTROLYTICS

1500 Mfd 150v
4000 Mfd 72v
5000 Mfd 36v 7/6 each
16000 Mfd 12v P. & P. 1/6d.
£3 10 0 Doz. P. & P. 10/-

EXTENSION TELEPHONES

19/6 Ea. P. & P. 5/-
35/- for 2 P. & P. 7/-



These phones are extensions and do not contain bells.

MAILING ADDRESS
52 EARLS COURT ROAD, LONDON W8
WAREHOUSE & DISPATCH
01 478 8499

VALVE BARGAINS

Any 5. 9/-: 10. 14/-: 100. £5 10s
P&P 1/6 from the following:
ECC82. ECL80. EF85. EF183. EBF89.
EB91. E786. PCC84. PCC89. PCF80.
PCF86. PCL82. PCL83. PCL84. PL36.
PL81. P733. P781. P782. P7800.

AERIAL BOOSTERS 59/-

Three types of High Gain Transistorised pre-amplifiers all at the same price
UHF 625 Type L45. Tunable over the complete UHF Stations
VHF 405 Type L12 with Separate Tuning for Band 1 and Band 2. Pleaes state channel numbers.
FM UHF RADIO PRE-AMPLIFIER
SAE for Full Details. All complete with battery and leads. 7 day money back guarantee if not satisfied
VELCO ELECTRONICS, 62 BRIDGE ST., RAMSBOTTOM, BURY, LANCs.

RECEIVERS & COMPONENTS
(continued)

Free and Illustrated Lists of all types of Hi-Fi equipment; Tuners. Amps, etc., Electronic equipment, components, and gadgets at lowest prices from:
ALBION ELECTRONICS SUPPLIES, D/3, 16 Albion Road, Birchington, Kent.

EMSAC FOR ANTENNA SYSTEMS AND CONVERTERS. Please send s.a.c. for details of 2 metre converters, antennas and transmatchers for receiving and transmitting. **ELECTRONIC & MECHANICAL SUB-ASSEMBLY CO. LTD.,** Highfield House, West Kingsdown, Kent. Tel. W.K. 2344.

150 NEW ASSORTED Capacitors. Resistors. Silvered Mica. Ceramic, etc. Carbon, Hy-stab, Vitreous. ¼-20 watt. 15/- Post Free. **WHITSAM ELECTRICAL,** 33 Drayton Green Road, West Ealing, W.13.

BRAND NEW ELECTROLYTICS, 15/16 volt 0.5, 1, 2, 5, 8, 10, 20, 30, 40, 50, 100 mfd. 8-5d. 200 mfd. 10d., postage 1s. The C.R. Supply Co., 127 Chesterfield Road, Sheffield 8.

Stella Nine Range Cases

Manufactured in Black, Grey, Lagoon or Blue Stelvetite and finished in Plastic-coated Steel, Morocco Finish with Aluminium end plates. Rubber feet are attached and there is a removable back plate. There is also a removable front panel in 18 s.w.g. Alloy.
Now all Aluminium surfaces are coated with a strippable plastic for protection during manufacture and transit. All edges are polished.

LIST OF PRICES AND SIZES
which are made to fit Standard Alloy Chassis

Width	Depth	Alloy Chassis		
		4" Height £ s. d.	6" Height £ s. d.	7½" Height £ s. d.
6½"	3½"	12 6	15 0	18 0
6½"	4½"	13 6	18 0	1 0 0
8½"	3½"	15 0	1 6 0	1 1 0
8½"	4½"	1 1 0	1 6 6	1 18 9
10½"	3½"	1 8 6	1 15 6	1 18 9
12½"	3½"	1 1 0	1 6 6	1 11 0
12½"	4½"	1 8 0	1 14 0	1 17 6
12½"	5½"	1 16 0	2 3 0	2 7 3
14½"	3½"	1 5 0	1 11 6	1 14 0
14½"	4½"	2 3 0	2 15 6	2 15 6
16½"	3½"	1 18 6	2 6 3	2 11 6
16½"	10½"	2 10 0	3 5 0	3 11 9

Cases—Post 4s. 6d. per order.
Discounts available on quantities.

CHASSIS in Aluminium, Standard Sizes, with Gusset Plates

Sizes to fit Cases. All 2½" Walls

6" x 8"	8" x 8"	10" x 7"	8" x 6"	14" x 3"	s. d.
5 6	5 9	12" x 8"	6 9	14" x 9"	7 3
6 8	6 6	12" x 5"	7 0	16" x 6"	10 9
8" x 6"	7 9	12" x 10"	16" x 10"	16 0	16 0

Chassis—Post 3s. 0d. per order.
Discounts available on quantities.

E. R. NICHOLLS

Manufacturer of Electronic Instrument Cases
46 LOWFIELD ROAD
STOCKPORT - CHESHIRE
Tel: 061-480 2179

AERIALS

BAKER AND BAINES

BBC dipole 30/-, H 42/-, 3 ele 89/-, ITA 3 ele 26/-, 5 ele 34/-, 8 ele 47/5, 11 ele 57/6. ITA doubles 8 ele 112/-, 11 ele 140/-, 13 ele 159/-, Combined BBC/ITA D+5 45/-, D+8 52/-, H+5 69/-, X+5 75/-, Combined Loft Special D+5 with loft pole and fixings 37/-, UHF Aerials BBC-ITA 14 ele 37/-, 18 ele 54/-, 22 ele 63/-, Double 22 ele 142/-, CO-AX low loss at 1/3 and 2/3. CO-AX plugs 1/4. Diplexers - Triplexers-Matched UHF/VHF Diplexers, UHF/VHF Preamps. Poles, Lashings, Clamps, Couplers, etc. Postage paid on all aerials. Extra on accessories.
Please state channels when ordering.
11 Dale Cres. Tupton, Chesterfield.

JEF ELECTRONICS

New Full Specification Devices. Integrated Circuits complete with data:
GE PA230 Audio Pre-amplifier 18/6d
GE PA234 1W Audio Amplifier 17/6d
GE PA237 2W Audio Amplifier 32/6d
Plessey SL402A Preamp & 2W Amp 42/-
MEL 11 Photo Darlington Amp 9/6d
High quality low cost transistors:
GE 2N5172 NPN 200mW 1/9d: ME 0412 PNP 200mW 3/9d: TI 2N4059 PNP 250mW 3/6d: MUL BFX86 NPN 800mW 6/-: MUL BD124 NPN 15W 12/-: S 2N3055 NPN 115W 14/6d.
Triacs for full wave power control: RCA 40669 8A 400V 24/-: RCA 40583 Trigger Diode 5/3d.
Plastic rectifiers for power supplies: IN 4820 1.5A 400V Si Rectifier 2/6d: W005 1A 50V full wave bridge Si 7/6d: PD40 2A 400V full wave bridge Si 15/-.
C.W.O. P. & P. 1/- per order.
York House, 12 York Drive, Grappenhall, Warrington, Lanes. Mail order only



Norwich City College

DEPARTMENT OF ELECTRICAL ENGINEERING

The Department of Electrical Engineering of the Norwich City College offers students who have studied Physics and Mathematics at Advanced Level in the GCE and passed in one subject (or have obtained a good ONC or OND in Engineering) a modern sandwich course for the Higher National Diploma in Electrical and Electronic Engineering. Subjects studied include Computation, Statistics, Economics and Law, Electronics, Control, Telecommunications, Power and Machines. Well balanced and interesting industrial training with pay will be arranged as required. The course is approved for major grant awards by Local Authorities.

Accommodation will be arranged by the College if desired.

Enquiries about the course starting in September 1970 should be made to :-

E. JONES, B.Sc., Ph.D., C.Eng., M.I.E.E.
 Head of Department of Electrical Engineering
 Norwich City College
 Ipswich Road, Norwich, Norfolk. NOR 67 D.

BECOME "Technically qualified" in your spare time, guaranteed diploma and exam. home-study courses in radio, TV servicing and maintenance. T.T.E.B., City and Guilds, etc.: highly informative 120-page Guide—free. **CHAMBERS COLLEGE** (Dept. 857K), 148 Holborn, London. E.C.1.

CITY & GUILDS (electrical, etc.) on "Satisfaction or Refund of Fee" terms. Thousands of passes. For details of modern courses in all branches of electrical engineering, electronics, radio, TV, automation, etc., send for 132-page Handbook—FREE. **B.I.E.T.** (Dept. 168K), Aldermaston Court, Aldermaston, Berks.

RADIO OFFICER training courses. Write: Principal, Newport and Monmouthshire College of Technology, Newport, Mon.

TRAIN FOR SUCCESS WITH ICS

Study at home for a progressive post in Radio, TV and Electronics. Expert tuition for City & Guilds (Telecoms Techn's Cert. and Radio Amateurs') R.T.E.B., etc. Many non-exam courses incl. Closed circuit TV. Numerical control & Computers. Also self-build kit courses—valve and transistor.

Write for **FREE prospectus** and find out how ICS can help you in your career.
ICS, DEPT. 541 INTERTEXT HOUSE, STEWARTS ROAD, LONDON. SW8

RADIO OFFICERS see the world! Seagoing and shore appointments. Trainee vacancies during 1970. Grants available. Day and Boarding students. Stamp for prospectus. **Wireless College, Colwyn Bay.**

SITUATIONS VACANT

ENGINEERS, A TECHNICAL CERTIFICATE or qualification will bring you security and much better pay. Elem. and adv. private postal courses for C.Eng., A.M.E.R.E., A.M.S.E. (Mech. & Elec.), City & Guilds, A.M.I.M.I., A.I.O.B., and G.C.E. Exams. Diploma courses in all branches of Engineering—Mech., Elec., Auto., Electronics, Radio, Computers, Draughts., Building, etc. For full details write for **FREE 132 page guide: BRITISH INSTITUTE OF ENGINEERING TECHNOLOGY**, (Dept. 169K), Aldermaston Court, Aldermaston, Berks.

JUNIOR ELECTRONICS TECHNICIAN required for construction and repair of electronic instruments and maintenance of a Linear Accelerator. G.C.E. "O" level in Physics and Maths required. "A" levels or O.N.C. an advantage. Day release for further study is possible. Salary according to age and experience. Apply with full details to the Director, Medical Research Council Cyclotron Unit, Hammersmith Hospital, London, W.12.

SERVICE ENGINEER for repairing Audio Equipment required by Dixons Photographic Ltd., to be employed at North Acton. If interested, please contact P. Rowley for more details, either by telephone (01-965 0411) or by letter to Camera House, 95 Victoria Road, London. N.W.10.

SITUATIONS VACANT (continued)

TV and Radio, A.M.I.E.R.E., City & Guilds, R.T.E.B. Certs., etc on 'Satisfaction or Refund of Fee' terms. Thousands of passes. For full details of exams and home training Courses (including practical equipment) in all branches of Radio, TV, Electronics, etc. Write for 132 page Handbook—FREE. Please state subject. **BRITISH INSTITUTE OF ENGINEERING TECHNOLOGY** (Dept 137K), Aldermaston Court, Aldermaston, Berks.

Radio Operators

There will be a number of vacancies in the Composite Signals Organisation for experienced Radio Operators in 1970 and in subsequent years.

Specialist training courses lasting approximately nine months, according to the trainee's progress, are held at intervals. Applications are now invited for the course starting in September 1970.

During training a salary will be paid on the following scale:—

Age 21	£800 per annum
22	855
23	890
24	925
25 and over	965

Free accommodation will be provided at the Training School.

After successful completion of the course, operators will be paid on the Grade I scale:—

Age 21	£955 per annum
22	1025
23	1085
24	1145
25 (highest age point)	1215

then by six annual increases to a maximum of £1,650 per annum.

Excellent conditions and good prospects of promotion. Opportunities for service abroad.

Applicants must normally be under 35 years of age at start of training course and must have at least two years' operating experience. Preference given to those who also have GCE or PMG qualifications.

Interviews will be arranged throughout 1970.

Application forms and further particulars from:—

RECRUITMENT OFFICER, Government Communications Headquarters, Oakley, Priors Road, CHELTENHAM, Glos. GL52 5AJ
Tel: No. Cheltenham 21491 Ext 2270

Est. 1943 **JOHNSONS** Tel: 24864

New! CV2—a unique triple-purpose VHF kit for the Amateur enthusiast. Integrated converter, receiver, and tuner-feeder. Fantastic single transistor performance! Comprehensive kit of high grade parts with three coils covering 80-178MHz, 9v battery, etc., together with simplified diagrams and instructions. Price complete, £4, post, packing and insurance paid, direct from makers. S.A.E. for literature.

JOHNSON'S (RADIO)
 St. Martin's Gate, Worcester

Head Office and Warehouse
 44A WESTBOURNE GROVE
 LONDON W2
 Tel. PARK 5641/2/3

Z & I AERO SERVICES LTD.

Retail Shop
 85 TOTTENHAM COURT ROAD
 LONDON W1
 Tel. LANGHAM 8403
 Open all day Saturday

Please send all correspondence and Mail-Orders to the Head Office
 When sending cash with order, please include 2/6 in £ for postage and handling
 MINIMUM CHARGE 2/6. No C.O.D. orders accepted
 PLEASE NOTE THAT THE VALVES OFFERED BELOW ARE NOT NECESSARILY OF U.K. ORIGIN



0A2	6/8	6DA6	4/8	6F22	6/8	10L1	8/-
0A3	9/-	6RE6	5/-	6F23	15/6	10L11	11/-
0B2	6/8	6DF6	10/6	6F24	13/6	10L13	11/-
0B3	10/-	6BF6	9/-	6F25	15/-	10P14	20/-
0C2	7/-	6BG6G	12/-	6F26	7/-	12A3	10/-
0D3	6/8	6BH6	8/8	6F28	14/-	12A6	7/8
1B9GT	7/8	6BJ6	8/8	6F29	8/8	12AD8	7/8
1L4	3/8	6BK7A	10/-	6F30	7/-	12A7	9/-
1R4	6/8	6BL4	7/-	6F34	9/8	12AQ5	8/-
1R5	7/-	6BN5	8/8	6G5GT	6/-	12AT6	5/-
184	5/8	6BR6	8/-	6J7	8.6	12AT7	8/8
185	5/-	6BQ5	5/-	6K6GT	10/-	12AU8	5/8
1T4	4/8	6BQ7A	7/8	6K7	6/8	12AU7	7/8
1U4	6/8	6BR7	17/-	6K8G	6/8	12AV6	9/-
1U5	9/8	6BR8	19/-	6K23	10/-	12AV7	9/-
1V2	9/-	6BST	20/-	6K25	15/-	12AX7	6/-
1X2R	7/8	6BW6	10/8	6L6GT	9/-	12AY7	13/6
2D1	6/8	6BW7	13/8	6L7	6/8	12BA4	10/-
2A4	4/-	6BX6	5/-	6L18	6/8	12BA6	6/8
3Q4	8/-	6BZ6	6/8	6LD20	8/8	12BA7	6/8
384	7/-	6C4	9/-	6N7GT	9/-	12BE6	6/8
3V4	8/-	6CG5T	7/8	6P1	12/-	12BF6	6/8
3RA4Y	11/-	6C4A	5/8	6P25	21/-	12BY7	10/-
5U4G	8/-	6CA7	10/8	6P28	12/6	12K5	10/-
5U4GB	7/8	6CB6	6/8	6Q7	7/8	12K7GT	7/-
5V4G	8/-	6CDDGA	6/8	6R7G	7/8	12Q7G	5/-
5Y2GT	6/-	6C6T	23/-	6B2	8/8	12R7	5/-
5Z8	9/-	6CG7	8/-	6B4	11/8	12S7	7/-
6Z4GT	8/-	6CH6	11/8	6BA7	7/8	12SH7	5/-
6/80L2	15/-	6CL6	10/8	6SG7	6/8	12SK7	8/-
6AB4	6/8	6CWA	12/6	6S7	7/8	12SK7	8/-
6AF4	9/8	6CY9	8/-	6SK7	6/8	12SL7GT	8/-
6AG7	7/8	6CY7	12/-	6SL7GT	6/8	12SN7GT	8/-
6AH6	10/-	6D9	9/-	6BN7GT	6/8	12SQ7	8/-
6AJ8	8/8	6DC6	13/8	6D7	8/8	12ST	7/8
6AK5	8/8	6DK6	8/8	6BT7	7/8	1487	16/-
6AL3	8/8	6D8A	15/-	6E8	6/8	20D1	9/-
6AL5	3/8	6EA8	11/-	6U4GT	12/6	20L1	20/-
6AM5	5/8	6EH7	6/8	6U7	7/8	20P1	10/-
6AM6	4/8	6EJ7	7/8	6X	5/-	20P3	20/-
6AQ5	6/8	6EY6	12/-	6X5GT	5/8	20P5	20/-
6AQ6	10/-	6F1	14/-	6G8	11/-	20P5	3/8
6AR3	6/8	6F5	8/8	6Y6G	12/-	20L6GT	7/8
6AR6	6/8	6FG6	5/8	6BWX	8/8	22Z4G	6/8
6AS5	7/-	6F1J	6/8	10C2	10/-	22Z6G	10/-
6AS7G	16/-	6F12	4/6	10D1	8/8	22Z6G	10/-
6AT6	5/8	6F13	7/8	6E	8/8	30A5	8/8
6AT8	6/8	6F15	12/8	10P1	18/-	30A3	8/8
6AV8	6/8	6F16	11/8	10P9	10/-	30C1	6/8
6AW8A	11/8	6F18	8/8	10P18	8/8	30C15	15/-
						30C17	16/-

30C18	15/-	31A	60/-	DYN7	7/-	ECH81	5/9
30P5	25/-	812A	65/-	DY802	10/-	ECH83	8/6
30FL1	15/-	813	75/-	E55L	55/-	ECH84	9/8
30FL12	18/6	866A	14/-	E130L	90/-	ECL80	9/8
30FL13	10/6	6180	27/6	E140P	19/-	ECL81	8/8
30FL14	15/8	6148	30/-	EAC850	6/-	ECL82	6/8
30L15	7/-	6146B	47/8	EAP42	10/-	ECL83	12/6
30L17	17/-	8267	6/8	EBC33	9/8	ECL84	11/8
30P12	16/-	6898	42/-	EBU41	10/8	ECL85	10/8
30P18	7/-	7199	15/-	EBU90	5/-	EFL86	9/8
30P19	15/-	7380	36/-	EBU91	6/8	EFL87	9/8
30P21	18/-	7582	35/-	EBP80	8/8	EFL88	7/8
30P24	17/-	9003	10/-	EBP83	8/8	EFL89	10/-
30P25	13/-	A230	12/-	ECS3	10/-	EFL90	8/8
35B5	13/-	CB1L	16/-	EC86	12/-	EFL91	8/8
35C5	7/-	CB1L3	17/-	EC88	12/-	EFL92	8/8
35D13	8/-	CE2	6/8	EC89	9/8	EFL93	8/8
35Z13	11/-	DAF41	11/-	EC92	6/8	EFL94	8/8
35Z14	5/-	DAF51	5/-	EC93	9/8	EFL95	8/8
35Z25	7/8	DAF52	9/8	EC94	5/-	EFL96	8/8
35Z26	7/8	DAF56	7/8	EC95	6/8	EFL97	6/8
35Z27	7/8	DAF57	7/8	EC96	6/8	EFL98	6/8
35Z28	7/8	DAF58	7/8	EC97	4/8	EFL99	6/8
35Z29	7/8	DAF59	7/8	EC98	6/8	EFL90	6/8
35Z30	7/8	DAF60	7/8	EC99	11/8	EFL91	6/8
35Z31	7/8	DAF61	7/8	EC99	11/8	EFL92	6/8
35Z32	7/8	DAF62	7/8	EC99	11/8	EFL93	6/8
35Z33	7/8	DAF63	7/8	EC99	11/8	EFL94	6/8
35Z34	7/8	DAF64	7/8	EC99	11/8	EFL95	6/8
35Z35	7/8	DAF65	7/8	EC99	11/8	EFL96	6/8
35Z36	7/8	DAF66	7/8	EC99	11/8	EFL97	6/8
35Z37	7/8	DAF67	7/8	EC99	11/8	EFL98	6/8
35Z38	7/8	DAF68	7/8	EC99	11/8	EFL99	6/8
35Z39	7/8	DAF69	7/8	EC99	11/8	EFL90	6/8
35Z40	7/8	DAF70	7/8	EC99	11/8	EFL91	6/8

EL41	11/-	N78	21/-	PL82	9/-	UAB80	6/9
EL42	11/6	PA3C80	8/7	PL83	8/8	CAF41	10/8
EL81	10/8	PC88	11/6	PL84	7/8	CAF42	10/8
EL83	8/8	PC89	13/8	PL85	15/8	UCB1	6/8
EL84	5/-	PC97	8/8	PL86	15/8	UCB1	9/8
EL85	8/8	PC90	9/8	PL87	16/8	UCB1	8/8
EL86	8/8	PC94	7/8	PL88	17/8	UCB80	7/8
EL89	6/8	PC95	8/8	PL89	30/8	UCB81	7/8
EL91	5/-	PC98	12/8	PL90	17/8	UCB1	10/-
EL95	7/8	PC98	10/8	PL91	14/8	UCB21	12/8
EL98	23/-	PC189	11/8	PL92	14/8	UCB2	6/8
EL99	17/-	PC285	17/-	PL93	5/8	UCX85	8/8
EL99	11/8	PC286	17/-	PL94	9/8	UCP80	10/8
EL99	11/8	PC287	17/-	PL95	9/8	UCH2	11/8
EL99	11/8	PC288	17/-	PL96	12/8	UCH2	13/8
EL99	11/8	PC289	17/-	PL97	12/8	UCH2	13/8
EL99	11/8	PC290	17/-	PL98	12/8	UCH2	13/8
EL99	11/8	PC291	17/-	PL99	12/8	UCH2	13/8
EL99	11/8	PC292	17/-	PL99	12/8	UCH2	13/8
EL99	11/8	PC293	17/-	PL99	12/8	UCH2	13/8
EL99	11/8	PC294	17/-	PL99	12/8	UCH2	13/8
EL99	11/8	PC295	17/-	PL99	12/8	UCH2	13/8
EL99	11/8	PC296	17/-	PL99	12/8	UCH2	13/8
EL99	11/8	PC297	17/-	PL99	12/8	UCH2	13/8
EL99	11/8	PC298	17/-	PL99	12/8	UCH2	13/8
EL99	11/8	PC299	17/-	PL99	12/8	UCH2	13/8
EL99	11/8	PC300	17/-	PL99	12/8	UCH2	13/8

TRANSISTORS

Quantity prices quoted on request.

2N404	3/6	2N3709	3/5	BCY30	7/-
2N410	3/6	2N3710	3/6	BCY31	5/-
2N412	3/6	2N3819	12/-	BCY33	5/-
2N444A	5/-	2N3906	6/8	BCY34	6/8
2N696	4/6	AC113	3/6	BCY39	5/-
2N697	4/6	AC125	6/8	BCY72	3/10
2N698	4/6	AC126	6/8	BCY73	3/10
2N705	15/-	AC127	5/8	BD121	18/-
2N706	3/6	AC128	4/6	BD123	25/-
2N708	3/6	AC129	4/6	BF173	6/8
2N753	4/9	AC153	5/8	BF193	6/8
2N929	6/8	AC154	3/8	BF184	7/8
2N930	4/8	AC155	3/8	BF185	7/8
2N987	6/6	AC169	2/8	BF195	3/8
2N1131	6/6	AC176	6/9	BF288	5/4
2N1132	9/6	AC177	6/9	BF297	5/4
2N1134	25/-	AC178	6/9	BF298	5/4
2N1301	7/8	AC191	4/9	BF418	5/-
2N1302	7/8	AC192	4/9	BF419	5/-
2N1304	4/6	AC193	4/9	BF420	5/-
2N1305	4/6	AC194	4/9	BF421	5/-
2N1306	5/8	AC195	4/9	BF422	5/8
2N1307	6/8	AD140	16/-	BSY26	5/-
2N1308	7/8	AD141	9/8	BSY27	5/8
2N1309	9/8	AD162	9/8	BSY65	4/8
2N1711	6/8	AF102	15/8	BSY95A	3/9
2N1756	15/8	AF114	6/8	OC16	15/-
2N2147	14/9	AF115	6/8	OC22	13/-
2N2160	25/-	AF116	5/8	OC23	12/6
2N2177	6/6	AF117	4/6	OC24	15/-
2N2178	7/8	AF118	10/8	OC25	7/6
2N2179	8/8	AF119	8/8	OC26	6/8
2N2369A	4/6	AF125	6/8	OC28	14/8
2N2477	12/6	AF126	5/8	OC28	14/8
2N2646	12/6	AF127	5/8	OC29	14/8
2N2905	10/8	AF178	12/6	OC30	15/-
2N2923	3/8	AF186	11/8	OC35	11/3
2N2924	3/8	AF239	10/8	OC36	6/8
2N2925	3/8	AF239	10/8	OC36	6/8
2N2926	3/8	AF239	10/8	OC42	6/8
2N2927	3/8	AF239	10/8	OC44	4/8
2N2928	3/8	ASV26	6/8	OC45	4/8
2N2929	3/8	ASV28	6/8	OC46	4/8
2N2930	3/8	ASV28	6/8	OC71	3/8
2N2931	3/8	ASV28	6/8	OC72	8/8
2N2932	3/8	ASV28	6/8	OC73	8/8
2N2933	3/8	ASV28	6/8	OC75	5/8
2N2934	3/8	ASV28	6/8	OC76	5/8
2N3134	8/8	ASV74	10/8	OC78	7/8
2N3135	7/8	ASV74	10/8	OC80	3/8
2N3136	7/8	ASV74	10/8	OC81	4/8
2N3137	7/8	ASV74	10/8	OC81D	4/8
2N3138	7/8	ASV74	10/8	OC82	4/8
2N3139	7/8	ASV74	10/8	OC84	5/8
2N3140	7/8	ASV74	10/8	OC85	5/8
2N3141	7/8	ASV74	10/8	OC86	5/8
2N3142	7/8	ASV74	10/8	OC87	5/8
2N3143	7/8	ASV74	10/8	OC88	5/8
2N3144	7/8	ASV74	10/8	OC89	5/8
2N3145	7/8	ASV74	10/8	OC90	5/8
2N3146	7/8	ASV74	10/8	OC91	5/8
2N3147	7/8	ASV74	10/8	OC92	5/8
2N3148	7/8	ASV74	10/8	OC93	5/8
2N3149	7/8	ASV74	10/8	OC94	5/8
2N3150					

In just 2 minutes, find out how you can qualify for promotion or a better job in Engineering...

That's how long it will take you to fill in the coupon below. Mail it to B.I.E.T. and we'll send you full details and a free book. B.I.E.T. has successfully trained *thousands* of men at home - equipped them for higher pay and better, more interesting jobs. We can do as much for YOU. A low-cost B.I.E.T. Home Study Course gets results fast - makes learning easier and something you look forward to. There are no books to buy and you can pay-as-you-learn on 'SATISFACTION - OR REFUND OF FEE' terms. If you'd like to know how just a few hours a week of your spare time, doing something constructive and enjoyable, could put you out in front, post the coupon today. No obligation.

WHICH SUBJECT WOULD INTEREST YOU?

Mechanical
A.M.S.E. (Mech.)
Inst. of Engineers
Mechanical Eng.
Maintenance Eng.
Welding
General Diesel Eng.
Sheet Metal Work
Eng. Inspection
Eng. Metallurgy
C. & G. Eng. Crafts
C. & G. Fabrication

Draughtsmanship
A.M.I.E.D.
Gen. Draughtsmanship
Die & Press Tools
Elec. Draughtsmanship
Jig & Tool Design
Design of Elec. Machines
Technical Drawing
Building

Electrical & Electronic
A.M.S.E. (Elec.)
C. & G. Elec. Eng.
General Elec. Eng.
Installations & Wiring
Electrical Maths.
Electrical Science
Computer Electronics
Electronic Eng.

Radio & Telecomms.
C. & G. Telecomms.
C. & G. Radio Servicing
Radio Amateurs' Exam.
Radio Operators' Cert.
Radio & TV Engineering
Radio Servicing
Practical Television
TV Servicing
Colour TV
Practical Radio & Electronics (with kit)

Auto & Aero
A.M.I.M.I.
MAA-IMI Diploma
C. & G. Auto Eng.
General Auto Eng.
Motor Mechanics
A.R.B. Certs.
Gen. Aero Eng.

Management & Production
Computer Programming
Inst. of Marketing
A.C.W.A.
Works Management
Work Study
Production Eng.
Storekeeping
Estimating
Personnel Management
Quality Control
Electronic Data Processing
Numerical Control
Planning Engineering
Materials Handling
Operational Research
Metrication

Constructional
A.M.S.E. (Civ.)
C. & G. Structural
Road Engineering
Civil Engineering
Building
Air Conditioning
Heating & Ventilating
Carpentry & Joinery
Clerk of Works
Building Drawing
Surveying
Painting and Decorating.
Architecture
Builders' Quantities

General
C.E.I.
Petroleum Tech.
Practical Maths.
Refrigerator Servicing.
Rubber Technology
Sales Engineer
Timber Trade
Farm Science
Agricultural Eng.
General Plastics

General Certificate of Education
Choose from 42 'O' and 'A' Level subjects including:
English
Chemistry
General Science
Geology
Physics
Mathematics
Technical Drawing
French
German
Russian
Spanish
Biology
B.I.E.T. and its associated schools have recorded well over 10,000 G.C.E. successes at 'O' and 'A' level.

WE COVER A WIDE RANGE OF TECHNICAL AND PROFESSIONAL EXAMINATIONS.

Over 3,000 of our Students have obtained City & Guilds Certificates. Thousands of other exam successes.

THEY DID IT—SO COULD YOU

"My income has almost trebled... my life is fuller and happier." - Case History G/321.

"In addition to having my salary doubled, my future is assured." - Case History H/493.

"A turning point in my career - you have almost doubled my standard of living." Case History K/662.

"Completing your Course meant going from a job I detested to a job I love." - Case History B/461.

FIND OUT FOR YOURSELF

These letters - and there are many more on file at Aldermaston Court - speak of the rewards that come to the man who has given himself the specialised know-how employers seek. There's no surer way of getting ahead or of opening up new opportunities for yourself. It will cost you a stamp to find out how we can help you.

Free!

Why not do the thing that really interests you? Without losing a day's pay, you could quietly turn yourself into something of an expert. Complete the coupon (or write if you prefer not to cut the page). We'll send you full details and a FREE illustrated book. No obligation and nobody will call on you... but it could be the best thing you ever did.

BRITISH INSTITUTE OF ENGINEERING TECHNOLOGY

Dept D258, Aldermaston Court, Reading RG7 4PF.

(Write if you prefer not to cut this page)



BIET

POST THIS COUPON TODAY

To: B.I.E.T., Dept D258, Aldermaston Court, Reading RG7 4PF
Please send me book and details of your Courses in

Name..... Age.....

Address.....

Occupation.....

453A

B.I.E.T. - IN ASSOCIATION WITH THE SCHOOL OF CAREERS - ALDERMASTON COURT, BERKSHIRE

Published approximately on the 7th of each month by IPC Magazines Limited, Fleetway House, Farringdon Street, London, E.C.4. Tel: 01-834 4444. Printed in England by Index Printers, Dunstable, Beds. Sole Agents for Australia and New Zealand - Gordon and Gotch (A/asia) Ltd.; South Africa - Central News Agency Ltd.; Rhodesia and Zambia - Kingston Ltd.; East Africa - Stationery and Office Supplies Ltd. Subscription rate (including postage): For one year to any part of the world £2-6s.
PRACTICAL WIRELESS is sold subject to the following conditions, namely, that it shall not, without the written consent of the Publishers first given, be lent, resold, hired out or otherwise disposed of by way of Trade at more than the recommended selling price shown on the cover, and that it shall not be lent, resold or hired out or otherwise disposed of in a mutilated condition or any unauthorised cover by way of Trade, or affixed to as part of any publication or advertising, literary or pictorial matter whatsoever.

HENRY'S RADIO LTD. ENGLAND'S LEADING COMPONENT AND EQUIPMENT CENTRES

HENRY'S RADIO Fully Illustrated CATALOGUES

A
ALL TYPES OF ELECTRONIC COMPONENTS
TEST EQUIPMENT
KITS
BUILT UNITS



B
HIGH FIDELITY & GENERAL AUDIO EQUIPMENT CATALOGUE

COMPREHENSIVE CLEAR CONCISE CATALOGUES
A. 350 pages fully detailed and illustrated with more than 6,000 stock items. Everything for amateur and professional use. Complete with 5 vouchers. 10/- value, for use with purchases. New 6th impression now ready.

ORDER AS CATALOGUE A. PRICE 7/6 pp. 2/-.
B. New Audio and high fidelity catalogue. 120 pages containing ideas and equipment for every application. Special low prices for all leading makes. Plus 12/6 extra discount voucher. Over 40 recommended Stereo Systems.
ORDER AS CATALOGUE B. PRICE 5/- pp. 1/-.

WHY NOT SEND AWAY TODAY!

BUILD A QUALITY 4 TRACK TAPE RECORDER



To get the best out of your MAGNAVOX DECK, you need a MARTIN RECORDAKIT. This comprises a special high quality 6 valve amplifier and pre-amplifier which comes to you assembled on its printed circuit board—in fact everything for making a superb Tape Recorder. You need no experience or technical skill to bring this about.

THE INSTRUCTIONS MANUAL MAKES BUILDING EASY, AND SUCCESS IS ASSURED. Kit comprises Deck, Amplifier, Cabinet and speaker, with microphone, 7in. 1200ft. tape, and spare spool.

ASK FOR BROCHURE 6. TODAY'S VALUE £60.
PRICE 39 gns. pp. 22/6. NOTHING ELSE TO BUY.

AMPLIFIERS IN STOCK

- * 1 watt Mullard £2 5 0
- * PA7 7 watt £3 12 6
- * MPA12 3 12 watt £4 10 0
- * MPA12 15 12 watt £5 5 0
- * MA7 7 watt Amp
- * Preamp Mono £8 10 0
- * MA66 Stereo Amp/Preamp £16 10 0
- * 70 watt Amp £35 0 0

- * PA25 25 watt £7 10 0
- * PA50 50 watt £9 10 0
- * 100 watt PA £49 10 0

SINCLAIR 60 complete
Stereo 60. 2 x Z30 PZ5 (usual price) £19
£23.18.0.

MONO STEREO UNIT EQUIPMENT

Mono or Stereo Audio equipment developed from Dinsdale Mk. II—each unit or system will compare favourably with other professional equipment selling at much higher prices.

COMPLETE SYSTEMS AND MIXERS from £11 12 6 to £38 17 6 (all units available separately).

THE FINEST VALUE IN LOW COST HIGH FIDELITY—CHOOSE A SYSTEM TO SUIT YOUR NEEDS AND SAVE YOURSELF POUNDS. 7, 12 and 25 WATT AMPLIFIERS, STEREO AND MONO PREAMPLIFIERS AND MODULES.

* SEND FOR BROCHURES No. 12/14 21 TODAY!

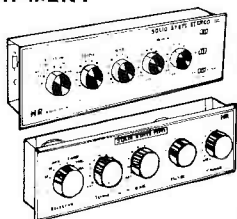

HENRY'S STOCK EVERY TYPE OF COMPONENT YOU NEED — A CATALOGUE IS A MUST!

ALSO SEE EARLIER PAGES FOR MORE ADS.

HI-FI equipment to suit EVERY POCKET

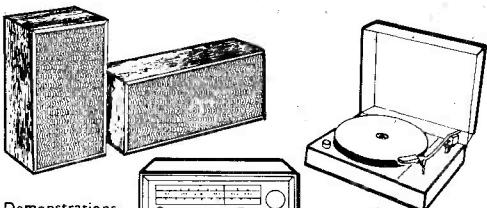

Demonstrations, quotations FREE

* Credit Terms (CALLERS ONLY) For Purchases at 309 Branch only From £30*

VISIT OUR HI-FI CENTRE AT 309 EDGWARE ROAD, for all leading makes of—AMPLIFIERS, TUNERS, DECKS, SPEAKERS, MICROPHONES, TEST EQUIPMENT. ALL WITH DISCOUNTS—IT WILL PAY YOU TO PAY US A VISIT. AUDIO SYSTEMS £40-£300 TO SUIT. SEND FOR STOCK LIST 16/17.

BUILD THIS VHF FM TUNER

5 MULLARD TRANSISTORS 300 kc/s BANDWIDTH. PRINTED CIRCUIT. HIGH FIDELITY REPRODUCTION. MONO & STEREO. A popular VHF FM Tuner for quality and reception of mono and stereo. There is no doubt about it—VHF FM gives the REAL sound. All parts sold separately.
PARTS TOTAL COST £6 19 6 DECODER £5 19 6
ASK FOR BROCHURE No. 3 (FOR STEREO)



HENELEC 5-5 STEREO AMPLIFIER

Excellent low priced British designed Stereo Amplifier for use with Record Decks. Tuners. 16 transistor mains operated. Output 5+5 watts for 8—15 ohm speakers. Black, silver and wood finish. size 13in x 3in x 6in.

PRICE £13 10 0 pp. 7/6
Complete Stereo System 5-5, Garrard 2025 TC or 3000LM with 97AHC Diam. Ceramic cartridge, 5-5 Amplifier, Plinth Cover. Two 10 watt speakers with tweeters in polished cabinets. Size 18" x 11" x 7"



Usual price £50.0.0. OUR PRICE £39 10 0 pp. 20/- ASK FOR BROCHURE 13

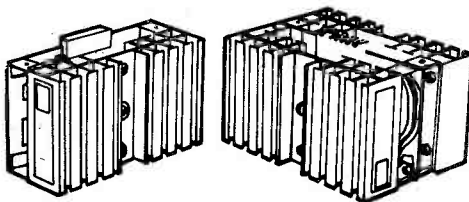

PA25 (25 watts RMS)

PA50 (50 watts RMS)

SILICON POWER AMPLIFIERS WITH DIRECT COUPLED, SYMMETRICAL OUTPUT

* HENELEC 'PA25' POWER AMPLIFIER

This silicon design from Henry's Radio uses complementary transistors in the symmetrical output stage direct coupled to a loudspeaker of 8 ohms impedance or higher. Power output is 25 watts RMS with an 8 ohms load or 12 watts for 15 ohms, over a frequency range of 15Hz—25kHz 3dB. Cool running is assured by the use of generously dimensioned black anodised heatsinks. Input 700mV 15K ohm. Price £7 10 0

* HENELEC 'PA50' POWER AMPLIFIER

Basically similar to the 'PA25' the 'PA50' will deliver 50 watts RMS to a 3-4 ohm load. Extra power is handled by complementary triplet circuits using the latest PNP and NPN silicon power transistors. As a result of extra heatsinking the 'PA50' runs as cool as the 'PA25'. Price £9 10 0

* HENELEC MU442 POWER SUPPLY

Designed to run one or two 'PA25's or one 'PA50' the MU442 connects to the amplifiers by means of plug-on harnesses. No soldering is required to connect up the system. Audio input plug and speaker plug go to the panel of the MU442. Price £6 0 0

* SEND FOR FREE BROCHURES No.: 24/25

Transistors, integrated circuits, test equipment, Garrard and Goldring turntables all at special save money prices—See our adverts on earlier pages of this magazine.

FREE 16 Page Testgear Catalogue Ref 'T'
10 Page Record Player Decks List Ref 16/17
Semiconductor Price List Ref. 36.

SEND NOW!

ELECTRONIC ORGANS

CALL IN and SEE THE NEW MODELS!

- ★ MODERN ALL BRITISH TRANSISTORISED DESIGNS AVAILABLE AS KITS OR READY BUILT
- ★ TEAK VENEERED CABINETS FOR ALL MODELS
- ★ 49 NOTE, 61 NOTE SINGLE MANUAL DESIGNS ALSO TWO MANUAL 49 NOTE
- ★ KITS AVAILABLE IN SECTIONS AS REQUIRED
- ★ HP and CREDIT SALE FACILITIES

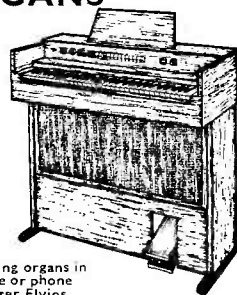

FREE 16 page organ brochure covering organs in kit form and ready built—write or phone to ORGAN DEPT. Ask for Peter Elvins.

HENRY'S RADIO LTD.

Mail Order Dept, Electronic Components and Equipment, and Electronic Organ Dept.
303 EDGWARE ROAD, LONDON W2.
Telephone: 01-723 1008/9
Open Mon-Sat. 9am-6pm. Thurs. 9am-1pm

High Fidelity and Audio Centre
309 EDGWARE ROAD, LONDON W2.
Telephone: 01-723 6963
Open all day Saturday.