

# PENTAX



Digital Camera

# Optio M60

## Operating Manual

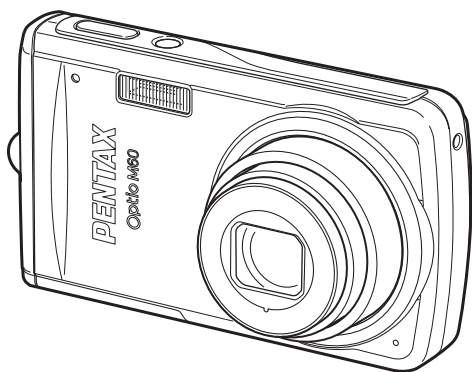

To ensure the best performance from your camera, please read the Operating Manual before using the camera.

Thank you for purchasing this PENTAX Digital Camera.

Please read this manual before using the camera in order to get the most out of all the features and functions. Keep this manual safe, as it can be a valuable tool in helping you to understand all the camera capabilities.

### **Regarding copyrights**

Images taken using the PENTAX Digital Camera that are for anything other than personal enjoyment cannot be used without permission according to the rights as specified in the Copyright Act. Please take care, as there are cases where limitations are placed on taking pictures even for personal enjoyment during demonstrations, performances or of items on display. Images taken with the purpose of obtaining copyrights also cannot be used outside the scope of use of the copyright as laid out in the Copyright Act, and care should be taken here also.

### **To users of this camera**

- There is a possibility that recorded data may be erased or that the camera may not function correctly when used in surroundings such as installations generating strong electromagnetic radiation or magnetic fields.
- The liquid crystal panel used in the display is manufactured using extremely high precision technology. Although the level of functioning pixels is 99.99% or better, you should be aware that 0.01% or fewer of the pixels may not illuminate or may illuminate when they should not. However, this has no effect on the recorded image.
- There is a possibility that the illustrations and the display screen in this manual are different from the actual product.
- In this manual, both an SD Memory Card and an SDHC Memory Card are referred to as SD Memory Cards hereafter.
- In this manual, the generic term “computer(s)” refers to either a Windows PC or a Macintosh hereafter.

### **Regarding trademarks**

- PENTAX and Optio are trademarks of HOYA CORPORATION.
- SDHC logo () is trademark.
- This product supports PRINT Image Matching III. PRINT Image Matching enabled digital still cameras, printers and software help photographers to produce images more faithful to their intentions. Some functions are not available on printers that are not PRINT Image Matching III compliant. Copyright 2001 Seiko Epson Corporation. All Rights Reserved. PRINT Image Matching is a trademark of Seiko Epson Corporation. The PRINT Image Matching logo is a trademark of Seiko Epson Corporation.
- All other brands or product names are trademarks or registered trademarks of their respective companies.

### **Regarding PictBridge**

PictBridge allows the user to connect the printer and digital camera directly, using the unified standard for the direct printout of images. You can print images directly from the camera through a few simple operations.

### **Regarding Product Registration**

In order to serve you better, we request that you complete the product registration, which can be found on the CD-ROM supplied with the camera or the PENTAX website. Thank you for your cooperation.  
Refer to the PC Connection Manual (bottom right of the front side) for more information.

## USING YOUR CAMERA SAFELY

We have paid close attention to the safety of this product. When using this product, we request your special attention regarding items marked with the following symbols.



### **Warning**

This symbol indicates that violating this item could cause serious personal injuries.



### **Caution**

This symbol indicates that violating this item could cause minor or medium personal injuries, or material losses.

## About the Camera



### **Warning**

- Do not attempt to take the camera apart or remodel the camera. High voltages are present within the camera, and there is therefore a danger of electric shocks if the camera is taken apart.
- If the inside of the camera should become exposed as a result of, for example, the camera being dropped, please do not under any circumstances touch such exposed portions, as there is a danger of receiving an electric shock.
- To avoid the risk of it being swallowed by mistake, keep the SD Memory Card out of the reach of small children. Seek medical attention immediately if a card is accidentally swallowed.
- Wrapping the strap of the camera around your neck is also dangerous. Please take care that small children do not hang the strap around their necks.
- Use an AC adapter that is of the power and voltage specified for exclusive use with this product. The use of an AC adapter other than that specified exclusively for use with this product may cause fire or electric shocks.
- If the camera emits smoke or a strange smell, or in the event of any other irregularity, stop using the camera immediately, remove the battery and contact your nearest PENTAX Service Center. Continued use of the camera may result in fire or electric shock.

## **Caution**

- Do not charge any batteries other than rechargeable lithium-ion battery D-LI78. The battery could explode or catch fire.
- Do not place your finger on the flash when it is discharging as there is a risk of burns.
- Do not discharge the flash while it is touching your clothing as there is a risk of discoloring.
- If any leakage from the battery should come in contact with your eyes, it may cause a loss of sight. Flush your eyes with clean water and get medical attention immediately. Do not rub them.
- If any leakage from the battery should come in contact with skin or clothes, it may cause irritation to the skin. Wash the affected areas thoroughly with water.
- Precautions for D-LI78 Battery Usage:
  - USE SPECIFIED CHARGER ONLY.
  - DO NOT INCINERATE.
  - DO NOT DISASSEMBLE.
  - DO NOT SHORT CIRCUIT.
  - DO NOT EXPOSE TO HIGH TEMP. (140°F / 60°C)
- Remove the battery from the camera immediately if it becomes hot or begins to smoke. Be careful not to burn yourself during removal.
- Some portions of the camera heat up during use, so please take care, as there is a risk of low temperature burns if such portions are held for long periods of time.
- Should the LCD be damaged, be careful of glass fragments. Also, be careful not to allow the liquid crystal to get on your skin or in your eyes or in your mouth.
- Depending on your inherent factors or physical condition, the use of the camera may cause itching, rashes or blisters. In case of any abnormality, stop using the camera and get medical attention immediately.

## **About the Battery Charger and the AC Adapter**

## **Warning**

- Do not use the product at a voltage other than the specified voltage. Use with a power source or voltage other than that designated can cause a fire or electrical shock. The specified voltage is 100-240V AC.
- Do not disassemble or modify the product. This can cause a fire or electrical shock.

- If the generation of smoke or strange odor from the product or other abnormality occurs, immediately discontinue using and consult a PENTAX Service Center. Continuing to use the product can cause a fire or electrical shock.
- If water should happen to get inside the product, consult a PENTAX Service Center. Continuing to use the product can cause a fire or electrical shock.
- If a thunder storm should be present during use of the battery charger or AC adapter, unplug the power cord and discontinue use. Continuing to use the product can cause damage to the equipment, fire or electrical shock.
- Wipe off the plug of the power cord if it should become covered with dust. This can cause a fire.

 **Caution**





- Do not place heavy objects on the AC plug cord, allow heavy objects to drop onto it or allow the AC plug cord to become damaged due to excessive bending. If the AC plug cord becomes damaged, consult a PENTAX Service Center.
- Do not short or touch the output terminals of the product while it is still plugged in.
- Do not plug in the AC plug cord with wet hands. This can cause an electrical shock.
- Do not subject the product to strong impacts or allow it to drop onto a hard surface. This can cause a malfunction.
- Do not use the battery charger to charge batteries other than rechargeable lithium-ion battery D-LI78. This can cause overheating or malfunctions.
- To reduce the risk of hazards, use only CSA/UL Certified power supply cord set, cord is Type SPT-2 or heavier, minimum NO.18 AWG copper, one end with a molded-on male attachment plug cap (with a specified NEMA configuration), and the other is provided with a molded-on female connector body (with a specified IEC nonindustrial type configuration) or the equivalent.

## Care to be Taken During Handling

- When traveling, take the Worldwide Service Network listing that is included in the package. This will be useful if you experience problems abroad.
- When the camera has not been used for a long time, confirm that it is still working properly, particularly prior to taking important pictures (such as at a wedding or during traveling). Contents of the recording cannot be guaranteed if recording, playback or transferring your data to a computer, etc. is not possible due to a malfunction of your camera or recording media (SD Memory Card), etc.
- The lens on this camera is not interchangeable. The lens is not removable.
- Do not clean the product with organic solvents such as thinner, alcohol or benzene.
- Places of high temperature and humidity should be avoided. Particular care should be taken regarding vehicles, which can become very hot inside.
- This camera is not waterproof. Do not use this camera where it might come in contact with rain, water, or any other liquid.
- Storing the camera where pesticides and chemicals are handled should be avoided. Remove the camera from its case and store in a well-ventilated place to prevent the camera from becoming moldy during storage.
- Ensure that the camera is not subjected to substantial vibrations, shocks or pressure as this may cause damage or malfunction. Place the camera on a cushion for protection when the camera is subjected to the vibrations of a motorbike, car, ship, etc. If the camera is subjected to substantial vibrations, shocks or pressure, take your camera to your nearest PENTAX Service Center and have it checked.
- The temperature range in which the camera can be used is 0°C to 40°C (32°F to 104°F).
- The liquid crystal display will become black at a high temperature but will return to normal when normal temperatures are returned to.
- The response speed of the liquid crystal display becomes slow at low temperatures. This is due to the properties of the liquid crystal and is not a fault.
- Periodic checks are recommended every 1 to 2 years in order to maintain high performance.

- If the camera is subjected to rapid temperature changes, condensation may form on the inside and outside of the camera. Therefore put the camera in a bag or plastic bag, and take the camera out when the difference in temperature has subsided.
- Refer to “Precautions When Using an SD Memory Card” (p.35) regarding the SD Memory Card.
- Please note that formatting an SD Memory Card or the built-in memory will delete all data; however it may still be possible to recover that data using off-the-shelf data recovery software. Please manage your camera memory at your own risk.
- Please do not press forcefully on the display. This could cause breakage or malfunction.
- Be careful not to sit down with the camera in your back pocket as this may damage the exterior of the camera or the display.
- When using a tripod with the camera, be careful not to overtighten the screw in the tripod socket on the camera.
- The AC plug cord supplied with the camera is for exclusive use with the battery charger D-BC78. Do not use it with any other equipment.
- Storing the battery fully charged may decrease the battery performance. Avoid storing it especially in high temperatures.  
If the battery is left inserted and the camera is not used for a long time, the battery will over-discharge and shorten the battery’s service life.
- Charging the battery a day before use or on the day of use is recommended.

# Contents

USING YOUR CAMERA SAFELY .....	1
Care to be Taken During Handling .....	4
Contents .....	6
Composition of the Operating Manual .....	11
<b>Camera Features</b> .....	<b>12</b>
Checking the Contents of the Package .....	15
Names of Parts .....	16
Names of Operating Parts .....	17
Monitor Indications .....	18
<b>Getting Started</b> .....	<b>25</b>
<b>Attaching the Strap</b> .....	<b>26</b>
<b>Powering the Camera</b> .....	<b>27</b>
Charging the Battery .....	27
Installing the Battery .....	28
Using the AC Adapter .....	31
<b>Installing the SD Memory Card</b> .....	<b>33</b>
Number of Images Recordable on an SD Memory Card .....	36
<b>Turning the Camera On and Off</b> .....	<b>37</b>
Playback Mode .....	38
<b>Initial Settings</b> .....	<b>39</b>
Setting the Display Language .....	39
Setting the Date and Time .....	43
<b>Common Operations</b> .....	<b>45</b>
<b>Understanding the Button Functions</b> .....	<b>46</b>
 Mode .....	46
 Mode .....	48
Switching Between  Mode and  Mode .....	50
<b>Setting the Camera Functions</b> .....	<b>51</b>
Operating the Menus .....	51
Menu List .....	55
<b>Taking Pictures</b> .....	<b>57</b>
<b>Taking Still Pictures</b> .....	<b>58</b>
Taking Pictures .....	58
Setting the Shooting Mode .....	60
Using the Face Recognition Function .....	63
Taking Pictures Automatically (Auto Picture Mode) .....	65



Taking Pictures in the Custom Settings (Program Mode) .....	66
Taking Pictures in the Basic Mode (Green Mode).....	67
Using the Zoom .....	69
Taking Pictures of Dark Scenes (Night Scene/Night Scene Portrait/ Digital SR (Blur Reduction)/Fireworks/Candlelight Mode) .....	71
Taking Pictures of People (Half-length Portrait/ Portrait/ Natural Skin Tone Mode) .....	73
Taking Pictures of Children (Kids Mode).....	74
Taking Pictures of Your Pet (Pet Mode).....	75
Taking Pictures of Sports and Leisure Activities (Surf & Snow/ Sport Mode) .....	76
Taking Pictures of Text (Text Mode) .....	78
Framing Your Pictures (Frame Composite Mode).....	79
Using the Self-timer .....	81
Taking a Series of Pictures (Continuous Shooting/ HS Cont. Shooting Mode) .....	82
Using the Digital Wide Function (Digital Wide Mode).....	84
Taking Panoramic Pictures (Digital Panorama Mode).....	86
<b>Setting the Shooting Functions.....</b>	<b>89</b>
Selecting the Flash Mode .....	89
Selecting the Focus Mode .....	91
Selecting the Recorded Pixels.....	94
Selecting the Quality Level .....	96
Setting the Exposure (EV Compensation).....	97
Adjusting the White Balance.....	98
Setting the AE Metering.....	100
Setting the Sensitivity .....	101
Setting Blink Detection .....	102
Setting the Instant Review Time (Instant Review).....	103
Setting the Image Sharpness (Sharpness).....	104
Setting the Color Saturation (Saturation).....	105
Setting the Image Contrast (Contrast).....	105
Setting the Date Imprint Function .....	106
Calling Up a Specific Menu .....	107
<b>Recording Movies .....</b>	<b>109</b>
Recording a Movie.....	109
Selecting the Recorded Pixels for Movies .....	111
Selecting the Frame Rate.....	112
Recording Movies in Black and White or Sepia Tones (Color Mode) .....	113
Setting the Movie SR (Movie Shake Reduction) Function.....	114
<b>Saving the Settings (Memory) .....</b>	<b>115</b>

<b>Playing Back Images</b> .....	<b>118</b>
Playing Back Still Pictures .....	118
Playing Back a Movie .....	119
Nine-Image Display, Folder Display and Calendar Display .....	120
Using the Playback Function .....	122
Slideshow .....	124
Rotating the Image .....	126
Zoom Playback .....	128
Zoom In On the Subject's Face Automatically (Face Close-up Playback) .....	129
Correcting Camera Shake with Digital SR .....	130
<b>Deleting Images</b> .....	<b>132</b>
Deleting a Single Image/Sound File .....	132
Deleting Selected Images and Sound Files .....	134
Deleting All Images and Sound Files .....	136
Recovering Deleted Images .....	137
Protecting Images and Sound Files from Deletion (Protect) .....	138
<b>Connecting the Camera to AV Equipment</b> .....	<b>141</b>

**Editing and Printing Images** **143**

<b>Editing Images</b> .....	<b>144</b>
Changing the Image Size and Quality (Resize) .....	144
Cropping Images .....	145
Using the Digital Filters .....	147
Red-eye Compensation .....	150
Adding a Frame (Frame Composite) .....	151
Editing Movies .....	154
Copying Images and Sound Files .....	156
<b>Setting the Printing Service (DPOF)</b> .....	<b>158</b>
Printing Single Images .....	158
Printing All Images .....	160
<b>Printing Using PictBridge</b> .....	<b>161</b>
Connecting the Camera to the Printer .....	161
Printing Single Images .....	162
Printing All Images .....	164
Printing Using the DPOF Settings .....	165
Disconnecting the Cable from the Printer .....	166

## **Recording and Playing Back Sound** **167**

---

<b>Recording Sound (Voice Recording Mode)</b> .....	<b>168</b>
Recording Sound.....	168
Playing Back Sound .....	170
<b>Adding a Voice Memo to Images</b> .....	<b>171</b>
Recording a Voice Memo .....	171
Playing Back a Voice Memo.....	172

## **Settings** **173**

---

<b>Camera Settings</b> .....	<b>174</b>
Formatting an SD Memory Card.....	174
Changing the Sound Settings.....	175
Changing the Date and Time.....	176
Setting the World Time .....	179
Changing the Display Language .....	181
Changing the Naming Rule of the Folder .....	182
Changing the USB Connection Mode.....	183
Changing the Video Output Format.....	184
Adjusting the Brightness of the Display .....	185
Using the Power Saving Function .....	186
Setting Auto Power Off.....	187
Setting the Quick Zoom Function .....	188
Changing the Start-up Screen .....	189
Resetting to Default Settings (Reset).....	190

## **Appendix** **191**





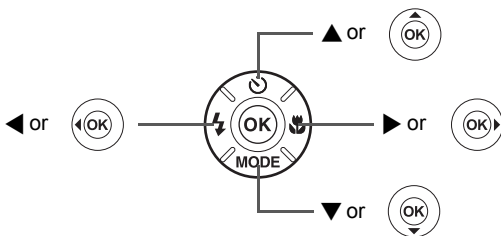

---

<b>Functions Available for Each Shooting Mode</b> .....	<b>192</b>
<b>Messages</b> .....	<b>194</b>
<b>Troubleshooting</b> .....	<b>197</b>
<b>Default Settings</b> .....	<b>199</b>
<b>List of World Time Cities</b> .....	<b>204</b>
<b>Optional Accessories</b> .....	<b>205</b>
<b>Main Specifications</b> .....	<b>206</b>
<b>WARRANTY POLICY</b> .....	<b>210</b>
<b>Index</b> .....	<b>216</b>

In this manual, the method for operating the four-way controller is shown in illustrations, such as in the one below.



The meanings of the symbols used in this Operating Manual are explained below.

	indicates the reference page number for an explanation of the related operation.
	indicates information that is useful to know.
	indicates precautions to be taken when operating the camera.
 mode	This is the mode for capturing still pictures and recording movies and sound files. In this manual, the mode for taking still pictures is referred to as the “Still Picture Capture Mode”, the mode for recording movies is referred to as the “  mode” and the mode for recording sound files is referred to as the “  mode”.
 mode	This is the mode for viewing still pictures and playing back movies and sound files.

# Composition of the Operating Manual

This Operating Manual contains the following chapters.

## 1 Getting Started

This chapter explains what you need to do after purchasing the camera before you start taking pictures. Be sure to read it and follow the instructions.

## 2 Common Operations

This chapter explains common operations such as the functions of the buttons and how to use the menus. For more details, refer to the respective chapters below.

## 3 Taking Pictures

This chapter explains the various ways of capturing images and how to set the relevant functions.

## 4 Playing Back and Deleting Images

This chapter explains how to view still pictures and movies on the camera or on a TV and how to delete images from the camera.

## 5 Editing and Printing Images

This chapter explains the various ways of printing still pictures and how to edit images with the camera. For information on transferring images to a computer and installing the provided application software, see the supplied "PC Connection Manual". For details on editing and printing images on a computer, see the Help menu of the application software.

## 6 Recording and Playing Back Sound

This chapter explains how to record sound files or add sound (a voice memo) to an image, and how to play back sound files.

## 7 Settings

This chapter explains how to set the camera-related functions.

## 8 Appendix

This chapter deals with troubleshooting and lists the optional accessories.

1

2

3

4

5

6

7

8

# Camera Features

In addition to basic picture-taking, the Optio M60 has a variety of shooting modes to suit different situations. This section describes how to make the most of the key features of your camera. Together with the explanations of camera operations, it will enable you to enjoy your camera to the full.

## Advanced Movie Recording and Picture Taking Functions

The Optio M60 has a shake reduction function to reduce camera shake during movie recording (p.114). It can also shoot in black and white or sepia tones to add atmosphere to your movies.

- **Use the camera to shoot fun-filled movies of your children or pets as a visual diary of their development (p.109).**

## Perfect for Portrait Shots!

The Optio M60 comes with a “Face Recognition” function that spots the faces in your shot and automatically adjusts the focus and exposure for the faces. It can recognize up to 32 people per shot (\*), so it will help you take perfect group shots too. It will automatically release the shutter when people are smiling, or if anyone blinked, it will tell you so you can take the shot again until it is perfect. It also has a feature that lets you enlarge each person’s face in sequence during playback so you can quickly check their facial expressions.

\* Up to 15 face recognition frames are displayed on the monitor.

- **Face Recognition function (p.63)**
- **Modes for taking stunning pictures of people (p.73)**
- **Close-ups of people’s faces for easy checking during playback (p.129)**

## Add Various Frames to Your Pictures!

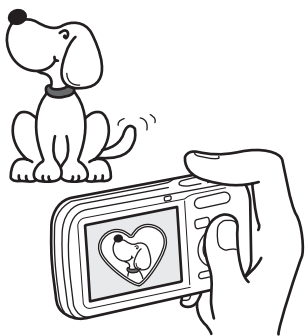

When you take a picture with the Optio M60, you can choose from a wide range of fun frames to create attractive framed shots (p.79). You can also add frames to pictures you have taken. Adjust the position of the subject in the picture or reduce or enlarge the picture size to match the frame shape and size. Now you no longer have to worry about the subject not being aligned in the frame (p.151).

- For decorating your pictures with a frame.

## Easy-to-Navigate Capture and Playback Functions!

The user-friendly design of the Optio M60 enables easy operation with only a few buttons. Simply by choosing the appropriate icon, you can select the shooting mode (p.60) and choose the optimal settings for the situation, or the playback mode (p.122, p.144) and enjoy the various playback and editing functions. A guide on the display lets you check the functions available in each mode and how to use them.



- A shooting mode guide is displayed in the Capture Mode Palette and a playback mode guide in the Playback Mode Palette (p.60, p.122).
- Use the Green Mode to take pictures easily using standard settings (p.67).

## Display Images and Sound Files in Calendar Format!

With the Optio M60, you can display recorded images and sound files by date in calendar format (p.121). This lets you quickly find the image or sound file you want to play back.

## A multitude of functions inside the camera for enjoying images without a Computer!

The Optio M60 has a variety of functions to let you enjoy playing back and editing images without having to connect the camera to your computer and transfer the images first. The camera is all you need to take and edit still pictures and movies (p.144). And no more worries about accidentally deleting images, because now, with the Optio M60, you can recover them again (p.137).

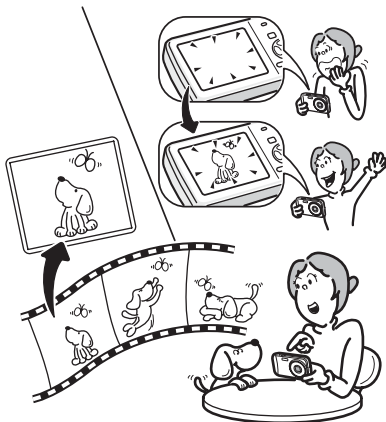

- **Resize (p.144), Cropping (p.145) and Red-eye Compensation (p.150) can be used, while the image is displayed in the playback mode.**
- **You can divide a movie into two or select a frame from a movie to save it as a still picture (p.154).**



## Checking the Contents of the Package



Camera  
Optio M60

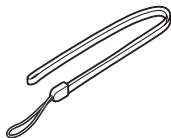

Strap  
O-ST51 (\*)

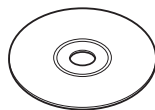

Software (CD-ROM)  
S-SW81

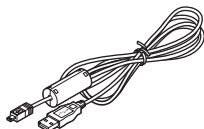

USB cable  
I-USB7 (\*)

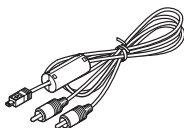

AV cable  
I-AVC7 (\*)



Rechargeable lithium-ion  
battery D-LI78 (\*)

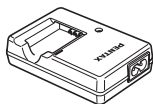

Battery charger  
D-BC78 (\*)



AC plug cord  
D-CO24 (\*)

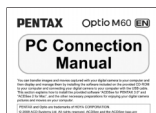

PC Connection Manual



Operating Manual  
(this manual)



Quick Guide

Items marked with an asterisk (\*) are also available as optional accessories. The battery charger and AC plug cord are only sold as a set (Battery Charger Kit K-BC78).

For other optional accessories, refer to "Optional Accessories" (p.205).

## Names of Parts

### Front

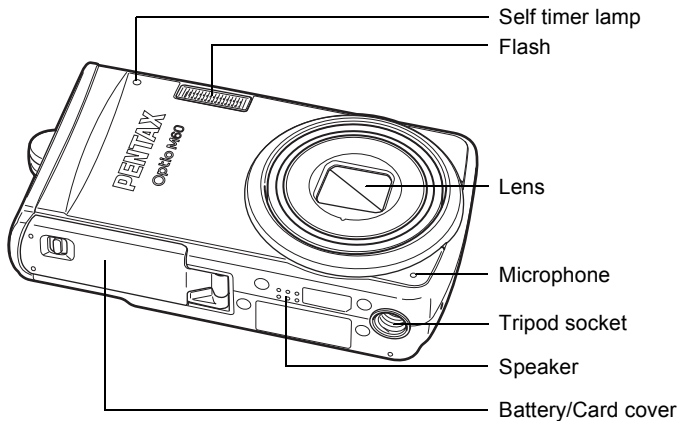

### Back

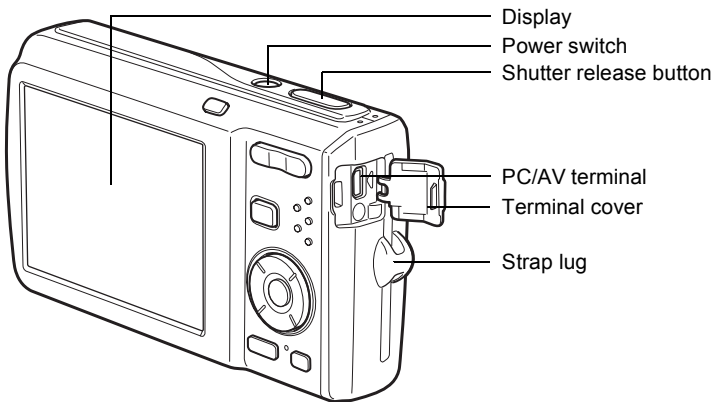

## Names of Operating Parts

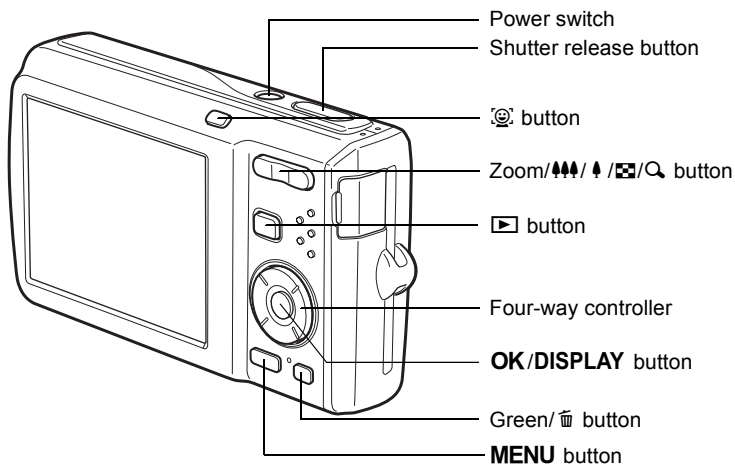

Refer to “Understanding the Button Functions” (p.46 - p.49) for an explanation of the function of each button.



# Monitor Indications

## Display in Mode

The display shows information such as the shooting conditions in the capture mode.

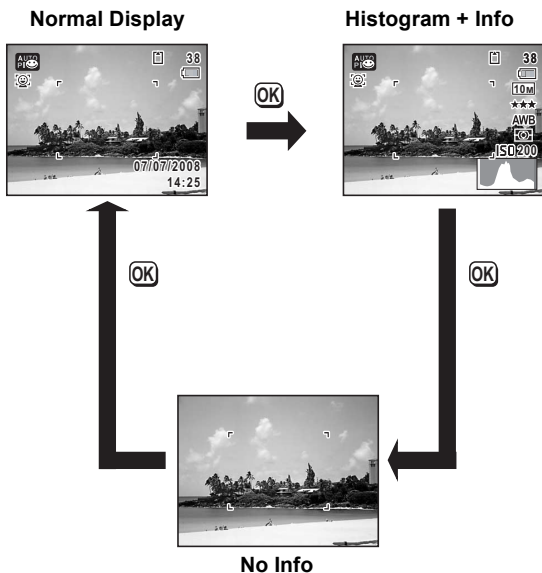
The display changes in the following sequence each time you press the **OK/DISPLAY** button: Normal Display, Histogram + Info, No Info.



-  appears if you press the shutter release button halfway when camera shake is likely to occur. To prevent camera shake, use a tripod and/or the self-timer function (p.81).
- When the shooting mode is set to  (Green) mode, the monitor display is as shown on the right. You cannot change the information on the display by pressing the **OK/DISPLAY** button.



## Normal Display in Still Picture Capture Mode

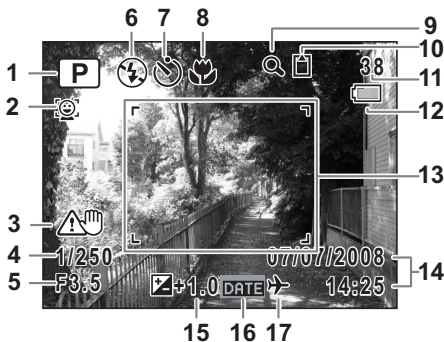

- |   |                                     |
|---|-------------------------------------|
| 1 Shooting mode (p.60)                      | 10 Memory status (p.37)             |
| 2 Face Priority icon (p.63)                 | 11 Remaining image storage capacity |
| 3 Camera shake warning                      | 12 Battery level indicator (p.30)   |
| 4 Shutter speed                             | 13 Focus frame (p.58)               |
| 5 Aperture                                  | 14 Date and time (p.43)             |
| 6 Flash mode (p.89)                         | 15 EV compensation (p.97)           |
| 7 Drive mode (p.81, p.82)                   | 16 Date Imprint setting (p.106)     |
| 8 Focus mode (p.91)                         | 17 World time setting (p.179)       |
| 9 Digital zoom/Intelligent zoom icon (p.69) |                                     |

- \* 3 appears only if you press the shutter release button halfway when camera shake is likely to occur.
- \* 4 and 5 appear only when the shutter release button is pressed halfway.
- \* As to 8, when the focus mode is set to **AF** and the Auto-Macro function is activated, the 🍄 appears on the display (p.91).
- \* Some indications may not appear depending on the shooting mode.

## Histogram + Info/No Info Display in Still Picture Capture Mode

A1 to A20 and B1 appear when “Histogram + Info” is selected. Only B1 appears when “No Info” is selected.

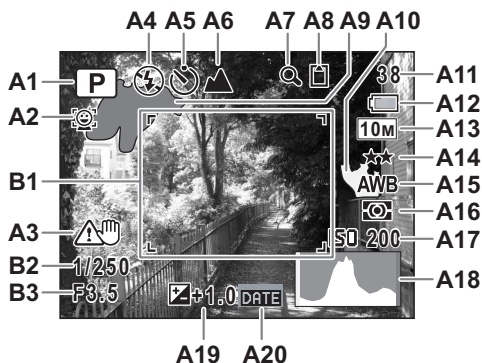

- |   |   |
|---|---|
| <b>A1</b> Shooting mode (p.60)                          | <b>A12</b> Battery level indicator (p.30) |
| <b>A2</b> Face Priority icon (p.63)                     | <b>A13</b> Recorded pixels (p.94)         |
| <b>A3</b> Camera shake warning                          | <b>A14</b> Quality level (p.96)           |
| <b>A4</b> Flash mode (p.89)                             | <b>A15</b> White balance (p.98)           |
| <b>A5</b> Drive mode (p.81, p.82)                       | <b>A16</b> AE Metering (p.100)            |
| <b>A6</b> Focus mode (p.91)                             | <b>A17</b> Sensitivity (p.101)            |
| <b>A7</b> Digital zoom/<br>Intelligent zoom icon (p.69) | <b>A18</b> Histogram (p.23)               |
| <b>A8</b> Memory status (p.37)                          | <b>A19</b> EV compensation (p.97)         |
| <b>A9</b> Bright portion (blinks red) (p.24)            | <b>A20</b> Date Imprint setting (p.106)   |
| <b>A10</b> Dark portion (blinks yellow) (p.24)          | <b>B1</b> Focus frame (p.58)              |
| <b>A11</b> Remaining image storage capacity             | <b>B2</b> Shutter speed                   |
| <b>B3</b> Aperture                                      |   |

- \* In “Histogram + Info”, A3 appears only if you press the shutter release button halfway when camera shake is likely to occur.
- \* B2 and B3 appear only when the shutter release button is pressed halfway.
- \* When the shooting mode is **AUTO PICT** (Auto Picture) and if you press the shutter release button halfway, the selected shooting mode appears in A1 even when “No Info” is selected (p.65).
- \* Some indications may not appear depending on the shooting mode.

## Display in Mode

The display shows the shooting information of the image in  mode. The display changes in the following sequence each time you press the **OK/DISPLAY** button: Normal Display, Histogram + Info, No Info.

### Normal Display



### Histogram + Info



### No Info



## Normal Display/Histogram + Info Display in Still Picture Playback Mode

(All of the display items are displayed here for explanatory purposes.)

The display shows information such as the shooting conditions. A1 to A11 appear when “Normal Display” or “Histogram + Info” is selected. B1 to B10 appear only when “Histogram + Info” is selected.



- |  |   |
|--|---|
| <b>A1</b> Playback mode<br>▶ : Still Picture Playback Mode (p.122)<br>Ⓢ : Digital SR (p.130) | <b>A10</b> Captured date and time (p.43)      |
| <b>A2</b> Face Priority icon (p.63)  | <b>A11</b> Four-way controller guide          |
| <b>A3</b> Memory status (p.37)   | <b>B1</b> Bright portion (blinks red) (p.24)  |
| <b>A4</b> Folder number (p.182)  | <b>B2</b> Recorded pixels (p.94)              |
| <b>A5</b> File number  | <b>B3</b> Quality level (p.96)                |
| <b>A6</b> Protect icon (p.138)   | <b>B4</b> White balance (p.98)                |
| <b>A7</b> Voice memo icon (p.172)  | <b>B5</b> AE Metering (p.100)                 |
| <b>A8</b> Battery level indicator (p.30)   | <b>B6</b> Sensitivity (p.101)                 |
| <b>A9</b> Volume icon  | <b>B7</b> Dark portion (blinks yellow) (p.24) |
|  | <b>B8</b> Shutter speed                       |
|  | <b>B9</b> Aperture                            |
|  | <b>B10</b> Histogram (p.23)                   |

- \* A2 appears only if the Face Recognition function worked when the image was shot.
- \* In “Normal Display”, A8 and A10 disappear if no operation is performed for two seconds.
- \* A9 appears only when the volume is being adjusted during playback of movies, sound files or voice memo. (p.119, p.170, p.172)
- \* A11 appears even when “No Info” is selected, but disappears if no operation is performed for two seconds. When no operation is performed for two seconds in “Normal Display” or “Histogram + Info”, only “Edit” disappears.



## Guide Indications

A guide for each available button operation appears as follows on the display during operation.

Four-way controller (▲)	▲
Four-way controller (▼)	▼
Four-way controller (◀)	◀
Four-way controller (▶)	▶
<b>MENU</b> button	<b>MENU</b>

Zoom button	
<b>OK/DISPLAY</b> button	<b>OK</b>
Shutter release button	<b>SHUTTER</b>
Green/  button	
button	

## Using the Histogram

A histogram shows the brightness distribution of an image. The horizontal axis represents brightness (dark at the left and bright at the right) and the vertical axis represents the number of pixels.

The shape of the histogram before and after shooting tells you whether the brightness and contrast are correct or not, and lets you decide if you need to use EV compensation and take the picture again.

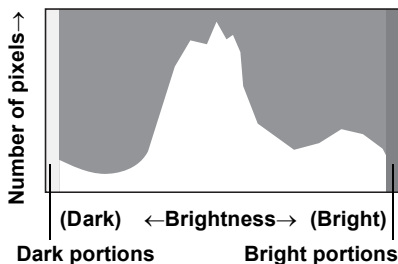

Setting the Exposure (EV Compensation) p.97

## Understanding Brightness

If the brightness is correct, the graph peaks in the middle. If the image is too dark, the peak is on the left side, and if it is too bright, the peak is on the right side.

**Dark image**

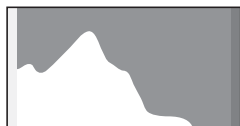

**Correct image**

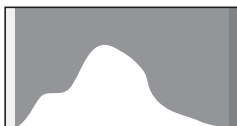

**Bright image**

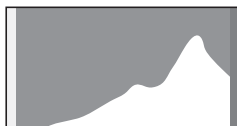

When the image is too dark, the part to the left is cut off (dark portions) and when the image is too bright, the part to the right is cut off (bright portions).

### **Understanding Bright and Dark Portions**

When there is an area in the frame that is so bright it appears white, the indicated area blinks red as a warning. Similarly, when there is an area that is so dark it appears black, the indicated area blinks yellow as a warning.

### **Understanding Contrast**

The graph peaks gradually for images in which contrast is balanced. The graph peaks on both sides but sinks in the middle for images with a large difference in contrast and low amounts of mid-level brightness.

# 1 Getting Started

---

<b>Attaching the Strap .....</b>	<b>26</b>
<b>Powering the Camera .....</b>	<b>27</b>
<b>Installing the SD Memory Card .....</b>	<b>33</b>
<b>Turning the Camera On and Off .....</b>	<b>37</b>
<b>Initial Settings .....</b>	<b>39</b>

# Attaching the Strap

Attach the strap (O-ST51) supplied with the camera.

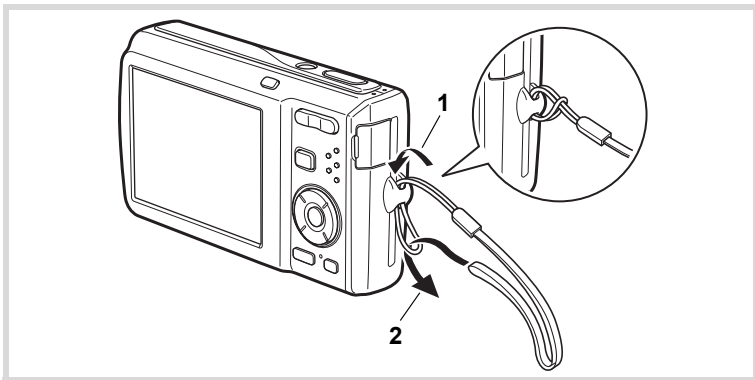

- 1** Pass the narrow end of the strap through the strap lug.
- 2** Pass the other end of the strap through the loop and pull tight.

## Charging the Battery

Use the supplied battery charger (D-BC78) to charge the supplied rechargeable lithium-ion battery (D-LI78) before using it in the camera for the first time or after a long period of non-use, or when the [Battery depleted] message appears.

Note: AC plug cord “Listed, Type SPT-2 or NISPT-2, 18/2 flexible cord, rated 125 V, 7A, minimum 6ft (1.8m)”

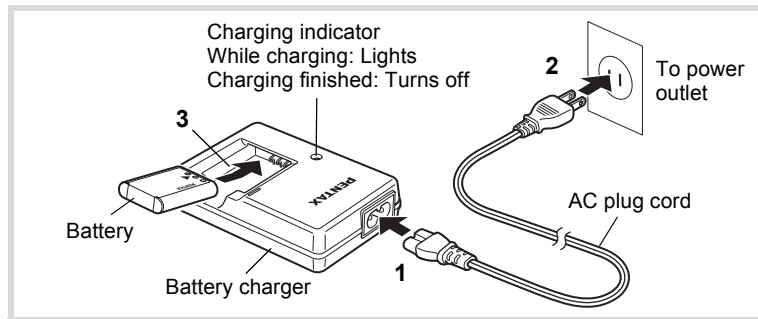

- 1** Connect the AC plug cord to the battery charger.
- 2** Plug the AC plug cord into the power outlet.
- 3** Place the battery in the battery charger so that the **PENTAX** logo is facing up.  
The charging indicator lights while the battery is charging and turns off when charging is finished.
- 4** Remove the battery from the battery charger when charging is finished.



- Do not use the supplied battery charger (D-BC78) to charge batteries other than the rechargeable lithium-ion battery D-LI78, as the battery charger may overheat or be damaged.
- The battery has reached the end of its service life when it starts to run down soon after being charged. Replace with a new battery.
- If the battery is inserted correctly but the charging indicator fails to light, the battery may be faulty. Replace with a new battery.



The time required to fully charge the battery is about 150 minutes (max.). (The charging time may vary depending on the ambient temperature and charging conditions.) The appropriate ambient temperature for charging the battery is 0°C to 40°C (32°F to 104°F).

## Installing the Battery

Use the rechargeable lithium-ion battery D-LI78 that is provided with the camera. Charge the battery before using it in the camera for the first time.

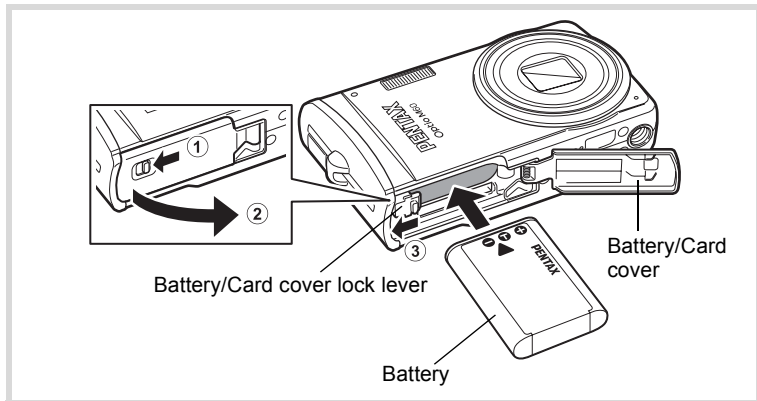

### 1 Open the battery/card cover.

Move the battery/card cover lock lever to the OPEN position ① and open the battery/card cover ②.

## 2 Using the side of the battery to press the battery/card cover lock lever in the direction of ③, insert the battery with the PENTAX logo pointing toward the lens.

Push the battery in until it is locked in place.



Make sure that the battery is inserted with the PENTAX logo pointing toward the lens. If the battery is incorrectly oriented, malfunction may result.

## 3 Close the battery/card cover.

Close the battery/card cover and move the battery/card cover lock lever to the LOCK position.

### Removing the Battery

## 1 Open the battery/card cover.

## 2 Press the battery/card cover lock lever in the direction of ③ to release the battery.

The battery will be ejected. Take care not to drop the battery when removing it.



- This camera uses a rechargeable lithium-ion battery D-LI78. Use of any other type of battery may damage the camera and cause malfunction.
- Insert the battery correctly. If the battery is incorrectly oriented, malfunction may result.
- Do not remove the battery while the camera is turned on.
- When storing the battery for more than 6 months, charge the battery for 30 minutes using the battery charger and store the battery separately.  
Be sure to recharge the battery every 6 to 12 months. Storing the battery below room temperature is ideal. Avoid storing it in high temperatures.
- The date and time may be returned to the default setting if the camera is left without the battery for a long time.
- Be careful as the camera or the battery may become hot when the camera is used continuously for a long period of time.

- **Image Storage Capacity, Movie Recording Time, Sound Recording Time, and Playback Time**  
(at 23°C with the display on and the battery fully charged)

Image Storage Capacity* <sup>1</sup> (flash used for 50% of shots)	Movie Recording Time* <sup>2</sup>	Sound Recording Time* <sup>2</sup>	Playback Time* <sup>2</sup>
Approx. 210 pictures	Approx. 80 min.	Approx. 270 min.	Approx. 215 min.

- \*1 Recording capacity shows approximate number of shots recorded during CIPA-compliant testing (with display on, flash used for 50% of the shots, and 23 degrees centigrade). Actual performance may vary according to operating conditions.
- \*2 According to the result of in-house testing.



- In general, battery performance may temporarily deteriorate as the temperature decreases.
- Be sure to take a spare battery with you when traveling abroad or to a cold region, or if you intend to take a lot of pictures.

## • Battery Level Indicator

You can check the battery level by the indicator on the display.

Screen Display	Battery Status
(green)	Adequate power remains.
(green)	Battery is running low.
(yellow)	Battery is running very low.
(red)	Battery is exhausted.
[Battery depleted]	The camera will turn off after this message appears.



## Using the AC Adapter

Use of the optional AC adapter kit (K-AC78) is recommended if you intend to use the camera for a long time or connect it to a computer.

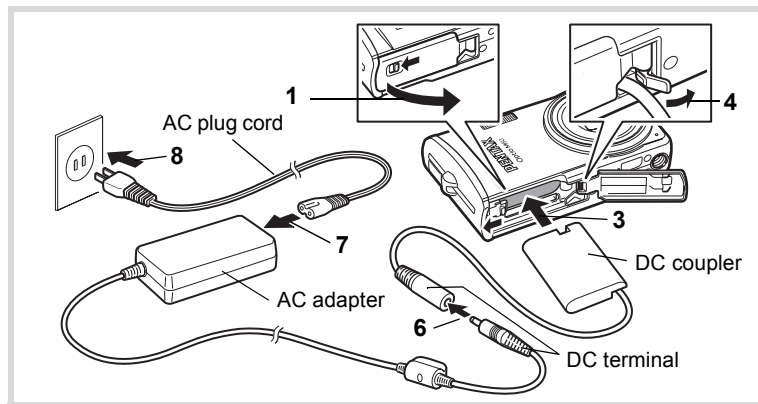

- 1 Make sure that the camera is turned off and open the battery/card cover.**
- 2 Remove the Battery.**  
Refer to p.28 - p.29 on how to open/close the battery/card cover and remove the battery.
- 3 Insert the DC coupler.**  
Using the side of the DC coupler to press the battery/card cover lock lever, insert the DC coupler. Confirm the DC coupler is locked in place.
- 4 Extract the DC coupler cord.**  
Pull out the tab at the joint of the camera and the battery/card cover so that the DC coupler cord extracts from there.
- 5 Close the battery/card cover.**

- 6** Connect the DC terminal of the AC adapter to the DC terminal of the DC coupler.
- 7** Connect the AC plug cord to the AC adapter.
- 8** Plug the AC plug cord into the power outlet.



- Make sure that the camera is turned off before connecting or disconnecting the AC adapter.
- Make sure that the AC plug cord and the power cord connecting the AC adapter to the camera are inserted securely. The data may be lost if either becomes disconnected while data is being recorded on the SD Memory Card or the built-in memory.
- Use the AC adapter with due care to avoid fire or electric shock. Be sure to read “About the Battery Charger and the AC Adapter” (p.2) before using the AC adapter.
- Be sure to read the operation manual accompanying the AC adapter kit K-AC78 before using the adapter.
- When connecting the AC adapter, you cannot set the camera upright on the table because the cord from the DC coupler is extracted from the bottom side of the camera. Additionally, do not place the camera with the lens facing down because the lens extends when the camera turns on. Hold the camera in your hand or use a tripod when using the AC adapter and confirming the display to take pictures, view pictures or adjust the camera settings.

# Installing the SD Memory Card

This camera uses either an SD Memory Card or an SDHC Memory Card. (Both cards are referred to as SD Memory Cards hereafter.) Captured images and sound files are saved on the SD Memory Card if a card is inserted in the camera. They are saved in the built-in memory if a card is not inserted (p.37).



- **Be sure to use this camera to format (initialize) an SD Memory Card that is unused or has been used on other cameras or digital devices. Refer to “Formatting an SD Memory Card” (p.174) for instructions on formatting.**
- Make sure that the camera is turned off before inserting or removing the SD Memory Card.



- The still picture storage capacity varies depending on the capacity of the SD Memory Card and the selected number of recorded pixels and quality level (p.36).
- The self-timer lamp blinks while the SD Memory Card is being accessed (data is being recorded or read).

## Backing Up Data

The camera may not be able to access data in the built-in memory in the case of a malfunction. Use a computer or other device to back up important data in another location.

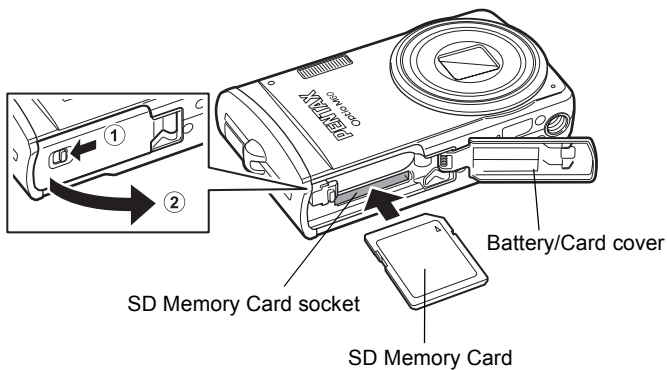

### 1 Open the battery/card cover.

Move the battery/card cover lock lever to the OPEN position ① and open the battery/card cover ②.

### 2 Insert the SD Memory Card into the SD Memory Card socket so that the label is facing toward the front of the camera (the side with the lens).

Push the card in all the way. Images and sound may not be recorded correctly if the card is not inserted all the way.

### 3 Close the battery/card cover.

Close the battery/card cover and move the battery/card cover lock lever to the LOCK position.

## To Remove the SD Memory Card

### 1 Open the battery/card cover.

### 2 Push the card into the SD Memory Card socket to eject it.

Pull the card out.

## Precautions When Using an SD Memory Card

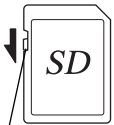

- The SD Memory Card is equipped with a write-protect switch. Setting the switch to LOCK prevents new data from being recorded on the card, the stored data from being deleted, and the card from being formatted by the camera or computer.  
An illustration of an SD memory card with a write-protect switch on its left edge. The switch is shown in the 'LOCK' position, indicated by a downward-pointing arrow. The letters 'SD' are printed on the card's surface.

 appears on the display when the card is write-protected.
- Care should be taken when removing the SD Memory Card immediately after using the camera, as the card may be hot.
- Do not remove the SD Memory Card or turn the camera off while images or sound files are being played back or saved to the card, or the camera is connected to a computer with the USB cable, as this may cause the data to be lost or the card to be damaged.
- Do not bend the SD Memory Card or subject it to violent impact. Keep it away from water and store away from high temperature.
- Do not remove the SD Memory Card during formatting as this may damage the card and render it unusable.
- The data on the SD Memory Card may be deleted in the following circumstances. We do not accept any liability for data that is deleted
  - (1) when the SD Memory Card is mishandled by the user.
  - (2) when the SD Memory Card is exposed to static electricity or electrical interference.
  - (3) when the card has not been used for a long time.
  - (4) when the card is ejected or the battery is removed while the data on the card is being recorded or accessed.
- If it is not used for a long time, the data on the card may become unreadable. Be sure to regularly make a backup of important data on a computer.
- Avoid using or storing the card where it may be exposed to static electricity or electrical interference.
- Avoid using or storing the card in direct sunlight or where it may be exposed to rapid changes in temperature or to condensation.
- When using an SD Memory Card with a slow recording speed, recording may stop while you are taking movies even when there is adequate space in the memory, or shooting and playback may take a long time.
- For information on compatible SD Memory Cards, visit the PENTAX website.
- Be sure to format an SD Memory Card that is unused or has been used on another camera. Refer to "Formatting an SD Memory Card or the Built-in Memory" (p.174).
- Please note that formatting the SD Memory Card will not necessarily delete the data so that it cannot be recovered using off-the-shelf data recovery software. There are off-the-shelf secure data deletion software programs available that will completely delete the data. If you are going to discard, give away or sell your SD Memory Card, you should ensure that the data on the card is completely deleted or the card itself is destroyed if it contains any personal or sensitive information. In any case, the data on your SD Memory Card should be managed at your own risk.

## Number of Images Recordable on an SD Memory Card

The sizes of the recorded images differ depending on the number of recorded pixels and the quality level of the images, so the number of images that will be saved on an SD Memory Card also differs.

Choose the appropriate number of recorded pixels and quality level for still pictures on the [ Rec.Mode] menu.

Selecting the Recorded Pixels  p.94  
Selecting the Quality Level  p.96

Choose the appropriate number of recorded pixels and frame rate in [Movie] on the [ Rec.Mode] menu.

Selecting the Recorded Pixels for Movies  p.111  
Selecting the Frame Rate  p.112

For an approximate guide to the number of images or the length of recorded movies that will be saved on an SD Memory Card, see “Main Specifications” (p.206).

# Turning the Camera On and Off

1

Getting Started

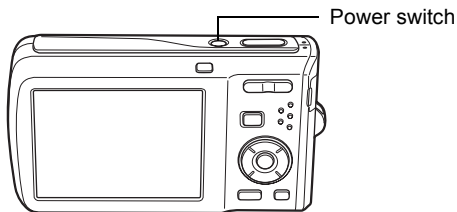

## 1 Press the power switch.

The camera turns on and the display turns on.

When you turn the camera on, the lens cover opens and the lens extends.

If the [Language/言語] screen or [Date Adjust] screen appears when you turn the camera on, follow the procedure on p.39 to set the display language and/or current date and time.

## 2 Press the power switch again.

The display turns off, the lens closes, and the camera turns off.

Taking Pictures p.58

## Checking the Memory Card

The memory card is checked when the camera turns on and the memory status is displayed.

- : The SD Memory Card is inserted.  
Images and sound files will be saved on the SD Memory Card.
- : The SD Memory Card is not inserted.  
Images and sound files will be saved in the built-in memory.
- : The write-protect switch on the SD Memory Card is in the LOCK position (p.35).  
Images and sound cannot be recorded.

Memory status



37

## Playback Mode

Use this mode when you want to play back an image or sound file straightaway without taking any more pictures.

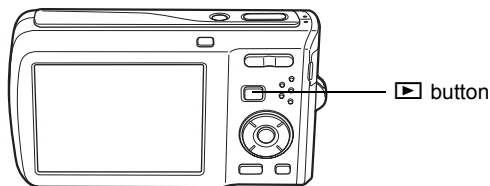

### 1 Press the power switch while holding down the ▶ button.

The display turns on with the lens retracted and the camera turns on in the playback mode.



To switch from the playback mode to the capture mode, press the ▶ button or press the shutter release button halfway.

Playing Back Still Pictures  p.118



# Initial Settings

1

Getting Started

The [Language/言語] screen appears when the camera is turned on for the first time. Perform the operations in “Setting the Display Language” below to set the language, and in “Setting the Date and Time” (p.43) to set the current date and time.

Language, Date, and Time can be changed later. Refer to the pages below for instructions.

- To change the language, follow the steps in “Changing the Display Language” (p.181).
- To change the date and time, follow the steps in “Changing the Date and Time” (p.176).

## Setting the Display Language

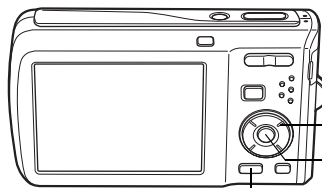

Four-way controller

OK button

MENU button

1

Use the four-way controller (▲▼◀▶) to choose the display language.

Language/言語		
English	日本語	Türkçe
Français	Dansk	Ελληνικά
Deutsch	Svenska	Русский
Español	Suomi	ไทย
Portugués	Polski	한국어
Italiano	Čeština	中文繁體
Nederlands	Magyar	中文简体
[MENU] Cancel		[OK] OK

## 2 Press the OK button.

The [Initial Setting] screen appears in the selected language. If the desired settings for [Hometown] and [DST] (Daylight Saving Time) appear, press the **OK** button again to display the [Date Adjust] screen. Go to “Setting the Date and Time” (p.43). Go to Step 3 in “To Set Hometown and DST” (p.42) if the desired settings do not appear.

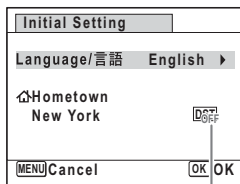

Daylight saving time

If you accidentally select another language and go to the next procedure, perform the following operation to set the language back.

● **When Another Language Has Been Inadvertently Selected**

- 1 Press the four-way controller (▶).**
- 2 Use the four-way controller (▲ ▼ ◀ ▶) to select the language and press the OK button.**

The [Initial Setting] screen appears in the selected language.

● **When the Screen After Step 2 Appears in Another Language**

- 1 Press the OK button.**
  - 2 Press the MENU button.**
  - 3 Press the four-way controller (▶).**
  - 4 Use the four-way controller (▼ ▲) to select [Language/言語].**
  - 5 Press the four-way controller (▶).**
- The [Language/言語] screen appears.
- 6 Use the four-way controller (▲ ▼ ◀ ▶) to select the language.**
  - 7 Press the OK button.**

The [↖ Setting] menu appears in the selected language.

The language is now switched to your desired language. To reset [Hometown], [Date] and [Time], refer to the pages below for instructions.

- To change [Hometown], follow the steps in "Setting the World Time" (☞p.179).
- To change the [Date] and [Time], follow the steps in "Changing the Date and Time" (☞p.176).

## To Set Hometown and DST

1

Getting Started

### 3 Press the four-way controller (▼).

The frame moves to [Hometown].

### 4 Press the four-way controller (▶).

The [Hometown] screen appears.

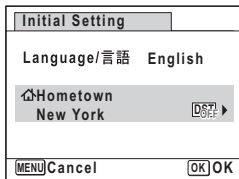

### 5 Use the four-way controller (◀▶) to choose the city.

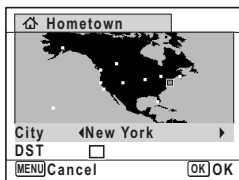

### 6 Press the four-way controller (▼).

The frame moves to [DST] (Daylight Saving Time).

### 7 Use the four-way controller (◀▶) to select (On) or (Off).

### 8 Press the OK button.

The [Initial Setting] screen appears.

### 9 Press the OK button.

The [Date Adjust] screen appears. Next, set the date and time.

## Setting the Date and Time

Set the current date and time and the display style.

### 1 Press the four-way controller (▶).

The frame moves to [mm/dd/yy].

### 2 Use the four-way controller (▲▼) to choose the date and time display style.

Choose from [mm/dd/yy], [dd/mm/yy] or [yy/mm/dd].

Date Adjust	
Date Style	mm/dd/yy 24h
Date	01/01/2008
Time	0:00
[MENU]Cancel [OK]OK	

### 3 Press the four-way controller (▶).

The frame moves to [24h].

### 4 Use the four-way controller (▲▼) to select [24h] (24-hour display) or [12h] (12-hour display).

Date Adjust	
Date Style	mm/dd/yy 24h
Date	01/01/2008
Time	0:00
[MENU]Cancel [OK]OK	

### 5 Press the four-way controller (▶).

The frame returns to [Date Style].

### 6 Press the four-way controller (▼).

The frame moves to [Date].

### 7 Press the four-way controller (▶).

The frame moves to the month.

Date Adjust	
Date Style	mm/dd/yy 24h
Date	▶01/01/2008
Time	0:00
[MENU]Cancel [OK]OK	

## 8 Use the four-way controller (▲▼) to change the month.

Change the day and year in the same manner. Next, change the time.

If you selected [12h] in Step 4, the setting switches between am and pm corresponding to the time.

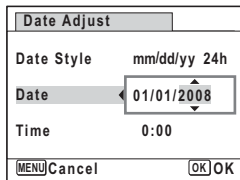

## 9 Press the OK button.

The setting is saved and the camera returns to capture status.

[Language/言語], [Date], [Time], [Hometown], and [DST] can be changed. Refer to the pages below for instructions.

- To change the language, follow the steps in “Changing the Display Language” (p.181).
- To change the date and time, follow the steps in “Changing the Date and Time” (p.176).
- To change the city or turn DST on and off, follow the steps in “Setting the World Time” (p.179).



When the [Initial Setting] or [Date Adjust] screen is displayed, you can cancel the setting operation and switch to the capture mode by pressing the **MENU** button. In this case, the [Initial Setting] screen will appear next time you turn the camera on.



If you press the **OK** button in Step 9, the camera clock is reset to 00 seconds. To set the exact time, press the **OK** button when the time signal (on the TV, radio, etc.) reaches 00 seconds.

The video output format (NTSC/PAL) is set to the format of the city selected in [Hometown] on the [Initial Setting] screen. Refer to “List of World Time Cities” (p.204) for the video output format of each city set as the initial setting, and “Changing the Video Output Format” (p.184) for changing the setting of the video output format.

# **2 Common Operations**

---

<b>Understanding the Button Functions .....</b>	<b>46</b>
<b>Setting the Camera Functions .....</b>	<b>51</b>

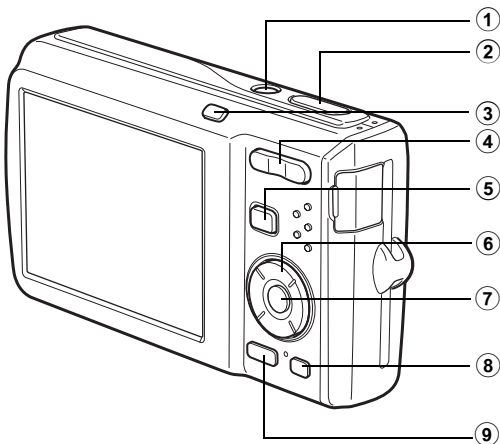

# Understanding the Button Functions

## Mode









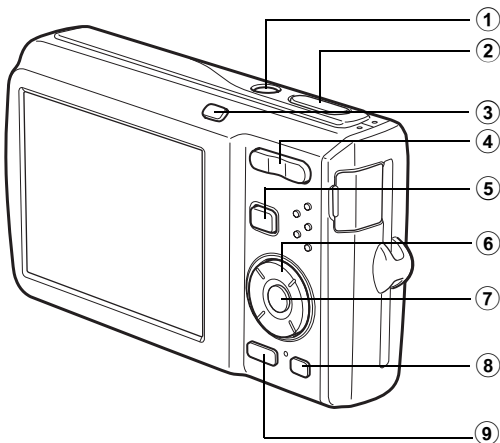







- ① **Power switch**  
Turns the camera on and off (p.37).
- ② **Shutter release button**  
Focuses the camera on the subject when pressed halfway in Still Picture Capture Mode (except in **PF**, **▲** and **MF** modes) (p.59).  
Takes the still picture when pressed down fully (p.59).  
Starts and stops movie recording in **Movie** mode (p.109).  
Starts and stops sound file recording in **Voice Recording** mode (p.168).
- ③ **Smiley face button**  
Switches the Face Recognition function (p.63). The Face Recognition function is switched as follows each time the Smiley face button is pressed:  
Smile Capture → Face Priority Off → Face Priority On
- ④ **Zoom/AF-ON button**  
Changes the captured area (p.69).





- ⑤ **▶ button**  
Switches to the  mode (p.50).
- ⑥ **Four-way controller**  
(▲) Changes the drive mode (p.81, p.82).  
(▼) Displays the Capture Mode Palette (p.60).  
(◀) Changes the flash mode (p.89).  
(▶) Changes the focus mode (p.91).  
(▲▼) Adjusts **MF** in **MF** mode (p.92).
- ⑦ **OK/DISPLAY button**  
Changes the information on the display (p.18).
- ⑧ **Green button**  
Switches to the  (Green) mode (p.67).  
Calls up the assigned menu (p.107).
- ⑨ **MENU button**  
Displays the [ Rec.Mode] menu (p.51).



- ① **Power switch**  
Turns the camera on and off (p.37).
- ② **Shutter release button**  
Switches to  mode (p.50).
- ③ ** button**  
Zooms in on the subject's faces in the face-recognized image in the order the faces were recognized when the picture was taken. (Face close-up playback) (p.129).
- ④ **Zoom// button**  
Press  during single-image display to change to nine-image display. Returns to the previous display when  is pressed (p.120).  
Enlarges the image when  is pressed during single-image display. Returns to the previous display when  is pressed (p.128).  
Press  during nine-image display to change to folder or calendar display (p.121).  
Press  during folder display to change to the normal nine-image display (p.121).  
Press  during calendar display to change to the normal nine-image display (p.121).  
Adjusts the volume during playback of movies, sound files or voice memo (p.119, p.170, p.172).

- ⑤ **▶ button**  
Switches to  mode (p.50).
- ⑥ **Four-way controller**  
(▲) Plays back and pauses a movie or sound file (p.119, p.170).  
(▼) Displays the Playback Mode Palette (p.123).  
Stops a movie or sound file during playback (p.119, p.170).  
(◀▶) Displays the previous or next image or sound file during single-image display (p.118).  
Frame forwards, frame reverses, reverses a movie and makes a movie play forwards during playback (p.119).  
Fast forwards, reverses, and moves to the next index in sound file playback (p.170).  
(▲▼◀▶) Moves the display area during zoom display (p.128).  
Selects an image in nine-image display, a folder in folder display, and a date in calendar display (p.120, p.121).  
Moves the image when using the Frame Composite function (p.151).
- ⑦ **OK/DISPLAY button**  
Changes the information on the display (p.18).  
Returns zoom display or nine-image display to single-image display (p.120, p.128).  
Changes to nine-image display of the selected folder during folder display (p.121).  
Changes to single-image display of the selected date during calendar display (p.121).
- ⑧ **Green/  button**  
Switches from single-image display to the Delete screen (p.132).  
Switches from nine-image display to the Select & Delete screen (p.134).  
Switches from folder display to the calendar display screen (p.121).  
Switches from calendar display to the folder display screen (p.121).
- ⑨ **MENU button**  
Displays the [ Setting] menu during single-image display (p.51).  
Returns to single-image display during Playback Mode Palette display (p.122).  
Returns zoom display or nine-image display to single-image display (p.120).  
Changes to nine-image display of the selected folder during folder display (p.121).  
Changes to nine-image display of the selected date during calendar display (p.121).

## Switching Between Mode and Mode

In this manual, the capture mode, such as for taking still pictures, is referred to as “ mode” (the capture mode). The playback mode, such as for displaying captured images on the display, is referred to as “ mode” (the playback mode). In  mode, you can perform simple editing operations on the images that are played back.

Follow the procedure below to switch between  mode and  mode.

### To Switch from Mode to Mode

#### 1 Press the button.

The camera switches to  mode.

### To Switch from Mode to Mode

#### 1 Press the button or the shutter release button halfway.

The camera switches to  mode.



### Displaying data stored in the built-in memory

When an SD Memory Card is inserted in the camera, images, movies, and sounds on the SD Memory Card are displayed. If you want to display images, movies, and sounds in the built-in memory, turn the camera off and remove the SD Memory Card, or follow the procedure below to use the “Built-in memory display” function.



Make sure that the camera is turned off before inserting or removing the SD Memory Card.

#### ● Viewing images in the built-in memory while the SD Memory Card is inserted (built-in memory display)

- When you press and hold down the  button for more than one second in  mode, the lens retracts. After the message [Display image/sound from built-in memory] appears, images, movies and sound files stored in the built-in memory are displayed.
- In the built-in memory display, you can play back still pictures (including enlarged display) (p.118, p.128), movies (p.119), and sounds (p.170), and switch between nine-image display, folder display, and calendar display (p.120).
- In the built-in memory display, you cannot delete data, delete a selection, display the Playback Mode Palette, or display the menu. If you want to perform any of these operations on images, movies, or sounds in the built-in memory, do so after removing the SD Memory Card.

# Setting the Camera Functions

To change the camera settings, press the **MENU** button to display the [📷 Rec.Mode] menu or [⚙️ Setting] menu. Menus for playing back and editing images and sound files are displayed from the Playback Mode Palette.

## Operating the Menus

Press the **MENU** button in 📷 mode to display the [📷 Rec.Mode] menu. Press the **MENU** button in ▶ mode to display the [⚙️ Setting] menu. Use the four-way controller (◀▶) to switch between [📷 Rec.Mode] menu and [⚙️ Setting] menu.

During recording

During playback

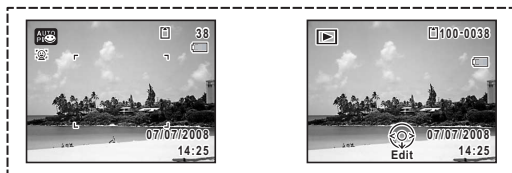

MENU

MENU

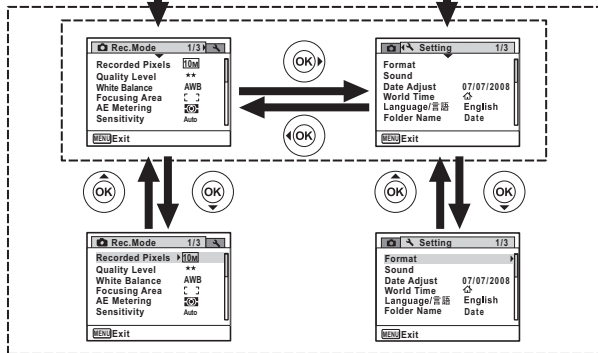

SHUTTER

MENU, OK or ►

Press halfway

The setting is complete and the camera returns to mode



The setting is complete and the camera returns to mode



Available button operations appear on the display during menu operation.

Ex.) To set the [Quality Level] on the [Rec.Mode] menu

**1 Press the MENU button in  mode.**

The [ Rec.Mode] menu appears.

**2 Press the four-way controller (▼).**

The frame moves to [Recorded Pixels].

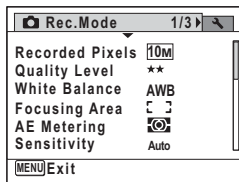

**3 Press the four-way controller (▼).**

The frame moves to [Quality Level].

**4 Press the four-way controller (▶).**

A pull-down menu appears with the items that can be selected.

The pull-down menu displays only those items that can be selected with the current camera settings.

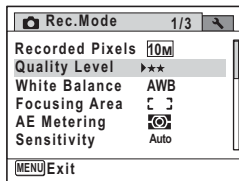

**5 Use the four-way controller (▲▼) to change the setting.**

The quality level changes each time the four-way controller (▲▼) is pressed.

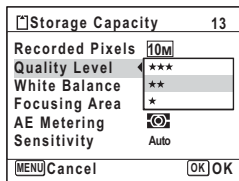

**6 Press the OK button or the four-way controller (◀).**

The setting is saved and then the camera is ready for setting the other functions. To exit the settings, press the **MENU** button.

To use another operation, refer to the alternate Step 6 options on the next page.

## To Save the Setting and Start Taking Pictures

### 6 Press the shutter release button halfway.

The setting is saved and the camera returns to capture status.  
When the shutter release button is pressed fully, the picture is taken.



When the [ Setting] menu is displayed from mode, you can switch to mode by pressing the button.

## To Save the Setting and Begin Playback of Images

### 6 Press the button.

When the [ Rec.Mode] menu is displayed from mode, the setting is saved and the camera returns to playback status.

## To Cancel the Changes and Continue with Menu Operations

### 6 Press the MENU button.

The changes are canceled and the screen returns to Step 3.



The **MENU** button function differs depending on the screen. Refer to the guide indications.

- Exit : Exits the menu and returns to the original screen.
- : Returns to the previous screen with the current setting.
- Cancel : Cancels the current selection, exits the menu and returns to the previous screen.



## Menu List



This displays the items that can be set with the menus and provides descriptions of each item. See the list of default settings in the Appendix “Default Settings” (p.199) to decide whether you want the settings saved when the camera is turned off and whether you want the settings returned to the defaults when the camera is reset.

### Rec.Mode] Menu

This menu shows the functions related to taking still pictures and recording movies.

Item		Description	Page
Recorded Pixels		For choosing the number of recorded pixels of still pictures	p.94
Quality Level		For choosing the quality level of still pictures	p.96
White Balance		For adjusting the color balance according to the lighting conditions	p.98
Focusing Area		For changing the area of the autofocus	p.93
AE Metering		For setting the area of the screen that is metered to determine the exposure	p.100
Sensitivity		For setting the sensitivity	p.101
EV Compensation		For adjusting the overall brightness of the picture	p.97
Movie	Recorded Pixels	For choosing the number of recorded pixels of movies	p.111
	Frame Rate	For setting the frame rate (number of frames per second)	p.112
	Color Mode	For choosing a color mode for movies	p.113
	Movie SR	For choosing whether or not to use the movie shake reduction function	p.114
Blink Detection		For choosing whether to use the Blink Detection function when the Face Recognition function worked	p.102
Digital Zoom		For choosing whether or not to use the digital zoom function	p.70
Instant Review		For setting the Instant Review time	p.103
Memory		For choosing whether to save the set values of the shooting function or return to the defaults when the camera is turned off	p.115
Green Button		For assigning a function to the Green button in  mode	p.108
Sharpness		For choosing sharp or soft outlines	p.104
Saturation		For setting the color saturation	p.105
Contrast		For setting the image contrast level	p.105
Date Imprint		For choosing whether to imprint the date and/or time when taking still pictures	p.106



- Use the  (Green) mode to enjoy easy picture-taking using standard settings, regardless of the settings in the [ Rec.Mode] menu (p.67).
- Assigning frequently used functions to the Green button enables you to go straight to the menu item (p.107).

## [ Setting] Menu

Item	Description	Page
Format	For formatting the SD Memory Card	p.174
Sound	For adjusting the operation volume and playback volume, and setting the start-up sound, shutter sound, key operation sound and self-timer sound	p.175
Date Adjust	For adjusting the date and time	p.176
World Time	For setting the Hometown and Destination	p.179
Language/言語	For setting the language in which menus and messages appear	p.181
Folder Name	For choosing how names are assigned to folders for storing images and sound files	p.182
USB Connection	For setting the USB cable connection (to a computer or a printer)	p.183
Video Out	For setting the output format to the AV equipment	p.184
Brightness Level	For changing the brightness of the display	p.185
Power Saving	For setting the time until the camera enters power-saving mode	p.186
Auto Power Off	For setting the time until the camera turns off automatically	p.187
Quick Zoom	For choosing whether to use the Quick Zoom function (p.128) when playing back images	p.188
Reset	For returning settings other than the date and time, language, world time and video out to their defaults	p.190

# **3 Taking Pictures**

---

<b>Taking Still Pictures .....</b>	<b>58</b>
<b>Setting the Shooting Functions .....</b>	<b>89</b>
<b>Recording Movies .....</b>	<b>109</b>
<b>Saving the Settings (Memory) .....</b>	<b>115</b>

## Taking Pictures

The Optio M60 features a wide range of shooting modes and functions to suit almost any subject or scene. This chapter describes how to take pictures with the most commonly used standard settings (the initial factory default settings).

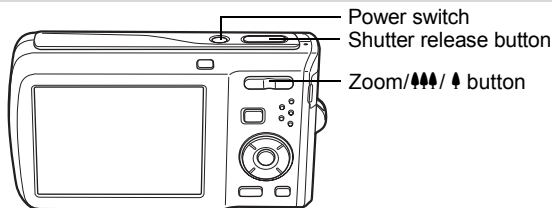

3

### 1 Press the power switch.

The camera turns on and is ready to take still pictures. In this manual, this is called Still Picture Capture Mode.

### 2 Confirm the subject and shooting information on the display.

The focus frame in the middle of the display indicates the zone of automatic focusing.



Focus frame

When the camera recognizes a face, the Face Recognition function is activated and the face recognition frame appears (p.63).

You can change the captured area by pressing the Zoom/▲▲▲/▲ button to the left or right (p.69).

- ▲ (Right) enlarges the subject.
- ▲▲▲ (Left) widens the area that is captured by the camera.



Face recognition frame

### 3 Press the shutter release button halfway.

The focus frame (or face recognition frame) on the display turns green when the camera focuses on the subject at the correct distance.



### 4 Press the shutter release button fully.

The picture is taken.

The flash discharges automatically depending on the light conditions. The image appears on the display for one second (Instant Review) and is saved to the SD Memory Card or the built-in memory (p.60).



Press the Green button to switch to the  (Green) mode and let the camera set all the shooting functions automatically (p.67).

## Using the Shutter Release Button

The shutter release button works in a two-step action as follows.

### Press halfway

This refers to pressing the shutter release button gently to the first position. This locks the focus setting and the exposure. The green focus frame lights on the display when the shutter release button is pressed halfway and the subject is in focus. If the subject is out of focus, the frame turns red.

### Press fully

This refers to pressing the shutter release button all the way down to the fully depressed position. This takes a picture.

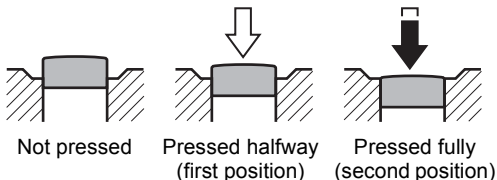

### Poor focusing conditions

The camera may not be able to focus under the following conditions. In these cases, lock the focus on an object the same distance away as the subject (by pressing and holding the shutter release button halfway), then aim the camera at your subject and press the shutter release button fully.

- Objects that lack contrast such as a blue sky or white wall
- Dark places or objects, or conditions that prevent light being reflected back
- Horizontal lines or intricate patterns
- Fast moving objects
- When there is an object in the foreground and an object in the background in the captured area
- Strongly reflected light or strong backlighting (bright background)

### Instant Review

The image appears on the display for one second (Instant Review) immediately after it is captured. You can change the Instant Review time (p.103).

When you press the  button during Instant Review, a confirmation dialog appears. Use the four-way controller (▲▼), select [Delete] and press the **OK** button to delete the image.

### Blink Detection

If the camera detects that the subject's eyes are closed while the Face Recognition (p.63) is activated, the message [Closed eyes have been detected.] appears during Instant Review.

- Even when Instant Review is set shorter than [3sec], the message [Closed eyes have been detected.] appears for 3 seconds.
- When the Face Recognition function (p.63) does not work, Blink Detection also does not function. Even if the subject's faces are recognized, Blink Detection does not function depending on the condition of the recognized faces.
- You can also disable Blink Detection function (p.102).

### Setting the Shooting Mode

The Optio M60 has a variety of shooting modes that let you take pictures or record movies and sound in different situations simply by choosing the

appropriate mode for the particular situation from the Capture Mode Palette.

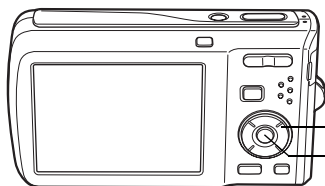

Four-way controller  
OK button

**1 Press the four-way controller (▼) in mode.**

The Capture Mode Palette appears.

**2 Use the four-way controller (▲▼◀▶) to choose a shooting mode.**

When an icon is selected in the Capture Mode Palette, the selected shooting mode guide appears.























**3 Press the OK button.**

The shooting mode is selected and the camera returns to capture status.





- In shooting modes other than , , , , , and , saturation, contrast, sharpness, white balance, etc. are automatically set to the optimal settings for the selected mode.
- Some functions may not be available or may not function fully depending on the selected shooting mode. For details, refer to "Functions Available for Each Shooting Mode" (p.192).

There are 24 available shooting modes.

Shooting Mode		Description	Page
	Auto Picture	Automatically selects the best capture mode.	p.65
	Program	Used for basic shooting. Various functions can also be set with this mode.	p.66
	Night Scene	Used for night scenes. Use a tripod, etc. to prevent image shake.	p.71
	Night Scene Portrait	For portraits in night scenes. Use a tripod, etc. to prevent image shake.	p.71
	Half-length Portrait	For portraits with proper framing by automatic zoom. Fixed to [3M] pixels.	p.73
	Movie	For capturing movies. Sound is also recorded.	p.109
	Landscape	For capturing landscape views. The camera focuses on a wide range.	—
	Flower	For capturing flowers. Reproduces the outline of the flower softly.	—
	Portrait	For capturing portraits. Makes the skin tone brighter and look healthy.	p.73
	Surf & Snow	For capturing images with dazzling backgrounds, snowy scenes or beaches.	p.76
	Sport	For fast moving subjects. Keeps the camera in focus until the shutter release.	p.76
	Digital SR (Blur Reduction)	Higher sensitivity reduces blur.	p.71
	Kids	For capturing moving kids. Reproduces healthy and bright skin tone.	p.74
	Pet	For capturing pets in motion. Select the color of the pet's coat.	p.75
	Food	For capturing food. Saturation is higher to make it look appetizing.	—
	Fireworks	For capturing fireworks. Use a tripod, etc. to prevent image shake.	p.71
	Frame Composite	For capturing images with a frame. Recorded pixels is fixed to [3M].	p.79
	Voice Recording	For recording sound. Do not cover the microphone with your hands.	p.168
	Natural Skin Tone	Adjusts color & brightness to reproduce skin more beautifully than Portrait.	p.73
	Candlelight	For capturing scenes in candlelight.	p.71
	Text	For taking clear pictures of text in color or B/W, normal or reversed.	p.78



Shooting Mode		Description	Page
	Blog	For capturing blog images and the like. Recorded pixels fixed at 640x480.	—
	Digital Wide	Composites two images to capture a wider area.	p.84
	Digital Panorama	Stitches images taken with the camera to create a panoramic photograph.	p.86

## Using the Face Recognition Function

With the Optio M60, the Face Recognition function is available with all shooting modes except  (Voice Recording) mode.

When the camera detects a person's face in the image, the Face Recognition function displays a yellow face recognition frame around the face on the display screen, sets the focus (Face Recognition AF) and compensates the exposure (Face Recognition AE).

If the subject in the face recognition frame moves, the frame also moves and changes size as it tracks the face.

The Face Recognition function can recognize up to 32 people's faces. If it recognizes multiple faces, the camera displays a yellow frame over the main face and white frames over the other face(s). It can display up to a total of 15 frames, including a main frame and white frame(s).

By pressing the  button, you can switch to the Smile Capture function, which automatically releases the shutter when your subject smiles (p.64).



Face recognition frame

When the multiple faces are recognized

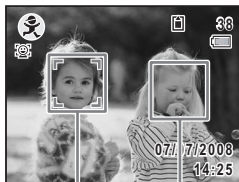

Main frame White frame



- Face Recognition AF and AE may not work if the subject is wearing sunglasses, has part of the face covered or is not looking toward the camera.
- If the camera cannot recognize the subject's face, the camera focuses using the setting currently selected in [Focusing Area].
- When the Smile Capture function is On, the shutter may not be released automatically because the Smile Capture function may not work in some situations, such as when the recognized face is too small.

## To Switch the Face Recognition Function

By default, the Face Recognition function is set to Face Priority On. The Face Recognition function is switched as follows each time the  button is pressed:

Smile Capture → Face Priority Off → Face Priority On

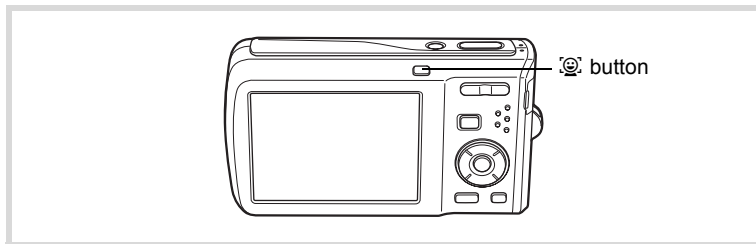

Face Priority On



Smile Capture















Face Priority Off



An icon indicating either Face Priority On or Smile Capture appears on the display. (The icon does not appear when the Face Recognition function is not activated.)



- The Face Recognition function cannot be set to off in **AUTO PICT** (Auto Picture),  (Night Scene Portrait),  (Half-length Portrait),  (Portrait),  (Kids) or  (Natural Skin Tone) mode. You can select either Face Priority On or Smile Capture.
- Face Priority On is automatically selected in  (Green), **AUTO PICT** (Auto Picture),  (Night Scene Portrait),  (Half-length Portrait),  (Movie),  (Portrait),  (Kids) or  (Natural Skin Tone) mode. When switching to another mode from one of these modes, the Face Recognition setting returns to the previous setting.

## Taking Pictures Automatically (Auto Picture Mode)

In **AUTO PICT** (Auto Picture) mode, the camera automatically selects the most appropriate mode depending on the situations and subjects.

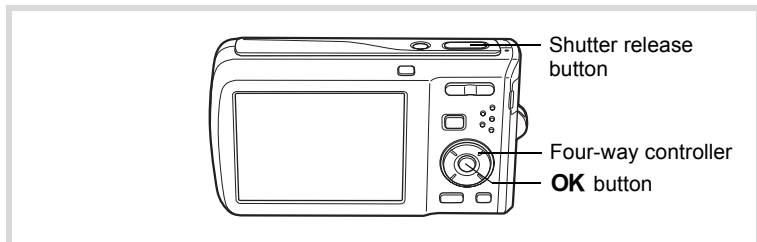

**1 Press the four-way controller (▼) in **AUTO PICT** mode.**  
The Capture Mode Palette appears.

**2 Use the four-way controller (▲▼◀▶) to select **AUTO PICT**.**

**3 Press the OK button.**

The **AUTO PICT** (Auto Picture) mode is selected and the camera returns to capture status. When you aim the camera at the subject, the selected shooting mode is displayed on the top left of the screen.



	Standard		Night Scene		Night Scene Portrait
	Landscape		Flower		Portrait
	Sport		Candlelight		

When the camera recognizes a face, the Face Recognition function is activated and the face recognition frame appears (p.63).

**4 Press the shutter release button halfway.**

The focus frame on the display turns green when the camera focuses on the subject at the correct distance.

## 5 Press the shutter release button fully.

The picture is taken.



The following restrictions apply in **AUTO PICTURE** mode:

- You cannot turn the Face Recognition function off.
- The Focusing Area setting is fixed at (Multiple).
- The (Flower) mode cannot be selected when using Digital Zoom or Intelligent Zoom.
- If the (Night Scene) mode is selected when the flash mode is (Auto) or (Auto + Red-eye), the flash mode automatically changes to (Flash Off).
- When the drive mode is set to (Continuous Shooting) or (HS Cont. Shooting), pictures are taken continuously in the appropriate shooting mode selected for the first picture.
- The camera automatically focuses on the subject when the focus mode is set to **AF** (Standard) or (Macro).

3

## Taking Pictures in the Custom Settings (Program Mode)

In **P** (Program) mode, the camera automatically sets the shutter speed and aperture for taking still pictures. However, you can select other functions such as the flash mode and recorded pixels.

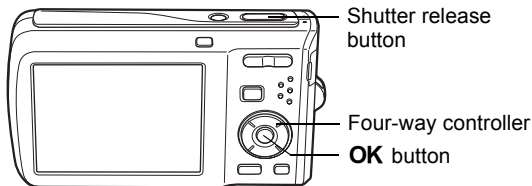

### 1 Press the four-way controller (▼) in **P** mode.

The Capture Mode Palette appears.

### 2 Use the four-way controller (▲▼◀▶) to select **P**.

### 3 Press the OK button.

The **P** (Program) mode is selected and the camera returns to capture status.

When the camera recognizes a face, the Face Recognition function is activated and the face recognition frame appears (p.63).



### 4 Set the functions you want to change.

Refer to “Setting the Shooting Functions” (p.89 - p.106) for details on how to set the functions.

### 5 Press the shutter release button halfway.

The focus frame on the display turns green when the camera focuses on the subject at the correct distance.

### 6 Press the shutter release button fully.

The picture is taken.

## Taking Pictures in the Basic Mode (Green Mode)

In the **●** (Green) mode, you can enjoy easy picture-taking using standard settings, regardless of the settings in the [**📷** Rec.Mode] menu.

**●** mode settings are as shown below.

Flash Mode	<b>⚡</b> (Auto)	Sensitivity	Auto
Drive Mode	<b>□</b> (Standard)	EV Compensation	±0.0
Focus Mode	<b>AF</b> (Standard)	Blink Detection	<input checked="" type="checkbox"/> (On)
Face Recognition	On	Digital Zoom	<input checked="" type="checkbox"/> (On)
Information Display	Normal	Instant Review	1sec
Recorded Pixels	<b>10M</b> (3648×2736)	Sharpness	<b>—■—+</b> (Normal)
Quality Level	<b>★★</b> (Better)	Saturation	<b>—■—+</b> (Normal)
White Balance	<b>AWB</b> (Auto)	Contrast	<b>—■—+</b> (Normal)
Focusing Area	<b>[ ]</b> (Multiple)	Date Imprint	Off
AE Metering	<b>📷</b> (Multi-segment metering)		

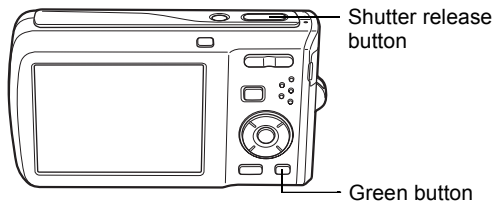

3

## 1 Press the Green button in mode.

The camera switches to  mode.

**Press the Green button again to return to the status before  mode was selected.**

When the camera recognizes a face, the Face Recognition function is activated and the face recognition frame appears (p.63).













## 2 Press the shutter release button halfway.

The focus frame on the display turns green when the camera focuses on the subject at the correct distance.

## 3 Press the shutter release button fully.

The picture is taken.



- Assign  mode to the [Green Button] on the [ Rec.Mode] for using  mode (p.107). (The default setting is  mode).
- In  mode, you cannot change the information on the display by pressing the **OK/DISPLAY** button.
- Press the **MENU** button in  mode to display the [ Setting] menu. The [ Rec.Mode] menu cannot be displayed.
- When the camera is turned off in  mode, it turns on in  mode next time the power switch is pressed.

## Using the Zoom

You can use the zoom to change the captured area.

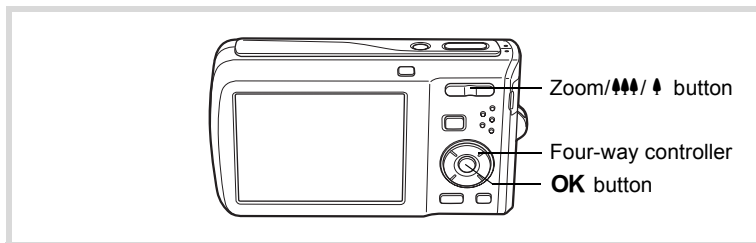

### 1 Press the Zoom/▲▲▲/▲ button in mode.

- ▲ (Right) enlarges the subject.
- ▲▲▲ (Left) widens the area that is captured by the camera.

When you press and hold the ▲ button, the camera automatically switches from optical zoom to intelligent zoom.

Once the button is released and pressed again, the camera switches to Digital Zoom.

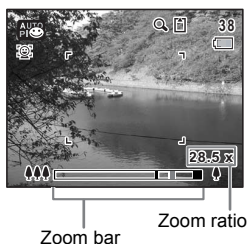

The zoom bar is displayed as follow.

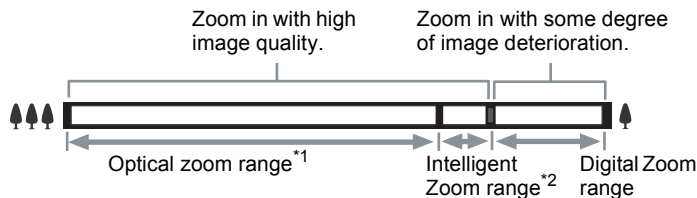

\*1 You can zoom in to a maximum of 5× optically.

\*2 The Intelligent Zoom range differs depending on the recorded pixels. See the following table.

## Recorded pixels and the maximum zoom ratio

Recorded pixels	Intelligent Zoom	Digital Zoom
10M	Not Available (5× optical zoom only)	Equivalent to approx. 28.5×
7M	Approx. 5.9×	
5M	Approx. 7.0×	
3M	Approx. 8.9×	
2.1M	Approx. 9.5×	
1024	Approx. 17.8×	
640	Approx. 28.5× (Same as 28.5× Digital Zoom)	

3



- It is recommended to use a tripod to prevent camera shake when taking pictures at a high magnification rate.
- Pictures taken in the digital zoom range appear grainier than pictures taken in the optical zoom range.
- Intelligent Zoom is not available under the following conditions:
  - when the recorded pixels is set to 10M (5× optical zoom available)
  - in (SR) (Digital SR) mode
  - when the sensitivity is set to 3200 or 6400
- The image enlarged using Intelligent Zoom may appear rough on the display. This does not affect the quality of recorded image.
- In (Movie) mode, only Digital Zoom is available.

### To Set the Digital Zoom



The digital zoom is set to  (On) in the default settings. To take pictures using only the optical zoom and Intelligent Zoom, set the digital zoom to  (Off).

1

**Press the MENU button in  mode.**

The [ Rec.Mode] menu appears.

2

**Use the four-way controller ( ) to select [Digital Zoom].**



### 3 Use the four-way controller (◀▶) to select (On) or (Off).

The setting is saved.

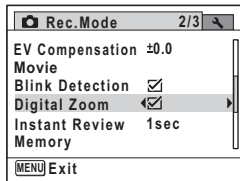

### 4 Press the MENU button.

The camera returns to capture status.

Saving the Digital Zoom Function setting p.115

## Taking Pictures of Dark Scenes (Night Scene/ Night Scene Portrait/Digital SR (Blur Reduction)/ Fireworks/Candlelight Mode)

You can choose settings appropriate for taking pictures of dark scenes, such as nightscapes.

	Night Scene	Used for night scenes. Use a tripod, etc. to prevent image shake.
	Night Scene Portrait	For portraits in night scenes. Use a tripod, etc. to prevent image shake.
	Digital SR (Blur Reduction)	Higher sensitivity reduces blur.
	Fireworks	For capturing fireworks. Use a tripod, etc. to prevent image shake.
	Candlelight	For capturing scenes in candlelight.

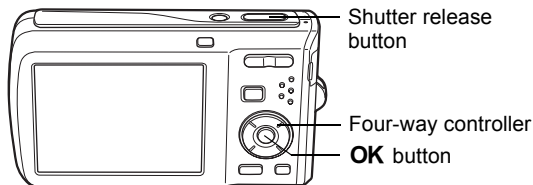

3

**1 Press the four-way controller (▼) in  mode.**

The Capture Mode Palette appears.

**2 Use the four-way controller (▲▼◀▶) to select , , ,  or .****3 Press the OK button.**

The shooting mode is selected and the camera returns to capture status.

When the camera recognizes a face, the Face Recognition function is activated and the face recognition frame appears (p.63).



**4 Press the shutter release button halfway.**

The focus frame on the display turns green when the camera focuses on the subject at the correct distance.



**5 Press the shutter release button fully.**



The picture is taken.



- The shutter speed tends to be slower when taking pictures of dark scenes.
- To prevent camera shake, use a tripod and/or the self-timer function (p.81).
- In  mode, sensitivity is automatically set to Auto and the number of recorded pixels is fixed at **5M** (2592 × 1944).
- In  mode, the sensitivity is fixed at its minimum setting.

## Taking Pictures of People (Half-length Portrait/Portrait/Natural Skin Tone Mode)

 (Half-length Portrait),  (Portrait) and  (Natural Skin Tone) modes are suitable for taking pictures of people. Face Recognition (p.63) operates for each shooting mode, making it easier to emphasize the subject's face when taking pictures.

	Half-length Portrait	For portraits with proper framing by automatic zoom. Fixed to <b>3M</b> pixels.
	Portrait	For capturing portraits. Makes the skin tone brighter and look healthy.
	Natural Skin Tone	Adjusts color & brightness to reproduce skin more beautifully than Portrait.

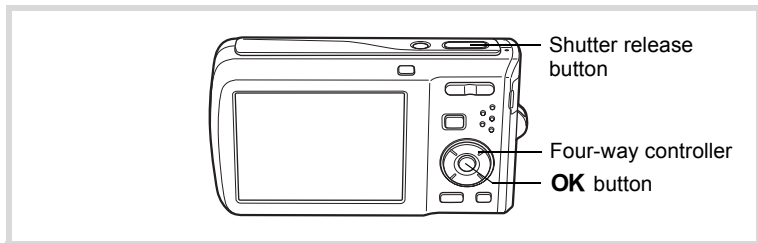

### 1 Press the four-way controller (▼) in mode.

The Capture Mode Palette appears.

### 2 Use the four-way controller (▲▼◀▶) to select

,  or  and press the OK button.

The shooting mode is selected and the camera returns to capture status.

When the camera recognizes a face, the Face Recognition function is activated and the face recognition frame appears (p.63).

If the camera recognizes a person's face in  mode, an orange frame appears showing the area to be zoomed in.



### 3 Press the shutter release button halfway.

The focus frame on the display turns green when the camera focuses on the subject at the correct distance.

If the camera recognizes a person's face in  mode, the camera automatically zooms in to enlarge the area in the orange frame shown in Step 2.

### 4 Press the shutter release button fully.

The picture is taken.

## Taking Pictures of Children (Kids Mode)

 (Kids) mode is suitable for taking pictures of moving children. It also reproduces healthy and bright skin tone. Face Recognition (p.63) operates automatically for this mode, making it easier to emphasize the subject's face when taking pictures.

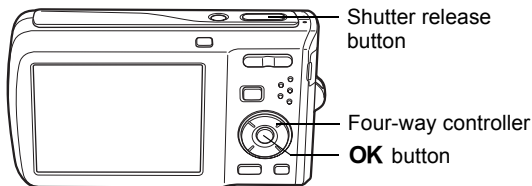

### 1 Press the four-way controller (▼) in mode.

The Capture Mode Palette appears.

### 2 Use the four-way controller (▲▼◀▶) to select .

### 3 Press the OK button.

The  (Kids) mode is selected and the camera returns to capture status.

When the camera recognizes a face, the Face Recognition function is activated and the face recognition frame appears (p.63).



---

#### **4 Press the shutter release button halfway.**

The focus frame on the display turns green when the camera focuses on the subject at the correct distance.

---

#### **5 Press the shutter release button fully.**

The picture is taken.

---

### **Taking Pictures of Your Pet (Pet Mode)**

Use this mode to keep your moving pet in focus while you take the picture and capture the color of your pet's coat. Choose the appropriate icon depending on what color your pet is (closer to black or white or in between).

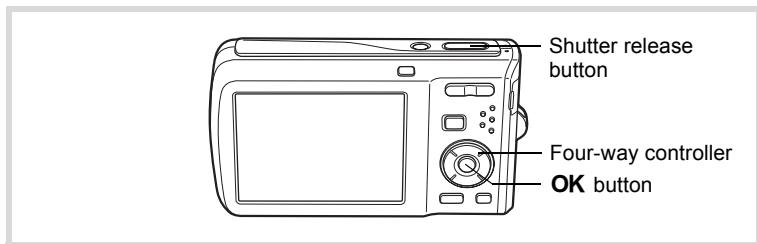

---

#### **1 Press the four-way controller (▼) in mode.**

The Capture Mode Palette appears.

---

#### **2 Use the four-way controller (▲▼◀▶) to select .**

---

#### **3 Press the OK button.**

The Pet mode selection screen appears.

---

#### 4 Use the four-way controller (▲▼) to select , , , , or .

There are two types of icons: a cat and dog icon. Choosing either the cat or dog icon does not affect the resulting picture. Choose whichever you prefer.

Choose an icon (white, gray, or black) whose tone best matches your pet's coat or fur.



#### 5 Press the OK button.

The Pet mode is selected and the camera returns to capture status.

When the camera recognizes a face, the Face Recognition function is activated and the face recognition frame appears (p.63).



#### 6 Press the shutter release button halfway.



The focus frame on the display turns green when the camera focuses on the subject at the correct distance.

The focus frame follows the subject while the shutter release button is pressed halfway.

#### 7 Press the shutter release button fully.

The picture is taken.

## Taking Pictures of Sports and Leisure Activities (Surf & Snow/Sport Mode)

	Surf & Snow	For capturing images with dazzling backgrounds, snowy scenes or beaches.
	Sport	For fast moving subjects. Keeps the camera in focus until the shutter release.

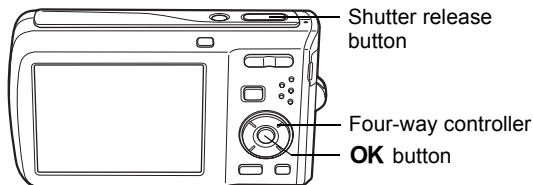

**1 Press the four-way controller (▼) in  mode.**

The Capture Mode Palette appears.

**2 Use the four-way controller (▲▼◀▶) to select  or .**

**3 Press the OK button.**

The shooting mode is selected and the camera returns to capture status.

When the camera recognizes a face, the Face Recognition function is activated and the face recognition frame appears (p.63).

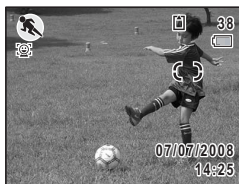

**4 Press the shutter release button halfway.**

The focus frame on the display turns green when the camera focuses on the subject at the correct distance.





When the Sport mode is selected, the focus frame follows the subject while the shutter release button is pressed halfway.

**5 Press the shutter release button fully.**

The picture is taken.

## Taking Pictures of Text (Text Mode)

This mode allows you to take clear pictures of written text. This is convenient for capturing a digital copy of an important document or enhancing legibility of small print.

	Color	Maintains original colored text.
	Neg. Color	Reverses colored text.
	B & W	Turns colored text into black and white.
	Neg. B & W	Turns colored text into reversed black and white.

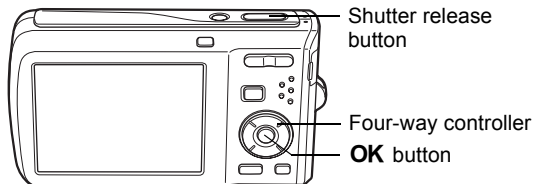

### 1 Press the four-way controller (▼) in mode.

The Capture Mode Palette appears.

### 2 Use the four-way controller (▲▼◀▶) to select .

### 3 Press the OK button.

The Text mode selection screen appears.

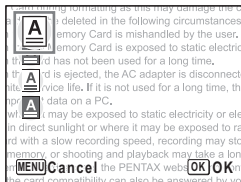

### 4 Use the four-way controller (▲▼) to select , , or .



## 5 Press the OK button.

The desired text mode is selected and the camera returns to capture status.

When the camera recognizes a face, the Face Recognition function is activated and the face recognition frame appears (p.63).

Card during formatting as this may damage the  
are deleted in the following cir  
The Memory Card is mishandled by the  
SD Memory Card is exposed to static electric  
the card has not been used for a long time,  
the card is ejected, the AC adapter is disconnect  
filled service life. If it is not used for a long time, th  
important data on a PC,  
where it may be exposed to static electricity or el  
in direct sunlight or where it may be exposed to ri  
rd with a slow recording speed, recording may str  
memory, or shooting and playback.  
Memory Card, access the PENTAX website  
the card compatibility can also be announced

## 6 Press the shutter release button halfway.

The focus frame on the display turns green when the camera focuses on the subject at the correct distance.

## 7 Press the shutter release button fully.

The picture is taken.

## Framing Your Pictures (Frame Composite Mode)

In  (Frame Composite) mode, you can take pictures using the frames stored in the camera.

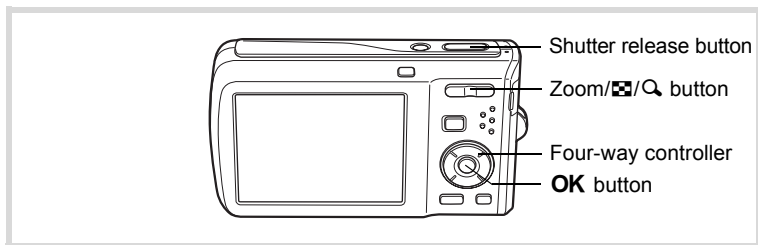

## 1 Press the four-way controller (▼) in mode.



The Capture Mode Palette appears.

## 2 Use the four-way controller (▲▼◀▶) to select and press the OK button.

A 9-frame display of the frame selection screen appears.

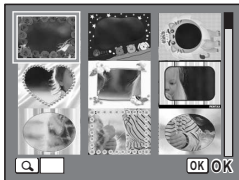
- 3 Use the four-way controller (▲▼◀▶) to choose the frame you want to use.**





- 4 Press  on the Zoom// button.**

The selected frame appears in single-image display.

You can choose another frame using either of the following operations.

Four-way controller (◀▶) Press to choose a different frame.

Zoom// button () Press to return to the 9-frame display of the frame selection screen, and then perform Step 3 to choose a different frame.

- 5 Press the OK button.**

The frame appears on the display.

When the camera recognizes a face, the Face Recognition function is activated and the face recognition frame appears (p.63).





- 6 Press the shutter release button halfway.**

The focus frame on the display turns green when the camera focuses on the subject at the correct distance.

- 7 Press the shutter release button fully.**

The picture is taken.



- In  mode, recorded pixels is fixed at  (2048 × 1536).
- At shipment, the camera includes 3 default frames and 77 optional frames built-in. (The CD-ROM supplied with the camera contains a total of 80 frames, including the default frames.)

## Optional Frames



The optional frames are stored in the built-in memory in the Optio M60. These optional frames are deleted if the camera settings are reset or if the built-in memory files are deleted with a computer. To reload the optional frames into the built-in memory, copy the files from the CD-ROM (S-SW81) supplied with the camera (p.153).

Adding a Frame to a captured image  p.151

## Using the Self-timer

In Self-timer mode, the picture is taken ten seconds or two seconds after the shutter release button is pressed.

Stabilize the camera with a tripod when taking a picture with the self-timer.

	<p>Use this mode when you want to be included in a group picture. The picture is taken approximately ten seconds after the shutter release button is pressed.</p>
	<p>Use this mode to avoid camera shake. The picture is taken approximately two seconds after the shutter release button is pressed.</p>

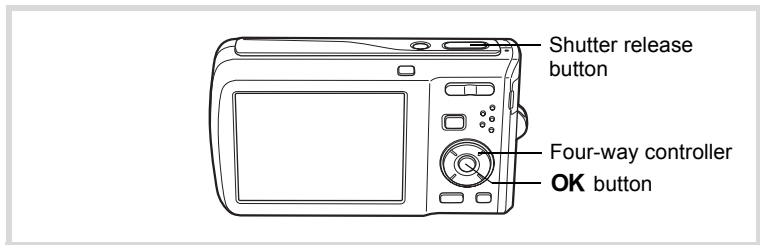

**1** Press the four-way controller (▲) in  mode.

## 2 Use the four-way controller (◀▶▼) to select or and press the OK button.

The camera is ready to take the picture using the self-timer.

When the camera recognizes a face, the Face Recognition function is activated and the face recognition frame appears (p.63).



## 3 Press the shutter release button halfway.

The focus frame on the display turns green when the camera focuses on the subject at the correct distance.





## 4 Press the shutter release button fully.

The picture is taken ten seconds or two seconds later.





Focusing may be compromised if you move the camera while the self-timer lamp is blinking when taking still pictures.



- In  (Movie) mode, recording will start after ten seconds (or two seconds).
- Press the shutter release button halfway while the self-timer is engaged to stop the countdown and press fully to restart the countdown.
-  cannot be selected while  (Green) mode is in default setting. Select  in another shooting mode and then switch the shooting mode to .

## Taking a Series of Pictures (Continuous Shooting/HS Cont. Shooting Mode)

In this mode, pictures are taken continuously as long as the shutter release button is pressed.

	Continuous Shooting	Each time a picture is taken, the image is saved in the memory before the next image is taken. The higher the image quality, the longer the interval between shots.
	HS Cont. Shooting	Recorded pixels is fixed at  (2592×1944) and up to four frames are taken continuously.

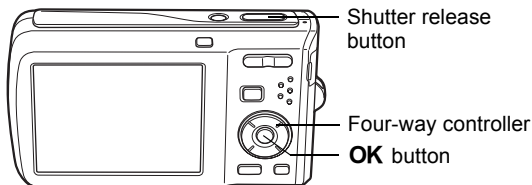

**1 Press the four-way controller (▲) in mode.**

**2 Use the four-way controller (◀▶) to select or and press the OK button.**

The camera is ready to take a series of pictures.



**3 Press the shutter release button halfway.**

The focus frame on the display turns green when the camera focuses on the subject at the correct distance.

**4 Press the shutter release button fully.**

Pictures are taken continuously as long as you keep the shutter release button pressed.



- The flash does not discharge in and modes.
- and cannot be selected in (Green), (Movie), (Fireworks), (Frame Composite), (Voice Recording), (Digital Wide) or (Digital Panorama) mode.



- In mode, you can continue shooting until the memory capacity of the SD Memory Card or the built-in memory is full.
- The interval of (Continuous Shooting) varies according to the Recorded Pixels and Quality Level settings.
- The focus, exposure and white balance are locked with the first shot.
- When the Face Recognition is activated (p.63), it works only when taking the first shot.
- Blink Detection function works only for the last shot.
- In (Auto Picture) mode, pictures are taken continuously in the appropriate shooting mode selected for the first shot.

## Using the Digital Wide Function (Digital Wide Mode)

In **WIDE** (Digital Wide) mode, you can stitch two captured images into a single frame up to approx. 28mm coverage (35mm film equivalent).

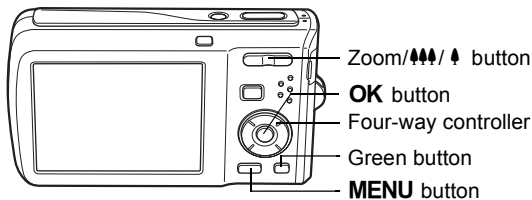
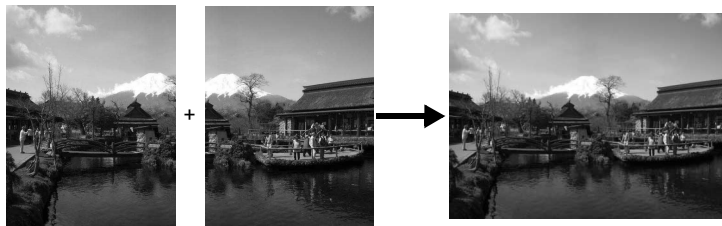

- 1 Press the four-way controller (▼) in  mode.**  
The Capture Mode Palette appears.
- 2 Use the four-way controller (▲▼◀▶) to select **WIDE**.**
- 3 Press the OK button.**

The camera enters the **WIDE** mode.  
Turn the camera 90° counterclockwise and align your first picture.  
When the camera recognizes a face, the Face Recognition function is activated and the face recognition frame appears (p.63).



**4 Press the shutter release button halfway.**

The focus frame on the display turns green when the camera focuses on the subject at the correct distance.

**5 Press the shutter release button fully.**

The first captured image is temporarily saved, and the shooting screen for the second image is displayed.

**6 Take the second image.**

Overlap the image on the preview guide on the left of the screen to compose the second image. Repeat Steps 4 and 5 to take the second image.

The stitched first and second image appears on the display for one second (Instant Review), and then saved to the built-in memory or the SD Memory Card.



- To minimize distortion when taking the second image, turn the camera so that it pivots around the right edge of the preview guide on the screen.
- Some distortion may result from moving objects, repeating patterns, or if nothing exists when overlapping the first and second image on the preview guide.
- When the Face Recognition is activated (p.63), it works only when taking the first image.
- The number of recorded pixels for images captured with **WIDE** mode is fixed at **5M** (2592 × 1944).

**To Cancel after Taking the First Shot****1 When the shooting screen for the second image is displayed in Step 5, press the OK button or the four-way controller (▼).**

A confirmation dialog appears.

## 2 Use the four-way controller (▲▼) to select an option and press the OK button.

**Save:** Saves the first image and you can retake the first shot. The first image is saved in **3M** (2048 × 1536).

**Discard:** Discards the first image and you can retake the first shot.

**Cancel:** Returns to the shooting screen for the second image.

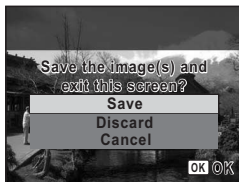

## Taking Panoramic Pictures (Digital Panorama Mode)

In **■ ■ ■** (Digital Panorama) mode, you can stitch two or three captured frames to create a panoramic photograph with the camera.

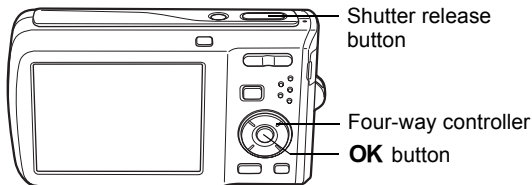

### 1 Press the four-way controller (▼) in **📷** mode.

The Capture Mode Palette appears.

### 2 Use the four-way controller (▲▼◀▶) to select **■ ■ ■**.

### 3 Press the OK button.

The camera enters the **■ ■ ■** mode and the message [Set shift direction] is displayed.



#### 4 Use the four-way controller (◀▶) to choose the direction in which the images will be joined.

The screen for taking the first frame is displayed.



When the camera recognizes a face, the Face Recognition function is activated and the face recognition frame appears (p.63).



#### 5 Press the shutter release button halfway.

The focus frame on the display turns green when the camera focuses on the subject at the correct distance.

#### 6 Press the shutter release button fully.

The screen for taking the second frame is displayed after you take the first frame.

##### If you select right (▶) in Step 4:

The right edge of the first frame appears in semi-transparent form on the left edge of the display.

##### If you select left (◀) in Step 4:

The left edge of the first frame appears in semi-transparent form on the right edge of the display.

#### 7 Take the second frame.

Move the camera so that the semi-transparent image and the actual view overlap and press the shutter release button.

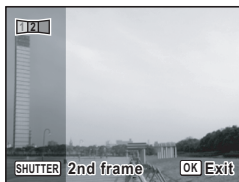

## Take the third frame.

Repeat Steps 5 to 7 to take the third frame.

The panorama stitching starts and a stitched image appears.

The stitched image does not appear when the Instant Review (p.60, p.103) is off.



- To minimize distortion when taking the second or third frame, turn the camera so that it pivots around the right edge of the preview guide on the screen.
- Some distortion may result from moving objects, repeating patterns, or if nothing exists when overlapping the first and second frames or the second and third frames on the preview guide.
- When the Face Recognition is activated (p.63), it works only when taking the first frame.

### To Cancel after Taking the First or Second Frame

## 1

**After shooting the first frame in Step 6 or second frame in Step 7, press the OK button or the four-way controller (▼).**

A confirmation dialog appears.

## 2

**Use the four-way controller (▲▼) to select an option and press the OK button.**

- Save:** Saves the captured image(s) and you can retake the first frame. When this option is selected after shooting the second frame, the first and the second frames are stitched and saved as a panoramic photograph.
- Discard:** Discards the captured image(s) and you can retake the first frame.
- Cancel:** Returns to the previous shooting screen.

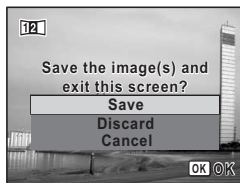

# Setting the Shooting Functions

## Selecting the Flash Mode

	Auto	The flash discharges automatically depending on the light conditions.
	Flash Off	The flash does not discharge, regardless of the brightness. Use this mode to take pictures where flash photography is prohibited.
	Flash On	The flash discharges regardless of the brightness.
	Auto + Red-eye	This mode reduces the phenomenon of red eyes caused by the light from the flash being reflected in the subject's eyes. The flash discharges automatically.
	Flash On + Red-eye	This mode reduces the phenomenon of red eyes caused by the light from the flash being reflected in the subject's eyes. The flash discharges regardless of the light conditions.
	Soft Flash	This mode reduces the intensity of the flash so that the flash is not too bright even when fired at close range. The flash discharges regardless of the light conditions.



- The flash does not discharge () in (Movie) or (Fireworks) mode, or when the drive mode is set to (Continuous Shooting) or (HS Cont. Shooting), or the focus mode is set to (Infinity).
- A pre-flash discharges when using the red-eye reduction function.
- In (Green) mode, you can only select or .
- In (Night Scene) mode, you cannot select and .



Using the flash when capturing images at a close distance may cause irregularities in the image due to the light distribution.

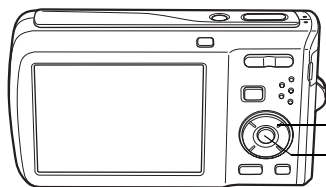

Four-way controller

OK button

3

## 1 Press the four-way controller (◀▶) in mode.



The flash mode changes each time the button is pressed. You can also change the setting using the four-way controller (▲▼).



## 2 Press the OK button.

The setting is saved and the camera returns to capture status.



### About the red-eye phenomenon

Taking pictures using the flash may cause the subject's eyes to appear red in the resulting picture. This phenomenon occurs when the light from the flash is reflected in the subject's eyes. It can be reduced by illuminating the area around the subject or moving closer to the subject and zooming out to a wider angle. Setting the flash mode to  (Auto + Red-eye) or  (Flash On + Red-eye) is also an effective way of reducing red eyes.

If the subject's eyes appear red despite such precautions, they can be corrected by the red-eye compensation function (p.150).

Saving the Flash Mode setting  p.115

## Selecting the Focus Mode

<b>AF</b>	Standard	Use this mode when the distance to the subject is 40 cm (16 in.) or more. The camera is focused on the subject in the autofocus area when the shutter release button is pressed halfway.
	Macro	This mode is used when the distance to the subject is approx. 10 cm to 50 cm (4 in. to 20 in.). The camera is focused on the subject in the autofocus area when the shutter release button is pressed halfway.
<b>PF</b>	Pan Focus	This mode is used when you ask someone to take pictures for you, or when taking pictures of the scenery through the window of a car or train. The entire picture, from the front to the back, is focused.
	Infinity	This mode is used for taking distant objects. The flash is set to  (Flash Off).
<b>MF</b>	Manual Focus	This mode lets you adjust the focus manually.

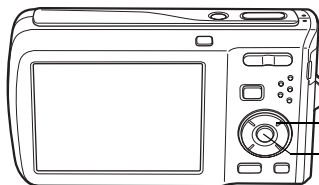

Four-way controller  
OK button

### 1 Press the four-way controller (▶) in mode.

The focus mode changes each time the button is pressed. You can also change the setting using the four-way controller (▲▼).

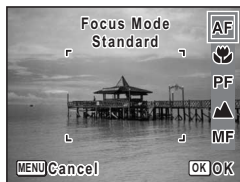

### 2 Press the OK button.

The setting is saved and the camera returns to capture status.



- In **AF** (Green) mode, you can only select **AF**, or **PF**.
- In (Fireworks) mode, the focus mode is fixed at **▲**.
- When **AF** (Standard) is selected and the subject is closer than 40 cm, the camera automatically focuses from 10 cm (Auto-Macro function). In this case, appears on the display.
- When shooting with selected, if the subject is further than 50 cm away, the camera automatically focuses to  $\infty$  (Infinity).

Saving the Focus Mode setting p.115

3

## To Set the Manual Focus

The procedure for setting the focus manually (**MF**) is described below.

**1** Press the four-way controller (**▶**) in mode.

**2** Use the four-way controller (**▶**) to select **MF**.

**3** Press the **OK** button.

The central portion of the image is magnified on the display to full screen.

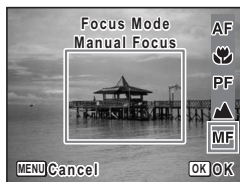

**4** Press the four-way controller (**▲▼**).

The **MF** indicator appears on the display to indicate the approximate distance to the subject. Use the four-way controller (**▲▼**) to adjust the focus using the indicator as a guide.

- ▲ for distant focus
- ▼ for closer focus

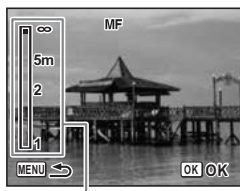

**MF** indicator

## 5 Press the OK button.

The focus is fixed and the camera returns to capture status. After the focus is fixed, you can press the four-way controller (▶) again to display the **MF** bar and readjust the focus.



Shooting mode and drive mode cannot be changed while the **MF** bar is displayed.



To switch from **MF** to another focus mode, press the four-way controller (▶) while the **MF** bar is displayed.

## To Set the Focusing Area

You can change the autofocus area (Focusing Area).

	Multiple	Normal autofocus area
	Spot	The autofocus area becomes smaller.
	Automatic Tracking AF	Keeps moving subjects in focus.

## 1 Press the MENU button in mode.

The [ Rec.Mode] menu appears.

## 2 Use the four-way controller (▲▼) to select [Focusing Area].

## 3 Press the four-way controller (▶).

A pull-down menu appears.

## 4 Use the four-way controller (▲▼) to change the Focusing Area setting.

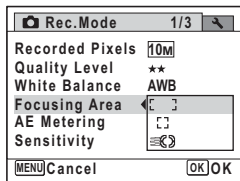

## 5 Press the OK button.

The setting is saved.

## 6

**Press the MENU button.**

The camera returns to capture status.



- In (Movie) and (Frame Composite) modes, Focusing Area cannot be set to .
- In (Green) and (Auto Picture) modes, Focusing Area is fixed at .
- If you change the [Focusing Area] setting frequently, you can save time by assigning it to the Green button (p.108).

## 3

## Taking Pictures

**Selecting the Recorded Pixels**

You can choose from seven recorded pixels settings for still pictures. The larger your recorded pixels, the clearer the details will appear when you print your picture. As the quality of the printed picture also depends on the image quality, exposure control, resolution of the printer and other factors, you do not need to select more than the required number of recorded pixels. **3M** (2048×1536) is adequate for making postcard-size prints. The more pixels there are, the larger the picture and the bigger the file size. The file size also varies depending on the quality level setting (p.96).

Refer to the table on the next page for the appropriate settings according to use.

Recorded Pixels	Use
<b>10M</b> 3648×2736	For printing high quality photos or A4-size pictures or larger, or editing images on a computer.
<b>7M</b> 3072×2304	
<b>5M</b> 2592×1944	For making postcard-size prints.
<b>3M</b> 2048×1536	
<b>2.1M</b> 1920×1080 (16 : 9)	
<b>1024</b> 1024× 768	For a natural feeling of expansiveness with the same aspect ratio as HDTV.
<b>640</b> 640× 480	
	For posting on a website or attaching to e-mail.

The default setting is **10M** (3648×2736).



## Shooting/Playback screen when **2.1M** is selected

If you select **2.1M** as the Recorded Pixels setting, the aspect ratio of the image is 16:9 and the monitor display is as shown on the right.



### 1 Press the **MENU** button in **📷** mode.

The [**📷** Rec.Mode] menu appears.

### 2 Use the four-way controller (**▲▼**) to select [**Recorded Pixels**].

### 3 Press the four-way controller (**▶**).

A pull-down menu appears.

### 4 Use the four-way controller (**▲▼**) to change the number of recorded pixels.

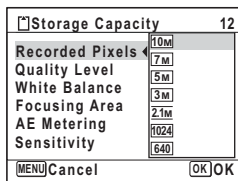

### 5 Press the **OK** button.

The setting is saved.

### 6 Press the **MENU** button.

The camera returns to capture status.



- The number of recorded pixels for images captured in **🟢** (Green) mode is fixed at **10M**.
- The number of recorded pixels for images captured in **📷** (Half-length Portrait) or **📷** (Frame Composite) is fixed at **3M**.
- The number of recorded pixels for images captured in **👤** (Digital SR (Blur Reduction)) or **WIDE** (Digital Wide) mode is fixed at **5M**. (The number of recorded pixels will be **3M** if you exit the Digital Wide mode without taking the second picture.)
- If you change the [Recorded Pixels] setting frequently, you can save time by assigning it to the Green button (p.108).

## Selecting the Quality Level

You can select the quality (compression rate) of still pictures. The more stars, the lower the compression rate and the clearer the picture, but the file size becomes larger. The recorded pixels setting also affects the file size (p.94). Refer to the following table for the appropriate settings according to use.

★★★	Best	Lowest compression rate. Suitable for photo prints.
★★	Better	Standard compression rate. Suitable for viewing the image on a computer.
★	Good	Highest compression rate. Suitable for posting on a website or attaching to e-mail.

The default setting is ★★ (Better).

### 1 Press the MENU button in mode.

The [ Rec.Mode] menu appears.

### 2 Use the four-way controller (▲▼) to select [Quality Level].

### 3 Press the four-way controller (▶).

A pull-down menu appears.

### 4 Use the four-way controller (▲▼) to change the quality level.

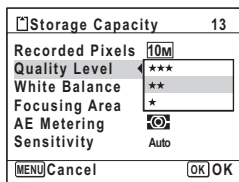

### 5 Press the OK button.

The setting is saved.

### 6 Press the MENU button.

The camera returns to capture status.



If you change the [Quality Level] setting frequently, you can save time by assigning it to the Green button (p.108).

## Setting the Exposure (EV Compensation)

You can adjust the overall brightness of the picture.

Use this function to take pictures that are intentionally overexposed or underexposed.

### 1 Press the **MENU** button in mode.

The [ Rec.Mode] menu appears.

### 2 Use the four-way controller ( ) to select [EV Compensation].

### 3 Use the four-way controller ( ) to select the EV value.

To brighten, select a positive (+) value. To darken, select a negative (-) value.

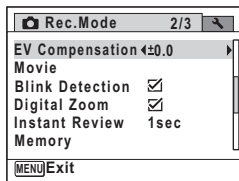

You can choose the EV setting in the range of -2.0 EV to +2.0 EV in 1/3 EV steps.



### 4 Press the **MENU** button.

The camera returns to capture status.







- When the histogram is displayed in Still Picture Capture/Playback mode, bright portions and dark portions are indicated on the display, enabling you to check the exposure (p.23).
- The EV compensation function cannot be used in  (Green) or  (Auto Picture) mode.
- If you change the [EV Compensation] setting frequently, you can save time by assigning it to the Green button (p.108).

Saving the EV Compensation Value setting  p.115

## Adjusting the White Balance

You can take pictures in natural colors by adjusting the white balance according to the light conditions at the time of shooting.

<b>AWB</b>	Auto	The camera adjusts the white balance automatically.
	Daylight	Use this mode when taking pictures outside in sunlight.
	Shade	Use this mode when taking pictures outside in the shade.
	Tungsten Light	Use this mode when taking pictures under electric or other tungsten light.
	Fluores. Light	Use this mode when taking pictures under fluorescent light.
	Manual	Use this mode when adjusting the white balance manually.



- Set another white balance if you are not satisfied with the color balance of pictures taken with the white balance set to **AWB**.
- Depending on the selected shooting mode, the white balance setting may not be changed. Refer to “Functions Available for Each Shooting Mode” (p.192) for details.

### 1 Press the **MENU** button in mode.



The [ Rec.Mode] menu appears.

### 2 Use the four-way controller ( ) to select [White Balance].

### 3 Press the four-way controller () .

The [White Balance] screen appears.

### 4 Use the four-way controller ( ) to change the setting.

You can check the results of available white balance settings on the preview image each time you press the four-way controller ( ) .

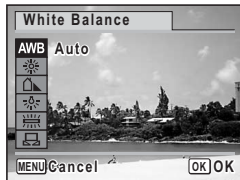

**5 Press the OK button.**

The setting is saved.

**6 Press the MENU button.**

The camera returns to capture status.

Refer to the following “Manual Setting” for instructions on adjusting the white balance manually.



If you change the [White Balance] setting frequently, you can save time by assigning it to the Green button (p.108).

Saving the White Balance setting p.115

**Manual Setting**

Have a blank sheet of white paper or similar material ready.

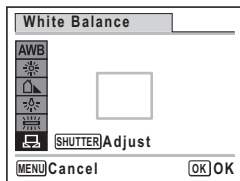
**1 In the [White Balance] screen, use the four-way controller (▲▼) to select (Manual).****2 Point the camera at the blank sheet of paper or other material so that it fills the frame displayed in the center of the screen.****3 Press the shutter release button fully.**

The white balance is automatically adjusted.

**4 Press the OK button.**



The setting is saved and the screen returns to the [ Rec.Mode] menu.

**5 Press the MENU button.**

The camera returns to capture status.

## Setting the AE Metering

You can set the area of the screen where the brightness is metered to determine the exposure.

	Multi-segment metering	The camera divides the image into 256 areas, meters the brightness and determines the exposure.
	Center-weighted metering	The camera takes a reading of the overall brightness of the picture with the center of the image having more influence on the exposure.
	Spot AE metering	The camera determines the exposure by metering the brightness only at the center of the image.

3

### 1 Press the MENU button in mode.

The [ Rec.Mode] menu appears.

### 2 Use the four-way controller ( ) to select [AE Metering].

### 3 Press the four-way controller ().

A pull-down menu appears.

### 4 Use the four-way controller ( ) to select the AE Metering setting.

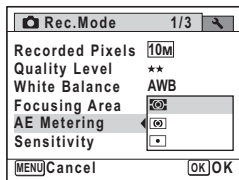

### 5 Press the OK button.

The setting is saved.

### 6 Press the MENU button.

The camera returns to capture status.





- When the shutter release button is pressed halfway, the brightness is metered and the exposure is determined.
- When the subject is outside the focusing area and you want to use spot AE metering, aim the camera at the subject and press the shutter release button halfway to lock the exposure, then compose your picture again and press the shutter release button fully.
- Depending on the selected shooting mode, the AE metering setting may not be changed. Refer to “Functions Available for Each Shooting Mode” (p.192) for details.
- If you change the [AE Metering] setting frequently, you can save time by assigning it to the Green button (p.108).

Saving the AE Metering setting p.115

## Setting the Sensitivity

You can select the sensitivity to suit the brightness of the surroundings.

Auto	The sensitivity is automatically adjusted by the camera. (Sensitivity 64 - 800)	
64	 The lower the sensitivity, the less noise that affects the image. The shutter speed will be slower in low light conditions.	
100		
200		
400		
800		
1600		
3200		 Higher sensitivity settings use faster shutter speeds in low light conditions to reduce camera shake, but the image may be affected by noise.
6400		

### 1 Press the MENU button in mode.

The [ Rec.Mode] menu appears.

### 2 Use the four-way controller ( ) to select [Sensitivity].

### 3 Press the four-way controller () .

A pull-down menu appears.

- 4 Use the four-way controller (▲▼) to change the sensitivity.**

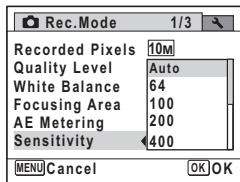

- 5 Press the OK button.**

The setting is saved.

- 6 Press the MENU button.**

The camera returns to capture status.



- When Sensitivity is set to 3200 or 6400, the number of recorded pixels is fixed at [5M].
- When set to (Green) or (Movie) mode, only Auto (sensitivity 64 - 800) is available.
- When set to (Digital SR (Blur Reduction)) mode, only Auto (sensitivity 64 - 6400) is available.
- When set to (Fireworks) mode, the sensitivity is fixed at its minimum setting.
- If you change the [Sensitivity] setting frequently, you can save time by assigning it to the Green button (p.108).

Saving the sensitivity setting p.115

## Setting Blink Detection

This specifies whether Blink Detection works when you use the Face Recognition function.

- 1 Press the MENU button in mode.**

The [ Rec.Mode] menu appears.

- 2 Use the four-way controller (▲▼) to select [Blink Detection].**



### 3 Use the four-way controller (◀▶) to select (On) or (Off).

The setting is saved.

- (On) Blink Detection function works.
- (Off) Blink Detection does not function.

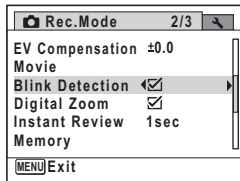

### 4 Press the MENU button.

The camera returns to capture status.

Blink Detection p.60

## Setting the Instant Review Time (Instant Review)

You can choose the Instant Review time (the length of time the image is displayed immediately after capture) from 5 sec, 4 sec, 3 sec, 2 sec, 1 sec, 0.5 sec and Off (no display).

### 1 Press the MENU button in mode.

The [ Rec.Mode] menu appears.

### 2 Use the four-way controller (▲▼) to select [Instant Review].

### 3 Press the four-way controller (▶).

A pull-down menu appears.

### 4 Use the four-way controller (▲▼) to change the display time.

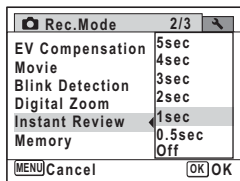

**5 Press the OK button.**

The setting is saved.

**6 Press the MENU button.**

The camera returns to capture status.

Instant Review p.60



If the Blink Detection function worked when shooting, [Closed eyes have been detected.] is displayed during Instant Review.

## Setting the Image Sharpness (Sharpness)

You can give the image sharp or soft outlines.

**1 Press the MENU button in mode.**

The [ Rec.Mode] menu appears.

**2 Use the four-way controller (▲▼) to select [Sharpness].****3 Use the four-way controller (◀▶) to change the sharpness level.**

- Soft
- Normal
- Sharp

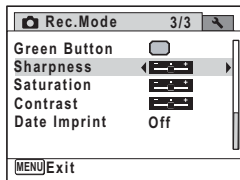
**4 Press the MENU button.**







The setting is saved and the camera returns to capture status.





If you change the [Sharpness] setting frequently, you can save time by assigning it to the Green button (p.108).

## Setting the Color Saturation (Saturation)

You can set the color saturation.

- 1 Press the MENU button in  mode.**  
The [ Rec.Mode] menu appears.
- 2 Use the four-way controller ( ) to select [Saturation].**
- 3 Use the four-way controller ( ) to change the saturation level.**

-  Low
-  Normal
-  High

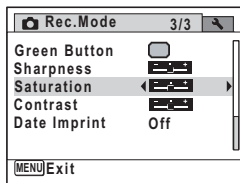





- 4 Press the MENU button.**  
The setting is saved and the camera returns to capture status.



If you change the [Saturation] setting frequently, you can save time by assigning it to the Green button (p.108).

## Setting the Image Contrast (Contrast)

You can set the image contrast level.

- 1 Press the MENU button in  mode.**  
The [ Rec.Mode] menu appears.
- 2 Use the four-way controller ( ) to select [Contrast].**

### 3 Use the four-way controller (◀▶) to change the contrast level.

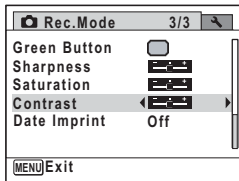
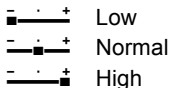

### 4 Press the MENU button.

The setting is saved and the camera returns to capture status.



If you change the [Contrast] setting frequently, you can save time by assigning it to the Green button (p.108).

## Setting the Date Imprint Function

You can choose whether to imprint the date and/or time when taking still pictures.

### 1 Press the MENU button in mode.

The [ Rec.Mode] appears.

### 2 Use the four-way controller (▲▼) to select [Date Imprint].

### 3 Press the four-way controller (▶).

A pull-down menu appears.

### 4 Use the four-way controller (▲▼) to select the Date Imprint details.

Choose from [Date], [Date & Time], [Time] or [Off].

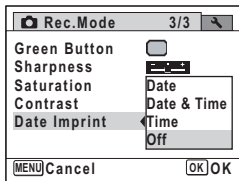

### 5 Press the OK button.

The setting is saved.

## Press the MENU button.

The camera returns to capture status.



- **DATE** appears on the display in mode when [Date Imprint] is set.
- The date and/or time imprinted with the Date Imprint function cannot be deleted.
- The date and/or time are imprinted on the picture with the display style set in the [Date Adjust] screen (p.43).
- Note that if the printer or the image editing software is set to print the date and the images to be printed already have the date and/or time imprinted, the imprinted dates and/or times may overlap.

## Calling Up a Specific Menu

Assign menu items to the Green Button and recall the function quickly by simply pressing the Green Button. This is useful for going straight to the setting screens of frequently used functions.







The following functions can be assigned to the Green button:

- (Green) Mode
- Recorded Pixels
- Quality Level
- White Balance
- Focusing Area
- AE Metering
- Sensitivity
- EV Compensation
- Sharpness
- Saturation
- Contrast





- The Green Button setting can be returned to its default setting by selecting [Reset] on the [ Setting] menu.
- The functions assigned to the Green button can be used in the usual manner on the [ Rec.Mode] menu.
- You cannot save different settings for the same function on the Green button and on the [ Rec.Mode] menu.

## To Assign a Function to the Green Button

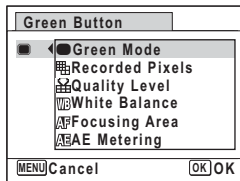
- 1 **Press the MENU button in  mode.**  
The [ Rec.Mode] menu appears.
- 2 **Use the four-way controller ( ) to select [Green Button].**
- 3 **Press the four-way controller ()**.  
A pull-down menu appears.
- 4 **Use the four-way controller ( ) to choose a function and press the OK button.**
- 5 **Press the MENU button.**  
The selected function is assigned to the Green button.



## To Use the Green Button

- 1 **Press the Green button in  mode.**  
The function assigned to the Green button is called up.
- 2 **Use the four-way controller ( ) to change the settings and press the OK button.**  
The camera returns to capture status.



If a function other than the  (Green) mode has been assigned to the Green button, the camera returns to the original screen if no operation is performed for 1 minute after the Green button is pressed.

# Recording Movies

## Recording a Movie

This mode enables you to record movies. Sound is recorded at the same time.

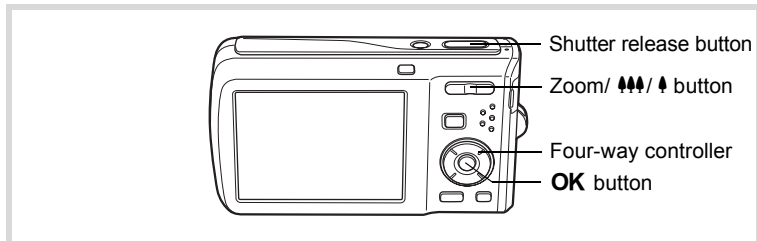

**1 Press the four-way controller (▼) in mode.**

The Capture Mode Palette appears.

**2 Use the four-way controller (▲▼◀▶) to select (Movie).**



**3 Press the OK button.**

(Movie) mode is selected and the camera returns to capture status.

The following information appears on the display.

- 1 Movie mode icon
- 2 Recording indicator (blinks during recording)
- 3 Remaining recordable time
- 4 Focus frame (does not appear during recording)
- 5 Movie shake reduction function icon

You can change the captured area by pressing the Zoom/▲▲▲/▲ button to the left or right.

▲ (Right) enlarges the subject.

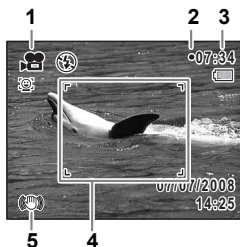

▲▲▲ (Left) widens the area that is captured by the camera.



## 4 Press the shutter release button fully.

Recording starts. You can continue recording until the built-in memory or the SD Memory Card is full, or the size of the recorded movie reaches 2 GB.



- The flash does not discharge in  (Movie) mode.
- The focus mode can be changed before recording starts.
- When the Focus Mode is set to **MF** (Manual Focus), you can adjust the focus before recording starts.
- You can use the optical zoom only before recording, while the digital zoom is available both before and during recording.
- Changing the display mode by pressing the **OK/DISPLAY** button while recording a movie will not display the histogram.
- When the shooting mode is set to  (Movie), Face Priority is automatically set to on. You can select Smile Capture or Face Priority Off by pressing the  button before starting recording a movie (p.63). When Smile Capture is activated, movie recording starts automatically when the camera recognizes the subject's smile. However, depending on the condition of the recognized faces, movie recording may not start automatically because the Smile Capture function will not work. If this happens, press the shutter release button to start movie recording.

## 5 Press the shutter release button fully.

Recording stops.

Playing Back a Movie  p.119

### Keeping the Shutter Release Button Pressed

If you keep the shutter release button pressed for more than one second, recording will continue as long as you keep the button pressed. Shooting stops when you take your finger off the shutter release button.





## Selecting the Recorded Pixels for Movies

You can choose from two recorded pixels settings for movies: **640** and **320**.

The more pixels there are, the clearer the details and the bigger the file size. The file size also varies depending on the [Quality Level] and [Frame Rate] settings.

<b>640</b> (640×480)	Suitable for viewing on a TV or computer screen.
<b>320</b> (320×240)	Suitable for posting on a website or attaching to e-mail.

The default setting is **640** (640×480).

- 1 Press the MENU button in  mode.**  
The [ Rec.Mode] menu appears.
- 2 Use the four-way controller (▲▼) to select [Movie].**
- 3 Press the four-way controller (▶).**  
The [Movie] screen appears.
- 4 Use the four-way controller (▲▼) to select [Recorded Pixels].**
- 5 Press the four-way controller (▶).**  
A pull-down menu appears.
- 6 Use the four-way controller (▲▼) to change the number of recorded pixels.**
- 7 Press the OK button.**  
The setting is saved.
- 8 Press the MENU button twice.**  
The camera returns to capture status.

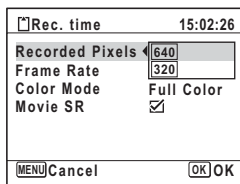

## Selecting the Frame Rate

You can choose from two frame rates (number of frames per second) for movies: 30fps (frames per second) and 15fps. The more frames per second, the better the quality of the movie, but the file size becomes larger.

30fps	Produces high quality movies.
15fps	Increases the total recording time by making the file size smaller.

The default setting is 30fps (frames per second).

### 1 Press the **MENU** button in mode.

The [ Rec.Mode] menu appears.

### 2 Use the four-way controller ( ) to select **[Movie]**.

### 3 Press the four-way controller ().

The [Movie] screen appears.

### 4 Use the four-way controller ( ) to select **[Frame Rate]**.

### 5 Press the four-way controller ().

A pull-down menu appears.

### 6 Use the four-way controller ( ) to select the frame rate.

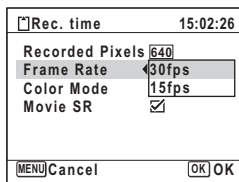

### 7 Press the **OK** button.



The setting is saved.

### 8 Press the **MENU** button twice.

The camera returns to capture status.

## Recording Movies in Black and White or Sepia Tones (Color Mode)

In  (Movie) mode, you can set the color mode to black and white or sepia, as well as full color.

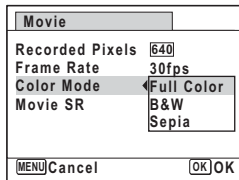

- 1 Press the MENU button in  mode.**  
The [ Rec.Mode] menu appears.
- 2 Use the four-way controller (▲▼) to select [Movie].**
- 3 Press the four-way controller (▶).**  
The [Movie] screen appears.
- 4 Use the four-way controller (▲▼) to select [Color Mode].**
- 5 Press the four-way controller (▶).**  
A pull-down menu appears.
- 6 Use the four-way controller (▲▼) to choose a color.**
- 7 Press the OK button.**  
The setting is saved.
- 8 Press the MENU button twice.**  
The camera returns to capture status.



The color mode setting for a recorded movie cannot be changed.

## Setting the Movie SR (Movie Shake Reduction) Function

In  (Movie) mode, you can compensate for camera shake while you are recording a movie with the Movie SR (Movie Shake Reduction) function.

- 1 Press the MENU button in  mode.**  
The [ Rec.Mode] menu appears.
- 2 Use the four-way controller (▲▼) to select [Movie].**
- 3 Press the four-way controller (▶).**  
The [Movie] screen appears.
- 4 Use the four-way controller (▲▼) to select [Movie SR].**
- 5 Use the four-way controller (◀▶) to select  (On) or  (Off).**  
The setting is saved.
- 6 Press the MENU button twice.**  
The camera returns to capture status.

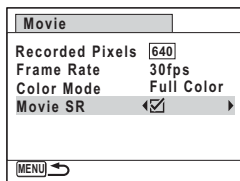













# Saving the Settings (Memory)

The Memory function is for saving the current camera settings when the camera is turned off.

For some camera settings, the Memory function is always set to  (On) (the settings are saved when the camera is turned off), while for others you can choose on or off (to choose whether the settings are saved or not when the camera is turned off). The items which can be set to  (On) or  (Off) in the Memory function are shown in the table below. (Items not listed here are always saved in the selected settings when the camera is turned off.)

If you select  (On), the settings will be saved in the status they were in immediately before the camera was turned off. If you select  (Off), the settings will be reset to the defaults when the camera is turned off. The table below also shows whether the Memory default setting for each item is on or off.

Item	Description	Default Setting	Page
Face Priority	A Face Recognition mode set by using the  button.	<input type="checkbox"/>	p.63
Flash Mode	The flash mode set with the four-way controller (  )	<input checked="" type="checkbox"/>	p.89
Drive Mode	The drive mode set with the four-way controller (  )	<input type="checkbox"/>	p.81 p.82
Focus Mode	The focus mode set with the four-way controller (  )	<input type="checkbox"/>	p.91
Zoom Position	The zoom position set with the Zoom/  button	<input type="checkbox"/>	p.69
MF Position	The manual focus position set with the four-way controller (  ) (  )	<input type="checkbox"/>	p.92
White Balance	The [White Balance] setting on the [  Rec.Mode] menu	<input type="checkbox"/>	p.98
Sensitivity	The [Sensitivity] setting on the [  Rec.Mode] menu	<input type="checkbox"/>	p.101
EV Compensation	The [EV Compensation] setting on the [  Rec.Mode] menu	<input type="checkbox"/>	p.97
AE Metering	The [AE Metering] setting on the [  Rec.Mode] menu	<input type="checkbox"/>	p.100
Digital Zoom	The [Digital Zoom] setting on the [  Rec.Mode] menu	<input checked="" type="checkbox"/>	p.70
DISPLAY	The information display mode set with the <b>OK/DISPLAY</b> button	<input type="checkbox"/>	p.18
File No.	If a new SD Memory Card is inserted when On has been selected, file numbers are assigned sequentially.	<input checked="" type="checkbox"/>	—

---

**1** Press the **MENU** button in **📷** mode.

The [📷 Rec.Mode] menu appears.

---

**2** Use the four-way controller (▲▼) to select [Memory].

---

**3** Press the four-way controller (▶).

The [Memory] screen appears.

---

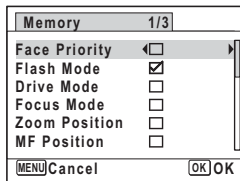
**4** Use the four-way controller (▲▼) to choose an item.

---

**5** Use the four-way controller (◀▶) to select  (On) or  (Off).

---

**6** Press the **OK** button.

The setting is saved.

---

**7** Press the **MENU** button.

The camera returns to capture status.

# 4 Playing Back and Deleting Images

---

Playing Back Images .....	118
Deleting Images .....	132
Connecting the Camera to AV Equipment .....	141

# Playing Back Images

## Playing Back Still Pictures

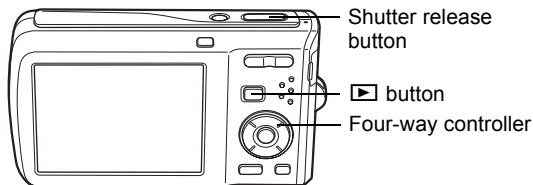

4

Playing Back and Deleting Images

### 1 Press the ▶ button after taking a picture.

The camera enters the ▶ mode and the image appears on the display. Displaying one image in full in ▶ mode (▶ mode default setting) is called single-image display.

File number



### To Play Back the Previous or Next Image

### 2 Press the four-way controller (◀▶).

The previous or next image appears.

### To Delete the Displayed Image

Press the button while the image is displayed to display the Delete screen. Press the four-way controller (▲) to select [Delete] and press the **OK** button (p.132).







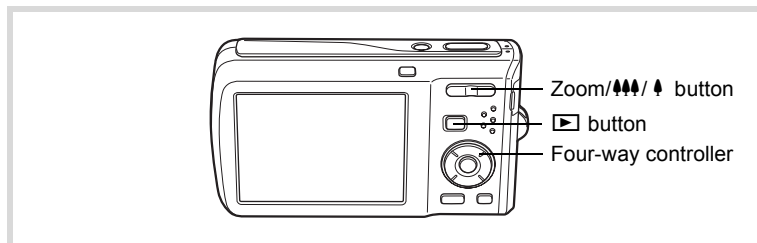

## Playing Back a Movie

You can play back the movies you have taken. Sound is played back at the same time.







**1** Enter the  mode and use the four-way controller ( ) to choose the movie you want to play back.



**2** Press the four-way controller ().  
Playback starts.



The following operations can be performed during playback.

- Four-way controller () Plays back in reverse
- Four-way controller () Pauses playback
- Zoom/▲▲▲/▲ button () Increases the volume
- Zoom/▲▲▲/▲ button () Reduces the volume

The following operations can be performed while playback is paused.

- Four-way controller () Reverses the frame
- Four-way controller () Forwards the frame
- Four-way controller () Resumes playback

**3** Press the four-way controller ().  
Playback stops.

# Nine-Image Display, Folder Display and Calendar Display

## Nine-Image Display

You can display nine thumbnails of captured images at a time.

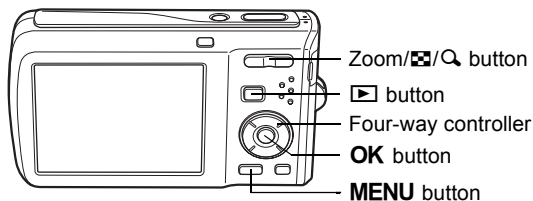

4

### 1 In **Play** mode, press **Matrix** on the Zoom/Matrix/Zoom Out button.

A page consisting of nine thumbnail images appears. The displayed images change nine at a time page by page.

Use the four-way controller (**Up** **Down** **Left** **Right**) to move the frame. When 10 or more images have been saved, if you choose image ① and press the four-way controller (**Up** **Left**), the previous page appears. Similarly, if you choose image ② and press the four-way controller (**Down** **Right**), the next page appears.

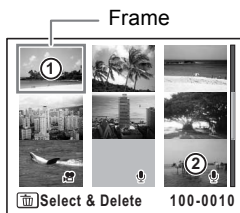



The icons that appear on the images indicate the following:

- |           |  |
|-----------|--|
| (No icon) | Still picture without sound                        |
|           | Still picture that can have camera shake corrected |
|           | Still picture with sound                           |
|           | Movie (the first frame appears)                    |
|           | Sound file only                                    |

Press the **OK** button to switch to single-image display of the selected image.

Press the **Play** button to switch to **Camera** mode.

## To Switch to Folder Display or Calendar Display

In nine-image display, press  on the Zoom//Query button to switch to folder display or calendar display. Press the Green button to switch between folder display and calendar display.

### 1 In mode, press on the Zoom//Query button.





The screen changes to nine-image display.

### 2 Press on the Zoom//Query button.

The screen changes to folder display or calendar display.

#### Folder display

The list of folders with recorded images and sound files appears.

Use the four-way controller () to move the frame.

Press the **OK** button or Query on the Zoom//Query button to display the images in the selected folder in nine-image display.

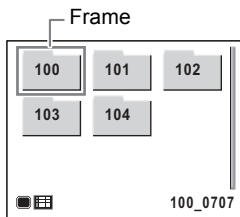





#### Calendar display

Recorded images and sound files are displayed by date in calendar format.

The first image recorded on a date is displayed for that date on the calendar.



 appears for dates on which a sound file was the first recorded file.

Use the four-way controller () to move the frame to a different date.

Press Query on the Zoom//Query button to display the images for a date in nine-image display.

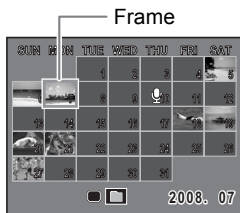
Select a date and press the **OK** button to switch to single-image display of the first image recorded on that date.



- Press the **MENU** button in folder display or calendar display to switch to normal nine-image display.
- Press the  button or half-press the shutter release button in folder display or calendar display to switch to  mode.

## Using the Playback Function

Press the four-way controller (▼) in ▶ mode to display the Playback Mode Palette.

You can display the playback function you want to use simply by using the four-way controller (▲▼◀▶) to choose an icon and pressing the **OK** button.

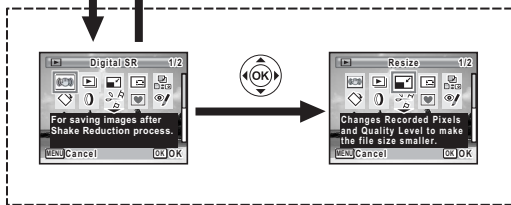
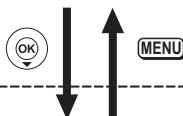

**SHUTTER**  
Press halfway

**OK**



Closes the Playback Mode Palette and goes to mode.

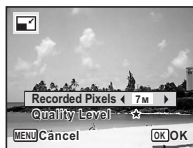















Goes to the screen for selected playback function.





When an icon is selected in the Playback Mode Palette, a guide for the selected function appears.

## Playback Mode Palette

Playback Mode		Description	Page
	Digital SR	For saving images after Shake Reduction process.	p.130
	Slideshow	For continuously playing back images. Screen or sound effects can be set.	p.124
	Resize	Changes Recorded Pixels and Quality Level to make the file size smaller.	p.144
	Cropping	For cropping images to the size you like. Saved as a new image.	p.145
	Image/Sound Copy	For copying images and sounds between the built-in memory and SD Memory Card.	p.156
	Image Rotation	Rotates captured images. Useful when viewing vertical images on a TV.	p.126
	Digital Filter	For modifying images with a Color filter or Soft filter.	p.147
	Save as Still Image	For saving one frame from a movie as a still picture.	p.154
	Divide Movies	For dividing a movie into two.	
	Frame Composite	For composing an image with a frame. Select Overwrite or Save as to save.	p.151
	Red-eye Compensation	For compensating red-eye. May not work due to the condition of the image.	p.150
	Voice Memo	Attaches sound to images. Recording is possible till the memory card is full.	p.171
	Protect	Protects images and sounds from accidental deletion. Formatting will delete.	p.138
	DPOF	For the print settings. Useful when printing at a printing service.	p.158
	Image Recovery	For recovering image and sound files which were accidentally deleted.	p.137
	Start-up Screen	For setting a captured image as the Start-up Screen.	p.189





## Slideshow

You can play back recorded images one after another.

**1** Enter the  mode and use the four-way controller ( ) to choose an image to start the slideshow with.

**2** Press the four-way controller (.

The Playback Mode Palette appears.

**3** Use the four-way controller (   ) to select  (Slideshow).



**4** Press the **OK** button twice.

The slideshow starts.

Pressing the **OK** button during the slideshow pauses the slideshow. To resume the slideshow, press the **OK** button again.

**5** Press any button other than the **OK** button.

The slideshow stops.

### To Set the Slideshow Conditions

You can set the playback interval and also a screen effect and sound effect for when one image changes to the next.

**1** Press the four-way controller ( in  mode.

The Playback Mode Palette appears.

**2** Use the four-way controller (   ) to select  (Slideshow).

**3 Press the OK button.**

The screen for setting the slideshow conditions appears.

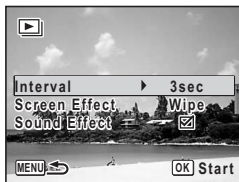
**4 Use the four-way controller (▲▼) to select [Interval].****5 Press the four-way controller (▶).**

A pull-down menu appears.

**6 Use the four-way controller (▲▼) to change the interval and press the OK button.**

Choose from [3sec], [5sec], [10sec], [20sec] or [30sec].

**7 Use the four-way controller (▲▼) to select [Screen Effect].**

After selecting [Screen Effect], press the four-way controller (▶). A pull-down menu appears with the following items. Use the four-way controller (▲▼) to select an item and press the **OK** button.

Wipe	The next image slides over the previous one from left to right
Checker	The next image appears in small square mosaic blocks
Fade	The current image gradually fades out and the next image fades in
Off	No effect

**8 Use the four-way controller (▲▼) to select [Sound Effect].****9 Use the four-way controller (◀▶) to select  (On) or  (Off).**

Except when the [Screen Effect] is set to Off, you can choose  (On) or  (Off) for the sound that is played when one image changes to the next.

## 10 Press the OK button.

The slideshow starts using the selected interval and effect.



- The slideshow will continue until you press any button other than the **OK** button.
- Movies or pictures with sound will normally be played through to the end before the next picture is played back, regardless of the interval setting. However, pressing the four-way controller (▶) while playing back a movie or a picture with sound skips to the next image.
- Sound files made in 🎤 (Voice Recording) mode are not played back in the slideshow.
- Panorama images will be scrolled for display from left to right in 4 seconds before the next picture is played back, regardless of the settings of [Interval] or [Screen Effect].

4

Connecting the Camera to AV Equipment p.141

## Rotating the Image

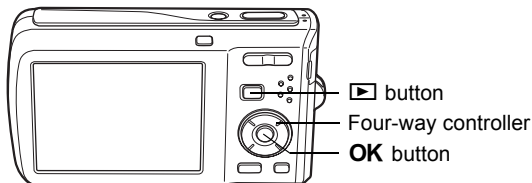

### 1 Press the ▶ button after taking a picture.

The image appears on the display.

### 2 Press the four-way controller (▼).

The Playback Mode Palette appears.



- 3** Use the four-way controller (▲▼◀▶) to select (Image Rotation) and press the OK button.

The rotation selection screen (0°, Right 90°, Left 90°, or 180°) appears.

- 4** Use the four-way controller (▲▼◀▶) to choose the rotation direction and press the OK button.

The rotated image is saved.

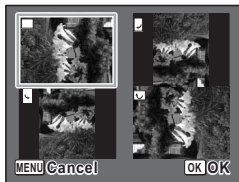

- Panoramic images and movies cannot be rotated.
- Protected images can be rotated, but they cannot be saved in a rotated state.

## Zoom Playback

You can magnify an image up to ten times.

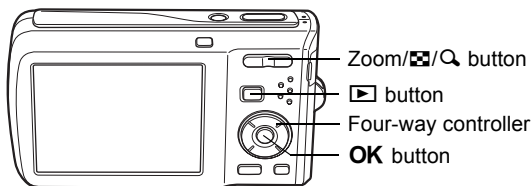

**1** Enter the ▶ mode and use the four-way controller (◀▶) to choose the image you want to magnify.

**2** Press Q on the Zoom/Zoom/Zoom button.

The image is magnified ( $\times 1.1$  to  $\times 10$ ). Holding down Q on the Zoom/Zoom/Zoom button changes the magnification continuously. When the Quick Zoom function (p.188) is set to , you can magnify the image at a maximum of  $\times 10$  simply by pressing Q once.



Guide

You can use the + mark of the guide at the bottom left of the screen to check which portion of the image is magnified.

**The following operations can be performed while the magnified image is displayed.**

- |                            |  |
|----------------------------|--|
| Four-way controller (▲▼◀▶) | Moves the position to be magnified           |
| Zoom/Zoom/Zoom button (Q)  | Makes the image bigger (max. $\times 10$ )   |
| Zoom/Zoom/Zoom button (Q)  | Makes the image smaller (min. $\times 1.1$ ) |

**3** Press the OK button.

The image returns to single-image display.





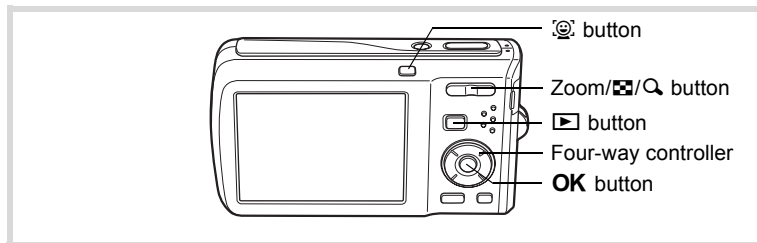

Movies cannot be magnified.

## Zoom In On the Subject's Face Automatically (Face Close-up Playback)

You can enjoy playing back images with the subject's faces zoomed up simply by pressing the  button (Face close-up playback) if Face Recognition operated when the images were taken.



- 1** Enter the  mode and use the four-way controller ( ) to choose the image you want to magnify.
- 2** Confirm that the  icon is displayed in the image and press the  button.

The image is magnified around the face first recognized when the image was taken.



If multiple faces were recognized when the image was taken, the subject's faces are zoomed up on each time the  button is pressed in order of the recognition during shooting.



- 3** Press the OK button.  
The image returns to single-image display.



- The magnification ratio for Face close-up playback may differ depending on the conditions such as the size of the face recognized when shooting.
- Press on the Zoom// button during Face close-up playback to switch to the zoom playback; the image is displayed at an equal or slightly larger magnification ratio. Press on the Zoom// button to switch to the zoom playback; the image is displayed at an equal or slightly smaller magnification ratio.

## Correcting Camera Shake with Digital SR

For correcting the camera shake in recorded images. Images with shake that can be corrected have displayed on the top left of the screen.

4

**1** Enter the mode and use the four-way controller ( ) to choose the image to correct camera shake for.

**2** Press the four-way controller ().  
The Playback Mode Palette appears.

**3** Use the four-way controller ( ) to select (Digital SR).

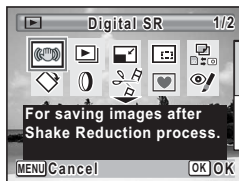

**4** Press the OK button.  
The image to correct is displayed.



**5** Press the OK button.  
When an image is protected, the image will be saved as a new image without the following confirmation dialog displayed on the screen.

- 6** Use the four-way controller (▲▼) to select [Overwrite] or [Save as].

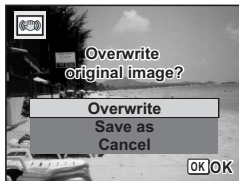

- 7** Press the **OK** button.

The corrected image is saved in the built-in memory or the SD Memory Card.



- If you overwrite the image, the shake information is lost, and you cannot perform shake correction again.
- Even where an image has  on the screen, it may not be possible to correct the camera shake if it is too severe. In such cases, the error message will appear in Step 5.

# Deleting Images

Delete images and sounds with mistakes or that are unnecessary.

## When images or sounds are inadvertently deleted

Deleted images and sounds can be recovered with the Optio M60 (p.137). Deleted images and sounds can be recovered even if the camera has been turned off after deletion as long as the SD Memory Card has not been removed. However, deleted images and sounds cannot be recovered after operations to write data such as taking pictures, recording movies, protecting images, saving DPOF settings, resizing images, cropping images or formatting have been performed.

4

Playing Back and Deleting Images

## Deleting a Single Image/Sound File

You can delete a single image or sound file.



Protected images and sound files cannot be deleted (p.138).

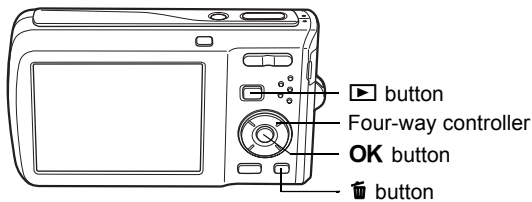

- 1 Enter the ▶ mode and use the four-way controller (◀▶) to choose the image/sound file you want to delete.**
- 2 Press the 🗑 button.**  
A confirmation screen appears.

- 3** Use the four-way controller (▲▼) to select [Delete].



- 4** Press the OK button.

The image or sound file is deleted.



If you press the  button during Instant Review, the screen in Step 2 appears, enabling you to delete the image you have just taken (p.118).

Recovering Deleted Images  p.137

4

### To Delete a Sound File

If sound (voice memo) has been recorded with an image (p.171), you can delete the sound without deleting the image.

- 1** Enter the  mode and use the four-way controller (◀▶) to choose an image with sound.

- 2** Press the  button.

A confirmation screen appears.

- 3** Use the four-way controller (▲▼) to select [Delete Sound].



## 4 Press the OK button.

The sound file is deleted.



- Select [Delete] in Step 3 above to delete both the image and sound file.
- You cannot delete only the sound in a movie.

## Deleting Selected Images and Sound Files

You can delete several images/sound files selected from the nine-image display at once.



Protected images and sound files cannot be deleted.

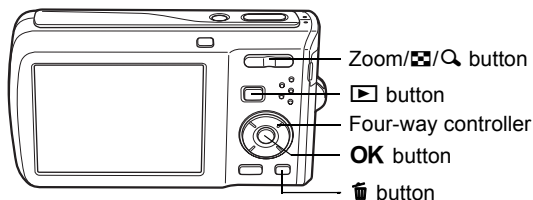

### 1 In Play mode, press Matrix on the Zoom/Matrix/Quality button.

Nine thumbnail images appear.

### 2 Press the Delete button.

□ appears on the images and sound files.





- 3** Use the four-way controller (▲▼◀▶) to choose the images and sound files that you want to delete and press the OK button.

☑ appears on the selected images and sound files.

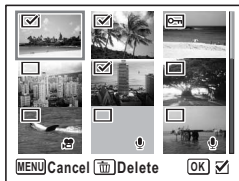

If you select an image and press Q on the Zoom/☒/Q button, the selected image appears in single-image display as long as the button is pressed, enabling you to check whether you really want to delete it or not. (The display returns to the nine-image display when you release the button.) However, protected images cannot be displayed in single-image display.

- 4** Press the ☒ button.

A confirmation dialog appears.

- 5** Use the four-way controller (▲▼) to select [Select & Delete].



- 6** Press the OK button.

The selected images and sound files are deleted.

## Deleting All Images and Sound Files

You can delete all the images and sound files at once.



Protected images and sound files cannot be deleted (p.138).

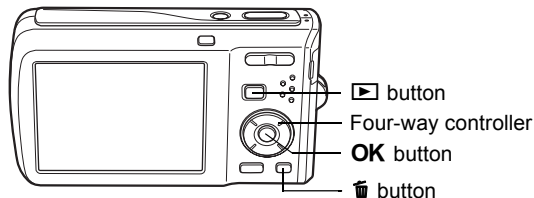

4

**1 Press the 🗑 button in ▶ mode.**

A confirmation dialog appears.

**2 Press the 🗑 button.**

A confirmation dialog appears.

**3 Use the four-way controller (▲▼) to select [Delete All].**

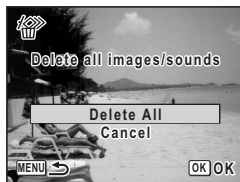

**4 Press the OK button.**

All the images and sound files are deleted.

Recovering Deleted Images p.137

## Recovering Deleted Images

You can recover images or sound files that were taken with this camera and then deleted.



After deleting an image, once operations to write data such as taking pictures, recording movies, protecting images, saving DPOF settings, resizing images, cropping images or formatting have been performed, or the SD Memory Card has been removed, the message [No image to be processed] appears in Step 3 and the deleted images and sound files cannot be recovered.

### 1 After deleting a file, press the four-way controller (▼).

The Playback Mode Palette appears.

### 2 Use the four-way controller (▲▼◀▶) to select (Image Recovery).



### 3 Press the OK button.

The number of recoverable images appears.

### 4 Use the four-way controller (▲▼) to select [Recover].



### 5 Press the OK button.

Deletion of the images is cancelled and the files are recovered.



- Recovered images and sound files have the same file name as before they were deleted.
- Up to a maximum of 999 deleted image files can be recovered.

## Protecting Images and Sound Files from Deletion (Protect)

You can protect stored images and sound files from being accidentally deleted.

### 1 Press the four-way controller (▼) in mode.

The Playback Mode Palette appears.

### 2 Use the four-way controller (▲▼◀▶) to select (Protect).



### 3 Press the OK button.

The screen for selecting [Single Image/Sound] or [All Images/Sounds] appears.

### 4 Use the four-way controller (▲▼) to select [Single Image/Sound].



### 5 Press the OK button.

The message [Protect this image/sound] appears. To protect another image or sound file, use the four-way controller (◀▶) to select another image or sound file.

### 6 Use the four-way controller (▲▼) to select [Protect].



**7 Press the OK button.**

The selected image or sound file is protected.



- To cancel the Protect setting, select [Unprotect] in Step 6.
- appears below the file number on protected images and sound files during playback.
- The maximum number of images and sound files you can protect in succession with [Single Image/Sound] cannot exceed 99.

## To Protect All Images and Sound Files

**1 Press the four-way controller (▼) in mode.**

The Playback Mode Palette appears.

**2 Use the four-way controller (▲▼◀▶) to select (Protect).****3 Press the OK button.**

The screen for selecting [Single Image/Sound] or [All Images/Sounds] appears.

**4 Use the four-way controller (▲▼) to select [All Images/Sounds].****5 Press the OK button.**

**6** Use the four-way controller (▲▼) to select [Protect].

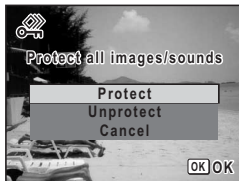

**7** Press the **OK** button.

All the images and sound files are protected.



Protected images and sound files will be deleted when the SD Memory Card is formatted (p.174).

4



To cancel the Protect setting on all your images and sound files, select [Unprotect] in Step 6.

# Connecting the Camera to AV Equipment

By using the supplied AV cable (I-AVC7), you can capture and play back images on equipment with a video IN jack, such as a TV. Make sure the camera and TV are turned off before connecting the camera to the TV.

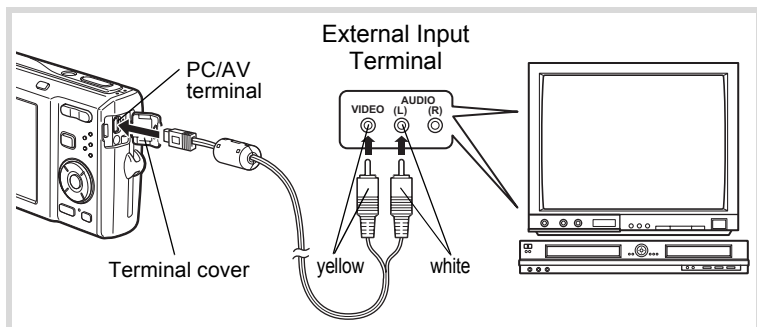

- 1 Open the terminal cover and connect the AV cable to the PC/AV terminal.**

Connect the terminal of the AV cable with  pointing toward the ◀ on the PC/AV terminal of the camera.

- 2 Connect the other ends of the AV cable (yellow: video, white: audio) to the video input terminal and audio input terminal of the AV device.**

When using stereo sound equipment, insert the sound terminal into the L (white) terminal.

- 3 Turn the AV device on.**

When the device that the camera is connected to and the device that plays back images are different, turn both devices on.

When viewing images on AV equipment with multiple video input terminals (such as a TV), refer to the operation manual of the device and select the video input terminal to which the camera is connected.



- It is recommended to use the optional AC adapter kit K-AC78 if you intend to use the camera for a long time.
- Depending on the country or region, images and sound files may fail to be played back if the video output format is set different from the one in use there. If this happens, change the video output format setting (p.184).
- The camera display turns off while the camera is connected to AV equipment.
- Volume cannot be adjusted with the Zoom/▲▲▲/▼ button while the camera is connected to AV equipment.



# **5 Editing and Printing Images**

---

<b>Editing Images .....</b>	<b>144</b>
<b>Setting the Printing Service (DPOF) .....</b>	<b>158</b>
<b>Printing Using PictBridge .....</b>	<b>161</b>

## Changing the Image Size and Quality (Resize)

By changing the size and quality of a selected image, you can make the file size smaller than the original. You can use this function to continue taking pictures when the SD Memory Card or the built-in memory is full, by making the images smaller and overwriting the original images to make more space available.







- Images taken with 2.1M, panoramic images and movies cannot be resized.
- You cannot select a larger resolution or higher quality than that of the original image.

5

**1** Enter the  mode and use the four-way controller ( ) to choose the image you want to resize.

**2** Press the four-way controller ().

The Playback Mode Palette appears.

**3** Use the four-way controller (   ) to select  (Resize).



**4** Press the **OK** button.

The screen for choosing the size and quality appears.

## 5 Select [Recorded Pixels] and [Quality Level].

Use the four-way controller (◀▶) to choose the size and quality.

Use the four-way controller (▲▼) to switch between [Recorded Pixels] and [Quality Level].



## 6 Press the OK button.

A confirmation dialog for overwriting the image appears.

When an image is protected, the image will be saved as a new image without the following confirmation dialog displayed on the screen.

## 7 Use the four-way controller (▲▼) to select [Overwrite] or [Save as].

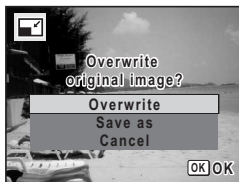

## 8 Press the OK button.

The resized image is saved.

## Cropping Images

You can delete the unwanted part of a picture and save the cropped image as a separate image.



Images taken with 2.1m, panoramic images and movies cannot be cropped.

## 1 Enter the mode and use the four-way controller (◀▶) to choose the image you want to crop.

## 2 Press the four-way controller (▼).

The Playback Mode Palette appears.

- 3 Use the four-way controller (▲▼◀▶) to select  (Cropping).**

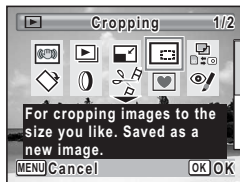

- 4 Press the OK button.**

The cropping screen appears.

The maximum range for cropping is shown with a green frame on the screen. Cropping cannot be performed inside of this area.

- 5 Choose the cropping conditions.**

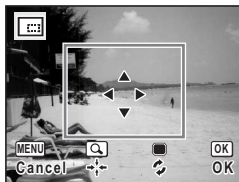

The following operations move the green frame and set the area for cropping on the screen.

- |   |  |
|---|--|
| Zoom/  /Q button | Changes the size of the cropped section              |
| Four-way controller (▲▼◀▶)  | Moves the cropping position up, down, left and right |
| Green button  | Rotates the cropping frame                           |

- 6 Press the OK button.**

The cropped image is saved with a new file name.

The cropped image is saved in the same quality as the original image. The number of recorded pixels is selected automatically according to the size of the cropped section.





## Using the Digital Filters

This mode lets you change the color tones and perform special processing on a selected image.

B&W filter	Processes the image using the B&W filter.
Sepia filter	Processes the image using the sepia filter.
Color filter	Processes the image using the selected color filter. You can choose from six filters: red, pink, purple, blue, green, and yellow.
Color extraction filter	Processes the image using the selected color extraction filter. You can choose from three filters: red, green, and blue.
Soft filter	Processes the image into a soft image.
Brightness Filter	Adjusts the brightness of the image.

**1** Enter the  mode and use the four-way controller ( ) to choose the image you want to edit.

**2** Press the four-way controller ().  
The Playback Mode Palette appears.

**3** Use the four-way controller (   ) to select  (Digital Filter).

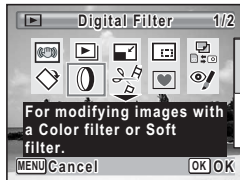

**4** Press the **OK** button.

The digital filter selection screen appears.

- 1 B&W filter
- 2 Sepia filter
- 3 Color filter
- 4 Color extraction filter
- 5 Soft filter
- 6 Brightness Filter



## To Select a B&W Filter, Sepia Filter or Soft Filter

- 5 Use the four-way controller (▲▼) to choose a digital filter.**

The preview image of the results of the filter effect appears.

- 6 Press the OK button.**

A confirmation dialog for overwriting the image appears. When an image is protected, the image will be saved as a new image without the following confirmation dialog displayed on the screen.

- 7 Use the four-way controller (▲▼) to select [Overwrite] or [Save as].**

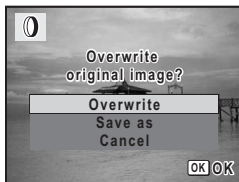

- 8 Press the OK button.**

Images processed with the filter are recorded with the same number of recorded pixels and quality level as the original image.

## To Select a Color Filter or Color Extraction Filter

- 5 Use the four-way controller (▲▼) to choose a digital filter.**

- 6 Use the four-way controller (◀▶) to adjust the effect.**

The color filter changes in the following sequence each time you press the four-way controller (▶): Red, Pink, Purple, Blue, Green, Yellow. The color extraction filter changes in the following sequence each time you press the four-way controller (▶): Red, Green, Blue.

- 7 Press the OK button.**

A confirmation dialog for overwriting the image appears. When an image is protected, the image will be saved as a new image without the following confirmation dialog displayed on the screen.

- 8** Use the four-way controller (▲▼) to select [Overwrite] or [Save as].

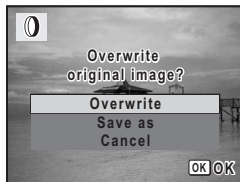

- 9** Press the OK button.

Images processed with the filter are recorded with the same number of recorded pixels and quality level as the original image.

### To Select a Brightness Filter

- 5** Use the four-way controller (▲▼) to select the digital filter you want to use.

- 6** Use the four-way controller (◀▶) to adjust the effect.

The brightness increases each time you press the four-way controller (▶) and decreases each time you press the four-way controller (◀).



- 7** Press the OK button.

A confirmation dialog for overwriting the image appears.

When an image is protected, the image will be saved as a new image without the following confirmation dialog displayed on the screen.

- 8** Use the four-way controller (▲▼) to select [Overwrite] or [Save as].

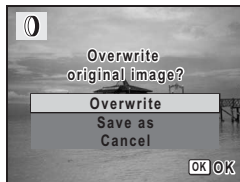

## 9 Press the OK button.

Images processed with the filter are recorded with the same number of recorded pixels and quality level as the original image.



Panoramic images, movies or images taken with another camera cannot be edited using Digital Filter function. An error message appears if you choose this function from the Playback Mode Palette and press the **OK** button.

## Red-eye Compensation

You can correct images where the flash has caused the subject to appear with red eyes.

**1** Enter the mode and use the four-way controller ( ) to choose the image you want to correct.

**2** Press the four-way controller ().

The Playback Mode Palette appears.

**3** Use the four-way controller ( ) to select (Red-eye Compensation).

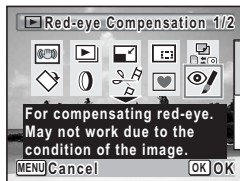

**4** Press the **OK** button.

A confirmation dialog for overwriting the image appears.

When an image is protected, the image will be saved as a new image without the following confirmation dialog displayed on the screen.

**5** Use the four-way controller ( ) to select [Overwrite] or [Save as].

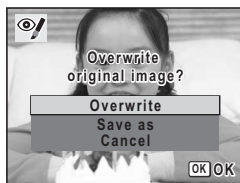



## 6 Press the OK button.

The edited image is saved with the same number of recorded pixels and quality level as the original.



- The red-eye compensation function cannot be used on panoramic images, movies or on images where red eyes cannot be detected on the camera. An error message appears in Step 4.
- The red-eye compensation function can only be used with still pictures taken with this camera.

## Adding a Frame (Frame Composite)

This function lets you add a decorative frame to still pictures. There are 80 frames already stored in the camera.

**1** Enter the mode and use the four-way controller (◀▶) to choose the image to which you want to add a frame.

**2** Press the four-way controller (▼).  
The Playback Mode Palette appears.

**3** Use the four-way controller (▲▼◀▶) to select (Frame Composite).

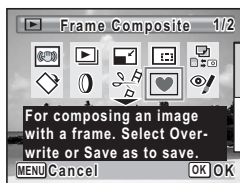

**4** Press the OK button.  
A 9-frame display of the frame selection screen appears.

**5** Use the four-way controller (▲▼◀▶) to choose a frame.

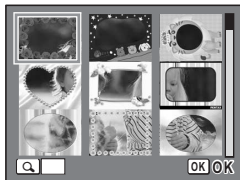



## 6 Press on the Zoom// button.

The selected frame appears in single-image display.









You can choose another frame using either of the following operations.

Four-way controller () Press to choose a different frame.

Zoom// button () Press to return to the 9-frame display of the frame selection screen, and then perform Step 5 to choose a different frame.

## 7 Press the OK button.

The frame position and size adjustment screen appears.

Use the four-way controller () () () () to adjust the position of the image, and use the Zoom// button to make the image larger or smaller.

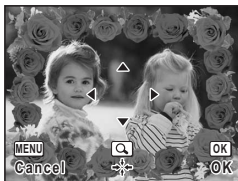

## 8 Press the OK button.

A confirmation dialog for overwriting the image appears.

When an image is protected, the image will be saved as a new image without the following confirmation dialog displayed on the screen.

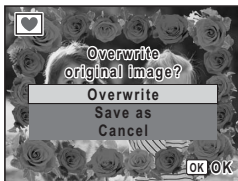

## 9 Use the four-way controller () () to select [Overwrite] or [Save as].



## 10 Press the OK button.

The edited image is saved with the recorded pixels of .



The Frame Composite function cannot be used on images taken with , panoramic images, movies or images of size  or smaller. An error message appears in Step 4.

## Optional Frames

The optional frames are stored in the built-in memory in the Optio M60. These optional frames are deleted if the camera settings are reset or if the built-in memory files are deleted from a computer. To reload the optional frames into the built-in memory, copy the files from the CD-ROM (S-SW81) supplied with the camera.

### To Copy Frames

- 1 Remove the SD Memory Card from the camera.**  
If you leave the SD Memory Card in the camera, the frames will be copied onto the card, not into the camera's built-in memory.
- 2 Connect the camera to the computer using the provided USB cable (I-USB7).**  
Refer to the "PC Connection Manual" for instructions on connecting the camera to a computer.
- 3 When the device detection window opens, click [Cancel].**
- 4 Insert the CD-ROM (S-SW81) into the CD-ROM drive.**
- 5 When the installer window opens, click [EXIT].**
- 6 If there is not already a "FRAME" folder in the root directory of the camera (removable disk), create the folder.**
- 7 Copy the desired files from the FRAME folder in the root directory of the CD-ROM to the FRAME folder on the camera (removable disk).**  
For information on working with files on your computer, refer to the instruction manual supplied with the computer.
- 8 Disconnect the USB cable from the computer and camera.**  
Refer to the "PC Connection Manual" for instructions on disconnecting the cable.

- Frames can be stored both in the built-in memory and on SD Memory Cards, but using large numbers of frames may slow down processing times.

## To Use a New Frame

Frames downloaded from a PENTAX website or other source can be used for adding a frame to pictures.



- Extract the downloaded frame and copy it to the FRAME folder in the built-in memory or the SD Memory Card.
- The FRAME folder is created when the SD Memory Card is formatted with this camera.
- For more information on downloading, refer to the PENTAX website.

## Editing Movies

You can select a frame from a recorded movie to save as a still picture or divide a movie into two.

5

Editing and Printing Images

**1** Enter the mode and use the four-way controller ( ) to choose the movie you want to edit.

**2** Press the four-way controller ().  
The Playback Mode Palette appears.

**3** Use the four-way controller ( ) to select (Movie Edit).



**4** Press the **OK** button.  
The movie edit selection screen appears.  
You can proceed to the following steps.



## To Save a Frame from a Movie as a Still Picture

**5** Select [Save as Still image] on the movie edit selection screen.

**6** Press the OK button.

The screen appears for selecting a frame to be saved as a still picture.

**7** Use the four-way controller (▲▼◀▶) to choose the frame you want to save.

- ▲ Plays or pauses the movie
- ▼ Stops the movie and returns to the first frame
- ◀ Reverses the movie frame by frame
- ▶ Advances the movie frame by frame

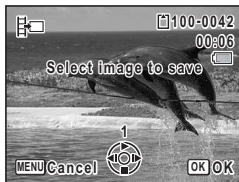

**8** Press the OK button.

The selected frame is saved as a still picture.

## To Divide a Movie

**5** Select [Divide Movies] on the movie edit selection screen.

**6** Press the OK button.

The screen for choosing the dividing position appears.

**7** Use the four-way controller (▲▼◀▶) to determine the dividing position.

- ▲ Plays or pauses the movie
- ▼ Stops the movie and returns to the first frame
- ◀ Reverses the movie frame by frame
- ▶ Advances the movie frame by frame

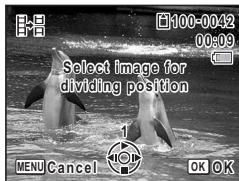

**8** Press the OK button.

A confirmation dialog appears.

- 9** Use the four-way controller (▲▼) to select [Divide].

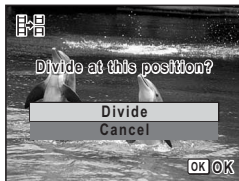

- 10** Press the OK button.

The movie is divided at the specified position, the two portions are saved as new files, and the original one is deleted.



Protected movies cannot be divided.

## Copying Images and Sound Files

5

You can copy images and sound files from the built-in memory to the SD Memory Card and vice versa. This function can only be selected when an SD Memory Card has been inserted in the camera.



Make sure that the camera is turned off before inserting or removing the SD Memory Card.

- 1** Press the four-way controller (▼) in  mode.

The Playback Mode Palette appears.

- 2** Use the four-way controller (▲▼◀▶) to select  (Image/Sound Copy).



- 3** Press the OK button.

The copying method selection screen appears.

## To Copy Files from the Built-in Memory to the SD Memory Card

All the images and sound files in the built-in memory are copied to the SD Memory Card at once. Before copying the images, make sure that there is enough space on the SD Memory Card.

- 4** Use the four-way controller (▲▼) to select [**●** → **SD**].

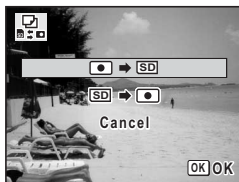

- 5** Press the **OK** button.

All the images and sound files are copied.

## To Copy Files from the SD Memory Card to the Built-in Memory

Selected images and sound files from the SD Memory Card are copied to the built-in memory one at a time.

- 4** Use the four-way controller (▲▼) to select [**SD** → **●**].

- 5** Press the **OK** button.

- 6** Use the four-way controller (◀▶) to select the image/sound file you want to copy.



- 7** Press the **OK** button.

The selected image/sound file is copied.



- If sound (Voice memo) has been recorded with the image, the sound file is copied with the image.
- When a file is copied from the SD Memory Card to the built-in memory, it is assigned a new file name.

# Setting the Printing Service (DPOF)

DPOF (Digital Print Order Format) is the format for storing print order data on still pictures captured with a digital camera. Once the print order data has been stored, the pictures can be printed according to the DPOF settings using a DPOF-compatible printer or photo processing lab. You cannot store print order data for movies or sound-only files.



If the picture already has the date and/or time imprinted on it (p.106), do not set [Date]  (On) in DPOF settings. If you select  (On), the imprinted date and/or time may overlap.

## Printing Single Images

Set the following items for each image.

5

Copies	Choose the number of copies up to 99.
Date	Specify whether you want the date inserted on the print or not.

### 1 In mode, press the four-way controller (▼).

The Playback Mode Palette appears.

### 2 Use the four-way controller (▲▼◀▶) to select (DPOF).

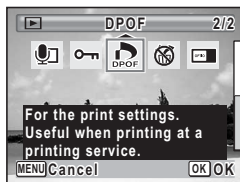

### 3 Press the OK button.

The screen for selecting [Single Image] or [All Images] appears.



- 4** Use the four-way controller (▲▼) to select [Single Image].



- 5** Press the **OK** button.

The message [DPOF setting for this image] appears.

To make DPOF settings for another image, use the four-way controller (◀▶) to select another image.

If DPOF settings have already been made for an image, the previous number of copies and date setting (☑ or ☐) will be displayed.

- 6** Use the four-way controller (▲▼) to choose the number of copies.

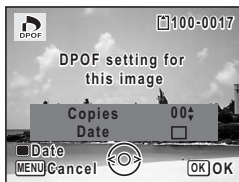

- 7** Use the **Green** button to choose whether to insert the date or not.

- (On) The date will be imprinted.
- (Off) The date will not be imprinted.

To continue setting DPOF print order data, use the four-way controller (◀▶) to choose another image and repeat Steps 6 and 7.



- 8** Press the **OK** button.

The setting is saved and the screen returns to the DPOF menu.





Depending on the printer or printing equipment at the photo processing lab, the date may not be imprinted on the pictures even if ☑ (On) was selected in the DPOF settings.



To cancel DPOF settings, set the number of copies to [00] in Step 6 and press the **OK** button.

## Printing All Images

When you choose the number of copies and whether or not to insert the date, the settings are applied to all the images stored in the camera.

- 1 Display the screen for DPOF settings in  mode.**  
Refer to Steps 1 to 3 on p.158.
- 2 Use the four-way controller ( ) to select [All Images].**
- 3 Press the OK button.**  
The message [DPOF setting for all images] appears.

- 4 Choose the number of copies and whether to insert the date or not.**  
Refer to Steps 6 and 7 in “Printing Single Images” (p.159) for details of how to make the settings.

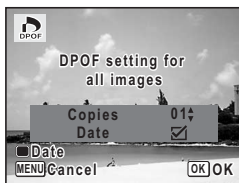

- 5 Press the OK button.**  
The settings for all the images are saved and the camera returns to the DPOF setting screen.



The number of copies specified in the DPOF settings applies to all the images. Before printing, check that the number is correct.



Settings for single images are canceled when settings are made with [All Images].

# Printing Using PictBridge

By connecting the camera to a printer that supports PictBridge using the USB cable (I-USB7) provided, you can print images directly from the camera without using a computer. Connect the camera to the printer and select the images you want to print and the number of copies on the camera.



- It is recommended to use the optional AC adapter kit K-AC78 when the camera is connected to the printer. The printer may not work properly or the image data may be lost if the battery runs out of power while the camera is connected to the printer.
- Do not disconnect the USB cable during data transfer.
- If the picture already has the date and/or time imprinted on it (p.106), do not set [Date]  (On) in PictBridge setting. If you select  (On), the imprinted date and/or time may overlap.
- Depending on the model of printer, not all the settings made on the camera (such as print settings and DPOF settings) may be valid.
- A printing error may occur if the selected number of copies exceeds 500.
- Printing the index of the images (printing multiple images on a single sheet) cannot be performed directly from the camera. Make the settings on a printer supporting index printing function or use a computer.

## Connecting the Camera to the Printer

- 1 Select [PictBridge] for the [USB Connection] mode on the [ Setting] menu.**  
Refer to "Changing the USB Connection Mode" (p.183).
- 2 Turn off the camera.**
- 3 Connect the camera to the printer using the USB cable.**
- 4 Turn on the printer.**

## 5 When the printer is ready to print, turn the camera on.

The printing mode selection screen appears.

Go to the following pages.

- “Printing Single Images” (p.162)
- “Printing All Images” (p.164)
- “Printing Using the DPOF Settings” (p.165)

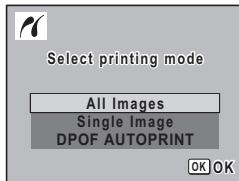

## Printing Single Images

### 1 In the printing mode selection screen, use the four-way controller (▲▼) to select [Single Image].

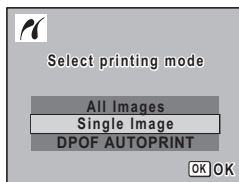

### 2 Press the OK button.

The setting screen appears.

### 3 Use the four-way controller (◀▶) to choose an image to print.

### 4 Use the four-way controller (▲▼) to choose the number of copies.

You can print up to 99 copies.



### 5 Use the Green button to choose whether to insert the date or not.

- (On) The date will be imprinted.
- (Off) The date will not be imprinted.

**6 Press the OK button.**

A confirmation dialog appears.

To print the pictures according to the print settings on the printer, press the **OK** button.

To change the print settings, go to Step 7.

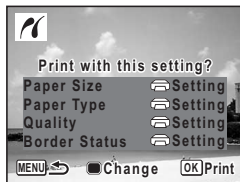
**7 Press the Green button.**

The screen for changing the print settings appears.

**8 Select [Paper Size] and press the four-way controller (▶).**

The [Paper Size] screen appears.

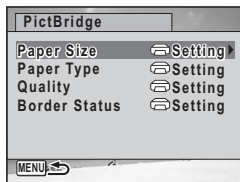
**9 Use the four-way controller (▲▼◀▶) to choose the paper size.**

You can only choose a size that is supported by your printer.

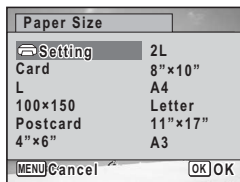
**10 Press the OK button.**

The [Paper Size] setting is saved, and the screen returns to the print settings screen.

**11 Use the four-way controller (▲▼) to select [Paper Type] and press the four-way controller (▶).**

A pull-down menu appears.

## 12 Use the four-way controller (▲▼) to select the paper type and press the OK button.

The [Paper Type] setting is saved, and the screen returns to the print settings screen. Set [Quality] and [Border Status] in the same way as in Steps 11 and 12.

If you select [☰ Setting] for each print setting, images are printed according to the settings made on the printer.

Paper Type with more ★ supports higher quality paper.

Quality with more ★ indicates higher print quality.

A confirmation dialog appears after each item has been set.

## 13 Press the MENU button.

The screen returns to the confirmation dialog.

## 14 Press the OK button.

The image is printed according to the settings.

Press the **MENU** button to cancel printing.

5



- The self-timer lamp lights while the camera is communicating with the printer, and blinks while the card is being accessed and during printing. Do not disconnect the USB cable while the self-timer lamp is blinking.
- The [Paper Size], [Paper Type], [Quality] and [Border Status] settings are reset to the defaults when the camera is turned off.

## Printing All Images

### 1 In the printing mode selection screen, use the four-way controller (▲▼) to select [All Images].

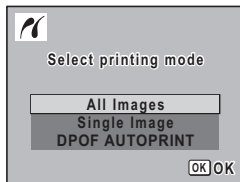

### 2 Press the OK button.

The setting screen appears.

### 3 Choose the number of copies and whether to insert the date or not.

The number of copies and date setting that you choose apply to all the images.

Refer to Steps 4 and 5 in “Printing Single Images” (p.162) for details of how to make the settings.

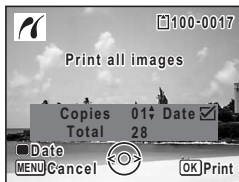

### 4 Press the OK button.

A confirmation dialog appears.

Refer to Steps 7 to 11 of “Printing Single Images” (p.163) for details of changing print settings.

### 5 Press the OK button on the print settings confirmation screen.

All the images are printed according to the settings.

Press the **MENU** button to cancel printing.

## Printing Using the DPOF Settings

### 1 In the printing mode selection screen, use the four-way controller (▲▼) to select [DPOF AUTOPRINT].

### 2 Press the OK button.

The DPOF settings you have made appear.

Use the four-way controller (◀▶) to check the number of copies for each picture, whether to insert the date or not, and the total number of copies. Refer to p.158 for instructions on how to make the DPOF settings.

### 3 Press the OK button.

A confirmation dialog appears.

Refer to Steps 7 to 11 of “Printing Single Images” (p.163) for details of changing print settings.

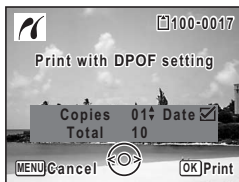

---

#### **4 Press the OK button.**

The images are printed according to the settings.  
Press the **MENU** button to cancel printing.

### **Disconnecting the Cable from the Printer**

Disconnect the USB cable from the camera and printer when you have finished printing.

---

#### **1 Turn off the camera and printer.**

---

#### **2 Disconnect the USB cable from the camera and printer.**



# **6 Recording and Playing Back Sound**

---

<b>Recording Sound (Voice Recording Mode)</b> .....	<b>168</b>
<b>Adding a Voice Memo to Images</b> .....	<b>171</b>

# Recording Sound (Voice Recording Mode)

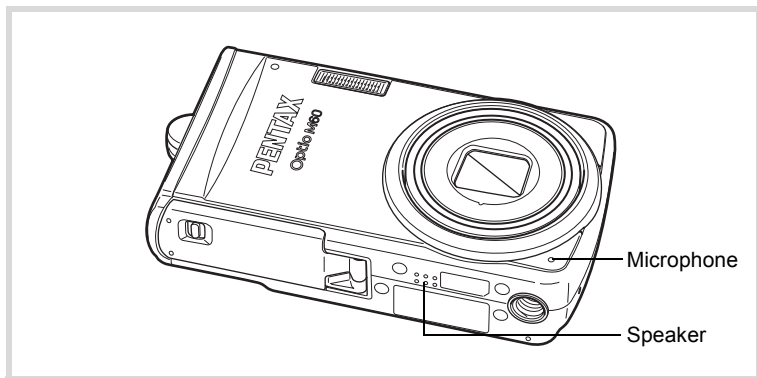

You can record sound with the camera. The microphone is located on the front of the camera. When recording sound, aim the camera at the sound source to obtain the best sound quality.



6

Recording and Playing Back Sound

## Recording Sound

- 1 Press the four-way controller (▼) in  mode.**  
The Capture Mode Palette appears.
- 2 Use the four-way controller (▲▼◀▶) to select  (Voice Recording).**



### 3 Press the OK button.

The remaining recordable time and the recording time of the current file appear on the display.

- 1 Recording time
- 2 Remaining recordable time

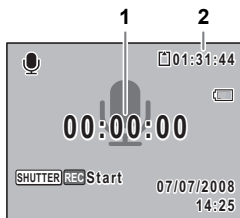

### 4 Press the shutter release button fully.

Recording starts. The self-timer lamp blinks during recording.

You can record sounds continuously for up to 24 hours.

When the Green button is pressed during recording, an index is added to the current sound file.



### 5 Press the shutter release button fully.

Recording stops.



- If you press and hold down the shutter release button for more than one second in Step 4, recording continues until you take your finger off the button. This is useful for making short sound recordings.
- Sound is saved in WAVE monaural files.

## Playing Back Sound

You can play back the sound files you made in  (Voice Recording) mode.

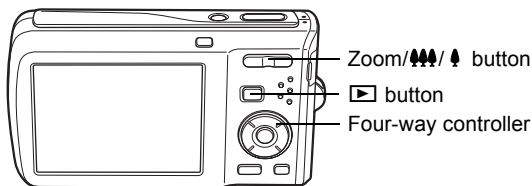

- 1 Press the ▶ button.**
- 2 Use the four-way controller (◀▶) to choose a sound file to play back.**

- 3 Press the four-way controller (▲).**

Playback starts.

- 1 Total file recording time
- 2 Playback time

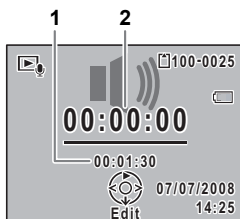

**The following operations can be performed during playback.**

- Four-way controller (▲) Pauses playback
- Zoom/▲▲▲/▲ button (▲) Increases the volume
- Zoom/▲▲▲/▲ button (▲▲▲) Reduces the volume

If there are no recorded indexes:

- Four-way controller (◀) Reverses playback
- Four-way controller (▶) Fast forwards playback

If there are recorded indexes:

- Four-way controller (◀) Plays back starting from the previous index
- Four-way controller (▶) Plays back starting from the next index

**The following operations can be performed while playback is paused.**

- Four-way controller (▲) Resumes playback
- Four-way controller (◀) Rewinds approx. 5 seconds
- Four-way controller (▶) Advances approx. 5 seconds

- 4 Press the four-way controller (▼).**

Playback stops.

# Adding a Voice Memo to Images

You can add a voice memo to your still pictures.

## Recording a Voice Memo

**1** Enter  mode and use the four-way controller (◀▶) to choose the still picture to which you want to add a voice memo.

**2** Press the four-way controller (▼).  
The Playback Mode Palette appears.

**3** Use the four-way controller (▲▼◀▶) to select  (Voice Memo).



**4** Press the OK button.  
Recording starts. You can record a voice memo continuously for up to 24 hours.



**5** Press the OK button.  
Recording stops.



- A voice memo cannot be added to an image that already has a voice memo. Delete the old voice memo (p.133) and record a new one.
- A voice memo cannot be added to protected images (p.138).

## Playing Back a Voice Memo

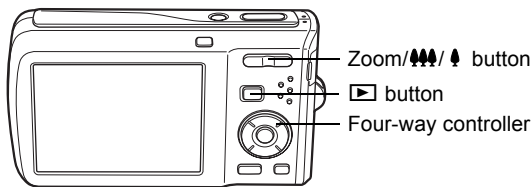

- 1** Enter mode and use the four-way controller (◀▶) to choose the still picture with the voice memo that you want to play back.

appears on images with voice memos in single-image display.

- 2** Press the four-way controller (▲).

Playback starts.



The following operations can be performed during playback.

- Zoom/▲▲▲/▲ button (▲) Increases the volume
- Zoom/▲▲▲/▲ button (▲▲▲) Reduces the volume

- 3** Press the four-way controller (▼).

Playback stops.

To Delete a Sound File p.133

# 7 Settings

---

Camera Settings .....	174
-----------------------	-----

## Formatting an SD Memory Card



Formatting will delete all the data on the SD Memory Card. Be sure to use this camera to format (initialize) an SD Memory Card that is unused or has been used on other cameras or digital devices.



- Do not remove the SD Memory Card during formatting as this may damage the card and render it unusable.
- Formatting will delete protected images and any data recorded on the card with a computer or camera other than this camera.
- SD Memory Cards formatted on a computer or device other than the camera cannot be used. Be sure to format the card with the camera.
- The built-in memory cannot be formatted except when an error occurs.

### 1 Press the **MENU** button in mode.

[ Setting] menu appears.

When you press the **MENU** button in  mode, press the four-way controller () once.

### 2 Use the four-way controller ( ) to select [Format].

### 3 Press the four-way controller () .

The [Format] screen appears.

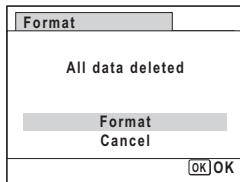

### 4 Use the four-way controller ( ) to select [Format].





## 5 Press the OK button.

Format starts.



When formatting is completed, the camera returns to  mode or  mode.

## Changing the Sound Settings

You can adjust the volume of operation sounds and change the type of sound.

### 1 Press the MENU button in mode.

[ Setting] menu appears.

When you press the **MENU** button in  mode, press the four-way controller () once.

### 2 Use the four-way controller ( ) to select [Sound].

### 3 Press the four-way controller () .

The [Sound] screen appears.

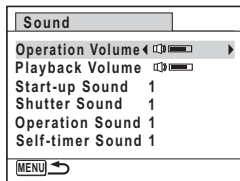

## To Change the Operation Volume/Playback Volume

### 4 Use the four-way controller ( ) to select [Operation Volume].

### 5 Use the four-way controller ( ) to adjust the volume.

Set the volume to 0 to mute the start-up sound, shutter sound, operation sound, and self-timer sound.

### 6 Change [Playback Volume] in the same way as in Steps 4 and 5.

## To Change the Sound Type

- 4 Use the four-way controller (▲▼) to select [Start-up Sound].**
- 5 Press the four-way controller (▶).**  
A pull-down menu appears.
- 6 Use the four-way controller (▲▼) to select the sound type.**  
Choose from [1], [2], [3] or [Off].
- 7 Press the OK button.**
- 8 Set [Shutter Sound], [Operation Sound] and [Self-timer Sound] in the same way as in Steps 4 to 7.**
- 9 Press the MENU button.**  
The screen returns to the [ Setting] menu.

## Changing the Date and Time

You can change the initial date and time settings. You can also set the style in which the date appears on the camera.

- 1 Press the MENU button in mode.**  
[ Setting] menu appears.  
When you press the **MENU** button in mode, press the four-way controller (▶) once.
- 2 Use the four-way controller (▲▼) to select [Date Adjust].**
- 3 Press the four-way controller (▶).**  
The [Date Adjust] screen appears.

**4 Press the four-way controller (▶).**

The frame moves to [mm/dd/yy].  
Depending on the initial setting or previous setting, [dd/mm/yy] or [yy/mm/dd] may be displayed.

Date Adjust	
Date Style	▶mm/dd/yy 24h
Date	01/01/2008
Time	0:00
[MENU]Cancel [OK]OK	

**5 Use the four-way controller (▲▼) to choose the date and time display style.**

Choose from [mm/dd/yy], [dd/mm/yy] or [yy/mm/dd].

Date Adjust	
Date Style	◀mm/dd/yy 24h
Date	01/01/2008
Time	0:00
[MENU]Cancel [OK]OK	

**6 Press the four-way controller (▶).**

The frame moves to [24h].

**7 Use the four-way controller (▲▼) to select [24h] (24-hour display) or [12h] (12-hour display).**

Date Adjust	
Date Style	◀mm/dd/yy 24h
Date	01/01/2008
Time	0:00
[MENU]Cancel [OK]OK	

**8 Press the four-way controller (▶).**

The frame returns to [Date Style].

**9 Press the four-way controller (▼).**

The frame moves to [Date].

## 10 Press the four-way controller (▶).

The frame moves to one of the following items depending on the date style set in Step 5.

For [mm/dd/yy] month (Example: [01])

For [dd/mm/yy] day (Example: [01])

For [yy/mm/dd] year (Example: [2008])

The following operations and screens use [mm/dd/yy] as an example. The operations are the same even if another date style has been selected.

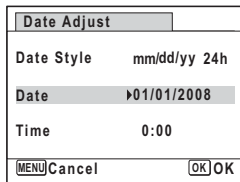

## 11 Use the four-way controller (▲▼) to change the month.

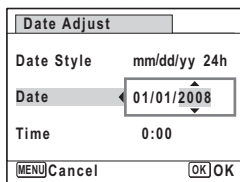

## 12 Press the four-way controller (▶).

The frame moves to the day field. Use the four-way controller (▲▼) to change the day. After changing the day, change the year in the same manner.

## 13 Change the time in the same way as in Steps 8 to 11.

If you selected [12h] in Step 7, the setting switches between am and pm corresponding to the time.

## 14 Press the OK button.



## 15 Press the OK button.

The date and time settings are saved.



When you press the **OK** button in Step 15, the camera clock is reset to 00 seconds. To set the exact time, press the **OK** button when the time signal (on the TV, radio, etc.) reaches 00 seconds.



## Setting the World Time

The date and time selected in “Setting the Date and Time” (p.43) and “Changing the Date and Time” (p.176) serve as the  (Hometown) date and time. By using the world time function, you can display the time in a city other than the Hometown ( Destination). This is useful when taking pictures in a different time zone.

### To Set the Destination

#### 1 Press the MENU button in mode.

[ Setting] menu appears.

When you press the MENU button in  mode, press the four-way controller () once.

#### 2 Use the four-way controller ( ) to select [World Time].

#### 3 Press the four-way controller ().

The [World Time] screen appears.

#### 4 Use the four-way controller ( ) to select (Destination).

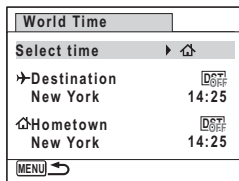

#### 5 Press the four-way controller ().

The [Destination] screen appears. The city that is currently selected blinks on the map.

#### 6 Use the four-way controller ( ) to change the Destination city.

The current time, location and time difference of the selected city appear.

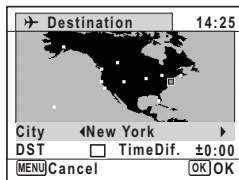

- 7** Use the four-way controller (▲▼) to select [DST].
- 8** Use the four-way controller (◀▶) to select  (On) or  (Off).  
Select  (On) if the Destination city uses daylight saving time.
- 9** Press the OK button.  
The [World Time] setting is saved.
- 10** Press the MENU button twice.  
The camera returns to capture status with the current setting.



Select (Hometown) in Step 4 of p.179 to set the city and DST setting for the Hometown city.

## To Display the Time of the Destination on the Display (Select Time)

- 1** Press the MENU button in mode.  
[Setting] menu appears.  
When you press the MENU button in mode, press the four-way controller (▶) once.
- 2** Use the four-way controller (▲▼) to select [World Time].
- 3** Press the four-way controller (▶).  
The [World Time] screen appears.
- 4** Use the four-way controller (▲▼) to select [Select time].

World Time	
Select time	▶
▶ Destination	<input type="checkbox"/> DST
London	20:25
Hometown	<input type="checkbox"/> DST
New York	14:25
MENU	

- 5** Press the four-way controller (▶).  
A pull-down menu appears.

## 6 Use the four-way controller (▲▼) to select → (Destination) or ↻ (Hometown).

- Displays the time of the Destination city
- ↻ Displays the time of the Hometown city

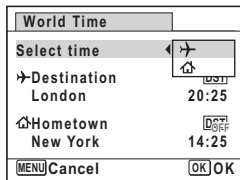

## 7 Press the OK button.

The setting is saved.

## 8 Press the MENU button twice.

The camera returns to 📷 mode or ▶ mode.

When → (Destination) is selected in Step 6, the → icon appears on the display to indicate that the destination date and time are displayed in 📷 mode.



## Changing the Display Language

You can change the language in which the menus, error messages, etc. are displayed.

The camera supports the following 20 languages: English, French, German, Spanish, Portuguese, Italian, Dutch, Japanese, Danish, Swedish, Finnish, Polish, Czech, Hungarian, Turkish, Greek, Russian, Thai, Korean and Chinese (traditional and simplified).

## 1 Press the MENU button in ▶ mode.

[↻ Setting] menu appears.

When you press the **MENU** button in 📷 mode, press the four-way controller (▶) once.

## 2 Use the four-way controller (▲▼) to select [Language/言語].

### 3 Press the four-way controller (▶).

The [Language/言語] screen appears.

### 4 Use the four-way controller (▲▼◀▶) to select the language.

Language/言語		
English	日本語	Türkçe
Français	Dansk	Ελληνικά
Deutsch	Svenska	Русский
Español	Suomi	ไทย
Português	Polski	한국어
Italiano	Čeština	中文繁體
Nederlands	Magyar	中文简体
MENU/Cancel		OK/OK

### 5 Press the OK button.

The menus and messages are displayed in the selected language.

## Changing the Naming Rule of the Folder

You can change the naming rule of the folder for storing images. When the name is changed to the date, pictures are saved in separate folders by the date they were taken.

Date	xxx_mmdd (3-digit folder number_month day) * xxx_ddmm (3-digit folder number_day month) when the date style is set to [dd/mm/yy]
Standard	xxxPENTX (where xxx is the 3-digit folder number)

Taken with the folder name setting [Standard].  
(e.g. September 25)

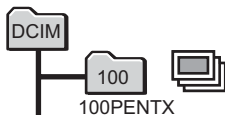

Taken with the folder name setting [Date].  
(e.g. September 25)

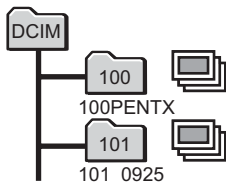



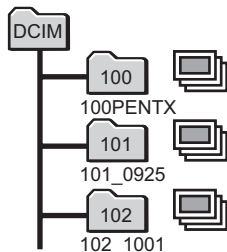





Next time, taken with the folder name setting [Date] again.  
(e.g. October 1)



- Up to 999 folders can be created.
- Up to 9999 images or sounds can be saved in a folder.



- 1 Press the MENU button in  mode.**  
[ Setting] menu appears.  
When you press the **MENU** button in  mode, press the four-way controller () once.
- 2 Use the four-way controller ( ) to select [Folder Name].**
- 3 Press the four-way controller ().**  
A pull-down menu appears.
- 4 Use the four-way controller ( ) to select [Standard] or [Date].**
- 5 Press the OK button.**  
The setting is saved.

## Changing the USB Connection Mode







Set the device to which the camera is connected with the USB cable.



Make sure to set the USB Connection mode before connecting your camera to the computer or printer. You cannot perform the following setting if your camera is connected to the computer or printer with the USB/AV cable.



Refer to the "PC Connection Manual" for instructions on connecting the camera to a computer.

- 1 Press the MENU button in  mode.**  
[ Setting] menu appears.  
When you press the **MENU** button in  mode, press the four-way controller () once.
- 2 Use the four-way controller ( ) to select [USB Connection].**
- 3 Press the four-way controller ().**  
A pull-down menu appears.

#### 4 Use the four-way controller (▲▼) to select [PC] or [PictBridge].

- PC : For transferring image data to a computer
- PictBridge : For connecting the camera to a PictBridge-compatible printer

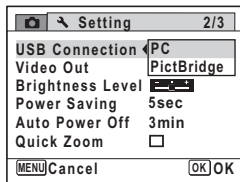

#### 5 Press the OK button.

The setting is saved.



Do not connect the camera to your computer while [PictBridge] is selected for the USB Connection mode. And do not connect the camera to your printer while [PC] is selected.

Printing Using PictBridge p.161

## Changing the Video Output Format

When you connect the camera to AV equipment, choose the appropriate video output format (NTSC or PAL) for taking and playing back images.

#### 1 Press the MENU button in mode.

[ Setting] menu appears.

When you press the **MENU** button in mode, press the four-way controller (▶) once.

#### 2 Use the four-way controller (▲▼) to select [Video Out].

#### 3 Press the four-way controller (▶).

A pull-down menu appears.

#### 4 Use the four-way controller (▲▼) to select video output format.

Choose the video output format to match the output format of the AV equipment.

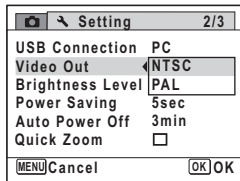

#### 5 Press the OK button.

The setting is saved.



Depending on the country or region, images and sound files may fail to be played back if the video output format is set different from the one in use there. If this happens, change the video output format setting.

Connecting the Camera to AV Equipment p.141  
Video output format of each city p.204

## Adjusting the Brightness of the Display

You can adjust the brightness of the display.

#### 1 Press the MENU button in mode.

[ Setting] menu appears.

When you press the **MENU** button in mode, press the four-way controller (▶) once.



#### 2 Use the four-way controller (▲▼) to select [Brightness Level].

#### 3 Use the four-way controller (◀▶) to adjust the brightness.

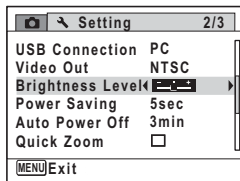
- Dark
- Normal
- Bright



## 4 Press the MENU button.



The camera returns to  mode or  mode.  
The display appears with the set brightness.

## Using the Power Saving Function

You can save battery power by setting the display to dim automatically when no operation is performed for a fixed time. After the power saving function has been activated, the display returns to the ordinary brightness by pressing any of the buttons.

### 1 Press the MENU button in mode.

 Setting] menu appears.

When you press the **MENU** button in  mode, press the four-way controller () once.

### 2 Use the four-way controller ( ) to select [Power Saving].

### 3 Press the four-way controller (.

A pull-down menu appears.

### 4 Use the four-way controller ( ) to select the time until the camera enters power saving mode.

Choose from [2min], [1min], [30sec], [15sec], [5sec] or [Off].

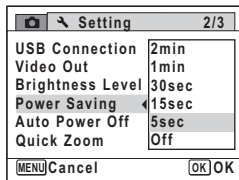

### 5 Press the OK button.

The setting is saved.



- Power Saving does not function in the following situations:
  - while taking pictures in Continuous Shooting mode
  - in the playback mode
  - while recording a movie
  - while the camera is connected to a computer or printer
  - when using the AC adapter
  - while a menu is being displayed
- When no operation is performed after the camera is turned on, Power Saving is activated only after 15 seconds elapse even if [5sec] is set.

## Setting Auto Power Off

You can set the camera to turn off automatically when no operation is performed for a fixed time.

### 1 Press the MENU button in mode.

[ Setting] menu appears.

When you press the **MENU** button in mode, press the four-way controller () once.

### 2 Use the four-way controller ( ) to select [Auto Power Off].

### 3 Press the four-way controller () .

A pull-down menu appears.

### 4 Use the four-way controller ( ) to select the time until the camera turns off automatically.

Choose from [5min], [3min] or [Off].

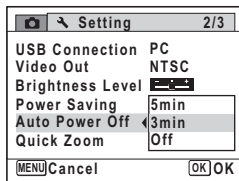

### 5 Press the OK button.

The setting is saved.



Auto Power Off does not function in the following situations:

- while recording sound in (Voice Recording) mode
- while taking pictures in Continuous Shooting mode
- while recording a movie
- during a slideshow or movie/sound playback
- while the camera is connected to a computer or printer

## Setting the Quick Zoom Function

You can choose whether or not to use the Quick Zoom function that magnifies an image to a maximum of  $\times 10$  by just pressing on the Zoom// button while playing back an image in mode.

### 1 Press the MENU button in mode.

[ Setting] menu appears.

When you press the **MENU** button in mode, press the four-way controller () once.

### 2 Use the four-way controller ( ) to select [Quick Zoom].

### 3 Use the four-way controller ( ) to select (On) or (Off).

- (On) The Quick Zoom is available.
- (Off) The Quick Zoom is not available.

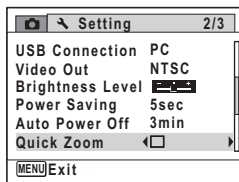

### 4 Press the MENU button.

The camera returns to mode or mode.

## Changing the Start-up Screen

You can choose the start-up screen displayed when the camera is turned on.

You can choose any of the following images as the start-up screen:

- The Guide Display Start-up Screen showing a guide to the shooting modes and buttons
- One of the 3 Optio logos
- One of your own images (compatible images only)

### 1 In mode, press the four-way controller (▼).

The Playback Mode Palette appears.

### 2 Use the four-way controller (▲▼◀▶) to select (Start-up Screen).



### 3 Press the OK button.

The image selection screen appears.

### 4 Use the four-way controller (◀▶) to choose an image for the start-up screen.

Only images suitable for the start-up screen are displayed. You can also choose one of the 3 Optio logos or the Guide Display Start-up Screen already stored in the camera.



### 5 Press the OK button.

The setting is saved.





- Once the start-up screen has been set, it will not be deleted even if the original image is deleted or the SD Memory Card is formatted.
- Select [Off] to hide the start-up screen.
- The start-up screen is not displayed when you turn the camera on in the playback mode.

## Resetting to Default Settings (Reset)

You can reset the camera settings to their defaults. Refer to “Default Settings” (p.199) for the reset settings.

### 1 Press the **MENU** button in mode.

[ Setting] menu appears.

When you press the **MENU** button in  mode, press the four-way controller () once.

### 2 Use the four-way controller ( ) to select [Reset].

### 3 Press the four-way controller (). The [Reset] screen appears.

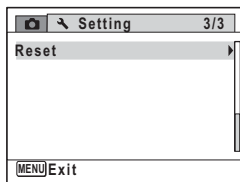

### 4 Use the four-way controller ( ) to select [Reset].

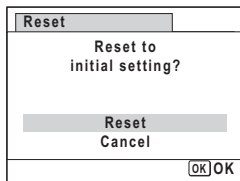

### 5 Press the **OK** button.

The settings return to the defaults.



The following settings are not affected by resetting:

- Date Adjust
- World Time
- Language/言語
- Video Out



# 8 Appendix

---

<b>Functions Available for Each Shooting Mode .....</b>	<b>192</b>
<b>Messages .....</b>	<b>194</b>
<b>Troubleshooting .....</b>	<b>197</b>
<b>Default Settings .....</b>	<b>199</b>
<b>List of World Time Cities .....</b>	<b>204</b>
<b>Optional Accessories .....</b>	<b>205</b>
<b>Main Specifications .....</b>	<b>206</b>
<b>WARRANTY POLICY .....</b>	<b>210</b>
<b>Index .....</b>	<b>216</b>

# Functions Available for Each Shooting Mode

Yes: Can be set.

No: Cannot be set.

Function	Shooting Mode							
Face Priority On	Yes	Yes	Yes	Yes	Yes	Yes	Yes	Yes
Smile Capture								
Face Priority Off	No	Yes	Yes	Yes	No	No	Yes	Yes
Blink Detection	Yes	Yes	Yes	Yes	Yes	Yes	No	Yes
Flash Mode	(Auto)	Yes	Yes	Yes	No	Yes	Yes	Yes
	(Flash Off)	Yes	Yes	Yes	Yes	Yes	Yes	Yes
	(Flash On)	Yes	No	Yes	Yes	Yes	Yes	No
	(Auto + Red-eye)	Yes	No	Yes	No	Yes	Yes	No
	(Flash On + Red-eye)	Yes	No	Yes	Yes	Yes	Yes	No
	(Soft Flash)	Yes	No	Yes	Yes	Yes	Yes	No
Drive Mode	(Standard)	Yes	Yes	Yes	Yes	Yes	Yes	Yes
	(Self-timer)	Yes	Yes	Yes	Yes	Yes	Yes	Yes
	(2 Sec. Self-timer)							
	(Continuous Shooting)	Yes	No	Yes	Yes	Yes	Yes	No
	(HS Cont. Shooting)							
Focus Mode	<b>AF</b> (Standard)							
	(Macro)	Yes	Yes	Yes	Yes	Yes	Yes	Yes
	<b>PF</b> (Pan Focus)							
	(Infinity)	Yes	No	Yes	Yes	Yes	Yes	Yes
	<b>MF</b> (Manual Focus)	Yes	No	Yes	Yes	Yes	Yes	Yes
Recorded Pixels	Yes	No*1	Yes	Yes	Yes	No*2	Yes	Yes
Quality Level	Yes	No*6	Yes	Yes	Yes	Yes	No	Yes
White Balance	No*7	No*7	Yes	Yes	No*7	No*7	Yes	No*7
Focusing Area	No*8	No*8	Yes	Yes	Yes	Yes	Yes*9	Yes
AE Metering	No*10	No*10	Yes	Yes	No*10	No*10	No*10	No*10
Sensitivity	Yes	No*11	Yes	Yes	Yes	Yes	No*11	Yes
EV Compensation	No*13	No*13	Yes	Yes	Yes	Yes	Yes	Yes
Zoom	Yes	Yes*14	Yes	Yes	Yes	Yes	Yes*14	Yes
Sharpness								
Saturation	No	No	Yes	Yes	No	No	Yes	No
Contrast								
Date Imprint	Yes	No	Yes	Yes	Yes	Yes	No	Yes

\*1 Fixed at **10M**

\*2 Fixed at **3M**

\*3 Fixed at **5M**

\*4 Fixed at 640×480

\*5 Fixed at **5M** (Fixed at **3M** for the first frame)

\*6 Fixed at **★★**

\*7 Fixed at **AWB**

\*8 Fixed at (Multiple)

								Shooting Mode	Page	
								Function		
Yes	Yes	Yes	No	Yes	Yes	Yes	Yes	Face Priority On	p.63	
								Smile Capture		
Yes	Yes	Yes	No	Yes	Yes	Yes	Yes	Face Priority Off	p.60	
Yes	Yes	Yes	No	Yes	Yes	No	No	Blink Detection		
Yes	No	Yes	No	Yes	Yes	Yes	Yes	(Auto)	Flash Mode	p.89
Yes	Yes	Yes	No	Yes	Yes	Yes	Yes	(Flash Off)		
Yes	No	Yes	No	Yes	Yes	Yes	Yes	(Flash On)		
Yes	No	Yes	No	Yes	Yes	Yes	Yes	(Auto + Red-eye)		
Yes	No	Yes	No	Yes	Yes	Yes	Yes	(Flash On + Red-eye)		
								(Soft Flash)		
Yes	Yes	Yes	No	Yes	Yes	Yes	Yes	(Standard)	Drive Mode	—
Yes	Yes	Yes	No	Yes	Yes	Yes	Yes	(Self-timer)		
								(2 Sec. Self-timer)		p.81
Yes	No	No	No	Yes	Yes	No	No	(Continuous Shooting)	p.82	
								(HS Cont. Shooting)		
Yes	No	Yes	No	Yes	Yes	Yes	Yes	<b>AF</b> (Standard)	Focus Mode	p.91
								(Macro)		
								<b>PF</b> (Pan Focus)		
Yes	Yes	Yes	No	Yes	Yes	Yes	Yes	(Infinity)		
Yes	No	Yes	No	Yes	Yes	Yes	Yes	<b>MF</b> (Manual Focus)		
No*3	Yes	No*2	No	Yes	No*4	No*5	No	Recorded Pixels	p.94	
Yes	Yes	Yes	No	Yes	Yes	Yes	Yes	Quality Level	p.96	
Yes	No*7	Yes	No	No*7	No*7	Yes	Yes	White Balance	p.98	
Yes	No*8	Yes*9	No	Yes	Yes	Yes	Yes	Focusing Area	p.93	
Yes	No*10	Yes	No	No*10	No*10	Yes	Yes	AE Metering	p.100	
No*11	No*12	Yes	No	Yes	Yes	Yes	Yes	Sensitivity	p.101	
Yes	Yes	Yes	No	Yes	Yes	Yes	Yes	EV Compensation	p.97	
Yes*15	Yes	Yes	No	Yes	Yes	No	Yes	Zoom	p.69	
								Sharpness	p.104	
Yes	No	Yes	No	No	No	Yes	Yes	Saturation	p.105	
								Contrast	p.105	
Yes	Yes	Yes	No	Yes	Yes	Yes	Yes	Date Imprint	p.106	

\*9 (Automatic Tracking AF) is not available

\*10 Fixed at (Multi-segment)

\*11 Fixed at Auto

\*12 The sensitivity is fixed at its minimum setting

\*13 Fixed at  $\pm 0.0$

\*14 Intelligent Zoom is not available

\*15 Only Optical Zoom is available

# Messages

Messages such as the following may appear on the display during camera operation.

Message	Description
Battery depleted	The battery is exhausted. Charge the battery using the battery charger (p.27).
Memory card full	The SD Memory Card is full and no more images can be saved. Insert a new SD Memory Card or delete unwanted images (p.33, p.132). Change the recorded pixels or quality level of recorded images and try again (p.144).
Memory card error	Shooting and playback are impossible due to a problem with the SD Memory Card. You may be able to display or copy the images on the card using a computer.
Card not formatted	The SD Memory Card you have inserted is unformatted or has been formatted on a computer or other device and is not compatible with this camera. Format the SD Memory Card in the camera (p.174).
Card locked	The SD Memory Card is write-protected (p.35).
Compression error	This message occurs when the camera fails to compress an image. Change the quality level or recorded pixels of the image and try shooting or saving it again.
No image/sound	There are no image/sound files on the SD Memory Card.
Movie recording stopped	This message appears when the internal temperature of the camera has exceeded normal operating limits while recording a movie.
Deleting	This message appears when deleting an image or sound file.
Camera cannot play this image and sound	You are trying to play back an image or sound in a format not supported by this camera. You may be able to play it back on another brand of camera or on your computer.
Image folder could not be created	The largest file number (9999) has been assigned to an image in the largest folder number (999) and no more images can be saved. Insert a new SD Memory Card or format the card (p.174).
Protected	The image or sound file you are trying to delete is protected.

Message	Description
Data being recorded	This message appears when you try to switch to  mode while an image is still being recorded, or when the protect setting or DPOF setting is being changed. It disappears after the image is recorded or the setting is changed.
Data being processed	This message appears when the camera takes more than five seconds to display an image due to image processing, or when the SD Memory Card or the built-in memory is being formatted.
Built-in memory full	Displayed if the built-in memory is full when saving a file.
No image to be processed	Displayed when there are no images or sound files.
This image/sound cannot be processed	Displayed for files that cannot be processed.
No card in the camera	Displayed when no SD Memory Card is inserted.
The built-in memory is not enough to copy images/sounds	Displayed when there is insufficient built-in memory to perform copying.
Cannot process correctly	Displayed when Red-eye Compensation processing fails.
Display image/sound from built-in memory	Displayed when the camera enters the built-in memory display.







Messages such as the following may appear on the display when using the PictBridge function.

Message	Description
Low paper level in the printer	The paper level of the printer is low.
No paper in the printer	There is no paper in the printer.
Paper stuck in the printer	The paper is stuck in the printer.
Low ink level in the printer	The ink level of the printer is low.
No ink in the printer	There is no ink in the printer.
Printer error	An error message has been sent from the printer.
Data error	A data error message has been sent from the printer.
Connection error Check printer	Displayed when a PictBridge connection fails.
Printing now	Displayed when printing is being executed.
Printing is completed. Continue printing?	Displayed when printing completes.

Message	Description
Print Canceled	Displayed when printing is canceled.
No image to be processed	Displayed when there are no images to print.
Wrong DPOF setting	Displayed when DPOF printing cannot be performed.

# Troubleshooting

Problem	Cause	Remedy
The camera will not turn on	The battery is not installed	Check if a battery is installed. If not, install a battery.
	The battery is installed incorrectly	Check orientation of the battery. Reinsert the battery according to the ⊕ ⊖ symbols in the battery compartment (p.28).
	The battery is exhausted	Charge the battery.
No image appears on the display	The camera is connected to a computer	The display is off when the camera is connected to a computer.
	The camera is connected to a TV	The display is off when the camera is connected to a TV.
The display is hard to see	The brightness level of the display is set too dark	Adjust the brightness level in [Brightness Level] in the [Setting] menu (p.185).
	Power Saving function is on	When the Power Saving function is on, the display automatically darkens after a certain amount of time. Press a button to return to the normal brightness level. Select [Off] in [Power Saving] in the [Setting] menu to turn the Power Saving function off (p.186).
The shutter will not release	The flash is charging	Pictures cannot be taken while the flash is charging. Wait until charging is finished.
	There is no available space on the SD Memory Card or in the built-in memory	Insert an SD Memory Card with available space or delete unwanted images (p.33, 132).
	Recording	Wait until recording is finished.
The picture is dark when using the flash	The subject is too far away in a dark environment, such as a night scene	The picture becomes dark if the subject is too far away. Take pictures within the specified flash range.

Problem	Cause	Remedy
The subject is not in focus	The subject is difficult to focus on with autofocus	The camera may have difficulty in focusing on such subjects as: low contrast subjects (a white wall, a blue sky, etc.), dark subjects, finely-patterned objects, rapidly-moving objects. It is also difficult to get proper focus when shooting through a window or a net. Try shooting using the focus lock (p.59), or Manual Focus (p.92).
	The subject is not in the focusing area	Locate the desired subject in the focus frame (focusing area) in the center of the display. If it is difficult to do so, first lock the focus on the desired subject (focus lock), and then move the camera to recompose.
The flash does not discharge	The flash mode is set to  (flash off)	Set to Auto or  (Flash On) (p.89).
	The drive mode is set to  or  The focus mode is set to  The shooting mode is set to  or 	The flash does not discharge in these modes.
The USB connection with a personal computer does not function properly	The USB connection setting of the camera is set to [PictBridge]	Set the USB connection setting to [PC] (p.183).
The USB connection with a printer does not function properly	The USB connection setting of the camera is set to [PC]	Set the USB connection setting to [PictBridge] (p.183).



Very occasionally, static electricity may cause camera malfunction. In this case, remove the battery and install it again. If the camera is then working properly, normal condition is restored and you can continue using the camera.



# Default Settings

The table below lists the factory default settings.  
The meaning of the indications for menu items with a default setting is explained below.

## Last Memory Setting



- Yes : The current setting (last memory) is saved when the camera is turned off.  
No : The setting returns to the default setting when the camera is turned off.  
\* : The setting depends on the [Memory] setting (p.115).  
— : N/A

## Reset Setting



- Yes : The setting returns to the default setting with the Reset function (p.190).  
No : The setting is saved even after reset.  
— : N/A

## ● [📷 Rec.Mode] Menu Items

Item	Default Setting	Last Memory Setting	Reset Setting	Page	
Recorded Pixels	(3648×2736)	Yes	Yes	p.94	
Quality Level	★★ (Better)	Yes	Yes	p.96	
White Balance	<b>AWB</b> (Auto)	*	Yes	p.98	
Focusing Area	(Multiple)	Yes	Yes	p.93	
AE Metering	(Multi-segment)	*	Yes	p.100	
Sensitivity	Auto	*	Yes	p.101	
EV Compensation	±0.0	*	Yes	p.97	
Movie	Recorded Pixels	(640×480)	Yes	Yes	p.111
	Frame Rate	30fps	Yes	Yes	p.112
	Color Mode	Full Color	Yes	Yes	p.113
	Movie SR	<input checked="" type="checkbox"/> (On)	Yes	Yes	p.114
Blink Detection	<input checked="" type="checkbox"/> (On)	Yes	Yes	p.102	
Digital Zoom	<input checked="" type="checkbox"/> (On)	*	Yes	p.70	
Instant Review	1 sec	Yes	Yes	p.103	

Item		Default Setting	Last Memory Setting	Reset Setting	Page
Memory	Face Priority	<input type="checkbox"/> (Off)	Yes	Yes	p.63
	Flash Mode	<input checked="" type="checkbox"/> (On)	Yes	Yes	p.89
	Drive Mode	<input type="checkbox"/> (Off)	Yes	Yes	p.81 p.82
	Focus Mode	<input type="checkbox"/> (Off)	Yes	Yes	p.91
	Zoom Position	<input type="checkbox"/> (Off)	Yes	Yes	p.69
	MF Position	<input type="checkbox"/> (Off)	Yes	Yes	p.92
	White Balance	<input type="checkbox"/> (Off)	Yes	Yes	p.98
	Sensitivity	<input type="checkbox"/> (Off)	Yes	Yes	p.101
	EV Compensation	<input type="checkbox"/> (Off)	Yes	Yes	p.97
	AE Metering	<input type="checkbox"/> (Off)	Yes	Yes	p.100
	Digital Zoom	<input checked="" type="checkbox"/> (On)	Yes	Yes	p.70
	DISPLAY	<input type="checkbox"/> (Off)	Yes	Yes	p.18
File No.	<input checked="" type="checkbox"/> (On)	Yes	Yes	—	
Green Button		Green Mode	Yes	Yes	p.107
Sharpness		 (Normal)	Yes	Yes	p.104
Saturation		 (Normal)	Yes	Yes	p.105
Contrast		 (Normal)	Yes	Yes	p.105
Date Imprint		Off	Yes	Yes	p.106

















● [  Setting ] Menu Items

Item		Default Setting	LastMemory Setting	Reset Setting	Page
Format		Cancel	—	—	p.174
Sound	Operation Volume	3	Yes	Yes	p.175
	Playback Volume	3	Yes	Yes	
	Start-up Sound	1	Yes	Yes	
	Shutter Sound	1	Yes	Yes	
	Operation Sound	1	Yes	Yes	
	Self-timer Sound	1	Yes	Yes	
Date Adjust	Date Style (date)	According to initial setting	Yes	No	p.43 p.176
	Date Style (time)	24h	Yes	No	
	Date	1/1/2008	Yes	No	
	Time	According to initial setting	Yes	No	
World Time	Select time	Same as  Hometown	Yes	Yes	p.179
	Destination (City)	According to initial setting	Yes	No	
	Destination (DST)	<input type="checkbox"/> (Off)	Yes	No	
	Hometown (City)	According to initial setting	Yes	No	
	Hometown (DST)	<input type="checkbox"/> (Off)	Yes	No	
Language/言語		According to initial setting	Yes	No	p.39 p.181
Folder Name		Date	Yes	Yes	p.182
USB Connection		PC	Yes	Yes	p.183
Video Out		According to initial setting	Yes	No	p.184
Brightness Level			Yes	Yes	p.185
Power Saving		5 sec	Yes	Yes	p.186
Auto Power Off		3 min	Yes	Yes	p.187
Quick Zoom		<input type="checkbox"/> (Off)	Yes	Yes	p.188
Reset		Cancel	—	—	p.190

## ● Playback Mode Palette Items

Item		Default Setting	Last Memory Setting	Reset Setting	Page
Digital SR		—	—	—	p.130
Slideshow	Interval	3 sec	Yes	Yes	p.124
	Screen Effect	Wipe	Yes	Yes	
	Sound Effect	<input checked="" type="checkbox"/> (On)	Yes	Yes	
Resize	Recorded Pixels	Depending on the picture taken	—	—	p.144
	Quality Level	Depending on the picture taken	—	—	
Cropping		Depending on the picture taken	—	—	p.145
Image/Sound Copy		Built-in memory → SD Memory Card	—	—	p.156
Image Rotation		Normal	—	—	p.126
Digital Filter		B&W	No	—	p.147
Movie Edit	Save as Still image	—	—	—	p.154
	Divide Movies	—	—	—	
Frame Composite		Default1	Yes	Yes	p.151
Red-eye Compensation		—	—	—	p.150
Voice Memo		—	—	—	p.171
Protect	Single Image/ Sound	Depending on the recorded image/sound	—	—	p.138
	All Images/Sounds	Depending on the recorded image/sound	—	—	
DPOF	Single Image	Copies: 0	—	—	p.158
	All Images	Date: □ (Off)	—	—	
Image Recovery		Cancel	—	—	p.137
Start-up Screen		Off	Yes	Yes	p.189

## ● Key Operation

Item	Function	Default Setting	LastMemory Setting	Reset Setting	Page
 button	Operation Mode	 mode	—	—	—
Zoom/     button	Zoom Position	Full wide-angle	*	No	p.69
Four-way controller	 Drive Mode	 (Standard)	*	Yes	p.81 p.82
	 Shooting Mode	 (Auto Picture)	Yes	Yes	p.60
	 Flash Mode	 (Auto)	*	Yes	p.89
	 Focus Mode	<b>AF</b> (Standard)	*	Yes	p.91
<b>MENU</b> button	Menu Display	Capture mode:  Rec.Mode] menu Playback mode:  Setting] menu	—	—	p.51
<b>OK/DISPLAY</b> button	Information Display	Normal	*	Yes	p.18
 button	Operation Mode	Face Priority On	*	Yes	p.63

# List of World Time Cities

**City:** indicates cities that can be set as either the Initial Setting (p.39) or the World Time (p.179).  
**Video Output Format:** indicates the video output format of the city set as the Initial Setting.

Region	City	Video Output Format	Region	City	Video Output Format
North America	Honolulu	NTSC	Africa/ West Asia	Istanbul	PAL
	Anchorage	NTSC		Cairo	PAL
	Vancouver	NTSC		Jerusalem	PAL
	San Francisco	NTSC		Nairobi	PAL
	Los Angeles	NTSC		Jeddah	PAL
	Calgary	NTSC		Tehran	PAL
	Denver	NTSC		Dubai	PAL
	Chicago	NTSC		Karachi	PAL
	Miami	NTSC		Kabul	PAL
	Toronto	NTSC		Male	PAL
	New York	NTSC		Delhi	PAL
Halifax	NTSC	Colombo		PAL	
Central and South America	Mexico City	NTSC		Kathmandu	PAL
	Lima	NTSC		Dacca	PAL
	Santiago	NTSC	East Asia	Yangon	NTSC
	Caracas	NTSC		Bangkok	PAL
	Buenos Aires	PAL		Kuala Lumpur	PAL
	Sao Paulo	PAL		Vientiane	PAL
Rio de Janeiro	NTSC	Singapore		PAL	
Europe	Lisbon	PAL		Phnom Penh	PAL
	Madrid	PAL		Ho Chi Minh	PAL
	London	PAL		Jakarta	PAL
	Paris	PAL		Hong Kong	PAL
	Amsterdam	PAL		Beijing	PAL
	Milan	PAL		Shanghai	PAL
	Rome	PAL		Manila	NTSC
	Copenhagen	PAL		Taipei	NTSC
	Berlin	PAL		Seoul	NTSC
	Prague	PAL	Tokyo	NTSC	
	Stockholm	PAL	Guam	NTSC	
	Budapest	PAL	Oceania	Perth	PAL
	Warsaw	PAL		Adelaide	PAL
	Athens	PAL		Sydney	PAL
	Helsinki	PAL		Noumea	PAL
	Moscow	PAL		Wellington	PAL
Africa/ West Asia	Dakar	PAL		Auckland	PAL
	Algiers	PAL		Pago Pago	NTSC
	Johannesburg	PAL			

# Optional Accessories

A number of dedicated accessories are available for this camera. Products marked with an asterisk (\*) are the same as those supplied with the camera.

- **Power supply**

- Rechargeable lithium-ion battery D-LI78 (\*)**

- Battery charger kit K-BC78 (\*)**

- (Battery charger D-BC78, AC plug cord)

- AC adapter kit K-AC78**

- (AC adapter D-AC64, DC coupler D-DC78, AC plug cord)

- The battery charger and AC plug cord are only sold as a set.

- **Cable**

- USB cable I-USB7 (\*)**

- AV cable I-AVC7 (\*)**

- **Strap**

- O-ST51 (\*)**

- O-ST24**                      Genuine leather strap

- O-ST8**                         Silver chain strap

- O-ST30/O-ST81**      Waterproof strap

- **Camera case**

- O-CC78**

- O-CC79**

- O-CC81**

# Main Specifications

Type	Fully automatic compact digital still camera with built-in zoom lens	
Number of Effective Pixels	Approx. 10 megapixels	
Image Sensor	1/2.3 inch CCD	
Number of Recorded Pixels	Still	<b>10M</b> (3648×2736 pixels), <b>7M</b> (3072×2304 pixels) <b>5M</b> (2592×1944 pixels), <b>3M</b> (2048×1536 pixels) <b>2.1M</b> (16:9) (1920×1080 pixels), <b>1024</b> (1024×768 pixels) <b>640</b> (640×480 pixels)
		<ul style="list-style-type: none"> <li>* Fixed at <b>3M</b> (2048×1536) in Half-length Portrait mode.</li> <li>* Fixed at <b>5M</b> (2592×1944) in Digital SR mode.</li> <li>* Fixed at <b>3M</b> (2048×1536) in Frame Composite mode.</li> <li>* Fixed at <b>5M</b> (2592×1944) in Digital Wide mode, however, the first frame uses <b>3M</b> (2048×1536).</li> <li>* Fixed at <b>2M</b> (1600×1200) for one frame in Digital Panorama mode.</li> <li>* Fixed at <b>5M</b> (2592×1944) when the sensitivity is set to 3200 or 6400.</li> <li>* Fixed at <b>5M</b> (2592×1944) in HS Cont. Shooting mode.</li> </ul>
	Movie	<b>640</b> (640×480 pixels), <b>320</b> (320×240 pixels)
Sensitivity (Standard Output Sensitivity)	Auto, Fixed (ISO 64 - 6400) * The sensitivity is fixed at Auto (64-6400) in the Digital SR (Shake Reduction).	
File Format	Still	JPEG (Exif 2.2), DCF 2.0, DPOF, PictBridge, PRINT Image Matching III
	Movie	AVI (Motion JPEG), approx. 30fps/15fps, PCM system, monaural sound, full color/sepia/black and white, Movie SR (Movie Shake Reduction)
	Sound	Voice memo, voice recording: WAVE (PCM) system, monaural
Quality Level	Still	★★★ "Best", ★★ "Better", ★ "Good"
Storage Media	Built-in memory (approx. 36.5 MB), SD Memory Card, SDHC Memory Card	



## Approximate Image Storage Capacity and Recording Time Still Pictures

	★★★ (Best)		★★ (Better)		★ (Good)	
	Built-in Memory	512 MB	Built-in Memory	512 MB	Built-in Memory	512 MB
<b>10M</b> 3648×2736	9 pictures	117 pictures	17 pictures	228 pictures	24 pictures	321 pictures
<b>7M</b> 3072×2304	12 pictures	157 pictures	22 pictures	287 pictures	29 pictures	377 pictures
<b>5M</b> 2592×1944	14 pictures	188 pictures	27 pictures	355 pictures	38 pictures	503 pictures
<b>3M</b> 2048×1536	22 pictures	293 pictures	44 pictures	570 pictures	63 pictures	816 pictures
<b>2.1M</b> 1920×1080	32 pictures	425 pictures	64 pictures	839 pictures	86 pictures	1119 pictures
<b>1024</b> 1024× 768	75 pictures	974 pictures	122 pictures	1590 pictures	155 pictures	2014 pictures
<b>640</b> 640× 480	155 pictures	2014 pictures	233 pictures	3022 pictures	259 pictures	3358 pictures

- The image storage capacity is for reference only. The actual image storage capacity may vary depending on the SD Memory Card and the subject.

## Movie/Sound

	30fps		15fps		Sound	
	Built-in Memory	512 MB	Built-in Memory	512 MB	Built-in Memory	512 MB
<b>640</b> 640×480	34 sec.	7 min. 31 sec.	1 min. 08 sec.	14 min. 48 sec.	28 min. 54 sec.	6 hr. 14 min. 15 sec.
<b>320</b> 320×240	55 sec.	11 min. 59 sec.	1 min. 46 sec.	22 min. 53 sec.		

- The above figures are based on our standard shooting conditions and may vary depending on the subject, shooting conditions and type of the SD Memory Card used.
- Recording can continue until the built-in memory or the SD Memory Card is full, or the size of the recorded movie reaches 2 GB (when using an SDHC card). If recording stops at 2 GB, start recording again to continue to record the rest of the movie in blocks of 2 GB.

White Balance	Auto, Daylight, Shade, Tungsten Light, Fluorescent Light, Manual	
Lens	Focal Length	6.3 mm - 31.5 mm (approx. 36 mm - 180 mm in 35mm equivalent focal length)
	Aperture	F3.5 (W) - F5.6 (T)
	Lens Composition	8 elements in 6 groups (4 aspherical elements)
	Zoom Type	Electrically driven
Optical Zoom	5×	
Intelligent Zoom	Approx. 5.9× at <b>7M</b> (3072×2304), Approx. 28.5× at <b>640</b> (640×480) (when combined with optical zoom)	

Digital Zoom	Max. 5.7× (combines with 5× optical zoom to give zoom magnification equivalent to 28.5×)	
Motion Blur Reduction	Still	Hi-sensitivity shake reduction mode (Digital SR)
	Movie	Movie shake reduction (Movie SR)
Display	2.5 inch LCD, approx. 230,000 dots, Wide viewing angle	
Playback modes	Single-frame, 9-frame Index, Enlargement (max. 10×, scrollable), Face Close-up Playback, Folder Display, Calendar Display, Sound Playback, Histogram Display, Bright/Dark Portion Display, Deleting Selected Images, Digital SR, Slideshow, Resize, Cropping, Image&Sound Copy, Image Rotation, Digital Filter, Movie Playback/Edit (Save as still pictures), Frame Composite, Red-eye Compensation, Voice Memo, Protect, DPOF, Image Recovery, Start-up Image Setting	
Focus Modes	Autofocus, Macro, Infinity, Pan Focus, Manual Focus	
Focus	Type	TTL contrast detection system by sensor 9-point autofocus (multiple/spot/automatic tracking AF changeable)
	Focus range (From lens face)	Standard : 0.4 m - ∞ (Wide-angle) 0.9 m - ∞ (Telephoto)
		Macro : 0.1 m - 0.5 m (Wide-angle) 0.6 m - 1.0 m (Telephoto)
	* It is possible to switch to Pan Focus, Infinity and Manual Focus.	
	* Face Recognition AF is available only while the camera recognizes the subject's face.	
Focus Lock	By half-pressing the shutter release button	
Exposure control	Metering System	Multi-segment metering, Center-weighted metering, Spot metering
	Exposure Compensation	±2 EV (can be set in 1/3 EV steps)
Face Priority	Recognition of up to 32 people's faces (up to 15 faces in the face recognition frame on the display), Smile Capture, Blink Detection	
Shooting modes	Auto Picture, Program, Night Scene, Night Scene Portrait, Half-length Portrait, Movie, Landscape, Flower, Portrait, Surf & Snow, Sport, Digital SR (Blur Reduction), Kids, Pet, Food, Fireworks, Frame Composite, Voice Recording, Natural Skin Tone, Candlelight, Text, Blog, Digital Wide, Digital Panorama, Green * Face Recognition AE is available only while the camera recognizes the subject's face.	
Digital Filters	B&W, Sepia, Red, Pink, Purple, Blue, Green, Yellow, Soft, Color extraction (Red, Green, Blue), Brightness	
Movie	Continuous	Approx. 1 second - until built-in memory or SD
	Recording Time	Memory Card is full (however, maximum size is limited to 2 GB)
Shutter Speed	1/2000 sec. - 1/4 sec., max. 4 sec. (Fireworks mode)	

Built-in Flash	Modes	Auto, Flash Off, Flash On, Auto + Red-eye, Flash On + Red-eye, Soft Flash
	Flash Range	Wide-angle: approx. 0.2 m - 4.4 m (approx. 0.66 ft - 14.44 ft) (Sensitivity: in Auto condition) Telephoto: approx. 0.6 m - 2.8 m (approx. 1.97 ft - 9.19 ft) (Sensitivity: in Auto condition)
Drive Modes	Single-frame, Self-timer (approx. 10 sec., approx. 2 sec.), Continuous, HS Cont. Shooting	
Self-timer	Electronic control type, control time: Approx. 10 sec., 2 sec.	
Time Function	World Time	75 cities (28 time zones)
Power Source	Rechargeable lithium-ion battery D-LI78, AC adapter kit (optional)	
Battery Life	Number of Recordable Images approx. 210 pictures	* Recording capacity shows approximate number of shots recorded during CIPA-compliant testing (with display on, flash used for 50% of the shots, and 23 degrees centigrade). Actual performance may vary according to operating conditions.
	Playback Time approx. 215 min.	* According to the result of in-house testing. Actual time may differ depending on usage conditions.
	Movie Recording Time approx. 80 min.	
	Sound Recording Time approx. 270 min.	
Interfaces	USB 2.0 (high-speed compatible) /PC/AV terminal	
Video Output	NTSC/PAL (monaural)	
PictBridge	Printer	PictBridge-compatible printer
	Print Modes	Print One, Print All, DPOF AUTOPRINT
	Paper Size	Card, L, 2L, Postcard, 100 mm×150 mm, 4"×6", 8"×10", Letter, 11"×17", A4, A3, printer setting
	Paper Type	★★★, ★★, ★, printer setting
	Quality	★★★, ★★, ★, printer setting
	Border Status	With/without, printer setting
Dimensions	Approx. 95 (W) × 55 (H) × 23.5 (D) mm (excluding operating or protruding parts)	
Weight	Approx. 110 g (excluding battery and SD Memory Card) Approx. 130 g (including battery and SD Memory Card)	
Accessories	Rechargeable lithium-ion battery, battery charger, AC plug cord, USB cable, AV cable, software (CD-ROM), strap, Operating Manual, PC Connection Manual, Quick Guide	

# WARRANTY POLICY

All PENTAX cameras purchased through authorized bona fide photographic distribution channels are guaranteed against defects of material or workmanship for a period of twelve months from date of purchase. Service will be rendered, and defective parts will be replaced without cost to you within that period, provided the equipment does not show evidence of impact, sand or liquid damage, mishandling, tampering, battery or chemical corrosion, operation contrary to operating instructions, or modification by an unauthorized repair shop. The manufacturer or its authorized representatives shall not be liable for any repair or alterations except those made with its written consent and shall not be liable for damages from delay or loss of use or from other indirect or consequential damages of any kind, whether caused by defective material or workmanship or otherwise; and it is expressly agreed that the liability of the manufacturer or its representatives under all guarantees or warranties, whether expressed or implied, is strictly limited to the replacement of parts as hereinbefore provided. No refunds will be made on repairs by non-authorized PENTAX service facilities.

## Procedure During 12-month Warranty Period

Any PENTAX which proves defective during the 12-month warranty period should be returned to the dealer from whom you purchased the equipment or to the manufacturer. If there is no representative of the manufacturer in your country, send the equipment to the manufacturer, with postage prepaid. In this case, it will take a considerable length of time before the equipment can be returned to you owing to the complicated customs procedures required. If the equipment is covered by warranty, repairs will be made and parts replaced free of charge, and the equipment will be returned to you upon completion of servicing. If the equipment is not covered by warranty, regular charges of the manufacturer or of its representatives will apply. Shipping charges are to be borne by the owner. If your PENTAX was purchased outside of the country where you wish to have it serviced during the warranty period, regular handling and servicing fees may be charged by the manufacturer's representatives in that country. Notwithstanding this, your PENTAX returned to the manufacturer will be serviced free of charge according to this procedure and warranty policy. In any case, however, shipping charges and customs clearance fees to be borne by the sender. To prove the date of your purchase when required, please keep the receipt or bills covering the purchase of your equipment for at least a year. Before sending your equipment for servicing, please make sure that you are sending it to the manufacturer's authorized representatives or their approved repair shops, unless you are sending it directly to the manufacturer. Always obtain a quotation for the service charge, and only after you accept the quoted service charge, instruct the service station to proceed with the servicing.

- This warranty policy does not affect the customer's statutory rights.
- The local warranty policies available from PENTAX distributors in some countries can supersede this warranty policy. Therefore, we recommend that you review the warranty card supplied with your product at the time of purchase, or contact the PENTAX distributor in your country for more information and to receive a copy of the warranty policy.



The CE Mark is a Directive conformity mark of the European Union.

## **For customers in USA**

### **STATEMENT OF FCC COMPLIANCE**

This device complies with Part 15 of the FCC Rules. Operation is subject to the following two conditions: (1) This device may not cause harmful interference, and (2) this device must accept any interference received, including interference that may cause undesired operation.

Changes or modifications not approved by the party responsible for compliance could void the user's authority to operate the equipment.

This equipment has been tested and found to comply with the limits for a Class B digital device, pursuant to part 15 of the FCC Rules.

These limits are designed to provide reasonable protection against harmful interference in a residential installation. This equipment generates, uses and can radiate frequency energy and, if not installed and used in accordance with the instructions, may cause harmful interference to radio communications. However, there is no guarantee that interference will not occur in a particular installation.

If this equipment does cause harmful interference to radio or television reception, which can be determined by turning the equipment off and on, the user is encouraged to try to correct the interference by one or more of the following measures:

- Reorient or relocate the receiving antenna.  
Increase the separation between the equipment and receiver.  
Connect the equipment into an outlet on a circuit different from that to which the receiver is connected.
- \* Consult the dealer or an experienced radio/TV technician for help.

## **For customers in Canada**

This Class B digital apparatus complies with Canadian ICES-003.

### **Pour les utilisateurs au Canada**

Cet appareil numérique de la classe B est conforme à la norme NMB-003 du Canada.

### **FOR CALIFORNIA, U.S.A. ONLY**

Perchlorate Material-special handling may apply. The lithium battery used in this camera contains perchlorate material, which may require special handling. See [www.dtsc.ca.gov/hazardouswaste/perchlorate](http://www.dtsc.ca.gov/hazardouswaste/perchlorate)

**Declaration of Conformity**  
According to 47CFR, Parts 2 and 15 for  
**Class B Personal Computers and Peripherals**

We: PENTAX Imaging Company  
A Division of PENTAX of America, Inc.

Located at: 600 12<sup>th</sup> Street, Suite 300  
Golden, Colorado 80401 U.S.A.  
Phone: 303-799-8000 FAX: 303-790-1131

Declare under sole responsibility that the product identified herein complies with 47CFR Parts 2 and 15 of the FCC rules as a Class B digital device. Each product marketed is identical to the representative unit tested and found to be compliant with the standards. Records maintained continue to reflect the equipment being produced can be expected to be within the variation accepted, due to quantity production and testing on the statistical basis as required by 47CFR §2.909. Operation is subject to the following two conditions: (1) This device may not cause harmful interference, and (2) This device must accept any interference received, including interference that may cause undesired operation. The above named party is responsible for ensuring that the equipment complies with the standards of 47CFR §15.101 to §15.109.

Product Name: PENTAX Digital Still Camera

Model Number: Optio M60

Contact person: Customer Service Manager

Date and Place: August, 2008, Colorado

## Information on disposal for users



### 1. In the European Union

If your product is marked with this symbol, it means that used electrical/electronic products should not be mixed with general household waste. There exists a separate collection system for these products.

Used electric/electronic equipment must be treated separately and in accordance with legislation that requires proper treatment, recovery and recycling of these products. Following the implementation by member states, private households within the EU states may return their used electrical/electronic equipments to designated collection facilities free of charge\*. In some countries your local retailer may also take back your old product free of charge if you purchase a similar new one.

\*Please contact your local authority for further details.

By disposing of this product correctly you will help ensure that the waste undergoes the necessary treatment, recovery and recycling and thus prevent potential negative effects on the environment and human health which could otherwise arise due to inappropriate waste handling.

### 2. In other countries outside the EU

































If you wish to discard this product, please contact your local authorities and ask for the correct method of disposal.







For Switzerland: Used electrical/electronic equipment can be returned free of charge to the dealer, even when you don't purchase a new product. Further collection facilities are listed on the home page of [www.swico.ch](http://www.swico.ch) or [www.sens.ch](http://www.sens.ch).





# Memo

## Symbols

 mode .....	10, 50
 mode .....	10, 50
 button .....	47, 49
 button .....	46, 48
[  Rec.Mode]	
menu .....	55, 199
[  Setting] menu .....	56, 201
 Green Mode .....	67
 Delete .....	118, 132
 Tele .....	69
 Wide .....	69
 Magnify .....	128
 Nine-image display .....	120
 Self-timer .....	81
 Continuous Shooting .....	82
 HS Cont. Shooting .....	82
 Auto Picture .....	65
 Program .....	66
 Night Scene .....	71
 Night Scene Portrait .....	71
 Half-length Portrait .....	73
 Movie .....	111
 Landscape .....	62
 Flower .....	62
 Portrait .....	73
 Surf & Snow .....	76
 Sport .....	76
 Digital SR (Blur Reduction) .....	71
 Digital SR (Camera Shake Reduction) .....	130
 Kids .....	74
 Pet .....	75
 Food .....	62
 Fireworks .....	71
 Frame Composite .....	79

 Voice Recording .....	168
 Natural Skin Tone .....	73
 Candlelight .....	71
 Text .....	78
 Blog .....	63
 Digital Wide .....	84
 Digital Panorama .....	86

## A





AC adapter .....	31
Adding sound (Voice Memo) .....	171
AE metering .....	100
Auto + Red-eye  .....	89
Auto <b>AWB</b> .....	98
Auto Picture Mode .....	65
Auto Power Off .....	187
Auto  .....	89
Automatic Tracking AF .....	63, 76, 93
AV cable .....	141
AV equipment .....	141

## B

B&W .....	113, 147
Basic mode .....	67
Battery level indicator .....	30
Blink Detection .....	60, 102
Blog mode .....	63
Blur Reduction Mode .....	71
Bright portions .....	24
Brightness Level .....	185
Built-in memory .....	156
Built-in memory display .....	50

## C

Calendar display .....	121
------------------------	-----





Camera shake .....	18, 70, 130
Candlelight Mode .....	71
Capture Mode Palette .....	60
Center-weighted metering  .....	100
Changing volume ....	170, 175
Charging a battery .....	27
Checking the Memory .....	
Card .....	37
City name .....	204
Color Mode .....	113
Compression rate .....	96
Computer .....	184
Connecting to a printer ....	161
Connecting to a TV .....	141
Continuous Shooting  .....	82
Contrast .....	105
Copy .....	156
Cropping .....	145
<b>D</b>	
Dark portions .....	24
Date and time setting .....	43, 176
Date Imprint .....	106
Daylight  .....	98
Daylight saving time .....	42
Default setting .....	39, 199
Delete  .....	118, 132
Deleting sounds .....	133
Destination .....	179
Digital Filter .....	147
Digital SR (Blur Reduction) .....	71
Digital SR (Camera Shake Reduction) .....	130
Digital Wide Mode .....	84
Digital Zoom .....	69, 70
Display brightness .....	185

Display Language .....	181
Dividing movies .....	155
DPOF printing .....	165
DPOF settings .....	158
Drive mode .....	81, 82

## E







Editing Movies .....	154
Error messages .....	194
Exposure setting .....	97







## F

Face close-up playback ...	129
Face Recognition .....	63
File number .....	115
Filters .....	147
Fireworks Mode .....	71
Flash Mode .....	89
Flash Off  .....	89
Flash On + Red-eye  .....	89
Flash On  .....	89
Flower mode .....	62
Fluores. Light  .....	98
Focus Mode .....	91
Focusing .....	91
Focusing Area .....	93
Folder display .....	121
Folder Name .....	182
Food mode .....	62
Format .....	174
Four-way controller .....	47, 49
Frame Composite .....	79, 151
Frame Rate .....	112

## G

Green Button .....	47, 49, 107
Green Mode .....	67
Guide Indications .....	23

- H**  
 Half-length Portrait  
 Mode ..... 73  
 Histogram ..... 23  
 Hometown ..... 42, 179  
 HS Cont. Shooting  ..... 82
- I**  
 Image Recovery ..... 137  
 Image Storage  
 Capacity ..... 207  
 Infinity ▲ ..... 91  
 Info Display ..... 20  
 Installing a battery ..... 28  
 Instant Review ..... 60, 103  
 Intelligent zoom ..... 69
- K**  
 Kids Mode ..... 74
- L**  
 Landscape mode ..... 62  
 Language setting ..... 39, 181
- M**  
 Macro  ..... 91  
 Magnify  ..... 128  
 Manual Focus **MF** ..... 91  
 Manual  ..... 98  
 Memory ..... 115  
**MENU** button ..... 47, 49  
 Movie ..... 109  
 Movie SR (Movie Shake Reduction) Function ..... 114  
 Multi-segment  
 metering  ..... 100
- N**  
 Natural Skin Tone Mode .... 73  
 Night Scene Mode ..... 71  
 Night Scene Portrait  
 Mode ..... 71  
 Nine-image display  ..... 120  
 NTSC ..... 184  
 Number of pixels ..... 94
- O**  
**OK/DISPLAY** button ...47, 49  
 Opening screen ..... 189  
 Operating the Menus ..... 51  
 Optional accessory ..... 205
- P**  
 PAL ..... 184  
 Pan Focus **PF** ..... 91  
 Panoramic Pictures ..... 86  
 PC ..... 184  
 Pet Mode ..... 75  
 Photo processing lab ..... 158  
 PictBridge ..... 161, 184  
 Playback  
 ..... 118, 119, 170, 172  
 Playback Mode ..... 38  
 Playback Mode  
 Palette ..... 122, 202  
 Playing back movies ..... 119  
 Playing back sounds ..... 170  
 Portrait Mode ..... 73  
 Power Saving ..... 186  
 Power switch ..... 37, 46, 48  
 Press fully  
 (shutter release button) ..... 59  
 Press halfway  
 (shutter release button) ..... 59  
 Printing ..... 161  
 Program Mode ..... 66  
 Protect  ..... 138
- Q**  
 Quality Level ..... 96  
 Quick Zoom ..... 188

<b>R</b>	
Rec.Mode Menu .....	55, 199
Recorded Pixels .....	94, 111
Recording movies .....	109
Recording sounds .....	168
Recovering images .....	137
Red-eye Compensation ...	150
Red-eye reduction  .....	89
Registering menu items ...	107
Reset .....	190
Resize .....	144
Rotating .....	126
<b>S</b>	
Saturation .....	105
Saving as still picture (movie) .....	155
Saving pictures by date ...	182
Saving settings .....	115
Screen Effect .....	125
SD Memory Card .....	33
Select time .....	180
Self-timer  .....	81
Sensitivity .....	101
Sepia .....	113, 147
Setting Menu .....	56, 201
Shade  .....	98
Sharpness .....	104
Shooting information .....	19
Shooting Mode .....	60
Shutter release button .....	46, 48, 59
Slideshow .....	124
Smile Capture .....	63
Soft Flash  .....	89
Sound settings .....	175
Sound types .....	176
Specifications .....	206
Sport Mode .....	76
Spot AE metering  .....	100
Standard <b>AF</b> .....	91
Start-up screen .....	189
Strap .....	26
Surf & Snow Mode .....	76
<b>T</b>	
Text Mode .....	78
Time imprint .....	106
Transfer mode .....	183
Tungsten Light  .....	98
TV .....	141
<b>U</b>	
USB connection mode ....	183
<b>V</b>	
Video output format .....	184
Voice Memo .....	171
Voice Recording Mode ....	168
<b>W</b>	
White Balance .....	98
World Time .....	179
<b>Z</b>	
Zoom /  .....	69, 84
Zoom button .....	46, 48

# Memo

# Memo

<b>HOYA CORPORATION</b> <b>PENTAX Imaging Systems Division</b>	2-36-9, Maeno-cho, Itabashi-ku, Tokyo 174-8639, JAPAN ( <a href="http://www.pentax.jp">http://www.pentax.jp</a> )
<b>PENTAX Europe GmbH</b> <b>(European Headquarters)</b>	Julius-Vosseler-Strasse 104, 22527 Hamburg, GERMANY (HQ - <a href="http://www.pentaxeurope.com">http://www.pentaxeurope.com</a> ) (Germany - <a href="http://www.pentax.de">http://www.pentax.de</a> )
<b>PENTAX U.K. Limited</b>	PENTAX House, Heron Drive, Langley, Slough, Berks SL3 8PN, U.K. ( <a href="http://www.pentax.uk">http://www.pentax.uk</a> )
<b>PENTAX France S.A.S.</b>	112 Quai de Bezons, B.P. 204, 95106 Argenteuil Cedex, FRANCE ( <a href="http://www.pentax.fr">http://www.pentax.fr</a> )
<b>PENTAX Italia S.r.l.</b>	Via Dione Cassio 15, 20138 Milano, ITALY ( <a href="http://www.pentaxitalia.it">http://www.pentaxitalia.it</a> )
<b>PENTAX (Schweiz) AG</b>	Widenholzstrasse 1, 8304 Wallisellen, Postfach 367, 8305 Dietlikon, SWITZERLAND ( <a href="http://www.pentax.ch">http://www.pentax.ch</a> )
<b>PENTAX Europe GmbH</b> <b>(Tyskland) Filial Sverige</b>	Box 650, 75127 Uppsala, SWEDEN ( <a href="http://www.pentax.se">http://www.pentax.se</a> )
<b>PENTAX Imaging Company</b> <b>A Division of PENTAX of America, Inc.</b>	(Headquarters) 600 12th Street, Suite 300 Golden, Colorado 80401, U.S.A. (PENTAX Service Department) 12000 Zuni Street, Suite 100B Westminster, Colorado 80234, U.S.A. ( <a href="http://www.pentaximaging.com">http://www.pentaximaging.com</a> )
<b>PENTAX Canada Inc.</b>	1770 Argentia Road Mississauga, Ontario L5N 3S7, CANADA ( <a href="http://www.pentax.ca">http://www.pentax.ca</a> )
<b>PENTAX Trading</b> <b>(SHANGHAI) Limited</b>	23D, Jun Yao International Plaza, 789 Zhaojiabang Road, Xu Hui District, Shanghai, 200032 CHINA ( <a href="http://www.pentax.com.cn">http://www.pentax.com.cn</a> )

<http://www.pentax.jp/english>

- Specifications and external dimensions are subject to change without notice.