

**ELECTRONICS
ILLUSTRATED**

RADIO REPAIR

By Robert Hertzberg

How To Fix...

- * AC-DC Sets
- * Transistor Portables
- * Solid State Table Models
- * Multi-Band Receivers
- * Auto Radios
- * FM Sets



633

A

**FAWCETT
BOOK**

95¢



BUILD YOUR OWN BOAT AND SAVE!

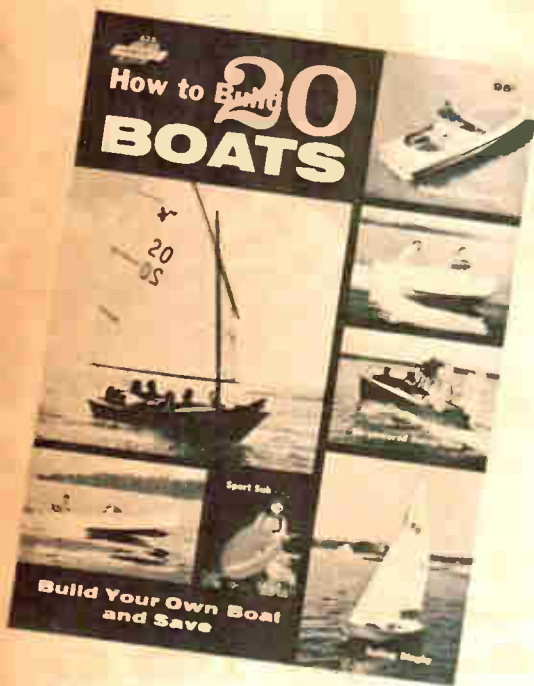

- Cruisers and Auxiliary Sailers
- Ketches, Catboats and Catamarans
- Inboard and Outboard Speedboats
- Skiffs, Prams and Novelty Craft

Only 95¢

At leading newsstands, drug stores, supermarkets—wherever magazines are sold

To order send 95¢ plus 10¢ mailing charge to FAWCETT BOOKS, Fawcett Publications, Inc., Greenwich, Connecticut. 06830. Specify FB No. 628.

Let I.C.S. equip you for success in radio-TV-electronics—

with professional equipment!



Brand-new "Electronic Laboratory," now being offered for the first time, can help you land in this big money-making field—FAST!

Here's an opportunity for you to turn spare time into cold cash, or begin a whole new career—in a field where the rewards have never been greater. And you *don't* need previous experience to do it!

International Correspondence Schools has just developed a new I.C.S. Electronic Laboratory you can construct in your own home. Includes series of training kits, plus the new I.C.S. VTVM—the professional quality vacuum tube voltmeter shown here. With it comes complete course instruction combining all the fundamentals with practical knowledge you can apply at once. And best of all, you build your own professional test instrument!

I.C.S. instruction gets you going with equipment you can really use!

A famous manufacturer of nationally known electronic testing equipment worked closely with I.C.S. to develop the Electronic Laboratory and the VTVM itself. Everything you get is geared to increase your skill and knowledge step by step. Until finally, you've completed a precision testing

unit you can use for practically any kind of experimentation, design or servicing work.

Here's how I.C.S. instruction works. You begin with basic study lessons. Texts are clearly worded and easy to follow. At the same time, you "act out" what you learn with simple experiments. Then, in 3 easy stages, you assemble your own precision testing unit. Throughout, your instructor gives you expert, professional help. You learn at home, in spare time, as fast as ability permits.

Coupon brings full details on your future in this fast-growing field!

Make up your mind right now to find out how I.C.S. training in Radio-TV-Electronics can pay off for *you*. See how it can help you cash in on the tremendous demand for men skilled in installation, maintenance and servicing of radios, TV sets, hi-fis, computers, automation systems and a host of other space-age devices. Clip and mail the coupon below. You'll receive 3 valuable *free* booklets—including sample lesson. They'll show how you can land in this big-money field *fast!*

Coupon brings 3 valuable FREE booklets. MAIL IT TODAY!

INTERNATIONAL CORRESPONDENCE SCHOOLS I C S

Dept. 34049C, Scranton, Penna. 18515

(In Hawaii: P.O. Box 418, Honolulu. In Canada: I.C.S. Canadian, Ltd. In other countries: I.C.S. World, Ltd.)

Please rush me your new 64-page booklet "ElectronICS" which answers the most often-asked questions about preparing for an electronics career. Also send me "How to Succeed," and a sample I.C.S. lesson. I have indicated my field of interest below.

- | | | | | |
|---|---|---|---|---|
| <input type="checkbox"/> Electronic Fundamentals | <input type="checkbox"/> Hi-Fi Stereo & Sound Systems | <input type="checkbox"/> Electronic Principles for Automation | <input type="checkbox"/> Industrial Electronics Engineering | <input type="checkbox"/> Industrial Electronics Telephony |
| <input type="checkbox"/> Electronic Instrumentation | <input type="checkbox"/> General Electronics | <input type="checkbox"/> Semiconductor-Transistor Circuits | <input type="checkbox"/> FCC Radiotelephone Licenses | <input type="checkbox"/> Other (please specify) |
| <input type="checkbox"/> Computer Fundamentals | <input type="checkbox"/> Electronics Technician | | | |
| <input type="checkbox"/> Radio-TV Servicing | | | | |

Name _____ Age _____

Address _____

City _____ State _____ Zip Code _____

Occupation _____ Employed by _____

Working Hours _____ A.M. to _____ P.M. Convenient payment plan _____ Training Programs for Industry _____

I am a member of U.S. Armed Forces. Send me facts about special low rates.

RADIO REPAIR

By Robert Hertzberg

A FAWCETT BOOK • NUMBER 633
 LARRY EISINGER • EDITOR-IN-CHIEF
 GEORGE TILTON • MANAGING EDITOR
 SILVIO LEMBO • ART EDITOR
 HAROLD E. PRICE • ASSOC. ART EDITOR

W. H. Fawcett, Jr. President
 Roger Fawcett General Manager
 Gordon Fawcett Secretary-Treasurer
 Roscoe K. Fawcett Circulation Director
 Donald P. Hanson Assistant General Manager
 George H. Allen Vice President
 Ralph Daigh Vice President
 George H. Carl Production Director
 Al Allard Art Director
 Ralph Mattison Associate Art Director
 Annette C. Packer Production Manager

FRANK BOWERS EDITOR

STAFF ARTISTS

Mike Gaynor • John Selvaggio
 Richard Rhodes • Herbert Jonas
 Alex Santiago • Paul Howard
 Mel Skriloff • Bill Kuch

Catherine S. Carr Production Editor
 Claire Herman Assistant Production Editor

RADIO REPAIR, Fawcett Book 633 is published by Fawcett Publications, Inc., Greenwich, Conn. Editorial and Advertising Offices: 67 West 44th Street, New York, New York 10036. General Offices: Fawcett Building, Greenwich, Connecticut 06830. Printed in U.S.A. Copyright © 1967, by Fawcett Publications, Inc. RADIO REPAIR is registered in the U.S. Patent Office.

Cover Photos by Grayson Tewksbury, Fawcett Photo Studio

Printed by Fawcett-Haynes Printing Corp., Louisville, Ky.

Fawcett Publications, Inc., is a member of American Book Publishers Council, Inc.

CONTENTS

Problems of Interference 4
 The Tools for the Job 8
 AC-DC Sets 10
 Straight AC Sets 34
 Tubes and Tube Testing 46
 The VOM Is For Testing 52
 Transistor Portables 60
 How Transistors Work 74
 Solid-State Table Sets 76
 FM Sets 82
 Multi-Band Receivers 92
 Auto Radio Sets 98
 Tips on Soldering 104
 How to Buy Radio Parts 106
 Resistor and Capacitor Chart 108
 Tube and Transistor Data 110
 Private Listeners 111
 Symbols Used in Schematic Diagrams . . 112

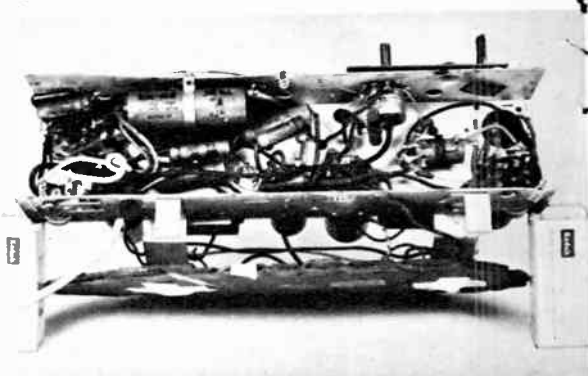

BUILD 20 RADIO

CIRCUITS AT HOME

with the New Improved

PROGRESSIVE RADIO "EDU-KIT"®

A Practical Home Radio Course

Now Includes

- ★ 12 RECEIVERS
- ★ 3 TRANSMITTERS
- ★ SQ. WAVE GENERATOR
- ★ SIGNAL TRACER
- ★ AMPLIFIER
- ★ SIGNAL INJECTOR
- ★ CODE OSCILLATOR

- ★ No Knowledge of Radio Necessary
- ★ No Additional Parts or Tools Needed
- ★ EXCELLENT BACKGROUND FOR TV
- ★ SCHOOL INQUIRIES INVITED
- ★ Sold In 79 Countries

\$26.95



Reg. U.S. Pat. Off.

Training Electronics Technicians Since 1948

YOU DON'T HAVE TO SPEND HUNDREDS OF DOLLARS FOR A RADIO COURSE

The "Edu-Kit" offers you an outstanding PRACTICAL HOME RADIO COURSE at a rock-bottom price. Our Kit is designed to train Radio & Electronics Technicians, making use of the most modern methods of home training. You will learn radio theory, construction practice and servicing. THIS IS A COMPLETE RADIO COURSE IN EVERY DETAIL. You will learn how to build radios, using regular schematics; how to wire and solder in a professional manner; how to service radios; and how to work with the standard type of punched metal chassis as well as the latest development of Printed Circuit chassis.

You will learn the basic principles of radio. You will construct, study and work with RF and AF amplifiers and oscillators, detectors, receivers, test equipment. You will learn and practice code, using the Progressive Code Oscillator. You will learn and practice trouble-shooting, using the Progressive Signal Tracer, Progressive Signal Injector, Progressive Dynamic Radio & Electronics Tester, Square Wave Generator and the accompanying instructional material.

You will receive training for the Novice, Technician and General Classes of F.C.C. Radio Amateur Licenses. You will build Receiver, Transmitter, Square Wave Generator, Code Oscillator, Signal Tracer and Signal Injector circuits, and learn how to operate them. You will receive an excellent background for television, Hi-Fi and Electronics.

Absolutely no previous knowledge of radio or science is required. The "Edu-Kit" is the product of many years of teaching and engineering experience. The "Edu-Kit" will provide you with a basic education in Electronics and Radio, worth many times the low price you pay. The Signal Tracer alone is worth more than the price of the kit.

THE KIT FOR EVERYONE

You do not need the slightest background in radio or science. Whether you are interested in Radio & Electronics because you want an interesting hobby, a well paying business or a job with a future, you will find the "Edu-Kit" a worth-while investment.

Many thousands of individuals of all

ages and backgrounds have successfully used the "Edu-Kit" in more than 79 countries of the world. The "Edu-Kit" has been carefully designed, step by step, so that you cannot make a mistake. The "Edu-Kit" allows you to teach yourself at your own rate. No instructor is necessary.

PROGRESSIVE TEACHING METHOD

The Progressive Radio "Edu-Kit" is the foremost educational radio kit in the world, and is universally accepted as the standard in the field of electronics training. The "Edu-Kit" uses the modern educational principle of "Learn by Doing." Therefore you construct, learn schematics, study theory, practice trouble-shooting—all in a closely integrated program designed to give you an early-learned, thorough and interesting background in radio.

You begin by examining the various radio parts of the "Edu-Kit." You then learn the function, theory and wiring of these parts. Then you build a simple radio. With this first set you will enjoy listening to regular broadcast stations, learn theory, practice testing and trouble-shooting. Then you build a more advanced radio, learn more advanced theory and techniques. Gradually, in a progressive manner, and at your own rate, you will find yourself constructing more advanced multi-tube radio circuits, and doing work like a professional Radio Technician.

Included in the "Edu-Kit" course are Receiver, Transmitter, Code Oscillator, Signal Tracer, Square Wave Generator and Signal Injector circuits. These are not unprofessional "breadboard" experiments, but genuine radio circuits, constructed by means of professional wiring and soldering on metal chassis, plus the new method of radio construction known as "Printed Circuitry." These circuits operate on your regular AC or DC house current.

THE "EDU-KIT" IS COMPLETE

You will receive all parts and instructions necessary to build twenty different radio and electronics circuits, each guaranteed to operate. Our Kits contain tubes, tube sockets, variable, electrolytic, mica, ceramic and paper dielectric condensers, resistors, tie strips, hardware, tubing, punched metal chassis, instruction Manuals, hook-up wire, solder, selenium rectifiers, coils, volume controls and switches, etc.

In addition you receive Printed Circuit materials, including Printed Circuit chassis, special tube sockets, hardware and instructions. You also receive a useful set of tools, a professional electric soldering iron, and a self-powered Dynamic Radio and Electronics Tester. The "Edu-Kit" also includes Code Instructions and the Progressive Code Oscillator, in addition to F.C.C. Radio Amateur License training. You will also receive lessons for servicing with the Progressive Signal Tracer and the Progressive Signal Injector, a High Fidelity Guide and a Quiz Book. You receive Membership in Radio-TV Club, Free Consultation Service, Certificate of Merit and Discount Privileges. You receive all parts, tools, instructions, etc. Everything is yours to keep.

PRINTED CIRCUITRY

At no increase in price, the "Edu-Kit" now includes Printed Circuitry. You build a Printed Circuit Signal Injector, a unique servicing instrument that can detect many Radio and TV troubles.

This revolutionary new technique of radio construction is now becoming popular in commercial radio and TV sets.

A Printed Circuit is a special insulated chassis on which has been deposited a conducting material which takes the place of wiring. The various parts are merely plugged in and soldered to terminals.

Printed Circuitry is the basis of modern Automation Electronics. A knowledge of this subject is a necessity today for anyone interested in Electronics.

FREE EXTRAS

- SET OF TOOLS
- SOLDERING IRON
- ELECTRONICS TESTER
- PLIERS-CUTTERS
- VALUABLE DISCOUNT CARD
- CERTIFICATE OF MERIT
- TESTER INSTRUCTION MANUAL
- HIGH FIDELITY GUIDE & QUIZZES
- TELEVISION BOOK & RADIO TROUBLE-SHOOTING BOOK
- MEMBERSHIP IN RADIO-TV CLUB: CONSULTATION SERVICE & F.C.C. AMATEUR LICENSE TRAINING
- PRINTED CIRCUITRY

SERVICING LESSONS

You will learn trouble-shooting and servicing in a progressive manner. You will practice repairs on the sets that you construct, you will learn symptoms and causes of trouble in home, portable and car radios. You will learn how to use the professional Signal Tracer, the unique Signal Injector and the dynamic Radio & Electronics Tester. While you are learning in this practical way, you will be able to do many a repair job for your friends and neighbors, and charge fees which will far exceed the price of the "Edu-Kit." Our Consultation Service will help you with any technical problems you may have.

FROM OUR MAIL BAG

J. Stataite, of 25 Poplar Pl., Waterbury, Conn., writes: "I have repaired several sets for my friends, and made money. The 'Edu-Kit' paid for itself, I was ready to spend \$240 for a Course, but I found your ad and sent for your Kit."

Ben Valerio, P. O. Box 21, Magna, Utah: "The Edu-Kits are wonderful. Here I am sending you the questions and also the answers for them. I have been in Radio for the last seven years, but like to work with Radio Kits, and like to build Radio Testing Equipment. I enjoyed every minute I worked with the different kits; the Signal Tracer works fine. Also like to let you know that I feel proud of becoming a member of your Radio-TV Club."

Robert L. Shuff, 1534 Monroe Ave., Huntington, W. Va.: "Thought I would drop you a few lines to say that I received my Edu-Kit, and was really amazed that such a bargain can be had at such a low price. I have already started repairing radios and phonographs. My friends were really surprised to see me get into the swing of it so quickly. The 'Trouble-shooting Tester' that comes with the Kit is really swell, and finds the trouble, if there is any to be found."

UNCONDITIONAL MONEY-BACK GUARANTEE

Please rush my Progressive Radio "Edu-Kit" to me, as indicated below:

Check one box to indicate choice of model.

- Regular model \$26.95.
- Deluxe model \$31.95 (same as regular model, except with superior parts and tools plus Radio & TV Parts Jackpot worth \$15.)

Check one box to indicate manner of payment.

- I enclose full payment. Ship "Edu-Kit" post paid.
- Ship "Edu-Kit" C.O.D. I will pay postage.
- Send me FREE additional information describing "Edu-Kit."

Name _____

Address _____

PROGRESSIVE "EDU-KITS" INC.

1186 Broadway, Dept. 501-EO, Hewlett, N. Y. 11557

Problems of Interference

RADIO reception is sometimes marred by a variety of noises generally referred to as "interference" or "static." The two terms are not truly synonymous, as static is merely one form of interference.

Real static is a random form of electricity generated in the atmosphere around the earth, apparently by the friction of clouds against each other or against the air. It is most noticeable before or during storms. A large accumulation of charges usually shows up as lightning flashes from the sky to the ground or between clouds, and is heard in radio sets as a crashing roar.

A tube-type receiver can work satisfactorily over a long period of time and then develop a steady humming noise either suddenly or gradually. The trouble might be in either of two major areas:

1. In an aging tube the heater element, which carries raw AC, has sagged a little and is touching the cathode element, which is the source of the free electrons that jump through the vacuum to the plate and other elements in the tube. This touching constitutes a partial or complete short-circuit and should show up quickly with a continuity check with a VOM. However, this test can be performed only with the tube out of its socket, and when it is cold the heater wires might contract enough to clear the short and thus make the continuity check meaningless. However, the fault might show up on some of the better do-it-yourself tube testers. Actually, a simple substitution routine is faster and more definite. Tubes are cheap, and it pays to have a spare set of them on hand for just such a purpose.

2. One or more sections of the filter capacitor has gone bad. A voltage check here is usually significant, as detailed in the section "The VOM Is For Testing." The substitution routine is again recommended, because filters, like tubes, are cheap. It takes only a few minutes to unsolder the "hot" leads of a suspected unit and to hook in the leads of a replacement temporarily. If the new filter kills the hum, pull out the old one, throw it away, and install the new one permanently.

A line-operated solid-state receiver might conceivably develop hum. The occurrence is rare because the voltages re-

quired by transistors are very low and neither the rectifiers nor the filters are ever overtaxed. However, the possibility cannot be ruled out. The rectifier is a "diode" about the size of an under-nourished pea; the filter the size and shape of half a cigarette. The substitution act is again suggested.

Outside Noises

Whether a set is of the tube or solid-state type, line or battery operated, it is susceptible to interference created by electrical machines of many kinds and radiated through space exactly like radio waves. Eliminating interference of this nature is a matter of tracking down the source. This is sometimes simple, sometimes downright impossible. In modern homes and offices, to say nothing of industrial buildings, the air is literally saturated with radiant energy.

The Federal Communications Commission, which receives thousands of complaints of "interference" annually from irate listeners, has tracked many of them down to such seemingly innocent devices as electric blankets, refrigerator thermostats, television sets, garage door openers, electric furnaces, doorbells, elevator controls, and even ordinary electric lights.

Let's consider electric lights. If a common incandescent bulb is slightly loose in its socket or if the points of contact in the latter are dirty, the flow of electricity at this point becomes irregular, and possibly very minute sparking might take place. The exposed wires connected to the lamp can readily be shocked into "oscillation" by this action and can act as an aerial that spins off irregular radio waves. In a sensitive receiver the latter register as scratchy or frying noises. In some locations the signals from broadcasting stations are strong enough to override or mask this interference; in some places they might not be.

To find the offending lamp, if it is in your own home or apartment, you merely have to go around turning all your fixtures on and off and noting what happens. Also remove the line plugs, examine the prongs for cleanliness, and push them in and out of the outlets several times to renew the

LA SALLE EXTENSION UNIVERSITY

A Correspondence Institution • 417 South Dearborn, Dept. 63-059, Chicago, Illinois 60605

Please send me, without cost or obligation, FREE booklet and full information on the field I have checked below:

ACCOUNTING

- Complete Accounting with CPA Training
- General Accounting
- Income Tax
- Accounting Fundamentals
- Auditing
- Controllorship
- CPA Training
- Modern Bookkeeping

BUSINESS MANAGEMENT

- Complete Business Management
- Credit and Collections
- Office Management
- Personnel Management
- Business Correspondence

LAW COURSES

- Bachelor of Laws Degree
- Business Law
- Insurance Law
- Claim Adjusting Law
- Law for Police Officers
- Law for Trust Officers

SALESMANSHIP

- Sales Management
- Complete Sales Training

DRAFTING

- Basic Drafting
- Aeronautical Drafting
- Architectural Drafting
- Electrical Drafting
- Mechanical Drafting
- Structural Drafting

REAL ESTATE

- Complete Real Estate
- Real Estate Brokerage
- Real Estate Management
- Real Estate Sales

TRAFFIC AND TRANSPORTATION

- Complete Traffic Mgt.
- Transportation Law
- Rates and Tariffs
- Agency and Services
- Motor Truck Traffic

STENOTYPE

- Machine
- Shorthand

TECHNICAL COURSES

- Mechanical Refrigeration
- Air Conditioning, Refrigeration and Heating
- Diesel

HIGH SCHOOL

- High School Diploma

CAREERS FOR WOMEN

- Interior Decorator
- Dental Assistant
- Secretarial
- Accounting
- Bookkeeping
- Real Estate

Name Age

Address County

City & State Zip No.

Occupation Working Hours A.M. P.M. 322

If you had mailed this coupon a year ago, your salary could be way up too!



WHY NOT MAIL IT TODAY?

Look at these enthusiastic letters. Have you ever seen anything like them? There are hundreds and hundreds more that pour in from LaSalle students week after week, month after month, year after year.

Do you know that many graduates attribute their increases in income largely to their LaSalle training?

All LaSalle students have one ambition in common—to get out of the ranks of the untrained and earn big money, prestige and security in a key job. Isn't that your goal too?

Without interfering with your present work—and by devoting only a little of your spare time—you too can prepare rapidly for advancement in the field of your choice through LaSalle home study. The cost is surprisingly low.

LaSalle has been an acknowledged leader in home education for more than half a century. It has provided training in business, high school, and technical subjects to more than 1,000,000 ambitious men and women. Its distinguished faculty includes some of the country's most outstanding authorities. That is why your LaSalle diploma is a credential recognized and respected everywhere.

Check the subject you are interested in—then send the coupon above for FREE booklet. No obligation.

"My salary has increased 400% as a direct result of my LaSalle studies"

Rudolph Urbatis,
Port Chester, N.Y.



"Salary more than doubled since enrolling"

William T. Black,
Canoga Park, Calif.



"Income has increased 100 per cent since graduation"

James L. Yanning,
Manhattan, Kansas



"I now earn three and a half times my former pay"

Robert Fisher,
Holbrook, Ariz.



LA SALLE EXTENSION UNIVERSITY

A Correspondence Institution • 417 S. Dearborn, Chicago, Illinois 60605

contact surfaces. This sometimes works wonders. Of course, also make sure all bulbs with screw bases are tightly seated.

Fluorescent lamps are prolific generators of radio impulses, but in most cases these are pretty well squelched right at the fixture by small "suppressor" capacitors that are built into the starter devices. As with incandescent lamps, a defective unit can be found by the turning-on-and-off method.

Very often, identifiable interference from a particular fixture can be reduced or eliminated by swapping either the starter or the tube with the corresponding part of another fixture.

Plug-In Interference Filters

In the case of a particularly stubborn fixture, the only cure for noise may be the addition of an interference filter between the outlet and the line cord. This is a simple plug-in gadget. If it works, consider yourself lucky. If it doesn't have any appreciable effect on the noise, try it instead between the outlet and the line cord of the radio set itself. Sometimes the interference is radiated directly from the fluorescent lamp, impinges on the AC wiring of the house, and rides through to the set via the wall outlet. A filter at this point might very well absorb it and keep it from entering the set.

Very strong popping noises are often created by fluorescents after the switch is turned on and the starter is initiating a voltage "kick" to fire electricity through the tube. This interference is usually of short duration. If it continues, the lamp itself usually keeps blinking, and anyone within sight of it is sure to turn it off.

Interference From Motors

Much interference is blamed on motors, but actually very few of the types found in major labor-saving appliances are even capable of causing it. The real offenders are high-speed motors of the "universal" type used in some electric razors and in most food mixers, small electric fans, vacuum cleaners, hair dryers, etc. These motors have carbon brushes making contact with a revolving cylinder called the "commutator." Even when the machines are new there is considerable sparking here, and this causes strong radio impulses to be created in the associated circuitry. In a nearby radio receiver they usually have a whining sound, which varies with the speed of the motor. An un-suppressed vacuum cleaner, particularly, can be a nuisance.

Interference From The Outside

In your own home you can check wiring, clean contacts here and there, install suppressors, etc., and then enjoy interference-free reception, not only of radio programs but also of television pictures. But suppose you live in an apartment and find that while all your own appliances are "clean" some noises still persist. The obvious conclusion is that they come from other apartments. In this case there is no substitute for neighborly cooperation. If this can't be arranged, you have to go back to reading books, or you can move!

At one time the complicated control devices used for elevators caused quite a radio clatter. However, landlords of older houses were quick to install suppressors, which are nothing more than small, inexpensive capacitors, when they learned that the life of the controls themselves was greatly extended because the suppressors either reduced or eliminated the heavy sparking at contact points. In any newer installations the capacitors are invariably part of the original wiring.

Heterodyne Whistles

There is one kind of interference you can do very little about. This is called "heterodyning," and is the result of the mixing of signals from two or more stations broadcasting on frequencies very close together. The sound is a warbling whistle or squeal.

The Federal Communications Commission distributes frequencies in such a manner that stations with the same or nearly the same assignments are separated geographically as much as possible. This works out pretty well for people who live on either the Atlantic or the Pacific Coast, but those in between are bound to hear more than they really want.

About the only way to reduce heterodyning is to take advantage of the directional properties of the loop aerials built into most receivers. The direction of weakest reception, called the "null," is much more marked than the direction of best reception. In most cases this means that you null out the relatively weak distant station that is causing the interference, without appreciably reducing the strength of the local station you want to hear.

Heterodyning is always more noticeable in the cold winter months than at other times of the year, because atmospheric conditions are more favorable then for long-distance transmission. This is especially true at night. ●

Live Better Electronically With

LAFAYETTE RADIO ELECTRONICS

COMSTAT® 9 5-WATT TWO-WAY RADIO KIT



- 9-Crystal-Controlled Transmit and Receive Channels 42-0915WX°
- Front Panel Transmit and Receive Crystal Socket
- 23-Channel Tuneable Receiver
- 115 VAC and 12 VDS Power Supply
- Pi-Network Antenna Matching

59⁹⁵
No Money Down

MODEL HA-130A 5-TRANSISTOR SUPERHETERODYNE CB WALKIE-TALKIE



*Superheterodyne—
Not Superregenerative*
Ideal for Sports, Camping
Farm, Home and Industry

11⁹⁵ 99-3089L°

- Power Packed 4 Transistor Distance Spanning Transmitter
- Greater Sensitivity and Selectivity with Less Receiver Noise
- No License Required FCC Reg. Part 15

LAFAYETTE 20-IN-1 TRANSISTOR EXPERIMENTERS KIT



Fun To Build — Educational — and all 20 projects result in a useful working instrument!

17⁹⁵

19-0902

MADE IN U.S.A.

PROJECTS YOU BUILD

1. TRANSISTOR TESTER
2. VOICE ACTUATED ALARM
3. PHOTO TIMER
4. AUDIO AMPLIFIER
5. CRYSTAL SET
6. SOLAR RADIO
7. RAIN ALARM
8. TIMER
9. ONE TRANSISTOR RECEIVER
10. CODE PRACTICE OSCILLATOR
11. METROPHONE
12. TWO TRANSISTOR RECEIVER
13. ELECTRONIC RELAY
14. HOME BROADCASTER
15. PHOTO ELECTRIC RELAY
16. BURGLAR ALARM
17. WIRELESS TRANSMITTER
18. REGENERATIVE RECEIVER
19. CITIZENS BAND MONITOR
20. AUDIO OSCILLATOR

"THE BIG EAR"

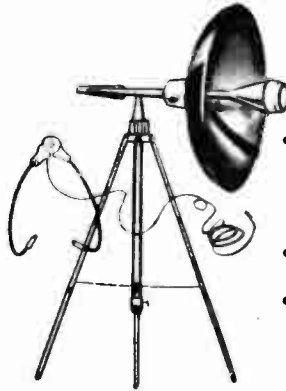

12⁹⁵

13-2510W

- Big 18" Reflector Disk Concentrates Sound Waves Into Transistor Unit Which Amplifies Them Loud and Clear
- Hear Sounds Over One Block Away
- With Tripod and Stethoscope-Type Earphones



FREE
1967 CATALOG
NO. 670
512 Pages

NOW! OFF PRESS—BETTER THAN EVER!

Featuring Everything in Electronics for

• HOME • INDUSTRY • LABORATORY

from the "World's Hi-Fi & Electronics Center"

LAFAYETTE Radio ELECTRONICS

Dept. 32-7, P.O. Box 10

Syosset, L. I., N. Y. 11791

*Imported

Convenient Locations

NEW YORK

Bronx
Brooklyn
Jamaica
Manhattan
Scarsdale
Syosset

NEW JERSEY

Newark
Paramus
Plainfield

MASSACHUSETTS

Boston
Natick
Saugus

PENNSYLVANIA

Pittsburgh
Philadelphia

WASHINGTON, D.C.

(Area)
Falls Church, Va.
Mt. Rainier, Md.

CONNECTICUT

Hamden
W. Hartford

Send me the FREE 1967 Lafayette Catalog 670 32-7

Name _____

Address _____

City _____

State _____ Zip _____

The Tools for the Job

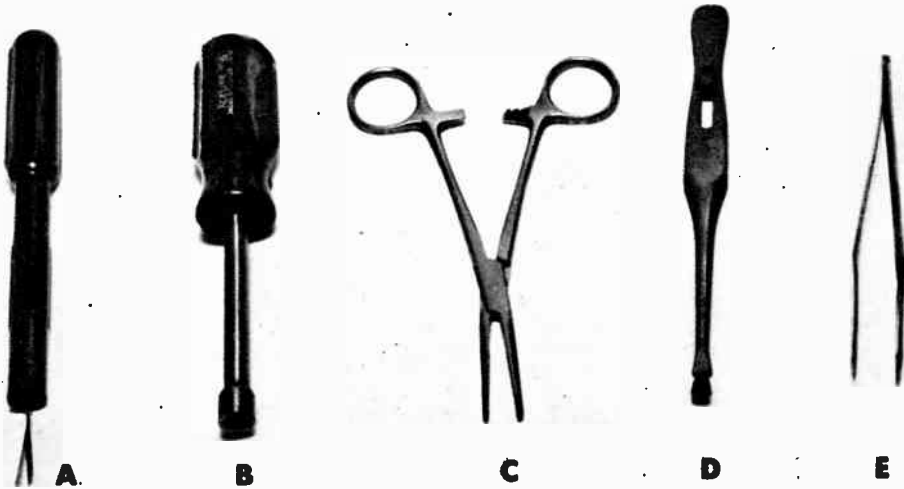

WHAT do you need in the way of tools for working on radio sets? Just look in your own tool box or on the wall of your basement or garage shop. An assortment of small screwdrivers, some pliers and a soldering iron or gun will enable you to take care of most jobs. However, there are some other tools that you probably don't own now that you will find very useful and timesaving, not only for electronic work but for other purposes too. Fortunately, they are cheap. Five that I recommend highly are shown in the accompanying photo.

A. Did you ever remove a screw from a tight spot with a long, thin screwdriver and then try to put it back with that same screwdriver? It's a frustrating chore. You probably tried sticking the screw to the blade with chewing gum, rubber cement, cellulose tape, or the like, and you swore to yourself each time it fell off at the critical moment. What you need is a screw-holding driver. The blade of this particular model consists of two leaves of spring steel. Squeeze them together, insert in screw slot, release your fingers, and the screw is held firmly. There are other types which grab the head of the screw. Once you've used this tool you'll wonder how you ever got along without it.

B. Instead of mashing the flats of small nuts with pliers, use nut drivers and leave the surfaces unmarred. There are sizes for all standard nuts from $\frac{1}{16}$ inch up. The tools have hollow shafts and can slide over long bolts to engage nuts at their bottoms.

C. This interesting gadget comes from the field of medicine. Your doctor would call it a hemostat, but your hardware or radio jobber calls it a "Seizer." The nose section is very slender. The projections on the handles are serrated, so when the tool is closed the serrations engage and clamp it closed. To open, you merely squeeze the handles and at the same time twist them slightly. The Seizer takes a firm grip on any small object. It can get into places in a radio chassis which are much too crowded for regular long-nose pliers.

D. The locking tweezer is another "third hand," of simpler design. A short stud rides in a slot near the top. To close the points, you push the stud down; to release it, up. This tool doesn't have the holding power of the Seizer, but it is useful for many of the same purposes and often supplements it.

E. This is an ordinary pair of tweezers with sharp points. It is great for picking the right nut or washer from a trayful of loose hardware, for holding wires for soldering, etc. •

NEW!
MASTER COURSE
IN COLOR TV...

WITH NTS COLOR KITS

Big 25" Color TV kits included in new Master Color TV Home Study program. Learn Color TV; keep the new 25" color TV receiver you build with exciting kits we send you. 10 million homes in this country will have color TV by the end of 1967. This industry needs technicians as never before, and NTS-trained men can move quickly into the big money.

COLOR TV SERVICING BRINGS HIGH PROFITS

New color sets need careful installation, precision tuning and skilled servicing. NTS home training can put you in this profit picture—prepare you for big pay, security, or start a business of your own.



LIFT OFF... TO A "SPACE AGE" CAREER IN ELECTRONICS

This is the "space age". It offers new opportunities in communications, industrial electronics, computer technology, and many others. Automation has increased the need for skilled electronics technicians in thousands of manufacturing plants. Only the well trained man makes it big. Industry wants and demands this kind of man... the NTS man. Pick your field. Let an NTS Project Method Program help you toward a well-paid career in Electronics wherever you travel.

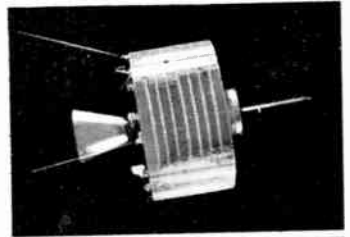

NEW CAREER KIT ... FAST, EASY START TO NTS HOME TRAINING

The exclusive Project Method Career Kit helps you move quickly into your training program. Earn while you learn as you progress with your shop-tested Project Method lessons and kits.

Send for the New illustrated NTS Color Catalog. It shows the equipment and kits you work with and keep. Describes in detail the advantages of NTS Project Method Home Training. Tells you everything you need to know about starting your career in electronics.



HIGH SCHOOL AT HOME

National offers accredited high school programs. Take only subjects you need. Study at your own pace. Everything included at one low tuition. Check special High School box in coupon for full information & FREE catalog.

CLASSROOM TRAINING AT LOS ANGELES

You can take Classroom Training at Los Angeles in Sunny Southern California. NTS occupies a city block with over a million dollars in facilities devoted exclusively to technical training.

MAIL REPLY CARD OR
 COUPON FOR NEW, FREE
 COLOR CATALOG AND
 SAMPLE LESSON.



NATIONAL TECHNICAL SCHOOLS

4000 S. Figueroa St., Los Angeles, California 90037

APPROVED
 FOR
 VETERANS



Please rush Free Color Catalog and Sample Lesson, plus detailed information on field checked below. No obligation.

Dept. 234-37

- MASTER COURSE IN COLOR TELEVISION
- COLOR TV SERVICING
- MASTER COURSE IN ELECTRONICS-TV-RADIO plus
- ADVANCED TV and INDUSTRIAL ELECTRONICS
- ELECTRONICS-TV-RADIO SERVICING AND COMMUNICATIONS
- FCC LICENSE COURSE
- RADIO SERVICING (AM-FM-TRANSISTORS)
- TELEVISION SERVICING (including color lessons)
- STEREO, HI-FI and SOUND SYSTEMS
- BASIC ELECTRONICS
- ELECTRONICS MATH HIGH SCHOOL AT HOME

Name _____ Age _____

Address _____

City _____ State _____ Zip _____

Check if interested in Veteran Training under new G.I. Bill.

Check if interested ONLY in Classroom Training at Los Angeles.



NATIONAL TECHNICAL SCHOOLS

World Wide Training Since 1905

4000 S. Figueroa St., Los Angeles, Calif. 90037

You enroll by mail under NTS "No Obligation" plan.

We have no salesmen: This means lower tuition for you.

Accredited Member National Home Study Council

Member: National Association of Trade & Technical Schools

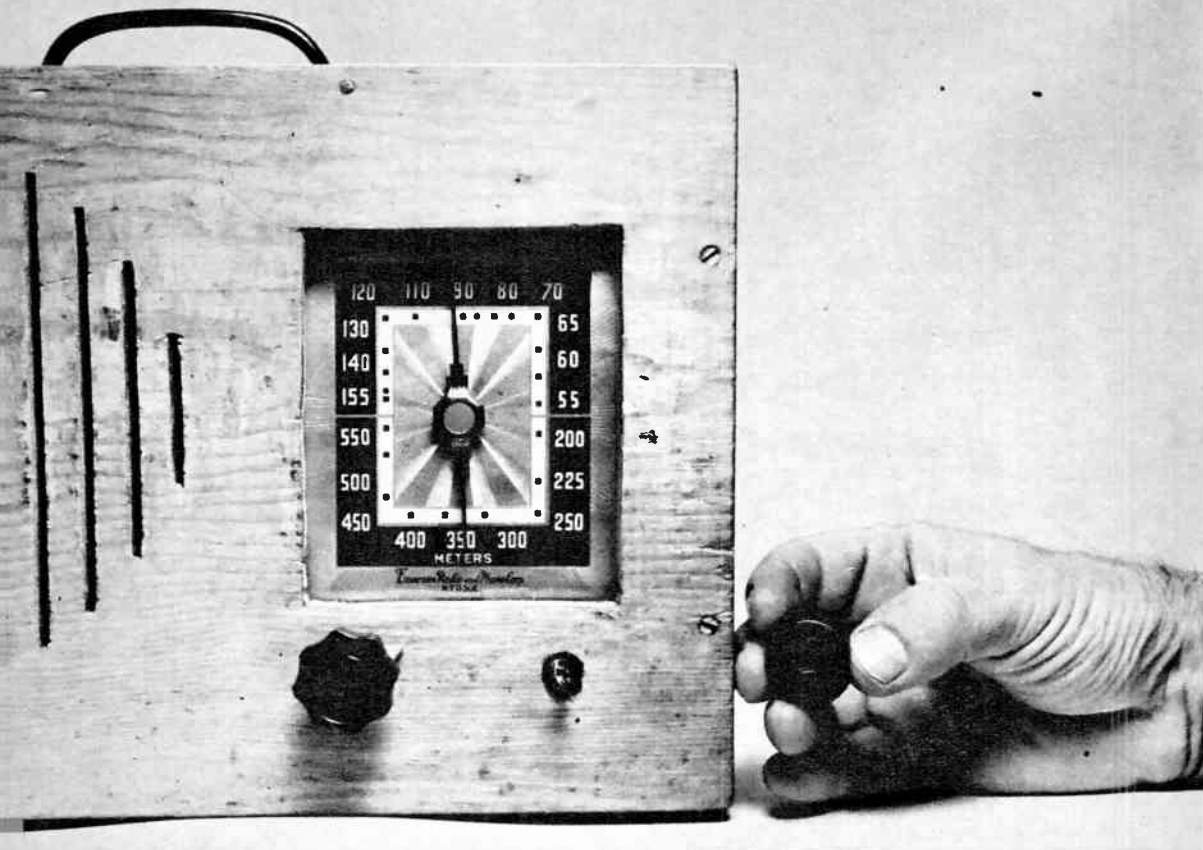

Typical AC-DC set has two controls: Combined on-off switch volume and tuning. The knobs generally are of pull-off type, without set-screws. The cabinet is of wood or molded plastic to insulate the "hot" chassis.

AC-DC Sets

SINCE the late 1930's, the most widely used radio receiver for regular "AM" ("amplitude modulated") broadcasting has been the "AC-DC" set, invariably in a small table model. Millions upon millions have been made and are still providing unending diversion for their owners.

Popularly known as the "All-American Five" because of the number of tubes it contains, this set is called "AC-DC" to distinguish it from previous designs which worked only on AC. The tubes then available for receiving purposes all had filaments for low voltages, generally 6.3 or 12.6, and to obtain these values it was necessary to use transformers working off the 110-volt house line. Transformers are

both heavy and expensive, since they consist of a great deal of copper wire wound on laminated frameworks of a rather special kind of iron.

An ingenious rearrangement of the tube circuits made the elimination of the transformer possible. Only incidentally it also enabled the set to work on DC as well as AC lines. This actually was a very unimportant feature, because even in the 30's there was very little DC in homes and in the years since it has disappeared altogether. However, the DC capability at least justified the term "AC-DC," which is now used for a variety of transformerless electronic equipment.

The AC-DC set endures because it is

Control shafts on almost all sets are $\frac{1}{4}$ " in diameter and can be fitted with inexpensive replacement knobs that have headless set-screws under their flanges. These require very thin screw-driver. Make sure that screws are well below surface of knobs, to eliminate chance of the user making contact with metal. This is an important safety consideration.

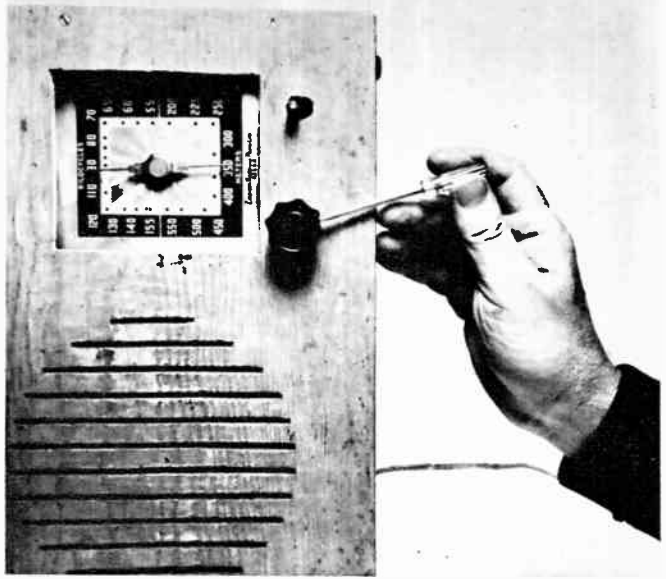

If AC-DC set does not have an insulated back, or if the original one has disappeared, make one of perforated hardboard such as Masonite. This is excellent insulator and at same time holes provide good ventilation. Fasten with wood screws or self-tapping screws. Cut slot at bottom for line cord. Even a piece of stiff cardboard tacked in place is better than no protective cover at all.



relatively simple in construction and circuitry, is non-critical in adjustment, is cheap to manufacture, and is easy to repair. Inasmuch as sets made in 1937 are still going strong in the late 60's, it is pretty safe to predict that current models will bring celebrations of the year 2000 into many space-age homes.

The early AC-DC receivers used tubes of the "octal" type, with either glass or metal bodies*. The common combination consisted of one each of the numbers 12SA7, 12SK7, 12SQ7, 50L6 and 35Z5. Present-day models use the all-glass "miniatures" 12BE6, 12BA6, 12AV6, 50C5 and 35W4. The filaments are connected in "series string," just like old-fashioned Christmas tree

lights. Therefore, if any one tube burns out the circuit to the others opens and they go out too. They don't burn out; they merely don't light because they no longer receive juice from the house line.

* See "Tubes and Tube Testing."

Why Sets Go Bad

Tubes have filaments, just like ordinary electric lights. They run hot, and sooner or later they are bound to burn through. Probably 85% of all set "failures" are nothing more than tube failures, so if you can isolate the one dud of the five (a very easy job), you can quickly restore normal operation merely by replacing it.

Let's assume that the set has been work-

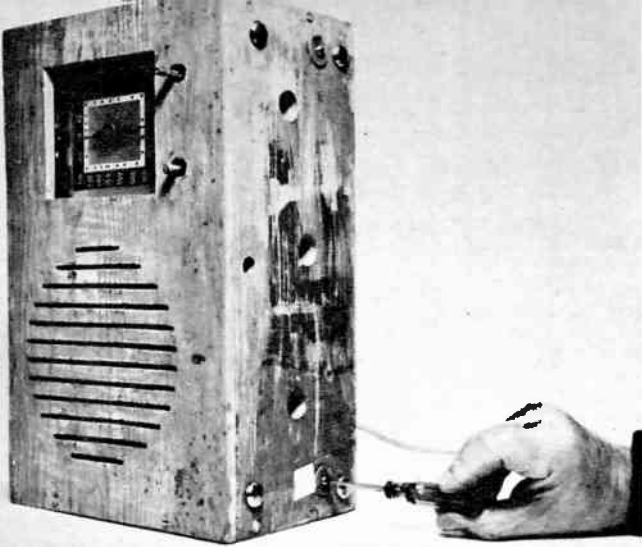

After removing knobs and insulated back of set, the next step in getting at chassis is to undo the bottom screws. These should be in deep counter-bored holes, so that they can't touch grounded objects. If heads are on surface, remember to cover them with adhesive tape or other strong plastic tape when you put set back together again. Another good idea is to use nylon screws.

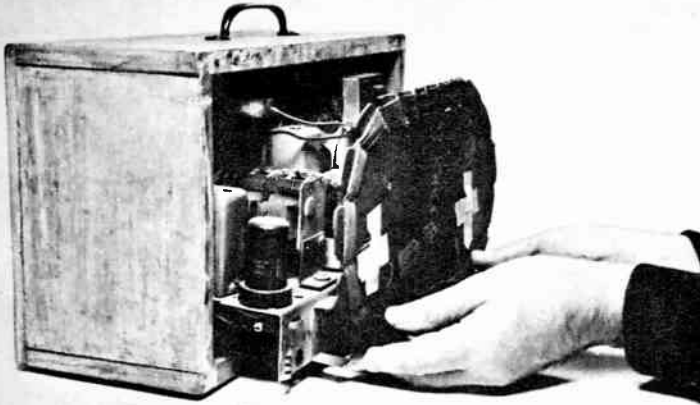

After bottom screws are out, return set to normal position, grasp chassis at any protruding edge and pull it out slowly. In most sets loud speaker is part of chassis, but in some it is attached to inside of cabinet, so look for connecting wires. Speaker is held usually by four screws, is easily dismounted for inspection. Look inside cabinet for the tube layout diagram.

ing normally and has not been pushed off the table or otherwise mistreated physically, but has merely quit. Check the line cord to make sure that it is still plugged in and snap the switch on and off a couple of times. You can't see the tubes through the back, but you do notice that the dial light is off. The only thing to do now is to get at the tubes and to remove them for testing, either with your own meter* or on the do-it-yourself tester in the local drug-store or hardware store. The accompanying series of pictures shows how to disassemble a typical All-American Five. Your own set may vary in some details, but you can probably get a few clues from the pictures.

The first step is to unplug the line cord.

The next is to remove the back of the set, which is either stiff cardboard or perforated hardboard. At the most, it is secured by a few small screws. In some sets of late manufacture the line cord disconnects automatically from the chassis, in exactly the same manner as the cords of virtually all television receivers. This is done to prevent uninformed people from possibly getting a shock from the exposed chassis, which under some circumstances can be "hot" electrically. This matter is discussed later.

* See "The VOM Is For Testing."

In older receivers the aerial that picks up the radio signals is a flat pancake of wire



Above: Loop aerial in this set is a fiber board with wire around edge. The mounting screws, which go into the chassis, had exposed heads, so they were covered with two layers of adhesive tape.

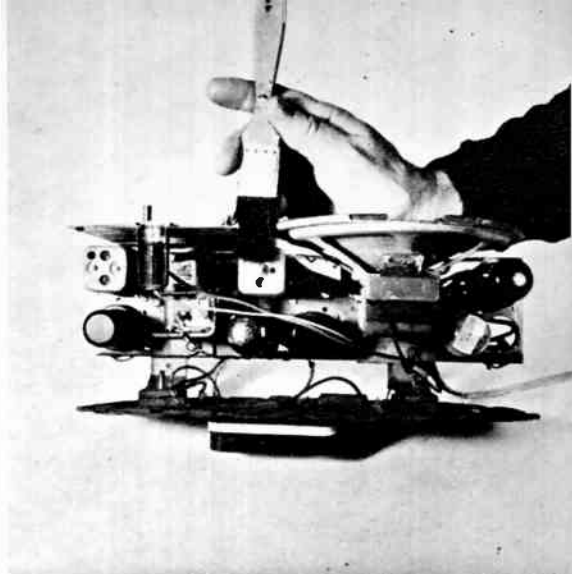

Top right: Set that has been in use for some time is sure to be covered with layer of dust. Clean off with soft paint brush, and be careful not to disturb wires. Look for loose screws, tubes, etc.

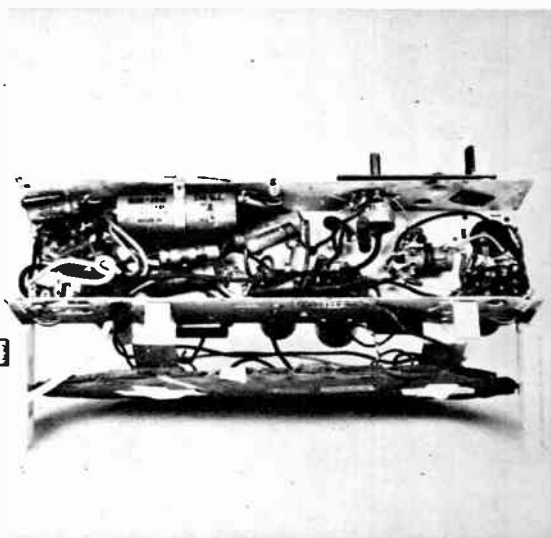

Right: Turn chassis over carefully and prop it up with small boxes. Clean here also and examine all connections and components for signs of overheating, corrosion, looseness, unsoldered joints.

on a fiber form. This might be attached to the inside of the removable back of the set or directly to the chassis. In the latter case look for one or two screws and remove them, at the same time handling the aerial carefully because a couple of thin wires from it disappear into the chassis. Just lay it flat on the table and it will be safe.

In newer sets the aerial is a "loopstick" mounted on the chassis. It looks like a dowel with some wire wound around it, but the "stick" is actually a composition of powdered iron.

In most AC-DC receivers made since the end of World War II there is no provision for the connection of an outside aerial. It

isn't needed because most broadcasting stations put out powerful signals to which the combination of a small aerial and a sensitive circuit responds quite satisfactorily.

Pulling the Chassis

In very few sets are all the tubes readily accessible while the chassis is still in the cabinet. Be prepared to pull the chassis, because the last and most innermost tube is sure to be the one that burned out! However, before proceeding look inside the cabinet or on the cover for a tube layout diagram. Some manufacturers are thoughtful enough to provide this useful bit of paper, but don't fret if it isn't there; you can make

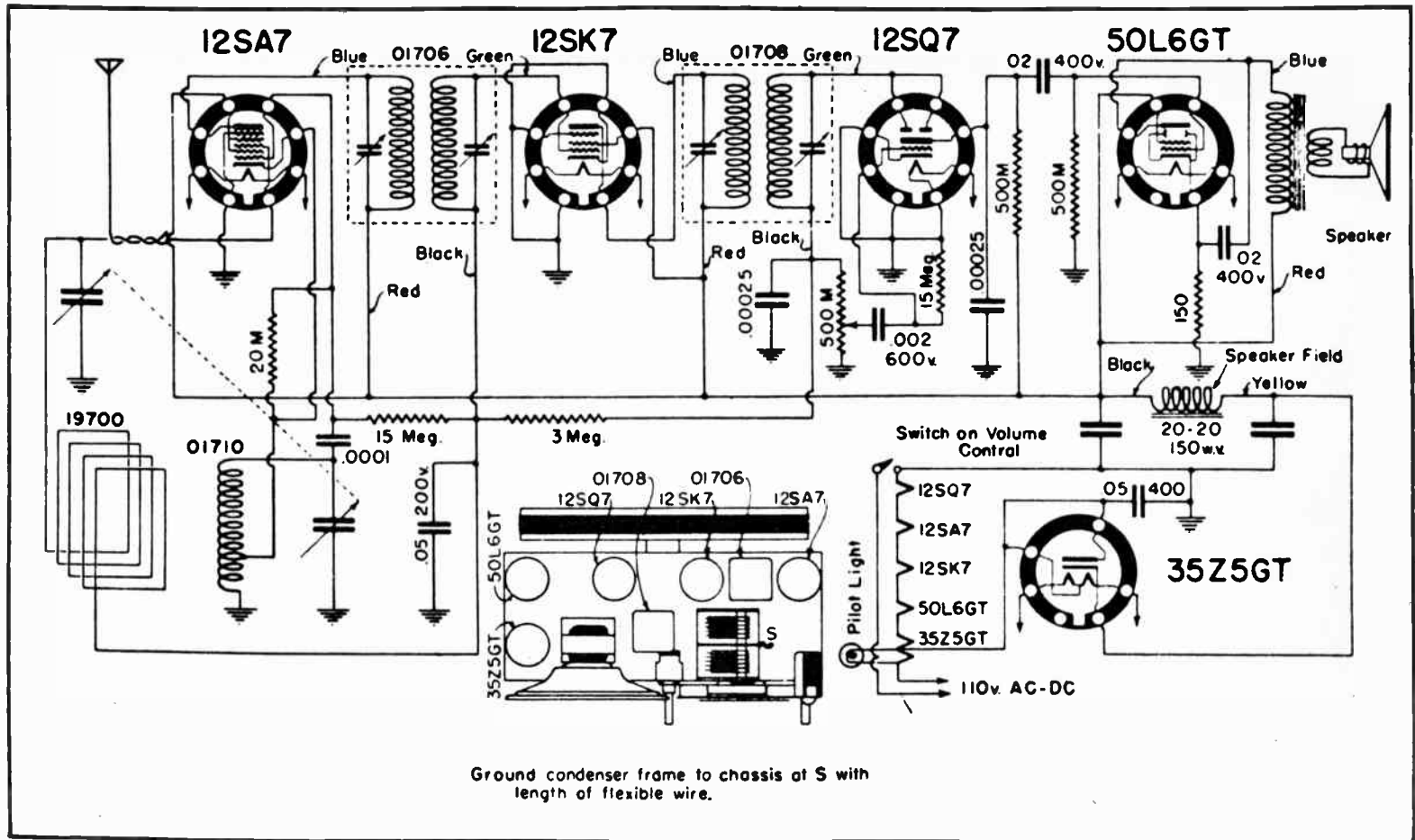

Above: Schematic diagram of typical "All-American Five" AC-DC receiver. The heavy black circles represent the bottoms of the tube sockets. Note particularly, in the diagram to the left of the tube marked 35Z5GT, how the filaments of the five tubes are wired in series. Below: Pictorial layout of connections and components on the underside of the set. The filter capacitor, the part most likely to need replacement after long service, is marked "20-20 mid. 150 w.v.electrolytic." to left of volume control.

5 TUBE AC-DC

PICTORIAL WIRING DIAGRAM

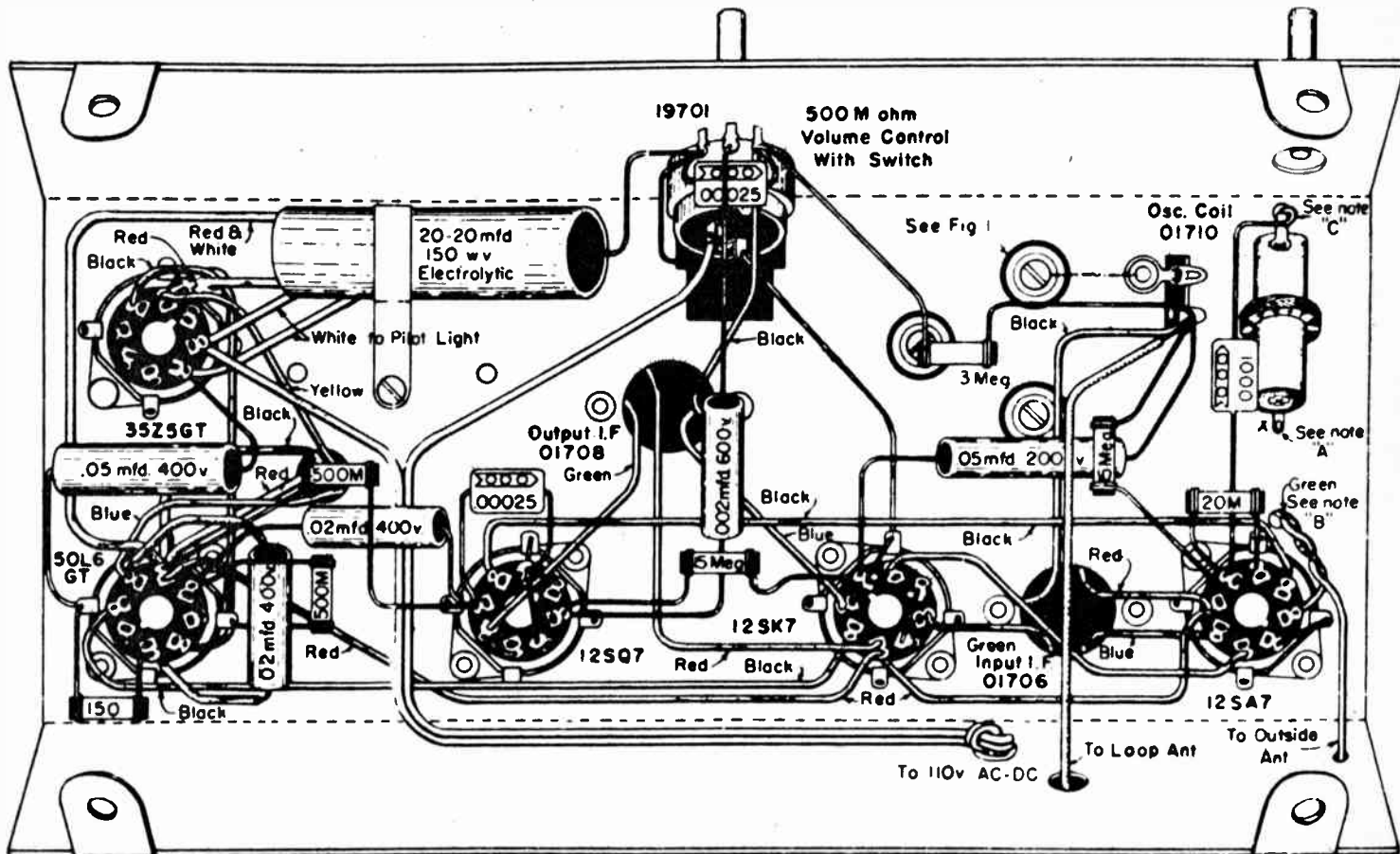

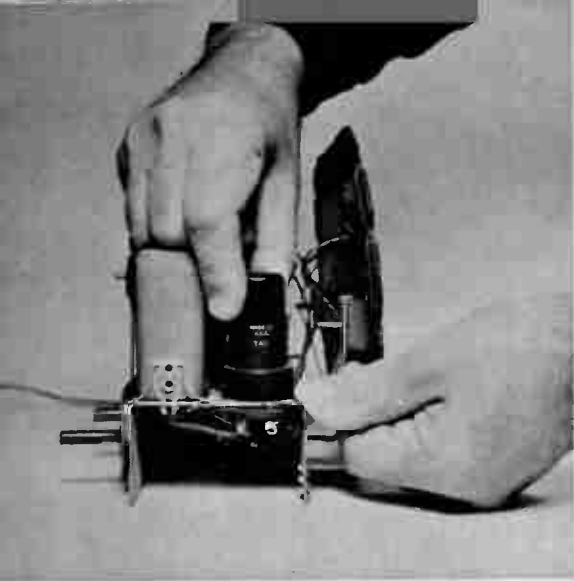

All radio tubes must be pulled straight up. Resist the temptation to twist them, as this surely bends the pins of miniature tubes or breaks the base of the eight-pin "octal" type, as shown here above.

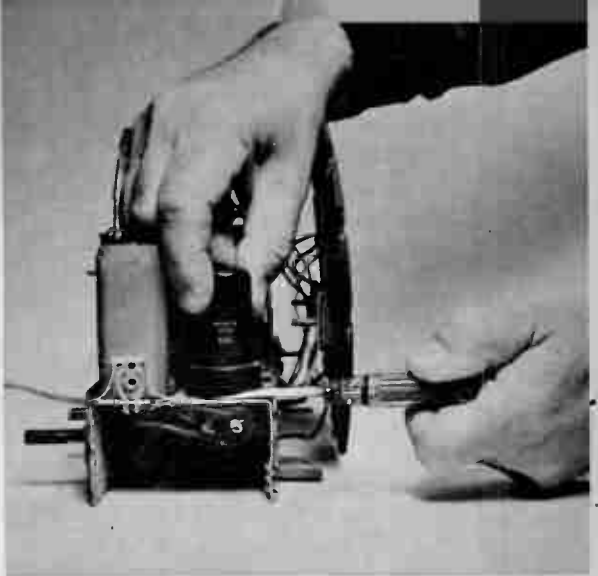

Closed tear or rip in cone of loud speaker shows up in form of slightly distorted speech or music. It is usually the result of drying out, brought on by proximity to hot tubes in enclosed cabinet.

If a tube has been in its socket a long time and refuses to come up easily, wedge the blade of a thin screwdriver between the base and the chassis and pry it upward gently. This usually does trick.

Quick repair can be made with any kind of sticky tape. Ordinary white adhesive tape from medicine chest is fine for purpose. Apply strips to both sides of cut, pressing them carefully with fingers.

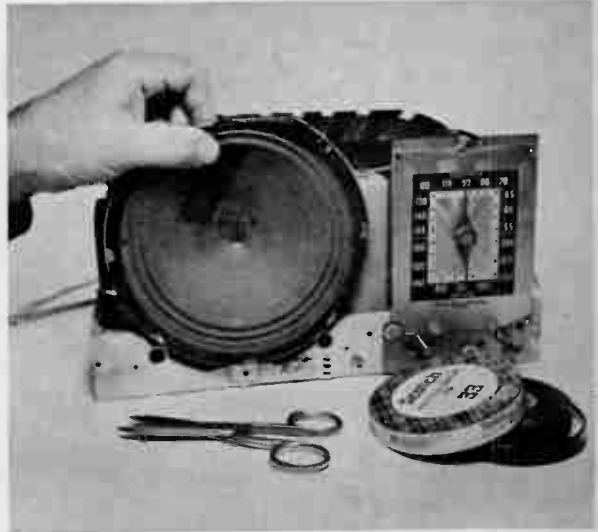
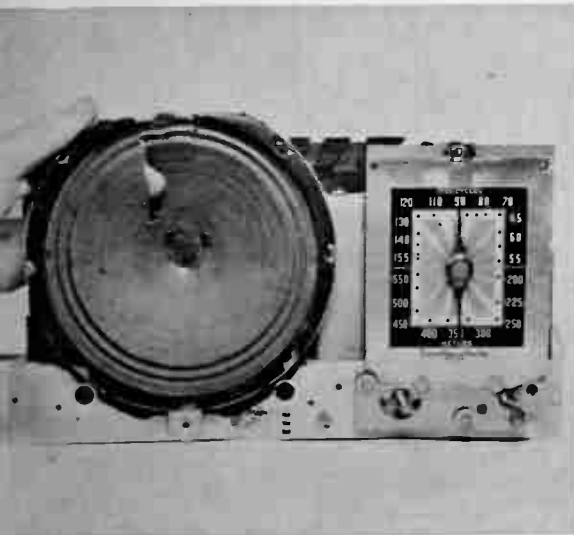

your own diagram in just a few minutes.

The next step is to remove the front panel knobs and the screws that go through the bottom of the cabinet into the chassis. In old sets the knobs have set screws, for which you need a small screwdriver with a blade a little less than $\frac{1}{8}$ inch wide. In newer sets the knobs are held to the shafts

merely by springs. Shape the first three fingers of your hand like claws, grasp the knob, and pull straight out without jerking. Watch closely for the springs; they frequently snap loose when the knobs pop off.

As a matter of convenience in manufacture, the loud speaker is usually mounted along the front edge of the chassis, so when

The dial light or "pilot" is a small bulb with a miniature bayonet base. Usually it is mounted on one edge of the dial so as to cast a soft light over it. The set will work without this bulb, but if it burns out it should be replaced immediately because it is actually part of the filament circuit of one tube. Finger points to the dial light in a typical AC-DC 5-tube set.

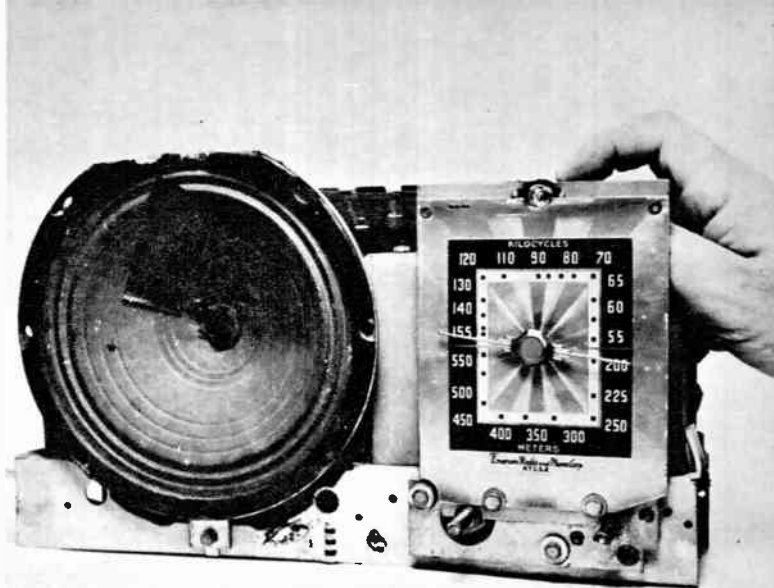

In this set the bulb assembly is a U-shaped clip. To release it, merely squeeze the sides and lift it out. Identify bulb for replacement by number on its base (47 is common size) or by color of the little bead inside that supports the filament. Buy two and keep one always on hand for use in future.

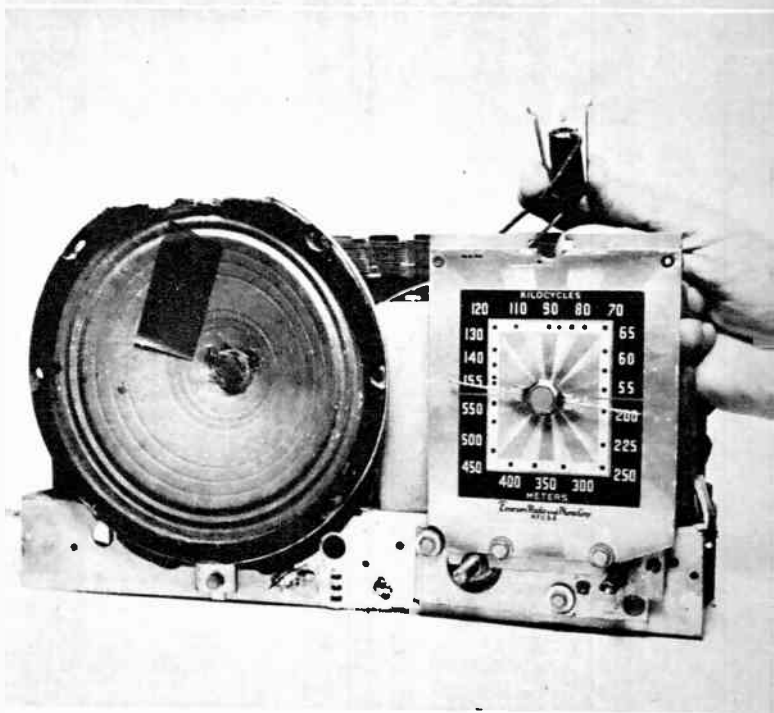

the latter slides out you have the complete set in front of you. Be careful to keep fingers and tools away from the speaker. Its paper cone is rather thin, and after a few years of sitting next to five hot tubes it is probably very brittle too.

If the set hasn't been opened in a long time you can expect to find it thick with

dust and possibly the remains of small insects that made it their nest. Clean with a soft paint brush or put it in front of an open window and blow on it vigorously.

In the absence of a tube diagram you'd think that manufacturers would at least stamp the type numbers next to the tube sockets, but they don't. The responsibility

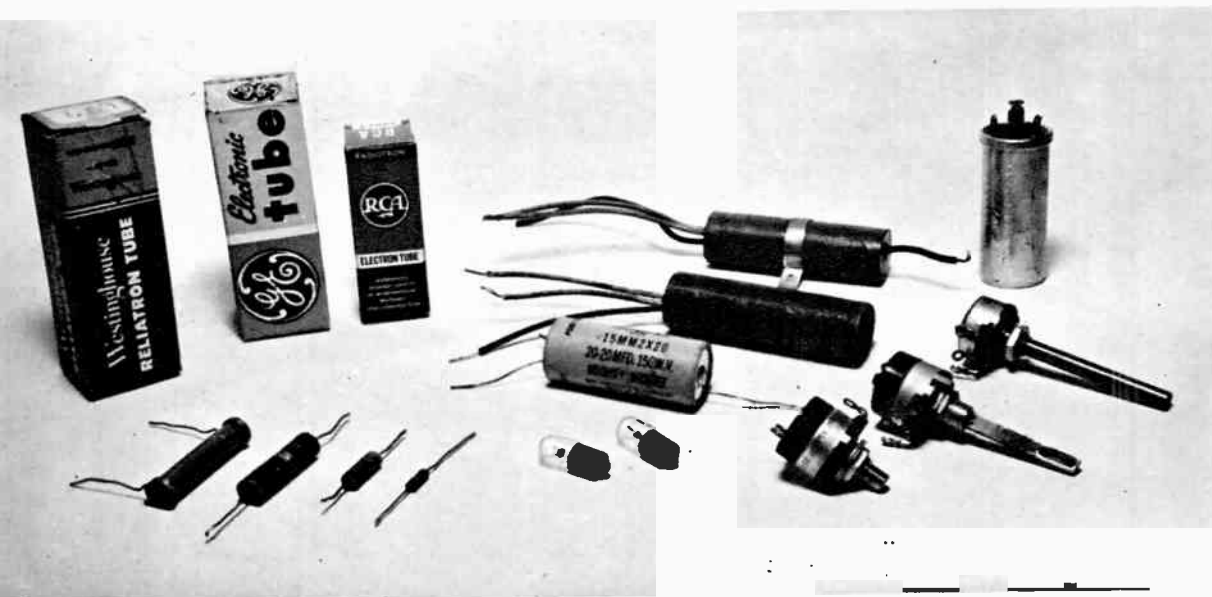

Some common replacement parts for AC-DC sets. Foreground, l. to r.—fixed resistors, pilot lights, volume controls with switches. Back—tubes, paper cased electrolytic capacitors, aluminum case type.

for keeping the record straight is up to you.

Before you start struggling with the tubes you must understand that they are not based like electric bulbs, which screw into their sockets, or like automobile bulbs, which seat with a short bayonet twist. *All radio receiving tubes go straight into and straight out of their sockets. Don't under any circumstances twist them.* If you do, you can easily break off the indexing stub in the base of octal tubes or mash the thin pins of the miniature types. Some tubes resist removal because their pins are corroded to the contact springs in the sockets, but you can pry out the most stubborn ones with a screwdriver.

Identifying the Tubes

Remove the easiest tube to get at, wipe it clean with a soft rag and look for its type number. If the shell is of metal you'll find it quickly; the markings on metal tubes don't seem to be affected by heat. Glass tubes, however, can be a problem. The legends are usually stamped rather lightly and are known to fade. If you can't find a number right away, hold the tube up to a light, turn it slowly and wait for a refractive effect that makes a faint marking legible. Sometimes breathing lightly on the glass also helps because the condensation of moisture is different on the marked and unmarked areas.

Let's be optimistic and say that the type number is clear. With a soft pencil, a marking pen or a crayon from a child's coloring set, mark the number on the chassis, close to the socket. As an added precaution, make a little sketch of the chassis on a piece of cardboard and mark the positions of the sockets. Remove and identify the remaining tubes, and you will be ready to check them.

But wait a moment. Suppose you pull four tubes and find them nice and clean, and the fifth turns out to be blank. How do you identify it? By a process of elimination, usually, and perhaps with an assist from a knowledgeable salesman in a radio store or from a service technician. For example, if the four are 12BE6, 12BA6, 12AV6 and 50C5, you can be pretty sure that the blank is a 35W4. Sometimes even a single legible type number is sufficient clue to the full combination.

If you are lucky and the failure of your set is in the 85% /tube category, one new tube is all you need to buy. Chuck out the old one, put in the new one and the others. Before you reassemble the chassis in the cabinet you should air-test the set to make sure that the new tube really does the trick. Now the problem of the hot chassis presents itself. Replace the knobs on the tuning control and the switch/volume control. Plug in the line cord. Being careful not

AC/DC SUPERHETERODYNE RECEIVER

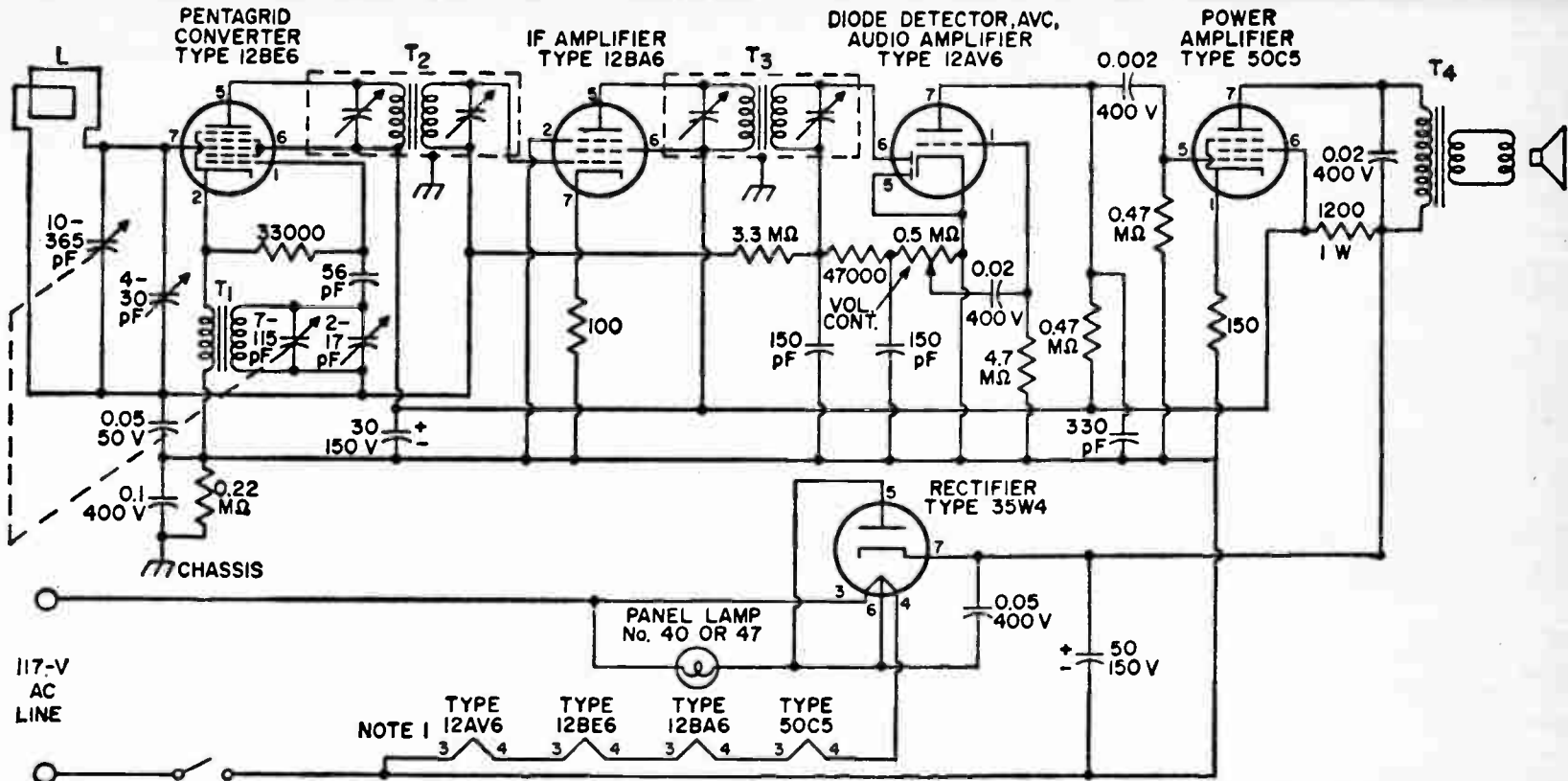

L_1 = Loop antenna or ferrite-rod antenna, 540 to 1600 kc/s (with specified values of tuning and trimmer capacitance)
 T_1 = Oscillator coil for use with 7- to

115-pF tuning capacitor and 455-kc/s intermediate-frequency transformer
 T_2, T_3 = Intermediate frequency transformers (include if trimmer capacitors),

455 kc/s (permeability-tuned type may be used)
 T_4 = Audio output transformer matches impedance of speaker voice coil to 2500-ohm tube plate load

Another version of the 5-tube AC-DC set, using miniature glass tubes. Note particularly how the panel lamp connects across pins 3 and 6 of the rectifier. Dotted line represents two-section tuning capacitors.
 (From "RCA Receiving Tube Manual")

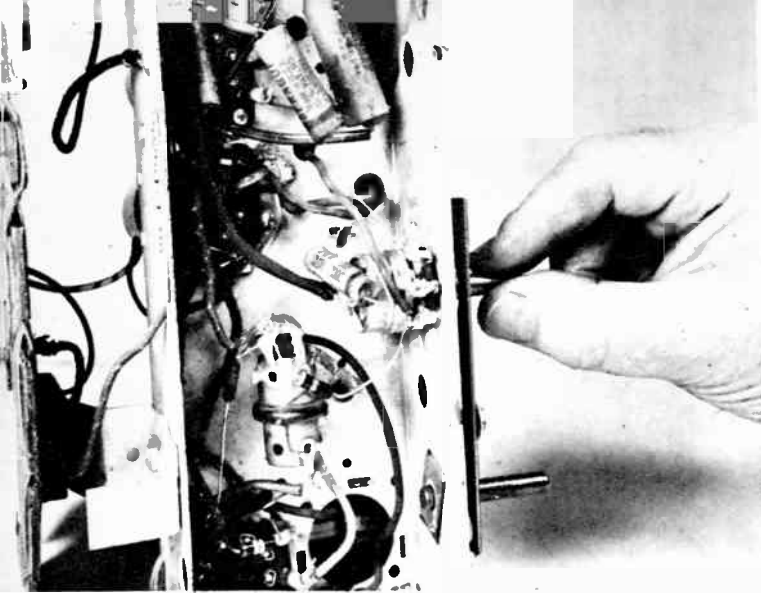

The combined on-off switch and volume control takes a great deal of physical punishment in normal service and therefore can be expected to fail sooner or later. The switch has two connections, the volume control has three. In some receivers the switch comes on with a turn to the right; in others it operates with an easy pull action.

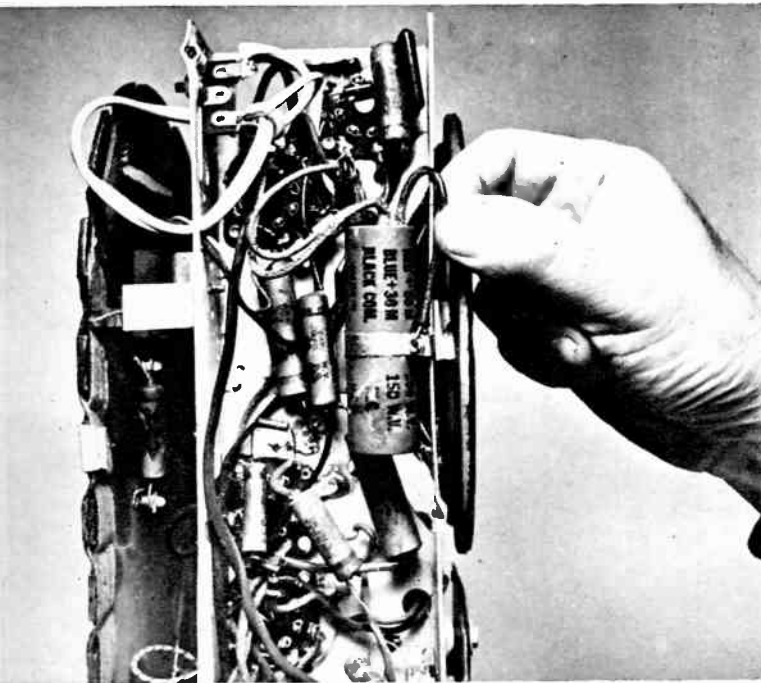

The filter capacitor in AC-DC sets is usually a paper cylinder, clamped to the under side of the chassis. It has three wires, the black one soldered to the chassis. Bulging and leaking of a salt-like chemical from the case are signs of deterioration and a warning to replace the unit before it causes very serious circuit faults.

to touch the chassis proper, turn the set on and tune in the usual manner. If you hear stations, turn the set off, unplug the line cord, put the set together again, and congratulate yourself on a productive, interesting and educational repair job.

Check the Dial Light

One moment. Did you notice if the dial light was OK? The set will work without it, but the life of one of the tubes (the

35Z5 or 35W4 rectifier) will be shortened because the current distribution through its filament, which is in two sections, will be unbalanced. The bulb is of the miniature bayonet type and can be replaced in a few seconds.

If an AC-DC set is not working but if the pilot light goes on with the line switch, the circuit through the filaments of the tubes is complete and none of the latter are burned out. A tube can have an intact

To test resistors, it is always necessary to free one end; otherwise, other circuit components to which they are connected will invariably give misleading readings on the VOM. Clip the negative lead of meter to one resistor terminal and touch the red probe to the other, and observe the readings on the ohms scales.

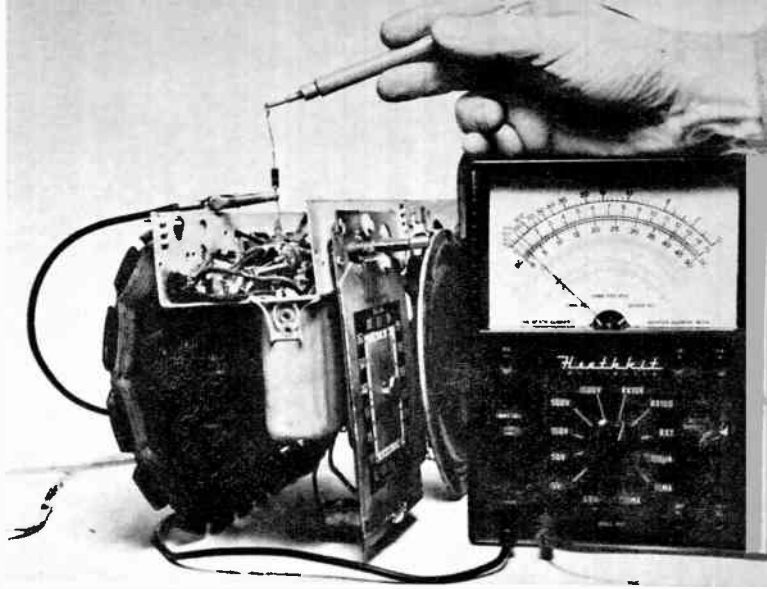

Before disturbing any wiring in a set or removing any components for test or replacement, make a sketch of the original connections for reference purposes. Many wires in a chassis are colored, to facilitate circuit tracing. It is helpful sometimes to attach small tags to wires to prevent confusion if the colors are alike.

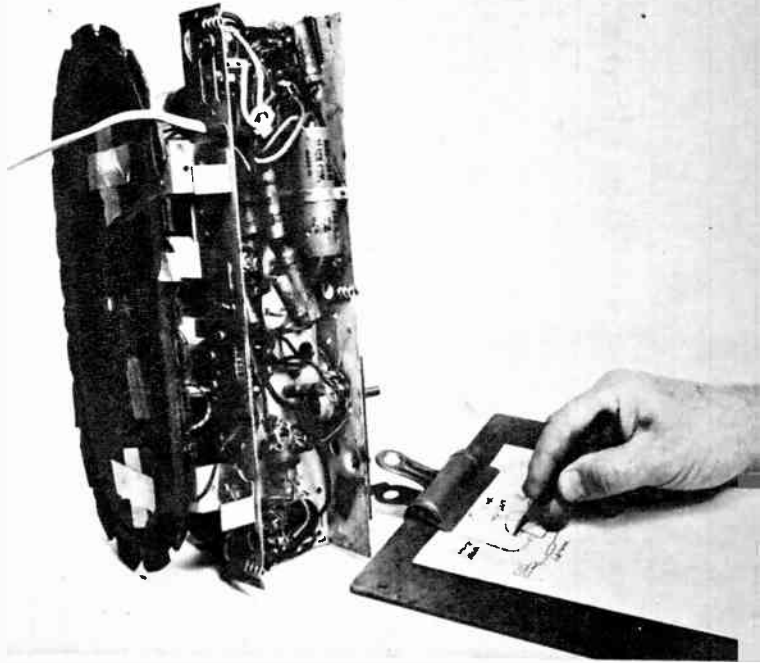

filament and still be inoperative for several reasons, but in these receivers a burn-out after long service is much more likely.

If the tubes appear to be OK, where do you start to look for the trouble? You don't. First you must arm yourself with some basic technical information on the set. This usually takes the form of a schematic diagram and appended notes about points of adjustment, voltage readings in sensitive parts of the circuit, etc. If the manufacturer

of your set is still in business and if you can identify it by model number or some other marking on the chassis or cabinet, make a request for "service notes" and enclose a stamped and addressed envelope to facilitate a quick reply . . . if any. Some manufacturers lose all interest in their products once they leave the factory and they don't give a hoot about retaining the good will of their customers; they simply ignore letters from individuals and even

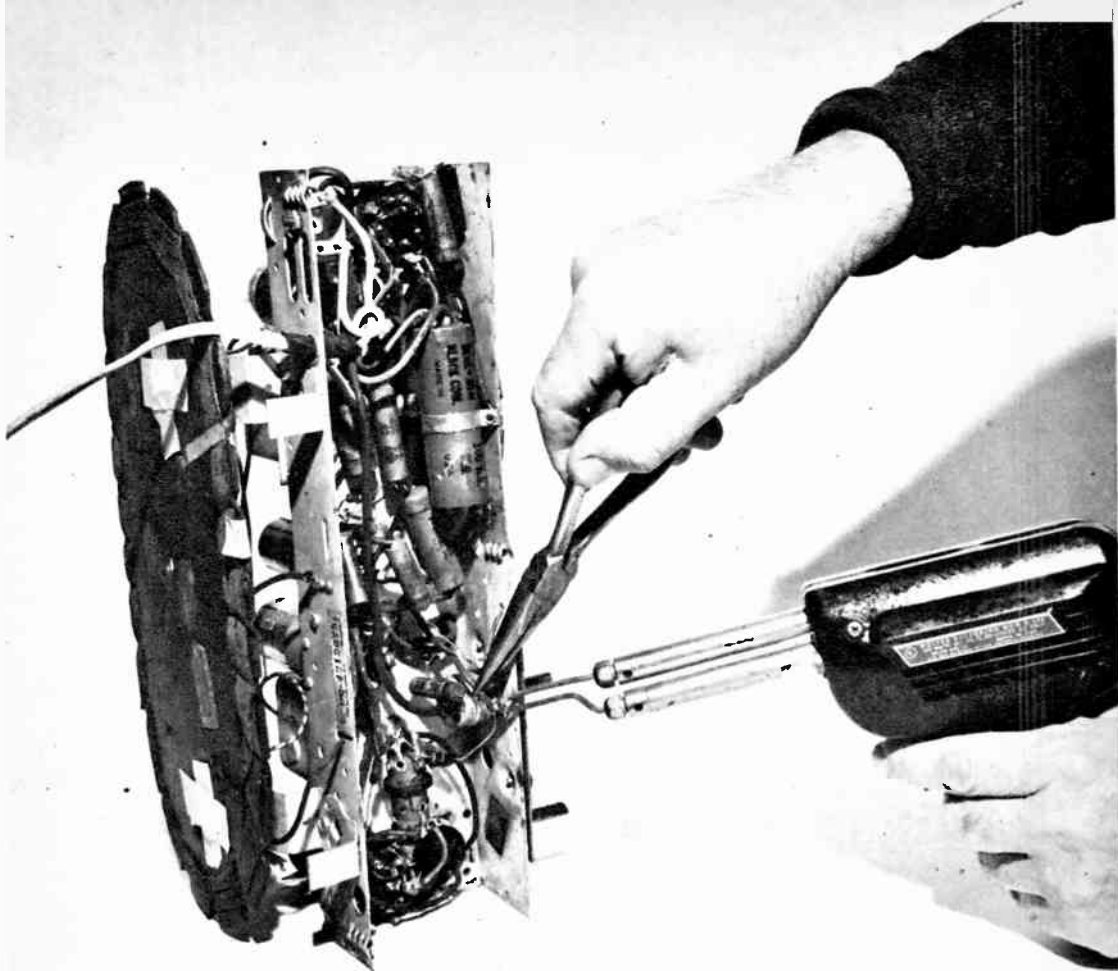

from professional service technicians. Others are very helpful. Actual copies of service sheets printed ten or twenty years ago might not be available, but with modern dry copying machines legible reproductions can be made quickly.

One supply house that does not underestimate the ability or intelligence of its customers is Sears, Roebuck. This firm doesn't wait for them to write in for service data, but includes excellent professional-type diagram sheets in the original boxes of most sets. The information is of tremendous help in that it enables a user to become familiar with the details of his set *before* trouble develops. Even if it continues to work without a murmur for years, it is comforting to have the "dope" on hand.

Two firms specialize in gathering service data and making it available to all who might need it. They are Howard W. Sams

& Co., of Indianapolis, and Supreme Publications, of Chicago. The Sams "Photofact" folders cover the staggering total of more than 55,000 radio and television sets and related equipment. The Supreme diagram manuals go all the way back to 1926. You can get free indexes for both series, and helpful suggestions, from Allied and Lafayette. *

Poking around a live chassis without the guidance of service notes is not only futile and time-consuming but also a little dangerous. Their value is that they tell you exactly where to probe to get significant voltage and resistance measurements safely.

*See "How To Buy Radio Parts."

The Noisy Volume Control

If the loud speaker emits scratchy noises when the volume knob is turned the con-

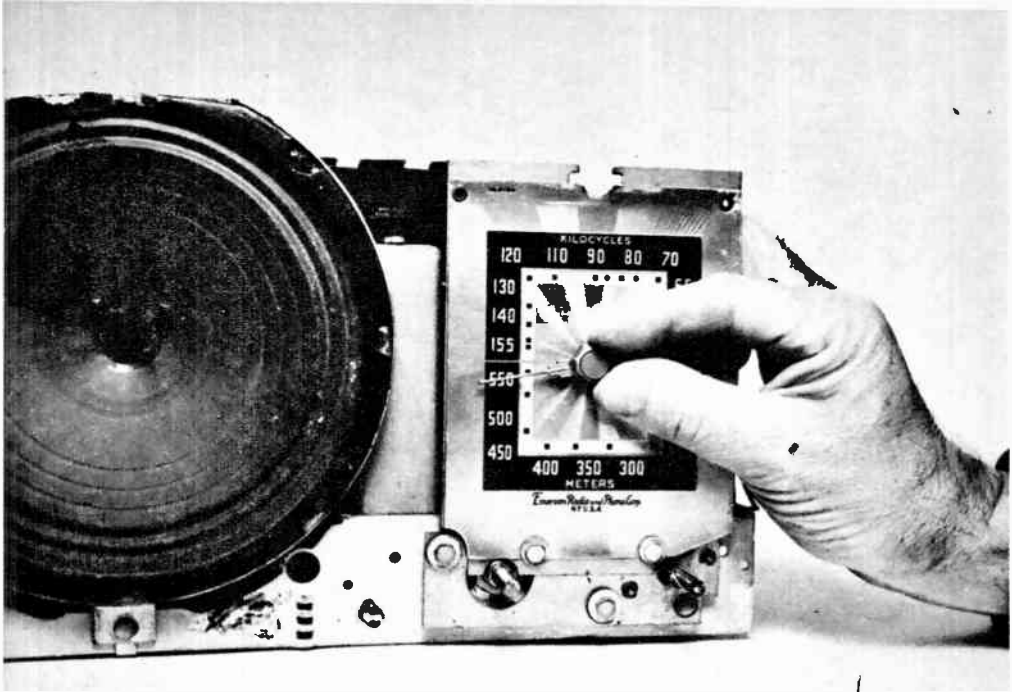

Above: On most sets the dial pointer is held only by friction, and can be removed readily if dial disassembly becomes necessary. It can also be adjusted to give correction indications of station frequencies.

Left: Molten solder is very hot! When either making or undoing connections, keep your fingers away from the joints, and use a pair of long-nose pliers to hold the wires or to twist them loose as solder melts.

trol should be replaced. This is a mechanical rather than an electrical operation and is easily performed with the chassis out of the cabinet. Before unhooking it, make a little sketch of the wires connected to it, so that you can resolder them correctly later.

In all small AC-DC sets the volume control is combined with the line switch, and one knob actuates both. Usually, the switch snaps on with a clockwise twist of the knob. In some newer models it works with a pull-push action. In most cases the switch is held to the body of the volume control itself by a couple of small lugs, and can be lifted off if the latter are pried open carefully. With this arrangement you need to buy a replacement only for the half that goes bad.

The standard volume control has a value of half a megohm, or 500,000 ohms. You can identify it by its round body and the

three terminals sticking out from it. The switch has only two terminals. Most replacement controls come with shafts several inches long, so that they can be adapted to chassis of different construction. Measure the old unit and saw off any excess. The shaft itself might be of brass, aluminum or an insulating material.

The Filter Capacitor

The chassis component most likely to fail after prolonged service is the "filter capacitor." The function of this item is to smooth out the rough form of direct current that comes out of the 35Z5 or 35W4 rectifier after alternating current from the line goes into it. Without this capacitor the set would produce a loud and raucous growl that would drown out all voice and music.

Two things can happen to any capacitor:

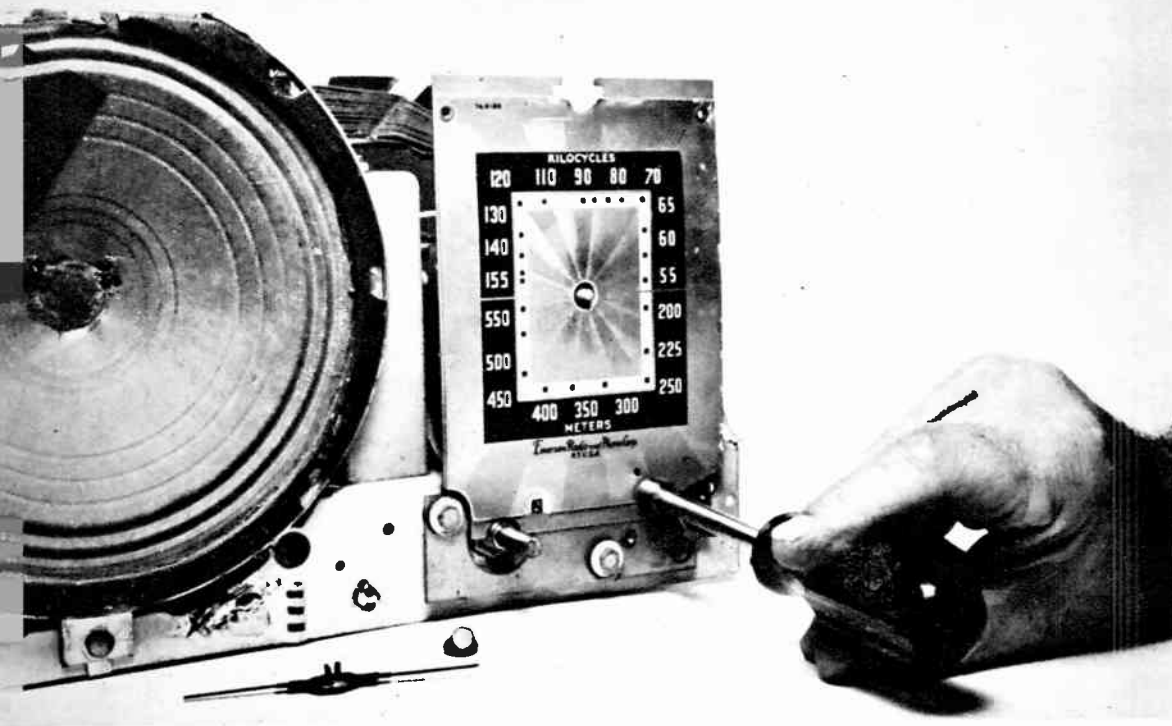

Most of the small hex-head screws and hex nuts used for radio chassis are $\frac{1}{4}$ ". A nut driver in this size is a very useful tool for them. Here, dial assembly is being removed to give access to volume control.

1) It can lose all its filtering action by going "open," thus in effect removing itself entirely from the circuit in which it is connected. 2) It can develop either a partial or a complete internal short-circuit, thus seriously disrupting the circuit. An "open" identifies itself quickly by the growl from the loud speaker, and does no damage. Unfortunately, the usual trouble is not an "open" but a "short." This can readily overload the rectifier heavily and either shorten its life drastically or terminate it altogether.

A shorted filter can usually be detected by a quick voltage check with the VOM. If the service notes indicate a normal voltage of perhaps 100 or 105 at a certain point in the circuit and the meter reads zero, the capacitor is undoubtedly a dead short on the rectifier tube. If the short is only partial, the meter might read a few volts, per-

haps enough to make the set work very weakly.

The filter is a waxed paper or aluminum cylinder about $\frac{3}{4}$ or 1 inch in diameter and about 3 inches long, and is marked "20-20 mfd. 150 v." The first two figures mean that there are two identical sections having a rated capacitance of 20 microfarads; the last is the rated operating voltage of the unit. Up to a certain point, the higher the capacitance the better the filtering action, but in any event the values are not at all critical. Another widely used combination is "30-50 mfd. 150 v."

The paper cased capacitor is fastened somewhere to the chassis, invariably on the under side, by a riveted strap. It has three wires coming out of it. One is always black and is "grounded" to the chassis. The others might be both red, or red and some other color. They represent the "hot" side

of the filter circuit from the rectifier tube, and to them the VOM probe is connected for most voltage readings.

The aluminum cased capacitor is usually mounted upright in a hole in the chassis, like a tube socket. Its case is the "grounded" connection. The "hot" connections are to two short terminals on an insulated cap. on the underside. To remove a defective unit, look for two or three twisted lugs in slots in the chassis and straighten them with a pair of flat-nose pliers; the can will then lift right out.

The "Hot Chassis"

The one unhappy feature of the AC-DC set is its "hot chassis." Hot *electrically*, not thermally. The metal body does get warm from the tubes, but this is unimportant. The expression "hot chassis" derives from the common manufacturing practice of connecting one side of the AC line to the chassis, either directly, in older sets, or through the combination of a resistor and a capacitor, in newer sets. This is of no concern if the chassis is inside a wooden or plastic cabinet with a hardboard or other

With the dial plate off, the volume and tuning controls become accessible. Their usual mounting nuts are $\frac{1}{2}$ " hex. A nut driver in this size is a necessity in most cases, to reach into tight, recessed holes.

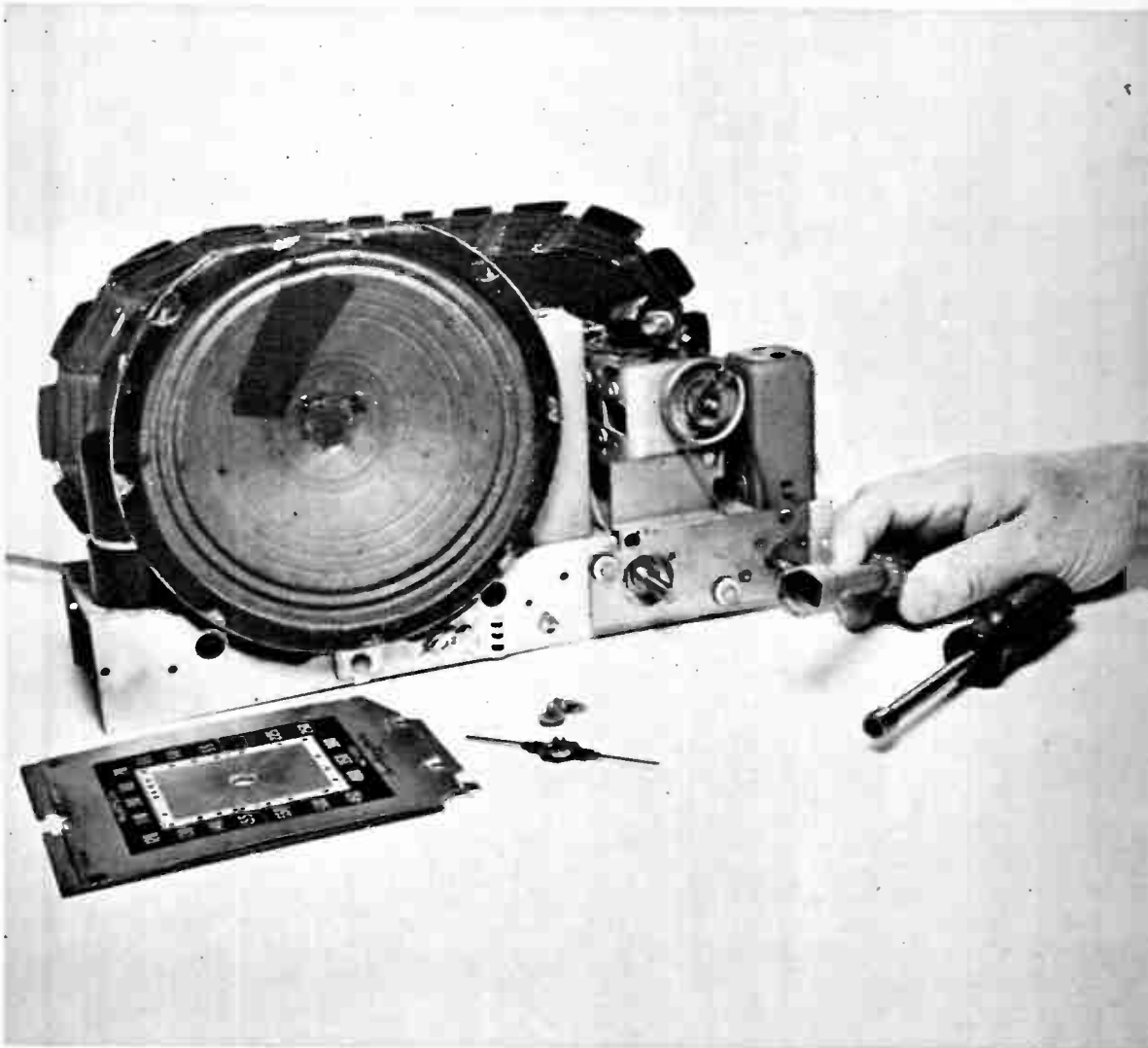

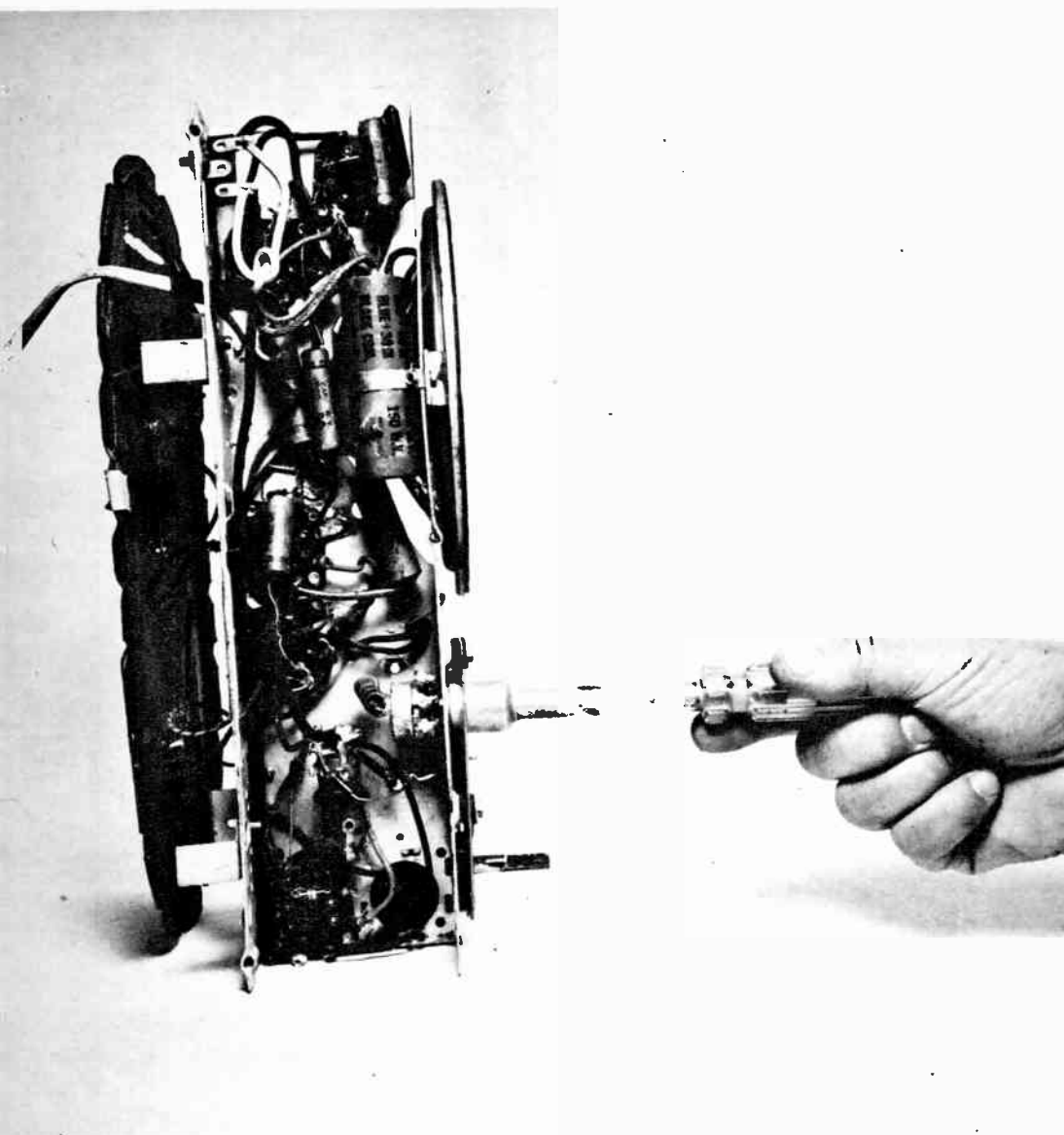

Removal of volume control, a common repair job with all radio sets, is greatly facilitated by use in this manner of nut driver. In many cases a wrench of ordinary type cannot be used because of lack of space.

insulated back, if the heads of the chassis screws are well below the surface of the cabinet's bottom, and if plastic knobs fully cover the shafts of the tuning dial and the volume control: in other words, if the entire metal framework is insulated to the touch of a person using the set.

However, a potentially dangerous situa-

tion develops if a knob is pulled off accidentally, exposing a metal shaft, or if the chassis is removed from the cabinet for repair and is plugged into the house line. One side of the latter is always grounded, primarily to provide a measure of protection against lightning surges on the long lines that run from power generating stations.

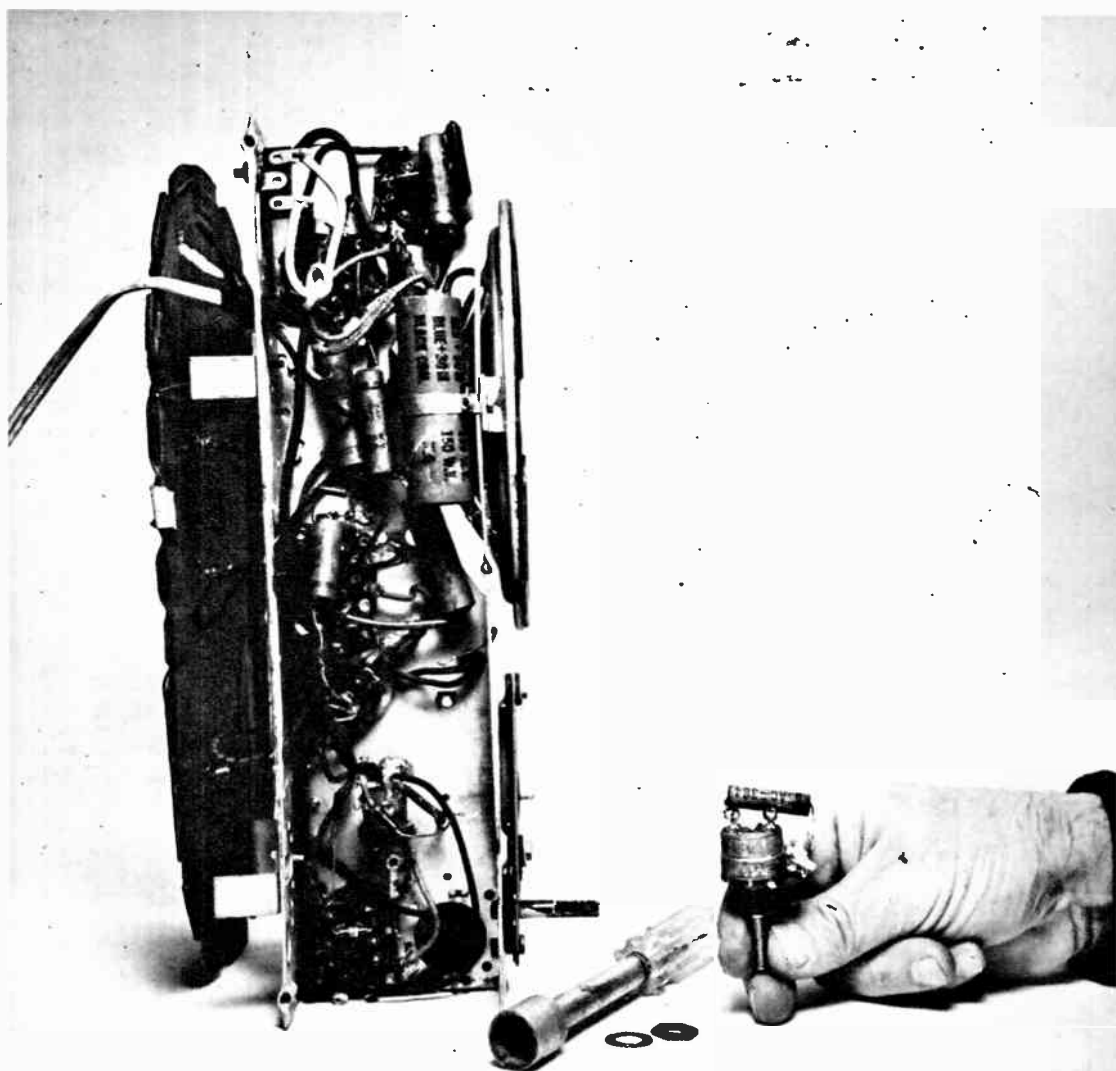

Under the large hex nut of the volume control might be found a lock washer or a plain washer, or both. As removed, control has small capacitor still attached. Unsolder this carefully before testing the part.

Remember that an ordinary two-prong plug can be inserted into a wall outlet in two ways. Suppose for a start that it is inserted so that the wire from the chassis goes to the grounded slot of the outlet. (This is, or should be, the wider of the two.) The chassis is now "cold" electrically in relation to any object that is grounded

the way power lines are grounded; that is, to the actual earth. In the home, this ground exists in the form of water and gas pipes, since these are buried in the earth for much of their length. With complete impunity you could touch the chassis with one hand and a water tap with the other, because the chassis and the tap together

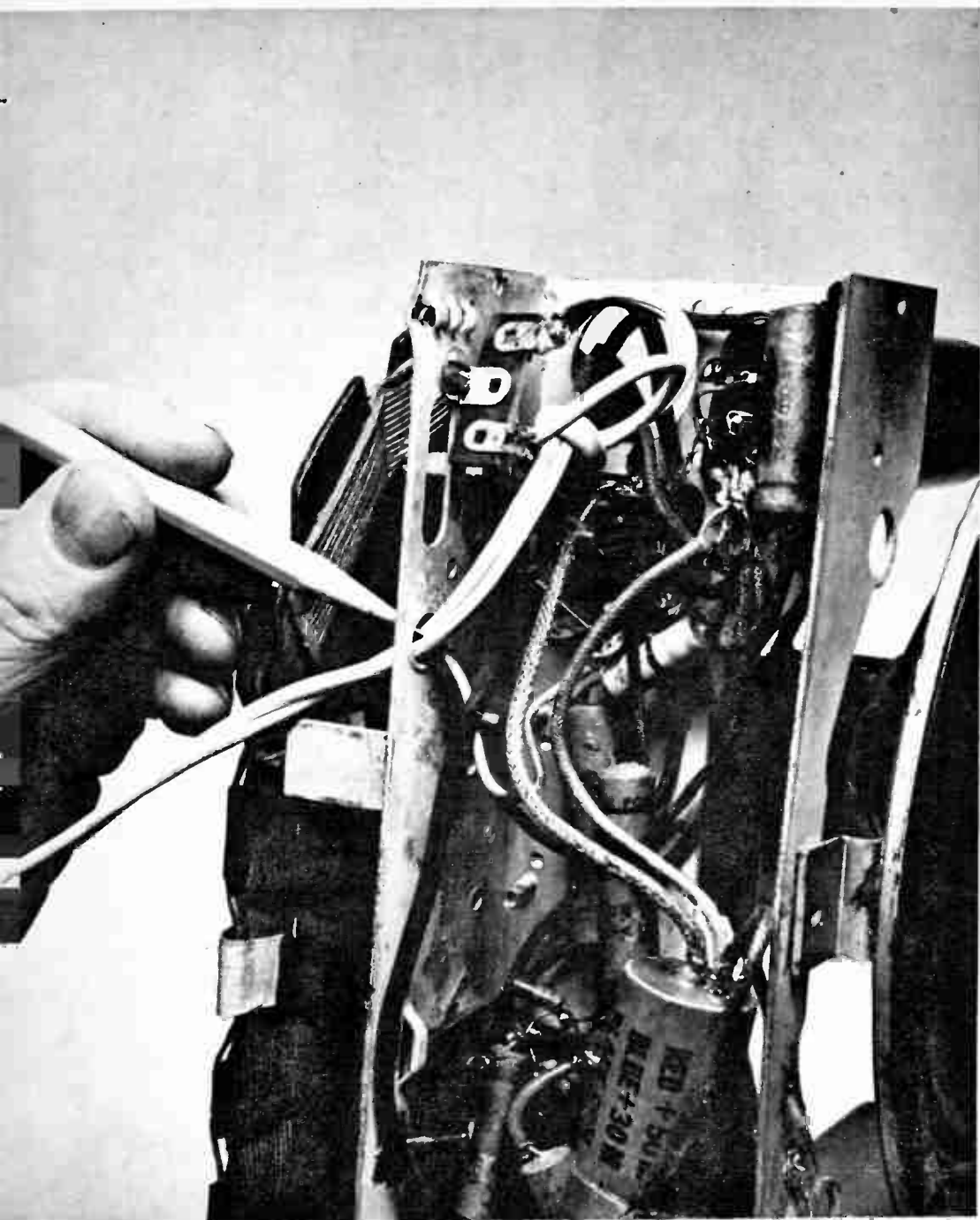

If a set is moved around a great deal, the line cord is bound to chaff at the point where it goes through the chassis, as indicated here by the pencil. Sooner or later the insulation will wear through and the result is likely to be a flashy short-circuit. Anticipate and prevent this by winding a layer of insulating tape of any kind around the wire where it meets the chassis. Check rest of cord for wear.

The "hot" electrical condition of the chassis of many AC-DC sets can be demonstrated by a couple of simple experiments. Remove one knob from the set and connect one lead from an ordinary lamp to it; connect the other lamp lead to metal wall outlet box, which is always grounded. Turn the set on and insert the line plug. If it happens to go in the "safe" way, the lamp does not light. Now turn page.

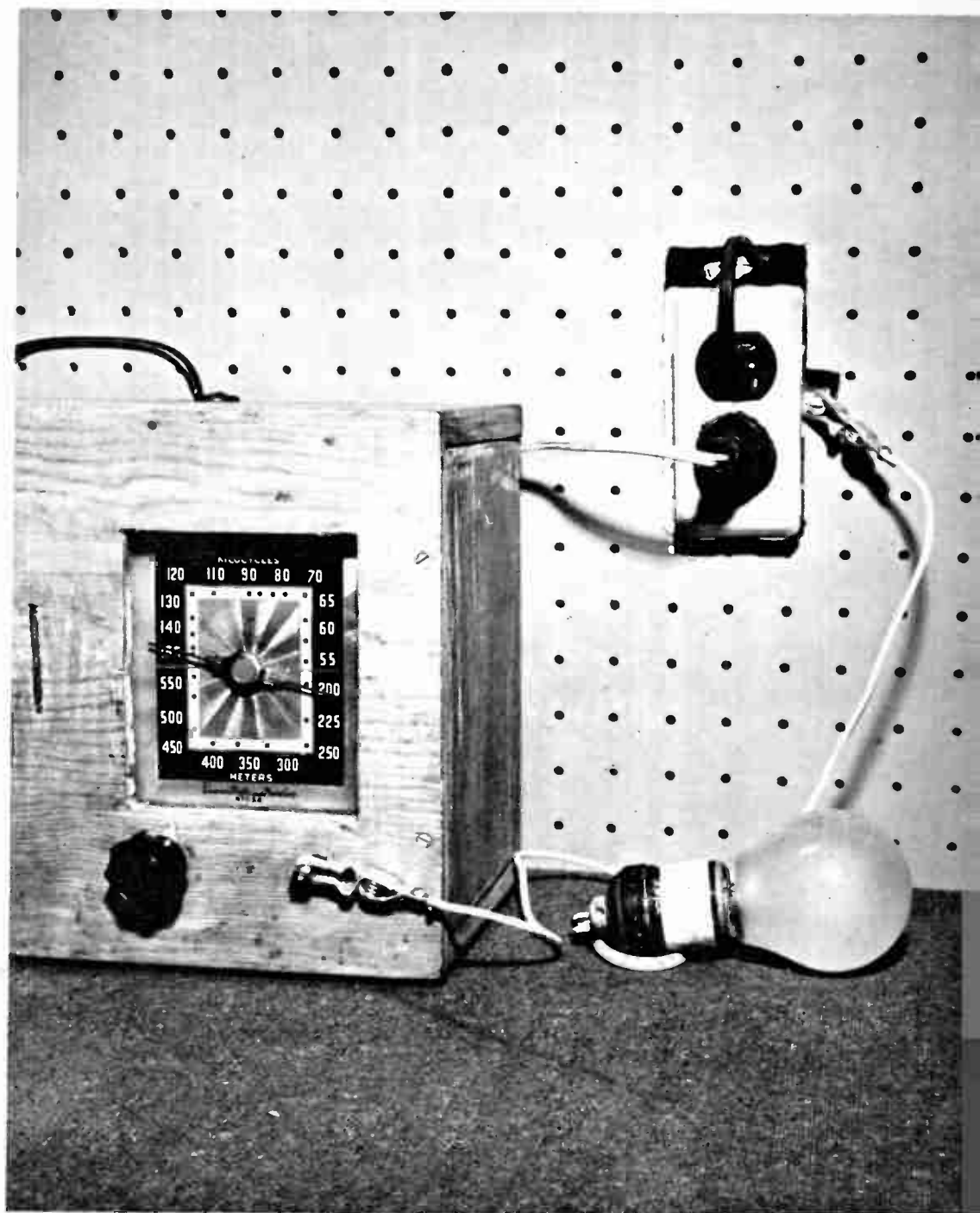

constitute only half of the AC circuit. You could, but it's wiser to perform the experiment with an ordinary lamp in a socket, as some accompanying photos show.

If we reverse the plug the situation changes radically. The wire from the chassis now goes to the hot or ungrounded side of the AC line, so the chassis is now also hot in relation to any grounded object because the latter completes the circuit. If you use the lamp, as suggested, you will be

startled to see it light up. If your own body were in place of the lamp the current would pass through you and you'd probably be knocked across the room by the shock.

The set works exactly the same way whether the chassis is grounded or ungrounded. The difference is merely one of possible danger to the user.

A curious fact is that you can feel an appreciable tingle from a hot chassis even if

Reverse the line plug and surprise . . . the lamp goes on, showing that the chassis is definitely "hot" in relation to a grounded object. It is also dangerous to a person touching the latter and the set.

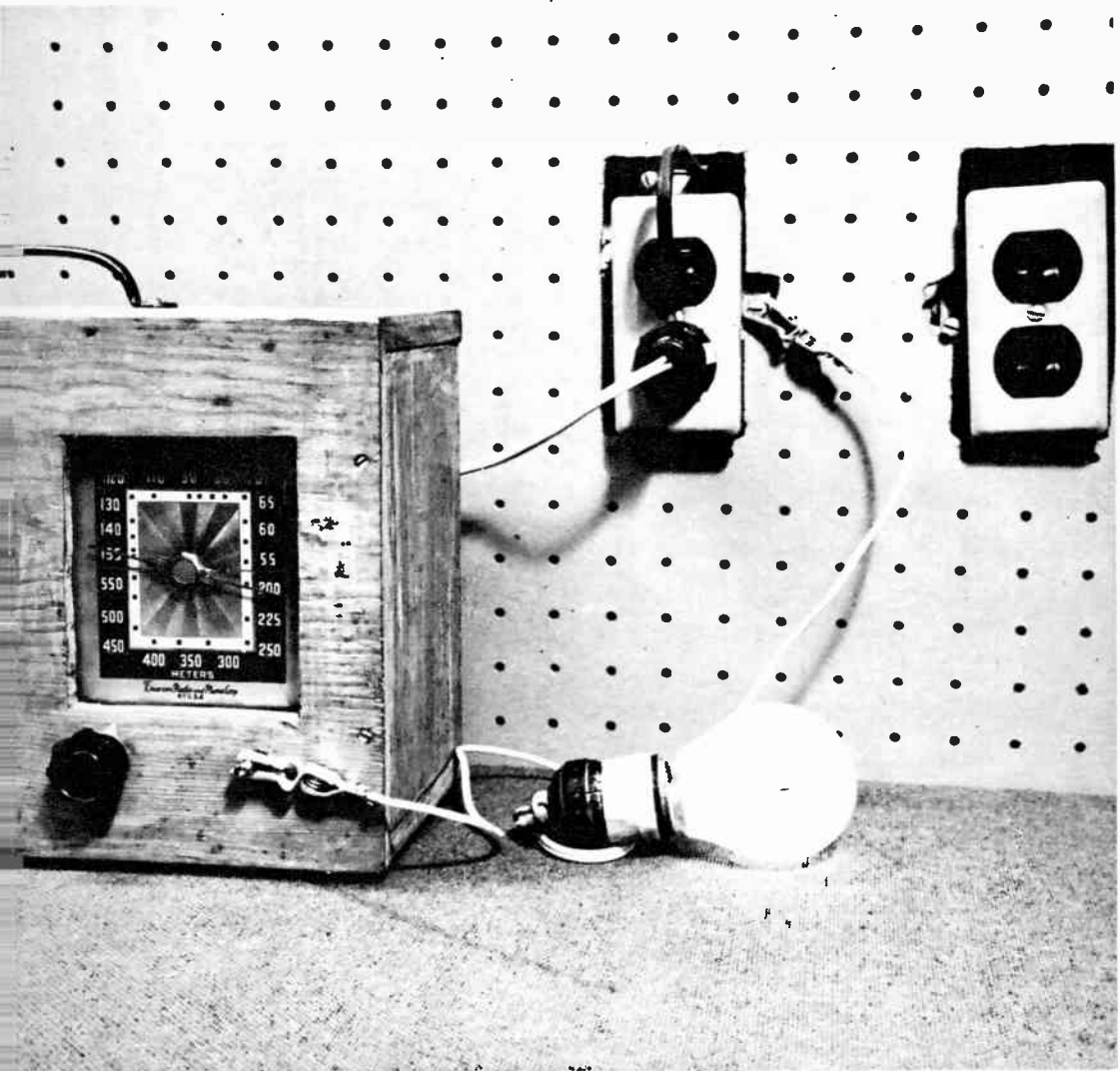

you wear shoes and stockings and stand on a wooden or carpeted floor. These materials are all good insulators, so how is a circuit through your body to a grounded pipe possible? The answer is "body capacity," more properly "body capacitance." Your body, in relation to nearby surfaces and objects that make contact with piping in the house, acts as a capacitor, or condenser. Not a very large one, but large enough to allow some weak AC to flow through. The

effect is particularly marked if you stand on the bare cement floor of a basement; first, because the surface is faintly conductive, and second, because water and other pipes run close by.

Don't let the word "danger" frighten you. It should only be a reminder to check the fitting of the knobs, since they are handled constantly and might loosen. If the springs in them seem to be losing their grip, buy new knobs. They are plentiful

To reduce possibility of accidental shock, mark the prong that engaged the wider of the outlet slots when the lamp did NOT light. Use white adhesive tape. Similarly mark the wide slot of the outlet.

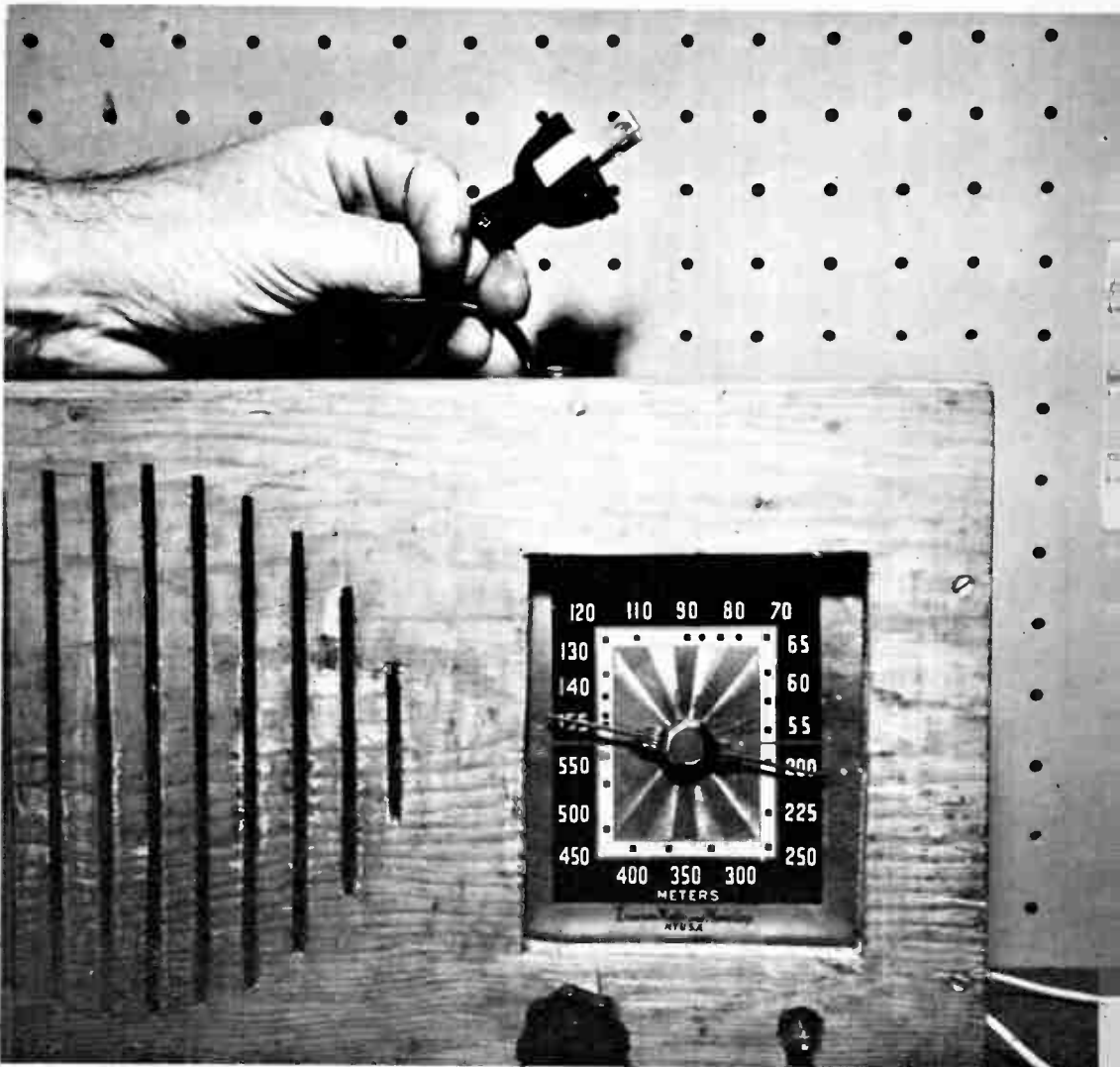

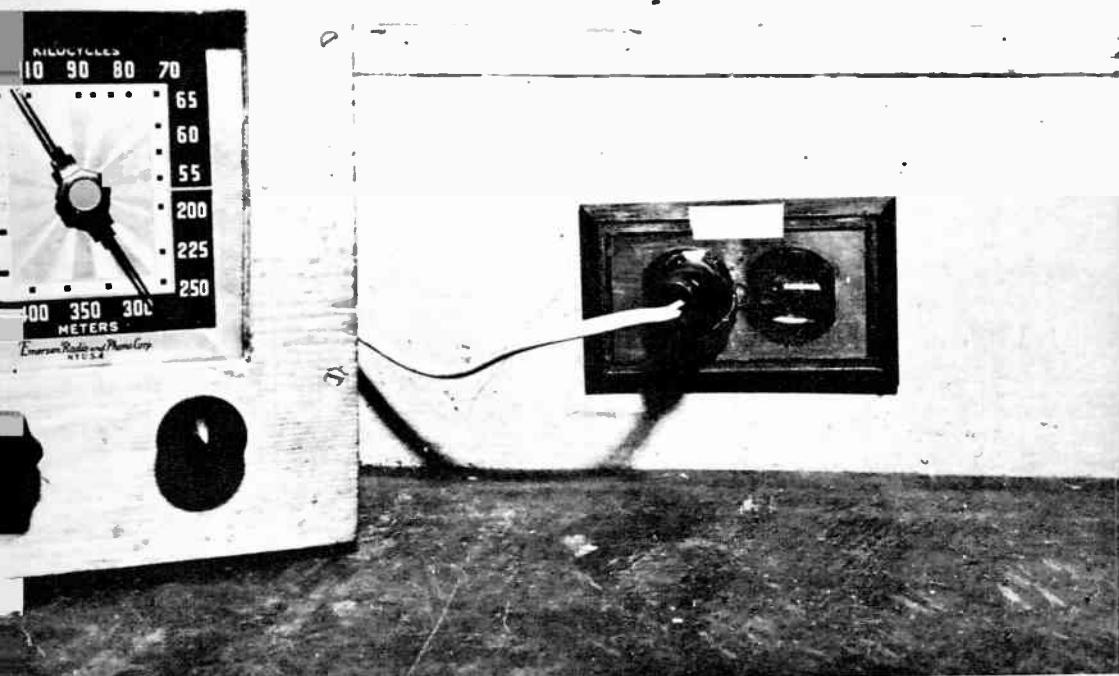

White strip of tape makes position of wider slot of outlet (the grounded side) unmistakable. With the line plug of the radio set inserted with its marker up, the chassis is safe against unsafe grounding.

and cheap, whereas springs by themselves are not generally available.

What Not To Do About Alignment

You may find some data on "alignment" in the service notes for your receiver. Don't attempt any of the mentioned adjustments. Not one radio receiver in 100,000 ever needs them, unless, as is most unlikely, an inquisitive child has removed the back, the knobs and the chassis and has used the special tool needed for the purpose to turn some movable slugs that can't even be seen inside square aluminum cans mounted upright on the chassis near the tubes. These cans contain small transformers called "IF's" (pronounced "eye-ef's," not "ifs"), meaning "intermediate frequency." The factory settings of the slugs, not critical to begin with, usually last the life of the set.

Because of slippage in the dial mechanism, the pointer or other indicator might not show readings on the scale that agree with the announced operating frequencies of stations. In most cases the pointer is held only by friction and can be moved easily, like the hands of a clock.

The American AM broadcasting band covers 540 to 1600 kilocycles. If a dial is small and crowded the figures are abbreviated by the dropping of the last digit or even the last two digits. Thus, a dial might read 54, 60, 65, 70, 80, 90, 110, 120, 140, 160, or 5, 6, 7, 8, 10, 12, 14, 16; you have to interpolate for intermediate values. With most small sets it is not possible to make the dial read accurately all over the scale. If it is precise at one end it is usually off a bit at the other. A compromise setting at about the center of the dial is satisfactory under most circumstances. •

Exclusive with **RCA...**

AUTOTEXT

faster, easier way toward a career in electronics

EXCLUSIVE WITH RCA. "AUTOTEXT," developed by RCA and introduced by RCA Institutes, Inc., is a system of programmed instruction, accurately planned so that as you read a series of statements, questions, and answers, you learn almost without realizing it! It's fast! It's easy! It's fun!

NEW TREND IN EDUCATION! Programmed instruction has been proved with thousands of students. People who have had trouble with conventional home training methods in the past can now master the fundamentals of electronics almost automatically!

PROVE IT TO YOURSELF NOW! An interest or inclination in electronics is all you need. RCA "AUTOTEXT" will help you do the rest. And the future is unlimited; the jobs are available! The important thing is to get started now!

COMPLETE COURSE AVAILABLE. RCA Institutes now offers you a complete Home Training Course ("Introduction to Electronics") using the "AUTOTEXT" method. You get a complete set of theory lessons, service practice lessons, experiment lessons, and all the kits you need. You'll learn faster with less effort!

ATTENTION VETERANS!

All RCA Institutes Courses
available under new G.I. Bill

COMPLETE SELECTION OF HOME TRAINING COURSES

- Communications Electronics
- FCC License Preparation
- Mobile Communications
- Automation Electronics
- Automatic Controls
- Industrial Applications
- Nuclear Instrumentation
- Digital Techniques
- TV Servicing (with new transistorized TV Receiver Kit)
- Color TV Servicing
- Transistors
- Electronics Fundamentals
- Electronics Fundamentals (in Spanish)
- Computer Programming
- Drafting

● LIBERAL TUITION PLAN FOR ALL HOME TRAINING COURSES

This plan affords you the most economical possible method of home study training. You pay for lessons only as you order them. If, for any reason you wish to interrupt your training, you can do so and not owe one cent. No other obligations! No installment payments required.

● YOU GET PRIME QUALITY EQUIPMENT

All kits furnished with home training courses are complete in every respect and the equipment is top grade. You keep all the equipment furnished to you for actual use on the job, and you never have to take apart one piece to build another!

Licensed by the New York State Department of Education.

Classroom Training Available in New York City, and Cherry Hill (near Camden) New Jersey.

Send postcard for free illustrated book today! Specify home training or classroom training!

Dept.
RCA INSTITUTES, INC., RG-27
A Service of Radio Corporation of America
350 West 4th St., New York, N.Y. 10014



THE MOST TRUSTED NAME IN ELECTRONICS

Straight AC Sets

EVEN though it requires the use of a power transformer, the straight AC type of circuit is generally favored over the AC-DC variety for larger table model radio sets, for console installations, and for all high-fidelity equipment, including tuners and amplifiers. The transformer is easily the most costly individual component of the chassis, but it offers a number of advantages from both the operating and servicing standpoints.

In its usual form the transformer con-

sists of four separate windings on a common laminated iron core. The "primary" connects to the AC line, through an on-off switch. There are three "secondaries." One delivers about 250 or 300 volts of AC which is turned into DC by a rectifier tube. The second gives five volts of AC exclusively for the filament of the latter. The third produces either 6.3 or 12.6 volts of AC for the heaters of the rest of the tubes in the set, ranging from six or seven to fifteen or eighteen.

The difference between AC-DC and straight AC receivers is quickly revealed by an examination of their chassis. The AC set is invariably larger, to accommodate the heavy power transformer, shown here being pointed out at the right rear. The only other encased transformer likely to be found in the receiver is a much smaller one mounted on the loud speaker. As with this set, latter may be a separate unit.

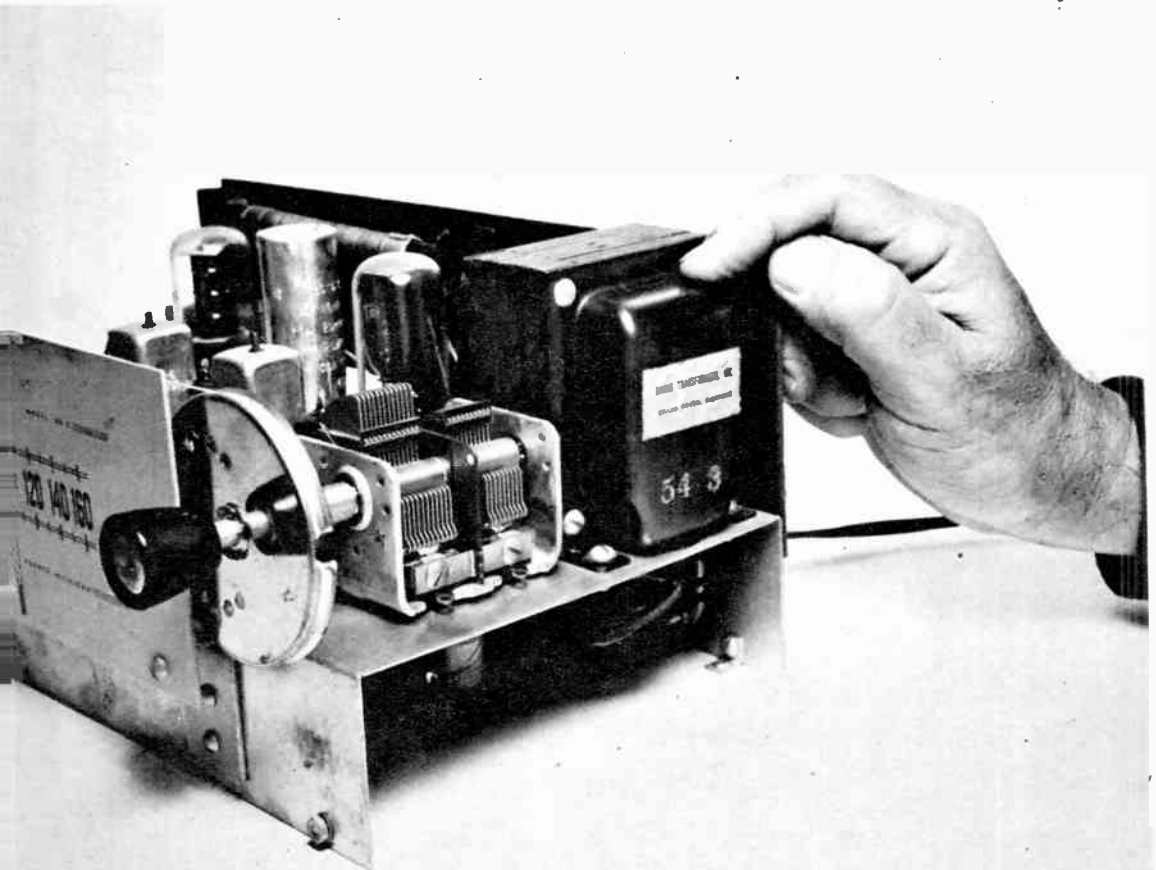

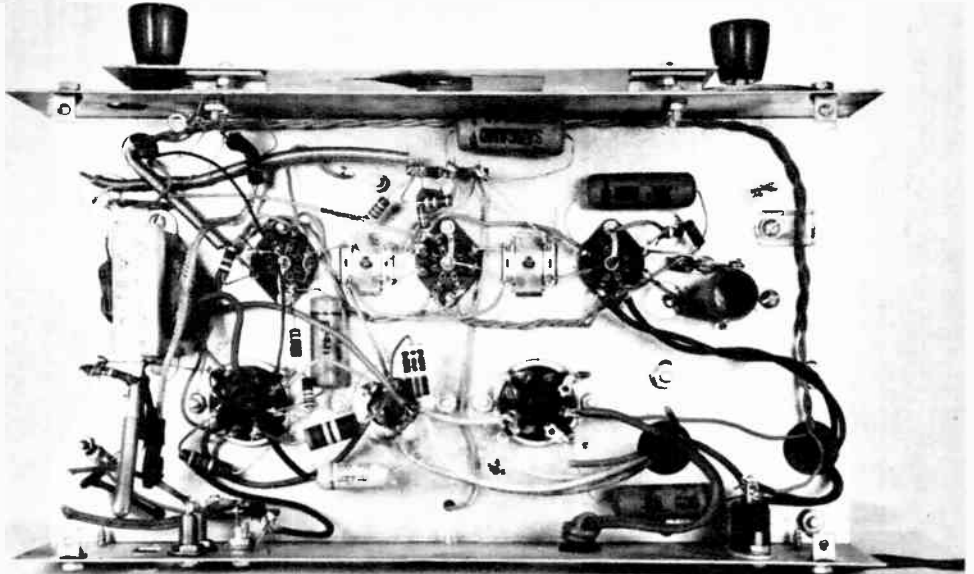

Larger chassis of an AC set allows components to be spread out comfortably. Wiring is more open and parts are readily accessible for test and for replacement if needed. Object at extreme left, center, is not a transformer, but a filter choke. Chassis is common "ground" for all circuits but it is not "hot" electrically and can be touched safely. However, do not touch resistors, for they can be hot thermally.

Right: Aerial in this typical AC set is a "loop-stick," mounted on insulating back of the chassis. The can in front is electrolytic filter capacitor.

The tube heaters are connected in parallel, sometimes also called "shunt." The burn-out of any one tube does not affect any of the others, so it is very easy to spot a "dud" if a single burn-out is the only cause of set failure—as it is in most cases. If there is a slight background noise in the loud speaker the rectifier tube is probably OK. Turn off the room lights, leave the set on, and look carefully at the other tubes. If they are all of the glass type, you'll be able to tell in a minute which are lit and which aren't. The heaters glow dull red and usually cast their light toward the top of the tube rather than out through the side. If some of the tubes are glass and others metal, or all are metal, leave the set on for a few minutes; then pull the line plug and quickly run a finger over them. There's a considerable difference in temperature between a good tube and a dead one: by comparison the latter feels stone cold.

For use in a series-connected AC-DC set, tubes must all have exactly the same

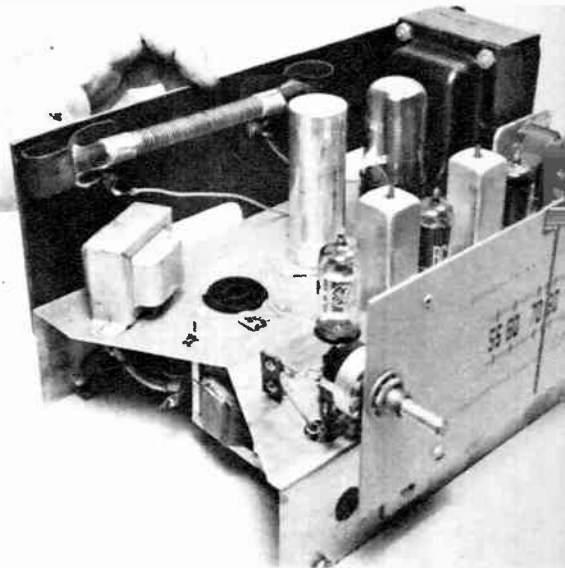

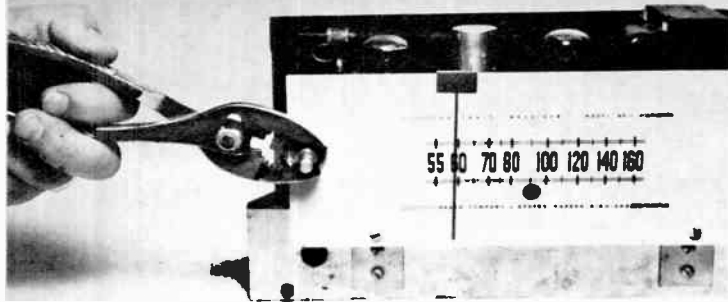

A common repair operation requires removal of large hex nut holding volume controls, switches, dial assemblies, etc., to the front panel of chassis. If nothing else is available, job can be done with adjustable "gas" pliers, but at risk of scoring surface of panel.

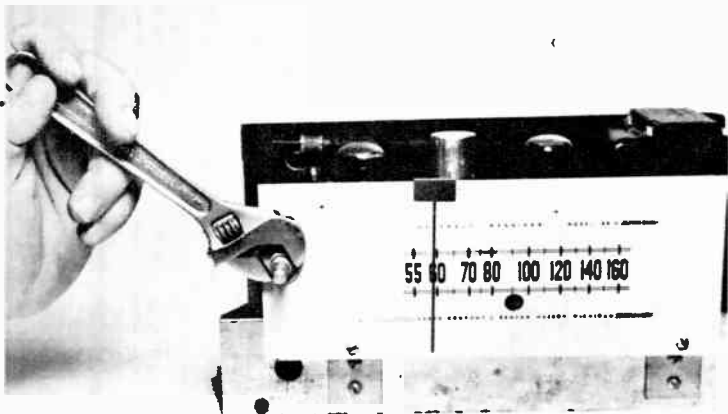

There is less danger of slippage if a small wrench of the adjustable jaw type is used. Close the jaws to fit snugly, hold assembly with one hand to prevent it from turning, and apply push to wrench handle. Once nut is loosened, it can be run off quickly by fingers.

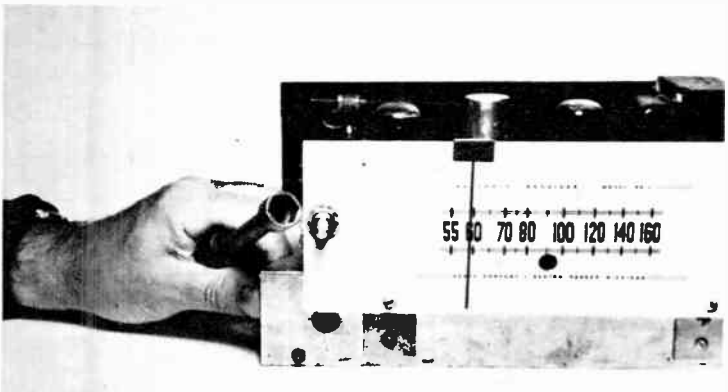

Quickest, easiest and cleanest job of dismounting assembly is done with a nut driver. It has a hollow shaft and slips over the control shaft to engage the large hex nut firmly without mangling it or damaging dial surface, as in this set.

heater-current rating, although their voltage ratings can and do vary from about 3 to 50 volts. In a typical combination there are three tubes at about 12 volts, one at 35 and one at 50; these add up to about 121 volts, which means they are a shade underloaded at 115, 117 or 119 volts. The current through this circuit is uniformly a fraction of an ampere; 100 milliamperes, 150 milliamperes or 300 milliamperes, depending on the particular tubes. One problem with this arrangement is that the warm-up times of the heaters must be pretty much the same. If they aren't, some

of the tubes can be overloaded heavily for a few seconds, and their life is thereby shortened. The variety of tubes having the necessary characteristics is rather limited.

The straight AC transformer set is not subject to these restrictions. Designers can pick and choose from among literally thousands of kinds of tubes having the same voltage rating. The current ratings can vary, but this is of no importance in a parallel circuit. For example, in a typical seven-tube AC receiver using 6.3-volt tubes, there are five taking .3 ampere each and two taking .45 ampere, for a total

AC-OPERATED SUPERHETERODYNE RECEIVER

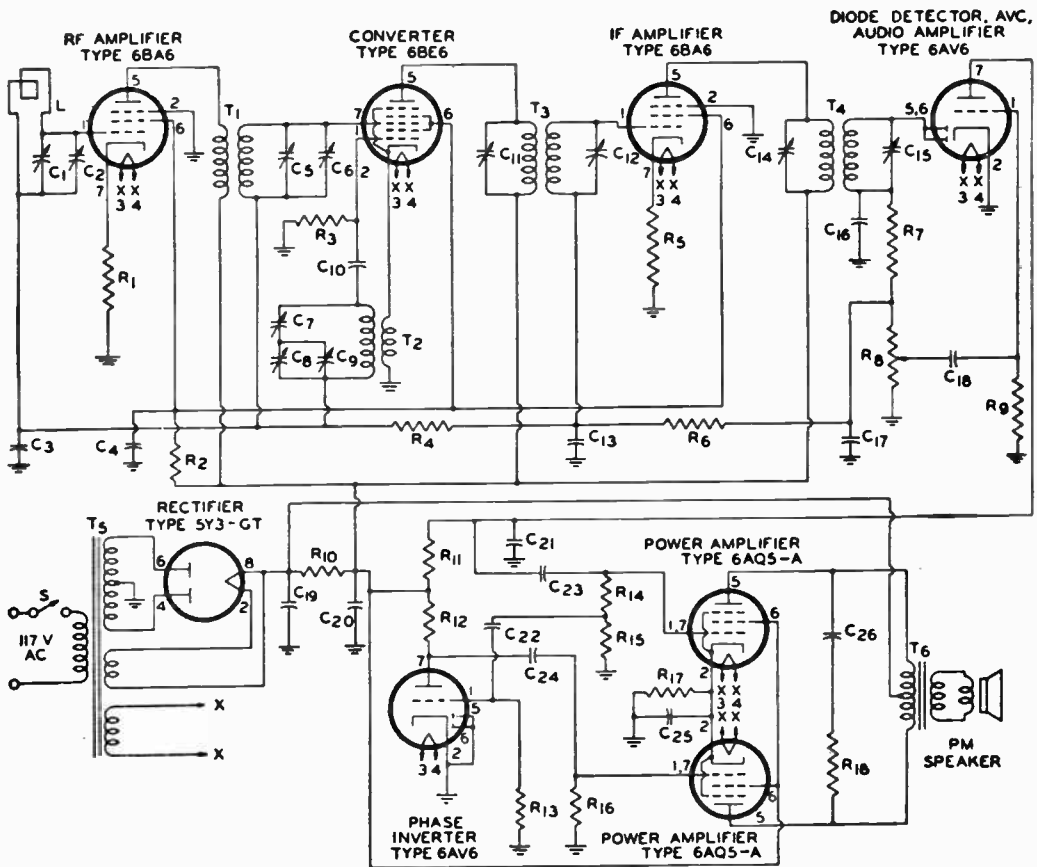

- C₁ C₂ C₃**=Ganged tuning capacitors, 10-365 pf
C₂ C₄ C₅=Trimmer capacitors, 4-30 pf
C₃ C₁₈=0.05 μ f, paper, 50 v.
C₄=0.05 μ f, paper, 400 v.
C₇=Oscillator padding capacitor—follow oscillator-coil manufacturer's recommendation
C₁₀=56 pf, mica
C₁₁ C₁₂ C₁₄ C₁₂=Trimmer capacitors for if transformers
C₁₆ C₁₇=180 pf, mica
C₁₈ C₂₂=0.01 μ f, paper, 400 v.
C₁₉=20 μ f, electrolytic, 450 v.
C₂₀=80 μ f, electrolytic, 450 v.
C₂₁=120 pf; mica
C₂₁ C₂₁=0.02 μ f, paper, 400 v.

- C₂₃**=20 μ f, electrolytic, 50 v.
C₂₆=0.05 μ f, paper, 600 v.
L=Loop antenna or ferrite-rod antenna, 540-1600 Kc (with specified values of capacitance for **C₁** and **C₂**)
R₁ R₅=180 ohms, 0.5 watt
R₂=12000 ohms, 2 watts
R₃=33000 ohms, 0.5 watt
R₄ R₆=2.2 megohms, 0.5 watt
R₇=0.1 megohm, 0.5 watt
R₉=Volume control, potentiometer, 1 megohm
R₉ R₁₃=10 megohms, 0.5 watt
R₁₀ R₁₃=1800 ohms, 2 watts
R₁₁ R₁₅=0.22 megohm, 0.5 watt
R₁₄ R₁₅=0.47 megohm, 0.5 watt
R₁₆=8200 ohms, 0.5 watt
R₁₇=270 ohms, 5 watts

- R₁₈**=15000 ohms, 1 watt
S=Switch on volume control
T₁=RF transformer, 540-1600 Kc
T₂=Oscillator coil for use with 10-365- μ f tuning capacitor and 455-Kc if transformer
T₃ T₄=Intermediate-frequency transformers, 455 Kc (permeability-tuned type may be used)
T₅=Power transformer, 250-0-250 volts rms, 120 ma. dc
T₆=Output transformer for matching impedance of voice coil to a 10000-ohm plate-to-plate tube load

This AC receiver is a little more advanced in design than the one diagrammed on page 36. It uses eight tubes, but with the effect of ten because the converter tube 6BE6 and the detector and audio amplifier tube 6AV6 both perform two functions. The power amplifier tubes type 6AQ5-A constitute

a "push-pull" stage, which affords better tone quality than a circuit using a single tube. In the parts listed, "pf" stands for picofarad, "uf" for microfarad, "v" for volts, "Kc" for kilocycles, "if" for intermediate frequency, and "ma" for milliamperes. (From "RCA Receiving Tube Manual".)

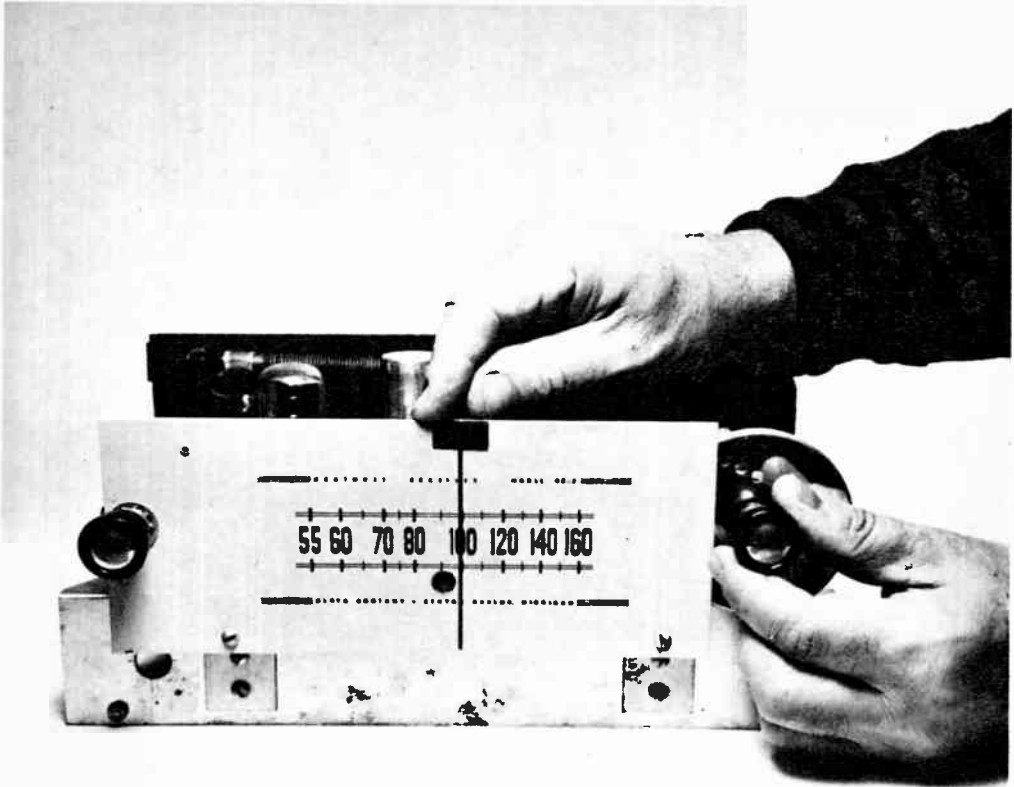

In most receivers the pointer of the dial mechanism is held only by friction to a running cord or to a central shaft. This is done to permit it to be set easily on the face of the dial. Tune in a station whose announced frequency is about 1000 kilocycles and move the pointer to match the marking of 100.

of 2.4 amperes. They draw their current independently and are not affected by each other's warm-up time, condition, or characteristics.

The Push-Pull Puzzle

In many of the better AC sets the circuit in which the loud speaker is connected uses two identical tubes, usually identified as the "power amplifiers," in an arrangement known as "push-pull." This offers the advantage of very high quality of reproduction, particularly at high volume levels. In familiarizing yourself with such a receiver, you can perform an interesting and puzzling experiment. Remove either of the push-pull tubes and observe that there is no immediately noticeable change in the sound! The difference does show up, however, on classical music performed by a competent orchestra or soloist. "Pop" music and ordinary voice

signals do not need quality amplifiers and loud speakers in the first place, so for them the loss of half the amplifier stage is not serious.

You might not even be aware of the failure of one push-pull tube until a set stops working for some other reason and you make the hot-finger test described previously.

Hi-fi addicts pay special attention to the power amplifier stage. When a tube here fails, they don't buy just one as a replacement; they pay a slight premium and buy a matched pair, to assure themselves of the very best performance of which their equipment is capable.

The rectifier tube in an AC set runs quite hot, because it supplies a considerable amount of DC to the other tubes. Under normal conditions a faint blue glow can be seen surrounding its elements. A

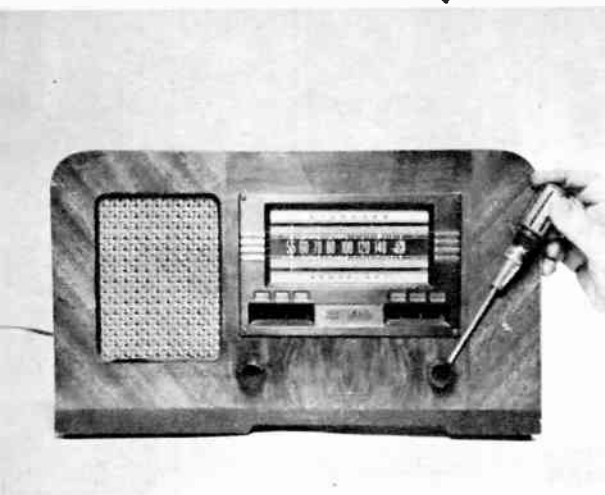

Left: Here is another type of straight AC receiver, with the loud speaker built in on the left. Control knobs, of pull-off type, are being helped along with the blade of a thin screwdriver, as first step in removing chassis for maintenance.

Below: Heavy chassis of AC set is usually pretty well anchored by several bolts through bottom of the cabinet. Before removing last one, tilt the whole set forward a little from this position, to prevent chassis from hitting inside of cabinet.



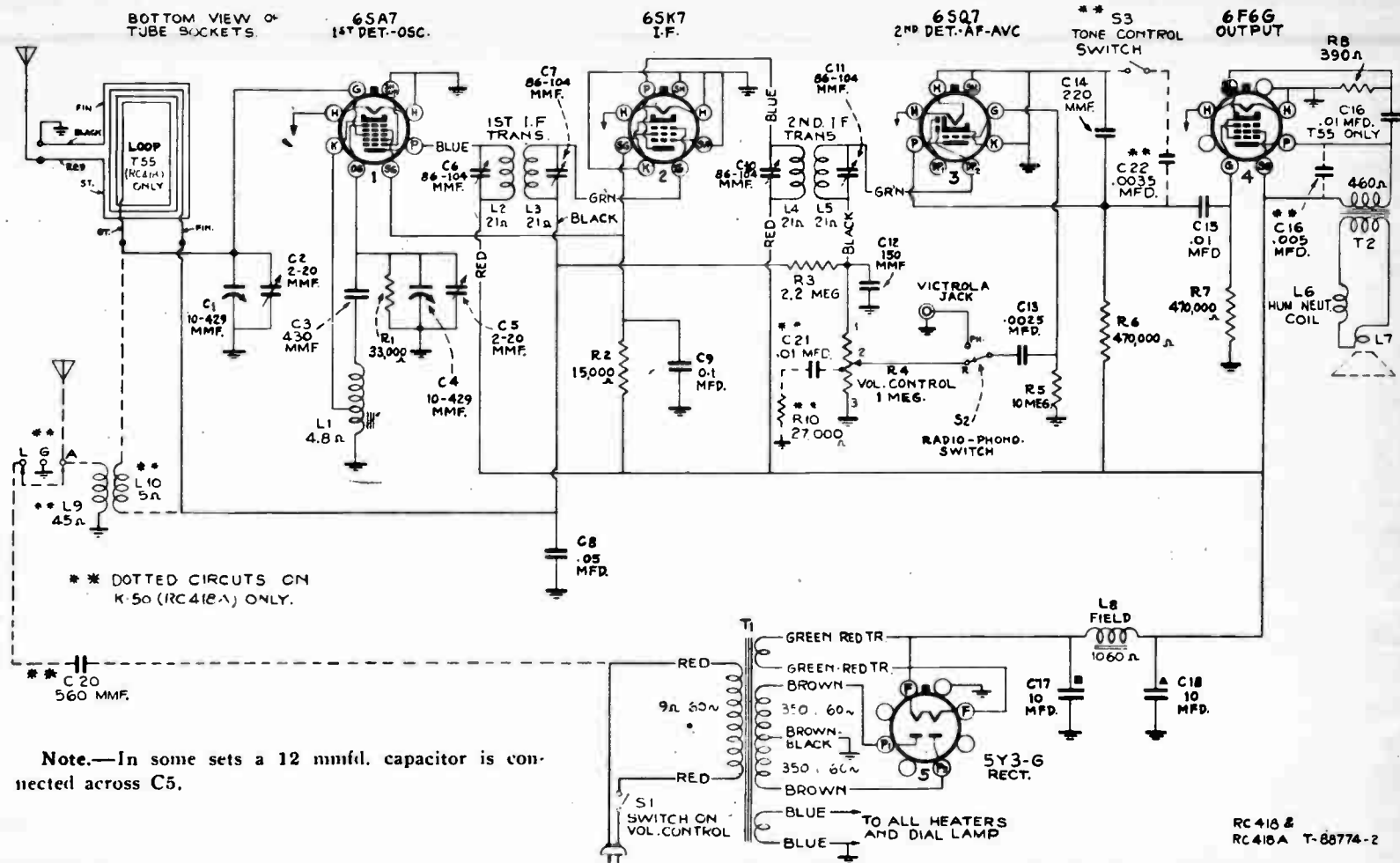

Note.—In some sets a 12 mmf. capacitor is connected across C5.

Wiring diagram of receiver shown on opposite and on following pages. Note particularly color coding of leads of the power transformer T1, bottom center of diagram, important data if a transformer ever needs to be replaced. "Victrola jack" permits addition of external record player. Loop aerial is built in.



Left: Neglected chassis is thick with dust, encrusted with kitchen grease, and a home for insects. Dust is especially bad because it prevents proper radiation of heat from hot tubes, other components.

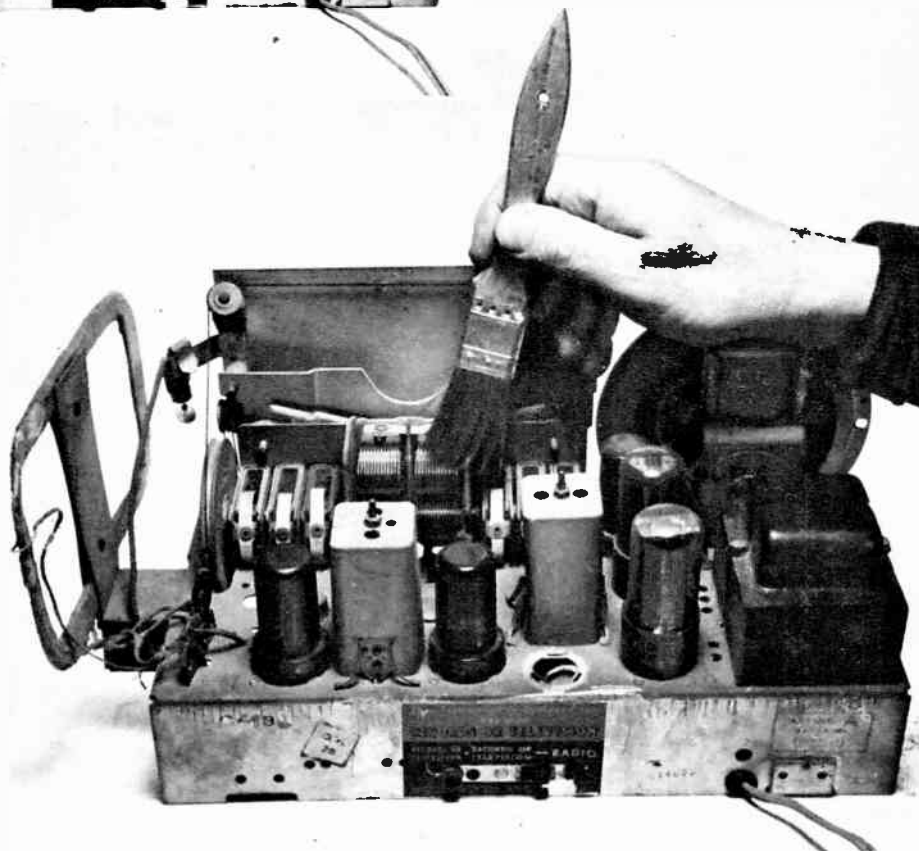

Major part of accumulation of dirt on chassis can be removed with paint brush, preferably one that has never been used for painting and still has soft bristles. Brush gently, so as not to disturb parts or wiring. Open and close tuning capacitor to allow bristles to get between plates.

very bright glow that diffuses throughout the bulb is a sign that the tube is getting gassy; that is, admitting a minute quantity of air. If the output voltage is what the service notes say it should be, and if the set sounds good, leave the rectifier in, but

as a precaution get a replacement if you don't already have one on hand. Anything more than a minute quantity of air will cause the filament to burn up and of course render the tube useless.

The same blue glow can also be seen

Dust dislodged from old chassis can be irritating. Good idea is to supplement brushing with use of a vacuum cleaner. Hold nozzle close to brush to let it suck up dirt as quickly as it is loosened. Cleaner can also be used as blower to clean out odd spots.

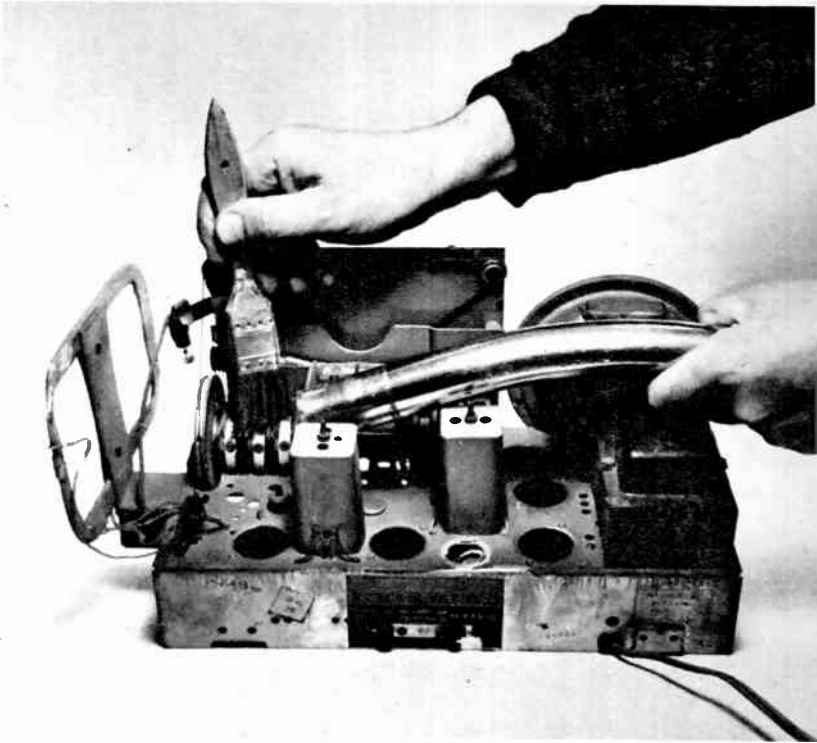

In this set the socket for the dial light is on a clip next to the dial plate, so it slips off quite easily. Bulb is of the bayonet type. Only one wire comes out of socket; second connection is to the chassis.

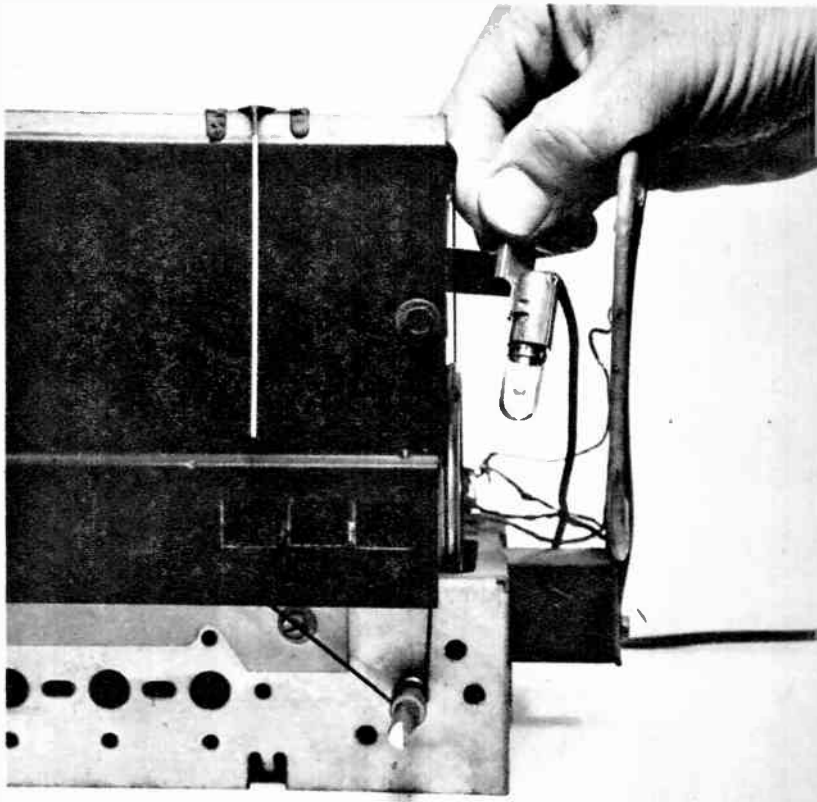

in some power amplifier tubes. It doesn't usually occur in smaller tubes because they work on lower voltages than those applied to the amplifiers.

As with AC-DC sets, tube substitution and voltage checking are the first moves in investigating a dead AC receiver. A noisy volume control calls for replacement; a noisy function switch for a squirt of contact cleaner. Look for white goo seeping out of the filter capacitor, a sign that it is

cooking internally from a partial short-circuit. Push tubes in and out of their sockets to remove possible corrosion. If the set is completely dead, without even the pilot light shining, make a continuity check on the primary of the power transformer and on the line switch. Once in a blue moon a transformer does go open, although it's more likely that only the line switch is blocked in its open position.

In making voltage measurements with

Loop antenna in this receiver is mounted on one end of the chassis instead of at the rear. Insulating mounting strip is fastened by two self-tapping screws into chassis. Keep them tight, don't overtighten.

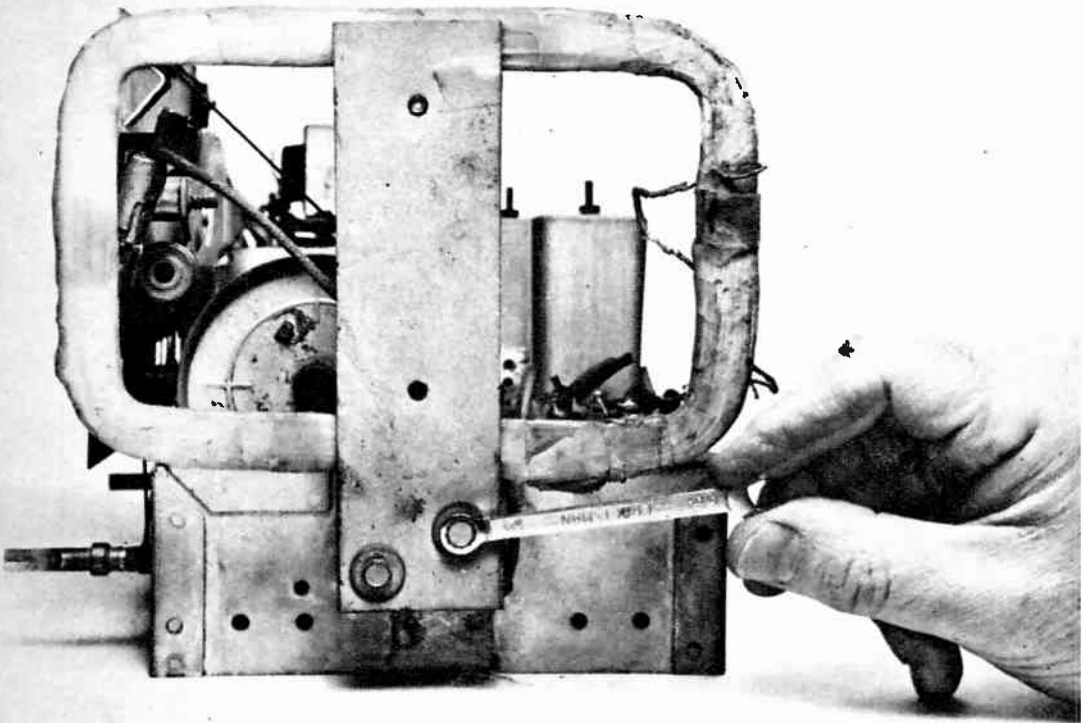

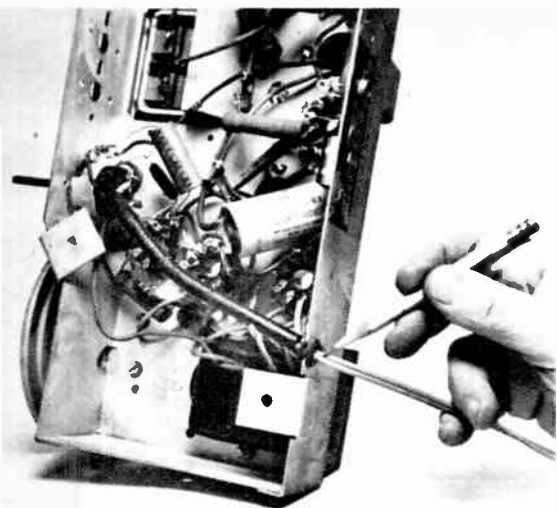

Frequent cause of trouble is wearing away of insulation on line cord where latter enters chassis. Soft rubber grommet at this point is recommended.

the VOM, remember that a healthy set has several hundred volts running through many of its circuits. Clip the negative lead of the meter to the chassis and hold the positive probe at the end away from the exposed metal tip. Also, set the range switch to 250 or 500 volts DC for your first checks and study the scales carefully to make sure you are reading the correct one.

An important feature of the AC set is its "cold" chassis; that is, cold electrically. This safety results from the fact that the primary and secondary windings of the power transformer are coupled only magnetically and are not actually connected together. The metal chassis is a common "ground" for the various internal circuits, but it is not directly part of the power-line ground that makes AC-DC sets potentially dangerous.

Removing an AC chassis for examination involves the same procedure suggested for AC-DC sets. The loud speaker may require a bit more attention, because generally it is not mounted on the chassis but to the inside of the cabinet. Either remove it or extend its wires, whichever is easier and more convenient. ●

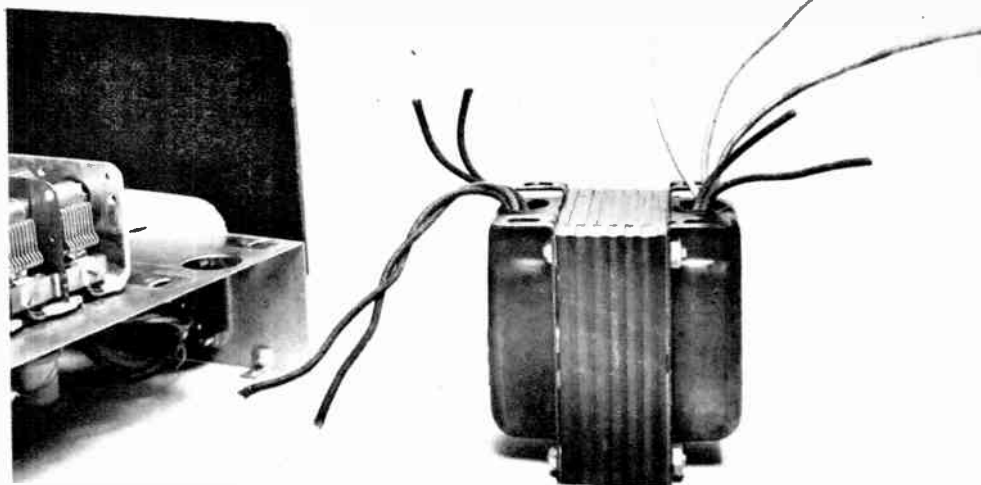

In its usual construction, the power transformer of an AC set has its leads coming out through one of holes in its base. The only way to identify the wires is by their colors and the corresponding notations in the service notes for the receiver. Transformer in normal operation runs comfortably warm, not hot.

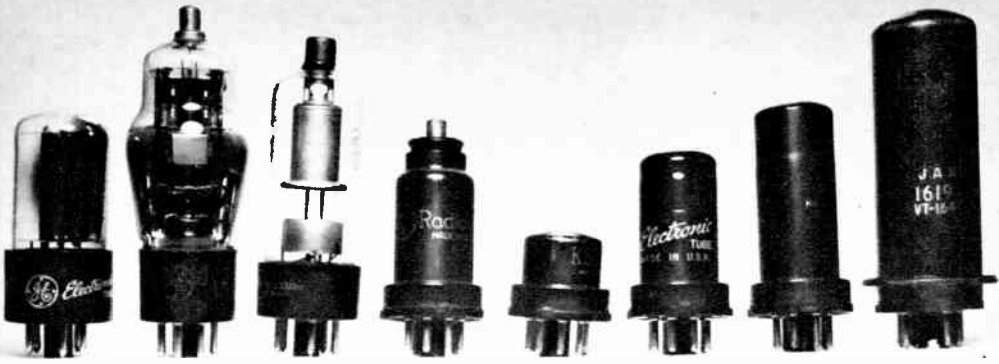

Assortment of typical tubes having identical octal bases. Left to right: Straight glass type. Next two, glass type with extra top cap. Remaining four on the all-metal cap with top cap. Remaining four on the right, different sizes of all-metal tubes. Some tubes are made in both glass and metal styles.

Tubes and Tube Testing

THE important difference between the "octal" and "miniature" tubes commonly found in radio receivers of all types is not so much in size or performance as it is in basing.

The octal is called the octal because its base of insulating material has provision for eight contact pins, evenly spaced. These pins are rigid, are firmly anchored in the base, and cannot readily be broken or even bent. Not all tubes need eight external connections, so don't be alarmed if you encounter types in which a few pins are absent.

An octal tube cannot be inserted in a socket in any way but the right way. This is assured by the use of an indexing stub in the center of the base. It protrudes slightly beyond the tips of the pins, so it seats in the center hole of the socket before the pins have a chance to find their holes. The trick is to place the tube lightly in the socket and to turn it slowly either clockwise or counterclockwise until you feel it drop slightly. The index is now engaged properly with a slot in the center hole of the socket, and you merely press down firmly to engage the pins with their mating contact springs. This is a very good arrangement, as it permits you to replace tubes quickly and positively, even in crowded areas of a chassis, without fum-

bling. To remove a tube, you pull straight up, without twisting.

A Quick Cure . . . Sometimes

You can sometimes cure a mysteriously sick set, one that is weak but not silent, just by removing and replacing the tubes a couple of times in their own sockets. This movement cleans off small spots of corrosion and re-establishes good connections between the pins and the socket springs.

The all-glass miniature tube does not have a separate base like the octal. Its contact pins are thin, somewhat soft, and easily bent. They protrude directly from the bottom of the glass "envelope," as the body of the tube is known. The "7-pin" type always has all seven pins, and the "9-pin" all its nine.

The miniatures are often something of a nuisance to handle because they do not have a positive indexing mechanism. Instead, two of the pins of each type are more widely spaced than the others, and the mating holes in the sockets are likewise spaced. With no means of guidance whatsoever, you must aim the pins downward and rock a tube back and forth slightly in the hope of finding the right holes. It helps to run a crayon mark down the side of the envelope toward the open space and to line this up with a similar mark on the chassis

next to the tube socket.

Also, the pins themselves must be straight and well lined up in relation to each other. If they aren't, it becomes all too easy to squash one or more over at right angles while the others go in properly as the tube is pressed downward. With very little practice while a chassis is out of its cabinet, you can learn the trick of seating the pins correctly.

There are several other types of tubes that you might encounter. The "Nuvistor," with five pins, is so small that it is often mistaken for a transistor. It is not used very much in ordinary sets, but has important applications in television and cer-

tain short-wave receivers. The "Novar" is a 9-pin tube, somewhat larger than the 9-pin "miniature." There are also a few 12-pin tubes.

"Self-service" tube testers are now common fixtures in many radio supply houses, drugstores, supermarkets and other retail establishments. The question everyone asks about them is, "Are they any good?" The answer is, "Yes and no."

If this doesn't sound very definite, neither is the operation of the testers. Of necessity these machines must be simple in construction, because they are handled . . . and often manhandled . . . mostly by people who don't know what they're all

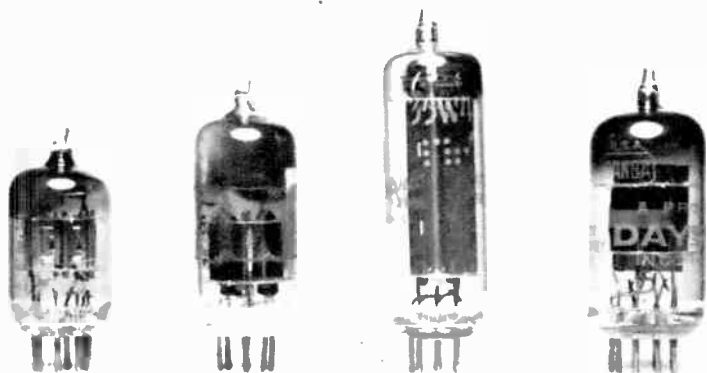

Left: Three sizes of 7-pin "miniature" glass tubes and one sample of the 9-pin size. In these "baseless" tubes the pins are set directly into the bottom of the glass shell or "envelope." They are well anchored but tend to bend because they are thin for their length. Handle with care!

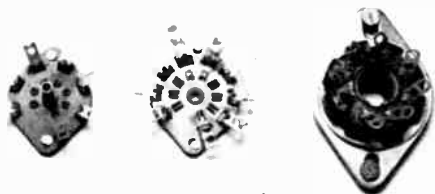

Bottom view of the types of tube sockets found in virtually all radio receivers. Left to right: 7-pin miniature, 9-pin miniature, 8-pin octal. The octal has a center hole with indexing keyway, to accommodate a matching stub in base of octal tubes.

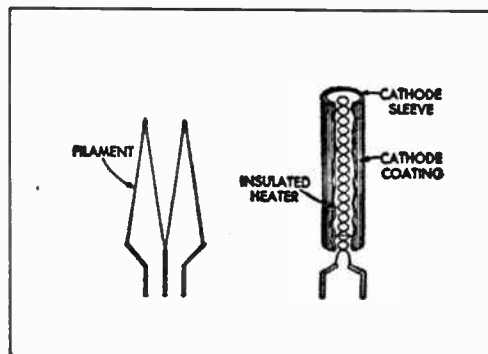
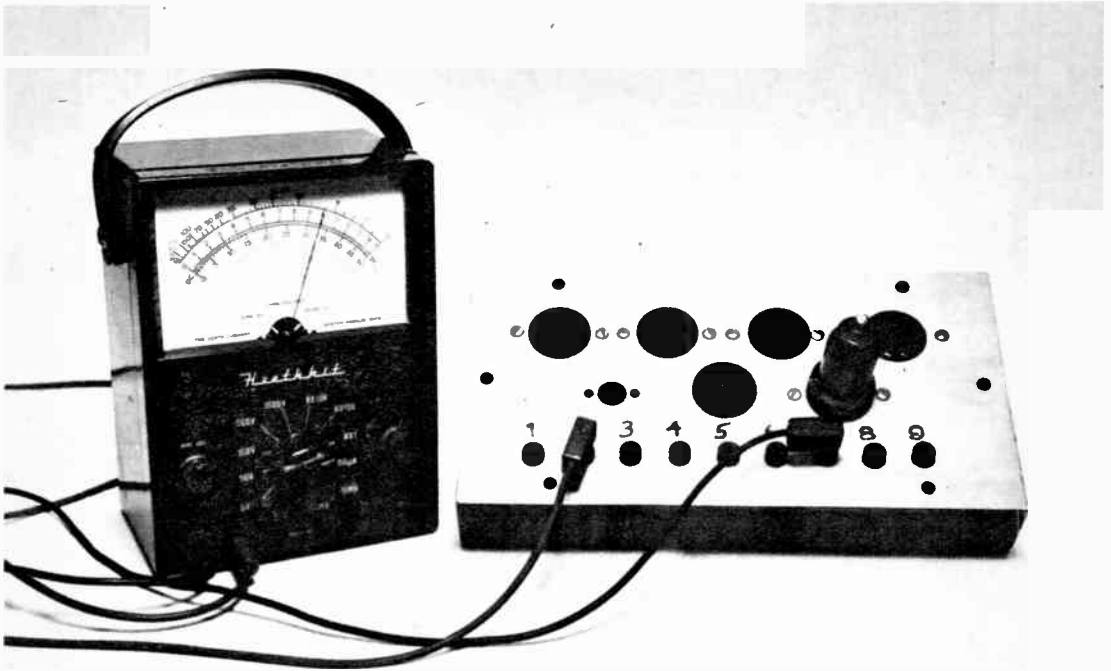

Fig. 1: Directly-heated filament of some tubes is exactly like filament of ordinary lamp, but burns at lower temperature. Fig. 2: In cathode-type tube central heater warms it up and makes it release electrons. (From "RCA Receiving Tube Manual.")



Handy box for testing tubes quickly for heater continuity and internal short-circuits consists merely of various types of sockets on aluminum panel, with all pins connected to numbered pin jacks. Test leads from VOM are plugged into latter and meter is set for high or low resistance, depending on the test.



For occasional testing of just a few tubes, use individual sockets, which cost only a few cents each, and touch the VOM leads to their soldering lugs. This is a much more positive method than attempting to touch the probes directly to the base pins. The latter are too close for comfort.

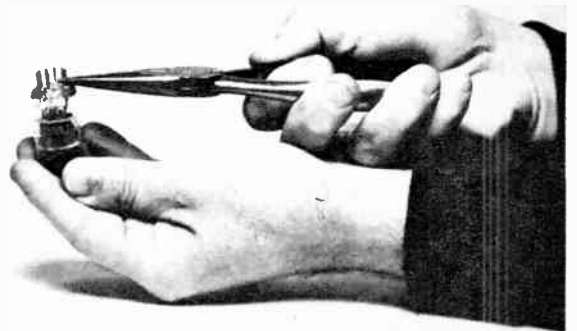

Miniature tubes will not make proper contact in their sockets unless all the pins are straight and are well aligned in relation to each other. Examine the tubes closely and use a pair of very thin long-nosed pliers very slowly for straightening.

about and who merely want to see "Good" or "Bad" readings on a big meter when they plug in tubes of uncertain condition.

On the positive side, a typical drugstore tester does indicate immediately if a tube is burned out or if the internal elements are touching each other and thus setting up a complete or partial short circuit. Such a tube is, of course, useless and must be replaced. If the new tube brings your set back to life, consider yourself fortunate.

For what is supposed to be the "condition" test, the circuitry of most testers is such that all the internal elements of the tube except the heater-cathode are connected together, to form a basic two-element tube, or "diode," exactly like the lamp developed experimentally by Thomas A. Edison in 1884. A low voltage is applied between the combined elements and the cathode, and a sensitive milliammeter (for thousandths of an ampere) reads the current that flows between them in the vacuum of the tube. Current can flow only if the cathode sends out electrons, so this test is called an "emission" check. If the emission is below what the manufacturer of the tester assumes to be a satisfactory level, the needle of the meter moves to an area of the scale marked "Bad." If the emission is relatively higher, the needle swings to the "Good" zone.

The trouble with the emission test is that it is vague and meaningless. Isn't that enough? It takes very little experimenting with a radio receiver to learn that many tubes which check out as "Poor," "Bad" or "Dead" work perfectly well in some sockets. How can this be? Simply because operating conditions in a live set are completely different from the static conditions in a tester that must accommodate a couple of thousand different types. It can be very disconcerting to put a twenty-year-old tube in a tester and get a "Dead" reading; then put in a brand-new one of the same type number and get a banging "Good" reading; and then interchange them in the same socket in the set and find that there is absolutely, but absolutely, no difference in the performance!

It is an old trick of service technicians, when working on radio, television or other entertainment gear, to switch existing tubes of the same type number. In a surprising number of cases this restores normal operation, for the simple reason that some circuits aren't as critical as others and work fine even with tubes having relatively low emission.

The Radio Corporation of America has produced billions of tubes over the years

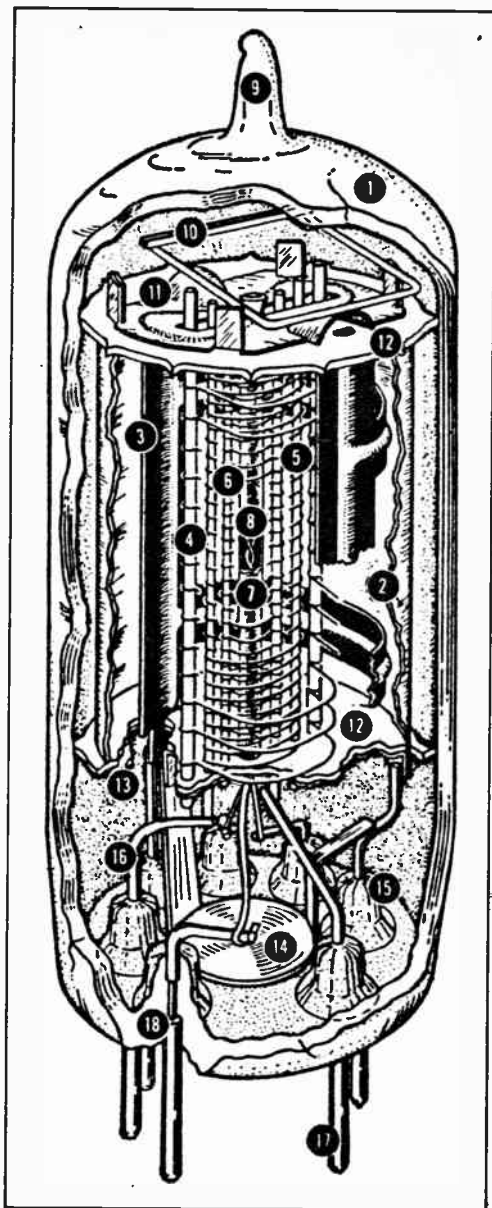

Exploded view of glass tube. 1-Envelope. 2-Shield. 3-Plate. 4,5,6-Grids. 7-Cathode. 8-Heater. 9-Exhaust tip. 10-Getter. 11,12-Spacers. 13,14-Shields. 15-Button-steam seal. 16-Wire. 17-Pin. 18-Seal. (From "RCA Receiving Tube Manual.")

and knows a lot about them. Therefore, the following excerpt from its 576-page "RCA Receiving Tube Manual" is of interest to people who fix their own sets:

"*Tube-Tester Limitations.* A tube-testing device can only indicate the difference

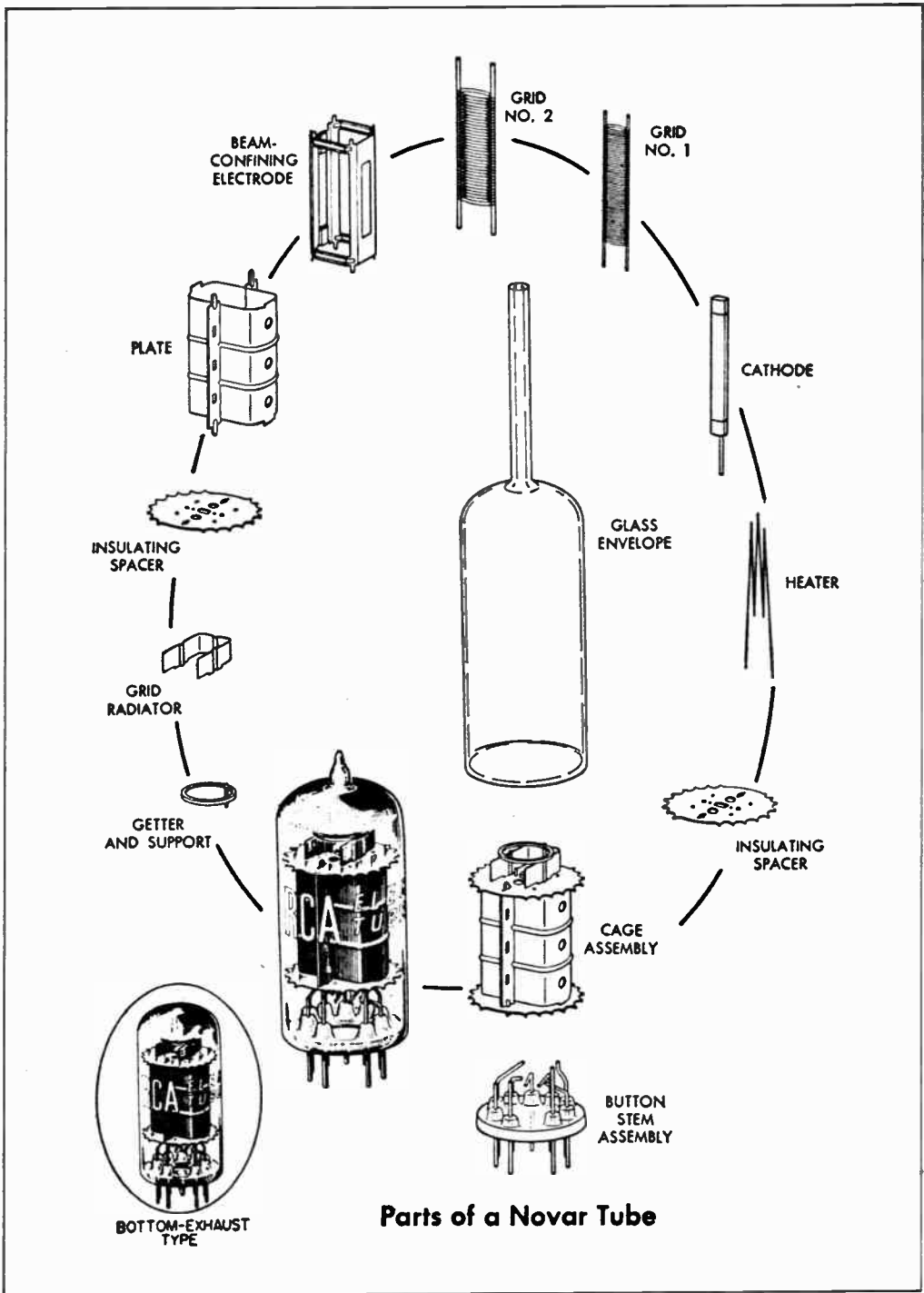

The "novar" tube has a 9-pin base and is of all-glass construction, but it is larger than the 9-pin "miniature" tube and takes a different socket.

The parts of a typical novar are shown here. The air in the envelope is exhausted from either top or bottom. (From "RCA Receiving Tube Manual.")

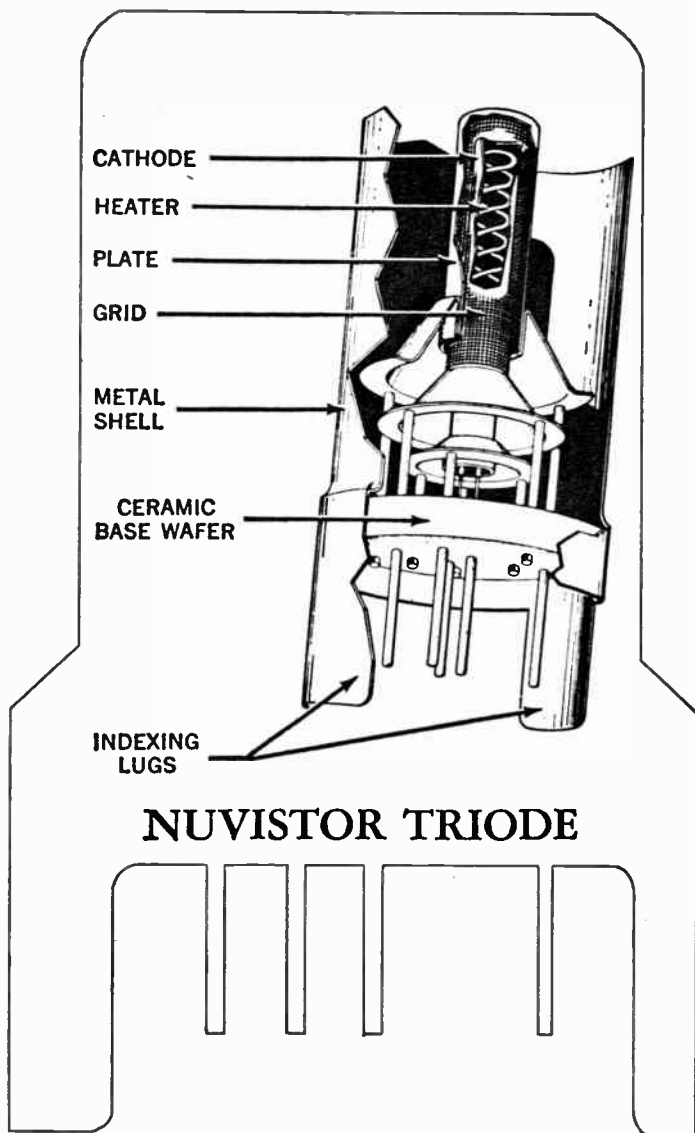

Left: The "Nuvistor" is a regular triode (three-element) vacuum tube, but it is so small that it is often mistaken for a transistor. It is less than $\frac{1}{2}$ inch in diameter and slightly more than $\frac{3}{4}$ inch high. This drawing showing its construction has been blown up considerably to better display the details. The Nuvistor requires a special socket, and fits it readily because of the indexing lugs on the side of the metal shell.

Certainly the smallest vacuum tube now in regular production, the Nuvistor is so tiny that three can go into an ordinary thimble! Its technical advantages are notable. It provides very high amplification with low noise level, and is especially valuable for use in TV, FM and other very short-wave receivers.

between a given tube's characteristics and those which are standard for that particular type. Since the operating conditions imposed upon a tube of a given type may vary within wide limits, it is impossible for a tube-testing device to evaluate tubes in terms of performance capabilities for all applications. The tube tester, therefore, cannot be looked upon as a final authority in determining whether or not a tube is always satisfactory. Actual operating test in the equipment in which the tube is to be used will give the best possible indication of a tube's worth."

The last sentence is the kicker. What it suggests in effect is, "Try it yourself!" •





Heathkit Model MM-1 "VOM" is representative meter, easily assembled and easy to use. It measures resistance to 20 megohms, voltage to 1500, AC or DC, and current to 15 amperes. Flexible test leads plug in.

The VOM is for Testing

YOU can fix some radio sets by replacing a dead tube or two or by tightening connections here and there. However, there comes a time when you need a piece of equipment that really can test both circuits and components. This pays for itself the first time it reveals to your astonishment that an innocent looking switch is just plain open, or that a resistor that should measure 500 ohms reads 150,000 instead.

The instrument that fulfills the requirement is the "volt-ohm-ammeter," sometimes identified also as "voltmeter." However, because these terms are a bit awkward the meter is universally called the "VOM," pronounced "vee-oh-em." I would venture the guess that the VOM does 90% of the basic troubleshooting in all electronic gear used in homes, shops, schools, laboratories and industry in general. It is inexpensive in either kit or

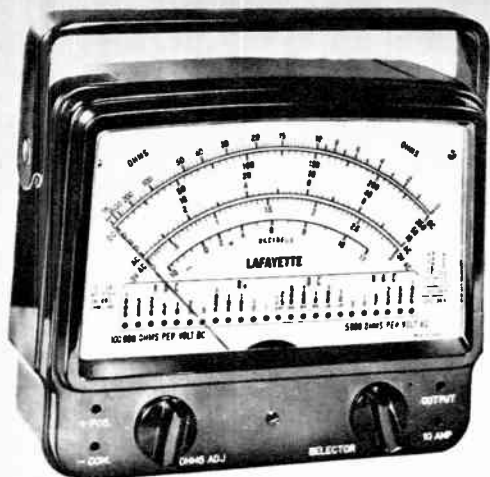

Above: Lafayette factory-built "Lab-Tester" is advanced VOM with built-in burnout protection. It has 33 ohm, volt and ampere ranges, switch selected.

Eico Model 526 is basic VOM, available in kit or assembled form. Excellent instrument at low price, suitable for wide variety of radio troubleshooting.



factory-made form. It is a very good investment for the home handyman and do-it-yourselfer because it also can be used to advantage on household appliances of all kinds and on automobile electrical systems.

Lafayette has a line of serviceable VOM's starting at under \$10. The Allied Knight-Kit Model KG-640, at about \$40, and the Heath Model MM-1, at about \$30, are both highly popular because they are interesting kit projects that can be as-

sembled and wired in a couple of evenings by anyone who can use a screwdriver, a pair of pliers and a soldering gun. The KG-640 is pictured on the cover, and the MM-1 in several stages of assembly is illustrated on these pages.

The VOM derives its name from its functions. It can measure AC and DC voltages from fractions of a volt to several thousand; resistances from a fraction of an ohm to several million; and currents from a few microamperes (that is, millionths) to a maximum of about 15 amperes. The two most important applications are in voltage and resistance. In practical work the measurement of current is rarely undertaken because wiring must be cut or unsoldered for the connection of the meter. In voltage checking you don't disturb anything; you merely touch two probes from the VOM to live points in a circuit. If the voltages are correct, the current values are also correct in by far the majority of cases.

However, the low current ranges of a VOM are particularly useful to a student of transistors and other solid-state devices. The incredibly small currents circulating in them . . . in the order of a few microamperes in typical transistor portables . . . explain why the use of tiny batteries is practicable and also why the batteries last as long as they do in normal service.

VOM's follow a rather well-established design pattern. The front panel is dominated by a meter on whose face is printed six or eight scales, over which a single thin pointer travels in an arc. The various ranges and functions are selected by rotary switches. The only variable control is a small knob or wheel marked "Ohms Adj" or "Ohms Zero" or simply "Adj." The purpose of this control is to bring the needle of the meter to the 0 position on the ohms scale when the test probes are touched together (that is, "shorted") and the function switch is in any of its R (for resistance) settings. If the probes are separated the needle immediately swings to the other end of the scale. This is marked with the infinity sign, and represents a completely "open" circuit. If any component such as a resistor, a tube filament or a mere length of wire is now inserted between the probes, a circuit through the meter is completed and the needle moves. The lower the resistance of the component the nearer the reading toward 0; the higher, the nearer toward infinity. You read the value in ohms right off the scale.

In many instances the actual value of a part or circuit in ohms or megohms is less important than the fact that the device is

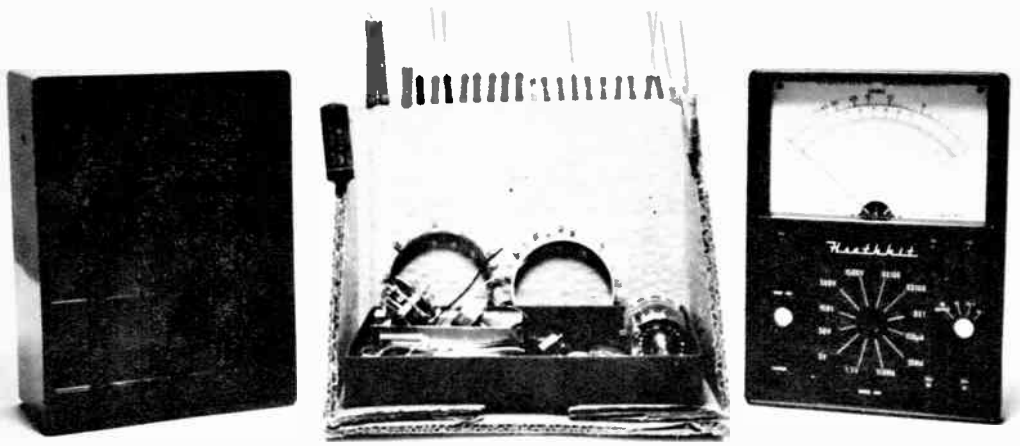

All the parts needed for the assembly of the Heath VOM are supplied in the kit. The meter itself is already mounted to the front panel. Only a few basic hand tools, such as pliers, screwdriver, soldering iron, etc., are required for the job, which is both interesting and educational. A detailed instruction book includes step-by-step directions and large work drawings, which can be followed by anyone.

Any kitchen or bridge table or small workbench makes a convenient work area for the meter kit. The large drawings are easy to follow if they are stapled or taped to stiff pieces of cardboard, propped upright as shown. Sort out the small hardware into saucers or shallow boxes. Straighten the leads of resistors and capacitors and stick them into edge of a corrugated carton so they can be selected readily.

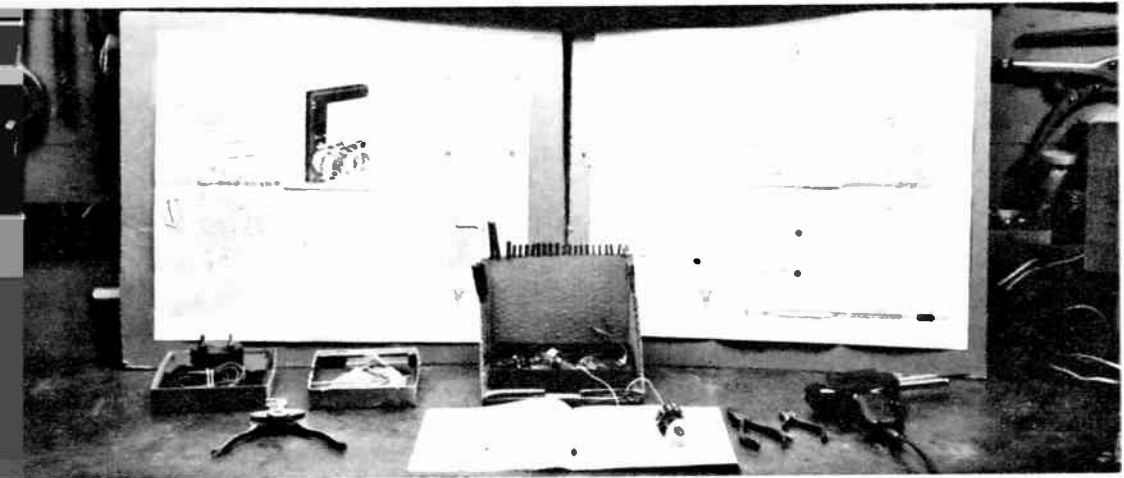

or is not intact. This application of the VOM is called "continuity checking" and is probably the instrument's most valuable feature. Is a tube burned out? Is an enclosed fuse still good? The VOM gives instant answers.

The extreme in continuity checking is exemplified by a common on-off switch. In its "on" position its internal contacts touch very firmly, to allow current to pass without hindrance; that is, without "resistance." A VOM applied to the switch's terminals should therefore bang over to 0. In the "off" position the contacts are well

separated and allow no current to pass. The internal resistance is so high as to be immeasurable by ordinary means, so when the VOM is connected the needle stays at infinity to indicate an open circuit.

Any switch readings other than 0 or infinity spell trouble. Suppose, for example, that the VOM reads 0 whether the switch handle is "on" or "off." This clearly means that the internal contacts have burned or corroded shut or that the operating spring has merely snapped. If the meter reads infinity in both switch positions, in all probability only the spring is at fault.

Inside view of the completed VOM. The resistors and the capacitors are mounted on a double ring surrounding the central range selector switch. Finger points to one of the batteries used for resistance measurements. There are four others, of the penlite type, in the compartment just above. Meter is completely self-contained and is easy to carry. It is highly useful for testing electrical appliances as well as electronic entertainment gear.

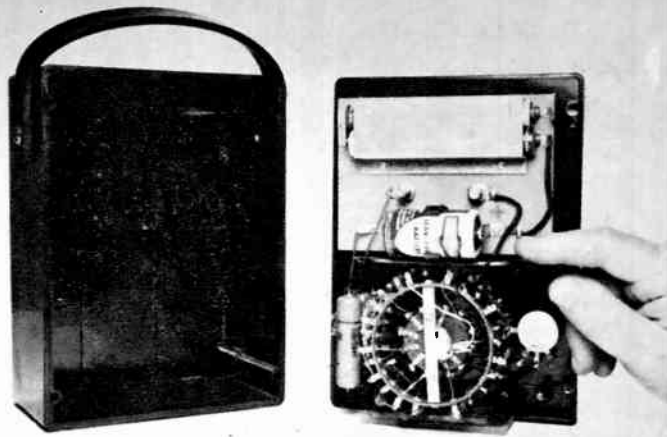

The only preliminary adjustment needed for resistance and continuity checking is called "zeroing the meter." The routine is to set the range switch to any one of the "R" positions, to short-circuit the two probes by clipping them together, and then to turn the "Ohms Adj" knob until the needle swings over to the zero mark on the scale. Some slight readjustment may be necessary when shifting from one resistance range to another.

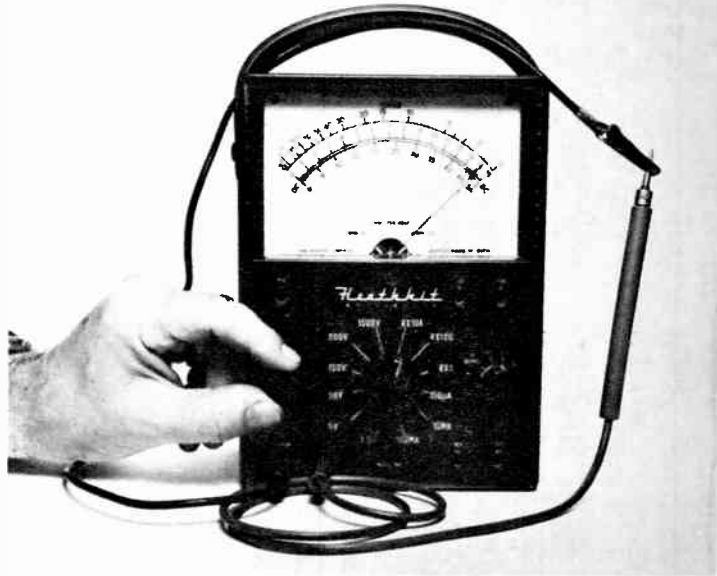

Switches take appreciable physical abuse, being turned on and off perhaps dozens of times a day, so they are always suspect when a set doesn't come on . . . or refuses to go off! For this reason, the combined volume control and switch that is virtually standard on radio sets is constructed so that a defective switch can be pried off the back of the control and replaced by a new one in a couple of minutes.

A caution in using the VOM for continuity checking: Make sure that the circuit or part under test is completely dead. With line-cord sets don't trust the switch, but

remove the plug from the wall outlet. With battery portables simply remove the battery. If a set is alive, the meter readings will probably be false, as a minimum; under some circumstances the meter itself can be damaged.

Learn to use a VOM by using it. Initially, take resistance readings on an ordinary electric light, a razor, a toaster, an iron, etc.

Unplug an AC radio set, turn its switch on, and connect the test probes to the prongs of the line plug.

With the range switch at the highest ohm position, wet your fingers slightly in your

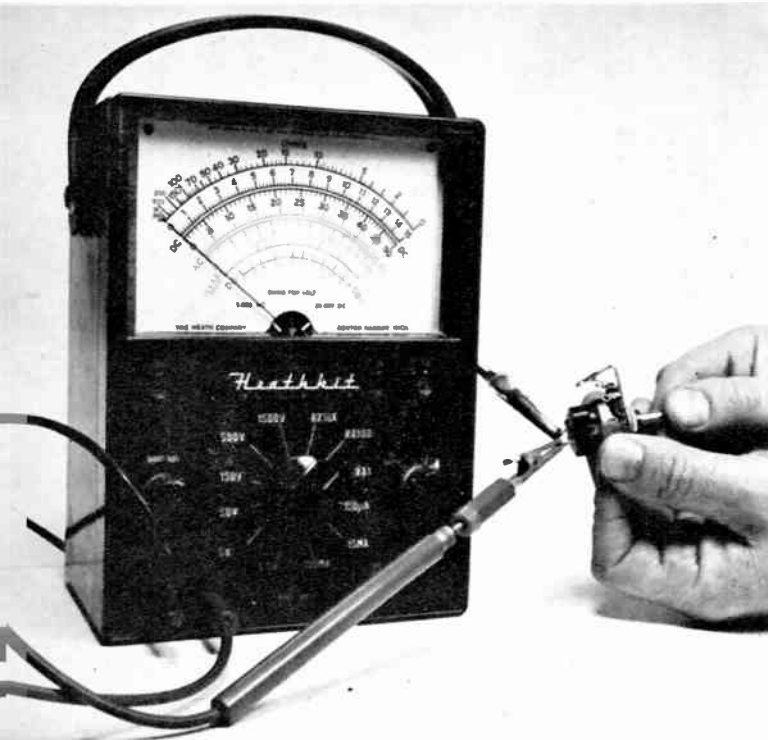

The simplest of all electronic tests, the continuity check is at the same time the quickest, the most positive and the most useful. Here is a very common application. A combination line switch and volume control has been removed from a radio set. Is the switch in working order? To tell, set the VOM's selector to the higher resistance range, zero the needle as shown on the preceding page, and then connect the probes to the terminals of the switch. In the latter's off position the needle shouldn't budge, indicating that the switch is properly open. If the needle flutters, the switch contacts are probably loose, and if it bangs over to zero they are short-circuited. The entire switch should then be replaced.

If the switch passed the above test, now turn it on. If it is OK, the needle will swing immediately to zero and stay there, indicating that the contacts are properly closed. Any flutter of the needle or any fixed reading of resistance means that the contacts are defective. Snap the switch on and off vigorously several times to make sure that all the readings, regardless of what they are, repeat themselves. In both of the tests shown on this page, notice that the positive probe has been fitted with a clip, like the one on the negative wire. The use of these clips frees the hands. To check the volume control for continuity, connect the clips to the center terminal and either outside one, turn shaft, watch the scale.

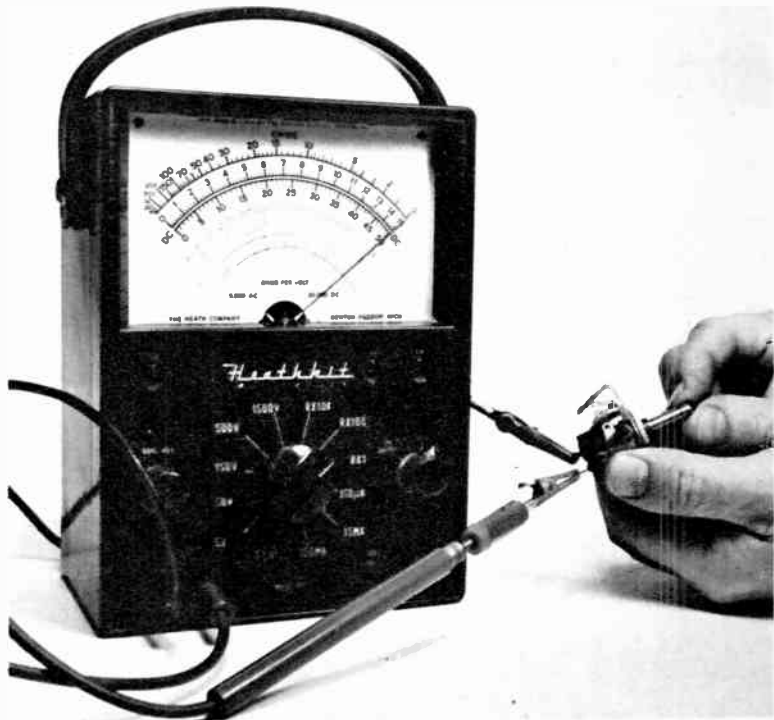

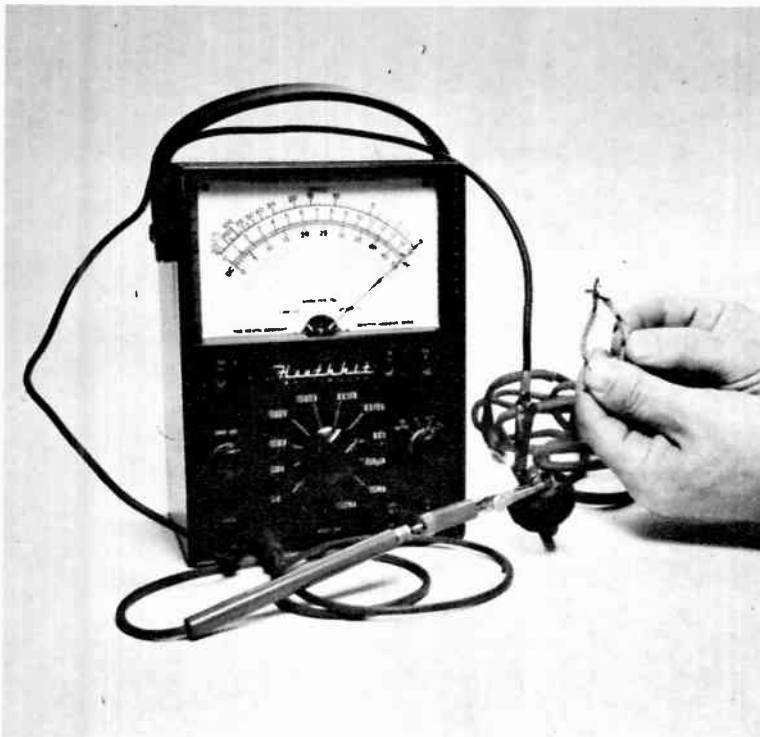

If stepped on or run over by appliances and furniture, line cords can develop complete or intermittent breaks inside the insulation, with no sign of the fault on the outside. Here again the VOM is valuable. Zero the meter at its lowest resistance range and attach the clips to the prongs of the line plug. With the free ends of the cord separated, the needle should not move; with the wires touched together as shown, it should register zero. These readings indicate that the individual wires of the pair are intact and are not shorting internally. Be careful that the test clips do not move against each other, as this will give a false indication of a dead short-circuit.

A physical injury usually affects both wires, since they lie close together inside a common outer sheath of fabric insulation. This usually shows up as an intermittent wire-to-wire short-circuit, either intermittent or steady. With the test clips in place and the ends of the wire well separated, squeeze the cord, twist it into odd shapes, roll it up, etc., at the same time watching the meter. Any sign of movement is positive indication that the internal insulation has broken down. It is usually cheaper to replace the entire cord than to spend the time and effort to find the breaks and repair them.



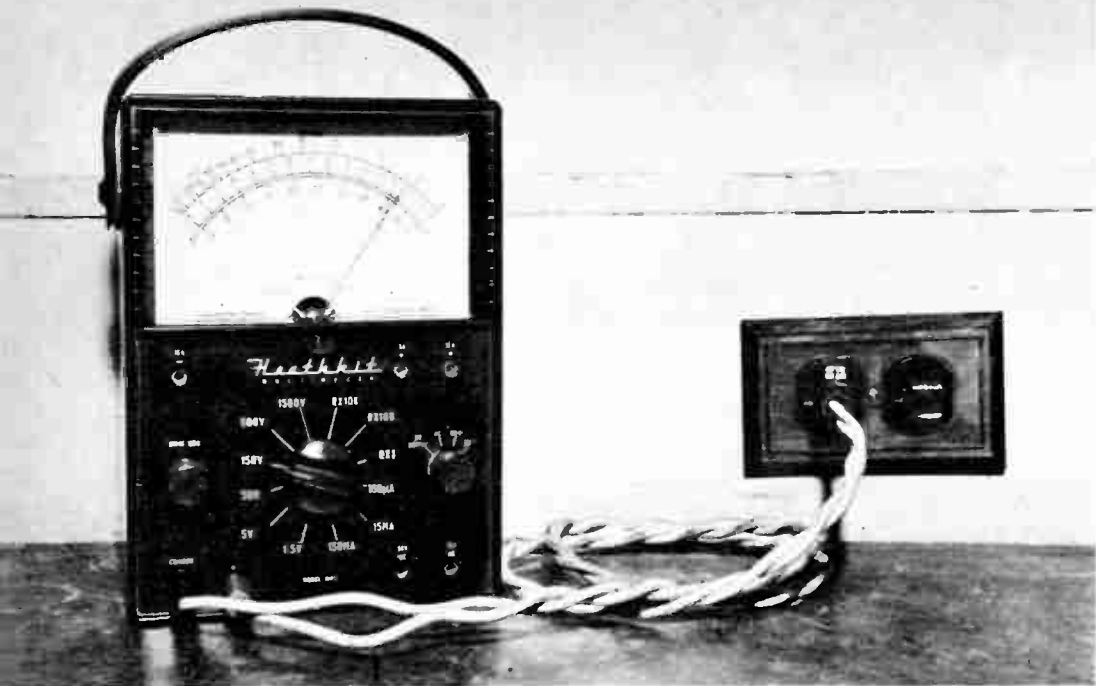

The test leads furnished with most VOM's have a test clip permanently connected to one wire and an insulated probe to the other. Obviously, these do not lend themselves for connection to outlets for the measurement of AC line voltage. Instead, cut a two- or three-foot length of lamp cord, fit one end with a line plug and the wires at the other end with individual tip plugs of a size to fit the meter jacks.

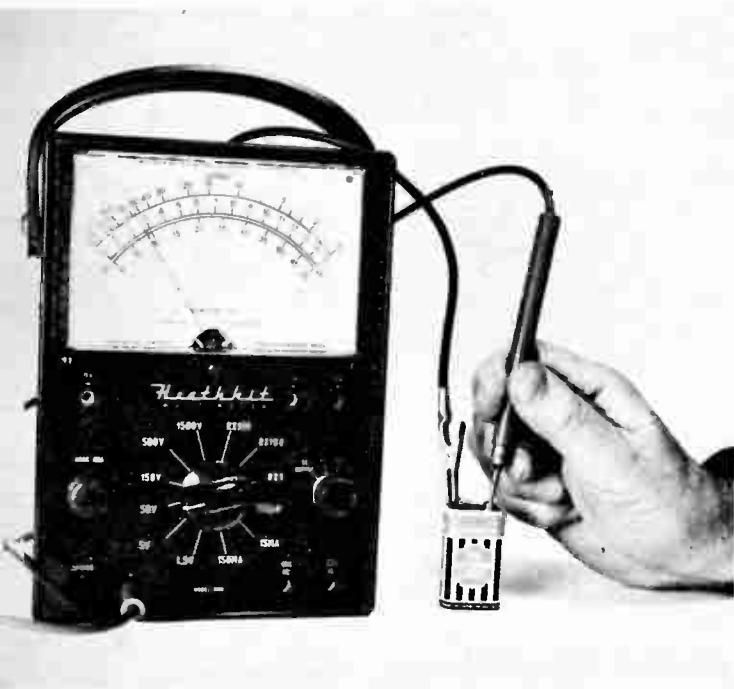

Checking batteries of all kinds is a simple job for the VOM. Read the label first to determine the rated voltage and then pick a range on the scale on which this value falls about half way. Also, observe the polarity markings of the terminals, and connect the black test clip to the negative post and the red probe to the positive. If the meter reads backwards, reverse the leads quickly.



"How did they jam all those parts into such a small space?" This question is asked by many people the first time they open a transistor portable. A magnifying glass is a necessity for a close examination.

Transistor Portables

WHEN the subject of transistor radio repair comes up, most service technicians assume a look of disgust and say, "Forget it!" The majority of imported sets are so small, so jammed full of microscopic parts, so difficult to work on, that it just doesn't pay professionals to handle them. If a new battery or a simple adjustment here or there doesn't restore a silent set to life, it is usually cheaper from the owner's standpoint to buy a new one than to agree to repair charges on the basis of the American labor scale. Let's face it: For what it costs in the United States just for a shop's electricity, heat, rent, insurance and other ordinary overhead expenses, a manufacturer in Japan can pay the wages of a dozen skilled girl workers.

The picture is not entirely black. Keeping a palm-size portable in working order is as much a matter of attention and maintenance as it is of actual repair. The number one item to consider is the battery. You cannot leave a set running all day and part of the night and expect it to remain peppy throughout. Ordinary dry cells, of the type intended for use in flashlights, become exhausted after periods of steady use. The first sign of weakening is distortion of the received programs. If you turn off the receiver at bedtime and try it again the next morning, you may be agreeably surprised to note that it is again loud and clear. This points up a characteristic of regular dry batteries that is well worth remembering: If allowed to rest after an hour or so, even

Try and count 'em! There are more than two dozen transistors in the palm of this hand. Most are pea-sized, but some of the "audio power" type resemble coat buttons in size and appearance. Small transistors are usually soldered directly to printed circuit boards; larger ones are in sockets, like tubes.



With the back cover removed, the bottom of the printed circuit board (left) comes into view. Although made in Japan, this set bears the name of a U. S. manufacturer, and the labels pasted inside the cover contain useful maintenance information. This distinguishes a good set from a cheap one. The battery fits in the lower section of the case and connects by means of a double snap connector.



Here is a slightly different model, in which the printed circuit is mounted etched side down. The transistors and all other parts are in view with the back cover of the case removed. Loopstick antenna is at top, battery compartment at bottom. Circuit board surrounds loud speaker. Latter is usually held by clips or small screws, and entire chassis can be taken out if latter are removed or loosened. Look for tiny ear-phone jack on side of case. This may have to be dismantled to permit chassis to be wiggled out properly.

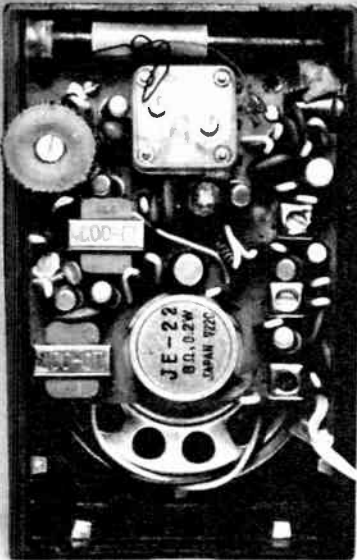

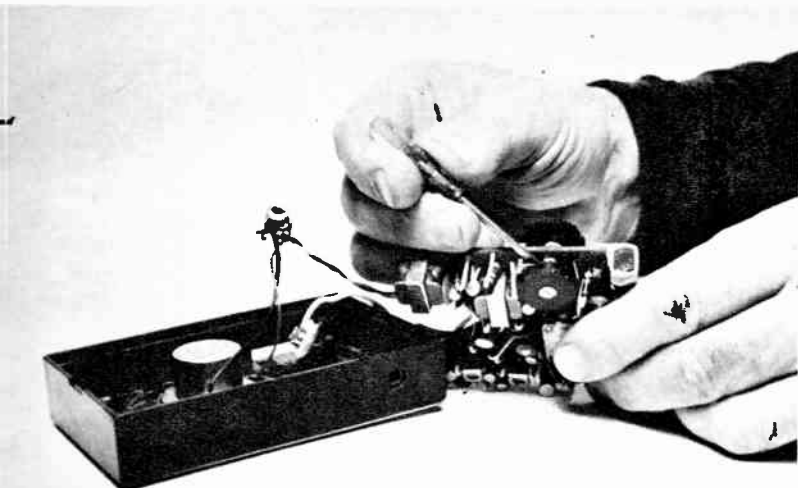

Here, a very thin screwdriver is being used to close the contacts of the on-off switch of a portable that appeared to be in normal condition but didn't produce any signals. Re-establishing the circuit at the switch brought the set to life immediately. Switch trouble is common because of weakness of springs used in the units.

In portables fitted with earphone jacks another common trouble occurs after the phone plug has been inserted and removed a number of times; the contacts remain open and the loud speaker then fails to function, although reception is normal when the plug is re-inserted. Note how this particular portable comes apart. The entire printed circuit board (right) lifts away from the loud speaker, which remains fastened to the case. Flexible wires go from the speaker and the phone jack to the board.

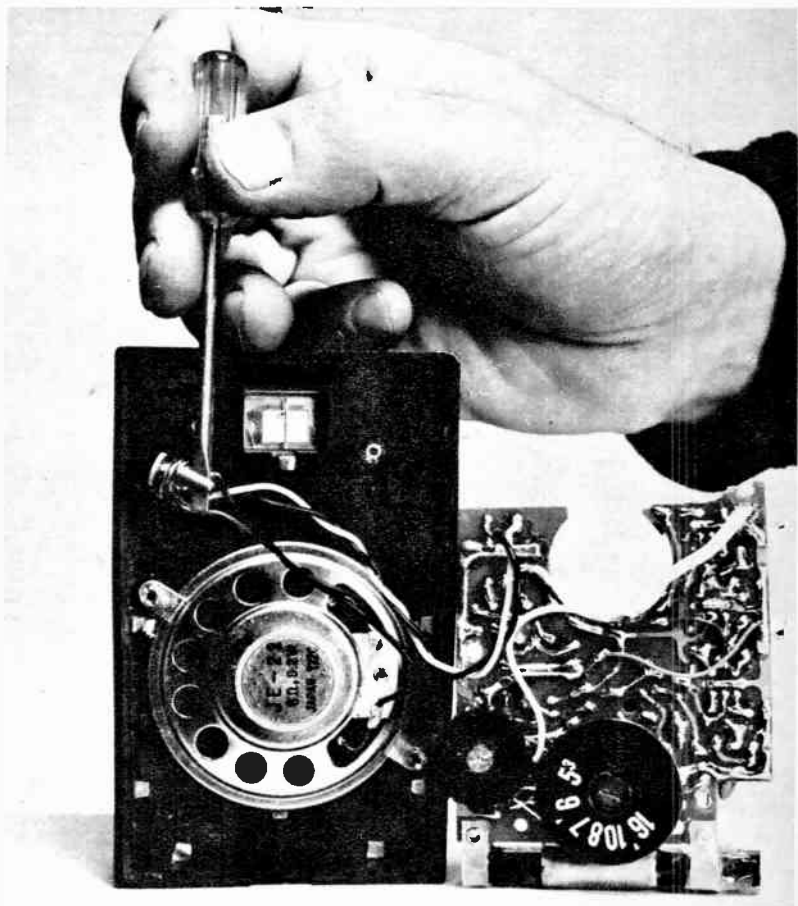

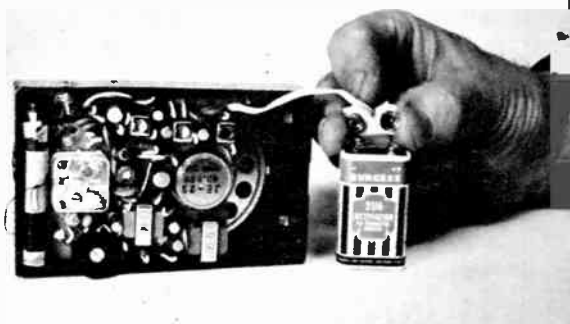
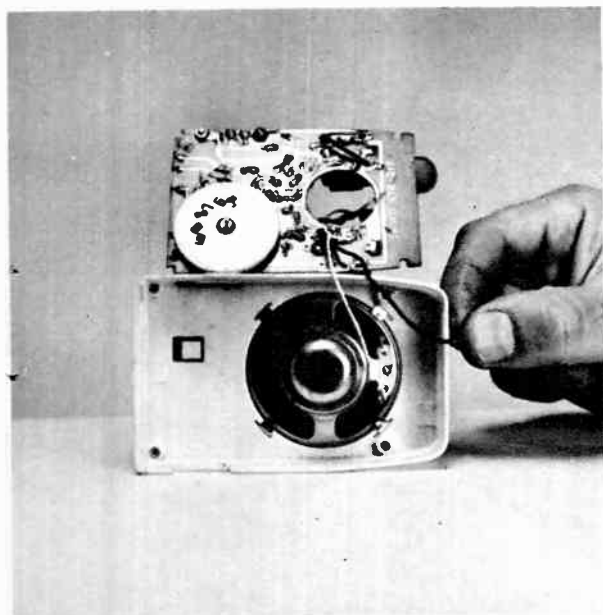

Above: Widely used battery in portables is a flat unit with snap terminals on top. Mating connector, on cord from chassis, cannot be put on incorrectly.

Left: Why this set stopped working after it was dropped: one wire to the speaker broke off. Five-second application of a soldering iron fixed it.

for a few minutes, they tend to restore themselves.

This process of self-rejuvenation can continue only as long as the chemicals inside the battery last. Eventually, of course, the cells expire. However, it is a well-known fact that conventional batteries, when used intermittently, do last two or three times longer than those subjected to extended runs.

The obvious piece of advice in this connection is this: Turn off the set whenever you don't actually need it; as little "resting" time as a minute is helpful. When the phone rings or someone comes to the front door or the baby cries or if a long-winded commercial bores you, don't merely reduce the volume; turn the knob so that it clicks "off." The set will return to life the instant you turn the knob back on, so you won't miss much.

Because batteries are the heart of all transistor portables and of "cordless" table models, they are treated in detail at the end of this chapter.

Battery Switch is Vulnerable

Most self-contained battery transistor equipment is made *without* dial lights. Why? Because the light itself takes far more current than the entire transistor circuitry and this would exhaust any small battery. In a very few sets of the table-model type there is a weak light that can be turned on temporarily only, by means

of a spring-loaded switch that snaps off when finger pressure on it is released.

The absence of a pilot means that you cannot tell whether a set is on or off just by looking at it. Many a good battery dies before its time simply because the set owner neglects to turn the volume control all the way around counterclockwise until the switch that is attached to it goes off.

Like everything else in a transistor portable, the switch is very small, its contacts are very thin, and the spring that produces the snapping action is very light. It is not surprising, therefore, that the mechanism has a tendency to fail after the set has been used a great deal, especially by vigorous youngsters. Sometimes a little careful poking with a hairpin brings the contacts together temporarily, thus closing the circuit and reviving the set instantly. The problem then is not so much to remove the defective unit—a job in itself—as it is to find a suitable replacement.

If there is a label of some kind inside the set bearing the name and address of the manufacturer or at least of the seller, you can try writing to him. Don't send the old unit with your first letter, but first wait for an answer and learn if parts are available at all. If, as in the case with about 90% of imported receivers, there is no identification on your set other than a meaningless tag like "Valiant" or "Five Transistor," about your only hope is to obtain a similar volume-control/switch from a local service



This type of transistor portable not only far out-performs the hand-size sets but is much easier to keep in operation because its parts are larger and are easier to get at. About as big as a woman's handbag, it houses a loud speaker of respectable size and enough batteries to assure both good volume and long life. Tuning control is at right; the volume control is at the left, out of sight here,

In this particular set, made from a Heathkit, the back of the leatherette case is hinged at the top and is secured at the bottom by two snap fasteners. The batteries are at the bottom, and lend stability to the receiver. Sets of this kind are useful around a home, because they can be carried easily from room to room and have absolutely no shock danger.



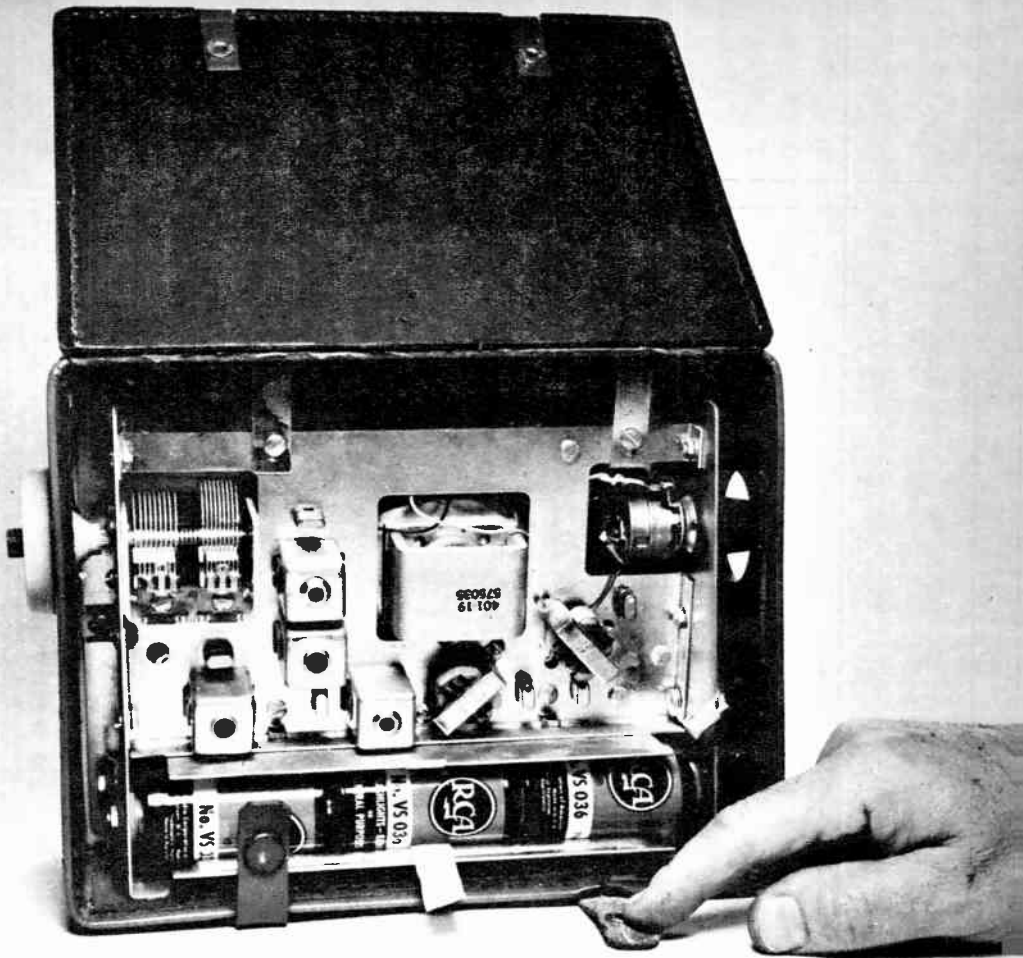

With flap folded back, chassis and battery compartment are readily accessible. Six "D" size dry cells are in two rows of three each along bottom, in spring clips. Cells have long life and replacements are cheap.

technician who might have removed it from a junked set.

Don't be surprised if all your efforts are wasted. The sad fact is that most small transistor sets are built to be expendable, not repairable.

Opening the Case

Most small portables use a plastic case of split construction. To remove the back, look for an opening along the joint between it and the main body of the set. Insert a nail file, knife blade or thin coin here, twist slightly, and the sections will separate. Observe very carefully how the battery fits. If the latter is of the flat type it is probably connected by two flexible wires (red for positive and black for negative) soldered to a pair of snap fasteners that in turn fit fasteners on the battery proper. The fasteners can be mated only in one manner,

so there is little danger of hooking the battery in with reverse polarity. An error of this kind can readily result in the quick ruination of the transistors in the set the first time the switch is turned on.

In some sets the batteries are cylindrical, like the ones used in flashlights, and fit between spring clips. Before removing such a battery, note carefully which end goes to the clip marked with a plus sign, for positive, and which with a minus sign, for negative. Depending on the size of the receiver, there might be several identical cells, as many as six or eight, in a head-to-toe arrangement.

Here we encounter a curious and potentially troublesome situation. Batteries of the conventional carbon-zinc type, made originally for use in flashlights, toys, etc., do not carry polarity markings. You are supposed to know that the center stub is



Above: If loose batteries like these "D" cells are used, it is important to keep their terminals clean and bright, so that they make good contact when they are stacked. A few strokes against a piece of sandpaper or emery cloth do the job satisfactorily.

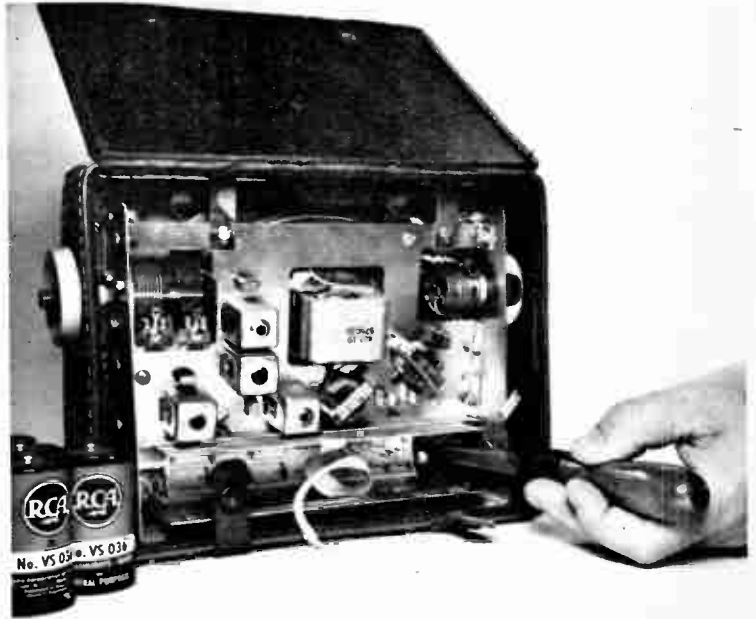

Right: Do not neglect the fixed contacts against which the ends of the batteries rest. Sometimes chemical corrosion develops at these points, introducing a high resistance into the circuit. Touch up the contact surfaces lightly with a fine file, but be careful not to poke it against chassis parts.

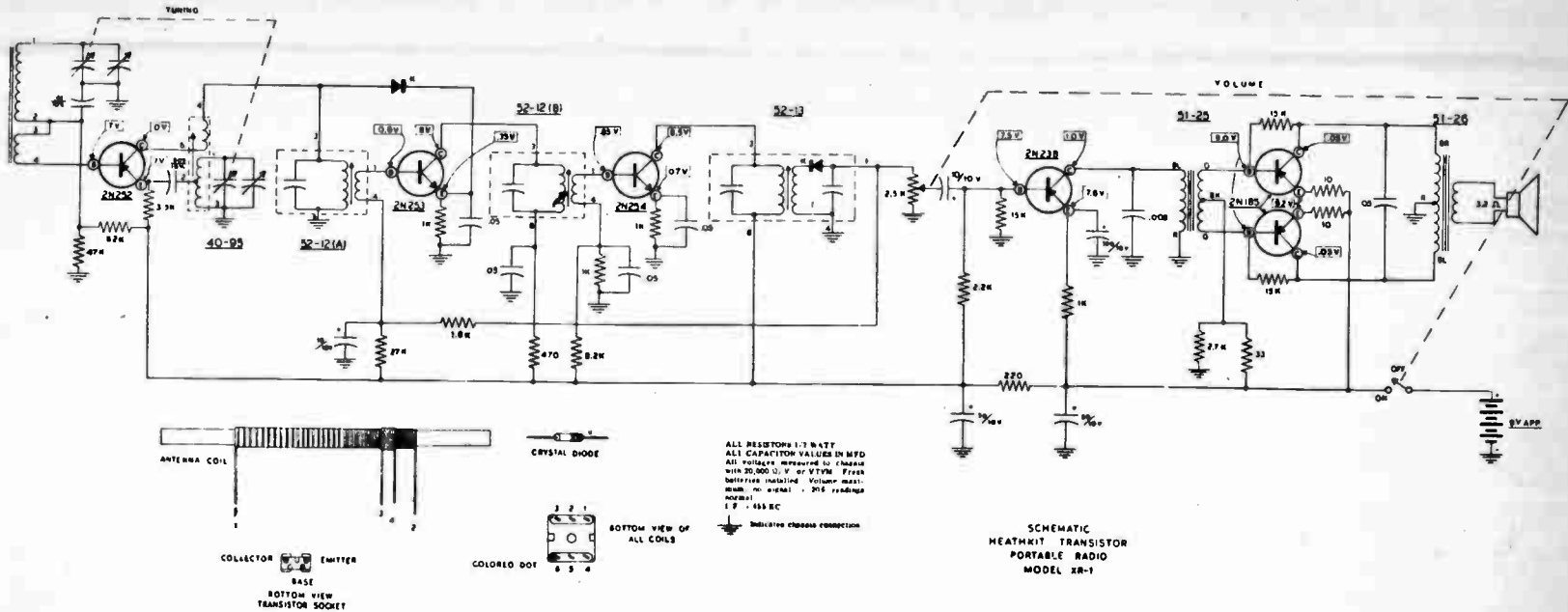

The wiring of the Heathkit transistor portable shown on these pages is relatively simple. Six plug-in transistors are used in a super-heterodyne circuit. The tuning range is 538 to 1680 kilocycles, covering the entire AM broadcast band. Signals are picked up by the antenna coil, or "loopstick," indicated at the extreme left of the diagram. They are selected by one section of a dual tuning capacitor and fed to the base of the 2N252 transistor by a small coupling coil, represented by the leads marked 3 and 4 on the antenna coil.

The second section of the tuning capacitor, in conjunction with the coil marked

40-95 and the 2N252 transistor, functions as the heterodyne oscillator. The signals from this oscillator mix with the incoming signals in such a manner as to produce heterodyne or "beat" signals all at the frequency of 455 kilocycles. These are amplified by two fixed amplifier stages in which the 2N253 and 2N254 transistors are used.

The diode marked K, shown just above the 2N253, provides protection against overloading of the circuit by very strong signals, by conducting when the latter exceed a certain value. This is an important circuit feature, because most small

transistors are essentially low-level devices and do not perform properly if overloaded.

The output of the second 455-kilocycle stage, at the transformer marked 52-13, is rectified by another diode in conventional manner and further amplified by the straight audio stage using the 2N238 transistor and a push-pull stage using two 2N185's. As indicated by the dotted lines at the right end of the diagram, the volume control and the on-off switch are set in the usual fashion.

All operating energy for the receiver is furnished by the six "D" size flashlight cells, giving a maximum of nine volts.

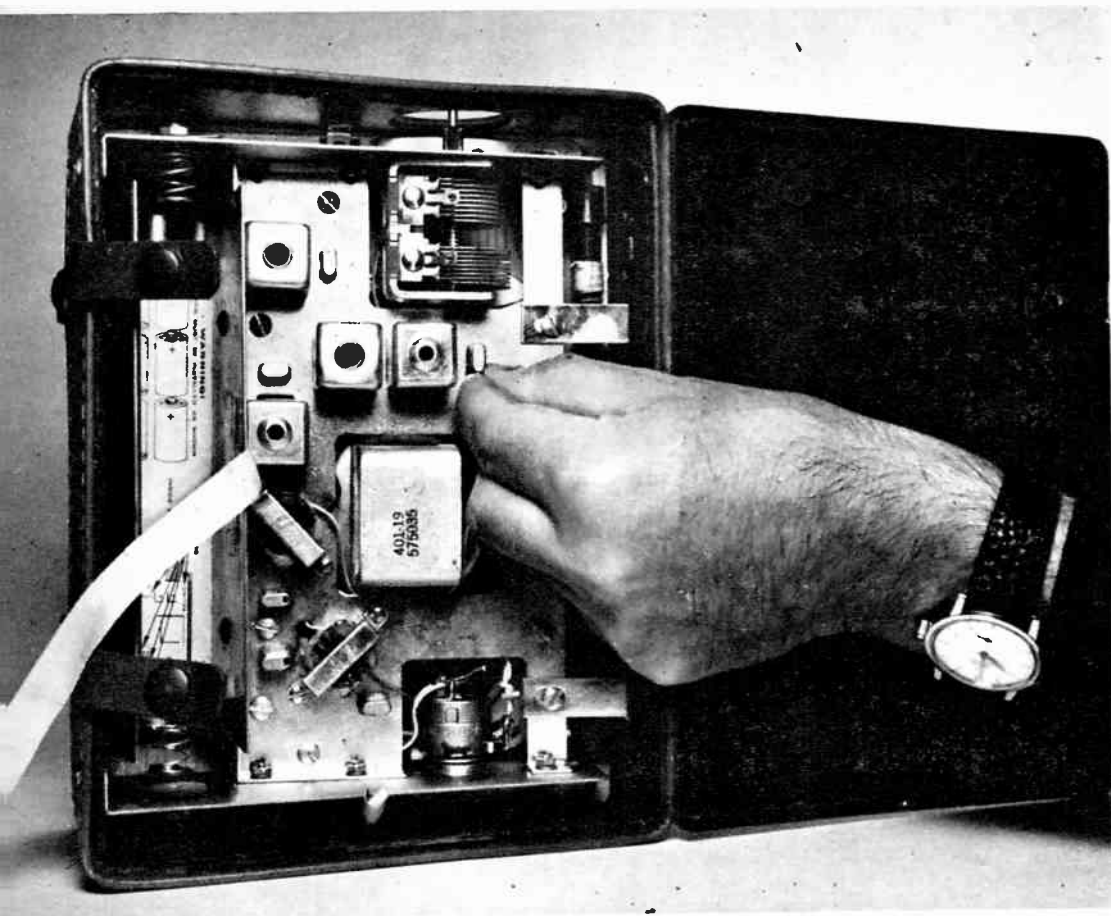

In this Heathkit portable, the transistors are not only accessible but can actually be removed or inserted by the fingers, or in a tight corner by means of pliers or tweezers. They have three leads apiece.

positive and the bottom of the case negative. Polarity is not important in non-radio devices, but it is extremely important in transistor sets. If more than one loose dry cell is used, there is—or should be—a small diagram in the battery compartment showing exactly how they must be stacked. For example, in a typical portable requiring six individual “D” size cells, the first cell of the first row starts at the left with the negative end facing left, followed by two more in the same direction. However, the first cell of the second row starts with the positive end facing left, followed by two more in the same layout. The cells are thus connected in simple series, and their voltages add up. Six cells give six times $1\frac{1}{2}$ volts, or 9 volts; eight cells give 12 volts. If by accident you reverse one cell of a group, it bucks the overall voltage and reduces it

by $1\frac{1}{2}$ volts. This does no harm, but the set might sound a bit weak.

Batteries of the alkaline type generally follow the construction of the carbon-zinc type, with the center post positive and the case negative. Oddly enough, many of these cells do have the center post marked with a plus sign! You'd think it would be logical for manufacturers to include the same sign on the carbon-zinc types, but they don't.

The real trouble starts with batteries of the mercury type. In these the center post is negative and the case is positive. Confusion arises from the fact that most portables can take either mercury or carbon-zinc/alkaline batteries, at the discretion of the owner. You have to look carefully and be pretty certain that the polarity signs on the batteries match up with the signs in

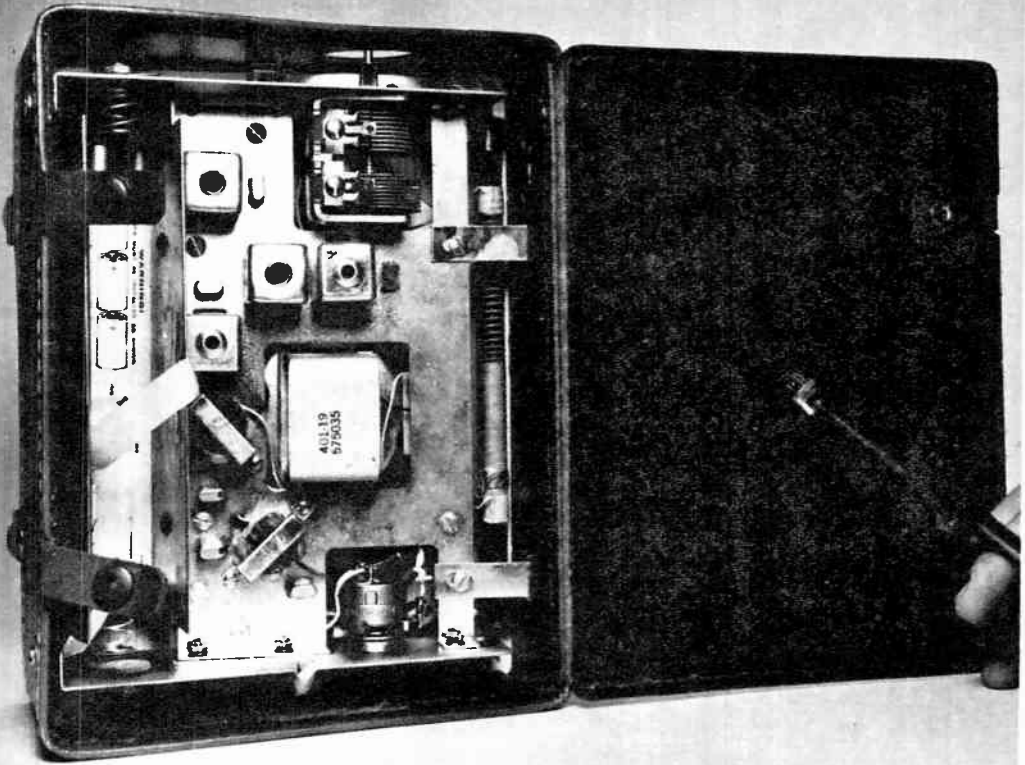

Almost lost against the cover of the set, typical transistor used in it has flat metal case. The three leads are very thin and must be perfectly straight and parallel in order to fit in tiny sockets for them.

the case of the set! Make a boo-boo here when you're installing a new battery and you can end up buying a new set.

Just to make things jollier, there are certain small batteries, of square cross-section, that have absolutely identical flat ends. The only clues to their polarity identity are small plus and minus signs printed on the bodies.

How Long Is "Unlimited?"

You may have gotten the impression, from reading some advertising copy, that transistors have unlimited life because they do not contain hot filaments that can burn out. This might mean something if the word "unlimited" could be made more specific. After all, the transistor as a technical achievement was announced only in 1948 and quantity production of consumer

products using the device didn't get rolling until the middle 1950's. Given the proper electrical, mechanical and thermal attention, a transistor radio set undoubtedly will last a long time. An "unlimited" time? Who knows?

The importance of proper battery polarity has already been mentioned. It is also important to protect all solid-state devices against severe shock and high temperatures, either of which can upset the delicate, man-made crystalline structure that makes transistors work in the first place. Dropping a set on a hard pavement or letting it stew in the glove compartment on a hot day can put it out of action.

The Printed Circuit Board

If dropping a set doesn't ruin the transistors, it might easily do something equally

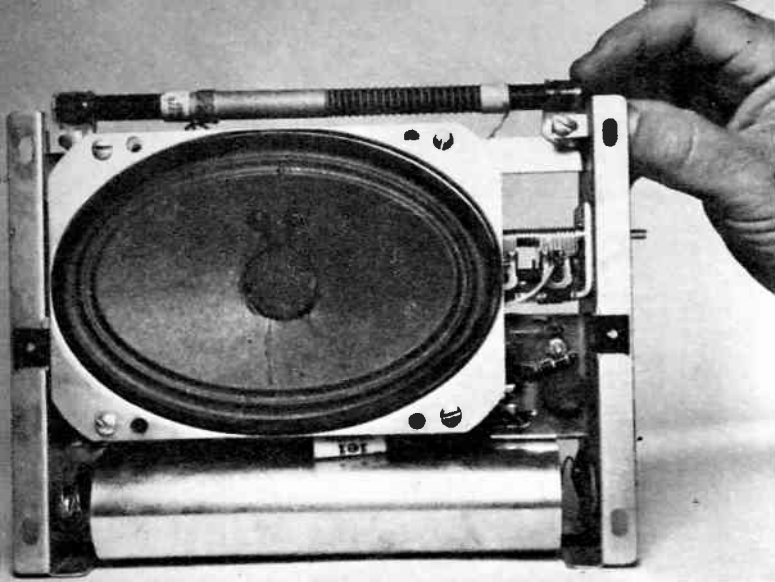

Removed from the carrying case, the chassis reveals 4x6" oval shape loud speaker, which provides excellent quality of sound. Loopstick is at top, battery compartment at bottom. Tuning capacitor is in cutout at the right of speaker.

Under view of portable chassis, with the loud speaker unmounted. Set can be operated in this manner, making testing easy. In this photo the tuning capacitor is at top, volume control and on-off switch at bottom. All wiring is on latter.

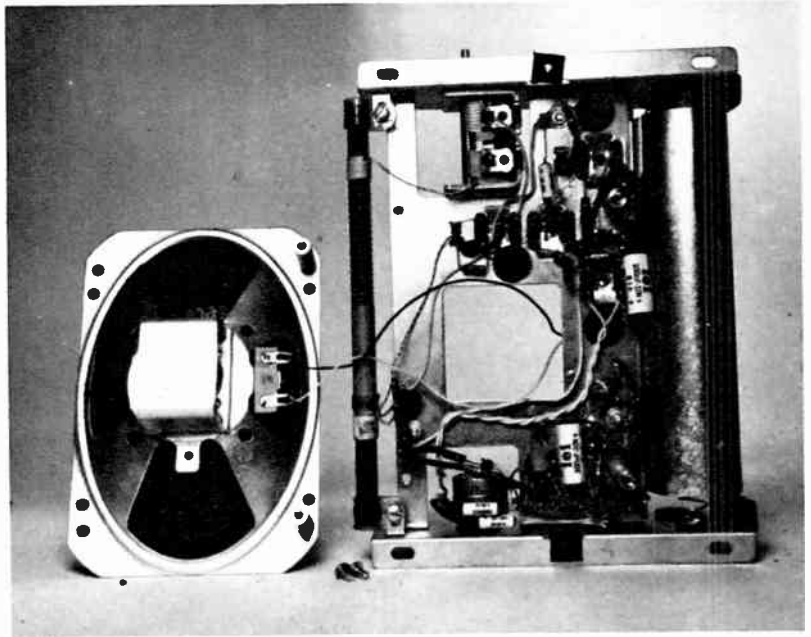

undesirable: It can crack the printed circuit board on which the transistors and most of the other components are soldered. The most infinitesimal crack, hardly visible to the naked eye, is usually enough to interrupt the circuit somewhere and to silence it.

If a portable has a cracked or dented case and obviously has been dropped, stepped on or otherwise mistreated, a service technician will make one attempt at repairing the chassis. He will put it under a strong light, and with the aid of a large magnifying glass and a small soldering

iron try to bridge gaps in the printed metallic lines on the board with tiny beads of solder. You can readily do as much yourself. You have nothing to lose by this operation, and if luck is with you it might bring the set back to life. It is certainly worth the effort.

By this time you're probably saying, "How about removing the transistors for checking?" The answer to this is, "Just try and do it!" If you'll examine the board again, you will see that virtually all the components are snug against it, with their leads through holes soldered on the under-

side. To remove a part, you must unsolder two or more wires simultaneously, without damaging adjacent parts. This may require two soldering irons and three hands. There are special de-soldering tips for standard soldering irons and guns, of square, triangular and round shape to bridge a number of joints at the same time, but their application to a very small chassis is limited.

Besides, there is very little you can do with the transistors once you get them loose. You're lucky just to find type numbers on them, and even luckier if you can get replacements or at least near-substitutes of different type numbers but of similar characteristics.

The Earphone Connection

Many portables are fitted with a tiny jack on the side of the case into which a pair of earphones, or more usually a single earphone, can be connected for "private" listening. Inserting the phone plug disconnects the loud speaker.

The contact springs in small jacks are notoriously weak and have a habit of staying open when the plug is removed. If the set works normally with the earphone but is dead with the plug out, open the case of the set carefully, disconnect the battery, examine the jack closely and tighten the springs.

If it is necessary to lift the printed circuit board to gain access to the jack, do so very slowly, with the set flat on its face. In some sets the loud speaker is held by clips, but in many it is braced only by the circuit board, and is therefore loose when the latter is dismantled.

Representative dry cells used in transistor radio sets. First two at the left are "D" and "C" flashlight types; others were designed especially for transistor service. Fingers hold tiny button type.



Rules For Transistor Health

1. Turn tuning and volume control/switch knobs slowly. Don't force them beyond their stops.
2. To make sure that set is properly turned off, hold it to one ear and listen for snap as knob reaches maximum counter-clockwise position.
3. Turn set off whenever you aren't actually listening to it. This will greatly lengthen battery life.
4. Don't drop the set, or swing it from your wrist like a purse.
5. Don't expose the set to excessive heat. In the summer, keep it out of direct sunshine and also out of the glove compartment of a closed car.
6. Don't put cigarettes on the set. Its case is undoubtedly made of plastic and will scorch or burn.
7. Open the case occasionally and inspect the battery for possible leakage. Replace immediately if a sticky chemical is oozing out of it.

Transistor Batteries

A little label pasted inside the cover of transistor portable reads as follows:

Recommended Battery Replacements

	Mallory	Eveready
Leclanché	M1604	216
Mercury	TR146	E146

What, you may well ask, does "Leclanché" mean? To be precise and

Long-life mercury type batteries in three voltages, 9, 45 and 22½, and in 3 sizes. Single round cell at left is intended for pocket-size portables. Others, for larger equipment, have special terminals.



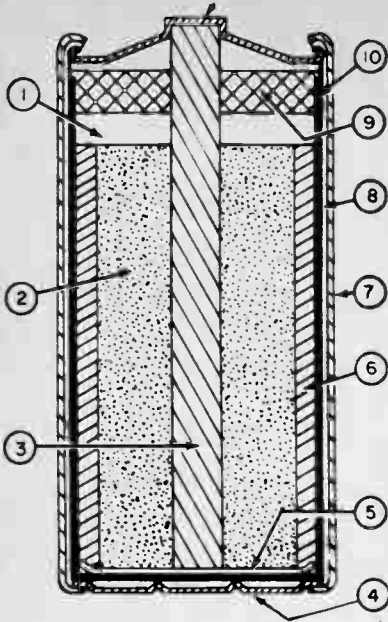

1. Air Space
2. Manganese-Dioxide-Carbon-Electrolyte Cathode Mix
3. Carbon Electrode
4. Steel Bottom
5. Paper Bottom Washer
6. Starch-Flour-Electrolyte Gel Separator
7. Steel Jacket
8. Laminated Paper Tube
9. Pitch Seal
10. Zinc Anode Can

Cross-section drawing of typical cylindrical zinc-carbon dry cell, the kind used by the million in flashlights and now also in transistor radio sets. The top cap is always positive, the bottom negative.

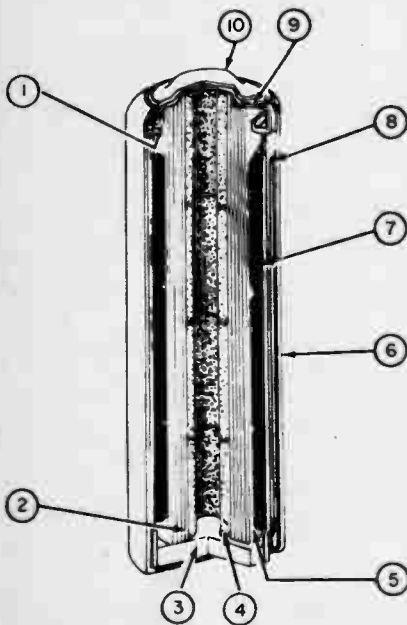

1. Sealing and Insulating Gasket
2. Electrolyte Absorbent Separator Material
3. Insulator Spacer
4. Powdered Zinc Anode
5. Microporous Plastic
6. Outer Steel Case
7. Mercuric Oxide-Graphite Cathode Cylinders
8. Absorbent Sleeve
9. Tin-plated Steel Inner Top
10. Nickel-Plated Steel Outer Top

Construction of the zinc-mercuric oxide dry cell. Advantages of this type are longer life and steadier voltage output. Top cap is negative, while case is positive. (Illustrations from "RCA Battery Manual.")

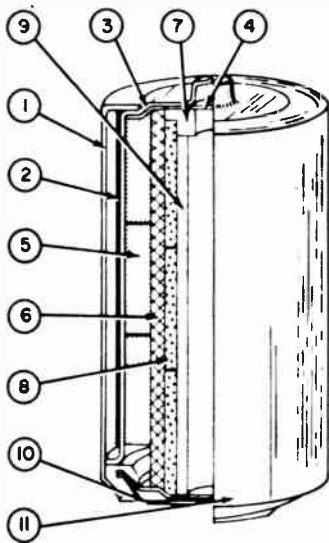

1. Outer Nickel-Plated Can
2. Tube Adapter
3. Inner Gold-Plated Can
4. Insulator Disk
5. Manganese-Dioxide Cathode Cylinders
6. Electrolyte Absorbent with Barrier
7. Insulating Ring
8. Zinc Anode Cylinders
9. Inner Absorbent
10. Molded Double Top
11. Insulating Plastic Jacket

Cross-section of zinc-manganese dioxide ("alkaline") battery. Construction resembles that of zinc-carbon type but chemical electrolyte is different. This cell is noted for efficiency at high current requirements.

historical, Georges Leclanché was a French chemist who, in 1868, developed a reliable battery using a simple and inexpensive combination of liquid chemicals and carbon-zinc electrodes. The basic idea was improved about twenty years later by Dr. Carl Gassner, a German who ingeniously converted the liquid electrolyte into a wet paste and sealed the whole mixture in a zinc can which also acted as the negative electrode. Thus was born what we today call the common "dry cell," which isn't dry at all but which at least doesn't leak. It really should be called the Gassner cell, but somehow the name Leclanché has endured and Gassner is all but forgotten.

The carbon-zinc-salammoniac battery is now generally identified as the Leclanché type to distinguish it from two very much newer types which are also "dry" and of very similar appearance—the mercury and the alkaline. The first uses red mercuric oxide as the positive electrode and zinc-mercury amalgam as the negative. The second is much like the Leclanché, but uses an electrolyte of potassium hydroxide.

If a dry cell is not specifically marked "mercury" or "alkaline" you can be pretty sure that it is a Leclanché flashlight type, regardless of what other description is printed on it. The terms "energizer" and "activator" are familiar to everyone.

The gradual deterioration of the Leclanché cell in radio service is described earlier in this chapter. The factor that makes this battery practical at all for small radio receivers is the very low current requirement of transistors. Low or not, the voltage of the cell does drop off markedly and steadily with use. The mercury battery has quite different characteristics. It not only lasts much longer than the Leclanché but it holds its voltage at a very much steadier rate during its lifetime. When it does finally give out, it does so rather quickly. It also has a greater capacity per unit of weight and volume, and better shelf-life.

A transistor portable energized by a mercury battery works at top effectiveness all the time, or not at all. The cell lasts so long that the owner of the set is likely to forget when he installed it.

This superior performance has its price, of course, but in the long run it is worth it. The catalog price of the Leclanché battery for the portable mentioned a page or so back is 48 cents; for the mercury type, \$1.31.

The alkaline battery offers no particular advantages over the Leclanché or mercury for transistor purposes, but it is better for devices requiring relatively heavy currents. •

How Transistors Work

UNLIKE other electronic devices, such as tubes, which depend for their operation on the flow of electric charges through a gas or a vacuum, "semiconductor" or "solid-state" devices make use of the current flow in a solid. In the public mind the term "transistor" has come to mean all semiconductors, but actually there were solid-state devices in practical use in radio equipment shortly after the turn of the century, even before the development of the vacuum tube. The transistor, as a radical refinement of the crystal detector of 1906, was introduced only in 1948.

There is no quick, simple explanation of semiconductor operation, for the simple reason that there is still no agreement among our most learned scientists as to the very nature of electricity itself. However, a few pertinent facts can be presented.

Materials Classified

In general, all materials can be classified from the electrical standpoint in three major categories—conductors, semiconductors, and insulators—depending on their relative ability to conduct electricity. The dividing lines are not sharply marked. A semiconductor has poorer conductivity than a conductor, but better conductivity than an insulator.

The materials most often found in semiconductor devices are germanium and silicon. Germanium has higher conductivity than silicon and is used in most low-power devices. Silicon is better for higher-power devices because of its natural ability to withstand heat. An enormous amount of experimenting is being done along physical-chemistry lines, and new compounds for semiconductor purposes are being produced almost weekly.

The ability of a material to conduct electricity depends on the number of free or loosely held electrons in it. Good conductors, mostly the common metals such as silver, copper, aluminum, etc., have large numbers of free electrons. Insulators such as glass, rubber, mica, etc., have relatively few. In their pure state semiconductors are somewhere in between. However, and this is very important, the resistance

of semiconductors can be controlled by the addition of minute quantities of certain chemical "impurities" which are actually elements having different atomic structure. The proportion is extremely small, in the order of only one part in ten million, which perhaps is why it is rather difficult to manufacture transistors in quantity and keep their characteristics uniform.

Effect of Impurities

Depending on the kind of impurity added to the basic semiconductor material, the latter either takes on a few extra electrons or loses some. In the first case it becomes slightly over-negative and is therefore called an N-type material. The extra electrons apparently are a bit crowded in the internal structure and require only slight excitation, in the form of applied voltage, to break away and flow into a more receptive material.

When the semiconductor loses electrons, the spaces they formerly occupied become empty and are thus called "holes." The va-

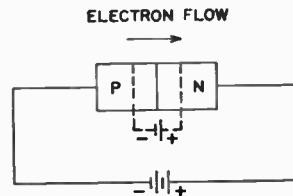

(a) REVERSE BIAS

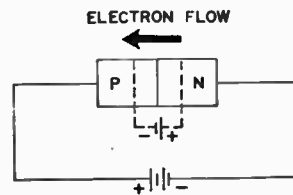

(b) FORWARD BIAS

When voltage is applied to a PN diode with the polarity as in (a), the electron flow is so small as to be negligible. When the polarity is changed as in (b) the flow is almost unimpeded. This is the fundamental rectifying action of the diode.

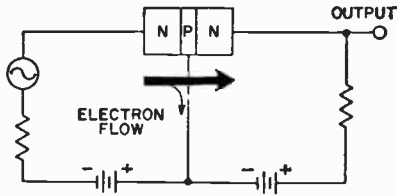

In a basic transistor, a light electron flow in the input circuit, to the left of the center connection from the P layer, triggers a heavy flow in the output circuit. This is what constitutes amplification. (Drawings from "RCA Transistor Manual.")

cancies are considered to represent positive polarity because they have lost the negative electrons that otherwise would bring about a neutral condition. This "hole" concept is not universally accepted by scientists, but it is reasonable. Materials with holes are said to be of the positive or P-type.

Action of N-P Diode

When bits of N and P materials are placed together to form a "junction," they assume what is called unilateral properties. In plainer English this means that they conduct electricity much better in one direction, as shown in figure on first page. Devices having this property are called "diodes" (for *two electrodes*) and are widely used to change alternating current into pulsating direct current; in other words, they are rectifiers. Ideally, a diode should have no resistance in its forward or conducting mode and infinite resistance (an "open circuit") in its backward or nonconducting mode, but this is not usually obtainable with practical devices.

The basic crystalline structure of many common minerals makes them natural rectifiers: the "impurities" apparently are built-in. The first crystal detectors used for radio reception were merely bean-sized pieces of silicon, still a highly favored semiconductor today. A very popular material was "galena," chemically lead sulphide, a cheap by-product of silver-refining processes. Even selected bits of coal did the trick.

A simple diode, regardless of the material it uses, can only control the direction of current flow in a circuit and cannot strengthen (that is, "amplify") it in any way. In fact, because it has a small but definite amount of resistance even during its conducting cycle, it actually reduces the current and hence the current in the circuit. Until the development of the transis-

tor, only the vacuum tube was capable of amplification; that is, taking in a weak electrical impulse, of almost any kind, and putting out a strengthened duplicate of it.

The construction of the transistor is deceptively simple; the theory of its operation is subject to many interpretations. Anyway, the basic transistor consists either of two N-type layers separated by a P-type filler (see figure above), or of two P's and one N. The amplifying action is the same with both arrangements, only the direction of electron flow being different. Note that the transistor is a three-element device. It could be called a "triode," as a follow-up on the two-element diode, but it isn't because the term is too well established as a designation for vacuum tubes having three elements.

About the easiest way to describe the action is to say that the input signal, represented by the thin arrow on the left side of figure (above) triggers a flow of those electrons in the N-P area and permits them to diffuse copiously in the P area and then through the P-N or output circuit under the attraction of a small DC voltage there. This constitutes amplification of the input. Any amplifier can also be used as an "oscillator" or generator of alternating current in an associated circuit. Since amplification and oscillation capabilities are what made the vacuum tube the Aladdin's Lamp of the mid-20th Century, it is easy to understand why the tiny transistor in its multiple forms is now the magical electronic key of the second half of the 1900's. •

This is the brilliant team of scientists of the Bell Telephone Laboratories whose investigations of semiconductor materials led to the practical development of the transistor. The device has completely revolutionized the design of electronic equipment that formerly depended on vacuum tubes. Seated is Dr. Wm. Shockley, standing (left) is Dr. John Bardeen, and (right) Dr. Walter H. Brattain.

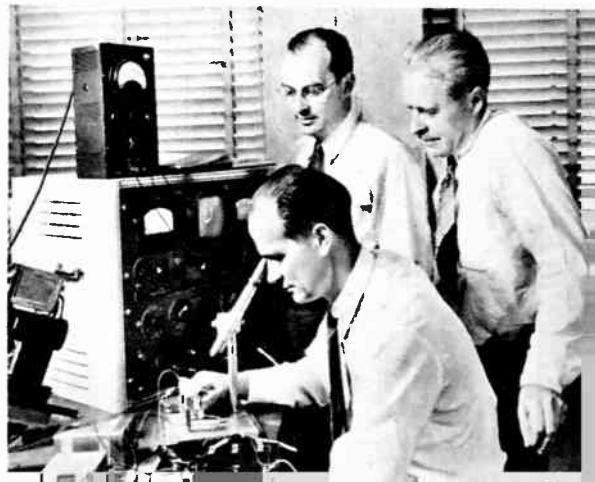

Solid-State Table Sets

THE expression "solid state" was adopted during the 1950's to distinguish transistors and related new devices that do the work of vacuum tubes from vacuum tubes themselves. However, a curious distinction between the terms "solid state" and "transistors" arose in the consumer-products field as the market was flooded with "transistorized" equipment of many kinds. Today, the word "transistor" by itself has come to mean a small, self-contained, battery-operated, Japanese-made AM radio receiver. The words "solid state" are widely used to signify a much larger AC line-operated set.

An incidental term, somewhat negative in nature, is "cordless." The cord that is not present is the AC connection, which means that the receiver is battery operated. Since all "transistors" (that is, complete little sets) work on batteries and do not have AC cords, they might logically be called cordless, but generally they aren't. The way the word is used in the electronics trade it usually means a table-model set that is much bigger than a "transistor" but smaller than a "solid-state" receiver. Just to help the confusion a little, there are cordless sets which can be run on AC by means of adapter cords, to save the bat-

Typical solid-state receiver resembles older AC-DC and AC sets, but is much lighter and more compact.

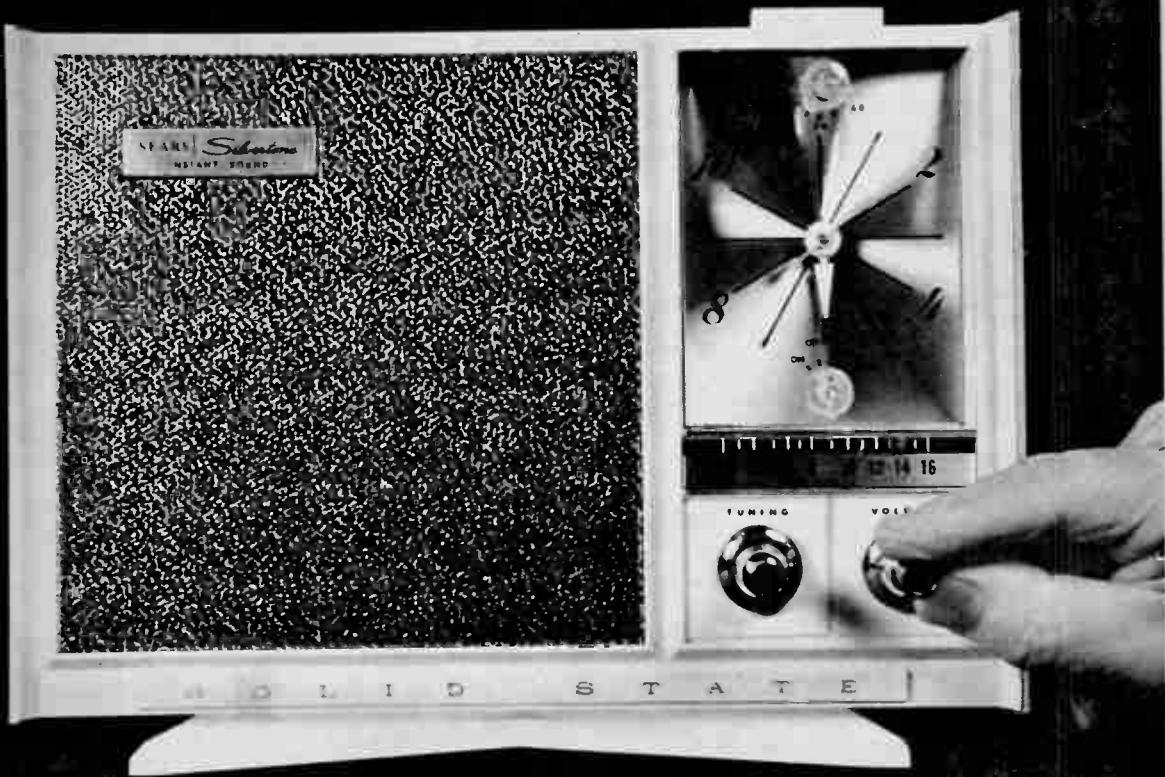

Right: This particular set contains an electric clock. Before the back can be removed, knob of the clock must be taken off. Trick is to grasp shaft with "Seizer" and to unscrew knob gently with flat-nose pliers.

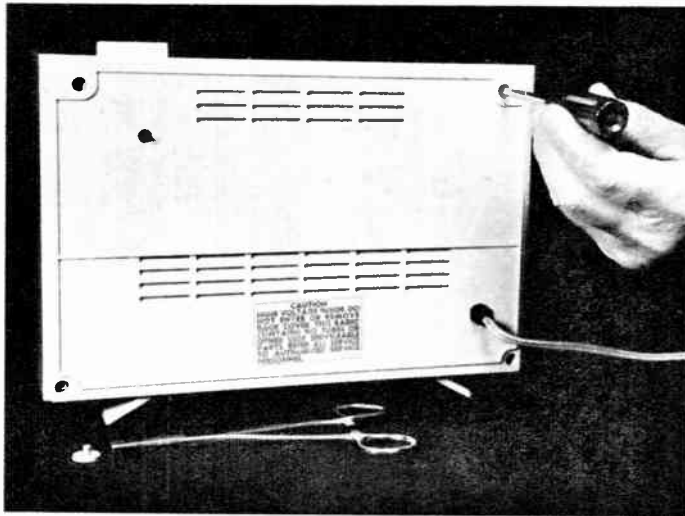
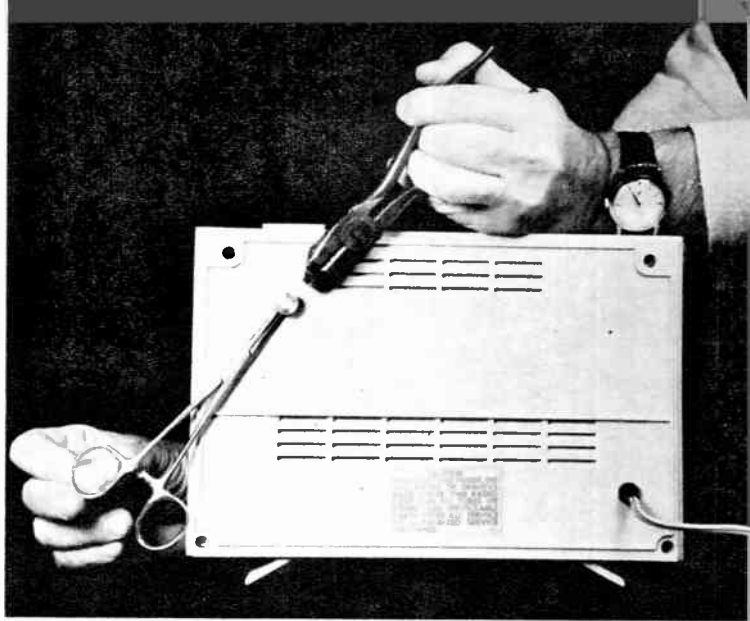

Left: Sections of molded plastic cabinet are secured by self-tapping screws in corners. These generally have X-shaped slots in heads and must be loosened with Philips type screwdriver. Ordinary screwdriver is likely to damage the slots.

teries. They are then no longer cordless, but corded, and possibly they can be considered cord-adapted solid-state receivers, or . . . oh, skip it! They're all just plain radio sets in the final analysis.

Solid-state sets offer several advantages over the little portables. For one thing, the larger cabinets permit the use of loud speakers of decent size, and the sets thus have far better tone quality. Then, with practically unlimited electrical energy available from the AC line, they can use more and bigger transistors and additional circuits, and thus have better sensitivity and selectivity. And last, but by no means least, the components can be spread out comfortably and are thus really accessible

for inspection, adjustment or replacement.

As an additional bonus, it is a simple matter to add an electric clock, or a combined clock/timer/switch to the cabinet. Producing a loud buzz mixed with loud music, at any pre-set hour, the receiver is sure to awaken even the soundest sleeper.

Since transistors create little or no heat, a solid-state job can be left running practically all the time. The power consumption from the AC line is negligible; the representative set shown in the accompanying photos draws only seven watts, about as much as an ordinary little night light.

Neither is there much possibility of

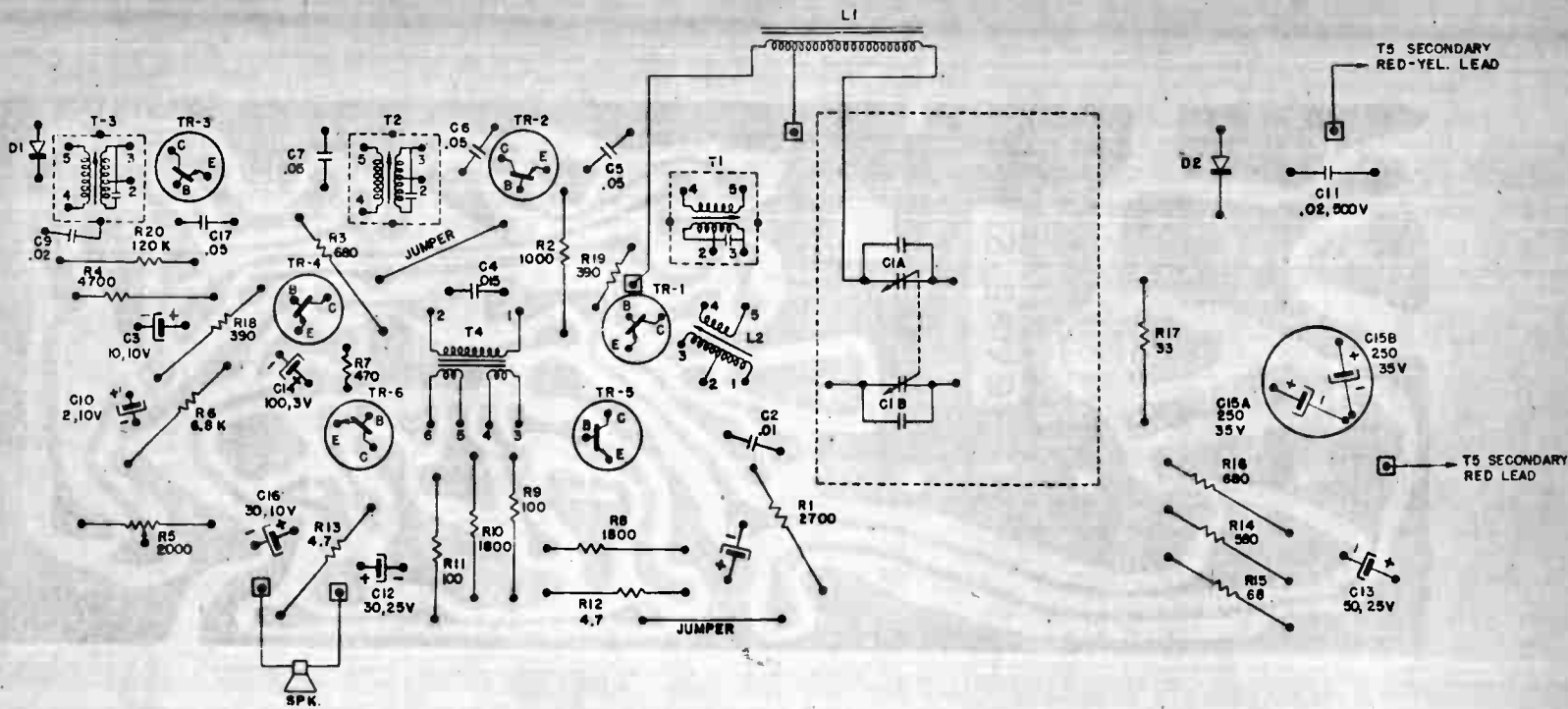

This is a phantom view of the printed circuit board of the solid-state receiver shown in the accompanying photographs. The connections between the various components are completed by the copper plating on the board, to correspond with the schematic diagram on the opposite page. The leads of the components are

pulled through holes in the board, soldered to the surface, and then cut off flush.

The coil marked L1 is the loopstick. It is mounted on the back of the front panel of the set, above the loud speaker. The power transformer T5 (see schematic diagram) also is mounted on the back, below the speaker. The wiring of the clock-timer

is not included in this drawing because it is independent of the circuit board. The clock motor is connected directly to the line plug, so it runs as long as the latter is in a live wall outlet. A compact, instant-on set with these features is particularly useful for use in a bedroom; its alarm signal plus music rules out oversleeping.

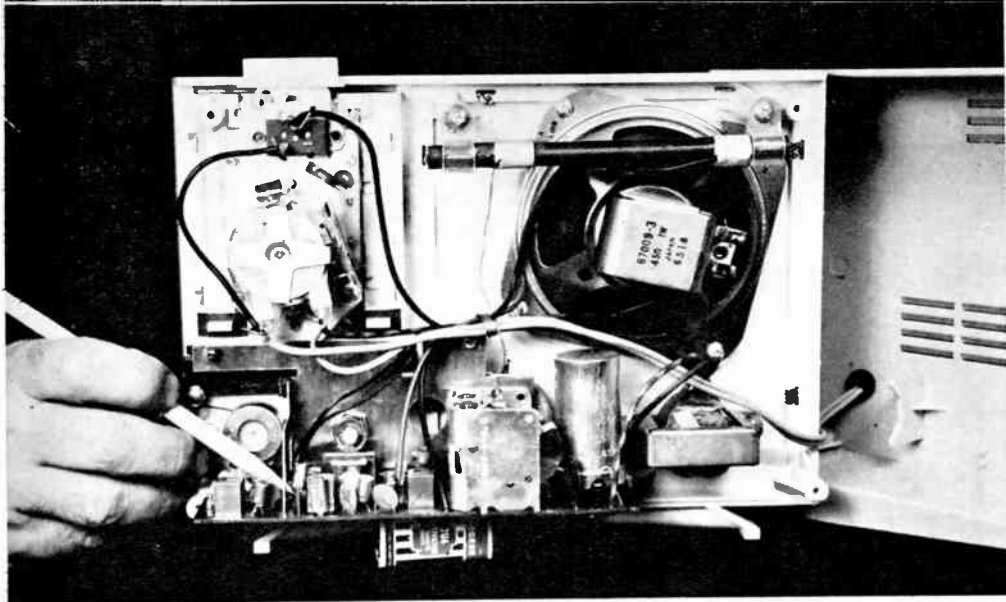

Pencil identifies one of the transistors on circuit board. Components on latter are quite accessible.

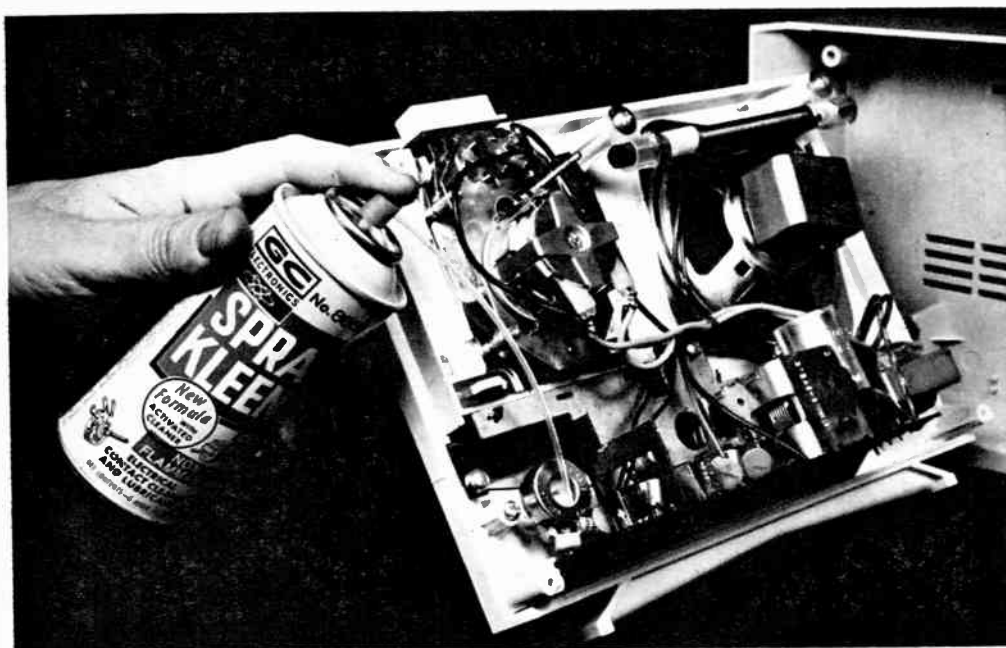

As in any radio set, volume control of solid-state can get noisy with use. Dose of spray cleaner helps.

shock, because a step-down transformer is used between the line and the chassis. The maximum DC voltage, in the set illustrated, is a little less than 24.

With no heat to attract dust and insects, and no batteries to replace, a receiver of this type requires very little technical attention. What you really have to guard against is the danger of pulling it off the table accidentally. It is very light, com-

pared with ordinary AC-DC and AC sets, and is easily upset. If only the plastic cabinet suffers after a fall, while the chassis itself continues to produce programs, patch it with cellulose cement or with sticky tape of appropriate color.

You will at least want to see what the inside of a set looks like. The disassembly procedure is the same as with any other. Remove the front-panel knobs and then

Top view of printed circuit board shows placement of components. The printed metal surface, to which leads are soldered, is on underside. In electronics diagrams standard practice is to use C to designate capacitors, R resistors, L coils, T transformers, TR transistors, J jacks, SW switches, D diodes. Compare markings here with those in schematic diagram and phantom layout of circuit board on pages 78 and 79.

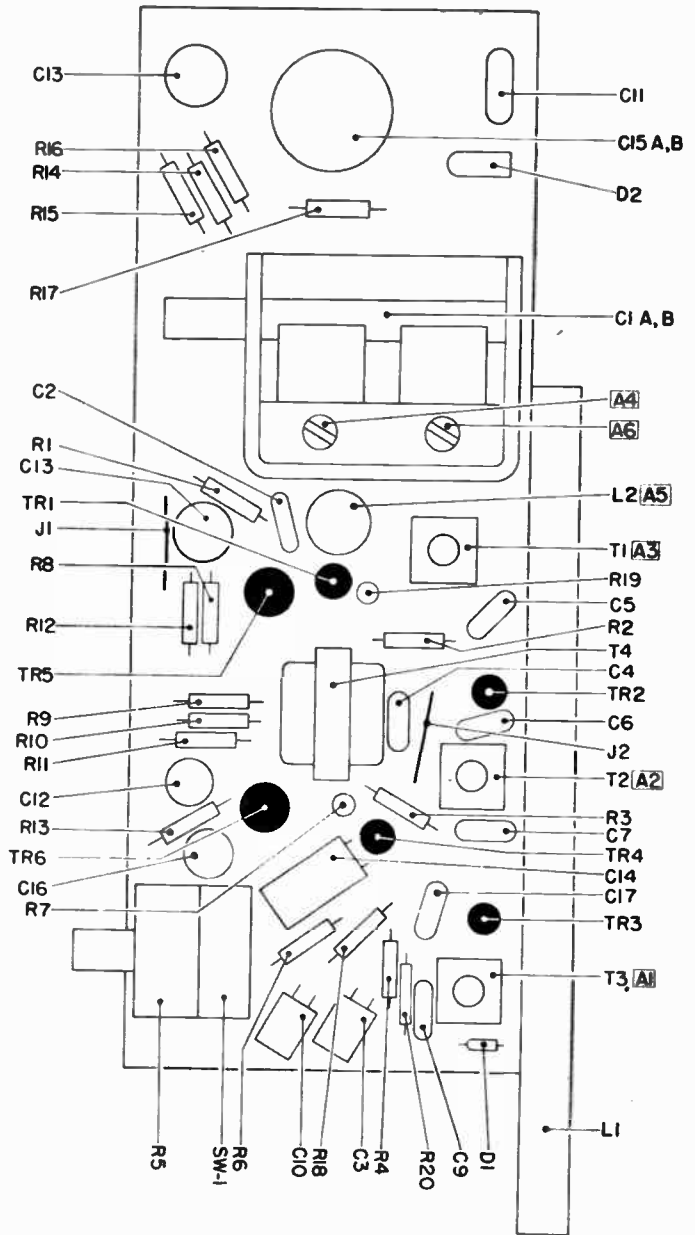

look for the screws that hold the sections of the cabinet together.

The construction of some receivers is rather tricky. After you take out the screws from what looks like the back of the cabinet, you may discover that there is no chassis in the conventional sense and that the entire "works" is mounted to the rear surface of the front panel. This arrangement is practical for transistor sets because the

components used are small and very light.

The use of self-tapping screws to hold plastic cabinets together is very common. When putting these back, hold them perfectly straight, turn them slowly, and stop when you feel a little resistance. Go beyond this point and the screw will churn out the hole, because its sharp metal threads are much stronger than the plastic itself. •

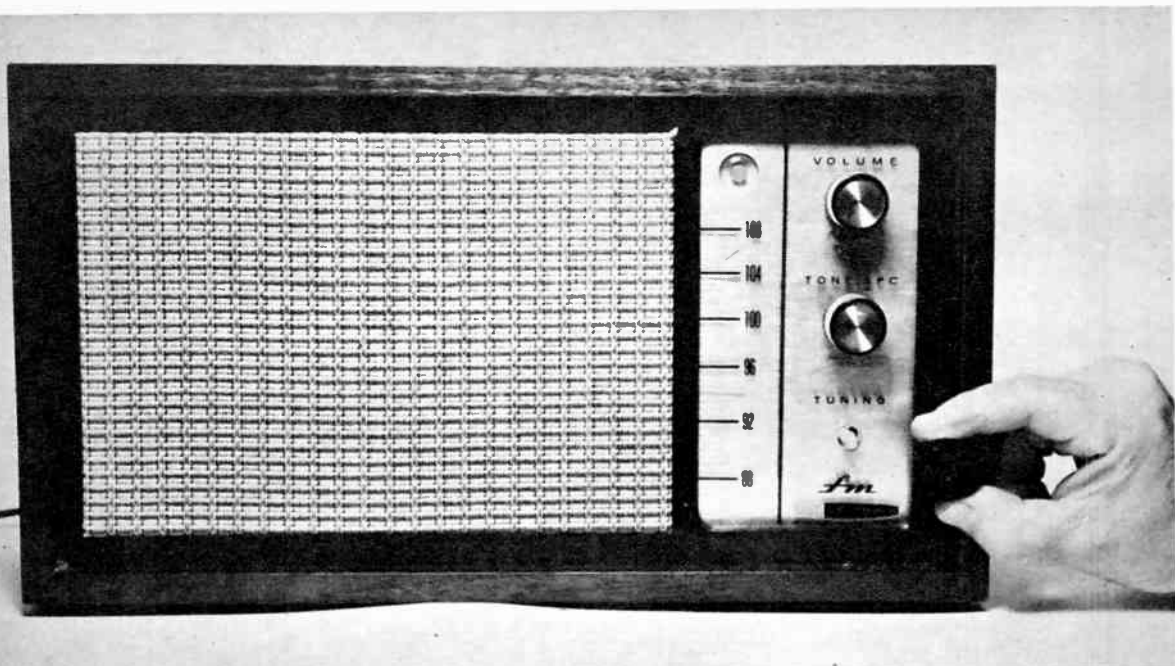

This representative FM receiver, built by Heath, has a large "coaxial" loud speaker occupying the left section of cabinet. Controls on the right, with pull-off knobs, are for tuning, volume and tone control.

FM Sets

FREQUENCY-modulation broadcasting ("FM") differs from conventional amplitude-modulation ("AM") in that it operates on a much higher frequency band and is capable of transmitting a much wider range of musical tones. The second characteristic is what endears FM to "hi-fi" fans who like to hear everything from the booming of big drums to the tweeting of delicate violins.

Of course, these advantages have their price. Under most circumstances you need a good outside antenna, to feed a strong signal to the receiver, and the latter itself is quite a bit more complicated than most straight AM sets of either the AC-DC or AC type. Fortunately, as is generally true of all-wave sets, FM receivers are well built and usually require only basic maintenance.

Good tonal reproduction requires a good loud speaker, or several loud speakers, so single-unit FM sets of necessity are rather

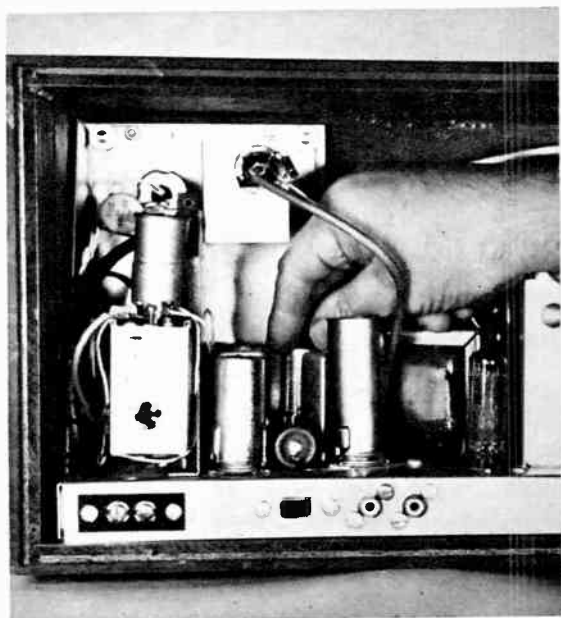

Because the cabinet is of generous size, to accommodate the loud speaker, getting at the tubes of this receiver is a fairly easy job. A "magic eye" tuning indicator is mounted just above the hand.

Wide slots along the top section of the backboard of this FM set provide good ventilation for the chassis. Latter is not "hot" electrically, so it can be exposed safely to facilitate connections to terminals along bottom.

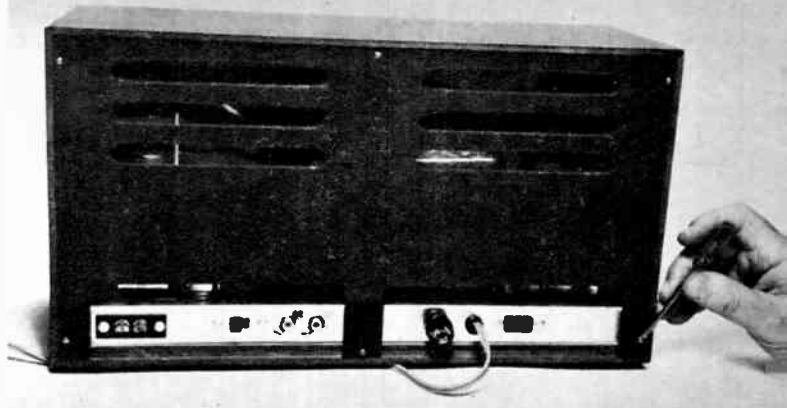

Slots in bottom of cabinet allow air to circulate naturally upward and out of slots in the backboard. This arrangement is easily adapted to other sets; a series of holes made with brace and bit is quite suitable.

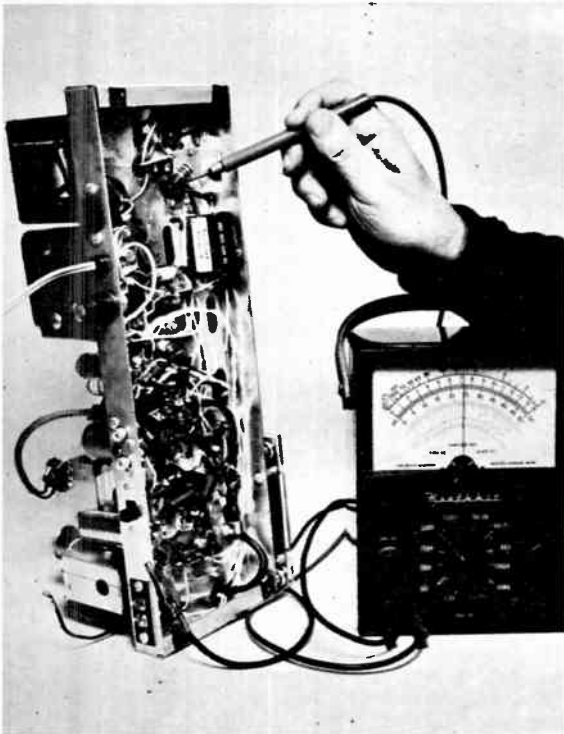
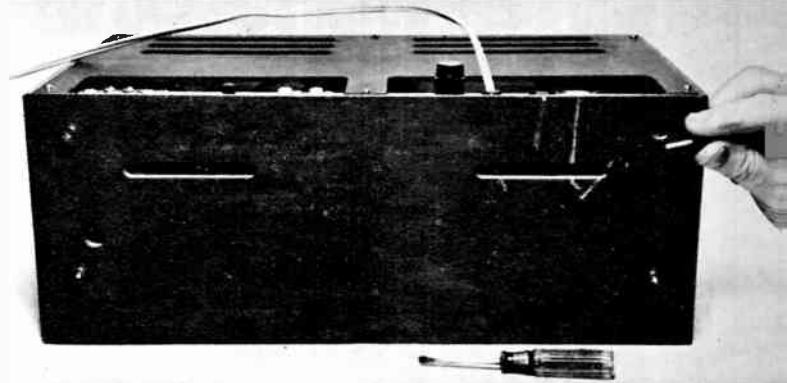

Left: When making voltage tests on this, or any other receiver, clip the negative meter lead to the chassis and apply the positive probe with the fingers well away from the point. This is standard safety measure, necessary because DC voltages in transformer-operated chassis can be 200 to 300.

large. Installations of true hi-fi calibre use separate speakers and a relatively small tuner-amplifier combination. In the typical table-model set shown in the accompanying illustrations the speaker is of the coaxial type and occupies most of the front of the cabinet. A coax speaker is actually a double unit. It consists of a large cone, called the "woofer" because it favors the low notes, inside of which is a small horn, called the "tweeter" because it sends out the high notes.

About all you can do with an FM set is test the tubes and make an infrequent replacement, keep the chassis clean, run a few voltage checks, etc. If the reception drops off markedly without disappearing, inspect the antenna before you touch the chassis. It may have shifted with the wind or a lead could have broken off. Serious trouble is a job for a skilled professional service technician, because of the complexities of practically all FM circuits.

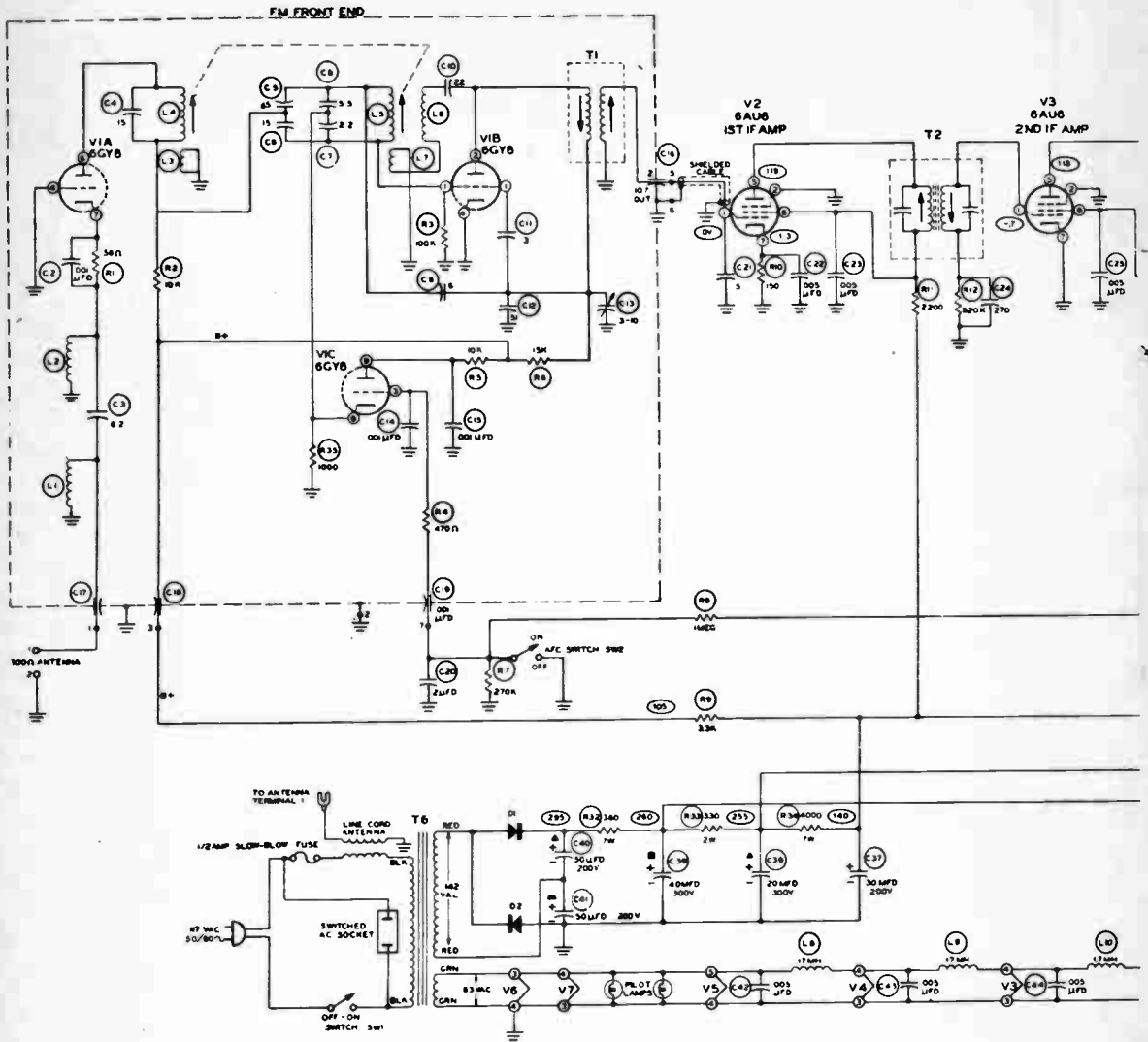

The diagram above shows the wiring of a straightforward FM receiver using conventional vacuum tubes. This is a single-band set, covering the American FM broadcasting band.

The section at the extreme left marked "FM Front End" represents the tuning section. The interesting thing about it is that the three tubes marked V1A, V1B and V1C are actually the sections of a single large tube having a single heater. The socket terminals for the latter are 4 and 5, as shown in the small dotted box in

the lower center of the diagram.

The ratio detector/audio driver tubes, marked V5A and V5B, are also contained in one envelope and have a common heater. This arrangement is common in broadcast receivers, but the front-end set-up is unusual.

The switch at the lower right end marked "Aux Input Switch SW3" is normally left in the position shown for radio reception. When the shaded contacts are pushed down, the entire tuner section of the set is disabled and the audio

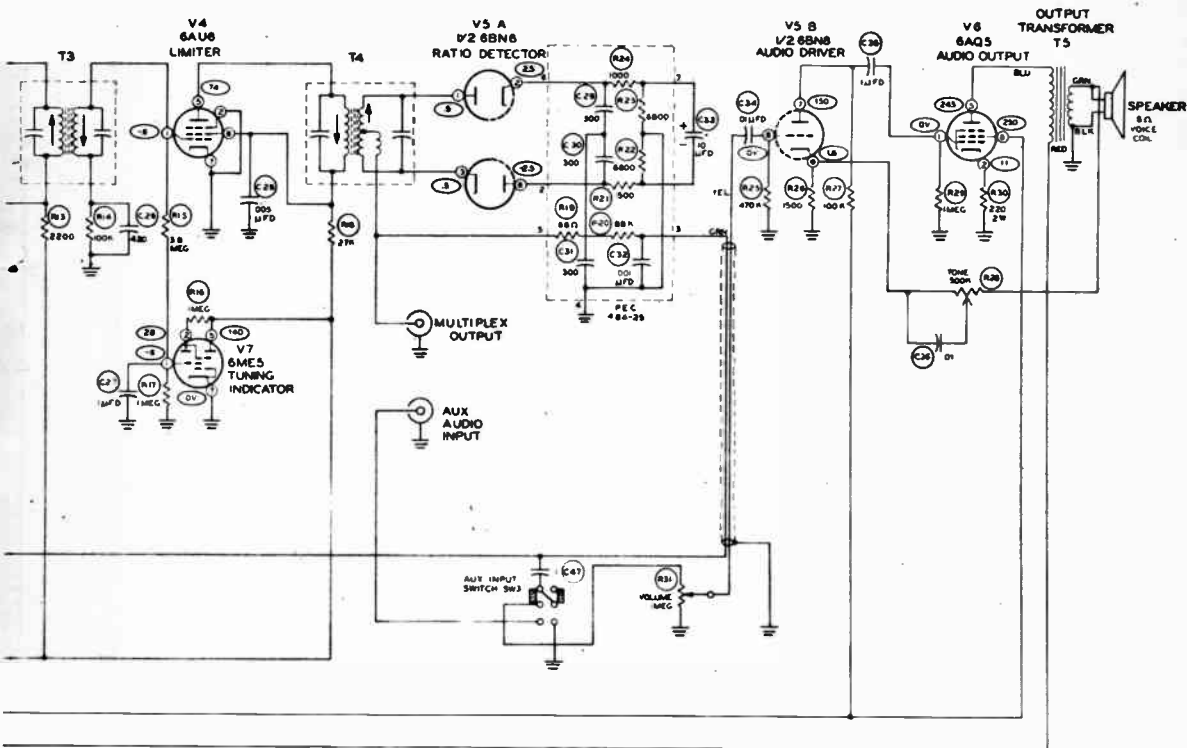

FM RADIO
MODEL GR - 21

- ALL RESISTORS ARE 1/2 WATT UNLESS OTHERWISE SPECIFIED.
 ALL CAPACITOR VALUES IN μ F UNLESS OTHERWISE SPECIFIED.
 ALL VOLTAGES TAKEN FROM POINT INDICATED TO CHASSIS GROUND.
 NO SIGNAL APPLIED.
 ALL VOLTAGES MAY VARY $\pm 10\%$.
 VOLTAGE READINGS TAKEN WITH 20,000 OHMS PER VOLT METER.
- \oplus INDICATES CHASSIS FEED-THROUGH CAPACITOR.
 - \oplus INDICATES CONNECTION.
 - \ominus INDICATES NO CONNECTION.
 - \oplus INDICATES CHASSIS GROUND.
 - \uparrow INDICATES TOP SLUG.
 - \downarrow INDICATES BOTTOM SLUG.
- ALL CONTROLS FULL COUNTERCLOCKWISE.
 SWITCH SW-2 SHOWN IN NORMAL POSITION.



amplifier section alone then works with whatever signal is fed into the jack marked "Aux Audio Input." This outside signal can be a phonograph pick-up, a microphone, a tape recorder, a musical instrument pick-up, etc.

Tube V7 is a "magic eye" tuning indicator. The technique in using it is to turn down the volume control so as to silence the loud speaker and then to adjust the tuning control to the frequency of a desired station to the point where the eye closes down to its smallest opening; when

the volume control is now turned up, the signals will be perfectly clear. This method of tuning eliminates the blasting and distortion that accompany ordinary tuning procedures.

The "line cord antenna" is a small transformer of a few turns connected in series with the power transformer T6. It depends for its operation on the fact that some outside power wires, in some locations, can pick up radio signals. The only way to tell if it is effective in a particular home is to try it. If it doesn't work, a regular outside aerial must be used.

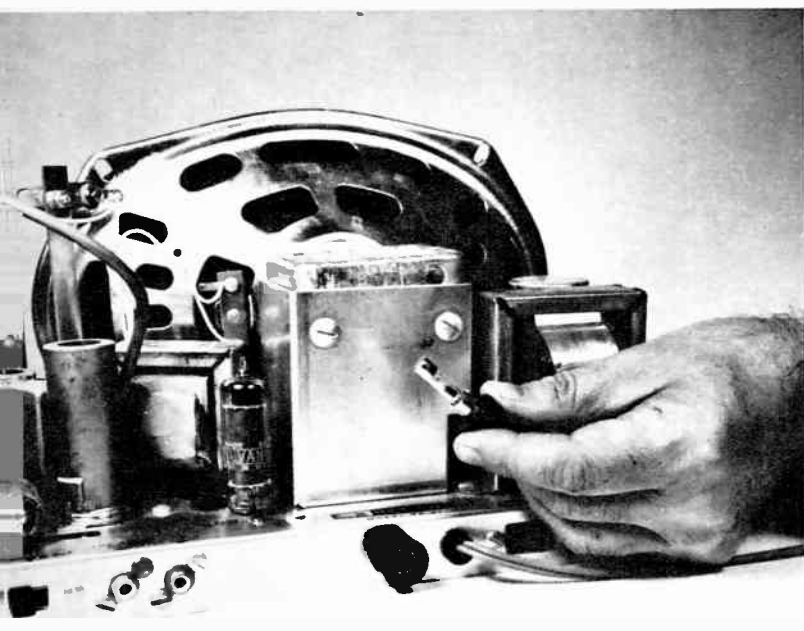

Protective line fuse is a feature of this high-grade FM set. It fits in a screw-in holder along bottom apron of chassis. Note size and shape of the coaxial loud speaker. This is mounted on front end of chassis and fits snugly against inside surface of front panel of the cabinet.

Finger points to a useful and innocent switch that is sometimes cause of mysterious trouble. It permits use of phono pick-up with set's excellent amplifier and loud speaker. If it is left in "auxiliary" instead of in "normal" setting, or is pushed that way inadvertently, with no phono pick-up in use, set remains absolutely dead.

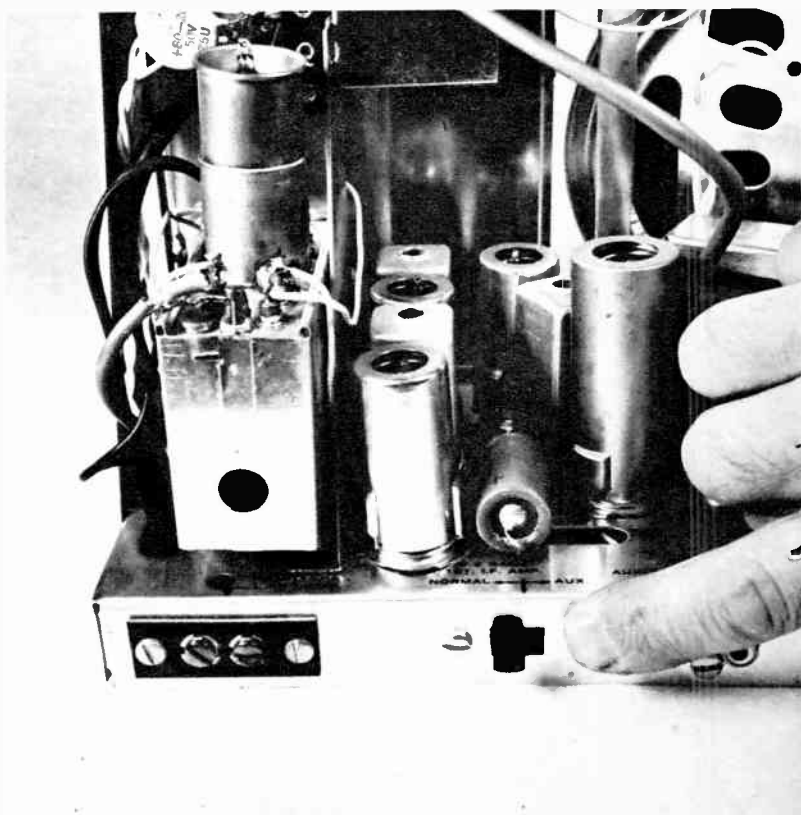



Observe same precautions in handling tubes of an FM set as with any AC or AC-DC receiver. Let them cool off; then tug gently without twisting. This photo also shows two small jacks on chassis apron for connection of external phono pick-up or FM multiplex adapter.

If tube pins appear to be stuck, help loosen them by prying carefully with thin screwdriver inserted between chassis and base of glass envelope. At same time, keep pulling upward, and the tube will come out soon.

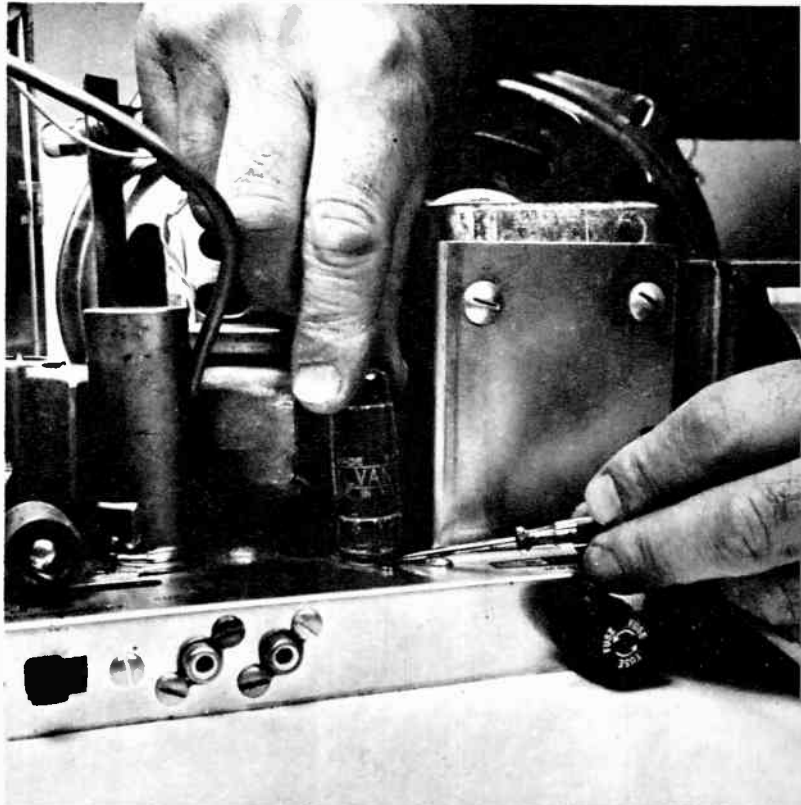

AM/FM RECEIVER

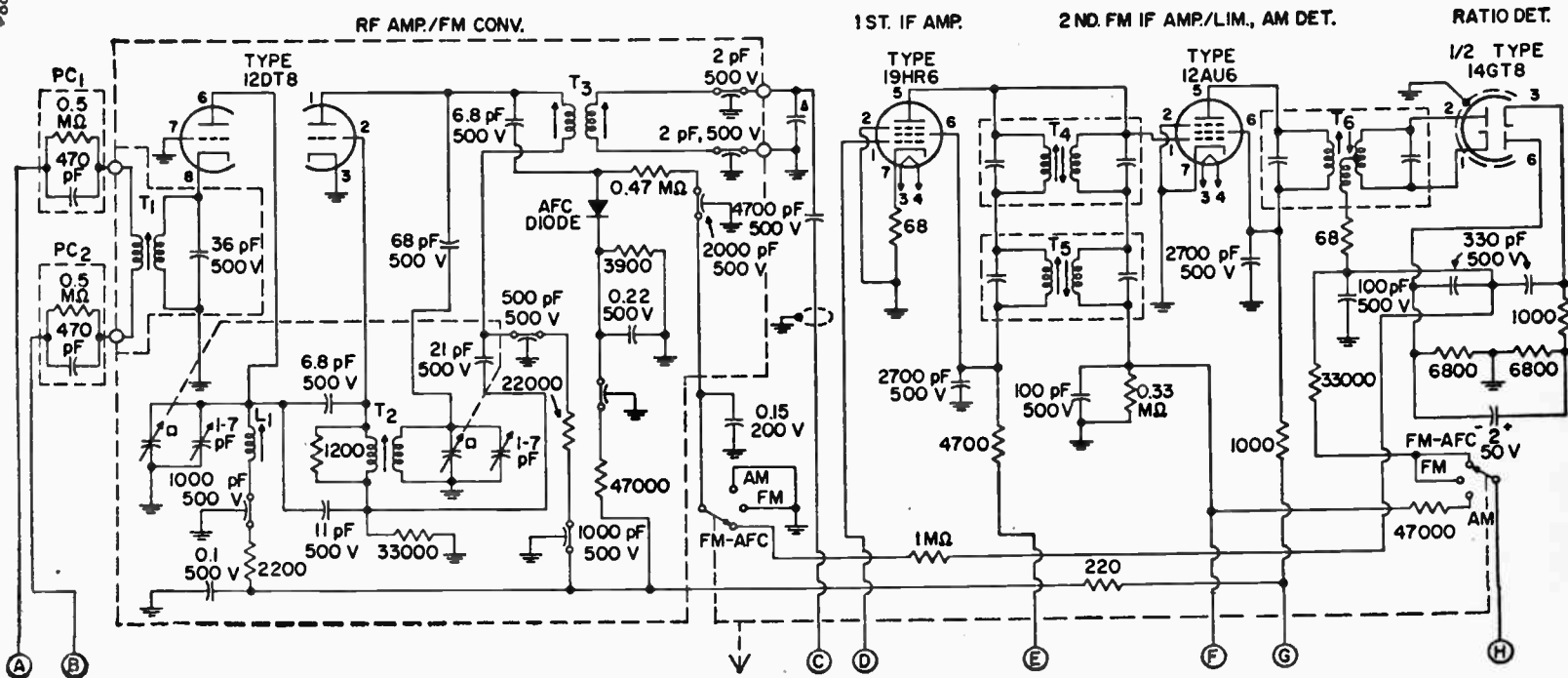

- Ganged tuning capacitors; tune L_1 and T_2 to 80 to 108 Mc/s
- # Ganged tuning capacitors; tune AM antenna (L_2) and T_7 to 540 to 1650 kc/s
- △ IF transformer tuning capacitor; value, with cable capacitance, tunes T_3 to 10.7 Mc/s.
- * On FM, the ac line serves as an FM antenna by means of a special line cord having a third wire which is not physically connected to the line. Alternatively, an external FM antenna may be connected to terminals G and F with the connection to the third wire of the power cord omitted.

Combination AM-FM receivers are popular because they offer the best of two broadcasting services. This section connects with the one below.

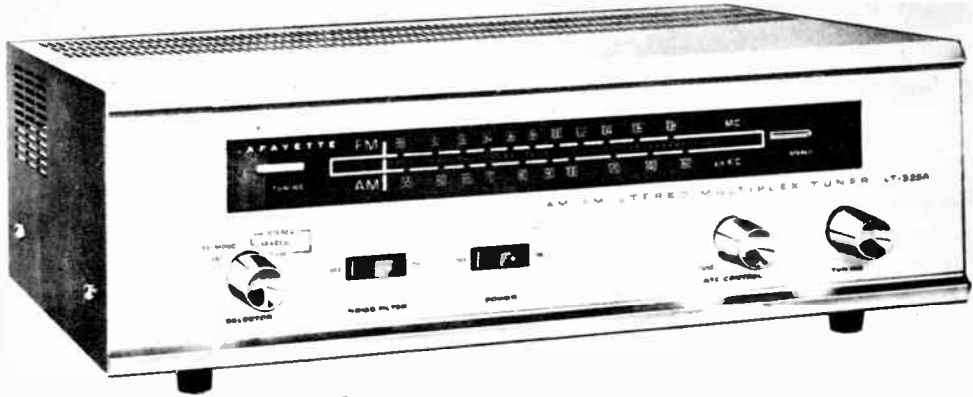

This representative FM receiver, built by Heath, has a large "coaxial" loud speaker occupying the left section of cabinet. Controls on the right, with pull-off knobs, are for tuning, volume and tone control.

Both FM and TV reception require the use of good antennas, to feed good signals to the receivers. Wind damage is common, and must be repaired as soon as possible before the whole aerial assembly comes down. This is a typical antenna after a storm; elements twisted, lead-in broken off.

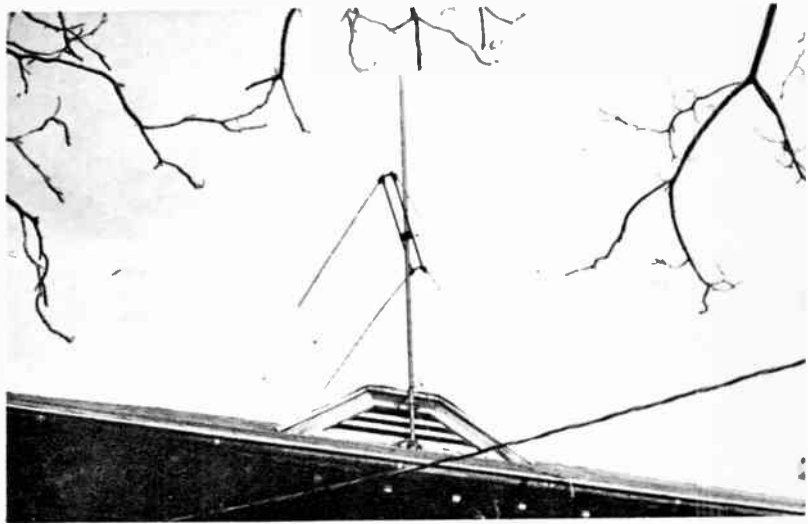

It is often wise to replace an old antenna with a new one having multiple elements, like this one. It provides much improved results with any FM or TV set, or combinations of them. Common operation is readily possible with "2-set coupler."

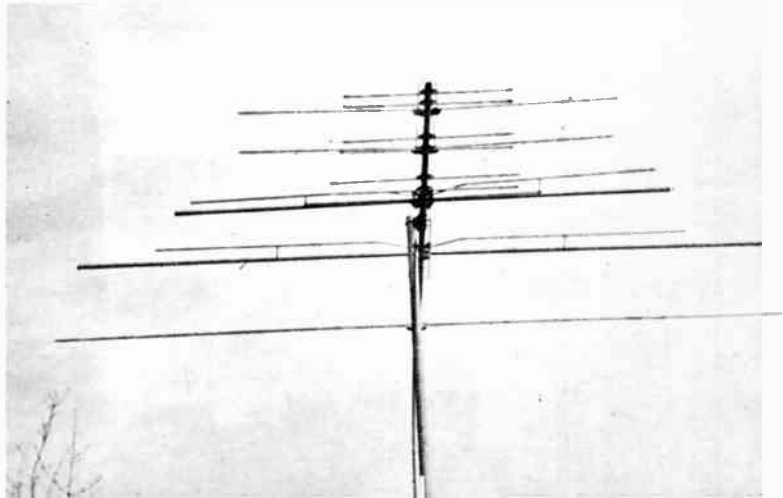

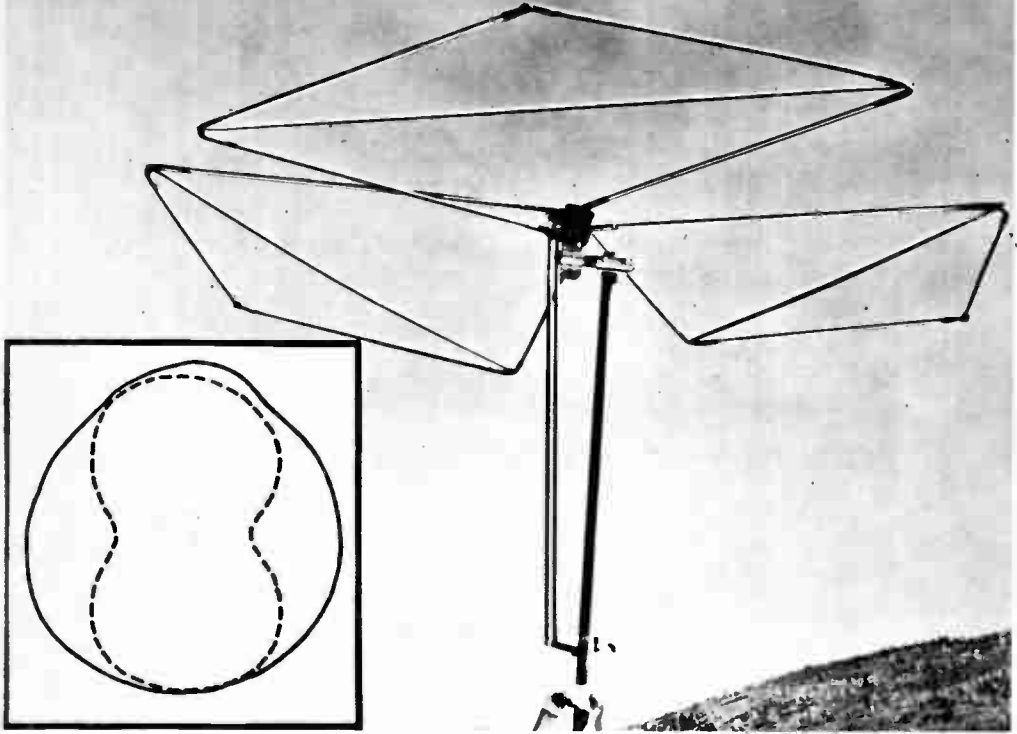

This odd-shaped antenna is the Channel Master FM "Rondo," designed to receive equally well in all directions. Its directivity effect is shown by the solid line in the "polar pattern" at the left, as compared with that of most other fixed antennas, represented by the peanut-shaped dotted line.

In areas where even a large antenna does not give satisfactory FM or TV reception, results can usually be improved greatly by the use of a "power booster" like this Blonder-Tongue Model B-24. Can feed four sets, FM or TV, or combinations, without mutual interference. This can feed as many as four sets, FM or TV, or combinations of them, without mutual interference.

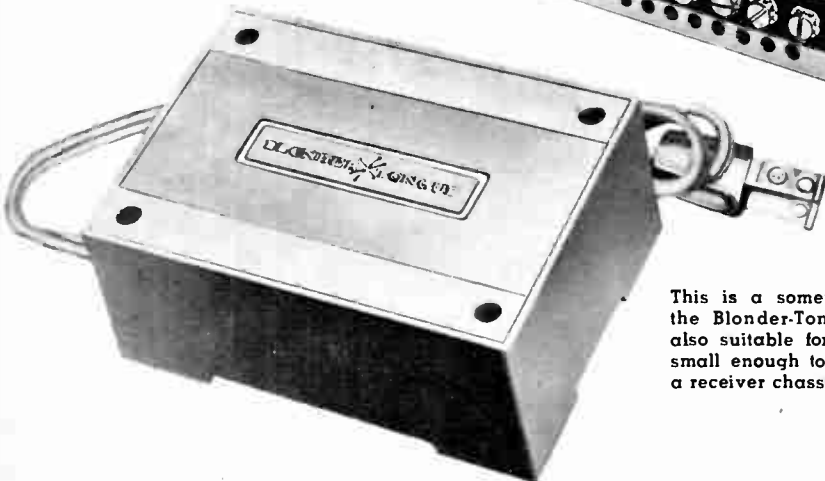
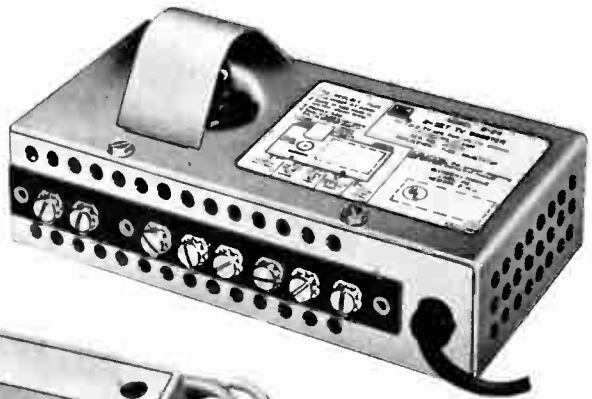

This is a somewhat simpler amplifier, the Blonder-Tongue "Quadrabooster," also suitable for two to four sets. It is small enough to hang from the back of a receiver chassis. Installation is simple.

Multi-Band Receivers

RADIO receivers that tune to several frequency bands have been popular for many years among people who want to listen to something more interesting and exciting than mere music and news. These sets are known generally as "multi-band," although this term is a bit too inclusive. More specifically, they can be two-band, three-band and all the way up to fifteen-band.

The starting band common to all these receivers is the regular American "AM" (amplitude modulated) broadcasting band. In most models the additional coverage is usually of the "short-wave" (corresponding to "high frequency") channels. The more elaborate sets favored by enthusiastic dial-twirlers also include the American "FM" (frequency modulated) channels and some of the "long-wave" (low fre-

Here's a set-up to delight the heart of any short-wave listener or "ham" operator. The multi-band receiver on the left is a National NC-183D, which has seven frequency ranges. Next to it is a Collins 75S3, covering fourteen bands, mostly the specialized ham frequencies. The sets have individual loud speakers.



quency) bands occupied by certain aeronautical and ship-to-shore communication services.

The owner of a multi-band receiver never knows a dull moment. If one band is quiet, because of unfavorable atmospheric conditions, he can switch to another. He has on tap literally thousands of stations transmitting in voice, in addition to thousands of others using the dits and dahs of the International Morse Code. It is thrilling to hear conversations between jet planes and ground control stations; police cars and station houses; ships at sea and shore stations; and especially between licensed amateurs (who never refer to themselves as anything but "hams") from the North Pole to the South Pole and all points between.

In design, multi-band—or all-wave—sets are generally superior to ordinary broadcast receivers. They are more sensitive, and respond better to weak signals from distant stations; they are more selective, and thus minimize interference between stations on adjacent frequencies; and they are more stable, and thus keep signals from fluctuating. These characteristics are obtained with extra tubes or

transistors, better components, heavier chassis construction, etc. All these cost money, but the result in most cases is a set that keeps on working for years and years and requires only a minimum of attention and repair.

"Minimum" does not, of course, mean "no" attention. In a chassis containing a dozen or more tubes one or two are bound to pass out eventually. They are easy to identify, because these sets are almost all of the straight AC type.

The component that requires special attention is the band switch. This can consist of as many as ten individual sections with a single control shaft running through them. With as many as six or eight contacts on each section, the total number of possible contact points is as high as eighty. Dust or other dirt that is attracted to a warm chassis is known to lodge in the switches and sometimes to degrade the connection between the contacts and the rotating arms that engage them. This condition does not make the set inoperative; worse, it makes it behave erratically.

At one time the job of cleaning several dozen little switch tabs, many of them out of convenient reach, was both difficult and

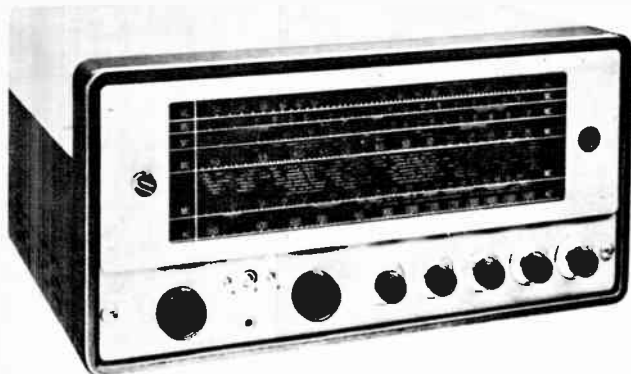

"Slide-rule" type dial is used in Hallicrafters SX-62A, a six-band job that includes the FM broadcast range, AM radio and four short-wave bands. Never a dull moment with this set!



Hammarlund HQ-100A is a five-band receiver with two tuning dials; one for coarse adjustment, the other for spreading the readings. Meter at right indicates signal strengths; clock at left reads international time on 24-hour face.



Above: Five-band "Mohican" receiver, made from a Heathkit, is a solid-state set. Works either on dry cells or AC power unit. The slide-rule dial has separate scales for regular tuning of AM and short-wave bands and for band-spreading the special ham bands.

Right: This is probably most important service operation performed on multi-band set: Cleaning the switch contacts with special spray preparation in a pressure can. Use sparingly, as a little goes long way. This is under view of chassis of the Mohican.





Multiplicity of knobs and switches gives operator of multi-band receivers complete control of all circuit functions. In this Heathkit "Mohawk" eight-band set, a different slide-rule scale pops into view in the long dial bezel as the band-selector switch is rotated. Set includes crystal-controlled calibrator.

time-consuming. It had to be done with pipe-cleaners, cotton swabs, small brushes and other improvised applicators. Nowadays, fortunately, it can be done safely, quickly and effectively with special combination lubricant-cleaners in spray cans. These chemicals were developed originally to treat the switches in television receivers, in which the identical cleaning problem exists, but of course they can be used to advantage on any switches.

The nozzle on the top of the can is fitted with a thin, flexible plastic tube. The technique merely is to place the end of the tube close to the switch contacts and to press the nozzle for one short squirt. It is neither necessary nor desirable to douse the switch. The cleaner has a tendency to soften certain types of plastics which are sometimes used as coil forms or insulation, so it must be used sparingly rather than generously.

Immediately after each squirt, rock the switch back and forth gently a couple of times to spread the chemical over the contact surfaces. The improvement in reception is often both immediate and startling.

Getting at the Switch

The major part of this cleaning operation is just getting at the switch. Some sets have a removable bottom plate which gives quick access. With others it is usually necessary to slide the entire chassis out through the front of the cabinet and then to remove either a bottom plate or the cover of a shield compartment on the top side.

With the chassis exposed, look for additional switches and give them small doses. The earphone jack and similar connectors with exposed spring-type contacts might also benefit from the treatment.

The circuits surrounding the band-changing switch are complicated, but there is nothing here that might wear out or need replacement, other than the tubes. The usual voltage checks with a VOM generally give a clue as to any real troubles. As with any set, the manufacturer's service notes or at least a complete schematic diagram must be available for reference and guidance.

A curious thing about all-wave sets is that very few of them have built-in loud speakers; the better the receiver the more

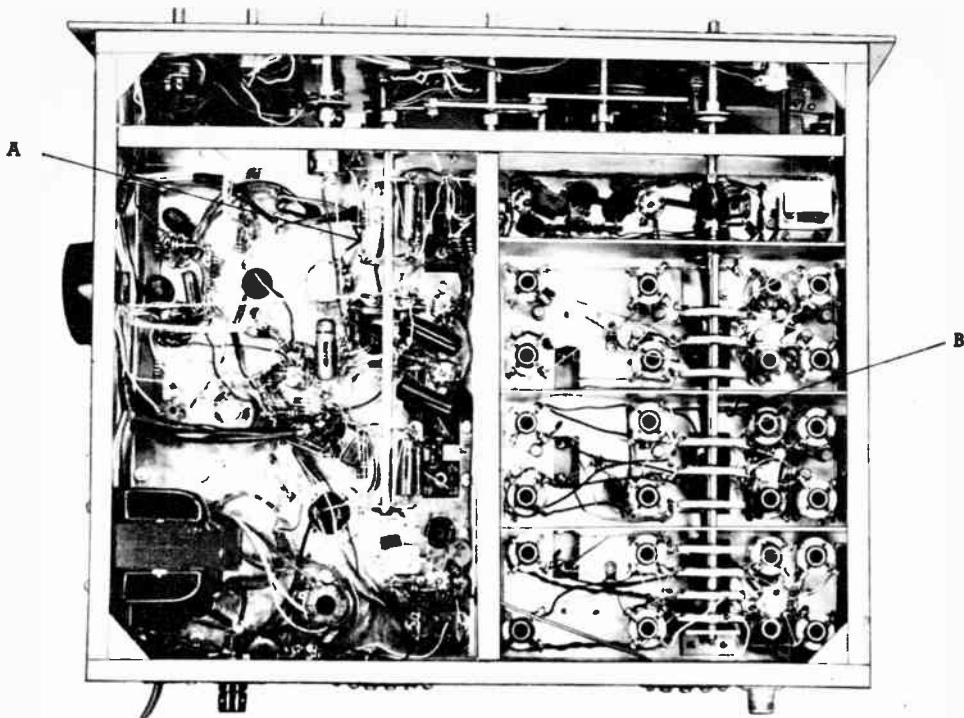

This under-view of Mohawk chassis clearly shows the selectivity control switch A and the band changing switch B. Latter has ten individual decks, all controlled by single long shaft running through them. Occasional injection of contact cleaner is important maintenance job. This set was home-made from kit.

components it contains and the less room there is for a speaker. Some manufacturers offer an external speaker in a box matching the set in appearance; others leave the matter entirely to the purchaser. An expensive speaker of the high-fidelity type isn't needed. An inexpensive unit about six inches in diameter, in a plain metal or wooden enclosure, provides all the "tone quality" to satisfy an avid searcher of interesting "DX" (long distance) stations.

Terminals for an external loud speaker are invariably located on the back apron of the set's chassis. Ordinary flexible lamp cord is fine for the connection.

Jack for Earphones

A jack for the quick connection of a pair of earphones is usually provided on the front panel; only rarely on the rear apron. When the phone plug is inserted the loud speaker is silenced. If the speaker remains silent after the plug is removed, examine the springs of the jack closely and squeeze them together slightly with your fingers so that they make firm contact.

An optional accessory with some receiv-

ers is a 24-hour electric clock, mounted in a corner of the front panel. This is very useful because the operating schedules of international radio stations are always given in four figures, to eliminate the confusion attending the use of duplicate numbers from 1 to 12 with A.M. and P.M. In the 24-hour system, usually called "GMT" because the original starting line for time-keeping was a meridian running through an astronomical observatory in Greenwich, England, the day commences just after midnight. Midnight is 2400 hours and therefore also 0000 hours, but the latter is never used. The first two digits represent the hours from 1 to 24, the second two the minutes of each hour. One minute of a new day is 0001, breakfast time is 0730, lunch 1200, but supper is 1800 (not 6.00 P.M.) or perhaps 1845.

The clock is connected directly to the line cord of the receiver, so that it runs whether the on-off switch is on or off. It will stop, of course, if you unplug the set for any reason. This is nothing to worry about, as there are plenty of accurate time signals on the air all the time. ●



Radio reception starts with the aerial, so this part must be kept in good condition. The auto antenna is subject to breakage if it hits an obstruction and to loosening from vibration. A half turn with a wrench is usually enough to secure it. Also check the fit of the shielded cable that runs from the bottom end of the aerial to the receiver. If the telescoping sections do not slide easily, lubricate them with a small application of graphite grease. Don't use ordinary grease or oil, which are insulators.

Auto Radio Sets

AUTO radio sets fall into three distinct classifications:

1. *Vibrator.* Sets made until about the late 1950's use tubes of the same types found in AC-line operated home receivers. The filaments or heaters of these tubes run directly off the 6- or 12-volt battery system of the car. The high voltage required for the plate circuits, in the order of 150 to 250 volts, is obtained by stepping up the battery voltage through a transformer with the assistance of a "vibrator." This is a sort of overgrown buzzer, whose function is to interrupt the direct current from the battery and to change it into a rough form of alternating current that can actu-

ate the transformer. Direct current by itself, especially the pure DC from batteries, cannot be "transformed" to higher or lower voltages the way AC can.

Just like AC sets, auto receivers of the vibrator type take a little time to warm up to operating condition: about ten seconds.

2. *Hybrid.* With the appearance of transistors in the 1950's, manufacturers tried to benefit from the publicity they were getting by throwing them into auto sets. However, the transistors then available could replace only some of the tubes, so the sets are called "hybrid." The tubes used in these combinations are special ones that work on the low voltage of the car's bat-

tery, just as the transistors do. They do not need a vibrator system, but they still need warm-up time.

3. *Solid State.* The development of transistors to replace all receiving tubes came as expected during the 1960's, and all newer sets are solidly "solid state." This general term distinguishes transistor equipment from vacuum-tube equipment. It is easy to identify a solid-state receiver; the instant you turn on its switch it springs to life. Sets of this type are of very simple construction and wiring and are generally reliable and trouble-free. They don't need vibrators because the 12 volts of the car's regular battery is more than enough for them; transistors are essentially . . . and for this purpose very fortunately . . . low-voltage devices.

The Vibrator Problem

In vibrator sets the major cause of trouble is the vibrator itself. This makes and breaks a fairly heavy current, so its contact points become pitted or corroded with time and inevitably they stick shut. This puts a heavier than usual drain on the battery and under normal circumstances blows out the protective fuse, which is located in a separable sleeve in a wire to the ignition switch or on a block along with other fuses, on the firewall of the car or under the dashboard. The vibrator unit is a plain metal can, about 1 or 1½ inches in diameter, with a plug fitting. Most sets are constructed with the vibrator openly accessible on the underside of the chassis, so that it can be pulled out and replaced without the necessity of dismantling the entire assembly. With the help of an ordinary hand mirror you can readily identify and reach the vibrator.

A blown fuse is a fairly certain sign that the vibrator is stuck, but hold off on buying a new one. Provide yourself with a new fuse, but before putting it in tap the end of the vibrator can lightly with the handle of a screwdriver. Sometimes this unsticks the points and the unit works again for months or years. However, if the second fuse blows you know what to do. Replacements cost only about \$1.50.

If the set is inoperative, but the fuse is intact and you can hear or feel the vibrator vibrating, the likelihood is that only a tube is at fault. If the tubes are accessible from the bottom of the chassis, as the vibrator usually is, touch a finger to each at a time. If one is definitely cold while the others are just as definitely warm, you've probably put your finger on the trouble . . . literally.

Two of the troubles that turn up in home

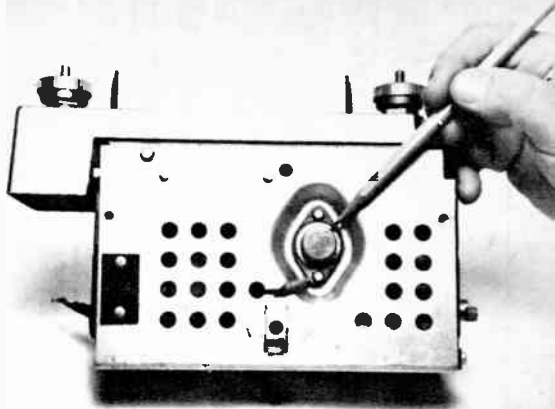

In auto sets of either the hybrid or the straight transistor type, one or two large transistors are generally mounted on the outside of the case, like this, for purposes of ventilation. They are the power amplifier units, and while they don't really get hot, they handle a few watts—can get warm.

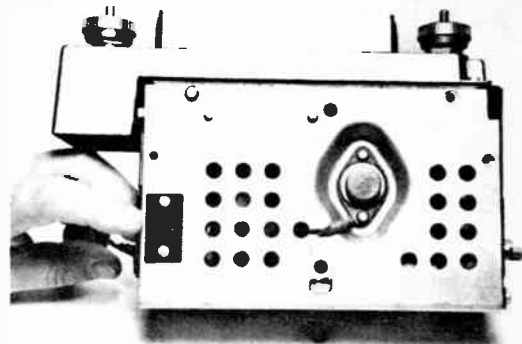

In most auto radio installations the loud speaker is separate from the set itself and connects to it by a pair of wires with a two-prong plug on its end. This fits into a small jack on the bottom of the chassis, as indicated here, or on the side. Make sure that the plug is clean and fits tightly.

radio sets are common also in auto sets: Noisy volume control and broken on-off switch. To get at these components for inspection you must remove the chassis from the dashboard. This isn't nearly as difficult a job as it appears at first. The routine is as follows:

Removing a Set

Find the single flexible insulated wire that goes to the battery circuit. This in-

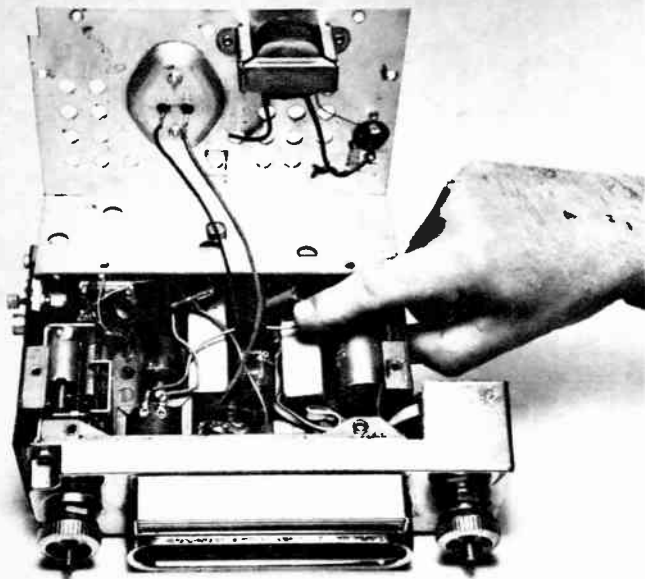

Finger points to an almost inaccessible tube in the chassis of a hybrid receiver. This, of course, was the tube that proved to be burned out when the inoperative set was removed from the car for inspection. A new one restored the set immediately to normal operation. Cramped construction is typical of thoughtlessly designed receivers that are made to be sold, but not to be serviced.

variably is fitted with a separable connector of some kind just to facilitate service work. Unhook it. This eliminates any possibility of accidental flare-ups in the car's electrical system. Look for the antenna lead. This is a rather thick cable, with a cover of metallic braid and possibly an additional outer cover of plastic. The end that goes into the set has a friction plug. Twist it very slightly and at the same time pull firmly.

If the loudspeaker is separate from the chassis, look for another flexible cord terminating in a small plug on the back or side of the chassis. Pull this out straight. You may have to help it by poking a thin screwdriver blade between it and the set.

Practically all auto sets are secured to the dashboard by hex nuts over the studs of the tuning control and the volume control/switch. Pull off the knobs, and note carefully how they are slotted to fit the ends of the shafts. If the volume control is combined with a tone control as well as a switch, you will find that the solid shaft for one turns inside a hollow shaft for the other, and that the knobs are slotted in such a manner that there is no chance of confusing them.

Before loosening the hex nuts, run your hand along the back edge of the set to determine if there is a supporting bracket here that needs to be removed. If there isn't, take off the hex nuts and the chassis will pretty much fall into your hands.

It will take you probably thirty minutes to pull the chassis and only five to replace it. Remember to reconnect the battery lead last.

A component of the radio installation that often suffers mechanical rather than electrical damage is the aerial. At some time or other almost everybody leaves it pulled out to its full height and then blithely runs the car into the garage. This is such a common occurrence that replacement antennas are widely stocked by hardware and automobile supply stores that don't otherwise carry radio parts.

Many hybrid sets quite evidently were designed with no consideration whatsoever for the possibility that they might require servicing at some time after their initial installation. In the earlier vibrator models the tubes and the vibrators are accessible from the bottom and can be removed and replaced quite readily; in some of the hybrids the tubes and most of the

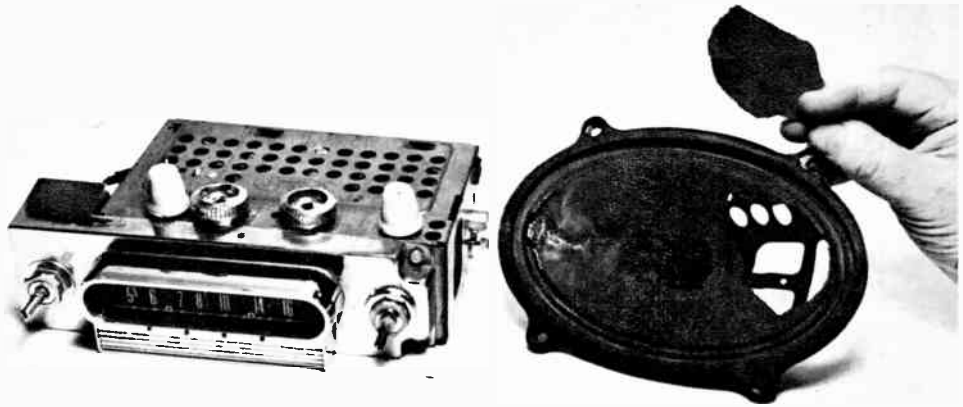

No wonder this set didn't sound right; look at the loud speaker! The vibrating cone, which is made merely of thin paper, had dried out so thoroughly, probably because the car was kept outdoors during hot weather, that it simply disintegrated. Damage is too extensive to permit patching with tape. New speaker will last longer if it is of weatherproof type, or if ordinary cone is sprayed with varnish.

transistors are buried inside the chassis, which must not only be dismantled from the dashboard but must also be pried open like a big can of sardines.

Transistors are known to go bad, but generally they last a very long time . . . certainly longer than most tubes. Therefore, if a hybrid goes dead the tubes must be checked, and this means digging them out of their sockets.

From the repair standpoint, solid-state auto sets must be treated like table-model AC receivers; that is, there's very little you can do except to look for loose connections, worn-out switches and volume controls, etc. About the only difference between these types is that the auto set has no "power supply" at all, working as it does right off the vehicle's battery, while the AC type has a very small power unit that reduces the 117 volts of the house line to a mere 10 or 12 volts through a rectifier to convert the AC to DC.

Although solid-state sets are fused, the chance that a fuse will blow because of an actual failure in the chassis is very remote. The components are under virtually no electrical strain because the circuit voltages are very low, and overheating is unheard

of because transistors do not have red-hot heater elements in them as tubes do.

When a fuse does go, the cause of the trouble is most likely to be found away from the radio set itself. For example, the "hot" lead to the battery circuit might be pinched in the movable flap of a ventilator duct or entangled in the windshield wiper mechanism; a few miles of driving and the vibration causes the insulation on the wire to wear through. The result is a simple short-circuit and the fuse quickly "pffts" out.

Sometimes a fuse that has been good for months or years suddenly blows, or at least a continuity check with a VOM shows it to be open, and a new one restores the set to full operation with no hint of trouble. Had there been a temporary short-circuit of some kind, somewhere? Not necessarily and not even probably. More likely the thin fuse wire inside the tiny glass body merely crystallized and broke, without burning at all. Remember, cars shake a lot. It is a wise trouble-shooter, amateur or professional, who tries a new fuse before he starts digging into the car's messy wiring harness for an elusive "short" or pulls the set out. •

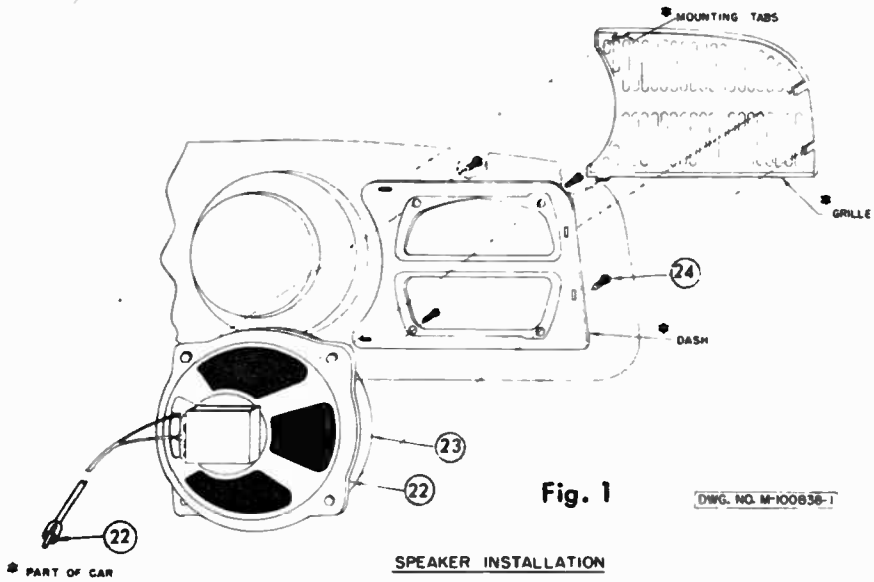

Fig. 1

DWG. NO. M-100658-1

SPEAKER INSTALLATION

Excerpts from the excellent folder provided for purchasers of an auto set made for the Volkswagen and sold by Sears, Roebuck. Similar mounting arrangements are used for other receivers. Fig. 1:

How the loud speaker is attached to the inside surface of the dashboard. Fig. 2: The chassis proper is supported by the studs of the tuning and volume controls. The knobs go on last. Fig. 3: The part marked 19 is a brace from the back edge of the radio chassis to the body of the car. It prevents the set from shaking up and down. No. 22 is the plug-in antenna lead. No. 18 is the "hot" lead to the car's battery circuit. Because of the nut-and-bolt fastenings and the plug-in connections, a set can be removed quickly for inspection as a result.

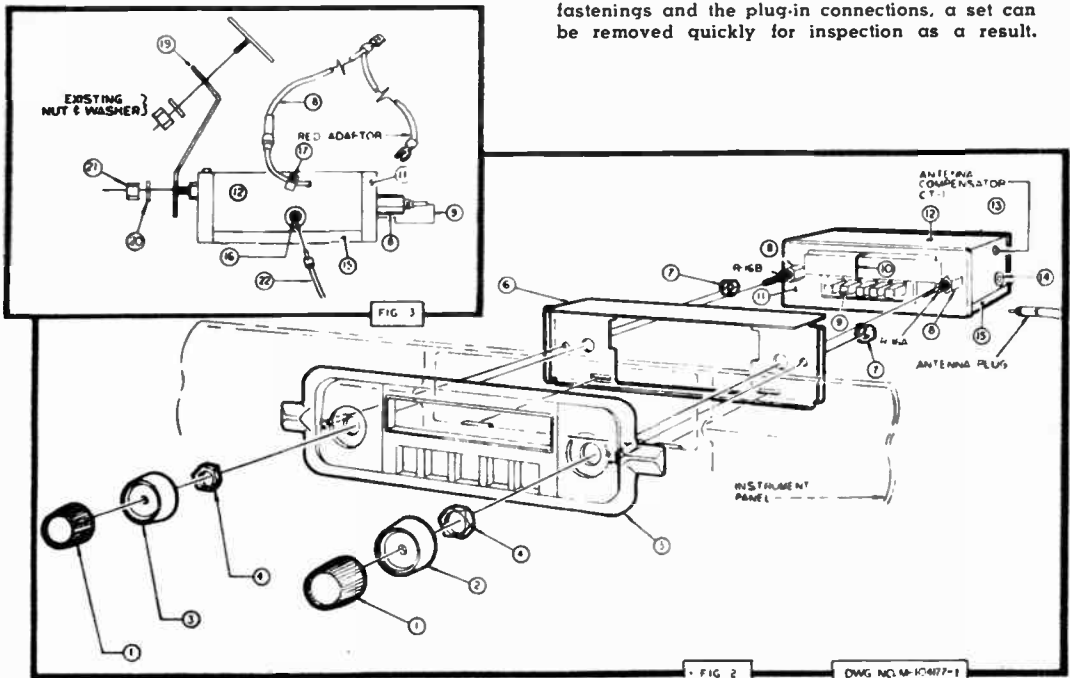
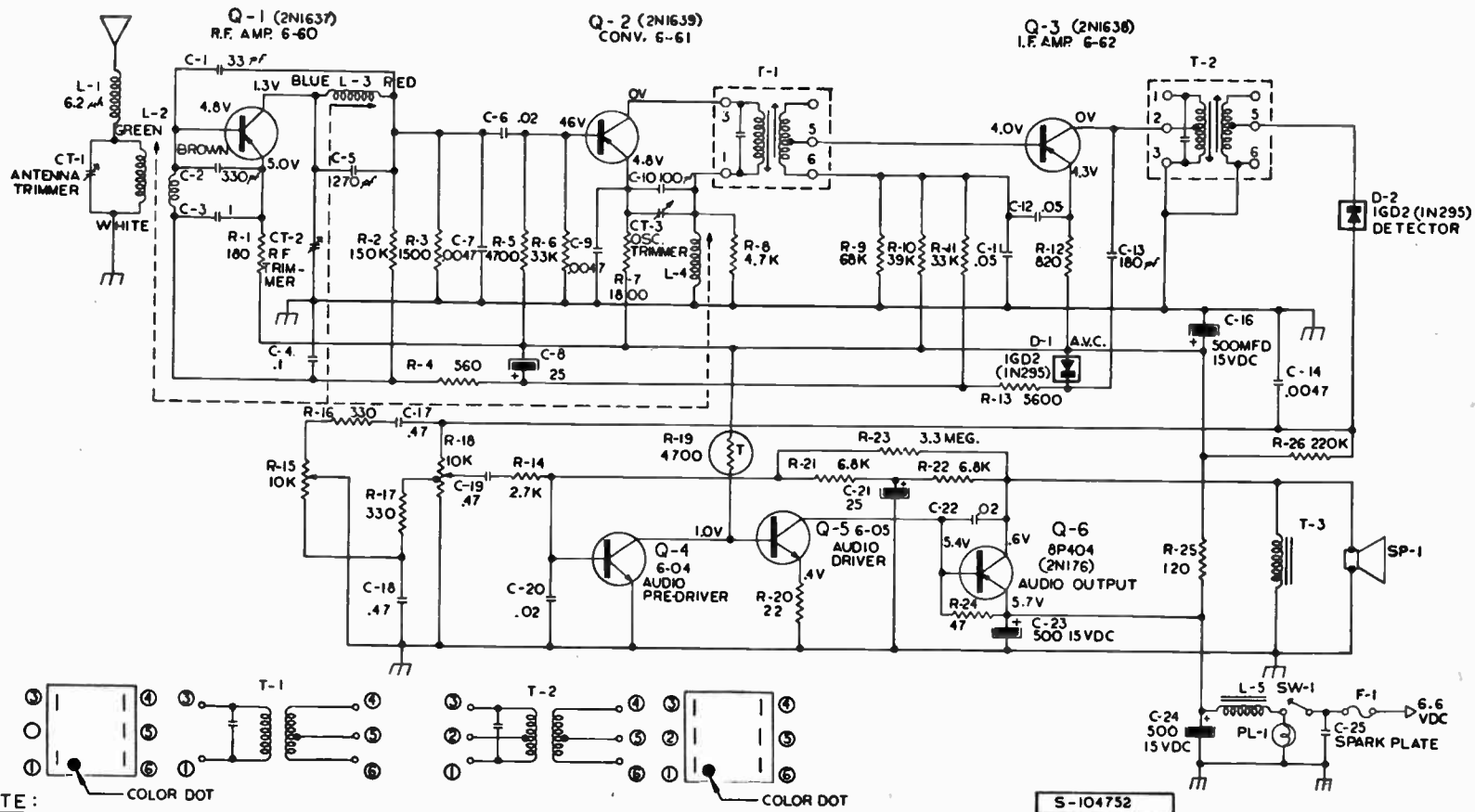

FIG. 3

FIG. 2

DWG. NO. M-10487-1



The complete circuit diagram of the all-transistor VW receiver. This arrangement is typical of solid-state sets of the late 1960's. There is no "power unit" as such; set works off car battery.

Tips on Soldering

With its very slender tip, soldering "pencil" is fine for work in tight corners. This tool is made by Ungar.

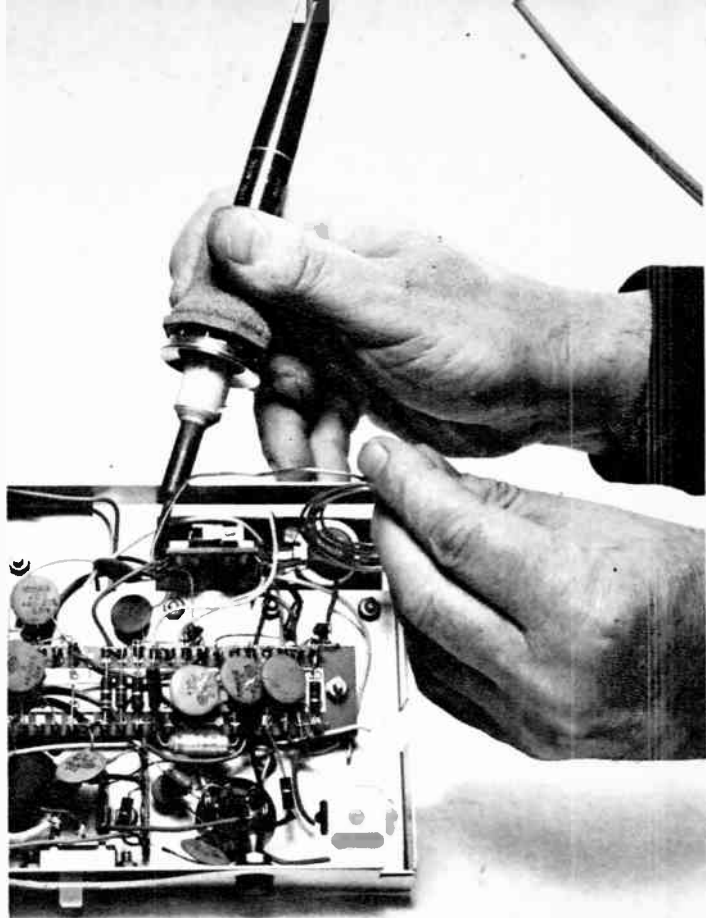

PROBABLY the most important single operation in the manufacture and repair of radio equipment is soldering. It is really very simple, but it troubles many people because they fail to observe its prime requirement . . . *cleanliness*.

The solder universally used in electronic work is known as "50-50," this being the proportion of the lead and tin in it. It takes the form of a soft wire having a hollow center filled with resin, a derivative of turpentine. The resin is called "flux." Its function is to absorb the thin layer of oxidation that forms on the surfaces of two pieces of metal that are being joined, and thus to allow the molten solder to bond firmly to them. If a flux of some kind is not used, the solder simply forms little globules that run off the joint like water.

Flux does not remove surface dirt. The metal must be clean and bright at the start, to permit the resin to do its chemical job the instant the heat of the iron permeates the joint. Fortunately, copper and brass, the metals used for virtually all electrical

connections, are easy to clean and take to solder very well. Resin works on them effectively without any corrosive after-effects.

Other common metals are not so responsive. Aluminum has a natural film over its surface and is so difficult to solder that the job is rarely undertaken. Sheet iron oxidizes quickly when heated and it must be treated with a virulent acid flux. This does the trick, but its corrosive action is most unwelcome in delicate electronic gear. However, tin cans, which are really made of thin sheet iron, are easy to solder because the outer surface of the metal is a layer of shiny tin.

The first time you examine a piece of wire in a radio set you may note with surprise that it is light gray in appearance. If you cut into it with a pair of pliers you will see that it really is copper and that the outside surface is only a coating. The latter is actually solder, applied during manufacture to facilitate the soldering of connections. Wire of this kind is called "tinned."

Below: Popular Weller soldering "gun" heats very quickly, is easy to use despite its size and shape.

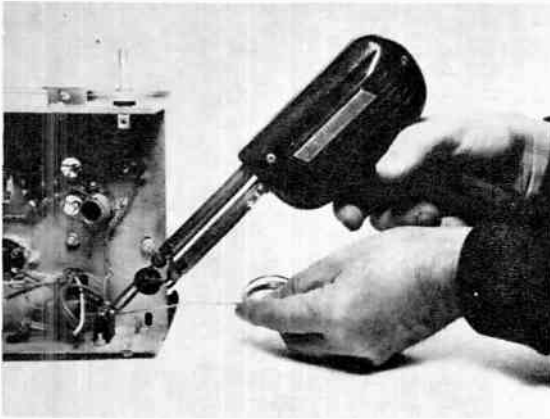

Below: Tips for the soldering pencil have ceramic body, copper end and screw-in base to fit handle.



Most connection lugs and other terminals are similarly prepared.

Soldering tools fall into two distinct classes. The soldering "iron," which isn't made of iron at all but of copper, is heated by means of a coil of resistance wire wound around the base of its tip. This takes several minutes to come up to solder-melting temperature. A popular style of iron uses a pencil-like handle with a small socket at one end. Into this is screwed a tip assembly consisting of a copper point, a resistance coil imbedded in a ceramic body and a screw base like the one found on small night lights. The points vary from about $\frac{1}{8}$ to $\frac{3}{8}$ inch in diameter. When the copper finally burns away after repeated use the tip is discarded and replaced. This is cheaper than buying a whole new tool.

The soldering "gun," so-called because it resembles a pistol in outline, is actually a small transformer. The primary consists of several hundred turns of thin wire, connected to the AC line through a trigger switch. The secondary is only a single turn



Above: Actual soldering tip of gun is removable loop of copper wire. Ends are secured under nuts.

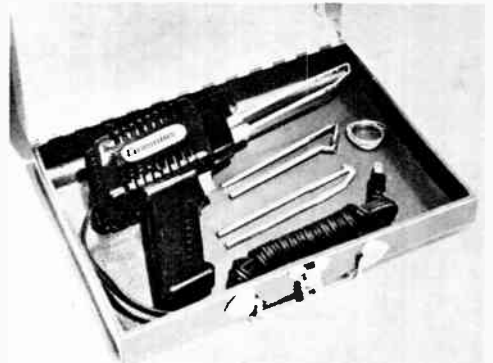

Above: Cummins soldering gun, available in single and dual heat models, uses non-pitting alloy tips.

of a heavy strip or tubing, the ends of which stick out of the handle like the barrel of a gun. They terminate in a removable U-shaped loop of copper wire about $\frac{1}{8}$ inch in cross-section. Because of the step-down transforming action of the multi-turn primary in relation to the single-turn secondary, the voltage across the latter is only a volt or two, but the current in it can be 100 amperes or more. This heats the tip to soldering temperature.

Soldering guns are generally advertised as "instant heating," but this is only a relative term, not an absolute one. Most sizes take three or four seconds, which is very fast compared with three or four minutes for resistance-type irons.

Although they look awkward, guns are versatile and easy to use. Tips are available in a variety of shapes and most of them can be bent to make them fit into tight spots. You can even make your own tips from scrap pieces of ordinary No. 14 or No. 12 wire which are used for house circuits. •



One corner of the main sales floor of Allied Radio in Chicago. Customers make out their own orders from the catalog, or obtain advice from the counter personnel if they are uncertain as to their needs.

How to Buy Radio Parts

YOU'VE investigated an ailing set and have identified a dead tube or a broken switch or a noisy volume control. What do you do now about obtaining a replacement?

If you live in a city of any size the first thing to do is to consult the Yellow Pages. Look under "Electronic Equipment and Supplies," or "Radio Supplies and Parts," or "High Fidelity Sound Equipment," or "Radio Dealers and Service." The only difference between "electronic" parts and "radio" parts is one of semantics. The listings under the first three headings are likely to be duplicated to a large extent.

For many years now, the merchants who sell radio supplies across counters in public stores, for cash, generally call themselves "distributors," "jobbers," or "wholesalers." The word "wholesale" often appears as part of their company names, and signs reading "wholesale only" often are displayed prominently on their store windows. Clearly, their intention is to give

buyers the impression that the prices they charge are lower than "retail." In most cases this is a lot of nonsense, and doesn't fool a generation of shoppers that has been brought up on "discount houses." There are many genuine distributors who act as intermediaries between manufacturers and small dealers and service technicians, but they don't spend money on high-rent, street-level stores when they can get warehouse space for much less.

Contributing to this fiction is the matter of "list prices," especially as applied to tubes. These are usually pegged so high that retail distributors (to coin a term) openly advertise and sell tubes, and other accessories, at discounts as high as 60% . . . and still make the normal profit they need to stay in business.

List prices are intended primarily to enable service technicians to stay alive. Many repair jobs on radio sets are not so much difficult as they are time-consuming, and

professionals know from sad experience that they can't always collect what they should for their efforts. By showing customers printed price lists from manufacturers containing list prices only, and obtaining these prices for tubes and other components, they are able to make the profit *they* need to stay in business.

Buying by Mail

If there's no radio store in your town or within reasonable driving distance, you can take advantage of the excellent facilities of several large mail-order firms that specialize in electronic supplies. The acknowledged leaders in this field are Allied Radio Corporation, 100 N. Western Avenue, Chicago, Ill., 60680, and Lafayette Radio Electronics, 111 Jericho Turnpike, Syosset, N.Y., 11791. Both of them issue fat annual catalogs of more than 500 pages, crammed full of illustrations and descriptions of every imaginable device from transistors

the size of a pinhead to 100-foot high steel towers for receiving and transmitting antennas. Just reading these elaborately gotten up books is an education in electronics.

In urging you to write for copies, which are absolutely free in return for your clearly written name and address, I am doing you a service that you will appreciate more fully the first time you buy tubes at 65 cents each or a new volume control for \$1.02. The prices really aren't as important as the fact that both Allied and Lafayette maintain huge stocks and can furnish, off the shelf, literally thousands of items that local stores cannot afford to keep.

And there's no double-talk about the prices; they are "net"; that is, with all the phony discounts already taken from the phony list prices. For many years most mail-order firms showed both prices in their catalogs, but nowadays they no longer bother because few buyers take "list" seriously. ●

Left: Typical newspaper advertisement of local merchant, offering large "discounts." Right: Containing more than 500 pages each, these catalogs are the "Bibles" of experimenters, students, hams, do-it-yourselfers and others interested in electronics. Copies are free. Below: Located in Syosset, L. I., Lafayette supplies the needs of a large local community.

.....

TV DO IT YOURSELF
TV TUBES & PARTS
 UP TO **60%** OFF LIST
 PHILCO - RCA - SYLVANIA, Etc.
 YOUR OLD TUBES TESTED FREE
 INCLUDING PICTURE TUBE
FREE BENCH CHECK
 Radio and T.V.
 ● Parts ● Yokes ● Flybacks
 ● Phono Cartridge ● Needles ● Etc.
PICTURE TUBE

No Money Down



INSTALLED FREE
 PURCHASE PICTURE TUBE
 AT STORE - CHASSIS ONLY

Home Service Calls **\$3** Per Call Bonded Technician

DEALER AID SERVICE

TELEVISION PARTS & SERVICE
WHOLESALE DISTRIBUTOR

Astoria
 Bet. 37th & 38th Sts., opp. A&P

FOR THE MOST RELIABLE NEW & USED CAR DEALER, CHECK OUT



Resistor and Capacitor Chart

MOST of the small capacitors and resistors used in radio sets do not carry figures giving their values in microfarads or ohms. Instead, they bear color bands or dots in accordance with the above schemes. If the markings on a resistor are obliterated, its value can be determined easily and quickly with a VOM. However, there is no similarly simple method of measuring capacitors; you must depend on their markings, or on other clues usually found in the services notes for the set. •

RESISTOR-MICA CAPACITOR COLOR CODE				
Color	Significant Figures	Multiplier	Tolerance %	Voltage Rating*
Black	0	1	±20*	—
Brown	1	10	±1*	100
Red	2	100	±2*	200
Orange	3	1,000	±3*	300
Yellow	4	10,000	±4*	400
Green	5	100,000	±5*	500
Blue	6	1,000,000	±6*	600
Violet	7	10,000,000	±7*	700
Gray	8	100,000,000	±8*	800
White	9	—	±9*	900
Gold	—	.1	±5	1,000
Silver	—	.01	±10	2,000
None	—	—	±20	500

*Applies to capacitors only

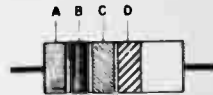

HOW TO DETERMINE THE VALUE OF A RESISTOR

- A — First significant figure (digit) of resistance in ohms.
- B — Second significant figure.
- C — Decimal multiplier (number of zeros to be added).
- D — Tolerance of resistor in percent. No color is 20%.

EXAMPLE:

A resistor has the following color bands: A, yellow; B, violet; C, yellow; and D, silver. The significant figures are 4 and 7 (47) and the multiplier is 10,000. The value of resistance is 470,000 ohms and the tolerance is ±10%.

TUBULAR PAPER CAPACITOR COLOR CODE				
Color	Significant Figures	Decimal Multiplier	Tolerance %	Voltage Rating (v d-c)
Black	0	1	±20	—
Brown	1	10	—	100
Red	2	100	—	200
Orange	3	1,000	±30	300
Yellow	4	10,000	—	400
Green	5	—	—	500
Blue	6	—	—	600
Violet	7	—	—	700
Gray	8	—	—	800
White	9	—	—	900
Gold	—	—	—	1,000
Silver	—	—	±10	—



HOW TO DETERMINE THE VALUE OF A PAPER TUBULAR CAPACITOR

- A — First significant figure (digit) of capacitance in μf .
- B — Second significant figure.
- C — Decimal multiplier (number of zeros to be added).
- D — Tolerance of capacitor in percent.
- E — Voltage rating.

EXAMPLE:

A paper tubular capacitor has the following color bands: A, brown; B, green; C, orange; D, black; and E, yellow. The significant figures are 1 and 5 (15) and the decimal multiplier is 1,000. The value of capacitance is 15,000 μf . The tolerance is ±20%. The voltage rating is 400 V DC.

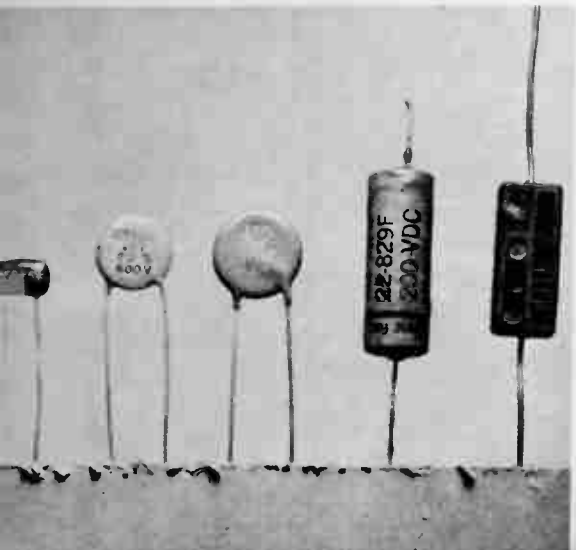
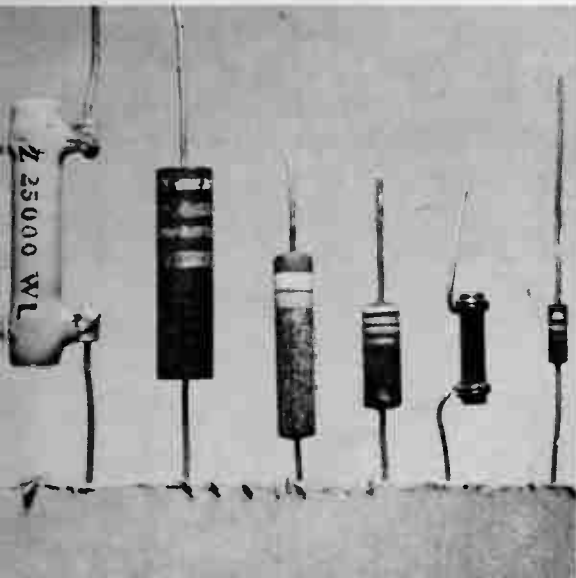

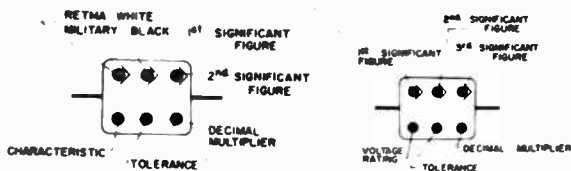

HOW TO DETERMINE THE VALUE OF A MICA CAPACITOR

EXAMPLES:

A capacitor with a 6 dot code (new RETMA standard REC-115A and military MIL-C-5A) has the following markings. Top row, left to right, white, green, brown; bottom row, right to left, brown, red, red. The first color white indicates mica. The significant figures are 5 and 1 (51), and the decimal multiplier is 10. So the capacitance is 510 μmf . Tolerance is $\pm 2\%$. For most general applications the characteristic can be ignored.

A capacitor with a 6 dot code has the following markings: Top row, left to right, brown, orange, red; bottom row, right to left, brown, red, green. Since the first dot is neither black or white, this is the obsolete RETMA code. The significant figures are 1, 3, and 2 (132), and the decimal multiplier is 10. So the capacitance is 1320 μmf . Tolerance is $\pm 2\%$. Voltage rating is 500 V DC.

CERAMIC CAPACITOR COLOR CODE

Color	Significant Figures	Decimal Figures	Tolerance		Temp. Coef. (Parts per million per °C.)
			10 μmf or less (μmf)	Over 10 μmf (%)	
Black	0	1	± 2.0	± 20	0
Brown	1	10	± 0.1	± 1	-33
Red	2	100	—	± 2	-75
Orange	3	1,000	—	± 2.5	-150
Yellow	4	10,000	—	—	-220
Green	5	—	± 0.5	± 5	-330
Blue	6	—	—	—	-470
Violet	7	—	—	—	-750
Gray	8	0.01	± 0.25	—	+150 to -1500
White	9	0.1	± 1.0	± 10	+100 to -750
Gold	—	—	—	—	—

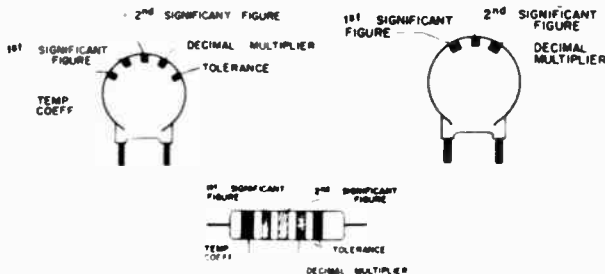

HOW TO DETERMINE THE VALUE OF A CERAMIC CAPACITOR

EXAMPLES

A ceramic tubular capacitor has the following color bands Black, red, red, red, green. The significant figures are 2 and 2 (22), and the decimal multiplier is 100. The capacitance is, therefore, 2200 μmf . Tolerance is $\pm 5\%$. Temperature coefficient is 0. Voltage rating is always 500 V.

A ceramic disc capacitor has the following 5-dot code: Red, brown, green, red, green. The significant figures are 2 and 2 (22), and the decimal multiplier is 100. The capacitance is, therefore, 2200 μmf . Tolerance is $\pm 5\%$. The temperature coefficients — 75. Voltage rating is always 500 V.

A ceramic disc capacitor has the following 3-dot code: Green, brown, brown. The significant figures are 5 and 1 (51), and the decimal multiplier is 10. Therefore, the capacity is 510 μmf . Voltage rating is always 500 V and the tolerance is always — 0.

Now there's a full line of

Weller® Soldering Tools for all soldering needs

Each model outperforms any other soldering tool of comparable size and price. All have replaceable tips of solid copper, instant heat, long reach, and rugged construction that means long-life, dependable performance.



Weller Dual Heat Guns

Feature trigger-controlled dual heat, efficient double-barrel design, long-life tip, and work spotlight. Available in three wattage ratings, and in handy soldering gun kits. Priced from \$6.95 list.

Weller MARKSMAN Irons

Best for intricate soldering or continuous-duty operation. Five sizes—all lightweights—with replaceable, premium-plated $\frac{1}{8}$ " to $\frac{3}{8}$ " tips. From \$2.98 list. Also in complete kit form with a soldering aid, solder and 2 extra soldering tips.



Try them all . . . at your electronic parts distributor!

WELLER ELECTRIC CORP., Easton, Pa.
WORLD LEADER IN SOLDERING TECHNOLOGY

Tube and Transistor Data



KEEPING track of the tubes and transistors used in modern radio equipment is something of a problem, even for practicing radio engineers and professional service technicians. At the time this book was published there were at least 2,000 different types of tubes and probably as many as 8,000 varieties of solid-state devices, and they were proliferating unchecked at a very rapid rate.

The electronic age was opened in 1908 with the introduction of the three-element vacuum tube, or "triode," by Dr. Lee de Forest. Forty years later a new era opened with the development of the transistor by a team of scientists of the Bell Telephone Laboratories. The vacuum tube spawned long-distance telephony, world-wide radio communication, sound broadcasting and television. The equipment it requires is bulky but sensationally effective. The transistor, while not yet a complete replacement for the tube, is making possible a dramatic reduction in the size of everything from radar sets to hearing aids.

The evolution of the vacuum tube has been controlled and gradual. Competing manufacturers find it expedient to standardize the characteristics of tubes of the same industry-designated type number. Thus, if a socket calls for a 6SL7, you can accept a 6SL7 of any make from a dealer with the assurance it will work properly.

The situation with solid-state devices is quite different. Eager young engineers of the post-World War II period, most of whom got their education under the GI Bill, are engaged in a continuing orgy of transistor design. At first they competed with each other in producing the smallest

possible devices, and then they turned their attention to making equipment in which the devices could do something useful. We now have complete hearing aids that fit directly in the ear, heart stimulators that are sewn into the patient's body, radio sets smaller than a pack of cigarettes, and TV sets the size of a loaf of bread.

The pace of transistor evolution is so rapid that manufacturers themselves can hardly keep track of the new types that appear daily. There is relatively little standardization of type numbers; in fact, it is not unusual to encounter transistors bearing the same number but having slightly different characteristics. Worse yet, in many of the very cheap pocket portables made in Japan some or all of the transistors have no markings or identification at all! These are probably sub-standard units, not good enough for TV purposes, for instance, but adequate for reception of nearby sound stations.

About the best way to keep informed on the subject is to invest a few dollars in the tube and transistor manuals published more or less annually by such responsible American firms as RCA, General Electric, Motorola, etc. Three representative books are shown above. The "RCA Receiving Tube Manual" contains 576 pages, the "GE Transistor Manual" 650 pages, and the "RCA Transistor Manual" 480 pages. There are also specialized manuals dealing with tunnel diodes, integrated circuits, zener diodes and silicon-controlled rectifiers. These books are not mere catalogs. They contain excellent explanatory material written in language any electronic experimenter can understand. •

'Private Listeners'

NATIONWIDE newspaper publicity was given recently to a family incident involving TV watching by the children of a man who works nights and sleeps days. Seems that the kids insisted on turning up the volume, thus keeping papa awake. Finally getting fed up with this nonsense, he loaded a revolver and shot out the picture tube. Now he gets the obedience and attention the head of the household deserves!

This was doing things the hard way. What papa didn't know is that he could have fitted the set with any one of a variety of "private listeners." These are control boxes which connect to the loud speaker and permit one or two people to use ear-phones, with the speaker either cut off entirely or left on at low volume. It is necessary to cut one of the wires running to the speaker and to hook in the wires from the control box. This is a very simple job that takes only minutes, as the speaker in most sets is generally accessible. With some portables it may be necessary to pull the chassis, but the effort is well worth while.

Any piece of equipment containing a loud speaker can be "gimmicked." This includes not only television and radio sets but also hi-fi systems. The latter can be particularly annoying to a captive, unmusical listener because they are invariably turned up to the point where the windows rattle.

Many couples keep a TV set in the bedroom so that they can watch the uninhibited interview programs and the late-late movies. This is great as long as both partners have the same sleeping patterns. Comes a time, however, when husband wants to turn over but wife wants to see the end of the show. This is when a "private listener" prevents a hot argument from even starting.

An incidental but highly important use of the device is to keep elderly, hard-of-hearing persons happy. If the volume of a radio or TV set is turned up to satisfy them, the rest of the family is blasted by the sound. If there is only one set in the household, the trouble is further aggravated by disagreement as to which program to see or hear. An extra set then becomes a very inexpensive investment in family peace.

You can assemble a "private listener" from junk-box parts, but ready-made units are so cheap that the effort is wasted. They cost as little as about \$5.00, and the most expensive, with dual controls for stereo hi-fi, is only about \$11. •

ELECTRONICS

Electronics Engineering Technology
Electricity-TV-Radio
Electrical Maintenance
Refrigeration-Air Conditioning
Industrial Electronics



COYNE ELECTRONICS INSTITUTE

Founded
1899

Learn on a quarter of a million dollars worth of equipment for top salaries and an Exciting Career. Many special finance plans. Part time employment service while in school. Also free graduate employment service.



★ VA APPROVED-G. I. BILL ★

Use this coupon to get our FREE BOOK
"YOUR OPPORTUNITIES IN ELECTRONICS"

COYNE ELECTRONICS INSTITUTE, Dept. of Electronics 37-F
1501 W. Congress Parkway, Chicago, Illinois 60607

Name _____ Age _____

Address _____ Phone _____

City _____ State _____ Zip _____

I only want information on Home Study TV

BESTSELLING NOVEL OF OUR TIME

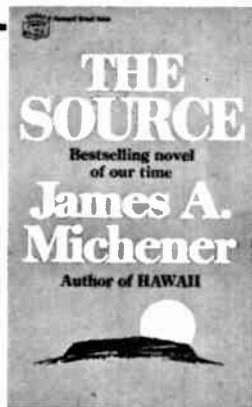

a995

**NOW
IN
PAPERBACK**

More than a year on the nation's leading bestseller lists

A Fawcett Crest Book
Wherever Paperbacks Are Sold

Buy this Fawcett Crest Book from your paperback bookseller. If sold out, send \$1.65 plus 10¢ for postage and handling to Fawcett Crest Books, P.O. Box 1014, Greenwich, Connecticut. Please order by number and title. No Canadian orders.

Symbols Used in Schematic Diagrams

<p>RESISTOR</p>	<p>CAPACITOR</p>	<p>TUBE</p>
<p>POTENTIOMETER (CONTROL)</p>	<p>ELECTROLYTIC CAPACITOR</p>	<p>TRANSISTOR</p>
<p>TRANSFORMER (IRON CORE)</p>	<p>VARIABLE CAPACITOR</p>	<p>RECTIFIER (DIODE)</p>
<p>TRANSFORMER (ADJUSTABLE POWDERED IRON CORE) ARROW INDICATES DIRECTION OF CORE MOVEMENT TO INCREASE INDUCTANCE</p>	<p>BATTERY</p>	<p>NEON BULB</p>
<p>TRANSFORMER (ADJUSTABLE CORE)</p>	<p>PHONO JACK</p>	<p>ILLUMINATING BULB</p>
<p>POWER TRANSFORMER</p>	<p>PHONE JACK</p>	<p>METER</p>
<p>INDUCTOR (COIL)</p>	<p>RECEPTACLE</p>	<p>SPST SWITCH (TOGGLE) DPDT</p>
<p>PIEZOELECTRIC CRYSTAL</p>	<p>SPEAKER</p>	<p>SWITCH (ROTARY)</p>
<p>BINDING POST</p>	<p>MICROPHONE</p>	<p>FUSE</p>
<p>ANTENNA</p>	<p>EARTH GROUND CHASSIS GROUND</p>	<p>CONDUCTORS</p>

Chart courtesy Heath Company

Schematic symbols represent either the function or the construction of electronic components. For example, resistors are designed to restrict the flow of electricity, so their symbol is a jagged line, to indicate a difficult path. All capacitors consist basically of metallic or other conducting surfaces separated by air or other insulating materials, so their symbol is merely two parallel lines. Trans-

formers comprise two or more windings on a common core, which might be laminated sheet iron, powdered iron, an insulated form, or just air; the coils are shown as curly-cues, the iron cores as solid or dotted lines, and the open forms as white space. Arrows through or next to a symbol mean that the device is variable or adjustable in some manner. Most other symbols explain themselves.

NOW 12 EASY, EXCITING WAYS TO LEARN ELECTRONICS, TV-RADIO WITH NRI

NRI has a training plan to fit your interest, your need, your education . . . from Color TV Servicing to Electronics for Printers. Pick the field of your choice and mail postage-free card now.



TELEVISION-RADIO SERVICING

Learn to fix home entertainment equipment like radio, hi-fi and stereo sets, all kinds of TV sets. Training kits include choice of black-and-white or color TV set you build. A profitable field full or part-time.



INDUSTRIAL-MILITARY ELECTRONICS

From basic principles to computers. Comprehensive training teaches fundamentals, then takes you into such modern-day miracles as servos, telemetry, multi-plexing, phase circuitry, others.



COMPLETE COMMUNICATIONS*

Teaches and provides actual practice in operation, service, maintenance of AM, FM, and TV broadcasting stations. Also covers marine, aviation, mobile radio, facsimile, microwave, radar.



FCC LICENSE*

Prepares you for First Class FCC Radiotelephone License exams. You begin with fundamentals, advance to required subjects covering equipment, procedures.



MATH FOR ELECTRONICS

A brief course for engineers and technicians who need a quick review of essential math used in industry, communications, government. Basic arithmetic review, short-cut formulas, modern digital number systems, much more.



BASIC ELECTRONICS

A concise course in Electronic terminology and components. A wealth of useful information to help you better understand the field. For anyone who wants a basic understanding of Radio-TV Electronics.



ELECTRONICS FOR AUTOMATION

Not for beginners, but for men with some knowledge of Electronics who want an understanding of process control, ultrasonics, telemetering and remote control, electromechanical measurements, other subjects.



AVIATION COMMUNICATIONS*

Prepares you to install, maintain, service direction finders, ranges, markers, Loran, Shoran, Radar, landing systems. Earn your FCC License with Radar Endorsement.



MARINE COMMUNICATIONS*

Covers transmitters, direction finders, depth indicators. Radar, Sonar, other equipment on commercial ships, pleasure boats. Prepares for FCC License with Radar Endorsement.



MOBILE COMMUNICATIONS*

Learn to install and maintain mobile transmitters and receivers used by police and fire departments, public utilities, construction firms, taxis, etc. Prepares for FCC License.



ELECTRICAL APPLIANCE REPAIR

Prepares you quickly to repair all types of appliances, including air conditioning, refrigeration, small gasoline engines. An easy, practical course leading to profitable part-time or full-time business of your own.



ELECTRONICS FOR PRINTERS

Designed to teach operation and maintenance of Electronic equipment which controls the latest devices developed for the graphic arts industry. From basic principles to computer circuits. Approved by major manufacturers.

* NOTE: You must pass your FCC License exam (any Communications course) or NRI refunds in full the tuition you have paid.

SEE
OTHER
SIDE

EARN YOUR FCC
LICENSE OR YOUR
MONEY BACK

FILL OUT
AND MAIL
POSTAGE-FREE
CARD



TRAIN UNDER NEW GI BILL.
If you served since Jan. 31, 1955,
or are in service now, check GI
line in postage-free card.

FIRST CLASS
PERMIT
NO. 20-R
Washington, D.C.

BUSINESS REPLY MAIL

NO POSTAGE STAMP NECESSARY IF MAILED IN THE UNITED STATES

POSTAGE WILL BE PAID BY

NATIONAL RADIO INSTITUTE

3939 Wisconsin Avenue

Washington, D.C. 20016





NRI GIVES YOU YOUR OWN COLOR KIT

Discover the Ease and Excitement of Learning TV-Radio, Electronics at Home with NRI

Begin now an exciting adventure. NRI—the home-study school that pioneered learn-by-doing training kits is now first to bring you COLOR TV training equipment. Learn Color TV Servicing by building your own high-quality Color set. You get “on-the-job” experience as you train. Your family enjoys the thrills of vibrant color shows for years to come. And, thanks to NRI training, you can do your own servicing—no costly service contract.

Earn \$4 to \$6 an Hour Extra Spare Time

Color TV is booming. Set sales exceed 5,000,000 a year now. 10-million-color-set years are predicted soon. And 60% of color set owners also own black-and-white sets. TV Technicians are in demand now to serve this giant, money-making, growing market. NRI shows you how to cash in on Color TV: how

to earn \$4 to \$6 an hour extra in spare time while learning; how to be your own boss in a full-time Radio-TV Servicing business, or qualify quickly for jobs in the fascinating fields of broadcasting/communications, industrial electronics, automation and space projects.

Act Now to Move Ahead

NRI offers you a choice of 12 different training plans, designed for people with all kinds of interests, all levels of education. Courses are described briefly on the other side of this page. To find out how you can be a part of the Electronics Age, mail postage-free card for free NRI color catalog. Don't delay. Electronics and Color TV need you now. NATIONAL RADIO INSTITUTE, Electronics Div., Washington, D.C. 20016. No salesman will call.

◀ SEE OTHER SIDE

NATIONAL RADIO INSTITUTE, ELECTRONICS DIVISION
WASHINGTON, D.C. 20016 121-037

Please send me your new color Catalog. I have checked the field(s) of most interest to me. (No obligation. No salesman will call.)

- | | |
|---|--|
| <input type="checkbox"/> Television-Radio Servicing | <input type="checkbox"/> Electronics for Automation |
| <input type="checkbox"/> Industrial Electronics | <input type="checkbox"/> Aviation Communications |
| <input type="checkbox"/> Complete Communications | <input type="checkbox"/> Marine Communications |
| <input type="checkbox"/> FCC License | <input type="checkbox"/> Mobile Communications |
| <input type="checkbox"/> Math for Electronics | <input type="checkbox"/> Electrical Appliance Repair |
| <input type="checkbox"/> Basic Electronics | <input type="checkbox"/> Electronics for Printers |

Check for facts on New GI Bill



**PICK YOUR
FIELD** and
mail postage-free
card for free
color catalog



OVER 50 YEARS
OF LEADERSHIP
IN ELECTRONICS TRAINING

Name..... Age.....

Address.....

City..... State..... Zip Code.....

ACCREDITED MEMBER NATIONAL HOME STUDY COUNCIL