

Ion 540™ Kit – OT2

USER GUIDE

Instructions for template preparation, chip loading, and sequencing

for use with:

Ion OneTouch™ 2 System

Ion S5™ System

Ion S5™ XL System

Ion GeneStudio™ S5 System

Ion GeneStudio™ S5 Plus System

Ion GeneStudio™ S5 Prime System

Catalog Number A27753

Publication Number MAN0010850

Revision E.0



The information in this guide is subject to change without notice.

DISCLAIMER: TO THE EXTENT ALLOWED BY LAW, THERMO FISHER SCIENTIFIC INC. AND/OR ITS AFFILIATE(S) WILL NOT BE LIABLE FOR SPECIAL, INCIDENTAL, INDIRECT, PUNITIVE, MULTIPLE, OR CONSEQUENTIAL DAMAGES IN CONNECTION WITH OR ARISING FROM THIS DOCUMENT, INCLUDING YOUR USE OF IT.

Revision history: Pub. No. MAN0010850

Revision	Date	Description
E.0	05 December 2018	<ul style="list-style-type: none"> Updated for Ion GeneStudio™ S5 Systems. Clarification made to dilute barcoded library pools, if used. Updated for the Qubit™ 4 Fluorometer. References to ISP quality control user guides updated to the <i>Ion Sphere™ Quality Control Kit User Guide</i> (Pub. No. MAN0017531). Updated for Torrent Suite™ Software 5.10; Planned Run creation topics reorganized for ease of use. Ion S5™ Controls Kit replaced with Ion S5™ Controls Kit Plus. Removed reference to quality control of ISPs using the Attune™ NxT Acoustic Focusing Cytometer.
D.0	21 January 2017	<ul style="list-style-type: none"> “Perform an instrument reset run with an initialized, unused Ion S5™ Sequencing Reagents cartridge” topic added to Supplemental procedures Ion OneTouch™ ES Instrument setup clarified ISP quality control sections updated and moved to new user guides: <ul style="list-style-type: none"> – <i>Ion Sphere™ Assay on the Qubit™ 2.0 Fluorometer User Guide</i> (Pub. No. MAN0016387) – <i>Ion Sphere™ Assay on the Qubit™ 3.0 Fluorometer User Guide</i> (Pub. No. MAN0016388) Web links updated
C.0	27 July 2016	Updated for Torrent Suite™ Software v5.2.
B.0	16 November 2015	Update to Ion S5™ Sequencing Reagents (Cat. No. A27768) shipping and storage conditions.
A.0	27 August 2015	User guide, includes instructions for using the Ion 540™ Kit – OT2 to prepare and enrich ISPs on the Ion OneTouch™ 2 System and sequencing with Ion S5™ or Ion S5™ XL Sequencers.

Important Licensing Information: These products may be covered by one or more Limited Use Label Licenses. By use of these products, you accept the terms and conditions of all applicable Limited Use Label Licenses.

Trademarks: All trademarks are the property of Thermo Fisher Scientific and its subsidiaries unless otherwise specified. Agilent and Bioanalyzer are trademarks of Agilent Technologies, Inc. Agencourt and AMPure are trademarks of Beckman Coulter, Inc. Guava is a trademark of Merck KGaA. Kimwipes is a trademark of Kimberly-Clark Corporation. Eppendorf and Eppendorf LoBind are trademarks of Eppendorf AG. Tween is a trademark of Uniqema Americas LLC. Luer-Lok is a trademark of Becton, Dickinson and Company. Microsoft and Windows are trademarks of Microsoft Corporation. Parafilm is a trademark of Bemis Company, Inc.

©2018 Thermo Fisher Scientific Inc. All rights reserved.

Contents

■	CHAPTER 1	Product information	7
	Product description		7
	Library compatibility		7
	Sequencer compatibility		8
	Software compatibility		8
	Kit contents and storage conditions		8
	Ion 540™ Kit – OT2 configuration		8
	Kit contents		8
	Related products		10
	Compatible Ion Chip™ kits		10
	Ion S5™ Controls Kit Plus		10
	Required materials not supplied		10
	Recommended materials for the Ion OneTouch™ 2 System		11
	Additional materials required for Ion OneTouch™ ES		12
	Prerequisites		12
	Instrument clearances		12
■	CHAPTER 2	Before you begin	13
	Precautions		13
	Avoid nucleic acid contamination		13
	Avoid chip damage		13
	Protection by equipment		13
	Procedural guidelines		13
	Unpack and install the Ion OneTouch™ 2 System		14
	Check the firmware		14
	Initialize the Ion OneTouch™ 2 Instrument		14
	Workflow		15
■	CHAPTER 3	Create a Planned Run	16
	About Planned Runs		16
	Create a Planned Run		17
	Planned Run workflow key fields		21

■	CHAPTER 4 Prepare template-positive Ion 540™ ISPs	23
	Ion OneTouch™ 2 Instrument layout	24
	Select the Ion OneTouch™ protocol	25
	Set up the Ion OneTouch™ 2 Instrument	26
	Materials required	26
	Install the Ion OneTouch™ Recovery Tubes and Ion OneTouch™ Recovery Router	27
	Install the Ion OneTouch™ Amplification Plate	28
	Install the disposable injector	30
	Install the Ion OneTouch™ Oil	31
	Install the Ion OneTouch™ Recovery Solution	32
	Empty the Waste Container	32
	Inspect the oil waste tray	32
	Prepare and install the amplification solution	33
	Materials required	33
	Prepare the amplification solution	33
	Fill the reaction filter assembly	35
	Install the filled Ion OneTouch™ Reaction Filter	37
	Start the run	38
	Abort and restart a run	38
	Recover the template-positive Ion Sphere™ Particles	39
	Materials required	39
	Recover the template-positive ISPs	39
	Wash the template-positive ISPs	40
	Maintain the Ion OneTouch™ 2 Instrument	42
	Materials required	42
	Clean the Ion OneTouch™ 2 Instrument	42
■	CHAPTER 5 Enrich the template-positive Ion 540™ ISPs	45
	Materials required	45
	Residual volume test	46
	Prepare reagents then fill the 8-well strip	46
	Prepare Melt-Off Solution	46
	Wash and resuspend the Dynabeads™ MyOne™ Streptavidin C1 Beads	46
	Fill the 8-well strip	47
	Prepare the Ion OneTouch™ ES	48
	Perform the run	50
	Remove and wash the enriched ISPs	52
	<i>(Optional)</i> Perform enriched ISP quality control	53

■	CHAPTER 6 Initialize the sequencer	54
	Ion S5™ /Ion GeneStudio™ S5 Systems component positions	54
	Before you begin	55
	When a manual cleaning of the sequencer is required	55
	Initialize the sequencer	56
■	CHAPTER 7 Load the Ion 540™ Chip	58
	Materials required	58
	Before you begin	59
	Chip loading guidelines	60
	Prepare the template-positive ISPs for sequencing	61
	Add Control Ion Sphere™ Particles to the enriched ISPs	61
	Anneal Sequencing Primer to the enriched ISPs	61
	Load the sequencing chip	62
	Load the sample on the chip	62
	Flush the chip and load the Ion S5™ Sequencing Polymerase	63
■	CHAPTER 8 Start the sequencing run	64
	Chip handling guidelines	64
	Start the sequencing run	65
	Maintain the sequencer	67
	Materials required	67
	Clean or decontaminate the sequencer	67
	Reagent consumables disposal	67
	CO ₂ scrubber removal and disposal	67
	Recycle Ion S5™ Wash Solution and Ion S5™ Cleaning Solution bottles	68
■	APPENDIX A Troubleshooting	69
	Ion OneTouch™ 2 Instrument	69
	Ion OneTouch™ ES	71
	Ion S5™ /Ion GeneStudio™ S5 Systems setup and operation	73
	Instrument alarms and events	73
	Initialization—General errors	74
	Ion Sphere™ Assay troubleshooting table	74

- **APPENDIX B Supplemental procedures 75**
 - Perform a manual cleaning of the sequencer 75
 - Perform an instrument reset run with an initialized, unused Ion S5™ Sequencing Reagents cartridge 76
 - Quality control of Ion 540™ ISPs 77
 - Quality control using the Ion Sphere™ Assay on the Qubit™ Fluorometer 77
 - Acceptance criteria for unenriched Ion 540™ ISPs 77
 - Quality control using the Guava™ easyCyte 5 Benchtop Flow Cytometer 77

- **APPENDIX C Safety 78**
 - Instrument safety 78
 - Chemical safety 79
 - Biological hazard safety 80

- Documentation and support 81**
 - Related documentation 81
 - Customer and technical support 82
 - Limited product warranty 82



Product information

■ Product description	7
■ Kit contents and storage conditions	8
■ Related products	10
■ Required materials not supplied	10
■ Prerequisites	12
■ Instrument clearances	12

IMPORTANT! Before using this product, read and understand the information in the “Safety” appendix in this document.

Product description

The Ion 540™ Kit – OT2 contains all the reagents and materials that are required to perform the following steps in the sequencing workflow:

- Prepare enriched, template-positive Ion Sphere™ Particles (ISPs) using the Ion OneTouch™ 2 System.
- Load the enriched, template-positive ISPs on an Ion 540™ Chip.
- Sequence the loaded chips on an Ion S5™ Sequencer, Ion S5™ XL Sequencer, or Ion GeneStudio™ S5 Series Sequencer.

Each kit contains all the supplies that are required to prepare 8 reactions of enriched, template-positive ISPs, then load and sequence 8 chips. The kit is compatible for use with up to 200-base-read libraries and supports 4 sequencer initializations (2 sequencing runs/sequencer initialization).

Note: The Ion OneTouch™ 2 System includes the Ion OneTouch™ 2 Instrument and the Ion OneTouch™ ES Instrument.

IMPORTANT!

- Use *only* the Ion 540™ Kit – OT2 (Cat. No. A27753) with this user guide and with the Ion OneTouch™ 2 System. Do not use with the Ion OneTouch™ System.
 - Do *not* mix reactions or disposables including plates, solutions, and kit reagents from these or other template preparation kits.
 - Template-positive ISPs prepared with the Ion 540™ Kit – OT2 should only be used in conjunction with the Ion S5™ Sequencing Solutions (Cat. No. A27767) and the Ion S5™ Sequencing Reagents (Cat. No. A27768).
-

Library compatibility

The Ion 540™ Kit – OT2 can be used with up to 200-base-read libraries of any type prepared using any available Ion Torrent™-branded library kit.

Sequencer compatibility

Ion GeneStudio™ S5 Series Sequencer or System refers generically to the three Ion GeneStudio™ S5 Systems, unless otherwise specified:

- Ion GeneStudio™ S5 System (Cat. No. A38194)
- Ion GeneStudio™ S5 Plus System (Cat. No. A38195)
- Ion GeneStudio™ S5 Prime System (Cat. No. A38196)

Software compatibility

The Ion 540™ Kit – OT2 is compatible with Torrent Suite™ Software 5.2 and later. Be sure to update your Torrent Suite™ Software to the latest available version before using this kit. For more information, see the *Torrent Suite™ Software User Guide* for your version of the software.

Kit contents and storage conditions**Ion 540™ Kit – OT2 configuration**

The Ion 540™ Kit – OT2 (Cat. No. A27753) includes the following components. This protocol has been verified using these specific materials. Substitution can adversely affect performance.

IMPORTANT! Follow these special reagent handling instructions:

- Ion S5™ Reagent Mix in the Ion 540™ Kit – OT2 is shipped at –30°C to –10°C and should be thawed before use. Store the thawed Master Mix at 2°C to 8°C.
- Use only the supplied screw cap tubes to store the reagents. Do not seal the reagents with any plastic paraffin film such as Parafilm™ M film.

Contents	Part No.	Quantity per kit
Ion S5™ OT2 Solutions	A27747	1 box
Ion S5™ OT2 Supplies	A27748	1 box
Ion 540™ OT2 Reagents	A27752	1 box
Ion 540™ Loading Reagents OT2	A27897	1 box
Ion S5™ Sequencing Solutions	A27767	2 boxes
Ion S5™ Sequencing Reagents	A27768	2 boxes (2 × 4 cartridges)

Kit contents

Ion 540™ Kit – OT2 (Cat. No. A27753) kit contents

Contents	Amount / box	Storage
Ion S5™ OT2 Solutions (Part No. A27747)		
Ion OneTouch™ Oil	450 mL	15°C to 30°C
Ion OneTouch™ Recovery Solution	350 mL	
Ion OneTouch™ Reaction Oil	25 mL	
Ion OneTouch™ Wash Solution	16 mL	

Contents	Amount / box	Storage
Tween™ Solution	6 mL	15°C to 30°C
Nuclease-free Water	30 mL	
Ion OneTouch™ Breaking Solution (black cap)	2 × 1.2 mL	
MyOne™ Beads Capture Solution (green cap)	2 × 1.5 mL	
ISP Resuspension Solution (red cap)	1.25 mL	
Ion OneTouch™ ES Wash Solution	7.2 mL	
Ion S5™ OT2 Supplies (Part No. A27748)		
Ion OneTouch™ Reagent Tubes	2	15°C to 30°C
Ion OneTouch™ Recovery Tubes	16	
Ion OneTouch™ Recovery Routers	8	
Ion OneTouch™ Sipper Tubes	2	
Ion OneTouch™ Amplification Plate	8	
Ion OneTouch™ ES Supplies (12 pipette tips and 1 box of ES 8-well strips)	1	
Ion OneTouch™ Cleaning Adapter (use each adapter for <i>one</i> cleaning only)	8	
Ion OneTouch™ Reaction Filter	8	
Ion 540™ OT2 Reagents (Part No. A27752)		
Ion S5™ Enzyme Mix (brown cap)	960 µL	-30°C to -10°C
Ion S5™ Reagent Mix (violet cap)	8 × 2 mL	
Ion 540™ ISPs (black cap)	800 µL	
Ion 540™ Loading Reagents OT2 (Part No. A27897)		
Ion S5™ Annealing Buffer	30 mL	-30°C to -10°C Thaw at room temperature prior to first use, thereafter store at room temperature. Do <i>not</i> refreeze.
Ion S5™ Foaming Solution (violet cap)	1 mL	
Ion S5™ Loading Buffer (brown cap)	80 µL	
Ion S5™ Sequencing Polymerase (yellow cap)	48 µL	-30°C to -10°C
Ion S5™ Sequencing Primer (white cap)	160 µL	
Ion 540™ Control Ion Spheres (clear cap)	40 µL	

Contents	Amount / box	Storage
Ion S5™ Sequencing Solutions (Part No. A27767)		
Ion S5™ Wash Solution	4 × 1.5 L	15°C to 30°C
Ion S5™ Cleaning Solution	250 mL	
Ion S5™ Sequencing Reagents (Part No. A27768)		
Ion S5™ Sequencing Reagents	4 cartridges	-30°C to -10°C ^[1]

^[1] Cartridges ship at 2°C to 8°C. Store as indicated, do not store on dry ice.

IMPORTANT! Do not store the Ion S5™ Sequencing Reagents (Part No. A27768) on dry ice or in a closed environment containing dry ice.

Related products

Compatible Ion Chip™ kits

Description	Catalog No.	Quantity	Storage
Ion 540™ Chip Kit (2 × 4-pack)	A27766	8 chips	15°C to 30°C

Ion S5™ Controls Kit Plus

The Ion S5™ Controls Kit Plus (Cat. No. A30729) is ordered separately. See the *Ion S5™ Controls Kit Plus Product Information Sheet* (Pub. No. MAN0016206) for details.

Contents	Amount	Storage
Human CEPH Genomic DNA Control (red cap)	30 µL	-30°C to -10°C
Human CEPH Control 200 Library (yellow cap)	12 µL	
<i>E. coli</i> DH10B Control 400 Library (orange cap)	16 µL	

Required materials not supplied

Unless otherwise indicated, all materials are available through **thermofisher.com**.
MLS: Fisher Scientific (**fisherscientific.com**) or other major laboratory supplier.

Description ^[1]	Source
Ion OneTouch™ 2 System The system includes: <ul style="list-style-type: none"> • Ion OneTouch™ 2 Instrument • Ion OneTouch™ ES Instrument • AC Power Supply and Cords • Ion S5™ Installation Kit 	4474779
Dynabeads™ MyOne™ Streptavidin C1 Magnetic Beads	65001

Description ^[1]	Source
Thermal cycler with heated lid	MLS
Eppendorf™ DNA LoBind™ Microcentrifuge Tubes	Fisher Scientific 13-698-791
Microcentrifuge ^[2]	MLS
2-, 20-, 200-, and 1,000-µL pipettes and appropriate low- retention tips	MLS
Vortexer with a rubber platform	MLS
Tube rack to fit 15-mL conical tube	MLS
Tube rack for 50-mL conical tube	MLS

^[1] We have verified this protocol using this specific material. Substitution may adversely affect system performance.

^[2] Must fit standard 1.5- and 0.2-mL microcentrifuge tubes; must generate 15,500 × g. To convert the RPMs of your centrifuge to RCF in units of gravity, see tools.thermofisher.com/content/sfs/brochures/TR0040-Centrifuge-speed.pdf.

Note: We recommend using an uninterruptible power supply (UPS) for laboratories that experience frequent power outages or line voltage fluctuations. The UPS must be rated for 1,500 W output or higher. The 1,500 VA unit from APC provides several minutes of backup power for the Ion OneTouch™ 2 Instrument, the Ion OneTouch™ ES Instrument, the sequencer, and the Torrent Server. Use a surge protector or line conditioner as needed (for further information, see the *Ion S5™ and Ion S5™ XL System Site Preparation Guide*, Pub. No. MAN0010810, or the *Ion GeneStudio™ S5 System Site Preparation Guide*, Pub. No. MAN0017529).

Recommended materials for the Ion OneTouch™ 2 System

The Ion OneTouch™ 2 System uses common molecular biology equipment, supplies, and reagents. Unless otherwise indicated, all materials are available through **thermofisher.com**. MLS: Fisher Scientific (**fisherscientific.com**) or other major laboratory supplier.

Description ^[1]	Source
Ion S5™ Controls Kit Plus	A30729
Benchtap absorbent paper or mat	MLS
Bleach	MLS
Ethernet cable	MLS
1/8-inch L-wrench (hex wrench) or equivalent tool	MLS

^[1] We have verified this protocol using these specific materials. Substitution may adversely affect system performance.

Additional materials required for Ion OneTouch™ ES

The following additional materials are required for use of the Ion OneTouch™ ES Instrument. Unless otherwise indicated, all materials are available through **thermofisher.com**. MLS: Fisher Scientific (**fisherscientific.com**) or other major laboratory supplier.

Item ^[1]	Source
DynaMag™ -2 magnet	12321D
0.2-mL PCR tubes (Axygen™ MAXYMum Recovery™ PCR Tube)	Fisher Scientific 14-222-283 <i>or</i> MLS
1 M NaOH	MLS

^[1] We have verified this protocol using these specific materials. Substitution may adversely affect system performance.

Prerequisites

The manufacturer is not liable for any damage or injury that results from use of this manual by unauthorized or untrained parties. This guide uses conventions and terminology that assume a working knowledge of the Microsoft™ Windows™ operating system, the Internet, and Internet-based browsers.

Instrument clearances

Position the Ion OneTouch™ 2 Instrument and the Ion OneTouch™ ES Instrument so that the front is a minimum of 12 in. (30.5 cm) from the front of the laboratory bench. Position the Ion S5™ Sequencer, Ion S5™ XL Sequencer, or Ion GeneStudio™ S5 Series Sequencer so that there is 12 in. (30.5 cm) of clearance at the front, back, top, and right side of the instrument, and 4 in (10 cm) of clearance at the left side of the instrument. Place all instruments at least 40 in. (1 meter) away from major sources of electronic noise such as refrigerators or microwaves. For more information, refer to the *Ion S5™ and Ion S5™ XL System Site Preparation Guide* (Pub. No. MAN0010810), or the *Ion GeneStudio™ S5 System Site Preparation Guide* (Pub. No. MAN0017529).

2

Before you begin

■ Precautions	13
■ Procedural guidelines	13
■ Unpack and install the Ion OneTouch™ 2 System	14
■ Check the firmware	14
■ Initialize the Ion OneTouch™ 2 Instrument	14
■ Workflow	15

Precautions

Avoid nucleic acid contamination

IMPORTANT! A primary source of contamination is spurious DNA fragments from previous sample processing steps. Do not introduce amplified DNA into the library preparation laboratory or work area.

Avoid chip damage

IMPORTANT! To avoid possible damage to the chip due to electrostatic discharge, ground yourself before picking up a chip or placing a chip on a surface such as a lab bench. For example, touch the metal trim on the chip compartment before inserting or removing a chip from the chip clamp.

Protection by equipment

 **WARNING!** The protection that is provided by the equipment can be impaired if the instrument is operated outside the environment and use specifications, the user provides inadequate maintenance, or the equipment is used in a manner that is not specified by the manufacturer (Thermo Fisher Scientific).

Procedural guidelines

Preventing cross-contamination:

- Use good laboratory practice to minimize cross-contamination of products and reagents.
- When designing the laboratory layout, consider the need for space separation of pre-PCR and post-PCR activities. Dedicate laboratory supplies and/or equipment to the appropriate space to reduce the potential for contamination.
- A primary source of contamination is DNA fragments from previous sample processing steps. Do not introduce amplified DNA into library preparation laboratory or work area.

Reagent thawing:

- Unless otherwise specified, thaw reagents on ice before use. Ensure that no ice crystals are visible in the thawed reagent.

Pipetting recommendations:

- Vortex all reagents, *except* for enzymes, for 5 seconds. Mix enzymes by flicking the tube with your finger 4 times. Pulse centrifuge before use.
- Pipet viscous solutions slowly and ensure complete mixing.
- Change tips between pipetting steps.

Unpack and install the Ion OneTouch™ 2 System

For detailed instructions on site preparation and installation of the Ion OneTouch™ 2 Instrument and the Ion OneTouch™ ES Instrument, see:

- Site preparation and installation requirements: *Ion S5™ and Ion S5™ XL System Site Preparation Guide* (Pub. No. MAN0010810), or the *Ion GeneStudio™ S5 System Site Preparation Guide* (Pub. No. MAN0017529).
- Unpacking and installation instructions: *Ion OneTouch™ 2 System User Guide* (Pub. No. MAN0014388).

Check the firmware

To check the firmware version, tap **Options** on the home screen, then tap **Info**. To update the firmware to the appropriate version, see the *Ion OneTouch™ 2 System User Guide* (Pub. No. MAN0014388).

Initialize the Ion OneTouch™ 2 Instrument

IMPORTANT! Before operating the Ion OneTouch™ 2 Instrument for the first time, you must initialize the instrument. Initialization primes the pumps and tubing lines for reliable operation. Perform initialization at any time before the first run.

In addition, re-initialization is recommended when switching between the Ion 520™ & Ion 530™ Kit – OT2 and Ion 540™ Kit – OT2, and between kits with different lots of Ion OneTouch™ Oil.

For detailed instructions on initialization of the Ion OneTouch™ 2 Instrument, see the *Ion OneTouch™ 2 System User Guide* (Pub. No. MAN0014388).

Note: To set up the Ion OneTouch™ 2 Instrument when switching between sequencing platforms, see the *Ion OneTouch™ 2 System User Guide*, Chapter 3 "Demonstrated Protocol: Setting up the Ion OneTouch™ 2 Instrument when switching between template preparation kits."

Workflow

The following workflow illustrates how to prepare and load samples using the Ion 540™ Kit – OT2 and Ion OneTouch™ 2 System for sequencing on an Ion S5™ Sequencer, Ion S5™ XL Sequencer, or Ion GeneStudio™ S5 Series Sequencer.

Create a Planned Run in Torrent Suite™ Software (see page 16).



Prepare template-positive ISPs containing clonally amplified DNA, using the Ion 540™ Kit – OT2 (for up to 200 base-read libraries) with the Ion OneTouch™ 2 Instrument (see page 23).



Enrich the template-positive ISPs with the Ion OneTouch™ ES Instrument (see page 45).



Load the enriched, template-positive ISPs onto an Ion 540™ Chip (see page 58).



Clean and initialize an Ion S5™ Sequencer, Ion S5™ XL Sequencer, or Ion GeneStudio™ S5 Series Sequencer in preparation for sequencing (see page 54).



Sequence the loaded Ion 540™ Chip on an Ion S5™ Sequencer, Ion S5™ XL Sequencer, or Ion GeneStudio™ S5 Series Sequencer (see page 64).



Create a Planned Run

- About Planned Runs 16
- Create a Planned Run 17
- Planned Run workflow key fields 21

About Planned Runs

Planned Runs are digital instructions that are created in Torrent Suite™ Software for controlling the template preparation and sequencing instruments. Planned Runs contain settings such as number of flows, kit types, barcodes, sample information, and reference files (if any). Planned Runs are also used to track samples, chips, and reagents throughout the workflow, from template preparation on the Ion OneTouch™ 2 Instrument through sequencing on an Ion S5™ Sequencer, Ion S5™ XL Sequencer, or Ion GeneStudio™ S5 Series Sequencer and subsequent data analysis. Each chip that will be used in the sequencing run requires its own Planned Run.

IMPORTANT! For more information on creating a Planned Run in Torrent Suite™ Software, including a complete description of each field in the **Create Plan** workflow bar, see the *Torrent Suite™ Software Help*, available by clicking the **Help** button in the software.

Create a Planned Run

1. Sign in to the Torrent Suite™ Software.
2. In the **Plan** tab, in the **Templates** screen, select the application that you want to run (such as AmpliSeq™ DNA) from the left navigation menu, then click one of the following options:
 - **Plan New Run** – to plan a new run using the **Generic Sequencing** template for the selected application.
 - **⚙️ (Actions) ▶ Plan Run** in the row of the template – to plan a new run using a specific Planned Run template.

The screenshot shows the 'Plan' tab in the Torrent Suite software. The main heading is 'AmpliSeq DNA'. There are search filters for 'Date', 'Instrument: S5', 'Sample Prep: All', and 'Project: All'. A 'Plan New Run' button is highlighted in red in the top right. Below the filters is a table of templates. The first row is 'Oncomine Focus DNA for S5'. A dropdown menu is open for this row, and the 'Plan Run' option is highlighted in red. Other options in the menu include 'Set as Favorite', 'Review', 'Plan Multiple', 'Copy', and 'Export'.

Template Name	Instr	Sam... Prep	R... App	Barcodes	Reference	Project	Ion Reporter Account	Ion Reporter Workflow	Date	Source
Oncomine Focus DNA for S5				IonXpress	hg19				May 27 2018	ion torrent
Oncomine BRCA Research for S5				IonXpress	hg19					
Oncomine Comprehensive v3 DNA for 550				IonXpress	hg19					
Oncomine Comprehensive v3 DNA				IonXpress	hg19					
Oncomine Childhood Cancer Research DNA				IonXpress	hg19				Jan 20 2018	ion torrent

3. In the **Create Plan** workflow bar, review the **IonReporter** and **Research Application** steps, then make selections appropriate to your run. Click **Next**.

Select the research application and target technique, then hit next.

Research Application	Target Technique
<input checked="" type="radio"/> DNA	<input checked="" type="radio"/> AmpliSeq DNA
<input type="radio"/> DNA and Fusions (Separate Libraries)	<input type="radio"/> AmpliSeq Exome
<input type="radio"/> DNA and Fusions (Single Library)	<input type="radio"/> AmpliSeq HD - DNA
<input type="radio"/> Fusions	<input type="radio"/> Other
<input type="radio"/> Human Identification	<input type="radio"/> TargetSeq
<input type="radio"/> Immune Repertoire	<input type="radio"/> Whole Genome
<input type="radio"/> Metagenomics	
<input type="radio"/> Mutation Load	
<input type="radio"/> Oncology - Liquid Biopsy	
<input type="radio"/> Pharmacogenomics	
<input type="radio"/> RNA	
<input type="radio"/> Typing	

Summary

Research Application:	DNA
Research Category:	
Target Technique:	AmpliSeq DNA
Ion Reporter:	None
Sample Grouping:	

Previous Next

4. In the **Kits** step, make the following selections.
- Select **Ion GeneStudio™ S5 System** from the **Instrument** dropdown list.
 - Select the **Ion 540™ Chip** from the **Chip Type** dropdown list.
 - Select the library kit used to prepare your libraries from the **Library Kit Type** dropdown list.
 - (Optional) For barcoded libraries, select the barcode set used during library preparation from the **Barcode Set** dropdown list.
 - Select **OneTouch** for **Template Kit**, then select **Ion 540 Kit–OT2** from the **Template Kit** dropdown list.
 - Select **Ion S5 Sequencing Kit** from the **Sequencing Kit** dropdown list.

- g. Enter the appropriate number of flows in the **Flows** field.

Sequencing type	Number of flows
200-base-read	500
150-base-read	400
100-base-read	260

IMPORTANT! Do not exceed 1,200 total flows for one Ion S5™ Sequencing Reagents cartridge.

- h. Select or edit the remaining optional information fields appropriately for your run.
- i. Click **Next**.

The screenshot shows the 'Kits' configuration step in the 'Create Plan' workflow. The main configuration area includes:

- Instrument:** Ion GeneStudio™ S5 System
- Sample Preparation Kit (optional):** (empty dropdown)
- Library Kit Type:** (empty dropdown)
- Template Kit:** OneTouch (selected), IonChef, IA: Ion 540 Kit-OT2
- Read Length:** 200 (selected), 400
- Sequencing Kit:** Ion S5 Sequencing Kit
- Chip Type:** Ion 540™ Chip
- Control Sequence (optional):** (empty dropdown)
- Barcode Set (optional):** (empty dropdown)
- Flows:** 500
- Mark as Duplicates Reads:** (checkbox)
- Enable Realignment:** (checkbox)

The **Advanced Settings** section at the bottom left has 'Use Recommended Defaults' selected. The **Summary** panel on the right shows the following values:

- Research Application: DNA
- Research Category: (empty)
- Target Technique: AmpliSeq DNA
- Ion Reporter: None
- Sample Grouping: (empty)
- Instrument: Ion GeneStudio™ S5 System System
- Chip Type: Ion 540™ Chip
- Sample Preparation Kit: (empty)
- Control Sequence: (empty)
- Library Kit Type: (empty)
- Barcode Set: (empty)
- Template Kit: Ion 540 Kit-OT2
- Sequencing Kit: Ion S5 Sequencing Kit
- Library Read: (empty)

5. Review the **Plugins** and **Projects** steps, then make selections appropriate to your run. Click **Next**.
6. In the **Plan** step, enter or make the following selections.
- Enter a Run Plan Name, then select Reference and BED files appropriate to your run.
 - Enter the number of barcodes you are using in your combined library in the **Number of barcodes** field, then click to the right of this field. Edit the auto-populated list of barcodes that appears, if needed.

Note: If you did not use barcode adapters in library preparation and did not select a **Barcode Set** in the **Kits** step, fields appear in the **Plan** step where you enter the number of chips that are used, then enter the sample name and chip barcode for each sample.

- c. Scan or enter the chip barcode into the **Chip Barcode** field.
- d. Enter a sample name for each barcode in the appropriate **Sample Name (required)** fields.

Create Plan
Ion Reporter
Research Application
Kits
Plugins
Projects
Plan

Template Name : Show Summary

Oncomine Focus DNA

Run Plan Name (required) :

Oncomine Focus DNA for S5 1

Analysis Parameters: Default (Recommended) Custom Details +

Default Reference & BED Files -

Reference Library: hg19(Homo sapiens)

Target Regions: Oncomine_Focus.20150415.designed.forIR.bed

Hotspot Regions: Oncomine_Focus.20150709.hotspots.bed

Use same reference & BED files for all barcodes

Number of barcodes : 8 ↻ Save Samples Table Load Samples Table

Sample Tube Label :

Chip Barcode :

Enter a sample name for each barcode used (require at least one sample) ↓ 🗑️ :

#	Barcode	Sample Name (required)	Control Type	Sample ID	Sample Description	Reference
1	IonCode_0101 (CTAAGGTAAC)	Sample 1				
2	IonCode_0102 (TAAGGAGAAC)	Sample 2				
3	IonCode_0103 (AAGAGGATTC)	Sample 3				

7. After you have completed your selections, click **Plan Run** at the bottom right of the **Plan** step screen to save the run.

The run is listed in the **Planned Runs** screen under the name that you specified. You can select the appropriate Planned Run when you are setting up the run on an Ion S5™ Sequencer, Ion S5™ XL Sequencer, or Ion GeneStudio™ S5 Series Sequencer.

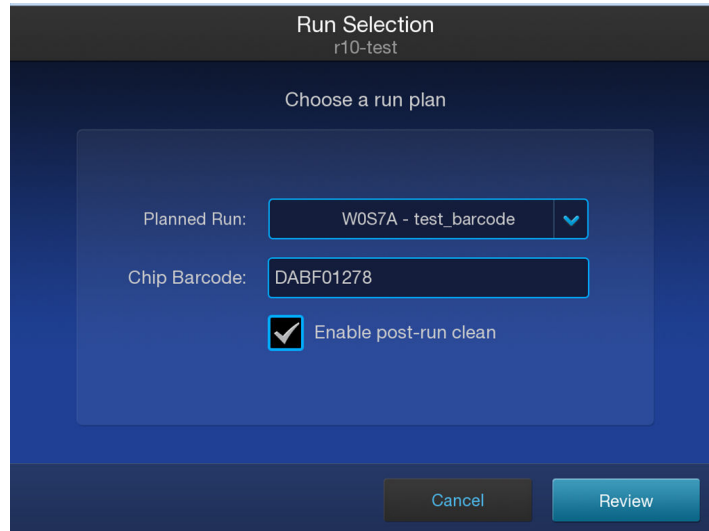

If you are performing 2 sequencing runs per sequencer initialization, repeat step 2–step 7 to create a Planned Run for the second chip. You can copy the first Planned Run in the Planned Runs screen, then edit appropriately.

Planned Run workflow key fields

Step or field name	Description
Ion Reporter	If the Ion Reporter™ Software is installed and enabled, and you want to analyze the run data using the software, select the Ion Reporter Account , then select the Ion Reporter™ workflow from the Existing Workflow dropdown list.
Research Application	Select the Research Application and Target Technique that represent your sequencing experiment.
Instrument	Select Ion GeneStudio™ S5 System .
Chip Type	Select the Ion 540™ Chip .
Library Kit Type	Select the kit used to prepare the library.
Template Kit	Select Ion 540 Kit–OT2 .
Sequencing Kit	Select Ion S5 Sequencing Kit .

Step or field name	Description
Barcode Set (optional)	<p>If you are using barcodes with:</p> <ul style="list-style-type: none"> • DNA libraries – Select the appropriate barcode set used. • RNA libraries prepared using the Ion Total RNA-Seq Kit v2 – Select the IonXpressRNA barcode set, which contains all 16 barcodes in the Ion Xpress™ RNA-Seq Barcode 1–16 Kit. <p>If you are <i>not</i> using barcodes with:</p> <ul style="list-style-type: none"> • DNA libraries – Leave the Barcode Set field blank. • RNA libraries prepared using the Ion Total RNA-Seq Kit v2 – Select RNA_Barcode_None from the dropdown list. This will ensure that the proper trimming is performed on the resulting sequence when the RNA library does not have a barcode.
Flows	Enter the appropriate number of flows for the read length (for example, 500 flows for 200-base-read sequencing).
Plugins	Select the appropriate plugins for your application.
Projects	Select or add a project to group your run data. You can include runs in multiple projects, and remove runs from a project at any time.
Run Plan Name	Enter a name for the run.
Reference Library	Select a reference library uploaded to the Torrent Suite™ Software, if any.
BED files	Select the Target Regions or HotSpot Regions BED file in the Torrent Suite™ Software, if any.
Sample Tube Label	Enter the sample tube label.
Chip Barcode	Enter or scan the chip barcode.
Sample Name (Required)	<p>Did you select a Barcode Set in the Kits step?</p> <ul style="list-style-type: none"> • No – Enter the sample name for each sample loaded onto each chip in the Sample Name (required) column, then enter or scan the corresponding chip barcode in the Chip Barcode column. • Yes – Enter the sample name for each sample in the Sample Name (required) column, then select the barcode that is associated with each sample from the dropdown list in the Barcode column. <p>Did you select the Ion Reporter Account and the associated Ion Reporter™ workflow?</p> <ul style="list-style-type: none"> • No – For each sample name listed, make the appropriate selections in each column in the table. • Yes – For each sample name listed, also make the appropriate selections in the Ion Reporter Workflow, Relation, Gender, and IR Set ID columns.
Monitoring Thresholds	Set thresholds for Bead Loading, Usable Sequence, and Key Signal . In the Torrent Suite™ Software Monitor ▶ Runs in Progress screen, an alert is displayed if the values for a run fall below the selected thresholds.





Prepare template-positive Ion 540TM ISPs

- Ion OneTouchTM 2 Instrument layout 24
- Select the Ion OneTouchTM protocol 25
- Set up the Ion OneTouchTM 2 Instrument 26
- Prepare and install the amplification solution 33
- Start the run 38
- Recover the template-positive Ion SphereTM Particles 39
- Maintain the Ion OneTouchTM 2 Instrument 42

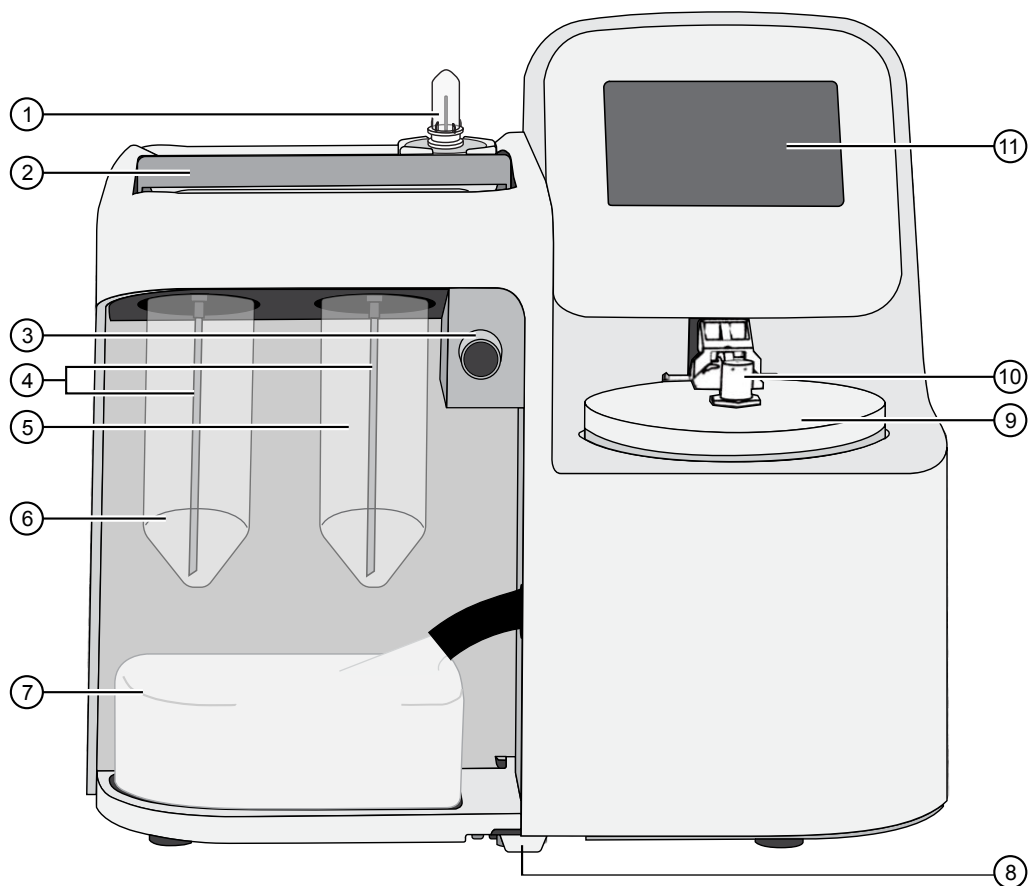
Ion OneTouch™ 2 Instrument layout



- ① Ion OneTouch™ Reaction Filter
- ② Clamp handle to access the Ion OneTouch™ Amplification Plate in the heat block
- ③ Pinch valve to hold disposable tubing
- ④ Ion OneTouch™ Sipper Tubes
- ⑤ Ion OneTouch™ Recovery Solution 
- ⑥ Ion OneTouch™ Oil 
- ⑦ Waste Container
- ⑧ Oil waste tray (pull out)
- ⑨ Centrifuge to spin the Ion OneTouch™ Recovery Tubes and Ion OneTouch™ Recovery Router
- ⑩ Ion OneTouch™ DL Injector Hub
- ⑪ Instrument display

Note: The line drawing does not show the disposable tubing.

Select the Ion OneTouch™ protocol

Note: Ensure that you have the correct firmware update for your system (see “Check the firmware” on page 14).

1. Ensure that the centrifuge lid of the Ion OneTouch™ 2 Instrument is closed.

IMPORTANT! If you raise the centrifuge lid, do not hit the disposable injector against the instrument. You can damage the disposable injector. If you damage the disposable injector, appropriately discard the injector, tubing, and Ion OneTouch™ Amplification Plate. Use a new disposable injector and Amplification Plate.

2. On the home screen, tap **Run**.

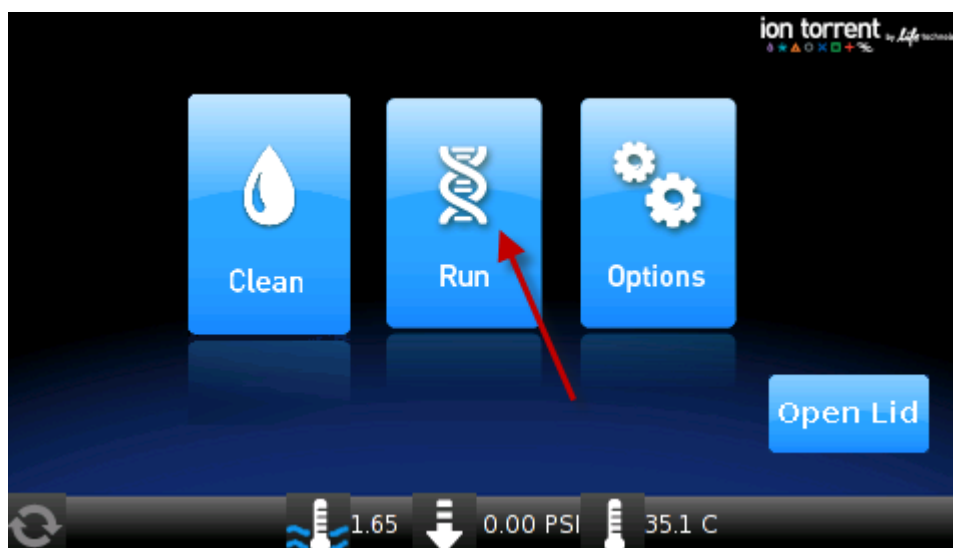

3. Tap the **Protocol** dropdown list, then select the appropriate sequencing length protocol (for example, **Ion S5™ : Ion 540™ Kit – OT2**).

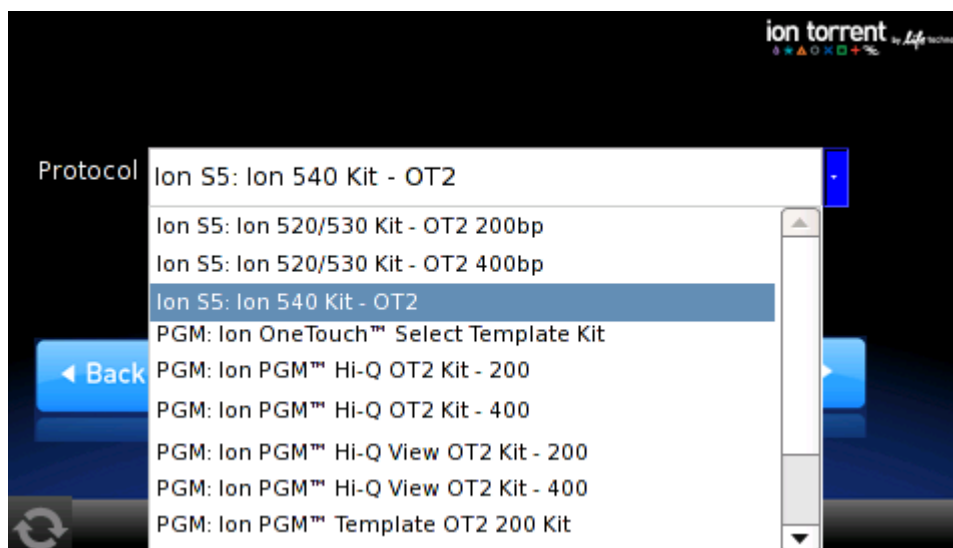

4. Tap **Next**.
5. Tap **Assisted** or **Expert**.

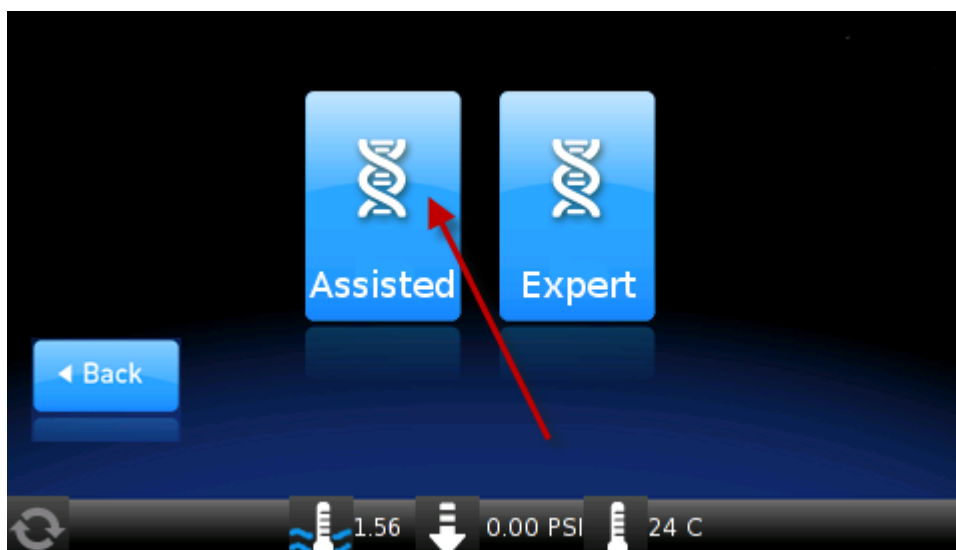

- **Assisted** run. Complete each task, then tap **Next**. After you tap **Next** on the last task, you see a progress bar, and the run starts. After the run starts, you hear clicks from the instrument. This sound is normal.
- **Expert** run. Set up the instrument as described in “Set up the Ion OneTouch™ 2 Instrument”, then tap **Next**. You see a progress bar, and the run starts without the list of task screens.

Set up the Ion OneTouch™ 2 Instrument

Note:

- To set up the Ion OneTouch™ 2 System when switching between sequencing platforms, see the procedure in Chapter 5 of the *Ion OneTouch™ 2 System User Guide* (Pub. No. MAN0014388). Cleaning and initialization using Ion OneTouch™ Recovery Solution and Ion OneTouch™ Oil from the new kit are required.
- If this is the first run after instrument initialization, proceed to “Prepare and install the amplification solution” on page 33. The instrument consumables are already installed and ready for the run.

Materials required **Provided in Ion S5™ OT2 Supplies (Part No. A27748):**

- 2 Ion OneTouch™ Reagent Tubes
- Ion OneTouch™ Recovery Router
- 2 Ion OneTouch™ Recovery Tubes
- Ion OneTouch™ Amplification Plate
- 2 Ion OneTouch™ Sipper Tubes

Provided in Ion S5™ OT2 Solutions (Part No. A27747):

- Ion OneTouch™ Oil (450 mL size)
- Ion OneTouch™ Breaking Solution
- Ion OneTouch™ Recovery Solution

Note: We have verified this protocol using only the material specified. Substitution may adversely affect performance and safety.

IMPORTANT! Follow these special reagent handling instructions:

- Use only the Ion 540™ Kit – OT2 (Cat. No. A27753) with this user guide and with the Ion OneTouch™ 2 System. Do not mix reactions or disposables including plates, solutions, and kit reagents from other template preparation kits.
- Use only the supplied screw cap tubes in the Ion 540™ Kit – OT2 to store the reagents. Do not seal the reagents with any plastic paraffin film such as Parafilm™ M film.

**Install the
Ion OneTouch™
Recovery Tubes
and
Ion OneTouch™
Recovery Router**

1. On the instrument display, tap **Open Lid**, wait until the lid clicks open, then lift and hold the side of the centrifuge lid.

IMPORTANT! Do *not* lift the lid by the tubing that is attached to the Ion OneTouch™ DL Injector Hub. Do *not* force the lid open.

2. Dispense 150 µL Ion OneTouch™ Breaking Solution into each of the two Recovery Tubes.

Note: The Recovery Tubes have rounded collars at their openings.

IMPORTANT!

- Breaking Solution is viscous. Draw and dispense slowly.
- Ensure that the Breaking Solution is stored and used at room temperature. If a white precipitate is present in the tube, warm the solution at 30°C until the precipitate redissolves.

3. Insert the Recovery Tubes containing Breaking Solution into the two centrifuge positions.

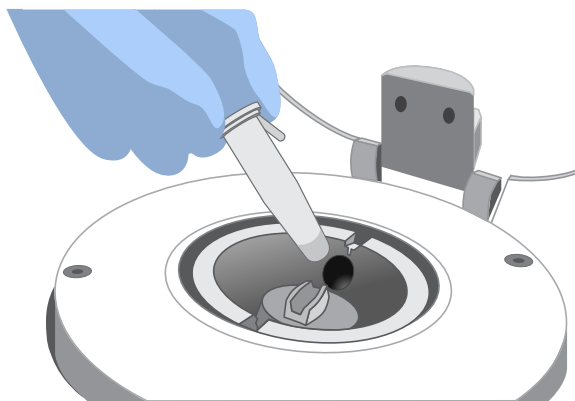

4. Slide the Recovery Router in position around each Recovery Tube extension. Pinch the sides of the Recovery Router, then push it down into the center slot of the centrifuge.

IMPORTANT! The Recovery Router must be seated flat and secure in the center of the rotor.

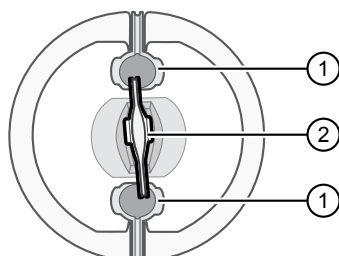

① Recovery Tube

② Recovery Router

5. Close the centrifuge lid.

Install the Ion OneTouch™ Amplification Plate

1. If there is a used Ion OneTouch™ Cleaning Adapter on the instrument, remove and appropriately discard it.
Note: The Cleaning Adapter can be filled with Ion OneTouch™ Oil.
2. Push the handle back to open the heat block.



CAUTION! Hot Surface. Use care when working near this area to avoid being burned by hot components.



WARNING! Safety Hazard. Do not use the instrument with flammable or explosive materials. Use only the materials specified for use with the instrument to ensure safety.

3. Insert the Amplification Plate.
 - a. Inspect the Amplification Plate to ensure that the plate port is straight and perpendicular to the plate.

IMPORTANT! The disposable tubing and disposable injector are attached to the Amplification Plate. Do *not* disconnect tubing from the top plate port. If you have questions about the plate, contact Technical Support.

- b. Hold the disposable injector, which is connected to the disposable tubing, in one hand and the Amplification Plate in the other hand.



CAUTION! PHYSICAL INJURY HAZARD. The pointed end of the disposable injector can puncture your skin. Keep your hand away from the point of the disposable injector.

- c. Insert the Amplification Plate into the heat block so that the single plate port aligns with the *left* hole of the Ion OneTouch™ 2 Instrument.

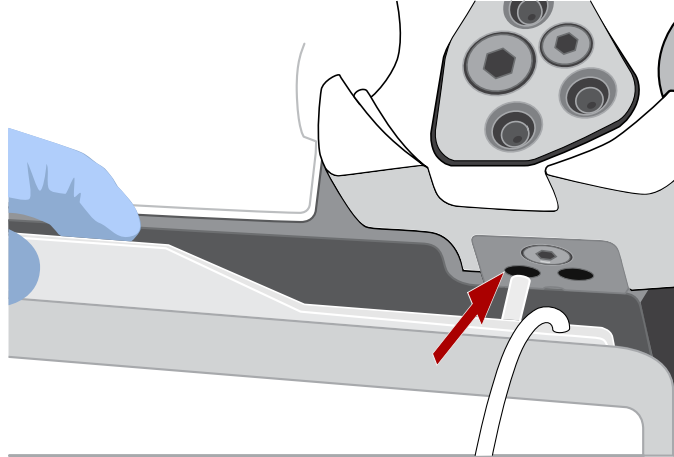

- 4. Pull the heat block handle forward to close the block, then thread the disposable tubing through the Ion OneTouch™ DL Tubing Catch.

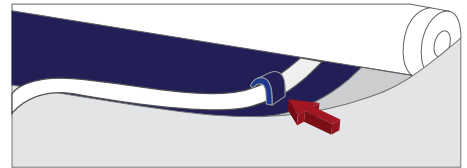

Note: The disposable tubing is under the handle.

- 5. Install the disposable tubing in the pinch valve.
 - a. Align the disposable tubing with the slot that runs along the bottom of the pinch valve.
 - b. Gently pull the disposable tubing upward on both sides of the pinch valve until the disposable tubing is in the slot and fastened in the round notch on each side of the pinch valve.

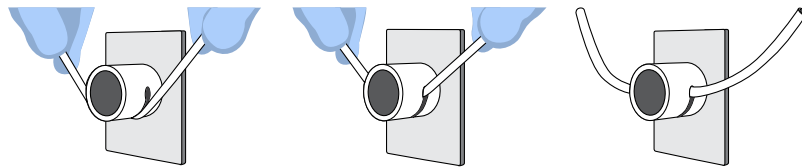

- c. If needed, adjust the disposable tubing along the notches of the open pinch valve so that there is sufficient length of disposable tubing to install the disposable injector (see “Install the disposable injector” on page 30).

Install the disposable injector

Note: The long metal shaft of the disposable injector can be slightly bent, which is normal. If you have questions regarding the disposable injector, contact Technical Support.

1. Ensure that the needle of the injector is screwed tightly onto the rubber tubing. Hold the centrifuge lid down with one hand, then with other hand install the disposable injector by inserting it straight down into the injector hub. Push down until it just touches the router.



CAUTION! PHYSICAL INJURY HAZARD. The pointed end of the injector can puncture your skin. Keep your hand away from the point of the injector.

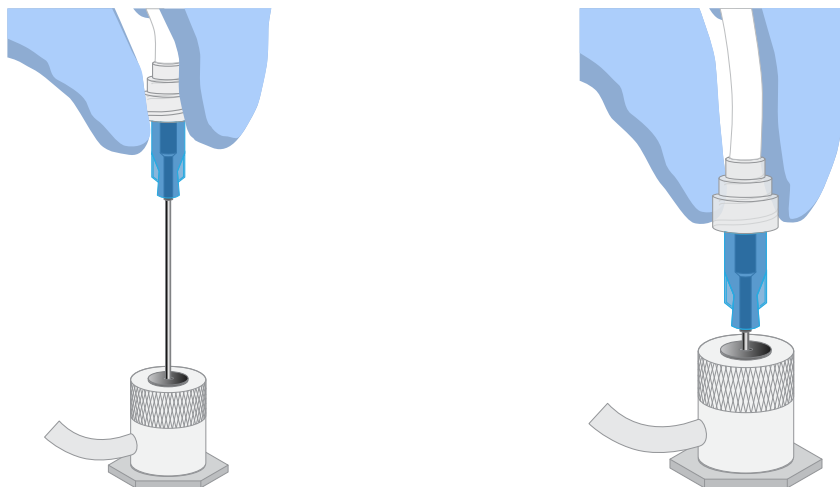

Note: The color of the injector can vary.

2. The spring-loaded top of the injector hub clicks on release, automatically adjusting the tip to the correct distance from the router surface. You can test this by gently pushing the injector down again, then releasing. You should hear a click from the hub.

Up position

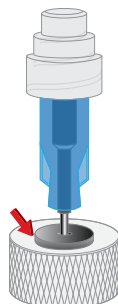

Down position

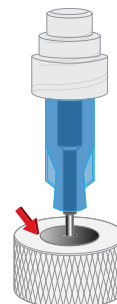

IMPORTANT! If the Injector Hub remains in the down position, see Appendix A, “Troubleshooting”.

IMPORTANT! If you raise the centrifuge lid, do not hit the injector against the instrument. If you damage the disposable injector, appropriately discard the injector, tubing, and Amplification Plate. Use a new injector and Ion OneTouch™ Amplification Plate.

Install the Ion OneTouch™ Oil

Fill the appropriate Ion OneTouch™ Reagent Tube with Ion OneTouch™ Oil on the left front port , as described in the following table.

If you are	Action
Using a new Template Kit	<ol style="list-style-type: none"> 1. Use a new Reagent Tube from the kit. 2. Discard the used Reagent Tube and the Ion OneTouch™ Sipper Tube. Appropriately discard the residual Oil. 3. Use fresh gloves to attach the Luer-Lok™ end of a new Sipper Tube to the <i>left</i> front port. Do not let the Sipper Tube touch any surface. 4. Invert the Oil bottle (450-mL size) 3 times to mix, then fill the Reagent Tube <i>half</i>-full with Oil. Minimize bubbles. 5. Insert the filled Reagent Tube into the <i>left</i> front port, then screw the Reagent Tube clockwise until it is fastened firmly into place.
Refilling the Reagent Tube between runs	<ol style="list-style-type: none"> 1. Remove the Reagent Tube from the instrument. 2. Invert Oil bottle (450-mL size) 3 times to mix. 3. Fill the Reagent Tube <i>half</i>-full with Oil. Minimize bubbles. Note: It is not necessary to re-mix the Oil. 4. Insert the filled Reagent Tube into the <i>left</i> front port, then screw the Reagent Tube clockwise until it is fastened firmly into place.

Install the Ion OneTouch™ Recovery Solution

IMPORTANT! Use only the Ion OneTouch™ Recovery Solution provided as part of the Ion 540™ Kit – OT2 for the Ion OneTouch™ 2 Instrument. Do *not* use a different recovery solution from another kit.

1. Ensure that the Recovery Solution is clear. If it is clear, proceed to the next step. If the Recovery Solution is not clear, heat the bottle of Recovery Solution in a 30°C bath until the Recovery Solution is clear.
2. Fill the appropriate Ion OneTouch™ Reagent Tube with Ion OneTouch™ Recovery Solution on the right front port , as described in the following table.

If you are	Action
Using a new Template Kit	<ol style="list-style-type: none"> 1. Use a new Reagent Tube from the kit. 2. Discard the used Reagent Tube and Sipper Tube. Appropriately discard the Recovery Solution. 3. Use fresh gloves to attach the Luer-Lok™ end of a new Ion OneTouch™ Sipper Tube to the <i>right</i> front port. Do not let the Sipper Tube touch any surfaces. 4. Invert the Recovery Solution 3 times to mix, then fill the Reagent Tube <i>one-third</i>-full with Recovery Solution. Minimize bubbles. 5. Insert the filled Reagent Tube into the <i>right</i> front port, then screw the Reagent Tube firmly into place, one-quarter turn on the instrument.
Refilling the Reagent Tube between runs	<ol style="list-style-type: none"> 1. Remove the Reagent Tube from the instrument. 2. Invert the bottle of Recovery Solution 3 times. 3. Add more Recovery Solution to the solution in the Reagent Tube until the tube is <i>one-third</i>-full. Minimize bubbles. 4. Insert the filled Reagent Tube into the <i>right</i> front port, then screw the Reagent Tube firmly into place, one-quarter turn on the instrument.

Empty the Waste Container

1. Pull the external tubing from the port of the Waste Container.
2. Empty the Waste Container into the appropriate receptacle.
3. Reinstall the empty Waste Container.

Inspect the oil waste tray

1. Slowly pull out the oil waste tray but do not remove it completely from the slot underneath the center of the instrument.
2. Check for oil in the oil waste tray.
 - If there is little or no oil, push the tray back fully into the instrument.
 - If there is excessive oil, remove the tray, then appropriately discard the oil. Reinsert the oil waste tray into the slot, then push the tray back fully into the instrument. Contact Technical Support.

Prepare and install the amplification solution

- Materials required**
- Provided in Ion S5™ OT2 Solutions (Part No. A27747):**
- Ion OneTouch™ Reaction Oil
 - Nuclease-free Water
- Provided in Ion S5™ OT2 Supplies (Part No. A27748):**
- Ion OneTouch™ Reaction Filter
- Provided in Ion 540™ OT2 Reagents (Part No. A27752):**
- Ion S5™ Reagent Mix
 - Ion S5™ Enzyme Mix
 - Ion 540™ Ion Sphere™ Particles
- (Optional) Provided in the Ion S5™ Controls Kit Plus (Cat No. A30729):**
- Human CEPH Control 200 Library
- Other Materials and Equipment:**
- Diluted library
 - Microcentrifuge
 - Eppendorf™ DNA LoBind™ Microcentrifuge Tubes
 - Tube rack for 15-mL conical tube
 - Pipettes
 - Vortexer

Prepare the amplification solution

IMPORTANT! Use *only* the Ion 540™ Kit – OT2 with this user guide and with the Ion OneTouch™ 2 Instrument. Do not use the kits with the Ion OneTouch™ System. Do *not* mix reactions or disposables including plates, solutions, and kit reagents from other template preparation kits.

IMPORTANT! We recommend preparing the amplification solution in a room that is dedicated to pre-PCR activities or in a controlled pre-PCR hood.

1. Prepare the reagents as described in the following table.

Reagents	Preparation
Ion S5™ Reagent Mix	<ol style="list-style-type: none"> 1. Allow the tube of Reagent Mix (2 mL) to come to room temperature before use. 2. Vortex the solution for 30 seconds, then centrifuge the solution for 2 seconds. Note: Visually inspect the solution at the bottom of the tube and verify that there is no remaining precipitate. If precipitate is visible, see Appendix A, “Troubleshooting”. 3. Keep the tube of Reagent Mix at room temperature during use. Store thawed Reagent Mix at 2°C to 8°C.

Reagents	Preparation
Ion S5™ Enzyme Mix	<ol style="list-style-type: none"> 1. Flick the tube with your finger 4 times to mix. 2. Centrifuge the enzyme for 2 seconds. 3. Place on ice.
Ion Sphere™ Particles	Place the suspension at room temperature.

IMPORTANT! Use only Ion Sphere™ Particles (ISPs) from the Ion 540™ Kit – OT2 with the Ion OneTouch™ 2 System. Do *not* use ISPs from other or previously used kits.

2. Dilute the library, or combined library (barcoded library pool), as described in the following table. Use the diluted library within 48 hours of preparation.

Recommended dilutions for:

- Ion AmpliSeq™ DNA Library
- Ion AmpliSeq™ RNA Library
- gDNA Fragment or Amplicon Library
- Ion TargetSeq™ Exome-Enriched Library
- Ion Total RNA-Seq Library

Component	Volume
100-pM library or combined library	6–8 µL
Nuclease-free Water	92–94 µL
Total volume of diluted library to add to the amplification solution	100 µL

- a. Vortex the diluted library for 5 seconds, then centrifuge for 2 seconds.
- b. Place the diluted library on ice.

Note: If you are troubleshooting the amplification process, dilute the control libraries, obtained from the Ion S5™ Controls Kit Plus (Cat. No. A30729), as described in the following table. Use 100 µL of this diluted control library instead of your library in the amplification solution.

Control library	Volume of library	Nuclease-free Water
Human CEPH Control 200 Library	1 µL	260 µL

3. Prepare the ISPs.
 - a. Vortex the ISPs at maximum speed for 1 minute to resuspend the particles.
 - b. Centrifuge the ISPs for 2 seconds.
 - c. Pipet the ISPs up and down to mix.
 - d. *Immediately* proceed to the next step.

- To the tube containing 2 mL of Ion S5™ Reagent Mix at 15°C to 30°C, add the following components in the designated order, then pipet the amplification solution up and down to mix.

Order	Reagent	Cap color	Volume
1	Nuclease-free Water	—	80 µL
2	Ion S5™ Enzyme Mix	Brown	120 µL
3	Ion Sphere™ Particles	Black	100 µL
4	Diluted library (<i>not</i> stock library)	—	100 µL
—	Total volume (including Master Mix)	—	2,400 µL

- Proceed *immediately* to “Fill the reaction filter assembly”.

IMPORTANT! Start the run on the Ion OneTouch™ 2 Instrument ≤15 minutes after preparing the amplification solution.

Fill the reaction filter assembly

IMPORTANT! We recommend filling the Ion OneTouch™ Reaction Filter in a room that is dedicated to pre-PCR activities or in a controlled pre-PCR hood. Do *not* use a reaction filter assembly from any other template preparation kit.

- Obtain an Ion OneTouch™ Reaction Filter from the Ion 540™ Kit – OT2.

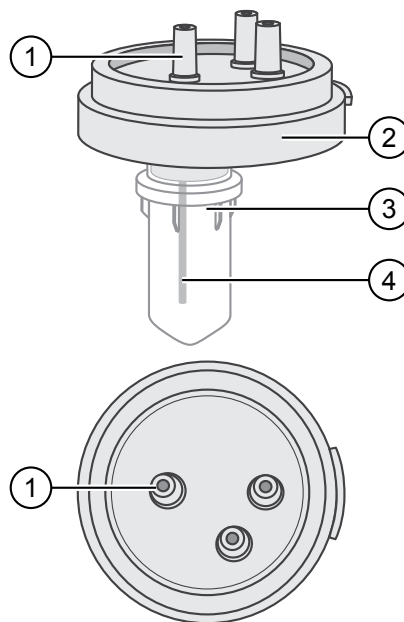

- Sample port
- Ion OneTouch™ Reaction Filter
- Ion OneTouch™ Reaction Tube
- Short tubing from sample port to Ion OneTouch™ Reaction Tube

- Place the Ion OneTouch™ Reaction Filter into a tube rack so that the 3 ports of the Ion OneTouch™ Reaction Filter face *up*.

3. Identify the sample port on the Ion OneTouch™ Reaction Filter.

Note:

- The short tubing in the Reaction Tube is connected to the sample port.
- The color of the short tubing attached to the sample port can vary.

4. Add the amplification solution through the sample port.
 - a. Set a 1,000- μ L pipettor to 800 μ L, and attach a new 1000- μ L tip.
 - b. Vortex the amplification solution at maximum speed for **a full 5 seconds**, then centrifuge the solution for 2 seconds. *Immediately* proceed to the next step.
 - c. Pipet the amplification solution up and down to mix, then fill the tip with 800 μ L of the amplification solution.
 - d. Insert the tip firmly into the sample port so that the tip is perpendicular to the Ion OneTouch™ Reaction Filter Assembly and fully inserted into the sample port to form a tight seal.

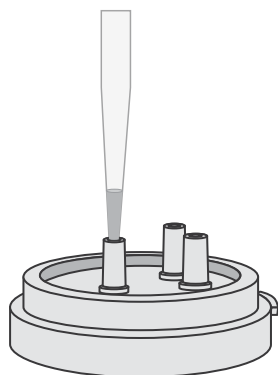

- e. Slowly pipet 800 μ L of the 2.4-mL amplification solution through the sample port. Keep the plunger of the pipette depressed to avoid aspirating solution from the Ion OneTouch™ Reaction Filter. With the plunger still depressed, remove the tip from the sample port.
 - f. Repeat substep 4c–substep 4e two more times (for a total of 3 times) to load the entire amplification solution volume into the Ion OneTouch™ Reaction Filter.
 - g. If needed, gently dab a Kimwipes™ disposable wipe around the ports to remove any liquid.
5. Add Ion OneTouch™ Reaction Oil through the sample port.
 - a. Set a 1,000- μ L pipettor to 200 μ L, and attach a new 1000- μ L tip.
 - b. Draw up 200 μ L of Ion OneTouch™ Reaction Oil into the pipette tip.
 - c. Insert the tip firmly into the sample port so that the tip is perpendicular to the Ion OneTouch™ Reaction Filter and fully inserted into the sample port to form a tight seal.

- d. Slowly pipet 200 µL of the Reaction Oil through the sample port, then keep the plunger of the pipette depressed.
- e. With the plunger depressed, remove the tip from the sample port, then appropriately discard the tip.
- f. If needed, gently dab a Kimwipes™ disposable wipe around the ports to remove any liquid.

Install the filled Ion OneTouch™ Reaction Filter

IMPORTANT! Follow the steps exactly to minimize contact of the short tubing in the Reaction Tube with the amplification solution.

1. Position the tube rack containing the Ion OneTouch™ Reaction Filter so that the sample port on the filter is on the left.
2. Lift the Ion OneTouch™ Reaction Filter straight out of the tube rack. With the sample port still on the left, rotate the filter assembly clockwise as shown in the following figure, until the Reaction Tube is inverted and the three ports point down.

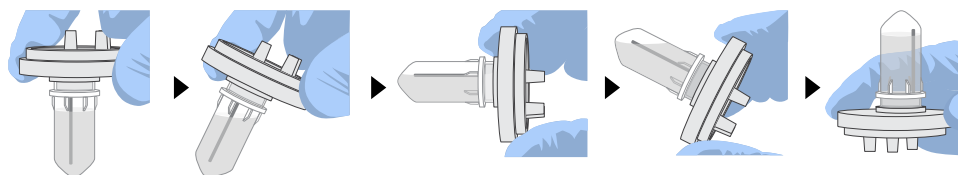

IMPORTANT! Correct rotation of the Ion OneTouch™ Reaction Filter ensures minimal exposure of the short tubing in the Reaction Tube with the amplification solution.

3. Wipe the three holes on the top stage of the Ion OneTouch™ 2 Instrument with a Kimwipes™ disposable wipe to remove any oil or residue from the previous run.
4. Insert the three ports into the three holes on the stage, so that the Ion OneTouch™ Reaction Filter is firmly seated (right) on the instrument. The tab protruding from the outer edge of the Reaction Filter fits into the front notch of the stage.

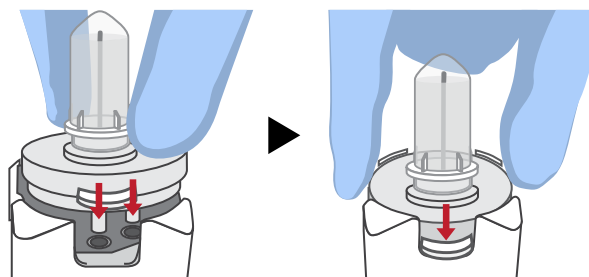

Note: After inserting the Ion OneTouch™ Reaction Filter, bubbles can shoot up into the Reaction Tube.

Start the run

1. After installing the Ion OneTouch™ Reaction Filter, tap **Next** to start the run.

IMPORTANT! Remember to add 150 µL of Ion OneTouch™ Breaking Solution to each Recovery Tube before starting the run. On the reminder screen, confirm and tap **Yes** to advance.

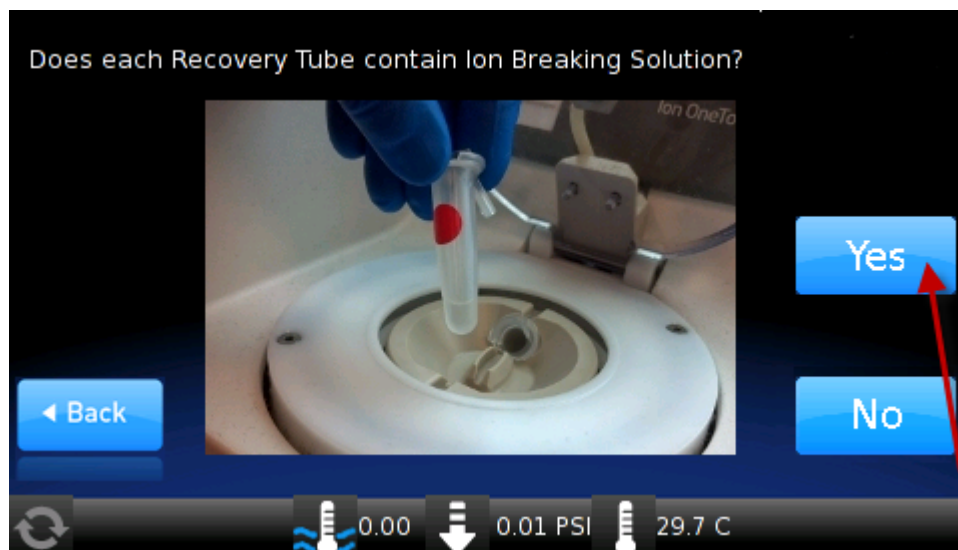

Note: After the run starts, the instrument makes clicking sounds. This sound is normal.

2. Remove the samples ≤16 hours after starting the run. If you tapped **Next** on the centrifuge screen to centrifuge samples at the end of the run, proceed *immediately* to “Recover the template-positive ISPs” on page 39.

Note: Typical instrument run time is 4.8–6.5 hours.

Abort and restart a run

If it is necessary to abort and restart a run, follow these steps in the order listed.

1. Tap **Abort**, then tap **Yes** to confirm cancellation.

Note: If there is a high-pressure event on the instrument, the instrument aborts the run *automatically*, and you do *not* have to tap **Abort**.

2. After a run is aborted, download the log files for troubleshooting by Technical Support. For more information, see the *Ion OneTouch™ 2 System User Guide* [Pub. No. MAN0014388].
3. Power off the instrument.
4. If needed, retain all consumables on the instrument for troubleshooting.
5. After successful troubleshooting, appropriately discard all used consumables, then power on the instrument.
6. Set up the instrument with new kit components (see “Set up the Ion OneTouch™ 2 Instrument” on page 26).

7. Prepare a new amplification solution (see “Prepare and install the amplification solution” on page 33).
8. Start a new run.

Recover the template-positive Ion Sphere™ Particles

Materials required Provided in Ion S5™ OT2 Solutions (Part No. A27747):

- Ion OneTouch™ Wash Solution
- ISP Resuspension Solution
- Nuclease-free Water

Other materials and equipment:

- Eppendorf™ DNA LoBind™ Microcentrifuge Tubes
- Pipettes
- Vortexer
- Microcentrifuge

Recover the template-positive ISPs

1. At the end of the run, follow the screen prompts to centrifuge the sample. If you removed the Reaction Tubes at the end of the run *before* the Ion OneTouch™ 2 Instrument had centrifuged the sample or have not processed the sample after 15 minutes, centrifuge the sample on the instrument.
 - a. On the home screen of the instrument, tap **Open Lid**, wait until the lid clicks open, then insert the two filled Ion OneTouch™ Recovery Tubes from the run into the centrifuge rotor. Close the lid until it locks.
 - b. Tap **Options** ▶ **Final Spin**, then follow the screen prompts until the centrifugation starts.

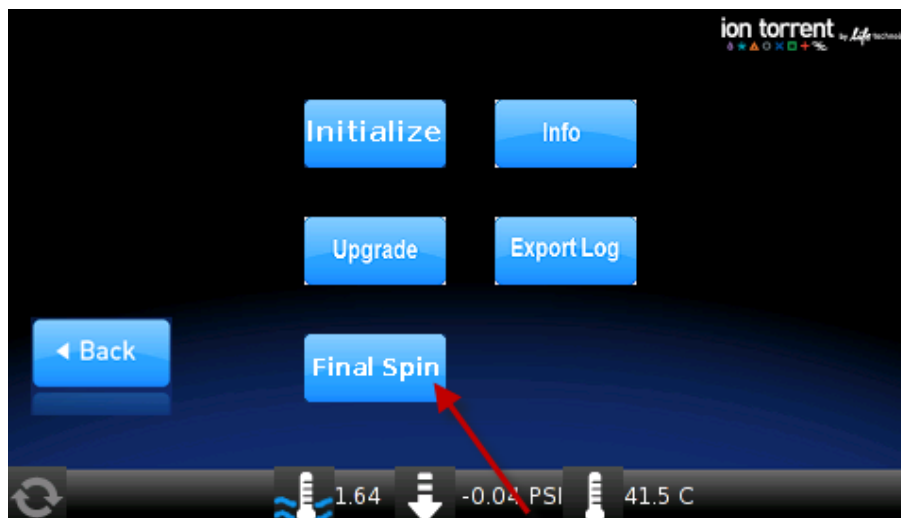

Note: Centrifugation of the samples takes 10 minutes.

- c. When the centrifuge stops, *immediately* proceed to step 3–step 5.



CAUTION! ROTATION HAZARD. Wait until rotation stops before opening. Rotating parts can cause injury.

2. During the final centrifuge spin, place a 50-mL conical tube in a tube rack, then place the tube rack with the empty tube next to the instrument.

Note: During the centrifugation, you can start preparing reagents for ISP enrichment (see “Prepare reagents then fill the 8-well strip” on page 46).

3. *Immediately* after the centrifuge stops, perform the following steps.
 - a. Gently pull the disposable tubing downward on both sides of the pinch valve until the disposable tubing is out of the valve.
 - b. Place one hand on the centrifuge lid, then with the other hand firmly grip the rigid plastic connector at the top of the disposable injector and steadily pull the disposable injector straight up from the Injector Hub.



CAUTION! PHYSICAL INJURY HAZARD. The pointed end of the disposable injector can puncture your skin. Keep your hand away from the point of the disposable injector.

- c. Place the disposable injector into the empty 50-mL conical tube in the tube rack.
4. In the instrument display, tap **Open Lid**, wait until the lid clicks open, then remove and discard the Ion OneTouch™ Recovery Router.
5. *Carefully* remove both Recovery Tubes from the instrument, then put the two Recovery Tubes in a tube rack.

Note: You may see some cloudiness in the tube, which is normal.

IMPORTANT! Do not store the recovered, template-positive ISPs at -30°C to -10°C . Proceed immediately to “Wash the template-positive ISPs”. There is a stopping point in the next section.

Wash the template-positive ISPs

1. Use a pipette to remove all but $\sim 100\ \mu\text{L}$ of Ion OneTouch™ Recovery Solution from each Ion OneTouch™ Reagent Tube. Withdraw the supernatant from the surface and on the opposite side from the pellet. Do not disturb the pellet of template-positive ISPs.
2. Resuspend the template-positive ISPs in the remaining Recovery Solution in each tube by pipetting the suspension up and down.
3. Combine the suspension from each Recovery Tube into a new labeled 1.5-mL Eppendorf LoBind™ tube.

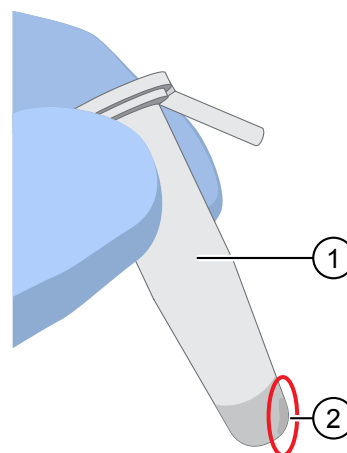

- ① Ion OneTouch™ Reagent Tube
- ② Location of ISP pellet

4. Add 100 µL of Nuclease-free Water to each Recovery Tube, pipet up and down to mix, then transfer the remaining beads into the labeled 1.5-mL tube.
5. Bring the combined suspensions in the labeled 1.5-mL tube to 1 mL with Nuclease-free Water.

STOPPING POINT The ISPs can be stored at 2°C to 8°C for up to 3 days. If you stored the template-positive ISPs at 2°C to 8°C, proceed to step 8. Do not store the recovered ISPs in Ion OneTouch™ Recovery Solution.

6. Vortex for 30 seconds to completely resuspend the template-positive ISPs, then centrifuge the tube for 2 seconds.
7. (Optional) Evaluate the quality of the unenriched, template-positive ISPs using the following methods.

If you have a	Action
Qubit™ Fluorometer ^[1]	Continue to step 8. You can perform quality control on the ISPs in step 12.
[Optional] Guava™ easyCyte 5 Benchtop Flow Cytometer	Perform quality control on the diluted, unenriched ISPs. Transfer a 2.0-µL aliquot of the diluted, unenriched ISPs (from step 6) to a 1.5-mL Eppendorf LoBind™ tube. See the <i>Ion Sphere™ Particles Quality Assessment Using the Guava™ easyCyte 5 Benchtop Flow Cytometer User Bulletin</i> (Pub. No. MAN0007496), available at thermofisher.com .

^[1] This protocol supports Qubit™ 2.0 Fluorometer or later.

8. Centrifuge the template-positive ISP suspension for 8 minutes at 15,500 × g.
Note: To convert the RPMs of your centrifuge to RCF in units of gravity, see tools.thermofisher.com/content/sfs/brochures/TR0040-Centrifuge-speed.pdf.
9. Remove all but 20 µL of supernatant.
10. In the new labeled tube, bring the volume of combined washed suspensions to 100 µL with the ISP Resuspension Solution (in other words, add 80 µL of ISP Resuspension Solution to bring the total volume up to 100 µL).
11. Vortex the pellet for 30 seconds to completely resuspend the template-positive ISPs, then centrifuge the tube for 2 seconds.
12. (Optional) If you have not used the Guava™ easyCyte 5 Benchtop Flow Cytometer to perform quality control on the ISPs, you can retain a sample at this point to evaluate quality of the resuspended, unenriched template-positive ISPs using a Qubit™ Fluorometer. Transfer a 2.0-µL aliquot of the resuspended, unenriched ISPs to a 0.2-mL PCR tube, then analyze the QC sample as described in the *Ion Sphere™ Quality Control Kit User Guide* (Pub. No. MAN0017531) available at thermofisher.com.

For more information on QC sample analysis, see “Quality control of Ion 540™ ISPs” on page 77 .

Proceed to “Maintain the Ion OneTouch™ 2 Instrument” and Chapter 5, “Enrich the template-positive Ion 540™ ISPs”. You can start the enrichment procedure while the Ion OneTouch™ 2 Instrument cleaning is in progress.

IMPORTANT! Do not store the recovered, template-positive ISPs at -30°C to -10°C . Do not store the recovered ISPs in Ion OneTouch™ Recovery Solution.

Maintain the Ion OneTouch™ 2 Instrument

IMPORTANT! Follow the cleaning procedure in this section to clean the Ion OneTouch™ 2 Instrument with the Ion OneTouch™ Cleaning Adapter. *Perform the cleaning procedure after every run. Do not skip this procedure.* The cleaning procedure is performed according to the steps displayed on the instrument after removing the Recovery Tubes.

Note: To set up the Ion OneTouch™ 2 Instrument when switching between sequencing platforms and/or template preparation kits, refer to Chapter 5 of the *Ion OneTouch™ 2 System User Guide* (Pub. No. MAN0014388).

Materials required

Provided in Ion S5™ OT2 Supplies (Part No. A27748):

- Ion OneTouch™ Cleaning Adapter (single-use)

Provided in Ion S5™ OT2 Solutions (Part No. A27747):

- Ion OneTouch™ Oil

Other materials and equipment:

- Kimwipes™ disposable wipes
- 50-mL conical tube
- Tube rack for 50-mL conical tube

Note: To ensure continued safe operation, visually inspect the rotor assembly and casing periodically to ensure there are no signs of cracks or other physical damage.

Clean the Ion OneTouch™ 2 Instrument

1. Determine the appropriate reagents to use for maintaining the Ion OneTouch™ 2 Instrument.

If you are	Action
Switching to the Ion 540™ Kit – OT2 from another kit	See Chapter 5 of the <i>Ion OneTouch™ 2 System User Guide</i> (Pub. No. MAN0014388). Use the reagents from the appropriate kit to maintain the Ion OneTouch™ 2 Instrument.
Already using the Ion 540™ Kit – OT2	Proceed to step 2. Continue to use the reagents that are provided in the Ion 540™ Kit – OT2.

2. Check the level of Ion OneTouch™ Oil in the Reagent Tube. If the Reagent Tube has <20 mL of Oil, pour Oil into the Reagent Tube until it is half-full.

3. Remove and appropriately discard the used Ion OneTouch™ Reaction Filter. Remove the assembly from the instrument by grasping the *filter*.
Note: The Reaction Tube is filled with Ion OneTouch™ Oil.
4. Keep the Ion OneTouch™ Amplification Plate in the heat block.
5. Firmly insert the 3 ports of a new *single-use* Cleaning Adapter into the three holes on the top stage of the Ion OneTouch™ 2 Instrument (see the following illustration). One of the two tabs protruding from the outer edge of the Cleaning Adapter fits into the front notch of the stage.

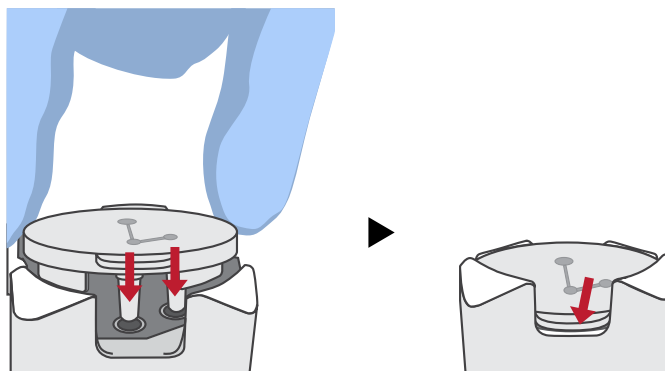

6. Place a 50-mL conical tube in a tube rack, then place the tube rack next to the instrument.
Note: step 6 through step 9 are only necessary if you have not already removed the disposable injector before removing the Recovery Tubes from the instrument.
7. Gently pull the disposable tubing downward on both sides of the pinch valve until the disposable tubing is out of the valve.
8. Remove the disposable injector from the Ion OneTouch™ DL Injector Hub.
 - a. Place one hand on the centrifuge lid.
 - b. With the other hand, firmly grip the rigid plastic connector at the top of the disposable injector.
 - c. Slowly and steadily withdraw the disposable injector straight from the port of the Injector Hub.



CAUTION! PHYSICAL INJURY HAZARD. The pointed end of the disposable injector can puncture your skin. Keep your hand away from the point of the disposable injector.

9. Place the used, disposable injector into the empty 50-mL conical tube in the tube rack.

Note: The conical tube is used to collect waste.

10. On the home screen of the instrument, tap **Clean**.

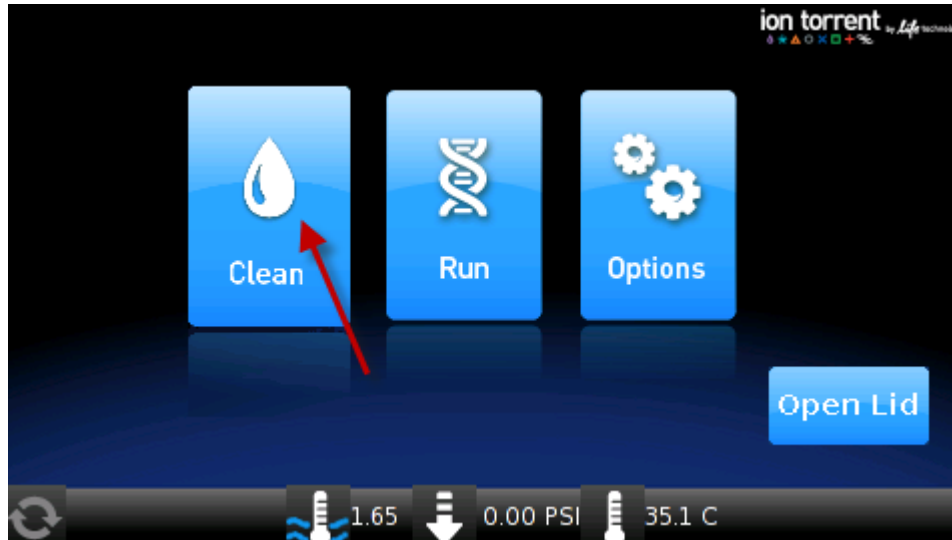

11. Complete each task that is displayed on the screen, then tap **Next**. After you tap **Next** on the last task, a progress bar appears, and the cleaning starts. At the end of the cleaning run, the screen displays **Time Remaining 00:00:00, Cleaning Run Complete**.
12. Tap **Next**, then ensure that the task "**Remove plate, injector, conical tube, and waste**" is displayed.
Note: Keep the used Cleaning Adapter on the instrument between runs.
13. Appropriately discard the waste that was collected in the 50-mL conical tube.
14. Remove and appropriately discard the used Amplification Plate, disposable injector, and tubing.
- Push the handle to open the heat block.
 - Remove the disposable tubing from the Ion OneTouch™ DL Catch.
 - Gently pull back the Amplification Plate from the inlet and outlet holes of the instrument.
 - Remove the Amplification Plate from the heat block, then appropriately discard the used Amplification Plate, injector, and tubing.
 - Leave the heat block open.



CAUTION! Hot Surface. Use care when working near this area to avoid injury from contact with hot components.

15. On the instrument display, tap **Open Lid**, wait until the lid clicks open, then open the centrifuge lid. Wipe the residue from the centrifuge lid with dry Kimwipes™ disposable wipers, then close the centrifuge lid.
16. Tap **Next** to return to the home screen on the instrument.



Enrich the template-positive Ion 540™ ISPs

■ Materials required	45
■ Residual volume test	46
■ Prepare reagents then fill the 8-well strip	46
■ Prepare the Ion OneTouch™ ES	48
■ Perform the run	50
■ Remove and wash the enriched ISPs	52
■ (Optional) Perform enriched ISP quality control	53

Materials required

Provided in Ion S5™ OT2 Solutions (Part No. A27747):

- Ion OneTouch™ Wash Solution
- MyOne™ Beads Capture Solution
- Ion OneTouch™ ES Wash Solution
- Tween™ Solution
- Nuclease-free Water

Provided in Ion S5™ OT2 Supplies (Part No. A27748):

- 8-well strip
- Eppendorf™ LoRetention Dualfilter Tips (P300)

Other materials and equipment:

- Dynabeads™ MyOne™ Streptavidin C1 Beads
- Eppendorf™ DNA LoBind™ Microcentrifuge Tubes
- 0.2-mL PCR tubes
- 1 M NaOH
- Pipettes
- Vortexer
- DynaMag™-2 magnet
- Microcentrifuge

Residual volume test

IMPORTANT! Ensure that the AC line voltage module is installed correctly into the Ion OneTouch™ ES Instrument. For more information, see the *Ion S5™ and Ion S5™ XL System Site Preparation Guide* (Pub. No. MAN0010810) or the *Ion GeneStudio™ S5 System Site Preparation Guide* (Pub. No. MAN0017529).

If the condition is...	Then...
First use of the instrument and during monthly maintenance	Perform a residual volume test, refer to the <i>Ion OneTouch™ 2 System User Guide</i> (Pub. No. MAN0014388).
Routine use and residual volume in Well 1 and Well 8 is >5.0 µL	
Routine use and residual volume in Well 1 and Well 8 is ≤5.0 µL	Operate the instrument without performing the residual volume test. Proceed to “Prepare reagents then fill the 8-well strip” on page 46.

Prepare reagents then fill the 8-well strip

Prepare Melt-Off Solution

Prepare fresh Melt-Off Solution by combining the components in the following order.

Order	Component	Volume
1	Tween™ Solution	280 µL
2	1 M NaOH	40 µL
—	Total	320 µL

IMPORTANT! Prepare Melt-Off Solution as needed, but appropriately discard the solution after 1 day.

The final composition of the Melt-Off Solution is 125 mM NaOH and 0.1% Tween™ 20 detergent.

Wash and resuspend the Dynabeads™ MyOne™ Streptavidin C1 Beads

- Vortex the tube containing the Dynabeads™ MyOne™ Streptavidin C1 Beads for 30 seconds to resuspend the beads thoroughly, then *immediately* proceed to the next step.
- Transfer 100 µL of Dynabeads™ MyOne™ Streptavidin C1 Beads to a new 1.5-mL Eppendorf DNA LoBind™ Tube.
Note: If you are preparing MyOne™ Streptavidin C1 Beads for more than one sample, use a separate 1.5-mL Eppendorf DNA LoBind™ Tube for each sample.
- Place the tube on a magnet such as a DynaMag™-2 magnet for 2 minutes, then remove and discard the supernatant without disturbing the pellet of Dynabeads™ MyOne™ Streptavidin C1 Beads.

4. Add 1 mL of Ion OneTouch™ Wash Solution to the aliquot of Dynabeads™ MyOne™ Streptavidin C1 Beads.
5. Remove the tube from the magnet, vortex the tube for 30 seconds, then centrifuge the tube for 2 seconds.
6. Place the tube on a magnet such as a DynaMag™-2 magnet for 2 minutes, then remove and discard the supernatant.
7. Add 130 µL of MyOne™ Beads Capture Solution to the Dynabeads™ MyOne™ Streptavidin C1 Beads.

Note: You add the resuspended Dynabeads™ MyOne™ Streptavidin C1 Beads in the 130-µL MyOne™ Beads Capture Solution to Well 2 of the 8-well strip.

8. Remove the tube from the magnet, vortex the tube for 30 seconds, then centrifuge the tube for 2 seconds.

Fill the 8-well strip

1. Ensure that the template-positive ISPs from the Ion OneTouch™ 2 Instrument are in 100 µL of ISP Resuspension Solution. If the template-positive ISPs were stored in 1-mL Nuclease-free Water at 2°C to 8°C, follow the washing procedure for ISPs (see “Wash the template-positive ISPs” on page 40).
2. Ensure that the square-shaped tab of the 8-well strip is on the *left*.

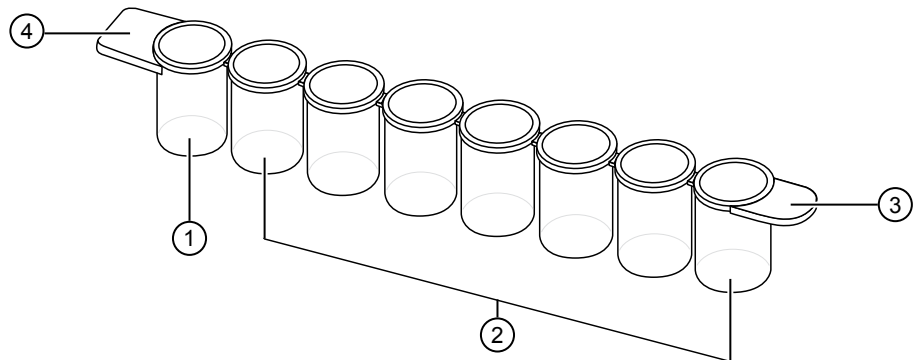

- ① Well 1
- ② Wells 2–8
- ③ Rounded tab
- ④ Square-shaped tab

3. Pipet the ISPs up and down 10 times to mix, then transfer the entire volume (100 µL) of resuspended ISPs in ISP Resuspension Solution (see step 1) into Well 1 of the 8-well strip.

4. Fill the remaining wells in the 8-well strip as described in the following table (see the figure in step 5).

Well number	Reagent to dispense in well
Well 1 ^[1]	Entire template-positive ISP sample (100 µL; prepared in step 1)
Well 2	130 µL of Dynabeads™ MyOne™ Streptavidin C1 Beads resuspended in MyOne™ Beads Capture Solution (prepared in “Wash and resuspend the Dynabeads™ MyOne™ Streptavidin C1 Beads” on page 46)
Well 3	300 µL of Ion OneTouch™ ES Wash Solution
Well 4	300 µL of Ion OneTouch™ ES Wash Solution
Well 5	300 µL of Ion OneTouch™ ES Wash Solution
Well 6	Empty
Well 7	300 µL of freshly prepared Melt-Off Solution [prepared in “Prepare Melt-Off Solution” on page 46]
Well 8	Empty

^[1] Well nearest to the square-shaped tab

5. Confirm that the square-shaped tab is on the left, then insert the filled 8-well strip with the 8-well strip pushed all the way to the right end of the slot of the Ion OneTouch™ ES Instrument tray.

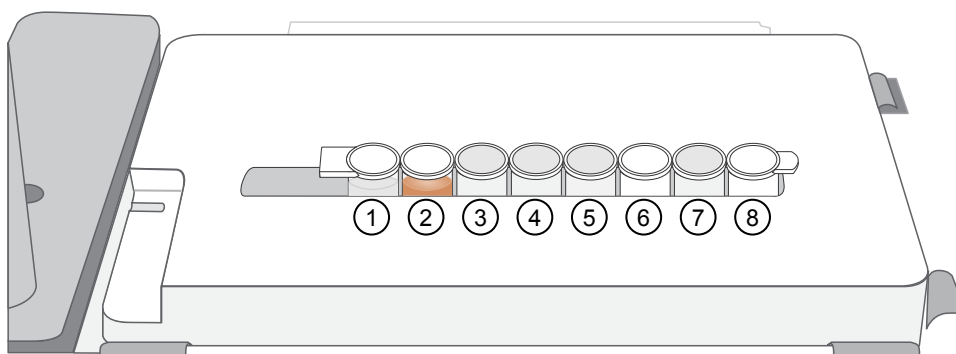

Prepare the Ion OneTouch™ ES

Before every enrichment performed on the Ion OneTouch™ ES Instrument, install a new PCR collection tube and a new Eppendorf™ LoRetention Dualfilter P300 pipette tip.

1. Insert an open 0.2-mL PCR tube into the hole in the base of the Tip Loader, as shown in the figure in step 3.
2. Place a new tip in the Tip Loader. Remove the Tip Arm from the cradle, then align the metal fitting of the Tip Arm with the tip.

3. Keeping the fitting on the Tip Arm vertical, firmly press the Tip Arm down onto the new tip until the Tip Arm meets the Tip Loader. Hold the Tip Arm to the Tip Loader for ~1 second to ensure proper installation of the tip.

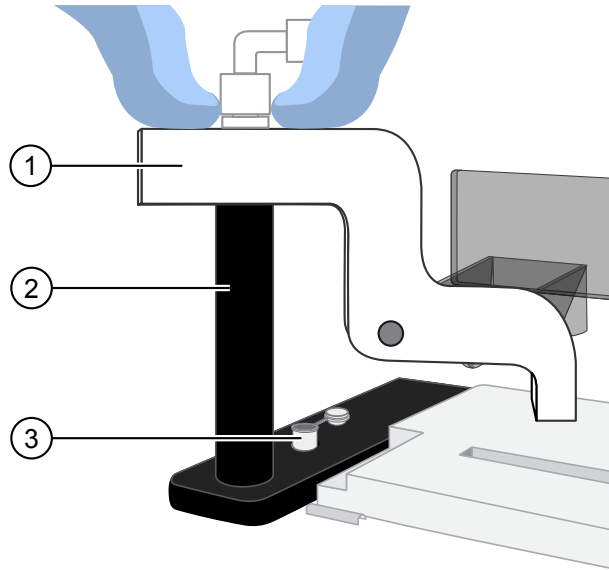

- ① Tip Arm
- ② Tip Loader
- ③ 0.2-mL PCR collection tube

4. Lift the Tip Arm *straight* up to pull the installed tip from the Tip Loader tube.
5. Return the Tip Arm to the cradle.
 - a. Tilt the Tip Arm back (below left), then align the pins with the round notches in the cradle (below center).
 - b. Lower the Tip Arm into position (below center).
 - c. Move the Tip Arm forward into the working position (below right).

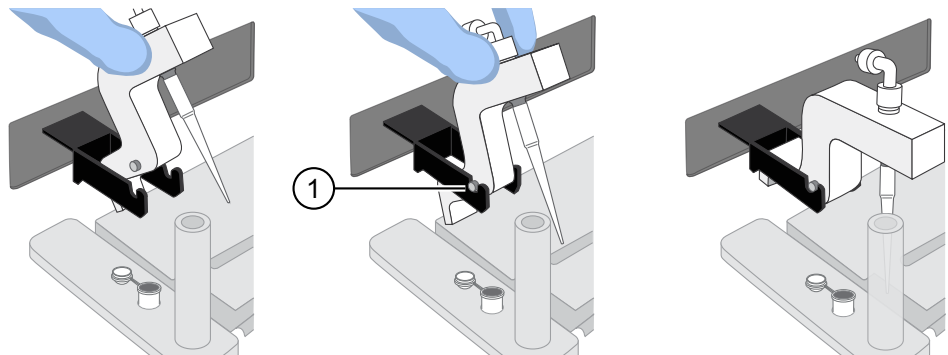

- ① Tip Arm pins resting in the notches in the cradle

IMPORTANT! Ensure that the back/bottom end of the Tip Arm is not resting on top of the thumb screw, causing the Tip Arm to tilt forward.

Perform the run

Before starting the run, confirm that the following criteria are met:

- A new tip and an open 0.2-mL PCR tube are loaded in the Ion OneTouch™ ES Instrument, and the 8-well strip is correctly loaded.
 - Well 1 (ISP sample) is the left-most well and the 8-well strip is pushed to the right-most position in the slot.
1. Pipet the contents of Well 2 up and down to resuspend the beads before starting the run. Do not introduce bubbles into the solution.
 2. If needed, power on the Ion OneTouch™ ES Instrument, then wait for the instrument to initialize. The screen displays **rdy**. The Tip Arm performs a series of initialization movements and returns to the home position (~5 seconds).
 3. Tap **Start/Stop**. The screen displays **run** during the run. The run takes ~35 minutes.

IMPORTANT! Remove the enriched ISPs ≤15 minutes after the end of the run. Evaporation and prolonged exposure to the Melt-Off solution can cause ISP and DNA damage. Do not leave the enriched ISPs in Melt-Off solution overnight.

Note: To stop a run, tap **Start/Stop**. The instrument completes the current step, then stops the run and displays **End**. Tap **Start/Stop** again to return the Tip Arm to the home position. It is not possible to restart (where you left off) after stopping a run.

4. At the end of the run, the instrument displays **End** and beeps every 60 seconds. Tap the **Start/Stop** button to silence this alarm, then reset the Ion OneTouch™ ES Instrument for the next run. The instrument can be left on between runs.
5. Immediately after the run, securely close, then remove the PCR tube containing the enriched ISPs.

Note: Ensure that the 0.2-mL PCR tube has >200 µL of solution containing the enriched ISPs. After a successful run on the instrument, the sample is in ~220 µL of Melt-Off Solution and Ion OneTouch™ Wash Solution. If the tube has <<200 µL of solution containing the enriched ISPs, contact Technical Support.

6. Remove the used tip: with the Tip Arm in its cradle, twist the tip counterclockwise (as viewed from above), then pull it downward to remove and discard the tip.

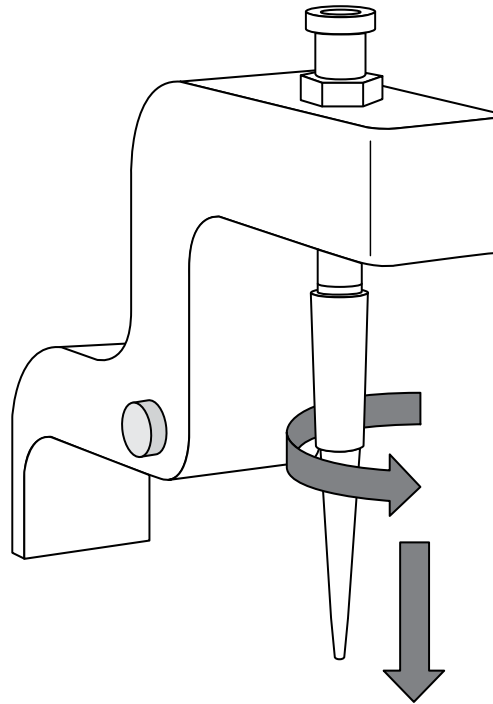

IMPORTANT! Improper removal of tips can loosen the metal tip adapter fitting on the Tip Arm and affect instrument operation.

7. Remove, then discard the used 8-well strip.

Proceed immediately to “Remove and wash the enriched ISPs” on page 52.

Remove and wash the enriched ISPs

1. Centrifuge the 0.2-mL PCR tube containing the enriched ISPs at $15,500 \times g$ for 5 minutes.
2. Remove all but $\sim 10 \mu\text{L}$ of supernatant without disturbing the pellet, then add $200 \mu\text{L}$ of Nuclease-free Water.
3. Pipet the solution up and down 10 times to resuspend the pellet. The pellet can be difficult to see.
4. Centrifuge the 0.2-mL PCR tube at $15,500 \times g$ for 5 minutes.
5. Check for Dynabeads™ MyOne™ Streptavidin C1 Beads (a brown-tinted pellet) at the bottom of the centrifuged tube.

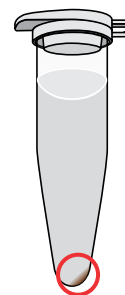

Are Dynabeads™ MyOne™ Streptavidin C1 Beads (brown pellet) present?	Action
No	<ol style="list-style-type: none"> 1. Remove all but $\sim 10 \mu\text{L}$ of supernatant without disturbing the pellet. 2. Add sufficient Nuclease-free Water for a final volume of $100 \mu\text{L}$. 3. Pipet up and down 10 times to resuspend the pellet. 4. Sequence or store the template-positive ISPs. <ul style="list-style-type: none"> • Proceed to Chapter 6, "Initialize the sequencer" <i>or</i> • Store the enriched ISPs at 2°C to 8°C for up to 3 days.
Yes	<ol style="list-style-type: none"> 1. Pipet up and down 10 times to resuspend the pellet. 2. Place the 0.2-mL PCR tube against a magnet such as a DynaMag™ -2 magnet for 4 minutes. 3. Transfer the supernatant to a new 0.2-mL PCR tube without disturbing the pellet of Dynabeads™ MyOne™ Streptavidin C1 Magnetic Beads. 4. Centrifuge the supernatant at $15,500 \times g$ for 5 minutes. 5. Remove all but $\sim 10 \mu\text{L}$ of supernatant without disturbing the pellet. 6. Add sufficient Nuclease-free Water for a final volume of $100 \mu\text{L}$. 7. Pipet up and down 10 times to resuspend the pellet. 8. Sequence or store the template-positive ISPs. <ul style="list-style-type: none"> • Proceed to Chapter 6, "Initialize the sequencer" <i>or</i> • Store the enriched ISPs at 2°C to 8°C for up to 3 days.

***(Optional)* Perform enriched ISP quality control**

You can determine the appropriate library dilution and/or the enrichment efficiency by using the Guava™ easyCyte 5 Benchtop Flow Cytometer. Transfer a 2.0-μL aliquot of the enriched ISPs to a 1.5-mL Eppendorf LoBind™ Tube. For more information, see the *Ion Sphere™ Particles Quality Assessment Using the Guava™ easyCyte 5 Benchtop Flow Cytometer User Bulletin* (Pub. No. MAN0007496), available at **thermofisher.com**.

6

Initialize the sequencer

- Ion S5™/Ion GeneStudio™ S5 Systems component positions 54
- Before you begin 55
- When a manual cleaning of the sequencer is required 55
- Initialize the sequencer 56

Initialization takes ~50 minutes.

Ion S5™ /Ion GeneStudio™ S5 Systems component positions



- ① Touchscreen
- ② Power button
- ③ Ion S5™ Sequencing Reagents cartridge
- ④ Chip clamp
- ⑤ Ion S5™ Wash Solution bottle. Waste reservoir located behind the Ion S5™ Wash Solution bottle (shown on the right).
- ⑥ Ion S5™ Cleaning Solution bottle
- ⑦ Waste reservoir

Note:

- The system uses RFID technology to verify that the proper reagents are loaded in positions 3, 5, and 6. Reagents that exceed their expiration date or usage count generate an error message prompting the user to replace the reagent before performing the run.
- RFID regulatory information can be found on the main screen under **Options ▶ Regulatory info.**

Before you begin

The Ion S5™ Sequencer, Ion S5™ XL Sequencer, and Ion GeneStudio™ S5 Series Sequencer are equipped to verify the compatibility of each chip and consumable that is loaded during initialization and sequencing, and that these components do not exceed their expiration date. To avoid exceptions during initialization, inspect this information for each consumable before installing onto the instrument.

- Unbox the Ion S5™ Sequencing Reagents cartridge 45 minutes before use, then allow it to equilibrate to room temperature.
Do not remove the Ion S5™ Sequencing Reagents cartridge from its packaging until immediately before loading, so that you can return the unused cartridge to storage if your sequencing run is delayed.
- Unbox the W2 Solution bottle. Invert the bottle 5 times within its vacuum-sealed bag, then swirl at an angle to mix thoroughly.
- Remove the W2 Solution bottle from its vacuum-sealed bag, then remove the red cap from the W2 Solution and Ion S5™ Cleaning Solution bottles immediately before installing on the instrument.

When a manual cleaning of the sequencer is required

The Ion S5™ Sequencer, Ion S5™ XL Sequencer, and Ion GeneStudio™ S5 Series Sequencer require that a cleaning be performed before initialization. Cleaning is normally performed automatically at the completion of the previous sequencing run. When two sequencing runs are performed on a single initialization, the post-run cleaning is performed after the second sequencing run. However, if the "Enable post-run clean" checkbox (see "Start the sequencing run") is deselected to allow a second run, and a second run is not performed, the instrument will not allow the subsequent initialization to proceed until a manual cleaning has been performed. See "Perform a manual cleaning of the sequencer" on page 75 for more information on how to perform a manual cleaning.

If the sequencer is initialized and a sequencing run is not started within 24 hours, or a run is not started or completed due to a power failure or an abort, do not perform a manual cleaning. An instrument reset run is required before reinitialization. See "Perform an instrument reset run with an initialized, unused Ion S5™ Sequencing Reagents cartridge" on page 76 for more information.

Initialize the sequencer

1. In the instrument touchscreen main menu, tap **Initialize**.



The door, chip, and Reagent cartridge clamps unlock.

2. When prompted, remove the W2 Solution bottle to access the waste reservoir, then remove and empty the waste reservoir.
3. Reinstall the empty waste reservoir.
4. Replace the expended Ion S5™ Sequencing Reagents cartridge with a new cartridge equilibrated to room temperature.
5. Ensure the new W2 Solution bottle is thoroughly mixed. Then remove the red cap and install.

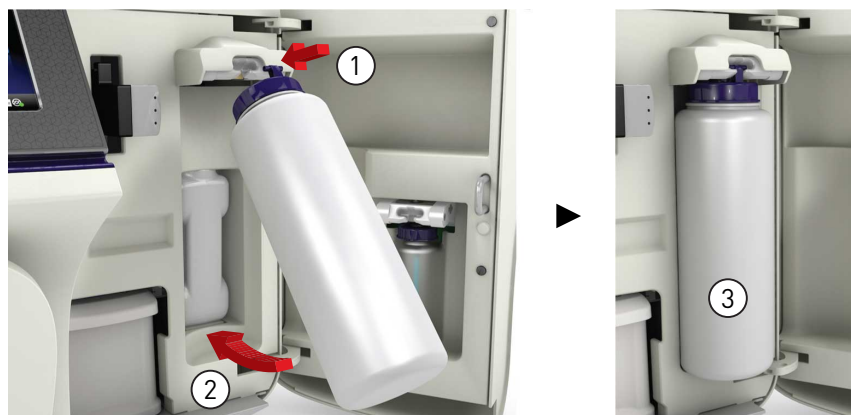

6. Ensure that the used sequencing chip from the previous run is properly seated in the chip clamp and the chip clamp is pushed in all the way.

7. If necessary, install a new Ion S5™ Cleaning Solution bottle.

Note: The Ion S5™ Cleaning Solution bottle contains sufficient reagent to complete 4 cleanings.

8. Close the door, then tap **Next**.

The instrument confirms that the consumables and chip are properly installed and that the Ion S5™ Cleaning Solution contains sufficient reagent to perform the post-run clean. Follow all on-screen recommendations to ensure proper installation of required consumables.

IMPORTANT! If the allowed number of post-run cleans has been met, the instrument prompts the user to replace the Ion S5™ Cleaning Solution bottle.

Note: If a **Checking Reagent: Failed** warning appears, see “Bottle leak check fails” on page 74.

9. When initialization is complete (~50 minutes), tap **Home**.

The instrument is now ready for a sequencing run.

See “Reagent consumables disposal” on page 67 for information on recycling and disposal of used components.



Load the Ion 540™ Chip

■ Materials required	58
■ Before you begin	59
■ Chip loading guidelines	60
■ Prepare the template-positive ISPs for sequencing	61
■ Load the sequencing chip	62

Materials required

Materials provided in the Ion 540™ Loading Reagents OT2 Kit (Part No. A27897)

- Ion S5™ Annealing Buffer
- Ion S5™ Foaming Solution
- Ion S5™ Loading Buffer
- Ion S5™ Sequencing Polymerase
- Ion S5™ Sequencing Primer
- Ion 540™ Control Ion Spheres

Other Materials and Equipment:

- Ion 540™ Chip Kit (Cat. No. A27766)
- Enriched template-positive Ion Sphere™ Particles prepared with the Ion 540™ Kit – OT2 (Cat. No. A27753)
- Rainin™ Pipet-Lite™ XLS LTS with RFID pipette and tips
- P200 and P10 pipette and filtered tips
- Vortex mixer
- Molecular-biology grade nuclease-free water
- Thermal cycler with heated lid (programmed at 95°C for 2 minutes and 37°C for 2 minutes)
- Ion Chip™ Minifuge (Cat. No. 4479672 or 4479673) equipped with Minifuge Proton Rotor and Bucket (Cat. No. 4482578)

Before you begin

IMPORTANT! Use enriched, template-positive Ion Sphere™ Particles prepared using the Ion 540™ Kit – OT2.

IMPORTANT! For best results, begin your run within 4 hours after initialization completes.

- Thaw the Sequencing Primer on ice.
- Before first use, thaw the Ion S5™ Annealing Buffer, Ion S5™ Foaming Solution, and Ion S5™ Loading Buffer at room temperature.

IMPORTANT! Do *not* refreeze. After thawing, store at room temperature.

- Prepare the following stock solutions fresh weekly or as needed:
 - **50% Annealing Buffer.** In a 1.5-mL tube, combine 0.5 mL Ion S5™ Annealing Buffer with 0.5 mL of nuclease-free water (you need 519 µL of 50% Annealing Buffer for each run).
 - **Flushing solution.** In a 1.5-mL tube, combine 0.25 mL of 100% isopropanol with 0.25 mL of Ion S5™ Annealing Buffer (for use in “Flush the chip and load the Ion S5™ Sequencing Polymerase”; you need 200 µL of Flushing solution for each run).

Note: You can prepare multiple 1-mL aliquots of stock solutions and store at room temperature. After opening an aliquot, use the contents within 1 week. Discard any opened, unused solution after 1 week.

- Check for updates to the Torrent Suite™ Software and sequencer instrument software, and install the updates if available.
- Before using the Ion Chip™ Minifuge for the first time, set up and test the Ion Chip™ Minifuge (see the *Ion S5™ and Ion S5™ XL Instrument User Guide* (Pub. No. MAN0010811), or the *Ion GeneStudio™ S5 Instrument User Guide* (Pub. No. MAN0017528)).

Chip loading guidelines

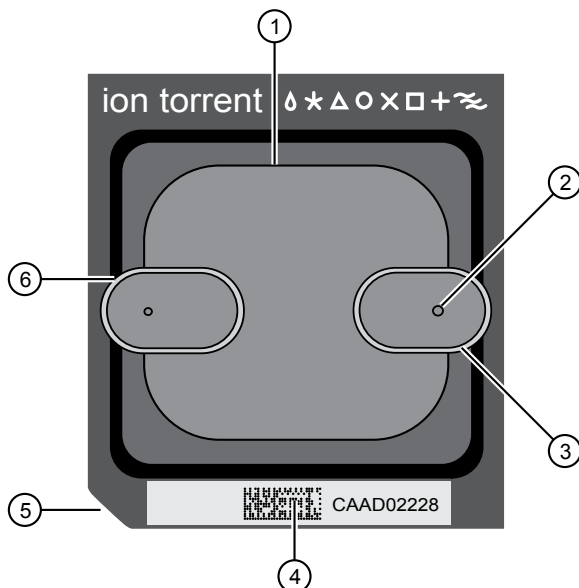

Ion 540™ Chip

① Flow cell

② Loading port

③ Loading well

④ Barcode

⑤ Chip notch

⑥ Exit well

Guidelines for successful sample loading:

- Place the chip on a flat, stable surface such as a benchtop.
- Pipet the sample into the chip loading well.

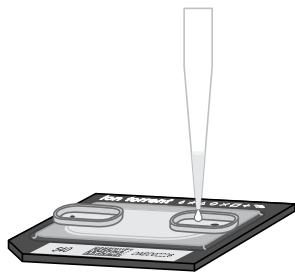

Guidelines for successful injection of reagents or buffers:

- Place the chip on a flat, stable surface such as a benchtop.
- With the pipette tip at a 90° angle to the chip, press the tip firmly into the circular loading port, and apply gentle pressure between the pipette tip and chip.

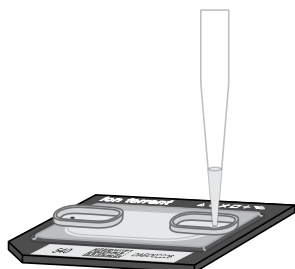

- Pipet carefully to avoid introducing bubbles into the chip flow cell (see example with introduced air bubbles).
- After each injection, remove the expelled liquid from the exit well, opposite the loading well.

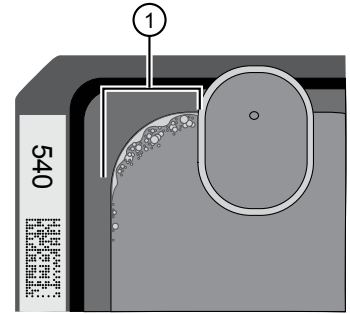

① Air bubbles

Prepare the template-positive ISPs for sequencing

Add Control Ion Sphere™ Particles to the enriched ISPs

IMPORTANT! If you are performing an installation or troubleshooting run, do not use enriched ISPs. Refer to "Troubleshooting using Control Ion Sphere™ Particles" in *Ion OneTouch™ 2 System User Guide* (Pub. No. MAN0014388) to prepare the Ion 540™ Control Ion Spheres for the installation or troubleshooting run.

IMPORTANT! Ensure that you use the correct Control Ion Sphere™ Particles for the chip type being used.

1. Vortex the Control Ion Sphere™ Particles for 5 seconds, then centrifuge for 2 seconds before taking aliquots.
2. Add 5 µL of Control Ion Sphere™ Particles directly to the entire volume of enriched, template-positive ISPs in a 0.2-mL PCR tube (non-polystyrene), then pipet up and down to mix.

Anneal Sequencing Primer to the enriched ISPs

Note: The Ion 540™ ISPs are difficult to see. To avoid aspirating the particles in the following steps, orient the PCR tube the same way each time when centrifuging so that it is easy to know where the pellet has formed, and remove the supernatant from the top down.

1. Centrifuge the enriched, template-positive ISPs for 5 minutes at $15,500 \times g$.
2. Carefully remove the supernatant without disturbing the pellet, leaving 10 µL of supernatant in the tube (visually compare to 10 µL of liquid in a separate tube).
3. Add 15 µL of Ion S5™ Annealing Buffer for a total volume of 25 µL.
4. Add 20 µL of Ion S5™ Sequencing Primer, then confirm that the total volume is 45 µL. Add Ion S5™ Annealing Buffer if needed to bring the total volume to 45 µL.
5. Briefly vortex to mix, then centrifuge briefly to collect the contents at the bottom of the tube.
6. Program a thermal cycler for 95°C for 2 minutes and then 37°C for 2 minutes, using the heated lid option.

7. Place the tube in the thermal cycler, then run the program.
8. After cycling, add 10 μL of Ion S5™ Loading Buffer, briefly vortex to mix, then centrifuge briefly to collect the contents at the bottom of the tube.

Load the sequencing chip

Load the sample on the chip

We recommend performing chip loading while the sequencer is initializing. By loading the chip while the sequencer initializes, you ensure that the chip can be sequenced as soon as possible after loading is complete. See “Initialize the sequencer” on page 56 for more information.

1. Place the Ion 540™ Chip on a flat, stable surface.
2. Dispense the entire prepared sample (55 μL) into the chip loading well (not the chip loading port) of the chip.

Note: Some sample will enter the flow cell at this point by capillary action; the remaining sample will be loaded into the flow cell by centrifugation.
3. Transfer the chip to a bucket in the Ion Chip™ Minifuge with the chip notch pointing **out**, away from the center of the minifuge. Place a used chip in the opposite bucket with the chip notch also pointing out.
4. Centrifuge for 10 minutes.
5. In a 1.5-mL tube, combine 49 μL of 50% Annealing Buffer with 1 μL of Foaming Solution (10% Triton™ X-100 solution).

Note: You can prepare a bulk mixture by combining 4.9 mL of 50% Annealing Buffer with 100 μL of Foaming Solution. The mix can be stored at 4°C and used for up to 6 months.
6. Create foam by injecting air into the 50- μL mixture from the previous step using a Rainin™ SR-L200F pipette set to dispense 100 μL . Next, break the large bubbles into smaller bubbles by rapidly pipetting for ~5 seconds. Repeat this step one more time.

Note: Do not over-inject the air; the final volume of foam should be approximately 250 μL .

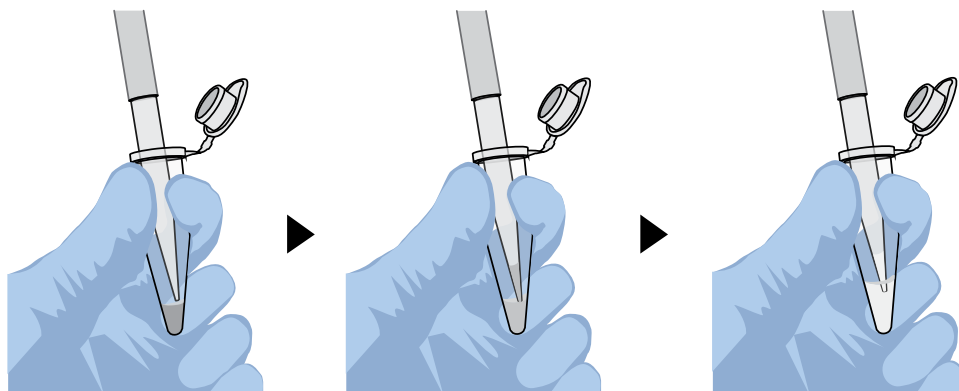

7. Place the chip on a stable surface, such as a benchtop, then inject 100 µL of foam into the chip loading port. Remove the expelled liquid from the opposite port.
8. Dispense 55 µL of 50% Annealing buffer into the chip loading well (not the chip loading port).
9. Place the chip back in the minifuge with the chip notch pointing out, and centrifuge for 30 seconds.
10. Place the chip on a stable surface, such as a benchtop. Remove the liquid that has accumulated in both of the chip wells.
11. Briefly "re-foam" the foam sample by pipetting rapidly for ~5 seconds, then inject 100 µL of foam into the chip loading port. Remove the expelled liquid from the opposite port.
12. Dispense 55 µL of 50% Annealing buffer into the chip loading well (not the chip loading port).
13. Place the chip back in the minifuge with the chip notch pointing out, then centrifuge for 30 seconds. Proceed to "Flush the chip and load the Ion S5™ Sequencing Polymerase".

**Flush the chip and
load the Ion S5™
Sequencing
Polymerase**

1. Inject 100 µL of the Flushing solution into the chip loading port 2 times. After each injection, discard the solution that is expelled from the opposite port.
2. Inject 100 µL of 50% Annealing Buffer into the chip loading port 3 times. Do not introduce air bubbles. After each injection, remove the expelled liquid from the opposite port.
3. Combine 6 µL of Ion S5™ Sequencing Polymerase with 60 µL of 50% Annealing buffer.
4. Inject 65 µL of the polymerase solution into the chip loading port and remove the expelled liquid from the exit port. Be careful to avoid introducing air bubbles.
5. Allow the chip to incubate for 5 minutes, then immediately proceed to "Start the sequencing run".

Start the sequencing run

- Chip handling guidelines 64
- Start the sequencing run 65
- Maintain the sequencer 67
- Reagent consumables disposal 67

Chip handling guidelines

To place a chip in the chip clamp, perform the steps that are described in the following figure:

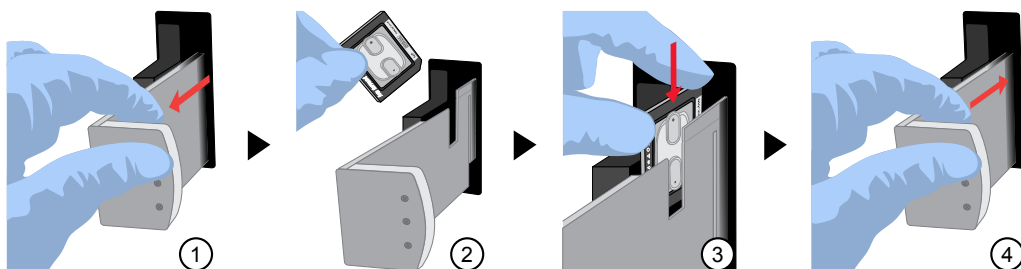

- ① Slide the chip clamp out.
- ② Remove the chip currently in the clamp.
- ③ Place the appropriate loaded chip in the chip clamp with the chip notch in the bottom-front corner.

Note: Do not force the chip into the clamp. If the chip does not fit easily in the clamp, confirm that the notch is oriented as shown in the drawing.

- ④ Slide the metal tab in fully to engage the clamp, then close the instrument door.

Start the sequencing run

We recommend that you start a sequencing run as soon as possible after chip loading and instrument initialization are complete. However, successful sequencing runs can be started up to 24 hours after instrument initialization.

IMPORTANT! Do *not* press the power button during a run. Interrupting power to the instrument during a run can result in sequencing run failure and loss of sample.

1. After completion of initialization, tap **Run** in the instrument touchscreen. The door and chip clamp unlock.
2. Remove the used sequencing chip, then secure a chip loaded with template-positive Ion Sphere™ Particles in the chip clamp.
3. Push the chip clamp all the way in to engage, close the instrument door, then tap **Next**.

Note: Do not remove the chip from the chip clamp until completion of the run. Removing and reinserting the chip risks introducing air bubbles in the chip.

4. In the dropdown list, select the Planned Run that you created in the Torrent Suite™ Software. If this run is the first of two sequencing runs on this initialization, **deselect** the **Enable post-run clean** checkbox, then tap **Review**.

Note: You can also select **Planned Run (none)**, then enter your run information on the following screen. We recommend selecting a predefined Planned Run.

IMPORTANT!

- Failure to deselect the checkbox results in a cleaning performed automatically after the first run. A second run is not available.
 - When starting the second sequencing run on a single initialization, ensure that the **Enable post-run clean** checkbox is selected so that the post-run cleaning is performed automatically.
-

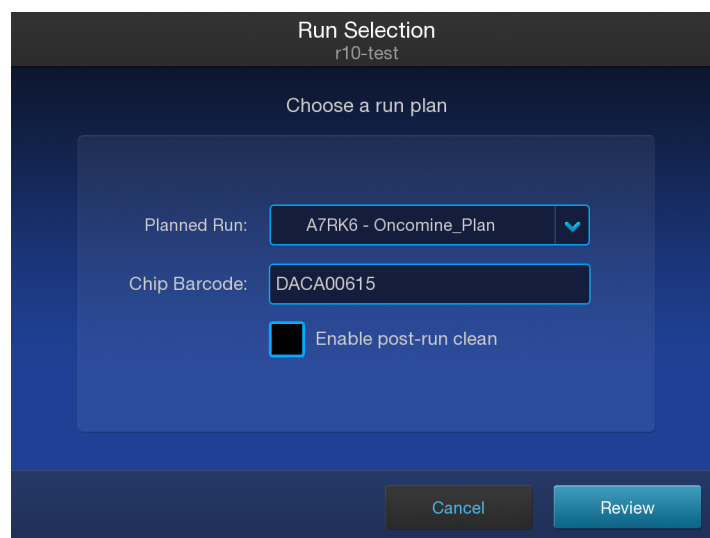

Run Selection
r10-test

Choose a run plan

Planned Run: A7RK6 - Oncomine_Plan

Chip Barcode: DACA00615

Enable post-run clean

Cancel Review

5. Confirm that the pre-populated settings are correct, or tap **Edit** to make changes if needed.

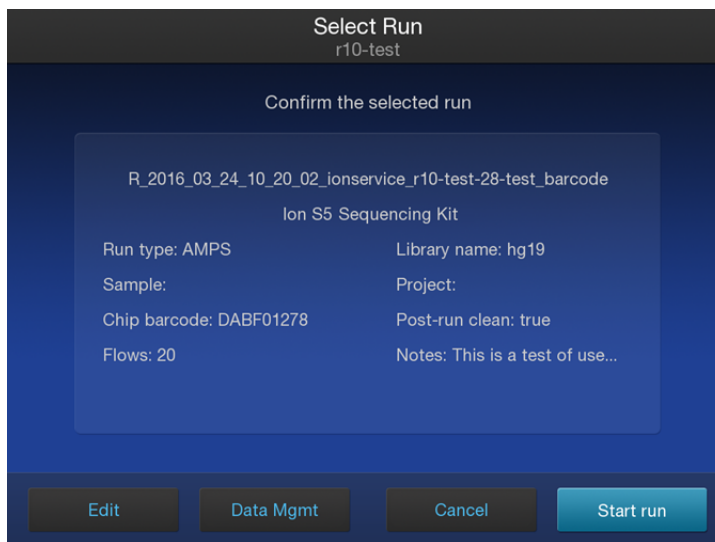

6. Confirm that the instrument door is closed, then tap **Start run** to begin the sequencing run.

IMPORTANT! During a run, do not open the instrument door, and avoid touching the instrument. Touching the instrument during the sequencing run can reduce the quality of the measurements.

When the sequencing run is complete, the instrument automatically performs the cleaning procedure unless the **Enable post-run clean** checkbox was deselected. After cleaning, the touchscreen returns to the main menu. Use Torrent Suite™ Software to review the results.

If you are sequencing a second chip on a single initialization, start the second run within 24 hours of start of initialization.

Maintain the sequencer

- Materials required**
- Lint-free wipes
 - 70% isopropanol
 - (Optional) 10% bleach solution

Clean or decontaminate the sequencer

In the event of a spill or leak on or inside the instrument, perform the following steps.

Note: Dispose of all waste in appropriate liquid or solid waste containers.

1. Remove the W2 Solution bottle, then remove and empty the waste reservoir.
2. Remove the Ion S5™ Sequencing Reagents cartridge.
3. Inspect the waste and nucleotide reagent bays for liquid.
4. Using absorbent paper soak up as much liquid as possible, then wash the affected area with 10% bleach solution.
5. Wipe the affected surfaces with 70% isopropanol, then allow to air-dry.

Reagent consumables disposal

IMPORTANT! Follow all applicable local, state/provincial, and/or national regulations when recycling or disposing of Ion S5™ reagent consumables.

CO₂ scrubber removal and disposal

To properly dispose of the CO₂ scrubber, you must first remove it from the Ion S5™ Sequencing Reagents cartridge.

1. Invert the Ion S5™ Sequencing Reagents cartridge over an appropriate receptacle to drain all residual liquid.
2. Wearing gloves, insert the Ion S5™ Cartridge Tool firmly into the CO₂ scrubber until the flange stops on the top of the cartridge.

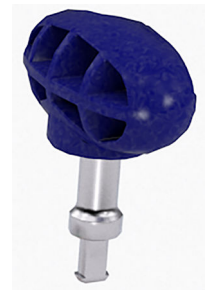

Ion S5™ Cartridge Tool

3. Pull straight up on the tool while holding the nucleotide reagent cartridge down.



4. Remove the scrubber from the cartridge tool, then dispose of the scrubber according to applicable hazardous waste regulations.

The remaining nucleotide reagent cartridge should be disposed of appropriately.

Recycle Ion S5™ Wash Solution and Ion S5™ Cleaning Solution bottles

The Ion S5™ Wash Solution and Ion S5™ Cleaning Solution bottles are made of recyclable plastic.

1. Open the expended bottle by unscrewing the cap.
2. Remove the cap, sipper, and filter, then pour any residual liquid into an appropriate receptacle.
3. Rinse the empty bottle with water. Pour out the rinse water into the same liquid waste receptacle.
4. Recycle or dispose of the clean bottle, cap, sipper, and filter according to applicable regulations.



Troubleshooting

- Ion OneTouch™ 2 Instrument 69
- Ion OneTouch™ ES 71
- Ion S5™/Ion GeneStudio™ S5 Systems setup and operation 73
- Ion Sphere™ Assay troubleshooting table 74

Ion OneTouch™ 2 Instrument

Observation	Possible cause	Recommended action
Disposable injector remains in "down" position in the Ion OneTouch™ DL Injector Hub	Reagent has built up around Injector Hub.	Clean any excess reagent from Injector Hub with moistened Kimwipes™ wipe.
	Newly installed Injector Hub does not move freely.	<ol style="list-style-type: none"> 1. <i>Gently</i> pull from the top of the disposable injector until the disposable injector just returns to the "up" position in the Injector Hub. 2. Briefly press then release the spring-loaded top of the Injector Hub 5– 10 times at the point indicated by the arrow. You should hear a click. 3. If the Injector Hub remains in the "down" position, repeat step 2 once (up to 10 more clicks). <p>Note: If the Injector Hub still does not move freely and click up into place, contact Technical Support.</p>

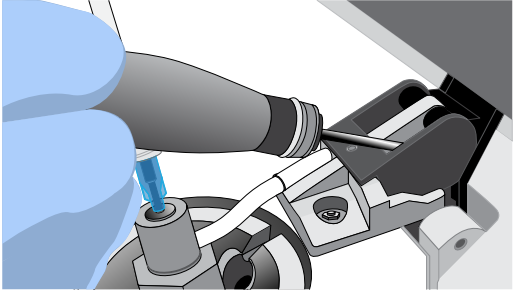
Observation	Possible cause	Recommended action
Centrifuge lid does not open	<ul style="list-style-type: none"> • A power failure occurred. • A software crash occurred. 	<ol style="list-style-type: none"> 1. Slide a 1/8-inch L-wrench (hex wrench) or equivalent tool into the right hole and along the top edge of the centrifuge hinge.  <ol style="list-style-type: none"> 2. Push the tool into the hole until there is a slight compression of the tool against the instrument and the centrifuge lid unlocks and opens. 3. Remove the tool from the hole, then open the lid. 4. If necessary, troubleshoot the lid lock, then use the instrument normally. Do <i>not</i> force the lid open.
The run fails	Various causes are possible.	<p>Retrieve the log files. See the <i>Ion OneTouch™ 2 System User Guide</i> (Pub. No. MAN0014388) for the procedure.</p> <p>IMPORTANT! Do <i>not</i> turn off or power cycle the instrument until the log files are downloaded. If a run fails, contact Technical Support.</p>
Precipitate is visible in the Ion S5™ Reagent Mix after vortexing	Thawed Reagent Mix has been stored at <2°C.	<ol style="list-style-type: none"> 1. Ensure that the solution is fully thawed. 2. Vortex the solution for 30 seconds, then leave the tube at room temperature for 15 minutes. 3. Vortex the solution again at maximum speed for 1 minute. 4. Centrifuge the tube for 30 seconds. 5. Visually inspect the solution at the bottom of the tube and verify that there is no residual precipitate. If precipitate is visible, then repeat steps 1–4. <p>Note: If precipitate is still visible, then contact Technical Support.</p> <ol style="list-style-type: none"> 6. Keep the Reagent Mix at room temperature during use. 7. After use, store the solution at 2°C to 8°C.



Observation	Possible cause	Recommended action
Recovery Tubes filled with gel after run.	Breaking Solution was not added to Recovery Tubes prior to start of run.	<ol style="list-style-type: none"> 1. Add 150 µL Ion OneTouch™ Breaking Solution to each Recovery Tube. 2. Seal the Recovery Tubes with Parafilm™ M film and vigorously invert and vortex the tubes for 10 seconds to break the emulsion. 3. Follow the Final Spin procedure (see “Recover the template-positive Ion Sphere™ Particles” on page 39) to recover the ISPs. Alternatively, transfer samples to two 1.5-mL tubes and spin in an Eppendorf™ centrifuge for 10 minutes at 15,500 × <i>g</i> to pellet the ISPs. 4. Proceed to the ISP washing steps (see “Wash the template-positive ISPs” on page 40). Perform the ISP wash in 1 mL Nuclease-free Water (step 5–step 8) twice.

Ion OneTouch™ ES

For Ion OneTouch™ ES vertical and horizontal axis calibration and residual volume test procedures, see Chapter 3 of the *Ion OneTouch™ 2 System User Guide* (Pub. No. MAN0014388).

Observation	Possible cause	Recommended action
Excessive foaming occurs	<ul style="list-style-type: none"> • Instrument was improperly calibrated resulting in inadequate volume in one or more wells. • Fitting was loose. • Pipette tip was cracked. 	<ol style="list-style-type: none"> 1. Use the recommended volumes for all wells. 2. Ensure that fittings are tight, especially at the elbow fitting, and the pipette tip is not cracked. 3. If necessary, perform the residual volume test. If the residual volume test fails, then calibrate the instrument.
Solution overflows during run	Reagent volumes were overloaded.	Repeat with reagent volumes described in enrichment procedure.
Tip is causing 8-well strip to lift out of Tray slot during run	Tip is not aligned vertically.	Perform vertical calibration procedure, refer to the <i>Ion OneTouch™ 2 System User Guide</i> (Pub. No. MAN0014388).
Percent template-positive ISPs after enrichment is <50% as measured by flow cytometry	Multiple causes are possible.	Contact Technical Support.



Observation	Possible cause	Recommended action
One of the following: <ul style="list-style-type: none">Strip lifts up during strip pushStrip lifts up when tip is raised from wellImmediately after strip push, the strip is not in contact with the magnet	Instrument is not calibrated properly.	<ul style="list-style-type: none">Perform horizontal position calibration.Perform vertical calibration.Perform horizontal position calibration. Refer to the <i>Ion OneTouch™ 2 System User Guide</i> (Pub. No. MAN0014388) for more information.
Tip grinds into base of instrument and Code "1999" displays	<ul style="list-style-type: none">Unit not calibrated properly.Vertical calibration setting too low or out-of-range.	<ol style="list-style-type: none">Erase the memory on the instrument: Hold down the vertical adjust button while powering ON the instrument. The instrument beeps several times.Recalibrate the instrument.Perform a residual volume test. Refer to the <i>Ion OneTouch™ 2 System User Guide</i> (Pub. No. MAN0014388) for more information.
Tip hits the top of the tray at start of run	Tray was not properly seated in the instrument.	Check for debris between the tray and the instrument, then reinstall the tray. Press down firmly to ensure that tray is fully seated in the instrument.
Instrument does not aspirate or dispense liquids	Fitting(s) were loose.	<ul style="list-style-type: none">Ensure that the Luer-Lok™ connections at the elbow on the Tip Arm and at the tubing on the rear syringe pump are finger-tight.Ensure that the metal tip adapter fitting on the Tip Arm is finger-tight. IMPORTANT! After any adjustments to the metal tip adapter, recalibrate the <i>Ion OneTouch™ ES</i> .

Ion S5™ /Ion GeneStudio™ S5 Systems setup and operation

Instrument alarms and events

Observation	Possible cause	Recommended action
<p>Red "Alarms" and/or "Events" message in Main Menu</p>  <p>The screenshot shows the Ion GeneStudio S5 main menu. At the top, it says 'Ion GeneStudio S5'. In the center, there is a large circular button labeled 'Initialize'. Below this, there are two icons: a red circle labeled 'Alarms' and a gear labeled 'Settings'. At the bottom, there is a status bar with several indicators: a signal strength icon, a battery icon, and numerical values for pressure (-0.12 psi, 11.89 psi), temperature (27.00 °C, 28.22 °C), and battery level (81%, 19%).</p>	<ul style="list-style-type: none"> • Available software updates were detected. • Connectivity issues were detected. • Instrument did not detect required files or hardware. 	<p>Tap the red Alarms icon to see detailed messages.</p> <ul style="list-style-type: none"> • If a message states "Newer Software Available": <ul style="list-style-type: none"> IMPORTANT! After updates are installed, the instrument must be restarted. <ol style="list-style-type: none"> a. In the main menu, tap Settings ▶ Check for Updates. b. Select the Released Updates checkbox, then tap Update. c. When installation is complete, follow the onscreen prompts to restart the instrument. <p>Note: In some cases, the instrument restarts automatically after software installation.</p> • If a message states "No Connectivity to Torrent Server", "No Connectivity to ftp server", or "Network Manager not connected", disconnect and re-connect the ethernet cable, confirm that the router is operational, and verify that the network is up and running. • For any other messages: <ol style="list-style-type: none"> a. Power off the instrument: On the home screen, tap Settings ▶ System Tools ▶ Shut Down ▶ Shut Down. b. Wait 30 seconds, then press the button on the side of the instrument to power on the instrument. • If the red "Alarms" and/or "Events" message still appears in the main menu, contact Technical Support.



Initialization— General errors

Observation	Possible cause	Recommended action
Bottle leak check fails	<ul style="list-style-type: none"> Bottle seal was not tight. Bottle was damaged or defective. 	<ol style="list-style-type: none"> Finger-tighten the bottles. If the bottle continues to leak, replace the bottle. If leak check continues to fail, contact Technical Support.

Ion Sphere™ Assay troubleshooting table

The following table contains troubleshooting information for unenriched ISPs tested with the Ion Sphere™ Assay on a Qubit™ Fluorometer.

Qubit™ Fluorometer ^[1] observation	Ion S5™ /Ion GeneStudio™ S5 Systems observation	Possible cause	Recommended action
<10% Templated ISPs	<ul style="list-style-type: none"> Lower loading Lower % enriched Lower key signal Lower throughput 	Too little library input into template preparation.	<ul style="list-style-type: none"> Increase library input to target 10–25% templated ISPs. <p><i>or</i></p> <ul style="list-style-type: none"> Continue with sequencing; expect lower throughput.
>25% Templated ISPs, but <70%	Increased number of filtered out reads	Too much library input into template preparation.	<ul style="list-style-type: none"> Decrease library input to target 10–25% templated ISPs. <p><i>or</i></p> <ul style="list-style-type: none"> Continue with sequencing; expect lower throughput.
>70% Templated ISPs	<ul style="list-style-type: none"> Increased % primer dimer filtered out reads Lower throughput 	Adapter dimer contaminating library, more likely in short amplicon, Ion AmpliSeq™ or miRNA libraries.	<ul style="list-style-type: none"> Check Agilent™ 2100 Bioanalyzer™ traces for adapter dimer peak (Amplicon library or Ion AmpliSeq™ library peak around 70 bp; miRNA library peak around 60bp). Re-purify library using Agencourt™ AMPure™ XP Kit clean-up steps as outlined in the appropriate user guides.
	<ul style="list-style-type: none"> Low loading Low % enriched Lower throughput High % filtered out reads 	Ion OneTouch™ 2 Instrument underperformance	Troubleshoot with Technical Support or a Field Application Scientist.

^[1] Qubit™ 2.0 Fluorometer or later.



Supplemental procedures

- Perform a manual cleaning of the sequencer 75
- Perform an instrument reset run with an initialized, unused Ion S5™ Sequencing Reagents cartridge 76
- Quality control of Ion 540™ ISPs 77

Perform a manual cleaning of the sequencer

A cleaning protocol is normally performed automatically at the completion of each sequencing run. If a cleaning is necessary, perform the following procedure.

1. On the home screen, select **Settings ▶ Clean Instrument**.
The instrument door unlocks allowing access to the consumables.
2. Remove the W2 Solution bottle to access the waste reservoir, then remove and empty the waste reservoir.



3. Reinstall the empty waste reservoir and a *used* W2 Solution bottle.
4. Ensure that the Ion S5™ Sequencing Reagents cartridge and W2 Solution bottle are properly installed.

IMPORTANT! Perform the cleaning with a used reagent cartridge and wash solution bottle installed. The cleaning procedure pumps cleaning solution into the wash solution bottle and reagent cartridge making them unsuitable for sequencing.

5. Place a used sequencing chip in the chip clamp, then push the chip clamp in all the way to engage.

6. Close the instrument door, then tap **Next**.
Cleaning takes ~35 minutes to complete. On completion the instrument door automatically unlocks and the chip and cartridge clamps disengage.
7. Proceed to “Initialize the sequencer” on page 56.

Perform an instrument reset run with an initialized, unused Ion S5™ Sequencing Reagents cartridge

Cleaning is normally automatically performed at completion of a sequencing run. If an Ion S5™ Sequencer, Ion S5™ XL Sequencer, or Ion GeneStudio™ S5 Series Sequencer is initialized and

- a sequencing run is not started within 24 hours after initialization, *or*
- a sequencing run is not completed due to a power failure or an abort, and <200 flows occurred before the stoppage,

then an instrument reset run is required to ensure proper cleaning before reinitialization. Do NOT perform a manual cleaning with an unused, initialized Ion S5™ Sequencing Reagents cartridge.

Note:

- If a power failure or abort occurs during the second of two runs started after a single initialization, a manual cleaning is sufficient (see “Perform a manual cleaning of the sequencer” on page 75).
- If the number of flows that occurred before a power failure or abort is unknown, perform an instrument reset run.

To perform an instrument reset run, use the following procedure before reinitialization.

1. In the instrument touchscreen main menu, tap **Run**.
The instrument door unlocks and the chip clamp disengages.
2. Ensure that a used sequencing chip is in the chip clamp, then push the chip clamp in all the way to engage.
3. Close the instrument door, then tap **Next**.
4. When prompted, select **Planned Run (none)**. Ensure that the **Enable post-run clean** checkbox is selected, then tap **Review**.
5. In the **Select Run** screen, tap **Edit**, then in the **Detail** screen set the number of flows to **200**. Ensure that the **Post-Run/Clean** checkbox is selected, then tap **Close**.
6. Tap **Start run**, then tap **Accept** to confirm that Post-Run Clean is enabled, and to start the run.

When the instrument reset run completes, the instrument automatically performs the cleaning procedure. After cleaning, the touchscreen returns to the main menu.

Quality control of Ion 540™ ISPs

Quality control using the Ion Sphere™ Assay on the Qubit™ Fluorometer

The Qubit™ Fluorometer can be used with the Ion Sphere™ Quality Control Kit (Cat. No. 4468656) to perform a quality assessment of unenriched Ion 540™ ISPs generated for up to 200-base-read sequencing on an Ion S5™ Sequencer, Ion S5™ XL Sequencer, or Ion GeneStudio™ S5 Series Sequencer.

For detailed protocols, see the *Ion Sphere™ Quality Control Kit User Guide* (Pub. No. MAN0017531) available at thermofisher.com.

Note: This protocol supports the Qubit™ 2.0 Fluorometer or later.

Acceptance criteria for unenriched Ion 540™ ISPs

The optimal amount of library corresponds to the library dilution point that gives Percent Templated ISPs between 10–25%.

Samples that fall within the recommended range generally produce the most data; however, samples that fall outside of the recommended range can still meet the throughput specifications on the Ion Chips™.

The recommended optimal range is not intended to be a pass/fail criteria. The range provides guidance for the quality of the sample.

Note: If the results are outside the desired Percent Templated ISPs range, then increase or decrease the library input appropriately. See the “Ion Sphere™ Assay troubleshooting table” on page 74 for more information.

Percent Templated ISPs	Description
<10%	Sample contains an insufficient number of templated ISPs to achieve optimal loading density on the Ion Chip™.
10–25%	Optimal amount of library.
>25%	Sample will yield multi-templated ISPs (mixed reads).

Quality control using the Guava™ easyCyte 5 Benchtop Flow Cytometer

The Guava™ easyCyte 5 Benchtop Flow Cytometer can be used for quality assessment of unenriched and enriched Ion Sphere™ Particles generated for up to 200-base-read sequencing on the Ion S5™/Ion GeneStudio™ S5 Systems. For details, see the *Ion Sphere™ Particles Quality Assessment for the Ion Proton™ and Ion S5™ Systems Using the Guava™ easyCyte 5 Benchtop Flow Cytometer User Bulletin* (Pub. No. MAN0007496), available at thermofisher.com.



Safety

■ Instrument safety	78
■ Chemical safety	79
■ Biological hazard safety	80

 **WARNING! GENERAL SAFETY.** Using this product in a manner not specified in the user documentation may result in personal injury or damage to the instrument or device. Ensure that anyone using this product has received instructions in general safety practices for laboratories and the safety information provided in this document.

- Before using an instrument or device, read and understand the safety information provided in the user documentation provided by the manufacturer of the instrument or device.
 - Before handling chemicals, read and understand all applicable Safety Data Sheets (SDSs) and use appropriate personal protective equipment (gloves, gowns, eye protection, and so on). To obtain SDSs, see the “Documentation and Support” section in this document.
-

Instrument safety

For detailed information on instrument safety symbols and alerts, safety and electromagnetic compatibility standards, and general instrument safety, see the Safety appendices of the *Ion OneTouch™ 2 System User Guide* (Pub. No. MAN0014388), the *Ion S5™ and Ion S5™ XL Instrument User Guide* (Pub. No. MAN0010811), and the *Ion GeneStudio™ S5 Instrument User Guide* (Pub. No. MAN0017528) available at thermofisher.com.



Chemical safety



WARNING! GENERAL CHEMICAL HANDLING. To minimize hazards, ensure laboratory personnel read and practice the general safety guidelines for chemical usage, storage, and waste provided below. Consult the relevant SDS for specific precautions and instructions:

- Read and understand the Safety Data Sheets (SDSs) provided by the chemical manufacturer before you store, handle, or work with any chemicals or hazardous materials. To obtain SDSs, see the “Documentation and Support” section in this document.
 - Minimize contact with chemicals. Wear appropriate personal protective equipment when handling chemicals (for example, safety glasses, gloves, or protective clothing).
 - Minimize the inhalation of chemicals. Do not leave chemical containers open. Use only with adequate ventilation (for example, fume hood).
 - Check regularly for chemical leaks or spills. If a leak or spill occurs, follow the manufacturer's cleanup procedures as recommended in the SDS.
 - Handle chemical wastes in a fume hood.
 - Ensure use of primary and secondary waste containers. (A primary waste container holds the immediate waste. A secondary container contains spills or leaks from the primary container. Both containers must be compatible with the waste material and meet federal, state, and local requirements for container storage.)
 - After emptying a waste container, seal it with the cap provided.
 - Characterize (by analysis if necessary) the waste generated by the particular applications, reagents, and substrates used in your laboratory.
 - Ensure that the waste is stored, transferred, transported, and disposed of according to all local, state/provincial, and/or national regulations.
 - **IMPORTANT!** Radioactive or biohazardous materials may require special handling, and disposal limitations may apply.
-



Biological hazard safety



WARNING! BIOHAZARD. Biological samples such as tissues, body fluids, infectious agents, and blood of humans and other animals have the potential to transmit infectious diseases. Conduct all work in properly equipped facilities with the appropriate safety equipment (for example, physical containment devices). Safety equipment can also include items for personal protection, such as gloves, coats, gowns, shoe covers, boots, respirators, face shields, safety glasses, or goggles. Individuals should be trained according to applicable regulatory and company/ institution requirements before working with potentially biohazardous materials. Follow all applicable local, state/provincial, and/or national regulations. The following references provide general guidelines when handling biological samples in laboratory environment.

- U.S. Department of Health and Human Services, *Biosafety in Microbiological and Biomedical Laboratories (BMBL)*, 5th Edition, HHS Publication No. (CDC) 21-1112, Revised December 2009; found at:
www.cdc.gov/biosafety/publications/bmb15/BMBL.pdf
 - World Health Organization, *Laboratory Biosafety Manual*, 3rd Edition, WHO/CDS/CSR/LYO/2004.11; found at:
www.who.int/csr/resources/publications/biosafety/Biosafety7.pdf
-

Documentation and support

Related documentation

Document	Pub. No.	Description
<i>Ion OneTouch™ 2 System User Guide</i>	MAN0014388	Provides reference information for the installation, setup, and maintenance of the Ion OneTouch™ 2 System.
<i>Ion GeneStudio™ S5 System Site Preparation Guide</i>	MAN0017529	Explains how to prepare your site to receive and install the specified sequencing system. Intended for personnel who schedule, manage, and perform the tasks required to prepare the site for installation of the specified sequencing system.
<i>Ion S5™ and Ion S5™ XL System Site Preparation Guide</i>	MAN0010810	
<i>Ion GeneStudio™ S5 Instrument User Guide</i>	MAN0017528	Provides reference information for use and maintenance of the Ion GeneStudio™ S5 Sequencer, Ion GeneStudio™ S5 Plus Sequencer, and Ion GeneStudio™ S5 Prime Sequencer.
<i>Ion S5™ and Ion S5™ XL Instrument User Guide</i>	MAN0010811	Provides reference information for use and maintenance of the Ion S5™ Sequencer and Ion S5™ XL Sequencer.
<i>Ion Sphere™ Quality Control Kit User Guide</i>	MAN0017531	Provides detailed instructions for how to use the Ion Sphere™ Quality Control Kit to determine the percentage of template-positive ISPs in ISP samples with Qubit™ Fluorometer.
<i>Ion S5™ Controls Kit Plus Product Information Sheet</i>	MAN0016206	Provides contents and storage information for the Ion S5™ Controls Kit Plus, and includes usage recommendation for each kit component.
<i>Torrent Suite™ Software 5.10 User Guide</i>	MAN0017598	Describes the Torrent Suite™ Software and provides general instruction for viewing sequencer activity, planning and monitoring sequencing runs, and reviewing sequencing data for Ion PGM™ Sequencer, Ion S5™ Sequencer, Ion S5™ XL Sequencer, and Ion GeneStudio™ S5 Series Sequencer.
<i>Ion Sphere™ Particles Quality Assessment for the Ion Proton™ and Ion S5™ Systems Using the Guava™ easyCyte 5 Benchtop Flow Cytometer User Bulletin</i>	MAN0007496	Describes how to use the Guava™ easyCyte 5 Benchtop Flow Cytometer for quality assessment of the unenriched and enriched template-positive ISPs prepared with the Ion OneTouch™ 2 System or the Ion Chef™ System for the Ion S5™/Ion GeneStudio™ S5 Systems.

Note: For additional documentation, see “Customer and technical support”.

Customer and technical support

Visit thermofisher.com/support for the latest service and support information.

- Worldwide contact telephone numbers
- Product support information
 - Product FAQs
 - Software, patches, and updates
 - Training for many applications and instruments
- Order and web support
- Product documentation
 - User guides, manuals, and protocols
 - Certificates of Analysis
 - Safety Data Sheets (SDSs; also known as MSDSs)

Note: For SDSs for reagents and chemicals from other manufacturers, contact the manufacturer.

Limited product warranty

Life Technologies Corporation and/or its affiliate(s) warrant their products as set forth in the Life Technologies' General Terms and Conditions of Sale at www.thermofisher.com/us/en/home/global/terms-and-conditions.html. If you have any questions, please contact Life Technologies at www.thermofisher.com/support.

