

MASTER DETECTIVE TOOLKIT

TK Intelligence

CONFIDENTIAL.

WARNING.

Not suitable for children under 8 years. For use under adult supervision. Read the instructions before use, follow them and keep them for reference.



Important Information for Parents and Users

WARNING. Not suitable for children under 3 years. Choking hazard — small parts may be swallowed or inhaled. Strangulation hazard — long bands and tapes may become wrapped around the neck.

WARNING. Contains a device that emits ultraviolet radiation. In addition to a certain amount of visible light, the UV flashlight primarily emits high-energy ultraviolet light. Therefore, do not shine it directly in your eyes or into the eyes of another living creature!

Keep the packaging and instructions as they contain important information.

The supervising adult should discuss the warnings and safety information with the child or children before commencing the experiments.

Safety and disposal instructions for the UV flashlight and batteries are on the outside back cover.

Have an adult check the assembly before you use it so you can be sure it was assembled properly!

Handling Precautions for Plaster Powder (Gypsum)

Advice for Supervising Adults

- > This chemical toy is not suitable for children under 8 years. For use under adult supervision.
- > Keep this chemical toy out of reach of children under 8 years old.
- > Store chemical toys out of reach of young children.
- > Read and follow these instructions, the safety rules, and the first aid information and keep them for reference.
- > The incorrect use of chemicals (the plaster, particularly swallowing or inhaling it) can cause injury and damage to health. Only carry out those activities which are listed in the instructions.
- > Because children's abilities vary so much, even within age groups, supervising adults should exercise discretion as to which activities are suitable and safe for them. The instructions should enable supervisors to assess any activity to establish its suitability for a particular child.
- > The supervising adult should discuss the warnings, safety information and the possible hazards with the child or children before commencing the activities.
- > The area surrounding the activity should be kept clear of any obstructions and away from the storage of food. It should be well lit and ventilated and close to a water supply. A solid table with a heat resistant top should be provided. When working with plaster wear suitable clothes that can get dirty.
- > The working area should be cleaned immediately after carrying out the activity.
- > Disposal: Spilled or leftover plaster should be placed in the household trash.

Safety Rules for Handling Plaster

- > Keep younger children under the specified age limit and animals away from the activity area.
- > Store chemical toys out of reach of young children.
- > Wash hands after carrying out activities.
- > Clean all equipment after use.
- > Do not use any equipment which has not been supplied with the set or recommended in the instructions for use.
- > Do not eat, drink or smoke in the activity area.
- > Do not place the material in the mouth.
- > Do not inhale dust or powder.
- > Do not apply to the body.

First Aid Information

- > **In case of eye contact:** Wash out eye with plenty of water, holding eye open. Seek immediate medical advice.
- > **If swallowed:** Wash out mouth with water, drink some fresh water. Do not induce vomiting. Seek immediate medical advice.
- > **In case of doubt seek medical advice without delay:** Take the chemical and/or product together with the container with you.
- > **In case of injury always seek medical advice.**

Important Information

Dear Parents and Adults,

This experiment kit gives kids lots of fun ideas for playing detective. It has exercises that will train them to observe and remember things carefully, and its simple experiments present techniques for finding and evaluating clues, just like the ones that real police or professional detectives use.

Please provide your child or children with support and supervision during their experiments. Before you begin, read through the instructions together and be sure to follow the directions. Also, please be careful that pieces from the kit do not get into the hands of small children.

TK I

Tip Handling plaster

- > Choose a quiet workspace. Keep younger children under the specified age limit and animals away from the activity area.
- > Wear clothing that can get dirty and protect the table or work surface with newspaper.
- > Avoid contact between the plaster and your mouth and eyes. Work carefully and slowly to keep the plaster dust to a minimum. Plaster dust should never be inhaled!
- > Clean up after you finish your work. Clean your utensils as soon as possible, because plaster is a lot easier to clean when it is wet than after it has hardened.
- > Pour out any leftover plaster onto a piece of newspaper and let it harden. Solid pieces of leftover plaster can be thrown away in the household garbage. After you finish, wash your hands thoroughly with soap and water.

Table of Contents

<i>Important Information</i>	1
<i>Master Detective Toolkit: Investigator's Training Manual</i>	2
<i>Kit Contents</i>	3
<i>Becoming a Detective</i>	4
<i>Your Detective's Office</i>	10
<i>The Crime Scene</i>	20
<i>Analyzing Evidence</i>	32
<i>Secret Codes and Messages</i>	40
<i>Checklist for Master Detectives</i>	47
<i>Solutions</i>	48

Master Detective Toolkit: Investigator's Training Manual

Welcome to the Thames & Kosmos Intelligence Agency, TK Intelligence or TKI for short. You have been chosen to work alongside three skilled detectives — Detective Wright, Detective Lee, and Detective Franklin — to develop your skills in forensic science and criminology. This unbeatable team has solved many cases around the world. This is your training manual and toolkit. Let's begin.

TK Intelligence

THE SCIENCE AND ART OF SOLVING MYSTERIES

Chief Detective: *James Wright*
Deputy Detective: *Carolyn Lee*
Research and Archives: *Mike Franklin*

James Wright is the Chief Detective. He founded TKI and knows everything there is to know about being a good detective. He is an excellent leader, who can efficiently manage the other detectives to best use each of their particular skills. He is excited to learn more about your specific talents and see how you will contribute to the team.

Carolyn Lee is the Deputy Detective. She is strong, athletic, and skeptical. Her excellent intuition is almost never wrong. Mentally and physically fit, criminals simply cannot outsmart — or outrun — her! Some people think she has a special sixth sense that helps her solve crimes, but she will tell you that it is just good instincts and a perceptive eye.

Mike Franklin is the detective in charge of research and archives. He has a superior intellect and a photographic memory. He can effortlessly remember faces, names, and facts, and piece together clues with ease. This makes him a great asset to the team. He organizes the archives of evidence and conducts research whenever needed.

TK Intelligence gets asked a lot of questions about how to become a detective and what kind of equipment a detective needs. That is why we have compiled this detective tool kit, which

presents the theory and practice of forensic science and criminological work, expertly illustrated with practical exercises.

Kit Contents



No.	Description	Qty.	Item No.
1	Barrier tape	1	705076
2	Round fastener	2	719315
3	Sticker sheet	1	716551
4	Fingerprint stickers	1	705067
5	Fingerprint powder (iron oxide)	1	774972
6	Invisible ink pen	1	721301
7	Plaster powder (gypsum)	1	771052
8	Wooden spatula	3	000239
9	Sheet of profile cards	1	716550
10	Plastic bag	5	705557
11	Magnifying glass	1	702387
12	Measuring tape	1	716643
13	Measuring cup	1	087077
14	Petri dish with lid	1	702184
15	Brush	1	705976
16	Forceps	1	700127
17	Screw-top tube	2	705073
18	Screw-top canister	2	704528
19	Blue chalk	1	705361
20	Red chalk	1	705075
21	Die-cut cardboard	1	716549
22	Ink pad	1	705072
23	Crime scene notepad	1	716552
24	Ultraviolet flashlight	1	713927

If you are missing any parts, please contact Thames & Kosmos customer service.

The additionally required items are highlighted in italic script at the beginning of each experiment.

You will also need:

One AAA battery (1.5-volt/LR03), felt-tip pen, pencil, ballpoint pen, permanent marker, glue stick, passport-like photo(s), string, tape, watch or stopwatch, white paper (letter size), scissors, graph paper (letter size), research books, water, plastic bottle, a few real paper money bills.

Becoming a Detective

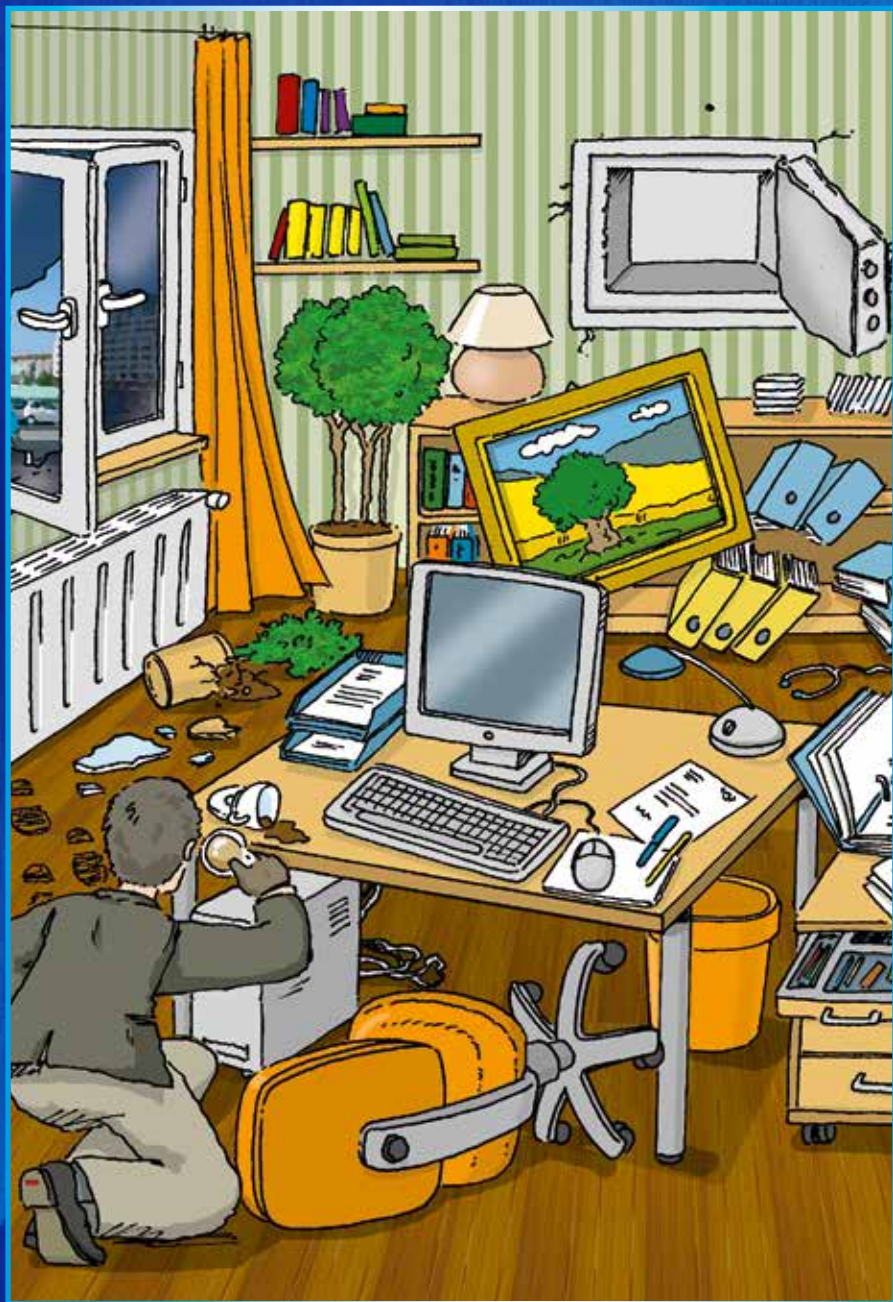

What is forensic science, and how do detectives use it?

Forensic science, or simply forensics, is a term commonly used to describe the use of science and technology to gather evidence, investigate incidents, and establish facts that are of interest in criminal or civil legal proceedings. Some fields of forensic science include ballistics, fingerprint analysis, DNA analysis, toxicology, and footwear analysis. Detectives use forensic science to help them solve crimes and answer questions.

Detectives are most often employed by government agencies (e.g. the police, the FBI). They can also operate privately, working for companies or individuals. In this case, they are often called **private investigators**. The government employs detectives to investigate a wide variety of legal violations, such as fraud, homicide, theft, or illegal sales. A company might hire a detective to find out if a competitor is trying to steal its secrets, or to track down shoplifters. Or a woman might hire a private investigator to locate her long-lost sister. It always has to do with discovering secrets. Even the word “detective” tells you that: It is based on the Latin verb *detegere*, meaning “to uncover.”

There are many legal and ethical issues associated with detective work. Detectives must not violate anyone’s civil rights, even those of suspects, and they must abide by the law. They have no special rights.

How can I be a detective?

A good portion of curiosity, a well-trained eye, and a lot of practice in logical thinking are the most important requirements for successful detective work. A detective has to collect a lot of different kinds of information and facts, check them and sort through them, and then later assemble them like pieces of a puzzle to extract some sort of meaning from them. It helps to be able to imagine how other people might be thinking about something, and to be able to look at a scenario from a completely different point of view.

A detective must have a good understanding of the current forensic science techniques, and the legal system. Since so many small details play a large role in detective work, a professional detective has to have a thorough, careful style of work. He also needs to have dedicated people working and thinking along with him in performing deductive analysis, doing research, and working through the many possibilities of a case. In addition, a detective should be persistent and stubborn, so that all the little miss-hits and false leads don’t throw him off the track.

Important! You should never involve yourself as a detective in actual criminal cases. That is a job for the police alone! Not only are criminals dangerous, but you could unintentionally interfere with the work of law enforcement officials.

Assistants wanted!

Detectives seldom work alone. Even in movies or novels, they usually have one or more assistants, since any case will typically demand the completion of several tasks as quickly as possible. It is always good if these tasks can be divided among several partners.

TK Intelligence detectives James, Carolyn, and Mike offer a good example of successful teamwork, because they complement each other perfectly:

James possesses exceptional leadership abilities, quick powers of deduction, and the ability to think logically. He is good at motivating the other two detectives and getting them to work at peak performance.

Carolyn, on the other hand, is a technically gifted and manually skilled detective. She also has good physical conditioning, which always comes in handy during lengthy stakeouts.

The third detective, Mike, gathers and arranges facts, undertakes research, and runs the detectives' archive. He also has an excellent memory and an extensive knowledge of past cases and criminals.

How do you go about solving a case?

There are three things that are particularly important in detective work:

1. Good powers of observation
2. Broad knowledge
3. Deductive ability

These skills help you to use clues and statements to conjure up a picture of the way an event must have unfolded, while quickly identifying discrepancies and recognizing the clues that point to a possible culprit.

TK |

Tip

Useful tools

A small pair of *binoculars* helps when you want to perform observations from a discreet distance. A *flashlight* will let you investigate dark corners and areas in suspicious rooms. You can use a *camera* to retain an image of the facts of a case. You can get in touch with club members by *cell phone* when you are on the trail of a suspect, for example. And if you have a *microscope*, you can use it to study clues (particles of paint or fibers).

To keep a record of sudden inspirations, statements by witnesses and all sorts of observations, you should always keep a *small notebook* with pencil or pen at hand in your jacket pocket.

TK Intelligence Pro Tips

James' Pro Tip:

How to find a perpetrator ...

In any case, you should first collect as many pieces of evidence as possible: statements from witnesses, clues, and suspicious facts. The details you collect must be supplemented by further information, and then thoroughly cross-checked and studied for inconsistencies. With the help of information that has been filtered — people also say “confirmed” — in this way, the precise timing of a possible sequence of events can be reconstructed. The number of suspects can then be considerably reduced on the basis of a possible motive or a specific clue. In the process, all the statements, clues, and alibis have to be checked again and compared against the time sequence. In the ideal case, just one single suspect remains at the end.

Carolyn's Pro Tip:

Describe the individuals as precisely as possible!

When observing people, pay careful attention to individual features such as body size, hair color, and body build, as well as the type and color of their clothing. Specific details or additional things such as (sun)glasses, piercings, rings, necklaces or a watch are also important. Many people are immediately recognizable based on a characteristic way of walking or other peculiarities (body posture or typical gestures). Make a note of features like these and write them down on the individual's file card. You can train yourself to observe people — ideally together with several other detective colleagues — in the city, in front of a movie theater, on a bus or train, in a department store or in any interesting location where a lot of people are passing by.

Mike's Pro Tip:

Hide a secret message between the lines!

You should never send a message written in invisible ink on an otherwise completely blank piece of paper. That would immediately raise the suspicion that it's a secret message. Instead, write a completely harmless-sounding letter and then write the invisible message between the lines. The spacing between the lines has to be big enough for this.

For a short message, you could just use the envelope, because that is the last place someone will look if they happen to find it — after all, the writing is invisible! You will find out on page 40, in the “Secret Messages” chapter, how to encode a message as securely as possible.

Keyword:

Piece of evidence — a suspicious fact which doesn't directly prove anything, but which still lets you draw a conclusion about participation in a crime, e.g. the discovery of a piece of stolen property on a suspected robber. The opposite case is “catching someone in the act” — the direct observation of a perpetrator at the scene of the crime.

Keyword:

Cognitive abilities — the word “cognitive” goes back to the Latin word *cognito* (knowledge). A detective with cognitive abilities (such as Mike) demonstrates that fact by consistently and correctly perceiving and interpreting important signs and details in even the most complicated cases.

Keyword:

Cryptology — The science of secret languages and secret writing. The name comes from a composition of the Greek words *kryptos* (hidden, secret) and *logos* (word, knowledge).

Who was the Robber?

Practice your powers of deduction on this case from the bureau of criminal investigation. Can you figure out who did it?

Chief Inspector Carter on the job:

"A robber has struck the Goldy jewelry store and knocked out the owner. The loot includes several diamond rings as well as two particularly valuable pearl necklaces. There is quite a commotion in the city on the following morning, as the residents read about the attack in the paper."

While the citizens are still digesting the excitement over breakfast, Chief Inspector Carter has already called in three suspects. The very next day, the papers are able to report that the perpetrator has been caught. A statement provided by one of the suspects made him suspicious.

Which one do you think it was?

And how did the inspector substantiate his suspicion?

JEWELRY STORE ROBBERY

Yesterday afternoon around 5 o'clock, the well-known jeweler Goldy fell victim to an armed robbery. He is laid up in the hospital and has not yet regained consciousness. His co-owner has determined that several very valuable items were stolen. Apparently, the perpetrator waited until there were no customers in the store. Then he

entered the store and had the proprietor show him several pieces of jewelry. He suddenly attacked the owner, snatched up several valuable items, and got away without being recognized. A customer who later entered the store discovered the injured owner and called the police. No trace of the perpetrator has yet been found. The investigation continues.



A further event on Friday evening, on the other hand, had nothing to do with the robbery. A young soccer player blasted his ball directly into the jewelry store's plate glass window, which had to be replaced. The store's insurance covered the damage, and the young man was let off with just a warning.

Statement 1:

"My name is *Will Harte*, I am 31 years old and work as a pharmaceutical consultant. I was not in the city yesterday, but driving in my car. I wanted to visit my cousin who lives in the suburbs, but he wasn't home. I had nothing to do with the robbery."



Statement 2:

"My name is *Clinton Rogers*. I am 38 years old and I work at the post office. At the time that the robbery took place, I was at the department store to buy a pair of shoes. But I didn't find anything and didn't buy anything else. I have never been to that jewelry store."

Statement 3:

"My name is *Ralph Winkler*, I am 25 years old and still a student. Yesterday afternoon I was alone at home watching television and I fell asleep. I don't know who knocked out the jeweler and stole the two pearl necklaces. I only read about the robbery this morning in the paper."



Your Detective's Office

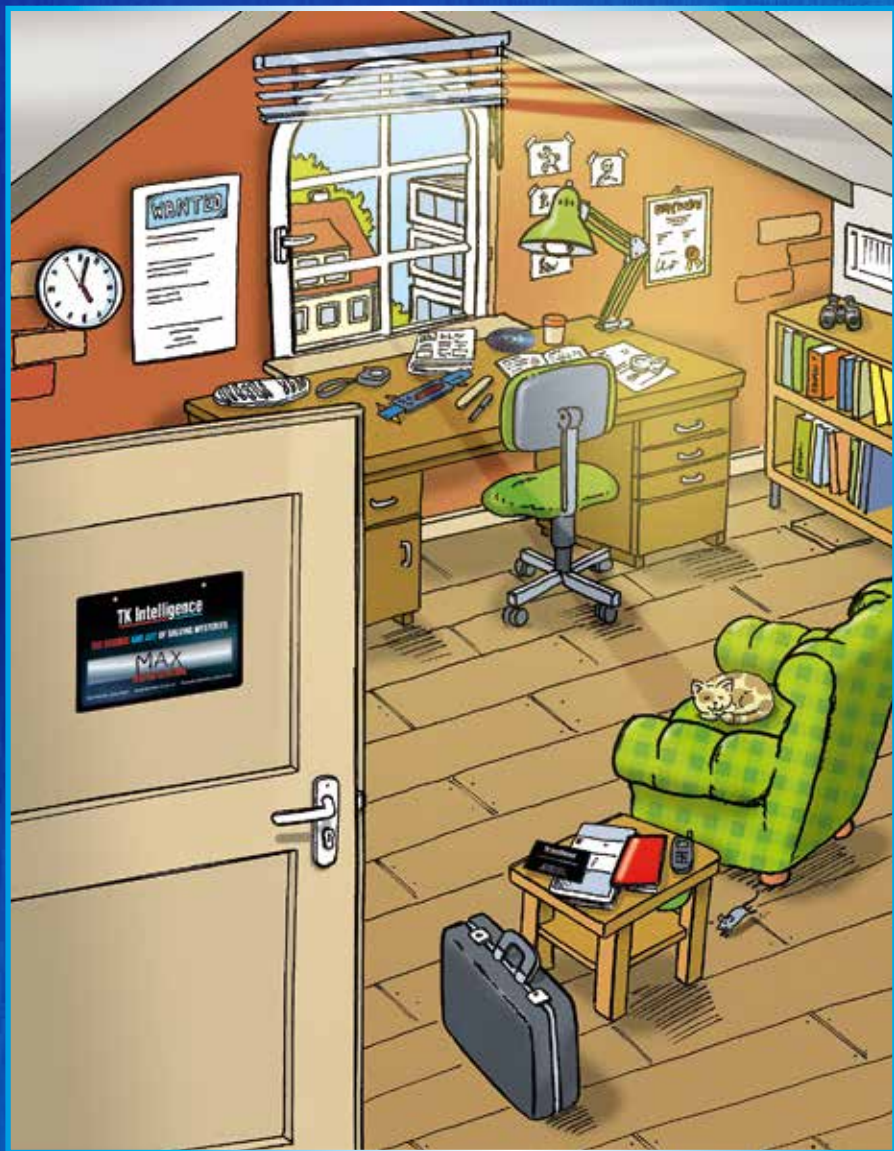

A real detective naturally needs an office. This is where you will carry out investigations of clues and do your written work.

Maybe your room will do the trick, or you might be able to use a garden shed, an attic space, or a room in the basement.

Doorplate

Detectives need assignments, so they need clients. To help them find your office, the best thing is to attach a name plate to your door.

Detective Bureau Sign



You will need:

Doorplate (die-cut sheet)
Felt-tip pen

Here's how:

Remove the doorplate from the sheet and write in your name or the name of your detective bureau. You can use a felt-tip pin, or you might prefer to stamp it on or use a printer.

Detective ID

It is sometimes helpful to be able to identify yourself as a detective. For that, you need a detective ID. That way, you will be able to show that you are seriously interested in solving cases. If you start a detective club, of course, each member will need his or her own ID.

Detective ID Card



You will need:

Detective ID (die-cut sheet)
Passport photo
All-purpose glue
Felt-tip pen or ballpoint

Here's how:

Remove the ID from the sheet. Fold it and glue it together as shown in the drawing. Write your name, specialization, and other information, and glue on a passport photo.



Hiding places for secret things

Naturally, you wouldn't want anyone to go snooping around in your secret documents. Confidential papers, passwords, and personal files should be kept well hidden away. A good hiding place depends on the specifics of your office.

The best hiding places are ones that seem the most innocent: an old cookie tin or a shoebox, for example. Or, you can also use a file folder labeled with an inconspicuous name such as "completed" or "math."

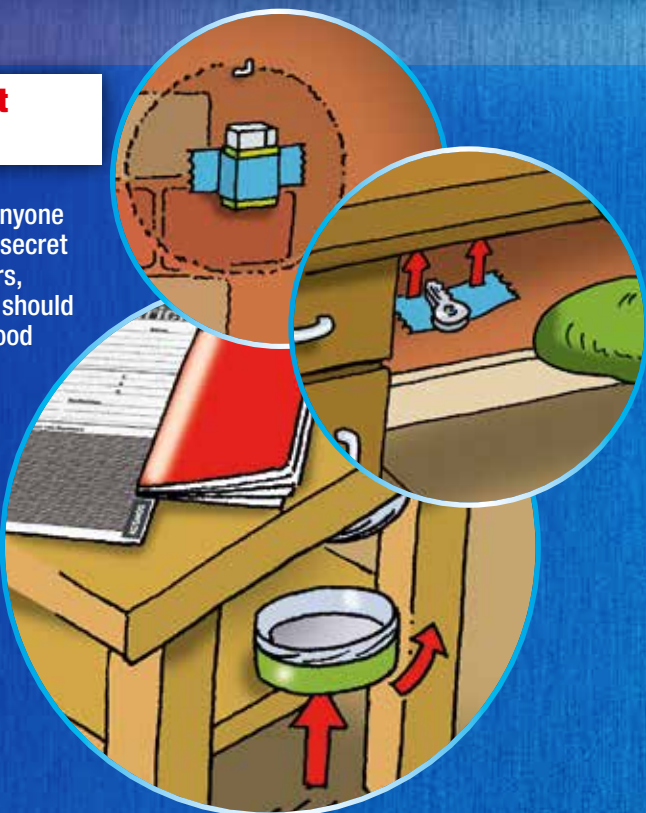

TK |

Tip

Book cover hiding place

A special book cover hiding place is particularly sneaky. First get a plastic box. Then find an old or beat-up book of the appropriate size. Remove all the pages and glue the box inside the book cover. If you place your book between others in the book shelf, it will be a good place to store secret documents.

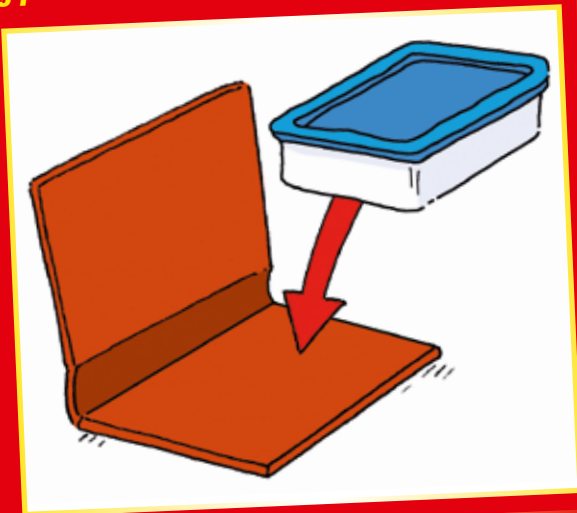

Ultraviolet flashlight

You can use the ultraviolet flashlight (UV flashlight for short) to search for invisible traces of evidence that become visible under the UV light. Lights like these are used to look for evidence at real crime scenes. Before you can use the lamp, you must insert the battery. An adult should help you. Remove the four screws on the bottom of the flashlight with a Phillips head screwdriver, insert the battery, and replace the screws. To turn on the light, slide the small switch forward.



Do not shine the light into your eyes, or the eyes of any other people or animals.

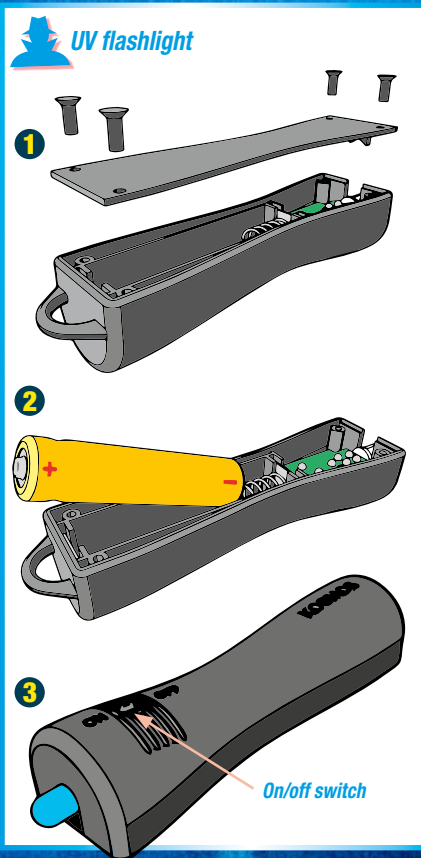

How does the UV flashlight work?

You can examine the behavior of various objects and materials under UV light. In a darkened space, try shining the light on white paper, white clothing, reflective panels on backpacks and bicycle clothing, colored markers, and paper money.

The UV flashlight emits some bluish visible light and a lot of ultraviolet light which is invisible to our eyes. This is also sometimes called black light. Many everyday things, such as white clothing, reflective strips, and colored ink on paper, shine brightly in the darkness when they are irradiated with UV light.

Bills contain UV-luminous threads as an anti-counterfeiting measure. You can easily detect counterfeit money because it does not light up in the UV light the same way real money does. You can read more about the security features of money on pages 37-39.

Criminology observation exercises

To be a good detective, it's quite important to have well-trained powers of observation and to be skilled at thinking about things and reasoning deductively. Those are things you can practice, and it's most fun when at least two people do it together. In any case, you should get used to observing people carefully. You can figure out a lot that way: age, occupation, family status, hair color, special characteristics...

Look carefully!



You will need:

Sheet of paper

Pencil

Everyday objects

Watch with second hand, or timer

Here's how:

1. Carefully study the large picture on the right for 30 seconds. Then close the manual and write down from memory, as accurately and precisely as you can, what you saw. Then answer these questions:

- What kind of clothing are the people wearing?
- What are they doing?
- At what time and on what day of the week is the scene taking place?
- How many people are in the picture?
- How many of them are sitting?
- Which of them are acting suspiciously, and why?
- Which of them is the oldest?
- Did you notice anything else unusual?

2. Now study the two small pictures at the top. At first glance, they may look the same, but the artist changed a few details in the one on the right: How quickly can you find the seven differences?

3. This exercise requires a partner. Leave your office for a few minutes. Your partner will change something or other while you are out of the room. For example, he or she could pull open a drawer, place a book on the table, turn on a light, open the window, or put a cookie on a shelf. Time how long it takes you to discover the change. Then have him or her leave while you change something.

4. This exercise only works with a partner too: While you are out of the office, have him or her hide something that normally doesn't belong there: for example, a bag of flour from the kitchen, a tube of toothpaste, or a ball of yarn.

How long does it take you to find it?

Imagine that you are carrying out your search as a detective in someone else's room. You have to search cautiously, so the owner doesn't notice any signs of your activity afterwards.



Catching secret visitors and intruders

It is certainly important for you to know if someone took an interest in the documents in your bureau while you were out. There are several ways of finding that out.

TK 1

Tip An orderly desk

Always arrange scissors, pens, or other objects in a certain particular way on your desk or a stack of papers. That way, you can immediately recognize if someone has been doing anything with them.

Invisible door seal



You will need:

Hair

String

All-purpose glue or tape

Here's how:

If you tape some sort of marker to the door and door frame after you leave the room, you can check

when you return if it has been damaged. For this purpose, you can use a hair or a piece of thread. Attach it with some tape far down on the door where nobody will notice it. The trick works with desk drawers too. Make sure the marker is as hidden as possible, or the intruder may see it.

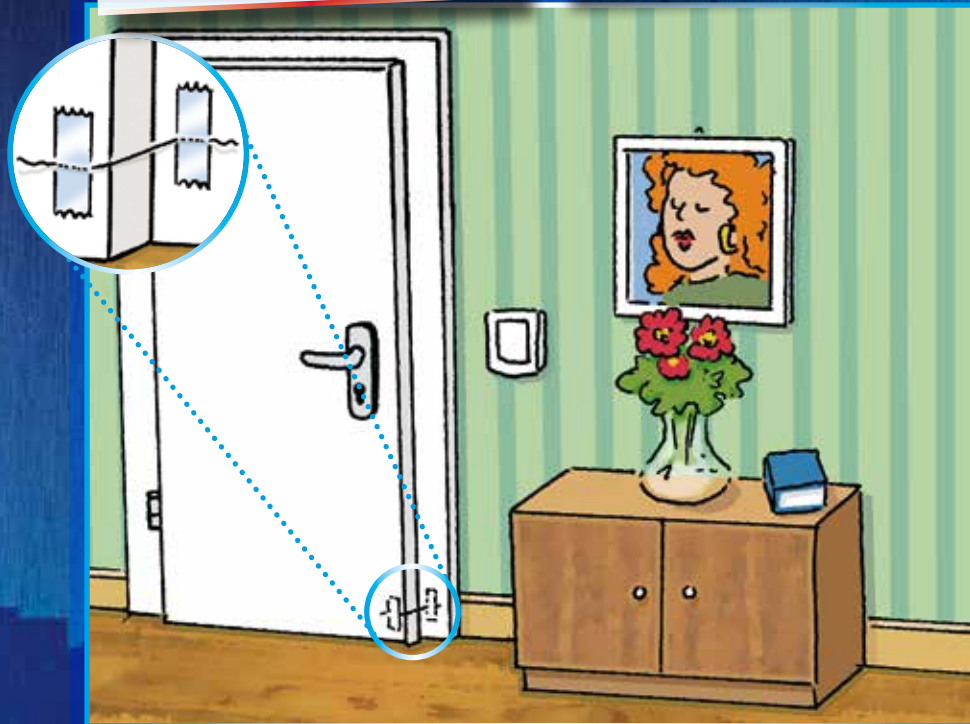

Gathering information

The most important activity that a detective performs is to gather information (also called “researching”), which may come from many different sources.

Among them are telephone books (including yellow pages), city maps, lexicons, dictionaries, or field guides for animals, plants, and animal tracks. On an easy-to-see note or notepad, you should write down important telephone numbers such as the police, fire department, emergency physician, directory assistance, as well as your local contacts.

Whatever you can’t find in your own book collection, you can learn about in a public library or through the Internet. You should familiarize yourself with those resources and learn what to find where.

TK 1

Tip

Information archive

It’s a good idea to save your important information in a file folder or an electronic archive file, so you can find it quickly when you need it. You can sort newspaper articles and other information from the Internet according to subject areas or key words and file them alphabetically by date in your folder or in a file on your computer.

Profiles

Detectives occupy themselves above all with people — as suspects, as witnesses, or as victims — and collecting information about them. You can practice this by compiling profiles on all your acquaintances and relatives: school friends, playmates, family members, neighbors, and teachers. Remember, you are doing this for practice only. You must always respect people’s privacy and never write anything false.

Important! While detectives compile their files secretly, you must not invade anyone’s privacy or civil rights. You should get permission before gathering information on anyone.

Compiling a profile...



You will need:

Profile cards

Ink pad

White paper (letter size)

Scissors

All-purpose glue

Here’s how:

Compile a separate profile card for each person. Enter the person’s name, address, and other data, to the extent that you know it or can find it out. Only add a photo and fingerprints if you can obtain them with the individual’s permission. Otherwise, include a description of the person that is as precise and detailed as possible.

This checklist will help. Order your profile cards alphabetically. If you find fingerprints later on at a crime scene, you should be able to distinguish them from those of your partners and family members. So collect their fingerprints in your files as well. Just ask them to press all ten fingers on the stamp pad and then on a sheet of white paper. Take several sample prints, then cut out the best ones and glue them onto the file card.

Be careful with the ink, so that you don't get your clothes dirty! Also, make sure people wash their hands after fingerprinting.



Enter information about a person or suspect on the front side.

Profile Card TK 1

Personal Data: Date: 06/03/2015

Name: Henry Miller

Address: 5 Green Street

Place of Birth: Bayville Date of Birth: 07/13/1981

Telephone: Der Schreier

Physical Description:

Eye Color: Brown Height: 6' 3" Build: II

Hair Color: Brown Weight: 165 lb Complexion: Large

Other Characteristics:

Short hair, glasses, mole on cheek, scar on left leg

On the back side, glue on that person's fingerprints.



Profile description checklist:

- Approximate age
- Posture: straight, leaning forward or sideways
- Voice: high, deep, raspy
- Speech: slang, broken English, preferred expressions
- Walk: quick, sluggish, hesitant
- Approximate weight and height
- Body shape: skinny, stocky, chubby, athletic
- Hair: straight, wavy, curly, parted, long, short, pony tail, afro, wig, toupee
- Shape of face: chubby, flat, elongated, oval, angular
- Beard: stubble, mustache, full beard, beard color
- Nose: snub nose, hooked nose, large, small, crooked
- Facial skin: smooth, wrinkly, red, bloated, freckles, pimply
- Eyes: brown, blue, gray, squinty
- Clothing, shoes
- Other: watch, eyeglasses, earring, tattoos, piercings...

Following and shadowing suspicious people

When investigating suspicious people, you should always stick to a few simple rules to keep them from becoming aware of the fact that they're being watched.

- Try to blend in to your surroundings and try not to attract attention to yourself.
- Always keep your distance and wear inconspicuous clothing (without loud colors or things printed on them).
- Try to walk along the inside edge of the sidewalk or on the shadowy side of the street.
- Always vary your distance from the person under observation and keep a little change in your pocket so you can buy a bus or subway ticket if necessary.
- If possible, trade off with other partners while tailing someone. You can use the A-B technique (see Tip Box) to maintain your watch at crosswalks or in pedestrian areas, so you can shadow your target over long distances.
- Don't ever let on that you're following someone: Stop and tie your shoelaces every now and then, read the newspaper or talk to each other.
- Practice pursuits among yourselves by having one detective play the role of

TK 1

Tip Shadowing with the A-B technique

When pros want to shadow a suspicious person as unobtrusively as possible, they usually apply the A-B technique. The pursuer takes position A directly behind the suspect. The second detective follows at position B. Detective B stays behind A or follows at some distance on the other side of the street. At crosswalks or when the suspect takes a detour onto a side street, the two detectives can switch roles at a quick signal: Then, B assumes position A directly behind the person being followed, and A keeps in the background in the new position B until the next switch.

a suspect while two others try to follow the first one unobtrusively over a certain distance. For this practice assignment, you should first agree on a period of time or some kind of goal, so you all know when and where the pursuit is supposed to be over!



The Crime Scene

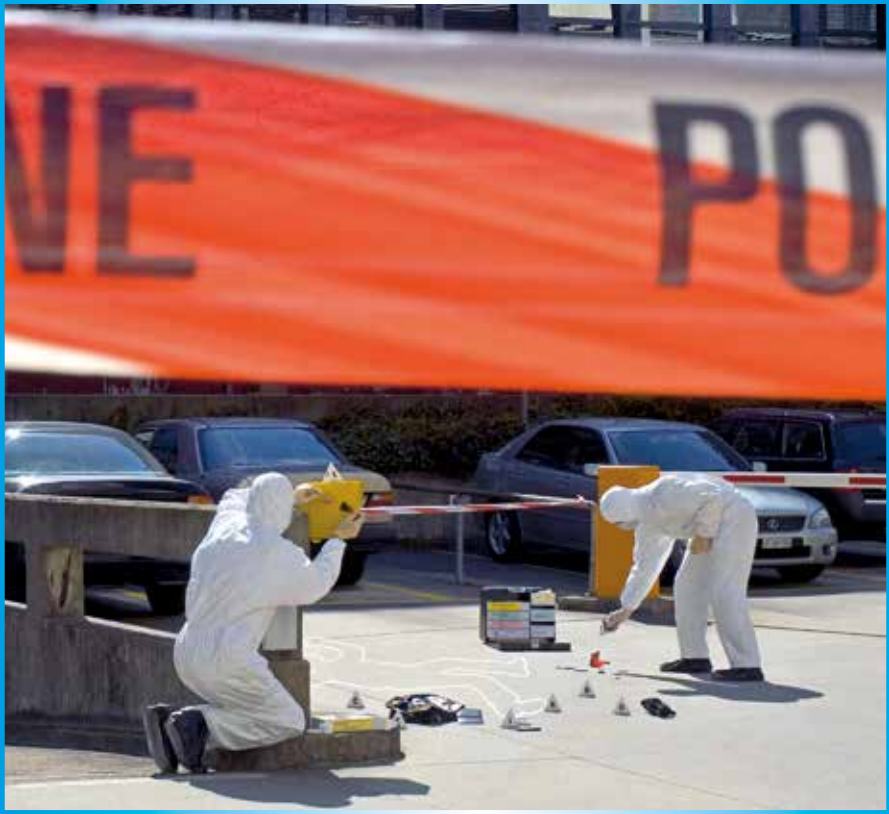

You can spot a good detective or criminologist right away at a crime scene. There, it is crucial to locate and secure the area and everything in it quickly and reliably, without erasing anything. Any clues that are not secured will tend to be irretrievably lost.

By clues, we don't just mean fingerprints. In criminology, anything that may point to a crime or a perpetrator is referred to as evidence. That can include fibers from a piece of clothing, fingerprints, dust, discarded

cigarette butts, bullets, weapons, or traces of blood.

In the event of an actual crime, ordinary patrol officers are usually the first ones on the scene. They will seal off the crime scene from curious people (among whom may be the perpetrator), so no clues are destroyed. Then, the experts at securing evidence will arrive. They bring everything they need to find and secure evidence in their crime scene case. They wear protective clothing and gloves while they do their work.

Securing the crime scene

Before you investigate a crime scene, you first have to secure the room or outdoor area, so that curious individuals don't trample everything or mix things up.

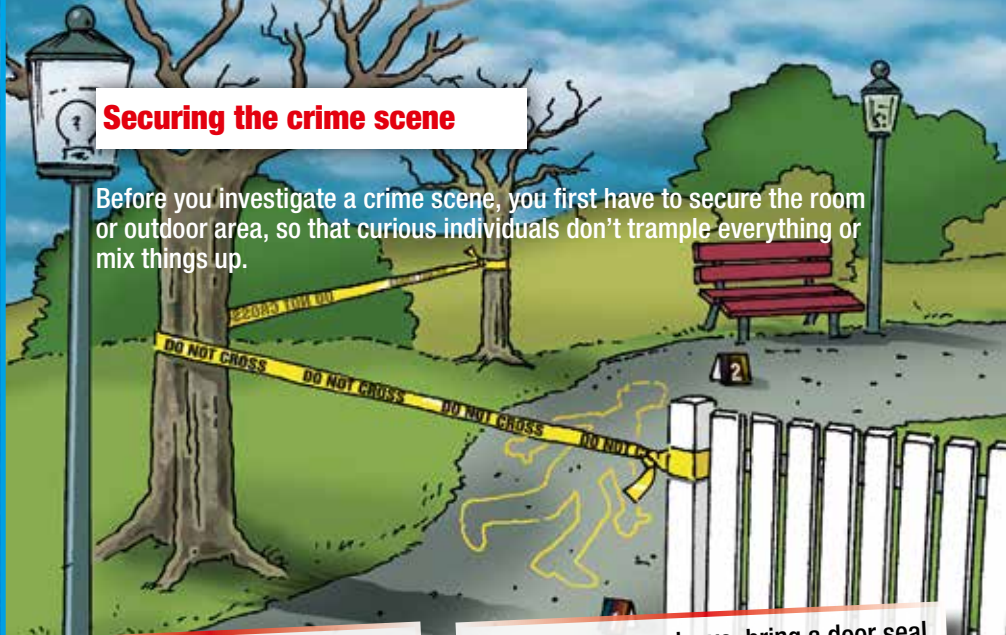

Barricade tape & door seal



You will need:

Door seal
Barricade tape

Here's how:

While you are working at the crime scene, you can seal it off with the barricade tape, which has "Do not cross!" written on it. If the scene is outdoors, tie the tape to trees, bushes, fences, or whatever objects happen to be there, such as trash cans. Inside, you can stretch the tape across the doorway. If you want to be sure that nobody enters the

location after you leave, bring a door seal with you. Of course, it won't keep any unwanted visitors from getting in if they really want to, but if the seal is broken, it will tell you whether any have been there.

The crime scene suitcase

Thanks to the handy carrying case, your detective equipment is not only kept neatly organized, but you can quickly grab it when you need to rush off to a new crime scene. All your tools for investigating the crime scene are right at your fingertips. Make sure that everything you need to use is stored in the case: caution tape, door seal, magnifying glass, forceps, tape measure, brush, fingerprint powder and foil, equipment for plaster casts, containers for collecting evidence, the UV flashlight, the crime scene notepad, and pencil, chalk, and perhaps a flashlight and a camera.



Crime scene sketch and crime scene report

If a person suspected of a crime has been found, sometimes after months have passed, one has to be able to prove that the crime was committed by that person. Of course, when working at the scene of the crime one doesn't yet know which pieces of evidence will later be important. That means that everything has to be studied carefully and every detail retained: What does the crime scene look like? Where exactly is it situated? Which piece of evidence was found at what location? Was the light on or off? Doors and windows open or shut? What was discovered on the table, in the waste basket, in the closets?

All the information has to be recorded in a crime scene report. Secure and record evidence from a crime scene immediately, and don't just rely on your memory. The very next day you will have forgotten whether a certain fingerprint was found on the desk lamp, door, window, or coffee cup.

Your crime scene report will also include statements from the victim, witnesses, and suspects. These have to be compared with the evidence that was discovered and with the other statements, and you should study them for inaccuracies and lies. A crime scene sketch will help you to orient yourself later on.



TK |

Tip *The seven questions of criminology*

There is a list of questions that should be answered after any crime. They are known as the seven questions of criminology.

- 1. Where did the crime happen?*
- 2. What happened? What did the perpetrator do?*
- 3. Who took part? As victim, culprit, or witness, for example.*
- 4. When did the crime occur?*
- 5. How did the event happen?*
- 6. With what, i.e. with what tool or weapon, did the perpetrator do his work?*
- 7. Why did the perpetrator commit the act? There is usually a reason, or motive, that helps to explain the crime.*

Crime scene report

You will need:

- Crime scene notepad
- Measuring tape
- Pencil
- Large sheet of paper (letter or tabloid size)
- Camera

Here's how:

Sketch the overall layout of the crime scene. Use your crime scene notepad. Do not make the sketch too small, because you will also have to write in the numbers of whatever evidence you find. If you don't have enough room on the notepad, you can take a larger



sheet of paper and include this with the crime scene report. As soon as you have secured all the evidence, you should measure the dimensions of the crime scene and enter the numbers into the sketch. If you have a camera, photograph the crime scene from various angles, getting all the important details and pieces of evidence. Include all the photos with the crime scene report.

Don't forget to include the following: name of the case, location or address of the crime scene, date, time, weather conditions, and, of course, your name.

Crime Scene Report TKI

Assignment/Client: *Dead body in the park* Date: *7/10/2014*

Detective: *Max Agent*

Location: *Park downtown*

Weather Conditions: *Clear skies, 70 degrees F, sunny*

Description of Situation: *Victim (male, about 35 years old) was found in the middle of the path in the park.*

Evidence: 1. <i>Body</i>	2. <i>Cell phone</i>	3. <i>Cigarette butt</i>
4.	5.	6.
7.	8.	9.

Witnesses: *Ann Hollerbush, lives around the corner. Found the body and called police.* Suspects: *Henry Miller, was seen by Ms. Hollerbush in park around time of crime.*

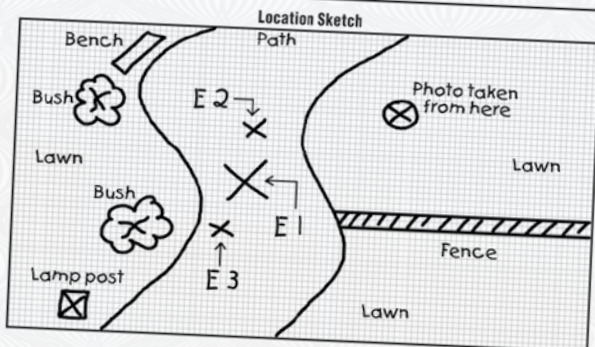

Enter all the important details that you learned about at the crime scene here.

Here, make a rough sketch of the crime scene, so you know later what was located where.

Marking the evidence

Every piece of evidence found at a crime scene should be marked with a numbered sign, so you don't overlook or destroy anything while working on another piece of evidence.

Numbered signs and chalk

You will need:

Numbered signs (die-cut)

Colored chalk

Crime scene notepad

Pencil

Camera

Here's how:

1. Remove the cards from the sheet and fold them.
2. Place one card at each piece of evidence you find and enter the



corresponding numbers into your crime scene sketch. If you have a camera, photograph the sign along with its immediate surroundings.

3. Document each piece of evidence on a special sheet of paper, where you also write in all the information you gathered about it.

4. Mark larger pieces of evidence with chalk. For example, you can draw on the asphalt how a bike was lying after it was hit by a car. In this way, police outline the positions of victims with chalk.



TK 1

Tip

Is there an alibi?

The exact time of the crime can be very important when you want to check the alibi of a suspect. *Alibi* is a Latin word meaning "elsewhere." If, in other words, the suspect was elsewhere, i.e. not at the crime scene, when the crime was committed, he cannot be the perpetrator.

Making fingerprints visible

Fingerprints are incredibly important for criminologists and detectives. Every year, thousands of criminals are convicted based on fingerprints found at the scene of the crime. It works because everyone has somewhat different patterns on their fingertips, which never change as long as they live.

Collecting fingerprints

You will need:

Fingerprint powder
Ink pad
Brush
Magnifying lens
Fingerprint stickers
Profile cards (cut-out sheet)
Sheet of paper (letter size)

Here's how:

1. First, examine the tip of your index finger under the magnifying lens. You will see a pattern of curved lines. Some of these lines stand out like tiny mountain ranges, with valleys lying between them. Now look at the other fingers. Check to see if every finger has the same pattern on it.
2. Press one finger onto the ink pad and then onto a sheet of white paper. You will get an image of your fingerprint pattern. Repeat with your other nine fingers and store your prints in the file.



Caution! The ink in this kit can cause stains! Be careful that nothing gets onto carpet, clothing, or tablecloth! After use, immediately close the ink pad so that it doesn't dry out or get on anything. Always wash your hands after using the ink pad.

For this to happen, though, fingerprints have to be found at the crime scene and rendered visible. At the crime scene itself, you should think about where a perpetrator may have touched something. Those are the locations where you should focus your search. But remember that any print you find may be old, and that not everyone who leaves behind a fingerprint is a perpetrator.

Taking fingerprints





Collecting fingerprints

1

Use the brush to transfer some fingerprint powder to the location where the print is. Carefully blow away any excess powder.



2

Remove one clear fingerprint sticker and press it carefully, sticky side down, onto a clearly visible print.



3

Firmly press on it once, and then slowly peel the sticker away.



4

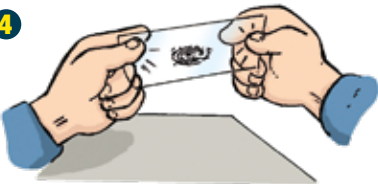

Now the powder is sticking to the sticker surface, and you can archive the print on the profile card. If you used a lot of powder, you can remove the impression a second time with a new sticker.

3. Wash off an empty glass bottle with soap, and then dry the outside without touching it. Press a few fingers onto the glass and immediately inspect the location with the magnifying lens. You will see that the pattern has imprinted itself on the glass. But this kind of print fades quickly and is hardly recognizable after just a few seconds.

4. Compare the fingerprints saved with special powder and tape against the ink pad prints on your file card. Now, whenever you find a suspicious fingerprint, you can immediately determine if it is your own.

What footprints and tire prints reveal...

It takes a lot of practice to be able to read tracks skillfully. Whenever possible, you should take advantage of the opportunity to study tracks in soft ground. You should also try out different gaits: running, hopping, pacing, limping, creeping. Compare the different kinds of tracks that result. Also inspect the tracks made by bicycles and cars. Finally, you should also learn how to distinguish the most common animal tracks.



Measuring tracks and prints

You will need:

- Measuring tape (centimeters)
- Slide gauge (die-cut sheet)
- Glue stick
- Paper
- Pencil
- Soft ground, sandbox if necessary



Here's how:

1. Assemble the slide gauge as shown in the illustration on page 28. Be careful to read the right measurement numbers on the scale that goes with it. The different colors will help you. Men's, women's, and children's shoe sizes are shown in different colors. All of the shoe sizes are approximations because there are a lot of variations in shoe sizes. Try measuring different kinds of shoes at home or at a friend's house, and check how well the length of the soles matches the indicated shoe size.
2. Walk slowly across a sandy surface, and then try running next to where you walked. Which prints are deeper? Did the stride length change?
3. Repeat the experiment, but this time try walking backwards. How do the footprints look now?
4. Compare different footprints and shoes. With a little experience, you can learn to draw conclusions about the kind of shoe from the kind of print: high-heeled shoes, gym shoes, soccer shoes, hiking shoes, rubber boots, sandals, etc. The condition of the pattern also reveals something about the age of the shoes.

TK 1

Tip

Shoe size table

If you really want to be precise, you could go to a shoe store on a quiet day and measure the length and breadth of different sizes of shoe. A table showing the length and width of the soles along with the matching shoe sizes will make your work easier on later assignments. You can also use the "footprint length (in cm) minus two centimeters times seven" rule of thumb to determine the approximate height (in centimeters) corresponding to the shoe size, and then write this into your table as well. Remember, this is just an approximation.

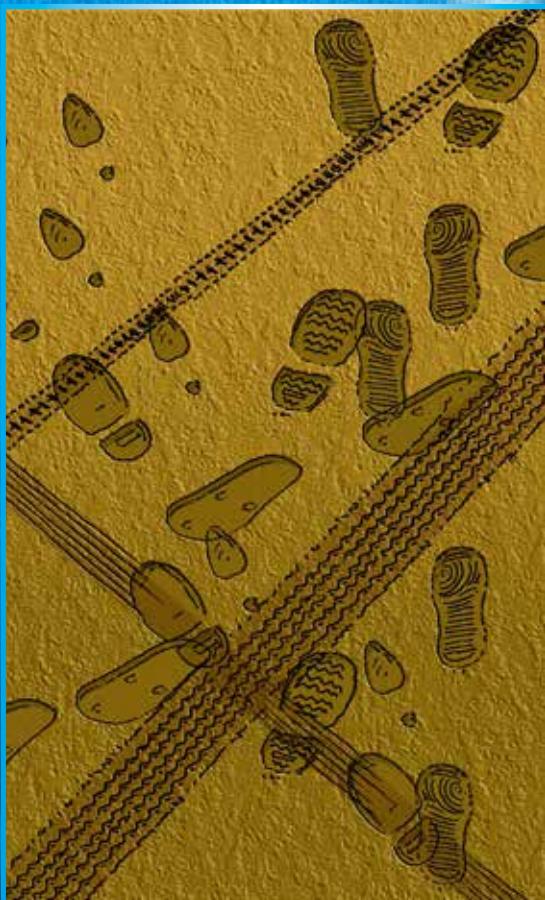

5. The same goes for bicycle tracks: By comparing different kinds (at a bike shop), you can learn to recognize the tire brand and the kind of bike (mountain bike, racing bike, road bike, and so on). Measure the tire width and also pay attention to the different tire tread patterns.

6. With four-wheeled vehicles, you can draw conclusions about the type and size of the vehicle by measuring the track width (distance between left and right wheels). Blades of grass will always be bent in the direction the vehicle was driving.

7. More recent tracks will cover any older ones, never the other way around. If you look carefully, you can tell who walked or drove by first.

8. Use your own bike to find out how different speeds influence the tire tracks. The rear wheel usually presses in more deeply, since it is carrying a heavier load. The faster the bike is moving, the closer together the front and rear wheel tracks will lie. If you ride very slowly, the front wheel will make distinct curves. This will help you determine the riding direction.

The Special Slide Gauge: How to assemble and measure tracks...

1

Bend the two flaps of the rear section of the slide gauge inward and glue them in place.

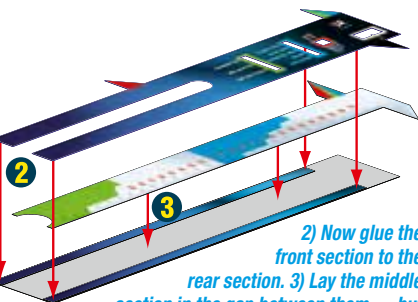
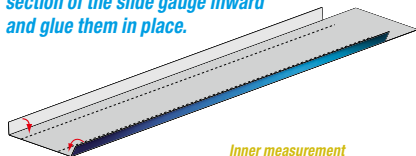

2) Now glue the front section to the rear section. 3) Lay the middle section in the gap between them — but don't let it get glued in place!

4

You can use your gauge to take internal and external measurements (see yellow arrows). If you follow the red arrows, you will see how to identify shoe sizes. Use the colors to help you differentiate men's (red), women's (teal), and children's (light orange) shoe sizes.

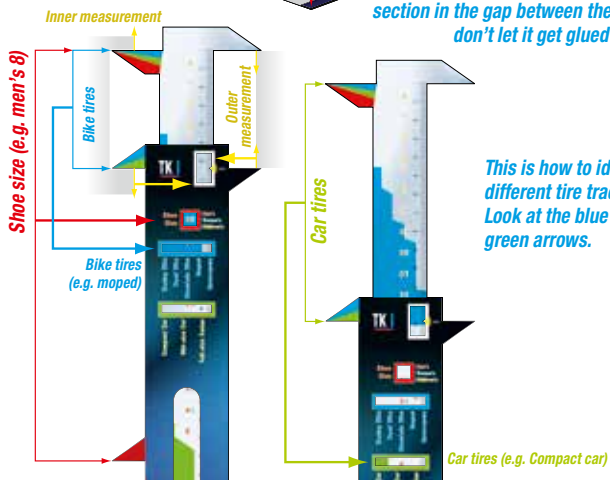

This is how to identify different tire tracks. Look at the blue and green arrows.

Casting footprints in plaster

Tracks in the ground can disappear quickly. Rain, pedestrians, or bicyclists can destroy them in the blink of an eye. That is why you have to save suspicious tracks. You can do that by pouring out plaster mixture, which then hardens to retain the shape of the track.

Preserving footprints

You will need:

Adhesive tape
Casting frame (die-cut sheet)
Plaster powder
Measuring cup
Wooden spatula
Forceps
Water (plastic bottle)
Permanent marker for labeling
Brush
Large plastic bag

Here's how:

1. Insert the four cardboard casting frame sections into one another at the pre-cut locations to make a frame that is slightly bigger than the track. Position the frame around the track.
2. With the forceps, carefully remove any extraneous objects, such as leaves, from the track.
3. Mix a little plaster with water in the measuring cup, to form a gray paste (2 parts plaster + 1 part water). Don't make it too thick, or it won't flow into all the nooks and crannies of the track.
4. Pour the mixture into the track, and spread it around with the tongue depressor.

Important! Pay attention to the warnings on page 1 and on the inside front cover about working with plaster!
Caution! Plaster can create dust. Do not inhale the dust.

5. Wait at least one hour. Now the plaster will have hardened and you can carefully take the block out of the ground.

6. Carry it home in a large plastic bag and carefully brush off any pieces of dirt before you place it in a labeled archive box.



Who trampled the flowerbed?

Tensions are high in the house. Carolyn's mother just discovered that somebody has run through her carefully-tended bed of rosebushes and she's pretty mad. But who actually did the deed? The three detectives take the case and start by meeting at the scene of the crime. "Now I understand why your mother is so furious," says James, looking at several deep footprints and broken rose stems.

The three detectives make a plaster impression of one particularly deep footprint. In addition, Mike measures its length and width.

"Who could the suspects be?" ponders Carolyn. "Really, just the people who live in the house: Dad, Mom,

Grandma, and then besides me there's just Jack and Steve, two kids from the neighborhood who come by to play almost every day after dinner. It couldn't really have been a stranger, because they would have had to climb over a high fence. Still, a manageable number of crime suspects."

Now it's time for the three detectives to do their work. They track down all the shoes they can find of the people who live in the house, as well as those of the two neighbor kids, and then they make sketches of the patterns on their soles, measure their length and width, and compare them with the plaster cast of the shoe print found in the bed. And voilà: One of the shoes matches the print found in the rose bed.



Carolyn



Jack



Steve



Father



Mother



Grandma

All kinds of evidence

Every crime scene is different, and each has different kinds of clues. It requires all the skills of a detective to be able to recognize what counts as evidence, to secure it, and to draw the correct conclusions from it later on. Try practicing searching for evidence in one of the rooms of your house, and note everything you find.

In search of clues...



You will need:

Magnifying lens
Screw-top container
Forceps
Plastic bag
Crime scene notepad
Felt-tip pen, permanent

Here's how:

1. Begin with the floor, so you don't trample on any evidence. Then check what's on the table and other furniture. Next, inspect windows, doors, walls and ceiling, beginning with the entryway and working in a clockwise direction. Don't forget to look under and on top of cabinets, in drawers, and under the sofa. Is there a wastepaper basket? Did something slip behind a cabinet? Is there really just water in the flower vase? Can you find any stains on the wall or the floor, and if so what caused them? Outside, pay special attention to footprints.
2. Don't touch the pieces of evidence with your hands, but use the forceps.

3. For every piece of evidence, make an immediate note of what it is and where you found it, and, if relevant, the condition it is in. Use your magnifying lens to help you inspect it. If something is worth inspecting more closely, put it in a plastic bag or screw-top container and label your sample clearly with a felt-tip pen.



TK 1

Tip

Potentially important types of evidence

- **Fibers** (examine under magnifying lens to deduce type and color)
- **Hairs** (reveal hair color of the person they're from. Caution! Could also be from an animal.)
- **Buttons** (compare to determine the article of clothing they came from)
- **Dirt**, such as soil on carpet (may reveal source)
- **Note** (interesting contents?)
- **Cigarette butts** (reveal brand)
- **Dirty glasses on table** (reveal what was drunk)
- **Movie tickets, train tickets** (reveal where the owner was and when)

Analyzing Evidence



	Finger	Score	Eng	M
93 152 4257 28 5	1 RHF	56352	NULL	0
97 878 2895 28 7	2 RHF	26239		0
97 898 3217 28 4	3 LHF	25862		0

931524267206-RHF
1496 Marker 9

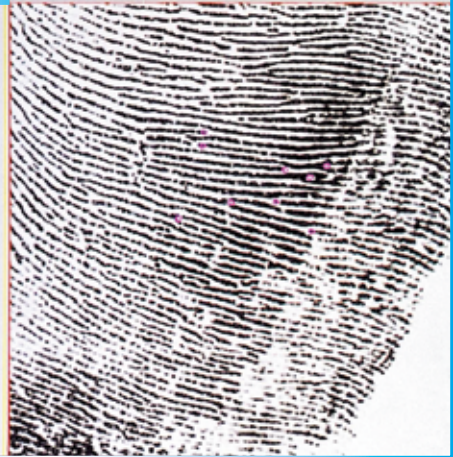
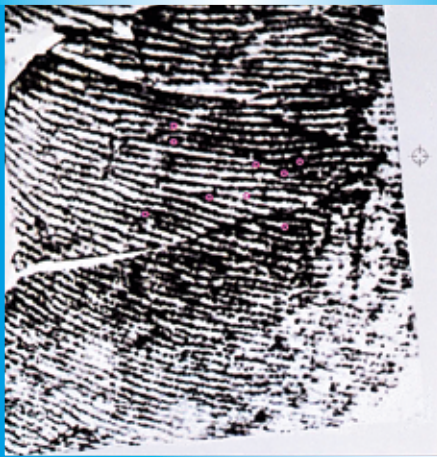

Take the collected evidence to your detective bureau for study. In addition to the evidence and other things you found at the crime scene, you may also need samples for comparison: soil samples from different areas, for example, fibers from pieces of clothing, tree leaves or pollen. Take the samples to their proper locations, label them clearly, and save them in your office.

Comparing fingerprints

A fingerprint can only be used as proof when you can compare it with prints from someone whose identity you know. But you have to be very careful, because different patterns can look very similar. You should therefore practice comparing fingerprints with a partner.

For the FBI, which stores millions of fingerprints, it isn't enough just to compare patterns. The tiniest details within patterns can be crucial, such as little hooks, branchings, islands, crossings. They are translated into a formula, i.e. a combination of letters and numbers, using a specified schema, and saved like that in a computer. The computer can then sort through all the formulas in a matter of minutes.

Ridge pattern types



You will need:

Fingerprint card
Magnifying lens
Ink pad
Paper
Pencil

Here's how:

1. When looking over the fingerprints you have collected, you have probably noticed that there are different kinds of prints. For example, there are swirls, arches, loops, T shapes, and mixtures of all of them.
2. If you find two similar prints, you have to compare them point for point under the magnifying lens. Only after you have determined that they are really the same can you say with certainty that they come from the same person.
3. Ask your relatives and friends whether you can take their fingerprints. Afterwards, they can easily wash off the stamp

pad ink. Write down the person the print is from, and which finger it is.

4. Now have your partner give you one of the prints from your collection, but without telling you whose it is. Can you figure out who it belongs to?

The FBI identifies fingerprints by these eight basic types.

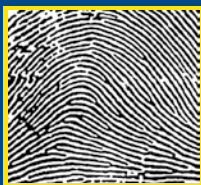

1. Plain Arch

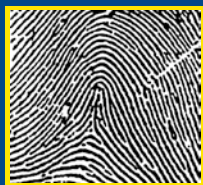

2. Tented Arch



3. Radial Loop



4. Ulnar loop

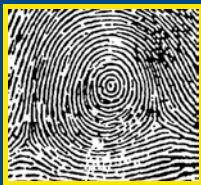

5. Central Pocket Loop



6. Plain Whorl



7. Double Loop Whorl



8. Accidental

Who broke the mirror?

"Workers in the house always cause trouble!" Aunt Matilda is visibly irritated as she tells her complaint to the three detectives: "I was just having my hallway repainted. Now I discover that one of the painters damaged the wardrobe mirror. He removed it and leaned it against the wall, but he did it so carelessly that one of the sides got cracked. I wish I knew which one of those four fellows it was!"

"Let me take a look at the mirror," says James reassuringly to his aunt, as Carolyn quickly fetches the crime scene case from TKI's secret office. The damage to the mirror is considerable. "But wait a minute, what's that?" mumbles Carolyn as she fishes out her magnifying glass: "The culprit left behind a clear fingerprint." In two minutes, she has cleanly removed it and stuck it onto a file card.

A moment later, the aunt's fingerprints are also attached to the card — for a comparison. "So it's not your fingerprint," determine Carolyn and James after a moment's inspection.

"Yes, but what now?" complains the aunt, who has been following their work with curiosity. "I can't exactly ask the painters for their fingerprints."

"You don't have to, Auntie." James has a great idea. "I know a trickier way to do it. Offer each one of them a glass of soda. Pay attention to who gets which glass, and then give the glasses to me. Then we'll have our comparison fingerprints for sure."

No sooner said than done. A quarter of an hour later, the three detectives have 19 good prints lying in front of them from the four glasses, plus the one from the mirror. "Now I know who broke the mirror," says James triumphantly. Can you figure it out too?



Examining fibers and hairs

Sometimes, all it takes is a tiny fiber or a single hair found at the scene of a crime to track down the perpetrator. After all, it may prove that he was at the scene. Nevertheless, the analysis of such evidence is by no means simple. Try practicing it along with your detective colleagues on samples of a few different kinds of material.

Hairs and fibers



You will need:

Magnifying lens
Plastic bag
Paper
Pencil
Adhesive tape

Here's how:

1. Carefully remove samples of fiber from several articles of clothing (but without damaging them!). Tape the fibers to a sheet of white paper and write down their source.
2. Examine them under the magnifying glass and pay careful attention to their differences: What do the fibers look like? What can you say about their coloring and structure?
3. Practice your skills with a partner. Have him place a fiber from one of the articles of clothing in a plastic bag. Then try to figure out which piece of clothing it came from, simply by analyzing the fiber.



Human hairs



Wool



Bird feather

What can soil samples reveal...

Pieces of dirt from the soles of shoes can reveal a lot about where the person had recently been walking. Sand, loamy soil or humusy earth can all be clearly distinguished under the magnifying glass. Little pieces of grass may point to a freshly-mowed lawn. Bits of decayed leaves could come from a path through a woody area with deciduous trees, while a walk through a pine forest would be revealed by bits of pine needles. To learn how to differentiate various kinds of soil with confidence, you should first try practicing on some samples.

Analyzing soil samples



You will need:

Petri dish
Forceps
Plastic bag
Magnifying lens
Evidence pad
Pencil
Water



Here's how:

1. Collect soil samples from as many different places as possible (one handful is enough) and save them in clearly labeled plastic bags.
2. For each different sample, place a little in the petri dish, break it up with the forceps, and examine it under the magnifying glass. What is its color? Do you see granules or grit? Do you recognize any plant matter, and if so what does it look like? Add a little water and watch how the soil reacts. How quickly does it dry and how does it change as it does so? That helps you estimate how long the dirt had been on the sole of the shoe.
3. Have your partner test you. Can you match the sample he or she gives you to one of the samples you collected?



Detecting counterfeit money

These days, counterfeit paper money is usually made with color printers or color copiers. The U.S. Treasury has redesigned the 5, 10, 20, and 50 dollar bills with security features that make them harder to counterfeit. Printers and copiers can't reproduce those features, so they are what you should pay attention to. Try this with one of the new redesigned bills, not an older one or a one dollar bill.



Paper money test



You will need:

Magnifying lens

UV flashlight

Lamp (for watermark)

Different denominations of paper money

Here's how:

1. To find a counterfeit, it usually helps to view the bill at different angles. With a real 10, 20, 50, or 100 dollar bill, the numeral in the lower right-hand corner changes from green to copper as you tilt it from side to side.

2. Hold the note up to the light and look near the right edge for a face similar to the one printed in the center. Also, look for the security thread strip, which repeats the words "USA FIVE," "USA TEN," "USA TWENTY," "USA 50," or "USA 100" in tiny print.

Security threads glow in UV light

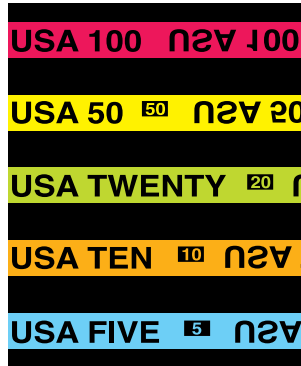

The security threads embedded in newer bills each glow a different color in UV light. Try shining the Multi-Pen light on the security threads of different bills.

Which bill is counterfeit?

Sometimes, an unusual assignment can fall quite suddenly into a detective's lap.

"Mike, can you help me?" asked Chris one afternoon. Chris is the business manager of Mike's favorite soccer team. "I read in the paper that some counterfeit 20 dollar bills have been showing up around town." Mike nods. He also read the same article, and saved it in his archive.

"Now I'm worried that we might have some fake money in our cash box. Can you tell whether any of the bills are counterfeit?"

Counterfeit money? No problem for a good detective. The next afternoon, they huddle together over the cash box, putting each of the bills under the magnifying glass and the UV light. Suddenly Mike cries out: "You were right, Chris! This bill is definitely fake."

Can you figure out which of the bills he recognized as counterfeit?



Currency Security Features at a Glance

Federal Reserve Indicators

A letter-number combination identifies the issuing Federal Reserve Bank.

Paper

Currency paper is made of 75% cotton and 25% linen, and contains small red and blue fibers distributed throughout the paper.

Serial Numbers

The first letter of the serial number corresponds to the year in which the series was first introduced. For example, "E" indicates the bill is from the 2004 series.

Watermark

Most bills have a watermark (a faint image that looks like the portrait) that is visible from either side when held up to the light.

Face Plate Number



Check Letter/
Quadrant
Number

Series Year

Security Thread

A clear polyester thread embedded vertically in the paper is inscribed with the denomination of the note and is visible when held up to the light. Different bills have different thread locations and the threads will glow different colors in UV light.

Color-Shifting Ink

The color of the number in the lower right-hand corner of most bills shifts from copper to green, or green to black, as the note is tilted 45 degrees.

Portrait

The portraits of past US Presidents are very detailed and made of very fine lines and dots that are hard to reproduce.

Note:

The word "SPECIMEN" is written all over this sample bill because it is not a real bill. These words do not appear on the real bills.

Secret Codes and Messages

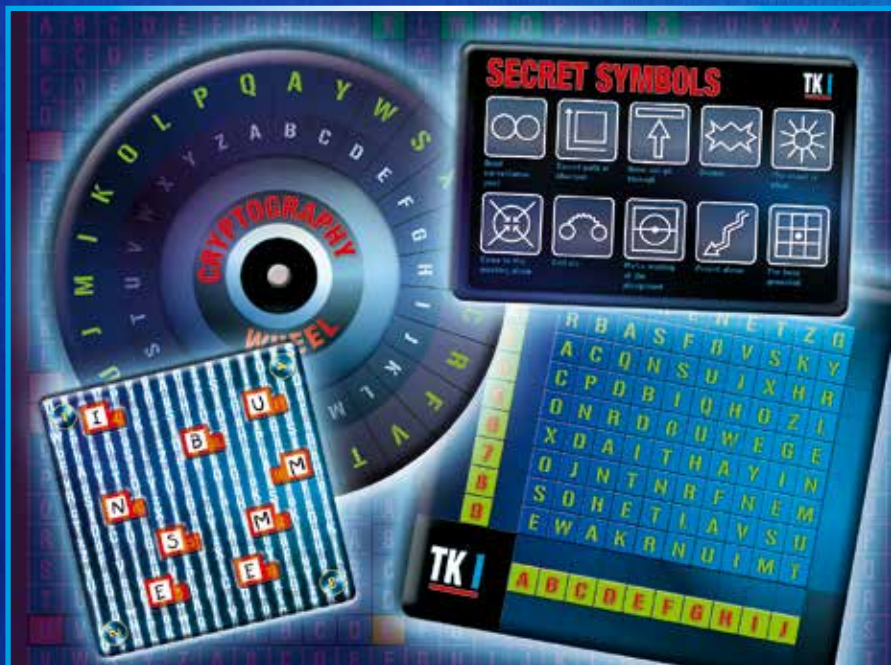

One of the most important skills of a detective is the ability to send and receive secret messages. You too can share secret notes with your partners which will only be decipherable by them. There are countless methods for encoding text. Here, you will learn about a few of them.

Invisible writing

An ideal kind of secret writing is one that nobody can read except someone who has the means to render it visible. Invisible inks have been around for hundreds of years. They can be made from almost any colorless liquid, such as milk or lemon juice. By heating

the paper carefully, the writing turns visible.

In your kit, though, you have something much better — an ultraviolet flashlight, which makes certain invisible inks visible, such as the ink in the invisible ink pen included in your kit.

A hand holding a blue ultraviolet flashlight that illuminates a piece of paper with the words 'TOP SECRET' written in invisible ink.

The flashlight emits light in the ultraviolet (UV) wavelength, which lies beneath that of ordinary light, and cannot be perceived by our eyes. But there are colorless substances that emit a colored glow as soon as they are hit by UV light. This is the kind of substance that the pen contains.

Invisible ink

You will need:
UV flashlight
Invisible ink pen
White paper
Pencil

Here's how:

1. Write a message on the paper with the pen. After a few seconds, the ink will be dry and invisible. Turn on your UV flashlight and shine it on your sheet of paper. Under the special light, the ink glows and the text is visible. Only someone who has a UV lamp can read your secret message.

2. Now you can send the sheet to the recipient. But if someone were to intercept this secret message, the blank sheet of paper would probably make him suspicious, because he would immediately think there might be invisible ink on it. It's better to write to short, innocent piece of made-up text on the sheet — with a pencil, because it will interfere least with the process of deciphering.

3. The recipient, of course, will need a UV light of some sort. If he or she uses it to illuminate the secret writing, it will become visible.



Letter substitutions

There are also techniques for encoding visible text in a way that makes it impossible (or at least very hard) to decipher. One of the simplest involves substituting every letter with a different one. You can use the two encoding wheels to help you use this technique to encode, send, and decode messages.

Cryptography wheel

You will need:
4 Encoding wheels
(die-cut sheet)
2 Round fasteners

Here's how:

1. Remove the two large and two small encoding wheels from the sheet. Lay each small wheel on one of the large wheels and affix them with the round fasteners so they can rotate. (See diagram on next page.)

2. You have to agree with your partner how to set the wheels, in other words which letter from the large wheel will point to the "A" of the small wheel (in our example, it is "E").

Or, you can agree to have this letter always be the first or the last letter written in the message, or to hide the letter in a certain way in the address.

3. For example, if you want to encode the word "danger," instead of writing the actual letters, you should write the ones they line up with on the large disk. In this case, from "danger" you get: R E J T F O.



4. The recipient does it exactly in reverse. First, he or she lines up the encoding wheel properly. Then he or she looks for the "R" on the large wheel and writes down the corresponding letter on the small wheel, in this case "D," and so on.

Assembly instructions for the cryptography wheel

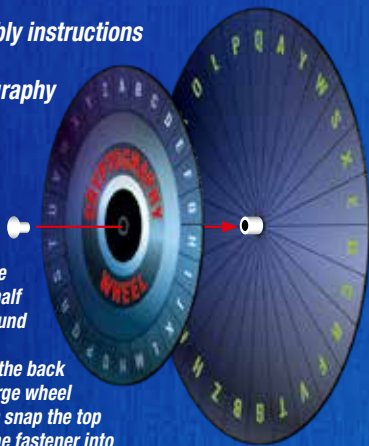

Insert the bottom half of the round fastener through the back of the large wheel and then snap the top half of the fastener into the bottom half through the small wheel.

Example setting: "Danger"

Setting code:
A on E



Secret perforated grid

A different encoding technique works with a square grid. The messages can't be too long, but the advantage is that they will be virtually impossible to decipher by anyone who doesn't know the encrypting technique or the grid pattern.

Perforated grid coding



You will need:

2 Grids (die-cut sheet)
Sheet of white paper
(8.5 x 11 inch)
Pencil

Here's how:

1. Remove the two grids from the sheet and push all the cardboard pieces out of the pre-cut holes. One grid is for you, and the other is for the recipient of the message.
2. Lay a grid on the paper and write the first part of the message in the holes, letter by letter, beginning in the one marked with the number 1.
3. When all the holes are filled, reposition the grid by rotating it 90 degrees to the right. A new set of free squares will appear in the holes, and you can continue with the message.
4. Repeat as necessary until you have completely rotated the grid back to its starting position.
5. Remove it from the paper and fill the remaining spaces with whatever letters you like.

Example message:
AT THE TOWER AT SEVEN
WITH FLASHLIGHTS

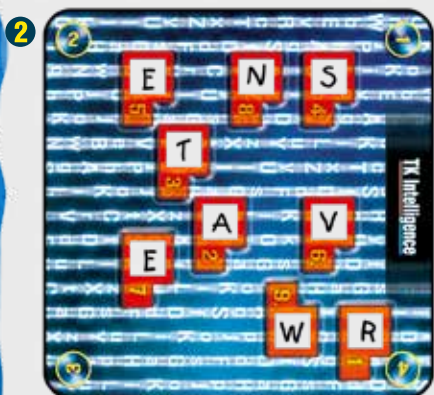

6. Now the note is ready to send. First, though, you will have to let the recipient know which corner of the grid to start with. Then he will be able to decode the message without any problem.

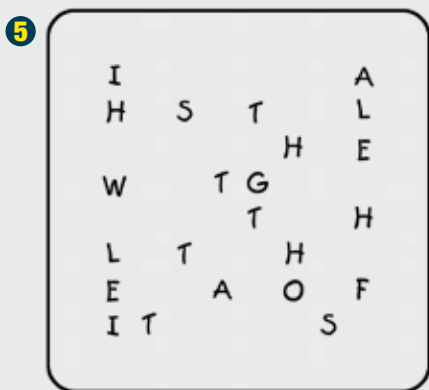
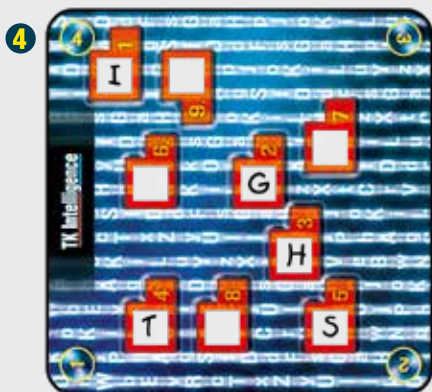

At the end, fill the remaining spaces with whatever letters you want.

Tip: *When you lay the grid on the paper, draw a line along each of the edges, so the stencil doesn't slip as you rotate it.*

The “Battleship” code



You will need:

Coordinates key (die-cut sheet)

Pencil

Sheet of paper (half of a letter sheet, 5.5 x 8.5 inch)

Here’s how:

1. In the die-cut sheet, you will find two squares covered with letters, which you can use to encode or decode the letters of your messages with the help of the coordinate numbers 1 through 9 and letters A through J.

2. Write the message on a sheet of paper. Use the “Battleship” grid to assign the corresponding coordinates, letter by letter (sometimes there may be multiple

possibilities, which is deliberate, because it makes the encryption more secure).

3. The second detective can use his letter table to “translate” the coordinates back into legible text by the same method.

*Example message: NINE OCLOCK =
C7-E4-F9-D8 A5-B3-J4-H4-A4-D9*

1	A	R	D	R	E	N	E	T	Z	G
2	R	B	A	S	F	B	V	S	K	Y
3	A	C	Q	N	S	U	J	X	H	R
4	C	P	D	B	I	Q	H	O	Z	L
5	O	N	R	D	B	U	W	E	G	E
6	X	D	A	I	T	H	A	Y	I	N
7	O	J	N	T	N	R	F	N	E	M
8	S	O	H	E	T	L	A	V	S	U
9	E	W	A	K	R	N	U	I	M	T

TK I

A B C D E F G H I J

The Vigenère square

The method you are about to learn is an almost unbreakable encryption code. It was used for hundreds of years in various secret services. In addition to the table below, you need a secret codeword known only to the sender and receiver.

The code for the pros



You will need:

Vigenère square

Graph paper

Pencil

Codeword

Here’s how:

1. Write the message to be encrypted in a row on a piece of graph paper, with one letter per square. In our example, the message is “the tower at nine.”

Secret symbols for detectives

Thieves and vagabonds used to use secret symbols to indicate whether a given house or street was “profitable” or “dangerous.” Among those symbols, they had signs designating policemen, judges, and owners of vicious dogs.

In the die-cut sheet, you will find two cards with secret symbols for detectives, which you should commit to memory so you can use them for certain specific situations. If desired, you can enlarge your repertoire of secret symbols by creating additional symbols.

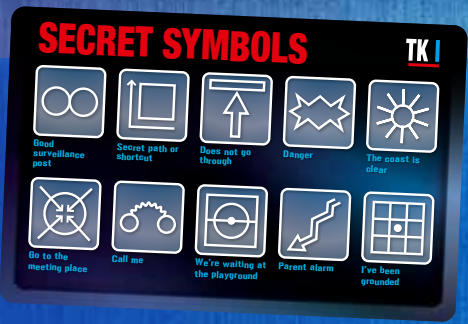

You can draw these symbols on the sidewalk in front of your friend's house, for example, to send a secret message.

TK I Tip Text message code

For quick communication by cell phone, think of a few codes that you can send, encrypted or not, as text messages.

Blinking Morse code



You will need:

Morse code alphabet
UV flashlight *or* regular flashlight
Codeword

Morse Alphabet

A ..	M _ _	Y _ _ _ _
B _ _ _ _	N _ .	Z _ _ _ _
C _ _ _ .	O _ _ _	1 . _ _ _ _
D _ _ .	P _ . . .	2 _ . _ _ _
E .	Q _ _ _ .	3 _
F _ . . .	R _ . .	4 _
G _ _ .	S _ . .	5 _
H _ . . .	T _ _	6 _
I _ . .	U _ . .	7 _ _ . . .
J _ _ _ _	V _ . . .	8 _ _ . . .
K _ . .	W _ . . .	9 _ _ . . .
L _ . . .	X _ . . .	0 _ _ _ . .

Here's how:

You can use the UV flashlight, a regular flashlight, or even just a lamp in a room with a window to transmit silent signals at night or dusk to your detective friends.

The Morse code alphabet translates letters and numbers into a sign language using short and long signals. Normally, a radio operator sends these signals as a sequence of tones, but the code also works as blinking light signals.

In any case, it's important to agree beforehand on signals that you can use to identify each other. Also, you should always allow a small pause between individual letters.

Checklist for Master Detectives

Equipment:

- Doorplate for detective bureau
- Detective ID
- Hiding places in the office
- UV flashlight with invisible ink pen
- Morse code alphabet
- Magnifying lens, ink pad, forceps
- Profile cards
- Fingerprint file cards
- Crime scene suitcase
- Door seals and crime scene notepad
- Measuring tape, barricade tape, number signs
- Colored chalk
- Fingerprint powder, brush, special tape
- Slide gauge
- Plaster powder and pouring frame
- Tongue depressor and measuring cup
- Various containers for evidence
- Encoding wheel, perforated grid, coordinates
- Secret symbols for detectives



Tasks/Detective Training:

- Morse code
- Surveillance practice
- Find the 7 differences
- Invisible door seal
- Following and shadowing
- Sealing off and investigating crime scenes
- Crime scene sketch and crime scene report
- Marking evidence
- Securing fingerprints
- Measuring tread patterns and footprints
- Plaster cast of a track
- Looking for all kinds of evidence
- Comparing fingerprints
- Hair and fiber samples
- Analyzing soil samples
- Currency test
- Secret codes and secret symbols



Assignments:

- Who was the robber?
- Who trampled the flowerbed?
- Who broke the mirror?
- Which bill is counterfeit?



Solutions

Robber (p. 8/9):

Ralph Winkler is highly suspicious, because he mentioned the pearl necklace. Only the perpetrator could have known about it, because it wasn't mentioned in the newspaper report.



Flowerbed (p. 30):

Obviously, it was Jack. Carolyn shows him the print and Jack admits that he inadvertently ran into the rose bed while playing ball.



7 Differences (p. 15):

- 1 more cup (table)
- Different money
- 1 cup missing (counter)
- Green apple
- T-shirt design
- Skateboard color
- Waiter's bow tie



Mirror (p. 34):

Fingerprint No. 9 belongs to the scatterbrained painter. His print precisely matches the one on the mirror...



Counterfeit money (p. 38):

The \$20 bill with the number 4 next to it is missing the color-shifting number "20" in the corner.



Important Information

Safety Information for UV Flashlight:

- Batteries should be installed and replaced by adults only.
- One AAA battery (1.5-volt/LR03) is required.
- The battery is to be inserted with the correct polarity. Press it gently into the battery compartment.
- The supply terminals are not to be short-circuited. A short circuit can cause the wires to overheat and the batteries to explode.
- Be sure not to bring batteries into contact with coins, keys, or other metal objects.
- Non-rechargeable batteries are not to be recharged. They could explode!
- Rechargeable batteries are only to be charged under adult supervision.
- Rechargeable batteries are to be removed from the toy before being charged.
- Exhausted batteries are to be removed from the toy.
- Avoid deforming the batteries.
- Dispose of used batteries in accordance with environmental provisions.
- **IMPORTANT!** Protect the device from moisture. Clean it with a damp cloth and allow it to dry thoroughly before using it again.

Notes on Disposal of Electrical Components



None of the electrical or electronic components in this kit should be disposed of in the regular household trash when you have finished using them. Instead, they must be delivered to a collection location for the recycling of electrical and electronic devices. The symbol on the product, instructions for use, or packaging will indicate this. The materials are reusable in accordance with their designation. By reusing or recycling used devices, you are making an important contribution to the protection of the environment. Please consult your local authorities for the appropriate disposal location.



Kosmos Quality and Safety

More than one hundred years of expertise in publishing science experiment kits stand behind every product that bears the Kosmos name. Kosmos experiment kits are designed by an experienced team of specialists and tested with the utmost care during development and production. With regard to product safety, these experiment kits follow European and US safety standards, as well as our own refined proprietary safety guidelines. By working closely with our manufacturing partners and safety testing labs, we are able to control all stages of production. While the majority of our products are made in Germany, all of our products, regardless of origin, follow the same rigid quality standards.

1st Edition 2015

© 2015 Franckh-Kosmos Verlags-GmbH & Co. KG, Pfizerstrasse 5-7, D-70184 Stuttgart, Germany. Tel. +49 (0)711 2191-343

This work, including all its parts, is copyright protected. Any use outside the specific limits of the copyright law without the consent of the publisher is prohibited and punishable by law. This applies specifically to reproductions, translations, microfilming, and storage and processing in electronic systems and networks. We do not guarantee that all material in this work is free from copyright or other protection.

Project management: Annette Büchele, Bettina Klein
Technical product development: Monika Schall, Armin Vetter
Text: Ruth Schildhauer

Editing of text and images: Norbert Fasching, lektorat & textlabor (Gärtringen)
Manufacturing and design: Michael Schlegel, komunikati – print & web (Würzburg)
Illustrations: Wolfgang Peschke (Ostfildern); Michael Schlegel (Würzburg); Claus Rayhle (Stuttgart)
Packaging design: Michael Schlegel (Würzburg), unter Verwendung einer Zeichnung von Silvia Christoph (Berlin)

Photos: M. Bachofer (Stuttgart): p. 35 (feather); BKA Bundeskriminalamt (Wiesbaden): p. 18, 32 (Collage of three designs), 35 (t); Kantonspolizei Zürich, Kriminaltechnische Abteilung: p. 20 [retouched], 22, 26 (b.), 35 (m); Kosmos Archives: p. 35 (hair and wool); Michael Flaig (Stuttgart): p. 3; www.aboutpixel.de: p. 26 (t).

The publisher has made every effort to locate the holders of image rights for all of the photos used. If in any individual cases any holders of image rights have not been acknowledged, they are asked to provide evidence to the publisher of their image rights so that they may be paid an image fee in line with the industry standard.

2nd English Edition © 2015, 2019 Thames & Kosmos, LLC, Providence, RI, USA
Thames & Kosmos® is a registered trademark of Thames & Kosmos, LLC.

Editing: Ted McGuire
Additional illustrations: Dan Freitas and Ted McGuire
Packaging artwork: Dan Freitas

Distributed in North America by Thames & Kosmos, LLC, Providence, RI 02903
Phone: 800-587-2872; Web: www.thamesandkosmos.com

Distributed in United Kingdom by Thames & Kosmos UK LP, Cranbrook, Kent TN17 3HE
Phone: 01580 713000; Web: www.thamesandkosmos.co.uk

We reserve the right to make technical changes.
Printed in Germany / Imprimé en Allemagne