

# Mini-Micro Systems

A CAHNERS PUBLICATION

AUGUST 1984

**Single-board computer blazes  
at 8 or 16 bits**

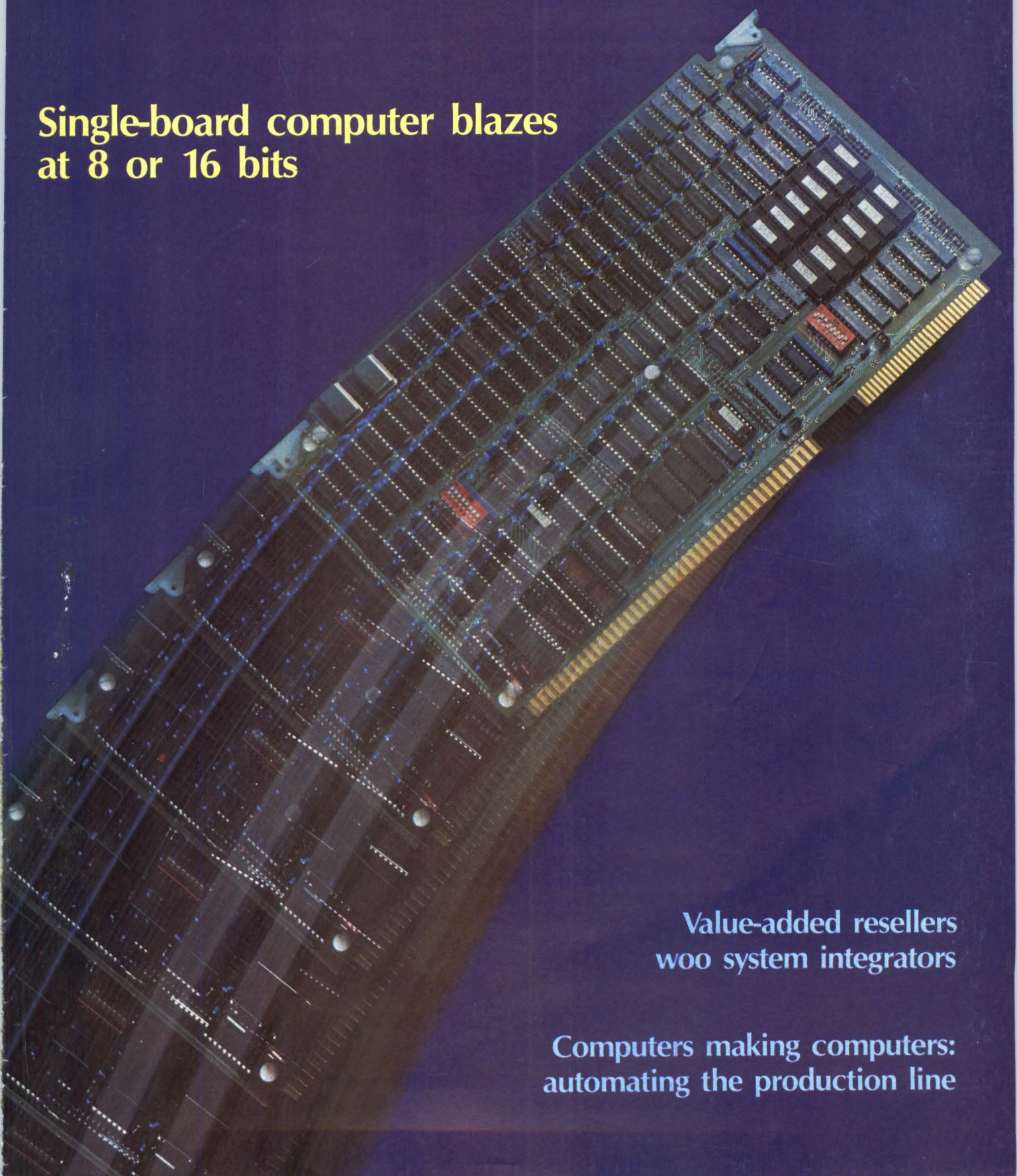

Value-added resellers  
woo system integrators

Computers making computers:  
automating the production line

# WIDE WORD™

## 200 MB/second!



### World's Fastest Bulk Memory System

It's true. Dataram's WIDE WORD memory system delivers an incredible data rate of 200 MB/sec! Achieved by utilizing 80 or 160 bits per word and four-way interleaving.

Much faster than even the fastest minicomputers can handle...but not too fast for your real-time applications, image processing, array processing or data acquisition needs.

Multi-port capability enables you to bring WIDE WORD speed to your host minicomputer. Simply connect one port to your high-speed input; the other to your mini.

Our library of dedicated interfaces allows you to run with Digital Equipment, Data General, Ampex, Control Data, CSPI, Honeywell, Intel (MULTIBUS), MODCOMP, Motorola (VERSAbus), Perkin-Elmer, ROLM, and SEL. And, possibly even more importantly, we can work with you to develop a custom WIDE WORD interface.

WIDE WORD. 128 MB of high-performance memory in a compact 15 1/4" system. Word lengths up to 160 bits. And, of course, a data rate of 200 MB/second.

Our new WIDE WORD brochure will tell you more. And you can have it at no charge by circling the Reader Response Number or calling us at (609) 799-0071.

WIDE WORD is a trademark of Dataram Corporation. MULTIBUS is a registered trademark of Intel Corporation. VERSAbus is a trademark of Motorola, Inc.

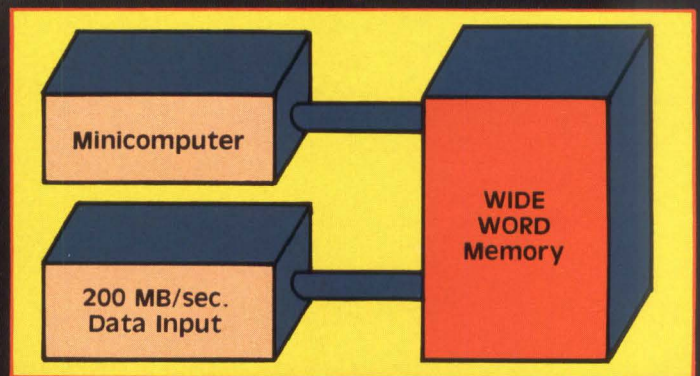

## DATARAM

Princeton Road □ Cranbury, NJ 08512 □ (609) 799-0071 □ TWX: 510-685-2542  
CIRCLE NO. 1 ON INQUIRY CARD

Zilog now gives users of the System 8000 the kind of choice the big three cereal companies have given breakfast eaters for years.

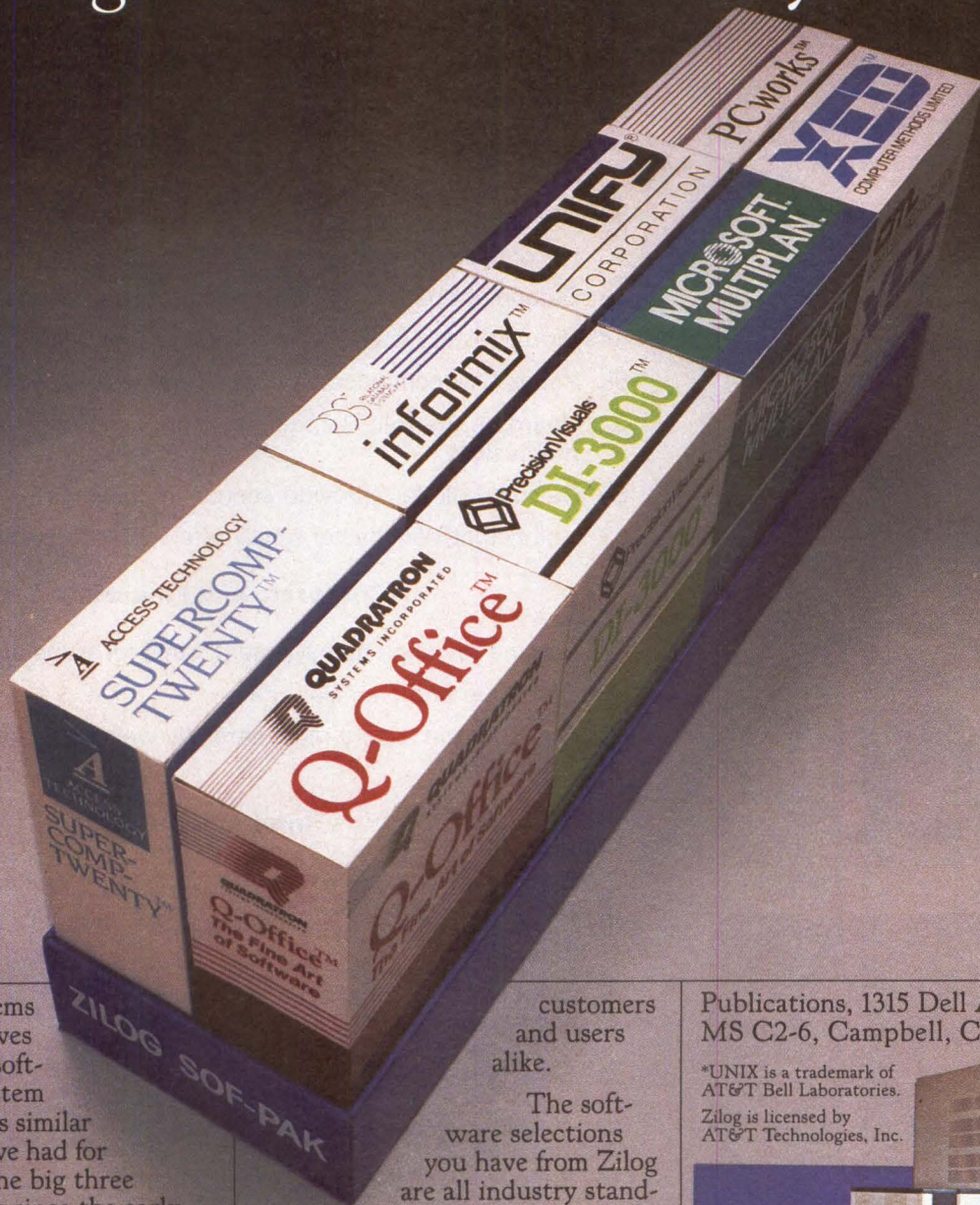

Zilog Systems Division now gives you a choice in software for the System 8000 supermicros similar to the kind you've had for breakfast from the big three cereal companies since the early 1960's. You get to select the software you need when you need it. It's an easy and practical way to satisfy individual tastes.

We give you a choice of the best software you can buy. All from a single source.

We give you a choice of the best software applications packages you can buy. All from a single source. It's efficient, convenient and it saves you money. While satisfying the individual needs of

customers and users alike.

The software selections you have from Zilog are all industry standard packages. Your customers will recognize them instantly. What's more, Zilog provides complete software support. So you don't waste energy seeking vendors for help if and when you need it.

Get a taste of what it's like to run the most satisfying menu of software on the best high-performance UNIX\* multi-user supermicros ever built — the System 8000. Call Zilog Systems Division at (800) 841-2255. Or write: Zilog Systems Division, Corporate

Publications, 1315 Dell Avenue, MS C2-6, Campbell, CA 95008.

\*UNIX is a trademark of AT&T Bell Laboratories. Zilog is licensed by AT&T Technologies, Inc.



*Systems Division*  
**Zilog**

an affiliate of EXON Corporation

# Mini-Micro Systems



p. 159 . . . . Art direction and design by Vicki Blake. Photography by Richard Wood.

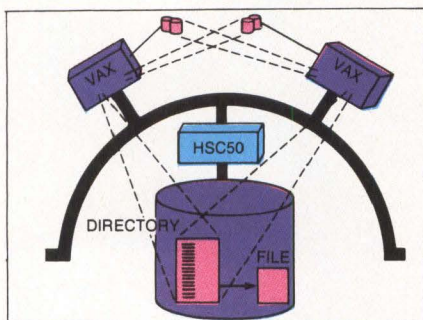

p. 38 . . . . . Streamlining VAXcluster

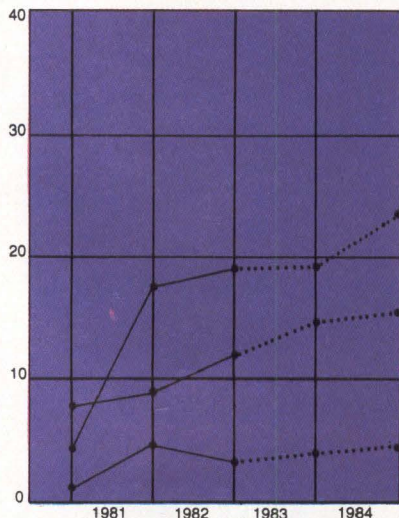

p. 133 . Watch CAD/CAM/CAE sales take off

## MINI-MICRO WORLD News

- 33 TeleVideo enters DEC market with VT220-compatible terminal
- 34 HP is first with low-cost laser printer
- 35 Data General's engineering workstations push price/performance boundaries
- 38 New VAX/VMS version streamlines VAX cluster
- 43 HP phases out three terminals with low-priced model
- 48 Datapoint opens ARCNET LAN to outside vendors
- 54 Virtual Microsystems adds PC-DOS compatibility to DEC micros
- 58 Xebec Owl combines on-board controller, electronics
- 62 Heard on the Hill: Unhappy electrical engineers bewail U.S. productivity
- 65 Calcomp plotters provide economic drawings
- 68 Half-height Winchester family offers 57M to 202M bytes

## Corporate and Financial

- 79 Fortune revamps management, aims for value-added resellers
- 85 Corporate and financial briefs
- 88 Guest Forum: Users must carefully weigh PBX/office equipment purchases

## International

- 101 European PC users demand high-quality, on-site maintenance
- 106 Olivetti acts as AT&T's counterpart to push AT&T micros in Europe
- 109 Overheard Overseas: Honeywell takes a bold step toward helping startups

## INTERPRETER

- 114 Software vendors zero in on marketing
- 125 IBM LAN announcement raises many questions

## INTEGRATOR

- 133 Technology continues to define leaders of CAD/CAM and CAE market
- 147 Automated testing and material handling streamline production and raise yields

**FEATURES**

- 157 **Feature Highlights**
- 159 **Single-board computer merges 8-, 16-bit performance . . .**  
mini strategy packs power on a single board
- 171 **Eurocard/DIN single-board computers signal era of**  
**international standards . . .**debate surrounding standards  
highlights trends
- 183 **Mature software tools speed development tasks . . .**making a  
better product in less time
- 195 **Low-cost multiuser system exploits PC-compatible**  
**workstations . . .**micro allows up to 12 users to run concurrent  
applications
- 205 **Value-added resellers pursue system integrators with**  
**support and services . . .**vendors seek to penetrate vertical  
markets
- 217 **HP's model 9000: squeezing a mainframe into a shoe**  
**box . . .**32-bit micro runs at 1 MIPS
- 233 **Computer-integrated-design graphics terminal incorporates**  
**local database . . .**reducing host intervention in graphics  
applications

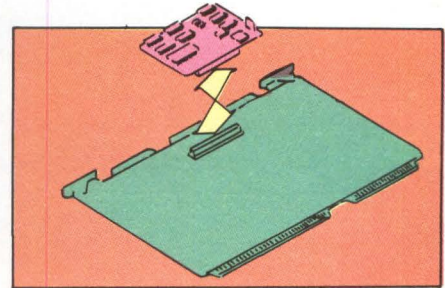

p. 171 . . . . . Eurocard goes international

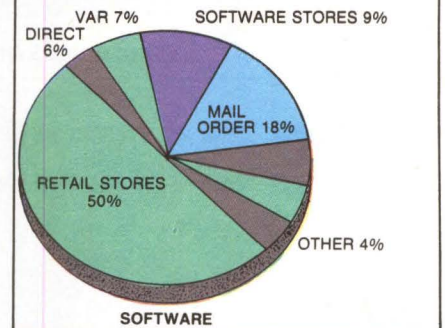
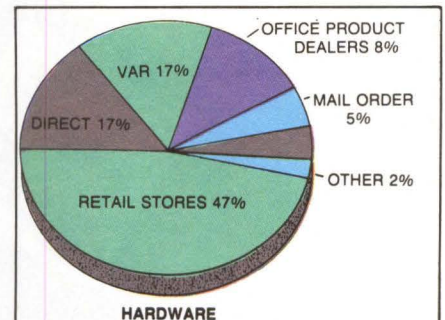

p. 205 . . . . . Pursued by VARs

**DEPARTMENTS**

- |                     |                            |
|---------------------|----------------------------|
| 4 Editorial Staff   | 266 Calendar               |
| 9 Editorial         | 269 Career Opportunities   |
| 13 Letters          | 273 Classified Advertising |
| 17 Breakpoints      | 274 Index to Advertisers   |
| 245 Guest Viewpoint | 275 Mini-Micro Marketplace |
| 246 New Products    |                            |



MINI-MICRO SYSTEMS (ISSN 0364-9342) is published monthly (with additional issues in spring, summer and fall) by Cahners Publishing Company, Division of Reed Holdings, Inc., 221 Columbus Avenue, Boston, MA 02116. Norman L. Cahners, Chairman; Saul Goldweitz, President and Chief Executive Officer; Ronald G. Segel, Executive Vice President and Chief Operating Officer. MINI-MICRO SYSTEMS is published by the Cahners Magazine Division: J. A. Sheehan, President; William Platt, Executive Vice President. Circulation records are maintained at Cahners Publishing Co., 270 St. Paul St., Denver, CO 80206. Second class postage paid at Denver, CO 80202 and additional mailing offices. Postmaster: Send address changes to MINI-MICRO SYSTEMS, 270 St. Paul St., Denver, CO 80206. MINI-MICRO SYSTEMS is circulated without charge by name and title to U.S. and Western Europe based corporated and technical management, systems engineers, and other personnel who meet qualification procedures. Available to others at the rate of \$55.00 per year in the U.S.; \$60.00 in Canada and Mexico; \$75 surface mail in all other countries; \$120 foreign air mail (15 issues). Single issues \$4.00 in the U.S.; \$5.00 in Canada and Mexico; \$6.00 in all other countries.

© 1984 by Cahners Publishing Company, Division of Reed Holdings, Inc. All rights reserved.

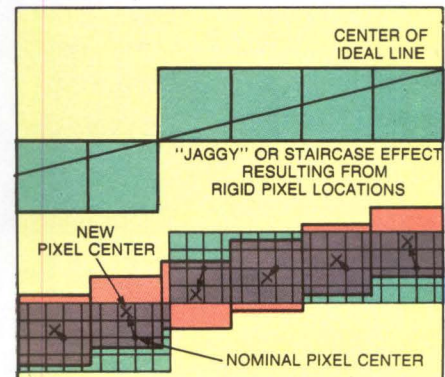

p. 233 . . . . . Eliminate those "jaggies"

## Powerful Z80 emulation, priced well within your grasp. That's NICE.™

NICE may be only 3" square and 1/2" thick, but it hands you full speed, real-time emulation for the Z80—over 50 emulation functions, software breakpoints, all memory addresses and all I/O ports.

Just plug NICE directly into the target Z80 socket and any RS232 terminal for system development, troubleshooting, debugging or testing . . . at home, in the lab or in the field.

And NICE hands you all this performance, portability and versatility for only \$498\* . . . the best emulator price/performance ratio on the market, hands down.

Call in your order today using

your VISA or Mastercard number: (800) NICOLET outside CA, or (415) 490-8300 in CA.

Or send your check or money order to NICE, Nicolet Paratronics Corporation, 201 Fourier Avenue, Fremont, CA 94539.

\*Payment by check, money order, VISA or Mastercard.  
NICE is a trademark of Nicolet Paratronics Corporation.  
Z80 is a trademark of Zilog, Inc.

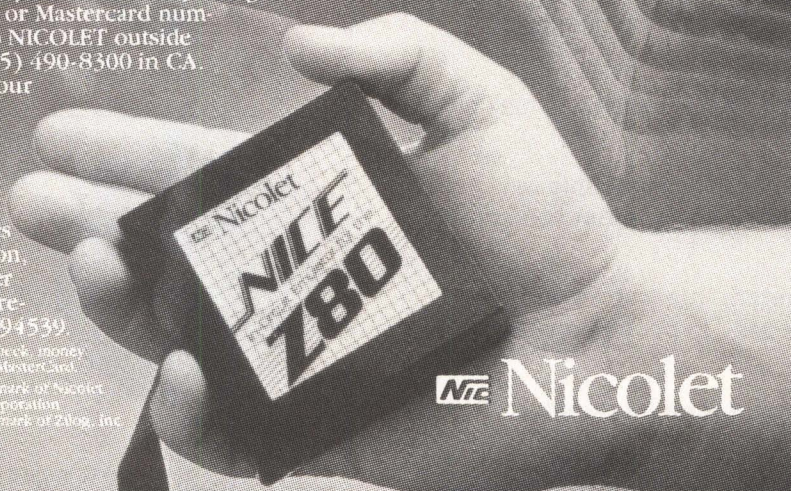

**Nicolet**

CIRCLE NO. 5 ON INQUIRY CARD

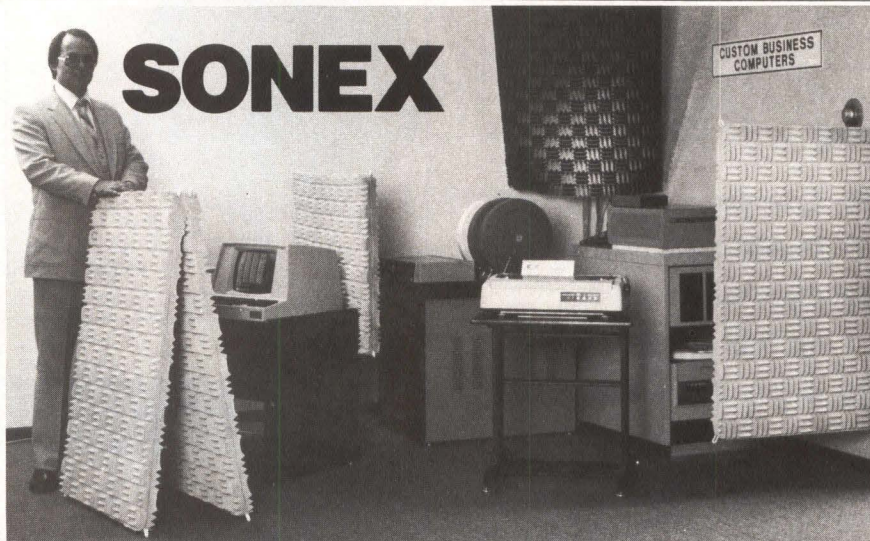

## SONEX kills disk drive hum.

SONEX acoustical foam's absorption coefficient is four times that of conventional materials. Send for the tests, charts, specs, and color examples from 3800 Washington Ave. N., Minneapolis, MN 55412, or call 612/521-3555.

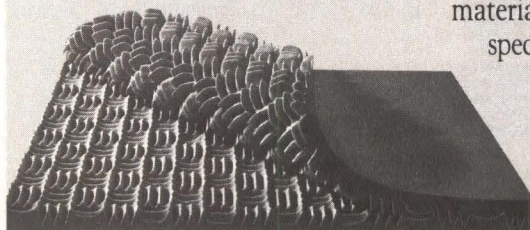

**illbruck/usa**  
techniques with foams

CIRCLE NO. 6 ON INQUIRY CARD

### STAFF

Vice President/Publisher  
**S. Henry Sacks**

Editor-in-Chief  
**George V. Kotelly**

Managing Editor  
**James F. Donohue**

Assistant Managing Editor  
**Bruce J. MacDonald**

Senior Western Editor: **Jerry Borrell**  
San Jose, (408) 296-0868  
Senior Editor: **Sarah Glazer**  
Senior Editor: **Paul Sniger**  
Senior Editor: **Lori Valigra**  
Senior Projects Editor: **Rick Dalrymple**

Western Editor: **Carl Warren**,  
Los Angeles, (213)826-5818  
Associate Editor/Research:  
**Adrienne DeLeonardo**  
Associate Editor: **Frances T. Granville**  
Associate Editor: **Lynn Haber**  
Associate Editor: **Tom Moran**,  
San Jose, (408)296-0868  
Associate Editor: **David Simpson**  
Associate Editor: **Marjorie Stenzler-Centonze**,  
New York, (516)595-2737  
Associate Editor: **Michael Tucker**  
Associate Editor: **Jesse Victor**  
Assistant Editor: **David Bright**  
Assistant Editor/New Products: **Eileen Milauskas**  
Assistant Editor/Research: **Megan Nields**

#### Contributing Editors:

London: **Keith Jones**, (011-441-661-3040)  
Data Communications: **Walter A. Levy**  
Computer Architecture: **Efrem Mallach**  
Office Automation: **John Murphy**  
Frankfurt: **Maureen O'Gara**  
Artificial Intelligence: **Steven Roberts**  
Washington, D.C.: **Stephen J. Shaw**,  
(202)387-8666

#### Editorial Production

Senior Copy Editor: **Arsene C. Davignon**  
Production Editor: **Mary Anne Weeks**  
Copy Editor: **Gregory Solman**  
Word Processing: **Kathleen Appignani**  
Administrative Assistant: **Frances C. Michalski**

#### Editorial Services

**Sharon Hassell, Robin Sheehan**

Assistant to the Publisher: **Linda L. Lovett**

Executive Editor,  
Cahners Computer Publications:  
**Alan R. Kaplan**

#### Art Staff

Art Director: **Vicki Blake**  
Assistant Art Director: **Cynthia McManus**  
Artist: **Anne Tregay**

Director of Art Dept.: **Lee Addington**  
Associate Director: **Norm Graf**

#### Production Staff

VP Production: **Wayne Hulitzky**  
Supervisor: **William Tomaselli**  
Production Manager: **Nancy Norton**  
Composition: **Diane Malone**

#### Editorial Offices

**Boston:** 221 Columbus Ave., Boston, MA 02116.  
(617)536-7780. **Irvine:** 2041 Business Center Dr.,  
Suite 109, Irvine, CA 92715. **Los Angeles:** 12233 W.  
Olympic Blvd., Los Angeles, CA 90064. **San Jose:**  
3031 Tisch Way, San Jose, CA 95128. **New York:**  
33 Arcadia Dr., Dix Hills, NY 11746. **London:** Busi-  
ness Press International, Quadrant House, The  
Quadrant, Sutton, Surrey, SM2 5AS, England.

**Reprints** of Mini-Micro Systems articles are available on a custom printing basis at reasonable prices in quantities of 500 or more. For an exact quote, contact Art Lehmann, Cahners Reprint Service, Cahners Plaza, 1350 E. Touhy Ave., Box 5080, Des Plaines, IL 60018. Phone (312)635-8800.

Gould...Innovation and Quality in UNIX-based systems

# Our Firebreathers are scorching old performance standards.

Gould's PowerNode™ 9000 blasts through UNIX\* benchmarks at 4.5 times the speed of the VAX™ 11/780. Sound impossible? Give us your real production code or benchmarks and let us prove it.

## Firebreathing Performance.

Now you can run software development and production at the same time, with highly responsive performance. Tightly coupled dual processors nearly double throughput and virtual memory accommodates large programs. Hardware fixed point and floating point accelerators retain high performance in heavy number-crunching situations. The PN9000 handles mainframe jobs in a multi-user UNIX system or serves as a backend processor in a widely distributed network.

## Unique UNIX Software.

Gould's own high performance UNIX-based operating system (UTX/32™)—a unique combination of Berkeley 4.2 with special Bell System V features—makes it easy for you to use your VAX-based UNIX software. This allows easy conversion from your system to the increased power of a Firebreather.

## Compatible Family.

Gould's Compatibility Suite is a collection of application software packages that are compatible across the entire PowerSeries™ product line. Use C, Cobol, BASIC, or Pascal languages intermixed. This close-knit processor family offers all the advantages of

a dedicated system plus the lower-cost-per-user option of sharing resources with Gould's standard networking capabilities including Ethernet™. The Firebreathers are the high end of the widest range of UNIX-based systems in the industry.

Gould's Firebreathers are scorching the UNIX market.

**Gould Inc.,  
Computer Systems Division**  
Distributed Systems Operation  
6901 West Sunrise Boulevard  
Ft. Lauderdale, Florida 33313  
(305) 797-5459

\*UNIX is a trademark of AT&T Bell Labs  
™PowerNode, PowerSeries and UTX/32 are trademarks of Gould Inc.

™Ethernet is a trademark of Xerox Corporation.

™VAX is a trademark of Digital Equipment Corporation

CIRCLE NO. 7 ON INQUIRY CARD



**GOULD**  
Electronics

# 68000-based Just tell us

## *68000-based systems to fit your application.*

Right from the pages of our catalog, we can deliver 68000-based super-micro systems to match virtually any application.

Including yours.

Here's how.

Built on the IEEE-696 (S-100) bus, Cromemco systems offer up to 21 board slots. And a family of 35 boards — CPU, memory and specialized I/O — to fill the slots any way you choose.

At the heart of each system is our 68000/Z-80 dual processor. Backed by as much as 16 Mb of error-correcting RAM. Full multi-tasking capability. I/O to handle up to 16 terminals.

And that's just the beginning.

You can select single or dual floppies, 5¼" or 8". A 50 Mb 5¼" Winchester hard disk. And a nine-track tape drive.

We can accommodate your taste for the exotic, too. With boards like our SMD interface that supports up to 1200 Mb of disk storage. A fast floating-point processor. A color graphics interface. A TV camera digitizer. An IEEE-488 bus interface. Communications. And more.

## *Intelligent workstations.*

Then, if you're designing a dis-

tributed processing system, you'll want to take a look at our C-10 personal computer. The Z-80-based C-10 can serve our 68000-based systems as a powerful intelligent workstation in a distributed processing mode. Or as an independent personal computer with its own floppy storage.

## *High-level languages and applications software.*

That brings us to software. It starts with CROMIX®, our UNIX™-like operating system that you're free to tailor to your application.

CROMIX can execute both 68000- and Z-80-based programs. So right along with your 68000-based packages, your system will accommodate a wide selection of CP/M® software written for the Z-80.

And our high-level language support is second to none. From a 68000 Macro Assembler. To 68000 FORTRAN 77, PASCAL, GSA-certified high-level COBOL, C and BASIC.

## *Cromemco means business. Your business.*

You see, when we say, "Just tell us what you need," we're not kidding. You won't find another family of



# systems. what you need.

68000-based microcomputers that can fit your needs as exactly as ours.

So if you're in the business of providing specialized computing solutions, you really should be doing business with Cromemco.

For a copy of our Systems Catalog, contact Cromemco, Inc., 280 Bernardo Avenue, P.O. Box 7400, Mountain View, CA 94039. (415)964-7400.

In Europe: Cromemco GmbH, 6236 Eschborn 1, Frankfurter Str. 33-35, P.O. 5267, Frankfurt Main, Germany or Cromemco Ltd., The Cambridge House, 178-182 Upper Richmond Rd., Putney, London SW15 England.

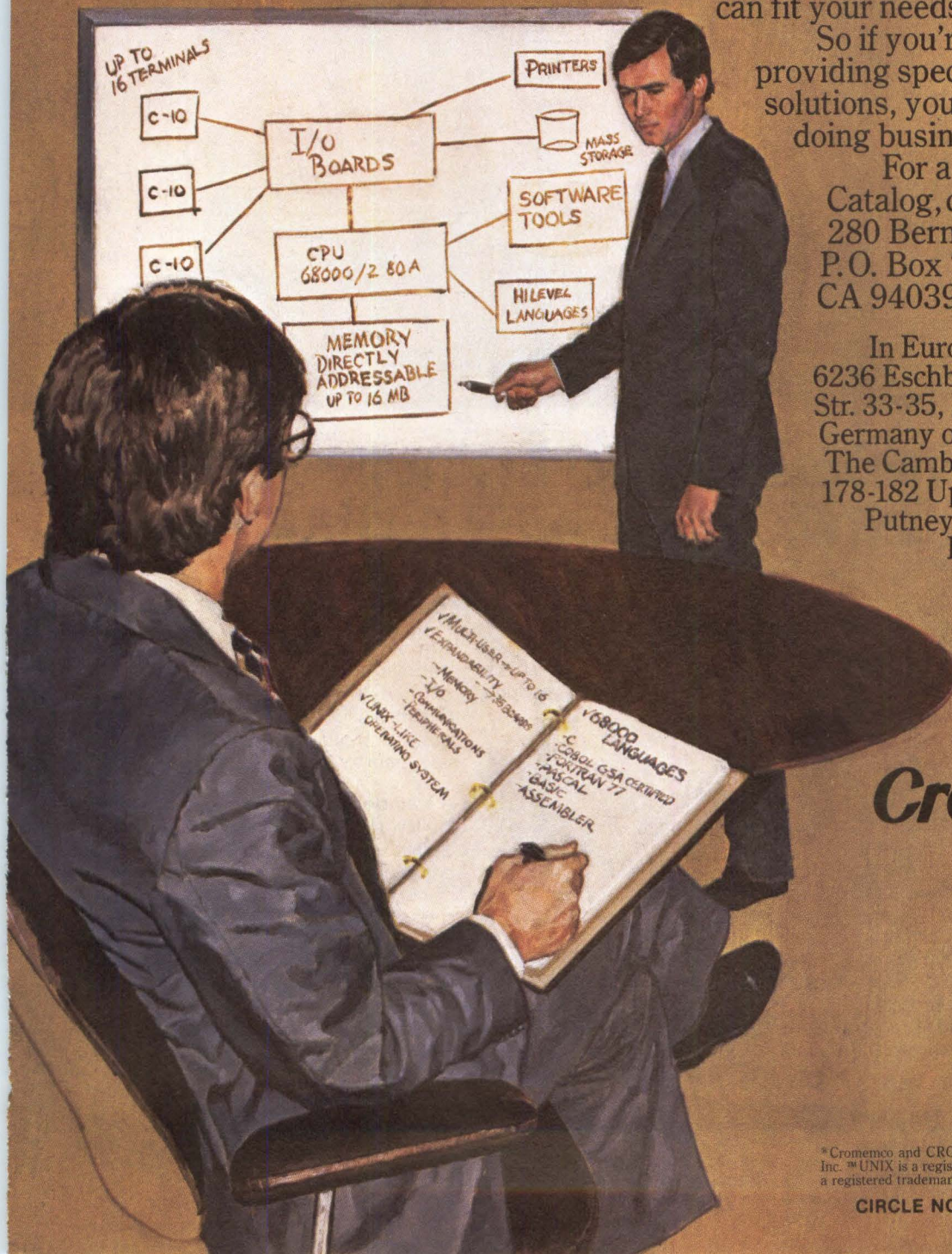

**Cromemco**®

\* Cromemco and CROMIX are registered trademarks of Cromemco, Inc.™ UNIX is a registered trademark of Bell Laboratories.™ CP/M is a registered trademark of Digital Research. ©1983, Cromemco, Inc.

**CIRCLE NO. 8 ON INQUIRY CARD**

50,000 DRIVES DELIVERED



## WE'VE BEEN DELIVERING 3 1/2" WINCHESTER DISK DRIVES FOR OVER A YEAR.

Rodime has been setting a new standard in Winchester disk drive storage for more than a year. Its 3 1/2" drive with 5 and 10 megabytes of formatted storage has become the industry leader for sub 4" Winchester disk drives. Rodime has now delivered tens of thousands!

### The proven compact drive and proven quantity supplier

With thousands of its 3 1/2" Winchester drives in operation today Rodime has further demonstrated its reputation for reliability, a major design consideration for its 3 1/2" drive, and quality. It has a rugged design with high resistance to shock, an important consideration for portability and for vibration prone environments. Using advanced large-scale integration, the entire electronics for the drive are on a single compact board and there are no adjustments or select-on-test components.

### New design horizons

The compact size of Rodime's drive suddenly puts large-scale storage into areas never considered before. The 350 series is one-fourth the volume of a 5 1/4" Winchester drive. And the 250 series, which includes



mounting brackets and a face plate, fits into the same space as a half-height 5 1/4" Winchester offering even further shock and vibration isolation. Now, system designers have a new level of flexibility. One area that has received attention is use with portable computers. Several major portable computer manufacturers have already incorporated Rodime 3 1/2" Winchester disk drives into

their products. There are other equally exciting areas such as desk top computer systems, intelligent terminals, point-of-sale terminals, industrial controllers, telecommunications systems, navigation and guidance systems, and portable instrumentation. In fact, the list of potential uses is only limited by the imagination of the system designer.

### A tradition of excellence

In a few short years, Rodime has established itself as a major force within the Winchester disk drive industry. Rodime is one of the few manufacturers that are delivering 5 1/4" Winchester drives with a broad range of capabilities up to 54 megabytes. And is the only manufacturer delivering high-performance 3 1/2" Winchester drives in production quantities.

For the compact 3 1/2" Winchester disk or other 5 1/4" Winchester requirements, look to Rodime. Rodime delivers.

# RODIME

**Western Sales Office:** (714) 770-3085 • **Eastern Sales Office:** (512) 453-5135

**Distributors:** San Jose, CA (408) 946-8000 • Tustin, CA (714) 730-8000 • San Diego, CA (619) 279-5200, 453-9005 • Chatsworth, CA (818) 700-1000 • Tempe, AZ (602) 244-0900 • Englewood, CO (303) 790-4500  
Redmond, WA (206) 881-0850 • Addison, TX (214) 733-4300 • Austin, TX (512) 835-0220 • Sugarland, TX (713) 240-2255 • Burlington, MA (617) 272-9400 • Hauppauge, NY (516) 273-1660 • Fairfield, NJ (201) 227-7960 • Horsham, PA (215) 443-5150 • Columbia, MD (301) 964-0040 • Tulsa, OK (918) 644-8812

CIRCLE NO. 9 ON INQUIRY CARD

©1984 Rodime, Inc.

## Personal computers: boom and bane

The recently published report, "Trends in Computing Systems and Services for the 80's," produced by International Data Corp. (IDC), a Framingham, Mass.-based market research company, for *Fortune* magazine, discussed the expected changes and challenges of personal computers, as well as minicomputers and mainframes. The report essentially states that during 1984 and 1985 the movement of innovative computer technologies into commercially available products will greatly accelerate.

In fact, the sale and shipment numbers boggle one's mind. For example, IDC claims that worldwide computer shipments for 1983 exceeded \$42 billion, and that the installed base is now worth more than \$200 billion. But this decade, says IDC, belongs particularly to the personal computer. By 1985, the dollar value of personal computer shipments in the United States, projected at \$12 to \$13 billion, will exceed those of mainframes. By 1987, personal computers will be king of the hill, with U.S. shipments achieving a predicted value of \$19 to \$20 billion.

Even more optimistic is Dr. Egil Juliussen of Future Computing Inc., a market research company located in Richardson, Texas. In his state-of-the-market, personal report (MMS, June 1984, Page 167), Dr. Juliussen prophesied that U.S. revenues for office personal computers will reach \$13.1 billion in 1985 and \$20.7 billion in 1987. Moreover, he states that the U.S. software market for office personal computers will expand from \$3.2 billion in 1985 to \$5.6 billion in 1987.

But what do all these numbers mean to system integrators? On the positive side, a flood of low-cost, high-performance personal computers should inundate the marketplace. On the negative side, though, system integrators will be paddling furiously against the tide to gain adequate product knowledge, to achieve full product utilization and to determine proper product application.

In fact, the IDC report predicts that the decade's outstanding trend is that all computer systems will eventually be integrated. First, the systems will be joined in-house and, second, to the outside world. Therefore, the trend implications point to integrating personal computers with mainframe operations and with existing microcomputer and minicomputer systems.

Consequently, the need for new computer product and system information becomes paramount. And most system integrators will rely on computer trade magazines, trade shows and seminars to meet their immediate information needs. For our part, *Mini-Micro Systems* serves you with the latest computer, peripheral and software product, industry and technology news, issues and events—in depth and in perspective. Let us know how we're doing.

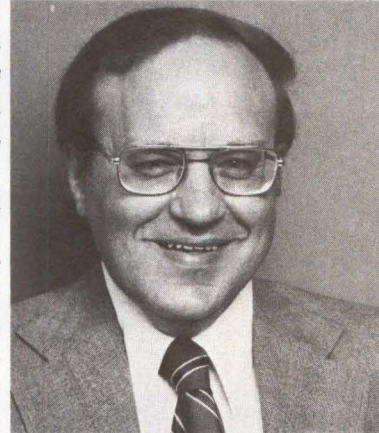

*George V. Kotelly*

George Kotelly  
Editor-in-Chief

# IF YOUR BUSINESS IS SHRINKING, SHUGART CAN HELP.

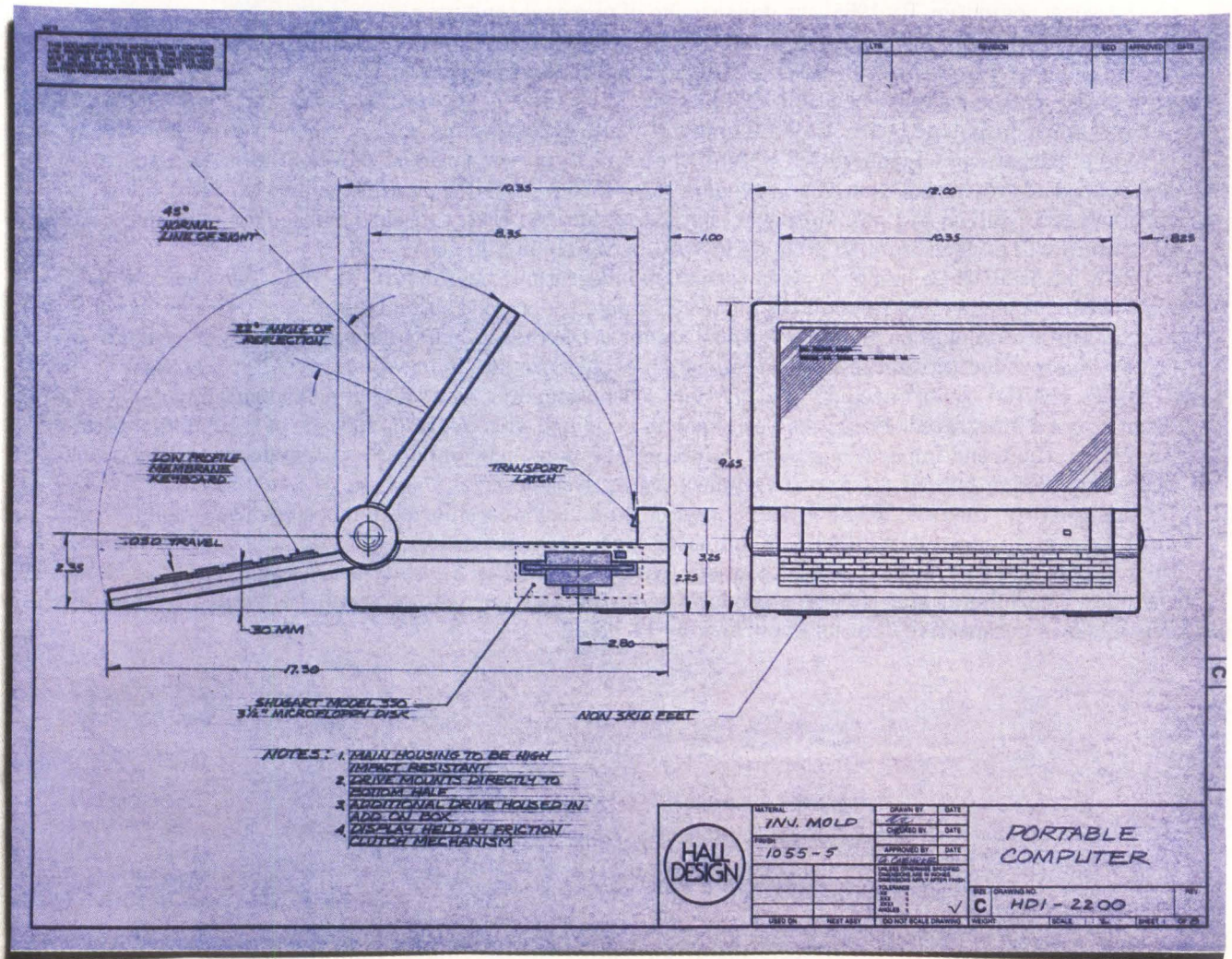

These days, computer designers everywhere face a problem of massive proportions: How do you cram a desktop computer into a briefcase?

Sound familiar? If so, there's a family of 3.5" single and double-sided microfloppy disk drives you should meet. The Shugart 300 and 350, respectively.

The perfect drive solution for a full-featured portable.

Tiny enough to fit easily into your smallest design. Yet with a 6 millisecond average access time, a capacity up to 1 megabyte and Minifloppy™ compatibility, your portable computer could easily run the same software as someone else's desktop.

And keep it running for quite some time.

Shugart drives are so reliable, you can count on an MTBF of 10,000 power on hours. One reason we're projecting delivery of over 100,000 microfloppy drives this year.

At just over a pound apiece, you could even use two. And still call your portable computer portable.

There's just one thing to remember. You should always check the activity light on a Shugart microfloppy. They're so quiet, there's no other way to tell if they're running.

What more could a shrinking

business need? A couple of other small things. Industry standard 3.5" microcartridges, to be exact. Their track densities offer a more than generous upgrade path. But more important, considering where they could end up, they come equipped with a hard shell plastic media cartridge. And an automatic head access shutter. Sure protection from all kinds of catastrophes. Stick them in your pocket. Throw them in your purse. Bang them around in your briefcase. They'll survive.

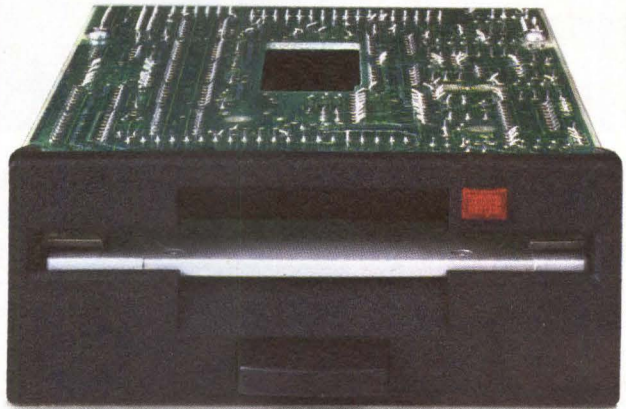

The 3.5" Shugart Microfloppy. Smaller than actual size, but not much.

Sound interesting? Call your local Shugart sales office. We'll do a private microfloppy workshop right in your office. But do it soon. The more your business shrinks, the more Shugart can help.

**Shugart**

Right from the start.

# Choose Precision Visuals graphics software and you're in the best company.

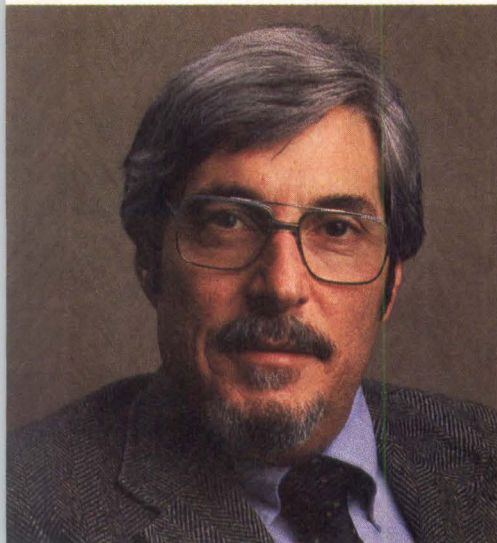

**"DI-3000® graphics software will meet the needs of a total enterprise."**

Phil Goss  
Honeywell

Precision Visuals' graphics software tools are today's standard for over 800 organizations, large and small. Here's why. Graphics programmers are saving hundreds of hours by using the appropriate Precision Visuals software tools for the project. They choose from our integrated family of graphics packages based on the commercially acclaimed DI-3000® subroutine library or the GKS implementation, GK-2000.™ With full support for most computers—IBM, DEC, CDC, PR1ME, Honeywell, Data General, Cray, Apollo, and many UNIX-based systems\*—and over 80 popular graphics peripherals, their investment in our software is secure . . . today and tomorrow. Look into Precision Visuals and see why.



**"Precision Visuals' documentation is a model for the industry."**

Dr. James D. Foley, President  
Computer Graphics Consultants, Inc.

Here's someone who knows how a good manual should look. Dr. Foley, Professor of Electrical Engineering and Computer Science at George Washington University, is co-author of *Fundamentals of Interactive Computer Graphics*. According to Dr. Foley, our DI-3000® manual is "ideal for people with little or no graphics experience." Our example-intensive documentation includes a quick reference guide for the experienced graphics programmer and step-by-step tutorials that quickly turn beginners into productive graphics programmers.

It's not surprising that many customers were sold on our graphics tools just by looking at our documentation. Ask to see a copy for yourself.

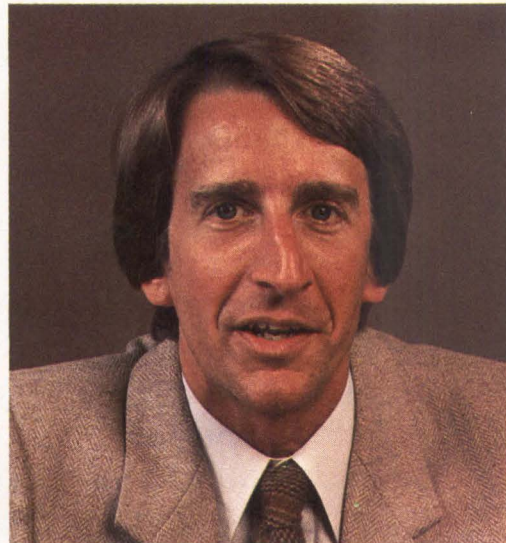

**"It's not just the package that's important. It's the people behind it."**

David Campbell  
INCYTE, Fairchild/A Schlumberger Co.

What adds even more value to our versatile graphics tools is the support you get from our people at Precision Visuals. Graphics software specialists staff a Help Line for quick answers to keep you on schedule; national training programs, for the novice to the advanced graphics programmer, help get your applications operating on time and within budget; active international and regional user groups that exchange creative and productive ideas; plus thoroughly tested products and documentation designed to meet your needs today and in the future.

Don't you think it's time to choose Precision Visuals? Call us today at 303/530-9000.



**Precision Visuals**

6260 Lookout Road / Boulder, Colorado 80301  
303/530-9000  
TELEX 45-0364 / TWX 910-940-2500

Presentation Graphics

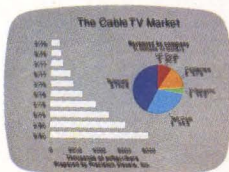

Enhanced Contouring

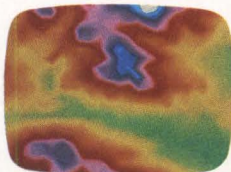

VLSI Design

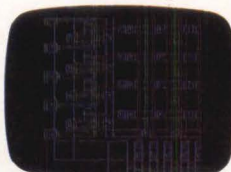

Solids Modeling



Process Control

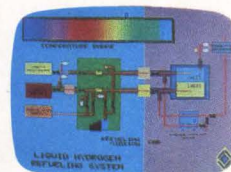

\*UNIX is a trademark of BELL Laboratories, Inc.

# Letters

## CORPORATION LOSS

### To the editor:

I take exception to some of the information in the article "Bypassing Local Telephone Lines—a Growing Option for Data Communications" (MMS, February, Page 115). The information, ostensibly provided by Pacific Northwest Bell (PNB), claims that corporation stands to lose \$800,000 annually because of Tektronix's microwave system. However, Tektronix's calculations show that PNB's unrealized revenue would come to only a small fraction of the stated amount.

The report provided by PNB to the Federal Communications Commission (FCC) describes Tektronix's microwave system as having the potential to avert annual charges of \$800,000. Your article, stating that PNB "stands to lose \$800,000," is almost unequivocal in its implication that such a loss is a reality.

The extent to which the article suffered from misleading source data is unclear. What is clear, however, is that, in these days when regulatory matters are being decided in the political arena and common carriers submit carelessly researched information to public agencies, it is more important than ever that the media research more assiduously and probe a bit deeper to provide accurate and informative assessments.

**C.J. Thomas**  
Telecommunications Manager  
Tektronix Inc.  
Beaverton, Ore.

### Author's response:

The \$800,000 figure as related to revenue losses experienced by Pacific Northwest Bell due to Tektronix's private microwave system was obtained directly from the FCC's Third Report and Order in the Matter of MTS and WATS Market Structure, released Feb. 28, 1983, FCC 82-579 32607, Attachment 1, Page 5. The report was cited accurately in my article. This report is a public document and can be obtained through the FCC's Office of Public Affairs.

**Stephen J. Shaw**  
Washington Editor

## BROADBAND NETWORKS

### To the editor:

In reference to "Broadband Networks Prove Expensive for Interconnecting

Terminals" (MMS, March, Page 139): I have been reading *Mini-Micro Systems* for several years. This is the first time I have found myself upset at what would appear to be a report that uses a specific, narrow instance to extract a general truth.

First, uninformed readers would probably not realize that, if the only requirement of an application is to interconnect terminals to host processors, purchasers of a network would be wasting money if they even study a broadband solution. That being the case, twisted-pair wiring is certainly the answer unless the application requires thousands of terminals.

Second, I'm not sure why you indicated maximum system terminal capacity for WangNet before major renovation was only 192 additional terminals. Pre-planning cable plant installation would allow that many terminals on one 6-MHz channel. If the bandwidth is approximately 360 MHz, you could get approximately 60 times that number. Therefore, the number of terminals to be supported is limited only by customers' ingenuity in defining future requirements while engineering their cable plants.

By the way, I'm not a big fan of WangNet, but I do believe your reporting lacks some fact or you are biased.

**Peter E. Donohue**  
Montgomery, Ala

### Author's response:

Mr. Donohue's letter reflects a widespread problem in the field of area networks: the tendency to confuse technology with products. I will respond to certain points in his letter.

Wang Laboratories Inc.'s workstations are directly connected to the VS-100 host via a twin coaxial cable over which signals travel at approximately 2M bits per second. The only alternative to direct connection is to use the WangNet's peripheral attach band. Even then, the terminals and the host must still connect to the WangNet system via the twin coaxial cable. Twisted-pair wiring simply cannot be used.

Whether or not a broadband system is economical is precisely what the study was trying to determine. Wang had aggressively promoted the benefits of WangNet to the client in the study and had provided encouragingly low, although informal, estimates of the cost of installation. The parallel cost studies were run to put the question on an

objective basis. In an industry in which people often make broad, sweeping generalizations, reporting on practical experience is the only way to clear the air.

Mr. Donohue's statement concerning maximum system capacity does not quote the article correctly, much less correct an error. The basic facts are these:

- The peripheral attach band of WangNet has a capacity of 192 workstations, serviced through six sub-channels, each having a capacity of 32 workstations. If users need to support more than 192 devices (which typically means a second VS-100 computer in the system), they can do so only through a complex procedure that involves splitting the population of the terminals into two groups, each associated with one of the two computers, using RF diplexors. The two groups of terminals and their associated computers must be on physically separate sections of the coaxial cable. Overlapping and intercommunications are not possible between terminals in one group and the computer in the other group. In a diplexed configuration, both segregated terminal-computer populations use the same RF band.

- This restriction would not exist if Wang permitted users to configure the network with several independent peripheral attach bands, each assignable to a different sector of the RF spectrum. But, since Wang did not do this, the restriction must be abided.

Wang could possibly release new features for WangNet that might remove some of these limitations, and users considering the system would most likely want the most current product information available. The study in the article was done in early 1983. Interested readers can consult the Wang brochure "WangNet Overview," dated August 1982, to verify our baseline.

Technologies and methodologies, like cabling methods, control schemes (CSMA/CS vs. token ring), topologies (rings, stars, buses) and transmission schemes (broadband, baseband, Manchester coding), do not provide service to users. They must be incorporated into workable products. Perhaps we should declare a moratorium on seminars and magazine articles about local-area-network technology and talk only about real products.

**Walter A. Levy**  
Edgewood Computer Associates Inc.

# ATRON Announces A State-of- the-Art Software Debugging Tool

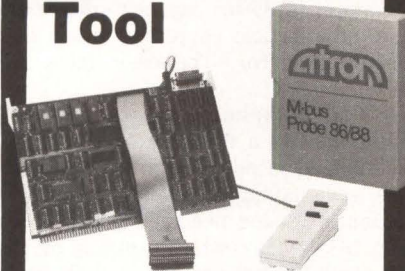

## FOR THE MULTIBUS®

- **DEBUG 86/88/87 BASED BOARDS**
- **HARDWARE BREAK-POINTS with pretrigger**
  - finds problems like memory overwrites
- **REAL TIME TRACE**
  - answers the question "How did I get here"
- **SYMBOLIC DEBUGGING**
  - no more hex addresses
- **MEMORY MAPPING**
  - test code before blowing proms
- **COMPATIBLE WITH INTEL OBJECT MODULE FORMATS**
  - simplifies language compatibility
- **8 CHANNEL LOGIC ANALYZER**
  - trace and trap external signals
- **MACRO COMMANDS**
  - create your own commands
- **PERFORMANCE ANALYZER**
  - time out program events
- **PROGRAM PATCHING**
  - on line symbolic assembler

**If you're developing MULTIBUS® based systems you need MBUS PROBE 86/88. Call us today.**

MULTIBUS is a registered trademark of Intel Corp.



20665 FOURTH STREET  
SARATOGA, CA 95070

CIRCLE NO. 12 ON INQUIRY CARD

## Letters

### ARETE SYSTEMS

To the editor:

I am writing to correct an article about Arete Systems Corp. (MMS, February 1984, Page 44).

Arete has chosen to occupy a high-performance (not low-end as mentioned in your article) niche with OEM systems ranging from \$52,600 (not \$15,000) to \$104,300 (not \$80,000).

Your article said: "As many as three 12.5-MHz 32-bit processors and a controller are contained in a memory-management unit with a capacity of 16M bytes." This sentence is confusing. The Arete 1000 supports up to four CPUs. The CPUs are 12.5-MHz 68000 microprocessors.

The Arete 1000 supports as many as 12 intelligent I/O controllers and a high-speed memory controller. The entire Arete 1000 supports 16M bytes of tightly coupled physical main memory. There is not a separate memory associated with each CPU.

The author missed the point of the Arete system architecture. Arete provides the computing and I/O capabilities of a superminicomputer using the advantages of inexpensive and reliable microprocessor components. Arete represents a major breakthrough in computer architecture. It is the first multithread, data-flow system that has been commercially produced. Until now, multithread machines have been found only in laboratories.

**John R. "Beau" Vrolyk**  
President  
Arete Systems Corp.  
San Jose, Calif.

### UNIQUELY UNIX

To the editor:

I thoroughly enjoyed the May 1984 issue of *Mini-Micro Systems*. As a UNIX operating system professional, I am gratified to see the expanding interest in this system. (UNIX was central in at least 30 ads and seven articles.)

I submit the following comments as a reader and not as a representative of Motorola Inc.

From the title of the article "Micro-soft makes XENIX compatible with UNIX System V" (MMS, May 1984, Page 93), the casual reader would conclude that this compatibility was a fait accompli. However, the first paragraph indicates that Logica UK Ltd. is merely investigating the technical issues in-

involved. Hence, compatibility with UNIX System V is not a current realization. I am sure Microsoft Corp. does not want potential customers to be confused about this.

In the same article, John Ulett of Microsoft notes that "porting the [System V] shared-memory feature to [non-VAX] processors poses problems" and that XENIX already provides another System V facility—record locking.

As part of the Motorola Microsystems team that ported the UNIX System V operating system to the MC68000 microprocessor under contract to AT&T Technologies Inc. (and without any subcontracting, despite rumors to the contrary), I believe I can speak with some authority on these statements. The port of the UNIX System V shared-memory feature to the MC68000, along with semaphores and message passing, was trivial. System V does not have record locking. I anticipate that AT&T will offer this in a future release. It is true that, in view of the current lack, many OEMs have added this enhancement.

On a separate topic, it appears de rigueur for computer industry writers to complain about IBM Corp.'s apparent inconsistencies in the UNIX market. "Version 7 on the Series/1, XENIX on the System 9000, System III on the PC. What is IBM's choice?" they cry. It seems to me the answer is, "the latest." The Version 7 release was the latest for the Series/1 port, called CPIX, and for Microsoft's XENIX port to the System 9000. The System III release was the latest when Interactive Systems Corp. began its port to the PC.

**Fred Christiansen**  
Staff Software Engineer  
Motorola Microsystems  
Tempe, Ariz.

### NEXT MONTH IN MMS

Line printers get the feature spotlight in the September issue of *Mini-Micro Systems*. Manufacturers of traditional impact line printers are foregoing technological innovations and, instead, are focusing on lower prices and higher reliability.

A comprehensive survey chart of over 130 products and 25 companies is included with the article.



# LOW POWER, CMOS 8086 SINGLE BOARD COMPUTER

Replace Your iSBC\* 86/05 and get the Benefits of CMOS Technology Without Redesign

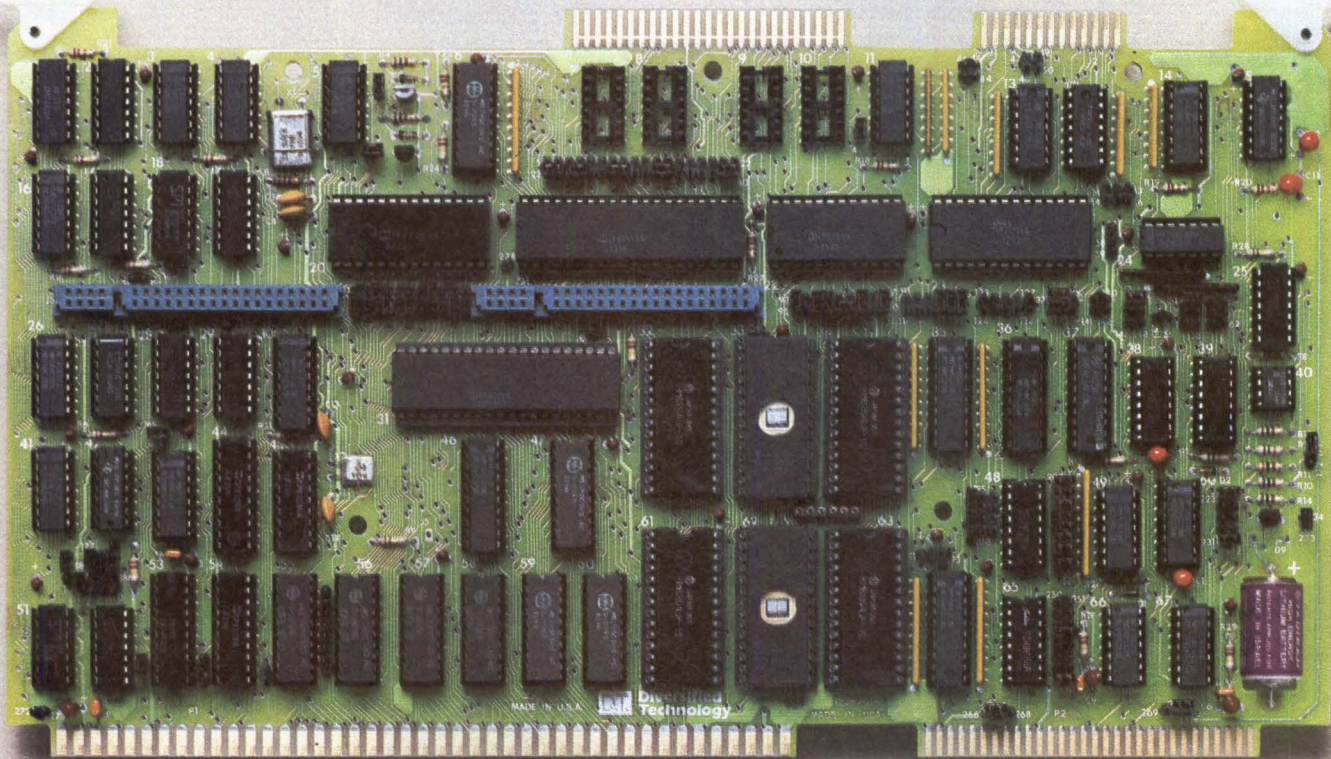

## Compare these Key Features:

	INTEL iSBC* 86/05	DIVERSIFIED TECHNOLOGY CBC 86C/05
Bus Type	MULTIBUS*	MULTIBUS*
CPU	8086	80C86
5V Operating Current	4.7 amps max.	200 milliamps max.
Operating Temperature	0°C to 55°C	0°C to 70°C
Supplied RAM (Bytes)	8K	16K
RAM Battery Back-Up On Board	No	Yes (2.5 yrs. data retention)

Whether your application is an existing system upgrade or a low-power CMOS system design, DTI's CBC 86C/05 will make your job easier. Full hardware and software compatibility with the iSBC\* 86/05 allows you to gain the low power advan-

tages of CMOS without sacrificing system performance or your development investment. You even get fast nonvolatile memory on-board, and a full-spec MULTIBUS\* interface to maintain compatibility with existing systems.

For more information regarding the CBC 86C/05 CPU board, or any of our other all-CMOS MULTIBUS\* boards, contact Bill Long, CBC Product Manager at **(601) 856-4121**.

**Diversified Technology**  
An Ergon Co.

P. O. Box 748, Ridgeland, MS 39157  
Telex 585326

**ASK ABOUT OUR NONVOLATILE CMOS RAM FOR MULTIBUS AND LSI-11 TOO!**

Above specifications taken from manufacturers' current published data.  
\*MULTIBUS and iSBC are trademarks of Intel Corp.

CIRCLE NO. 13 ON INQUIRY CARD

# Beautiful Streamer

*Kennedy proudly announces Model 9600, the first member of a new family of advanced low cost formatted tape drives. A few of its many features include; Autoload; 800/1600 CPI dual density; streaming capability of 100 ips; a capstan motor which provides an amazing 45 ips true start/stop mode; PC boards which may be moved or replaced in any order on a common bus for upgrading to higher performance levels or different interfaces — the list, fortunately, goes on and on. Write or call today.*

**KENNEDY**

*An Allegheny International Company*

1600 Shamrock Ave., Monrovia, CA 91016  
(818) 357-8831 • ITT TELEX 472-0116 KENNEDY

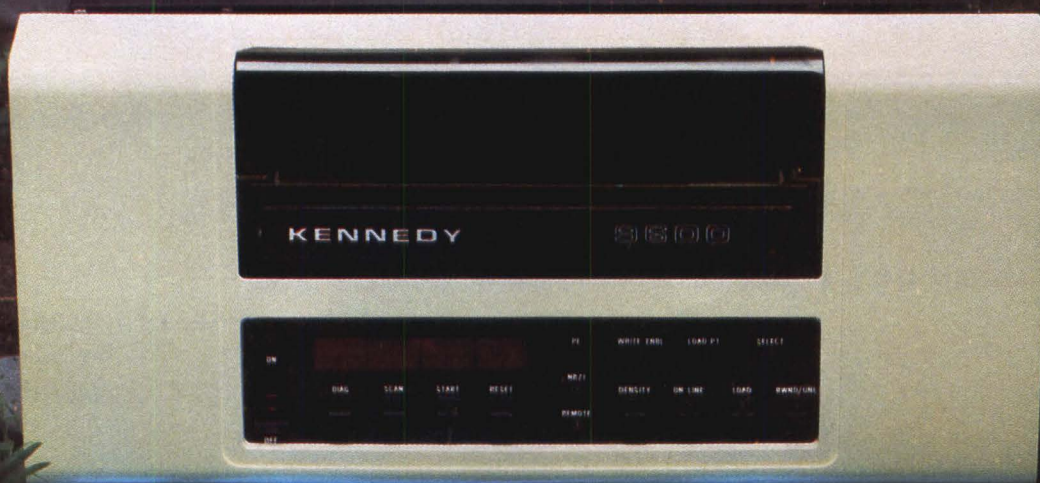

**KENNEDY • QUALITY • COUNT ON IT**

CIRCLE NO. 14 ON INQUIRY CARD

# Breakpoints

---

## **DATA GENERAL TO BROADEN PRODUCT SCOPE WITH LAP-TOP COMPUTER**

Taking the road less traveled by other minicomputer makers, Data General Corp., Westboro, Mass. plans to introduce a lap-top portable computer in about five months, sources say. The 7-pound model, which was shown privately at the recent National Computer Conference, will be built by the company's Nippon Data General subsidiary in Japan. It is said to be fully IBM PC-compatible and will run the MS-DOS operating system. The unit includes dual 3½-inch microfloppy drives, a 24 line by 80 character display with graphics capability, 256K bytes minimum memory, and an Intel Corp. 8088 processor. A hard disk may also be offered. DG is expected to sell the product through retail stores such as Businessland.—L. Valigra

## **U.S. CONGRESS TO ACT ON COMPUTER CRIME LEGISLATION**

The U.S. Congress is finally about to act on federal computer crime legislation. Stirred from years of inactivity by the disclosure of a recent TRW Inc. credit-database break-in, the House Judiciary Committee has approved the Counterfeit Access Device and Computer Fraud and Abuse Act. Similar to H.R. 1092 (MMS, July, Page 264) but containing stronger penalties, H.R. 5616 would permit fines of up to \$100,000 and up to 20 years' imprisonment for anyone who knowingly accesses without authorization a computer used in interstate or foreign commerce and gains \$5,000 or more from the break-in over a one-year period. Although it's expected to pass in the House, the bill would have to be reconciled in conference committee with a similar credit card abuse bill already passed by the Senate. That bill doesn't contain computer crime provisions.—J. Victor

## **SERVO WRITER REPLACES UNITS THREE TIMES ITS PRICE**

A low-priced servo writer from Pioneer Research Inc., Santa Monica, Calif., may solve both the availability and price problems of support tools for disk drive manufacturers. The model PR1000 Servowriter, at less than \$60,000, is designed to replace units three times its price and six times its size. It manages hard disks from 3½ inches to 14 inches. The company claims the unit is a universal device capable of writing servo information on as many as four drives at a time, with no restrictions on the servo formats. The user can either design formats for downloading from a microcomputer, or have hard-wired versions built in at the factory.—C. Warren

## **GRAPHICS CARD FOR IBM PC TRANSLATES COLOR INTO 16 GRAY SHADES**

Paradise Systems Inc., of Brisbane, Calif., has introduced its Modular Graphics Card in a bid to meet the strong demand for high-resolution graphics for IBM Corp.'s Personal Computer. Due to be shown in the United States later this month, the card already is available from Accent Computers International Ltd., of London. Accent president Terry Harris claims the card runs color graphics software written for the PC's color board, without modification. The \$495 Paradise card translates color graphics into 16 gray shades on IBM's monochrome screen. It also can be used with the IBM PC color monitor.—K. Jones

# Breakpoints

---

## **MICROCOMPUTER MEMORIES READIES 25M-BYTE 3½-INCH WINCHESTER**

Microcomputer Memories Inc.'s 25M-byte (unformatted) 3½-inch Winchester disk drive, available in three configurations, is scheduled for shipment in the fourth quarter. The Van Nuys, Calif. company will sell the drive for less than \$600 in OEM quantities. The 588-track-per-inch, 10,943-bits-per-inch drive has four platters, eight heads, and comes in three models: the 3½-inch model M-125, the half-high 5¼-inch model and the full-size 5¼-inch model M-325. The larger size is constructed by bolting on the appropriate 5¼-inch bezel.—C. Warren

## **DATA MANAGEMENT LABS EXTENDS DEC'S Q-BUS WITH CONTROLLER**

The model DML-660 standalone controller made by Data Management Labs, San Jose, Calif., extends the Q-bus architecture of Digital Equipment Corp.'s MicroVAX and Micro PDP-11 computers. Housed in a 19-inch rack, the controller provides Q-bus extension and offers DEC UDA-50 subsystem-type operation. The DML-660, priced at \$2,650 in 100-unit quantities, should be shipped in December. The controller can be attached to a DML D80 404.5M-byte disk system for \$8,400 or a DML D81, 640.5M-byte drive for \$10,100, both in 100-unit volumes.—C. Warren

## **XEBEC AND HEWLETT-PACKARD TO PURSUE 3½-INCH WINCHESTER MARKET**

Xebec Corp., Sunnyvale, Calif., and Hewlett-Packard Co., Greeley, Colo., are separately planning 3½-inch Winchester drives. Xebec currently has the 3½-inch, 20M-byte Micro-Owl, but company officials say they are looking to internal use before releasing it onto the market. The drive's capacity may range above 10M bytes.—C. Warren

## **BRITISH SUPERMINICOMPUTER AIMED AT ARTIFICIAL INTELLIGENCE USE**

High Level Hardware Ltd., of Oxford, England, is seeking OEM deals in the United States for its Orion 32-bit minicomputer. Because the Orion can be microprogrammed to execute as many as 16 different languages simultaneously, it facilitates implementation of artificial intelligence languages such as LISP or prolog, says Tim Robinson, High Level technical director. The Orion is based on bit-slice processors, runs Berkeley 4.1 UNIX, and operates at about the same speed as the Digital Equipment Corp. VAX-11/750, Robinson claims. Prices range from approximately \$25,000 for a four-user version with 1M byte of main memory and 80M bytes of disk storage, to \$35,000 for a 16-user system with 6M bytes of main memory and 260M bytes on disk.—K. Jones

## **ADAPSO EXAMINES SOFTWARE PROTECTION SCHEMES**

The Association of Data Processing Service Organizations (ADAPSO) plans to offer a testing service for developers of software protection schemes. ADAPSO is expected to contract with a major university this summer for a product evaluation service. The university then would make information on hardware-based and software-based protection systems available to the industry.—M. Stenzler-Centonze



## Now you can watch the entire Whizzard® family in 3D.

Because the industry's widest range of high performance graphics systems now has a whole new dimension.

A third dimension.

Which means now you can buy 3D Megateknology starting for *under* \$12,000. For instance, the Whizzard 1600 desktop design terminals with color or monochrome capabilities, very high resolution and VT-100™ compatibility.

Or our Whizzard 3355, which holds the speed record for its price range — 400,000 vectors per second — thanks to our one-of-a-kind Graphics Engine.™

Then there's the ultimate computer graphics system: the Whizzard 7200. It guarantees remarkable speed and flexibility, modular architecture that supports high resolution and real-time dynamic color raster displays, and unmatched interactive graphics capabilities.

Plus, with every one of our products you get Megateknology—our longstanding trademark of innovative design, quality and high reliability.

There's a whole new dimension to our Whizzard family, thanks to the latest in 3D Megateknology.

Watch it add more dimension to your creativity.

See us at NCGA Booth #318,  
Anaheim, California May 14-17

**MEGATEK CORPORATION**  
A UNITED TELECOM COMPANY  
Making History out of State-of-the-Art

# That's Megateknology.™

World Headquarters • 9645 Scranton Road • San Diego, California 92121 • 619/455-5590 • TWX: 910-337-1270  
International Headquarters • 50, Avenue Des Boveresses • CH-1010 Lausanne, Switzerland • Telephone: 41/21/335016 • Telex: 25037 mega ch  
VT-100 is a trademark of Digital Equipment Corporation.



**VAX 11-780, 11-750 &  
11-730 USERS! OUR  
SUPER SUMMER PRICES  
CONTINUE!\***

\*Through August

Call toll-free at  
800-854-3792  
in the USA  
(800-432-7271  
within California).

**STANDARD  
MEMORIES'  
NEWEST!**

"Stan"

Here's our newest arrival: the PINCOMM 73S! And we're as proud of it as we are of each of its predecessors in the STANDARD MEMORIES product family. Every one of them has gone out into the world and earned the respect of customers ranging from the Fortune 500 to government, universities, and the military. No small accomplishment.

Our new PINCOMM 73S is a 4 megabyte block mode CSR parity semiconductor memory card for large DEC Q-bus applications, including use in the MicroVAX I and the PDP-11/73. It is equivalent to the DEC MSV11PL (M8067) memory, but with up to eight times more capacity, and can be installed in H9273-A or DDV11-B backplanes.

The last addition to our STANDARD MEMORIES family back in August, was the PINCOMM 780SX, a 1 megabyte memory for use in late model VAX-11/780 computers. Installed at sites throughout the United

# Great Memories.

States, Canada, Europe and Japan, it has given our customers the high levels of dependability and reliability that STANDARD MEMORIES is known for. Every one of our DEC add-in memory boards is backed by a 4-year warranty. Just shows what you can do when you have over *seventeen* years experience in building Great Memories.

We also make computer memories for Hewlett Packard, Honeywell, Perkin Elmer, General Automation, Computer Automation, and Data General applications. Call us! We'll make it a memorable occasion.

**STANDARD MEMORIES**

DEC, Q-bus, MicroVAX I, PDP-11/73, and VAX-11/780 are trademarks of the Digital Equipment Corporation.

A DIVISION OF  **Trandata**  
CORPORATION

3400 West Segerstrom Avenue, Santa Ana, California 92704  
Phone: (714) 540-3605 TWX 910-595-1596

CIRCLE NO. 16 ON INQUIRY CARD

# Breakpoints

---

## **STARTUP TO SELL GKS SOFTWARE RUNNING UNDER UNIX**

A yet to be named company that begins operations late this month in Los Gatos, Calif., plans to sell software supporting the Graphics Kernel System standard and running under UNIX. Dennis Griswold, a former director of European operations for Contel Codata, set up the company. The software is likely to run on the TP 10m MC68000-based board-level computer from Tadpole Technology Plc., Cambridge, England. The TP 10m is Multibus-compatible.—K. Jones

## **TECH FILES: A QUICK LOOK AT INDUSTRY DEVELOPMENTS**

**NCC HIGHLIGHTS:** Last month's National Computer Conference in Las Vegas, Nev., had promised to be the largest in history, with 100,000 attendees expected to visit 3,800 booths. However, attendance was reportedly only 50,000 to 60,000. Some exhibitors expressed disappointment with the light traffic, and local merchants complained about lack of business. Conferees, it seemed, favored working over playing in the casinos. As a result, the Las Vegas Convention Authority reportedly is considering reviewing its convention-booking policies. Though major new product introductions were minimal, some companies attracted prospects to private suites in local hotels.

**Diconix Inc.**, an Eastman Kodak Co. subsidiary, demonstrated a non-impact, ink-jet printer in its hotel suite. Diconix was formerly known as Mead Digital Systems, a company that pioneered ink-jet technology. The printer uses a multiple-array, binary-deflection, continuous ink-jet that is not electrostatically charged. Company officials claim the technology allows more accurate dot placement on plain paper. The 18-page-per-minute printer places dots in a 300-by-300 dot matrix in high-quality mode, and in a 200-by-300 dot matrix in draft-quality mode. The printer includes two MC68000 processors; one for font creation and one for image and data management. The printer houses 64 jets on a printhead the width of an index finger. Introduction of the printer is slated for October, and availability is scheduled for the first part of next year. Tentative pricing is \$12,000 to end users, and \$5,000 to \$7,500 to OEMs. Printer supplier C. Itoh & Co., Ltd. was one visitor to the suite.—L. Valigra

**CompuPro** has added its blessing to the 6MHz NS32016 processor from National Semiconductor Corp. by using it in its 816/G series of microcomputers. The eight configurations of the G series, all IEEE 696/S-100-compatible, bring to 50 the number of products offered by CompuPro. The 816 line already includes machines built around Motorola Inc.'s MC68000 and Intel Corp.'s 80286 chips. A typical price for an 816 is \$14,995, including 40M bytes of hard disk storage and 1M byte of 16-bit static memory.—J. Donohue

**NEC Information Systems Inc.** has introduced a line of superminicomputers based on custom NEC processors. The computers, called

# Breakpoints

---

the Astra 300 series, begin in price at \$15,000, and use the proprietary NEC ITOS operating system, so they are compatible with earlier, Astra 200 series computers.—L. Valigra

The major knock against **Apple Computer Inc.'s** MacIntosh portable computer is a lack of applications programs. But the company is clearing up that problem. At its NCC booth, Apple demonstrated 80 packages from 65 vendors. Fifty of the packages should be available by the end of the summer, and 150 packages should be shipped by year's end.—D. Bright

**Digital Research Inc.** is preparing Concurrent PC-DOS for fourth-quarter availability on AT&T's PC6300 microcomputer. The multitasking operating system supports Concurrent CP/M and PC-DOS. AT&T also is considering Digital Research's StarLink multiuser add-in board for the PC6300, according to Digital Research sources.—D. Bright

In a move away from its traditional office environment, **NBI Inc.** introduced a workstation for scientific and technical workers. The U! Technical Workstation runs the Berkeley 4.2 version of UNIX and is said to support most applications designed to run on AT&T Co.'s UNIX System V. Based on a Motorola Inc. 8MHz MC68010 processor, the workstation has paged virtual memory and a high-resolution, 14-inch, 1024-by-768-dot, bit-mapped, monochrome display. The price in single quantity is \$15,495, including 1M byte of memory, one 640K byte, 5¼-inch, floppy disk drive and a 2M byte hard disk drive. The workstation may be attached to an IEEE 802.3 Ethernet local network with TCP/IP protocols.—J. Donohue

**Bellsoft Inc.**, a Bellevue, Wash., startup, next month plans to market its PopUp programs. Users can call the programs in windows while using application programs in a PC-DOS environment. PopUp programs with an assembly language kernel include a calculator, a notepad, a calendar, an alarm clock, a telecommunications program, and a POP-DOS utility that allows the user to perform system functions such as formatting disks. Package prices range from \$19.95 to \$79.95.—D. Bright

**Epson America Inc.'s** OEM products division introduced the model 3740 ink-dot, 40-column printer/plotter. An ink reservoir at the top of the printhead wets the head's four pins, which then place dots directly onto the paper. Print speed is 8.8 characters per second. The price has not yet been determined. Epson also unveiled a 25 line by 80 column, liquid crystal-display module for portable computers. The 640-by-200-dot display measures 9 inches by 3 inches. The price for 100 units is \$325. The accompanying LCD controller is \$17.70.—D. Bright

An 1800-by-1400-dot, color CRT was shown by **Panasonic Industrial Co.** The T101-01 CRT measures 40 inches diagonally, and is intended for computer-aided design, manufacturing, and engineering applications. Panasonic also



## LINE PRINTER COMPARISON CHART

STANDARD FEATURES	CIE TERMINALS CI-300	CIE TERMINALS CI-600	DATAPRODUCTS B-300/600	PRINTRONIX P-300/600
LOWEST PRICE	X	X		
L Q PRINTING	X	X	X	
COMPRESSED PRINT	X	X		
GRAPHICS RESOLUTION				
60 x 72	X	X		X
120 x 72	X	X		X
200 x 144	X	X		
200 x 288		X		
BOLDFACE PRINTING	X	X		
SLANTED PRINTING	X	X		
CHAR. ENLARGEMENT	X	X		
INT'L CHARACTERS	X	X		

# This printout proves we out-print the competition.

The chart above tells a telling story about our CI-300 and CI-600 Matrix Line Printers. Feature for feature, they out-print Dataproducts® and Printronix®—and at a lower cost. Our printers can accommodate many types of applications and computer systems. They provide both multimode printing and graphics plotting. Graphics resolution on the CI-300 and CI-600 printers is the highest available on a line printer in their speed class, with excellent graphics quality for business, scientific and

barcode applications. Barcode applications are easily developed with optional graphics card.

Interfacing is not a problem either. RS232-C Serial, Centronics® and Dataproducts Parallel, and IBM-compatible interfaces accommodate most types of computer systems.

The printers' sturdy design and small number of moving parts make them extremely dependable, and easy to maintain as well.

The CI-300 and CI-600 are the Matrix Line Printers with the versatility built in. And they're available immediately. To find out more, just write or call CIE Terminals, 2505 McCabe Way, Irvine, CA 92714. (714) 660-1421.

Call toll-free 1-800-854-5959.

In California, call toll-free 1-800-432-3687.

**CIE TERMINALS**  
A CATCH ELECTRONICS COMPANY



®Dataproducts is a registered trademark of Dataproducts Corp.  
Printronix is a registered trademark of Printronix Corp.  
Centronics is a registered trademark of Centronix Data Computer Corp.  
©1984 CIE Terminals.

# With the right terminal, WordStar™ can be simply beautiful.

The Wyseword™ 50 has a beautiful way of making WordStar® simpler.

Its special keyboard reduces WordStar's multiple keystroke command sequences to single keystrokes. Commands relate easily to what's written on the keys.

So, WordStar becomes easier to learn, faster, more accurate. More productive.

And it's never looked better. The 14" Wyseword non-glare screen tilts, swivels, and displays a full 132 columns, beautifully.

To find out where you can see the Wyseword 50 demonstrated, call the regional office nearest you:

Southwestern (213) 340-2013;

Midwestern (313) 471-1565;

Northeastern (201) 725-5054;

Southeastern (305) 862-2221;

Northwestern (408) 946-3075 ext. 256.

For more information about our complete line of products, write or call Wyse Technology, 3040 N. First Street, San Jose, CA 95134. (408) 946-3075. Outside of California, 800-421-1058.

## WYSE

CIRCLE NO. 18 ON INQUIRY CARD

WordStar is a registered trademark of MicroPro International Corporation. Wyseword is a trademark of Wyse Technology.  
© 1984 Wyse Technology

# Breakpoints

---

introduced its 19-inch graphics terminal with a 1365-dot-by-1024-dot resolution and a drawing speed of 40,000 short vectors per second.—D. Bright

**AlphaCom Inc.** unveiled a number of products in a private hotel suite. Aimed at the lap-sized computer market, the AlphaCom Traveler is a 60-character per second (cps), battery-powered, thermal printer that weighs 5½ pounds and is priced at \$199.95. The associated interface cable for RS-232 or RS-422 connections is \$49.95. The company's AlphaPro 18-cps \$399.95 daisy wheel printer can use Diablo Systems Inc. and Qume Corp. print wheels and ribbons. It has a 93-byte buffer expandable to 4K bytes. The interface cable is priced at \$49.95. AlphaCom also showed a \$49.95 interface cable that couples its model 801 thermal printer to Apple Computer Inc.'s Macintosh. All products are slated for October delivery.—C. Warren

**NOTES FROM OVERSEAS:** West Germany's electronics giant **Siemens AG** has earmarked about \$357 million for its mega-project, an effort aimed at producing its next two generations of microchips. Siemens chief executive Dr. Harlheinze Kaske said last month that the first stage of the project, with \$143 million budgeted, will be for a 1M-bit memory chip. The second stage is for development of a 4M-bit dynamic RAM by the end of this decade. Siemens already has 64K chips in volume production and is ramping up to produce 256K RAM chips in volume by next year.—M. O'Gara

**Hitachi Ltd.** said its output of 64K dynamic RAMs is growing from the present pace of 7 million to 8 million units a month toward 9 million a month by year's end, when it will peak. Hitachi is more interested in building capacity for 256K dynamic RAMs, now being produced at a rate of about 700,000 monthly, to one million monthly starting this month. Hitachi makes an estimated 80 percent of all 256K memory devices. Sutezo Hata, a Hitachi managing director, said the change in bit emphasis will probably show up in mid-1985. Hitachi is preparing a plastic package to add to the SIL- and DIP-packaged 256K dynamic RAMs now available. Chips with those packages should be ready by fall, and available in quantity early next year.—I. Takehashi

The **Samsung Semiconductor and Communication Co.**, a division of one of Korea's four biggest electronics companies, plans to start marketing in October for 64K dynamic RAMs being produced at its new VLSI plant in the Kiheong Industrial Complex in Kyunggi-do. The facility, a \$125 million investment in a first, 28,000-square-meter phase, plans to produce 6 million devices a month. Samsung will invest another \$750 million in the second phase of the plant this fall. That investment is, first, for producing 1M bit dynamic RAMs, static RAMs, and microprocessors, then for personal computers and peripherals, and, eventually, for minicomputers and mainframes. The development by Samsung of a 64K device last year made Korea the second country after Japan to develop a 64K dynamic RAM outside the United States.—I. Takehashi

# Breakpoints

---

**Toshiba Corp.** is shipping samples of two CMOS mask ROMs that have 200 nanosecond access times. One device, the TC531000P, can store 16-by-16-dot patterns for 3,418 characters at a time. The mask ROM is widely used in word processors, personal computers and printers for generating characters and patterns. The Japan-based sample prices are about \$26 for the 256K TC53527P device and less than \$110 for the 1M-byte TC531000P. Toshiba will start taking mask data for production orders in September.—I. Kakehashi

**Inmos Corp.**, the Colorado Springs, Colo., R&D unit of Britain's Inmos Group, has formed a production technology-sharing agreement with the newly-established NMB Semiconductor Company for the manufacture and sale of 256K CMOS dynamic RAMs. The five-year agreement provides for use of Inmos technology to make the devices at a plant being built in Tateyama, Japan, and representing a \$91.8 million investment. Initial production output will be about 200,000 chips a month, and will gradually grow to one million a month. Inmos will get half of the production volume. The companies plan to make the RAMs available to outside customers early in 1986.—I. Kakehashi

**AT&T** last month launched UNIX Europe Ltd., a London-based joint venture with Olivetti SpA. Heading the small 15-person startup is Digital Equipment Corp. veteran Vanni Papi. The appointment of an outsider to fill the post may signal to current and would-be European UNIX licensees that Olivetti, the exclusive European distributor of AT&T's UNIX-based 3B computers, will not receive preferential treatment from the venture. Some resellers had expressed fear about buying the operating system from a strong competitor such as Olivetti. Reports indicate AT&T is planning another UNIX marketing operation in the Far East.—M. O'Gara

U.K. distributor **Universal Computer Systems Ltd.** is charging its sole supplier, Datamedia Corp., with fraud and breach of contract in a \$5 million lawsuit filed in New Jersey. The action follows Datamedia's abrupt cancellation of the exclusive distribution pact it signed with Universal a year ago for Datamedia 932 computers running the Pick operating system. The suit demands damages, reimbursement for lost profits and investments, legal costs, and reinstatement of Universal's exclusive marketing rights in the U.K. The suit also asks to nullify the worldwide remarketing agreement for 932s Datamedia signed only months ago with Britain's ICL Plc.—M. O'Gara

**Taiwan's National Science Council** is planning to establish a liaison office in California's silicon valley for the purpose of attracting high technology and foreign investors to Taiwan's Hsinchu Science-based Industrial Park. The office, which is expected to be set up soon, will be administered in the United States by Taiwan's Coordination Council for North American Affairs, the equivalent of a consulate. Two similar offices were established in Los Angeles and Houston earlier this year. Hsinchu, established in 1980, is the offshore manufacturing site for a growing number of American computer companies, including Qume Corp. and Wang Laboratories.—C. Hintermeister

# HERE TODAY HERE TOMORROW

## Reliability.

The essential ingredient that OEMs and systems integrators need for today and tomorrow. Without it, you can't generate business.

Which is why CompuPro's System 816™ answers your needs.

## Survival of the Fittest.

This micro is The Essential Computer. It not only outperforms the competition, but also operates in extreme environments for virtually an unlimited number of applications.

Just one look at our specs and you know the System 816 will be around for a long, long time. And because the System 816 is structured on the IEEE 696/S-100 bus you can select the appropriate components, independently, in any combination. Even use boards for graphics and other unique applications.

## One of the Strongest Warranties.

And since only the strong survive, we housed

the System 816 in a rugged metal enclosure . . . and backed it with one of the industry's longest warranty coverages: From 12 to 24 months.

To find out more about how the System 816 outlasts and outperforms anybody else, call (415) 786-0909 and ask for an OEM/systems integrator application package and our 1984 catalog.

You'll find CompuPro will be just as essential tomorrow as we are today.

# CompuPro<sup>®</sup>

A GODBOUT COMPANY

3506 Breakwater Court, Hayward, CA 94545

System 816 and The Essential Computer are trademarks of CompuPro. System 816 front panel design shown is available from Full Service CompuPro System Centers only. ©1984 CompuPro

CIRCLE NO. 19 ON INQUIRY CARD

## The Essential Computer™



# HOW TO STRETCH A PC TO CREATE NEW MARKETS.

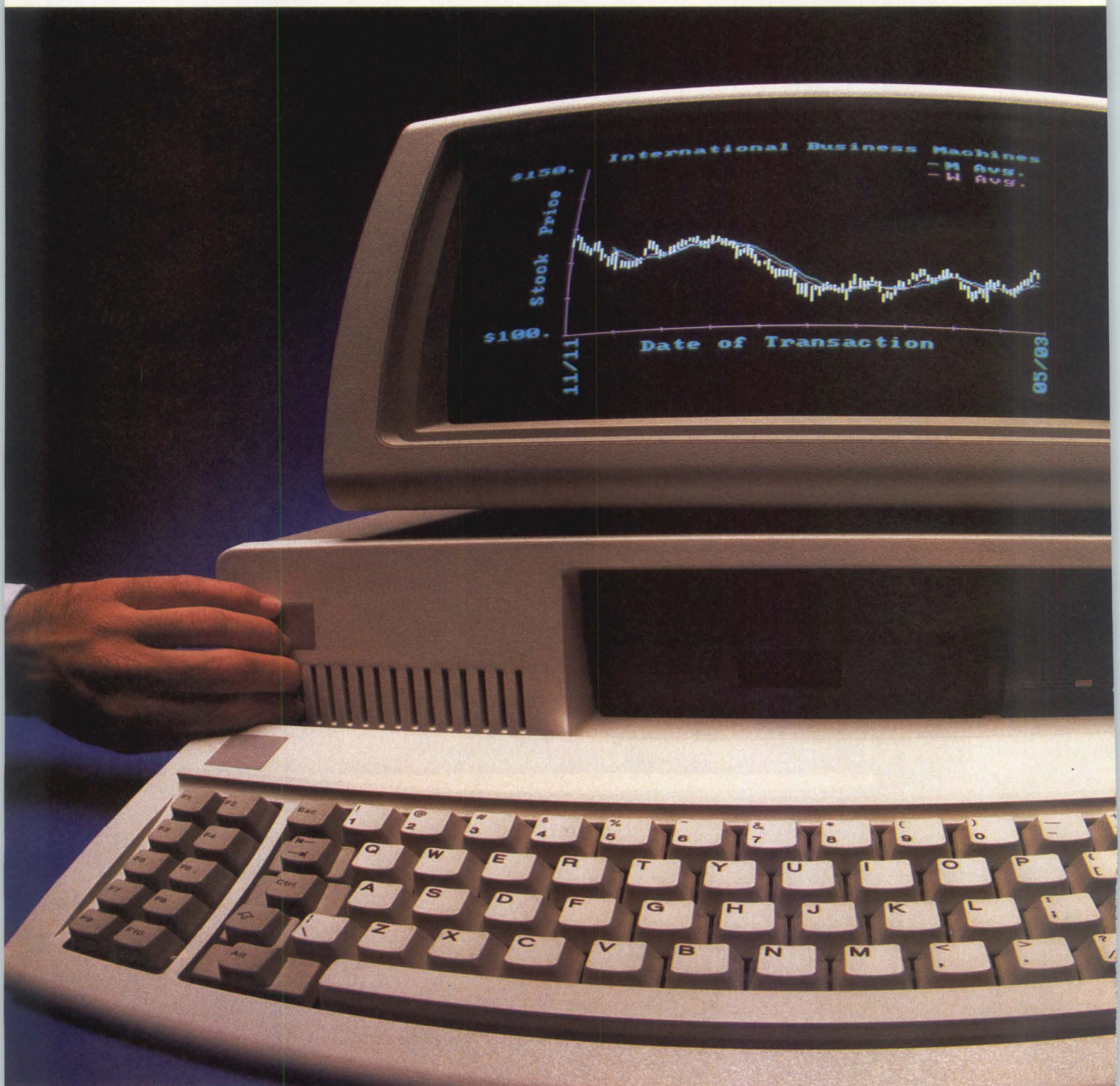

# OR EXPAND EXISTING ONES.

When is a PC not a PC? When you turn it into a personal data base cruncher. Or a personal graphics workstation. A personal image processor. Even a personal signal processor.

You can do all that and more with the Marince board pictured below. It's your key to unlocking new opportunities and new markets.

## Power to the PC.

We've put array processor technology to work to supercharge the PC. Suddenly a spectrum of applications that were beyond that PC's capabilities are wide-open possibilities.

If your strength is software, the Marince array processor gives you incredible performance improvements. Even the most complex spreadsheets can ripple faster than you can say 1-2-3. Enormous data bases can search, sort and report in the blink of a cursor. And high speed arithmetic calculations which slow a standard PC down to a crawl are performed in split seconds.

If you're a systems integrator, VAR or OEM looking for a competitive advantage, a PC with a Marince array processor is a natural line extension, enabling you to offer a cost-effective "personal" version of your best-selling product.

## The Race Is to the Swift.

The Marince array processor is especially flexible and easy to program. So you can get to market quickly. Which, after all, is the name of the game.

We could fill pages with pertinent performance specs on our PC-compatible array processor. So we did. We've put together an 8-page brochure that will stretch your imagination. And just might open a world of opportunity. Write for a copy. Marince Computer Products, 3878 Ruffin Rd., San Diego, CA 92123. Or call 1-800-421-4807, in CA (619) 268-4814.

Marince array processors include a 24-bit floating point board with optional IEEE-754 compatibility and a 16-bit integer-only board for maximum price/performance.

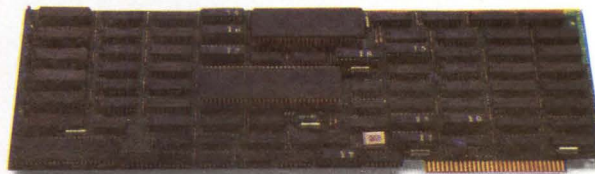

**MARINCO**

CIRCLE NO. 20 ON INQUIRY CARD

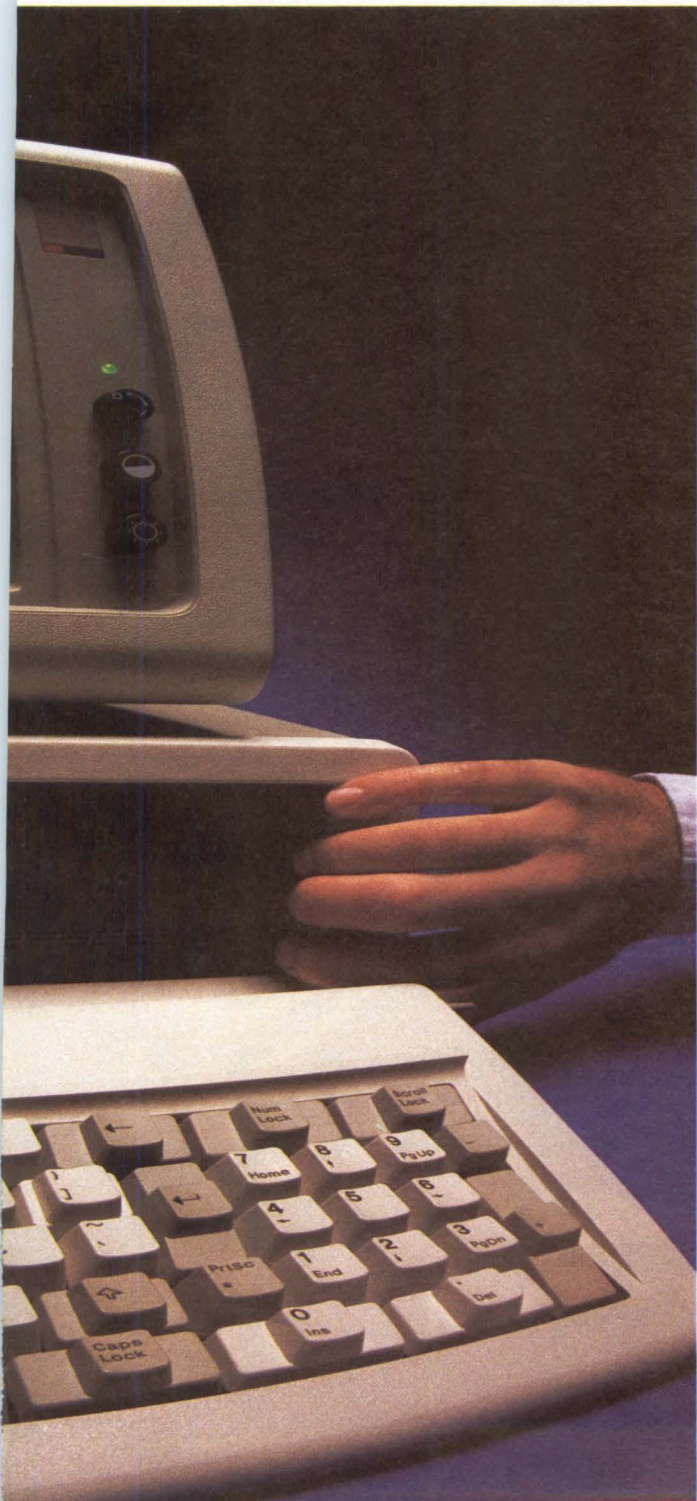

# IT TAKES A LOT OF DRIVE

In CAD/CAM. In seismic and transaction-based systems. Or PBX's. Or anywhere else you need a lot of data fast.

That's why we created the Ampex 825.

This 14" Winchester family delivers everything you need to take the lead in multi-user, multi-tasking applications: 825, 660 or 330 MB of unformatted capacity.

The new standard 1.859 megabyte per second data transfer rate.

Access times of 21 milliseconds. Plus the best price per megabyte on the market.

Fact is, we offer a better 825 MB price than any combination of small drives. And—thanks to a design that teams RLL encoding with proven, standard head and media technologies—better yields than other big drives. So you won't have to wait for us to get our act together in manufacturing.

825 MB

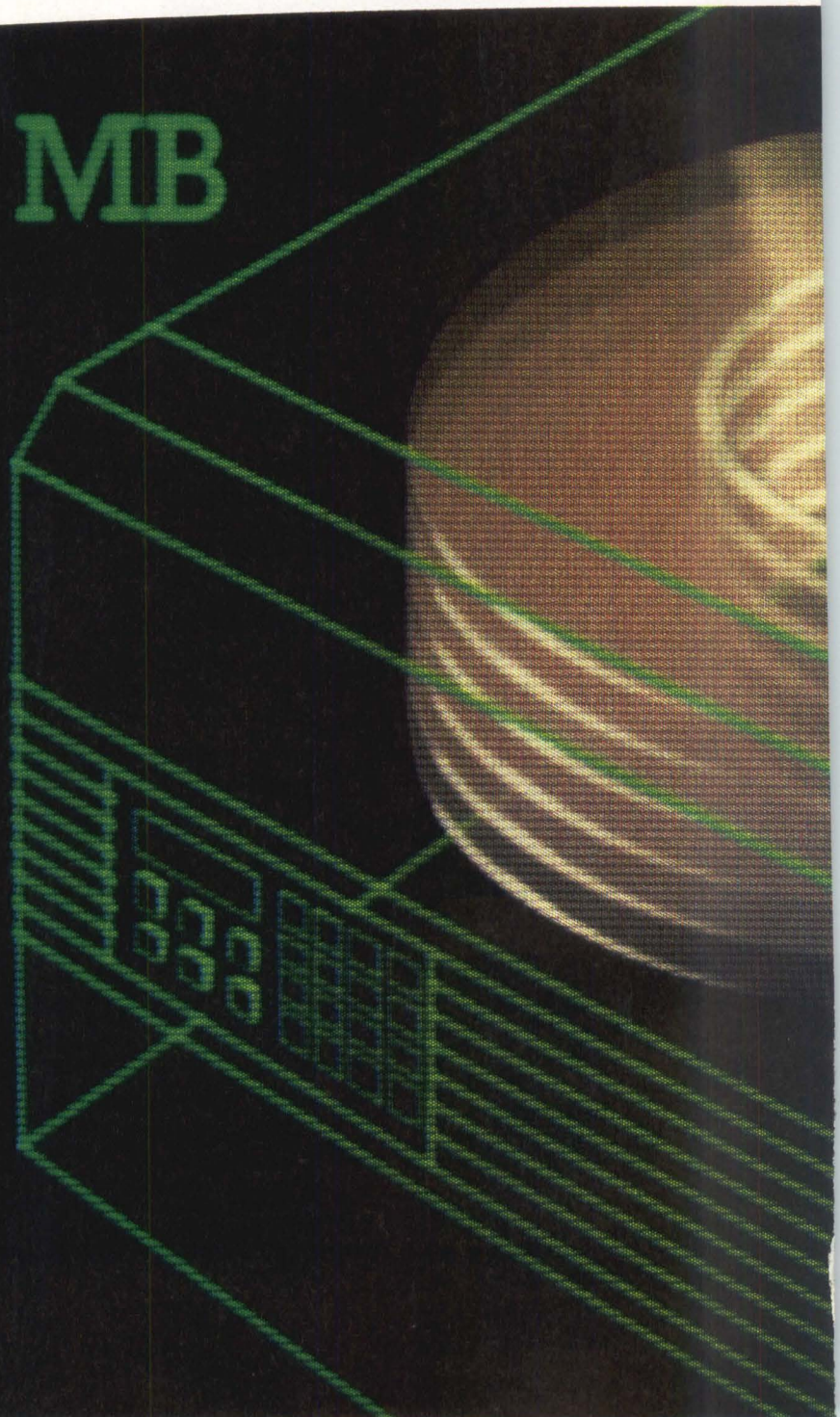



# TO MAKE IT BIG IN PICTURES.

Or in QA. Or field service. Because we designed the Ampex 825 with features that keep it on the fast track. There's a unique control panel with an LED/keypad for push-button diagnostics and configuration. A modular head/disk assembly so you can upgrade capacity in minutes. A reliable, brushless DC motor, a universal power supply and a dual port option.

Plus something else no one else can

match: our vertical integration and 20 years of computer peripheral and offshore manufacturing expertise.

So if you're looking for someone with the drive it takes to play a supporting role in your next big release, contact Ampex. Call us tollfree at 800 621-0292. 800 821-9473 in California. We'll be happy to set up an

## AMPEX

Ampex Corporation • One of The Signal Companies

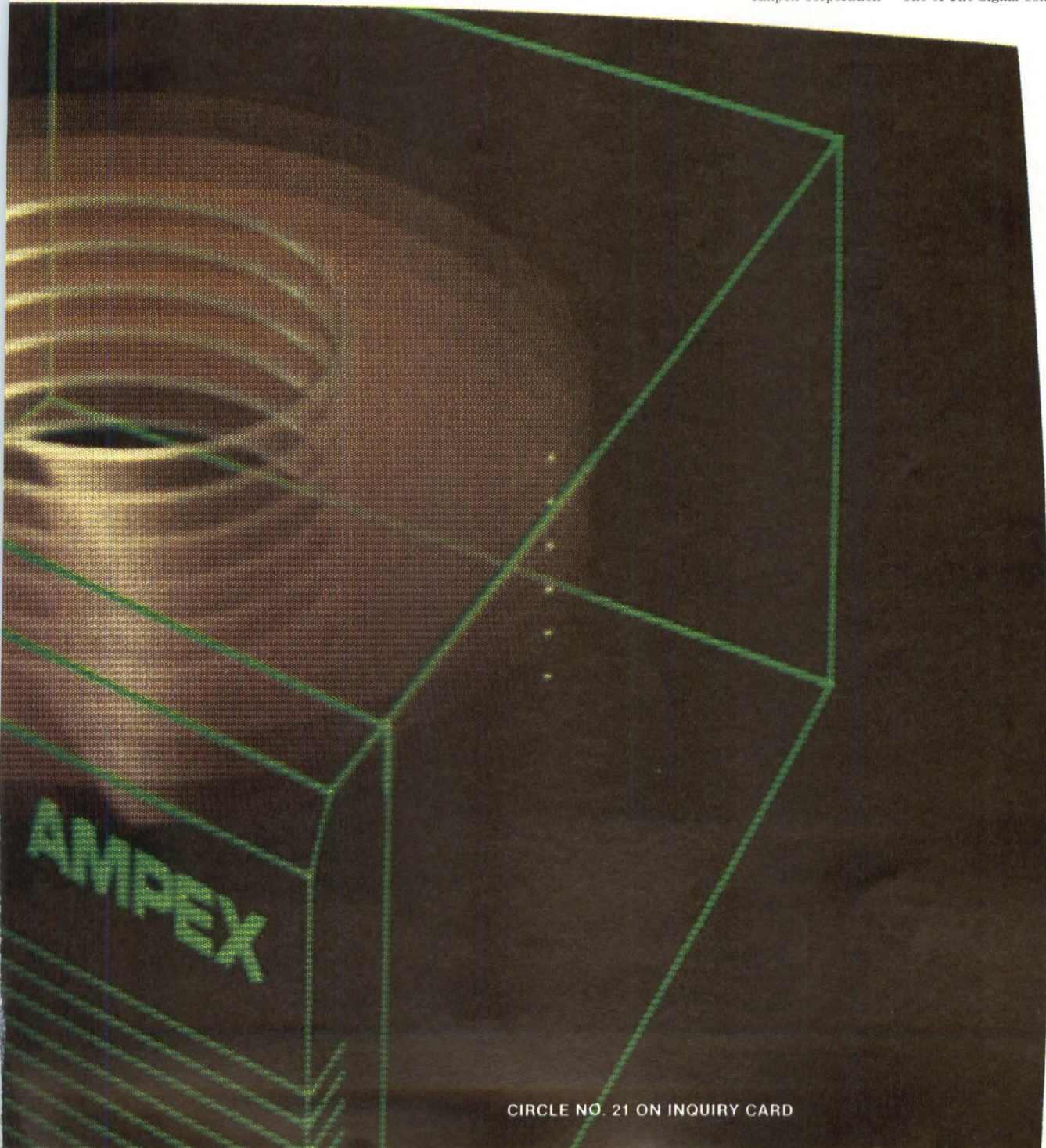

CIRCLE NO. 21 ON INQUIRY CARD

# READ. WRITE.

It is the highest performance, most reliable 5¼" cartridge disk drive in the industry.

It features more resistance to shock and vibration than any other disk drive, fixed or removable.

Its cartridge is the least expensive among formatted 5-megabyte cartridges on the market today.

Its cartridge interchangeability from drive to drive is absolute. Its start/stop time is the fastest available of any high-performance disk drive.

It is the Beta 5 Cartridge Disk Drive from IOMEGA. And it is, in a word, superlative.

**IOMEGA Corporation**  
1821 West 4000 South  
Roy, Utah 84067  
Or call (801) 776-7330



**IOMEGA™**

High Performance Cartridge Disk Drives

CIRCLE NO. 22 ON INQUIRY CARD

REGIONAL AND DISTRICT SALES OFFICES: SOUTHEAST (305) 755-1060; SOUTHCENTRAL (214) 458-2534; WESTERN (714) 855-1211, (408) 263-4476; NORTHEAST (617) 933-2000; MIDWEST (414) 782-5229; EASTERN OFFICE (203) 359-9858.

# Mini-Micro World

NEWS

## TeleVideo enters DEC market with VT220-compatible terminal

Tom Moran, Associate Editor

TeleVideo Systems Inc., Sunnyvale, Calif., has introduced the model 922 terminal, which the company hopes will enable it to compete head-to-head against Digital Equipment Corp. in the VT200 market. Code-compatible with both the VT220 and VT100, the \$995 TeleVideo 922 will undercut the retail price of the VT220 by \$300. TeleVideo showed the monochrome, alphanumeric 922 at the National Computer Conference in July, and the company expects to begin shipments this month.

### A major departure

TeleVideo's only previous DEC-compatible product is the TeleVideo 970, which is aimed at the high-end market for American National Standards Institute (ANSI)-compatible units. The 970 contains a VT100 subset, but, according to Steve Tatum, TeleVideo's vice president for national sales, "The 970 was never targeted to go directly into the DEC market, and it was not a DEC emulator."

The 922 offers a low-profile keyboard, a tilt-and-swivel screen, a 10-key, accounting-style keypad, block mode, eight character fonts and space for an auxiliary option board. The 12-inch, non-glare screen uses a P31 green phosphor and displays 80 or 132 columns by 25 lines. An optional Tektronix-compatible monochrome graphics board should be available when the 922 is introduced. The graphics upgrade board will match the 922 against DEC's VT240 monochrome text and graphics terminal.

Tatum says the company agonized

*Intended to compete with DEC terminals, TeleVideo's 922 monochrome alphanumeric terminal is said to be code-compatible with the VT220 and VT100. The 922's keyboard is nearly identical with that of the VT100 but differs from the VT220 keyboard.*



over designing the 922's keyboard because, when DEC designed the VT220, it ignored the VT100 keyboard. Instead, DEC used the Rainbow microcomputer keyboard for the VT220 and placed the >/< key adjacent to the letter "z"—where most typists expect to find the shift key. "If you're going to enter somebody's market, the golden rule is that you must emulate the keyboard—key-for-key and stroke-for-stroke," says Tatum, but "we couldn't bring ourselves to put the key there, so we decided to break the golden rule." A number of other keys on the 922, including "break" and "escape," are also in positions different from the VT200.

TeleVideo director of marketing Craig Lynar does not believe the keyboard differences will present a problem for the company, "since [the VT220] is not out in the field yet and does not have an installed base." He adds that TeleVideo is prepared to move the keycaps on the 922 if the VT220 keyboard becomes a standard. The installed base for VT100 keyboards is estimated at 500,000 units.

### DEC market to grow

Tatum expects the DEC market to grow at a compound annual growth rate of 15 percent to 20

percent. He estimates that more than 270,000 units are being shipped into the DEC market and that about 80,000 of those units are captive customers of DEC. The major competition for the remaining 190,000 units is DEC. "We are going to try to get as large a share of that as possible," he adds.

Bob Sanekoff, vice president for display terminals for Dataquest Inc., a San Jose, Calif., research concern, predicts that the demand for DEC and DEC-compatible terminals will be strong for the next two years. "Because of the basic uses of data input, data retrieval, information updates and so on, [terminals] will continue to show good strength," he says. Dataquest says that DEC has about 60 percent to 62 percent of the DEC-compatible market and forecasts that DEC will ship about 250,000 terminals worldwide this year.

TeleVideo will distribute and service the 922 through 35 active distributors, including two-tier distributors (through dealers), wholesale distributors and full-service, value-added resellers. TeleVideo will service large OEMs directly only if the OEM's volume is greater than the amount a distributor could handle. TeleVideo does not plan a direct retail effort. □

### HP is first with low-cost laser printer

Tom Moran, Associate Editor

Hewlett Packard Co.'s Boise, Idaho, division has unveiled the \$3,495 LaserJet printer, described as the first laser-beam printer to retail for significantly less than \$10,000.

The LaserJet uses Canon USA Inc.'s LBP-CX print engine to produce 8 pages per minute of 300-by-300-dot resolution text and 75-by-75-dot resolution graphics. Billed by HP as a one-to-one replacement for daisy-wheel printers, the page printer sells for about the same price as high-end daisy-wheel units. Producing less than 55 decibels adjusted (dBA) during operation, the LaserJet is aimed at small businesses and offices. The unit offers the flexibility of a number of fonts and graphics capability, and the print quality of text is said to be difficult to distinguish from fully formed impact printing.

#### HP adds formatter and interface

HP designed its own interface and formatter for the Canon engine, which has only a video formatter. Canon USA, Lake Success, N.Y., will build the electronics for the HP design. HP also offers system integration, support and distribution. According to product marketing manager Robert Granger, "We've aggressively taken [the LaserJet] to independent software vendors for them to interface with their packages." The LaserJet supports Lotus Development Corp.'s Lotus 1-2-3, Multimate International Corp.'s Multimate, MicroPro International Corp.'s WordStar, Software Publishing Corp.'s pfs:Write, BPI Systems Inc.'s BPI Accounting and other software packages.

The printer is compatible with the HP 150 touch-screen personal

computer, the IBM PC and IBM PC compatibles. When linked to the HP 150 via its RS232 port, the LaserJet copies the 150's screen on a one-keystroke command. HP says it will provide screen-copy software for the IBM PC this year.

HP offers the LaserJet with a Courier 10 font, but an optional plug-in ROM cartridge provides three additional fonts. The font cartridges allow use of four typefaces on a single page. Other ROM cartridges with additional fonts are scheduled to be released this year. LaserJet also rotates images 90 degrees, which allows the printing of spreadsheets in "landscape" mode using compressed type.

The LaserJet prints on letterhead paper, labels, envelopes and transparencies. Its paper cassettes feed standard 8½-by-11-inch sheets, legal-size pages and European sizes A4 and B5. Manual feed permits printing on both sides of a sheet and the use of odd-sized paper. The LaserJet opens like a clamshell to permit easy clearing of the paper path.

#### Same engine as Imagen

The LBP-CX print engine is also the heart of the previously announced Imagen 8/300 from Imagen Corp., Mountain View, Calif. The Imagen 8/300 has a more sophisticated controller than the LaserJet and retails for less than \$10,000.

Edward Webster, president of Datek Information Services Inc., Newtonville, Mass., says one source of buyer resistance to the LaserJet may be the \$99 disposable, electrophotographic cartridge. He also believes that the 100-sheet capacity of the paper cassette is not large enough for small business environments. "There's a lot of resistance to new things in the market. For several reasons, people are not real-

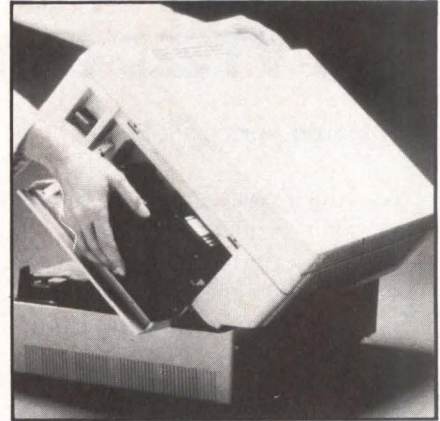

The LaserJet printer from HP opens like a clamshell to permit easy clearing of the paper path. A disposable cartridge containing toner, developer and a rotating drum is the heart of the print engine supplied by Canon USA.

ly unhappy with daisy-wheels."

Webster says that the LaserJet print quality is "great for a laser printer but not as good as a daisy. There's nothing wrong with the HP machine. I think its amazing that they can sell it for \$3,500."

According to the Boise division's general manager, Raymond A. Smelek, changing the electrophotographic cartridge produces extremely consistent print quality. "All the key imaging components, including the drum, are replaced each time. This makes the LaserJet simple to maintain." The cartridge includes mono-component toner, developer, a rotating photoconductive drum, a charge corona assembly and a drum-cleaner blade.

HP will distribute the LaserJet through approximately 1,100 dealers of its personal computer and plotter products in the United States. The company will also sell the printer through its direct sales force. HP projected quantity shipments by June 1, with European availability scheduled for late 1984. □

# Data General's engineering workstations push price/performance boundaries

Lori Valigra, Senior Editor

Data General Corp., Westboro, Mass., recently introduced two 32-bit minicomputer-based engineering workstations with an entry-level price tag of \$35,500.

DG is entering the low end of a market in which machine prices reach \$100,000. In doing so, it is trying to attract the growing ranks of cost-sensitive Fortune 1,000 and OEM companies that need to increase their engineers' productivity and decrease product design time.

"Customers must change from system integrators and R&D groups to Fortune 1,000 and OEM operations for the market to explode," says David Rome, marketing manager for the workstation group in DG's Technical Products Division. Rome figures Fortune 1,000 companies employ more engineers than other companies, because they account for 80 percent of computer sales.

The single-user DS4000 and DS4200 superminicomputers borrow their processor technology from DG's low-cost 32-bit system, the MV/4000. The DS4000 is a monochrome model sporting 1,024-by-1,024-by-2-bit-map resolution and having 256K bytes of graphics memory. The DS4200 offers 16 colors from a palette of 4,096 on a 1,024-by-1,024-by-4-bit-map raster display. The products are among the first to use Texas Instruments Inc.'s dual-ported, video dynamic RAM components. Both compact models fit under a desk and measure 25 by 13 by 20 inches. They are said to execute as many as 2.5 million instructions per second. A hardware floating-point unit executes 600,000 single-precision Whetstones.

DG's Technical Products Division, which sells to technical OEMs and system builders, and its Information Systems Division, which sells systems for large businesses and office-automation environments, will both handle the product.

## Supports eight office users

The Information Systems Division's version, the MV/4000 small cluster (SC), supports four to eight office users. The new processors are not as configurable as standard MV/4000 models, which support 64 terminals. Also, they have comparatively limited mass-storage options because drives cannot be attached externally. It is the first MV/4000-based system to support 5¼-inch disk drives rather than 8-inch drives.

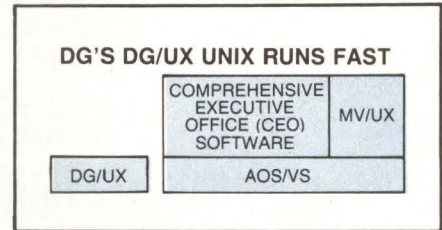

DG's DG/UX native UNIX runs faster than its MV/UX, which runs atop the AOS/VS operating system on DG's MV/ superminicomputers. DG/UX does not run with CEO software because of differing file structures and languages.

The new processors include three new boards designed to minimize system size. The integrated I/O controller board has floppy disk and hard disk drive controllers, extra asynchronous lines for a mouse or tablet, and an Ethernet local-area network (LAN) interface. The multiuser asynchronous board includes

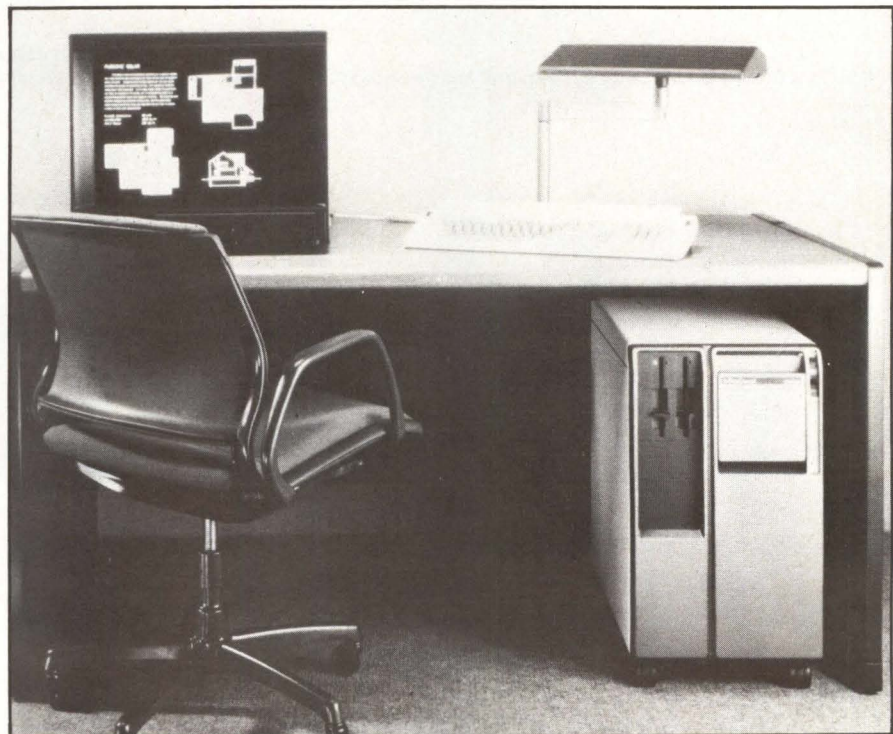

DG's DS/4200 32-bit minicomputer-based engineering/graphics workstation is a low-priced tool that fits under desks.

# Mini-Micro World

NEWS

## A challenge from Apollo, Skok

As Data General Corp. prepared to release its low-priced 32-bit minicomputer-based engineering/graphics workstations, competitors Apollo Computer Inc. and Skok Systems Inc., a Hewlett-Packard Co. system integrator, had a similar pricing notion

in mind when they introduced microcomputer-based systems.

Like DG's systems, Apollo's DN550 fits under a desk. It measures 24½ by 13½ by 28½ inches. Configured with Apollo's AEGIS operating system, 1M byte of memory, a color monitor, a

keyboard, and a Domain local-area network interface, the DN550 is priced at \$31,500. Adding a 50M-byte Winchester drive increases the price to \$40,000. A rack-mounted version for OEMs and system integrators also is available for \$30,000 with 1M byte

### APOLLO'S MODULAR DN550 MEANS EASY REPAIR

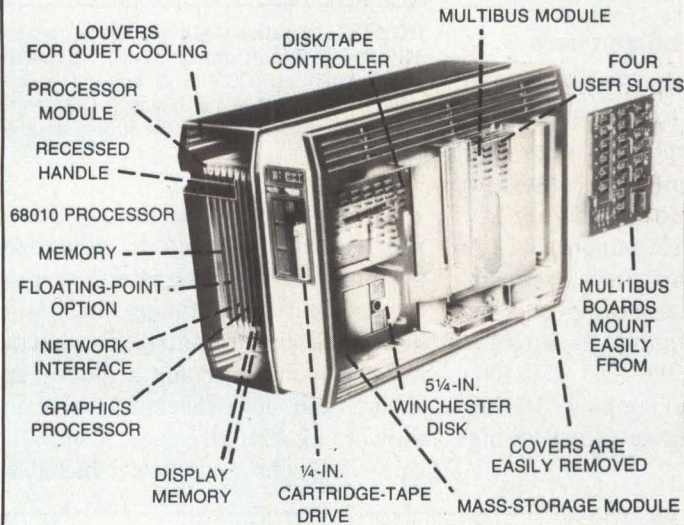

Apollo's DN550 under-desk system unit has three modules for easy repair.

Skok's Artech computer-aided-design and -drafting system competes with low-priced machines. Showing off the HP processor-based Skok system is Skok president and co-founder David Skok.

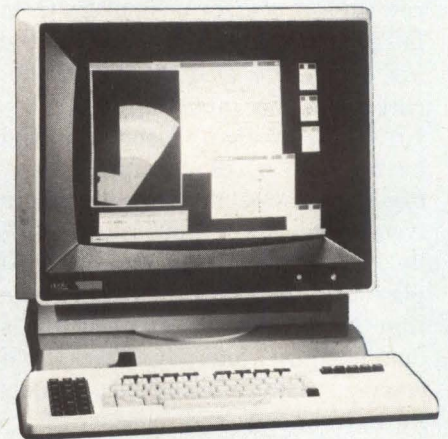
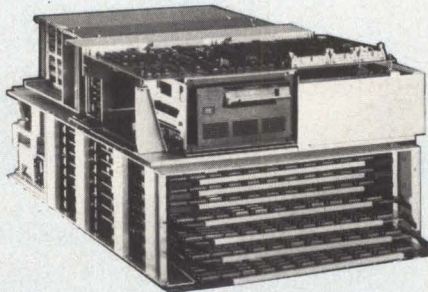
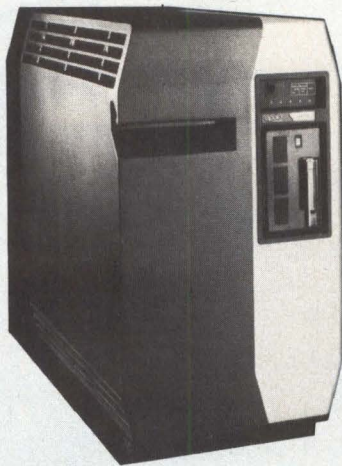

Apollo's low-priced Domain DN550 engineering workstation is available in under-the-desk (left) and rack-mount (center) versions. Display (right) shows multiple windows.

of memory, 1M byte of display memory, a 19-inch color display and a low-profile keyboard.

The monitor has 1,024-by-800-dot graphics and displays as many as 256 colors. The system is based on the MC68010 processor. Options include a 45M-byte, 1/4-inch cartridge-tape drive, a four-slot Multibus peripheral adapter and a floating-point hardware accelerator.

Apollo's processor is capable of 32-bit MC68020 processor performance, according to Lou Reynolds, product group manager for high-end systems and graphics at Apollo. Apollo is still sticking with a 16-bit bus. "When 32-bit CPUs [such as the MC68020] are available, then it will make sense to go to a 32-bit bus," he says.

One feature added across the Apollo DN processor line is the graphics metafiles resource (GMR), which Reynolds says appears to the application program like a series of functions or subroutines. Reynolds says GMR affords application independence and supports bit-mapped graphics devices. It creates and edits graphics primitives; handles interactive user input; provides scaling, translation, rotation and installation of graphics; and supports viewing 2-D objects. The company plans to add 3-D displays later. Users can distribute metafiles libraries across Apollo's Domain network, making it seem much like a distributed database for graphics routines. GMR software and firmware is free to Apollo users who are members of the software support program.

Also touting low price for its workstations is Skok. The company has based its Artech computer-aided-design and -drafting system on HP's 32-bit HP9920 microcomputer. An Artech DesignStation is priced at \$27,000. A fully configured entry-level system sells for \$59,500, including dual disk drives, a D-sized plotter, and Skok's Arplan 2-D design and drafting software. The 3-D Arview program sells for \$7,500 more. A graphics processor system adds \$35,000. The graphics processor is manufactured by Silicon Graphics Inc., Mountain View, Calif.

eight asynchronous and two synchronous ports and is for use with the MV/4000 SC eight-user commercial system. The graphics board supports a 19-inch color or raster-scan monitor.

### **DG announces native UNIX**

Along with the processor announcements, DG released a native UNIX operating system called DG/UX, which is based on UNIX System V Release 2 and supports the Berkeley extensions that are popular in engineering applications. Unlike DG's earlier MV/UX UNIX, which runs atop its AOS/VS mini-computer operating system, DG/UX runs directly on the CPU. Rome claims the DG/UX thus runs faster, requires half the memory and uses one-third the disk space. Programs written under DG/UX are said to be compatible with those written under MV/UX, so users have access to Ada development software running under the AOS/VS environment.

DG/UX works with all DG products except those running its Com-

prehensive Electronic Office (CEO) system software, which "sits" atop the AOS/VS operating system. CEO machines employ the AOS/VS operating-system file structure and a language different from DG/UX, Rome explains. The system also runs RT32, a subset of DG's AOS/VS operating system.

Other new products include IEEE 802.3 LAN support and transmission-control protocol/network protocol (TCP/IP) communications support, which allows DG equipment to coexist with non-DG equipment using the UNIX operating system in a LAN.

Price for the DS4000 with 1M byte of memory, a 19-inch monochrome display, a 38.6M-byte, 5 1/4-inch Winchester disk drive, a 736K-byte floppy disk drive, a LAN interface and software is \$35,500. The maximum 4M-byte DS4000 sells for \$50,000. Similarly configured DS4200s with color displays run from \$44,000 to \$59,000. Similarly configured MV/4000 SCs with CEO software are priced from \$34,400 to \$47,400. □

### **DOW PLANS SOFTWARE FOR SALES MANAGEMENT**

Dow Jones Software, Princeton, N.J., is expected to announce a modular software series this summer that focuses on sales-management functions. The modules are designed for tracking sales, forecasting, etc. The first module, Prospect Organizer, is expected to retail for \$395.

### **HIGH-END UNIX TO GAIN APPLICATION SOFTWARE**

Pyramid Technology Corp., Mountain View, Calif., is moving to close the application gap in software for high-end UNIX systems. In conjunction with approximately 20 software vendors, Pyramid planned to announce in June the establishment of a third-party software support program for its 90x SuperMinicomputer. The 32-bit 90x is one of the first dual-port UNIX systems that supports both American Telephone & Telegraph Co.'s UNIX System V and the popular Berkeley 4.2 version of UNIX. Among the programs successfully ported to the system are relational database management, spreadsheets, high-level languages, an IBM PC link, word processors, menu systems and advanced typesetting programs.

### New VAX/VMS version streamlines VAXcluster

David Bright, Assistant Editor

Digital Equipment Corp. recently announced a new version of the VAX/VMS operating system that makes a 16-node VAXcluster function more like a single, distributed system.

Along with the new product, called VMS Version 4.0, DEC also introduced several other VAX products: the MicroVMS operating system for the MicroVAX I computer, Common LISP, an enhanced FORTRAN, the VAX graphical kernel system (GKS) graphics software package, DECnet software with extended network addressing and a local-area network (LAN) terminal server.

Marion Dancy, VAX software marketing manager, describes the VAXcluster, a loosely connected group of VAX superminicomputers, as a cross between a tightly coupled multiprocessor scheme and a LAN. A passive star coupler links as many as 16 VAX-11/750s, 11/780s, 11/785s and hierarchical storage controllers over a 70M-bit-per-second coaxial cable. Dancy says several hundred VAXclusters have been installed since the product's introduction a year ago.

#### VMS system balances jobs

A major feature of VMS 4.0 is the distributed job controller. The controller balances the number of jobs per system and maintains single-print and batch queues for the entire cluster. A distributed-file system manages all files in a cluster as a single entity; users don't have to specify the drive location when accessing a file. A distributed-lock manager provides concurrent control of the clusters' resources. One of the main advantages is that, should a system crash, the manager

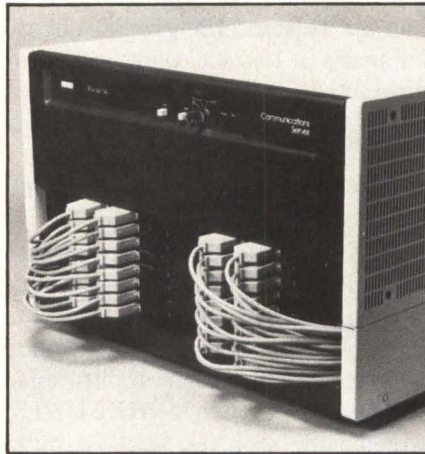

DEC's new communications server provides load balancing to as many as 32 terminals across a VAXcluster or an Ethernet LAN.

can direct another system to unlock any of its records.

The operating system also includes security enhancements such as a log-on retry limit and auditing of log-ons, log-offs, mounts, dismounts and file accesses. A VMS 4.0 license sells for \$10,000, which is the same price as that of the previous version. DEC plans to begin shipments in late 1984.

#### PDP-11s convert to servers

The terminal server adds to the 4.0's job-balancing capability. It can be used in a VAXcluster or in an Ethernet LAN. Instead of hooking terminals directly to a host machine, the server distributes the hookups across the cluster or LAN, according to system use. The server can offload jobs from a host to intelligent terminals and personal computers.

The server, which can connect as many as 32 terminals, is based on the PDP-11/24 minicomputer. The 32-line version sells for \$20,000. DECnet-VAX 4.0 software converts a PDP-11 to a terminal server and extends the routing algorithm, ena-

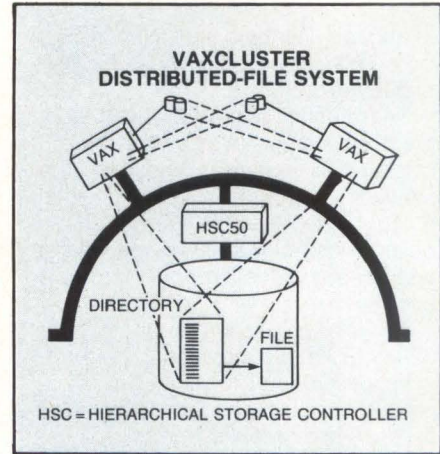

With VMS 4.0's distributed-file system, users can transparently access all files from any system in a VAXcluster. However, specified files can be locked for security.

bling LANs and wide-area networks to include several thousand nodes. The previous limit was 1,023 nodes. The software, which also increases communication-interface support, runs on both VAX/VMS and MicroVMS and sells for \$3,000. The software should be available this summer.

#### Recompiling unnecessary

MicroVMS is truly compatible with the VAX/VMS of the larger machines without recompiling or re-linking, claims Dancy. This is because the only code deleted from VAX/VMS concerns Massbus, Unibus and PDP-11 compatibility mode. (MicroVAX I uses the Q-bus but is based on the VAX architecture.) The only user-written application program changes that might be necessary, Dancy says, are to accommodate peripherals specific to the MicroVAX I. In addition to MicroVMS, DEC will continue to offer VAXELN, the MicroVAX I's first operating system. While MicroVMS is a general-purpose operating system, VAXELN is mainly for real-time development.



# Like DEC's.

\$8,845 system price\*

256 KB minimum...  
up to 4 MB!

Media and software  
compatibility with  
DEC's RX02 8" floppy  
(vs. Micro/PDP-11's  
non-compatible 5¼" floppy)

8-quad slot  
Q-BUS card cage

Supports RT-11, RSTS,  
RSX-11M-PLUS,  
UNIX, and  
TSX-PLUS

Two fans in card cage  
area (vs. one in  
Micro/PDP-11)

1.0 MB floppy disk  
back-up (vs. 2 x 400 KB  
for Micro/PDP-11)

RL02-compatible  
5¼" Winchester disk;  
10 MB, 20 MB, or  
40 MB capability

Cartridge tape  
capability

## Only better.

You can buy DEC's Micro/PDP-11 with its impressive array of features...or you can get Dataram's A22 — an LSI-11/23 based minicomputer that gives you a whole lot more...for a lot less dollars! Like an 8" RX02-compatible floppy. 40 MB 5¼" Winchester and ¼" cartridge tape capability. And two fans that provide push-pull air flow in the card cage area.

For more information, forward this coupon to us, or, for faster response, call (609) 799-0071.

Send information.       Contact me immediately.

Name \_\_\_\_\_

Company \_\_\_\_\_

Address \_\_\_\_\_

City \_\_\_\_\_

State \_\_\_\_\_

Zip \_\_\_\_\_

Phone \_\_\_\_\_

Dataram Corporation, Princeton Road, Cranbury, NJ 08512

\*\$8,845 is single-quantity domestic price for A22 with LSI-11/23, 256 KB, 10 MB Winchester and RX02-compatible 8" floppy.

DEC, LSI-11, Micro/PDP, PDP, RSTS, RSX, and RT-11 are trademarks of Digital Equipment Corporation. TSX-PLUS is a trademark of s&h computer systems, inc. UNIX is a trademark of Bell Laboratories.

# DATARAM

Dataram Corporation □ Princeton Road □ Cranbury, New Jersey 08512 □ Tel: 609-799-0071 □ TWX: 510-685-2542

MINI-MICRO SYSTEMS/August 1984

CIRCLE NO. 23 ON INQUIRY CARD

39

# EMULEX IMPROVES AND TAPE BACKUP BY

Emulex sets the pace with three great storage subsystems for the full range of DEC QBus and Unibus systems. Whether you need Winchester disk, cartridge disk,  $\frac{1}{4}$ " streaming tape, or a combination unit, you'll be a step ahead with Emulex.

## INTRODUCING VAULT.™

Emulex rises above the competition with the Vault.™ This 70-MByte tape subsystem is built around the CDC Sentinel  $\frac{1}{4}$ " cartridge tape streamer and uses Emulex's own TC05 (QBus) or TC15 (Unibus) tape coupler to interface with your system. The Vault is totally software transparent to standard TS11 software. So this compact tape unit looks just like a big  $\frac{1}{2}$ " TS11 subsystem to your operating system and diagnostics.

Vault comes complete with power supply in a single compact cabinet. It's the perfect backup unit for smaller QBus systems such as the MICRO/PDP-11 and MICRO/VAX.

## PRESENTING SABRE.™

SABRE™ is a sharp solution for LSI users who need more storage and backup. It packs 31.2 MBytes of main storage onto a  $5\frac{1}{4}$ " Winchester and 10.4 MBytes of backup onto a removable 8" cartridge disk.



And since SABRE is an exact RL02 emulation, all existing operating and diagnostic software can be used as is.

SABRE is  $5\frac{1}{4}$ " high and slips into any 19" RETMA enclosure. A desktop version is also available. Both come complete with power supply, host adapter and connecting cables.

SABRE needs only one-eighth the space and one-quarter the power of four RL02s. And it eliminates the need for a separate system bootstrap, bus terminator and clock control board.

\*DEC, QBus, Unibus, TS11, MICRO/PDP-11, MICRO/VAX, LSI, and RL02 are trademarks of Digital Equipment Corporation. CDC and Sentinel are trademarks of Control Data Corporation.

GSA Contract # G500K840135575

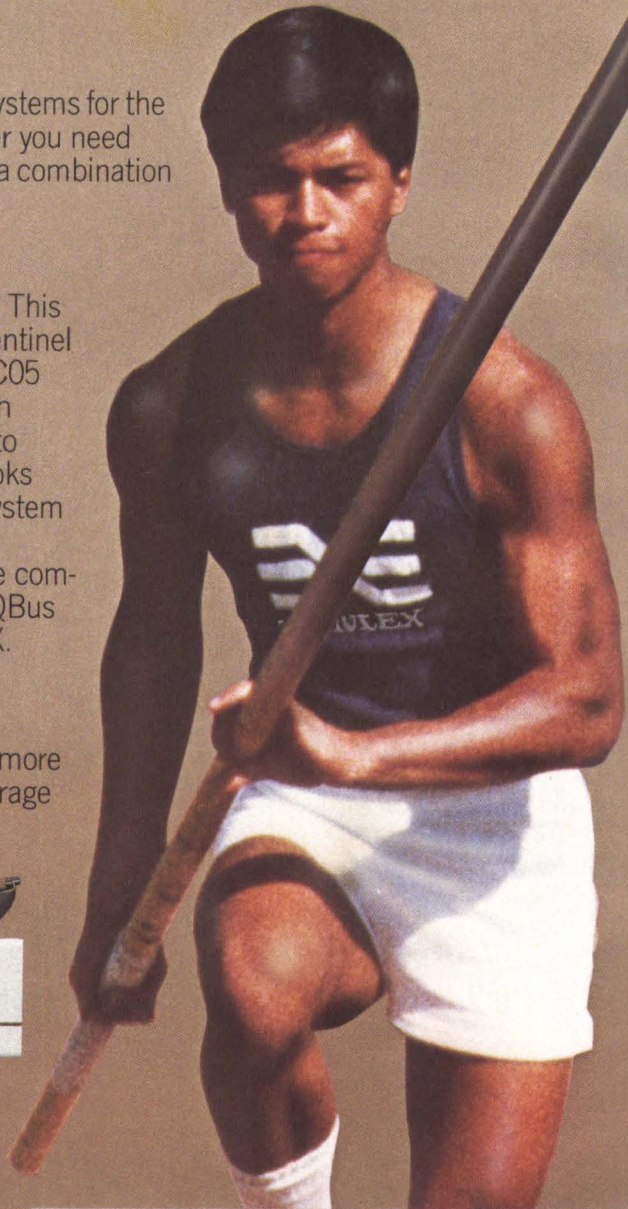

# DEC DISK STORAGE LEAPS AND BOUNDS.

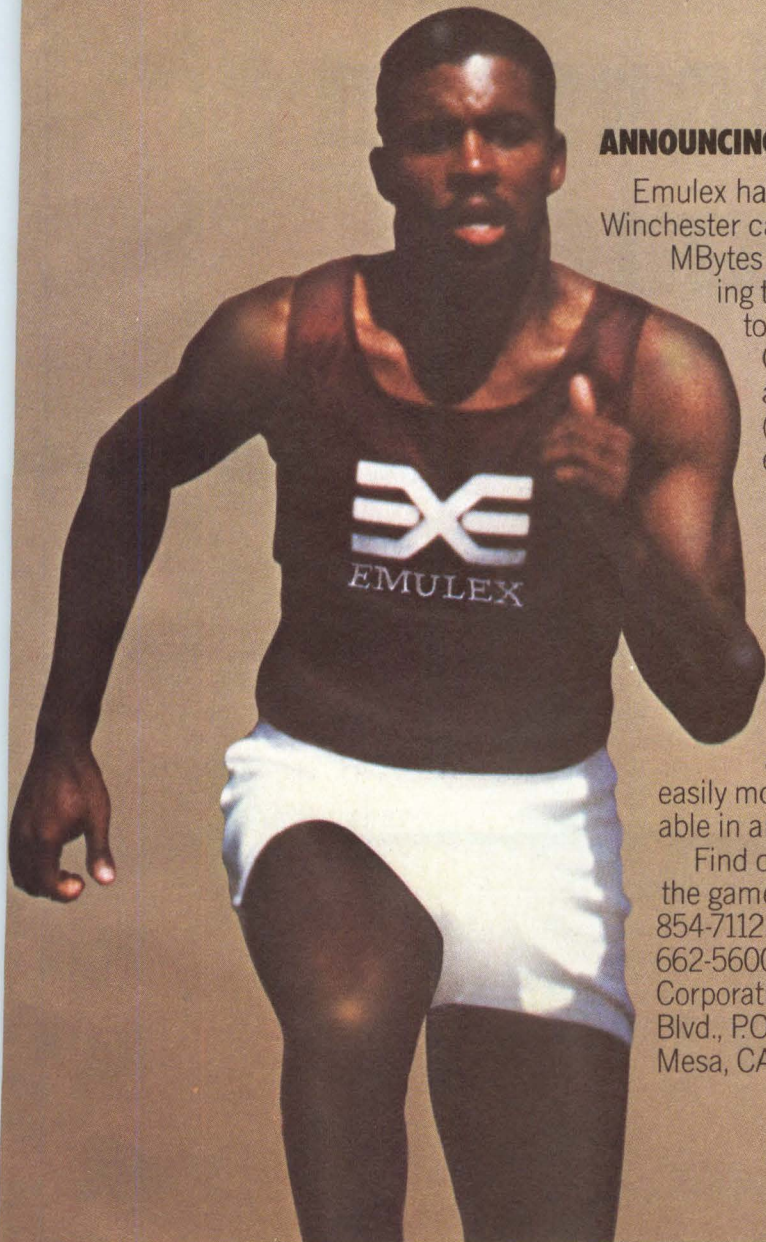

## ANNOUNCING MEDLEY.™

Emulex has another winning combination with the Medley™ Winchester cartridge tape subsystem. It gives you either 35 or 110 MBytes of formatted storage and up to 70 MBytes of streaming tape backup. The Medley is fully software transparent to the operating system and diagnostic software of QBus and Unibus CPUs. And it uses the powerful and versatile Small Computer System Interface (SCSI) which keeps your options open for peripheral expansion.

Medley is interfaced to the system with a TC05/TC15 tape coupler and a UC02 (QBus) or UC12 (Unibus) host adapter. By using the Mass Storage Control Protocol (MSCP), the UC02 and UC12 allow the operating system to utilize the precise characteristics of the Winchester disk drive without patches or modifications to the operating system.

For convenience, Medley's disk drive, tape drive and power supply all fit into an attractive cabinet that easily mounts in a standard 19" rack. The Medley is also available in an attractive desktop version.

Find out how Emulex subsystems can keep you ahead of the game. Call toll-free (800) 854-7112. In California (714) 662-5600. Or write Emulex Corporation, 3545 Harbor Blvd., P.O. Box 6725, Costa Mesa, CA 92626.



**The genuine alternative.**

CIRCLE NO. 24 ON INQUIRY CARD



# The lean, mean plotting machine from Houston Instrument

Houston Instrument's brand new servo driven DMP-51 is the fastest drum plotter we've designed to date. This superb plotter offers a pen speed of up to 22 inches/second; programmable accelerations, and a pen-on-paper resolution of 1/1000 of an inch! That means you'll turn out quality 17" x 22" and 22" x 34" drawings a lot faster, increasing your firm's productivity and profitability.

Now, for more good news. The DMP-51, priced at \$4,495\*, is as fast as other plotters costing three times more. At that price, you can afford to put a DMP-51 at individual drafting work stations.

This is the professional plotter that meets the needs—and the budgets—of all companies, large or small.

The DMP-51 is intelligent, too. The DMP-51 can execute complex graphics operations from the simplest commands. A mechanical/architectural version, the DMP-52, with its 18" x 24" and 24" x 36" paper size, is available for the same price from Houston Instrument.

So, watch our new plotter in action . . . it won't take much time to realize it's the best buy for your money. For the name, address and phone number of your nearest dealer or distributor, write Houston Instrument, 8500 Cameron Rd., Austin, Texas, 78753. You can also call 1-800-531-5205 or 1-512-835-0900 (Texas residents). In Europe, contact Houston Instrument Belgium NV, Rochesterlaan 6, 8240 Gistel, Belgium. Tel: 059-27-74-45. Tlx: 846-81399.

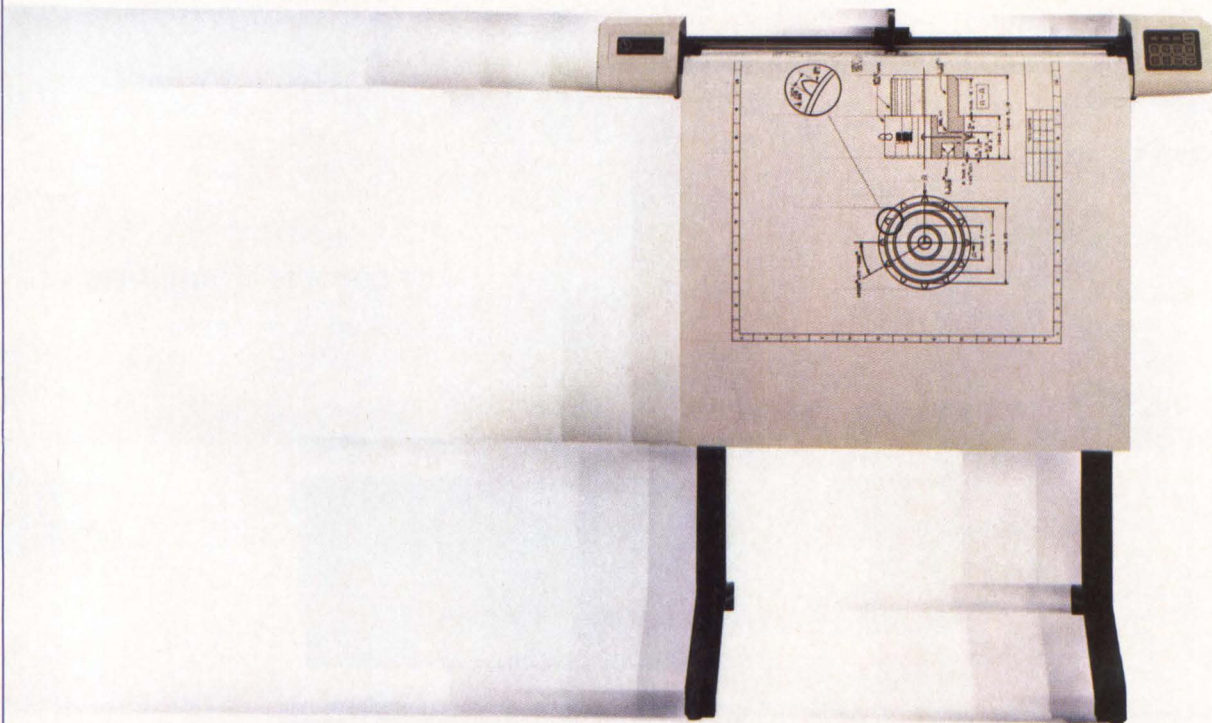

\*Suggested U.S. retail price

**houston  
instrument**



CIRCLE NO. 25 ON INQUIRY CARD

# Mini-Micro World

## NEWS

MicroVMS should be available next month in modular form. The license for the basic system with the program-development module sells for \$1,500, while the DECnet group sells for \$1,450. DEC also expects to add the ULTRIX UNIX-like operating system to the MicroVax I late this year.

### Common LISP on VAX

DEC's VAX LISP is one of the first fully supported artificial-intelligence languages developed by a major computer manufacturer. With this implementation of Common LISP, DEC hopes to achieve standardization of the language.

Art Beane, product manager of DEC's artificial-intelligence technology group, claims VAX LISP is more cost-effective for application development than are dedicated LISP machines. Dedicated machines are best for research, he says.

VAX superminicomputers running the language must have at least 512K bytes of memory per user. Features include both interpreter and compiler modes, dynamic linking of compiled and interpreted code, lexically scoped variables, an editor with multiple window capabilities, integrated debugging facilities, a "pretty-printer" utility for enhancing print readability and the ability to call routines written in any other VMS language.

The new FORTRAN compiler reportedly improves application-program performance by as much as 50 percent. The compiler features a multiphase global optimizer that works across entire program units. Such operations include constant folding, arithmetic "if," logical "if," block "if-then-else," global elimination of common sub-expressions, removal of invariant expressions from loops and global allocation of general registers across program units. □

### Perkin-Elmer emulates latest AT&T UNIX V release

While Digital Equipment Corp. was attempting to help set an industry standard with its Common LISP implementation, Perkin-Elmer Corp. continued to stick with existing standards. P-E's new XELOS operating system for its Series 3200 line of superminicomputers is a "true derivative" of American Telephone & Telegraph Co.'s UNIX System V, release 5.2, says Jeffrey Bork, P-E's UNIX product manager. "We have made a commitment to follow the AT&T baseline standard," he asserts.

The XELOS operating system comes with the standard AT&T command interpreter shell as well as the C shell from the University of California at Berkeley. XELOS also includes an assembler, a C compiler, a FOR-

TRAN compiler Bork calls "the best optimizing compiler in the world" and a symbolic debugger. Another addition is the MenuMaker for creating menus that run XELOS and application programs. The Documenter's Workbench word-processing package also comes standard with XELOS. The popular RM/COBOL language system from Ryan-McFarland Corp. is optional. P-E plans to ship XELOS in October. Prices range from \$1,500 to \$30,000.

P-E at the same time announced the availability of the Unify relational database-management system on XELOS. Developed by Unify Corp., the system can interface with P-E's C compiler and RM/COBOL.

## HP phases out three terminals with low-priced model

Tom Moran, Associate Editor

Following a trend among major systems manufacturers to reduce competition from makers of plug-

compatible devices, Hewlett-Packard Co. will "protect the ports" of its HP 1000, 3000 and 9000 computers with a \$1,295 HP 2392A ergonomic display terminal.

The 2392A will replace the HP 2622A block-mode terminal, the HP 2382A office display terminal and the HP 2621B interactive terminal.



The HP 2392A display terminal's ergonomic features include a tilt-and-swivel screen, adjustable-slant keyboard, and a non-glare green-phosphor screen. At \$1,295, the 2392A will replace three previous HP terminals and will be more competitive with terminals from other manufacturers.

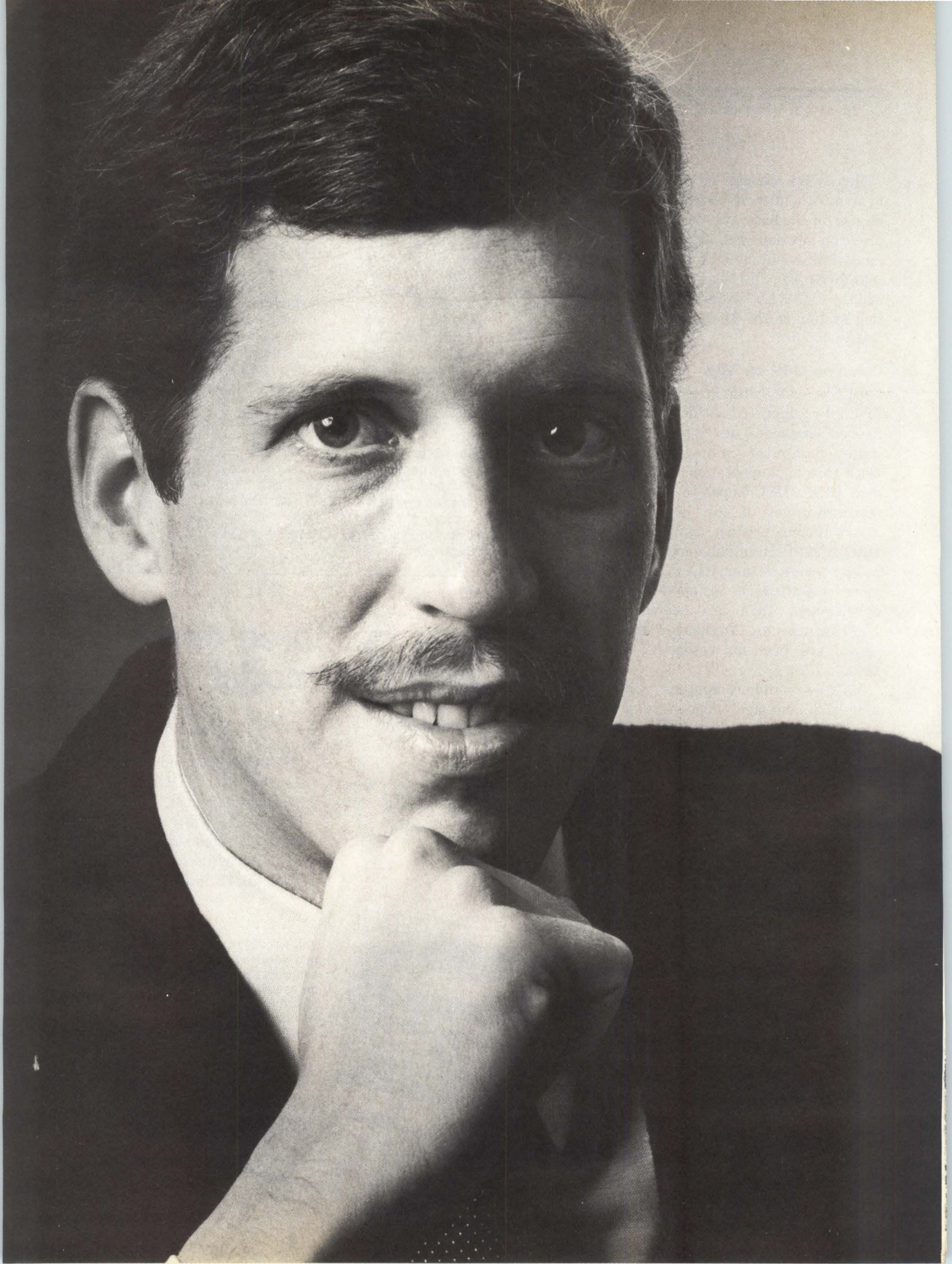

“Simply stated, we’re a great Winchester  
Sdisk drive company dedicated to serving  
customers with smaller disk drive needs.

We don’t pretend to be all things to all  
people. We’re here to service the disk drive  
customer looking for 2000 to 5000 disk  
drives over, say, the next year.

We won’t promise you the world.  
We’ll never sell a disk drive that doesn’t  
exist, and we won’t oversell our capacity.  
It’s that simple.

Building customer confidence and loyalty  
is first and foremost, so we’re geared to  
doing our share of hand-holding. We’ll  
guarantee a style of service that’s second-to-  
none which ensures your critical production  
schedules are met.

On every disk drive, we offer a solid  
one-year warranty and back it up with an  
off-the-shelf product exchange to keep your  
production line up and running. Of course,  
we’ll be more than happy to send you an  
evaluation sample right now, today; just  
pick up the phone and tell us what you’re  
looking for.

We’re out to build the Otari brand of  
confidence for both our products and our  
people. We’re committed to giving you the  
best of both worlds — great disk drives and  
great disk drive people.

In short, we’re here for the long run, and  
so are our drives.”

—Michael Bernard, Manager, Otari Data Inc.

**OTARI**

**OTARI DATA INC.**

Subsidiary of Otari Electric Co., Ltd., Japan

271 N. Mathilda Ave.

Sunnyvale, CA 94086 (408) 738-4808

Disk Drive Confidence, Guaranteed.

CIRCLE NO. 26 ON INQUIRY CARD

# Mini-Micro World

## NEWS

It is priced 40 percent less than the 2622A. Dan Jorgenson, product manager of HP's Roseville, Calif., terminals division, says the pricing helps differentiate the 2392A from personal computers. In a similar strategic move last year, both IBM Corp. and Digital Equipment Corp. introduced terminals priced 25 percent to 33 percent less than their previous models.

### Ergonomic features added

HP created the HP 2392A by adding ergonomics to a modified version of the 2622A. It has all the 2622A's functions but not its optional \$12,000 integral printer. New features are a tilt-and-swivel screen with smooth scrolling, an adjustable-slant keyboard, four pages of screen memory with an option for eight pages, a printer port option and a 19.2K-baud maximum transmission rate. The 2392A operates with HP 1000 real-time computers, HP 3000 business computers and HP 9000 engineering workstations. A further option allows compatibility with the ANSI X3.64 standard and DEC's VT100 terminal at no extra cost. Typical applications include block-mode and character-mode data entry, program development and data inquiry.

The HP 2392A swivels 360 degrees on a pedestal, while the separate CRT tilts 20 degrees inside the casing. The 12-inch, etched, antiglare screen displays text in a 24-lines-by-80-column format with two additional lines for function-key labels and one line for status information. The P31 green phosphor used for the display is refreshed at 60 Hz. Characters appear in a 7-by-11 dot matrix inside a 9-by-14-dot cell with 1/2-dot shift.

The 2392A's detachable, low-profile keyboard is identical to that of the HP 150 touch-screen personal computer. It can be adjusted to slant at 3 degrees or 11.5 degrees.

The 107 sculptured keys include a numeric keypad and independent user, editing and cursor keys. Seventeen international keyboard options will eventually be available. The documentation has been translated from English into nine major languages and is included in ROM.

A combined RS232/HP 422 port links the 2392A to the host system. The 2392A has full-duplex, asynchronous point-to-point transmission and is compatible with Racal-Vadic's VA3400, Bell Laboratories' 212A, Bell's 103A and other Bell-compatible modems. For \$150, users can add an optional Centronics port or a second RS232 port to support a printer.

### VLSI reduces costs

Jorgenson says HP was able to keep the cost of the 2392A down by using very-large-scale-integration (VLSI) circuits and improved manufacturing techniques. The 2392A's VLSI chips, all designed by an HP team in Grenoble, France, reduced the number of parts to 370 from 700 components in the HP 2622A. According to Jorgenson, the reduced chip count makes the 2392A more reliable than the terminals it will replace.

HP sources will not talk about intended production capacity or the number of terminals HP expects to sell. Dataquest Inc., a San Jose, Calif., research group, estimates that HP's domestic 1983 sales of non-graphics terminals amounted to

47,000 units. The total installed base is 200,000 units. HP's Jorgenson says that HP's worldwide installed base is more than 500,000 terminals.

According to Louise Herndon Wells, research analyst for Dataquest, HP's growth rate for terminals is strong. Wells cites the complexity of HP terminals as a barrier to would-be emulators. "Probably half of the development effort in a new HP terminal is spent ensuring its compatibility with previous HP products," she says. "I think that HP, like other system manufacturers such as IBM and DEC, is attempting to protect the ports of its systems from competitors with low-priced, full-functional products." Companies offering HP-compatible terminals include Direct Inc., Santa Clara, Calif., Falco Data Products Inc., Sunnyvale, Calif., and Semicoa Data Systems, Costa Mesa, Calif.

Wells points out, "HP's distinctive features have been high quality, high level of functionality and service. In today's very competitive terminal market, although these are necessary, they are not sufficient. At \$1,295, the 2392A should discourage potential emulators."

HP will produce the 2392A at its plants in Roseville, Calif., and Grenoble, France. The company expects to start taking orders around July 2, with a delivery time of six weeks. Distribution will be through HP's direct sales force. □

### INDUSTRY REVENUES TO REACH \$90 BILLION BY 1988

The computer services and software industry's annual revenues will hit \$90 billion by 1988, according to an Association of Data Processing Service Organizations survey. The industry grew from \$27.6 billion in 1982 to \$33.5 billion in 1983. Revenues per market segment during 1983 were \$9.3 billion in software products, \$12.7 billion in processing services, \$5 billion in turnkey systems and \$6.5 billion in professional services.



# Quality 5<sup>1</sup>/<sub>4</sub> Inch Drives.

## From FUJITSU.

Fujitsu quality has come to mean a lot of things to a lot of people. High performance, unparalleled reliability, and technical expertise, built on more than 15 years experience.

This consistent quality is reflected in Fujitsu's complete line of 5<sup>1</sup>/<sub>4</sub>-inch drives. The product line includes half high drives ideally suited for compact applications, standard ST506 drives for general applications, and high performance drives for applications where greater capacities and faster access times are required.

Fujitsu's complete 5<sup>1</sup>/<sub>4</sub>-inch product line. Quality that's exclusively Fujitsu.

For more information contact the Fujitsu America Sales Office nearest you. Northwest: (408) 946-8777, Central: (612) 835-7025, East Coast: (617) 229-6310, Southwest: (714) 476-0852, Europe: 44-1/493-1138.

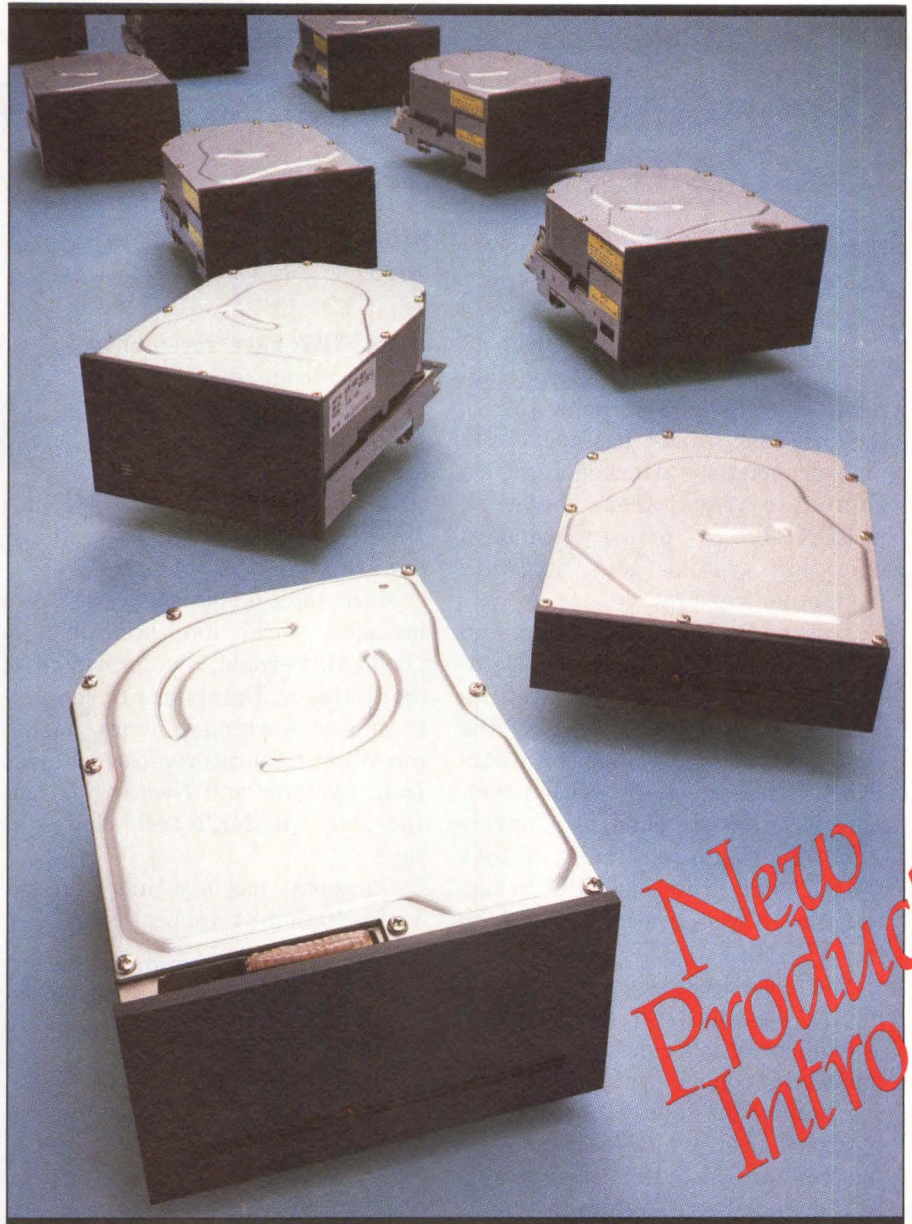

	HALF HIGH	STANDARD	HIGH PERFORMANCE
CAPACITY (MBytes)	7 / 13	7 / 13 / 20 / 27	31 / 55 / 86
AVERAGE POSITIONING TIME (ms)	95	83	35
DIMENSIONS (inch) (HxWxD)	1.6x5.7x8.0	3.3x5.7x8.0	3.3x5.7x8.0
INTERFACE	ST506 / SA4000	ST506 / SA4000	ST506 / SA4000
POSITIONING METHOD	Buffered Stepper	Buffered Stepper	Rotary Voice-Coil

New products are indicated in red.

### STORAGE PRODUCTS DIVISION

Quality Lives



# Mini-Micro World

NEWS

## Datapoint opens ARCNET LAN to outside vendors

**Marjorie Stenzler-Centonze**  
Associate Editor

In a significant departure from its marketing and product development philosophy, Datapoint Corp., San Antonio, Texas, has opened its once-proprietary attached resource computer local-area network (ARCNET) to industry-standard operating systems and hardware from other vendors.

Edward P. Gistaro, president and chief executive officer, says Datapoint's commitment to opening ARCNET is demonstrated by the company's introduction of the Vista-PC, which is the 16-bit N-Gen computer system supplied by Convergent Technologies Inc., Santa Clara, Calif. The Vista-PC brings the MS-DOS operating system to the ARCNET.

The Vista-PC can emulate terminals in an ARCNET and operates standalone or in a clustered environment. It comes with a high-resolution color monitor and 256K bytes of user-available RAM, expandable to 1M byte. It is available as a dual-diskette system or with a hard disk. The basic system price is \$4,795. The significance of the Vista-PC, according to Michael Gallup, vice president of product marketing at Datapoint, "is the fact that it opens MS-DOS to office-automation users."

### IBM PC to work in ARCNET

The company plans to integrate the IBM PC into the ARCNET as well, Gistaro says, and to enhance access between the network and IBM mainframes. Datapoint officials expect the network to be compatible with IBM's token-ring LAN planned for release in two to three

**Datapoint's Vista-PC opens MS-DOS access to ARCNET LAN users.**

years. "We have researched IBM's recent description of a cabling scheme for LANs, and based on that information we have concluded that Datapoint's ARCNET [could] directly utilize this cabling system," Gistaro states.

More than 6,000 ARCNETS are installed worldwide, according to David R. Fernald, vice president of marketing at Datapoint; 16 computer and networking vendors, including Wang Laboratories Inc., Zenith Data Systems and Nestar Systems Inc. use ARCNET technology, he says.

Datapoint has also unveiled the Vista-Station-84 application proces-

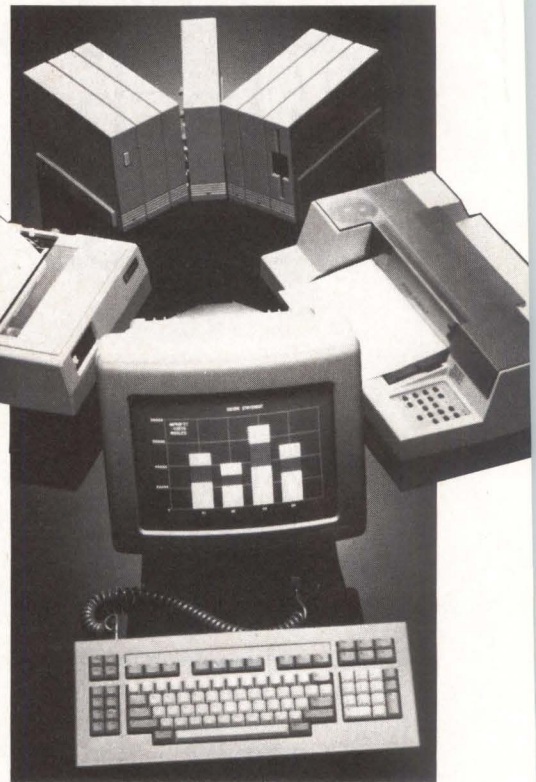

sor, based on Intel Corp.'s 80286 microprocessor, and the Vista-Station-

**DATAPOINT'S VISTA-VIEW SOFTWARE  
LETS USERS VIEW MULTIPLE WINDOWS OF DATA**

**DATE AND TIME**

5 Jun 1984 2:48 pm

DDDDDDDDDDDDDDDD  
 DDDDDD DDDDDDDDD  
 DDDDDD DDDDDDDDD  
 DDDDDD DDDDDDDDD  
 DDDDDD DDDDDDDDD  
 DDDDDD DDDDDDDDD  
 DDDDDD DDDDDDDDD  
 DDDDDD DDDDDDDDD  
 DDDDDD DDDDDDDDD  
 DDDDDD DDDDDDDDD  
 DDDDDD DDDDDDDDD  
 DDDDDD DDDDDDDDD  
 DDDDDD DDDDDDDDD  
 DDDDDD DDDDDDDDD  
 DDDDDD DDDDDDDDD  
 DDDDDD DDDDDDDDD  
 DDDDDD DDDDDDDDD

**VISTA-MAIL**

Welcome to Datapoint's VISTA-MAIL

Mailbox contains 6 Total messages  
4 New messages

8 Socks	886	948	985
9 Sweat Shirts	4,265	5,559	5,987
10 Shorts	782	845	928
11 T-Shirts	2,988	3,388	3,598
12 Warm-ups	985	1,056	1,345
13			
14 Total Sales	\$18,183	\$21,113	\$22,197

MULTIPLAN

Document RECOVERY has been greatly enhanced. Every keystroke made during an edit session is automatically recorded. If a power failure occurs or the document editing session does not end normally, VISTA-

-----1-----2-----3-----4-----5-----6-----7-----  
 DOCUMENT VISTA-WORD PAGE 1 LINE 14 COLU

VISTA-WORD

Datapoint's Vista-View windowing software displays as many as 14 windows and monitors as many as eight programs running concurrently.

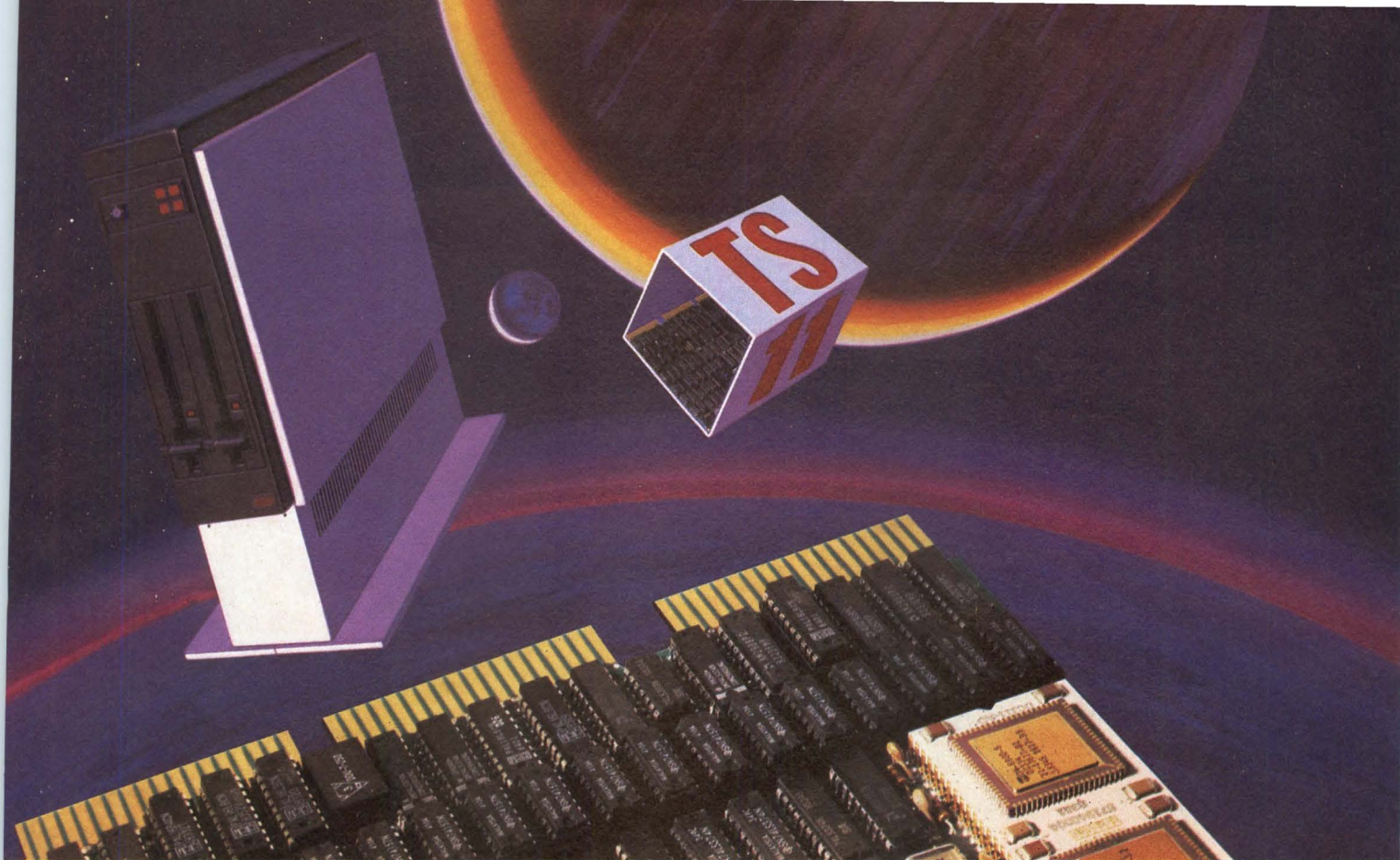

# Get On-board the J11 Breakthrough.

We didn't invent the J11—we just took advantage of the technological breakthrough it represents to create the most powerful front end communications processor for Q-bus\* applications in the world. It's called the MLSI-JFEP11, and now, for the first time, co-processing on the Q-bus is possible. And with this multi-processing capability, comes a substantial cost savings for system designers as a new world of applications are available to the smaller, yet faster, CPU based systems.

Powerful is an understatement. The MLSI-JFEP11 is the first application of the DEC J11\* processor other than on the 11/73 single board computer. It features 512KB dual ported memories, two high speed serial ports (one megabaud each) and an external parallel bus for I/O expansion.

And getting that power underway has never been easier. The MLSI-JFEP11 is programmed in the most

widely used machine language in the world—the PDP-11\* instruction set. Needless to say, that means a rapid transportation of countless existing programs and a minimum start-up time for new ones.

So if you're committed to the new micro architecture with macro capabilities, we should travel in the same circles. Especially when it comes to such system applications as dynamic communication line resource allocation, data compression/decompression, message processing, message routing, protocol conversion and multi-processing.

Because the MLSI-JFEP11 is part of the new world of MDB capabilities. One that started with the TS11 Controller/Coupler, followed by our MICRO/11 and MICRO/32 packaging breakthroughs. All tools to help you go as far in the building of a super micro computer system as your design imagination allows.

\*Q-bus, DEC J11 and PDP-11 are Trademarks of Digital Equipment Corporation

**MDB**  
SYSTEMS INC.

**Corporate Headquarters**  
1995 N. Batavia Street, Box 5508  
Orange, CA 92667-0508  
Tel. 714-998-6900 TWX: 910-593-1339  
FAX: 714-637-4060

**MDB Systems U.K., Ltd.** Berkshire, Tel. 44 06286 67377  
**MDB Systems GmbH** Munich, Tel. 49 89 9101272  
**MDB Systems Australia** Neutral Bay, Tel. 612 929-6526

In the western states MDB products are also distributed by

**WYLE**  
LABORATORIES

ELECTRONICS MARKETING GROUP

Circle 195

See us at **MINIMICRO SOUTHWEST**  
and the **Federal Computer Conference**



"The Quality  
and Resolution  
Are Both There."

"But  
Half The Price  
Is Missing."

# VISUAL 500/550 Graphics Terminals

Our VISUAL 500 and 550 graphics terminals emulate the Tektronix® 4010/4014 in nearly every way, but one: Price. Ours costs less than half as much.

Our 768x585 high-resolution also gives you remarkably sharp text and graphics display. While our larger 14" screen makes viewing easier.

What's more, both the VISUAL 500 and 550 are compatible with most standard software, including PLOT 10®, DISSPLA®, TELL-A-GRAF®, SAS/GRAPH, DI 3000/GRAFMAKER, INFOgraph, SPSS®, TEMPLATE™, DR Graph™, GSX™ and all GSS products.

And both terminals come with a wide variety of advanced graphics features. Resident vector draw. Point plot. Circle

and arc draw. Rectangle draw. Multiple line styles and patterns with rectangle pattern fill. Plus an auxiliary port to support printer/plotters and data tablets.

As an alphanumeric terminal, the VISUAL 500 provides selectable emulations of the DEC VT52®, Data General D200, Lear Siegler ADM-3A™ and Hazeltine 1500 terminals. While the VISUAL 550 is DEC VT100® protocol-compatible as well as a character or block mode terminal which complies to the ANSI X3.64 standard.

For complete information, call or write Visual Technology today. And find out how easy it is to get all the quality and features you want in a graphics terminal. Without paying all the price.

CIRCLE NO. 28 ON INQUIRY CARD

**VISUAL** See for yourself®

Visual Technology Incorporated  
540 Main Street, Tewksbury, MA 01876  
Telephone (617) 851-5000. Telex 951-539

REGIONAL OFFICES:

Northwest: (415) 490-1482  
Southwest: (213) 534-0200  
North Central: (513) 435-7044  
South Central: (214) 255-8538  
Northeast: (201) 528-8633  
Southeast: (301) 924-5330

# Mini-Micro World

## NEWS

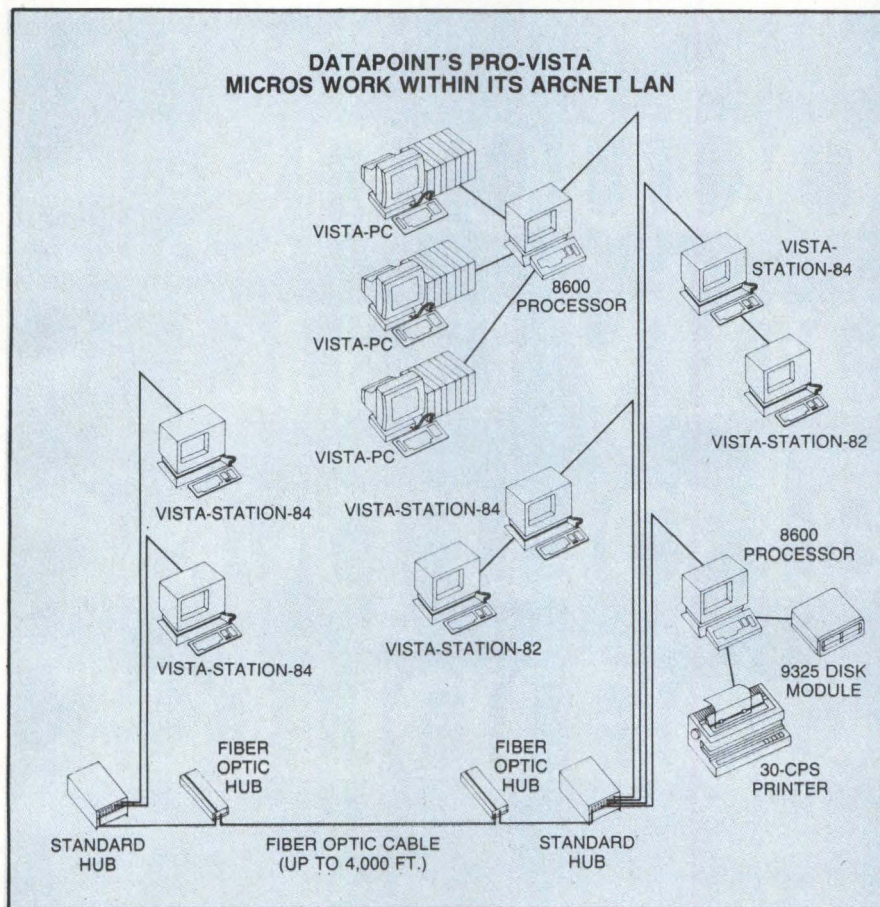

Datapoint has opened its ARCNET LAN to outside vendors' products with the introduction of the Convergent Technologies-based Vista-PC. The PC operates as part of the Pro-Vista office-automation family.

RS232C or RS422 serial communications interface.

Vista-Station-82 provides I/O support through an RS422 link to Vista-Station-84. The price of Vista-Station-82 starts at \$2,295.

To provide simultaneous multiple-task management of computing resources within ARCNET, Datapoint offers Vista-View, a windowing technique that operates on Vista-Station-84 and Station-82, according to Gallup. Vista-View, which is licensed for \$1,000 per installation, enables users to switch back and forth from one application to another, as well as exchange data between these applications, Gallup says.

Datapoint has also developed a fiber-optic link that enables users to extend the distance between standard network junctions to 4,000 feet from 2,000 feet.

Datapoint is expanding its marketing channels to strengthen existing indirect and end-user sales, Fernald explains. The company will continue its emphasis on OEMs and Fortune 1,000 companies. □

tion-82 multifunction terminal, based on the Intel 80186. The application processor performs office-automation tasks such as word processing, electronic mail, financial

modeling and windowing. As part of the ARCNET, the application processor (prices start at \$8,550) offers from 0.5M bytes to 1M byte of error-correction code memory, and an

### Burroughs unveils Convergent-based microcomputer

Burroughs Corp. recently joined the flock of computer companies integrating Convergent Technologies Inc. microcomputers and unveiled its version, the B 25 desktop system. The B 25 is compatible with the earlier B 20, yet less expensive and more powerful, according to Edwin F. Carlson, president of Burroughs Information Systems Group.

The B 25 system has snap-together modules designed to meet the requirements of first-time and more experienced users as their needs expand. The system supports clusters of as many as 32 workstations when

used with the company's XE 520 shared-resource processor, which further expands the B 25's capabilities.

For a basic standalone system, including 256K bytes of RAM, a 12-inch display, a keyboard and a dual floppy disk storage module, prices begin at less than \$4,000. Price of a cluster workstation is less than \$2,700.

Burroughs, which claims to be Convergent's largest OEM customer for this line, has the right to manufacture the system, Carlson says, "if the quantities sold are beyond CT's capabilities to manufacture."

The B 20 operating system (BTOS),

MS-DOS and CP/M-86 are available for the B 25. BTOS enables MS-DOS and CP/M-86 to be used in a clustered environment in which multiple MS-DOS applications can concurrently access the same hard disk.

The B 25 and the XE 520 are available through the Burroughs direct sales force as well as the company's dealer network and distribution channels.

Burroughs is putting significant effort into developing application software for the B 25, and more than 250 third-party applications packages are being announced for the system.

**Introducing  
the only true  
general purpose  
multicomputer.**

# Flex/32™

All computers are not created equal. Especially when it comes to their ability to tolerate change. In fact, most computers have a hard time trying to adapt when you need to expand or modify their capabilities.

The Flex/32™, on the other hand, is a scaleable, general purpose multicomputer. That means it can be configured and reconfigured as often as needed at different levels of capacity and performance. All the way up. And down again.

## True scaleability.

Each Flex/32 MultiComputer cabinet can contain up to twenty 32-bit CPU's, each operating in excess of one million instructions per second with 1 megabyte of RAM each. That's more power and memory than some of the largest mainframes available today. The Flex/32 is easy to maintain with automatic and continuous self diagnostics built in.

With an entry level system, you get two 32-bit computers with 2 megabytes of local memory, 128 kilobytes of common memory, and 2 VMEbus I/O interfaces all located inside one card cage. It's card cage can accept another 18 cards allowing up to 18 more computers or another 152 megabytes of memory. As you expand your multicomputer, additional computers, memories and interfaces are merely slipped into slots.

As powerful as the entry level system is, Flex/32 can go much, much further. Your ability to expand the system is literally without limits.

## True concurrency.

Because Flex/32 is a multicomputer, it can provide

true concurrency in processing. Which means it can run many processors at exactly the same instant in time. And since it provides direct programmer control over the use of concurrency, Flex/32 can be tuned to your application needs.

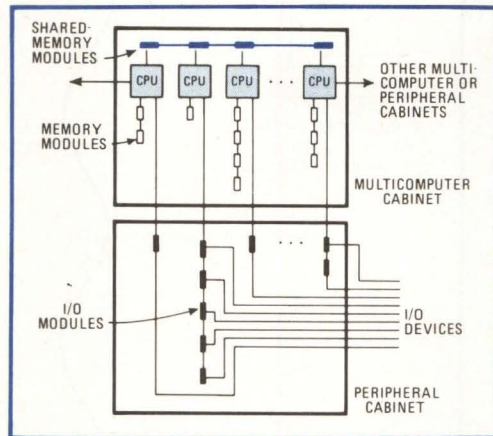

## True programming freedom.

Just as the Flex/32 hardware gives you freedom from restrictions of growth, its software will set you free, too. Free from vendor dependence. Because it uses the universal UNIX™ System V operating system, and languages like C, FORTRAN 77, RATFOR, Flexible's own Concurrent C™, for real time and concurrent programming, and a selftest capability. And for enhanced performance, Flex/32 supports the

ISA extensions to FORTRAN 77.

It even contains a concurrency simulator and optimization procedures to improve run time performance—to enable you to tune your application.

## True cost efficiency.

Given that a basic Flex/32 can outperform two superminis, it still only costs about the same as a single VAX™ 750. And since Flex/32 is scaleable, the economies continue throughout its growth path.

When you add it all up, the Flex/32 has few equals in terms of its performance and value in the supermini computer world. And you can't take away from that.

For more information, call (214) 869-1234, or write to us at 1801 Royal Lane, Suite 810, Dallas, Texas 75229.

**Flexible  
Computer Corporation**

UNIX is a trademark of Bell Laboratories.  
Flex/32 and Concurrent C are trademarks of Flexible Computer Corporation.  
VAX is a trademark of Digital Equipment Corporation.

### Virtual Microsystems adds PC-DOS compatibility to DEC micros

Chris Bailey, West Coast Editor

Will adding IBM PC capabilities to Digital Equipment Corp. microcomputers broaden the market for DEC's small computer offerings? Virtual Microsystems Inc. (VMI), Berkeley, Calif., thinks it will. It has DEC's support in the effort.

VMI's PC-Bridge creates an IBM PC environment on DEC's Professional 350 and Micro-11 small computers. Comprising a software package and an 8086-based coprocessor board, the PC-Bridge allows users to access such popular PC-DOS- and MS-DOS-based software packages as Lotus Development Corp.'s 1-2-3, MicroPro International Corp.'s WordStar and Ashton-Tate's dBASE-II. At the same time, it maintains the functionality of the underlying DEC system with its mass-storage and peripheral devices. The single-unit price is \$1,750.

#### Emulates graphics card

Using an 8-MHz 8086 and 256K bytes of RAM, the 8086 board fully emulates an IBM PC color graphics card, enabling the system to run programs that take advantage of the IBM bit-mapped graphics memory.

The specially adapted PC-DOS operating system runs as a task under the sophisticated P/OS operating system—a user-friendly version of DEC's popular RSX-11—that comes with DEC microcomputers. This allows users to run PC-DOS programs concurrently with P/OS applications.

Although developed and marketed by VMI, the PC-Bridge project received close technical support from DEC. Nathan Kolwaski, group

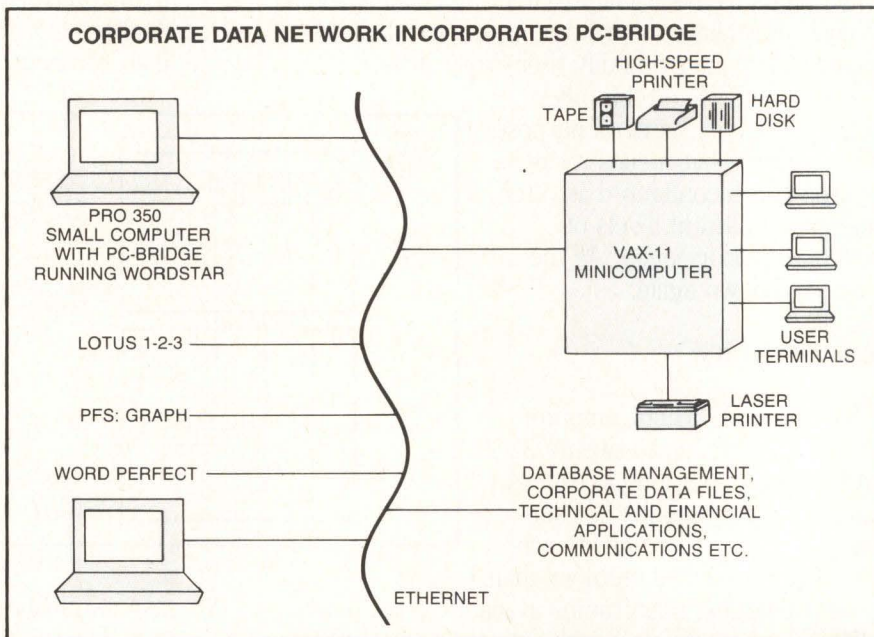

Using DEC equipment and Virtual Microsystems utilities, files can be transferred among microcomputers and minicomputers. Local applications running under PC-Bridge, such as Lotus 1-2-3, dBASE-II and WordStar, can access corporate data files stored under VAX-11-based database-management systems.

product manager for the Professional 300 series, says DEC has committed to volume purchases of the VMI product.

Kolwaski believes the new products will have a significant impact on sales of the Professional line. Because the PC-Bridge is highly compatible with PC-DOS software at the basic input/output system (BIOS) and bit-mapped graphics levels, almost all popular IBM PC software packages should generate on DEC microcomputers. "This should appeal to our targeted customer base and help us broaden our market penetration," Kolwaski says.

Michael Stone, senior analyst with Future Computing Inc., a Richardson, Texas, market research concern, agrees that the availability of IBM PC software packages will

help sell the Pro and Micro-11 system products.

Ken Churilla, vice president of the microcomputer industry group at Creative Strategies Inc., San Jose, Calif., concurs, adding, "The product concept is a good one. The low cost and widespread availability of IBM PC-based software would be a plus for anyone considering the purchase of a Pro or Micro-11 system."

#### Target: networks

Lance Batten, vice president of VMI, says the company targets distributed-processing applications for PC-Bridge. "Micros make user-friendly front ends for network access, and systems such as the [DEC] VAX-11 make very good back-end nodes for handling central functions such as data management, commu-



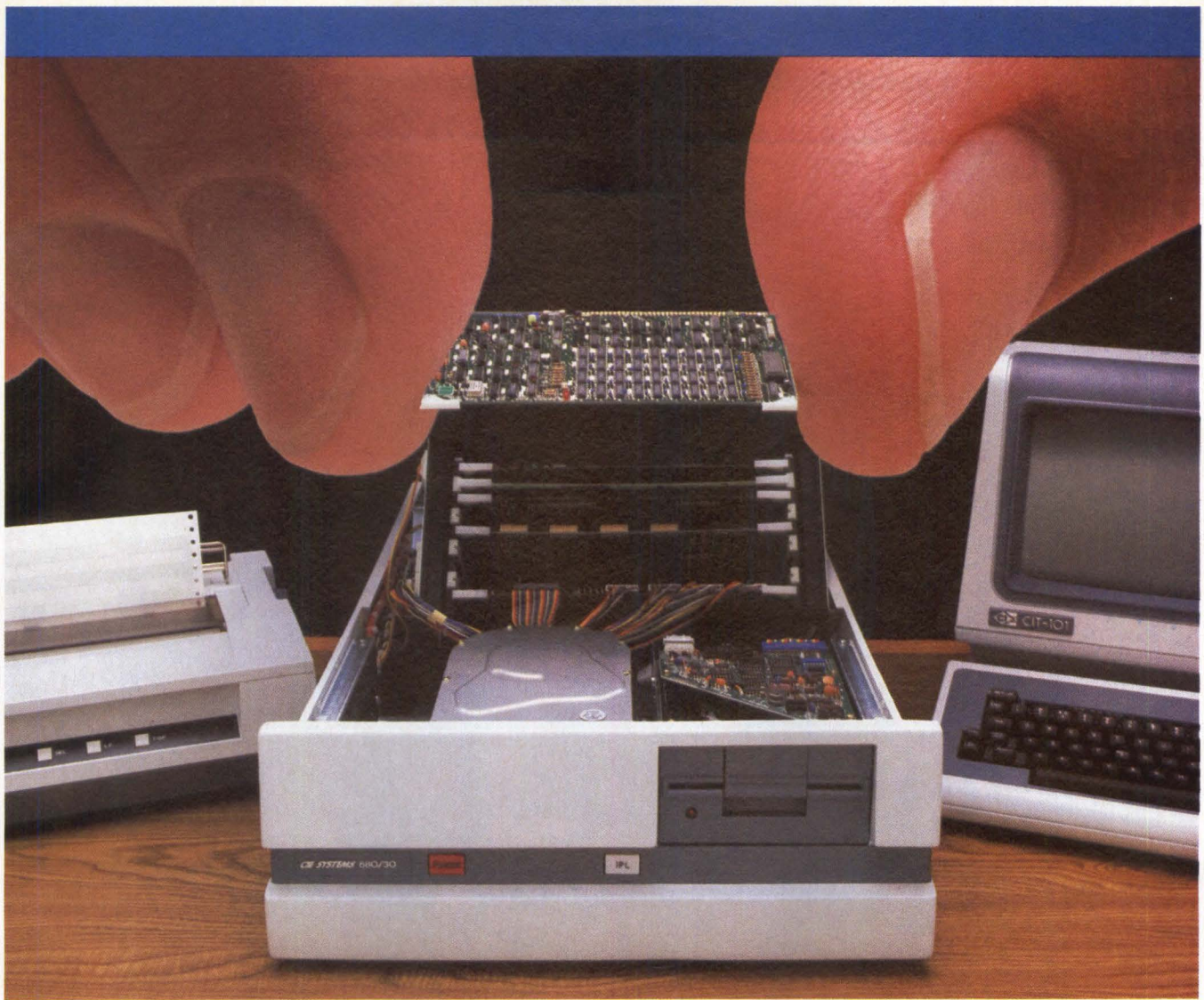

*Our giant commitment to OEMs*

## BOARDS TO SYSTEMS. YOU NAME IT.

CIE Systems is committed to being your source for the very latest in micros and all that goes with them.

The micros are the CIES 680™ Business Computers with the advanced 32/16-bit 68000 micro-processor and Intel's Multibus™ architecture. So from boards to systems, you can easily configure your product line for virtually any business.

There are four 680 models. The 680/30 (shown above), 680/20 (on the right), 680/35 and the 680/40.

MINI-MICRO SYSTEMS/August 1984

The 680/30 and 680/35 will accommodate up to eight interactive users. The 680/20 expands to four users. And the 680/40 expands to as many as 16 users.

Disk capacities range from 10 to 300 Mbytes, memory from 256K to one Mbyte.

Operating systems include REGULUS™ and CNIX™ (both UNIX™ compatible), as well as RM/COS™.

Language processors include BASIC, FORTRAN, COBOL and PASCAL.

Applications offered are general accounting, financial worksheet and word processing, as well as a wide range of vertical applications.

And you can include PRO-IV™, the applications processor that allows you to develop applications in one-tenth the time or modify applications in one-hundredth

the time it normally takes.

Boards up to complete CIES 680 systems. Our name or your name on them. That's an ongoing commitment to OEMs from CIE Systems, the company backed by the third largest trading company in the world with well over \$60 billion in sales.

Just call or write CIE Systems, Inc., 2515 McCabe Way, Irvine, CA 92713-6579. Call toll free 1-800-854-5959. In California, call 1-800-432-3687.



CIRCLE NO. 30 ON INQUIRY CARD

**CIE SYSTEMS**  
A CITICORP ELECTRONICS COMPANY

TM CIES 680 is a Trademark of CIE Systems, Inc.  
Multibus is a Trademark of Intel Corporation.  
REGULUS is a Trademark of Alcyon Corporation.  
CNIX is a Trademark of CIE Systems, Inc.  
UNIX is a Trademark of Bell Laboratories.  
RM/COS is a Trademark of Ryan-McFarland Corporation.  
PRO-IV is a Trademark of Data Technical Analysts, Inc.

© CIE SYSTEMS, INC. 1984

# Introducing Quadnet™

## The family of four LAN systems that can grow with you.

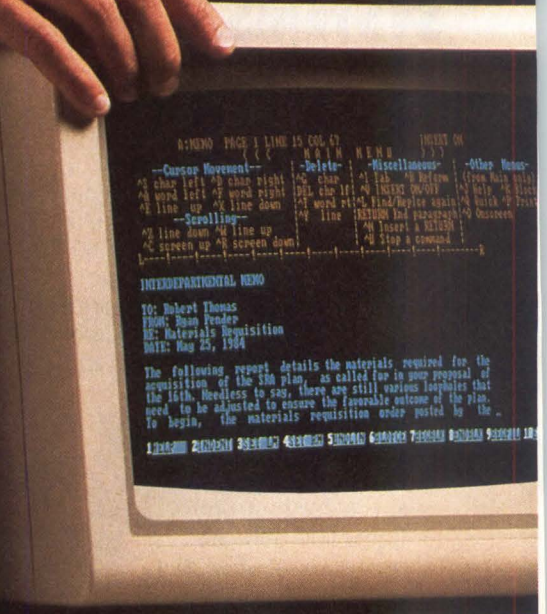
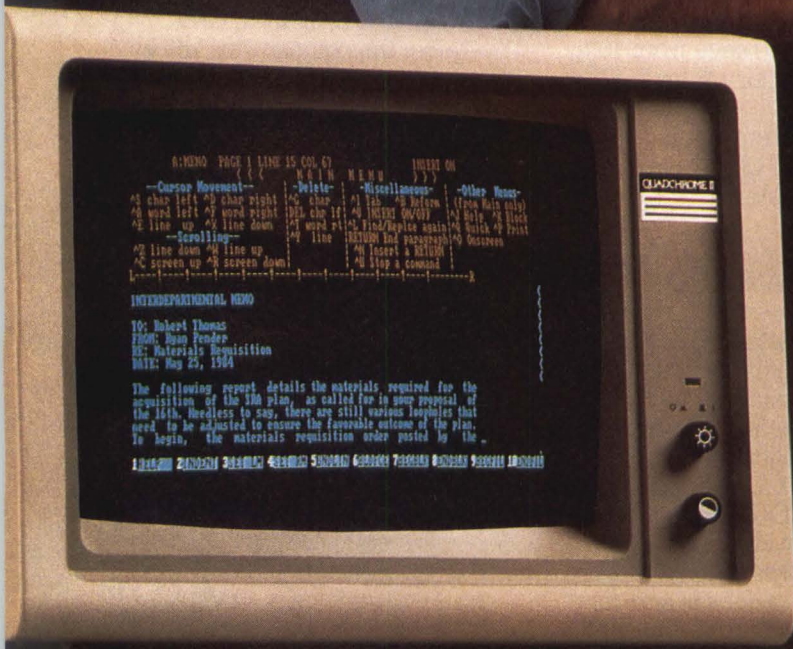
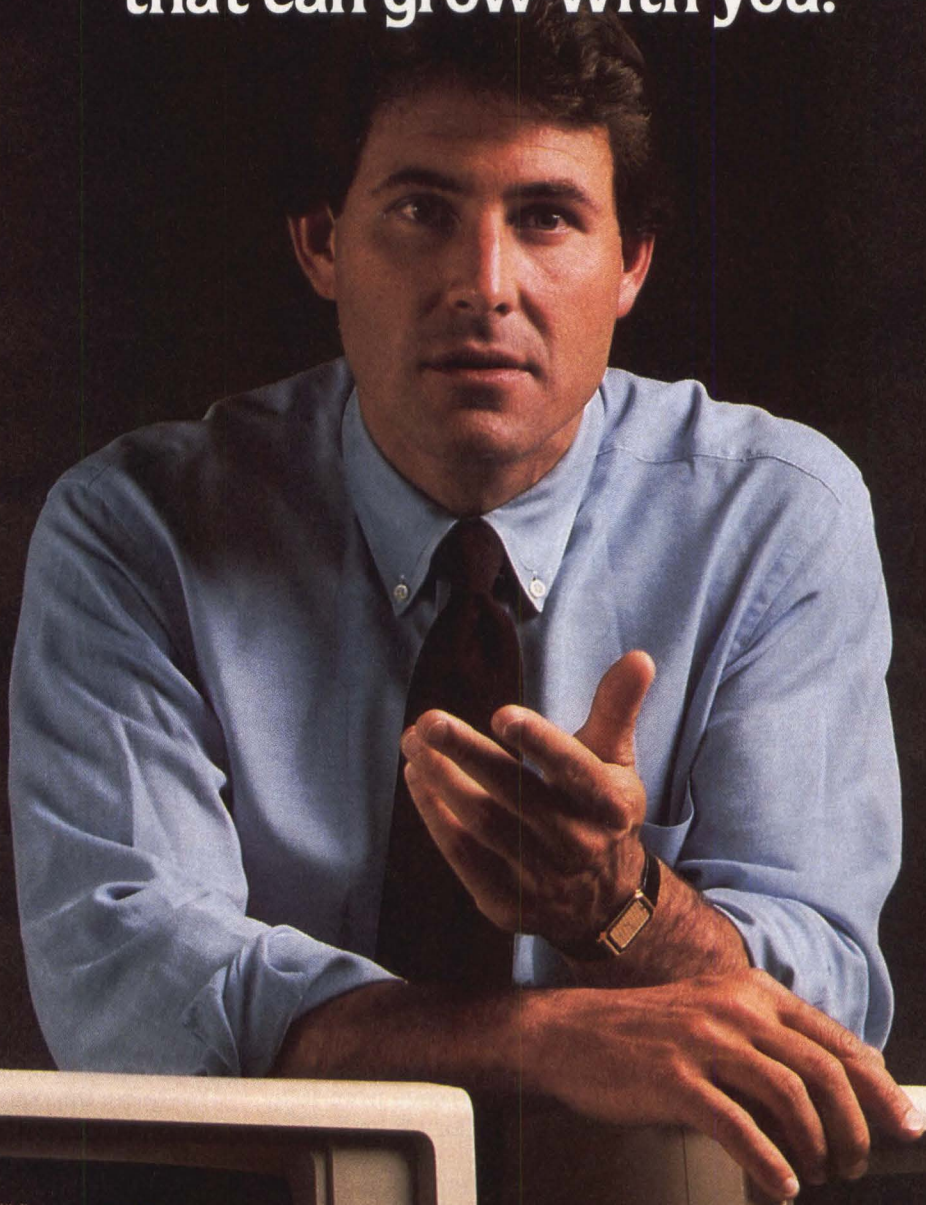

## The family tie.

Each member of the Quadnet family of local area network systems has its own unique characteristics. Yet all four share one family trait. The same network software.

That means you can start with the LAN system that suits your needs today. And upgrade tomorrow without having to learn a whole new set of commands. It's the only LAN system for IBM PCs, XT's and compatibles that you won't outgrow.

## Making the right match.

If you're not sure which Quadnet LAN system is right for you, your Quadram dealer and our SelectNet™ software can help. This easy-to-use software will ask you a variety of questions about your planned applications, number of users operating system, and more. Then SelectNet will recommend the ideal Quadnet match.

Quadnet comes with its own powerful multi-user operating system. Perfectly

compatible with PC-DOS, Quadnet software lets you keep your current software and add on exciting multi-user packages. And while some systems limit each user to about 360K worth of data (just enough for one floppy disk), Quadnet lets you segment your hard disk any way you like.

When you're ready to order, all the accessories are pre-packaged so you're sure to get everything you need to get your Quadnet system up and running. The master package includes hardware, software and documentation. A workstation kit contains hardware for one workstation. And the cabling kit comes complete in three workstation increments.

## Quadram Quality.

Insist on the Quadram name. It's your assurance that you're getting a quality product from an established and reliable company. Ask your dealer about Quadram. We don't make personal computers, we make them better.

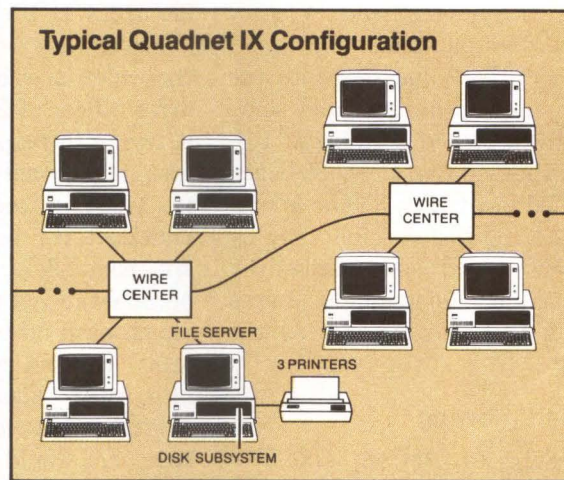
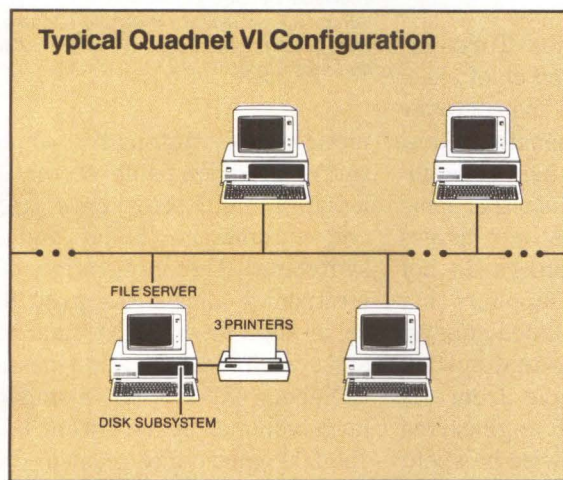

4355 International Blvd./Norcross, Ga. 30093  
(404) 923-6666/TWX 810-766-4915 (QUADRAM NCRS)

### INTERNATIONAL OFFICES

Interquadram Ltd. 442 Bath Road, Slough, England SL16BB Tel: 6286-63865 Tlx: 847155 Auriema G Interquadram GmbH Fasanenweg 7, 6092 Kelsterbach, West Germany  
Tel: 6107-3089 Tlx: 417770 Seva G Interquadram s.a.r.l. 41, Rue Ybry, 92522 Neuilly Tel: 758-1240 Tlx: 630842 Iso Bur Chevco Computing 6581 Kitimat Road, Mississauga,  
Ontario, Canada L5N-2X5 Tel: 416-821-7600

IBM® PC, XT are registered trademarks of International Business Machines Corporation.  
Wordstar is a registered trademark of Micropro International Corporation.

© Copyright 1984 Quadram Corporation. All rights reserved.

nications and peripheral management. With the PC-Bridge product, DEC's front-end product line is improved through the availability of popular IBM software packages."

Kenneth Lim, a personal computer research analyst at Dataquest Inc., likes PC-Bridge's technology but wonders how big a market exists for it. He points out that purchasers of DEC Professional 350 systems may not have cared about IBM PC compatibility; otherwise, they wouldn't have bought DEC equipment.

A three-year-old company with \$3 million in annual sales, VMI has established itself with the DEC after-market community and UNIX microcomputer market as a supplier of hardware and software packages. These products add CP/M, MS-DOS and p-System compatibility to DEC's VAX-11 and PDP 11 systems and to several 68000-based UNIX systems, including those from Altos Computer Systems and Victory Computer Systems Inc.

These VMI products fit into the minicomputer mainframe and service locally attached terminals. PC-Bridge differs in that the 8086 board is installed in the Pro 350 or Micro-11 chassis and is accessible only by local users. Other users, linked by communication lines or local-area networks (LANs), can access the files.

### Good and growing

According to Batten, the PC-Bridge market is a good fit now for his small, software-oriented company. But he sees even greater growth in the future as personal computers are integrated into corporate data networks.

Analyst Stone agrees, adding that half of large companies recently surveyed by Future Computing are planning LANs or distributed data-processing networks with small systems as workstations. □

## Xebec Owl combines on-board controller, electronics

Tom Moran, Associate Editor

Xebec, San Jose, Calif., maker of intelligent Winchester disk drive controllers and subsystems, is introducing the Owl, a half-height, Shugart Associates systems interface- (SASI-) compatible, 5¼-inch Winchester disk drive with drive electronics and controller combined in one built-in printed-circuit board. Xebec claims the 10M-byte Owl is the first 5¼-inch drives with an on-board controller.

Xebec has also begun pilot production of its own head/disk assemblies (HDAs) at its plant in Sunnyvale, Calif. Previously, the company had manufactured only controllers, selling them and also complete subsystems that contained other manufacturers' HDAs.

According to James Toreson, chairman, president and chief executive officer of Xebec, the company is trying to reap the benefits of low cost, high quality and high reliability. He adds that, when the same manufacturer provides both drives and controllers, customers do not become the victims of suppliers that blame each other for failed subsystems. Toreson projects that system integrators should save from six months to a year of engineering time that would otherwise be spent in evaluation and compatibility testing of a new system.

The Owl measures 1.63 by 5.75 by 8 inches. The drive's data-transfer rate is 5M bits per second, and average access time is 99 msec. A band actuator and an open-loop stepper head position the four heads over the two metal-oxide platters. The Owl's controller is compatible with Xebec's S1410 controller and offers position verification, auto-

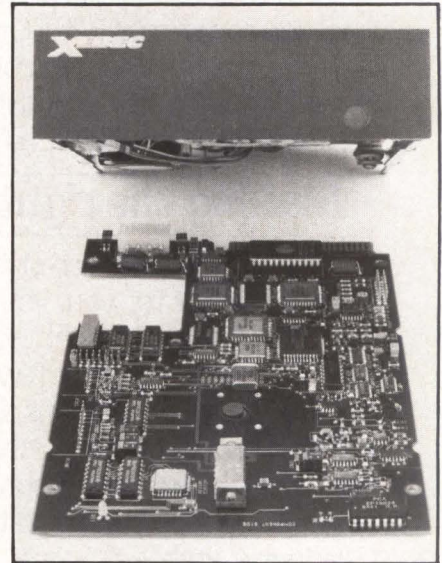

The half-height, 5¼-inch Xebec Owl Winchester disk drive includes a single printed-circuit board incorporating both drive electronics and controller. Elimination of the interface between controller and drive electronics allows system integrators to use high-level SASI fault-status and system-configuration messages.

matic seek, automatic command retry, programmable sector interleaving, multisector data transfer and automatic cylinder and head switching. The integration of the electronics allows the host to receive high-level SASI fault-status and system-configuration messages.

Xebec expects to manufacture large volumes of the Owl at its new 150,000-square-foot plant in Carson City, Nev. The facility will have three HDA assembly lines, each with a 5,000-square-foot clean room. Toreson says Xebec will announce a second source for the Owl that, if necessary, will augment the company's ability to produce HDAs.

### Owl uses LSI technology

Xebec was able to combine the Owl's drive electronics and controller by using surface-mounted chips

# MOVING UP TO UNIX?

Don't Scrap Your  
Fortran Programs  
And Files.



## FORTRIX™ THEM!

At last you're stepping up to UNIX! You probably can't wait to get your hands on the power, productivity, portability and standardization that a system operating in C-language will give you. But what about the programs and files you've built over the years in FORTRAN? They represent a significant investment in time and effort. So why scrap them? Save them with **FORTRIX™—C**, the program that converts FORTRAN code to C-code at approximately 600 lines per minute!

And not only will **FORTRIX™—C** salvage your FORTRAN material, it will also help you to learn coding in C-language as you compare your own familiar FORTRAN programs with the corresponding C-language programs automatically generated by **FORTRIX™—C**.

**FORTRIX™—C** is supplied complete, and runs as-is. Special programs needed to account for your particular UNIX environment will be included in your package, even if they're not available in the standard C libraries.

**FORTRIX™—C** can make the transition from FORTRAN to C as painless as a simple boot-up. While saving you a boot-full of money! Find out more now. Call us at (212) 687-6255 or fill out the coupon and mail to **Rapitech Systems Inc., 565 Fifth Avenue, New York, NY 10017.**

Rapid Solutions from **Rapitech™  
Systems Inc.**

Dear Rapitech;  
Yes! I'd like my FORTRAN programs and files to move up to UNIX with me. Send full details about **FORTRIX™—C** to:

NAME \_\_\_\_\_

COMPANY \_\_\_\_\_ TITLE \_\_\_\_\_

ADDRESS \_\_\_\_\_

CITY \_\_\_\_\_ STATE \_\_\_\_\_ ZIP \_\_\_\_\_

TELEPHONE \_\_\_\_\_

Available for any UNIX and XENIX system  
Including IBM CS9000.

CIRCLE NO. 32 ON INQUIRY CARD

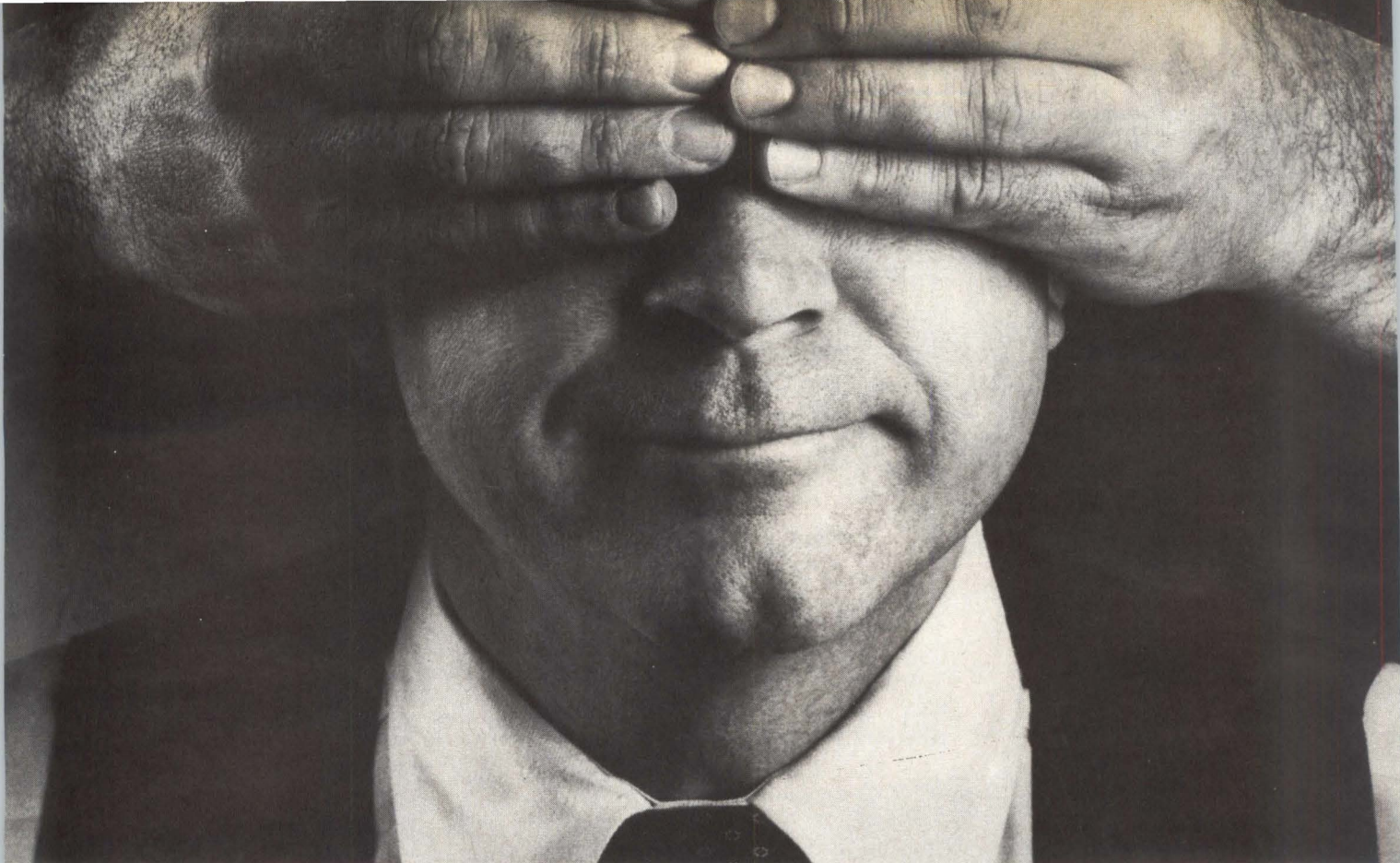

# The only reason you're not using Pioneer's disk drive tester already.

If you still haven't seen the Pioneer hard disk drive tester in action, it's time to take a look. And judge for yourself.

Beginning with the price tag, every aspect of the Pioneer Qualifier™ is designed to meet your requirements for pocketbook *and* performance.

It's the only tester to interface with any and all SMD drives.

It's the only one with a hefty 20-megabit per second capability. Even at triple the price.

It's the only one that can read and transfer Fujitsu's error map right into your computer. In seconds.

It's the only one that will format to your custom specs. And it does it at one megabyte per second. Over five times faster than by computer.

It pinpoints your errors to a specific media sector. And separates the correctable from the uncorrectable. So you can detect and log either set.

Have you ever seen a tester that does all that?

And also checks the address mark capability of your drive? And isolates

intermittents in the output? And works with embedded servos? And can be multiplexed to test four drives at once?

The Pioneer Qualifier does all those things. And easily, at that.

It's almost turnkey. It's totally programmable through the simplified keyboard. And you can input a custom set of drive characteristics with no EPROMS to modify or boards to change.

Plus, there's even a standard RS232 port for remote operation, data print-out, uploading and downloading.

Call Pioneer for a demonstration today. It's an eye opener.

Pioneer Research, 1745  
Berkeley St., Santa  
Monica, CA 90404.  
(800) 233-1745  
(outside California).  
(800) 848-1745 (in  
California). Rep opportunities available.



 **Pioneer  
Research**

Qualifier is a registered trademark.

**CIRCLE NO. 33 ON INQUIRY CARD**

# Mini-Micro World

## NEWS

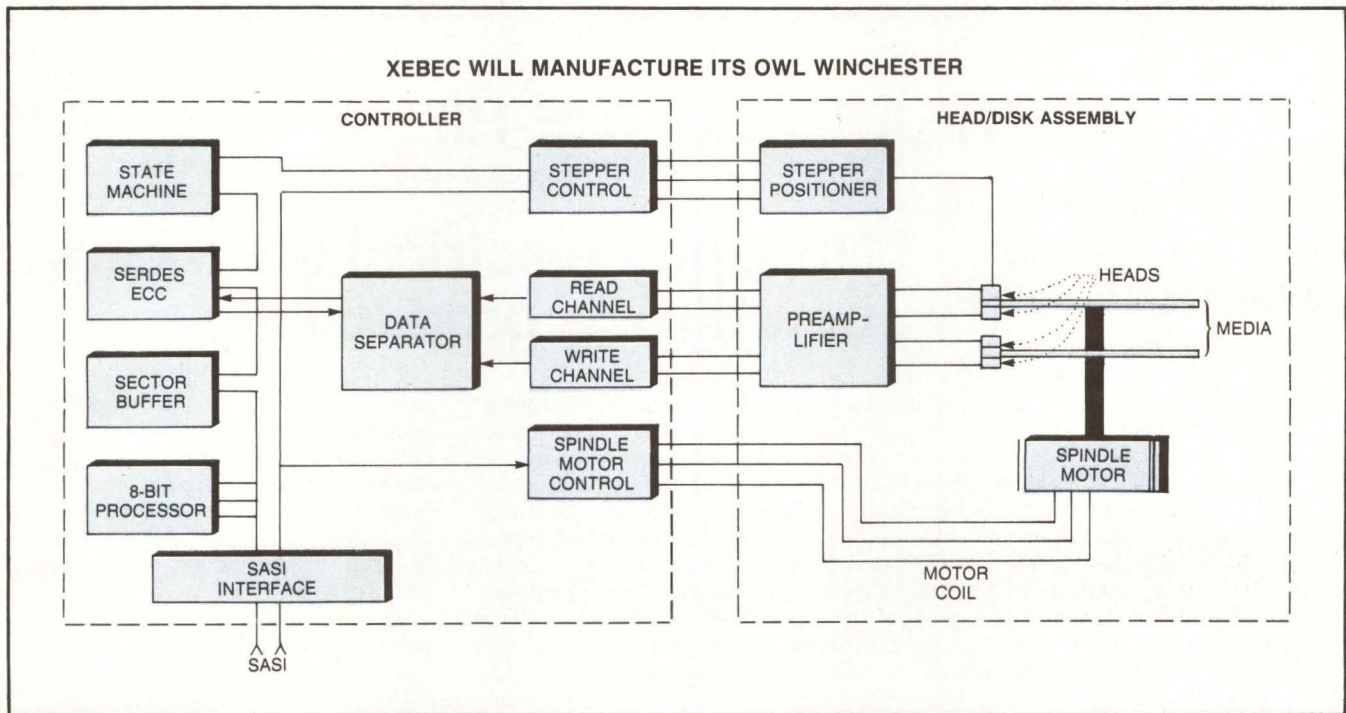

The Xebec Owl's one integral printed-circuit board incorporates both disk controller and drive electronics. LSI surface-mounting technology allows Xebec to eliminate one printed-circuit board and the ST-506 analog interface.

and large-scale integration and by eliminating the need for the separate ST-506 interface that normally connects the controller to the drive electronics. The interface cable, drivers and receivers, a micro-processor and its support chip are all unnecessary. Xebec also eliminated the controller's ability to support multiple drives, a function that Toreson says is seldom-used in the small systems for which the Owl is intended.

Xebec expects to announce a 3½-inch version of the Owl. Toreson says the initial capacity of the 3½-inch drive will likely be 10M bytes and will be raised to 20M bytes when improved heads and media become available. Xebec will sell the Owl through its direct sales force and selected distributors, with units possibly going to large computer chain stores by next year.

Jim Porter, editor of *Disk/Trend Report*, Los Altos, Calif., says the Owl has a good chance of success.

"[Xebec is] offering a very appropriate product that potentially has a very wide customer base. The general climate among system manufacturers is acceptance of SASI and the small computer system interface (SCSI), which is closely related, for a very high proportion of the sys-

tems now under development. This is the beginning of [realizing] a long-established Xebec intent to make its own disk drives."

The company expects to ship the Owl in pilot production quantities in August. They will be priced at less than \$500 in OEM quantities. □

### IBM EUROPE ALTERS DEALER STRUCTURE

IBM Europe has altered its dealer sales structure for the first time, giving it some semblance of a Value Added Reseller (VAR) program (MMS, April, Page 25). IBM is not using that terminology but instead has come up with an Authorized Reseller tag that would allow dealers to buy Series/1 minicomputers and CS9000 MC68000-based microcomputers at 15 percent to 30 percent discounts. In return, the dealer would have to attend IBM-sponsored classes, get IBM approval of marketing plans, buy demonstration machines and provide suitable sales sites and adequate user support. In addition, IBM now has the Application Resellers program, which offers third parties the 4300, System 36 and System 38 hardware at 12 percent to 18 percent off list. The operating system carries a 25 percent discount, provided the remarketer is addressing a vertical market. For software and systems houses not adding much value but focusing on sales, support and installation, IBM offers the Complimentary Marketing Program with 3 percent to 8 percent discounts on hardware.

Stock, Boston/Bohdan Hrynewych



## HEARD ON THE HILL

### Unhappy electrical engineers bewail U.S. productivity

**Stephen J. Shaw**  
Washington Editor

One-quarter of electrical engineers (EEs) are dissatisfied with their jobs, according to a recent survey conducted by Louis Harris and Associates Inc. for the Institute of Electrical and Electronics Engineers (IEEE). The Harris poll also found that U.S. productivity is the top concern among EEs surveyed, and more than seven out of 10 rate this country's productivity only "fair" or "poor."

Electrical engineers are highly critical of their own managers' productivity and efficiency. More than one in three flatly stated that engineering managers in their organizations are not at all effective or productive. This harsh view is also shared by 28 percent of the engineering managers surveyed.

The survey was conducted to determine the EEs' perceptions of their training, profession, social responsibilities and co-workers. Earlier this year, Harris contacted 4,000 IEEE members and received 1,646 responses to its questionnaire and follow-up telephone calls.

"It's a surprising indicator of problems that must exist in engineering management today in U.S. firms," says Ellis Rubinstein, managing editor of IEEE *Spectrum*, the official publication of the engineering association and sponsor of the survey.

The Harris study should be placed on the required reading list of all electrical engineering companies. The study's insights into the thinking of U.S. engineers, and some of its recommended responses to the disturbing trends, could prove valuable in shaping the future role of EEs in

business and academic environments.

The survey suggests telling characteristics of the EE profession's composition today. The largest block of respondents, 17 percent, identified themselves as working in the computer hardware and software fields. Thirteen percent work in communications, and only 1 percent work in consumer electronics.

The survey base also indicates that the EE profession is still overwhelmingly male-dominated. A minuscule portion of the respondents, 3 percent, are women. But the study does show that women are slowly entering the profession in greater numbers as they complete their educations. Ten percent of the EEs under 30 years old are female.

The most disturbing findings are the relatively high rate of job dissatisfaction and the concern expressed about the nation's productivity. According to the Harris analysis, the number of EEs not satisfied with their jobs (25 percent) is twice as high as among lawyers, and five times as high as among doctors. Productivity worries, and the ability of the United States to compete in world markets, far outstripped EEs' concerns about the nuclear arms race and threats to job security posed by automation.

Not surprisingly, dissatisfaction is most prevalent among those under 30 years old (29 percent) and among those with 1983 incomes of less than \$35,000 (32 percent)—almost twice the percentage of those earning more than \$50,000. The youngest EEs also reported the greatest disappointment with their careers, symptomatic of what Harris calls "me-generation attributes." "It is nonetheless jarring to see signs that the new generation of electrical engi-

neers—who hold the future of the profession in their hands—show less enthusiasm for the future of the profession than for satisfying their own immediate needs," states the report. The majority of under-30 EEs are not likely to be concerned about U.S. competitiveness (51 percent), their companies' technical reputations (65 percent) and national politics unrelated to engineering and technology (67 percent).

However, the nation's competitive position in world markets ranks as the chief worry of EEs of all ages, suggesting their anxiety about the erosion of U.S. technological superiority. EEs who feel that poor productivity is to blame for the decreasing ability of the United States to compete internationally are far more likely to point to labor unions as the chief cause. But almost one-third say that managers of engineers must bear the primary responsibility for poor productivity, and 10 percent blame engineers. Among EEs working in computer hardware, one-third describe U.S. productivity as "excellent" or "pretty good," which is somewhat more than any other EE employment category.

Engineering managers are classified as neither effective nor productive by 35 percent of the EEs surveyed. Supervisors are more likely than any other group to be considered highly effective (24 percent) and are perceived to be the most likely group to work "somewhat" (41 percent) or "considerably" more than the required work week.

For a copy of the report, contact the IEEE Service Center, 445 Hoes Lane, Piscataway, N.J. 08554. Publication number TH-0112-3. □



# LAN. THE DECISION TO WAIT AND SEE JUST PAID OFF.

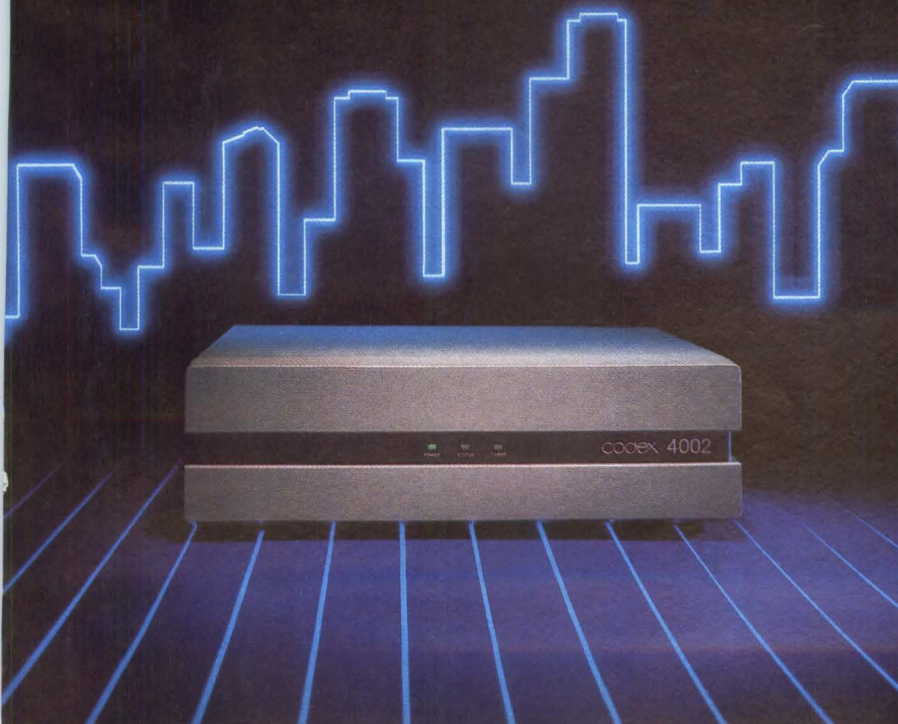

Now there is a company that can satisfy your LAN needs both today and ten years from today. A company with flexible solutions backed by over 20 years of networking experience.

Codex.

In the 4000 Series LAN, we offer a system that lets you configure and control the precise mix of LAN technologies that suit your company needs.

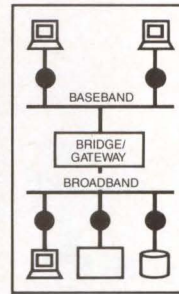

A system, for example, that lets you combine a broadband backbone for data, video and voice applications, and less expensive Ethernet baseband feeders to support individual work areas.

A system that supports a wide array of industry standard interfaces. So you can connect practically any vendor's equipment.

Later, when your needs for internet-working and network management expand, those needs can best be met by the company that has literally written the book on adaptive routing, network management, protocol intervention, and statistical multiplexing.

Codex.

We just made the decision to get into local area networking a safe decision to make.

For more information, call 1-800-821-7700, ext. 879. Or write: Codex Corporation, Dept. 707-79, 20 Cabot Boulevard, Mansfield, MA 02048.

**codex**  
MOTOROLA INC.  
Information Systems Group

**In September, see us at the Federal Computer Conference and TCA.**

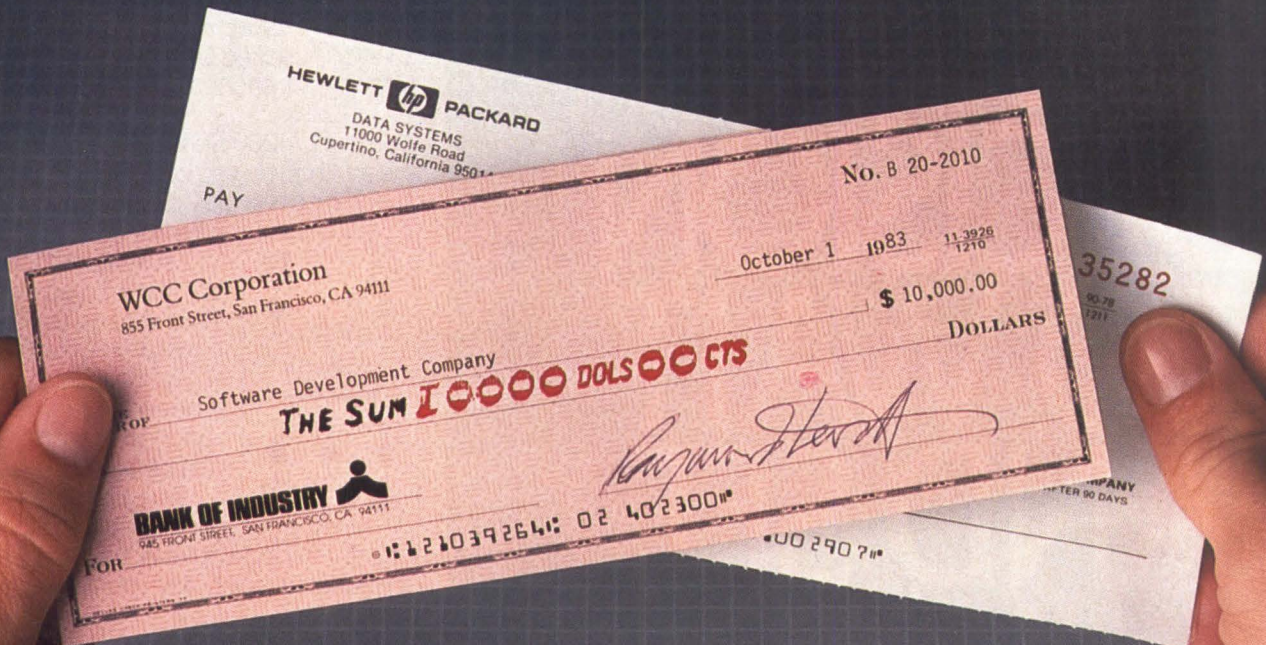

## Writing HP software can be doubly rewarding.

Doubly rewarding, because every time Hewlett-Packard sells a new system with your software, you'll not only get a check from the customer, but one from HP as well!

As thanks for writing software for our systems, we'll give you a bonus of 30% of your software's sales price—up to 6% of the net HP system's price. That could mean \$3,000 on a \$50,000 system... or as much as \$30,000 on a \$500,000 system. And you'll get it *every time a new system is sold with your software.*

We won't tell you what kind of program to write. What industry to write it for. Or even specify the system. Our only restriction is that, to qualify for the bonus, your software must sell for at least \$10,000.

Of course, extra cash isn't the only incentive. To help you get started, we'll sell you a development computer at a 40% discount.

We'll also promote your software in HP catalogs, direct mail and advertisements. And you'll have the benefits of being associated with HP—one of the worldwide leaders in computing systems. A company whose products range from widely-used business computers, like the HP 3000, to one of the world's most advanced 32-bit computers, the HP 9000.

If you'd like to learn more, write to Hewlett-Packard, Attn Gwen Miller, Dept. 08173, 19447 Pruneridge Avenue, Cupertino, CA 95014. In Europe, write to Henk van Lammeren, Hewlett-Packard, Dept. 08173, P.O. Box 529, 1180 AM Amstelveen, The Netherlands.

We'll give you all the details on our HP Plus Software Supplier program. And all the reasons why it will be rewarding for *you* to develop software for HP.



CIRCLE NO. 34 ON INQUIRY CARD

U.S. List prices only.  
BD-02301

### Calcomp plotters provide drawings at workstation economies

Ron Shinn, Senior Editor

The new 1040 series of eight-pen vector plotters from California Computer Products (Calcomp) Inc., Anaheim, Calif., brings A- through E-sized drawings on cut-sheet or roll-feed media into the \$7,500 to \$12,000 price range, making high-speed, large-sized plotting available at workstation economies.

The series comprises four plotters with performance levels designated as either "low" or "high"—0.5G acceleration at 6 inches per second (ips) and 1G at 14 ips, respectively. Two machines are offered in each designation, one handling cut-sheet only and one handling both cut-sheet and roll-feed (dual-mode) media. Resolution for all four plotters is 0.001 inch.

According to Calcomp president Bill Conlin, the new series addresses the high end of the personal computer market. "We are very serious about going after this market because it represents a big, untapped potential," he says.

#### Series boasts new design

The 1040 series incorporates many new design features and sets Calcomp standards for the other products that fall between the company's \$2,000 model M84 and the \$15,000 to \$25,000 1070 series of plotters. The 1040's supports are made of injection-molded structural foam, and most pen block parts are made of injection-molded plastic. The three lower-priced units incorporate a grip drive instead of a traditional sprocket drive, and the plotters include 68008 microprocessor intelligence, 6803 servo controllers for the linear voice-coil motor in the pen block, and user-

programmable electrically erasable read-only memory (EEROM) holding four sets of plotting parameters.

The eight-pen, turret-type pen-exchange mechanism rotates a pen into place directly above the writing site on-the-fly, eliminating the slow throughput of pen-picking schemes that position the pens from the side. Calcomp engineers claim that the turret should yield throughput increases of as much as 40 percent, depending on applications, over competitively priced units with side pen-picking designs.

Analysts see Calcomp's new plotter as a significant addition to the vector plotter market. For example, Laura Nichols, an industry analyst for Dataquest Inc., San Jose, Calif., says, "Look to Calcomp to be active in the low end of the market in which microcomputers have been constrained by a lack of software interfaces. When a company with this kind of graphics background enters the market, [it] could be fairly potent."

Neil Kleinman, general manager and analyst at International Data Corp.'s Pacific Technology Center, Santa Monica, Calif., believes that Hewlett-Packard Co.'s 7500 series of plotters defined the market for computer-aided-design/computer-aided-manufacturing systems selling for \$50,000 to \$100,000. He sees the Calcomp product as a response to the emerging market for computer-aided-engineering systems that will sell for \$15,000 to \$40,000. "[The Calcomp product] makes large, high-speed plotting affordable at the workstation level instead of at the low-cost, turnkey, computer-aided-design system level."

Kleinman sees desktop pen plotters as a 50,000-unit-per-year mar-

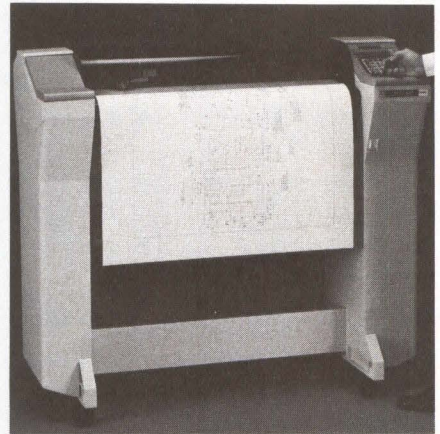

Calcomp's new 1040 series of eight-pen vector plotters handles A- through E-sized drawings at 6 or 14 ips. The model 1043 (shown) is the cut-sheet-, high-performance version. Prices for the series range from \$7,495 to \$11,995.

ket, freestanding units as a 10,000-unit-per-year market and the new 1040 series in "volumes of 20,000 to 25,000 per year by 1987 or 1988, as it gains market-wide acceptance."

Kleinman believes the number of pens is the key to the 1040 series' effectiveness because the use of eight will provide users with multiple windows (integrated software) and allow them to issue plot commands without changing pens for each task. "Someone with a single workstation doesn't want to spend \$15,000 for a plotter, and this [product provides] high performance for only \$7,000 to \$8,000."

The 1040 series uses Calcomp's 960 Driver software and will have a built-in controller for serial and parallel interfaces. The interfaces reside in a ROM pack and are field-level replaceable. The first available ROM pack will serve RS232C serial and IEEE 488 parallel interfaces, and a second version, scheduled for early 1985 availability, will have RS232C and HP Graphics Lan-

# "My customers tell me we have the best computer service in the industry."

*Dan Tims*

"IBM, DEC or Control Data systems—when you need computer service, Control Data will be there. Absolutely. You get a full line of service, including installs and deinstalls, even on mixed-vendor environments.

Our service is responsive. Flexible. More than 2,800 engineers, like me, maintain whatever needs to be maintained. We're backed by a national network of parts warehouses, and a Central Support Center staffed with experts on hardware and software support. All to help us do it right the first time.

Besides the quality, there's one more factor: Control Data has a 26-year track record. We'll be there when you need us—where you need us. I wouldn't sign my name to something I couldn't live up to.

Call Control Data Engineering Services—we won't let you down."

**1-800-828-8001 ext. 58.**

In Minnesota 612/921-4400 ext. 58.

Outside the U.S. call your local office.

**GD CONTROL DATA**

CIRCLE NO. 35 ON INQUIRY CARD

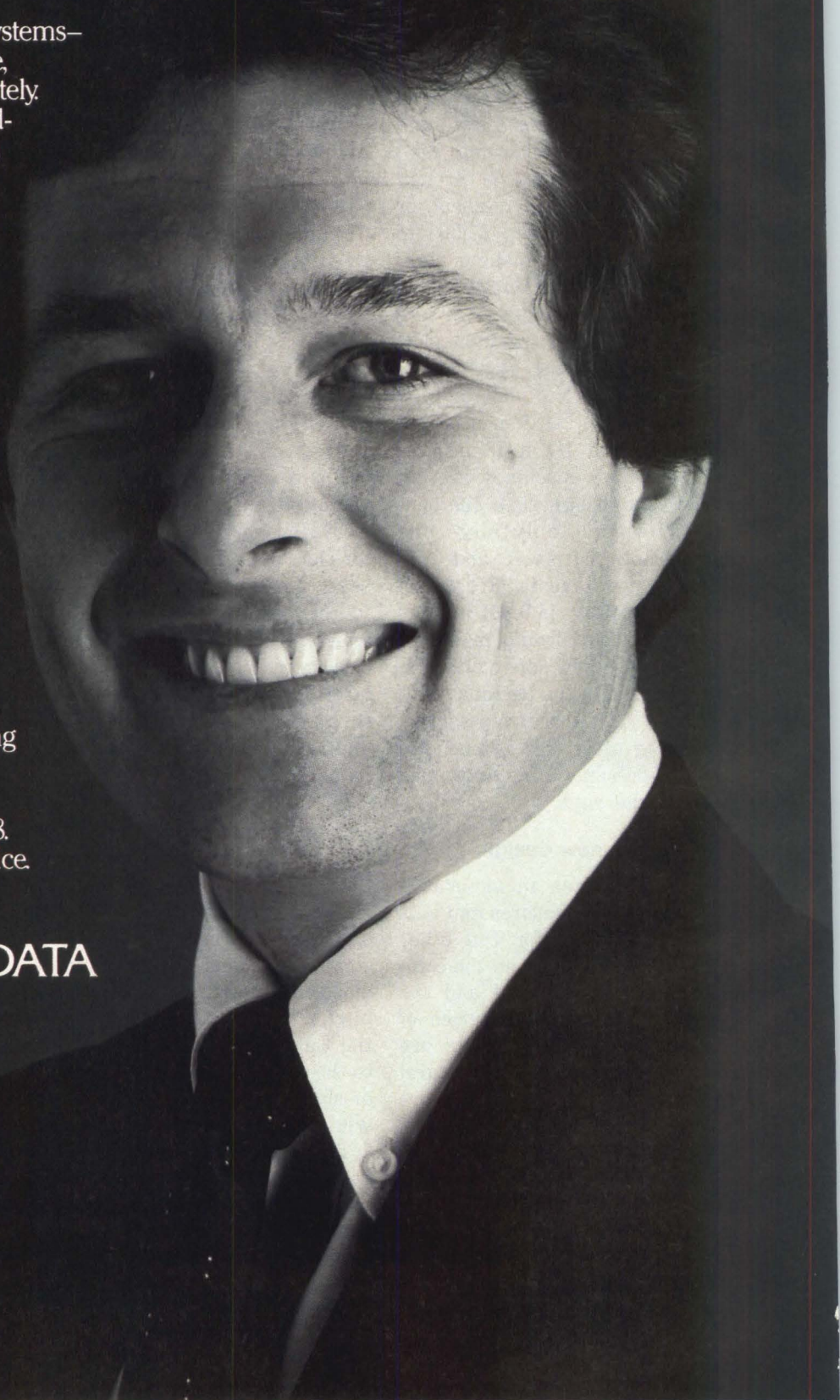

# Mini-Micro World

## NEWS

guage compatibility.

The pens used in the new plotters can be liquid ink, nylon-tipped or ceramic-tipped. To select a pen, the turret's optical sensors read the metallic-band code integral to each pen as it travels toward the writing surface. A user selects pen pressure, which is stored in the EEROM, to set parameters for media such as mylar or paper. The pens are unique to the series, and Calcomp is setting second-sourcing and prices that will be comparable with competing pen plotters.

A built-in automatic logging feature using the on-board microprocessor allows users to set up a plot using a 40-character, 2-line liquid-crystal display and an associated, tactile-feedback keypad rather than a separate control terminal.

Adding a standard modem enables the plotters' built-in display and intelligence to communicate in conversation mode with a host.

### Self-diagnostics for all

Each plotter has ROM-based self-diagnostics that are included on the plotter's two standard boards—a system controller board and an analog board. The sprocketed, high-performance, dual-mode model uses a third board that incorporates Calcomp's Sonic Sensor to determine paper position within the castors. The two basic cards can be interchanged among the plotters.

Calcomp offers service contracts with a standard 90-day warranty period for the plotters. Service contracts could be priced as low as 5 percent of purchase price, says Con-

lin. Because the new plotters weigh approximately 120 pounds each, Calcomp will most likely provide on-site service.

The company plans to begin production shipments of the cut-sheet low- and high-performance versions by October, the dual-mode, low-performance version by November and the dual-mode, high-performance model by December.

Preliminary single-unit prices are \$7,495 for the cut-sheet, low-performance model 1041, \$8,495 for the dual-mode, low-performance model 1042 and the cut-sheet, high-performance 1043 and \$11,995 for the dual-mode, high-performance 1044. The 1041 can be field-upgraded to the 1043. According to Conlin, OEM quantity discounts will be competitive. □

### A PROGRAMMING LESSON

machine language [muh • shēn' lang' gwij] – a program written in a form that the computer can understand directly.

mCP™ [m • c • pē] – acronym for Micro Concurrent Pascal, a high level language alternative to machine language.

Considering your software investment, isn't it important to use your programming resources effectively by utilizing a high level language in order to increase your programmer productivity. mCP not only offers the advantages of a high level language (well structured, easy to learn, use and maintain), it also offers the multi-tasking features enabling the programming of real-time embedded systems. mCP targets to most popular 8-bit and 16-bit microprocessors.

Before you begin your next software project, call or write us so you don't learn your lesson the hard way.



Enertec inc.

19 Jenkins Avenue  
Lansdale, PA 19446

Phone: (215) 362-0966  
Telex: 834-247

CIRCLE NO. 36 ON INQUIRY CARD

## Half-height Winchester family offers 57M to 202M bytes

Carl Warren, Western Editor

To address the increasing demand for more storage on a 5¼-inch spindle, Advanced Storage Technology Inc. (ASTI) has been privately showing its family of high-performance, high-capacity Winchester half-height drives.

The family of drives ranges in capacity from 57M to 202M bytes and uses thin-film media and heads from parent company Cybernex Corp., San Jose, Calif., of which ASTI is a recently formed subsidiary. The equipment is said to provide tighter margins and what

ASTI vice president Dan Klang states is superior disk-to-head compliance.

Besides employing thin-film media and heads, the drives use a voice-coil-driven linear carriage. Electronics are contained on a single printed-circuit board in very-large-scale-integration (VLSI) circuits. To ensure data reliability, a dedicated quadrature servo surface, rather than an embedded wedge servo, has been incorporated. Klang insists that a wedge servo is primarily for drives with stepper motors and smaller areal densities, adding that, for drives that use a voice coil

and have track densities of around 1,200 tracks per inch (tpi), the wedge servo tends to limit performance.

### ESDI needed

Because the drives have been designed as a reduced version of storage module device (SMD) drives and sport 10M-bit-per-second (bps) transfer rates, ASTI has found it necessary to employ the enhanced small disk interface (ESDI). Until now, ESDI has been offered only by such companies as its primary developer, Maxtor Corp.

According to Klang, the goal is to compete on a cost-per-byte and box basis with SMD drives. Moreover, he contends that SMD has run out of gas and something else has to step in to replace it. For the ASTI family

# GCR

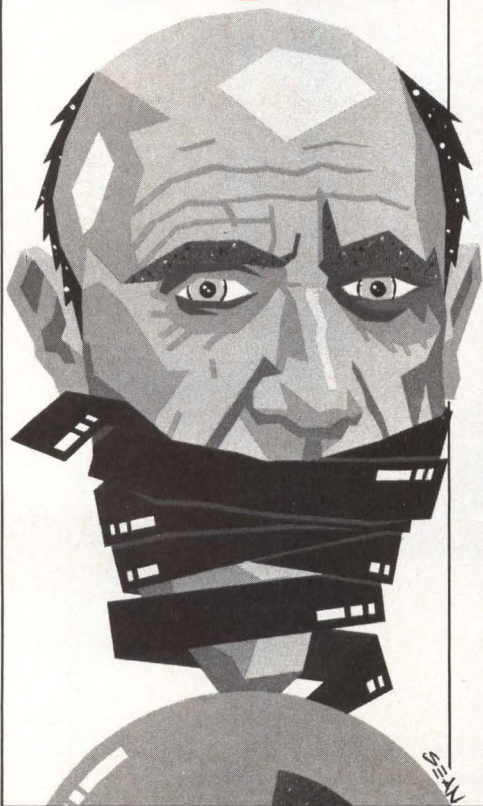

## YOUR BACKUP REMEDY

Take a minute... let's talk about the benefits of GCR (group-coded recording) tape subsystems.

Today's disk drives offer faster transfer rates and larger storage capacities than ever before, placing stringent demands on the tape subsystems used to back them up.

A high density GCR tape subsystem is your logical choice for high performance backup.

### Let's Talk Benefits

GCR packs data at 6250 bits per inch—a standard tape reel holds up to 180 megabytes of data! That translates into fewer tape mounts and rewinds, reducing operator involvement... and that's a saver. GCR also provides an outstanding improvement in read/write reliability. Time that was previously spent in retries and error recovery can now be used for computing. That's another saver!

### Let's Talk Affordability

Until now, many thought GCR technology was out of their budget. Not anymore! At CCG - California Computer Group, our GCR subsystems start as low as \$10,500

### Let's Talk Choice

You can't make the right choice unless you have a choice. And CCG helps you choose the right GCR subsystem for your DEC, DG, HP, PE and TI systems. Whether it's a Kennedy 9400, a CDC 92185 "Keystone" or a

STC 2920 "Avalanche".

### Let's Talk Expertise

At CCG, we're not just selling hardware... we're sharing knowledge. Our configuration specialists examine your needs, then help you determine the right GCR subsystem for your application.

And CCG's been around—our clients include Lockheed, USC, TRW, Citibank, Mobil Oil, University of Chicago... even Notre Dame.

### Let's Talk Teamwork

CCG works with you every step of the way... from your first call! until your systems are up and running. And whenever you need us, we're only a phone call away.

### Let's Talk . . . . .

There's so much more to talk about. Call us—we'll show you how CCG can put GCR to work for you!

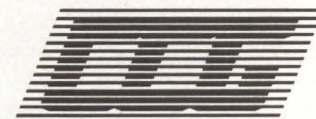

California Computer Group

3303 Harbor Blvd., Suite G-10  
Costa Mesa, CA 92626

(800) 854-7488 - Nationwide  
(800) 232-1661 - California  
(714) 966-1661 - Corporate

DEC, DG, HP, PE and TI are trademarks of Digital Equipment Corp., Data General Corp., Hewlett-Packard Corp., Perkin-Elmer Corp., and Texas Instruments, Inc., respectively. © Copyright 1984, California Computer Group, Inc.

CIRCLE NO. 37 ON INQUIRY CARD

**Once in a generation:  
introducing the  
32-bit microprocessor  
performance standard.**



# Unleash the potential of your the complete 32-bit

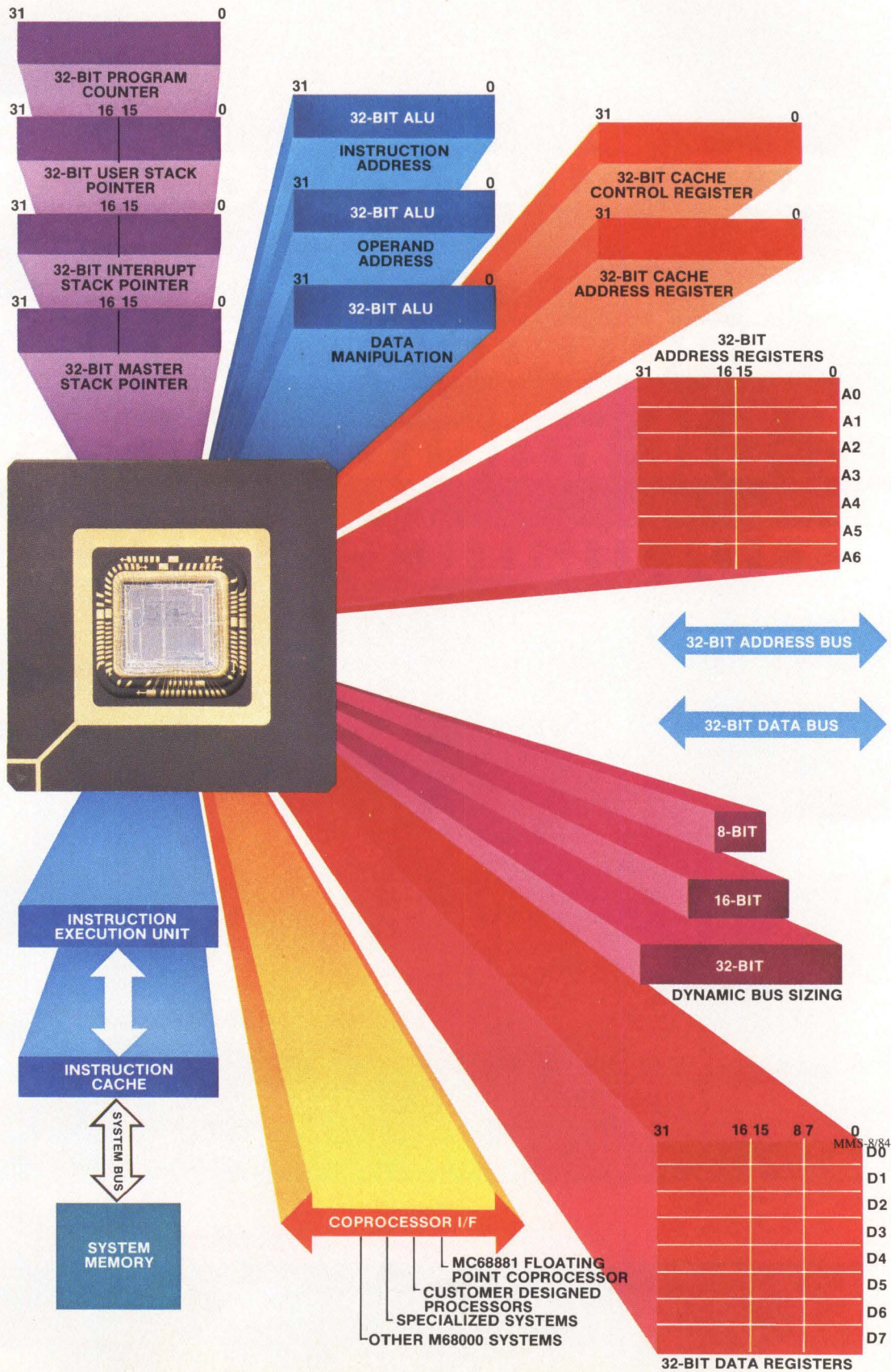



# new system with the MC68020: microprocessor.

## The new performance standard.

Motorola's new MC68020 performs at speeds typically 400% of the established standard of comparison, the MC68000. It's up to ten times faster in dedicated 32-bit applications.

No other 32-bit MPU makes this extensive a leap in performance improvement. At 16.67 MHz the MC68020 typically runs at 2.5 MIPS for integer processing. MIPS rates several times typical are achievable in dedicated 32-bit applications.

The advanced two-micron HCMOS manufacturing technology which allows this unparalleled performance also results in very low power dissipation. In fact, the MC68020 consumes less power in a system than the original MC68000.

The MC68020 creates opportunities you've never had before--opportunities to unleash the full potential in your 32-bit MPU-based systems because it sets the standard for 32-bit microprocessors. And, because it's the first complete 32-bit microprocessor available, more than just a 16-bit design on a data bus stretched to 32 bits. A detailed look at the architecture reveals this totality.

## A fully compatible M68000 Family member.

Yes, the MC68020 has features new to the M68000 Family to maximize its true 32-bit capabilities.

Yes, it's an all new design built with advanced, highly manufacturable HCMOS technology.

And, yes, it's a fully-compatible member of the M68000 Family of MPUs and peripherals. All user object code written for previous M68000 Family MPUs executes without revision. In fact, MC68020 enhancements allow it to run more than three times faster.

Family compatibility is further enhanced by dynamic bus sizing, which supports the use of 8-, 16- and 32-bit ports in 68020-based systems. In fact, the MC68020 can be used in existing 8- or 16-bit systems.

## New features enhance 32-bit architecture.

The MC68020 design is new, however its architecture is based on the proven M68000 Family 32-bit register set. And, the MC68020 is highly enhanced.

On-board instruction cache speeds operation and provides increased multiprocessing efficiency. The coprocessor interface allows direct expansion of the architecture off the MC68020 chip to coprocessors or customer-specified processing systems.

New addressing modes, new instructions and a 32-bit barrel shifter support

new capabilities. Operating system efficiency is improved with a 32-bit program counter.

These enhancements and more optimize the MC68020 for 32-bit operations.

## Design support brings projects together, fast.

Making the most of your new 32-bit design opportunities with the MC68020 is simple and effective with the backing of powerful new hardware and software support from Motorola.

The Benchmark 20™ evaluation system has been developed as a maximum environment testbed for resultant software. For initial software development, cross-support packages under both the UNIX™-derived System V/68™ and the real-time VERSAdos™ operating systems run on standard Motorola VME/10™ and EXOrmacs® hosts.

You'll find MC68020 designs a breeze with Motorola's advanced development tools--real time emula-

tion and bus-state analysis with the HDS400 development system.

## Move up to the MC68020.

The opportunity to design new-generation systems around the MC68020 and the M68000 Family is yours today. Marketplace attention will be focused directly on the growth-oriented companies that take advantage of this opportunity. Motorola's sales engineers and field applications specialists are available and equipped to assist you in moving up to the new 32-bit microprocessor performance standard. Contact one of them today.

Additional technical information is available by writing or sending the completed coupon to Motorola Semiconductor Products Inc., P.O. Box 20912, Phoenix, AZ 85036.

Benchmark 20, SYSTEM V/68, VME/10 and VERSAdos are trademarks of Motorola

EXOrmacs is a registered trademark of Motorola

UNIX is a trademark of AT&T Bell Laboratories.

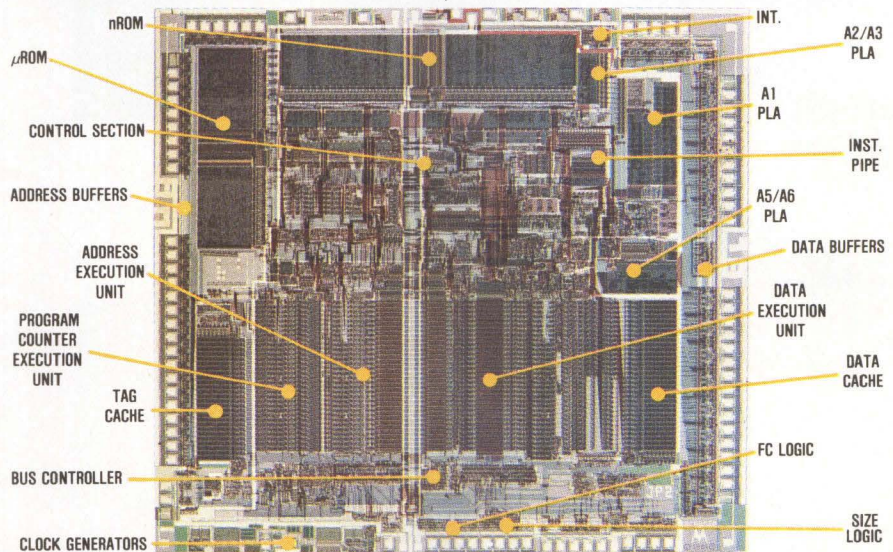

# MOTOROLA

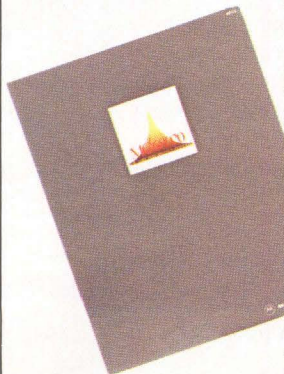

TO: Motorola Semiconductor Products Sector  
P.O. Box 20912, Phoenix, AZ 85036

**Please send me more information on MC68020.**

193MMS080084

Name \_\_\_\_\_

Title \_\_\_\_\_

Company \_\_\_\_\_

Address \_\_\_\_\_

Call Me. Phone: \_\_\_\_\_

# Mini-Micro World

## NEWS

96200, consisting of the 57M- and 103M-byte models, EDSI meets part of the need. "It may not be the best interface, but it does put the data separator on the drive, where it belongs, and that's the beauty of it, especially for drives with high

transfer rates," says Klang.

ASTI plans to sell the "low-end" family for as little as \$850 for the 57M-byte model and \$1,100 for the 103M-byte model—prices that are almost 20 percent lower than market rates. But Klang is quick to

point out that the prices are for very large OEM quantities.

Although achieving 57M and 103M bytes seems like an optimistic goal to reach by September—when evaluation versions are anticipated—Klang asserts that the 96200 drives represent only a small part of the family architecture. "We are taking a full-family approach to propel us, as a company, into the 1990s," he says. For example, Klang expects the 12200 (76M- and 127M-byte) and the 12330 (121M- and 202M-byte) series to be available for sampling by mid-1985. He says the families represent the next step up the performance ladder and will require a better system architecture. The 12330 series, for example, offers a 15.87M-bps transfer rate and a 1,200-tpi track density. To achieve the high areal densities required to provide high capacities in half-height configurations using a maximum of three disks for the 202M-byte model, ASTI is relying on 2,7 run-length-limited code. As a result, a recording density of 30,502 bpi is easily achieved.

# (flek'sə-bil'ə-ti)

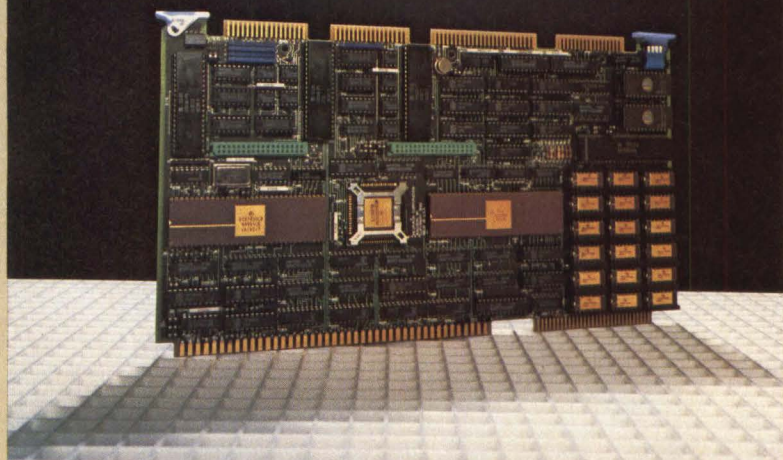

## Defines The Heurikon HK68

For the systems integrator, power is flexibility . . . and flexibility is the Heurikon HK68!!!

Sporting an extremely well considered array of on-board features, the Heurikon HK68 presents itself as a single board one to eight user UNIX system!!!

Designed around the Motorola MC68000 microprocessor, the HK68 is compatible with the 24 bit Intel Multibus™ and includes quad channel

DMA controller, memory management unit, 128K or 256K bytes of dual access RAM with parity expandable to 1M byte on-card!!!, twin EPROM sockets providing a total capacity of 64K bytes, four RS-232-C ports with optional RS-422 on one port, winchester interface, streamer tape/printer interface, three 16 bit counter/timer channels, eight user definable LEDS and four dip switches, and two iSBX™ connectors for further expansion!!!



heurikon corporation  
3001 Latham Dr., Madison, WI 53713

Call Heurikon Direct 1 800 356•9602 In Wisconsin 1 608 271•8700

Multibus & iSBX are trademarks of Intel Corp.

CIRCLE NO. 38 ON INQUIRY CARD

### Looking beyond ESDI

As ASTI sets its sights on the higher-performance family, it is also convinced that a more powerful, almost-SMD-like interface is required. "ESDI can take it to one plateau. To get to the performance levels we need, it looks like the intelligent peripheral interface (IPI) is the way to go," says Klang.

According to chairman William Roberts of Emulex Corp., Costa Mesa, Calif., IPI is a better device-level interface for high-performance drives. Roberts expects that, as more drives like ASTI's become available, controller manufacturers will embrace IPI.

Specifically, ASTI will use the IPI 2 version when implemented, which is a device-oriented interface. IPI 2 allows transfer rates greater

THE SHARP PC-5000

# COMPUTERS TO GO

Finally, Sharp's PC-5000 puts desktop computing where it's never been before. In the field. Now you can do word processing on the train, information management on site and spread sheet analysis in your hotel room. You can now communicate with mainframes and databases. Plus, it's designed so it can easily be integrated into your systems.

Specifications:

- Weighs under 10 lbs\*/3½"H x 12"D x 13"W
- 16-bit, 8088 CPU/128K expandable to 256K RAM
- Two 5¼ floppy drives/320K each\*\*
- Integrated 37 CPS whisper-quiet correspondence-quality printer\*\*
- MS-DOS® operating system/IBM® compatibility
- Fold-down display for briefcase transporting/8 lines x 80 columns
- 6-hour rechargeable battery
- Software offering—number processing, word processing, communications and information management
- Direct connect modem\*\*
- Nationwide service program
- Immediately available

So before you decide to buy a computer that's not going anywhere, look into Sharp's PC-5000. It goes everywhere!

For more information just call toll-free 1-800-BE SHARP or send in the coupon.

\*\*Options.

\*Without optional printer and modem.  
MS-DOS® is a registered trademark of Microsoft Corporation.  
IBM® is a registered trademark of International Business Machines Corporation.  
Sharp Electronics Corp., Paramus, NJ 07652

CIRCLE NO. 39 ON INQUIRY CARD

Sharp Electronics Corp., 1909 E. Cornell, Peoria, IL 61614

- Please send me more information about Sharp's PC-5000.  
 Please set up a demonstration.

Name \_\_\_\_\_ Title \_\_\_\_\_  
Company \_\_\_\_\_  
Street \_\_\_\_\_  
City \_\_\_\_\_ State \_\_\_\_\_ Zip \_\_\_\_\_  
Phone (\_\_\_\_) \_\_\_\_\_



FROM SHARP MINDS  
COME SHARP PRODUCTS

# Mini-Micro World

## NEWS

### THE ASTI HALF-HEIGHT WINCHESTERS AT A GLANCE

Specification/model number	96202	96203	12202	12203	12332	12333
<b>Capacity unformatted</b>						
• per drive (M bytes)	57.5	103	76.5	127.5	121	202
• per surface (M bytes)	19.2	20.6	25.6	25.6	40.5	40.5
• per track (bytes)	20,880	20,880	20,880	20,880	33,060	33,060
<b>Transfer rate (M bits/sec)</b>	10	10	10	10	15.87	15.87
<b>Access time (msec. incl. settling)</b>						
• average	30	30	30	30	20	20
• track to track	5	5	5	5	4	4
• maximum	50	50	50	50	35	35
<b>Rotational speed (rpm)</b>	3,600	3,600	3,600	3,600	3,600	3,600
<b>Average latency (m sec.)</b>	8.33	8.33	8.33	8.33	8.33	8.33
<b>Recording density (2.7 RLL code)</b>	18,462	19,405	19,264	19,264	30,502	30,502
<b>Recording density (FCI-flux changes/in.)</b>	12,308	12,937	12,843	12,843	20,335	20,335
<b>Track density (tpi)</b>	960	960	1,200	1,200	1,200	1,200
<b>Cylinders</b>	921	987	1,225	1,225	1,225	1,225
<b>Tracks</b>	2,763	4,935	3,675	6,125	3,675	6,125
<b>Data heads</b>	3	5	3	5	3	5
<b>Servo heads</b>	1	1	1	1	1	1
<b>Platters</b>	2	3	2	3	2	3

Note: All drives measure: 1.625 x 5.750 x 8 in. However, the three platter version is 1.95 inches in height.

than 10M bps and offers more attributes and control but keeps such things as error-correction code (ECC) and other control functions on the controller—where most drive and controller makers believe they belong. Further, Priam Corp.'s I. Dal Allan, a member of the American National Standards Institute's X3T9.2 committee for IPI, speculates that with the availability of higher-performance differential line drivers—such as the American Micro Devices 2638—transfer rates of 10M bps and higher can be easily achieved.

High-volume production of the ASTI 96200 family is set for the first quarter of 1985. Evaluation models of the 12200 and 12330 families also are planned for the first quarter of next year. □



## HIGH PERFORMANCE, VERSATILITY, VIVID COLOR, CRISP IMAGE TOEI COLOR DISPLAYS FTC/CDM — SERIES.

TOEI, experienced Display Monitor specialists, offer a wide selection of Color CRT Displays. You can choose from our versatile standard models or OEM versions to meet your exacting requirements.

### FTC Series (Housed in lightweight, impact-resistant Cabinet)

Versions CRT Size	RGB Version	NTSC Version	PAL Version	NTSC & RGB	PAL&RGB Version	IBM PC Compatible only
12" (CRT Pitch)	FTC-1201-R* (0.47mm Stripe)	FTC-1200-N (0.64mm Stripe)	FTC-1200-P (0.64mm Stripe)	FTC-1201-NR (0.47mm Stripe)	FTC-1201-PR (0.47mm Stripe)	FTC-1203-H* (0.38mm Dot trio)
	FTC-1203-R* (0.38mm Dot trio)	FTC-1201-N (0.47mm Stripe)	FTC-1201-P (0.47mm Dot trio)			FTC-1208-H (0.28mm Dot trio)
	FTC-1208-R* (0.28mm Dot trio)					
14" (CRT Pitch)	FTC-1423H-R (0.42mm Stripe)	FTC-1410H-N (0.52mm Stripe)	FTC-1410H-P (0.52mm Stripe)	FTC-1410H-NR (0.52mm Stripe)	FTC-1410H-PR (0.52mm Stripe)	FTC-1435-H (0.39mm Dot trio)
	FTC-1435H-R (0.39mm Dot trio)	FTC-1416-N (0.64mm Stripe)	FTC-1416-P (0.64mm Stripe)			FTC-1455-H (0.31mm Dot trio)
	FTC-1455H-R (0.31mm Dot trio)					

Application/NTSC: PAL (Commodore Apple II, IIe), RGM (IBM PC Apple II, IIe, III RGB TTL & Analog)

\*FTC-1201-R, 1208-R: Applying for FCC Standard (Class B).

\*through Interface-Module

\*FTC-1203-R: Acquired FCC Standard (Class B). FTC-1203-R, 1203-H: Non-Glare

FTC-12" Series

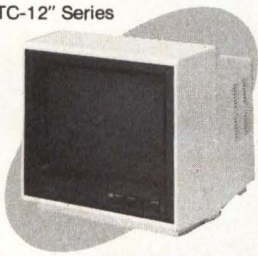

CDM-14" Series

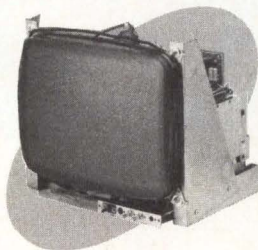

### CDM Series (Unit for OEM)

Model	CRT Size	CRT Pitch
CDM-1208	12"	0.28mm Dot trio
CDM-1203	12"	0.38mm Dot trio
CDM-1201	12"	0.47mm Stripe
CDM-1455H-R	14"	0.31mm Dot trio
CDM-1435H-R	14"	0.39mm Dot trio
CDM-1423H-R	14"	0.42mm Stripe
CDM-1410H-R	14"	0.52mm Stripe

- Green/Orange CRT Displays are also available. (Included IBM Compatible.) CRT size: 9" or 12". Horizontal frequency: 15.75-64kHz. [15.75kHz version: acquired FCC Standard (Class B).]
- Conform to UL Standard.
- Special made products: Select Horizontal Frequency within 31-40kHz (Color), 24-64kHz (Monochrome). Models display providing with more than 640x400-dot-resolution are also available.
- We are looking for reliable and established distributor worldwide.

### TOEI ELECTRONICS (MFG) CO., LTD. [Japanese Name: Toei Tsusho Co., Ltd.]

Kanda Cent Bldg., 2-4, Yushima 1-chome Bunkyo-ku, 113 Tokyo JAPAN  
Tel. (03) 257-1131 Telex. 0222-2555 TOEICO J FAX (03) 258-3560

IBM PC is a Trademark of IBM Corp. Apple II, IIe, III are Trademarks of Apple Computer Inc.  
Commodore is a Trademark of Commodore Business Machine Inc.

CIRCLE NO. 40 ON INQUIRY CARD

# Multibus<sup>®</sup> Microcomputer Systems Made Easy

OEMs get products to market faster with SMS Winchester controllers, storage systems and microcomputer foundation systems.

Whether you select 8086, M68000, Z8000 or another Multibus single board computer, you can choose the SMS product to fit your packaging needs.



For large configurations, choose the DSX80000 foundation system with eight Multibus slots, 10, 20, 40 or 80Mb of Winchester storage plus an 8" IBM compatible floppy.

Small table top applications can use the MDX80000 foundation system with five Multibus slots, 10, 15, or 40Mb of 5-1/4" Winchester storage plus an 8" IBM compatible floppy.

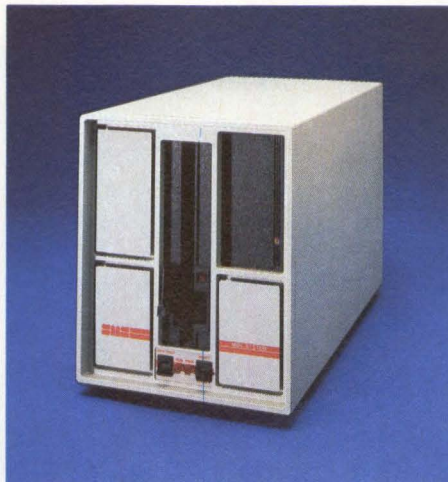

If you have your own Multibus backplane, plug in the SMS FWT80000 storage system. It occupies only 5-1/4" of rack space and comes with either 10, 20, 40 or 80Mb Winchester storage plus an 8" IBM compatible floppy.



For high volume or unique packaging requirements, the SMS FWD8001/FWD8006 single board controllers are INTEL 215 compatible and support 8" Winchester/floppy or 5-1/4" Winchester and 5-1/4" or 8" floppy disk drives.

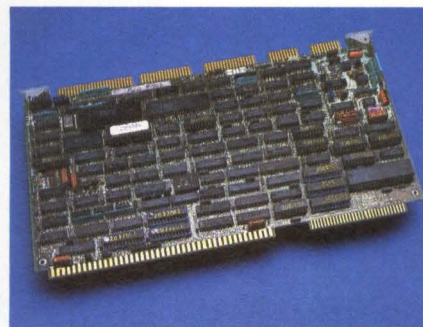

## SMS

**Scientific Micro Systems, Inc.**

777 East Middlefield Road Mountain View, CA 94043  
(415) 964-5700 TWX: 910-379-6577

SMS SALES OFFICES:  
Seattle, Washington (206) 883-8303  
Boston, MA (617) 246-2540; Atlanta, Georgia  
(404) 296-2029; Morton Grove, Illinois (312)  
966-2711; Yorba Linda, California (714) 993-3768.

®TRADEMARK OF INTEL CORPORATION.

MINI-MICRO SYSTEMS/August 1984

CIRCLE NO. 41 ON INQUIRY CARD

75

*An average terminal gets this far in 1.4 seconds. You'll twiddle your thumbs for 14 seconds before it's finished.*

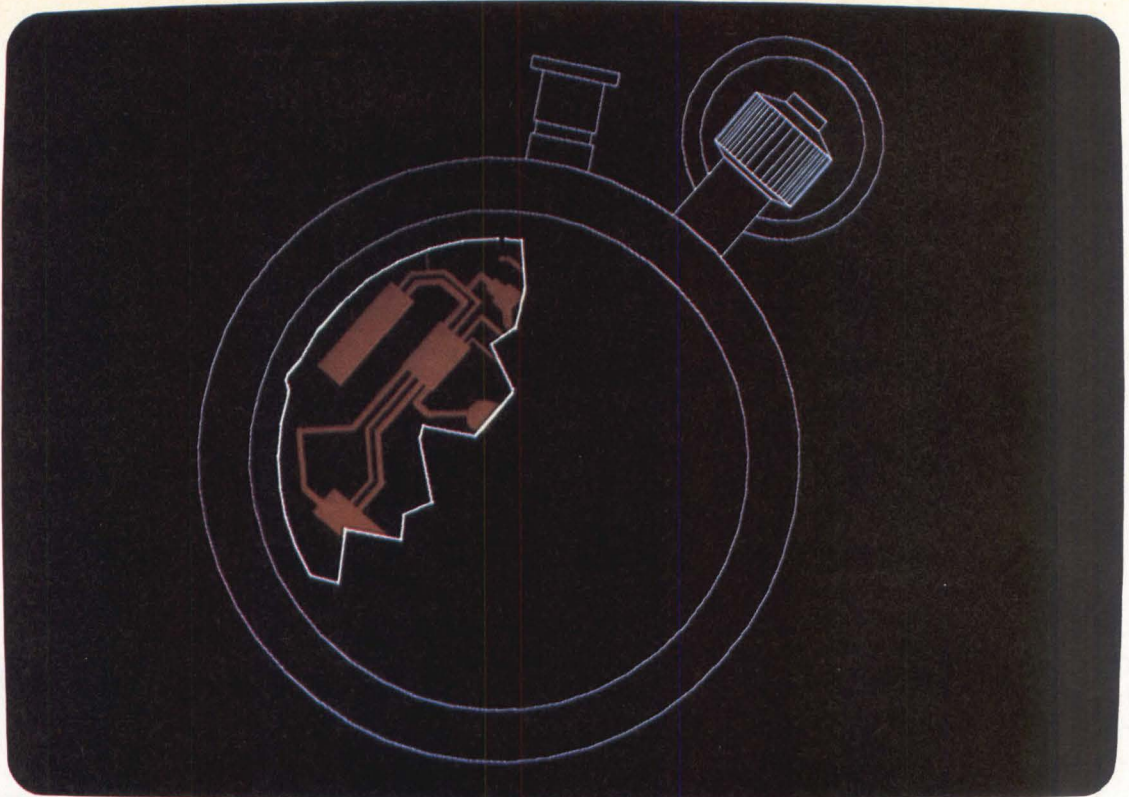

*New HiSCAN terminals complete the entire drawing in just over one second.*

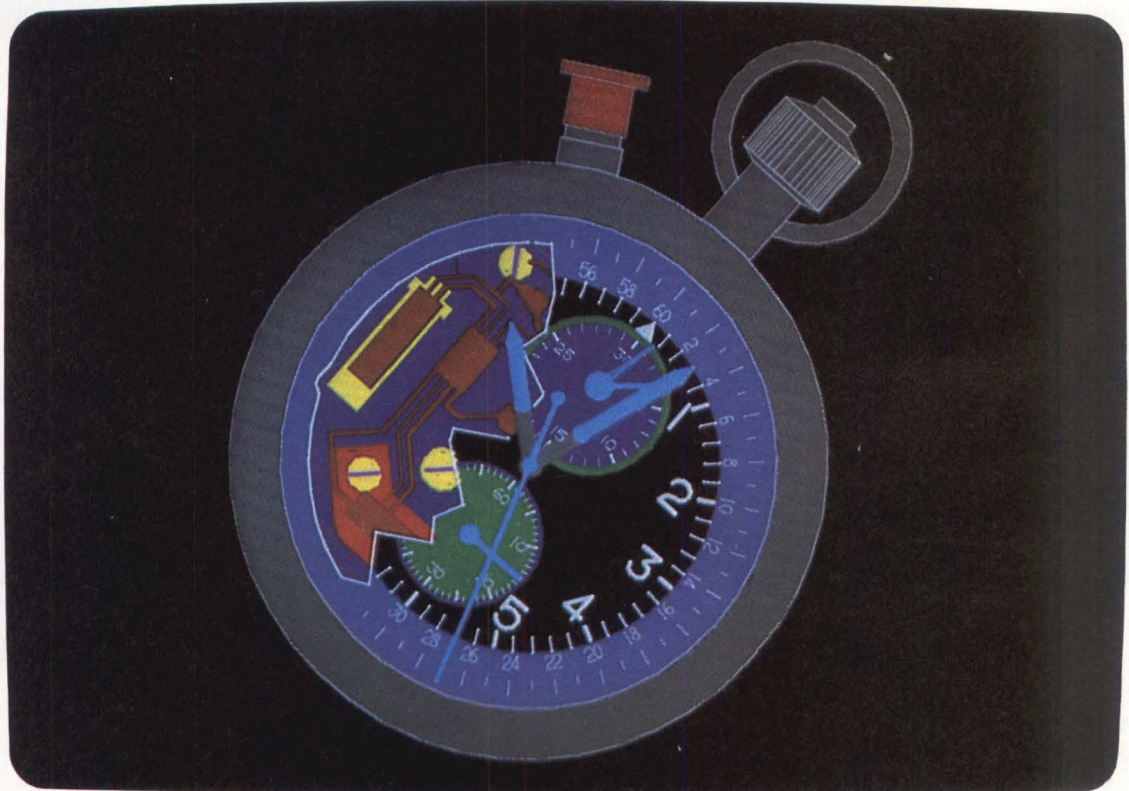

Graphics terminals with ten times the drawing speed. \$2,195 Monochrome, \$2,995 Color.

Stop watch courtesy of Heuer Electronic Corp.

# "One, one thousand...

Our new graphics co-processor technology gives you a faster draw than anything under \$10,000. It's ten times as fast as others in its price range. A hundred times as fast as the slowest terminals.

You get superior resolution, too: 800 x 600 monochrome, 800 x 300 color. The monochrome terminal displays four gray levels. The color terminal displays 16 colors (out of 64 choices). Plus fifteen programmable,

non-volatile function keys. Simple menus. Superior ergonomics.

You don't sacrifice a thing for superior graphics. The alphanumeric quality equals the best text terminals. The display is not interlaced (not running at half speed), so there's no smearing or ghosting when you scroll. You can even choose an 80- and 132-column display to get a full spreadsheet on the screen.

HiSCAN™ graphics terminals have full DEC VT220 and TEK® 4010/4014 compatibility. Plus your choice of DEC ReGIS, TEK 4027 or TEK 4105 compatibility at no extra cost. They're cable-ready for light pens, mice, digitizing tablets and inkjet printers.

They're designed to help you be more productive and creative. Because they work almost as fast as you think. So now you can play "what-if" with graphics.

You have to get your hands on a HiSCAN graphics terminal to believe it. And that's easy. We'll even arrange a 30-day trial at no risk. Just send the coupon.

# done!"



**New  
HiSCAN Terminals**  
From the people  
who brought you Retro-Graphics®

MMS-8/84

- Send complete information
- I want a 30-day trial with no

risk. Call me about my compatibility requirements.

NAME _____	TITLE _____	
COMPANY _____	PHONE _____	
ADDRESS _____		
CITY _____	STATE _____	ZIP _____

Mail to: Digital Engineering, 630 Bercut Drive, Sacramento, CA 95814

**DIGITAL  
ENGINEERING**  
630 Bercut Drive, Sacramento, CA 95814  
Phone (916) 447-7600 Telex 910-367-2009

© 1984 Digital Engineering, Inc. Retro-Graphics is a registered trademark and HiSCAN is a trademark of Digital Engineering, Inc.

CIRCLE NO. 42 ON INQUIRY CARD

AVAILABLE NOW FROM

# MICRO-TERM



**ERGO<sup>®</sup> 201**  
**COMPLETE**  
**PERFORMANCE**  
**FOR ONLY**  
**\$795**

ERGO 201 is the first user definable block mode terminal available in this low price range. While fully emulating TeleVideo 925, VT52, Lear Siegler ADM3A, and Micro-Term's ACT-5A, the ERGO 201 also performs extremely well in most ADDS and Hazeltine environments.

Standard Equipment includes:

- 16 host definable or user programmable function keys to provide 48 functions. User programmable functions are programmable from the keyboard and saved in non-volatile memory.

- \* "MT" video attribute control means the ERGO 201 can display 17 combinations of reverse, underline, half, blink and blank on the same screen without using a character space.

- Custom mode allows the operator to define the terminal's control codes and escape sequences and save designations in non-volatile memory.

All these features, plus a built-in tilt mechanism, 7 x 9 character matrix, green, non-glare screen. Check the comparison chart at left and you will agree that ERGO 201 is the performance leader.

FEATURE	ERGO 201	Visual 50	ADDS Viewpoint	Hazeltine Esprit II	Televideo 925
<b>LIST PRICE</b>	<b>\$795</b>	<b>\$695</b>	<b>\$650</b>	<b>\$645</b>	<b>\$995</b>
User defined function keys	16	0	3	0	11
"MT" Video Attribute Control	Yes*	No	No	No	No
Custom Mode	Yes	No	No	No	No
Keyboard LED's	7	1	0	0	0
25th Status Line	Yes	Yes	No	No	No
2-Speed Smooth Scroll	Yes	No	No	No	No
Graphics Characters	Yes	Yes	No	No	No
Configurable Print & Send	Yes	Yes	No	No	No
Set Up Mode	Yes	Yes	No	No	Yes
Settable Tabs	Yes	Yes	No	No	Yes
Choose Protected Attribute	Yes	Yes	No	No	No
Screen Saver	Yes	Yes	No	No	Yes
Max. Number of Displayable Characters on one screen	**	256	128	128	128
2 Pages of Memory	Opt	No	No	No	Opt
Amber Phosphor	Opt	No	No	No	No
Plot 10 Graphics from Manufacturer	Opt	No	No	No	No
Warranty (Days)	365	90	90	90	90

\*\*128 Characters Standard; 256-Optional

## MICRO-TERM, INC.

Terminals are our only product, and we put more into them.

CALL OR WRITE: 512 RUDDER ROAD, FENTON (ST. LOUIS COUNTY), MISSOURI 63026  
 (314) 343-6515, TWX: 9107601662, MICROTERM, STL.

On site service available at over 450 locations through Western Union.

VT52, Esprit II, ADDS Viewpoint, TeleVideo 925 and ADM3A are Registered Trademarks.



# Mini-Micro World

CORPORATE AND FINANCIAL

## Fortune revamps management, aims for value-added resellers

Chris Bailey, Western Editor

Buffeted by misfortune in the second half of 1983, Fortune Systems Corp., Redwood City, Calif., is working on a comeback. Its strategy includes new management, improved product performance and greater reliance on value-added resellers (VARs) such as system houses. James S. Campbell, president since December, believes Fortune's major problems are solved and that the company will be profitable by mid-year. Fortune has not been profitable for a full year since its founding in 1981.

"Fortune's multiuser systems did not achieve the performance levels demanded by typical customer applications, and, as a result, sales suffered during 1983," Campbell says. "But the company acted decisively to solve the performance problems and has added new products that make the systems compatible with Wang [Laboratories Inc.] and IBM [Corp.] office-automation products, and the changes have paid off."

In addition to personnel changes, Fortune has revamped its 32:16 product, a 68000-based multiuser system, by improving the hardware and its FOR:PRO operating system. Because multiuser UNIX makes heavy demands on the disk system, due to swapping pages of memory back and forth from RAM to disk, Fortune upgraded the system. The company's systems now use a Control Data Corp. Winchester disk with a 35-msec. average access time. This compares favorably with the 90-msec. average access time of the previous systems.

The company also increased sys-

tem performance by optimizing the menu-handling, multitasking-scheduler and file-blocking portions of the UNIX Version 7-compatible

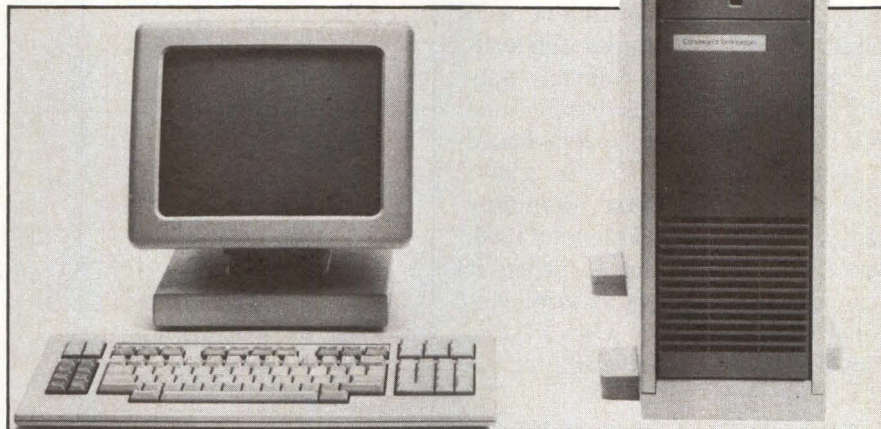

**Competitors abound**, with Convergent Technologies' MiniFrame representing a threat to Fortune's low-end system. Although the two companies rarely compete directly—Convergent's main thrust is OEM and Fortune's is VARs and direct sales—the MiniFrame is priced at less than \$5,000, and its OEMs can effectively compete with the Fortune resellers. The eight-user MiniFrame boasts a virtual-memory capability and UNIX System V compatibility.

FOR:PRO operating system. The result is a system that supports six to eight users—or as many as 13 in non-I/O-intensive applications—with little performance degradation, the company says. Previously, the Fortune system was hard-pressed to support five users.

Fortune achieved industry compatibility by creating software products that can link 32:16 systems to Wang office-automation systems and IBM mainframes. Campbell points out that 75 percent of Fortune 1,000 companies have Wang or IBM mainframe installations. The new software will help Fortune link into corporate-wide information networks using these systems.

Sales reflect these improvements, with fourth-quarter 1983 results 40 percent higher than the depressed third-quarter figures. This momentum carried through to 1984, with

first-quarter sales surpassing \$15 million.

Throughout its sales slump, Fortune continued to spend heavily—in the neighborhood of \$12 million—on research and development. Thanks to the \$100 million raised on its initial public offering, the company had a cash position of more than \$53 million as recently as May and a total working capital balance of more than \$92 million. "This healthy financial position will enable us to continue to support our systems and customers and refute those observers who may feel that Fortune might go the way of Osborne [Computer Corp.] or Victor [Technologies Inc.]. We're committed to spending over 15 percent of annual revenues on R&D," explains Campbell. While company officials are reluctant to project sales or earnings, analysts predict sales of more than

# Mini-Micro World

## CORPORATE AND FINANCIAL

\$80 million for 1984, compared to sales of \$26 million in 1982 and \$54 million in 1983.

### Customers like the new systems

While agreement on Fortune's future is far from unanimous, many observers like the changes they've seen. Jean Yates, president and founder of Yates Ventures, the leading market research company specializing in UNIX, predicts Fortune will be among the top UNIX-based system manufacturers in 1984. Notes Yates, "Fortune definitely had performance problems in 1983, but they seem to have turned it around. I expect Fortune to release a more powerful system in 1984 and remain a serious competitor in the UNIX arena."

More important, customers are lining up to purchase the revised systems. BellSouth of Atlanta took delivery of more than 800 systems this year. Because of the system's hardware and software improvements, BellSouth can run 13 users on the Fortune 32:16 XT30. Other large Fortune 1,000 companies, such as Ford Motor Co., the Crocker Bank of San Francisco and Crown Zellerbach Corp., Oakland, Calif., have major installations. Private-label OEMs such as Bunker Ramo Information Systems, Trumble, Conn. and France's Thomson-CSF are major contributors to sales.

One area in which sales are not expected to improve is at the retail computer store level. States Robert Ruebel, senior vice president of marketing, "In the past, Fortune expended a lot of energy with storefront dealers. Unfortunately, these outlets were ill-equipped to handle sophisticated multiuser systems. They lacked software knowledge and the support needed to be successful." As a result, he says, Fortune is steering away from retail outlets and taking aim at VARs,

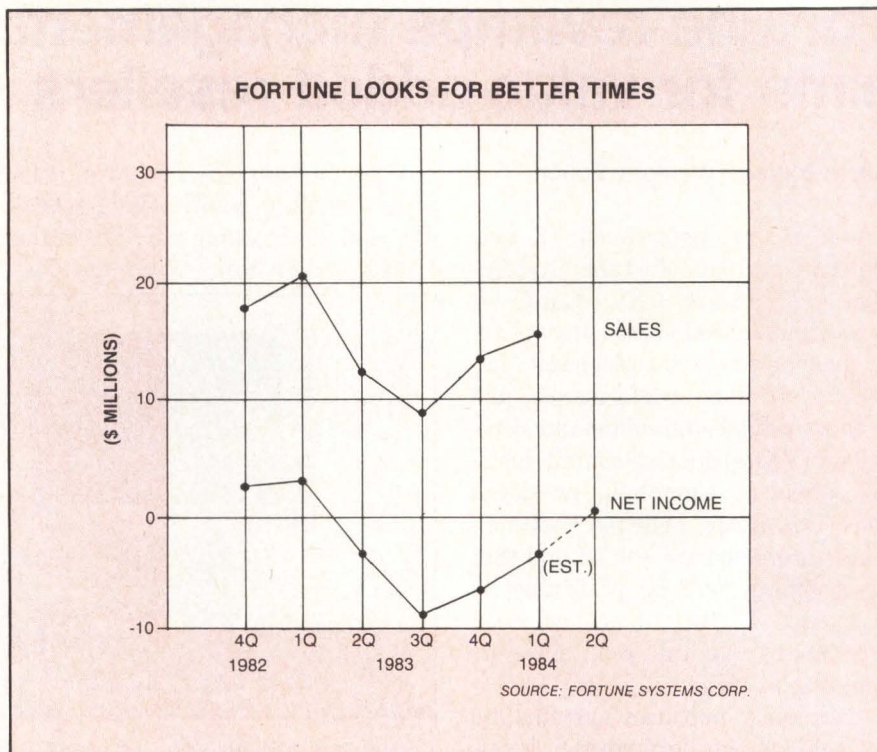

**After shaky mid-1983 results, Fortune is back on track. With a revamped product and new marketing strategy, sales have recovered, and the company expects profits by midyear.**

Fortune 1,000 companies and OEMs.

Besides directing efforts at dealers who can add support and application software, Fortune has created a direct sales force to sell to large companies. Also, Ruebel has created a customer-support center with company-wide responsibility for customer satisfaction. As part of that effort, the company is attempting to duplicate in-house customer configurations that can be used to track problems faster.

### Making inroads on AT&T

While Fortune is making progress, its competitors have also been active. In particular, Convergent Technologies Inc., Santa Clara, Calif., has announced an OEM agreement with AT&T Information Systems to release a Convergent-designed system this year. Although details of the system and the quantities involved are not yet

known, the system is expected to be a variant of Convergent's Data Systems Division's MegaFrame and MiniFrame systems. Both are multiuser systems based on the 68000 processor family, as is the 32:16 system, and can support as many as 128 and eight users, respectively.

The MiniFrame, featuring an OEM price of less than \$5,000, runs the CTIX UNIX System V-compatible operating system and, in its more advanced configurations, can support as many as eight users. Unlike the Fortune FOR:PRO operating system, it supports demand-paged virtual memory through the use of the 68010 processor. It does not come with a built-in display unit like the Fortune system, but Convergent offers a high-speed RS422 intelligent terminal that can reduce I/O-processing overhead in the main CPU—a traditional problem with single-processor UNIX-based systems. It also allows the use of win-

# COMMITTED TO DEC?

So are we. And, we're committed to the individual systems buyer, too. We give the little guy the edge he just can't get anywhere else. We understand the system builder's time constraints, and we're flexible enough to work with them.

We bring the latest technology to our added value DEC systems long before anyone else. And, we relieve you of the complex, time-consuming task of searching for and evaluating new high-performance products and system possibilities.

Plus, we give you considerably faster turn-around. With the Cambridge Digital "Edge" you can get many fully integrated, PDP or VAX systems in as little as 10 days. And, your system will be up and running upon delivery with your entire complement of fully supported software and peripherals. The best, most advanced products on the market today. All tested and ready to go.

So, whether you want a fully integrated pre-packaged system or you want to mix and match system components, Cambridge Digital can give you the performance you need in an economical package, ready to go the day you get it. That's what the Cambridge Digital "Edge," is all about.

To receive our DEC PDP-11 based system catalog including a description of the seven guarantees you get when you get The Edge, call or write. Main Office, Dept. 7401, P.O. Box 568, 65 Bent Street, Cambridge, Massachusetts 02139. Telex 92-1401/COMPUMART CAM. 800-343-5504. In Mass. call 617-491-2700. New York District Office 516-935-3111.



## I want The Edge:

Name \_\_\_\_\_ Title \_\_\_\_\_

Organization/Company \_\_\_\_\_

Address \_\_\_\_\_

City \_\_\_\_\_ State/Province \_\_\_\_\_

Zip/Postal Code \_\_\_\_\_ Country \_\_\_\_\_

Phone No. ( ) \_\_\_\_\_

7401

**Cambridge**  
**Digital**  
DIVISION OF COMPUMART

**The Edge in System Integration**

**800-343-5504**

In Massachusetts call 617-491-2700

CIRCLE NO. 44 ON INQUIRY CARD

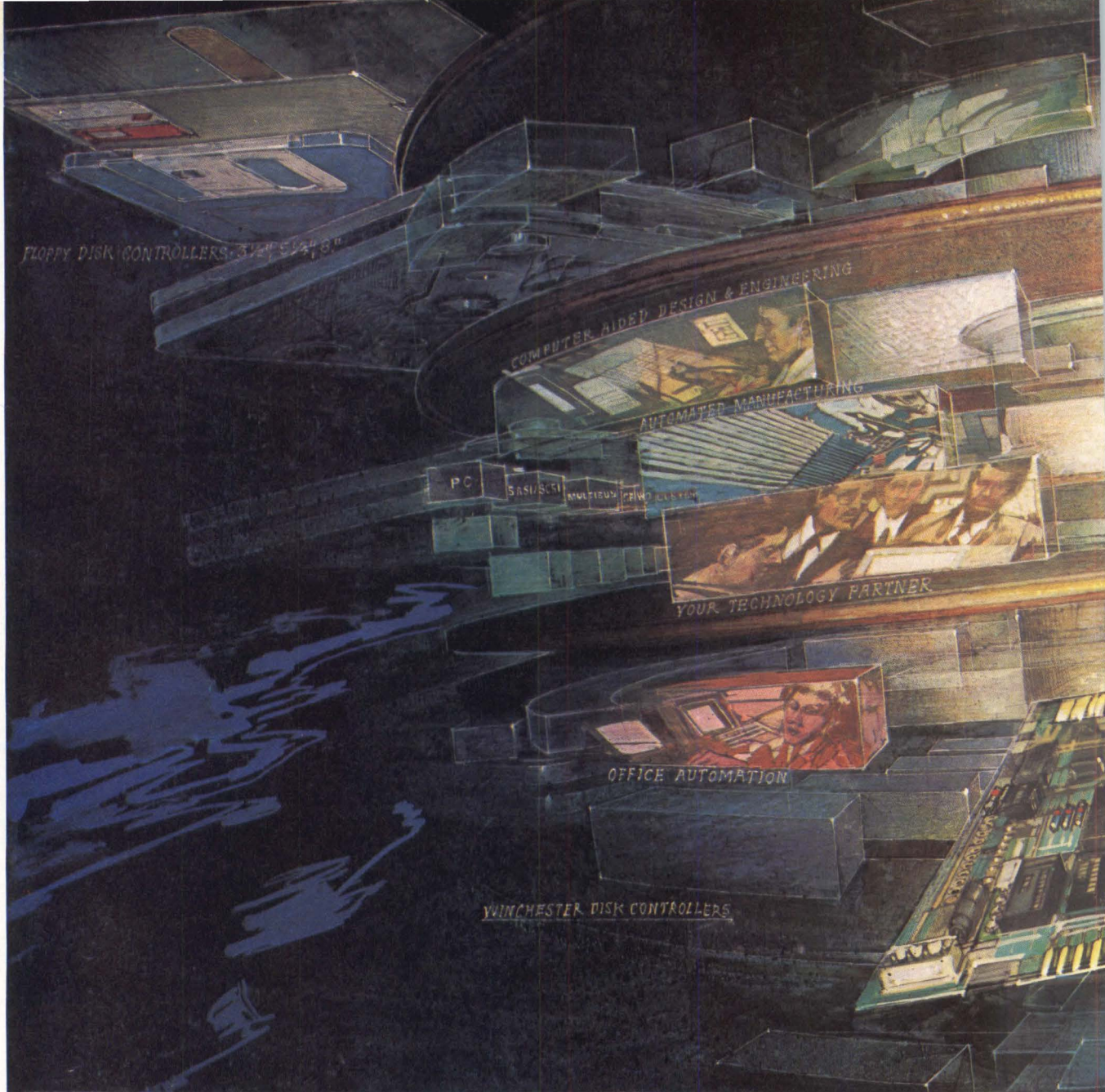

# WHAT'S IN STORE FOR DISK STORAGE? THE FUTURE...

Your future is ensured when you make Western Digital your partner in storage management technology. We've led the way with non-stop innovation, from the first single chip floppy disk controller nearly a decade ago to the broadest offering of chip and board-level floppy, Winchester and tape controllers today.

#### **Systems in Silicon.**

What makes us unique are our extensive VLSI capabilities. Designing and manufacturing our own proprietary chips enables us to 1) pack more performance into our controllers than is possible using general purpose LSI, 2) continuously integrate more and more functionality into fewer and fewer devices, 3) and provide you with an unending path to lower cost and higher performance as we ride the experience curve.

#### **Chip-to-board synergy.**

Solutions are what we offer systems builders. Having us build you a board-level disk controller

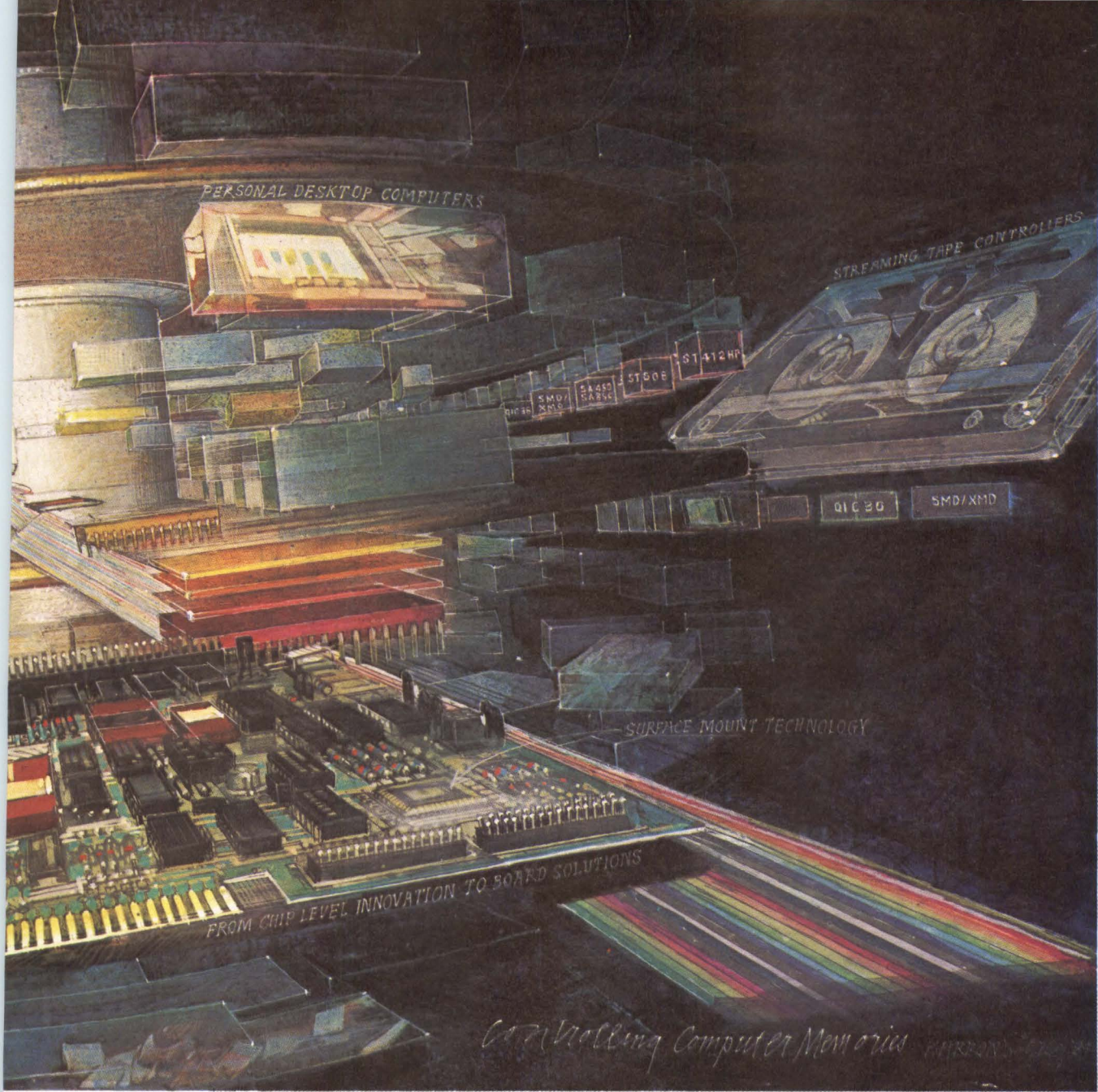

based on our chips does more than get you to market more quickly. It enables you to make us your technology partner at the systems integration level.

Whether you choose one of our standard boards, with more than a dozen combinations of host and drive interfaces, or have us design and build a custom, proprietary version for your system's special needs, our engineers work as a virtual extension of your own engineering capabilities.

**Leading edge manufacturing.**

To meet your high volume needs, we've invested in new, state-of-the-art automated board manufacturing and test facilities in the U.S. and Europe.

To keep you competitive, we're constantly integrating more functionality onto our board-level products, driving down cost while we boost performance. Our investments in surface-mount technology, and commitment to stay at the leading edge of this revolutionary approach to board manufacturing, will accelerate the integration process, enabling us to pack dramatically more into dramatically less space.

**Take control of the future.**

More leading manufacturers of personal computers and office automation systems buy storage management controllers from Western Digital than from any other company. Make us your source for disk and tape controllers and you get more than high technology products. You get a corporate commitment to do all we can to see you succeed. Take control of the future. Call our Controller Hotline, 714/863-7827. And ensure *your* success.

**...STARTS HERE.**

For the complete story of our storage management capabilities and a poster-size reproduction of the illustration above, send your business card to Western Digital, SM Literature, 2445 McCabe Way, Irvine, CA 92714.

**WESTERN DIGITAL**  
C O R P O R A T I O N

\_\_\_\_\_NET  
(fill in blank)



# Multiple Choice Made Easy.

Confused about which Local Network to choose? You're not alone. In today's personal computer environment, new LANs seem to pop up daily, adding even more choices. And more questions.

Questions about performance. Price. Security. Expandability. And software availability. It isn't hard to see that multiple choice has become multiple guess.

**We Provide The Answer.** At Novell, we offer a unique new approach. An approach which answers the multiple choice question. We've taken our field-tested network operating system and made it work on all of today's LANs. ARCnet. Ethernet. OMNINET. proNET. PCnet. G-NET. Even tomorrow's Anynet.

We call it NetWare.™

NetWare is designed to bring the user and software supplier together for maximum performance, security and functionality. No matter which LAN hardware you choose.

**Software, Software And More Software.** Because each LAN is different, today's leading software companies view NetWare as the single unifying answer to the multiple choice question. Many have become NetWare "Do It Once and For All" affiliates, adapting their software for application in multiuser NetWare environments.

Quickly. Easily. Uniformly. And only once for all LANs.

**Novell Means Service.** To serve the LAN market better, we've initiated a series of benchmark tests on all the major LAN configurations—both with the supplier's native operating system and with NetWare. The results are available now.

Interested? Give us a call to order your copy of the "LAN Benchmark Report." It's free. We'll also try to answer any questions you might have about personal computer networking. Call us at 1-800-LANKIND.

**NetWare. Dedicated to serve  
all LANKind.**



**Novell Inc.**

1170 N. Industrial Park Dr.  
Orem, Utah 84057  
801 226-8202

# Mini-Micro World

## CORPORATE AND FINANCIAL

dows similar to those gaining popularity on the IBM PC.

A companion product to the MiniFrame is PCworks, a software package from TouchStone Software Corp., Seal Beach, Calif. PCworks links IBM PCs and compatibles to the MiniFrame by making the MiniFrame a UNIX file server, thus allowing PCs to be networked and to transfer data files, mail and messages, and print reports. Steve Blank, vice president of marketing for Convergent's Data Systems Division, underlines Convergent's enthusiasm: "PCworks provides the

first available MS-DOS-to-UNIX link and opens an enormous market in the base of PC users for Convergent."

Fortune president Campbell discounts the significance of the Convergent/AT&T agreement. He notes that AT&T is also marketing its own UNIX-based OEM systems and believes that there will be room for everyone. Confirming that is a Yates Ventures study that predicts that the UNIX system market will grow from \$4.5 billion this year to nearly \$7 billion in 1985. □

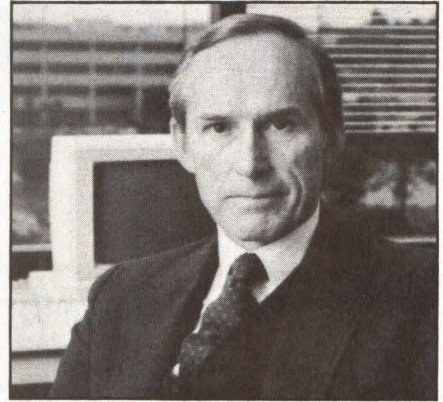

**James S. Campbell**, president since December, has made changes designed to turn around Fortune's fortunes.

## Financings

Computerworks, Westport, Conn., has acquired \$5 million in venture capital to finance nationwide expansion of its corporate sales, service and retail operations. Participating in the funding were General Electric Venture Capital Corp. and Harrison Capital Corp.

Davox Communications Corp., a Merrimack, N.H., supplier of data and voice workstations, has secured \$6.4 million in venture financing. Hambrecht & Quist led the group of investors. Just before the financing, Daniel Hosage, formerly of IBM Corp. and Datapoint Corp., was named president as part of a corporate reorganization. President John Tincler, previously president of Centronics Data Computer Corp., and founding chairman Rubin Gruber have left Davox.

Portland, Ore., start-up Sequent Computer Systems has completed a \$7.5 million second round of venture funding. Sequent is developing computers for OEM customers based on National Semiconductor Corp. 16032 and 32032 microprocessors and running the UNIX operating system. Kleiner Perkins Caufield & Byers and Hambrecht & Quist participated in the financing.

Fault-tolerant start-up company,

Sequoia Systems Inc., recently garnered \$8.4 million to help introduce its transaction-processing systems. Investors in the Marlborough, Mass., company include Sperry Corp. and Citibank Investments.

## Wet ink

Apollo Computer Inc., Chelmsford, Mass., recently signed an 18-month agreement with Racal-Redac Inc. The agreement, worth as much as \$10 million, involves Apollo's Domain workstations, which will be sold with Racal-Redac's new CIEE electronic-design-integrated software. . . . Arete Systems Corp., San Jose, Calif., will sell \$3.6 million worth of its transaction-processing computer systems to field marketing Inc. over the next 18 months. . . . Control Data Corp. (CDC) has announced what it believes is one of the largest single OEM contracts for peripherals in history. Under a \$540 million, multiyear agreement, CDC will supply AT&T Technologies Inc. with disk drives, tape drives and media to be used with AT&T's 3B computer line. . . . Western Digital Corp., Irvine, Calif., has received a multimillion-dollar contract from Matsushita Electric Industrial Co. Ltd., Osaka, Japan. Western Digital will supply custom Winchester con-

troller boards for Matsushita's new Sr. Partner IBM PC-compatible portable computer, which was introduced under the Panasonic label in May at Comdex. Western Digital says the contract is its largest for custom Winchester controllers sold to the Japanese market.

## Quarterly reports

Centronics Data Computer Corp. has reported losses for the second quarter in a row. The Hudson, N.H., printer manufacturer suffered a net loss of \$1.9 million, or 17 cents per share, for the quarter ended April 1, compared to a gain of \$200,000, or 2 cents per share, in the same period a year earlier. Sales for the quarter were \$39.5 million, compared to \$43.7 million a year earlier. In the quarter ended Jan. 1, the company lost \$6.2 million, or 55 cents per share, on sales of \$46.9 million.

Centronics president John Morrison points to two factors he hopes will help turn the company around. First is a corporate reorganization that added management from Control Data Corp., Digital Equipment Corp., Memorex Corp. and Data Terminal Systems. Second is a previously announced OEM contract that could garner as much as \$100

# The Big Apple Hosts The World's Largest End-User Business Computer & Communications Show

Personal Business Computers  
Minicomputers  
Mainframe Computers  
Computer Peripherals  
Work Stations/Computer  
Support Furnishings  
Data Communications  
Voice Communications  
Software

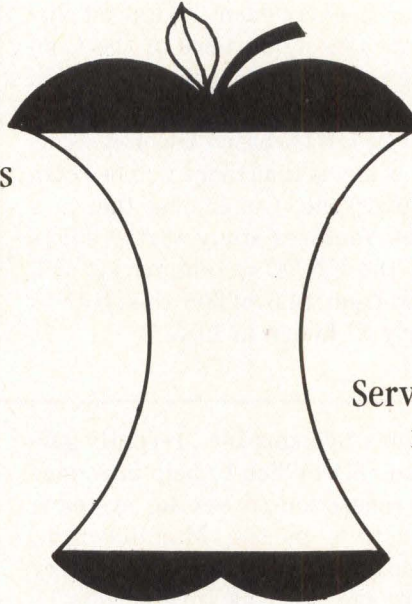

Word Processing/Records  
Retention & Retrieval Systems  
Electronic Mail  
Microfilm Equipment  
Duplicating/Copy Systems  
Services (education/training, facilities  
management, consulting, etc.)  
Computer Supplies

Plan now to join over 40,000 corporate executives and MIS/DP professionals as they explore the world's largest exhibition of business computer systems.

## SEE INFO/SOFTWARE...A SHOW WITHIN A SHOW.

The Eleventh International  
**INFORMATION MANAGEMENT  
EXPOSITION & CONFERENCE**

New York Coliseum • October 1-4, 1984



**MAIL TODAY FOR REDUCED-RATE TICKETS!**

- Send \_\_\_\_\_ Reduced Rate Tickets.  
 Send \_\_\_\_\_ Conference Programs.

NAME \_\_\_\_\_

TITLE \_\_\_\_\_

COMPANY \_\_\_\_\_

DIVISION \_\_\_\_\_

STREET \_\_\_\_\_

CITY \_\_\_\_\_ STATE \_\_\_\_\_ ZIP \_\_\_\_\_

I am interested in *exhibiting* at INFO 84

Call me at ( \_\_\_\_\_ ) \_\_\_\_\_

Mail to: **INFO 84**  
Cahners Exposition Group  
999 Summer Street, P.O. Box 3833  
Stamford, CT 06905



# Compare TAB's 132 column, 15 inch terminal with any other smart terminal.



## The difference is more than clear!

"Perhaps the finest quality 132 column display on the market today..." See for yourself. Send for your FREE unretouched, actual size photo of the TAB 132/15. Place it by any other terminal. Compare the non-glare 15 inch screen, the crisp, clear 132 characters per line with the large 7" x 11" dot matrix resolution. Even with just a photo print, you'll see the difference . . . and more!

**More productivity, more throughput.** Give people a better tool and they'll produce more—whether they're the president, accountant, engineer or order entry clerk. An easier to read, easier to use terminal means more effective, error free throughput.

**More data, larger screen.** Display data in the same 132 column format you're used to seeing on your printer. Reduce or eliminate slow, expensive printed reports. Break away from the old 80 column display limitation. Whether you're involved with inquiry, interactive or word processing applications, the TAB 132/15 can give you the display flexibility you need.

**More than compatible.** ANSI and DEC<sup>1</sup> VT52<sup>1</sup>, VT100<sup>1</sup> and VT132<sup>1</sup> compatibility, plus a special TAB mode for even more capabilities. All standard. The TAB 132/15 also gives you four page memory, 14 function keys, status line and

English prompts on the screen. With options like printer port and current loop.

**More capability with full graphics.** TAB's optional graphics package is full featured and emulates Tektronix 4010<sup>2</sup> terminals and is compatible with PLOT IO<sup>2</sup>, TELLAGRAF<sup>3</sup>, DISSPLA<sup>3</sup>, Template<sup>4</sup> and Plot Pak<sup>5</sup> software. Features include arc and vector drawing, point plotting, area fill, selective erase and more.

 **More desk space with internal modem.** TAB terminals are now available with a new Internal Modem that is Bell 212A compatible. This 1200/300 Baud modem with memory is keyboard controlled to initiate calls and automatically answer calls. Ten phone numbers can be stored for auto-dialing. For a free photo print or a demonstration of the TAB 132/15 Series Terminals, call or write TAB Products Co., 1400 Page Mill Road, Palo Alto, CA 94304, (415) 852-2400. Outside Calif. (800) 672-3109.



**TAB**  
PRODUCTS CO

TECHNOLOGY  
AND  
BUSINESS

1 Trademarks of Digital Equipment Corporation  
2 Trademarks of Tektronix Inc.  
3 Trademarks of Integrated Software Systems Corp.

4 Trademarks of Megatec  
5 Trademark of Digital Engineering

# Mini-Micro World

## CORPORATE AND FINANCIAL

million over the next three years. Centronics will not reveal the other party involved in that contract.

TeleVideo Systems Inc., Sunnyvale, Calif., reported record sales of \$48.4 million for its second quarter, ended April 30. Sales for the comparable quarter a year earlier were

\$41.6 million. TeleVideo attributed the gain to volume shipments of its IBM PC-compatible computers, the Tele-PC and the Tele-XT, which were introduced this year.

Sales for the first and second quarter of this year rose to \$91.7 million from \$80.5 million in the

same period a year earlier, while net income increased to \$11.4 million from \$10.5 million. As a result of the company's initial public offering, earnings per share decreased to 27 cents from 28 cents between the first two quarters of this year and last. □

## GUEST FORUM

*The voice for guest experts*

Lee B. Kauffman is director of the Industry Analysis Center for The Office Systems Consulting Group Inc., Cambridge, Mass.

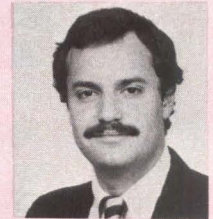

## Users must carefully weigh PBX/office-equipment purchases

**Lee B. Kauffman**

The Office Systems Consulting Group Inc.

The use of private-branch-exchange (PBX) systems as a conduit for office-automation communication has been evolving slowly (but noticeably) over the past few years. Several factors are responsible for a marked acceleration in this development in the past six months. Chief among them are the demand for voice/data network integration in the office-automation (OA) environment, the increasing number of desktop workstations and the need to "network" these systems, IBM Corp.'s postponed introduction of its local-area network—which forced some prospective buyers to stop waiting and seek other solutions—and the divestiture of American Telephone & Telegraph Co.

Three distribution channels from which to buy a PBX system have emerged. Most OA vendors either have or are forming relationships with the leading PBX vendors. The two best-known examples of this are Rolm Corp./IBM and Wang Laboratories Inc./Intecom Inc. Since the divestiture of AT&T, the Bell Operating Companies have also been anxious to market PBX equipment, thus assuming the role of system integrators. Finally, a main channel for PBX distribution is the PBX vendors themselves.

There are approximately 32 vendors scrambling for a market share in

the PBX industry. Most industry analysts predict a major shakeout, leaving only a few competitors. While from the buyers' perspective this might simplify the market, they will still have to contend with multiple distribution channels. The new question is: what is the difference in buying a PBX from a PBX vendor, from a Bell Operating Company or from an OA vendor?

All seven of the Bell Operating Companies have multiple-vendor distribution rights for PBX systems. Five of the seven have multiple-vendor distribution rights for OA systems as well. While this positions them well in terms of "one-stop shopping," prospective buyers must still scrutinize the level of integration these systems offer. A PBX may be compatible with an OA vendor's offerings, but this does not necessarily ensure that the PBX environment will provide full functionality—or enhancement of the OA system's functionality.

In the recent Wang/Intecom agreement, Wang purchased 1.5 million shares of Intecom stock and will acquire 3.5 million more shares over the coming year (approximately 30 percent ownership). Both companies intend to share development and marketing projects.

Concurrently, Wang revealed its attitude toward the PBX industry as

a whole. It has created what it terms "the four levels of connectivity":

- Wang intends to interface with all leading PBX vendors to provide the basic communication transport between Wang and non-Wang equipment,

- Wang will provide the basic connectivity plus value-added services by integrating with the leading PBX vendors,

- Wang will work closely with interested PBX vendors to provide the full features and functions of Wang systems and to develop application packages for selected market segments and

- Wang's strategic affiliation with Intecom will enable it to pursue joint development and marketing projects and to share technology.

These levels of connectivity establish differing levels of integration.

As yet, there's little evidence of products arising from the strategic affiliations between OA and PBX vendors, yet it seems clear that the fully integrated (fully functional) products will first become available through these channels. This does not imply that the Bell Operating Companies will not have a role in the industry. Rather, it suggests that customers requiring high levels of OA-PBX integration and functionality in the near future will most likely find their solutions from OA vendors that are strategically affiliated with PBX vendors. □

VMEsystem  
VME VME VME  
VME VME VME

Today's rugged standard guarantees tomorrow's compatible growth.



**MOTOROLA INC.**

# VMEsystem

TOKEN BUS

ETHERNET

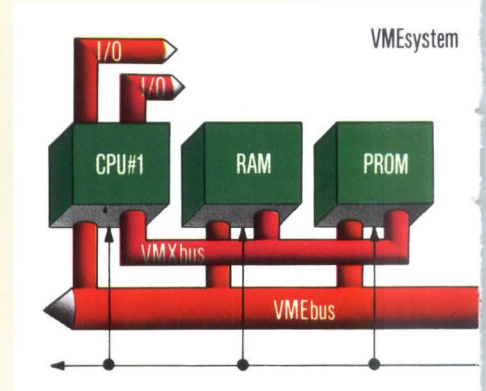
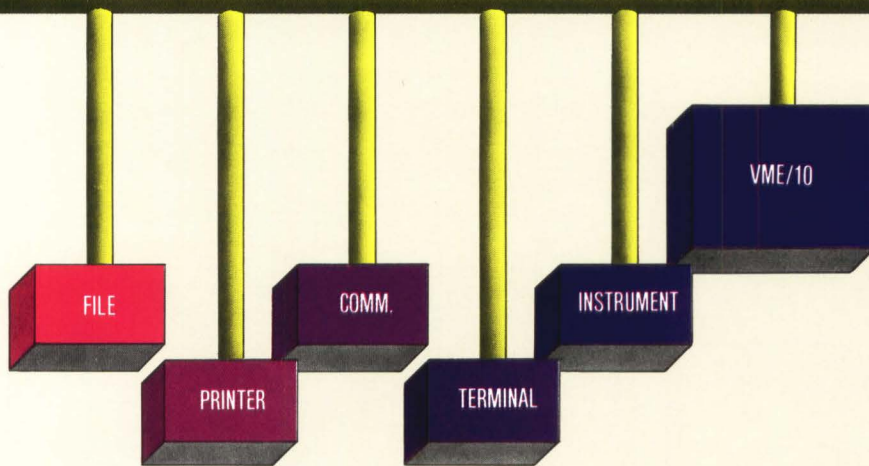

The VMEbus is part of the Motorola porated into the VME module system and the

Your high-tech future is speeding toward you requiring you to combine technical and business considerations when making your design-in decisions. As a systems integrator, you face a major decision in your choice of a microcomputer system architecture.

Major because in order to utilize 32-bit microprocessors or 32-bit microprocessor based boards in the next five years you must choose between high performance system buses that support 32-bit machine functionality. Your decision will last throughout the computer system's lifetime. VMEsystem Architecture is the systems designers leading choice in providing high performance support of 32-bit designs, according to the Electronics News 1984 MPU Based Processor Study.

VMEsystem leads also with the broadest line of available modules and support products for 8/16/32-bit applications. With over 400 products now available from over 90 manufacturers. The line continues to expand while providing smooth, planned growth for the future.

Rugged VMEmodules and standardized VME-system architecture coupled with a broad base of manufacturer and vendor support guarantee tomorrow's compatible growth.

## VMEbus: the heart of VMEsystem.

Originally introduced in 1981, VMEbus has become the standard high performance system interconnect structure through several years of intensive design activity. It is the bus of choice for the present and future of microcomputer architecture, supporting data transfer rates as high as 30Mbytes per second with today's chip technology.

VMEbus has a master/slave asynchronous non-multiplexed data transfer structure, seven levels of priority interrupt, four levels of arbitration with rapid fault detection and control for bus, system and AC failures.

One of the many features of the 32-bit configured VMEbus system is that the bus dynamically senses whether 8-, 16-, or 32-bit data paths are needed and adjusts automatically.

VMEbus specifications were originally developed jointly by Motorola, Mostek, and Signetics/Philips and have been accepted by close to 100 manufacturers worldwide.

In integrating 8-, 16-, and 32-bit system components VMEbus is innovative, publicly documented, and eminently adaptable to new technologies. LSI/VLSI technology is providing interface and peripheral chip functions that vastly increase the functionality/cost ratio of VMEbus modules.

Based on the most popular Eurocard formats with DIN pin and socket connectors, VMEbus is presently being formally standardized by both the IEEE (P1014) and the IEC (47B) standards organizations.

## ARCHITECTURE

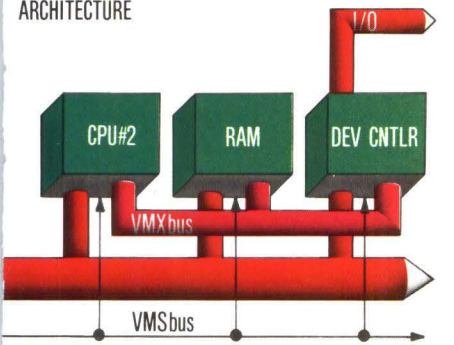

Microsystem Architecture. VMEbus is incorporated in VME/10 microcomputer system.

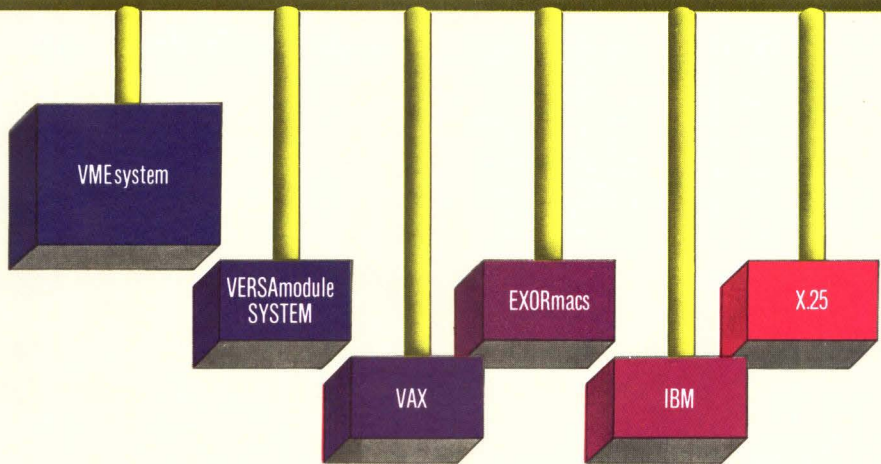

To the hundreds of present VMEbus users this is a formality. VMEbus has earned its position as the standard through hard usage, not through mere speculation based on paper specifications.

VMEbus is designed from the ground up for multiprocessing applications while still providing a high level of fault tolerance. Consider its full 32-bit address and data paths, clear arbitration and interrupt schemes and diagnostic capability.

VMEbus is also *the* cost-effective system bus. It can be economically configured according to design requirements for multiple processors and controllers. Manufacturers now provide VMEbus compatible modules for many applications.

## VMXbus: *high speed private access.*

Designed for multiprocessing applications, VMXbus is a high speed, parallel, private access bus that allows local operation between the MPU and memory. Its local interconnection between processor and memory takes the load off the main bus for rapid, efficient multiprocessing.

In communicating to I/O or other functions over the dedicated VMXbus, the processor can carry out operations independent of the VMEbus.

VMXbus has a 32-bit data path with a 16M byte address range. It handles up to six functional modules per "group" and runs on either a backplane or cable.

## VMSbus: *self arbitrating, global access.*

VMSbus is designed as a self arbitrating, serial global bus for short messages between processors while allowing for diagnosis and fault tolerance.

Its 3.2 Mbit/second transfer rate allows rapid communication of brief messages between system modules using only two conductors (clock and data) to provide an efficient "party line" between system components. It provides urgent event message passing in both tightly and loosely coupled multiprocessing environments.

## I/O Channel: *Motorola enhancement*

The Motorola I/O Channel provides low cost modular I/O expansion on a local processor bus not tied to a specific board or enclosure.

It permits interconnection of slower peripherals up to two megabytes per second directly with their respective processor, freeing the VMEbus to handle simultaneous high speed data exchange and multiprocessor activities.

I/O Channel utilizes 12-bit address with 8-bit data bus and 4K byte memory mapped I/O. Its asynchronous operation combines 4 levels of interrupts. Modules can be selected for a wide range of requirements including analog conversion, discrete parallel, serial I/O, plus mass storage.

# VMEsystem vs. MULTIBUS II

There are significant business reasons for the systems integrator to make the Motorola VMEsystem design-in decision. In a comparison with the proposed MULTIBUS II the business advantages of wide industry support for VME-system Architecture become apparent.

## Proprietary constraints.

VMEbus carries no patents or trademarks on the bus nor are the bus specifications copyrighted. A sound business advantage.

There are trademarks on the MULTIBUS II components, patents pending on MULTIBUS II, copyrights on all specifications and licensing and fees required by Intel to use MULTIBUS II.

The VME system is free of licensing fees and other proprietary restraints. A truly open system geared for broadbased use *today*.

## Reliability and the migration path.

The VMEbus has shown no significant problems since being originally released in 1981. It owes much of this reliability to the orderly migration path from its dependable precursor VERSAbus. MULTIBUS II as specified is synchronous and highly multiplexed while its predecessor MULTIBUS I is neither. There is no orderly migration path.

## VMEbus Manufacturers Group: getting together to promote compatibility.

The VMEbus Manufacturers Group is an international association of independent manufacturers who support the VMEsystem standard. The purpose of the group is to create a forum for technical exchange to promote VMEsystem as a compatible industry standard.

Key goals are to maintain and enhance the standard, encourage other independent manufacturers to produce compatible products and provide identification of compatible equipment.

The active VMEbus Manufacturers Group has a mail list of over 500 individuals and convenes 4 times a year. The Group publishes the VMEbus Compatible Products Directory listing vendors, addresses and products. To receive a copy of the Directory check the appropriate box on the request card.

The Manufacturers Group also administers the VME-system specifications. A comprehensive VMEsystem Architecture Manual with complete specifications is available. Check the appropriate box on the response card.

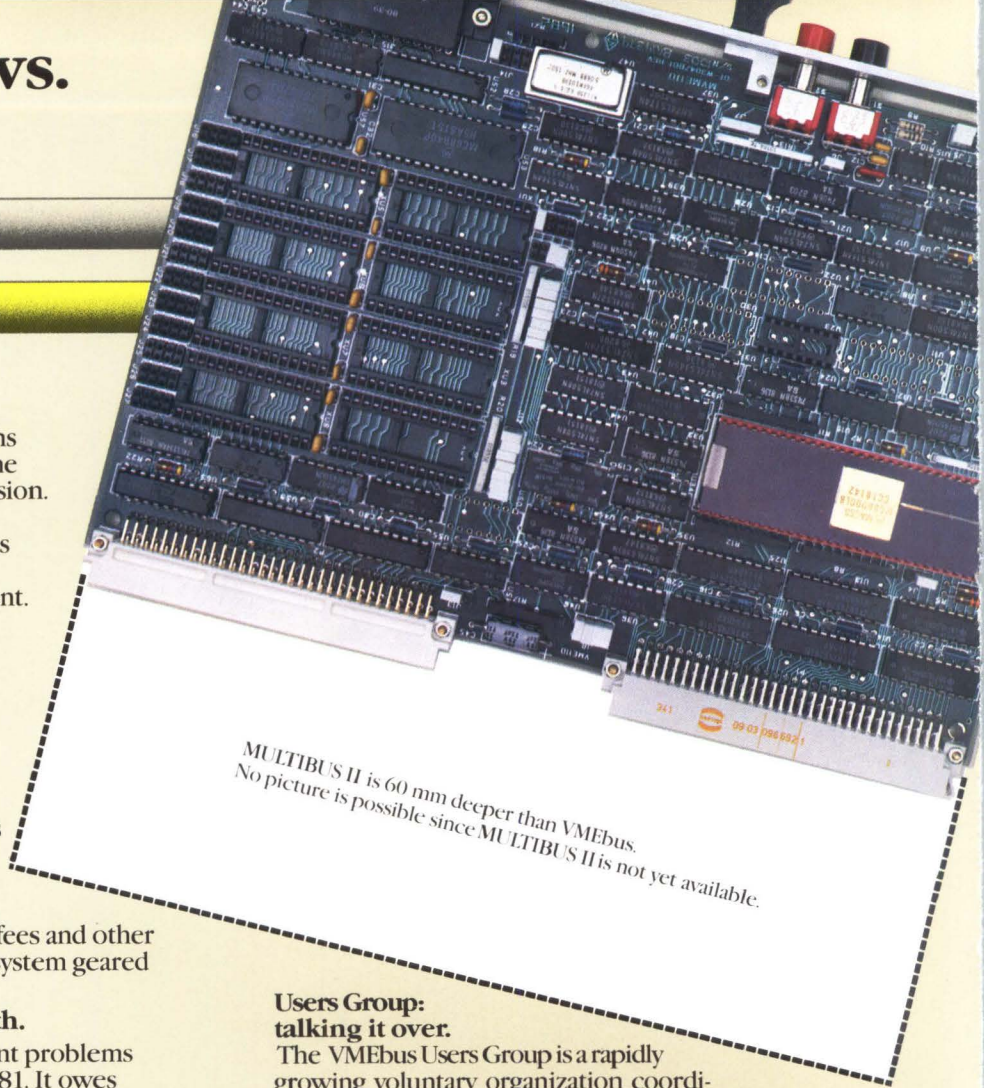

MULTIBUS II is 60 mm deeper than VMEbus.  
No picture is possible since MULTIBUS II is not yet available.

## Users Group: talking it over.

The VMEbus Users Group is a rapidly growing voluntary organization coordinating user meetings in North America and corresponding with affiliates in Europe.

There are active sub-committees on product compatibility, application support and distribution media. The group publishes application notes, and encourages detailed presentations on VME applications at its meetings.

For membership information on the VME Manufacturers or Users Groups check the appropriate box on the request card.

## Future VLSI: The world continues to get smaller.

The major movers behind VMEsystem Architecture have announced additional bus support chips in various stages of planning and production;

Number	Function	Company
68452	Bus Arbiter	Motorola
68153	Bus Interrupter	Motorola
68154	Bus Interrupter	Signetics
68155	Interrupt Handler	Signetics
68172	Master/Slave Interface	Signetics
68174	Bus Arbiter and Clock Driver	Motorola
68171	VMSbus Controller	Signetics
68173	VMSbus Interface	Signetics

LSI is not available for competitive 32-bit buses. VMEsystem is well designed, well defined, solidly supported and publicly available.

The reasons are clear for a Motorola design-in decision.

# Specifications

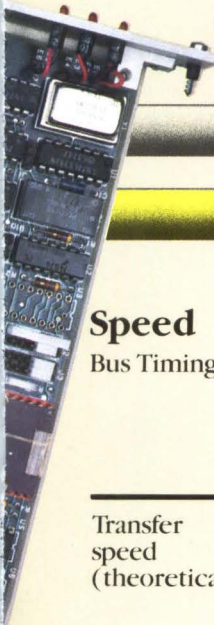

	VMEsystem	MULTIBUS II	Comments
<b>Speed</b>			
Bus Timing	Asynchronous (except VMSbus)	Synchronous (Fixed at 10 MHz clock rate)	Today's technology exceeds 10MHz clock rate. The MULTIBUS II fixed clock rate degrades high performance processors.
Transfer speed (theoretical)	VMEbus 57Mbyte/sec. VMXbus 80Mbyte/sec. VMSbus 3.2 Mbit/sec.	iPSB 40 Mbyte/sec. iLBX II 48 Mbyte/sec. iSSB 2 Mbit/sec. MULTICHANNEL 8 Mbyte/sec.	VMEsystem offers higher total system throughput
Serial Bus Protocol	Sender self check Collision Tolerant	CRC CSMA/CD	VMS rate stabilizes under heavy usage. CSMA/CD declines under heavy usage.
<b>Flexibility</b>			
Bus Timing	Asynchronous	Synchronous	VME transfer rate adjusts better to processor clock rate: 12.5 MHz with MC68000; 16 MHz with MC68020
Arbitration	Centralized or Distributed Control (4-level daisy chain) Priorities 4 (20 per level)	Distributed Control Parallel Contention Priorities 2 (20 per level)	Flexible arbitration and interrupt configurations of VMEbus simplify the use of multiprocessors.
Interrupt Request Lines	7	0	
Address width	a.) 16 bits b.) 24 bits c.) 32 bits	a.) 16 bits b.) 32 bits	Only Multibus II <u>requires</u> full 32-bit decoding logic in ALL applications.
Interrupt Request Structure	Allows deterministic protocol on VMEbus	Does not allow deterministic protocol on iPSB	VMEbus offers significantly greater flexibility for the system designers.
Arbitration	a.) Priority b.) Round Robin c.) Single level	a.) Priority	
Requester	a.) Release when done b.) Release on request c.) Release on BCLR d.) Release on AC Fail	a.) Release when done	
Number of Address Spaces	64	4	
<b>Size</b>			
	Double Eurocard (233.3mm x 160mm) Single Eurocard (100mm x 160mm)	Double Eurocard (233.3mm x 220mm) Single Eurocard (100mm x 220mm)	VME card sizes are popular and accepted today and will maximize functionality/cost tomorrow. MULTIBUS II card size is unpopular and hard to fit today and will be too cumbersome for tomorrow.

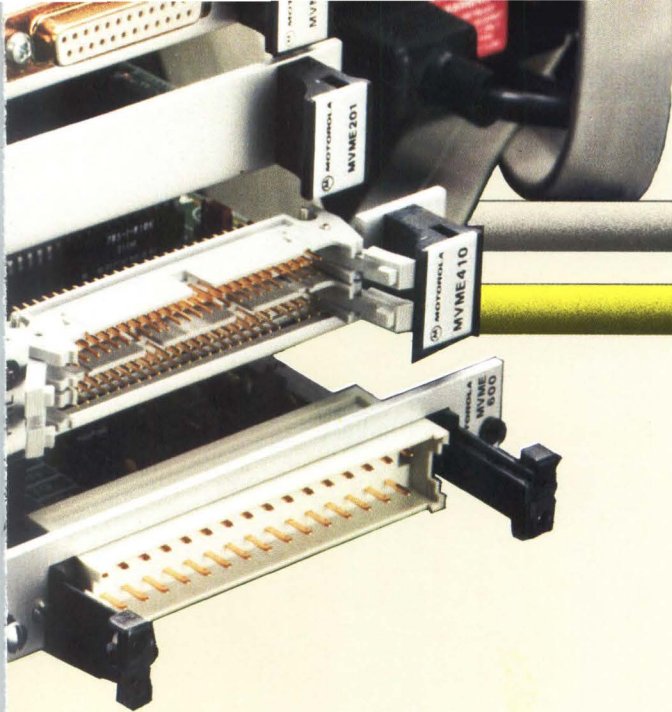

*VME/10 Microcomputer can be custom configured through rear-panel plug-in of VME modules and I/O modules.*

### **600 Series-Industrial I/O Modules**

**MVME 600/601** analog/digital converter with 8, 16 input channels

**MVME 605** digital/analog converter with 4 output channels

**MVME 610** AC sensing with 8 input channels

**MVME 615/616** AC switching with 8 output channels

**MVME 620** DC sensing with 8 input channels

**MVME 625** DC switching with 8 output channels

### **700 Series-Non-Eurocard I/O**

**MVME 700\*** 6U x 80MM wire wrap board

**MVME 701\*** 6U x 80MM DIN connector To DB25 and 50 Pin dual row header (Used with MVME 050)

**MVME 702\*** 6U x 80MM. Provides 50, 34 & 20 pin dual row headers for mass storage extension (Used with MVME 820/821)

### **800 Series-Mass Storage Support Products**

**MVME 820\*** 6U (double high) plug-in mass storage module including 15 MByte Winchester drive and 1 MByte DS/DD 5¼" floppy drive

**MVME 821\*** 6U (double high) plug-in mass storage module including two 1-MByte DS/DD 5¼" floppy drives

### **900 Series-Packaging Hardware Backplanes**

**MVME 920** 20 slot VMEbus

**MVME 921** 9 slot VMEbus

**MVME 922** 5 slot I/O channel

**MVME 924\*** 3 slot I/O channel

#### **Extender Boards**

**MVME 930** VMEbus extender

**MVME 932** VMEbus and I/O channel extender

#### **Wire Wrap Boards**

**MVME 931-1** VMEbus wire wrap

**MVME 933-1** I/O channel wire wrap

**MVME 940-1** chassis with 7 double-high VMEbus slots, 2 I/O slots

**MVME 941** card cage with 9 double-high VMEbus slots and 2 I/O slots

**MVME 942** card cage with 20 double-high VMEbus slots

**MVME 943\*** chassis with 8 double-high VMEbus slots, 6 I/O channel slots (front) and 16 I/O channel or 80MM double-high slots (rear) and accepts MVME 820/821 mass storage devices

**MVME 944\*** chassis with 20 VMEbus slots (front) and 16 I/O channel or 80MM double high slots (rear)

\*In development. Contact your Motorola sales representative for current availability.



# VME modules: Today's rugged standard.

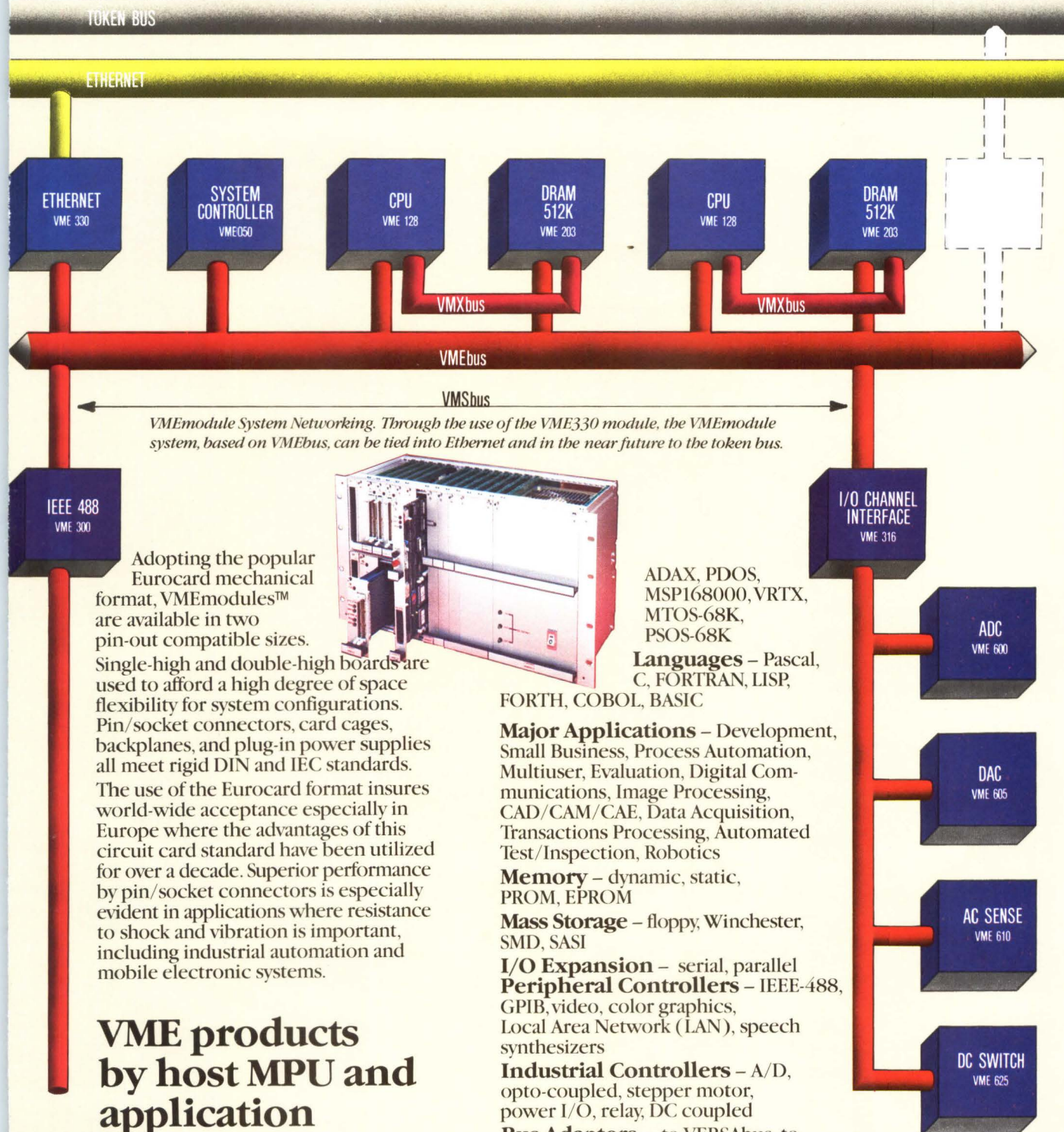

VMEmodule System Networking. Through the use of the VME330 module, the VMEmodule system, based on VMEbus, can be tied into Ethernet and in the near future to the token bus.

Adopting the popular Eurocard mechanical format, VMEmodules™ are available in two pin-out compatible sizes. Single-high and double-high boards are used to afford a high degree of space flexibility for system configurations. Pin/socket connectors, card cages, backplanes, and plug-in power supplies all meet rigid DIN and IEC standards. The use of the Eurocard format insures world-wide acceptance especially in Europe where the advantages of this circuit card standard have been utilized for over a decade. Superior performance by pin/socket connectors is especially evident in applications where resistance to shock and vibration is important, including industrial automation and mobile electronic systems.

## VME products by host MPU and application

**Single Board Computers** – 68000, 68008, 68010, 16032, 32032, Z80, Z8000, 80186

**Operating Systems** – UNIX, CPM, VERSAdos, PVS, UNIPLUS, DSSDOS,

ADAX, PDOS, MSP168000, VRTX, MTOS-68K, PSOS-68K

**Languages** – Pascal, C, FORTRAN, LISP, FORTH, COBOL, BASIC

**Major Applications** – Development, Small Business, Process Automation, Multiuser, Evaluation, Digital Communications, Image Processing, CAD/CAM/CAE, Data Acquisition, Transactions Processing, Automated Test/Inspection, Robotics

**Memory** – dynamic, static, PROM, EPROM

**Mass Storage** – floppy, Winchester, SMD, SASI

**I/O Expansion** – serial, parallel  
**Peripheral Controllers** – IEEE-488, GPIB, video, color graphics, Local Area Network (LAN), speech synthesizers

**Industrial Controllers** – A/D, opto-coupled, stepper motor, power I/O, relay, DC coupled  
**Bus Adapters** – to VERSAbus, to MULTIBUS I

**Other Boards** – SCM, floating, point CPU, BASIC interpreter, real time executives, bus debug, EPROM programmer

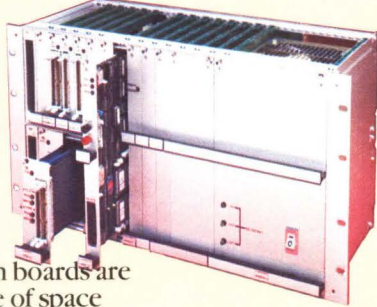

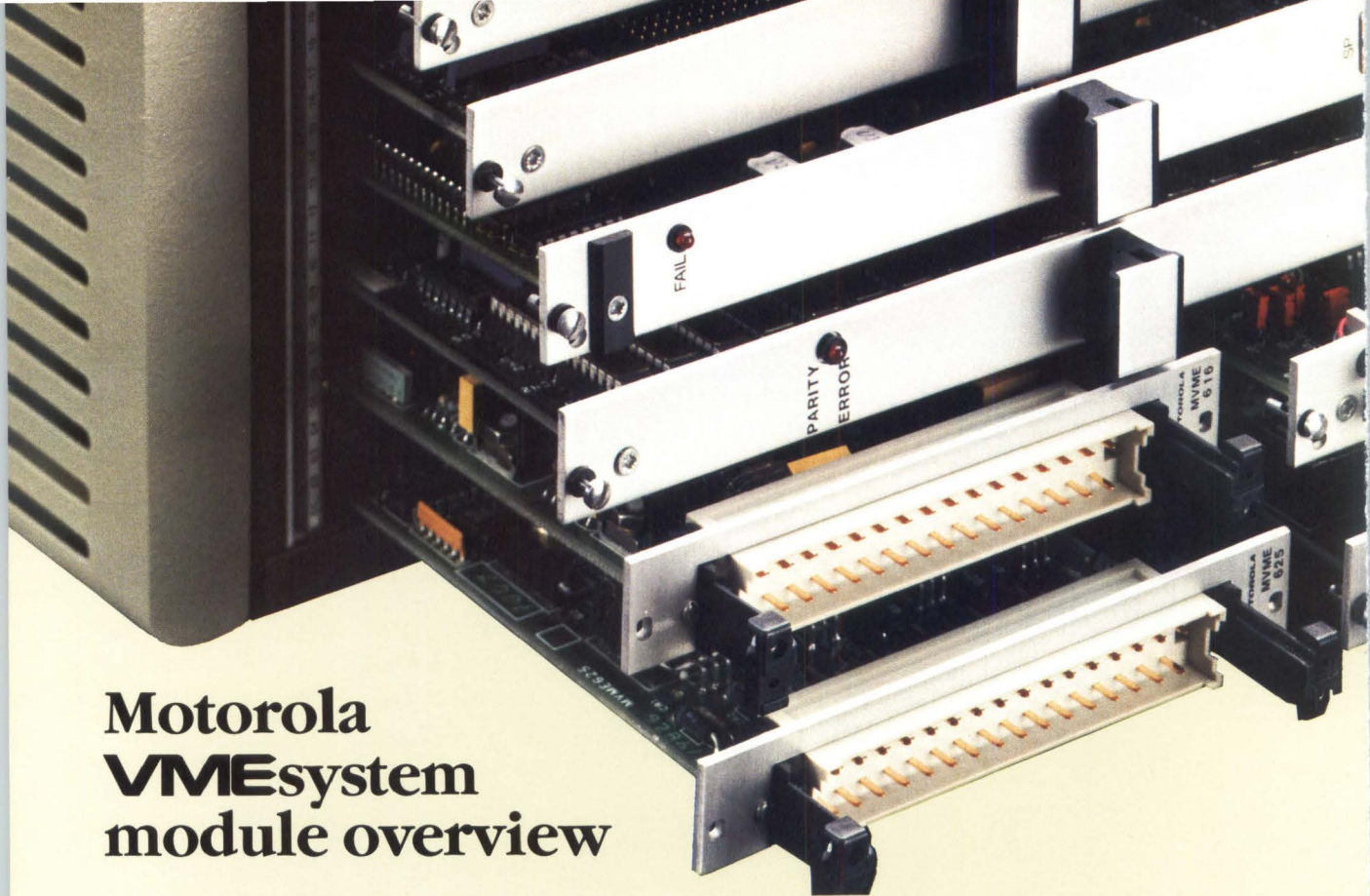

## Motorola VME system module overview

### 100 Series-Monoboard Computers and System Controllers

**MVME 101** MC68000 (8MHz) monoboard with 2 RS-232C serial ports and 2 parallel ports

**MVME 110-1** MC68000 (8MHz) monoboard with RS-232C debug port and I/O channel interface

**MVME 115M** MC68010 (8MHz) monoboard with MC68451 MMU optional plus 2 RS-232C serial and 2 parallel ports

**MVME 120\*** MC68010 (10MHz) monoboard with 12.5MHz optional. MC68451 MMU optional. 4 KByte cache option with 128/512 KByte dual port RAM, plus RS-232C debug port.

**MVME 128\*** MC68010 (12.5MHz) monoboard with 10 MHz optional; MC68451 MMU optional; 4 KByte instruction cache optional. 256 KByte dual port RAM and VMXbus interface plus RS-232C debug port

**MVME 130\*** MC68020 (16MHz) monoboard with 512 KByte dual port RAM or MC68851 (16MHz) PMMU optional. MC68881 (16MHz) math co-processor optional.

**MVME 025** Used With MVME 115 and 120. Provides: bus arbitration, AC fail and system clock functions.

**MVME 050\*** Used with MVME 115, 120, 128 and 130. Provides: interrupt handlers, bus arbitration, system clock, time-of-day clock, plus eight 28-pin sockets.

### 200 Series-Memory Modules

**MVME 200** 64K DRAM

**MVME 201** 256K DRAM

**MVME 202/222** 512K/2M DRAM

**MVME 203/223\*** 512K/2M DRAM with VMXbus interface

**MVME 210** Up to 128 KBytes ROM and up to 32 KBytes static RAM

**MVME 211** Up to 1 MByte ROM and up to 128 KByte static RAM

**MVME 212\*** same as MVME 211 with VMXbus interface added.

### 300 Series-Peripheral Controllers

**MVME 300** GPIB controller with up to 500 KByte/Sec transfer rate

**MVME 310** Universal IPC with 4 channel DMA

**MVME 315** Intelligent SASI interface with floppy controller for 4 5¼" or 8" floppies

**MVME 316\*** I/O channel interface

**MVME 320** Winchester/floppy controller for 5¼" drives

**MVME 330** Ethernet 2.0 compatible controller with MC68000 (10MHz) and LANCE chip and SIA

**MVME 331\*** 6-Channel serial I/O controller

**MVME 340\*** 6-Channel parallel I/O interface

### 400 Series-I/O Channel Modules

**MVME 400** dual channel serial port

**MVME 410** dual channel parallel port and Centronics compatible printer interface

**MVME 420** SASI™ interface adapter

**MVME 435** ½" magnetic tape adapter

# OEM VME/10 microcomputer system

TOKEN BUS

ETHERNET

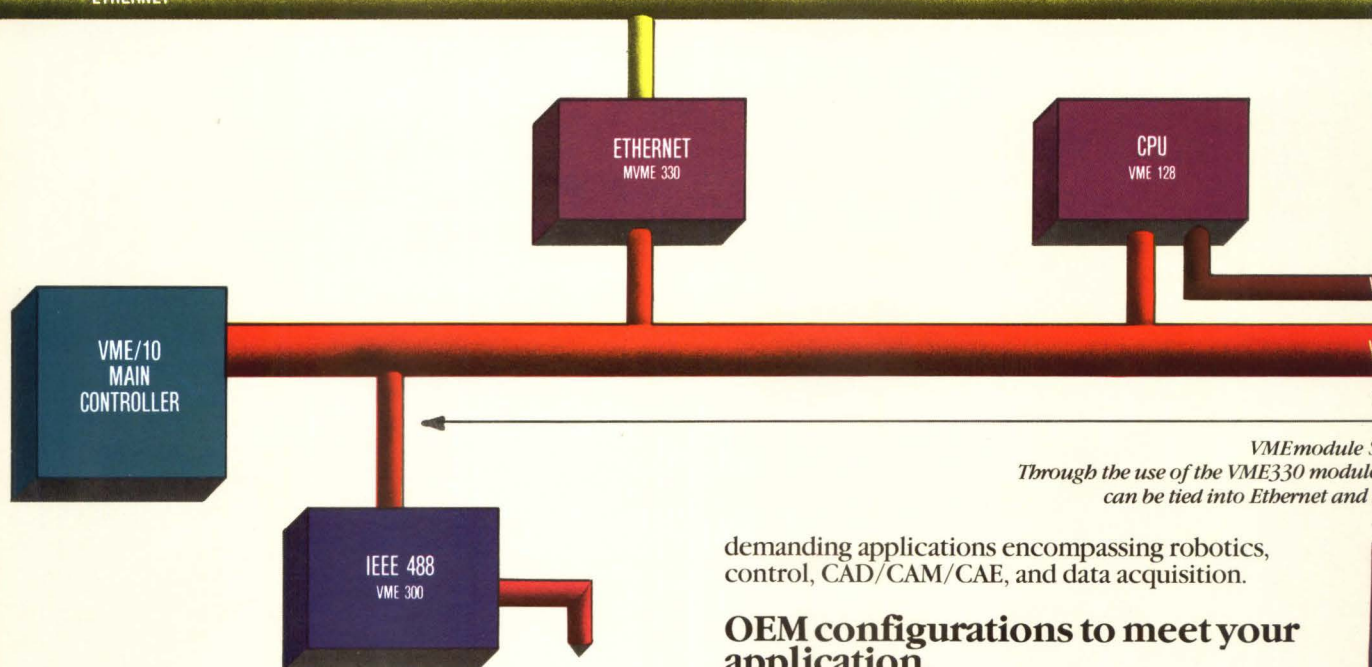

*VME module S  
Through the use of the VME330 module  
can be tied into Ethernet and i*

## Notes to the OEM marketer

A full range of integrated products is of prime importance for the value added resale marketer. For the OEM, selecting a vendor that provides the full range of integration from chip, board or box is essential.

The Motorola choice can minimize your initial risk while maximizing your flexibility. Combine Motorola's half billion dollar R&D budget with its third party hardware and software and you have a complete vendor solution. From M68000 Microprocessor Family to Ethernet, VERSAdos to UNIX Operating Systems and VMEbus to I/O Channel, Motorola utilizes reliable, compatible and competitive products that remain, time after time, the smart assured investment for your future.

## VME/10. OEM microsystems from Motorola.

M68000 performance, UNIX™ portability. VMEbus flexibility. Modern tools for the system integrator. In a field overrun with specialized, dedicated, and limited OEM micro's, there is the VME/10 System alternative. It's the only VMEbus based user-configurable OEM "engine" combining the high-performance mainframe capabilities of the MC68010 Microprocessor with standard VMEsystem Architecture and a choice of two powerful operating systems.

The VME/10 System is designed to allow OEMs and system integrators to harness a wide range of

demanding applications encompassing robotics, control, CAD/CAM/CAE, and data acquisition.

## OEM configurations to meet your application.

The VME/10 Control Unit starts with 384K Bytes of RAM, a 655K Byte floppy disk drive, and 5M, 15M or 40M Byte Winchester disk drive unit. High resolution color graphics system is also standard. An optional keyboard, plus separate color or monochrome display unit mean you use only what you need for your application.

And the VME/10 goes far beyond simple "one-on-one" applications. As a Level II supervisory control computer, multiple VME/10s may be networked together for large-scale distributed control usage.

## Mainframe performance, micro simplicity.

At the heart of the VME/10 OEM system is the MC68010 MPU – the latest addition to the upward-compatible, 16/32-bit M68000 microprocessor family. The combination of the MC68010 MPU and the MC68451 memory management unit provides processing power permitting multiple tasks to proceed simultaneously with full protection for program code and data in each task. You get fast, efficient application development on the VME/10 System.

## VMEbus, global standard.

VMEbus makes the VME/10 System highly configurable. The bus structure is currently being approved as a global, standard, 16/32-bit microsystem architecture by working committees of both the IEEE (P1014) and the International Electrotechnical Committee (47B). Increasingly widespread adoption of VMEbus means that you can customize your

# The intangible extras... from Motorola.

Since the earliest days of semiconductors, Motorola has earned for itself an enviable reputation as a frontrunner in both technology and support. Its leadership, first in discrete devices... then in integrated circuits... has quite naturally expanded to encompass the still-infant field of microcomputers where the M68000 microprocessor family has become an internationally-sourced 16-, 32-bit standard.

First with the component "chips," then with board-level microcomputer modules, finally with box-

- Field-proven Motorola quality and reliability... backed by the Motorola warranty.
- Field application assistance... available through an extensive network of over 50 Motorola semiconductor sales offices in North America.
- Comprehensive technical training seminars... on a wide variety of hardware, software, and systems topics... at the factory, at diverse locations throughout the world, even at your own plant site!
- Field and factory service arrangements... on-site installation and repair... in over 125 cities nationwide... maintenance contracts... factory repair/exchange services.

level system entries... Motorola offers equipment manufacturers both the appropriate building blocks and advanced development support instrumentation to streamline the implementation of their end-system products.

And beyond these direct benefits, Motorola offers the following unique combination of advantages to users of VMEsystem products.

- Third party software support... a continuing program of assistance to independent software vendors, to encourage development of both systems and applications packages for VMEsystem products.
- Commitment to VMEsystem architecture... with Motorola's active participation and support of the VMEbus Manufacturers Group, and of the VMEbus IEEE and IEC standardization activities.
- Comprehensive reference documentation... covering all hardware and software elements of the VMEsystem product offering.

## MOTOROLA SEMICONDUCTOR SALES OFFICES

### MOTOROLA SEMICONDUCTOR AMERICA'S DISTRICT OFFICES

ALABAMA, Huntsville	(205)830-1050
ARIZONA, Phoenix	(602)244-7100
CALIFORNIA, Encino/ Sherman Oaks	(818)706-1929 (213)872-1505 (213)417-8848
CALIFORNIA, Los Angeles	(714)634-2844
CALIFORNIA, Orange (Orange Exch.) (L.A. Exch.)	(714)560-4644 (213)445-5585
CALIFORNIA, San Diego	(714)560-4644
CALIFORNIA, San Jose	(408)985-0510
COLORADO, Colorado Springs	(303)599-7404
COLORADO, Denver	(303)773-6800
CONNECTICUT, New Haven/ Hamden	(203)281-0771
FLORIDA, Pompano Beach/ Ft. Lauderdale	(305)491-8141
FLORIDA, Casselberry/Maitland	(305)831-3422
FLORIDA, St. Petersburg	(813)576-6030
GEORGIA, Atlanta	(404)256-0222
ILLINOIS, Chicago/Schaumburg	(312)576-7600
INDIANA, Fort Wayne	(219)484-0436
INDIANA, Indianapolis	(317)849-7060
INDIANA, Kokomo	(317)457-6634
IOWA, Cedar Rapids	(319)373-1328
KANSAS, Kansas City/Mission	(913)384-3050
KANSAS, Wichita	(316)721-2449
MASSACHUSETTS, Berlin	(617)582-3856
MASSACHUSETTS, Burlington	(617)273-8020
MICHIGAN, Detroit/Westland	(313)261-6200
MINNESOTA, Minneapolis	(612)545-0251

MISSOURI, St. Louis	(314)872-7681
NEW JERSEY, Hackensack	(201)488-1200
NEW YORK, Poughkeepsie/ Fishkill	(914)473-8102
NEW YORK, Long Island/ Hempstead	(516)231-9000
NEW YORK, Pittsford	(716)248-5494
NEW YORK, Syracuse	(315)455-7373
NORTH CAROLINA, Raleigh	(919)876-6025
OHIO, Cleveland	(216)461-3160
OHIO, Dayton	(513)294-2231
OHIO, Columbus/ Worthington	(614)846-9460
OKLAHOMA, Tulsa	(918)664-5227
OREGON, Portland	(503)641-3681
PENNSYLVANIA, Philadelphia/ Horsham	(215)443-9400
TENNESSEE, Knoxville	(615)690-5592
TEXAS, Austin	(512)452-7673
TEXAS, Dallas	(214)931-9222
TEXAS, Houston	(713)783-6400
UTAH, Salt Lake City	(801)539-1190
VIRGINIA, Charlottesville	(804)977-3681
WASHINGTON, Bellevue Seattle Access	(206)454-4160 (206)622-9960
WASHINGTON, DC/MARYLAND, Hyattsville	(301)577-2600
WISCONSIN, Milwaukee/ Wauwatosa	(414)476-5554

Field Applications Engineering Available  
Through All Sales Offices

### MOTOROLA SEMICONDUCTOR — CANADA

MANITOBA, Winnipeg	(204)889-0693
ONTARIO, Downsview/Toronto	(416)661-6400
ONTARIO, Ottawa	(613)235-4388
QUEBEC, Montreal	(514)731-6881

### MOTOROLA SEMICONDUCTOR INTRA-COMPANY OFFICES

ARIZONA, Scottsdale	(602)949-3811
FLORIDA, Ft. Lauderdale	(305)475-6120
ILLINOIS, Schaumburg	(312)576-2788
ILLINOIS, Schaumburg/ Automotive	(312)576-7800
TEXAS, Ft. Worth	(817)232-6255

### MOTOROLA SEMICONDUCTOR INTERNATIONAL SALES OFFICES

AUSTRALIA, Melbourne	(03)561-3555
AUSTRALIA, Sydney	438-1955 439-2242
AUSTRIA, Vienna	(0222)65 01 26
BRAZIL, Sao Paulo	(011)572-3553
DENMARK, Gladsaxevej	(01)67 44 22
ENGLAND, Wimbley, Middlesex	01-902-8836
FRANCE, Grenoble	(076)90 22 81
FRANCE, Paris	(01)555-91-01
FRANCE, Toulouse	(06)141 11 88
GERMANY, Langenhagen/ Hannover	(0511)78-20-37
GERMANY, Munich	(089)92 481
GERMANY, Nuremberg	(0911)65761

GERMANY, Sindelfingen	(07031)83074
GERMANY, Wiesbaden	(06121)76-1921
HONG KONG, Hung Hom, Kowloon	3-63201-8 3-36211-22 3-388-388
ITALY, Bologna	(051)533-446
ITALY, Milan	(02)824-2021 824-2046
ITALY, Rome	(06)305-1421
JAPAN, Osaka	(03)831-4746
JAPAN, Tokyo	03-440-3311
KOREA, Seoul	261-7137
MEXICO, D.F.	(525)596-84-28
NETHERLANDS, Utrecht	(030)443-808
NORWAY, Oslo	(02)167-1467
SCOTLAND, East Kilbride	(03552)39 101
SINGAPORE	2945438
SOUTH AFRICA, Bramley	786-1184
SPAIN, Madrid	(01)279-0802
SWEDEN, Solna	08-82 02 95
SWITZERLAND, Geneva	(022)991 111
SWITZERLAND, Zurich	(01)730 40 74
TAIWAN, Taipei	7528944-9

## MOTOROLA SYSTEMS REPRESENTATIVES

ALABAMA, Huntsville EMA	(205)830-4030
CALIFORNIA, Inglewood Basic Systems Corporation	(213)673-4300
CALIFORNIA, San Diego Basic Systems Corporation	(714)999-6566
CALIFORNIA, Santa Clara Basic Systems Corporation	(408)727-1800
CONNECTICUT, Goshen Northern Computer Sales	(203)491-3585
GEORGIA, Atlanta EMA	(404)329-0530
ILLINOIS, Northbrook Marketch Assoc. Inc.	(312)291-0315
INDIANA, Carmel Carter, McCormick & Peirce	(317)844-4175

MASSACHUSETTS, Westwood Northern Computer Sales	(617)326-3454
MICHIGAN, Farmington Hills Carter, McCormick & Peirce	(313)477-7700
MINNESOTA, Minneapolis P. S. I. Company	(612)944-8545
MISSOURI, Independence Dy-Tronix Inc.	(816)373-6600
NEW MEXICO, Albuquerque I.M. Systems	(505)293-2440
NEW YORK, Elmont Crane & Egert Corporation	(516)872-0800
NEW YORK, Fairport Biare Data Systems, Inc.	(716)223-8765
NORTH CAROLINA, Raleigh EMA	(919)781-9369

OHIO, Cleveland Carter, McCormick & Peirce	(216)779-5100
OHIO, Dayton Carter, McCormick & Peirce	(513)836-0951
OREGON, Beaverton Thorson Co. Northwest	(503)644-5900
PENNSYLVANIA, Monroeville Carter, McCormick & Peirce	(412)372-4415
PENNSYLVANIA, King of Prussia K S I	(215)783-6440
TENNESSEE, Jonesboro EMA	(615)753-5844
WASHINGTON, Bellevue Thorson Co. Northwest	(206)455-9180
WISCONSIN, Germantown Marketch Associates	(608)628-3663



**MOTOROLA Semiconductor Products Inc.**

P.O. BOX 20912 • PHOENIX, ARIZONA 85036 • A SUBSIDIARY OF MOTOROLA INC.

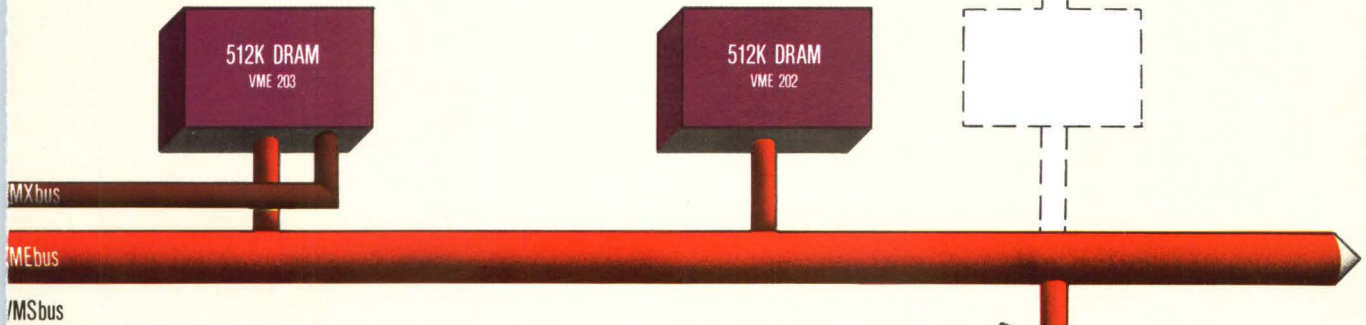

System Networking.

the VME module system, based on VMEbus,  
in the near future to the token bus.



VME/10 System for your particular applications with a broad array of over 400 VMEbus based hardware and software products available today from over 90 manufacturers worldwide. You avoid the high cost of specialized custom system designs while still tailoring the VME/10 to your individual situation.

### Two powerful operating systems

With the VME/10 microcomputer you can choose between two powerful operating system packages, both fully supported by Motorola.

For the expanding UNIX™ environment, select Motorola's SYSTEM V/68 Operating System, the first validated by AT&T through exhaustive functional testing against the original UNIX System V source code. For the system integrator, the emerging standard of UNIX means increased "application portability." UNIX System V applications are now portable from mainframe or minicomputer to the M68000 micro world... quickly, efficiently, reliably.

For real-time applications, take VERSAdos – the original M68000 Family operating system. It has all you need to control multiple real-time application tasks, even in a multiuser environment.

### Total VME/10 support: A Motorola pledge

The VME/10 System is supported by Motorola's professional field service network, with facilities in over 125 cities nationwide offering technical assistance, parts, repair services, regular software updates, and a problem-reporting hotline. Our comprehensive user documentation and technical training seminars are complete and available.

Quality, standards, performance and support. Important reasons why you should make Motorola your OEM Systems vendor.

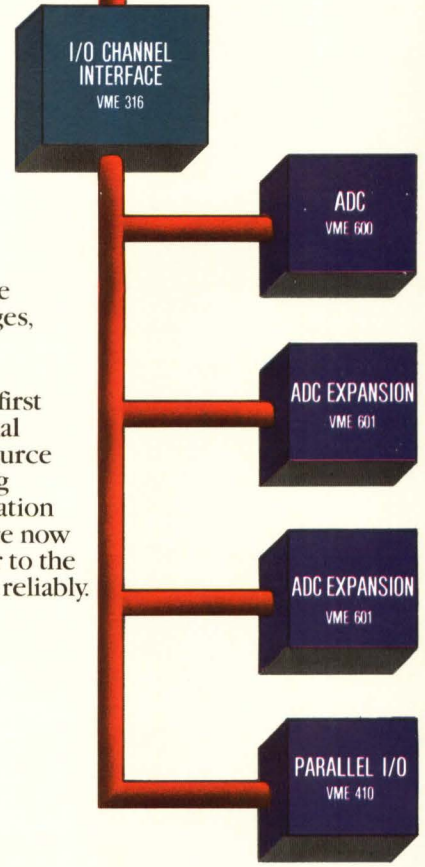

## **Broad based support: A league of interdependent vendors.**

Continuing support by Motorola, Mostek and Signetics/Philips insures that VMEbus and its supporting bus structures VMXbus, VMSbus and Motorola's I/O Channel undergo further refinements in response to market needs.

### **VMEbus compatible manufacturers\***

AEG-TELEFUNKEN CORP.  
AMP INC.  
AMPHENOL NORTH AMERICA  
ASTRAEA COMPUTER CORP.  
AUGAT INTERCONNECTION SYSTEMS GROUP  
BFE FERNMELDE + ELEKTRONIK KG  
BICC-VERO ELECTRONICS INC.  
BURR BROWN  
DATARAM CORP.  
ELTEC ELECTRONIC GmbH  
FORCE COMPUTERS INC.  
HEMENWAY CORPORATION  
HUNTER & READY INC.  
MOSTEK-UNITED TECHNOLOGIES  
MOTOROLA INC.  
PANDUIT CORP.  
PHILIPS  
SIGNETICS CORP.  
VECTOR ELECTRONIC COMPANY  
XYCOM INC.

\*This is a partial list of over 90 manufacturers. For a complete list check the VMEbus Compatible Products Directory box on the response card.

## **MC68000: quality right from the start.**

Motorola's full line of VME integration starts with the MC68000 Microprocessor. From this preferred building block for systems design come VME processor and support modules, VME module chassis plus the all-in-one VME/10, the emerging leader in user configurable OEM microcomputers.

The MC68000 is preferred for multi-processing applications where performance and reliability are required. Its asynchronous interface to the system solves bus arbitration problems in large configurations and its powerful instruction set allows automatic execution of repeated program sequences for reducing high level development efforts.

The M68000 Family includes the economical MC68008 with its 8-bit bus, the MC68010 with virtual memory capabilities and, the latest addition, 32-bit MC68020 with co-processing and cache memory.

Direct object code compatibility up the M68000 line allows utilization of previously developed code. This allows the use of modular software designs that minimize development costs.

The cutting edge of technology is a double edged sword. If some outdated elements of an integrated system are replaced, adjustments ripple through the system, translating into cost and lost benefits of being "state-of-the-art." With Motorola's M68000 Family you won't be backed into a corner by a design that can't be upgraded.

VMEsystem Architecture is the only standard allowing full utilization of the impressive power of the M68000 Family.

VERSAdos, VME/10, VMEmodules, and SYSTEM V/68 are trademarks of Motorola, Inc.

EXORmacs is a registered trademark of Motorola, Inc.

UNIX is a trademark of AT&T Bell Laboratories.

SASI is a trademark of Shugart Associates.

Ethernet is a trademark of Xerox Corp.

MULTIBUS, iPSB, iSSB, iLBX, MULTICHANNEL are trademarks of Intel Corp.

Motorola reserves the right to make changes without further notice to any products herein to improve reliability, function or design. Motorola does not assume any liability arising out of the application or use of any product or circuit described herein; neither does it convey any license under its patent rights nor the rights of others. The software described herein will be provided on an "as is" basis and without warranty. Motorola accepts no liability for incidental or consequential damages arising from use of the software. This disclaimer of warranty extends to Motorola's licensee, to licensee's transferees and to licensee's customers or users and is in lieu of all warranties whether expressed, implied or statutory, including implied warranties of merchantability or fitness for a particular purpose. Motorola and Ⓜ are registered trademarks of Motorola, Inc. Motorola, Inc. is an Equal Employment Opportunity/Affirmative Action Employer.

# Mini-Micro World

INTERNATIONAL

## European PC users demand high-quality, on-site maintenance

Keith Jones, European Editor

European companies using multiple personal computers will not accept depot maintenance only; they also want the kind of same-day, on-site arrangements enjoyed by large computer users, according to a new survey published by Lyons Associates, Reading, England. Coincidentally, IBM Corp. recently changed its personal computer service policy in Europe to allow its engineers to provide customers with on-site maintenance as an alternative to depot service.

Lyons surveyed about 500 users in Britain, France and West Germany, most of whom are employed in companies with annual revenues of more than \$1 million. Nearly half of those questioned said they planned

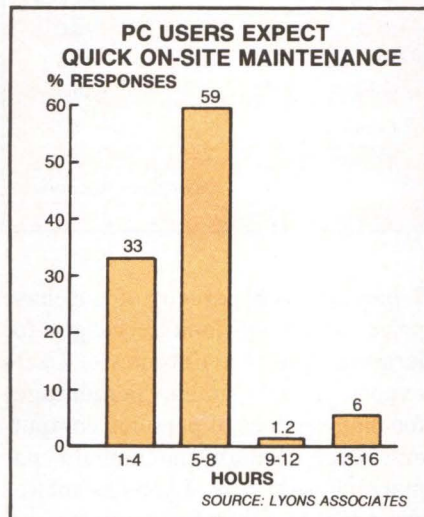

to buy 10 or more personal computers over the next two years.

The survey also indicates that personal computer users often dislike dealer maintenance. Lyons

principal David Lyons understands this attitude. He says many dealers have only one service engineer, so the user may end up without maintenance if that engineer becomes ill or quits. He notes that the quality of dealers' service engineers can vary considerably, even when the manufacturer provides training. Another danger users see in dealer maintenance is that many dealers have the right to cancel their agreements with manufacturers within three months of signing.

Third-party maintenance can solve the service problems of personal computer manufacturers lacking large, established field engineering staffs. However, research company Input Ltd., London, sees a shortage of third-party maintenance companies in Europe, except

### Bell and Howell seeks partners for maintenance deals

Bell and Howell Service Co., Ashford, England, is seeking European, Japanese and U.S. computer manufacturers needing third-party maintenance in West Germany, Britain, France and the Benelux countries (Belgium, the Netherlands and Luxembourg). One of the first independent companies to serve most of Western Europe, Bell and Howell offers nearly 300 service engineers.

"A big attraction of Bell and Howell is that it does not compete in the computer business," declares Richard Bernholt, marketing and sales manager of the new company. Bernholt points to the considerable experience of Bell and Howell engineers in maintaining the computers incorporated in its micrographics and document-handling systems. The machines serviced include Digital Equipment Corp. and Data General Corp. minicomputers.

General service manager Mike

Brereton says the activities of Bell and Howell Service will largely parallel those of a similar enterprise set up last year in the United States. He says equipment the company maintains there includes personal computers from Eagle Computer Inc., Los Gatos, Calif., and Columbia Data Products Inc., Columbia, Md. Brereton explains that Bell and Howell is looking for products sold to commercial users, such as computer system manufacturers.

He stresses that Bell and Howell is seeking long-term agreements in accordance with its intended commitment level. It will appoint an account manager to handle relations with each client manufacturer and with the manufacturer's distributors. The manufacturer must train Bell and Howell's instructors and supply spare parts at agreed-upon prices.

Before the company can strike a deal with a manufacturer, both sides

must agree on the rates Bell and Howell will charge. Rates will vary, depending on type of equipment and Bell and Howell's estimate of maintenance requirements. Each country will have a separate price list, although Brereton expects charges to be roughly equal in all countries.

Bernholt assumes that most users will want on-site maintenance, and the company plans to provide resident engineers if required.

Bernholt notes that the Bell and Howell service will cover all types of minicomputer and microcomputer systems and peripherals, except for repairing head/disk assemblies of Winchester disk drives. The repair of these assemblies requires the clean-room facilities offered on a pan-European basis by specialist companies such as Memory Maintenance Ltd., Swindon, England, and Kode Services Ltd., Calne, England (MMS, October 1983, Page 126).

# Mini-Micro World

INTERNATIONAL

for Britain. Input estimates that 70 percent of the 150 third-party organizations in Europe are based in Britain.

Compounding manufacturers' problems is the lack of pan-European third-party maintenance service similar to that covering the United States. One of the few maintenance groups operating in more than one country is Euroserve, an association of five third-party companies covering Northern Europe. They offer their services jointly to large multinational users and thus compete with the maintenance organizations of large vendors such as IBM Corp. A spokesman for Euroserve's British member, Computer Field Maintenance Ltd., Hitchin, England, notes that Euroserve is also interested in maintenance deals with manufacturers needing service for customers in Britain, West Germany and Scandinavia.

Andy Thomas, principal consultant of Input, notes that a number of large U.S.-based companies have expressed an interest in European third-party maintenance business opportunities. One company has already taken the plunge: the European service organization of Bell and Howell Corp., Chicago.

## Distributors also offer service

Another possible maintenance solution Lyons identifies is the distributor-owned organization. One example is Geveke Electronics B.V., Amsterdam, the Netherlands, which operates a service division in the Benelux countries of Belgium, the Netherlands, and Luxembourg. Eagle Computer Inc., Los Gatos, Calif., has appointed Geveke to sell and maintain Eagle's IBM PC-compatible microcomputers.

The Lyons survey identifies a price dilemma affecting all personal computer vendors in Europe. Lyons says the vendors are trapped by the

## MEAN TIME BETWEEN FAILURE EXPECTED FOR SYSTEM COMPONENTS

Component	MTBF (months)
CPU	16.6
Hard disk	13.5
Software	10.0
Floppy disk	8.7
Printer	6.3

Source: Lyons Associates

7 percent to 8 percent of purchase price rates traditionally charged for large computer maintenance. Users expect to pay similar percentages for maintenance of personal computers, even though the amount per machine is far less. Lyons estimates the average cost of one on-site service call to be \$200, about equal to the charge of maintaining a low-

priced personal computer, so a maintenance vendor could lose money if its engineer has to repair the same machine more than once a year.

The 20 personal computer vendors Lyons surveyed charge on-site personal computer maintenance fees of 7 percent to 15 percent—more than the charge for depot maintenance.

A spokesman for IBM's European Personal Computer marketing center in Feltham, England, notes that IBM's service charges vary from country to country, but he reveals that the new on-site service will be priced 50 percent more than the existing carry-in depot service. Each country will decide whether to offer on-site service; it is available in the Netherlands and is in its final implementation in other countries, he says. □

## DG ANNOUNCES RELATIONAL DBMS

Data General Corp. recently announced the DG/SQL relational database-management system (DBMS) targeted for technical applications on Eclipse MV series minicomputers that run the AOS/VS operating system. The DBMS is based on the SEQUEL data sub-language and stores data in a collection of tables. DG/SQL features system-wide referential integrity. That prevents mistakes such as deleting a customer record when order records exist for that customer. The system has COBOL, FORTRAN 77 and PL/1 interfaces. Initial licenses are \$20,000. Subsequent licenses are \$15,000.

## AT&T FORMS ISV PROGRAM

AT&T has started an independent software vendor (ISV) support program to encourage vendors to write applications for the company's UNIX System V and 3B computer line. The company will offer both discounts and training to qualified ISVs and will publish selected packages.

## PRINTRONIX SUES MANNESMANN TALLY

Printronix Inc., Irvine, Calif., has filed a lawsuit in the U.S. District Court for the Central District of California, against Mannesmann Tally Corp., New York. The suit alleges patent infringement by Mannesmann Tally in the design, manufacture and sale of the MT630, MT660 and MT690 dot-matrix line printers. Printronix is seeking damages and an injunction against further infringement.



**FINALLY,  
A CORPORATE NAME CHANGE  
MADE FOR THE  
BEST POSSIBLE REASON.**

# WE DIDN'T LIKE THE OLD ONE.

## DATA SYSTEMS DESIGN

January 1, 1984

Does it make sense for us to think about changing our company name? Your comments please.

Route to: list

*RPD*

*WE DON'T JUST DESIGN, DO WE?*

*FUD FACTOR  
WILL OUR  
KNOW WEY  
IN THE D  
BUSINESS*

*How 'bout "DecStorage" or  
"International MULTIBUS Storage  
State-of-The-Art Corporation"?*

*Are we really getting  
into the "systems" biz?*

*Bert*

*How many co's named  
"Data Systems"? Must be 50!*

*Milt*

*FSMOT*

*Don*

*New name  
say: hi  
oriented,  
responsi  
competit  
market*

*Shouldn't  
say "S  
can*

Leadership certainly has its advantages. As well as its problems.

Consider a corporate name change. Problem is, most people expect a long-winded rationale. Full of "new commitment" and "new dedication" and other such profundities. Boring stuff to be sure.

But one of the rewards of leadership is that you don't have to create excuses. If your heart is true. And your products are outstanding.

So good-bye Data Systems Design. Hello Qualogy.

We didn't really like the old name. And we've become quite attached to the new one.

Qualogy represents where we've been. And where we're going. It stands for the quality OEMs have banked on for over nine years. Quality that's sold through to customers. And supported for the life of a system.

It also represents technology. Practical. User-oriented. And reliable.

The Qualogy name will appear on the industry's foremost line of DEC®-compatible mass storage devices. Products that are currently shipping. And others that are being developed to meet market demands.

The name will also appear on our complete family of MULTIBUS® products. Our current line. With innovations to help you compete. And win.

Look for some surprises on the way, too. Products that will fit very nicely into your future profit picture. Products that are being readied for introduction in the very, very near future.

If you'd like to know more about our products and services, call the sales office nearest you.

The phone numbers haven't changed.

## QUALOGY

Eastern Regional Sales: Norwood, MA (617) 769-7620. South Central Regional Sales: Dallas, TX (214) 980-4884.  
North Central Regional Sales: Chicago, IL (312) 920-0444. Western Regional Sales: Santa Clara, CA (408) 727-3163.  
Distributors Worldwide. Corporate Headquarters: 2241 Lundy Avenue, San Jose, CA 95131

®DEC is a registered trademark of Digital Equipment Corp. MULTIBUS is a registered trademark of Intel Corp.  
PSMOT means Please See Me On This. © 1984, Qualogy.

CIRCLE NO. 47 ON INQUIRY CARD

should  
ch. growth-  
d. solver,  
high quality,  
reliable,  
ader. SBV's,  
will oriented,  
real; world-  
vide. Can one  
get all that

STOMERS  
SPYING  
AND

SYSTEMS  
we  
for

## Olivetti acts as AT&T's counterpart to push AT&T micros in Europe

Keith Jones, European Editor

Olivetti & Co. SpA, Ivrea, Italy, is paralleling AT&T Technologies Inc. by moving AT&T's recently introduced 3B microcomputers into Europe (MMS, June, Page 34). Olivetti is seeking OEM customers and value-added resellers as the main sales channels for the 32-bit 3B computers built by AT&T Technologies' Lisle, Ill., computer division. AT&T Co. acquired 25 percent of Olivetti late last year; the 3B computers are among the first AT&T products Olivetti has made available in Europe.

The 3B machines run under the UNIX System V operating system, the version of UNIX that AT&T Technologies is promoting as a standard. AT&T formed AT&T Technologies last year to take over most of AT&T's manufacturing activities. AT&T's group also includes Bell Laboratories, which developed UNIX in the late 1960s.

### Olivetti micros use 32-bit chip

The three machines Olivetti offers center on AT&T's 32-bit WE32000 microprocessor. The two larger models sold as the Olivetti-AT&T 3B5 line compete with the VAX superminicomputer family from Digital Equipment Corp., says Giovanni Gurrieri, director of sales and marketing support for minicomputers and microcomputers at Olivetti's international marketing headquarters in Milan, Italy.

The 3B5 machines are both floor-standing units. The 3B5/100 is configured around the 7.2-MHz version of the WE32000, and the more powerful 3B5/200 employs the 10-MHz WE32000 chip. The third machine is



Olivetti-AT&T's 3B2 32-bit microcomputer attracted crowds to Olivetti's booth at the recent Hannover Trade Fair in West Germany.

the 3B2, a desktop computer that is the size of a personal computer. It incorporates the 7.2-MHz WE-32000. All the models should be available in high volumes by September, says Gurrieri.

Gurrieri underlines Olivetti's strategy of selling the machines only to customers who can add value: "Olivetti will provide just the hardware and UNIX System V. We are leaving our customers to add the rest of the hardware and software, including languages and database-management systems." Customers can add their own workstations or use the terminals offered by Olivetti, such as the AT&T graphics terminals and the DEC VT100-compatible WS584.

Gurrieri notes that Olivetti is preparing a local currency price list for each European country and that the translation of prices for each country is Olivetti's problem. How-

ever, to give a rough idea of prices, he quotes \$15,000 as the single-unit price of an entry-level 3B2 with 0.5M bytes of main memory, a 1M-byte integral floppy disk drive, an integral 10M-byte Winchester disk drive and two asynchronous communication ports. The single-unit price for an entry-level 3B5 is \$67,000, including 1M byte of main memory, an 8K-byte cache memory, eight asynchronous ports and a 48M-byte hard disk drive.

Gurrieri says Olivetti plans to manufacture the 3B machines when volumes are high enough and that Olivetti will maintain end users' hardware when required.

UNIX specialist Sphinx Ltd., Maidenhead, England, is one European software house readying packages for the 3B machines. Sphinx's software catalog should be available by September, says Sphinx managing director Dr. Pamela Geisler. It will include database-management, spreadsheet, word-processing and accounting software. Geisler says some of Sphinx's packages, written in C or a high-level language such as COBOL, run under System V on other manufacturers' machines.

Olivetti owns a minority share in Sphinx, but Geisler stresses that the link between the two companies did not inspire Sphinx to become interested in the 3B. "The AT&T machines were always a prime target for us," Geisler declares.

AT&T Technologies and Digital Research Inc., Pacific Grove, Calif., are jointly preparing the UNIX System V Certified Library of Programs (MMS, March, Page 33). The library will support programs for the WE32000, says a spokeswoman for AT&T Technologies, as well as

# HOW TO CONTROL THE RISE AND FALL OF POWER.

Your small business computer can give you the power to raise your productivity. But first you have to control the power you give it. Because even the slightest dip or surge of electricity can result in a shocking surprise. An instant loss of important data or misinformation. Even worse, a total power line failure can create department devastation... a total system crash. You can't afford errors, delays and other problems. After all, you've invested in a computer to increase efficiency. But now there's a solution you can afford. The Sola SPS. This economical, UL listed Standby Power System is designed to protect personal, micro and mini computers from AC line disturb-

ances and failures. Sola SPS provides clean, regulated AC power to your computer when your power line experiences irregular voltage. Line dips or line surges are immediately converted to proper voltage. When the AC line is present, the SPS filters power to eliminate electrical noise. And when the AC line fails, the SPS goes into full action, providing precise AC power to the load from its internal battery. So the only noise you'll hear is the sound of performance. There's no maintenance. No installation. No kidding. Just plug it in and turn it on. Why let your productivity rise and fall with your power? The solution is as simple as SPS. The standby system that Sola stands behind.



CIRCLE NO. 48 ON INQUIRY CARD

Write for free literature. 1717 Busse Hwy., Elk Grove Village, IL 60007 (312) 439-2800

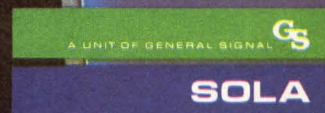



## ABLE's ATTACH customers enjoy their spaghetti in the dining room, not the computer room.

**ABLE's ATTACH**, the breakthrough multi-host terminal switching system for DEC UNIBUS computers that eliminates the spaghetti-like mess of cables in your computer room.

One ATTACH host board and a *single* cable replaces 16 DEC interfaces, and their associated "spaghetti." And it still supports up to 128 terminals on your system without the endless tangle of cables that tie-up your computer room.

One ATTACH host board does the work of many multiplexers. The immediate advantage is a dramatic reduction in mounting space and expansion cabinetry, resulting in significant cost savings. And ATTACH can be located up to a kilometer away from your computer room.

Cook up a system to meet your present data communication requirements with ATTACH. At the touch of a keyboard, terminals can be dynamically *switched* among any combination of VAX and PDP-11 UNIBUS systems. And,

ATTACH is compatible with RSX, RSTS/E, VMS and UNIX operating systems.

Expanding your capabilities, or adding terminals is easy with ATTACH. As your requirements grow, simply add modular ATTACH units to your system.

Whether you have 28, or 128 or more terminals, ATTACH has the right recipe for cost-effective connectivity. ABLE Computer's ATTACH is the most efficient terminal interconnection system on the table.

Contact the ABLE representative near you, or call ABLE toll-free at 800-332-2253.



The communication specialists

1732 Reynolds Avenue, Irvine, California 92714. In the Irvine area: (714) 979-7030. Or, TWX: 910-595-1729.

DEC, PDP, RSTS, RSX, UNIBUS, VAX and VMS are trademarks of Digital Equipment Corporation. UNIX is a trademark of Bell Laboratories. ATTACH is patent pending.

CIRCLE NO. 49 ON INQUIRY CARD

# Mini-Micro World

## INTERNATIONAL

for the MC68000 processor family from Motorola Inc. and the 80286 chip set from Intel Corp.

Paul Bailey, vice president of Digital Research European Operations, Newbury, England, says machines configured around the MC68000 and 80286 will be the most popular hosts for UNIX System V. "All of the major European computer companies are working with the MC68000, and there will be a significant num-

ber of 80286 machines by the end of 1984," he claims.

Bailey says the library will include packages from both European and U.S. software houses. A Digital Research team in Palo Alto, Calif., which is compiling the library, is evaluating the packages. Bailey hopes the first European titles will be available by the beginning of 1985; the first 30 U.S. packages are expected by the end of 1984. Digital

Research will offer the programs on 8-inch floppy disks, but, Bailey notes, value-added resellers can change the disk format.

Logica UK Ltd., London, which distributes Microsoft Corp.'s UNIX-based operating system, XENIX, in Europe, does not plan to port XENIX to the WE32000, according to Hector Hart, commercial manager of the software products group of Logica. □

## OVERHEARD OVERSEAS

### Honeywell takes a bold step toward helping start-ups

**Tim Palmer, European Contributor**

U.S. and European companies wishing to break into foreign markets, but afraid of the high investment, have a new vehicle to consider. Honeywell Inc. is opening its entire marketing operation, including premises, people, distribution facilities and stores, to third-party products.

Major U.S. manufacturers, led by NCR Corp., Xerox Corp. and Control Data Corp. (CDC), already offer their maintenance networks and personnel to a host of small new businesses with limited resources. But the Honeywell venture is a bold initiative that could prove to be of great benefit to system integrators.

Last September, Honeywell announced plans to establish Honeywell High-Tech Trading Inc. Although the company was officially born on Jan. 1 and is now 250 people strong, little has been heard of it. Its first two contracts in Europe were negotiated quietly.

High-Tech is looking for appropriate products from small- and medium-sized U.S., European and Japanese companies and is offering to market, distribute and—importantly—service the products worldwide. The full range of services offered by the new company start with product

evaluation. High-Tech president and general manager Bjorn Bjornstad reckons that even aggressive Japanese traders who are clamoring for new electronic products to distribute do not have the same ability to assess a product's potential that Honeywell does.

Evaluation will be followed by market research, arrangement of export financing and worldwide distribution and service. If the client wants its products manufactured abroad, Honeywell is prepared to offer space in its own plants if it has one in the right location with the capability. High-Tech will also repackage European products for the U.S. market.

But High-Tech does not have a hard-and-fast rule about the services offered to a company; each case will be handled separately. Honeywell will arrange, rather than provide, financing; unlike CDC and Xerox, Honeywell does not have a strong financial-services arm. Agreements will vary. In some cases, Honeywell will share the risk of product failure; in other cases, it will guarantee a certain revenue over a given number of years.

Ideally, High-Tech's products should complement Honeywell's own. High-Tech has outlets in 50 countries but plans to sell Honeywell products

to markets in which they are not already sold. And, since it is ready to sell competitive products such as those from Future Technology, it seems that "complementary" will be loosely interpreted.

The European offices of High-Tech in Brussels, Belgium; Milan, Italy; Athens, Greece; and Vienna, Austria, are two-way operations; they take in new European products for marketing within the rest of the network, and they sell products from the rest of the world. The U.S. offices are in New York and San Francisco. There are also offices in Singapore and Tokyo.

People who know only the computer side of Honeywell's business may be surprised at the Continental cities chosen for High-Tech's operation, since they appear to compete with operations of Groupe Bull of France. (Groupe Bull represents Honeywell Information Systems Inc.'s computer operations throughout the Continent, except Italy.) But, since High-Tech is not part of Honeywell Information Systems, Honeywell has opened a back door into all the markets currently within Bull's province. This makes the move by Honeywell not only bold but also beneficial to third parties needing access to foreign markets. □

Start/Stop And Stream.

INTRODUCING

# DOUBLE DRIVE™



Series 50 Drive. High Performance. High Capacity.



If you've been pondering whether you need a streaming tape drive to back up your Winchester, or a start/stop tape drive, or maybe both, we have good news. You no longer have to decide.

Because now there's a drive with the capabilities of both. Rosscomp's Double Drive.

It saves you the agony of decision. And an incredible amount of money at the same time.

### There Are Two Sides To Our Story

When our engineers set out to design the Double Drive, they too had a decision to make. Quarter-inch tape? Or half-inch tape? But then they found that, even by pushing quarter-inch technology to its absolute limit, they wouldn't be able to give us the capabilities we wanted.

So half-inch became the only choice. That also meant they could assure us of something else we demanded. Reliability. For instance, they could design-in the industry's highest quality read/write half-inch heads. Meanwhile, they could make the system stream at unbeatable speeds.

And do practically everything a large start/stop machine can do for a fraction of the cost.

#### Side One

One of the fruits of their labors is, you get a Winchester backup that does something no other can. It scoops 190 MBytes of data onto standard half-inch tape that's housed on our Back-Pac™ four inch self-threading reel. (Which costs less than a cartridge.)



The Back-Pac™ self-threading reel stores 190 MB on 1/2" tape. Costs less than 1/4" cartridges.

That translates into the lowest cost per byte of any tape drive, anywhere.

And it streams at a blazing 90 ips standard.

In fact, the Double Drive's electronic speed and capacity are matched by only one thing we know of. Its mechanical reliability. The simplest and most

dependable tape-handling method yet devised.

Threading is automatic. The tape travels a path of proven design, kept on course by both spring-loaded and ball-bearing guides.



Spring loaded and ball bearing tape guides.

Tension control is equally precise. A single capstan motor drives both supply and takeup reels with one belt, while



Simple, dependable automatic tape threading.

an advanced controlling device main-

tains identical tension between them.

So you experience very little ISV.

As well as lower power dissipation. The motor uses less than 15W.



Single capstan motor.

#### Side Two

For your selective file-search and backup jobs, the Double Drive acts as a start/stop unit. Because it has 64 KBytes of cache memory right in its interface.

That means no time loss. An optimized I/O. And apparent real-time operation for every user.

Plus more efficient use of your tape, covering a full 95% of it.

Online, it gives ample secondary storage for files during

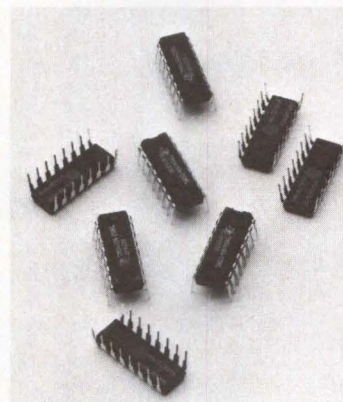

64 KB cache memory in its interface makes it look like a start/stop drive.

restructuring and in hierarchical memory management schemes.

Now, if the Double Drive sounds like it might be just what you need, here's more good news. It will fit your system.

Series 80 to right. Series 50 below.



Or rather, one of our Double Drives will. Our Series 80 fits an 8" envelope, our Series 50 a 5 1/4" envelope.

They'll each hold 190 MBytes of data, stored on 24 serpentine tracks.

Both are available with standard industry interfaces. So one of them is right for you.

Which means there's no painful decision to make. Just put the Double Drive to work. Doing double duty.

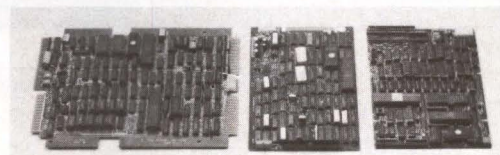

Available formatters include QIC-02, SCSI and 9-track.

16643 Valley View Avenue, Cerritos, California 90701. Phone (213) 926-5533

# ROSSCOMP

The way with tape.

# The TeleVideo PC

## The best hardware for



TeleVideo versus IBM. Make a few simple comparisons and you'll find there is no comparison.

### **RUNS IBM SOFTWARE.**

With the TeleVideo® IBM Compatible line—PC, XT and portable computers—you'll get the most out of all the most popular software written for the IBM® PC—more than 3,000 programs.

Because every TeleVideo Personal Computer offers the highest level of IBM compatibility on the market and

### **THE BEST HARDWARE FOR THE BEST PRICE.**

Features	Tele-PC	IBM PC	Tele-XT	IBM XT
Monitor	YES	OPTIONAL	YES	OPTIONAL
Screen Size	14"	12"	14"	12"
Tilt Screen	YES	NO	YES	NO
Quiet Operation	YES (NO FAN)	NO	YES	NO
Memory	128K	128K OPTION	256K	256K OPTION
Graphics Display (640 x 200 resolution)	YES	OPTIONAL	YES	OPTIONAL
Printer Port	YES	OPTIONAL	YES	OPTIONAL
Communications Port	YES	OPTIONAL	YES	YES
MS™DOS/BASIC®	YES	OPTIONAL	YES	OPTIONAL
System Expansion Slot	YES	YES	YES	YES
RGB and Video Port	YES	OPTIONAL	YES	OPTIONAL

# compatibles. the best software.

has the standard — not optional — features your people need to take full advantage of every job their software can do.

Study the chart at the left. It proves that TeleVideo — not IBM — offers the best hardware for the best price.

Note that TeleVideo's ergonomic superiority extends from fully sculpted keys and a comfortable palm rest to a 14-inch, no glare screen that tilts at a touch.

## THE BEST MICROCHIPS.

What is perhaps most impressive about the TeleVideo IBM PC Compatible can be found deep within its circuitry. We use the same 8088 central processing unit that runs an IBM PC. But we also employ new VLSI (Very Large Scale Integration) microchips that are designed and built exclusively for TeleVideo. These interface more efficiently with the powerful 8088 and yield numerous benefits.



For example, our tiny custom chips do the work of many of the larger, more expensive circuit boards in an IBM PC. So we can offer a computer system that comes in one attractive, integrated case, is ready to run and occupies less desk space. A computer that edges out IBM's added-cost component system for reliability, ease of service and purchase simplicity.

Fewer circuit boards to cool also allowed us to eliminate the noisy, irritating fan IBM and most other PCs force you to put up with. And TeleVideo compatibles accept any



## THE BEST PORTABLE FOR THE BEST PRICE.

Features	TPC II-S	IBM PC
High Capacity Storage	YES	YES
Quiet Operation	YES (NO FAN)	NO
Display	YELLOW	AMBER
Memory	256K	256K
Graphics	YES	YES
Communications Port	YES	OPTIONAL
Printer Port	YES	OPTIONAL
MS™ DOS 2.11	YES	OPTIONAL

IBM hardware options without modification.

## THE BEST LINE.

But the Tele-PC is only one element of the TeleVideo IBM PC Compatible line.

The TeleVideo XT is the best hardware for users of popular IBM XT software who would appreciate an extra 10 megabytes of storage capacity along with the advantages listed on the preceding chart.

As the chart above demonstrates, our portable IBM compatible computer, the TPC II, is far and away better hardware than IBM. Better hardware — standard — at a better price.

## THE BEST MANUFACTURER.

The TeleVideo IBM PC Compatible line is made by the world leader in multi-user computer systems and the number one independent manufacturer of terminals.

So not only can you count on the service and support of an established industry leader, you can get it all — desktop, hard disk desktop and portable computers — from one single vendor.

Contact the TeleVideo office nearest you. You'll find that TeleVideo — not IBM — has the best hardware for the best software. At the best price.

For more information, call 800-538-8725 (in California, 800-345-8008).

IBM is a registered trademark of International Business Machines. MS is a trademark of MicroSoft Corporation. CW Basic is a registered trademark of MicroSoft Corporation.

**TeleVideo®**  
Personal Computers  
● TeleVideo Systems, Inc.

CIRCLE NO. 51 ON INQUIRY CARD

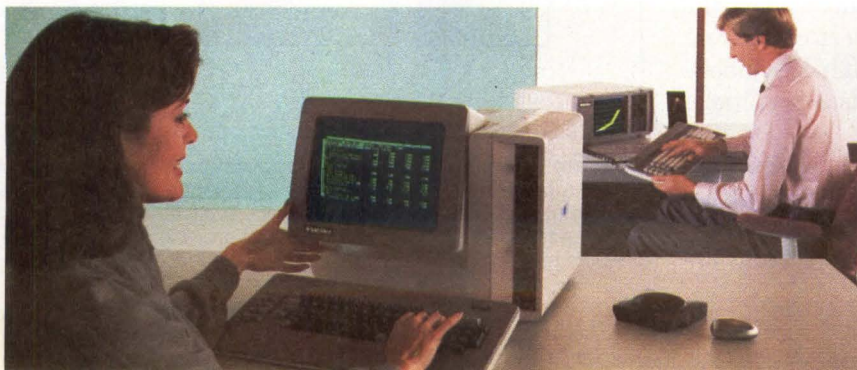

# The Interpreter

An analysis of news, issues and trends affecting the computer industry

## Software vendors zero in on marketing

*It takes more than product quality to score a hit in the crowded microcomputer software field*

**Marjorie Stenzler-Centonze, Associate Editor**

In the early days of selling microcomputer software, suppliers could count on product quality alone to produce a hit. Now, they must solve a jigsaw puzzle with pieces as diverse as customer needs, technological expertise, distribution channels, support and—to a growing extent—marketing strategy.

As the base of microcomputer users grows, the software field is blossoming. Sales of microcomputer business software should reach \$2.2 billion this year and swell to \$8.1 billion by 1989, predicts market research company Future Computing Inc., Richardson, Texas. But high-quality software is also easier to find, making competition fiercer.

"Today, having a good product is not enough," says Rod Turner, vice president of sales for Ashton-Tate, Culver City, Calif., a leading supplier of application packages. "There's no way that a product is going to be successful in 1984 without a strong marketing campaign behind it."

With even successful companies under pressure and rethinking their strategies, some look toward diversifying as a path to long-term survival. Two of the best-known suppliers of operating systems—Microsoft Corp. and Digital Research Inc. (DRI)—are making a strong push into the application software domain. Microsoft, Bellevue, Wash., is the developer of MS-DOS, and DRI, Pacific Grove, Calif., is the developer of CP/M.

DRI views system software as a narrow segment of its business but one that the company will continue to address, says Mark Duchesne, director of marketing. DRI plans to release a major addition to its operating software line this summer. The company claims the addition, Concurrent PC-DOS, will support concurrent CP/M and PC-DOS applications, offer built-in windowing capability and run as many as four tasks simultaneously.

In an effort to diversify further, the company is making major moves into applications this year. DRI is stressing presentation graphics with its DRI Graph and DRI Draw programs. In addition, the company an-

nounced a joint venture with AT&T Co. to publish a UNIX System V application library comprising packages licensed from independent software vendors. The first 10 of 30 applications due out this year will be licensed to OEMs starting in September, Duchesne says.

Similarly, Microsoft plans to make significant strides in applications this year while maintaining its strength in system software. Supplying system software is a high-risk, high-return business in which companies have either a large share of the market or almost no share, contends Steven A. Ballmer, vice president of marketing at Microsoft. "Although competition is intense in the applications side, it's still a lot easier to have, say, a 20 percent market share," Ballmer says. "In the operating-system business, it seems your market share is under 4 percent or over 90 percent." In an effort to leapfrog the competition, Ballmer says, Micro-

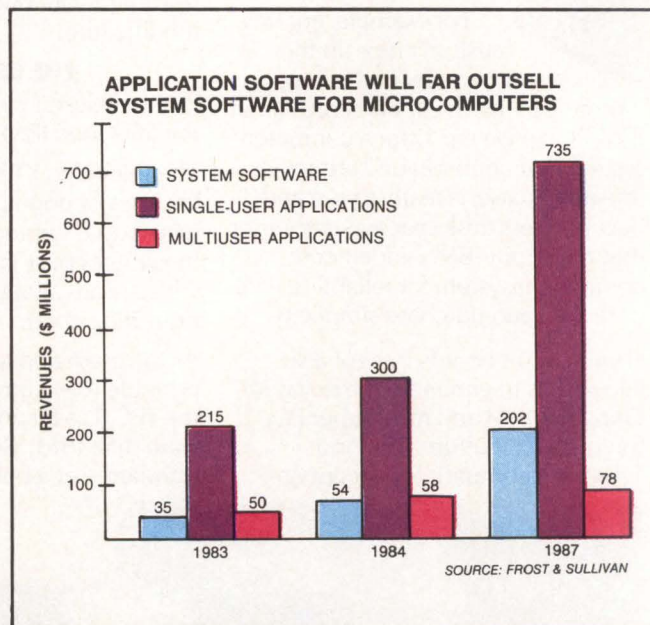

**Software vendors look toward applications for the biggest growth opportunities, even though microcomputer system software remains a viable and growing market. Application packages for single-user micros will make up the fastest-growing market segment, predicts research company Frost and Sullivan Inc.**

soft is directing significant application-development resources toward Apple Computer Inc.'s Macintosh computer. These packages will take advantage of the advanced graphics the machine incorporates in its user interface.

### Diversifying may hold dangers

The software community greets the diversification efforts of its competitors with mixed reactions. Companies throughout the industry are desperately trying to broaden their product lines, says Burt Bralliar, director of strategic marketing for Peachtree Software, Atlanta, a leading supplier of microcomputer application software. But, he warns, companies moving from system software into applications may have to watch out for new obstacles.

In moving from system software into applications, a company such as Microsoft may face a backlash from application suppliers, Bralliar explains. "Now, these [application] companies are going to have to re-evaluate their incestuous relations with Microsoft because the

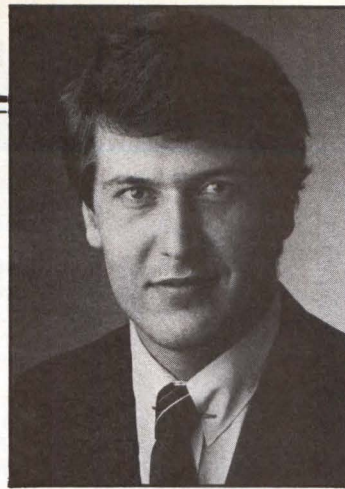

"Today, having a good product is not enough," says Rod Turner of Ashton-Tate. He speculates that a software supplier might sell 5,000 units a year without a good marketing campaign but emphasizes, "to be successful today, you have to have a much higher unit volume than that."

company is starting to produce packages that are in direct competition with their own applications," Bralliar asserts.

Ashton-Tate's Turner points to another problem. While the market may have room for a company that develops only system or utility software, such a narrow focus might limit a company's growth to the point that it becomes uncompetitive. Ashton-Tate is expanding into productivity software with its introduction of Framework, an integrated package that includes word-processing, spreadsheet, file-management and graphics functions. However, Turner cautions, over-diversifying can put a company in a precarious position. "It's unwise to

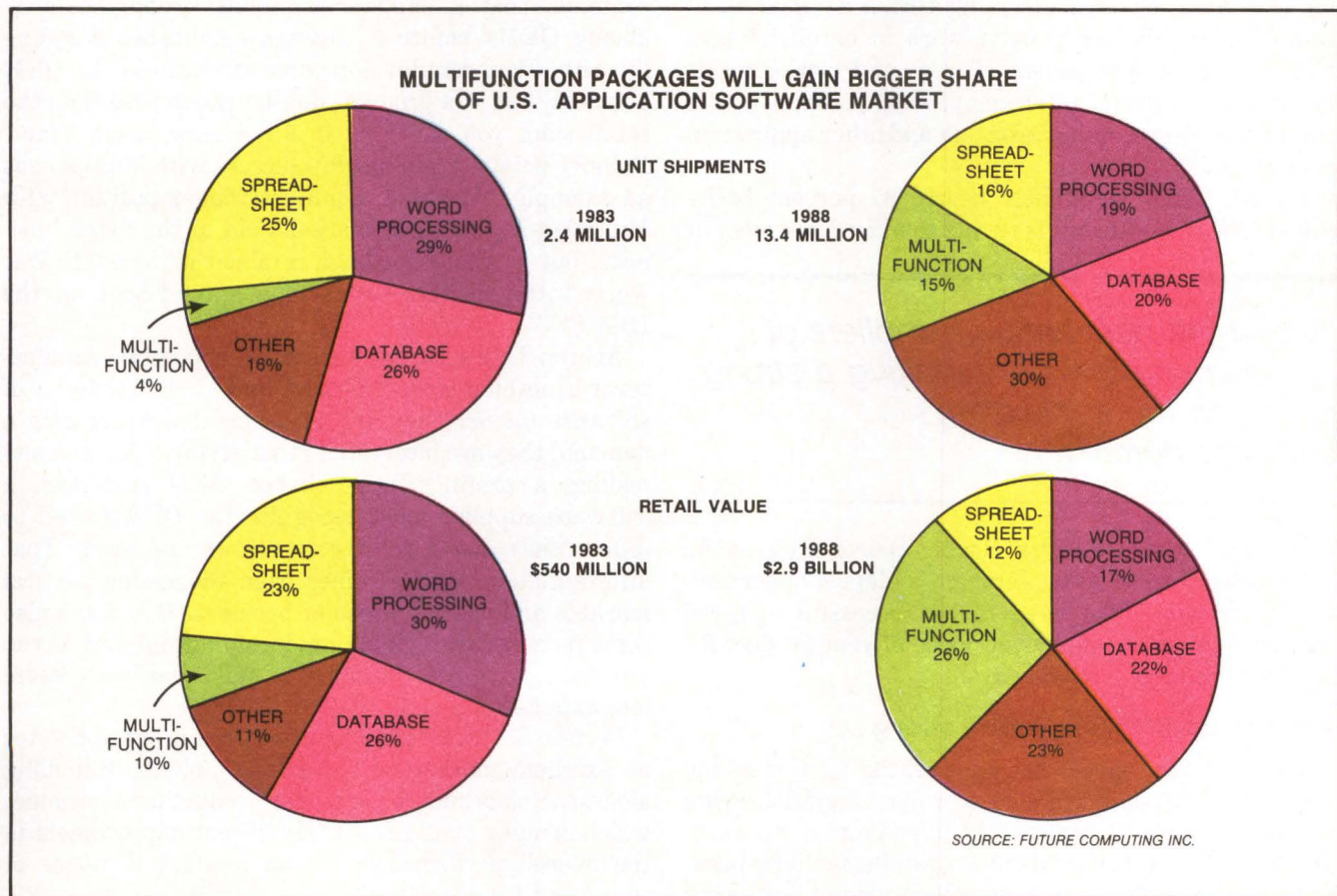

Users will turn increasingly toward multifunction software by 1988, predicts research company Future Computing. In the past,

users had to purchase separate packages to perform functions such as spreadsheet and word processing.

# The Interpreter

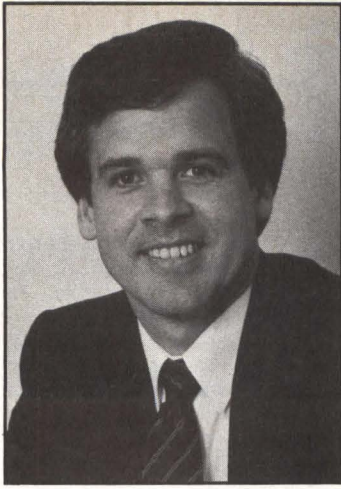

**"It's very important to make strategic alliances with companies like IBM and AT&T,"** says DRI's Mark Duchesne of marketing systems software. "Small companies like DRI and Microsoft don't create standards."

**"We need to emphasize the design of products that people want,"** stresses Microsoft's Steven Ballmer. "It's easy to spend a lot of money advertising, but it's hard to design the kinds of products that people really need."

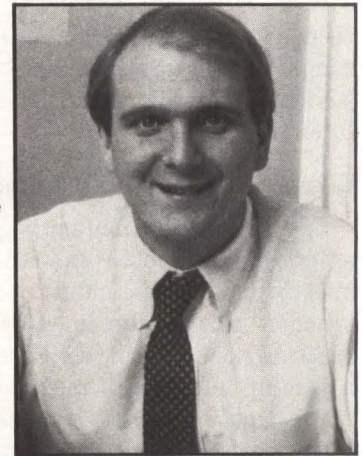

diversify too far because the main line of the company can become secondary to other less important lines," he says. "It's difficult to be a winner in everything."

With diversification, companies must re-define distribution channels and realign marketing strategy. Suppliers that once sold most of their software to OEM customers are now expanding into the retail area by adding application packages to their offerings.

Successfully selling software to OEMs, value-added resellers and retail dealers involves developing marketing tools that include support, demonstrations and advertising, vendors say. "There are different marketing considerations in addressing OEMs as opposed to retail dealers, but they must work in parallel," says Nick Roche, vice president of sales and marketing at Perfect Software, the Berkeley, Calif., supplier of a popular word-processing program and other application packages.

Perfect Software funnels nearly 85 percent of its sales through OEMs but is trying to move 50 percent of

---

***Two of the best-known suppliers of operating systems are making a strong push into the application software domain.***

---

its sales into the retail area, Roche reports. He sees the retail sales channel as his company's biggest opportunity for growth. "You have to be successful in retail marketing to give a perceived value of your product for the OEM market," Roche says.

## **Product identity must remain strong**

Most vendors agree that an essential part of selling application software is creating product identity among end users and throughout the distribution network. DRI's Duchesne maintains that even best-selling packages had to build their reputations among end users before they became popular with OEMs. "If Lotus had gone out to sell its 1-2-3 product to OEMs without first

having created an identity, there would not have been a very high demand for the product," he argues. "After it becomes a known brand, which is done through the retail channel, it becomes a highly desirable product for the OEMs."

Microsoft's Ballmer supports this view, although he contends that a supplier can make some headway among OEMs before a package establishes a strong identity. "You can develop some strength in the OEM business, but if [a product] doesn't prove [itself] on the retail side, you could be in for a very tough time." Ballmer points to Microsoft's success with Multiplan as an example. "We have a much stronger position with Multiplan in the OEM market than in the retail business, but it would not have retained its strength if it weren't the number-two selling spreadsheet on the IBM PC."

Ashton-Tate's Turner agrees: "A computer manufacturer is nothing more than a value-added distributor of software for us. They are not interested in creating a demand, they are interested in satisfying a demand and making a profit." To reach the OEM customer, a software supplier must recognize the OEM's need to differentiate itself from competitors, he says. That differentiation usually comes from addressing vertical markets and specific areas of business. But it can also come from software bundling: including software in the purchase price of a machine to make hardware seem less expensive.

Perfect Software's Roche thinks the practice creates an excellent market for software suppliers: "Bundling allows us to optimize a particular product for a machine, which in many cases enables significant improvement in the overall performance of the product in terms of speed and functionality."

Peachtree's Bralliar believes the software-bundling market will continue to grow because manufacturers



## Now Local Multiplexing is as Easy as Plugging in a Lamp

Within minutes you can put Line Miser™ multiplexers to work handling your local data traffic. Line Misers allow you to network your terminals, word processors, PC's and other data terminal equipment with minimal cabling requirements. The line savings can be tremendous! And now there are three types to choose from.

The popular Line Miser DOVs can

turn your ordinary phone system into a versatile local area network supporting simultaneous data and voice communications. Everywhere you have a telephone you can quickly and easily add a terminal.

The new Line Miser GLM 528 combines T-1 speeds with large capacity. You get 128 async channels over a 1.544 Mbps T-1 link.

And for low cost local multiplexing you can't beat the new Line Miser GLM 510. In less than 3 minutes, you can add the GLM 510 to your private wire network to handle up to 8 async channels at 9600bps.

Bright ideas in local multiplexing. Three more reasons to switch to Gandalf. Ask your local Gandalf Sales representative for details today.

### Line Misers™ make networks easier to build

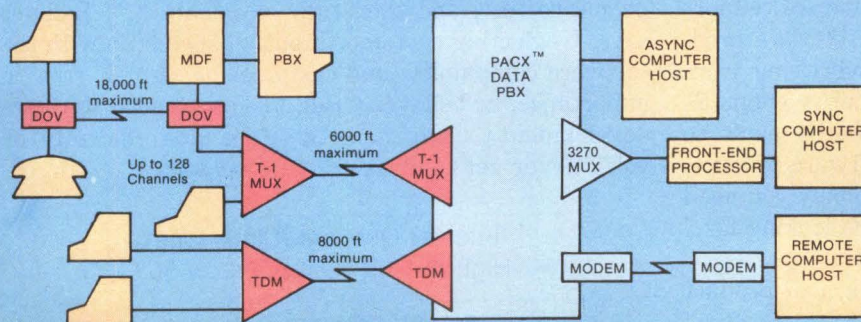

CIRCLE NO. 52 ON INQUIRY CARD

# gandalf™

Fully supported technology from concept to customer.

USA (312) 541-6060  
 Canada (613) 226-6500  
 U.K. Padgate (0925) 818484  
 Switzerland (022) 98-96-35

# The Interpreter

---

are clamoring for it. But, he reasons, as software becomes the computer industry's driving force, bundling will become less attractive to software suppliers. "Software companies are going to feel they don't have to offer the extortionate discounts to sell through this channel when they go out and sell through distributors and dealers," he explains.

Ashton-Tate's Turner views the bundling market as risky, cautioning that it could snuff out demand for a product at the retail level. "If we were to focus too heavily on hardware manufacturers for bundling, we would quench retail demand, and OEMs would no longer find our products exciting," he says.

Bundling presents risks for hardware manufacturers, too, points out Microsoft's Ballmer. Other software vendors may lose interest in supporting and selling

---

*'In the operating system business, it seems your market share is under 4 percent or over 90 percent.'*

---

software for the machines, afraid their market will be taken away. "I don't see bundling as a particularly viable long-term approach," he says. "Take Apple, for example. Early on, they said they would bundle the Macintosh with MacPaint and MacWrite [software packages], but they intend to unbundle later on because they want to get other quality word processors on their machine."

One area in which bundling may remain viable in the future is in bulk sales of standalone personal computers. Dan McGee, director of marketing for Lotus Development Corp., Cambridge, Mass., points out, "Hardware manufacturers are now getting serious about the bulk selling of microcomputers. As you see more massive purchases in the multiple-thousand-unit range, companies are trying to standardize by having everyone work on a similar package."

## Marketing becomes sophisticated

Whatever the marketing approach, software vendors agree that launching and maintaining a software product today is expensive. Expensive advertising campaigns are becoming the rule since Lotus spent \$1 million to launch its 1-2-3 program. Lotus plans to spend even more launching its latest software product, Symphony, than it did for 1-2-3. "The money you need is a function of the market share you are looking for," comments McGee.

An important part of such a campaign is product

positioning. "If people cannot understand in common terms what the product is and what benefits it delivers, they will not try the product," McGee says. Peachtree Software's Bralliar underlines the importance of positioning, especially for an intangible product such as software: "You have to define for the potential customer what the package is and what it is supposed to do. Many technically sound products have not succeeded simply because of bad marketing."

Many other software companies agree that customers don't buy what they don't know—and that it takes big money to lift a product above the noise in the market today. In many cases, companies must prepare to accept early losses and to defer profits. And the ante is constantly rising: vendors say launching an integrated productivity package today can cost \$2 million to \$5 million.

Ray Boggs, a consultant with the research company Venture Development Corp., Wellesley, Mass., sees a hefty advertising budget as essential for software success today. "It's a function of what it takes to sit at the grown-ups' table. You need to invest at the same level at which other major companies are spending," Boggs says.

But the more money it takes to market and support a product, the more smaller software companies are overshadowed by major competitors. There are concerns in the market about whether small companies with sound software offerings can succeed. Perfect Software's Roche believes there is room for new companies and that ongoing opportunities still exist: "I think the retail market is still very open. As it matures, it will be more and more competitive, but if a company does a lot of things right and has a good product, they will find their niche."

Microsoft's Ballmer expects effective marketing to give companies the ability to focus on customer needs rather than on technology alone. He emphasizes the importance of introducing a product, letting customers use it and then refining and improving it repeatedly based on customer feedback. "Designers too often have a concept in mind, and they code it up, give it to a few people to test, and then they say, 'ship it,'" Ballmer says. Neglecting customer input will catch up with the software community, and customer needs will grow in importance, he believes. "But it requires good software development tools to make these changes efficiently, or you'll never get to market," he concludes. □

---

Interest Quotient (Circle One)  
High 801 Medium 802 Low 803

---



World's largest  
local distributor  
with 48 locations  
stocking the finest  
lines of electronic  
components and  
computer products

JOIN US IN SUPPORT OF THE 1984 U.S. OLYMPIC TEAM.

# DIABLO's 630: BRINGING CLASS TO THE WORLD OF 1984.

**ALABAMA**  
Montgomery (205) 837-7210

**ARIZONA**  
Phoenix (602) 231-5100

**CALIFORNIA**  
Avnet, L.A. (213) 558-2345  
Avnet, S.F.V. (818) 700-2600  
Avnet, O.C. (714) 754-6111  
Hamilton, L.A. (213) 558-2121  
Hamilton, S.F.V. (213) 558-2323  
Hamilton, O.C. (714) 641-4100  
Sacramento (916) 925-2216  
San Diego (619) 571-7510  
San Francisco (408) 743-3355

**COLORADO**  
Denver (303) 779-9998

**CONNECTICUT**  
Danbury (203) 797-2800

**FLORIDA**  
St. Petersburg (813) 576-3930  
Miami (305) 971-2900  
Orlando (305) 628-3888  
Melbourne (305) 725-2700

**GEORGIA**  
Atlanta (404) 447-7507

**ILLINOIS**  
Champaign/Urbana (800) 625-8654  
Chicago (312) 860-7700

**INDIANA**  
Indianapolis (317) 844-9333

**KANSAS**  
Kansas City (913) 888-8900  
Wichita (800) 532-6720

**KENTUCKY**  
Louisville (800) 428-6012  
Lexington (800) 543-4783

**MARYLAND**  
Baltimore (301) 995-3500

**MASSACHUSETTS**  
Boston (617) 273-7500

**MICHIGAN**  
Detroit (313) 522-4700  
Grand Rapids (616) 243-8805

**MINNESOTA**  
Minneapolis (612) 932-0600

**MISSOURI**  
St. Louis (314) 344-1200

**NEBRASKA**  
Lincoln/Omaha (800) 255-6702

**NEW JERSEY**  
Fairfield (201) 575-3390  
Cherry Hill (609) 424-0100

**NEW MEXICO**  
Albuquerque (505) 765-1500

**NEW YORK**  
Long Island (516) 231-9800  
Syracuse (315) 437-2641  
Rochester (716) 475-9130

**NORTH CAROLINA**  
Raleigh (919) 878-0810

**OHIO**  
Cleveland (216) 831-3500  
Columbus (614) 882-7004  
Dayton (513) 433-0610

**OREGON**  
Portland (503) 635-8831

**PENNSYLVANIA**  
Philadelphia (215) 831-1300  
Pittsburgh (800) 321-6890

**SOUTH CAROLINA**  
Columbia (800) 334-1597

**TEXAS**  
Dallas (214) 659-4111  
Houston (713) 780-1771  
Austin (512) 837-8911

**UTAH**  
Salt Lake City (801) 972-2800

**WASHINGTON**  
Seattle (206) 453-5844

**WEST VIRGINIA**  
Charleston (800) 543-4783  
Huntington (800) 543-4783

**WISCONSIN**  
Milwaukee (414) 784-4510

**INTERNATIONAL EXPORT**  
Los Angeles (213) 558-2441  
New York (516) 997-6868  
Telex 66-4329

**CANADA**  
Toronto (416) 677-7432  
Montreal (514) 335-1000  
Ottawa (613) 226-1700  
Calgary (403) 230-3586  
Vancouver (604) 224-0619  
Richmond (604) 272-4242

**JAPAN**  
Tokyo (03) 662-9911

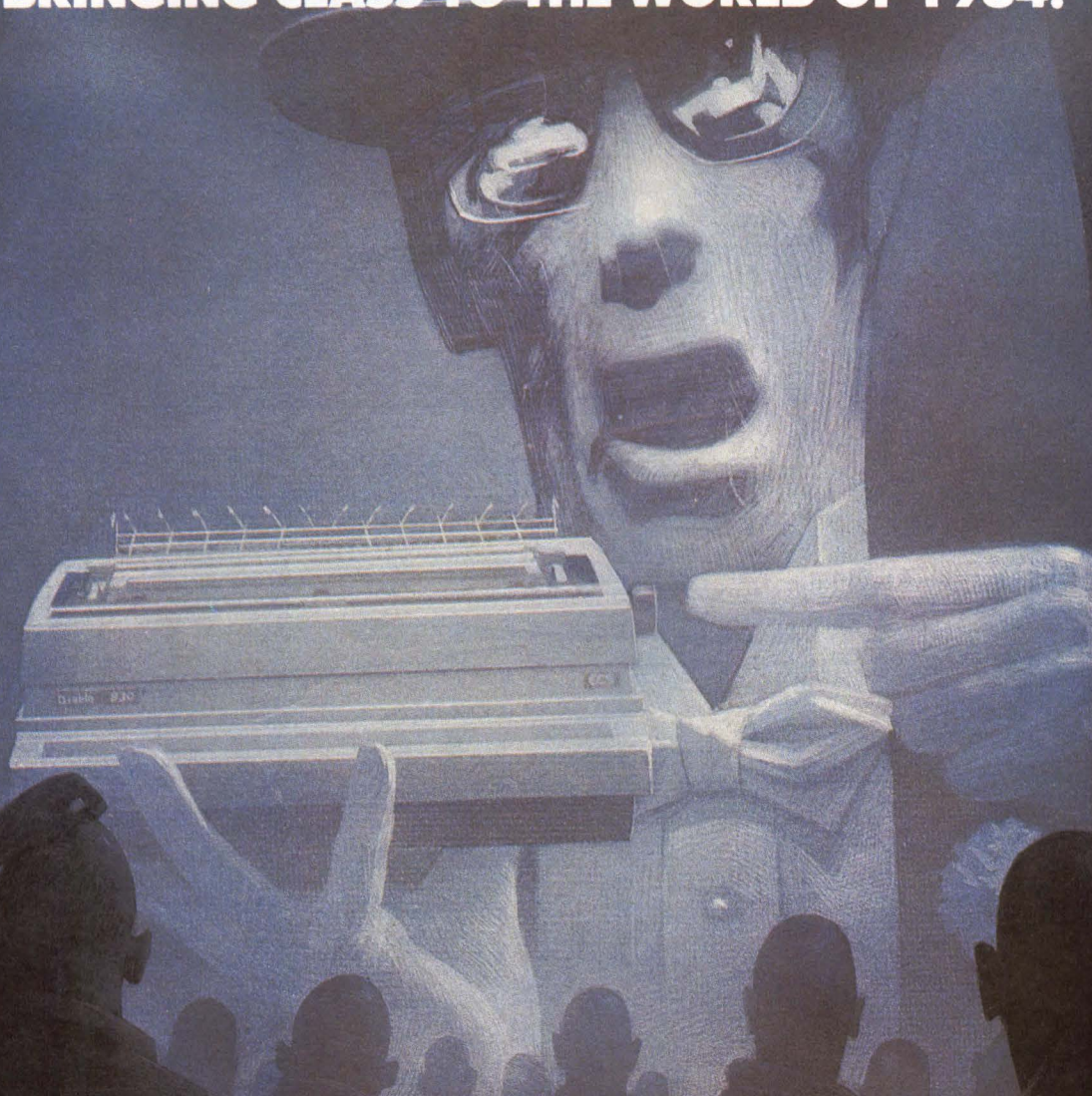

## DIABLO from HAMILTON/AVNET

All business equipment is not created equal. That's fact, not philosophy. Introduce the Diablo 630 into a business environment, and you've immediately raised the issue of class . . . first class. Because the Diablo 630 API isn't built to blend in with the woodwork, it's built to stand out with outstanding, high quality performance.

With connector cables that plug into all major microcomputers, including Apple, IBM and Xerox, the Diablo 630 API is the ideal printer for business systems where productivity is the highest priority.

The Diablo 630 provides maximum flexibility with the largest selection of metal and plastic printwheels available on any printer; superior letter-quality printing; and unmatched reliability, field proven over the largest installed base of any letter-quality daisywheel printer on the market today.

**Hamilton Avnet**



**SUPPLIER OF ELECTRONIC COMPONENTS AND COMPUTER PRODUCTS TO THE U.S. OLYMPIC COMMITTEE.**

From January 1 through July 31, 1984, \$50 of each \$500 of Diablo orders shipped will be donated to the U.S. Olympic Committee. Help us support our 1984 Olympic Team.

That's first class. And so is the way Hamilton/Avnet meets your requirements for the Diablo 630 and the complete Diablo line of printers and terminals. Hamilton/Avnet offers demonstrations at our facilities and follows that up with on-line evaluations with your system. In addition, there's a 90-day trial period after purchase, covered by a money back guarantee. We also offer leasing and value added system configuration and testing.

It doesn't stop there. When you call one of our local stocking facilities, that's your link to instant delivery of spare parts and supplies as well as extended warranties and service contracts, giving you access to nationwide Xerox Service Centers.

All distributors of computer products are not created equal. Call Hamilton/Avnet today and see what we mean.



**Hamilton Avnet**  
ELECTRONICS AN AVNET COMPANY

CIRCLE NO. 53 ON INQUIRY CARD

A commitment to stock and serve your local market!

NCR

- Disk
- Communications
- Fault
- Battery

On  
Off

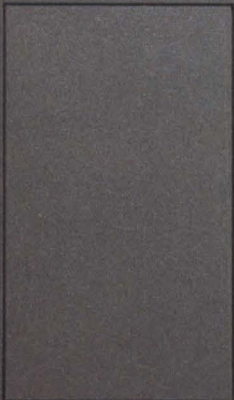
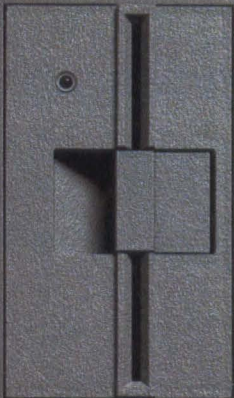

# FOR OEMs, THE GREATEST STRENGTH OF OUR TOWER IS OUR TOWERING STRENGTH.

To build a successful system, OEMs need more than just a strong product. You need a strong product backed by a strong company.

A company like NCR.

NCR designed and manufactures Tower 1632 especially for OEMs. But that's only the first of many reasons why you should put your name on our famous shape.

NCR is a high volume, high speed, high reliability manufacturer. We're deeply committed to 16 and 32-bit VLSI technology. With truly significant R&D expenditures that only a multibillion-dollar, international corporation can sustain. And long-term dedication to the UNIX\* market.

That means you can rely on getting all the product you need from us, when and where you need it. It means that you get quality control from a company that knows real quality and can afford to build it into every product. For example, our field engineers participate in the design of our products to ensure exceptionally cost-effective serviceability.

Our award-winning design engineers packed Tower's 7"-wide cabinet with up to 2MB of ECC memory, 7 controller slots, standard interfaces, power-fail recovery and 92MB of Winchester disk storage. Not to mention maximum software compatibility and flexibility.

But the real reason Tower is becoming the industry standard for multi-user, 16-bit and 32-bit UNIX-based systems is the strength of NCR.

Which proves that the shape you're in is determined by the company you keep.

\*UNIX is a trademark of Bell Laboratories.



**BUILT FOR SYSTEMS BUILDERS.  
TOWER 1632.**

**NCR**

OEM Systems Division

NCR Corporation, World Headquarters, OEM Systems Division, Dayton, Ohio 45479. Nationwide (800) 222-1235. In Ohio (513) 445-2380. In Canada (800) 268-3966.

**CIRCLE NO. 54 ON INQUIRY CARD**

# There Are Only Two Things New Tested Pairs

## The Testing.



OEMs face major problems trying to decide which hard disk drives to build into their microcomputer systems. What with the wide range of drives, and so many hidden costs associated with evaluation, testing and integration, the process

becomes a time-consuming and costly hassle.

But there's a way out—from the company that's helped solve OEM disk controller integration problems more often and over a longer period of time than anybody in the business. That company is Xebec.

From standard-setting to vertical integration, from heavy investment in computer-aided design to the total commitment to the most automated manufacturing technologies, Xebec has demonstrated its leadership position in supplying microcomputer storage solutions.



### **Tested Pairs. The Guaranteed Match.**

With its new tested pairs program, Xebec solves a major industry problem: post-delivery drive failure when interfaced to the controller. Having to do "after

the fact" drive testing for many of our OEM customers, we have decided to offer a "before the fact" program. We'll guarantee quality and reliability by assuring a match between our zero defect controllers and a choice of drives in different capacities and form factors.

It's simple. Tell us which drives you're considering and we'll test them on Xebec-designed equipment against the most rigorous standards in the industry. Standards we at Xebec have set. Then we'll tell you which of our controllers is the best match for that drive—or we'll customize a controller for you—and accelerate your time to market.



### **The Edge In Controller Technology.**

Xebec controllers are well known as the best in the industry. Their single-board designs incorporate MOS microprocessors and the latest standard cell and surface mount IC technology. Compatible with standard interfaces, our controllers have set the pace with sophisticated data separation, advanced error detection and correction, hard-fault isolation, a high-level

CORPORATE HEADQUARTERS  
2055 Gateway Place, Suite 600  
San Jose, California 95110 U.S.A.  
(408) 287-2700

# That Distinguish Xebec's Storage Solutions.

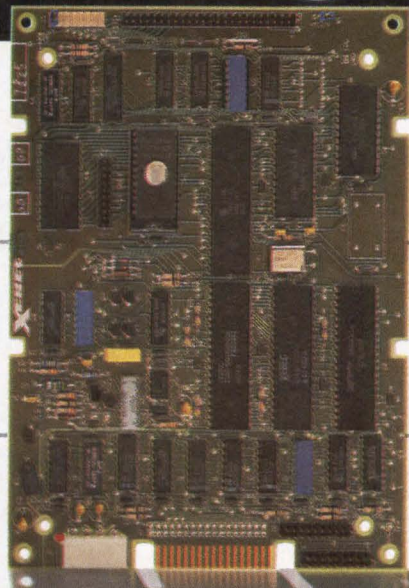

## And The Pairing.

command set and other performance and reliability features.

Now these superior controllers can be paired with high-quality, Xebec-qualified drives. And you save time and money on evaluation engineering, incoming inspection, and service—while gaining a single-source, single purchase order solution to disk drive integration.

### The Front Line Of Drive Testing.

We were recently asked to design and build a disk drive tester for one of the world's largest OEMs. We'll be using that tester to analyze disk drive performance for you. Full environmental testing, including shock and vibration. Full functional testing at elevated temperatures, with read/write tests at marginalized voltages. Careful calculation of hard and soft bit error rates. Complete checking of FCC and other agency emission standards. We'll make sure any drive meets its stated specifications and performance and quality claims.



### How Xebec Does It. And Why.

Xebec can offer its tested pairs service to OEMs because of our commitment to quality. Zero defect quality symbolized by our "Xero D" signature and demonstrated by our superior computer-aided design, manufacturing and testing. Our talented people. Our experience. That's *how* we can provide high-quality products for prices no more than products that deliver a lot less.



Why offer our tested pairs? Why originate a new concept in quality? Enlightened self-interest. Because if we don't, someone else will. Frankly, we want to continue to enjoy the benefits of our leadership position as much as our customers do.

Call Xebec today. Pair up with one of our representatives to find out more about how Xebec tested pairs can benefit you.

**Xero D.**

**XEBEC**  
The Zero Defect  
Company

CIRCLE NO. 55 ON INQUIRY CARD

#### SALES, INTERNATIONAL

Belgium  
32-02-762-9494  
TWX: 65054 Xebec B  
England  
44-628-71138  
TWX: 84443 Xebec G  
Italy  
39-6-344412  
TWX: 622685

#### SALES, U.S.A.

Sunnyvale, CA (408) 733-4200  
Irvine, CA (714) 851-1437  
Atlanta, GA (404) 457-9872  
Boston, MA (617) 740-1707  
Dallas, TX (214) 361-0687  
Baltimore, MD (301) 465-7771  
Chicago, IL (312) 931-1420

#### U.S.A. AND CANADA DISTRIBUTORS

Kierulff  
Hamilton-Avnet  
Avnet Electronics  
Hamilton Electro Sales

# Crack the Nut.

A large, dark-colored nutcracker is shown in the process of cracking a nut. The nut is glowing with a bright orange and yellow light, suggesting it is hot or being heated. The background is a deep, dark blue, creating a dramatic and focused scene.

## The LAN nut.

When you're developing a LAN-based computer system, you're faced with a tough nut to crack. You need to know what's going on in your Local Area Network system. Many computers are carrying on many conversations. Simultaneously. And at speeds 10,000 times faster than traditional data communications. How do you test it? How do you debug it? How does the system really perform?

Excelan can help you crack that nut with the Nutcracker™, the world's only comprehensive analyzer/simulator for Ethernet systems. Packaged as an integrated workstation, the Nutcracker provides advanced

LAN instrumentation hardware capable of making real-time diagnostic decisions at 10 million bits per second. Also included is an 8086-based CPU, about 1 MB of RAM, a 20 MB disk, a 600 KB floppy, keyboard, 12" CRT and 100 cps external printer, and complete menu-driven software that brings the power of the Nutcracker to you.

With the Nutcracker connected to the Ethernet cable, you're in control. You can create

and detect pathological conditions for shake-down testing. Powerful filtering facilities allow you to extract precise packet substreams for triggering and tracing functions to find those elusive bugs. You can generate traffic for simulation of various load conditions. And high resolution time-stamping means you can track system performance against this regulated traffic load.

Increase your productivity, speed development time, and get your network system up and running — with confidence in its performance and integrity.

Join computer industry leaders. Crack the LAN nut with the Excelan Nutcracker.

## EXCELAN

*"Excellence in Local Network Technology"*

2180 Fortune Drive  
San Jose, California 95131  
(408) 945-9526 TELEX 176610

CIRCLE NO. 56 ON INQUIRY CARD

Nutcracker is a trademark of Excelan, Inc. Copyright Excelan, Inc., 1984. All rights reserved.

# The Interpreter

## IBM's LAN: To wait is the question

*Should system integrators wait years for IBM's LAN  
or take the plunge with solutions from other suppliers?  
Opinion is divided*

**Marjorie Stenzler-Centonze**, Associate Editor

IBM Corp. recently broke its silence on plans for local-area networks (LANs). It introduced a star-wired LAN cabling system, which connects wall outlets in offices to wiring closets, and announced its intention to implement a token-passing ring LAN based on that system—but not for two to three years.

Industry observers greeted the token-ring aspect, tucked into a press release on the cabling scheme, with mixed reactions. Some insiders weren't surprised, having anticipated IBM's commitment to token-ring technology as a natural extension of its work on LAN standards (MMS, January, Page 31). Others claim the announcement is premature.

Some see the announcement as an attempt to stymie sales by LAN vendors over the next few years. Still others see it as an impetus for customers to buy sooner, since they now know how long they'll have to wait for IBM's version. IBM watchers agree, however, that companies considering networking will have to evaluate their plans seriously before deciding whether to wait for IBM or go with an alternative LAN scheme such as Ethernet.

Despite the uncertainty, most feel IBM's announcement adds credibility to this fast-growing market. Nonetheless, many expressed disappointment that the long-awaited announcement contained no new technical details about IBM's projected LAN.

Randall L. Sherman, vice president of telecommunications and office automation for Creative Strategies International, San Jose, Calif., echoes the disappointment. He notes that IBM announcements are usually more exciting. "This was sort of a Band-Aid to what we'd like to see." He contends that IBM needs a LAN for its System 34, System 36 and System 38 equipment that integrates a controller for a PC network, not just a pipeline between the different classes of equipment.

"Wang [Laboratories Inc.], Xerox [Corp.] and Hewlett-Packard [Co.] are moving right ahead," Sherman says, "and IBM is left with a little dust on them." He argues that, rather than basing its strategy on innovation, IBM has a predatory philosophy: "It prefers

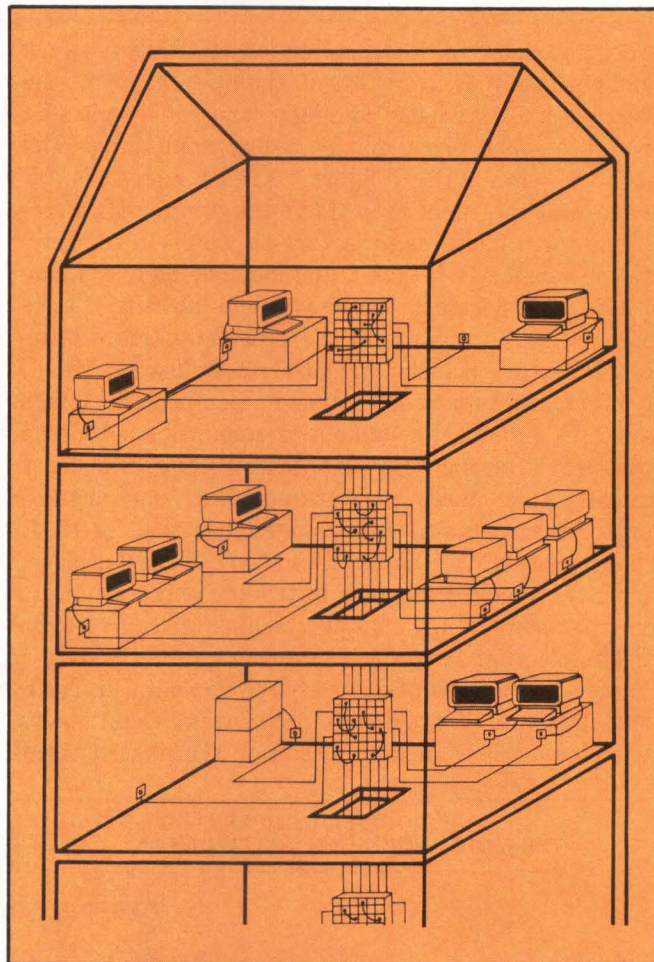

**The IBM cabling system is installed permanently, just like telephone lines. The company claims that such a system will eliminate most of the expense of moving workstations within a building.**

that markets mature and show some potential; then it learns from others' mistakes, so it doesn't have to make the mistakes itself."

Ethernet vendors applaud IBM's announcement, according to Bill Krause, president and chief executive officer of 3Com Corp., Mountain View, Calif. He views IBM's announcement as a triple win: "It's a win for IBM, it's a win for the customer, and it's a win for the independent local network vendors."

3Com and other Ethernet vendors believe the two- or

# The Interpreter

## A close look at the cabling system

IBM Corp.'s cabling system, available this fall, is permanently wired and connects to outlet plates in office walls. The single cabling system can be used instead of coaxial or twin-axial cable, existing twisted-pair wiring or other special cabling, according to IBM. The system enables connec-

tions to be made between devices with a common cable consisting of twisted pairs of copper conductors.

The system connects wall outlets to distribution panels in wiring closets, with cables fanning out from each closet in a star-shaped pattern. Each distribution panel can accept as many

as 64 cables from different devices.

Most currently available IBM workstations and small- and intermediate-sized computers can be connected to the cabling system, claims IBM. It announced that customers could begin ordering cables and accessories this month.

three-year delay in the introduction of IBM's network could push many fence sitters off their perch. "Now, the customer knows what's coming. If he can't wait that amount of time, he's going to buy something—and that's the win for the vendors," Krause maintains. "If he can wait the time, then that's the win for IBM."

Customers have many factors to weigh in the buy-now-or-wait-for-IBM game, and much is likely to hinge on how much legwork they have done already. Leone Pease, research analyst in the office-automation division of Venture Development Corp., Wellesley, Mass., says that, from many an end user's perspective, IBM's intentions have come none too soon. She admits a three-year wait for IBM can seem a long time for a company that needs networking. But, she argues, companies have waited a lot longer than that for IBM. "Unfortunately," Pease says, "in today's marketplace, people see many companies in trouble and still others going bankrupt. They may just be likely to say, 'Maybe we'd better wait for IBM.'"

Maureen Fleming of the research company International Resource Development, Norwalk, Conn., says customers need to look at what's on the market right

now, rather than at what they imagine is coming. "After the PCjr bomb, with its keyboard problems, performance limitations and disappointing sales, IBM has to be careful too," she says. "Two blows, one after the other, wouldn't be too smart either." Fleming feels that delaying its LAN may affect other IBM products as well—particularly the expected supermicrocomputer dubbed "Popcorn," which she thinks will be a LAN-based system. She speculates that the LAN delay will in turn hold up the Popcorn's introduction.

3Com's Krause says his company already is seeing more interest by customers who cannot wait—or choose not to wait—for IBM. He doubts that today's Ethernet buyers are necessarily making the decision to cast aside IBM. Instead, Krause predicts that many companies are likely to end up with both Ethernet and IBM installations. "We have felt for some time that there would be more than one standard," he says. "There are at least two companies that have the marketing muscle to set de facto standards; those two companies are AT&T and IBM."

Krause believes that IBM's choice of the token-ring architecture will establish that technology as a de facto standard, but making it standard is proving harder than the company would like. Indeed, he says, IBM has received a strong message from customers that its token-ring network must be accepted as an industry standard to be successful. "It appears that customers have said to IBM that it's not enough just to be IBM," says Krause.

Creative Strategies' Sherman says of IBM that an announcement is simply not enough to establish a token-ring LAN as a standard. "It's a bit like chasing a shadow. The fact that they've said it does establish a kind of 'phantom' de facto standard, but I don't think it locks them into a particular type of architecture." He believes the company could still change course for any number of reasons: "Two years down the road, technology will evolve." □

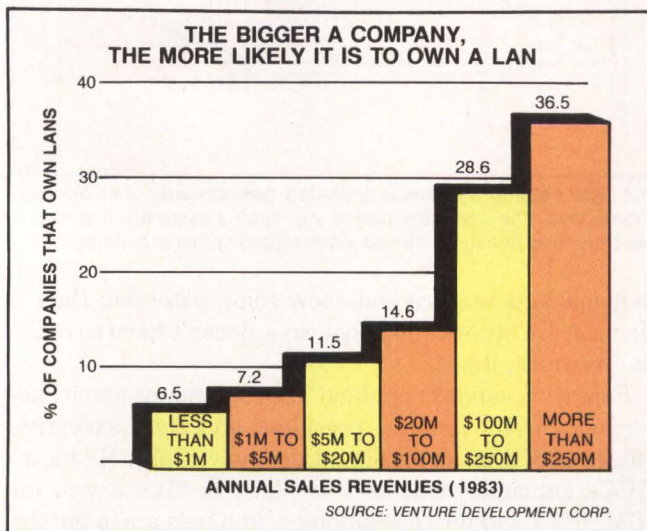

Only the biggest companies possess LANs in any significant percentage, according to Venture Development.

Interest Quotient (Circle One)  
High 804 Medium 805 Low 806



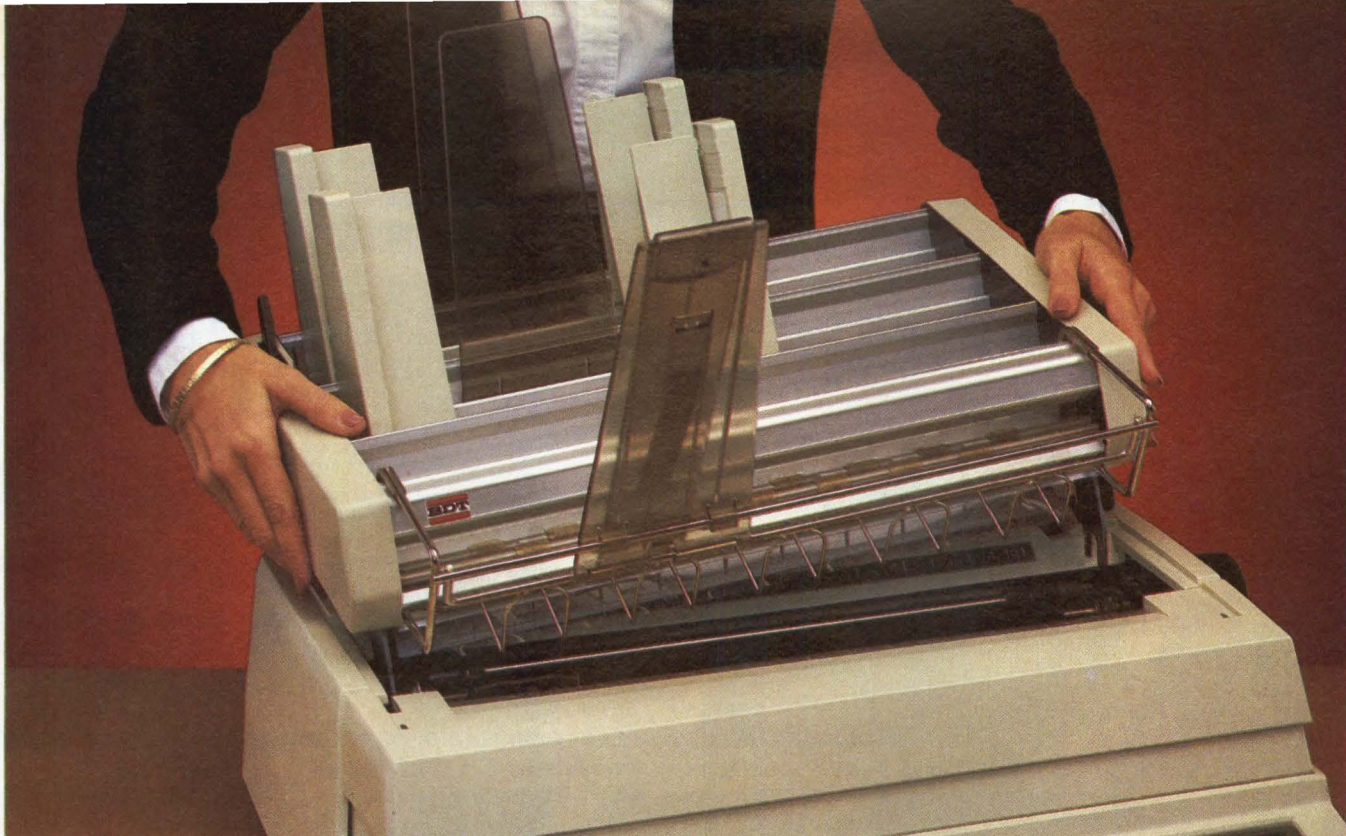

The dual tray ASF 522, like most BDT sheet feeders, installs in seconds.

# You must be putting us on

**A** BDT sheet feeder belongs on every office automation system you make.

Simply, because your customers demand it.

BDT sheet feeders are the largest selling sheet feeders in the world, with more models, for more printers, than any other manufacturer.

Our line includes models with single and dual bins, as well as a triple unit with envelope capability.

And best of all, BDT sheet feeders are designed for easy integration into virtually any office automation system.

**Reliability through simple design**

People who buy office

automation systems want reliability.

When you put on a BDT sheet feeder, you're installing the most reliable sheet feeder ever made.

Its tested mean time to failure of 5,000 hours, and misfeed rate of less than 1 in 1,000 sheets, are the best in the history of the industry.

Through twenty-five years of design innovation in paper handling technology, we've continuously sought to create products praised for reliability, with no limit to their useful life.

**Lowest Cost**

Some people find it hard to believe that the most reliable sheet feeders are also the least expensive.

That is, until they talk with us, and find out how inexpensive a sheet feeder can be.

And that makes your systems just that much more profitable.

So isn't it time that you consider putting us in our place, on your system? Call us today, (714) 660-1386.

**Nothing tops a printer like a BDT sheet feeder**



**BDT Products, Inc.**  
 17152 Armstrong Ave., Irvine, CA 92714  
 • 714/660-1386 **In New York:** 101 Green St., Herkimer, NY 13350 • 315/866-1244 **In Europe:** BDT GmbH, P.O. Box 80, D-7210 Rottweil, West Germany (0741) 248-0 Telex 762876 (bdtr) d

# UDS Modems—

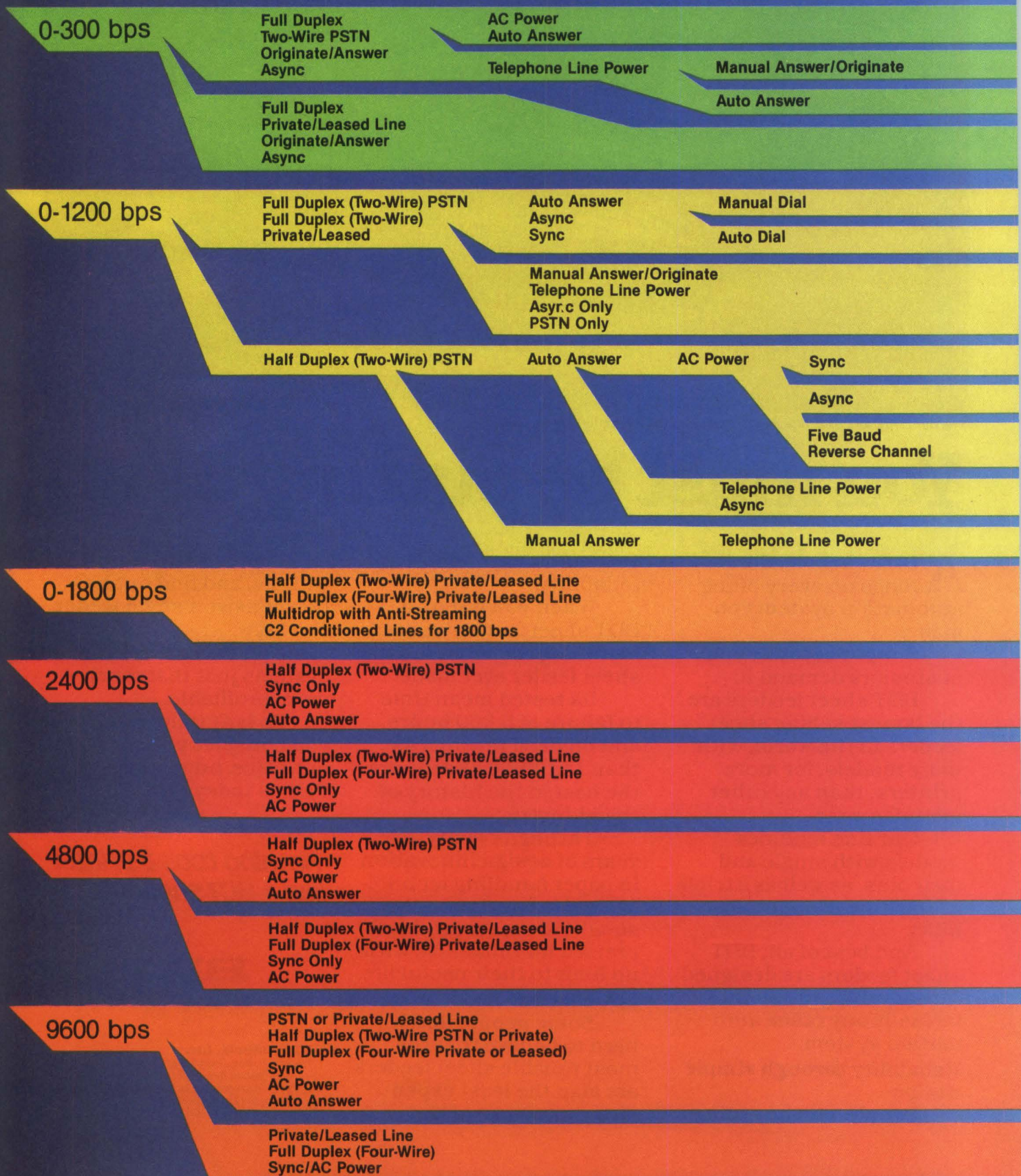

GLOSSARY: Private/Leased Line: A line that is not dialed, also termed a dedicated line.

Telephone Line: A dial-up line on the public phone network. Also termed PSTN—Public Switched Telephone Network (formerly called DDD).

# Easy to Buy,

# Advantageous to Own



If you have decided on the speed for your data communications system, the decision tree at left will make it easy for you to select the proper UDS modem. Start with the speed, make decisions such as synchronous/asynchronous, full-duplex/half-duplex or dial-up/dedicated lines, and you'll be led to the right decision!

The decision tree *doesn't* show you the ownership advantages inherent in your choice of a UDS modem. They include competitive prices, one of the industry's best reliability records and a history of exceptionally helpful customer support.

Easy specification and ownership advantages make Universal Data Systems the logical choice as your modem supplier. For additional specifications and price quotation, contact Universal Data Systems,

5000 Bradford Drive,  
Huntsville, AL 35805.  
Telephone 205/837-8100;  
TWX 810-725-2100.



 Universal Data Systems

 **MOTOROLA INC.**  
Information Systems Group

CIRCLE NO. 58 ON INQUIRY CARD

UDS Modems are offered nationally by leading distributors. Call the nearest UDS office for distributor listings in your area.  
DISTRICT OFFICES: Atlanta, GA, 404/998-2715 • Bellevue, WA 206/455-4429  
Blue Bell, PA 215/643-2336 • Boston, MA, 617/875-8868 • Columbus, OH, 614/895-3025 • Englewood, CO, 303/694-6043 • Glenview, IL, 312/998-8180 • Houston, TX, 713/988-5506 • Huntsville, AL, 205/837-8100 • Mountain View, CA, 415/969-3323  
Old Bridge, NJ, 201/251-9090 • Richardson, TX, 214/680-0002 • Silver Spring, MD, 301/587-0166 • Tampa, FL, 813/684-0615 • Tustin, CA, 714/669-8001

103J

103 LP 0/A

103J LP

108

212A

212A/D

212 LP

202S/SS

202S

202S/5

202S LP

202 LP

202T

201C

201B

208A/B

208A/B

9600A/B

9600

Announcing the WY-75.



Our new WY-75, VT-100\* software-compatible terminal is specially fitted for use with your DEC\* computer.

It offers a combination of features you can't find in any other VT-100 software-compatible terminal. Like a compact, ergonomic design. A finely sculpted, low-profile keyboard. And a swivel and tilt non-glare 14" screen, tailored with an 80/132 column format.

At a price of \$795, the WY-75 won't cost the shirt off your back.

Contact Wyse Technology for more information. And put your DEC on the best dressed list.

**\$795**

**VT-100 software  
compatible and  
dressed for success.**



**WYSE**

Make the Wyse Decision.

Wyse Technology, 3040 N. First Street, San Jose, CA, 95134, 408/946-3075,  
TLX 910-338-2251, Outside CA call toll free, 800/421-1058, in So. CA 213/340-2013.

\*VT-100 and DEC are trademarks of Digital Equipment Corporation.

**CIRCLE NO. 59 ON INQUIRY CARD**



## If you're a major league VAR, we want you on our team.

IBM is scouting for the most valuable of VARs: those with outstanding new ideas and a great batting average.

If you're one of them, you could become a Value Added Reseller of IBM products. And what could that mean to you?

First, IBM can add clout to your marketing efforts. For example, we can help with product literature, direct mail and business show support. To add to your skills, IBM offers a wide range of professional classes for VARs.

Furthermore, thanks to the online referencing system used by our own sales force, we can direct prospects with special needs right to VARs with appropriate solutions.

And, as one of the finest of VARs, you'll be selling the finest equipment: some of IBM's most competitive products. Our VARs can apply for the IBM 4300 systems, System/36, Series/1, System/38, the IBM Personal Computer and the System 9000 family.

To find out more about the advantages of becoming an IBM VAR, simply send in the coupon below or call 1 800 IBM-VARS, Ext. 96.

If you think your company can qualify, now's the time to touch base.



Larry Humphreys  
IBM Distribution Channels  
P.O. Box 76477  
Atlanta, GA 30358

96/8-84

Please send me your free booklet, "Looking for Leaders."

Name \_\_\_\_\_ Title \_\_\_\_\_

Company \_\_\_\_\_

Address \_\_\_\_\_

City \_\_\_\_\_ State \_\_\_\_\_ Zip \_\_\_\_\_

Phone \_\_\_\_\_ Product Interest \_\_\_\_\_

# It's easy to see why our new CRT series is an improvement down the line.

Improvements that give our HD-100 Series the good-looking features you expect from a quality CRT. You get sharper, cleaner lines and characters, plus improved focus and stability—even in the corners. And you can display over one million pixels on 15- or 17-inch screens, vertically or horizontally. In your choice of standard video or inverted displays, with line rates from 26 to 36 kHz. In effect, you can have enhanced visibility any way you want it, no matter whether your customers are processing words or graphics.

Our CRT line includes a number of other significant improvements. The HD-100 Series displays are 33% lighter than our previous HD Series. That adds up to easier handling, integrating and lower freight costs.

We also built in an efficient switch mode power supply that reduces power consumption for your customers while enabling a stable display over a wide voltage input range. In addition, our new HD-100 Series features an advanced CRT/yoke combination for better focusing. All our improvements are packaged neatly in a compact chassis design that offers convection cooling and makes

service a breeze, and naturally, our CRTs are UL-478 approved and CSA certified.

All these enhancements put the focus on quality inside and out. High quality manufactured with great efficiency to give you a new, low price that's an improvement in itself. Call your nearest Ball sales office and ask to see our new HD-100 Series. The CRTs designed to give you a clear advantage with every line.



**Electronic  
Systems  
Division**

P.O. Box 64376 • St. Paul, MN 55164

*Bright ideas for better visibility.*

General Sales Offices: Downers Grove, IL (312) 960-4434 • Ocean, NJ (201) 922-2800 • Campbell, CA (408) 374-4120 • Upland, CA (714) 981-9404 • Salem, NH (603) 893-3050  
• Offenbach, West Germany (0611) 817041-44 • Newbury, Berkshire UK (0635) 30770

*Ball*

LOOK INTO OUR HD150 & HD170 CRTS

- \* 15 INCH OR 17 INCH DIAGONAL CRTS
- \* ONE MILLION PIXEL DISPLAYS
- \* HORIZONTAL AND VERTICAL DYNAMIC FOCUS
- \* LINE RATES TO 36KHZ TO FIT YOUR NEEDS
- \* DIGITAL VIDEO AMPLIFIER FOR LOW NOISE
- \* EFFICIENT, LIGHT, SWITCHING SUPPLY
- \* OPTIONAL PHOSPHORS, P4 WHITE STANDARD

CIRCLE NO. 60 ON INQUIRY CARD

# The Integrator

Applying integrated systems in industry, engineering and commerce

## Technology continues to define leaders of CAD/CAM and CAE market

*Sales of computer-aided design, manufacturing and engineering systems rebounded from a slow start in 1983, may reach 40 percent growth in 1984*

Charles M. Foundyler, Daratech Inc.

Although 1983 began with only modest revenue gains for the computer-aided-design/computer-aided-manufacturing (CAD/CAM) and computer-aided-engineering (CAE) industry, it ended with a record-breaking final quarter for market leaders Computervision Corp., Bedford, Mass., IBM Corp., Intergraph Corp., Huntsville, Ala., and Calma Co., Santa Clara, Calif. Revenues topped \$1.7 billion in 1983, representing a 32 percent annual growth rate—up from the 28 percent growth rate recorded in 1983 but still below 1981's phenomenal 40 percent growth rate.

A buying surge in the last two months of 1983 increased estimated 1983 industry revenues by \$100 million and raised predictions of this year's growth to a bullish 40 percent annual rate. Supporting this optimism are forecasts from economists, who estimate that 1984 corporate earnings will rise more than 22 percent, spurring investment in plants and equipment.

Vendors continue to enter the CAD/CAM and CAE market in record numbers. By Daratech Inc.'s count, the number of vendors selling CAD/CAM and CAE systems in the United States has increased fivefold, from about 20 at the end of 1980 to more than 100 in 1983. The shakeout of weaker companies, predicted by many observers in 1983, never materialized.

In the battle for market share, IBM, Intergraph, McDonnell Douglas Automation Co. (McAuto) and Control Data Corp. (CDC) all gained ground last year. Intergraph, the fastest-growing vendor in 1982, was again the growth leader in 1983. With 1983 revenues projected at \$252 million, Intergraph grew 62 percent to capture 14.6 percent of the market. Its growth places Intergraph only 8.5 percentage points behind Computervision and 4.6 points behind IBM. Intergraph continues to benefit from being the first to market systems with 32-bit superminicomputer power and advanced, high-performance raster displays, while

competitors Computervision, IBM, Calma and Applicon were unable to offer comparable systems until the second half of 1983.

Computervision, the industry sales leader, increased its revenues by 23 percent to an estimated total of \$400 million in 1983, giving it a 23.1 percent market share. Computervision's release last September of the CDS 4000 system, which incorporates the company's long-delayed proprietary 32-bit processor, rallied sales after a slow first six months. Almost 74 percent of Computervision's 1983 growth took place in the second half of the year.

Also contributing to Computervision's 1983 revenue

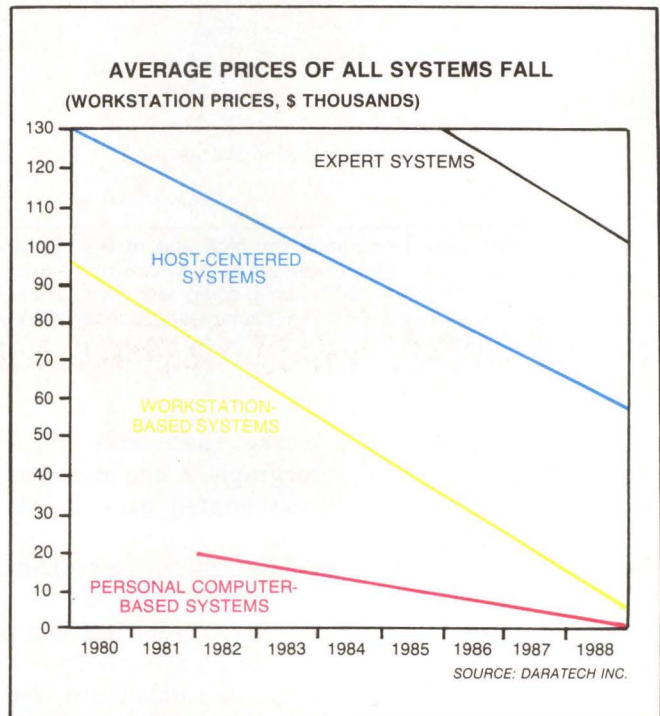

Prices of CAD/CAM and CAE systems should continue to fall, reflecting a trend established by most computer-based equipment. Although price reductions were most dramatic in the early 1980s, they should continue to decline steadily until the end of the decade.

# The Integrator

growth was its first-quarter acquisition of Cambridge Interactive Systems (CIS) Ltd., Cambridge, England, developer of Medusa, a CAD/CAM software system marketed in the United States by Prime Computer Inc. With sales of \$20 million, CIS accounted for 26 percent of Computervision's 1983 revenue increase.

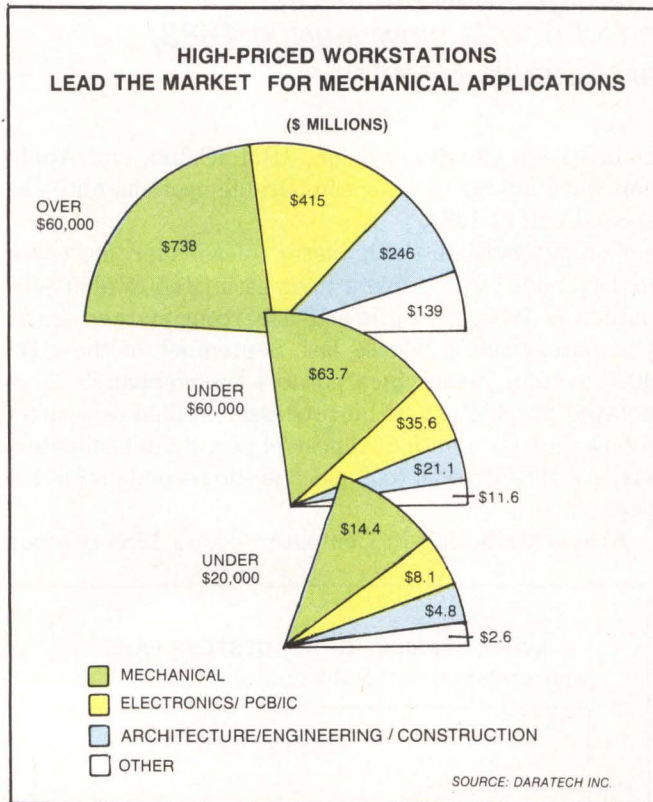

**Mechanical applications dominate the high end of the market.** Such applications frequently include software for solids modeling and interfaces to automated manufacturing equipment. Although they can be quite complex, systems for electronics applications usually include only 2-D graphics.

Having consistently lost market share since 1981—principally to IBM and Intergraph—Computervision might be on the verge of accelerated growth. The company has had problems bringing products to market on time; for example, the company's new 32-bit computers, which power the CDS 4000 system, were more than a year late. Now, Computervision insists it is determined to step up R&D and bring new products to market more quickly. Recently, in a departure from past practices, Computervision began looking outside the company for hardware, software and expertise to speed new systems to market.

Two examples of the new direction are new Comput-

ervision systems based on IBM 4300 computers and the high-performance workstations to be developed jointly by Computervision and Sun Microsystems Inc. If completed on time, they promise to give Computervision competitive, up-to-date systems at the high- and low-priced ends of the market. Once the company starts shipping these advanced systems in volume, its revenues will grow. But Computervision may not gain market share until 1985 because of strong competition and because it lost customers while it lacked a leading-edge product.

IBM, with 1983 sales of CAD/CAM and CAE systems to end users that grew a little faster than the industry norm, will probably pass Computervision to become the industry's leading supplier in 1984. IBM's growth was slow for most of 1983 because its model 3250 workstations had shortcomings that limited applications in areas such as solids modeling and electronic design. Nevertheless, IBM's CAD/CAM and CAE sales reached an estimated total of \$332 million, giving the company a 19.2 percent market share. This year, innovative products such as the newly announced model 5080 high-performance raster workstation, scheduled to be shipped in the second quarter of 1984, should improve IBM's position. With its aggressive pricing, attractive leasing options and well-known marketing skills, IBM should capture a dominant share of the end-user CAD/CAM and CAE market.

In addition to direct sales, IBM's Distribution Channels Unit is becoming a major OEM supplier of computers and workstations for CAD/CAM and CAE. Moving into a market long dominated by Digital Equipment Corp., Data General Corp. and Hewlett-Packard Co., IBM is re-establishing itself as a supplier of computers to the engineering community—a role it gave up in the late 1960s. So far, Computervision and Matra Datavision have announced plans to become IBM value-added remarketers (VARs). Computervision systems will incorporate the IBM model 4300 series of superminicomputers for database management; Matra's Euclid software will run on model 4300s using IBM's model 5080 workstations.

## Other contenders fill market niches

McAuto, St. Louis, the sixth-largest CAD/CAM and CAE vendor, made impressive gains in 1983. In spite of increasingly strong competition from IBM and Computervision, McAuto's sales grew 48.2 percent to reach \$70 million, giving the company a 4 percent market share. McAuto owes much of its market strength to the depth and range of its CAM software. Although sales of its highly regarded solids-modeling package have been



# TAKE ONE FOR A TEST DRIVE.

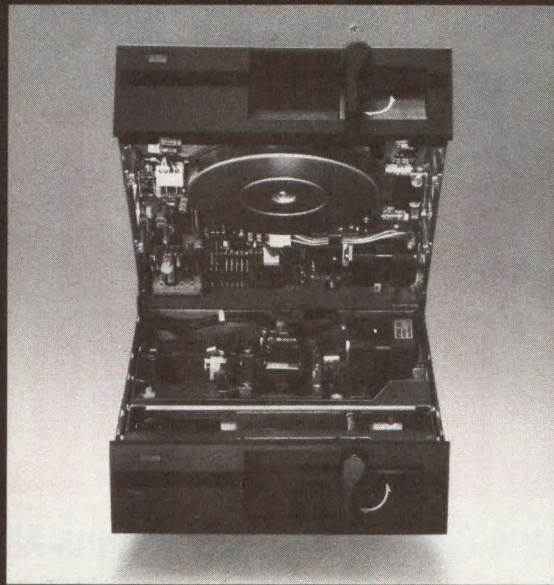

Introducing the 1984 TEACS.

A full line of 5 1/4 inch half-high flexible disk drives. Available in single/double sided, 48 tracks per inch/96 tracks per inch, single/double density.

With Teac's exclusive system of half-high at half power you get less heat build-up, less media expansion and disk off-tracking problems. Which means more reliability plus more adaptability.

And, Teac's brushless DC direct drive motors are proven mileage champs with up to 10,000 hours MTBF. Which only goes to show, as always, Teac quality pays off down the road.

**TEAC** ICPD

BUILT TO FANATICAL STANDARDS.

COPYRIGHT 1983. TEAC INDUSTRIAL COMPUTER PRODUCTS DIVISION, 7733 TELEGRAPH ROAD, MONTEBELLO, CALIFORNIA 90640

CIRCLE NO. 61 ON INQUIRY CARD

# UNBEATABLE VALUE

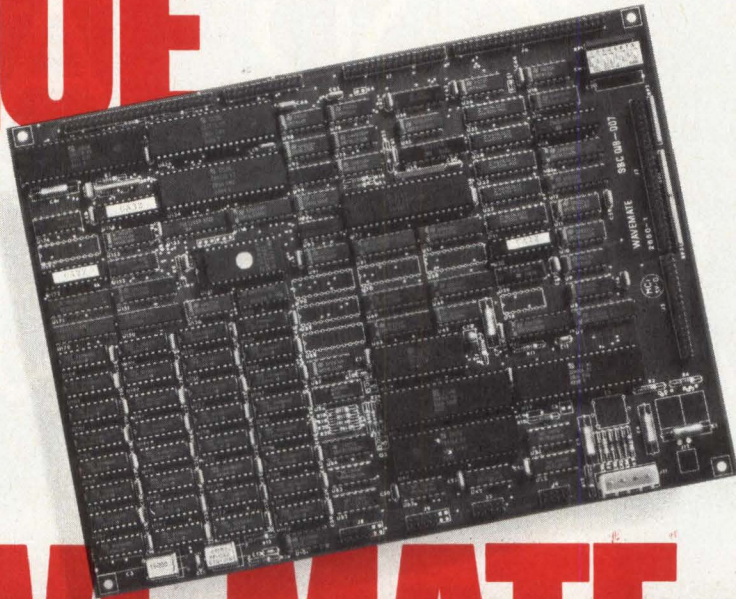

# WAVE MATE SUPER BULLET

## 8MHz Z-80H Single Board Computer. Outperforms All Micros & Most Minis

### DON'T PAY MORE TO GET LESS

You get more for your money with the Wave Mate Super Bullet. Much more than any micro on the market. It outperforms most minis, too. You just can't find a better value. OEMs and systems integrators are finding that they pay *less* for Super Bullet and offer *more* to their customers. This makes better business sense, and bigger margins, too!

### THE ONLY 8MHz Z-80H MACHINE OF ITS KIND

Super Bullet is unique. Wave Mate's exclusive enhancements of the basic Z-80H architecture offers 8MHz operation with flexible DMA facility, enhanced C-BIOS,

fully interrupt-driven I/O and high-speed floppy disk controller. The CPU is utilized with a full complement of Zilog-compatible peripheral chips. Never so much sophistication and flexibility on a single board.

### POWER/FLEXIBILITY

For years, the Wave Mate Bullet SBC has been recognized as the most sophisticated and cost-effective Z-80A, CPM-based single-board microcomputer on the market. A truly unbeatable price-performance package for the single user. Now, the "Super Bullet" adds a new dimension to Wave Mate's state-of-the-art technology. Our new 8-bit, 8MHz

machine beats every 16-bit micro we've tested it against and there's documentation to prove it. "Super Bullet" has been designed especially for multi-user systems.

### MULTI-USER ORIENTED

You get both CP/M 3.0 and MP/M II operation. You get an exclusively enhanced Z-80H-based CPU at a full 8MHz. You get 256K RAM and four serial ports. High-speed floppy disk with track-buffered controller. Plus SCSI port and LAN option. All of the above and more with the tested and proven Super Bullet. It's an unbeatable value.



WAVE MATE INC. • 14009 S. Crenshaw Blvd. • Hawthorne, CA 90250 • Tel: (213) 978-8600 • Telex: 194369

WAVE MATE EUROPE • 159 Chee de Vleurgat • 1050 Brussels, Belgium • Tel: (02) 649 10 70 • Telex: 24050

CIRCLE NO. 62 ON INQUIRY CARD

# The Integrator

slow, McAuto remains a leader in CAM. This position and an increased emphasis on the architecture, engineering and construction (AEC) market, should help McAuto continue to gain overall market share in 1984.

After losing ground for two years, Auto-trol Technology Corp., Denver, rebounded in 1983 and may finish the year with two consecutive profitable quarters—its first since 1980. Although the company is still far from regaining the 8 percent market share it commanded

four years ago, its revenues grew an estimated total of 20.5 percent to \$53 million, topping the 1980 high of \$51 million.

Auto-trol's turnaround was mainly due to the success of its AGW line of systems for mechanical and AEC applications, which are based on workstations from Apollo Computer Inc. The mechanical system, released in mid-1982, and the AEC system, released in the first quarter of 1983, account for 80 percent of Auto-trol's system sales. Indications are that the company will continue to do well in 1984.

CDC, Minneapolis, is making considerable progress establishing itself in the CAD/CAM and CAE industry. In 1983, the company posted revenues of \$82 million from all CAD/CAM- and CAE-related sources. An estimated total of \$49.2 million from the sale of systems and related services represented a 46.4 percent increase over the previous year's sales. The company's good performance came mainly from stronger-than-anticipated acceptance of its low-cost ICEM/120 series of design/drafting systems introduced in late 1982.

CDC appears committed to expanding its CAD/CAM and CAE operations. In November 1983, the company

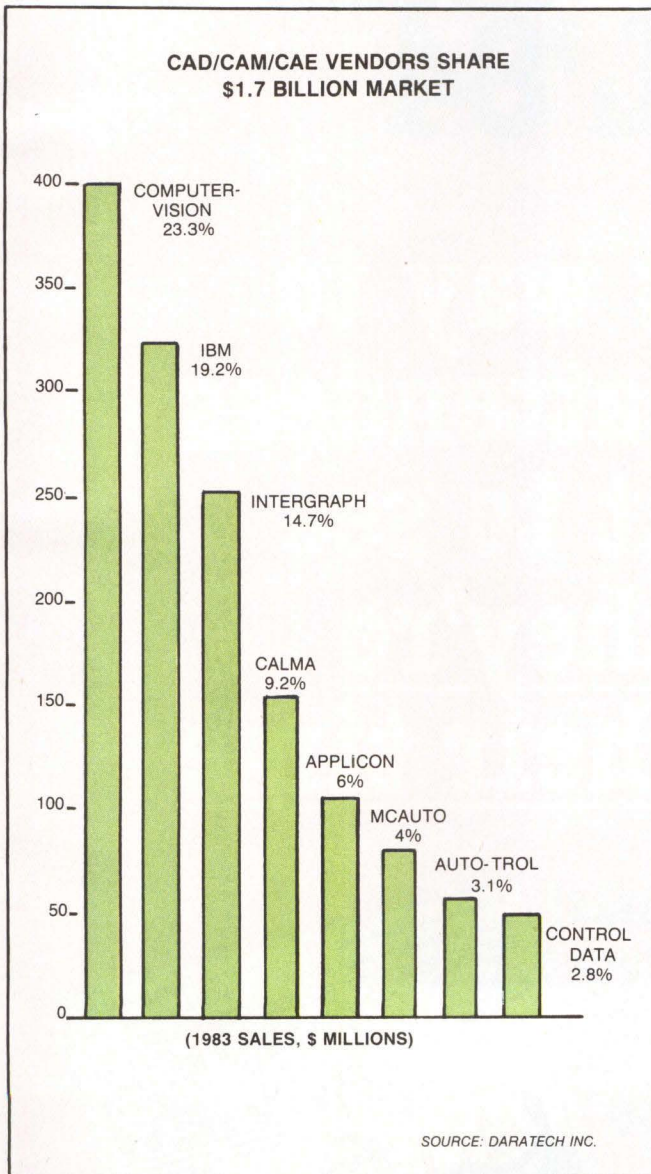

Computervision is the CAD/CAM and CAE industry leader, although it has lost the dominance it held just a few years ago. IBM and Intergraph, second and third, respectively, now account for a third of industry revenues.

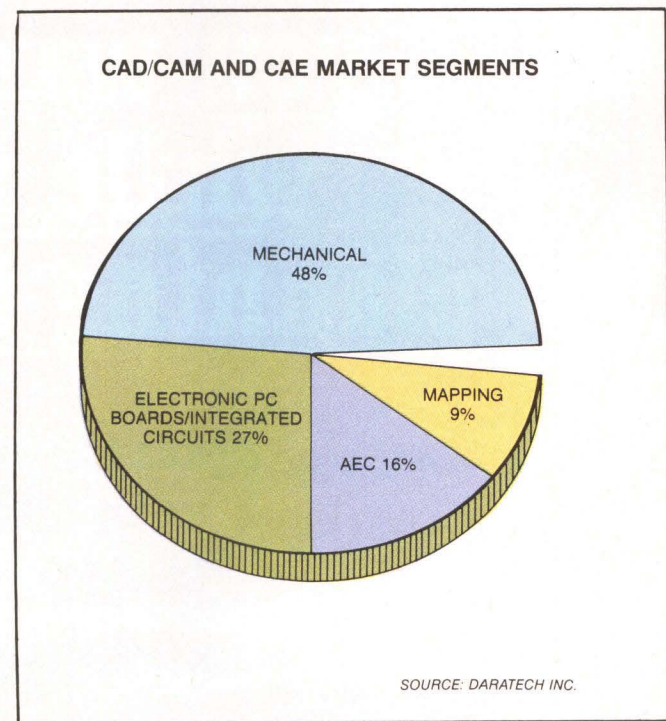

Mechanical applications account for nearly half of the CAD/CAM and CAE market, partly because the mechanical and industrial engineers comprise a majority of engineers and partly because the value of systems tends to be higher than that of systems in the other market segments.

# ANNOUNCING COMDEX PREVIEW FALL '84

The best way to reach the attendees you want to see while they're planning their time

**Space is limited!**

If you're exhibiting call NOW and get all of the details

**1-800-325-3330**

Published by



World's leading producer of computer conferences and expositions including COMDEX/Winter, COMDEX/Spring, COMDEX/Fall, COMDEX/Europe, COMDEX in JAPAN, INTERFACE, FEDERAL DP EXPO & CONFERENCE, The Nationwide COMPUTER SHOWCASE EXPOS and THE BYTE COMPUTER SHOWS.

300 First Avenue, Needham, Massachusetts 02194  
(800) 325-3330 • In Massachusetts (617) 449-6600



# WORK FAST. BUT WORK SMART.

You've got to work fast to get ahead in the systems and sub-systems business. But you'll just spin your wheels if you don't also work smart.

That's why disk drive vendor selection is so important. And VERTEX is the smart choice.

We work fast. In our first full year of production we will deliver over 30,000 30MB, 50MB and 70MB V100 5¼" Winchester. That's because the V100 was designed intelligently with a low parts count, simple assembly procedure and "off the shelf" components. This design approach provides greater manufactureability, but it also means higher reliability and margins.

Our new V185 85MB 5¼" Winchester is an extension of this design philosophy. The V185 family is based upon our V100 family. By increasing the number of tracks and track density, and maintaining the ST412 interface (with 5Mbit/second transfer rate) we've maintained our four-platter, eight-head configuration. So you get lower cost and higher reliability.

And since few changes were made to upgrade the V100 family to the V185, we'll be able to get up the high volume production ramp faster.

Speaking of fast... the V185 also has a 30msec average access time (including settling) and a microprocessor interface that starts head arm movement at the first seek pulse.

Every VERTEX drive is backed by the best Winchester engineering and manufacturing team in the business. So get your system and sub-system plans going now. Call us at (408) 942-0606. Or write VERTEX, 2150 Bering Drive, San Jose, CA 95131. It's the smart decision.

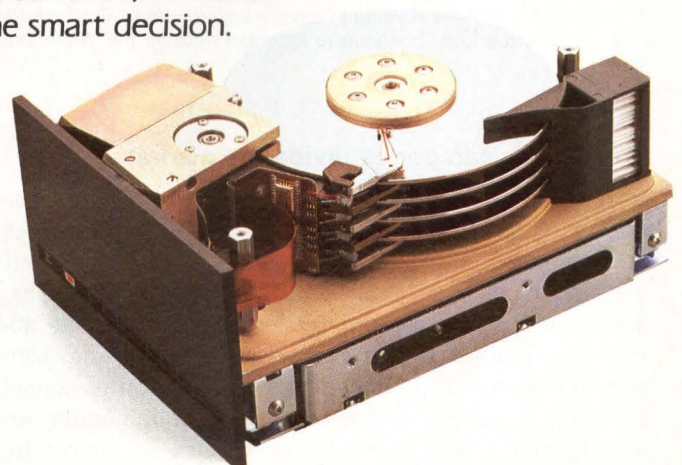
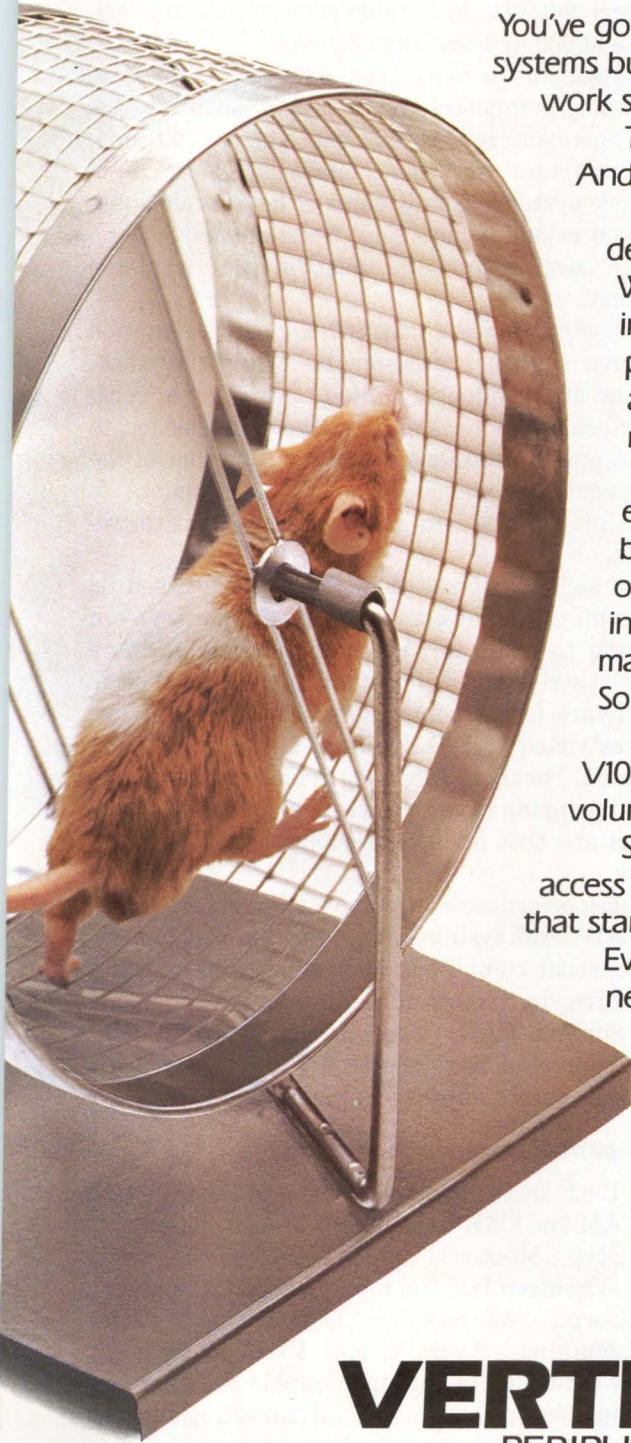

**VERTEX**  
PERIPHERALS

You Can Plan On Us...

# The Integrator

formed a division to integrate its CAD/CAM and CAE and manufacturing-support activities. Called the Computer-Integrated Manufacturing (CIM) Division, the unit will help CDC coordinate its CAD/CAM and CAE development, marketing and support efforts. Citing product introductions scheduled for this year, a spokesman for the CIM Division estimates that CDC's 1984 revenues from CAD/CAM and CAE system sales and related services would reach \$75 million. If this projection proves accurate, the company will probably pass Auto-trol to become the industry's seventh-largest vendor with a 3.3 percent share of the 1984 CAD/CAM and CAE market.

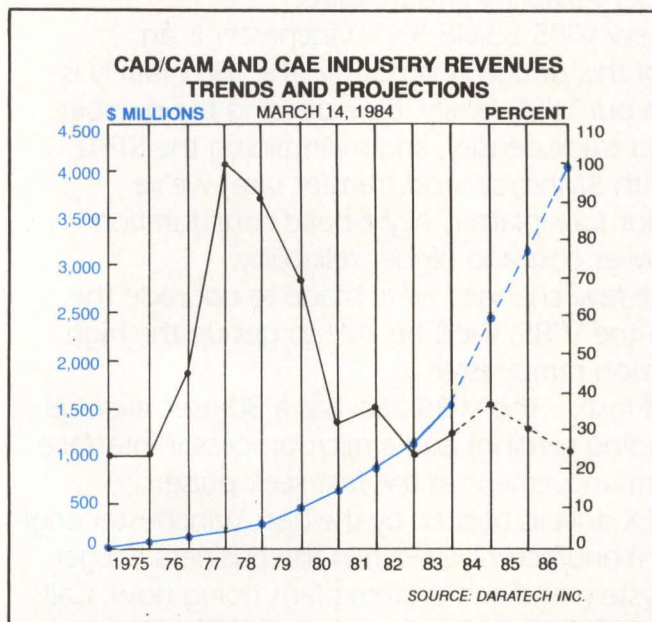

Revenue growth in 1984 should equal and may even surpass the recent high of 40 percent experienced in 1981. Despite a fluctuating growth rate, industry revenues have climbed steadily since the mid-1970s and should continue to increase through the 1980s and early 1990s.

## Three price categories divide the market

Today's CAD/CAM and CAE products are a confusing patchwork of systems based on mainframes, superminicomputers, minicomputers and microcomputers that have 16-, 16-/32- and 32-bit processors. They are sometimes connected by local-area networks and can include high- or low-resolution displays, digitizers and any of hundreds of software application packages. But beginning to emerge from this pandemonium are applications and price ranges to suit an increasing number of industry needs. Applications address me-

chanical and electronics design and manufacturing and AEC. Prices fall into three ranges: more than \$60,000, less than \$60,000 and less than \$20,000.

Systems selling for more than \$60,000 per workstation, including computers, plotters and software, are generally host-centered systems based on a mainframe, superminicomputer or minicomputer. These high-performance systems usually support large-scale applications such as solids modeling, finite-element modeling, logic simulation and associative database management.

Systems selling for less than \$60,000 per workstation usually have system processors built into the workstations and are frequently limited to drafting applications. Performance, measured by the time needed to respond to operator actions, is poorer than that of the more expensive systems, although performance is improved for workstations based on 16-/32-bit microprocessors.

Systems selling for less than \$20,000 are based on personal computers. This fast-growing market segment is beginning to make inroads into the sales of more expensive systems and will become more important in 1984. Software for personal computer-based systems, initially restricted to 2-D drafting, is becoming more sophisticated. Packages for solids modeling, electronics design and mapping have recently been introduced, and indications are that additional sophisticated software will follow.

Although performance of personal computers is still limited CAD/CAM systems based on the next generation of personal computers may emerge as a major industry force. In the meantime, innovative companies such as Summit CAD Corp., Houston, which adds 16-/32-bit coprocessors to the IBM PC XT to improve performance, obtain impressive results.

## New companies advance technology

In late 1982, small companies began to take the lead in CAD/CAM and CAE technology. They include Daisy Systems Corp., Mentor Graphics Corp., Apollo, Meth-eus Corp., Orcatech Inc., Cadnetix Corp., Cadline Inc., Cadtrak Corp., CAE Systems, Engineering Automation Systems Inc., Avera Corp., VLSI Technology, Formative Technologies Inc. and Graphic Horizons Inc. These companies and others started marketing systems based on networked workstations that incorporate 32-bit microprocessors with multiple coprocessors, very large memory and disk capacities and high-resolution color displays with picture memory sizes measured in megabytes. These systems deliver a lot of performance at far lower prices than the high-end

# ADD TO AND TO



To add markets as well as profits to your business, add Zaisan to your system.

The ES.1 voice/data workstation offers single-key access to simultaneous voice, data or text. With the touch of a button, users can also access internal and external databases, PBX functions, and electronic mail.

The ES.1 is also upgradeable. So you can add application and communication software to tailor the ES.1 to the individual information needs of your users. Which can add sales to your business.

Another plus is the price. And the wide range of service options.

Add these all up and you'll see the formula for success is rather elementary. Add Zaisan.

13910 Champion Forest Drive, Houston, Texas 77069. 713.580.6191.

**ZAISAN**<sup>™</sup>

*The new direction in business communications.*

# SIMPLY OUTSTANDING



**Kimtron** is building the #1 terminal company and proudly presents its KT-7 Display terminal.

KT-7 provides not only technological excellence, but also True Ergonomics, Highest Value and Unique Features to improve user efficiency and comfort.

#### **True Ergonomics**

- *Height Adjustability*
- Tilt and Swivel
- Low Profile Keyboard with three level tilt and easy touch
- Sharp Display with High Resolution
- Green or Amber Phosphor

#### **Small Size and Light Weight**

- Less than 18 inches deep and fits in a Secretarial Return Desk
- Less than 22 pounds net

#### **Unique Features**

- *User-Selectable Hidden or Embedded Attributes*

#### **Best Features**

- 9 X 13 Cell Resolution
- 25th Status/Set-Up/Message Line
- Set-up, 20 Programmable Function Keys and Answerback stored in Non-Volatile Memory
- 4 International Character Sets
- 94 Business Graphics Characters
- Block Mode and Protect Mode
- Up to 4 Pages of Memory Optional
- All the Smarts

#### **Compatibility**

*Standard:* TeleVideo\* 910, 920, 925.  
*Option:* ANSI X3.46 or DEC\*\* VT\*\* 52/100/132 (80 column), or DG\*\*\* D100, or OEM Customization for other terminal emulation available

## Only \$595

for all these features.

Call us or your terminal supplier for more information

## Kimtron

2225-I Martin Avenue  
Santa Clara, California 95050  
(408) 727-1510

**OEM/Systems Integrator/  
Distributor/Dealer Inquiries Invited**

\*TeleVideo is a trademark of TeleVideo Systems, Inc.  
\*\*DEC and VT are trademarks of Digital Equipment Corporation  
\*\*\*DG is a trademark of Data General Corporation



# The Integrator

systems. Software for these workstations is usually based on the UNIX operating system and includes extended engineering-analysis functions that are impractical to run on 16-bit, minicomputer-based systems.

Leading the pack in graphics workstation technology is Silicon Graphics Inc., Mountain View, Calif., which in mid-1983, introduced a workstation capable of computing shaded images fast enough to display complex, shaded models of solids moving in real time. To do this, the workstation performs 7 million floating-point operations per second—five to 10 times as many as a VAX-11/780 can perform. With a top-of-the-line model priced at \$59,500, these workstations promise to make today's solids-modeling software substantially more useful and to open a wealth of CAD/CAM and CAE applications.

Although only one or two vendors were selling IBM PC- or PC XT-based CAD/CAM and CAE systems at the end of 1982, 13 companies have entered this market segment, and more are on the way. The systems they offer range from simple 2-D drafting packages for AEC applications to printed-circuit-board design systems and a solids-modeling system capable of producing complex shaded images.

Suppliers of PC-based systems are marketing the systems in three principal ways: directly from software developers to end users, indirectly through manufacturers' representatives and through system integrators. System integrators purchase software from developers, buy hardware directly from hardware manufacturers or from dealers and sell the entire package—hardware, software, training and maintenance—to end users. System integrators tend to have an affinity for their market niches. Integrators selling to the AEC market, for example, are often spin-offs from architectural and professional engineering companies.

Prices in the low-end market segment start at about \$1,000 for simple 2-D drafting software. Price of a solids-modeling package installed on a 19-inch, 4,096-color (from a palette of 16.8 million), 512-by-512-pixel, 30-Hz interlaced graphics display with 1M byte of pixel memory is \$16,000. A 2-D mechanical design/drafting system with numerical-control capability can be priced as high as \$25,000. Revenues from the sale of IBM PC-based systems will probably grow 400 percent this year—from \$5 million in 1983 to more than \$25 million in 1984—representing a 1 percent market share. Companies marketing IBM PC-based systems include Autodesk Inc., CadCal Products Inc., Carrier Corp., FutureNet Corp., Integrated Computer Technologies Inc., Micro Control Systems Inc., Personal CAD Systems Inc., Summit CAD, T&W Systems Inc. and Cubicomp Corp. □

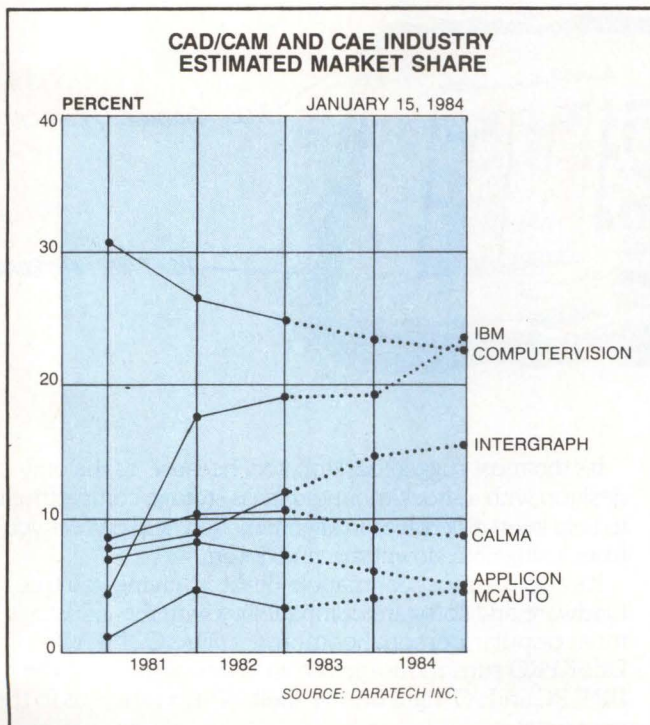

**IBM should pass industry leader Computervision to capture the largest market share in the CAD/CAM and CAE market by the end of 1984. Among other leaders, Intergraph and McAuto should increase their market shares, while Computervision, Calma and Applicon should each lose share.**

**Charles M. Foundyler** is president of Daratech Inc., Cambridge, Mass., a market research and publishing company specializing in the CAD/CAM and CAE industry.

This article is based on material contained in Daratech Inc.'s publication, *CAD/CAM, CAE: Survey, Review and Buyer's Guide*. The \$199 survey contains detailed information on 209 CAD/CAM systems and 105 vendors. For more information on this publication, contact Daratech, 16 Myrtle Ave., P.O. Box 410, Cambridge, Mass. 02238, (617) 354-2339.

Interest Quotient (Circle One)  
High 807 Medium 808 Low 809

# Computer dreams.

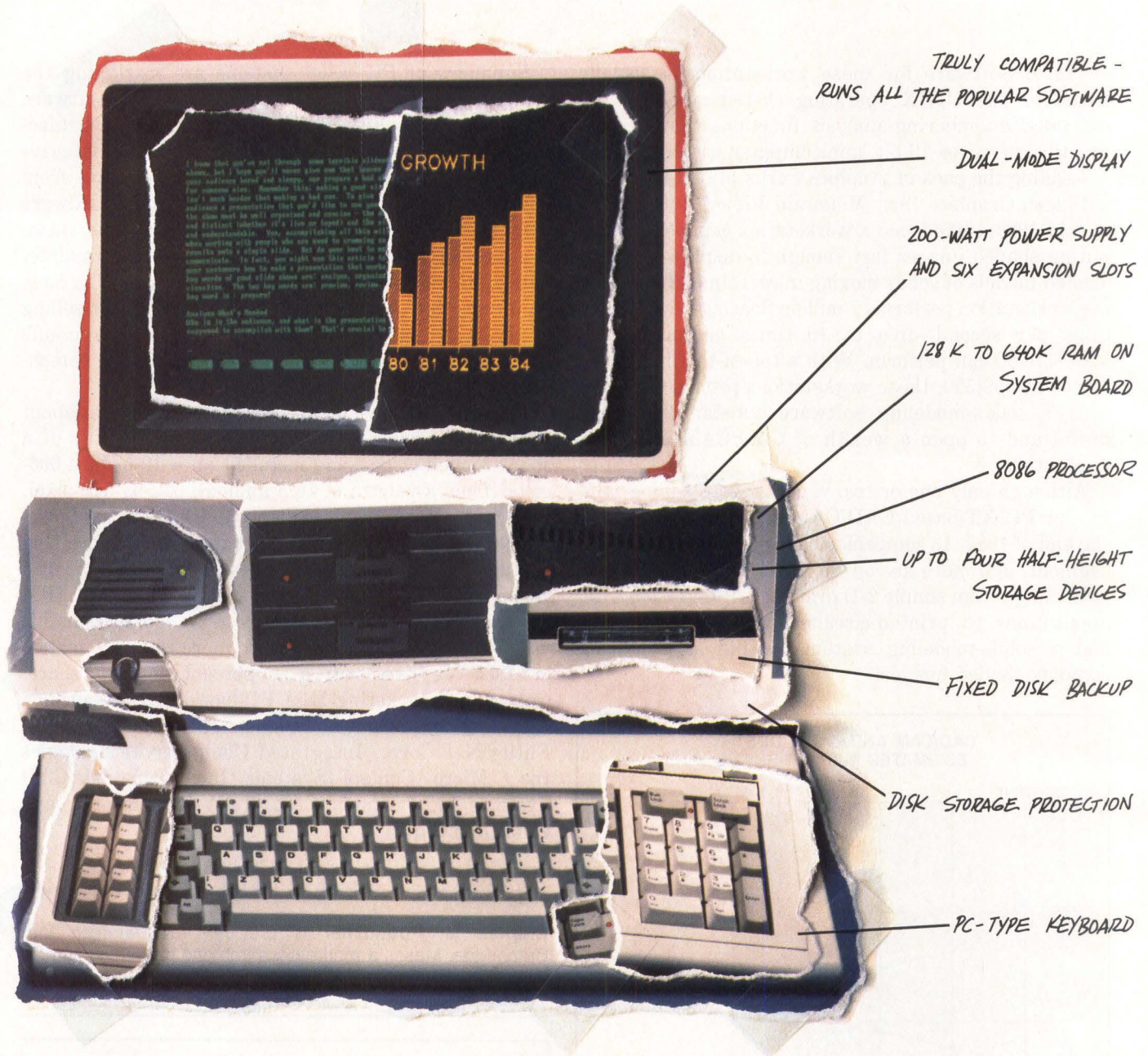

Introducing the new COMPAQ DESKPRO.<sup>™</sup> COMPAQ combined the best features of the best desktop computers. And then added exclusives you won't find on others. Today they're together in *one* personal computer. The COMPAQ DESKPRO.

The COMPAQ DESKPRO is the most expandable desktop you can buy. It can grow as you grow, with up to six available expansion slots and four storage devices, including a unique fixed disk drive backup—all *inside the computer instead of out*, saving your desk from clutter.

It's the most rugged desktop, too, because it's the only desktop with a shock-mounted mass storage compartment to help keep disk drives in alignment and help protect you from losing data, downtime, and dollars.

It's also the most compatible desktop, giving you true hardware and software compatibility with the industry's most popular personal computers. The COMPAQ DESKPRO runs thousands of programs written for the IBM<sup>®</sup> PC and XT right off the shelf. Which brings us to the next point.

# Dream computer.

*The industry leader in compatibility.*

*Text and graphics on one screen, not two.*

*Power and space for almost unlimited expansion.*

*Add up to 640K of memory on system board and save expansion slots.*

*Runs software 2X to 3X faster.*

*10MB fixed disk drive  
10MB fixed disk backup  
Two diskette drives*

*Exclusive tape backup helps protect data.*

*Unique shock mounting helps protect your data and hardware investment.*

*Familiar layout enhanced with LED's on caps and num-lock keys.*



The COMPAQ DESKPRO is the fastest truly compatible desktop you can buy. It's two to three times faster than the industry standard. That saves time now. And in the future, as software becomes more sophisticated and integrated, it will save you even more time as well as protect your personal computer investment.

But there's more. We gave the COMPAQ DESKPRO one other feature not found on any other machine. You can choose between an amber or green dual-mode monitor that displays high-resolution text *and* graphics with equal

brilliance, saving you the cost and clutter of a second monitor.

See the Dream Computer. Then pinch yourself. It's for real.

For the location of the nearest Authorized COMPAQ Computer Dealer, or for a free brochure, call 1-800-231-0900, Operator 5 or Telex #795437 COMPAQCOMP HOU.

*The New*

**COMPAQ**

**DESKPRO™**

*It simply works better.*

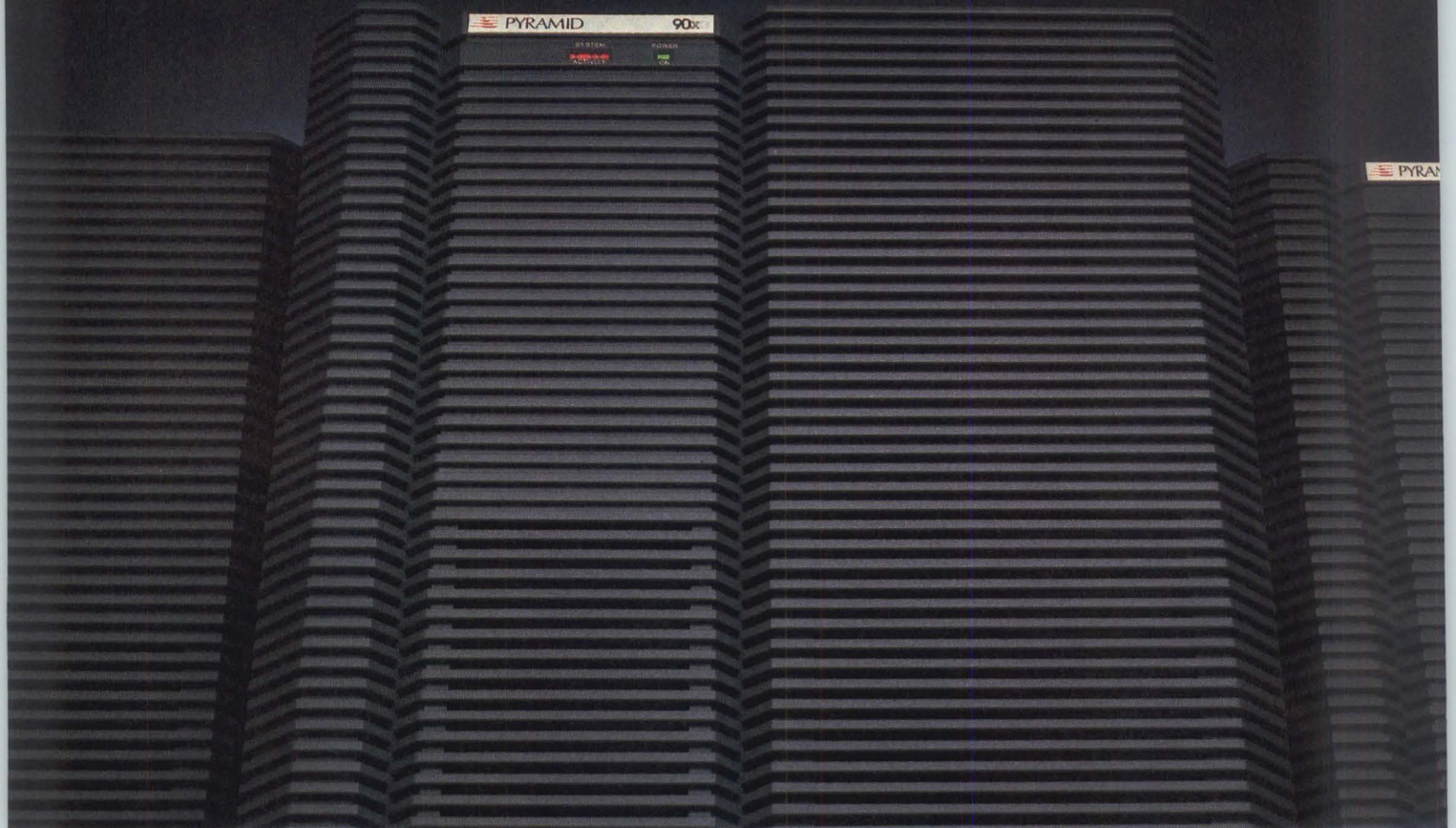

## IF IT WEREN'T FOR UNIX WE NEVER COULD HAVE BUILT THE PYRAMIDS

Ordinary computers, yes. But not a Pyramid Technology 90x.

After all, here's a supermini not just capable of running UNIX,<sup>™</sup> but born to run it. And run it up to four times faster than the most popular UNIX host. For a lot less money.

The secrets of this Pyramid are a thorough understanding of UNIX, a few fundamentals of RISC (Reduced Instruction Set Computer) theory, more registers than 30 VAXs, and a 32-bit proprietary architecture that outperforms a roomful of micros.

All combined to speed up UNIX just where it likes to slow down.

For example, gone are 85% of performance-robbing memory references. The endless parameter shuffling of yesterday's technology has been replaced with a hardware register window. Even context switching takes less than one percent of the CPU's time.

It's amazing what hardware architects can do, given the chance. It's almost as startling as what our software wizards did.

They crafted OSx, a dual port of Berkeley's 4.2 BSD and Bell's System V. Because you can switch environments at will, no UNIX port offers more capabilities. With absolutely no loss

of compatibility.

Well, almost.

We do admit to one feature not compatible with other UNIX systems. Our single-source support.

One telephone number instantly connects you to both hardware and software experts. In-house pros, who spend their energy pointing you towards solutions. Not pointing fingers at each other.

So no matter how you see your requirements shaping up, contact Pyramid Technology, 1295 Charleston Road, Mountain View, California 94043. Or call (415) 965-7200.

Because when it comes to running UNIX, a Pyramid looks good from any angle.

 **PYRAMID  
TECHNOLOGY**

# The Integrator

## Automated testing and material handling streamline production and raise yields

*Faced with choice between moving overseas or automating, disk drive maker opts to automate*

Joseph Smith, Priam Corp.

Early in 1982, Priam Corp., a San Jose, Calif., manufacturer of high-capacity Winchester disk drives, recognized the need to increase productivity and achieve lower manufacturing costs. With sales doubling annually, we realized that limited production capacity was keeping us from growing. The goal was to increase manufacturing capacity fivefold—from 250 to 1,200 drives per day—without sacrificing quality standards.

We considered moving production overseas but determined that the drawbacks, including substantial management and support costs, training of foreign workers and lack of contact between technical and production groups, outweighed the benefits of lower labor costs. By carefully studying and implementing automation, we have achieved production goals while maintaining tighter control over manufacturing processes.

Priam's manufacturing operation consists of assembling and testing 5¼-, 8- and 14-inch Winchester disk drives. To achieve the production volume initially targeted, the logical first step was automating material handling and testing. For material handling, we presumed that decreasing human contact with components during assembly would help eliminate contamination and lead to higher yields. We also presumed that workers would be more productive if parts were continually available. Automating the testing of disk drives also offered more than increased efficiency. Because testing amounts to 60 percent of Priam's manufacturing process, we looked to automation as a means of collecting additional data about the drives.

After a year of investigating equipment for the new facility, Priam settled on three main suppliers: Litton Unit Handling Systems, Florence, Ky.; Rapistan Co., Grand Rapids, Mich., a division of Lear Siegler Inc.; and Dreyden Engineering Co., Santa Clara, Calif., a supplier of modular clean tunnels from Integrated Air Systems (IAS) Inc. The reputation of each supplier—its track record and overall expertise—and the support each supplier offered were critical considerations. Once we chose the equipment, a new building was designed. Ground-breaking for the 142,000-square-foot facility

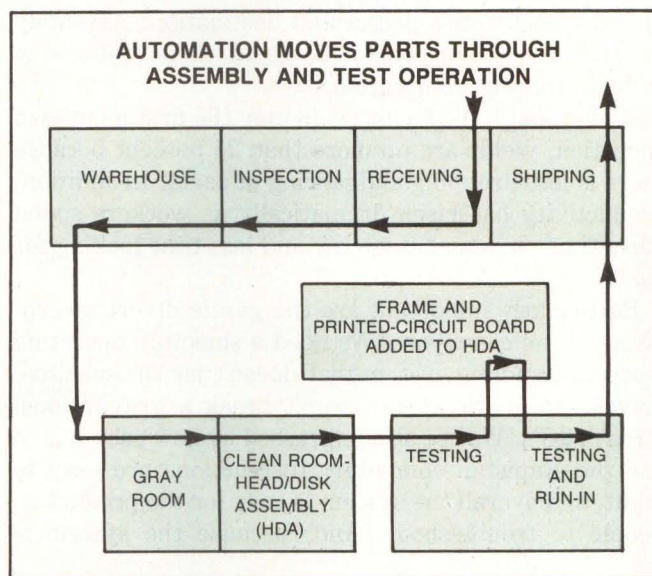

Starting in the receiving area, parts travel on automated material-handling equipment. Ultrasonic cleaning takes place in the gray room, and assembly of delicate components takes place in four clean rooms. In the final stages, both testing and material handling is automated.

was in May 1983, and, by December, disk drives were traveling along the newly installed conveyor system.

### Material moves efficiently but gently

Automated material handling begins when components arrive in the receiving area and continues through assembly, testing and shipping. Currently, warehousing is not automated, although delivery of parts to and from the warehouse is automated. Components, including printed-circuit boards assembled at another Priam facility, motors, media and heads, move on conveyors to and from inspection stations and the warehouse. Workers then move parts manually from storage to "gray rooms," where components for the head/disk assembly (HDA) are initially assembled and cleaned. An HDA consists of magnetic heads and disks for writing, storing and reading data, a spindle and spindle motor for spinning disks and a linear voice-coil actuator for positioning heads.

# The Integrator

Once workers assemble the parts kits, Rapistan's production-management system routes material to and from assembly workstations within four clean tunnels. Workers place parts such as drive spindles and disk platters into totes designed to transport these delicate assemblies. The Rapistan conveyors move material in a predetermined sequence from one set of stations to the next as assembly progresses. Sensors tell the system which stations are open and able to receive parts and, by keeping a 6½-foot "window" between totes, allows it to track each tote's origin and destination. Assembly workers also have control boxes at their stations to indicate routing information.

Even though the facility is in only the first months of operation, yields are up more than 25 percent because there is less dropping and jarring of parts. In addition, productivity has risen dramatically as workers spend more time on actual assembly and less time looking for parts.

Particularly important are the gentle divert mechanisms of the conveyors. We need a smoothly operating material-handling system that doesn't jar the sensitive drives—so gentle that it won't break a gravitational force of 2G's. We are also impressed by how easy it is to use the Rapistan computer. Instructions are easy to input, and overall the system is easy for the production people to troubleshoot. And, because the system is

modular, it can be re-configured to meet changing production needs.

We also plan to take advantage of features that allow us to collect information about the assembly process itself. The material-handling system has distributed process-control/communication functions that offer a real-time window on the assembly process, providing information such as the number of units in assembly, assembly completion times and pass/fail rates. Local devices plug in at various workstations and are linked to a supervisory-level microprocessor, the tote director controller (TDC).

Supporting the TDC is a combination Winchester/floppy disk subsystem that stores basic parameters, operating programs and operation data. Once operators are comfortable with the material-handling system, we plan to use it to collect data and will eventually tie it into a mainframe to allow more fully integrated computerized manufacturing.

Priam chose clean tunnels from IAS because of the company's reputation for high-quality air systems and because of the support IAS offered. Our deadline for getting the facility up and running was a major consideration, and Dreyden Engineering, the supplier of the IAS system, was able to meet it.

In addition to guaranteeing that 1 square foot of air has no more than 100 particles that measure 0.5  $\mu\text{m}$ . or



**Inside the clean room, a worker completes a head/disk assembly.** Delicate parts move from station to station on conveyors, minimizing accidental dropping and jarring.



**If you have one of these,  
Infotron can have you  
communicating data  
in just 48 hours.**

**Modems and stat  
muxes, to go.**

Infotron offers a complete line. And now, with our unique distributor warehousing program, we can have any of them on your doorstep within 48 hours of your call. 48 hours, max. Just say the word.

**Full system flexibility.**

Infotron modems combine advanced features and inherent reliability.



bility. Our statistical multiplexers handle from 4 to 32 channels in a range of models—with full provision for expansion.

All with the same high quality that earns us top marks in performance and reliability from our present users.

Add competitive pricing, and we start making real sense.

Then add our 48-hour delivery, and we're awfully hard to beat.

**1-800-345-4636**

**To find out more.  
Your Infotron distributor.**

There are Infotron distributors nationwide, ready to give you more information, provide equipment and offer expert advice on the best way to meet your needs. For the name of the distributor near you, dial toll-free 1-800-345-4636 and ask for ISO. Or write Infotron Independent Sales Organization, 9 North Olney Avenue, Cherry Hill, NJ 08003.

**Infotron. First in  
performance and reliability.**

 **INFOTRON** SYSTEMS



EROSTEKE DEVELOPMENT AGENCY, INC.  
1234 N. 5th Street  
ROSELAND, CALIFORNIA

CHIEF ENGINEER: J. SANDER  
CHIEF DESIGNER: M. OSBY  
SUPERVISOR: S. MITI

CONTRACTS DIV.  
WATER PUMPS & PIPING  
ENGINEERING

GENERAL NOTES: Construction must start on or before 3/15/92. All  
requests must be given to consideration of the health  
of employees and the environment.

010-42-68014	06/20/92
010-42-70860	07/06/92
010-42-70955	08/21/92
010-42-79242	09/01/92

STREET FRANCHISING  
1501 N. 1st Street  
1501 N. 1st Street  
1501 N. 1st Street

Lotus

PART NUMBER: 974232989  
DESCRIPTION: 1992 Ford Fairlane Sedan, left rear brake shoe  
PRICE: \$28.00

UN 1890 UN 1893 UN 1894

4	12	26
---	----	----

Don 8-15 confirmed Honda!!! Mr. Shivers via  
Track # 8  
1-1 from contract Thomas News, Ruda

ROELFORD HARDWARE

SUPPLY TO: RUTLAND, MIDDLETOWN, BURLINGTON, VERMONT  
ITEM: S. L. TORGER, MANAGER

ITEM: S. L. TORGER, MANAGER

ITEM: S. L. TORGER, MANAGER	ITEM: S. L. TORGER, MANAGER
ITEM: S. L. TORGER, MANAGER	ITEM: S. L. TORGER, MANAGER
ITEM: S. L. TORGER, MANAGER	ITEM: S. L. TORGER, MANAGER

ITEM: S. L. TORGER, MANAGER

ADM II

ADM 24E



# Lear Siegler

## Quality and Reliability You Trust.

### High Touch™ Style You'll Prefer.

This new generation of Lear Siegler video display terminals brings elegant High Touch™ style to our American Dream Machine (ADM™) tradition. The family features three new ergonomic terminals designed to meet the needs of OEMs and end users alike: the ADM 11, the ADM 12 and the ADM 24E.

Here is a whole new way for terminals to relate to people. Dozens of little touches add up to the convenience and comfort of High Touch.

For example, we put the power "on/off" switch and contrast control knob in front where they're easy to reach.

The monitor not only tilts and swivels, it stops positively in almost any position.

The clean, crisp display features a large character matrix on an easy-to-read green or amber non-glare screen—made even easier to read by the hooded bezel. Screens are available in 12" or 14" sizes.

You get the best in style and ergonomics, plus all the outstanding performance features you'd expect from Lear Siegler (see chart).

Lear Siegler High Touch terminals are backed by the broadest network of full service centers anywhere, serving 3000 cities nationwide. And they're made in America—designed, engineered, manufactured and shipped from Anaheim, California to provide you with the best local support.

Place your order today by calling your local Authorized Distributor or, for quantities in excess of 500 units, your Regional OEM Sales Office.

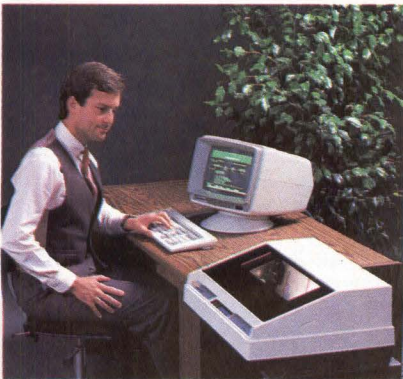

Lear Siegler's new VersaPrint™ 500 Series printers combine with Lear Siegler video display terminals for hard copy output.

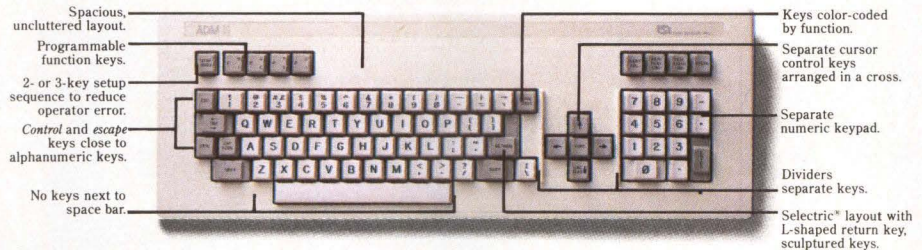

Low-profile, tapered, DIN-standard keyboards with Selectric layout feature logical key groupings and adjustable tilt for comfort and efficiency. ADM 11 shown above.

	<b>ADM 11</b>	<b>ADM 12</b>	<b>ADM 24E</b>
	Conversational	Editing	Host Programmable
Programmable Function Keys	4 (Shiftable to 8)	16 (Shiftable to 32)	16 (Shiftable to 32)
Non-Volatile Function Keys	Optional	Standard	Standard
Function Key Legends on 25th Line	From Host	From Host	Standard Non-Volatile
No. of Pages of Display Memory	1	2	4
Display Memory Configurations (Plus 25th Message/Status Line)	24 Lines by 80 Characters	(2) 24 x 80 or (1) 48 x 80 or (1) 24 x 158	User Definable up to 96 x 80
Scrolling	Standard Scrolling	Smooth, Jump or Horizontal Scrolling Split Screen	Smooth or Jump Scroll Split Screen
Transmission Mode	Conversation Mode	Conversation or Block Mode	Conversation or Block Mode
Editing	Limited	Full Editing & Protected Fields	Full Editing & Protected Fields
Visual Attributes: Reduced Intensity, Blink, Blank and Reverse Video. Underline also on ADM 12 and ADM 24E	3 Embedded 1 Non-Embedded	4 Embedded, 1 Non-Embedded or All Non-Embedded, plus Full Screen Reverse Video	5 Embedded, 1 Non-Embedded or All Non-Embedded, plus Full Screen Reverse Video and Highlight
OEM Flexibility	Modifiable Set-Up Characteristics	Modifiable Set-Up Characteristics & Personality	Modifiable Set-Up Characteristics. Add to Program in ROM or Down-Line Load in RAM (56K ROM or RAM. Up to 22K Display Available) Room for additional Logic Boards.
Terminal Compatibility	ADM 3A, ADM 5, ADDS Viewpoint & Regent 25, Hazeltine 1400, 1420 & 1500, DEC VT-52	ADM 3A, ADM 5, ADM 31, ADM 32	ADM 3A, ADM 5, ADM 31, ADM, 32, ADM 42

Call Lear Siegler at **800/532-7373** for the phone number of an authorized distributor near you: Advanced Technology · Continental Resources · The Datastore · Data Systems Marketing · David Jamaison Carlyle, Inc. · Digital Source · Dytec/South · Gentry Associates · Hall-Mark Electronics · Inland Associates · Kierulff Electronics · M/A Com Alanthus, Inc. · Marva Data Services · M.T.I. · National Computer Communications · Pioneer (Standard, Harvey, Gaithersburg) · 2M Corp. · Wyle Electronics

**Distributor Sales & Service:** Boston (617) 456-8228 · Chicago (312) 279-7710 · Houston (713) 780-9440 · Los Angeles (714) 774-1010, ext. 219 · Philadelphia (215) 245-4080 · San Francisco (415) 828-6941 · England (04867) 80666 · From the states of CT, DE, MA, MD, NJ, RI, VA and WV (800) 523-5253.

**OEM Sales:** Chicago (312) 279-5250 · Houston (713) 780-2585 · Los Angeles (714) 774-1010, ext. 582 · New York (516) 549-6941 · San Francisco (415) 828-6941 · England (04867) 80666



901 E. Ball Road, Anaheim, CA 92805 (714) 774-1010

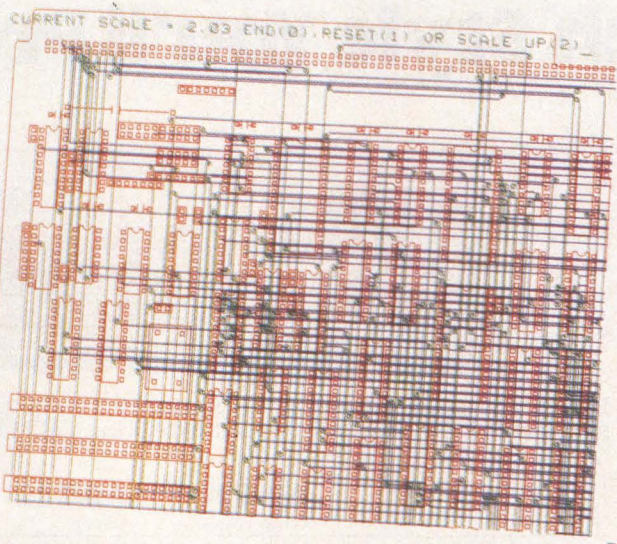

- \* PROBLEM AREA
- \* MTBF
- \* COST TO REPAIR

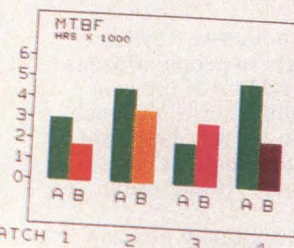

CPU BOARD FAILURE ANALYSIS

## Read The Fine Print.



Letters. Numbers.  
Charts. Graphs.  
Fine curved or  
straight lines.  
Engineering  
drawings and  
presentation

materials. On paper or film.

The CH 5201 puts high quality color hard copy in your hands.

With amazing consistency. Ask for 100 copies and the last one looks as good as the first. No wash-out. And no color deviations. Lines remain parallel. Curves look like curves. And details don't turn into blobs. Whether you're using plain paper or transparency film.

There are no long waits, either. Because

the 5201 is fast. In the time it takes most other copiers to produce a sheet, the 5201 can produce a stack! Its built-in frame buffer captures the image and lets you make up to 99 copies. Without operator attendance. Plus, it frees your terminal. Which frees you from wasting a lot of time.

Finally, the 5201 is a system manager's delight. Our Adaptable Video Interface (AVIF) accepts a wide variety of video inputs, making interface a breeze.

For a demonstration of this rather inexpensive miracle contact your Seiko Instruments representative, or us at 1623 Buckeye Drive, Milpitas, CA 95035, (408) 943-9100.

You'll be amazed at how easy and inexpensive it is to read the fine print.

**SEIKO**  
INSTRUMENTS

© 1984 Seiko Instruments U.S.A., Inc., Graphic Devices & Systems Division.

# The Integrator

more in diameter, these Class-100 clean tunnels provide laminar airflow at 100 feet per minute through wall-to-wall ceiling filters. Air travels downward and is recirculated through return air walls in which it is filtered again. The improvement in yields is largely due to the conditions of the clean tunnels. Because temperature and humidity can be controlled, working conditions have also improved for assembly workers, who must don nylon outerwear to work in the clean tunnels. Greater humidity control has also added to the increase in yields.

## Drives move through automated test setup

After an HDA is assembled and just before it leaves the clean room, it is placed in a "hot pallet," a plastic carrier designed for use in the Litton test system. An elevator then moves the pallet onto the conveyor that takes it to the Litton ToteStacker, a computerized storage-and-retrieval area. An automated crane, similar to a forklift, moves in the aisles between rows of shelves. Two storage-and-retrieval systems handle each of the four clean tunnels. The front end of each tunnel is dedicated to initial testing, and the back end is used for run-in and final testing.

The pallets' bar-code labels are an important part of the tracking and test procedures. Once an HDA is placed in a pallet, a worker uses a bar-code reader to enter the pallet identification number and the drive's part number into the Litton system. This procedure tells the system whether the pallet contains a 14-inch,

8-inch or 5¼-inch drive and allows it to track the drive and compile a history of its test results. The pallet also serves as part of the test system and was designed and wired to Priam's specifications.

We evaluated equipment from a number of vendors before automating our testing process, and we liked the fact that Litton already had a prototype burn-in scheme similar to the procedure we wanted to implement. Litton also offers a light crane that can move pallets quickly. We also like Litton's hardware and software support. Both Rapistan and Litton have installed modems at the facility to help us troubleshoot software used in their systems.

The front end of the Litton system stores HDAs and delivers them to test stations, where workers perform initial functional tests such as contamination testing and surface analysis. As an HDA passes a test, it is sent back into the storage-and-retrieval equipment, in which it remains until the pallet can be delivered to the next test station. If a drive fails, it's sent to an HDA debugging station.

The back end of the Litton system is used for run-in and final testing. After the HDA passes its initial tests, the crane delivers it to a drive-assembly station. There, an assembly worker puts the HDA and disk drive electronics into a frame. From framing, the assembled drive is sent into the second stage of the storage-and-retrieval system for run-in and final testing. The storage compartments in the second ToteStacker are fitted with fans and extensive wiring so that run-in and final

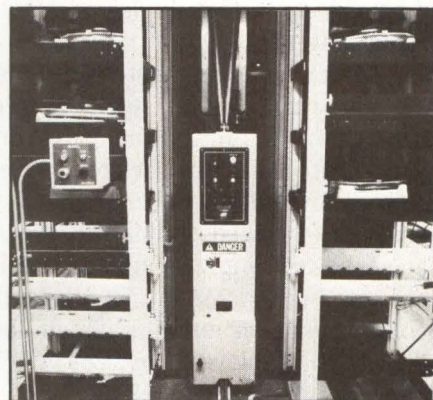
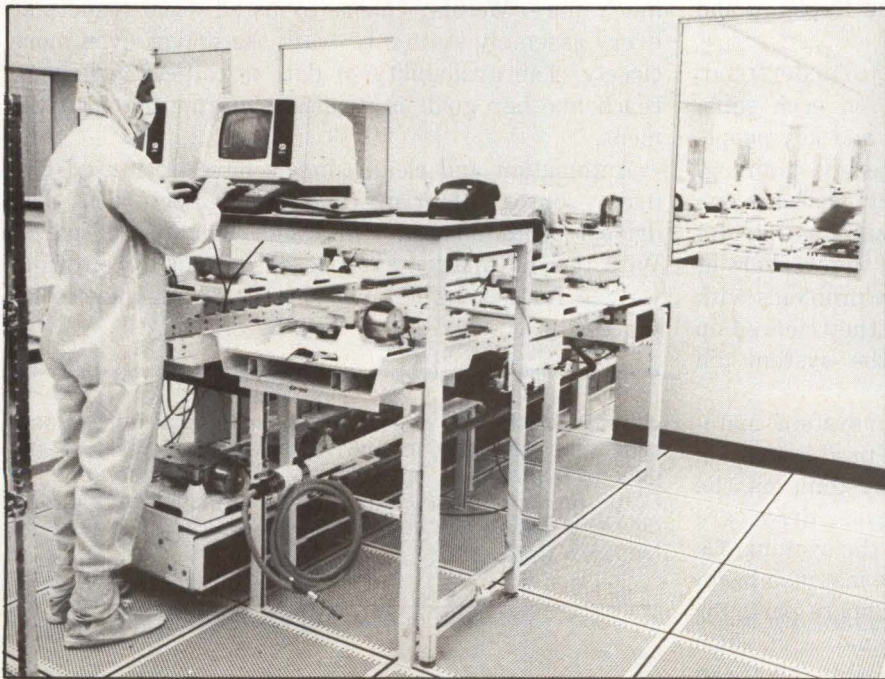

**At the heart of the automated test area is a computerized crane that stores and retrieves disk drive assemblies from racks. The pallets on which the assemblies rest contain cables for automated testing procedures.**

**At the automatic material-induction station, part of the computerized conveyor system, an operator enters information used by the system to route components through the clean room for assembly.**

# The Integrator

testing can be performed automatically.

When the pallets leave the framing area, they contain the completed drive and a power supply along with a standalone test (SAT) card developed by Priam that contains instructions for run-in and final test. Each drive is plugged into a hot pallet and sent back into the system, which brings it to an open test slot. There, they plug themselves in and begin run-in and testing.

The SAT card can send messages about the status of a drive to the Litton system or to a mainframe computer, as well as record data on the disk itself about the drive's performance. A network of communication loops lets test equipment share data and report results to a mainframe. Once the drive completes final testing, it receives a last quality check and travels by conveyor to shipping.

---

*Since testing is 60 percent of Priam's manufacturing process, we looked to automation as a means of collecting additional data about the drives.*

---

## Learning to use the systems

In designing the facility, we tried to simplify overall manufacturing by making it unnecessary for employees to move heavy, bulky materials. We kept workers informed from the beginning and showed them slides and a videotape that explained both the Rapistan and Litton systems.

The Rapistan equipment is fairly easy to understand. An industrial engineer spent a week on each shift, training workers to use the conveyors, and key people who operate the computer got more extensive training. Litton provided all operators and key workers one month of extended training in areas such as maintenance and test engineering and trained the workers at each workstation. We initially had a few problems with people working around the system, but they cleared up quickly as employees realized that the system did indeed do what it was designed to do.

Should problems occur in the Rapistan system, materials can be moved manually so that production can continue. Malfunction of the Litton system, on the other hand, could affect production because drives are difficult to retrieve once they're inside the system. We don't anticipate problems because we've installed back-up computer systems and have stocked spare parts for both systems, which should limit downtime. And, since we designed production lines to be flexible, they can



Workers perform contamination tests on the head/disk assembly before putting it into a frame with the printed-circuit board assembly and sending it into the automated test system for run-in and final testing.

handle production of any size drive if a line goes down.

Both the Rapistan and Litton systems provide extensive data-collection capability that will determine where a drive failed in the manufacturing process, how many drives of a given size are available at any time and much more. We may choose to install wand readers at every assembly station to track the drives even more closely. The availability of data is critical in helping reach another goal: centralized information management.

Automation and clean tunnels have decreased two major sources of errors in the manufacture of disk drives: contamination and rough handling of parts. With the information automated systems can provide, we can further refine and control the manufacturing process. □

---

**Joseph Smith**, vice president of operations at Priam Corp., joined the company in 1981. Former vice president and general manager of rigid disk drive operation for Shugart Corp., Smith has spent 17 years in the manufacture of disk drives, including five years at IBM Corp. and five years at Memorex Corp.

---



YOUR GOAL IS TO WIN.  
IT'LL TAKE YEARS OF COMMITMENT.

## YOU'LL NEED A PARTNER WHO CAN CUT IT.

**How We Look At The Future.** Designing information systems for the business office of the future is a lot like planning the flawless performance in ice skating.

Choosing the right printer partner can be critical.

Are the same strong goals for success shared? Is the necessary talent, commitment, and dedication to meeting and exceeding those goals present?

As a major designer and manufacturer of state-of-the-art printers, worldwide, Okidata knows the importance of goals and commitment. And living up to them.

**What We're Doing Today. For Tomorrow.** Right now, our dedicated

research and new product design teams are pushing and testing the limits of present technology to find better ways to build better printers.

Through an on-going and expensive commitment to robotic assembly, we're assuring smoother and faster-than-ever product flow.

And, elsewhere, we're streamlining our customization and modification turnaround times to respond even more quickly to your rapid startups.

**We'll Be There When You Need Us.** In OEM system building, just like in the Olympics, commitment is everything.

If your audience will be looking to you for more flawless performances in the future, we're the printer com-

pany who'd like to join you. In fact, we're already working on it. Call 1-800-OKIDATA. Or write OKIDATA, Mt. Laurel, NJ 08054.

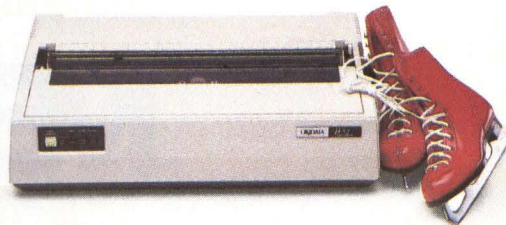

**OKIDATA**  
an OKI AMERICA company

# 212 MB

## 8" Winchester Drives

■ SMD INTERFACE

■ SCSI INTERFACE

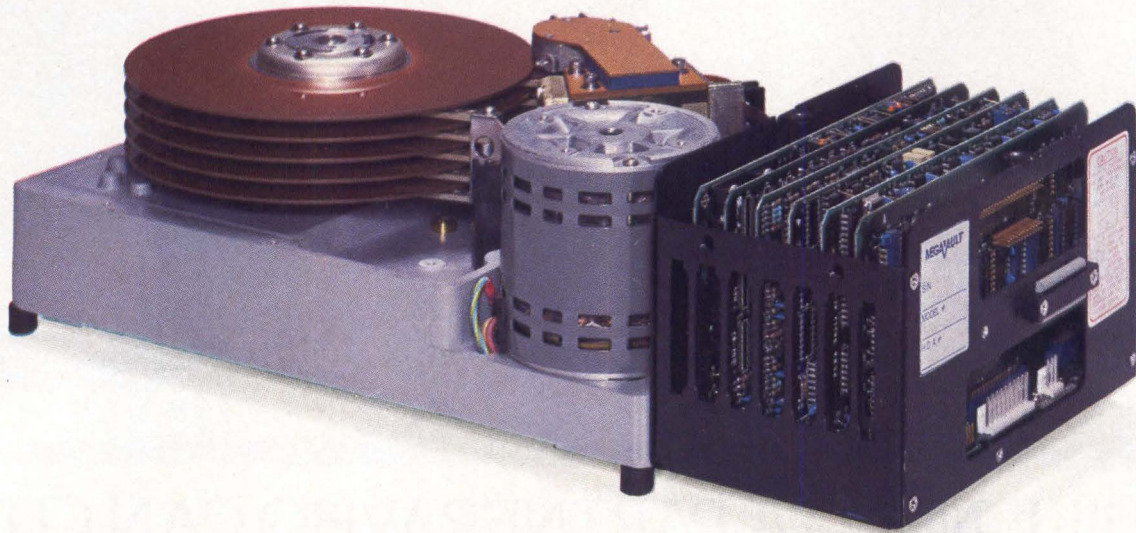

Yes! Our 212 MB, 8 inch Winchester drives are available in either SMD or SCSI interfaces immediately. Just send us your purchase order and we will ship your drives today. By the way, if 212 MB is just too large for your needs, we can ship 166 MB or 83 MB just as fast.

Call today:

# MEGA VULT

... a safe place for data

6431 Independence Avenue, Woodland Hills, CA 91367 (818) 884-7300 Outside California 1-800-MEGAVLT

# FEATURE HIGHLIGHTS

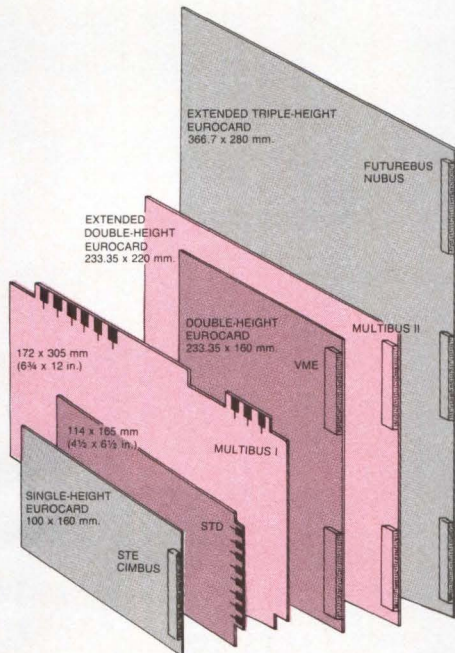

**SINGLE-BOARD COMPUTERS:** Although microcomputer manufacturers have said incompatibility is necessary to achieve high performance levels, a new single-board computer from Advanced Computing Technologies Inc. incorporates a 16-bit processor that is faster than the 8086 and 68000, yet is 100 percent object-code-compatible with the industry-standard Intel 8080. For a closer look, turn to **p. 159**.

**EUROCARDS:** In the first of a two-part series on microcomputer bus standards, Senior Editor Rick Dalrymple explores 8- and 16-bit buses, with a close examination of the Eurocard/DIN-based STE-bus and CIMbus and the edge-connector-based Multibus, Q-bus and STD-bus. For more details, see **p. 171**.

**DEVELOPMENT SOFTWARE:** Software developers find their job much easier these days with the variety of tools available to them—tools that includes optimized language compilers, operating system environments and sophisticated fault finders, and which can even help to create other tools for more complex applications. See **p. 183** for more details.

**MICROCOMPUTERS:** System integrators are incorporating single-user micros into networks that allow multiple users to pool programs, data and peripheral devices. North Star Computer Inc.'s Dimension includes multiple processors that communicate through shared memory using an architecture that incorporates aspects of both loosely- and closely-coupled networks. More information appears on **p. 195**.

**PERSONAL COMPUTERS:** A significant and growing market for personal computers in applications normally served by system integrators and OEMs has emerged. This market is catching the eye of almost all of the major participants in the personal-computer arena. If it's caught yours as well, turn to **p. 205**.

**WORKSTATIONS:** Designing a 32-bit desktop computer with 1-MIPS power requires innovations spanning component chips, physical packaging and even a temperature-control system. A close look at Hewlett-Packard's top-end model 9000, starting on **p. 217**, reveals why it's billed as the machine that can compete with superminis at a fraction of their price.

**TERMINALS:** Because the major advantage of a computer-integrated-design (CID) terminal is the virtual elimination of communications delays, internal throughput is a primary design consideration. Megatek Corp.'s Merlin 9200 achieves that goal at an affordable price. See **p. 233**.

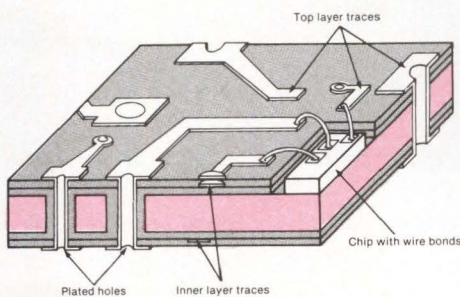
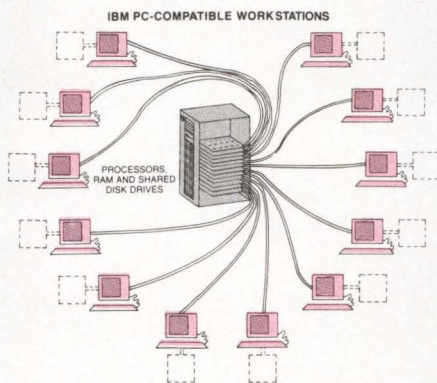



U.S. Congress

M.I.T.

Nº 10  
Downing St.

## Those who know, pick Pacific

However it's defined, quality has a way of being recognized.

For some of our customers, it might be product versatility. Two years ago we began making a 68000-based 16/32 bit CPU board that could operate with or without the popular UNIX operating system, depending on whether the customer had system- or real-time needs.

For others, performance is important. We designed a memory management unit that protects multiuser programs with no wait states. That's when we discovered that performance and versatility become interconnected.

For instance, Congress needed some method of debugging the networking system currently used by the Members'

staffs. We packaged our CPU board with the necessary peripherals, and from this computer system we discovered even more applications. Our board now helps the U.S. Geological Survey analyze minor quakes from the Atlantic seafloor, while across the ocean the Prime Minister's Office uses the same product to edit correspondence.

To increase performance even further we later designed a feature known as "dual porting". This allows two or more processors to work together in tandem. Like a bicycle pedaled-by-two, the speed is impressive. So too is its versatility. M.I.T. uses our new "D" board to study astronomy; General Electric uses it to control a robot for welding jet turbines.

Versatility and performance aside, we like to think that our list of "Who's

Who" is most attracted to us by our unique brand of personal service. Pacific sales representatives provide pre-sales consultation and we pride ourselves on our post-sales service and support . . . no matter who you are.

*For additional information, contact*  
Sherrell Harper  
Pacific Microcomputers, Inc.  
160 Chesterfield Drive  
Cardiff, California 92007  
(619) 436-8649

**PACIFIC**  
MICROCOMPUTERS, INC.  
*Quality Across the Board*

CIRCLE NO. 72 ON INQUIRY CARD



# Single-board computer merges 8-, 16-bit performance

*Minicomputer strategy packs power on a single board:  
3 million instructions per second,  
8080 object-code compatibility  
and supermicrocomputer operation*

**Robin Fosheim and Douglas R. Grundman**  
Advanced Computing Technologies Inc.

In the race to get to market with higher-performance processors, microcomputer manufacturers have frequently neglected to make their new processors object-code-compatible with earlier machines. The result for OEMs and system integrators has been costly delays in new product introductions as software is translated from the current processor to a new one. Attempts to sidestep the compatibility problem have met with various degrees of success. High-level languages ease the transition from one computer to another, but, in practice, few languages are totally portable across machines. Some companies offer dual-processor systems that typically include an 8-bit processor for continued access to 8-bit software, and a 16-bit processor for the use of new products. This strategy, however, does not allow system integrators to port their 8-bit code to the higher-performance 16-bit processor without substantial modification.

Though microcomputer manufacturers have justified incompatibility as necessary to achieve current performance levels, a new single-board computer (SBC) from Advanced Computing Technologies Inc. (ACTI) incorporates a 16-bit processor that is faster than the 8086 and 68000, yet is 100 percent object-code-compatible with the industry-standard Intel 8080. By providing an integrated 16-bit extension, the processor solves the problem of merging 8-bit compatibility with 16-bit performance, without the drawbacks of dual-

processor architecture. The extended instruction set, ability to address as much as 16M bytes of memory and a hardware-supported Zilog Z80 emulation scheme make this processor a logical 16-bit upgrade consideration for 8-bit users.

## **Three key goals were met**

The ACT-3 processor was designed with three main goals in mind. First, it had to be fast enough to qualify as a supermicrocomputer in order to compete with other high-performance 16- and 32-bit machines (Table 1); the specific design goal was an average throughput of 3 million instructions per second (MIPS). Second, it had to be upwardly object-code-compatible with a popular 8-bit microprocessor family to ensure immediate (and continued) access to a large base of field-proven code. The Intel 8080 family was chosen because of the impressive amount of development and application software written for it. And, third, the ACT-3 processor had to have true 16-bit functionality to provide a growth path for future applications.

The performance goal of 3 MIPS was accomplished with superminicomputer design strategies, including use of the latest high-speed logic. The ACT-3 is implemented entirely in Fairchild Space and Electronics Co.'s FAST family of transistor-to-transistor logic (TTL) chips, the same technology chosen for Digital Equipment Corp.'s recently announced VAX-11/785. The processor is clocked at 15 MHz, achieving a microcycle time of 67 nsec. This extremely short microcycle time (the VAX-11/780's is more than 200 nsec.) is made

possible in part by use of multilayered printed-circuit boards. These boards permit shorter lead lengths and thus minimize trace propagation delays and capacitive loading. The ACT-3 processor is horizontally micro-coded with a microword width of 96 bits. This micro-code organization requires less decoding circuitry than vertically microcoded machines, thereby minimizing attendant gate delays. The microcode is pipelined to allow parallel control of certain overlapped functions. While one microinstruction is being executed, the next microinstruction is fetched. On-board memory consists of 64K bytes of RAM incorporated directly into the processor (see "Mini on a board," Page 162), enabling the ACT-3 to access on-board memory for both 8- and 16-bit instructions in only two microcycles (134 nsec.).

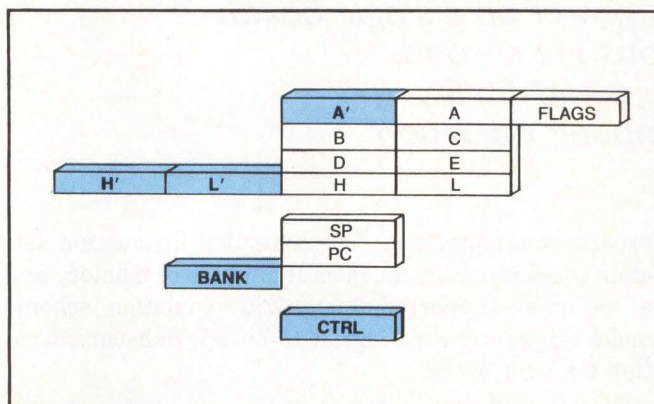

**Fig. 1** The ACT-3 register set is a straight-forward enhancement of the 8080. Five new registers (shown in color) support the ACT-3's 16-bit instructions and 24-bit addressing scheme. Register A' serves as the high byte of a 16-bit accumulator for double-precision instructions. Byte-sized instructions do not affect register A'. Register L' is used in tandem with registers H and L to perform an indirect access to data stored at a 24-bit address. Programs that do not require more than 64K bytes of memory can use H'L' as a second pointer register. The BANK register determines the default high-address byte for original 8080 instructions. It therefore supports bank-oriented and multiuser operating systems. The CTRL (control) register contains bits that activate or deactivate several special features such as Multibus arbitration override, Multibus LOCK, interrupt-processing mode selection and Z80 compatibility mode.

**Sample execution times** (in nanoseconds) show the ACT-3's performance advantage over other processors.

Complete 8080 compatibility, the second design goal, was achieved by adding the entire set of 8080 instructions to the ACT-3's instruction set. This approach distinguishes the ACT-3 from the Intel 8086. Although the 8086 can perform operations that the 8080 performs, it does not offer instruction-set compatibility.

Therefore, the software must be modified—sometimes extensively—to be executed on the 8086. The ACT-3 also differs from machines like the 80286 and the VAX, which use a "mode bit" to indicate whether the processor should run compatibly with its predecessor or run in an extended mode. The advantage of an integrated instruction set, such as those provided by Data General Corp.'s Eagle or ACTI's ACT-3, is that the machine is always compatible with its predecessor—even when the extended features of the processor are exploited.

The ACT-3 processor is a full 16-bit machine in all aspects. New instructions support this architectural extension to the 8080 to provide true 16-bit functionality. It is worth noting, however, that the 16-bit nature of the machine improves the performance of the basic 8080 instruction set as well. Widened 16-bit data paths allow the ACT-3 to fetch 2 bytes at once, cutting the number of clock cycles for each instruction to half that of the 8080. To store the accumulator, for example, the 8080 requires 13 states, whereas the ACT-3 requires seven; the instruction "exchange top of stack with HL"

Operation	ACT-3 (nsec.)	8080A 2MHz (nsec.)	8085 5MHz (nsec.)	8086 10 MHz (nsec.)	68000 10 MHz (nsec.)
Add register byte to Accum	267		800	300	400
Add register word to Accum**	267	5,000	2,000	300	400
Add memory word to Accum**	400	15,000*	6,000*	1,400	800
Add immediate word to Accum**	333	10,000*	4,000*	400	800
Add register pair to HL	267		2,000	300	400
Load Accum direct with word**	467	8,000	3,200	1,400	1,200
Load Accum indirect with word**	333	12,000*	4,000*	1,300	800
Load HL direct	467	8,000	3,200	1,400	1,200
Load immediate register pair	333	5,000	2,000	1,000	800
Push register pair on stack	400	5,500	2,400	1,000	900
Pop register pair on stack	333	5,000	2,000	800	800
Branch	333	5,000	2,000	700	1,000
Branch on carry (avg.)	300	5,000	1,700	600	900
Jump to subroutine	533	8,500	3,600	1,100	2,000
Return	333	5,000	2,000	8,000	1,600
Return on carry		4,000			
Multiply (signed)** (max)	5,667	?	?	14,000	7,000
Multiply (unsigned)** (max)	5,800	?	?	12,400	7,000
Divide (signed)** (max)	9,400	?	?	17,700	15,800
Divide (unsigned)** (max)	9,467	?	?	15,500	14,400
Swap DE and HL	400	2,000	800	400	1,200*
Swap top of stack with HL	533	9,000	3,200	2,000*	2,100*

\*Requires multiple instructions. \*\*8085 uses HL. Source: Advanced Computing Technologies

## Spec summary

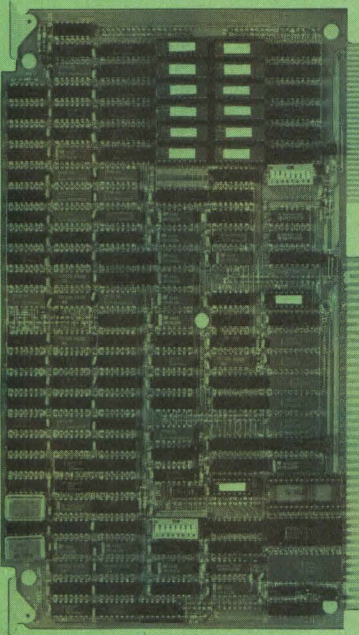

- **Name:** aSBC 80/300 single-board computer

- **Manufacturer:** Advanced Computing Technologies Inc. (ACTI), 1214 Eisenhower Place, Ann Arbor, Mich. 48104, (313) 973-2762

- **Price:** \$2,651 in 100-unit quantities

- **Main features:** 15-MHz ACT-3 CPU (3 million instructions per second, 8080-compatible, 8-/16-bit instruction set, 16M-byte addressing), 64K-byte RAM, 64K-byte electrically programmable read-only memory (EPROM)/electrically erasable PROM (EEPROM) space, one serial I/O port, eight levels of vectored interrupt control

- **Market:** OEMs and system integrators with installed base of 8080, 8085 or Z80 software and/or computation-intensive applications

- **Operating systems:** CP/M 3.0 (available from ACTI) and all other 8080 operating systems (CP/M 2.2, MP/M, OASIS, etc.)

- **Development tools:** ACTI relocatable macro assembler and linker, machine-level debugger in EPROM, ACTI Pascal and C compilers, real-time kernel for multitasking applications plus all existing 8080/8085 development tools.

## Programming the ACT-3

ACTI's ACT-3 instruction set contains 68 new instructions that ease the job of assembly-language programming and provide efficient support for high-level languages (see "Software tools ready for new product development," Page 163). Word-wide operations reduce the number of instructions needed to perform a task, and extended addressing instructions directly access large amounts of memory without worrying about bank switching or segment registers. The

ACT-3 mnemonics need little explanation: instructions appended with a "W" operate on words, mnemonics with an "F" indicate far-reaching addresses, and instructions with "WF" operate on words located anywhere in the 16M-byte address space.

To demonstrate the power of the ACT-3 instructions, two program examples are given. The first program is a simple 16-bit subtraction of two words in memory, symbolically illustrated by "X := Y - Z":

ACT-3		bytes/cycles	8080A		bytes/Tstates
lrpi	h,2	3/5 ; HL : = offset of p2	lxi	h,2	3/10
add	d	1/4 ; add DE to HL	dad	d	1/10
movw	h,m	2/5 ; HL : = p2	mov	a,m	1/7
movw	a,m	2/5 ; A'A : = j	inx	h	1/5
stw	LOCAL	4/7 ; store A'A into LOCAL	mov	h,m	1/7
		12/26 = 1.7 $\mu$ sec.	mov	l,a	1/5
			mov	a,m	1/7
			inx	h	1/5
			mov	h,m	1/7
			mov	l,a	1/5
			shld	LOCAL	3/16
					15/84 = 42 $\mu$ sec.

The ACT-3 code is easier to understand, primarily because it handles the task in a straightforward manner and contains fewer instructions. The main benefit of concise code is that it is less likely to contain bugs and is more likely to be easily modifiable in the future. Note that the 8080 code on the right runs on the ACT-3 in 2.9  $\mu$ sec. but takes nearly 13 times longer or 38  $\mu$ sec. when run on an 8080A.

The second program example comes from a common method of passing parameters, especially in

FORTRAN. Register DE, in this case, holds the address of a memory region that contains pointers to actual data objects. Pictorially,

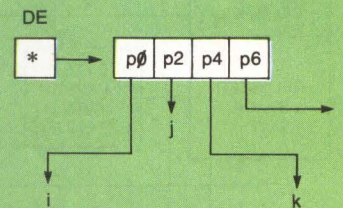

Assuming the p0, p2, p4 and p6 are 16-bit pointers with respective offsets

of 0, 2, 4 and 6 from DE, the assignment "LOCAL = j" is coded:

ACT-3		bytes/cycles	8080A		bytes/Tstates
ldw	Y	4/7 ; load Y into A'A	lhld	Y	3/16
idd	Z	3/7 ; load Z into HL	lda	Z	3/13
subw	h	2/4 ; subtract HL from A'A	sub	l	1/4
stw	X	4/7 ; store A'A into X	sta	X	3/13
		13/25 = 1.7 $\mu$ sec	lda	Z+1	3/13
			sbb	h	1/4
			sta	X+1	1/5
					17/76 = 38 $\mu$ sec

The 8080 code executes in 3.5  $\mu$ sec. on the ACT-3, or more than 10

times faster than on the 8080A running at 2 MHz.

(XTHL) takes 18 states on the 8080 but only six on the ACT-3. The ACT-3 is also able to fetch odd words in a single memory cycle, saving clock cycles on all 3-byte 8080 instructions that contain 16 bits of address or data on an odd boundary.

**Instructions simplify software development**

Taking advantage of the opcode space not used by the 8080, ACTI created a comprehensive superset of instructions that allows straightforward access to and manipulation of 16-bit data. Each 8-bit instruction of the 8080 has a 16-bit analog on the ACT-3. The instruc-

tion CMP, for example, compares a byte to the accumulator; the instruction CMPW compares a word. The 16-bit register and register-indirect instructions take the same amount of time as their 8-bit counterparts; (instructions SUB and SUBW, for instance, both take 267 nsec.). In addition to extending all the 8080 instructions, several entirely new instructions have been added. Most notably, the 16-bit multiply and divide instructions were implemented to ensure maximum support for computation-intensive applications. The ACT-3 register set (Fig. 1) supports these extensions in a logical way: the accumulator was widened to 16 bits

**Mini on a board**

Dominating ACTI's aSBC 80/300 single-board computer is the ACT-3 processor built from advanced Schottky transistor-to-transistor logic (TTL). The arithmetic-logic unit (ALU) path (yellow) comprises four main modules: a register stack containing all the CPU registers, a byte-swapper/sign-extend

er that converts bytes to words, the 16-bit-wide ALU and a rotator. The ALU path can perform a byte-swap/sign-extend 16-bit arithmetic operation and bit-rotate all in one microcycle. The processor is controlled by a pipelined microprogram control unit (orange) that has a basic microcycle time of 67 nsec. Wait states are generated only during accesses to slow external devices. Blue represents the 64K bytes of

on-board erasable programmable read-only memory (EPROM) space and the 64K bytes of on-board high-speed RAM. Because the RAM is integrated directly into the processor, memory accesses occur with zero wait states. The byte swapper performs word-wide fetches from even or odd boundaries with no performance penalty.

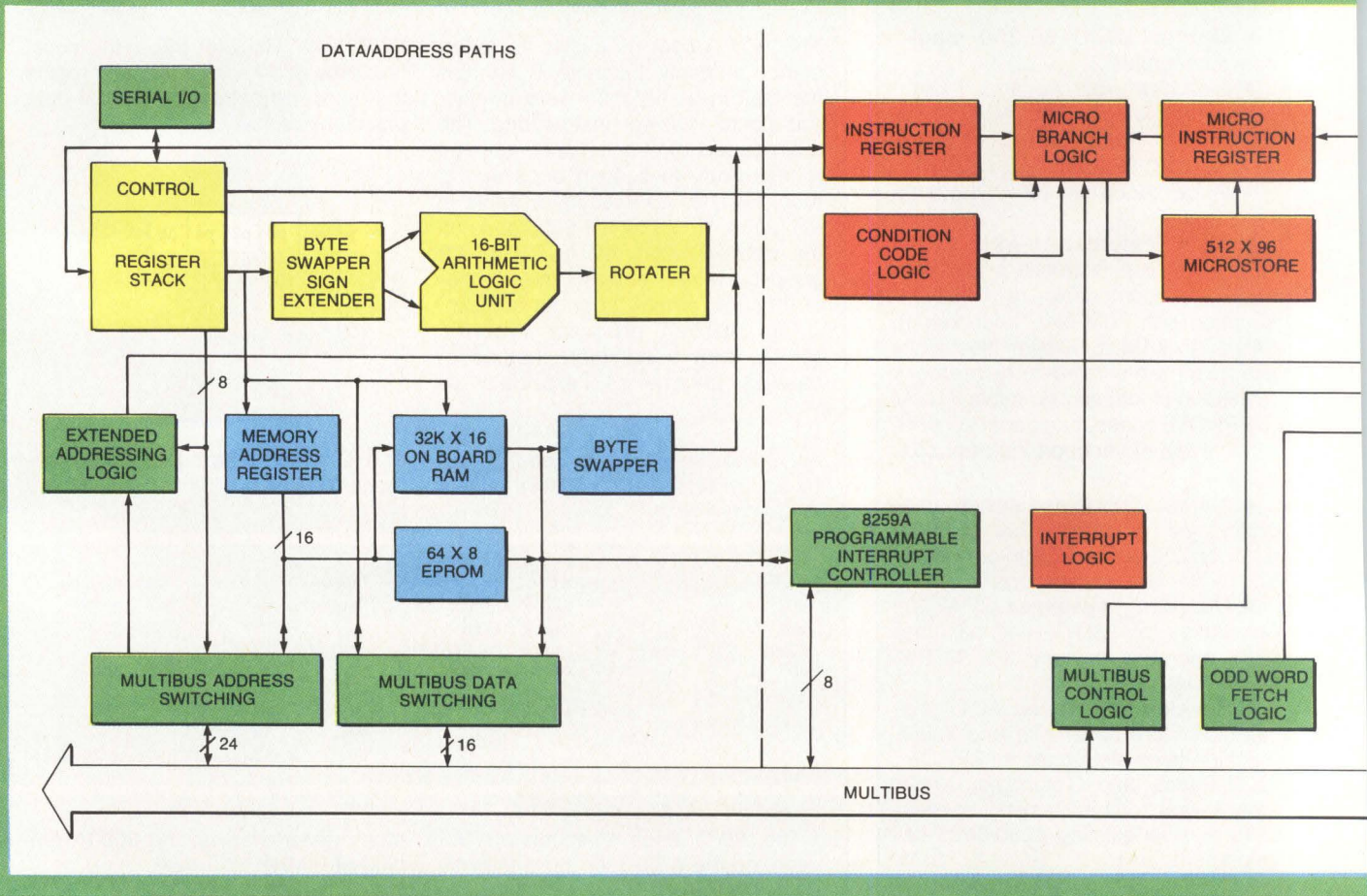

for word-wide manipulations on data, and the HL register was doubled in width to allow large-scale memory addressing.

Using the ACT-3's 16-bit instructions, software can be written that averages more than 20 times the speed of ordinary 8080 code running on a 2-MHz 8080 (see "Programming the ACT-3," Page 161). Note, however, that unmodified 8080 code already runs as much as 13 times faster on the ACT-3, depending on the clock rate of the current processor. In many cases, this improvement in performance is sufficient. However, system integrators with more stringent speed requirements

need only modify a critical portion of code—for instance, an often-used subroutine—to realize further substantial gains in performance.

The ACT-3's extended instructions improve code density as well, primarily because fewer instructions are needed to perform a given task. On the average, a program coded in ACT-3 assembler takes 80 percent of the space it would occupy if coded in 8080 assembler. Thus, programs that employ the ACT-3's extended instructions can include more features (than pure 8080 programs) and still be accommodated in a 64K-byte memory space.

The "real-world" interface circuitry is in green and includes interrupt control, an RS232 channel, a second path into on-board RAM from the Multibus, multimaster Multibus interfacing and circuitry for extended memory addressing. In combination, these components represent the technology and performance of a large-scale mini-computer.

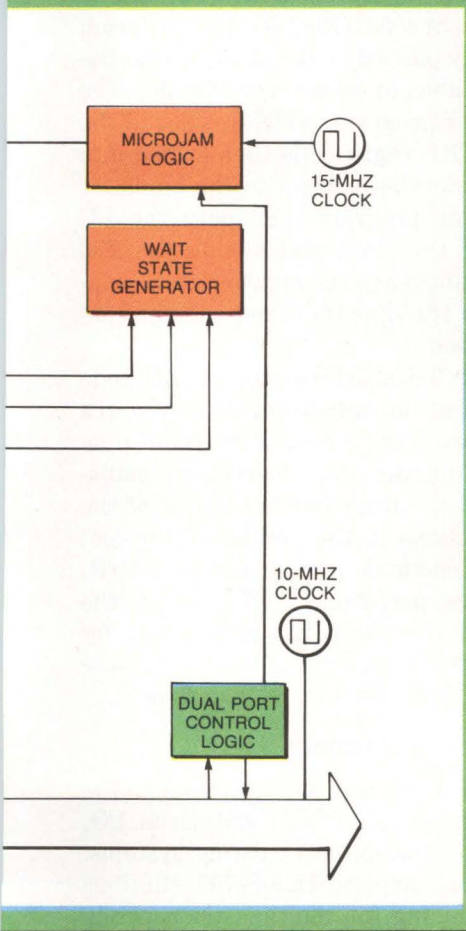

### Software tools ready for new product development

Because ACTI's ACT-3 is 100 percent compatible with the 8080, all development tools written for the 8080 run on the ACT-3 without modification. Executed without change, these programs average more than 13 times their former speed on a standard 8080A. To pull still more performance out of the ACT-3, a full line of development tools take advantage of the ACT-3's extensions to the 8080. Among the software packages available is the ACTI Pascal compiler, which makes full use of the ACT-3's 16-bit capabilities and also transparently exploits the processor's ability to address more than 64K bytes of memory. In other words, it allows programs in memory to be much larger than can be accommodated on the 8080 without requiring fancy programming tricks.

The ACTI Pascal compiler is also

user-friendly. Advanced error-recovery techniques ensure that compile-time errors are reported succinctly and informatively. The most important feature of the compiler, however, is its output quality. The accompanying bar chart compares the performance of this compiler with offerings by other manufacturers in a popular Pascal benchmark. Using ACTI Pascal under the CP/M 3.0 operating system, the ACT-3's 80/300 outperforms the 8086, 68000, 80286 and the VAX-11/780—all by at least a factor of two.

Other support software now available includes a relocatable macro assembler and linker, a machine-level debugger, and CP/M 3.0, already configured for the ACT-3. Upcoming software tools include a C compiler (fall '84 delivery), a real-time kernel for multitasking applications and data-communications software.

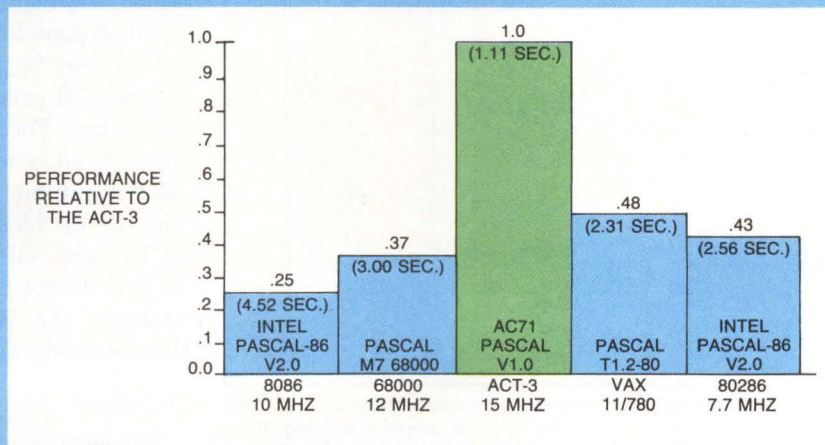

The Eratosthenes Sieve benchmark program computes prime numbers from 3 to 8,190. Performance figures reflect compiler efficiency, CPU memory organization and processing power. Object-code lengths for this program are Intel Pascal-86: 274 bytes; ACTI Pascal: 184 bytes; Pascal MT 68000: 410 bytes.

### More memory is accessible

Larger programs, increasingly sophisticated application and growing databases make memory addressability a critical issue for system integrators. Another design goal for the ACT-3, therefore, was to extend its addressing beyond the 64K-byte limit of the 8080. In doing so, the main criterion was to provide a straightforward means of accessing large amounts of memory. Segmented addressing schemes increase the total amount of memory space available, but only 64K bytes of data can be directly addressed at a time. And memory-management hardware is required to move the 64K-byte window around within the larger memory space. To avoid these restrictions, the ACT-3 was designed with a linear addressing scheme much like the 68000's. Figure 2 illustrates the implications of this design for programming.

The ACT-3's scheme is implemented with instructions that allow programmers in a single step to move data or transfer control to or from any location in a 16M-byte memory space. For instance, the instruction

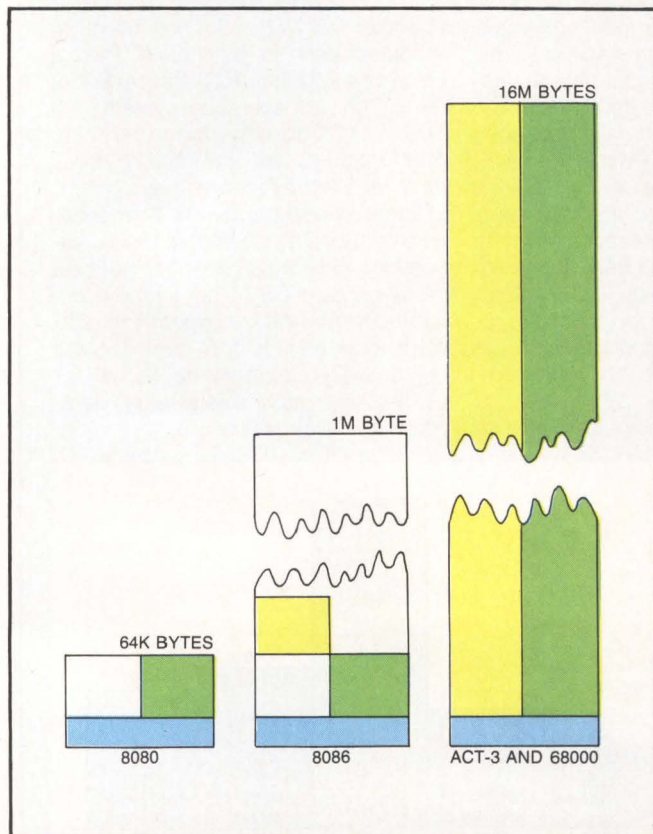

**Fig. 2. Single-instruction addressing capabilities of the 8080, 8086, ACT-3 and 68000 are illustrated for a program running at the bottom of memory (blue). Green regions are accessible via flow-of-control instructions (jumps, calls, etc.); yellow regions are accessible via data-access instructions (loads, stores, etc.) Note that the segmented approach allows access to only 64K bytes of data at a time, whereas a linear addressing scheme (employed by the 68000 and the ACT-3) gives direct access to the full 16M-byte address space.**

BRF branches "far" to any 24-bit physical address, and the instruction LDWF loads the widened accumulator (A'A) with a 16-bit word from anywhere in the extended memory space. Large-scale indirect addressing is facilitated by the ACT-3's L' register, which is used with registers H and L to form a 24-bit indirect address. Instruction STINF, for example, indirects through the L'HL registers to store the accumulator.

Even with this 16M-byte addressing scheme, 8080 programs run compatibly on the ACT-3 due to the BANK register, which forms the default upper 8 bits of a 24-bit physical address. Two new instructions specifically alter the BANK register to select the 64K-byte boundaries on which the 8080 programs should reside. The BANK register also supports multiuser and bank-oriented operating systems.

### Hardware supports Z80 emulation

The ACT-3's compatibility with 8-bit software goes one step further to include emulation of Z80 code. A bit in the ACT-3's CTRL register determines whether the processor is in the ACT-3's extended mode or in the Z80 compatibility mode. Both modes run the standard 8080 instruction set as a matter of course. When the machine detects a Z80-specific opcode (Fig. 3), the program counter is automatically pushed on the stack so that the emulator program is able to access the opcode. The address of the emulator program, which resides in the upper 8 bits of the CTRL register, is then loaded into the PC register, transferring control to the emulator program. The emulator program then pops the PC register's contents off the stack and fetches the Z80 instruction. It then branches to the appropriate emulation routine, performs the operation and returns control to the main program.

One reason for the ACT-3's fast execution of Z80 code is that over 90 percent of the opcodes encountered in a typical Z80 program are 8080 opcodes that require no emulation. For those opcodes that do require emulation, speed is attained by using the full power of the ACT-3's 16-bit instructions in the emulation routine. The Z80's block instructions (for example, LDIR, LDDR and CPIR) are particularly efficient on the ACT-3. In its emulation of the LDIR instruction, for example, the ACT-3 moves 1K byte of memory in less than 3 msec.; a 4-MHz Z80 takes more than 5 msec.

### Immediate benefits for applications

The ACT-3 processor is already at board level on the aSBC 80/300 SBC with RAM, PROM and serial I/O, allowing immediate integration into existing systems. The SBC supports the complete IEEE-796 Multibus interface protocol, including full multimaster capabili-

# Microbar. Your future system is our current project.

At Microbar, we're working today on the Multibus™ single-board computer (SBC) you'll need tomorrow. We specialize in developing SBCs that put OEMs and system integrators in front of the competitive pack—in technology, in time-to-market, and in cost. Doing that means maintaining a clear focus on the future and anticipating your needs—maybe even before you do.

Keeping you ahead means we've got to stay flexible. We refuse to lock in to particular CPUs and technologies. Because we're independent, we continuously—and objectively—evaluate the newest microprocessors, busses and operating systems. So you can count on getting the best fully-integrated SBC solution for your application. And on getting it early enough to make that critical difference.

Today, we're exacting maximum performance from the leading 16- and 32-bit microprocessors implemented with the industry-standard Multibus. We do it by applying systems engineering concepts to board-level design. And through special architectures leading to speed and efficiency far beyond typical Multibus capabilities.

One thing we don't—and won't—do is compete with *you*. Our business is high-performance CPU boards, not systems. So our resources are 100% committed to developing and producing SBCs that make *your* systems successful, that give you a real edge in the market.

Microbar. We're working on your next system—today.



1120 San Antonio Road  
Palo Alto, CA 94303  
(415) 964-2862

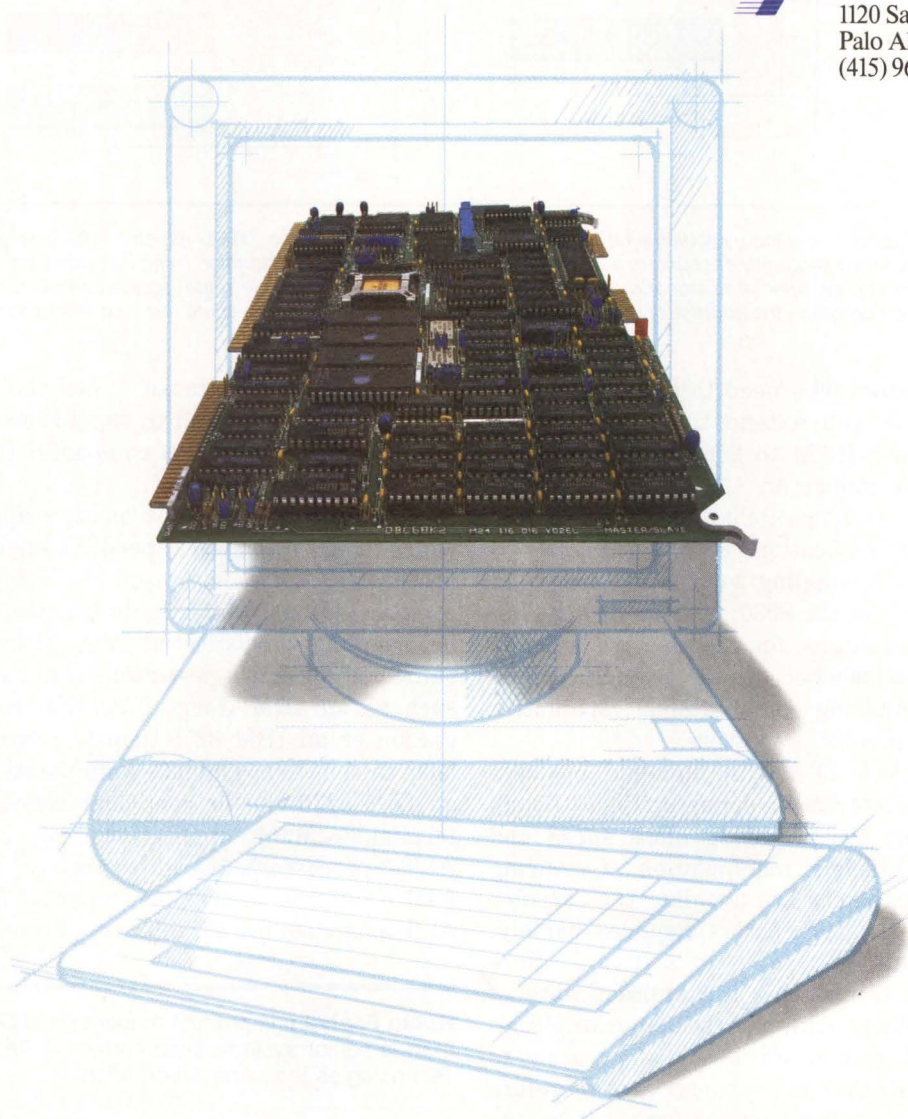

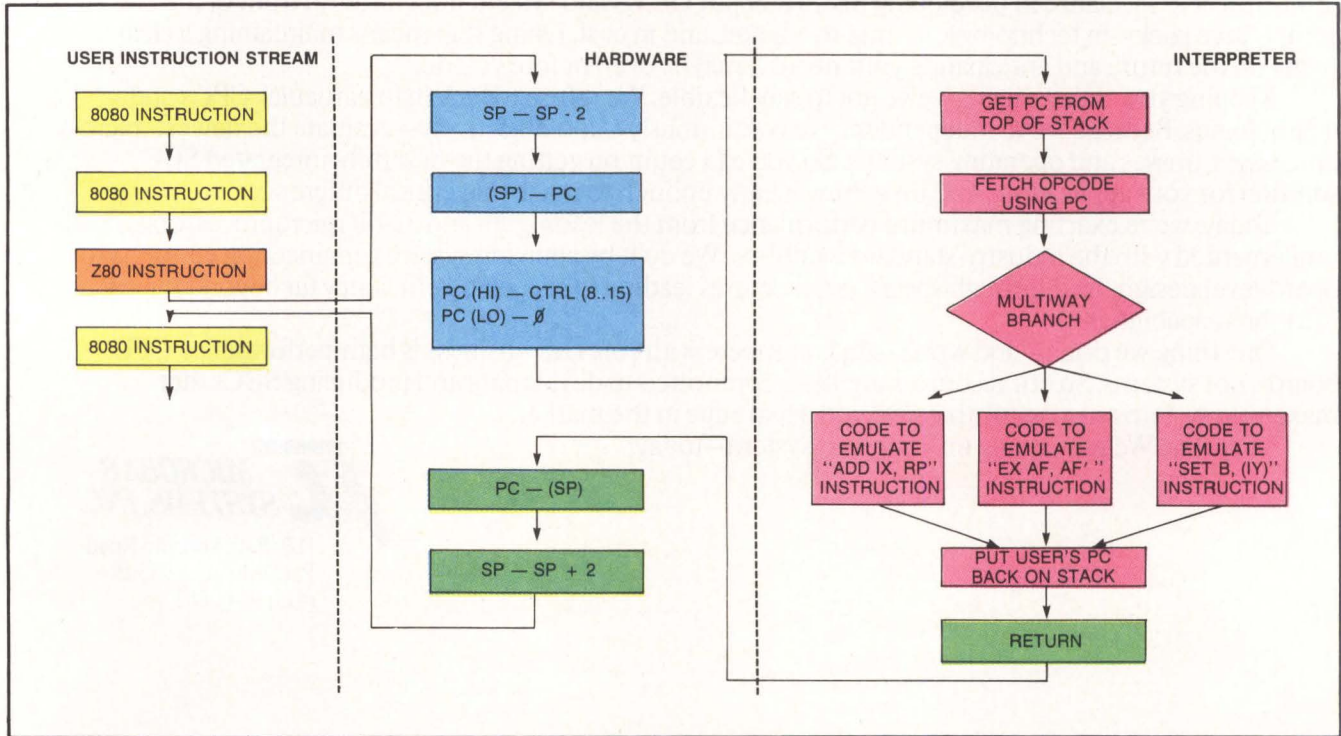

Fig. 3. The ACT-3's Z80 mode is enabled by setting a bit in the CTRL register. When the processor subsequently encounters a Z80 opcode (orange) in the instruction stream, special microcode (blue) is executed to trap to the emulator program, the address of which lies in the

upper 8 bits of the CTRL register. The emulation software (red) performs the Z80 instruction using extended instructions to maximize performance. A simple return (green) sends the processor back to the main program to execute the next instruction.

ties. System integrators who need to minimize Multi-bus memory accesses can extend the 64K bytes of on-board no-wait-state RAM to 256K bytes, using a high-speed expansion connector.

Because of its 8-bit compatibility and high rate of throughput, the best applications for the aSBC 80/300 are by those who are struggling with the memory and processing constraints of the 8080, 8085 or Z80. Industrial-automation applications, for example, are a prime target for the aSBC 80/300 because increasingly sophisticated tasks are requiring computational capabilities beyond the abilities of 8-bit processors.

Exploiting the aSBC 80/300 in high-end business systems provides an interesting opportunity. Although business applications are requiring more speed and memory space for efficient manipulation of growing databases, many companies are avoiding the sacrifice that higher-performance processors require—namely, losing access to their installed 8-bit software. More businesses are also confronting the impracticality of equipping each employee with a personal desktop computer, because such computers do not allow users to share files easily. Multiuser systems are therefore regaining popularity, though processors such as the Z80 and 8080 are not fast enough to support multiple workstations. The aSBC 80/300 thus fills a niche in

business systems because it has the throughput and memory space required to support multiple users and at the same time allows companies to maintain their 8-bit software investment.

Data communications is another application area in which the aSBC 80/300's speed is valuable. Today's 8-bit processors, commonly used for implementing data-communications products, do not have the throughput for handling sophisticated jobs. Although the 8080 is sufficient for a single-station communications device such as an IBM Corp. 2780/3780 remote-data-entry station or an IBM 3275 display terminal, it does not have the power to emulate a multistation device such as an IBM 3276 cluster controller connected to multiple terminals. Many applications can also employ the ACT-3 processor's fast interrupt-response time. In the EDN/Carnegie Mellon benchmarks, for example, the ACT-3 handles the I/O interrupt kernel in just 28 μsec.

Robin Fosheim is product manager and Douglas R. Grundman is senior systems programmer at Advanced Computing Technologies Inc., Ann Arbor, Mich.

Interest Quotient (Circle One)  
High 813 Medium 814 Low 815



# CREATIVE EXORbus\* ARCHITECTURE



Creative system designs call for CMS architecture. We manufacture an extensive line of EXORbus compatible support modules and accessories for use in M6800/6809 micro-processor-based systems. More goes into our products so you can build more with them.

## BUILDING WITH CMS

Start building with our 9619 Advanced Micro-computer—a complete MC68B09-based system on a single card. You'll appreciate its extensive on-board memory and I/O capacity. It may be the only module you'll ever need.

We support the 9619 with a variety of EXORbus compatible memory, input/output and data acquisition modules. These boards are fully supported with mother boards, power supplies and packaging accessories.

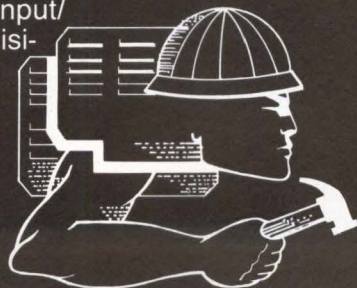

## NEW BUILDING BLOCKS

Since the last time you heard from us we've introduced some exciting new products. The 9639 Memory Management Processor module features fast task-switching hardware and can access up to a megabyte of memory. And we have the 9633 256K-byte CMOS static RAM module to support it. Our 9671 Universal Floppy Disc Controller is intelligent enough to take a load off your best programmer, and you'll never be at a loss for words with the 9623 Speech Synthesizer.

## THE CMS ADVANTAGE

System designers who specify CMS EXORbus architecture have found that system design is simpler, fabrication and testing is faster and costs are lower and more predictable. The next time you feel creative, give us a call or write for your free copy of our latest catalog. We'd like to supply your building materials.



## CREATIVE MICRO SYSTEMS

3822 Cerritos Avenue  
Los Alamitos, California 90720 USA  
Telephone (213) 493-2484



\*Trademark of Motorola, Inc.

# The Perfect Match



**Davong** has a beautiful way to solve both your hard disk storage and backup needs. Our new DataSystem for IBM® PCs.

**Davong combines good looks with hard disk and tape.**

We offer a full range of disk sizes, all including a hard disk drive plus tape backup unit. And the capability of using the tape as a start/stop systems device.

In fact, this Davong DataSystem has a lot of other beautiful benefits, too. Like compressed or full-volume backup with file-by-file or full-volume restore. And automatic flaw mapping to ensure complete media interchangeability.

Our full XT compatibility actually offers performance a cut above other XTs. And if you want even higher performance and password protection, you can use our Multi-OS® software.

To top it off, there's the sleek, contemporary styling of our DataSystem. And a low price that's equally attractive.

**Davong  
DataSystem  
for IBM  
PC's.**



®Multi-OS is a registered trademark of Davong Systems, Inc. ®IBM is a registered trademark of IBM Corp.

168

CIRCLE NO. 75 ON INQUIRY CARD

Davong Systems, Inc.  
217 Humboldt Court  
Sunnyvale, CA 94089  
(408) 734-4900 Telex: 176386

MINI-MICRO SYSTEMS/August 1984

# Write your own success story with Epson®



You've had the idea for years. Or maybe you just got it. But no matter what application you have in mind, Epson has the hardware to make it work. And the sales and technical support to make it a success.

Whether you want a portable, like the HX-20, or a desktop, like the QX-10. Or printers and other peripherals. When you build your system around Epson hardware, you get more than just machines. You get the support of a \$3 billion company, one of the worldwide leaders in the computer industry, and the number-one manufacturer of printers in the world. A company that has committed the human and technical resources you need. One that will be in business, and maintain our commitment to yours, over the long term.

WE'VE ALREADY INVESTED IN YOUR SUCCESS.



Within Epson, we've formed a nationwide program to support VAR marketers. Your initial inquiry will immediately be directed to one of our 12 regional VAR support centers. Then to one of our representatives who will contact you for further details. Each of our VAR representatives is well-versed in the hardware and software aspects

▼ VAR SUPPORT CENTERS

of Epson machines. There's no runaround, just answers.

OTHER SUCCESS STORIES ARE ALREADY BEING WRITTEN.

The Epson HX-20 has been used in many applications that would have been impossible without it.

A major overnight delivery service uses it in their trucks, to input airbill data for tracing packages. It's also been developed into an on-site estimating system for everything from insurance to interior decorating.

How about the pilot who uses the HX-20 as his electronic co-pilot?

The QX-10 has seen duty as a medical/dental accounting system and on-line commodity quoter with high-  
Epson is registered trademark of Epson America.



resolution graphics.

Of course these are only a sample. But if you're interested, Epson has an up-to-date directory of VAR applications using our machines. Just another way we can help you develop your own successful system.

WE'LL TREAT YOU LIKE A PARTNER.

Epson has put together a complete development kit for each of our machines. The kit includes all the detailed technical specifications you need to develop your software around our directory. Our VAR rep will continue to work closely with you and your programmers until the job is done. If necessary, he has ready access to a VAR technical group back at Epson headquarters.

No matter what application you have in mind, Epson has a machine to make it real.

To put Epson's VAR support to work for you, just mail this coupon to Epson today. Send it to Epson America, VAR Program, 3415 Kashiwa St., Torrance, CA 90505. Or call us at (800) 421-5426 (in Calif., call 213-539-9140).

Start writing here:

MM-8/84

NAME \_\_\_\_\_

COMPANY \_\_\_\_\_

ADDRESS \_\_\_\_\_

CITY \_\_\_\_\_

STATE \_\_\_\_\_

ZIP \_\_\_\_\_

PHONE NO. \_\_\_\_\_

TYPE OF COMPANY:  VAR/SYSTEMS HOUSE  END-USER  CONSULTANT

YOUR APPLICATION \_\_\_\_\_

**EPSON**

V.A.R. PROGRAM, EPSON AMERICA • 3415 Kashiwa St., Torrance, CA 90505

# OMNIBYTE™

Performance so reliable  
we back it with a 2-year warranty.

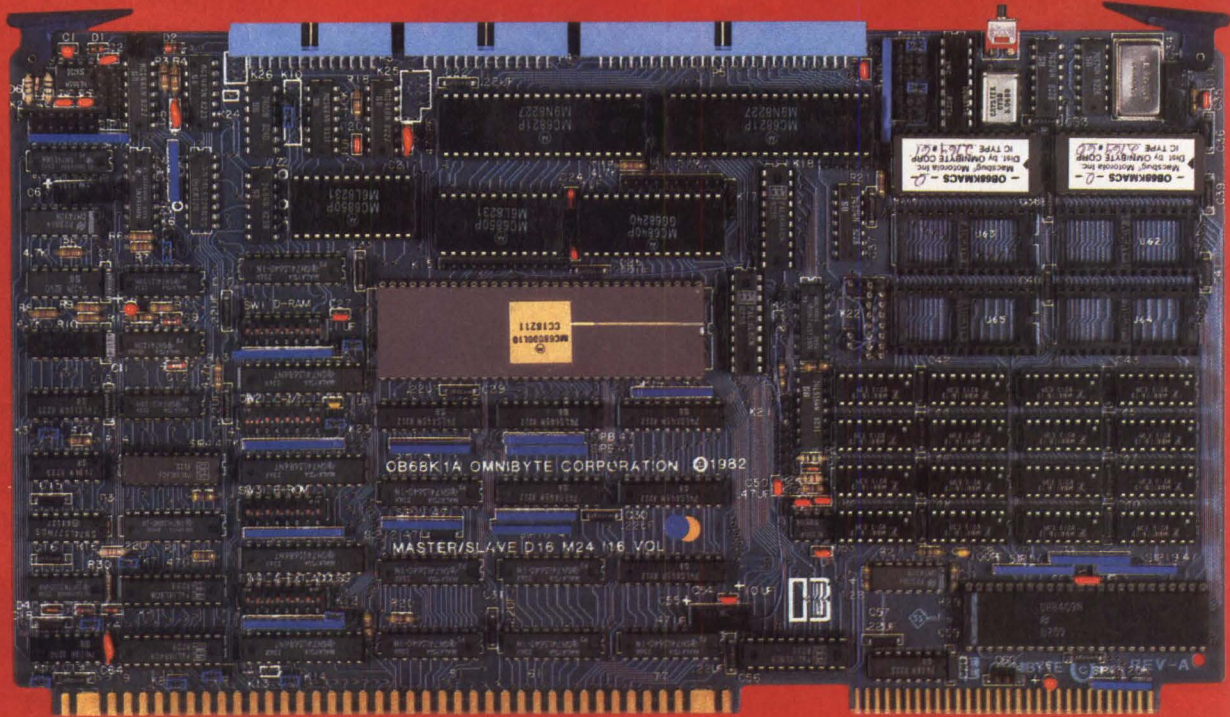

OB68K1A – 10MHz, 16/32 BIT

## How Can We Do It?

Our confidence in the product you receive from Omnibyte begins with a solid, well thought-out design. All non-socketed components are pre-burned-in and pre-tested.

All our boards pass these extensive tests:

- A thorough visual inspection of all completed P.C. board assemblies.
- Bed of nails testing on our Zehntel Troubleshooter Automatic Testing Equipment (more complex boards).
- In-circuit Functional Testing.
- 72 hr. burn-in at 65 °C. under power.
- A second in-circuit Functional Test following Burn-in.

Each Omnibyte board level product must pass these tests before shipping.

Is it worth it? The results speak for themselves.

- Less than 1% of our boards are returned for repair.

- In over 90% of the cases where a return is necessary, your board is repaired, tested and sent back to you within 24-48 hours.

Reliability is only one of the benefits of our board level and system products. They are loaded with state-of-the-art features like those on our OB68K1A shown above.

The OB68K1A is an extremely powerful stand-alone microcomputer board. It is designed for applications requiring high performance at lowest cost.

Important features include:

- 10MHz 68000 16/32 BIT CPU.
- 32K/128K/512K-bytes of dual-ported zero wait state on-board RAM.
- Up to 192K-bytes of EPROM.
- (2) RS232C serial ports.
- (3) 16-BIT timer/counters.
- (7) prioritized-vectored interrupts.
- Switch selectable memory mapping.

- Software/hardware selectable baud rate generator (50-19.2K Baud).
- Directly addresses 16M-bytes.
- IEEE-796 (MULTIBUS)\* compatible (MASTER/SLAVE D16 M24 I16 VOL).
- Low noise multilayer design.

## SOFTWARE SUPPORT

A variety of software packages are available for the OB68K1A. They range from the optional VERSABUG\* or MACSBUG\* monitor/debuggers to Realtime Executive and Target Operating Systems in silicon.

At Omnibyte, quality control is extremely important, resulting in performance so reliable we back each and every board level product with a 2-year warranty.

For more information, ask for our free summary sheets or send \$10 for a detailed technical manual. Contact Peter Czuchra, Marketing Manager.

*A Look at Today. . .  
A Vision of Tomorrow.*

CIRCLE NO. 77 ON INQUIRY CARD



OMNIBYTE CORPORATION

245 W. Roosevelt Rd.  
West Chicago, IL 60185  
(312) 231-6880

Intl. Telex: 210070 MAGEX UR

\*MACSBUG, VERSABUG & MC68000 are trademarks of Motorola, Inc.  
\*\*MULTIBUS is a trademark of Intel Corporation. ©1984 OMNIBYTE CORPORATION

# Eurocard/DIN single-board computers signal era of international standards

*Debate surrounding interface bus standards highlights trends in system integration*

**Rick Dalrymple**, Senior Editor

Although the Eurocard/DIN-based VMEbus is now one of the four dominant board-level buses in the U.S. market, it may be several years before it and other Eurocard/DIN buses gain a domestic market share rivaling the edge-connector-based Multibus, Q-bus and STD-bus. These three popular U.S. standards have a track record of adapting to current application requirements. This fact, coupled with the wide variety and availability of tried-and-true support boards, leads many system integrators to conclude that these "old" standards deserve their continued loyalty.

In this article, the first of two, the emphasis is on those three popular 8- and 16-bit buses and two new 8-bit buses, the STE-bus and the CIMbus. Both the STE-bus and CIMbus incorporate the Eurocard/DIN mechanical specifications. The reason for this packaging standard's popularity goes beyond its reliability. As a family of boards and connectors, it offers the flexibility to keep pace with new architectures and performance requirements for many years to come (see "Eurocard's two families," Page 172). That is why all bus standards now in the proposal stage have incorporated the Eurocard/DIN specification.

The Multibus, Q-bus and STD-bus date to the mid-1970s, when 8-bit, single-processor systems with 64K-byte addressing represented the state of the art. Over the years, each of those buses has taken advantage of available technology to meet market demand. That process continues today as innovative board-level manufacturers find new ways to extend the capability of these old buses.

This is the first installment of a two-part series on microcomputer bus standards. The second article will focus on 32-bit buses, such as the VMEbus, the Multibus II, the NUBus and the Futurebus.

## STD VS. STE

	STD	STE
IEEE no.	P961	P1000
Board size	6.5x4.5 in.	100x160mm Eurocard
Connector/pins	edge/56	DIN 41612/64
Data transfer	synchronous	asynchronous
Data lines	8	8
Address lines	16 (24 by multiplexing)	20
Multiple processor architecture	unspecified	master/slave
Interrupts	2	4
Daisy chain	1	2

Perhaps the most limited of the three popular buses, the STD-bus, was conceived for control applications using 8-bit microprocessors. The STD-bus now has the capacity to compete in high-performance applications such as image and speech processing. It is found in fast-Fourier-transform (FFT) machines and flight simulators—all a far cry from the simple process-control tasks usually associated with the STD-bus.

## Extending STD-bus performance

The STD-bus' new-found computational power comes from 16-bit microprocessors with 8-bit I/O, such as the 8088, 68008 and Z800. By coupling these devices with math coprocessors, number-crunching applications are improved as much as 100 to 1 in calculation speed. Also, new STD-bus, single-board computers overcome 64K-byte addressing limitations by sharing four lines between memory address and data. This scheme creates the necessary 20 lines to address 1M byte of memory.

Jim Eckford, marketing manager at Ziatech Corp., San Luis Obispo, Calif., considers his company's 8088/8087 board as a product that can compete with the Multibus in certain applications. "What we offer the

**Eurocard's two families**

The key difference between Eurocards and the mechanical specifications of other buses is that Eurocards are a family of cards coupled with a family of connectors. This system allows system integrators to take advantage of several different card sizes and connector configurations without leaving the Eurocard family. This results in a mechanical specification that has the flexibility to keep pace with new architectures and performance requirements for many years.

Within the Eurocard family, system integrators can use single-height (100 by 160 mm.) cards as compact modules or take advantage of the maximum board area accommodated by the Eurocard system by using the four-connector cards (500 by 400 mm.). This family of compatible card sizes allows system integrators to mix cards in the rack. For instance, they could use a combination of double-height, high-performance processor cards and lower-cost, single-height I/O modules.

Although the two-piece, pin-in-socket DIN 41612 connector offers a gas-tight, environmentally secure seal, reliability is just one facet of its appeal. Again a family, it offers compatible units with a range of accessories that includes ribbon and coaxial cable connections. The DIN connector's 96 pins provide the high pin density required to place all bus lines on a single connector. So, as technology allows a card to shrink from, say, double height to single height, no connector modifications are necessary.

Because the Eurocard is an open international standard, plenty of Eurocard hardware is on the market. And, because all new bus standards are adopting the Eurocard system, Eurocard hardware volume will increase and competition will keep prices down.

**Eurocard sizes range from 100 by 160 mm. to 500.05 by 400 mm., based on a grid system that allows card sizes to be configured in standard increments. Stacking cards from several bus standards side by side demonstrates the flexibility of the Eurocard specification and how STD's and Multibus' card sizes compare to Eurocards.**

**EUROCARD CONFIGURATION GRID**

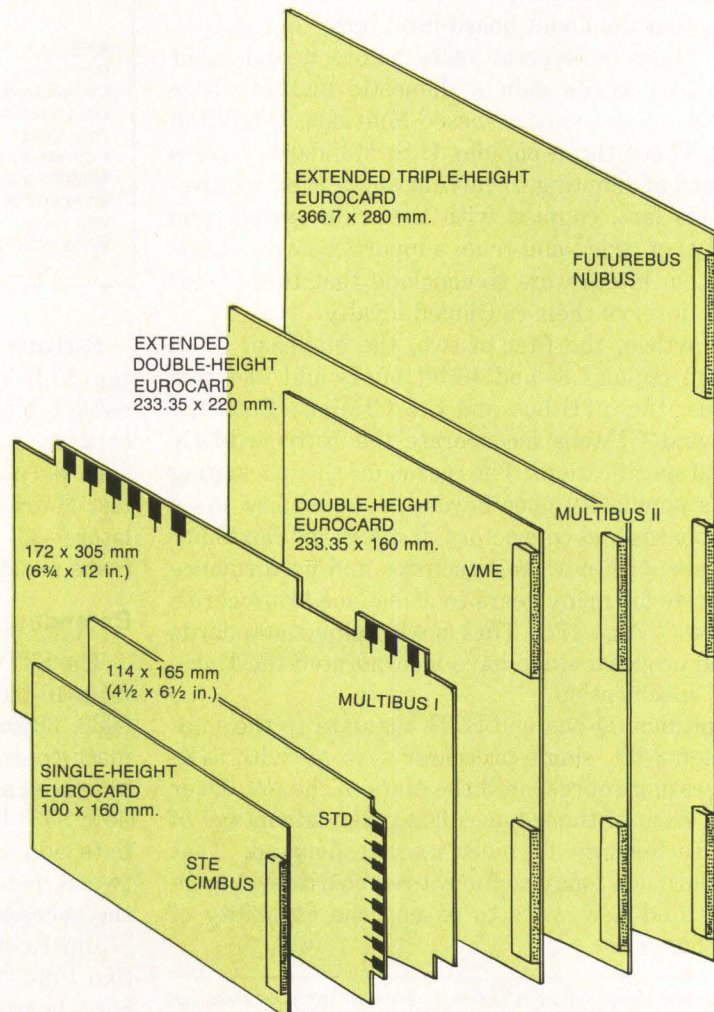
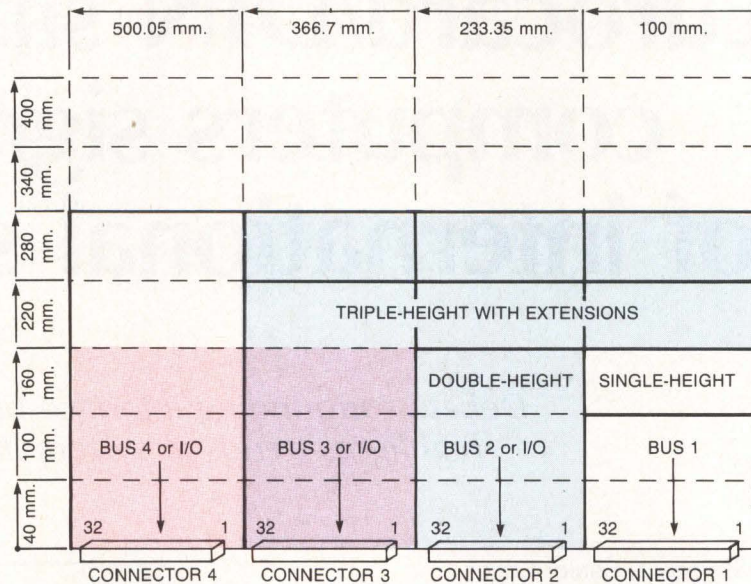

customer," states Eckford, "is a 16-bit product that is half Multibus' size and half Multibus' typical price." He therefore sees the STD-bus' small form factor—4½ by 6½ inches—and the availability of many low-cost boards well-suited to test and measurement functions as his company's edge over Multibus boards. "Where we can do well," notes Eckford, "is in compact, dedicated, computation-intensive applications such as blood analyzers, oil-well loggers and spectrum-analysis systems."

Users shouldn't confuse processing power with I/O capability. The STD-bus is an 8-bit bus that does not perform well in I/O-intensive operations. Both the 16-bit Multibus and the 32-bit VMEbus are better suited to I/O-intensive applications. Therefore, the STD-bus continues to pose no threat to buses used on commercial data-processing systems.

### Distributed processing on STD-bus

Another trend benefiting all board-level products is the ever-increasing amount of function that will fit on a single card. With each new generation of integrated circuits (ICs), board manufacturers can place more processing power on peripheral cards. At the system level, this means that peripheral processing tasks can be offloaded from the CPU card and that operations on several different peripheral boards can run concurrently.

In the case of the STD-bus, this concept has been applied to peripheral cards that could be called "intelligent slaves." These modules are single-board computers that function as intelligent I/O cards acting as slaves

to one master CPU card. Ziatech offers STD single-board computers with a second connector that interfaces to the Multibus' iSBX Multimodules, thus allowing each slave processor to have dedicated memory or I/O. These cards suit the one master/multiple-slave configuration because they allow the slave to address its own memory or other I/O card without using the STD-bus.

Smart I/O cards also help alleviate the STD-bus' I/O limitations. As Matt Biewer, vice president of research and development at Prolog Corp., Monterey, Calif., points out, "The concept of distributed processing uses hardware to achieve the multitask environment in a parallel, rather than serial, mode of operation. The use of smart I/O cards eliminates the need for a more sophisticated multitasking operating system because the host processor is relieved of most of the peripherals' task." Shifting the software load onto the peripheral card means that adding I/O functions does not add significantly to the CPU's load. This approach allows performance features to be added without seriously impacting the operating system software.

The STD-bus has yet to be adopted as an IEEE standard, but it carries a working group number, P961. In moving toward a standard, the STD Manufacturers Group has developed an arbitration scheme that allows a two-master/two-slave configuration. The latest item, however, is a proposal from Ziatech, suggesting an additional surface connector on STD boards positioned so that iSBX Multimodules from the Multibus can be used in conjunction with the STD-bus.

Despite its improvements, the STD-bus is missing several features found in the newer bus standards.

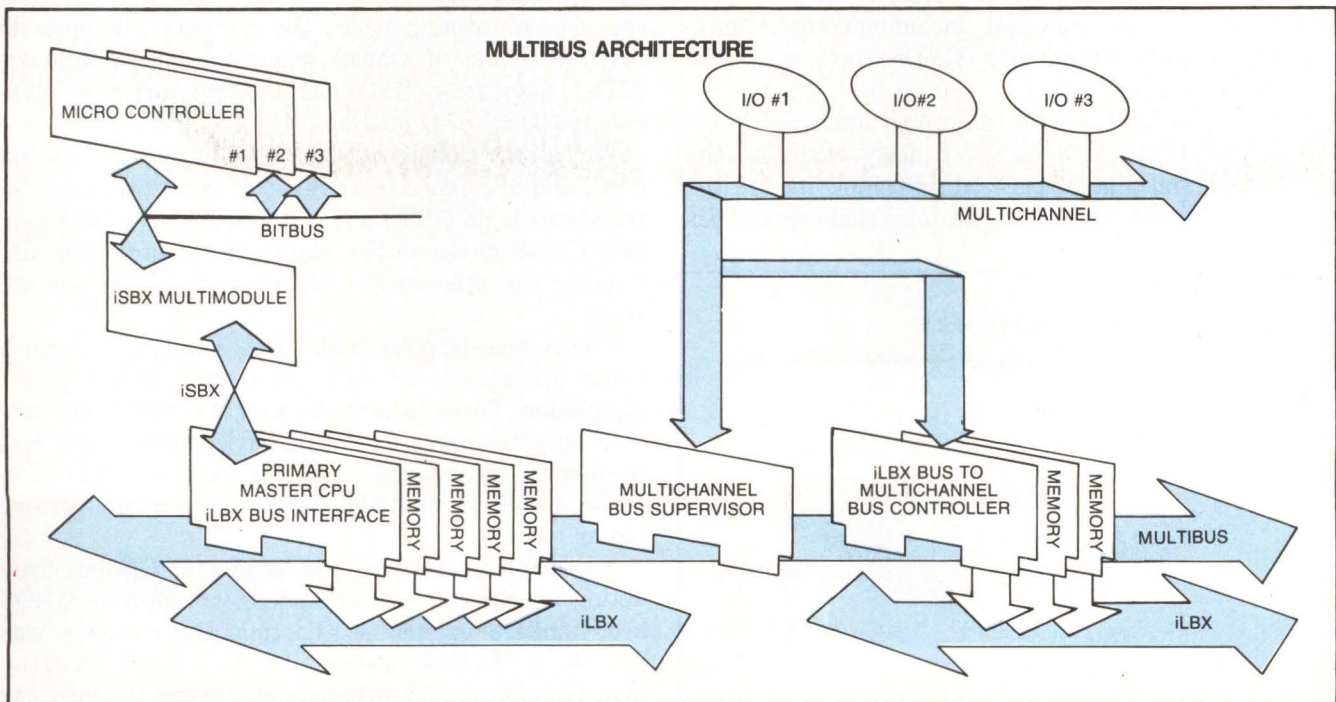

Another IEEE working group, the P1000 committee, has formulated a bus specification dubbed the STE-bus. While it retains STD's simple, low-cost interfacing, it is a fundamentally different 8-bit bus. The STE-bus offers system integrators an asynchronous, multimaster scheme on standard single-height or optional double-height Eurocards.

### STE-bus committee circulates spec

According to committee chairman Bill Shields, president of Seaport Computers Inc., San Diego, committee members and other interested parties are now reviewing version 3.1 of the STE specification. Following this comment stage, the committee will print and submit a final specification document to the IEEE for approval.

The STE-bus' Eurocard standardization allows cards designed around it to function in Eurocard-based dual-bus systems. In such a system, a high-end 32-bit bus, such as the VMEbus, uses STE cards as low-cost I/O. An STE board interfaces neatly with the two-connector VME scheme because the STE scheme uses only the outside two rows of the P2 DIN connector.

The STE-bus offers six improvements over the STD-bus, including:

- processor independence,
- asynchronous operation,
- master/slave daisy-chained bus arbitration,
- improved interrupt structure,
- extended addressing range,
- higher system integrity.

These improvements, along with the lines to address 1M byte of memory, accommodate the latest generation of 16-bit processors such as the 8088, 68008 and Z800. However, any 8-bit processor, including complementary-metal-oxide-semiconductor (CMOS) devices, can be used on the bus.

With regard to bus arbitration and improved interrupts, the STE-bus defines two daisy chains to the STD's one, and four prioritized interrupt lines to the STD's two. In the STE spec, one daisy chain serves bus

arbitration, and the other assigns priority to interrupt-slaves. The STD's single daisy chain can be used for bus arbitration or interrupts—but not for both.

The items that provide the STE-bus with greater system integrity are the more reliable DIN connectors, careful provision of grounds and the added safety of using a bus-error line to monitor data transfers and arbitration. In addition, extra 0V lines around the data-transfer strobes provide greater data-transfer integrity and the possibility of ribbon-cable connection for remote I/O.

The big problem now facing the STE-bus is the lack of support from major board manufacturers. The STE-bus needs a champion with the marketing clout to rally board manufacturers and system integrators to the STE standard. Without this support, the STE-bus may languish until enough products come onto the market to make it a real alternative to other 8-bit buses.

The first STE products are coming from the United Kingdom. Several British manufacturers have planned products, but only one—GMT Electronic Systems, Wimbledon, England—is shipping STE boards. Several small U.S. companies are interested in the STE-bus, but none has announced products.

### Enthusiasm runs high for CMOS

One technology that may boost the STE-bus is CMOS. The STE specification takes the interfacing requirements of CMOS devices into account, and board manufacturers incorporating CMOS devices into their products may find the STE-bus attractive. But a big CMOS promoter, National Semiconductor Corp., Santa Clara, Calif., has chosen to offer its own CIMbus specification around which the company has built its Series/800 line of CMOS industrial microcomputers (CIM). Also, many STD manufacturers are now introducing CMOS STD boards.

Why all the CMOS activity? CMOS prices are coming down and are expected to start pushing transistor-to-transistor logic (TTL) out of the market. In addition, new CMOS devices offer higher clock rates, thus answering the other major objection to CMOS—device speed.

CMOS boards offer high noise immunity, a much wider operational temperature range and low power dissipation. These features mean that CMOS boards are well-suited to harsh operating environments, cost less to operate and maintain and lend themselves to inexpensive, uninterruptible backup power or battery power sources.

According to National Semiconductor CIMbus marketing manager Steve McGinness, no effective CMOS bus standard existed at the time the company was developing the CIM product line. National rejected the idea of adapting to previous standards because the

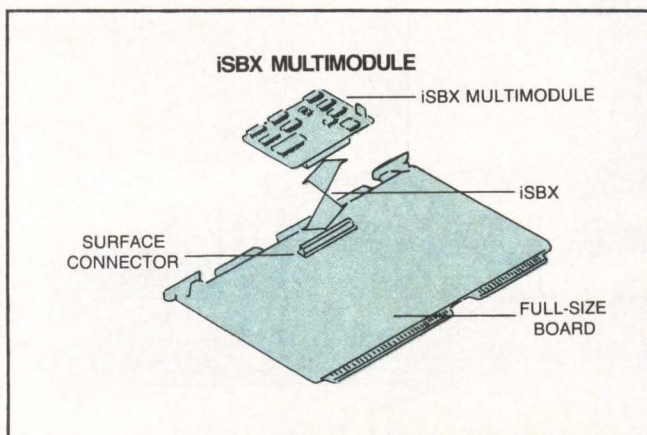



# Put the Power of the IBM PC Bus into Your OEM System

## NEW Single Board Computer/PC Bus System

The power of the IBM PC is now available to OEM system designers with the new I-Bus Single Board Computer and Enclosure systems. Now you can make use of that vast array of PC-compatible expansion cards—for communications, graphics, data acquisition, peripheral control, and every other imaginable task.

I-Bus Systems has packaged Intel's powerful new 80188 CPU into a Single Board Computer. It has 64K of RAM and up to 160K of ROM on board, plus a serial console port to talk to a terminal or a PC. Just plug the SBC into an I-Bus 6-slot chassis or 9-slot card cage and you have the heart of a computer system, ready to run.

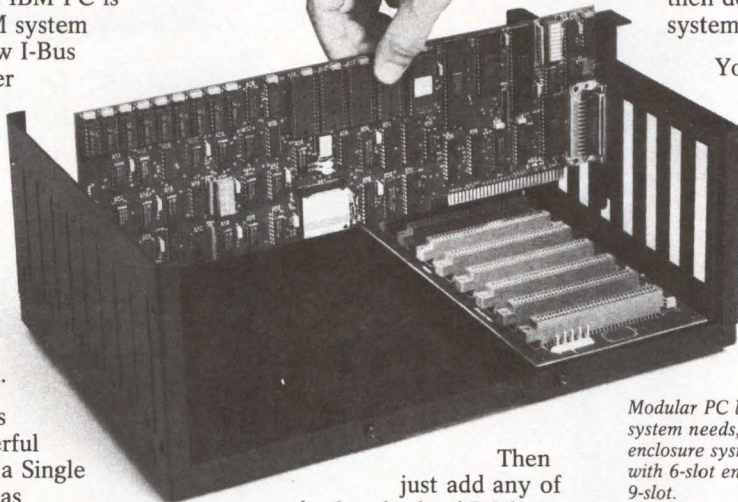

then download them to the I-Bus system for dedicated execution.

You'll have the best of both the PC world and the OEM bus-structured world with this new single board computer from I-Bus.

For all the details, give us a call today at (800) 382-4229. In California, call (619) 569-0646.

Then just add any of the hundreds of PC bus cards already on the market, to customize your system.

Best of all, the IBM PC works perfectly as a software development system. You can assemble and test applications programs on the PC,

*Modular PC bus packaging matches your system needs, from basic cage to complete enclosure system. Internal 40W power supply with 6-slot enclosure, external supply for the 9-slot.*

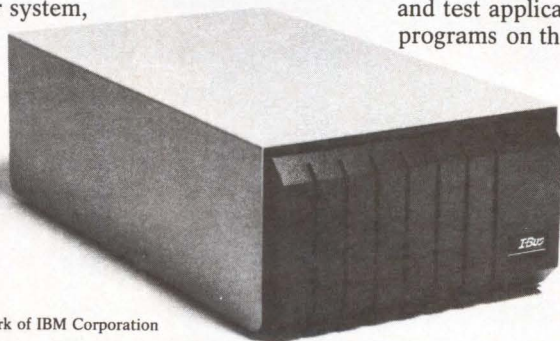
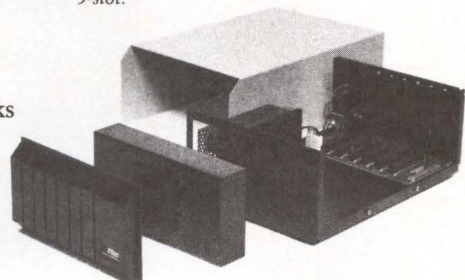

IBM PC is a trademark of IBM Corporation

**I-BUS**  
SYSTEMS

9235 Chesapeake Drive  
San Diego, CA 92123

# MORE HIGH PERFORMANCE FROM CIPRICO™ RIMFIRE™ 50 SMD DISK CONTROLLER

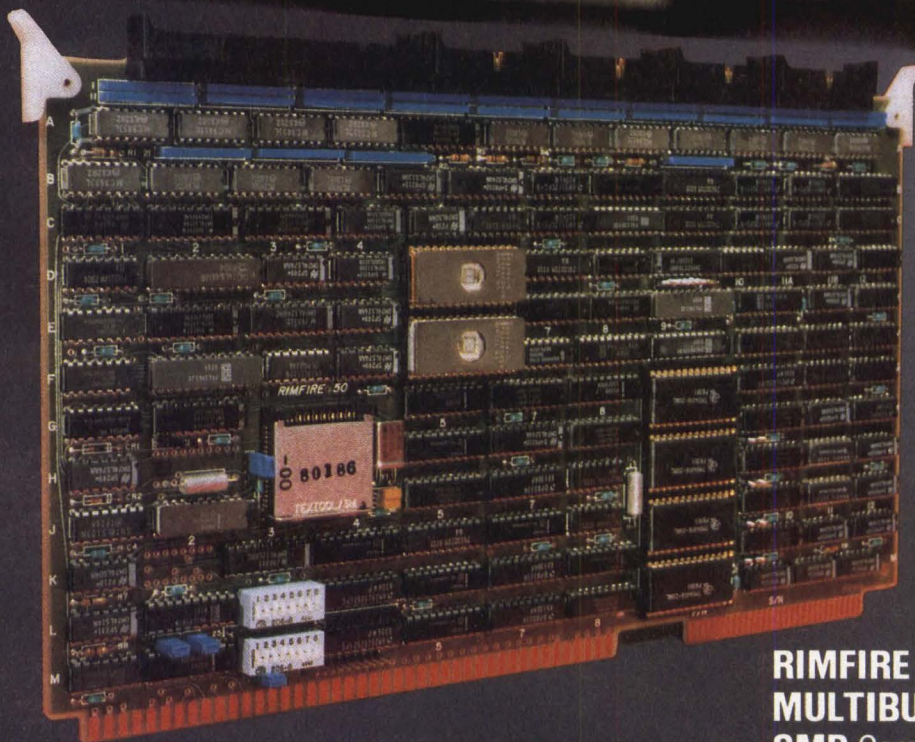

**RIMFIRE 50**, Intelligent  
**MULTIBUS\* CONTROLLER** for  
**SMD-Compatible** disk drives.

- Programmable sector sizes
- 24 bit DMA
- High-speed disc interface
- 1:1 Interleave
- 48 bit ECC

... and much, much more!



**CIPRICO, INC.**

Formerly Computer Products Corp.

2405 Annapolis Lane  
Plymouth, MN 55441  
Phone: (612) 559-2034

CIRCLE NO. 79 ON INQUIRY CARD

\* Multibus is a registered trademark of the Intel Corporation

## CMOS CIMBUS COMPARISON

	CIMbus	STD-bus	Multibus
IC technology	CMOS	NMOS	NMOS
Board size	100x160mm Eurocards	4.5x6.5 in.	6.75x12 in.
Connector	DIN 41612	edge	edge
Data transfer	synchronous	synchronous	asynchronous
Temperature range	-40°C to 85°C (-40°F to 185°F)	0°C to 55°C (32°F to 131°F)	0°C to 55°C (32°F to 131°F)
Power supply voltage	10VDC to 17VDC (unregulated)	+5VDC, ±12VDC (regulated)	+5VDC, ±12VDC (regulated)
Power dissipation (watts)	.3	7.5	20
Bus speed	1MHz to 4MHz	2MHz to 5MHz	2MHz to 5MHz

*Source: National Semiconductor Corp.*

drive/sink translation logic would take up valuable board space and power. Therefore, the company designed a new bus—a synchronous bus based on single-height Eurocards with DIN 41612 connectors. No efforts are under way to make the CIMbus an IEEE standard. If a CMOS bus evolves, it's a safe bet that it will adhere to the Eurocard/DIN mechanical standards. As to a CMOS bus itself, it remains to be seen whether STE, a derivative of the CIMbus or a new effort altogether will result in an effective CMOS bus standard.

Meanwhile, system integrators can choose from CIMbus, STD-bus and Multibus products. The Multibus CMOS board manufacturer is Diversified Technology Inc., Rigland, Miss. Notes board products manager Bill Long, "Part of our success has been based on retrofitting old Multibus designs to make them more reliable." CMOS boards work well in sealed enclosures, allowing system integrators to move computers out of protected areas onto the factory floor or to other harsh environments.

### Q-bus products pace market demand

The Q-bus, oldest of the U.S. bus standards, and Multibus, the standard now holding the largest U.S. market share, have been head-to-head competitors since the mid-1970s. During the last couple of years, the Q-bus has lost market share. However, recent Q-bus product introductions are stemming the flow of Q-bus customers to the Multibus. A key product is Digital Equipment Corp.'s 11/73, a higher-performance single-board computer offering a fully compatible upgrade path for DEC 11/23 users. Alcyon Corp., San Diego, was the first to offer DEC 11/23 users an upgrade replacement board; DEC followed with the LSI-11/73. Either product slips neatly into the DEC PDP-11/23 CPU slot.

According to Gene Banman, director of marketing at Data Systems Design Inc., San Jose, Calif., a disk drive supplier to both Q-bus and Multibus integrators, "Be-

fore the LSI-11/73, design wins for the Multibus included Q-bus customers. Now, Multibus design wins continue at a rapid pace, but Q-bus integrators are not among them." Banman observes that products like DEC's MicroVAX I superminicomputer and JFEP11 board from MDB Systems Inc., Orange, Calif. (MMS, June, Page 269), are providing the performance improvements and upgrade paths that are keeping the Q-bus integrators happy.

The strength of the Q-bus lies in the large volume of developed software. As Q-bus integrators move to the MicroVAX I, a two-board product with prices starting at less than \$10,000, they must also move up to VAX software to take advantage of features such as a 4G-byte virtual-address space, a 32-bit word size and full memory management. Once again a large library of VAX programs is available to system integrators, many of whom have programming experience on VAX systems.

The battle for market share in the single-board computer market pits DEC against semiconductor giants Intel Corp., Santa Clara, Calif., and Motorola Inc., Phoenix, Ariz. Each comes to the market championing different bus standards: DEC, the Q-bus; Intel, the Multibus; and Motorola, the VMEbus. Historically, DEC has been the leading single-board vendor. Intel has been second, and other single-board computer vendors lag far behind. But there is movement in this horse race. When 1984 sales figures are tallied, the leader could be Intel.

According to Dataquest Inc., a Cupertino, Calif., market research concern, 16-bit single-board computers will continue to dominate the market. The most popular 16-bit bus is the Multibus. A number of other high-performance 16-bit Multibus boards that promise to boost system performance well into the supermini-computer range are on the way.

### Multibus offers configuration wealth

By adding a bus here and tacking on another there, the Multibus has grown from one bus to five. More than 200 manufacturers produce Multibus products. Multibus integrators are confronted with a wealth of configuration possibilities.

The first addition to the Multibus was the iLBX execution bus. This architectural extension allows a processor board to access as much as 16M bytes of off-board memory as if it resided on the processor board. This effectively removes local memory traffic from the Multibus. The benefits of this scheme quickly become apparent in multiprocessor configurations. With each processor board using a separate bus for local memory, the Multibus is free for I/O operations or processor-to-processor communications.

Intelligent I/O cards also free the Multibus to handle

more processor and I/O ports. With a dedicated microprocessor and memory located on the I/O card, the need to hold a dialogue between host processor and peripheral is greatly reduced.

Among the single-board computer manufacturers exploiting the benefits of the iLBX extension is Central Data Corp., Champaign, Ill. The company is offering two high-performance processor boards—one based on the Z8000; the other, on the 68000. Neither board contains RAM or serial I/O devices. Instead, these boards feature full demand-paged, virtual-memory-management circuitry, an interface to both the Multibus and iLBX extension that includes bus-vectored interrupts and a powerful state sequence machine that handles all processor cycles on the board. It also leaves room for as much as 32K bytes of programmable read-only memory (PROM) for bootstrap and on-board diagnostics.

Both boards are intended for use with Central Data's cache memory board. By using the cache board, the effective memory access time totals 160 nsec. for an average cycle. Clearly, this powerful combination aids Multibus-based multiuser systems.

The next addition to the Multibus was the Multichannel I/O bus. This architectural expansion allows the

Multibus to accommodate high-speed I/O transfers—as fast as 8M bytes per second—at distances as long as 15m. Typical applications include I/O bus communications with graphics processors, data-acquisition modules and Multibus system-to-system links. The bus provides block transfers across an 8- or 16-bit-wide data path using a simple asynchronous IEEE-488-like protocol.

The Multichannel is an alternative to the IEEE-488 bus, which is limited by a 1M-byte-per-second transfer rate. However, the 488 bus does stretch to 20m. and has the advantage of ready-made links to peripherals and instruments with ports for the 488.

### Small items offer large benefits

The most recent Multibus additions include the iSBX modular I/O bus and associated Multimodule. These, in turn, connect to Intel's Bitbus and new distributed-control modules (iDCMs). Each of these small items could offer large benefits.

The iSBX bus and Multimodules allow the addition of a small, low-cost board that attaches directly above a full-sized Multibus processor board. This allows system integrators to configure each processor board to its application more precisely by adding functions such as high-speed math, memory management, voice synthesis and a board-level modem. Because each of these functions can be accomplished using smaller Multimodules, system integrators save the expense and space of full-sized Multibus boards. There are two other advantages: first, Multimodules can be accessed as quickly as on-board memory, and they free both the Multibus and iLBX bus for other tasks.

The Bitbus opens new vistas in control applications. The key item in the Bitbus is the microcontroller, an Intel term for a single-chip microcomputer on a small board that includes the necessary drive circuitry. Microcontrollers are dedicated to specific control devices such as temperature monitors, motor controllers, heating/air-conditioning system controllers, badge readers and door and window alarms. All these dedicated systems can be connected to a Multibus computer system via the Bitbus, a serial bus with a maximum data rate of 2.4M bits per second using the synchronous data-link-control (SDLC) protocol. The Bitbus extends to 2 km., compared with the RS232C at 50 feet and the RS422 at less than 1,000 feet.

To review single-board computers now on the market, refer to *Mini-Micro Systems' Computer Digest*, June 15, Page 23. □

## Single Board Computer



**6 MHz  
Z80**

### Fast, Powerful and Compact Microcomputers

- 4 or 6 MHz Z80\* CPU
- 2K to 64K ROM or EPROM
- Expandable RAM from 64K to 256K
- DMA for Floppy and Hard Disk Data Transfers
- 2/4 RS-232 Serial Ports
- Centronics Parallel Port
- 50 Pin Expansion Bus for Additional I/O Capability
- CP/M Operating System and Networking Available
- Custom Systems and Private Label Packaging Available

**Davidtge**

1951 Colony Street, Suite X  
Mountain View, CA 94043  
(415) 964-9497

\*Z80 is a registered trademark of Zilog

Interest Quotient (Circle One)  
High 825 Medium 826 Low 827

**YOU CAN'T  
PREDICT  
THE FUTURE.**

**BUT  
YOU CAN BE  
PREPARED  
FOR IT.**

# WITH INFORMIX AND File-it!

THE FIRST DATABASE SOFTWARE FAMILY  
FOR UNIX AND MS-DOS.

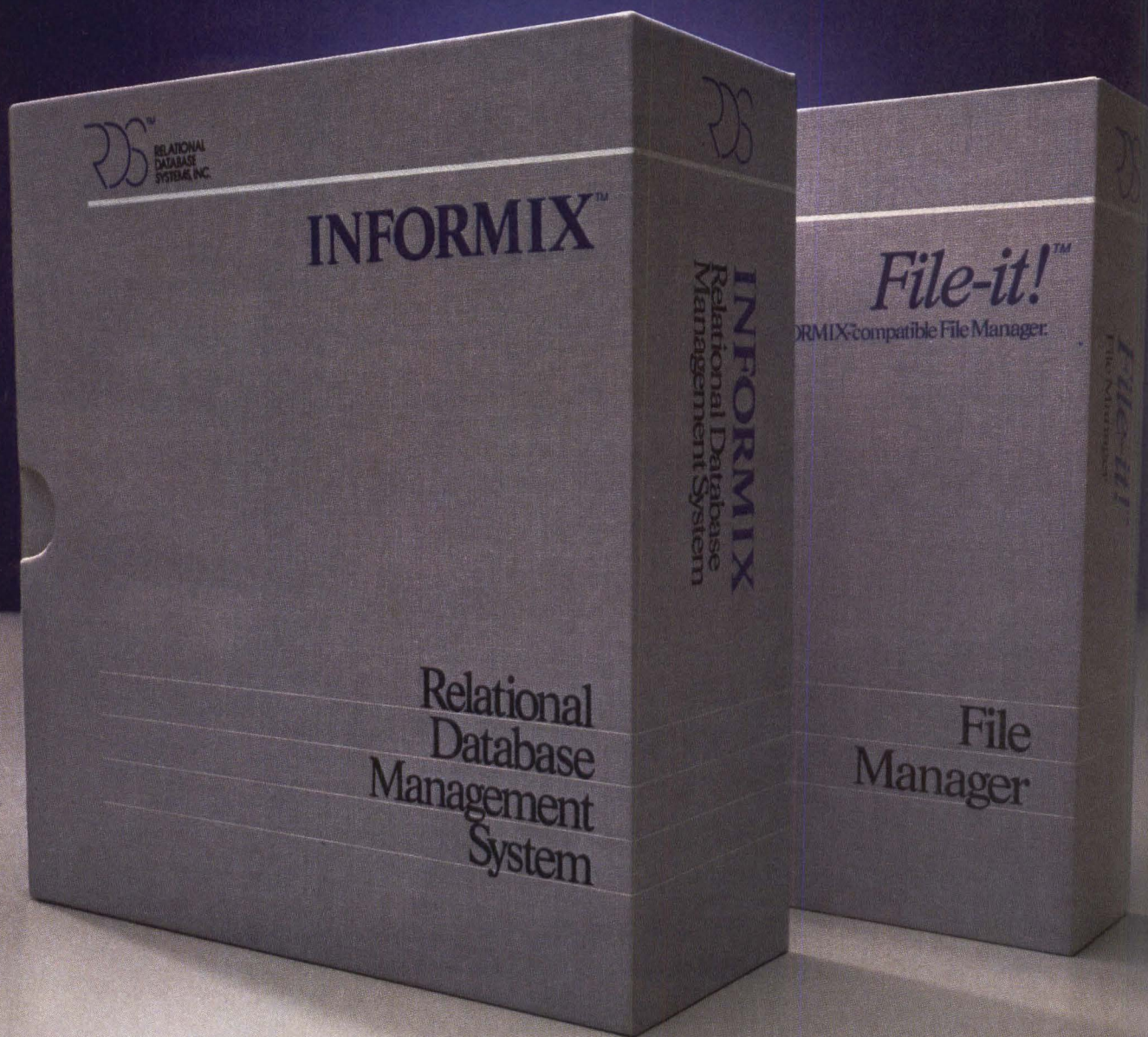

Now OEMs and systems integrators can sleep better at night. Because one company has taken the worry out of buying the right software.

RDS.

The company that produces a family of database software designed to take on the future.

### **Incompatibility is a thing of the past.**

INFORMIX® and File-it!™ are compatible with UNIX™, MS™-DOS, PC-DOS™, and PC/IX systems (over 60 micros and minis\* at last count).

INFORMIX is a true relational database system designed to take full advantage of the power of UNIX. It includes the most widely used report writer on the market.

Then there's File-it! The first easy-to-use UNIX file manager. Together, they have the flexibility to accommodate novices and experts alike.

INFORMIX and File-it! are fully integrated. Users can upgrade from File-it! to INFORMIX or access data from one program or the other without re-entering data, retraining employees or reprogramming.

Applications can also be moved from MS-DOS to UNIX and vice versa without having to rewrite the application.

### **Simplify program development.**

RDS offers C-ISAM™, the de facto standard ISAM for UNIX. It's a library of C subroutines with a B<sup>+</sup>-Tree based access method that stores, retrieves and modifies data from indexed files. It's embedded in INFORMIX and File-it! Or is available as a standalone product.

### **Software good enough for AT&T.**

AT&T, inventor of UNIX, has co-labeled INFORMIX, File-it! and C-ISAM to run on their full AT&T 3B Computer line (from micros to minis).

Hewlett-Packard, Altos, Zilog, Siemens, Cromemco, Perkin-Elmer, Sydis and General Automation have selected RDS as well.

In fact, INFORMIX has an installed base of over 6,000 copies. And RDS has sold over 35,000 licenses for all their products to date.

But before you make up your mind, check the facts one more time.

There's only one database software family that's UNIX-, PC-DOS-, MS-DOS- and PC/IX-based. It runs on more than 60 systems. And it's ideal for both novice and expert.

Now it doesn't matter where the future's headed. You're already there.

\*RDS products are available for the following systems:

Altos 586, 986, 8600, 68000	Hewlett-Packard 9000
Apollo DN300	Series 200, 9000 Series 500
AT&T 3B2, 3B5, 3B20,	IBM PC, PC-XT
AT&T Personal Computer	Intel System 86/330
BBN C machine (all models)	Masscomp NC 500
Bunker Ramo Aladdin 20	Momentum Hawk 32
Charles River Data Systems	NCR Tower
Universe 68	Onyx C8002, C8002A
Convergent Technologies	Perkin-Elmer 3210, 3220,
Miniframe and Megaframe	3240, 3250
Corvus Systems Uniplex	Pixel 100/AP, 80 Supermicro
Cromemco System 1	Plexus P/25, P/35, P/40, P/60
DEC 11/23, 11/34, 11/44, 11/60,	Pyramid Technologies 90x
11/70, VAX 11/730, 11/750,	Radio Shack Model 16
11/780	SCI Systems IN/ix
Dual Systems System 83	Wicat System 150WS, 160,
ERG Mini System (all models)	200
Fortune 32:16	Zentec 2020
Forward Technology 320	Zilog System 8000
General Automation Zebra	(all models).
(all models)	

Demos of INFORMIX and File-it! are available. Demonstration software and complete manuals included.



**RELATIONAL  
DATABASE  
SYSTEMS, INC.**

2471 East Bayshore Road, Suite 600, Palo Alto, California 94303  
(415) 424-1300 TELEX 467687

INFORMIX is a registered trademark of Relational Database Systems, Inc. RDS, File-it! and C-ISAM are trademarks of Relational Database Systems, Inc. UNIX is a trademark of AT&T Bell Laboratories. MS is a trademark of Microsoft and PC-DOS is a trademark of International Business Machines.

# Pascal-2™

## PROVING GROUNDS

*Pascal-2 Performs in Parametric Testing for VLSI Technology Group at Jet Propulsion Laboratory.*

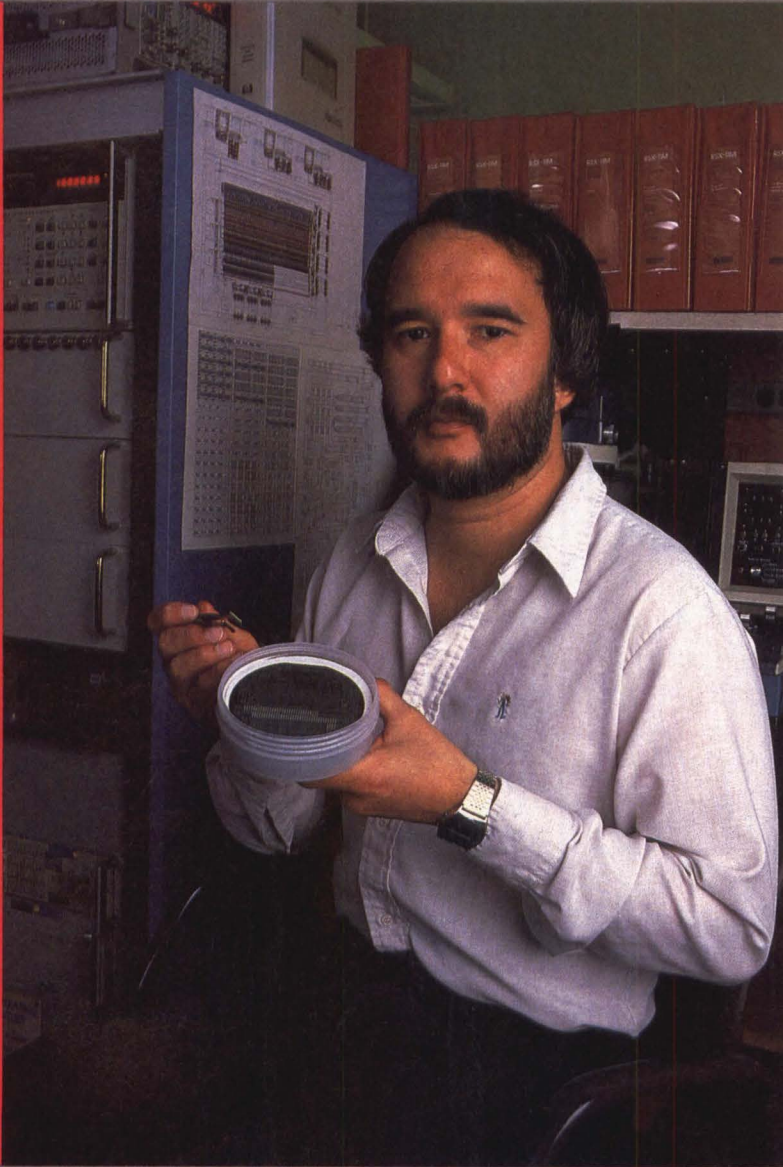

**“T**he nature of the instrumentation we use and the speed at which we need to acquire data created the need for a compiler that would let us push our PDP-11 to the limit.”

**Glenn Jennings**

*Senior Engineer, Programming  
Jet Propulsion Laboratory  
Pasadena, California*

*Glenn Jennings' parametric testing software is used in a quality assurance program for the VLSI circuits in deep space exploration spacecraft. Pascal-2 permits ease and speed of programming in acquiring data from the tested VLSI circuits.*

*Why is Pascal-2 the group's choice in software? "This highly optimizing compiler produces code which is very efficient, using our RSX operating system to the maximum. Pascal-2 allows us to easily use memory overlays for writing our very large programs. It has a very clean interface to assembly level language modules."*

*To see how Pascal-2 meets your application needs, call*

**1-800-874-8501.**

CIRCLE NO. 82 ON INQUIRY CARD

## Oregon Software

2340 S.W. Canyon Road  
Portland, Oregon 97201  
(503) 226-7760

*The Pascal-2 system is available on Digital's PDP, VAX and Professional Computer systems running on the RSTS, RT-11, RSX and Unix Operating Systems.*

Digital, PDP, VAX, RSTS, RT-11 and RSX are trademarks of Digital Equipment Corporation. Unix is a trademark of Bell Laboratories. Pascal-2 is a trademark of Oregon Software.



# Mature software tools speed development tasks

*The latest software tools provide a mature environment for the development of complex applications, allowing greater productivity*

**Carl Warren**, Western Editor

Software developers now have a robust set of tools. These include optimized language compilers, operating system environments that aid software development and sophisticated fault finders (debuggers).

With these tools, software writers can make a better product in less time. Although in most cases the tools are used to create application programs, they also lend themselves to the creation of still other development tools, or to the establishment of a fertile development ground.

One example of a tool used to create tools is Modula 2 for the 8086, developed by Logitech Corp., Redwood City, Calif. According to company president Pierluigi Zappacosta, Logitech's version of Modula 2 is a true compiler. It generates native code rather than p-code that must be interpreted. "We aren't pushing Modula 2," says Zappacosta. "Rather, we are more interested in creating a programming environment and providing tools to the software developer similar to those used by hardware designers."

Modula 2 is an extension or, more correctly, a robust version, of Pascal. Logitech believes Modula 2 offers the right environment because it is many tools within a tool. Moreover, it permits the creation of other tools by using modules that can be used to define operation-specific libraries. "We have essentially addressed the problem of real-time programming," says Zappacosta, "but we have no illusions about supplanting the C programming language."

Another company embracing Pascal is Intel Corp., Santa Clara, Calif., with its Pascal-286 compiler. It employs a version of Pascal conforming to the standards established by the International Standards Organization (ISO). The code produced is transportable to any

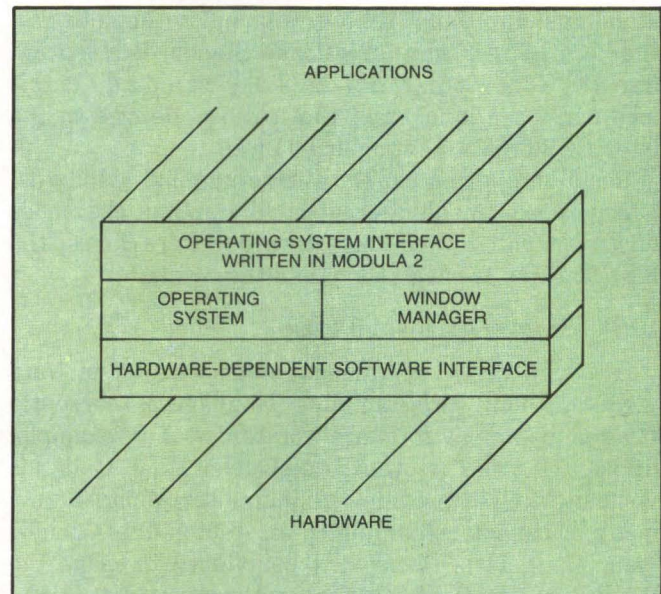

**Logitech's Modula 2** is designed to match applications with the operating environment by providing a software interface to the operating environment. Much like the hardware interface, the software link is written by the system integrator.

other ISO-standard Pascal environment.

By offering Pascal-286, Intel hopes that software writers and system integrators will develop a host of products around its powerful 80286 microprocessor. Pascal-286, sold as iMDX-324, is priced at \$3,900 and includes enhancements that take advantage of support chips such as the 80287 numeric coprocessor. Like Logitech's Modula 2, Pascal-286 also produces native object code.

Softech Microsystems Inc., San Diego, offers the UCSD Pascal and p-system. Softech has added a little extra in the form of a window manager called Insight

Window Designer. The entire package—with the window manager, UCSD Pascal and the p-system for IBM Corp.'s PC, Digital Equipment Corp.'s Rainbow and Apple Computer Inc.'s IIe—sells for less than \$500.

Prospero Software Ltd., London, may have taken the language extension further with Pro Pascal and Pro FORTRAN. Both of these products are for 16-bit microcomputers using the Intel 8086 or 8088 microprocessor and the CP/M-86 operating system from Digital Research Inc. (DRI), Pacific Grove, Calif. Support for the Intel 8087 matching coprocessor is built-in.

To relieve software writers of the tasks of cross-referencing modules and performing cumbersome linking operations, Prospero provides a full set of command files that handle these tasks dynamically. To ensure conformity of the source-level code, Pro Pascal conforms to the ISO 7185 standard and is certified by the British Standards Institution for meeting international standards. Pro FORTRAN is a complete implementation of the American National Standards Institute (ANSI) X3.9-1966 (FORTRAN 66) standard, but it incorporates a number of the features defined in the later FORTRAN 77 standard as well.

Besides adhering closely to international standards, Prospero has made provisions to combine the codes written in both compilers. Software writers can use the best features of each and couple the results.

**UNIX establishes a solid base**

Although Pascal provides an alternative to software writers, the C programming language is currently favored by many software companies. For example, dBase III, from Ashton-Tate, Culver City, Calif., is written in C to provide maximum portability across many machines. According to an Ashton-Tate spokesman, the goal is to use C's portability to make the product as beneficial to system integrators as possible.

Robert Anton Byers, an independent software consulting engineer in LaCrescenta, Calif., says system integrators can use C because UNIX provides a plush environment in which to build software. "In UNIX, you have literally rafts of libraries to choose from. Therefore, software writers have the tools at the touch of a button."

The C language lends itself well to producing other tools. One company, Digital Information Systems Corp., Sacramento, Calif., has used C to create Data Business Language (DBL). This "new" language is a superset of the DIBOL-11 business language from DEC, Maynard, Mass. As the name implies, the \$449 DBL-4 is written to support business applications. Existing applications can get easily transported due to compatibility with the DEC product. Furthermore, DBL-4 operates in a variety of operating-system envi-



Extending the operating environment of the IBM PC can be achieved using DRI's Concurrent CP/M-86 and a Starlink expansion add-on to support as many as five users.

ronments including MS-DOS; thus, source code can be created on the IBM PC or a compatible microcomputer and up-loaded to a DEC PDP/11.

**Tools locate data**

Byers contends that, in reality, what computers are used for is managing databases. "The trick is to figure out a method of getting to the data quickly. Sophisticated tools now provide the programmer with that ability."

One such tool that aids software writers in handling databases is Trio Systems' C-INDEX+. This package, priced at \$400, links into C language applications and provides variable-length data-storage and -indexing functions. Moreover, company president Alan Bartholomew says that indexed sequential access method (ISAM) techniques are used to keep track of the data and to provide quick access to it. Although Trio does sell the object-code version, it also makes available a source-code OEM version for system integrators.

For developers who are creating applications for the IBM PC world, XOR Corp., Minnetonka, Minn., provides a tool kit of 50 C routines for \$99.95. "This is a superior set of extensions to the standard C library," says vice president of research and development Michael de St. Hippolyte. "The standard C library doesn't have built-in input/output commands but uses general functions. Our C Tools is a set of functions for I/O specifically optimized for the IBM PC; thus, a programmer can quickly have keyboard and sound routines by simply specifying a library call in the source code."

Taking a different approach to C compilers is Boston Systems Office, Waltham, Mass., with an optimized Motorola 68000 microprocessor BSO/C compiler. The compiler, priced at \$5,000, is designed to run on the DEC VAX to produce microprocessor target code, turning the powerful minicomputer into a microprocessor development system. BSO also plans versions for

# The new Canon® Handy Terminal makes any computer system go farther.

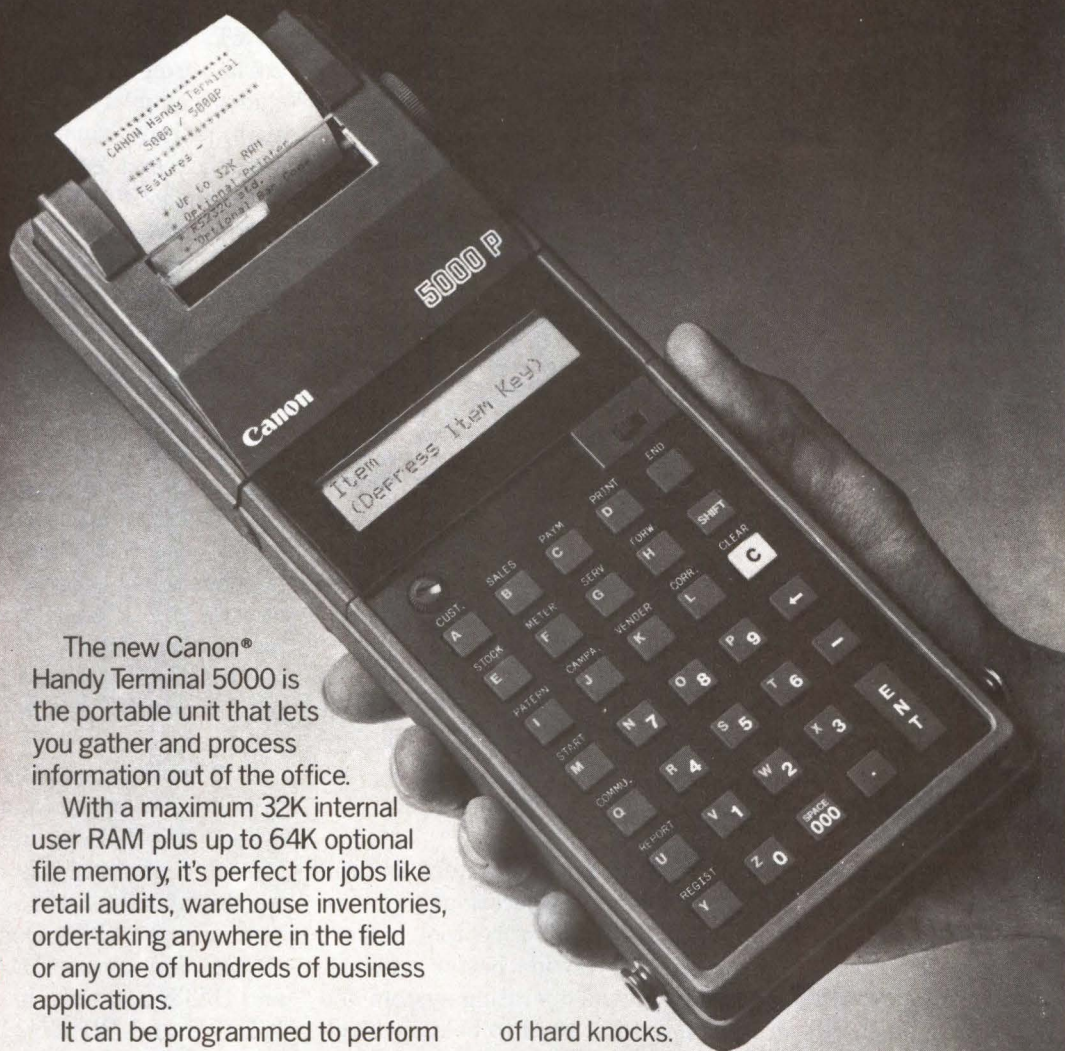

The new Canon® Handy Terminal 5000 is the portable unit that lets you gather and process information out of the office.

With a maximum 32K internal user RAM plus up to 64K optional file memory, it's perfect for jobs like retail audits, warehouse inventories, ordertaking anywhere in the field or any one of hundreds of business applications.

It can be programmed to perform almost any task, adopting BASIC and Assembler languages.

And can even relay information to your computer via phone hookup.

Portability is also the key word of the 5000, because Canon's Handy Terminal was especially designed for traveling light.

At a weight of less than 2 lbs., it can operate on a rechargeable battery and can be carried by neck strap or in an attache case. Yet it's highly durable, water resistant and shock resistant. Which means it can take its fair share

of hard knocks.

Also available is the 5000P (shown above) which has a built-in thermal dot printer that can print one original and a copy.

And both terminals can incorporate an optional bar code reader.

So why not widen your computer horizons with Canon's new Handy Terminal. It lets you go as far as you like.

**For more information:**  
Call 1-800-323-1717, Ext. 302.  
(In Illinois call 1-800-942-8881, Ext. 302.)  
Or Write Canon U.S.A., Inc.,  
Systems Division/Handy Terminal,  
P.O. Box CN 11250, Trenton, N.J. 08638.

© 1984 Canon U.S.A., Inc.

**Canon Systems Division**

CIRCLE NO. 83 ON INQUIRY CARD

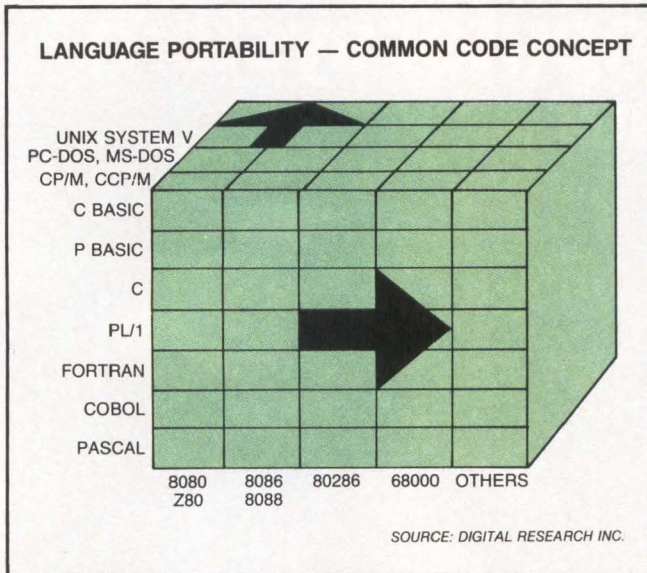

The basic concepts of DRI's common code are to provide a common syntax on the front-end (languages), a link to the various processors and common links to the operating systems. This 3-D approach means that code generated on one machine type for a given operating system can be used in a completely different environment with little or no changes.

the Intel 8086/88 and 8087 microprocessors as well as Motorola's 6809 and Zilog's Z80 family of processors.

The BSO development series includes the necessary software interfaces to allow linking to a variety of microcomputer operating systems. In addition, a runtime math library is incorporated to institute floating-point capability.

### Tool makers are challenged

Because computer systems, minicomputers and microcomputers and the attendant applications grow increasingly more sophisticated, software tool makers are continually challenged to provide better widgets. DRI, one of the mainstays of the operating system and tool business has recognized the need to bolster developers' tools. "The biggest challenge we see is to provide source-level portability across a number of processors," says Fred Langhorst, vice president of DRI's corporate planning and development. He admits that this isn't news. "It may be the single most important factor, however," he says.

According to Langhorst, because of the number of chips with 32-bit power being produced by the semiconductor industry, the software has to be available to take advantage of it.

Due to the diversity in the various chips, Langhorst says, the new generation of development tools are designed to remove "bit-twiddling," thus ensuring that they meet the portability demands of the industry. "We match the code to maximize the processor—and we may

be pushing the state-of-the-art with Concurrent CP/M-86—but it does open up a new environment for the software writer."

Even though DRI has traditionally skirted the UNIX issue, it is now aggressively developing a series of tools and applications in concert with AT&T Technology Systems, Summit, N.J. Specifically, under the aegis of AT&T, DRI is developing products in three distinct areas: professional programming library, which includes compilers and other development tools; office automation—spreadsheets, word processors and graphics; and engineering scientific, with statistics, finite analysis and surface representations. "The products are primarily for the AT&T B-series of minicomputers, but it is an open-architecture scheme to permit portability across a variety of devices and to allow developers to increase the value of the base product."

### Ease of creation sought

To achieve portability and ease of creation, DRI uses the common code-compiler generator. This is a technique whereby the compiler has a front end and a back end. The front end always has the same syntax regardless of the CPU, and the back end makes it CPU-dependent. An intermediate translator from the source code to the chip-specific generator serves as the communications vehicle. "This doesn't mean multiple steps are required; we handle all the translation in a transparent manner at compile and link time," Langhorst says.

Still another company that is working with AT&T to provide developers with tools for the powerful computers is Feith Systems and Software Inc., Bala Cynwyd, Pa. Its contribution is UX-BASIC. "This is a product we distribute for UXSoftware Inc., Toronto, explains company president Don Feith. "This is a superset of BASIC and contains statements such as TRIM, DAY and DATE and even has Pascal-like constructs such as WHILE and WHEN. This language allows software writers to quickly create applications that will run on a host of UNIX-based machines."

One company that has taken an aggressive posture in providing high-performance software, especially for the graphics industry, is Megatek Corp., San Diego, with the Template graphics package. "This is a powerful tool that lets you develop sophisticated graphics that are usable in a variety of environments, ranging from large-scale, computer-aided design workstations to the IBM PC," claims Template director of operations Robert W. Adams. The newest version of the package for the IBM PC, priced at \$300, aims at OEMs, system integrators and sophisticated end users.

Basically, Template is a library of FORTRAN programmer routines—a graphics development tool kit.

# Now you don't have to sacrifice print quality for speed.

## The Canon® Impact Matrix Series Printers.

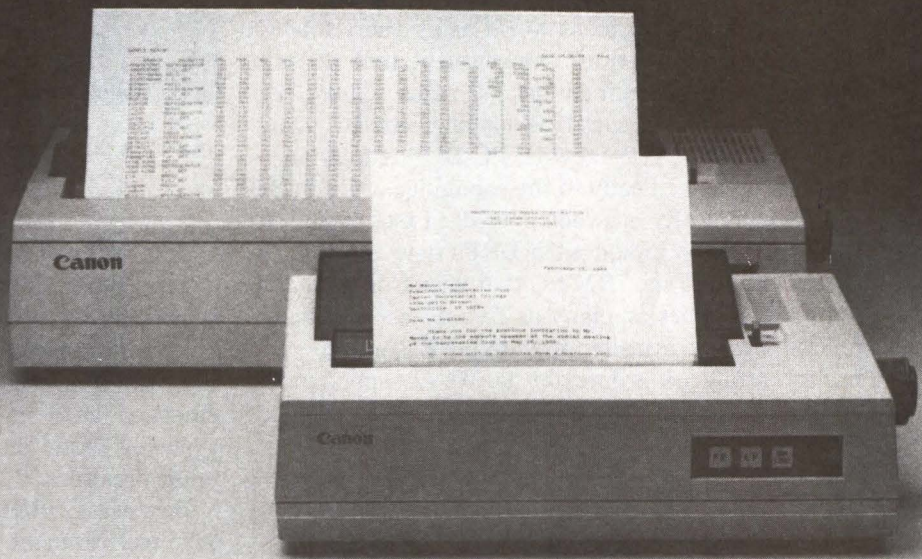

High speed and high quality in one functional, compact unit. That's what Canon's Impact Matrix Printers offer you.

They print hard copy at a rapid 160 characters per second. While in the double pass mode you get an impressive, high-density 23 X18 dot matrix that gives near letter quality printing suitable for word processing.

Canon's unique technology has also dramatically reduced bothersome clatter down to a muted noise level of less than 60dB.

Even at high speed.

And that, unlike many other impact matrix printers, makes them a pleasure to work with.

Plus there's limitless flexibility with the optional down-loading function that lets you print

whatever character fonts your host computer can create. As well as a choice of four different character styles (all printable on the same line) that you can enlarge or condense.

The Impact Matrix Series Printers give you a convenient choice of special paper widths—the PW-1080A for 80-character column printout and the PW-1156A for 156-character column.

Exceptional quality and high speed.

The Canon® Impact Matrix Series Printers give you the best of both worlds.

**For more information:**  
Call 1-800-323-1717, Ext. 300.  
(In Illinois call 1-800-942-8881, Ext. 300.)  
Or Write Canon U.S.A., Inc.,  
Printer Division, P.O. Box CN 11250,  
Trenton, N.J. 08638.

**Canon Printer Division**

CIRCLE NO. 84 ON INQUIRY CARD

Included are 21 font styles and device drivers to handle various input and output devices. As with the C libraries, Template's FORTRAN routines can be coupled into a total development environment.

**Operating environments important**

Because power, portability and ease of development are important to software writers, they are naturally looking for the most productive environment they can find. Craig S. Jelinek, president of Micro Business Applications Inc., Burnsville, Minn., runs one such company. "Because we have products that are aimed at being generic in the business world using the IBM-PC and look-alikes, we need an environment that doesn't restrict us to a predefined set of rules. Thus, we decided that we could satisfy a lot of needs by using DRI's Concurrent CP/M-86 with PC-DOS emulation."

Jelinek refers specifically to the capability of CP/M-86 to switch dynamically between operating modes (CP/M or PC-DOS). When linked with DRI's new Starlink, a multiport add-on to the IBM PC that uses Concurrent's capability to support as many as five users, multiuser capability is automatically provided. "Essentially, all the background work is done for us. We can spend most of our time developing the application."

```

002240 DATEFROM.
002250 MOVE 320 TO IO-LENGTH.
002260 MOVE 1601 TO SCREEN-OFFSET.
002270 MOVE 1 TO BUFFER-OFFSET.
002280 CALL SCREEN-TO USING WRITE-ATTR FORM-PARAMS DATEFROM-00-ATTR.
002290 DISPLAY DATEFROM-00 AT 2201.
002300 DISPLAY DATEFROM-01 AT 2201.

TEST-RESULTS.
IF UK
MOVE " date in UK format -" TO FORMAT-MSG
ELSE
MOVE " date in USA format " TO FORMAT-MSG.
MOVE "date is OK" TO RESULT-MSG.
IF DAY-NO = SPACE
MOVE "Day is invalid" TO RESULT-MSG
IF UK MOVE 0956 TO CURSOR-POSITION
ELSE MOVE 0959 TO CURSOR-POSITION
ELSE IF MONTH-NAME = SPACE
MOVE "Month is invalid" TO RESULT-MSG

DATECALL.
Level-02-Speed-0-
Am-Scroll
F1 F2-view F3-context F4-swap F5-where F6-line F7/F10-word-l/r Escape
S C Z := next-If Perform Reset Break Env Query Find Locate Text Do 0-9-speed
    
```

Micro Focus' Level II COBOL is designed for ease of application creation by providing structured mainline coding techniques.

**COBOL remains an important tool**

The Common Business-Oriented Language (COBOL) is proving to be a powerful mainstay for a variety of business applications. Developed in the early '50s as a tool to handle batch business applications, it has emerged as a useful tool in interactive applications typically found on most microcomputers and business minicomputers.

Because COBOL does offer software writers a mature environment to create applications, a number of companies are actively supporting the language. Among these are Ryan-McFarland Corp., Rolling Hills Estates, Calif.; Micro Focus Ltd., Palo Alto, Calif.; and Microsoft, to name a few. Micro Focus, however, is the only company that has built a complete development philosophy around the language and created a host of products to support the development process.

Among the products Micro Focus offers are: Level II COBOL, which conforms to ISO standards, ANIMATOR, a program that analyzes and debugs COBOL source-level code, and Personal COBOL, which is essentially a fast version of the large-scale COBOL.

Although Level II COBOL is priced at a hefty \$1,995, it does support code written in mainframe environments, thus easing the translation process. Moreover, users of smaller systems such as the IBM PC can use Personal COBOL, priced at \$395, and develop code that can be easily ported to the more robust Level II.

Even with most of the industry appearing to stress other languages, International Data Corp., Boston, sees COBOL as retaining the lion's share of the software market with an average of about 45 percent across large and small systems. This represents about \$100 billion in worldwide investment. Thus, the profitability of COBOL-oriented products is easily assessed.

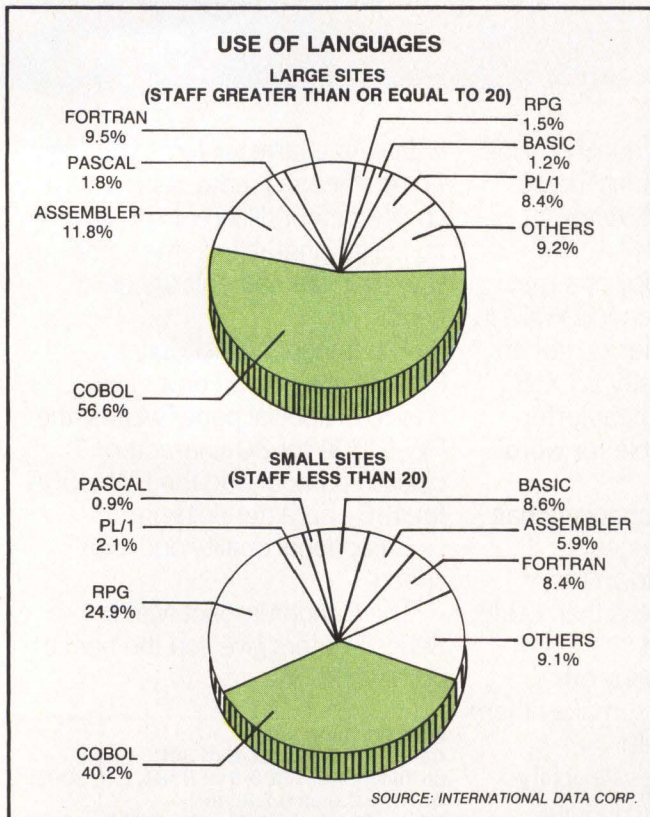

Across large and small systems, COBOL still remains the most favored development language. (Source: International Data Corp.)

# What's more incredible about Canon's color ink-jet printer? The quality... or the price?

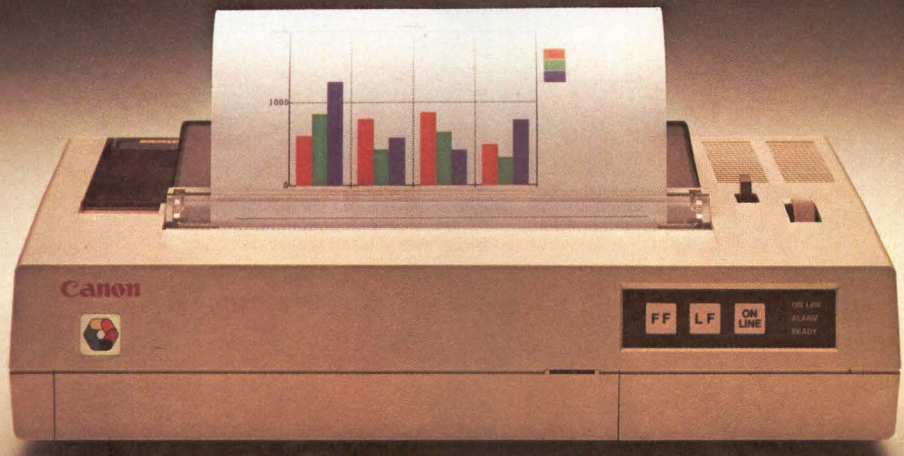

Take a look at the beautiful clarity of the Canon®PJ-1080A's color ink-jet printing. Then discover that Canon's color printer actually costs well under a thousand dollars. You'll be hard-pressed to decide which is more amazing.

What makes the quality so incredible? Features like:

- The advanced drop-on-demand printing system. Canon's patented ink-jet technology gives a sharp 640 dot-per-line scan mode, for dazzling high-resolution color and exceptionally clean, crisp printouts.
- Whisper-quiet operation of less than 50dB and an impressive speed of 37 c.p.s.
- A choice of seven bold colors for bright, imaginative graphics.
- A special dual-ink cartridge system that gives cleaner

resolution on blacks and saves you money, because when black is used up only the black cartridge need be replaced.

- The ability to print high-fidelity characters and images on transparencies for overhead projection.

▪ Compatibility with most computers you can buy. And how much does all this cost? Far less than a thousand dollars.

So what's more incredible about the PJ-1080A color ink-jet printer? There's only one way you'll really be able to find out.

And that's to buy one and decide for yourself.

**For more information:**  
Call 1-800-323-1717, Ext. 300.  
(In Illinois call 1-800-942-8881, Ext. 300.)  
Or Write Canon U.S.A., Inc.,  
Printer Division, P.O. Box CN 11250,  
Trenton, N.J. 08638.

© 1984 Canon U.S.A., Inc.

CIRCLE NO. 85 ON INQUIRY CARD

**Canon Printer Division**

# Early to Market

## Through the Market Window: On Time

In the race to market, OEMs and system integrators are faced with a greater challenge today than ever before. To get to the market before the window closes, with reliable, leading edge products.

At Zitel, we'd like to help you get there before the pack, by working with your engineering and manufacturing teams to develop your system's memory or microcomputer system requirements using the latest in our building block modules.

Because today's race requires shorter time to market, substantially increased engineering resources, and, more than ever, an advanced level of innovation in memory and microcomputer technologies in order that your system has that performance edge necessary to capture and maintain market share.

### Building Block Modules

At Zitel, we'll show you how to take proven memory and microcomputer building blocks, and couple them with application-unique interfaces to cut your time to market by a fraction of your current plan. And we'll do it at a lower cost, for a far smaller investment of your company's time and resources. You avoid the learning curve along the way.

And once you're in the market, we'll show you how to stay there, with our Guarantee Against Obsolescence. With Zitel as a manufacturer of your product, we'll provide the ongoing design and engineering expertise to keep your product competitive.

From board level to bulk memory systems, or memory-intensive microcomputer systems — you can count on Zitel, *your* application specific solution.

Because the only sure thing about the race to market is that there *will be* a winner.

**We'd like to bring you there . . . on time.**

Please Send Me More Information on the Following Zitel Products:

- |  |  |
|--|--|
| <input type="checkbox"/> Multibus® Memory                | <input type="checkbox"/> Series 20 Microcomputer Building Blocks |
| <input type="checkbox"/> Series 90 Family of Bulk Memory | <input type="checkbox"/> Custom Microcomputer Cards              |
| <input type="checkbox"/> VME/Versabus™ Interface         | <input type="checkbox"/> Special Interface                       |
| <input type="checkbox"/> Custom Memory Cards             | <input type="checkbox"/> Other _____                             |

My application is \_\_\_\_\_  
Name \_\_\_\_\_ Title \_\_\_\_\_  
Company \_\_\_\_\_ Phone ( ) \_\_\_\_\_  
Division \_\_\_\_\_  
Address \_\_\_\_\_  
City, State \_\_\_\_\_ Zip \_\_\_\_\_

Multibus is a registered trademark of Intel Corp.

Versabus is a trademark of Motorola Inc.

CIRCLE NO. 86 ON INQUIRY CARD

# zitel®

Zitel Corporation • Attn: Applications Manager • 399 W. Trimble Road • San Jose, California 95131  
Zitel International: 53 Boulevard, De Waterloo, bte 2, 1000 Brussels, Belgium.



To speed COBOL programming, Bytel Corp., Berkeley, Calif., has COGEN 6.0. This powerful front end to COBOL allows software writers to define COBOL code lines interactively by using screen definitions. Bytel's COGEN isn't limited to either micros or minis but is available for MS-DOS/PC-DOS systems as well as UNIX-based systems. An MS-DOS version is priced at \$950; the microcomputer UNIX version is \$1,250. Minicomputers supported include those from Texas Instruments Inc., NCR Corp., Prime Computer Inc. and DEC and range in price from \$2,900 to \$7,500 plus an annual maintenance fee.

Another company offering a 74 COBOL-compatible compiler is S&H Computer Systems Inc., Nashville, Tenn. The company's COBOL Plus, which ranges in price from \$2,000 to \$3,500, depending on licensing arrangements, is optimized to run under DEC's RT-11 and RT-11XM single-user operating systems, and S&H's TXX-Plus multitasking/multiuser operating system. Moreover, the package includes facilities to allow applications written under other versions of COBOL to be transported with minor modification.

#### Other tools emerge

Not all development strategies involve just the software. Digital Datacom Inc., Laguna Niguel, Calif., for example, has developed a complete workstation concept for increasing programmer productivity. Called the WorkForce Development System, it comes with a custom COBOL code generator that matches ANSI requirements for the 74 COBOL standard. This generator, claims the company, permits the creation of structured, consistent code.

Working in concert with Nastec Corp., South Field, Mich., Spectrum International Inc., Culver City, Calif., has developed the LifeCycle Manager, which integrates standard development methods and design tools for software development on Nastec's CASE 2000 workstation.

The total system, including software and workstation, is priced at \$29,000. But the developers claim that it speeds software development and cuts costs by providing a fully automated tracking—auditing—system for the entire process.

Because software development can be cumbersome and the management difficult, Oregon Software Inc., Portland, Ore., has developed SourceTools. This series of programs, which runs on the DEC PDP-11 under RSX or RSTS operating systems, manages the development and maintenance of software projects.

The SourceTools system operates with any language and consists of three groups of programs that work together to create a development environment. The first group, Source Control (SOURCECON), is made

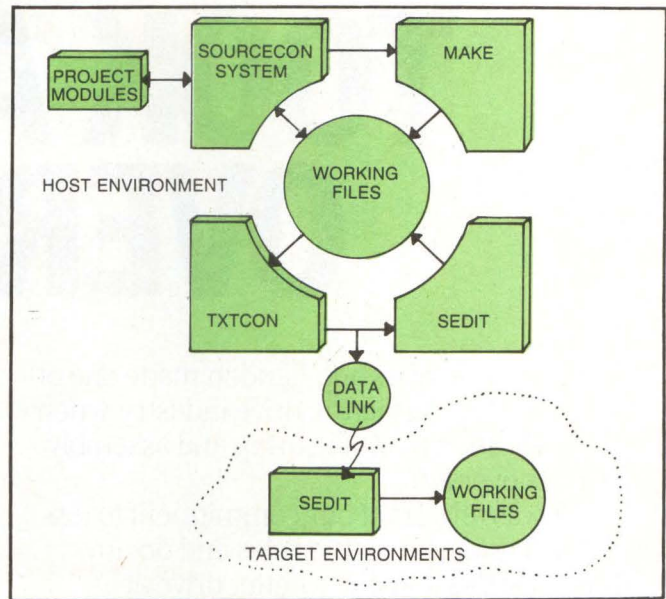

**A detailed view of Oregon Software's SourceTools components** in both the host and target operating environments shows a set of project-control modules from which the working files are called. Notice that each working file can share the control modules, so many applications can be looked at concurrently. MAKE accesses the modules only through the SOURCECON by executing description-file commands to retrieve the working files, which are text source files. The arrows depict the flow of operations.

up of four programs that control the creation and modification of source files. The second group is a single program called MAKE, which handles the rebuilding of programs from control modules. The third module is made up of two programs: TXTCOM, a file-comparison utility, and SEDIT, a stream editor that reads the TXTCOM script and applies changes to a parallel source file. This latter group serves as the management audit trail for keeping track of changes.

Basically, SourceTools ensure that proper testing and documentation are updated. Moreover, various versions of the code are kept and compiled as changes are made, thus eliminating time-consuming recompilation of the complete system.

Even with sophisticated tools becoming available for microcomputers, most of the powerful tools still reside on minicomputers and mainframes. Industry experts, such as DRI's Langhorst and independent consultant Byers, believe that it will still be another two years before many of the functions find their way to microprocessors. "The semiconductor industry is providing more power in microprocessor technology," says Langhorst. "Even with 32-bit devices emerging, it will still take us 18 to 24 months to create the software tools to maximize the use." □

Interest Quotient (Circle One)  
High 819 Medium 820 Low 821

# HOW WE TOOK A DRIVE OVERSEAS.

Over five years ago, Tandon made one of the boldest moves in the drive industry when we established manufacturing and assembly facilities overseas.

It was all part of our commitment to toss protocol aside, break the rules and do anything possible to make a better drive at a lower cost.

Well, just look where it got us.

Now we're all over the world. Our prices have dropped by more than half. We've made quality control an art form. We're keeping up with the highest volume product demands without a hitch.

Of course, not everything is going over-

seas. We've been rather judicious about selecting the right tasks to make the move.

And happily, our manufacturing success over there has made for some important achievements over here, too. We've kept our most advanced technology and research and development at home where it belongs. Right where we have a large, stable, experienced group of high-tech experts.

As a result, we're stronger than ever.

So now when you look at drive companies, there's one other characteristic you should keep in mind.

Foresight.

At Tandon, it's never been a foreign idea.

**Tandon**  
**THE DRIVING FORCE BEHIND THE SMALL COMPUTER INDUSTRY.**

Tandon Corporation, 20320 Prairie, Chatsworth, CA 91311. (818) 993-6644, TWX: 910-494-1721, Telex: 194794. Regional Sales Offices: Boston (617) 938-1916 • New York (201) 851-2322 • Atlanta (404) 934-0620 • Chicago (312) 530-7401 • Dallas (214) 423-6260 • Irvine (714) 669-9622 • Santa Clara (408) 727-4545 • Frankfurt, West Germany 6107-2091, Telex: 411547 • London, England (0734) 664-676, Telex: 848411. Distributors: Hall-Mark, Kierulff, Schweber.

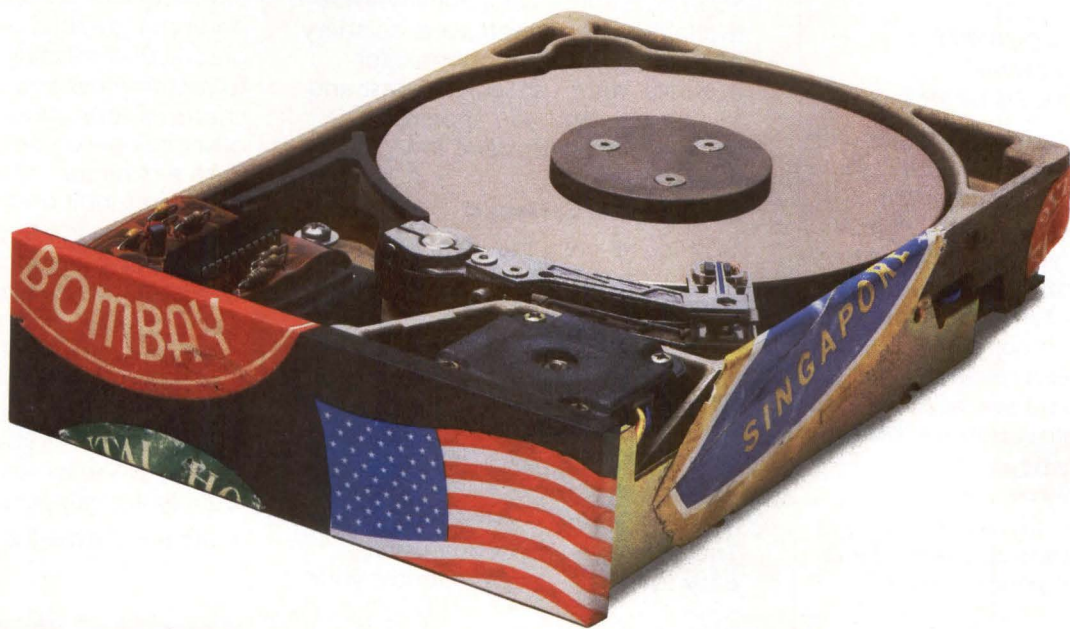

# Not Very Interesting...



**There's a way of getting graphics on your old terminal... BUY a Selanar Graphics Enhancement Board.**

DEC  
TELEVIDEO  
QUME  
LEAR SIEGLER

Bring your old terminals to life with Selanar's Graphics breakthrough. Selanar has done something no other graphics technology company has done. **We've developed retrofit graphics boards with pen plotter interfaces that provide high resolution hard copy no matter what the screen resolution of your terminal is—and we've done it for some of the most popular terminals.**

### **Selanar Quality, Selanar Service**

There's a lot to say about Selanar's retrofit graphics boards—Tektronix 4010/4014™ emulation, exclusive

Selanar features, compatibility with available graphics software, a variety of hard copy output options, for instance. You trust Selanar's fast and fair service. And you appreciate Selanar's low prices and low operating costs.

### **Low CPU Overhead**

With completely independent graphics memory, Selanar graphics boards provide a range of local terminal functions. Reducing transmission between terminal and output devices, and between terminal and CPU, means lower processing overhead, higher efficiency—and lower operating costs.

### **Easy To Install And Use**

The Selanar graphics boards are easy to install—in just minutes your

alphanumeric terminal becomes a powerful graphics terminal. And the graphics functions you gain are easy to access. Now you can create charts, graphs, plots, histograms and other complex monochrome images with a minimum of training—and make presentation-quality hard copies on your pen plotter.

### **Buy Selanar For Graphic Answers**

Call us today. Whether you're an OEM or end-user, we're ready to tell you just how Selanar can provide solutions to your need for high quality, low cost graphics upgrades—with Selanar's top-flight quality and support.

**Call now 408-727-2811**

Actual printer output



Tektronix 4010, 4014 and are trademarks of Tektronix Inc.  
DEC is a trademark of Digital Equipment Corp.

Actual pen plotter output



**CIRCLE NO. 88 ON INQUIRY CARD**

# SELANAR

GRAPHICS

437-A Aldo Avenue, Santa Clara, CA 95050

European Hq:

Selanar GmbH, AHASTRASSE 5, D-6100 DARMSTADT  
FDR Germany, Tel. 06161/33391, Tlx. 4197201 sela d

# Low-cost multiuser system exploits PC-compatible workstations

*By incorporating several processors and emulating the IBM PC I/O system, a microcomputer allows as many as 12 users to run concurrent applications*

**Mark Greenberg and Stephen Kanzler**  
North Star Computers Inc.

Hardware manufacturers and system integrators increasingly are incorporating single-user microcomputers into networks that allow multiple users to pool programs, data and peripheral devices. One such multiuser system is Dimension from North Star

Computers Inc., which includes as many as 12 IBM PC XT-compatible workstations at a price of approximately \$2,500 per station. The system achieves this per-station price by having multiple processors communicate through shared memory using an architecture that is a compromise between a loosely coupled and a closely coupled network.

Most multiuser microcomputers employ a single

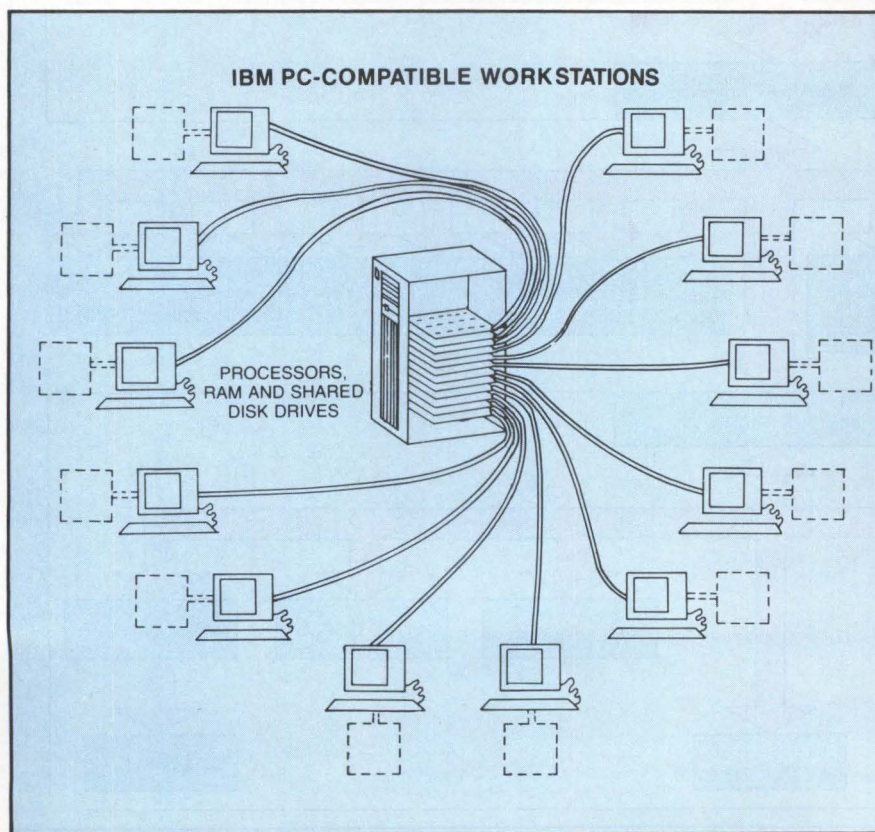

**Fig. 1. A star network links as many as 12 Dimension workstations, each a maximum of 325 feet from the server. Each workstation is functionally equivalent to an IBM PC XT.**

## Spec summary

- **Name:** Dimension multiuser microcomputer
- **Manufacturer:** North Star Computers Inc., 14440 Catalina St., San Leandro, Calif. 94577, (415) 357-8500
- **Architecture:** multiuser, multiprocessing, star-type network with an 80186 server processor and as many as 12 8088-2 workstation processors
- **Memory:** 128K to 512K bytes per workstation, 256K to 512K bytes with the server
- **Disk storage:** 15M to 60M bytes per system
- **Video display:** 12-inch monochrome screen, 640-by-200-pixel or 640-by-400-pixel resolution
- **Software:** runs MS-DOS and IBM PC-compatible applications
- **Price:** \$7,000 to \$23,000 per system

processor and a timesharing operating system. This structure provides an economical way to achieve multiuser capability, but it can result in sluggish system performance because of heavy demands on the CPU. Dimension solves this problem by giving each user a dedicated workstation that is functionally equivalent to an IBM PC XT (Fig. 1).

Each workstation incorporates an 8088 processor that runs an independent copy of Microsoft Corp.'s MS-DOS 2.0 operating system with a basic I/O system (BIOS) that emulates the IBM PC XT ROM BIOS. This emulation, combined with IBM PC-compatible keyboards and video displays, enables Dimension to run most off-the-shelf PC-compatible applications. The workstations contain their own RAM and connections

for user-specific printers, plotters and mice. Each workstation also maintains its own logical file system. However, Dimension stores user files on a shared hard disk, rather than on multiple private disks—a difference that is transparent to programs and users.

An Intel Corp. 80186 processor on a central server board coordinates access to shared system resources (Fig. 2). A real-time multitasking kernel schedules the 80186's workload. The server board includes as much as 512K bytes of main memory, controller interfaces for hard disks and a PC-compatible floppy disk drive, one parallel and two serial ports and a clock/calendar. The server also controls a PC-compatible system bus, which contains 13 slots for the workstation boards. The bus and backplane are mechanically compatible with the

**Fig. 2. The 80186 processor on the server board coordinates data flow throughout the system. The 8088-2-based workstation boards plug into a 13-slot IBM bus connected to the server. The bus**

*backplane accommodates IBM-compatible add-in boards such as controllers for communications and tape backup.*

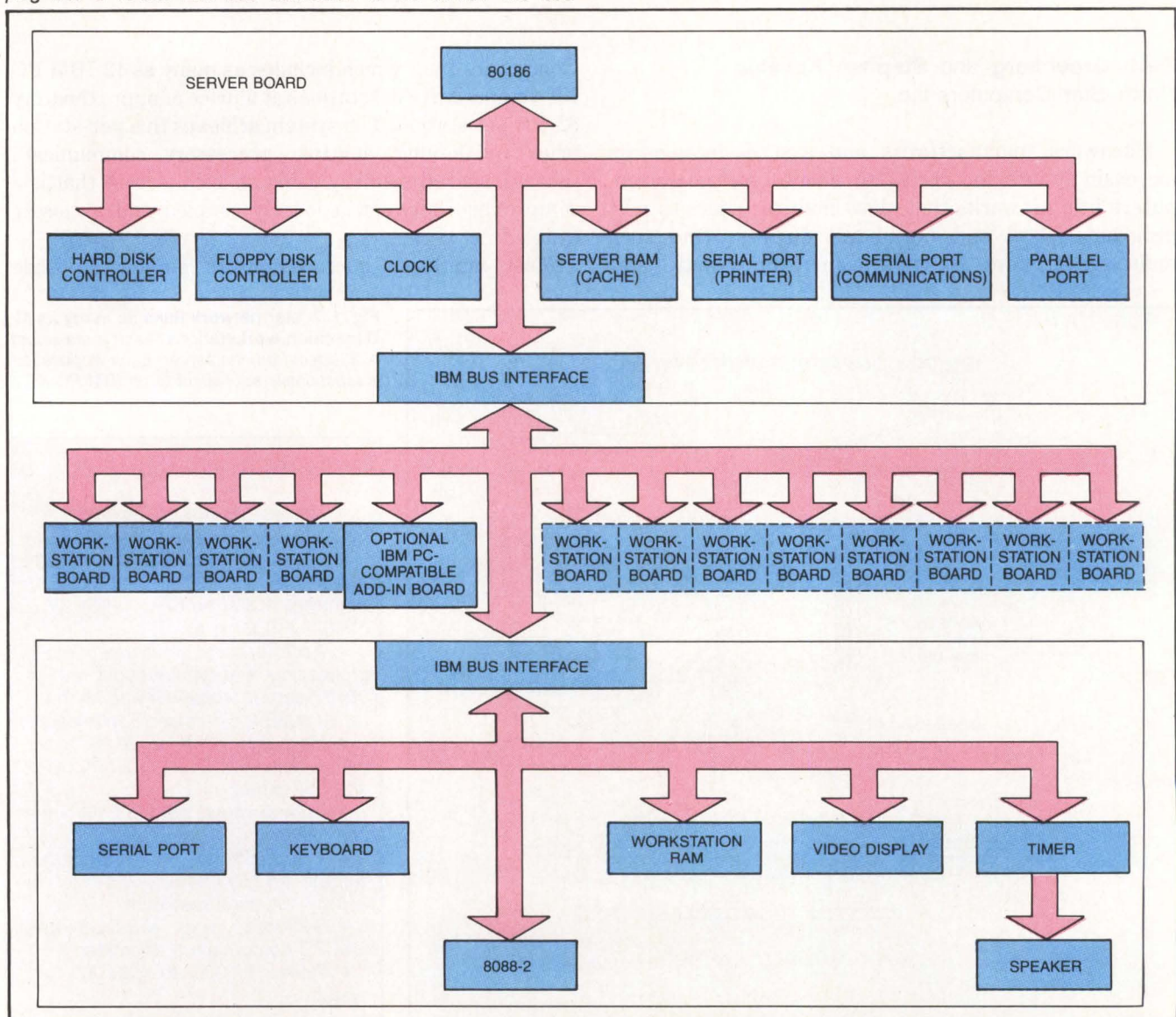

**From**

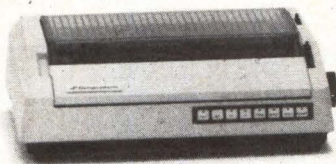

**, to**

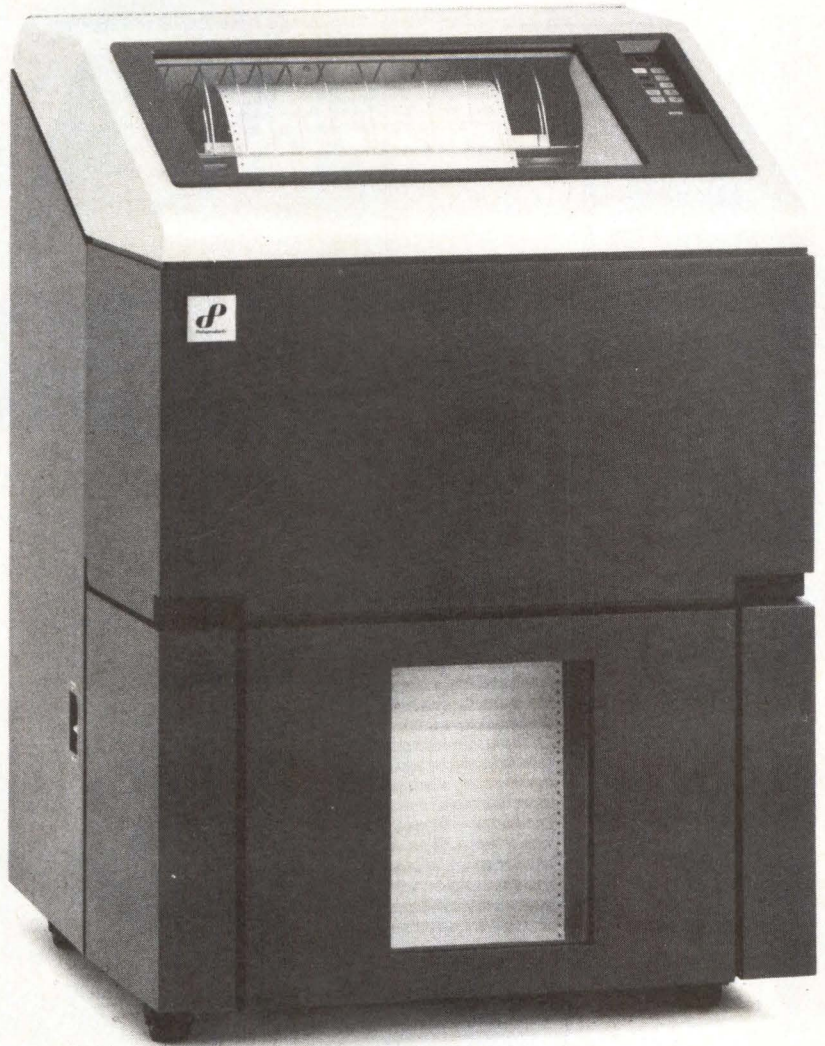

## Nobody puts ideas on paper so many ways.

If you're using your printer with a personal computer, you probably need one that can handle a variety of functions.

At the same time, the price should be in line with the computer itself. Low.

The pint-sized Dataproducts printer in the picture costs about as much as one good software package.

It prints spreadsheets, graphics and illustrations, labels, multi-part forms—even letters that look like they were typed.

But let's say you're running a big computer and it's hundred-page reports you need. Pronto. Or documents by the millions.

The printer on the right finishes a full computer printout page in less time than it takes to sneeze. At 2,000 lines a minute, it prints much faster than you can see. Three shifts a day. Year after year.

In between these two special-duty Dataproducts printers are whole families of other Dataproducts printers—daisywheel

printers, non-impact printers, high-security printers for the government, and more.

In fact, we make more different kinds of computer printers than any other independent printer company in the world.

Very likely we make one that fits your needs exactly.

Write us at 6200 Canoga Avenue, Woodland Hills, CA 91365. Or phone (818) 887-3924. In Europe, 136-138 High Street, Egham, Surrey, TW 20 9HL England.

## Dataproducts computer printers.



2710 Walsh Avenue  
Santa Clara, California 95051  
Telephone: (408) 988-2800  
TWX: 910-338-0243  
Telex: 334421

VERSATEC EUROPEAN MARKETING  
27/35 London Road  
Newbury, Berkshire, England  
Telephone: 44-635-42421  
Telex: 847259

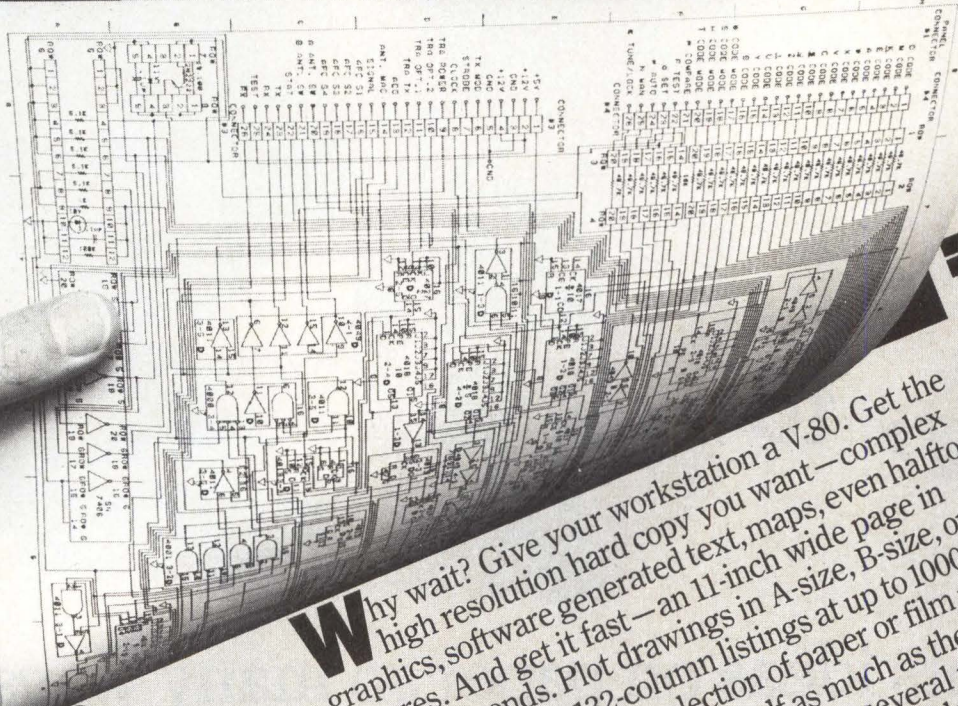

# V-80. YOUR OWN PRINTER/ PLOTTER.

**W**hy wait? Give your workstation a V-80. Get the high resolution hard copy you want—complex graphics, software generated text, maps, even halftone pictures. And get it fast—an 11-inch wide page in just 8.5 seconds. Plot drawings in A-size, B-size, or any length. Print 132-column listings at up to 1000 lines per minute. On a wide selection of paper or film media. An electrostatic V-80 costs half as much as the typical laser device. And one V-80 can serve several users without contention. Quickly. Quietly. Reliably. Versatec interfaces, including IEEE-796 (multibus) and IEEE-488 (GPIB), intelligent controllers, and multiplexers link V-80 with many popular workstations and computers. Versatec support and supplies are available throughout the world.

So why wait? Circle our readers' service number for your free brochure.

**THE FAST WAY TO HARD COPY.**

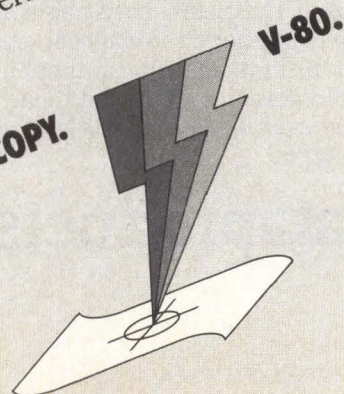

Versatec is a trademark of Versatec, Inc.  
XEROX is a trademark of XEROX CORPORATION.

CIRCLE NO. 90 ON INQUIRY CARD



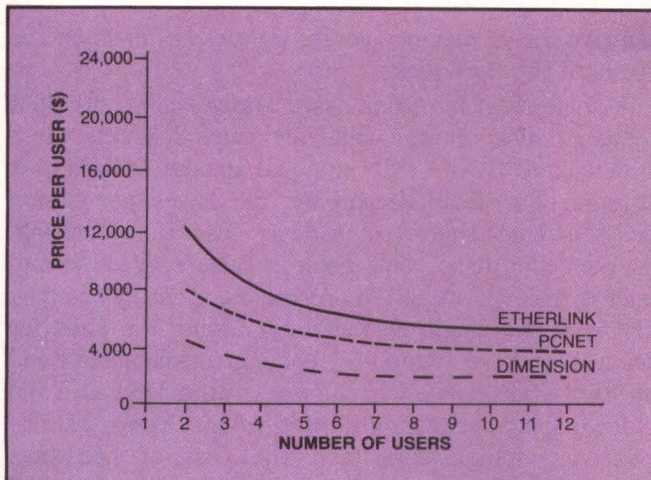

Fig. 3. Dimension's price per user is less than that of IBM PC networks such as Santa Clara Systems Inc.'s PCNet and 3Com Corp.'s EtherLink. The low price stems from shared peripherals and the use of one cabinet for all processors, disk drives and power supplies.

IBM PC, so users can allot spare slots in the bus to a tape-backup controller or to IBM-compatible add-in boards such as an Ethernet or a 3270 communications controller.

Integrating multiple processors yields efficiencies. Workstation processors run programs and manage files, while the central server processor handles system I/O. Throughput of the workstation processors increases because the server relieves them of such time-consuming tasks as writing data to the hard disk.

Communications between workstation processors and the server processor occur via I/O ports and shared-memory data transfers. This approach incorporates features of both loosely coupled and closely coupled networks.

A loosely coupled network such as Ethernet links multiple processors by cable connected to the processors' I/O ports. The disadvantage of this architecture is that serial data transmission by cable is inherently slow. Because multiple processors contend for the communications medium, collisions and retries cause delays. The risk of errors in transmission requires elaborate protocols for detecting errors, so that software overhead reduces effective bandwidth by as much as 90 percent. With the exception of a few very expensive systems, therefore, loosely coupled networks have low throughput.

In a closely coupled system, multiple processors communicate through shared memory. Reading and writing to memory are operations a processor performs rapidly. Moreover, memory-to-memory transfers entail a low risk of error. The results are that software overhead is minimal and throughput is high. The major disadvantage of a closely coupled system is the

processor address space it requires. A closely coupled network that provides each of 12 workstations with 1M byte of address space would require a server processor with much more address space than the 1M byte of the 80186.

The solution to the address-space constraint is to allow the workstation processors to operate independently except when they need to access system resources. A

---

*Throughput of the workstation processors increases because the server relieves them of such time-consuming tasks as writing to the hard disk.*

---

workstation initiates a request for system resources by interrupting the server and setting a service-request bit in an I/O port. When the server processor is ready to respond to the request, it uses the I/O port to establish a closely coupled relationship with the workstation processor. The processors transmit data through an area of memory that both can access. When data transfer finishes, the server restores the workstation processor to independent status.

Dimension uses shared memory in two ways. First, the server processor learns the details of a service request by mapping the top quadrant of a workstation's memory into the server's address space. This quadrant contains the system overhead area of 32K bytes that each 8088 processor uses to define its requests for system resources. The 80186 writes to this area to return the status of these requests. Second, when the 80186 needs to read data from or supply data to a workstation processor, it maps in the appropriate quadrant of workstation memory, copies the data to or from the server's cache RAM and then maps the quadrant back out again.

Segregating shared-memory areas protects their contents. No workstation processor can access the server's memory, so the programs and data stored there are protected from interference. Workstation RAM is accessible to the workstation processor and the 80186 server but not to any other workstation in the system.

Although workstation memory is accessible to two processors, it is not dual-ported. In a dual-ported arrangement, the memory arbitrates access by the processors. In Dimension, the server controls access to shared memory. Before the server can access an area of workstation memory, it must suspend the operation of the workstation processor and take control of the private workstation bus. It does not relinquish control until it has completed the transaction. In short, the

*Each Dimension workstation incorporates an 8088 processor that runs an independent copy of MS-DOS.*

server functions as master of not just the system bus but also the bus on each workstation board. This setup increases the server's efficiency because the 80186 does not need to compete with the 8088 processors for access to workstation memory, and it does not have to wait for arbitration on each cycle.

Dimension uses most of the server's 512K bytes of RAM as a cache memory for selected data from the hard disks, reducing the need for physical access to the disks. This configuration increases system responsiveness because the system can retrieve data from the cache in 1 percent of the time it takes to access the hard disks. The system reduces hard disk seek time by processing seek requests in the same kind of sequence an elevator uses to order its movements between floors, and it expedites the data transfer between the disk buffer and the server's cache RAM by dedicating one of

the two direct-memory-access (DMA) channels on the 80186 to the hard disks.

A network of five Dimension workstations with 30M bytes of disk storage sells for much less than five standalone PC XT's with an equal amount of hard disk storage. The main reason for the lower per-station price is that shared disks cost less than multiple user-specific disks. This network also realizes economies by incorporating the processors, memory and disk drives into a single cabinet, eliminating the need for separate power supplies, cooling mechanisms and enclosures (Fig. 3). Also, the workstation keyboard and video display are standard, high-volume items that are relatively inexpensive, and the cost of hardware overhead in the server processor is spread across the network. □

**Mark Greenberg** is vice president, research and development, and **Stephen Kanzler** is Dimension product marketing manager for North Star Computers Inc., San Leandro, Calif.

Interest Quotient (Circle One)  
High 822 Medium 823 Low 824

## More power than a Thunderchief.

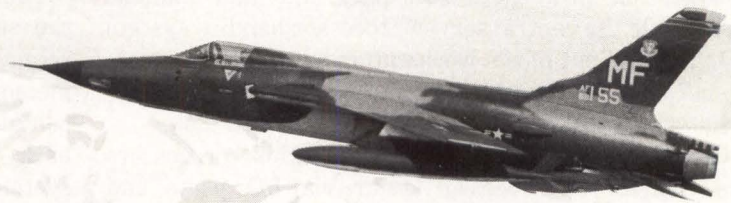

When it comes to choices in tape transports, Innovative Data Technology puts unprecedented power and technology in your hands. Its Series TD-1012, TD-1050 and TD-1750 tape transports offer full 7- and 9-track IBM/ANSI/ECMA/ISO 1/2-inch magnetic tape compatibility and can be configured for a variety of data transportation, data logging and data back-up. Integrated with these tape transports are a complete line of controllers for: RS-232C, IEEE-488 (GPIB), Unibus/Q Bus, Intel Multibus, Parallel I/O and the new Small Computer Systems Interface (SCSI).

The TD-1012 operates at 12.5 ips Start/Stop and 100 ips Streaming, 1600 bpi (PE). Dual mode, 800 (NRZI) and 1600 bpi (PE), operation is offered at 45 ips Start/Stop for the Series TD-1050 and 75 ips Start/Stop for the Series TD-1750. The Series TD-1750 represents even more advanced engineering—an active tension arm technique that eliminates noisy vacuum columns—a first in 75 ips tape transports to take advantage of this technology. IDT's family of tape transports. They'll give you more power than a Thunderchief.

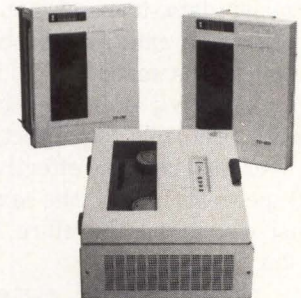

**INNOVATIVE DATA TECHNOLOGY**  
**ON THE RIGHT TRACK**

**General Offices:**  
P.O. Box 178160 • 4060 Morena Blvd. • San Diego, CA 92117  
(619) 270-3990 • TWX: (910) 335-1610

**Eastern Regional Office:**  
P.O. Box 1093 • 6845 Elm St., Suite 608 • McLean, VA 22101-1093  
(703) 821-1101 • TWX: (710) 833-9888

**Solutions for '84 AND BEYOND**

Aircraft photo courtesy of Squadron Signal Publications from "Air War over Southeast Asia"

IBM is a trademark of International Business Machines Corp.

# See Software.

Dick is a programmer. Dick gets caught in tedious testing. Drowned in printout. Never to know the sweet smell of success.

Jane has the perfect programming environment. Because it speeds applications to market. It's specially tailored to the IBM® PC.

It's from  
Micro Focus.

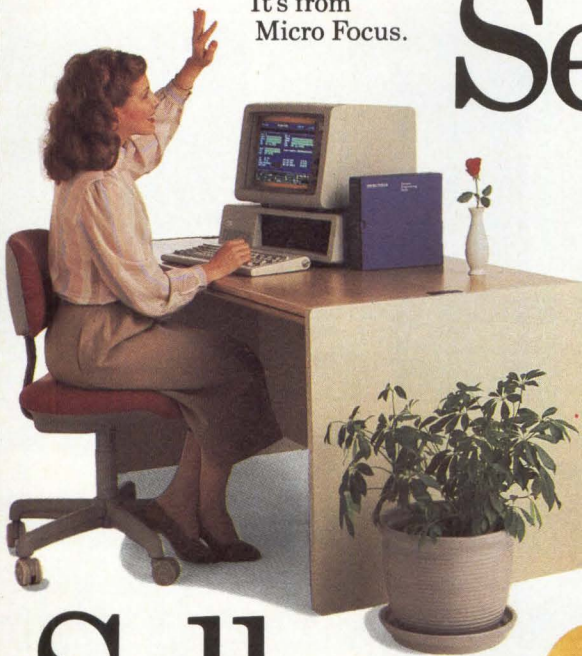
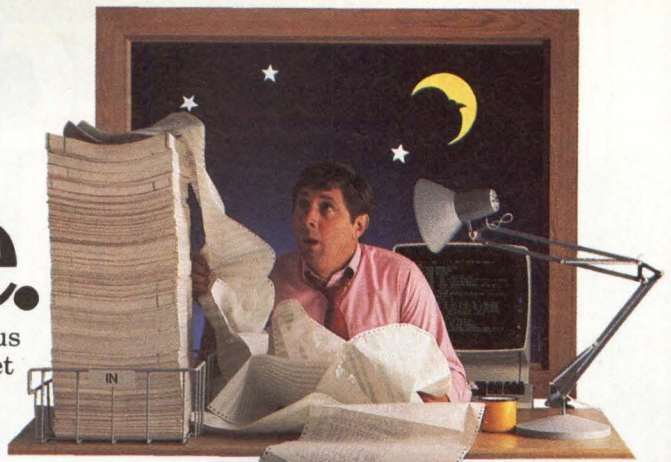

# See Software Sell.

Writing programs is fast with integrated PERSONAL COBOL™. Jane gets powerful editing. Syntax checking. Interactive source code debugging. And forms painting. Plus support for IBM PC keyboard and display functions.

Compiling is also fast. And running too. Thanks to High Performance LEVEL II COBOL™. With native code generation. And it's certified at the highest federal level.

Maintenance and enhancement is a snap with ANIMATOR™. So Jane's applications are the latest. The greatest. And Jane's the fastest, most effective programmer around.

This software vendor has just gone public. Because programmers are productive. Customers are contented. And dealers are delirious. All thanks to Micro Focus.



# Sell, Software, Sell!

Get on the fast track too. Run to your phone. Or fill out the coupon. Right now.



## MICRO FOCUS

2465 East Bayshore Road, Suite 400  
Palo Alto, CA 94303, (415) 856-4161

© 1984 Micro Focus Inc. All Rights Reserved. IBM is a registered trademark of International Business Machines Corporation. PERSONAL COBOL, High Performance LEVEL II COBOL, ANIMATOR, VISUAL PROGRAMMING, MICRO FOCUS and the MICRO FOCUS Logo are trademarks of Micro Focus Ltd.

Micro Focus, 2465 East Bayshore Rd., Suite 400,  
Palo Alto, CA 94303.

MMS-8/84

Quick, send me more information.

Name \_\_\_\_\_ Title \_\_\_\_\_

Company \_\_\_\_\_ Phone \_\_\_\_\_

Address \_\_\_\_\_

City \_\_\_\_\_ State \_\_\_\_\_ Zip \_\_\_\_\_

CIRCLE NO. 92 ON INQUIRY CARD

# INTRODUCING A TERM AN IBM PC COMPAT

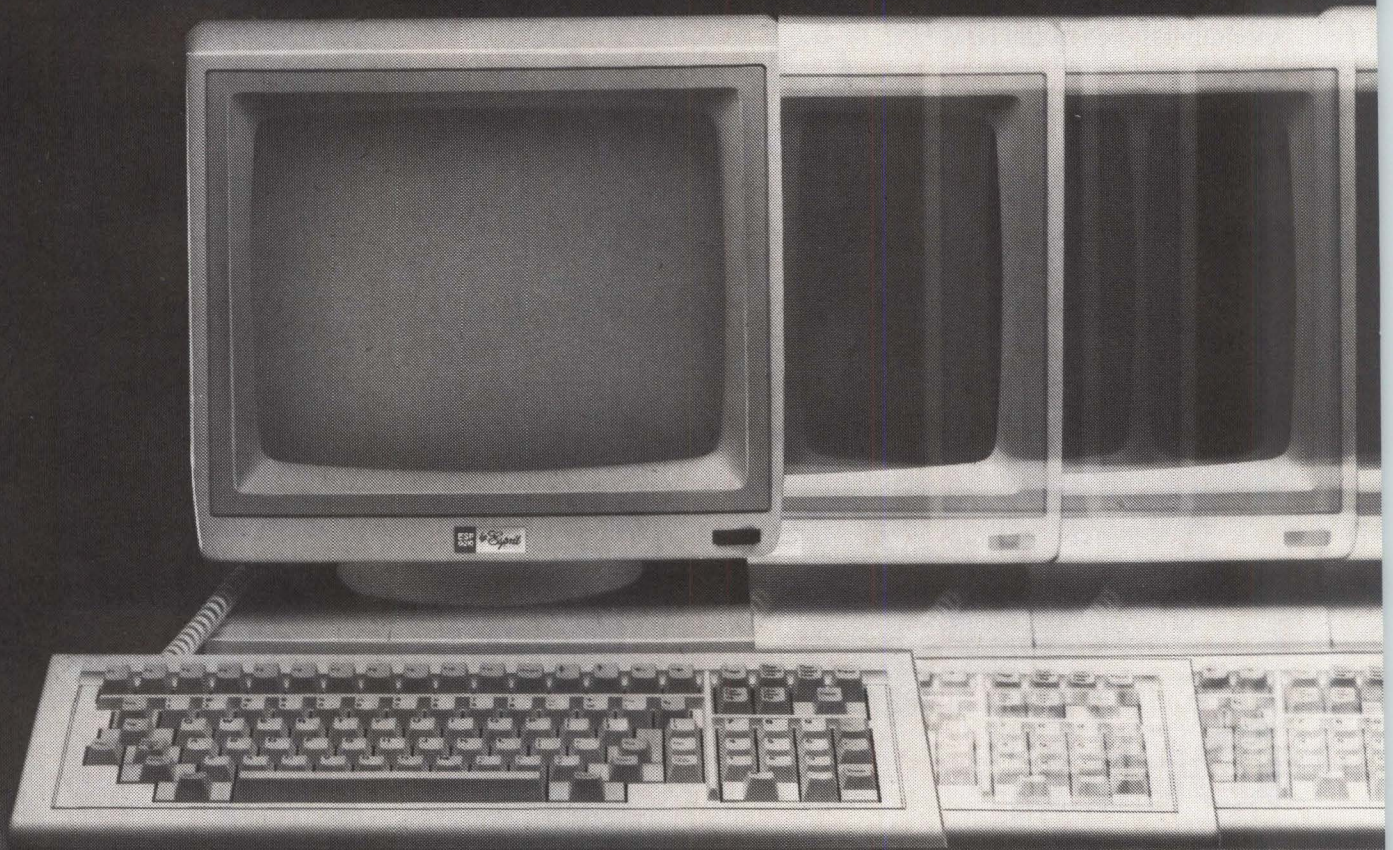

**T**ake one remarkable ESP 6310, a fully-featured, ASCII terminal. Add the remarkable ESP 9310 computer module (Patent Pending). Now, you have it—a fully IBM® \*PC compatible workstation with one footprint.

In the ESP 6310 terminal mode you have all these features:

- Seven menu selectable emulations: Esprit II®, TVI 925/910 +®, Hazeltine 1500®, ADM3A®, ADDS Regent 25® and Viewpoint®
- Hidden attributes. Positions not taken up on screen
- Unique feature: compatibility to both hidden and non-hidden attributes
- Menu-selectable set-up mode in non-volatile memory, line drawing graphics and smooth scroll
- 14", high resolution, high contrast, non-glare screen
- Small footprint, tilt and swivel display
- Low profile sculptured DIN standard keyboard
- 22 non-volatile, programmable function keys

\*IBM® and PC-DOS™ are the registered trademarks of International Business Machines, Inc. TVI 925/910 +® are the registered trademarks of Televideo Systems, Inc., ADM3A® is the registered trademark of Lear Siegler, Inc., ADDS Regent 25® and Viewpoint® are the registered trademarks of Applied Digital Data Systems, Inc. MS-DOS™ is the registered trademark of Microsoft Corp.)

# INAL THAT TURNS INTO IBLE WORKSTATION.



**A**dd the even more remarkable ESP 9310 and you have it—a fully IBM PC compatible workstation on a single footprint. It doesn't sacrifice any of the ESP 6310 terminal functions. It's field upgradable and runs IBM PC compatible software off the shelf. The ESP 9310 features:

- 8088 microprocessor and 8087 coprocessor socket
- 128K RAM memory expandable to 640K
- Dual DS/DD 360 KB format floppy disk drives
- Fixed disk drive support
- Dual RS 232C serial ports, optional RS 422 serial port
- IBM PC bus compatible—5 expansion slots
- MS-DOS™ and PC-DOS™ compatibility
- 64KB printer buffer with parallel Centronics port

Get acquainted with this amazing Esprit breakthrough at the July 9th NCC Show in Las Vegas at Booth B 3732. Or call 800-645-4508. (In New York State call 516-293-5600.) You'll see the best way to add PC capability to your multi-user system.

*Esprit*  
Systems, Inc.

## PEACE OF MIND TECHNOLOGY.

CIRCLE NO. 93 ON INQUIRY CARD

# In microcomputers today, UniSoft sets the standard.

AT&T has recently been advertising that their UNIX™ operating system will be the standard OS for microcomputers. That's true. But if you want AT&T's UNIX software on micros today, talk to UniSoft Systems.

UniSoft has been delivering AT&T's UNIX adapted for 68000-based microcomputers for two years. More than 75 different computer systems run the UniSoft software, UniPlus+.™ At each Bell release level, all these systems are object code compatible. This means that applications software developed on any UniPlus+ system will work on any other. This is where software portability pays off.

UniSoft enhances Bell's vanilla UNIX with the best features from the Berkeley BSD research version of the UNIX operating system. IP/TCP networking, record and file locking, and virtual memory from UniSoft turn UNIX into a commercial product. All this added value is still Bell-compatible.

Don't wait six months to get System V running on your hardware. UniSoft's customers can ship it now.

If you're building or selling a 68000-based UNIX system, your operating system should come from UniSoft Systems, the UNIX experts.

**UniSoft**  
S Y S T E M S

**THE BERKELEY PORT AUTHORITY**

\*UNIX is a trademark of Bell Laboratories

739 Allston Way, Berkeley, CA 94710 • (415) 644-1230  
TWX II 910 336-2145 • UUCP ucbox!unisoft!unisoft

# Value-added resellers pursue business markets with support and services

*Led by IBM and Apple, personal computer vendors are seeking to penetrate vertical markets with sales organizations that provide solutions to problems, not just products*

**Chris Bailey**, Western Editor

The burgeoning personal computer market has attracted wide attention, particularly in the area of retail computer store sales. But a significant and growing market for personal computers in applications normally serviced by system integrators and OEMs has emerged. This market is catching the eye of almost all of the major participants in the personal computer arena and provides an attractive channel for the smaller start-ups as well.

## A healthy market forecast for personal computers

According to Erna Arnesen, senior analyst for personal computer market research concern Future Computing Inc., Richardson, Texas, personal computer sales will reach \$12.2 billion this year in the United States. Of this figure, value-added resellers (VARs) will contribute over 17 percent of the hardware sales and 7 percent of the software sales. Sales through these channels—including system integrators, OEMs and independent sales organizations—are expected to grow to \$5 billion by 1989.

While these figures are impressive, in the opinion of some analysts they do not take into account much of the added-value application software sales that will accompany the sales of hardware and standard software packages by VARs. These analysts believe that the typical VAR will add more than 10 percent to product value through software.

Steven P. Korn, product manager of PC Network

**RETAIL STORES DOMINATE PERSONAL COMPUTER MARKET (HOW PRODUCTS ARE SOLD—1984)**

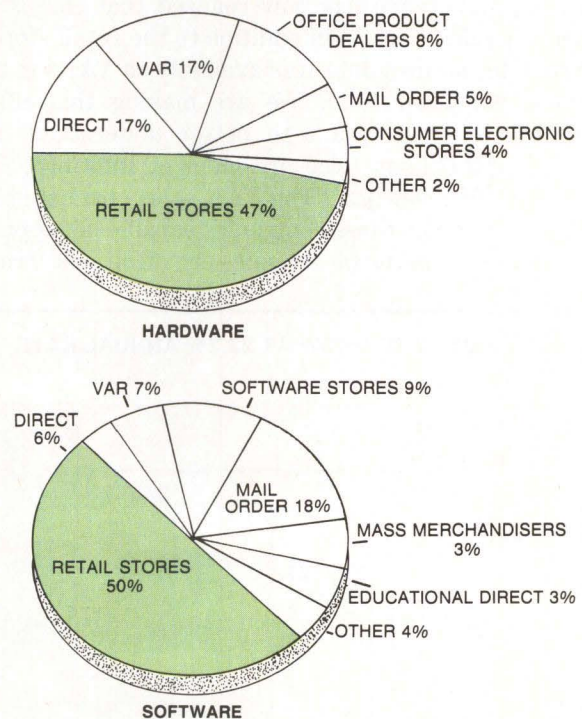

SOURCE: FUTURE COMPUTING INC.

Operations at General Electric Information Services Co., Rockville, Md., says it is imperative for VARs to develop unique software products that make their systems more attractive than those sold through retail channels. GE Information Services historically has capitalized on selling mainframe-based application software and services through timesharing networks.

In 1982, GE began marketing IBM Corp. PCs to its customers along with a wide range of application programs utilizing the data-sharing and access capabilities of its network. A typical PC installation with 20M bytes of hard-disk storage, a modem, surge protectors and several application packages might sell for approximately \$15,000. "These special applications programs make our systems more valuable and justify a greater cost than a simple PC system with standard software. Because our systems solve difficult end-user problems that aren't addressed with standard software, our customers aren't lured by the widespread discounting by retailers," says Korn.

**VARs compete with systems**

Unlike the retailers who compete primarily on price and delivery, VARs depend on their ability to provide a hardware and software system solution. All major personal computer vendors now solicit and support VARs. Research companies such as Future Computing have begun tracking this sales channel. Notes analyst Arnesen, "Everyone has now realized that this is an important sales channel in addition to the retail stores. But to date, no firm data was available on VARs in the personal computer field. We are making this effort because our clients want to better understand this area." Ralph Gilman, vice president of InfoCorp, Cupertino, Calif., concurs: "The VAR sales channel holds great potential for those companies capable of supporting and attracting the better sales organizations. Tradi-

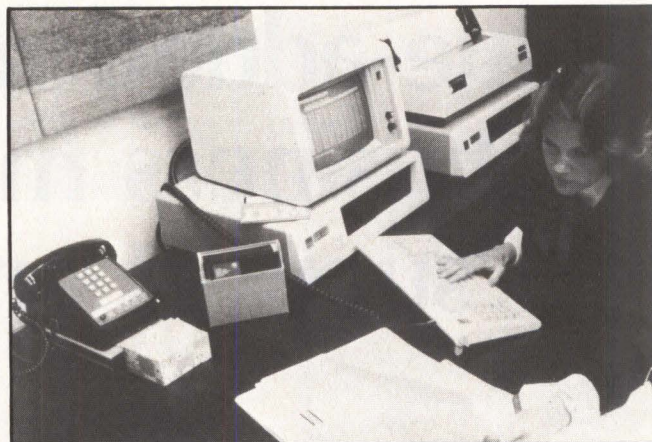

GE Information Services is selling IBM PCs as value-added workstations. End users access a variety of corporate databases with applications ranging from just-in-time inventory scheduling to claim processing and financial services.

tional minicomputer VARs are well-tracked, but many of the personal computer turnkey system suppliers are new to the computer business and thus not as well-understood."

Even before IBM officially announced their value-added dealer (VAD) program, it was negotiating with resellers eager to formalize a relationship based on PC and XT products. In 1983, IBM formed a new division, the National Distribution Division (NDD), to focus sales efforts in new directions.

In addition to responsibility for the IBM product centers, this new division has responsibility for the VAR channel that primarily supports IBM small-system products other than the PC and the VAD channel for PC and related products. Notes NDD representative Nadine Fletcher, "The purpose of this division was to bring single-management focus. . . for IBM's small computers." The new division focuses non-retail sales (except for IBM product centers) through a single organization based in White Plains, N.Y.

A pool of IBM machines is available for VARs or VADs participating in business shows. A direct-marketing kit with mailers, prospect forms and suggested telemarketing strategies is available. A national remarketer database is on-line for IBM field representatives with information on services offered by VARs and VADs nationwide. Seminars and special classes for resellers—focusing on handling the business problems—are part of a professional-enhancement program. There are also several classes of technical support, some free and some offered on a fee basis. These include call-in help as well as on-site training, service and consulting. Additionally, there are regional customer system centers for handling product questions. Finally, special VAD advisory councils have been formed to improve communications with IBM.

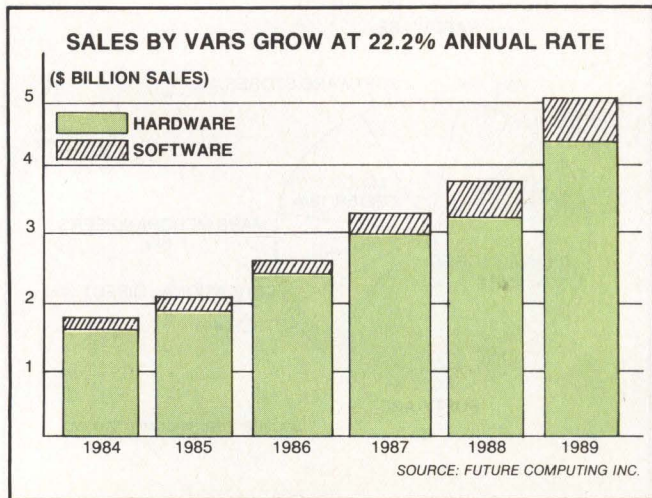



# Peripherals Digest

## Mini-Micro Systems

Semi-Annual\* Guide to  
Computer Peripherals

The Peripherals Digest is the indispensable selection guide to computer peripheral equipment for systems integrators and high volume end users. The Peripherals Digest consolidates, categorizes and interprets each offering with extensive data and comprehensive text.

Mini-Micro Systems magazine has helped define the value-added market for mini and microcomputers and related peripheral equipment on a monthly basis for over 15 years. The Peripherals Digest adds regularly updated reference coverage to our monthly news and features in Mini-Micro Systems.

The Peripherals Digest, a reference source to keep handy throughout the year.

For advertising information, please contact your regional sales manager.

\*Second issue in April and November. Spring and Fall editions

Cassette/Cartridge Tape Drives

Disk Drives

Graphics Terminals

DDD Modems

Disk Drive Subsystems

Alphanumeric Terminals

Diskette Drives

Directory of Manufacturers

Printers

# Peripherals Digest

CIRCLE NO. 136 ON INQUIRY CARD

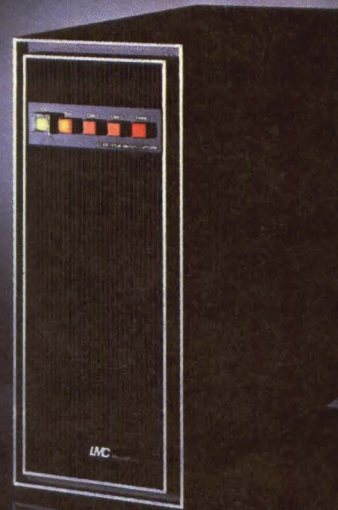

## LMC's 32-Bit Virtual Memory MegaMicro Is The-State-Of-The-Art UNIX Microcomputer

LMC's 32-bit MegaMicro provides mainframe or super-minicomputer performance at prices competitive with today's far less powerful 8- and 16-bit microcomputers. This is made possible by use of the next generation of logic chips—the National Semiconductor 16000-series. LMC MegaMicros incorporate: the NS16032 central processing unit which has true 32-bit internal logic and internal data path configured on the IEEE 796 multibus; demand-paged virtual memory implemented in hardware; and hardware 64-bit double-precision floating-point arithmetic.

The LMC MegaMicro is supplied with HCR's UNITY\* which is a full implementation of UNIX\*\* and includes the Berkeley 4.1 enhancements to take advantage of demand-paged virtual memory. Also included are C and FORTRAN. Typical multi-user systems with 33 megs. of fast (30 ms. average access time) winchester disk storage, a half meg. of RAM, virtual memory, hardware floating-point arithmetic, UNIX, C, and FORTRAN 77 are available for \$20,000 (and even less with quantity or OEM discounts).

\* UNITY is a Trademark of Human Computing Resources.

\*\*UNIX is a Trademark of Bell Laboratories.

LMC MegaMicros *The Logical Alternative™*

# LMC

The Logical MicroComputer Company

4200 W. Diversey, Chicago, IL 60639 (312) 282.9667



A member of The Marmon Group of companies

CIRCLE NO. 135 ON INQUIRY CARD



The IBM PC and XT configurations lead the "most-wanted list" for VARs. The PC is the most widely emulated computer system in history.

**Product and program options abound**

IBM, Apple Computer Inc. and Tandy Corp. pioneered development of personal computer system integrator sales channels. According to Apple's manager of VAR market research, Bill Broderick: "In the early days of personal computers, it was Apple and Tandy battling it out. Originally, Apple had better success with hardware OEMs because of its tremendous flexibility in supporting hundreds of add-in hardware products. Tandy, meanwhile, often did well with software geared for professional and business markets."

Apple's success with the Apple II product line significantly influenced the traditional minicomputer vendors in their system house/VAR marketing efforts. It also spurred them to provide competing personal computer products. In the past two years, minicomputer vendors Digital Equipment Corp., Data General Corp., Wang Laboratories Inc., Texas Instruments Inc. and Hewlett-Packard Co. have introduced personal computer products and programs geared toward VARs.

One of Apple's strengths has been its willingness to work with potential software vendors before officially announcing a new product. Apple won high praise for

its support of software vendors before February's introduction of the Macintosh. More than 100 software vendors received technical documentation, and 50 or so systems were in place at developers as early as nine months before the official introduction. These efforts paid off. Apple expects Macintosh software to have a large and growing market in its first year.

Particularly attractive to software application developers is the ease of interfacing with the Macintosh's internal ROM-based software drivers for screen and menu manipulations. Handcrafted for speed in use with Apple's Desk Manager software, the ROM code contains "hooks" for external software to access routines driving the screen and other input/output devices. This relieves software developers of the burden of analyzing the internal workings of the Macintosh hardware and creating their own driver routines.

Like IBM, Apple qualifies potential VARs before they are approved to resell Apple products. According to VAR program manager Matt Slavik, a strong business plan is a must. "Of course, they must add value in the form of a software application or hardware addition to the system, but foremost in our minds is whether the potential VAR can actually achieve its sales goal. This is usually revealed in a good business plan."

**HP makes its move**

Long a respected OEM and VAR supplier in the minicomputer arena, Hewlett-Packard struggled with its initial personal computer offerings, especially at the retail level. But its systems were highly regarded by traditional scientific and technical OEMs. This year, the company made a four-pronged attack on the mainstream personal computer market with the introduction of the HP150 desktop computer, the Portable, and the Thinkjet and Laserjet printers.

With these products, strategists believe, the company is poised not only to penetrate the general retail personal computer market but also to provide attract-

Apple's Lisa and Macintosh computers sport high-resolution graphics, interactive mouse interfaces and menu-driven operation.



HP's Portable weighs 9 pounds, features a 16-line-by-80-character display, built-in application software like word-processing and spreadsheet programs, and terminal-emulation capabilities.

# Application Programmer.



# Ambitious Salesman.

Introducing the WorkForce™ Development System.

A powerful hardware/software combination that lets you take custom turnkey systems to market faster, easier than ever before.

Thanks to WorkForce — a 68000-based, multi-user system that's built for dependability and expandability.

And thanks to a software system with an advanced COBOL program generator and built-in word processing, DBMS and spreadsheet packages. Packages that integrate perfectly with the custom programs you design yourself.

With this combination, you can create consistent code, making custom-designing faster and simpler. You can spend more time developing and less time programming. You can offer the most comprehensive solutions your customers will ever use. And because the code is so consistent, it's easy to maintain.

The WorkForce Development System. Put our application programmer to work for you. And watch it sell itself, ambitiously.

**WorkForce™**

Good help isn't hard to find.

WorkForce by Digital Datacom, Inc.,  
27721 South La Paz Road, Laguna Niguel, CA 92677 (714) 831-8470.  
CIRCLE NO. 96 ON INQUIRY CARD

### VARs, VADs, ISOs—what are they?

Few agree on how to define VARs, VADs and ISOs. IBM Corp.'s National Distribution Division (NDD) defines a "VAR" as a value-added *remarketer*. It's an organization that buys a computer from IBM and resells it to the end user after adding software products that turn the computer into a turnkey system.

The rest of the industry uses the term "VARs" to mean value-added *resellers*. These are system houses or

system integrators. This term originally applied to minicomputer turnkey suppliers who received the "iron" or plain-vanilla computers from the minicomputer vendors, added application software or operating systems and sold the bundled system to the end user complete with support/service.

Organizations that resell IBM PCs are called "VADs," or value-added dealers. These groups are entitled to buy and resell products in the IBM PC

family if they pass stiff qualification standards. In this group are resellers who add software and hardware to create turnkey systems.

The term "ISO," or independent sales organization, can mean large dealers who buy systems wholesale and resell them to smaller dealers, distributors or system houses, making a profit on the markup. But often they add value in training, support, software and other services, too.

ive alternatives for VARs and OEMs. HP commercial OEM market manager Vince Mancuso explains, "The OEM and VAR portion of sales is a large part of the overall personal computer business. In the past, we have done well with the scientific and technical OEMs, but with our new products we have a much more appealing general-purpose product line."

One of HP's strengths is its long-term relationships with traditional minicomputer system houses. These companies are especially interested in applications that tie personal computer workstations to existing minicomputer-based information networks. Analysts such as the Yankee Group have given HP high marks for its office-automation product strategies, and the personal computers are designed to fit in information networks.

The HP150 has built-in hardware and software to support standard HP block-mode terminal emulation. Versions without disks are available to provide a low-cost avenue for connecting computers to networks.

Tom Anderson, general manager of personal software operations at HP, says the company has improved many standard software packages and added proprietary software that helps broaden the appeal of its small computers. Proprietary software includes desk-manager functions and communications links to other systems, including the IBM PC. Improvements to existing third-party software include a user-friendly shell around the MS-DOS operating system and utilization of soft function keys for programs like MicroPro International Corp.'s WordStar.

Extra hardware features have been added to the HP small-systems lineup. In particular, the HP150 sports a touch-screen interface that eliminates the need for keyboard input of many commands. The Portable features a 16-line liquid-crystal display and a battery-driven electronic RAM disk that allows users to access a minifloppy-equivalent, mass-storage device without rotating storage drives.

Anderson explains that system integrators are very important to HP's personal computer program. He sees the most activity in two areas: use of a personal computer as a productivity tool—primarily in stand-alone applications—and use of a personal computer as a low-cost network workstation node. HP's large business computers serve as ideal back-end database managers in such a configuration. The built-in communications facilities of the HP personal computers help them serve as easy-to-use front-end systems.

This communications effort is part of HP's AdvanceNet communications strategy that integrates data-communications capability with data-management capability. Based around the International Standards Organization (ISO) Open Systems Interconnect (OSI) model for a layered approach to open system architecture, the AdvanceNet idea is to develop communications protocols that allow computers, terminals, personal computers and other workstations to communicate, even when manufactured by different vendors. Included in the AdvanceNet umbrella are communications products supporting access to IBM, DEC and IEEE 802.3 and IEEE 802.4 standards.

Like HP, TI is pursuing an MS-DOS product strategy that is not fully compatible with the mainstream IBM PC. But it hopes to attract VARs and OEMs by offering better product features than IBM does.

TI says its Professional computer offers better screen resolution, more colors, a more familiar IBM Selectric-oriented keyboard and a number of specialized peripherals that provide natural-language and speech-command capabilities, as well as mainframe and Ethernet communications. □

---

Interest Quotient (Circle One)  
High 834 Medium 835 Low 836

---



# Ampex announces more of a good thin.

The demand for small discs in 1984 alone will reach 6 million units.

Thirty percent of these discs will be thin film media. A technology we pioneered at Ampex.

One we will continue to lead the way in.

Which is why our new \$15 million automated ALAR™ disc thin film facility is continually stepping up production quantities.

So your disk drives can have more of the good things thin film has to offer.

More storage capacity. Greater performance. More durability.

More of what you need to build the best little disk drive in the world.

## AMPEX

Ampex Corporation • One of The Signal Companies 

Disc Media Operations, Media Products Division,  
960 Rincon Circle, San Jose, CA 95131,  
(408) 945-5600, TWX 910-378-5920, TLX 34-84-64

™ALAR is a trademark of Ampex Corporation.  
© 1983 Ampex Corporation

CIRCLE NO. 97 ON INQUIRY CARD

# THE MOST IMPORTANT FEATURE YOU'LL FIND IN DIGITAL'S TELEPRINTERS IS THE COMMITMENT BEHIND THEM.

When Digital pioneered the concept of interactive computing some 25 years ago, an interesting side benefit occurred. Out of necessity, we had to develop our first teleprinter.

But rather than simply approaching the task as a sideline, we genuinely committed ourselves to the job of developing a truly outstanding product. The end result was the LA36™ teleprinter. A system that provided far more features, capabilities and durability than most people needed just then. The fact that over 200,000 LA36 teleprinters remain in active duty across the country today is a true testament to the careful thought and foresight that went into the original design.

Each new model introduced since the LA36 teleprinter has been yet another demonstration of our commitment to the needs of the marketplace. And an equally strong demonstration of the market's commitment to us. For the popularity of our products, in several cases, has actually helped drive the industry to adopt new standards. With the introduction of the LA36 teleprinter, for instance, came the wide acceptance of the 300 baud communications rate. And the LA120™ teleprinter helped popularize the faster 1200 baud rate.

Digital's commitment to the teleprinter market remains rock-solid. Our terminals manufacturing plant in Arizona currently produces more teleprinters than ever before. So as long as there's a need for

teleprinters, you can count on Digital to fulfill that need. With a product specifically designed for the job.

---

## **THE DECWRITER III. THE IDEAL TERMINAL FOR HIGH DUTY CYCLES AND RUGGED ENVIRONMENTS.**

---

Even the briefest glance explains why the DECwriter III™ (the LA120) teleprinter has established Digital's long-standing reputation in the terminals market. This heavy duty teleprinter is every bit as tough as it looks.

It gives you exactly what

you want. Fast draft speed printing at 180 characters per second. Fanfold paper capabilities in widths up to 15". A choice of 8 character widths. And extensive communications support, including auto answerback and auto disconnect.

Most importantly, the DECwriter III teleprinter is a true master of forms. Some 45 features, like horizontal pitch, left/right and top/bottom margins, as well as horizontal and vertical tabs, are all summarized right on the keyboard, allowing you to set up formats in an unusually quick and sim-

ple manner. Then, once set, all can be stored in non-volatile memory. And the DECwriter III teleprinter can provide crisp, legible forms up to an impressive 6 parts.

---

## **DIGITAL'S LETTERWRITER 100. THE BEST ENGINEERED TELEPRINTER FOR THE OFFICE.**

---

Flexibility is the word that best describes the Letterwriter 100™ teleprinter. For starters, you have a choice of multiple print speeds. You can print a draft copy of a one page proposal in just 10 seconds. Then,

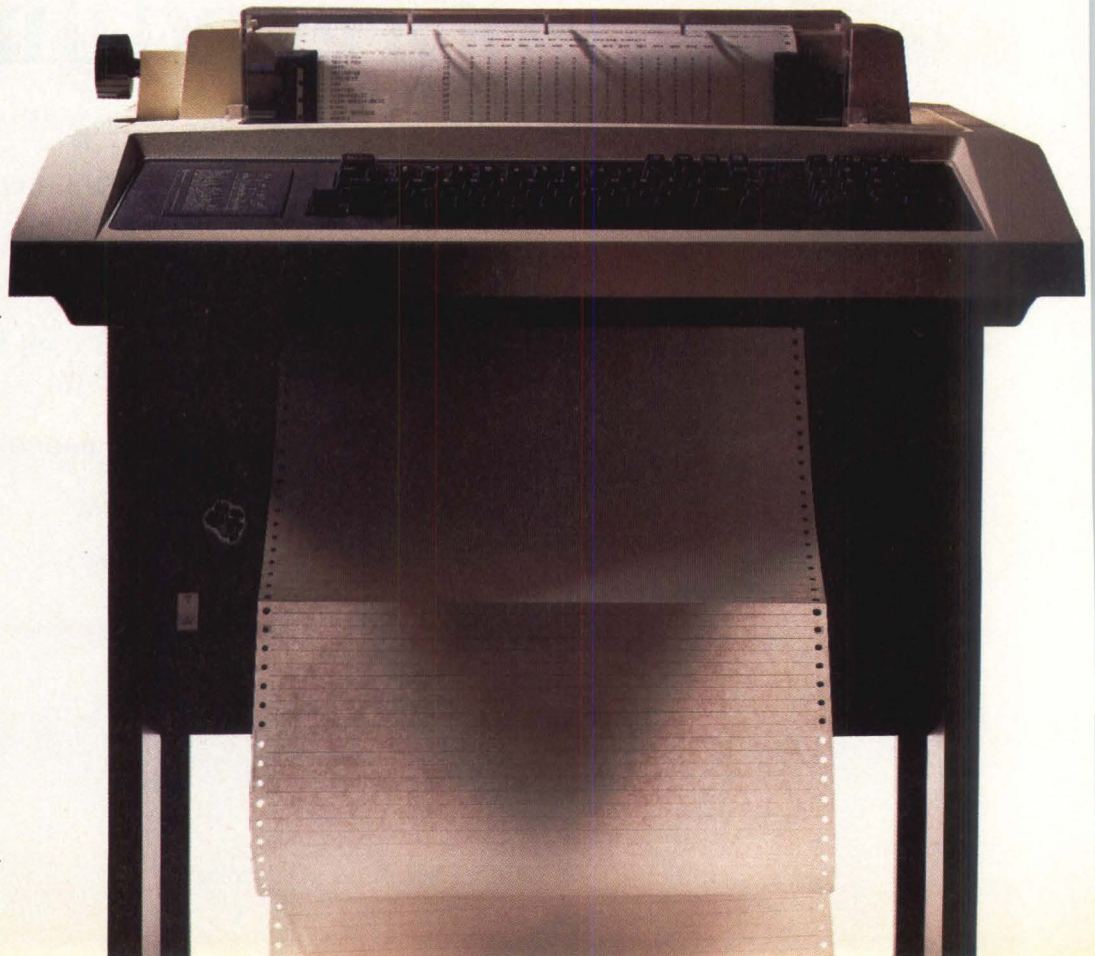

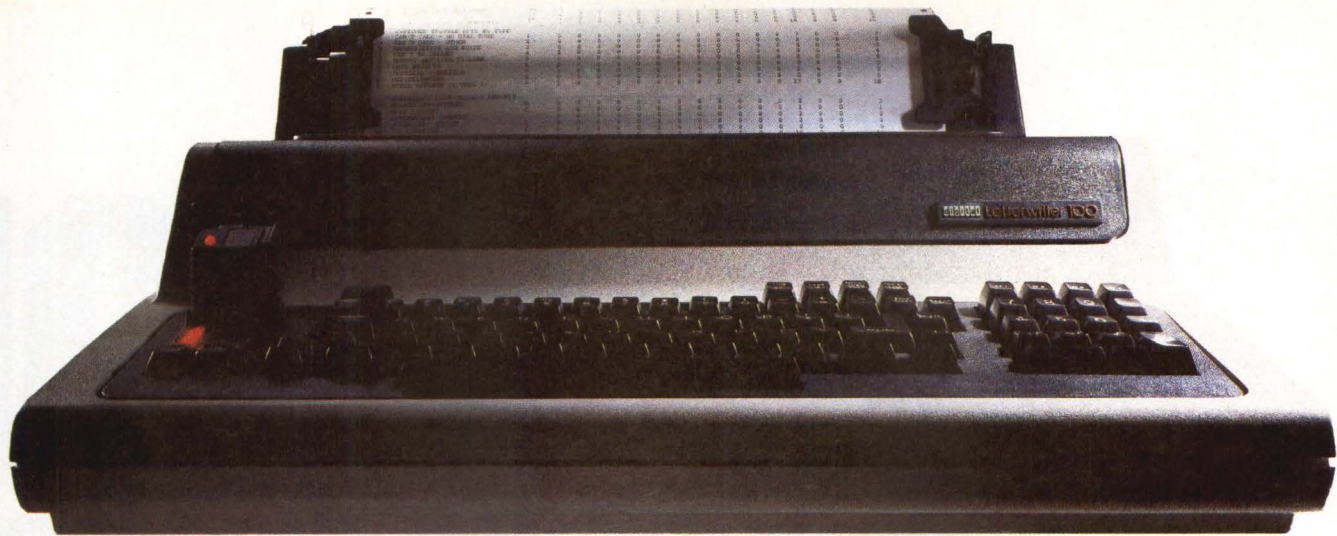

by simply pressing a single button, you can shift from a high speed 240 characters per second to a high quality 30 characters per second, with printing that's difficult to distinguish from true letter quality. There's even an optional 80 character per second memo mode that's ideal for interoffice correspondence.

For further versatility, the Letterwriter 100 teleprinter lets you select from 8 different character widths, multiple character sets and a wide variety of typefaces. In fact, you can store 5 different typefaces resident within the teleprinter, and the selection can include Courier 10, 12, and Italics, Gothic 10 and 12, Orator 10, and APL, so you can select the style that suits the job as easily as pressing a key. And, in the event you'd like to illustrate a particular point, bit map graphics help you do just that.

The Letterwriter 100 can handle the paper that best suits your needs. Sheet, fanfold or roll, in any width up to 15"

Finally, the Letterwriter 100 product tackles all your forms. Setup is simple, and the high quality dot matrix printhead provides crisp, legible copies through 4 part forms.

In short, the Letterwriter 100

is the one teleprinter that finally lives up to the requirements of your whole office.

---

**THE DECWRITER  
CORRESPONDENT. THE  
ONLY FULL-FEATURED  
COMPACT YOU'LL FIND.**

In many situations, the applications themselves suggest a clear solution.

But just as often, the solution isn't quite so clear.

That's when you need Digital's Correspondent™ teleprinter. It's the closest thing to an ideal, all-around terminal.

Consider its wealth of features. The Correspondent teleprinter allows you to use ordinary single sheet, roll, or fanfold paper for high quality

output that won't fade over time like thermal paper. It also gives you the flexibility to print multiple part forms and labels. And you may customize the text output to your own particular style by selecting from a wide variety of character sets, widths and sizes alone or in conjunction with bit map graphics.

But what makes the Correspondent teleprinter truly impressive is that you get all these features in a compact little 20-pound package. A package complete with three communications interfaces. Not just the usual RS232-C port, but a 300 baud acoustic coupler and a 300/1200 baud modem as well. That means the Correspondent teleprinter

can function as a console or as a transportable terminal that can move from desk to desk or office to office, ready to communicate in whatever mode is available.

No matter how you look at it, the Correspondent teleprinter gives you a lot of capability in a small package.

---

**BEST ENGINEERED  
MEANS ENGINEERED  
TO A PLAN.**

Digital's teleprinters, like all Digital hardware and software products, are engineered to conform to an overall computing strategy. This means that our products are engineered to work together easily and expand economically. Only Digital provides you with a single, integrated computing strategy direct from desktop to data center.

For more information and the name of the Authorized Terminals Distributor or Digital Representative near you, call 1-800-DIGITAL, extension 700. Or write Digital Equipment Corporation, 2 Mount Royal Avenue, UP01-5, Marlboro, MA 01752.

---

**THE BEST ENGINEERED  
COMPUTERS  
IN THE WORLD.**

**digital™**



# SCHOOL

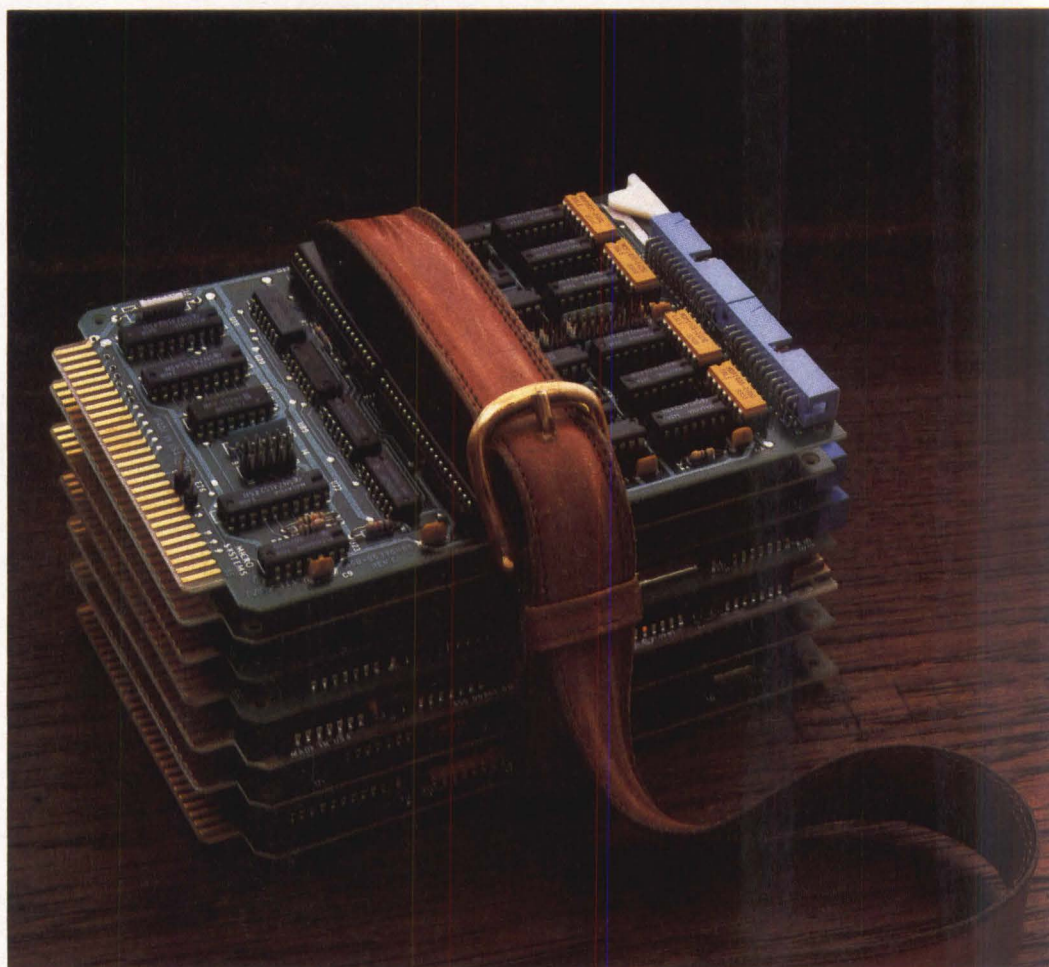



# ED BUS

## Take advantage of our learning curve with the STD BUS.

Sometimes, there's just no substitute for experience. And that's why so many smart designers continue to develop new ideas with our MD Series™ STD-Z80 BUS-compatible boards. For energy, environmental and process control. Test and measurement equipment. Computer peripherals. High-speed printers. Medical electronics. Data communications. And an ever-expanding list of applications too numerous to mention.

Because for a wide variety of situations, our compact boards provide all the power designers need. At a price that's powerfully cost-efficient.

Not only that, our boards are already designed and proven in thousands of applications. Plus, they're assembled. Tested. Debugged. And modularized by function so you only have to buy what you need. And there are more than 30 boards to choose from. Available through Mostek or your local Mostek distributor.

We also offer development software and operating systems, plus a complete array of card cages and sub-system enclosures to ease and speed your design and packaging.

What's more, the STD-BUS is fully expandable. Which makes it simple and economical to add, delete, or interchange boards when you want to redesign or upgrade.

Take advantage of our learning curve experience with the STD-Z80 BUS. It's a time-proven course that can add a degree of success to your own system designs. For more information, contact Mostek, 1215 W. Crosby Road, MS2205, Carrollton, TX 75006, (214) 466-8816. In Europe, (32) 02/762.18.80. In Japan, 03/496-4221. In the Far East (Hong Kong), 5-681157.

MD Series is a trademark of Mostek Corporation.





## A MARRIAGE OF CONVENIENCE.

### INTRODUCING THE FIRST MULTIFUNCTION MULTIBUS<sup>®</sup> CONTROLLERS FOR SUPERMICROS WITH SIMULTANEOUS DISK/TAPE TRANSFERS.

The marriage of your system with Xylogics' new 420 Series controllers results in a level of user convenience and speed never before available in a supermicro.

Now your supermicro can support either the ST506 or ESDI 5 1/4" disk and QIC-02 1/4" tape interfaces—simultaneously.

At DMA rates of up to 2.5MB/sec.

Other controllers allow access of only disk or tape at one time, and require significantly greater bus capacity to do it.

The Xylogics 421 simultaneously controls two ST506 disks and up to four QIC-02 tape drives. The 422 provides even greater throughput, supporting two ESDI disks and up to four QIC-02 tape drives. And both the 421 and 422 controllers require only one card slot in your system.

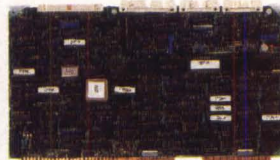
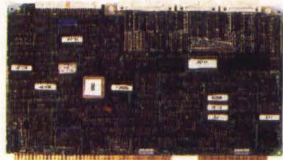

Advanced channel control using proprietary Xylogics DMA and ECC gate arrays and separate buffers for disk and tape give the 421 and 422 the lowest DMA overhead and highest data transfer rate in the industry—leaving considerably more bus bandwidth available to the CPU and other I/O devices.

And because Xylogics employs the industry's most rigid quality control and testing procedures, the 421 and 422 come with an infant mortality rate of virtually zero, and an MTBF approaching 100,000 hours.

Little wonder that Xylogics has built and sold more high performance Multibus peripheral controllers to more

major OEMs than any other manufacturer.

Call or write for more information on the 421, 422 and other Xylogics products.



The Peripheral Performance Leader.



144 Middlesex Turnpike, Burlington, MA 01803 Tel: (617) 272-8140 TWX: 710-332-0262 (800) 225-3317 outside of Massachusetts  
 Xylogics European Headquarters: (Slough, U.K.) Tel: (0753) 78921 Telex: (851)847978  
 MULTIBUS is a registered trademark of Intel Corporation. MULTIBOOST is a trademark of Xylogics, Inc.

# HP's model 9000: squeezing a mainframe into a shoe box

*HP's top-end desktop system, a 32-bit micro, has as much as 2.5M bytes of RAM and runs at 1 MIPS*

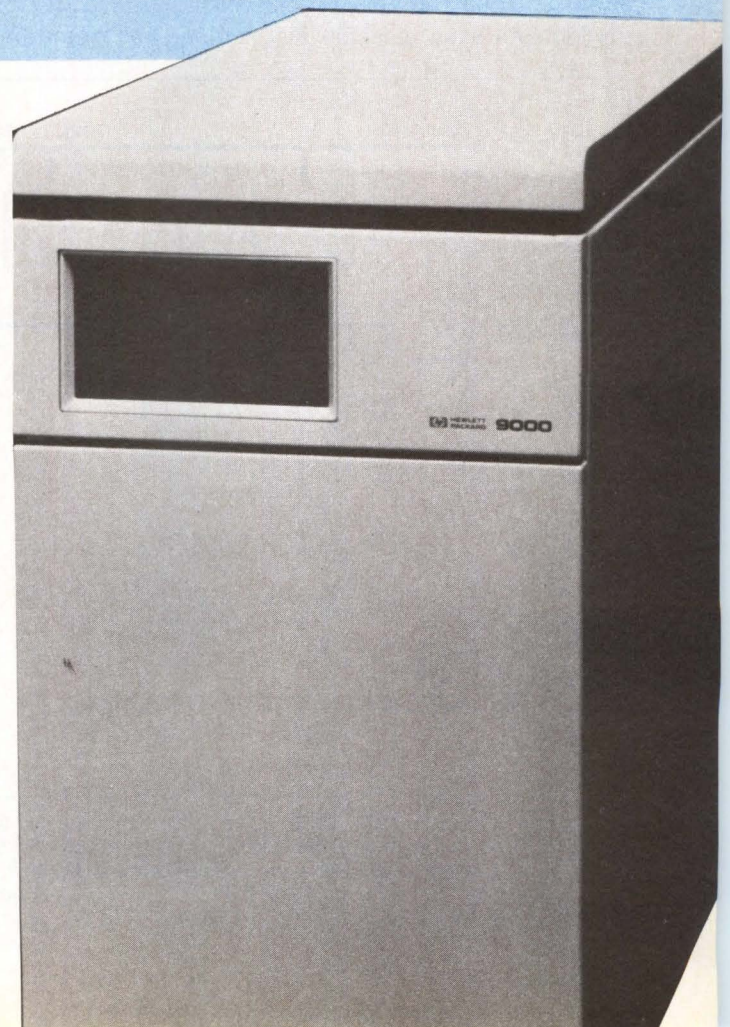
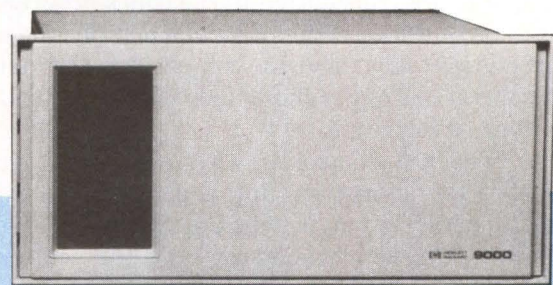
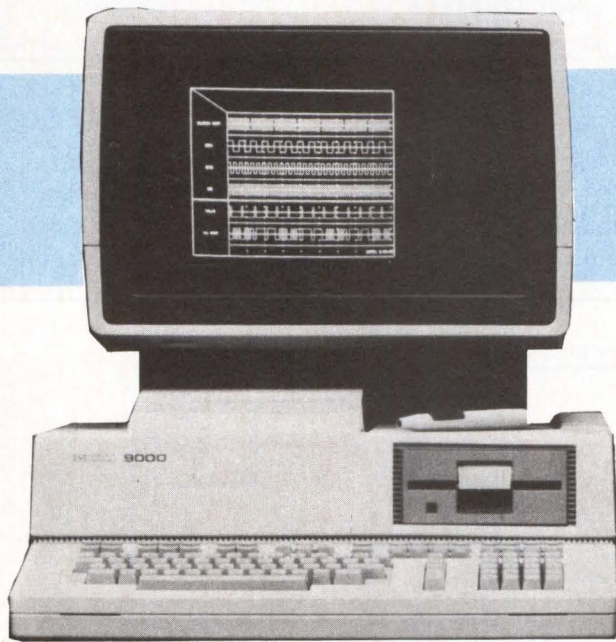

Chris J. Christopher, Hewlett-Packard Co.

Designing a 32-bit desktop computer with 1 million-instruction-per-second (MIPS) power requires technological advances and innovations spanning component chips, physical packaging and even a temperature-control system. A close look at Hewlett-Packard Co.'s HP 9000—its CPU, I/O and memory architectures and software environment—reveals why it's billed as a machine that can compete with superminicomputers at a fraction of their price.

**The HP 9000** is available in three models: the desktop model 20 (above), the model 30 (above, right) and the cabinet model 40 (right).

**Heart of the system: the HP-32 CPU**

The 9000 system's microprocessor, which is not available to the commercial market, is fabricated in HP's NMOS-III technology with 1.5- $\mu$ m. lines and 1- $\mu$ m. silicon-gate circuitry on three and one-half layers of interconnect. The microprocessor chip measures 6.3 mm. on a side, has 83 pins and comes bonded directly onto a 4 $\frac{3}{4}$ -by-7-inch board. The processor comprises seven major sections (Fig. 1). Its microcode control store ROM has 9,216 38-bit words arranged in 38 sections, each a 32-by-16 array of 18-bit "series field effect transistor" (FET) strings. Program instructions address the microcode ROM and access microinstructions that are transmitted to the chip's programmable-logic-array (PLA) section. The PLA decodes the microinstructions, which drive the control lines that determine the operations of the chip's 32-bit register stack and its arithmetic logic unit (ALU).

A sequence controller with nine 14-bit registers handles the instruction flow sequence. The controller has a microprogram counter, a set of incrementers, a machine instruction operator code (OP code) decoder and three registers for microcode subroutine return addresses. The op code decoder generates the starting address in control store for the microcode routine that implements each machine instruction. For conditional

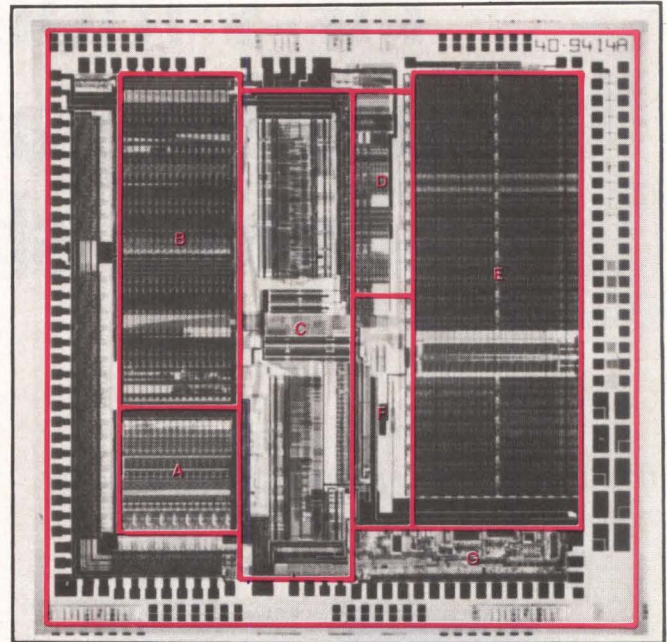

**Fig. 1. Floor plan of the CPU.** The overlay indicates the seven major sections of the chip: the arithmetic logic unit (A), the general registers (B), the program logic array (C), the sequencer (D), ROM (E), test circuitry (F) and the multiprocessor bus interface (G).

jumps and skips in the microcode, a test condition multiplexer uses a 6-bit microcode field to select one of

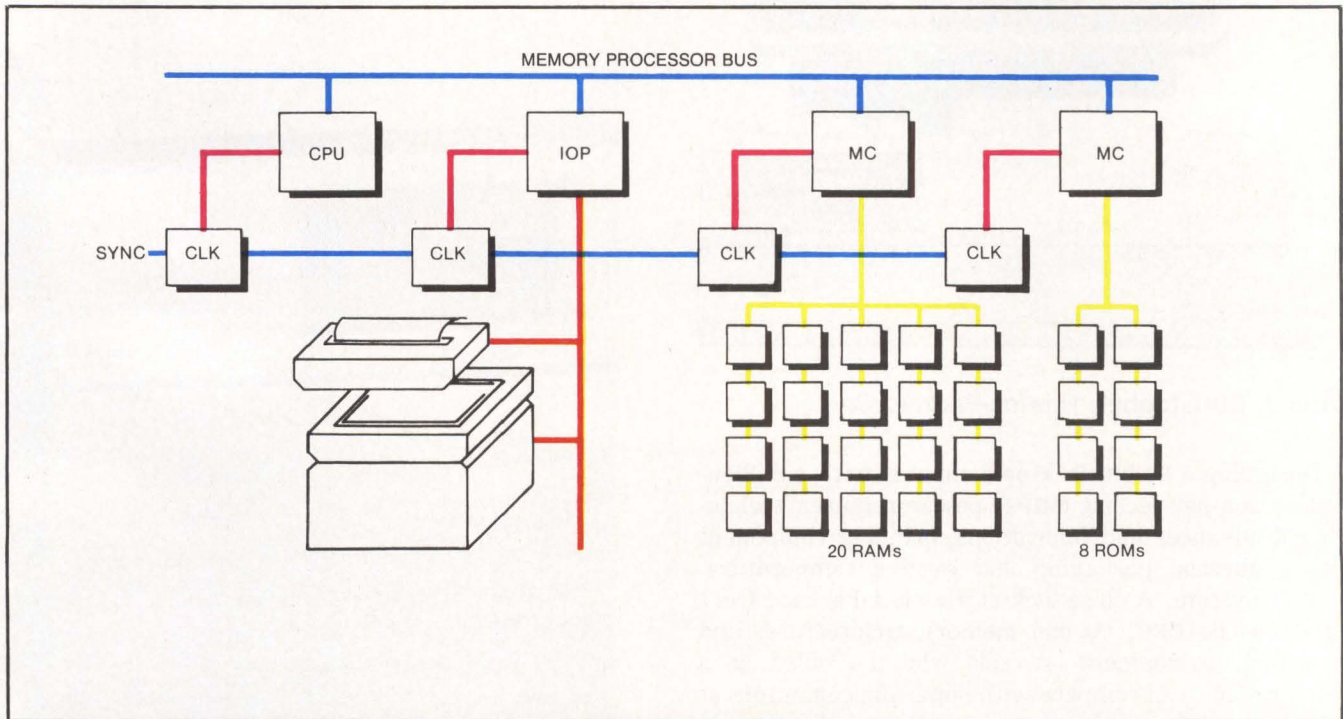

**The memory processor bus (MPB) is the backbone of the HP 9000 system architecture.** The bus has 32 parallel lines for data and 12 for control and can handle as much as 36M bytes per second. All subsystems interface with one another via the MPB. They are closely coupled and transfer data synchronously to the beat of the 18-MHz clock. As many as 20 RAMs and eight ROMs containing 128K bits each can be accessed via the memory controller (MC) chip. The CPU, I/O processor and RAM boards plug into connectors on the memory/processor module, a card cage for as many as 12 boards.

# A WORD TO ANYONE LOOKING FOR UNIX\* TRAINING:

## FREE.

Introducing Vision, the first Interactive Videodisc Training Curriculum for UNIX software. And our Free Introductory Offer.

Simply lease any 21 of 37 new Vision Units. And we'll give you the use of a complete interactive videodisc system. Absolutely free. That's an IBM Personal Computer, laser videodisc player, color monitor and system controller. At no extra charge, for as long as you lease Vision. All you pay for is shipping.

### Why interactive videodisc?

Interactive videodisc training combines the power of the computer, the speed of a laser disc and the personality of live classroom instruction. To involve, to motivate, to excite. To capture and hold a student's interest in a way no other medium can.

### Is Vision cost-effective?

If your company uses UNIX software, or sells UNIX-based products and services, you need UNIX training. If you have to train a staff of 10 or more, you need Vision. For you, there is no faster, more cost-effective method. Why?

Vision students learn by doing, so they learn quickly, comprehend more and retain information longer. They spend less time away from the job. And are more productive once they return.

Because training is targeted, you can choose just the Units you need for your employees. And Vision students learn only what they need to know to do the job. Now.

### Who developed Vision?

Vision was developed by Interactive Training Systems, the leader in interactive videodisc training, and Computer Technology Group, a leader in UNIX training. The result? A program that brings

the concepts and language of the UNIX operating system to life.

### 30-Day Money-Back Guarantee.

We think you'll find Vision so fast, so effective and so affordable, we back it with a full 30-Day Money-Back Guarantee.

### Free Introductory Offer.

Take advantage of our Free Introductory Offer. Send in the attached coupon. Or call us at 1-800-227-1127. In Massachusetts, call collect 617-497-6100.



### FREE INTRODUCTORY OFFER!

- Please have a representative contact me immediately.
- Please send me more information about Vision, the UNIX Interactive Video Training Curriculum.

Name \_\_\_\_\_

Company \_\_\_\_\_

Title \_\_\_\_\_

Address \_\_\_\_\_

City \_\_\_\_\_ State \_\_\_\_\_ Zip \_\_\_\_\_

Telephone \_\_\_\_\_

\*UNIX is a trademark of AT&T Bell Laboratories.



**Interactive Training Systems, Inc.**

4 Cambridge Center, Cambridge, MA 02142

CIRCLE NO. 101 ON INQUIRY CARD

# Tally Technology Works Great On Paper.

No other 600 LPM line printer is engineered like a Tally. So nothing else performs like a Tally. Or prints like a Tally.

- ▶ The proof's on paper.
- ▶ Everything from high volume report printing to high resolution graphics. And a quality, fully formed look for correspondence.
- ▶ All in one machine. All the result of Tally technology. Like the MT660's innovative hammer bank and linear "shuttle" system that perfectly positions every impression and prints with uniform impact.

▶ There's also more than enough resident intelligence and paper handling versatility to make programming shortcuts easy. For operator convenience, status reports are illuminated on a scrolling display. And it's quiet enough—at 60 dBa—to go almost unnoticed.

▶ Precision printing at its reliable and repeatable best. From Mannesmann Tally.

▶ For more information on the world's most advanced, most productive line printers call now: (206) 251-5524.

**MANNESMANN  
TALLY**

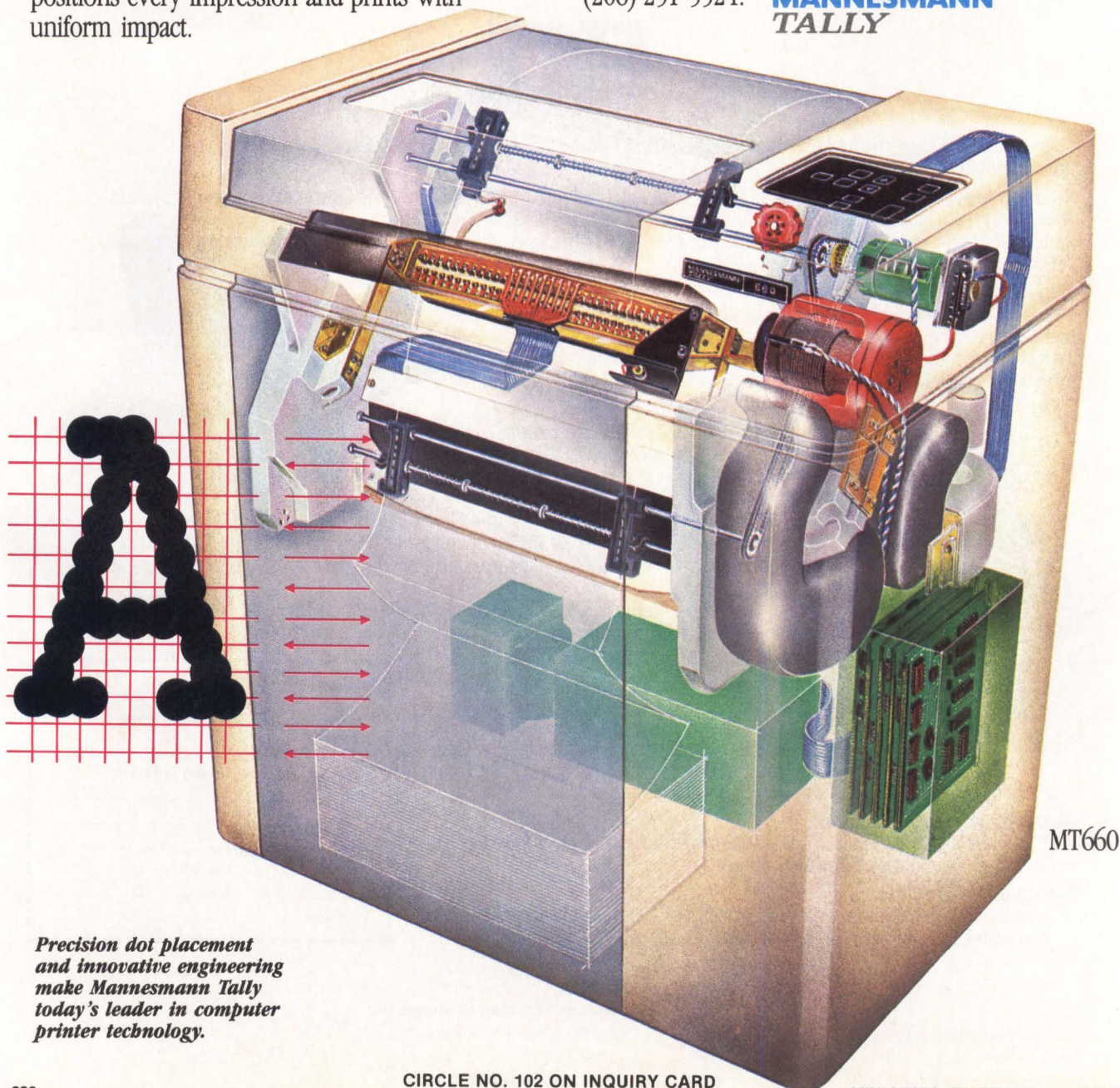

*Precision dot placement  
and innovative engineering  
make Mannesmann Tally  
today's leader in computer  
printer technology.*

55 qualifiers that originate in different portions of the chip.

The HP 9000 uses a stack-oriented architecture—a set of 28 32-bit registers and two buses. Each register comprises 32 identical bit cells, and each cell receives data from or dumps data to the two data buses, according to the PLA output codes.

The ALU cycles in 55 nsec. and consist of an N-bit shifter, a 32-bit logical selector and a 32-bit full look-ahead adder, which is used with special hardware for integer multiplication and division. ALU results are stored in four internal result registers. The ALU, under microcode control, can perform a 32-bit integer addition in 0.39  $\mu$ sec. and a 64-bit floating-point multiplication in 10.4  $\mu$ sec.

In addition to the CPU functions, the chip includes a section dedicated to inter-chip communications. The memory/processor bus (MPB) interface section is the communication channel between the internal chip data buses and the external MPB data bus. This section of the chip uses seven 32-bit registers for addresses and data entering and leaving the CPU.

Chips are mounted on “finstrate” (cooling *fin* substrate) boards. The finstrate boards cool as well as connect the chips, contributing to the CPU’s low power dissipation of 4W (see “Cooling off,” Page 222).

The system can support as many as three CPUs, offering 2.7 times the performance of a single CPU. The CPUs are mounted in a card cage that can house as many as 12 finstrate boards. Because multiprocessing is software transparent, the user program need not reflect the actual number of operating CPUs. The operating system treats each CPU as an allocatable resource.

I/O interface functions are classified as dependent or independent of peripheral hardware. The system’s I/O processor performs non-hardware specific, or independent, functions. Separate I/O cards that interface to direct-memory-access (DMA) channels handle hardware-specific, or dependent, functions, such as device drivers.

One card handles the 8-bit parallel HP-IB (IEEE-488) interface, which serves as the host interface for a local-area network (LAN) controller. HP-IB-based instruments can communicate with the HP 9000 at rates as high as 500K bytes per second. The card also supports disk storage systems with data-transfer rates as high as 1M byte per second. A general-purpose I/O (GPIO) serial interface has a 1M-bit-per-second (bps) rate, a programmable handshake interface and local data-sense-inversion facilities. It interfaces asynchronous peripherals, such as keyboards and displays, using the asynchronous serial I/O card with remote-terminal support, RS232C compatibility, half- or full-duplex

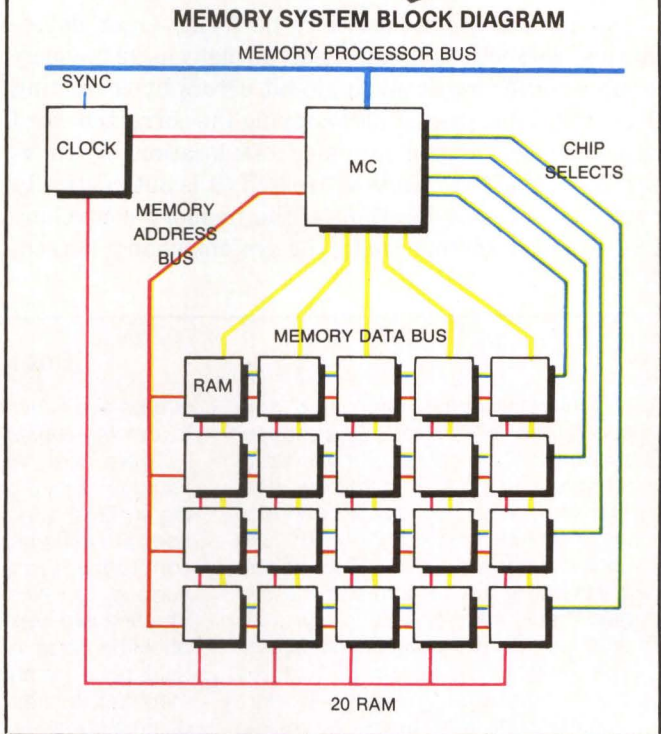
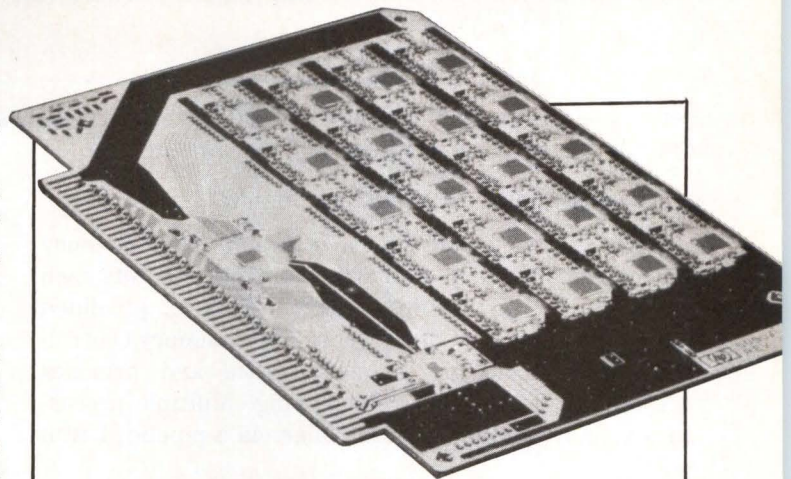

Fig. 2. The RAM board contains 20 RAM chips and a memory-controller chip.

channel support and baud rates as high as 19.2K bps.

A programmable serial interface card that lets OEMs tailor its characteristics to proprietary computer adjuncts or special I/O devices accommodates special peripherals. A color video interface card with 512-by-512- or 576-by-455-dot resolution, four display memory planes and a performance of 1,000 50-pixel vectors per second supports color video displays. An asynchronous eight-channel multiplex card brings eight terminals to one I/O slot. HP 9000 systems share data and resources via an Ethernet-based LAN control card.

At the heart of the I/O system is the host-independent I/O processor with eight DMA channels. Each channel can handle data bursts of as much as 6M bytes per second. The I/O system is message based: the I/O processor buffers data into message blocks and then

sends them to the CPU or to memory. The result is low CPU I/O overhead, freeing the CPU for computation.

**Memory system self-tests and 'heals'**

Each memory subsystem contains one memory controller chip and 20 RAM chips storing 128K bits each (Fig. 2). The RAM chips feature 165-nsec. pipelined access and 110-nsec. cycle times. Each memory controller has a 256K-byte memory space and provides self-test, memory test and mapping. Multiple processors access the memory controller via a pipelined MPB port.

The controller automatically performs error detection and correction. It can "heal" as many as 32 memory locations suffering from single-bit errors by correcting the error and transparently copying the corrected word into a memory controller healer RAM location. Whenever the original location is addressed, it is automatically routed to the new location on the memory controller. The memory controller halts the system when it detects

a double-bit error (Fig. 3).

The HP 9000 memory system is pipelined, and controller and RAM chips are structured so that memory accesses and returned data words are overlapped. For example, the system accepts three accesses during the first data-word interval (Fig. 4). Similarly, instructions are overlapped so that fetch, decode, execute and cleanup operations occur simultaneously.

**The software environment**

The HP 9000 features a choice of system software environments: a single-user environment based on the HP BASIC operating system for the desktop model 20, which includes an integral keyboard, a display and a floppy disk drive. The HP-UX operating system runs on any shared HP 9000 family computer.

HP 9000 BASIC is a memory-based, multiprogramming system limited only by the amount of physical memory available. Each program runs in its own "virtual" machine, or partition.

**Cooling off**

"Finstrates" take their name from cooling *fin* substrates. The copper substrate at the center of the finstrate multilayer sandwich is the key heat sink for the chips, which are bonded to the substrate with a heat-conducting epoxy adhesive (left). Two layers of insulating Teflon separate the two gold trace interconnection surfaces on each side of the copper substrate. The finstrate board plugs into the memory/processor module. A variable-speed DC fan blows a cooling

stream of air over the finstrate surface to remove heat dissipated by the chips.

There are nine layers on the finstrate board (right). All conducting surfaces are coated with Teflon. A special material is plated to the conducting layers to create a rougher surface, to which the Teflon adheres. The first two Teflon layers are applied on either side of the substrate and held by a combination of heat and mechanical pressure. The two conducting surfaces are then laid on top

of the first Teflon coatings and are then etched and drilled.

After the second layers of Teflon are applied, the second conducting surfaces are laid down, etched and drilled. Insulated plated-through holes are fashioned by laser-drilling a large hole, filling it with Teflon and then drilling and plating a smaller hole. This creates connections between the outer and inner conducting surfaces without shorting the central copper substrate.

The finstrate board comprises an all-copper substrate and two layers of metal interconnect on each side of the board. The chips are wire-bonded to the board.

The side view of a finstrate board shows the nine layers.

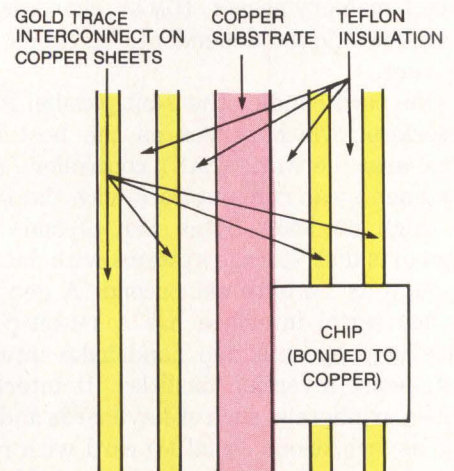
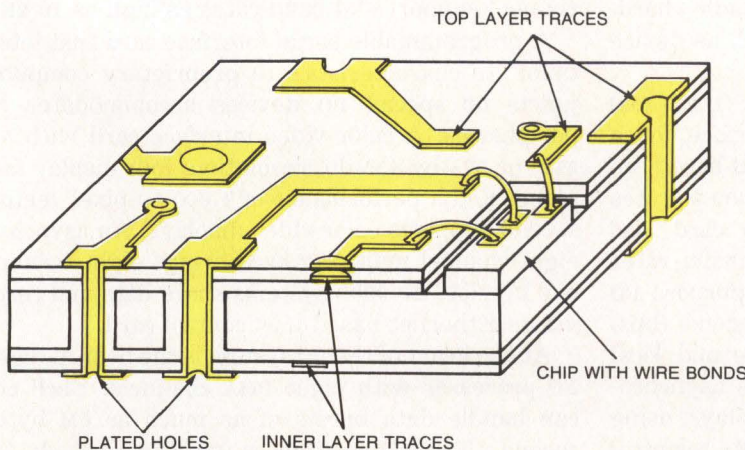



# FACIT

**TWIST** The Facit Twist Video Terminal can be viewed from an entirely new angle: a real multipurpose workstation with a large, dual display monitor that can be tilted, lifted and even twisted, to suit any operator's convenience.

The Twist capability means that you can use the conventional landscape format (24 lines by 80 characters) to display large detailed characters – or you can Twist the monitor to portrait format (72 lines by 80 characters) to display the information in full-page layout.

The flickerfree screen with superb video quality allows any number of positioning possibilities. Added features include a super-slim, ergonomically designed keyboard and a strikingly small footprint.

When comparing terminals, think professionally. Contact Facit – we'll introduce you to our whole family of video terminals.



Facit 4420 and Facit 4431 Smart Video Terminals are other Facit VDT alternatives with numerous user-oriented features for optimum operator comfort.

**CIRCLE NO. 103 ON INQUIRY CARD**

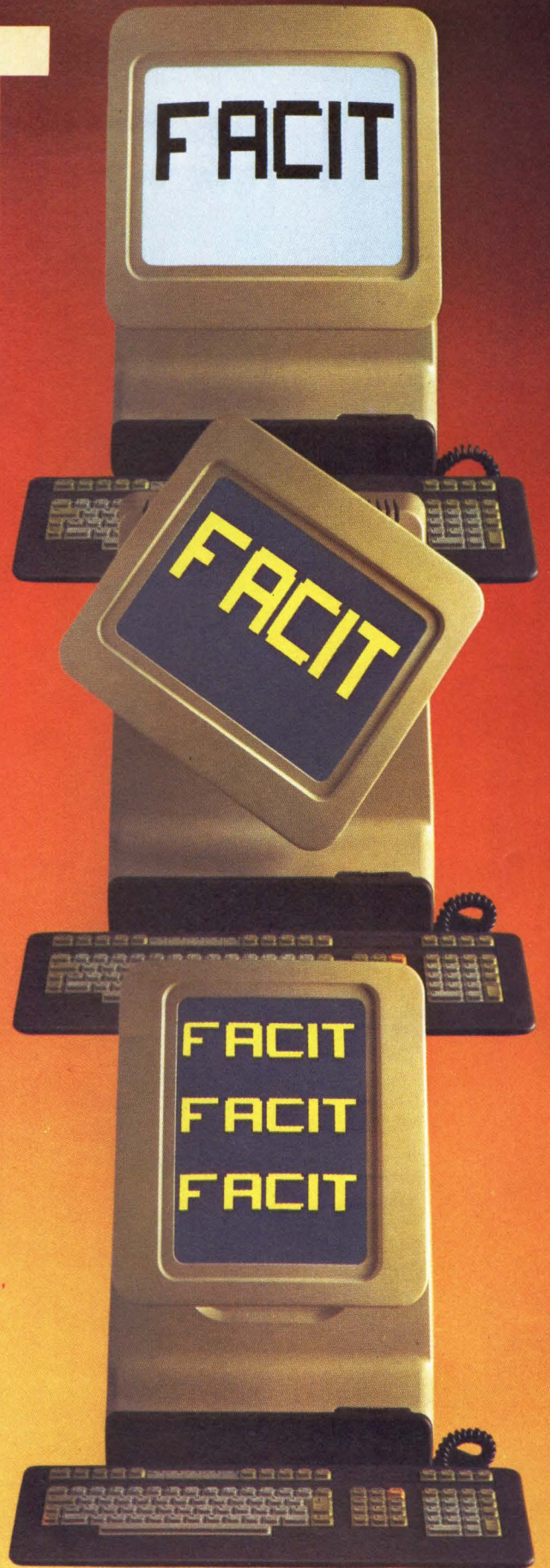

**FACIT**

Head office: P.O. Box 54 S-172 22 Sundbyberg, Sweden. Phone: (8) 282 720.

USA: 235 Main Dunstable Road. P.O. Box 828, Nashua, N.H. 03061. Phone: (603) 883-4157.

# ON THE FIRST WE CREATED

- Ethernet Activity ●
- Packet Received ●
- Data Received ●
- Boot State ●
- Self Test ●
- Reset ●
- Power ●



Communications Server #1



# DAY, MAN.™



When Bridge Communications first opened for business, we took a good look at what the computer age was creating.

We saw computers that couldn't talk to other computers. LANs that couldn't link up with other networks. Data PBXs so slow they could stop an entire organization in its tracks.

And we said, "Let there be MAN."

## MAN: The Multiple Area Network.

MAN is more than just another LAN or Data PBX. Much more.

It's a highly intelligent, high performance communications system designed from Day One to link multiple devices, multiple networks, and multiple locations.

MAN can link all kinds of devices from multiple vendors to Ethernet. And Ethernets to other Ethernets, remote nets, X.25 public nets, and SNA.

Computers, printers, terminals, personal computers, and mainframes all become one transparent system with MAN.

## The MAN who has everything.

Our Terminal Servers, Host Servers, and Gateways have the capacity to serve even the most demanding user. And they can grow to meet the needs of the largest organizations.

MAN systems use multiple 68000 microprocessors to move information faster and easier than any other network. There's no single failure point, and our expansion capability beats all other LANs or Data PBXs.

People who really need and depend on powerful communications systems have already gotten their MAN. People like Honeywell, Motorola, GTE, U.C.L.A., The U.S. Forest Service, and NASA.

Call 415-969-4400 or write Bridge Communications, Inc., 1345 Shorebird Way, Mt. View, CA 94043, and get the story of MAN.

It's the Genesis of a whole new way of networking.

**BRIDGE**   
COMMUNICATIONS

The Multiple Area Network

CIRCLE NO. 104 ON INQUIRY CARD



**Genicom would like to get personal with you.  
On a professional level, of course.**



Personal computers have become a valuable asset in business. The problem is that most personal computer systems are originally sold with "personal printers"...printers built for home use, not for heavier business work.

These "personal printers" are too slow for many business needs. They can tie-up your computer for extended periods of time...time you could be using to do other work.

Another problem is durability. In business, you need a printer that can produce high volume output over a long duty cycle. The common "personal printer" will often just quit under such continuous operation.

That's why Genicom has created the 3014, 3024, 3184, 3304 and 3404... professional printers built for personal computers.

Price/performance matched for small business systems, the Genicom 3000 PC printers are designed to increase productivity and maximize the value of your personal computer.

The 3000 PC printers provide 160-400 cps draft, 80-200 cps memo, and 32-100 cps NLQ printing...performance for both high productivity and high quality printing.

The 3014/3024 models print 132 columns. The 3184, 3304

and 3404 models give you a full 136 column width, and offer color printing as well.

Each printer is easy to use, lightweight, functionally styled and attractive. And you can choose options from pedestals and paper racks to document inserters, sheet feeders and 8K character buffer expansion, plus more.

Genicom 3000 PC printers feature switch selectable hardware, dual connectors and dual parallel or serial interfaces. Plus the 3014 and 3024 emulate popular protocols for both Epson MX with GRAFTRAX-PLUS™ and Okidata Microline 84 Step 2™, while the 3184, 3304 and 3404 emulate popular protocols for Epson MX with GRAFTRAX-PLUS™. So your current system is most likely already capable of working with these Genicom printers without modification.

Most important, the Genicom 3000 PC printers are quality-built, highly durable printers designed for rapid, continuous duty cycle printing. So take some personal advice. Get a Genicom professional printer for your personal computer today.

Genicom Corporation, One General Electric Drive, Dept. C421, Waynesboro, VA 22980. In Virginia, call 1-703-949-1170.

**GENICOM**

**The New Printer Company.**

For the solution to your printing needs call  
**TOLL FREE 1-800-437-7468**

In Virginia, call 1-703-949-1170.

Epson MX with GRAFTRAX-PLUS is a trademark of Epson America, Inc.  
Okidata Microline 84 Step 2 is a trademark of Okidata Corporation

**CIRCLE NO. 105 ON INQUIRY CARD**

The CPU uses a round-robin discipline to allocate programs of equal priority on five priority levels. Users can support inter-program synchronization with event semaphores. To guarantee uninterrupted access, devices can be "locked" to a particular partition. Within a program, a user controls task execution via the keyboard, another program or external interrupt.

The BASIC run-time compiler combines the interactive program-development environment of an interpreter with the performance of a compiled language. Line-by-line compilation of the code begins when a user runs a program in source-code form. The code executes as it is compiled, and both the source and object code remain in memory. Because the object code is stored, it has to be compiled only once. Thus, an iterative loop routine is compiled and executed the first time. If the combined source and object code exceed available memory, a portion of the previously compiled code is "thrown away" to make room for a new compiled routine. This process gives the "throwaway compiler" its name.

The compiler also stores the source code, so all BASIC debug and development capabilities, such as trace, pause and edit, are available to the programmer. Furthermore, each subprogram can be completely compiled before program execution by appropriate directives.

With HP 9000 BASIC, a user can divide a CRT display into separate screens, or windows, attached to various system functions such as PRINT or INPUT. Windows are defined as "public" (always displayed) or "private" (displayed only when the CRT is "attached" to the defining partition or virtual machine).

Three mass-storage file system directory formats can

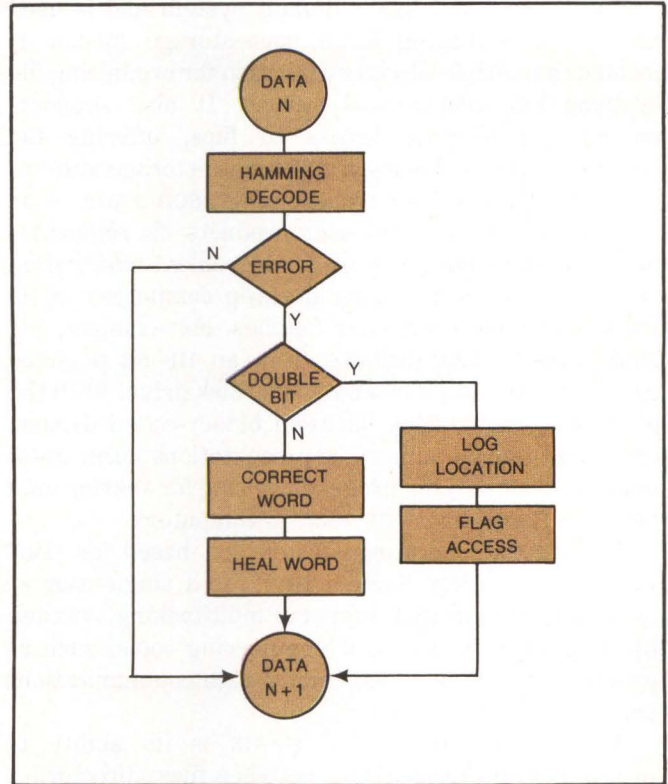

Fig. 3. The memory controller automatically performs error detection and correction. The diagram illustrates the method for "healing" single-bit errors as well as the flag subroutine for double-bit errors.

be selected: a hierarchical file format called structured directory format (SDF), a logical interchange format (LIF) and the 9845 desktop computer format (DCF). LIF and DCF provide a convenient growth path with HP 9845 and 9826/9836 desktop computers.

Fig. 4. The memory cycles in the HP 9000 are pipelined. The three-stage pipelining shows the overlapping of functions in each 55-nsec. cycle. The functions in orange are in the first stage of the pipeline, those in yellow are in the second stage, and those in green are in the third stage.

MEMORY PROCESSOR BUS	READ ADDRESS		READ ADDRESS		READ ADDRESS	READ DATA		READ DATA		READ DATA
MEMORY ADDRESS BUS		X ADDRESS	Y ADDRESS	X ADDRESS	Y ADDRESS	X ADDRESS	Y ADDRESS			
CHIP SELECTS			READ SELECT		READ SELECT		READ SELECT			
MEMORY DATA BUS					READ DATA		READ DATA		READ DATA	
	55 NSEC.									

SDF is HP 9000 BASIC's default system and is used mainly for managing large mass-storage media. It includes a multiple-directory function for organizing file systems into hierarchical format. It also supports password read/write access to files, offering file security to users sharing a large mass-storage system.

LIF is a standard for transporting ASCII source code and data among HP computer products via removable mass-storage media. It is also a convenient information transport format for tying desktop computers to HP 1000 and HP 3000 computer families. For example, one could take a data diskette from an HP 86 personal computer and read it on an HP 9000 disk drive. With the 9845 DCF, conversions between binary-coded decimal (BCD) and binary numeric representations occur automatically, simplifying program writing for sharing data between HP 9000 and HP 9835/45 computers.

The HP-UX operating system is based on Bell Laboratories' UNIX System III. It is a single-user or multiuser system that supports multitasking, virtual-memory management and engineering tools, such as graphics, database management, data communications and local-area networking.

A prominent feature of HP-UX is its ability to program all I/O transactions between files, directories, processes and devices using identical read and write

**Spec summary**

- **Model:** HP 9000 (models 20, 30, 40)
- **Microprocessor:** 32-bit HP-32
- **Clock cycle:** 18 MHz
- **Main memory:** 256K to 2.5M bytes
- **Speed:** 1 MIPS
- **Operating systems:** HP BASIC, HP-UX
- **Languages:** BASIC, FORTRAN 77, Pascal, C

statements. This facility is further enhanced by the HP-UX command interpreter, which lets the programmer declare an input and an output as standard when programming in FORTRAN or Pascal. This means that programs can be copied without directing I/O toward a specific object. The command interpreter lets users specify the I/O objects at run time, a productivity booster for programmers modifying, testing and reusing software.

HP-UX supports as many as 59 concurrent processes using UNIX system III's "pipes" and first-in, first-out (FIFO) files. These two features permit inter-process communication, in which data can be passed asynchro-

### Benchmarking the HP 9000

One standard for comparing scientific and engineering systems is the Whetstone B1D, which is expressed in thousands of double-precision instructions per second. Using this benchmark, Hewlett-Packard Co.'s HP 9000 Series 500 (single CPU) with HP BASIC system software is rated at 130. The same hardware using HP-UX rates 340, and a dual-CPU Series 600 rates a 680. A three-CPU Series 700 (and HP-UX system) garners the

highest rating—1,010 (left). In contrast, the Digital Equipment Corp. VAX-11/750, running the VMS operating system, is rated at 150, and equipped with a floating-point accelerator, at 490.

Other parameters can be used to gauge a system's performance (right). The HP 9000 CPU, for example, has a 230-instruction repertoire. A 32-bit LOAD instruction takes 0.3 μsec. It performs a 32-bit addition in

0.3 μsec., a 32-bit multiplication in 2.9 μsec. and a full 32-bit division (with a 64-bit dividend) in 9.4 μsec. CPU performance is measured at 1 million instructions per second (MIPS).

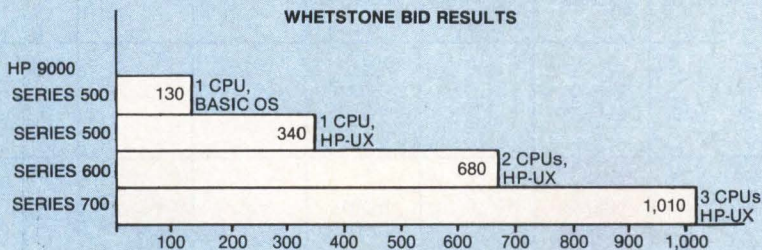

Data path width	32 bits
Instructions	230
Memory access time	165 nsec.
Memory cycle time	110 nsec.
32-bit addition	0.3 μsec.
32-bit multiplication	2.9 μsec.
32-bit division	9.4 μsec.
32-bit load instruction	0.3 μsec.
64-bit floating-point multiplication	10.4 μsec.

# WE SOLVE THESE PROBLEMS EVERY DAY.



*Get everyone into the act with the new TS-600 Series.*

If increasing demand for computer ports and distributed resources has your system in a stranglehold, there's no limit to the breathing space you could enjoy with the TS-600 Switching Stat Mux.

The newest addition to the ComDesign family of networking products, the TS-600 Series provide the same cost savings and network control as the popular TC-500A. With no limit to the number of users who may contend for any available ports, the TS-600 offers all the features of a data switch, port contention unit and intelligent statistical multiplexer in one.

When used individually, a TS-600 acts as a port selector and front-end processor, permitting local resource sharing. Connected in pairs, TS-600's become the central point of control in a powerful transparent switching network, concentrating up to 32 devices over a single communications link. ComDesign's modular hardware and firmware plan allows for easy network expansion and access to the latest software developments.

The TS-600 Series multiplexers are designed for ease of use, and are available with integral 4800 or 9600 bps modems. For more information on the new TS Series or for help with any data comm problem, call us. Toll-free (800) 235-6935, or in California (800) 368-8092.

**ComDesign**  
Leaders in Data Communications

751 South Kellogg Avenue  
Goleta, California 93117

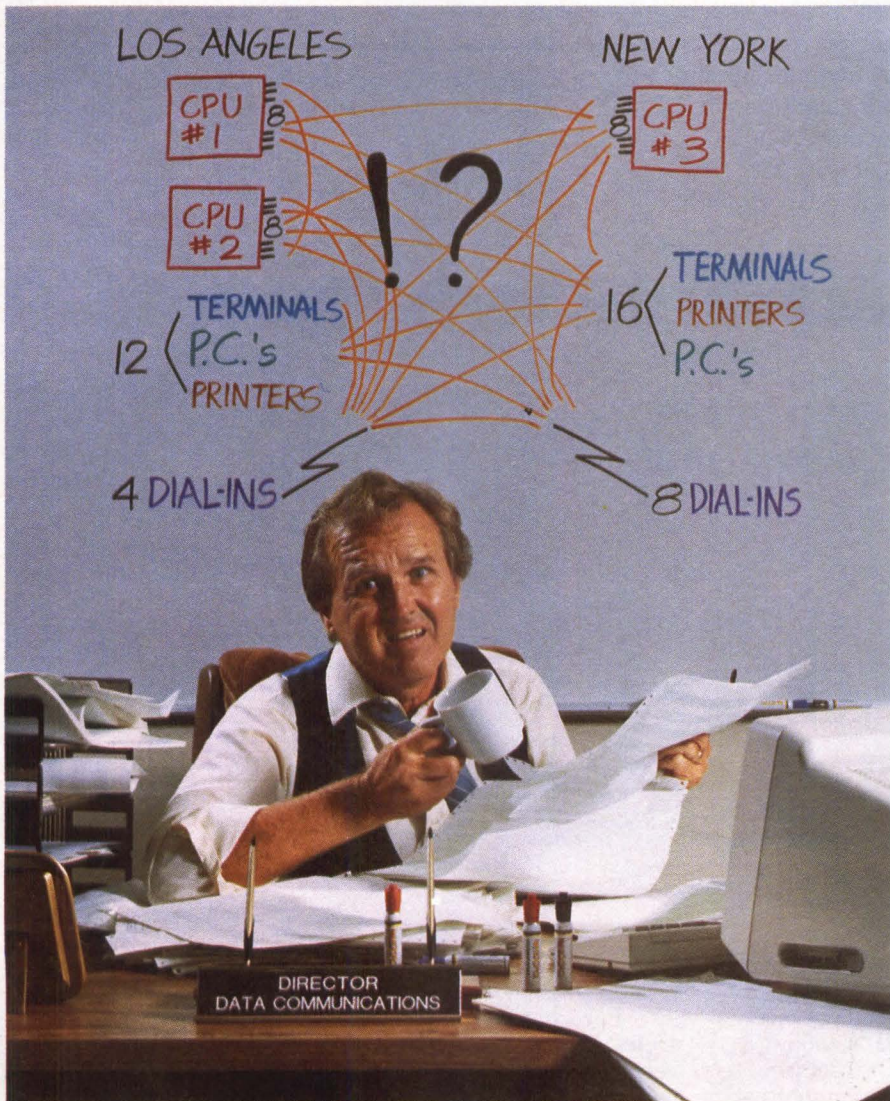

*Struggling to tie everything and everyone together without sacrificing performance or breaking the bank? Let your stat mux do it for you!*

nously between two tasks using a high-level language's read and write commands.

HP-UX's virtual memory allows program code segmentation and data segmentation or paging. Each process has a maximum virtual address space of 1G byte, half of which can be used for local code and data and half for shared system code.

The minimum HP-UX operating system occupies 300K to 400K bytes of memory. A demand-loading feature lets users choose between loading an entire program into memory before execution or only those segments needed for execution, leaving the remaining segments in mass storage.

The HP-UX file system is hierarchical and supports large mass-storage media, making it well-suited to a multiuser software-development environment. Each file is set up with controlled access for read, write or execute to tailor the system to each project team member. HP-UX also includes utilities for converting and copying files to LIF ASCII files, allowing information exchange between a wide variety of HP computers.

HP-UX supports FORTRAN 77, Pascal and C, and both system software environments support graphics and database management. HP 9000 BASIC 3D graphics

implements the full SIGGRAPH CORE standard and supports the IMAGE/QUERY database-management package used with the HP 3000, HP 1000, HP 250 and HP 9845 computer families. Graphics/9000 on the HP-UX system consists of two sets of procedure libraries, both of which can be called from application programs: the advanced graphics package (AGP) and device-independent graphics language (DGL). DGL provides fundamental graphics functions and device support; AGP builds on DGL to provide 2D or 3D viewing transformations with parallel or perspective projections and picture segmentation for rapid, interactive graphics image manipulation.

The HP 9000 can be used as a general-purpose computer, but its strengths are in engineering and scientific applications. Application-software support is mainly in the electrical, mechanical and software engineering areas.

**Chris J. Christopher** is research and development manager of Hewlett-Packard Co.'s Systems Division, Fort Collins, Colo.

Interest Quotient (Circle One)  
High 828 Medium 829 Low 830

## Delta makes your deliveries DASH.



Delta DASH<sup>®</sup> delivers the same day to over 90 cities across the U.S and abroad, covering 10,000 communities. Why get that small package delivered tomorrow when you can DASH it today? DASH (Delta Air Lines Special Handling) delivers packages up to 70 lbs. . . to over 10,000 communities. So give us a ring at the Delta Marketing Office in the

city nearest you. Or call DASH at (800) 638-7333 for pick up or delivery.

**For top priority shipments over 70 lbs., use Delta Air Express.** It guarantees your shipment gets on the flight specified. For full details, call your nearest Delta Marketing Office.

**DELTA AIR CARGO. READY ALL-AROUND.**



# TeleVideo corrects the VT220 key mistakes.

The new TeleVideo® 922 shares but one feature with the VT220®: full DEC® compatibility. The similarity ends there.

**1.** Take our keyboard, for example. The RETURN key is within direct, easy reach. But VT220 users must stretch over an additional key to hit RETURN. Or have the hands of a concert pianist.

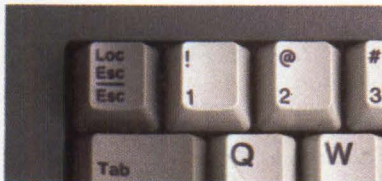

Here's ours.



Where's the VT220 ESCAPE key?

That's a true accounting keypad, complete with a Clear Entry, Double Zero and a TAB key. Not merely the numeric keys you get with the VT220.

**2.** Our ESCAPE key is located above the TAB key, right where you'd expect to find it.

Theirs isn't. In fact, you have to go hunt for the VT220 ESCAPE key halfway across the row of function keys.

**3.** Take a look below at the 922 key-



DEC VT220

**4.** Our SHIFT key is exactly where it should be, so it does exactly what it should do—shift. Their SHIFT key is shoved over by the < and > key to create lots of < and > on the CRT. Of course with a little practice, you could re-learn their keyboard. But why, now that you've seen our 922?

Moving The Shift Key Is A Mistake.

922 Display Screen.

<oving <he <hift Key <s A <istake.

VT220 Display Screen.

**5.** And after we built a better keyboard, we built a better terminal. With exceptional reliability. Quality. Advanced ergonomics. Everything you'd expect from the industry ANSI leader.

The new 922 is available now and priced to move now. And it's backed by a worldwide sales and support network. Which means doing business with TeleVideo is yet another key difference.

**6.** Here are 6 more advantages to the 922.

	TeleVideo 922	DEC VT220
Programmable Function Keys	15 (30 with shift)	15 (shifted only)
True Accountant Keypad	YES	NO
Plug-in Graphics Upgrade Option	YES	NO
Non-glare, Green Phosphor Screen	YES	NO
Full Tilt & Swivel	YES	NO
Enhanced ANSI Mode	YES	NO

DEC, VT220 are registered trademarks of Digital Equipment Corporation.

800-538-8725.

In California, call 408-745-7760.

## The TeleVideo® 922

TeleVideo Systems, Inc.



CIRCLE NO. 106 ON INQUIRY CARD

STRONG STATEMENTS FROM PEOPLE WHO GIVE YOU...

# STRAIGHTTALK

No claims. No boasts. Just straight facts and commitments from Jeffrey Liu, president of Microscience, on our growing family of half-height Winchester disk drives.

"By introducing the new HH-725 20 MB 5.25" and HH-312 10 MB 3.5" half-height Winchester disk drives to our product line, we now offer the proven quality and performance most OEMs need in volume today.

"Combined with our HH-612 10 MB 5.25" half-height disk drive, Microscience now provides a product family of superior quality and better performance than any other drives available.

"Time after time, we have proven that Microscience has the performance, quality, and price personal and portable computer manufacturers demand.

"The secret is the way we design and manufacture drives for you.

"Microscience disk drives have extremely low

voltage requirements because small business and portable computers don't have the luxury of excess power or cooling capacity.

"We've used procedures and components that will be power misers, yet they still provide long-term performance and reliability.

"Our drives feature a thermally isolated stepper motor for precise head alignment and optimum seek performance. A proprietary linear actuator assembly was employed to ensure data reliability

and provide greater drive durability.

"A buffered seek mode and highly accurate proprietary micro-processor-controlled closed-loop servo positioning system keeps the head precisely on track. This maintains data integrity through a wide range of operating conditions regardless of thermal expansion, system hysteresis, or long-term wear.

"Microscience drives are not limited to functioning horizontally. Because of the growing use of portable computers and increasingly compact packaging, we designed our Winchester drives so you can use them in almost any position.

"While volume production is important, what you're really concerned about is the quality of product you use in your system or application. We have made a major commitment to

manufacturing and quality programs.

"Microscience test equipment and tooling have been carefully selected to meet our exacting standards.

"This ensures Microscience ships only zero defect half-height Winchester product that does not eat away at your profits... and your reputation.

"There's a lot more I could say about the Microscience half-height Winchester disk drive family. But what will convince you is using a Microscience drive in your application.

"For more straighttalk regarding your half-height Winchester needs, call or write us today."

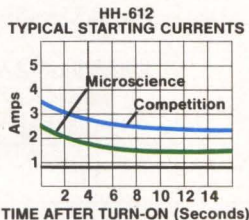
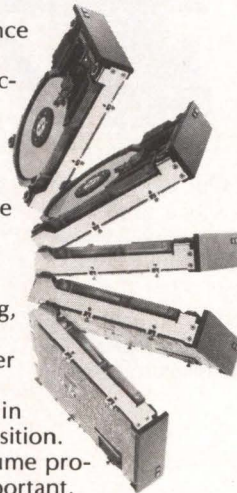

Microscience  
International  
Corporation

575 E. Middlefield Road  
Mountain View, CA 94043 (415) 961-2212

Area Sales Offices: Orlando, FL (305) 339-8283 • Boston, MA (617) 229-5823 • Mountain View, CA (415) 961-2212  
International Sales Office: Munich, West Germany, Tel. 0894315669, TTX 5213442 Distributors: U.S. - Gulf Stream, Weatherford, North East Peripherals, Orion • International - Multitek, Canada • Pericomp, Australia • Dataguild, U.K. • Wide Trade Foundation Ltd., Hong Kong

CIRCLE NO. 107 ON INQUIRY CARD

# Computer-integrated-design graphics terminal incorporates local database

*CID terminal combines a graphics engine,  
a hierarchical graphics database  
and a local processor to reduce host intervention  
in graphics applications*

**Stephen H. Van Horn, Megatek Corp.**

Unlike most graphics terminals, computer-integrated-design (CID) terminals combine a graphics engine with a local database and a local task processor. CID terminals perform most of the real-time database updates and transformations traditionally handled by the host, thus providing faster response to input data and a corresponding reduction in design time. Incorporating a local database reduces delays resulting from lengthy queues that can develop when a host is supporting a large number of users.

Because the major advantage of a CID terminal is the virtual elimination of communications delays, internal throughput is a primary design consideration. But price is a consideration, too. In the case of Megatek Corp.'s Merlin 9200 CID terminal, achieving the required level of performance at an affordable price meant a new approach to graphics-terminal architecture.

## **Communicating within and between terminals**

To provide maximum throughput, the 9200's internal functions are distributed among several independent logical units. Partitioning internal functions simplifies resource sharing among units in a multiterminal installation and improves throughput via a pipelined architecture.

The basic 9200 CID terminal contains dedicated processor boards that handle peripheral interfacing,



**The Merlin 9200 computer-integrated-design graphics terminal combines a graphics engine with a local database and a local task processor.**

the local graphics database and the graphics display. An optional Ethernet interface with a dedicated Intel 80186 is also available (Fig. 1).

Logical units on the same processor board communicate with each other over standard parallel microprocessor buses. Because there is only one processor on a board, there are no local bus-contention problems. However, arbitration can be added should it become necessary for expansion.

Board-to-board communications take place over a 32-bit, 32M-byte-per-second, synchronous transmit-receive message bus. The use of byte-by-byte multiplexing and a rotating priority that interleaves messages and provides "concurrent" communications eliminates contention between logical units for access to the inter-board message bus.

To facilitate communications, the system transmits data in 512-byte packets specifically addressed to the destination logical unit. A real-time executive controls communications. When a logical unit needs to transmit data to another logical unit, it requests a block of local memory from the local executive's memory manager, forms as many packets as are needed to contain the data and adds a header that contains the logical address to which they are to be sent. The executive's communications utility then examines the pointer, determines how to route the packets and begins the data transmission.

An optional fourth processor board, the extended communications processor (ECP), provides a gateway between the logical units and an Ethernet cable. The Ethernet gateway facilitates high-speed communications between the Merlin 9200 and the host computer and between logical units in different Merlins on the network.

**Local task processor links terminal to peripherals**

A local task processor (LTP) board provides the man-machine interface (Fig. 2). The LTP contains an Intel 80186 microprocessor because its architecture facilitates handling numerous peripherals. An added

benefit is its compatibility with existing application software.

The LTP has a local memory consisting of 32K bytes of bootstrap and diagnostic code in ROM and 256K bytes of program and user memory in dynamic RAM, expandable by 1M byte with a plug-in local task extension (LTE) board. A modified Multibus handles communications between the LTP and LTE boards.

The LTP board also includes a gateway to the inter-board message bus, as well as a Centronics-compatible printer interface and a floppy disk controller that can support two drives. The Merlin includes at least one 5¼-inch, 1M-byte drive because, with the exception of the bootstrap and basic diagnostic routines, the system is completely soft-loaded. The decision not to follow the conventional practice of loading graphics-terminal operating instructions in firmware was based on the amount of code involved. A typical 9200 comes with more than 400K bytes of functional and diagnostic code, far more than is practical to put in ROM. Soft-loading allows updating by replacing the system floppy disk.

Users control the LTP via a local task language (LTL), a high-level language that facilitates the configuration of, and provides access to, the system's logical devices. With LTL, users can create and run small programs that, among other things, can control graphics peripherals. One supervisory and eight subordinate user tasks can run concurrently. The supervisory task controls the creation, initiation and suspension of the other eight user tasks.

To achieve application compatibility, the internal

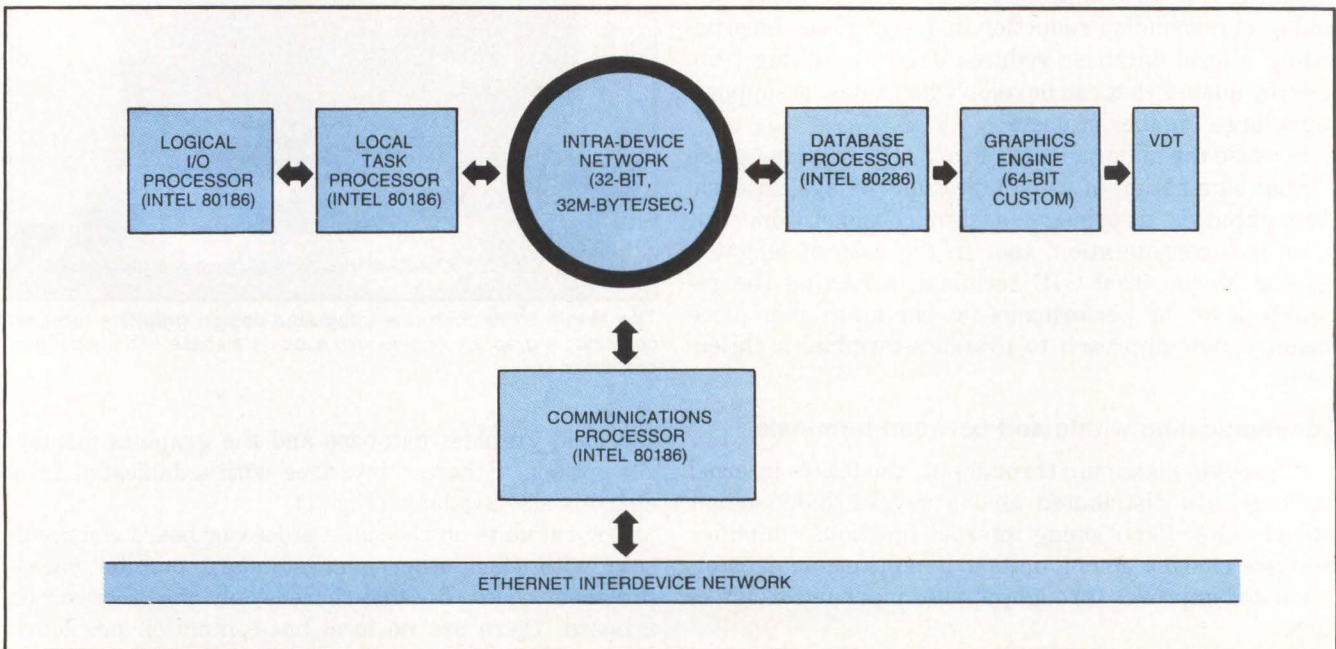

**Fig. 1. The Merlin 9200 multiprocessor architecture** includes processors dedicated to local database processing, local task processing, communications and networking, peripheral control and graphics.



# THE GREATER GOOD FOR THE LESSER NUMBER

**Introducing The Ridge 32.  
A Mainframe That's Engineered  
For Your Engineering Team.**

Great things happen through teamwork. As long as the team works, not waits for computer access. Now, with the Ridge 32, the wait is over.

It gives you unprecedented power and the freedom to explore more. Accomplish more. To increase total team productivity.

The Ridge 32 is a 32-bit, UNIX™ System V based computer. It can power four high-resolution graphics terminals. Yet for under \$43,000, it's practical for single users. And as your needs grow, you can expand one Ridge 32 at a time.

The Ridge 32 also comes in a logical new package. It gives you enormous

computational power without the frustrations of timesharing. Or the costs of an air-conditioned room. All in a workstation suited for any office environment.

So give your lesser number the power to accomplish more. Call Ridge Computers today at 408/986-8500. Or write us at 2451 Mission College Blvd., Santa Clara, CA 95054. And lead

your team to greatness with the Ridge 32.



CIRCLE NO. 108 ON INQUIRY CARD

# QUAD3278.™

## It's almost like a desk-top mainframe.

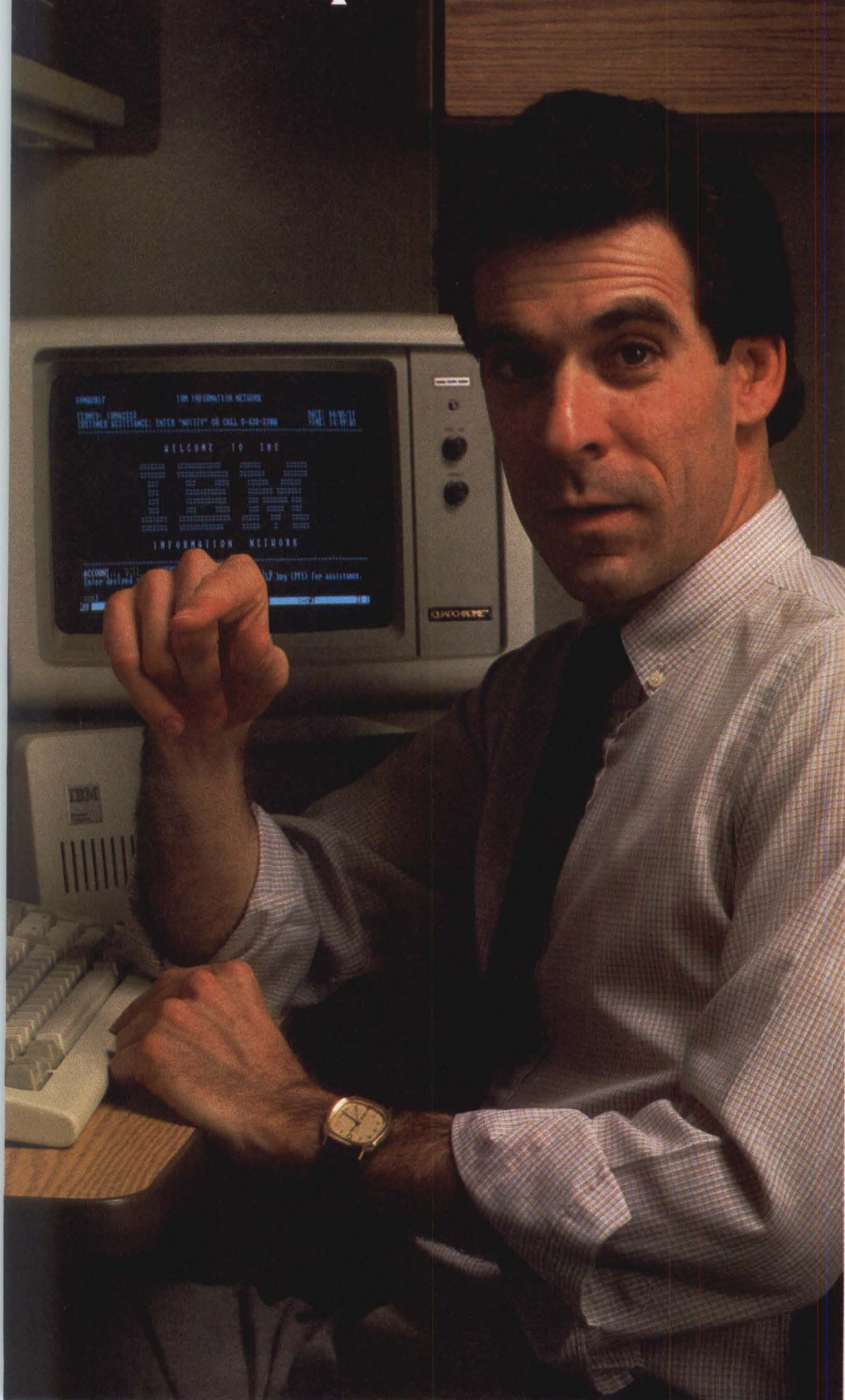

**Convert your IBM PC to full 3278 emulation. And back it up with Quadram Quality.**

Now you can have all the features of the IBM PC (mass storage and peripherals) plus the incredible power of a mainframe right at your desk. Introducing the new Quad3278 from Quadram. The complete system that makes your IBM PC emulate the 3278 Display Work Station at the touch of a key.

The Quad3278 contains everything you need for converting your PC to total 3278 emulation: hardware, software and full documentation. So you're quickly on-line; where the IBM mainframe sees you as just another 3278 terminal. But thanks to Quadram, you're actually a high-performance, intelligent work station.

And with Quad3278 not only do you retain all the functions of your PC but you can reconfigure your PC keyboard to personal taste. In addition, Quad3278 has its own high-speed microprocessor to keep your PC's microprocessor from being burdened with communications responsibility. And it incorporates the 3279's color mode to give you stunning color displays directly from the mainframe.

Make the connection from micro to mainframe. And back it up with Quadram Quality. Ask for Quad3278. It's the logical step for the future.



4355 International Blvd./Norcross, Ga. 30093  
(404) 923-6666/TWX 810-766-4915 (QUADRAM NCRS)

**INTERNATIONAL OFFICES**  
Interquadram Ltd. 442 Bath Road, Slough, England SL16BB  
Tel: 6286-63865 Tlx: 847155 Auriema G Interquadram GmbH  
Fasanenweg 7, 6092 Kelsterbach, West Germany Tel: 6107-3089  
Tlx: 417770 Seva G Interquadram s.a.r.l. 41, Rue Ybry, 92522 Neuilly  
Tel: 756-1240 Tlx: 630842 Iso Bur Checco Computing 6581 Kilmat  
Road, Mississauga, Ontario, Canada L5N-2X5 Tel: 416-621-7600

IBM® PC and IBM Information Network are registered trademarks of International Business Machines Corporation.  
© Copyright 1984 Quadram Corporation.  
All Rights Reserved.

**CIRCLE NO. 109 ON INQUIRY CARD**

database has to use the same kind of data constructs and structures as those typically found in an application database. The 9200's freely structured database eliminates the need for a complex program to convert information in the application database into the graphics database needed by the graphics terminal. The Merlin 9200 can accommodate a hierarchical database, among others, in which information is stored in a pyramid-like tree structure consisting of a series of linked files.

Each file can be named by a 32-bit symbolic address that usually represents an entity's part number or a code number that identifies it. Some users tie the symbolic address to the numbers of the disk sector in which the file is stored.

The database processor (DBP) board contains the local database and comprises an Intel 80286 microprocessor and a 512K-byte database memory. A user can expand the DBP's memory by adding as many as four 1M-byte plug-in database expansion (DBE)

boards. Communications between the DBP and DBE take place over a modified Multibus.

The database operating system includes a traverser and a filter function. Integrating the traverser into the DBP itself speeds data retrieval. The filter function enables the operator to restrict the information the traverser retrieves to items that meet certain criteria.

To minimize the amount of memory needed for a given application and to maximize transaction speed, the system uses a free-structured database language. Because the language is not bound by fixed-length memory structures, the Merlin can handle individual database entries, called entities, from a few bytes on up. Each entity fills only as much memory space as it needs. Equally important, the database processor retrieves and manipulates only the number of bytes needed to contain the required data.

### Graphics engine paints the picture

The Merlin 9200 supports vectors, polygons, meshes,

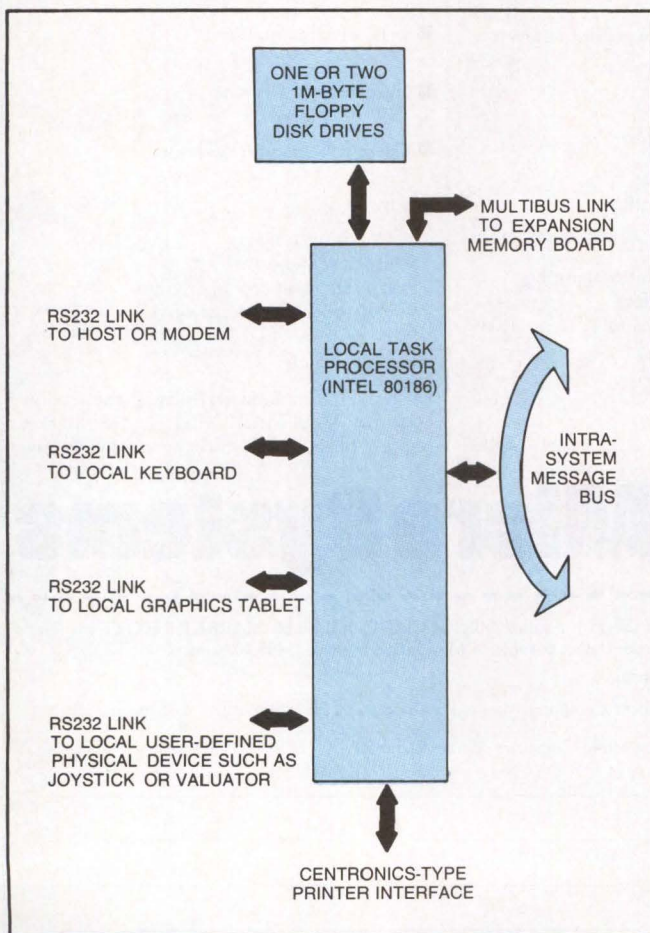

**Fig. 2. The local task processor** includes an Intel 80186 microprocessor with 256K bytes of dynamic RAM. The task processor supports as many as eight concurrent user tasks and provides the man-machine interface via RS232 ports to peripherals, input devices and the host.

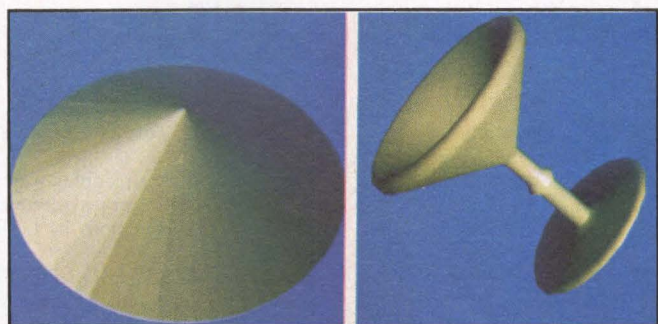

**Fig. 3. Solids modeling** on the Merlin 9200 is available with three types of shading: flat (left), Gouraud (right) and Phong (not shown).

pixel data, run codes, hidden-surface removal, real-time shading and the ability to "wrap" a predefined pattern around a complex shape. The hardware needed to support these graphics functions comprises two processor boards and a number of frame-buffer memory boards. A raster display processor (RDP) provides the gateway between the graphics engine and the remaining hardware. The RDP is a 64-bit microcoded processor with dual memories and dual input buses. Microcoding enables the RDP to fetch two pieces of data from memory, perform a multiply and write the results back to memory within one 150-nsec. machine cycle. The RDP converts the information contained in the database into X, Y and Z coordinates. It also provides perspective, and 3-D clipping and viewport transforms.

A digital vector generator/video timing and control (DVG/VTC) board converts coordinate information from the RDP into the pixel map the monitor needs to paint the vector on the CRT screen. Pixel information



# Key in on Your Hot Prospects

with **Mini-MicroSystems** 13th Annual Mini-Micro Computer Market Report

This year Mini-Micro Systems readers will spend \$50 billion on minicomputers, microcomputers, peripherals, software and supplies. The 13th annual Mini-Micro Computer Market Report outlines 8,511 sites (buying centers) representative of the explosive value-added market. Data is available in the following formats:

## MAGNETIC TAPE OF COMPLETE DATABASE

For those marketers who wish to receive all the information and be able to generate their own analysis, the complete database is available on magnetic tape. Data includes:

- 1983 Expenditures for minicomputers, microcomputers, peripherals, and software.
- 1984 Estimated Expenditures for minicomputers, microcomputers, peripherals, and software.
- Geographical Regions
- Type of Organization
- Minicomputers/Microcomputers purchased in 1983 and those installed in prior years:
  - Vendor name and model number
  - Units acquired
  - Major applications
- Minicomputers/Microcomputers planned 1984 purchases:
  - Vendor name and model number
  - Units planned to be acquired
  - Major applications
  - Sites planning to change major vendor
  - Fail-safe computer operations
  - Electronic office functions

- Boston (617) 536-7780
- Chicago (312) 635-8800
- Dallas (214) 980-0318
- Denver (303) 388-4511
- Los Angeles (213) 826-5818
- Mid-Atlantic (215) 293-1212
- in New York (212) 724-1790
- Orange County (714) 851-9422
- Northern California & Northwest (408) 243-8838
- Southeast (404) 955-6500

**CPA Publishers:** Publishers of 33 specialized magazines in Building & Construction, Electronics & Computers, Foodservice, Manufacturing, Healthcare

## Mini-MicroSystems

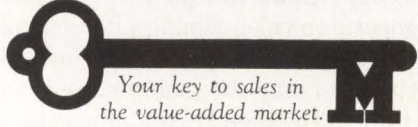

## PRESELECTED LISTS AND MAILING LABELS

All selections are available as a listing or as cheshire or pressure sensitive labels. Cross tabulations of categories are also available.

Site Selection	Site Count
■ Total sites surveyed.....	8,511
■ Sites by planned 1984 expenditure levels	
\$50,000-99,999.....	4,829
\$100,000-249,999.....	3,582
\$250,000-499,999.....	2,218
\$500,000 or more.....	1,403
■ Sites planning to install integrated electronic office functions in 1984.....	1,642
■ HOT PROSPECTS... Sites planning to change major vendors in 1984.....	1,085
■ Value-added OEMs and third parties.....	3,110
■ Value-added user sites.....	4,813

## 13th ANNUAL MINI-MICRO COMPUTER MARKET REPORT

All data is available in a 200-plus page bound report for \$495. In addition to an executive summary, the report's tables include:

- 1983 Unit expenditures
- Type of Organization
- Geographical Regions
- Current Computer Vendors
- 1984 plans for:
  - switching vendors
  - unit expenditures
  - fail-safe computer operations
  - electronic office functions

For more information on prices, list selections, and the MINI-MICRO SYSTEMS Market Report, fill out and send the coupon below.

# Mini-MicroSystems

Please send \_\_\_\_\_ copies of the 13th Annual MINI-MICRO COMPUTER MARKET REPORT to the address below. (Please make checks payable to Mini-Micro Systems. \$495.00/report.)

Please send more information on . . .

\_\_\_\_\_ The complete Mini-Micro Computer Market Database \_\_\_\_\_ Preselected lists and mailing labels

\_\_\_\_\_ The 13th Annual Mini-Micro Computer Market Database

Name \_\_\_\_\_

Title \_\_\_\_\_

Company \_\_\_\_\_

Address \_\_\_\_\_

City \_\_\_\_\_ State \_\_\_\_\_ Zip \_\_\_\_\_

Telephone (\_\_\_\_) \_\_\_\_\_

MINI-MICRO SYSTEMS COMPUTER MARKET REPORT, 221 Columbus Avenue, Boston, MA 02116

CIRCLE NO. 110 ON INQUIRY CARD





# You won't get over what this 350 CPS printer does for under \$2,000.

When you see what the CI-3500 Serial Printer can do, you might not believe it's priced under \$2,000.

Besides giving you data processing printing at 350 CPS, the CI-3500 delivers letter quality printing at a rapid 87 CPS—more than twice the speed of most daisy wheel printers.

And you also get the capability for high resolution graphics, up to 240 X 144 DPI.

The office friendly CI-3500 is as flexible as it is versatile, especially for a table top, workstation printer. For example, a convenient interface cartridge system allows you to change your printer interface simply by changing cartridges.

A DEC-LA100® compatible cartridge is standard, but additional cartridges are available for interfacing with other systems, such as the IBM PC.

A similar font cartridge system accommodates multiple fonts and character sets, so you can avoid costly PROM installations.

The CI-3500 Serial Printer for under \$2,000. Whatever you need in a printer, you won't get over what it will do for you. To find out more, just write or call CIE Terminals, 2505 McCabe Way, Irvine, Ca. 92714-6297. (714) 660-1421.

Or call toll-free 1-800-854-5959. In California, call 1-800-432-3687.



**CIE TERMINALS**  
A CITECH ELECTRONICS COMPANY

® DEC LA100 is a Registered Trademark of Digital Equipment Corp.  
© CIE TERMINALS, INC. 1984

CIRCLE NO. 111 ON INQUIRY CARD

generated by the DVG/VTC board is stored in the frame buffer memory contained on additional plug-in boards.

The RDP can directly address the frame buffer to load data already in pixel form. This data includes information such as photographs or schematic diagrams stored in pixel form in the database, as well as alphanumeric characters. The monitor can simultaneously display as many as 4,096 distinct colors from a palette of 16.7 million.

The VTC reads the logic state of the bit in each of the raster planes at each pixel address to recreate the 12-bit color word. The VTC then refers to its video look-up table to determine the percentages of red, green and blue needed to produce the corresponding user-defined color. These percentages are applied to three on-board digital-to-analog converters that change them into the analog signals that drive the CRT's guns.

The DVG/VTC board contains four DVGs that perform interpolation functions. Three are used for shading and hardware pattern generation, and the fourth performs z-axis address generation. The hardware pattern generator provides a 64-by-64 or 128-by-32 arbitrary surface pattern.

Merlin provides three kinds of shading: flat, Gouraud and Phong (Fig. 3). Flat shading provides uniform intensity across a polygon surface. Gouraud and Phong shading provide realistic, smooth color shading, based on a light source via interpolation.

An important attribute of a graphics terminal is the ability to remove hidden surfaces when solids are modeled. The Merlin 9200 includes back face testing as

standard; true z-buffer hidden surface removal is optional. The z-buffer and associated processor maintain depth information for each surface of the solid. To facilitate this, the terminal uses a DVG and a dedicated frame buffer connected directly to the RDP. The z-axis frame buffer contains 16 raster planes, each corresponding to one bit of a 16-bit z-axis "granularity" word. With 16 bits of depth information, the terminal can recognize as many as 64,000 distinct depth values.

The z-axis DVG provides the pixel data needed for depth cueing, a process in which depth is simulated by varying pixel intensity. Depth cueing can be used on solid surfaces as well as on wire models. When depth cueing is implemented, the user trades off the breadth of the color palette in the video lookup table for variable intensity. Typically, the 12-bit word read-out of the display raster planes is divided into a 4-bit color word and an 8-bit intensity word. With 8 intensity bits, Merlin can provide 256 distinct levels of intensity along its z-axis.

#### Pixel phasing reduces 'jaggies'

The CID terminal provides an economical display that is virtually free of the staircase "jaggies" normally found in raster displays. Jaggies are most apparent in lines drawn at angles very close to one of the major axes. They result from the inability of a raster display to represent the small change in one axis that occurs during a large change in the other axis.

Pixel phasing (patent pending) virtually eliminates jaggies and involves the displacement of pixels from their screen location into a 4-by-4 array. With precise beam steering, the center of each pixel can be shifted to any one of the resulting 16 subpixel addresses in accordance with data contained in four raster planes in the frame buffers (Fig. 4).

To minimize the dark areas that would result if a pixel were fully shifted to one extreme of its address grid, the terminal elongates the affected pixels along their axis of displacement. In other words, the pixel is expanded on one side rather than simply displaced. Although not as smooth as the lines drawn on a calligraphic vector stroke display, the lines drawn with pixel phasing exceed the best high-resolution raster scan monitors. □

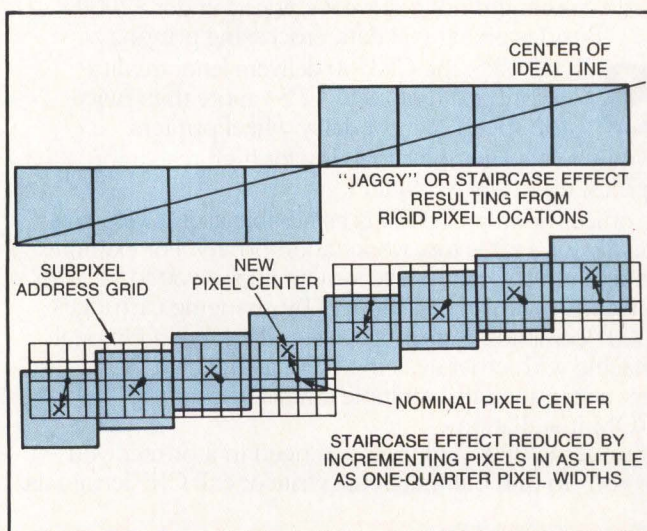

**Fig. 4. Pixel phasing** eliminates jaggies by displacing pixels from their normal screen locations. Traditional raster display terminals produce jagged lines (top). Pixel phasing divides each pixel's screen location into a 4-by-4 array and shifts the center of the pixel (bottom) to get a smoother line.

**Stephen H. Van Horn** is a product specialist and technical liaison on the Merlin 9200 system at Megatek Corp., San Diego. He holds a B.S. in computer engineering from the University of California, San Diego.

Interest Quotient (Circle One)  
High 831 Medium 832 Low 833

# The first thing ISI International put on this new Multibus® card was 2 megabytes...

And that was just  
the beginning.

Squeezing 2 megabytes of memory onto a single Multibus® card is quite an accomplishment in itself. But we believe it takes more than just memory to meet the increasing needs of today's systems. That's why our new MCB-2X Multibus card is designed with a number of significant special features. And why ISI International is truly a leader in Multibus memory products.

## Superior Dynamic Memory Relocation.

The new MCB-2X can relocate up to eight 64K or 256K blocks MCB-364 independently — making it a very powerful tool for "RAM disk," graphics display or multiple table look-up applications.

## Expanded Error Correction Logic.

All single bit errors are automatically scrubbed during refresh cycles without system interruption. And thanks to the automatic memory initialization feature, software doesn't have to be pre-conditioned.

On-board ECC detects

all single and double bit errors, while providing 370ns read access

through standard 64K or 256K RAMs. Plus, the MCB-2X

has CSR and ESR interrogation capability and software control of ECC enable/disable, allowing users to provide comprehensive system-level diagnostics.

## Flexible Addressing Capabilities.

Board addresses starting on any 4K boundary can be mapped to cross 1 and 4 megabyte boundaries. The MCB-2X can also occupy a continuous 512K or 2048K memory space within its 16 megabyte range.

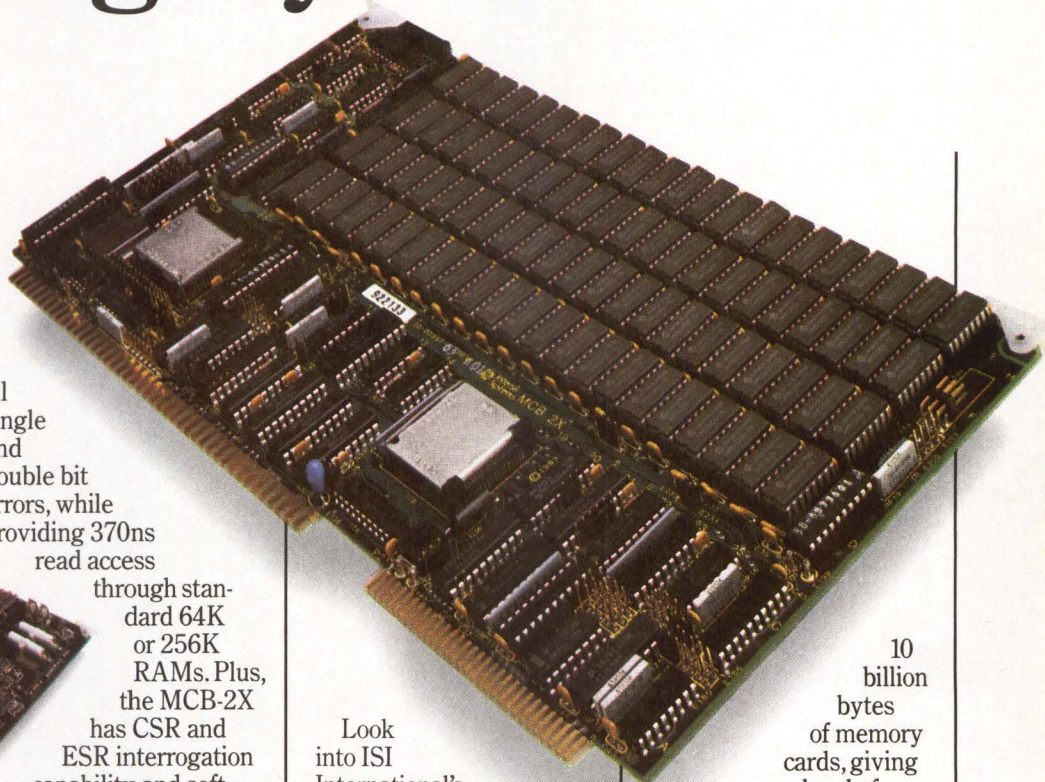
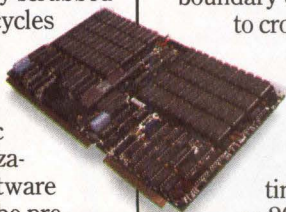
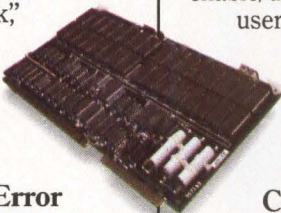
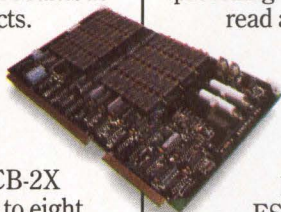

Look into ISI International's new MCB-2X. You'll find all the features you need... plus up to 2 megabytes of memory for the largest capacity available on a single card. Or, for non-volatile CMOS requirements, see our MCB-364 and MCB-332 modules. For simpler dynamic requirements, investigate our MCB-512.

Since 1970, ISI International has shipped over

10 billion bytes of memory cards, giving us a level of experience that's hard to match. Put it to work for you. For systems needs just call us in the West at (408) 743-4442, in the East (201) 272-3920, or in the Midwest call (513) 890-6450. For off-the-shelf products, contact your nearest ISI International distributor: Alliance, Anthem, Arrow, Future Electronics, R.A.E., Quality Components or Schweber.

\*Multibus is a Trademark of Intel Corp.



**INTERNATIONAL Formerly Intersil Systems**

ISI International Corporation

1275 Hammerwood Avenue, Sunnyvale, CA 94089 • (408) 743-4443

CIRCLE NO. 112 ON INQUIRY CARD

You can't build  
tomorrow's systems  
with yesterday's drives.

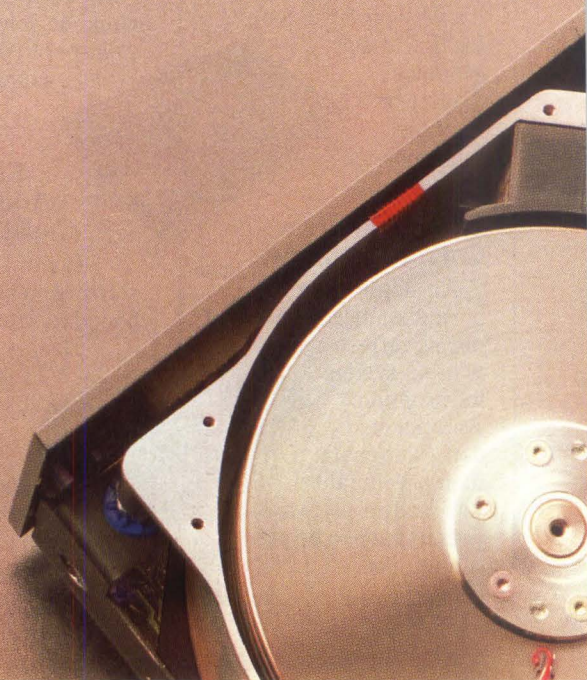

You've seen one small disk drive, you've seen them all, right?  
Not exactly. One disk drive stands above all the rest.

It comes from Maxtor.

The company that refuses to produce disk drives merely as good as everybody else. Instead, we set new standards by producing the only 5¼" disk drives worthy of the next generation of supermicros. Winchester with 65 to 380 megabytes of storage. And average access times of less than 30 msec.

And we don't mean prototypes. We mean full production. So, you can build the systems of tomorrow, today. And that can be a big advantage.

For you. Or your competition.

Maxtor Corporation, 150 River Oaks Parkway,  
San Jose, California 95134,  
(408) 942-1700, TELEX: 171074.  
Eastern Regional Sales Office:  
(617) 872-8556.  
Southwest Regional Sales Office:  
(714) 859-3100.

**Maxtor**

CIRCLE NO. 113 ON INQUIRY CARD



# STATE OF THE ART.

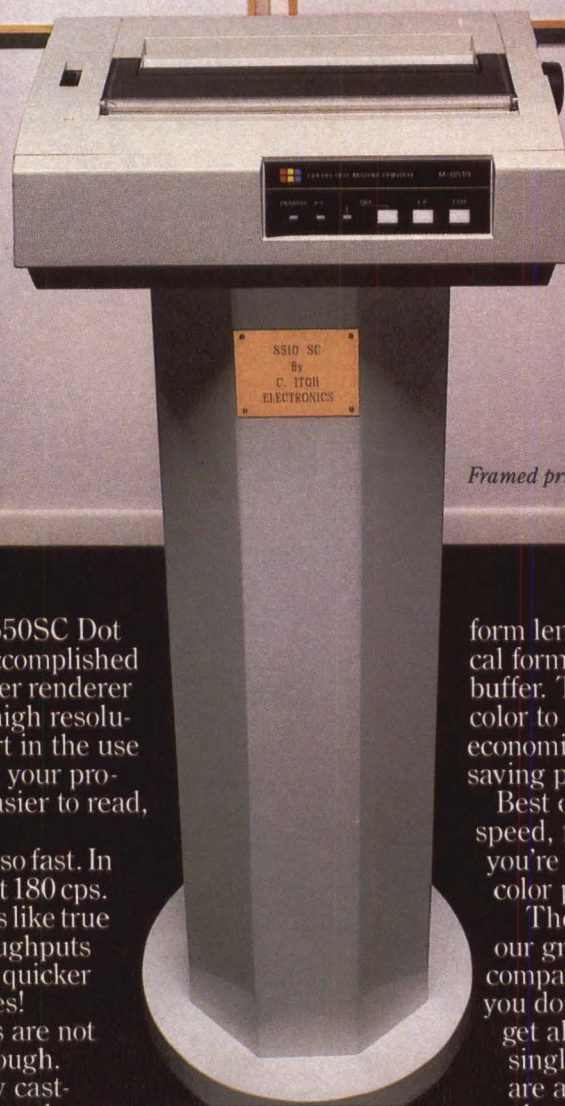

*Framed prints were produced by C. Itoh's 8510 SC Printer.*

**C** Itoh's new 8510SC/1550SC Dot Matrix Printer is an accomplished graphic artist. A master renderer of tables, charts and other high resolution graphics. And an expert in the use of color. All of which boosts your productivity by making data easier to read, organize and interpret.

The 8510SC/1550SC is also fast. In single-color mode, it prints at 180 cps. And thanks to advancements like true logic seeking printing, throughputs are a fast 100 LPM — that's quicker than many 200 cps machines!

Of course, C. Itoh printers are not only fast and colorful, but tough. They come with heavy duty castings, a rugged stepper motor and a synthetic ruby print head that has a 100-million-plus character life — all standard.

Also standard are down-loading for special character sets. Variable

form length, 6-channel electronic vertical formatting. An expandable print buffer. The capability to switch from color to a black ribbon, quickly and economically. Plus a long list of time-saving paper handling features.

Best of all, you can get all this high speed, full-color performance for what you're probably paying for a single-color printer!

The 8510SC/1550SC is part of our growing family of software-compatible low-profile printers. So if you don't need multi-color, you can still get all these features in a choice of single-color printers. All of which are available in two carriage widths, plus serial or parallel interfaces.

C. Itoh's expanded 8510/1550 family. The state of the art in printers. For full details, contact C. Itoh Electronics, Inc., 5301 Beethoven St., Los Angeles, CA 90066. (213) 306-6700.



Shown are 8510B/1550B, 8510SC and 1550S.

**C. ITOH ELECTRONICS**  
A World of Quality

CIRCLE NO. 114 ON INQUIRY CARD

## GUEST VIEWPOINT

# Needed: new Winchester error specifications

**James Adkisson,**  
Executive Vice President  
Vertex Peripherals Inc.

System integrators continually demand that Winchester disk drive manufacturers provide more capacity, lower cost, greater capability and greater volume, while maintaining high data integrity. Currently, high-capacity Winchester disk drive manufacturers maintain high data integrity and low defects even with densities of 1,000 tracks per inch (tpi) and greater than 10,000 bits per inch (bpi).

Acceptable system data integrity is determined arbitrarily more by disk technology capability than by pre-defined system requirements. Current 5¼-inch Winchester disk drive products support error rates of one error in  $10^{10}$  bits for recoverable, or soft, errors and one error in  $10^{12}$  bits for non-recoverable, or hard errors. Acceptable system data integrity requires an error rate of one in  $10^{12}$  bits transferred.

The increased cost penalty for high-capacity disk drives to maintain these error rates is not necessary for system integrators to achieve the specified system data integrity.

By definition, soft errors are recoverable by multiple read retries and therefore do not necessarily affect system data reliability. However, excessive soft errors might degrade throughput because of multiple read retries to recover data. On the other hand, hard errors occur primarily as a result of defects in the recording surface of a disk. Most drive manufacturers guarantee that no more than one defect per megabyte of storage will be allowed on a drive.

As disk drive capacity increases, particularly with higher tracks per inch and bits per inch, maintaining minimum defects per megabyte becomes increasingly expensive. A small disk defect that is not noticeable in a 300-tpi disk drive is a repeatable hard error in a 10,000-tpi disk drive.

Generally, hard errors or defects are mapped by disk drive manufac-

turers before disk drives are integrated into a system. These mapped defects are entered into the system disk controller by the system integrator or OEM and then are omitted during disk-formatting operation. Thus, the system never sees hard errors (according to the specification, only one error in  $10^{12}$  bits are read).

But what about the hard errors that were not mapped as they should have been? And what about hard errors that show up later? What does a system integrator do about them?

The solution requires the use of error-correction codes (ECC). The most common type of ECC are called Fire codes (named after their inventor). Fire codes are especially constructed to detect and correct single-burst errors. The new generation of ECC, sometimes called "computer generated," has improved detection capabilities for even multiburst errors.

With the use of ECC, both hard and soft errors are correctable. However, care must be taken in its use. ECC should not necessarily be invoked to correct soft errors, depending on the correcting code used, where a code's miscorrection is greater than the probability of recovery from multiple read retries. ECC solutions vary in terms of redundancy required, correction capability and miscorrection errors. The significance of ECC centers on its ability to detect and correct hard errors, thus maintaining high system data reliability.

An industry consultant on ECC, Neal Glover of Data Systems Technology, believes that disk drive manufacturers unnecessarily carry the primary burden for maintaining disk system data reliability. According to Glover, "Disk manufacturers, by providing nearly perfect disk media and sophisticated read/write channels, have maintained very low disk drive error rates. If the controller manufacturers/designers were to improve the error-correction schemes with greater redundancy and a selection of ECC that increase correction capability while minimizing miscorrection,

then the system data reliability could be easily maintained, even with a significant increase in raw disk drive error rates. However, system manufacturers should implement ECC in any case to guard against error-rate variations among disk drives."

Larry Boucher, president of Adaptec Corp., a leading controller manufacturer, agrees: "With the use of the more sophisticated computer-generated ECC incorporated with new controllers, it is possible to maintain system data integrity of one in  $10^{12}$  bits error even if the native disk drive error rate is several orders of magnitude higher."

Offering high storage capacities, optical disks are currently operating with inherent hard-error criteria of one in  $10^6$ . However, with use of redundancy and ECC, the system data reliability from optical disks is maintained at one in  $10^{12}$ . The same is possible if magnetic-disk-inherent data errors are similarly reduced.

Now is an ideal time for the industry to review and reduce error and disk-media-defect criteria. Many alternative proposals offered for interface standards are still up in the air, and ECC schemes could be easily incorporated into any one of them. A reduction of error rates by two orders of magnitude could provide significant cost reductions in disk-drive-media and read-channel implementation without jeopardizing system data integrity. Those emerging higher-performance disk drive interface proposals supporting higher data rates and more efficient encoding, such as run length limited (RLL) will make disk quality requirements even greater and, therefore, bring higher costs unless error criteria are reduced.

The market is demanding higher-capacity/higher-performance disk drives in large volumes—but at lower costs. A cooperative effort between disk drive manufacturers, system integrators and controller manufacturers to maintain system data reliability and reduce disk drive error and criteria would offer benefits to all.

# New Products

## SYSTEMS



### Display workstation features high resolution

The WY-1000x10 graphics workstation can be configured with windowing software for business or CAD/CAM applications. Containing all of the features available in the company's WY-1000 workstation, the WY-1000x10 also includes a 15-inch, monochrome monitor with a 1,000-by-800 bit-mapped display, the GSX operating system and a serial input/output port. The WY-1000 16-bit, 80186 microprocessor-based microcomputer provides two 5¼-inch IBM-PC-compatible floppy disk drives, 128K bytes of RAM and three I/O ports. Less than \$5,000. **Wyse Technology**, 3040 N. First St., San Jose, Calif. 95134, (408) 946-3075. **Circle No 300**



### Microcomputers run IBM PC software

The Z-150 series desktop and Z-160 series portable microcomputers offer software and expansion-board compatibility with the IBM PC. Both series use the Intel 8088 processor, the IBM expansion bus and the MS-DOS operating system. The computers include two RS232 ports and a Centronics-compatible parallel port. They come standard with 128K bytes of RAM, expandable to 640K bytes. The products also have RGB color output and a redesigned, IBM-compatible, detachable keyboard. Desktop models

also provide gray-scale monochrome output. All models support basic, smooth and jump scrolling modes. Desktop systems are available in three configurations with 5¼-inch floppy disk drives: a single-drive system (\$2,699), a dual-drive system (\$3,099) and a dual-drive system with one floppy disk drive and one 10.6M-byte Winchester disk drive (\$4,799). Desktop systems do not include a monitor as standard equipment. The two portable systems, both with built-in 9-inch amber monitors, are priced at \$2,799 for the single-floppy-disk-drive version and \$3,199 for the dual-floppy-disk-drive version. **Zenith Data Systems**, 1000 Milwaukee Ave., Glenview, Ill. 60025, (312) 391-8744. **Circle No 301**

### Workstation meets engineering needs

The System One integrated workstation engineering and scientific package is based on a Motorola 68010 main processor and features virtual-memory support, high-resolution graphics and a multiwindow extension of BSD 4.2 UNIX. The package includes a 640K-byte, 5¼-inch floppy disk drive, a 24M-byte Winchester disk drive, a 14-inch, 1,024-by-768-pixel, bit-mapped display with 128K bytes of memory and a graphics processor, a general I/O processor with a mouse pointing device and a battery-backed clock/calendar. Standard software includes a UNIX-derived operating system, a window manager, a software-integration shell and the C programming language. \$15,475. **NBI Inc.**, P.O. Box 9001, Boulder, Colo. 80301, (303) 938-2795. **Circle No 302**

### Multiuser microcomputer is 80286-based

The system 816/F, an IEEE-696-compatible multiuser microcomputer based on a 6-MHz 80286 CPU with a 287 math processor, features 512K bytes of 16-bit static memory, 12 serial ports, a Centronics printer port, a parallel port, 1.2M bytes of floppy disk storage, 40M bytes of hard disk storage and 1.5M bytes of M-Drive/H solid-state disk storage. The computer includes the CP/M-86 and MP/M-86 operating systems. \$14,995. **CompuPro**, 2506 Breakwater Court, Hayward, Calif. 94545, (415) 786-0909. **Circle No 303**

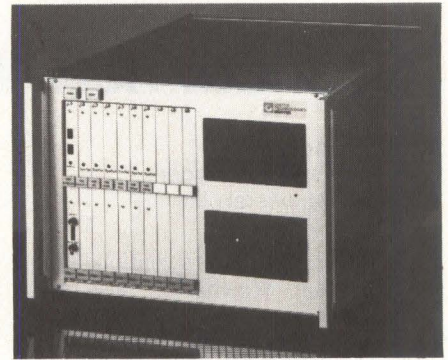

### Multiuser UNIX system is VMEbus-based

The VME Matrix 68K is a multiuser, VMEbus-based UNIX system designed around the 68000 microprocessor. The product has seven VMEbus-compatible cards in a 10-slot card cage, 36M bytes of Winchester disk storage and 1M byte of floppy disk storage. The system also has five serial ports, one parallel printer port (Centronics compatible) and 640K bytes of main memory (512K bytes on the two DRAM boards and 128K bytes on the MMCPU). Software includes the UniPlus+ UNIX System III operating system, 68000 assembler, C compiler and a system diagnostics package. The system firmware initializes the system and controls bootstrap loading. \$16,500. **Mostek Corp.**, 1215 W. Crosby Road, Carrollton, Texas 75006, (214) 466-6000. **Circle No 304**



### Hand-held microcomputer draws graphics

The Husky Hunter hand-held microcomputer measures 8½ by 6¼ by 1¼ inches and weighs 2 pounds. The water-proof unit incorporates an NSC800-4 microprocessor, 80K to 208K bytes of CMOS RAM, an RS232 port, an LCD and a 57-key QWERTY-style keyboard.



The product displays alphanumeric in an 8-line-by-40-character format and can draw 240-by-64-dot resolution graphics. The microcomputer has a BASIC interpreter and can run CP/M-compatible software. Programs and data are stored in battery-supported memory. Prices start at approximately \$2,000. **Sarasota Automation Inc.**, 1500 N. Washington Blvd., Sarasota, Fla. 33577, (813) 366-8770. **Circle No 305**

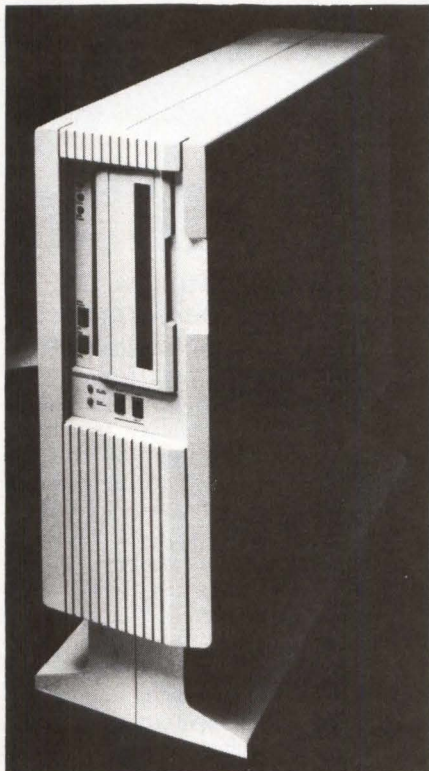

### Variable computer offers flexibility

The Powerframe series of variable-architecture computer systems offers a selection of processors, operating software and peripherals. Model 2340 employs a DEC PDP-11/23 Plus processor, a DEC operating system and an 8-inch fixed/removable rigid disk drive with 40M bytes of user storage. Standard equipment also includes 256K bytes of dynamic RAM, dual ports and an expandable pedestal cabinet. The free-standing cabinet contains a slide-out wire cage that provides access to internal components for exchanging logic and memory boards as well as storage subsystems. \$13,990. **Ford/Higgins Ltd.**, 4755 Walnut St., Boulder, Colo. 80301, (303) 449-8803. **Circle No 306**

INTRODUCING THE CTS 212AH MODEM

Discover in nine minutes  
what it's taken ninety years  
to develop;  
**Reliability.**



### CTS Technological Reliability

The high speed, digital signal processor in our 212AH modem was originally engineered for very complex, custom modem systems. We now have applied this advanced technology to a standard Bell 212A compatible product. You get clear, error free transmission despite varying phone line conditions. Other features include auto dial/answer, remote digital loopback, full duplex 300 bps and 1200 bps asynchronous operation and 1200 bps synchronous operation. In a few minutes you'll discover our modem has all the bells and whistles you could ask for. Yet, at a surprisingly low price.

### CTS Field Reliability

We warranty our 212AH modem for two years, and we demand our distributors service and support your needs immediately. Once in the field, our modems operate with all data terminals, more than 100 types of computers and are Hayes compatible.

### CTS Brand Reliability

In 1896 CTS began manufacturing hand cranked, wooden, wall mounted telephones. Today, we offer the sophisticated 212AH modem. It's taken us almost ninety years of hard work, intensive research and innovative products to develop a reputation for reliability. Take nine minutes, examine our 212AH modem, and find out for yourself.

**CTS**®

**DATAComm Products Division**

131 West St.  
Danbury, CT 06810  
203-743-3681

New to the industry since 1896.

# New Products

## DISK/TAPE

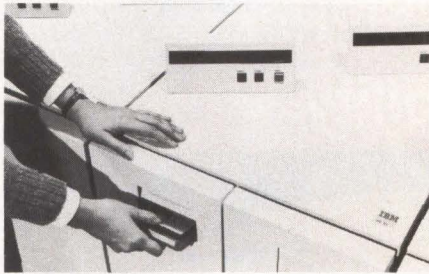

IBM's 4-by-5-inch magnetic-tape cartridge inserts in a slot in the model 3480 subsystem.

### Tape cartridges feature 20 percent more storage

The model 3480 magnetic-tape subsystem employs tape cartridges instead of standard tape reels. Approximately one-fourth the size of a 10½-inch reel of magnetic tape, the rectangular cartridges store as much as 20 percent more data. Designed for large-machine backup, the model 3480 contains dual drives, each of which stores 200M bytes unformatted and arranged in 18 tracks with a packing density of 38K bytes per inch. The subsystem transfers data at 3M bytes per second—more than double the rate at which other IBM tape drives read and write information. The 3-foot-by-2-foot-by-39-inch unit moves the tape at 80 ips in a streaming-only mode. Decoupled control maintains steady operation of the drive, freeing the host from handling tape operation. A typical configuration, consisting of one controller and eight drives, is priced at \$237,910. **IBM Corp., Information Systems Group**, 900 King St., Rye, N.Y. 10573. **Circle No 307**



### Tape streamers pack 500M bytes

The MT-2000 family of streaming-tape drives packs 500M bytes on a book-sized cartridge containing 1,500 feet of ½-inch-wide tape. The drives operate at 200 or 50 ips in streaming mode and at 50 ips in start/stop mode. The devices

transfer data at 240K bytes per second at 200 ips and store data using a 24-track, bit-serial, serpentine format with a 9,600-bpi packing density. An integral formatter encodes data in a 4/5 GCR format and is transparent to the controller. The head-stepping arrangement permits random access of stored files within an average of 30 seconds. The full-width model MT-2210, priced at \$5,500, measures 19 by 8¾ by 17½ inches. The half-width model MT-2220, priced at \$5,750, measures 8.4 by 10.2 by 24 inches. **MegaTape Corp.**, 1041 Hamilton Road, P.O. Box 317, Duarte, Calif. 91010, (213) 357-9921.

**Circle No 308**

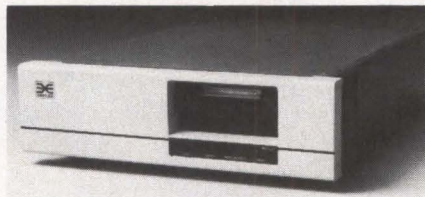

### Storage subsystems enhance DEC computers

Employing the SCSI, Medley subsystems provide software-transparent storage and backup for DEC Q-bus and Unibus computers. The subsystems come in a 5¼-by-19-by-22-inch RETMA rack-mounted cabinet or an optional desktop unit and include a 5¼-inch Winchester disk drive, a CDC Sentinel ¼-inch cartridge-tape drive, power supply and a cooling fan. The Winchester disk drive offers 36M or 110M bytes of formatted data storage; the tape drive offers as much as 70M bytes of backup storage, depending on block size. The Medley is offered in a Q-bus version for the DEC LSI-11 through 11/23 Plus, the Micro/PDP-11 and the Micro/VAX CPUs or in a Unibus version for applicable PDP-11 and VAX-11 CPUs. The subsystem package includes the appropriate host adapter: the vendor's UC02 for Q-bus applications and UC12 for Unibus applications. The company's TC05 (Q-bus) and TC15 (Unibus) tape couplers handle tape-control functions. Prices for the subsystem with 110M-byte disk and tape backup is \$12,455 for the Q-bus version and \$12,855 for the Unibus version. **Emulex Corp.**, P.O. Box 6725, 3545 Harbor Blvd., Costa Mesa, Calif. 92626, (714) 662-5600 or (800) 854-7112. **Circle No 309**

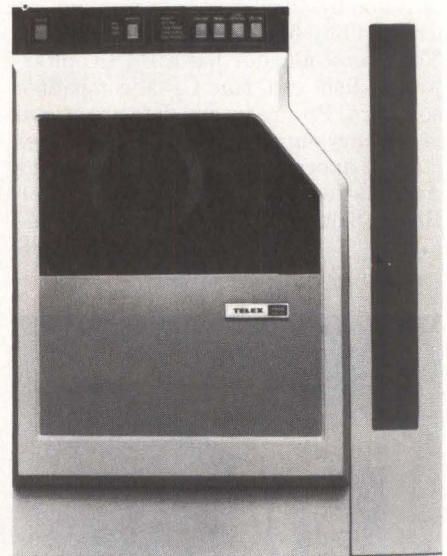

### GCR tape product offers large-system performance

The 50-ips Shamrock model 9250, a start/stop, auto-load/auto-thread, vacuum-column tape drive, has an embedded GCR formatter. Standard recording densities are 6,250 and 1,600 bpi; an 800-bpi recording density is optional. The peak throughput rate at 6,250 bpi is 312.5K bytes per second. At 1,600 bpi, the unit transfers data at 80K bytes per second. It maintains a 0.3-inch inter-record gap and provides 3-msec. write and 3.4-msec. read access times. In GCR mode, the drive can store as much as 145M bytes of formatted data on one 2,400-foot reel of tape. It incorporates the Telex bus-structured standard interface. \$7,399 (OEM quantities); deliveries begin in October. **Telex Computer Products Inc.**, 6422 E. 41st St., Tulsa, Okla. 74135, (918) 627-1111.

**Circle No 310**

### Winchester subsystem replaces four RL01 drives

The 4xRL01 disk system for DEC Q-bus microcomputers emulates four 14-inch DEC RL01 cartridge drives. It incorporates a controller and two fixed/removable 5¼-inch Winchester drives, providing a storage capacity of 20.8M bytes. Data-transfer rate is 625K bytes per second; average seek time is 40 msec. \$10,000. **Winchester Systems**, 400 W. Cummings Park, Woburn, Mass. 01801, (617) 933-8550.

**Circle No 311**

# More than A Memory A Commitment To Quality

Every department, every person in our organization is dedicated to one goal—to deliver the finest in disk memories.

At Century Data Systems, we see quality as a pervasive, company-wide attitude. And our customers share this perspective.

Leading OEMs continue to rely on Century Data Systems disk memories for superb reliability, year after year. That's the real payoff from our total approach to quality.

At Century Data Systems, quality is much more than a memory. It's a living company commitment. And it can work to your advantage. Write or call for specifics.

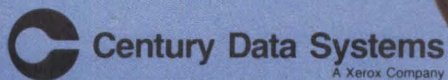

Marketing Communications  
1270 N. Kraemer Boulevard  
Anaheim, California 92806  
(714) 999-2660

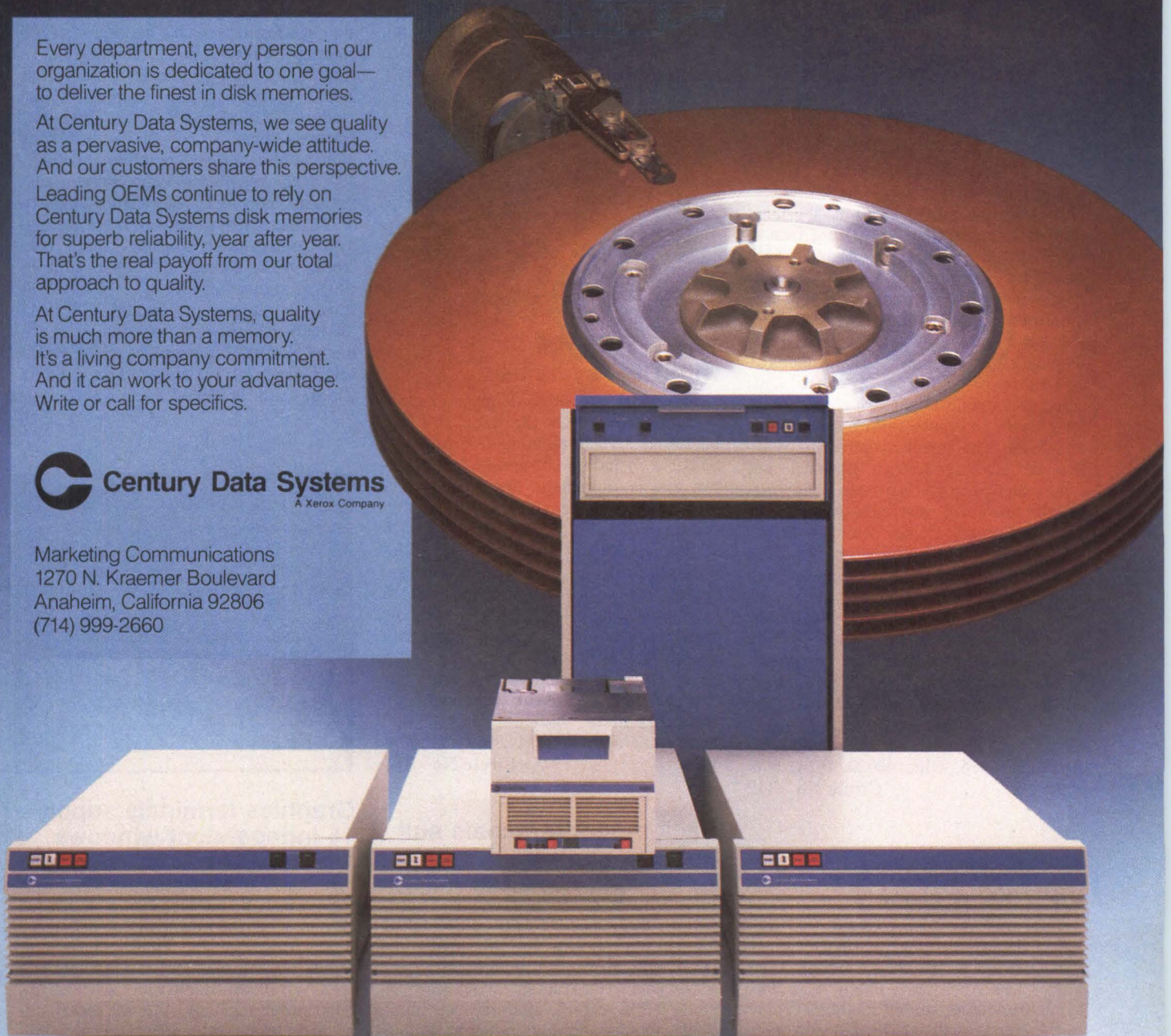

CIRCLE NO. 116 ON INQUIRY CARD

# New Products

## TERMINALS

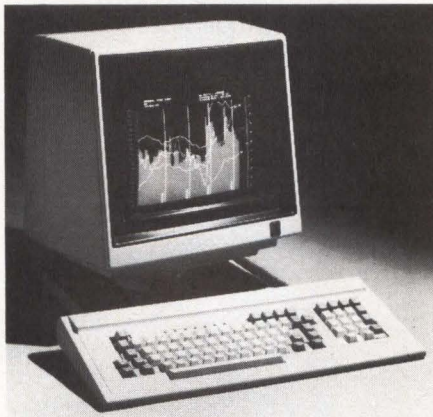

### Terminals feature NTSC color signal output

The ID-200 series of graphics terminals offers dual display architecture, NTSC compatibility, 1,280-by-480-pixel resolution and a display writing rate of 1.25M pixels per second. A dual video generator can split and display alphanumeric and graphics images on separate monitors. The terminal provides hardware pan and 16 levels of zoom and can display eight windows simultaneously. A palette of eight or 16 colors with selectable graphics pattern elements allows users to create textures, patterns and hues. The terminal performs polygon fill and seed with fill-until and -while algorithms. Users can draw vectors by absolute, relative or concatenated coordinates. Other drawing primitives include circle, bar, arc, pie and polygon; programmable window and scales; and four independent plane controls. The unit also has graphics-command compatibility with Tektronix models 4010, 4014 and 4027 terminals; VT100 features; and VT132 multipage editing compatibility. ISSCO, SAS and Template software supports the series. \$4,295. **ID Systems Corp.**, 4089 Leap Road, Hilliard, Ohio 43026, (614) 876-1595. **Circle No 312**

### Terminals support VIP-7800 protocols

The microprocessor-based TE-780x video display terminals support Honeywell VIP-7800 protocols. Model A replaces the Honeywell model VIP-7801 asynchronous terminal, model S replaces the Honeywell VIP-7814 synchronous terminal, and model V operates in a user-selectable DEC VT100 or ANSI X3.64 mode. All models feature a 14-

inch green screen that displays 7-by-11-dot-matrix characters in a 24-line-by-80-column format. The terminals also offer more than 60 menu-selectable setup options and an auxiliary printer port. Other features include a detachable keyboard; a tilt-and-swivel monitor; 12 user-programmable non-volatile function keys; and blink, underline, reverse, bold and blank video attributes that require no display space. Model A: \$1,695; models S and V: \$1,895 each. **Thomas Engineering Co.**, 1040 Oak Grove Road, Concord, Calif. 94518, (415) 680-8640. **Circle No 313**

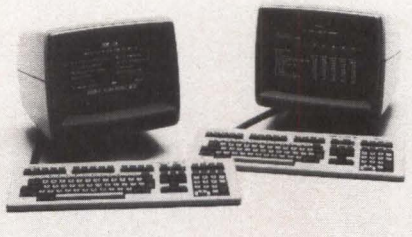

### Terminal works with DEC systems

The ADM 220 video display terminal is compatible with the DEC VT220, VT100 and VT52 terminals. Ergonomic features include a tilt-and-swivel monitor and a detached, low-profile keyboard. The unit provides an 80- or 132-column-by-24-line display (plus a 25th status line), a split screen, double-width/double-height line attributes, vertical or horizontal scrolling and 15 function keys. A 12-inch, green or amber screen is standard. Users can display the terminal's selectable setup parameters in English, French or German. \$1,165. **Lear Siegler Inc., Data Products Division**, 901 E. Ball Road, Anaheim, Calif. 92805, (714) 774-1010. **Circle No 314**

### Rack-mount terminals suit process control

The R6210 family of rack-mountable color terminals for process-control applications measures 7 by 19 by 21 inches. The entry-level model R6210/01 (\$3,495), features VT100 emulation and extensions. Character attributes include eight colors, underscore, blink, bold, reverse and double-height/double-width lines. Users can design special fonts and symbols for charts and flow diagrams, locally store the fonts and



symbols and display them in as many as six page formats with a maximum of 160 characters by 48 lines. The terminal's communications protocol meets ANSI X3.64 standards. The top-of-the-line model R6210/21 (\$4,995) has R6210/01 features plus an overlay with four planes of bit-mapped graphics at 640-by-480 pixel resolution. The system displays as many as 16 colors from a palette of 64. Users can program in the company's Colorgraphic language or in Tektronix 4014 commands. User subroutines are stored in 40K bytes of RAM. A third configuration, model R6210/11 (\$3,995), has the same attributes as the model R6210/21 in graphics mode. **Ramtek Corp.**, 2211 Lawson Lane, Santa Clara, Calif. 95050, (408) 988-2211. **Circle No 315**



### Graphics terminals supply 16 independent windows

The Graphos II and III color graphics terminals feature shifttable cell architecture and 16 independently managed screen windows that can smooth scroll in any direction. The windows have individual color tables and can emulate the DEC VT100 and Tektronix 4010 terminals simultaneously. An MC68000 microprocessor runs subroutines in a 130-command set supplied in firmware. Both terminals offer user-selectable resolution of 640-by-480-by-4-bit pixels or 640-

by-384-by-4-bit pixels. Priced at \$3,995 without a monitor, Graphos II runs at 6.25 MHz and displays 16 colors on a TTL monitor. It has a 128K-byte graphics RAM and a 128K-byte local-storage RAM. Priced at \$5,495 without a monitor, Graphos III operates at a 12.5-MHz clock speed and generates 32,768 colors on an analog RGB monitor. It has 256K bytes of graphics RAM and 224K bytes of local-storage RAM. **Ithaca InterSystems Inc.**, 1650 Hanshaw Road, Ithaca, N.Y. 14850, (607) 273-2500.

Circle No 316

### Displays use high-speed technology

Featuring a proprietary CMOS graphics coprocessor working with a Z8002 16-bit microprocessor, HiScan graphics terminals achieve graphing speeds of 1M pixels per second. The terminals are based on DEC VT200 series monitors and keyboards. They offer a non-interlaced display and deliver 800-by-600-pixel resolution on the monochrome model 4210 and 800-by-300-pixel resolution on the color model 4205. Using two memory planes, HiScan monochrome terminals provide a four-level gray scale; using four memory planes, HiScan color terminals can display 16 colors simultaneously from a palette of 64. The terminals support 80- and 132-column formats, with characters formed in a 10-by-20 cell. Standard features include DEC VT220 text and Tektronix 4010/4014 graphics functions as well as buyer-specified Tektronix 4027, Tektronix 4104 or DEC ReGIS protocols. \$2,195 and \$2,995 for the models 4210 and 4205, respectively. **Digital Engineering Inc.**, 630 Bercut Drive, Sacramento, Calif. 95814, (916) 447-7600.

Circle No 317

### Intelligent terminal can be customized

The Ovation 1041 and 1051 terminals feature soft setup using non-volatile RAM, firmware customization and expansion capabilities to support custom logic. The Ovation 1051 features 256 graphics characters and 128 alphanumeric characters and provides an 80- or 132-column display mode and 16K bytes of memory, expandable to 64K bytes. The low-profile, detached keyboard has 103 alphanumeric keys and 16 user-pro-

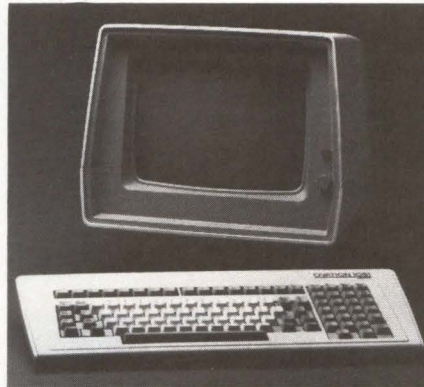

grammable function keys. Based on the Z80A microprocessor, the terminal incorporates RS232C/RS422 and RS232C communication ports and is compatible with DEC VT132 and ANSI X3.64 standards. The Ovation 1041 terminal features an 84-key low-profile keyboard with eight user-programmable function keys, displays 24 lines by 80 columns with a 25th status line and offers 32 graphics characters. Based on the 8085A microprocessor, the product emulates the Lear Siegler ADM 31 and TeleVideo 925 terminals and contains 16K bytes of memory. Both models incorporate non-glare green or amber, 12-inch screens on a tilt-and-swivel base. Ovation 1051: \$1,295; Ovation 1041: \$1,095. **Zentec Corp.**, 2400 Walsh Ave., Santa Clara, Calif. 95050, (408) 727-7662.

Circle No 318

### Terminal displays large characters

The Annunciator graphics terminal can instantaneously draw large characters on its 19-inch video screen in response to one ASCII code. Users can construct messages in a combination of eight colors, letter sizes as high as 3 inches and blinking. Operators can also store as many as 96 full-screen formats (including graphics diagrams) in the terminal's non-volatile memory and access the formats via simple codes. Graphics display resolution is 384 by 480 pixels. The unit can display a maximum of 80 characters by 48 lines with ¼-inch-high characters and a minimum of 13 characters by 3 lines with 3-inch-high characters. RS232C and current-loop interfaces come standard. Prices start at \$4,660. **Mystic Valley Engineering Co. Inc.**, 400 W. Cummings Park, Woburn, Mass. 01801, (617) 933-9383.

Circle No 319

### Asynchronous terminal features ergonomic design

The model 7811 asynchronous terminal has a detached, low-profile keyboard and a non-glare, high-contrast, 12-inch display screen. The tilt-and-swivel screen features a 24-line-by-80-column format, displays a 128-character set and supports reverse video, underline and reduced-intensity attributes. The 93-key keyboard includes 14 function keys and a numeric keypad. The product provides 45 special characters for foreign languages and 64 graphics characters and transmits data over an RS232 asynchronous link at selectable baud rates from 300 to 19.2K. \$695. **Paradyne Corp.**, 8550 Ulmerton Road, Largo, Fla. 33540, (813) 530-2000.

Circle No 320



### Video display is TeleVideo 950-compatible

Code-compatible with the TeleVideo 950, the Smart Link 150 terminal features a tilt-and-swivel display, a 12-inch, non-glare, green or amber phosphor screen and a detached, low-profile, DIN-standard keyboard. The product furnishes four pages of memory that can be used as one 96-line page or four independent pages. Other features include 11 programmable function keys, soft setup, full editing, protected fields, smooth or jump scroll, 15 independent baud rates as high as 19.2K bps and business graphics. \$895. **Link Technologies Inc.**, 1887 O'Toole Ave., San Jose, Calif. 95131, (408) 943-0142.

Circle No 321

# New Products

## PRINTERS

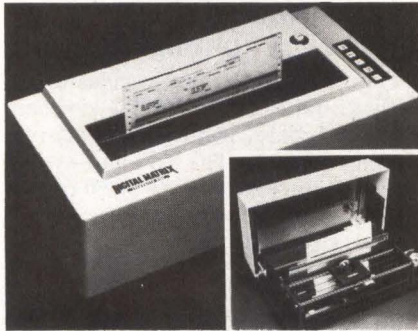

### Machine emulates journal printer

Aimed at applications in which multi-part, continuous forms are printed singly or in the demand-document mode, the 132-column Formwriter 9/132 dot-matrix printer performs like a journal printer and requires no special programming or instruction codes for normal operation. Depressing the "tear form" button advances the paper so that the last line printed or the head-of-form is brought to the tear bar for separation. Releasing the button reverses the tractors so that the head-of-form is again aligned with the print head. This setup allows handling of continuous forms in demand-document mode while printing within  $\frac{1}{8}$  inch of the top or bottom. The printer operates at 165 cps. RS232C and Centronics interfaces are standard. \$1,595. **Digital Matrix Corp.**, 105 Filley St., Bloomfield, Conn. 06002, (203) 242-3048. **Circle No 322**

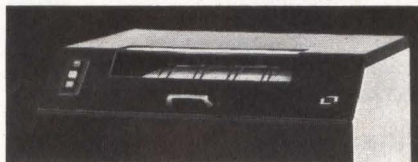

### Line printer emulates IBM 2780/3780 devices

The Innovator 202-FC line printer provides IBM 2780/3780 emulation with its built-in printer and ASCII terminal port. It supports space compression/expansion, processor-interrupt reception, conversational mode, reception of EBCDIC transparent data, vertical-format control and horizontal-format control. The device also features processor-interrupt transmission, switch-selectable 2780/3780 modes, switched network/leased-line control, auto-answer, switch-selectable ASCII/EBCDIC modes and built-in diagnostics. The printer uses chain technology and prints

at 300 lpm. It prints 80 or 132 columns on one- to six-part forms and comes in a freestanding, acoustically-damped metal enclosure. Operating noise level is less than 50 dBa. \$5,495 for the 132-column model. **Innovative Electronics Inc.**, 4714 N.W. 165th St., Miami, Fla. 33014, (305) 624-1644. **Circle No 323**



### Dot-matrix printers suit text processing

The model H80 dot-matrix printer features an 8-inch print line, 140-cps draft printing using an 11-by-9-dot-matrix pattern, 27-cps near-letter-quality printing using a 23-by-16-dot-matrix pattern, overstrike, condensed, pica, elite and expanded print modes and true superscript/subscript printing. Model H136 has the same print capabilities as model H80 but features a 15.6-inch print line. Both models include built-in, adjustable tractors, pin-addressable graphics in seven densities, down-line loading of character sets, italics, and resident international character sets. The printers can handle cut-sheet, fan-fold and roll paper. A Centronics interface is standard; an RS232 interface is optional. H80: \$699; H136: \$899. **Centronics Data Computer Corp.**, 1 Wall St., Hudson, N.H. 03051, (603) 883-0111. **Circle No 324**

### Multimode unit prints at 220 cps

The DS220 multimode matrix printer provides correspondence printing for word-processing applications, draft-quality printing for data-processing applications and dot-addressable graphics. In correspondence mode, the printer generates an 18-by-48 dot matrix for near-letter-quality appearance. Using a two-pass technique, the unit prints at 40 cps. Multiple type fonts can be selected from the operator panel or under program control. Features include two correspondence-quality fonts, two memo fonts, variable pitch draft fonts, a

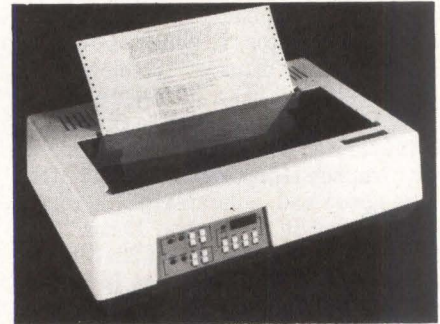

micro-character set and seven international character sets. For print-intensive applications, the unit operates at 220 cps using bidirectional logic-seeking printing. In this mode, the printer uses a 9-by-7-dot matrix and offers selectable pitches of 10, 12 and 16 cpi. The unit prints as many as 217 cpl. An RS232 and a Centronics-compatible interface are standard. \$1,995. **Datasouth Computer Corp.**, P.O. Box 240947, Charlotte, N.C. 28224, (800) 222-4528. **Circle No 325**

### Portable matrix printers operate in multiple modes

The Riteman line of 9-by-9-dot-matrix, bidirectional, logic-seeking, portable printers possess word-processing and graphics capabilities. The Riteman Plus (\$399) prints at 120 cps, offers 66 character modes and has Epson MX-80FT Type III Graftrax Plus software compatibility. The Riteman Blue Plus (\$499) prints at 140 cps, offers 128 character modes and is compatible with the IBM graphics printer and Epson RX-80FT and Epson MX-80FT Type III Graftrax Plus software. This printer also prints in elite pitch, proportional spacing and 70-cps quiet modes. The Riteman II (\$599) prints at 160 cps, offers 128 character modes and has Epson FX-80 software compatibility. It includes an 8K buffer, and prints in proportional spacing and 80-cps quiet modes. The Riteman 15 (\$799) prints at 160 cps, offers 128 character modes and is Epson FX-100 software-compatible. This printer features a 15-inch carriage and adjustable tractor feed, and prints in elite and 80-cps quiet modes. The printer also has a character set of 256 units that can be re-defined as a 9-by-11 matrix for custom character sets. **Inforunner Corp.**, 1621 Stanford St., Santa Monica, Calif. 90404, (800) 824-3044 or (800) 421-2551. **Circle No 326**

# “Only the Invitational Computer Conferences bring the latest OEM computer and peripheral products to your front door. You’ll find us there!”

And you’ll find other top OEM manufacturers, such as IBM, Control Data, DEC, Fujitsu, NEC and Seagate, to name a few.

In their 14th year, the “OEM Only” Invitational Computer Conferences bring you, the volume buying decision makers, together with the key suppliers of computer and peripheral products. The ICCs, a series of ten, one-day regional shows are convenient to where you live and work. The social business setting makes it easy for you to meet poten-

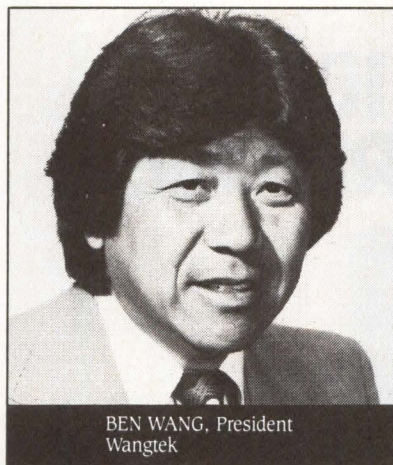

BEN WANG, President Wangtek

tial suppliers one-on-one, and attend high tech seminars of your choice. As an invited guest, there is no cost to you.

Hear what the OEM manufacturers have to say, learn more about their products, and remember, you may attend “by invitation only.”

### 1984/85 U.S. ICC Locations

Sept. 6, '84	Newton/Boston, MA
Sept. 25, '84	Southfield/Detroit, MI
Oct. 10, '84	Cherry Hill, NJ
Oct. 23, '84	Englewood/Denver, CO
Jan. 8, '85	Irvine, CA
Jan. 29, '85	Houston, TX
Jan. 31, '85	Dallas, TX
Feb. 26, '85	Ft. Lauderdale, FL
Mar. 19, '85	Palo Alto, CA
Apr. 2, '85	Nashua, NH/No. MA

Call your local OEM supplier for your invitation or fill out the coupon and mail to:

B. J. Johnson & Associates, Inc.  
3151 Airway Ave., #C-2  
Costa Mesa, CA 92626  
Phone: (714) 957-0171  
Telex: 188747 TAB IRIN



Yes! I need an invitation to your “OEM Only” ICC. The nearest ICC to me is: \_\_\_\_\_

I buy in volume:

- Computers
- Disk/Tape Drives
- Controllers/Interfaces
- Terminals/Graphic Displays
- Software
- Printers
- Memory Boards
- Modems/Multiplexers
- Power Supplies

Name \_\_\_\_\_

Title \_\_\_\_\_

Company/Division \_\_\_\_\_

Address \_\_\_\_\_

City \_\_\_\_\_ State \_\_\_\_\_ Zip \_\_\_\_\_

Mail To: B. J. Johnson & Associates, Inc., 3151 Airway Avenue, #C-2, Costa Mesa, CA 92626  
Phone: (714) 957-0171 Telex: 188747 TAB IRIN

# New Products

## DATACOMM

### Low-cost network shares resources

The Plan 2000 system links IBM PCs, PC XT's and IBM PC-compatible computers, allowing users to access shared multiuser database applications and hard disks and printers. The network consists of interface cards for each PC,

software for network-wide resource sharing and cabling. The network software features exclusive access to personal work volumes, read-only access to program libraries or information owned by other users, locks to implement multiuser applications and passwords to protect private information. Plan 2000 uses the ARCnet token-passing protocol

that has a 2.5M-bps data rate. It can link clusters of PCs—typically two to four per disk server. The PC that acts as a file server is not dedicated to network functions; it can run applications while processing network functions. File printer server program: \$750; interface cards: \$595 each. **Nestar Systems Inc.**, 2585 E. Bayshore Road, Palo Alto, Calif. 94303, (415) 493-2223.

Circle No 327

**\$1850**

## THE IBEX MAINSTREAMER<sup>®</sup>



**At \$1850\* the price is the least of the breakthroughs!**

This IBM format-compatible 9-track tape drive weighs 60% less than any equivalent system available. And occupies 25% less space. (Save up to \$200 on freight costs alone!).

It's simple and reliable. Fewer moving parts. No automatic threading failures. No noisy blower. And look at all you get:

- Storage of up to 136M bytes per reel
- Transfer rates of 20K to 160K bytes / second
- 800 bpi NRZI, 1600 and 3200 bpi PE
- Cipher / Pertec interface
- Internal diagnostics
- Mounting options: Door, Drawer or Table Top

The IBEX MAINSTREAMER. **Right for the times.**

Call, TWX or write today for the rest of the story. And for the telephone number of the sales office nearest you.

\*OEM quantities, 1600 bpi PE format, domestic prices.

**IBEX**

Right for the times

**IBEX COMPUTER CORPORATION**  
20741 Marilla St., Chatsworth, CA 91311  
(818) 709-8100-TWX 910-493-2071

CIRCLE NO. 119 ON INQUIRY CARD

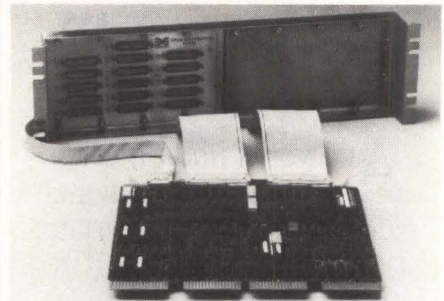

### Multiplexers work with DEC computers

The CS02 series communications multiplexer for DEC computers has two configurations. The CS02/HA configuration works with LSI-11/23 and LSI-11/23 Plus CPUs and comprises the model CC02 communications controller and the model CP22/B 16-line distribution panel that uses 25-pin connectors. The CS02/HB configuration works with Micro/PDP-11 CPUs and comprises the model CC02 communications controller and the model CP24 16-line distribution panel that uses nine-pin connectors with RS423 capability. The model CC02 printed-circuit board features bipolar microprocessor architecture that supports 16 terminals. The first four distribution lines provide full- or half-duplex modem support. The remaining 12 lines provide full-duplex-only modem support. The board features switch-selectable emulation of the DEC DHV11 or DH11 multiplexers, allowing transparent operation with installed DEC software and diagnostics. Each of the 16 lines can simultaneously transmit and receive data at speeds as fast as 38.4K baud. The controller board installs in one Q-bus backplane slot of the resident CPU. The CS02/HA and CS02/HB sell for \$2,300 each. **Emulex Corp.**, 3545 Harbor Blvd., P.O. Box 6725, Costa Mesa, Calif. 92626, (714) 662-5600 or (800) 854-7112.

Circle No 328



# New Products

## SOFTWARE

### Integrated software package runs on IBM PCjr, PC and XT

The Electric Desk, claimed to be the first integrated software productivity program for the IBM PCjr personal computer, combines spreadsheet, word-processing, database-management and communications functions. The program also runs on the IBM PC and PC XT computers. The product provides concurrent operations, a windowing feature, a macro programming language and context-sensitive help screens. Use of function keys simplifies program operation.

The word-processing program offers automatic page numbering, headers and footnotes; copy and insert text; continuous justification; on-screen center, bold and underline; and the ability to print six type styles with a dot-matrix printer. Users can insert information, such as from a database or a spreadsheet, into the document using Electric Desk's windowing and cut-and-paste facility. Users can also open as many as nine documents simultaneously.

The spreadsheet occupies 255 rows by 255 columns. It features variable cell widths, numeric formats, text formats and automatic recalculations. The spreadsheet's viewport (windows) function allows a user to see two views of a spreadsheet on the screen at once.

The database can have as many as 50 fields and 1,000 characters per record and as many as 65,000 records per file. Users can define as many as five index fields. Field types include alpha, numeric and capitalized. Field attributes can

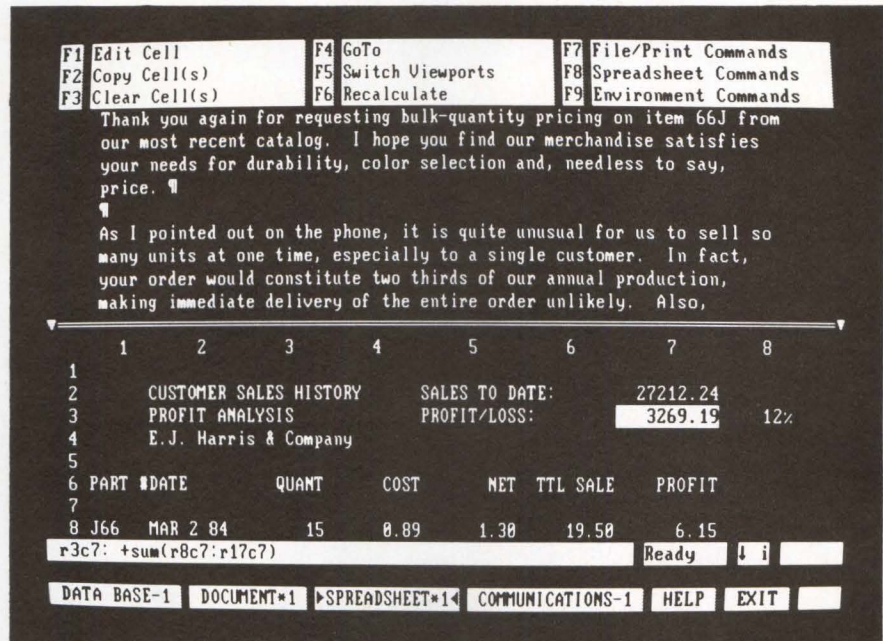

Alpha's Electric Desk provides a windowing function that enables users to move screen information between spreadsheet and word-processing documents simultaneously.

be set as underline, reverse video and bold. The database can also automatically dial a phone number.

The communications service transmits information at eight baud rates from 110 bits per second (bps) to 9,600 bps. It provides electronic mail and enables users to access commercial databases and automatically dial telephone numbers stored in a Rolodex-like file.

Priced at \$295, the Electric Desk for

the PCjr requires 128K bytes of RAM and one disk drive. Most of the program code resides on ROM cartridges, and the remaining code resides on diskette. The IBM PC and PC XT versions require 256K bytes of RAM and one disk drive and sells for \$345. Alpha Software Corp., 300 B St., Burlington, Mass. 01803, (617) 229-2924.

Circle No 329

### BASIC language version displays program flow

The Professional BASIC language accesses the full memory of the IBM PC and can use the 8087 coprocessor. It contains a window-oriented system of more than 12 tracing and debugging screens. Users can view changes in variables or array elements and the progress of FOR...NEXT loops or GOSUBS as a program executes. The package provides a dynamic syntax-checking feature and permits labeled GOSUBS, cross-referencing and the setting of breakpoints. The product is written in

assembler and requires 256K bytes of RAM. \$345. Morgan Computing Co. Inc., 10400 N. Central Expressway, Suite 210, Dallas, Texas 75231, (214) 739-5895.

Circle No 330

### Software emulates many terminals

The Impersonator communications software package for IBM PC and IBM PC-compatible microcomputers features emulations of seven CRT terminals, an

auto-dial directory and file-transfer and internal text-editing capabilities. With the Impersonator, an IBM PC can emulate Lear Siegler's ADM-3A, DEC's VT52 and VT100, Hazeltine's Esprit, IBM's 3101, DG's D210 and TeleVideo's 912 terminals. A macro command language allows users to custom-design additional emulations and to pre-define actions in handling data transfers. The package provides more than 60 context-sensitive help screens for creating a custom emulation program. \$195. Direct.aid, P.O. Box 4420, Boulder, Colo. 80306, (303) 442-8080.

Circle No 331

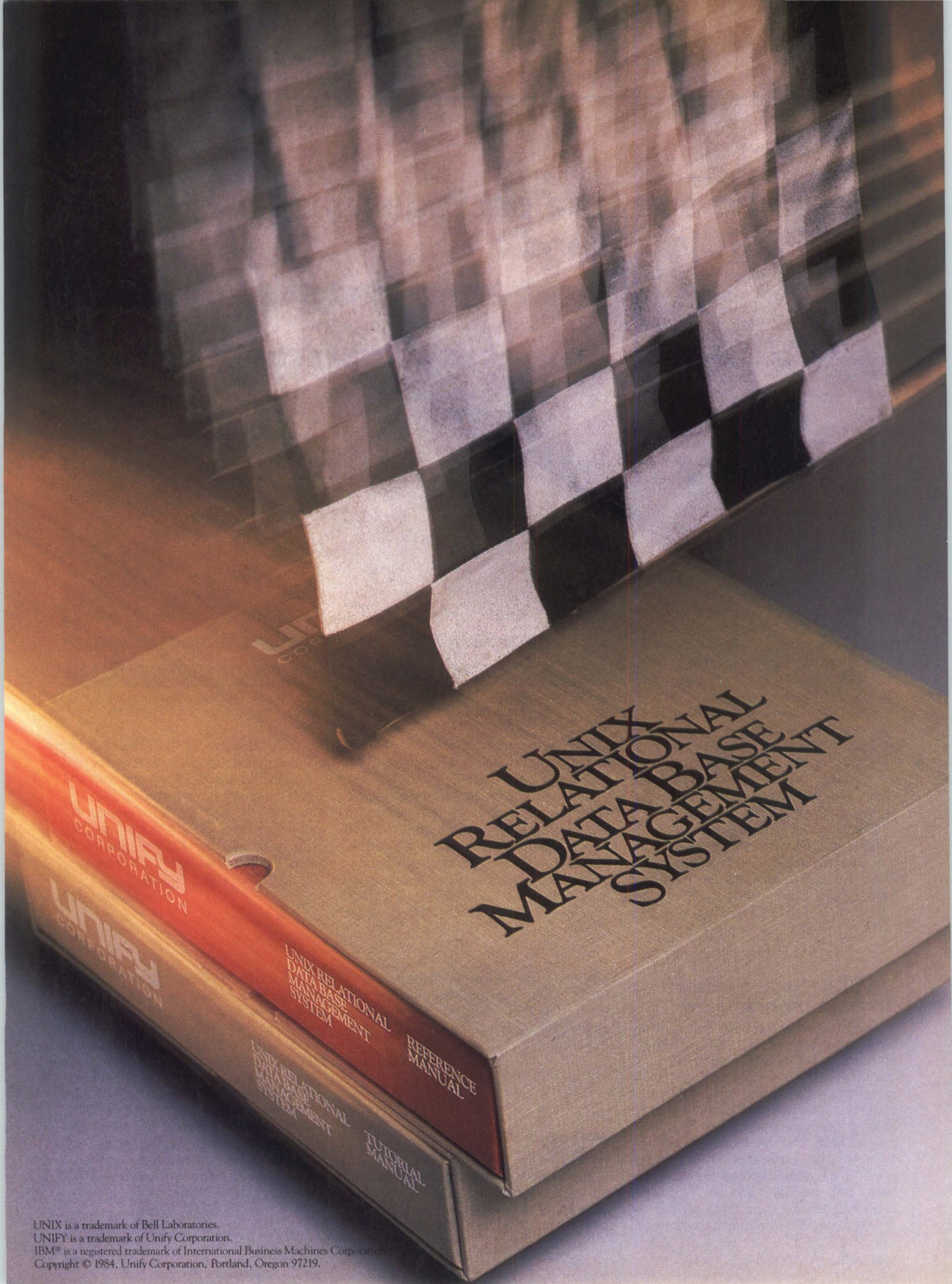

**UNIX  
RELATIONAL  
DATABASE  
MANAGEMENT  
SYSTEM**

**UNIFY  
CORPORATION**

**UNIFY  
CORPORATION**

UNIX RELATIONAL  
DATABASE  
MANAGEMENT  
SYSTEM

REFERENCE  
MANUAL

UNIX RELATIONAL  
DATABASE  
MANAGEMENT  
SYSTEM

TUTORIAL  
MANUAL

UNIX is a trademark of Bell Laboratories.  
UNIFY is a trademark of Unify Corporation.  
IBM® is a registered trademark of International Business Machines Corporation.  
Copyright © 1984, Unify Corporation, Portland, Oregon 97219.



# UNIFY FINISHES FIRST!

In one independent competition after another, UNIFY has proved itself the fastest UNIX data base management system. No wonder it's been selected by more computer manufacturers than all other UNIX data bases combined.

UNIFY speeds you through development and expedites program execution with some of the most powerful utilities of all, including:

Fully menu-driven design.

A powerful screen handling package that helps you format screens quickly, with no coding required.

Raw I/O, that lets you bypass the UNIX file system for up to 40% faster performance in large data bases.

Built-in optimizers that select the fastest of four data access methods.

Industry standard IBM SQL query language, plus our powerful report

writer, for easy access by end-users.

Ninety subroutines for advanced program development... the most complete package of its kind.

UNIFY's integrated design links program modules like screens, query language and report writer to help you quickly create complete, friendly, easily expandable applications.

#### **Horsepower for the long run.**

Unlike other data bases, UNIFY won't slow down under the weight of additional data or multiple users. It's built with the power to support new features later.

**Judge for yourself.** Send for our 300-page tutorial and 500-page reference manual—yours for only \$95—that show you how to build virtually any application. Contact UNIFY, Dept. MMS-8, 9570 S.W. Barbur Blvd., Portland, OR 97219, 503/245-6585.

**UNIFY®**  
**THE PREFERRED UNIX DBMS.**

CIRCLE NO. 120 ON INQUIRY CARD

# “Only the Invitational Computer Conferences bring the latest OEM computer and peripheral products to your front door. You’ll find us there!”

And you’ll find other top OEM manufacturers, such as Bull Peripheriques, IBIS, Fujitsu, Tandberg, Tandon, Olivetti and Control Data, to name a few.

In their 4th year, the “OEM Only” Invitational Computer Conferences bring you, the volume buying decision makers, together with the key suppliers of computer and peripheral products. The ICCs, a series of six, one-day regional shows are convenient to where you live and

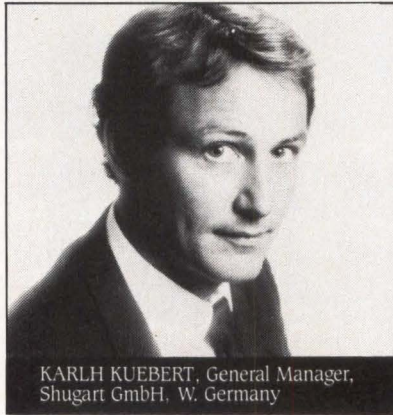

KARLH KUEBERT, General Manager, Shugart GmbH, W. Germany

work. The social business setting makes it easy for you to meet potential suppliers one-on-one, and attend high tech seminars of your choice. As an invited guest, there is no cost to you.

Hear what the OEM manufacturers have to say, learn more about their products, and remember, you may attend “by invitation only.”

### 1984/85 Europe ICC Locations

- Oct. 9, '84 Munich, W. Germany
- Oct. 16, '84 Vienna, Austria
- Oct. 23, '84 Milan, Italy
- Feb. 28, '85 Paris, France
- Mar. 7, '85 Frankfurt, W. Germany
- Mar. 14, '85 London, England

Call your local OEM supplier for your invitation or fill out the coupon and mail to:

B. J. Johnson & Associates, Inc.  
3151 Airway Ave., #C-2  
Costa Mesa, CA 92626  
Phone: (714) 957-0171  
Telex: 188747 TAB IRIN



Yes! I need an invitation to your “OEM Only” ICC. The nearest ICC to me is: \_\_\_\_\_

I buy in volume:

- Computers
- Disk/Tape Drives
- Controllers/Interfaces
- Terminals/Graphic Displays
- Software
- Printers
- Memory Boards
- Modems/Multiplexers
- Power Supplies

Name \_\_\_\_\_

Title \_\_\_\_\_

Company/Division \_\_\_\_\_

Address \_\_\_\_\_

City \_\_\_\_\_ State \_\_\_\_\_ Zip \_\_\_\_\_

Mail To: B. J. Johnson & Associates, Inc., 3151 Airway Avenue, #C-2, Costa Mesa, CA 92626  
Phone: (714) 957-0171 Telex: 188747 TAB IRIN

# New Products

## SUBASSEMBLIES

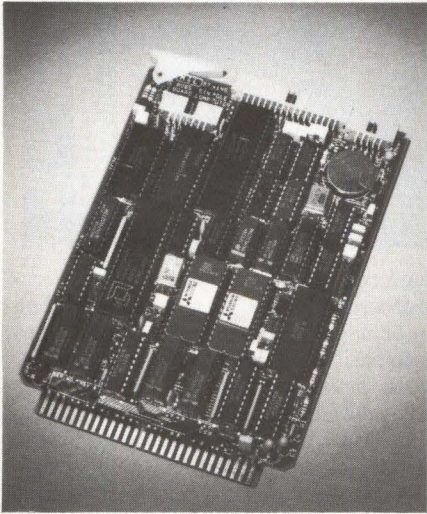

### Board furnishes 8085A processor functions

The single-board STD-145 computer furnishes an 8085A processor on an STD-bus-compatible card. Two 28-pin JEDEC sockets accept EPROM memories and static RAMs. The product features a battery-backed time-of-day clock, a full-duplex serial USART port, 24-bit programmable parallel I/O and three programmable counter/timers. It accommodates ROM/RAM implementations as small as 2K bytes or as large as 64K bytes, and the RAM can be battery-backed. The card's peripheral functions are I/O-mapped and occupy 32 consecutive locations. Users can set the base address of the on-board I/O at 32-byte boundaries. \$325. **Micro-Link Corp.**, 14602 N. U.S. Highway 31, Carmel, Ind. 46032, (317) 846-1721 or (800) 428-6155. **Circle No 332**

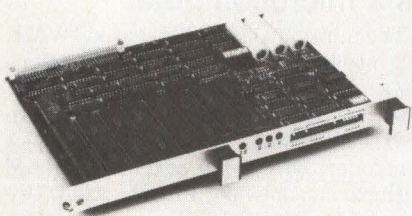

### VMEbus memory board provides 128K bytes

Providing 128K, 64K or 32K bytes, the model MM-6500C memory board is compatible with 16-bit VMEbus microcomputers. It employs low-power, 8K-by-8 or 2K-by-8 CMOS static RAMs, which users can mix with 2764 or 2716

EPROMs, respectively. Three redundant, on-board, paralleled and separately fused backup batteries ensure operation in the event of a power failure. An on-board, real-time calendar/clock provides programmable, periodic, switch-selectable interrupts that occupy 32 locations in the memory map. Other features include 24-bit addressing of as much as 16M bytes and 220-nsec. cycle and access times. The 128K-byte, rechargeable-battery version sells for \$1,175. **Micro Memory Inc.**, 9436 Irondale Ave., Chatsworth, Calif. 91311, (213) 998-0070. **Circle No 333**

### Adapters interface controllers to LSI-11 bus

The TDL-11WD and TDL-11SA dual-width host adapters reside on the DEC LSI-11 bus and interface to a variety of Winchester disk controllers. Both versions emulate DEC RLX11/12 controllers with RL01/02 disk drives and are

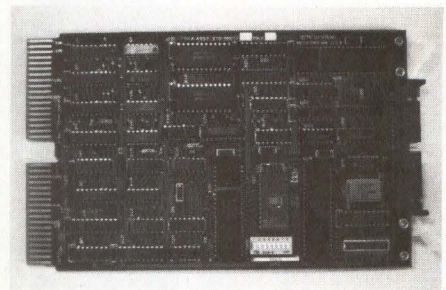

software-compatible with DEC LSI-11 operating systems. The products feature multiple-sector buffering and perform host-transparent flaw mapping. The TDL-11WD interfaces to Western Digital's WD100X family of controllers, which handle as many as four 5¼- or 8-inch Winchester disk drives that have standard ST-506 or SA1000 interfaces. The TDL-11SA interfaces to SASI bus controllers. \$575 for either version. **TD Systems Inc.**, 7 Williams St., Medford, Mass. 02155, (617) 391-1166. **Circle No 334**

# Heavy duty.

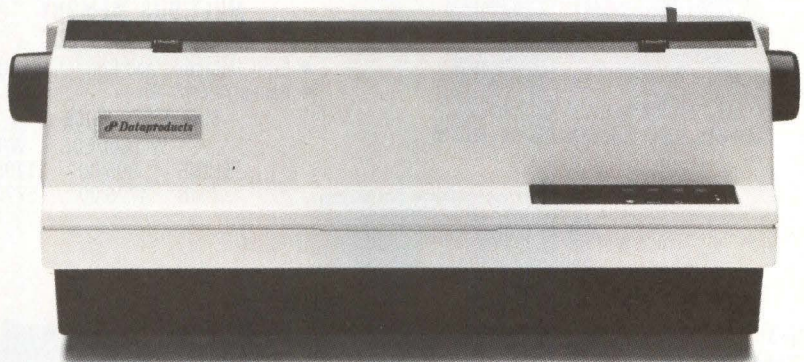

If you can't afford printer downtime, pick the ones designed to take all the punishment you can dish out and still keep printing. Our 35 and 55 character-per-second daisywheels print sheaves of crisp, sharp letters at doubletime, with never a moan or groan. Call your distributor. Or contact Dataproducts at (213) 887-3924, 6200 Canoga Avenue, Woodland Hills, CA 91365. In Europe, 136-138 High Street, Egham, Surrey, TW 20 9HL England.

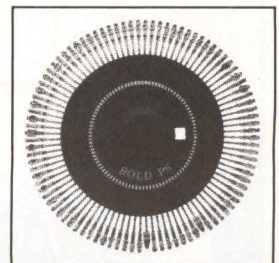

## Dataproducts Daisywheel Printers

CIRCLE NO. 122 ON INQUIRY CARD

# New Products

## SUBASSEMBLIES

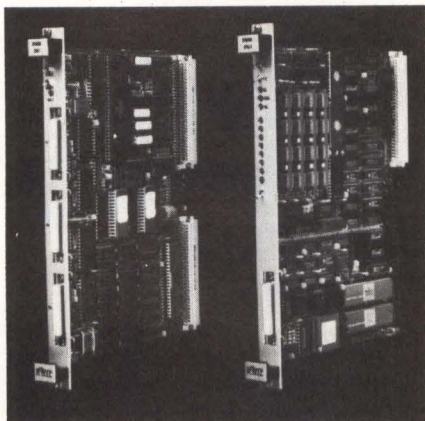

### CPU boards suit industrial applications

Aimed at industrial applications, the CPU-1B and CPU-2 boards work with the 68000 microprocessor and the VMEbus. The CPU-1B board incorporates an 8- or 10-MHz 68000 microprocessor, 128K or 512K bytes of dynamic RAM, three RS232 I/O ports (110 to 38,400 baud) and one parallel I/O

port. It also features a 24-bit programmable timer, an on-board, real-time clock with battery and sockets for 128K bytes of EPROM or as much as 16K bytes of static RAM. The CPU-2 board incorporates an 8- or 10-MHz 68000 or 68010 microprocessor and from 128K bytes to 1M byte of dynamic RAM. It also contains support circuits for as many as four SA460-compatible 5¼-inch floppy disk drives. Both boards include on-board operating firmware that facilitates up- and down-loading of S-record format program transfers. CPU-1B: \$907 (100 units); CPU-2: \$1,432 (100 units). **Force Computers Inc.**, 2401 Mission College Blvd., Santa Clara, Calif. 95054, (408) 988-8686.

Circle No 335

### Management system serves small factories

Intended for small manufacturers, the StarMate industrial productivity-management system monitors as many as 20 machines that perform repetitive



manufacturing of discrete parts. Microprocessor-based local monitors installed on or near the manufacturing machines automatically gather data on status, cycle time and downtime; operators input data on scrap and rejects as problems occur. An IBM PC, located off the factory floor, serves as the system's CPU. Users can view real-time data in color-coded graphics and tabular displays on the IBM PC and send the data to a printer or store it on disk. Approximately \$20,000. **PlantStar Inc.**, 725 Concord Ave., Cambridge, Mass. 02138, (617) 661-1950. Circle No 336

## UNFORGETTABLE MEMORIES MULTIBUS — QBUS

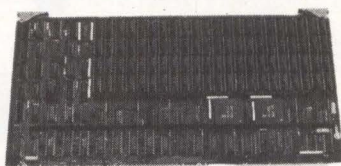

### MULTIBUS MEMORY 512KB TO 2MB EDC

- Error Detecting and Correcting (EDC)
- Faster Access Times

#### SINGLE QTY. PRICE

	Without/EDC	W/EDC
512KB	895.00	1495.00
2MB	4775.00	5775.00

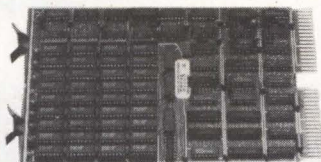

### Q-BUS MEMORY 256KB TO 4MB

- Battery Backup Mode
- Block Mode DMA, ECC or Parity
- Works with LSI-11, J-11, MicroVAX

#### SINGLE QTY. PRICE

1MB	1975.00
256KB	525.00

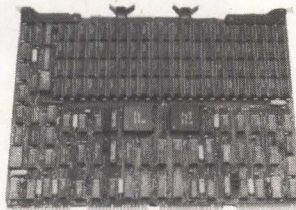

"OFFERING QUALITY WITH AFFORDABLE PRICING"



**Chrislin Industries, Inc.**

31352 Via Colinas • Westlake Village, CA 91362 • 818-991-2254  
TWX 910-494-1253 (CHRISLIN WKVG)

J-11, LSI-11, MicroVAX, Q-BUS are trademarks of Digital Equipment Corporation. MULTIBUS is a trademark of Intel Corporation.

CIRCLE NO. 123 ON INQUIRY CARD

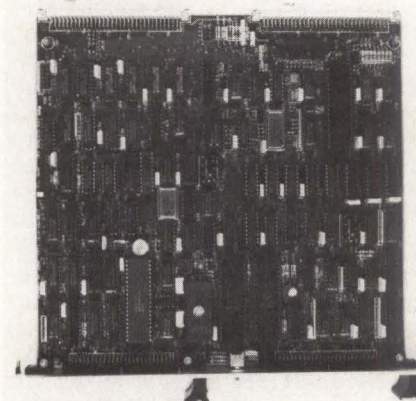

### Disk controller doubles as a microcomputer

The multipurpose Z80A-based DVME 712 intelligent disk controller functions as a general-purpose microcomputer. The card operates as a master or a slave on the VMEbus. It provides a DMA controller, 64K bytes of dynamic RAM with parity, one boot PROM socket, two serial I/O channels, a dual-density floppy disk controller and an SASI Winchester host adapter. One serial I/O channel can be configured synchronously with a maximum data rate of 800K bps and provides software selection of RS232C or RS422 drivers. \$2,000. **DY-4 Systems Inc.**, 1475 S. Bascom Ave., Suite 202, Campbell, Calif. 95008, (408) 377-9822. Circle No 337

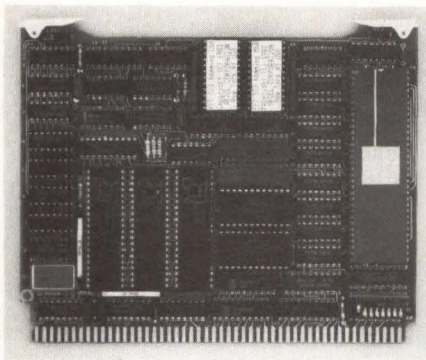

### Board performs fast Fourier transforms

The model FFT 523 single-card FFT processor plugs into a single backplane slot of HP's Series 200 desktop computers. Execution of a single program line in BASIC or Pascal performs an FFT. Supplied disk-based, machine-language driver routines make the host/peripheral interface user-transparent. Standard algorithms include forward and inverse FFT, Hamming window and power spectral density. Operating on 16-bit

integer data, the device transforms arrays of as many as 1,024 complex points in a maximum of 9.2 msec. \$1,600. **Ariel Corp.**, 600 W. 116th St., Suite 84, New York, N.Y. 10027, (212) 662-7324.

Circle No 338

### QIC-02 tape controller resides on LSI-11 bus

Implemented on a dual-width LSI-11 bus card, the TS-11-compatible IS-QIC 2 1/4-inch cartridge-tape controller emulates the TS-11 command set, except for commands involving reading and writing a tape in reverse. The controller supports variable record sizes and 30- or 90-ips QIC-02-compatible tape drives. It also features 22-bit LSI-11 bus addressing and a 12K- or 48K-byte buffer that serves as a data cache for reads and writes. The data cache allows the controller to simulate the functions of the start/stop TS-11 tape unit while doing individual file backup. 12K-byte version: \$900; 48K-byte version: \$1,200. **Inte-**

**grated Solutions Inc.**, 2240 Lundy Ave., San Jose, Calif. 95131, (408) 943-1902.

Circle No 339

### Controller plots arcs at 800 nsec. per pixel

The dual-width VMEbus bit-mapped IV-1651 VMEgraf graphics display controller produces a 16-color display at 600-by-800-dot resolution and a four-color display at 1,024-by-1,024- or 1,280-by-768-dot resolution. Two IV-1651 cards can be synchronized to provide 16-color operation and faster plotting at the higher resolutions. The device features a hardware pixel processor that plots vectors and arcs at 800 nsec. per pixel, integer zoom and a DMA port for rapid screen updates. It can also operate in an eight-color mode using the fourth image plane memory to provide a blink attribute or a white overlay. \$1,995 with 128K bytes of display memory. **Ironics Inc.**, 117 Eastern Heights Drive, P.O. Box 356, Ithaca, N.Y. 14850, (607) 277-4060.

Circle No 340



**NEW**

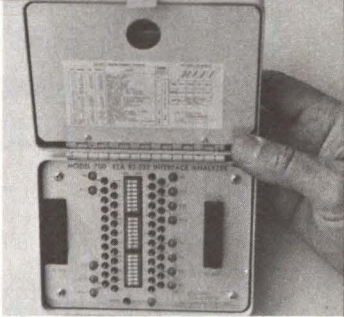

TRI STATE DISPLAY!!!  
RS232C INTERFACE  
ANALYZER WITH  
TRI STATE LED'S  
DISPLAYS RED, GREEN  
AND OFF.

ORDER YOUR STATE OF THE ART ANALYZER TODAY!!

EXTENDED DISTANCE DATA CABLES	1000' REELS
EDC25 \$16.00 both ends & .60 per foot	EDC25 \$384
EDC12 12.00 both ends & .40 per foot	EDC12 \$215
EDC08 12.00 both ends & .30 per foot	EDC08 \$149
EDC04 11.00 both ends & .20 per foot	EDC04 \$ 93



TOLL FREE \* CALL NOW!  
800-243-5760  
203-356-9315  
CRAIG DATA CABLE CO.  
652 GLENBROOK ROAD  
STAMFORD, CT 06906

CIRCLE NO. 124 ON INQUIRY CARD

MINI-MICRO SYSTEMS/August 1984

# 9600bps MODEM \$97.\*

The MADZAR Z9600® series of short haul modems are a cost effective way to get your asynchronous data down the hall or down the street at rates from 75 to 9600 bps. The MADZAR Z9600® series out performs any other brand in its price range and it's available in a rack mount version that packs 16 short haul modems in only 5-1/4 inches of rack space.

Try a pair of our MADZAR Z9600® series short haul modems for 30 days on credit approval. Then decide. Be particular. Buy the best and join the ranks of our growing list of customers like General Electric, NASA, Aerojet Strategic and General Dynamics to name just a few.

Want more information? Call or write us now for a brochure and complete pricing. (We have generous discounts for quantity buyers).





37490 Glenmoor Drive  
Fremont, CA 94536-9990  
415/794-7400  
\*100 Unit Price

CIRCLE NO. 125 ON INQUIRY CARD

261

# New Products

## LITERATURE

### Report projects 1984-1985 micro sales

Compiled from a survey of top-level DP/MIS executives from more than 150 of the largest U. S. companies, the 1984 edition of *Microcomputer Usage Trends in Fortune Corporations* presents quantitative data and insights on microcomputer sales estimates for Fortune companies. The 250-page report projects 1984 and 1985 sales of specific desktop and portable computers and identifies the key factors that influence brand selection. \$750. **Newton-Evans Research Co. Inc.**, Suite 204, Bethany 40 Center, 10176 Baltimore National Pike, Ellicott City, Md. 21043, (301) 465-7316.

Circle No 341

### Catalog lists ANSI standards

The 1984 edition of the *Catalog of American National Standards* lists approximately 8,000 ANSI-approved stand-

ards. The standards establish dimensions, ratings, terminology, symbols, test methods and performance and safety requirements for materials, equipment and products. The 168-page catalog alphabetically lists titles of all standards under subject headings. Each entry includes title, designation, price and discount information. \$10. **American National Standards Institute Inc.**, 1430 Broadway, New York, N.Y. 10018, (212) 354-3315.

Circle No 342

### Guide covers CAD/CAM products

The 1,100-page *Directory of Computer Graphics and CAD/CAM* indexes more than 3,000 products from more than 1,000 vendors into more than 60 categories by name, function and vendor. Each listing describes a product, when it became available, the number of users, the price, configuration requirements and programming languages

used. Listings on each supplier include locations, size, areas of specialization, agents and contacts. \$185. **Computing Publications Inc.**, 401 First Federal Building, Pottstown, Pa. 19464, (215) 326-5188.

Circle No 343

### Report examines Winchester disk drives

Compiled by Jonah McLeod, *Winchester Disks in Microcomputers* examines the disk memory industry. The 180-page report analyzes recent technological developments and their applications, surveys the main suppliers and details major products. With more than 50 diagrams and illustrations, the report covers the problems of backup, read/write heads, disk media and system integration. \$95. **Elsevier Journal Information Center**, 52 Vanderbilt Ave., New York, N.Y. 10164, (212) 867-9040.

Circle No 344

## MAGNETIC TAPE SYSTEM

for IBM System/34/36/38  
and Model 5362

Connects to  
communication line  
directly or via modem

Communicate  
tape-to-host,  
tape-to-tape,  
tape-to-print,  
tape-to-PBX

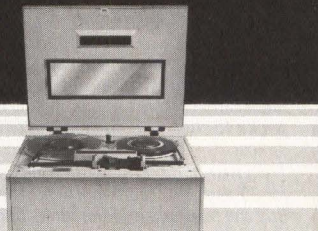

Complete tape utility software  
package permits file read/write to or from tape

Ideal for applications including:

- Mainframe data transfer
- Service bureaus
- Banking, brokerage and insurance company data exchange, microfiche
- Medical insurance reporting
- Telephone system billing/recordkeeping
- Mailing list maintenance, sales
- Collection agency recordkeeping
- IBM bisynchronous tape communication
- Asynchronous data logging, communication

Request full technical details today.

**GENERAL SYSTEMS CENTER, INC.**

A data communications company

95 Centershore Road • Centerport, NY 11721

Telephone: (516) 754-9140

CIRCLE NO. 133 ON INQUIRY CARD

## Wondering Where To Turn Next?

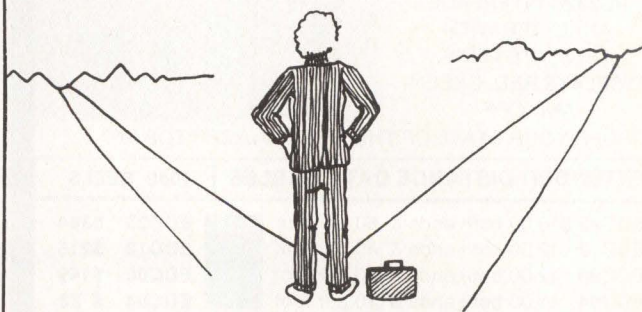

## Turn To Mini-MicroSystems

## Career Opportunities Section

CIRCLE NO. 134 ON INQUIRY CARD



# EXCELLENCE FOUND

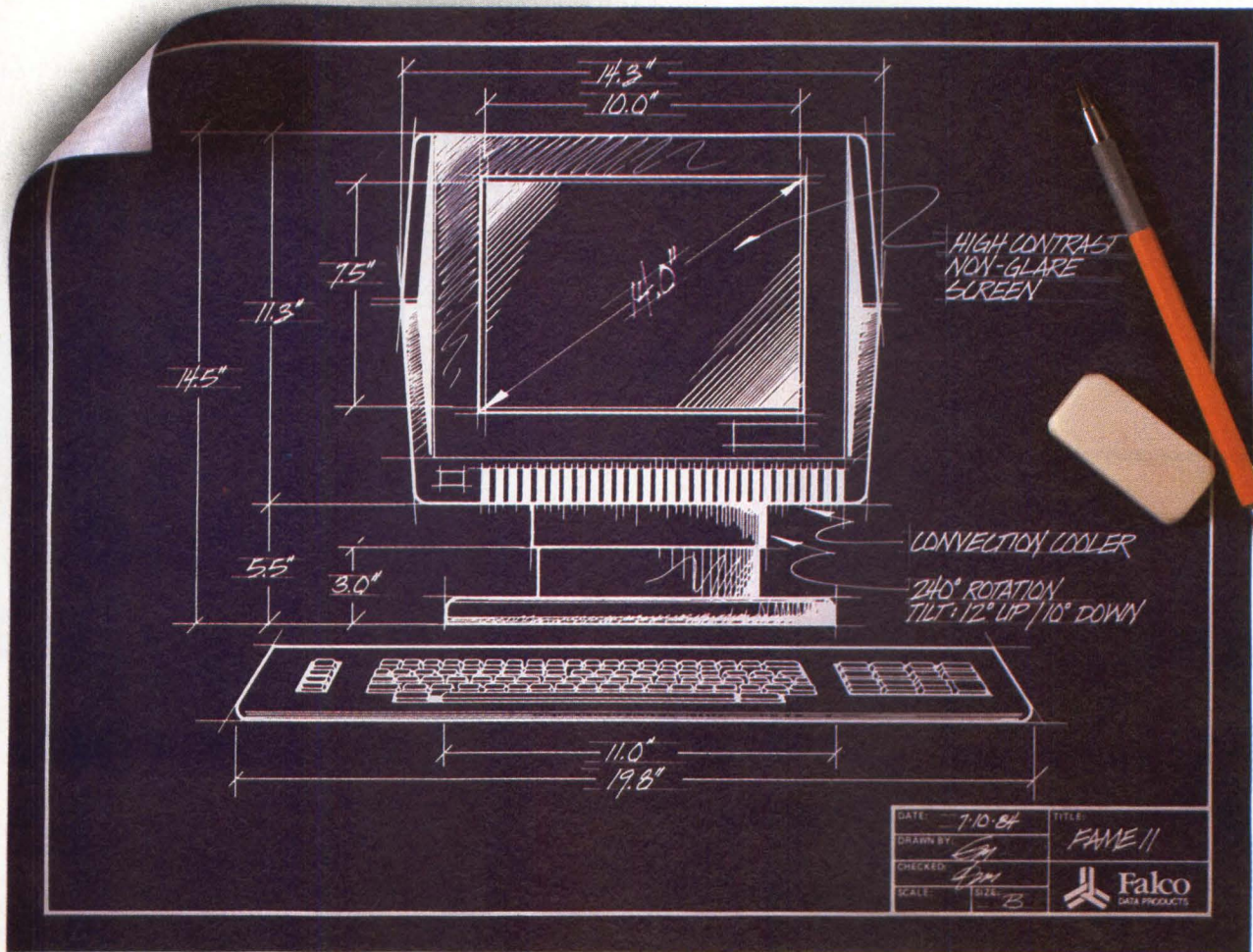

- FAME II's advanced features make it the perfect multi-purpose terminal.
- VT100 compatible (ANSI 3.64) and VT52 mode with 80/132 columns
  - TVI 925 mode with 2 pages of memory
  - 24 or 25 lines plus status and user line
  - 50 non-volatile programmable function keys with 900-character storage (77 per key)
  - Two independently configurable communications ports
  - Block and monitor modes
  - Transparent print
  - Soft extension port

- Screen saver (protects screen from burned-in shadows)
- Full page or single line soft screen set-up
- Buffered printer port
- Standard line character graphics plus 64 mosaic characters

Whether you choose our top-of-the-line FAME 100, or our low-cost FAME III, you get a lot more terminal for a lot less money.

For more information call toll free:

**800-538-5383** (within California)    **800-835-8765** (outside California)

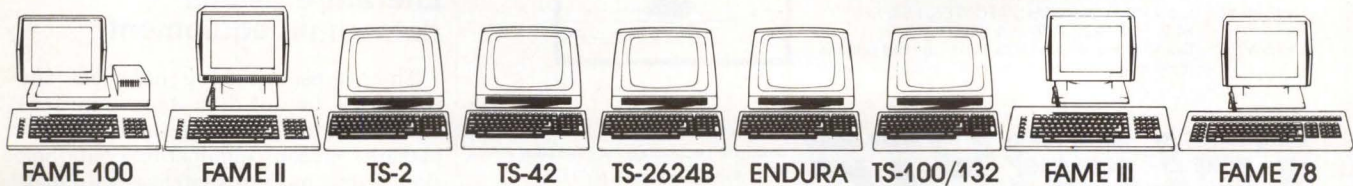

## FALCO DATA PRODUCTS

WESTERN REGIONAL OFFICE  
1286 Lawrence Station Road  
Sunnyvale, CA 94089  
(408) 745-7123

SOUTHERN REGIONAL OFFICE  
2091 Business Center Drive  
Suite 100  
Irvine, CA 92715  
(714) 476-3111

CENTRAL REGIONAL OFFICE  
9801 West Higgins Road  
Suite 220  
Rosemont, Illinois 60018  
(312) 823-5340

EASTERN REGIONAL OFFICE  
855 Valley Road  
Suite 1000  
Clifton, New Jersey 07013  
(201) 472-2801

# New Products

## LITERATURE

### Publications list PDP-11 application software

The two-volume second edition of the PDP-11 Software Source Book covers more than 1,500 PDP-11 software products in 33 categories. Volume 1 describes application software for engi-

neering, accounting and finance, and Volume 2 details system software, such as language processors, operating systems, communications, tools and utilities. Each listing provides the program name; operating systems under which it runs; its price; and its vendor's name, address and telephone number. **Digital**

**Equipment Corp., Printing and Circulation Services**, 444 Whitney St., Northboro, Mass. 01532.

Circle No 345

# MAG TAPE POWER FOR YOUR PC!

Microcomputer users and vendors can now add nine-track, main-frame-compatible tape drives to their single- and multi-user systems and reap the benefits of having the only TRUE STANDARD for DATA INTERCHANGE WORLD-WIDE. Choose from two drives: the hi-performance 75ips (non-vacuum coluum) drive, and the auto-loading 45ips drive. Both come with the following interfaces.

- RS-232C: supports full handshaking and async/bisync/isosync protocols.
- IEEE-488: supports subsets SH1, AH1, TE5, LE3, SR1, RL2, PP2, DC1, DT0 and CO.
- IBM-PC: DMA interface with DOS 2.0 driver and utilities, including hard-disk fast copy.

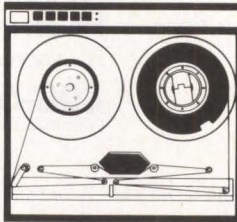

# TELEBYTE

TDX Peripherals Division  
Telebyte Technology Inc., 148 New  
York Avenue, Halesite, NY 11743  
(516) 423-3232

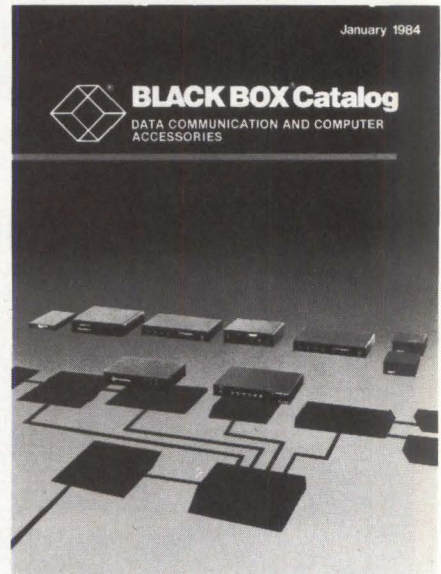

### Catalog details 300 datacomm devices

This data-communications catalog lists more than 300 devices, including cables, data switches, junction panels, wall plates, modems, line drivers, interface test sets, data concentrators, data multiplexers, protocol converters, interface converters, code converters, speed converters, printer interfaces, printer spoolers and station protectors. The catalog describes each product with text, photographs, diagrams and price. **Black Box Corp.**, P.O. Box 12800, Pittsburgh, Pa. 15421, (412) 746-5500.

Circle No 346

### Literature details datacomm equipment

This 20-page catalog describes the company's line of data-communications equipment including statistical multiplexers, modem eliminators, data-link simulators, modem switches, auto dialers and data-protection devices. **Datatel Inc.**, Department DK, Pin Oak and Springdale Roads, Cherry Hill Industrial Center, Cherry Hill, N.J. 08003, (609) 424-4451.

Circle No 347

CIRCLE NO. 127 ON INQUIRY CARD

# “With the Interphase Storerger,<sup>TM</sup> I can make a 5¼” hard disk perform like an 8” disk.”

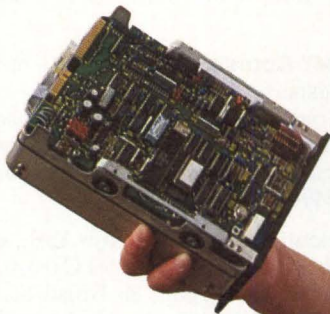

**Frank Emser**  
Manager Hardware Development  
Paradyne Corporation

The Interphase Storerger Multi-bus<sup>TM</sup> controller can give a 5¼” Winchester disk capabilities never before possible. Storerger not only gets more performance from existing ST506 drives, but also supports the new ESDI and ST412HP interfaces for more power and capacity than ever before. And since Storerger can control two Winchester disks, four ¼” tapes (QIC-02), and two 3½”, 5¼” or 8” floppies, the same controller can be used for every storage need.

Storerger features 1:1 interleave, with concurrent disk and tape transfers and simultaneous disk and bus transfers for speed and high performance. And Storerger’s unique “virtual buffer” architecture with UNIX<sup>TM</sup>-optimized

intelligent caching can reduce or eliminate disk rotational latency and overcome data overrun/underrun problems of FIFO-based controllers. Plus,

line of high-performance Multibus controllers. Interphase also offers Multibus controllers for SMD disks, local area networks and video monitors. Plus powerful disk controllers for the IBM<sup>®</sup> PC. They’re all backed by a great customer support team that works full time with Interphase customers to assure that our products work the way they should — in the system.

Find out how Storerger can make a 5¼” disk perform like an 8” disk. Call Interphase today at

(214) 350-9000.

Storerger is a trademark of Interphase Corporation  
Multibus is a trademark of Intel Corporation  
UNIX is a trademark of Bell Laboratories  
IBM is a registered trademark of International Business Machines

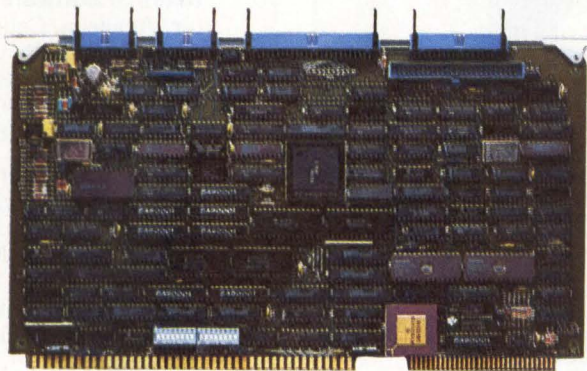

for the very first time on a controller, Storerger has an *on-board* 68000 CPU.

The Storerger controller is the latest product in Interphase’s



2925 Merrell Rd. • Dallas, TX 75229  
CIRCLE NO. 128 ON INQUIRY CARD

# PROGRAMMABLE COMMUNICATIONS TRANSLATOR



MSI's PCT-100 IS A CONFIGURABLE IN-LINE RS-232 PROTOCOL AND DATA TRANSLATOR WHICH CAN PROVIDE:

- \* TERMINAL OR PRINTER EMULATION
- \* DEC OR IBM SYSTEM COMPATIBILITY
- \* MACRO-FUNCTION KEYS
- \* "TYPE-AHEAD" AND DATA BUFFERING
- \* BAUD RATE CONVERSION
- \* HANDSHAKE PROTOCOL TRANSLATION (E.G. CTS/RTS, XON/XOFF)

THE PCT-100 CONFIGURATION IS EASILY ENTERED AND MODIFIED USING A BUILT-IN EDITOR, COMPILER, AND DEBUGGER. CODING TRANSLATION ALGORITHMS IS SIMILAR TO PROGRAMMING A CALCULATOR.

WITH POWER SUPPLY AND CASE, THE PCT-100 IS \$398 FOR SINGLE UNIT QUANTITIES.

*Method Systems Incorporated*  
3511 LOST NATION ROAD SUITE 202  
WILLOUGHBY, OHIO 44094  
(216) 942-2100

CIRCLE NO. 129 ON INQUIRY CARD

*the Black Jack™*

A NEW PORTABLE  
MODULAR JACK FOR MODEMS

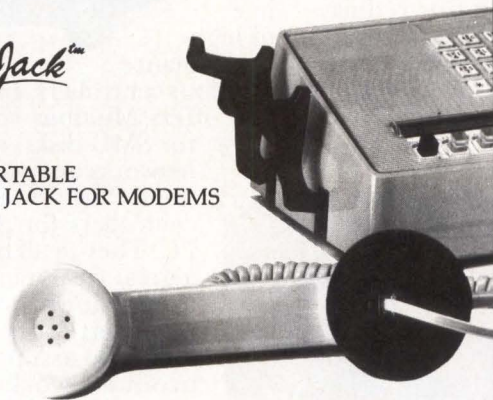

Have you ever been dealt out of telecommunications in hotels, offices and other places on the road? Why gamble on finding a telephone jack that will accept your modem. Deal yourself a winning hand with **the Black Jack**.

Simply unscrew the mouthpiece together with the microphone and carefully set them to one side. Attach **the Black Jack** on the handset, insert your RJ11C direct connect line cord from your modem and you're ready for action. You may now dial direct from your computer if your modem has Touch Tone® dialing.

If not, simply dial from the telephone itself. When your telecommunications are complete, snap off **the Black Jack** and replace the mouthpiece.

Suggested Retail Price: \$49.95.

For enduser orders contact: 1-800-227-3800 Ext. 245.

For dealer inquiries and  
OEM information contact: **the micropipheral corporation**

Patent pending.  
\*the Black Jack is a trademark of The Micropipheral Corporation. 2565 - 152nd Avenue NE, Redmond, WA 98052 (206) 881-7544

CIRCLE NO. 130 ON INQUIRY CARD

# Calendar

## AUGUST

**13-15 American Society of Mechanical Engineers (ASME) International "Computers in Engineering" Conference & Exhibit**, Hilton Hotel, Las Vegas, Nev., sponsored by ASME Contact: Mary S.H. Benedict, Exhibits Manager, or Eileen Dengler, Exhibits Administrator, ASME, United Engineering Center, 345 E. 47th St., 13M, New York, N.Y. 10017, (212) 705-7100.

**13-17 "Database '84" Course**, Wang Institute of Graduate Studies, Tyngsboro, Mass. sponsored by the Wang Institute of Graduate Studies. Contact: Roberta Wesley, Coordinator of Special Programs, Wang Institute of Graduate Studies, Tyng Road, Tyngsboro, Mass. 01879, (617) 649-9731.

**15-16 Telecommunications Seminar**, New York, sponsored by The Yankee Group. Contact: Lisa Caruso, Seminar Director, The Yankee Group, 89 Broad St., Boston, Mass. 02110, (617) 542-0100. Also to be held on Aug. 22-23 in San Francisco.

**22-24 Sixth Annual Conference on Interactive Videodisc in Education and Training**, J.W. Marriott, Washington, sponsored by the Society for Applied Learning Technology (SALT). Contact: Raymond G. Fox, SALT, 50 Culpeper St., Warrenton, Va. 22186, (703) 347-0055.

## SEPTEMBER

**5-7 National Software Show**, Anaheim Convention Center, Anaheim, Calif., sponsored by Raging Bear Productions Inc. Contact: Philip J. Russell, National Software Show, Raging Bear Productions, 21 Tamal Vista Drive, Suite 175, Corte Madera, Calif. 94925, (415) 924-1194 or (800) 732-2300.

**6-8 Halifax Computer and Office Automation Show**, Halifax Metro Centre, Halifax, Nova Scotia, organized by Industrial Trade Shows. Contact: Robert Grainger or Peter McLean, Show Managers, or James K. Mahon, Group Show Manager, Industrial Trade Shows, 20 Butterick Road, Toronto, Ontario M8W 3Z8, (416) 252-7791.

**9-12 First International Conference on Computer-Aided Technologies (COMPINT '85)**, Palais des Congres, Montreal, sponsored by the Institute of Electrical and Electronics Engineers (IEEE). Contact: Stephen G. Leahey, General Chairman, COMPINT '85, P.O. Box 577, Desjardins Postal Station, Montreal, Quebec H5B 1B7, (514) 870-3526.

**11-13 Midcon/84 High-Technology Electronics Exhibition and Convention**, Dallas, produced by Electronic Conventions Inc. Contact: Nancy Hogan or Kent Keller, Electronic Conventions Inc., 8110 Airport Blvd., Los Angeles, Calif. 90045, (213) 772-2965.

# Classified Ads

## hardware

**HEWLETT  
PACKARD**  
Desktop CAD/CAM  
Computer  
Systems



**SAVINGS ON ALL  
SERIES 200/500  
WORK STATIONS**

9836S 9000 Non-HP memory  
9020S 9826A and peripherals  
CALL OR WRITE FOR DISCOUNT PRICES

**graphia  
systems center**

Box 23051 Portland, OR 97223 USA  
503-246-0202  
International Sales Telex 360-143

CIRCLE NO. 225 ON INQUIRY CARD

This space should be  
working for you.  
For details call:



**Linda Lovett**  
(617)536-7780

## software

**MicroPERT®**  
Project Management  
for Tektronix, IBM PC, XT

For information, call or write  
**SHEPPARD SOFTWARE COMPANY**  
4750 Clough Creek Rd.  
Redding, CA 96002  
(916) 222-1553

CIRCLE NO. 226 ON INQUIRY CARD

**IBM-PC - PLOT-10**

PC-PLOT-III is an intelligent emulation of the Tektronix Model 4010 graphics terminal which runs on the IBM-PC. The program allows display and creation of picture files when connected to a host computer running PLOT-10 (tm) or compatible software. The user may save picture data files on a local diskette as they are received from the host. The program also includes local printer control, and a serial line debug mode. Utility programs included allow the drawing of a local picture data file on the screen, plotting it on a HP Model 7470A pen plotter, printing on a local printer, and scaling. VISA, MasterCard, checks, PO's accepted. \$95.00

**MicroPlot Systems Co.**  
2151 East Dublin-Granville Rd.  
Suite 205  
Columbus, OH 43229  
614-882-4786

CIRCLE NO. 227 ON INQUIRY CARD

## software

**INTEGRATED ACCOUNTING**  
System for  
CP/M Microcomputers  
GL, AP, AR, & Payroll  
Total \$300.00!  
Source Code Included  
**BASIC BUSINESS SYSTEMS**  
P.O. Box 3453,  
Reston, VA 22090

CIRCLE NO. 230 ON INQUIRY CARD

**custom equipment**

**EQUIPMENT**  
(To your spec's)  
**HARDWARE/SOFTWARE**  
[call/write Pres. ABACI INC]  
201-263-8649; 201-263-0417  
Parsippany, N.J.—Dagsboro, Del.  
07054-0136 19939-0232  
[25 Yrs. Electronics Dev.]

CIRCLE NO. 228 ON INQUIRY CARD

**inventions wanted**

**inventors, Entrepreneurs,  
Product Promoters**

wanted to display concepts at  
national technology trade show

**Call: 1-800-528-6050 X831**

CIRCLE NO. 229 ON INQUIRY CARD

## Copy Deadline:

Space reservations and advertising copy must be received by the 10th of the month preceding the issue date. Camera-ready mechanicals must be received by the 15th of the month preceding the issue date. For example, to appear in the February issue, copy must be received by January 10; mechanicals by January 15.



**Linda Lovett**  
(617)536-7780

## CLASSIFIED ADVERTISING ORDER FORM

*Mini-Micro Systems classifieds reach more mini-micro people*

**Rates: \$80.00 per column inch (non-commissionable)**  
**6x program earns 5% discount; 12x program earns 10% discount.**

There is no charge for typesetting classified listings. Plan approximately 50 average words to a column inch, 8 lines of approximately 38 characters per line (3 inch maximum). Please send clean typewritten (double-spaced) copy.

**Category:** The following categories are available; be sure to specify the category you wish to be listed under: Business Opportunities, New Literature, Selling, Buying, Trading, Seminars, Services, Software, Supplies & Accessories. (Other categories may be employed at our discretion.)

Run this ad in \_\_\_\_\_ (number issues) Reader Inquiry No. YES  NO   
Ad size 1 col. wide by \_\_\_\_\_ inches deep Under \_\_\_\_\_ (category)  
Check enclosed for \$ \_\_\_\_\_ (Pre-paid orders only)

Signature \_\_\_\_\_

Name \_\_\_\_\_ Title \_\_\_\_\_

Company \_\_\_\_\_ Telephone No. \_\_\_\_\_

Address \_\_\_\_\_

City \_\_\_\_\_ State \_\_\_\_\_ Zip \_\_\_\_\_

**MAIL TO: Linda L. Lovett, Classified Advertising, Mini-Micro Systems,  
221 Columbus Ave., Boston, MA 02116**

**BOSTON**

Robert K. Singer  
National Sales Manager  
Norma E. Lindahl  
Assistant To The National  
Sales Manager

John J. Fahey  
Regional Manager  
Katie Kress  
Sales Coordinator  
221 Columbus Ave.  
Boston, MA 02116  
(617) 536-7780

**PHILADELPHIA**

Stephen B. Donohue  
Regional Manager  
1837 Route 70, Suite 302  
Cherry Hill, NJ 08003  
(609) 751-0170

**ATLANTA**

Larry Pullman  
Regional Manager  
6445 Powers Ferry Rd.,  
Ste. 140  
Atlanta, GA 30339  
(404) 955-6500

**CHICAGO**

Robert D. Wentz  
Regional Manager  
Marianne Majerus  
Sales Coordinator  
Cahners Plaza  
1350 E. Touhy Ave.  
P.O. Box 5080  
Des Plaines, IL 60018  
(312) 635-8800

**DALLAS**

Don Ward, Regional Manager  
13740 Midway Suite 515  
Dallas, TX 75234  
(214) 980-0318

**DENVER**

John Huff  
Regional Manager  
270 St. Paul St.  
Denver, CO 80206  
(303) 388-4511

**LOS ANGELES**

Len Ganz  
Regional Manager  
12233 West Olympic Blvd.  
Los Angeles, CA 90064  
(213) 826-5818

**ORANGE COUNTY**

Debra Huisken  
Regional Manager  
2041 Business Center Dr.  
Suite 109  
Irvine, CA 92715  
(714) 851-9422

**SAN FRANCISCO**

Frank Barbagallo  
Regional Manager  
Rick Jamison  
Regional Manager  
Janet Ryan  
Regional Manager  
Laura Obradovic  
Sales Coordinator  
Sherman Building, Suite 1000  
3031 Tisch Way  
San Jose, CA 95128  
(408) 243-8838

**AUSTRIA**

Elan Marketing Group  
Neutor g. 2  
P.O. Box 84  
1010 Vienna, Austria  
Tel: 43-222-663012 or -638461

**BENELUX**

Elan Marketing Group  
Boschdijk 199B  
5612 HB Eindhoven  
The Netherlands  
Tel: 32-40-455724

**ISRAEL**

Elan Marketing Group  
13 Haifa St., P.O. Box 33439  
Tel Aviv, Israel  
Tel: 972-3-252967 or -268020  
Telex: 341667

**JAPAN**

Tomoyuki Inatsuki  
General Manager  
Trade Media Japan Inc.  
R. 212 Azabu Heights  
1-5-10 Roppongi Minato-ku,  
106, Japan  
Tel: (03) 587-0581

**TAIWAN**

Mr. Donald H. Shapiro  
Trade Winds, 2nd Floor  
132 Hsin Yi Road, Sec. 2  
Taipei, Taiwan

**UNITED KINGDOM**

Elan Marketing Group  
5th Floor, Suite 10  
Chesham House  
136 Regent St.  
London W1R 5FA  
Tel: 437-6900  
Telex: 26153

**SWEDEN**

Elan Marketing Group  
Humlegardsgatan Nr. 5  
11446 Stockholm, Sweden  
Tel: 46-8-677243 or -676243

**WEST GERMANY**

Elan Marketing Group  
Sudring 53  
7240 Norb/Neckar, West Germany  
Tel: 49-7451-7828

**Mini-Micro Marketplace**

Helen Benedict  
221 Columbus Ave.  
Boston, MA 02116  
(617) 536-7780

**Direct-Response Postcards**

Carol Anderson  
221 Columbus Ave.  
Boston, MA 02116  
(617) 536-7780

**Career Opportunities**

Peggy Gordon  
Recruitment Advertising Manager  
P.O. Box 10277  
8 Stamford Forum  
Stamford, CT 06904  
(203) 328-2550

**Cahners Magazine Division**

J.A. Sheehan, President  
William Platt  
Executive Vice President, Tom Dellamaria  
VP/Production  
Ira Siegel, VP/Research

**Promotion Staff**

Susan Rapaport  
Marketing Communications Director  
Wendy Whittemore  
Promotion Coordinator  
Mary Gregory  
Promotion Coordinator  
Liz Phillips  
Promotion Assistant

**Circulation**

Denver, CO:  
(303) 388-4511  
Sherri Gronli  
Group Manager

# Calendar

**11-13 Mini/Micro Southwest '84 Computer Conference and Exhibition**, Dallas, produced by Electronic Conventions Inc. Contact: Nancy Hogan or Kent Keller, Electronic Conventions Inc., 8110 Airport Blvd., Los Angeles, Calif. 90045, (213) 772-2965.

**11-14 "Distributed Processing: Mini & Microcomputer Implementation" Course**, Washington, sponsored by Integrated Computer Systems. Contact: Ruth Dordick, Integrated Computer Systems, 6305 Arizona Place, P.O. Box 45405, Los Angeles, Calif. 90045, (213) 417-8888, (800) 352-8251 or (800) 421-8166. Also to be held on Sept. 25-28 in Boston, Oct. 2-5 in Palo Alto, Calif., and Oct. 30-Nov. 2 in Long Island, N.Y.

**11-14 "Data Communications" Course**, Washington, sponsored by Integrated Computer Systems. Contact: Ruth Dordick, Integrated Computer Systems, 6305 Arizona Place, P.O. Box 45405, Los Angeles, Calif. 90045, (213) 417-8888, (800) 352-8251 or (800) 421-8166. Also to be held on Sept. 25-28 in San Diego, Nov. 13-16 in Boston and Nov. 27-30 in Los Angeles.

**12-14 Fifth Annual Software/Expo**, Hyatt Regency, Chicago, organized by PEMCO News Bureau. Contact: Richard Lewis, Software/Expo, 2400 East Devon Ave., Suite 205, Des Plaines, Ill. 60018, (313) 299-3131 or (800) 323-5155.

**17-19 "Industrial Robots" Course**, Center for Robotics Research of the University of Cincinnati, Cincinnati, sponsored by the University of Cincinnati. Contact: Susan Lyons, Mechanical and Industrial Engineering Department Mail Location #72, University of Cincinnati, Cincinnati, Ohio 45221, (513) 475-4387 or (513) 475-2738.

**17-19 Data Storage '84**, Fairmount Hotel, Denver, sponsored by **Disk/Trend** Inc. and Freeman Associates. Contact: Carlidge & Associates Inc., 4030 Moorpark Ave., Suite 205, San Jose, Calif. 95117, (408) 554-6644.

**17-24 FOC/LAN '84**, Las Vegas, Nev., sponsored by Information Gatekeepers Inc. Contact: Michael O'Bryant, General Manager, Information Gatekeepers Inc., 138 Brighton Ave., Boston, Mass. 01234, (617) 787-1776.

**18-20 SEMICON/East '84**, Boston, sponsored by Semiconductor Equipment and Materials Institute Inc. Contact: Mary Beth Kern, Semiconductor Equipment and Materials Institute, 625 Ellis St., Suite 212, Mountain View, Calif. 94043, (415) 964-5111.

**18-20 Federal Computer Conference**, Washington Convention Center, Washington, sponsored by National Council for Education on Information Strategies. Contact: (617) 358-5301.

**18-21 "Implementing Local-Area Networks" Course**, San Diego, sponsored by Integrated Computer Systems, 6305 Arizona Place P.O. Box 45405, Los Angeles, Calif. 90045, (213) 417-8888, (800) 352-8251 or (800) 421-8166.

# Career Opportunities/Recruitment Advertising

## Rates

	Page	3/4	1/2	1/3	1/4	Col. Inch
1x	\$3,990	\$3,140	\$2,145	\$1,605	\$1,075	\$110
3x	3,885	3,025	2,060	1,550	1,015	100
6x	3,765	2,935	1,995	1,490	985	95
9x	3,655	2,845	1,935	1,445	955	90
12x	3,530	2,755	1,880	1,430	930	85
15x	3,425	2,675	1,820	1,385	900	80
18x	3,295	2,565	1,750	1,370	870	75
24x	3,235	2,520	1,720	1,310	850	70

## Circulation

Over 122,000 technically sophisticated professionals in computer operations/systems management, data communications, engineering management, systems engineering/integrators, educators and systems programming specialists.

Recruitment  
Hot Line

**(203) 328-2550**

Call your ad in—  
we'll set the type  
at no charge.

Mail Film to:

**Peggy Gordon**  
Recruitment Manager

**CAHNERS PUBLISHING CO.**  
8 Stamford Forum  
P.O. Box 10277  
Stamford, CT 06904

## ENGINEERS

Choice positions available in New England and Nationwide. If you earn \$25,000 or more we have a more rewarding job for you.

**Networking • Communications  
ATE Engineers • Tools & Utilities SW  
Real-Time SW • Memory Design**  
All fees & expenses paid. Call or send resume to:

**LARSEN PERSONNEL**  
1492 Highland Avenue  
Needham, MA 02192  
(617) 449-3840

Serving the high tech industries.

Explore growth opportunities. Check **BEALL!**  
New Plant and Plant Expansion Teams need:  
Fee Paid  
Technical-R & D, Manufacturing, Telecommunications  
Engineering-Design, Systems, Products  
Automatic-Test, Assembly  
Management-Production, QC, Facilities  
Planning  
**BEALL ASSOCIATES**-Call **Ray Schmitt**  
919/887-3193, or mail resume  
P.O. Box 5225 High Point, NC 27262

**CIRCLE NO. 241**

## ELECTRONIC ENGINEERS SOUTHEAST

Openings for design engineers of circuits, computers, logic, signal, communications, testing, ATE, systems, and controls. Professional confidential service. Fee paid by employer. Send resume to:

**Ted McCulloch**  
**McCulloch & Co.**  
P.O. 10211  
Greenville, SC 29603

**CIRCLE NO. 244**

## EMPLOYMENT SERVICE FOR PROGRAMMERS AND ANALYSTS

National Openings With Client Companies  
and Through Affiliated Agencies

Scientific and commercial applications • Software development and systems programming • Telecommunications • Control systems • Computer engineering • Computer marketing and support.

Call or send resume or rough notes of objectives, salary, location restrictions, education and experience (including computers, models, operating systems and languages) to either one of our locations. Our client companies pay all of our fees. We guide; you decide.

**RSVP SERVICES, Dept. MM**  
Suite 700, One Cherry Hill Mall  
Cherry Hill, New Jersey 08002  
(609) 667-4488

**RSVP SERVICES, Dept. MM**  
Suite 211, Dublin Hall  
1777 Walton Road  
Blue Bell, Penna. 19422  
(215) 629-0595

From outside New Jersey, call toll-free 800-222-0153

## RSVP SERVICES

Employment Agents for Computer Professionals

**CIRCLE NO. 242 ON INQUIRY CARD**

## Computer Consultants Corner

### TKC

• THE KEENAN CORPORATION

FCC 15J WE WROTE THE BOOK

"Digital Design for Interference Specifications"

• FCC/VDE & Static Retrofit and Testing  
• "Front End" Design Guidance

R. Kenneth Keenan, Ph.D.

8609 66th Street North Pinellas Park, FL 33565  
(813) 544-2594

**CIRCLE NO. 243**

MINI-MICRO SYSTEMS/August 1984

### 800/68000 Experts

• Microprocessor hardware and software design • Industrial control specialists • Hierarchical software design methodology • Complete prototype facilities

**CLIENTS INCLUDE:** Sohio • Elgar • Schlumberger • Motorola • Gulf Oil • Carborundum • Renal Systems

**CSA**

**Computer System Associates**

7564 Trade St., San Diego, CA 92121 (619) 566-3911

**CIRCLE NO. 244**

## UNIX\*

National Registry  
of UNIX\* job  
openings / professionals

P.O. Box 19949, Dept. MMS  
Houston, TX 77224  
Please send resumes.

**Scientific Placement, Inc.**

UNIX is a registered trademark of Bell Lab

### DATA PROCESSING POSITIONS

\$25-\$70,000+

East Coast - Midwest - West  
Coast - Southeast - Southwest

• Directors of D.P. • D.P. Managers  
• Project Leaders • Systems Analysts  
• Programmer • Analysts • Software  
Programmers • IBM, DEC, Univac, Honeywell • Mfg., Banking, Insurance, Telecommunications.

Please send resume & location Preference to P.B. Darrah, (402) 330-2814.

### RELIABLE "COMPUTERS"

11318 Davenport Street  
Omaha, Nebraska 68154



## We're looking for people who can see beyond the obvious.

If Isaac Newton hadn't been astute enough to look beyond a simple act of nature to one of nature's fundamental principles, he would have missed the opportunity to discover the law of gravity.

If LINKABIT engineers weren't thinking about what could be, instead of what is, we wouldn't be at the forefront of the telecommunications industry.

You'll find our employment opportunities provide far different challenges than what you've experienced before. **All positions require a Bachelor's in EE, ME, CS or Math.**

### Engineering Manager

Create and lead new concepts in our growing MILSATCOM Modem Products areas. Current projects include work on AFSATCOM, FLTSATCOM, MILSTAR and DSCS. Knowledge of modulation waveform design, demodulation signal processing, forward error correction, anti-jam techniques, multiple access control (TDMA, FDMA, CDMA) and demand assignment.

### Software

**REAL-TIME** — Assembler experience to work on LINKABIT microprocessor firmware development for real-time modem applications; must be able to obtain security clearance.

**SENIOR SYSTEMS** — Minimum 10 years' experience, knowledge of military satellite communications, real-time firmware, embedded processing and software project leadership to lead large firmware upgrade effort on LINKABIT microprocessor for real-time modem applications; must be able to obtain security clearance.

**SYSTEMS** — Experience in the following areas: compiler design/computer languages, microprocessor simulation, object code utilities and VLSI tools.

### Senior C3I

3-5 years' experience and background in digital signal processing, satellite and terrestrial communication systems and network architecture.

### Nuclear Hardness

3-5 years' experience in design, design analysis, EMP and TREE. Proposal writing and cost estimating experience and an understanding of neutron and gamma effects on electronics.

Our benefits include twice yearly salary reviews, three weeks vacation first year and compensation for unused sick leave in addition to generous medical, dental, life insurance and stock purchase, profit sharing and pension plans. **Other professional opportunities are also available in San Diego, Boston and Washington, D.C.** Send resume to: Dennis Vincent, Dept. MM M/A-COM LINKABIT, 3033 Science Park Road, San Diego, CA 92121.



**M/A-COM LINKABIT, INC.**

Equal Opportunity/  
Affirmative Action Employer

CIRCLE NO. 245 ON INQUIRY CARD

COMPUTER

## UNIX/C

\$27-\$65K

We are currently recruiting for 35 Washington, D.C. and nationwide based client companies who are offering challenging positions for UNIX/C Computer Professionals. Positions exist in both Systems Software and Applications Software Development. Our clients are working in the State of the Art in the areas of data communications, office automation, LANS, image processing and interactive graphics. Opportunities exist for professionals from entry level through Senior Systems Programmers with some positions in project and program management. A BS degree in CS, EE, Math or the equivalent plus at least 1 year of C programming experience is required. Knowledge of UNIX OS internals and Berkley UNIX a plus. For more information call or send your resume to:

800-336-3755

in VA call (703) 790-1284

### STAFFING CONSULTANTS

8027 Leesburg Pike, Vienna VA 22180

ALL FEES PAID BY CLIENT COMPANIES

CIRCLE NO. 246 ON INQUIRY CARD

# SOFTWARE ENGINEERS

UNIX\*, C, PDP11, M68000

Computer Consoles, Inc. designs, develops, manufactures, markets, and services a variety of minicomputer-based **fault-tolerant** information systems. Headquartered in Rochester, New York, we have all the cultural and educational advantages of a large metropolitan area as well as the ambience and scenic beauty of a small, relaxed town.

CCI currently has immediate opportunities for:

## Group Leaders/ Senior Software Engineers

You'll be responsible for the design and implementation of data base applications and utilities, or fault-tolerant operating system development including development of a multiprocessor UNIX-compatible transaction processing system.

We prefer a technical degree plus a minimum of 4 years' experience. Knowledge of C, UNIX, and data structures plus experience with data bases in a minicomputer Real Time or on-line environment and/or OS internals are also desired. We are willing to train otherwise qualified candidates with high level languages. U.S. citizenship or permanent residence is preferred.

\*UNIX is a trademark of Bell Laboratories

We offer opportunities for growth plus attractive compensation and benefits including relocation. For immediate confidential consideration, please forward your resume including salary history to, or call:

**CCI**  
COMPUTER  
CONSOLES  
INCORPORATED®

T. M. Foley  
Computer Consoles, Inc.  
97 Humboldt Street  
Rochester, New York 14609  
(716) 482-5000 x2816

Equal Opportunity Employer M/F/H/V



# SHAPE YOUR OWN FUTURE.



General Dynamics Data Systems Division helps shape the future of many significant programs at its major locations in San Diego, California; Fort Worth, Texas; and Norwich, Connecticut; as well as at satellite locations including Detroit, Michigan, and Pomona, California. We provide diverse support functions for such high-technology programs as the F-16 multimission fighter/attack aircraft, the M1 main battle tank, nuclear-powered submarines, and the entire family of cruise missiles. Throughout our division you'll find a variety of opportunities to apply your own scientific and engineering expertise

to create a more exciting future.

The Data Systems Division gives you the chance to join one of the most skilled teams in the industry today, and offers excellent salaries and benefits.

If you're interested in shaping your own future on our innovative support team, one of our opportunities listed below may be just right for you.

For immediate consideration, send your resume to the Vice President/Director at the Data Center of your choice.

## **PRODUCT SOFTWARE**

- Bachelor's and/or Master's degree, and 3-8 years' experience.
- SKILLS: FORTRAN, JOVIAL, PASCAL, Ada, Assembly Languages, Applied Math, Data Bases, Operating Systems, Documentation (MIL Standards).
- APPLICATIONS: Command & Control Software (Guidance, Navigation, C<sup>3</sup>I, Display Systems, Executive & System Support Software), Mission Planning, Data Handling & Communication, Automatic Testing Equipment/Simulations, Image Processing, Estimation & Control Theory.
- Embedded Systems: Real-Time Software.

## **CAD/CAM**

- Bachelor's and/or Master's degree, and 3-8 years' experience.
- SKILLS: FORTRAN, Ada, Assembly Languages, IBM, CDC & VAX Operating Systems, Computational Geometry, Information Modeling & Data Dictionaries.
- APPLICATIONS: Turn-key Graphic Systems, Solid Modeling, Robotics, CNC-DNC, Real-Time Processing Control, Group Technology.
- CADAM, CAT/A, Computervision, SC/CARDS, Model 204, Systems Engineering, Group Management.

## **ENGINEERING SYSTEMS**

- Bachelor's and/or Master's degree, and 3-8 years' experience.
  - SKILLS: Simulation Languages, FORTRAN, COBOL & IBM Assembler, TSO, SPF, DISSPLA, RAMIS, Scientific Programming and Microcomputer experience.
  - APPLICATIONS: Simulation, SLAM, Manufacturing, Operations Research, Image Processing, Graphics Application Development, Sneak Circuit Analysis, Program Marketing.
- U.S. CITIZENSHIP REQUIRED  
Equal Opportunity Employer, M/F

## **GENERAL DYNAMICS** *Data Systems Division*

WESTERN CENTER  
P.O. Box 85808, Drawer 004  
San Diego, CA 92138

CENTRAL CENTER  
P.O. Box 748, Drawer 004  
Fort Worth, TX 76101

EASTERN CENTER  
100 Winnenden Rd., Drawer 004  
Norwich, CT 06360

CIRCLE NO. 247 ON INQUIRY CARD

# CAREER OPPORTUNITIES...

## Spokane, Washington

**ISC** Systems Corporation, the leader in microprocessor-based terminal systems for the financial industry, has outstanding opportunities for **HARDWARE AND SOFTWARE PROFESSIONALS** to join our expanding Spokane operation.

We are seeking:

**RELIABILITY ENGINEERS** - 5+ years in micro design analysis, MTBF calculations and failure analysis.

**COMPONENTS ENGINEERS** - 3-5 years components engineering experience in state-of-the-art microprocessor technology.

**VENDOR LIAISON ENGINEER** - 3-5 years in computer industry selecting, qualifying and coordinating electronic and mechanical vendors for a high volume production environment.

**MANAGER - QUALIFICATION TEST** - 5-10 years experience managing a qualification test organization in the computer industry.

**TEST ENGINEER** - 5+ years experience in product design and qualification testing.

**DIAGNOSTICS TEST ENGINEER** - 3-5 years experience writing diagnostic software for microprocessor-based products.

**SENIOR DIGITAL DESIGN ENGINEERS** - 5-7 years designing with microprocessors for a high volume production environment. Must have project management experience.

**GURU - OPERATING SYSTEMS DEVELOPMENT** - define and develop a structured multi-tasking O/S with open-ended migration path in a micro networking environment.

**SOFTWARE DEVELOPMENT SPECIALISTS** - 5-7 years microprocessor experience on operating systems, networks, data communications, languages and file-server applications.

**BANKING APPLICATIONS SPECIALISTS** - 4+ years software design experience on credit systems and commercial lending systems.

**INTERNATIONAL SOFTWARE SPECIALISTS** - 4-5 years of software design experience, preferably using Z-80 assembler on financial applications. Commercial banking and data communications experience a plus.

**SOFTWARE SUPPORT ENGINEERS** - 2-4 years microprocessor experience preferably in Z-80 assembler language.

ISC offers an excellent salary, extensive fringe benefits and plenty of room for advancement. To explore these unparalleled opportunities, please send your resume to: **Bill Baumann, ISC Systems Corporation, P.O. Box TAF C-8, Spokane, WA 99220.** ISC is an equal opportunity employer.

**WE'RE CHANGING THE PACE OF BANKING!**



CAD/CAM....GRAPHIC DESIGN....ROBOTICS.... TELEMETRY....C<sup>3</sup>I SYSTEMS....

# ENGINEERING AND DATA PROCESSING PROFESSIONALS

FIND CAREERS WITH PROMISE  
AT

# GRUMMAN DATA SYSTEMS

Grumman Data Systems, a leader in computer systems development and maintenance is expanding as a result of our continued success in the commercial, industrial, financial and government markets. This expansion provides outstanding career opportunities for engineering and data processing professionals, at various levels to work in our Long Island, NY facilities.

We are a total systems company, involved in graphics, advanced robotics technology, CAD/CAM, mathematical modeling and simulation technology. Our engineering and data processing professionals work in one of the largest, non-government computer facilities in the Eastern United States and are involved with creating sophisticated solutions to complex problems from the scientific and business sectors. To qualify for work assignments in any of the disciplines listed here, a BS in Computer Science or equivalent and a minimum of two years applicable experience are required.

Telemetry...Design and Development Real Time Systems...  
Systems Design and Analysis...ADA...C<sup>3</sup>I Systems...Graphics...  
Networking...Robotics...CAD/CAM...Applications Program-  
ming...Computer Maintenance...Hardware/Software Inte-  
gration...Mathematical Modeling...Systems Programming...  
Product Assurance...Reliability/Maintainability

At Grumman Data, your future is our concern. We offer excellent salaries and comprehensive, company-paid benefits including health, dental, investment plans and relocation assistance.

Your resume is welcomed and will receive prompt attention when sent, with salary requirements, in confidence to: Employment Department, JB-M 884, Grumman Data Systems, 20 Crossways Park North, Woodbury, NY 11797.

An Equal Opportunity Employer  
U.S. Citizenship Required



CIRCLE NO. 249 ON INQUIRY CARD



# Advertisers Index

Able Computer	108	Gandalf Data, Inc.	117	Okidata Corp.	155
Ampex Corp., Computer Products Div.	30-31	General Systems Center, Inc.	262	Omnibyte Corp.	170
Ampex Corp., Disc Media Operation	211	Genicom	226	Oregon Software	182
Atron	14	Gould Inc. Computer Systems Div.	5	Otari Electric Co.	44-45
Ball Computer Systems	132	Hamilton/Avnet Electronics	119	Pacific Microcomputers	158
BDT Products	127	Heurikon Corp.	72	Pioneer Research	60
Bridge Communications	224-225	Hewlett-Packard	64	Precision Visual	12
C. Itoh Electronics	244	Houston Instrument Div. of Bausch & Lomb	42	Pyramid Technology	146
Cahners Exposition Group	86	Ibex Computers Corp.	254	Quadram Corp.	56-57, 236
California Computer Group Inc.	68	IBM Corp.	131	Qualogy, Inc.	103-105
Cambridge Digital Systems (Div. of Compumart)	81	I-Bus Systems Inc.	175	Rapitech Systems	59
Canon U.S.A.	185, 187, 189	Illbruck/USA	4	RDS- Relational Database Systems	179-181
Century Data Systems (a Xerox Co.)	249	Infotron Systems Corp.	149	Ridge Computers	235
Chrislin Industries, Inc.	260	Innovative Data Technology (IDT)	200	Rodime	8
CIE Systems	55	Interactive Training Systems	219	Rosscomp Corp.	110-111
CIE Terminals	C3, 23, 239	Interface Group	138	Scientific Micro Systems	75
Ciprico	176	Interphase Corp.	265	Seiko Instruments USA	207
Codex Corp.	63	Invitational Computer Conferences	253, 258	Selancar Corp.	194
ComDesign	229	Iomega Corp.	32	Sharp Electronics	73
Compaq Computer Corp.	144-145	ISI International	241	Shugart Corp.	10-11
CompuPro	27	Kennedy Co.	16	Sola Electric	107
Control Data Corp.—Engineering Services	66	Kimtron	142	Tab Products	87
Craig Data Cable	261	Lear Siegler Inc.	150-151	Tandon Corp.	192-193
Creative Micro System	167	Logical Microcomputer	207	TEAC Corp. of America	135
Cromemco Inc.	6-7	Mazdar Corp.	261	Telebyte Technology	264
CTS Corp. - Datacomm Products	247	Mannesmann Talley	220	TeleVideo Systems Inc.	112-113, 231
Dataproducts	197, 259	Marinco Computer Products	28-29	Toei Electronics Co. Ltd.	74
Dataram	C2, 39	Maxtor Corp.	242-243	Trendata Corp.	20
Davidge Corp.	178	MDB System Inc.	49	Unify Corp.	256-257
Davong Systems	168	Megatek Corp.	19	Unisoft Systems	204
Delta Airlines	230	Megavault	156	Universal Data Systems Inc.	128-129
Digital Datacom Inc.	209	Method Systems	266	Versatec Inc., a Xerox Co.	198
Digital Engineering	76-77	Micom Systems Inc.	C4	Vertex Peripherals	139
Digital Equipment Corp.	212-213	Microbar Systems	165	Visual Technology Inc.	50
Diversified Technology	15	Micro Focus Inc.	201	Wave Mate	136
Emulex Corp.	40-41	Micro Peripherals Corp.	266	Western Digital	82-83
Enertec Inc.	67	Microscience International	232	Wyse Technology	24, 130
Epson America, Inc.	169	Micro-Term	78	Xebec	122-123
Esprit Systems, Hazeltine Terminals Div.	202-203	Mini-Micro Systems	207, 238, 262	Xylogics, Inc.	216
Excelan	124	Mostek Corp.	214-215	Zaisan	141
Facit Inc.	223	Motorola Semiconductor Products	69-71, 89-100	Zilog Inc.	1
Falco Data Products	263	NCR Corp.	120-121		190
Flexible Computer	52-53	Nicolet Paratronics Corp.	4	See P.267 for Classified Advertisers	
Fujitsu America Inc.	47	Novell Data Systems	84	See P. 269-273 for Career Opportunity Advertisers	
				See P. 275-276 for Mini-Micro Marketplace	

This index is provided as an additional service. The publisher does not assume any liability for errors or omissions.

# Mini-Micro MARKETPLACE

Products and services for the value-added market.

**READERS:** Please circle reader service numbers for additional information.

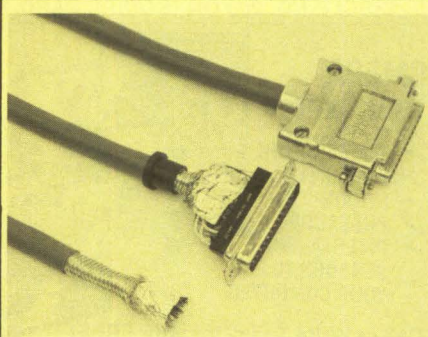

**FULLY SHIELDED CABLE** helps meet FCC requirements. Data Set Cable supplies Double Shielded Cable (shown) with foil plus tinned copper braid shielding, die-cast metal hoods, tinned connectors to provide 100% grounding. Also STANDARD SHIELDED CABLE with foil shield, copper-shielded connector area, tin-plated connectors - meets most requirements. SH-SS06 (Standard), 6 conductors all connected - \$18.50 plus 25¢/ft. Also in 12, 18, 25, 36, 50 conductors. **Data Set Cable Co.**, 722 Danbury Road, Ridgefield, CT 06877 - (203)438-9684. Also Las Vegas - (702)382-6777.

CIRCLE NO. 200 ON INQUIRY CARD



## THE RSX/VMS SPECIALISTS

THE LSI-11/73 BASED CM-300/Q22 COMPUTER SYSTEMS WITH RSX-11M+ SUPPORTING SUPERVISOR-MODE LIBRARIES AND SEPARATE I AND D SPACE

THE MICRO-VAX I BRINGS VAX POWER AND HIGH PERFORMANCE TO THE Q-BUS

CM-300/Q22 computer systems are configured with DEC's NEW LSI-11/73 CPU, giving these systems 11/70 PERFORMANCE AT LSI-11 PRICES. CM-300/Q22 systems can be configured with up to 1200MB of fixed Winchester disk, up to 4MB of main memory and up to 64 terminals. System back-up is provided by an industry standard 9 track 1/2" 1600 BPI tape drive. Optional software packages include accounting software, mailing list, FORTRAN 77, FMS-11, BASIC +2 and DATARETRIEVE. An LSI-11/73 based 300MB system including RSX-11M+ license, media and documentation, with a VT220 terminal may be purchased for under \$23,000.

MICRO-VAX I computer systems can be configured with up to 4MB of main memory, up to 31MB of fixed disk and up to 5 terminals. Prices start at \$13,730.

Call A.C.S. and let us configure a hardware/software solution for your specific problems.

CIRCLE NO. 201 ON INQUIRY CARD

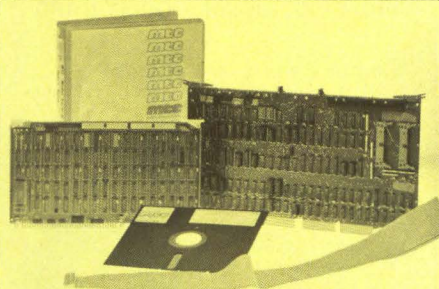

## HIGH SPEED BUS COUPLER

MTC's Bus Couplers provide high speed DMA Data Transfers between Multibus and Unibus, Q-Bus or other Multibus based computers. Transfer rates from one to four MB/SEC are possible depending on the busses connected. Double buffered operations, 64K word block transfers and a parity mode are also possible. The link to DEC Systems is DR11W compatible and fully supports interprocessor link mode.

A coupler kit includes two boards, cables, user manual, and an iRMX 86 Driver. OEM configurations available.

### MESA TECHNOLOGY CORPORATION

16021 Industrial Drive, Gaithersburg, MD 20877  
Tel.: 800-638-2039. Inside MD 800-492-3198

CIRCLE NO. 202 ON INQUIRY CARD

## The Little Board® Quantity One... \$349\*

The world's simplest and least expensive single board computer

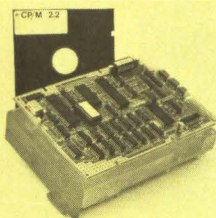

- 4MHz Z80A1 CPU, 64K RAM
- Mini floppy controller
- On-board -12V converter
- Power Requirement: +5VDC @ .75A; +12VDC @ .05A
- Screws directly onto a mini floppy drive
- Two RS232 serial ports
- Parallel printer port
- Only 5.75 x 7.75 inches

\*Substantial Quantity discounts available

All this...  
and CP/M™ 2.2 also!

**AMPRO**  
COMPUTERS INCORPORATED

† Z80A is a registered trademark of Zilog, Inc.  
‡ CP/M is a registered trademark of Digital Research.

67 East Evelyn Ave. • Mountain View, CA 94041 • (415) 962-0230

CIRCLE NO. 203 ON INQUIRY CARD

## THE MICRO 68000

Completely Portable 68000 Training System

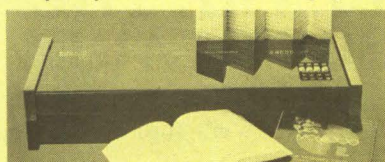

Designed for Engineer and Technician training, demonstrating logic analyzer, and prototyping, the MICRO 68000 comes complete with: 6 amp switching power supply • Keyboard • Display-Hex & Binary • Pete Bug keyboard monitor • Optional Macs Bug CRT monitor • Attractive cabinet • Dual RS232 interface • 32 bit parallel I/O • Versabus compatibility • The only system that provides for direct entry of 68000 machine code • An optional padded carrying case is also available.

Perfect for the classroom as well as the lab or self study. The MICRO 68000 comes complete with Lance Leventhal's "68000 Assembly Language Programming" text, Motorola's "68000 Users Manual", a complete Laboratory Manual, and CSA's "MICRO 68000 Users Manual."

**CSA Computer System Associates**  
7562 Trade St., San Diego, CA 92121 (619)566-3911

CIRCLE NO. 204 ON INQUIRY CARD

## Hardware Protection For DEC Equipment Users

### C-XX Overtemperature Protection System

Standard DEC PDP 11, VAX, and System 10-20 machines are NOT adequately protected from equipment damage due to high machine room temperatures. This unit provides aural warning signal and total system power shutdown with two customer adjustable temperature limits and approved interface to standard DEC AC power control system.

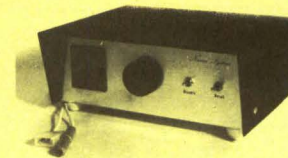

**NS**

Nassau Systems  
P.O. Box 19329  
Cincinnati, Ohio 45219  
(513) 231-1283

CIRCLE NO. 205 ON INQUIRY CARD

## Like-new products



Like-new electronic instruments For Sale Now!

Catalog (800) 225-1008

REPRESENTATIVE  
REI Sales Company

For free catalog, phone toll-free (800) 225-1008 In Massachusetts (617) 938-0900  
**Genstar REI Sales Company**

CIRCLE NO. 206 ON INQUIRY CARD

## ZX-5000™ EXTENDED RANGE™ SURGE SUPPRESSORS



SUTTON DESIGNS INC

111 S. Cayuga, Suite 200 • Ithaca, NY 14850 • 607/277-4301

CIRCLE NO. 207 ON INQUIRY CARD

\*IBM® PC Compatible



E-PROMS — Call! Lowest Prices Anywhere

\*4164-150/200 ..... 4.80  
2764-250 ..... 6.75  
6116-LP3 ..... 4.99  
HMM 256K. .... Call for quote  
TTL Parts — now avail ..... Call

Disk Drives: (F.O.B. Tampa)

\*TM-100-2 ..... 169.95  
\*Half-Heights-2. .... 169.95  
\*10 mb Microscience w/cable & controller ..... 959.99

Add \$3.95 shipping to all orders • Prices subject to change • P.O.'s on approval • C.O.D. OK • All new, no surplus, no seconds. QUANTITY DISCOUNTS.

4920 Cypress St., Ste. 100, Tampa, FL 33607  
In FL and for info, call 813-875-0299

**FOR ORDERS ONLY, 800-237-8910**



8 AM-7 PM EDT

CIRCLE NO. 208 ON INQUIRY CARD

## Simple Genius in Multibus® • Intel Trademark

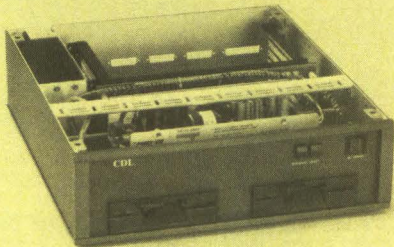

Relax!

Now you can just hook up the terminal, plug in the system boards, turn on power, and you're up and running.  
**Series VI** system chassis from CDL is the key to turn your design into reality.

**CHEN DIGITAL LABORATORIES**

Contact (206)881-5031

16718 NE 41st Street, Redmond, WA 98052

CIRCLE NO. 209 ON INQUIRY CARD

## Minitab Data Analysis Software

An interactive and easy-to-use system for:  
**DATA MANAGEMENT**—subsetting, editing, sorting and transforming data.

**STATISTICAL ANALYSIS**—descriptive statistics, regression, analysis of variance, nonparametrics, multiway cross-tabulations, time series analysis, exploratory data analysis and matrix operations (including eigenanalysis).

**DATA DISPLAY**—histograms, scatterplots, stem-and-leaf displays and boxplots.

Minitab is available for a wide variety of:  
**Mainframes • Minicomputers • Microcomputers**



Minitab, Inc. • 215 Pond Laboratory • University Park, PA • 16802  
[814] 865-1595 Telex: 881612

CIRCLE NO. 210 ON INQUIRY CARD

## OMEGA Your Source

- TEMPERATURE
- HUMIDITY
- STRAIN
- PRESSURE
- INTERFACING
- SENSORS TO YOUR COMPUTER



Call or Write Today for your FREE! copies of the OMEGA Temperature Measurement and Control Handbook and Encyclopedia™, the OMEGA Pressure and Strain Measurement Handbook™, and the OMEGA Computer Interface Handbook.

**OMEGA ENGINEERING, INC.**

One Omega Drive, Box 4047, Stamford, CT 06907 U.S.A.  
Telex 996404 Cable OMEGA FAX (203) 359-7700

**(203) 359-1660**

CIRCLE NO. 211 ON INQUIRY CARD

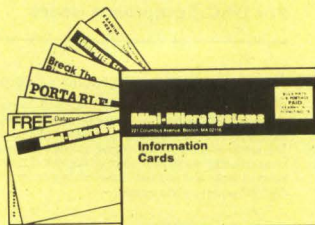

## HIGH INQUIRIES LOW COST

- Sell products and services directly
- Introduce new products
- Investigate new applications
- Develop new sales leads

**MINI-MICRO SYSTEMS  
DIRECT RESPONSE POSTCARDS**

CIRCLE NO. 212 ON INQUIRY CARD

## DON'T BLAME THE SOFTWARE!

Complete Hi-Tech Equipment Protection: Write for Free Catalog!

- Power line isolators
- Spike/surge suppressors
- Power line filter/suppressors
- Twist type socket protection
- Line voltage regulators
- Line conditioners
- Modem protectors



**Electronic Specialists**

171 S. Main, Natick, MA 01760 (617) 855-1532  
Toll Free Order Desk 1-800-225-4876

CIRCLE NO. 213 ON INQUIRY CARD

## PIN GRID ARRAY & DIP SOCKETS

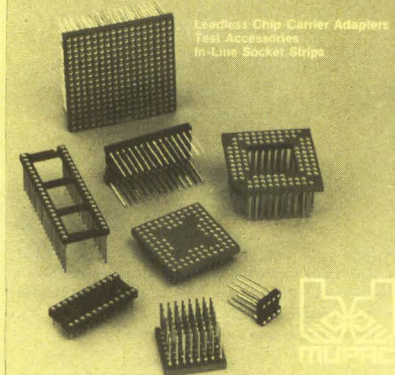

10 Mupac Drive, Brockton, MA 02401  
Tel (617) 588-6110 TWX (710) 345-8458

CIRCLE NO. 214 ON INQUIRY CARD



# We've got DEC's<sup>®</sup> number, plus a lot more.

We've really done another number on DEC. We've added in more features and more reliability than their 220 offers, all without adding to the cost. Fact is, our

CIT220+ costs even less than the DEC VT220. Yet, it has all of DEC's features, *plus*: Four additional enhanced menus. Enhancement set-ups for Display, General, Auxiliary Port and Keyboard.

*Plus*: A bi-directional Auxiliary Port, not just uni-directional like DEC's. So with the CIT220+, you can have the flexibility of adding either a second host or a printer.

*Plus*: Not just smooth scroll like DEC's, but variable speed smooth scroll for fast or slow review.

*Plus*: Two more LEDs than you'll find on the DEC keyboard—one for online, the other for shift lock. We give you more usable cable length, too, and a better keyboard elevating mechanism.

*Plus*: An on/off switch on the front of our monitor (DEC's is on the back), along with an on/off light indicator at eye level for better visibility.

That's the CIT220+, the one with all the pluses. Including a lower price. So now that we've got DEC's number, you'll most likely want ours. It's (714) 660-1421. Or call toll free

1-800-854-5959. In California, call 1-800-432-3687. Or write CIE Terminals, 2505 McCabe Way, Irvine, CA 92714.

**CIE TERMINALS**  
A CITIZEN ELECTRONICS COMPANY

® DEC is a Registered Trademark of Digital Equipment Corp.  
© 1984 CIE Terminals

**CIRCLE NO. 2 ON INQUIRY CARD**

# You can have a local data network running this afternoon!

*In fact, you already have most of it installed.*

Whether you're adding only a few more terminals or personal computers, or implementing a more efficient minicomputer access method for hundreds of terminals at a time, you probably don't even have to pull new cables, much less install a complicated new network.

Your in-plant telephone network is already wired into almost every office and potential terminal site in your building. And fortunately for your data communications needs, its wires can carry voice conversations and data at the same time — with a little help.

All you really need is a way to connect a terminal and the telephone to the same set of wires, and that's where MICOM's INSTALINK Voice/Data Multiplexor comes in.

A component of MICOM's INSTANET™ Local Network — the "instant" remedy to local area communications headaches — INSTALINK plugs into your existing telephone jack and allows you to use your terminal and your phone independently — without interference of any kind.

It supports asynchronous transmissions of up to 19,200

bps, full-duplex, for over a mile — plenty for almost any local networking application.

And it provides something else that many other in-house networks don't or can't: complete portability. A terminal can be moved to a new site and connected to any telephone line already in place. No rerouting of cables. No complicated interfacing. Just plug it in.

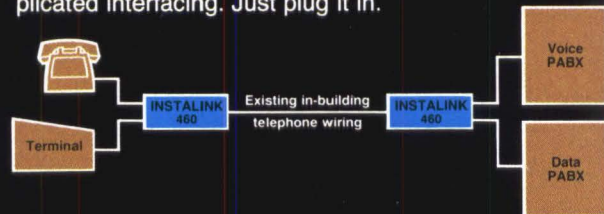

Best of all, INSTALINK provides all this without requiring any long-term commitment, without major investment, without disrupting normal business operations, and without fuss — "instantly."

Call or send for a brochure which explains how.

Tired of fighting the terminal wiring problem?

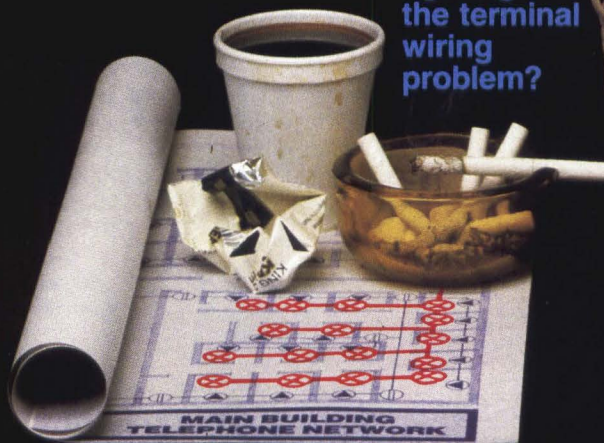

INSTALINK™  
relieves the  
cabling headache fast!

## MICOM®

MICOM Systems, Inc. • 20151 Nordhoff Street • Chatsworth, CA 91311 • Telephone (805) 583-8600 • TWX 910/494-4910  
Regional Sales/Service • Atlanta, GA • (404) 435-2999 • Boston, MA • (617) 527-4010 • Chicago, IL • (312) 789-2430  
Dallas, TX • (214) 258-0774 • San Francisco • (415) 327-0890 • St. Louis, MO • (314) 576-7626 • Teaneck, NJ • (201) 836-4000  
MICOM-Borer Ltd. • Bel Court • 15 Cradock Road • Reading, Berkshire RG20JT, England • (0734) 866801 • Telex 847135

For literature please call: (800) "MICOM U.S."

AVAILABLE NOW FROM THESE STOCKING REPS... AK: Anchorage (907) 561-1776 / Juneau (907) 789-4101 • AL: (800) 327-6600 • AR: (214) 620-1551 • AZ: (602) 994-5400  
CA: Anaheim (714) 635-7600 / Lodi (209) 334-1961 / San Diego (619) 565-1557 / San Jose (408) 298-7290 • CO: Colorado Springs (303) 594-0880 / Denver (303) 777-8070  
CT: (617) 235-5520 • DE: (609) 779-0200 • FL: (800) 432-4480 • GA: (800) 327-6600 • HI: (808) 537-9758 • IA: (402) 895-5850 • ID: (801) 466-6522 • IL: (312) 255-4820  
IN: (317) 846-2591 • KS: (816) 252-3700 • KY: (502) 228-5401 • LA: (800) 327-6600 • MA: (617) 235-5520 • MD: (301) 340-0600 • ME: (617) 235-5520 • MI: (313) 588-2300  
MN: (612) 425-4455 • MO: Independence (816) 252-3700 / St. Louis (314) 721-0401 • MS: (800) 327-6600 • MT: (801) 466-6522 • NC: (800) 327-6600 • ND: (612) 425-4455  
NE: (402) 895-5850 • NH: (617) 235-5520 • NJ: North (201) 569-2353 / South (609) 779-0200 • NM: Albuquerque (505) 292-1212 / Las Cruces (505) 524-9693  
NV: (714) 635-7600 • NY: Albany (518) 459-5891 / Buffalo (716) 662-4568 / New York City (201) 569-2353 / Rochester (716) 424-7492 / Syracuse (315) 455-5841 • OH: Cleveland (216) 524-5930 / Dayton (513) 434-7500 • OK: (405) 478-5000 • OR: (503) 224-3145 • PA: East (609) 779-0200 / West (412) 892-2953 • RI: (617) 235-5520 • SC: (800) 327-6600  
SD: (612) 425-4455 • TN: (800) 327-6600 • TX: Dallas (214) 620-1551 / Austin (512) 327-8600 / El Paso (915) 542-1762 / Houston (713) 353-7728 • UT: (801) 466-6522  
VA: North (301) 340-0600 / South (800) 327-6600 • VT: (617) 235-5520 • WA: (206) 454-2383 • WI: (414) 784-9379 • WV: East (301) 340-0600 / West (412) 892-2953  
WY: (303) 777-8070 • Washington, DC: (301) 340-0600 • Puerto Rico: (809) 753-1771

MD002

CIRCLE NO. 3 ON INQUIRY CARD