

CARE AND REPAIR OF THE HOUSE

PHELAN

BUILDING AND HOUSING PUBLICATION BH15

U. S. DEPARTMENT OF COMMERCE
BUREAU OF STANDARDS

BRITISH LIBRARY
4.5.4.1931
LIBRARY
Reference book not to be
taken from the Library.

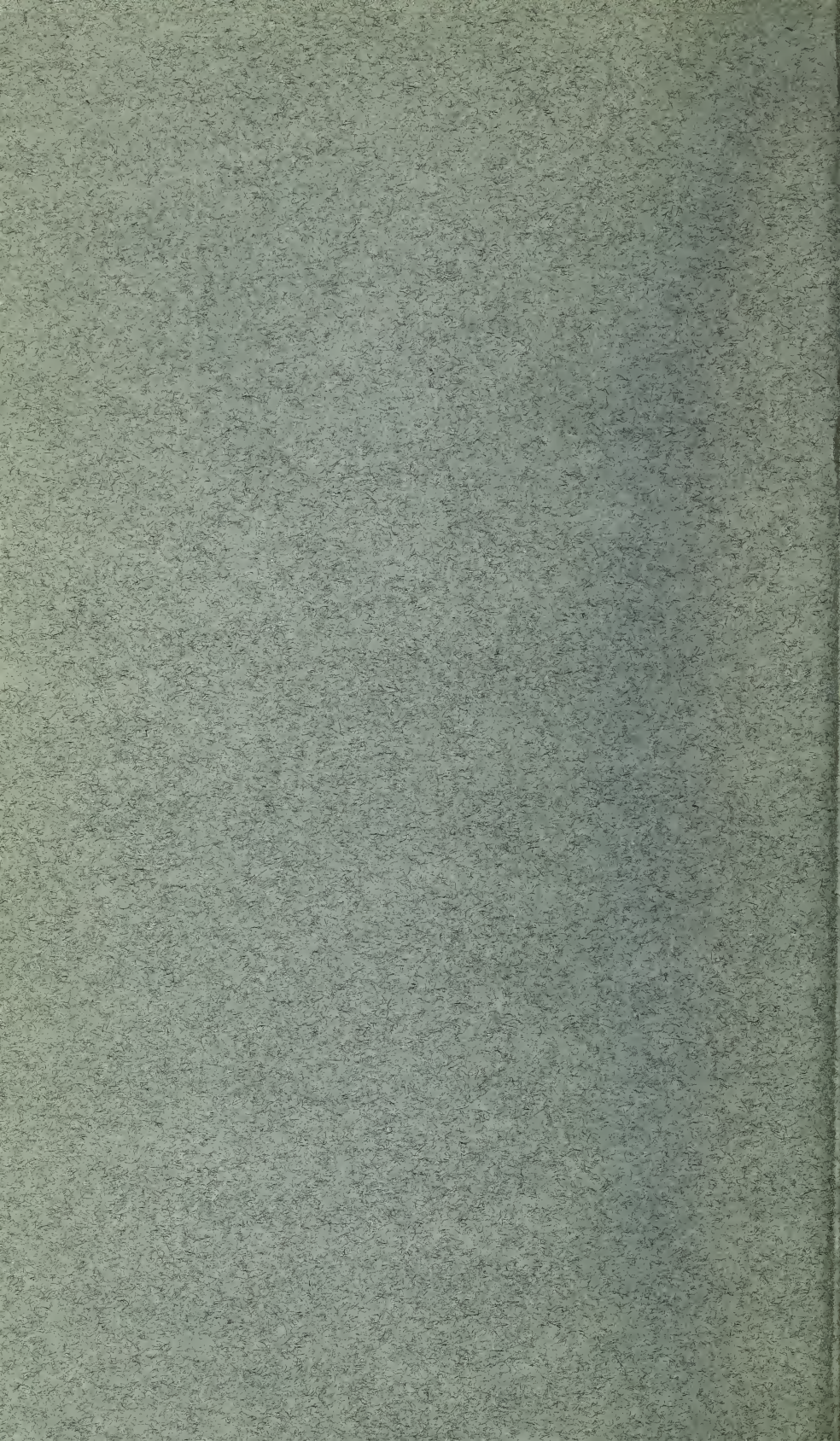

U. S. DEPARTMENT OF COMMERCE

ROBERT P. LAMONT, Secretary

BUREAU OF STANDARDS

GEORGE K. BURGESS, Director

CARE AND REPAIR OF THE HOUSE

INCLUDING MINOR IMPROVEMENTS

By

VINCENT B. PHELAN

BUILDING AND HOUSING PUBLICATION BH15

[Issued March 31, 1931]



UNITED STATES
GOVERNMENT PRINTING OFFICE
WASHINGTON : 1931

	Page
XII. Painting and varnishing.....	82
1. General observations.....	82
2. Quality and care of materials.....	82
3. Selection and care of brushes.....	83
4. Methods of applying and brushing.....	84
5. Exterior painting.....	84
6. Interior painting.....	87
7. Painting stucco or concrete.....	87
8. Painting brick or stone surfaces.....	89
9. Painting on plaster.....	89
10. Painting metal work such as roofs and gutters.....	90
11. Varnishing.....	91
XIII. Electricity.....	92
1. Some precautions to be observed in using electricity.....	92
2. Extent to which home repairs may safely be made.....	93
3. How to cut off the current.....	93
4. Replacing a fuse plug.....	94
5. Repairing an electric doorbell.....	95
6. How to splice electric wires.....	97
7. Repairing damaged appliance cords.....	98
XIV. Miscellaneous.....	99
1. How to stop creaking of floors.....	99
2. Relieving a sticking drawer.....	101
3. How to make a miter box.....	101
XV. Closing the house.....	102
XVI. Other sources of information.....	103
XVII. List of published material of interest to home owners.....	104
XVIII. Glossary.....	113
XIX. Check list.....	114
XX. Index.....	119

ILLUSTRATIONS

Figure		
1. Essential parts of a house.....		2
2. Cross section of foundation wall showing drain tile and exterior coating.....		8
3. Two types of support used in roof repairing.....		23
4. A method of repairing valley flashing.....		27
5. Hinge readjustments to correct binding or sticking doors.....		30
6. Door-jamb section showing filler strip.....		33
7. Section showing a striking latch bolt.....		34
8. Glazing.....		37
9. Double-hung window details.....		41
10. A convenient screen storage rack.....		45
11. Window-head details showing methods of flashing.....		50
12. Applying split pipe covering around hot-water heating pipes.....		59
13. Applying "chicken wire" in connection with boiler covering.....		60
14. Covering warm-air furnace pipes.....	facing	62
15. Method of marking pipe-bend covering for cutting.....		62
16. Insulating a warm-air furnace.....	facing	62
17. Typical radiator valve.....	facing	63
18. Typical water shut-off cock.....	facing	63
19. Section of a compression faucet.....		68
20. Section of a Fuller faucet.....	facing	70
21. A ground-key faucet.....		70
22. Section of a water-closet tank.....	facing	70
23. Section of a typical water-closet flush valve.....		75
24. A P-type trap showing clean-out plug and joints.....	facing	78
25. A "plumber's friend".....	facing	78
26. Section through a water-closet bowl showing use of a coil spring-steel auger.....	facing	78
27. Typical bell circuit.....		97
28. Method of splicing electric wires.....		98
29. Details of an electric-cord plug.....		99
30. A homemade miter box.....		101

CARE AND REPAIR OF THE HOUSE

Including Minor Improvements

I. INTRODUCTION

Every house, even the most carefully built, needs attention and repair occasionally to keep it in good condition and to retard depreciation. Like other kinds of property, a house will show signs of wear and begin to decline in value, if it is not properly cared for.

Repair jobs which require special knowledge and skill should be done only by a qualified person. Others can be performed by the householder who is handy with tools. Perhaps the majority find the making of small repairs and improvements enjoyable and have some degree of skill in this direction.

Thousands of householders who have the ability to make small repairs and improvements satisfactorily and who desire to effect the savings which result hesitate to undertake the work because they lack simple and specific directions for determining the causes of common defects and failures that occur in the house and its equipment and instructions for correcting them.

This handbook is written to assist those who are sometimes faced with vexing problems in the care and repair of the house. It aims to point out the more common conditions of disrepair arising in the house from time to time, to describe briefly their causes, and to prescribe the tools, materials, and methods to be employed in their correction. It also deals to some extent with minor improvements that may be effected by the amateur mechanic who wishes to make his house more attractive, more comfortable, and of greater value.

II. INSPECTION OF THE HOUSE AND ITS EQUIPMENT

Some householders give their houses attention only when acute trouble, such as a leaky roof or burst pipe, demands it, but it is neither wise nor safe to wait until something breaks or gives way completely. Such troubles should be anticipated by making regular inspections and applying remedies where needed. Many of the inconveniences and discomforts experienced in the household may thus be avoided, and considerable money may be saved.

The house may be inspected by members of the family owning or occupying it, who are often aware of some of its defects and inconveniences, or by an experienced workman whose knowledge and skill should enable him to discover defects not apparent to the average householder.

When outsiders are employed to do repair work it is often advantageous to have it done, when possible, during the least busy season of the building year. At that time workmen in the building trades, as well as builders and repairmen, are glad to have employment and will generally do the work more reasonably.

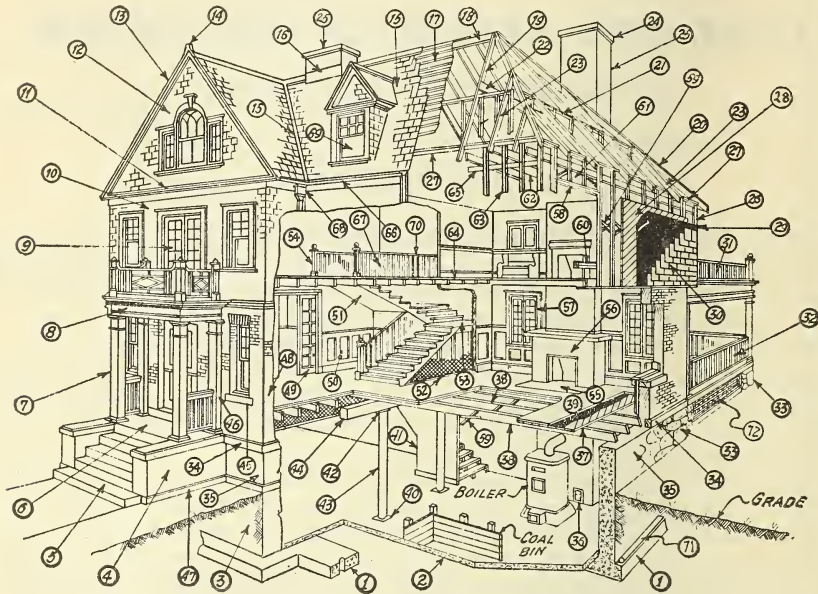

FIGURE 1.—Essential parts of a house

- | | | |
|-----------------------|-------------------------|--------------------------|
| 1. Footings. | 25. Chimney. | 49. Sliding door. |
| 2. Basement floor. | 26. Corner post. | 50. Wainscoting. |
| 3. Foundation wall. | 27. Plate. | 51. Stair soffit. |
| 4. Buttress. | 28. Diagonal sheathing. | 52. Metal lath. |
| 5. Steps. | 29. Sheathing paper. | 53. Platform. |
| 6. Platform. | 30. Shingle. | 54. Newel post. |
| 7. Porch column. | 31. Balcony. | 55. Hearth. |
| 8. Porch cornice. | 32. Veranda. | 56. Fireplace. |
| 9. French doors. | 33. Piers. | 57. Casement window. |
| 10. Frame wall. | 34. Water table. | 58. Rough head. |
| 11. Eaves cornice. | 35. Underpinning. | 59. Bridging. |
| 12. Gable end. | 36. Clean-out door. | 60. Rough sill. |
| 13. Rake cornice. | 37. Subfloor. | 61. Truss over opening. |
| 14. Finial. | 38. First-floor joists. | 62. Ceiling joists. |
| 15. Valley. | 39. Finish floor. | 63. Studding. |
| 16. Chimney flashing. | 40. Column base. | 64. Second-floor joists. |
| 17. Shingle battens. | 41. Plaster partition. | 65. Ribbon board. |
| 18. Ridge board. | 42. Column cap. | 66. Gutter. |
| 19. Common rafter. | 43. Iron column. | 67. Balustrade. |
| 20. Hip rafter. | 44. Girder. | 68. Leader head. |
| 21. Purlin. | 45. Window sill. | 69. Dormer window. |
| 22. Collar beam. | 46. Pilaster. | 70. Handrail. |
| 23. Jack rafter. | 47. Ground course. | 71. Drain. |
| 24. Chimney cap. | 48. Brick wall. | 72. Lattice. |

If one is handy with tools and able to perform the ordinary tasks, he probably will wish to make his own inspection, in which case the following brief description of where to look and what to look for, may be helpful ¹ (see fig. 1, Essential parts of a house) :

¹ The remedies will be discussed later.

Foundation Walls and Basement.

To avoid overlooking important points, the inspection should be conducted in a systematic manner. The inspection might well begin in the basement.

Examine the foundation walls for cracks and observe whether mortar in joints is loose or has fallen out. The floor should be examined for cracks or signs of disintegration, and any evidence of leakage through the walls or the floor should be noted.

If there are wooden sills on top of the walls, see whether they are sound and whether cracks between wall and sills are calked to keep out moisture and cold air.

See whether there is fire stopping on the sills between floor joists and, if so, whether it fits snugly, especially around pipe openings. (Careless fire stopping allows fire to spread and permits rodents to get into the walls above.)

If the basement is not ceiled, the joists can be examined for signs of sagging or of warping. These defects often occur because the support or bridging is not sufficient. Look for possible shrinkage in the framing.

See whether there are signs of damage in posts, sills, joists, and other woodwork caused by termites or other destructive insects. Also look for evidences of decay from dry-rot, especially in sills or at ends of joists adjoining masonry.

Make sure that all exposed water pipes are protected from freezing, especially if located under a porch, or in some other unheated space.

If there are floor drains in the basement or garage, see that there is sufficient water in them to maintain a seal in the traps.

Heating Equipment.

As there are various types of heating systems, the details of the inspection of such equipment will necessarily vary. The most favorable time for this inspection is in the spring when the plant is shut down for the season.

If the smoke pipe is taken down in the spring, and cleaned, and put in a dry place until fall, its life will be greatly prolonged. Ashes should be removed from the fire box and ash pit and soot from the chimney. The baffles in a hot-water boiler above the fire box also require frequent brushing to remove soot. The hinges of the boiler doors should be oiled and the doors left open during the summer.

If the grates are warped or broken, or if the walls of the fire box are cracked, such matters should be noted and repairs made, or new parts ordered promptly. Boilers should be examined for possible cracks or leaks.

The coating on the boiler may need patching, or some of the heating pipes may require covering.

Examine the chimney to see whether it needs pointing and whether the cement is sound around the smoke pipe where it enters the chimney. Notice whether woodwork adjoining the chimney requires covering to lessen the fire hazard.

Stoves and stovepipe should be carefully inspected during the summer, and necessary repairs or replacements should be made before the colder seasons begin.

Exterior Walls.

After the structure and equipment of the basement have been thoroughly examined, the inspection of the exterior parts of the house might follow.

If the walls are of masonry, look for cracks or broken bricks, or blocks, especially above door and window openings, and see whether mortar joints require pointing. Also note if there is efflorescence (moldy or white blotches or streaks) on the face of the wall, particularly below window sills and near down spouts.

The principal signs of defects or deterioration in stucco are cracks and the chipping off or falling out of particles. The most likely places to observe such signs are over doors and windows and near the ground. These surface marks are more readily seen after a rain, where dampness penetrates. Discoloration in the form of dust or rust streaks may appear below window sills or other ledges.

If the house is of frame construction, examine the siding for loose or decayed boards. Look for blisters on painted surfaces and indications of cracking or of the paint peeling off. As blisters are generally caused by moisture back of the paint film, look for the possible sources of such moisture, as, for instance, leaky roofs, down spouts, or water pipes.

Exterior Side of Windows.

See whether flashing is provided over the widow caps to turn the water and, if so, whether it is in good condition.

Look for holes or large cracks at window sills. They will appear if the inside stool, or ledge, is not well nailed down. They may exist where parting strips and pulley stiles meet the sill, or where the top sill joins the wood or brick subsill.

If backband molding is used around the top and sides of the outside casing, see that it is nailed tightly against the casing.

Probe between the frame and the wall at each side of the window to see whether calking is needed to keep out dampness and cold.

While looking over the windows examine the putty around the panes to find out whether it is firmly in place.

Roof, Flashing, and Gutters.

Leaks in the roof are seldom easily detected from the outside. If the attic is unceiled, holes in the roofing are often readily visible from the inside, in which case they can be marked by pushing straws or wires through the holes to protrude above the roof surface. If the attic is ceiled there may be stains on the plaster indicating leakage.

If the roof is of slate, tile, wood shingles, or composition shingles, examine closely to see if any pieces have been broken or blown off, or are loose. In the case of wood or composition shingles, see if they are warped, or partly decayed, or disintegrated.

If the house is covered with metal roofing, look for holes, cracks, or open joints. See if paint or special coating has worn off. A similar examination should be made where roll roofing has been used.

Examine carefully the flashing around the chimney and vent pipes and in the valleys of the roof, and note whether there are signs of its rusting or of its being out of place.

Leaves, rubbish, and birds' nests in gutters may stop up the down spouts if the débris is not removed. If there are strainers over the mouths of the down spouts see whether they are clear. Also notice the condition of gutters and conductor pipes and determine whether they need replacing or whether they require a coat of paint.

Skylights should be examined for signs of leakage. The frame may need painting and the putty around the glass may need to be replaced. Note whether the flashing around the base of the frame is in good condition.

In looking over the chimney top, see whether all the bricks are in place and whether pointing is needed. If a cap is used, it should be securely cemented to the chimney. If there is no special chimney cap, see that mortar is spread over the top of the brickwork and sloped down from the flue opening to the outside edge of the chimney.

Interior Portion.

Defects in the interior of a house are generally more apparent than those on the outside. A clogged drain, a leaky faucet, or a sticking door or window, quickly attracts the attention of some member of the household. There may be other faults, however, which frequently are not noticed, except by inspection.

Examine all doors to see how true they hang and to find out if they squeak. Raise and lower all windows to learn how they slide and whether or not the cords are broken or are of unequal length. Observe how the sash fit and see if weather stripping is needed around the windows and doors. Notice whether there are any openings in or around the screens where insects can enter.

If baseboards do not fit snugly to the floor it is usually because they have shrunk, but in some cases the floor supports have settled and caused the condition. Creaking in a floor may be detected by bearing heavily upon various sections of it.

Look for cracks in the plaster, particularly over door openings, and note whether there is danger of plaster falling in case the ceiling is cracked.

Household Equipment.

When the structure of the house has been inspected, it might be well to examine some of the equipment where trouble may develop.

Inspect the cords on all electrical appliances to see whether they should be renewed, and examine all exposed wires for poor insulation. Be sure there are extra fuses for the fuse box in case one is needed.

If gas is used for cooking, the burners on the gas stove may need cleaning, or the air vents may require adjusting. If gas is used for lighting, see whether gas tips need cleaning or whether mantles should be replaced. Never search for a gas leak with a match, candle, lantern, or with the aid of any other burning lighting appliance.

III. LIST OF TOOLS AND SUPPLIES

The tools listed below are those recommended for the jobs described in this handbook.

The first list includes those most frequently needed. Such a set of tools will enable the householder to perform the ordinary tasks in the upkeep of a house.

Claw hammer.	Steel square.
Two screw drivers (one large, one small).	Nail set ($\frac{1}{8}$ -inch).
Wire-cutting pliers.	Mason's trowel.
Monkey wrench.	"Plumber's friend."
Hand saw (crosscut).	Three-cornered file.
Two wood chisels ($\frac{1}{4}$ -inch and $\frac{7}{8}$ -inch).	Stilson wrench.
Small flat paintbrush.	Carpenter's pencil.
Jackknife.	Metal shears.
Putty knife	Brace and bits.
Hack saw.	Soldering iron.
Cold chisel.	Glass cutter.
Folding rule.	Drawknife.
Hatchet.	Galvanized water bucket.
Gimlet.	Small washtub.
Smoothing plane.	Funnel.
	Flash light.

The second list includes special tools which are very useful, but are not required so often as those in the above list. The advisability of their purchase rests with the individual householder.

Rip saw.	Gasoline blow torch.
Jack plane.	Coil spring-steel pipe-cleaning auger.
Miter box.	Seat-dressing tool for valve seats.
Vise.	Force pump.
Plasterer's trowel.	Suction pump.
Steel crowbar.	Carpenter's level.
1-inch bar.	

The following supplies will be found useful in many cases and should be kept on hand to meet emergencies:

Sandpaper.	Rubber tape.
Sponge.	Electric fuses.
Seat washers.	Nuts and bolts.
Candles.	Wire (copper and iron).
Assorted nails.	Soft solder.
Assorted screws.	Rubber tubing (small).
Friction tape.	

Materials, as well as tools, required for specific jobs are mentioned throughout the text of this handbook. Bureau of Standards Circular No. 70, Materials for the Household (259 pages), may also be helpful in this connection. This circular is listed on page 108 of this handbook.

IV. FOUNDATION WALLS AND BASEMENTS

1. REMEDYING A DAMP OR WET CELLAR

In general, there are two classes of cellars where wetness prevails all or part of the time. First, those which may be classed as damp, where the walls and floors seem to "sweat" and where moisture runs down the walls. This damp condition is more pronounced during

long, wet periods. Second, the cellar into which water flows freely during heavy rainfall or when snow is melting rapidly, resulting in a flooded condition.

Frequent Causes of Damp Cellars.

In the first or damp type the difficulty is sometimes caused by penetration of moisture through the walls and floor because of improper subdrainage. More often, however, the damp condition is due to condensation of moisture on chilled wall surfaces.

Flooding will be found, in most cases, to be caused by defective walls, careless back filling, or improper grading around the walls, which allows surface water to pass into the cellar.

In any case, the condition of the walls themselves should be examined in order to detect cracks or loose mortar, and repairs should be made in accordance with instructions contained in section 2 of this chapter (pp. 10 to 11).

Diverting Surface Water from Foundation Walls.

Since wet cellars often result from water penetrating the walls or floors, provision should be made to carry off this water before it comes in contact with the foundation.

Water from eaves should be carried away by adequate gutters, conductors, and down spouts. The down spouts should be connected to a drain emptying into a storm sewer, dry well, open water course, or other suitable outlet. (Many communities prohibit the draining of surface water into sanitary sewers.) Where down spouts are not so connected, it is advisable to place a spatter board or splash block of good size at the outlet to throw the roof water away from the wall.

Quick shedding of water is essential and in many cases this may be accomplished by proper grading. The usual method is to place additional filling against the cellar wall and grade it down to a sharp, smooth slope that extends at least 8 or 10 feet from the wall. The slope should be sown with good lawn grass seed or sodded, and then rolled firmly and evenly. If necessary to grade above the cellar window sills, a curved or rectangular area wall of concrete or brick should be built around them. Hinged covers for closing the openings during heavy rains or snow may also be provided. In any case it is advisable to provide some means of drainage for these ground depressions and to place a protecting grill or grating over the opening.

Another method sometimes employed to turn surface water away from cellar walls is to lay a concrete pavement, walk, or gutter, 2 or 3 feet in width, around the house with a gradual slope away from the walls. Where the sidewalk joins the wall, the wall surface should be roughened, cleaned, and moistened and the concrete rounded up to meet the face of the wall. This method will make a good bond and turn water away from the joint.

The gutter type of construction is used to conduct surface water along the wall and lead it to some low spot. The gutter should be at least 2 feet wide over all, with an outer lip, or edge, about 5 inches in width. The depression should be about 4 inches deep at the outer edge and sloped gradually up to meet the wall, and the joint should be treated in the same manner as above recommended for the sidewalk.

Providing Drains to Carry off Ground Water.

In low damp locations, or in other places where there is a large amount of water in the subsoil, it is advisable to install draintile around the footings to lower the water table, or water level, and to carry the water away before it can penetrate into the cellar. (See fig. 2.) Where conditions are unusually bad, waterproofing may be necessary in addition to the drain.

To lay the tile, dig a trench adjoining, and to a depth of a few inches below the level of the bottom of the cellar floor but not below the footing level. The tile should be at least 4 inches in diameter (although 3-inch tile has proved satisfactory in some cases) and

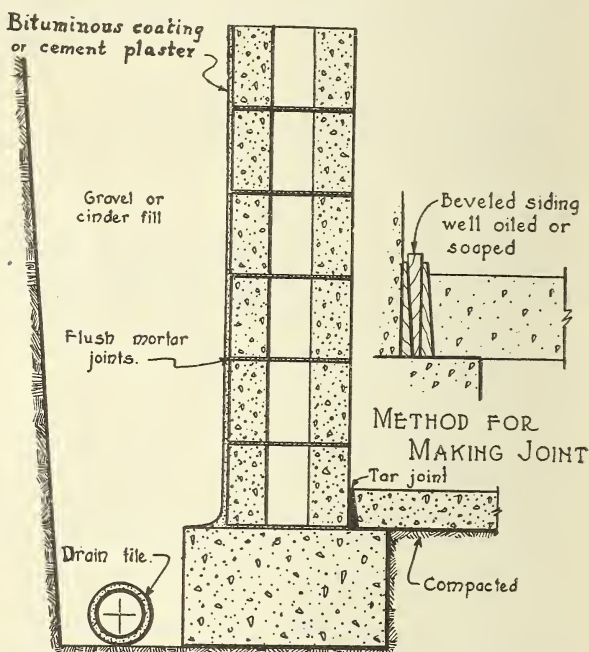

FIGURE 2.—Cross section of foundation wall showing draintile and plaster coat

should be laid so that the grade or fall will be smooth and as sharp as possible to avoid settlement of mud within the pipe. The tile should also be connected to an outlet similar to those recommended for down spouts. The cracks between the joints should be covered with pieces of tin or strips of roofing paper, to prevent sediment running into the pipe. The pipe should be carefully laid and protected against settlement or breakage under strain, but surrounding it with fine screened gravel or broken stone, tamped firmly around it. Following this, coarser material up to 1 inch in size should be covered over the pipe to a depth of 1 or 2 feet. Before back filling to grade with earth, it is well to spread burlap or bagging or to place sods, grass side down, on top of the stone to prevent fine material falling or washing down into the stone.

Waterproofing Methods—Exterior Surfaces.

If waterproofing is to be applied, it should, of course, be done before back filling. There are various methods used, depending largely upon local conditions.² In applying a coating to a wall, it is well to put it on the outside. Water is thus prevented from entering the wall, and water pressure tends to force the coating into tighter contact. If the coating is placed on the inside, water pressure through the wall may force it away.

Cement Plaster Coats.

Where ground-water conditions are not especially bad and dampness only is to be guarded against, a cement-mortar coating is easiest to apply and is perhaps in most common use. This may consist of a half-inch coating of Portland cement mortar (mixed in the proportion of 1 sack of Portland cement to 2 cubic feet of clean, well-graded sand, plus finely divided materials, such as hydrated lime or diatomaceous silica), or a plastic cement applied to the exterior surface of the wall with a trowel. To insure a good bond, the wall surface should be thoroughly scraped and cleaned with sharp-edged instruments and a wire brush and then dampened before the mortar is applied.

Bituminous Coatings.

It is best to cover the surface with a bituminous coating if worse conditions than mere dampness exist. This may consist of a simple coating of coal-tar pitch or asphalt, or may be a built-up covering of alternate layers of the bituminous material and tar paper. These coatings are often used alone on new walls or in cases where the walls are in such good condition that they do not require the plaster coat. If walls are rough, however, like brick, stone, or concrete block, they usually require a plaster coat before being waterproofed.

In applying cold bituminous coatings, first apply a priming coat of the same bitumen thinned with gasoline or with kerosene to the consistency of paint. This mixture is applied cold with a mop or large brush and is intended to soak into the pores and provide a good bond for the top coating.

The ordinary bituminous coatings are usually applied hot and swabbed on with a roofing mop to a thickness of at least one-eighth inch. Several coats may be applied if necessary, and dull spots, which indicate absorption, should be touched up until a uniform shiny appearance is produced.

There have been recent developments in the application of such materials, one of which is the use of compressed air to "shoot" the material upon the surface in much the same manner as that employed in paint spraying.

Bituminous layers, or membranes, are similar to ordinary bituminous coatings, except that they are much thicker and consist of alternate layers of bituminous material and tar paper. The membranes should be used in extremely wet conditions or where there is water pressure against the walls from a spring or other source. The number of layers to be applied depends on the conditions to be overcome.

² In most larger cities there are representatives of waterproofing companies who are glad to inspect damp basements and make recommendations for waterproofing.

Damp Proofing Methods—Exterior Surfaces.

For damp proofing a brick foundation wall, heavy penetrating bituminous damp-proofing paint may be used, after which a cement mortar coat may be troweled directly on the painted surface, to prevent the paint from flaking and peeling.

The application of a coating of any material upon the inner surfaces of walls that are pervious to water is generally ineffective. If such method is used, however, a thick layer of mortar is suggested. This should be made of 1 part Portland cement and 3 parts of well-graded sand mixed with as little water as practicable. The mortar should be applied to the dampened wall after the leakage through the wall has stopped. The finished coat should be kept damp for a week after it has set to increase its water-tightness.

Good Ventilation Essential.

Fresh air and sunshine are essential to a dry cellar, and to this end plenty of window space should be provided. When the air out of doors is cool and dry, open the windows freely. When there is dampness without, keep the windows closed, as warm, moist air results in mildew and condensation of moisture upon the colder surfaces within the cellar. A little care in these respects will aid materially in maintaining a dry cellar.

2. REPAIRING CRACKS AND REPOINTING JOINTS

Cracks or fissures in foundation walls and the falling out of mortar from between joints may be attributed to various causes.

Cracks between mortar and the material to which it was originally bonded may be caused by shrinkage of the mortar during setting, or soon thereafter, or by the expansion of mortar through saturation. Often the volume change of the mortar is greater than the material to which it is bonded and sets up a movement that destroys the bond.

If the walls are built on ground that will not support an equal weight at all points, uneven settlement may cause cracks to develop. An underground spring or flowing water under one corner or section of a foundation may produce similar results.

Small cracks thus started may become larger in time from action of the weather and other forces. Frost has a tendency to attack weak spots, and expansion and contraction, due to extremities of heat and cold, do their part in increasing the damage. Water seeping through the cracks gradually wears away the material and causes it to crumble and fall apart. The disintegration is generally more rapid in mortar joints.

The results of these failures are far-reaching and, if not remedied, may result in further damage, not only to the walls themselves but to the structure they support. A cellar will probably become damp and insanitary if these inlets for moisture are not stopped up.

Degree of Damage—Skill Required for Repair.

If the walls are otherwise in good condition, minor cracks and places where mortar has fallen out may be repaired by an unskilled workman. If, however, a wall is badly cracked and crumbled and beyond the aid of minor repairs, it may be necessary to engage an experienced workman to reconstruct all or part of the wall.

Tools.

The minor repairs in this section require the following tools: A hammer, a sharp-edged and pointed instrument (such as a cold chisel or old screw driver), a wire brush or old whisk broom, a small mixing board, mason's trowel, and a water bucket.

Materials.

Portland cement, a finely divided material such as hydrated lime, clean sharp sand, and water.

Preparing the Old Surfaces.

Loose mortar between masonry courses should be chipped and picked out and the joint brushed thoroughly to remove all dust and loose particles. The cleaned surface should be dampened before new mortar is applied, so that the water in the mixture will not be absorbed.

In the case of cracks in walls, especially in concrete walls, it is considered good practice to chip out the crack to a V or wedge shape, leaving the surface of the crack rough and irregular, so that the new material may get a good grip and be held firmly in place. The crack should then be brushed, as explained above, and dampened before new material is inserted.

Material Mixtures to be Used.

The same proportions of material may be used for both classes of repairs referred to. A mixture of 1 part cement to 2½ parts sand, or 1 part cement to 3 parts sand, is recommended in ordinary cases, but for damp cellars or those exposed to very moist conditions, a 1 to 2 mixture might be better. The proportion to be used depends entirely upon conditions and must be left to the judgment of the man on the job. A larger proportion of cement is necessary where excessive moisture prevails.

A 1 to 2 mixture represents 1 part of Portland cement to 2 parts of sand, measured by volume. Enough water should be used to make a fairly dry mortar of about the consistency of putty, and the mortar should be thoroughly mixed and worked to insure best results. In filling up cracks it should be applied like a calking material; that is rammed and tamped in well to form contact with all corners and depressions and make a complete bond. When the crack has been tightly packed, the surface should be smoothed off with a trowel.

In pointing up joints in masonry, the mortar may be applied with a trowel and the surface finished to conform with the old mortar.

Care of the Finished Work.

When the pointing up and repairing have been completed and the material has hardened, the new work should be wetted down daily for several days to increase the strength of the cement. If the work has been done on the outside of walls, a tarpaulin or similar covering should be suspended over it, to protect it from direct exposure to the sun and drying winds.

3. HOW TO MAKE A DARK CELLAR LIGHTER

Many cellars could be made lighter by enlarging the window openings or by putting in additional ones, but if this is done, proper lintels should be placed over the openings and such precautions taken

as to insure the stability of the wall. Keeping clear the spaces in front of cellar windows, especially by removal of shrubbery, grass, and weeds, will allow the maximum amount of light to enter.

The Use of Whitewash.

A coat of whitewash will generally do much to brighten a dark cellar. It is the cheapest of all coverings and makes a sanitary coating. The surface to be treated should be cleaned of all dirt, scales, or other loose material by brushing well with a clean, stiff brush, or by first scraping and then brushing. If the walls have been previously whitewashed, all of the old material should be washed off with a cloth or sponge and hot water. Nail holes and cracks should be filled with a mixture of 4 parts hydrated lime, or lime putty, and 1 part of plaster of Paris, with enough water to make a thick paste. The paste should be forced into the holes and carefully smoothed off flush with the surface by means of a putty knife or old case knife.

Whitewashes and lime paints must be applied thin. In fact, best results will be secured if the application is so thin that the surface to which it is applied may easily be seen through the film while it is wet. The coating will dry opaque, however, and the thin coat will give better results than a thick one.

If a brush is used, a large high-grade brush is preferable. One should not attempt to brush out the coating, as in applying oil paint, but simply spread the whitewash on as evenly and quickly as possible.

Much time and labor can be saved, and a job as good, if not better than when a brush is used, can be done by using a pressure spray pump or a paint gun. In using either of these appliances, however, the whitewash should be strained through cheesecloth, to free the mixture from any lumps which might clog up the working parts of the sprayer. An advantage in using a sprayer is that corners and crevices are more readily covered than with a brush. A suitable sprayer may be purchased at a hardware or implement store.

Two Whitewash Formulas.³

In basements where there is a tendency toward dampness, and where a durable nonrubbing wash is desired, the following formula should be satisfactory and easy to prepare:

Soak 5 pounds of casein⁴ (glue substitute) in about 2 gallons of water (preferably hot) until thoroughly softened (about 2 hours). Dilute 3 pints of commercial ammonia with about 1 gallon of water. Add the ammonia to the casein and allow the mixture to dissolve thoroughly. Make a thick cream by thoroughly mixing 50 pounds (1 sack) of hydrated lime and 6 gallons of water or by carefully slaking and screening 38 pounds (one-half bushel) of quicklime. When both the lime and the casein mixtures are cold, slowly add the casein-ammonia solution to the lime, stirring constantly. Just before use, dilute 5 pints of formaldehyde with about 3 gallons of cold water and slowly add this solution to the lime mixture, stirring constantly and vigorously. Be careful not to add the formaldehyde too rapidly. Thin to desired consistency.

³ Whitewash formulæ from Whitewash and Cold Water Paint, a pamphlet issued by the National Lime Association. (This pamphlet is listed on p. 109.)

⁴ Casein may be obtained at drug stores or from the manufacturer. Skimmed milk may be used as a substitute for the casein and water. It is not so effective, but will produce a much better whitewash than would be secured if the casein were omitted.

If the basement is dry, the following nonrubbing formula should be satisfactory:

Dissolve 3 pounds of glue in about 2 gallons of water. Make a thick cream of 50 pounds (1 sack) of hydrated lime and about 7 gallons of water, or carefully slake 38 pounds (one-half bushel) of quicklime, straining the soft paste through a fine screen. Add the glue solution to the lime, stirring constantly. Thin to desired consistency.

The area covered by a gallon of either of the above mixtures depends on the nature of the surface. A gallon will cover about 225 square feet on wood, about 180 square feet on brick, and about 270 square feet on plaster. The first formula given will make about 16 gallons of whitewash and the second about 11 gallons. If a smaller quantity is desired, the amount of each ingredient may be reduced accordingly. For instance, for 4 gallons of whitewash, according to the first formula, take one-fourth the amounts of liquids and solids given and mix as specified.

Other Cellar Finishes.

If the walls are damp, they should first be treated by a method such as outlined in section 1 of this chapter (pp. 6 to 10). Cleaning and brushing, as heretofore recommended, is also necessary.

After the walls have thoroughly dried, they may be treated and painted with a cold-water wash or oil paint as described in Chapter XII, section 7 (pp. 87 to 89).

If the cellar floor is below grade, it is not advisable to use oil paint, even though the floor appears to be dry. In this case, it can be treated with sodium silicate or aluminum sulphate.⁵ These treatments when properly applied give a hard surface, bright and uniform in appearance, and easy to keep clean.

Better Lighting Facilities.

If the house is equipped for electricity, extension wires will permit the use of portable or additional lamps in any part of the cellar. Frosted bulbs are best for cellar lighting, as they give a more uniformly diffused light. In so far as distribution of light is concerned, two or three 25-watt frosted bulbs are better than one 50 or 100 watt plain bulb.

In case a lamp is placed where the bulb is liable to be broken, it is advisable to protect it with a wire basketlike covering or guard.

Porcelain fittings are recommended for cellar fixtures on account of the danger of shock.

4. PUTTING A CEILING IN THE BASEMENT

Although it is common practice to omit ceilings in basements, a ceiling in this part of the house improves the appearance, does away with numerous corners and spaces between joists where cobwebs and dust collect, and prevents dust from passing through the first-story flooring to the rooms above, especially where the floors are of only a single thickness.

⁵ Described in Bureau of Standards Letter Circular 139, pp. 9 and 10. This circular can be obtained free of charge by addressing the Bureau of Standards, Washington, D. C.

Of far greater importance, if the ceiling is of tight-fitting fire-resistant materials, is the safety it affords by delaying the spreading of a cellar fire to floors above, and by reducing smoke damage.

If the cellar is dry and well built, it can often be made into an attractive place by putting in a ceiling, painting the walls and floor as described in Chapter XII, section 7 (pp. 87 to 89), and partitioning off the coal bin and furnace. It may then be used as a summer dining room, game room, or for other purposes if extra space is needed.

Before putting on the ceiling, all openings, through which fire might find quick passage to the structure above, should be adequately fire stopped. Such openings may be found around service pipes and registers, and between joists or studs, where they join the foundation. It is best to use incombustible materials for fire stopping, such as crushed refuse mortar, plaster, concrete, hollow tile, gypsum block, broken brick, or other similar material, containing sufficient fine stuff to fill voids. The fire stopping can be supported by horizontal wood strips, not less than 2 inches thick, or by metal or wire mesh.

Several materials are used for ceiling purposes. Gypsum or asbestos board, plaster on metal lath or on gypsum plaster board, or metal ceiling, properly furred, may be used, depending on the taste of the individual and the amount that may be expended.

It is recommended that any such material within 2 feet of the top of a boiler or furnace, or within 1 foot of a smoke pipe, shall at least be protected by a loose-fitting metal shield, arranged to preserve an air space of an inch or two between the metal and the wood. The air space may be provided by the use of small blocks of incombustible material between metal and joists, or by suspending the metal sheets on wires or hooks fastened to the joists. If tin is used for a shield, it should have locked joints, as soldered joints are not reliable.

Similar protection should be placed over any woodwork or wood lath and plaster partition, within 4 feet of the sides or back or 6 feet from the front, of any boiler, furnace, or other heating equipment. This covering should extend at least 4 feet above the floor, and at least 3 feet beyond the heating device, on all sides. It is advisable to have all such installations inspected by a representative of the fire insurance company.

5. INSTALLING PARTITIONS IN THE BASEMENT

A dry, clean, well-lighted, and well-ventilated basement can be made a most useful part of a house by partitioning off spaces for different purposes. It is generally necessary, at least, to partition off a coal bin, and sometimes the furnace also is inclosed to protect the rest of the basement from dust and soot. The remaining space may be divided off for a laundry, a workroom for the handy man, or a playroom for the children. It may also be desirable to provide a cold room for the storage of preserves and fruits and vegetables.

If a definite storage space is set aside for garden tools, bicycles, and various equipment, they can be kept in good condition and more readily located when needed. An orderly arrangement in a basement tends to encourage neatness and lessen work.

Before partitions are put in, a careful study of the requirements should be made and a plan outlined, so that, regardless of the order in which the partitions are built, they will conform to the general scheme.

The partitions may be of wall board, lumber, brick, tile, or concrete, depending upon the wishes of the owner regarding permanence and the amount of money available for the purpose.

If the partition is to be sheathed with wall board or lumber it will be first necessary to construct a framework on which to nail the sheathing. For this purpose, 2 by 4 inch lumber is generally used for plates and studs, as in ordinary wall construction. If wall board is used, the studs should be placed on 16-inch or 24-inch centers depending upon the width of the material. If a tight, neat-appearing wooden wall is desired, tongued-and-grooved three-quarter-inch boards may be used.

If brick, concrete blocks, or hollow tile are used, the question of thickness is not important, as the wall is not a load-bearing wall. It should, however, be substantial enough to withstand considerable lateral pressure and rough usage.

V. EXTERIOR WALLS

1. REPAIRING CRACKS IN STUCCO

Since the use of stucco has become widespread there have been many unsatisfactory results in such work due principally to faulty construction and lack of knowledge as to proper methods of mixing and applying the material. Cracks are the most common defects found. They may be merely hair cracks, or may be large enough to admit moisture, which in turn may result in damage to the underlying structure and interior walls.

Hair cracks may be caused by using too rich a mixture or by employing inferior stucco material. They may also result from too rapid drying. Larger cracks are generally caused by settlement of the walls of the house or by some movement within them, as a result of improper foundations or poorly designed framing in the superstructure.

Stucco over brick, stone, or similar materials is liable to crack, especially around chimneys. The reason for this cracking is that the stucco has a different rate of expansion and contraction than the material that it covers, and a shearing stress or "crawling" effect takes place in the plane of contact between the two materials.

If cracks are unsightly and large enough to admit moisture, it is advisable to repair them. If, however, they are not very noticeable and seem to be doing no damage, it may be possible to postpone repairs, since the plastered cracks may present a worse appearance than the open ones.

Tools.

A hammer, a sharp-edged and pointed instrument (such as a cold chisel or screw driver), a wire brush or whisk broom, a mixing board, a mason's trowel, and a water bucket.

Materials.

Portland cement, plastic cement, or Portland cement rendered plastic by the use of finely divided materials, clean sharp sand, and water.

Preparing the Cracks Before Pointing.

Before pointing, clean out the cracks thoroughly and chip them out to the shape of an inverted **V** so that the mortar may be keyed securely to the old work. The cracks should be brushed to remove all dust and loose particles and the cleaned surface and adjoining stucco dampened before new mortar is applied, so that the water in the mixture will not be absorbed.

Pointing the Cracks.

In pointing it is desirable to use the same brand of cement and mix to the same proportions as in the original work. If the previous mixture can not be determined, it is usually safe to use a 1 to 3 mixture, containing 1 part cement, 3 parts sand, and one-tenth part finely divided materials, such as hydrated lime, measured by volume.

The mortar should contain just enough water to make a fairly dry mixture—of about the consistency of putty. It should be applied like a calking material; that is, rammed and tamped in well so that it will make a complete contact and form a secure bond.

Care of Finished Work.

The new work should be wetted down daily for several days after it has hardened to increase the strength of the cement. It is a good plan, if practicable, to hang a tarpaulin or similar covering over the completed work to protect it from direct exposure to the sun and drying winds.

Concealing the Cracks.

If the cracks show up badly after pointing work is finished, it may be necessary to paint the entire surface with a cold-water wash or oil paint, as described in Chapter XII, section 7 (pp. 87 to 89).

2. CLEANING A STUCCO SURFACE

When Portland cement stucco becomes soiled it may be washed without injury by the application of water alone or water containing cleaning materials.

Ordinary dust and dirt may usually be removed by washing the walls with water from a hose and brushing with a wire or fiber brush. If this does not accomplish satisfactory results, the surface should be scrubbed vigorously with a soap-and-water solution and then rinsed with clear water. It is difficult to clean stucco thoroughly without marring the surface. A dashed surface may be badly injured by too much brushing and rubbing.

If the stucco has other than a pebble or stone-dash surface and is badly soiled and stained, it may be washed with a solution of muriatic acid⁶ (containing 1 part of acid to 6 or 7 parts of water) applied

⁶ In mixing the solution, pour the acid very slowly into the water. Care should be exercised in the use of muriatic acid, as it is harmful to the skin and particularly to the eyes. It is advisable to wear glasses and gloves. If the acid should come in contact with the person, it can be removed by the use of large quantities of fresh water.

with a fiber broom and then thoroughly rinsed with cold water. To remove every trace of acid, wash the surface again with very dilute ammonia (1 pint of ammonia to 2 gallons of water).

For white cement stucco it is better to use a sulphuric-acid solution, as the muriatic acid has a tendency to produce a yellowish tinge on white cement.

Stucco may be brightened, and all rust stains and other discolorations concealed, by painting the entire surface with a cold-water wash or oil paint, as described in Chapter XII, section 7.

3. REMOVING EFFLORESCENCE FROM WALL SURFACES

Efflorescence is the accumulation of salts upon the outer surface of a wall, particularly noticeable on those built of brick. It is a whitish, crystalline deposit resembling hoarfrost or mold, and it usually appears in patches.

These salts may exist in mortar, brick, concrete stucco, or other masonry materials. They are brought into solution by water in the wall, carried to the outer surface, and deposited there as the water evaporates.

Efflorescence may be more pronounced in new work, owing to an excessive amount of water in the mortar and a maximum amount of salts in the new materials. As the building becomes older, however, the accumulation often disappears without being removed.

It is commonly found in places where the wall is subjected to frequent wetting, as below window sills and copings, or near gutters and down spouts where there may be leakage. A prolonged wet spell may also bring it out in other places.

Water gets into the wall in various ways. In addition to the absorption of rain, melting snow, and humidity from the air, it may rise from the ground through mortar joints or seep in through cracks around window or door frames.

To Remove Efflorescence.

Efflorescence may sometimes be removed by brushing the spots vigorously with a stiff fiber or wire brush.

If this does not produce satisfactory results, prepare an acid wash composed of 1 part of muriatic acid⁷ and from 4 to 10 parts of water, and scrub the spots well with a fiber brush dipped in the solution. Avoid the mortar joints as much as possible during the scrubbing process and when the work is finished, rinse the surface of the wall with clear water. It is advisable to wash the surface again with a diluted solution of ammonia (1 pint of ammonia to 2 gallons of water) to remove every trace of acid.

The deposits may reappear from time to time and require additional washings, but will disappear entirely when the supply of soluble salts in the materials has been exhausted.

Precautions Against Recurrence.

Since efflorescence is caused by the evaporation of water which has previously been absorbed, it is obviously important that the opportunities for this absorption be reduced as much as possible, if the trouble is to be checked.

⁷ See footnote 6, p. 16.

It is well to examine gutters and down spouts for leaks, and to see that window sills and copings have drip grooves cut along the underside, so that water running over them will not reach the wall and run down its face.

If conditions are unusually bad, and it is felt that the expense is warranted, there are a number of colorless waterproofing compounds that may be applied to the surface of the wall to check absorption and thus tend to eliminate the formation of efflorescence.

VI. INTERIOR WALLS

1. REPAIRING CRACKS AND BREAKS IN PLASTER

The Architects' Small House Service Bureau has given 40 reasons for cracks in ceilings and walls. Space does not permit the enumeration of all these causes, but some of the more important ones are listed below.

Structural Cracks.

Structural cracks, as the name implies, are caused by structural weaknesses in a building, chief among which are: Settlement resulting from inadequate or improperly located footings, the use of undersized or improperly spaced members, omission of bracing, or shrinkage of lumber. These cracks are usually large and well defined, extending across the surface and through the plaster. They may start near the corner of a door or window, or run up and down the corner where two walls join, or along the joints between walls and ceiling.

Map and Shrinkage Cracks.

Inferior workmanship and the use of a poor quality of plastering materials are the main causes of what are known as "map cracks" and "shrinkage cracks"; that is, shrinkage in the plaster itself.

Map cracks are usually caused by improper bonding between the plaster and the base. They are less noticeable than structural cracks and go through the plaster, but do not extend entirely across the surface, as do the latter. They are made up of a series of cracks running at various angles and embracing areas usually 6 inches or more across.

Shrinkage cracks resemble map cracks, except that the cracks themselves and the areas they inclose are much smaller. They differ from the map cracks inasmuch as they do not go entirely through the plaster and are usually confined to the finish coat. Careless workmanship is usually the cause of these cracks. In a sanded finish they are caused by plaster which is allowed to dry too rapidly or which it not sufficiently troweled. Troweling at the wrong time in a white finish will often produce equally unsatisfactory results.

Loose Plaster.

Sometimes the keys or clinches that hold the plaster to the base break off or become loosened and cause the plaster to bulge and crack. On ceilings, especially, it will often hang in this condition for a long time before falling off, being held together by the hair

or fiber in the plaster. Occasionally the nails or fastenings used to hold lath in place may corrode and break, allowing that part of the plaster covering the loosened lath, or laths, to sag and crack.

Repairing Structural Cracks.

Tools.

For cracks and small holes a small diamond-shaped mason's trowel or broad-bladed putty knife, for plastering larger areas a plasterer's trowel and a shallow pan.

Materials.

Plaster of Paris or commercial patching plaster, a small amount of ordinary glue if necessary, and clean water.

The repair of structural cracks, or cracks extending through the plaster to the base, does not require refinishing of the whole surface, and, consequently, may readily be done by the unskilled workman.

To repair a deep crack, it is necessary to have the crack wide enough so that the fresh plaster may be forced in and form a good bond with the old plaster. If the crack is not sufficiently wide, it should be scraped with a knife blade until the opening is at least one-quarter inch across. All particles of loose sand and plaster should be brushed out and the surface should be thoroughly wetted before the fresh plaster is applied. The plaster should then be pressed well into place and struck off flush with the surface of the main body of plaster. If the old plaster has not been thoroughly wetted, it may draw the water out of the fresh plaster to such an extent that it will not set, but will dry out and remain in a chalky condition without appreciable strength. The drying out may be avoided by spraying water onto the surface after the plaster has set, and keeping the surface damp for a period of about 24 hours.

Shrinkage Cracks.

Shrinkage cracks, which usually occur only in the finish coat, are generally so numerous, if the job has not been well done, that it is necessary to refinish the whole surface, which work requires the services of an experienced plasterer.

Holes in Plaster.

The loose plaster around each hole should be removed, the remaining sound plaster wetted thoroughly, and the plaster applied in the same manner as prescribed for structural cracks. Because larger amounts of plaster are usually required for holes than cracks, it is advisable to retard the setting of plaster so that it may be worked for a longer period. (The process of retarding is explained later in this discussion.)

Bulged or Hanging Plaster.

If the plaster is bulged or hanging it is best to remove all of the loose plaster around the break and apply new material. In case the lath, or backing, has drawn away from the joists, it will have to be refastened before new plaster is applied. If the patch is an unusually large one, it is generally best to employ a plasterer, as this work requires so much skill that it is difficult for an amateur to make a neat-looking job.

Mixing the Plaster.

All mixing boxes and utensils should be clean, and clean water should be used in the mix. Particular care should be taken that no traces of old set plaster have been left in the mixing box.

The water should be placed in the mixing box before the dry plaster is sifted into the water. The mix should then be stirred thoroughly to dissolve all lumps. It should be of such a consistency that the putty may be picked up on a broad-bladed knife and forced into the crack or break in the wall.

Plaster of Paris.

If only a small amount of fresh plaster is needed, plaster of Paris alone may be used. Plaster of Paris sets very quickly. If it is to be used without a retarder, only so much should be mixed at one time as can be put in place in 10 minutes or less.

To Retard the Setting of Plaster.

If the plaster sets too rapidly, and difficulty is found in getting it into place, the hardening may be retarded by the addition of small amounts of ordinary glue dissolved in the mixing water. Commercial patching plasters usually contain retarding material so that they may be worked for a longer period than the ordinary plaster of Paris. They may also contain other ingredients to improve the working qualities of the plaster.

2. PREVENTING DAMP SPOTS ON WALLS

Damp spots or more generally wet conditions on inside surfaces of exterior walls are usually caused by leakages around window frames or by condensation of moisture on the chilled surfaces of the plaster.⁸ Occasionally, however, there may be leakages through a masonry wall, but they are generally traceable to defective joints. Damp spots may also be caused by leaking pipes and on ceilings, by sweating pipes.

The question is sometimes raised as to whether water coming through brick walls penetrates the brick themselves. It has been fairly well established that a wall made of a good grade of brick will transmit little moisture through the brick. A thin brick wall may become frosted through to the inside surface during unusually cold, wet weather, and moisture which is often regarded as leakage, may be melted frost running down inside the wall.

Leakage Through Joints.

Sometimes the quality or condition of the mortar in the joints, or the condition of the bond, may allow moisture to seep through the joints. When the bricks do not make a good bond with the mortar, shrinkage cracks may appear between the bricks and mortar as the materials dry out. If the mortar is not of good quality, it may disintegrate and fall out, causing leakage.

Occasionally there is leakage around a closure, or short piece of brick, inserted to fill out a course. This leak occurs when the closure

⁸ Discussions of leakages around window frames and condensation on inside wall surfaces are contained in Ch. IX, secs. 2 and 5, pp. 49 to 51 and 54 to 55.

is not cut small enough to allow plenty of mortar to be placed around it on all sides.

For best results bricks should be laid in a full bed of mortar, and all vertical joints should be well filled and packed with mortar. Vertical joints which are merely "buttered" with mortar, cause more leaky walls than almost any other single factor. All exterior joints should be carefully struck smooth with the trowel to compress the mortar in order to make it dense and impervious. Joints raked out, or rough cut for artistic effect, are common causes for leaking walls, since ice, snow, and rain water have an opportunity to lodge in the recesses thus formed, and gradually work through the wall.

Some prefer, when it is found that a particular spot or area of a wall requires frequent repointing to use an integral waterproofing compound in the mortar, thoroughly mixing it with the other ingredients.⁹

Repointing and Waterproofing.

Carefully examine the exterior surface of the wall where damp spots appear, to see whether the mortar is in place and otherwise in good condition.

If it is found that the mortar is cracked and has fallen out in places, these joints should be repointed. For this purpose, a mixture consisting of 1 part Portland cement, 3 parts well-graded but not too coarse sand, and 10 to 15 per cent of the volume of cement in a finely divided material, such as hydrated lime, is recommended. When the right quantity of water is added, this makes a workable mortar, which, if thoroughly mixed and troweled in well, should be practically impervious to moisture.

Before beginning to point, remove all loose mortar and brush small particles and dust out of the joints. Dampen the joints and adjoining surfaces before applying the new mortar, so that the moisture in the latter will not be absorbed.

After this preliminary work, pack the mortar tightly into the joints to fill all voids and form a good bond with the old mortar and bricks. The surface of the joint should then be troweled firmly to make a smooth finish, preferably sloped downward to shed water readily.

If the bricks seem unusually porous and it is felt that repointing alone will not be sufficient to keep out dampness, the surface of the wall may then be painted with a good waterproof paint. (See Ch. XII, sec. 8.) If painting is not desirable, the face of the wall may be coated with colorless damp proofing, of which there are several kinds on the market.

Walls Next to Chimney.

Sometimes damp spots appear on the walls next to a chimney. They may be caused by leakage through the joint between the chimney and roof, but are often brought about by settling of the chimney foundation, or vice versa, by the chimney not settling and the frame shrinking and settling. If the top of the chimney is not properly covered with a coping or chimney top, water may run down between

⁹ See Wet Walls and Efflorescence, American Face Brick Association, listed on p. 104 of this publication.

the bricks and the flue lining and appear on the surface of the walls below.

The connection between the roof and masonry of the chimney, or any other masonry, should be flashed with metal to turn the water away from the joint. Before applying the flashing, calk the joint with roofing cement to insure a water-tight job. After the flashing has been applied, seal the cracks around the edges of the flashing with roofing cement.

Leakage Around the Tops of Walls.

If the top of a parapet wall is not protected by a proper coping, water may get in and run down through the wall and appear on the inside surface. In this case a coping (or cap) of concrete, tile, or metal, should be provided.

VII. ROOFS AND ROOF DRAINAGE

1. REPAIRING A LEAKY ROOF

One of the principal sources of annoyance to the average householder is a leak in the roof. The roof is generally subject to the hardest wear of any part of the house. Beating rains and sleet, strong winds, scorching sunshine, and alternate freezing and thawing with sliding snow and ice, all contribute to the wear and tear on the roof surface.

The flashing in valleys and around chimneys and where different sections of the roof meet frequently causes trouble; this phase of the problem is described in section 2 of this chapter (pp. 24 to 28). The present section will be confined to a discussion of leaks in the roof proper.

Importance of Prompt Repairs.

When a leak develops, it is important that repairs be made without unnecessary delay. If repairs are neglected over a long period the plaster may become cracked and loosened and eventually fall, and the framework below the leak may rot. Even small leaks will often cause discoloration of wall decorations and stains on finished floors.

Although it may not be possible for the average man to apply a new roof or to do extensive repair work, he should at least be able to patch up leaky spots until such time as more permanent repairs can be made, or the old roof replaced with a new one.

Recommended Safety Measures.

Do not attempt to walk on a steep roof without at least a strong rope for support. This is the simplest of safety rules, and a rope is usually adequate to insure balance for small patching jobs. It is advisable to wear tennis shoes or go shoeless on a pitched roof to insure better footing, and to avoid possible damage to the roof covering. Avoid walking on an old shingle roof or one of other brittle material in making temporary repairs, as more leaks may be made.

In laying roofing or in making repairs, a long straight ladder or a so-called "chicken ladder" may be used. The ladder is made by nailing 1 by 2 inch cleats about 1 foot apart to a 1 by 10 inch plank or similar long board. Either type of ladder may be hooked

over the ridge of the roof, as shown in Figure 3. Hooks for this purpose are made by nailing a strong piece of wood to each leg near the upper end of the ladder at an angle with the legs, as shown in the figure. This angle should conform as nearly as possible to the slope of the roof, and the pieces should be braced or stiffened by nailing short boards across them and the legs of the ladder. (See fig. 3.)

Locating the Leaks.

It is often difficult to locate the point of leakage from a wet spot on the ceiling, especially if the underside of the roof is not easy of access, since water may follow along the roof boards or rafters before dripping down. It is equally difficult to locate a hole from the roof's surface. However, if there is an unceiled attic in the house, most small holes may be readily located from the attic on a

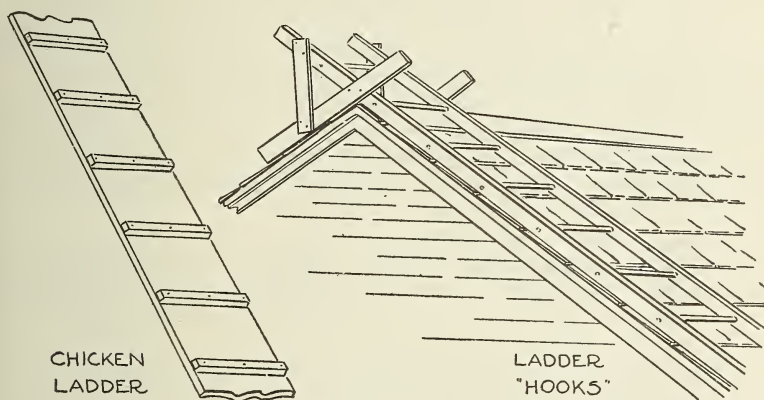

FIGURE 3.—Two types of support used in roof repairing

bright day. Even the most minute holes will be plainly visible and may be marked by straws or wires pushed through the holes far enough to protrude above the roof surface.

Making Temporary Repairs.

Leaks in a shingle roof may often be temporarily stopped by inserting a new shingle, a piece of roll roofing or tarred felt, or a piece of tin under the shingles to cover the hole. If no sheet tin or similar material is available, cut a tin can apart with a can opener or heavy shears, flatten it out, and paint it on both sides before using it.

There are various roofing compounds on the market composed of heavy plastic bituminous materials, which are recommended for covering holes in roofs. These compounds may be applied with a heavy brush if a large surface is to be covered, or with a putty knife or paint scraper if small holes or cracks are to be plugged. The manufacturers of such compounds usually furnish directions covering their use.

Leaks in a composition-shingle roof may be repaired in much the same manner as those in a wood-shingle roof.

Small leaks in a metal roof may often be mended with a drop of solder, after the spot has been thoroughly cleaned to make the solder hold.

It is not advisable for an inexperienced person to attempt to repair a slate or tile roof, as such a task is difficult and he may cause additional damage.

Reroofing.

Although reroofing does not fall strictly under the head of repair work it is closely associated with it. The type and condition of the old roofing may make the removal of the old covering desirable, but many of the modern types of roofing can be applied directly over old wood shingles or other kinds of material, and it is claimed that there are numerous advantages in this method. Chief among these is the insulation provided. Labor costs of removing the old material and cleaning up the premises after the work is completed are considerably reduced, and the scattering of dirt and debris over the house and surroundings is eliminated. In case of rain during the period of reroofing, the interior of the house is protected.

Before new roofing is applied over old, all loose shingles should be nailed securely, protruding nails driven in, and the surface made as uniform as possible. These precautions are necessary to insure a smooth finish on the roof and to avoid punching holes in the new material.

In nailing the new roofing, care should be taken to avoid cracks between boards underneath. In case a nail is driven through a crack do not attempt to remove it, but drive another into the solid surface close by. Sufficiently long nails should be used to fasten the covering securely.

In reroofing with wood shingles over old wood shingles, it is possible to obtain a neat job and to retain good roof lines. It may be done by cutting away a few inches of the old shingles at the eaves and gables and laying in, where they are cut away, a furring strip, or batten, to hide the sides and butts of the old shingles.

The Importance of Good Nails.

The deterioration of nails used for roofing purposes is the principal cause of many roof failures. Nails often rust out and break off, allowing the covering to become loose long before the material itself shows signs of wear. The use of rust-proof roofing nails is, therefore, an important factor in preserving roof surfaces. For wood shingles, cut shingle nails are said to be best, and for composition shingles and roll roofing large-headed roofing nails are preferred. Roofing nails come in different lengths and should be selected according to the thickness to be penetrated. For two layers of wood shingles 5d (fivepenny) nails are best, and for one layer 3d (threepenny) are sufficient.

2. REPAIRING FLASHING TO PREVENT LEAKAGE

Flashing a roof is the process of making water-tight, by means of a lap joint, the angle where a roof meets other intersecting surfaces. It is employed at junctions between the roof and walls, chimneys, skylights, and similar places, and in the valleys or depressions where

two planes of the roof join. Flashing around walls, chimneys, or other vertical surfaces is designed to shed water from the joint, causing it to seek lower levels; while flashing in valleys is intended to conduct the water to the gutters.

Methods of Applying Flashing.

Several materials (cut in strips or pieces) such as lead, tin, copper, zinc, galvanized iron, or roll roofing are used for flashing, and the methods of applying them may vary according to conditions.

When flashing is placed against a vertical surface, there are different methods of fastening the upper edge of the flashing, depending on the material in the vertical surface; when placed against a brick or other masonry surface, the upper edge is usually bent and inserted into a groove or joint in the masonry, and the crack sealed with mortar or elastic roofing cement.

The best flashing material, and the one which should be used wherever possible, is one which is noncorrodible.

Sometimes two pieces are used in connection with masonry walls. The first is bent in the middle, the upper half nailed to the vertical surface of the wall, and the lower half nailed over one thickness of roofing and covered by another thickness. The second piece, known as counterflashing, is hung over the first to form an apron. It is suspended by bending the upper edge and inserting it into a joint in the vertical surface of the masonry, as previously described. The lap formed by the two pieces is fastened together and made watertight with elastic roof cement. Since the two pieces of flashing are independent of each other, they are not likely to break if parts of the building settle or shrink.

Against stucco or other plastered walls the upper edge of the flashing may be inserted behind the lath or fastened in such a way that it will be covered by the plaster when the latter is applied. In frame construction the upper edge of the flashing is generally run up behind the siding, or shingles, as the case may be.

Where the vertical surface intersects another surface in a horizontal line, as at the face of a chimney nearest the eaves, or at a horizontal roof line at the base of a wall, the flashing is generally extended down over the top course of the roofing, or the next course to the top, and nailed down, after the space to be lapped has been coated with elastic cement to make a tight joint. Similarly, when a roof covered with roll roofing or other flat roofing material meets a vertical surface in a horizontal intersection, the flashing from the vertical surface usually extends down and is sealed and nailed on top of the roofing. However, where any roof meets a vertical surface in a sloping line, such as along the sides of a chimney on a sloping roof, and the roofing consists of shingles or similarly lapped material, the "over and under" system of joint lapping is generally employed. The "over and under" means that, working upward on the roof, each succeeding piece of flashing extends from the vertical surface down over a shingle on the roof, and is then covered by the next higher shingle course. This course is then covered by the next higher piece of flashing, and so on up the slope. For such an intersection where roll roofing is used, it is either turned up under the side wall material, or the flashing is nailed over it, with elastic cement applied between to seal the joint.

At the back of a chimney which protrudes through a sloping roof, a so-called cricket, or saddle, is usually constructed in the roof's surface. As the name "saddle" indicates, it is a small ridge formed behind the chimney to divide the water running down the roof and throw it to each side away from the chimney instead of allowing it to dam up back of it. Water accumulating back of the chimney might eventually result in leakage at that point. Of course, the joint between the chimney and cricket is also flashed.

In an open valley the flashing is applied before the roofing is laid. The roofing material is then extended over the flashing to make a lap joint.

Both open and closed valleys are used in roof construction. In the open valley the center portion of the flashing is visible the entire length and the open space is usually wider at the bottom than near the ridge, to accommodate the increasing volume of water as it nears the eaves. In the closed valley the flashing is inserted by the over-and-under method, so that it makes an unbroken surface, which is generally considered more pleasing in appearance. The flashing material in either case should be wide enough to extend under the roofing material a sufficient distance to insure good protection.¹⁰

Causes of Leakage.

Occasionally metal-wall flashing may warp and be drawn out of the groove or joint in the vertical surface or, when roll roofing is used, it may break at its junction with the vertical surface, allowing water to run down behind it. The force of the wind may tear flashing loose from the face of the roofing allowing water to enter under it during heavy rains. Valley flashings, if too narrow, may allow water that is backing up to find its way under the roofing. This seeping sometimes occurs when the valleys are dammed up with snow and ice. Flashing material in valleys may corrode or break, causing cracks or holes, through which water may enter and drip through the joint below.

How to Make Repairs.

The approximate location of leaks in flashing may often be determined by wet spots on the walls or ceiling of the house. Carefully examine the flashing above and near such spots to ascertain the exact location and cause of leakage if possible.

If the leak is near a chimney or below the junction between the roof and a vertical wall or similar surface, see whether the flashing has become loose at any place. It may be found that the mortar has fallen out and needs repointing after the flashing has been replaced. Elastic roofing cement and similar compounds are useful and effective in sealing cracks around flashing.

If the flashing that extends over the top of roofing, as at the base of a vertical surface, becomes loosened, it should be nailed down after the underside of the lap has been well coated with elastic cement. The elastic cement serves to seal the spaces around nails and the cracks along the edges, which otherwise might allow leakage. It

¹⁰ For methods of flashing for open valleys, see Bureau of Standards Research paper, No. 123, listed on p. 110 of this handbook. See also Copper Flashings, Cooper and Brass Research Association and Zinc Workers' Manual, American Zinc Institute, listed on p. 110.

is also best to use short nails for this purpose in order to avoid penetrating through the roof boards.

When exposed metal flashing shows signs of rusting, it should be painted with a good metal paint to preserve it from further corrosion. This paint coat should be examined at regular intervals and renewed when it shows signs of wear. (See Ch. XII, sec. 10, pp. 90 and 91.)

To make valley flashing water-tight, it is advisable to cover with elastic cement that portion which is to be overlapped, immediately before applying the roof covering. This should seal the space between the two and prevent water from backing up over the edge of the flashing.¹¹

If the flashing in a valley is too narrow, or if it is corroded or broken, it will probably be necessary to replace it with new pieces of metal. This is not difficult in an open valley, but is rather troublesome in a closed one.

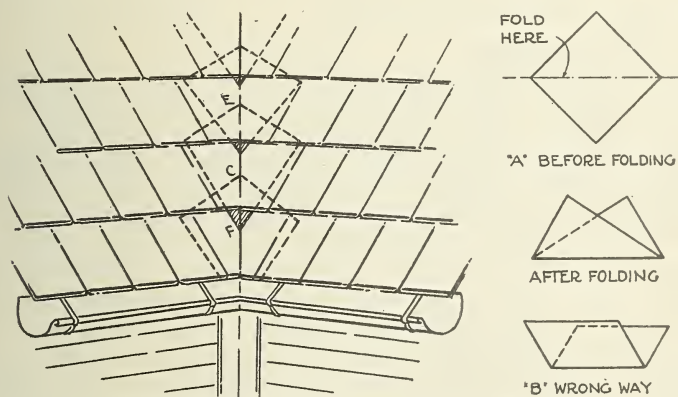

FIGURE 4.—A method of repairing valley flashing

In a closed valley covered with shingles, it is quite difficult to repair leaks in the flashing by pushing pieces of metal up under the shingles to cover the leaky spots, unless the metal is folded into a wedge-shaped point (as in *A*, fig. 4). Folding makes the task of pushing the sheets past such obstacles as nails easier. If nails interfere too much, they can be cut off under the shingle with a plumber's chisel or flat, sharp cold chisel and later replaced with new nails. The size of the sheets to be used for flashing depends on the pitch of the roof and the exposure of shingles to the weather.

Insert piece *A* (see fig. 4) under top layer of first course of shingles at the eaves and over the top of the old flashing and slide it up until the upper point of the sheet is at least 2 inches above the butts of the second course of shingles shown dotted at *C*.

Then insert another sheet under the second course of shingles pushing it up on top of the old flashing until upper point is at *E*. The lower point of this piece will show below the butts of the second course of shingles, as at *F*.

¹¹ See footnote 10, p. 26.

Continue this process until the top of the valley has been reached or until you are satisfied that all broken flashings have been covered.

On a well-nailed wooden-shingled roof, the sheets of flashing may not require nailing, as the pressure of the roofing material should hold them in place, but if the shingles are loose, or if the roofing is of flexible shingles, it will probably be necessary to nail each sheet at a point which will be covered by the sheet above it. If a larger sheet is used more of the flashing will be exposed at the base of the shingle courses (as at *F*, fig. 4) and the nails in the lower flashing will be completely covered.

If a good material is used the method just described makes a permanent repair and covers the cracks or holes rusted out in the angle of the original flashing.

3. CLEANING OUT AND REPAIRING GUTTERS AND DOWN SPOUTS

Gutters and down spouts require some attention from time to time to keep them in good condition.

Keeping Gutters Clean.

Perhaps the most frequent difficulty arises from an accumulation of leaves, rubbish, and birds' nests in the gutter, which, if not promptly removed, may stop up the opening to the down spout and cause water to back up and flow over the edge. This overflow may cause considerable damage if the gutters are built into the cornice so that the water finds its way down inside the walls of the house. Unsightly streaks and stains on the exterior wall surfaces may also result if the overflow is not stopped. To prevent leaves and other refuse from being washed into the down spout, it is advisable to place a wire basketlike strainer over the gutter outlet. Strainers are usually kept in stock by hardware dealers and are inexpensive. Even though there be no stoppage or overflow, it is advisable to keep gutters clean, since rotting leaves if allowed to remain will cause the metal to corrode and eventually leak. Fine ash and dirt should be removed regularly. Cinders in contact with the metal will set up a corrosive action. When dirt of this kind is removed the gutter should be flushed out with clean water to remove any trace of acid. Conditions such as those mentioned may be avoided if the householder will remember to clean out the gutters occasionally, especially in the autumn after the leaves have fallen.

It is also essential that unusually heavy snow and ice be removed from gutters in order to facilitate roof drainage and to guard against damage to the gutter or its fastenings by the excessive weight of such masses. The life of gutters and down spouts may be extended considerably by occasionally painting them with a good grade of metal paint.¹²

Replacement and Care of Leaders, or Down-Spout Pipe.

Leaders require less attention than gutters, but a certain amount of care is necessary. Slush working down into elbows will freeze there. Often it forces the seams and folds to open slightly and a small amount of water begins to drip. A leak is more common

¹² See Ch. XII, sec. 10, pp. 90 and 91.

where leaders are not corrugated to allow for expansion. When a leak starts it should be promptly checked, for otherwise the defect will develop quickly until the whole elbow is broken. A metal leader tube filled with water subjected to recurrent freezing and thawing will fail by splitting.

It is sometimes necessary to replace all or part of a down-spout pipe because of corrosion. This should not be a difficult task, since the pipe usually comes in sections and one piece fits into another like stovepipe. When inserting a piece, be sure that the upper piece fits inside the lower, so that the water can not escape. For an extra good job the sections may be soldered together at the joints.

In many localities it is unlawful to connect a down spout to a sanitary sewer. In case such connection is permitted, however, a clean-out trap should be provided at the base of the down spout to facilitate cleaning and to prevent the passage of foul odors from the sewer.

Repairs to Fastenings.

Metal gutters are often attached to the eaves by means of straps of tin or other metal. These straps may become broken or pulled loose from their fastenings, allowing the gutter to sag, preventing proper draining. In this event broken pieces should be removed and replaced by new ones, and loose straps should be refastened securely. After completing these repairs, sight along the top of the gutter to see that there is a uniform grade or slope down to the outlet end. If the slope is not uniform, it may be necessary to shorten or lengthen a strap or two.

Box-Type Gutters.

In case the gutter is of the box or trough type, made of wood and lined with metal, the lining should be examined for signs of cracking. If the trough is deep and narrow, expansion of ice in the gutter may force out the exterior wall of the trough, causing the metal to split. On account of this possibility, shallow and wide box gutters are best, since they permit ice to expand over the edge without injuring the box. Box-type gutters should be lined with rustless metal, or swabbed with bituminous material, or both.

VIII. DOORS AND WINDOWS

1. WHAT TO DO WHEN A DOOR BINDS OR STICKS

The binding or sticking of a door against the doorframe may be caused by loose or ineffective hinges, settlement of the frame, swelling of the door or frame, or warping of the door.

Unless one is somewhat skilled in carpentry, however, it usually pays to get a carpenter to make adjustments on doors in finished parts of the house.

Tools.

Screw driver, wood chisel, hammer, plane, jackknife, chalk, and small paint brush.

Materials.

A few pieces of cardboard or thin wood for "shims"; a small amount of putty to finish off the woodwork; and stain, paint, or varnish of the proper color to touch up bare surfaces after planing.

Loose Hinges.

To determine whether the fault lies with the hinges, first examine the margin or crack between the door and frame when the door is closed. Loose hinges, whether top or bottom, usually allow the door to sag, causing the upper outside corner to strike against the side of the jamb and the lower outside corner to drag on the threshold, making an uneven margin around the door. As a further test, try to shake the hinges by taking hold of the knob at each side, when door is open, and pulling and pushing the door away from and toward the hinges.

If the hinges move, try tightening the screws. It may be necessary to insert wooden plugs in the screw holes or to substitute longer screws, to make them hold properly.

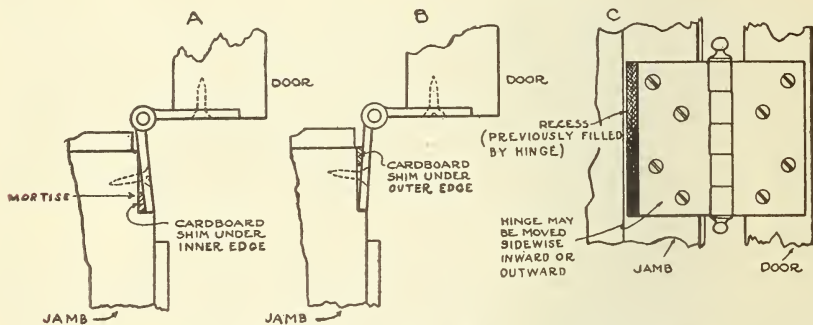

FIGURE 5.—Hinge readjustments to correct binding or sticking doors

If hinges are not loose, or if upon tightening the screws the margins or cracks are not made uniform, it might be well to try the effect of cardboard "shims" under the hinge leaves. To do this, loosen the screws of the top hinge in the leaf, which is fastened to the jamb, and insert a strip of cardboard under the inner edge, as shown in sketch *A* (fig. 5). Then tighten up the screws and try closing the door. This will usually correct the trouble, since it will tend to pull the upper part of the door closer to the jamb.

If this corrects the trouble as far as the striking is concerned but leaves considerable space above the door and along the outside edge (lock edge), loosen the screws in the leaf of the bottom hinge, which is attached to the jamb, and insert cardboard under the outer edge, as shown in sketch *B* (fig. 5).

If, after tightening the screws and again trying the door, it is found that there is an even crack, or margin on all sides, and that the hinge pins do not move when the door is closed, the repair is permanent. If, however, the hinge pins move when the door is being closed, it will probably be necessary to use thinner shims under the hinge leaves.

On the other hand, if the door strikes all along the outer edge, remove the pins, take down the door, and remove the hinge leaves from the jamb. Then with a sharp chisel cut away some wood from the outer edge of the mortises in the jamb, being careful to taper the cut so that no wood is removed from the back edge. When the hinges are replaced, this beveled deepening of the mortise will tend to pull the door away from the lock jamb and toward the hinge jamb. If, upon closing the door, the hinge pins move it is a sign of binding against the hinge jamb, as a result of excessive beveling of the mortises. This binding can be remedied by slight shimming under the outer edge of the jamb leaves.

Planing a Door.

It will seldom be necessary to plane the door if the trouble has been caused by loose or improperly mortised hinges. However, if it is necessary to plane, as in the case where the side margins are uneven and the door strikes at top or bottom due to settlement of the frame or similar causes, points of contact can generally be located by noting where paint is worn. If this is not possible, open and close the door several times and mark with chalk or pencil those places where the door seems to stick.

Then plane the edges of the door slightly where marked. Care should be taken not to plane too much off the door, for, when dry weather comes the wood may shrink, and, if it is an outside door and has been planed too much, it may require weather stripping or filling in. After planing a little it is well to try the door by opening and closing it, to see whether additional planing is needed.

If planing is required on the top or front edge, it can usually be done without removing the door. If the bottom or back edges need planing the door will, of course, have to be taken down.

If it is of the type having removable hinge pins, it is a simple matter to remove them and lift the door off. If not, the screws holding one leaf of the hinges will have to be removed to release the door.

After planing touch up the bare spots to match the finish on the door.

Swelling.

Damp weather is often the cause of a door sticking. The absorption of moisture results in the swelling of the framework and door and causes the paint or varnish to soften and become sticky.

If the door has an even margin along the top and bottom edges, and if the hinges are firm, it will be necessary to plane either the hinge or lock edge. Usually it is best to plane the hinge edge, as the hinges are more easily removed and remortised than the lock. Care should be taken not to plane off too much wood, however.

If a Door Binds at the Hinge Edge.

If a door is too tight on the hinge edge and binds against the hinge jamb, the hinges will become loosened, unless the condition is promptly remedied.

If such a door has plenty of clearance on the lock side and the entire pin seems to move slightly when door is closed, loosen both hinges at frame and insert cardboard under jamb leaves along the

outer edges, as shown in sketch *B* (fig. 5). If, upon tightening the hinges and closing the door, the margins are more uniform and the pins do not move, the repairs should be permanent.

If a Door Has Sprung at the Hinge Edge.

If a door has sprung inward or outward at the hinge edge as a result of warping, it will be almost impossible to close it without exerting considerable pressure against the bulging part. The difficulty is generally overcome by putting on an additional hinge midway between the other two to hold the door straight. Care should be taken to give this hinge the same margin on the edge of the door and on the jamb as the other two, so that all three pins will be in a straight line.

Before removing the door to attach the additional hinge, close the door and make two marks across the crack to mark the top and bottom of the hinge leaves, so that mortises may be cut in the door and jamb exactly opposite each other.

If for any reason it is impossible at the time to provide another hinge, temporary relief may be had by shifting the hinges outward on the door jamb. (See sketch *C*, fig. 5.) No cutting will be necessary, but the depressions left at the sides of the hinges after moving should be filled with putty or a strip of wood and stained to match the jamb. Old screw holes should be plugged with wooden pegs before the screws are replaced.

2. WHAT TO DO WHEN A DOOR IS TOO NARROW

Settling of the house foundation may cause a doorframe to spread apart, thus widening the doorway. As a result the bolt in the lock may not reach the strike plate, making it impossible to lock the door securely. A gap may also appear between the door and the frame, and, if the door is an outside one, cold air, wind, and rain will enter.

Tools.

Screwdriver, hammer, nail set, wood chisel, plane, and a small paintbrush.

Materials.

Narrow, thin strip of wood the same length as the door; a few small finishing nails or small wood screws; a little putty; and enough stain or varnish to cover the strip.

To correct the defects one of two courses may be followed. First, try inserting thick cardboard strips, the same width as the hinge leaf, under the leaves attached to the jamb to shift the door toward the lock side. This method may leave a large crack along the hinge edge of the door, which may not be objectionable, however, on an inside door.

The other method, though more complicated, may produce better results. Remove the screws, lift off the strike plate, and nail or screw under it a strip of wood of sufficient thickness to allow the bolt to catch firmly when the plate is replaced. It will be necessary to cut a hole in this strip to admit the bolt. If the door is an outside one, apply a strip extending up and down the entire length of the doorframe and cut a hole in this strip for the latch bolt. (See

fig. 6.) Countersink the nails or screws, putty over the holes, and paint the strip to match the finish of the doorframe.

As an alternate method, which calls for more care and skill, the hinges may be removed from the door and the strip screwed to the hinge edge of the door. This method necessitates removal of the hinge leaves attached to the door, and cutting notches or recesses in the strip to receive the hinges when they are replaced.

3. HOW TO REMEDY A STRIKING LATCH BOLT

Settlement or shrinking in partitions adjoining and under a door-frame may cause it to move, carrying the strike plate with it, while

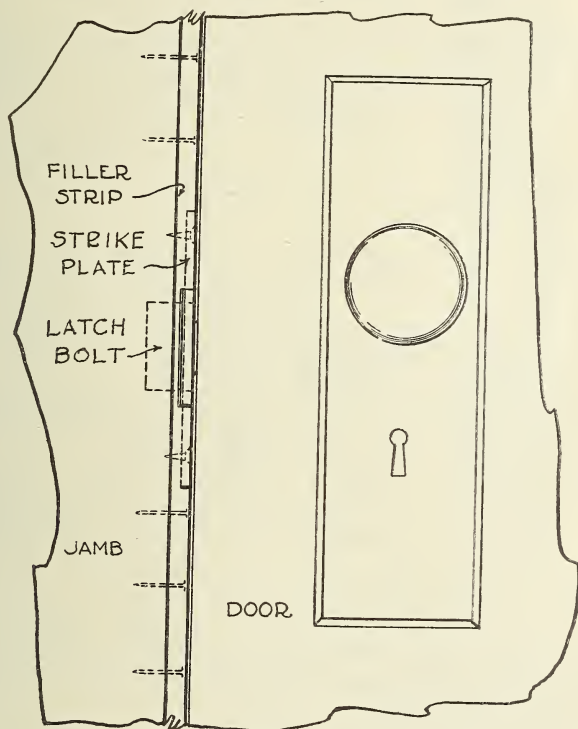

FIGURE 6.—Door jamb section showing filler strip

the lock attached to the door remains fixed. This causes the bolt to strike instead of entering the hole in the plate, making it difficult if not impossible, to lock the door.

Tools.

Screw driver, slim 3-cornered taper file, small wood chisel, hammer, and jackknife.

To remedy one condition—where the bolt strikes the plate just a little—notice whether the bolt strikes too high or too low on the plate by closing the door slowly, then remove the screws, take off the plate, and file the metal to make a larger opening to accommodate the bolt.

If the bolt strikes squarely on the plate so that it requires filing of possibly one quarter of an inch of metal, remove the strike plate, and raise it or lower it as necessary, chiseling out the mortise above or below the existing opening to set the plate flush. (See fig. 7.) Replace the plate in the new position so that the bolt will work back and forth freely. If old screw holes interfere, drive small plugs of wood into them before replacing the screws.

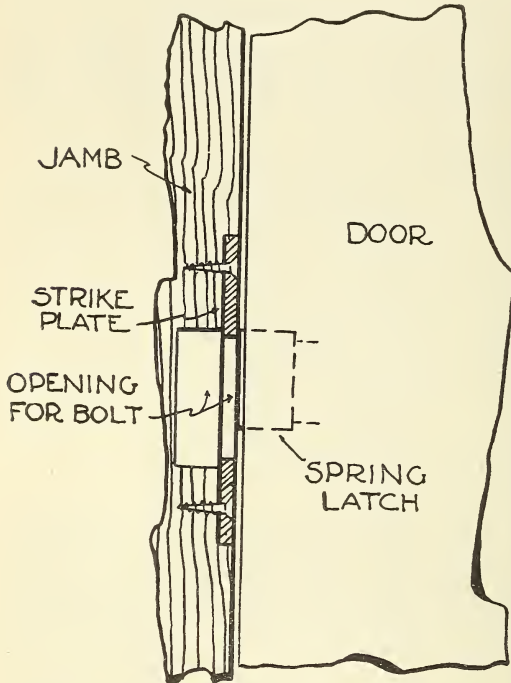

FIGURE 7.—Section showing a sticking latch bolt

to fit the openings after removal of wooden panels, small finishing nails or brads for renailling molding, a little linseed oil or thin paint, and putty to bed the glass.

It will be easier to do this work if the door is removed and laid upon a bench or on the floor. In the case of an outside door, it is best to cut away the molding on the inside face of the door rather than the outside to lessen the liability of decay and to make the door more weather tight on the side exposed to the weather.

If the molding that retains the panel is not a separate piece, cut around the edges of the molded portion of the rail and stiles to a line, being careful to avoid splitting the four pieces, in order that they may be replaced as moldings to retain the glass. Remove the panel, trim the chiseled edges if necessary, and carefully measure the opening for glass size, allowing a slight margin for putty and expansion space.

A Door That Rattles.

If a door rattles there may be too much play between the latch and its strike plate. The condition can be corrected by moving the plate back toward the stop.

4. REMOVING TOP PANELS IN DOOR AND INSERTING GLASS

It may be desirable to remove the upper panels from a wooden door and insert glass in their places to afford more light. It is not a difficult task and the expense involved is relatively small.

Tools.

Claw hammer, sharp flat chisel, putty knife, and small paintbrush.

Materials.

Panels of glass (preferably double thickness)

When ready to set the glass, paint the bed in which it is to rest with linseed oil or thin paint for a filler, and then lay a thin layer of putty around this bed to make the glass weather tight.

Carefully set the glass in the opening and fasten it in place, like the glass in a mirror or picture frame, by nailing the molding to the stiles and rails. In driving the nails, be sure that they do not touch the glass.

If the molding should become broken during the operations described, new pieces of equal size may be substituted.

Before rehanging the door, touch up any spots which may have been marred during the progress of the work.

5. FITTING KEYS TO DOOR LOCKS

The filing of an ordinary door-lock key is not a difficult task. If a key is available to be used as a guide, the fitting of a key is comparatively easy. However, if there is no original key, the job is slightly more complicated.

Tools.

Vise, thin flat file, and a candle.

Materials.

Key blanks of the same size as the original.

Where an Original Key is Available.

Clamp the blank and the finished key together in the vise and file notches in the bit of the blank to correspond with those in the key. When the notches have been filed down so far that there is danger of filing the original key, remove the latter from the vise and finish filing the blank by itself, comparing it from time to time with the original. Care should be taken to make the new key as near like the old one as possible, but often a slight variation will make no material difference in the fit of the key.

Where no Key is Available.

File the lower part of the bit of the blank key until it will start in the lock. Then withdraw the blank and hold it over a lighted candle or a match until it is well smoked, after which insert the blank into the keyhole and try to turn. It will be found upon withdrawing the blank that those points of the bit which need filing have been rubbed clean and appear bright. (The blank should be inserted and withdrawn carefully, to avoid rubbing off the soot.) File out the bright places, resmoke the key and repeat the operation until the key works properly.

Fitting Key to Complicated Lock.

The fitting of a key to a more complicated lock usually requires more precise workmanship. With such locks the best course usually is to have the work done by a man experienced in making keys. But where a key is available to serve as a guide, a person skilled with tools frequently can make a satisfactory duplicate. In any case, however, the work must be very carefully done, for, if the original key is filed even slightly, both keys may be rendered useless.

6. REPLACING A BROKEN WINDOW PANE IN WOODEN SASH

A broken window pane can be replaced by the average person without much difficulty. In some cases it may be advisable to remove the sash, which contains the broken pane, and lay it on some flat surface, such as a table or workbench. If the sash is removed the work can be done easier and more neatly. This course is especially recommended if the broken pane is in an upstairs window. If, however, it is on the ground floor, it is possible to do the work while standing upon a stepladder.

Tools.

An old chisel or jackknife for removing old putty and for driving in glazier's points, a putty knife, a rule to measure size of glass needed, a small flat paintbrush, and (if one intends to cut his own glass) a glass cutter, and a yardstick or steel square.

Materials.

Glass of the same thickness as the broken pane, glazier's points, putty, raw linseed oil to soften the putty and to be used as a filler, and paint of the same color as the window frame with which to paint the putty when it hardens. Good putty suitable for ordinary household use can be made by mixing the best grade of whiting and pure raw linseed oil. Explain your problem to the hardware or paint store man where glass is purchased, so that he may advise what quantity of each kind of material will be needed.

Removing the Old Glass and Putty.

The broken glass should be removed from the sash and the old putty chipped off with an old chisel or jackknife. Then pull out any remaining glazier's points and, with an old jackknife or similar tool, scrape the wood well where the new glass is to rest. This wood should then be given a coat of linseed oil or thin paint to act as a filler, so that the oil in the putty will not be absorbed, causing it to dry out and crumble.

Measuring for New Glass.

As a rule, rather than attempt to cut the glass at home, it is best to take accurate measurements and give dimensions to the hardware or paint dealer, who will cut a pane to the proper size. It is safest to measure all four sides from wood to wood in the sash and deduct one-sixteenth or one-eighth of an inch to allow for expansion and irregularities. Measuring the four sides is advisable, for the reason that some sash are not true and do not form a perfect rectangle. Single-strength glass is suitable for small panes such as are found in sash containing several lights, and double strength is used mostly for larger panes similar to those in single-light sash.

Setting the Glass.

Spread a thin coat of putty, about one-sixteenth inch thick, on the rebate or groove in the sash where the glass rests, to form a bed. Lay the pane in, concave side down, to avoid breaking the glass. (The concave side is easily determined by sighting along the edge of the pane.) Care should be taken to get this putty bed evenly distributed, so that unfilled gaps will not appear between the sash

and the glass. By pressing gently on the glass to inclose the edges of the pane in the putty, the pane can be made water-tight, and the cushion of putty thus formed will reduce a liability of cracking the glass when the glazier's points are driven in. The glazier's points, which are small flat triangular metal pieces, are used in addition to putty to hold the glass in place. They should be laid on the glass, about three or four to a side, and driven into the sash along the long sides first with the side edge of a chisel or screw driver, sliding the tool over the surface of the glass. If the glass is still loose after the points have been driven in, remove all ill-fitting points and replace them, pressing the glass more firmly against the bed of putty during the process.

Applying the Putty.

Putty should be used promptly, but if there is delay the putty may be softened by adding a few drops of raw linseed oil and kneading

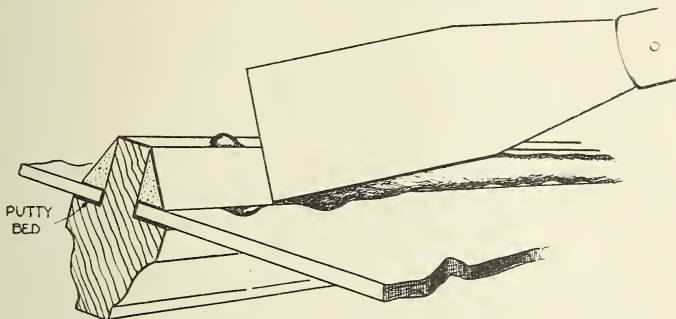

SHOWING HOW PROPER BEVEL IS OBTAINED



FIGURE 8.—Glazing

the mass thoroughly. Place the putty on a sheet of broken glass or a plate to keep it clean. It is best for the inexperienced worker to take a small piece at a time and roll it out between the palms of the hands to form a pencil-shaped roll. (See fig. 8.) Then lay the rolls end to end on the glass where it abuts the sash, along one side at a time. Now with the putty knife press down firmly, but gently, on the putty, drawing the knife along the sash from one end to the other. To lessen the danger of breaking the glass by strong pressure, the putty should be soft and pliable. The knife should be held at such an angle, guided by the glass and the sash, as to form a good smooth bevel. All excess putty that spreads outside this bevel should be cut off, and depressions should be filled up. Care should be taken not to spread the putty too far out over the surface of the glass, where it may be seen from the inside of the window. Proceed in the same manner along the other sides. It will be found that the workmanship will improve as the work progresses.

Finishing Touches.

Remove all putty stains from the glass with a cloth moistened with turpentine or gasoline. After a day or two, when the putty has hardened, it should be painted to match the window sash.

7. GLAZING METAL SASH

Most metal sash are constructed so that the glass may be replaced with little difficulty. As there are many kinds of such sash, the steps to be taken may vary to some extent. The manufacturer usually issues a set of instructions for his particular brand, and it is best to follow these instructions, if they are available. In case no such information is at hand when the emergency arises, it might be well to mention two methods commonly used.

Tools.

A screw driver, a putty knife, and a small flat paint brush.

Materials.

Double-strength glass or plate glass (single-strength glass is not recommended in metal sash), putty made of whiting and white lead, and enough paint of the same color as the sash for covering the top-coat of putty.

In some cases the glazing must be done on the outside of the sash, while others provide for glazing on the inside. In one of the methods to be described, the old putty and broken glass should be removed as in wooden sash and the metal sash scraped clean where the new glass is to rest. There may also be wire-spring clips to be removed before the old glass will come out. Then the new glass must be embedded in putty, in order not to come directly in contact with the metal. Spread the putty over the metal where the glass is to rest and push the glass firmly into place so that the putty fills every crevice. Now fasten the glass in tightly by means of the wire-spring clips provided for that purpose. As a rule, these clips are held in place by holes bored through the sash. When the glass is thus secured, apply the face putty in the same manner as prescribed for wooden sash. When the putty has thoroughly hardened, it should be painted the same color as the sash frame.

In the other method, remove the broken glass by unscrewing and taking off the metal beading or glazing strips. Then scrape the old bedding putty from the sash. Now, as in the previous method, the new glass must be embedded in putty, as described. When the glass has been placed, the metal beading or glazing strips should be refastened tightly against it. These strips are usually held in place by brass screws and form a neat frame around the glass.

8. RELIEVING A STICKING WINDOW SASH

The sticking of a window sash may be due to hardened paint, which fastens the sash to the frame, or it may be the result of damp weather. In the latter case, the wood in the sash and adjoining frame swells, causing binding, or the paint or varnish becomes soft and sticky, making it difficult to raise the sash. In most cases the trouble will disappear when the wood dries out, but during

prolonged wet weather it may be necessary to obtain relief more quickly.

Tools.

Jackknife, screw driver, plane, medium sandpaper, claw hammer, flat wood chisel, nail set, pieces of cloth or felt for pads to protect woodwork from tool marks, and a small paint brush.

Materials.

Beeswax, linseed oil, and a small quantity of paint or varnish to touch up the woodwork.

Sash Fastened by Hardened Paint.

If the sash is held fast to the frame by hardened paint, it may be loosened by running the point of a knife blade around the edges, between the sash and the frame, being careful not to mar the surface.

If it should be necessary to push up on the center rail of the lower sash in order to raise the window, be sure that the thrust is placed near the side rails and not in the middle in order to avoid the possibility of breaking the slender rail.

If Sash Binds.

Examine the window to see where sash binds against stop beads or pulley stiles. (See fig. 9, p. 41.) Before doing any repair work, it would be well to experiment to see if a thorough waxing with beeswax of the parts in contact will not correct the excessive friction.

If the inside stop beads press too tightly against the sash, they can either be removed and planed down along the edge adjacent to the sash, or moved farther from the sash. If the stops are fastened by nails, it probably will be better to move them over a little; but if they are fastened by screws, it may be easier to plane them off.

In replacing the stop beads, it is well to remember that in order to make the windows more weather tight it is important to have but a small margin between the inside stop and the bottom sash, when the latter is down or closed. The upper part of the stop, however, can be fastened with a larger margin between it and the bottom sash in the raised position, to allow the sash to slide more readily, since there is no problem of weather tightness when the lower sash is raised.

When the window sash swells to the extent that the vertical edges bind against the pulley stile, or running face of the window frame, the sash should be removed and the vertical edges planed off a little. They should then be coated with linseed oil and waxed when the oil has dried. Directions for removing stop beads and window sash are contained in section 9 of this chapter.

9. REPAIRING BROKEN OR STRETCHED WINDOW-WEIGHT CORDS

If a window-weight cord is broken the window will fall when it is raised and not supported. If the cord is too long or has stretched the window will not be carried to the top and, in case the upper sash is the one affected, it will be necessary to force it up the remaining distance and to lock it, to make it stay closed. Replacing or

adjusting the cord does not require any special skill, but calls rather for patience and care to avoid marring the woodwork.

Tools.

Claw hammer, wood chisel, screw driver, nail set, piece of string, small weight or nail, and pieces of cloth or felt for pads to protect woodwork from tool marks.

Materials.

New sash cord. (A good grade that will not twist and require frequent renewal is recommended. Size No. 7 cord, which is seven thirty-seconds of an inch in diameter, is generally used in dwelling-house windows.)

The steps to be taken are practically the same for either the upper or lower sash, but the amount of preliminary work depends on which sash requires attention. If it is the lower sash, that one only will have to be removed; but if it is the upper sash, both will probably have to be taken out. Usually the outside stop bead, which holds the window in place, is made a part of the frame and can not be removed. In case the frame has a removable outside stop, it could be taken off on one side and the upper sash thus released, but this course is not generally recommended.

The upper sash is not raised and lowered so frequently as the lower and does not wear out its cords often, and therefore requires less attention.

The first step is to remove the inside vertical stop bead on the same side of the window as the defective cord, just inside the lower window sash. (See fig. 9.) If fastened by means of screws its removal should be accomplished readily. If nailed on, a flat wood chisel is a good tool to use in prying it off, as it is least likely to damage the woodwork. It might be well to wrap the blade with cloth, or to use a piece of felt as a pad under the blade.

It is best to start at the bottom. By reaching through the window opening and prying from the outside there is less danger of marring the woodwork where it will show from the inside. If proper care is exercised, the brads will come out with the stop and then, instead of knocking them through and pulling them out in the usual way, bend them slightly and pull them through from the back of the stop with a claw hammer, so that no unsightly holes will be left on the face of the finish. When nails are driven through in the usual way, the wood may chip out, since it is often fastened to the head of the nail with putty and paint. After the stop has been removed, the lower sash can be taken out.

To remove the upper sash, lower it to the sill, and pull out the parting strip, on one side of the frame. This usually is not nailed and should be easy to remove, but, in case it is fast, pry it out with a flat chisel, starting at the middle of the strip.

Beneath the inside stop bead or in some cases adjacent to it, will be found a small oblong cover concealing a pocket in the sash. In the better forms of construction this cover is fastened by screws, while in other cases it is nailed on. By removing the cover, the cords and weights will be revealed, suspended in a long, narrow slot. There are four weights to a double-hung window, two on each side

of the window frame. The two nearest the inside of the house balance the lower sash, and the two outside ones balance the upper sash.

It will be observed that one end of the cord is knotted or anchored into a hole bored in the side of the window sash near the top. It then passes over the pulley near the top of the window frame, and is attached to the weight, usually by several knots. To avoid difficulty in working the new cord over the pulley and down through the slot to the bottom, a small lead fishline sinker or similar weight

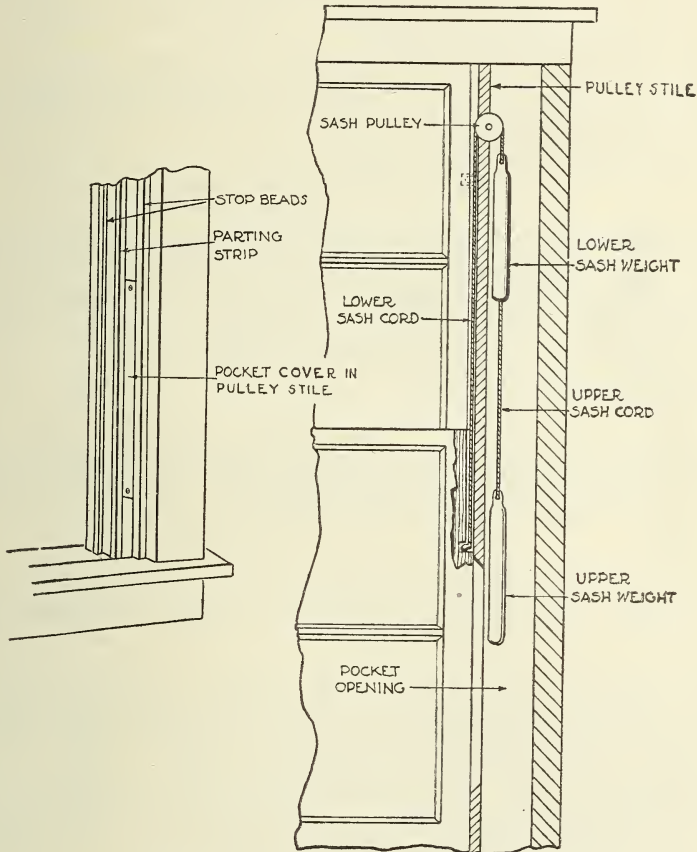

FIGURE 9.—Double-hung window details

may be attached to a string and passed over the pulley and let down inside the slot until it can be reached through the pocket. Then by attaching the string to the cord the latter can be pulled down within reach of the hand. Now, fasten the cord to the weight before cutting it to length, and pull the cord over the pulley until the top of the weight is up against the pulley. Then cut the cord about 3 inches below the knot-retaining hole in the sash, when the sash is in the extreme low position. The extra length is provided for forming the retaining knot. Tie the knot, pull the sash out far enough

to insert the knot in the mortise, and replace the window. Care should be taken in fixing the proper length of cord. If too long, the weight will rest on the bottom of the box when the sash is raised to the top, thus reducing its effectiveness; and if too short, it will strike against the pulley at the top when the sash is pulled down. In time, the friction may result in a broken cord or damaged pulley. For those not familiar with this work it is better to allow a few inches additional length over that prescribed above. If, upon replacing the window, the sash does not work properly, cut sufficient length from the cord so that the sash will be held in place against the top of the frame by the weight.

Before replacing the pocket cover and stop bead, raise and lower the window a few times to see whether it is in perfect working order.

These suggestions may also be followed in shortening cords which have become stretched.

10. CARE AND REPAIR OF SCREENS

Screen doors and window screens require attention at least twice a year. They should be renovated and put on in the spring, and removed and prepared for storage in the fall. If a good grade of screen wire has been used and the screens and doors have been well cared for, the work involved will not be great.

Replacing Broken Screening.

Tools.

Pair of metal shears or old scissors, light claw hammer, nail set, a screw driver for prying off moulding, and a tack puller or pair of pliers for pulling out old brads and tacks.

Materials.

Screen wire, small tacks, and small brads or nails for refastening the molding. If painting is necessary, a small brush and the required amount of screen paint in the color desired must be added to the list.

If the screening is worn out or badly broken, purchase a new piece at least an inch wider and longer than the opening in the frame and cut it to fit with a pair of metal shears or old scissors. The piece cut should, of course, include enough around the edges to permit tacking to the frame. Pry up and remove the molding which holds the old screening and pull out all tacks which may have remained. Then tack the new screening along one end completely, holding it tight as the tacking proceeds. Now tack the opposite end, pulling the wire from end to end, as well as along the side which is being tacked. Finally tack along the other two sides, which should require practically no pulling. Care should be taken not to pull the mesh out of shape and to keep the separate strands parallel to the sides of the frame. The molding may now be replaced and it will be found that, if fastened down firmly, it will take up any remaining slack in the wire and give it a finished appearance.

As an aid in placing screen wire in a number of frames of uniform width at one time, the following method is suggested: Lay the frames end to end and in line on a plane surface, such as a floor or sidewalk. Tack one end of the screen wire in place on the

extreme end of the first screen. Unroll the screening over all the frames, tacking it at the extreme end of the last frame. Drive small wedges between the frames to tighten the wire lengthwise. When it is tight enough, tack the wire across all of the ends before cutting it. Then tack one side all along the group, draw the wire toward the opposite side and tack all along that side. Finally, replace the face moldings and cut the wire around the outside of the moldings with a sharp knife or similar tool. This method will save time and result in an excellent job.

Lifts and Reinforcing Angles.

Tools.

Gimlet and screw driver.

Materials.

Two handles or lifts for each window, four small angle irons, flat metal pieces or metal corrugated fastener for each window, and a sufficient quantity of small screws.

Many window screens have no pulls or handles with which to raise the screen, and the screens are usually opened by pushing upward on the upper sash rail. This pressure tends to pull the frame apart. Handles, or pulls, can be obtained at slight expense and screwed to the lower sash rails. Handles make the opening of the screens easier and relieve the pressure on the sash rails. The sash may be reinforced and made more rigid by means of small angle irons screwed into each inside corner of the frame, or by attaching flat metal pieces. Metal corrugated fasteners may be driven into the face of the frame across the corners for this purpose if there are no nails to interfere, and if the frames have butt or mitered joints.

Protection for Screen Doors.

Tools.

Claw hammer.

Materials.

A sufficient quantity of heavy wire mesh to cover lower portion of screen door frame and small staples to fasten mesh to frame.

Where screen doors are liable to be damaged by small children running in and out, or by a dog jumping against them, it is advisable to have a protection for the lower half of the door. Although doors equipped with guards can be purchased, good results may be obtained by applying over the regular screening in the lower portion of the frame a protective screen of heavy wire, woven with relatively large openings—from one-half inch to 2 inches across.

Reducing the Noise of Closing Screen Doors.

Tools.

A light hammer and a screw driver.

Materials.

Screen-door spring or patent check.

The slamming of screen doors is annoying, and doors that do not close tightly are a source of trouble. These difficulties can be overcome by applying one of the various devices designed to close screen

doors noiselessly and tightly. Such devices are inexpensive and easy to apply.

A simple but effective way to deaden the sound of screen-door slamming is to tack three small square pieces of felt cloth or rubber to the main door frame at points of contact. One piece should be placed near the top, another near the bottom, and the third midway between.

Hinges and Closing Devices.

There are two types of hinges generally used on screen doors: Spring hinges and loose-pin butt hinges. Since, with the ordinary spring hinge, it is necessary to remove the screws and plug up the holes when the door is taken down, some prefer butt hinges with removable pins. If butt hinges are used or if spring hinges have lost their pulling power, the door may be made to close tightly and remain so by fastening a slender coil spring¹³ between the screen doorframe and the main door jamb. The spring should be placed so that there will be sufficient pull to close the door tightly when it is released. To accomplish this purpose, one end should be attached to the door jamb with a small screw hook 3 to 5 inches away from the screen door, as space permits, and the other end attached to the middle cross rail of the screen door by means of a similar hook at the point where the spring will be under enough tension to keep the door closed. If the hook on the door jamb is too near the screen door, the spring exerts too little pull or closing force when the door is only slightly open.

In case the door jamb is too narrow to permit the use of such a spring as the one described above, a short heavy coil spring¹³ made for the purpose, may be placed on the outside face of the screen door. It should be placed at some point between the hinges and run diagonally across the crack between the screen door and the main door jamb, its ends being fastened with wood screws to the frame of the screen door and to the front of the main door jamb.

Correcting Sagging in a Screen Door.

If the joints in the frame of a screen door become loosened and allow the lower half of the door to sag and the bottom edge to drag on the threshold, a metal rod equipped with a turnbuckle may be used to raise the bottom rail clear of the floor. One end of the rod should be fastened to the face of the frame at the center of the intersection between the bottom rail and the outer vertical rail, and the other end should be fastened as high up on the face of the vertical rail carrying the hinges as it will reach. When the two ends of the rod have been screwed on firmly, the turnbuckle may be turned to shorten the rod, and thus lift the bottom rail.

Painting the Screens.

Tools.

Small flat brush and whisk broom.

Materials.

Screen paint or enamel in color desired and a small amount of boiled linseed oil or turpentine for thinning.

¹³ Various types of screen-door springs and other accessories are sold by dealers in hardware.

A screen door or window screen lasts longer and looks better if kept well painted at all times. If ordinary paint is used, it should be thinned out considerably to avoid clogging up the mesh. There are many special screen paints on the market which may be used, if desired. A coat of thin white paint on the screening makes the interior of the house less visible from the outside.

A cheap grade of screening will probably require painting every year, while galvanized wire may show signs of rust only after long usage, and then may require only a light coat of paint. Copper or bronze screening lasts for many years and needs little attention.

Storing for the Winter.

Tools.

Screw driver for removing doors and claw hammer and saw for building hanging frame.

Materials.

Numbered thumb tacks, a few short lengths of boards, and sufficient nails for the hanging frame.

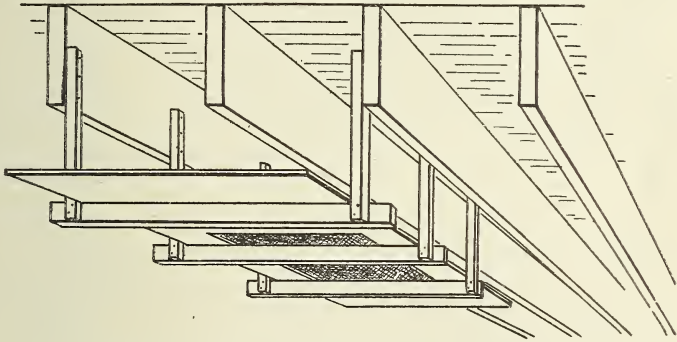

FIGURE 10.—A convenient screen storage rack

Screens will last longer if they are taken down in the fall and stored in a dry place for the winter. A good plan, if convenient, is to suspend them from the ceiling in a corner of the basement, on a framework made of wood, as illustrated in Figure 10. The hangers should be about 2 feet apart and hung at the same elevation so that the screens will lie perfectly flat. This flatness will be more certain if two or three boards are laid down first to form a shelf.

The doors may be placed on the hangers first and then the window screens laid on top with perhaps some laths between to keep them separated. A covering of paper or canvas will protect them from dust. To prevent rusting during the winter months, some authorities recommend giving the wire a thin coat of screen enamel and when it is dry, wrapping the screens well with paper. This care preserves the mesh, and when the screens are enameled in the fall they are ready to be put up in the spring without further treatment.

By use of the method of storage described above, the screens are out of harm's way, removed from floor dampness, have the advantage of free air circulation, and in lying flat are not likely to become

warped. The screen sash and window frames should be numbered so that they can be readily identified in the spring. They can be inconspicuously marked in Roman numerals with a small chisel or screw driver. One easy method is to use thumb tacks with numbers clearly visible on the top. One tack with the number 3, for example, may be placed in the screen sash and another with the same number may be placed in the window sill, or in some convenient window location.

Assembling "Knock-Down" Screens.

Tools.

Saw, claw hammer, nail set, and small flat paintbrush.

Materials.

Screen frames complete, screen wire, small tacks, paint, and a small quantity of putty and glue; also, if desired, four angle irons with screws for each frame.

It is possible to purchase at reasonable prices so-called knock-down screen frames, which are easy to assemble. These sets come complete in every detail, excepting the screening itself, which leaves the purchaser free to select whatever grade of screen wire he desires. They include 4 pieces, or 1 each, for the 2 sides and the top and bottom. These pieces are properly notched at one end to insure a firm joint. The other end is left square, to be sawed to the proper length to fit the window. Grooves are already cut in the side pieces to permit sliding, and provision is made for tacking on the screening, and attaching the molding. In addition to the four pieces mentioned, there are four pieces of molding to be tacked over the edges of the screening, two sliding rails to be attached to the sides of the window frame, and a metal lift, or handle, for raising the screen. A sufficient quantity of nails and tacks is provided to complete the job. To make the frame hold its rigidity and remain square, small angle irons should be screwed into each corner. Paint the joints with waterproof glue before nailing them, countersink the nails, and fill nail holes with putty to make a neat job. A priming coat and one or two finishing coats, in any color desired, will complete the work.

Screens Placed Inside of Windows.

In summer cottages, and sometimes in permanent dwelling houses, it may be desirable to have the screens placed inside of the windows. Inside screens are necessary if there are casement windows which open outward.

In the case of double-hung windows, half-length screens may be desired. These can be made to slide up and down on runners placed just inside the lower window sash. The screens should be placed as close to the window sash as possible, so that space will not be left between the sash rail and the screen frame, where insects may enter.

Full-length screens, suitable for either out-swinging casement or double-hung windows, may be made in two sections, each section being half the width of the window opening. The sections may be made to slide past each other horizontally, by placing them on separate runners, laid side by side on the window sill and along the top of the window frame. In this case also, care should be taken to

avoid leaving cracks between the frames. Roll screens are also desirable for full-length inside protection.

Interior screen frames may be painted or enameled on the inside to match the woodwork, and on the outside may be finished in a color to harmonize with the outside window trim.

Inside screens, being protected from the weather when windows are closed, should last longer than outside ones. They are usually easier to slide, since they are not subject to warping as a result of exposure.

IX. WEATHERPROOFING AND INSULATING

1. APPLYING WEATHER STRIPPING

All houses should be well ventilated, but this does not mean that unregulated drafts of cold air should sweep through the house at all times. In cold weather the warm air escapes around loose windows and doors and is at once replaced by the cold out-of-doors air. The result is that the heating plant must be pushed to capacity to maintain an even temperature, and on windy days, where such conditions prevail, it will be found difficult to keep the house warm.

It is to improve these conditions that the weather stripping of doors and windows is recommended. It is generally agreed that weather stripping provides greater comfort and soon pays for itself in reduced fuel bills. In some cases it may also be necessary to insulate the outside walls of the house to obtain satisfactory results.

Kinds of Weather Stripping.

There are many kinds and grades of weather stripping on the market at various prices.

Most metal weather strips must be installed by an expert, as they usually involve removal of the sash and cutting of grooves, but some of the simpler forms can be applied by the average householder.

Space does not permit a full discussion of the methods of applying the various types of metal strips. However, it is not essential, since complete instructions are furnished by the manufacturers of those types which do not require the services of an expert.

There are many other kinds of strips, however, which are easy to apply, and inasmuch as these types are similar and are attached in about the same manner, their installation will be discussed as a group. This group might be divided into two types: The rigid type, which includes narrow wooden strips with rubber or felt edges made in standard-length pieces; and the flexible type, which includes the patent cloth variety with a padded contact edge; and, the cheapest and simplest of all, the ordinary felt strip. The flexible-type strips are put up in rolls of various lengths.

Taking Measurements.

Measure the four sides of the window frame where the face of the sash adjoins the casing, and also the distance across the meeting rail. Measure around the four sides of the door on the outside where they abut the door stops and threshold.

Tools.

A rule or steel tape, marking pencil, and light hammer. If the strips are of wood, a small saw and miter box are also needed, but if the strips are of cloth a pair of scissors may be used for cutting them.

Materials.

A number of linear feet of stripping; some three-quarter-inch wire brads, if wooden strips are used; 4-ounce size tinned trunk tacks (rustless) for padded cloth stripping; smaller trunk tacks or common carpet tacks for felt stripping. It is advisable to use tacks that will be least noticeable and that will not rust.

Weather-Stripping a Window.

The window should be locked when weather-stripping is attached to insure best results. Care should be taken to see that the contact edge presses snugly at all points against the sash or casing, as the case may be, before the tacks or brads are driven.

Upper sash.—The weather-stripping for the upper sash should be tacked to the frame adjoining the sash on the outside of the window. If the flexible type is used, one piece can be cut to extend around the two sides and top. If, however, the rigid kind is used, three separate pieces will have to be cut, with the two corners mitered, to make a neat fit.

Lower sash.—The weather-stripping for the lower sash is attached on the inside, and four separate pieces are required, regardless of the type used. The two side pieces are tacked to the face of the inside stop bead adjoining the sash, with the contact edge pressed against the face of the sash, and should extend from the top face of the stool, or inside sill, to the top of the meeting rail. The piece across the width of the meeting rail is tacked to the top of the lower sash, so that the contact edge will cover the crack where the upper and lower sash rails meet. This piece will probably have to be cut in two parts to provide space for the window lock. The piece across the bottom is tacked to the face of the sash with the contact edge down to butt against the top of the stool or inside window sill.

Weather-Stripping a Door.

The door should be closed and locked while weather-stripping is being applied. If flexible-type stripping is used, two pieces will do; one, the width of the bottom of the door; and the other, long enough to extend around the two sides and top. If rigid strips are used, four pieces will be required, with the two top corners mitered, to make a neat joint. The bottom piece should be tacked to the inside face of the door with the contact edge down and pressed snugly against the top of the threshold. If the threshold is so badly worn that it is impossible to obtain a tight contact at all points, it should be replaced with a new one. The side and top pieces are tacked to the door stops on the outside, with the contact edges pressed evenly, but not too tightly, against the face of the door.

Bedroom Doors.

It is sometimes advisable to weather-strip bedroom doors, at least at the bottom, to prevent drafts and the escape of heat from the rest of the house when bedroom windows are open.

Doors Leading to Basements.

Weather-stripping applied to the door leading from the living rooms to the basement helps to keep out dust, gases, and laundry odors.

Casement Windows.

Casement windows are weather stripped in the same manner as doors, with the stripping tacked to the window stop and the contact edge pressed against the face of the sash when the window is closed. A strip of felt tacked to the inside face of the meeting strip will seal the vertical crack where the two windows meet.

2. HOW TO WEATHERPROOF AROUND OUTSIDE OF WINDOW FRAMES

For various reasons damp spots may appear on the interior surfaces of walls, but contrary to the impression of some householders, only in relatively few cases are they caused by leakages through the walls proper.

Most of the trouble is usually found around window frames which are poorly built or improperly weatherproofed. Such frames admit air and moisture and the adjoining interior walls soon become unsightly with dirt and water stains.

Water, finding its way into the wall around the window frame, may work along inside the wall and make a spot on the plaster surface several feet distant. For this reason, it is sometimes difficult to locate the source of trouble.

Correct Methods in Frame Houses.

In extra good frame construction the blind casing (behind the outside casing) extends back to the window studs, and the building paper (between the sheathing and siding) extends over the crack between the blind casing and the sheathing. In addition, the outside casing is nailed directly to the blind casing and the siding or shingles butted up against it.

If there is no blind casing, waterproof paper is used under the joint between the outside casing and the siding to prevent the entry of wind and rain.

The cap over the window should be constructed to turn water away from the joint between the frame and the siding. In some types of frames, the siding or shingles extend over the cap, and a drip groove is provided along the underside of the cap or, in case the cap does not have these features the joint may be covered with metal flashing. (See fig. 11.)

The connection between the upper sill and subsill should also be tight. In the newer types of frames, the bottom of the lower sill is plowed to allow the siding or shingles to extend into the sill a short distance, and an offset, or rabbet, is cut near the back edge to make a tight joint with the top sill.

Inspection and Repairs in Frame Construction.

If there are leakages around a window frame a careful examination should be made and repairs made where they are needed.

Around the lower part of the window, look particularly for holes or large cracks at the top of the window sill. There may be a crack

under the inside stool or window ledge, if it is not nailed down securely; and if the stool has been cut too short, there may be cracks at either or both ends. Also, where parting strips and pulley stiles meet the top sill there may be holes left as a result of careless fitting. Such cracks and openings may be closed satisfactorily by driving the stool down firmly and filling the spaces with white-lead putty or calking compound, as previously described.

Sometimes driving rain or water from melting ice on the sill outside the window may be forced in under the window and stool and run down the wall. This seepage may usually be prevented by removing the lower sash and plowing a furrow or groove along the bottom of the lower rail from one side to the other with a plow plane having a one-half or three-quarter inch blade. A cavity is thus formed that will check blowing rain before it can get inside the window.

Good weather stripping carefully applied, as explained in section 1 of this chapter, will do much to prevent air leakage and keep moisture from entering around windows and doors.

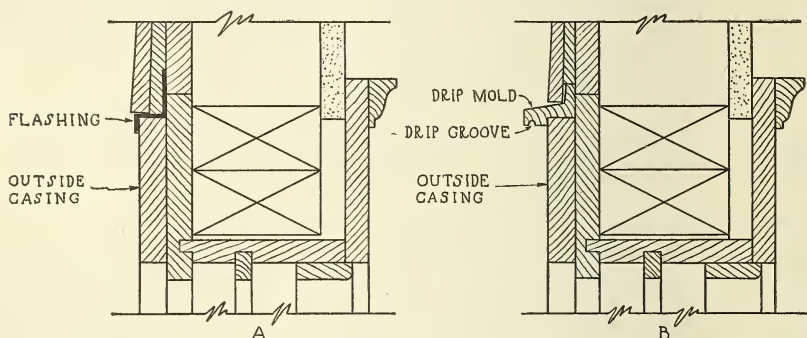

FIGURE 11.—Window head details, showing methods of flashing

Where the top sill joins the subsill, there may be a crack that will admit air and moisture unless it is calked with white-lead putty or calking compound, or covered with metal flashing.

Examine the drip mold and flashing at the top of the frame to see whether they are in good condition. Put on new flashing, if necessary, preferably copper, with the upper edge bent up under the siding or shingles and the lower edge extending over the outer edge of the window cap about one-half inch and bent down to form an apron.

Before putting on the flashing it may be well to seal the cracks around the frame with white-lead putty or calking compound (a puttylike substance made for calking purposes).

Sometimes the outside casing or adjoining molding may become loose and require renailling.

In some instances the outside casing may be nailed over the siding or shingles instead of being fastened directly to the blind casing. This method leaves triangular openings between the back of the casing and each shingle or siding board, and, if the joints under the outside covering are not properly protected, air will enter.

In such cases the outside casing may be removed and the cracks underneath filled with white-lead putty or calking compound, or the triangular openings may be closed without removing the casing by employing one of two methods. They may either be calked with oakum (hemp fiber from tarred hemp rope) to within one-half inch of the surface and then filled with calking compound, or covered by means of a strip of wood (about 2-inches wide and as thick as the casing) notched out to fit the irregularities in the surface and nailed to the siding or shingles adjoining the outside casing.

In Stucco Construction.

Window frames in stucco houses are usually of the same type as those used in frame houses, and the same instructions for weather-proofing may be followed in either case. To apply flashing over the cap mold at the top of the frame, however, it may be necessary to cut away a few inches of stucco along the top of the frame. When the flashing has been applied, it should be sealed along the top edge against the backing with elastic cement of good quality. The stucco should then be patched with proper precautions, as described in Chapter V, section 1.

In Brick Construction.

In good brick construction the window frames are usually set in a thin bed of mortar and the spaces between the brickwork and frame filled solid with mortar to seal the joints.

There is seldom any trouble at the tops of the windows, since the frames are generally set back under the brickwork in such a way that water can not enter under ordinary conditions.

If there are leaks around a window in a brick house, they are usually found along the sides, or around the top or bottom of the sill.

In making repairs, remove the molding adjoining the brickwork, calk all cracks, which appear to need attention with oakum, and finish off the job with calking compound or good Portland cement mortar. Before replacing the molding, it is considered good practice to paint the back with white-lead as a further precaution against leaks and decay.

If it is not desirable to remove the molding, cracks between the brickwork and the molding can be sealed with a plastic calking compound. This material can be applied with a putty knife, a calking knife, or a calking gun, which may possibly be borrowed from a dealer in such material. If this method is used, care should be taken to obtain a high-grade compound, which will not shrink, crack, run, or dry out under the action of the weather.

Defects may exist around window sills in brick houses, similar to those in frame houses, and repairs should be made in the manner previously described.

Dormer Windows.

If the sill of a dormer window rests on the roof, and flashing has not been provided, metal flashing should be worked into the underside of the sill and run down over the roofing material so that water will not get into the crevices between the sill and the roofing. As an added precaution, it might be advisable to calk the crack with roofing cement before applying the flashing.

3. PREVENTING FROSTING OF WINDOW PANES

In the wintertime, in certain localities, frost may form on the inner surface of window panes, often to such an extent that it is impossible to see through the glass. If obstruction of vision were the only result of such a condition, it might not be seriously considered, but often, when the frost melts, water runs down over the woodwork and plaster, ruining the finish on the woodwork and the wall decorations.

Cause of Frosting.

Frost is formed by the condensation and freezing of moisture from the air upon the cold surfaces of the window panes. It would seem therefore that the logical solution would be to protect the window panes as much as possible against extreme cold and to reduce the amount of evaporation in the rooms.

Protection Around Windows.

The windows may be protected by installing storm sash tight enough to prevent cold air striking the inner windows. It might also be well to tighten the stops around the windows, and to install weather stripping.

Humidity and Health.

It is claimed by physicians and others familiar with the subject, that a certain amount of humidity is necessary to preserve good health in the household. It is held that colds, which are prevalent during the heating season, often result from overheated rooms, particularly where the percentage of moisture in the air is not sufficient. According to the "comfort chart," prepared by the American Society of Heating and Ventilating Engineers, a humidity of 45 per cent (saturation of the air) at 70° F. room temperature is considered good from a comfort standpoint.

In addition to health requirements, a certain amount of moisture is necessary in a house to prevent the drying out and opening of joints in furniture and woodwork. Too much moisture, however, may result in condensation, and because of these possibilities, it is quite essential that a proper average be maintained.

Measuring Humidity.¹⁵

The room temperature is easily determined by means of a thermometer, but measurement of humidity is a process not familiar to the average householder. There are two instruments, the psychrometer and the hygrometer, which are used for measuring humidity and which are sold at reasonable prices by dealers in scientific instruments. Instructions for their use are usually furnished by the manufacturer.

Sources of Moisture.

Moisture in the air is traceable to numerous sources. House plants throw off moisture; steam from cooking and evaporation from the laundry and bathroom also contribute to the supply.

In localities where a considerable amount of gas is burned, a large portion of the moisture in the air often comes from that source.

¹⁵ See Bureau of Standards Circular No. 55, Measurements for the Household, listed on p. 108 of this publication.

Gas is composed chiefly of compounds of carbon and hydrogen and, in burning, the hydrogen unites with the oxygen in the air to form water vapor.

Regulating the Amount of Moisture.

If the humidity is too great, it can be reduced by eliminating, as much as possible, the sources of the moisture, and by frequent changing of air in the rooms by ventilation.

Much of the difficulty arising from the burning of gas may be overcome by providing an adequate vent or hood over the gas stove to carry the fumes to the outside.

During the heating season, the amount of moisture in the air of a house is often less than required, rather than more. In such cases, moisture may be supplied by means of various appliances used in connection with the heating system. There are also a number of humidifying devices on the market.

4. INSTALLING STORM DOORS AND WINDOWS

Providing storm doors and windows is a more expensive method of keeping out the cold and retaining warmth in a house than some of those already mentioned, but storm doors and windows often pay for themselves within a reasonable period in reduced fuel bills. Although this type of protection is not so popular as it was in years gone by, it is still used to a considerable extent in cold climates where the benefits to be derived are more pronounced.

Storm Windows.

Storm windows, when properly installed, provide a dead-air space, reducing heat conduction to the outside, and preventing infiltration of cold air. They are particularly helpful in preventing frosting of windows, inasmuch as they protect the surface of inner panes from chilling winds which cause condensation and subsequent freezing. If storm windows can not be afforded for all window openings they may be provided for those on the side of the house facing prevailing winter winds.

To insure good protection, storm sash should fit tightly. They may be fastened with ordinary wood screws, hooks and eyes, or other devices. They may also be provided with a sliding opening in the bottom rail to admit air when it is desired. Perhaps a better way is to hang them from the top on hinges or other hangers, so that they may be swung outward, when necessary, for ventilation or other purposes. If storm windows are hung, rather than fastened permanently in place, special care must be taken to obtain a good fit all around the sash. They may be held open when necessary, by means of long hooks inserted in screw eyes or by special devices made for the purpose. If the storm sash is placed flush with the facing board of the window casing, loose-pin butt hinges may be used to support them. This will allow removal of the sash by simply pulling the pin of the hinge. In case ordinary hinges can not be used, there are special storm-window hinges designed to fit any type of frame. A local hardware dealer might be consulted regarding the type of fastenings best fitted for use on a particular house.

Storm Doors.

Storm doors involve some expense, but in many cases it is profitable to install one on the windward side of the house. If made in the form of a vestibule, such a space will prevent the inrush of cold air when the house door is opened, and provide a place to remove overshoes and shake off snow.

To save time in removing and replacing storm doors and screen doors, and to avoid the necessity of removing screws and plugging up screw holes, interchangeable loose-pin butt hinges may be used. Four hinges are required. Two hinge leaves are attached to the door jamb to serve both the storm and the screen door, and the two corresponding ones may be discarded. The remaining halves of the hinges should be attached to the doors, so as to fit into the two parts attached to the jamb.

Storm doors and windows should last a long time if they are kept well painted and are stored in a dry place during the summer.

5. TREATMENT OF WALLS TO PREVENT "SWEATING"

Dampness may appear on the inside surfaces of exterior walls as a result of other conditions than leakage through mortar joints or around window frames. In some cases, such dampness is so pronounced that frost can be swept off the walls during prolonged cold spells. It causes wall paper to become loosened and stained and has similar damaging effects on other wall decorations. It also creates a damp, musty atmosphere in the rooms affected, which is unhealthful and generally unpleasant.

Cause of Damp Spots.

This dampness may not come from the outside as is often suspected, but may be the result of condensation of moisture from the air in the room upon the cold surfaces of the plaster. It develops by the same process as that which causes beads of moisture to form on the outside surface of a pitcher of ice water on a warm day.

Eliminating the Dampness.

It would seem that the natural solution to the problem would be first to reduce the amount of moisture in the air by eliminating as far as possible the sources of such moisture, or when an excessive amount of moisture is present, to ventilate frequently the rooms. It must be remembered, however, that a certain amount of moisture is necessary in a house from a health standpoint. Therefore, care should be taken not to make the air too dry in an effort to avoid excessive moisture.¹⁶ If reduction of moisture does not overcome the difficulty, an attempt should be made to make the interior wall surfaces warmer by insulating them against the chilling effects of outside temperatures. Insulating is desirable, but, in completed houses, is difficult and usually expensive to install. There are several methods of insulating walls while the house is being constructed, but it is rather difficult to provide a remedy after the house is built.

¹⁶ See discussion on humidity and health in sec. 3 of this chapter.

Furring and Waterproofing Masonry During Construction.

Whether or not insulating material is used, it is advisable to use furring strips (strips of wood to form an air space) on exterior walls, especially in regions subject to low temperature, high winds, heavy rains, or extreme humidity of considerable duration. Where plaster is applied to a masonry wall without furring or other form of insulation, condensation may occur, and in addition, unless the walls are waterproofed, any moisture which penetrates the joints will probably appear as wet spots on the surface of the plaster.

Furring is always advantageous, but it adds to the cost to such an extent that in some cases, recourse is had to waterproofing, applied to the inside surface of the masonry wall before plastering is put on. This waterproofing may be of bituminous material which is swabbed on with a roofer's mop, or may consist of a scratch coat of Portland cement mortar containing waterproofing compound. A recent development in bituminous waterproofing demands that the material be applied through a gun, which method is considered more efficient than swabbing. It is claimed that by spraying a more water-tight job is possible, since the pores and inequalities in the surface are more thoroughly filled. If bituminous or other plaster material is used, plastering should be applied while the bitumen is still sticky, to insure proper adhesion. Waterproofing of any kind when used by itself will tend to stop leakage only through the joints and will provide no insulation against condensation.

Insulating Old Walls.

The simplest way to treat old walls to make them warmer and prevent "sweating" is to nail furring strips over the old plaster upon which to apply new lath and plaster, insulating board, or insulating material and wall board.

Before the new surface is applied, it will probably be necessary to remove the trim and, when the wall is finished, to insert pieces of wood behind the trim before it is replaced, to bring it forward to form a suitable offset. Another method is to leave the old trim in place and to apply new trim on top of this after plastering.

Replastering, especially in a furnished house, is rather objectionable, because of dampness resulting from the large quantity of water required and because of the splashing and spattering in applying the materials. There are several good wall boards and insulating boards on the market, however, which can be applied upon the stripping in place of lath and plaster, and with less difficulty. A specially prepared joint-treating system is used with these boards, and when completed the wall has the appearance of a plastered surface and may be decorated if desired. Directions covering the application and decoration of these boards are usually furnished by the manufacturers.

6. INSULATING THE ATTIC

Heat passes through a wall or roof if there is a difference in temperature between the two sides. The direction of flow is from the warmer to the cooler side, and heat seeks the lowest temperature level, just as water seeks the lowest plane.

It is therefore apparent that, in order to heat a house economically it is necessary to prevent, as far as possible, this flow of heat. In the wintertime for economy the heat must be kept within the house and in the summertime for comfort the out-of-doors heat must be kept out.

Concerning Insulating Materials.

While no material will entirely stop the passage of heat through a wall or roof, marked progress has been made in recent years in the manufacture of efficient insulating materials, many good brands having been placed on the market. Some are made in blanket form of soft, flexible materials, such as felt, wool, hair, and fiber, to be stretched and tucked between the studs, floor joists, and rafters; others come in loose form and can be packed into hollow spaces; and others are in stiff board form to be used as sheathing, plaster base, or merely as insulation.

The manufacturers of insulating materials are usually glad to cooperate with the prospective users by furnishing literature describing their products and giving full instructions for applying them and by also supplying special advice where necessary.¹⁷

Where Insulation is Most Needed.

The roof is the most exposed part of the house, being subject to the direct rays of the sun in summer and to strong cold winds in winter. In an unfinished attic a great amount of heat is lost through the roof during the winter months. The rapid melting of snow on the roof is evidence of this. In the summertime the heat passes through into the attic, making the temperature in the upper part of the house almost unbearable. It is therefore important that the roof or the upper story of the house be insulated.

How to Improve Conditions.

If the attic is being used and there is necessity for keeping it at a comfortable temperature throughout the year, application of at least one-half inch, preferably more, of good insulation to the underside of the roof rafters or against the roof boards between the rafters is advisable.

If there is no necessity for keeping the attic space at a comfortable temperature, insulation is best applied under the attic floor on top of or between the joists. If there is no floor, a few boards may be laid down to walk upon.

Spaces between the studs at the floor line should be boarded over. This boarding not only blocks the free passage of air from within the walls but also provides a fire stop, which is recommended for good construction.

Attic windows should be weather tight, and if there are louvers, or vents, to admit air, they should be made to close like shutters or be provided with doors on the inside to be closed during severe weather. The louvers should also be screened to keep out insects, especially those which injure woodwork.

¹⁷ The National Bureau of Standards has made tests of various insulating materials and the results of its findings are contained in Circular No. 376, Thermal Insulation of Buildings, listed on p. 108 of this publication.

X. HEATING AND VENTILATING

1. HOW TO FILL A HOT-WATER OR STEAM-HEATING SYSTEM

The method used in filling a hot-water heating system is the reverse of that used in draining the system (explained in Ch. XI, sec. 3). The filling is more easily done if two persons work together—one controlling the flow of water into the boiler and the other operating the radiator relief valves.

Open all radiator shut-off valves and be sure that the air valve on each radiator is closed. See that the draw-off cock at the lowest point in the system is closed, and then open the valve in the supply pipe which feeds the boiler. As soon as the water begins to rise in the pipes, open the air valve on each radiator, beginning at the one nearest the boiler, to release the air so that the radiators may fill with water. When water begins to spurt from the air valve, shut it off, and proceed to the next radiator. Repeat this operation until all radiators are free from air and full of water.

When adding water to a boiler with fire under it, be sure that the fire is low, and let the water in gradually. A large volume of cold water suddenly injected into a hot boiler may cause it to crack.

Gravity System.

In the case of the gravity system, the supply-pipe valve should be shut off when the water has risen to such a height that the expansion tank at the top of the system is one-third full. (The expansion tank is usually located on an upstairs closet shelf or in the attic, preferably near the chimney, to protect it from freezing.) The height of water in the tank is usually indicated on a water-gage glass attached to it. Always keep the water at the level mentioned, to insure complete circulation throughout the system.

Pressure System.

In the case of a pressure system, see that the radiators are all well filled with water. Whether or not they are full may be determined by opening the air valves. The flow of water from the supply pipe is usually controlled by a separate automatic valve, which shuts off the supply when the water rises to the proper height. Expansion of an oversupply of water is taken care of by an automatic release valve attached to the outlet pipe, which opens and allows excess water to flow out of the system. When the water falls below the required height, the automatic valve opens, allowing enough water to enter to fill the system. The regular shut-off valve in the supply pipe is left open where an automatic valve is used.

Altitude Gage.

The red, or stationary hand, of the dial, or altitude gage, on top of hot-water boilers, is generally set at the proper elevation mark for that particular system, and the black hand should be kept at that point for best results. If the black hand does not cover the red hand when the system is properly filled, the latter, which is merely a marker, may be moved to its proper position by removing the glass face from the dial.

Steam-Heating Boilers.

In steam-heating boilers keep the boiler filled with water to the center of the water gauge glass.

Instruction Card.

A printed instruction card, furnished by the manufacturer of the boiler, should be hung near it, and the instructions should be carefully followed.

2. INSULATING HOT-WATER AND STEAM-HEATING SYSTEMS

Insulating, or covering the boiler and pipes of a heating system, is done to increase the efficiency of the system and to reduce the cost of operation.

It has been found that the heat loss from bare or improperly insulated pipes and boiler may amount to 15 per cent to 25 per cent of the boiler capacity, and that a good covering will save from 80 per cent to 95 per cent of bare surface losses.

The small percentage of heat which escapes through the insulating material, combined with radiation from the doors and other exposed parts of the boiler, will be sufficient in many cases to warm the cellar, especially if it is well constructed and the doors and windows are properly weatherproofed.

Extent of Insulation.

The extent of covering is governed principally by the type of heating system and existing conditions in individual cases. It is generally agreed that, in any case, it is well to cover at least the boiler and the pipes through which water is distributed to the radiators. The advisability of covering the return pipes depends on the type of system and the amount of heat desired in the cellar.

Covering the return pipes of hot-water heating systems is recommended so that the water may be returned to the boiler with a minimum heat loss. In vacuum and vapor steam-heating systems, it is considered better to leave the return pipes bare, to aid in the condensation of any steam which might escape into the returns through defective thermostatic traps.

Properties and Structure of Insulating Materials.

The covering should be fire resistant and a poor conductor of heat. These qualities are found in asbestos air cell, asbestos cement, magnesia, mineral (or rock wool), and similar coverings. The application of some of these materials is described in the following paragraphs:

The air-cell covering is made of layers of corrugated asbestos paper wrapped in canvas. It is manufactured in sections 3 feet long in the shape of hollow cylinders split lengthwise on one side so that it may be readily placed around the pipe. (See fig. 12.) The covering is made in several thicknesses and for various pipe sizes. Each section has a canvas lap to be pasted over the longitudinal joint and a canvas flap at one end to be pasted over the joint between sections. To further bind the covering and to make a neat-looking job, metal bands are furnished, to be placed about 18 inches apart, over the joints between sections and around the middle of each section.

For insulating boilers and pipe fittings, such as valves, ells, and tees, where the use of fabricator coverings is not practicable, asbestos cement may be used. This material, because of its natural cell-like structure and fire-resisting qualities, serves the same purpose as the pipe covering.

Tools.

A steel tape measure, plasterer's trowel, hand saw, sharp pocket knife, pliers, a metal tub or similar container for mixing cement, a pan or dish for paste, and a small, flat paste brush.

Materials.

A 4-ply, or 1 inch thick, asbestos air-cell covering is frequently used for insulating pipes in home heating plants. To estimate the quantity needed, carefully measure between fittings all pipes that are to be covered and combine measurements for each size of pipe to obtain the total linear feet of each size of covering. Metal band fasteners are furnished with the covering.

To estimate the quantity of asbestos cement needed to cover the boiler and pipe fittings, measure the entire surface of the boiler to be covered, together with the surfaces of pipe fittings, and compute the square-foot area of each. A 100-pound bag of cement will cover from 20 to 25 square feet of surface to a thickness of 1 inch. Some brands are sold also in 10-pound bags.

A sufficient quantity of 1-inch mesh wire netting, commonly called "chicken wire," to cover the surface of the boiler is needed.

As it is well to inclose the cement covering around pipe fittings in a canvas jacket, obtain a sufficient quantity of canvas for this purpose of the same weight as that on the air-cell covering.

For pasting the canvas laps on air-cell coverings and for fastening canvas jackets over pipe fittings, a suitable paste is sold by manufacturers of the covering material.

A satisfactory paste may be made of flour and water, similar to that used in paper hanging. Mix 1 part of powdered alum with 50 parts of sifted white flour and add enough cold water to make a smooth paste. Then pour on boiling water until the paste begins to thicken, at which point stop pouring and stir the mixture thoroughly.

Mixing and Applying Asbestos Cement.

Mix the asbestos cement thoroughly in a tub or similar container, using only enough water to make the mixture workable. At least two coats should be applied to the boiler and pipe fittings, and they should be put on when the pipes are warm to insure best results. For the boiler, use a 1-inch first coat and a half-inch second coat; for

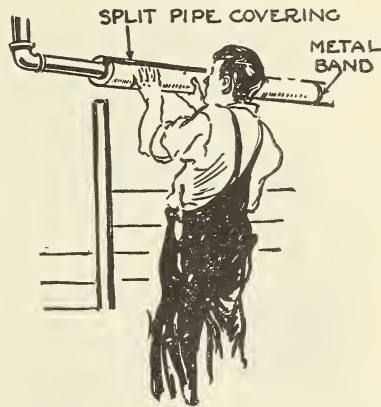

FIGURE 12.—Applying split pipe covering around hot-water heating pipes

the pipe fittings, use one-half inch for each coat. The first coat in all cases should be applied roughly with the hands or with a plasterer's trowel, and the surface roughened or scratched so that it will form a good bond with the second coat.

Methods and Order of Procedure.

To start the job apply the first coat to the boiler so that it can dry while the pipe covering is being placed. When the first coat is fairly dry, and before applying the second coat, stretch and fasten the wire netting over the surface to hold the first coat. It probably will have cracked, but the wire will serve as a reinforcement for both coats. (See fig. 13.)

Before covering the pipes, see that they are clean and in good condition. Then, loosen the canvas lap to open the section of covering and brush paste along the edge for refastening the lap. Then slip the section around the pipe with the open side up and with the end which has no canvas joint overlap toward the fittings. Now, press the section tightly together, paste the lap securely over the longitudinal joint, and push the section tightly against the fitting. The second coat should be applied in the same manner, and pushed tightly against the first. The joint between the two should be sealed over by pasting the overlap on the first section over the joint. Continue to cover the pipe in this way until the next fitting is reached. When a short section is needed, it can be cut with a sharp knife and handsaw.

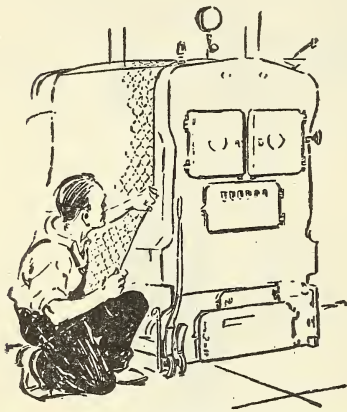

FIGURE 13.—Applying "chicken wire" in connection with boiler covering

The first coat on the fittings should be applied roughly with the hands to about one-half inch in thickness. It will have an opportunity to dry while the finishing coat is being placed on the boiler. The second coat on the boiler should be troweled down hard and smooth as it dries.

The next step is to finish covering the fittings by applying a half-inch second coat, or enough to make the same thickness as the pipe covering. This coat should be troweled hard and smooth and beveled down to meet the surface of the pipe covering.

The cement on the fittings will be protected and will present a neater appearance if it is covered with a canvas jacket. The canvas should be of the same weight as that used on pipe covering and should be pasted down smoothly. For the sake of appearance and to preserve the canvas, all such material may be sized and painted with two coats of lead and oil in a suitable color.

The metal bands around the pipe covering should be applied after all of the other work is completed, so that they may be kept clean and give a neat finished appearance to the job. The bands should be placed about 18 inches apart, over the joints and midway

between. They should be pulled up tightly and fastened like a belt. This can be done with the pliers.

3. INSULATING WARM-AIR FURNACES AND PIPES

Warm-air furnaces may be made more efficient and the consumption of coal reduced by insulating the furnace and pipes in the cellar. It is not so essential, however, to cover a pipeless or 1-pipe furnace, because the space between the inner and outer shells is filled with cold air, which provides considerable insulation.

In the ordinary type of warm-air furnace, with pipes to various rooms, if the entire system is well covered, the cellar will be kept sufficiently cool for the storage of foods, and more heat will be delivered to the upper rooms where it is most needed. If a warmer cellar is desired, insulating the pipes only and leaving the furnace bare will afford the necessary radiation.

Tools.

A steel tape measure, a pencil, a pair of heavy shears or a sharp knife, a pair of wire-cutting pliers, a small trowel, and an old dish pan or similar container for mixing asbestos cement.

Materials.

A sufficient quantity of corrugated asbestos paper to provide a 3-layer covering for all pipes and the furnace. (This material is made in rolls about 37 inches wide, containing about 250 square feet of material. For the average 7-room or 8-room house two rolls are sufficient.)

A small roll of No. 16 or No. 18 gage black or galvanized wire to hold the covering in place.

One 100-pound bag of asbestos cement should be sufficient to cover the sloping shoulder of the furnace. This amount will cover from 20 to 25 square feet of surface to a thickness of 1 inch. Some brands are sold also in 10-pound bags for convenience.

Kinds of Insulating Materials for Warm-Air Systems.

Some of the insulating materials are similar to those used on hot-water or steam-heating systems. The corrugated paper insulators, or those designed to form a tight-fitting jacket, are usually preferred. Plastic material is often used to cover the irregular surfaces of the furnace.

The application of corrugated asbestos paper and asbestos cement is as follows: The paper is wrapped around the pipes and around the cylindrical surface of the furnace and placed on top of the furnace. Asbestos cement is generally used to cover the sloping shoulder.

Applying the Straight Pipe Covering.

Before covering the pipes, see that they are clean and in good condition. Then measure around the pipe and add $1\frac{1}{2}$ inches to allow for the thickness of the material. Cut a strip off the roll to this length and wrap around the pipe, tying it with string in three places, near each end and in the middle. (See fig. 14, facing p. 62.) Then measure around the outside of the covering and add $1\frac{1}{2}$ inches

to get the length of the second piece. Tie this piece around the pipe over the first, breaking end and longitudinal joints, and proceed in the same way to apply the third or top layer. By adding $1\frac{1}{2}$ inches to each measurement the ends of the pieces should just meet when wrapped around the pipe. The joints of each succeeding layer should be covered by staggering or "breaking joints" as it is commonly called. The three layers may finally be bound together by fastening bands of wire around the covering at intervals of about 18 inches.

Covering the Bends.

It is not absolutely necessary to cover the bends in the pipes as they form but a small part of the system. However, it is not a difficult task, and it will add to the efficiency and appearance of the covering. A 90° bend will require two or three specially cut pieces to cover it, depending on the number of separate sections in the bend.

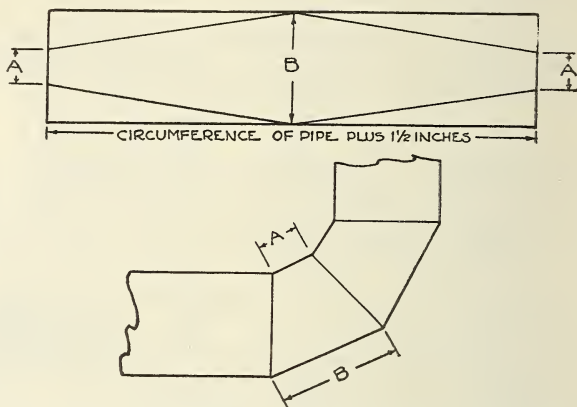

FIGURE 15.—Method of marking pipe bend covering for cutting

These pieces are cut diamond shape to conform to the surface to be covered, and the dimensions are obtained by measuring the widest and the narrowest parts of the bend as illustrated in Figure 15.

When all of the pipes and bends have been covered, a smooth, finished appearance may be had by pasting strips of asbestos paper over the joints.

Insulating the Furnace.

To cover the vertical surface of the furnace, wrap from one to three layers of corrugated asbestos paper around it, and fasten with bands of tie wire, or stove wire. (See fig. 16.) At the furnace doors the ends of the wires may be attached to bolts or other projections. Obviously, holes should be cut in the covering for doors and other attachments.

The top of the furnace may be hollow shaped and filled with sand, but the sand does little toward preventing heat losses. The furnace top can be covered by laying three or four layers of asbestos paper over it. These pieces may be held in place by extending the asbestos cement shoulder coating up over the edges of the paper, as shown in

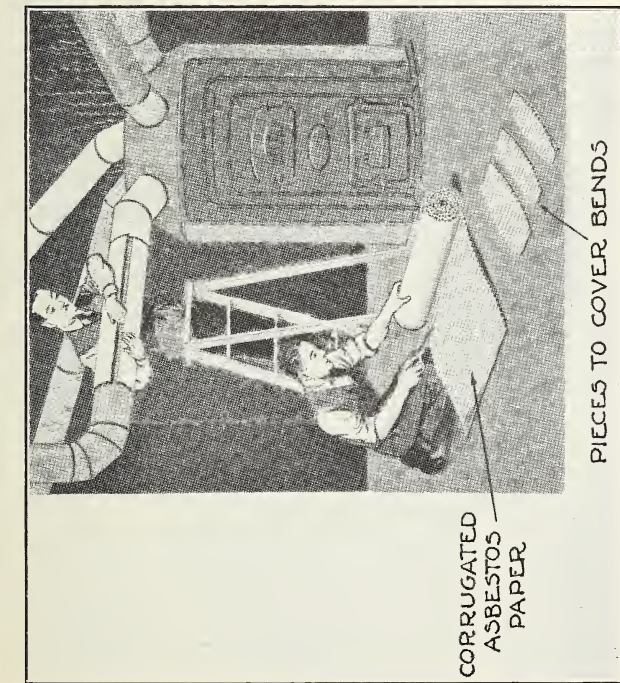

FIGURE 14.—Covering warm-air furnace pipes

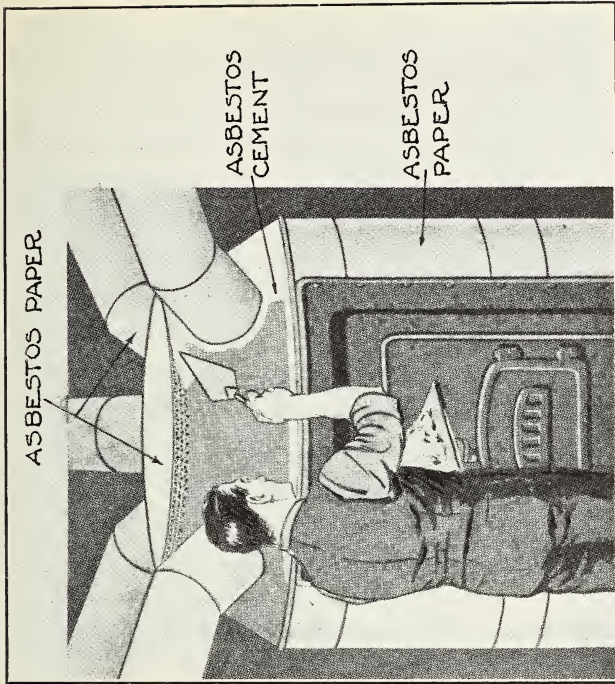

FIGURE 16.—Insulating a warm-air furnace

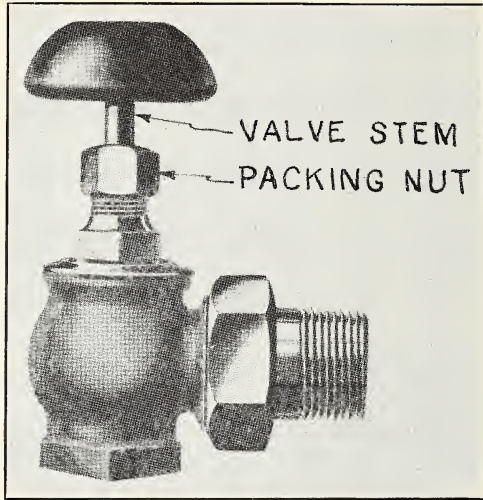

FIGURE 17.—Typical radiator valve

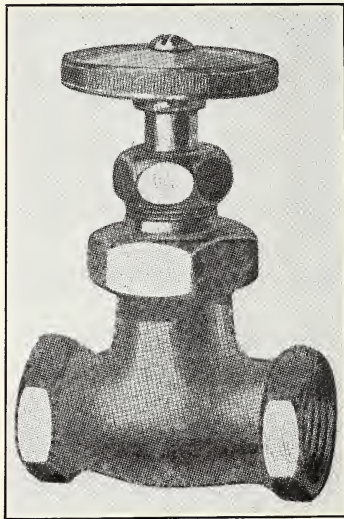

FIGURE 18.—Typical water shut-off cock

the illustration. The paper can be marked for cutting to the size and shape of the top by means of a string and a pencil. Tie the pencil to one end of a piece of string half as long as the diameter of the top and use this device as a compass.

The sloping shoulder of the furnace from which the pipes lead can be insulated with a covering of asbestos cement to a thickness of one-half to 1 inch. The cement, which comes in powdered form, is mixed with just enough water to make it workable, and then applied and troweled down hard and smooth with a plasterer's trowel.

4. INSULATING A HOT-WATER STORAGE TANK

An uninsulated hot-water storage tank has been likened to a huge hot-water radiator. Much of the heat that should be retained by the water passes out through the walls of the tank. If the tank is located in the kitchen, the radiation may cause much discomfort during the summer.

Covering on a tank insures greater efficiency by keeping the water hot for a much longer period, thereby reducing the amount of fuel needed.

Tank covers may be bought ready-made to fit any standard size of tank. They are made of incombustible heat-insulating materials, similar to those used in pipe and boiler coverings. Some have the appearance of a large section of pipe covering, split lengthwise on one side, so that they may be readily wrapped around the tank. If connection pipes are in the way, openings for them can easily be cut in the covering at the joint edge. Metal bands, laces, or other forms of fasteners are furnished to hold the covering together. The top of the tank may be covered with asbestos cement or similar plaster material, in the same manner as the shoulders of a furnace. (See sec. 3 of this chapter.)

5. REPACKING A LEAKY RADIATOR VALVE

If a radiator valve leaks around the stem, it should be promptly attended to, in order to avoid damage to the floor and, possibly, to the ceiling below the radiator.

The trouble may result from a loose packing nut at the base of the stem (see fig. 17, p. 64), or from worn or insufficient packing inside the nut. Try tightening the nut. If this does not stop the leakage, it will be necessary to repack the valve.

To do this it is generally advisable, especially for one who is not familiar with such work, to let the fire go out before starting to pack. It is always advisable to have a very low fire.

In the case of a hot-water system, lower the level of the water to a point below the radiator being repaired by opening the draw-off cock at the lowest point in the system, as described in Chapter XI, section 3. To determine whether the water is sufficiently low, loosen the packing nut a little. If water spurts out, continue to draw water from the system until flow ceases at that point. The elevation of water in the system above the gage on top of the boiler is marked by the black pointer.

In the case of a steam-heating system, it is likewise advisable to let the fire go out, or at least to have a low head of steam, before starting work on the valves.

When these preliminaries have been attended to, close the valve tightly, unscrew the packing nut at the base of the stem, and pack the space between the inside of the nut and the stem with plastic, metallic packing compound, using a small screw driver for the purpose. This compound may be purchased in small quantities from a dealer in heating supplies. It may be found easier to pack the nut if it is removed from the stem. To do this, remove the handle, held in place by a screw, and lift the nut from the stem.

After the nut has been well packed, screw it down tightly and refill the system, as described in section 1 of this chapter, pages 57 to 58.

6. CLEANING A CLOGGED GRATE

A fire should be shaken down at least twice a day to remove ashes and to provide a better draft through the grates. The ash pit should be cleaned out daily, for if it is allowed to fill up to the grate bars there is danger of warping or burning out the grates.

In most stoves and furnaces, just above the grate surface, there are clean-out doors through which a poker may be inserted to break up and pull out clinkers. If an unusually large, hard clinker lodges between the plates in such a way that the grate can not be shaken or turned over and the obstruction can not be readily broken up or removed with a poker, it will be necessary to clean out the fire pot to get free access to the obstruction. When the fire pot is empty, the poker can again be used to better advantage. Do not try to turn the grate by force to dislodge or break up such an obstruction, as this action may break the grate.

7. HOW TO MEND A CRACK IN A STOVE

A crack in the iron casing of a stove can be fixed by filling the crack with stove putty or iron-repair cement made by mixing iron filings and water glass (silicate of soda), using enough of the filings to form a thick paste. Force the paste well into the crack with the aid of a trowel or old table knife, and plaster over the surface of the crack with the same material. The heat from the stove will harden the cement almost like iron and make a tight joint.

Another iron mender is made of iron filings, flowers of sulphur, and water, mixed to a stiff paste and applied to the crack in the manner described above. The mixture burns when heated and turns into iron sulphide, which fuses and welds into one mass with the iron of the stove.

8. REPLACING AND CLEANING MICA IN STOVES

Broken mica in a stove door is not only unsightly but it is a menace, in that it may permit dust, smoke, and coal gas to escape into the house, besides allowing cool air to pass over the fire, thus decreasing its efficiency.

To Replace Broken Mica.

The mica is usually held in place by metal clips screwed to the inside of the door. By removing these clips the broken pieces can be removed and new ones inserted. It may be possible to renew the mica without removing the clips by merely bending it and slipping the edges under the clips, but this method is not recommended, as there is danger of cracking or breaking the material. The openings requiring new mica should be measured and new pieces purchased at a hardware store to conform to the measurements. It may be necessary to trim the pieces slightly with a pair of scissors in order to fit them neatly into the openings.

How to Clean Mica.

Mica often becomes clouded or blackened by gases and soot, but it can be cleaned and made to look almost like new. Remove the doors by lifting out the hinge bolts, and then, with a damp cloth, wipe off all dust and as much soot as possible. Then saturate a cloth with vinegar and go over both sides of each piece. This will remove the stains and produce a polished appearance.

9. STORING THE STOVE AND STOVEPIPE FOR THE SUMMER

Many householders store their stoves during the summer months. Before placing them in storage, they should be cleaned and polished. If possible, they should be wrapped with newspaper, burlap, or old carpet to protect them from dust and rust, and stored in a dry place.

It is well to examine the grates and lining as soon as the stove is taken down and to have needed repairs made for the autumn. If parts are found to be defective, an order should be placed promptly for new parts. The make and number of the stove is usually marked on it, and these identifications should be reported to the hardware man, or dealer in heating equipment, when new parts are purchased.

Cleaning and Storing Stovepipe.

Stovepipes need cleaning often, especially if the draft is poor. Soot will collect in the pipe, particularly if soft coal is burned.

Before taking down the pipe, it is well to cover the floor about the stove with newspaper to catch whatever soot drops out. Carefully carry the pipe out of doors away from the house before removing the soot. The ends of the pipe should not be pounded nor should the pipe be otherwise roughly handled.

Stovepipe, as a rule, is made of sheet iron and should be kept enameled and polished to prevent rusting. When it is put away for the summer each length should be wrapped in paper and all should be stored in a dry place.

XI. PLUMBING AND WATER SYSTEM

1. GENERAL COMMENTS ON PLUMBING

The plumbing of a building includes the pipes for distributing the water supply, the fixtures for using water, and the drainage pipes for removing waste water and sewage, together with fittings and

appurtenances of various kinds, all within or adjacent to the building.

To many, the plumbing system appears to be a very complicated part of the household equipment and they hesitate to undertake even the simplest repairs.

Although it is not to be expected that the average householder will be able to perform all of the work of an experienced plumber, it is possible for him, in cases of emergency, to make the simpler repairs that are frequently necessary. Trouble and expense may be averted by prompt repairs to a leaky faucet, or by the cleaning out of a fixture drain at the first signs of clogging. Occasionally some difficulty involving the pipes may arise, and then, unless it is comparatively simple to adjust, a plumber should be called in to do the work.

Each part of a plumbing system is designed for a specific purpose and must be used for that purpose alone, if the system is to function properly. Grease or refuse should not be thrown into closet bowls, sinks, or lavatories; faucets should be tightly closed when not in use; and waste pipes should be flushed frequently with hot water to keep them in good working order.

2. WHERE AND HOW TO SHUT OFF THE WATER

The flow of water in a house is controlled by means of stopcocks, or shut-off valves, in the pipes. To shut off the main supply as it enters the house, it is necessary to close a valve which is usually in the main pipe in the cellar. The valve may have a handle, or a wrench may be required to turn it.

This valve may be of the ground-key type with a small hole bored in its side for draining the pipes after the water is shut off, or it may be a compression stop with a cap nut covering the drain opening. In either case, this opening should be closed when the water is turned off, for unless this is done, a stream of water will shoot from the hole with considerable force.

Where no means have been provided for shutting off a drain opening, a small wooden peg may be driven into it temporarily, until the pressure is relieved by draining the pipes through the faucets.

If the house is left vacant during the winter months it is safest to have the water shut off at the official stopcock in the street to prevent freezing between the cellar wall and the main shut-off.

In modern plumbing, separate shut-off cocks are often provided below the sink, lavatory, water-closet, or other fixtures, for convenience when repairs are to be made, so that the flow of water may be cut off from any one fixture without disturbing the flow to the other parts of the system. (See fig. 18, facing p. 63.)

It is important that all members of the family know where these various shut-offs are located, in case of emergency.

3. HOW TO DRAIN THE PIPES AND SYSTEM

For minor repairs, such as replacing a washer in a faucet, the temporary shutting off of the water from the branch shut-off (described in sec. 2 of this chapter) is sufficient. Where extensive repairs,

such as pipe changes, are proposed, the main water supply should be cut off and the pipes drained. If the fires are allowed to go out, and the house is to be vacant during cold weather, it is a wise precaution to drain the entire water system, to guard against freezing and resulting damage.

To drain the pipes, first shut off the water, as previously described. Then, starting at the top floor, open all faucets on the way down. When the water from the faucets ceases to run, the small cock or cap in the main pipe valve may be opened or the plug removed to drain into a bucket or tub what little water remains.

If the house is to be vacated during the winter, in addition to draining the pipes, the water still remaining in the traps under sinks, water-closets, tubs, lavatories, and showers, should be removed by opening the traps and draining them, or by forcing the water out by means of a force pump, or by drawing it out with a suction pump or siphon hose. The traps may then be filled with kerosene, crude glycerine, or some similar nonfreezable liquid to form a seal against bad odors from the waste pipes. Alcohol and kerosene mixed is a good solution to use, since the kerosene will rise to the top and prevent evaporation of the alcohol.

The water-closet tanks should be emptied by flushing, after the water has been turned off, and any surplus water taken out with a sponge or cloth. The water-closet traps can be cleared of water by means of a sponge tied to a stick or wire.

The hot-water tank should be emptied. It usually has a cock in the piping at the top that will allow air to enter the tank and permit the water to be drawn off through the faucet at the bottom.

If the house is heated by hot water or steam, the system should be drained before the house is vacated in winter. Assuming that all of the fires are out, shut off the main water supply at the wall or street, then draw off the water from the boiler by opening the draw-off cock at the lowest point in the system. Open the water-supply valve to the boiler so that no water will remain trapped above it. Then, in any hot-water system, beginning with highest radiators, open the air valve on all radiators as fast as the water lowers. In a 1-pipe steam system every radiator valve should be opened to release condensation. When a heating system has been drained, be sure that it is properly refilled before starting a fire under the boiler. (See Ch. X, sec. 1.)

If the house is left vacant in the summer, it is not necessary to drain the supply pipes or system. Shut off the water at the cellar wall as a precaution against waste of water from a dripping faucet or possible leak in the piping.

4. REPAIRING A LEAKY FAUCET

Tools.

Monkey wrench, screw driver, pliers, and a small piece of cloth to avoid marring the faucets.

Materials.

Fiber, rubber, leather, or special composition washers for compression-type faucets. (Assorted sizes are readily obtained at a hardware store.)

Rubber or composition Fuller balls for Fuller faucets.

Small quantity of valve-grinding compound (composed of emery dust and grease) for ground-key faucets.

Compression Type.

General description.—The compression type¹⁷ of faucet is being used almost exclusively in modern household plumbing and is rapidly replacing the Fuller and ground-key types. (See fig. 19.) In the compression-type faucet, the flow of water is regulated by turning a lever, tee, or 4-ball handle, which is attached to a threaded spindle. When the spindle is turned down, the washer or disk at-

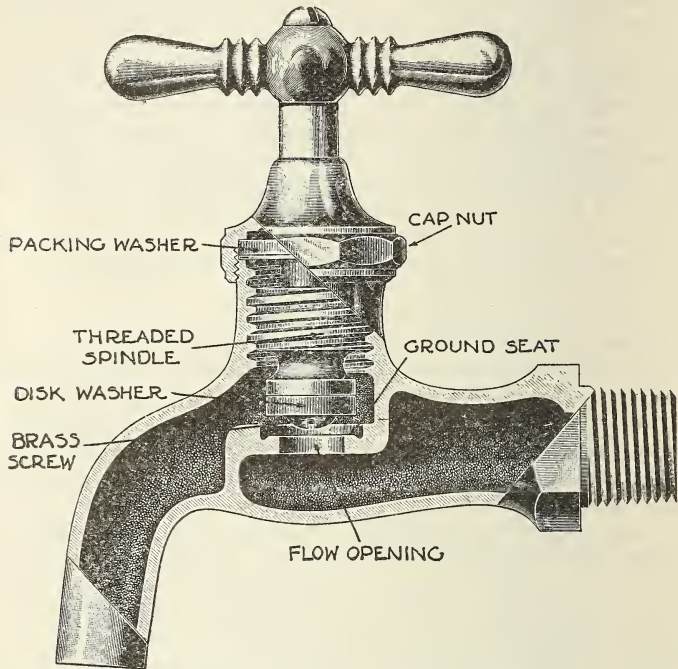

FIGURE 19.—Section of a compression faucet

tached to its lower end is pressed tightly against the smoothly finished ring, or "ground seat" which surrounds the "flow opening," thus shutting off the flow of water. If the washer and the seat do not make a firm contact at all points, water will leak through and drip from the faucet. A leak usually results from a worn-out washer. If the washers wear out rapidly, it may be because a poor grade of washer is used, or because the ground seat has become sharp and rough as a result of corrosion, or has been scratched or worn by grit.

It is important that faucets be tightly closed after they are used, since dripping faucets tend to produce or aggravate leaks, and can waste much water.

¹⁷ For suggested means of identifying the three principal types of faucets, see p. 71.

Care in Selecting Washers.

To avoid frequent renewals, get a good grade of washer that will wear well. It does not pay to use leather or other washers suitable for cold water only in a hot-water faucet. The $\frac{3}{8}$ -inch, $\frac{1}{2}$ -inch, and $\frac{5}{8}$ -inch sizes are most frequently used, and it may be well to have a supply of these sizes on hand. One good type of washer, made of a hard composition, has one side flat and the other side rounded out slightly; and a better contact is made with this type because the washer, by fitting partly down into the seat, is subject to both horizontal and vertical pressure. Some faucets are designed to take a specially shaped washer, and examination of the one already in use may save an extra trip to the plumbing supply or hardware store.

Replacing the Washer.

Shut off the water below the fixture, if possible, or in the main pipe. With a wrench, using the cloth to protect the fixture from being marred, unscrew the top nut or cap of the faucet, which will allow the spindle to be unscrewed and removed. Carefully remove the brass screw that holds the washer to the bottom of the spindle, and replace the worn washer with a new one.

The head of the brass screw is often badly worn, making it difficult to remove and likely to twist off unless handled carefully. A drop or two of kerosene and gentle tapping of the screw may help to loosen it. The screw driver should have a good square edge and should be turned with a steady pressure. If the head of the screw chips off so that it does not hold the screw driver, the slot can be deepened by cutting into the head with a hack saw. It is well to replace a badly worn screw with a new one.

Grinding Down an Irregular Washer Seat.

A worn or roughened washer seat can often be ground true and smoothed off by the use of a faucet seat-dressing tool. Such a tool is inexpensive and will probably more than pay for itself within a reasonable time. One type consists of a stem with a cutter at the lower end and a wheel handle at the top to rotate the tool. It is fitted with a spiraled cone to be inserted into the body of the faucet and screwed down firmly for the purpose of centering and holding the cutter on the washer seat. When the tool is thus properly adjusted, it is carefully rotated back and forth several times by means of the wheel handle, until the seat is ground free of irregularities. When the grinding is finished, all metal cuttings should be wiped out with a cloth before the faucet is reassembled. If the seat is in such bad condition that it does not respond to this treatment and continues to cut the washers, it will be necessary to substitute a new faucet.

Leakage Around the Stem.

If water leaks out around the stem when the faucet is open, it may frequently be stopped by tightening the cap nut, but the nut should not be made so tight as to cause the faucet to bind. If this does not overcome the difficulty, it is probable that the packing washers under the cap nut are worn out. To remedy this condition, remove the handle and cap nut and replace the washers with a new set. To stop the leakage temporarily, wrap a small piece of candlewicking or

soft string around the stem under the cap nut where the stem enters the body of the faucet.

Fuller Type.

General description—In this type of faucet, which is often found in kitchen sinks, a hard-rubber or composition ball-like stopper, known as a Fuller ball, is fastened by a small nut or screw to a shaft having an eccentric end. (See fig. 20.) When the faucet handle is closed, this ball is drawn firmly against the opening, shutting off the flow of water; when opened, the ball is pushed away from the opening, allowing the water to pass through. The best grade of Fuller ball should be used. Such balls are made in various sizes, ranging from three-eighths inch to 1 inch and the most suitable one should be selected.

Replacing a Fuller Ball.

Shut off the water and unscrew and separate the faucet from the supply pipe. With pliers or a screw driver the nut or screw can be taken off and the ball removed and replaced with a new one.

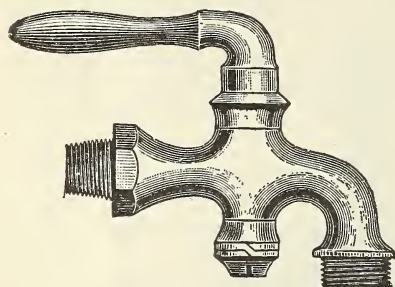

FIGURE 21.—A ground-key faucet

Leakage Around Axle of Fuller Ball.

Sometimes the metal axle which holds the Fuller ball or the eccentric part becomes worn, making it impossible to pull the ball tight against the seat, and allowing leakage between the ball and the seat. In this case it will be necessary to purchase new metal parts to replace the worn ones.

Leakage Around the Stem.

If water leaks out around the stem when the faucet is open, repairs can be made in the same manner as prescribed for similar leakage in compression-type faucets.

Ground-key Type.

General description—The ground-key type has a tapered cylindrical brass plunger or plug which should fit snugly into a sleeve, bored vertically through the body of the faucet. (See fig. 21.) The plunger is rotated by a handle. It has a hole or slot bored horizontally through it, to coincide with a similarly shaped horizontal opening in the body of the faucet. When the handle that rotates the plunger is parallel to the body of the faucet, these two openings are in line with each other and allow the water to pass through. A short turn of the handle to the right or left throws the openings out of line and cuts off the flow.

Cause of Leakage.

The plunger or its sleeve may become grooved or worn by sand particles rubbing against the metal, allowing the water to leak through and necessitating repolishing the adjoining surfaces. Again,

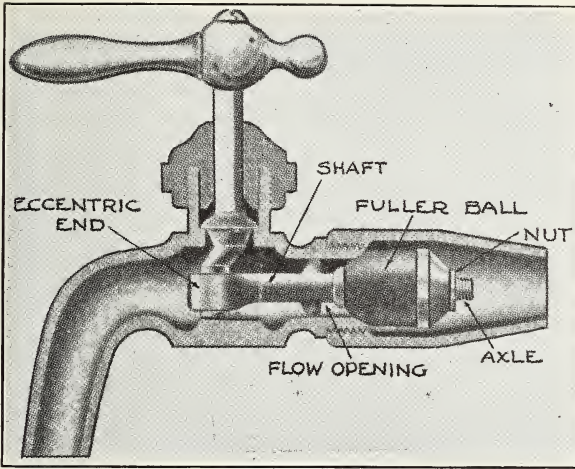

FIGURE 20.—Section of a Fuller faucet

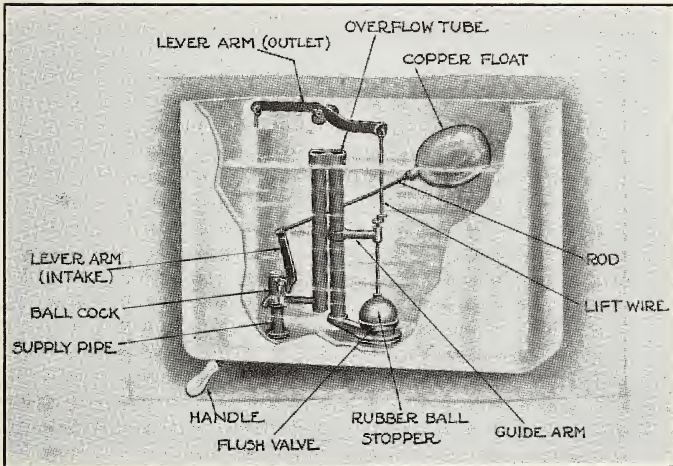

FIGURE 22.—Section of a water-closet tank



the nut or screw at the bottom may become loose and the plunger move out of its true position and allow leakage. On the other hand, if the nut or screw is too tight the plunger will bind and will be difficult to turn.

Repolishing the Surface.

To repolish the surfaces shut off the water supply, unfasten the nut or screw at the bottom which holds the plunger in place, and pull out the plunger. With a small flat stick, smear a little valve-grinding compound (a compound of emery dust and grease, obtainable from a dealer in plumbing goods) on the sides of the plunger, and after temporarily replacing the plunger in the sleeve rotate it back and forth to wear the two surfaces smooth so that they will form a leak-proof joint. If the parts are worn badly and refuse to respond to this remedy, it will be necessary to purchase a new faucet.

How to Distinguish the Type of Faucet.

Before attempting to repair a faucet its type should be known so that the proper materials may be provided, without the inconvenience and delay occasioned by guesswork.

The compression type of faucet is usually fitted with a lever, tee, or 4-ball handle and obviously offers firm resistance against efforts to turn down the spindle much beyond the point where the flow of water stops. The stem of the spindle may be seen to move in or out of the body of the faucet when the handle is turned. A self-closing faucet is usually of the compression type.

When a Fuller ball is in good condition, the handle should require but a quarter turn to open or close the flow opening. Fuller faucets are generally fitted with a lever handle, and the stem does not move in or out of the body of the faucet when the handle is turned.

The ground-key type is easily distinguished by the lever handle and plunger, which is made in one piece, and by the exposed nut or screw at the lower end which holds the plunger in place.

If it is impossible from the outside appearance to distinguish between a compression and a Fuller-type faucet, it will be necessary to dismantle it to decide the question. At the same time, the kind and size of washer or Fuller ball may be determined and the condition of the brass screw examined to see whether it requires renewal.

5. ELIMINATING THUMPING NOISE IN FAUCETS

Sometimes when a faucet is partly turned on, a thumping or pounding noise is heard. This may be caused, in a compression-type faucet, by a loose cap nut, a worn spindle, or a loose defective disk. In the Fuller-type faucet, the Fuller ball may be loose, or the metal eccentric, which connects the handle to the Fuller ball, may be worn.

Tools.

Monkey wrench, screw driver, pliers, and a small piece of cloth to prevent marring faucets.

A Remedy.

For a compression type of faucet try tightening the nut on top of the faucet. and if this does not produce the desired result, shut

off the water and take out and examine the spindle and disk washer. If the disk is loose, tighten the brass screw; but if the disk is worn, remove the brass screw and attach a new disk. If the threads on the spindle or in the body of the faucet are badly worn, causing the spindle to rattle, it probably will be necessary to purchase a new faucet.

If the faucet is a Fuller type, shut off the water and tighten the small nut or screw, which holds the Fuller ball, in case it should be loose, or replace the ball with a new one if the old ball is much worn. If parts of the eccentric are worn and tend to rattle, take the faucet to a plumber. If the eccentric is beyond repair and new parts can not be obtained it will be necessary to discard the faucet.

6. HOW TO STOP A LEAKAGE IN THE FLUSH TANK

If, after a toilet is flushed, the water continues to run into the closet bowl, it is evident that some part of the mechanism inside the flush tank is out of order. The parts comprising this mechanism are not oversubstantial and sometimes require renewal or adjustment.

It is sometimes difficult to detect leakage, but a failure to do so may prove costly. A small piece of paper held against the back of the closet bowl and above the level of the water will make it easier to detect flow of water. If the paper is quickly saturated it is evident that there is leakage. Leakage from the tank may also be indicated by a low humming noise.

How the Tank is Filled.

The supply pipe that fills the tank is fitted with a lever ball cock, which operates somewhat like a compression-type faucet having a plunger with a rubber washer to close the opening. (See fig. 22.) The water supply to the tank is turned on and off by the raising and lowering of this plunger by means of a hollow copper ball float, acting through a lever. When the flush valve is opened, and the water level begins to lower, the copper ball float goes down with it and, by means of the lever, raises the plunger, allowing a fresh supply of water to enter the tank. When the flush valve is again closed, the incoming water gradually refills the tank and, in rising, carries the float up with it, which action slowly lowers the plunger into its seat and stops the filling process. An overflow tube, or pipe, is provided in the flush tank to carry off the water should it rise above its accustomed level. This pipe empties into the closet bowl.

How the Tank is Emptied.

The opening and closing of the outlet from the tank to the closet bowl is accomplished by the raising and lowering of a rubber ball stopper suspended by lift wires, which are attached by another lever to the push button or handle on the outside of the flush box. When the button is pressed or the handle turned the rubber ball stopper is lifted from its seat on the outlet pipe, allowing the water in the tank to rush into and flush the toilet bowl. In the meantime, the stopper is suspended and floats until the tank is empty, when it again sinks to its seat. It is then held in place by suction, shutting off further discharge into the bowl.

Causes of Leakage.

Leakage may occur either from the supply cock or the outlet valve, and is usually caused by improper seating of the plunger in the one case, or of the rubber ball stopper in the other. Failure to seat properly may be attributed to various causes, the more common of which will be briefly described, with recommendations for repairs.

If the water in the tank rises so high that it flows off through the overflow tube, it indicates that the supply cock is out of order. If, on the other hand, water leaks past the rubber ball stopper and out through the outlet valve, the fault lies with the valve. In either case water will continue to run into the closet bowl after it has been flushed.

Tools.

Small monkey wrench, pliers, and a screw driver.

Leaking Outlet Valve.

If the rubber ball stopper does not fit tightly over the top of the outlet pipe, a defective ball, irregular seat, or bent lift wires may be responsible.

Defective Ball.

If the ball is worn, is out of shape, or has lost its elasticity and fails to drop tightly into the hollowed seat, it should be replaced with a new one. Sometimes the ball may be merely covered with a slimy coating, which can easily be wiped off. To replace the ball, empty the tank and, if there is no supply shut-off, place a stick under the lever arm of the copper-ball float to hold it up, thereby shutting off the intake cock and preventing the tank from refilling. Then unscrew the ball from the lower lift wire and attach a new ball of the same diameter as the old one.

Irregular Stopper Seat.

It may be found that the top of the outlet pipe is corroded or covered with grit in such a way as to make an irregular seat for the stopper ball. This seat should be scraped and rubbed down with emery paper until it is smooth and forms a uniform bearing for the stopper.

Bent Lift Wires.

Sometimes the handle and lever fail to work smoothly, or the lift wires get out of plumb, causing the ball stopper to remain suspended, or to incompletely cover the opening. The lift wires should be straightened and made plumb so that the ball will drop squarely into the hollowed seat. The lower lift wire can be adjusted by means of the adjustable guide arm, which is usually fastened to the overflow pipe. Loosen thumbscrews to raise, lower, or rotate the guide arm, until it is centered directly over the seat.

Leaking Intake Cock

There are various ways in which the intake cock might get out of order. The seat washer on the bottom of the plunger may be worn or the seat itself may be irregular. On the other hand, the intake cock may be in good condition, but may not work properly because of faults in the copper ball float or its attachments.

How to Repair a Defective Copper Ball Float.

A leaky water-logged float holds the plunger up and does not completely shut off the water. A small leak in the copper ball can be soldered, but if the ball is badly corroded or worn it is advisable to buy a new one. If the rod that connects the float to the plunger lever has become bent, it may prevent the float from reaching its full height, thus leaving the plunger up and allowing a leakage. In this case the rod should be removed and carefully straightened.

Sometimes, because of faulty installation, the tank may not fill sufficiently or it may fill to overflowing. These difficulties may be corrected without disturbing the supply cock by bending the rod attached to the copper float upward or downward. If bent upward, the water will rise higher in the tank, and if downward, the water will not rise so high.

To Replace Washer on Plunger of Intake Cock.

Shut off the water by means of the shut-off valve, which is usually located below the flush tank, and drain and bail out the tank. Unscrew the two thumbscrews to release the plunger. Remove the old washer, which is held in place by a nut and brass ring cap, and replace it with a new soft-rubber or leather washer. The brass ring cap, into which the washer fits, may be corroded and may therefore break while being removed, in which case a new ring should be substituted. See whether the seat upon which the plunger rests is free from nicks and grit. If not, it should be smoothed off.

7. HOW TO CORRECT FAULTY ACTION IN A WATER-CLOSET FLUSH VALVE

In some houses, especially those built during recent years, a flush valve instead of a tank is used to flush the water-closet bowl. There are several kinds of flush valves on the market, but the adjustments required are somewhat alike. A common type shown in Figure 23 will therefore be used as an example.

In this type the rubber diaphragm *A-26-A* separates the valve into an upper and lower chamber, with the pressure the same on both sides of the diaphragm, equalized by the by-pass *A-24*. The slightest touch of handle *B-2* in any direction pushes in plunger *B-8-A*, which tilts auxiliary valve *A-19-A*, releasing the pressure in the upper chamber. Then the pressure below raises the entire working parts (auxiliary valve *A-19-A*, disk *A-15-A*, diaphragm *A-26-A*, and guide *A-13*) allowing the water which flushes the bowl to go down through the barrel of the valve. While this is occurring, a small amount passes up through by-pass *A-24* and gradually fills the upper chamber and closes the valve.

The most noticeable difficulty is continuous running of the water into the bowl after the handle has been pressed. In valves similar to the type shown in Figure 22 (facing p. 70) this flow may result from stoppage of the by-pass *A-24*, or from a deposit of grit on auxiliary valve seat *A-17*. If the by-pass is clogged, water can not pass into the upper chamber to close the valve. If there is sediment on the auxiliary valve seat, or if the seat is badly worn the valve may not close tightly, allowing water to escape. The diaphragm *A-26-A*

may also deteriorate in time and need to be replaced. The auxiliary valve seat, or washer, and the diaphragm are made of rubber and are usually sold together, as it is generally advisable to replace both at one time.

It is not often necessary to cut off the entire water supply while repairing a flush valve. The water-closet supply may be cut off by turning the large screw in the body of the flush valve, or by means of a shut-off valve in the supply pipe.

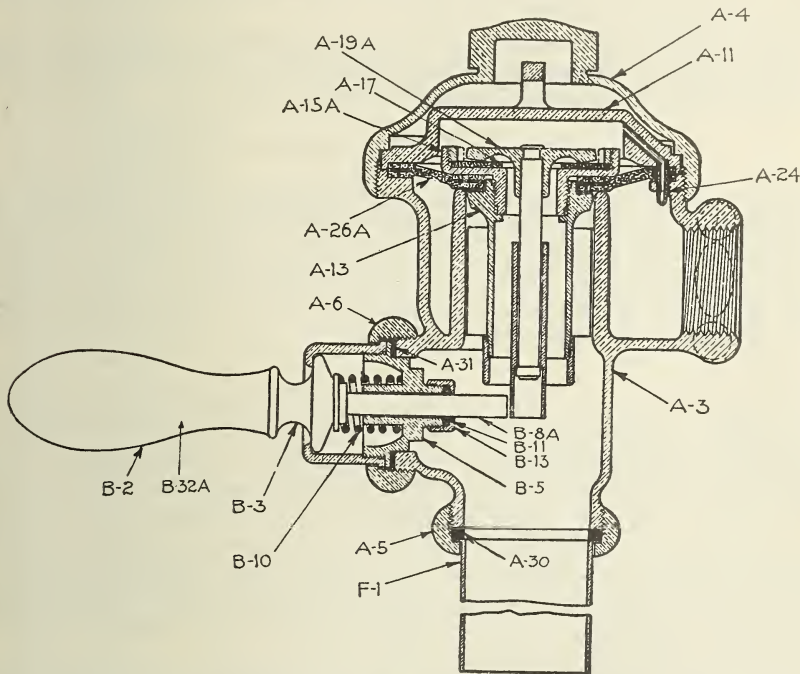

FIGURE 23.—Section of a typical water-closet flush valve

A-3, Body only.
 A-4, Outside cover.
 A-5, Outlet coupling.
 A-6, Handle coupling.
 A-11, Inside cover.
 Guide.
 A-15-A, Disk complete.
 A-17, Auxiliary valve seat.
 A-19-A, Auxiliary valve.
 A-24, By-pass tube.
 A-26-A, Diaphragm.

A-30, Outlet gasket.
 A-31, Handle gasket.
 B-2, Porcelain grip.
 B-3, Handle shank.
 B-5, Bushing.
 B-8-A, Plunger.
 B-10, Handle spring.
 B-11, Felt washer.
 B-13, Packing nut.
 B-32-A, Metal handle complete.
 F-1, Outlet.

To get at the parts mentioned, unscrew the outside cover *A-4*, being careful not to mar the nickel finish. The inside cover *A-11* can then be lifted out together with the auxiliary valve complete, *A-19*.

The by-pass *A-24* and corresponding hole in cover *A-11* can be cleaned by running a fine wire through the openings.

In replacing the rubber washer (auxiliary valve seat *A-17*), insert a screw driver under the washer at the hole in the center and pull the washer out. Then, with a spanner wrench, unscrew the disk ring which holds the washer in place, and clean the surface of the seat on

which the washer rests. Insert new washer and replace disk ring, screwing it down until it is firm, but not too tight.

When the disk *A-15-A* is unscrewed, the diaphragm *A-26-A* can be lifted out. In replacing the diaphragm, it should be laid in with the cup down and the copper gasket on the under side. It will be noted that the dowels and tube, holding the diaphragm in position are unequally spaced, to prevent its being placed in the valve upside down. It may require a few trials to find the correct position. When this has been done, fasten the diaphragm by screwing disk *A-15-A* into guide *A-13*.

If the above suggestions are not applicable in a particular case, directions for repairing the valve in question may be obtained from the local dealer or from the manufacturer.

8. PROTECTING WATER PIPES AGAINST FREEZING

Water pipes which are exposed to freezing temperature should be covered in some manner, especially those located out of doors or in unheated spaces, as under porches or in outbuildings. Small water pipes are more likely to freeze than waste or sewer pipes, since the latter carry water usually warmed to some extent, which flows off quickly leaving the pipe empty.

Pipe Coverings.

For pipes located in an unheated cellar or garage, it is well to use a commercial covering made of a layer of hair felt and a layer of wool felt. This generally comes in lengths of 3 feet, split on one side to slip around the pipe, and is fastened by means of metal bands. In severe climates, it is well to apply two thicknesses of this covering and to break or stagger the joints and seams in order to make a tight covering. If exposed to the weather, this covering should be protected by a jacket of roofing paper or similar material, wired on with copper wires, or it may be protected in another way by a water-tight box constructed around the pipe.

Homemade coverings can be made by wrapping the pipe first with tar paper and then with felt, held in place by a jacket of canvas fastened by paste or wires and painted with waterproof paint. Another covering is made by wrapping the pipe with old cloth, then with layers of newspaper, and finishing up with strips of burlap. This type of covering should be at least 4 or 5 inches thick.

Underground Pipes.

When pipes are laid underground they should be at a sufficient depth to protect them from being damaged by heavy vehicles passing over them and to eliminate danger of freezing. This depth depends on latitude and local soil conditions.

9. THAWING OUT FROZEN PIPES

If a water pipe becomes frozen, it should be attended to promptly to avoid a possible bursting of the pipe. In lead pipes a bulge in the pipe will usually mark the defect, whereas in other metals a bulge does not appear.

Some form of heat must be applied to the pipe to melt the ice. In applying heat to water-supply pipes it is best to work toward the supply end, keeping a faucet open to know when flow starts. When thawing out a waste or sewer pipe, start at the lower end and work upward, to allow the water to flow off as the ice is melted.

There are various ways of applying heat to the exterior of a frozen pipe. It may be in the form of a direct flame, hot applications, or concentrated heat waves.

Direct Flame Heat.

A direct flame can be applied by means of a gasoline blowtorch or a lighted candle, where there is no danger of burning adjoining woodwork. The flame should be played along the pipe gradually, to spread the heat.

Hot Applications.

Hot applications applied to a frozen pipe do not produce as quick results as a direct flame, but they are much safer in that they lessen the possibility of bursting the pipe and eliminate the fire hazard.

One method frequently used is to wrap cloths around the pipe and saturate them with boiling water; or boiling-hot water can be applied directly to the pipe. Another method for applying heat is that of using heated flatirons or bricks.

Concentrated Heat Waves.

Heat may be conveyed along a pipe by setting a lighted lamp or oil stove near or under it. A V-shaped piece of tin, placed back of the pipe and opposite the heater, will reflect the heat to the pipe and serve to protect adjoining woodwork.

Heat Supplied Internally to Frozen Drainpipes.

Frozen traps, waste pipes, drains, and sewer pipes may frequently be opened by the internal application of heat given off by boiling water poured into them through the fixture opening or trap, as the case may be. If the frozen section is beyond the trap it may be advisable to remove the trap and pour the mixture into the pipe.

10. CLEANING OUT TRAPS AND WASTE PIPES

Plumbing fixtures from which waste water is discharged are furnished with traps designed to retain enough water to form a seal against gases and bad odors entering the house from the drain. As a general rule they cause little trouble, but occasionally they may become stopped up with accumulations of hardened grease and dirt and require cleaning out.

Signs and Causes of Stoppage.

When waste water gurgles and seeps away slowly from a sink, washbowl or bathtub, or backs up in the water-closet bowl, it indicates that there is foreign matter somewhere in the waste line retarding the flow of water. For example, it may be that the trap on the kitchen sink is filled with hardened grease and settleings or that the waste pipe beyond the trap is clogged, either in the same way or by some more solid object lodged in it. Water-closet drains

are often clogged by toilet articles or other objects, which have been accidentally dropped into the bowl, or by cloth or heavy paper.

Types of Traps.

The U-bend trap.—The simplest type of trap is the **U** bend, which may consist of a single or a double reverse bend in the outlet pipe below the fixture. Most fixtures at present are equipped with either the **P** or the **S** form, as the bends are designated. In the case of water-closets, similar bends are cast in the vitreous material in the lower portion of the bowl.

Some of the newer types of traps are fitted with a screw clean-out plug on the lower side of the bend. (See fig. 24.)

Drum and bottle type traps.—These types may sometimes be found attached to bathtubs or kitchen sinks. They consist of a cylindrical-shaped metal box or settling basin attached to the waste pipe, having inlet and outlet openings. They are generally provided with a screw-cap cover, which can be removed when cleaning is necessary.

Tools.

Monkey wrench, screw driver, stiff wire with hook bend at one end, "plumber's friend" (see fig. 25), coil spring steel auger, small funnel, and a galvanized water bucket.

Materials.

Caustic potash (potassium hydroxide) and hot water, or a good commercial pipe-cleaning compound in which caustic potash predominates.

Cleaning a Fixture Drain Provided with a U-Bend Trap.

Use of a "plumber's friend."—It is usually best to try a "plumber's friend" first on a clogged waste line. This is the simplest method and is

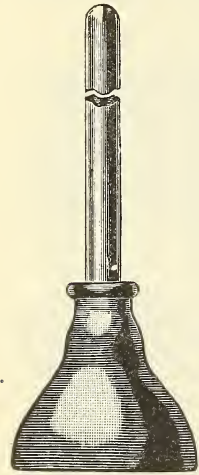

FIGURE 25.—A
"plumber's
friend"

effective in most cases. A "plumber's friend" is a stiff rubber bell-shaped cup about 5 inches in diameter fastened by its top to a broom stick. (See fig. 25.) The sink or bowl should be partly filled with water and the cup placed over the mouth of the fixture opening. Work the stick up and down several times with considerable force with the cup held fast over the opening. The alternate compression and suction thus created will usually loosen the simpler obstructions. The operation should be repeated until the pipe is cleared. When water flows freely again, pour boiling water through the fixture to further clear the waste line. The plumber's friend is equally effective in moving obstructions on water-closet lines. Place the cup over the outlet in the bowl and force the handle up and down until the passage is clear. Have sufficient water in the bowl to cover the rubber cup of the plumber's friend.

Opening and cleaning the trap.—If the plumber's friend does not produce the desired result, it is possible that the trap is clogged with refuse which must be cleaned out. For cleaning purposes, a removable clean-out plug is sometimes provided in the lower side

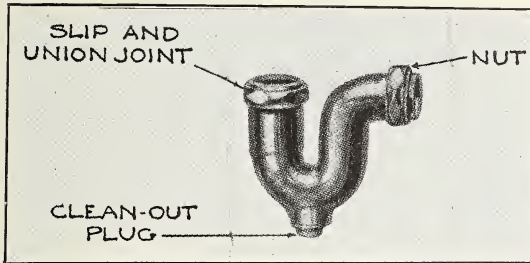

FIGURE 24.—A "P" type trap, showing clean-out plug and joints

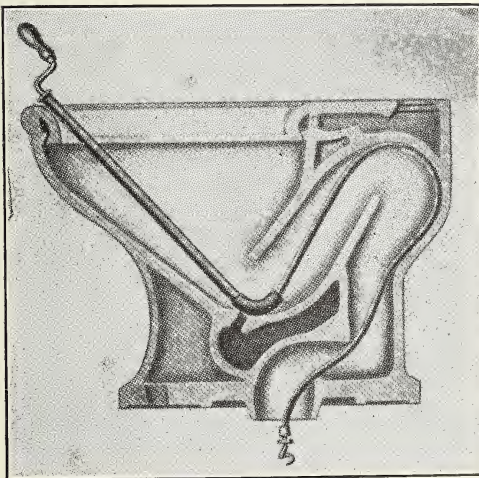

FIGURE 26.—Section through a water-closet bowl, showing use of coil spring steel auger

of the **U** bend. Before opening the trap, place a bucket under it to catch the surplus water. Unscrew the plug with a wrench and when the water has drained out, insert a bent wire into the trap opening and pull out the grease and dirt which has accumulated therein. If possible, brush the trap out well with a bottle brush, and flush it by pouring boiling water into the fixture. If the washer, or gasket, around the plug is broken it should be renewed before the plug is replaced.

If a trap has no clean-out plug, remove the trap at the slip-and-union joint provided for that purpose and clean out the trap and adjoining pipes with the wire hook and bottle brush, as previously described.

Use of coil spring-steel auger.—In most cases the cleaning out of the trap will solve the problem. However, there may be an obstruction in the pipe beyond the trap which is responsible for the trouble, and it may be reached with a coil spring-steel auger, inserted through the trap opening, and either pulled out or bored through and forced out. The coil spring-steel auger is especially effective in opening clogged water-closet traps, drains, and long sections of waste pipe lines. (See fig. 26, facing p. 78.) This tool is used like an ordinary auger, but is best handled by two persons, one to guide and keep the spring in line, and the other to turn the handle.

Cleaning Out a Drum or Bottle-Type Trap.

In a drum or bottle type trap the screw cap is fastened in either the top or bottom, and may be removed when cleaning is required. In some cases this cap is just as accessible as the plug on a **U**-bend trap, but, when used in connection with bathtubs, the trap may be placed below the level of the floor and covered by a metal plate, which must first be removed before the cap is exposed. When the cap has been taken off, the grease and dirt can be dug out with an old spoon or stick and the trap and its openings washed out with boiling water.

The various methods recommended for cleaning out **U**-bend traps can be used with equal success on the drum or bottle trap.

The Use of Chemicals.

If the trap, waste line, water-closet, or drain can not be cleared and all efforts to dislodge the obstruction have failed, a strong solution of caustic potash (potassium hydroxide) and hot water can be poured into the line through fixture opening in an effort to burn away the obstruction.

This chemical generates heat and eats its way through an ordinary stoppage. Upon coming in contact with grease it forms a soft soap which is readily soluble in cold water and quickly dissolves in hot water. The chemical is usually sold in stick form, and one pound dissolved in two or three quarts of hot water will be sufficient to treat the average case.

The hands should be covered and the eyes guarded while mixing and handling or dissolving caustic potash, as it is a powerful chemical and may cause serious burns if proper care is not exercised. Put the sticks into an old pail or similar vessel and slowly pour a kettleful of hot water over them, holding the kettle at arms length

to avoid being splashed with the liquid. There is much sizzling and sputtering while the water is being poured on.

First withdraw as much water from the trap as possible with a suction pump or siphon hose to avoid weakening the solution by its mixing with water in the trap. It is a good plan to pour the solution into the pipes at night and let it stand there until morning to give it a good opportunity to work before finally flushing the drain with boiling water. Most chemicals of this nature produce no harmful effect on lead, iron, or brass, but are injurious to aluminum, glazed earthenware, porcelain, and enameled iron. To prevent contact with such surfaces it is advisable to pour the mixture slowly and directly into the pipe by means of a funnel.

If it is found that the obstruction is in the pipe beyond the trap, and that the trap can be opened or removed, pour the mixture directly into the pipe through a funnel, or if the mouth of the pipe is inaccessible by that means, force a piece of rubber tubing or hose into the pipe and attach the funnel to the upper end.

To keep the drains in good working order it is well to flush them occasionally with a smaller quantity of this mixture. If it is difficult to obtain caustic potash there are numerous prepared drain-pipe solvents on the market at a reasonable price, the best of which probably depend mainly on caustic potash for their grease-cutting qualities.

In flushing out drains, avoid the use of what is popularly known as "lye" or any other preparation in which caustic soda (sodium hydroxide) predominates. Upon coming in contact with grease such chemicals form a hard soap, which is dissolved with difficulty in hot water and is practically insoluble in cold water.

The same chemicals and methods of application prescribed for cleaning out traps, waste lines, and drains may also be used to melt obstructions of ice in frozen drainpipes.

It must be remembered that such chemicals should be used only in cleaning waste lines and traps and should never be placed in water-supply pipes.

If All of the Preceding Methods Fail.

In case the obstruction can not be located and removed by any of the methods described above, it is best to call a plumber, as complicated pipe cutting and fitting may be involved.

11. HOW TO OPEN FLOOR DRAINS

Floor drains are found in bathroom, cellar, and garage floors where water, dirt, and oil accumulate and frequent flushing or washing of the floor is necessary. The ordinary type of drain consists of a metal boxlike cup attached to the end of the drain pipe and covered with a strainer or grating. Just below the cup there often is a trap or bend in the pipe to catch particles which may pass through the strainer and also to form a water seal against odors rising from the pipe. Where there is no separate trap the box itself is constructed so as to perform these functions.

Causes of Clogging.

Floor sweepings and particles washed into the drain may lodge in the trap and, together with grease and oil, gradually fill it up

and block the flow of water. Sometimes the holes in the strainer become clogged and prevent water from flowing into the drain.

Tools.

Screw driver, monkey wrench, plumber's friend, a small scoop or spoon-like instrument, a piece of stiff wire bent to form a hook at one end, and possibly a coil spring-steel auger with which to bore out the pipe.

Materials.

For dissolving congealed grease masses and for an occasional flushing out of the drain, caustic potash (potassium hydroxide) and hot water are recommended.

Steps to be Taken.

Raise or remove the strainer or grating which covers the drain box. Dig out the dirt with some ladlelike tool as far as it can be reached, and then, with the hooked wire or coil spring-steel auger, clean out the bend or trap. There may be a removable clean-out plug above or below the trap to facilitate this work. When the drain has been thus cleared, as much as possible, pour a pail or two of hot water into the mouth of the pipe to wash out any remaining particles.

To remove greasy material, which sticks to the sides of the pipe, or to dissolve an accumulated mass of such material, pour a hot solution of caustic potash into the drain. Directions for the use of this chemical are contained in section 10 of this chapter.

Before replacing the strainer, see that all of its holes are open, and remove all dirt clinging to the underside.

If water seldom flows into the floor drain, the water seal may evaporate and allow sewer gas and objectionable odors to enter the building. To avoid this odor, it is advisable to pour a pail or two of water into the drain occasionally to insure a permanent seal in the trap.

12. CARE OF REFRIGERATOR DRAINS

A refrigerator or ice-box waste pipe should not be directly connected to the house plumbing system. If it is allowed to drip into a floor drain, the drain should empty into an open sink, which is trapped like other fixtures, a down spout or rain-leader trap located inside the building, or a cellar floor drain. In any case both ends of the refrigerator waste line should be left open.

These precautions are necessary to prevent sewer gas or vermin from entering the food compartments of the refrigerator. The slime prevalent in refrigerator waste pipes would probably clog up the plumbing waste pipe, if the pipes were directly connected.

If there is a floor drain under the refrigerator, it should be cleaned frequently and the waste pipe flushed thoroughly with hot water to remove the slimy substance. Similarly, the refrigerator itself, including its drip pipe and trap, should be scoured and scalded out occasionally to keep it clean and sanitary. The drip pipe and trap are usually removable so that they may be easily cleaned. The trap, when filled with water, prevents warm air and odors from entering the refrigerator.

XII. PAINTING AND VARNISHING

1. GENERAL OBSERVATIONS

Painting and varnishing is a broad subject, and because it involves so many different kinds of materials and practices it will not be possible to treat it fully in this publication. However, since such work is necessary to a varying extent in the household, and as there are many paint jobs that can be done satisfactorily by a person with little or no experience, some of the fundamental principles of this work will be discussed.

Much useful information will be found in the directions printed on the container labels and in booklets distributed by the manufacturers of paint materials. These instructions should be carefully followed, since different materials usually require different treatments to produce the best results.

2. QUALITY AND CARE OF MATERIALS

The quality of paint, varnish, and other materials to be used on surfaces to preserve them or improve their appearance is of great importance. It is also essential to have good brushes with which to apply the materials. Without good materials and tools no amount of care or skill on the part of the worker will produce satisfactory results.

Paint Selection.

Where a large quantity of paint is required, considerable saving may be effected by purchasing the necessary ingredients and mixing the paint on the job. If, however, only a small amount is needed and the amateur is not willing to risk mixing his own paint, it is better to buy it ready mixed. There are many high-grade paints on the market, and if the purchaser will buy one of these in the original sealed container of the manufacturer he need have no fear regarding the quality of such material.

Mixing.

Since paint is a mixture of solid and liquid components, it is important to mix thoroughly the contents of any container before using any portion thereof. To do this, pour the greater portion of the liquid contents of the can into a clean bucket somewhat larger than the paint can. Then with a stiff paddle loosen the settled pigment in the original container and, with a lifting and beating motion, mix thoroughly the material in that container. Stir the mixture vigorously while slowly adding the liquid that was previously poured off the top. Complete mixing by pouring the paint several times back and forth from one container to the other. This process is called "boxing."

Straining.

Paints should be strained after they have been mixed, to remove hard lumps and skin and to mix the ingredients more completely. A piece of wire fly screen may be used for this purpose, or, better still, a suitable strainer may be made by tying a double thickness of cheesecloth over the top of an empty pail. Pour the paint slowly

through the cloth, using a small brush to stir the paint in the cloth pocket, until it all passes through.

Protection.

When not in use the paint container should be covered to prevent evaporation of the liquid material.

3. SELECTION AND CARE OF BRUSHES

The importance of a good brush can not be overestimated. Besides wearing better than a poor one, it holds more paint, does not leak nor spatter, leaves a clean-cut edge, makes a more uniform finish, and does not shed its bristles.

Though brushes with bristles set in cement or vulcanized in rubber cost somewhat more than other varieties, the investment always proves to be a wise one. The best advice that can be given is to buy good brushes and take proper care of them.

Selection of Brushes.

The shape and size of the brushes to be selected depends both upon the materials used and the types of surfaces to be treated. For painting broad surfaces, flat brushes 4 inches wide with 4-inch bristles are recommended for the unskilled. Such a brush is easy to handle, and with it surfaces may be covered rapidly. With wide, flat brushes, however, the paint can not be rubbed out so well as with a suitable round brush. For window sashes and other narrow surfaces a 1-inch oval brush with a chisel-shaped end is generally used. Varnish brushes are also tapered at the end in order to permit the necessary even flowing on of the material. A very wide brush is usually employed in applying whitewash or calcimine, since these materials are spread lightly over the surface and are not rubbed in.

Care of Brushes.

When a painting job is carried over from one day to the next, it is generally sufficient to wrap the brushes in several thicknesses of paper to keep them soft and pliable. If, however, a brush is not to be used for several days, it should be well cleaned before laying it away. One of the most satisfactory materials for washing a brush is turpentine, but it is expensive, and kerosene can be used with almost equally good results. After removing as much paint as possible with one of these solvents, wash the brush thoroughly with soap and warm water and shake all excessive moisture out before hanging it up to dry, bristles down. After the brush is thoroughly dry, wrap it in paper to protect it from dust, being careful not to bend the ends of the bristles.

If much painting is being done the brushes may be left suspended in the paint or in linseed oil to keep them in good condition. To keep the oil from getting fatty, a little turpentine may be added from time to time. The brush can be suspended by drilling a small hole through the handle near the top of the ferule or binding, pushing a straight piece of wire through the hole, and resting the ends of the wire on the edges of the pail or container. Some brushes are made with holes drilled for this purpose. The bristles of the brush should be completely submerged in the liquid, but the ends

should not touch the bottom of the container, as the weight tends to bend or curl the ends of the bristles and ruin the brush.

In general a varnish brush may be suspended in the varnish in which it is used and may be cleaned by washing it first with turpentine and then with warm water and soap.

Brushes used with whitewash or calcimine should simply be washed thoroughly in clean water and hung up, bristles down, to dry.

4. METHODS OF APPLYING AND BRUSHING

The paint should be worked well into the brush before it is used. Dip the brush about 2 inches into the paint several times and scrape it each time on the edge of a stick held over the paint pot. The brush should not be dipped too deeply into the paint, as an over supply on the brush will spatter and run down over the handle.

When applying the paint, dip the brush and slap it against the inside of the pot to remove excess paint.

Hold the brush lightly but firmly. Use a free and easy stroke, letting the wrist do most of the work. In applying the paint make two or three quick, light strokes to transfer most of the paint to the surface before it spatters. Then quickly spread the film to hide the surface and follow up with uniform strokes to smooth it off. Do not brush the paint too much in an effort to obtain smoothness. If the paint has partially set, this will roughen the surface and do more harm than good.

Exterior Application.

In exterior painting it is customary to start at the upper left-hand corner and work across the top to the opposite end. A convenient width is covered at one time, and before stopping for the day the belt should be completed to leave a straight line across the house, usually at the bottom of a shingle or siding course. This method may necessitate shifting the ladder more but will eliminate vertical joints in the painting.

When near the end of the house, brush only from the end toward the center, otherwise the paint will be scraped off on the corner of the house and run down or make a thick film along the edge.

Interior Application.

For interior wall painting it is best to start in the upper left-hand corner and work from the ceiling down to the base, painting a strip a foot or two wide. By painting a narrow strip the next strip can be joined neatly before the first has set too much. An up-and-down motion is used, except in joining up two strips, where a slightly semi-circular motion is needed to work the strips together.

A good light, preferably sunlight, is essential in painting interior wall surfaces, and this is especially true of ceilings where it is difficult to obtain a smooth appearance.

5. EXTERIOR PAINTING

Outside painting should preferably be done in clear, moderately warm weather (not below 50° F.). Summer and fall are ideal seasons for painting. The wood is generally in dry condition dur-

ing these seasons. Paint should never be applied while rain or snow is falling, nor while the wood is wet or damp. Neither should it be applied when rain threatens, if the surface to be painted is exposed.

Number of Coats—New Work.

On new work, at least three coats of paint are necessary to produce good results. The first or priming coat may be mixed rather thin to spread more easily and to fill the pores in the surface; the second coat should form a solid color base for the third or finish coat, which coat should be smooth and glossy.

It is important that each coat of paint be thoroughly dry before another coat is applied.

Preparing the Surface—New Work.

On new buildings little preparation is required before the first or priming coat is put on. Before starting to paint, brush over the surface with a dry brush or duster to remove all dust, and with a putty knife scrape off any particles of plaster or other material which may have been splashed on the surface. Knots and other excessive sappy places in the wood should be brushed over with turpentine, orange shellac, solvent naphtha, or aluminum knot primer to prevent the resin in such places from being drawn to the surface by the sun and staining the paint.

The Priming Coat.

As the priming coat is the foundation for all future painting, it should be carefully applied with the best of materials. The use of old left-over paint for this purpose is not recommended.

An excellent priming coat for new work can be made by mixing 100 pounds of pure white-lead paste with 4 gallons of pure raw linseed oil, 2 gallons of pure turpentine, and 1 pint of liquid drier. These quantities will make about 9 gallons of paint. If a smaller amount is desired, the quantity of each ingredient should be reduced proportionately. The priming coat should be brushed out well. If possible, it is best to wait two or three weeks before applying the second coat, to allow any moisture in the new wood to come to the surface and evaporate.

When the priming coat is dry, all nail holes and cracks in the wood should be filled with putty so that the finished surface will present a smooth appearance. Putty made from pure linseed oil and genuine whiting is entirely satisfactory, but much commercial putty contains adulterated linseed oil and is worthless. An excellent putty can be made by mixing dry whiting with lead in oil paste. If putty is too stiff, it can be softened by adding a few drops of linseed oil; if it is too soft, it can be made stiffer by working some dry whiting into it.

Other Coats.

The second coat should dry with a "flat" (not glossy) appearance. This effect is obtained by using less linseed oil. For example: To 100 pounds of white-lead paste add $1\frac{1}{2}$ gallons of raw linseed oil, $1\frac{1}{2}$ gallons of turpentine, and 1 pint of liquid drier. This formula will make about 6 gallons of paint and the amount may be reduced,

as previously described. This coat should completely hide the grain of the wood and present a more solid appearance than the priming coat.

If white-lead paint is to be used for the third, or finish coat, it should consist of white-lead paste, linseed oil, and small quantities of liquid drier. For example: To 100 pounds of white-lead paste, add $3\frac{1}{2}$ to $4\frac{1}{2}$ gallons of raw linseed oil, 1 pint of turpentine, and 1 pint of liquid drier. To get a surface, to which less dirt will adhere 10 to 25 per cent of zinc oxide may be added; that is, 10 to 25 pounds of zinc oxide per 100 pounds of white-lead paste, and 10 to 25 per cent more linseed oil, turpentine, and drier. All coats, especially the finish coat, should be carefully applied to avoid brush marks and marks caused by spattering of paint, which results from using too much paint on the brush.

Ready-Mixed Paints.

When ready-mixed paints are used, it is well to have a white-lead priming coat, but the ready mixed may be used for the first coat as well as for body coats, after it is properly thinned. Ready-mixed paint as received is generally intended for finish coats. The manufacturer's labels frequently give directions for reducing the paint to proper consistency for the under coats. If no directions are given, however, the paint may be thinned by adding linseed oil and turpentine, mixed in about the same proportions as recommended for white-lead paint. No drier should be added to ready-mixed paints.

Number of Coats—Old Work.

The number of coats to be applied to old work depends on the condition of the old paint. If it is in good condition, one coat applied after a thorough dusting may be sufficient. In many cases, not more than two coats will be required. If painting has been neglected for several years and the house has a weather-beaten appearance, or if the paint is badly cracked or peeling, it may be necessary to remove most of the old paint and apply three new coats.

Preparing the Surface—Old Work.

The amount of work necessary to prepare a surface for repainting depends largely upon its condition. If the house has been painted at proper intervals and the surface is in good condition, a simple dusting of the surface just ahead of the painting may be all that is necessary. Nail holes or cracks in the wood should be filled with putty after the first coat is applied, as described for new work.

If the old paint is blistered, cracked, or peeling in places, it should be removed and the surface sandpapered until it is smooth and then dusted before new paint is put on. If there are any bare spots they should be touched up with a priming coat in order to obtain an even appearance.

Paint blisters can be removed with a putty knife or broad knife scraper and a wire brush. Some of the cracked and scaling paint may be removed in the same manner, but most of it may require other treatment. Coarse sandpaper is also an efficient remover of old paint. It is easiest handled when tacked to a flat block of wood. Probably the most efficient, though expensive, method of removing oil paint is burning it with a gasoline blowtorch. This

burning causes the film to soften so that it can be scraped off easily. This method, however, can be used only on flat surfaces and where slight scorching of the wood is not objectionable. On account of the fire risk, a blowtorch must be used with great care. Because of this hazard, the work should ordinarily be done by an experienced painter.

6. INTERIOR PAINTING

Paint on the interior of a house, being protected from the weather, may be expected to last as a protective coating for a long period, but light tints and brilliant colors may fade and become soiled and require freshening up.

Selection of Paint.

In selecting paints for interior woodwork, attention should be given to hiding power, beauty of finish, and permanence of color, rather than durability. In general, the same directions apply as in outside work. However, with white or light tints, the amount of linseed oil should be reduced to avoid possible yellowing. If white lead and oil paint is used, a small amount of Prussian blue, dissolved in oil or turpentine and worked into the paint, will intensify its whiteness. A little varnish in the last coat will take the place of linseed oil as a binder, and will also give a higher gloss to the surface, if it is desired.

Preparing the Surface.

The surface should be perfectly smooth and clean. If it is rough, wrap and tack a piece of fine sandpaper around a flat block of wood and go over the surface lightly. If the woodwork is not badly soiled, it may be dusted and washed with soap and warm water. After washing, remove the soap with clear water, and allow the surface to dry thoroughly before applying paint. If the woodwork is greasy, wipe it with turpentine or gasoline.

Finishing.

A little extra effort to obtain a good finish is worth while in interior painting. To obtain a smooth surface and improve the final appearance, each coat, when dry, should be rubbed lightly, avoiding scratching, with fine sandpaper or with fine steel wool.

The natural beauty of the woodwork may be preserved, whenever practicable, by varnishing. If the quality of the wood is such that the use of varnish is not advisable, paint or enamel may be applied. Stain is used on woods which are poorly matched for color and it is usually best to stain them their natural color, following the stain with a coat of clear varnish.

7. PAINTING STUCCO OR CONCRETE

If it is desirable to change the color of a stucco or concrete surface, or to bring a repaired structure to a uniform color, it can be accomplished by the application of either a cold-water wash or an oil paint. It must be borne in mind, however, that once stucco or concrete surface is painted it becomes a painted surface, and as such, requires the same periodical attention as do painted surfaces of other materials.

Before painting, remove all loose mortar and repaint such places and large cracks with fresh mortar, as explained in Chapter IV, section 2 and Chapter V, section 1.

Cold-Water Washes.

Cement washes of practically any color can be prepared by using the proper portions of gray and white cement, and light or dark sand, with a small amount of mineral pigment. A mixture of 1 part white cement and 1 part yellow sand, all passing the No. 20 sieve, with hydrated lime to the amount of 5 per cent of the weight of the cement will give a good, practically white color.

In preparing the mix, the cement, lime, coloring material, and sand should be properly proportioned and thoroughly mixed dry. The dry batch should be large enough to do the entire job or at least one side of the structure, in order to maintain uniformity of color. Pour the dry material into a bucket containing clean water and stir vigorously until it has the consistency of a stiff oil paint. The mixture, while being applied, should be stirred from time to time with the brush. In refilling the container, clean out and discard all of the old wash, and use the same amount of clean dry materials as was used in the previous batch.

The area to be coated should be thoroughly wetted just before applying the wash, but there should be no free water on the surface. Start at the top and one end of the wall and brush on the wash to the thinnest possible coat which will cover the surface. A thick coating is liable to crack or peel. The work should be carried on so that jointings come at natural breaks in the surface, and care should be taken to blend the adjoining areas together to prevent lines showing between them.

After the coating has been applied it should be gently sprinkled with water for several days. If it dries out before the cement has attained its set, the wash will eventually dust off. The period of sprinkling may be greatly shortened by dissolving 4 pounds of commercial calcium-chloride crystals in each 12 gallons of water used in mixing the wash. This chemical assists in securing early set and strength.

Oil Paints.

The following discussion of painting stucco, concrete, and brick with oil paints is based on the assumption that it is desirable to completely hide the texture as well as the color of the material. Although this practice is most common in painting such a structure, a better plan is simply to color the cement or brick by applying a thin paint that will wet and penetrate the surface. Use the minimum number of coats to give the desired color, and do not attempt to build up an impervious film on the surface, but try to leave the surface porous, so that water getting into the structure back of the paint can evaporate without blistering the coating.

Before stucco, concrete, or similar materials are painted with oil paints, it is advisable to let them stand at least a year to allow them to dry thoroughly and to give the lime in such materials sufficient time to age, so that it will not mar the painted surface. However, if it is necessary to paint before sufficient time has elapsed, the free lime in the material may be neutralized by washing the surface with

a solution composed of 3 to 4 pounds of zinc-sulphate crystals dissolved in a gallon of water. This wash may be applied with a calcimine brush or sprayer and then should be allowed to dry for about a week before paint is applied. All fresh spots of mortar, where repairs have been made, must be thoroughly dry and similarly treated with zinc sulphate.

The surface can be painted in the same manner as wood, using either a white-lead mixture, or mixture of white lead and zinc oxide. The priming coat should contain some boiled linseed oil, and special attention should be paid to this coat, since it must bind the loose particles of cement on the surface and form a firm foundation for the other coats. After priming, small defects on the surface may be puttied up if a smooth finish is desired.

Before painting stucco or concrete, which has been previously painted, scrape off all loose paint, fill all cracks with mortar or white-lead putty, and treat all fresh mortar spots with zinc sulphate.

8. PAINTING BRICK OR STONE SURFACES

It is generally better to leave brick or stone surfaces unpainted, but in some cases painting may be advisable. The brick or stone should be dry and clean before paint is applied. If there are white spots on the surface, known as efflorescence, they should be treated as recommended in Chapter V, section 3. All loose mortar and crumbling brick must be removed by thorough brushing, and joints and cracks must be repointed as explained in Chapter IV, section 2. To neutralize the alkali in new mortar, treat with a solution of zinc sulphate, as in cement painting.

Before painting very porous bricks or similar materials the first time, it is advisable to apply a coat of boiled linseed oil and turpentine (mixed half-and-half) to fill the pores and "kill the suction."

These surfaces should not be painted in cold weather, and at least two or three days of dry weather should precede the painting.

Three coats are usually sufficient. The first coat should be brushed in well. When it is dry, the joints should be filled with a putty made of linseed oil and whiting, and colored with the same pigments as those used in the paint. For the second coat, the pigment should be mixed with 2 or 3 parts of raw linseed oil, 1 part turpentine, and a small amount of drier. This coat should be brushed out well and uniformly. For a gloss finish, the pigments that give the desired color, should be mixed with linseed oil and a little drier, and the paint should be spread on in such a way that it will not run. If a flat effect is desired, 3 parts of oil to 1 part of turpentine should be used for the second coat, and for the last coat the pigment, ground to a stiff paste in raw linseed oil, should be thinned with one-third liquid drier and two-thirds turpentine.

9. PAINTING ON PLASTER

Old walls, especially of kitchens, have a thin layer of grease and smoke upon them which, though it may not be perceptible, will prevent paint from adhering properly. Such walls should be washed thoroughly with soap and water, to which a little ammonia may be

added, and finally rinsed with water. New plaster, being alkaline, does not afford a good foundation for paint. To neutralize the free lime in the plaster, treat the walls with a solution of 3 to 4 pounds zinc sulphate in 1 gallon of water. This solution may be applied with a calcimine brush or a paint sprayer and should be allowed to dry thoroughly before the walls are painted.

If the walls have been whitewashed, the old whitewash should all be removed with a cloth or sponge and hot water and the surface treated with zinc-sulphate solution, as described above.

Cracks in the plaster should be well dampened and filled with a paste of plaster of Paris or patching plaster. Large cracks should be first cut out carefully in such a way that they are slightly wider at the bottom than at the surface.¹⁸ When the plaster of Paris has hardened, it should be scraped or sandpapered until it is smooth. It is likely to be more porous than the plaster of the wall and should therefore be given preliminary applications of the paint that is to be used on the whole surface.

Before applying calcimine to an ordinary plaster wall, it is generally advisable to treat the wall with a coat of "size"; this treatment is also generally given to a wall before it is papered, and some painters use size before applying a coat of paint. This latter usage is not, however, considered good practice; a priming coat of paint is preferred.

Glue size is made by soaking good glue in water over night, pouring off the excess of water, and dissolving the glue by pouring boiling water over it slowly with constant stirring, finally thinning it with hot water to a proper brush consistency.

First-class interior varnish thinned with turpentine and colored with a little of the wall paint makes a good priming coat for plaster or wall board.

In painting plaster walls with ordinary oil paint, the same general procedure may be followed as recommended for new woodwork, though the priming coat is generally a little thinner; some authorities recommended boiled oil instead of raw oil and drier in the liquid portion of the paint. The modern flat washable wall paints are cheap and very satisfactory. In applying them, the paint for the priming coat should generally be thinned with about 1 quart of linseed oil to 1 gallon of paint. Subsequent coats should be applied as purchased, though in all cases, when using ready-mixed or prepared paints, it is best to follow the manufacturer's explicit directions rather than any general instructions.

10. PAINTING METAL WORK, SUCH AS ROOFS AND GUTTERS

It is important that metal surfaces, such as roofs and gutters, be kept well painted to prevent corrosion and to eliminate unnecessary repairs.

Tin, galvanized iron, and other metals used for roofing, spouts, garages, and other purposes, present difficulties in painting. Often the paint does not stick well, probably owing to a thin film of grease left on the material in the process of manufacture. Oil or grease must be thoroughly removed by scrubbing with soap and water or

¹⁸ See Ch. VI, sec. 1, p. 18.

with a cloth moistened with benzine. All loose rust must be cleaned off thoroughly with scrapers, wire brushes, or sandpaper, and finally with dry scrubbing brushes. Galvanized iron and zinc, especially when new, may be made to hold paint, if it is first treated with a solution containing 2 ounces of copper chloride, copper acetate, or copper sulphate in one-half gallon of water. The solution should be prepared in a wooden or stoneware vessel, applied evenly to the metal, and allowed to stand overnight. This treatment gives the paint a firm anchorage, but removes some of the surface metal, especially on galvanized iron. Consequently, only a thin coating should be applied, 1 pint being enough to cover about 300 to 350 square feet.

For the priming coat on metal surfaces 30 to 35 pounds of pure dry red lead should be mixed in 1 gallon of pure raw linseed oil by stirring the oil in gradually, and finally straining the mixture, if it becomes lumpy, through a wire gauze. Red lead is also sold in paste form, which is easier to mix than the dry lead. It may be thinned with linseed oil. No drier is usually needed with red lead, but 1 gill may be used if the job is a hurried one, and one-half pint of turpentine should be added if other coats of paint are to be applied over it. The paint should be brushed out so thoroughly that 1 gallon will cover about 700 square feet. Red lead is expensive and rather hard to apply, but, with the possible exception of American vermilion (scarlet lead chromate), which is even more expensive, no better paint is known for adhering to metal work and protecting it. It may be followed by one or more coats of any kind of paint desired.

If a cheaper treatment than those mentioned is necessary, red iron oxide or metallic brown (to which some authorities recommend the addition of 15 per cent of zinc oxide) mixed in linseed oil may be used.

11. VARNISHING

It is important that all materials and tools used be kept as free from dust as possible, since dust is harmful to good results in varnishing. Keep the rooms in which varnishing is being done free from dust. Keep the brushes clean and the varnish cans closed. Varnish should be applied in smooth thin coats and ample time should be allowed between coats for thorough drying. Follow carefully the instructions printed on the can labels or in booklets distributed by varnish manufacturers.

Interior Work.

Wood fillers.—Open-grained woods such as oak, chestnut, mahogany, and walnut should be treated with a filler before being varnished. There are two classes of fillers on the market—paste fillers and liquid fillers.

The paste fillers which are most commonly used should be thinned with turpentine to brushing consistency before being used. The filler is first brushed across the grain and then with the grain. An old stiff brush may be used for this purpose, and if the filler sets too quickly the surface may be wiped with turpentine. After the filler has set for about a half hour wipe across the grain with excelsior to remove the excess. Curled hair or burlap may be used instead of

excelsior for this purpose. Some liquid fillers are intended for use on open-grained woods, but most are intended for use on close-grained woods, and are applied by simply brushing them on. Some authorities recommend ordinary shellac in alcohol as a liquid filler.

Applying the Varnish.

The surface should be allowed to dry a day or two after a filler has been used, before the first coat of varnish is applied. The first coat should be allowed to dry from 5 to 10 days, after which time it should be rubbed with curled hair or excelsior to remove the gloss. The second coat is then applied and treated similarly, or rubbed with fine sandpaper or glass paper. If a first-class job with a gloss finish is desired, the next to last coat should be well rubbed with pumice and water before applying the finishing coat. The final coat (preferably the fourth coat) may be left with the natural gloss, or rubbed with pumice and water, if a dull or flat finish is desired. Some manufacturers now make varnishes which dry with a flat finish.

Shellac.

Shellac is often used as an interior finish, especially where it is desired to retain the natural color of the wood. It should not, however, be used for exterior work. Nor should it be used where it will become hot, as near a fireplace, since it is likely to blister.

Shellac should be applied in thin coats and given ample time to dry. The first two coats may be applied six hours apart, and two days should be allowed between additional coats. It does not require rubbing, except, perhaps, after every third or fourth coat.

Exterior Work.

No filler is used in exterior work, since it is apt to be forced out of the wood by direct sunlight. All surfaces exposed to the sun, such as window sashes, sills, and inside blinds, are considered as outside work. The material generally used is spar varnish, the successive coats being lightly sandpapered, except the last, which is usually left with the natural gloss. Exterior work, especially if exposed to the direct sunlight, will require varnishing annually, but good interior varnishing will last 15 to 20 years.

XIII. ELECTRICITY

1. SOME PRECAUTIONS TO BE OBSERVED IN USING ELECTRICITY¹⁹

Electricity is one of the most conveniently applied forms of energy for household uses. In addition to its great convenience and adaptability for various purposes, it has the further important advantage, when properly used, of increased safety over many of its predecessors. However, there are possible serious hazards to both life and property from electric wiring and devices, if wrongly installed or if carelessly handled.

Do not touch or disturb any electric wiring or appliances, except such as are intended to be handled. In handling electrical devices,

¹⁹ For a more complete discussion of precautions necessary in the use of electricity and other home conveniences, see Bureau of Standards Circular No. 75, Safety for the Household, listed on p. 106 of this publication.

use the insulated handles provided. Never touch interior live metal parts of sockets, plugs, or receptacles which are used to carry current without first cutting off the current at the main switch.

Never touch any part of an electric cord, or fixture, even though it is apparently a nonconductor, with wet hands, or while any part of the person is in water. In bathrooms, kitchens, laundries, basements, garages, or other rooms where floors may be damp, avoid touching any metal part of lamp sockets, fixtures, or other electric devices; do not touch any of these while also touching a water pipe, plumbing fixture, radiator, stove, or heater. There is danger of shock by the passage of electricity from an ungrounded electric fixture through the body to the water or grounded metal.

2. EXTENT TO WHICH HOME REPAIRS MAY SAFELY BE MADE

Only minor repairs to the electrical system and equipment of a house should be undertaken by the home repairman. These may include such tasks as replacing a blown-out fuse, overhauling an electric-bell system, or repairing broken appliance cords. He should not attempt to disturb the permanent wiring or make extensions thereto, even though he may be familiar with such work. Work of this nature should be done by an experienced electrician in accordance with local regulations or the provisions of the latest edition of the National Electrical Code.

3. HOW TO CUT OFF THE CURRENT

As in the case of the water supply, the main electrical supply may be completely cut off where it enters the house system. The incoming current is controlled by means of a main switch, the location and operation of which the occupants of the house should learn. The switch is usually in a metal box near the meter and may be located in the basement, a rear hall, or in some other out-of-way place. It may be either a knife switch inside the box or it may be operated by means of a handle protruding from the side of the box. In opening a main switch, especially the knife kind, care should be taken not to touch bare metal parts.

In case of fire or other emergency, or when a house is to be left unoccupied for long periods, the main switch should be opened, thereby cutting off the building from the source of electrical supply.

If it is not desirable to cut off the current from all of the circuits at the same time, the current in any one circuit may be cut off by removing the fuse plugs controlling it. Before removing a fuse it is advisable to open the main switch, as it is dangerous to handle fuses on line circuits. In modern installations there is one fuse for each branch circuit, but in older work there may be two. Branch circuit fuses may be in the cabinet with the switch, or this cabinet may contain main fuses only, the fuses for branch circuits being in a separate cabinet. In order to facilitate future repair work the fuse holder should be labeled and a chart should be made showing the rooms and outlets which the fuses control. To determine which circuits are controlled by the various fuses, let one person try the

lights throughout the house while another removes and replaces fuses. Every light which "goes out" when a certain fuse is removed is on the circuit controlled by that fuse.

Be sure that a line is "dead" before doing any work on it. The careful electrician would make sure of it by pulling the main switch and removing the fuse plug controlling that particular circuit.

4. REPLACING A FUSE PLUG

The wires in each house circuit are intended to carry a certain load of current and if overloaded may become heated and cause a fire. To guard against this danger, the current passes through a safety device known as a fuse. This consists of a small screw plug fitted with a short length of metal having a low melting point. When more than the specified load is placed on the wire this metal strip promptly melts, breaking the circuit. This is commonly called "blowing out a fuse." It is sometimes difficult to determine which fuse has blown, but usually the mica "window" covering the front of the plug is badly smoked, and upon closer examination, it will be seen that the small metal piece inside the plug has burned out. A blown-out fuse may be more easily located if a chart is made, showing the outlets controlled by each fuse. The chart is especially useful in case a fuse blows out at the inner base of the plug, without discoloring its "window."

The capacity of the fuse is usually marked on the metal rim around the face or on the metal contact end. This may be 6, 10, 15, and up to 30 amperes, depending on the normal loading capacity of the circuit. The larger-rated fuses are generally used on the main service wires and where electric ranges or electric water heaters are installed. As these units consume considerably more current than is normally used for lighting purposes, it is necessary that they be put on special wiring, capable of carrying the greater load. All such installations should be approved by the local electrical inspector.

It is well to have an extra supply of fuse plugs in or near the fuse box, for use in an emergency.

A 15-ampere fuse, which is generally used, will take care of two electric appliances and a lighting circuit, but the wiring should be of sufficient size to carry the current without overheating. Usually the wiring to wall outlets or floor plugs is designed to take care of two or more appliances, in addition to the lamps on the circuit.

Before replacing a fuse, it is well to open the main switch to avoid possible shock. The fuse should be replaced with one of the same capacity. The use of fuses of higher rating would defeat the safety purpose for which they are intended. Since larger-rated fuses will not blow out so readily, there is danger of fire if they are used, especially if the wiring is defective. Pennies or similar devices should never be used in place of fuses, because of the great fire hazard.

Overloading a circuit is a common source of domestic lighting troubles. Electric irons, vacuum cleaners, toasters, and similar appliances add greatly to the load. If a toaster which uses 6 amperes and an electric iron which uses the same amount of current are simultaneously attached to a circuit designed to carry but 10 amperes, the fuse may blow.

As a rule, all electrical appliances have a name plate attached to them on which the current rating is stated. The following list of electrical appliances with their approximate watts and amperes may be useful in determining the amount of current used and serve as a guide to prevent overloading a circuit:

Capacity of electrical appliances

Electrical appliance	Approximate watts	Approximate amperes for 110 volts	Electrical appliance	Approximate watts	Approximate amperes for 110 volts
Chafing dish.....	550	5	Immersion heater.....	300	3
Curling iron.....	25	$\frac{1}{4}$	Pressing iron.....	550	5
Fan.....	40-60	$\frac{1}{2}$	Kettle.....	420	4
Fireless cooker.....	400	4	Mangle.....	950-1,100	9-10
Grill.....	660	6	Percolator.....	400	4
Heater.....	460-1,000	4-9	Samovar.....	420	4
Heating pad.....	45	$\frac{1}{2}$	Toaster.....	550	5
Hot plate.....	550	5	Waffle iron.....	600	6

Motor-driven home appliances draw much less current than heating appliances. They are rated in horsepower, and 1 horsepower is equal to 746 watts. An electric washing-machine motor develops about one-quarter horsepower, a vacuum cleaner one-fifth, a dish washer one-eighth, a refrigerator one-eighth, and a sewing machine one-twelfth horsepower. Converted into watts and amperes, these appliances range from about 190 watts to less than 70 watts, and draw less than 2 amperes of current.

Every branch circuit is good for at least 15 amperes, when appliances are attached at wall receptacles. Lighting fixtures employ smaller wires, and lamp sockets should not have irons, toasters, percolators, and similar heating devices attached to them. If there are no other outlets, only one heating device (or motor-driven device) should be operated from a lighting fixture at a time.

A short circuit will also cause a fuse to blow out. It may result from defective electrical equipment or a worn cord, which allows the wires to come in contact with each other. If, however, appliances and cords are in good condition and fuses continue to blow out, the trouble is probably in the main wiring system, in which case an electrician should be called.

5. REPAIRING AN ELECTRIC DOORBELL

Electric doorbells may be operated by means of batteries consisting of dry or wet cells or by reduced house current. In homes supplied with alternating electric current for lighting, the most satisfactory scheme is to use the bell-ringing transformer, whose primary winding is connected to the lighting circuit and the secondary winding to the bell circuit. It provides the proper voltage for operating a bell. Such transformers can not be used, however, on farm lighting outfits, or storage batteries, since they furnish direct current. Where a battery is used, the dry cells are usually preferred to wet cells, since replacement of the former is easier than maintenance of the latter. Since cells lose their efficiency

in time and require replacement or rejuvenating, it is well to install a transformer if possible, as it is inexpensive and requires no periodical attention. Transformers should be installed by an electrician.

There are several ways in which electric-bell systems, especially those operated by batteries, may get out of order. If the bell has been ringing weakly, a worn battery is usually responsible. The battery usually consists of two or more wet or dry cells. Either type of cell may be tested by connecting a short wire to one terminal or binding post, and rubbing the loose end against the other terminal. If the cell is run down there will be no sparks, or if sparks do result, they will be weak. The exact rating of a battery may be determined by means of a small clocklike battery tester or meter, which is inexpensive and handy to have around for testing other batteries also, such as those used in radios. Dry cells are not rechargeable and when they wear out, new ones must be purchased.

The type of wet-cell batteries ordinarily used for bells may be recharged with a solution made by dissolving ammonium chloride, commonly known as sal ammoniac, in water. This chemical, which has the appearance of salt, can be purchased at hardware or electrical supply stores in packages containing a sufficient amount to charge a cell. The contents of a package should be placed in each cell jar and warm water added until the solution reaches the line marked on the glass. To prevent evaporation of the solution and to keep the salt from crystalizing on the jar, a small amount of mineral oil may be poured on the surface of the solution to form a film. If the zinc electrode, which runs through the middle of the cell, is badly eaten away it should be replaced with a new one.

If a test of the battery cells shows them to be strong, the trouble may be due to a loose connection on the battery, the bell, or in the push button. A broken circuit wire may be responsible for the trouble, or perhaps the bell needs adjusting, or the push button fails to make contact.

In order to examine the connections in the push button, it is necessary either to unscrew it from the wall or to remove its outside shell, depending upon the type of button. Sometimes the contact becomes dirty or corroded from exposure to the weather, in which case the contact points should be cleaned with emery paper. Examine the connections in the button and tighten any which appear to be loose. Do the same with the connections on the bell and battery.

A derangement of the bell parts sometimes occurs, but not frequently. Where it does, tightening the adjusting screw may be all that is necessary. This screw is located inside the bell box and may need to be moved closer to or farther away from the spring. If the spring is too stiff, bend it toward the coils a little.

If the bell refuses to work after all of these adjustments have been made, look for a short circuit or broken wire in the system. A short circuit seldom occurs, but a piece of metal carelessly placed across the lead wires on battery terminals, or a staple touching both lead wires where the insulation is badly worn, will create the condition. This causes the current to return to the battery before it reaches the bell mechanism. Worn places on the insulation should be wrapped with friction tape.

A broken wire is sometimes difficult to locate. Feel along the wire and examine with particular care places where it is fastened with staples, or where there is a sharp bend in the wire. If the break can not be found in this way, tests will have to be made to locate the seat of trouble. This may be done in either battery or transformer systems by means of the spark test previously described. At approximately the middle of the system, scrape some of the insulation from the two wires and with a small piece of wire make a short circuit by touching both bare wires with the ends of the small piece. (See fig. 27.) If sparks result, they indicate that the wires are not broken between that point and the battery, or transformer, whichever is used, and that the trouble lies in the opposite direction or farther away from the battery. By putting the short-circuiting wire on different points of the line while moving away from the battery the break may soon be located. When no sparks appear, the break will be found between that point and the last point tested.

If, however, there are no sparks at the first point tested, it indicates that the wires are broken between that point and the battery, and the break may be found by making the spark test while moving toward the battery.

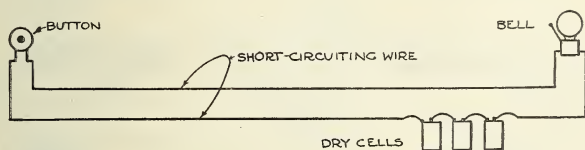

FIGURE 27.—Typical bell circuit

When the system is tested between the bell and push button, and it is in order between those points, both sparks and the ringing of the bell will result. Sparks only will result when tests are made between the battery and bell.

When the break has been found, the wires should be spliced and the joint covered with friction tape. All places where insulation has been removed should be taped.

6. HOW TO SPLICE ELECTRIC WIRES

Two pieces of wire can be joined together by splicing. If the wires to be joined are attached to a fixture or appliance they should be disconnected from the house system before the work is undertaken. A careful electrician always cuts off the house current before splicing wires which are a part of the house-wiring system.²⁰

Remove the insulation for a length of about 3 inches from the end of each wire and scrape these portions bright with a knife or piece of sandpaper. Then bend the ends at right angles to the wires, hook them together and twist each end tightly around the other wire with pliers so that firm contact is made. (See fig. 28.) To prevent corrosion and to obtain a good electrical contact the joint should be soldered. It should then be wrapped securely with rubber tape and then by a complete covering of friction tape. The rubber tape

²⁰ See section 2 of this chapter, p. 93.

should be applied while the joint is still hot from soldering, so that the rubber will become vulcanized. The friction tape should extend at least one-half inch beyond the points where insulation was removed and should be compressed firmly.

7. REPAIRING DAMAGED APPLIANCE CORDS

The cords by which electrical appliances are connected to a circuit often cause trouble. In most cases this is due either to wear or to improper handling. A cord usually shows the first signs of wear at the end where it is most frequently handled. If the cord is frequently twisted and bent sharply some of the small wires beneath the covering may become broken. If they come in contact with adjacent bare wires, a short circuit will result, requiring at least the replacement of blown-out fuses. If a wire breaks without coming in contact with the other wire the appliance will not work. The break

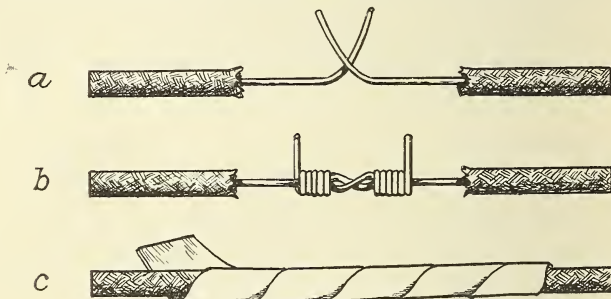

FIGURE 28.—Method of splicing electric wires

in this case may not be evident on the outside of the insulation. Defective cords should either be promptly repaired or discarded.

Proper Handling of Cords.

To avoid twisting the cord, if a screw plug is used, do not screw the plug into the socket with the cord attached to the plug. If possible, separate the screw half of the plug from the cap and screw it into the socket. When this has been done, the prongs of the cap may be inserted into the plug without twisting the cord. For future convenience in attaching the cord, the threaded half of the plug should be left in the socket, if possible.

Most of the modern receptacles are made to accommodate the bayonet-type plug. As the name implies, this plug is equipped with two bayonet like prongs, to be inserted into corresponding slots in the receptacle. With this type of plug the cords are not subject to twisting as they are in a screw plug.

When disconnecting an appliance do not pull on the cord, as this strain may cause the wires to break or pull out of the cap. It is better to grasp the cap and pull it from the plug. It is now possible to obtain cords with handles attached to the cap, so that no strain will be placed on the cord.

If a cord becomes badly damaged it should be replaced with a new one. However, if the cord has merely broken near the plug end, or has been pulled out of the plug, it can readily be repaired.

Tools.

Small screw driver, pocketknife, pair of old shears, and a pair of pliers.

Materials.

Electrician's so-called friction tape.

How Repairs Are Made.

The first step is to loosen the screws inside the plug cap and remove any short pieces of wire which may be attached to the screws. (See fig. 29.) Then clip the end of the cord and push it through the hole in the cap from the rounded side. Next, split and remove the outside braid of the cord for about 1 inch from the end, which will expose the two separately covered wires within. Then carefully remove the insulation from these wires and scrape them until bright. To relieve pulling strain on the individual wires, tie them together in a knot intended to rest in the recessed part of the cap. (See fig. 29.) The knot portion should not have the insulation scraped off, and the knot should be wrapped with a small piece of friction tape.

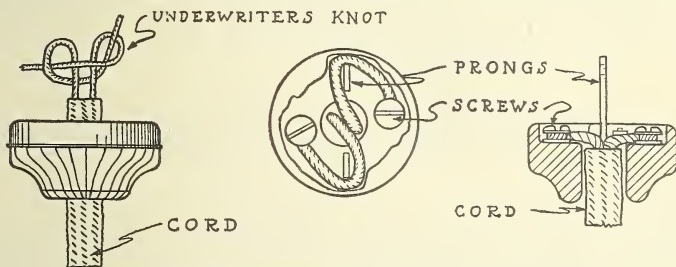

FIGURE 29.—Details of an electric cord plug

Twist the strands of each wire to keep them together, wind clockwise, one wire around each of the binding screws, and tighten the screws. The tightening of the screws should also tighten the wires around them. Be sure there is no opportunity for bare wires to come in contact with each other. If there is, remove the screws and shorten the bare portions.

As a finishing touch to the job, snip off the loose ends of wire and pull the cord until the knot and wires settle firmly inside the cap.

New Cord—Type to be Used.

If a cord becomes badly worn, it should be replaced with a new one. It is advisable to get a reinforced cord of a make approved by the Underwriters' Laboratories. A type S cord is recommended for use in a garage, or wherever it will be subjected to severe usage.

XIV. MISCELLANEOUS**1. HOW TO STOP CREAKING OF FLOORS**

If the boards in a floor are not properly laid, or not well attached to the joists or subfloor, they will creak when walked upon.

The trouble may be due to improper nailing, warping of the boards or floor joists, or faulty construction of the floor as a whole.

The boards in warping may have loosened or drawn out the nails or perhaps an insufficient number of nails were used in the first place.

If the finish boards were laid in a wet condition, or if the subfloor was damp when the finish floor was laid, shrinking and warping of the boards would follow.

Where the finished floor is laid in the same direction as the subfloor, the former may warp and cause creaking.

Again, the subfloor may have been omitted and the finish floor nailed directly to the floor joist. In such cases the joists themselves may warp and not provide a level bearing for the flooring.

Making an Inspection.

If the basement is unceiled it will be easier to determine whether the first floor is single or double and the location and direction of floor joist can be noted if renailing is required.

The floor joists and bridging should be examined and the latter strengthened if necessary.

It is not easily determined whether there is single or double flooring on the second floor of a house. However, if the finished flooring runs in the same direction as that of the first floor, it may safely be assumed that the same type of construction has been used in both cases.

Tools.

Claw hammer, nail set, flat-headed axe or maul, and a block of wood.

Materials.

A small quantity of nails. For three-eighths inch thick dressed and matched hardwood flooring, 3d (threepenny) wire finishing nails are recommended. For similar flooring, thirteenth-sixteenths inch thick, use 8d cut flooring nails, and for $1\frac{1}{16}$ -inch flooring use 10d cut flooring nails. For 1-inch common flooring use 8d floor brads.

Methods to be Used.

If the boards have lifted slightly from the joists, place a block or board on the floor at that point and strike it with an axe or heavy hammer to drive the flooring back into place. A piece of old carpet or several thicknesses of paper should be placed under the block to avoid marring the floor.

In case this does not produce the desired result, the driving of a few nails around the loose point will probably draw the boards down tight. Care should be taken not to bend the nails, and when the heads are within a quarter of an inch of the floor, a nail set should be used to drive the nail heads below the floor surface in order to prevent marking the floor with the hammer. The nail holes should then be filled with putty or wood filler and finished in the same way as the floor.

If the boards on the first floor can not be driven down by either of these methods, it might be advisable to drive a thin strip of wood between the bottom of the flooring and the top of the joist, or to nail a cleat of wood to the side of the joist sufficiently high to support the flooring and eliminate the play. This nailing can be done from the basement.

2. RELIEVING A STICKING DRAWER

Damp weather often causes drawers to stick and overloading of drawers sometimes makes them warp and bind.

The wood in the drawer and in the adjoining partitions swells as a result of absorbing moisture. The paint or varnish may also become soft and sticky during prolonged wet spells. Some woods also become warped, and overloading of drawers makes them difficult to open.

Tools.

Plane.

Materials.

Small quantity of paraffin.

Remove the drawer and lay it on a work bench or on the floor and plane the bottom edges or the sides until the drawer slides in and out readily. Never plane the top edges, as this would spoil the appearance when the drawer is open. Then apply paraffin to the runways and to the bottom edges of the drawer to make it run smoothly.

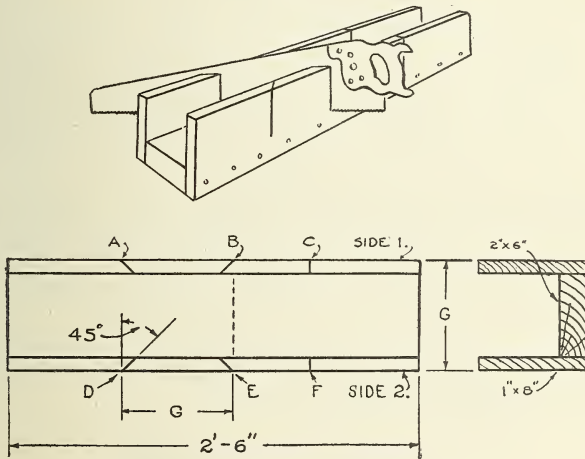

FIGURE 30.—A homemade miter box

3. HOW TO MAKE A MITER BOX

For sawing molding, weather strips, bridging strips, or small-sized lumber where diagonal ends are desired, the best and quickest work is done with a miter box. The ordinary miter box is a 3-sided, or trough-shaped box, having both ends open, and with slits cut down through the sides to guide the saw. (See fig. 30.)

There are many kinds and grades of adjustable metal boxes on the market, which are desirable, but for occasional use in home repairs, a homemade wooden box will prove satisfactory and is quickly and easily made.

As the most frequent angle cut is 45° , and as a square-end cut, especially in molding, is more accurately made by use of a miter box, it may be well to describe the making of one of these cuts.

If a job is encountered where many cuts of a certain angle are required, it is advisable to make a special miter box for that particular angle.

Tools.

Screw driver, saw, and steel square.

Materials.

Three pieces of dressed lumber, consisting of one piece of 2 inches by 6 inches by $2\frac{1}{2}$ feet long for the bottom and two pieces of 1 inch by 8 inches by $2\frac{1}{2}$ feet long for the two sides, and about a dozen and a half 2-inch wood screws.

Making the Box.

Screw the two side pieces to the edges of the bottom piece to form a channel or 3-sided box, being careful to have the sides flush with the bottom. It might be advisable to bore holes for the screws to avoid splitting the side pieces. Then, as shown in Figure 30, square a line between *B* and *E*, across the top of the box near the middle, marking the line on top of side pieces 1 and 2. Next measure from point *B* along the outside edge of side 1, the same distance *G* as between the outside faces of the side pieces, and mark point *A*. From point *A*, draw diagonal line *AE*. This diagonal line will be on a 45° angle drawn from one outside face to another. Each end of the diagonal line *AE* should then be squared down the outside face of each side, to form a perpendicular. Proceed in the same manner to lay out a second diagonal line *BD* in the opposite direction, to form an *X* with diagonal *AE*.

Before cutting through on the diagonal lines, be sure that there are two screws in each side between points *A* and *B* and *D* and *E* to fasten securely the two short side pieces thus formed. Saw carefully through the two sides along the diagonal lines and down the perpendiculars until the top face of the bottom piece is reached.

Near one end cut a third line *CF* across the box, at right angles to the sides and perpendicular to the bottom, to be used for cutting off square ends. Screws should be placed close to this cut also, on both sides, to make the sides more rigid.

XV. CLOSING THE HOUSE

When a house is to be unoccupied for an extended period, especially during the winter, it should be inspected carefully before it is left, and precautions should be taken to guard against possible damage during the absence of the family. Such damage might result from a leaky roof, burst water pipe or cracked fixture, defective wiring, or other causes.

Whenever a house is being closed there is always more or less haste to leave it. It is in this rush that things are often left in a disordered state. It is best to plan ahead and to go about such preparations as are necessary in a systematic manner, to avoid confusion at the last minute and to insure that nothing important is being left undone.

The roof should be examined for possible leaks, and repairs should be made, if necessary. Gutters and down spouts should be cleared of leaves and rubbish to prevent overflow.

All rubbish should be gathered up and burned, particularly accumulations in the basement. Piles of paper, rags, shavings, and similar discarded material sometimes cause fires by spontaneous combustion. It is perhaps needless to say that all matches should be put in a glass, metal, or earthen container or removed from the premises, and all oil, gasoline, and paint cans disposed of.

Most fire insurance companies require the insured to obtain a "vacancy permit" before leaving a house unoccupied for an extended period. The necessary requirements in this respect are usually outlined in the policy. A small additional premium may be charged for granting this privilege.

Before the occupants leave the house, the refrigerator drain should be cleaned out and the interior of the refrigerator should be cleaned and aired. All perishable food should be disposed of, and preserves and jellies should be put in a place where they will be protected against excessive heat in summer and freezing in winter.

The water should be shut off, and such other precautions taken in regard to the water system and heating system as are recommended in Chapter XI, sections 2 and 3.

The electrical supply should also be cut off as described in Chapter XIII, section 3. This is a wise precaution to take, since fires are sometimes started by a short circuit caused by crossed bare wires or other faults in the wiring system. It also provides protection against damage caused by lightning passing through the house circuit. The radio antenna should be grounded before it enters the house or a lightning arrester provided, to guard against damage to the set and possibly to the house.

The telephone service may be temporarily discontinued by notifying the telephone company. There is usually a reduced charge during the period the telephone is out of service.

The gas company should be requested to shut off the gas supply, to guard against possible damage resulting from a leak in a pipe or fixture.

All doors and windows should be closed and locked and shades drawn. If there are blinds or shutters on the house, they should be closed and locked as an extra bar against intruders and as a protection for the windows during heavy storms. The cellar doors should be securely bolted.

It is often advisable to leave a key to the house with a neighbor or at the nearest police station, so that entrance may be readily gained in case of an emergency. In some cities, where police are notified that a house is to be left vacant, an officer on his regular rounds makes an occasional inspection.

XVI. OTHER SOURCES OF INFORMATION

In addition to the suggestions contained in this publication, there are various sources of information concerning the care and repair of the house which should be known to the home repair man.

Often the material dealer from whom purchases are made may be consulted regarding the correct amounts and grades of materials required for a specific job. In addition to his personal knowledge he may have printed instructions covering the use of the products

which he handles. These instructions are prepared by the manufacturers of the materials and are usually comprehensive and useful.

In addition to the assistance rendered by the manufacturers, there are many national trade associations which retain a staff of experts to make tests and recommend correct methods of using the products which they represent. The results of these studies are usually published and distributed by the associations, and many of these publications are in the form of booklets touching upon subjects particularly interesting to the small home owner, with illustrations, plans, specifications, and detailed instructions for performing tasks around the house. The names and addresses of some of these organizations together with the titles of a few of their publications, which may be of interest to home owners, are shown in Chapter XVII.

In addition to their publications, many of these associations have established an information service for the benefit of the users of their products and are glad to answer inquiries or decide questions involving their properties and uses. Manual-training teachers and friends who are experienced in repair work may also be consulted. In any case, the inquirer should assure himself that the person consulted is competent to give such advice, and that the information obtained is reliable. Sometimes it is found that one who is free to give advice is a good talker but a poor mechanic.

XVII. LIST OF PUBLISHED MATERIAL OF INTEREST TO HOME OWNERS

Government publications after which a price is noted on the following list may be obtained from the Superintendent of Documents, Government Printing Office, Washington, D. C. Remittances should be made in the form of postal money order, express money order, or New York draft. Postage stamps or mutilated or foreign money should not be sent. Currency is sent only at the sender's risk.

Government publications distributed free of charge may usually be obtained from the department issuing them.

Publications prepared by trade associations may be procured by addressing the association concerned.

In addition to the sources mentioned in this list, many universities and colleges, through their engineering experiment stations and agricultural extension divisions, publish pamphlets of interest to home owners.

BRICK

United States Department of Commerce:

Bureau of Standards—

Cause and Prevention of Kiln and Dry-House Scum and Efflorescence of Face-Brick Walls. Technologic Paper No. 370.....	\$0.20
Ideal Wall Construction. Letter Circular No. 29.....	Free
Recommended Minimum Requirements for Masonry Wall Construction. BH6.....	.15
Recommended Minimum Requirements for Small Dwelling Construction. BH1.....	.15
American Face Brick Association, 130 North Wells Street, Chicago, Ill.:	
The Story of Brick.....	Free
Wet Walls and Efflorescence.....	Free
The Charm of Face Brick Homes.....	Free
How to Read Plans for Building a Home.....	Free
A Manual of Face Brick Construction.....	.50

The Common Brick Manufacturers' Association of America; 2121 Guarantee Title Building, Cleveland, Ohio:	
Brick—How to Build and Estimate.....	\$0.25
Homes of Lasting Charm.....	.25
Farm Homes of Brick.....	.05
Skintled Brickwork.....	.15

CHIMNEYS AND FIREPLACES

United States Department of Agriculture:	
Chimneys and Fireplaces, How to Build Them. Farmers' Bulletin No. 1230.....	.05
Clay Products Association, 111 West Washington Street, Chicago Ill.:	
How to Build a Safe Chimney.....	Free.
The Chimney.....	Free.
A Standard Ordinance for Chimney Construction.....	Free.
The Common Brick Manufacturers Association of America, 2121 Guarantee Title Building, Cleveland, Ohio:	
The Heart of the Home.....	.25
Eastern Clay Products Association, 906 Colonial Building, Philadelphia, Pa.:	
Flues and Flue Linings with Related Data on Chimneys and Fireplaces.....	Free.
National Association of Manufacturers of Heating and Cooking Appliances, 3440 A. I. U. Building, Columbus, Ohio:	
Extracts from Various Publications Respecting Chimneys, Drafts, etc.....	Free.
National Board of Fire Underwriters, 85 John Street, New York, N. Y.:	
A Standard Ordinance for Chimney Construction.....	Free.

CLAY PRODUCTS

Associated Tile Manufacturers (Inc.), 220 Graybar Building, 420 Lexington Avenue, New York, N. Y.:	
Beautiful Association Tiles.....	Free.
Basic Specification for Tilework and Related Documents.....	Free.
Enduring Beauty in Your Home through Ceramic Tiles.....	Free.
Tiled Swimming Pools.....	1.00
Clay Products Association, 111 West Washington Street, Chicago, Ill.:	
Tentative Standards.....	Free.
Eastern Clay Products Association, 906 Colonial Building, Philadelphia, Pa.:	
Standards.....	Free.

CONCRETE

United States Department of Agriculture:	
Plain Concrete for Farm Use. Farmers' Bulletin No. 1279.....	.05
Small Concrete Construction on the Farm. Farmers' Bulletin No. 1480.....	.10
United States Department of Commerce:	
Bureau of Standards—	
Recommended Minimum Requirements for Masonry Wall Construction. BH6.....	.15
Recommended Minimum Requirements for Small Dwelling Construction. BH1.....	.15
American Concrete Institute, 2970 West Grand Boulevard, Detroit, Mich.:	
Concrete Primer.....	.25
Portland Cement Association, 33 West Grand Avenue, Chicago, Ill.:	
Foundation Walls and Basements of Concrete.....	Free.
Concrete Improvements Around the Home.....	Free.
Old Homes Made New.....	Free.
Permanent Farm Construction.....	Free.
Design and Control of Concrete Mixtures.....	Free.

ELECTRICAL

United States Department of Agriculture:	
Electrical Light and Power in the Farm Home. Separate No. 799—	\$0.05
United States Department of Commerce:	
Bureau of Standards—	
Safety for the Household. Circular No. 75—	.40
Committee on the Relation of Electricity to Agriculture, 1120 Garland Building, Chicago, Ill.:	
Wiring the Farm for Light, Heat, and Power—	.50
Copper and Brass Research Association, 25 Broadway, New York, N. Y.:	
Wiring and Rewiring to Modernize the Home—	Free.
National Electric Light Association, 420 Lexington Avenue, New York, N. Y.:	
More Power to the Home, a series of booklets—	Free.
1. Wiring the House.	
2. Better Lighting.	
3. Washing.	
4. Ironing.	
5. Many Motors Make Light Work.	
6. Electric Range Cookery.	
7. Cooking with Small Electrical Appliances.	
8. Electric Refrigeration.	
9. Electrical Household Devices, specifications for wiring in residential structures.	
National Electrical Manufacturers Association, 420 Lexington Avenue, New York, N. Y.:	
The National Code—Its Purpose and Development—	Free.

FLOORS AND WALLS

United States Department of Agriculture:	
Floors and Floor Coverings. Farmers' Bulletin No. 1219—	.05
Preventing Cracks in New Wood Floors. Leaflet No. 56—	.05
United States Department of Commerce:	
Bureau of Standards—	
Report of Service Test on Concrete Floor Treatments. Letter Circular No. 139—	Free.
Rubber Floor Tile. Letter Circular No. 270—	Free.
Scouring Powder for Floors. Circular No. 370—	.05
Associated Tile Manufacturers (Inc.), 220 Graybar Building, 420 Lexington Avenue, New York, N. Y.:	
Beautiful Association Tiles—	Free.
Enduring Beauty in Your Home—	Free.
The Common Brick Manufacturer's Association of America, 2121 Guarantee Title Building, Cleveland, Ohio:	
Are You Proud of Your Front Porch?—	Free.
Maple Flooring Manufacturers' Association, 332 South Michigan Avenue, Chicago, Ill.:	
New Floors for Old—	Free.
Three Native Hardwoods of Sterling Worth—	Free.
National Lumber Manufacturers Association, Transportation Building, Washington, D. C.:	
Wood Floors—	Free.
National Slate Association, Drexel Building, Philadelphia, Pa.:	
The Charm of Slate Floors and Walks—	Free.
Oak Flooring Manufacturers' Association of the United States, 1812 Sterick Building, Memphis, Tenn.:	
The Story of Oak Floors—	Free.
Laying, Finishing, and Care of Oak Floors—	Free.
Oak over Old—	Free.
Portland Cement Association, 33 West Grand Avenue, Chicago, Ill.:	
Concrete Sidewalks—	Free.
Concrete Floors for Residences—	Free.
Southern Pine Association, New Orleans, La.:	
Beauty Plus Service in Floors—	Free.
Structural Clay Tile Association, 1401 Engineering Building, Chicago, Ill.:	
Structural Clay Tile Floor Data—	Free.

GAS

United States Department of Commerce:

Bureau of Mines—

Waste and correct Use of Natural Gas in the Home. Mines Technical Paper No. 257-----	\$0.05
Natural-Gas Manual for Home. Mines Technical Paper No. 325-----	.10

Bureau of Standards—

How to Get Better Service with Less Natural Gas in Domestic Gas Appliances. Circular No. 116-----	.05
---	-----

HEATING AND VENTILATING

United States Department of Agriculture:

One-Register Furnaces. Farmers' Bulletin No. 1174-----	.05
Operating Home Heating Plant. Farmers' Bulletin No. 1194-----	.05
The Domestic Oil Burner. Department Circular No. 405-----	.10

United States Department of Commerce:

Bureau of Mines—

Saving Fuel in Heating a House. Mines Technical Paper No. 97-----	.05
Five Ways of Saving Fuel in Heating Houses. Mines Technical Paper No. 199-----	.05
How to Improve the Hot-Air Furnace. Mines Technical Paper No. 208-----	.05
Why and How Coke Should be Used for Domestic Heating. Mines Technical Paper No. 242-----	.05

Bureau of Standards—

Information on Heating and Ventilation. Letter Circular No. 110-----	Free.
Domestic and Industrial Fuel Oils. CS12-29-----	.05
List of Publications and Articles Relating to Home Heating Problems. Letter Circular No. 284-----	Free.

Public Health Service—

Indoor Tropics: Injurious Effect of Overheating Dwellings, Schools, etc. Supplement 2 to PH Reports-----	.05
--	-----

The Natural Resources Intelligence Service, Department of the Interior, Ottawa, Canada:

Humidity in House Heating-----	Free.
--------------------------------	-------

American Gas Association, 420 Lexington Avenue, New York, N. Y.:

House Heating (with gas)-----	.50
-------------------------------	-----

American Oil Burner Association (Inc.), 342 Madison Avenue, New York, N. Y.:

Handbook of Domestic Oil Heating-----	3.00
---------------------------------------	------

National Warm Air Heating Association, 3440 A. I. U. Building, Columbus, Ohio:

Health and Comfort with Warm Air-----	Free.
Warm Air Heating for Residences-----	Free.
The Standard Code-----	Free.
Trade Names of Furnaces-----	Free.

The Oil Heating Institute, 342 Madison Avenue, New York, N. Y.:

Your Guide to Oil Heating Satisfaction-----	Free.
Oil Heat and the Business of Living-----	Free.
Oil Heat—A New Standard of Living-----	Free.
A Few Steps to Comfort-----	Free.

HOLLOW BUILDING TILE

United States Department of Commerce:

Bureau of Standards—

Hollow Building Tile. R12-----	.05
Recommended Minimum Requirements for Masonry Wall Construction. BH6-----	.15
Recommended Minimum Requirements for Small Dwelling Construction. BH1-----	.15

The Structural Clay Tile Association, 1400 Engineering Building, Chicago, Ill.:

Homes of Permanency.....	Free.
Structural Clay Tile Buildings for the Up-to-Date Farmer.....	Free.
Manual.....	Free.
Structural Clay Tile Handbook.....	Free.

HOUSEHOLD HELPS

United States Department of Agriculture:	
Farm-Home Conveniences. Farmers' Bulletin No. 927.....	\$0.05
House Cleaning Made Easier. Farmers' Bulletin No. 1180.....	.05
Methods and Equipment for Home Laundering. Farmers' Bulletin No. 1497.....	.05
Convenient Kitchens. Farmers' Bulletin No. 1513.....	.05
Principles of Window Curtaining. Farmers' Bulletin No. 1516.....	.10
Kitchen Charts (Home Economics) per set.....	.50
Well-Planned Kitchen. Department Circular No. 189.....	.05
United States Department of Commerce:	
Bureau of Standards—	
Measurements for the Household. Circular No. 55.....	.45
Materials for the Household. Circular No. 70.....	.50
Safety for the Household. Circular No. 75.....	.40
Household Weights and Measures (card). M39.....	.05
Washing, Cleaning, and Polishing Materials. Circular No. 383.....	.10
United States Treasury Department:	
Public Health Service—	
What to do in Case of Accident. Public Health Service Miscellaneous Publication No. 21.....	.15

HOUSE PLANS

The following organizations issue house plans, floor plans, and suggestions for small-house design. In addition to the organizations listed, many of the leading newspapers show floor plans, pictures, and descriptions of houses. Some building and home magazines have a similar service:

Architects' Small House Service Bureau, 1200 Second Avenue South, Minneapolis, Minn.

American Face Brick Association, 130 North Wells Street, Chicago, Ill.

Common Brick Manufacturers' Association of America, 2121 Guarantee Title Building, Cleveland, Ohio.

Division of Agricultural Engineering, Department of Agriculture, Washington, D. C.

Home Owners' Institute, 441 Lexington Avenue, New York, N. Y.

National Lumber Manufacturers' Association, Transportation Building, Washington, D. C.

Portland Cement Association, 33 West Grand Avenue, Chicago, Ill.

Southern Pine Association, Interstate Bank Building, New Orleans, La.

The Structural Clay Tile Association, 1400 Engineering Building, Chicago, Ill.

INSULATING AND SOUNDPROOFING

United States Department of Commerce:	
Bureau of Standards—	
Thermal Insulation of Buildings. Circular No. 376.....	\$0.05
Sound-Proof Partitions. Letter Circular No. 205.....	Free.
Transmission of Sound Through Building Materials. S552.....	.05
Transmission of Sound Through Wall and Floor Structures. RP48.....	.10
Soundproofing of Apartment Houses. T337.....	.05
National Committee on Wood Utilization—	
Wall Boards and Insulating Boards. (Apply to National Committee on Wood Utilization.).....	Free.
The Natural Resources Intelligence Service, Department of the Interior, Ottawa, Canada:	
Why You Should Insulate Your Home.....	Free.

Associated Metal Lath Manufacturers (Inc.), 1821 Engineering Building,
Chicago, Ill.:

Partition Handbook (chapter 6—Sound Insulation)..... \$1.00

LANDSCAPING

United States Department of Agriculture:

Lawn Soils and Lawns. Farmers' Bulletin No. 494..... .05

Beautifying the Farmstead. Farmers' Bulletin No. 1087..... .15

Planning the Farmstead. Farmers' Bulletin No. 1132..... .05

Planting and Care of Street Trees. Farmers' Bulletin No. 1209..... .05

LIME

National Lime Association, 927 Fifteenth Street NW., Washington, D. C.:

Lime in Concrete..... Free.

Outline of the Uses of Lime. Bulletin No. 251..... Free.

1-2-9 Cold Weather Mortar..... Free.

PAINTING AND DECORATING

United States Department of Agriculture:

Painting on the Farm. Farmers' Bulletin No. 1452..... .05

United States Department of Commerce:

Bureau of Standards—

Paint and Varnish. Circular No. 69..... .15

Shingle Stains. Letter Circular No. 64..... Free.

Painting Steam and Hot-Water Radiators. Letter Circular No.
263..... Free.

American Paint and Varnish Manufacturers' Association, 1002-1004

Public Ledger Building, Independence Square, Philadelphia, Pa.:

Painting with Prepared Paint..... .25

Why Paint Peels..... .25

Institute of Paint and Varnish Research, 2201 New York Avenue NW.,
Washington, D. C.:

The Durability of Exterior Paints on Wood Surfaces. Circular No.
361..... (1)

Painting Stucco Surfaces. Circular No. 327..... (1)

Causes of Paint Failure on Sidewalls. Circular No. 355..... (1)

International Society of Master Painters and Decorators, 127 North
Jefferson Street, Peoria, Ill.:

Painting and Decorating Working Methods. (Theo Audel & Co.,
publishers, 65 West Twenty-third Street, New York, N. Y.)..... 2.00

National Lime Association, 927 Fifteenth Street NW., Washington, D. C.:

Whitewash and Cold-Water Paint..... Free.

Save the Surface Campaign, 18 East Forty-first Street, New York, N. Y.:

The Guide Book of Painting and Varnishing..... .25

Save the Surface Magazine (monthly)..... Free.

The Wallpaper Association of the United States, 10 East Fortieth Street,
New York, N. Y.:

How to Handle Wallpaper, by the Craftsmen Themselves..... Free.

PLASTER AND STUCCO

United States Department of Commerce:

Bureau of Standards—

Wall Plaster—Its Ingredients, Preparation, and Properties.
Circular No. 151..... .15

Stucco Investigations at the Bureau of Standards with Recom-
mendations for Portland Cement Stucco Construction. Circu-
lar No. 311..... .15

Associated Metal Lath Manufacturers, 1821 Engineering Building, Chi-
cago, Ill.:

Better Plastering for Modern Homes..... Free.

Metal Lath News..... Free.

Metal Lath Construction..... Free.

Partition Handbook..... 1.00

¹ Prices will be given upon request.

Gypsum Institute, 110 West Fortieth Street, New York, N. Y.:	
Brief on Gypsum Plaster-----	Free.
Gypsum—A Non-Metallic Mineral-----	Free.
Gypsum Plaster Affords Fire Protection-----	Free.
Incombustible Lathing Material-----	Free.
National Lime Association, 927 Fifteenth Street, NW., Washington, D. C.:	
Outline of the Uses of Lime. Bulletin No. 251-----	Free.
Portland Cement Association, 33 West Grand Avenue, Chicago, Ill.:	
Plasterers' Manual-----	Free.
Portland Cement Stucco-----	Free.

PLUMBING

United States Department of Agriculture:	
Farm Plumbing. Farmers' Bulletin No. 1426-----	\$0.10
Simple Plumbing Repairs in the Home. Farmers' Bulletin No. 1460-----	.05
United States Department of Commerce:	
Bureau of Standards—	
Recommended Minimum Requirements for Plumbing BH13-----	.35
Copper and Brass Research Association, 25 Broadway, New York, N. Y.:	
Practical Brass Pipe Plumbing-----	Free.
A Real Home-----	Free.

REFRIGERATION

United States Department of Commerce:	
Bureau of Standards—	
Electric and Gas Refrigerators. Letter Circular No. 255-----	Free.
The National Electric Light Association, 420 Lexington Avenue, New York, N. Y.:	
Electric Refrigeration-----	Free.

ROOFING

United States Department of Commerce:	
Bureau of Standards—	
Eaves Trough and Conductor Pipe. Research Paper No. 29-----	.05
Roofing Terns. Research Paper No. 30-----	.05
Iron and Steel Roofing. Research Paper No. 78-----	.05
Corrosion of Open Valley Flashings. Research Paper No. 123-----	.10
Recommended Minimum Requirements for Small Dwelling construction. BH1-----	.15
American Zinc Institute, 60 East Forty-second Street, New York, N. Y.:	
Zinc Workers' Manual-----	1.50
Copper and Brass Research Association, 25 Broadway, New York, N. Y.:	
Real Roofings-----	Free.
Copper Roofings, a manual-----	Free.
Copper Flashings, a handbook-----	Free.
National Association of Flat Rolled Steel Manufacturers, Terminal Tower Building, Cleveland, Ohio:	
How to Lay Steel Roofing-----	Free.
Steel Roofing—Its Use and Application-----	Free.
How to Ground a Galvanized Roof Against Lightning-----	Free.
National Slate Association, Drexel Building, Philadelphia, Pa.:	
Slate Roofs-----	1.50
The Incomparable Beauty of Slate Roofs-----	Free.
Red Cedar Shingle Bureau, 2017 Conway Building, Chicago, Ill.:	
Reroofing with Red Cedar Shingles-----	Free.

SAND AND GRAVEL

National Sand and Gravel Association, Munsey Building, Washington, D. C.:	
Relation of Aggregates to Concrete. Bulletin No. 2-----	Free.
Representative Specifications for Different Uses of Sand and Gravel. Bulletin No. 3-----	Free.
Tables of Quantities of Materials for Concrete. Bulletin No. 4-----	Free.

SEWAGE DISPOSAL

United States Department of Agriculture:	
Sewage and Sewerage of Farm Homes. Farmers' Bulletin No. 1227_	\$0.10
United States Treasury Department:	
Public Health Service—	
Sanitary Privy; Its Purpose and Construction. PH Bulletin No. 37_	.05
Safe Disposal of Human Excreta at Unsewered Homes. PH Bulletin No. 68_	.10
Sanitary Disposal of Sewage Through a Septic Tank. PH Reprint No. 625_	.10
Sewage Disposal for Suburban and Country Homes. Supplement 58 to PH reports_	.10
Eastern Clay Products Association, 906 Colonial Building, Philadelphia, Pa.:	
Sewage Disposal for Farms and Suburban Homes_	Free.
Portland Cement Association, 33 West Grand Avenue, Chicago, Ill.:	
Safe Sewage Disposal for Farm and Suburban Homes_	Free.

SMALL-DWELLING CONSTRUCTION

United States Department of Commerce:	
Bureau of Standards—	
Recommended Minimum Requirements for Small Dwelling Construction. BH1_	.15
Recommended Minimum Requirements for Plumbing. BH13_	.35
Recommended Minimum Requirements for Masonry Wall Construction. BH6_	.15
How to Own Your Home. BH4_	.05
Present Home Financing Methods. BH12_	.05
Recent Trends in Small Dwelling Construction (in preparation). Architects' Small House Service Bureau—Plan Service Described_	Free.
National Committee on Wood Utilization—	
How to Judge a House_	.10
Light Frame House Construction (in preparation).	

WATER

United States Department of Agriculture:	
Farmstead Water Supply. Farmers' Bulletin No. 1448_	.10
United States Treasury Department:	
Public Health Service—	
Good Water for Farm Homes. Public Health Bulletin No. 70_	.05

WOOD AND LUMBER

United States Department of Commerce:	
National Committee on Wood Utilization—	
Marketing of Short Length Lumber No. 1_	.10
End-matched Softwood Lumber and Its Uses. No. 2_	.05
Grade Marking for the Consumer's Protection. No. 4_	.05
Seasoning, Handling, and Care of Lumber. (Consumer's edition). No. 5_	.15
You Can Make It, vol. 1_	.10
You Can Make It, for camp and cottage, vol. 2_	.10
Wood Construction. McGraw-Hill Book Co. (700 page handbook)_	6.00
Treated Lumber—Its Uses and Economies_	.15
National Lumber Manufacturers' Association, Transportation Building, Washington, D. C.:	
House Framing Details_	.25
Choosing the Materials for the Home_	Free.
The Use of Lumber on the Farm_	Free.
The Cost of Comfort_	Free.
For Home Lovers_	Free.
Modern Home Interiors_	Free.
Transformation: From an Old House to a New Home_	Free.

California Redwood Association, 24 California Street, San Francisco, Calif.:	
Redwood Mountain Cabins and Week-End Cottages.....	Free.
Redwood Home Plans by California Architects.....	Free.
Redwood for Better Farm Structures.....	Free.
California Redwood—Its Physical and Mechanical Properties in Comparison with Other Woods.....	Free.
California White and Sugar Pine Manufacturers' Association, 600 Call Building, San Francisco, Calif.:	
Pine Homes.....	Free.
Some Dollar Sense about Timber on the Farm.....	Free.
Hardwood Manufacturers' Institute, Bank of Commerce Building, Memphis, Tenn.:	
The Charm of Sovereign Wood, Vol. II.....	Free.
Northern Hemlock and Hardwood Manufacturers' Association, Oshkosh, Wis.:	
Beautiful Birch for Beautiful Woodwork.....	Free.
The Northern Pine Manufacturers' Association, 1103 Lumber Exchange Building, Minneapolis, Minn.:	
For Beauty—Permanence—Economy—Build with White Pine.....	Free.
Southern Cypress Manufacturers' Association, Jacksonville, Fla.:	
Money Saved for Builders.....	Free.
Money Saved for Farmers.....	Free.
A Versatile Wood for Interiors.....	Free.
Southern Pine Association, Interstate Bank Building, New Orleans, La.:	
A Hundred Handy Helps.....	Free.
Beauty Plus Service in Floors.....	Free.
Southern Pine Garages.....	Free.
Southern Pine Homes.....	Free.
West Coast Lumbermen's Association, 364 Stuart Building, Seattle, Wash.:	
The Short Length House of West Coast Woods.....	Free.
Forever Homes from Forests.....	Free.
Prize Homes of West Coast Woods.....	Free.
Western Pine Manufacturers' Association, 510-517 Yeon Building, Portland, Oreg.:	
Handy Facts About Inland Empire Lumber, Lath, and Woodwork.....	Free.
Construction Specification for Inland Empire Lumber.....	Free.
Bingo of Flathead—A Dog's Story of Ponderosa, the Pick o' the Pines.....	Free.
Paneling Need Not Be Expensive.....	Free.

MISCELLANEOUS

United States Department of Agriculture:	
Preventing Damage by Termites or White Ants. Farmers' Bulletin No. 1472.....	\$0. 05
Rammed Earth Walls for Buildings. Farmers' Bulletin No. 1500.....	. 05
Protection of Buildings and Farm Property from Lightning. Farmers' Bulletin No. 1512.....	. 10
Making Cellars Dry. Farmers' Bulletin No. 1572.....	. 05
Protection of Log Cabins, Rustic Work, and Unseasoned Wood from Injurious Insects. Farmers' Bulletin No. 1582.....	. 05
Fire-Protective Construction on the Farm. Farmers' Bulletin No. 1590.....	. 05
Farm Drainage. Farmers' Bulletin No. 1606.....	. 05
United States Department of Commerce:	
Bureau of Standards—	
Protection of Life and Property Against Lightning. Technologic Paper No. 56.....	. 35
Screen Manufacturers' Association of America, 462 East McMillan Street, Cincinnati, Ohio:	
The Fine Art of Screening the Modern Home.....	Free.

XVIII. GLOSSARY

- Backband molding:** A separate molding around the outside edge of a window or door casing and fitted against the wall to provide a decorative finish.
- Beading:** On window frames—a small molding.
- Brads:** Small thin nails with small heads, used to fasten small molding and other thin pieces of material.
- Bridging:** Pieces of wood or metal crisscrossed and securely fastened between floor joists to stiffen the framing, distribute the load, and hold the members in their original position.
- Buttered joints:** A thin mortar joint made by scraping a quantity of mortar with the trowel on the edges of the brick and laying the brick with a thin mortar bed.
- Casing:** The trim around a door or window opening.
- Calk:** To fill cracks, joints, and holes with a pliable material, such as elastic cement, mortar, putty, and oakum, to seal them against the passage of air and water.
- Conductor:** A pipe to carry water from the roof gutters of a building to the ground.
- Coping:** The cap or top course of a wall, designed to shed water.
- Countersink:** To drive nail heads below a surface or make depressions for screw heads, so that they will be below the surface of the wood in which they are inserted.
- Course:** A horizontal row of brick, stone, or other building units in a wall. The term is also applicable to shingles, slates, and similar roofing materials.
- Dormer window:** A vertical window projecting from a sloping roof, providing light, ventilation, and additional headroom.
- Down spout.** See Conductor.
- Drip cap:** Molding along the top of a window casing on the exterior side to shed water.
- Dry well:** A pit or well dug in the ground and walled in to receive waste roof water.
- Elastic cement:** A thick plastic-cement composition commonly used to waterproof joints in flashing, roofing material, and for calking around the outside of window and door frames. It adheres to practically all materials and being elastic is not broken by slight movement of the joined surfaces.
- Fire stopping:** The filling of hollow spaces in dwelling construction at floor and roof lines to retard the spread of fire. The material used for this purpose may consist of well-fitted board or plank strips, or of incombustible materials, such as brick and mortar, broken tile, block or plaster refuse mixed with mortar, or gypsum, infusorial earth (kieselguhr), or mineral wool, properly secured in place.
- Flashing:** Sheet metal or other material so inserted over joints in roofs and walls as to shed water; used especially in roof valleys, around the base of chimneys, and along the top of window and door frames.
- Furring:** Strips of wood applied to a surface to make an even base for other material, such as lath and plaster, and form an air space within the finished wall.
- Gable:** The vertical triangular portion of the end of a building extending from the eaves line to the ridge or peak of the roof.
- Hinge leaf:** One of the two main parts or sides of a hinge.
- Joists:** Timber placed on the edge and equally spaced to support the flooring, and to which ceiling lathing is nailed. The ends of the joists are usually supported by bearing walls, bearing partitions, or by girders.
- Lap joint:** A joint formed by lapping the edge of one piece of material over the edge of another.
- Leader.** See Conductor.
- Load-bearing wall:** A wall which supports any vertical load in addition to its own weight.
- Louver:** Horizontal slats in a window arranged to exclude rain and allow the passage of air to ventilate attics and similar places.
- Miter joint:** A joint formed by cutting two members at an angle and fitting them together.
- Mortise:** A pocket or slot cut in a piece of wood to receive a tenon.
- Oakum:** Hemp fiber obtained by untwisting and picking out loosely the yarns of old tarred hemp rope; used for calking cracks, etc.

- Parapet wall:** A low wall extending above the surface of a roof around the edges or between two houses.
- Plates:** Timbers set singly or doubly at the top of the studs to support the ends of roof rafters and attic floor joists.
- Point:** To fill and finish carefully with mortar, cracks and joints in masonry walls.
- Rabbeted:** Joined by cutting a recess or groove in or near the edge of one piece of material to receive the edge of another piece cut to fit therein.
- Rafters:** Single timbers placed on edge and equally spaced, which support the roof deck and roofing material.
- Rails and stiles:** The horizontal and vertical pieces of a door surrounding the panels, and into which the latter are fitted.
- Sash:** The framing in which panes of glass are set in a glazed window.
- Scratch coat:** The first coat of plaster on a wall.
- Shim:** A piece of material used to fill in or true up a space between two surfaces.
- Sills:** Timbers set on top of foundation walls on which rest the exterior wall studs and first-floor joists.
- Spatter board or splash block:** A flat piece of material such as wood, stone, and concrete, placed on the ground below the outlet of a down spout to spread the water and prevent ground washing.
- Stool:** The inside sill of a window frame.
- Strike plate:** The metal plate surrounding the opening in a door jamb where the latch bolt enters.
- Studs:** The uprights in either exterior walls or interior partitions to which sheathing boards and lath and plaster are applied.
- Tenon:** A projection, usually of a rectangular cross section, at the end of a piece of wood, to be inserted in a socket or mortise in another piece, to make a joint.
- Turnbuckle:** A threaded coupling between two rods, used to shorten or lengthen the combined rods.
- Union joint:** A special kind of pipe coupling designed to permit disconnection of two pipes without disturbing adjoining sections.

XIX. CHECK LIST

These suggestions for possible repairs and improvements in the house and its equipment may be helpful to those who are not familiar with the different parts of a house. The list may be used in taking an inventory; checking up to see what repairs are needed.

EXTERIOR

Foundation and Side Walls.

1. Masonry walls with large cracks or broken portions requiring filling.
2. Mortar joints or minor cracks requiring pointing.
3. Porous or leaky walls requiring damp proofing.
4. Leakage around eaves or tops of walls requiring repairs or coping.
5. Efflorescence or scum on walls requiring acid cleaning or special treatment.
6. Cracks, discoloration, or fallen-out portions of stucco walls requiring pointing, cleaning, or restuccoing.
7. Loose or decayed boards or open joints in frame siding requiring repairs or replacement.
8. Blistering, cracking, or peeling of painted surfaces requiring repainting.
9. Replacing wall surfaces with newer or more attractive materials.
10. Grading around foundation.

Windows and Door Frames and Sash.

1. Window caps requiring new flashing or repairing over existing joints.
2. Holes or cracks around window frames requiring caulking or repairing.
3. Broken glass panes requiring replacing.
4. Defects in putty around panes requiring reputtying or patching.
5. Windows needing washing.
6. Overhauling screens in readiness for next spring.
7. Need for storm doors and windows or painting and repairing existing ones.
8. Repairs to blinds and shutters.
9. Need for awnings or repairs to existing ones.
10. Loose or shabby balconies and railings requiring repairs or painting.
11. Advisability of additional windows.

Roof, Flashing, Gutters, and Down Spouts.

1. Broken, loose, or missing shingles, slate, tile, or other material requiring replacement or repairs.
2. Metal or roll roofing with cracks, open joints, or worn off coatings requiring application of waterproofing materials, painting, or replacing.
3. Rusted or defective flashing requiring painting, repairs, or replacement.
4. Leaky gutters or conductor pipes requiring repainting or replacing.
5. Leakage around skylights requiring repainting of the frames, glazing, flashing, or repairing.
6. Leakage around scuttles, trapdoors, or other roof openings, requiring flashing, painting, or repairs.
7. Defects in chimney requiring pointing or replacement of brick.
8. Need for chimney cap or chimney pots.
9. Ineffective draft may require lengthening the chimney or applying metal hoods.
10. Adjustments or repairs to radio antenna, lightning arrestors, or weather vane.
11. Providing splash blocks at outlet end of down spouts, or connecting down spouts to drainage system.

Porches and Steps.

1. Decayed column bases requiring repairing or renewal.
2. Broken, loose, or missing balusters requiring repairs or replacements.
3. Broken or loose railings needing repairs or strengthening.
4. Decayed, broken, or loose floor boards requiring repairs.
5. Decayed or inefficient floor supports needing replacements or strengthening.
6. Broken, loose, or worn steps requiring repairs.
7. Advisability of installing latticework to hide open spaces under porch.
8. Advisability of inclosing porches with glass or screening.
9. Need for floor paint or general repainting.
10. Open joints or cracks in masonry requiring pointing.
11. Broken or loose floor tile or other masonry material requiring repairs.

Garage.

1. Advisability of applying insulating material.
2. Repairs to roof, doors, and windows.
3. Advisability of laying concrete floors.
4. Advisability of installing pit for servicing of car.
5. Advisability of installing heating equipment.
6. Necessary painting.

Grounds.

1. Walks and driveways; new, additional, and repaired.
2. Fences, trellises, and latticework requiring repairing or painting.
3. Weeds, brush, and tree stumps requiring removal.
4. General cleaning up of premises.
5. Advisability of additional landscaping.

INTERIOR**The Basement.**

1. Large cracks or broken places in foundation walls requiring filling.
2. Smaller cracks or mortar joints in walls requiring pointing.
3. Dark walls and ceiling needing white coatings to brighten the basement.
4. Leaks through the walls or floor requiring waterproofing applications or provisions for drainage.
5. Cracks between wood sills and walls requiring caulking.
6. Spaces between floor joists at the sills and holes around pipes requiring fire stopping.
7. Floor joists sagging or warped, requiring additional support or bridging.
8. Basement floor badly cracked or disintegrated, requiring repairing or new topping.
9. Need for partitions to provide special space.
10. Desirability of ceiling and wall coverings to obtain finished rooms.
11. Floor painting or treatments to improve appearance.
12. Shelves, closets, cupboards, bins, etc., for storage purposes.
13. Clean basement and put things in order.
14. Advisability of constructing basement garage.

Heating and Ventilation.

1. Clogged smoke pipes or flues requiring cleaning.
2. Boiler coils or baffles requiring cleaning.
3. Grates warped and broken requiring replacement.
4. Cracked fire box requiring repairs.
5. Boilers with cracks or leakages requiring repairs or new parts.
6. Cracks in chimney masonry requiring pointing.
7. Woodwork adjoining pipes and heating system requiring fire protection.
8. Coating on boilers requiring patching or recovering.
9. Heating pipes requiring covering or repairs to existing covering.
10. Advisability of installing automatic stokers, ash conveyors, or similar labor-saving devices.
11. Leaky radiator valves requiring repacking.
12. Installation of additional radiators if needed.
13. Proper painting of radiators to increase efficiency.
14. Need for radiator covers and radiator tops.
15. Installing thermostatic heat-control system.
16. Providing humidifiers for air conditioning.
17. Advisability of building a fireplace.
18. Putting in ash dump for fireplace.
19. Installation of additional room-heating device in existing fireplace.
20. Repairing or replacing of fireplace screens, andirons, and similar equipment.
21. Installation of gas or electric log or similar heating apparatus.
22. Repairs to hearth, fireback, dampers, etc. in fireplace.
23. Remodeling of mantle or fireplace front.
24. Installation of ventilating devices in kitchen.
25. Providing insulating material to walls or ceilings where possible.

Plumbing.

1. Clogged drains needing attention.
2. Leaky faucets requiring washers, tightening, or new parts.
3. Defective flush valves in water-closet requiring repairs or replacement.
4. Covering for water papers or other precautions to prevent freezing.
5. Installing refrigerator drainpipe and trap to replace pan.
6. Installing additional shut-off cocks or valves.
7. Installing water-heating equipment, water softeners, etc.
8. Replacing worn-out piping with more modern type.
9. Replacing old or worn-out fixtures with newer types.
10. Providing additional bathroom, or lavatory and toilet for convenience.
11. Providing toilet and shower in basement.

Lighting and Power.

1. Rewiring with modern system to reduce fire hazard.
2. Exposed wires requiring insulating.
3. Renewal of appliance cords.
4. Installation of additional convenience outlets, such as floor and base plugs.
5. Additional fuse plugs for fuse box.
6. Repairs to doorbells or buzzers.
7. Installing transformers for bells in place of batteries.
8. Additional bells for convenience.

Doors and Windows.

1. Sticking doors or windows requiring refitting or repairs.
2. Doors out of plumb requiring refitting or new hardware.
3. Advisability of replacing wood panels with glass in doors.
4. Defective locks, chains, or bolts, requiring repair or replacement.
5. Purchasing extra keys for various locks.
6. Broken or defective window cords and pulleys needing replacement.
7. Replacing broken window latches or other window devices.
8. Cracks around window sash and doors requiring weather stripping.

Walls and Ceilings.

1. Cracks or holes in plaster requiring patching or replastering.
2. Installation of partitions, either temporary or permanent, to provide additional rooms or closets.
3. Removal of partitions to afford additional space.

4. Replacing narrow doorways with plastered arches or similar larger openings.

5. Refinishing or redecorating—painting, papering, calcimining, etc.

Floors.

1. Creaking floors requiring nailing, additional supports, or bridging to stiffen joists.

2. Cleaning and refinishing.

3. Applying new flooring over old.

4. Repairing or replacing floor coverings.

5. Adjusting or replacing baseboard and molding moved out of position by shrinking or settling.

6. Replacing or repairing broken tile.

Stairs and Stairways.

1. Creaking stairs requiring attention.

2. Replacing worn-out treads on stairs.

3. Providing rubber or composition treads for slippery steps.

4. Rickety cellar stairs requiring additional supports or repairs.

5. Installing railing on cellar stairs to prevent accidents.

6. Transforming closed stairways into open stairways by removing one or more walls.

7. Replacing old posts and railings with modern types.

8. Installing disappearing stairs to attic.

The Attic.

1. Need for insulation materials applied to walls, floor, or underside of roof.

2. Installation of louvres or additional windows to provide ventilation.

3. Mortar joints in chimney requiring pointing.

4. Cracks between chimney and side walls requiring filling or covering.

5. Fire stopping between studs at floor line.

6. Application of wall and ceiling coverings to provide finished room.

7. Installation of partitions.

8. Applying flooring.

9. Clean attic and put things in order.

Miscellaneous.

1. Need for additional closets, and lining existing ones.

2. Need for shelves, bookcases, and cupboards.

3. Advisability of providing clothes chute, telephone cabinet, and other built-in conveniences.

INDEX

[See also list of published material of interest to home owners, Chapter XVII]

	Page		Page
A			
Appliances, capacity of.....	93, 94	Doors—Continued.	
Attic:		Correcting rattling.....	34
Inspection of.....	4	Fitting keys to locks.....	35
Insulation for.....	55, 56	Hinges and closing devices for.....	44
B			
Baseboards, inspection of.....	5	Inspection of.....	5
Basement:		Installing storm doors.....	53-54
Ceiling.....	13, 14	Placing glass in.....	34-35
Cleaning.....	103	Planing.....	31
Dampness, causes of.....	7	Remedies for sticking.....	29
Draining.....	7, 8	Repairing electric bell for.....	95-97
Fire protection.....	3, 14, 103	Screens. <i>See</i> Screens.	
Illumination.....	13	Too narrow.....	32, 33
Inspection of.....	3	Weather stripping. <i>See</i> Weather stripping.	
Insulating.....	14	Down spouts:	
Making brighter by redecorating.....	11-13	Care and replacement of.....	28, 29
Partitions, putting in.....	14, 15	Cleaning.....	28, 102
Batteries, door-bell types.....	95-96	Connected with drain.....	7
Bells, repairing electric door bell.....	95-97	Inspection of.....	5
Bins, in basement.....	14-15	Painting.....	28, 90-91
Bricks:		Drains:	
Damp proofing.....	20-21	Care of refrigerator drains.....	81
Efflorescence, removing and preventing.....	17-18	How to clean floor drains.....	80, 81
Flashing against.....	25	Inspection of.....	3
Leakage through.....	20	Providing cellar drains.....	8
Protection of walls.....	10	Repairing roof drains (<i>see</i> Plumbing).....	21, 22
Brushes, paint, selection and care of.....	83	Shutting off opening to water system.....	66
C			
Calking, around window frames.....	49-51	Drawer, relieving sticking.....	101
Ceiling, basement.....	13, 14	E	
Cellar. <i>See</i> Basement.		Efflorescence:	
Cement:		Method of removing.....	17
Asbestos for insulating.....	59-60	Precautions against.....	17, 18
Coating, method of applying.....	9	Solution for removing.....	17
Mortar, method of mixing.....	11	Electricity:	
Repairing walls with.....	10	Bell repairing.....	95, 97
Roofing cement used in calking.....	22	Batteries, bell.....	96
Chimneys:		Capacity of appliances.....	94, 95
Flashing.....	21, 22	Capacity of fuses.....	94
Inspection of.....	5	Caution in using.....	92-93, 98-99
Circuits, electric:		Chart of wiring.....	94
Capacity of.....	95	Cords, appliance.....	98-99
Overloading.....	94	Extent of home repairs.....	93
Short circuit in.....	95-96, 103	Fuse, replacing.....	94-95
Cords:		How to cut off current.....	93
Electric appliance, repairing.....	98-99	How to locate a broken wire.....	97
Window.....	39-42	Inspection of.....	5
Closing the house.....	102	Overloading blows out fuse.....	94
Cracks:		Splicing wires.....	97
Around chimneys.....	5	Transformer, bell.....	96
Around window frames.....	4, 49-51	F	
In fire boxes or boilers.....	3	Faucets:	
In foundation walls.....	3, 10, 11	Compression type.....	68
In plaster.....	18-20	Fuller type.....	70
Map and shrinkage.....	18	Ground-key type.....	70
Structural.....	19	How to distinguish type.....	71
In stucco.....	4, 15, 16	Repairing.....	67-71
In roofs.....	4	Replacing washer in.....	69
Method of filling up in plaster.....	90	Thumping noise.....	71-72
Method of filling up in exterior walls.....	10, 16	Fire protection:	
Method of repairing in interior walls.....	18-20	Around heating equipment.....	14
D			
Damp spots on walls.....	20-22, 54	Fire stopping.....	3, 14
Doors:		Removing causes of fire.....	102
Adjusting hinges.....	31-32	Flashing:	
Adjusting latch bolt.....	33-34	Around chimney.....	21-22, 26
		Inspection of.....	5
		Methods of applying.....	25-28
		Roof.....	22-24
		Floors:	
		Causes of creaking in.....	99-100
		Inspection of.....	5
		Method of repairing.....	99-100

