



Badger Meter

M-Series® Mag Meter

Model M-2000



IMPORTANT:
This manual contains important information.
READ AND KEEP FOR REFERENCE.



CONTENTS

Safety Precautions and Instructions	5
System Description.....	5
Unpacking and Inspection.....	6
Rigging, Lifting and Moving Large Units	6
Meter Location, Orientation and Applications	8
Remote Amplifier Outdoor Location	8
Pipelines and Fluid Flow.....	8
Meter Orientation	8
Vertical Placement	9
Horizontal Placement	9
Straight Pipe Requirements	10
Pipe Reducer Requirements.....	10
Chemical Injection Applications.....	11
Partially-Filled Pipe Situations	11
Meter Gaskets and Grounding	13
Meter/Pipeline Connection Gaskets.....	13
Meter Grounding	13
Conductive Pipe Grounding.....	13
Non-Conductive Pipe Grounding	14
Amplifier Mounting Configuration Options.....	14
Meter Mount Configuration	14
Remote Mount Configuration	14
Submersible Option.....	14
Wiring	15
Wiring Safety	15
Opening the M-2000 Cover	15
Power Connections	16

External Disconnect	16
AC Power Wiring	16
Remote Mount Installation	16
Mount Bracket to Amplifier.....	16
Wiring Configuration	16
Wiring for Remote Configuration	17
Empty Pipe Detection Considerations	17
Configuring Input/Output (I/O)	18
Analog Output Wiring Diagram	19
Digital Output Wiring Diagrams	20
Digital Input Wiring Diagram	20
Programming the M-2000.....	21
Displays.....	21
Menu Selection Display	21
Numeric Entry Display	21
Function Buttons.....	22
Security	24
Setting the Administration PIN.....	24
Setting the Service PIN	24
Setting the User PIN.....	24
Entering Your Personal Identification Number (PIN)	25
Setting Up the M-2000 with Quick Setup	26
Using the M-2000's Main Menu Programming Options	28
Maintenance	50
Cleaning the Flow Tube and Electrode	50
Replacing the Fuse	50
Troubleshooting	51
Appendix: Detector Specifications	53
Appendix: Amplifier Specifications	54

Safety Precautions and Instructions

Some procedures in this manual require special safety considerations. In such cases, the text is emphasized with the following symbols:

Symbol	Explanation
	Warning indicates the potential for severe personal injury, death or substantial property damage. Comply with the instructions and proceed with care.
	Caution indicates the potential for minor personal injury or property damage. Comply with the instructions and proceed with care.

System Description

The Badger Meter M-Series® model M-2000 electromagnetic flow meter is intended for fluid metering in most industries including water, wastewater, food and beverage, pharmaceutical and chemical.

The basic components of an electromagnetic flow meter are:

- The **detector**, which includes the flow tube, isolating liner and measuring electrodes.
- The **amplifier**, which is the electronic device responsible for the signal processing, flow calculation, display and output signals.

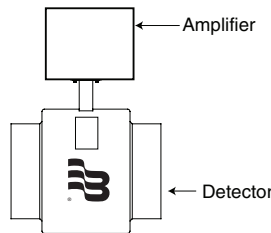

The construction materials of the wetted parts (liner and electrodes) should be appropriate for the specifications on the intended type of service. We recommend that you review all of the compatibilities consistent with the specifications.

Each meter is factory tested and calibrated. A calibration certificate is included with each meter.

Unpacking and Inspection

Follow these guidelines when unpacking the M-Series equipment.

- If a shipping container shows any sign of damage, have the shipper present when you unpack the meter.
- Follow all unpacking, lifting and moving instructions associated with the shipping container.
- Open the container and remove all packing materials. Store the shipping container and packing materials in the event the unit needs to be shipped for service.
- Verify that the shipment matches the packing list and your order form.
- Inspect the meter for any signs of shipping damage, scratches, or loose or broken parts.

Note: If the unit was damaged in transit, it is your responsibility to request an inspection report from the carrier within 48 hours. You must then file a claim with the carrier and contact Badger Meter for appropriate repairs or replacement.

- All detectors with polytetrafluoroethylene (PTFE) liners are shipped with a liner protector on each end to maintain proper form of the PTFE material during shipping and storage.

Note: Do not remove the liner protectors until you are ready to install.

- Storage: If the meter is to be stored, place it in its original container in a dry, sheltered location. Storage temperature ranges are: -40°F to 160°F (-40°C to 70°C).

Rigging, Lifting and Moving Large Units

⚠ CAUTION

When rigging, lifting or moving large units, follow these guidelines:

- DO NOT lift or move a meter by its amplifier, junction box or cables.
- Use a crane rigged with soft straps to lift and move meters with flow tubes that are between two inches and eight inches (50 mm and 200 mm). Place the straps around the detector body, between the flanges, on each side of the detector.
- Use the lifting lugs when lifting meter flow tubes that are 10 inches (250 mm) in diameter or larger.

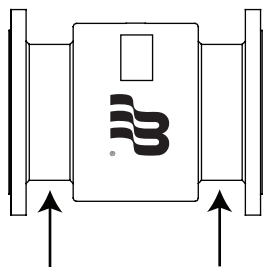

Place straps between flanges.

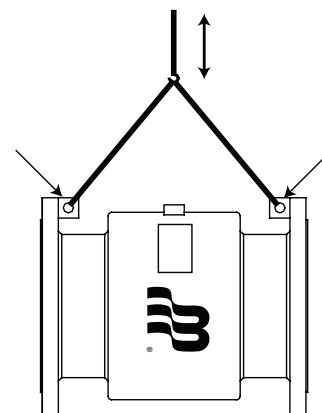

Use lifting lugs with 10-inch or larger meters.

- Use the sling-rigged method to lift large detectors into a vertical position while they are still crated. Use this method to position large detectors vertically into pipelines.

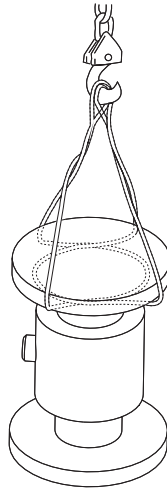

- Do not lift a detector with a forklift by positioning the detector body on the forks, with the flanges extending beyond the lift. This could dent the housing or damage the internal coil assemblies.
- Never place forklift forks, rigging chains, straps, slings, hooks or other lifting devices inside or through the detector's flow tube to hoist the unit. This could damage the isolating liner.

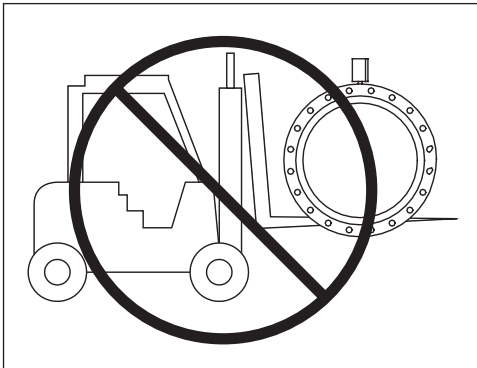

Do not lift detector with forklift.

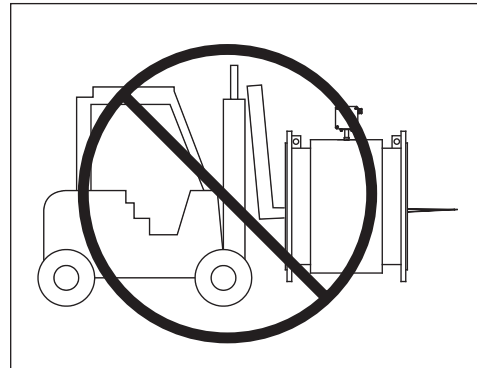

Do not lift or rig lifting devices through detector.

Meter Location, Orientation and Applications

The M-2000 provides two amplifier mounting options: an integral or meter mount option and a junction box/remote option.

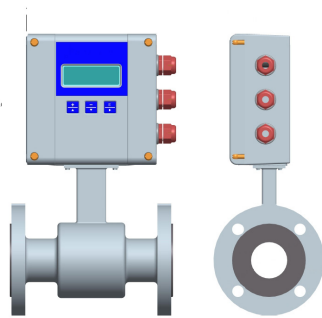

Meter mount amplifier

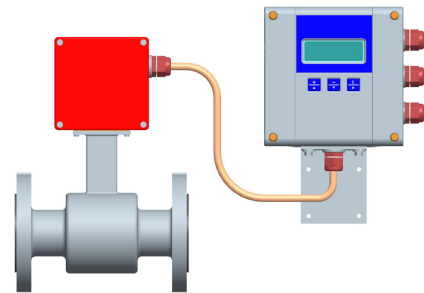

Junction box with remote amplifier

Remote Amplifier Outdoor Location

The amplifier can be installed and operated outdoors. However, it must be protected from the elements, as follows:

- The ambient environment/temperature rating for the unit is -4° F to 140° F (-20° C to 60° C).
- If an indoor location is within 500 feet (152 meters) of the detector, consider increasing the cable length and mounting the amplifier indoors.
- At minimum, fabricate a roof or shield over and/or around the amplifier to protect the LCD display screen from direct sunlight.

Pipelines and Fluid Flow

Take the following precautions during installation:

- Do not install the meter on pipes with extreme pipe vibrations. If pipes are vibrating, secure the piping with appropriate pipe supports in front of and behind the meter. If vibrations can't be restrained, mount the amplifier in a remote location.
- Do not install the detector close to pipeline valves, fittings or impediments that can cause flow disturbances.
- For detectors with PTFE liners, do not install the detector on suction sides of pumps.
- Do not install the detector on outlet sides of piston or diaphragm pumps. Pulsating flow can affect meter performance.
- Avoid installing the detector near equipment that produces electrical interference such as electric motors, transformers, variable frequency, power cables, etc.
- Verify that both ends of the signal cables are securely fastened.
- Place power cables and signal cables in separate conduits.
- Place the meter where there is enough access for installation and maintenance tasks.

Meter Orientation

Mag meters can operate accurately in any pipeline orientation and can measure volumetric flow in forward and reverse directions.

Note: A "Forward Flow" direction arrow is printed on the detector label.

Vertical Placement

Mag meters perform best when placed vertically, with liquid flowing upward and meter electrodes in a closed, full pipe.

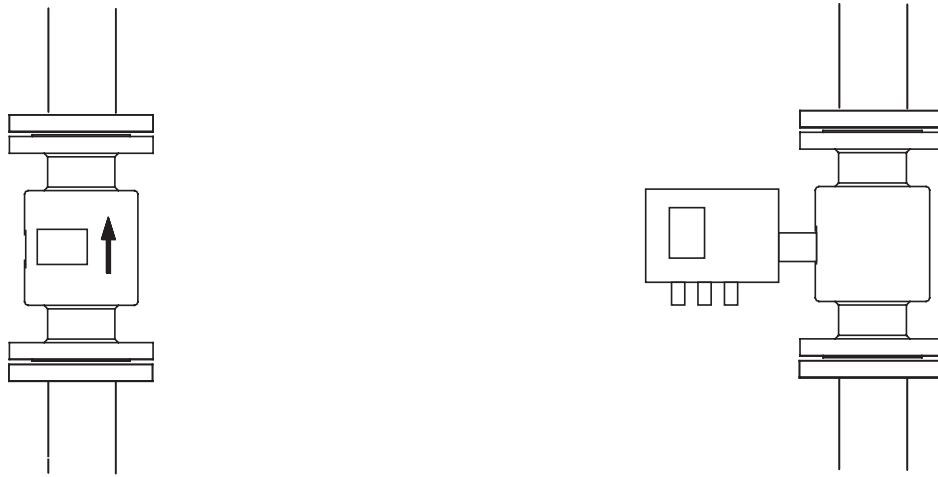

Vertical placement allows the pipe to remain completely full, even in low flow, low pressure applications, and it prevents solids build-up, sediment deposit and accumulation on the liner and electrodes.

Note: Carefully observe the "Forward Flow" label on the meter body and install the meter accordingly. When installed vertically, rotate amplifier so that cable glands are facing down.

Horizontal Placement

M-2000 meters are equipped with an "Empty Pipe Detection" feature. If an electrode mounted in the pipe is not covered by fluid for five seconds, the meter will display an "Empty Pipe Detection" condition. The meter will send out an error message and stop measuring flow. When the electrode is again covered with fluid, the error message disappears and the meter will begin measuring.

When installing the meter on a horizontal pipe, mount the detector to the pipe with the flow-measuring electrode axis in a horizontal plane (three and nine o'clock). This placement helps prevent solids build-up, sediment deposit and accumulation on the electrodes.

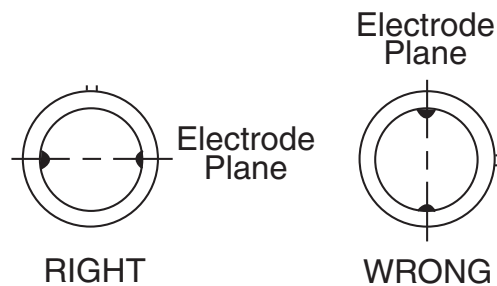

Straight Pipe Requirements

Sufficient straight-pipe runs are required at the detector inlet and outlet for optimum meter accuracy and performance. An equivalent of three diameters of straight pipe is required on the inlet (upstream) side. Two diameters are required on the outlet (downstream) side.

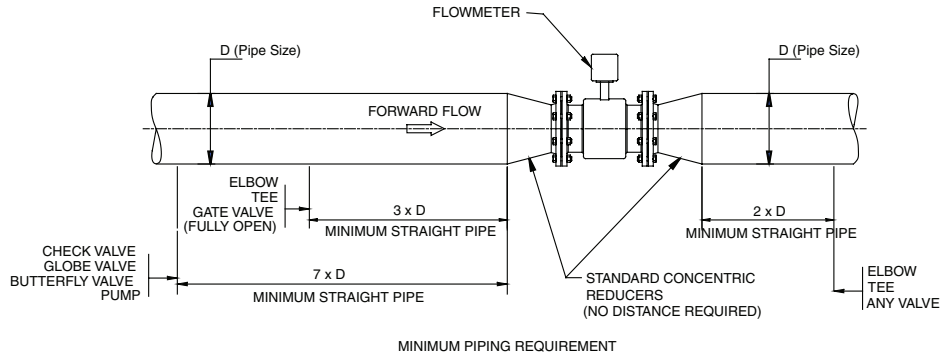

Pipe Reducer Requirements

With pipe reducers, a smaller meter can be mounted in larger pipelines. This arrangement may increase low-flow accuracy.

There are no special requirements for standard, concentric, pipe reducers.

Custom fabricated pipe reducers must have an approximate slope angle of 15 degrees to minimize flow disturbances and excessive loss of head. If this is not possible, install the custom pipe reducers as if they were fittings and install the required amount of straight pipe.

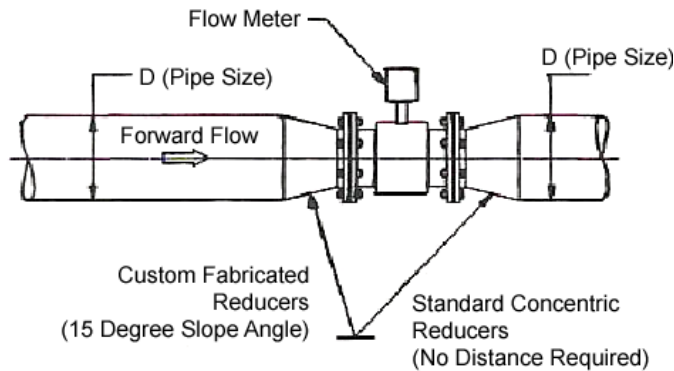

Chemical Injection Applications

For water line applications with a chemical injection point, install the meter upstream of the injection point. This eliminates any meter performance issues.

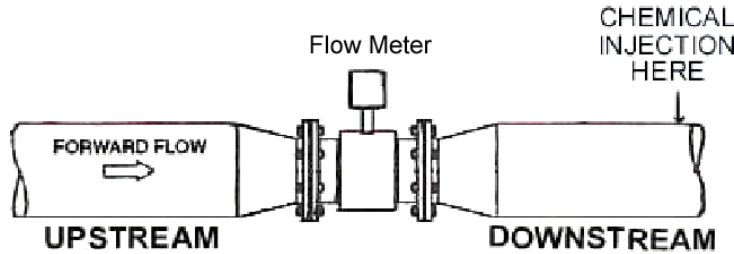

If a meter must be installed downstream of a chemical injection connection, the distance between the meter and the injection point should be between 50 and 100 feet (15 and 30 meters). The distance must be long enough to allow the water/chemical solution to reach the meter in a complete, homogeneous mixture. If the injection point is too close, the meter senses the two different conductivities for each liquid. This will likely result in inaccurate measurements. The injection method – spaced bursts, continuous stream of drips or liquid or gas – can also affect downstream readings by the meter.

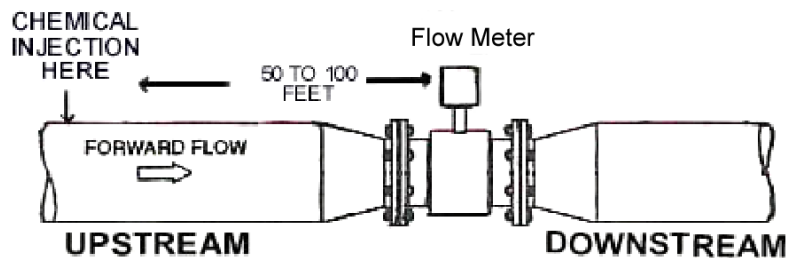

Sometimes, due to circumstances, it's difficult to specify the exact downstream placement distances. Contact Badger Meter Technical Support to review your application if necessary.

Partially-Filled Pipe Situations

In some locations, the process pipe may be momentarily only partially filled. Examples include: lack of back pressure, insufficient line pressure, gravity flow applications, etc.

To eliminate these situations, do not install the meter at the highest point of the pipeline.

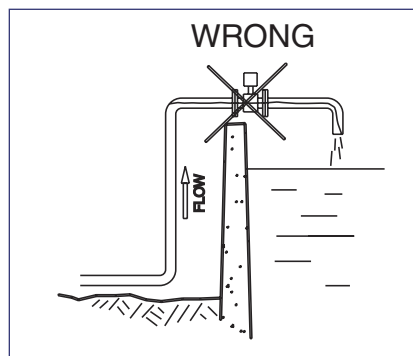

Model M-2000 Mag Meter

Do not install the meter in a vertical, downward flow section of pipe.

Always position the ON/OFF valves on the downstream side of the meter.

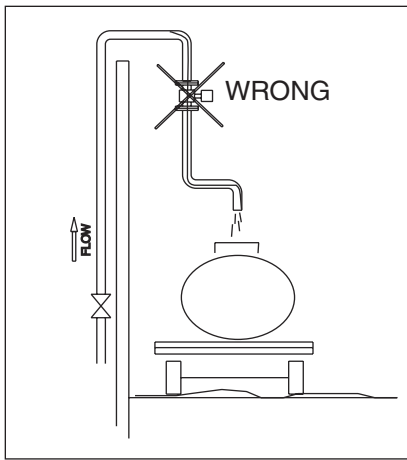

Do not install in a vertical, downward position.

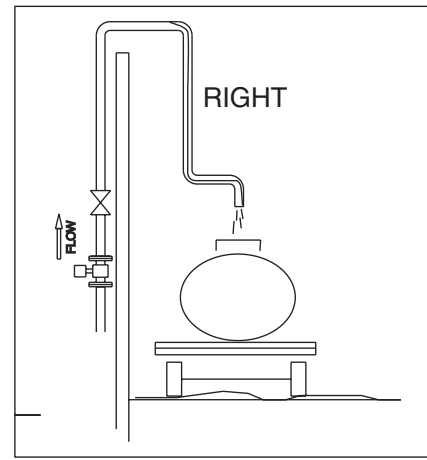

Position "On/Off" valves on downstream side.

To minimize the possibility of partially-full pipe flows in horizontal, gravity or low pressure applications, create a pipe arrangement that ensures the detector remains full of liquid at all times.

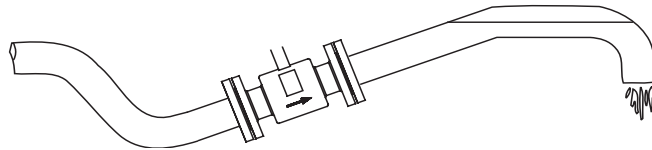
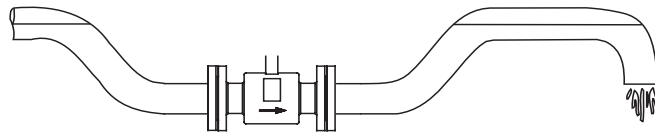

Meter Gaskets and Grounding

Gasket and grounding requirements must be considered when determining the meter location, orientation and application.

Meter/Pipeline Connection Gaskets

You must install gaskets (not provided) between the detector's isolating liner and the pipeline flange to ensure a proper and secure hydraulic seal. Use gaskets that are compatible with the fluid. Center each gasket on the flange to avoid flow restrictions or turbulence in the line.

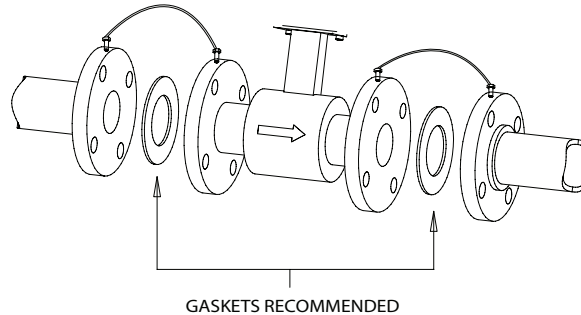

During installation, do not use graphite or any electrically conductive sealing compound to hold the gaskets. This could compromise the accuracy of the measuring signal.

If you are using a grounding ring in the detector/pipeline connection, place the ring between two gaskets. (See *Non-Conductive Pipe Grounding* section, page 14.)

Meter Grounding

Process pipeline material can be either electrically conductive (metal) or not electrically conductive (made of or lined with PVC, fiberglass or concrete).

IMPORTANT

It is essential that the mag meter amplifier's input ground (zero voltage reference) be electrically connected to the liquid media and to a good, solid earth ground reference.

Conductive Pipe Grounding

To achieve an adequate ground, the meter body **MUST** be electrically connected to the liquid media. The mag meter flanges are provided with grounding bolts for this purpose.

If the pipe material is electrically conductive, simply install grounding straps between these grounding bolts and the mating flanges.

To ensure a good electrical connection at the mating flanges, we recommend that you drill and tap the flanges and install a grounding screw (not provided).

These grounding straps must be copper wire, at least 12AWG size. They must be connected on both sides (inlet and outlet) of the detector and to a local, earth ground.

Non-Conductive Pipe Grounding

IMPORTANT

If the process pipe is not electrically conductive (PVC, fiberglass, cement-lined pipes or any other non-conductive material) and the meter was not originally ordered with an optional grounding electrode, you must install a pair of grounding rings between the mating flanges at both ends of the meter. See the following illustration.

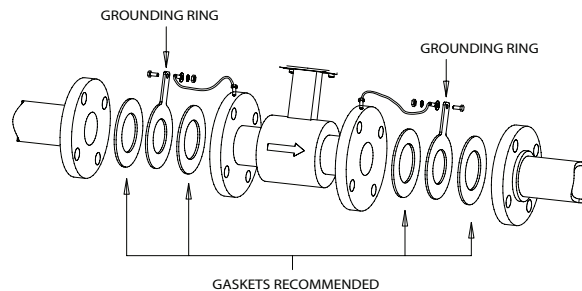

In this case, the grounding straps should be connected to both of the grounding rings and to a good, solid earth ground. Grounding rings are available in stainless steel. If your fluid is too aggressive for stainless steel, order a meter with the optional grounding electrode in a material compatible with the fluid.

Amplifier Mounting Configuration Options

There are two configuration options for mounting the amplifier. There are many options to accommodate a variety of meter-placement and environmental conditions.

Meter Mount Configuration

The meter mount configuration has the amplifier mounted directly on the detector. This compact, self-contained configuration minimizes installation wiring.

Remote Mount Configuration

The remote mount configuration places the amplifier at a location away from the fluid flow and detector. This is necessary in situations where process fluid temperature or the environment exceeds amplifier ratings.

The detector and amplifier are connected by wires, run through conduit, between junction boxes on the detector and the amplifier. The distance between the detector junction box and amplifier junction box can be up to 500 feet (152 meters). A remote mounting bracket is supplied.

Submersible Option

If you are installing the meter in a vault, you should order the remote amplifier option. You must not install the amplifier inside a vault. We also recommend ordering the remote meter package with the submersible option (NEMA 6P). This will eliminate any potential problems resulting from humidity or temporary flooding in the vault.

Note: The National Electronics Manufacturer's Association (NEMA) 6P enclosures are constructed for indoor or outdoor use to provide protection against access to hazardous parts; to provide a degree of protection against ingress of solid foreign objects and water (hose directed water and the entry of water during prolonged submersion at a limited depth); that provide an additional level of protection against corrosion and that will be undamaged by the external formation of ice on the enclosure.

Wiring

Wiring Safety

⚠ WARNING

At installation, be sure to comply with the following requirements:

- Disconnect power to the unit before attempting any connection or service to the unit.
- Do not bundle or route signal lines with power lines.
- Keep all lines as short as possible.
- Use twisted pair shielded wire for all output wiring.
- Observe all applicable, local electrical codes.

Opening the M-2000 Cover

The M-2000 amplifier's design lets you open the cover without completely removing it.

⚠ WARNING

Cover is attached with display ribbon cable.

To open the cover you will need a blade screwdriver.

Follow these steps:

1. Disconnect power to the unit.
2. Completely remove the two screws from either the left or the right side of the amplifier.
3. Loosen each of the remaining screws so that the round head of the screw clears the top edge of the cover.



4. Lift and pivot the cover into the open position.



Power Connections

External Disconnect

⚠ CAUTION

Install an external disconnect switch or circuit breaker that meets local standards.

Position the M-2000 in an accessible location.

Position and identify the disconnect device so as to provide safe and easy operation.

Label the disconnect device as being for the mag meter.

AC Power Wiring

For the AC power connections, use three wire-sheathed cable with an overall cable diameter of 0.2 inch to 0.45 inch (5 mm to 12 mm). For signal output, use 18 to 22 gauge (0.25 mm² to 0.75mm²) shielded wire. Overall cable diameter between 0.12 inch and 0.35 inch (3 mm to 9 mm).

⚠ CAUTION

To prevent accidents, connect main power only after all other wiring has been completed.

The amplifier is a microprocessor device. It is important that the power supply be as “clean” as possible. Avoid using power lines that feed heavy loads: pumps, motors, *etc.* If dedicated lines are not available, a filtering or isolation system may be required.

Power wiring is the same for meter mount and remote mount amplifiers.

Remote Mount Installation

If you are installing the M-2000 amplifier in a remote location, review the procedures in this section.

Mount Bracket to Amplifier

1. Align bracket-mounting holes with amplifier mounting holes.
2. Attach bracket to amplifier with supplied screws. Torque screws to 80 inch pounds.

Wiring Configuration

Wiring between the detector and the M-2000 amplifier comes complete from the factory. If your installation requires the use of conduit, we recommend that you follow these steps when wiring the detector to the amplifier.

1. Remove the junction box lid. Carefully remove the wires connected to the terminal blocks that run to the M-2000 amplifier. See the chart below for a reference of wire color to terminal connection.
2. Run cable through the conduit from the amplifier location while retaining the wiring of the cable to the amplifier, as supplied.
3. Complete conduit assembly on both ends and rewire the cable into the junction box as it was previously wired.

Wiring for Remote Configuration

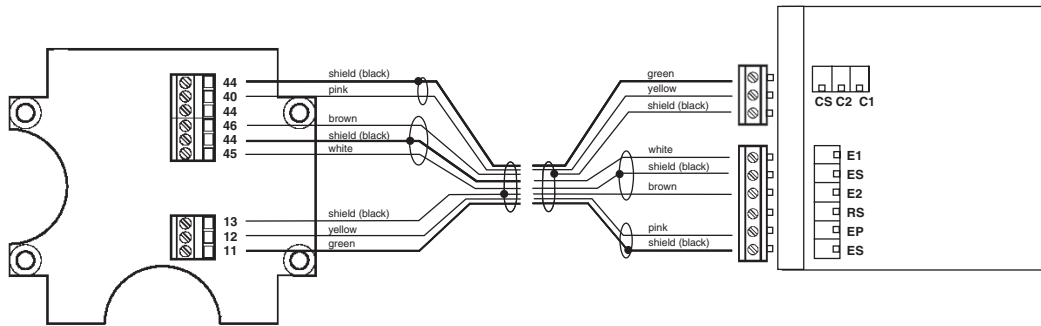

Remote style M-2000 amplifier models can be ordered with standard cables measuring 15, 30, 50 and 100 feet. In addition, cables up to 500 feet are available.

Junction Box			Amplifier
Connection No.	Description	Wire Color	Connection
11	Coil	Green	C1
12	Coil	Yellow	C2
13	Main Shield	Black (Red Ferrul)	CS
45	Electrode	White	E1
44*	Electrode Shield	Black	ES
46	Electrode	Brown	E2
40	Empty Pipe	Pink	EP
44*	Empty Pipe Shield	Black	ES

*Connections with the No. 44 are lying on the same potential.

Empty Pipe Detection Considerations

Take into account the following cable length and conductivity requirements, if you will be using empty pipe detection.

Cable Length (Feet)	Minimum Conductivity Required ($\mu\text{S}/\text{cm}$)
0*	5
100	20
500	100

* Meter Mount

Configuring Input/Output (I/O)

This section describes wiring the following M-2000 inputs/outputs:

- Analog output
- Digital input
- Digital outputs
- Communication

Once the sensor and the amplifier have been wired, wire any inputs and outputs to the M-2000 amplifier.

Do not connect the main power connection until you have made all other wiring connections. Follow all of the safety precautions and local code to prevent electrical shock and damage to the electronic components.

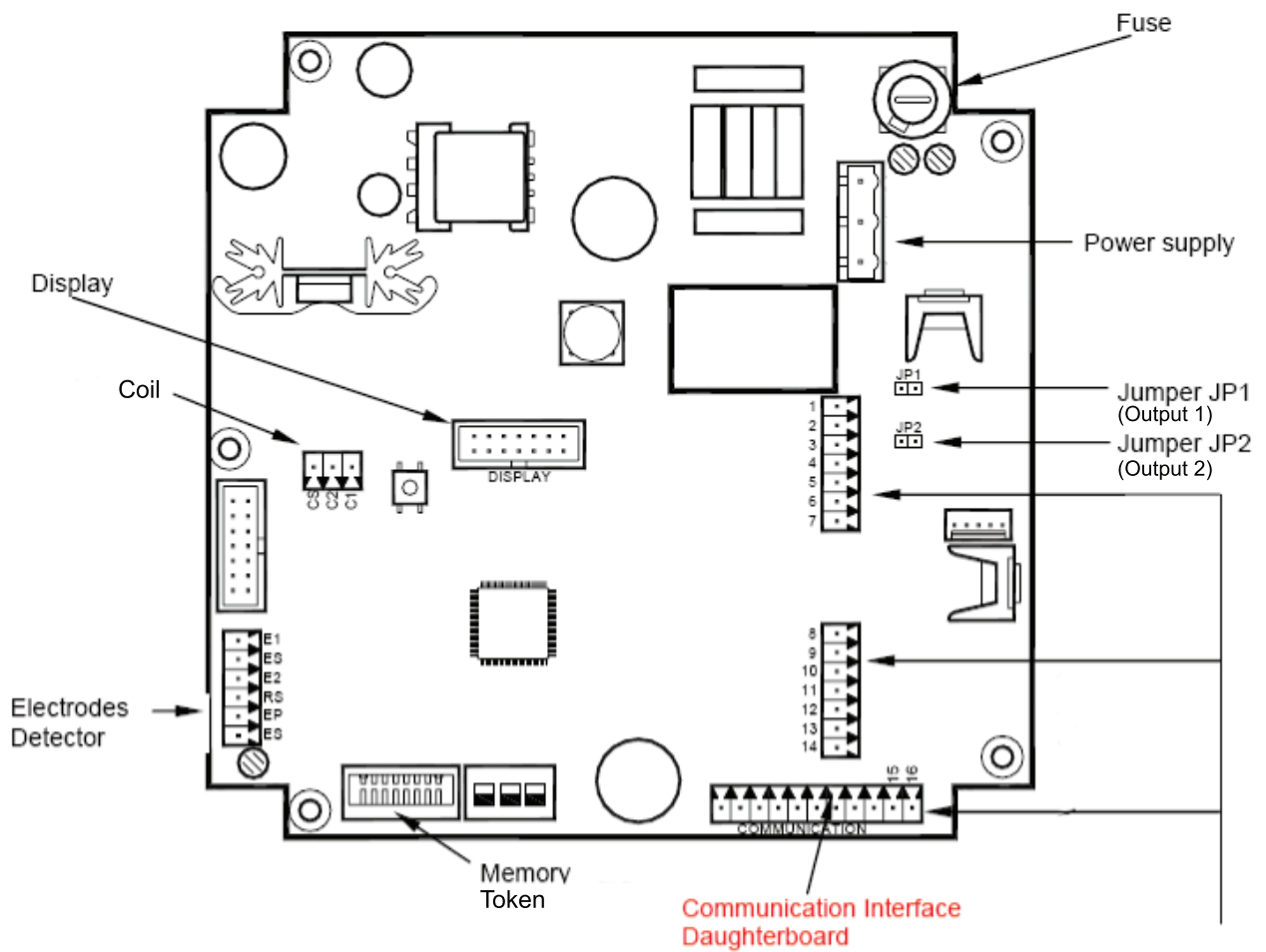

Input/Output	Description	Terminal
Analog Output	0-20 mA Resistive Load < 800 ohms 4-20 mA Resistive Load < 800 ohms 0-10 mA Resistive Load < 800 ohms 2-20 mA Resistive Load < 800 ohms	16 (+) 15 (-)
Digital Output 1	Passive max. 30 VDC, 100 mA Active 24 VDC, 50 mA (set Jumper JP1) Max. Frequency 10 kHz	1 (+) and 2 (-)
Digital Output 2	Passive max. 30 VDC, 100 mA Active 24 VDC, 50 mA (set Jumper JP2) Max. Frequency 10 kHz	3 (+) and 4 (-)
Digital Output 3	Passive Max 30 VDC, 100 mA, 10 kHz Solid State Relay 48 VAC, 500 mA, 1 kHz * Software configurable	10 (+) and 9 (-) 10 (+) and 11 (-)
Digital Output 4	Passive Max 30 VDC, 100 mA, 10 kHz Solid State Relay 48 VAC, 500 mA, 1 kHz * Software configurable	13 (+) and 12 (-) 13 (+) and 14 (-)
Digital Input	5 - 30 VDC	8 (+) and 9 (-)
Communications (Port A)	RS232, configurable, Modbus RTU or RDI.	7 GND 6 Rx 5 Tx

Analog Output Wiring Diagram

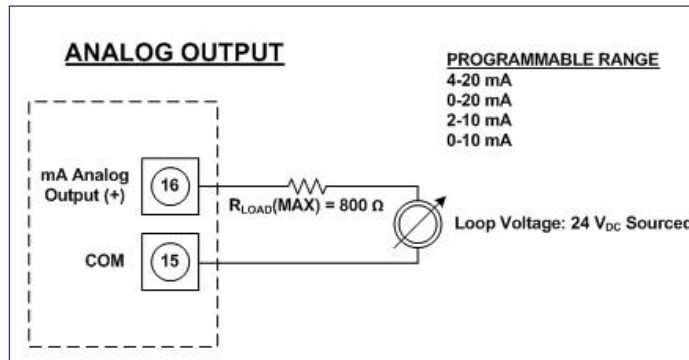

Digital Output Wiring Diagrams

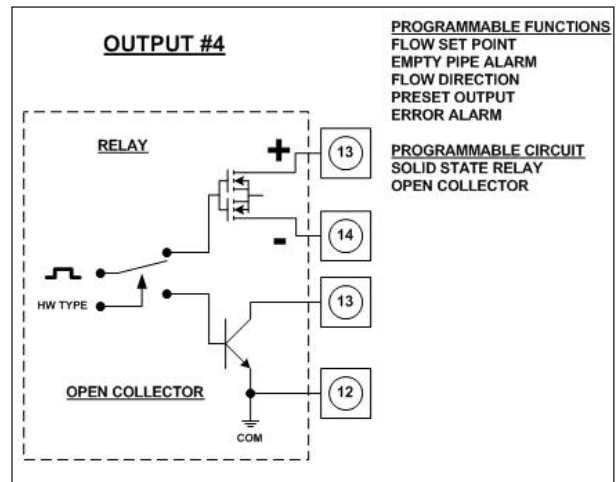
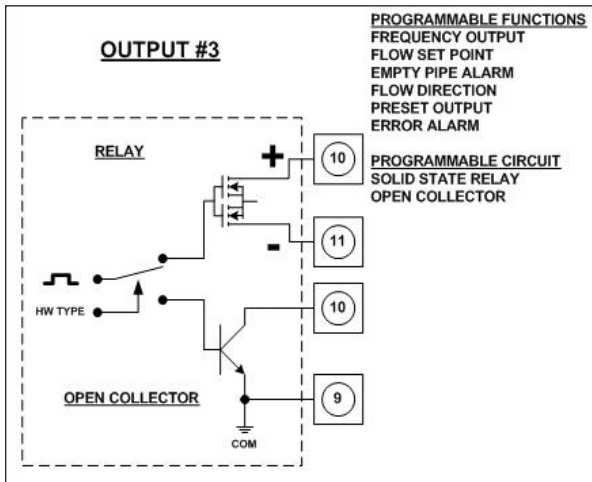
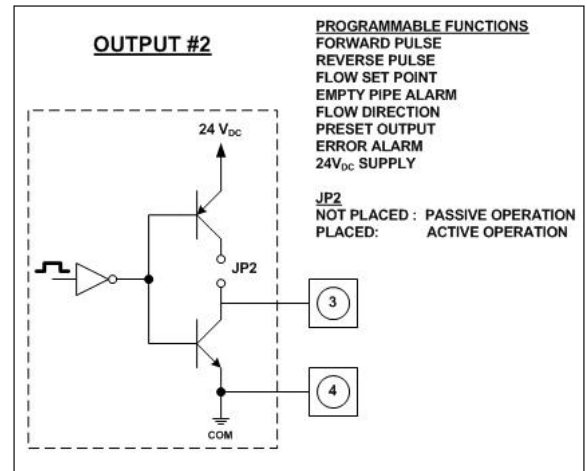
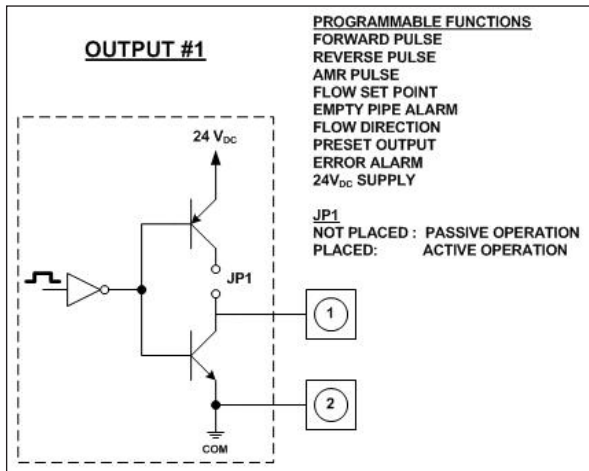

Digital Input Wiring Diagram

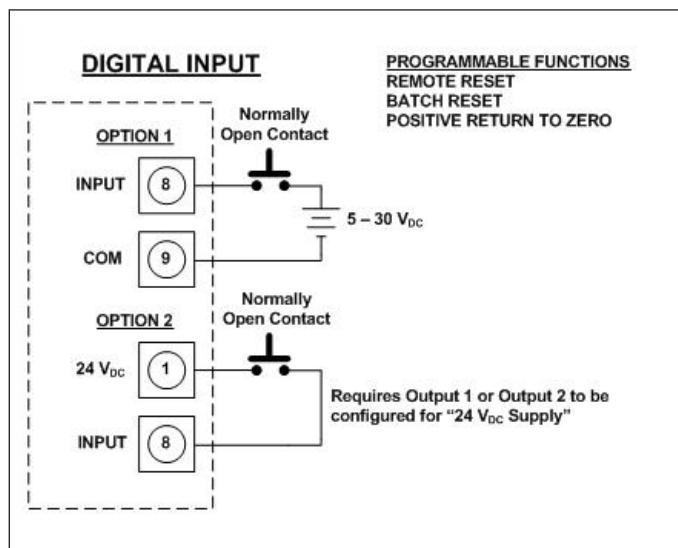

Programming the M-2000

The M-2000 amplifier comes preprogrammed from the factory. Typically, you will not need to do any additional programming. However, to take advantage of special features, you can program the meter for your specific needs. If you will be programming the meter, familiarize yourself with the M-2000 Function Buttons and follow the procedures outlined below.

Displays

There are two types of displays on the M-2000:

- Menu Selection
- Numeric Entry

Menu Selection Display

Menu selection displays will appear in the following format:

```

DISPLAY TITLE
>Menu Selection 1
  Menu Selection 2
DIRECTIONS LINE
    
```

Display format

```

START MENU
>Exit this Menu
  Main Menu
MORE: ↑,↓      ENTER:>
    
```

Example menu

The top line shows the title of of the display screen. Below that are two visible menu selections. The bottom line provides directions for user input.

Typically, a menu contains more options than will fit in the two, menu selection lines. Press the [↑] and [↓] buttons to scroll the display text up and down one line at a time. When the arrow is pointed to your desired menu option, press [E] to select the item and open its display.

Numeric Entry Display

Numeric entry displays will appear in the following format:

```

DISPLAY TITLE
  Description Line
  Numeric Value
DIRECTIONS LINE
    
```

Display format

```

LOW FLOW CUTOFF
% of      300.000 GPM
          2.00%
CHG: +,-      NEXT:E
    
```

Example numeric entry display

The top line shows the title of of the display screen. The second line is a description of the value. The third line shows the current value. The bottom line provides directions for user input.

Note: The bottom line of a numeric-value display provides prompts regarding the function of each button. The [+] or [-] button will change the value of the numeral. The [E] button will move the cursor one digit to the right. When the cursor is at the final, right-most digit, pressing [E] will reposition the cursor at the left-most digit. The bottom line display will change to reflect the new function of the [E] button. Press [E] to save the current entry. Press [+] to edit the current entry.

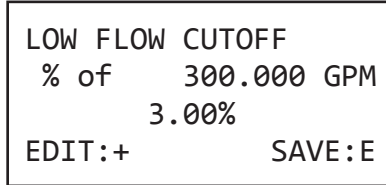

Details on how to change and set numeric values are described in the following section, **Function Buttons**.

Function Buttons

All M-2000 programming is accomplished using the three function buttons located on the front of the amplifier:



Note: Throughout this manual, the buttons will be referred to as: [↑] or [+] and [↓] or [-], depending on the context. The "Enter" button will be referred to as [E].



Consider the [+] [↑] button as the "next step" or "scroll text up" button. During programming, pressing this button will go to the next menu selection, or increment a numeral.

Example 1: The illustration below shows the M-2000 Main Menu. The selection arrow is pointing to the Exit this Menu selection.

To scroll up to the menu's next selection, press [↑] once. The menu text scrolls up to the next menu selection, Main Menu.



Example 2: Some procedures require you to enter a numeric value. The [+] button is used to increment the selected numeral. The illustration below, shows the Low Flow Cutoff parameter display. Notice the cursor under the 2 in the ones' place. In this case, press [+] once to increment the numeral to the value of 3.00%.





Consider the Down Arrow [- | ↓] button as the "previous step" button. During a procedure, pressing this button will go to the menu's previous selection or decrement a numeral.

Example 1: The illustration below shows the M-2000 Main Menu. The selection arrow is pointing to the Meter Setup selection. To scroll the text down to the menu's previous selection, Exit this Menu (which is not visible on the display), press [↓] once.



Example 2: For procedures that require you to enter a numeric value, the [-] button is used to decrement the selected numeral. The illustration below shows the Low Flow Cutoff parameter display. Notice the cursor under the 3 in the ones' place. In this case, press the [-] once to decrement the numeral to the value of 2.00 %.



The [E] button functions as an "Enter" button, or "cursor right" button.

Example 1: The illustration below shows the M-2000 Main Menu. The selection arrow is pointing to the Meter Setup selection. Press [E] to select Meter Setup, and open the Meter Setup display.



In cases where you are entering a numeric value, the [E] button does not function as the "Enter" button, but rather, will move the cursor to the right. When the cursor is at the right-most position, the [E] will now serve as the Enter key.

Example 2: The illustration below shows the Low Flow Cutoff display. The cursor is under the 3 in the ones' place. In this case, press [E] to move the cursor to the right one digit.



Security

The M-2000 security feature gives you the option to restrict access to the meter by way of a five-digit Personal Identification Number (PIN). The system administrator can set up a single PIN for each of the three different levels of access:

- **Administration** - allows access to all M-2000 menu configuration screens.
- **Service** - allows access to service-level and user-level menu configuration screens.
- **User** - allows access only to user-level menu configuration screens.

Not all levels of access need to be set. If no PINs are set up, any M-2000 user will have access to all functions.

Note: The security settings will also apply to remote access. All remote writes to the meter will be blocked unless the user is remotely logged in.

Setting the Administration PIN

Users logged in with the Administration PIN have access to all M-2000 menu configuration screens.

To set the administrator's PIN, follow these steps from the **Advanced Menu**:

1. Select **Security** to view the Security menu.
2. Select **Set Admin PIN** to view the Admin PIN display.
3. Set the five-digit PIN number to the desired value.
4. Press **[E]** to save the PIN and to return to the Security menu.

Setting the Service PIN

Users logged in with the Service PIN have access to service level menu configuration screens. Service users will not have access to administrative screens.

Note: In order to set a service-level PIN, you must first set up an administration PIN.

To set the service PIN, follow these steps from the **Advanced Menu**:

1. Select **Security** to view the Security menu.
2. Select **Set Service PIN** to view the Service PIN display.
3. Set the five-digit PIN number to the desired value.
4. Press **[E]** to save the PIN and to return to the Security menu.

Setting the User PIN

Users logged in with this User PIN have access to user-level procedures. Users will not have access to administrative or service screens.

Note: In order to set a user-level PIN, you must first set up an administration PIN and a service PIN.

To set the user's PIN, follow these steps from the **Advanced Menu**:

1. Select **Security** to view the Security menu.
2. Select **Set User PIN** to view the User PIN display.
3. Set the five-digit PIN number to the desired value.
4. Press **[E]** to save the PIN and to return to the Security menu.

Entering Your Personal Identification Number (PIN)

If your system has been set up with PIN security, you will need to enter a PIN to access programming functions. There are three possible access levels, each with its own unique PIN: User, Service and Administration. Your system administrator will provide you with the appropriate PIN.

Note: All PINs are factory set to 00000. At this setting, you will not be required to enter a PIN. If the system administrator has not set the PIN, pressing [E] from the Start Screen opens the Main Menu.

If you forget or misplace your PIN, call Badger Meter Customer Service to get a master password. When you call, have the security code that appears in the upper right corner of the PIN Request display.

Follow these steps to enter your PIN in the M-2000:

1. At the **Main Menu**, press [E]. The **PIN Request** display opens.

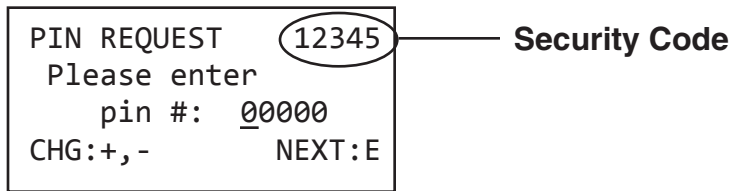

2. Press [+] to increment the numeral.
3. Press [E] to move the cursor to the next digit.
4. Repeat the steps to set each of the five digits to match your PIN.
5. Press [E]. If you entered a valid PIN, the **Main Menu** opens indicating your level of access.

If you entered the wrong PIN, you will see the following display:



- Press [E] to return to the **PIN Request** display.
- Repeat Steps 1 through 5.

Note: Be sure to log off when you have completed work with the M-2000. Otherwise, there will be a five-minute delay between your last activity and the time when the M-2000 will automatically log you off.

Setting Up the M-2000 with Quick Setup

The M-2000 provides you with a Quick Setup utility that allows you to set or change your Flow Units, Totalizer Units, Full Scale Flow and Low Flow Cutoff settings. To open the Quick Setup, select Quick Setup from the Start menu.

Quick Setup																																													
<p>Flow Unit</p> <p>[GPM]</p>	<p>Flow Unit lets you set the unit of measure for the flow rate and full scale flow.</p> <p>To change the Flow Unit value, follow these steps from the Quick Setup menu.</p> <ol style="list-style-type: none"> 1. Select Flow Unit to view the Flow Unit display. 2. Press [\uparrow] or [\downarrow] to position the arrow next to one of the following Flow Units: <table border="1" style="margin-left: 20px;"> <thead> <tr> <th>Code</th> <th>Flow Unit</th> <th>Code</th> <th>Flow Unit</th> </tr> </thead> <tbody> <tr> <td>LPS</td> <td>Liter/Second</td> <td>GPM</td> <td>Gallons/Min.</td> </tr> <tr> <td>LPM</td> <td>Liter/Minute</td> <td>GPH</td> <td>Gallons/Hour</td> </tr> <tr> <td>LPH</td> <td>Liter/Hour</td> <td>MGD</td> <td>MegaGallon/Day</td> </tr> <tr> <td>M3S</td> <td>Cubic Meter/Sec.</td> <td>IGS</td> <td>UKG/Sec.</td> </tr> <tr> <td>M3M</td> <td>Cubic Meter/Min.</td> <td>IGM</td> <td>UKG/Min.</td> </tr> <tr> <td>M3H</td> <td>Cubic Meter/Hour</td> <td>IGH</td> <td>UKG/Hour</td> </tr> <tr> <td>F3S</td> <td>Cubic Feet/Sec.</td> <td>LbM</td> <td>Pound/Min.</td> </tr> <tr> <td>F3M</td> <td>Cubic Feet/Min.</td> <td>OPM</td> <td>Ounce/Min</td> </tr> <tr> <td>F3H</td> <td>Cubic Feet/Hour</td> <td>BPM</td> <td>Barrel/Min</td> </tr> <tr> <td>GPS</td> <td>Gallons/Sec.</td> <td>--</td> <td>--</td> </tr> </tbody> </table> 3. Press [E] to save the Flow Units setting. 	Code	Flow Unit	Code	Flow Unit	LPS	Liter/Second	GPM	Gallons/Min.	LPM	Liter/Minute	GPH	Gallons/Hour	LPH	Liter/Hour	MGD	MegaGallon/Day	M3S	Cubic Meter/Sec.	IGS	UKG/Sec.	M3M	Cubic Meter/Min.	IGM	UKG/Min.	M3H	Cubic Meter/Hour	IGH	UKG/Hour	F3S	Cubic Feet/Sec.	LbM	Pound/Min.	F3M	Cubic Feet/Min.	OPM	Ounce/Min	F3H	Cubic Feet/Hour	BPM	Barrel/Min	GPS	Gallons/Sec.	--	--
Code	Flow Unit	Code	Flow Unit																																										
LPS	Liter/Second	GPM	Gallons/Min.																																										
LPM	Liter/Minute	GPH	Gallons/Hour																																										
LPH	Liter/Hour	MGD	MegaGallon/Day																																										
M3S	Cubic Meter/Sec.	IGS	UKG/Sec.																																										
M3M	Cubic Meter/Min.	IGM	UKG/Min.																																										
M3H	Cubic Meter/Hour	IGH	UKG/Hour																																										
F3S	Cubic Feet/Sec.	LbM	Pound/Min.																																										
F3M	Cubic Feet/Min.	OPM	Ounce/Min																																										
F3H	Cubic Feet/Hour	BPM	Barrel/Min																																										
GPS	Gallons/Sec.	--	--																																										
<p>Totalizer Unit</p> <p>[USG]</p>	<p>This parameter establishes the units of measure for the totalizers.</p> <p>To change the Totalizer Unit value, follow these steps from the Totalizer Unit display.</p> <ol style="list-style-type: none"> 1. Press [\uparrow] or [\downarrow] to position the arrow next to one of the following Totalizer Units: <table border="1" style="margin-left: 20px;"> <thead> <tr> <th>Code</th> <th>Totalizer Unit</th> <th>Code</th> <th>Totalizer Unit</th> </tr> </thead> <tbody> <tr> <td>L</td> <td>Liters</td> <td>UKG</td> <td>Imperial Gallons</td> </tr> <tr> <td>HL</td> <td>HectoLiters</td> <td>Lb</td> <td>Pounds</td> </tr> <tr> <td>M^3</td> <td>Cubic Meters</td> <td>Oz</td> <td>Fluid Ounces</td> </tr> <tr> <td>CFt</td> <td>Cubic Feet</td> <td>Aft</td> <td>Acre Feet</td> </tr> <tr> <td>USG</td> <td>U.S. Gallons</td> <td>BBL</td> <td>Barrel</td> </tr> <tr> <td>MG</td> <td>MegaGallons</td> <td></td> <td></td> </tr> </tbody> </table> 2. Press [E] to save the Totalizer Units setting. 	Code	Totalizer Unit	Code	Totalizer Unit	L	Liters	UKG	Imperial Gallons	HL	HectoLiters	Lb	Pounds	M^3	Cubic Meters	Oz	Fluid Ounces	CFt	Cubic Feet	Aft	Acre Feet	USG	U.S. Gallons	BBL	Barrel	MG	MegaGallons																		
Code	Totalizer Unit	Code	Totalizer Unit																																										
L	Liters	UKG	Imperial Gallons																																										
HL	HectoLiters	Lb	Pounds																																										
M^3	Cubic Meters	Oz	Fluid Ounces																																										
CFt	Cubic Feet	Aft	Acre Feet																																										
USG	U.S. Gallons	BBL	Barrel																																										
MG	MegaGallons																																												

Quick Setup

Full Scale Flow	<p>This parameter sets the maximum flow the system is expected to measure. This parameter has influence on other system parameters. These parameters include:</p> <ul style="list-style-type: none"> • Frequency Output – Full scale frequency is observed at full scale flow • Low Flow Cutoff – Changes to full scale flow affect the measuring cut-off threshold of the meter • Alarm Outputs – Changes to full scale flow adjusts the thresholds for generating set point alarms • Pulse Outputs – Changes to full scale flow adjusts the pulse frequency and duty cycle • Analog Outputs – Changes to full scale flow adjusts the interpretation of the analog output signal <p>Change the full scale flow based on the meter size and the application's requirements. Verify that the full scale flow falls within the meter's suggested flow range limits. In terms of flow velocity, the meter's limits are from 0.1 to 39.4 feet/second.</p> <p>The full scale flow is valid for both flow directions.</p> <p>Note: If the flow rate exceeds the full scale setting, an error message indicates that the configured full scale range has been exceeded. However, the meter will continue to measure. This will affect the latency of the pulse outputs and possibly cause overflow. Furthermore, the analog output may also be placed in alarm mode.</p> <p>To set or change the Full Scale Flow, follow these steps from the Quick Setup menu:</p> <ol style="list-style-type: none"> 1. Select Full Scale Flow to view the Full Scale Flow display. 2. Set the full scale flow value to the desired setting. 3. Press [E] to save the full scale flow value and return to the Measurements menu.
Low Flow Cutoff	<p>Low flow cutoff defines the threshold at which flow measurement will be forced to zero. The cutoff value can be set from 0% to 10% of the full scale flow. Increasing this threshold will help prevent false readings during “no flow” conditions possibly caused by pipe vibration or inherent system noise.</p> <p>To change Low Flow Cutoff, follow these steps from the Low Flow Cutoff display.</p> <ol style="list-style-type: none"> 1. Set the Low Flow Cutoff value to the desired setting, between 0% and 10%. 2. Press [E] to save the value.

Using the M-2000's Main Menu Programming Options

The following M-2000 programming options are available from the Main Menu:

- Meter Setup
- Measurements
- Inputs/Outputs
- Clear Totals
- Communications
- Advanced
- Info/Help
- Language Select

In the section that follows, the applicable security level for each menu option is indicated as follows:



Administrative



Service





User



Options that can be set at Quick Setup are indicated with: 



The factory default values are shown, enclosed in brackets.

Note: Options that are listed [Factory Set] should not be changed without specific directions from authorized Badger Meter personnel.

Meter Setup	
<p>Scale Factor</p> <p>[0.0%]</p> 	<p>Changing the scale factor lets you adjust the meter's accuracy without disturbing factory-set parameters. You can tune the meter to meet changing application requirements. For example, if the meter is under registering by 0.5 percent then set the scale factor to +0.5%. If the meter is over registering by 0.5 percent then set the scale factor to -0.5%.</p> <p>To set the Scale Factor, follow these steps from the Meter Setup menu:</p> <ol style="list-style-type: none"> 1. Select Scale Factor, to open the Detector Factor display. 2. Set the Detector Factor value to the desired setting. 3. Press [E], to save the new value and return to the Meter Setup menu.
<p>Empty Pipe Detect</p> <p>[Off]</p> 	<p>When set to On, Empty Pipe Detect indicates to the outputs and the display that the meter is not completely filled. When set to Off, empty pipe detect is disabled.</p> <p>Enabling empty pipe detect requires a one-time calibration. Calibration is described in the Advance Menu section under Empty Pipe Cal.</p> <p>To set Empty Pipe Detect, follow these steps from the Meter Setup menu:</p> <ol style="list-style-type: none"> 1. Select Empty Pipe Detect to view the Empty Pipe Detect display. 2. Position the arrow next to On or Off. 3. Press [E] to save the Empty Pipe Detect On or Off and return to the Meter Setup menu.

Meter Setup

<p>Power Line Freq</p> <p>[60 Hz]</p> <p></p>	<p>This parameter provides measuring immunity to industrial noise from a power supply feed.</p> <p>To set Power Line Frequency, follow these steps from the Meter Setup menu:</p> <ol style="list-style-type: none"> 1. Select Power Line Freq to view the Power Line Frequency display. 2. Position the arrow next to 50 Hz or 60 Hz. 3. Press [E] to save the power line frequency and return to the Meter Setup menu. 																																				
<p>Excitation Freq</p> <p>[Factory Set]</p> <p></p>	<p>This parameter is set at the factory. You can change Excitation Freq to configure the DC excitation of the coils. Supported frequencies are dependent on the configured power line frequency:</p> <table border="1" style="margin: 10px auto; border-collapse: collapse;"> <thead> <tr> <th style="padding: 5px;">50 Hz</th> <th style="padding: 5px;">60 Hz</th> </tr> </thead> <tbody> <tr> <td style="padding: 5px;">1 Hz</td> <td style="padding: 5px;">1 Hz</td> </tr> <tr> <td style="padding: 5px;">3.125 Hz</td> <td style="padding: 5px;">3.75 Hz</td> </tr> <tr> <td style="padding: 5px;">6.25 Hz</td> <td style="padding: 5px;">7.5 Hz</td> </tr> <tr> <td style="padding: 5px;">12.5 Hz</td> <td style="padding: 5px;">15 Hz</td> </tr> </tbody> </table> <p>To change Excitation Frequency, follow these steps from the Meter Setup menu:</p> <ol style="list-style-type: none"> 1. Select Excitation Freq to view the Excitation Frequency display. 2. Position the arrow next the desired frequency. 3. Press [E] to save the excitation frequency and return to the Meter Setup menu. 	50 Hz	60 Hz	1 Hz	1 Hz	3.125 Hz	3.75 Hz	6.25 Hz	7.5 Hz	12.5 Hz	15 Hz																										
50 Hz	60 Hz																																				
1 Hz	1 Hz																																				
3.125 Hz	3.75 Hz																																				
6.25 Hz	7.5 Hz																																				
12.5 Hz	15 Hz																																				
<p>Pipe Diameter</p> <p>[Factory Set]</p> <p></p>	<p>This parameter is set at the factory. In the event the amplifier is replaced, verify that the pipe diameter matches the installed pipe size.</p> <p>To change Pipe Diameter, follow these steps from the Meter Setup menu:</p> <ol style="list-style-type: none"> 1. Select Pipe Diameter to open the Pipe Diameter display. 2. Position the arrow next to one of the following pipe diameters. <table style="margin: 10px auto; border-collapse: collapse;"> <tr> <td style="padding: 5px;">6mm [1/4"]</td> <td style="padding: 5px;">65mm [2 1/2"]</td> <td style="padding: 5px;">400mm [16"]</td> <td style="padding: 5px;">1000mm [40"]</td> </tr> <tr> <td style="padding: 5px;">8mm [1/4"]</td> <td style="padding: 5px;">80mm [3"]</td> <td style="padding: 5px;">450mm [18"]</td> <td style="padding: 5px;">1050mm [42"]</td> </tr> <tr> <td style="padding: 5px;">10mm [1/4"]</td> <td style="padding: 5px;">100mm [4"]</td> <td style="padding: 5px;">500mm [20"]</td> <td style="padding: 5px;">1200mm [48"]</td> </tr> <tr> <td style="padding: 5px;">15mm [1/4"]</td> <td style="padding: 5px;">125mm [5"]</td> <td style="padding: 5px;">550mm [22"]</td> <td style="padding: 5px;">1400mm [54"]</td> </tr> <tr> <td style="padding: 5px;">20mm [1/4"]</td> <td style="padding: 5px;">150mm [6"]</td> <td style="padding: 5px;">600mm [24"]</td> <td style="padding: 5px;">1600mm [64"]</td> </tr> <tr> <td style="padding: 5px;">25mm [1"]</td> <td style="padding: 5px;">200mm [8"]</td> <td style="padding: 5px;">700mm [28"]</td> <td style="padding: 5px;">1800mm [72"]</td> </tr> <tr> <td style="padding: 5px;">32mm [1 1/4"]</td> <td style="padding: 5px;">250mm [10"]</td> <td style="padding: 5px;">750mm [30"]</td> <td style="padding: 5px;">2000mm [80"]</td> </tr> <tr> <td style="padding: 5px;">40mm [1 1/2"]</td> <td style="padding: 5px;">300mm [14"]</td> <td style="padding: 5px;">800mm [32"]</td> <td style="padding: 5px;">Other</td> </tr> <tr> <td style="padding: 5px;">50mm [2"]</td> <td style="padding: 5px;">350mm [14"]</td> <td style="padding: 5px;">900mm [36"]</td> <td></td> </tr> </table> <ol style="list-style-type: none"> 3. Press [E] to save the pipe diameter and return to the Meter Setup menu. 	6mm [1/4"]	65mm [2 1/2"]	400mm [16"]	1000mm [40"]	8mm [1/4"]	80mm [3"]	450mm [18"]	1050mm [42"]	10mm [1/4"]	100mm [4"]	500mm [20"]	1200mm [48"]	15mm [1/4"]	125mm [5"]	550mm [22"]	1400mm [54"]	20mm [1/4"]	150mm [6"]	600mm [24"]	1600mm [64"]	25mm [1"]	200mm [8"]	700mm [28"]	1800mm [72"]	32mm [1 1/4"]	250mm [10"]	750mm [30"]	2000mm [80"]	40mm [1 1/2"]	300mm [14"]	800mm [32"]	Other	50mm [2"]	350mm [14"]	900mm [36"]	
6mm [1/4"]	65mm [2 1/2"]	400mm [16"]	1000mm [40"]																																		
8mm [1/4"]	80mm [3"]	450mm [18"]	1050mm [42"]																																		
10mm [1/4"]	100mm [4"]	500mm [20"]	1200mm [48"]																																		
15mm [1/4"]	125mm [5"]	550mm [22"]	1400mm [54"]																																		
20mm [1/4"]	150mm [6"]	600mm [24"]	1600mm [64"]																																		
25mm [1"]	200mm [8"]	700mm [28"]	1800mm [72"]																																		
32mm [1 1/4"]	250mm [10"]	750mm [30"]	2000mm [80"]																																		
40mm [1 1/2"]	300mm [14"]	800mm [32"]	Other																																		
50mm [2"]	350mm [14"]	900mm [36"]																																			

Meter Setup	
<p>Detector Factor [Factory Set]</p> 	<p>This parameter is set at the factory. This factor compensates for accuracy error as a result of the installed detector. If accuracy adjustment of the meter is required, please refer to the scale factor.</p> <p>In the event the amplifier is replaced, this parameter must be reprogrammed with the original detector factor.</p>
<p>Detector Offset [Factory Set]</p> 	<p>This parameter is set at the factory. This parameter compensates for accuracy error as a result of the installed detector. If accuracy adjustment of the meter is required, please refer to the scale factor.</p>

Measurements																																													
<p>Flow Units [GPM]</p> 	<p>Flow Units lets you set the unit of measure for the flow rate and full scale flow. Changing the flow units parameter readjusts the full scale flow parameter. For example, changing from GPM to GPS would change the full scale flow from 60 GPM to 1 GPS.</p> <p>To change the Flow Unit, follow these steps from the Measurements menu:</p> <ol style="list-style-type: none"> 1. Select Flow Units to view the Flow Units display. 2. Position the arrow next to one of the following flow unit options: <table border="1" style="width: 100%; border-collapse: collapse; text-align: center;"> <thead> <tr> <th>Code</th> <th>Flow Unit</th> <th>Code</th> <th>Flow Unit</th> </tr> </thead> <tbody> <tr> <td>LPS</td> <td>Liter/Second</td> <td>GPM</td> <td>Gallons/Min.</td> </tr> <tr> <td>LPM</td> <td>Liter/Minute</td> <td>GPH</td> <td>Gallons/Hour</td> </tr> <tr> <td>LPH</td> <td>Liter/Hour</td> <td>MGD</td> <td>MegaGallon/Day</td> </tr> <tr> <td>M3S</td> <td>Cubic Meter/Sec.</td> <td>IGS</td> <td>UKG/Sec.</td> </tr> <tr> <td>M3M</td> <td>Cubic Meter/Min.</td> <td>IGM</td> <td>UKG/Min.</td> </tr> <tr> <td>M3H</td> <td>Cubic Meter/Hour</td> <td>IGH</td> <td>UKG/Hour</td> </tr> <tr> <td>F3S</td> <td>Cubic Feet/Sec.</td> <td>LbM</td> <td>Pound/Min.</td> </tr> <tr> <td>F3M</td> <td>Cubic Feet/Min.</td> <td>OPM</td> <td>Ounce/Min</td> </tr> <tr> <td>F3H</td> <td>Cubic Feet/Hour.</td> <td>BPM</td> <td>Barrel/Min</td> </tr> <tr> <td>GPS</td> <td>Gallons/Sec.</td> <td></td> <td></td> </tr> </tbody> </table> <ol style="list-style-type: none"> 3. Press [E] to save the flow units and return to the Measurements menu. 	Code	Flow Unit	Code	Flow Unit	LPS	Liter/Second	GPM	Gallons/Min.	LPM	Liter/Minute	GPH	Gallons/Hour	LPH	Liter/Hour	MGD	MegaGallon/Day	M3S	Cubic Meter/Sec.	IGS	UKG/Sec.	M3M	Cubic Meter/Min.	IGM	UKG/Min.	M3H	Cubic Meter/Hour	IGH	UKG/Hour	F3S	Cubic Feet/Sec.	LbM	Pound/Min.	F3M	Cubic Feet/Min.	OPM	Ounce/Min	F3H	Cubic Feet/Hour.	BPM	Barrel/Min	GPS	Gallons/Sec.		
Code	Flow Unit	Code	Flow Unit																																										
LPS	Liter/Second	GPM	Gallons/Min.																																										
LPM	Liter/Minute	GPH	Gallons/Hour																																										
LPH	Liter/Hour	MGD	MegaGallon/Day																																										
M3S	Cubic Meter/Sec.	IGS	UKG/Sec.																																										
M3M	Cubic Meter/Min.	IGM	UKG/Min.																																										
M3H	Cubic Meter/Hour	IGH	UKG/Hour																																										
F3S	Cubic Feet/Sec.	LbM	Pound/Min.																																										
F3M	Cubic Feet/Min.	OPM	Ounce/Min																																										
F3H	Cubic Feet/Hour.	BPM	Barrel/Min																																										
GPS	Gallons/Sec.																																												

Measurements

Totalizer Unit

[USG]



This parameter establishes the units of measure for the totalizers.

To change the Totalizer Unit value, follow these steps from the **Measurements menu**:

1. Select **Totalizer Unit** to view the Totalizer Unit display.
2. Position the arrow next to one of the following totalizer units:

Code	Totalizer Unit	Code	Totalizer Unit
L	Liters	UKG	Imperial Gallons
HL	HectoLiters	Lb	Pounds
M^3	Cubic Meters	Oz	Fluid Ounces
CFt	Cubic Feet	Aft	Acre Feet
USG	U.S. Gallons	BBL	Barrel
MG	MegaGallons		

3. Press **[E]** to save the totalizer unit and return to the Measurements menu.

Full Scale Flow

[Factory Set]



This parameter sets the maximum flow the system is expected to measure. This parameter has influence on other system parameters. These parameters include:

- Frequency Output – Full scale frequency is observed at full scale flow
- Low Flow Cutoff – Changes to full scale flow affect the measuring cut-off threshold of the meter
- Alarm Outputs – Changes to full scale flow adjusts the thresholds for generating set point alarms
- Pulse Outputs – Changes to full scale flow adjusts the pulse frequency and duty cycle
- Analog Outputs – Changes to full scale flow adjusts the interpretation of the analog output signal



Change the full scale flow based on the meter size and the application's requirements. Verify that the full scale flow falls within the meter's suggested flow range limits. In terms of flow velocity, the meter's limits are from 0.1 to 39.4 feet/second.



The full scale flow is valid for both flow directions.



Note: If the flow rate exceeds the full scale setting, an error message indicates that the configured full scale range has been exceeded. However, the meter will continue to measure. This will affect the latency of the pulse outputs and possibly cause overflow. Furthermore, the analog output may also be placed in alarm mode.



To change the Full Scale Flow, follow these steps from the **Measurements menu**:



1. Select **Full Scale Flow** to view the Full Scale Flow display.
2. Set the full scale flow value to the desired setting.
3. Press **[E]** to save the full scale flow value and return to the Measurements menu.



Measurements	
<p>Low Flow Cutoff [0.2%]</p> 	<p>Low flow cutoff defines the threshold at which flow measurement will be forced to zero. The cutoff value can be set from 0% to 10% of the full scale flow. Increasing this threshold will help prevent false readings during “no flow” conditions possibly caused by pipe vibration or inherent system noise.</p> <p>To change the Low Flow Cutoff value, follow these steps from the Measurements menu:</p> <ol style="list-style-type: none"> 1. Select Low Flow Cutoff to view the Low Flow Cutoff display. 2. Set the low flow cutoff value to the desired setting. 3. Press [E] to save the new low flow cutoff value.
<p>Flow Direction [Bi-Directional]</p> 	<p>Flow direction lets you set the meter to measure forward flow only (uni-directional) or both forward and reverse flow (bi-directional).</p> <p>Uni-Directional</p> <p>Flow is totalized in only one direction. The flow direction is indicated by the arrow printed on the detector label. Uni-directional measurements on the main display screen include:</p> <ul style="list-style-type: none"> • T1: Registers forward flow, resettable by menu or Modbus RTU • T2: Registers forward flow, resettable by menu, Modbus RTU, or digital input configured for Remote Reset <p>Bi-Directional</p> <p>Flow is totalized in both directions. Bi-directional measurements on the main display screen include:</p> <ul style="list-style-type: none"> • T+: Registers forward flow, resettable by menu or Modbus RTU • T-: Registers reverse flow, resettable by menu or Modbus RTU • TN: Registers total flow, T+ - T-, resettable by menu or Modbus RTU <p>To change the flow direction follow these steps from the Measurements menu:</p> <ol style="list-style-type: none"> 1. Select Flow Direction to view the Flow Direction display. 2. Select Uni-Directional or Bi-Directional. 3. Press [E] to save the flow direction and return to the Measurements menu.
<p>Damping Factor [No Damping]</p> 	<p>The damping factor establishes the stability of the measured flow rate. If back and forth oscillations of the flow rate are observed during normal flow conditions, increase this value incrementally until the flow rate stabilizes. This parameter has no affect on the totalizers.</p> <p>To change the Damping Factor value, follow these steps from the Measurements menu:</p> <ol style="list-style-type: none"> 1. Select Damping Factor to view the Damping Factor display. 2. Select one of the following damping factors: <ul style="list-style-type: none"> 1 Second 10 Seconds 2 Seconds 20 Seconds 3 Seconds 30 Seconds 4 Seconds No Dampening 5 Seconds 3. Press [E] to save the damping factor and return to the Measurements menu.







Inputs/Outputs		
Analog Output	Range [4 to 20 mA] 	This parameter establishes the range of the analog output signal. To change Analog Output range, follow these steps from the Inputs/Outputs menu : <ol style="list-style-type: none"> 1. Select Analog Output to view the Analog Output display. 2. Select one of the following options: <ul style="list-style-type: none"> • 4 to 20 mA • 0 to 20 mA • 2 to 10 mA • 0 to 10 mA 3. Press [E] to save the analog output and return to the Inputs/Outputs menu.
	Alarm Mode [HIGH] 	This parameter configures the behavior of the analog output during alarm conditions. Three options exist for this parameter: OFF, LOW, and HIGH . <p>OFF: Analog signal is based on flow rate and always within the configured range</p> <p>LOW: During alarm conditions, the analog signal will be 2mA less than the configured lower range</p> <p>HIGH: During alarm conditions, the analog signal will be 2mA more than the configured upper range</p> <p>For example, if the analog range is 4 to 20 mA and the alarm mode is set to HIGH, then during a full scale flow alarm condition, the analog output current will be 22 mA.</p> <p>To change the analog output alarm mode, follow these steps from the Inputs/Outputs menu:</p> <ol style="list-style-type: none"> 1. Select Alarm Mode to view the Alarm Mode display. 2. Select one of the following options: <ul style="list-style-type: none"> • OFF • LOW • HIGH 3. Press [E] to save the alarm mode and return to the Inputs/Outputs menu.
Digital Input	Digital input lets you configure the functional operation of the digital input. The following functions are supported: <ul style="list-style-type: none"> • Remote Reset – Clears totalizer T2 (uni-directional) • Batch Reset – Resets batch totalizer PS to preset amount and clears T2 (uni-directional) • Pos Zero Return – Forces flow rate to zero (does not totalize) To change Digital Input, follow these steps from the Inputs/Outputs menu : <ol style="list-style-type: none"> 1. Select Digital Input to view the Digital Input display. 2. Select the desired function. 3. Press [E] to save the digital input and return to the Inputs/Outputs menu. 	

Inputs/Outputs		
Digital Output	<p>Pulses/Unit</p> <p>[1]</p> 	<p>The Pulses/Unit parameter lets you set how many pulses per unit of measure will be transmitted to remote applications. For example, assuming the unit of measure is gallons:</p> <ul style="list-style-type: none"> Setting the Pulses/Unit to 1 will transmit 1 pulse every gallon Setting the Pulses/Unit to 0.01 will transmit 1 pulse every 100 gallons <p>You must configure pulses/unit if the function of the selected output is to be forward, reverse or AMR pulse.</p> <p>This parameter must be considered with the Pulse Width and Full Scale Flow parameters. The maximum pulse frequency is 10 kHz. The frequency is correlated with the flow rate. Violation of output frequency limits will generate a configuration error.</p> <p>To change the pulses/unit, follow these steps from the Inputs/Outputs menu:</p> <ol style="list-style-type: none"> Select Digital Output 1 or 2 and press [E] to open the Digital Output menu. From the Digital Output menu select Pulses/Unit, and press [E] to open the Pulses/Unit display. Enter the pulses/unit value. Press [E] to save the new parameter and return to the Digital Output menu.
	<p>Pulse Width</p> <p>[0 ms]</p> 	<p>This parameter establishes the On duration of the transmitted pulse. The configurable range is from 0 to 1000 ms.</p> <ul style="list-style-type: none"> Non-zero pulse width configuration – the Off duration of the transmitted pulse is dependent on flow rate. The Off duration is to be at least the configured On duration. At full scale flow, the On duration equals the Off duration. The maximum configurable output frequency is limited to 500 Hz. 0 ms pulse width configuration – the duty cycle of the transmitted pulse is at 50 percent allowing for a maximum configurable output frequency of 10 kHz. <p>This parameter must be considered with the Pulses/Unit and Full Scale Flow parameters. The maximum pulse frequency is 10 kHz. The frequency is correlated with the flow rate. Violation of output frequency limits will generate a configuration error.</p> <p>To change the pulse width, follow these steps from the Inputs/Outputs Menu:</p> <ol style="list-style-type: none"> Select Digital Output 1 or 2 and press [E] to open the Digital Output menu. From the Digital Output menu select Pulse Width, and press [E] to open the Pulse Width display. Enter the pulse width value. Press [E] to save the new parameter and return to the Digital Output menu.

Inputs/Outputs		
Digital Output	<p>Preset Amount</p> <p>[0.0]</p> 	<p>Preset amount lets you set the reset value for the associated PS totalizer when the digital input is set to Batch Reset.</p> <p>To change the preset amount, follow these steps from the Inputs/Outputs Menu:</p> <ol style="list-style-type: none"> 1. Select Digital Output 1, 2, 3 or 4 and press [E] to open the Digital Output menu. 2. From the Digital Output menu select Preset Amount, and press [E] to open the Preset Amount display. 3. Enter the preset amount value. Press [E] to save the new parameter and return to the Digital Output menu. <p>Note: You can only set one Preset Amount. If you set the Preset Amount for Digital Output 1, it will be the same for 2, 3 and 4.</p>
	<p>Set Point Min.</p> <p>[0%]</p> 	<p>This parameter establishes, as a percentage of full scale flow, the threshold at which the output alarm will be activated. Flow rates below the threshold will activate the output alarm.</p> <p>To change the set point minimum, follow these steps from the Inputs/Outputs Menu:</p> <ol style="list-style-type: none"> 1. Select Digital Output 1, 2, 3 or 4 and press [E] to open the Digital Output menu. 2. From the Digital Output menu select Set Point Min., and press [E] to open the Set Point Min. display. 3. Enter the set point minimum value. Press [E] to save the new parameter and return to the Digital Output menu.
	<p>Set Point Max.</p> <p>[100%]</p> 	<p>This parameter establishes, as a percentage of full scale flow, the threshold at which the output alarm will be activated. Flow rates above the threshold will activate the output alarm.</p> <p>To change the maximum set point, follow these steps from the Inputs/Outputs Menu:</p> <ol style="list-style-type: none"> 1. Select Digital Output 1, 2, 3 or 4 and press [E] to open the Digital Output menu. 2. From the Digital Output menu select Set Point Max., and press [E] to open the Set Point Max. display. 3. Enter the set point maximum value and press [E] to save the new parameter and return to the Digital Output menu.





Inputs/Outputs		
Digital Output	<p>Output Type</p> <p>[1: Normally Open]</p> <p>[2: Normally Open]</p> <p>[3: Normally Open]</p> <p>[4: Normally Closed]</p> <p></p>	<p>The Output Type parameter lets you set the output switch to normally open or normally closed. If normally open is selected, the output switch is open (no current) when the output is inactive, and closed (current flows) when the output is active.</p> <p>If normally closed is selected, the output switch is closed (current flows) when the output is inactive, and open (no current) when the output is active.</p> <p>To change the Output Type, follow these steps from the Inputs/Outputs Main Menu:</p> <ol style="list-style-type: none"> 1. Select Digital Output 1, 2, 3 or 4 and press [E] to open the Digital Output menu. 2. From the Digital Output menu, select Output Type, and press [E] to open the Output Type display. 3. Select Normally Open or Normally Closed. 4. Press [E] to save the new parameter and return to the Digital Output menu.
	<p>Hardware Type</p> <p>[3: Open Collector]</p> <p>[4: Open Collector]</p> <p></p>	<p>The hardware type parameter lets you select the type of hardware used to drive the output signal: either open collector or solid-state relay.</p> <p>To change the Hardware Type, follow these steps from the Inputs/Outputs Main Menu:</p> <ol style="list-style-type: none"> 1. Select Digital Output 3 or 4 and press [E] to open the Digital Output menu. 2. From the Digital Output menu select Hardware Type, and press [E] to open the Hardware Type display. 3. Select Open Collector or Relay. 4. Press [E] to save the new parameter and return to the Digital Output menu.
	<p>Full Scale Frequency</p> <p>[3: 1000 Hz]</p> <p></p>	<p>This parameter establishes the full scale flow output frequency when the flow rate equals the configured full scale flow.</p> <p>To change the Full Scale Frequency, follow these steps from the Inputs/Outputs Main Menu:</p> <ol style="list-style-type: none"> 1. Select Digital Output 3 and press [E] to open the Digital Output menu. 2. From the Digital Output menu select Full Scale Frequency, and press [E] to open the Full Scale Frequency display. 3. Set the full scale frequency value to the desired setting. 4. Press [E] to save the new parameter and return to the Digital Output menu.

Inputs/Outputs		
<p>Digital Output</p>	<p>Select Function</p> <p>[1: Forward Pulse]</p> <p>[2: Reverse Pulse]</p> <p>[3: Frequency Pulse]</p> <p>[4: Error Alarm]</p> <p> S</p>	<p>Digital Output lets you configure the functional operation of the associated output. The following operations are supported:</p> <ul style="list-style-type: none"> • Reverse Pulse – Generates pulses during reverse flow conditions • Forward Pulse – Generates pulses during forward flow conditions • Frequency Output – Generates pulses correlated to the absolute value of the flow rate • Preset Output – Provides indication when preset batch amount has been realized • Flow Set Point – Provides indication when flow rate exceeds thresholds defined by flow set points • 24 Vdc Supply – Provides constant 24 volts on output (forces output type to normally open) • Error Alarm – Provides indication when meter has error condition. Error conditions include, empty pipe error, full scale flow error, and detector error • Flow Direction – Provides indication on current flow direction (Inactive = Reverse or No Flow, Active = Forward) • Empty Pipe Alarm – Provides indication when pipe is empty <p>To change the Function Select, follow these steps from the Inputs/Outputs Main Menu:</p> <ol style="list-style-type: none"> 1. Select Digital Output 1, 2, 3 or 4 and press [E] to open the Digital Output menu. 2. From the Digital Output menu choose Select Function, and press [E] to open the Select Function display. 3. Select the desired function. 4. Press [E] to save and return to the Digital Output menu.
<p>Flow Simulation</p> <p>[Off]</p> <p> S</p>	<p>Flow Simulation provides output simulation based on a percentage of the full scale flow. Simulation will not accumulate the totalizers. The range of simulation includes -100% to 100% of the full scale flow.</p> <p>The Flow Simulation Parameter lets you set the range of simulation in 10% increments.</p> <p>To change the Flow Simulation, follow these steps from the Inputs/Outputs menu:</p> <ol style="list-style-type: none"> 1. Select Flow Simulation to view the Flow Simulation display. 2. Click [+] to increment the percentage by 10, or click [-] to decrement the percentage by 10. 3. Press [E] to save the displayed setting and return to the Inputs/Outputs menu. 	

Clear Totals	
T1 	The uni-directional totalizer is reset within the the menu manager or through remote communications. Clearing T1 also clears the associated rollover counter.
T2 	The uni-directional totalizer is reset within the the menu manager, through remote communications or with properly-configured digital input (function = remote reset). Clearing T2 also clears the associated rollover counter.
T+ 	The bi-directional forward flow totalizer is reset within the the menu manager or through remote communications. Clearing T+ also clears the associated rollover counter.
T- 	The bi-directional reverse flow totalizer is reset within the the menu manager or through remote communications. Clearing T- also clears the associated rollover counter.
Tn 	The bi-directional net totalizer, when reset, clears both the forward and the reverse flow totalizers (T+ and T-). This is reset within the the menu manager or through remote communications. Clearing Tn also clears the associated rollover counter.
PS 	The batch totalizer is reset to the configured preset amount value. It is reset within the menu manager, remote communications or through a properly-configured digital input (function = batch reset).
Tpwoff 	The totalizer accumulating meter time without external power is reset with the menu manager or through remote communications.

Communication: Port Settings	
Interface [Modbus RTU] 	<p>The Interface parameter lets you configure how the RS232 communication port will be used.</p> <ul style="list-style-type: none"> • Modbus RTU • Remote menu (RDI - Remote Display Interface) • Disable port <p>The remote menu interface will check for display updates once a second. If a change is detected, the display contents will be transmitted in ASCII format over the RS232 communication port. The remote menu interface also allows for menu navigation and control of the meter as if using the external push buttons. Keyboard control characters such as <UP>, <DWN>, and <ENTER> are supported to navigate the menus.</p> <p>To change the Interface follow these steps from the Port A Settings menu:</p> <ol style="list-style-type: none"> 1. Select Interface to view the Interface display. 2. Select the desired interface. 3. Press [E] to save and return to the Port A Settings menu.

Communication: Port Settings

<p>Port Address</p> <p>[1]</p> 	<p>This parameter establishes the Modbus RTU address. Modbus RTU requests will only be processed if the configured port address of the meter matches the request address found in the Modbus RTU packet. The range of addresses supported by Modbus RTU is 1-247. Modbus RTU request packets with an address of 0 imply the packet is to be treated as a broadcast packet.</p> <p>To change the port address, follow these steps from the Port A Settings menu:</p> <ol style="list-style-type: none"> 1. Select Port Address to view the port address display. 2. Select the desired port address (1-247). 3. Press [E] to save the option and to return to the Port A Settings menu.
<p>Baud Rate</p> <p>[9600]</p> 	<p>The following baud rates are supported</p> <ul style="list-style-type: none"> • 9600 • 19200 • 38400 <p>To change the baud rate, follow these steps from the Port A Settings menu:</p> <ol style="list-style-type: none"> 1. Select Baud Rate to view the Baud Rate display. 2. Select one of the following baud rates: 9600, 19200 or 38400. 3. Press [E] to save the option and to return to the Port A Settings menu.
<p>Parity</p> <p>[Even]</p> 	<p>The following parities are supported</p> <ul style="list-style-type: none"> • Even • Odd • None <p>To change the parity, follow these steps from the Port A Settings menu:</p> <ol style="list-style-type: none"> 1. Select Parity to view the Parity display. 2. Select one of the following: None, Even or Odd. 3. Press [E] to save the option and to return to the Port A Settings menu.
<p>Data Bits</p> <p>[8 bits]</p> 	<p>This parameter configures the port data bits. The following data bits are supported</p> <ul style="list-style-type: none"> • 8 bits • 7 bits • 5 bits <p>To change the data bits, follow these steps from the Port A Settings menu:</p> <ol style="list-style-type: none"> 1. Select Data Bits to view the Data Bits display. 2. Select one of the following: 8 Bits, 7 Bits or 5 Bits. 3. Press [E] to save the option and to return to the Port A Settings menu.

Communication: Port Settings

<p>Stop Bits</p> <p>[1 Stop Bit]</p> 	<p>This parameter configures the port stop bits. The following stop bits are supported:</p> <ul style="list-style-type: none"> • 1 Stop Bit • 2 Stop Bits <p>To change the stop bits, follow these steps from the Port A Settings menu:</p> <ol style="list-style-type: none"> 1. Select Stop Bits to view the Stop Bits display. 2. Select one of the following: 1 Stop Bit, or 2 Stop Bits. 3. Press [E] to save the option and to return to the Port A Settings menu.
---	--

Communication: Diagnostics

<p>Port Counters</p> <p>[0]</p> 	<p>Port counters are used for diagnostics when configured for Modbus RTU. These counters are only cleared on power up.</p> <table border="1" style="width: 100%;"> <thead> <tr> <th>Counter</th> <th>Description</th> </tr> </thead> <tbody> <tr> <td>Pkts Processed</td> <td>Number of packets processed by meter.</td> </tr> <tr> <td>Broadcast Pkts</td> <td>Number of broadcast packets (address = 0) processed by meter.</td> </tr> <tr> <td>CRC Errors</td> <td>Number of received packets with CRC error; packet is discarded.</td> </tr> <tr> <td>Pkts Rcvd</td> <td>Number of packets received with an address of the configured port address.</td> </tr> <tr> <td>Pkts Sent</td> <td>Number of packets transmitted in response to a received packet.</td> </tr> <tr> <td>Parity Errors</td> <td>Number of characters with parity errors (<i>i.e.</i>, received character has a mismatch between the number of 1s and its parity bit); packet is discarded.</td> </tr> <tr> <td>Framing Errors</td> <td>Number of characters with framing errors (<i>i.e.</i> missing stop bit is not found – indicates that synchronization with the start bit has been lost and that the character is improperly framed); packet is discarded.</td> </tr> <tr> <td>Overrun Errors</td> <td>Number of characters received that were not processed due to degradation of system performance.</td> </tr> <tr> <td>Break Detects</td> <td>Number of detections that transmission line is locked (<i>i.e.</i>, receive line is low for 10-bit transmissions following a missing stop bit).</td> </tr> </tbody> </table>	Counter	Description	Pkts Processed	Number of packets processed by meter.	Broadcast Pkts	Number of broadcast packets (address = 0) processed by meter.	CRC Errors	Number of received packets with CRC error; packet is discarded.	Pkts Rcvd	Number of packets received with an address of the configured port address.	Pkts Sent	Number of packets transmitted in response to a received packet.	Parity Errors	Number of characters with parity errors (<i>i.e.</i> , received character has a mismatch between the number of 1s and its parity bit); packet is discarded.	Framing Errors	Number of characters with framing errors (<i>i.e.</i> missing stop bit is not found – indicates that synchronization with the start bit has been lost and that the character is improperly framed); packet is discarded.	Overrun Errors	Number of characters received that were not processed due to degradation of system performance.	Break Detects	Number of detections that transmission line is locked (<i>i.e.</i> , receive line is low for 10-bit transmissions following a missing stop bit).
Counter	Description																				
Pkts Processed	Number of packets processed by meter.																				
Broadcast Pkts	Number of broadcast packets (address = 0) processed by meter.																				
CRC Errors	Number of received packets with CRC error; packet is discarded.																				
Pkts Rcvd	Number of packets received with an address of the configured port address.																				
Pkts Sent	Number of packets transmitted in response to a received packet.																				
Parity Errors	Number of characters with parity errors (<i>i.e.</i> , received character has a mismatch between the number of 1s and its parity bit); packet is discarded.																				
Framing Errors	Number of characters with framing errors (<i>i.e.</i> missing stop bit is not found – indicates that synchronization with the start bit has been lost and that the character is improperly framed); packet is discarded.																				
Overrun Errors	Number of characters received that were not processed due to degradation of system performance.																				
Break Detects	Number of detections that transmission line is locked (<i>i.e.</i> , receive line is low for 10-bit transmissions following a missing stop bit).																				

Advanced

Unit Multiplier

[Off]



This Unit Multiplier establishes the number of units of measure that have to accumulate before the display totalizers are updated. This is also known as setting the number of “dead” zeroes in the display totalizer. For example:

Unit Multiplier less than 1					
Unit Multiplier	Example				
OFF	0.00000 USG	0.00012 USG	0.00123 USG	0.01234 USG	0.12345 USG
0.0001	0.0000 USG	0.0001 USG	0.0012 USG	0.0123 USG	0.1234 USG
0.001	0.000 USG	0.000 USG	0.001 USG	0.012 USG	0.123 USG
0.01	0.00 USG	0.00 USG	0.00 USG	0.01 USG	0.12 USG
0.1	0.0 USG	0.0 USG	0.0 USG	0.0 USG	0.1 USG

Unit Multiplier greater than or equal to 1					
Unit Multiplier	Example				
OFF	0.00000 USG	1.23456 USG	12.34567 USG	123.4567 USG	1234.456 USG
1	0 USG	1 USG	12 USG	123 USG	1234 USG
10	0 USG	0 USG	10 USG	120 USG	1230 USG
100	0 USG	0 USG	0 USG	100 USG	1200 USG
1000	0 USG	0 USG	0 USG	0 USG	1000 USG

To change the Unit Multiplier, follow these steps from the **Advanced menu**:

1. Select **Unit Multiplier** to view the Unit Multiplier display.
2. Select the desired unit multiplier.
3. Press **[E]** to save the option and to return to the Advanced menu.

Backlight Control

[Timed Off]







You can set the meter's backlight to: Always On, Always Off and Timed Off.



When set to Timed Off, the backlight will automatically turn off after one minute of inactivity (no buttons pressed). Pressing any button will turn the backlight on, but will not immediately navigate the menu.

To change the backlight control, follow these steps from the **Advanced menu**:

1. Select **Backlight Control** to view the Backlight Control display.
2. Select the desired option.
3. Press **[E]** to save the option and to return to the Advanced menu.

Advanced		
Analog Calibrate	<p>Custom Settings</p> <p>[Zero Scale: 0 mA]</p> <p>[Full Scale: 0 mA]</p> <p></p>	<p>Scale/Full Scale offsets on site.</p> <p>To set the analog calibration custom settings, follow these steps from the Advanced menu:</p> <ol style="list-style-type: none"> 1. Select Analog Calibrate to view the Analog Calibrate menu. 2. Select Custom Settings to view the Custom Settings display. 3. Select one of the following: <ul style="list-style-type: none"> • Offset 4 mA • Offset 20 mA 4. Configure desired offset. 5. Press [E] to save the option and to return to the Custom Settings menu. 6. Press [E] to return to the Analog Calibrate menu.
	<p>Factory Settings</p> <p>[Factory Set]</p> <p></p>	<p>To change the analog calibration factory settings, follow these steps from the Advanced menu:</p> <ol style="list-style-type: none"> 1. Select Analog Calibrate to view the Analog Calibrate menu. 2. Select Factory Settings to view the Factory Settings display. 3. Select one of the following: <ul style="list-style-type: none"> • Calibration Point A • Calibration Point B 4. Set the calibration point to the measured output current. 5. Press [E] to save the option and to return to the Custom Settings menu. 6. Press [E] to return to the Analog Calibrate menu.

Advanced		
Software Filter	Description	The software filter operates as an acceleration filter. This filter when configured properly allows for filtering of fast changes in fluid flow. Generally, this filter is used in applications having highly conductive fluids. This filter is intended to help provide smoothing of the analog output and display fluctuations.
	Activation [Off] 	This parameter setting enables or disables the software acceleration filter. To change the Activation setting, follow these steps from the Advanced menu : <ol style="list-style-type: none"> 1. Select Activation from the Advanced menu. 2. Select the desired setting. 3. Press [E] to save the option and to return to the Advanced menu.
	Filter Delay [1] 	Filter Delay lets you set the amount of time that the flow will be held constant once the filter is activated. The filter is activated by an acceleration component of the fluid exceeding the configured limit. To change the Filter Delay follow these steps from the Advanced menu : <ol style="list-style-type: none"> 1. Select Filter Delay, from the Advanced menu. 2. Select the desired setting. 3. Press [E] to save the option and to return to the Advanced menu.
	Acceleration Factor [1] 	This parameter lets you set the maximum acceleration for a given pipe diameter and is dependent on the excitation frequency. The maximum fluid velocity is 12 m/s. The following equation defines the maximum fluid acceleration: $\text{Acceleration(MAX)} = \text{Acceleration Factor} * 12 \text{ m/s} * \text{Pipe Area} * \text{Excitation Frequency} / 1.5.$ If the realized fluid acceleration exceeds the configured maximum acceleration, fluid flow will be held constant for the time set at the Filter Delay parameter. To change the Acceleration Factor setting, follow these steps from the Advanced menu : <ol style="list-style-type: none"> 1. Select Acceleration Factor from the Advanced menu. 2. Select the desired setting. 3. Press [E] to save the option and to return to the Advanced menu.

Advanced		
Software Filter	<p>Constant Flow</p> <p>[150 M³/Sec²]</p> 	<p>During normal flow conditions, there is always a non-zero acceleration component.</p> <p>For example, if acceleration of the flow activates the filter, the meter will assume constant flow for the duration of the filter delay time unless the flow returns within limits.</p> <p>Properly configured, this parameter will help offset excessive impacts of the filter delay. The Constant Flow parameter lets you set the acceleration limit for constant flow.</p> <p>To change the Constant Flow setting, follow these steps from the Advanced menu:</p> <ol style="list-style-type: none"> 1. Select Constant Flow from the Advanced menu. 2. Select the desired setting. 3. Press [E] to save the option and to return to the Advanced menu.
	<p>Peak Detect</p> <p>[0 M³/Sec²]</p> 	<p>Peak Detect offers a diagnostic view of the acceleration components observed during flow conditions. This parameter records the “high water mark” of the measured accelerations component. This value will help to properly configure the Acceleration Factor parameter. Generally, you will set the acceleration factor at about 75% of the Peak Detect measurement.</p> <p>To reset the Peak Detect setting, follow these steps from the Advanced menu:</p> <ol style="list-style-type: none"> 1. Select Peak Detect from the Advanced menu. 2. Press [+] to reset. 3. Press [E] to return to the Advanced menu.

Advanced

Empty Pipe Cal.

[Default]



Fluid conductivity impacts the performance of empty pipe measurements. If you require empty pipe detection, you should perform this empty pipe calibration procedure.

Before starting the empty pipe calibration, verify that empty pipe detection is enabled. Also, run both the empty pipe and the full pipe calibration procedures.

Calibrating an Empty Pipe

Before calibrating an empty pipe, verify that the pipe is empty.

To calibrate with an empty pipe, follow these steps from the **Advanced menu**:

1. Select **Empty Pipe Cal** to view the calibration menus.
2. Select **Cal. Empty Pipe** to view the empty pipe calibration menu.
3. Enable calibration by placing the cursor on the calibration enable line and press **[E]**.

```
EMPTY PIPE CALIBRATE
Volts = 3.00
>Cal [ON]      E=OFF
Exit with Save
```

4. Wait 30 seconds for voltage measurement to stabilize.
5. Save setting by placing the cursor on Exit With Save menu line and press **[E]**.

Calibrating a Full Pipe



Before calibrating a full pipe, verify that the pipe is full.

To calibrate with a full pipe, follow these steps from the **Advanced menu**:





1. Select **Cal. Full Pipe** to view the calibration menus.
2. Select **Cal. Full Pipe** to view the full pipe calibration menu.
3. Enable calibration by placing the cursor on the calibration enable line and press **[E]**.



```
FULL PIPE CALIBRATE
Volts = 1.515
>Cal [OFF]     E=ON
Exit with Save
```

4. Wait 30 seconds for voltage measurement to stabilize.
5. Save setting by placing the cursor on Exit With Save menu line and press **[E]**.

Advanced		
Security	<p>Set Admin PIN</p> <p>[00000]</p> 	<p>Users logged in with this PIN will have access to all M-2000 procedures.</p> <p>To set the administrator's PIN, follow these steps from the Advanced Menu:</p> <ol style="list-style-type: none"> 1. Select Security to view the Security menu. 2. Select Set Admin PIN to view the Admin PIN display. 3. Set the five-digit PIN number to the desired value. 4. Press [E] to save the PIN and to return to the Security menu.
	<p>Set Service PIN</p> <p>[00000]</p> 	<p>Users logged in with this PIN will have access to all service level and user-level procedures. Service users will not have access to administrative procedures.</p> <p>To set the service PIN, follow these steps from the Advanced Menu:</p> <ol style="list-style-type: none"> 1. Select Security to view the Security menu. 2. Select Set Service PIN to view the Service PIN display. 3. Set the five-digit PIN number to the desired value. 4. Press [E] to save the PIN and to return to the Security menu.
	<p>Set User PIN</p> <p>[00000]</p> 	<p>Users logged in with this PIN will have access to user-level procedures. User at this level will not have access to administrative or service procedures.</p> <p>To set the user's PIN, follow these steps from the Advanced Menu:</p> <ol style="list-style-type: none"> 1. Select Security to view the Security menu. 2. Select Set User PIN to view the User PIN display. 3. Set the five-digit PIN number to the desired value. 4. Press [E] to save the PIN and to return to the Security menu.

Info/Help		
Error Counts [0] 	Description	This menu provides a diagnostic view of the meter's performance. Below are several system diagnostic counters and their definitions. Use discretion when interpreting these counters. These values could be altered during system setup or when using the verification device. We suggest that you reset these counters before you start monitoring your system and look for conditions possibly affecting performance.
	Detector	The number of times an invalid detector condition has been observed.
	Empty Pipe	The number of times an empty pipe condition has been observed by the meter.
	Full Scale	The number of times the flow has exceeded the full scale flow setting.
	Totalizer	The number of times the totalizers have exceeded limits of the meter.
	Pulse Sync.	The number of times the pulse outputs have fallen out of synchronization.
	ADC Interrupt	The number of times an analog input measurement has been missed.
	ADC Range	The number of times the analog input measurement range has been exceeded.
	System Error	A diagnostic system message indicating the reason for a system reset.
	System Resets	The number of times the meter has been reset.
	System Reset ID	Diagnostic information about a system reset as a result of expired internal timers.

Info/Help	
<p>Rollover Counts</p> <p>[0]</p> 	<p>The number of times the totalizers have rolled over 9,999,999,999 (10 billion).</p> <p>As the meter rolls over, a status indicator appears in the display. When this occurs, we suggest that you record the totalizers and rollover counter and reset the totalizers. Resetting totalizers will also clear the rollover counter.</p> <p>For a meter configured in bidirectional mode, rollover is represented by the net totalizer (TN) as "*****". During this condition, the net totalizer (TN) can be calculated using the following equation:</p> $T(\text{FWD}) = [(\text{ROLLOVER}_{T+} \times 10,000,000,000) + T+]$ $T(\text{REV}) = [(\text{ROLLOVER}_{T-} \times 10,000,000,000) + T-]$ $\text{TN} = T(\text{FWD}) - T(\text{REV})$ <p><i>Where ROLLOVER_{Tx} is the rollover count for the appropriate totalizer</i></p> <p>For a meter configured in unidirectional mode, the totalizer can be calculated using the following equation:</p> $T1 = [(\text{ROLLOVER}_{T1} \times 10,000,000,000) + T1]$ $T2 = [(\text{ROLLOVER}_{T2} \times 10,000,000,000) + T2]$ <p><i>Where ROLLOVER_{Tx} is the rollover count for the appropriate totalizer</i></p>
<p>PowerUp Counter</p> <p>[Not applicable]</p> 	<p>The number of times that the unit has been powered on.</p>
<p>Power Off Time</p> <p>[Not applicable]</p> 	<p>The length of time that the unit has been without power.</p>
<p>Version Info</p> <p>[Not applicable]</p> 	<p>The current software version.</p>
<p>Serial Number</p> <p>[Not applicable]</p> 	<p>The manufacturing serial number in the format YYMM####.</p> <p>Where YYMM indicates year and month of manufacturing and #### indicates the sequence number.</p>

Info/Help	
Restore Defaults [Not applicable] 	Restores all non-calibrated parameters to the factory defaults.
Restore Calibration [Not applicable] 	Restores the meter calibration as set at the factory.

Language Select	
Language Select [English] 	<p>The M-2000 supports one alternate language along with English. This alternate language choice is set at the factory. The options are: Spanish, German, Czech or French.</p> <p>To select the language, follow these steps from the Language Select menu:</p> <ol style="list-style-type: none"> 1. Press [↑] or [↓] to position the arrow/pointer next to either English or the Alternate Language. 2. Press [E] to save the selection.

Maintenance

Mandatory, routine or scheduled maintenance should not be required for the Badger M-2000 Mag Meter electronics or flow tube after proper installation.

However, some occurrences may require personnel to perform the following:

- Flow tube and electrode cleaning
- Fuse replacement
- Circuit board replacement

WARNING

These maintenance procedures are discussed in this section.

Disconnect main power to the unit before attempting any device maintenance or cleaning.

Do not clean components inside the amplifier or junction box.

Cleaning the Flow Tube and Electrode

At times flow tube, electrodes, amplifier/junction box housings and the amplifier window may need periodic cleaning, depending on process fluid properties, fluid flow rate and surrounding environment.

Clean the flow tube and electrodes by following the material handling and cleaning procedures documented in Material Safety Data Sheet (MSDS) guidelines for the product(s) that were in contact with the flow tube and electrodes.

Should flow tube and/or electrode cleaning become necessary:

1. Disconnect detector from pipeline.
2. Clean electrodes according to MSDS guidelines.
3. Reconnect detector to pipeline.

Replacing the Fuse

WARNING

Disconnect main power to the unit before attempting any device maintenance.

CAUTION

Risk of electrical shock. Replace the fuse only with 250 VAC, 2 amp, slow blow (5 x 20 mm).

Authorized personnel must replace fuses.

Troubleshooting

The M-2000 mag meter is designed for many years of optimal performance. However, should it malfunction, there are certain things that we recommend you check before contacting our Technical Support department or your local Badger Meter Representative.

Note: If the fluid measured has a high concentration of conductive solids, deposits may accumulate on the internal liner walls and electrodes. These deposits will cause a reduction of the measuring output. Thus, Badger Meter recommends that you remove the meter and inspect the liner and electrodes after six months. If deposits are found, remove them with a soft brush. Repeat inspection process every six months or until an appropriate inspection cycle can be established for the specific application.

Other general conditions include:

Description	Possible Cause	Recommended Action
Flow is present but display is "0"	Digital input is holding flow. Disconnected signal cable. Detector mounted opposite of the main flow direction (see arrow on the nameplate). Coil or electrode cables exchanged. Improper low flow cutoff or full scale flow.	Check signal cable. Turn detector by 180° or switch terminal E1 and E2 or reprogram to bidirectional mode. Check cable connections for cross wiring. Verify digital input configuration. Replace configuration defaults.
Inaccurate measuring	Improper calibration. Wrong calibration parameter. Pipe not fully filled, or air in pipe. Invalid fluid conductivity. Invalid fluid mixture.	Restore calibration defaults. Check the parameters (detector factor and size) according to supplied data sheet. Check if meter is completely filled with fluid. Purge line to eliminate air bubbles.
No display	No power. Incorrect power. Bad wiring connections. Blown fuse.	Apply power. Check power value. Replace fuse. (2 amp, 250 VAC, slow blow (5 x 20 mm) Check display ribbon cable.
Flow rate value known to be wrong	Detector factor. Deposits on electrodes and/or liner. Incorrect pipe size programmed.	Check value on label. Check and remove deposits. Check size if necessary.
Flow rate indication unstable	Cable issue. Grounding issue. Partially full pipe. Air in pipe. Amplifier location - outside electrical. Invalid fluid conductivity.	Make sure cable is shielded and not vibrating. Make sure meter is properly grounded to a good earth ground. Make sure pipe is full of fluid. Make sure fluid does not contain air bubbles. Make sure amplifier is not too close to sources of interference. Electrical interference.

Menu Manager Configuration Errors		
Error	Description	Recommended Action
110	Output 1/2: Pulse Output Configuration Error	<p>This error is observed when improperly configuring the full scale flow, pulse per unit, or pulse width.</p> <p>This error can indicate the following configuration violations:</p> <ol style="list-style-type: none"> 1. Pulse frequency exceeds limits at full scale flow 2. Pulse duty cycle is less than 50% at full scale flow (pulse on time > pulse off time) <p>Pulse frequency limit is 10 kHz. However, with a non-zero pulse width configuration, the limit is 500 Hz to achieve a 50% pulse duty cycle.</p> <p>If not using the pulse outputs, set the pulses per unit to zero to allow for reconfiguration of the full scale flow. If it is required to use the pulse outputs, reevaluate the pulse output configuration. Consider recording and clearing totalizers prior to changing totalizer units.</p>
120	Display: Totalizer Conversion Error – Totalizer cannot be properly converted for display	This error is observed while trying to change the totalizer units. Limits of display will prevent improper configuration of the volume unit dependent on current totalizer values. Consider recording and cleaning totalizers prior to changing totalizer.
121	Output 1/2: Pulse Output Configuration Error	This error is observed when changing the totalizer units of measure. This error implies the pulse configuration exceeds limits (see error 110). Please note the pulses per unit is not automatically updated on volume unit reconfiguration. The pulses per unit should be manually changed to accommodate the desired units of measure. It may be necessary to set the pulses per unit to zero then change to the desired totalizer units.
140	Output 3: Configuration Error – Full scale frequency exceeds limits of relay (1000 Hz)	Reduce full scale frequency setting of output when hardware is configured for relay operation.
150	Output 3: Configuration Error – Full scale frequency exceeds limits (10 kHz)	Reduce full scale frequency setting of output when hardware is configured for open collector operation.

Display Error / Status Messages		
Error Message	Possible Cause	Recommended Action
Err: Detector	No detector connection with amplifier.	Check detector and cable connections in accordance with this manual.
	Connection between amplifier and detector	Contact Technical Support.
	Supply voltage too low.	Contact Technical Support.
	Grounded coils in meter.	Contact Technical Support.
	Water in detector.	Contact Technical Support.
Err: Empty pipe	Pipe may not be full.	Make sure all trapped air is out of system. If fluid or fluid conductivity recalibrate the parameter.
Err: Full scale	Actual flow rate is exceeding programmed flow.	Reduce flow rate or increase the programmed full scale value by more than 5%.
Err: AD-Range	AD-Converter is exceeding signal limits.	Check the grounding scheme of the meter installation. See grounding section in this manual. Verify pipe is not empty.
Err: AD-INT	Initialization of AD-Converter unsuccessful.	Contact Technical Support.
Err: Rollover	Rollover counters have exceeded limit.	Clear all totalizers.
Err: Rollover Status	Totalizer rollover has occurred.	Reload totalizer then clear all totalizers.
Err: Simulation	I/O simulator is enabled.	Disable simulator in I/O menu.

Appendix: Detector Specifications

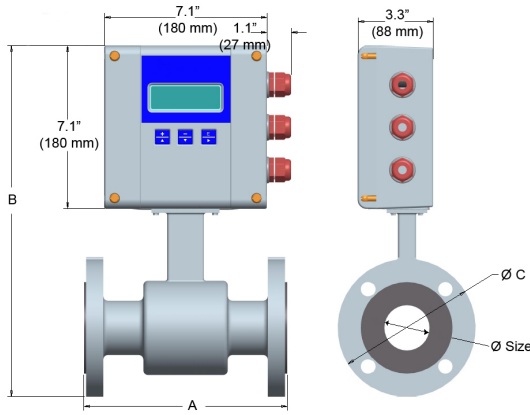

Meter with M-2000 amplifier

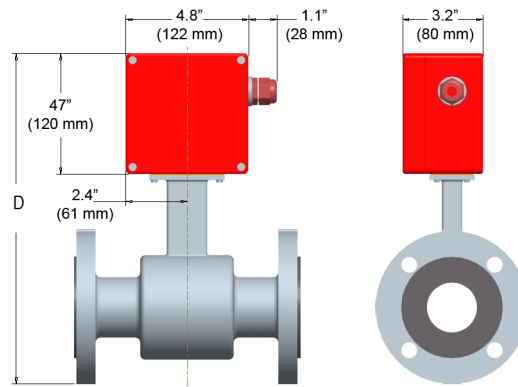

Meter with junction box for remote M-2000 amplifier

Size		A		B		C		D		Est. Weight with M-2000		Flow Range			
inch	mm	inch	mm	inch	mm	inch	mm	inch	mm	lbs	kg	LPM		GPM	
												min	max	min	max
1/4	6	6.7	170	14.0	356	3.5	89	11.4	288	10	4.5	0.063	20	0.02	5
5/16	8	6.7	170	14.0	356	3.5	89	11.4	288	10	4.5	0.114	34	0.03	9
3/8	10	6.7	170	14.0	356	3.5	89	11.4	288	10	4.5	0.177	53	0.05	14
1/2	15	6.7	170	14.0	356	3.5	89	11.4	288	10	4.5	0.416	125	0.11	33
3/4	20	6.7	170	14.2	361	3.9	99	11.5	293	13	5.5	0.75	225	0.2	59
1	25	8.9	225	14.4	366	4.3	108	11.7	298	18	8.0	1.20	350	0.3	93
1 1/4	32	8.9	225	15.2	386	4.6	117	12.5	318	20	9.0	2.00	575	0.5	152
1 1/2	40	8.9	225	15.4	390	5.0	127	12.7	322	21	9.5	3.00	900	0.8	239
2	50	8.9	225	15.9	403	6.0	152	13.2	335	26	11.5	4.70	1400	1	373
2 1/2	65	11.0	280	17.1	434	7.0	178	14.4	366	52	23.5	8	2400	2	631
3	80	11.0	280	17.3	440	7.5	191	14.7	372	54	24.5	12	3600	3	956
4	100	11.0	280	18.4	466	9.0	229	15.7	398	56	25.5	19	5600	5	1493
5	125	15.8	400	19.6	498	10.0	254	16.9	430	58	26.0	30	8800	8	2334
6	150	15.8	400	20.6	524	11.0	279	17.9	456	60	27.0	40	12700	11	3361
8	200	15.8	400	22.5	572	13.5	343	20.4	518	86	39.0	75	22600	20	5975
10	250	19.7	500	26.8	681	16.0	406	24.1	613	178	81.0	120	35300	30	9336
12	300	19.7	500	28.9	734	19.0	483	26.2	666	207	94.0	170	50800	45	13444
14	350	19.7	500	30.8	782	21.0	533	28.2	716	258	117	230	69200	60	18299
16	400	23.6	590	33.7	856	23.5	597	31.0	788	306	139	300	90400	80	23901
18	450	23.6	590	35.0	890	25.0	635	32.4	822	400	181	380	114000	100	30250
20	500	23.6	590	38.2	969	27.5	699	35.5	901	493	224	470	140000	125	37346
22	550	23.6	590	39.6	1005	29.5	749	36.9	937	523	237	570	170000	150	45188
24	600	23.6	590	42.2	1071	32.0	813	39.5	1003	552	251	680	200000	180	53778
28	700	23.6	590	46.2	1173	36.5	927	44.0	1118	648	294	920	275000	240	73100
30	750	31.5	800	48.3	1228	39.0	984	45.7	1161	702	319	1060	315000	280	84000
32	800	31.5	800	52.2	1325	41.4	1015	49.5	1257	768	349	1200	361000	320	95600
36	900	31.5	800	55.3	1405	46.0	1168	54.1	1374	848	385	1500	457000	400	121000
40	1000	31.5	800	60.0	1525	50.2	1230	57.4	1457	922	419	1900	565000	500	149300
42	1050	36.0	914	66.0	1675	53.0	1346	63.4	1610	1198	499	2100	620000	550	164600
48	1200	39.4	1000	69.9	1775	59.4	1455	67.2	1707	1208	549	2700	814000	720	215100
54	1400	39.4	1000	78.5	1995	68.4	1675	75.9	1927	1362	619	3700	1100000	980	292700

Flow Range: 0.1 - 39.4 fps (0.03-12 m/s)
Sizes: 1/4 inch to 54 inches (6 mm to 1400 mm)
Min. Conductivity: ≥ 5 micromhos/cm
Accuracy:
 ± 0.25 percent of rate for velocities greater than 1.64 ft/s (0.50 m/s)
 ± 0.004 ft/s (± 0.001 m/s) for velocities less than 1.64 ft/s (0.50 m/s)
Electrode Materials: Standard: Alloy C
 Optional: 316 stainless steel, gold/platinum plated, tantalum, platinum/rhodium
Liner Material: PFA up to 3/8 inch, PTFE 1/2 inch to 24 inches, Soft and Hard Rubber from 1 to 54 inches, Halar® from 14 to 40 inches
NSF Listed: Models with hard rubber liner 4-inch size and up; PTFE liner - All sizes.

Fluid Temperature:
 With Remote Amplifier:
 PFA, PTFE & Halar 311°F (155°C)
 Rubber 178°F, (80°C)
 With Meter Mounted Amplifier:
 PFA, PTFE & Halar 212°F (100°C)
 Rubber 178°F, (80°C)
Pressure Limits:
 Maximum allowable non-shock pressure and temperature ratings for steel pipe flanges, according to American National Standard ANSI B16.5. (Example: 150-pound flanges, rated 285 PSI at ambient temperature.) (Example: 300-pound flange rated 740 PSI at ambient temperature.)
Coil Power: Pulsed DC
Ambient Temperature: -4°F to 140°F (-20°C to 60°C)

Pipe Spool Material: 316 stainless steel
Meter Housing Material: Carbon steel welded
Flanges: Carbon steel - Standard (ANSI B16.5 Class 150 RF)
 316 stainless steel - Optional
Meter Enclosure Classification: NEMA 4X (IP66)
Optional: Submersible NEMA 6P (remote amplifier required)
Junction Box Enclosure Protection:
 (for remote amplifier option) Powder coated die-cast aluminum, NEMA 4 (IP65)
Cable Entries: 1/2-inch NPT Cord Grip
Optional Stainless Steel Grounding Rings:
 Meter Size Thickness (of one ring)
 up through 10 inches .135 inch
 12 to 20 inches .187 inch

Appendix: Amplifier Specifications

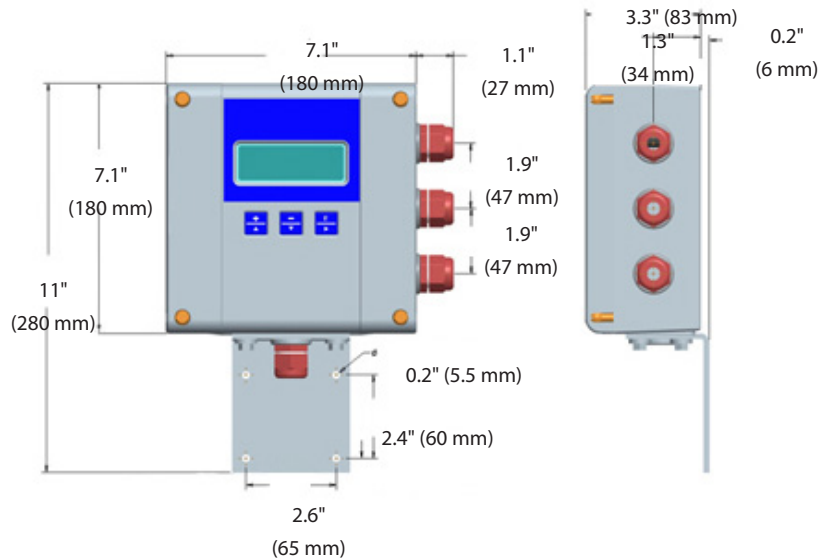

Power Supply:

AC supply (85-265 VAC)

Typical power: 20 VA or 15 Watts

Max. power: 26 VA or 20 Watts

Optional DC supply (10-36 VDC)

Typical power: 10 Watts

Max. power: 14 Watts

Accuracy: ± 0.25 percent of rate for velocities greater than

1.64 ft/s (0.50 m/s)

± 0.004 ft/s (± 0.001 m/s) for velocities less than

1.64 ft/s (0.50 m/s)

Repeatability: ± 0.1 percent

Flow Range: 0.10 to 39.4 ft/s (0.03 to 12 m/s)

Fluid Conductivity: Minimum 5.0 micromhos/cm

Flow Direction: Unidirectional or bidirectional two separate totalizers (programmable)

Totalization: Programmable/resettable

Unidirectional: T1, T2

Bidirectional: T+ (Fwd), T- (Rev), Tn (Net)

Minimum Fluid Conductivity: 5.0 micromhos/cm

Processing: 32-bit DSP

Analog Output: 4-20 mA, 0-20 mA, 0-10 mA, 2-10 mA

(programmable and scalable)

Voltage sourced 24 VDC – isolated

Maximum loop resistance < 800 ohms

Digital Outputs: Four total, configurable

24 VDC sourcing active output (up to two), 100 mA total,

50 mA each; sinking open collector output (up to four),

30 VDC Max, 100 mA each; AC solid-state relay

(up to two), 48 VAC, 500 mA max.

Pulse Outputs: Scalable up to 10 kHz, passive open collector up to 10 kHz, active switched 24 VDC. Up to two outputs (forward and reverse). Pulse width programmable from 1-1,000 ms or 50 percent duty cycle.

Frequency Output: Scalable up to 10 kHz, open collector up to 1 kHz, solid-state relay

Misc Outputs: High/low flow alarm (0-100 percent of flow), error alarm, empty pipe alarm, flow direction, preset batch alarm, 24 VDC supply

Noise Dampening: Programmable 0-30 seconds.

Empty Pipe Detection: Field tunable for optimum performance based on specific application

Excitation Frequency: 1 Hz, 3.75 Hz, 7.5 Hz or 15 Hz (factory optimized to pipe diameter)

Digital Input: Max. 30 VDC (programmable – positive zero return, external totalizer reset or preset batch start)

Units of Measure: Ounces, pounds, liters, US gallon, imperial gallon, barrel, hectoliter, megagallon, cubic meters, cubic feet, acre feet

Galvanic Separation: 250 volts

Low-flow-cutoff: Programmable 0-10 percent of max. flow

LCD Display: 4 x 20 character display with backlight

Programming: Three-button, external manual or remotely

Housing: Cast aluminum, powder-coated paint

Housing Rating: NEMA 4X (IP66)

Mounting: Meter mount or remote wall mount (bracket supplied)

Cable Connection: 1/2-inch NPT Cord Grip (three)

Ambient Temperature: -4 to 140° F (-20 to 60° C)

Serial Communication: RS232 – Modbus RTU or remote display

Logging: Power loss totalization

Relative Humidity: Up to 90 percent non-condensing

Locations: Indoor and outdoor

M-Series is a registered trademark of Badger Meter, Inc.

Other trademarks appearing in this document are the property of their respective entities.

Copyright 2011, Badger Meter, Inc. All rights reserved.



Due to continuous research, product improvements and enhancements, Badger Meter reserves the right to change product or system specifications without notice, except to the extent an outstanding contractual obligation exists.

Badger Meter | P.O. Box 245036, Milwaukee, Wisconsin 53224-9536
800-876-3837 | infocentral@badgermeter.com | www.badgermeter.com