

Electronic Design 24

VOL. 19 NO.

FOR ENGINEERS AND ENGINEERING MANAGERS

NOV. 25, 1971

Readouts: The choice is wide. They're brighter and dimmer, bigger and smaller than ever. At less cost, too. Each type has its special advantages. But each has

limitations as well. And specs, unfortunately, are no great guide. They're often written to conceal a product's weaknesses. For a perceptive view, see page 52.

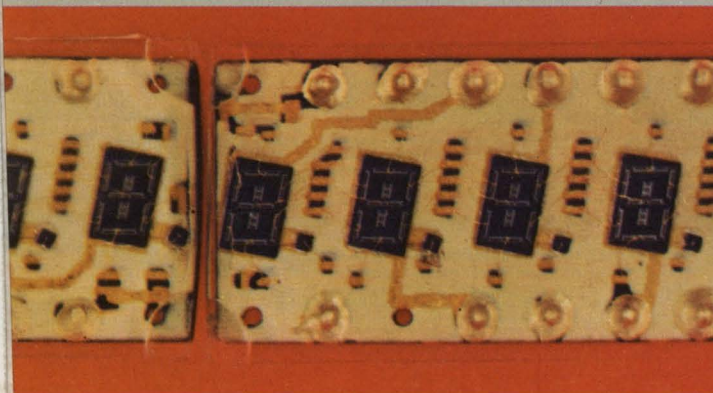
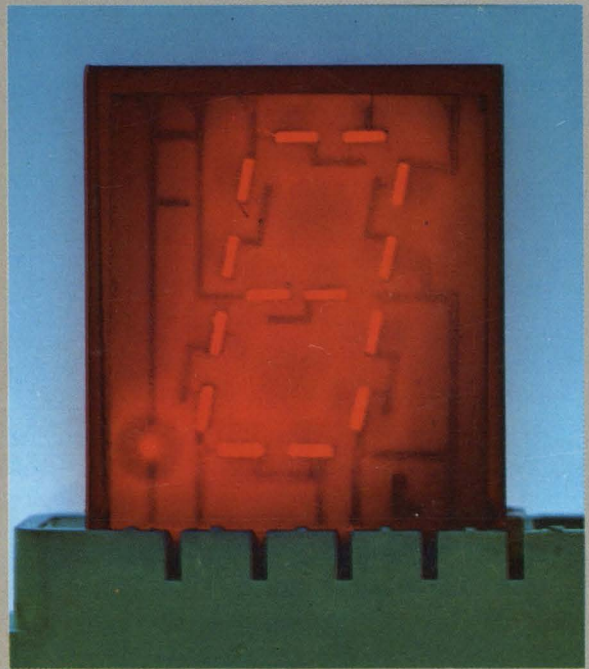
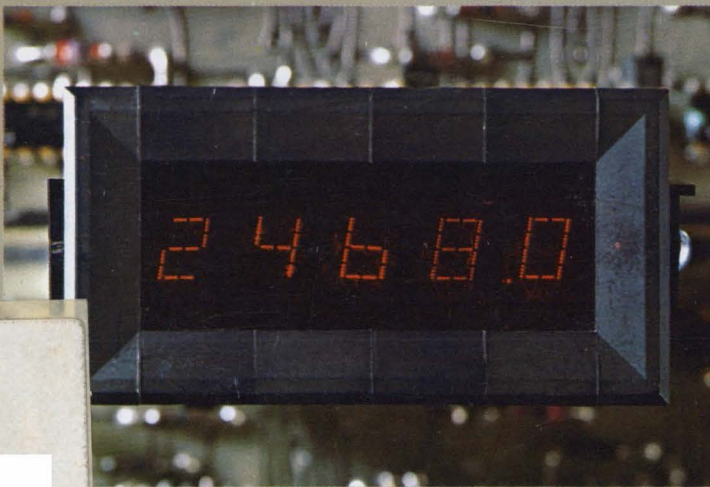
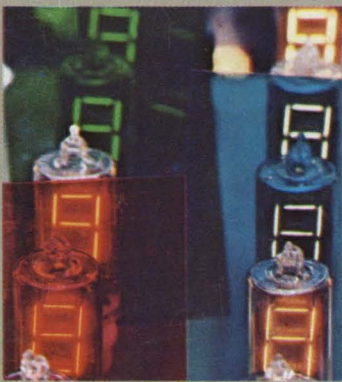

NEW FREE SERVICE!
Enroll Now
See Card Inside
Front Cover

Fluke's new low cost synthesizer with lower phase noise, low spurious content, high stability and high reliability means

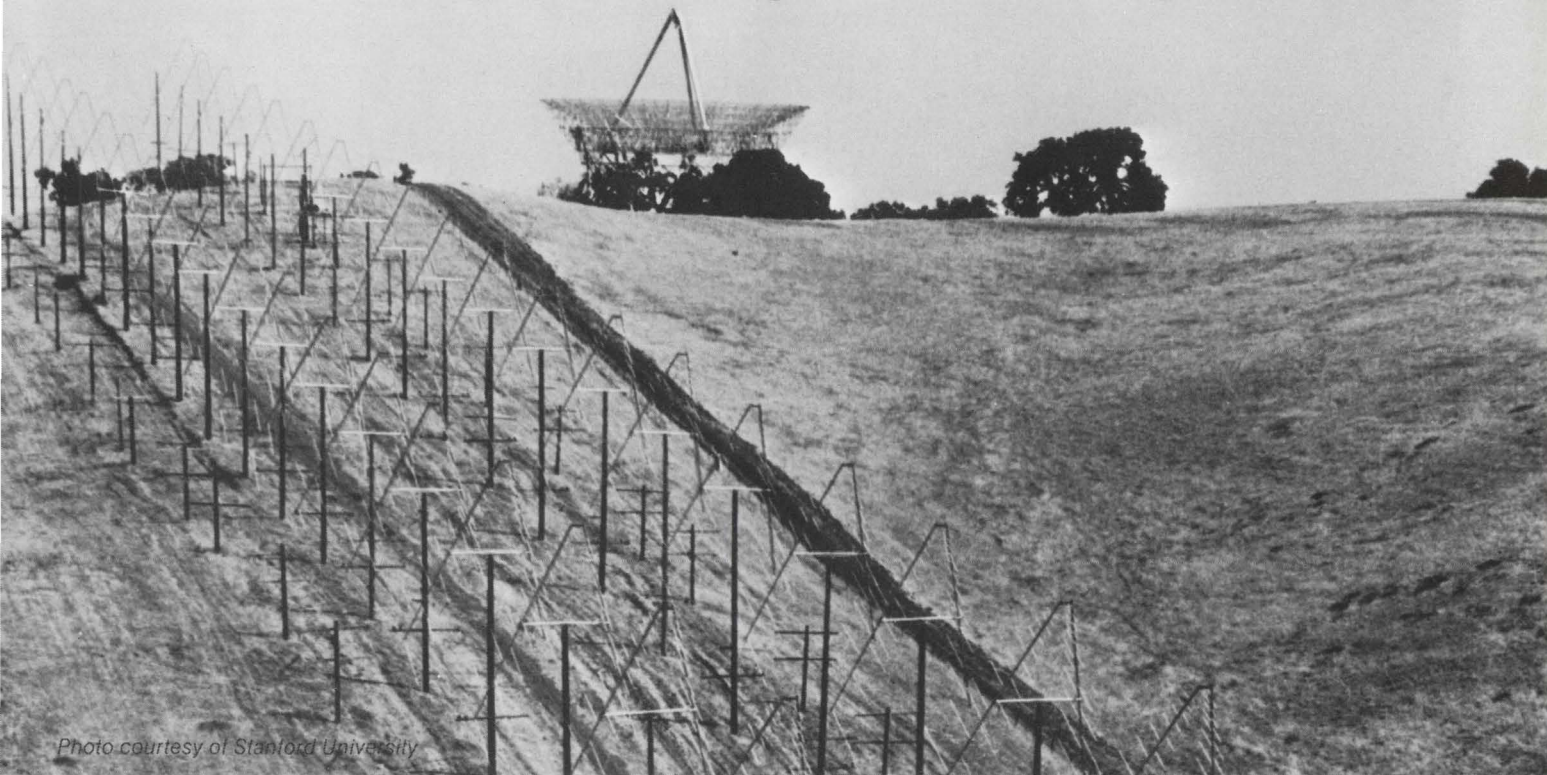

Photo courtesy of Stanford University

improved performance in all signal generation and measurement uses

- Low cost, \$4995 base price
- Excellent overall phase noise performance
- Widest frequency coverage per dollar, 1 to 160 MHz
- Low spurious content, -70 dB to -100 dB
- BCD programmable TTL positive true logic
- ALC gives better than ± 1 dB flatness
- Modular design simplifies special applications
- Stability to 2 parts in $10^7/24$ hours
- Switching speed is less than 1 ms



Fluke's new Model 6160 Frequency Synthesizer gives you a combination of flexibility, economy and overall performance heretofore unavailable. Meet the critical requirements of communications and test systems at an astonishing low price. Transform your design into practical applications.

Typical Applications

Communications—as a local oscillator for receivers and transmitters.

Microwave—as a stable incrementally tunable synthesizer for microwave sources.

Radar—as a frequency control in a large system.

Production test—as a programmable RF source to test filters and other RF devices.

Nuclear Magnetic Resonance and acoustic studies.

Arrange a demonstration today.

Because the performance of the Fluke 6160 so far exceeds that of competitive units, evaluation is difficult with conventional test equipment. We recommend an on site demo operating your equipment. No obligation of course. To arrange a demo or get complete information call your nearby Fluke Sales Engineer or write us directly.



Fluke, Box 7428, Seattle, Washington 98133. Phone: (206) 774-2211. TWX: 910-449-2850/
In Europe, address Fluke Nederland (N.V.), P.O. Box 5053, Tilburg, Holland.
Phone: (04250) 70130. Telex: 884-52237/In the U.K., address Fluke International Corp.,
Garnett Close, Watford, WD2, 4TT. Phone: Watford, 33066. Telex: 934583.

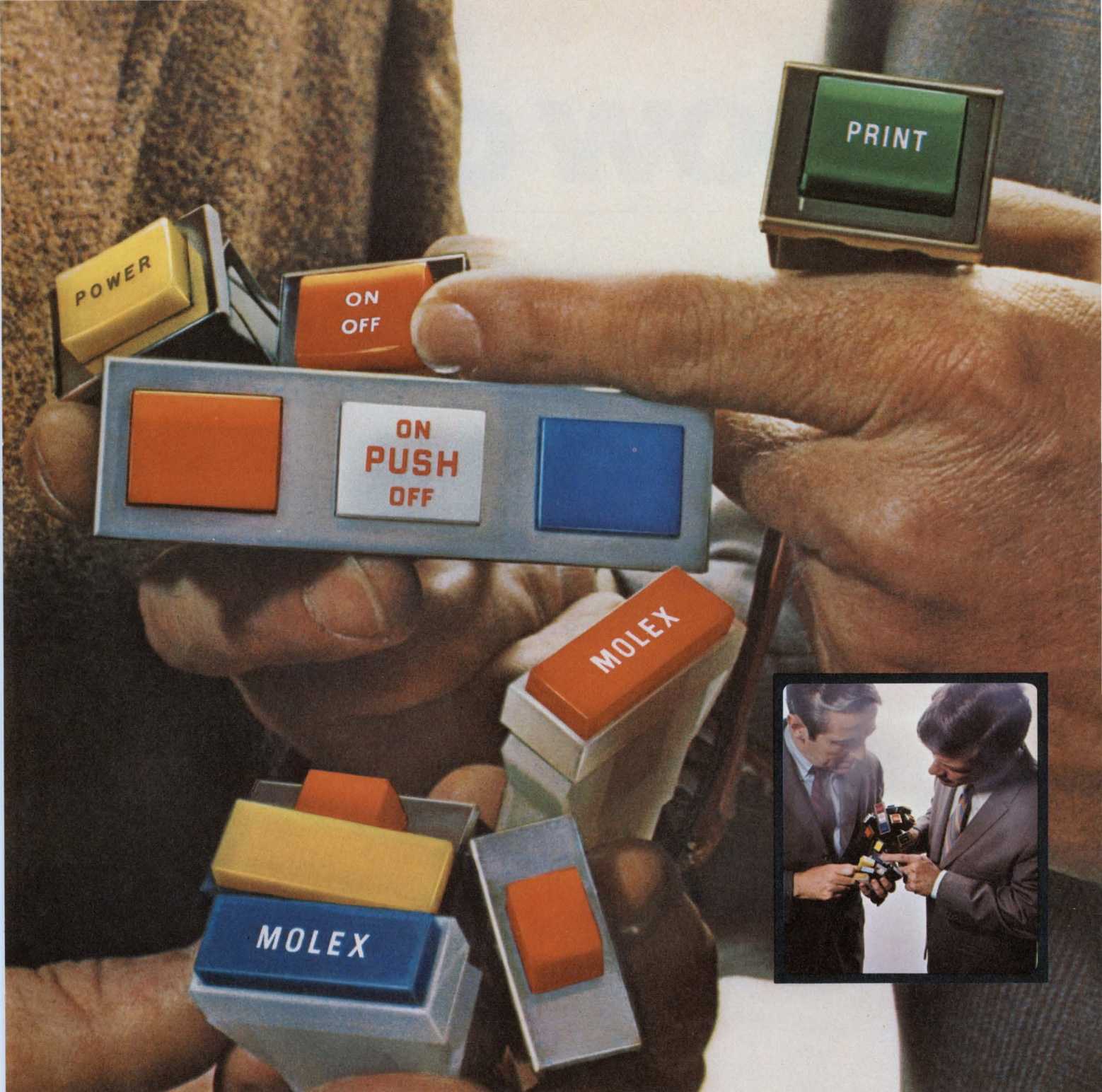

HERE ARE TWO EASY WAYS TO SOLVE LIGHTED PUSH BUTTON SWITCH PROBLEMS. Economically. Reliably. Fast. The Molex 1175 snap mounts. Offers spade or wire terminals for fast, easy assembly. A choice of nine colors, 500 variations. And look at the Molex 1820. You can use one, or a gang of them, for an infinite variety of applications. Lighted push button can be wired to light independently of the switch. And it's available in colors galore. Best of all . . . both switches are priced considerably under one

dollar in quantity. ■ These components are good examples of the Molex creative approach to design problems. And we have the ability to design reliability and ease of assembly into a product without letting costs run wild due to over-engineering. ■ If this makes sense, and you would like a *free sample* of either the 1175 or 1820 switch, write: Molex Incorporated, Downers Grove, Illinois 60515. Or phone (312) 969-4550.

... creating components that simplify circuitry



Show or tell

Please write in this space:

Show us or tell us what you need in a broadband hybrid RF amplifier from 5 MHz to 3GHz.*

Chances are, we have a hybrid RF module on shelf that will solve your problem.

In fact, we have dozens of RF amplifier modules ready to perform hundreds of different jobs in microwave, mobile radio and CATV applications. And every one of them is a problem-solver — designed to replace

discrete electronic circuitry with dramatic weight, size and cost savings.

So go ahead. Show us or tell us what you need. We can probably supply it immediately. Send this page to TRW Electronic Components, Semiconductor Division, 14560 Aviation Boulevard, Lawndale, Calif. 90260. Or phone (213) 679-4561. TWX 910-325-6206.

*If you need some thought-starters, send for our catalog.

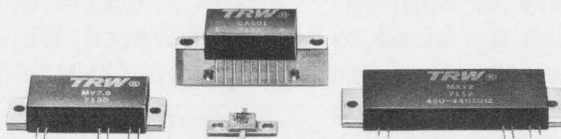

TRW
SEMICONDUCTORS

INFORMATION RETRIEVAL NUMBER 3

Electronic Design 24

VOL. 19 NO.

FOR ENGINEERS AND ENGINEERING MANAGERS

NOV. 25, 1971

NEWS

- 19 **News Scope**
- 23 **Microprogramming** is a computer design technique that has been around for a long time. However, only recently has it come into wide favor.
- 30 **Power industry asks designers to fill urgent need** for equipment to cope with rise in electric power demand.
- 34 **Bucket brigade ICs** said to cut audio delay line costs drastically.
- 38 **Technology Abroad**
- 43 **Washington Report**

TECHNOLOGY

- 52 **Focus on Readouts:** A special report on the most important specs to consider, such as: cost per character, brightness, viewing angle and so on.
- 66 **Establish the reliability of LSI ICs** early in the design phase with an evaluation program that considers failure mechanism on an individual basis.
- 70 **Cut battery size in portable equipment** by using time-sharing technique that keeps power OFF until it is needed. The method can also extend battery life.
- 74 **Ideas for Design**

PRODUCTS

- 84 **Microwaves & Lasers:** High-Q GaAs varactor diodes are available.
- 96 **ICs & Semiconductors:** Drift of $1 \mu\text{V}/^\circ\text{C}$ is a feature of a new IC op amp.
- 96 **ICs & Semiconductors:** Low-power CMOS multiplexer draws only 15 nA at 15 V.
- 81 Data Processing
- 88 Modules & Subassemblies
- 92 Components
- 98 Instrumentation
- 100 Packaging & Materials

Departments

- 49 **Editorial: Safety first**—where it doesn't matter
- 7 Letters
- 13 Designer's Calendar
- 102 Application Notes
- 104 New Literature
- 107 Bulletin Board
- 110 Advertisers' Index
- 112 Information Retrieval Card

Cover: Readouts, clockwise from upper right, Tung-Sol (fluorescent), Litronix (LED), Sperry (gas-discharge), Texas Instruments (LED), Monsanto (LED), RCA (seven filament), Burroughs (Self-Scan).

ELECTRONIC DESIGN is published biweekly by Hayden Publishing Company, Inc., 50 Essex St., Rochelle Park, N.J. 07662. James S. Mulholland, Jr., President. Printed at Brown Printing Co., Inc., Waseca, Minn. Controlled circulation postage paid at Waseca, Minn., and New York, N. Y., postage pending Rochelle Park, N. J. Copyright © 1971, Hayden Publishing Company, Inc. 82501 copies this issue.

Call on the power of the Kokomoans for your systems of the 70's.

The tough breed of High Voltage Silicon Power Transistors.

Transistor	V _{CEX} Voltage	Con- tinuous I _C	V _{CEO} (sus)	Maximum Power Dissipation	Typical Applications
DTS 401	400V	2A*	300V		*I _C Peak = 5A Vertical magnetic CRT deflection, has good gain linearity.
DTS 402	700V	3.5A*	325V		*I _C Peak = 10A Horizontal magnetic CRT deflection, features fast switching time, high reliability under horizontal sweep fault condition.
DTS 410	200V	3.5A	200V	80W	Voltage regulator, switching regulator, DC to DC converter, class A audio amplifiers.
DTS 411	300V	3.5A	300V	100W	
DTS 413	400V	2.0A	325V	75W	*I _C Peak = 10A High V _{CB0} and V _{CEO} ratings make it practical to operate directly from rectifier 117V or 220V AC line.
DTS 423	400V	3.5A*	325V	100W	
DTS 424	700V	3.5A*	350V	100W	*I _C Peak = 10A High V _{CB0} , V _{CEO} (sus) ratings make them ideal for use in deflection circuits, switching regulators and line operating amplifiers.
DTS 425	700V	3.5A	400V	100W	
DTS 430	400V	5A	300V	125W	Voltage regulators, power amplifiers, high voltage switching.
DTS 431	400V	5A	325V	125W	
DTS 701	800V	1A	600V	50W	Vertical magnetic CRT deflection circuits.
DTS 702	1200V	3A	750V	50W	Horizontal magnetic CRT deflection circuits operating off-line.
DTS 704	1400V	3A	800V	50W	
DTS 721	1000V	3A	800V	50W	High voltage DC regulators.
DTS 723	1200V	3A	750V	50W	Very high voltage industrial and commercial switching.
DTS 801	1000V	2A	700V	100W	Color vertical magnetic CRT deflection circuits.
DTS 802	1200V	5A	750V	100W	Color horizontal magnetic CRT deflection circuits.
DTS 804	1400V	5A	800V	100W	
2N3902†	700V	3.5A*	325V	100W	*I _C Peak = 10A Ideal for switching applications. Can be operated from rectified 117 or 220 volt AC line.
2N5157	700V	3.5A*	400V	100W	
2N5241	400V	5A	325V	125W	For general use in electrical and electronic circuits such as converters, inverters, regulators, etc.
2N2580	400V	10A	325V	150W	
2N2581	400V	10A	325V	150W	
2N2582	500V	10A	325V	150W	
2N2583	500V	10A	325V	150W	
2N3079	200V	10A	200V		
2N3080	300V	10A	300V		

†Mil. qualified units available.

Transistors are NPN triple diffused.



Delco Electronics

DIVISION OF GENERAL MOTORS CORPORATION,
KOKOMO, INDIANA



Now available from these distributors in production quantities.

ALA., BIRMINGHAM • Forbes Distributing Co., Inc. (205)-251-4104

ARIZ., PHOENIX • Cramer/Arizona (602)-263-1112 • Sterling Electronics (602)-258-4531

CAL., LOS ANGELES • Kierulff Electronics, Inc. (213)-685-5511 • Radio Products Sales, Inc. (213)-748-1271

CAL., PALO ALTO • Kierulff Electronics, Inc. (415)-968-6292

CAL., REDWOOD CITY • Cramer /San Francisco, (415)-365-4000

CAL., SAN DIEGO • Milo of California, Inc. (714)-232-8951

CAL., SAN DIEGO • Radio Products Sales, Inc. (714)-292-5611

COLO., COLORADO SPRINGS • Walker Electronics (303)-636-1661

COLO., DENVER • Cramer/Denver (303)-758-2100 • Denver Walker Electronics (305)-935-2406

ILL., ROSEMONT (Chicago) • Kierulff /F-J-R (312)-678-8560

ILL., SKOKIE (Chicago) • Merquip Electronics (312)-282-5400

IND., INDIANAPOLIS • Graham Electronics Supply, Inc. (317)-634-8486

MD., BALTIMORE • Radio Electric Service Co. (301)-823-0070

MASS., NEEDHAM HEIGHTS • Kierulff Electronics, Inc. (617)-449-3600

MASS., NEWTON • The Greene-Shaw Co., Inc. (617)-969-8900

MICH., ROMULUS • Harvey/Detroit (313)-729-5500

MINN., MINNEAPOLIS • Stark Electronics Supply Co. (612)-332-1325

MO., KANSAS CITY • Walters Radio Supply, Inc. (816)-531-7015

MO., NO. KANSAS CITY • LCOMP-Kansas City, Inc. (816)-221-2400

MO., ST. LOUIS • LCOMP-St. Louis, Inc. (314)-647-5505

N.J., CLIFTON • Eastern Radio Corporation (201)-471-6600

N.M., ALBUQUERQUE • Cramer/New Mexico (505)-265-5767 • Sterling Electronics (505)-247-2486

N.Y., BINGHAMTON • Harvey/Federal (607)-748-8211

N.Y., EAST SYRACUSE • Cramer/Eastern (315)-437-6671

N.Y., NEW YORK • Harvey/New York (212)-582-2590

N.Y., ROCHESTER • Cramer/Rochester (716)-275-0300

N.Y., WOODBURY • Harvey/New York (516)-921-8700

OHIO, CINCINNATI • United Radio, Inc. (513)-761-4030

OHIO, CLEVELAND • Pattison Supply (216)-441-3000

OHIO, DAYTON • Kierulff/F-J-R (513)-278-9411

OKLA., OKLAHOMA CITY • Radio, Inc. (405)-235-1551

OKLA., TULSA • Radio, Inc. (918)-587-9123

PENN., PHILADELPHIA • Almo Electronics (215)-676-6000

PENN., PITTSBURGH • RPC Electronics (412)-782-3770

S.C., COLUMBIA • Dixie Radio Supply Co., Inc. (803)-253-5333

TEXAS, DALLAS • Adleta Electronics Company (214)-741-3151

TEXAS, FORT WORTH • Adleta Electronics Co. (817)-336-7446

TEXAS, HOUSTON • Harrison Equipment Co., Inc. (713)-224-9131

UTAH, SALT LAKE CITY • Cramer/Utah (801)-487-3681

VA., RICHMOND • Meridian Electronics, Inc., a Sterling Electronics Company (703)-353-6648

WASH., SEATTLE • Kierulff Electronics, Inc. (206)-763-1550

WASH., TACOMA • C & G Electronics Co. (206)-272-3181

CANADA, ONT., SCARBOROUGH • Lake Engineering Co., Ltd. (416)-751-5980

ALL OVERSEAS INQUIRIES:
General Motors Overseas Operations
Power and Industrial Products Dept.,
767 Fifth Avenue, New York, N.Y.
10022. Phone: (212)-486-3723.

Ready Now for Your Systems of the 70's: The Kokomoans' new breed of silicon power is ready to handle your high energy switching and amplification circuits. Our high voltage transistors permit the design of simplified circuits . . . without the extra weight, bulk and complexity you get with low voltage, higher current systems.

Delco silicon power transistors have earned a reputation for survival in the most rugged applications. Their proven performance in solid state deflection circuits in the new, large-screen color TVs is but one example.

It's because we design Delco transistors to have greater peak energy capability—to be able to withstand higher surges of voltage and current for a specified time. And we back it up with Peak Energy Testing to verify our safe operating curves.

Designing for your new systems of the 70's? The Kokomoans have the silicon power you need.

Kokomoans' Regional Headquarters.

Union, New Jersey 07083, Box 1018, Chestnut Station, (201) 687-3770.

El Segundo, Calif. 90245, 354 Coral Circle, (213) 772-5181.

Kokomo, Ind. 46901, 700 E. Firmin, (317) 459-2175 (Home Office).



MARK OF EXCELLENCE

Prevent semiconductor failures . . . with a circuit breaker?

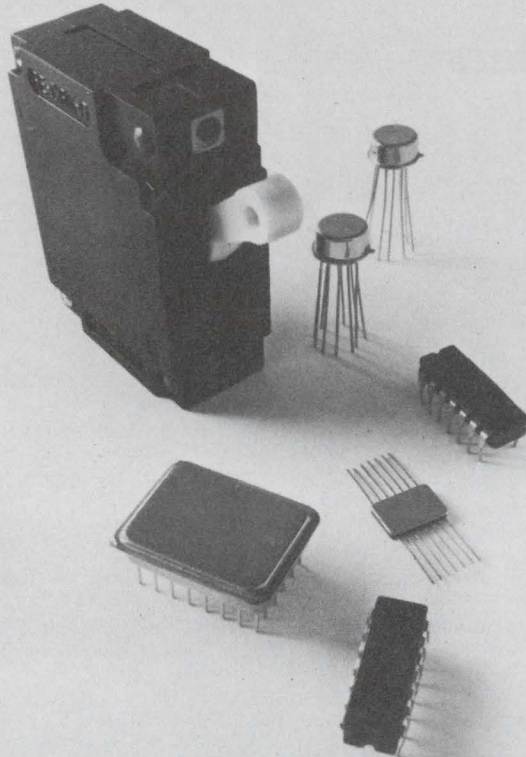

Send us \$20 and see for yourself.

What you'll get back is a sample of our JA/Q® electronics protector, which is no ordinary circuit breaker.

It's a circuit breaker with a built-in hybrid microcircuit crowbar. And that's where the failure prevention comes in.

When a dangerous transient or overvoltage occurs, the crowbar fires and shunts the load within 500 nanosec. Vulnerable semiconductors are never exposed to a condition which might destroy them.

The circuit breaker sees the shunted load as a dead short, and electromechanically disconnects the equipment within 10 millisecc, thus providing protection for the crowbar.

Normal overcurrent protection is in no way affected by the presence

of the crowbar. You can still order precision current ratings, job-matched time delays, and all the other options normally offered with our standard Series JA breakers.

The whole protection package is remarkably economical. In fact, we can provide the crowbar for less than you can build an equivalent circuit in-house. And there are related savings in space, and in the ability to use lower-rated semiconductors.

To evaluate the performance of the JA/Q for yourself, send a check for \$20, along with your name, department, and company letterhead to: Richard Kurtz, Heinemann Electric Company, 2616 Brunswick Pike, Trenton, N.J. 08602. Please specify 6.5, 14, 17, 26, 32, or 38-volt firing level; and 2, 5, or 10-amp current rating.



HEINEMANN

4775

Publisher

Peter Coley

Editors

Editorial Offices
50 Essex St.
Rochelle Park, N.J. 07662
(201) 843-0550
TWX: 710-990 5071
Cable: Haydenpubs Rochellepark

Editor: George Rostky
Managing Editor: Ralph Dobriner
Managing Editor: Raymond D. Speer
Microelectronics, Steven A. Erenburg
Computers, Raymond D. Speer
Microwaves, Michael J. Riezenman
Circuits, Edward A. Torrero
Special Projects, George Rostky
Management, Richard L. Turmail
Military-Aerospace, John F. Mason
News, Jules H. Gilder
New Products, Roger Allan

Field Offices

Massachusetts

Jim McDermott
P.O. Box 272
Easthampton, Mass. 01027
(413) 527-3632

West Coast

David Kaye
2930 Imperial Highway
Inglewood, Calif. 90303
(213) 757-0183

Washington

Don Byrne
1111 S. Army Navy Drive
Arlington, Va. 22202
(202) 296-8982

Editorial Production

Dollie S. Viebig

Art

Art Director, William Kelly
Richard Luce
Anthony J. Fischetto

Production

Manager, Thomas V. Sedita
Helen De Polo
Maxine Correal
Anne Molfetas

Circulation

Manager, Nancy L. Merritt
Joan Licari

Information Retrieval

Peggy Long

letters

A degree doesn't insure you'll be an engineer

In reply to the "Senior Engineer" of Escondido, Calif., whose letter ("A Call to Protect the Title 'Engineer'") was published in the Sept. 12 issue with "his name withheld on request."

Dear Sir:

Oddly enough, I also agree with the June 10 editorial, "All You Train Drivers Better Start Talking" (ED 12, p. 45). First, may I suggest that an anonymous letter hardly displays courage in your convictions. When it came to the second half of your letter, I saw red! It was very magnanimous of you to recognize the "merit of excellent technical workers." Would that I could apply a similar compliment to the average degree engineer.

Several months ago a college boy of my acquaintance bragged that he had received an "A" in his lab work for building a Schmitt trigger circuit. He admitted that the output looked more like a clipped sine wave, but he got an "A." At his suggestion I looked over his work and discovered that the textbook he used had omitted the regeneration so basic in a Schmitt trigger. His professor had "checked his work carefully" (I quote) and agreed that it was correct. Here we have two college profs (the author was lousy with degrees) and a fledgling engineer who does not know what a Schmitt circuit is. But what's worse, they don't know that they don't know.

In my years in the business I have been Quality Control Engineer, Inspection Engineer, Junior Design Engineer, Project Design Engineer, Assistant Chief Engineer and Chief Electronic Design Engineer in four companies. One

of the best design men I knew had a degree, but the other two did not. I suggest you boycott electric lights, record players, radios and thousands of other inventions created by non-degree men.

I have had three patents applied for, have designed equipment for missiles, submarines, aircraft, X-Y plotters, complete tape-operated automatic circuit testers, instruments for the petroleum, chemical, cryogenic, liquid-food processing industries, and many others. I have never taken any engineering course anywhere, but I can read a book without being told what chapter to read by some professor who never had to produce for a living.

After 30 years of having red-necks like you take credit for my work, refuse me jobs without an interview or refuse to pay me comparable salaries for equivalent work, I wised up. I now head my own corporation, and smug sheepskin holders like you are welcome to apply to me for a job, but you had better know what the hell you're doing before you come.

I now apologize to all the good engineers and college professors dedicated to doing a conscientious job in a relatively poor-paying profession.

Edwin J. Beck

R. D. 2
Jamesburg, N. J. 08831

Accuracy is our policy

Unfortunately an error has crept into the Idea for Design circuit "Light Pulse Generator Works on Variable Supply Voltage" (ED 19, Sept. 16, 1971 pp 86-87). The diode D1 is not connected properly but should be reversed.

Electronic Design welcomes the opinions of its readers on the issues raised in the magazine's editorial columns. Address letters to Managing Editor, Electronic Design, 50 Essex St., Rochelle Park, N. J. 07662. Try to keep letters under 200 words. Letters must be signed. Names will be withheld on request.

A Johanson Variable Capacitor for 45¢

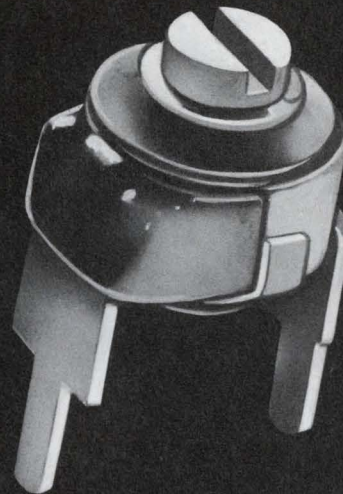

We are pleased to introduce the 9300 series. You will find the unit is truly micro-miniature (.315 high with a .230 diameter and .200 pin spacing). Its rotary assembly is designed with special ceramic materials which provide longer life and complete environmental stability. Capacitance values are available up to 70 pf. For immediate delivery, please phone (201) 334-2676.

STOCK MODELS

MODEL	CAPACITY RANGE pF	TEMP. COEF. @ ±10MHz	MIN. Q
9312	2.8 — 10	—350 PPM/°C	300
9313	3.2 — 18	—550 PPM/°C	300

45¢ EACH
IN QUANTITIES OF 1000

Johanson

MANUFACTURING CORPORATION

ROCKAWAY VALLEY ROAD
BOONTON, NEW JERSEY 07005

It's Here!

THE SOLID STATE *Seren* DIP* RELAY

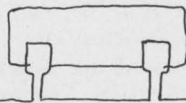

... AND NOBODY ELSE CAN MAKE THAT STATEMENT!

We've done it again . . . We found a need and filled it. The 640-1 completely Solid State SerenDIP* Relay is the result. This is truly a serenDIPitous† happening for our customers . . . In fact, we haven't been so excited since our TO-5 Relay innovation.

The SerenDIP* replaces reed DIP relays pin for pin. The SerenDIP* replaces FET analog switches.

The SerenDIP* handles loads up to 0.1 amp and 50 volts AC or DC and resistive, inductive or capacitive. The 640-1 is electrically equivalent to an SPST electromechanical relay. And best of all, the SerenDIP* is inexpensive: Only \$5.95 at 100; \$4.45 at 1000, and \$2.95 at 10,000.

- Totally Solid State — Complete Input-Output Isolation.
- Bipolar Output — Switches AC or DC Voltages (2 ohms typical contact resistance).

* TM APP.

- TTL Compatible.
- No Bounce — IC's (flip-flops) can be driven directly.
- High Speed Operation — 100K Operations/sec.

Use the 640-1 SerenDIP* for Series Choppers, A/D Converters, Multiplexers, Scanners, Sample and Hold Circuits, or Reset for Integrators.

Use it for Analog and Transducer Signal Switching, Programmable Gains for Operational Amplifiers, Lamp Drivers, and Modulators and Demodulators!

The Teledyne Solid State SerenDIP* Relay is NOW in stock at your local Teledyne Relays distributor.

Write or phone for additional information and data sheets . . . We are at your service.

†ser.en.dip.i.ty\ser-an-'dip-at-æn:
the gift of finding valuable or
agreeable things not sought for
—ser.en.dip.i.tous adj.

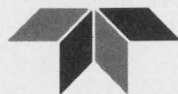
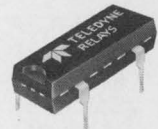

TELEDYNE RELAYS

3155 West El Segundo Boulevard, Hawthorne, California 90250 • Telephone (213) 679-2205

INFORMATION RETRIEVAL NUMBER 7

INFORMATION RETRIEVAL NUMBER 9 ►

Belden the Special "Specials" specialist

Here's what to do when cable catalog specs just won't do the job: Dial Area Code 317 ■
Then dial 966-6681 ■ You'll get action ■ From a man who devotes full time to solving
engineered cable problems ■ A Belden specialist that "lives"
with your design parameters from engineering through the
actual production run ■ Cables for underwater-under-
ground devices . . . extra-high voltage and pulse ap-
plications . . . medical instrumentation . . . low-level
signal interference problems . . . unusual environ-
mental conditions . . . he's tackled them all ■
Phone now. 8-5-0

DIAL (317) 966-6681



... new ideas for moving electrical energy

AIR-ISOLATED MONOLITHIC DIODE ARRAYS



Only from Fairchild: High-performance Air-isolated Monolithic Diode Arrays at less than 5¢/inserted junction.

Wherever there's a high current logic requirement there's an important place for our high quality monolithic diode arrays.

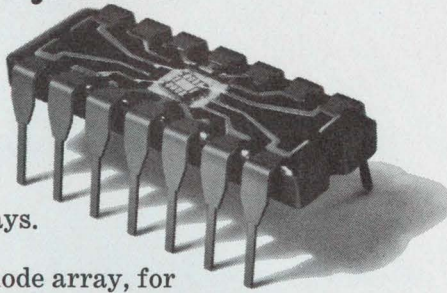

The FSA2510M 16-diode array, for example, replaces 16 discrete steering diodes in a core memory, does a better job (see benefits and specs below), at considerably less cost than either discretes or hybrids: less than a nickel per inserted junction in production quantities. Easy to use: one uniform monolithic structure means one insertion instead of 16. And deposited metal interconnects eliminate up to 30 wire bonds.

BENEFITS

- Less cost per inserted junction than discretes or hybrids.
- Higher performance from more uniform junction capacitance.
- Higher reliability from fewer wire bonds.
- Lower power requirements from reduced forward voltage drop.

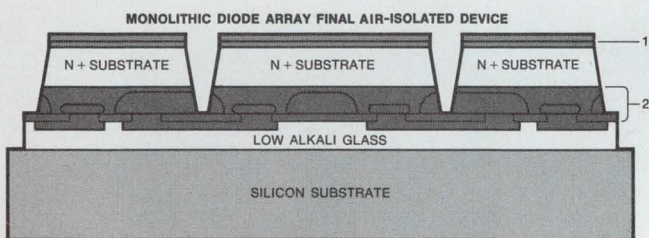

1. BONDING AREA 2. ACTIVE AREA WITH METALIZATION

SPECIFICATIONS

- Low capacitance: 5 pF max.
- Low forward voltage: 1.3V max at $I_F = 500$ mA
- Matched forward voltage: ± 15 mV
- Low leakage I_R max: 100 nA @ 40V
- Fast recovery time: t_{RR} max = 50nS @ I_F 500 mA

AVAILABILITY

Small quantities are available immediately from distributor stock. Or send us your application requirements—attention Ray Gouldsberry, Mail Stop 4-280—we'll send you free samples along with some application information and detailed specs.

Production quantities (orders up to 100K) will be filled within 6 to 8 weeks.

FAIRCHILD AIR-ISOLATED MONOLITHIC DIODE ARRAYS

This is a partial list. There are 23 standard devices from which to choose.

TYPE	PACKAGE
16 Diode Array	
FSA2510M	14 Lead Plastic Dip
FSA2501M	14 Lead Ceramic Dip
FSA2500M	10 Lead Ceramic FP
FSA2502M	10 Lead Metal
Dual 8 Diode Array	
FSA2509M	14 Lead Plastic Dip
FSA2503M	14 Lead Ceramic Dip
FSA2504M	14 Lead Ceramic FP
Quad 4 Diode Array	
FSA2508M	16 Lead Plastic Dip

**MADE IN
FAIRCHILD**

Make the simple move

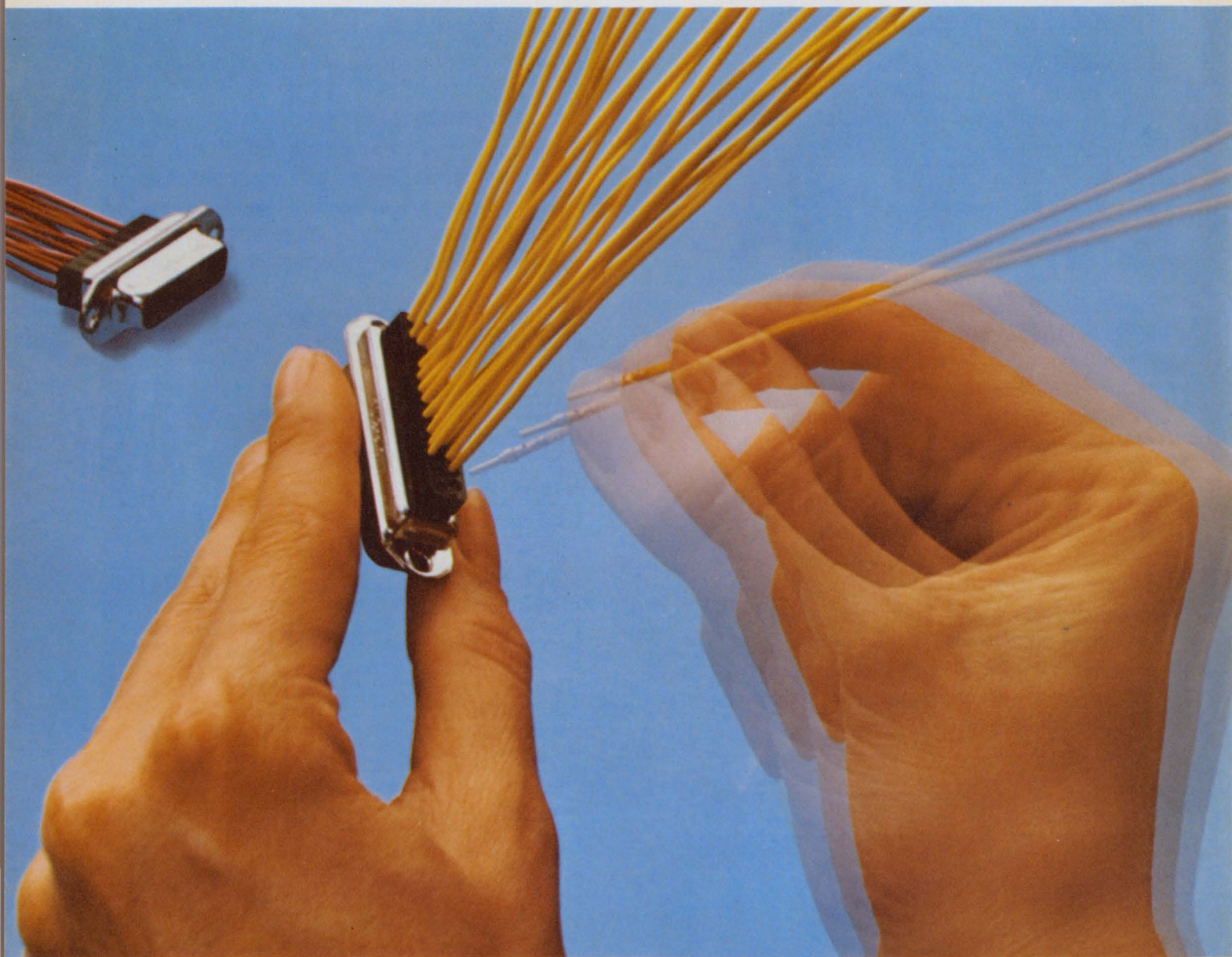

to less assembly time.

Do it the easy way with Amphenol's 17 Series miniature rear-release connectors.

A gentle push from the back of the connector and the contact snaps securely in place. No tools or broken fingernails, just easy fingertip assembly. And to remove the contact for fast field servicing, insert a simple plastic tool in the back of the connector and out pops the contact.

You can have a choice of screw-machine contacts in bulk packaging, or stamped and formed contacts on a carrier strip. Semi-automatic crimping or hand tools available for either type of contact.

The Min-Rac® 17 Series connectors are available in 9, 15, 25, 37, and 50 contact configurations. All meet EIA Standard RS-232C for data communications input-output connectors. And all are intermountable and intermateable with other Min-Rac 17 Series connectors as well as competitive "D" type connectors.

Find out how simple it really is. Just write Dick Colt asking for the whole story on our Min-Rac 17 Series rear-release connectors. Amphenol Industrial Division, Bunker Ramo Corporation, 1830 South 54th Avenue, Chicago, Illinois 60650.

**BUNKER
RAMO**

AMPHENOL

designer's calendar

JANUARY 1972

S	M	T	W	T	F	S
						1
2	3	4	5	6	7	8
9	10	11	12	13	14	15
16	17	18	19	20	21	22
23	24	25	26	27	28	29
30	31					

Jan. 25-27

Symposium on Reliability, (San Francisco), Sponsor: IEEE, J. H. Simm, Beckman Inst. Inc., 2200 Wright Ave., Richmond, Calif. 94804

CIRCLE NO. 422

Jan. 30-Feb. 4

Power Engineering Meeting, (New York City), Sponsor: IEEE, J. W. Bean, AEP Service Corp., 2 Broadway, New York, N. Y. 10004

CIRCLE NO. 423

FEBRUARY 1972

S	M	T	W	T	F	S
		1	2	3	4	5
6	7	8	9	10	11	12
13	14	15	16	17	18	19
20	21	22	23	24	25	26
27	28	29				

Feb. 8-10

Aerospace & Electronic Systems Winter Convention (WINCON), (Los Angeles), Sponsor: IEEE, Gerry Goldenstern, L.A. Council Office, 3600 Wilshire Blvd., Los Angeles, 90010

CIRCLE NO. 424

Feb. 16-18

International Solid-State Circuits Conference (Philadelphia), Sponsor: IEEE, A. V. Brown, T. J. Watson Res. Ctr., Box 218, Yorktown Heights, N.Y. 10598

CIRCLE NO. 425

Nytronics Chip Capacitors.



Nytronics Chip Inductors.



When a little has to do a lot

If you buy
Nytronics
leaded capacitors,
you *know* the
quality we must
put in our chips.

Building quality and reliability into sub-miniature chip capacitors takes talent. And it takes the experience and unequalled precision that has made Nytronics the number one name in sub-miniature capacitors and inductors.

Our ultra high stability chip capacitors provide highest possible lump capacitance per unit area. Especially suited for micro and hybrid circuits, Nytronics chip capacitors are available in solid tantalum and ceramic in the following sizes.

Ceramic: 4.7pf to 220pf; 0.170" x 0.065" x 0.070", 270pf to 4700pf; 0.28" x 0.95" x 0.070". Tantalum: .120" x .065" x .035", 4700pf to 1,500,000pf (1.5 μ f); .220" x .180" x .070"; 1.5 million pf to 22 million pf, .470" x .370" x .145"; 22 million pf to 220 million pf.

If you buy
Nytronics
leaded inductors,
you *know* the
quality we must
put in our chips.

Nytronics, one of the nation's largest suppliers of miniature precision-made RF inductors, is big in sub-miniature chip inductors too. Our little Wee-Chip, the highest quality magnetically shielded inductor available in the industry, is made especially for mounting on substrates. The inductor body is of high stability, low-loss ferrite combined with a coil cavity of optimum cross sectional area and mean radius, producing a unit with outstanding "W" factor. Wrap-around type copper terminations provide the highest degree of mounting flexibility. Available from stock in 23 standard values.

Whatever your capacitor or inductor requirements, it will be worth your while to check with Nytronics or your local distributor.



Nytronics, Inc.

Orange Street, Darlington, S.C. 29532 • (803) 393-5421 • TWX 810-665-2182

DIRECTIONS MOS

First in a series of explorations to illuminate the numerous facets of the MOS technology ...Why, How, What, and Where.

MOS vs. Bipolar Struggle For Survival? Or A Place For Each

MOS sales rose nearly \$50 million in 1970 to account for some 18% of total digital sales. No rampaging whirlwind sweeping all from its path. The increase, however, was principally due to the efforts of a few smaller semiconductor companies. Now that some of the major manufacturers are showing significant progress in development of the MOS art, interest is accelerating. MOS technology is heading toward dominance of digital electronics. The questions are, to what degree, and when.

On the conservative side is the Electronic Industries Association, with a projection of 45% by 1975. The more enthusiastic prognostications of groups engaged exclusively with MOS technology place the MOS share at a majority 55% share by that year. Certainly, an examination of the merits of MOS warrants enthusiasm, and consideration of the speed with which new technologies are implemented today justifies a shift to MOS in equipment designs. Yet, the hazards of going too far too fast are so great that the choice between bipolar and MOS circuits ranks as a vital decision facing the designer of future equipment.

The Obvious — Plus and Minus

Today's state-of-the-art has bipolar circuits operating well beyond 100 MHz. MOS presently has an upper frequency limit around 25 MHz. Obviously, for the very high speed requirements bipolar is the automatic choice. MOS circuits have the big advantage in power dissipation, operating in the nW/gate region. Bipolar structures bottom out at about 1 mW/gate. So, MOS for low power dissipation (or low-voltage operation) is a must. Technical considerations clearly place some equipment squarely with each of the two choices. Still, the much wider range of applications can be satisfied with both the lesser speeds of MOS and a power level within bipolar limits.

The Case For MOS

Why the steep growth curve for MOS? Advocates say the answer is LOWER SYSTEM COST. Several factors contribute to the smaller size of the MOS chip for an

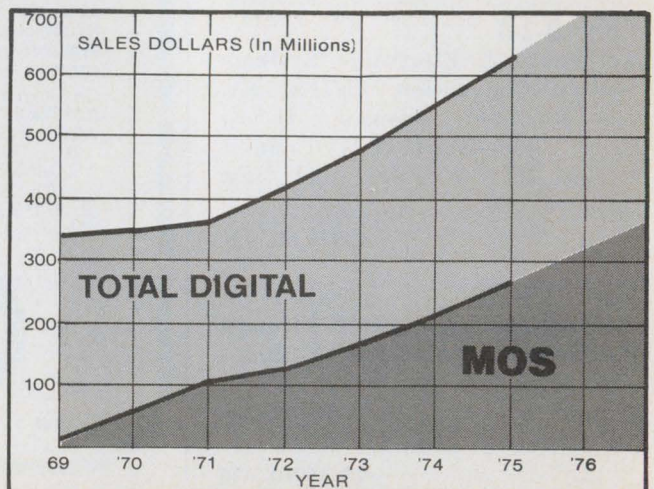

equivalent function, thus providing lower material costs. Smaller chips improve yields by minimizing circuit loss to randomly distributed wafer defects — another cost saver for MOS. The lesser number of process cycles in MOS fabrication is still another cost saver. A by-product advantage of the greater MOS chip density is the practicality of LSI now — still in the exotic category from the bipolar standpoint. When we accept as axiomatic that “the greater number of functions on a monolithic chip, the lower the potential cost per function,” practical LSI is a significant cost bonus. Higher LSI yields are, in turn, supported by the relatively simpler processing cycle of MOS.

For the equipment manufacturer planning to build enough units to make the design cost of custom circuits practical, additional overall systems savings can be realized. The savings in PC boards, system size, and reduced assembly cost, all due to fewer packages and interconnects, complement well the lower cost per function of the more complex chip. A ten percent system saving expectation is conservative.

The Bipolar Side

Circuit complexity of many designs today is reasonably within bipolar practicality. Under this condition, the chip size-related MOS cost advantage is nullified. The savings advantage of fewer process steps can be cancelled by the huge production runs of the established bipolar lines. So where systems aren't large enough to warrant LSI, bipolar appears to be the answer for the present.

There is another important consideration, even when LSI is advantageous. The desire for proprietary chip architecture can compel custom circuit design, and in these cases custom design costs form a major part of each device cost. Close figuring is required to calculate

MOS INVERTER		BIPOLAR INVERTER	
DIFFUSIONS	MASKING STEPS	DIFFUSIONS	MASKING STEPS
1 Source-drain	Diffusion	1 Isolation	Isolation
2 Gate	Gate	2 Buried Layer	Buried Layer
3	Pre Ohmic	3 Base	Base
4	Metal	4 Emitter	Emitter
5	Passivation	5	Metal Delineation
		6	Metal Etch

whether or not custom MOS/LSI chip costs are, indeed, lower than the cost of the greater number of mass-produced, simpler bipolar functions. Not all MOS/LSI will be custom, however. Standard MOS shift registers and memories are easily tailored, often less expensively than the same circuitry could be built with smaller bipolar units. This factor tilts the decision toward MOS again. But there are still other factors to consider.

Potential service cost with so large a portion of the total circuitry on one chip is an MOS/LSI deterrent. A

COST COMPARISON ESTIMATE FOR BIPOLAR AND MOS SYSTEMS				
Number of Systems to be built — 1000				
ITEM	BIPOLAR		MOS	
	No.	PRICE	No.	PRICE
No. of IC Packages (per system)	100		2	
Cost per Package		\$0.40		\$25.00
Total Package Cost		\$40.00		\$50.00
No. of PC Board and Connectors	4		1	
Cost per Board		\$5.00		\$5.00
Total Board Cost		\$20.00		\$5.00
Total Parts Cost		\$60.00		\$55.00
Manufacturing Cost (Estimated at twice the materials cost)		\$120.00		\$110.00
TOTAL COST		\$180.00		\$165.00

relatively long development cycle for very complex circuits is an obstacle, as is the possible commitment to a single supply source. A good, long-term future for bipolar devices appears to be inevitable.

Overcoming Some MOS Obstacles

Reduction or elimination of design-time and development-cost limitations of custom LSI is an area of active concern, and progress is good. In fact, custom systems have now been designed and built at lower cost than comparable designs with standard bipolar devices. When this is the norm, a formidable objection to MOS will have been dismissed.

Where Do We Stand Now

Some equipment manufacturers have completely embraced MOS. The desk calculator and electronic watch markets are good examples. The swing to MOS for other equipment is predictable. Medical equipment, particularly for attachment to the body, is a natural candidate. So is the automotive market, because of its low cost and low power drain requirement. On the other hand, high-speed computer circuitry appears wedded to bipolar designs at least for the immediate future. Driver circuits will also remain bipolar until MOS circuits can provide a significant amount of power. The probability of mixing MOS and bipolar circuits is yet another design alternative.

Summing up, bipolar is here for some time to come, with MOS increasing its share of the load to half or better. MOS vs. bipolar — the verdict? A place for each, at least until mid-decade, and opportunities for creative design have never been greater, nor the rewards for success more promising.

Motorola is committed in both MOS and bipolar technologies to the delivery of the electronic equipment industry's device requirements, whichever they may be. This is the first in a series designed to present a realistic, objective analysis of the position of the MOS technology in a dynamic, competitive industry. For an examination of this and other aspects of the MOS technology in greater depth than is permitted here, circle the reader service number or write to Motorola Semiconductor Products Inc., P. O. Box 20912, Phoenix, Arizona 85036.



MOTOROLA MOS
Directions in digital designs

Coming next — A LOOK AT “THE MANY FACES OF MOS”

She's learning to test semiconductors ... *FASTER!*



With the 172 Programmable Test Fixture for the TEKTRONIX 576 Curve Tracer, you program up to eleven sequential tests on FETs, transistors and diodes. This new fixture saves measurement time in applications such as incoming inspection where you make a series of tests on a number of devices.

Programming is straightforward. Inserting pins in holes in programming cards sets individual test conditions. Omit the pin from a particular test hole and the 172 skips that test.

Test limits can be graphed on a plastic card. This card is then overlaid against the 576 display area for comparison of test results and limits.

Even experienced operators are likely to make errors in applications where repeated adjustments in control settings are needed. The 172 removes this error source. Operators with little or no experience can make tests quickly and accurately. You'll save valuable training time.

Programmed testing frees your technically trained personnel to concentrate on more creative processes,

speeds incoming inspection, saves training time, reduces errors and decreases measurement time.

Do you have a TEKTRONIX 7000-Series or 5100-Series Oscilloscope? Planning to get one? If so, you'll want to know about our new plug-in curve tracers too. For complete information, call your local TEKTRONIX Field Office and ask for the new Semiconductor Curve Tracer Booklet. Or write Tektronix, Inc., P. O. Box 500, Beaverton, Oregon 97005. We will send you complete information—immediately.

172 Programmable Test Fixture \$1400

U.S. Sales Price FOB
Beaverton, Oregon



TEKTRONIX®

committed to
technical excellence

INFORMATION RETRIEVAL NUMBER 14



it's here!
the
book-of-
the-year

General Electric's 1st. Edition Semiconductor Data Handbook

Unijunctions, optoelectronics, SCR'S . . . they're all included in this comprehensive, complete product specification bound handbook. Over 1,200 pages, it covers some 30 product categories, plus quick-reference Selector Guides, Interchangeability Information, and check lists on what-and-how to benefit from GE's unparalleled application expertise.

It includes all devices introduced up to September 1971, over 2,500 types, arranged in alpha-numeric order. As never before, you can make sure you don't overlook a GE semiconductor that may work better . . . and more economically in your circuit design.

PRODUCT CATEGORIES (Partial List)

- | | |
|--------------------------|-------------------------------|
| Optoelectronics | Rectifiers |
| Power Transistors | Tunnel Diodes |
| SCR's | Germanium Transistors |
| Triacs | Signal Diodes |
| Unijunctions | Chips |
| Triggers | Darlingtons |
| Silicon Transistors | Assemblies |
| Choppers | Mil. & Hi Rel Types |
| Stacks | Integrated Voltage Regulators |
| High Voltage Multipliers | Metal Oxide Varistors |

HOW TO ORDER

To get your copy, contact your local GE authorized semiconductor distributor. He's an expert on semiconductors, providing up-to-date pricing and availability information, plus fast delivery service. Phone, or mail in your GE HANDBOOK order TODAY !

 SEMICONDUCTOR DATA HANDBOOK • List Price \$3.95 Ea.

To: _____
(GE Authorized Semiconductor Distributor)

(Street)

(City, State, Zip Code)

Please send ___ GE 1ST. EDITION SEMICONDUCTOR DATA HANDBOOKS.
Enclosed is check, money order, for \$ _____ payable to the above.

Name: _____ Title: _____

Company: _____

Address: _____

City: _____ State: _____ Zip Code: _____

GENERAL  ELECTRIC

DESIGN **IDEAS** FROM SYLVANIA

Let us mill.

Not all sheet-metal parts should be manufactured by force and violence. It's much more humane to dissolve away the unwanted metal. This process, called photo chemical machining, leaves the parts unstressed, unbent, unbroken, unbeaten. It's extremely accurate. And it may cost less than militant methods such as stamping and machining.

We became expert in photo chemical machining by running one of the largest chemical milling operations ever set up. It's a continuous process that turns out a couple of million color TV aperture masks per year. (Each mask is pierced by half-a-million tiny, round holes.)

If we can make masks, we can make almost anything by photo chemical machining: parts such as IC lead frames, display-tube numbers, grids, heaters, computer-card guides, electric-razor cutter heads. We do everything: artwork, milling, finish plating.

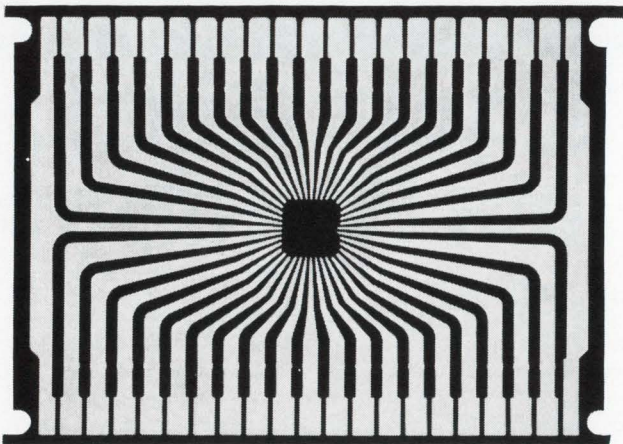

40-lead IC frame. (PCM part)

Naturally, we welcome run-of-the-mill chemical milling work. (It's our bread and butter.) But we're overjoyed when people give us a really tough PCM job. We have a whole crew of metallurgists, chemists and designers, and they can come up with sweet answers where others produced sour notes.

So if you're having any problem with PCM parts, come to us.

Instead of just milling around.

For more about PCM, call Bill Johnson at 717-265-2121. Or write him at GTE Sylvania, Chemical & Metallurgical Division, Towanda, Pa. 18848.

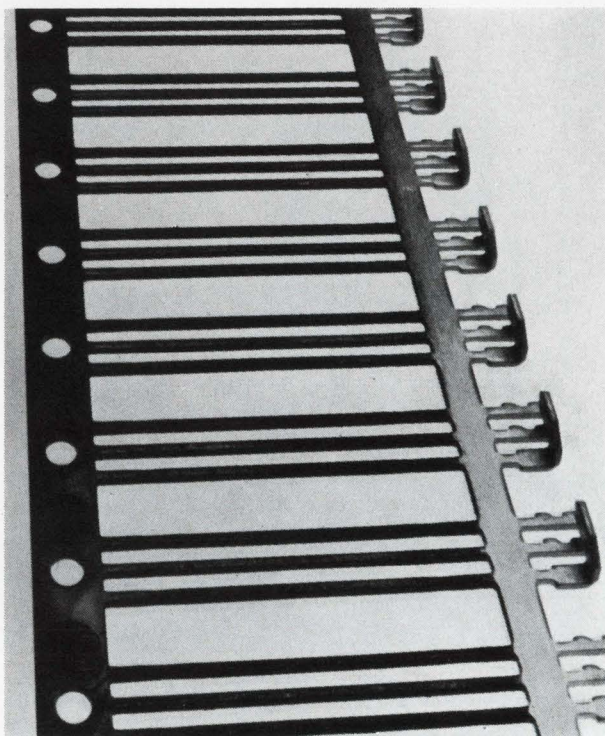

Gold-plated transistor lead frame. (Stamped part)

Stamp out everything.

One of our most creative areas is the stamping of electronic parts.

We can bang them out like a machine gun—about 10 million parts per day. From a wide range of materials. In all sorts of finishes and tempers. To extremely close tolerances.

We've got presses that will blank, cup, draw, pierce, bead, knurl and trim—all in one pass.

We'll take on the most intricate shapes you have, make our own dies for them and knock out beautiful parts by the barrelful.

And we'll do it at a reasonable cost. (After all, stamping is the most economical way to mass-produce metal parts.)

So give us your huddled contacts. Your teeming lamp bases. Your integrated circuit parts. Your cans and headers. Your anything and everything.

And we'll stamp 'em out for you.

Call our stamping people at 717-764-9853. Ask for Hal Martin. Or write to him at: GTE Sylvania, Parts Division, 1128 Roosevelt Ave., York, Pa. 17404.

GTE SYLVANIA

INFORMATION RETRIEVAL NUMBER 132

The most spectacular improvement in comparators since the 710.



You get a major boost in accuracy. At incredibly high speeds, 300% faster than any other voltage comparator available to date—including that old standby the 710.

527 and 529. Two more products in Signetics new third generation linears—a vastly improved IC series developed to jump performance capabilities without penalties.

Both chips offer breakthrough transit time. A 10ns propagation delay for our 529 comparator. (Vs. 40-60 ns for the slower 710.) With input impedance of 5 k Ω , typical bias current of 5 μ A.

At 15ns, the 527 trades a sliver of input-output speed for ten times higher input impedance, 50 k Ω , and seven times lower input bias current, 0.7 μ A. (Vs. the 20-30 μ A of 710.)

And the best is yet to come. Both comparators carry complementary Schottky-diode outputs, Q and \bar{Q} , a revolutionary two-gates-to-a-chip concept that minimizes system delay enormously. TTL and ECL compatible, operating from balanced ± 5 V to ± 15 V power supplies.

Sophisticated military and commercial versions in production. For applications in any system design where super high speed with optimized accuracy is crucial. Analog to digital converters, optical data couplers, memory sensing... the ideal interface with ECL, TTL and Schottky devices.

Do what you're doing better, or find something better to do. Signetics third generation linears let you have it both ways—improvement without penalty. With the ultra fast 527 and 529 comparators, as well as our 531 high slew rate op amp, 533 micro power op amp, 536 FET input op amp, 537 precision op amp, 528 4-channel sense amp, and 550 voltage regulator. All at your Signetics distributor or sales rep.

and

529

Signetics-Linear
811 E. Arques Avenue
Sunnyvale, California 94086
(408) 739-7700

Rush us everything you've got on the 527 and 529 comparators. And throw in your third generation linear package.

Name _____

Title _____

Company _____

Address _____

City _____

State _____

Zip _____

Telephone () _____

signetics
counts in linear.

SIGNETICS CORPORATION, A SUBSIDIARY OF CORNING GLASS WORKS

INFORMATION RETRIEVAL NUMBER 15

PANEL DISPLAY IT

now it's possible

We've done the hard work— by making the first commercially available panel display subsystem for use in your application. Burroughs new SELF-SCAN panel display subsystem provides 256-character alphanumeric panel display capabilities and all necessary electronics — *drivers, memory, timing and character generation* — in a compact module.

And because SELF-SCAN panel display technology reduces electronics by 90% and cuts display thickness to less than 1½ inch, you get unprecedented flexibility and cost advantages for display applications.

The easily-read characters used in this unit are formed of dots on .040" centers, with eight 32-character rows in a 5 x 7 dot matrix format.

Application versatility is designed-in with options including visual cursor, tab controls and expanded memory capability. The 256-character unit shown is available for off-the-shelf delivery; 64- and 128-character subsystems available soon. Units with only display and driver electronics are also available. Write or call for additional information:

Burroughs Corporation, Electronic Components Division, Box 1226, Plainfield, N. J. 07061 (201) 757-3400.



(Size 5.5 x 11 x 1.4)

256-Character **SELF-SCAN™** Panel Display Subsystems

Burroughs 

NOVEMBER 25, 1971

Quadrasonics advances with 4 developments

Four new developments have been reported in quadrasonics—the fastest-advancing technique in audio. The latest advances are in both matrix and discrete channeling. They are:

- New four-channel matrix decoding equipment that decodes all presently used matrixing systems—including CBS Laboratories' Stereo Quadraphonic—has been demonstrated by Electro Voice, Inc., Buchanan, Mich. It does not require listener switching.

- RCA Records of New York City has announced it will produce records with four discrete channels pressed on them. It will employ the JVC America system of multiplexing through use of high-frequency subcarriers that require a response of over 45 kHz in recording and playback.

- Panasonic, in collaboration with JVC, will produce decoding hardware for the JVC system in the next few months.

- A commercial model of the special phonograph pickup necessary to play the JVC records is under development by Empire Devices, Inc., of Garden City, N. Y., among others.

Electro-Voice, a leading producer of four-channel matrix decoding systems for the quadrasonic playback of records, has developed a new version of its Stereo 4 decoder. Decoding of the CBS Laboratories' matrixed signal could not previously be done with an older Electro-Voice model, notes Howard Durbin, senior vice president and technical director of Electro-Voice, because the CBS matrix parameters gave substantially less separation between the front and back pairs of speakers.

While technical details are proprietary, Durbin explained that a principal difference between the CBS and Electro-Voice equipment

was introduced by phase shifts that CBS used for the rear speakers.

Electro-Voice has added new circuitry ahead of that formerly used in its older Stereo 4 unit, so that the effect of the CBS phase shift is minimized; yet the unit can be used to decode all the other matrix systems on the market as well. And this is without switching of any kind.

On the discrete, four-channel equipment front, RCA Records has announced the solution of technical problems involved in producing the 50-kHz response disks needed for the JVC recording system.

Gerald Orbach, marketing manager of JVC America, Maspeth, N.Y., says that Panasonic, in collaboration with JVC, will be producing decoding hardware for the JVC system.

A big cost factor in the JVC playback system is a pickup capable of reproducing 50 kHz. Orbach notes that several pickup manufacturers are working with JVC to develop a low-cost, high-quality pickup.

Herbert Horowitz, president of Empire Scientific Devices, one of the pickup manufacturers, says that its first magnetic pickups will probably cost \$100, but these are still a few months from delivery.

(See also "Quadrasonics Giving Consumer Industry a New Sound to Sell," ED 18, Sept. 2, 1971, pp. 22-25.)

Smallest low-cost DPM introduced by Analog

Analog Devices of Norwood, Mass., a large manufacturer of analog and conversion modules and a small manufacturer of monolithic ICs, has introduced the smallest and lowest-priced digital panel meter around today.

The bipolar 3-1/2 digit AD2001 panel meter has a volume of just under eight cubic inches—less than half the 18 cubic inches of Digilin's LED readout 3330, which formerly was the smallest DPM till now.

In quantities of 100, the AD2001 costs \$89—\$6 less than Analog's AN2532, the lowest-cost bipolar-cased DPM.

While most DPMs use gas-discharge readouts and a few use LEDs, the AD2001 uses RCA's Numitron, a segmented incandescent digital display device.

Unlike most DPMs the AD2001 does not operate from the line; so it saves the price, size and weight of a line transformer, rectifier and filter. Also, the meter doesn't need the inverter required by other DPMs that operate from 5 V to allow bipolar operation.

This is made possible by new Analog circuitry, which the company declines to describe until its patent has been acted on.

'Stabilized' employment foreseen in aerospace

Employment in California's hard-hit aerospace industry should "stabilize near the end of this year and hold fairly steady" during 1972, according to the Bank of America in San Francisco.

However, the nation's largest bank predicted in its annual outlook on the state's economy that over-all aerospace employment in the state would not show "marked improvement until early 1973, when defense contracting and demand for commercial aircraft pick up."

Over-all unemployment in the state should drop to 6% of the labor force next year from this year's estimated 7.3%, the bank said. Even so, that rate will put California's unemployment "well above the U.S. rate," it added.

In a related development in California, the Lockheed Aircraft Corp.—considered by some a symbol of "ailing aerospace"—is hiring workers, according to the Wall Street Journal. And what's even more surprising, it's reported having trouble filling more than 1000 vacancies for skilled aerospace workers at its Burbank and Palmdale plants. Since Congress approved a \$250-million load guarantee to the com-

pany to produce the L1011 TriStar jumbo jet, Lockheed has been trying to rehire many of the 9200 workers it laid off early this year. But few appear to be banging at the gates to get inside the plants.

The reasons? Most of California's 53,000 unemployed aerospace workers are simply not all capable of filling the jobs. Many were white-collar workers or production workers who lack the skills currently required by Lockheed. Also, many aerospace workers have left California to find jobs in other states. Finally, the well-publicized economic problems of the aerospace industry seem to be discouraging many workers from signing up for jobs—even though many are unemployed or underemployed at present.

3 computer companies offering new systems

More for the money is being offered in three new mini and medium-scale computer systems. The systems are:

- Univac's new 9700 medium-scale computer system, which is said to offer over twice the processing power of the IBM 360/50.

- Hewlett-Packard's System/3000 disc-based computer system, which will be introduced at the Fall Joint Computer Conference in Las Vegas as "the first small-scale computer system with true multi-programming and multi-lingual capabilities."

- Three new models of Data General Corp.'s Nova computers, which will be introduced at the computer conference at prices "substantially less than their previous models."

Univac's new 9700, the largest in its 9000 series of general-purpose computers, is reported to be over three times as powerful as the Univac 9400. It uses plated-wire memory technology and has a basic storage capacity of 65,536 bytes, expandable to a maximum of 1,048,576. The main storage cycle time is 600 ns for each full four-byte word.

The 9700 also features microprogramming, which implements each computer instruction by micro-instructions, or subroutines, instead of hardwired logic. This allows the

machine to process IBM 1401, 1440 and 1460 programs, currently being processed on the IBM 360.

Hewlett-Packard's is priced from \$100,000 to \$300,000, depending on configuration. It can simultaneously handle time-sharing, real-time, multi-programmed batch and on-line terminal operations, each in more than one computer language. It employs a pushdown stack architecture, similar to that of Burrough's 5500 system.

The HP system provides for concurrent I/O and CPU operations. Central processor hardware provides an inherent re-entrant code, relative addressing, memory protection and virtual memory facilities. The hardware stack design, according to a company spokesman, makes possible a large instruction set (170), including hardware floating-point operations, as a standard feature.

The System/3000 also contains a microprocessor based on an LSI read-only memory with a micro-instruction time of 175 ns. The system can accommodate up to four independent memory modules on a single bus with a combined capacity of 131,000 bytes.

Data General's three offerings consist of the Nova 1210, a 5-1/4-inch-high machine with 4 K, 16-bit words of core memory for \$4350 or with 8 K words for \$5750; the Nova 1220, with 4 K of memory for \$5280 and with 8 K for \$6650; and the Nova 820, which gives users 800-ns second instruction execution for \$6450 with 4 K of memory. An 8 K Nova 820 costs \$7850. Like the Nova 1220, the 820 can give a user four subassembly slots for interfaces.

TV image sensor uses bucket-brigade circuit

Using the concept of charge transfer and bucket-brigade circuitry, RCA has developed an experimental tubeless TV sensor. The new sensor is said to offer higher reliability, lower power requirements, smaller size and lower cost than conventional image-sensing tubes.

According to Dr. William M. Webster, vice president of RCA Laboratories, Princeton, N.J., the new device, when fully developed,

may be used as the image sensor for a TV camera, as well as in character-recognition equipment and punched-card readers.

The sensor consists of a 0.02-inch-square silicon chip containing a 32×44 array of photosensitive elements. When exposed to an image, such as that produced when a slide is projected onto the chip, the photosensitive elements cause each stage in the bucket brigade to charge up to a specific value, which is determined by the intensity of the image at that point (for details on how a bucket brigade works, see "Bucket-Brigade Device Said to Cut Audio Delay-Line Costs Drastically," p. 34 this issue). The image information stored in the RCA bucket registers is then read out by another 32-stage bucket-brigade register on the same chip.

The latter register is used to scan vertically the other 32 registers, and it selects the rows to be read out, one line at a time, to form the over-all picture. This eliminates the need for a separate two-dimensional storage array.

Electronic key system may curb hotel thefts

One of the hotel industry's biggest security problems—the acquisition of duplicate room keys by thieves—is solved by a new electronic key system that permits changing of the door lock combinations from the hotel desk every time a guest checks out.

Using multiplexing signals, the system, developed by Instrument Systems, Corp., of Jericho, N.Y., permits key combinations to be issued electronically. A special key with several contacts, looking much like a conventional key, is part of the system.

According to the company, which also makes multiplexing entertainment systems for jet liners, the system uses but two wires. But with the multiplexing technique, it can carry an elaborate pattern of key identifications. Once, the two wires are installed, they can be readily adapted to provide other room services, such as a maid locator, heating and ventilation control, and even in-the-room vending machines.

GE DESIGNED THESE TRIACS FOR YOU

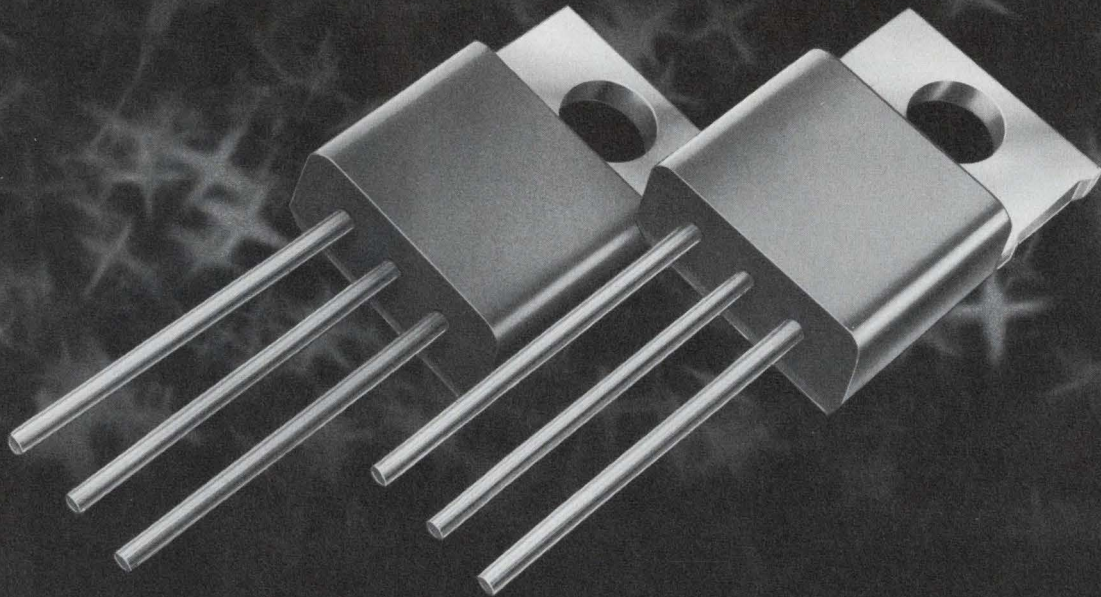

GE originated the triac in 1963 and now offers new standards of performance and reliability. Silicone encapsulated SC141 and SC146 triacs, up to 500 volts, and 6 and 10 amps respectively, feature the new proprietary **POWER-GLAS™** passivation process which creates a void free bond between the silicon chip and the matched glass. This results in low "off-state" currents of typically $10\mu\text{A}$. The SC141 and SC146, like all GE triacs, have inherent immunity from transient voltage damage and improved commutating dv/dt . Additionally these rugged packages incorporate a stress-free assembly system, which offers you torque limit-free tab mounting and easily formed round leads. For your convenience, GE offers 6 standard lead configurations. These features make the SC141 and SC146 your best value in 6 and 10 amp triacs.

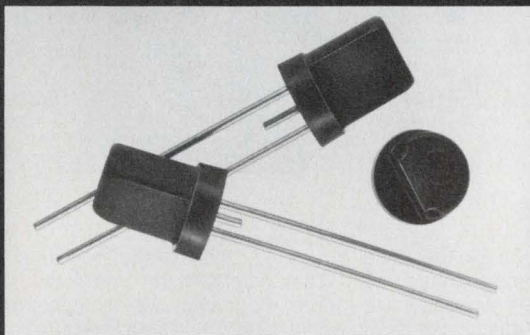

Another GE creative design, the ST4 asymmetrical trigger, is an ideal trigger for light dimmer applications. It features performance comparable to triggering circuits using at least 3 additional passive components and greatly reduces hysteresis effects by means of a single RC time constant. At 46¢ each in 1,000 unit level, it is truly an economical companion to GE **POWER-GLAS™** passivated triacs.

GENERAL  ELECTRIC

Interested in seeing how GE triacs and triggers can help you design? For free SC141B and ST4 samples write on company letterhead to GE Semiconductor Products Department, Electronics Park, Bldg. #7, Mail Drop 49, Syracuse, New York 13201.

Make your move to RCA's new "Hometaxial II" line-up to find exactly how much transistor you need

2N6261 $V_{CEO}(\text{Max.}) = 80\text{ V}$ $h_{FE} = 25-100$ @ $I_C = 1.5\text{ A}$	2N3054 $V_{CEO}(\text{Max.}) = 55\text{ V}$ $h_{FE} = 25-100$ @ $I_C = 0.5\text{ A}$	2N6260 $V_{CEO}(\text{Max.}) = 40\text{ V}$ $h_{FE} = 20-100$ @ $I_C = 1.5\text{ A}$
2N6254 $V_{CEO}(\text{Max.}) = 80\text{ V}$ $h_{FE} = 20-70$ @ $I_C = 5\text{ A}$	2N3055 $V_{CEO}(\text{Max.}) = 60\text{ V}$ $h_{FE} = 20-70$ @ $I_C = 4\text{ A}$	2N6253 $V_{CEO}(\text{Max.}) = 45\text{ V}$ $h_{FE} = 20-70$ @ $I_C = 3\text{ A}$
2N6258 $V_{CEO}(\text{Max.}) = 80\text{ V}$ $h_{FE} = 20-60$ @ $I_C = 15\text{ A}$	2N3772 $V_{CEO}(\text{Max.}) = 60\text{ V}$ $h_{FE} = 15-60$ @ $I_C = 10\text{ A}$	2N6257 $V_{CEO}(\text{Max.}) = 40\text{ V}$ $h_{FE} = 15-75$ @ $I_C = 8\text{ A}$
2N6264 $V_{CEO}(\text{Max.}) = 150\text{ V}$ $h_{FE} = 20-60$ @ $I_C = 1\text{ A}$	2N3441 $V_{CEO}(\text{Max.}) = 140\text{ V}$ $h_{FE} = 25-100$ @ $I_C = 0.5\text{ A}$	2N6263 $V_{CEO}(\text{Max.}) = 120\text{ V}$ $h_{FE} = 20-100$ @ $I_C = 0.5\text{ A}$
2N6262 $V_{CEO}(\text{Max.}) = 150\text{ V}$ $h_{FE} = 20-70$ @ $I_C = 3\text{ A}$	2N3442 $V_{CEO}(\text{Max.}) = 140\text{ V}$ $h_{FE} = 20-70$ @ $I_C = 3\text{ A}$	2N4347 $V_{CEO}(\text{Max.}) = 120\text{ V}$ $h_{FE} = 15-60$ @ $I_C = 2\text{ A}$
2N6259 $V_{CEO}(\text{Max.}) = 150\text{ V}$ $h_{FE} = 15-60$ @ $I_C = 8\text{ A}$	2N3773 $V_{CEO}(\text{Max.}) = 140\text{ V}$ $h_{FE} = 15-60$ @ $I_C = 8\text{ A}$	2N4348 $V_{CEO}(\text{Max.}) = 120\text{ V}$ $h_{FE} = 15-60$ @ $I_C = 5\text{ A}$

RCA now introduces "Hometaxial II", a second-generation line-up of silicon power transistors that will change your design thinking—with new heights in current, voltage, and dissipation ratings. Pick your device and price. Already workhorses of the industry, Hometaxial-base silicon devices measure up to their specifications—reliably. That's because Hometaxial-base means freedom from second breakdown!

Check the chart for exactly which—and how much—transistor you need. Then call RCA. See your local RCA Representative for more information. For technical data on specific types, write: RCA Solid State Division, Section UTL25, Box 3200, Somerville, N. J. 08876. International: RCA, Sunbury-on-Thames, U. K., or P. O. Box 112, Hong Kong. In Canada: RCA Limited, Ste. Anne de Bellevue, 810 Quebec.

RCA Solid State
products that make products pay off

Suddenly, everybody is building microprogrammed computers

Microprogramming—a computer design technique that's been around for some 20 years—produces smaller, more powerful and more versatile computers at lower cost. But only recently has it come into wide favor, particularly in the design of desk-top programmable calculators and minicomputers.

Although even a few years ago microprogramming was used in some larger computer systems, including those of IBM, RCA and Honeywell, it wasn't widely used primarily because of the high cost of a key element—a read-only or a random-access memory (ROM or RAM).

But with low-cost, high-capacity semiconductor ROMs reaching market, designers are applying their advantages to microprogramming. Among the advantages are these:

- The performance and capability of new machines can be substantially increased at lower cost and in less space than with former approaches.
- Diagnostic routines and servicing aids can be readily incorporated in the control portion of the computer.
- Field changes can be made easily by changing ROMs.
- The capability of the computer can be increased in the field at lower cost than with conventional computers.
- The system can be adapted to special tasks by changing a few program words.
- The programs of other computers can be duplicated—or emulated, as it's called in the literature—in a single, general-purpose computer.
- Final definition of the system

Jim McDermott
East Coast Editor

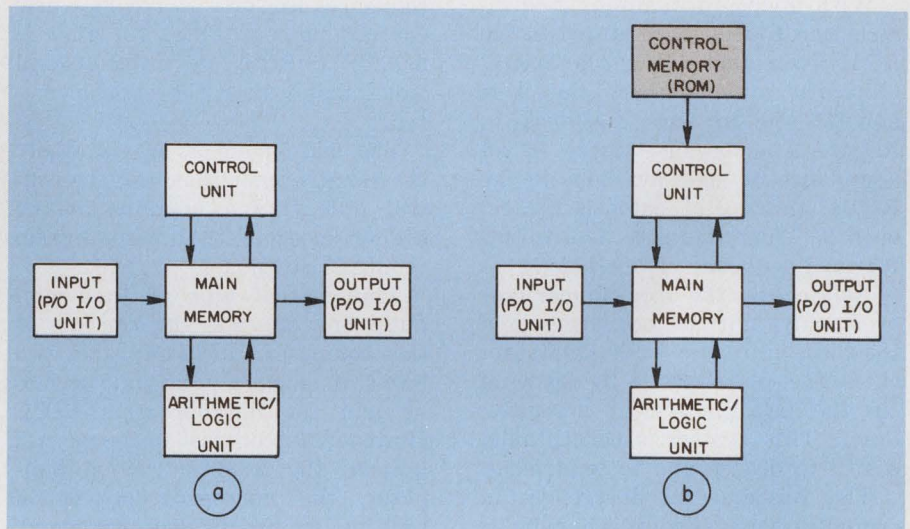

1. The significant difference between a conventional computer (a) and a microprogrammed computer (b) is in the addition of a control memory.

can be delayed to a later time in the design period.

- Computer documentation and service training costs can be reduced.

What is microprogramming?

The shortcomings of conventional procedures for designing computers was recognized by Prof. M. V. Wilkes of Cambridge University, England, as early as 1951 in a paper, "The Best Way to Design an Automatic Calculating Machine." The paper, delivered before the Manchester University Computer Inaugural Conference, pointed out that the conventional approach to computer design produced a costly, unwieldy and complex structure that was also difficult to design.

Professor Wilkes suggested that the design be simplified by substituting for the usual complex combining and sequencing control logic a combination of a simplified control unit and a memory (ROM or

RAM) containing what he called a "microprogram."

A microprogram is a sub-element of a conventional program. For example, the computer program consists of a sequence of instructions that are carried out in a specific order. Each instruction consists of a routine of one or more steps. This sequence of computer machine cycles necessary to execute a single instruction is called a microprogram.

The microprogram is built up of a sequence of even smaller operations called micro-instructions. Each micro-instruction is further subdivided into a collection of micro-operations carried out in one basic machine cycle.

With the conventional machine, the designer has literally given the programmer an essentially independent stockpile of computer logic elements. By assembling these elements in various sequences, the programmer sets up combinations of logic and timing paths interlinking the various registers, instruc-

tion decoders and other machine functional units.

Because the logic elements are seldom all used simultaneously, the computer designer further complicates the routing paths of signals and data flow by using elements for more than one purpose at different times in the machine cycle and in routines. The final pattern of the logic and data flow is frequently a Rube Goldberg type of sequence, unique to the particular computer.

With microprogramming, the instruction routines are stored in the ROM associated with each control unit. The logic is there, but it is now stored in fixed patterns in ROMs. And because there is an abundance of logic available in the ROMs, sharing of gates is not required. Thus there is a straightforward sequence of operations.

As a result, the programmer now need only initiate sequences and the data stored in each ROM executes the instructions by spewing out the data patterns in a regular order. This system is conceptually easier to design and to implement.

The fundamental differences in computer design approach may be seen in a comparison of the organization of a conventional computer and a microprogrammed machine made by Robert Oakley, product manager of Microdata Corp., Santa Ana, Calif., a leading proponent of microprogrammed minicomputer designs.

The conventional approach, Oakley says, produced a fixed-instruction, stored-program machine conceived of as a storage and retrieval scheme that used a single, main random-access core memory (Fig. 1a). The computer programs were stored in this memory, as was other data.

To execute a program, specific sequences of instructions were extracted from the memory and fed to the control unit.

The control unit timing was closely synchronized to the memory cycle speed, and the execution period of each instruction was usually some multiple of memory clock rate.

For the microprogrammed computer, differences appear in the control unit organization, Oakley points out. And the basic control sequences are now stored in a new control memory (Fig. 1b) that is usually a ROM operating several times faster than the main memory.

The main memory is essentially the same, except that now the control unit timing operates at the higher speed of the microprogram (control) ROM.

The control unit of this computer now operates the elements of the computer, including the two levels of memory—the main memory and the microprogram ROM. However, in contrast to the control unit of the fixed-instruction computer, the microprogram control unit is programmable, not fixed. And the programs operating on the control unit are called "firmware," because they are derived directly from the ROM in the machine and not from the program software.

In the general-purpose, fixed-instruction computer, instructions and data are stored in the main core memory. Both instructions and data can be altered by the programmer. In the microprogrammed system, instructions and permanent data are stored in the ROM.

The instruction repertoire in a general-purpose, fixed-instruction computer is usually small, and the memory reference instructions

have limited addressing modes.

The use of microprogramming is currently expanding at a rapid rate. While a few years ago its use was fairly limited, it is found today in both the central processing unit and peripheral controllers of the IBM 360 and 370 series, in the Honeywell 4200 and in many minicomputers and scientific calculators, including those built by Interdata, Microdata, Digital Equipment Corp., Hewlett-Packard, Data General, and Wang.

Design advantages are many

William Davidow, vice president of marketing for Signetics Memory Systems, Sunnyvale, Calif., feels that the microprogramming approach makes design faster and easier to change during the design.

"You can design a microprogram and make changes a lot easier than with conventional logic," he says.

In addition the design can be easily documented because it is directly related to fixed logic patterns in the ROM rather than a host of time-varying and event-varying sequences.

Another plus for microprogramming, Davidow points out, is the fact that it is easier and less costly to increase the logic complexity of a machine.

He gives as an example a simple conventional system with two PC cards that draw 6 A total current. To double the complexity, he says, you add two more PC cards. But, he points out, these require another 6 A and take up twice the original space.

On the other hand, he says, with a microprogrammed system, a comparable increase in complexity is obtained by doubling the size of the ROM. This addition might consume only an additional 200 mA. Thus power, space and cost are saved.

Checking and debugging a new system is also easier with the microprograms, because the diagnostics can be readily added, and at low cost.

For example, a system that requires 500 words of ROM would probably require 512 more words of diagnostics, Davidow estimates. And this could contain a sizable diagnostic program. Assuming a cost of 1 cent a bit, this amounts to about \$8.

The capabilities that can be built

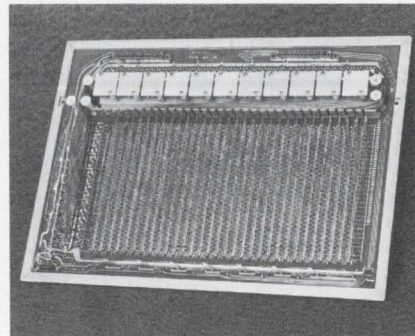
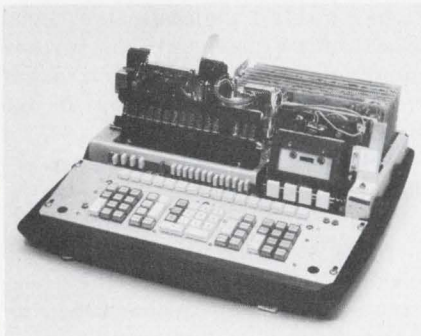

This microprogrammed Model 500 Wang calculator (left) has an 88-k bit braided-wire control ROM (right) that shrinks the machine to desk size.

**CAPACITORS
FILTERS**



Our filter/capacitor family takes experimentation out of circuit design.

We provide the comprehensive data you need for every one of our filter and capacitor components. Attenuation curves (by current, voltage or in combination at room temperature and maximum). Test procedures. Application aids. Specs. Dimension drawings. That's why the Allen-Bradley family is easier to work with. We also give you high volumetric efficiency and

a wide variety of styles. Backed by our famous track record for quality and improved performance. Request your personal copies of our literature. Call our nearest appointed electronics distributor, or write: Allen-Bradley Electronics Division, 1201 South Second Street, Milwaukee, Wisconsin 53204. Export: Bloomfield, New Jersey 07003. Canada: Galt, Ontario.

Publication 5409: type FA, FB, FW, SB, SS ceramic disc capacitors for VHF/UHF.
 Publication 5410: type FCS, SMFB, SMFO filters for the 50 MHz to 10 GHz range.
 Publication 5411: type CL multi-layer, coaxial capacitors for connectors.
 Publication 5414: type MT, MS by-passing capacitors for 50 KHz to 1 GHz.
 Publication 5416, 5417: type BE, SF filters for RFI/EMI suppression.
 Publication 5418: type AB broad band filters in Pi, T and L configurations.



NEW DIMENSION ELECTRONICS
ALLEN-BRADLEY



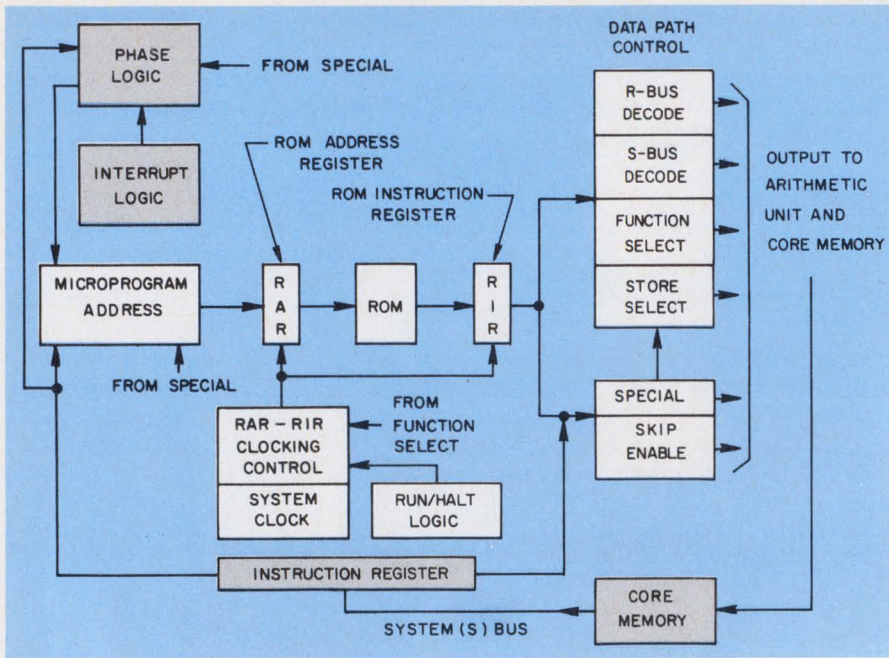

2. The Honeywell 2100A microprocessor, comprised of the white blocks above, fetches a 16-bit user instruction from the core memory and stores it in the instruction register. The processor then jumps to a microprogram routine in the ROM that causes the machine to execute the user instruction.

into a small microprogrammed machine with a substantial reduction in size are impressive. For example, in the Wang 500 Programmable Calculator, the microprogram ROM is a braided-wire assembly containing 88-k bits. With this system, the machine uses only 150 packages of ICs hardwired into the system, says Harold Koplow, manager of special products for Wang, Tewksbury, Mass.

But if the same machine were designed with conventional logic, he points out, it would have required 3000 ICs, would have been of much greater size and would have consumed orders of magnitude more power.

Because of the great size reduction achieved in the Wang 500, both a printer and a cassette for programming storage are also included in this desk-top unit as optional equipment, Koplow says. With some models, a single key stroke can execute a 16,000-step program through cassette programming.

Recognizing that a new computer can easily be designed to emulate—that is, be able to run the same programs of—an earlier machine, Hewlett-Packard designed the 2100A. It is a faster, more powerful microprogrammed version of earlier HP computers.

Charles T. Leis, system design-

er of the 2100A, notes that in the older machines the program was decoded and executed by permanent hardware. But in the 2100A the instructions are decoded and executed by a portion of the hardware, plus the contents of a microprogrammed ROM that is controlled by a microprocessor in the control section of the computer (Fig. 2). The microprocessor, Leis points out, can be thought of as a special-purpose computer within a computer.

If all the instructions were decoded and executed at the microprogram level, Leis says, the 2100A would be a general-purpose emulator. However, the partitioning between hardware and firmware has been optimized to emulate the earlier HP 2114, 2115, and 2116 machines.

Execution of instructions in the 2100A is performed by the microprogram stored in the microprocessor's ROM.

The HP 2100A demonstrates the relative ease of expanding computer capability at low cost. The minicomputer requires six IC bipolar ROM packages with a capacity of 256 24-bit words to implement the basic instruction set, including extended arithmetic instructions. However, enough space was built into the machine for 1024 24-bit words, with the additional

ICs serving to expand the instructions.

Although the ROMs are permanently programmed when manufactured, Leis notes that they can't be called software. However, since a ROM section can be added to implement the instruction set, it isn't hardware in the conventional sense either; hence, he likes the name "firmware."

When to use microprogramming

The use of semiconductor ROMs (or RAMs) to replace random bipolar logic will, in the great majority of cases, save money, space and power drain.

At just what point the decision should be made to use microprogramming instead of random logic is a point of some controversy. Davidow of Signetics has made a survey among design engineers of cost comparisons. For simple control systems, random logic is still usually the best way to go, he notes. For simple, sequential operations, counters—such as presettable or ring types—may be sufficient.

The direct cost of putting an IC into a system, Davidow estimates, is slightly over \$1, including parts, fabrication, power supply and testing. If it's assumed that the average IC contains about three gating functions, the direct cost per gate, installed in a system, is about 35 cents, Davidow says.

The cost of a system using random logic begins close to zero with the simplest configuration (Fig. 3). But as sequencing cycles are added, Davidow notes, the cost increases about four times as rapidly as that of a microprogrammed controller.

For the microprogrammer, there is, however, a certain built-in minimum cost associated with the addressing, sequencing and memory selection circuitry, no matter how simple the system. The break-even point—the point at which the costs of microprogram and conventional control become equal—occurs, Davidow says, with somewhere between 60 and 80 ICs in the system.

J. Kjell Hovic, president of International Peripherals and Computer Corp., Costa Mesa, Calif., evaluates the cost trade-off between random control and microprogramming in terms of the number of sequencing cycles. When sequencing cycles exceed 256, Hovic says,

MULTI-TURN SETABILITY... ...AT SINGLE-TURN PRICES!

... IN A SQUARE PACKAGE!

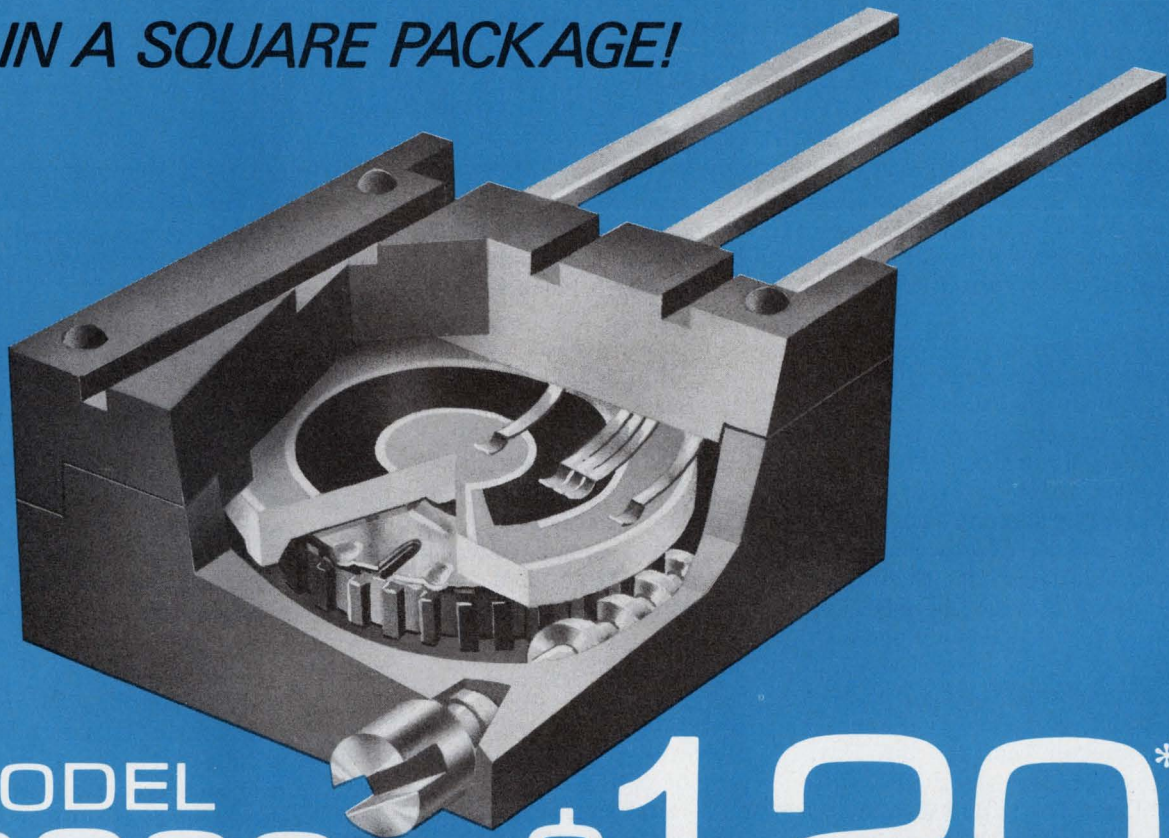

MODEL
3299

\$1.20*

*500-999 quantity

NEW CERMET TRIMPOT® POTENTIOMETER

THAT MAKES IT THE LOWEST-PRICED SQUARE MULTI-TURN ON THE MARKET.

In addition to low-cost, Bourns Model 3299 incorporates a number of features usually found only in higher-priced units.

PRECISE SETABILITY

... multi-turn adjustment provides quick, precise setability with infinite resolution.

POPULAR 3/8" SQUARE PACKAGE

... it occupies less space on the circuit board.

HIGH POWER RATING:

1/2 watt at 70°C.

CHOICE OF 3 PIN STYLES

... provides designers with the most popular pin styles for greater design flexibility.

MOLDED-IN TERMINALS

... enhance ruggedness of construction. Of course the unit is sealed to withstand printed circuit board cleaning processes.

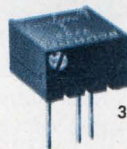

3299P

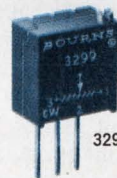

3299W

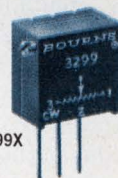

3299X

SPECIFICATIONS

Dimensions375" x .395" x .250"
Standard Resistance Range 100 to 1,000,000 ohms
Resistance Tolerance ±10% Standard
Power Rating05 Watts at 70°C
Operating Temperature Range -55 to +125°C
Temperature Coefficient ±150 ppm/°C

Delivery is off-the-shelf. Get full details on this new Cermet unit today by contacting your local Bourns Field Office, Representative, or the Factory direct.



BOURNS, INC., TRIMPOT PRODUCTS DIVISION • 1200 COLUMBIA AVE., RIVERSIDE, CALIF. 92507
INFORMATION RETRIEVAL NUMBER 20

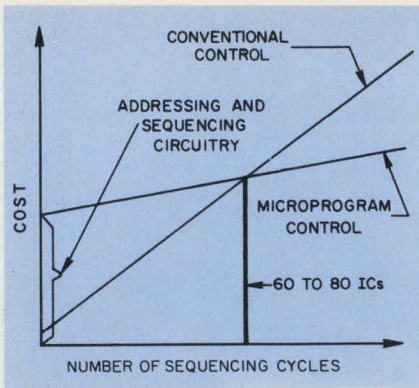

3. The cost per-sequencing-cycle of conventional control rises four times as fast as microprogram control.

the best approach is microprogramming. When the number exceeds 512, microprogramming is the only way to go, he insists.

Davidow points out that the cost of microprogramming control does not increase as rapidly as that of conventional logic with the number of sequencing cycles, because each added cycle requires only one additional word in the control ROM.

Assuming that the control ROM uses 32-bit words and that the cost is one-quarter cent per bit, Davidow figures that a single added control cycle costs only 8 cents.

According to Davidow's survey among designers, a logic gating function can be replaced, depending upon the system configuration, by somewhere between eight and 16 bits of ROM. For example, a 4096-bit ROM can replace between 256 and 512 gating functions.

On this basis, the cost of using a 4096-bit ROM in a microprogramming system—assuming one, one-half and one-quarter cent-per-bit costs—is shown in Figure 4. In this case, the cost of the ROM equals the cost per gate at 36, 66 and 132 bits per gate for one, one-half and one-quarter cents per bit, respectively.

Thus the designer can use substantially more than eight to 16 bits of ROM to replace a gating function and still come out ahead on costs.

More than one approach

There are at least two approaches to microprogram control design, according to Robert F. Rosin, microprogram computer researcher at the State University of New York

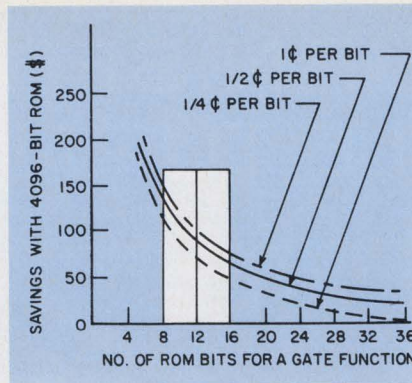

4. The savings incurred by substituting bits of 4096-bit ROM for gate functions can reach 80%.

at Buffalo. One approach is called "vertical," or sequential programming. The other is called "horizontal" and is essentially more parallel in its execution of microprogram functions.

Vertical programming is closer to the conventional method, in which an instruction contains an operation code and one or more address fields.

In horizontal programming, the instruction words are much longer. However, each bit causes some specific action to occur.

Vertical microprogramming was chosen for the HP 2100A, Leis explains, even though it has two disadvantages: Hardware is required for each field, and the execution of specific algorithms usually takes longer. There were, however, two offsetting reasons.

First, Leis notes, only two relatively inexpensive IC packages are required to decode the output of each ROM package. And second, a further increase in speed is not warranted, since the ROM would be idle most of the time, waiting for the memory.

The principal advantage that Leis finds in the vertical approach is that writing the programs is simplified, compared with the horizontal alternative. While a bit-per-function horizontal ROM output would simplify the hardware, it would make the programs harder to write, Leis argues. And from the user's viewpoint, HP developed an approach that would allow someone unfamiliar with the hardware to write useful microprograms.

While the use of semiconductor ROMs for microprogram applications is on the upswing, the future



Bill Davidow of Signetics Memory Systems says microprogramming makes computer design easier to change than with random logic.

trend appears to be one in which the control ROM is being replaced with a "writable control store"—a semiconductor read-write, random-access memory (RAM). The trend is significant because it enables the designer to add features or emulation routines, or to correct design errors, after the hardware design is frozen.

Signetic's Davidow points out that a computer with writable control stores can have different programs, one of which can make it compatible with the IBM 360 series, another of which can allow it to emulate the IBM 709, and still another that can permit an emulation of a Honeywell 200 system.

Although the writable control store or RAM is more costly than the ROM, it can substantially simplify debugging of the machine, even after the wiring is completed. Instead of making wiring changes, errors can be corrected by simply generating a new control program and writing it into the RAM.

Davidow estimates that on the cost-per-gate basis assumed in Fig. 4, RAMs are only about twice as expensive for these applications. Where the ability to alter the machine provides significant advantages, this cost increase is relatively small. ■■



**lighting
bug
collection**

Your logic level display problems are over with this new, Compatible Lighting Bug Collection of LED's and subminiature incandescent lamps. Now you can opt for either, or both types in your circuit design because they're practically equal in life, color, brightness and operating power. Only Chicago Miniature offers you the design freedom of interchangeable LED's and incandescents.

For example, CM4-50 solid state lamps operate from 1.65 to 2.0 volts at .040 amps maximum and the T 3/4 through T 1 - 3/4 incandescents operate from 1.0 to 5.0 volts at .008 to .022 amps. These low current incandescents permit highly extended lamp life to balance with the inherent long life of the LED's. Color displays

are red or amber for the LED's and red, blue, blue/white, green or yellow for the incandescents. Each incandescent lamp is carefully controlled to produce .002 - .022 MSCP for brightness compatibility with the LED's.

Chicago Miniature's balanced line includes a full selection of discrete LED or incandescent lamps, indicators, seven-segment alpha-numeric readouts and special assemblies all designed for integration into a single system. A full variety of mounting styles, package types and pin configurations are available, such as tinned wire leads, TO-18 headers, epoxy molded snap-in packages, cartridges, etc.

Just circle the reader service number

to receive complete information on our balanced line of LED's and incandescent lamps or write on your company letterhead to receive product samples.

Call Chicago Miniature Sales Representatives as they are specialists in optoelectronics and you'll find their application assistance very helpful. For off the shelf delivery, contact Chicago Miniature for the name of your local authorized Electronic Distributor.



CHICAGO MINIATURE
LAMP WORKS
4433 N. Ravenswood Ave.
Chicago, Illinois 60640
(312) 784-1020

a GENERAL INSTRUMENT company

THE LIGHTING BUGS

**LED'S/Incandescent
lamps, our
compatible bugs.**

Power industry asks designers to fill urgent need for equipment

The demand for electric power is going to increase sixfold in the United States by the end of this century, and the equipment to handle this immense rise in transmission and distribution loads hasn't been designed yet. Research is needed to develop equipment for overhead and underground power lines and for both ac and dc—with emphasis on dc.

This is the word from an expert—L. F. Lischer, vice president of the Commonwealth Edison Co. in Chicago.

R&D for dc equipment will be particularly important for long-haul lines, he notes, because of its advantages over ac transmission. It suffers less reactive power loss, and it can operate at a higher average value of current than ac.

Miniaturized components sought

Lischer, who addressed IEEE members at last month's Electronics and Aerospace Systems Convention in Washington D.C., points out that a critical need is to reduce the size of ac/dc converter stations—a requirement that automatically calls for miniaturization of a number of components: switches, circuit breakers and reactive components, such as air-core or magnetic-core coils.

To assure efficient dc transmission, the lines will have to be designed to operate as a network that can be tapped, Lischer says. This calls for new dc circuit breakers, an R&D project now in progress as a joint venture of Commonwealth Edison and Hughes Aircraft Research Laboratories in Malibu, Calif.

General Electric has developed an experimental 80-kV dc circuit breaker that consists of a combi-

nation of triggered and conventional vacuum interrupters. The company believes the circuit will be needed when dc transmission is expanded. It consists of a hermetically sealed envelope with a pair of contacts, one stationary and one movable. Mechanical motion to close and open the contacts is transmitted from outside to inside the vacuum by bellows.

Even faster than the triggered vacuum circuit breaker, GE says, is a device made with two silicon controlled rectifiers on a chip of silicon. The device behaves like a switch without contacts, and it can be operated in microseconds. This serves as a good current-limiting circuit breaker, says T. H. Lee, manager of GE's Technical Resources Operation in Philadelphia.

High-speed power interruption and restoration are of particular concern in computer operations, notes Charles H. Titus, manager of GE's Advanced Power Systems Operation in the Power Protection and Conversion Div., Philadelphia. Computers have a "disconcerting habit of losing their memories if incoming power varies only 10% for just a thousandth of a second," he stresses.

"Currently," Titus says, "the cost of a solid-state breaker is eight to 10 times the cost of its electromechanical equivalent. But the increased protection it offers, is worth it," he adds.

For the future, Titus predicts that greater speed in circuit interruption will be needed, with a corresponding increase in speed in the protective relays that control the operation of the breakers. "Solid-state control devices will be needed that operate at no more than a thousandth of a second," he says.

An urgent need is a device for tapping dc lines. "First," Titus says, "we decided that the mercury-arc (rectifier)—used through-

out the world as the conversion apparatus for high-voltage dc systems—was insufficiently reliable. To tap dc lines, we decided we would have to develop semiconductor switches—in this case thyristors."

The use of thyristors has reduced the size of conversion terminals by two-thirds and cut costs significantly, Titus says.

Dr. John Reeve, professor of electrical engineering at the University of Waterloo in Ontario, Canada, says that he has not found any reliability problems with mercury-arc rectifiers but that there are advantages to thyristors.

"Thyristors are easier to design," he says. "When higher ratings are needed, a larger system can be designed simply by extrapolating from the design of a smaller, existing system. More modules will do the trick. But to build a bigger mercury-arc system, this approach can't be used. The physics of a mercury-arc rectifier is more complex, and the whole thing must be redesigned."

System protection is vital

Protection of the transmission and distribution systems is a vital function. "The intelligence for this is provided by relays, which are on-line real-time analog computers," says GE's Thomas Lee. When any part of the power system is in trouble, the relays give the command to the proper circuit breakers to isolate the faulty portion from the rest of the system.

An area ripe for more investigation, Lischer says, is on-line monitoring to detect weaknesses in the system before a failure occurs. This is increasingly important as the capacity of the systems increase, since the greater the power, the worse the damage that can be inflicted. ■■

John F. Mason
Industrial Editor

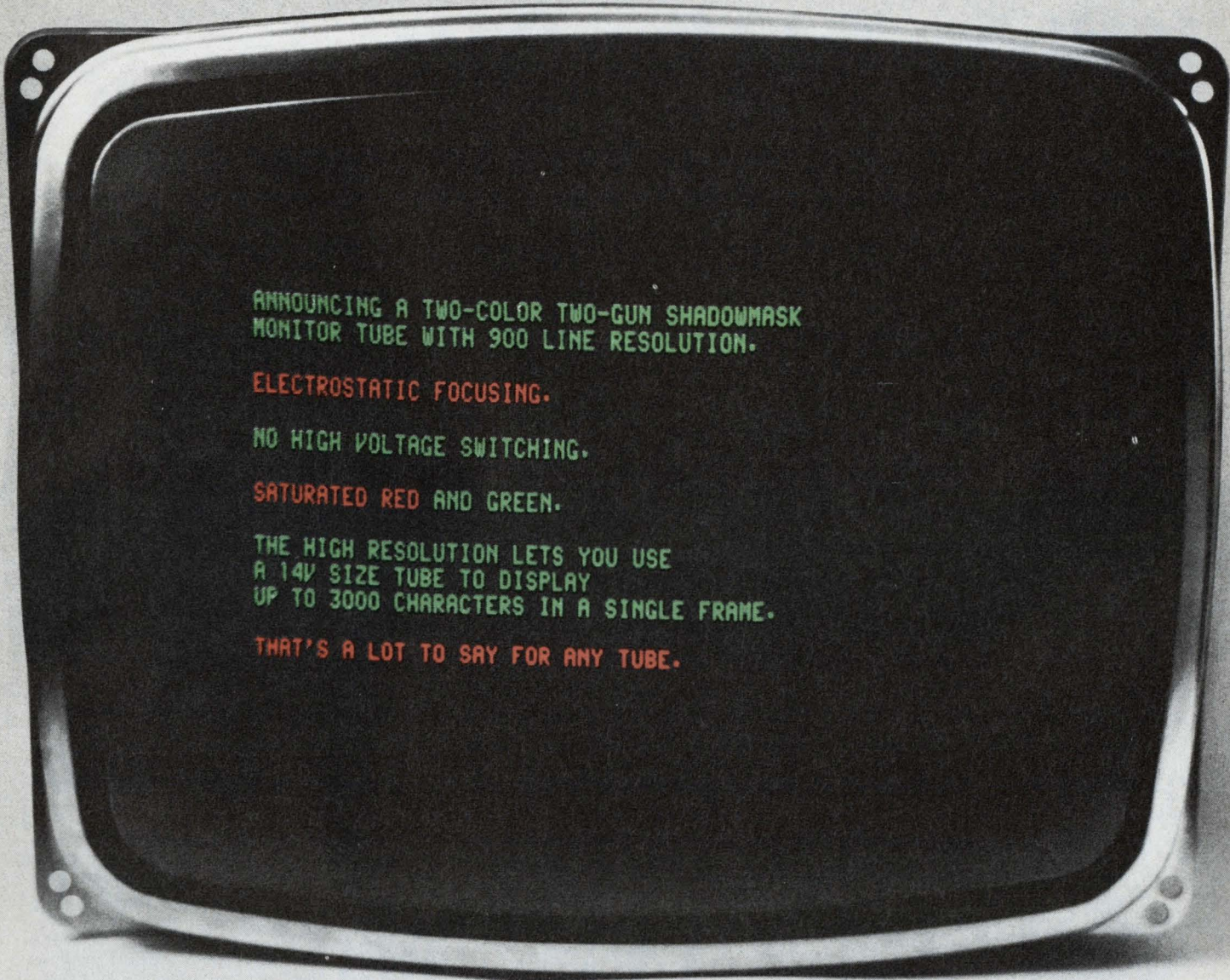

ANNOUNCING A TWO-COLOR TWO-GUN SHADOWMASK
MONITOR TUBE WITH 900 LINE RESOLUTION.

ELECTROSTATIC FOCUSING.

NO HIGH VOLTAGE SWITCHING.

SATURATED RED AND GREEN.

THE HIGH RESOLUTION LETS YOU USE
A 14V SIZE TUBE TO DISPLAY
UP TO 3000 CHARACTERS IN A SINGLE FRAME.

THAT'S A LOT TO SAY FOR ANY TUBE.

Sylvania Electronic Components, Seneca Falls, N.Y. 13148

GTE SYLVANIA

If We've Told You Once, We've Told You 10 Different Ways:

2. CASE 199 HANDLES MORE POWER

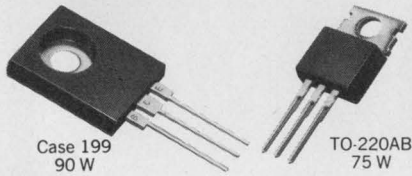

10 watts more power. Up to 90 watts total. Plug a plastic power transistor into your general-purpose amplifier/switching circuits that handles over 10% more P_D than the TO-220AB. Prime reasons: the biggest, most efficient package-heat-sink and the shortest, chip-to-chassis thermal path in the industry . . . only 0.032". θ_{JC} is the lowest, too — 1.39°C/W maximum on higher current types.

3. CASE 199 MOUNTS EASIER

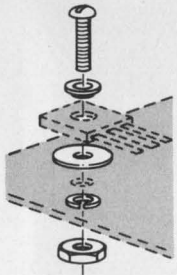

Throw out half your hardware. Use only one machine screw, 3 washers and a locknut for all metal-to-metal mounting arrangements. Period. We even bevel the hole on the heat sink side. No special washers or countersinking holes for extra bushings to line up mica washers. No more shorts. The 199 provides optimized collector isolation with a minimum of hardware. The 199, easy pieces.

4. CASE 199 OFFERS MORE LEAD FORMS



Lead forms for TO-66 and TO-220AA, plug-in replacement — lead forms for PCB sockets — lead forms for flat or flag-mounting — lead forms for virtually any socket/power requirement. A total of 7 standards. Pop them right into your sockets from the shipping carton. No extra bending operation . . . no possible in-house device damage. Use 100% of what you pay for.

5. CASE 199 OFFERS MORE DEVICES

More devices between 100 mA and 10 A — more types from 30 V to 350 V — more units from 20 to 90 W. Well over 40 different types . . . almost 4 times the devices than anyone else. Fit every socket you've got with the right performance.



10. CASE 199 FURNISHES 5 TECHNOLOGIES

High-efficiency, high-frequency EpiBase* workhorses . . . revolutionary and economical Darlington circuit simplifiers . . . complementary, PNP/NPN direct-couplers . . . high-speed, fast-response double-diffused switches . . . high-voltage, fast-switching, triple-diffused types. One is for you.

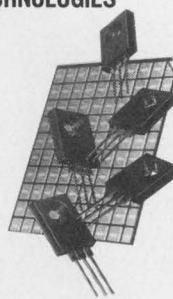

CASE 199 6. HAS MORE CHIP SIZES

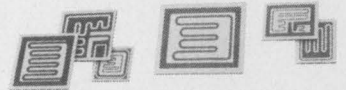

Choose the right size chip for your application from the widest, small-to-large size range: 60 x 60 to 120 x 140. They're all design-spec'd to afford the biggest choice of preferred standards and unsurpassed custom capability. And chip and package are completely compatible.

CASE 199 7. ALWAYS LIES FLAT

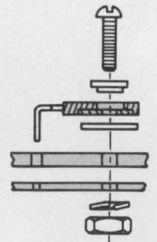

The hole-in-the-middle means equal thermal and/or electrical contact all around, not just on one end. No worries about die or case cracking — the screw never touches the plastic. Design in the 199. The only one with a ± 1 mil flatness spec.

CASE 199 8. PROVIDES THE NARROWEST PROFILE



20% less body thickness than the TO-220AB means a denser multiple-unit mounting advantage in applications like hammer drivers where close, standup mounting is required. Thin is in.

CASE 199 9. LETS YOU STANDARDIZE

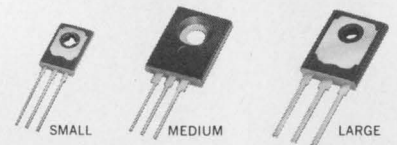

90% of the small Case 77 Thermopad types and the large Case 90 Thermopad types you've designed into volume-insertion, production lines can be had for the same setups in the medium Case 199 Thermopad. Same chips. Same package style. Optimized price to fit your needs.

Send for Case 199 data sheets and a copy of our LEADFORMS brochure. All about plastic power. Box 20912, Phoenix, AZ 85036.

*TRADEMARK MOTOROLA INC.



MOTOROLA 199 POWER
— In the 1st Place, It's Better

The new Merlin 1[®] connector.

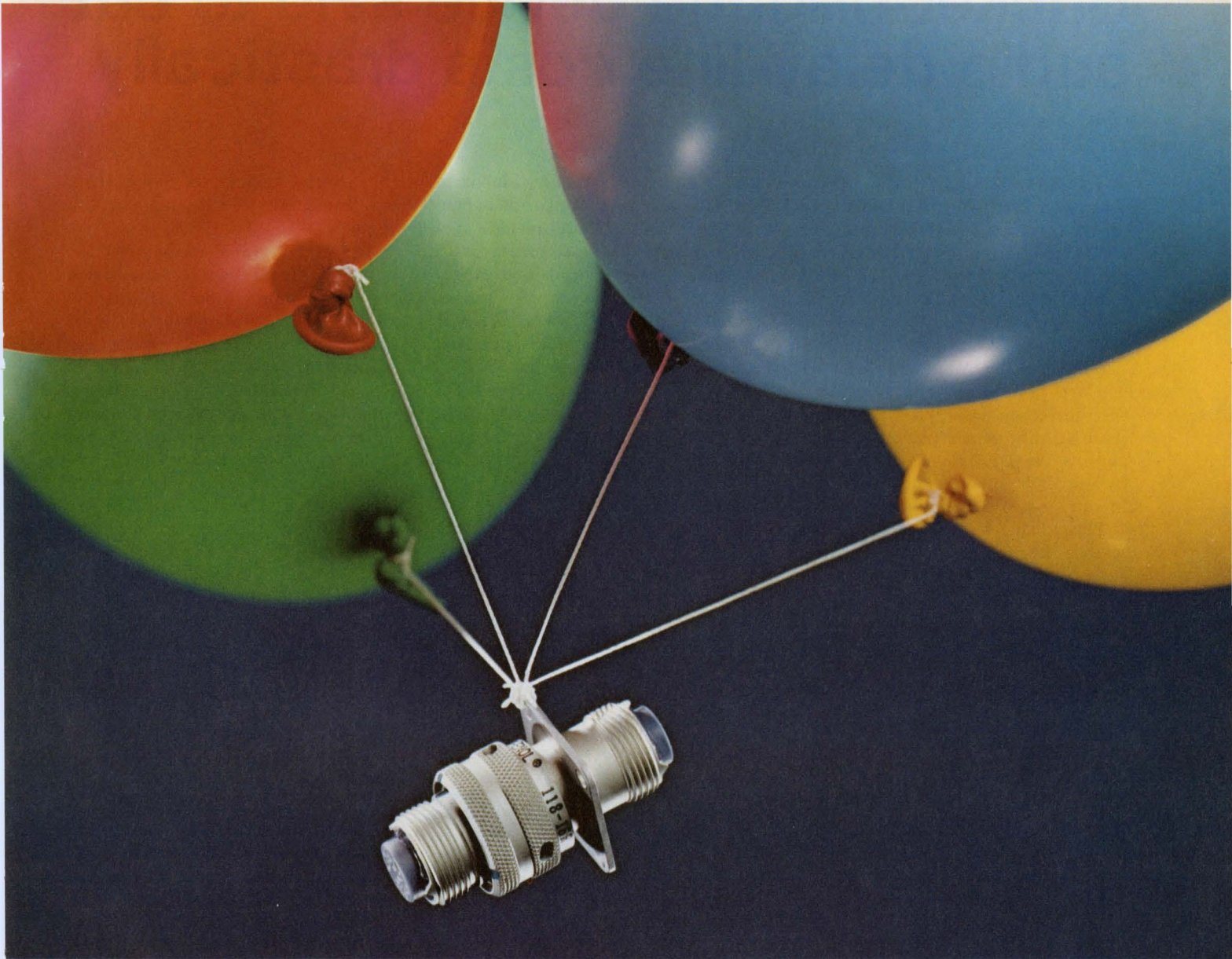

40% lighter than anybody else's.

Through the magic of Amphenol engineering we now bring you a rear-release, cylindrical, environmental connector that is not only 40% lighter than competition, but 1/2-inch shorter than most.

A one-piece thermoplastic retention disc, molded of tough Astrel 360* replaces the individual metal retention clips common in heavier connectors. Therefore, a 61-pin Merlin configuration has one retention disc instead of 61 individual metal clips. The result is a lot less useless weight. And, without all those parts, more reliability.

Adds a little magic to cost-cutting, too.

Our new Merlin exceeds all performance requirements of MIL-C-83723, MIL-C-26482 and NAS-1599 and is fully intermateable and intermountable with all three of these types.

Shell sizes are available in the eight most popular configurations with your choice of straight plug and both wall-mounted or jam-nut receptacles.

To get the full story on the new Merlin 1 connectors, just write or call Steve Kelleher, Amphenol Connector Division, Bunker Ramo Corporation, 2801 S. 25th Avenue, Broadview, Ill. 60153, (312) 261-2000.

*Registered Trade Mark 3M Company.

**BUNKER
RAMO** **AMPHENOL**

Bucket-brigade device said to cut audio delay-line costs drastically

The bucket-brigade device, a concept that has stirred interest in the electronics industry since the 1950s, has moved out of the laboratory and into production. The first commercially available unit is an analog delay line that can provide both fixed and variable delays.

Developed by Amperex Electronic Corp. and designated the M31, the device is being sold for less than \$10 and can replace, the company says, equipment costing between \$200 and \$2000 when used in audio delay line applications.

The term "bucket brigade" describes the way in which the device, an analog shift register, transfers information from stage to stage in response to timing signals.

Present methods for achieving

long audio delays require elaborate and according to Amperex expensive techniques. These include specially designed tape recorders, with movable playback heads and digital systems that convert the analog signal into digital form, delay it in digital shift registers, and then convert it back into an analog signal.

With the M31 however, these expensive techniques are no longer necessary, says George Fowler, applications engineer of Amperex. The new device, a p-channel MOS integrated circuit, is a 32-stage analog shift register. Since it operates directly on the analog input signal, no analog-to-digital or digital-to-analog signal conversions are necessary.

In operation (see diagram) analog information is stored in an array of capacitors as charge deficit. Charge-transfer circuits consisting of MOS transistors allow

the charge deficit to move from one capacitor to the next in the register.

The input signal is sampled at a rate of from two to four times the maximum input frequency. This is done by allowing the input capacitor to charge up to the instantaneous value of the input signal. At the same time the second capacitor is allowed to remain fully charged. Next, the sampling signal from a complementary clock reverses the state of the transistors associated with each storage capacitor, causing the second capacitor to try to dump its charge into the first capacitor. Since the first one is already partly charged with input information, the second capacitor can dump only part of its charge, leaving it at the same level that the first capacitor was originally at. Thus the information, or charge deficit, is effectively transferred from the first capacitor to the second.

Each time the transistors are switched ON and OFF, the charge deficit is transferred to the next capacitor. By varying the switching (sampling) rate, the delay time can be varied; the faster the sampling, the shorter the delay.

Because the integrated circuit contains MOS field-effect transistors, there are no dc gate currents, and thus attenuation is negligible, even after hundreds of stages. No amplifiers are necessary. In a test by Amperex of 20 M31s strung together to provide 640 stages of delay, the resultant delay line showed less than 1% harmonic distortion with a 58-dB dynamic range.

The first known commercial application of Amperex's new M31 is in a speech-compression system developed by the Cambridge Research and Development Group (see "Device Speeds Speech Without Distortion," ED23, Nov. 11, 1971, p. 19). ■■

Jules H. Gilder
News Editor

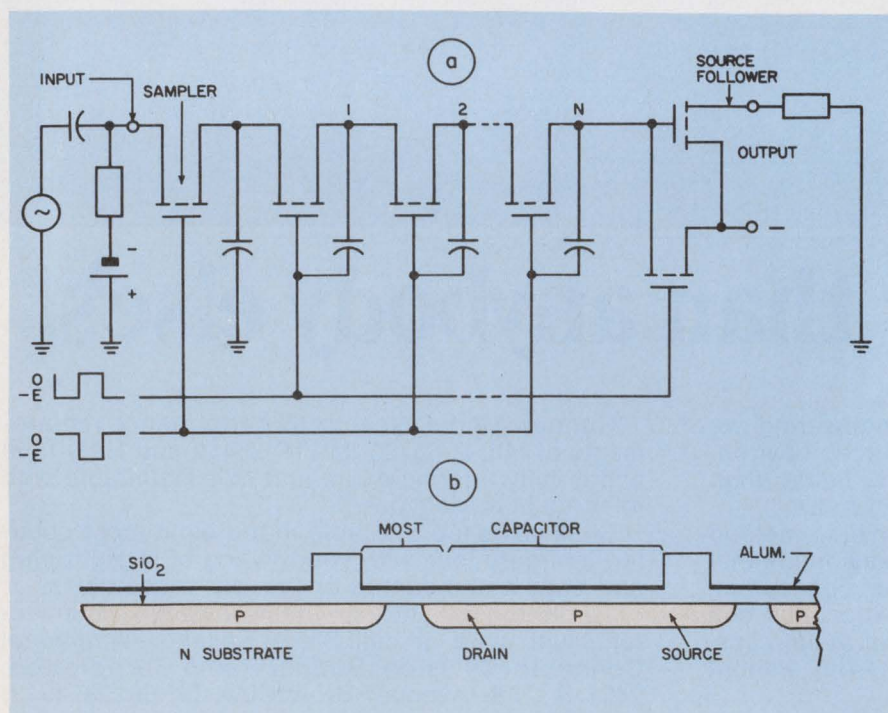

Circuit configuration of bucket-brigade analog shift register (a), and a cross-sectional view of a charge-deficit storage stage and its associated transfer circuit (b).

**You're
invited
to a private
screening**

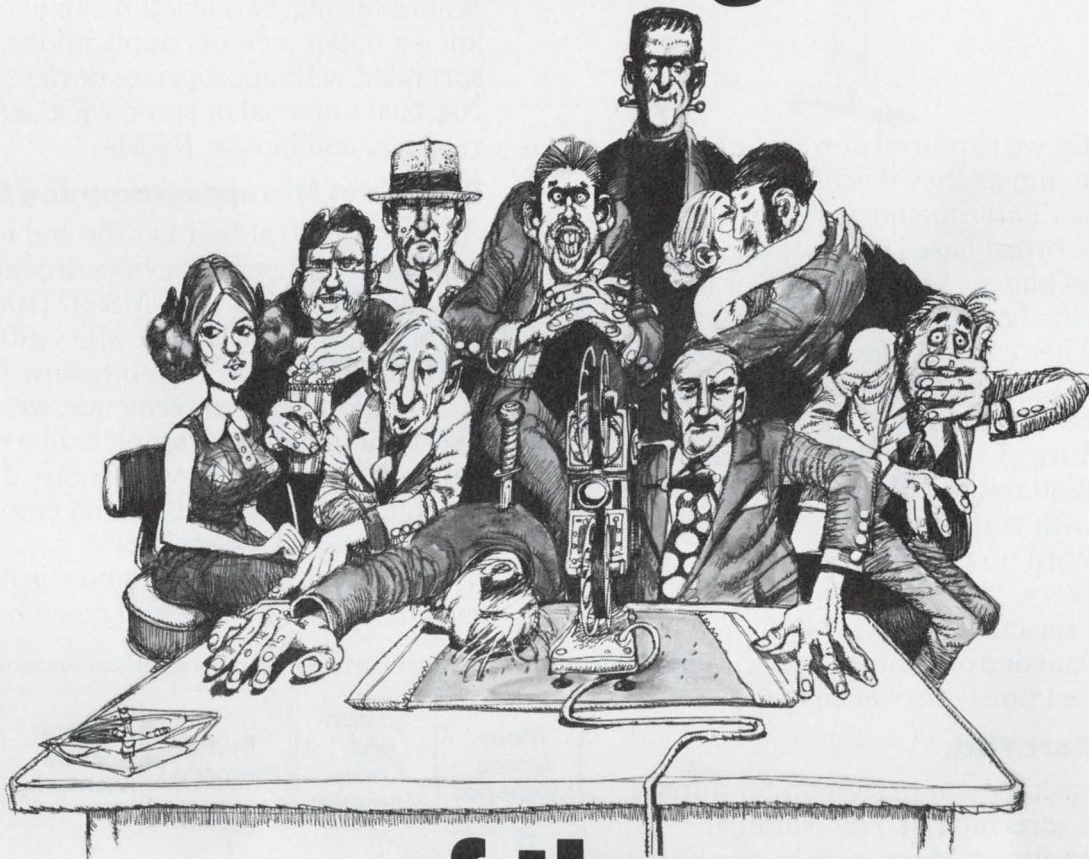

**of the
National
Semiconductor
Memory
Seminar
Film.**

In your office.

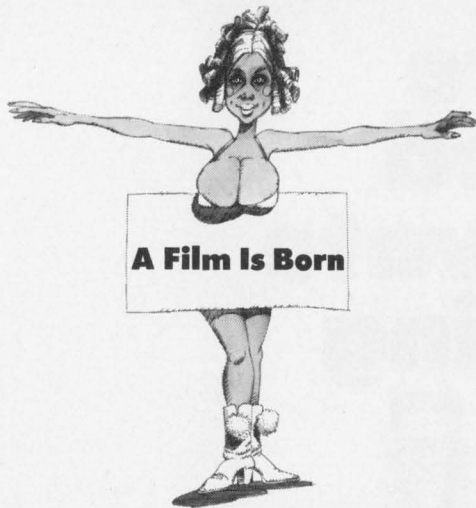

Recently, we captured our best memory spokesmen on film as they discussed the National Semiconductor memory design philosophy, our current broad-based product line, and upcoming new designs, as well as a number of memory system applications.

The result is *The National Semiconductor Memory Seminar Film*: an informative, no-holds-barred, no b.s. look at the past, present and future of semiconductor memories.

A 30-minute filmic experience we'd like to share with you in the privacy of your own office.

With up to 25 of your friends and co-workers.

Free crackerjacks.

And one of our best applications engineers as projectionist/answer man.

Five-Part Flick

Before asking you to sign up for a free private screening of *The National Semiconductor Memory Seminar Film*, we'd like to offer a brief summary (realizing of course that mere words can never fully describe the exact nature of this unique, five-part cinemagraphic work):

Part One: Mainframe Memories

A quick-paced, yet highly significant review of National's mainframe memory capability in which the MM1103 and a couple of dynamic MOS RAM superstars are put into proper focus. Namely, the Tri-State* 1024-bit MM5260 and the 2048-bit MM5262.

Part Two: Scratchpad/Cache Memories

A thought-provoking presentation of scratchpad and cache memory applications featuring the breathtaking (Tri-State, 256 x 1) DM74200 and a bevy of other highly talented National bipolar RAMs.

Part Three: Silicon Store Memories

This highly-informative, slickly-produced portion of the film is devoted to the introduction of the revolutionary new "silicon store" memory; an inertia-less electrically rotating data string ideally suited to the dual 256-bit MM5012 and 1024-bit MM5013, National's up-and-coming pair of new longer length dynamic accumulators with Tri-State logic.

Part Four: Buffer Memories

A hard-hitting, two-fisted recap of commonly known buffer memory applications, liberally sprinkled with appropriate devices from National's arsenal of static MOS RAMs, shift registers and bipolar RAMs.

Part Five: Microprogramming Memories

As the proverbial "light at the end of the tunnel" appears, a number of devices are quickly exposed; including the DM8597 (1024-bit bipolar ROM), MM5203 (2048-bit MOS pROM) and the MM5232 (Tri-State 4096-bit static MOS ROM).

(For your convenience, we've taken the liberty of listing our complete line of semiconductor memory devices. Look them over carefully. We'll be glad to send complete specs on any category you wish.)

All you have to do now is fill out and mail us the handy free film coupon.

*Tri-State is a trademark of National Semiconductor Corporation.



Mainframe Memories

MM5260 1024-bit Tri-State MOS RAM
MM1103 1024-bit MOS RAM
MM5262 2048-bit MOS RAM

Scratchpad/Cache Memories

DM7489 16 x 4 bipolar RAM
DM8599 16 x 4 Tri-State bipolar RAM
DM74200 256 x 1 Tri-State bipolar RAM (read-write)
DM86L99 16 x 4 low power bipolar RAM
DM8594 64 x 4 Tri-State bipolar RAM

Buffer Memories

DM7489 16 x 4 bipolar RAM
DM8599 16 x 4 Tri-State bipolar RAM
DM86L99 16 x 4 low power bipolar RAM
MM1101A2 256 x 1 MOS RAM
MM1101 256 x 1 MOS RAM
MM11011 256 x 1 MOS RAM
MM1101A 256 x 1 MOS RAM
MM1101A1 256 x 1 MOS RAM
MM5054 dual 80-bit tapped-static shift register
MM5052 dual 80-bit MOS shift register
MM5053 dual 100-bit MOS shift register

Silicon Store Memories

MM5012 dual 256-bit Tri-State dynamic shift register/accumulator
MM5013 1024-bit Tri-State dynamic shift register/accumulator
MM5016 500/512-bit dynamic shift register
MM5017 Dual 500/512-bit dynamic shift register
MM5019 Dual 256-bit mask programmable dynamic shift register

Microprogramming Memories

DM8598 256-bit Tri-State bipolar ROM
DM7488 256-bit bipolar ROM
DM8597 1024-bit Tri-State bipolar ROM (256 x 4)
DM74187 1024-bit bipolar ROM (256 x 4)
MM5203 2048-bit MOS PROM (256 x 8 or 512 x 4)
MM5231 2048-bit MOS (factory programmable) ROM
MM5241 3072-bit Tri-State static MOS ROM (64 x 6 x 8)
MM5232 4096-bit Tri-State static MOS ROM (512 x 8 or 1024 x 4)

Free Film Coupon. Sirs: sign me up for a free private showing of The National Semiconductor Memory Seminar Film in my office on _____ . I understand that crackerjacks and a projectionist/ applications engineer will be provided free. Would also like _____ complimentary "Admit One" tickets (maximum 25) to pass out to my friends and co-workers.

Name _____ Phone _____

Company _____

Address _____

City _____ State _____ Zip _____

Mail to: National Semiconductor Corporation,
2900 Semiconductor Drive, Santa Clara, California 95051.

National



INFORMATION RETRIEVAL NUMBER 24

CTS HAS A WAY WITH HYBRID MICROCIRCUITS

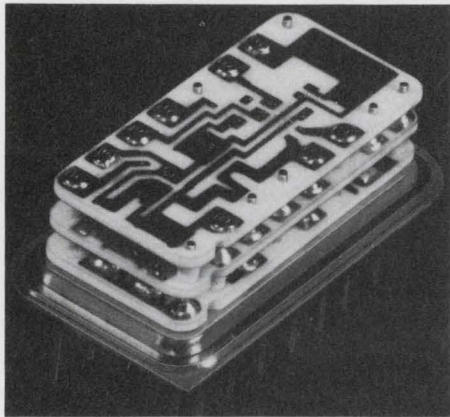

CUSTOM or STANDARD, CHIP or DISCRETE, WHETHER CONSUMER, MILITARY or INDUSTRIAL, THE SAME GREAT PERFORMANCE AND RELIABILITY IS BUILT IN.

We Pack More Than 13 Years of Cermet Circuitry Experience Into Every Circuit We Manufacture... Experience You Can Count On.

IN SHORT, CTS DOES IT ALL...AND HAS FOR A LONG TIME.

Call CTS Microelectronics and ask for our hybrid microcircuit brochure, CTS Microelectronics, Inc., P.O. Box 1278, Lafayette, Indiana 47902. Phone: (317) 463-2565.

CTS CORPORATION
Elkhart, Indiana



technology abroad

To minimize the possibility of misinterpreted railroad signals that could cause a disaster, the Italian railway system has granted a \$4-million contract to CIW (the Italian subsidiary of Wabco Westinghouse) to install locomotive in-cab signaling on all mainline and secondary routes. The locomotives will be fitted with a main-line system in which signals are injected as coded pulses down one rail in each track section. A secondary signaling system will give the engineer an indication as each track-side signal is passed. The track-side signals are picked up from two coils placed near the track. In the mainline signaling system, different pulse repetition rates correspond to different signal states. For example, 270 pulses per second indicates a clear track. Other pulse rates identify speed reductions. Each signal change is indicated by an audible alarm. If this is ignored for more than three seconds, train braking is initiated automatically.

CIRCLE NO. 440

An L-band, high-gain phased-array antenna for use by aircraft communicating with air traffic control stations via satellite has been produced by the British Aircraft Corp., Bristol, England. The antenna is made up of two plane arrays of dipoles set flush into the surfaces of the aircraft tailfin. Each array element is fed with an equal portion of the transmitter power and is controlled by a mini-computer-operated phase shifter. Beam steering is achieved by changing the position of the phase front—that is, by progressively delaying the relative phase of each dipole across the antenna aperture. The system can be used to steer the arrays by up to plus or minus 45° in both azimuth and elevation. In combination with a geostationary communications satellite, the new antenna is expected to provide a marked improvement over present hf com-

munication with air traffic control facilities, which are frequently disrupted by atmospheric conditions.

CIRCLE NO. 441

Hybrid techniques and infrared optical devices have been combined by one British manufacturer to produce a contactless electronic ignition system. In the new system the contact breaker and condenser are replaced by an infrared light source, or a photodetector and a segmented disc. This switching system can handle a heavier current than is possible with conventional contact breakers. Consequently the number of turns in the primary winding can be significantly reduced, lowering the inductance and the time constant of the circuit. As a result, voltage buildup is much faster. The spark level remains constant up to 5500 rpm, with only a gradual drop-off to 10,000 rpm. Starting, servicing, engine performance, gas consumption, plug life and exhaust emission are all improved.

CIRCLE NO. 442

A radar for detecting clear-air turbulence has been developed by Britain's Royal Radar Establishment. The system operates at a 107-mm wave-length and incorporates a magnetron pulse transmitter and parametric, fully steerable paraboloid antenna. A coherent detection system allows filtering of stationary target echoes and measurement of target radial velocities. The antenna, which is 25 m in diameter has a 52.3-dB gain and a 0.33° half-power beam width. Peak transmitter power is 1 MW with a 1.25- μ s pulse length. The radar range, 3 to 100 km, is virtually unaffected by ground echoes.

CIRCLE NO. 443

A fast, 1024-bit, polar read-only memory has been introduced by the French semiconductor company Sescosem and is being used in the T-1600 calculator recently unveiled by La Telemecanique. The ROM has 256 four-bit words. It incorporates on-chip decoding and on-chip address circuitry. Access time is 60 ns, and dissipation is 0.5 mW per bit.

CIRCLE NO. 444

When your machine has more to say...

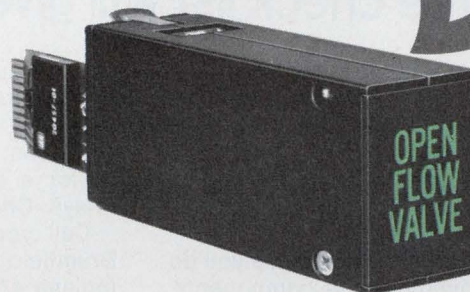
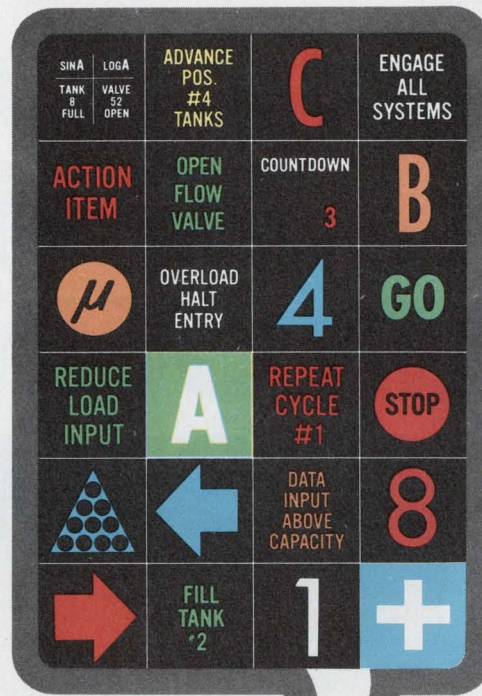

IEE Readouts provide the vocabulary.

When your machine has more to say, IEE rear projection readouts let it speak out with an eloquence that make other display systems seem taciturn.

For instance, just one IEE rear projection readout will improve the vocabulary of your machine with up to 64 new phrases expressed in any combination of alphanumeric, in any language, accompanied by the symbols of any discipline, all displayed in a variety of colors and in the type styles that go best with your panel decor.

No gas discharge tube, or LED or what have you, can make that statement.

IEE units communicate — loud and clear!

Our big Series 80 rear projection readout lets your machine shout in huge 3 3/8-inch characters. Or we can say things discretely

with our fit-anywhere 1/2 x 3/4-inch Series 345 model.

All with single-plane viewing, variable brilliance, and the capability to change vocabularies right in the field. To assist, we have a powerful new low-cost hybrid driver/decoder for any of the readouts. Plus a host of other driver/decoders... all, competitively priced... purchased separately or customer mounted.

Rear projection readouts give you an order of display versatility a world apart from other techniques, and IEE builds more of them than anybody. Send today for our Short-Form Catalog on units that are long on talk. Industrial Electronic Engineers, Inc., 7740 Lemona Ave., Van Nuys, California 91405. Telephone: (213) 787-0311 • TWX 910-495-1707



Industrial Electronic Engineers, Inc.



INFORMATION RETRIEVAL NUMBER 26

CAN YOU REALLY AFFORD TO MAKE YOUR OWN CUSTOM ASSEMBLIES?

P&B's free check list will give you the answer.

We make thousands of custom assemblies each year which include relays and electronic components. We're geared for this work. We have the know-how, the people, the test gear, the necessary production equipment. We normally purchase the components we do not make—diodes, resistors, capacitor, transistors—at maximum discounts.

When we supply your electronic assemblies you do not have to (1) buy and inventory the components, (2) set up a special production line, (3) acquire unusual test equipment, (4) train and pay the necessary produc-

tion and supervisory personnel. The opportunities for savings are obvious.

Ask for our Custom Assemblies Check List, which simplifies the make or buy decision. Better yet, ask us for a quotation on assemblies that incorporate relays. Chances are, we will save you money.

Call your local P&B representative or Potter & Brumfield Division of AMF Incorporated, Princeton, Indiana 47670. 812 385 5251

AMF | POTTER & BRUMFIELD

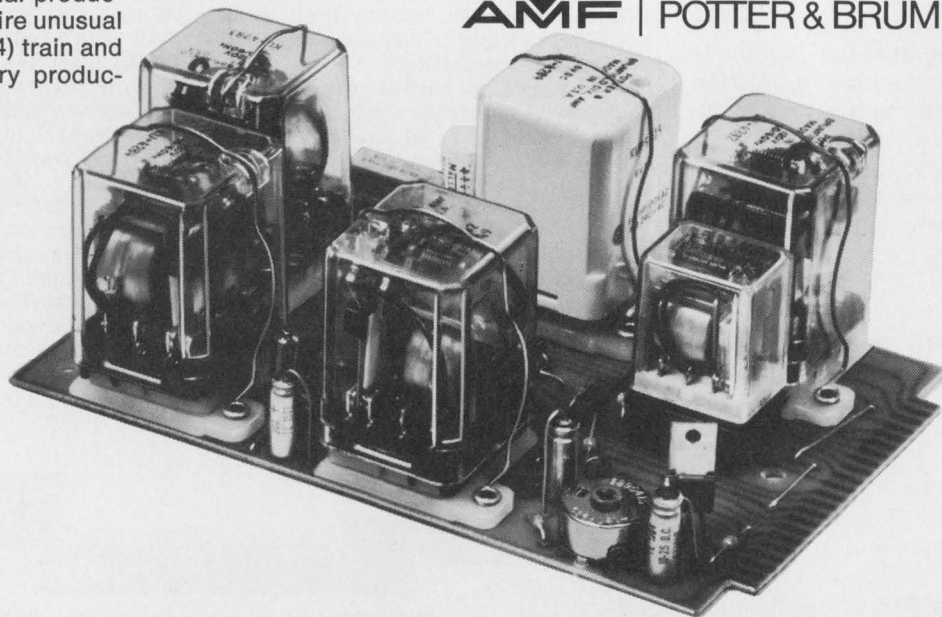

P&B performance. Nothing else comes close.

INFORMATION RETRIEVAL NUMBER 27

Take a turn for the better in rotary switches.

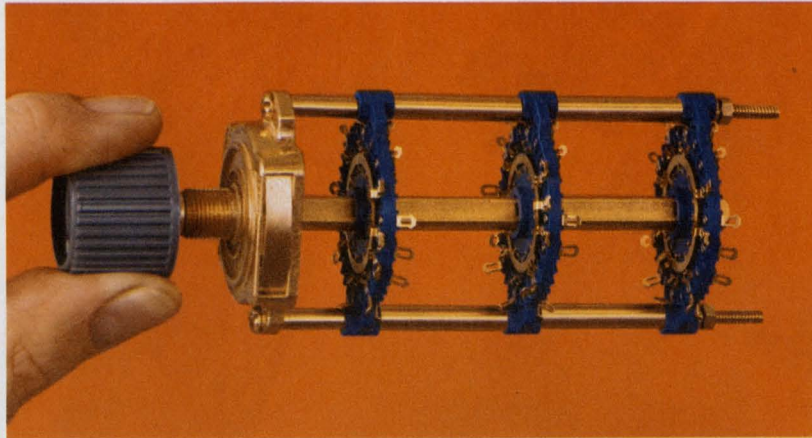

Oak continues to market the broadest line of rotary switches in sizes and configurations to fit your applications.

For example:



Our 1/2-inch subminiature rotary switch.

Ultra-compact, yet provides superior insulating qualities and dimensional stability in demanding environments at lowest competitive price.

A new 12-position Acorn rotary for printed circuits.



A size-saving design. Crisp, uniform detenting with Oak's patented Unidex™ indexing. Has glass epoxy wafer and tinned PC terminals ready for soldering.

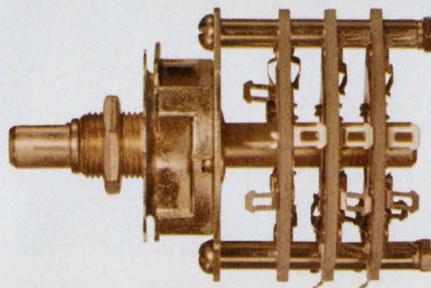

Rotary switches with Unidex indexing, too.

Our F and JKN series. Versatile, economical. And Unidex detent means uniform torque, crisp feel.



And our Multidex® rotary: the almost-universal switch.

Versatile enough to replace 7 old-style rotary designs. Thousands of variations available. With Unidex detent for sure switching time after time. Multidex cuts the cost of engineering design.

There's more.

Miniaturized lever switch: Type 184. Improved dielectric properties plus more clips per stator.



Miniature rotary trim switch For SPDT trim switching in tight PC-board locations. Long life. Low cost.

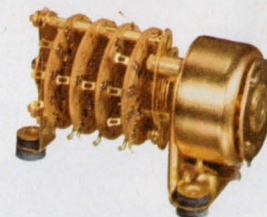

Stepping switches: Compact, lightweight. Subminiature to extra-heavy-duty types. Fast response.

Now: order Moduline™ Switches from your distributor.

Choose from 2-million possible switch combinations. 72-hour delivery. Write for the Moduline Catalog.



OAK MANUFACTURING CO.

CRYSTAL LAKE, ILLINOIS 60014 • A DIVISION OF OAK ELECTRO/NETICS CORP

Telephone: 815-459-5000

TWX: 910-634-3353

TELEX: 722-447

INFORMATION RETRIEVAL NUMBER 28

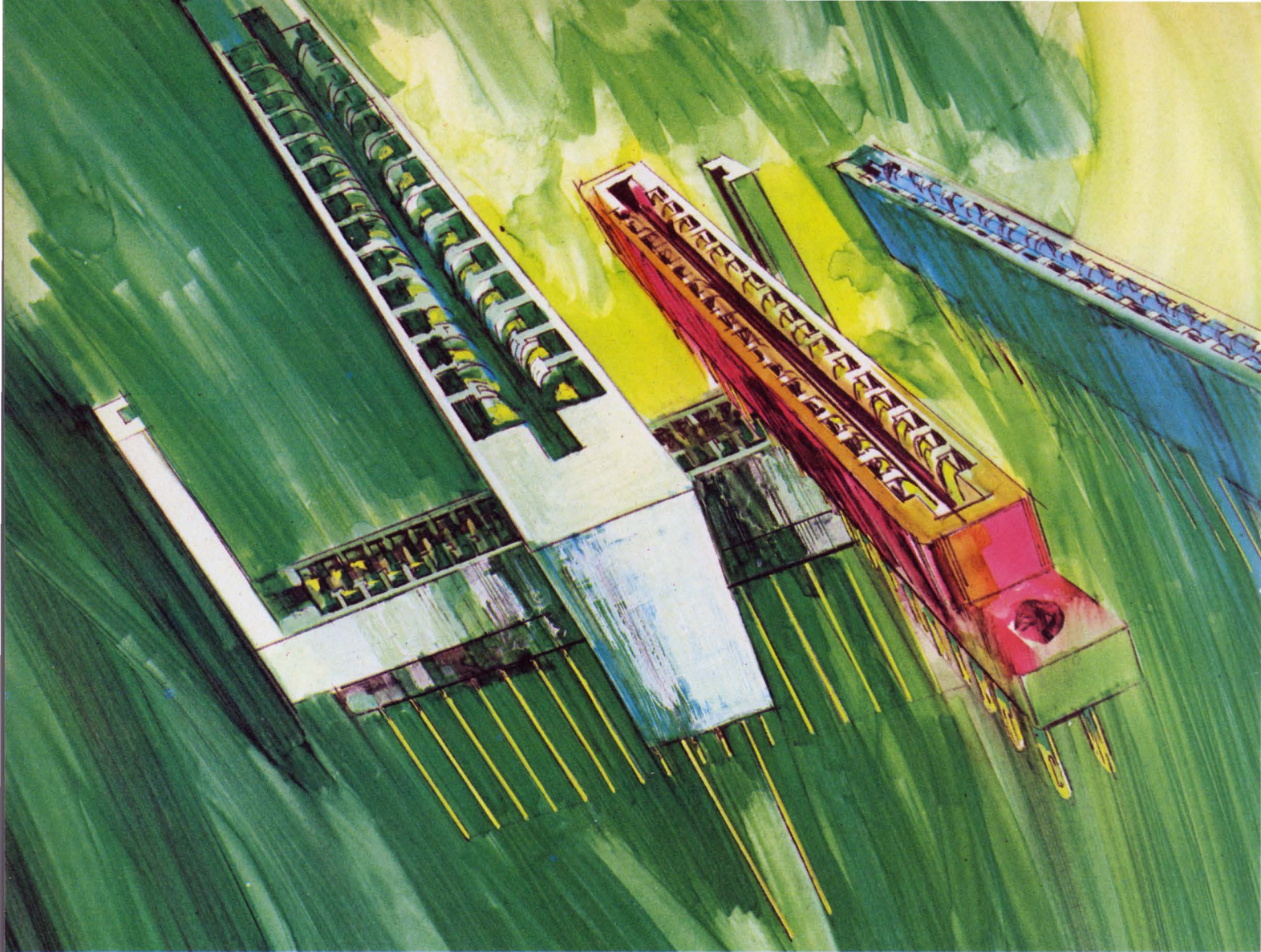

NEW CINCH .100" CENTER PC LINE ... THE CONNECTORS WITH SOMETHING EXTRA

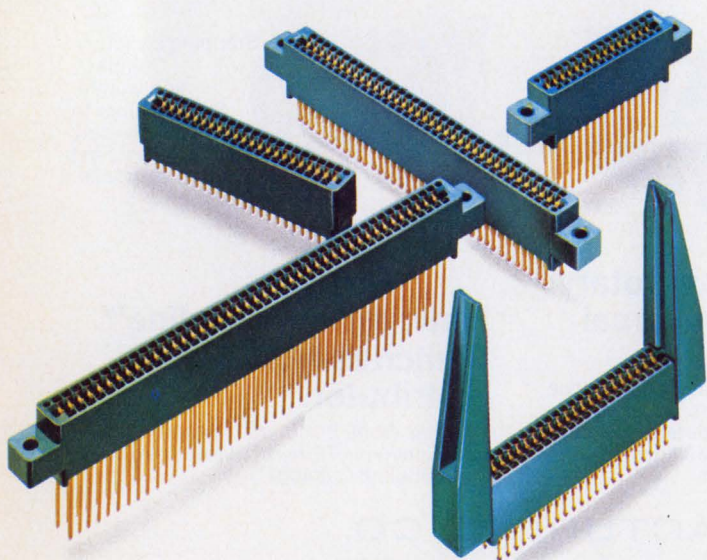

EXTRA—Selectively plated contacts with 30 microinches (or more on special order) gold on contact areas, with 10 microinches gold in non-contacting areas, means extra economy with no change in performance.

EXTRA—Cantilevered, bifurcated contact construction means uniform contact pressure, minimum insertion force and maximum withdrawal force for extra dependability.

EXTRA—Wire wrap, dip solder or solder tab terminals, 16 sizes from 10 to 50 double readout contact positions and detachable card guides for extra versatility.

EXTRA—Off-the-shelf delivery from Cinch distributors on five popular sizes (15, 22, 36, 40 and 43 position) in all three terminal types with or without card guides for extra convenience.

For information contact your Cinch Sales Office or Cinch Industrial Distributor, or write Cinch Manufacturing Company, a division of TRW Inc., 1501 Morse Avenue, Elk Grove Village, Illinois 60007; telephone (312) 439-8800.

C -7130



washington report



Don Byrne
Washington Bureau

Technology viewed as Presidential campaign issue

There's wide speculation here that technology and its potential for solving domestic problems will play a strong role in the Republican Presidential campaign next year.

A little over a month ago President Nixon installed William M. Magruder as head of the new Technology Opportunities Program, a high-priority program designed to wed technology and science to the solution of American problems. Magruder—whose last job was head of the ill-fated supersonic transport program for the Department of Transportation—will, according to White House sources, draw up a set of options from which President Nixon can choose one or more technological goals to pursue. Hopefully, this will be accomplished early in 1972. Nixon aides have joined in the program, lending weight to the thinking that technology and its uses may be part of the GOP platform next fall.

Magruder will report directly to the President and will work with John Ehrlichman, head of the Domestic Council; Peter Peterson, Special Consultant to the President on International Trade, and George Schultz, director of the Office of Management and Budget. Over 100 business and academic consultants will be used, and in addition groups have been set up in practically every Government agency to provide inputs to Magruder's office.

FCC told to move on domestic satellites

Clay T. Whitehead, director of the Office of Telecommunications Policy, has told the Federal Communications Commission that there is no reason to disapprove pending applications for a domestic satellite communications system. In a letter to Dean Burch, chairman of the FCC, Whitehead said that the pending applications had been examined in view of the Administration's open-competition policy and that "there are no technical, economic or legal considerations which preclude approval of any proposed system." A decision on the awards is expected to be issued by the FCC by the end of the year.

Teleprompter case could mean tougher scrutiny of CATV

"Irving Kahn took this industry to new heights, away from the community antenna concept to the broadband transmission concept. When a guy like that is taken out, it's going to hurt."

This is the way an authoritative source in the FCC's CATV Bureau

summed up the impact of a bribery conviction against the Teleprompter Corp. and its chairman, Irving B. Kahn. Noting that the conviction was being appealed, the FCC source said that all of the implications in the case and its connection with the CATV industry were not yet clear. But he added that Teleprompter operates under FCC licenses and the fact that the concern and its chief executive officer were convicted of bribing officials in Johnstown, Pa., will certainly have to be considered when those licenses come up for renewal.

The company, the nation's largest cable TV operator, and Kahn were convicted of bribery and extortion in obtaining the Johnstown franchise five years ago. Teleprompter could be fined up to \$10,000 and Kahn could be fined up to \$22,000 and sentenced to as much as 20 years in prison. Meanwhile Teleprompter also faces the possibility of a proxy fight at its annual meeting this month.

Just what effect the case will have on future filings with the FCC is hard to say. The commission is an extremely close-mouthed organization, but there is no question, reliable sources say, that closer scrutiny will be given to all CATV cases. It is also practically a foregone conclusion that local authorities will have a wedge in gaining tighter control over the granting of franchises and their operation.

Panel recommends "Wired City" in Washington, D.C.

A panel at the recent National Academy of Engineering Symposium here has recommended the establishment of a "Wired City" pilot project in the Washington area. The Wired City concept, talked about for some time, refers to a coordinated system of high-capacity communications networks carrying voice, data, facsimile and video by a wide variety of transmission methods for both civilian and government use. The panel recommends tests in an inner city area, a model suburb and a "new town." The system could be used for all kinds of meter reading, burglar alarms, vehicle location, emergency calls and data transmission.

Capital Capsules: A worldwide government-industry symposium on area navigation will be held in Washington Jan. 24-25. **The discussions will consider equipment, such as small on-board computers.** Call (202) 426-8241 before Dec. 1 if you're interested . . . Comsat is asking the FCC for permission to build two new antennas for earth-station backups for Atlantic region satellite communications. One antenna would be at Etam, W. Va., the other at Andover, Me. **Requests for proposals are due shortly.** . . . Honeywell Information Systems, Inc., of Bethesda, Md., has won a \$51.3-million contract for 35 computers to handle the worldwide military command and control system. The Pentagon refers to it as the first standardized family of computers. **If it works, selection of one company to provide a family of computers for a task is likely to be the order of the future.** . . . Final passage of the 7% investment credit seems an early possibility in the Senate. **The tax bill must then go to a House-Senate conference.** Communications equipment of types used by regulated common carriers would get a 4% credit, instead of 7%, under the Senate version. . . . The Army is trying to cut the cost of Lockheed's AH-56A Cheyenne Armed helicopter by \$400,000 each, primarily by slicing away at the electronics package. **A \$9-million cost-reduction study is under way, aimed at cutting the Cheyenne costs to \$3,876,000 apiece for 200 aircraft.** The initial buy was to have been 375 copters.

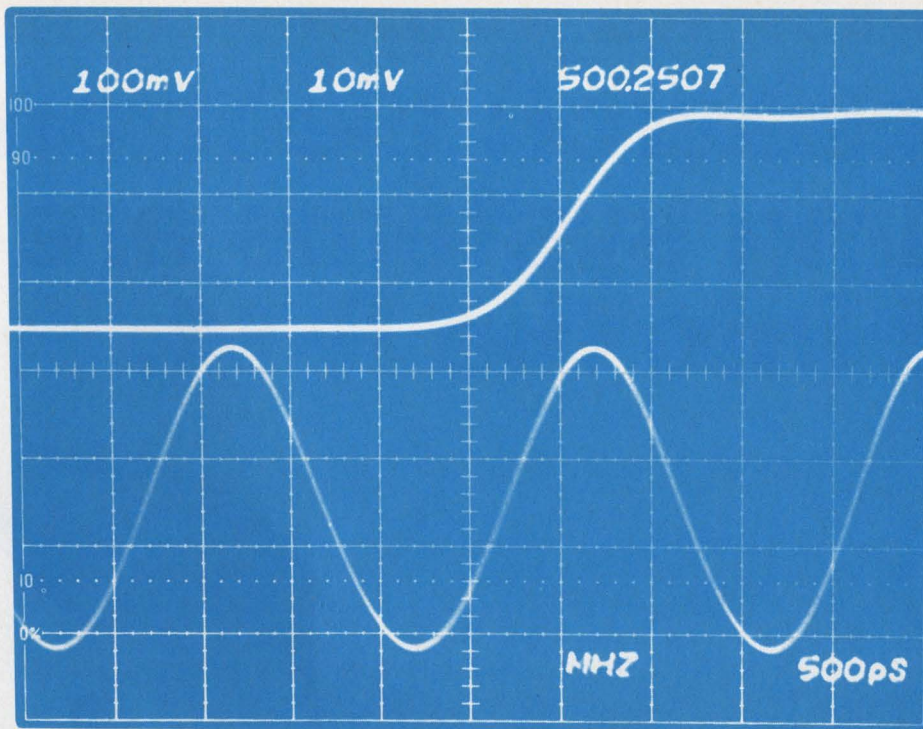

CRT READOUT

CHAR. SET ABCDEFGHIJKLMNOPQRSTUVWXYZ0123456789mnpdq</>Δ+-Ω
Actual Size

TEKTRONIX 7000-Series Oscilloscope Systems

CRT READOUT, unique to the *TEKTRONIX 7000-Series Oscilloscope Systems*, provides a combined display of waveforms, measurement parameters and symbols on the CRT for direct reading.

Wrong answers because of overlooked control settings are now passé. CRT READOUT tells you the full story. Speed, perception and convenience are available because the scale data is printed right on the display. These values are automatically corrected for both probe attenuation and sweep magnification. There are also special symbols for identifying trace position (IDENTIFY), amplifier polarity (\downarrow) and uncalibration ($>$).

Correct answers are always on your photographs with CRT READOUT. The photos will show the waveforms along with their parameters and symbols — A REAL TIME SAVER.

CRT READOUT is available for 7000-Series plug-ins working in *frequency, time, voltage, current, resistance and temperature domains* - - - AND there are MORE coming.

CRT READOUT functions in all 7000-Series mainframes and plug-ins except those having a suffix N (7403N, 7B53N, etc.).

Tektronix, Inc. lease and rental plans are available in the U.S.A. For information, call your local TEKTRONIX Field Engineer or write: Tektronix, Inc., P. O. Box 500, Beaverton, Oregon 97005.

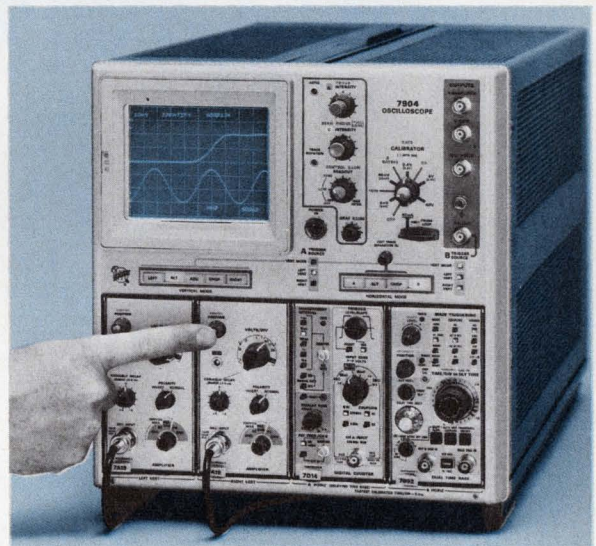

CRT READOUT responding to various functional instructions and generating up to 50 symbols is shown using the 500-MHz 7904, a four-plug-in Oscilloscope with a pair of 500-MHz, 10-mV 7A19 Amplifiers, a 525-MHz 7D14 Digital Counter and a 500-ps/cm 7B92 Dual Time Base.



TEKTRONIX®

committed to
technical excellence

AiResearch electronic cooling systems are built into the F-14.



We have designed and built complete electronic cooling systems for hundreds of airborne applications — both on board and pod mounted. In fact, a Garrett AiResearch built electronic cooling system is on board the Grumman F-14 air-superiority fighter. □ Whatever your specific airborne electronic cooling requirement, come to Garrett AiResearch for total system optimization.

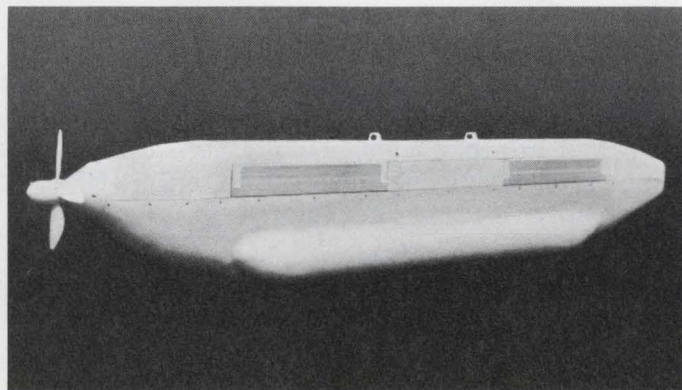

Garrett AiResearch enclosures are also cooling the pod mounted ALQ-76 and ALQ-99 electronic countermeasures systems. The enclosure in the ALQ-99 pod (shown above) for the EA-6B utilizes surface heat exchangers as the ultimate heat sink.



AiResearch Manufacturing Co.

9851 Sepulveda Boulevard, Los Angeles, Calif. 90009
one of The Signal Companies



Introducing the best DC power supply catalog in the world.

Forty-two informative pages. Specifications. Drawings. Photos. Prices. Three-day shipping guarantee. Organized for quick selection of the best model for your application. Included are:



Mini-modules with regulated single or dual outputs. Save space and improve reliability by mounting them directly on printed circuit boards. \$30 up.



Standard modules with ratings to 32 amps. Choose from single and dual output regulated models and single output unregulated. \$60 up.



Low-profile modules to 4.0 amp from a package only 1.68" thick. \$75 up.

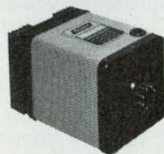

Plug-ins with single or dual outputs, for commercial or MIL-Spec. use, regulated or unregulated, high isolation, fixed or adjustable. \$45 up.

Acopian also offers rack mounting power systems, designed to meet specific multi-output power needs. Shipping time for these fully wired, fully tested systems is only 9 days from your order. \$150 up.



For your copy of the world's best power module catalog, write or call Acopian Corp., Easton, Pa. 18042. Phone: (215) 258-5441. The power modules you order from it will be shipped with (you'll happily agree) the world's best tag...



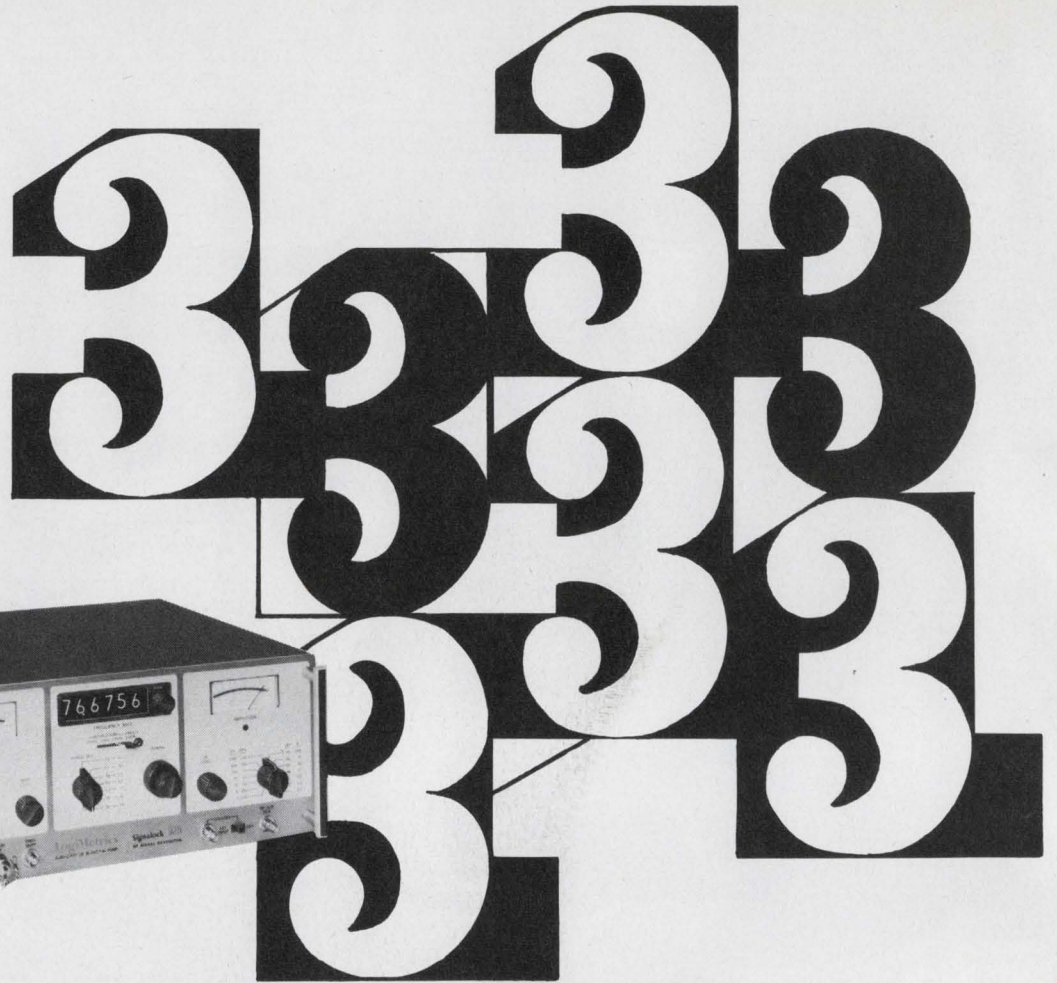

We invented an rf signal generator for people with a 3-instrument need and a one-instrument budget It contains a generator, a frequency stabilizer and a counter, all in one instrument

What a joy it is to have that six digit counter built right into LogiMetrics' Model 925 generator!

The counter's primary purpose is to display the generator frequency. But the counter can be used independently. It has variable resolution to 100 Hz, a frequency range that's the same as the generator — 50 kHz to 80MHz — and a maximum sensitivity to 50 mV rms. A counter with similar specifications is worth about \$995, but you get this one as a bonus with the model 925.

The built-in frequency stabilizer helps the generator produce the most remarkable result of all: a frequency stability of ± 10 Hz. This synthesizer-like stability was simply not available before the Signalock™ circuit was invented.

Whether it's the economy of getting three instruments in one, or the idea of having that amazing frequency stability and accuracy at your fingertips, or simply the instrument's

wide range of 50 kHz to 80 MHz that appeals most to you, it's best to get all the details now. Use the Readers Service Card, or write or call us directly.

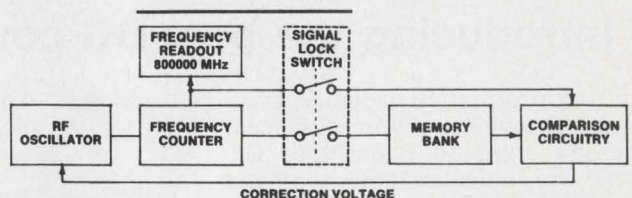

"Signalock" is a patented circuit which enables the output of the built-in rf oscillator to be locked into the crystal time base of the built-in counter. When the Signalock mode is switched in, the digital readout is stored in a memory, and then continuously compared to the generator's output frequency. If an error exists between the output frequency and the memory frequency, a correction voltage is fed back to the oscillator, causing frequency to return to the original setting.

LogiMetrics INC. 100 Forest Drive, Greenvale, New York 11548 • Phone (516) 484-2222 • Telex 96-1371

INFORMATION RETRIEVAL NUMBER 33

Safety first— where it doesn't matter

Arguing against safety standards is akin to arguing against flag and motherhood or taking a public stand on the side of sin. But a proposed safety standard for lasers leaves me feeling that someone's hanging his banner on a twig. The Z136 committee of the American National Standards Institute has proposed that maximum laser output be limited to 40 μ W, a rather sharp dip from today's 5-mW standard. (See "Laser Safety Standard Disputed by Industry," ED 22, Oct. 28, 1971, p. 20.)

There are two bad aspects to the proposed standard. First, the level at which laser output can injure a human's eye is very much in dispute, with some authorities arguing that 7 to 10 mW are still safe. Second, the standard, if adopted, could deal a savage blow to manufacturers of helium neon lasers at a time when the electronics industry needs more jobs and more markets—not less.

But even these two issues are not the crucial ones. The key question is: "What's the fuss about?" You'd think there were lasers at every street corner and that they were blinding crowds all over the place. You'd forget that the danger of eye damage is far greater with arc welders, and there are plenty of those around without benefit of 40-microwatt safety limits.

And you might forget that there are some products around that cause a lot more damage to eyes—and limbs, and lives—than lasers. I don't know how many injuries have been caused by lasers, but I suspect the number is close to zero. I don't know how many injuries have been caused by passenger cars either, but I suspect the number is quite a bit higher than zero.

There may be as many as 50,000 helium neon lasers in the United States. But there are 87,000,000 passenger cars registered. (I sometimes feel they're all parked on the Long Island Expressway.) Worrying about 50,000 lasers and neglecting 87,000,000 cars is like campaigning against dandruff in Vietnam.

Let's develop a sense of what's important. Let's horse around with laser safety after we've taken care of automobile safety. Though there's been some progress, we have a long way to go before we can consider a passenger car a safe contraption. We have thousands of electronics engineers who can help make it safe. Let's put them to work.

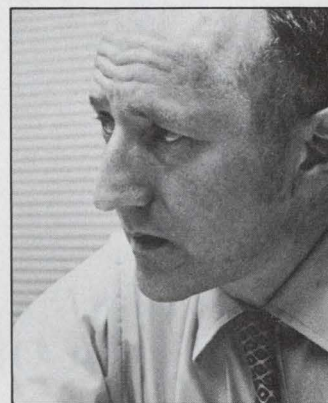

A handwritten signature in dark ink that reads "George Rostky". The signature is fluid and cursive, written in a professional style.

GEORGE ROSTKY
Editor

A better way to maintain oscillator specifications.

A lot of oscillators can't meet their own specs once in operation. That's why we came up with a better way. A die cast zinc enclosure to keep specs what they should be. No other oscillator offers our kind of enclosure. Or our kind of performance:

Models in 1MHz, 3MHz, and 5MHz ranges. And when you write for our spec sheets, what you read is what you get. Write to Motorola Component Products Dept., 4545 W. Augusta Blvd., Chicago, Ill. 60651.

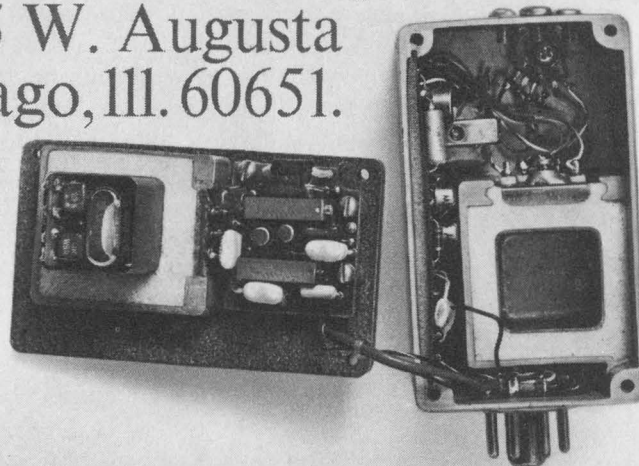

OPCOA sells LED displays and lamps...

lots of them.

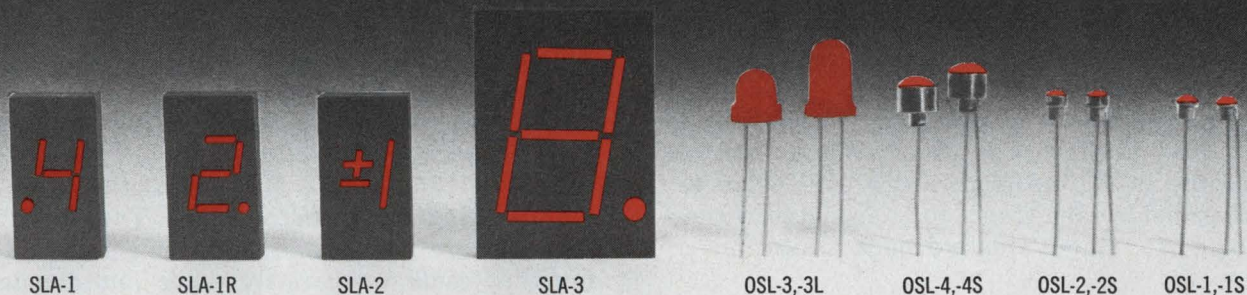

Lots of displays. All use gallium phosphide, the most efficient visible light emitting semiconductor with 200,000 hours typical half life. All are operable from standard low-voltage IC's. Numerals are red on an opaque black background. Choose from:

SLA-1: A seven-segment numeric display with decimal point featuring a large $\frac{1}{3}$ -in. character in a standard 14-pin dual-in-line package. Total power is less than $\frac{1}{4}$ watt. Operates directly from standard TTL decoder/drivers.

SLA-1R: Similar to SLA-1 but with right-hand decimal point.

SLA-2: For use with SLA-1 or -1R seven-segment displays to indicate the overflow numeral one and polarity.

SLA-3: The largest available solid state numeric display with an 0.8-in. character height—readable at distances of over 40 feet. It features a 0.17-in. thin package with 0.100-in. spaced leads for convenient socket mounting or soldering to a p-c board.

Lots of lamps. All use gallium phosphide LED's which emit light in all directions to provide an area light source rather than a pinpoint. All provide typical optical power output of 225μ watts (4.5 millilumens) at 15 mA. Choose from:

OSL-1 and -1S: Full 0.100-in. sources of light in 0.100-in. diameter packages with good visibility over 180° viewing angle. For coaxial or two-wire hookup.

OSL-2 and -2S: Provide 2.0 millicandelas at 15 mA in 0.100-in. diameter reflector packages. Recommended where high luminosity with more directional viewing is desired. For coaxial or two-wire hookup.

OSL-3 and -3L: Large indicator lamps with 0.200-in. lens diameters offer exceptionally wide viewing angle. Convenient socket or soldered mounting with 0.100-in. lead spacing. Available with short (OSL-3) or long (OSL-3L) dome in either red or clear plastic.

OSL-4 and -4S: Directional 0.175-in. diameter "head-light" type lamps provide 2.7 millicandelas. Particularly useful for panel backlighting. For coaxial or two-wire hookup.

And lots of the model you've chosen. When your design moves from prototype into production, you can count on OPCOA to meet your requirements.

For technical literature or applications assistance, contact OPCOA, Inc., 330 Talmadge Road, Edison, New Jersey 08817; call (201) 287-0355; TWX 710-998-0555.

OPCOA SOLID-LITE

FOCUS

on Readouts

Before you buy a readout, there's a lot you want to know. You ask about brightness, brightness uniformity, contrast, character height, package width and depth, viewing angle and distance, character ambiguity, availability of special characters, ease of decoding, noise, voltage and current requirements, power and heat dissipation, and life.

Before anything else, however, you're likely to ask: "How much does it cost?" For dollars are one of the most important specs, and there are few arguments that stand up against the withering logic of: "But it's only a buck a digit."

Money isn't everything

Published prices like those in this report are but a vague guide to actual prices. Prices here are for quantities of 1000, unless otherwise stated. That's the highest level most vendors quote in print. Prices for large production quantities are invariably negotiated, not published.

Dollars can be deceptive. The cost per display digit can be small while the cost of decoders, drivers and power supply can be high. If the life expectancy is poor, replacement and maintenance costs can make the initial price look like a poor bargain.

A question of life

All vendors suggest that their readouts have long life. Many are more specific, assigning numbers to the projected life or half life. A minimum figure is generally 10,000 hours.

That's 417 days of continuous operation, and some engineers feel that's not a very long time. Vendors of readouts using light-emitting diodes have generated much bigger numbers.

One, in fact, suggests a life expectancy (to half brightness) of a million hours. But the company doesn't commit itself to a cheerful cash refund if its LED readouts should fail before one million hours (114 years) have elapsed.

While no readout has been tested or operated for 114 years, manufacturers of all types find it necessary to generate life-test data—often by extrapolating from existing data. They may, for example, use accelerated high-temperature testing that could temporarily drive out damaging moisture. So extrapolations aren't always valid. One may not assume, for example, that a child who grows five inches a year during his first two years will be 12 feet tall when he's 20.

Photos don't give the picture

Before buying, you usually want to know what a readout looks like. That isn't easy until you energize some devices. For one device is worth a thousand pictures. Photographs in data sheets, catalogs and magazine articles are often flattering and sometimes deceptive.

Some readouts simply don't photograph well. They may look better to the eye than to film. Or a vendor may look at a photo and feel the camera lied. So the photo is often "helped" by an artist's airbrush and imagination. Unattractive metalization patterns (which may, in fact, not be apparent when the device is energized) are painted out. Too-thin strokes are widened. Contrast is enhanced. Or in the extreme case, by no means uncommon, a readout glows brightly, attractively and magically without application of power.

It's therefore wise to get several samples. Several! One sample can disclose much but several can tell a lot more. The samples should be

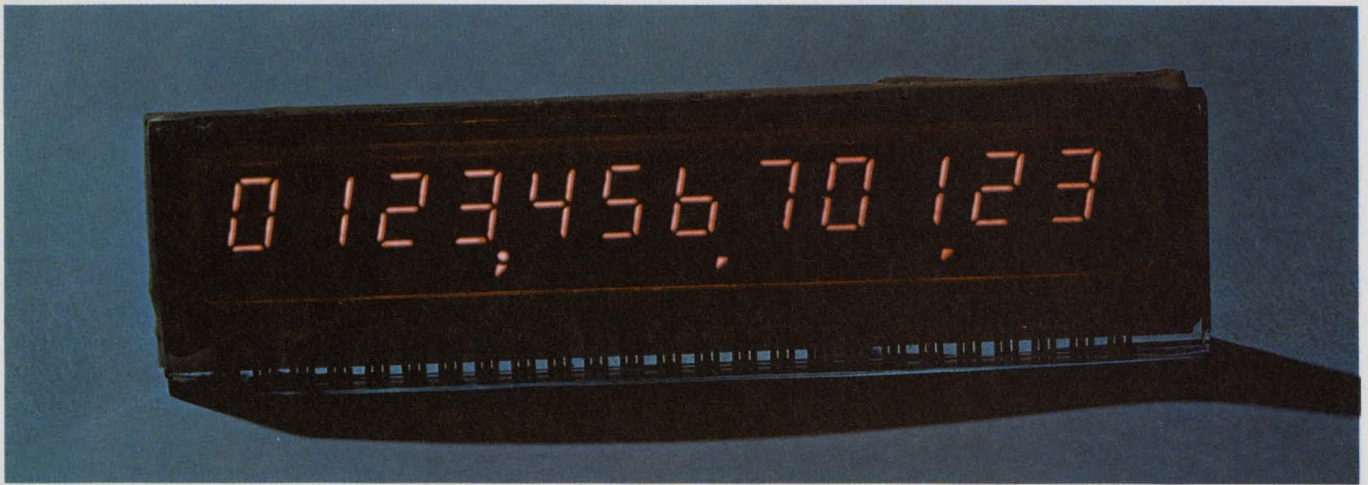

Gas-discharge numerics in Burroughs' Panaplex II are formed of bars, printed all at once, on a single substrate.

mounted in a row, as they would be in equipment, and energized.

It's then possible to see if character tops—or bottoms—are in a single line; if any characters are tilted, and if single-plane characters are really in the same plane. It's also possible to see the spread in brightness and color from character to character and sometimes from one part of a character to another.

The brightness game

Almost all readout vendors claim high brightness. Many feel their devices can be viewed in direct sunlight. They support their claims with "brightness" data in foot-lamberts. Unfortunately, these data are largely worthless.

Brightness is subjective and not directly measurable. It is a response of the human eyeball to visible electromagnetic radiation. That eyeball tends to see surfaces, not points or spots.

The foot-lambert, a unit of luminance, is a measure of light intensity at a spot, generally the most intense spot a vendor can find. If the light source is very thin, as it is with directly-viewed filaments, luminance ratings can soar to 10,000 ft-L or more. But to the eyeball, the filament display may appear no brighter than a LED readout or Nixie with 200 ft-L. While foot-lambert measurements can make interesting reading, the best way to compare brightness is to set up competing readouts side by side and look at them.

The readouts—good and bad

No readout is ideal for every application. For any specific application—like yours—almost any vendor can prove that one specific readout—his—offers the best compromises. Almost any readout

type is made by several manufacturers, each having good reasons for your buying his.

These reasons can include price, delivery, "unique" quality-control and materials-control procedures, history of innovation, longevity in the readout business, applications assistance, mounting provisions, availability of pre-packaged multidigit displays and availability of decoders and drivers.

In addition, a particular vendor may point to subtle, but "very significant," differences—like a character height of 116 mils instead of 110 mils, a slope of six instead of 10 degrees (or the other way around), extended segments that fill in corners to eliminate gappiness, shortened bars that allow the eye to round out corners, large characters for distant viewing or small characters "for today's compact equipment."

It can be helpful, then, to review the mixture of fact and opinion surrounding each type, even if it's difficult to distill the components.

Gas-discharge tubes

The commercial history of gas-discharge readouts began when Burroughs introduced the Nixie tube at the 1955 IRE Show. It came at a time when vacuum tubes were very popular and transistors, six years old, had not yet begun to drive tubes out of equipment. The Nixie's early price was about \$16 in quantities of 500.

The basic numeric gas-discharge tube has individual cathodes forming the numerals 0 to 9. In addition it may have a left or right decimal or both.

Prices today range from \$2 to \$30, depending on many factors. Larger characters (up to two inches) tend to cost more than smaller ones (down to 0.3 inch), though the 0.3-inch tube costs

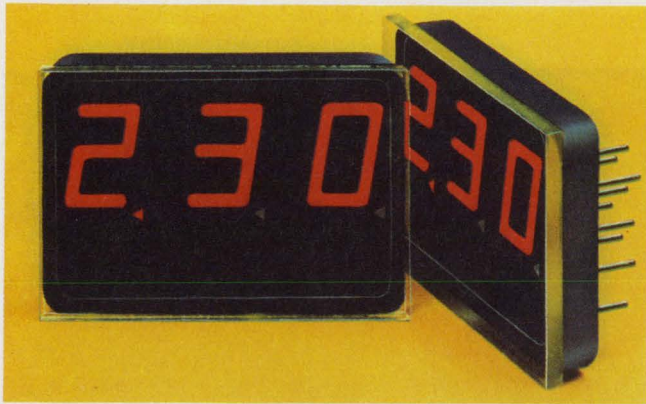

Small gas-discharge planes with three, two or 1-1/2 digits consume very little power. They're from Sperry

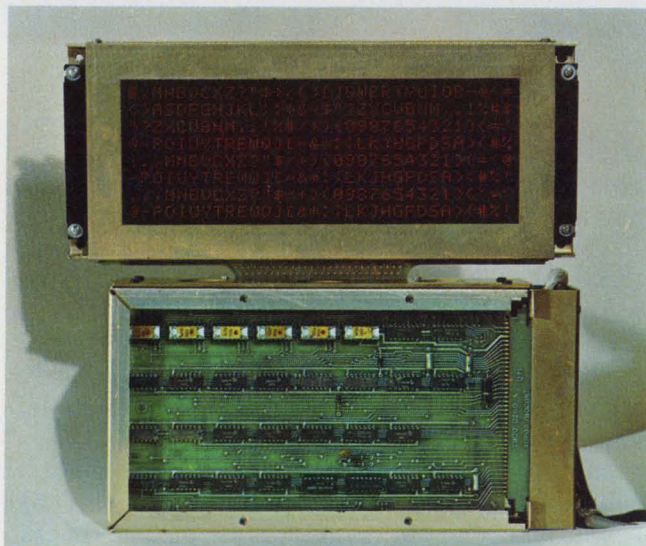

Gas-discharge cells in the Burroughs' Self-Scan panel can display 256 alphanumeric characters. The panel includes all decode, drive and scan circuitry.

more than the more popular 0.5-inch and 0.6-inch tubes. The most widely used tube, the Burroughs 5750, and equivalents from Amperex, National Electronics and Raytheon, have half-inch characters and cost about \$3.95.

The first alphanumeric tube was introduced by Burroughs in 1963, and it was the first tube to depart from stacked characters. It uses the segmented format, with 13 or 15 segments; so it offers an in-plane display. Since then, many seven- and nine-segment gas-discharge tubes have been made available for numeric-only, as well as alphanumeric displays.

Like most products, gas-discharge tubes have advantages and limitations. They're readily available from Burroughs, Amperex, National Electronics, Raytheon and Alco. They're inexpensive. The lowest published price in recent months has been \$2 for the Amperex ZM 1000, a tube with 0.55-inch numerics. In single-digit tubes with segmented characters, Alco's Elfins have the lowest price—\$2.69.

The gas-discharge tube can also last a long time. It's the only popular readout that's actually been operated for many years. Burroughs started 50 Nixies on a life test in 1958. One of them failed after 60,000 hours. The remaining 49 are still operating, having passed the 120,000-hour mark.

Vendors generally give life expectancy of 100,000 to 200,000 hours. But they sometimes measure life by running one cathode for 10,000 hours, then multiplying by 10 on the assumption that 10,000 hours for one cathode represents 100,000 hours for the tube.

Mercury for life and death

But the long-life tubes, unfortunately, require small quantities of mercury. For enclosed environments, like those in submarines, that's somewhat undesirable since, if a tube should break, escaping mercury vapor could kill people.

In addition the range of color in gas-discharge tubes is limited to neon's characteristic red-orange or, with a filter, to red. Brightness isn't usually easy to vary. But changing the duty cycle in multiplexing modes (for which most tubes are suitable) or changing the duty cycle of a power supply can alter the brightness.

Small gas-discharge planes

Introduced as commercial products by Sperry in March of this year, small gas-discharge planes are now available with 0.33-inch or 0.5-inch seven-bar numerics, the bars being extended to eliminate side and corner gaps.

Each Sperry series has three units—a three-digit plane, a two-digit plane and a plane with a full digit and a ± 1 . The "1," by a quirk of industry arithmetic, is popularly called a half digit. At the 1000-digit level, the cost per digit is \$2.52 for any of the Sperry displays, the ± 1 , in this case, counting as a full digit.

The Sperry plane shares advantages and limitations with other gas-discharge devices. It, too, requires 170 Vdc. But it draws rather little current, typically 200 μA per segment for the smaller (Series 730) characters and 525 μA per segment for the larger (Series 750) characters.

Sperry's package is flat, with a thickness of only 0.235 inch for the 730 series and 0.245 inch for the 750; so the characters are closer to the front surface. Luminance can be varied from 100 to 500 ft-L by segment-current programming with Sperry's decoder/driver.

Multidigit gas-discharge displays

In April, 1961, Amperex introduced the ZM 1200 Pandicon. It costs \$28. The Pandicon is es-

essentially 14 stacked-numeral, 0.4-inch gas-discharge decades in a single cylindrical bottle. But not quite. The tube requires only 27 external connections instead of the 168 required for 14 separate tubes with decimal points.

It has a common rail for the 14 decimal points, a common rail for 14 punctuation marks (upper-right decimal points), a common screen and a common rail for each of 10 numerals.

The device is used only in a multiplexed mode. It requires at least 175 V for the anodes, which draw 6 to 12 mA. It needs a cathode-selection voltage of 70 to 90 V and a similar screen supply.

The next important gas-discharge line came in August, 1969, when Burroughs introduced the Self-Scan display panel, an array of 112 seven-dot columns to display up to 18 full-alphanumeric 5×7 characters or up to 22 numeric 4×7 characters. The panel, 8-1/2 inches wide, 2-1/4 inches high and 1 inch thick, includes decode and drive electronics.

The Self-Scan panel has a glass plate with an array of holes sandwiched between top-wire anodes above the glass, cathode strips and bottom-wire anodes below it. The holes form pockets or cells for the neon.

The cathode strips, one for each seven-dot column, are scanned, and the gas in a cell becomes visible when the cathode is switched from +100 V to ground while the top anode is switched from +130 to +250 V and the bottom anode remains at +250 V.

A somewhat similar approach is used in the Digivue plasma panels, which Owens-Illinois expects to introduce commercially next January. They will be able to display 240 to 4000 characters, with resolution ranging from 33 to 60 lines per inch.

Burroughs now has several Self-Scan panels. Single-line panels are available with 16 or 18 positions for 0.4-inch characters, and with 32 or 80 positions for 0.2 inch characters. An eight-line panel can display 256 alphanumeric characters, 0.28 inch high. Prices in quantities of one to nine range from \$135 to \$998, depending on the number of character positions and the inclusion of memory with the decode/drive/scan electronics.

Self-Scan panels are aimed at a gap between applications calling for a series of single-character readouts and those calling for a CRT that can display hundreds of thousands of characters. To fill a narrower gap, Burroughs introduced the Panaplex panel in August, 1970, and then, last August, Panaplex II. Both displays compete directly with the Amperex Pandicon, but they're different.

Both are single-plane panels. Panaplex I is available with eight to 16 nine-bar, 0.4-inch numerics. Panaplex II is initially available with

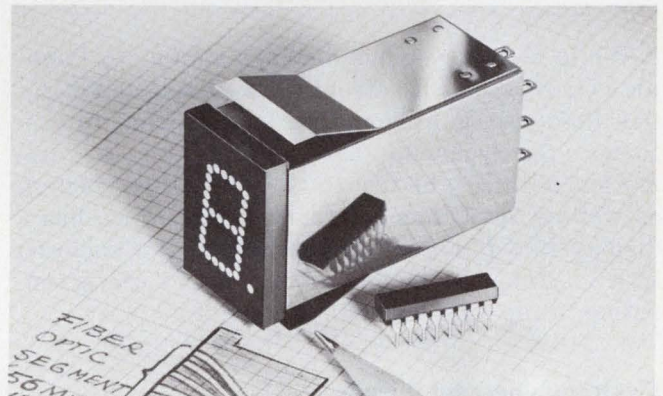
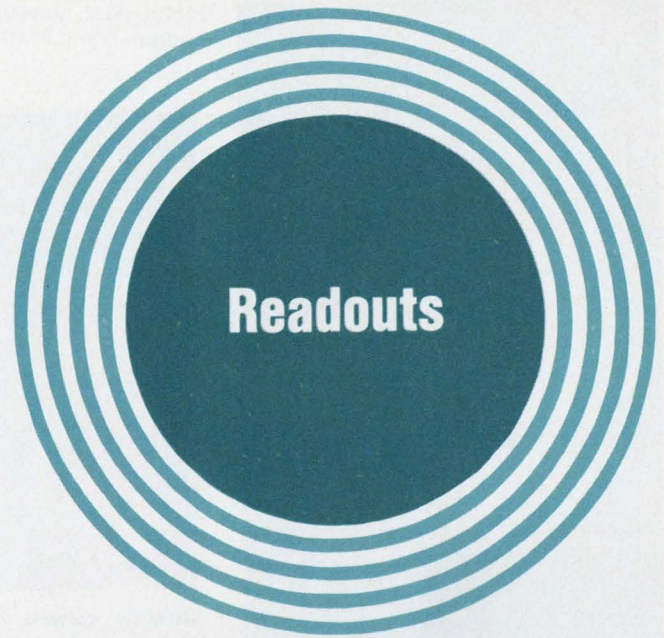

Optic fibers convey light from LEDs to form the dot-filled seven segments in this Master Specialties display.

nine or 12 seven-bar, 0.255-inch numerics.

The cathode segments, as well as anodes and the screen, in Panaplex I are made of stamped and formed metal strips, positioned in a glass form. In Panaplex II, commoned cathode segments and interconnections are screened onto a glass substrate.

Most important, while a 170-Vdc supply is still required, the voltage swing required to turn on a segment is as low as 25 V. That's about a third of the usual swing needed in gas-discharge displays, making Panaplex II the first that's directly compatible with MOS devices. Further, the average power consumption of a segment is as low as 5 mW—about a sixth of that required by other gas-discharge devices. No light-emitting readout takes less power.

As you might expect, the best per-digit price appears in panels with the most digits. A 16-digit Panaplex I display costs \$24.96 — \$1.56 per digit. A Panaplex II panel with 12 digits costs \$18.25—\$1.52 per digit.

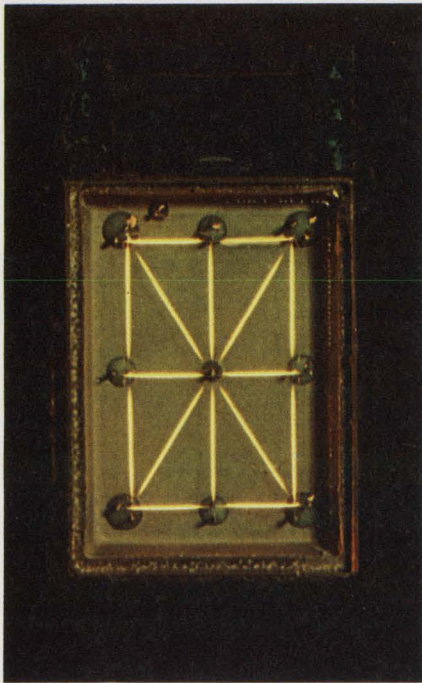

Double-post construction at the corners of this 16-filament, full-alphanumeric readout from Pinlites eliminates corner gaps.

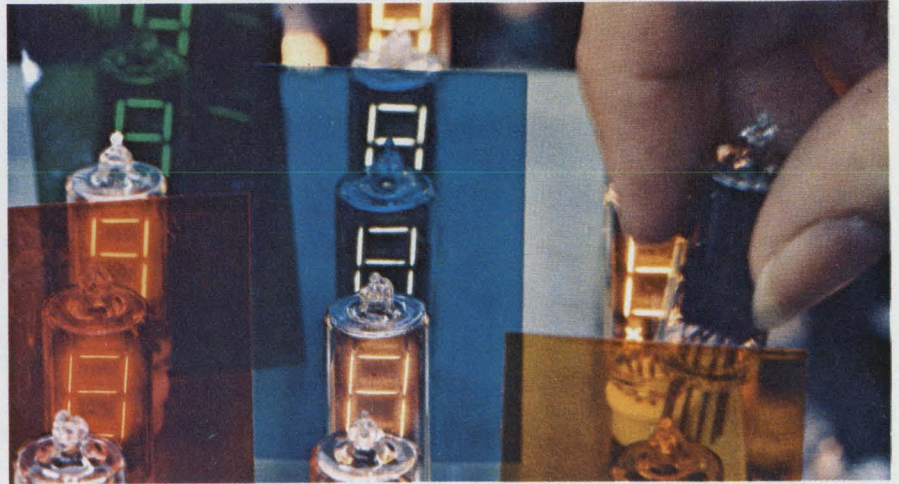

Directly viewed filaments in RCA's Numitron are operated at much lower temperatures than conventional lamps, so they can last a long time. With suitable filters, they can show a wide range of color.

While no one else has displays similar to Panaplex II, National Electronics has displays exactly like Panaplex I. National packages panels to customer requirements and offers nine-bar numerics, with height from 1/4 inch to three inches, as well as 16-segment alphanumeric. Alco has a display like Panaplex I, except that it's enclosed in a glass cylinder and the characters use seven, rather than nine, segments.

Electroluminescent displays

Made by Sylvania and used for many years by Beckman, the electroluminescent panel didn't fare well. Almost all EL panels used the seven-bar format for numerics. They often included fixed legends, like V, mV, cps and msec. And they had the advantage of low cost. But they were a dim green (about 10 ft-L), and they required high-voltage ac (about 120 V at 400 Hz).

The Sylvania EL display died. A new display using similar principles but different technology and materials was introduced by Sigmatron about a year ago. Called a Light-Emitting Film (LEF) display, it has a sandwich of glass, a transparent tin oxide front electrode, a transparent zinc sulphide film, a light-absorbing dielectric and opaque rear electrodes that form the segments.

Brightness is easy to vary with voltage and frequency. Though the LEF readout can be operated from 300 Vdc, it's best at high frequencies, where it still requires relatively high voltage.

About 140 Vrms at 2 kHz produce 10 ft-L of yellow-orange light. That's not brilliant, but the readout's high contrast ratio makes a modest 50 ft-L appear uncomfortably bright.

The LEF, like early EL displays, lends itself

to multidigit displays with legends. The device is still young, so the price isn't as low as it may be in the future. In quantities of 51 to 100, a six-digit display with seven-segment characters costs \$50.

Edge-lit readouts

Popular in its day—because it was used by Non-Linear Systems, then the largest manufacturer of digital voltmeters—the edge-lit readout is now all but defunct. It's called an in-line display, to distinguish it from the ancient columnar display (sometimes called a thermometer readout), which had columns of neon-lit holes for 0 to 9.

But it's not an in-plane display. It uses a stack of acrylic plates, each engraved with a numeral or other symbol. There's a miniature lamp at the edge of each plate. When a lamp is energized, the associated symbol glows.

Though edge-lit displays enjoy little popularity today, they're available in three models from Alco. In quantities of 500 to 999, they cost \$5.36 to \$10.24, depending on character height (0.566 and 1.062 inch), voltage and special symbols.

Edge-lit displays aren't popular because they're bulky and because many engineers, accustomed to replacing light bulbs at home, would rather avoid incandescents. However, if a numeral fails, it's cheaper to replace a lamp than a display.

Rear-projection displays

Objections to bulk and bulbs apply also to the rear-projection readout. But the rear-projection gives a single-plane readout. It uses individual,

replaceable lamps behind a system of lenses and a sheet of photographic film with an array of character and symbol images that can be projected singly or in combination to the front screen.

A single module normally has 10 to 12 character positions. But it can display full message legends with characters or background in almost any color.

In 1962, five years after it introduced the projection readout, Industrial Electronic Engineers added a switch to the display screen and called it the Cue-Switch. An operator can press the screen and change messages or switch external circuits.

Projection readouts are available from Industrial Electronic Engineers and Shelly Associates at prices from \$14 to \$35. These readouts sometimes suffer from imperfect focus. Part of a character, which can be as small as 3/8 inch or as large as 3-3/8 inches, can be dimmer than another part.

Seven-bar readouts

Though many displays use the seven-segment format, the seven-bar or seven-segment designation started with a type popularized by Dialight, starting in 1963. The name stuck—even for readouts that use nine or 16 segments and even when the segments are composed of dots.

In this display the front screen, or a mask behind it, has the segment pattern. Incandescent lamps, neons or light-emitting diodes provide illumination for each bar.

The basic seven-bar readout is available at prices that dip to below \$3 from Dialight and vendors like Alco, Industrial Electronic Engineers, and Oppenheimer (which specializes in multidigit, custom packages for avionic and space applications). But other vendors have variations on the same theme. Master Specialties, for example, has a series of fiber-optic readouts that use light-emitting diodes or 5-V, 20-mA incandescents.

Light is transmitted through 30-mil-diameter plastic fibers to form dots on the front screen. The dots are arranged in seven segments for numerics, 16 segments for alphanumeric.

Because of the high light transmission of the fibers, Master Specialties quotes luminance of 1000 ft-L with incandescent lamps at rated voltage for an average lamp life of 10,000 hours.

Tung-Sol uses a variation of this technique in its light-pipe readouts. Light from the lamps is transmitted to the viewing surface through flat, flared, plastic "pipes," so the surface shows bars rather than dots.

Tung-Sol has LED versions of these readouts. The brighter, incandescent, versions use specially manufactured lamps for average luminance of 500

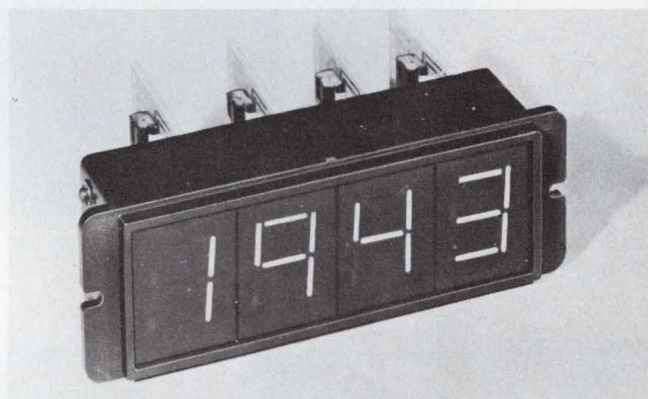
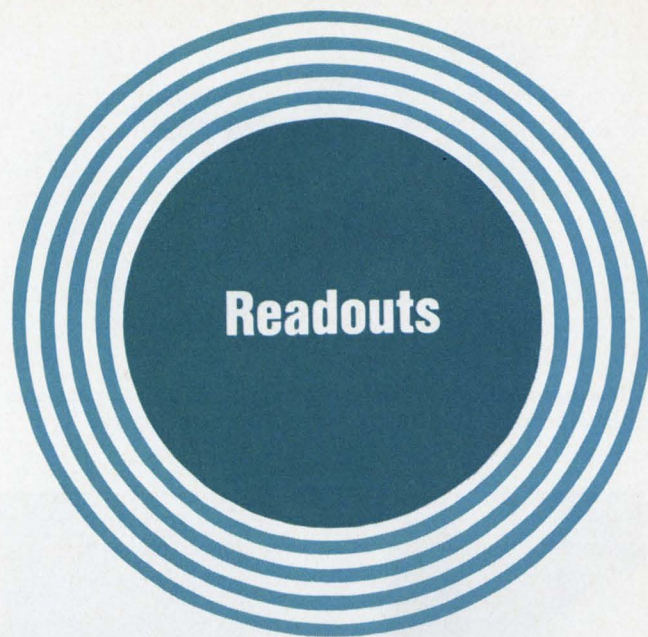

A light-gathering cell in this Dialight display conducts light from diodes, rather than incandescents, to the seven segments on the front screen.

ft-L at 4.5 V and 20 mA, or 1000 ft-L at 4 V and 70 mA. The lamps are rated for 5000-hour life at dc, a much tougher condition than ac operation because tungsten migration in dc operation of any incandescent causes hot spots that lead to early failure.

These readouts, which are available with filters bonded to the front screen and with circularly polarized filters as well, aren't inexpensive. They cost \$35, but they're designed for tough avionic applications.

With a similar approach, Dialight uses what it calls a light-gathering cell to form 0.625-inch characters in a seven-bar format. Each bar gets its light from a gallium phosphide light-emitting diode. The units sell for \$5.80.

Shelly Associates has a fiber-optic readout that's different from these. An interlacing arrangement of fiber-optic strands is used to form "Arabic," rather than seven-segment numerals, 0.475 inch high. Each numeral, formed of 10-mil spots, is illuminated by a single, 100-mW lamp,

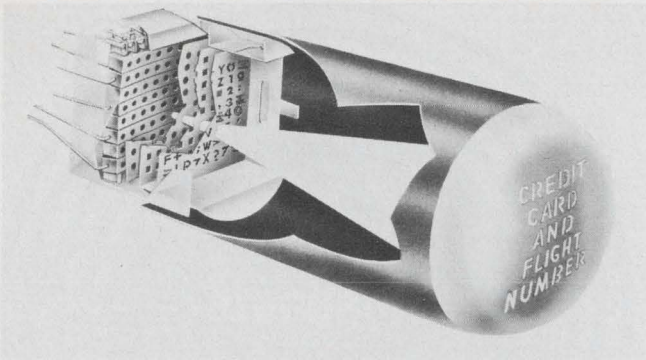

Miniature CRT from IEE can display any of 64 messages or symbols in a custom-tailored character mask.

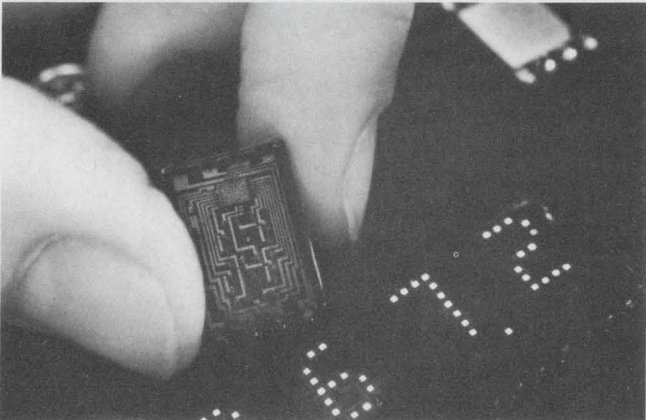

LED numerics in a 4 × 7 dot matrix from HP have an on-board decoder/driver with memory.

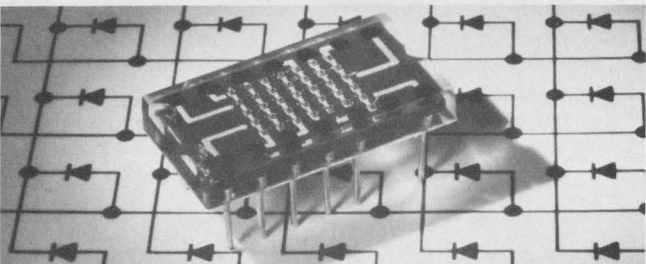

A 5 × 7 LED matrix from TI provides full-alphanumeric capability with 300-mil characters.

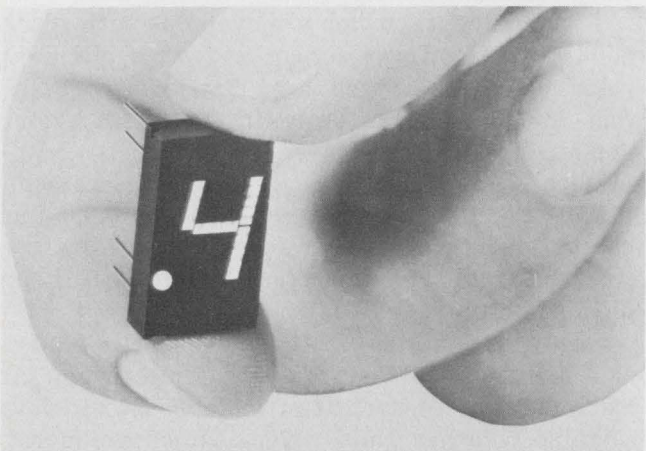

Gallium phosphide chips, one per segment, are used in Opcoa's display.

making for a drastic reduction in power consumption compared with displays that use a lamp for each bar.

All incandescent readouts are easily dimmed by reducing lamp voltage (which extends life but shifts the color towards yellow). Almost all can be used with a wide variety of color filters. Most allow easy lamp replacement and, in most of these, lamps can be replaced from the front without special tools. In some cases, however, the readout must be removed from its panel before lamps can be replaced.

Seven-filament readouts

Two incandescent readouts don't permit lamp replacement because they have no individual lamps. Instead, they use directly viewed, fine-wire filaments in seven-bar or 16-bar formats. Directly viewed filaments can provide high luminance (to 15,000 ft-L) and can operate at relatively low temperatures (down to 1200 K instead of the typical 2400 K with conventional lamps), where they can last a very long time.

Pinlites, which has been making filament readouts since 1965, rates its displays for 100,000 hours. Until recently the company's displays were aimed at military markets, and the prices reflected that fact.

Now, perhaps motivated by RCA's introduction of Numitron seven-filament displays in August, 1969, Pinlites has lower-cost versions. The DIP-Lite series, with 0.65, 0.85 and 1.05-inch numerics, costs \$5, and the price is scheduled to drop to \$3.25 for deliveries starting in January.

The DIP-Lite is mounted in a metal bathtub-like structure with a glass cover. Bead seals are required for the rear terminals and a glass-to-metal seal is required for the cover. A new series, soon to be introduced, will have an all-glass body that should allow substantially lower prices.

While Pinlites displays are in flat packages, RCA's Numitrons come in nine-pin miniature vacuum tubes, a package with which the company is rather familiar.

Numitrons in the DR2000 series have 0.6-inch characters and a price of \$2.95 for numerals alone, \$3.05 for numerals with a decimal point. The DR2100 series, introduced in March 1970, has 0.4-inch characters and costs \$3.20 for numerals, \$3.30 for numerals with a decimal. A DFT series, physically similar to the DR2100 and not yet priced, takes only 14 mA per segment at 2.5 V instead of 24 mA at 4.5 V, making for a 68% power reduction.

Fluorescent readouts

RCA isn't the only company with experience in vacuum-tube production. General Electric, Syl-

vania and Tung-Sol have made a few tubes, too. So it's not surprising that their readouts—fluorescent units—are packaged in vacuum tubes.

In early 1968, Tung-Sol introduced the Digivac I display with 0.6-inch numerics in a short, end-view vacuum tube. The tube was basically a multitriode display. Each anode, coated with a green phosphor, formed one of seven segments that could be switched on by applying 20 V to its control grid. The tube never achieved popularity because it required a 250-V plate supply and a 1.5-V (at 360 mA) filament supply.

Tung-Sol's engineers went back to the drawing boards and, just a few months later, unveiled the second generation—Digivac S/G—a diode display requiring a plate supply of 25 Vdc at 225 μ A per segment and a filament supply of 45 mA at 1.5 V to give a luminance of 150 ft-L. To vary brightness you can switch the plates with voltages as low as 20 V or as high as 50 V. The green color can be changed with filters. At \$2.55 Digivac S/G is far more attractive than Digivac I—at \$8.50.

A similar tube from GTE Sylvania, introduced in March 1970, has an additional advantage: It costs \$2—with or without decimal. But Sylvania's Fluortron display draws more power. For a somewhat higher luminance of 200 ft-L, it takes 90 mA from 1.2-V filament supply and 500 μ A per segment from a 25-V plate supply.

General Electric has similar fluorescent tubes that draw only 42 mA from a 15-V supply. The company offers 0.4-inch characters as well as the 0.57-inch characters available from the others. Unlike the others, GE's segments are not cantilevered; they're mounted on a mica substrate. GE's tubes start at \$2.55 for a seven-bar tube with decimal.

Legi, which distributes devices from the Japanese company Ise Electronics, has seven-bar and nine-bar tubes with characters from 0.32 to 0.6 inch. The segment current, about 1 mA, is two to three times what's required in the other tubes. Legi also has flat packages with eight or 10 digits for multiplexing.

Miniature CRTs

While several manufacturers offer cathode-ray tubes that can display any pattern dictated by signals applied to deflection plates or coils, one vendor, Industrial Electronic Engineers, has unique CRTs that use no deflection components. A few months ago, the company introduced a 64-gun CRT, the nimo 64. Like an older model, a 10-gun CRT, nimo 64 uses an internal metal mask with etched characters to shape an electron beam.

Near the base of the tube there's a vertical stack of eight horizontal bars, each 0.1 inch high

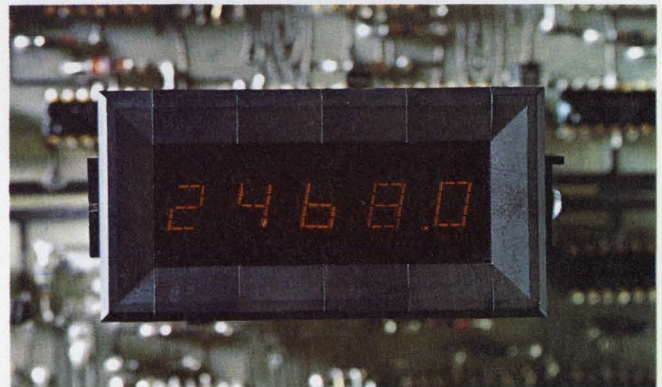
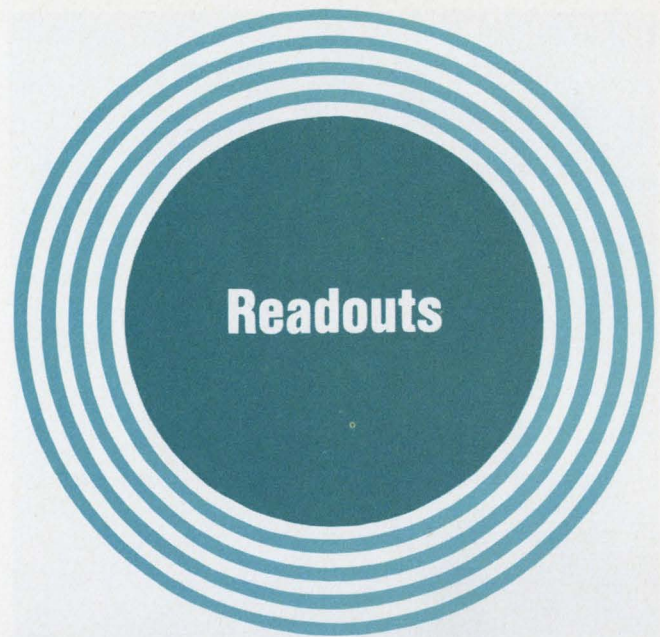

One of the most widely second-sourced LED readouts, Monsanto's MAN 1, with 14 half segments, is shown in a five-digit version.

by 0.9 inch wide. Each bar has a horizontal stack of eight vertical bars, each with a vertical column of eight holes. There's a directly heated cathode and a control grid behind each of these.

With the grids and cathodes, each pair of holes (a front hole in a horizontal bar and a rear one in a vertical) is a CRT gun. All bars and grids normally have -10 V applied. One gun is selected by switching its horizontal bar and its vertical grid to $+2.5$ V. It then emits a conical electron beam that's shaped as it passes through a position committed to it on a 64-position mask of copper, nickel or stainless steel.

Each position on the mask has an etched letter, number, symbol or complete message. One message can have up to five lines, each with up to eight characters.

The display area is 0.63 by 0.63 inch on the 1.5-inch CRT. The anode supply can be varied from 600 to 2500 V to increase luminance to about 200 ft-L. A level of about 110 ft-L gives about 20,000 hours of tube life.

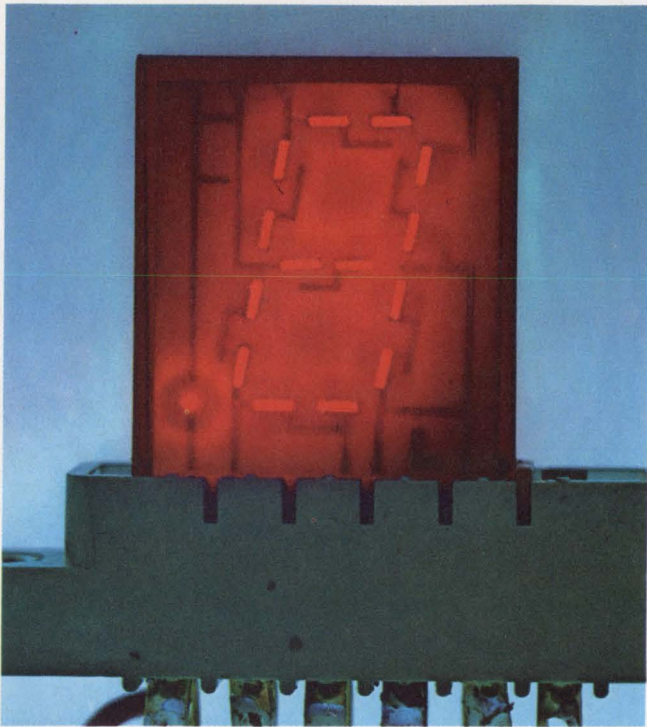

The first large LED readout, this Litronix device with 610-mil characters, plugs into a conventional PC edge connector making special sockets unnecessary.

Nimo 64 isn't cheap. In quantities of 1000, it costs \$38.50 in addition to a one-time mask charge of \$400 to \$5000, depending on complexity.

LED readouts

No single display device has attracted more vendors than the light-emitting diode. The list now includes Bowmar, Dialight, Fairchild, General Electric, Hewlett-Packard, Litronix, Monsanto, Motorola Opcoa and Texas Instruments.

LED readouts have obvious advantages and less-obvious limitations. They are solid-state devices; so they should enjoy tremendous longevity, at least in theory. But wire bonds can break, and leaks in packages can allow humidity or other contaminants to reduce life.

They operate from low voltages used by bipolar logic; so they don't need special power supplies. But they draw quite a bit of power. Each segment of the smallest seven-segment types typically draws at least 5 mA and drops 1.7 V, for a dissipation of 8.5 mW. But a series resistor, required if the display operates from a 5-V supply, dissipates 16.5 mW. And no numeral uses only a single segment. It's not uncommon to find 8's consuming 200 mW or more.

Almost every LED readout uses gallium arsenide phosphide; so the choice of color is red, often called "bright red." The wavelength peak for GaAsP is generally around 650 to 660 nano-

meters and most data sheets clearly spell out the specific value—as if it mattered.

Further, data sheets almost invariably spell out the spectral-line half width (usually 30 to 40 nm). That fact is useful for a diode whose spectral output is to be matched to film or to some detector. The information is useless in a visual application.

Luminance—with typical values from 100 to 500 ft-L (though a few vendors specify in millicandelas instead of foot-lamberts)—depends very much on how a manufacturer measures. The increased luminance in many recent data sheets may be a result of superior light emitters, better methods for locating brighter spots on a diode chip, or more liberal interpretation of the luminance modifier, "typical."

While all vendors specify the typical luminance and most add a minimum value, very few give the maximum value. So there can be a substantial brightness variation between adjacent digits and even among diodes in the same digit.

An enormous attraction of LED displays is their potential for very low cost—a potential whose full realization may be delayed until the supply of GaAsP becomes less scarce.

The earliest LED displays—both from Monsanto in early 1968—were priced at \$495 and \$165 in small quantities. There were no large quantities.

The first readout in production (September, 1968) was Hewlett-Packard's hermetically sealed 5082-7000, with an on-board monolithic decoder/driver. Its initial price in small quantities was \$75 and the 1000-up price was \$42. It's now \$27.50. In mid-1969 Monsanto introduced the MAN 1, which now costs \$7.75.

In March, 1970, nine months later, Monsanto introduced the MAN 3, the first monolithic LED display. All earlier LED readouts used what's now called hybrid construction, in which individual diode chips are bonded to a substrate and interconnected with thin-film metalization.

With monolithic fabrication, all diodes are on a single chip, suggesting the possibility of substantially lower prices. The monolithic MAN 3 came out at \$7.55. That looked a lot better than the price of the hybrid MAN 1, which had already dropped from \$25 to \$11.

But today, with the MAN 3 still at \$7.55, the MAN 1 is down to \$7.75. And the lowest prices now come in hybrids, not monolithics. The Monsanto MAN 3A, a hybrid version of the MAN 3, costs \$3.95, and the Litronix hybrid Data-Lit 300 costs \$3.80, which is the lowest price for a LED readout.

In general, but not always, monolithics are smaller. At the beginning of 1971, Fairchild had one of the tallest monolithic characters, 122 mils, in the FND 10, which costs \$5.80. Bowmar has

taller characters, 190 mils, in the R7M-190 displays. They had been priced as low as \$11.25, but the price schedule is being reviewed.

In March, General Electric introduced the monolithic SSL-140 and SSL-190 with 140-mil and 190-mil characters at \$6.40 and \$8.94. GE points out that its strokes at 8 and 10 mils are about twice as wide as those in competitive readouts. Other vendors don't tend to specify line width.

Though everybody agrees that LED characters look about twice as large as they really are, and though vendors point out that the small characters are fine "for today's compact equipment," the same vendors keep trying to make bigger ones. They're particularly eager to match the 500-mil and 600-mil characters of the most popular gas-discharge readouts. (Meanwhile gas-discharge vendors are making smaller characters.)

Big LED readouts

Making large displays is easy. Making large, inexpensive displays is not. It isn't difficult to stick lots of diodes (matched for brightness) on a substrate. But costs soar. So manufacturers have developed three basic approaches for moving beyond the 270-mil height of the MAN 1 and its followers.

The first approach involves directly viewed LEDs. In the second, light from the diodes is conducted to a viewing screen. And the third involves LEDs at the focuses of mirror-like structures.

The Litronix Data-Lit 6, with a 610-mil character and a \$14 price, uses the first approach. It uses two half-segments per segment (as does the MAN 1), but the segments are somewhat longer than most and they're further apart. This makes for a gappy character, but many observers don't find it objectionable.

Master Specialties uses a variation of the second approach to get 850-mil characters in its model 908. Each diode transmits light through

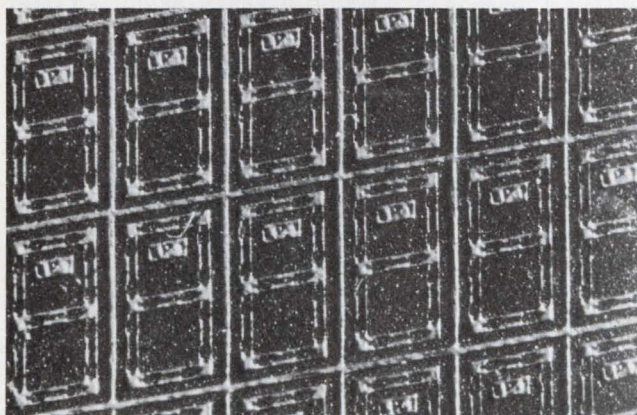

The first green or red-to-yellow LED readout, now in development at GE, uses gallium arsenide, whose invisible infrared emission triggers a phosphor coating that gen-

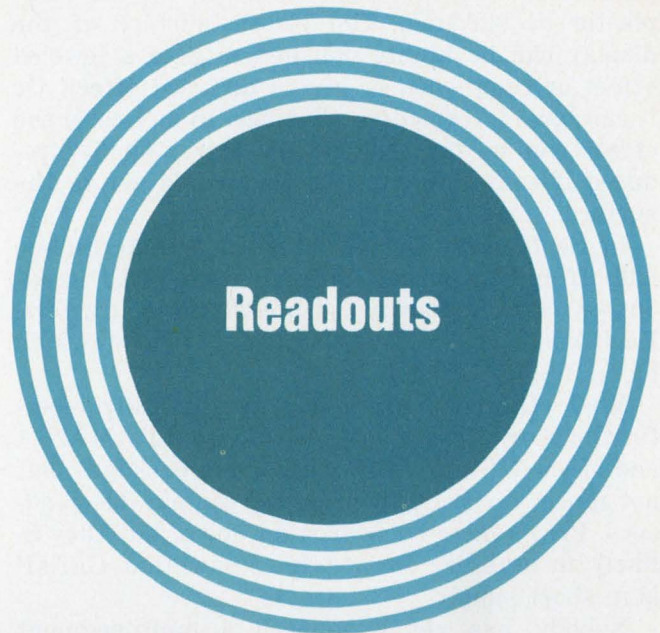

four or five optic fibers that deliver front-screen dots that form the segments in a seven-bar format. The unit costs \$23. Dialight uses a different variation—a light-gathering cell that creates 625-mil, seven-bar characters in the 730 series. The module costs \$5.80. Unlike almost every other LED readout, the Dialight unit uses gallium phosphide diodes.

Until recently, gallium phosphide readouts were the domain of a single vendor, Opcoa, whose \$7.30 SLA-1 uses a single diode chip per segment to form 334-mil characters. Unlike GaAsP, which emits light in a cone that's normal to the surface, GaP, which is transparent, emits light in all directions.

Opcoa uses this characteristic to advantage in a variation of the third big-LED technique. In the SLA-1 each of the seven bars is an elongated reflector with a single GaP chip. The reflector catches side light from the chip and throws it forward in the form of a bar.

Each segment is filled with a transparent red

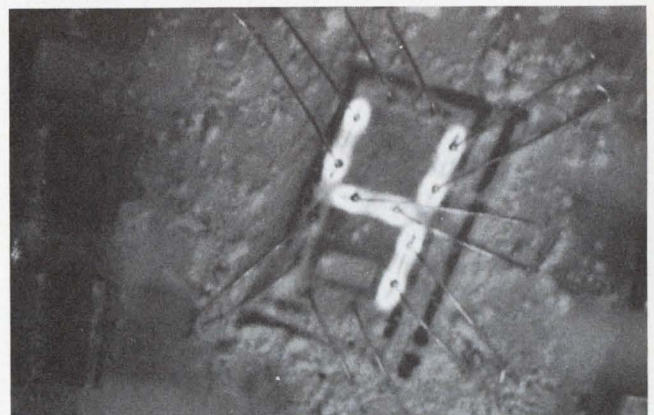

erates the light. On the wafer at left, before dicing, are monolithic numerics. Four of the seven bars on a single chip are energized at right.

plastic that provides high contrast with the black plastic background. The plastic surface of the display can be highly polished to give a jeweled effect or roughened to give a diffused effect. Or it can have intermediate finishes. In any case, the effect can be marred and off-axis visibility reduced if contaminants like finger oils get to the surface.

In September, Opcoa extended this technique and offered the largest directly viewed LED readout—a \$14.50 display with 770-mil characters. Each bar has two half-segments, each of which has a single GaP chip.

Most other displays today are basically modifications or direct copies of Monsanto's MAN 1 and MAN 3. There are variations in packages, but not much variation in price for comparable readouts. Prices have been drifting down, but they're likely to stabilize for a while, now that GaAsP is in short supply.

Nobody has yet announced a multi-segment display for alphanumerics, though Bowmar has announced plans to bring out a 14-segment display. The only alphanumeric readouts available today use a dot matrix, and they are being offered only by Hewlett-Packard, Monsanto, and Texas Instruments.

Even for numeric information, a dot matrix offers the advantage that a dead dot does not give a misreading. A bad bar in a seven-segment display can give a wrong number.

HP's first readout, the 5082-7000, has an incomplete 5×7 matrix, with 27 dots for the character and one for the decimal. The substrate in the hermetic package also has an LSI chip for driving the LEDs and for decoding numeric information.

The company's 5082-7100 series has three, four or five 5×7 matrices in hermetic packages. These full-alphanumeric displays are designed to time-share an external decoder/driver. The displays cost \$20 a character. The most recent HP series, the 5082-7300, has a 4×7 matrix with an on-board numeric decoder/driver/memory in

a plastic package. The unit costs \$10.

That's also the price of TI's 5×7 matrix, the TIL305, which gives full alphanumerics with an external decoder/driver. TI's characters, at 300 mils, are slightly taller than the 290-mil characters in HP's 5082-7300.

The characters in Monsanto's MAN 2 are, at 350 mils, even larger than TI's. This unit is the successor to the company's original \$495 readout. It costs \$16.

Most vendors offer multidigit displays. To minimize the number of external leads, these are generally designed for time-sharing a common decoder/driver.

Green LED displays

In many applications red is an undesirable color whose use is restricted to warning or danger signals. Men designing for these applications prefer almost any other color—especially green, which matches the peak sensitivity of the eye.

Unfortunately, while green is available in discrete GaP diodes (by doping p regions with nitrogen instead of zinc), it hasn't been available in readouts.

There's another problem: The eye's response tapers off gradually in the red region; so the eye isn't overly sensitive to slight differences in luminance. In the green region, where the response peaks, the eye could be very sensitive to small intensity variations, and these are common in LEDs. The problem is less severe with individual indicator lights than it would be with a display using closely spaced diodes to form characters. Further, the light-output efficiency of green GaP is only about 10% of red GaP's efficiency.

Red gallium phosphide is two to three times as efficient as GaAsP. But red GaP's color is closer to infrared, so the eye's falling response tends to offset the diode's higher efficiency.

Most observers expected the first green displays to be of gallium phosphide. They came, instead, in gallium arsenide, a low-cost semiconductor that's been used for years as an emitter of invisible infrared.

In February, 1971, GE announced developmental GaAs readouts for green or for red through yellow. The GaAs segments are coated with a phosphor that emits visible light when it's excited by infrared emission. For green, the phosphor is lanthanum trifluoride. For tuning from red to yellow (by varying current amplitude and duration), the phosphor is yttrium oxychloride.

Each segment consumes about 70 mW to produce about 100-ft-L of green or 50 ft-L of red to yellow. Characters are 150 mils high. But the display is not yet commercially available.

Another green-LED display made available for the first time this month, does use gallium

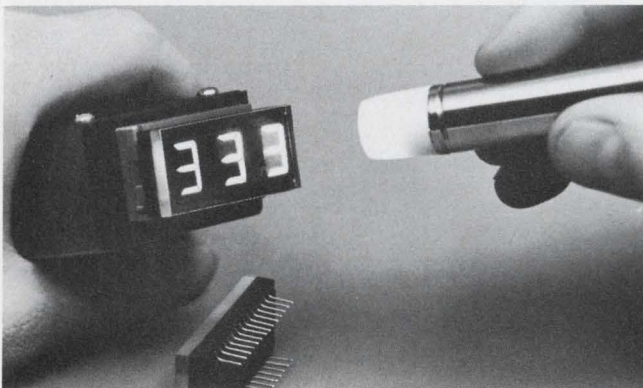

Liquid-crystal readouts were first moved from laboratory to production by Optel.

phosphide. It comes from Monsanto, and it looks just like the 270-mil character in the MAN 1. Like the MAN 1, it uses 14 half segments, each with eight diodes. Each half segment draws 20 mA at 2.3 V. It costs \$10.

Liquid-crystal readouts

RCA showed experimental liquid-crystal readouts in May, 1968, then fell silent for three years. Optel was first to bring them into production at the beginning of this year. In August, RCA announced six developmental types for sale in small quantities.

Other companies—like American Micro-systems, General Electric, International Liquid Crystal, Motorola, North American Rockwell, Sperry, and Texas Instruments—are actively experimenting with liquid crystals, and a few are selling sample readouts.

The basic LX readout is simple. It has a thin (about 1 mil) layer of transparent liquid crystal sandwiched between two conductor-coated sheets of glass. The front electrode, usually tin oxide, is transparent.

The rear electrode, shaped in segments to form the desired character, is transparent in transmissive displays. In reflective displays the rear electrode is an opaque mirror-surfaced film like nickel or aluminum. When voltage is applied between the electrodes of either type, the liquid gets turbulent and scatters ambient light in the form of the rear electrode's pattern.

If their problems are ever solved, many competitors say, liquid-crystal readouts could take all the marbles. Unlike all others, LX displays look brighter in brighter environments. Their power consumption is minuscule.

They operate from low voltages—6 to 60 V—but they should not be used with dc, which slashes life by causing an electroplating action. They're compatible with MOS. Their cost is potentially very low and, within limits, almost independent of display size.

LX displays not only thrive on ambient light; they need it. So if they're operated in the dark, they require auxiliary lighting—which draws power. At low temperatures, near 0 C, the liquid becomes too viscous and the display doesn't work. Storage temperatures below -10 or -20 C may possibly be destructive.

Speed is a problem, especially with voltages much below 15 V and especially at lower temperatures. The normal turn-on time is about 20 ms. That's not too bad. But turn-off time—100 to 200 ms or more—is definitely noticeable, and it makes multiplexing all but impossible. Multiplexing is very difficult anyway because of sneak paths through the material.

The normal life expectancy of an LX display

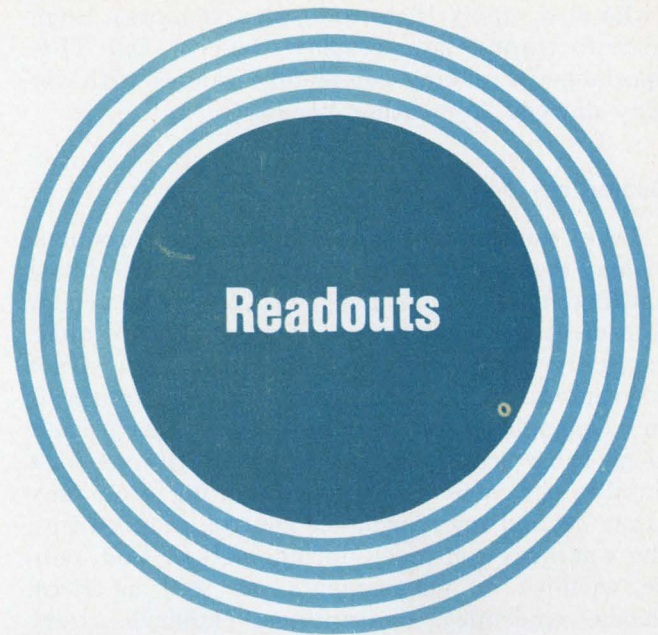

is still a matter of guesswork. Optel has operated plastic-packaged readouts for more than 13,000 hours. The company feels that hermetic packaging will extend life to well beyond 50,000 hours.

Optel has a three-digit display with 450-mil characters and three decimal points. It operates at 15 to 60 V and consumes 40 μ W per segment at 20 V. The complete display costs \$15 in 1000-up quantities. The company also has a four-digit clock display with a colon, and a 3-1/2-digit DVM display.

RCA has six displays—three reflective and three transmissive. Samples are now available, but there's no volume production yet. In small quantities a single 750-mil digit costs \$25. A four-digit module with four decimals or a centered colon has 400-mil characters, costs \$75.

With a 15-V supply and all segments energized, the single-digit display draws 35 μ A; the four-digit display with decimals takes 100 μ A, and the centered-colon display takes 95 μ A.

American Micro-systems readouts will soon appear in Digilin's digital panel meters. AMI is already quoting less than a dollar a digit for large quantities.

Displays alone don't work

With a few exceptions, the basic displays are available as displays alone. However, virtually every manufacturer offers decoder/drivers. In addition, many vendors offer circuits for counting, latching, blanking unwanted zeros and multiplexing. And most manufacturers offer multidigit packages, often complete with external circuitry, bezels, contrast-enhancement filters and mounting hardware.

In many cases decode/drive and count circuits are available directly from IC manufacturers

(who also supply them to display vendors). Some manufacturers, like Display General and TEC, specialize in making complete packages with display devices from other vendors.

Guarantees don't

Like guarantees for many other products, display-device guarantees often guarantee almost nothing. They are normally written by the vendor to protect the vendor. One warranty, for example, explicitly points out that the displays are not warranted for fitness for any particular purpose. In a splendid example of how lawyers earn their keep, the warranty goes on to deny the vendor's liability for delivery delays resulting from any cause beyond his reasonable control. Such causes, the warranty continues, include acts of God, public enemies or governments, as well as fires, floods, epidemics, quarantines, embargos, very bad weather or inability to get necessary materials, labor or transportation.

Leaving rather little to chance, this warranty points out that delay causes are not limited to these. Where delivery delays can cause severe problems, it's wise to negotiate a separate contract with the vendor.

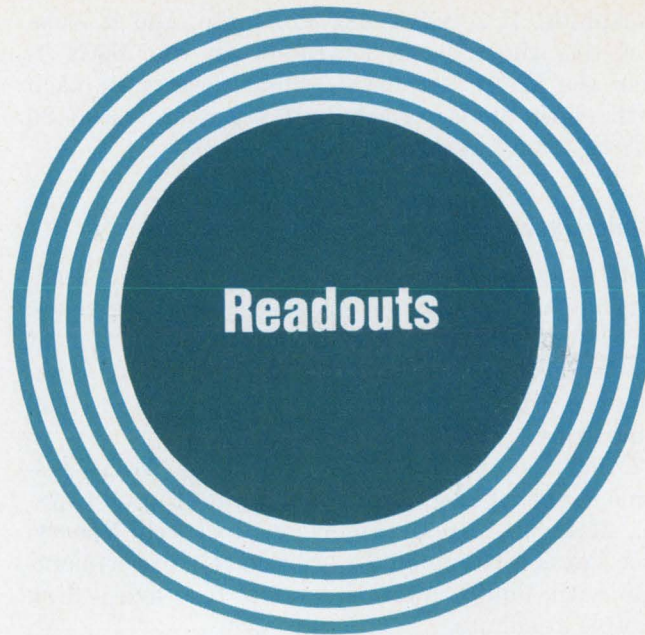

Many data sheets include fine-print "Notes" in addition to the main body of data. The Notes, like the fine print in insurance policies, should be read with care. It has been said that the big print gives it to you, while the fine print takes it away. ■■

Need more information?

Specifications mentioned in this report are, of necessity, incomplete. Further, the products cited don't represent vendors' full lines. Readers may wish to consult these manufacturers for further details:

- Alco Electronic Products, Inc., P.O. Box 1348, Lawrence, Mass. 01842. (617) 686-3887. (Thomas J. Clark, Product Sales Manager.)
- American Micro-systems, Inc., 3800 Homestead Road, Santa Clara, Calif. 95051. (408) 246-0330. (Dan Yoder.)
- Amperex Electronic Corp., P.O. Box 98, Slatersville, R. I., 02876. (401) 762-9000. (Carlo Sabetti, Product Marketing Manager.)
- Bowmar Canada Ltd., 1257 Algoma Road, Ottawa 15, Ontario. (613) 746-3100. (Roy Durnwirth, Sales Manager.)
- Burroughs Corp., Box 1226, Plainfield, N.J. 07061. (201) 757-3400. John Bethke, Sales Manager.)
- Dialight Corp., 60 Stewart Ave., Brooklyn, N.Y. 11237. (212) 497-7600. (Richard Lakin, Vice President Marketing.)
- Display General, 241 Crescent St., Waltham, Mass. 02154. (617) 899-2700. (Chet Fuller, Sales Manager.)
- Fairchild Microwave and Optoelectronics Div., 3500 Deer Creek Road, Palo Alto, Calif. 94304. (415) 493-3100. (James Lovette, Sales Manager.)
- General Electric Co., Imaging and Display Devices, Owensboro, Ky. 42301. (502) 683-2401. (E.L. Fox, Marketing Manager.)
- General Electric Co., Miniature Lamp Dept., Nela Park, Cleveland, Ohio 44112. (216) 266-2400. (John Hall, Solid State Lamp Product Planner.)
- GTE Sylvania, Inc., Electronic Components Group, 100 First Ave., Waltham, Mass. 02154. (617) 893-9200. (Donald W. Emden, Manager Public Relations Dept.)
- HP Associates, 620 Page Mill Rd., Palo Alto, Calif. 94304. (415) 493-1212. (Rick Kniss, Marketing Manager.)
- Industrial Electronic Engineers, Inc., 7720-40 Lemona Ave., Van Nuys, Calif. 91405. (213) 787-0311. (Kurt Kuhn, Director of Research and Development)
- Legi Electronic Corp., 3118A W. Jefferson Blvd., Los Angeles, Calif. 90018. (213) 737-1521. (George Iseda, Sales Manager.)
- Litronix, Inc., 19000 Homestead Rd., Cupertino, Calif. 95041. (408) 257-7910. (Bruce Blakkan, President, George Smith, Manager Applications Engineering.)
- Master Specialties Co., 1640 Monrovia Ave., Costa Mesa, Calif. 92627. (714) 642-2427. (D. Hanson, Advertising Manager.)
- Monsanto Electronic Special Products, 10131 Bubb Rd., Cupertino, Calif., 95014. (408) 257-2140.
- Motorola Semiconductor Products, Inc., 5005 E. McDowell Road, Phoenix, Ariz. 85036. (602) 273-6900. (William Toon, Product Marketing Manager, Optoelectronic Products.)
- National Electronics, Inc., Keslinger Rd., Geneva, Ill. 60134. (312) 232-4300. (William D. Ball, Senior Vice President, Marketing.)
- Opcoa, Inc., 330 Talmadge Rd., Edison, N.J. 08817. (201) 287-0355. (Richard W. Ahrons, Vice President Engineering.)
- Oppenheimer, Inc., Wyandotte Rd., Willow Grove, Pa. 19090. (215) 659-6000. (William D. Rhodes, Sales & Marketing Manager.)
- Optel Corp., Box 2215, Princeton, N.J. 08540. (609) 452-9250. (Gary Leffer, Sales Manager.)
- Owens-Illinois, Toledo, Ohio. 43601. (419) 242-6543. (J.W. Klotz, Marketing Manager.)
- Pinlites Inc., 1275 Bloomfield Ave., Fairfield, N.J. 07006. (201) 226-7724. (Murray I. Menkis, General Manager.)
- Raytheon Co., Microwave & Power Tube Div., 465 Centre St., Quincy, Mass. 02169. (617) 479-5300. (E.A. DeLollis, Product Marketing Manager.)
- RCA, Electronic Components, 415 S. Fifth St., Harrison, N.J. 07029. (201) 485-3900, Ext. 2948. (Arnold M. Durham, Manager News and Information) (Numitron)
- RCA, Solid State Div., Rt. 202, Somerville, N.J. 08876. (201) 485-2900, Ext. 2716. (Walter Dennen, Manager Public Information) (Liquid Crystals)
- Shelly Associates, Inc., 1562 Reynolds Ave., Santa Ana, Calif. 92711. (714) 557-3942. (Ben B. George, Jr., Marketing Manager.)
- Sigmatron, Inc., 849 Ward Drive, Santa Barbara, Calif. 93105. (805) 967-0131. (R. D. Webb, Vice President, Marketing.)
- Sperry Information Displays Div., 350 N. Hayden Rd., Scottsdale, Ariz. 85257. (602) 947-8371. (L.L. Pond, Jr., Marketing Manager.)
- TEC, Inc., 9800 N. Oracle Road, Tucson, Ariz. 85704. (602) 297-1111. (Bob Saffrin, Manager of Sales Administration.)
- Texas Instruments Incorporated, 13500 North Central Expressway, Dallas, Tex., 75222. (214) 238-3741. (Ian McCrae, Marketing Manager, Optoelectronics.)
- Tung-Sol Div., Wagner Electric Corp., 630 Mt. Pleasant Ave., Livingston, N.J. 07039. (201) 992-1100. (Rod Bell, Chief Engineer.)

Sperry explodes the LED myth

There has been a lot said in recent months about LED's representing the most significant advance in display technology and how they are destined to dominate the digital display market. We feel it's time to explode the myth and set the record straight. So, here's a direct, point-by-point, comparison of Sperry seven segment gas discharge planar displays† vs LED displays.

COST

For the price of a single $\frac{1}{4}$ " LED digit you can buy three $\frac{1}{2}$ " or three $\frac{1}{3}$ " Sperry display digits*. And, in the future, the Sperry displays should continue to be less expensive than LED displays. Gives you something to think about, doesn't it?



SIZE

Let the size speak for itself.



READABILITY

Have you tried to read a $\frac{1}{8}$ " or even a $\frac{1}{4}$ " LED display at 20'? On the other hand, the Sperry $\frac{1}{3}$ " display is easy to read at that distance and the $\frac{1}{2}$ " model can be read at up to 40'. See the difference?



COLOR

With LED's, you have the choice of red, red or red. Not so with Sperry. They come in an eye appealing orange — with amber and red available with filters. If you like red, why pay more for a LED?



APPEARANCE

Which do you prefer — looking at individual red dots on LED devices or at continuous unbroken Sperry figures. The choice is yours.



BRIGHTNESS

Sure you can read LED's indoors, but how about in bright light or direct sunlight? LED's fade fast while Sperry displays stay clearly legible with no appreciable loss in brightness. And, Sperry devices won't poop out when it gets hot!



Sperry advantages don't stop here either. The small Sperry package is only a shade larger than a LED and nearly as thin. Sperry power dissipation is also significantly lower. And, Sperry reliability is so good that they have proven fail-safe in stringent, high performance aircraft applications including the Boeing 747. There are no wire bonds to go bad, either. Don't just take our word for it. Arrange for a comparison demonstration and see for yourself what the difference will mean to your particular application.

For complete technical information on Sperry displays, use this publication's reader service card or phone or write:
Sperry Information Displays Division
P.O. Box 3579, Scottsdale, Arizona 85257
Telephone (602) 947-8371

SPERRY

INFORMATION DISPLAYS

It's a whole new ball game in display devices!

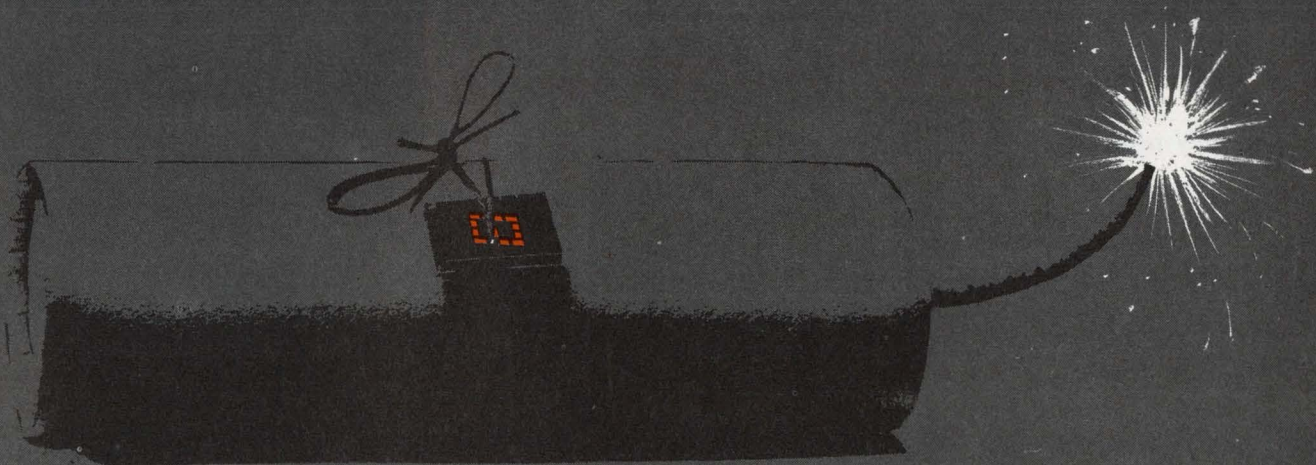

† Patents pending

*based on 1,000 digit quantity, and above. Sperry displays are available in 3 digit, 2 digit, and $1\frac{1}{2}$ (7 segment character and a 1 with + and -) digit models in both $\frac{1}{3}$ " and $\frac{1}{2}$ " sizes.

Establish the reliability of LSI ICs

early in the design phase with an evaluation program that considers failure mechanisms on an individual basis.

While it may be obvious that system reliability can be enhanced through MSI/LSI technology, it is not so obvious early in the life of a new product to tell to what extent this can be achieved. Add to this the extremely difficult failure analysis problems posed by these complex circuits, and it becomes clear that a new approach is required to arrive at a meaningful reliability estimate for complex MSI/LSI circuits.

One such approach, referred to as Total Reliability Requirement Procedure, has been developed by Harris Semiconductor and is currently being used for all complex MSI/LSI products. The same approach can be applied to any MSI/LSI product. It ensures that reliability is built into the product at the start and provides a systematic method of continually improving the reliability of existing products as new and better manufacturing processes are instituted.

The two main features of this program are the consideration of failure mechanisms on an individual basis and the application of the program in the very early stages of the development cycle.

To help understand the procedure, let's consider its application to a specific LSI product—the field-programmable read-only memory (PROM). This product underwent extensive testing when the Total Reliability Requirement Procedure was drawn up, and it is a good example of how the reliability of a complex product and process can be predicted early.

Qualify process, product and package

The procedure calls for evaluation in three areas (Fig. 1). They are:

- *Process qualification*, which deals with process-related matters, such as diffusion, passivation and single or multi-level metallization systems.
- *Product qualification*, which covers the circuit configuration, chip layout topography of the single-cell components, etc.
- *Package qualification*, which includes the

hermeticity of the package, the bonding considerations, etc.

Test vehicles are essential

A big item in process and product qualification is the concept of test vehicles (Fig. 2).

A test vehicle is a collection of one or more test elements on a single chip. And a test element is a structure specifically designed to permit direct measurement of all critical process parameters. In addition it furnishes preliminary indication of device quality, such as isolation oxide integrity, surface passivation condition and the electrical characteristics of junction voltage breakdown.

The use of test vehicles basically involves assembling test-element chips following wafer probe and chip scribing. With high-temperature, stress-testing techniques, a quantitative measure of device stability can be determined in a few days.

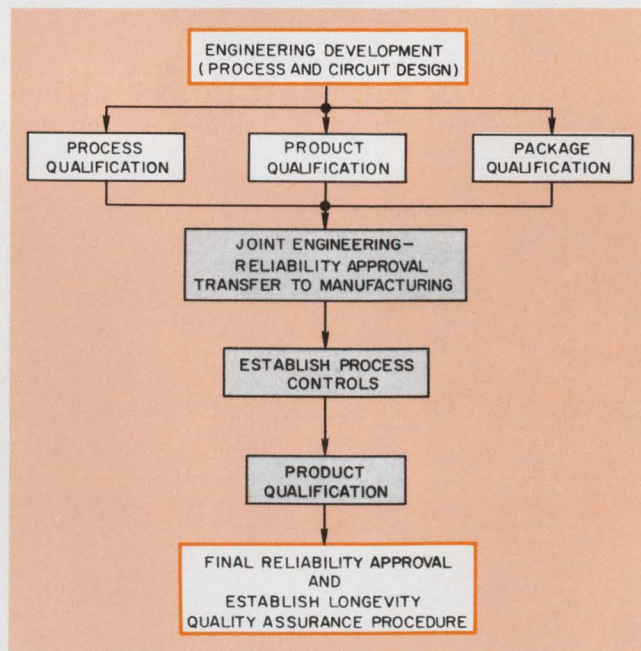

1. Separate qualification of process, product and package prior to the release of a product for manufacturing is the key feature of Harris Semiconductor's Total Reliability Requirement Procedure.

D. Uimari and C. Van Leeuwen, Harris Semiconductor, P.O. Box 883, Melbourne, Fla. 32901.

Reliability evaluation of test elements consists of a three-pronged approach:

1. Test element characterization—total characterization of the test element with respect to applied stress, to evaluate sensitivity and maximum stress yield point. This is essential before proceeding with step-stressing.

2. Step-stress testing—generation of failure distributions as a result of applied steps of increased stress. (Fig. 3). This is required to determine maximum stress capability and to determine design flaws, as well as to provide information as to the proper choice of stress level to be applied in the constant-stress test that is to follow. Temperature is generally employed as a variable stress medium under a fixed electrical bias condition.

3. Constant stress in time testing—concurrent generation of several failure distributions using different samples of test elements as a result of applied multiple high stresses (Fig. 4). These failure results will enable extrapolation to predict estimated failure rates at usage stress levels.

Evaluating process variables

Here are some examples of how certain test elements were used in evaluating the processing variables for the LSI PROM:

- Large-geometry, field-plate transistors were used to determine acceptable device and surface passivation stability. These transistors were characterized in terms of leakage current as a function of applied field-plate voltage and were

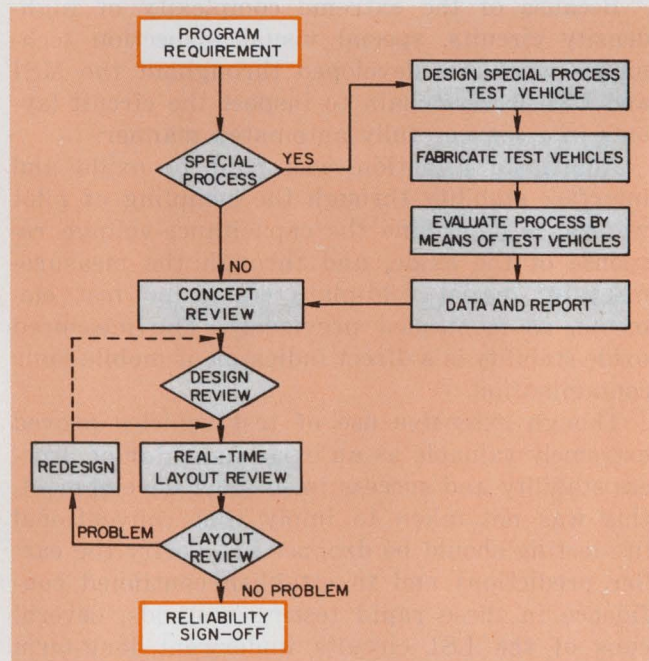

2. Specially designed test vehicles are fabricated to evaluate new manufacturing processes. The test vehicles, containing test circuit elements, also provide a preliminary indication of device quality.

back bias tested for 24 hours.

- Large-area metal/oxide/metal (MOM) capacitors were used to evaluate the insulating oxide integrity between metal and underlying silicon. These MOM capacitors characterize the dielectric strength and pinhole densities of the insulating and passivation layers. By application of a ramp voltage to the MOM capacitor, the voltage breakdown across the insulating oxide layer was plotted. To prevent self-healing, the ramp generator was current-limited to about 5 μ A.

- Via-contact test vehicles were used to determine the integrity of the via contact (through-hole interconnecting metal-to-metal layers). High-current stress of this test element was performed at high temperature.

Testing the product concept

In product qualification, different elements are used on the test vehicle. In the case of the LSI PROM, testing was required on the relatively new concept of using nichrome thin-film resistors as fuse elements on a fully decoded bipolar circuit.

The following unique test elements were evaluated:

- A nichrome fuse element, which was designed to evaluate opened fuse integrity with operating life. The design reflected the same geometry and underwent the same processing as it would on an actual PROM.

- A nichrome thin-film resistor element, which was designed to evaluate unopened fuse ability

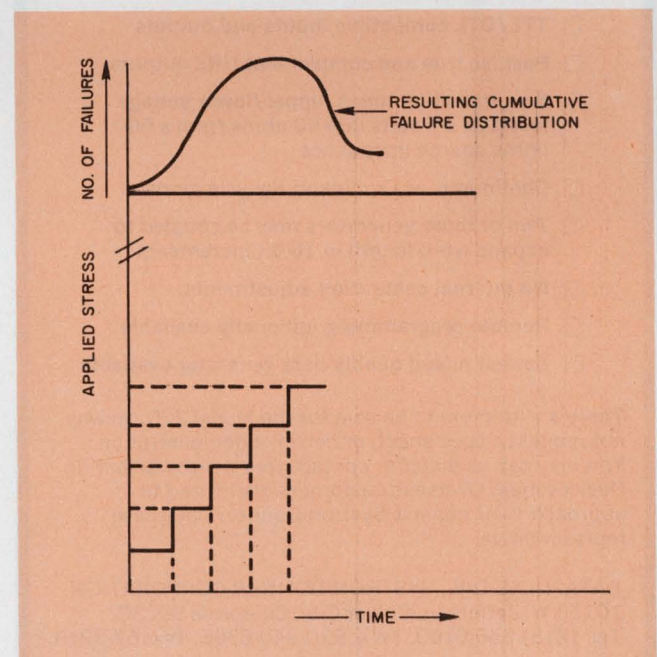

3. Step-stress tests determine the maximum stress capability of test elements and disclose design flaws. Temperature is generally used as the variable, while bias to the device is kept fixed.

If you're interested in spending

**Less
Jack**

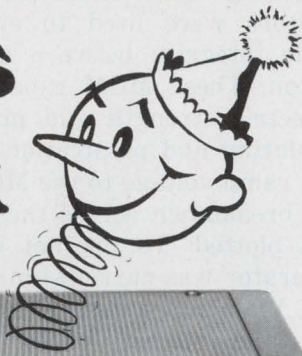

to purchase

More Box

...and the box you need happens to be a data generator, then you're sure to be interested in the Model 220, crafted by Datapulse. The 220 is a high quality, high performance instrument with an incredibly low (\$495) price tag — less than half the figure you'd have to pay for its nearest competitor. Here are some of the great features your \$495.00 buys you:

- Clock rates from 0 to 20 Megahertz
- TTL/DTL compatible inputs and outputs
- Positive true and complement NRZ outputs
- 6 ns transition times, upper/lower voltage levels to ± 5 volts into 50 ohms from a 50 ohms source impedance
- Continuous or Command Recycle modes
- Two or more generators may be coupled to expand word length in 16 bit increments
- No internal calibration adjustments
- Remote programming optionally available
- Lowest priced quality data generator available

There's a lot more to be said for the Model 220, so why not request a spec sheet, or better, a demonstration. You may call us direct or contact your nearby Scientific Devices man. Overseas customers are invited to approach their nearest Systron-Donner/Datapulse representative.

DATAPULSE DIV., SYSTRON-DONNER CORPORATION
10150 W. Jefferson, Culver City, California 90230.
Tel: (213) 836-6100. TWX: 910-340-6766. Tex: 67-3219.

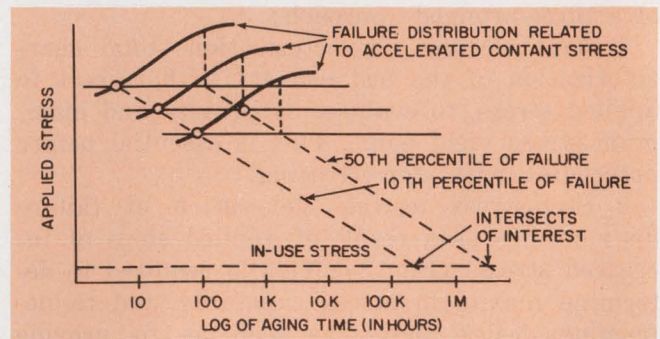

4. Constant-stress tests on different test element samples produce different failure distributions. These results are extrapolated to predict estimated in-use failure rates.

with operating life. The design employed the same thin-film process and chip topography as those used in the fabrication of an LSI PROM.

As part of the procedure, package qualification for the 24-lead flat pack and the 24-lead dual in-line package was performed in accordance with MIL-STD-883.

To ensure continued high-yield process performance and to guarantee that reliability was built into the product, additional process controls were instituted for LSI circuits. In these, because of the complex nature of MSI/LSI devices, control over pinholes was important, and mask inspection and procedures were critical. An improvement in inspection techniques resulted with the use of an optical microdensitometer. It provided a quantitative measure of opaqueness, edge acuity, stepping tolerances and line widths.

Because of the extreme complexity of high-density circuits, special visual inspection techniques were also developed throughout the MSI and LSI process chain to inspect the circuit layouts in a semi or fully automated manner.

Additional attention was paid to oxide and interface stability through the sampling of pilot wafers, to determine the capacitance-voltage response of the oxide, and through the measurement of special field-plate transistor test elements, as mentioned previously. The measured oxide stability is a direct indicator of mobile ionic contamination.

Though extensive use of test vehicles proved extremely valuable as an early indicator of process stability and success in product development, this was not taken to imply that conventional life-testing should be dropped. To verify the earlier predictions and to establish continued confidence in these rapid testing methods, several runs of the LSI circuits underwent long-term operating-life testing at operating levels.

The ROM was tested for operation and storage life for up to 10,000 hours with readouts at 1000, 2000 and 5000 hours. ■■

High-Voltage PNP and NPN Transistors



65 RUSHMORE ST., WESTBURY, N.Y. 11590
516-997-7474

designed as drivers for

Gas Discharge & Plasma Displays!

New! From Dionics! Available as complementary NPN and PNP discretes, or together as truly complementary NPN-PNP pairs—in TO-5 cans. (Also available in chip form, for hybrid circuit applications.)

At Competitive Prices! Produced by an exclusive process (patent pending) that develops high voltages (up to 225 V), with high DC current gains (typically greater than 100, @ 10 ma), while limiting leakage currents to extremely low values (50 nanoamps, typical). High frequency ($f_t = 50$ MHz min.)!

Immediate Delivery! Call the Dionics sales office nearest you, today! Or use the bingo card (if you have time to wait) for complete data sheets.

NPN (TO-5)

DTN 200
DTN 201
DTN 202

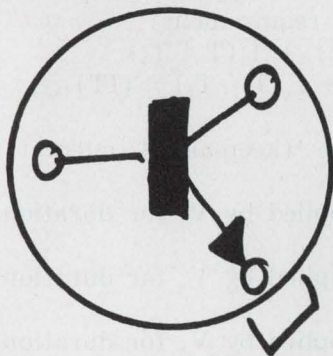

NPN-PNP (TO-78)

DTNP-201

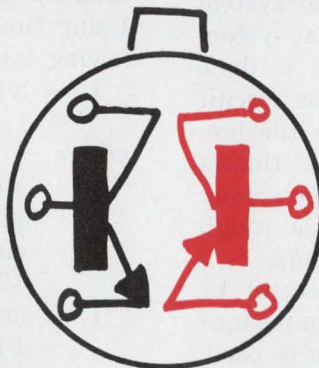

PNP (TO-5)

DTP 200
DTP 201
DTP 202

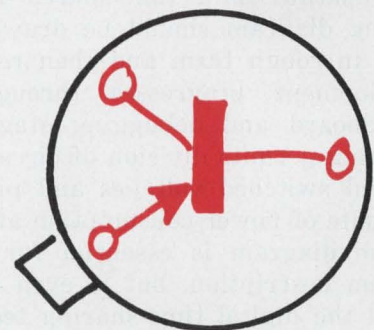

ARIZONA—Williams Assocs., Phoenix, 602-254-6085 ■ CALIFORNIA—Rical Assocs., Santa Ana, 714-557-6543 / Rical Assocs., Solana Beach, 714-755-1983 / Kottmeier Assocs., San Carlos, 415-592-8333 ■ COLORADO—Williams Assocs., Denver, 303-388-4391 ■ INDIANA—McFadden Sales, Indianapolis, 317-291-4486 ■ MASSACHUSETTS—Contact Sales, Lexington, 617-861-1550 ■ MINNESOTA—Furber Sales, Minneapolis, 612-823-3654 ■ OHIO—McFadden Sales, Columbus, 614-221-3363 ■ OKLAHOMA—Darl V. Falk & Assocs., Oklahoma City, 405-424-4629 ■ NEW MEXICO—Williams Assocs., Albuquerque, 505-255-1638 ■ NEW YORK—Dionics Inc., Westbury, 516-997-7474 ■ TEXAS—Darl V. Falk & Assocs., Addison, 214-357-5448 ■ VIRGINIA—Schibley Assocs., Fairfax, 703-591-3008 ■ WASHINGTON—Jon B. Jolly, Seattle, 206-938-4166 ■

OVERSEAS—Epak Electronics Ltd., England / Techniques et Produits, France / BFI Elektronik-GMBH, Germany / Rapac Electronics Ltd., Israel / BFI Electronica Spa., Italy / Shinden Trading Co. Ltd., Japan / A.S. Akers Electronics, Norway

INFORMATION RETRIEVAL NUMBER 38

Cut battery size in portable equipment

by using a time-sharing technique that keeps power OFF until it is needed. The method can also extend battery life.

The designer of portable, battery-powered equipment is confronted with the problem of maximizing useful battery life while minimizing battery size and weight. Unfortunately volume and weight are roughly proportional to power capacity in any battery, and providing adequate power often leads to excessive weight.

Here is a technique for reducing average power consumption from a battery used as the power source of a complex digital system. This technique has been successfully used with Holobeam's Direct Fire Simulator, a laser war-games simulator system that employs GaAs injection laser transmitters mounted on M16 rifles or other guns to simulate weapon fire.

A word of caution, though: The technique can be used only if the system can be operated on a time-shared or sequential basis. If proper operation can be achieved only with the total circuitry operating on a continual basis, then the technique does not apply.

Much ordinary equipment can be adapted for time-shared operation. For example, a radio receiver need not have its output stages turned ON until an input signal is picked up.

Draw a timing diagram

Once it has been determined that the system can operate in a time-shared mode, a system timing diagram should be drawn. This is done first in rough form and then refined as circuit development progresses through the design, breadboard and debugging stages. The timing diagram permits division of circuit power among several switched voltages and provides a rough estimate of power consumption and savings.

The diagram is essential for any circuit or system description, but is even more important when the digital time-sharing technique is used. When many switched voltages are required, circuit interfaces become more complex, particularly when noncoincidentally powered circuits are interfaced. All of these conditions must be identi-

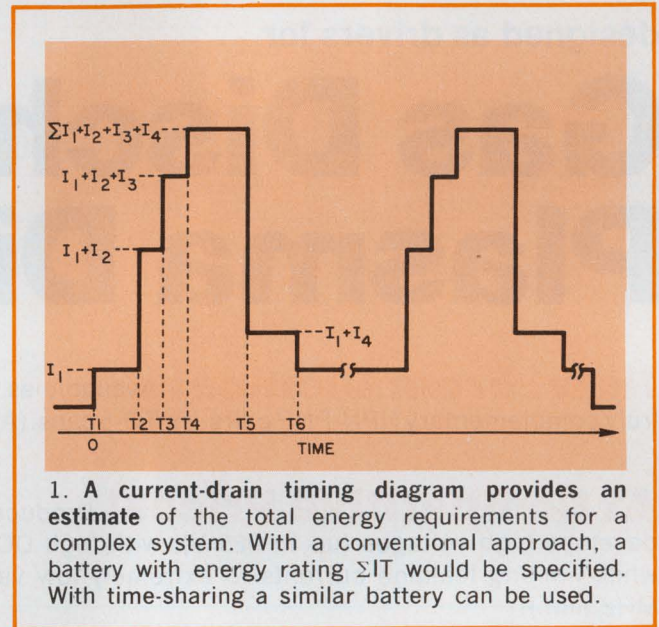

fied and analyzed individually to insure proper circuit performance.

The timing diagram (Fig. 1) illustrates the technique. With a conventional approach, the sum of the currents required for the individual circuits (ΣI) and the operation time (T) would be used to specify a battery with energy level ΣIT . Using time-sharing technique, we obtain the following total energy requirement:

$$I_1 + N[I_2(T_5 - T_2) + I_3(T_5 - T_3) + I_4(T_5 - T_4) + I_4(T_6 - T_5)] = (IT)_{ts}$$

where

I_1 = steady state (keep-alive) current supplied by V_1

I_2 = current supplied by V_2 for duration $(T_5 - T_2)$

I_3 = current supplied by V_3 for duration $(T_5 - T_3)$

I_4 = current supplied by V_4 for duration $(T_6 - T_4)$

N = number of times I_2 , I_3 and I_4 are supplied during mission time T

$(IT)_{ts}$ = total ampere hours using time-sharing technique.

The division of system power into a number of

Irwin Nissman, Electronics Section Head, Holobeam, Inc., 560 Winters Ave., Paramus, N. J. 07652

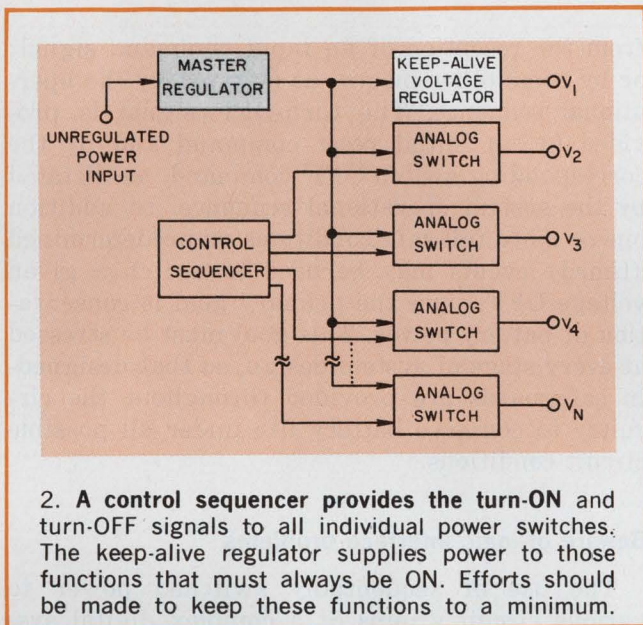

individual, switched power supplies or switched regulators depends on the parts of the circuit that must be kept ON at all times, the sequences in the circuit's operation and the current drains of individual load groups.

Those circuit functions that are required to operate at all times obviously cannot be digitally time-shared (switched ON and OFF). Therefore these functions must be identified and isolated. They must be minimized as to current drain, of course, but beyond this, they must be maintained in a continuously ON condition throughout the operation. Low power logic is recommended for all functions that must be kept continuously ON.

Those circuit functions that are intermittent in operation are switchable. Once the digital circuits have been separated into logical sequential groups, their current drains may be calculated and analog switches may be used to supply the regulated switched power (dc voltage) to each circuit. Depending upon the duty cycle of time-shared loads to switched-OFF nonoperation, and the circuit functions involved, low-power, medium-power or high-power logic may be used.

A master voltage regulator, together with a

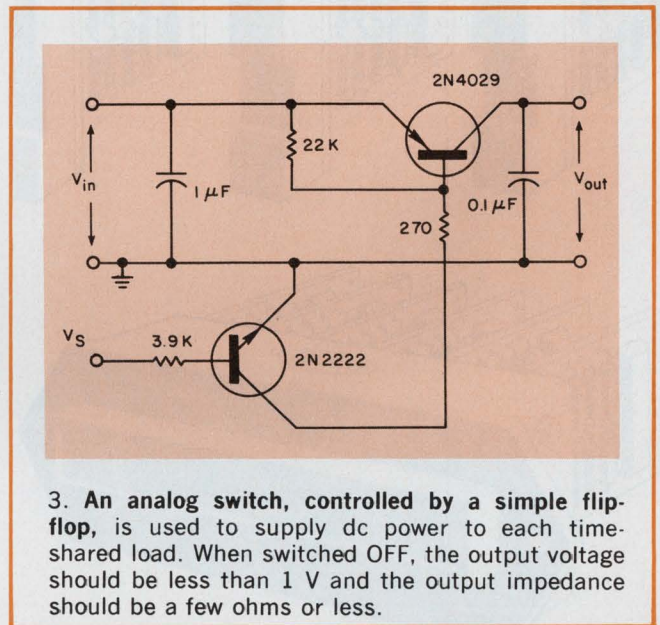

fixed voltage regulator and analog switches (Fig. 2), are used to supply regulated, switched power to each time-shared digital circuit group.

Each analog power switch (Fig. 3) must be capable of supplying the dc current required by the digital time-shared load circuit that it powers. It must be designed so that it may be controlled by a simple R-S flip-flop. When switched OFF, its output voltage should be low—typically under a volt—and when switched ON, its output impedance ideally should be low, too—on the order of a few ohms or less. However, satisfactory circuit operation is possible even if the turned-OFF output impedance of each analog switch is high and is the source impedance of a biased-OFF transistor switch.

The analog switches are controlled by a digital power-control sequencer consisting of simple NAND-gate-coupled R-S flip-flops. Note that power to these flip-flops must be provided by V_1 , the "keep-alive" dc power source, the source that powers those functions that must always be ON.

During system operation, each turn-ON signal is derived from decoding of a timed event; or from the sensing of prespecified conditions; or

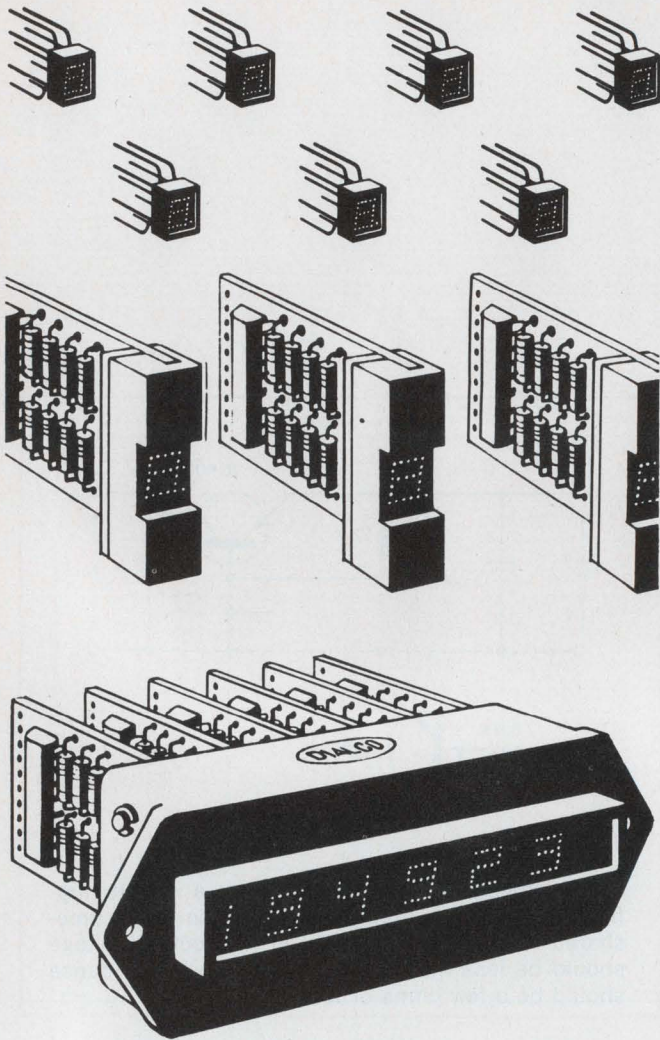

Dialight— supermarket for solid-state (LED) readouts.

Dialight's DIODE-LITE™ line gives you complete design flexibility with LED reliability. Start . . . or stop . . . wherever you like. Choose from DIODE-LITE readout modules . . . these modules incorporated in readout packages with IC-compatible decoder/drivers . . . or complete display assemblies of 1 to 10 readout packages mounted in a bezel frame with window. Three character heights: .125", .205" and .625". Supermarket pricing and availability too.

Write for the DIODE-LITE Data File. It spans the entire LED spectrum . . . light sources, cartridges, indicator lights, illuminated pushbutton switches and readouts. Just what you'd expect from Dialight.

DIALIGHT

DIALIGHT CORPORATION, A NORTH AMERICAN PHILIPS COMPANY
60 STEWART AVENUE, BROOKLYN, N.Y. 11237 • (212) 497-7600

INFORMATION RETRIEVAL NUMBER 39

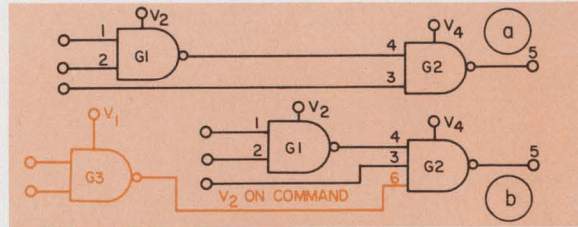

4. **Caution! An ambiguous output from gate G2 may exist when V_4 is ON after V_2 has been switched OFF (a). Adding another input, the V_2 ON command, to G2 (b) will correct for this condition by disabling G2 when V_2 is switched OFF.**

from the reception of an input command signal; or by some other means, as dictated by the operational sequence. The turn-OFF signal is provided by an initial reset command and by the corresponding switch-OFF command, as dictated by the system operational sequence. In addition one or more fail-safe conditions or predetermined (timed) events may be used to switch a given voltage OFF, since the primary goal is conservation of battery power. This goal must be stressed at every stage of system design, so that designed-in safeguards are provided throughout the circuitry to conserve battery life under all possible circuit conditions.

Beware of logic interface problems

The use of sequentially switched power to various circuit groups of a complex digital system leads to complications where logic circuits of noncoincident power interface. This situation occurs inevitably in some areas of nearly every system. It results in ambiguous conditions at some of the logic circuits, due to the "floating" condition of the output voltage of those logic circuits whose power is OFF. When these are connected with logic circuits whose power is ON, incorrect or undesired outputs can result.

When power is switched OFF to logic circuits that interface with other still-powered logic circuits, undesirable transient signals often result. As an example of this effect, consider the gates in Fig. 4a. The functions shown are NAND gates, and positive logic conventions are assumed. From Fig. 1, note that V_4 is still ON after V_2 to gate 1 has been switched OFF. This can result in a logically ambiguous voltage level at input 4 to gate 2. To correct for the ambiguous condition, another input, 6—the V_2 ON-command from V_1 -powered gate 3—has been added to gate 2. This input insures that gate 2 is disabled when V_2 is switched OFF. Also, since the V_2 command transitions from ONE to ZERO prior to the creation of ambiguity in the output of gate 1 (due to loss of V_2 power), no false negative-going transient signal can occur at the output of gate 2. ■■

NEW! 1024 PROM/ROM.

For greater flexibility in obtaining economical bipolar read-only memory devices from design through volume production.

We invented the PROM concept, established its reliability, and delivered in volume. Now we're adding to the most complete line offered in the industry and have used the knowledge obtained over a year's experience to bring you an even more dependable product. The application flexibility of our new PROM/ROM is achieved because both are electrically identical and pin-for-pin interchangeable with each other and other 1024 bit devices. The PROM is available with two outputs—open collector or tri-state. The ROM is mask programmable and available in standard ASCII to EBCDIC code converter patterns. Custom programming is also available. The reliability of both PROM devices is documented by 260,000,000 fuse hours of life test data. For further details see your Harris representative or distributor.

Features:

256 words/ 4 bits per word

Fully decoded

DTL/TTL compatible

50 ns access time

Expandable—"Wired-OR" outputs with chip select input

Available in military and commercial temperature ranges

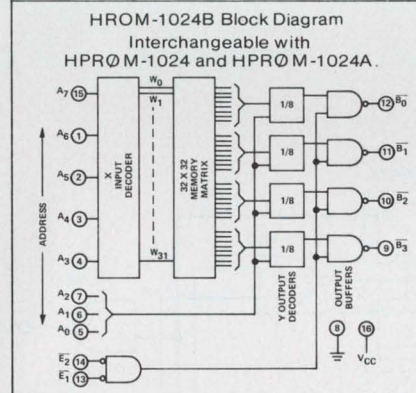
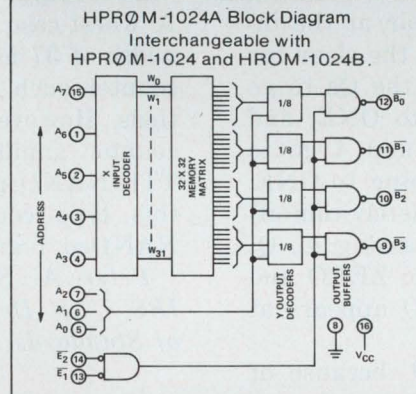
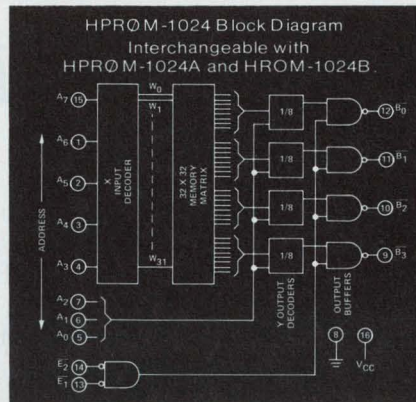

1024's are also available in the innovative Diacon package.

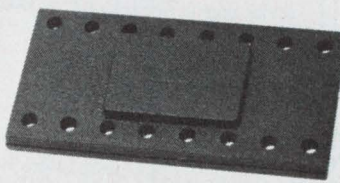

New too!

HROM-2561M Character Generator

One of the highest speed devices of its kind, with guaranteed A.C. performance over the full military temperature range.

Features:

1.5 MHz over full military temperature range

512 x 5 organization

ASCII to 5 x 7 dot matrix, p-MOS

	100-999 units	1000-9999 units
	0°C to +75°C	-55°C to +125°C
HPR0M-8256 Bipolar	\$12.00	\$24.50
32 x 8 TA= 40ns		
HPR0M-1256 Bipolar	\$14.75	\$24.50
256 x 1 TA= 35ns		
HPR0M-0512 Bipolar	\$27.50	\$43.00
64 x 8 TA= 55ns		
†HPR0M-1024 Bipolar	\$55.00	\$71.50
256 x 4 TA= 60ns		
†HPR0M-1024A Bipolar	\$55.00	\$71.50
256 x 4 TA= 60ns		
†HROM-1024B Bipolar	\$15.00*	\$18.75*
256 x 4 TA= 60ns		
†HROM-2561M p-MOS	\$19.25	\$28.60
512 x 5 f0= 1.5MHz		
† New		* 500-999 units

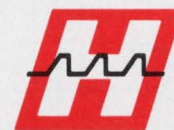

HARRIS SEMICONDUCTOR
A DIVISION OF HARRIS-INTERTYPE CORPORATION

P.O. Box 883, Melbourne, Florida 32901
(305) 727-5430

DISTRIBUTORS: Schweber Electronics: Westbury, New York (516) 334-7474; Rockville, Maryland (301) 881-2970; Hollywood, Florida (305) 927-0511
Harvey/R & D Electronics: Lexington, Massachusetts (617) 861-9200; Semiconductor Specialists, Inc.: Chicago (312) 279-1000; Detroit (313) 255-0300; Minneapolis (612) 884-8132; Kansas City (816) 452-3900; St. Louis (314) 428-6100; Dallas (214) 358-5211; Indianapolis (317) 243-8271; Pittsburgh (412) 781-8120; Dayton (513) 278-9455 / R.V. Weatherford Co.: Albuquerque (505) 265-5671; Anaheim (714) 547-0891; Austin (512) Enterprise 1443; Dallas (214) 231-6051; Denver (303) 427-3736; Glendale (213) 849-3451; Houston (713) Enterprise 1443; Palo Alto (415) 321-5373; Phoenix (602) 272-7144; Pomona (714) 623-1261; San Diego (714) 278-7400; Seattle (206) 762-4200.

INFORMATION RETRIEVAL NUMBER 40

ideas for design

Signal decoder eliminates jitter

Incremental encoders, widely used to determine the position of a rotatable shaft, are often connected to a shaft that jitters or oscillates randomly. These oscillations produce nonsymmetrical encoder outputs that can result in false counts. But with the circuit shown the possibility of a counting error due to jitter is eliminated.

Assume that the waveforms appear at the inputs of the decoder. As θ_1 is passed, the clear for all flip-flops goes to ONE, allowing the Qs to go to ONE. As θ_2 is passed, Q_1 goes to ONE, and the clear terminals of flip-flops 3 and 4 go to ZERO inhibiting Q_3 and Q_4 from going to ONE. Thus the down-count output is completely inhibited, and no count takes place. On passing θ_4 , Q_2 goes to ONE and output UP goes to ZERO and then to ONE when a delayed ZERO appears at the clears of all flip-flops.

This sequence ignores jitter at θ_2 because of

the memory nature of the D-type flip-flops. Jitter at θ_1 is accounted for because only a negative edge in the B input preceded by the θ_1 , θ_2 and θ_3 transitions produce an up-count output pulse. From symmetry, a down count is produced in a like manner.

The output pulse width is greater than 50 ns. A worst case calculation yields an output pulse width of 37 ns. The circuit can drive an up-down counter such as the SN74192 with no modifications. However, to drive a single clock up-down counter similar to the SN74190, an additional TTL NAND gate is needed. The clock pulse for this type counter is then the output of the NAND'ed 1 and 2 outputs.

Peter A. Schade, Physicist, Mechanics Div. IBS, U. S. Dept. of Commerce, National Bureau of Standards, Washington, D. C.

CIRCLE NO. 310

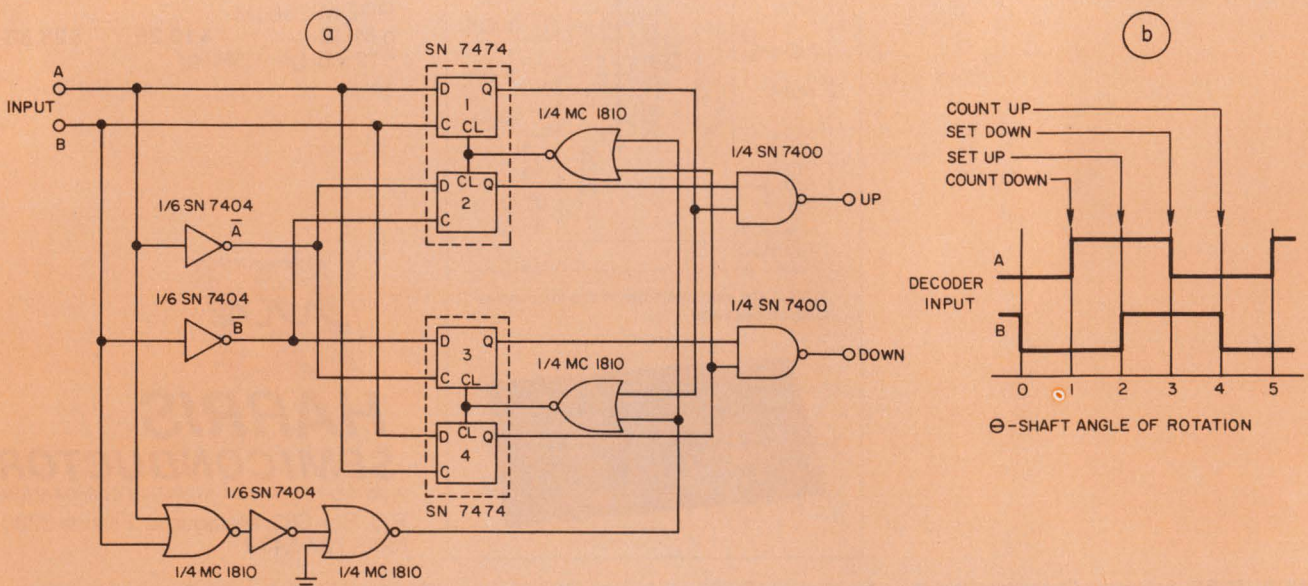

Jitter error is eliminated in this quadrature signal decoder (a). The random oscillations often origi-

nate in the servomechanisms used to drive the shaft. Waveforms indicate circuit operation (b).

13 STANDARD RESISTORS

13 STANDARD RESISTORS

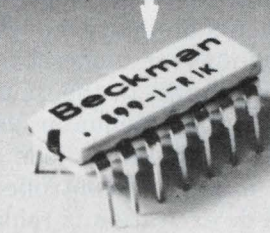
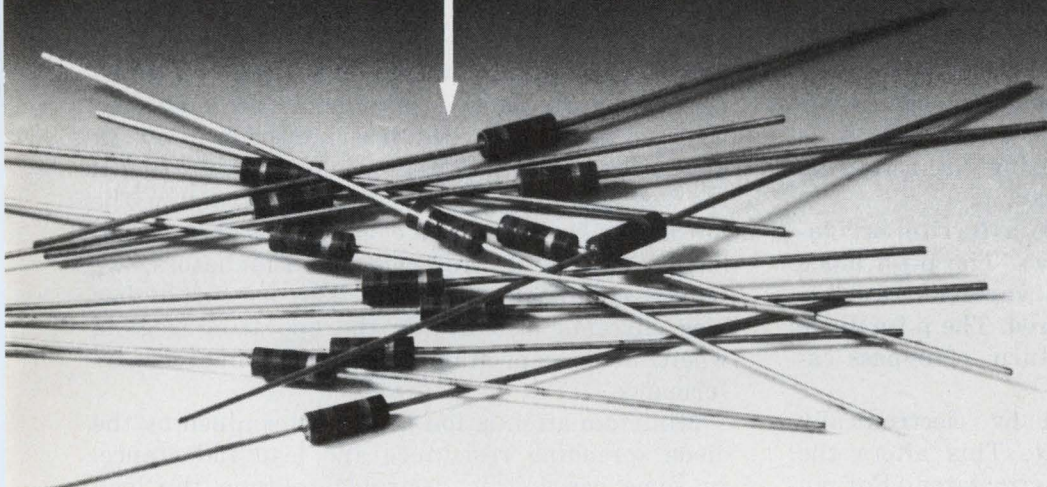

Helipot's one-piece money saver saves time and space, too.

To keep working with discrete standard resistors just isn't logical. Not when there are ceramic DIPs available that do the same jobs in less space—quicker, easier and cheaper. Whether inserted automatically or by hand.

Stocked locally for immediate delivery, too. At "on the board" cost-saving prices, in small or large quantities.

(Check the specs.) No wasted time while they're "made to order," unless you want custom modifications, which we can do fast.

And remember, ceramic. Ceramic reliability at plastic prices.

Why wait? Call your local Helipot Representative now for applications assistance or more information.

Beckman
INSTRUMENTS, INC.
HELIPOT DIVISION
Fullerton, California

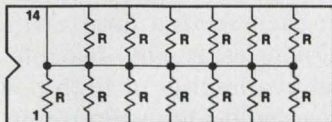

MODEL SERIES 899-1

Resistance Values (ohms): 100, 150, 220, 330, 470, 680, 1K, 1.5K, 2K, 2.2K, 3.3K, 4.7K, 6K, 6.8K, 10K, 15K, 22K.
Common Applications: Digital pulse squaring; MOS/ROM pull-up/ pull-down; "wired OR" pull-up; power driver pull-up; open collector pull-up; TTL input pull-down; TTL unused gate pull-up; high-speed parallel pull-up.

Standard Tolerance: $\pm 2.0\%$

Pricing:	1-99	\$1.45
	100-499	1.12
	500-999	0.97

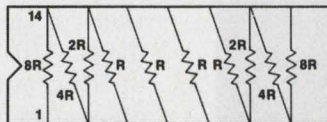

MODEL SERIES 899-2

Resistance Value (ohms): 10K
Common Applications: Inverting operational gain; potentiometric gain; differential gain; noninverting gain; gain adjustment.

Standard Tolerance: $\pm 2\%$

Pricing:	1-99	\$2.75
	100-499	2.15
	500-999	1.86

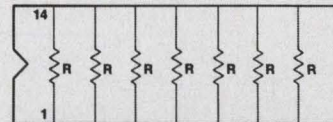

MODEL SERIES 899-3

Resistance Values (ohms): 68, 100, 110, 150, 220, 330, 470, 680, 1K, 1.5K, 2.2K, 3.3K, 4.7K, 6.8K, 10K, 15K, 22K.
Common Applications: Line termination; long-line impedance balancing; power gate pull-up; ECL output pull-down resistors; LED current limiting; power driver pull-up; "wired OR" pull-up; TTL input pull-down.

Standard Tolerance: $\pm 2\%$

Pricing:	1-99	\$1.25
	100-499	0.99
	500-999	0.86

An electronically varied attenuator eliminates the need for two p-i-n diodes

Electronically controlled variable attenuators usually employ three p-i-n diodes in a T or π section. This transmission type of attenuator network provides ultra-broadband operation at vhf and microwave frequencies. But where bandwidth requirements are more modest, you can economize on the number of diodes by using the reflection attenuator shown in the diagram.

The variable attenuator uses a ferrite circulator and a single p-i-n diode (a). The p-i-n diode acts as a current-controlled variable resistor. Only one dc excitation is required. The p-i-n diode network (b) includes a dc return, rf bypass capacitor and rf choke.

The attenuation is varied by electronically changing the diode resistance. This alters the power reflected back to the circulator. For an ideal circulator, the attenuation is the return loss of the p-i-n diode network. Input-output circuit

isolation can be enhanced if multi-port circulators are used.

The attenuator is best operated from maximum bias current (minimum attenuation) to an intermediary bias level (maximum attenuation), where the diode resistance approaches 50 Ω . Maximum practical attenuation is about 20 dB for a single attenuator section. By avoiding the low bias currents—those of much less than 1 milliamp—used with transmission attenuators, we reduce nonlinear distortion. The use of higher bias currents also avoids the operating region, where diode capacitances affect attenuator performance.

Minimum attenuation is still determined by the diode spreading resistance and lead inductance. In some cases it is desirable to tune the lead inductance to resonance. The forward insertion losses in the ferrite circulator also contribute to the minimum realizable attenuation.

When operating frequencies make the realization of very low bypass reactances impractical, the following approach can be used: The diode is short-circuited to ground and the dc bias is introduced through the dc return. This is connected to an rf bypass capacitance and the dc terminal rather than the ground.

Typical attenuator bandwidths are 10%. Bandwidths are limited by the ferrite circulators. Where loose performance requirements exist, bandwidths from 10% to an octave can be realized.

The rf bypass reactance should be less than 0.25 Ω . The dc return and rf choke reactances should be greater than 500 Ω .

A 40-dB attenuator can be built with two sections in cascade; each section uses a single p-i-n diode. This design is especially feasible because of the commercial availability of high power p-i-n diodes and broadband lumped-circuit ferrite circulators.

Bibliography:

"An Attenuator Design Using PIN Diodes," Hewlett-Packard Application Note 912

Richard M. Kurzrok., P. E., Consulting Engineer, 545 West End Avenue, New York, N. Y. 10024

CIRCLE NO. 311

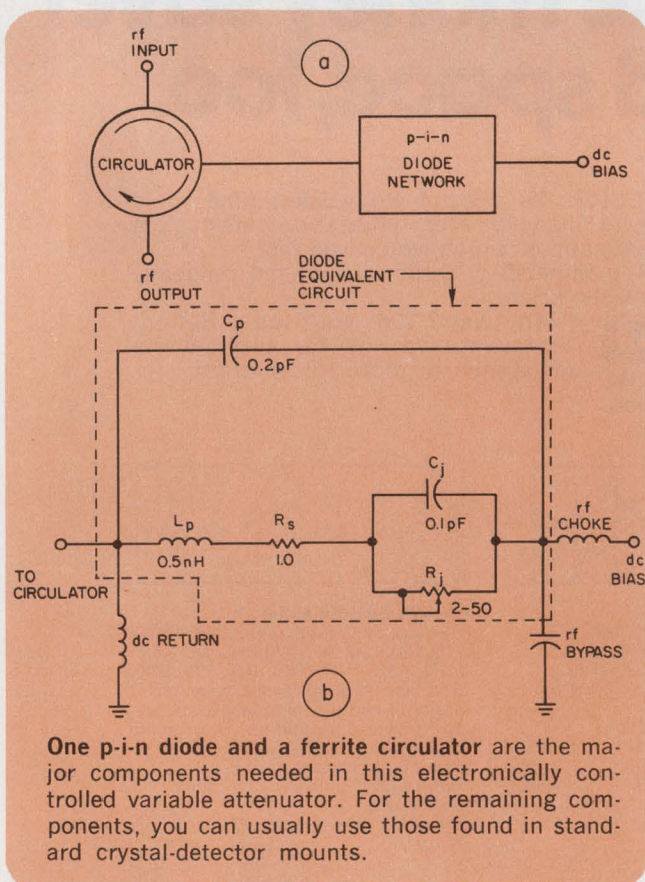

One p-i-n diode and a ferrite circulator are the major components needed in this electronically controlled variable attenuator. For the remaining components, you can usually use those found in standard crystal-detector mounts.

15 reasons why Monsanto counts with people who count.

Here are 15 Monsanto counters. Their capabilities are as varied as the requirements of you who read this ad. Frequencies range from DC to 12.5 GHz, prices from \$250 to \$3590.

1.

5 Hz-5 MHz \$250



2.

5 Hz-32 MHz \$475



3.

5 Hz-20 MHz \$350



4.

5 Hz-40 MHz \$575



5.

5 Hz-50 MHz \$695



6.

5 Hz-5 MHz \$795



7.

10 Hz-8 MHz \$815



8.

DC-75 MHz \$895



9.

DC-2.5 MHz \$995



10.

0.1 Hz-20 MHz \$995



11.

5 Hz-150 MHz \$995



12.

5 Hz-512 MHz \$1550



13.

DC-150 MHz \$1285



14.

DC-512 MHz \$1795

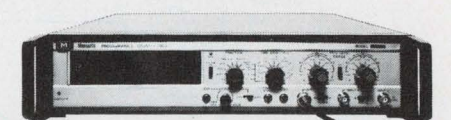

15.

DC-12.5 GHz \$3590



According to an independent, nationwide brand preference survey, we're No. 2 (of 67 counter manufacturers mentioned). Not bad. But not good enough. In the year ahead, we plan to give you even more reasons to specify Monsanto for anything you want to count. Meanwhile, one of the 15 shown here will probably do the job. Write for our catalog and see. Monsanto Company, Monsanto Electronic Instruments, West Caldwell, N. J. 07006.

Monsanto

Line regulator achieves 85% efficiency with control electronics on pcb

When several voltages are needed to run a system, a line regulator is often required to keep the power dissipation low. This is often achieved through use of bulky ferroresonant, linear inductors or power consuming series regulators. But it's possible to build an 85%-efficient line regulator with all control electronics on a small printed-circuit board (see diagram).

The regulator is basically a switching regulator with triac Q_1 the switching element. Diac D_1 , C_4 and R_3 form the triggering mechanism for the triac. Cadmium sulfide cell R_2 , R_1 , and C_3 vary the phase of the triggering voltage because R_2 and D_2 are optically coupled. Changing the current in D_2 changes the light intensity which in turn varies the resistance of R_2 . Changing the resistance of R_2 changes the phase of the trigger voltage, and this in turn varies the duty cycle

which changes the output voltage.

Transistor Q_3 is a comparator with D_4 as the reference. Resistors R_7 and R_8 form a voltage divider to determine the output voltage.

When you have light loads, the output time constant becomes longer, causing a lag, but by using C_7 in a lead network stability is achieved at light loads. Zener D_3 dc couples the comparator to emitter follower Q_2 . The emitter follower is a current source for D_2 .

Components T_2 , D_7 , D_8 , R_9 and C_8 form a separate supply for the electronics. Capacitors C_1 and C_2 are used to suppress noise that is generated by the switching of Q_1 .

R. S. Olla, Chief Engineer, Electro Dynamics Corp., 3139 Kermath Drive, San Jose, Calif. 95132

CIRCLE NO. 312

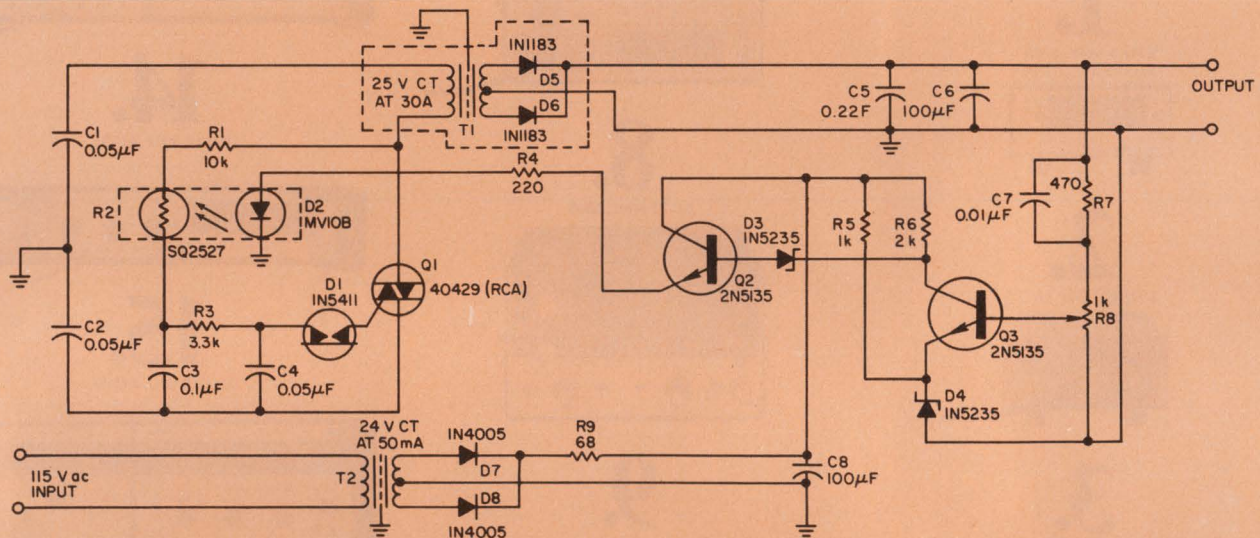

Avoid bulky inductors and dissipative series regulators by using this line regulator. The triac—at

8 A in a TO-66 case—requires no heatsink. Voltage regulation of 0.5% is achieved from 5 A to 30 A.

IFD Winner or July 22, 1971

Allan G. Lloyd, Holobeam, Inc., 560 Winters Ave., Paramus, N.J. 07652. His idea "Here's a better way to design a 90° phase-difference network" has been voted the Most Valuable of Issue award.

Vote for the Best Idea in this Issue

VOTE! Go through all Idea-for-Design entries, select the best, and circle the appropriate number on the Reader-Service-Card.

SEND US YOUR IDEAS FOR DESIGN. You may win a grand total of \$1050 (cash)! Here's how. Submit your IFD describing a new or important circuit or design technique, the clever use of a new component or test equipment, packaging tips, cost-saving ideas to our Ideas-for-Design editor. You will receive \$20 for each accepted idea, \$30 more if it is voted best-of-issue by our readers. The best-of-issue winners become eligible for the Idea Of the Year award of \$1000.

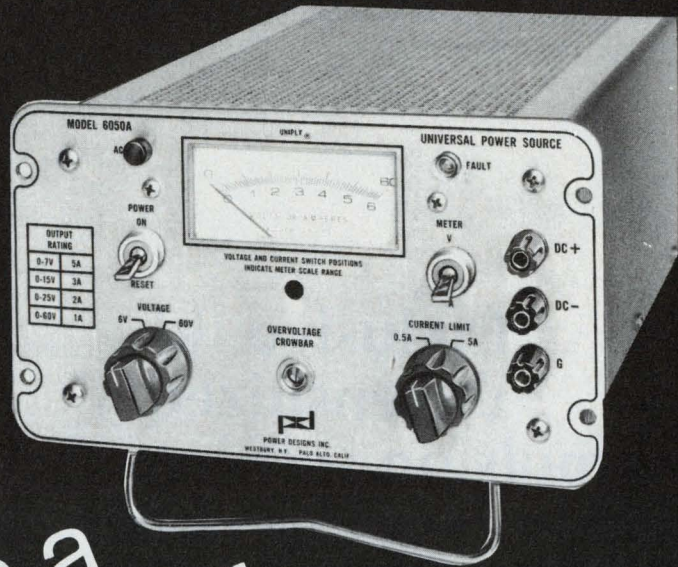

Power
Designs
*Uniply® is a
laboratory of
new power supplies

0-7V at 5A / 0-15V at 3A / 0-25V at 2A / 0-60V at 1A

UNIQUE REGULATOR CONCEPT FEATURES:

- Multi-range output with automatic electronic ranging
- Useful power output up to 150% of ratings at line voltages over 105 VAC
- Flashing light signals regulator inability to support increased power output levels
- Continuous operation into an overload or short circuit without damage
- Four range, taut-band panel meter
- Front panel adjustable overvoltage crowbar
- Performance of a high quality regulated DC source: .01% regulation, 1 mv peak-to-peak noise and ripple, etc.

Model 6050A \$199.

*Patents pending
Write or call for detailed specifications



power designs inc.

WESTBURY, NEW YORK:
1700 Shames Drive, Westbury, New York 11590
Tel: 516-333-6200 ▪ TWX: 510-222-6561
PALO ALTO, CALIFORNIA:
3381 Miranda Avenue, Palo Alto, California 34304
Tel: 415-321-6111 ▪ TWX: 910-373-1251

Exclusive IRI unsensitized emulsion screens offer fast turnaround, long life, lower costs.

Unsensitized emulsion screens is a mouthful. We just call them Q. R. for quick response. How quick? They can be processed in less than an hour. That's fast turnaround! We pre-coat the screens with an unsensitized emulsion that can be stored up to six months before use. When you're ready to expose and print, just apply our Q. R. sensitizer. Almost anyone can do it with a few minutes training. You eliminate messy in-house coating operations and lower your costs at the same time. Our Q. R. screens can be purchased in multiple emulsion thicknesses with tolerances to $\pm .0002''$. That's probably higher than your present control . . . and with greater repeatability to boot.

Want to learn more about this excellent product? Call or write our marketing department. Better still, see your IRI representative or local Buckbee-Mears consultant. He'll fill you in on all the details of our Q. R. screens, coated and exposed screens, or metal masks. IRI is a subsidiary of Buckbee-Mears, the world's largest volume producer of precision etched, stamped and electroformed parts. You can expect us to deliver, on time, what we say we can deliver. You'll save money with BMC, too, because we can choose from a wide range of capabilities to solve your particular needs. Fast delivery, reasonable prices, in-depth capability, well-trained sales force. Shouldn't you talk to us first? Industrial Reproductions, Inc., 100 Northeastern Blvd., Nashua, N. H. 03060, Telephone (603) 883-5541.



Turnaround time is less than an hour when you use the IRI unsensitized emulsion screens.

**INDUSTRIAL
REPRODUCTIONS
INC.** NASHUA, NEW HAMPSHIRE

A SUBSIDIARY OF
bmc
BUCKBEE-MEARS COMPANY

INFORMATION RETRIEVAL NUMBER 44

ELECTRONIC DESIGN 24, November 25, 1971

new products

Hand-held terminal eases data gathering



Electronic Laboratories, Inc., 3726 Dacoma St., Houston, Tex. Phone: (713) 686-8656.

The new data-kap System 900 keyboard-entry/magnetic-tape cassette recording and transmitting system simplifies data gathering. Information can be gathered and transmitted directly via a normal telephone and an acoustic coupler, via a data phone or a data access arrangement. System 900 consists of a hand-held keyboard/display, a lightweight portable read/write cassette recorder and a transmitter console for use at remote locations.

CIRCLE NO. 250

Modem test set simplifies data checks



Systron-Donner Corp., Datapulse Div., 10150 W. Jefferson Blvd., Culver City, Calif. Phone: (213) 836-6100. P&A: \$1650; 4 wks.

A new modem test set is the model 225 which is designed to simplify testing synchronous and asynchronous data. It has the capability of testing full and half-duplex and simplex systems and features a bias meter for mark/space bias distortion measurements. Six patterns and their inverse—2047, 511, 63, mark, space and dot—are all available.

CIRCLE NO. 251

Disc memory spans 0.8 to 3.2 megabits

Xerox Data Systems, El Segundo, Calif. Phone: (213) 679-4511. P&A: \$6000; Nov., 1971.

A small minicomputer disc storage unit is available in three models. The rack-mountable fixed-head 727 Mini Disc ranges in storage capacity from 0.8 to 3.2 megabits. All models feature an access time of 8.3 ms and a data transfer rate of 3 megabits/s. Each of the three models (16-track 0.8-megabit model A, 32-track 1.6-megabit model B and 64-track 3.2-megabit model C) mounts in a 19-in. rack and is 8-3/4-in. high.

CIRCLE NO. 252

Microfiche recorder is self-processing

Quantor Corp., 19000 Homestead Rd., Cupertino, Calif. Phone: (408) 255-1000. P&A: \$59,950 or \$1750/month rental.

The 105 delivers cut dried microfiche at a rate of one fiche/minute or 12,000 computer pages/h. Film is completely processed inside the recorder, allowing the system to be used in the computer room without support from a film lab or service company. The 105 operates offline on magnetic tape prepared by the host computer with software supplied as part of the new microfiche system.

CIRCLE NO. 253

Tape reader/perforator is a low-cost combo

Remex, 1733 Alton St., Santa Ana, Calif. Phone: (714) 557-6860. P&A: \$1995; 8 wks.

A high-speed punched-tape reader and perforator combination unit known as the 2075 is available at a cost of about one-fifth more than the normal cost for a premium tape perforator system alone. The combination comes in a choice of either roll or fanfold versions. All dc power supplies, reader amplifiers, motor drive circuitry and tape perforating and reader mechanisms are in a 19-in.-wide rack-mount package.

CIRCLE NO. 254

2400-bit/s modems come in two styles

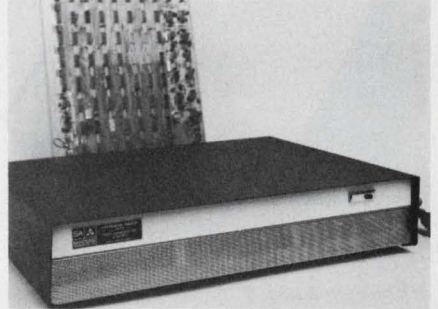

Sanders Assoc., Inc., Daniel Webster Hwy., South, Nashua, N.H. Phone: (603) 885-4741.

A line of 2400-bit/s synchronous modems is available in single PC-card and stand-alone pack versions. Series 24S modems are line compatible with Western Electric 201B units and are offered in full-duplex configurations with 10-ms turn-around time. Two-wire half-duplex operation is also offered with 200-ms turn-around time. The modems provide low error rates over C-2 conditioned lines.

CIRCLE NO. 255

Modem bandpass filters cut space requirements

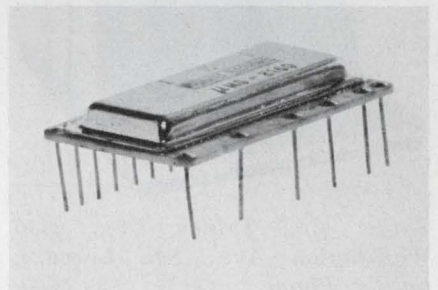

Integrated Electronics, Inc., 16845 Hicks Rd., Los Gatos, Calif. Phone: (408) 265-2410. Availability: Oct. 1971.

A line of modem bandpass filters eliminates 30% of the components currently required on an integral modem PC board. Capable of passing mark and space frequencies of one channel while rejecting adjacent ones, the filters feature responses tailored to insure 40, 50 or 60 dB of adjacent-channel separation, depending on the filter type selected.

CIRCLE NO. 256

Tone generator comes in a desk-top case



Bramco Control, Div. of Ledex Inc., College & South St., Piqua, Ohio. Phone: (513) 773-8271. Price: \$89 (100 quantities).

A push-button tone telemetry transmitter with built-in power supply is available in a desk-top configuration. The ME47C encoder generates tones that are identical to the ones used in standard tone telephone systems. It can be used in places where tone telephone isn't available or over private or leased lines.

CIRCLE NO. 257

High-speed terminal complements computer



Singer Co., Friden Div., 2350 Washington Ave., San Leandro, Calif. Phone: (415) 357-6800. P&A: \$5950; 4 months.

A new desktop alphanumeric display terminal designated model 80 is designed to function as a peripheral device for Singer's System Ten business computer. The model 80 adds high-speed visual data editing capability to the system and features a separate 10-key numeric keyboard, 1600 characters of display (20 lines of 80 each), a 1500-character transfer rate and 64-character ASCII.

CIRCLE NO. 258

Calculator interface gives formatted output

Tektronix, Inc., Box 500, Beaverton, Ore. Phone: (503) 644-0161. P&A: \$1390; Dec. 1971.

A new output interface device is available for the Scientist 909 and Statistician 911 calculators. The Teletype-terminal interface 944 permits the user to format printed information and to produce alphanumeric output, all under calculator control. A standard Tektronix calculator can be connected directly to a Teletype model ASR-33 without modification or operational-simplicity sacrifice.

CIRCLE NO. 259

16-bit minicomputer features small size

Digital Computer Products, Inc., 12 Industrial Rd., Fairfield, N.J. Phone: (201) 227-3443. P&A: \$2400; 30 days.

A 16-bit LSI/MSI minicomputer that is plug, program and mechanically interchangeable with 1200 series machines is the D-116 which incorporates its complete central processor on a 15-by-15-in. PC board. On the same-size board is a 4096-word 16-bit memory module. The two boards can be inserted in a 5-1/2-in.-high chassis with the power supply. The D-116 has a 1.2- μ s core-memory cycle time.

CIRCLE NO. 260

Disc memory system costs down to 5¢/bit

Applied Magnetics Corp., 75 Robin Hill Rd., Goleta, Calif. Phone: (805) 964-4881. P&A: see text, Oct. 1971.

A new expanded version of the M-200 series disc memory system features low cost—the memory system including all the electronics and the power supply ranges from 8¢ to \$1/bit for single units and from 5¢ to \$1/bit for OEM quantities. The memory also features a head-per-track configuration to provide a fast access time of 12.5 ms. The new M-200 series provides field expandable storage capacities from 564,000 to 9,024,000 bits.

CIRCLE NO. 261

Minicomputer cassette drive has many features



Cipher Data Products, 7655 Convoy Court, San Diego, Calif. Phone: (714) 277-8070. P&A: \$2450; 30 to 60 days.

A new minicomputer cassette drive system called the C-2000 offers ANSI/ECMA compatibility, read-after-write capability and useful tape drive features like record and file back-spacing, high-speed file load, and bi-directional search. It utilizes the ANSI/ECMA checking scheme including both a longitudinal check bit and a check sum.

CIRCLE NO. 262

Serial printer types 100 characters/s



Printer Technology, Inc., Sixth Rd., Woburn, Mass. Phone: (617) 935-4246. P&A: \$1760 (100 quantities); 60 days.

The Printec-100 is a new full-character impact serial printer with a 100-character/s printing rate. The new machine includes a built-in interface for receiving ASCII input data, standard 64-character ASCII font (other character sets available) and a throw-away ink roller that's good for 30 million impressions and is offered in a range of colors.

CIRCLE NO. 263

Have you filled out your REQUESTED DATA DELIVERY SERVICE enrollment form? See inside front cover.



ADVANCED MICROWAVE LABS
 Sunnyvale, California
 Type **OSCILLATOR**
 Model No. **YVOS1001**
 Freq. **2.0-4.0GHz**
 Serial No. **114**
 Made in U.S.A.

ADVANCED MICROWAVE LABS
 Sunnyvale, California
 Type **Circulator**
 Model No. **AMP-9087**
 Freq. **116-136MHz**
 Serial No. **195**
 Made in U.S.A.

ADVANCED MICROWAVE LABS
 Sunnyvale, California
 Type **MINI-CIRC**
 Model No. **32200**
 Freq. **0.8-20 GHz**
 Serial No. **106**
 Made in U.S.A.

AMLABS
AMF-4175
SN-101

YIG and ferrite components

Size and weight—these are the parameters that give you the most problems when you find that you need YIG or ferrite components.

Amlabs has the devices you need in the smallest possible package at the lowest possible weight.

And the line is complete—isolators, circulators, ferrite switches, YIG filters, integrated YIG filters-comb generators, and YIG tuned oscillators, from 50 MHz to 18 GHz. Over 200 devices are described in our short form catalog, yours for the asking.

One device you should know about now is our "Minicube" isolator. Only 1/2" square, it

provides 17 to 20 dB isolation in narrow band segments from 900 MHz to 16 GHz, and it weighs only 0.6 oz.

For complete specifications on the "Minicube" or any other YIG and ferrite components, call Amlabs, a subsidiary of Aertech Industries, 825 Stewart Drive, Sunnyvale, California 94086; 408/732-0880. You won't have a complete bid package without word from us.



Another branch of the Aertech family tree.



GaAs varactors are available commercially

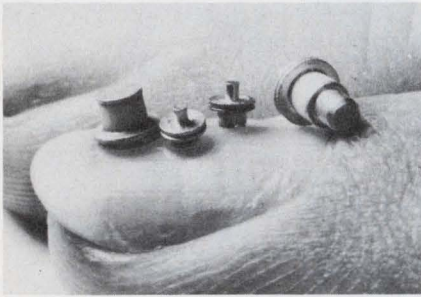

Varian, Solid State Div., Salem Rd., Beverly, Mass. Phone: (617) 922-6000.

New GaAs high-Q tuning varactor diodes are commercially available. Twenty standard diode types are offered in four VAT series with minimum breakdown voltages of 15, 30, 45 and 60 V. Zero-bias capacitance values from 0.5 to 5 pF are available at a tolerance of $\pm 10\%$ or ± 0.1 pF, whichever is greater, at no extra cost. Designers can choose from 11 case styles.

CIRCLE NO. 264

Self-scanning array has 256 photodiodes

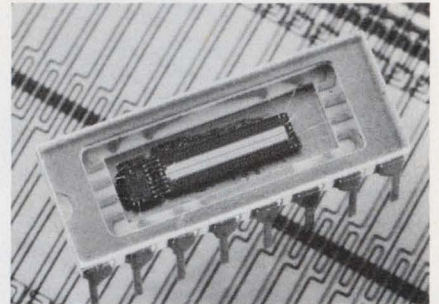

Reticon Corp., 365 Middlefield Rd., Mountain View, Calif. Phone: (415) 964-6800. P/A: \$250; stock.

A 256-element self-scanning optical array is available for facsimile, TV-camera and industrial control applications demanding high resolution. The RL-256 has photodiodes spaced on 1-mil centers with on-chip scanning circuitry for serial output on a single video line. TTL compatibility is assured by special drive circuitry in the same 16-lead DIP. The sensors scan up to 10 MHz.

CIRCLE NO. 265

RF wins the synthesizer numbers game

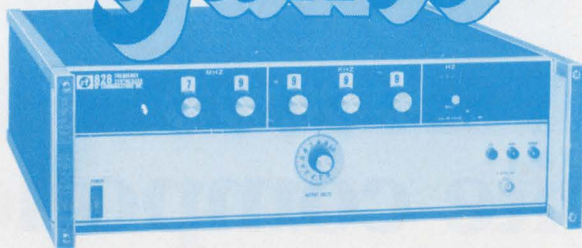

with Model RF-828 Frequency Synthesizer Specs & Prices

PRICE \$2,676
 RANGE 1 kHz to 80 MHz
 RESOLUTION... 1 kHz (1 Hz Optional)
 REMOTE PROGRAMMING
 MINIMUM SYSTEM INTERFACE



RF COMMUNICATIONS, INC.
 Electronic Instrumentation Operation
 1680 University Avenue, Rochester, N. Y. 14610
 Telephone: 716-244-5830; TWX: 510-253-7469
 A Subsidiary of Harris-Intertype Corporation

INFORMATION RETRIEVAL NUMBER 46

High-gain amplifiers increase laser outputs

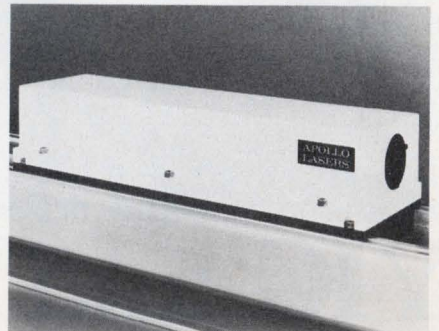

Apollo Lasers, Inc., 6365 Arizona Circle, Los Angeles, Calif. Phone: (213) 776-3343. Availability: stock to 30 days.

Outputs of existing solid-state laser systems can be dramatically increased with the use of new selected amplifiers. The amplifiers can use either ruby or neodymium-doped glass laser rods. Three sizes of pumped length of laser rods are available: 6, 12 and 16 in. The laser heads are designed to operate at 12 kV.

CIRCLE NO. 266

REQUESTED DATA DELIVERY SERVICE IS HERE, inside front cover.

Neodymium laser needs no mirror adjustments

GTE Sylvania, Box 188, Mountain View, Calif. Phone: (415) 966-2452. P&A: under \$3500; 60 to 90 days.

A new low-cost neodymium laser requires no mirror adjustments or outside power supply. Model 605 is an 11-lb laser that produces continuous output power of 1/4 W TEM₀₀ and is available at wavelengths of 1.06 or 1.08 micrometers. It operates from any standard 115 V receptacle and is only 4-1/4-in. wide, 4-3/8-in. high and 10-3/4-in. long. The compact unit uses a new laser material known as yttrium aluminate (YAlO₃).

CIRCLE NO. 267

Compact He-Ne lasers are also lightweight

Vari-Tech Co., 546 Leonard St. N.W., Grand Rapids, Mich. Phone: (616) 459-7281.

A new line of lightweight and compact He-Ne gas lasers can be used as precise straight-line references or as long-range light sources. These units weigh only 1-3/4 to 3 lbs and are approximately the size and shape of an ordinary mailing tube. They have the power efficiency to operate off a conventional 12-V battery. Each continuously operating laser produces a small coherent beam of single-frequency non-polarized red light visible to the eye.

CIRCLE NO. 268

Double balanced mixer spans dc to 300 MHz

Summit Engineering Corp., 1820 S. 7th Ave., Bozeman, Mont. Phone: (406) 587-0636. P&A: \$40; stock.

Broadband dc to 300-MHz coverage of the model 767 double balanced mixer makes it ideal for applications in the hf/vhf ranges. It has a conversion loss of 6.5 dB at 100 MHz and isolation of 40 dB at 100 MHz. The model 767 uses a computer-matched hot-carrier diode quad which provides uniformity from unit to unit. It will operate from -65 to +100°C and is provided in an 8-pin hermetically sealed metal package.

CIRCLE NO. 269

This new 3½ digit panel meter combines excellent specs., an aesthetic design, quick delivery, compact size and OEM prices of \$95 (Uni Polar) and \$101 (Auto Polar). Check these additional benefits:

- 100% overrange — 1999
- 0.1% ±1d accuracy
- Zero bias current
- 100uV sensitivity
- 0 to +60°C temp. range

Send for complete specs. and prices in Bulletin 88.



**NOW WE'RE
"SMALLEST"
ENOUGH
TO BE NO. 1**

"Smallest" Price
\$95

"Smallest" Size
2.6" W. x 3.2" H. x 4.6" D.

Datascan
/digital products group

Datascan Inc., 1111 Paulison Avenue • Clifton, N. J. 07013 • (201) 478-2800

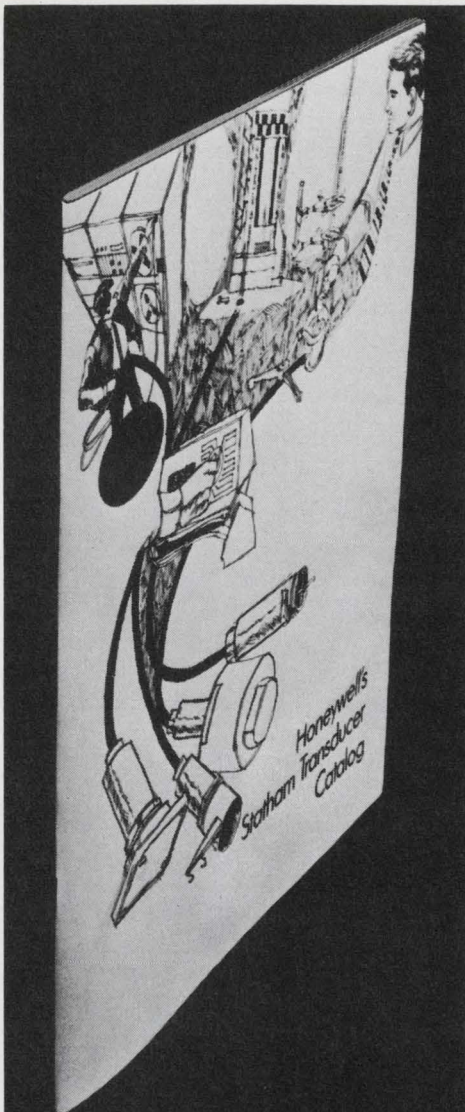

Order your FREE Statham Transducer Catalog today!

Transducer catalog features model descriptions of all transducers and readout accessories as well as notes on industrial, research and scientific applications. Write to Bob Shipman, MS 222, Honeywell, Test Instruments Division, P.O. Box 5227, Denver, Colo. 80217.

Honeywell engineers sell solutions

Honeywell

INFORMATION RETRIEVAL NUMBER 48

MICROWAVES & LASERS

1-to-18-GHz TWTs deliver 20 W cw



Hughes Aircraft Co., Electron Dynamics Div., 3100 W. Lomita Blvd., Torrance, Calif. Phone: (213) 670-1515. P&A: \$4650 to \$5550; 60 to 90 days.

A new 20-W (minimum) cw traveling-wave-tube amplifier series designated the 1277H covers the 1 to 18-GHz frequency range in five models. Each amplifier consists of a metal ceramic traveling-wave tube, a regulated supply and a complete air-cooling system assembled in a compact case.

CIRCLE NO. 270

Small coaxial relays operate 1 million times



Fifth Dimension, Inc., Princeton, N. J. Phone: (609) 924-5990. P&A: under \$70; stock to 5 wks.

Two new miniature coaxial relays feature high performance over a lifetime of at least 100 million operations. For rf applications, model RF1106 Logcell coaxial relay combines low VSWR of 1.2:1 and insertion loss of 0.3 dB with a minimum isolation of 37 dB over dc to 1 GHz. For high-speed pulse applications, model HS1107 will switch pulses of 150 ps risetime with less than 10% distortion. Time delay is 200 ps.

CIRCLE NO. 272

A new, free Hayden Service for you, see inside front cover.

Wide-range attenuators utilize pushbuttons

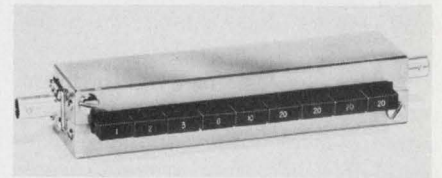

Texscan Corp., 2446 N. Shadeland Ave., Indianapolis, Ind. Phone: (317) 357-8781. P&A: \$85; 2 wks.

The PB series of pushbutton attenuators are available in bench-style or rack-mount configurations. Models are available in 50 or 75- Ω impedances. Attenuations of 0 to 102 dB in 1-dB steps and 0 to 82.5 dB in 0.5-dB steps are available. Frequency range is from dc to 1000 MHz.

CIRCLE NO. 271

Phototransistor scanner reads 3 mils at 75 mils

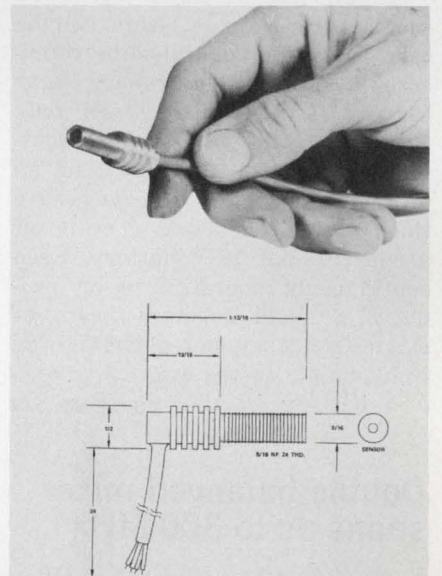

Accu-Sort Systems, Inc., 601 Lawn Ave., Sellersville, Pa. Phone: (215) 257-3638.

A miniature phototransistor with an incandescent light source detects variations in light intensity from the surface being scanned—it can read marks as small as 3 mils at 75-mil distances. The Accu-Sort 502 delivers an output of 1.5 V minimum when viewing high contrast marks (code bars) of 15 mils or larger and will resolve 10 marks/in. at a velocity of 3000 in./s.

CIRCLE NO. 273



WHAT IS IT COSTING YOU TO TEST, MONITOR, CONTROL, and RECORD?

An inexpensive DigiTec system will help you reduce these costs and free valuable personnel. How?

Our complete line of DVM's, Thermometers, and other measuring instruments can be readily combined with input/output peripherals. These combinations of modules are carefully designed for complete compatibility in flexible dedicated and non-dedicated systems. Here are a few of the peripherals we offer:

- Digital Printers
- Paper Tape Punches
- TTY Couplers
- Analog Scanners
- Digital Clocks
- Digital Setpoints

Our Application Engineers are experienced systems people on whom you can rely for expert assistance. Give us a call; you'll be amazed at the *modest* investment to solve big problems.



918 Woodley Road • Dayton, Ohio 45403 • (513) 254-6251
Representatives throughout the world
For complete specifications, request new catalog

INFORMATION RETRIEVAL NUMBER 49

Miniature High Voltage Resistors



new Mini-Mox resistors offer 100 ppm TCR plus low noise characteristics

Mini-MOX resistors have all the ingredients you need for new designs for ultra-critical applications. For instance, Mini-MOX resistors are a fraction the size of conventional types; they meet or exceed MIL-R-10509-F for environmental parameters . . . 100 ppm or less; T.C.R. stability better than $\pm 2\%$ for 2,000 hours at full load; low-voltage coefficient less than 5 ppm/volt, measured between 100 volts and full-rated voltage; in addition typical quantech noise at 20 megohms is less than 0.5 microvolt/volt.

Available off-the-shelf, Mini-MOX resistors are ideally-suited for high-voltage applications where long-term stability and power-to-size ratios are critical.

Model	Resistance	Rating @70°C	*Max. Oper. Volts	Length Inches	Diameter Inches
MOX-400	1-2500 megs	.25W	1000V	.420	.130
MOX-750	1-5000 megs	.50W	2000V	.790	.130
MOX-1125	1-10,000 megs	1.00W	5000V	1.175	.130

Write for complete Technical Data Sheet on Mini-MOX Resistors: Victoreen Instrument Div. of VLN Corp., 10101 Woodland Ave., Cleveland, Ohio 44104. Telephone: 216/795-8200. DMA 558

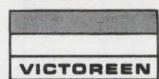

Expertise in high voltage

INFORMATION RETRIEVAL NUMBER 50

ELECTRONIC DESIGN 24, November 25, 1971

DIP-LITE®

NEW - LOW COST - READOUTS

- CONVENIENT DUAL-IN-LINE MOUNTING
- LOW VOLTAGE — 5 volts
- LOW CURRENT — under 20 milliamps
- LONG LIFE — over 100,000 hours
- MULTICOLORS
- BRIGHTNESS — up to 9,000 ft. lamberts
- LED REPLACEMENT (PIN-FOR-PIN)
- BOTH 7 SEGMENT DIGITAL AND 16 SEGMENT ALPHANUMERIC AVAILABLE

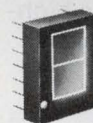

DIP. 650
5/16"

\$295*

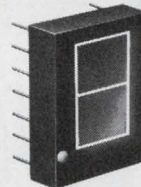

DIP. 850
1/2"

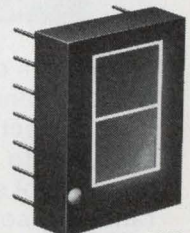

DIP. 1050
5/8"

(201) 226-7724

Pinlites

DIVISION OF REFAC



P.O. BOX 453, CALDWELL, NEW JERSEY 07006 U.S.A.

*In 5,000 lot quantities

INFORMATION RETRIEVAL NUMBER 51

MODULES & SUBASSEMBLIES

Digitally controlled supply delivers 250 W

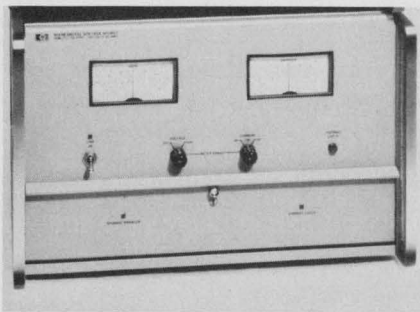

Hewlett-Packard, 1501 Page Mill Rd., Palo Alto, Calif. Phone: (415) 493-1501. P&A: \$2700; 7 wks.

A new digitally programmable voltage source, the model 6129B, supplies 250 W of dc or low-frequency ac power. It can swing its output voltage over the full range of -50 to +50 V or vice versa in less than 300 μ s while supplying any current between 0 and 5 A. The supply is designed to be controlled by computers, couplers and digital sources.

CIRCLE NO. 274

Hexadecimal LED display has 0.27-in. characters

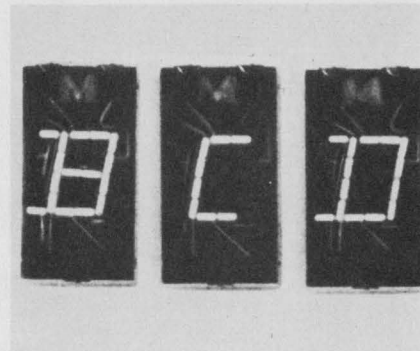

Monsanto Electronic Special Products, 10131 Bubb Rd., Cupertino, Calif. Phone: (408) 257-2140. P&A: \$11 (100 quantities); stock.

The MAN1002 is a new hexadecimal LED array capable of displaying the numbers 0 through 9 as well as 14 distinct letters. The new display features a 0.27-in.-high character made from eight segments of GaAsP LEDs—the eighth segment is two half-segments placed to make it easy to tell letters from decimals.

CIRCLE NO. 275

It Works Every Time...

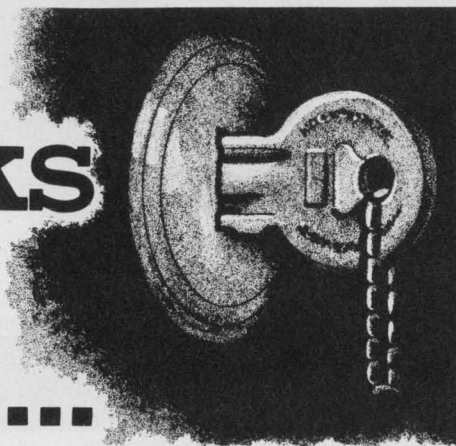

Durability testing is the reason why.

Stringent "in-process" quality control durability testing by Controls Company of America, a Division of the Singer Company, insures highest MTBF for their automobile electric switches.

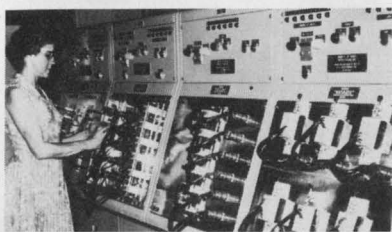

CCA's durability testing stands, manufactured by K. & L. Electronics, Inc., were designed to accept and test switches of several sizes, randomly selected from "in-process" production runs.

K. & L. Electronics required a compact, well-constructed, readily available, well-regulated power supply with low ripple. Electronic Measurements' SCR Power Supplies met these requirements.

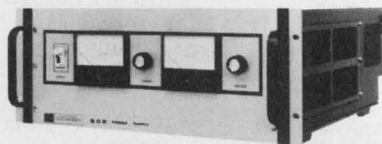

IF YOU DEMAND RELIABILITY AND NEED A LOW WEIGHT/SMALL SIZE, LOW RIPPLE, WELL-REGULATED POWER SUPPLY AT 2.5, 5 OR 10 KW . . . CALL TOLL FREE 800 - 631-4298, OR WRITE FOR OUR LATEST CATALOG.



ELECTRONIC MEASUREMENTS INC.

405 ESSEX ROAD, NEPTUNE, NEW JERSEY 07753

INFORMATION RETRIEVAL NUMBER 52

Match-box amplifier has switch-selectable gains



MDC Instruments, Inc., 16015 Valley View Ave., Santa Fe Springs, Calif. Phone: (213) 921-7016.

A new gain-switchable amplifier in a match-box size package is the MIN-DEK amplifier with gains of 1 to 10, 100 and 1000 in differential or single-ended modes. Its operating power is derived from rechargeable batteries that snap into the amplifier. Flexibility is achieved with the use of simple plug-in cables for input and output.

CIRCLE NO. 276

FET amplifiers range in gain from 1 to 2000

Dynamic Measurements Corp. 6 Lowell Ave., Winchester, Mass. Phone: (617) 729-7870. P&A: from \$35; stock to 2 wks.

A family of four encapsulated FET-input instrumentation amplifier modules have an externally programmable gain ranging from 1 to 2000, all set by a single resistor. Zero-trim, external-reference and external-sense capability are provided in the 300 series units. They exhibit up to 100 dB of CMRR at a gain of 1000. Maximum unity-gain response is 1 MHz. Four models are offered with stabilities from 50 through 3 $\mu\text{V}/^\circ\text{C}$.

CIRCLE NO. 277

+5-to- ± 15 -V converter sizes up to 1.6 in.³

Kratos Precision Products, 1161 W. Pico Blvd., Los Angeles, Calif. Phone: (213) 478-0635.

A new line of miniature power converters includes the model 721, which converts +5 to ± 15 V dc to power op amps, d/a and a/d converters, multipliers and other analog modules. This tiny converter—only 4-in. square by 0.4-in. high—contains a dc-dc converter and an IC regulator to produce a regulated dual output. The package is cast of solid epoxy.

CIRCLE NO. 278

250-MHz FET op amp slews at 200 V/ μs

Optical Electronics, Inc., Box 11140, Tucson, Ariz. Phone: (602) 624-8358. P&A: \$80; stock.

The 9722 differential-input FET op amp features 250-MHz gain-bandwidth product, a minimum slewing rate of 200 V/ μs and 300-ns maximum settling time to 0.1%. This 10^{12} - Ω -input-impedance op amp has a ± 10 -V ± 200 -mA output. It operates from ± 9 to ± 18 -V supplies. Additional characteristics include minimum open-loop gain of 66 dB, only 300 nV/ $\sqrt{\text{Hz}}$ of noise, input offset voltage of ± 10 mV maximum and voltage drift of ± 250 $\mu\text{V}/^\circ\text{C}$ maximum.

CIRCLE NO. 279

Announcing REQUESTED DATA DELIVERY, inside front cover.

LED 7-segment display increases brightness

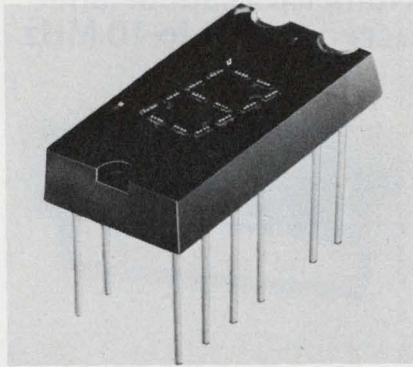

Litronix, Inc., 19000 Homestead Rd., Cupertino, Calif. Phone: (408) 257-7910. P&A: \$6.75 (1000 quantities); stock.

A low-cost seven-segment LED display is the new Data-Lit 10A which is a replacement for the Monsanto MAN-1 and MAN-1A. Its character height is 0.27 in. and it has three times the luminance output of the MAN-1. Minimum brightness is 100 foot-lamberts at 10 mA—typically 500 foot-lamberts at 10 mA. It is packaged in a 14-pin DIP.

CIRCLE NO. 280

Tiny digital controller has 1-degree set point



Thermo Electric, Saddle Brook, N.J. Phone: (201) 843-5800.

A new miniature controller measures less than 4-in. wide and 2-in. high. Called the TE100, it is so small that up to 18 units can be mounted in a square-foot panel. Despite its small size, the TE100 offers high resolution—set point is adjustable to one degree on the front panel. The adjustment knob is removable to eliminate tampering. The controller handles processes requiring up to 3 A at 115 V ac.

CIRCLE NO. 281

“O”T.C. Capacitor
“O”T.C. Capacitor
“O”T.C. Capacitor
“O”T.C. Capacitor
“O”T.C. Capacitor
“O”T.C. Capacitor
“O”T.C. Capacitor
“O”T.C. Capacitor

± 10 PPM/ $^\circ\text{C}$
 -55°C to $+85^\circ\text{C}$
Accurate to $\pm .01\%$

Part of EAI's component capability includes: thick-film amplifiers, filters, analog/digital function modules, hybrid function modules, precision capacitors . . .

EAI precision components

193 Monmouth Parkway
West Long Branch, New Jersey 07764
(201) 229-1100

Isolation amplifier isolates to 10 μ A

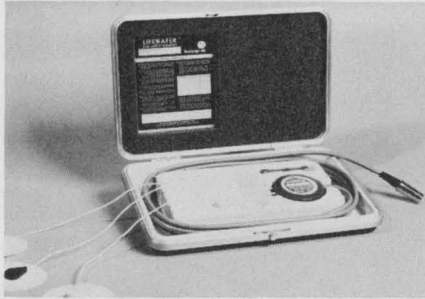

Terrasyn, Inc., Box 975, Longmont, Colo. Phone: (303) 772-4444.

A new isolation amplifier designated as Lifewater offers complete patient safety from electrical shocks. Its isolation is accomplished with a beam of light that keeps patient currents well below 10 μ A. No instructions are needed and no switches need be thrown since operation is automatic when the unit is removed from its case. Performance exceeds that proposed by UL, VA, NFPA and other regulating organizations.

CIRCLE NO. 282

Numeric readout unit accepts 5 Hz to 10 MHz

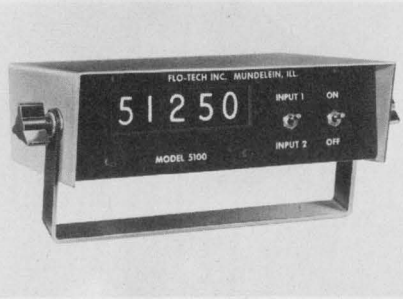

Flo-Tech, Inc., 403 Washington Blvd., Mundelein, Ill. Phone: (312) 566-9120. Price: \$375.

Model 5100 numerical readout is an IC digital frequency counter that provides unvarying crystal-controlled accuracy and has an input rate of 5 Hz to 10 MHz. It reads in common engineering units such as GPM, RPM, Hz, etc. The time base is adjustable in 10- μ s steps from 10 μ s to 10 s. Only a power switch and a 2-input selector switch are all that are required to operate the 5100.

CIRCLE NO. 283

8-bit d/a converter costs down to \$49

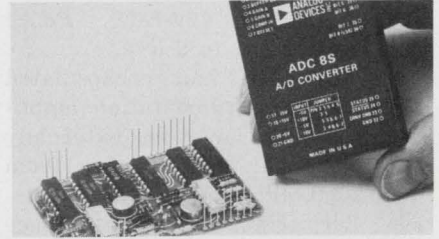

Analog Devices, Inc., Rte. 1 Industrial Park, Norwood, Mass. Phone: (617) 329-4700. P&A: \$79 (single quantities), \$49 (100 quantities); stock.

A new low-cost 8-bit a/d converter, model ADC-8S, provides $\pm 1/2$ LSB linearity, a 60-ppm/ $^{\circ}$ C temperature coefficient and 1-ms conversion time. This 2-by-3-by-0.4-in. unit has 100-M Ω input impedance and features four different input ranges: 0 to +5 V, 0 to +10 V, ± 5 V and ± 10 V. It requires ± 15 V at ± 28 mA and +5 V at 120 mA to operate and is TTL/DTL compatible.

CIRCLE NO. 284

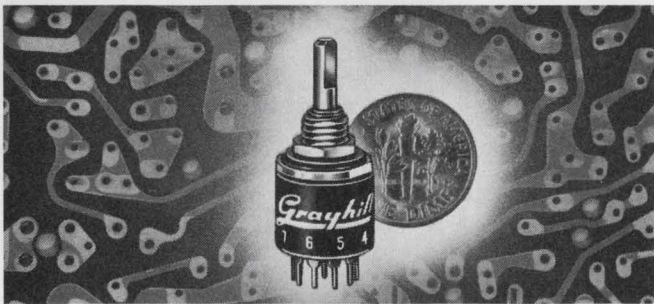

The dime-sized switch. 500,000 switching operations for less than \$3.75.*

Yes. It's the economy continuous rotation version of the Series 50. Just one example of a wide variety of readily available Grayhill rotary switches.

We have thousands of off-the-shelf miniature switches...single or multi-deck (recently we made some with 21 decks) with 15 $^{\circ}$ to 90 $^{\circ}$ angles of throw and a lot between, up to 12 poles per deck, 24 positions per pole, shorting or non-shorting, P.C. or solder lug terminals.

But if the life and load

ratings of our off-the-shelf switches are not acceptable for your application, we'll design and build one that is.

Like to know more? Write or phone for our latest general engineering catalog. Grayhill, Inc., 565 Hillgrove Ave., La Grange, Ill. 60525, (312) 354-1040.

*Quantities of 100 or more.

Grayhill
pioneers in miniaturization

INFORMATION RETRIEVAL NUMBER 54

the 5 1/2" family...

Brimar all electrostatic rectangular oscilloscope tubes... each one a unique contribution to the instrumentation engineer's repertoire.

- D14-170 — General purpose. Short length. Spiral p.d.a.
- D14-171 — Low wattage heater (6.3V 0.12A) version of D14-170.
- D14-180 — Medium bandwidth. Ultra-square face-plate. Spiral p.d.a.
- D14-200 — High bandwidth. Mesh p.d.a. Ultra-square face-plate.

This entire family of rectangular screen oscilloscope tubes have a face diagonal of 5 1/2 inches (10cm x 8cm) with overall lengths varying from 405mm down to 308mm. Beam blanking also is incorporated into all types to avoid d.c. coupling to the grid.

- D14-170
- D14-171
- D14-180
- D-14-200

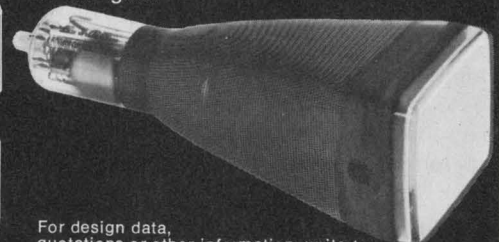

For design data, quotations or other information, write to:

THE INTER-TECHNICAL GROUP, INC.
P.O. BOX 23 / IRVINGTON-ON-HUDSON, NEW YORK 10533
TEL: (914) 591-8822 TWX: 710-564-0802

INFORMATION RETRIEVAL NUMBER 55

ELECTRONIC DESIGN 24, November 25, 1971

Multi-position switches offer low OEM costs

Controls Research Corp., 2100 S. Fairview, Santa Ana, Calif. Phone: (714) 557-7161. P&A: 30¢/position (1 million quantities); stock to 6 wks.

A new series of economy keyboard switches features dual spring-contact arrangements which require a light touch and a 0.15-in. stroke for actuation. Bi-pac switches are available in one through six-position unitized modules. They utilize two gold-plated conical wire-spring contacts which offer redundant contact points and wiping action.

CIRCLE NO. 285

FET-input differential op amp slews 400 V/ μ s

Dynamic Measurements Corp., 6 Lowell Ave., Winchester, Mass. Phone: (617) 729-7870. P&A: \$49, \$55; stock.

A new differential fast-settling FET op amp designated model 161A/B has a typical slew rate of 400 V/ μ s, a gain-bandwidth product of 45 MHz, full-power response of 6 MHz and will settle to 0.01% within 300 ns. Other features include an input resistance of 10^{12} Ω , gain of 400,000, output of ± 10 V at 20 mA and a voltage offset drift of 40 μ V/ $^{\circ}$ C (A) and 20 μ V/ $^{\circ}$ C (B).

CIRCLE NO. 286

A/d converters include high speed models

Phoenix Data Inc., 3384 Osborn Rd., Phoenix, Ariz. Phone: (602) 278-8528. P&A: \$800, \$1000, \$1200; 4 wks.

A new series of a/d converters features 0.8, 1 and 3- μ s conversions for 8, 10 and 12-bit models, respectively. The ADC900 series of plug-in module converters incorporate all conversion functions in the same package except for power supplies. Accuracy is $\pm 0.025\%$ of full range for the 12-bit unit and temperature coefficient is ± 20 ppm/ $^{\circ}$ C.

CIRCLE NO. 287

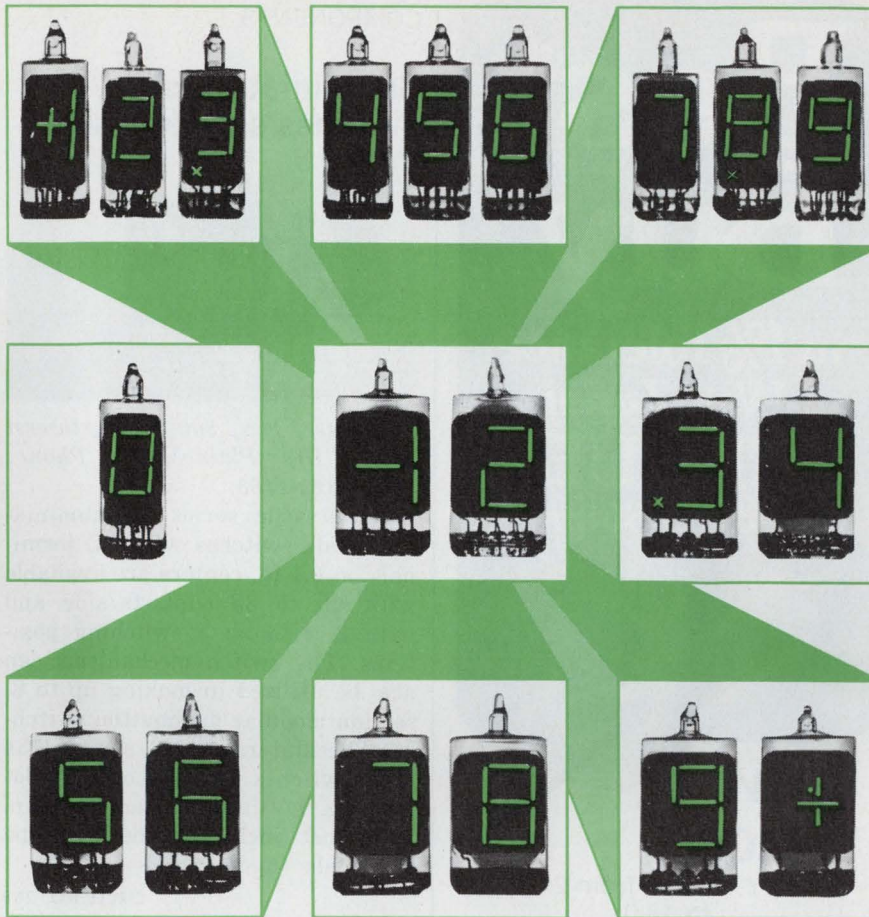

YOUR READOUT EQUIPMENTS ARE EASIER TO SELL WITH RCA DIGITAL DISPLAYS

Even in direct sunlight, the numerals of RCA's NUMITRON Digital Display Devices are sharp and clear. And, under normal indoor lighting conditions, numerals are legible to 40 feet or more with almost any color-filter. Here's why:

- High-contrast viewed against a dark background
- Controllable brightness
- Wide-spectrum light emission permits unlimited filter-color selection

RCA has two NUMITRON families—the DR2000 series (0.8" mounting centers) and the compact DR2100 series (0.5" mounting centers). Their 4.5 V operation makes them compatible with most integrated circuit drivers for low-cost digital-display system designs. And, their advantages are demonstrable sales features for your equipments.

For price, delivery and technical information on these devices, see your local RCA Representative or RCA Distributor. For a copy of Application Note AN-4277, "Description and Application of NUMITRON Digital Display Devices," write: RCA, Commercial Engineering, Section 57K-25/CN5, Harrison, N.J. 07029. International: RCA 2-4 rue du Lièvre, 1227 Geneva, Switzerland, or P.O. Box 112, Hong Kong.

RCA
Electronic
Components

INFORMATION RETRIEVAL NUMBER 56

Best Buy

in 1% Tolerance
1-Watt Zeners

SCHAUER
Immediate Shipment

No fragile
nail heads

All welded and
brazed assembly

Gold plated
leads

Low Prices

ANY voltage from 2.0
to 18.0

Quantity	Price each
1-99	\$1.07
100-499	.97
500-999	.91
1000-4999	.86
5000 up	.82

Write for complete rating data and
other tolerance prices.

Buy The Kit!

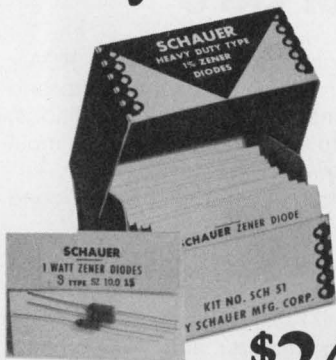

A
\$54.57
value
for
only

\$24.50

Kit contains a 51-piece assortment
of SCHAUER 1% 1-watt zeners
covering the voltage range of 2.7
to 16.0. Three diodes of each voltage
in reusable poly bags. Stored
in a handy file box. Contact your
distributor or order direct.

Semiconductor Division

SCHAUER

Manufacturing Corp.

4511 Alpine Ave. Cincinnati, Ohio 45242

Telephone: 513/791-3030

COMPONENTS

Subminiature slide switches shrink in size

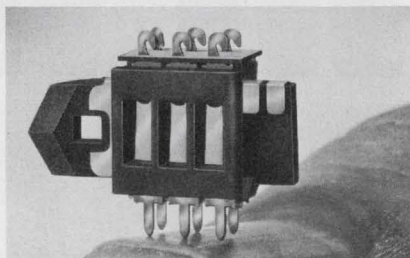

Littelfuse, Inc., 800 E. Northwest
Hwy., Des Plaines, Ill. Phone:
(312) 824-1188.

A versatile series of subminiature slide switches with PC terminals on 0.1-in. centers are available with up to 35 contacts/side and with 2, 3, 4 or 5 switching positions. The switch mechanisms can also be utilized in making up to 8-section modular pushbutton switches. The stators of the series 4134 slide switches measure only 23/64-in. long, 1/4-in. high and 13/64-in. wide, not including the PC type terminals (dpdt models).

CIRCLE NO. 288

Size 20 stepper motor has 50-oz-in. torque

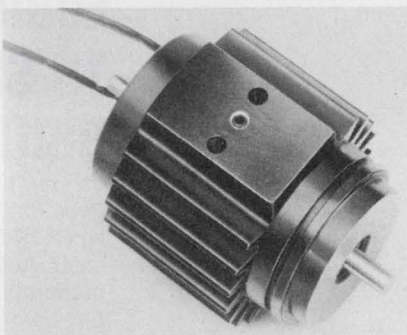

IMC Magnetics Corp., Western
Div., 6058 Walker Ave., Maywood,
Calif. Phone: (213) 583-4785.

Suitable for use as a positioner/
driver for recording pens, digital
tuners and tape drives, model 020-
0778 stepper motor combines a
versatile size 20 motor with 24-oz-
in. of running torque and 42 oz-in.
of stall torque at a 28-V dc input.
Up to 50 oz-in. can also be ob-
tained. Its maximum response is
350 steps/s bi-directionally in 15-
degree increments.

CIRCLE NO. 289

Multi-size steppers feature high torque



A. W. Haydon Co., 232 Elm St.,
Waterbury, Conn. Phone: (203)
756-4481.

The new 72000 series stepper
motors are available to operate in
increments of 15, 30, 45 or 90 de-
grees/pulse. The motors can pro-
vide running friction torque up to
17 oz-in. at 100 steps/s. Pull-in
stepping rates range to 1500 steps/
s. The motors are offered in frame
sizes 11, 13 and 17. Operating volt-
age is 26 V dc.

CIRCLE NO. 290

Miniature Scott "T" transformers cut cost

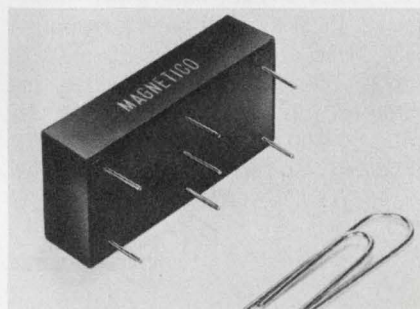

Magnetics, Inc., 6 Richter Court,
E. Northport, N.Y. Phone: (516)
261-4502. P&A: from \$16 (1000
quantities); stock to 3 wks.

A series of new 400-Hz Scott
"T" transformers convert 3-wire
synchro inputs into 2-wire resolver
outputs with 30 arc seconds of ac-
curacy in a 7/8 by 1-5/8 by 11/16-
in. package. The devices are de-
signed to mount on PC boards and
will meet the requirements of MIL-
T-27C. Input voltage is 90 V line-
to-line and output voltage is 6 V
rms.

CIRCLE NO. 291

Have you filled out your REQUEST DATA DELIVERY SERVICE enrollment form? See inside front cover.

RF FILTERS

for Transmitters & Receivers*

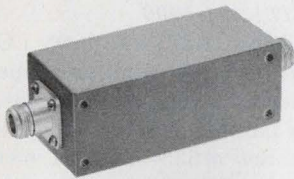

- Low Pass
- Band Pass
- Tunable
- Miniature
- High Power

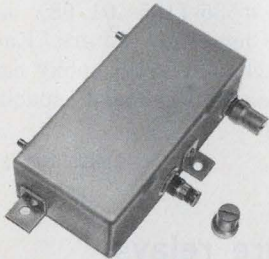

- 2-32 MHz*
- 110-150 MHz*
- 143-178 MHz*
- 225-400 MHz*
- 450-470 MHz*

MICROWAVE
FILTER
COMPANY, INC.

135 WEST MANLIUS STREET,
EAST SYRACUSE, NEW YORK 13057 (315) 437-4529

INFORMATION RETRIEVAL NUMBER 58

A new angle to cooling power devices...

SLANT SINKS

from Thermalloy!

- Optimum cooling
- 50% less weight
- up to 20% lower cost

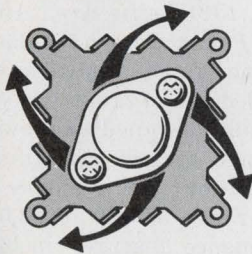
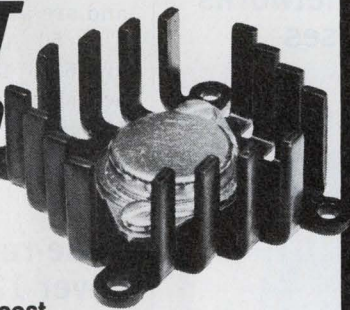

Thermalloy's
slant vane heat sink.

Thermalloy's new slant-vane heat sink improves heat dissipation per unit volume occupied through increased air flow and convection — with less weight and lower cost.

Six models available: four for single device and two for multiple device applications. Slant sinks are stocked for TO-3, TO-66 hole patterns, or blank for special pattern drilling. Single device bases are 1.81" square, heights .50" through 1.25".

For more information, write for FREE catalog.



Thermalloy

8717 DIPLOMACY ROW • DALLAS, TEXAS 75247
PHONE: 214/637-3333 • TWX: 910/861-4410

INFORMATION RETRIEVAL NUMBER 59

ELECTRONIC DESIGN 24, November 25, 1971

"Everything you need to know about yoke selection."

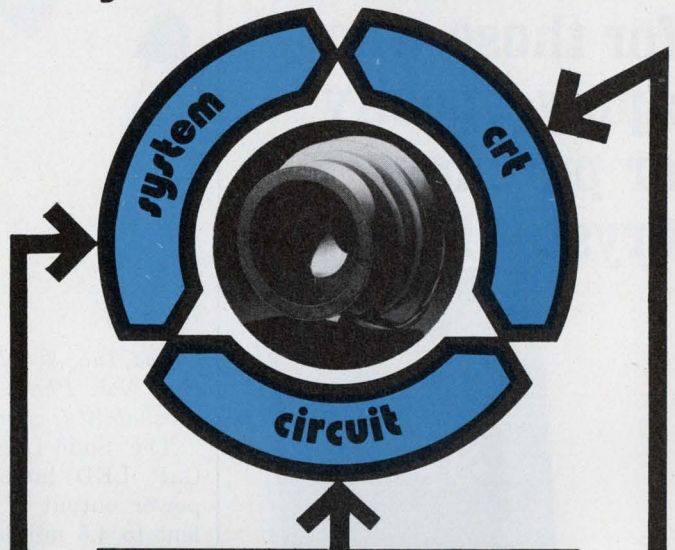

Yoke selection involves consideration of many interacting factors: the requirements of the display system, the cathode ray tube to be used, and the circuitry involved.

SYNTRONIC'S YOKE SELECTOR, based on twenty years of experience in the design and manufacture of yokes, has been developed to explain some of these interactions, and to provide you with a checklist of information to be evaluated by our yoke specialists.

As a result of thorough evaluation, a yoke of more reasonable cost can often be used when it is possible to allow some small trade-off variations in these interacting factors.

In using this yoke selector it is not necessary for you to become deeply involved in the design of the yoke. By filling out the APPLICATION CHECKLIST included, and submitting it to our engineers, you can make sure that all factors will be considered and that we will be able to recommend a yoke design that will be best suited for your application.

FREE YOKE SELECTOR



SYNTRONIC INSTRUMENTS, INC.
100 Industrial Road Addison, Ill. 60101 (312) 543-6444

INFORMATION RETRIEVAL NUMBER 60

The 'Answer Manual' for those who apply, specify or purchase Crystal Filters

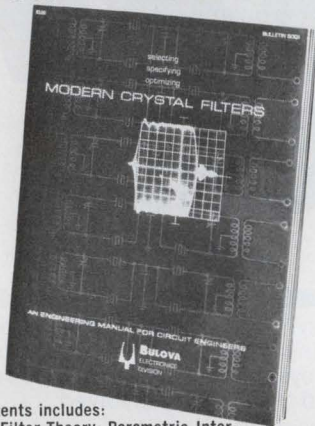

Table of Contents includes: materials on Filter Theory; Parametric Interdependence; Practical Considerations of Packaging vs. Performance; Specifying for Optimum Design; & Design Trade-offs for Maximum Performance/Minimum Cost.

Prepared by network designers who have pioneered the evolution of the modern crystal filter, this Bulova 'Answer Manual' contains all you need to know to Select, Specify and Optimize Modern Crystal Filters. Details the procedures to follow to get . . . • best performance per dollar • best performance per unit/weight • lowest cost for given requirement • highest quality, regardless of design. If your business is circuit designing, you need the Bulova Answer Manual "Selecting, Specifying, Optimizing Modern Crystal Filters." The cost to you of only \$3.00 will more than be made up by the man-hours and materials saved. Just fill out the request form below so that you can start saving immediately.



Electronics Division of Bulova Watch Co., Inc.
61-20 Woodside Ave., Woodside, N. Y. 11377

BULOVA WATCH COMPANY, INC.
ELECTRONICS DIVISION
61-20 Woodside Avenue, Woodside, N. Y. 11377

Gentlemen:

I would like to order a copy of your 'Answer Manual' entitled "Selecting, Specifying, Optimizing Modern Crystal Filters."

Check or Money Order
for \$3.00 is enclosed.

Name _____

Firm _____

Street _____

City, State, Zip _____

INFORMATION RETRIEVAL NUMBER 61

COMPONENTS

GaP red LED lamp delivers 4.5 millilumens

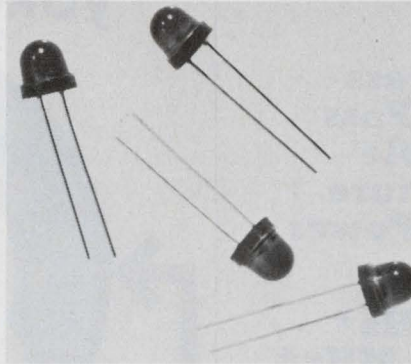

Opcoa, Inc., 330 Talmadge Rd., Edison, N.J. Phone: (201) 287-0355. Availability: stock.

The Solid-Lite type OSL-3 red GaP LED lamp provides optical power output of 225 μ W (equivalent to 4.5 millilumens at 15 mA). The lamp uses a diffused red plastic dome to distribute the light evenly. It can be viewed at a wide ± 90 -degree angle from the head-on axis. The lamp's two leads are spaced on 0.1-in. centers. Typical forward characteristics are 2.1 V at 15 mA.

CIRCLE NO. 292

Binary ladder networks come in DIP cases

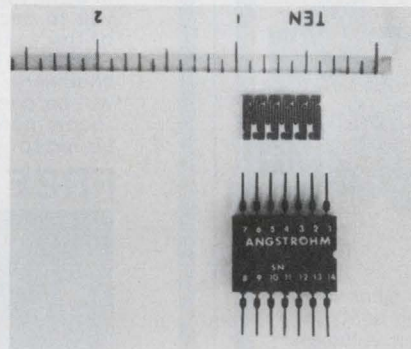

Ward Leonard, Box 1827, Hagerstown, Md. Phone: (301) 739-8722. P&A: \$20.38 (100 quantities of 10-bit, 1/2-LSB models); 4 to 6 wks.

New R-2R ladder networks are available in dual-in-line packages. The networks can be supplied with up to 12 bits at accuracies of 1/2 LSB. Values of R-2R can be supplied up to 10-20 k Ω . Compensation for switching transistor resistance can also be provided. Circuit types available are binary, summation and BCD.

CIRCLE NO. 293

LC bandpass filters come in similar sets

Cambridge Thermionic Corp., 445 Concord Ave., Cambridge, Mass. Phone: (617) 491-5400.

Designed as two sets, new LC bandpass filters have similar shape factors, terminating impedances, contiguous passbands and the same packaging. Set #535-7134-(01/08) are high-order Elliptic-function filters. Set #535-7135-(01/08) are 4th-order Chebyshev filters. Each filter is packaged in an epoxy case with standard PC-board spacing dimensions.

CIRCLE NO. 294

Miniature relays mount on PC boards

Guardian Electric Mfg. Co., 1550 W. Carroll Ave., Chicago, Ill. Phone: (312) 243-1100.

A compact new series of miniature enclosed two and single-pole relays with terminals on 0.1-in. grid spacing permit mounting directly to PC boards or through a chassis cutout using a special mating socket. The series 1360 relays measure 1-1/16 by 1-3/32 by 1 in. and are available with ratings from 5 to 50 A. Standard coil voltages are 6 to 48 V dc and 6 to 120 V ac. Mechanical life expectancy is 10,000,000 operations.

CIRCLE NO. 295

Wide-range capacitors cover 120 to 22,000 pF

Paktron Div. of Illinois Tool Works, Inc., 1321 Leslie Ave., Alexandria, Va. Phone: (703) 548-4400.

A new line of polypropylene capacitors called the Micromatic type PP is specially designed to provide a broad range of low capacitance values. Capacitors are available in a standard range of 120 to 22,000 pF. Performance features include low inductance and negative temperature coefficient, high insulation and moisture resistance and low dissipation factor.

CIRCLE NO. 296

REQUESTED DATA DELIVERY SERVICE is here, inside front cover.

Displays

We pioneered the 7-segment display field with the MAN1, .270" character. We also have the MAN1A — same character height with a red lens.

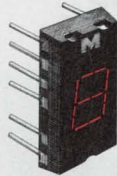

For smaller character requirements we have the MAN3A, .115" character height, red epoxy lens.

We also have displays with character heights of .127", .190", and .350" and in different package configurations.

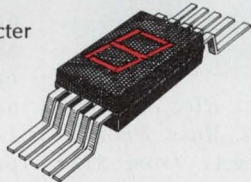

Display Module

Monsanto display modules, with complete driving circuitry built in, save design time and money. This option provides a clean "building block" approach with minimum engineering. Available for 7-segment or alpha-numeric displays, in many sizes.

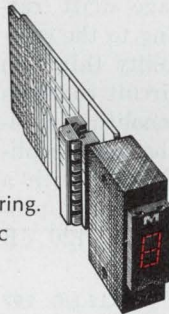

Visible and IR Discretes

The MV5025 red GaAsLITE features wide-angle viewing with its fully-flooded lens design and solid state reliability. The same package is available with other lens designs; all of them come with a snap-in clip for easy panel mounting.

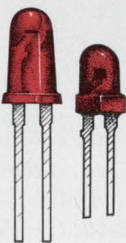

The MV50 gives you an extremely bright source in a small package. It can be mounted on 100-mil centers and features long-life and low cost. We have many more visible GaAsLITES available, as well as a full line of infrared light emitting diodes. They all have Monsanto's experience and dependability behind them.

GaAsLITE Update LITE Heavyweights

Monsanto has produced more GaAsLITE products than all other manufacturers combined. We're pretty proud of that: it means experience, production capability, reliable products. Take a look at some of the LITE Heavyweights available at distributors near you.

Opto-Isolators

Monsanto has a full line of opto-isolators that couple light emitting diodes to photo-transistors, photo-diodes, photo SCR's, and photo-darlingtons. The new MCA2 Photo-darlington coupled pair can be used to replace reed and mercury wetted relays and pulse transformers.

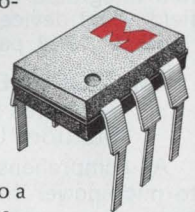

Our MCT2 couples a GaAsLITE emitter to a photo-transistor for use in many business machines, computers, and control applications. There are many more products in our coupled pair line. Complete information is available in our new catalog.

Arrays

Our custom array product group is available to you for all types of specific array applications. We offer 3½ and 4 digit arrays and multi-diode linear arrays. If you have a requirement, we invite your inquiry.

LITE Heavyweights — on the shelf at our distributors — in quantity. Call today to order or to discuss product applications.

U.S. GaAsLITE Distributors

Elmar Electronics **Schweber Electronics**
Kierulff Electronics **Semiconductor Specialists**
K-T/Wesco **Western Radio**
Liberty Electronics

Monsanto

For additional technical information write
Monsanto Electronic Special Products
10131 Bubb Road, Cupertino, California 95014
(408) 257-2140

Look Into These Design Aids from Wiley-Interscience

FIELD-EFFECT ELECTRONICS

By W. Gosling, T. G. Townsend, and J. Watson, all of University College of Swansea, Wales

Here is the most complete text available on the theory and applications of field-effect transistors and allied devices. Both junction and insulated gate transistors are given intensive coverage. In addition to describing the physics and applications of discrete devices, the book treats monolithic and film integrated circuits embodying field-effect devices.

1971 364 pages \$22.00

MICROPOWER CIRCUITS

By James D. Meindl, Stanford University

A comprehensive introduction to micropower circuit design, this book deals with the problem of achieving a given electronic circuit function with the minimum possible expenditure of energy. The author shows that the power drain of virtually all basic types of transistor and integrated circuits can be reduced by an order of magnitude or more if appropriate novel micropower design techniques are employed.

1969 260 pages illus. \$11.50

ELECTRICAL TRANSIENTS IN POWER SYSTEMS

By Allan Greenwood, General Electric Company

Elucidating the fundamentals of electrical transients, this volume enables engineers and students to recognize and solve transient problem in networks and components. It is relevant to today's systems. The Laplace transform method is used for analytical work, and digital and analog computer techniques are introduced. In addition, there are descriptions of transient measuring equipment and measuring methods, along with transients in D. C. systems and conversion equipment.

1971 544 pages \$22.50

wiley

WILEY-INTERSCIENCE

a division of JOHN WILEY & SONS, Inc.
605 Third Avenue, New York, N. Y. 10016
In Canada:
22 Worcester Road, Rexdale, Ontario

ICs & SEMICONDUCTORS

Monolithic op amp drifts only 1 $\mu\text{V}/^\circ\text{C}$

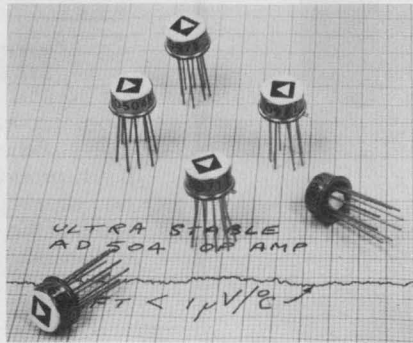

Analog Devices, Inc., Rte. 1 Industrial Park, Norwood, Mass. Phone: (617) 329-4700. P&A: from \$14 (100 quantities); stock.

The AD504 monolithic IC op amp features offset voltage drift ratings of 1 $\mu\text{V}/^\circ\text{C}$ owing to the combination of high-stability thin-film resistors with new circuit concepts and sophisticated monolithic processing techniques. The new amplifier handles 1000-pF loads with a single compensation capacitor, provides dc gain of 10⁶ and 120 dB of common-mode rejection.

CIRCLE NO. 297

Quad-transistor memory driver comes in a DIP

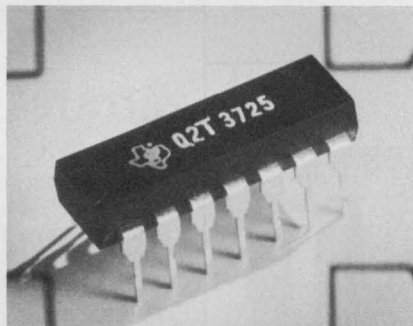

Texas Instruments, Inc., 13500 N. Central Expwy., Dallas, Tex. Phone: (214) 238-2011. P&A: \$3.65 (100 quantities); stock.

A new quad-transistor memory driver replaces four discrete 2N3725 transistors and allows designers to reduce PC-board space up to 70%. Offered in a 14-pin plastic DIP, the Q2T3725 features a guaranteed beta of 30 minimum at 500 mA. This second-source product exhibits a 40-V collector-emitter breakdown voltage and a collector-base breakdown voltage of 60 V.

CIRCLE NO. 298

CMOS analog multiplexer draws 15 nA at 15 V

Ragen Semiconductor, Inc., 53 S. Jefferson Rd., Whippany, N.J. Phone: (201) 887-4141. P&A: \$14.40 (100 quantities); stock.

A new monolithic CMOS 8-channel analog multiplexer features three-bit decoding and chip select. The new model MS-504 operates over the full $\pm 8\text{-V}$ signal range and features ultra-low power dissipation of 50 nA at 15 V. It has low ON impedance—100 Ω at 15 V and high OFF impedance of 10¹⁰ Ω . Less than 0.5 pF of coupling is present between any two pins and switching speed is 50 ns.

CIRCLE NO. 299

64-bit bipolar RAM accesses in 35 ns

Signetics, 811 E. Arques Ave., Sunnyvale, Calif. Phone: (408) 739-7700. P&A: \$6.94 (100 quantities); stock.

A 64-bit bipolar read-write 35-ns-access RAM organized as 16 words of 4 bits each is available for applications in scratch-pad and high-speed buffer memories. Words are selected through the 8225's 4-input binary decoder when the chip select input is at logic "0". Data is written into the memory when the read enable is at logic "0" and read from memory when it is at logic "1".

CIRCLE NO. 300

Four-channel IC op amp offers wide usage range

Harris Semiconductor, Melbourne, Fla. Phone: (305) 727-5430. P&A: \$10.45 (100 quantities); stock.

A new four-channel op amp known as the HA-2400 PRAM consists of four digitally selectable input stages sharing a common output stage. The selected input channel combined with the output stage forms a high performance op amp. Versatility is achieved by connecting similar or different feedback networks from the single output to each of the four input stages. The device can then be used to select and condition several input signals.

CIRCLE NO. 301

Where the answers are HAYDEN guides to computer equipment, languages, techniques, terminology

MODERN DATA COMMUNICATION: Concepts, Language and Media

William P. Davenport. This pioneering guide to a complex area of EDP provides an up-to-date working knowledge of how information is transmitted and received through electrical and electronic systems. Eliminating advanced mathematics, the book gets to the core of intricate theories and concepts, such as coding, channel capacity, and modulation and multiplexing. It describes limiting characteristics of transmission media, discusses efficiency and error control methods, and explores commercially available communications services. Both an in-depth introduction and a practical reference, this comprehensive source enables the data systems manager, engineer, student or technician to evaluate today's transmitting techniques and tomorrow's potential applications. 208 pp., 6 x 9, illus., cloth, #5810, \$7.95.

New and widely used programming texts

BEGINNING FORTRAN: Simplified 12-Statement Programming

J. Maniotes, H. B. Higley, and J. N. Haag. This new text teaches programming in Gotran, a subset of Fortran that can be mastered in only 10 to 15 classroom hours. From the outset portions of the Gotran language are applied in writing complete programs. Problems and end-of-chapter exercises reflect a wide range of practical applications. 260 pp., 7 1/8 x 9 3/4, illus., paper, #5869; cloth, #5870.

COMPREHENSIVE FORTRAN PROGRAMMING

James N. Haag. The highly successful course in Fortran II teaches the language as used by the IBM 1620 computer with an attached 1311 Disk Drive, with adaptations to suit other systems. 246 pp., 7 3/8 x 10 1/8, illus., paper, #5646, \$5.95.

BASICS OF DIGITAL COMPUTER PROGRAMMING

John S. Murphy. Providing a thorough introduction to business-data programming, this clearly written text uses general problems to illustrate practical computer applications. Discussion is clarified through continual reference to the organization of a typical computer. 118 pp., 6 x 9, illus., paper, #0405, \$3.95.

STANDARD DICTIONARY OF COMPUTERS AND INFORMATION PROCESSING

Martin H. Weik. Encompassing more than 10,000 hardware and software terms in general use throughout the field of computers and their applications, this authoritative reference has been widely praised for its detailed definitions, broad scope, and numerous illustrative examples. Thorough cross-referencing permits complete mastery of the vocabulary of hundreds of topics: programming and computer engineering to input-output devices and checking systems. The Computer Tree, reproduced on the end papers, traces the lineage of hundreds of computer models built to date. Up-to-date and thorough in every respect, this dictionary will prove indispensable to technical and non-technical personnel as well as trainees and students. 336 pp., 6 x 9, illus., cloth, #5677, \$10.95

BASIC BASIC: An Introduction to Com- puter Programming in Basic Language

James S. Coan. This text can be studied along with an existing math course or as a separate programming course. Progressing from short, complete programs to more sophisticated problems, it encourages the use of flowcharts as an aid in program-writing. 272 pp., 6 x 9, illus., paper, #5872, \$5.95; cloth, #5873, \$7.95.

COMPREHENSIVE STANDARD FORTRAN PROGRAMMING

James N. Haag. This well organized course uses sample problems from a variety of fields to teach how to program using the full version of Fortran IV as standardized by the U.S.A. Standards Institute. 312 pp., 7 3/8 x 10 1/8, illus., paper, #5811, \$6.95; cloth, #5812, \$8.95.

DISCOVERING BASIC: A Problem Solving Approach

Robert E. Smith. The reader begins programming on page three of this practical course, learning the vocabulary of Basic by working with it. The brief lessons and problems are reinforced by over forty pages of programs. 224 pp., 5 3/8 x 8 1/4, illus., paper, #5783, \$5.95; cloth, #5784, \$7.95.

BASICS OF DIGITAL COMPUTERS, Revised Second Edition

John S. Murphy. This profusely illustrated, three-volume work provides a thorough grounding in today's equipment and systems. It explains how data is programmed into the machine, discusses the function of individual components, and covers linkup and control of an overall system. 391 pp., 6 x 9, illus. 3 vol. set, paper, #0737, \$11.25; 3 vol. combined cloth, #0741, \$9.95; indiv. paper vols., #'s 0738-40, \$3.75.

BASICS OF DIGITAL COMPUTERS TRANSPARENCIES

Based on Murphy's widely acclaimed text, these two-color overhead transparencies illuminate the essential principles that underlie modern computers and systems. The series is available as a complete set of 125, or as ten separate subsets. Set, #6860, \$231.00. Write for complete brochure or 35mm film-strip preview.

UNDERSTANDING DIGITAL COMPUTERS

Ronald Benrey. Layman's guide describes computers in terms of building blocks that make up a system. Stressing the function of these elements, it explains programming, binary arithmetic, logical design, and other topics. 166 pp., 6 x 9, illus., paper, #0473, \$4.75.

DIGITAL MAGNETIC TAPE RECORDING: Principles and Computer Applications

Bernard B. Bycer. This unique design tool fully describes functions and operations. Data on specification, purchase, and use of the equipment is included. 328 pp., 6 x 9, illus., cloth, #5031, \$12.50.

COMPUTER ARITHMETIC

Henry Jacobowitz. A review of all positional number systems with applications in computers, this compact book explains binary, octal, hexadecimal, and ternary arithmetic, along with conversion methods. 128 pp., 5 1/2 x 8 1/2, illus., paper, #0297, \$3.75

COMPUTER NUMBERING SYSTEMS AND BINARY ARITHMETIC

Training Systems, Inc. and Stanley L. Levine. This programmed course proceeds gradually through all the required mathematical processes. No previous knowledge of binary or octal numbering systems, or computers, is needed. 232 pp., 6 x 9, paper, #0380, \$5.45.

FOR 15-DAY FREE EXAMINATION

Please send the book(s) circled on a 15-day examination basis. At the end of that time, I will remit payment, plus postage, or return the book(s) without further obligation.

5810 5869 5870 5646 0405 5677 5872 5873 5811 5812 5783
5784 0737 0741 0738 0739 0740 6860 0473 5031 0297 0380

\$10.00 minimum for free exam orders. Because of higher billing and collection costs, we must ask for payment in full with any order under \$10.00. Books will be shipped postpaid. Same 15-day return privilege for full refund if not satisfied.



Hayden Book Company, Inc., 116 West 14th St., New York, N.Y. 10011

NAME _____

FIRM _____

ADDRESS _____

CITY/STATE _____ ZIP _____

Save money! On all pre-paid orders Hayden pays postage—same return privilege!

71-91.

Digital microwave power meters provide BCD



Hewlett Packard, 1501 Page Mill Rd., Palo Alto, Calif. Phone: (415) 493-1501. P&A: \$975, \$1375; 45 to 60 days.

Model 432B microwave power meter has a digital readout and a BCD output. Another meter, model 432C, augments those features with auto-ranging and programmability forming a systems-oriented microwave a/d-converter-plus-meter. The two new meters use the same thermistor mounts that give coaxial coverage from 1 MHz to 18 GHz, and waveguide coverage from 2.6 to 40 GHz. Power is measured in four ranges from 10 μ W to 10 mW full scale.

CIRCLE NO. 302

Portable pyrometer checks -50 to +1500°F



Triplet Corp., Bluffton, Ohio. Phone: (419) 358-5015. Price: \$95.

The Model 825 portable pyrometer is built for use as a temperature standard with measuring ranges of -50 to +1500°F and -50 to +800°C. It requires no user calibration and utilizes an electrical compensation circuit for ambient-temperature changes. It is built with a large 8-in. easy-to-read mirrored-scale dial.

CIRCLE NO. 303

160-MHz synthesizer lowers cost and noise



John Fluke Mfg. Co., Box 7428, Seattle, Wash. Phone: (206) 774-2211. P&A: \$4995; 30 to 60 days.

A new low-cost frequency synthesizer known as the model 6160A features typical phase noise lower than -62 dB and frequency coverage of 1 to 160 MHz. Its spurious content ranges from -70 to -100 dB. Automatic level control is available to provide better than ± 1 dB of flatness. The model 6160A is BCD programmable with TTL positive logic. Stability is 2 parts in 10⁹/24 hours.

CIRCLE NO. 304

Low-cost DVM has many features



Non-Linear Systems, Inc., Box N, Del Mar, Calif. Phone: (714) 755-1134. P&A: \$1000; Oct. 1971.

The low-cost MX-1 is a 5-1/2-digit DVM with standard automatic ranging, dc-voltage measurement capability and a fast active filter. Ratio and printer outputs are optional. Dc voltage is measured from 100 μ V to 1000 V in 3 ranges and ac voltage is measured from 10 μ V to 500 V in 4 ranges. Ratio is measured from 0.001% to 12,000% of input reference in 3 ranges.

CIRCLE NO. 305

10-MHz 3-1/2-digit DVM resolves 10 μ V



Schlumberger, 57 Rue de Paris, 92-Bagneux, France.

A new ac digital voltmeter features resolution as high as 10 μ V over a 20-Hz-to-10-MHz bandwidth. The MVN713 has 0.1% accuracy. Readout is available either in volts or in dB. The instrument offers ten voltage ranges from 10 mV to 300 V and ten dB ranges from -40 to +50 dB with 0.02-dB resolution. Three outputs are available: direct access to the amplifier, an analog recorder output and BCD printer output.

CIRCLE NO. 306

Digital bridge reads two things at once

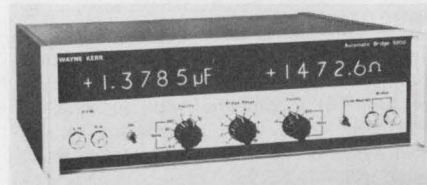

Wayne Kerr Co., Ltd., Surrey, England.

A new audio-frequency bridge has two digital displays that automatically provide readings of component characteristics as well as voltage values. Measurements are shown in the particular units of the quantity being measured— μ F, Ω , mH, etc. Known as the B900, it provides readings of capacitance, inductance or the reciprocal of capacitance on one display; and of resistance, conductance, loss factor (tan d) and Q on the other.

CIRCLE NO. 307

A new, free Hayden Service for you, inside front cover.

2 1/2¢ per chip!

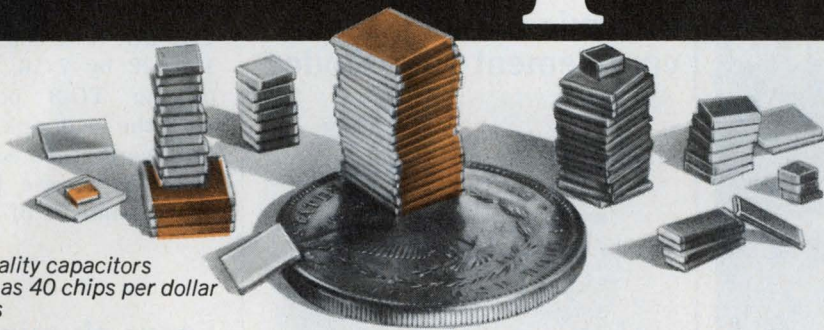

**These highest quality capacitors are priced as low as 40 chips per dollar in quantity orders*

Electro Materials compact monolithic ceramic chip capacitors exhibit quality levels developed for the tight specs of the aerospace/defense industry. But prices are now low enough to allow their use throughout the consumer electronics, computer and general communications fields. All because of Electro Materials' advanced automated production techniques. And looking at the total picture, they cost even less because they attach directly to substrates, headers, or printed circuit

boards. Right now these high volume efficiency capacitors are available in 25-, 50-, 100- and 200- volt ratings, in capacitance values from 0.47 pf to 4.7 mfd. In-depth stocks provide "when-needed" availability to fill most requirements. And for special capacitance problems, they can be tailored to the electrical, environmental and mechanical characteristics you need. Check with your Electro Materials distributor. For address,

catalog, and free samples, call or write:
**Electro Materials,
Division Illinois
Tool Works Inc.,
11620 Sorrento
Valley Road,
San Diego, Cal.
Ph. (714) 459-4355.
TWX
910-322-1130.**



ELECTRO MATERIALS

The Innovating Electronic Group of ITW... ELECTRO MATERIALS • PAKTRON • LICON

LET GPS HELP YOU
THINK FUNCTIONS

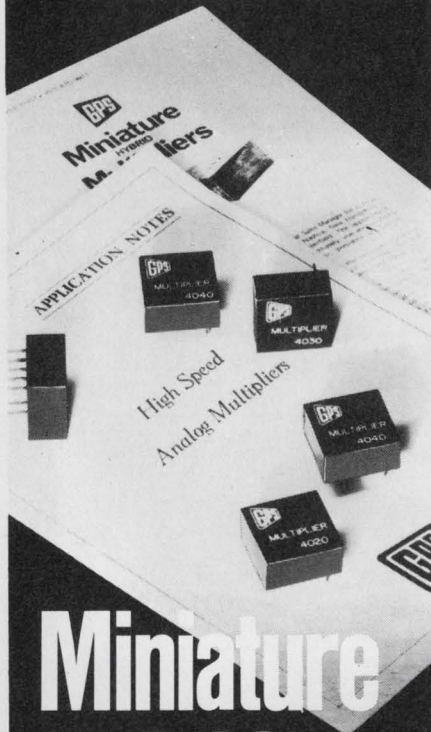

Miniature Hybrid Multipliers

- Available from stock.
- 6 different models with accuracies from 0.1% to 5%.
- Priced from \$45 in quantity.
- Completely self-contained and buffered inputs.
- Occupies one half cubic inch.
- Applications include modulation - demodulation, voltage controlled amplification, correlation, wattmeters.

Write for descriptive brochure and application notes to:

GPS CORPORATION
14 Burr Street,
Framingham, Mass. 01701
(617) 875-0607



GPS — The Complete Source for
Compatible Operational Elements.

PACKAGING & MATERIALS

19-in. blower unit delivers 515 CFM

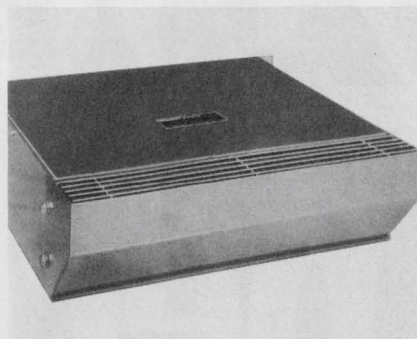

McLean Engineering Laboratories, Princeton Junction, N. J. Phone: (609) 799-0100.

A new air blower known as the Sidewinder employs flat blower wheels mounted sideways in a 19-in. unit to deliver up to 515 cubic feet/minute of air in an airstream 17-in. wide. The Sidewinder model 1EB921C is also quiet. The slow blower speed and high back pressure result in very low audible levels. The unit comes ready for quick and easy installation.

CIRCLE NO. 340

Ceramic-to-metal seals complement Gunn diodes

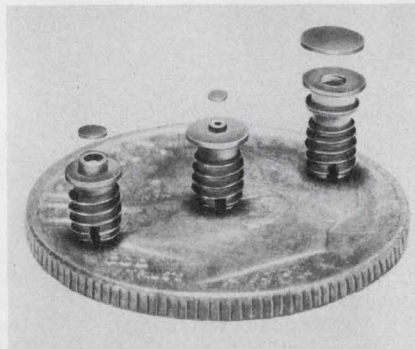

Electro Ceramic Industries, 75 Kennedy St., Hackensack, N.J. Phone: (201) 342-2630. Availability: stock.

Minipak is a new series of three ceramic-to-metal seal packages for use by manufacturers of Gunn (and similar) type diodes. Ranging from a 0.012-in.-dia pedestal with a 0.015-in. ceramic inside dia through the largest of three sizes with a 0.04-in. pedestal and a 0.05-in. ceramic inside dia, these packages are plated with a minimum of 100 μ in. of pure gold (more if specified).

CIRCLE NO. 341

Breadboard has plug-in distribution system

AP, Inc., 72 Corwin Dr., Painesville, Ohio. Phone: (216) 357-5597. P&A: \$60; stock.

Twenty-four buses, each with 25 connected plug-in terminals, provide an integral power/signal distribution system within the new Superboard I circuit development breadboard. The buses are conveniently located adjacent to matrices of 1920 component plug-in terminals for fast circuitry checkout. A front-mounted turret post allows direct ground-plane attachment on the back of the board.

CIRCLE NO. 342

PC-board heat sink raises TO-3 dissipation

International Electronic Research Corp., 135 W. Magnolia Blvd., Burbank, Calif. Phone: (213) 849-2481. Price: 25¢ (unplated).

Pairs of TO-3 semiconductor devices can be operated at over twice the power with no increase in case-temperature rise by using a new heat dissipator. Designated UP10-TO3-2U, it measures only 3-3/8 by 1-13/32 by 7/16. in. In tests employing TO-3 power transistors with the heat sink, the semiconductors were operated at 23 W in still air with a case temperature rise above ambient of 120°C.

CIRCLE NO. 343

Large alumina substrate is only 0.01-in. thin

Materials Research Corp., Orangeburg, N.Y. Phone: (914) 359-4200. Availability: stock to 3 wks.

New 0.01-in.-thick alumina substrate materials in large sizes up to 3-3/4 by 4-1/2 in. are available. The thin new Superstrates are composed of 99.5% alumina and retain the superior physical and electrical properties of the standard 0.027-in.-thick substrates. Other popular thicknesses are available—0.02, 0.027, 0.035 and 0.04 in.

CIRCLE NO. 344

A new, free Hayden Service for you, see inside front cover.

New! Low-profile keyboards

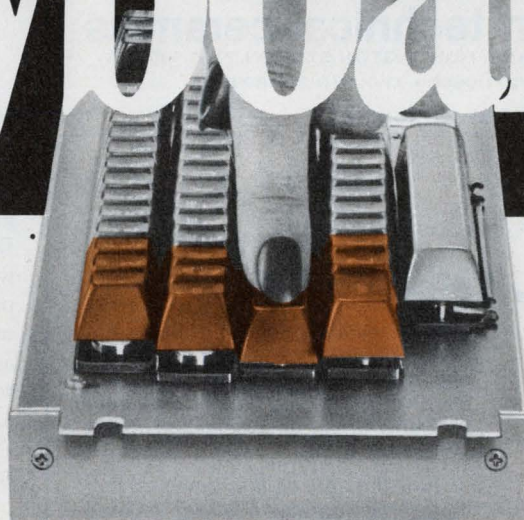

*New key station design
permits extra-thin keyboards*

The new Licon® low-profile keyboard is less than one inch high from mounting tabs to bottom. All IC components are protected inside the keyboard assembly. The key station has an ultrasonically welded thermo-plastic housing and umbrella type button to provide splash-proof security. Keeps out spilled sugar-content beverages, hairpins, paperclips and other common external causes of keyboard malfunction. And it's still based on Licon's proven reliable, low-cost

magnetic core switching device. With encoding right at the switch. All solid state, but simple! No diode matrix, no mechanical linkages, no make-and-break contacts. Very low power requirement, yet high-level output with outstanding signal-to-noise ratio. Licon keyboards are available with every option you may need, including Licon's N-key rollover that substantially eliminates the transmission of false codes. Bailing feature also available, as well as double depression and alternate key

stations. Interface with your equipment with a simple, plug-in connector. For full information on low-profile and light-weight keyboards, send for brochure or demonstration.
Licon, Division Illinois Tool Works Inc. 6615 W. Irving Park Road, Chicago, Ill. 60634. Phone (312) 282-4040.



itw LICON

The Innovating Electronic Group of ITW... LICON ■ ELECTRO MATERIALS ■ PAKTRON

LEADS

- for P.C. board mounting
- for microstrip connection
- that will withstand temperature to 1500°F

to connect your circuit, with low series inductance, into the finest UHF/MICROWAVE CAPACITOR available.



WANT MORE INFORMATION? Circle the reader interest number listed below

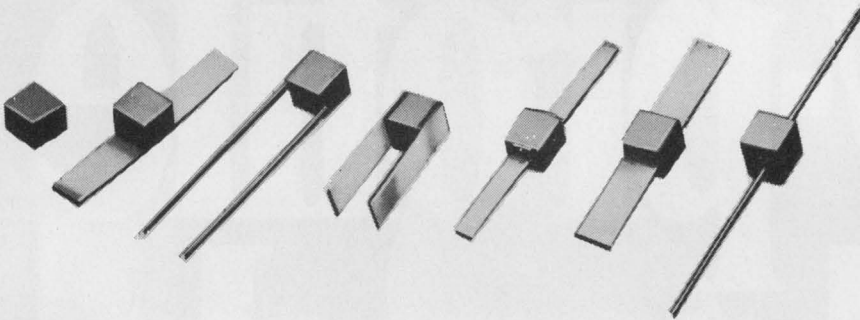

UHF/MICROWAVE CAPACITORS

american technical ceramics

1 NORDEN LANE, HUNTINGTON STATION, N. Y. 11746
516/271-9600 • TWX-510-226-6993

INFORMATION RETRIEVAL NUMBER 68

application notes

Microprogramming guide

A 25-page microprogramming implementation guide outlines third-generation computer architecture and the advantages and methods of implementing microprogramming. A detailed description of microprogrammed system data flow is explained. The use and advantages of alterable-core ROMs is described with a detail cost/performance curve analysis. The booklet also explains the development of a microprogram in a typical central processor. Computer software aids for microprogramming are outlined and a cost comparison analysis is given between second and third-generation architecture. Datapac Inc., Santa Ana, Calif.

CIRCLE NO. 345

Microwave capacitor design

A copy of a technical paper recently delivered at ISHM in Chicago and entitled "Chip Capacitor Dielectric Effects on Hybrid Microwave Amplifiers" is available. This paper is of great value to readers who work in the area of rf design, as it helps remove the magic from some of the effects noted with microwave components. American Technical Ceramics, Huntington, Station, N.Y.

CIRCLE NO. 346

Correcting tape errors

For those who use 9-track digital tape systems, a handy 20-page document on Cyclic Redundancy Check Character (CRCC)—an error-correction technique employing a modified cyclic code in conjunction with character parity—is available. The technique can correct error bursts of unlimited length in any one of the nine tracks of IBM-formatted digital tapes. A thorough explanation is given, supported by diagrams and tables. Pertec Corp., Chatsworth, Calif.

CIRCLE NO. 347

Meals in minutes, helped by Hansen

The microwave electronic oven is the newest kitchen miracle. It cooks a cupcake in 15 seconds. A hot dog in 30. This one by the Heath Company is doubly unique. It comes in Heath's famous kit form.

Hansen supplies the Synchron® motor that operates a "stirrer" to keep the electronic cooking molecules evenly distributed throughout the oven. Synchron motors were selected because consumers expect appliances to last up to 20 years. Then, too, Heath has a reputation for top-quality components. Nothing but the finest will do for the sophisticated Heath do-it-yourselfer.

If you also require long life and dependability, specify Hansen Synchron motors.

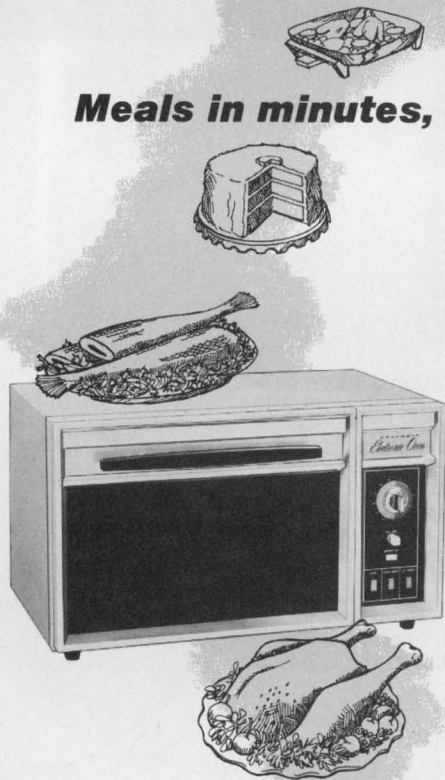

HANSEN

MFG. CO., INC.
Princeton, Indiana 47670

HANSEN REPRESENTATIVES: Carey & Associates, Houston and Dallas, Texas; R. S. Hopkins Co., Sherman Oaks, Calif.; Melchior Associates, Inc., San Carlos, Calif.; The Fromm Co., River Forest, Ill.; John Orr Associates, Grand Rapids, Mich.; H. C. Johnson Agency, Inc., Rochester, N.Y.; Winslow Electric Co., Essex, Conn.; Kiley Electric Co., Villanova, Pa.; Herbert Rude Associates, Inc., Teaneck, N.J.

Export Department: 2200 Shames Drive, Westbury, N.Y. 11590

INFORMATION RETRIEVAL NUMBER 69

5 new capacitor ideas.



Last year, nobody
could offer you any of these

From Paktron, the one U.S. company that keeps making news in film capacitor development and manufacturing automation advances. *Metalized Film Capacitors* for use in voltage multiplier circuits to replace and outperform more expensive ceramic disc capacitors. New *Paktron® Metalized Polypropylene Capacitors* for high voltage/high current application — up to 1200 volts. *Molded Polyester Capacitors*

designed for PC board use in the widest possible capacitance range and popular voltage ratings. *Micromatic® Type PP Polypropylene Capacitors* for specialized applications in the instrumentation and telecommunications industries. *Wrap and Fill Capacitors* that combine polycarbonate type performance with metalized type stability and miniaturization. For details on any of these — plus a long

line of standardized film capacitors — write to the domestic leader in film capacitors: **Paktron, Division Illinois Tool Works Inc., 1321 Leslie Ave., Alexandria, Va. 22301. Phone (703) 548-4400. TWX 710-832-9811.**



itw PAKTRON

The Innovating Electronic Group of ITW... PAKTRON ■ LICON ■ ELECTRO MATERIALS

new literature

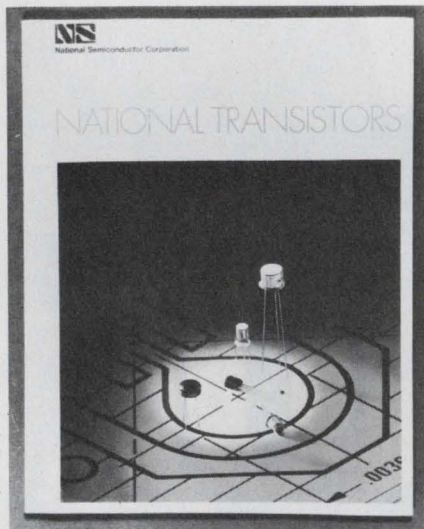

Transistors

A new 130-page transistor catalog provides complete data on National Semiconductor's entire transistor line including npn and pnp small-signal types and FETs. In addition to specifications, the catalog provides design and application data and test-limit information. A glossary of terms and package outlines are also provided. National Semiconductor Corp., Santa Clara, Calif.

CIRCLE NO. 348

Linear/digital ICs

A 48-page product guide covers RCA's comprehensive line of linear and digital ICs. RCA Solid State Div., Somerville, N.J.

CIRCLE NO. 349

Thumbwheel switches

Thumbwheel switches are illustrated in a 12-page brochure. Electronic Engineering Co. of Calif., Santa Ana, Calif.

CIRCLE NO. 350

Diode guide

Detailed specifications and dimensions are given in an eight-page catalog on a full line of voltage-variable capacitors, low-current zener, TC reference, logarithmic, high-voltage, multi-junction, noise and ultra-low-leakage diodes. CODI Semiconductor, Fair Lawn, N.J.

CIRCLE NO. 351

Data modules

An eight-page brochure describes data-input and programming techniques with miniature coding devices that are equivalent to 1-by-4 matrix boards or hexadecimal thumbwheel switches. Interswitch, Burlingame, Calif.

CIRCLE NO. 352

Fiber optic arrays

A brochure on custom fiber optic arrays covers the advantages of fiber optic technology in applications such as card/tape readers, including typical operating characteristics and examples of networks and modular design ideas. Sensor Technology, Inc., Van Nuys, Calif.

CIRCLE NO. 353

Semiconductor devices

A condensed catalog covering Solitron's full line of solid-state devices is available. These include single and dual FETs, linear ICs, ROMs and RAMs, dynamic and static shift registers and multiplexers. Solitron Devices, Inc., San Diego, Calif.

CIRCLE NO. 354

Rf coils and chokes

A new 80-page catalog describes a line of standard rf chokes, coils and related components. J. W. Miller Co., Compton, Calif.

CIRCLE NO. 355

I-f amplifiers

A 12-page catalog describes linear i-f, mixer and logarithmic amplifiers, limiters and pre-amplifiers. Environmental Communications, Inc., Santa Ana, Calif.

CIRCLE NO. 356

Relay socket

A 14-contact socket for 4pdt general-purpose relays is described in a new catalog sheet. Amphenol Industrial Div. of Bunker Ramo Corp., Chicago, Ill.

CIRCLE NO. 357

PC card frames

A 16-page catalog contains information on a complete line of PC card frames, kits and accessories. Vero Electronics, Inc., Hauppauge, N.Y.

CIRCLE NO. 358

Tape recorders

Descriptions and specifications of the Ampex line of instrumentation tape recorders are contained in short-form catalog. Ampex Corp., Redwood City, Calif.

CIRCLE NO. 359

Hardware

A new 24-page catalog features such diverse hardware items as IC terminal sockets available in pre-cut strips, microswitch connectors and terminals, 4pdt relay sockets (14 contact), edge connectors (straight-on, right-angle types) and PC photo sockets. Waldom Electronics, Inc., Chicago, Ill.

CIRCLE NO. 360

Permanent magnets

Magnetic and physical properties are shown for a line of Alnico permanent magnets in a 16-page catalog. Arnold Engineering Co., Mar-engo, Ill.

CIRCLE NO. 361

Connector patterns

Three basic continuous connector pattern types—insertion, staggered and in-line—are illustrated in a bulletin. Bishop Graphics, Inc., N. Hollywood, Calif.

CIRCLE NO. 362

Interconnection products

A short-form catalog comprehensively describes and illustrates connectors, terminals, wrapping posts, assembly machines, PC-board solder aids and interconnection systems. Berg Electronics, Inc., New Cumberland, Pa.

CIRCLE NO. 363

When RFI problems get sticky, try **stickn fingers**®

Attaches faster, shields better than anything else!

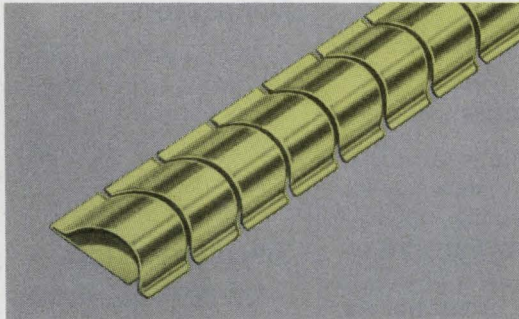

SERIES 97-500 The original Sticky Fingers with superior shielding effectiveness.

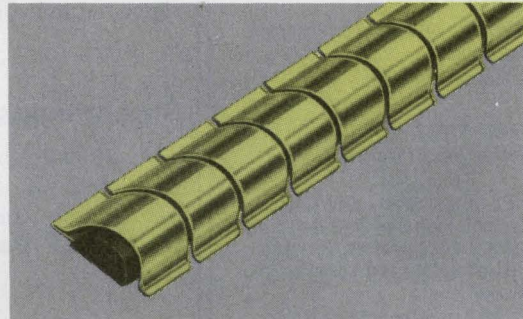

SERIES 97-510 Provides even better magnetic shielding with Magnefil® insert strips.

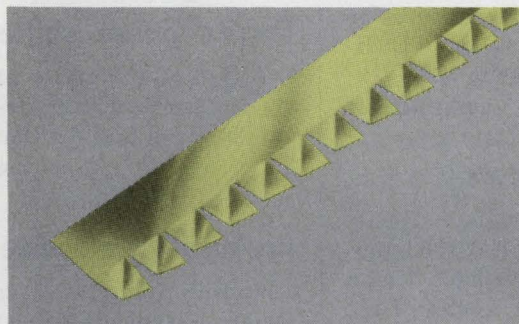

SERIES 97-555 New Single-Twist Series for use when space is at a premium. Measures a scant $\frac{3}{8}$ " wide.

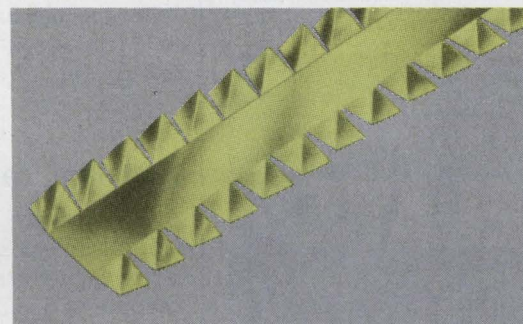

SERIES 97-560 New $\frac{1}{2}$ " wide Double-Twist Series, ideal for panel divider bar cabinets.

Now you can specify the exact type beryllium copper gasket that solves just about every RFI/EMI problem. Perfect for quick, simple installation; ideal for retro-fitting. Self-adhesive eliminates need for special tools or fasteners. Write for free samples and catalog.



INSTRUMENT SPECIALTIES COMPANY, Dept. ED-65

Little Falls, N.J. 07424

Phone—201-256-3500 • TWX—710-988-5732

PICTURE, PATTERN, OR PLOT

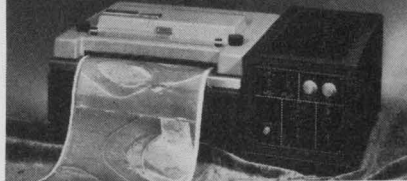

Alden recorder reproducing scanning electron microscope image of a 1 mil wire bond to an IC

Get sharp recordings displaying three dimensions and yielding greater detail and informational content than your present display with ALDEN COMPONENT FACSIMILE RECORDERS.

- Synchronizes easily with your scanning sensor or transducer
- Available in print-out widths from 2" to 48"
- Speeds range from 8 RPM to 3600 RPM
- Presentations, linear or non-linear . . . simply
- Used with a broad variety of systems such as ultrasonic/infrared flaw detectors, spectrum analyzers, computers, television, medical instrumentation and scanning radiometers, etc.

Call or write for free descriptive catalog.

ALDEN

ELECTRONIC &
IMPULSE RECORDING
EQUIPMENT CO., INC.

Westboro, Mass. 01581 Tel.: (617) 366-8851

INFORMATION RETRIEVAL NUMBER 72

LARGEST AND MOST DIVERSIFIED STOCK OF

RELAYS

IN THE WORLD!

We also stock MICROSWITCHES®

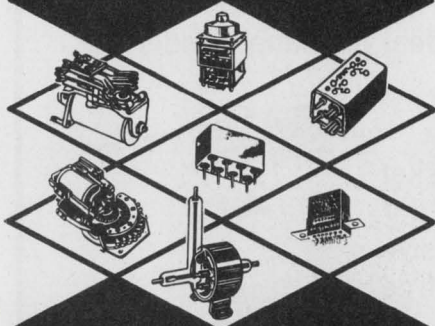

Faster Delivery / Lower Prices
All Types / Most Makes

SEND FOR
CATALOG E

Universal RELAY CORP.

42 White St., New York, N.Y. 10013
(212) 925-6900 • TWX 710-581-4461

©Honeywell, Inc.

INFORMATION RETRIEVAL NUMBER 73

NEW LITERATURE

COS/MOS ICs

An eight-page product guide covers RCA's broad line of COS/MOS CD400A series ICs. RCA Solid State Div., Somerville, N.J.

CIRCLE NO. 364

Transistor

A complete line of Teflon-insulated sockets and mounting devices for transistors and ICs is described in a 12-page catalog. Sealectro Corp., Mamaroneck, N.Y.

CIRCLE NO. 365

Synchronous motors

A 20-page bulletin is available with data on synchronous motors for timing and driving applications. AMF Paragon, Two Rivers, Wis.

CIRCLE NO. 366

Optical encoders

Some 1200 optical encoder configurations are shown within four different mechanical enclosures in an updated catalog. Data Technology, Inc., Watertown, Mass.

CIRCLE NO. 367

Tantalum capacitors

A catalog describing Kemet radial-lead epoxy dipped solid tantalum capacitors is available. Union Carbide Corp., Electronics Div., Greenville, S.C.

CIRCLE NO. 368

Voice-response systems

A brochure describes two voice-response units designed for use with any computer. Metrolab, Inc., a sub. of Cubic Corp., San Diego, Calif.

CIRCLE NO. 369

Automatic testers

"The Teradyne World of Automatic Testing," a 42-page catalog, describes and illustrates the firm's lines of test equipment for semi-conductors, passive components, relays, wiring harnesses, backplanes and other electronic devices. Teradyne, Inc., Boston, Mass.

CIRCLE NO. 370

IC packaging

New IC accessories and Wire-Wrap products and services are shown in a catalog. The booklet covers a complete line of high-density IC sockets, circuit boards, bread boards, card files, power planes, logic cards and other accessories. Cambridge Thermionic Corp., Cambridge, Mass.

CIRCLE NO. 371

Connectors

An illustrated eight-page bulletin outlines the advantages of dual-metal connectors. Berg Electronics, Inc., New Cumberland, Pa.

CIRCLE NO. 372

Silicon resistors

Silicon resistors with a positive-temperature coefficient are described in new data sheets. Ward Leonard, Hagerstown, Md.

CIRCLE NO. 373

Ferrite phase shifters

A line of 11 ferrite phase shifters is described in a six-page folder. Raytheon Co., Waltham, Mass.

CIRCLE NO. 374

Arc-discharge devices

A fully illustrated catalog describes a complete line of gas-filled arc-discharge devices applicable as circuit components, circuit protectors, and high-current transfer switches. Signalite, Neptune, N.J.

CIRCLE NO. 375

SCRs and triacs

A 12-page catalog describing in detail a new SCR and triac product line is available. Centralab Distributor Products, Milwaukee, Wis.

CIRCLE NO. 376

High-temp. furnaces

A two-page data sheet describes a line of 168 standard furnaces for high temperature processing. Aremco Products, Inc., Briarcliff Manor, N.Y.

CIRCLE NO. 377

bulletin board

Worth getting is the 1971 edition of the "Electronic News Financial Fact Book & Directory," with financial facts and figures on just about every public company in our industry. It's available for \$50 from Fairchild Publications, 7 E. 12th St., N.Y.C. 10003.

Stromberg DatagraphiX, Inc., San Diego, Calif., has announced a **breakthrough in computer-output microfilm system lease pricing** with its "pay-as-you-go" frame-usage lease plan. Through the plan, customers will be able to lease an entire on-line COM business system, complete with microfiche generating, processing and duplicating capabilities, for about the same price as the lowest-cost competitive online recorder alone.

CIRCLE NO. 378

Signetics, Sunnyvale, Calif., has an **MOS ROM IC that can generate the Japanese Katakana alphabet characters**. The 2560-bit static device comes in two versions: one encoded for the Katakana alphabet font (2513NX/CM2143) and another encoded with an ASCII Roman alphabet adapted to include the symbol for yen currency (2513NX/CM2170). Both cost \$18.10 each for quantities of 25 to 99.

CIRCLE NO. 379

A **broad line of unencapsulated linear ICs for hybrid design engineers** is available from RCA Solid State Div. Available in standard plastic, ceramic and TO-5 style packages, the line includes 32 devices.

CIRCLE NO. 380

Raytheon Semiconductor is second-sourcing the 9500 series of ECL ICs, originally introduced by Fairchild Semiconductor in 1970.

CIRCLE NO. 381

Memorex Corp., Santa Clara, Calif., is offering a **120-character/s terminal**.

CIRCLE NO. 382

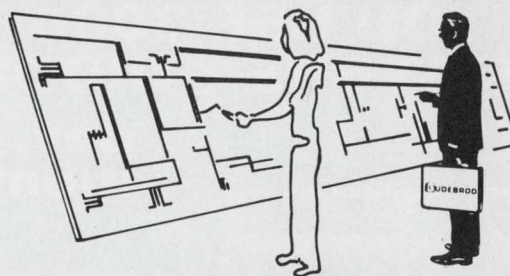

Talk to Gudebrod about your tying operation this month...

And about Lacing Tapes, harness rooms and systems. About temperature and vibration . . . speed and rejects! About Nylon, Dacron, Teflon, Nomex, Glass tapes and cords—treated and untreated . . . that meet or exceed military and industrial specifications, about cost comparisons with other methods . . . and all backed up with one hundred years of manufacturing knowledge.

Dacron, Teflon, Nomex—Du Pont Registered Trade Marks

Talk to Gudebrod this month!

Write to this address for prompt return of our Product Data Catalog.

Electronics Division
Dept. 4311

Gudebrod Bros. Silk Co., Inc. 12 South 12th Street, Philadelphia, Pa. 19107

INFORMATION RETRIEVAL NUMBER 74

Perfect mate for integrateds— Micro-Vectorbord® Tenth-Tenth Pattern "P"

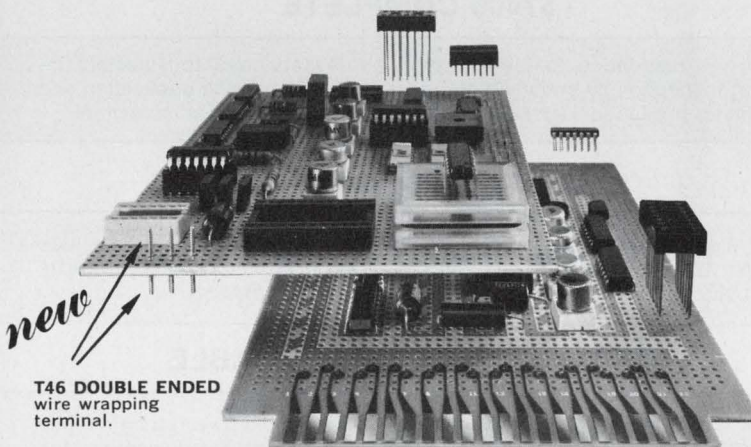

T46 DOUBLE ENDED wire wrapping terminal.

Precision punched .042" holes spaced .1" x .1" available in sheets of various sizes up to 8½" wide by 35" long, ¼" thick Epoxy Glass, Epoxy Paper, Phenolic.

Copper Clad and Non-Clad. Also available in Plugboards with etched or Elco Varicon contacts, buses, ground planes.

MINIATURE PUSH IN TERMINALS FOR .042" HOLES.



T44 MINIWRAP .025" Square, for wire-wrapping.



K27 .042" Diameter



T42-1 Micro-Klip

Vector

Send for complete literature

ELECTRONIC CO., INC.

12460 Gladstone Ave., Sylmar, California 91342

Phone (213) 365-9661 • TWX (910) 496-1539



INFORMATION RETRIEVAL NUMBER 75

DO YOU USE 3000 TRANSISTORS / DIODES

per
month?



NEW

FROM
LORLIN

Model T8BQ

FOR INCOMING INSPECTION

100% incoming inspection of discrete semiconductors is now economically feasible even if you use only 3000 devices a month. The new Lorlin Model T8BQ tester screens out defective transistors and diodes before assembly and substantially reduces the cost of trouble-shooting completed instruments both in the plant and in the field. In addition, inspection thruput is increased, and the quality of the finished product is enhanced. Write for Lorlin Application Note No. 38 to see how you can pay for a T8BQ with the first 33,700 devices you test.

\$7400 COMPLETE

Lorlin has responded to the industry's increased need to automate incoming inspection by streamlining a tester for this specific application and by refining production techniques to provide an economical instrument.

TESTS MOST DEVICES

Small signal through power devices are accommodated. Ranges include 0.1 nA - 10 A, 10 mV - 600V. Model T8BQ performs all common dc tests with 1% accuracy. An option is available for FET testing.

EASY TO USE - FAST - RELIABLE

Model T8BQ is an 8 test instrument, easily programmed by referring directly to the device data sheets. The operator simply inserts the device into the test socket, pushes the test button and instantly observes the test results on the fail indicators, one corresponding to each test. The tester is built and guaranteed for 10 years continuous service.

LORLIN MANUFACTURES A COMPLETE LINE OF DISCRETE COMPONENT TEST INSTRUMENTATION INCLUDING DIGIT SWITCH AND COMPUTER CONTROLLED SYSTEMS. SEND FOR DETAILED LITERATURE.



LORLIN industries inc.

Precision Road, Danbury, Conn. 06810 • (203) 744-0096

For Literature Circle 101

For Demonstration Circle 102

Electronic Design

ELECTRONIC DESIGN's function is:

- To aid progress in the electronics manufacturing industry by promoting good design.
- To give the electronics design engineer concepts and ideas that make his job easier and more productive.
- To provide a central source of timely electronics information.
- To promote two-way communication between manufacturer and engineer.

Want a subscription? ELECTRONIC DESIGN is sent free to qualified engineers and engineering managers doing design work, supervising design or setting standards in the United States and Western Europe. For a free subscription, use the postfree application form inside the back cover. If none is included, write to us direct for an application form.

If you do not qualify, you may take out a paid subscription for \$25 a year in the U.S.A., \$35 a year elsewhere. Single copies are \$1.50 each.

If you change your address, send us an old mailing label and your new address; there is generally a prepaid postcard for this inside the back cover. You will have to requalify to continue receiving ELECTRONIC DESIGN free.

The accuracy policy of ELECTRONIC DESIGN is:

- To make reasonable efforts to ensure the accuracy of editorial matter.
- To publish prompt corrections whenever inaccuracies are brought to our attention. Corrections appear at the end of the Letters column.
- To encourage our readers as responsible members of our business community to report to us misleading or fraudulent advertising.
- To refuse any advertisement deemed to be misleading or fraudulent.

Microfilm copies are available of complete volumes of ELECTRONIC DESIGN at \$19.00 per volume, beginning with Volume 9, 1961. Work is now in process to complete the microfilm edition of Volumes 1-8. Reprints of individual articles may be obtained for \$2.00 each, prepaid (\$.50 for each additional copy of the same article) no matter how long the article. For further details and to place orders, contact the Customer Services Department, University Microfilms, 300 North Zeeb Road, Ann Arbor, Michigan 48106; telephone (313) 761-4700.

Want to contact us? If you have any comments or wish to submit a manuscript or article outline, address your correspondence to:

Editor
ELECTRONIC DESIGN
50 Essex Street
Rochelle Park, N.J. 07662

Advertising Sales Staff

Bryce Gray
Sales Manager

Rochelle Park, N.J. 07662

Robert W. Gascoigne
Daniel J. Rowland
50 Essex Street
(201) 843-0550
TWX: 710-990-5071

Philadelphia

Thomas P. Barth
50 Essex Street
Rochelle Park, N. J. 07662
(201) 843-0550

Boston 02154

Joseph F. Palmer
1268 Main Street
Waltham, Mass.
(617) 894-2700

Chicago 60611

Thomas P. Kavooras
Berry Conner, Jr.
200 East Ontario
(312) 337-0588

Cleveland

Thomas P. Kavooras
(Chicago)
(312) 337-0588
(call collect)

Los Angeles 90303

Stanley I. Ehrenclou
Burt Underwood
2930 Imperial Highway
Inglewood, Calif
(213) 757-0183

San Francisco 94022

Jerry D. Latta
95 Main Street
Los Altos, Calif.
(415) 941-3084

London W. 1

For United Kingdom and Holland
Brayton C. Nichols

For Eastern Europe

Peter Kehr

The American Magazine Group

27 Maddox Street
London, W. 1, England
Phone: 499-0180
Cable: Ammagnic, London

Verviers, Belgium

For Continental Europe

Andre Jamar
1, Ru Mallar, 1
087) 253.83 Telex 41563

Tokyo

Haruki Hirayama
Electronic Media Service
5th Floor, Lila Bldg.,
4-9-8 Roppongi
Minato-ku
Phone: 402-4556
Cable: Electronicmedia, Tokyo



Design Data from Manufacturers

Advertisements of booklets, brochures, catalogs and data sheets. To order use Reader-Service Card.
(Advertisement)

500-line Real-Time Spectrum Analyzer Acts Like 650-Lines

The First MINI —
500-LINE REAL-TIME
SPECTRUM ANALYZER

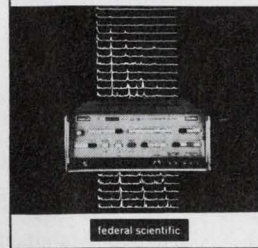

Second generation Mini-Ubiq™ Model UA-15A low frequency real-time spectrum analyzer — smaller, lighter, easier to use and less expensive than Federal's famous Ubiquitous® 500-line analyzer — is better for on-the-spot frequency analysis, machine noise diagnosis, computer automatic systems. Incorporates a sharper, computer-designed filter for increased selectivity — can separate closely spaced components as if it had 650 frequency lines. Widest choice of range — 12 ranges from 10Hz to 50kHz; highest frequency and amplitude accuracy; computer control of input amplitude range, analysis range, and presampling filter; operation with weighting function on or off; sweep termination adjustable for high sweep rates; earphone monitor of filtered input.

Federal Scientific Corp.

Subsidiary of Elgin National Industries, Inc.
615 West 131st Street, New York, N. Y. 10027

CIRCLE NO. 175

Circuit Zaps® for Instant PC Boards

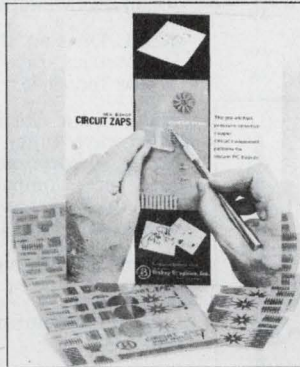

Circuit Zaps® are 1 ounce copper circuit component patterns, pads, and conductor paths, precision-etched on 5 mil (.005") glass epoxy base material, backed by a special pressure-sensitive adhesive. Circuit Zaps® completely eliminate the artwork, photography, photoprinting, touch up, etching, stripping, and other time-consuming steps in PC board development.

Write today for the FREE TECHNICAL BULLETIN 1003 with FREE SAMPLE.

CIRCLE NO. 172

Bishop Graphics, Inc.

7300 Radford Avenue (ED)
North Hollywood, California 91605
(213) 982-2000 Telex 674672

Economical High Performance Electrometers

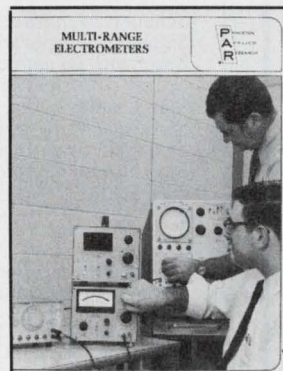

New P.A.R. electrometers offer superior performance at low cost. Model 134, with wide range and high stability, is priced at \$615; Model 135, with self-contained battery power supply, \$675; and Model 136 with digital display and BCD output, \$1125. Drift, offset and noise figures are lowest available in this price range. Other features include guarded input circuits and fast recovery from large overloads. Full line of accessories available. Request new brochure, demonstration or applications assistance.

CIRCLE NO. 173

Princeton Applied Research Corporation

Box 565, Princeton, New Jersey 08540 — (609) 452-2111

advertiser's index

Advertiser	Page
Acopian Corp.	47
Aertech Industries	83
Allen-Bradley Co.	25
Allen Electronic & Impulse Recording Equipment Co. Inc.	106
American Technical Ceramics	102
Amphenol Components Group	33
Amphenol Connector Division, Bunker Ramo Corporation	12
Beckman Instruments, Inc., Helipot Division	75
Belden Corporation	9
Bishop Graphics, Inc.	109
Bourns, Inc.	27
Bulova Frequency Control Products	94
Burroughs Corporation	18
CTS Corporation	38
Chicago Miniature Lamp Works	29
Cinch Manufacturing Company	42
Dale Electronics, Inc.	Cover II
Datascan, Inc.	85
Delco Electronics, Division of General Motors Corporation	4, 5
Dialight Corporation	72
Dionics, Inc.	69
EAI/Precision Components	89
Electro Materials, A Division of Illinois Tool Works, Inc.	99
Electronic Measurements, Inc.	88

Advertiser	Page
Fairchild Semiconductor, A Division Fairchild Camera and Instrument Corporation	10, 11
Federal Scientific Corporation	109
Fluke	Cover II
Fork Standards, Inc.	111
GPS Corporation	100
GTE Sylvania Electronic Components	31
GTE Sylvania Chemical & Metallurgical Division.....	16B
Garrett Airesearch Manufacturing Co.	46
General Electric Company	16A, 21
Grayhill, Inc.	90
Gudebrod Bros. Silk Co., Inc.	107
Hansen Manufacturing Co., Inc.	102
Harris Semiconductor, A Division of Harris Intertype Corporation	73
Hayden Book Company, Inc.	80B, 97, 111
Hayden Publishing Company, Inc.	Cover II A-B
Heinemann Electric Company	6
Honeywell Test Instrument Division	86
Industrial Electronic Engineers, Inc.	39, 111
Industrial Reproduction, Inc.	80
Instrument Specialties Company	105
Inter-Technical Group, Inc., The	90
Johanson Manufacturing Corp.	7
Licon, Division Illinois Tool Works, Inc.	101
LogiMetrics, Inc.	48
Lorlin Industries Inc.	108
Major Data Corporation	111
Microwave Filter Company, Inc.	93
Molex, Incorporated	1
Monsanto Company	77, 95, 111
Motorola Component Products Dept.	50
Motorola Semiconductor Products, Inc.	14, 15, 32
National Semiconductor Corporation	35, 36, 37
Nytronics, Inc.	13
Oak Manufacturing Co.	41
OPCOA, Inc.	51
Paktron Division, Illinois Tool Works, Inc.	103
Philips Electronic Components and Materials	80A
Pinlites Division of Refac	87
Pioneer Electric & Research Corporation	110
Potter & Brumfield, Division of AMF Incorporated.....	40
Power Designs, Inc.	79
Princeton Applied Research Corporation	109, 111
RCA Electronic Components	91
RCA Solid State Division	22, Cover IV
RF Communications, Inc.	84
Schauer Manufacturing Corp.	92
Signetics Corporation	17
Spectrum Dynamics, Inc.	111
Sperry Information Displays Division	65
Star Displays, Inc.	111
Stevens Tubing Corp.	111
Syntronic Instruments, Inc.	93
Systron-Donner Corporation Datapulse Division	68
TRW Electronic Components, Semiconductor Division	2
Tektronix, Inc.	16, 45
Teledyne Relays	8
Thermalloy Company	93
Triplett Corporation	112
United Systems Corporation	87
Universal Relay Corporation	106
Vector Electronic Company, Inc.	107
Victoreen Instrument, Div. of VLN Corp.	87
Wiley Interscience	96

**MEASURE
RPM's
INSTANTLY
ELECTRONICALLY**
with Pioneer Photo Tachometer



For speeds up to 12,000 RPM

The photo tachometer is easy to use. Hold in the hand like a flashlight, just point, press button, read RPM instantly—no wires or mechanical connections required.

Send complete information.

Available Under
GSA Contract No.
GS-OOS-04519

THE Pioneer
ELECTRIC & RESEARCH CORPORATION
Subsidiary of **PERCO** Controls, Inc.
743 Circle Ave. • Forest Park, Ill. 60130
Phone: 312 771-8242

USE FOR:



GRINDING
WHEELS



DRILL PRESSES



ENGINES AND
MOTORS



COUNTING



VACUUM AND
PRESSURE PUMPS

LABORATORIES

INFORMATION RETRIEVAL NUMBER 76

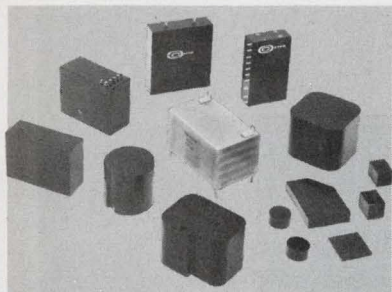

Glass laminated epoxy 155°C cases for component and circuit packaging are available in thousands of sizes. Thin wall tubes and headers offer optimum protection in all applications. Literature and samples available. Stevens Tubing Corp., 128 North Park Street, East Orange, New Jersey 07019. Telephone 201-672-2140.

INFORMATION RETRIEVAL NUMBER 181



5 MHz counter for \$250. Events counting and rate measurement priced to replace mechanical counters. Frequency range 5 Hz to 5 MHz. 4 digit plus "1" overrange. Monsanto Company, 620 Passiac Avenue, West Caldwell, N. J. 07006. (201) 575-9300.

INFORMATION RETRIEVAL NUMBER 182

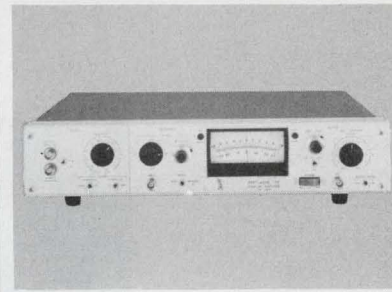

New \$1295 phase-sensitive detector simplifies bridge balancing and cross talk, op-amp open loop gain and other noisy signal measurements. Model 128 features include 0.5 Hz to 100 kHz range, 1 μ V sensitivity full scale, automatic tracking. Free application literature. Princeton Applied Research Corporation, Princeton, N. J.

INFORMATION RETRIEVAL NUMBER 187

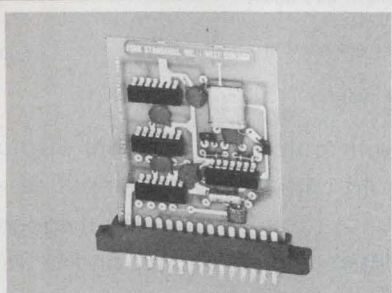

PC CARD CRYSTAL OSCILLATOR MODEL CQ IS CARD SOCKET MOUNTED. Standard or special frequencies 1Hz to 15MHz, Acc to .001%. TTL compatible, Tweakable, Multiple output. \$50-90 singly. Fork Standards, Inc., 217 Main St., West Chicago, IL 60185. (312) 231-3511.

INFORMATION RETRIEVAL NUMBER 184

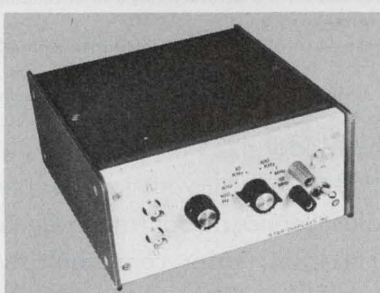

Combination Pulse Generator/Power Supply designed expressly for display check out, TTL & DTL circuits. Supplies 5 Volts, 2.5 Amps. for displays. Pulses from 30 Hz to 10 MHz in six ranges. Costs only \$149. Send for information. Star Displays, Inc., Eugene, Oregon (503) 342-8217

INFORMATION RETRIEVAL NUMBER 185

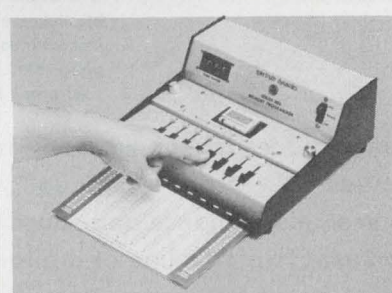

Program all fusible-link programmable ROMs manually with the Model 300. Designed with a 4096 bit (512 words x 8 bits) capacity. Both 115 VAC and 220 VAC versions available. Spectrum Dynamics, Inc., 2300 East Oakland Park Boulevard, Ft. Lauderdale, Florida. Phone (305) 566-4467 or 566-2547.

INFORMATION RETRIEVAL NUMBER 186

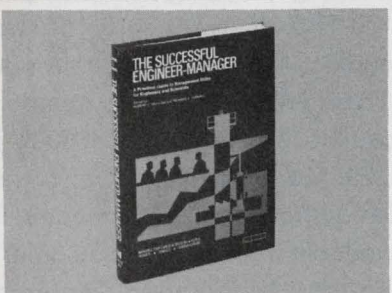

The Successful Engineer-Manager, Edited By R. C. Haavind and R. L. Turmail. Depth discussion and insights of the experts isolate the fine points of management: career, decisions, people, projects, finances, communications. Hayden Book Co., Inc., New York, N. Y. 10011.

INFORMATION RETRIEVAL NUMBER 182

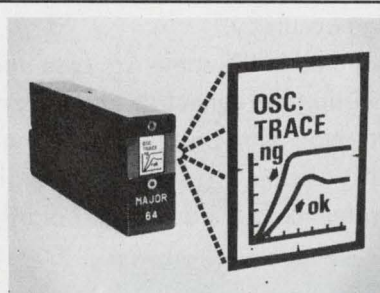

New, low cost, visual readout features self-decoding and random access to any of 64 image areas. Single optical projection system of symbols, text, graphs and instructions. Custom images and projection sizes available. Major Data Corporation, Costa Mesa, Cal. (714) 548-7898.

INFORMATION RETRIEVAL NUMBER 188

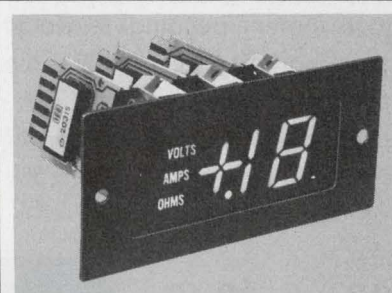

Versatile 7 Bar-Segment display features bright .78" high characters, including optional caption module, providing from 1 thru 6 messages. Plus, minus and overflow "1" also available. Lamp replacement from front or rear. Industrial Electronic Engineers, Inc., Van Nuys, Ca. Phone: (213) 787-0311.

INFORMATION RETRIEVAL NUMBER 189

If you need cool, accurate, reliable DPMs ... Buy Triplett

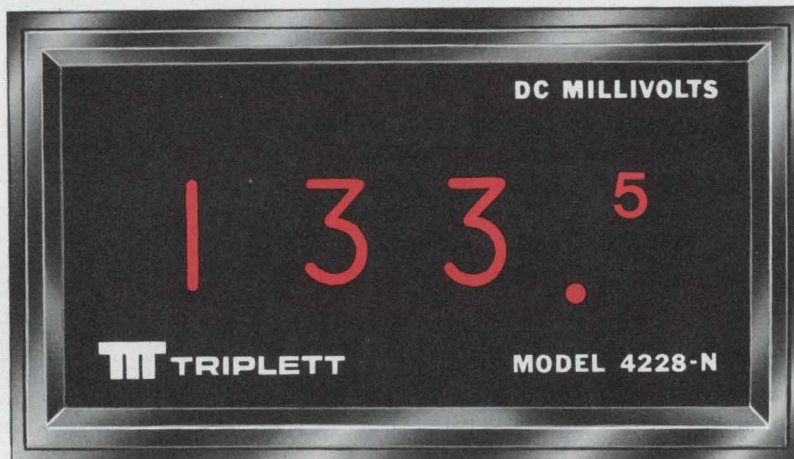

Model 4228-N

actual size

\$140

1. 2¾ digits — Provides double the accuracy (0.25% of reading $\pm 1/2$ digit) and double the resolution at lower cost.
2. Instantaneous Response — 16-millisecond display rate with 60 times per second sampling rate.
3. Fool-proof Numeral display blurs beyond over-range and with negative polarity.

Designed for OEM applications as well as R&D, production, quality control, maintenance and education use, Triplett's line of digital panel meters combine compactness, convenience and capability with characteristic Triplett accuracy and quality.

To 2 Watts power consumption (for reduced heat and increased reliability) and positive over-range and reverse polarity indications, Triplett's Model 4228-N adds a unique (patent pending) 2¾-digit display that effectively doubles the accuracy and resolution of 2½-digit instruments . . . at the cost of 2½-digits. Accuracy is $\pm 0.25\%$ of reading ± 1 digit.

Model

4235-F \$240

1. 3½ digits with auto-polarity.
2. Low Power Drain — provides low operating temperature and long-lived reliability.
3. Single-plane, Seven-bar Readout — for accurate, wide-angle readability.

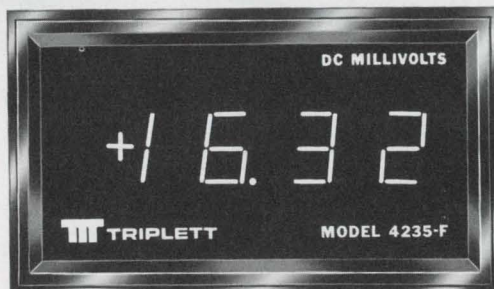

The Model 4228-N is a real value at \$140, so call your local Triplett Sales/Service/Modification Center or Triplett sales representative right now. Either will also be pleased to demonstrate two companion products: Triplett's Model 4225-N at \$125 which merely omits the neon lamp "1" (thus reading to 995) and offers $\pm 0.50\% \pm 1$ digit accuracy; and the Model 4220-N at \$110 — a 2-digit instrument (reading to 99) with $\pm 1\% \pm 1$ digit accuracy.

Mounted in the same size case and boasting the same low power consumption and positive over-range indication, Triplett's 3½-digit Model 4235-F adds auto-polarity

(with polarity indication) display hold capability, high input resistance (from 10 to 1,000 megohms depending on range) and a 3½-digit single-plane seven-bar fluorescent display. For many users, the wide-angle viewing capability — enhanced by a green, circularly-polarized viewing window that eliminates confusing internal reflections — will make the 4235-F the obvious choice.

Boasting a voltage accuracy of $\pm 0.10\%$ (current $\pm 0.15\%$) of reading ± 1 digit, Triplett's Model 4235-F sells for \$240. Its companion, the 3-digit Model 4230-F, is \$220. More information, or a free demonstration of both models, is available from your Triplett Sales / Service / Modification Center or your Triplett sales representative. Triplett Corporation, Bluffton, Ohio 45817.

TRIPLETT

Manufacturers of the World's most complete line of V-O-Ms.

We'll go to extremes extremes

We'll go to extremes to solve your resistive problems

Call Dale when you need to cut development and delivery time on non-standard resistors. Our design file contains more than 4,500 "specials" — all pre-engineered and ready for production. It includes everything from the most powerful and precise wirewounds to the industry's widest range of metal film values to tiny thick and thin film chips and microcircuits. If we have not already produced what you need, we're ready to assign a special engineering task force to the job. Call today. The difficult resistive function you're looking for—and the package to put it in—are waiting for you at Dale.

*Dale's new **Functional Guide To Non-Standard Resistors** is a must for every design file. Phone 402-564-3131 or write for your copy today!*

DALE ELECTRONICS, INC.
1300 28th Avenue,
Columbus, Nebr. 68601
In Canada:
Dale Electronics Canada, Ltd.
A subsidiary of
The Lionel Corporation

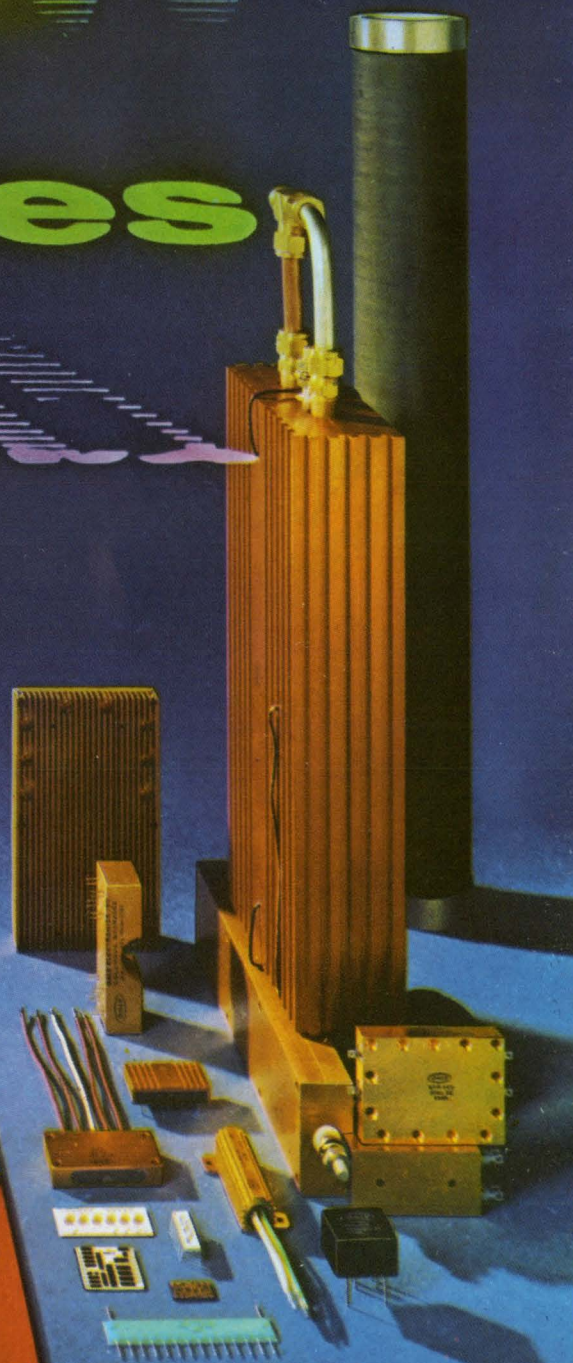
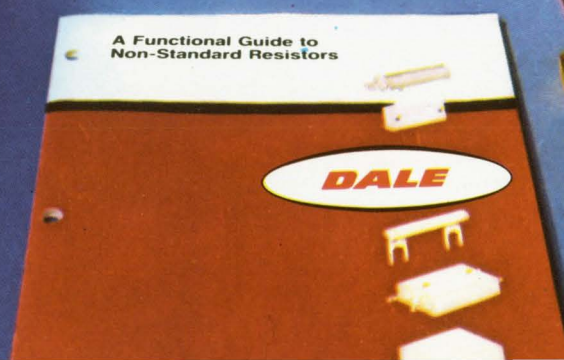

Quiet, please...

...we're introducing RCA's PREMIUM CA6000 Series of Low-"Popcorn"-Noise Op Amps

RCA premium Op Amps are tested for noise over a 30 second period.

Popcorn noise bursts are not detected by averaging test techniques.

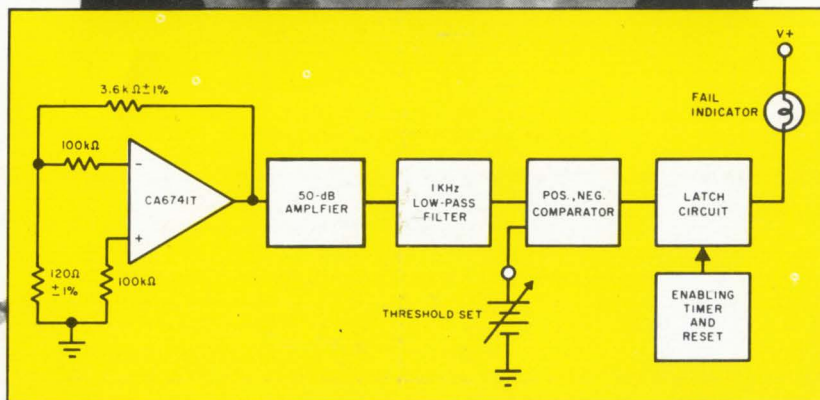

Op Amps in RCA's CA6000 Series are 100% tested for absence of "popcorn" noise. This unique test rejects any unit that produces a burst greater than 20 μ V (peak.)

... and just for starters here's our low-noise PREMIUM 741-RCA-CA6741T (\$3.30 1000-unit level*)

Here's an important new series of circuits for the designer who's looking for extra assurance of performance in op-amp applications. RCA's new Premium CA6000 Series now offers the results of two major assurances from RCA Solid State:

- **BUILT-IN ASSURANCE** inherently low burst noise and I/f noise performance, the result of processing developments.

- **TESTED-IN ASSURANCE** 100% testing for burst noise with a 1-kHz bandwidth test circuit for 1/2 minute on each device.

Now, try RCA's low-"popcorn"-noise PREMIUM CA6741T. It offers you the same design and application features as the industry-accepted 741 PLUS the new benefits of RCA's low-noise processing and specification.

For further details, check Technical

Bulletin, File No. 530, and Application Note, ICAN 6732. Contact your RCA Representative or your RCA Distributor, or write Section 57K-25/69 CA, RCA Solid State, P.O. Box 3200, Somerville, N. J. 08876. International: RCA, Sunbury-on-Thames, U.K., or P.O. Box 112, Hong Kong, or RCA Limited, Ste. Anne de Bellevue, 810 Quebec.

RCA Solid State
products that make products pay off

*Price indicated is Original Equipment Manufacturer price in the USA only.