

DuraLiner[®]
Insulated, double-wall
masonry relining.
UL 1777 and ULC S635.



Specifications

Applications

DuraLiner is a high-temperature, insulated double-wall masonry relining system for use with appliances fueled by gas, pellet, oil, wood, or coal. It safely protects masonry chimneys from the damaging effects of flue product condensation.

Materials and Construction

.016" 304 stainless steel inner liner.
Rigid relining pipe: double-walled with 304 stainless steel inner and galvalume outer. Factory insulated between inner and outer walls.
DuraLiner Rigid Pipe in round or oval, is constructed with built-in fittings and pre-drilled holes (stainless steel rivets included).
Round 5" DuraLiner rigid pipe is constructed with built-in twist-lock and pre-drilled holes.

Clearances

Rigid double wall: 0" clearance between the liner and masonry and 0" clearance between the masonry and combustibles.
DuraLiner Flex: 1" clearance to masonry.
Zero clearance with insulation.

Diameters

5", 6", and 8".

Listings

c-UL-us Listed to UL 1777 and ULC S635 (MH14420).



UL 1777 and ULC S635 System

DuraLiner

DuraLiner ensures safe and efficient venting of heating appliances, while protecting the masonry chimney from the damaging effects of flue gas. It is the only factory-insulated product with zero/zero clearance for high heat wood-burning appliances. No need to uncoil flex, insulate a majority of the pipe, or protect the insulation when installing. A smooth inner means less creosote buildup.

Installers reduce labor time by 50% or more with DuraLiner. No time wasted wrapping insulation around liner for UL 1777 approval.

No spacers needed to maintain clearance in tight offsets or dampers. Approved for use in both the USA and in Canada.



Typical Installations

Installation Key			
1	Extend-A-Cap Kit	8	30° or 45° SS Elbow
2	Round Tee with Round Branch	9	Transition Anchor Plate
3	DuraTech or DuraPlus Chimney	10	ProMesh & ProFoil
4	DuraLiner - rigid length	11	Insulation Clamp
5	DuraLiner - flexible length	12	DuraLiner Appliance Connector
6	Masonry Thimble w/ Slip Connector	13	DVL or DuraBlack Stovepipe
7	Slip Connector and Hanger		

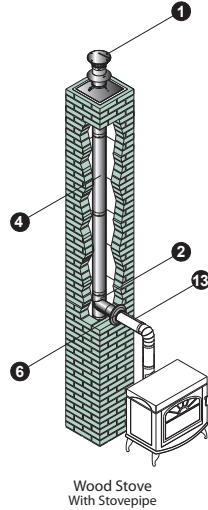
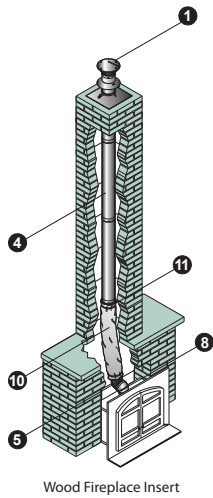

- Refer to our Typical Installation drawings to select the appropriate component parts for your installation
- The inner pipe diameter should match the outlet size of the appliance.
- Check the appliance manufacturer's installation instructions for any venting restrictions.
- Be fire safe! Follow local building codes and have your venting system inspected.

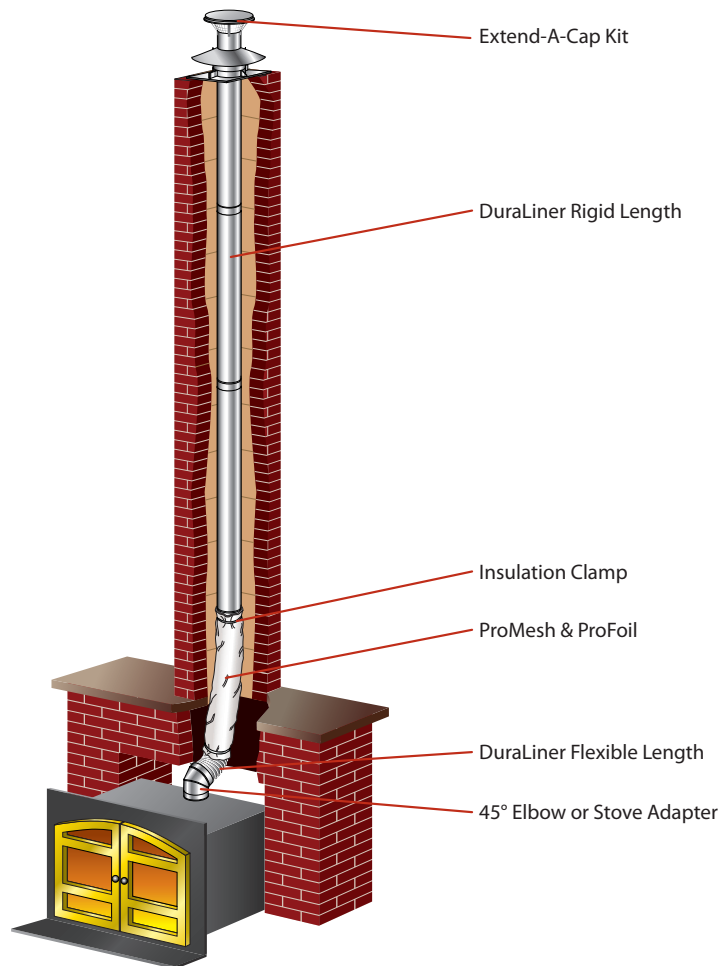
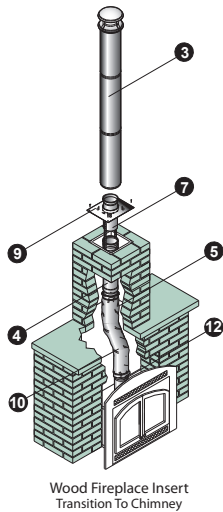

Planning Your Installation

1	Refer to the Typical Installations for the needed parts for installation.
2	The size of the liner should match the outlet size on the appliance.
3	Determine use of round or oval pipe based on the interior shape of the chimney.
4	Determine the length of liner needed. Subtract 1 ½" overlap per joint on pipe. When using Extend-A-Cap Kit, liner must extend 6" above top of the masonry surface.
5	Make sure the top of the masonry chimney has a leveled surface to ensure a proper fit for the Extend-A-Cap or Transition Anchor Plate and to provide a secure, leak-proof installation.
6	If a free-standing appliance is used, select the vent or stovepipe pieces to connect from the appliance to the liner. Refer to installation instructions.
7	For Installations using a Transition Anchor Plate, refer to the DuraTech, DuraPlus, or DuraTech Premium catalog section or installation instructions for proper parts and installation.
8	Important! Check to be sure the installation complies with all local and national code requirements, including clearance to combustibles. Contact the local building inspector for permit requirements.

Design Recommendations

- The following design recommendations are a general guideline to assist in the design and selection of liner components for your installation. Always follow DuraVent installation instructions enclosed with the cap or support box before installing your chimney system.
- Installation instructions can be viewed online at www.duravent.com, under support > literature.
- Before relining a chimney, it should be cleaned and inspected, by a certified chimney sweep, to verify the integrity of the mortar and masonry.
- DuraLiner is approved for 0" clearance between the liner and masonry and 0" clearance between the masonry and combustibles.
- DuraLiner is used for wood-burning appliances when zero-clearance or oval pipe is needed.
- Refer to the appliance manufacturer for installation requirements affecting venting. Keep the vent path as straight as possible for best performance.

Restore Deteriorating Chimneys with DuraLiner

When a masonry chimney is damaged or has fallen down, it can be replaced with a safe, listed liner system or factory-built chimney. DuraLiner, when used with a Transition Anchor Plate and in combination with DuraTech, DuraPlus, or DuraTech Premium Chimneys, replaces the damaged masonry chimney with a safe, efficient, and economical listed chimney system (DuraTech Premium is listed for use in Canada). See Typical Installations for details.

What makes us different from the rest?

DuraLiner: The only factory-insulated, zero clearance product protecting masonry chimneys from damaging flue gas.



DuraLiner Feature	Benefit	DuraLiner Feature	Benefit	DuraLiner Feature	Benefit
Zero/zero Clearance	The only factory-insulated product with zero/zero clearance for high heat wood-burning appliance. Approved for 0" clearance between the liner and masonry and 0" clearance between the masonry and combustibles.	No spacers needed	No spacers needed to maintain clearance.	Limited Lifetime Warranty	The best Warranty in the industry. 15 years 100%, 15 years and up 50%. Gives the installer and home owner the greatest peace of mind in a quality installation.
		UL1777 and ULC S635 listed	DuraLiner meets all the thermal, mechanical and material requirement of the UL1777 and ULC S635 (MH14420) standards.	Pre-formed buttons	The DuraLiner adjustable sleeve has pre-formed buttons that snap into branch rings.
Smooth inner wall	The smooth inner wall provides for no output reduction, allowing for full appliance efficiency, ease of cleaning and regular maintenance. This optimizes gas flow, minimizes back pressure, and facilitates condensate management.	Galvalume outer	More corrosion resistant than galvanized swl. Approved in both the US and Canada.	Flexible Section	Allows the liner to pass by the smoke shelf and damper to connect to the appliance.
		15, 30 and 45 Degree Stove Adapters	Provides greater installation flexibility.	Made in USA	100% manufactured in USA.

30° Stove Connectors

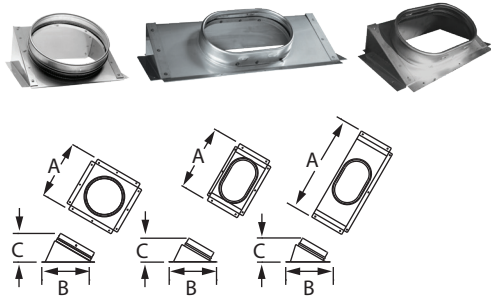

Use to connect insert to round or oval DuraLiner pipe at a 30° angle.

SIZE	CONNECTION	ORDER #	STOCK #	A	B	C
6"	Round - Round	6DLR-CNR	810001193	8 1/8"	9 3/4"	5 3/8"
6"	Round - Oval	6DLR-CNRO	810001194	9 3/8"	7 3/4"	5 7/8"
6"	Oval - Oval	6DLR-CNO	810001195	15"	7 3/8"	4"
8"	Round - Round	8DLR-CNR	810001233	10"	11 5/8"	6 1/4"
8"	Round - Oval	8DLR-CNRO	810001234	12 1/4"	9 3/4"	5 7/8"
8"	Oval - Oval	8DLR-CNO	810001235	15"	7 3/8"	4"

Flat Stove Connector

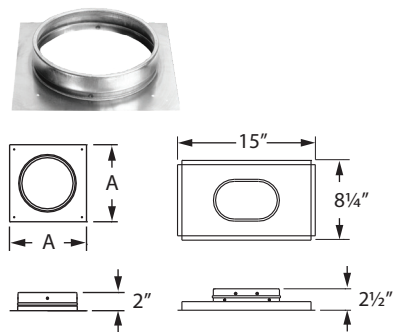

Use to connect insert to round or oval DuraLiner pipe. Oval stove connector is sized to convert round stove outlets to oval DuraLiner pipe.

SIZE	ORDER #	STOCK #	A
6" ROUND	6DLR-FCNR	810001196	10 1/4"
6" OVAL	6DLR-FCNO	810001197	--
8" ROUND	8DLR-FCNR	810001236	12 1/4"
8" OVAL	8DLR-FCNO	810001237	--

15° Stainless Steel Elbow Adapter



Use to offset obstructions as needed. Use as a stove connector to DuraLiner. Built-in fittings for connection to DuraLiner. Elbows are single-wall.

SIZE	ORDER #	STOCK #
6"	6DLR-E15ADSS	810001198

30° Stainless Steel Elbow - 5"

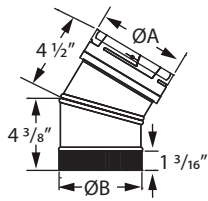

Use to offset obstructions as needed. Use as a insert connector to DuraLiner. Built-in fittings for connection to DuraLiner. Elbows are single-wall.

SIZE	ANGLE	ORDER #	STOCK #	A	B
5"	30°	5DLR-E30	810001179	5 1/2"	5"

30° Stainless Steel Elbow

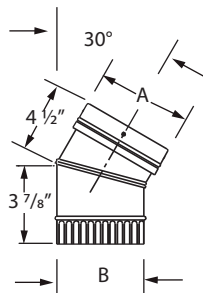

Use as a insert connector to DuraLiner. Features built-in fittings for easy connection to DuraLiner. Elbows are single-wall.

SIZE	ANGLE	ORDER #	STOCK #	A	B
6"	30°	6DLR-E30SS	810001199	6 1/2"	6"
8"	30°	8DLR-E30SS	810001238	8 1/2"	8"

45° Stainless Steel Elbow - 5"

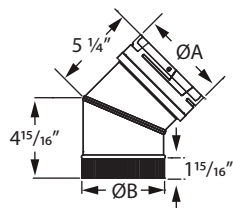

Use to offset obstructions as needed. Use as a insert connector to DuraLiner. Features built-in fittings for easy connection to DuraLiner. Elbows are single-wall.

SIZE	ANGLE	ORDER #	STOCK #	A	B
5"	45°	5DLR-E45	810001180	5 1/2"	5"

45° Stainless Steel Elbow

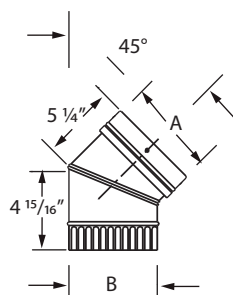

Use as a insert connector to DuraLiner. Features built-in fittings for easy connection to DuraLiner. Elbows are single-wall.

SIZE	ANGLE	ORDER #	STOCK #	A	B
6"	45°	6DLR-E45SS	810001200	6 1/2"	6"
8"	45°	8DLR-E45SS	810001239	8 1/2"	8"

Round Tee w/ 6" Branch - 5"

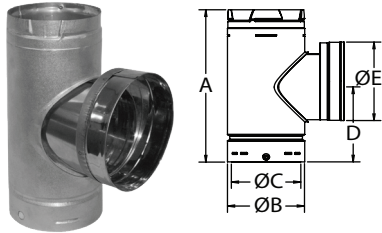

Provides connection between Masonry Wall Thimble or stove connector pipe to round DuraLiner. Branch is removable.

SIZE	ORDER #	STOCK #	A	B	C	D	E
5"	5DLR-TX6	810009937	12"	5 5/8"	5"	6"	6"

Round Tee and Round Branch w/ Cap - 5"

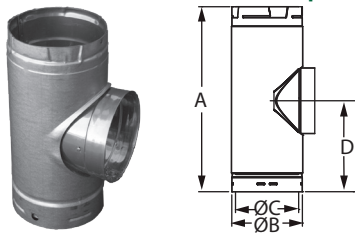

Provides connection between Masonry Wall Thimble or stove connector pipe to round DuraLiner. Branch is removable.

SIZE	ORDER #	STOCK #	A	B	C	D
5"	5DLR-T	810001181	12"	5 5/8"	5 1/2"	6"

Round Tee and Round Branch w/ Cap

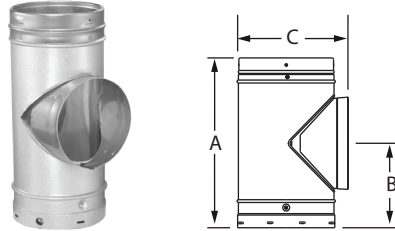

Provides connection between Masonry Wall Thimble, Wall Pass Through, or stove connector pipe to round DuraLiner. Branch is removable.

SIZE	ORDER #	STOCK #	A	B	C
6"	6DLR-T	810001201	15 1/8"	7 1/2"	8"
8"	8DLR-T	810001240	15 1/8"	7 1/2"	10"

Oval Tee and Round Branch w/ Cap

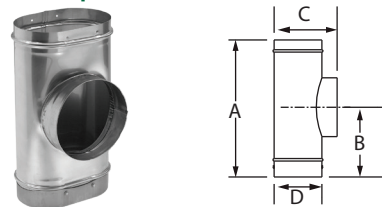

Provides connection between Masonry Wall Thimble, Wall Pass Through, or stove connector pipe to oval DuraLiner. Single-wall. May require additional insulation. Refer to DuraLiner installation instructions.

SIZE	ORDER #	STOCK #	A	B	C	D
6"	6DLR-OTRB	810001202	14 1/4"	7 1/2"	6 7/16"	4 7/8"
8"	8DLR-OTRB	810001241	14 1/4"	7 1/2"	6 7/16"	4 7/8"

6" - 5" Reducer

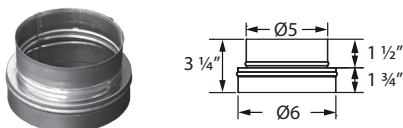

Use to reduce flue collar from 6" diameter to 5" diameter, when permitted by appliance manufacturer.

SIZE	ORDER #	STOCK #
5"	5DLR-R6	810001182

Spacer

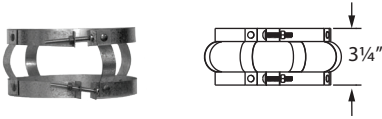

Use to maintain a 1" clearance with flex sections of DuraLiner.

SIZE	ORDER #	STOCK #
6" OVAL	6DLR-S	810001203
8" OVAL	8DLR-S	810001242

Adjustable Sleeve



Use for inserts with rear exhaust outlets. Sleeve adjusts from 8 1/2" to 12".

SIZE	ORDER #	STOCK #
6"	6DLR-AS	810001204
8"	8DLR-AS	810001243

Masonry Thimble w/ Slip Connector

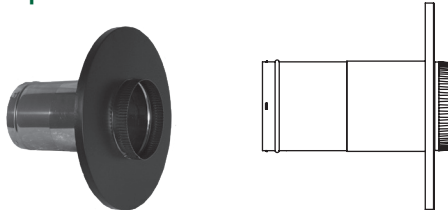

Use to penetrate masonry chimney to allow connection of DuraBlack or DVL to DuraLiner. Adapter must be used to attach the connector pipe to the masonry thimble.

SIZE	ORDER #	STOCK #
5"	5DLR-MTSC1	810014030
6"	6DLR-MTSC1	810014031
8"	8DLR-MTSC1	810014032

Wall Pass Through

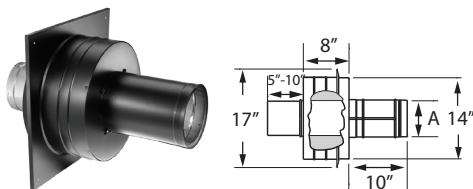

Use to connect to a DuraLiner tee. Transitions DuraLiner through a masonry chimney and a combustible wall. Allows the connection of DuraBlack pipe when used with the appropriate adapter. DVL black pipe will connect directly to the Wall Pass Through.

SIZE	ORDER #	STOCK #	A
6"	6DLR-WPT	810001205	6 1/2"
8"	8DLR-WPT	810001244	8 1/2"

Round-To-Round Heavy Duty Flex Pipe

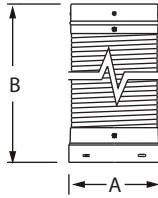

Use through damper and smoke shelf area. Built-in fittings. Use with DuraLiner Insulation Kit (ProMesh and ProFoil), where flex extends into clay liner, for zero-clearance applications. Round-to-Round Flex pipe built from .016", 304 stainless steel, 4-ply construction.

SIZE	ORDER #	STOCK #	A	B
6"	6DLR-36HF	810001206	6 5/8"	36"
6"	6DLR-60HF	810001207	6 5/8"	60"
8"	8DLR-36HF	810001245	8 5/8"	36"
8"	8DLR-60HF	810001246	8 5/8"	60"

Round-To-Round Flex Pipe - 5"

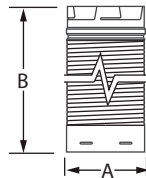

Use through damper and smoke shelf area. Built from 304 stainless steel. Use with DuraLiner Insulation Kit (ProMesh and ProFoil) to meet UL1777 zero-clearance standards. Twist-lock fittings.

SIZE	ORDER #	STOCK #	A	B
5"	5DLR-36F	810001183	5 5/8"	36"
5"	5DLR-60F	810001184	5 5/8"	60"

Round-To-Round Flex Pipe

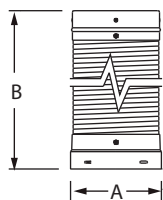

Use through damper and smoke shelf area. Use with DuraLiner Insulation Kit (ProMesh and ProFoil), where flex extends into clay liner, for zero-clearance applications. Built from 1-ply construction, .005" 304 stainless steel.

SIZE	ORDER #	STOCK #	A	B
6"	6DLR-36F	810001208	6 5/8"	36"
6"	6DLR-60F	810001209	6 5/8"	60"
8"	8DLR-36F	810001247	8 5/8"	36"
8"	8DLR-60F	810001248	8 5/8"	60"

Oval-To-Oval Heavy Duty Flex Pipe

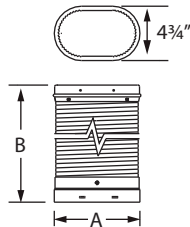

Use through damper and smoke shelf area. Built-in fittings. Use to connect from oval stove outlet to round DuraLiner. Use with DuraLiner Insulation Kit (ProMesh and ProFoil), where flex extends into clay liner, for zero clearance applications. Oval-to-Oval Flex pipe built from .016", 304 stainless steel, 4-ply construction.

SIZE	ORDER #	STOCK #	A	B
6"	6DLR-360HF	810001210	7 3/4"	36"
6"	6DLR-600HF	810001211	7 3/4"	60"

Oval-To-Oval Flex Pipe

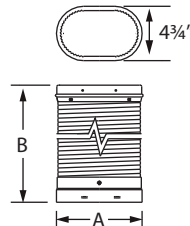

Use through damper and smoke shelf area. Use with DuraLiner Insulation Kit (ProMesh and ProFoil), where flex extends into clay liner, for zero-clearance applications. Built from 1-ply construction, .005" 304 stainless steel.

SIZE	ORDER #	STOCK #	A	B
6"	6DLR-360F	810001212	7 3/4"	36"
6"	6DLR-600F	810001213	7 3/4"	60"
8"	8DLR-360F	810001249	10 3/4"	36"
8"	8DLR-600F	810001250	10 3/4"	60"

Oval-To-Round Heavy Duty Flex Pipe

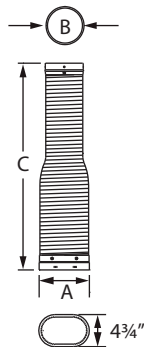

Use through damper and smoke shelf area. Use to connect from oval stove outlet to round DuraLiner. Use with DuraLiner Insulation Kit (ProMesh and ProFoil), where flex extends into clay liner, for zero clearance applications. Built from .016", 304 stainless steel, 4-ply construction.

SIZE	ORDER #	STOCK #	A	B	C
6"	6DLR-360RHF	810001214	7 3/4"	6 5/8"	36"
6"	6DLR-600RHF	810001215	7 3/4"	6 5/8"	60"

Oval-To-Round Flex Pipe

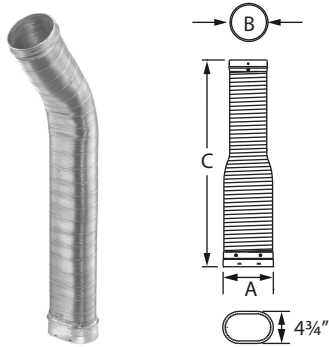

Use through damper and smoke shelf area. Use to connect from oval stove outlet to round DuraLiner. Use with DuraLiner Insulation Kit (ProMesh and ProFoil), where flex extends into clay liner, for zero-clearance applications. Built from 1-ply construction, .005" 304 stainless steel.

SIZE	ORDER #	STOCK #	A	B	C
6"	6DLR-360RF	810001216	7 3/4"	6 5/8"	36"
6"	6DLR-600RF	810001217	7 3/4"	6 5/8"	60"
8"	8DLR-360RF	810001251	10 3/4"	8 5/8"	36"
8"	8DLR-600RF	810001252	10 3/4"	8 5/8"	60"

Round-To-Oval Flex Pipe

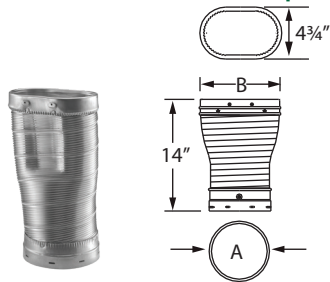

Use to connect a round stove outlet to oval DuraLiner. Use with DuraLiner Insulation Kit (ProMesh and ProFoil), where flex extends into clay liner, for zero-clearance applications. Built from 304 stainless steel.

SIZE	ORDER #	STOCK #	A	B
6"	6DLR-14ROF	810001218	6 5/8"	7 3/4"
8"	8DLR-14ROF	810001253	8 5/8"	10 3/4"

Round Rigid Pipe - 5"

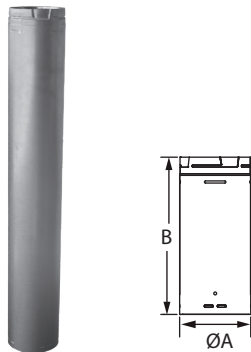

Use to reline masonry chimney with 0/0 clearance. Factory-insulated. Twist-lock fittings and pre-drilled hole (one screw required). UL Listed for zero clearance between masonry and combustibles, plus zero clearance between liner and masonry. 304 stainless steel inner and aluminized steel outer. Note: to calculate the installed length of 5", 6", and 8" DuraLiner pipe subtract 1 1/2" from each joint overlap of liner pipe sections.

SIZE	ORDER #	STOCK #	A	B
5"	5DLR-12	810001185	5 5/8"	12"
5"	5DLR-24	810001186	5 5/8"	24"
5"	5DLR-36	810001187	5 5/8"	36"
5"	5DLR-48	810001188	5 5/8"	48"

Round Rigid Pipe

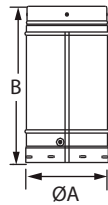

Use to reline masonry chimney with 0/0 clearance. Available in round 6" and 8" diameters in 12", 24", 36", and 48" lengths. Factory-insulated. Built-in, pre-drilled fittings for riveting joints. 304 stainless steel inner and aluminized steel outer. Note: to calculate the installed length of 5", 6", and 8" DuraLiner pipe subtract 1 1/2" from each joint overlap of liner pipe sections.

SIZE	ORDER #	STOCK #	A	B
6"	6DLR-12	810001219	6 5/8"	12"
6"	6DLR-24	810001220	6 5/8"	24"
6"	6DLR-36	810001221	6 5/8"	36"
6"	6DLR-48	810001222	6 5/8"	48"
8"	8DLR-12	810001254	8 5/8"	12"
8"	8DLR-24	810001255	8 5/8"	24"
8"	8DLR-36	810001256	8 5/8"	36"
8"	8DLR-48	810001257	8 5/8"	48"

Oval Rigid Pipe

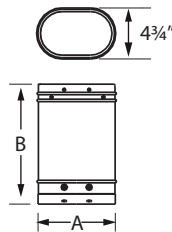

Use to reline masonry chimney with 0/0 clearance. Available in oval 6" and 8" diameters; 12", 24", 36", and 48" lengths. Factory-insulated. Built-in, pre-drilled fittings for riveting joints. 304 stainless steel inner and aluminized steel outer. Note: to calculate the installed length of 5", 6", and 8" DuraLiner pipe subtract 1 1/2" from each joint overlap of liner pipe sections.

SIZE	ORDER #	STOCK #	A	B
6"	6DLR-120	810001223	7 3/4"	12"
6"	6DLR-240	810001224	7 3/4"	24"
6"	6DLR-360	810001225	7 3/4"	36"
6"	6DLR-480	810001226	7 3/4"	48"
8"	8DLR-120	810001258	10 3/4"	12"
8"	8DLR-240	810001259	10 3/4"	24"
8"	8DLR-360	810001260	10 3/4"	36"
8"	8DLR-480	810001261	10 3/4"	48"

Twist-Lock Cap Kit

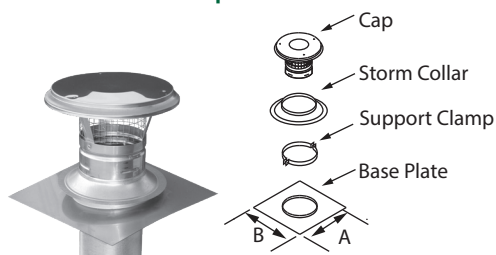

Use to terminate DuraLiner at the top of the masonry chimney. Pipe not included.

Kit includes Base Plate, Support Clamp, Storm Collar, and Cap.

SIZE	ORDER #	STOCK #	A	B
5"	5DLR-KVA	810001189	13"	13"
5"	5DLR-KVB	810001190	13"	18"

Extend-A-Cap Kit

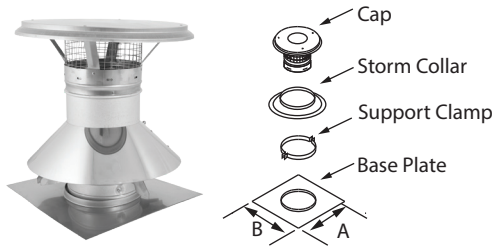

Use to terminate DuraLiner at the top of the masonry chimney.

Kit includes: Base Plate, Support Clamp, Storm Collar, and Cap. Pipe not included.

SIZE	ORDER #	STOCK #	A	B
6" Round	6DLR-KXC13	810001227	13"	13"
6" Round	6DLR-KXC18	810001228	13"	18"
6" Oval	6DLR-KXC20	810001229	13"	20"
6" Oval	6DLR-KXC22	810001230	10"	22"
8" Round	8DLR-KXC13	810001262	13"	13"
8" Round	8DLR-KXC18	810001263	13"	18"
8" Oval	8DLR-KXC20	810001264	13"	20"
8" Oval	8DLR-KXC22	810001265	10"	22"

Round Termination Cap

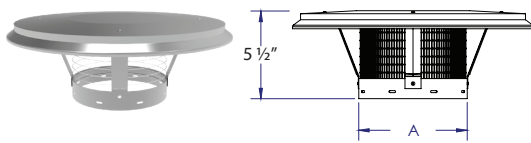

Replacement cap are an exact match to those in kits. Includes only the upper portion of the cap assembly that is removed for sweeping & inspection purposes.

SIZE	ORDER #	STOCK #	A
5" Round	5DLR-VC	810006064	5 5/8"
6" Round	6DLR-VC	810016984	6 5/8"
8" Round	8DLR-VC	810016985	8 5/8"

Oval Termination Cap

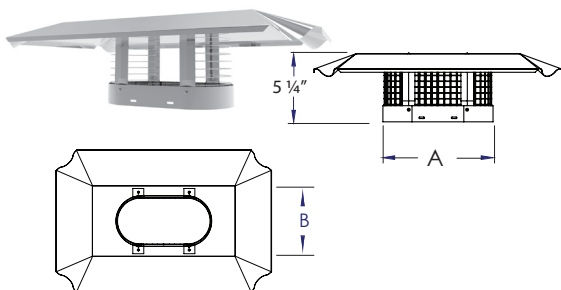

Replacement cap are an exact match to those in kits. Includes only the upper portion of the cap assembly that is removed for sweeping & inspection purposes.

SIZE	ORDER #	STOCK #	A	B
6" Round	6DLR-VCO	810016986	4 3/4"	6 5/8"
8" Round	6DLR-VCO	810016987	4 3/4"	8 5/8"

Slip Connector and Hanger

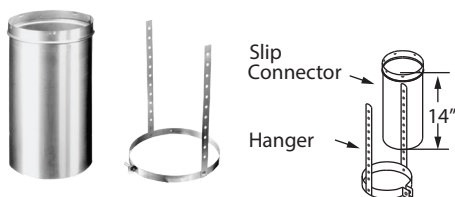

Use with Transition Anchor Plate to connect DuraLiner to DuraTech, DuraPlus, or DuraTech Premium chimney.

SIZE	ORDER #	STOCK #
6"	6DLR-SCH	810001231
8"	8DLR-SCH	810001266

Transition Anchor Plate

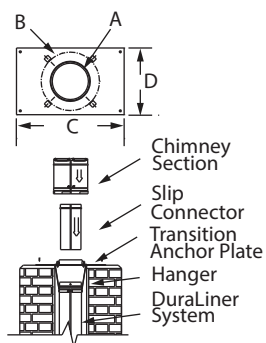

Use with Slip Connector and Hanger in chimney restoration to connect DuraLiner pipe to DuraTech, DuraPlus, or DuraTech Premium Chimney. Painted black. Pricing for Transition Anchor Plates are listed under DuraTech, DuraPlus, and DuraTech Premium.

DURAPLUS						
SIZE	ORDER #	STOCK #	A	B	C	D
6"	6DP-AP14x17	810000542	6 1/16"	10 3/8"	17"	14"
6"	6DP-AP17x17	810000543	6 1/16"	10 3/8"	17"	17"
6"	6DP-AP13x21	810000544	6 1/16"	10 3/8"	21"	13"
6"	6DP-AP17x21	810000545	6 1/16"	10 3/8"	21"	17"
8"	8DP-AP14x17	810000628	8 1/16"	12 3/8"	17"	14"
8"	8DP-AP17x17	810000629	8 1/16"	12 3/8"	17"	17"
8"	8DP-AP13x21	810000630	8 1/16"	12 3/8"	21"	13"
8"	8DP-AP17x21	810000631	8 1/16"	12 3/8"	21"	17"
DuraTech Premium						
SIZE	ORDER #	STOCK #	A	B	C	D
6"	6DTP-AP14x17	810000678	6 1/16"	10 3/8"	17"	14"
6"	6DTP-AP17x17	810000679	6 1/16"	10 3/8"	17"	17"
6"	6DTP-AP17x21	810000680	6 1/16"	10 3/8"	21"	13"
8"	8DTP-AP14x17	810000764	8 1/16"	12 3/8"	17"	14"
8"	8DTP-AP17x17	810000765	8 1/16"	12 3/8"	17"	17"
8"	8DTP-AP17x21	810000766	8 1/16"	12 3/8"	21"	13"
DURATECH						
SIZE	ORDER #	STOCK #	A	B	C	D
6"	6DT-AP14x17	810000117	6 1/16"	8 3/16"	17"	14"
6"	6DT-AP17x17	810000118	6 1/16"	8 3/16"	17"	17"
6"	6DT-AP13x21	810000119	6 1/16"	8 3/16"	21"	13"
6"	6DT-AP17x21	810000120	6 1/16"	8 3/16"	21"	17"
8"	8DT-AP14x17	810000258	8 1/16"	10 3/16"	17"	14"
8"	8DT-AP17x17	810000259	8 1/16"	10 3/16"	17"	17"
8"	8DT-AP13x21	810000260	8 1/16"	10 3/16"	21"	13"
8"	8DT-AP17x21	810000261	8 1/16"	10 3/16"	21"	17"

Insulation

Insulation Kit



Use to insulate flex inside clay liner area of the masonry chimney.

Kit includes: ½" x 5' ProFoil insulation and a 5' section of ProMesh.

SIZE	8"
ORDER #	8DL-IK
STOCK #	810001232

AluFoil Tape



Use to seal seams of ProFoil insulation. 2 mil aluminum foil tape has strength and adhesion.

SIZE	STOCK #
3" x 150'	RNS-ALF
STOCK #	810002486