

State of California
AIR RESOURCES BOARD

EXECUTIVE ORDER VR-204-F

Vapor Systems Technologies, Inc.
Phase II Enhanced Vapor Recovery (EVR) System
Including Veeder-Root In-Station Diagnostics (ISD) System

WHEREAS, the California Air Resources Board (ARB) has established, pursuant to California Health and Safety Code sections 25290.1.2, 39600, 39601 and 41954, certification procedures for systems designed for the control of gasoline vapor emissions during motor vehicle fueling operations (Phase II EVR vapor recovery systems) in its CP-201, **Certification Procedure for Vapor Recovery Systems at Gasoline Dispensing Facilities** (Certification Procedure) as last amended May 25, 2006, incorporated by reference in title 17, California Code of Regulations, section 94011;

WHEREAS, ARB has established, pursuant to California Health and Safety Code sections 39600, 39601, 39607, and 41954, test procedures for determining the compliance of Phase II vapor recovery systems with emission standards;

WHEREAS, Vapor Systems Technologies, Inc. (VST) requested certification of the VST Phase II Enhanced Vapor Recovery System Including Veeder-Root In-Station Diagnostics (VST Phase II EVR System Including ISD) pursuant to the Certification Procedure by Executive Order VR-204-A issued on April 1, 2008, and last modified on December 24, 2008, by Executive Order VR-204-E;

WHEREAS, the Certification Procedure provides that the ARB Executive Officer shall issue an Executive Order if he or she determines that the vapor recovery system conforms to all of the applicable requirements set forth in the Certification Procedure;

WHEREAS, G-01-032 delegates to the Chief of the Monitoring and Laboratory Division the authority to certify or approve modifications to certified Phase I and Phase II vapor recovery systems for gasoline dispensing facilities;

WHEREAS, I, William V. Loscutoff, Chief of the Monitoring and Laboratory Division, find that the VST Phase II EVR System Including ISD conforms with all requirements set forth in the Certification Procedure, including compatibility when fueling vehicles equipped with onboard refueling vapor recovery systems, and results in a vapor recovery system which is at least 95 percent efficient and shall not exceed 0.38 pounds of hydrocarbons per 1,000 gallons of gasoline transferred when tested pursuant to TP-201.2, **Efficiency and Emission Factor for Phase II Systems** (October 8, 2003);

NOW, THEREFORE, IT IS HEREBY ORDERED that the VST Phase II EVR System Including ISD is certified to be at least 95 percent efficient and does not exceed 0.38 pounds of hydrocarbon per 1,000 gallons of gasoline transferred in attended and/or self-service mode when used with an ARB-certified Phase I vapor recovery system and installed,

operated, and maintained as specified herein and in the following exhibits. Exhibit 1 contains a list of the equipment certified for use with the VST Phase II EVR System including Veeder-Root ISD. Exhibit 2 contains the performance standards, specifications, and typical installation drawings applicable to the VST Phase II EVR System Including Veeder-Root ISD as installed in a gasoline dispensing facility (GDF). Exhibit 3 contains the manufacturing performance standards and specifications. Exhibit 4 provides items required in conducting TP-201.3. Exhibit 5 is the liquid removal test procedure. Exhibit 6 is the VST ECS hydrocarbon sensor verification test procedure. Exhibit 7 is the VST and Veeder-Root Phase II EVR System Including Veeder-Root ISD Warranty. Exhibit 8 is the vapor pressure sensor verification test procedure. Exhibit 9 is a test procedure for determining the VST ECS vapor processor activation pressure. Exhibit 10 is the nozzle bag test procedure. Exhibit 11 is the Veeder-Root vapor polisher operability test procedure. Exhibit 12 is the Veeder-Root vapor polisher hydrocarbon emissions verification test procedure. Exhibit 13 is the operability test procedure for the Veeder-Root ISD flow meter. Exhibit 14 provides items required in conducting TP-201.4.

IT IS FURTHER ORDERED that compliance with the applicable certification requirements, rules and regulations of the Division of Measurement Standards of the Department of Food and Agriculture, the Office of the State Fire Marshal of the Department of Forestry and Fire Protection, the Division of Occupational Safety and Health of the Department of Industrial Relations, and the Division of Water Quality of the State Water Resources Control Board are made conditions of this certification.

IT IS FURTHER ORDERED that VST and Veeder-Root shall provide a warranty for the vapor recovery system and components to the initial purchaser. The warranty shall be passed on to each subsequent purchaser within the warranty period. The manufacturer of components listed in Exhibit 1 not manufactured by VST or Veeder-Root shall provide a warranty to each of their components certified herein. The warranty shall include the ongoing compliance with all applicable performance standards and specifications and shall comply with all warranty requirements in Section 16.5 of the Certification Procedure. VST, Veeder-Root, or other manufacturers may specify that the warranty is contingent upon the use of trained installers.

IT IS FURTHER ORDERED that every certified component manufactured by VST and Veeder-Root shall be performance tested by the manufacturer as provided in Exhibit 3.

IT IS FURTHER ORDERED that the certified VST Phase II EVR System Including Veeder-Root ISD shall be installed, operated, and maintained in accordance with the **ARB Approved Installation, Operation, and Maintenance Manual**. A copy of this Executive Order and the **ARB Approved Installation, Operation and Maintenance Manual** shall be maintained at each GDF where a certified VST Phase II EVR System Including Veeder-Root ISD is installed.

IT IS FURTHER ORDERED that equipment listed in Exhibit 1, unless exempted, shall be clearly identified by a permanent identification showing the manufacturer's name, model number, and serial number.

IT IS FURTHER ORDERED that any alteration in the equipment parts, design, installation, or operation of the system certified hereby is prohibited and deemed inconsistent with this certification, unless the alteration has been submitted in writing and approved in writing by the Executive Officer or Executive Officer delegate.

IT IS FURTHER ORDERED that the following requirements are made a condition of certification. The owner or operator of the VST Phase II EVR System Including Veeder-Root ISD shall conduct and pass the following tests no later than 60 days after startup and at least once in each twelve month period, using the following test procedures:

- TP-201.3, ***Determination of 2 Inch WC Static Pressure Performance of Vapor Recovery Systems of Dispensing Facilities*** (March 17, 1999);
- TP-201.4, ***Dynamic Back Pressure*** (July 3, 2002) in accordance with the condition listed in item 1 of the Vapor Collection section of Exhibit 2;
- Exhibit 4, ***Required Items in Conducting TP-201.3;***
- Exhibit 5, ***Liquid Removal Test Procedure;***
- Exhibit 6, ***VST ECS Hydrocarbon Sensor Verification Test Procedure (if a VST ECS membrane processor is installed);***
- Exhibit 8, ***Vapor Pressure Sensor Verification Test Procedure;***
- Exhibit 9, ***Determination of VST ECS Processor Activation Pressure (if a VST ECS membrane processor is installed);***
- Exhibit 11, ***Veeder-Root Vapor Polisher Operability Test Procedure (if a Veeder-Root Vapor Polisher is installed);***
- Exhibit 12, ***Veeder-Root Vapor Polisher Hydrocarbon Emissions Verification Test Procedure (if a Veeder-Root Vapor Polisher is installed);***
- Exhibit 13, ***Operability Test Procedure for the Veeder-Root ISD Flow Meter,*** and
- Exhibit 14, ***Required Items in Conducting TP-201.4.***

Shorter time periods may be specified in accordance with local district requirements. Notification of testing, and submittal of test results, shall be done in accordance with local district requirements and pursuant to policies established by that district. Alternative test procedures, including most recent versions of the test procedures listed above, may be used if determined by the ARB Executive Officer or Executive Officer delegate, in writing, to yield equivalent results.

IT IS FURTHER ORDERED that the following requirements are made a condition of certification. The owner or operator of the VST Phase II EVR System Including Veeder-Root ISD shall conduct, and pass, the following tests no later than 60 days after startup using the following test procedure: Exhibit 10, ***Nozzle Bag Test Procedure***. Notification of testing, and submittal of test results, shall be done in accordance with local district requirements and pursuant to the policies established by that district. Alternative test procedures, including most recent versions of the test procedures listed above, may be used if determined by the ARB Executive Officer or Executive Officer delegate, in writing, to yield equivalent results.

IT IS FURTHER ORDERED that, except as provided above, local districts at their option will specify the testing, related sequencing, and testing frequency of the nozzle vapor valves, VST ECS Membrane Processor, and Veeder-Root Vapor Polisher. If the district requires

the nozzle vapor valve be tested, the test shall be conducted in accordance with Exhibit 10, **Nozzle Bag Test Procedure**.

IT IS FURTHER ORDERED that the VST Phase II EVR System Including Veeder-Root ISD shall be compatible with gasoline in common use in California at the time of certification. The VST Phase II EVR System Including Veeder-Root ISD is not compatible with gasoline that has a methanol content greater than 5 percent, an ethanol content greater than 10 percent, or a methyl tert butyl ether (MTBE) content greater than 15 percent. Any modifications to comply with future California gasoline requirements shall be approved in writing by the Executive Officer or Executive Officer delegate.

IT IS FURTHER ORDERED that the certification of the VST Phase II EVR System Including Veeder-Root ISD is valid through April 1, 2012.

IT IS FURTHER ORDERED that Executive Order VR-204-E issued on December 24, 2008, is hereby superseded by this Executive Order. VST Phase II EVR System Including Veeder-Root ISD certified under Executive Order VR-204-A through E may remain in use at existing installations. This Executive Order shall apply to new installations or major modification of Phase II Systems with a throughput of more than 600,000 gallons per year. The installation of the Veeder-Root ISD System is not authorized on a GDF with a throughput of less than or equal to 600,000 gallons per year.

Executed at Sacramento, California, this 19th day of March 2009.

William V. Loscutoff, Chief
Monitoring and Laboratory Division

Attachments:

- Exhibit 1 Equipment List
- Exhibit 2 System Specifications
- Exhibit 3 Performance Standards and Specifications
- Exhibit 4 Required Items in Conducting TP-201.3
- Exhibit 5 Liquid Removal Test Procedure
- Exhibit 6 VST ECS Hydrocarbon Sensor Verification Test Procedure
- Exhibit 7 Warranty
- Exhibit 8 Vapor Pressure Sensor Verification Test Procedure
- Exhibit 9 Determination of VST ECS Processor Activation Pressure
- Exhibit 10 Nozzle Bag Test Procedure
- Exhibit 11 Veeder-Root Vapor Polisher Operability Test Procedure
- Exhibit 12 Veeder-Root Vapor Polisher Hydrocarbon Emissions Verification Test Procedure
- Exhibit 13 ISD Vapor Flow Meter Operability Test Procedure
- Exhibit 14 Required Items for Conducting TP-201.4

Executive Order VR-204-F
VST Phase II EVR System Including Veeder-Root ISD

Exhibit 1
Equipment List

<u>Component</u>	<u>Manufacturer/ Model</u>
Nozzle	VST Model VST-EVR-NB, VST-EVR-NB-R (Rebuilt) (Figure 1A-1)
Coaxial Curb Hose	VST Model VDV-EVR Series (Figure 1A-2)
Coaxial Whip Hose	VST Model VSTA-EVR Series (Figure 1A-2)
Breakaway Coupling	VST Model VSTA-EVR-SBK (Figure 1A-2)
Hanging Hardware with Liquid Removal Device	(Figure 1A-3)
VST Membrane Processor¹	VST Model VST-ECS-CS3-XXX (Figure 1A-4) where XXX represents motor phase and HC Sensor -110 Single-Phase with HC Sensor -310 Three-Phase with HC Sensor
Veeder-Root Vapor Filter¹	Veeder-Root Vapor Polisher Model 332761-002 (Figure 1A-5)
TLS Console Veeder-Root TLS-350 Series, including but not limited to TLS-350, TLS-350 Plus, TLS-350R, Red Jacket ProMax, Gilbarco EMC consoles	Veeder-Root 8482XX-XXX, 8470XX-XXX, Promax 847097-XXX, EMC PAO2620X000X (Figure 1A-6) X = Any digit
ISD Software Version Number	1.01 or 1.02 (1.02 required for Veeder-Root Vapor Filter)
Vapor Flow Meter (1 per Dispenser)	Veeder-Root 332374-XXX (Figure 1A-7) X = Any digit
Vapor Pressure Sensor (1 per GDF)	Veeder-Root 331946-001 (Figure 1A-8)
Smart Sensor Interface Module With Atmospheric Sensor ² (1 per GDF)	Veeder-Root 329356-004 Veeder-Root 332250-001 ² (Figure 1A-9)

¹ Either a VST Membrane Processor or a Veeder-Root Vapor Filter is required, but not both.

² Atmospheric Sensor is used with the Veeder-Root Vapor Filter System

³ Only required with the VST ECS Membrane Processor

Dispenser Interface Module (DIM)

Veeder-Root DIM Series
(Figure 1A-10)

RS232 Interface Module

Veeder-Root RS232 Interface Module Series
(Figure 1A-11)

Multiport Card³

Veeder-Root 330586-018³

Figure 1A-1
Model VST-EVR- NB Nozzle

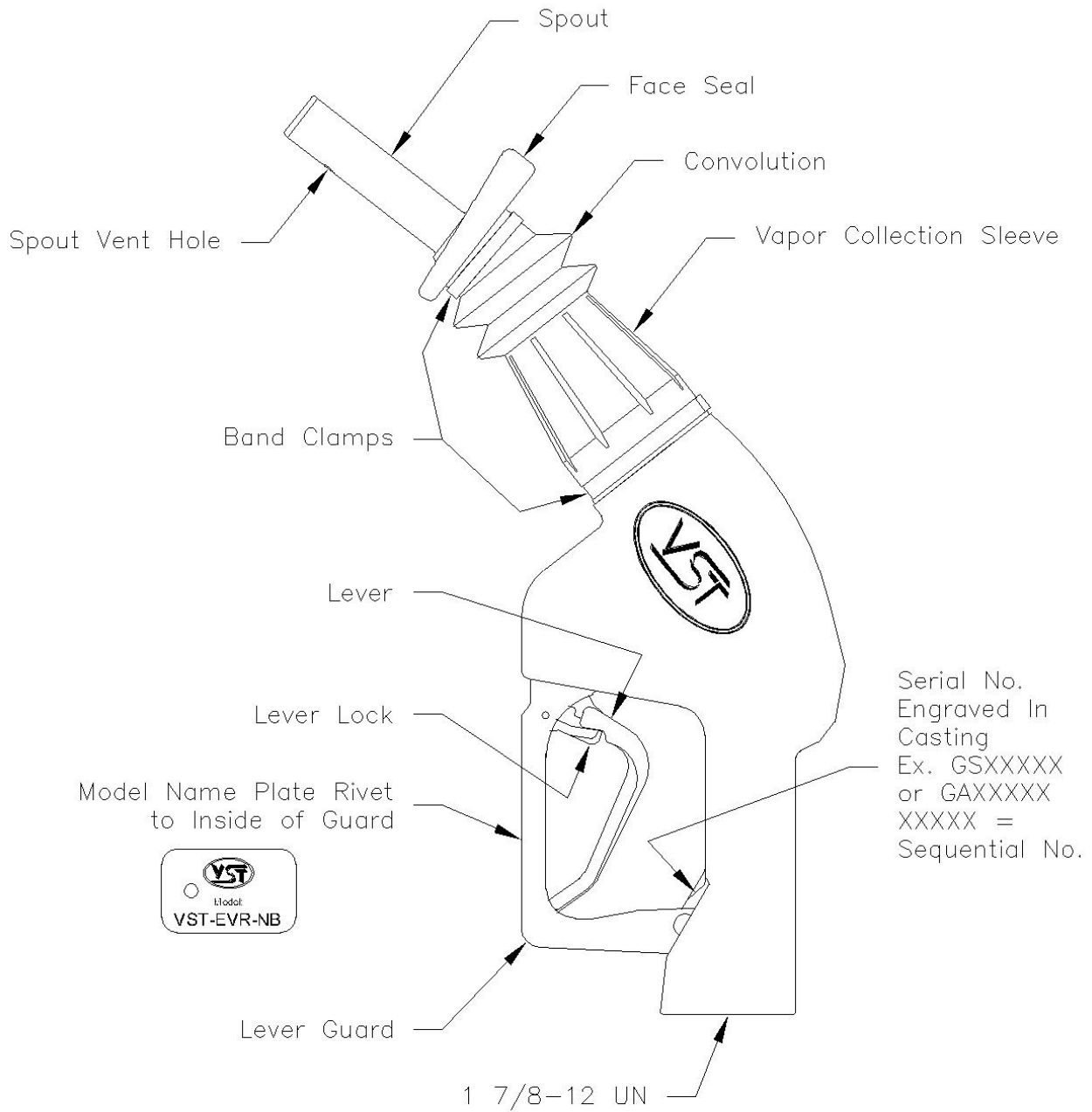

Figure 1A-2
VST Hanging Hardware
(Nozzle, Coaxial Curb Hose, Breakaway, and Coaxial Whip Hose)

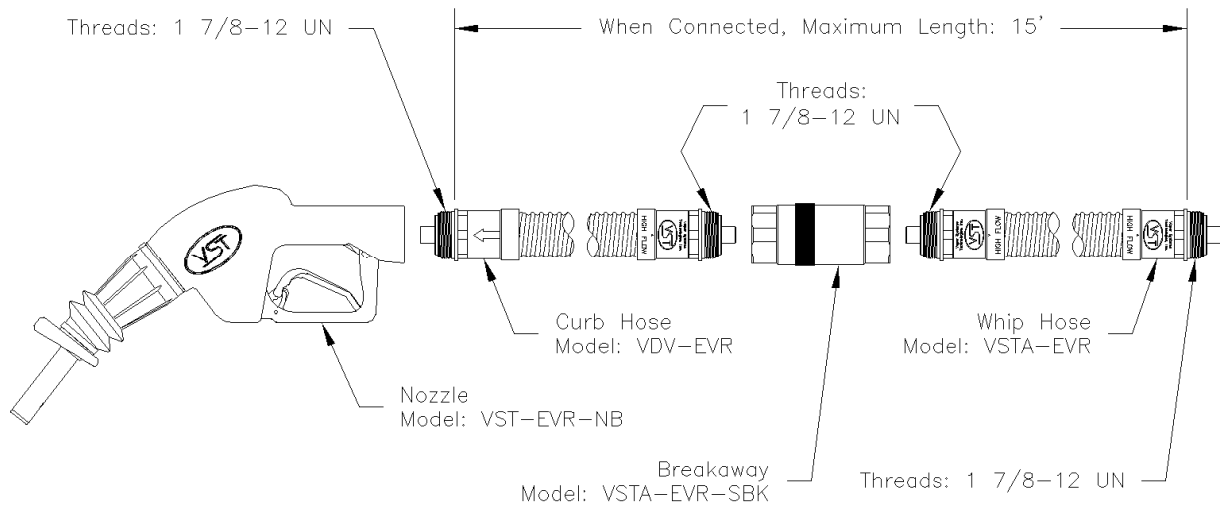

Figure 1A-2 (continued)
VST Hanging Hardware
(Nozzle, Coaxial Curb Hose, Breakaway, and Coaxial Whip Hose)

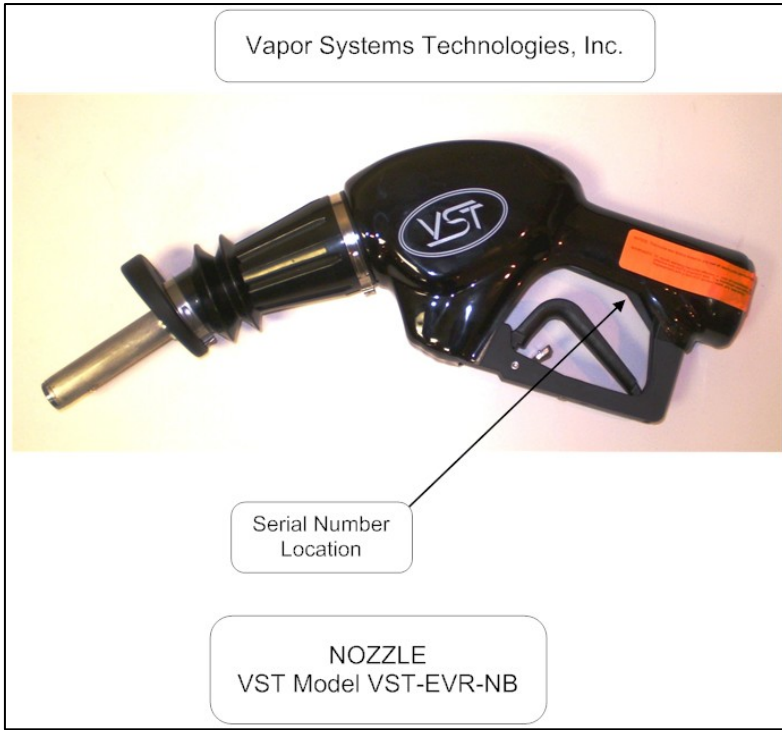

Figure 1A-3
Typical VST Hanging Hardware with Liquid Removal Device

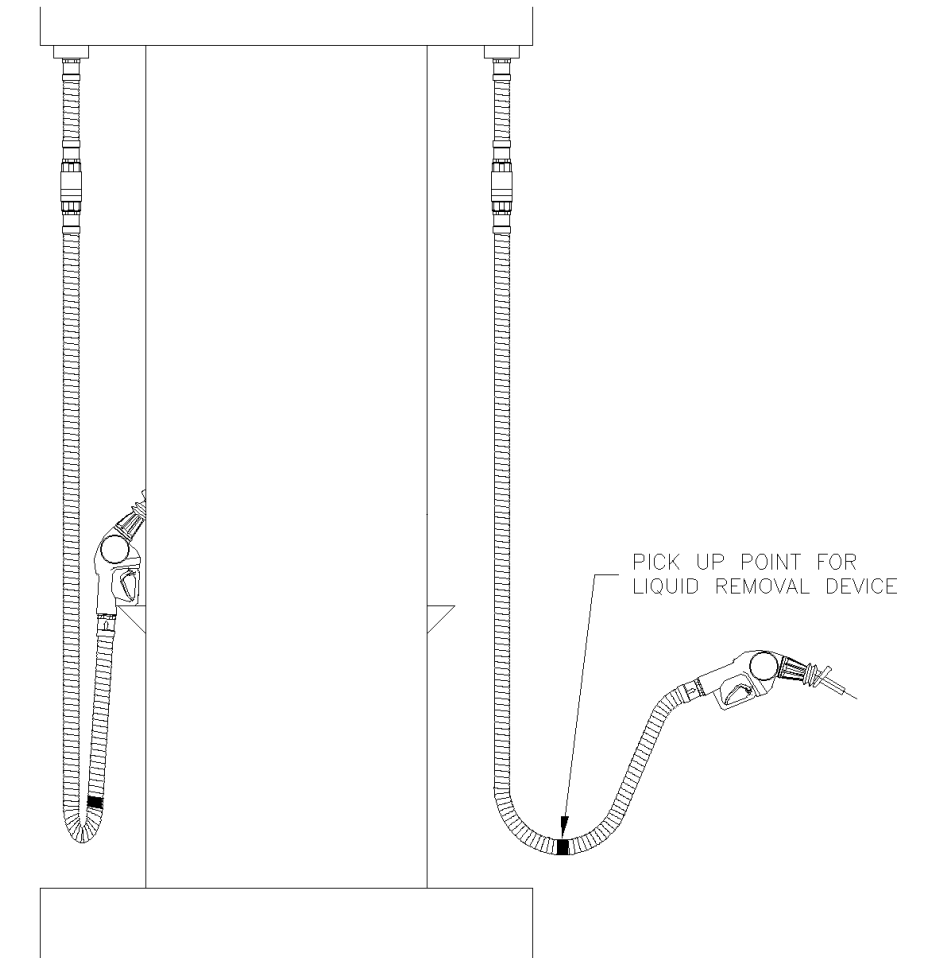
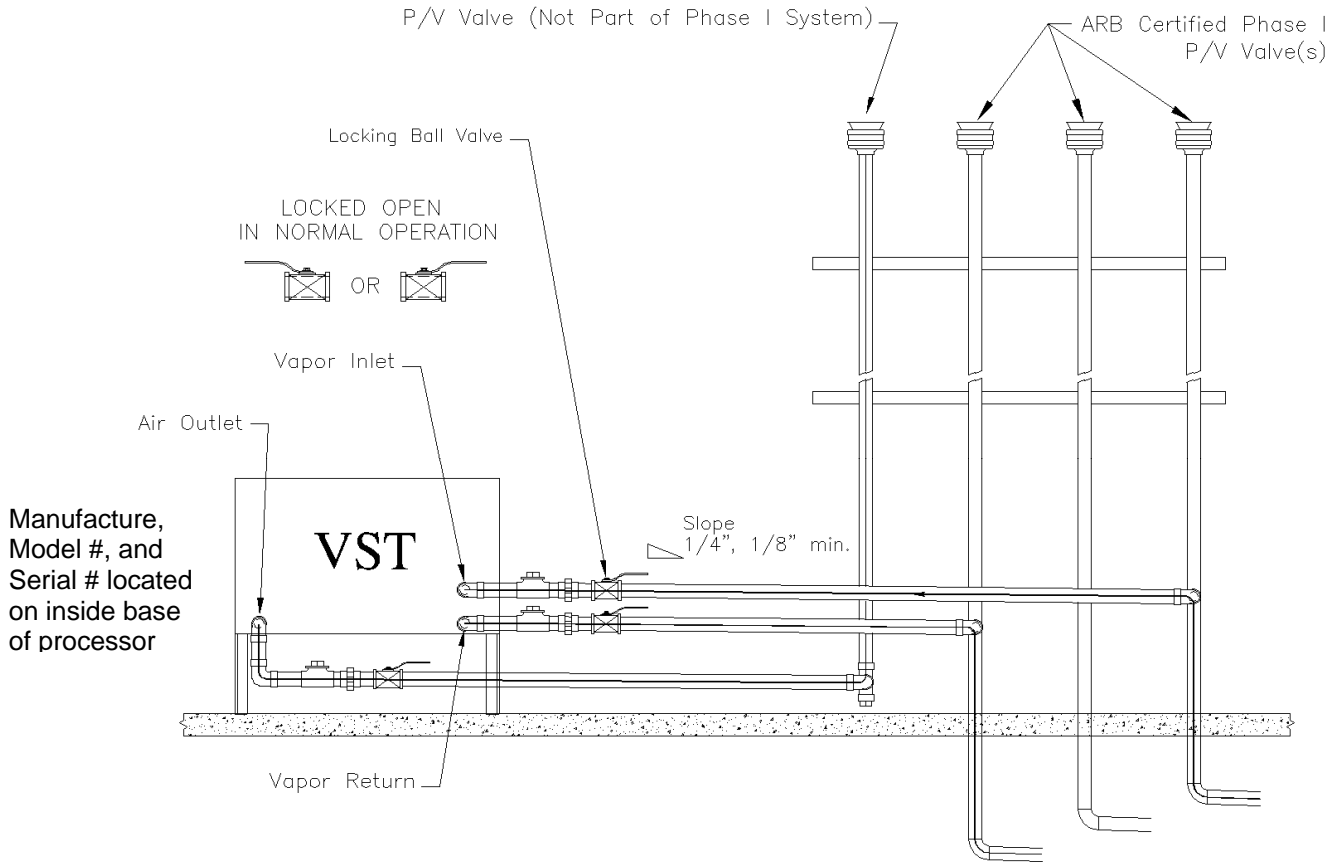

Figure 1A-4
Typical VST-ECS-CS3 Membrane Processor



CAUTION: THE HANDLES ON THE LOCKING BALL VALVES MUST NOT BE REMOVED

Figure 1A-5

Typical Veeder-Root Vapor Polisher

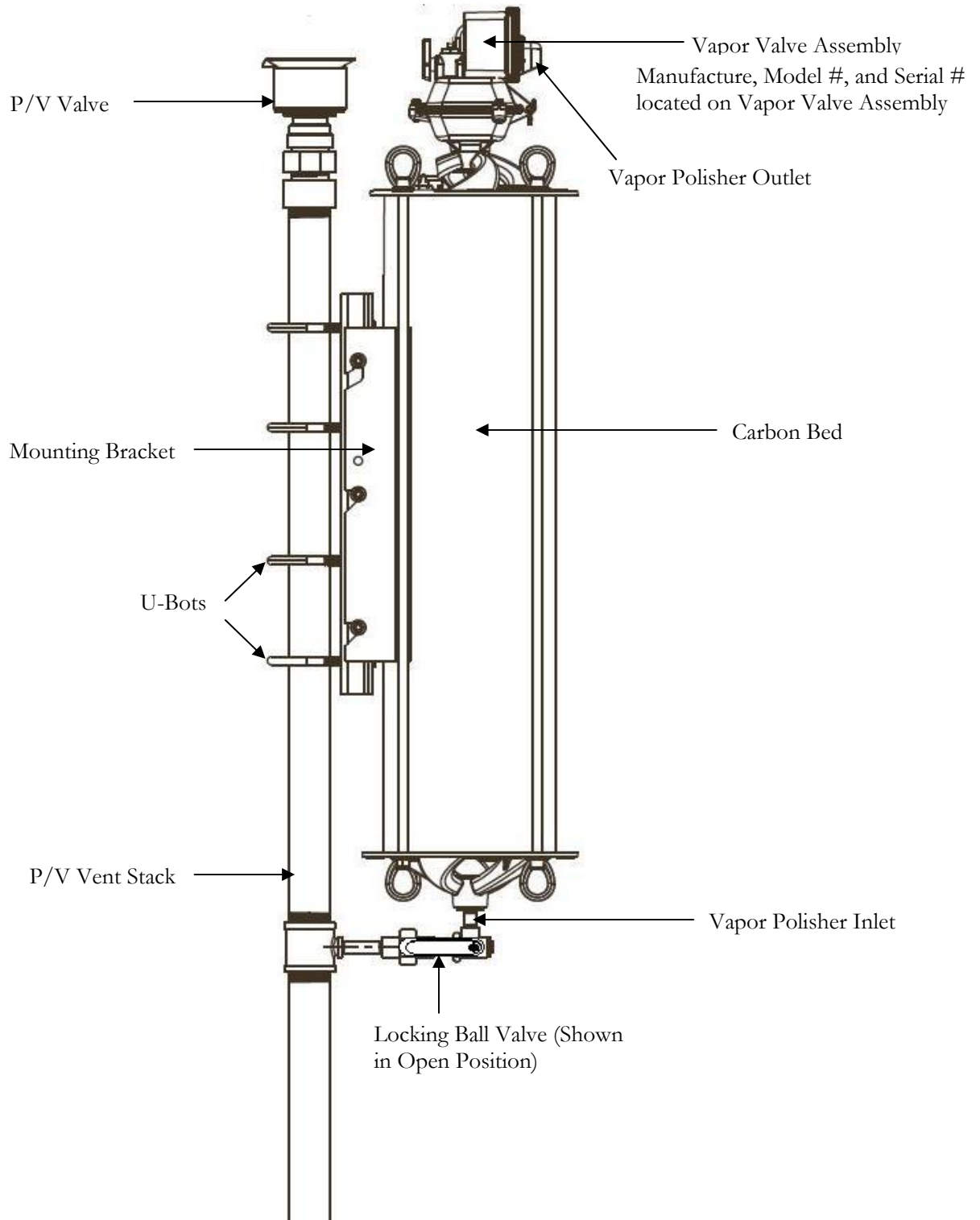

Figure 1A-6
Veeder-Root 8482XX-XXX
Veeder-Root 8470XX-XXX
Standard TLS Console

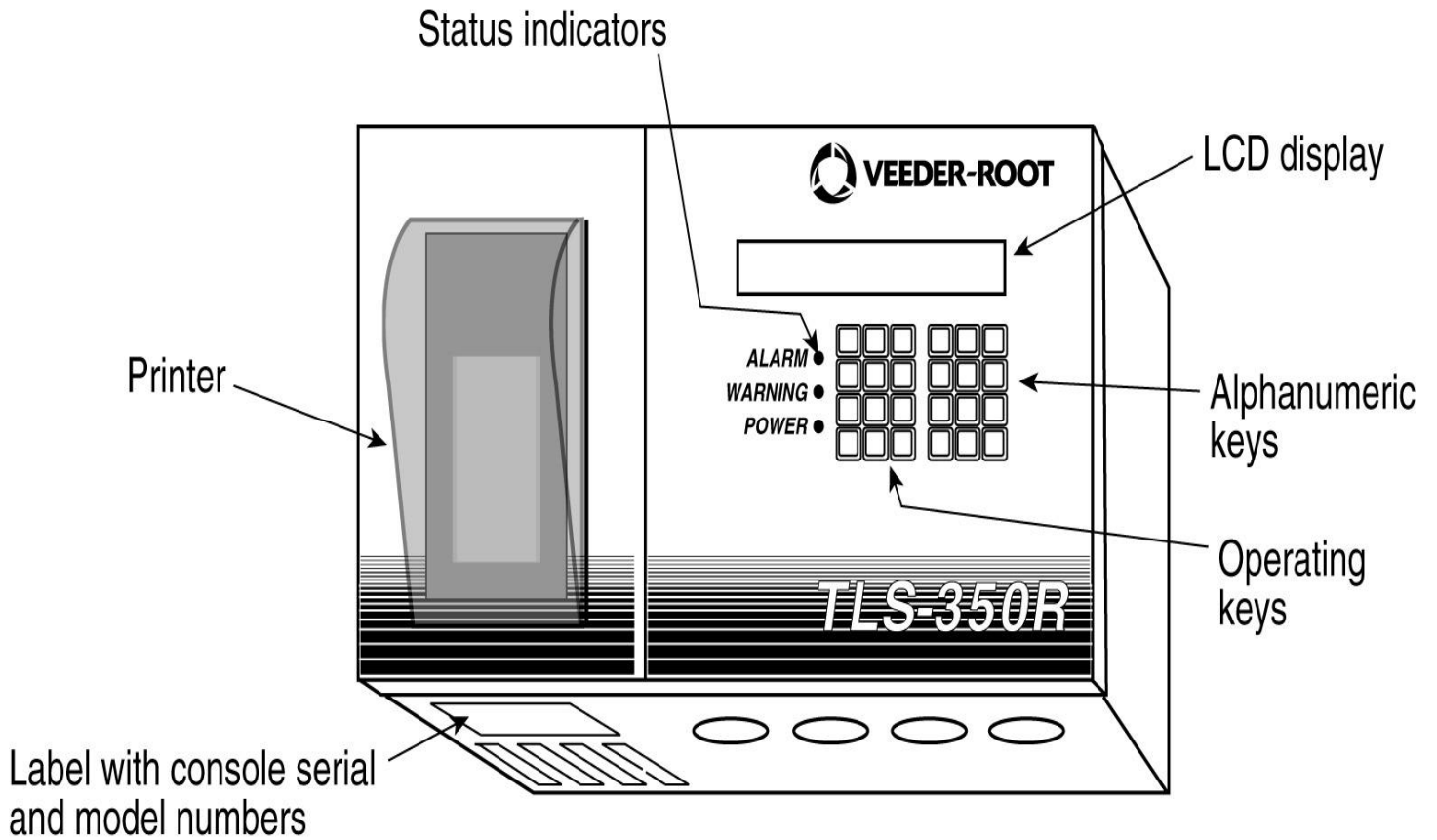

Figure 1A-7
Veeder-Root 332374-XXX
Vapor Flow Meter

The Low Pressure Drop Vapor Flow Meter

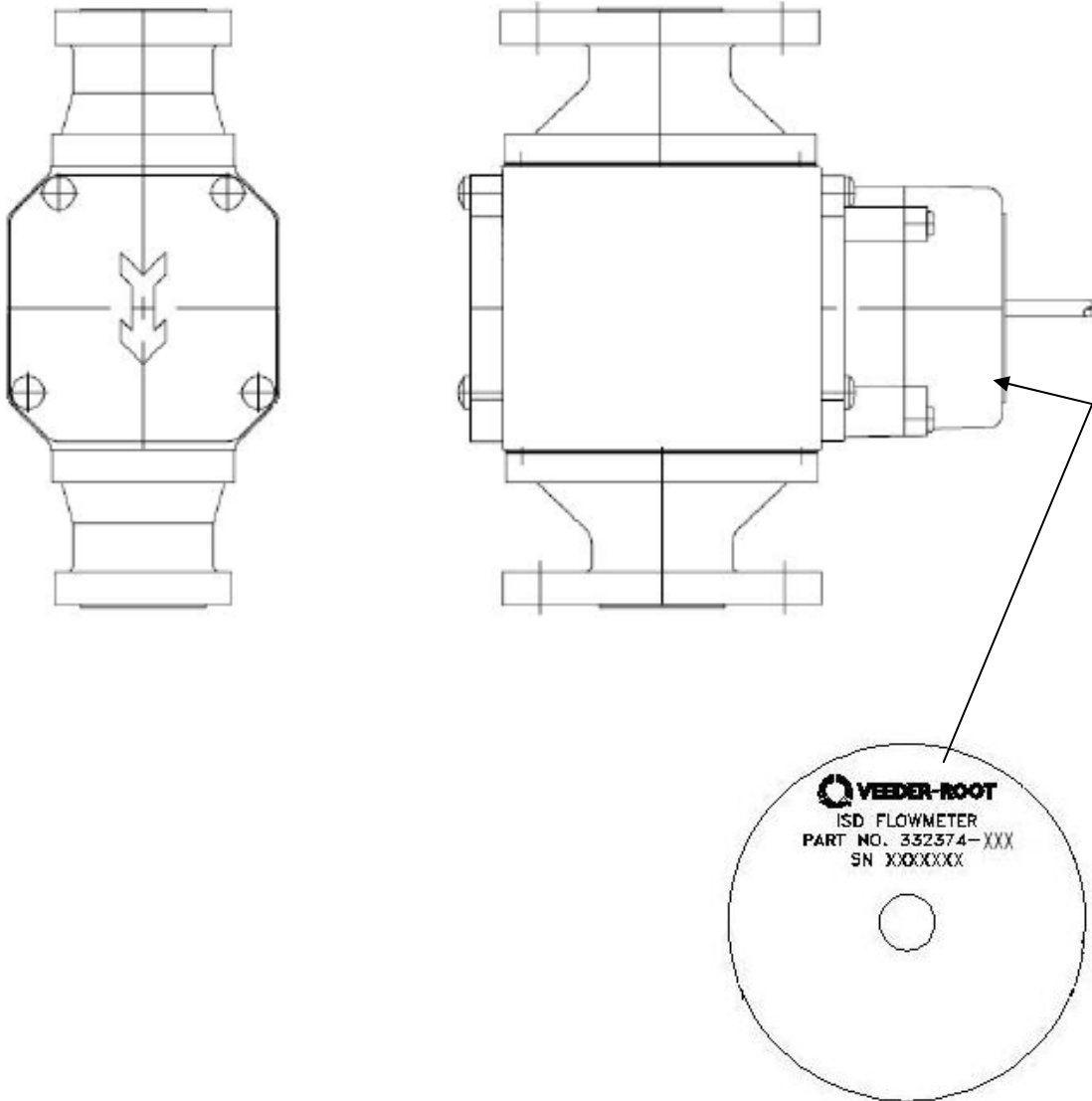

Figure 1A-8
Veeder-Root 331946-001
Vapor Pressure Sensor

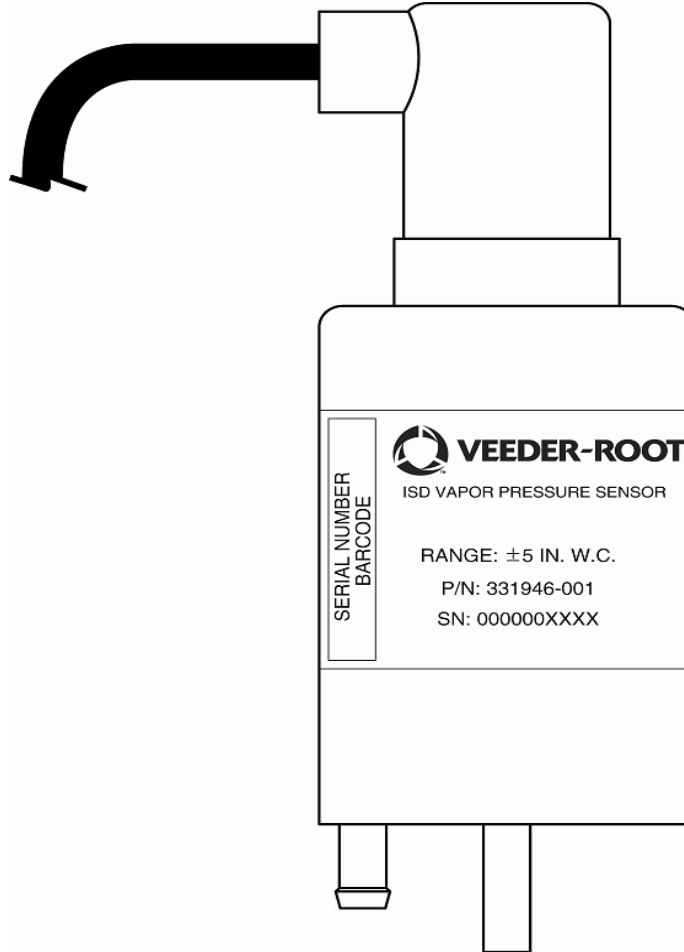

Figure 1A-9
Veeder-Root 329356-004, 332250-001
Smart Sensor Interface Module



Figure 1A-10
Veeder-Root DIM Series
Dispenser Interface Module (DIM)

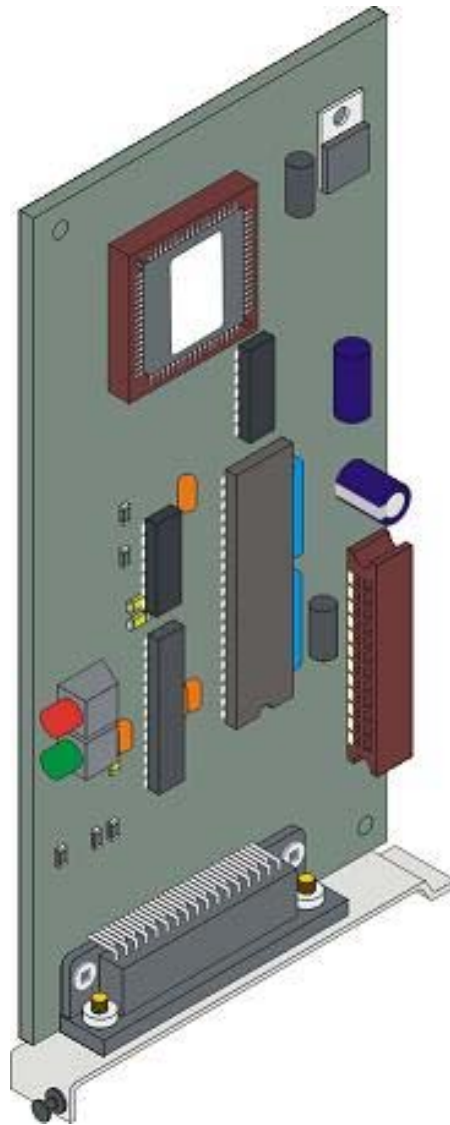
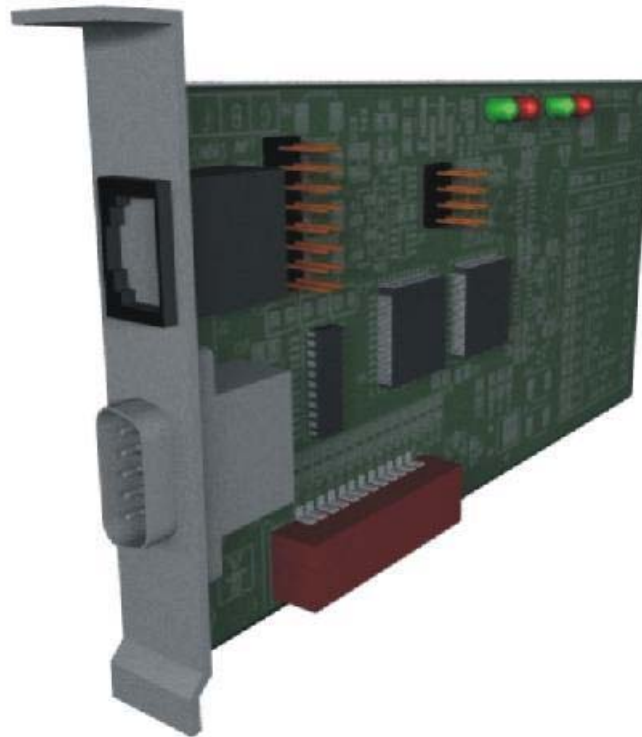

Figure 1A-11
Veeder-Root RS232 Interface Module Series
RS232 Interface Module



Executive Order VR-204-F
VST Phase II EVR System Including Veeder-Root ISD

Exhibit 2
System Specifications

This exhibit contains the installation, maintenance and compliance standards and specifications that apply to the VST Phase II EVR System Including Veeder-Root ISD installed at a gasoline dispensing facility (GDF). All components must be installed, maintained, and operated in accordance with the specifications in the **ARB Approved Installation, Operation and Maintenance Manual** (IOM). Installation, maintenance and repair of system components, including removal and installation of such components in the course of any required tests, shall be performed by technicians certified by the appropriate manufacturer. Additional certifications may be required in accordance with local district requirements. Provided that there are no other local district requirements, a GDF owner/operator can remove and install nozzles, curb hoses, breakaways, and whip hoses without a manufacturer certification.

Nozzle

1. A vapor collection sleeve shall be installed on the nozzle at the base of the spout, as shown in **Figure 2B-1**.
2. The VST Model VST-EVR-NB nozzle has an integral vapor valve which prevents the loss of vapor from the underground storage tanks, ensures proper operation of the system and prevents the ingestion of air into the system. The performance of the nozzle vapor valve can be determined by items 2.1 or 2.2.
 - 2.1. The maximum allowable leak rate for the nozzle vapor path, as determined by TP-201.2B, shall not exceed 0.07 cubic feet per hour (CFH) at a pressure of two inches water column (2.00" WC)
 - 2.2. Verification of the integrity of the vapor valve can be performed on installed nozzles using the nozzle bag test procedure in Exhibit 10.
3. The gasoline flow rate of the nozzle shall be between six (6.0) and ten (10.0) gallons per minute as determined by the applicable provisions of section 6 or 7 of Exhibit 5 or by direct observation for 30 seconds minimum at the maximum hand held position.

Vapor Collection

1. The system pressure drop from the nozzle to the UST, as determined by TP-201.4 (Methodology 1) and Exhibit 14, shall not exceed the following:

0.35 inches WC at a flow rate of 60 CFH of Nitrogen; and
0.62 inches WC at a flow rate of 80 CFH of Nitrogen.

Coaxial Hoses

1. The maximum length of the curb hose, breakaway, and whip hose combined shall not exceed fifteen feet as measured from the base of the nozzle to the end of dispenser adapter or dispenser, as appropriate.
2. The liquid removal rate shall not be less than five milliliters per gallon (5 ml/gal) as determined by Exhibit 5 when tested with a gasoline flow rate between six (6.0) and ten (10.0) gallons per minute. Liquid removal requirement is applicable to all grade of gasoline.
3. Any hose configuration is allowed when installed in accordance with IOM section 12.

Breakaway Couplings

1. The VST breakaway couplings are non-reconnecting and shall be replaced following a drive-off. If reusing hanging hardware other than the breakaway following a drive-off, testing is required to ensure proper operation and no observed leaks of the hanging hardware prior to returning the fueling point to operation. The procedure for testing the hanging hardware following a drive-off is referenced in the IOM section titled "Drive-offs and Other Customer Abuse."

Flow Limiter

1. No flow limiter is allowed for this system.

VST ECS Membrane Processor

1. The processor vapor integrity shall demonstrate compliance with the static pressure decay criteria of TP-201.3 and Exhibit 4.
2. Unless there is maintenance or testing being conducted on the processor, the processor shall be on and in the automatic vapor processor mode and the three ball valves shall be locked in the open positions shown in **Figure 2B-2** for normal processor operation. The handles of the ball valves shall not be removed.
3. Piping to and from the processor shall be sloped 1/8" per foot minimum toward the vent line(s).
4. The hydrocarbon concentration of the ECS membrane processor taken from the Hydrocarbon Diagnostic Report shall be between \pm one percent ($\pm 1\%$) for the zero and mid-range gas and \pm two percent ($\pm 2\%$) for the high-range gas, when tested in accordance with Exhibit 6.
5. The Vapor Pressure Sensor shall be between +0.2 and -0.2 inches WC when tested in accordance with section 9 of Exhibit 8.

6. The processor shall activate when the pressure of the underground storage tank is less than or equal to 0.4 inches WC (≤ 0.4 inches WC) as determined by Exhibit 9.
7. The TLS-350 alarm shall activate when the emission factor is at or greater than 0.64 pounds/1000 gallons dispensed over a 24 hour period. A visual and audible alarm shall activate when this emission factor is exceeded for the first and second 24 hour periods.
8. The pressure reading from the TLS console shall be within ± 0.2 inches WC of the measured ullage UST pressure as determined by section 8 of Exhibit 8.
9. The TLS-350 audible alarm shall be installed at a location that is most likely to be occupied by the station attendant during normal station operation (e.g., cash register).
10. The TLS console controlling the membrane shall have an RS232 port which shall be installed in a location that allows the RS232 port to be easily accessible, and if applicable per district requirements, for use at anytime. A vacant RS232 serial port shall always be available to electronically download reports.

Veeder-Root Vapor Polisher

1. The carbon type shall be BAX G1500 manufactured by MeadWestvaco.
2. Unless there is maintenance or testing being conducted on the processor, the vapor polisher shall be on and in the automatic vapor processor mode and the inlet ball valve shall be locked in the open position shown in **Figure 2B-3** for normal polisher operation. The handle of the ball valve shall not be removed.
3. The pressure reading from the TLS console shall be within ± 0.2 inches WC of the measured ullage UST pressure as determined by section 8 of Exhibit 8.
4. The Vapor Pressure Sensor shall be between $+0.2$ and -0.2 inches WC when tested in accordance with section 9 of Exhibit 8.
5. The Vapor Polisher pressure decrease between starting and ending pressures shall be less than 0.5 inches WC loss when tested in accordance with Exhibit 11. The ending pressure must be greater than 7.0 inches WC. Pressure drop across the Vapor Polisher at 18.0 standard cubic feet per hour flow shall be between 1.69 inches WC and 2.25 inches WC when tested in accordance with Exhibit 11. Differences in temperature readings shall not exceed 10 °F when tested in accordance with Exhibit 11. The atmospheric pressure sensor reading shall be within 10% of the atmospheric pressure obtained from a local independent source when tested in accordance with Exhibit 11.
6. The hydrocarbon concentration from the vapor polisher outlet shall not exceed 9,000 ppm iso-butane (0.9% by volume iso-butane) when tested in accordance with Exhibit 12.
7. The TLS console controlling the vapor polisher shall have an RS232 port which shall be installed in a location that allows the RS232 port to be easily accessible, and if applicable

per district requirements, for use at anytime. A vacant RS232 serial port shall always be available to electronically download reports.

8. Security seal tags must be installed on the vapor polisher. If for any reason the seal tags are damaged or missing, the district may require that Exhibit 11 and Exhibit 12 be conducted and pass prior to installing new security seal tags.

Pressure/Vacuum Vent Valves for Storage Tank Vents

1. Except for the P/V vent valve referenced in item 3 of this section, all P/V vent valves shall be an ARB certified P/V valve for a Phase I system.
2. At least one pressure/vacuum (P/V) vent valve shall be installed on each tank vent. The maximum number of P/V vent valves allowed and P/V vent valve performance specifications are listed in the applicable Phase I EVR Executive Order. Vent lines may be manifold to minimize the number of P/V vent valves and potential leak sources, provided the manifold conforms to all applicable fire regulations. However, the vents connecting the vapor inlet and vapor outlet to the VST ECS Membrane Processor cannot be manifold together.
3. The P/V valve installed on the VST ECS Membrane Processor vent is not part of the Phase I system and no testing is required.

Vapor Recovery Piping Configurations

NOTE: Vapor Return Piping shall meet the requirements specified in section 4.11 of CP-201.

1. Vapor Return and Vent Lines

For facilities installed on or after April 1, 2003, all vapor return and vent lines shall be a minimum nominal internal diameter of 2 inches from the dispensers or the vent stacks to the first manifold. All lines after the first manifold and back to the underground storage tank shall have a minimum nominal internal diameter of 3 inches.

Note: Facilities permitted by a local district prior to April 1, 2003 shall be required to meet the three inch diameter standard only upon facility modification which involves the addition, replacement, or removal of 50 percent or more of the buried vapor piping.

2. All vapor return lines shall have a minimum slope of 1/8 inch per foot from the dispenser riser to the riser of the UST. A slope of 1/4 inch or more per foot is recommended wherever feasible.
3. The dispenser shall be connected to the riser with either flexible or rigid material that is listed for use with gasoline. The dispenser-to-riser connection shall be installed so that

any liquid in the lines will drain toward the storage tank. The internal diameter of the connector, including all fittings, shall not be less than one inch (1").

Note: The dispenser-to-riser connection is defined as the piping connection between the dispenser piping and the inlet of the dispenser riser. A vapor shear valve may also be part of the riser connection.

4. There is no length restriction for the vapor return piping of the system as long as the system complies with the maximum pressure drop requirement, item 1 of the Vapor Collection section.
5. No product shall be dispensed from any fueling point at a GDF installed with the VST Phase II EVR System if there is a vapor line that is disconnected and open to the atmosphere.
6. No liquid condensate traps are allowed with this system.

Dispensers

1. For new installations and existing installations replacing dispensers or dispenser vapor piping, the minimum nominal internal diameter of dispenser vapor piping shall be one inch (1" ID). For existing installations, installed dispenser vapor piping may remain in use as long as the system complies with the maximum pressure drop requirement, item 1 of the Vapor Collection section.
2. Dispenser vapor piping shall be installed so that any liquid in the lines will drain toward the dispenser riser.

In-Station Diagnostics (ISD)

1. The gasoline dispensing facility operator/owner shall comply with local district requirements, if any, following a warning by the Veeder-Root In-Station Diagnostics (ISD) system and shut down of the submersible pumps to all gasoline tanks by the ISD systems.
2. Suggested Troubleshooting, found in Table 16-3 of the Veeder-Root In-Station Diagnostics (ISD) Install, Setup, and Operation Manual (ARB Approved Installation, Operation, and Maintenance Manual), recommends that certain tests be conducted to verify the cause of the ISD warning or failure alarms. Districts may require that these tests or other tests specified by the districts be conducted in response to the ISD alarms.
3. For this certification, the baseline vapor collection performance value used was 1.0. This value will not be used for enforcement purposes.

Phase I System

1. The Phase I system shall be an ARB-certified system that demonstrates compliance with the static pressure decay test criteria contained in TP-201.3 and Exhibit 4.

Maintenance Records

1. Each GDF operator owner shall keep records of alarms and maintenance performed at the facility. Such records shall be maintained on site in accordance with district requirements or policies. The records shall include alarm date and time, nature of the alarm, troubleshooting, maintenance or repair performed to validate and/or correct alarms, component, or system failures, date when maintenance or repair was conducted, name and Certified Technician Identification Number of individual conducting maintenance or test, affiliation, and telephone number. Additional information may be required in accordance with local district requirements. An example of a GDF maintenance and alarm record is shown in Figure 2B-12.

Each GDF operator/owner shall keep records of all alarms detected by the ISD system. Alarm History records shall be maintained on site or in accordance with district requirements or policies. The records shall include the alarm date, the nature of the alarm, type of test and test date to verify the validity of ISD alarm, maintenance or repair date to correct the cause of the alarm, maintenance or repair performed to correct the cause of the alarm, affiliation, telephone number, name and Certified Technician Identification Number of individual conducting maintenance or test. Additional information may be required in accordance with local district requirements. An example of a GDF maintenance and alarm record is shown in Figure 2B-12.

2. Maintenance shall be conducted in accordance with the VST Systems Scheduled Maintenance section of the ARB approved Installation, Operation, and Maintenance Manual.

Vapor Recovery Equipment Defects

The following is deemed a defect for the affected fueling point(s) or system.

Fueling Points

1. The fueling point shall be removed from service when more than 30% of a nozzle face seal is missing (e.g., a triangular or similar shape in which greater than 2.5 inches of the faceplate circumference is missing (accumulated).
2. The fueling point shall be removed from service when more than 0.375 square inches of a nozzle vapor collection sleeve is missing (e.g., a rectangular shape of greater than nine/sixteenth (9/16) inches or more on each side, a circular shape of eleven/sixteenth (11/16) inches or more in diameter, or a triangular shape of seven/eighth (7/8) inches on the side.
3. The fueling point shall be removed from service when the total slit length in the convolutions exceeds 18 inches as determined by direct measurements.

4. The fueling point shall be removed from service when a hose is found to have greater than 175 ml of gasoline in the vapor side as determined by sections 6.1 to 6.5 of Exhibit 5. Note: Prior to draining gasoline from the vapor side of the VST hose, use VST tool P/N VST-STP-100 and plug the fuel spout. **Do not activate dispenser when draining gasoline from the vapor side of the VST hose.**
5. The fueling point shall be removed from service when VST system pressure drops exceeding the following conditions as determined by Methodology 1 of TP-201.4:
 - 5.00 inches WC at a flow rate of 60 CFH of Nitrogen; and
 - 8.00 inches WC at a flow rate of 80 CFH of Nitrogen.
6. The fueling point shall be removed from service when the dispensing rate is greater than ten (10) gallons per minute (gpm) or less than five (5) gpm as determined by the applicable provisions of section 6 or 7 of Exhibit 5 or by direct observation for 30 seconds minimum at the maximum hand held position.
7. The fueling point shall be removed from service when any hose has a visible opening as determined by direct observation.
8. The fueling point shall be removed from service when the insertion interlock mechanism allows dispensing when the bellow is uncompressed as determined by direct observation or GDF-09 (see Vapor Recovery Defects List).
9. The fueling point shall be removed from service when the nozzle automatic liquid shut-off mechanisms malfunction in any manner as determined by EPO No. 26-F (See Vapor Recovery Defects List) or direct observation.
10. The fueling point shall be removed from service when any nozzle has a defective vapor valve as determined by Exhibit 10 or when the vapor valve has a leak rate that exceeds 0.07 cubic feet per minute at a pressure of two (2) inches WC as determined by TP-201.2B.
11. The fueling point or system shall be removed from service when any component required by this Executive Order is absent, installed improperly or disconnected as determined by direct observation.

System with VST ECS Processor

12. The system shall be removed from service when the ECS membrane processor is not on or in the automatic vapor processor mode as determined by the Diagnostic section of the Section 16 In-Station Diagnostics (ISD) Install, Setup, & Operation Manual of IOM.
13. The system shall be removed from service when the ECS membrane processor is not on or in the automatic vapor processor mode as determined by the Diagnostic section of Section 16 In-Station Diagnostics (ISD) Install, Setup, & Operation Manual of the IOM.
14. The system shall be removed from service when the VST ECS Processor alarms for emission factor are activated for two consecutive 24 hour periods as determined by direct observation.

15. The system shall be removed from service if the processor fails to activate when the UST pressure is less than or equal to 0.4 inches WC (\leq 0.4 inches WC) as determined by Exhibit 9.
16. The system shall be removed from service when the hydrocarbon concentration of the VST ECS Processor exceeds twelve percent (12%) as found in the Vapor Processor Status Report.

Veeder-Root ISD System Specifications

TLS Console & ISD Software Version Number

The ISD audible alarm shall be installed at a location that is most likely to be occupied by the station attendant during normal station operation (e.g. cash register) to hear the alarm. The TLS console shall be installed in a location that allows the RS232 port to be easily accessible, and if applicable, per district requirements, for use at anytime. A vacant RS232 serial port shall always be available to electronically download reports.

The presence of ISD and the ISD software version number can be verified on the TLS Console LCD screen by using the <STEP> key or by using the TLS Console <PRINT> key to print and review the latest ISD Daily Report. **See Figures 2B-4 and 2B-5** for TLS and ISD verification instructions.

The TLS Console must have a printer as well as an RS232 interface port.

If the TLS is equipped with security features which prohibit access to the TLS, instructions to override these security features shall be maintained on site in accordance with air district requirements and shall be available to the air district upon request.

Operability Test Procedure

The Veeder-Root ISD operability test procedure provided in Exhibit 8 and Exhibit 11, and in section 16 of the **ARB Approved Installation, Operation and Maintenance Manual (IOM)**, shall be used at GDF sites to determine the operability of the Veeder-Root ISD system to comply with applicable performance standards and performance specification in CP-201. Testing the ISD equipment in accordance with this procedure will verify the proper selection, setup and operation of the TLS Console sensors and interface modules.

The Vapor Flow Meter

The Veeder-Root ISD system requires one Vapor Flow Meter per dispenser installed in accordance with Section 18 of **ARB Approved IOM (Veeder-Root ISD Balance Vapor Flow Meter Manual Installation Guide (577013-916, Rev. B)) for the Veeder-Root ISD System**. The Vapor Flow Meter is an intrinsically safe sensor that is wired to the TLS Console Smart Sensor Module via a conduit dedicated to TLS Console low-voltage sensors. **Figure 2B-6** shows the ISD Vapor Flow Meter. **Figures 2B-10 and 2B-11** show the installation configuration.

The Vapor Pressure Sensor

The Veeder-Root ISD system requires one Vapor Pressure Sensor per GDF installed into one of the dispensers located closest to the tanks (If a row of dispensers are equal distance from the tank pad and within 10' of each other, any dispenser can be used) in accordance with Section 17 of the **ARB Approved IOM Manual**. For vapor vent stack installation, determine which vapor vent stack line is closest to the tank being monitored. Select this line for the addition of the pressure sensor. The connection must be BELOW the Veeder-Root Carbon Canister if equipped in accordance with Section 17 of the **ARB Approved IOM Manual**. **Caution:** Installation of the pressure sensor on the vapor vent stack is only allowed at facilities equipped with a Veeder-Root Vapor Polisher or Franklin Fueling/Healy Clean Air Separator. The Vapor Pressure Sensor is an intrinsically safe sensor that is wired to the TLS Console Smart Sensor

Module via a conduit dedicated to TLS Console low-voltage sensors. **Figure 2B-7** shows an ISD Vapor Pressure Sensor illustration. **Figures 2B-10** and **2B-11** show the dispenser installation configuration. **Figure 2B-12** shows the vapor vent stack installation configuration.

Dispenser Interface Module (DIM)

Existing Dispenser Interface Modules or DIM communication cards are used to interface to the dispenser Point Of Sale (POS) or controller system to gather fuel transaction data. The ISD Operability Test Procedure provided in Exhibit 8 and Exhibit 11 and in Section 4 of the Veeder-Root ISD Install, Setup and Operation Manual for VST ECS Membrane Processors can be used to verify the proper selection and setup of the Dispenser Interface Module. See **Figure 2B-8** for a typical Dispenser Interface Module Illustration.

Tank Inventory Probe Sensor

Existing Tank Inventory Probe sensors (one per tank) are used to measure the amount of vapor space in the Underground Storage Tanks (USTs). The ISD Operability Test Procedure can be used to verify the proper selection and setup of the Tank Inventory Probes. See **Figure 2B-9** for a typical Tank Inventory Probe Sensor.

Shutdown Control

The TLS Console must be wired per Section 16 of **ARB Approved IOM Manual (Veeder-Root ISD Install, Setup and Operation Manual for VST ECS Membrane Processors (557013-937, Rev. A))** such that it shall automatically prohibit the dispensing of fuel through shutdown of all the gasoline turbine pumps during a CP-201 ISD failure alarm or TLS Console ISD system power loss.

TLS Console Modules

The ISD Operability Test Procedure in Exhibit 8 and Exhibit 11 and in section 16 of **ARB Approved IOM Manual** (Section 4 of the Veeder-Root ISD Install, Setup, and Operation Manual for VST ECS Membrane Processors) shall be used to verify the proper selection and setup of the TLS Console Modules.

Training Program

All Veeder-Root contractors must successfully complete the applicable Veeder-Root training program before they can install, startup, and service TLS Console equipment. Contractors must have up-to-date Level 1 certification to install the TLS Console ISD system. Contractors must have an up-to-date Level 2, 3 or 4 certification and the ISD certification to startup and service the ISD system. The schedule, fee and registration information for the Authorized Service Contractor (ASC) training program can be found at <http://www.veeder.com>.

To confirm TLS or ISD training a regulator should send an email to technicaltraining@gilbarco.com with the name (and company) of the ASC to obtain verification of the ASC TLS/ISD training status or call 800-997-7725 and press “*” to get to the Veeder-Root menu and “*” again to speak to a representative.

Maintenance

The TLS console, including interface modules, does not require scheduled maintenance. ISD System Self-Test Monitoring algorithms are designed to verify proper selection, setup and operation of the TLS console and sensors.

There is no recommended maintenance, inspection nor calibration for the Vapor Flow Meter or the Vapor Pressure Sensor. Servicing should be performed in response to warning or alarm conditions.

Figure 2B-1
Model VST-EVR- NB Nozzle

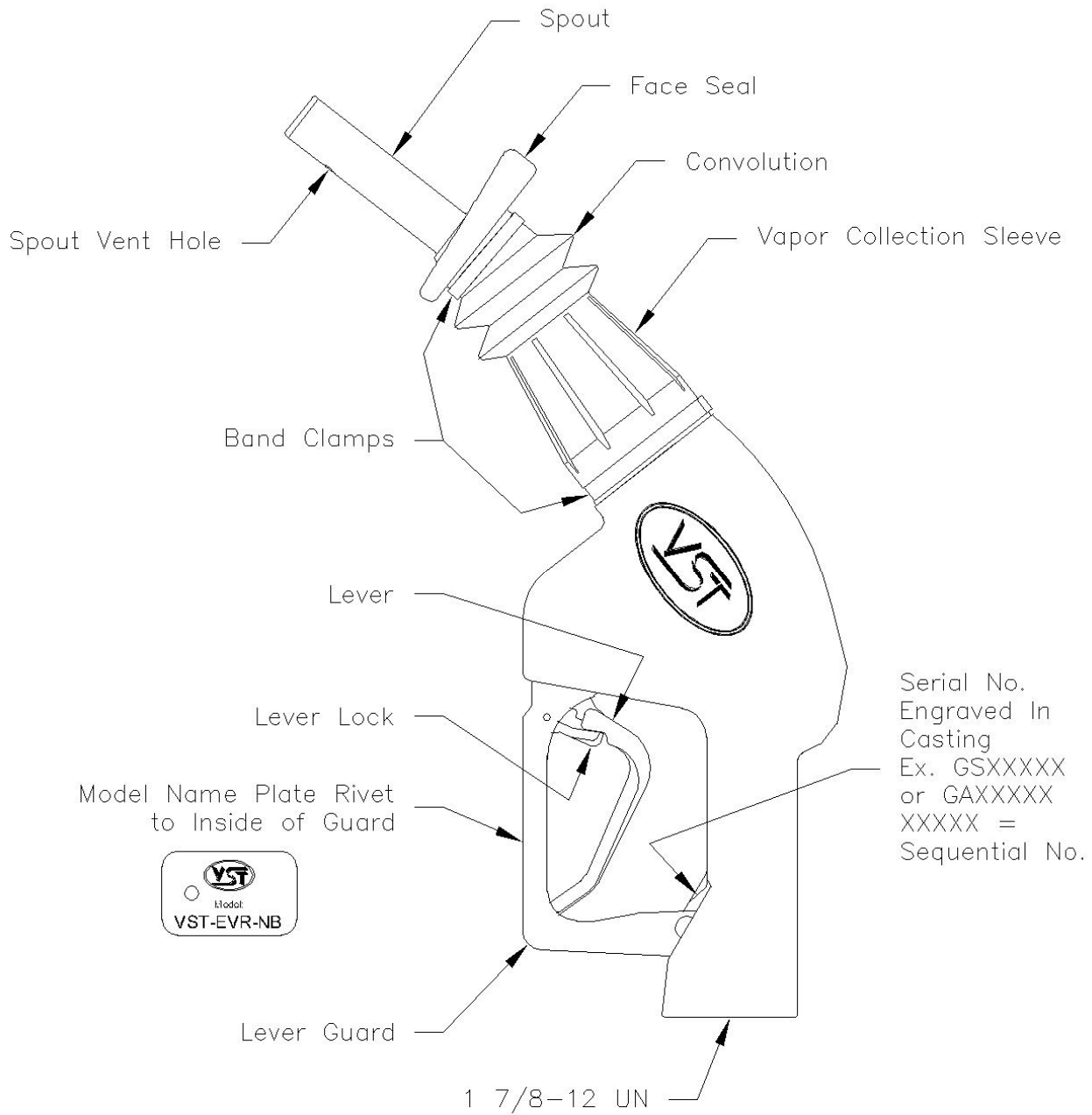
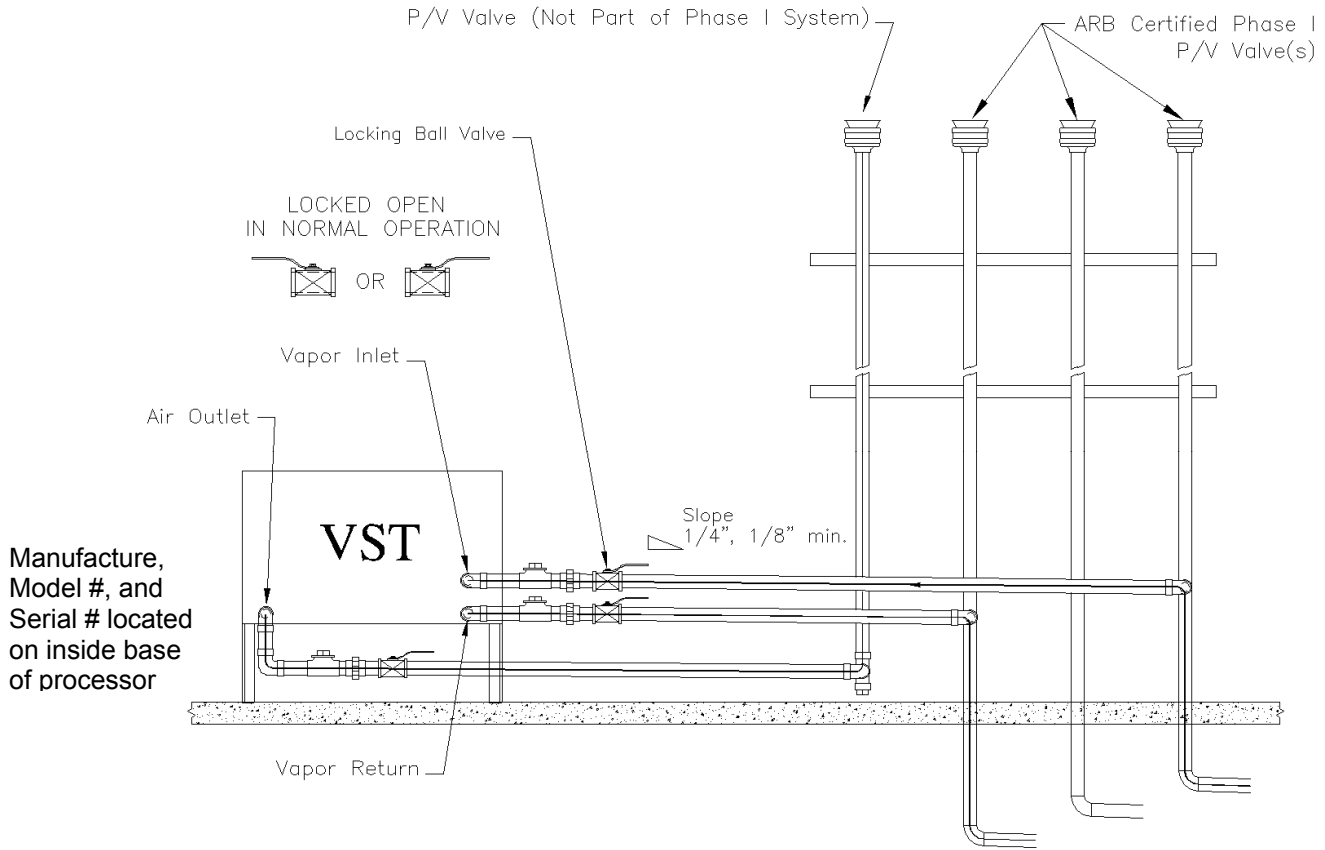

Figure 2B-2
Typical VST-ECS-CS3 Membrane Processor



CAUTION: THE HANDLES ON THE LOCKING BALL VALVES MUST NOT BE REMOVED

Figure 2B-3
Typical Veeder-Root Vapor Polisher

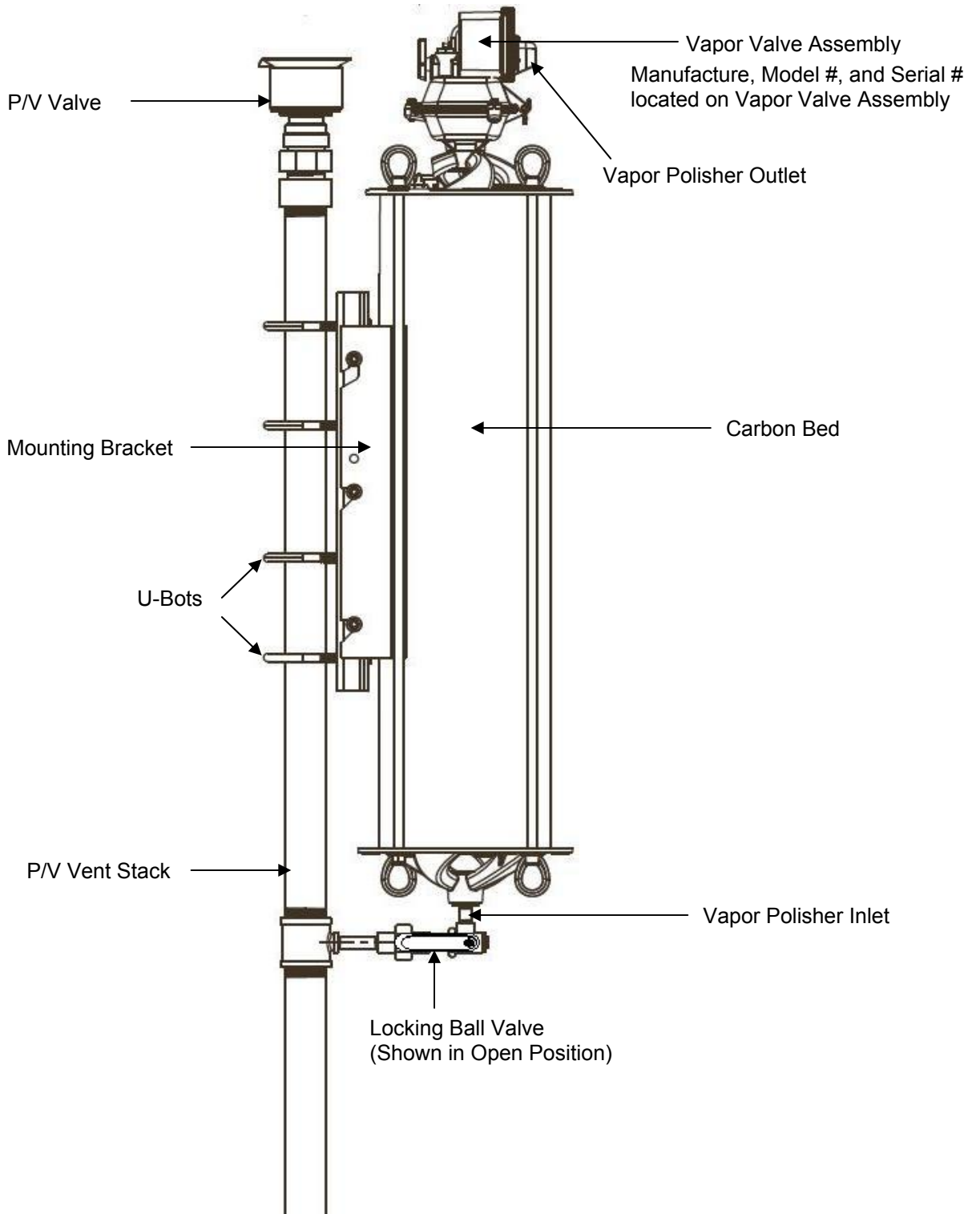
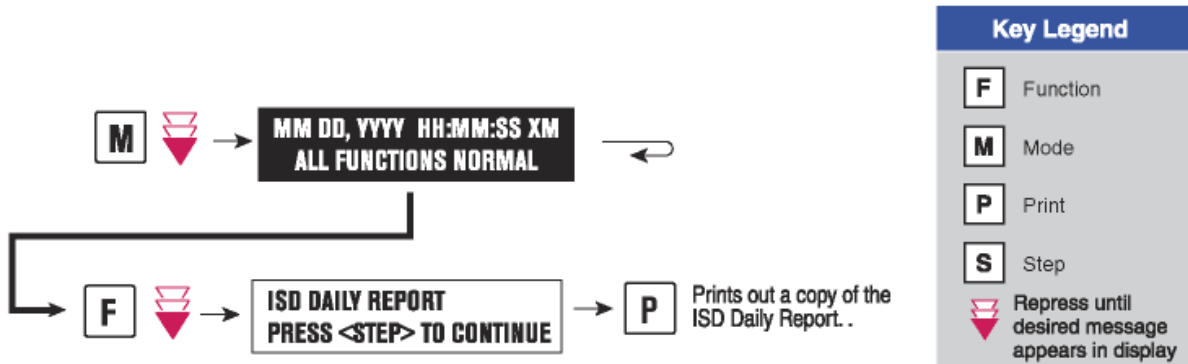
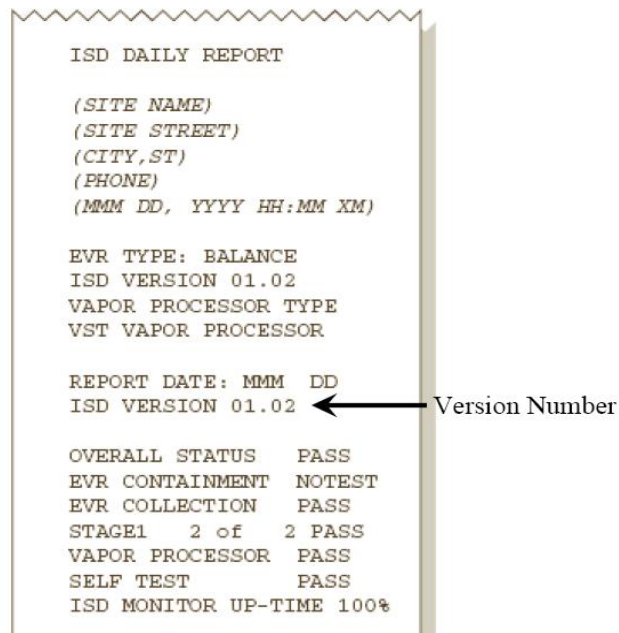

Figure 2B-4
Finding Veeder-Root ISD Version Number

Use the TLS Console <FUNCTION> key to find the ISD Daily Report menu:



The ISD version number can be verified on the TLS Console LCD screen using the <STEP> key or by using the TLS Console <PRINT> key to print and review the latest ISD Daily Report:



Presence of the ISD Daily Report menu and correct ISD software version number is evidence that ISD is installed and activated in the TLS Console.

**Figure 2B-5
Standard TLS Console**

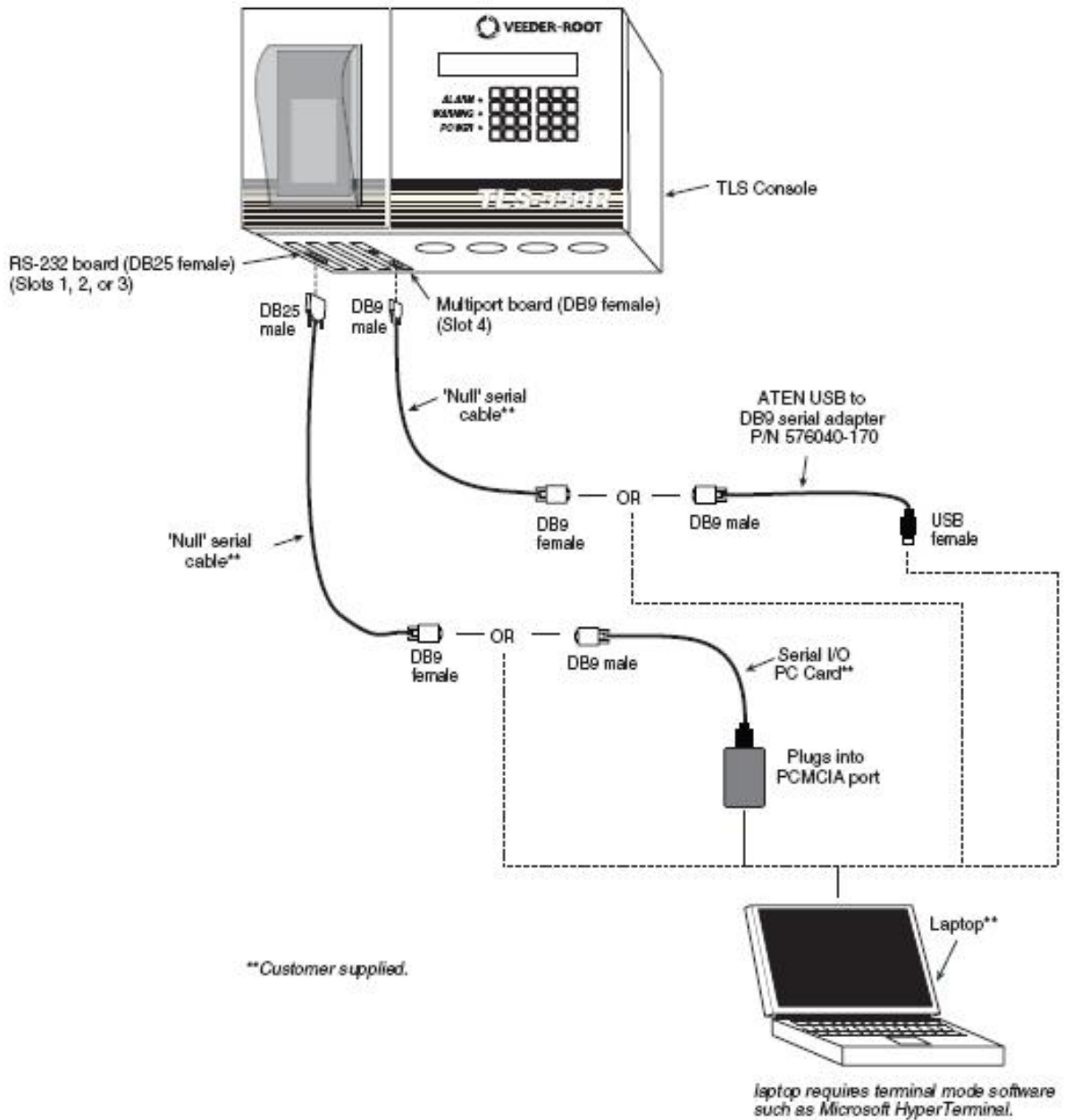

Figure 2B-6
Veeder-Root 332374-XXX
Vapor Flow Meter



Figure 2B-7
Veeder-Root 331946-001
Vapor Pressure Sensor



Figure 2B-8
Veeder-Root DIM Series
Dispenser Interface Module (DIM)

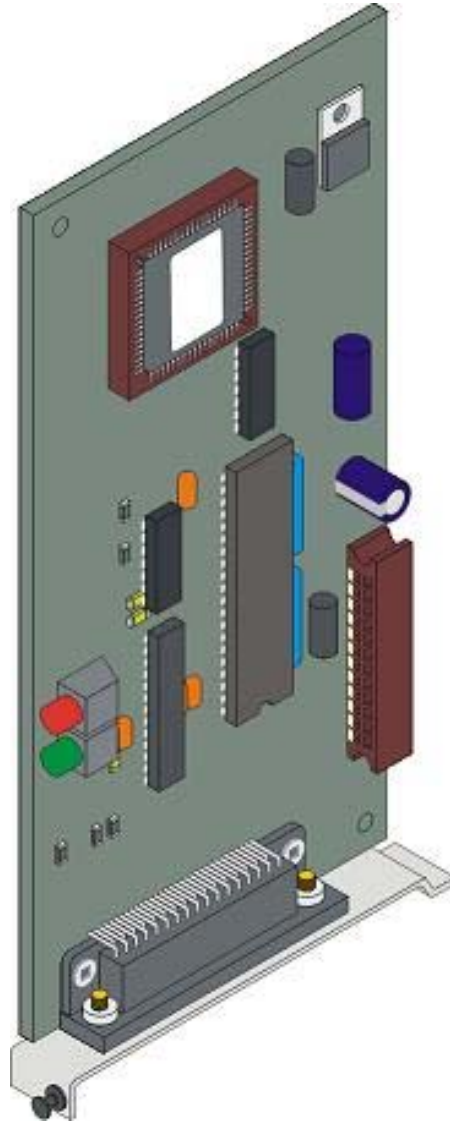

Figure 2B-9
Tank Inventory Probe Sensor

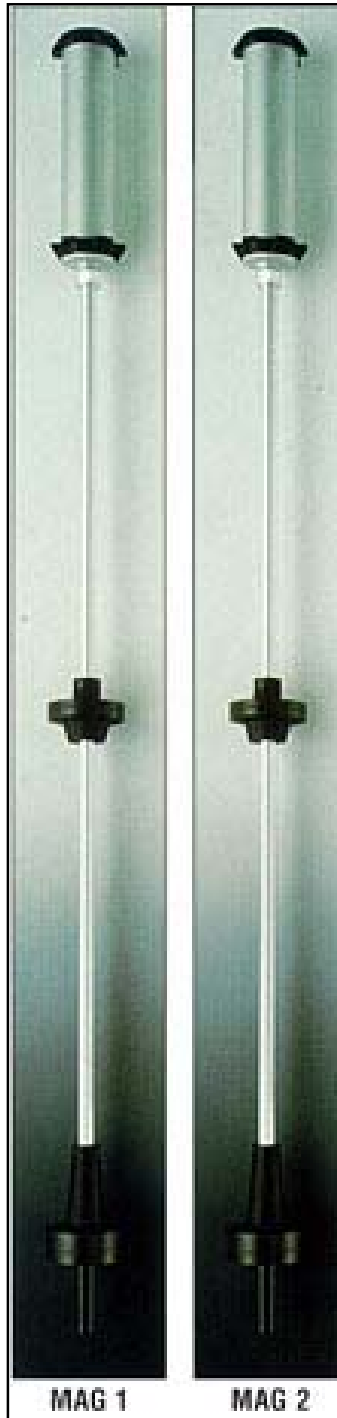

Figure 2B-10
Typical Installation of the Veeder-Root Vapor Pressure Sensor & Vapor Flow Sensor

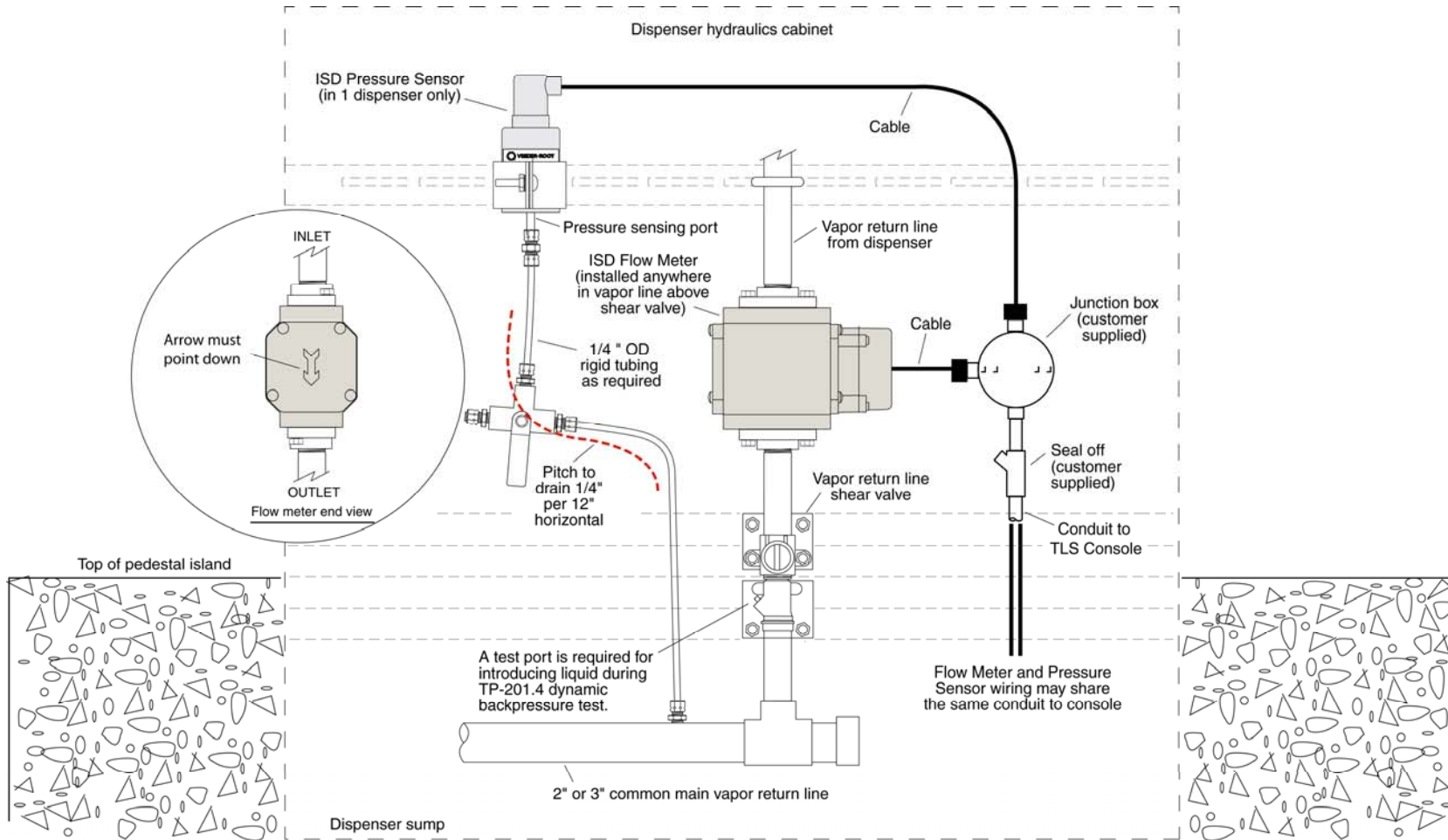

Figure 2B-11
Typical Installation of the Veeder-Root Vapor Pressure Sensor and Vapor Flow Sensor

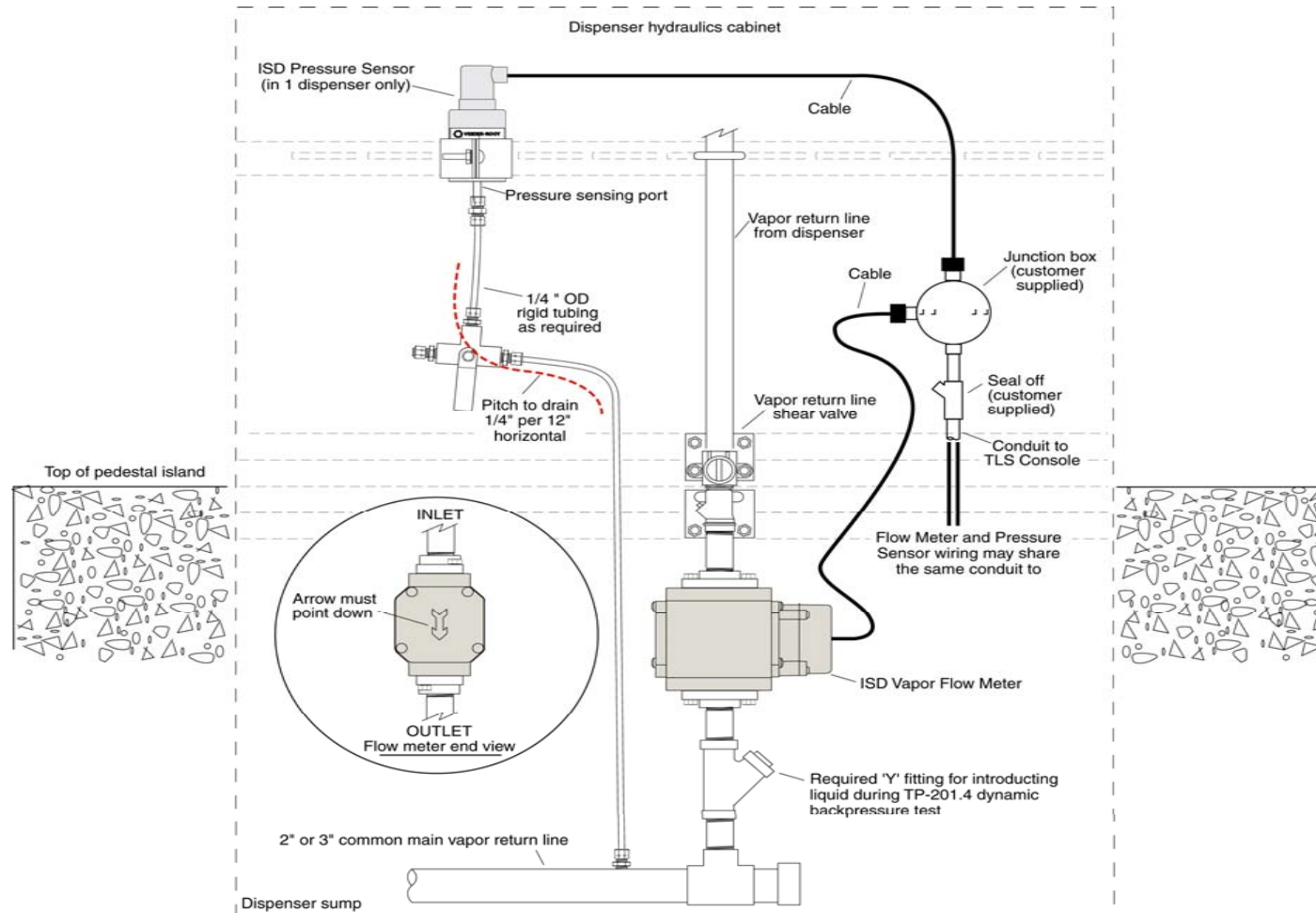

Figure 2B-12
Typical Installation of the Veeder-Root Vapor Pressure Sensor on a vapor vent stack

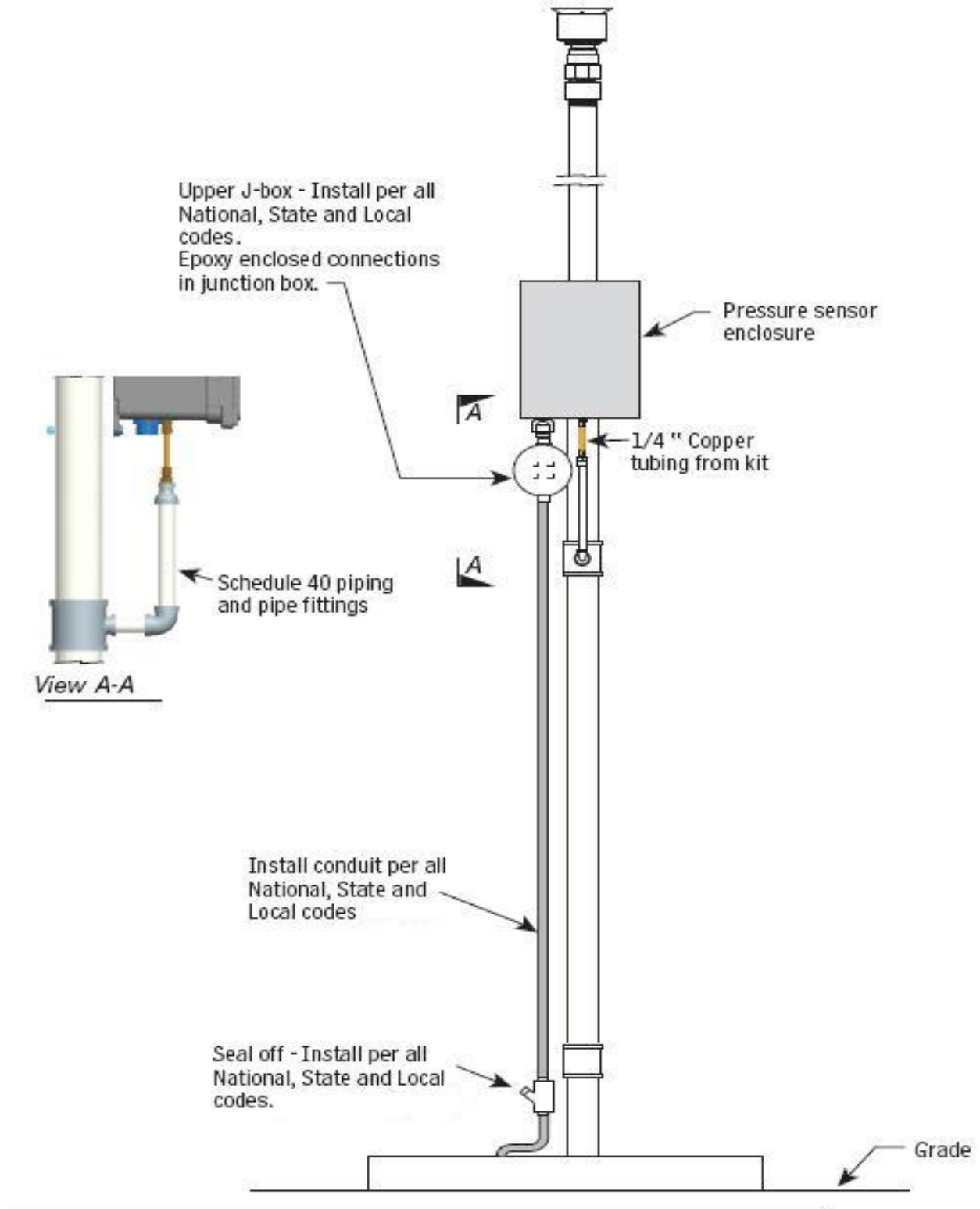

Figure 2B-13
Example of a GDF Maintenance and Alarm History Record

Date of Maintenance/ Test/Inspection/Failure/ alarm history (including date and time of maintenance call)	Repair Date To Correct Test Failure	Maintenance/Test/Inspection Performed and Outcome/Action Taken in Response to Alarm	Affiliation	Name and Technician ID Number of Individual Conducting Maintenance or Test	Telephone Number

Executive Order VR-204-F
VST Phase II EVR System Including Veeder-Root ISD

Exhibit 3
Performance Standards and Specifications

Part I - VST Manufacturing Performance Standards and Specifications

The VST Phase II EVR System including Veeder-Root ISD and all components shall be manufactured in compliance with the performance standards and specifications in CP-201 (amended May 25, 2006), as well as the requirements specified in this Executive Order. All components (Exhibit 1) shall be manufactured as certified; no change to the equipment, parts, design, materials or manufacturing process shall be made unless approved in writing by the Executive Officer or Executive Officer delegate. Unless specified in Exhibit 2 or in the **ARB Approved Installation, Operation and Maintenance Manual**, the requirements of this section apply to the manufacturing process and are not appropriate for determining the compliance status of a gasoline dispensing facility.

1. NOZZLES

Every nozzle shall be tested at the factory. Every nozzle shall have affixed to it a card or label stating the performance specifications listed below, and a statement that the nozzle was tested to, and met, the following specifications.

- a. The nozzle vapor valve leak rate shall not exceed 0.07 cubic feet per hour (CFH) at a pressure of +2 inches water column (WC) when tested in accordance with the latest version of TP-201.2B.
- b. The nozzle automatic shut off feature is tested at all service clip settings as well as handheld in accordance with Underwriters Laboratories (UL) Standard 842.
- c. The nozzle's primary and secondary shut-off mechanism shall be identical to the design that passed the California Department of Food and Agriculture, Division of Measurement Standards Article 2 (DMS 6-6-97).
- d. The nozzle is manufactured to the specifications that passed all tests conducted during the ARB certification for the following:

TP-201.2C	- Spillage from Phase II Systems
TP-201.2D	- Post Fueling Drips from Nozzles
TP-201.2E	- Gasoline Liquid Retention and Spitting in Nozzles and Hoses
TP-201.2J	- Nozzle Pressure Drop
- e. The nozzle vapor collection boot is manufactured such that the force necessary to compress the nozzle bellows 0.5 inches is in the range of 10-16 pounds force.
- f. The terminal end of each nozzle shall be manufactured in accordance with the specifications referenced in Section 4.7.3 of CP-201.

2. COAXIAL HOSES

- a. Every coaxial hose is tested for continuity and pressure tests in accordance with UL Standard 330.
- b. Every coaxial hose is manufactured to the standards and specifications that passed all tests conducted during the ARB certification for the following:
 - Exhibit 5 - Liquid Removal Test Procedure (for curb hoses)
 - TP-201.2J - Hose Pressure Drop (for curb and whip hoses)

3. BREAKAWAY COUPLINGS

- a. Every breakaway coupling is tested for continuity and pressure tests in accordance with UL Standard 567.
- b. Every breakaway coupling is manufactured to the standard that passed all tests conducted during the ARB certification for the following:
 - TP-201.2J - Breakaway Pressure Drop

4. ECS MEMBRANE PROCESSOR

- a. Every ECS Membrane Processor is subjected to a VST Pressure Decay Test to verify pressure integrity.
- b. Every ECS Membrane Processor is subjected to a VST Heat Trace Cable Continuity Test to ensure proper connections.
- c. Every ECS Membrane Processor is subjected to a VST operability test to ensure proper rotation and operation of the blower motor and vacuum pump.

Part II – Veeder-Root Manufacturing Performance Standards and Specifications

The Veeder-Root Vapor Polisher and all components shall be manufactured in compliance with the performance standards and specifications in CP-201 (amended May 25, 2006), as well as the requirements specified in this Executive Order. All components (Exhibit 1) shall be manufactured as certified; no change to the equipment, parts, design, materials or manufacturing process shall be made unless approved in writing by the Executive Officer or Executive Officer delegate. Unless specified in Exhibit 2 or in the ***ARB Approved Installation, Operation and Maintenance Manual***, the requirements of this section apply to the manufacturing process and are not appropriate for determining the compliance status of a gasoline dispensing facility.

1. VEEDER-ROOT VAPOR POLISHER

- a. The pressure drop across the Veeder Root Vapor Polisher is measured at a fixed flow rate.

- b. The Veeder-Root Vapor Polisher is tested for leaks.
- c. The Veeder-Root Vapor Polisher Vapor Valve Smart Sensor communication is tested using Veeder-Root Smart Sensor control protocol.
- d. The Veeder-Root Vapor Polisher Vapor Valve Smart Sensor electro-mechanical valve open and close operation is tested.
- e. The Veeder-Root Vapor Polisher Vapor Valve Smart Sensor electro-mechanical valve feedback control loop is tested for accurate reporting of the valve position.

Part III – Veeder-Root ISD Manufacturing Performance Standards and Specifications

The Veeder-Root ISD System and all components shall be manufactured in compliance with the performance standards and specifications in CP-201 (amended May 25, 2006), as well as the requirements specified in this Executive Order. All components (Exhibit 1) shall be manufactured as certified; no change to the equipment, parts, design, materials or manufacturing process shall be made unless approved in writing by the Executive Officer or Executive Officer delegate. Unless specified in Exhibit 2 or in the ***ARB Approved Installation, Operation and Maintenance Manual***, the requirements of this section apply to the manufacturing process and are not appropriate for determining the compliance status of a gasoline dispensing facility.

1. TLS CONSOLE

- a. Every Veeder-Root TLS Console equipped with MAG Series Tank Inventory Probe Sensor is built, tested and manufactured as an Automatic Tank Gauge System. The TLS Console has been third-party tested by Midwest Research Institute as a UST fuel leak detection system meeting Volumetric Tank Tightness Testing Method standards.
- b. Every Veeder-Root TLS Console has been designed and manufactured to have an Operating Temperature Range of 32°F to 104°F (0°C to 40°C) and Storage Temperature Range of -40°F to 162°F (-40°C to +74°C).
- d. Every Veeder-Root TLS Console system including software, sensors and modules have been designed and is Underwriters Laboratories (UL), Canadian Standards Association (CSA), and Canadian Underwriters Laboratories (cUL) approved for operation near potentially hazardous fuel storage tanks.
- e. Every TLS Console system including software, sensors and modules have been designed and tested in accordance with ISO-9001 manufacturing quality standards.

2. ISD SOFTWARE

- a. Every Veeder-Root TLS Console with ISD software is manufactured to the specifications that passed the operational test and is compliant with CP-201 ISD performance standards and specifications.

- b. Every Veeder-Root TLS Console with ISD software has been designed, manufactured and tested to continually monitor the connectivity and operability status of all ISD sensors and modules. All TLS Console ISD software has been designed, manufactured and tested to issue a visual, audible as well as printed notification upon failure of the connectivity or operability status of ISD sensors and modules.

3. VAPOR FLOW METER

- a. Every Veeder-Root ISD Vapor Flow Meter is designed, tested and manufactured to interface to the TLS Console system. The ISD Vapor Flow Meter has been designed and tested for measuring flow between 2 - 40 GPM in HC concentrations between 0 – 100% saturation across a –40°F to 150°F (-40°C to 65°C) operating range.

4. VAPOR PRESSURE SENSOR

- a. Every Veeder-Root ISD Vapor Pressure Sensor is designed, tested and manufactured to interface to the TLS Console system. The ISD Vapor Pressure Sensor has been designed and tested for measuring vapor pressure between –5 to +5 IWC in HC concentrations between 0 – 100% saturation across a –40°F to 150°F (-40°C to 150 °C) operating range.

5. TANK INVENTORY PROBE SENSOR

- a. Every Veeder-Root MAG Series Tank Inventory Probe Sensor is designed, tested and manufactured to interface to the TLS Console System. The MAG Series Tank Inventory Probe Sensor has been designed and tested to have an Operating Temperature Range of 32°F to 104°F (0°C to 40°C) and Storage Temperature Range of –40°F to 162°F (-40°C to +74°C).

6. TLS CONSOLE MODULES

- a. Every Veeder-Root TLS Console system module has been designed and tested to interface to the TLS Console System. The TLS Console system modules have been designed, tested and manufactured to have an Operating Temperature Range of 32°F to 104°F (0°C to 40°C) and Storage Temperature Range of –40°F to 162°F (-40°C to +74°C).

**Executive Orders VR-203-F and VR-204-F
VST Phase II EVR System**

**Exhibit 4
Required Items in Conducting TP-201.3**

The instructions below are required when conducting TP-201.3 for the VST Phase II EVR system with the VST ECS Membrane Processor or the Veeder-Root Vapor Polisher. The tester shall document that each step was followed as indicated below and shall include this page of the Exhibit with the submission of TP-201.3 test results. **See footnote regarding testing of pressure/vacuum vent valve.** Note that districts may require use of an alternate form to meet these requirements, provided the alternate form includes the same minimum parameters.

VST ECS Membrane Processor Installed

1. Prior to conducting TP-201.3, the three ball valves on the VST Membrane Processor shall be open, as shown in Figure 1.
2. The VST Membrane Processor shall be turned off. Refer to the ARB Approved Installation, Operation, and Maintenance Manual for instructions on turning off the processor. Not turning off the processor will bias the test toward failure.
3. After conducting TP-201.3, leave the three ball valves in the open locked position. Turn the VST Membrane Processor back on.

Required Steps	Verification (please circle)
1. All ball valves are in the open locked position before conducting TP-201.3?	Yes No
2. Processor is turned off before conducting TP-201.3?	Yes No
3. All ball valves in the open locked position and Processor is turned back on after conducting TP-201.3?	Yes No

Test Company: _____ Facility Name: _____

Print Name (Technician) Signature Date

Technician Certification Number and Expiration Date
(ICC or District Training Certification, as applicable)

Figure 1

Configuration of VST Membrane Processor to Conduct TP-201.3

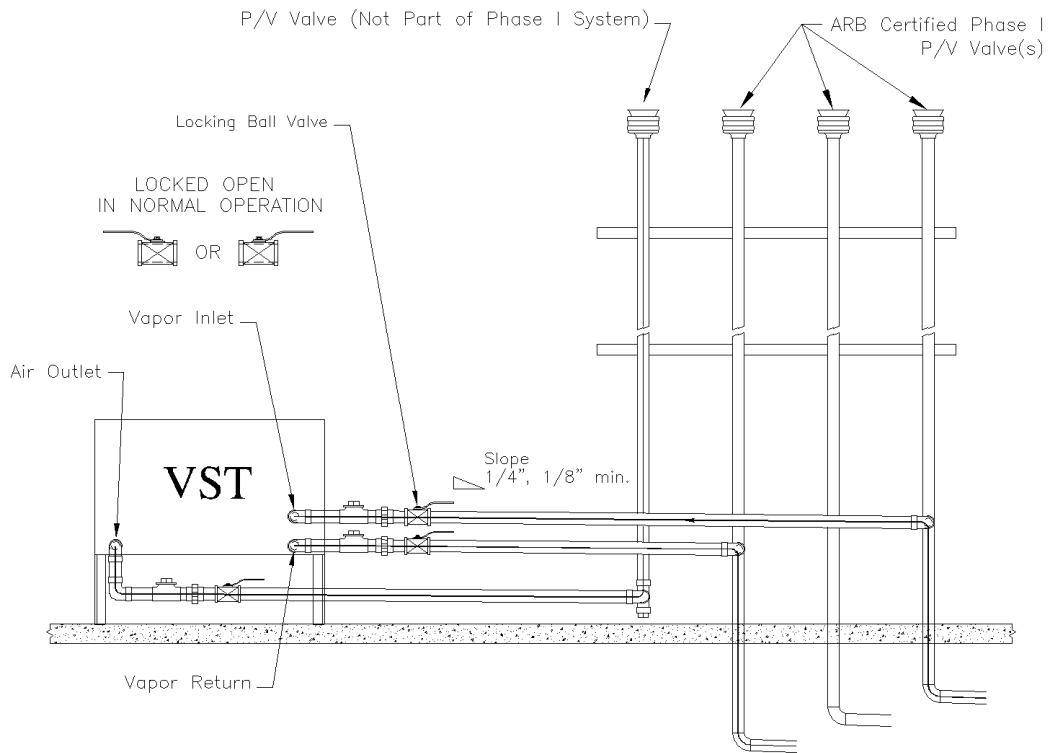

CAUTION: THE HANDLES ON THE LOCKING BALL VALVES MUST NOT BE REMOVED

Veeder-Root Vapor Polisher Installed

1. Prior to conducting TP-201.3, the ball valve on the inlet of the Veeder-Root Vapor Polisher shall be Open, as shown in Figure 2. At the TLS Console, manually close the vapor valve in the PMC Diagnostic menu (reference VR-203 IOM Section 16, PMC Diagnostic Menus, or VR-204 IOM Section 16, PMC Diagnostic Menus).
2. After conducting TP-201.3, enter the PMC Diagnostic Menu at the TLS Console and set the vapor valve to automatic mode.
3. The ball valve on the inlet of the Veeder-Root Vapor Polisher shall remain opened and locked.

Required Steps	Verification (please circle)
1. Inlet ball valve is open and vapor valve is closed before conducting TP-201.3?	Yes No
2. Vapor valve is in the automatic mode after conducting TP-201.3?	Yes No
3. Inlet ball valve is in the open locked position after conducting TP-201.3?	Yes No

Test Company: _____ Facility Name: _____

Print Name (Technician) Signature Date

Technician Certification Number and Expiration Date
(ICC or District Training Certification, as applicable)

Figure 2
Configuration of Veeder-Root Vapor Polisher to Conduct TP-201.3

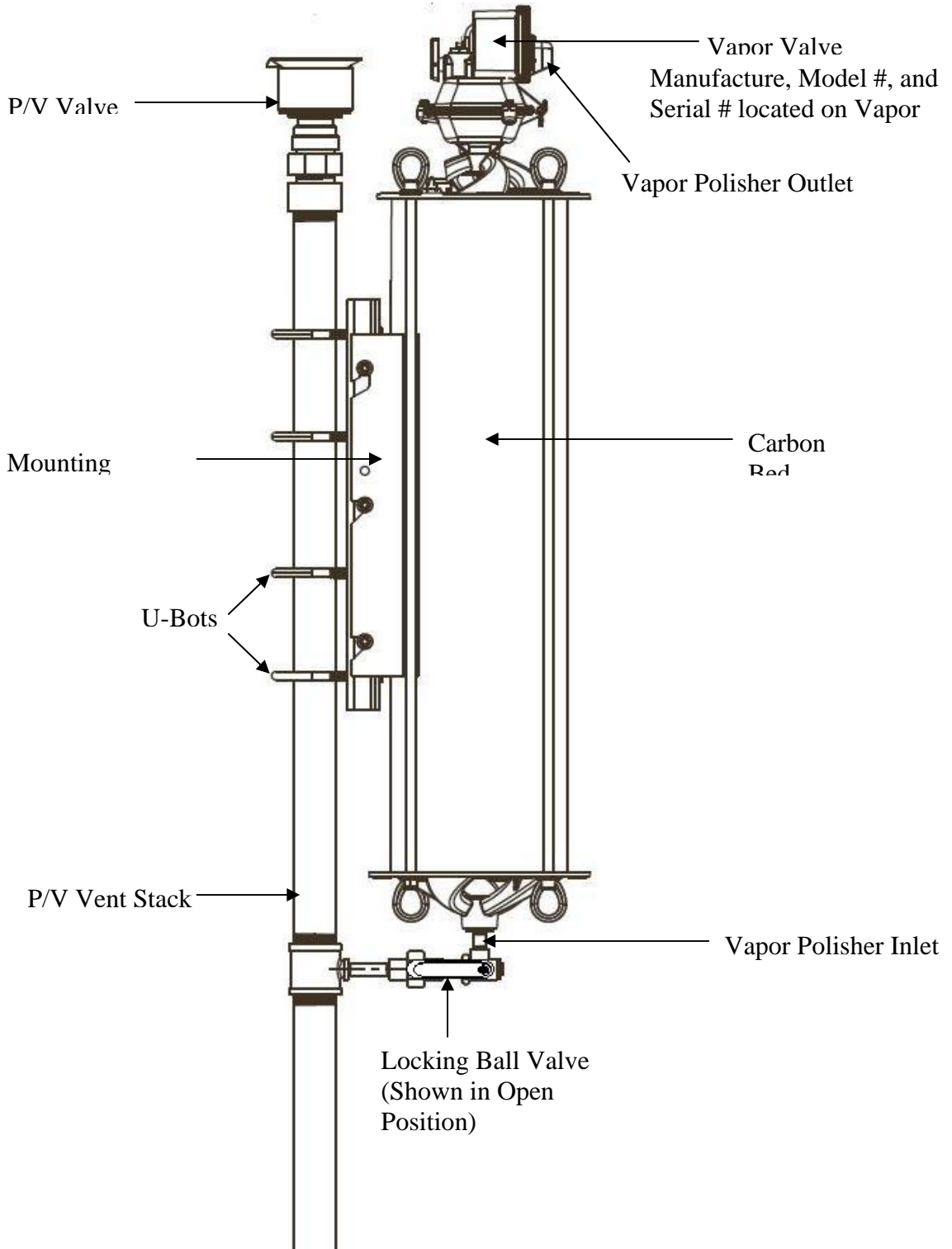

**Executive Orders VR-203-F and VR-204-F
VST Phase II EVR System**

**Exhibit 5
Liquid Removal Test Procedure**

Definitions common to all certification and test procedures are in:

D-200 Definitions for Vapor Recovery Procedures

For the purpose of this procedure, the term "ARB" refers to the California Air Resources Board, and the term "Executive Officer" refers to the ARB Executive Officer or his or her authorized representative or designate.

1. PURPOSE AND APPLICABILITY

- 1.1 This procedure is used to quantify the removal rate of liquid from the vapor passage of a Phase II balance system hose equipped with a liquid removal device. This procedure provides a method to determine compliance with the liquid removal requirements specified in ARB Executive Orders VR-203 and VR-204 and any subsequent amendments or revisions.

2. PRINCIPLE AND SUMMARY OF TEST PROCEDURE

- 2.1 This test procedure provides two options to determine the compliance of liquid removal devices. Under option 1 (short version), liquid in the vapor path of a coaxial hose is drained and measured. If the volume of liquid drained equals or exceeds 25 ml, a liquid removal test is conducted. For those hoses with less than 25 ml drained, no further testing is required. Under option 2 (long version), all hoses are evaluated regardless of the volume of liquid drained. Option 2 includes a prewetting and wall adhesion step. Both options test the liquid removal device by introducing gasoline into the vapor path of the coaxial hose through the nozzle bellows. After 7.5 gallons of gasoline is dispensed, the amount of gasoline remaining in the hose is measured and the liquid removal rate is determined. The district shall specify which testing option is to be used.

Caution: When draining liquid from the vapor side of the hose, make sure the dispenser is not activated. The nozzle vapor valve is on the same stem as the fuel valve. To drain gasoline from the vapor side of the hose, the fuel lever must be engaged. If the dispenser is activated, gasoline in the fuel hose may be pressurized when engaging the fuel lever.

3. BIASES AND INTERFERENCES

- 3.1. Slits or tears in the hose or nozzle vapor path may bias the results towards compliance.
- 3.2. This test shall not be conducted on any fueling point where the hanging hardware is defective as identified in Exhibit 2.

- 3.3. Any spillage of gasoline invalidates the test for any volumes that are required to be measured or recorded.
- 3.4. A breach of the inner product hose may introduce additional gasoline into the outer vapor path resulting in a larger volume drained than introduced.
- 3.5. Not having the liquid extraction device (indicated by the mark on the outside of the hose) at the bottom of the hose loop during liquid removal testing, as shown in Figure 1, will bias the results towards failure.
- 3.6. The test procedure requires the use of VST's nozzle spout plug, P/N VST-STP-100 as shown in Figure 2. This tool is used to plug the spout when draining liquid from the vapor side of the hose. Not plugging the spout may bias the results towards failure. Nicks, cuts, or tears in the plug o-rings will bias the results towards failure.
- 3.7. Dispensing rates not between 6.0 and 10.0 gallons per minute (GPM) invalidates the test.

4. SENSITIVITY, RANGE, AND PRECISION

- 4.1 The range of measurement of the liquid removal rate is dependent upon the range of the graduated cylinder used for testing.
- 4.2 To ensure precision, graduated cylinder readings shall be measured at the liquid level meniscus.

5. EQUIPMENT

- 5.1. Nozzle Spout Plug: Use VST's spout plug, P/N VST-STP-100 (Figure 2).
- 5.2. Stopwatch. Use a stopwatch accurate to within 0.2 seconds.
- 5.3. Funnels. Large and small gasoline compatible, non-breakable, funnels with dimensions similar to those as shown in Figure 3, or equivalent.
- 5.4. Graduated Cylinders. Gasoline compatible, non-breakable 0-25ml, 0-100ml, 0-250 ml, and 0-500 ml graduated cylinders with stable base plates. The 25ml cylinder may be necessary to quantify volumes of liquid less than 20 ml.
- 5.5. Gasoline Test Tank. (Optional) A portable tank, meeting fire safety requirements for use with gasoline, may be used to receive the gasoline dispensed during testing. The tank shall have sufficient volume so that at least 10.0 gallons may be dispensed prior to activating the primary shutoff mechanism of the nozzle. **When using a gasoline test tank, ensure that a ground strap is used and that it is properly connected to an acceptable ground.** To minimize testing-related emissions, vehicle refueling events should be used for this procedure whenever feasible.
- 5.6. Traffic Cones. Use traffic cones to encircle the area where testing is conducted.

- 5.7. Field Data Sheet. Use the appropriate data sheet to record liquid removal test information. Forms 1 and 2 serve as examples; districts may require modified versions.
- 5.8. Gasoline Container. Use a portable fuel container equipped with a tight fitting cap, of at least 1.0 gallon capacity.

NOTE: THIS TEST PROCEDURE PROVIDES TWO OPTIONS TO DETERMINE COMPLIANCE OF LIQUID REMOVAL DEVICES. THE DISTRICT SHALL SPECIFY WHICH TESTING OPTION IS TO BE USED

6. OPTION 1 (SHORT VERSION)

PRE-TEST PROCEDURE

- 6.1 Verify that the 500 ml graduated cylinder is empty. Position the large funnel into the graduated cylinder.
- 6.2 Remove the nozzle from the dispenser. **Do not activate dispenser!** Install VST's spout plug, P/N VST-STP-100 in the tip of the spout (Figure 2). Carefully tilt the spout into the funnel/graduated cylinder assembly.
- 6.3 Lower the nozzle and funnel/graduated cylinder assembly as close to the ground as possible. "Walk out" the hose while keeping the nozzle lowered and hose fully extended. The hose shall slope downward from the dispenser toward the nozzle.
- 6.4 **Do not activate dispenser!** Open the nozzle's vapor check valve by compressing the bellows and engaging the fuel lever. Allow 20 seconds for all liquid to drain. Use caution to avoid spillage.
- 6.5 Remove VST's spout plug and return the nozzle to the dispenser and measure the volume of liquid drained. If the volume drained is less than 200 ml, transfer the liquid into an appropriately sized graduated cylinder. For example, if 40 ml of liquid was drained, use the 100 ml graduated cylinder to take the measurement.
- 6.6 Record the amount of liquid drained on Form 1 ("PRE-TEST").
- 6.7 If the volume drained is greater than or equal to 25 ml, proceed to Section 6.8 of the procedure. Hoses with greater than 25 ml drained are considered to be pre-wetted. If the amount drained is less than 25 ml, proceed to the next nozzle/hose to be evaluated and repeat Section 6.1-6.6

TEST PROCEDURE (FOR HOSES WITH GREATER THAN 25 ML DRAINED)

- 6.8 Pour 150 ml to 175 ml of gasoline into the 250 ml graduated cylinder. Measure and record this volume on Form 1 (VI).
- 6.9 Remove the nozzle from the dispenser and position the nozzle upright so that the

spout is in a vertical position. **Do not activate dispenser!**

- 6.10 Open the nozzle's vapor check valve by compressing the bellows and engaging the fuel lever. Carefully insert the stem of the small funnel between the bellows and nozzle spout.
- 6.11 Pour the measured volume into the vapor path of the hose. Use caution not to spill the gasoline. Remove the small funnel after the gasoline has been introduced.
- 6.12 Insert the nozzle into a vehicle or test tank fill pipe.
- 6.13 Find the mark on the outside of the hose which indicates the location of the liquid pick-up device. Ensure the mark is at the bottom of the hose loop when dispensing as shown in Figure 1. This can be accomplished by lifting up the back of the hose, adjusting nozzle position, or adjusting the test tank position.
- 6.14 Dispense 7.5 (±0.5) gallons at the highest possible flow rate by holding the nozzle lever in the maximum handheld position. Use a stopwatch to measure the time elapsed while dispensing. Record the volume of fuel dispensed (G) and the elapsed time (T) on Form 1. Return nozzle to the dispenser.
- 6.15 Calculate the dispensing rate using the equation below. If the dispensing rate is not between 6.0 and 10.0 gallons per minute (GPM), the test results are invalid.

$$\text{GPM} = 60 \times \left(\frac{\text{G}}{\text{T}} \right)$$

Where:

GPM = dispensing rate (in gallons per minute)
G = gallons of fuel dispensed
T = number of seconds required to dispense

- 6.16 Using the 250 ml graduated cylinder and large funnel, carefully drain the remaining liquid from the vapor path of the hose as described in Section 6.1 through 6.5 (**make sure dispenser is not activated and spout plug is installed before draining liquid!**). Record this quantity on Form 1 (VF).
- 6.17 Use Equation 9.1 to calculate the liquid removal rate for all the applicable hoses tested.
- 6.18 If the liquid removal rate is less than 5.0 ml/gallon, but greater than or equal to 4.5 ml/gallon, repeat the test two additional times and average the three results.

7. OPTION 2 (LONG VERSION)

PRETEST PROCEDURE

- 7.1 Carefully pour 150 ml of gasoline into the 250 ml graduated cylinder.

- 7.2 Remove the nozzle from the dispenser. **Do not activate dispenser!** Install VST's spout plug, P/N VST-STP-100 in the tip of the spout as shown in Figure 2. Position the nozzle upright so that the spout is in a vertical position.
- 7.3 Open the nozzle's vapor check valve by compressing the bellows and engaging the fuel lever. Carefully insert the stem of the small funnel between the bellows and nozzle spout.
- 7.4 Pour the gasoline from the 250 ml graduated cylinder into the vapor path of the hose. Use caution not to spill the gasoline. Remove the small funnel after the gasoline has been introduced.
- 7.5 Verify that the 500 ml graduated cylinder is empty. Position the large funnel into the graduated cylinder.
- 7.6 Carefully tilt the spout into the funnel/graduated cylinder assembly. **Make sure VST's spout plug is installed and the dispenser is deactivated.**
- 7.7 Lower the nozzle and funnel/graduated cylinder assembly as close to the ground as possible. "Walk out" the hose while keeping the nozzle lowered and hose fully extended. The hose shall slope downward from the dispenser toward the nozzle.
- 7.8 Open the nozzle's vapor check valve by compressing the bellows and engaging the fuel lever. Allow 20 seconds for all liquid to drain. Use caution to avoid spillage. If necessary, drain full graduated cylinders into a portable gas can until the hose is empty.
- 7.9 Remove VST's spout plug and return the nozzle to the dispenser.

TEST PROCEDURE

- 7.10 Pour 150 ml to 175 ml of gasoline into the 250 ml graduated cylinder. Measure and record this volume on Form 2 (VI).
- 7.11 Remove the nozzle from the dispenser. **Do not activate dispenser!** Position the nozzle upright so that the spout is in a vertical position.
- 7.12 Open the nozzle's vapor check valve by compressing the bellows and engaging the fuel lever. Carefully insert the stem of the small funnel between the bellows and nozzle spout.
- 7.13 Pour the measured volume into the vapor path of the hose. Use caution not to spill the gasoline. Remove the small funnel after the gasoline has been introduced.
- 7.14 Insert the nozzle into a vehicle or test tank fill pipe.
- 7.15 Find the mark on the outside of the hose which indicates the location of the liquid pick-up device. Ensure the mark is at the bottom of the hose loop when dispensing

as shown in Figure 1. This can be accomplished by lifting up the back of the hose, adjusting nozzle position, or adjusting the test tank position.

- 7.16** Dispense 7.5 (± 0.5) gallons at the highest possible flow rate by holding the nozzle lever in the maximum handheld position. Use a stopwatch to measure the time elapsed while dispensing. Record the volume of fuel dispensed (G) and the elapsed time (T) on Form 2. Return nozzle to the dispenser.
- 7.17** Calculate the dispensing rate using the equation below. If the dispensing rate is not between 6.0 and 10.0 gallons per minute (GPM), the test results are invalid.

$$\text{GPM} = 60 \times \left(\frac{\text{G}}{\text{T}} \right)$$

Where:

GPM = dispensing rate (in gallons per minute)
G = gallons of fuel dispensed
T = number of seconds required to dispense

- 7.18** Using the 250 ml graduated cylinder and large funnel, carefully drain the remaining liquid from the vapor path of the hose as described in Section 7.5 through 7.8 (**make sure dispenser is deactivated and spout plug is installed before draining liquid!**). Record this quantity on Form 2 (VF).
- 7.19** Open the nozzle's vapor check valve by compressing the bellows and engaging the fuel lever. **Do not activate dispenser!** Carefully insert the stem of the small funnel between the bellows and nozzle spout
- 7.20** Use the 250 ml graduated cylinder and small funnel to pour 150 ml of gasoline into the vapor passage of the hose. Dispense no gasoline.
- 7.21** Using the 250 ml graduated cylinder and large funnel, completely drain the gasoline from the vapor passage back into the graduated cylinder as described in Section 7.5 through 7.9 (**make sure dispenser is deactivated and spout plug is installed before draining liquid!**).
- 7.22** Subtract the volume drained (value from Section 7.21) from the volume added (value from Section 7.20). This value represents the volume of gasoline lost due to wall adhesion. The purpose of the wall adhesion value is to quantify the amount of gasoline lost to evaporation from transfer to and from the graduated cylinders and adhesion of liquid to vapor passage surfaces in previous measurements. Record this quantity on Form 2 (VW).
- 7.23** Use Equation 9.2 to calculate the liquid removal rate for all the applicable hoses tested.
- 7.24** If the liquid removal rate is less than 5.0 ml/gallon, but greater than or equal to 4.5 ml/gallon, repeat the test two additional times and average the three results.

8. POST TEST PROCEDURES

- 8.1. Empty all containers and return any excess gasoline to the underground storage tank.
- 8.2. Remove the traffic cones from the testing area.

9. CALCULATING RESULTS

9.1 If using OPTION 1(short version), the liquid removal rate shall be calculated as follows:

$$VR = \frac{VI - VF}{G}$$

Where:

VR	=	Gasoline removed per gallon dispensed, milliliters/gallon
VI	=	Total initial volume poured into hose vapor passage, milliliters
VF	=	Volume of gasoline remaining in the hose vapor passage after dispensing, milliliters
G	=	Total dispensed, gallons

9.2 If using OPTION 2 (long version), the liquid removal rate shall be calculated as follows:

$$VR = \frac{(VI - VW) - VF}{G}$$

Where:

VR	=	Gasoline removed per gallon dispensed, milliliters/gallon
VI	=	Total initial volume poured into hose vapor passage, milliliters
VW	=	Volume of liquid lost due to wall adhesion, milliliters
VF	=	Volume of gasoline remaining in the hose vapor passage after dispensing, milliliters
G	=	Total dispensed, gallons

10. REPORTING RESULTS

- 10.1. Record all applicable liquid removal rate information on the appropriate form as shown in Form 1 and 2. Districts may require the use of alternate forms provided that the alternate forms include the same parameters as identified in Forms 1 and 2.
- 10.2. If the calculated liquid removal rate is greater than or equal to 5 milliliters/gallon, the liquid removal device has demonstrated compliance.
- 10.3. If the calculated liquid removal rate is less than 5 milliliters/gallon, the liquid removal

device is not in compliance.

11. ALTERNATIVE TEST PROCEDURES

This procedure shall be conducted as specified. Modifications to this test procedure shall not be used to determine compliance unless prior written approval has been obtained from the Executive Officer, pursuant to Section 14 of Certification Procedure CP-201.

FIGURE 1
Position of Liquid Removal Device
When Conducting Liquid Removal Testing

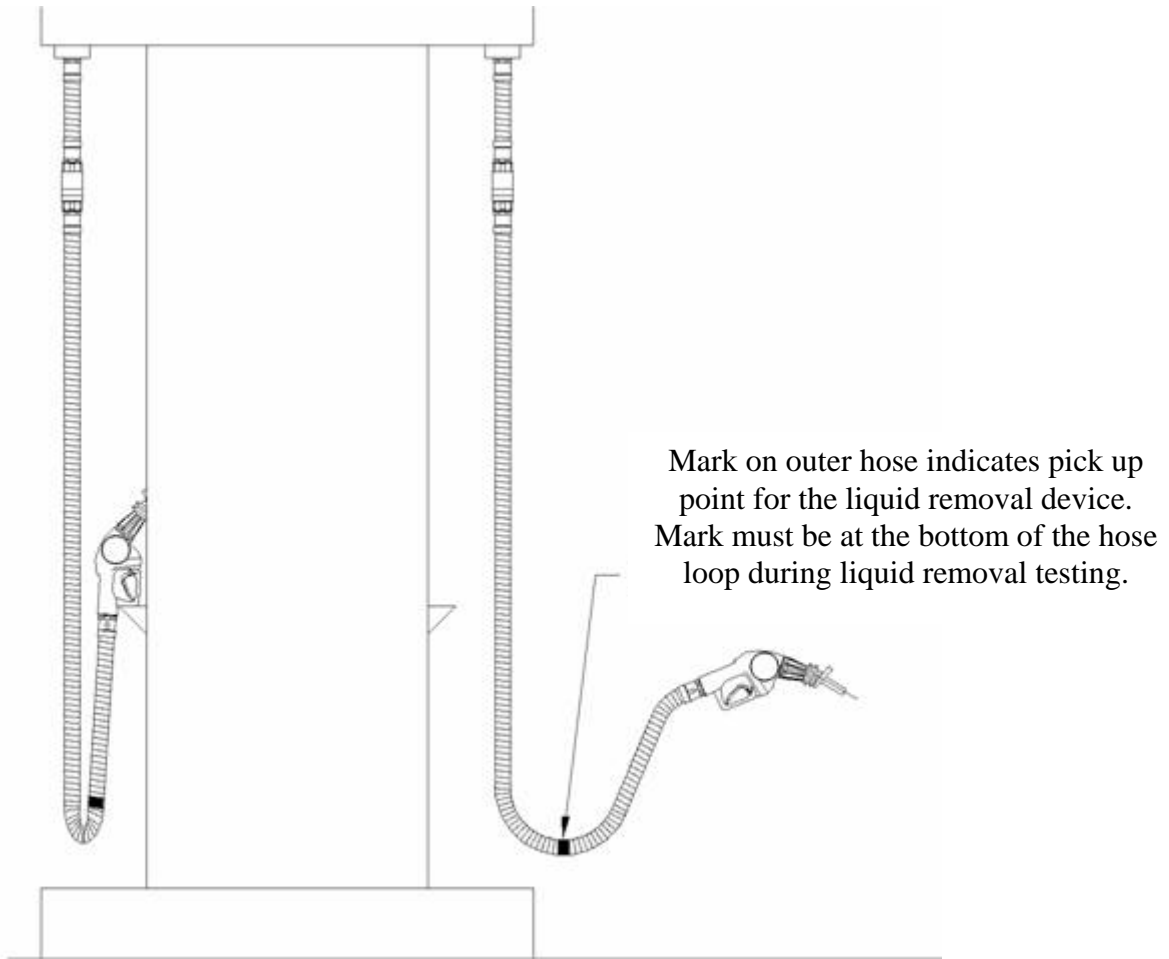

FIGURE 2
VST Nozzle Spout Plug P/N VST-STP-100

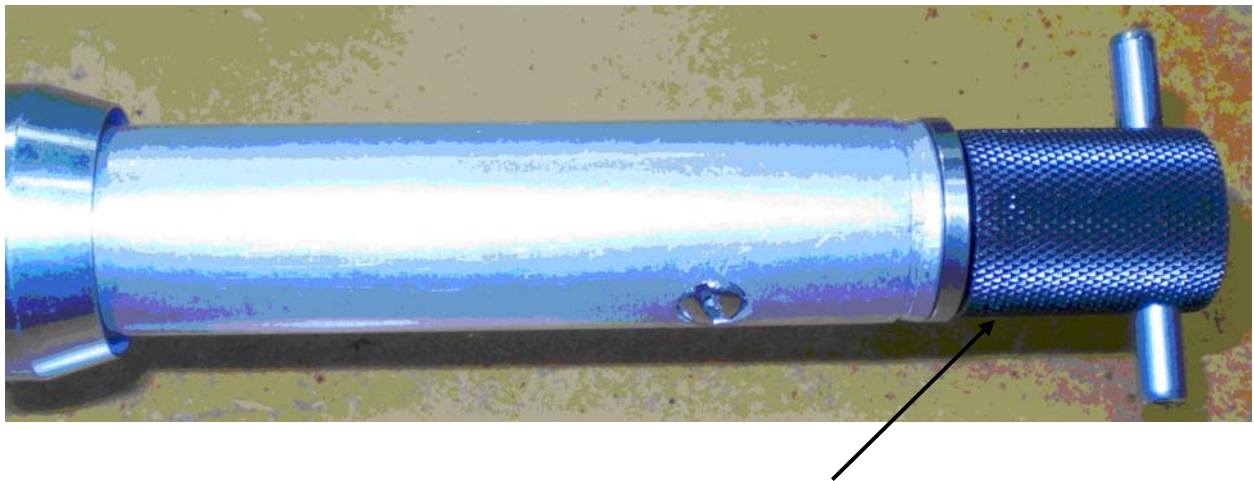
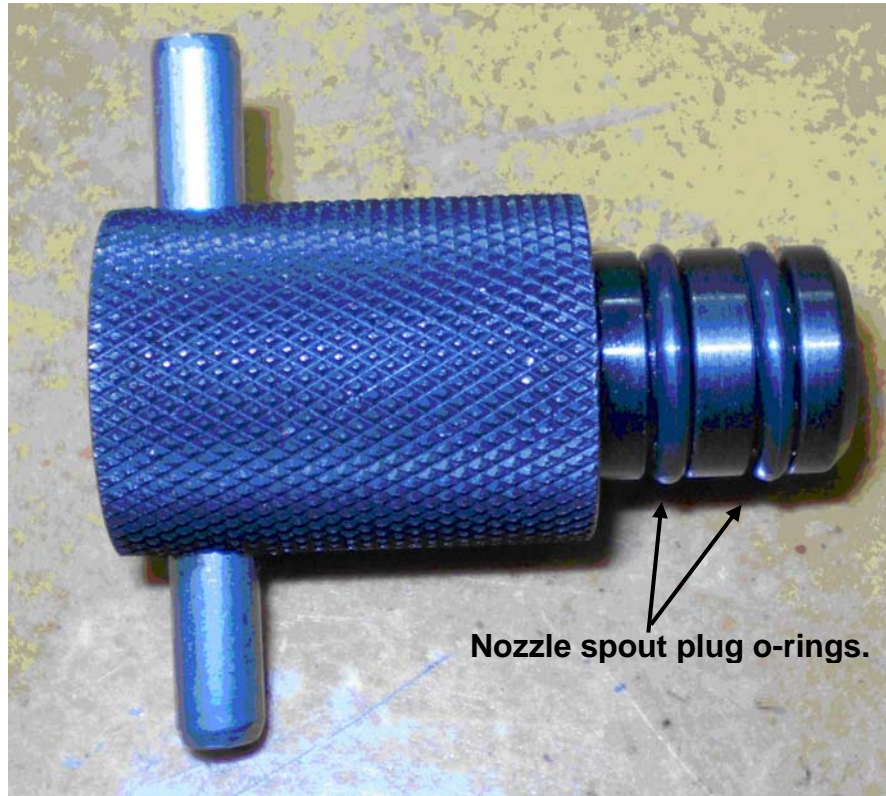
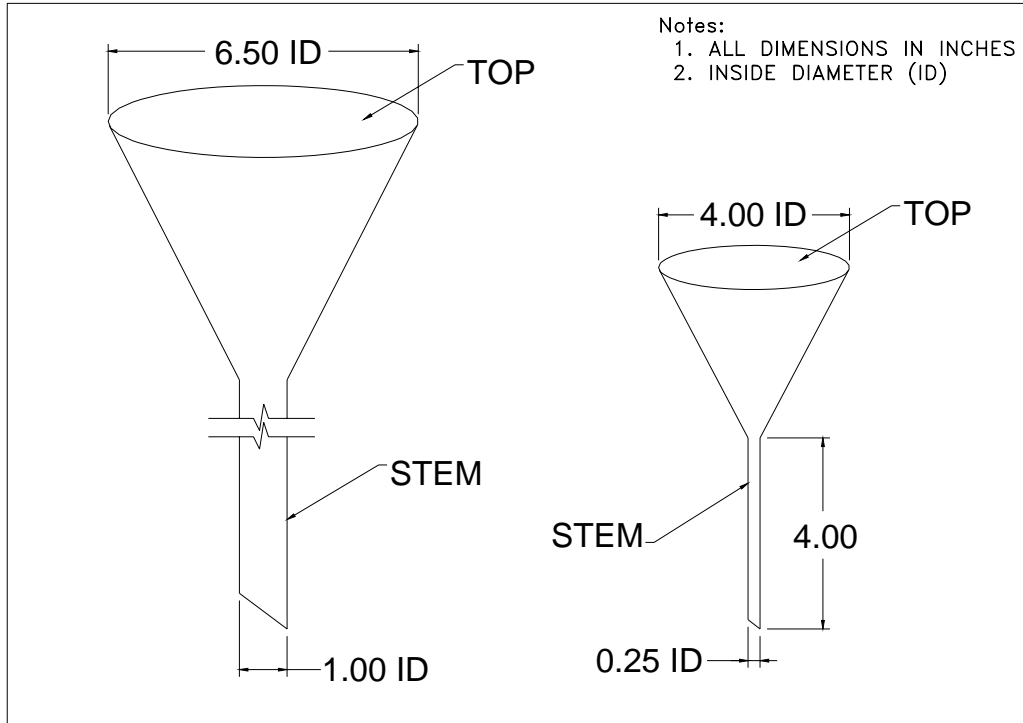

FIGURE 3
Recommended FUNNEL SPECIFICATIONS



FORM 1: LIQUID REMOVAL TEST DATA SHEET (OPTION 1)

Facility Name & Address	Facility Representative & Title	Test Date _____
		A/C or Permit No. _____
		Testing Company _____
		Tester Name _____
		VST Training Cert # _____
	Phone No. _____	(if applicable) _____
		Inspector Name _____

GENERAL INFORMATION				PRE-TEST	TEST RUN					VR=(VI-VF)/G
Dispenser Number	Product Grade	Make & Model of Hose	Serial Number of Hose	Volume Drained From Hose in mL	Volume Poured Into Hose in mL (VI)	Gallons Dispensed (G)	Seconds to Dispense (T)	Dispensing Rate (60*(G/T))	Volume Remaining in mL (VF)	Liquid Removal Rate (mL/gal)

FORM 2: LIQUID REMOVAL TEST DATA SHEET (OPTION 2)

Facility Name & Address	Facility Representative & Title	Test Date _____
		A/C or Permit No. _____
		Testing Company _____
		Tester Name _____
		VST Training Cert # _____
	Phone No. _____	(if applicable) _____
		Inspector Name _____

GENERAL INFORMATION				PRE-TEST	TEST RUN					$VR=((VI-VW)-VF)/G$
Dispenser Number	Product Grade	Make & Model of Hose	Serial Number of Hose	Volume Poured into Hose in mL (VI)	Gallons Dispensed (G)	Seconds to Dispense (T)	Dispensing Rate (60*(G/T))	Volume Remaining in mL (VF)	Volume Lost to Wall Adhesion in mL (VW)	Liquid Removal Rate (mL/gal)

**Executive Orders VR-203-F and VR-204-F
VST Phase II EVR System**

**Exhibit 6
VST ECS Hydrocarbon Sensor Verification Test Procedure**

Definitions common to all certification and test procedures are in:

D-200 Definitions for Vapor Recovery Procedures

For the purpose of this procedure, the term "ARB" refers to the State of California Air Resources Board, and the term "ARB Executive Officer" refers to the Executive Officer of the ARB or his or her authorized representative or designate.

1. PURPOSE AND APPLICABILITY

- 1.1 This procedure will determine the accuracy of the VST Hydrocarbon (HC) Non-Dispersive Infrared sensor (HC sensor) using known hydrocarbon concentrations (propane) calibration gases at gasoline dispensing facilities (GDFs).
- 1.2 This procedure is applicable for compliance testing.

2. PRINCIPLE AND SUMMARY OF TEST PROCEDURE

Known concentrations of certified calibration gases are passed through the HC sensor as illustrated in Figure 1 or 2, and then compared with the HC average concentration as determined from the PMC Percent Hydrocarbon Diagnostic Report. The Percent Hydrocarbon Diagnostic report can be downloaded onto a laptop computer via the TLS-350 RS-232 connection. Sampling is conducted for a minimum of five (5) minutes period for each certified test gas. To prevent any HC sensor biases, this test shall be conducted with the processor in the manually "off" mode from the TLS-350 control panel for the duration of the test. This test can be performed while product is being dispensed into motor vehicles.

3. EQUIPMENT AND SUPPLIES

3.1 Gas Cylinder Regulator

Use a two stage pressure regulator with gauges indicating cylinder pressure and supply line pressure. Supply line pressure shall be set between 5 and 10 pounds per square inch gauge (psig). A Mesa Model 400 or equivalent preset flow regulator with a fixed flow rate of one (1) liter per minute (LPM) can be used as an alternative to the above two stage regulator.

3.2 Flow Meter

Use a Dwyer Model RMA, or equivalent flow meter capable of reading a gas flow rate at one (1) liter per minute (LPM). A flow meter is not required if using a fixed rate regulator as specified in step 3.1

3.3 Calibration Gases

Cylinders of calibration gases using propane in nitrogen listed below.

- (1) High-Range Gas: Concentration between 10-14% by volume.
- (2) Mid-Range Gas: Concentration between 2-5% by volume.
- (3) Zero Gas: Nitrogen with a hydrocarbon concentration less than 0.25% by volume.

3.4 Laptop, associated cables, and software are required for RS232 connection to the TLS-350 (reference Section 16 "Pressure Management Control" of the ARB Approved Installation, Operation and Maintenance Manual for hardware and software requirements).

4. CALIBRATIONS

The calibration gases must be certified according to the following:

To an analytical accuracy of $\pm 2\%$, traceable to a reference material approved by the National Institute of Standards and Technology (NIST) and recertified at least every two years.

Information on calibration gas cylinders shall be entered into a log identifying each cylinder by serial number. Documentation of certification shall be maintained with the gas cylinders at all times and shall also be attached to Form 1. The calibration gas log shall be maintained with the gas cylinders at all times and made readily available to the district upon request. Sufficient information shall be maintained to allow a determination of the certification status of each calibration gas and shall include: (1) the date put in service, (2) assay result, (3) the dates the assay was performed, and (4) the organization and specific personnel who performed the assay.

5. PRE-TEST REQUIREMENTS

Install all required testing apparatus as illustrated in Figure 1 through 3. Connect the calibration test gas to the inlet tee of the HC sensor. Install the outlet tubing to the HC sensor outlet tee. This tubing is used to vent of the calibration gas to atmosphere.

6. TEST PROCEDURE

6.1 Manually turn off the VST membrane processor as follows:

6.1.1 On the TLS Console front panel, use the 'mode key' to scroll to 'DIAG MODE' and then use the function and step keys, as shown in Figure 4 to view the 'VAPOR PROCESSOR MODE' menu.

6.1.2 From the 'VAPOR PROCESSOR MODE' menu, change the vapor processor mode of operation from automatic to manual mode. From the 'VAPOR PROCESSOR STATE' menu, verify the VP STATE is in the "off" mode. The processor shall be in the off mode for the duration of the test.

6.2 Record the start time from the TLS-350, on Form 1. The testing technician shall synchronize his/her watch with the clock on the TLS-350.

- 6.3 Isolate the VST HC sensor by closing the in-line ball valve upstream of the HC sensor.
- 6.4 Introduce the zero, mid-range and high-range gases, in that order, into the VST HC sensor sample line at a flow of 1 LPM for five continuous minutes.
- 6.5 Record the time before and at the end of each five minute test run on Form 1. Districts may require the use of an alternate form, provided it includes the same minimum parameters as identified in Form 1.
- 6.6 From the TLS-350 front panel, return the membrane processor to the automatic run mode.
- 6.7 Press the <MODE> key to leave the 'PMC DIAGNOSTIC' menu.
- 6.8 Disconnect test apparatus from the VST HC sensor inlet and outlet tees and replace plugs. Return the in-line ball valve to the open position.

7. OBTAIN HC DATA FROM PMC

The HC data can be obtained from the PMC via an RS-232 connection to a laptop computer. Once connected, the HC data can be viewed from the "Percent Hydrocarbon Diagnostic Report". This report can be printed or saved to a file. A printed copy of this report must be attached to Form 1. Instructions on accessing this report via the RS-232 connection are found in Section 16 "Pressure Management Control" of the ARB Approved Installation, Operation, and Maintenance Manual. This report will provide HC concentration readings at 15 second intervals for each of the 5-minute test runs. Calculate the average HC concentration from the **last three minutes of each test run** and record on Form 1.

8. CALCULATION

Calculate and record the difference between the average HC concentration from the PMC Percent Hydrocarbon Diagnostic Report (Step 7) and compare with each corresponding calibration gas concentration.

$$\text{Difference} = (\text{Calibrations Gas Concentration (Step 3.3)}) - (\text{Average HC Concentration from PMC (Step 7)})$$

The difference shall be within $\pm 1.0\%$ HC concentration from the calibration gas for the zero and mid-range gas and $\pm 2.0\%$ for the high-range gas. Record "Pass" if within specified limits or "Fail" if not within specified limits on Form 1. If any failure is recorded, the VST ECS Processor is not in compliance with Exhibit 2.

9. ALTERNATIVE TEST PROCEDURES

This procedure shall be conducted as specified. Modifications to this test procedure shall not be used to determine compliance unless prior written approval has been obtained from the ARB Executive Officer, pursuant to Section 14 of Certification Procedure CP-201.

Figure 1
Equipment Configuration for Verifying Hydrocarbon Sensor Performance

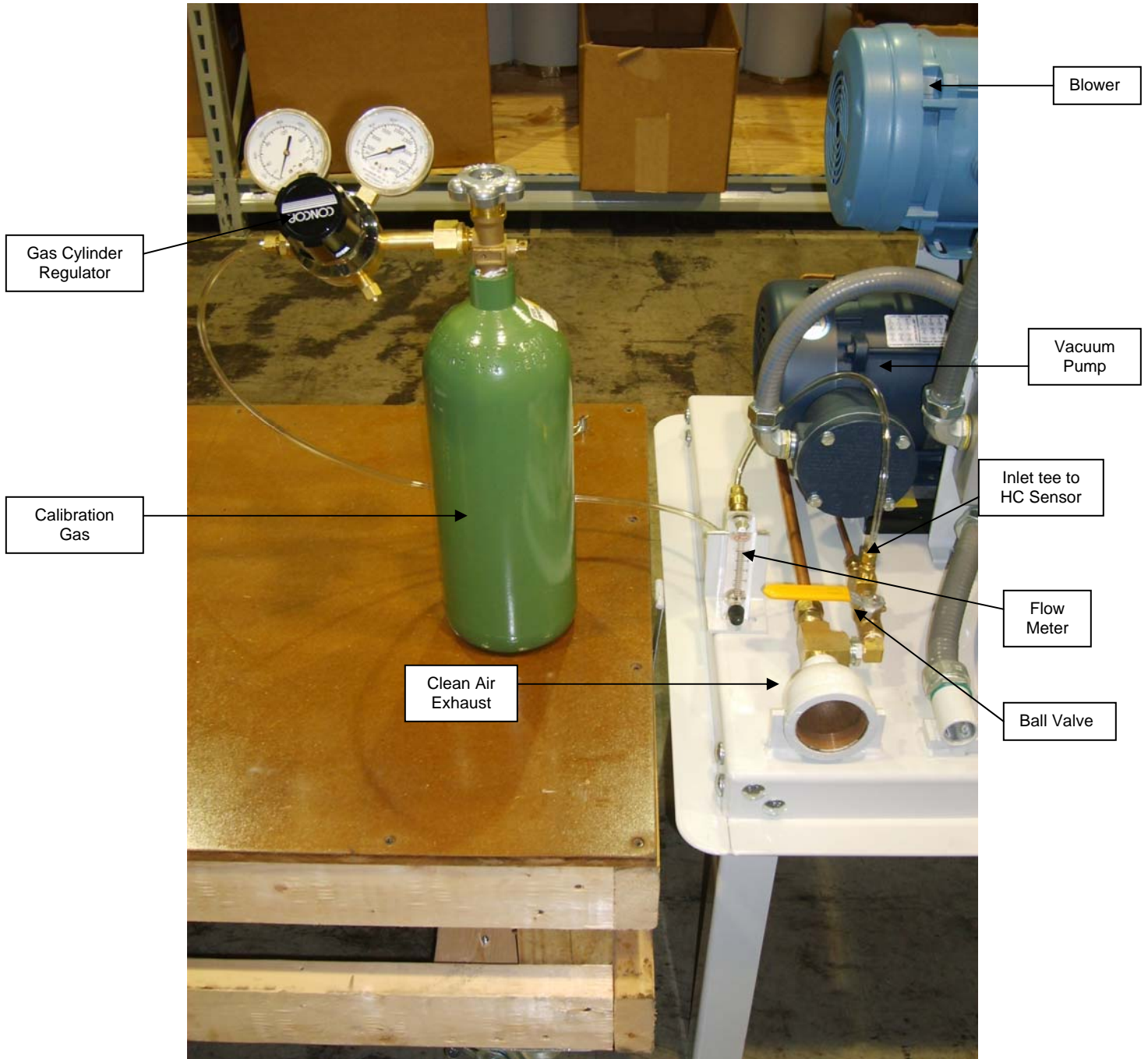

Note: Two stage pressure regulator configuration

Figure 2
Equipment Configuration for Verifying Hydrocarbon Sensor Performance



Note: Preset flow regulator configuration

Figure 3
Equipment Configuration for Verifying Hydrocarbon Sensor Performance

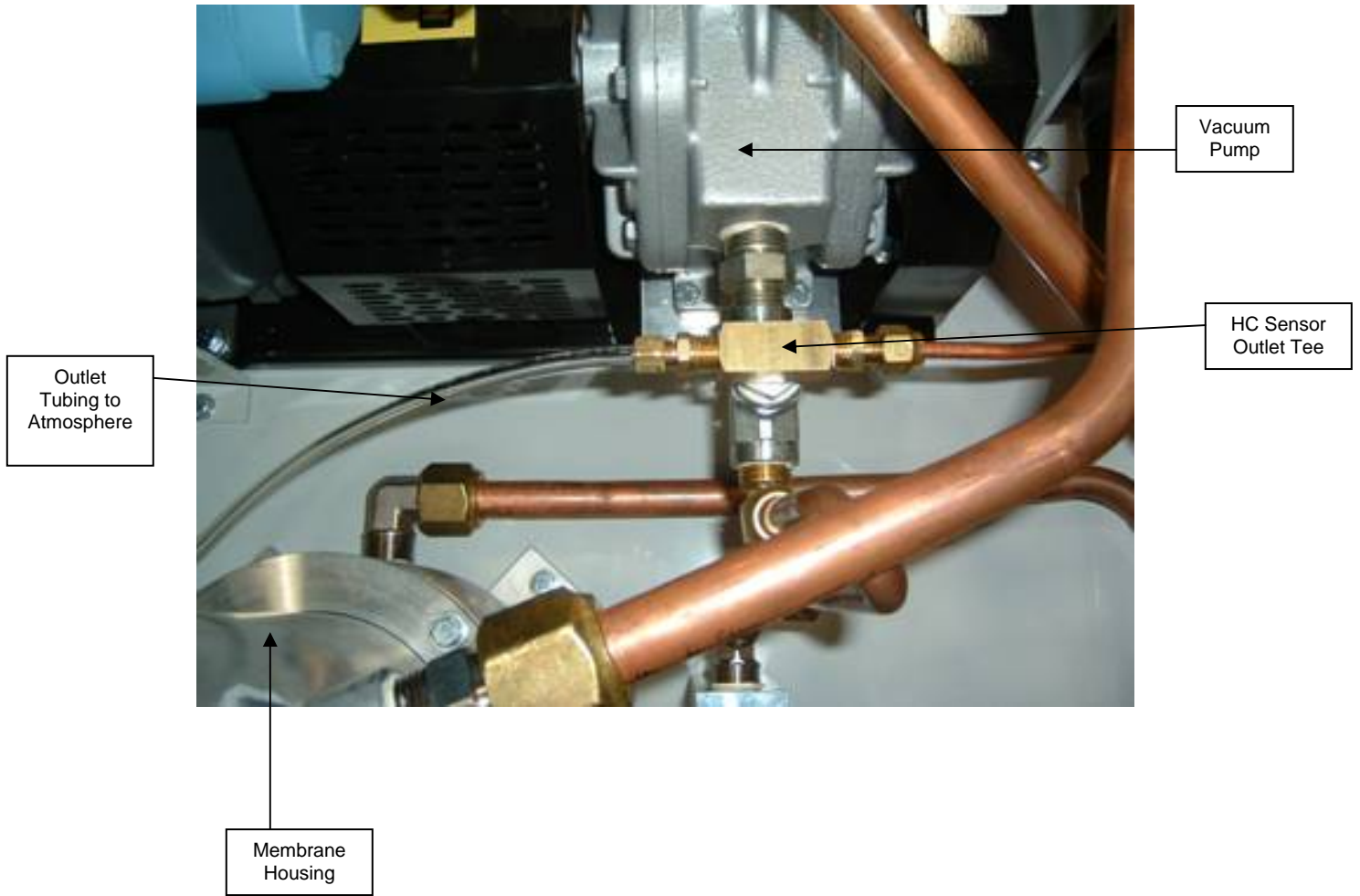
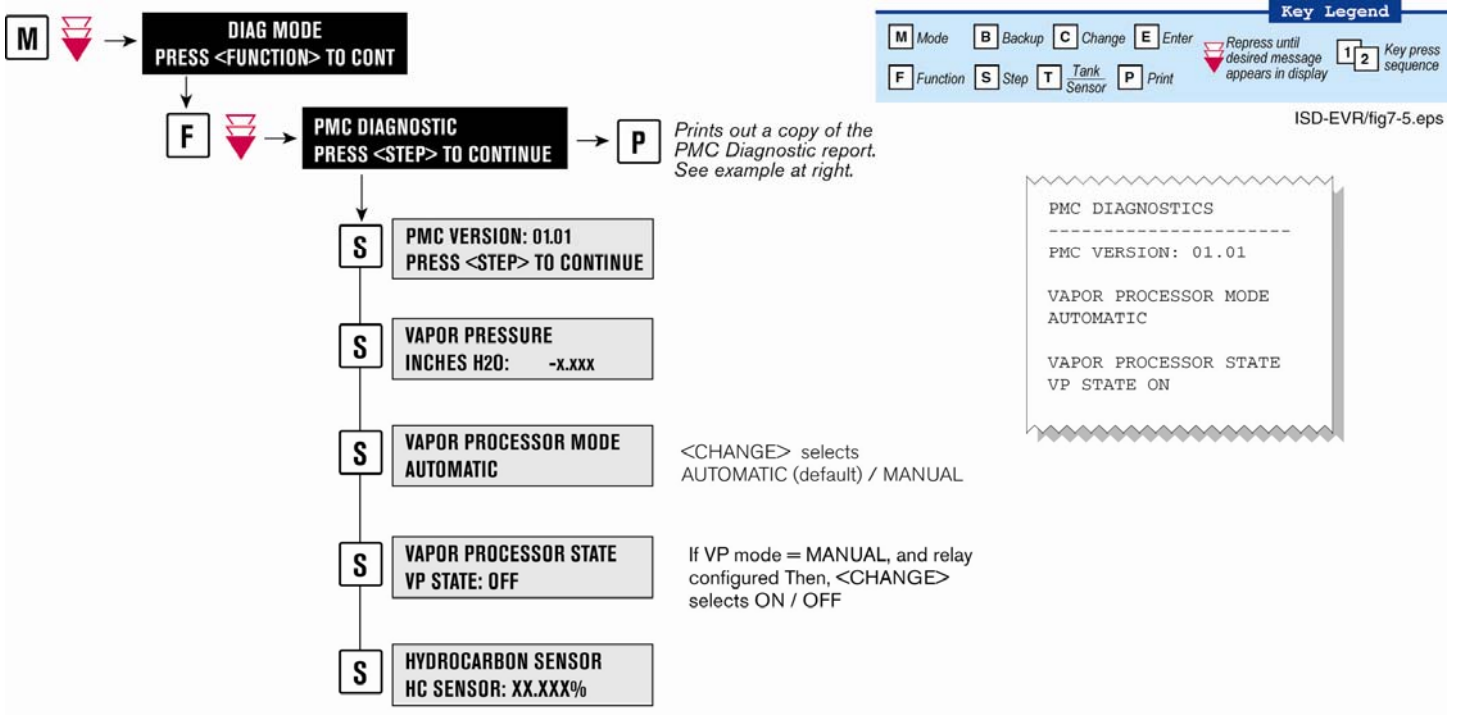

Figure 4



**Form 1
Hydrocarbon Sensor Verification Data Sheet**

Test Data Sheet for Performance Verification of VST NDIR Sensor		
Facility:	Test Company:	
Address:	Test Personnel:	
City:	VST or Veeder-Root Tech Certification # (as applicable)	
State:		
Zip Code:		
ICC or District Training Certification (as applicable)		
Calibration Gas Concentration (% Propane). Note: Calibration gas information listed in Section 4 of Exhibit 6 shall be attached to this form.		
Zero Gas:	High-Range Gas:	Mid-Range Gas:
Serial #:	Serial #:	Serial #:

Test Results

Start Time	Stop Time	Calibration Gas Percent Concentration (Propane) (step 3.3)	Average Percent HC Concentration from PMC (step 7)	Percent Difference (Difference shall be within ± 1% for zero and mid-range gas and within ± 2% for high-range gas) (step 8)	Pass/Fail

Executive Order VR-204-F
VST Phase II EVR System Including Veeder-Root ISD

Exhibit 7
Warranty

VST PHASE II EVR SYSTEM WARRANTY

This limited warranty is given by Vapor Systems Technologies, Inc. (hereinafter VST) to the purchaser of systems or products manufactured by it. VST products are warranted to be free from defect in material and workmanship under normal use, service, proper installation, and maintenance practices per manufacturer specifications.

VST warrants the materials and workmanship to be free from defects in accordance with the following provisions:

- This warranty will not apply to any products or systems that have:
 - been subject to misuse, abuse, tampering, negligence, accident, or drive off;
 - been misapplied, improperly installed, or not installed per VST's instructions or specifications;
 - been modified, altered, rebuilt or repaired by unauthorized persons or outside the criteria of VST specifications;
 - not been properly maintained in accordance with the system's or product's periodic maintenance schedule; or
 - been subject to damage resulting from acts of God.
- Use of VST products on non-UL systems or use that falls outside intended field of use voids any stated or implied warranty.
- The warranty for the material and workmanship of the systems or products extends to the purchaser and the duration of this warranty is TWELVE (12) MONTHS from the time of installation up to a maximum of EIGHTEEN (18) MONTHS from date of shipment, provided the Product Warranty Card is returned to VST. If the Product Warranty Card is not returned to VST, the warranty period is TWELVE (12) MONTHS from the date of shipment.
- VST warrants the material and workmanship of spare and/or replacements parts for NINETY (90) DAYS from the date of shipment.
- In the event of a warranty claim, the purchaser/distributor must obtain a copy of a Return Goods Authorization (RGA) from VST prior to returning product so as to insure proper processing. All warranty claim returns must be shipped freight prepaid by the purchaser/distributor.
- Warranty status will be determined upon inspection at VST's facility within THIRTY (30) DAYS of receipt of the warranted products. All returned merchandise deemed *Not Under Warranty*; will be held by VST for SEVEN (7) BUSINESS DAYS prior to disposal. Return of this product to the purchaser/distributor will require purchaser/distributor to issue a call tag within SEVEN (7) BUSINESS DAYS of notification.
- Repair or replacement of the warranted product is the **EXCLUSIVE REMEDY** under the terms of this warranty.
- This warranty does not cover any components exposed to contact with fuels containing greater than 5% methanol, 10% ethanol, or 15% MTBE by volume or any exposure to M85/E85 fuel.

- This warranty does not cover and VST is not liable for, incidental, consequential and/or indirect damages or loss including, but not limited to, personal injury, death, property damage, environmental damage, cost of labor, clean-up, downtime, installation and removal, product damage, and loss of product, revenue or profits.
- VST is not liable for any claims or lawsuits against the purchaser/distributor.
- VST is not responsible for labor or materials necessary to disconnect or connect the warranted product for return to VST.
- Use of non-VST replacement parts, the unauthorized addition of non-VST items to equipment, and the unauthorized alteration of equipment and/or systems voids this warranty.
- VST, as to each defect, shall be relieved of all obligations and liabilities under this Limited Warranty if the vapor recovery system(s) or components have been operated with any accessory, equipment, or a part not specifically approved by VST, and not manufactured by VST to VST design and specification, or parts not specifically approved by CARB to be used with VST products.

THIS LIMITED WARRANTY IS EXCLUSIVE AND IS IN LIEU OF ALL OTHER WARRANTIES.

VST MAKES NO OTHER WARRANTIES (WHETHER WRITTEN OR ORAL), EXPRESS OR IMPLIED, INCLUDING BUT NOT LIMITED TO ANY IMPLIED WARRANTY OF MERCHANTABILITY, FITNESS FOR A PARTICULAR PURPOSE, OR OTHERWISE, AND ANY OTHER SUCH WARRANTIES ARE HEREBY DISCLAIMED.

VST NEITHER ASSUMES NOR AUTHORIZES ANY OTHER PERSON OR ENTITY TO ASSUME FOR IT OR BIND IT TO ANY OTHER LIABILITY OR OBLIGATION RELATED TO OR IN CONNECTION WITH THIS LIMITED WARRANTY.

VST products should be used in compliance with applicable federal, state, and local laws and regulations.

VST reserves the right to make changes at any time to prices and designs, or make additions or improvements with respect to its products, without incurring any obligation to modify or install same on previously manufactured products.

 Vapor Systems Technologies, Inc. Phone: (937)-704-9333 • Fax: (937)-704-9443 www.vsthose.com	SERIAL NUMBER:
	INSTALLATION DATE:
	INSTALLATION SITE:
	CITY/STATE/ZIP:
	DISTRIBUTOR NAME:
	PRODUCT STYLE <input type="checkbox"/> HOSE <input type="checkbox"/> SAFETY BREAKAWAY <input type="checkbox"/> NOZZLE <input type="checkbox"/> ECS PROCESSOR

**IMPORTANT
PRODUCT WARRANTY
REGISTRATION CARD**

12 MONTH WARRANTY BECOMES EFFECTIVE AT TIME OF INSTALLATION. IF THIS CARD IS NOT RETURNED, WARRANTY BECOMES EFFECTIVE FROM DATE OF SHIPMENT FROM VST.

THE MAXIMUM WARRANTY LIFE IS 18 MONTHS FROM DATE OF SHIPMENT.

PLEASE CALL VST IF THIS PRODUCT IS BEING USED AS A REPLACEMENT. REPLACEMENT WITH A NON VST PRODUCT VOIDS ANY WARRANTY.

VST-0000-14/06

Warranty and Testing Stickers for Balance EVR Products

- VST will continue to use individual tracking serial numbers on every product shipped (nozzle, hose, safety breakaway, and membrane processor).
- VST will continue to include a warranty card with every product shipped.
- VST will attach additional **NOTICE** stickers to the EVR balance-style products.

Nozzle

- A florescent colored sticker will be placed over the threaded area of the nozzle where the hose is to be attached.
- This sticker will include the following text:

NOTICE: The nozzle was factory tested to and met all applicable performance standards & specifications to which it was certified: Reference all applicable CARB Executive Orders, CARB Test procedures, Exhibits, and UL Standard 842.

WARRANTY: 12-month warranty becomes effective at time of installation upon VST receipt of warranty card. If the warranty card is not returned to VST, the warranty becomes effective from VST's shipment date. The maximum warranty life is 18 months from date of shipment. Please call VST if this product is being used as a replacement. Replacement with a non-VST product voids any warranty.

Safety Breakaway

- A florescent colored sticker will be placed over one of the threaded ports of the breakaway.
- This sticker will include the following text:

NOTICE: This breakaway was factory tested to and met all applicable performance standards & specifications to which it was certified: Reference all applicable CARB Executive Orders, CARB Test procedures, Exhibits, and UL Standard 567.

WARRANTY: 12-month warranty becomes effective at time of installation upon VST receipt of warranty card. If the warranty card is not returned to VST, the warranty becomes effective from VST's shipment date. The maximum warranty life is 18 months from date of shipment. Please call VST if this product is being used as a replacement. Replacement with a non-VST product voids any warranty.

Hose

- A florescent colored sticker will be placed on the hose.
- This sticker will include the following text:

NOTICE: This hose was factory tested to and met applicable performance standards & specifications to which it was certified: Reference all applicable CARB Executive Orders, CARB Test procedures, Exhibits, and UL Standard 330

WARRANTY: 12-month warranty becomes effective at time of installation upon VST receipt of warranty card. If the warranty card is not returned to VST, the warranty becomes effective from VST's shipment date. The maximum warranty life is 18 months from date of shipment. Please call VST if this product is being used as a replacement. Replacement with a non-VST product voids any warranty.

Processor

- A florescent colored sticker will be placed on the processor.
- This sticker will include the following text:

NOTICE: This processor was factory tested to and met all applicable performance standards & specifications to which it was certified: Reference all applicable CARB Executive Orders, CARB Test procedures, Exhibits, and UL Standard 79.

WARRANTY: 12-month warranty becomes effective at time of installation upon VST receipt of warranty card. If the warranty card is not returned to VST, the warranty becomes effective from VST's shipment date. The maximum warranty life is 18 months from date of shipment. Please call VST if this product is being used as a replacement. Replacement with a non-VST product voids any warranty.

VEEDER-ROOT VAPOR POLISHER WARRANTY POLICY

We warrant that this product shall be free from defects in material and workmanship for a period of one (1) year from the date of installation or twenty-four (24) months from the date of invoice, whichever occurs first. We will repair or replace the product if the product is returned to us transportation prepaid by user within the warranty period, and is determined by us to be defective. The user must contact the Veeder Root Customer Service for specific detailed information concerning the failed component return to ensure proper processing.

This warranty applies only when the product is installed in accordance with Veeder-Root's specifications, and a Warranty Registration and Checkout Form has been filed with Veeder-Root by an authorized Veeder-Root Distributor. This warranty will not apply: (1) to any product which has been subject to misuse, abuse, negligence, accident, or drive-offs; (2) to systems that are misapplied or are not installed per Veeder-Root's specifications, or which have been modified, rebuilt or repaired by unauthorized persons; or (3) to damage resulting from acts of God.

Repair or replacement of the defective part or component under the terms of this warranty is the EXCLUSIVE REMEDY. Veeder-Root is not liable for incidental, consequential, or indirect damages or loss, including, without limitation, personal injury, death, property damage, environmental damages, cost of labor, clean-up, downtime, installation and removal, product damages, loss of product, or loss of revenue or profits. **THE WARRANTY CONTAINED HEREIN IS EXCLUSIVE AND THERE ARE NO OTHER EXPRESS, IMPLIED, OR STATUTORY WARRANTIES. WARRANTIES OF MERCHANTABILITY OR FITNESS FOR A PARTICULAR PURPOSE ARE EXPRESSLY EXCLUDED.**

The following warranty card will be shipped with the Veeder-Root Vapor Polisher:

<p>EQUIPMENT WARRANTY</p> <p>Veeder-Root warrants that this product shall be free from defects in material and workmanship for a period of one (1) year from date of installation or twenty-four (24) months from date of invoice, whichever occurs first.</p> <p>Date of manufacture:</p> <p>This component was tested at the time of manufacture and meets all the applicable performance standards and specifications to which it was certified: E.O. VR202, VR-203 and VR-204.</p> <p>For detailed warranty terms see EO warranty exhibits (VR202 Exhibit 6, VR203/VR204 Exhibit 7) on the ARB Web site at http://www.arb.ca.gov/vapor/eo-evrphase11.htm</p> <p>577013-888, Rev. D</p>	 VEEDER-ROOT
---	--

Veeder-Root Environmental Equipment Warranty Policy

TLS-350R and TLS-350 Plus Monitoring Systems

We warrant that this product shall be free from defects in material and workmanship for a period of one (1) year from the date of installation or twenty-four (24 months) from the date of invoice, whichever occurs first. During the warranty period, we or our representative will repair or replace the product, if determined by us to be defective, at the location where the product is in use and at no charge to the purchaser. Lamps and fuses are not covered under warranty.

We shall not be responsible for any expenses incurred by the user.

This warranty applies only when the product is installed in accordance with Veeder-Root's specifications, and a Warranty Registration and Checkout Form has been filed with Veeder-Root by an authorized Veeder-Root Distributor. This warranty will not apply to any product which has been subjected to misuse, negligence, accidents, systems that are misapplied or are not installed per Veeder-Root specifications, modified or repaired by unauthorized persons, or damage related to acts of God.

If "Warranty" is purchased as part of the Fuel Management Service, Veeder-Root will maintain the equipment for the life of the contract in accordance with the written warranty provided with the equipment. A Veeder-Root Fuel Management Services Contractor shall have free site access during Customer's regular working hours to work on the equipment. Veeder-Root has no obligation to monitor federal, state or local laws, or modify the equipment based on developments or changes in such laws.

ISD Components (Vapor Flow Sensor, Vapor Pressure Sensor & Software)

We warrant that these components shall be free from defects in material and workmanship and will comply with the performance standards of the California ARB CP-201 section 10 as amended May 25, 2006 for a period of one (1) year from the date of installation or twenty four (24) months from the date of invoice, whichever occurs first. We will repair or replace the product if the product is returned to us transportation prepaid by the user, within the warranty period, and is determined by us to be defective. This warranty will not apply to any product which has been subjected to misuse, negligence, accidents, systems that are misapplied or are not installed per the **ARB Approved Installation, Operation and Maintenance Manual**, modified or repaired by unauthorized persons, or damage related to acts of God. We shall not be responsible for any expenses incurred by the user.

Warranty Card

The Warranty Card shown in the Vapor Polisher Section shall accompany all ISD systems or components.

**Executive Orders VR-203-F and VR-204-F
VST Phase II EVR System**

**Exhibit 8
Vapor Pressure Sensor Verification Test Procedure**

Definitions common to all certification and test procedures are in:

D-200 Definition for Vapor Recovery Procedures

For the purpose of this procedure, the term “ARB” refers to the California Air Resources Board, and the term, “ARB Executive Officer” refers to the Executive Officer of the ARB or his or her authorized representative or designee.

1. Purpose and Applicability

1.1 The purpose of this test procedure is to determine if the Pressure Management Control (PMC) Vapor Pressure Sensor (listed in Exhibit 1) is operating in accordance with the pressure sensor requirements of Exhibit 2. This procedure is used:

1.1.1 To determine the measured ullage pressure in underground gasoline storage tanks (USTs) installed at gasoline dispensing facilities (GDFs) equipped with a VST Phase II enhanced vapor recovery system and compare to the pressure reading of the PMC at the TLS console.

1.1.2 To determine whether the Vapor Pressure Sensor complies with the performance specification when the sensor is exposed to ambient pressure.

1.2 This procedure is applicable for compliance testing.

2. Principle and Summary of Test Procedure

Determining UST Pressure - The pressure of the USTs is determined at the Phase I vapor recovery adaptor (dry break assembly) with a vapor coupler test assembly as shown in Figures 2 and 3 of TP-201.3 (*Determination of 2 Inch WC Static Pressure Performance of Vapor Recovery Systems of Dispensing Facilities*) or a modified dust cap test assembly as shown in Figures 8-1 and 8-2 of this exhibit. The test assembly is equipped with a center probe, which opens the dry break, and a quick connect fitting that is connected to an electronic pressure measuring device or digital manometer. The test assembly should open the dry break with minimal venting of the USTs. This test can be performed while product is being dispensed into motor vehicles.

Determining Ambient Pressure - The Vapor Pressure Sensor is subjected to ambient pressure by turning the Vapor Pressure Sensor valve, which is located on the vent stack or in the dispenser closest to the tanks, to the Atmospheric Valve Position as shown in Figure 8-3. This test can be performed while product is being dispensed into motor vehicles.

3. Biases and Interferences

3.1 This test shall not be conducted within 30 minutes following gasoline transfer from a cargo tank.

- 3.2 This test shall not be conducted if the processor is operating (audible indication that the processor is running).

4. Range and Accuracy

Electronic Pressure Measuring Device such as a digital manometer

Minimum readability shall be 0.01 inches WC with measurement range(s) to include at least up to positive and negative ten (± 10) inches WC with a minimum accuracy of plus or minus 0.05 inches WC of full scale.

5. Equipment

- 5.1 The dust cap test assembly shall be modified in the following manner:

- 5.1.1. Install a probe in the center of the dust cap as shown in Figure 8-1 (one method is to tap and thread probe). The probe shall be of sufficient length to open approximately $\frac{1}{2}$ inch of the dry break while allowing the cap to maintain a leak tight seal on the adaptor.
- 5.1.2. Install female quick connect fitting on the top of the dust cap, offset from the center probe as shown in Figure 8-1. A Swagelok, part number SS-QC4-B-4-PM, quick connect fitting or equivalent can be used.
- 5.1.3. Use "Tygon tubing" or equivalent to connect the manometer to the dust cap (Figure 8-2). Install a male quick connect fitting (Swagelok part number SS-QC4-5-400 or equivalent can be used) on one end of a ferrule stainless steel tube (or equivalent material). Connect one end of the "Tygon tubing" to the stainless steel tube and connect the other end to the digital manometer (Figure 8-2).

- 5.2 Alternatively, the vapor coupler test assembly, Figures 2 and 3 of TP-201.3 may be used in lieu of the dust cap test assembly.

- 5.3 Digital Manometer (Electronic Pressure Measuring Device)

Use a minimum range ± 10.00 inches WC digital manometer to monitor the UST pressure with a minimum readability of 0.01 inches of WC. Dwyer Series 475 Mark III Digital manometer or equivalent can be used. A copy of the manufacturer's operating instructions shall be kept with the equipment.

6 Calibration Requirements

- 6.1 A copy of the most current calibration of the electronic pressure measuring device shall be kept with the equipment.
- 6.2 All electronic pressure measuring devices shall be bench tested for accuracy using a reference gauge, incline manometer or National Institute of Standards and Technology (NIST) traceable standard at least once every twelve (12) consecutive months. Accuracy checks shall be performed at a minimum of five (5) points (e.g., 10, 25, 50, 75 and 90 percent of full scale) each for both positive

and negative pressure readings. Accuracy shall meet the requirements of Section 4.

Determining UST Pressure

7 Pre-Test Procedure

- 7.1 Turn on digital manometer and allow instrument to warm up for five minutes.
- 7.2 Zero out digital manometer using adjustment pod on top of instrument in accordance with manufacturer's instructions. Drift may be minimized by re-zeroing immediately after use by venting both pressure ports to atmosphere and adjusting the knob until the display reads exactly zero.
- 7.3 Attach the male quick connect fitting to the female quick connect fitting on the modified vapor dust cap.
- 7.4 Attach digital manometer to open end of Tygon tubing.

8 Test Procedure

- 8.1 Attach the dust cap or vapor coupler test assembly to the vapor adaptor (Figure 8-2).
- 8.2 On the TLS Console front panel, use the 'mode key' to scroll to "DIAG MODE" then use the function and step keys, as shown in Figure 8-4 to view the current pressure value.
- 8.3 Simultaneously record the ullage pressure from the digital manometer (connected to the vapor coupler test assembly) and the TLS Console. Record the above information on Form 1 "Data Form for Vapor Pressure Sensor UST Pressure Test." Districts may require the use of an alternate form, provided it includes the same minimum parameters as identified in the Data Form.
- 8.4 Verify that the pressure reading from the TLS Console is within ± 0.2 inches WC from the digital manometer reading. If difference is not within ± 0.2 inches WC, the pressure sensor is not in compliance with the pressure sensor requirements of Exhibit 2.
- 8.5 Press the <MODE> key to leave the 'PMC DIAGNOSTIC' menu

Determining Ambient Pressure

9 Test Procedure for Testing Sensor Under Ambient Pressure

- 9.1 Access the Vapor Pressure Sensor, which is located on the vent stack or in the dispenser closest to the tanks. Record pressure sensor location and serial number on the data form.
- 9.2 Remove the cap from the ambient reference port of the Vapor Pressure Sensor valve and open the valve to atmosphere by turning it 90 degrees so that the flow arrows point to both the Vapor Pressure Sensor sensing port and the ambient reference port (see Figure 8-3).

- 9.3 On the TLS Console front panel, use the 'mode key' to scroll to "DIAG MODE" then use the function and step keys, as shown in Figure 8-4 to view the current pressure value.
- 9.4 Verify that the pressure value is between +0.2 and -0.2 inches WC. If the pressure value is not within this range, the pressure sensor is not in compliance with the pressure sensor requirements of Exhibit 2.
- 9.5 Replace the cap on the ambient reference port of the Vapor Pressure Sensor valve. Restore the Vapor Pressure Sensor valve by turning it 90 degrees so that the flow arrows point to both the Vapor Pressure Sensor sensing port and the UST vapor space sensing line (ref. Figure 8-3).
- 9.6 Press the <MODE> key to leave the 'PMC DIAGNOSTIC' menu.
- 9.7 Record the above information on Form 2 "Data Form for Vapor Pressure Sensor Ambient Reference Test." Districts may require the use of an alternate form, provided it includes the same minimum parameters as identified in the Data Form.

10 Alternate Procedures

This procedure shall be conducted as specified. Any modifications to this test procedure shall not be used unless prior written approval has been obtained from the ARB Executive Officer, pursuant to Section 14 of CP-201.

Figure 8-1 - Typical Modified Vapor Adaptor Dust Cap (Bottom View)

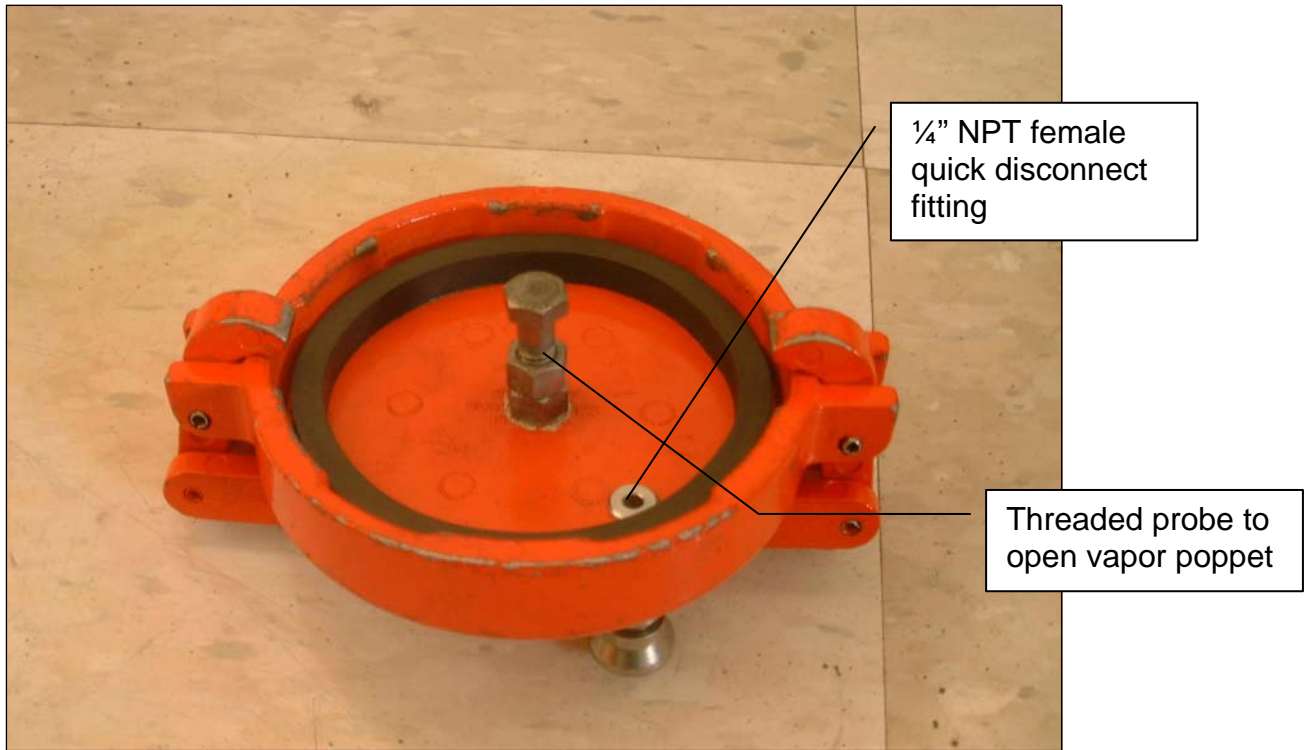

Figure 8-2 - Typical Field Installation of UST Pressure Measurement Assembly



Figure 8-3
Vapor Pressure Sensor Valve Position

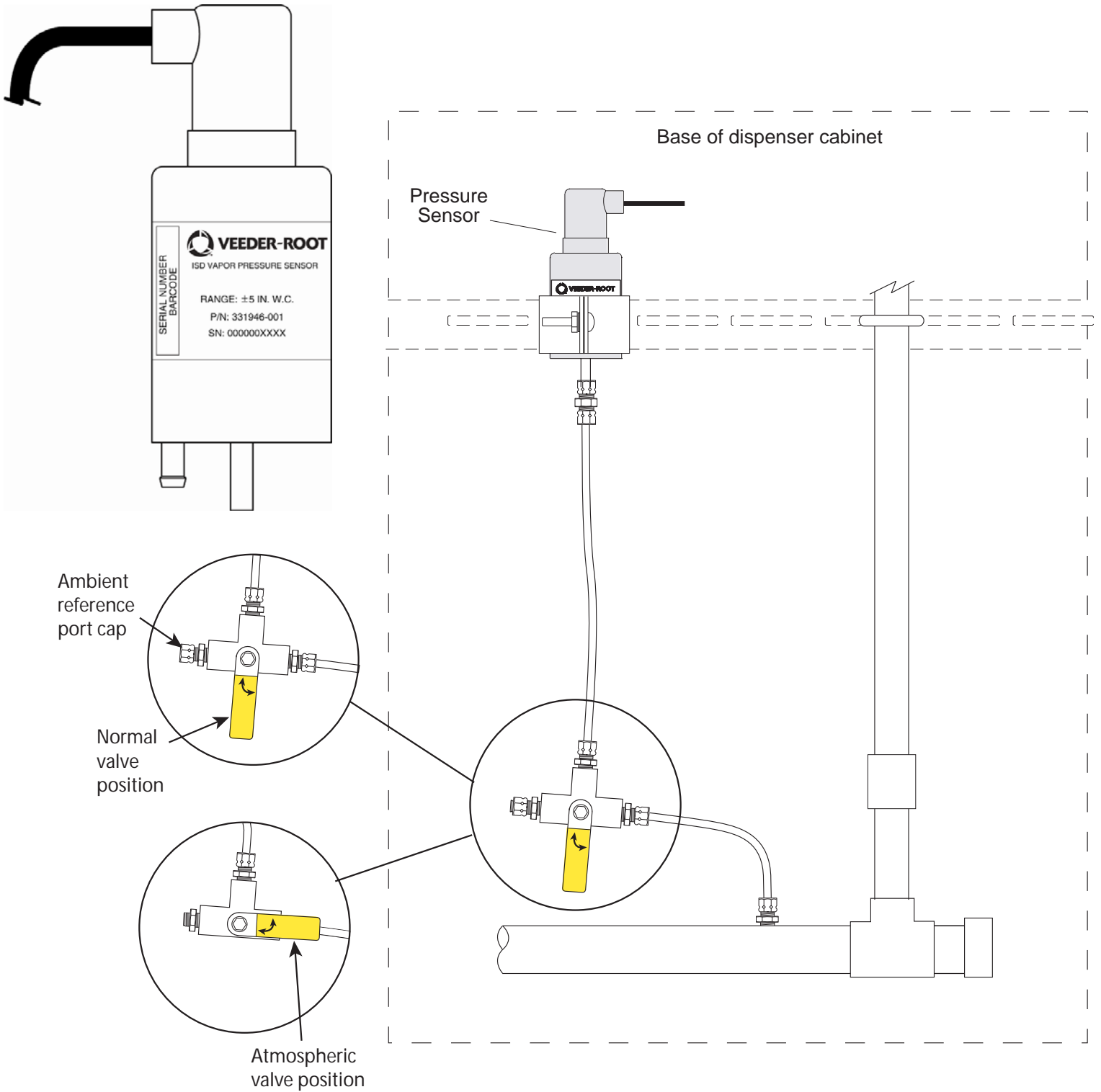
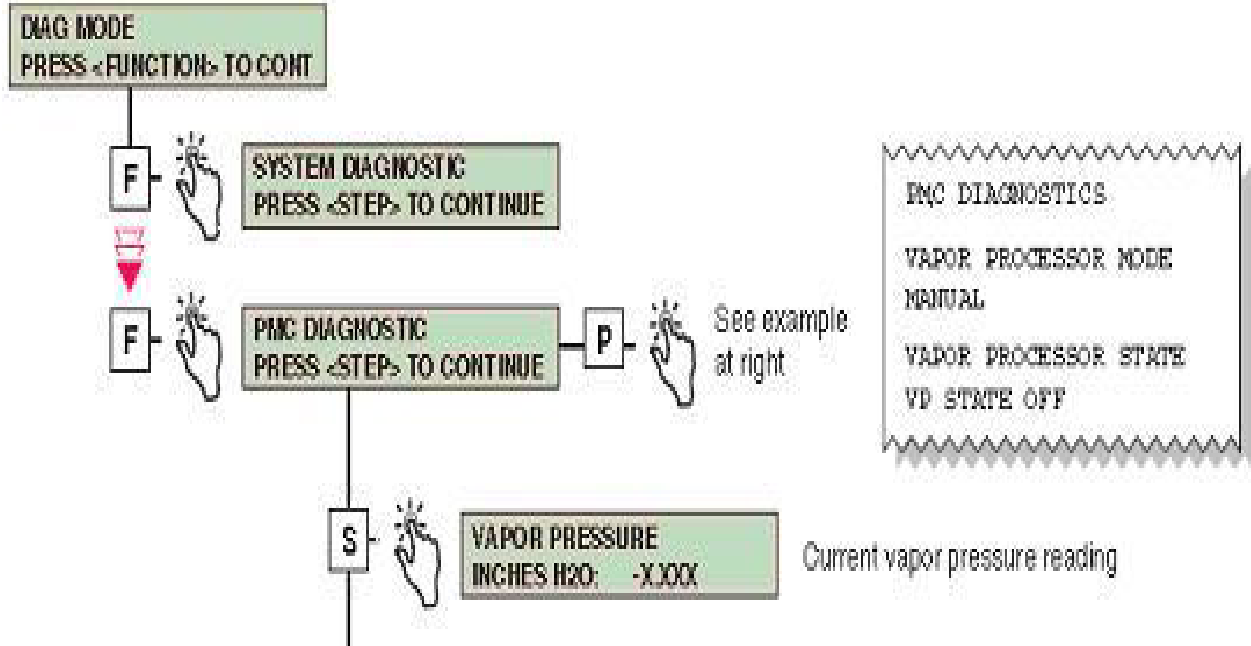

Figure 8-4
Accessing the Vapor Pressure Sensor Reading



Form 1

Data Form for Vapor Pressure Sensor UST Pressure Test

DATE OF TEST _____

SERVICE COMPANY NAME	SERVICE COMPANY'S TELEPHONE
SERVICE TECHNICIAN	VST or VEEDER-ROOT TECH CERTIFICATION # (as applicable) ICC or DISTRICT TRAINING CERTIFICATION (as applicable)
STATION NAME	DISTRICT PERMIT #
STATION ADDRESS	CITY STATE ZIP

PRESSURE SENSOR LOCATION: DISPENSER FUELING POINT (FP) or VENT STACK	FP # _____ <input type="checkbox"/>	PRESSURE SENSOR SERIAL NUMBER: _____
	VENT STACK <input type="checkbox"/>	

STEP 8.3	DIGITAL MANOMETER VALUE _____ inches WC
----------	---

STEP 8.3	TLS 350 SENSOR VALUE _____ inches WC (OBTAIN VALUE USING TLS CONSOLE KEYPAD SEQUENCE SHOWN IN FIG. 8-4, Vapor Pressure)
----------	---

STEP 8.4	TLS 350 Sensor Value within ± 0.2 inches WC of Digital Manometer Value? Yes <input type="checkbox"/> No <input type="checkbox"/> IF NO: THE PRESSURE SENSOR IS NOT IN COMPLIANCE WITH THE PRESSURE SENSOR REQUIREMENTS OF EXHIBIT 2.
----------	---

STEP 8.5	MODE KEY PRESSED TO EXIT PMC DIAGNOSTIC MENU? <input type="checkbox"/>
----------	--

Form 2

Data Form for Vapor Pressure Sensor Ambient Reference Test

DATE OF TEST _____

SERVICE COMPANY NAME		SERVICE COMPANY'S TELEPHONE	
SERVICE TECHNICIAN		VST or VEEDER-ROOT TECH CERTIFICATION # (as applicable) ICC or DISTRICT TRAINING CERTIFICATION (as applicable)	
STATION NAME		DISTRICT PERMIT #	
STATION ADDRESS		CITY	STATE ZIP
STEP 9.1	PRESSURE SENSOR LOCATION:	FP # _____ <input type="checkbox"/>	PRESSURE SENSOR SERIAL NUMBER: _____
	DISPENSER FUELING POINT (FP) or VENT STACK	VENT STACK <input type="checkbox"/>	
STEP 9.2	REFERENCE PORT CAP REMOVED?		<input type="checkbox"/>
	VALVE SET TO AMBIENT REFERENCE PORT (PER FIG. 8-3)?		<input type="checkbox"/>
STEP 9.3	NON-CALIBRATED SENSOR VALUE _____ Inches WC (OBTAIN VALUE USING TLS CONSOLE KEYPAD SEQUENCE SHOWN IN FIG. 8-4, Vapor Pressure)		
STEP 9.4	PRESSURE BETWEEN +0.20 & -0.20?		Yes <input type="checkbox"/> No <input type="checkbox"/>
	IF NO: THE PRESSURE SENSOR IS NOT IN COMPLIANCE WITH THE PRESSURE SENSOR REQUIREMENTS OF EXHIBIT 2.		
STEP 9.5	REFERENCE PORT CAP REPLACED?		<input type="checkbox"/>
	VALVE SET TO NORMAL VALVE POSITION (PER FIG 8-3)?		<input type="checkbox"/>
STEP 9.6	MODE KEY PRESSED TO EXIT PMC DIAGNOSTIC MENU?		<input type="checkbox"/>

**Executive Orders VR-203-F and VR-204-F
VST Phase II EVR System**

**Exhibit 9
Determination of
VST ECS Processor Activation Pressure**

Definitions common to all certification and test procedures are in:

D-200 Definition for Vapor Recovery Procedures

For the purpose of this procedure, the term “ARB” refers to the California Air Resources Board, and the term, “ARB Executive Officer” refers to the Executive Officer of the ARB or his or her authorized representative or designee.

1. Purpose and Applicability

- 1.1 The purpose of this test procedure is to determine compliance with the VST processor activation (e.g. turns on) pressure requirement of Exhibit 2.
- 1.2 This procedure is applicable for compliance testing.

2. Principle and Summary of Test Procedure

The UST pressure at which the VST membrane processor activates is determined by using a test assembly connected to the pressure sensor as shown in Figure 1 of this procedure (the pressure sensor is located in the dispenser closest to the tanks). The test assembly consists of an oral syringe (or other device capable of introducing low pressures up to approximately 0.5 inches WC) and an electronic pressure measuring device such as a digital manometer connected into a tee at the pressure sensor. This test can be performed while product is being dispensed into motor vehicles.

3. Range and Accuracy

Electronic Pressure Measuring Device (manometer). Minimum readability shall be 0.01 inches WC with measurement range(s) to include at least up to positive and negative ten (± 10) inches WC with a minimum accuracy of plus or minus 0.05 inches WC of full scale.

4. Biases and Interference's

- 4.1 No transfer of gasoline from any cargo tanks to the USTs shall occur within three hours prior to conducting this test.
- 4.2 This test shall not be conducted if TP-201.3 was conducted within the last three hours.
- 4.3 This test shall not be conducted if the processor is operating (audible indication that the processor is running).

5. Equipment

5.1 Digital Manometer (Electronic Pressure Measuring Device)

Use a minimum range ± 10.00 inches WC digital manometer to monitor the UST pressure with a minimum readability of 0.01 inches of WC. Dwyer Series 475 Mark III Digital manometer or equivalent can be used. A copy of the manufacturer's operating instructions shall be kept with the equipment.

5.2 Oral Syringe (used in determining processor activation pressure)

Use a 3 cubic centimeter (cc) or 6cc oral syringe or equivalent that is capable of introducing air pressure at approximately 0.1 inches WC increments up to a maximum pressure of 0.5 inches WC (see Figure 1).

6 Calibration Requirements

6.1 A copy of the most current calibration of the electronic pressure measuring device shall be kept with the equipment.

6.2 All electronic pressure measuring devices shall be bench tested for accuracy using a reference gauge, incline manometer or National Institute of Standards and Technology (NIST) traceable standard at least once every twelve (12) consecutive months. Accuracy checks shall be performed at a minimum of five (5) points (e.g., 10, 25, 50, 75 and 90 percent of full scale) each for both positive and negative pressure readings. Accuracy shall meet the requirements of Section 3.

7 Pre-Test Procedure

7.1 Turn on digital manometer and allow instrument to warm up for five minutes.

7.2 Zero out digital manometer using adjustment pod on top of instrument in accordance with manufacturer's instructions. Drift may be minimized by re-zeroing immediately after use by venting both pressure ports to atmosphere and adjusting the knob until the display reads exactly zero.

7.3 Prepare test assembly as shown in Figure 1. Lubricate seal of oral syringe plunger with petroleum jelly (or other lubricant). Use Tygon tubing (or equivalent) from the oral syringe (or equivalent) to the pressure sensor and to the digital manometer as shown in Figure 1. Plug or cap the end of the Tygon tubing (used to connect to the tee on the pressure sensor) and pressurize test assembly to approximately 2.0-5.0 inches WC for at least 5 seconds. There shall be no indications of vapor leaks when using liquid leak detection solution.

7.4 Remove the cap from the ambient reference port of the Vapor Pressure Sensor valve and connect the Tygon tubing (or equivalent) of the test assembly to the tee on the Vapor Pressure Sensor Valve as shown in Figure 1.

8 Test Procedure

- 8.1 Close the ball valve located at the tee to the pressure sensor to isolate the pressure sensor from the UST ullage (see Atmospheric Valve Position in Figure 2).
- 8.2 Slowly press the oral syringe (or equivalent) until a pressure of 0.10 inches WC is obtained. Maintain this pressure for at least 5 seconds. Does the VST membrane processor activate? If the membrane processor does not activate, continue increasing pressure at 0.1 inches WC intervals and hold for at least 5 seconds per interval or until the processor activates, up to a maximum pressure of 0.5 inches WC.

NOTE: Listen for audible indication that the processor activated (or turned on).

- 8.3 Record the VST membrane processor activation pressure on Form 1, Data Form for VST Processor Activation Pressure Test.
- 8.4 Verify that the processor activation pressure value is less than or equal to 0.4 inches WC. If the pressure value is not less than or equal to 0.4 inches WC, the VST processor is not in compliance with the activation pressure requirements of Exhibit 2.
- 8.5 Replace the cap on the ambient reference port of the Vapor Pressure Sensor valve. Restore the Vapor Pressure Sensor valve by turning it 90 degrees so that the flow arrows point to both the Vapor Pressure Sensor sensing port and the UST vapor space sensing line (see Normal Valve Position in Figure 2).

9 Alternate Procedures and Reporting Forms

- 9.1 This procedure shall be conducted as specified. Any modifications to this test procedure shall not be used unless prior written approval has been obtained from the ARB Executive Officer, pursuant to Section 14 of CP-201.
- 9.2 District may require the use of alternate forms, provided they include the same minimum parameters as identified in Form 1.

Figure 1: Typical Field Installation of Test Assembly for Determining VST Processor Activation

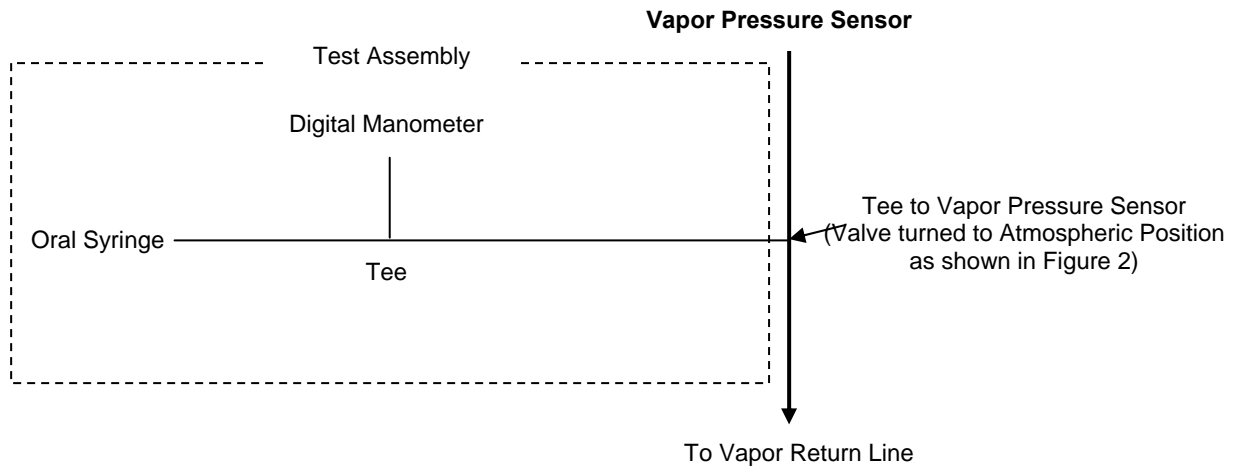
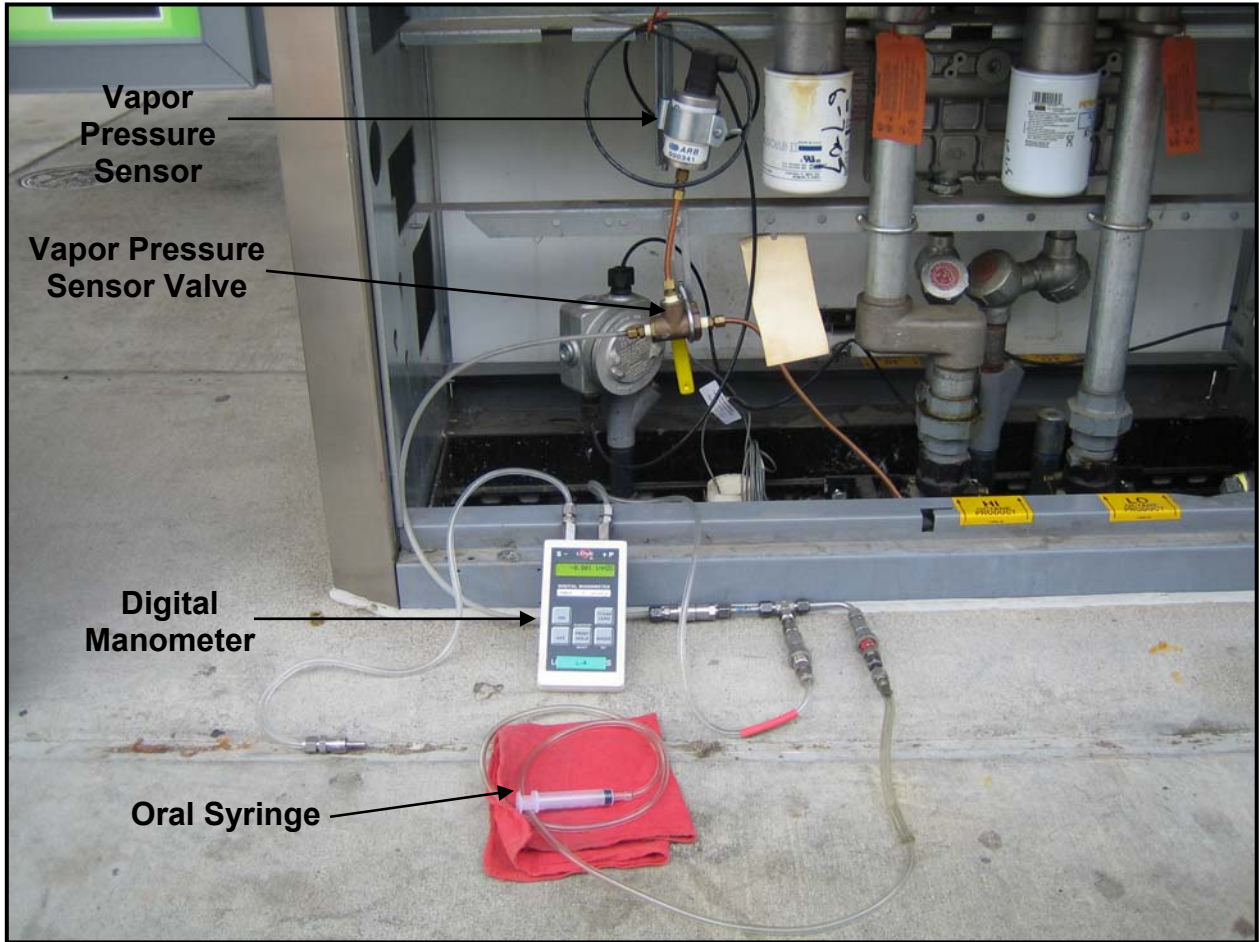
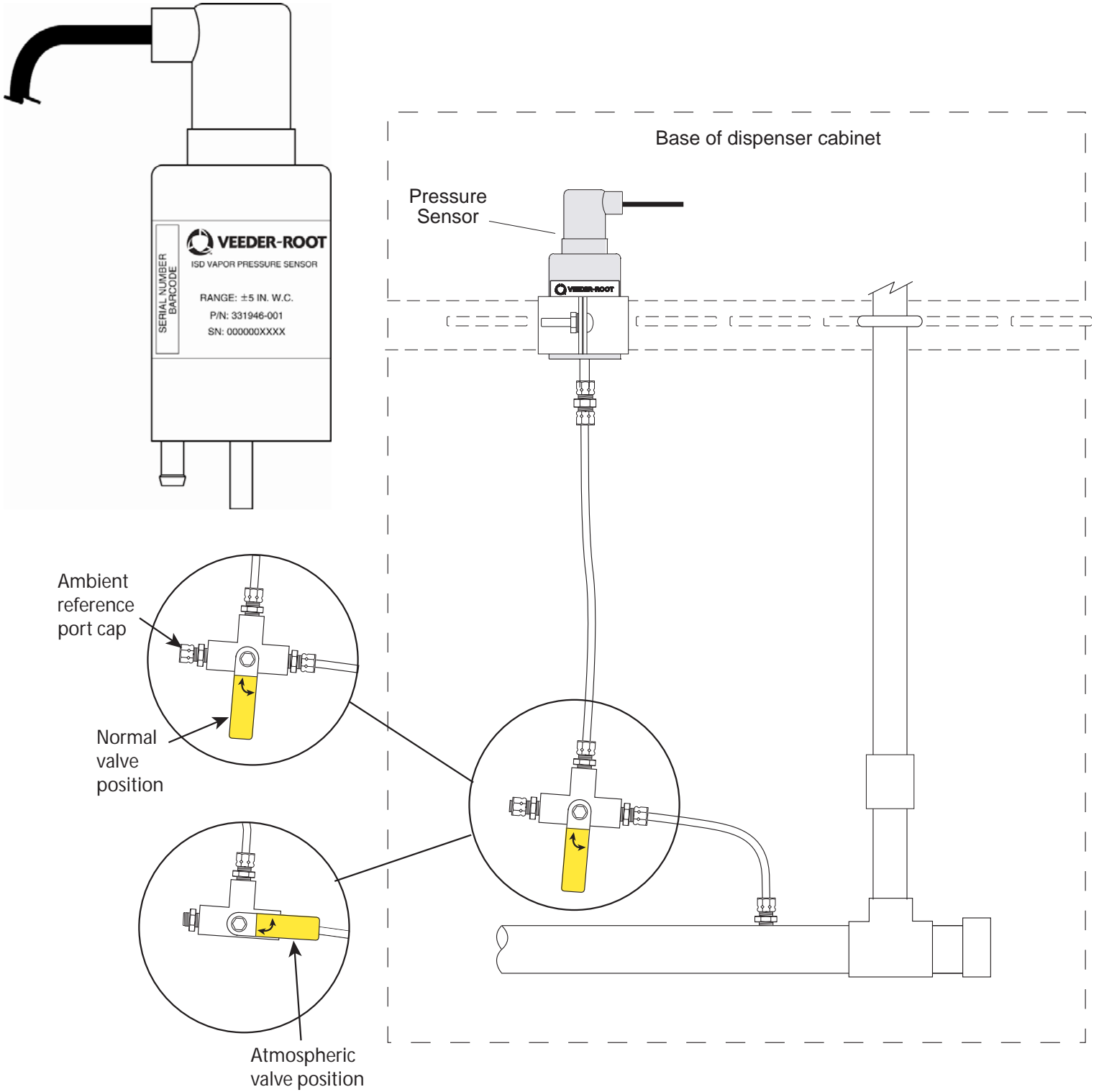

Figure 2: Vapor Pressure Sensor Valve Position



Form 1

Data Form for VST Processor Activation Pressure Test

DATE OF TEST _____

SERVICE COMPANY NAME	SERVICE COMPANY'S TELEPHONE		
SERVICE TECHNICIAN	VST or VEEDER-ROOT TECH CERTIFICATION # (as applicable) ICC or DISTRICT TRAINING CERTIFICATION (as applicable)		
STATION NAME	DISTRICT PERMIT #		
STATION ADDRESS	CITY	STATE	ZIP

PRESSURE SENSOR LOCATION: DISPENSER FUELING POINT (FP) NUMBERS	FP # _____	PRESSURE SENSOR SERIAL NUMBER: _____
STEP 8.1	VALVE SET TO ATMOSPHERIC VALVE POSITION (PER FIG. 2)?	<input type="checkbox"/>
STEP 8.3	VST PROCESSOR ACTIVATION PRESSURE: _____ Inches WC	
STEP 8.4	Is the VST Processor Activation Pressure \leq 0.4 inches WC? <input type="checkbox"/> Yes <input type="checkbox"/> No IF NO: THE VST PROCESSOR IS NOT IN COMPLIANCE WITH THE ACTIVATION PRESSURE REQUIREMENTS OF EXHIBIT 2.	
STEP 8.5	REFERENCE PORT CAP REPLACED?	<input type="checkbox"/>
	VALVE SET TO NORMAL VALVE POSITION (PER FIG 2)?	<input type="checkbox"/>

**Executive Orders VR-203-F and VR-204-F
VST Phase II EVR System**

**Exhibit 10
Nozzle Bag Test Procedure**

Verification of the integrity of the VST nozzle vapor valve shall be performed on installed nozzles by use of the following test.

1. Seal nozzle(s) at the gasoline dispensing facility (GDF) in a plastic bag, using tape or other means to secure the bag around the base of the nozzle (see Figure 1). Any plastic bag large enough to enclose the nozzle and having a thickness of no greater than 2 mils can be used. In California, 12" x 20" x 2 mil thick bags are available from the Air Resources Board by calling 800-952-5588.
2. Observe the bagged nozzle(s) for 30 seconds.
3. Any nozzle where the bag can be seen visually expanding or collapsing has a defective vapor valve and is not in compliance with Exhibit 2.
4. Record the test results on the "Nozzle Bag Test Results" form provided in this Exhibit. Districts may require use of an alternate form, provided that the alternate form includes the same minimum parameters.
5. Remove the bags from all the nozzles and return the nozzles to the dispenser holsters.

Figure 1
Example of Bagged Nozzle



NOZZLE BAG TEST RESULTS

SOURCE INFORMATION		TEST COMPANY INFORMATION	
Facility (DBA)/Site Address:	Facility Representative/Title:	Test Company Name	# of Nozzles: _____ # Nozzles Tested: _____
Print Name	Print Name	Print Name of Tester	# Nozzles Passed: _____ # Nozzles Failed: _____
Street Address	Title ()	Street Address	# Nozzles not Tested: _____
City Zip	Phone No.	City Zip	
District Inspector:	<input type="checkbox"/> P/O <input type="checkbox"/> S/A <input type="checkbox"/> A/C Number:	Date of Test:	Time of Test:

Dispenser	Gas Grade	Nozzle Type	Bag Expanded or Collapsed after 30 Seconds
			<input type="checkbox"/> Yes <input type="checkbox"/> No
			<input type="checkbox"/> Yes <input type="checkbox"/> No
			<input type="checkbox"/> Yes <input type="checkbox"/> No
			<input type="checkbox"/> Yes <input type="checkbox"/> No
			<input type="checkbox"/> Yes <input type="checkbox"/> No
			<input type="checkbox"/> Yes <input type="checkbox"/> No
			<input type="checkbox"/> Yes <input type="checkbox"/> No
			<input type="checkbox"/> Yes <input type="checkbox"/> No
			<input type="checkbox"/> Yes <input type="checkbox"/> No
			<input type="checkbox"/> Yes <input type="checkbox"/> No
			<input type="checkbox"/> Yes <input type="checkbox"/> No
			<input type="checkbox"/> Yes <input type="checkbox"/> No
			<input type="checkbox"/> Yes <input type="checkbox"/> No
			<input type="checkbox"/> Yes <input type="checkbox"/> No
			<input type="checkbox"/> Yes <input type="checkbox"/> No
			<input type="checkbox"/> Yes <input type="checkbox"/> No
			<input type="checkbox"/> Yes <input type="checkbox"/> No
			<input type="checkbox"/> Yes <input type="checkbox"/> No
			<input type="checkbox"/> Yes <input type="checkbox"/> No
			<input type="checkbox"/> Yes <input type="checkbox"/> No
			<input type="checkbox"/> Yes <input type="checkbox"/> No

**Executive Orders VR-203-F and VR-204-F
VST Phase II EVR System**

**Exhibit 11
Veeder-Root Vapor Polisher Operability Test Procedure**

Definitions common to all certification and test procedures are in:

D-200 Definitions for Vapor Recovery Procedures

For the purpose of this procedure, the term "ARB" refers to the California Air Resources Board, and the term "ARB Executive Officer" refers to the Executive Officer of the ARB or his or her authorized representative or designate.

1. PURPOSE AND APPLICABILITY

This test verifies the pressure integrity of the vapor polisher, confirms that the operating pressure is within certification parameters at a known flow rate, and verifies the readings of the various thermometer elements and atmospheric pressure sensor. Proper function of the valve is confirmed during the leakage and flow tests.

The pressure integrity test will identify leaks that can be caused by valve or seal failure, loose fittings, cracking or structural damage. The flow test identifies any restrictions that can be caused by dirty filters, clogged passageways, contaminated carbon or any other restriction or collapse of flow passages. The thermometer test will identify a failed sensor element that could lead to reduced performance in vapor containment or pressure management. The atmospheric pressure sensor test verifies the accuracy of that sensor.

The station may remain open (normal fuel dispensing, deliveries, etc.) while conducting this procedure.

2. PRINCIPLE AND SUMMARY OF TEST PROCEDURE

2.1 Pressure Integrity Test

This test confirms that the vapor polisher is capable of maintaining system pressures within certification limits. The leak tightness of the polisher is checked at 8 inches water column (WC). Proper closure of the vapor valve is verified during this test.

2.2 Flow Test

This test confirms flow characteristics through the vapor polisher are maintained within certification limits. The back-pressure across the polisher is checked at a flow rate of 18.0 standard cubic feet per hour (scfh). Proper opening of the vapor valve is verified during this test.

2.3 Thermometer Test

This test verifies that the temperature sensing elements are functioning correctly and indicating valid temperature readings within acceptable ranges. Thermometers are checked against each other as an indication of valid readings. If criteria are not met, accuracy of the thermometers is checked against a calibrated reference thermometer.

2.4 Atmospheric Pressure Sensor Test

This test verifies that the atmospheric pressure sensing element is functioning correctly and indicating valid readings within an acceptable range. The sensor is checked against a local independent source (e.g., U.S. Weather Service, airports, Districts etc.)

3. BIASES AND INTERFERENCES

- 3.1 The pressure integrity test should not be conducted within 2 hours of Vapor Polisher loading or purging to minimize affects of thermal decay in the carbon bed. Thermal conditions created by heavy loading of the vapor polisher can cause the test pressure to collapse as it cools.
- 3.2 The thermometer test should not be conducted within 2 hours after a delivery into any tank that is connected to the vapor recovery system. This allows sufficient time for the fuel and ullage temperatures to equalize in the event that fuel is dropped into the tank at significantly different temperatures from the ambient UST temperature.

4. EQUIPMENT, RANGE and ACCURACY

- 4.1 Nitrogen tank fitted with a pressure regulator capable of maintaining a 10 inch WC test pressure.
- 4.2 Flow control valve with a full scale of zero to 20 or 40 scfh.
- 4.3 A flow meter with 18.3 scfh full scale range and $\pm 2\%$ of full scale accuracy. The meter must be accurate within 0.4 scfh for any flow setting made during the prescribed tests.
- 4.4 A digital (electronic) manometer with 0.01 inches WC, or better, resolution. The sensor must have a minimum measuring range of ± 10 inches WC. The sensor must also be accurate to 0.05 inches WC for any pressure measurement made during the prescribed tests. For a manometer with a ± 10 inches WC measurement range, this requires a 0.25% basic accuracy.
- 4.5 A thermometer with 1°C (1.8°F), or better, resolution and accuracy is required to conduct the alternate thermometer test procedure.
- 4.6 Gasoline resistant hoses, fittings, connectors as required.

5. CALIBRATION REQUIREMENTS

- 5.1 A copy of the most current calibration shall be kept with all equipment.
- 5.2 All flow measuring devices shall be bench tested for accuracy using a reference gauge or National Institute of Standards and Technology (NIST) traceable standard at least once every 180 consecutive days. Accuracy checks shall be performed, with nitrogen, at a minimum of three (3) points (e.g., 20, 50 and 80 percent of full scale) and shall meet the requirements of Section 4.
- 5.3 All electronic pressure measuring devices shall be bench tested for accuracy using a reference gauge, incline manometer or National Institute of Standards and Technology (NIST) traceable standard at least once every 180 consecutive days. Accuracy checks shall be performed at a minimum of three (3) points (e.g., 20, 50 and 80 percent of full scale). Accuracy shall meet the requirements of Section 4.
- 5.4 Thermometer calibration shall be checked at least once every 180 consecutive days using an ice bath, ambient air, and boiling water. This accuracy check shall be conducted by comparison to a NIST traceable measurement device. Accuracy shall meet the requirements of Section 4.

6. PRE-TEST REQUIREMENTS

Install all required testing apparatus as illustrated in Figure 1. Connect the digital manometer using a tee to the Vapor Polisher inlet test port. Be sure the connection is made in-line with the 3-way valve. Connect the nitrogen tank via the flow control valve and meter to the tee at the polisher inlet test port. Be sure the connection is made at right angles to the 3-way valve connection so that flow must go through at a 90 degree corner.

7. TEST PROCEDURE

- 7.1 Pressure Integrity Test: At the TLS console in the GDF kiosk, confirm if the valve has been closed for two hours by checking the date and time when the valve was closed in the IV800 RS232 command (see example below and VR-203 IOM Section 16, Viewing PMC Reports via RS-232 Connection or VR-204 IOM Section 16, Viewing ISD Reports via RS-232 Connection). Manually close the vapor valve in the PMC Diagnostic menu (VR-203 IOM Section 16, PMC Diagnostic Menus, or VR-204 IOM Section 16, PMC Diagnostic Menus). If the valve had not already been closed for at least two (2) hours then wait two hours before beginning the Pressure Integrity Test. Connect the test apparatus to the vapor polisher inlet by moving the inlet 3-way valve to the test position. Start the nitrogen flow, at 15 to 18 scfh, to pressurize the closed polisher system to 8 ± 0.10 inches WC, then shut off the flow control valve. Wait for at least 1 minute before recording first reading. After 1 minute, record the starting pressure in inches of water column to 2 decimal places and wait for 60 seconds. Record the final pressure 60 seconds after the starting pressure. Record all results on Form 1.

Example IV8000 Command			
IV8000			
OCT 25, 2008 6:27 PM			
VAPOR POLISHER			
VALVE EVENT	PRESSURE		
DATE-TIME	"WC	EVENT CODE	
8-25-08 2:27PM	-1.528	OPEN EXCESS PURGE	
8-25-08 3:03PM	-0.480	CLOSE PURGE Hi P	
8-25-08 3:56PM	-1.511	OPEN EXCESS PURGE	
8-25-08 4:02PM	-1.330	CLOSE EMPTY	

Use leak detection solution to check for leaks at the compression fittings used to connect the bottom of the Vapor Polisher to the inlet 3-way valve during the above pressure integrity test.

7.2 Flow Test: At the TLS console in the GDF kiosk, enter the PMC Diagnostic Menu to manually open the polisher vapor valve (VR-203 IOM Section 16, PMC Diagnostic Menus, or VR-204 IOM Section 16, PMC Diagnostic Menus). After the valve is open, set flow control valve to 18.0± 0.2 scfh. Record pressure at the inlet in inches of water column to 2 decimal places. Turn off flow and set the polisher vapor valve to automatic mode and the inlet test port 3-way valve back to the normal operating position. Record all results on Form 1. Remove test equipment.

7.3 Thermometer Test:

7.3.1 At the TLS console front panel, verify that a delivery had not occurred in the last 2 hours by using the following commands.

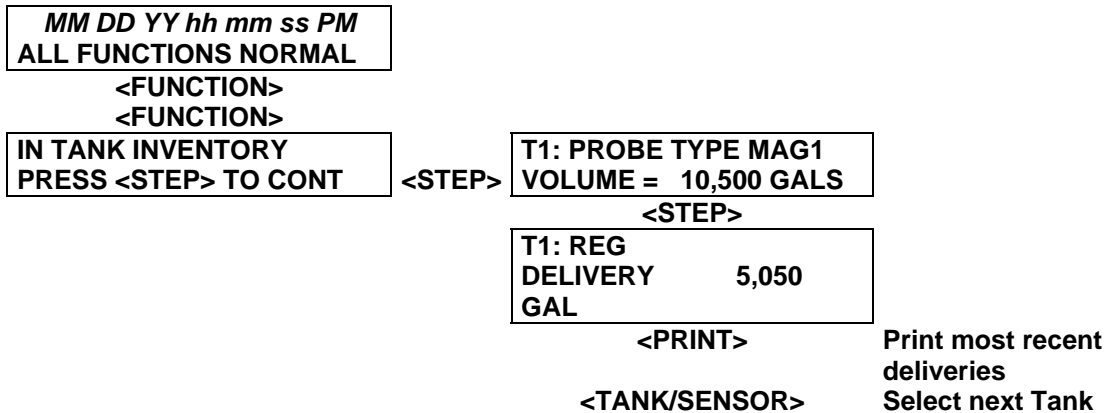

7.3.2 At the TLS console, record the Vapor Polisher Ambient temperature and the Outlet Temperature from the Vapor Polisher SMART SENSOR DIAGNOSTIC Menu on the TLS. See Table 1 below for procedures to access the diagnostic report. Record all results on Form 1.

7.3.3 At the TLS Console record the gasoline tank thermometer values, T4 and T5, from the IN-TANK DIAGNOSTIC Menu for each gasoline storage tank. See

Table 2 below for procedures to access the diagnostic report. Record all the results on Form 1.

7.4 Atmospheric Pressure Sensor Test:

7.4.1 At the TLS Console access the atmospheric pressure reading using the menus outlined below in Table 3 and record on Form 1.

7.4.2 Obtain an atmospheric pressure reading from a local (within 50 miles) independent source (e.g., U.S. Weather Service, airports, Districts, etc.) in inches mercury and record on Form 1.

7.5 Alternative to Form 1: Districts may require the use of an alternate Form, provided it includes the same minimum parameters as identified in Form 1.

Table 1

Accessing Vapor Polisher Ambient and Outlet Temperatures
On the TLS Console

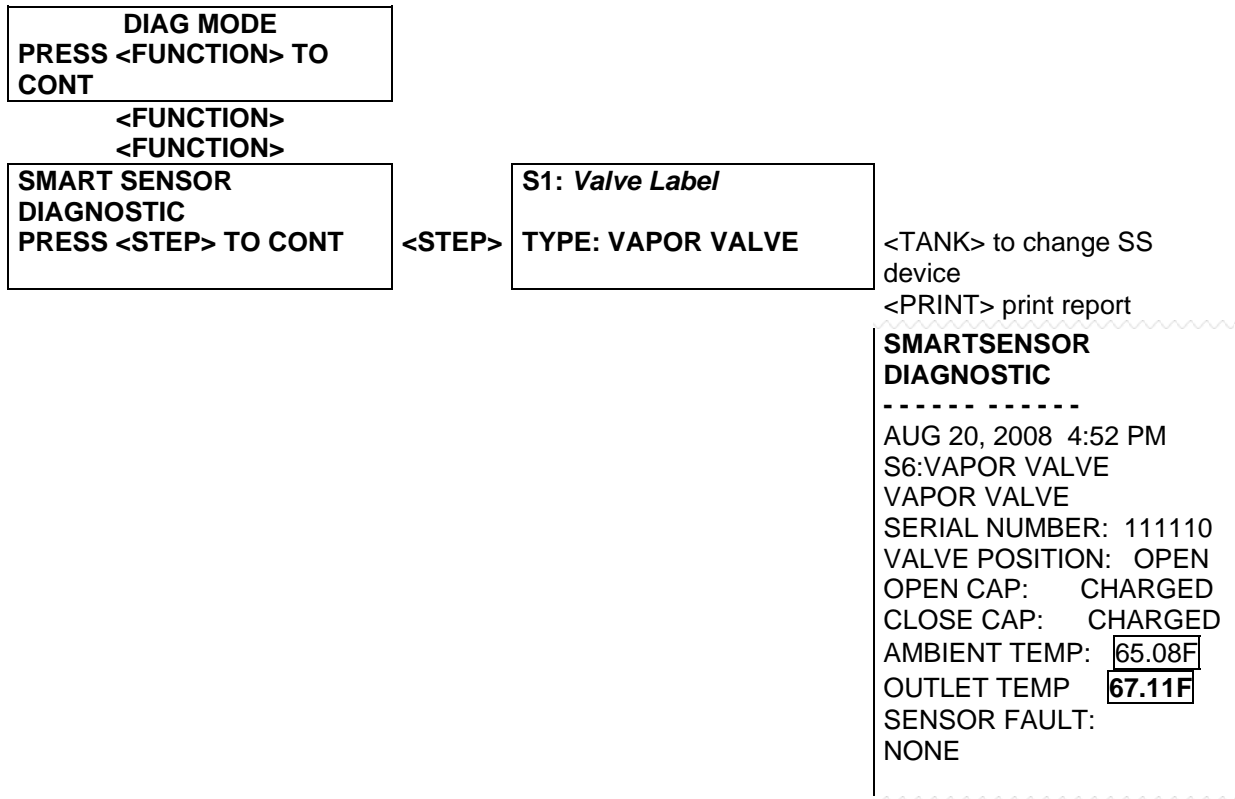

Table 2
Accessing Fuel Thermometer Data on TLS

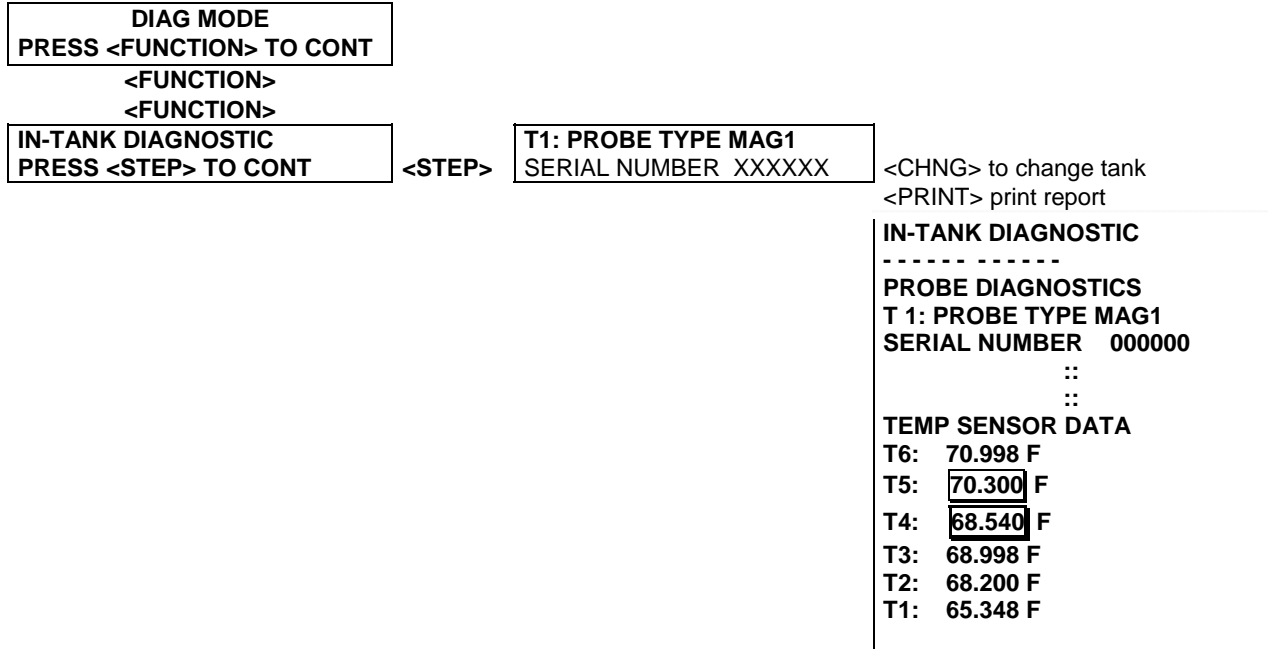
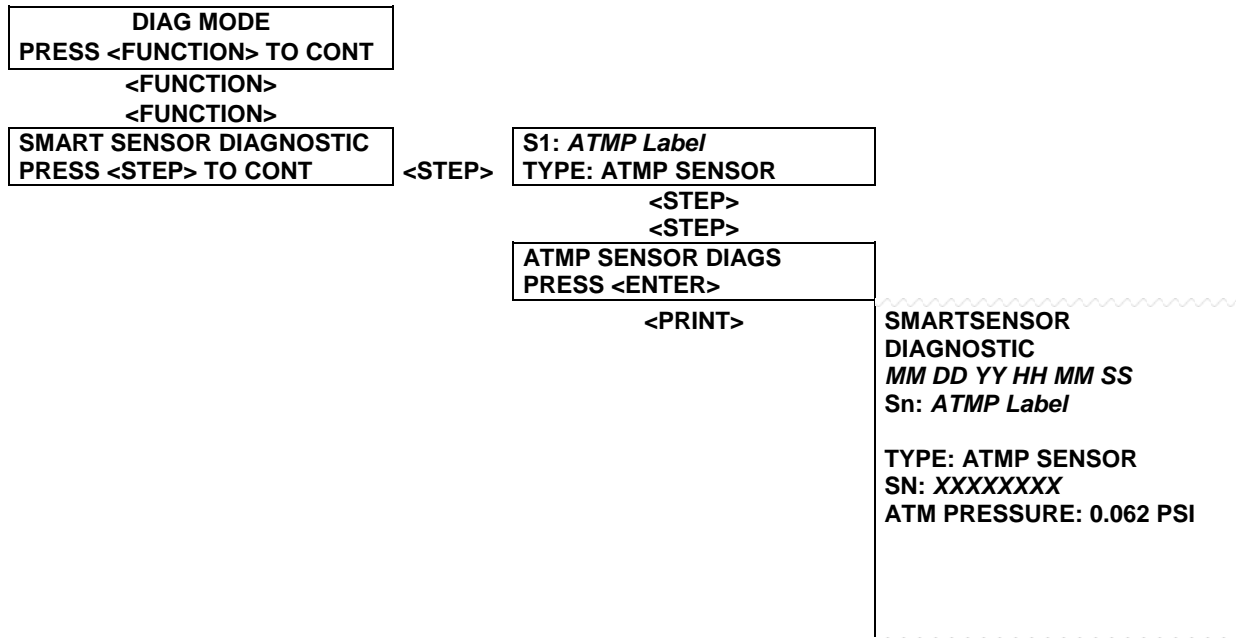

Table 3
Accessing Atmospheric Pressure on the TLS Console



8. RESULTS

8.1 Pressure Integrity Test

Verify that the end pressure is greater than 7.0 inches WC and that the decrease (see Form 1) between the start and end pressures is less than 0.5 inches WC. If not the polisher is not in compliance with the Exhibit 2 leakage requirements. This is equivalent to a leakage of about 0.01 CFH at 2 inches WC. If the decrease in pressure is greater than 0.5 inches WC, then retest (once) to be sure it is not due to thermal loss during the test. Correct valve function (closure and sealing) is confirmed if the pressure decrease between the start and end of the test are less than 0.5 inches WC.

8.2 Flow Test

Verify that the pressure drop across the polisher at 18.0 scfh flow is between 1.69 inches WC and 2.25 inches WC. If not the polisher is not in compliance with the Exhibit 2 back pressure requirements.

8.3 Thermometer Test

8.3.1 Gasoline (UST) Tank Thermometer

8.3.1.1 Subtract T4 from T5 and record the difference on Form 1.

8.3.1.2 If the difference between sensors in 8.3.1.1 exceeds 10° F, then the test procedures specified in Section 9 must be conducted.

8.3.2 Vapor Valve Thermometer

8.3.2.1 From the diagnostic report, compare the canister outlet temperature with the ambient thermometer.

8.3.2.2 If the difference between sensors in 8.3.2.1 exceeds 10° F, then the test procedures specified in Section 9 must be conducted.

8.4 Atmospheric Pressure Sensor Test

If the difference between the local and TLS atmospheric readings is greater than 10% of the local reading (see Form 1 for details) then the polisher is not in compliance with the Exhibit 2 atmospheric pressure sensor requirements.

8.5 All TLS and PMC reports used to access information to conduct this procedure must be attached to Form 1.

9 ADDITIONAL TEST PROCEDURES

The following tests are run in the event that the tests specified in Section 7.3 and 8.3 do not pass.

9.1. Gasoline (UST) Tank Thermometer -

- 9.1.1. Remove the tank probe from the tank and carefully lay it down on the forecourt while leaving it connected to the TLS. Wait 15 minutes for the probe to equalize with ambient temperature. Using the calibrated thermometer, obtain the ambient temperature near the probe. Access the Gasoline Tank Temperature T5 using Table 2. Record T5 and the calibrated thermometer reading (cal) on Form 1.
- 9.1.2. Compare the In-Tank Probe Diagnostic printout temperature T5 with the calibrated thermometer. If the difference between the two temperatures is greater than 10° F then the T5 thermometer does not meet the specifications set forth in Exhibit 2.

9.2. Vapor Valve Thermometer -

- 9.2.1. Using the setup described in Figure 1, introduce nitrogen flow (18 SCFH) into the canister for 2 minutes. Note: Pressure readings from the Vapor Polisher inlet do not need to be recorded if the canister has already passed the flow test.
- 9.2.2. Print the diagnostic Smart Sensor Vapor Valve Diagnostic report and record the Vapor Polisher outlet and ambient temperatures on Form 1.
- 9.2.3. If the difference between the canister outlet and ambient sensors is less than 10 degrees F, both sensors are operating properly. Otherwise, proceed to the next step.
- 9.2.4. Remove the Vapor Polisher outlet temperature probe from the canister, according to IOM Section 15, Canister Thermal Probe Replacement, and let it sit for 15 minutes to allow the sensor to equalize with ambient temperature. Record the ambient and outlet temperature readings on Form 1.
- 9.2.5. Using the calibrated thermometer (cal), record the ambient temperature taken near the probe on Form 1.
- 9.2.6. Compare the Smart Sensor Vapor Valve Diagnostic printout Outlet Temp with the calibrated thermometer. If the difference between the two temperatures is greater than 10° F then the outlet thermometer does not meet the specifications set forth in Exhibit 2.

- 9.2.7. Compare the Smart Sensor Vapor Valve Diagnostic printout ambient Temp with the calibrated thermometer. If the difference between the two temperatures is greater than 10° F then the outlet thermometer does not meet the specifications set forth in Exhibit 2.

Figure 1
Pressure Integrity and Flow Test Equipment Setup

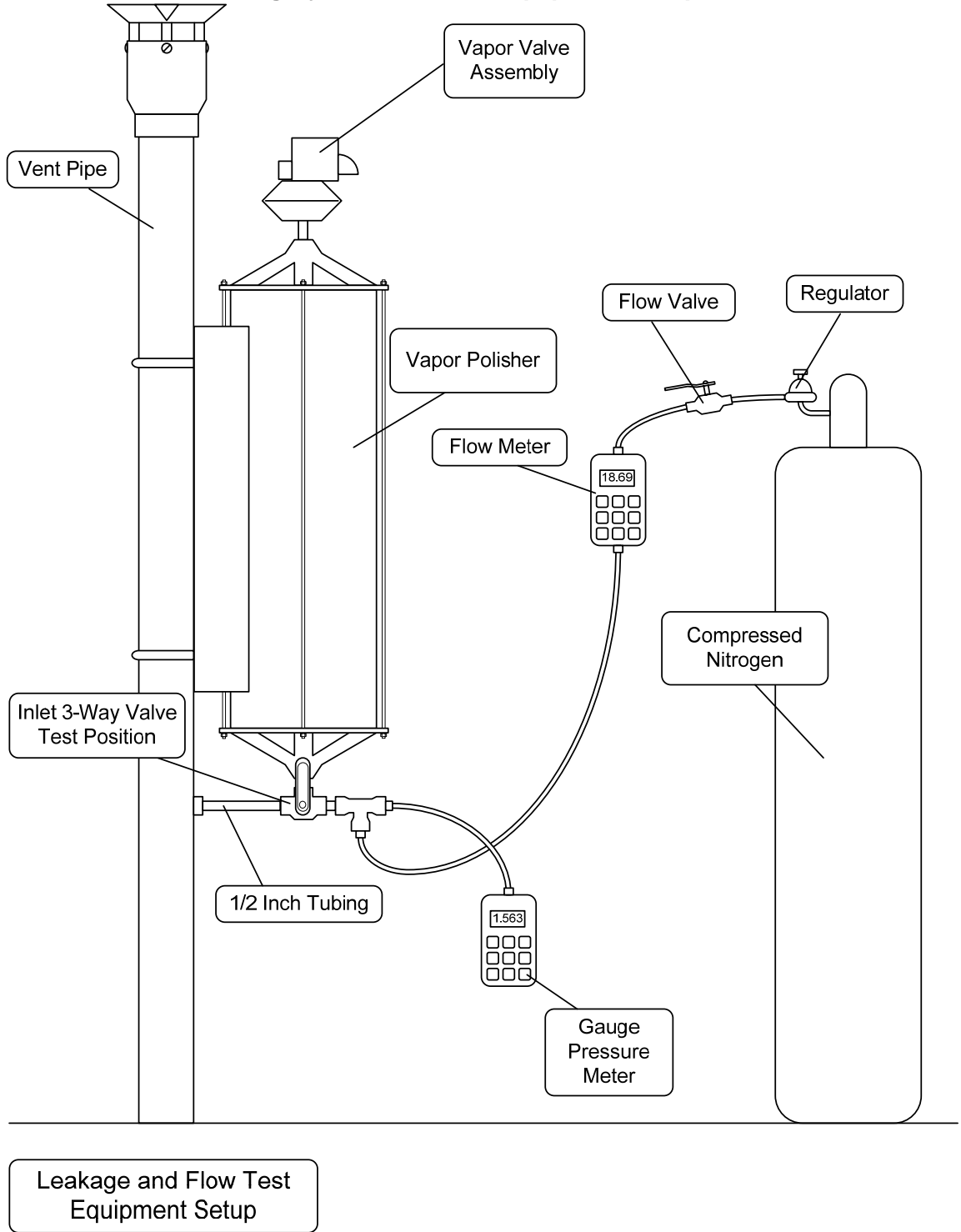

**FORM 1:
VEEDER ROOT VAPOR POLISHER OPERABILITY TEST**

DATE OF TEST:

SERVICE COMPANY NAME	SERVICE COMPANY'S TELEPHONE		
SERVICE TECHNICIAN	VEEDER-ROOT TECH CERTIFICATION #(as applicable)		
	ICC or DISTRICT TRAINING CERTIFICATION (as applicable)		
STATION NAME	DISTRICT PERMIT #		
STATION ADDRESS		CITY	STATE ZIP
STEP 7.1	3-WAY VALVE IN CORRECT POSITION (PER FIG. 1)? START PRESSURE: _____ FINAL PRESSURE: _____ DIFFERENCE: _____		<input type="checkbox"/>
STEP 8.1	1. IS THE FINAL PRESSURE > 7.0 INCHES WC? Yes No 2. IS THE FINAL PRESSURE > THE START PRESSURE Yes No 3. IF NO TO #2, IS THE <u>DECREASE</u> in PRESSURE <0.5 INCHES WC? Yes No (IF NO TO QUESTION 1 OR 3 ABOVE: THE VR POLISHER IS NOT IN COMPLIANCE WITH THE LEAKAGE REQUIREMENTS OF EXHIBIT 2.)		
STEP 7.2	VAPOR CONTROL VALVE OPEN? FLOW RATE: _____ PRESSURE: _____		<input type="checkbox"/>
STEP 8.2	IS THE PRESSURE BETWEEN 1.69 AND 2.25 INCHES WC? Yes No (IF NO: THE VAPOR POLISHER IS NOT IN COMPLIANCE WITH THE BACK PRESSURE REQUIREMENTS OF EXHIBIT 2.)		

IS THE DIFFERENCE BETWEEN SENSORS LESS THAN 10° F? Yes No (IF NO: THE VAPOR POLISHER IS NOT IN COMPLIANCE WITH THE TEMPERATURE RANGE REQUIREMENTS OF EXHIBIT 2.)																																																																																																																															
STEP 7.3	<table border="1" style="width:100%; border-collapse: collapse; text-align: center;"> <thead> <tr> <th style="width: 15%;">Test</th> <th style="width: 12.5%;">7.3.1</th> <th style="width: 12.5%;">9.2.2</th> <th style="width: 12.5%;">9.2.4&5</th> <th style="width: 12.5%;">Tank 1</th> <th style="width: 12.5%;">7.3.2</th> <th style="width: 12.5%;">9.1</th> </tr> </thead> <tbody> <tr><td>Ambient</td><td></td><td></td><td></td><td>T5</td><td></td><td></td></tr> <tr><td>Outlet</td><td></td><td></td><td></td><td>T4</td><td></td><td style="background-color: #cccccc;"></td></tr> <tr><td>Cal</td><td style="background-color: #cccccc;"></td><td style="background-color: #cccccc;"></td><td></td><td>T5 - T4</td><td></td><td style="background-color: #cccccc;"></td></tr> <tr><td>Diff</td><td></td><td></td><td style="background-color: #cccccc;"></td><td>Cal</td><td style="background-color: #cccccc;"></td><td></td></tr> <tr><td colspan="3">Diff Outlet & Cal (9.2.6)</td><td></td><td>T5 - Cal</td><td style="background-color: #cccccc;"></td><td></td></tr> <tr><td colspan="3">Diff Ambient & Cal (9.2.7)</td><td></td><td>Tank 2</td><td>7.3.2</td><td>9.1</td></tr> <tr><td colspan="4"></td><td>T5</td><td></td><td></td></tr> <tr><td colspan="4"></td><td>T4</td><td></td><td style="background-color: #cccccc;"></td></tr> <tr><td colspan="4"></td><td>T5 - T4</td><td></td><td style="background-color: #cccccc;"></td></tr> <tr><td colspan="4"></td><td>Cal</td><td style="background-color: #cccccc;"></td><td></td></tr> <tr><td colspan="4"></td><td>T5 - Cal</td><td style="background-color: #cccccc;"></td><td></td></tr> <tr><td colspan="4"></td><td>Tank 3</td><td>7.3.2</td><td>9.1</td></tr> <tr><td colspan="4"></td><td>T5</td><td></td><td></td></tr> <tr><td colspan="4"></td><td>T4</td><td></td><td style="background-color: #cccccc;"></td></tr> <tr><td colspan="4"></td><td>T5 - T4</td><td></td><td style="background-color: #cccccc;"></td></tr> <tr><td colspan="4"></td><td>Cal</td><td style="background-color: #cccccc;"></td><td></td></tr> <tr><td colspan="4"></td><td>T5 - Cal</td><td style="background-color: #cccccc;"></td><td></td></tr> </tbody> </table>	Test	7.3.1	9.2.2	9.2.4&5	Tank 1	7.3.2	9.1	Ambient				T5			Outlet				T4			Cal				T5 - T4			Diff				Cal			Diff Outlet & Cal (9.2.6)				T5 - Cal			Diff Ambient & Cal (9.2.7)				Tank 2	7.3.2	9.1					T5							T4							T5 - T4							Cal							T5 - Cal							Tank 3	7.3.2	9.1					T5							T4							T5 - T4							Cal							T5 - Cal		
	Test	7.3.1	9.2.2	9.2.4&5	Tank 1	7.3.2	9.1																																																																																																																								
	Ambient				T5																																																																																																																										
	Outlet				T4																																																																																																																										
	Cal				T5 - T4																																																																																																																										
	Diff				Cal																																																																																																																										
	Diff Outlet & Cal (9.2.6)				T5 - Cal																																																																																																																										
	Diff Ambient & Cal (9.2.7)				Tank 2	7.3.2	9.1																																																																																																																								
					T5																																																																																																																										
					T4																																																																																																																										
					T5 - T4																																																																																																																										
					Cal																																																																																																																										
					T5 - Cal																																																																																																																										
					Tank 3	7.3.2	9.1																																																																																																																								
					T5																																																																																																																										
					T4																																																																																																																										
					T5 - T4																																																																																																																										
				Cal																																																																																																																											
				T5 - Cal																																																																																																																											
STEP 7.4	<p> TLS ATM Pressure Reading _____ psi Convert PMC pressure reading which is in term of psi value to atmospheric pressure in inches mercury: $(\text{psi} + 14.7) \times 2.036 =$ _____ Atmospheric pressure from local source _____ inches mercury Difference between Local and TLS = _____ A $0.10 \times \text{Local} =$ _____ B IS A < B? Yes No (IF NO: THE VR POLISHER IS NOT IN COMPLIANCE WITH THE ATMOSPHERIC TEST REQUIREMENTS OF EXHIBIT 2.) </p>																																																																																																																														

**Executive Orders VR-203-F and VR-204-F
VST Phase II EVR System**

**Exhibit 12
Veeder-Root Vapor Polisher
Hydrocarbon Emissions Verification Procedure**

Definitions common to all certification and test procedures are in:

D-200 Definitions for Vapor Recovery Procedures

For the purpose of this procedure, the term "ARB" refers to the California Air Resources Board, and the term "ARB Executive Officer" refers to the Executive Officer of the ARB or his or her authorized representative or designate.

1. PURPOSE AND APPLICABILITY

This test procedure is used to verify the proper performance of the Veeder-Root Vapor Polisher. The test determines hydrocarbon (HC) emissions under iso-butane vapor loading conditions.

The station may remain open (normal fuel dispensing, deliveries, etc.) while conducting this procedure.

2. PRINCIPLE AND SUMMARY OF TEST PROCEDURE

This procedure is used to verify proper performance of the Veeder-Root Vapor Polisher in meeting the hydrocarbon (HC) emission specification listed in Exhibit 2. A 10% iso-butane compressed gas standard is used as the inlet test gas (i.e., to provide HC flow at the Vapor Polisher inlet) while monitoring HC emissions from the Vapor Polisher exhaust using a portable non-dispersive infrared (NDIR) analyzer calibrated to iso-butane. The flow through the Vapor Polisher and HC monitoring is maintained for six (6) minutes.

3. BIASES AND INTERFERENCES

- 3.1 This test shall not be conducted if the Vapor Polisher percent load is greater than 80% (VR-203 IOM Section 16, PMC Diagnostic Menu, or VR-204 IOM Section 16, PMC Diagnostic Menu).
- 3.2 Exhibit 11 (Vapor Polisher operability tests) must be conducted prior to conducting the Exhibit 12 test to assure valid results.
- 3.3 Catalytic bead HC sensors shall not be used for this test due to the absence of air in the inlet test gas.

- 3.4 Values measured at less than or greater than 9,000 ppm (0.9% by volume) should not be considered as quantitative results since accuracy and calibration checks are not required by this test at those levels.

4. EQUIPMENT

- 4.1 Flow control valve with a full scale of zero to 20 or 40 standard cubic feet per hour (scfh).
- 4.2 A flow meter with 18.3 scfh full scale range and $\pm 2\%$ of full scale accuracy. The meter must be accurate within 0.4 scfh for any flow setting made during the prescribed tests.
- 4.3 Gasoline resistant hoses, fittings, connectors.
- 4.4 Portable NDIR hydrocarbon analyzer, 0 to 18,000 ppm range (1.8 % by volume for iso-butane), with a minimum accuracy of $\pm 0.1\%$ by volume, such as RKI Instruments "Eagle" model (with NDIR HC sensor) or equivalent. Only an NDIR analyzer calibrated to iso-butane may be used for this test. The manufacturer's operating instructions for the HC analyzer and proof or evidence that the sensor is NDIR shall be kept with the equipment at all times so that proper procedure can be verified.
- 4.5 Ladder or other access means to manually sample vapor outflow from the top of the Vapor Polisher assembly.
- 4.6 A calibration check gas of iso-butane in nitrogen or air at a concentration of 9,000 ppm (0.9% by volume. The calibration check gas must be certified to an analytical accuracy of $\pm 2\%$ traceable to a reference material approved by the National Institute of Standards and Technology (NIST) and recertified at least every two years.
- 4.7 An inlet test gas of iso-butane **in nitrogen** (air balance gas not allowed) at a nominal concentration of 10% by volume (100,000 ppm). The actual value of the gas concentration shall be between 9.7 and 10.3% by volume (97,000 to 103,000 ppm). The calibration check gas must be certified to an analytical accuracy of $\pm 2\%$ traceable to a reference material approved by the National Institute of Standards and Technology (NIST) and recertified at least every two years.
- 4.8 Pressure regulators for the calibration check gas cylinder and the inlet test gas cylinder.
- 4.9 Stopwatch with an accuracy of ± 0.2 seconds.

5. CALIBRATION REQUIREMENTS

- 5.1 All flow measuring devices shall be bench tested for accuracy using a reference gauge or NIST traceable standard at least once every 180 consecutive days. Accuracy checks shall be performed, with nitrogen, at a minimum of three (3) points (e.g., 20, 50 and 80 percent of full scale) and shall meet the requirements of Section 4.
- 5.2 Information on the calibration check gas and inlet test gas shall be entered into a log identifying each cylinder by serial number. Documentation of certification shall be maintained with the gas cylinders at all times and shall also be attached to Form 1. The calibration check gas log shall be maintained with the gas cylinders at all times and made readily available to the district upon request. Sufficient information shall be maintained to allow a determination of the certification status of each calibration gas and shall include: (1) the date put in service, (2) assay result, (3) the dates the assay was performed, and (4) the organization and specific personnel who performed the assay.

6. PRE-TEST REQUIREMENTS

- 6.1 Follow the HC analyzer manufacturer's procedure for instrument start-up and warm-up.
- 6.2 Check the zero reading of the HC analyzer using ambient air. If the result is greater than 1,000 ppm (0.1% by volume) then re-zero the analyzer per the manufacturer's recommended procedures. Record results on Form 1.
- 6.3 Check the calibration of the HC analyzer by running the 9,000 ppm (0.9% by volume) calibration check gas following the manufacturer's procedures. The reading must be between 8,000 and 10,000 ppm (0.8% and 1.0% by volume). Record results on Form 1. If the result is outside of the required range then the analyzer shall be recalibrated per manufacturer's specifications prior to conducting this test.
- 6.4 Assemble the inlet test gas cylinder, regulator, flow meter and flow control valve, and transfer line as shown in Figure 1. Attach the HC analyzer sampling line to the outlet test port ¼ inch NPT fitting on the top of the polisher as shown in Figure 1.
- 6.5 Visually check to ensure the inlet 3-way valve (see **Figure 1**) to the Vapor Polisher is in the closed test position so the flow is coming from the inlet test gas to the inlet of the Vapor Polisher.

- 6.6 At the TLS console, set the Vapor Polisher to the manual open position (reference VR-203 IOM Section 16, PMC Diagnostic Menus, or VR-204 IOM Section 16, PMC Diagnostic Menus).

7. TEST PROCEDURE

- 7.1 Set the inlet test gas flow rate to 15 scfh. Adjust the flow rate as necessary during the test to maintain the flow rate of 14 to 16 scfh. Start the stopwatch. Record the start and end flow rates on Form 1.
- 7.2 Record the first HC reading three (3) minutes after starting the stopwatch. Take three (3) more readings one (1) minute apart for a total test time of 6 minutes.
- 7.3 Record the HC concentration for each minute from minute 3 to 6 on Form 1, with other required information. All results less than 9,000 ppm shall be recorded as "< 9000 ppm". All results greater than or equal to 9,000 ppm shall be recorded as "> 9000 ppm".
- 7.4 Alternative to Form 1: Districts may require the use of an alternate Form, provided it includes the same minimum parameters identified in Form 1.
- 7.5 Remove test equipment. Re-install the outlet test port cap by applying Teflon™ tape to the threads and tighten the cap ¼ inch turn past snug. Ensure that the 3-way inlet valve is in the normal operating ("open") position. At the TLS console re-set the Vapor Valve to the automatic mode.

8. RESULTS

If the emission concentration is ≥ 9000 ppm (0.9% by volume during any part of the test, then the Vapor Polisher is not in compliance with the Exhibit 2 HC emission requirements.

9. ALTERNATIVE TEST PROCEDURES

This procedure shall be conducted as specified. Modifications to this test procedure shall not be used to determine compliance unless prior written approval has been obtained from the ARB Executive Officer, pursuant to Section 14 of Certification Procedure CP-201.

Figure 1

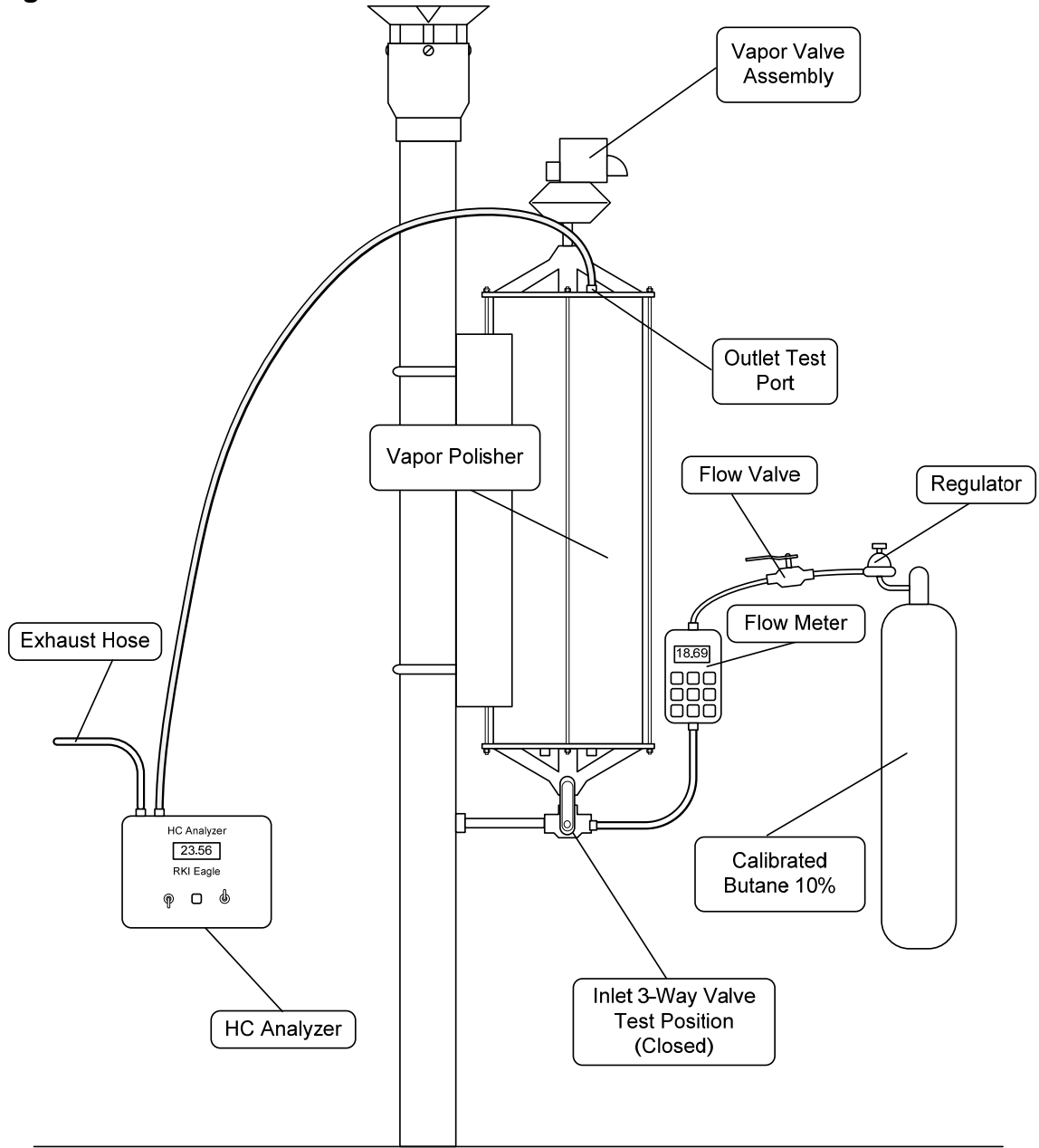

FORM 1: VEEDER ROOT VAPOR POLISHER HC EMISSIONS TEST

DATE OF TEST:

SERVICE COMPANY NAME	SERVICE COMPANY'S TELEPHONE		
SERVICE TECHNICIAN	VEEDER-ROOT TECH CERTIFICATION #(as applicable)		
	ICC or DISTRICT TRAINING CERTIFICATION (as applicable)		
STATION NAME	DISTRICT PERMIT #		
STATION ADDRESS	CITY	STATE	ZIP

STEP 6.2 6.3	CAL GAS DOCUMENTATION ATTACHED? <input type="checkbox"/> HC ANALYZER ZERO CHECK READING: _____ HC ANALYZER CAL CHECK READING: _____ IS THE ZERO READING < 1,000 ppm? Yes No IS THE CAL CHECK READING BETWEEN 8,000 and 10,000 ppm? Yes No (IF NO: THE HC ANALYZER MUST BE RE-CALIBRATED.)
STEP 6.5 6.6	3-WAY VALVE IN CORRECT POSITION (PER FIG. 1)? <input type="checkbox"/> PMC VALVE MODE SET TO MANUAL OPEN? <input type="checkbox"/>
STEP 7.1	START FLOW RATE: _____ END FLOW RATE: _____
STEP 7.3	HC READING AT 3 MIN: _____ HC READING AT 4 MIN: _____ HC READING AT 5 MIN: _____ HC READING AT 6 MIN: _____ IS THE HC CONC. < 9,000 ppm FOR ALL READINGS? Yes No (IF NO: THE VR POLISHER IS NOT IN COMPLIANCE WITH THE HC EMISSION REQUIREMENTS OF EXHIBIT 2.)
STEP 7.5	3-WAY VALVE SET TO NORMAL OPEN POSITION? <input type="checkbox"/> (UST Ullage to Vapor Polisher) RE-SET VAPOR VALVE TO AUTOMATIC MODE? <input type="checkbox"/>

Executive Order VR-204-F
VST Phase II EVR System Including Veeder-Root ISD

Exhibit 13
ISD Vapor Flow Meter Operability Test Procedure

The following procedures shall be used at field sites to determine the operability of the Veeder-Root ISD system to satisfy the requirements documented in VAPOR RECOVERY CERTIFICATION PROCEDURE, CP-201, CERTIFICATION PROCEDURE FOR VAPOR RECOVERY SYSTEMS AT GASOLINE DISPENSING FACILITIES. Testing the ISD equipment in accordance with this procedure will verify the equipment's operability for Vapor Containment Monitoring and Vapor Collection Monitoring.

Veeder-Root's TLS console ISD System Self-Test Monitoring algorithms are designed to verify proper selection, setup and operation of the TLS console modules and sensors and will not complete and report passing test results in the event of a failure of components used in the system. Completed ISD monitoring tests are evidence that:

- The system was properly powered for data collection
- All necessary ISD sensors were setup and connected
- All necessary ISD sensors were operating within specification
- All internal components including TLS console modules were properly setup and operating within specification

Veeder-Root recommends printing a copy of the ISD ALARM STATUS and ISD DAILY report (REF. Section 5, Operation of the ISD Install, Setup & Operation Manual for VST ECS Membrane Processors) periodically to determine that compliance tests are being completed in accordance with local and state regulations.

A step-by-step worksheet for recording data from the following operability tests is provided at the end of this Exhibit.

ISD VAPOR FLOW METER OPERABILITY TEST PROCEDURE

1. PURPOSE AND APPLICABILITY

- 1.1 This procedure is used to verify the setup and operation of the Vapor Flow Meter (VFM)

2. EQUIPMENT

- 2.1 **Nitrogen High Pressure Cylinder with Pressure Regulator.** Use a high pressure nitrogen cylinder capable of maintaining a pressure of at least 2000 pounds per square inch gauge (psig) and equipped with a compatible two-stage pressure regulator and a one psig relief valve. A ground strap is recommended during introduction of nitrogen into the system.
- 2.2 **Flow meter.** Use a flow meter (Rotometer) capable of accurately measuring nitrogen flow rate of 60 cubic feet per hour (cfh).
- 2.3 **Pressure Measuring Device.** An electronic pressure measuring device with a full range that shall not exceed 0-10 inches of water column (WC) with a minimum accuracy of 0.5 percent of full-scale. A 0-20 inches WC device may be used provided the minimum accuracy is 0.25 percent of full-scale.
- 2.4 **Squeeze Bulb.** A rubberized or equivalent device used to increase pressure to 5.00" WC.
- 2.5 **Balance Nozzle Adapter.** VST Part No. VST-STA-100.
- 2.6 **Surrogate Spout.** Only the VST Surrogate Spout Assembly, Part No. VST-TSS-100 can be used to conduct the pre-test leak check. Figure 1 shows the VST Surrogate Spout Assembly.
- 2.7 **Adapter Supply Hose.** The nominal inside diameter of the flexible hose shall be between 0.75 and 1.00 inches, and the length of the tubing shall be between 3 feet and 6 feet.
- 2.8 **Ball Valve.** The nominal inside diameter of the ball valve shall be 0.25".
- 2.9 **Nitrogen Supply Line.** The nominal inside diameter of the flexible tubing shall be between 0.25" and 0.375".
- 2.10 **Gas Volume Meter.** Use a Dresser Measurement Roots Meter®, or equivalent (preferably fitted with a digital readout), to measure the volumetric flow rate through the Balance Nozzle Adapter. The gas volume meter shall be calibrated within 180 days prior to conducting this procedure.
- 2.11 **Stopwatch.** Use a stopwatch accurate to within 0.2 seconds.
- 2.12 **Lubricant.** Appropriate lubricant, either grease or spray lubricant, shall be used to ensure a tight seal on the interface of the nozzle and the Balance Nozzle Adapter.
- 2.13 **Leak Detection Solution.** Any liquid solution designed to detect gaseous leaks may be used to verify the pressure integrity of test equipment during this test.
- 2.14 **Notebook personal computer (PC) with ISD PC Setup Tool Version 1.03 or later.** Serial communication cables are required to connect to the ISD system.

Figure 1
VST Surrogate Spout Assembly

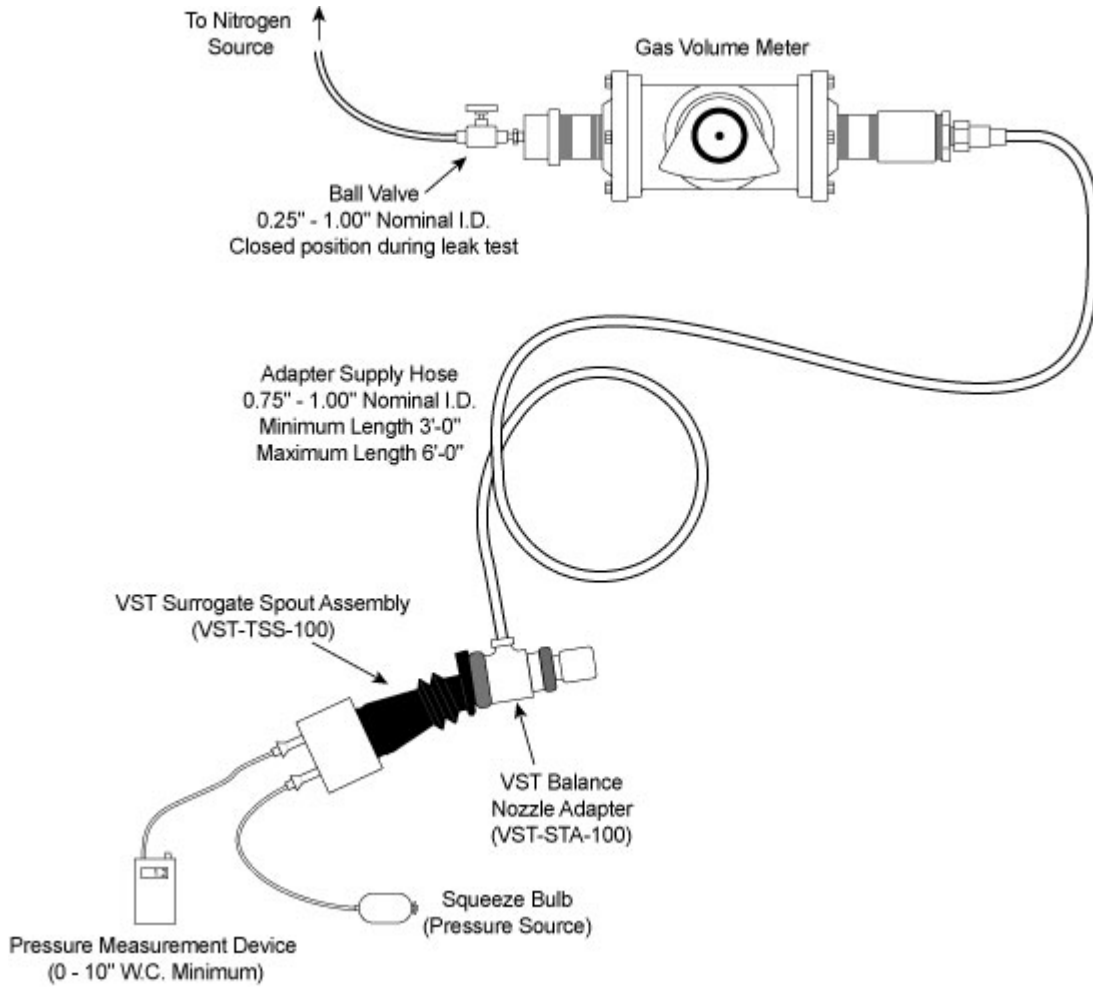
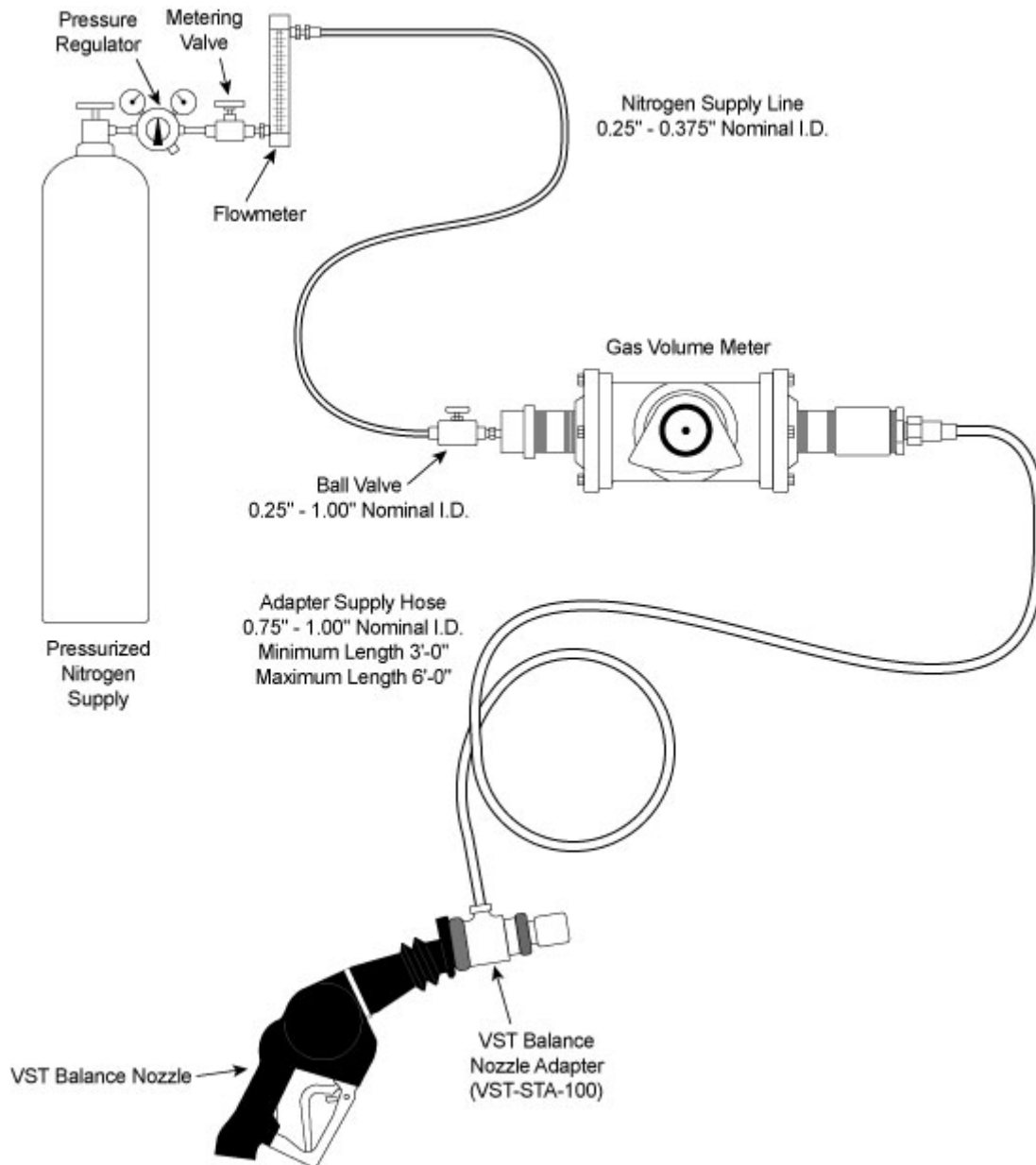

Figure 2
Vapor Flow Meter Test Assembly



3. PRE-TEST PROCEDURES

3.1 From the TLS, ISD Setup Menu print the ISD Setup Report. The ISD Hose Table will identify which VFM (column AA) is being used on each Fueling Position (FL)

```
ISD HOSE TABLE
ID  FP  FL  HL  AA  RR
-----
01  01  01  10  01  UU
02  02  02  10  01  UU
03  03  03  10  02  UU
04  04  04  10  02  UU
05  05  05  10  03  UU
06  06  06  10  03  UU
07  07  07  10  04  UU
08  08  08  10  04  UU
09  09  09  10  05  UU
10  10  10  10  05  UU
11  11  11  10  06  UU
12  12  12  10  06  UU

ISD AIRFLOW METER MAP
ID  SERIAL NUM LABEL
-----
 1  00000111  AFM1 FP1 -
 2  00000112  AFM2 FP3 -
 3  00000113  AFM3 FP5 -
 4  00000114  AFM4 FP7 -
 5  00000115  AFM5 FP9 -
 6  00000116  AFM6 FP11
```

3.2 Connect the notebook PC running Veeder-Root's "ISD PC Setup Tool" terminal mode, v1.03 or higher, or use Microsoft HyperTerminal to the dedicated TLS serial port that is required for ISD reports access. Access the individual airflow meter totals for the airflow meter being tested using the following RS232 command: IV8700

Typical IV8700 Report

```
DEC 14, 2007 5:47 AM
AIR FLOW METER TOTALS
DATE-TIME                VOLUME
                        AFM 1      AFM 2      AFM 3      AFM 4
07-12-14 05:46:00 76739.892 63139.977 42860.023 44139.693
```

3.3 Conduct a pre-test leak check of the Balance Nozzle Adapter, the gas volume meter and the adapter supply hose by connecting the Balance Nozzle Adapter to a surrogate spout as shown in Figure 1. Turn the ball valve in Figure 1 to the closed position. Raise the test pressure to 5.00" ±0.50" WC using a squeeze bulb. There shall not be a pressure drop of more than 1.00" WC from the above starting pressure for 30 seconds from the start of the test. If the leak test passes, proceed with the testing. If the leak test fails, proceed to isolate the source of the leak by pressurizing the test equipment again. Squirt liquid leak detector solution on interfaces and other potential leak sources and watch for the formation of bubbles. Once leak(s) are repaired, repeat the leak test procedure.

Note: Leak checks shall be conducted in a shaded area or away from direct sunlight. Leak checks may be conducted during the testing to ensure leak integrity of test equipment.

3.4 Assemble the equipment as shown in Figure 2, Vapor Flow Meter Test Assembly. Leave the Balanced Nozzle Adapter off of the nozzle at this time. Do not enable the dispenser to dispense product. Remove nozzle and utilize any method to keep the nozzle hook in the **off** position.

3.5 Ensure that the ground strap is properly connected to an acceptable ground.

Note: The test requires that the nozzle be squeezed and liquid product must not flow from the dispenser.

4. TEST PROCEDURES

4.1 Prevent dispensing from all other fueling positions that use the VFM being tested.

4.2 Record the VFM serial number and fueling position being tested on the worksheet.

4.3 Completely drain any gasoline that may be in the nozzle and hose vapor return path by any acceptable method.

4.4 Continuing from step 3.4, turn the ball valve to the open position and adjust the nitrogen flow using the Rotometer to 60 cfh +/- 5.0 cfh.

4.5 Once the nitrogen flow is set, turn the ball valve to the closed position to stop the flow of nitrogen through the gas volume meter. This will ensure the nitrogen flow rate is set and the nitrogen can instantaneously be activated when the ball valve is turned to the open position.

4.6 Apply appropriate lubricant on the surface area in the Balance Nozzle Adapter. Lubricant can also be applied to the nozzle spout and the face seal (rubber boot) of the nozzle and the back of the Balance Nozzle Adapter if necessary.

4.7 Wait for two minutes of no air or liquid flow activity on the dispenser with the airflow meter being tested.

4.8 With the notebook PC connected to the TLS ISD, and the IV8700 Report page open, record the initial meter total for the VFM being tested on the worksheet.

4.9 Record the initial gas volume meter reading on the worksheet.

4.10 **Ensure the dispenser is not enabled to dispense product.** Simultaneously squeeze the nozzle handle to the full dispensing position and turn the ball valve to the open position to allow nitrogen to flow.

Note: If the nozzle handle is not engaging the vapor/product valve within the nozzle, turn off the nitrogen flow using the ball valve; remove the Balance Nozzle Adapter from the nozzle to release the nitrogen pressure build up and repeat steps 4.7- 4.10. Excess pressure build up in the nozzle will engage the automatic shut-off diaphragm and not allow the vapor/product valve within the nozzle to open.

- 4.11 Monitor the gas volume meter display. Simultaneously stop the flow once 1.0 cubic feet (cf) +/- 0.10 cf of nitrogen is reached by turning the ball valve to the closed position and also releasing the nozzle handle.

Note: Final volume values may be biased if the ball valve and the nozzle handle are not activated at the same time.

- 4.12 Record the end meter reading from the gas volume meter. Calculate the total cubic feet value by subtracting the initial meter reading obtained in step 4.11 from the final meter reading in this step.
- 4.13 Convert the total cubic feet value to gallons using the equation on worksheet. Record the final gallon value on the worksheet.
- 4.14 Wait two minutes after each test run before obtaining the VFM reading from the notebook PC that is connected to the TLS ISD. A period of two minutes is required by the ISD system to receive and document total flow from the VFM.
- 4.15 Calculate the total VFM volume by subtracting the initial reading on step 4.8 from the final reading on step 4.14 and record the value on the worksheet.
- 4.16 Calculate the percent difference between the final gallons reading from the gas volume meter and the final VFM reading using the equation shown on the worksheet.

Pass: If the volume percent difference between recorded ISD VFM and the gas volume meter is within 15%, check "Pass" on the worksheet, and repeat the Test Procedures for the next dispenser.

Fail: If the volume percent difference between recorded ISD VFM and the gas volume meter is not within 15%, then go to Step 4.17.

- 4.17 Repeat Test Procedures using the opposite side of the dispenser. If test passes, continue to the next dispenser. If test fails, go to Step 4.18.
- 4.18 Conduct the leak test in step 3.3 to evaluate the test equipment. If the equipment passes the leak test, the ISD flow meter is not in compliance with Exhibit 2. If equipment leak test fails, repair the leak and go to Step 4.17.

5. POST-TEST PROCEDURES

- 5.1 Remove the Balance Nozzle Adapter and all equipment from the nozzle assembly.
- 5.2 A post-leak test of the equipment is not required if all the VFM's are within range. For the VFM's that are not within range, steps 4.17 – 4.20 must be conducted. The leak test in step 3.3 will be conducted to further evaluate the test equipment.
- 5.3 Prior to transportation, the inlet and outlet of the gas volume meter shall be carefully sealed to prevent foreign matter from entering the meter.

SITE SHUTDOWN TEST

VST Phase II EVR System Including Veeder-Root ISD, Exhibit 13 – VR-204-F

1. TEST PROCEDURES

- 1.1** This test must be performed by a certified Veeder-Root contractor.
- 1.2** Remove power from TLS console.
- 1.3** Confirm power to submersible pumps is off by verifying that gasoline dispensing has been disabled.
- 1.4** Restore power to TLS console.
- 1.5** Complete Site Shutdown Worksheet

Operability Test Procedure Data Worksheet

Veeder-Root In-Station Diagnostics (ISD) Balance Vapor Flow Meter Operability Test Procedure

Service Company Name		Date of Test	
		Service Company's Telephone	
Service Technician		Veeder-Root Tech Certification #	
Station Name		District Permit #	
Station Address	City	State	Zip

		ISD Flow Meter Total			Gas Flow Meter Total						
4.2	4.2	4.8	4.14	4.15	4.9	4.12	4.12	4.13	4.15		
Meter SN	Fueling Pos	Start	Stop	Difference Gal (Stop – Start)	Start	Stop	Difference Cubic Feet (Stop – Start)	Cubic feet To gallons ¹	% Diff ²	Pass	Fail

¹ Gallons = CubicFeet × 7.481 ² % Diff = $\frac{ISDDiffGal - GasFlowMeterDiffGal}{GasFlowMeterDiffGal} \times 100$

Veeder-Root In-Station Diagnostics (ISD) Site Shutdown Test Worksheet

DATE OF TEST _____

SERVICE COMPANY NAME	SERVICE COMPANY'S TELEPHONE
SERVICE TECHNICIAN	VEEDER-ROOT TECH CERTIFICATION #
STATION NAME	DISTRICT PERMIT #
STATION ADDRESS	CITY STATE ZIP

STEP 1.	POWER REMOVED FROM TLS CONSOLE?	<input type="checkbox"/>
STEP 2.	POWER TO SUBMERSIBLE PUMPS REMOVED BY TLS? (VERIFY GASOLINE FUELING DISABLED)	<input type="checkbox"/>
STEP 3.	POWER RESTORED TO TLS CONSOLE?	<input type="checkbox"/>

COMMENTS (INCLUDE DESCRIPTION OF REPAIRS MADE)

**Executive Orders VR-204-F
VST Phase II EVR System**

**Exhibit 14
Required Items for Conducting TP-201.4**

The instructions below are required when conducting TP-201.4 for the VST Phase II EVR system. The tester shall document that each step was followed as indicated below and shall include this page of the Exhibit with the submission of TP-201.4 test results. Note that districts may require use of an alternate form to meet these requirements, provided the alternate form includes the same minimum parameters.

The VST Model VST-EVR-NB nozzle incorporates a lever-actuated vapor valve. The vapor valve is on the same stem as the fuel valve. When conducting TP-201.4, the nozzle lever must be actuated to open the vapor valve and allow vapor to flow from the nozzle to the underground storage tank. The following steps must be taken when conducting Methodology 1 of TP-201.4:

1. The dispenser shall not be activated. If the dispenser is activated, gasoline in the fuel hose may be pressurized when engaging the fuel lever.
2. Prior to inserting the VST EVR nozzle into the fillpipe of the Dynamic Back Pressure Test Unit in step 7.1 of TP-201.4, completely drain any gasoline in the nozzle and vapor path of the hose. The dispenser must be deactivated and the nozzle lever and bellows shall be fully engaged.
3. When flowing nitrogen per step 7.1.2, fully engage the nozzle lever to allow vapor flow from the nozzle to the UST.

Required Steps For Each Nozzle Tested	Verification (please circle)
1. Is dispenser deactivated?	Yes No
2. Is nozzle and hose completely drained of gasoline prior to inserting nozzle into Dynamic Back Pressure Unit?	Yes No
3. Is nozzle lever fully engaged when conducting flow test?	Yes No

Test Company: _____ Facility Name: _____

Print Name (Technician)

Signature

Date

Technician Certification Number and Expiration Date
(ICC or District Training Certification, as applicable)