

# GENERAL PURPOSE THERMAL MASS FLOW METER MODEL 4040/4043/4045



OPERATION AND SERVICE MANUAL

P/N 1980339, REVISION L  
MARCH 2021



# START SEEING THE BENEFITS OF REGISTERING TODAY!

---

Thank you for your TSI instrument purchase. Occasionally, TSI releases information on software updates, product enhancements and new products. By registering your instrument, TSI will be able to send this important information to you.

**<http://register.tsi.com>**

As part of the registration process, you will be asked for your comments on TSI products and services. TSI's customer feedback program gives customers like you a way to tell us how we are doing.



UNDERSTANDING, ACCELERATED

**TSI Incorporated** - Visit our website **[www.tsi.com](http://www.tsi.com)** for more information.

**USA** Tel: +1 800 874 2811  
**UK** Tel: +44 149 4 459200  
**France** Tel: +33 1 41 19 21 99  
**Germany** Tel: +49 241 523030

**India** Tel: +91 80 67877200  
**China** Tel: +86 10 8219 7688  
**Singapore** Tel: +65 6595 6388

# GENERAL PURPOSE THERMAL MASS FLOW METER MODEL 4040/4043/4045

OPERATION AND SERVICE MANUAL

P/N 1980339, REVISION L  
MARCH 2021

## **U.S. & INTERNATIONAL**

### **Sales and Customer Service:**

(800) 680-1220 / +1(651) 490-2860

### **Fax:**

+1(651) 490-3824

## **TSI Instruments Ltd. (UK)**

### **Sales and Customer Service:**

+44 (0) 1494 459200





**Copyright©**

TSI Incorporated / 2002-2021 / All rights reserved.

**Address**

TSI Incorporated / 500 Cardigan Road / Shoreview, MN 55126 USA

	<b>WARNING</b>
	TSI® Incorporated flow meters employ a heated platinum sensor. They should not be used with flammable or explosive gasses or mixtures.

	<b>CAUTION</b>
	TSI® Incorporated flow meters are not medical devices under FDA 510k and in no situation should they be utilized for human respiration measurements.

**LIMITATION OF WARRANTY AND LIABILITY** (effective February 2015)

(For country-specific terms and conditions outside of the USA, please visit [www.tsi.com](http://www.tsi.com).)

Seller warrants the goods, excluding software, sold hereunder, under normal use and service as described in the operator's manual, to be free from defects in workmanship and material for **12 months**, or if less, the length of time specified in the operator's manual, from the date of shipment to the customer. This warranty period is inclusive of any statutory warranty. This limited warranty is subject to the following exclusions and exceptions:

- a. Hot-wire or hot-film sensors used with research anemometers, and certain other components when indicated in specifications, are warranted for 90 days from the date of shipment;
- b. Pumps are warranted for hours of operation as set forth in product or operator's manuals;
- c. Parts repaired or replaced as a result of repair services are warranted to be free from defects in workmanship and material, under normal use, for 90 days from the date of shipment;
- d. Seller does not provide any warranty on finished goods manufactured by others or on any fuses, batteries or other consumable materials. Only the original manufacturer's warranty applies;
- e. This warranty does not cover calibration requirements, and seller warrants only that the instrument or product is properly calibrated at the time of its manufacture. Instruments returned for calibration are not covered by this warranty;
- f. This warranty is **VOID** if the instrument is opened by anyone other than a factory authorized service center with the one exception where requirements set forth in the manual allow an operator to replace consumables or perform recommended cleaning;
- g. This warranty is **VOID** if the product has been misused, neglected, subjected to accidental or intentional damage, or is not properly installed, maintained, or cleaned according to the requirements of the manual. Unless specifically authorized in a separate writing by Seller, Seller makes no warranty with respect to, and shall have no liability in connection with, goods which are incorporated into other products or equipment, or which are modified by any person other than Seller.

The foregoing is **IN LIEU OF** all other warranties and is subject to the **LIMITATIONS** stated herein. **NO OTHER EXPRESS OR IMPLIED WARRANTY OF FITNESS FOR PARTICULAR PURPOSE OR MERCHANTABILITY IS MADE. WITH RESPECT TO SELLER'S BREACH OF THE IMPLIED WARRANTY AGAINST INFRINGEMENT, SAID WARRANTY IS LIMITED TO CLAIMS OF DIRECT INFRINGEMENT AND EXCLUDES CLAIMS OF CONTRIBUTORY OR INDUCED INFRINGEMENTS. BUYER'S**

**EXCLUSIVE REMEDY SHALL BE THE RETURN OF THE PURCHASE PRICE DISCOUNTED FOR REASONABLE WEAR AND TEAR OR AT SELLER'S OPTION REPLACEMENT OF THE GOODS WITH NON-INFRINGEMENT GOODS.**

TO THE EXTENT PERMITTED BY LAW, THE EXCLUSIVE REMEDY OF THE USER OR BUYER, AND THE LIMIT OF SELLER'S LIABILITY FOR ANY AND ALL LOSSES, INJURIES, OR DAMAGES CONCERNING THE GOODS (INCLUDING CLAIMS BASED ON CONTRACT, NEGLIGENCE, TORT, STRICT LIABILITY OR OTHERWISE) SHALL BE THE RETURN OF GOODS TO SELLER AND THE REFUND OF THE PURCHASE PRICE, OR, AT THE OPTION OF SELLER, THE REPAIR OR REPLACEMENT OF THE GOODS. IN THE CASE OF SOFTWARE, SELLER WILL REPAIR OR REPLACE DEFECTIVE SOFTWARE OR IF UNABLE TO DO SO, WILL REFUND THE PURCHASE PRICE OF THE SOFTWARE. IN NO EVENT SHALL SELLER BE LIABLE FOR LOST PROFITS, BUSINESS INTERRUPTION, OR ANY SPECIAL, INDIRECT, CONSEQUENTIAL OR INCIDENTAL DAMAGES. SELLER SHALL NOT BE RESPONSIBLE FOR INSTALLATION, DISMANTLING OR REINSTALLATION COSTS OR CHARGES. No Action, regardless of form, may be brought against Seller more than 12 months after a cause of action has accrued. The goods returned under warranty to Seller's factory shall be at Buyer's risk of loss, and will be returned, if at all, at Seller's risk of loss.

Buyer and all users are deemed to have accepted this LIMITATION OF WARRANTY AND LIABILITY, which contains the complete and exclusive limited warranty of Seller. This LIMITATION OF WARRANTY AND LIABILITY may not be amended, modified or its terms waived, except by writing signed by an Officer of Seller.

**Service Policy**

Knowing that inoperative or defective instruments are as detrimental to TSI attention to any problems. If any malfunction is discovered, please contact your nearest sales office or representative, or call TSI's Customer Service department at (800) 680-1220 (USA) or (001 651) 490-2860 (International) or visit [www.tsi.com](http://www.tsi.com).

**Trademarks**

TSI and the TSI logo are registered trademarks of TSI Incorporated in the United States and may be protected under other country's trademark registrations. HyperTerminal is a registered trademark of Hilgraeve, Incorporated. Windows is a registered trademark of Microsoft Corporation.

# CONTENTS

<b>1 UNPACKING AND PARTS IDENTIFICATION .....</b>	<b>1</b>
<b>2 SETTING-UP .....</b>	<b>3</b>
Supplying Power.....	3
Connecting Filter and Flow Tubes.....	4
RS232 Configuration and Operation .....	4
Configuration Software .....	5
<b>3 OPERATION.....</b>	<b>7</b>
Overview.....	7
ON/OFF Switch .....	7
Warm-up Time.....	7
Flow Rate Measurement .....	7
Temperature Measurement.....	8
Pressure Measurement .....	8
Volume Measurement .....	8
<b>4 MAINTENANCE .....</b>	<b>9</b>
Flow Sensor.....	9
Re-certification.....	9
Cases .....	9
Storage .....	9
<b>5 TROUBLESHOOTING .....</b>	<b>11</b>
<b>A SPECIFICATIONS* .....</b>	<b>13</b>
<b>B STANDARD FLOW RATE VS. VOLUMETRIC FLOW RATE .....</b>	<b>19</b>
<b>C OPTIMAL USE OF THE 4000/4100 SERIES ANALOG OUT CAPABILITY .....</b>	<b>21</b>
Introduction .....	21
Function of the Analog Out Feature .....	21
Considerations When Needing to Read Zero and Low Flow Accurately .....	22
Considerations for Setting the Span Flow Voltage.....	23
Process for Changing the Analog Zero and Span.....	23

*(This page intentionally left blank)*



# Chapter 1

## Unpacking and Parts Identification

---

Carefully unpack the instrument and accessories from the shipping container. Check the individual parts against the list of components in Table 1. If any parts are missing or damaged, notify TSI® Incorporated (TSI®) immediately.

**Table 1.** List of Components

Qty	Item Description	Part/Model
1	Mass Flow Meter, 22 mm ISO tapered inlet/outlet	4040
	Mass Flow Meter, 0.50 inch inlet/outlet	4043
	Mass Flow Meter, 0.75 inch inlet/outlet	4045
1	Computer Cable	1303583
1	Analog Cable	1303584
1	Filter	
	22 mm ISO-taper (for Model 4040)	1602292
	3/8" Female NPT (for Model 4043/45)	1602300
1	AC Adapter	
	100 to 240 V, N. America NEMA 5-15 plug, grounded	8918-NA
	100 to 240 V, Europlug, CEE 7/16, grounded	8918-EC
	100 to 240 V, Great Britain, grounded, fused	8918-GB
	100 to 240 V, Australia/NZ	8918-AT
1	Operation and Service Manual	1980339
1	RS232 Serial Command Set manual	1980340
1	Carrying Case (optional accessory)	1319176

## Parts Identification

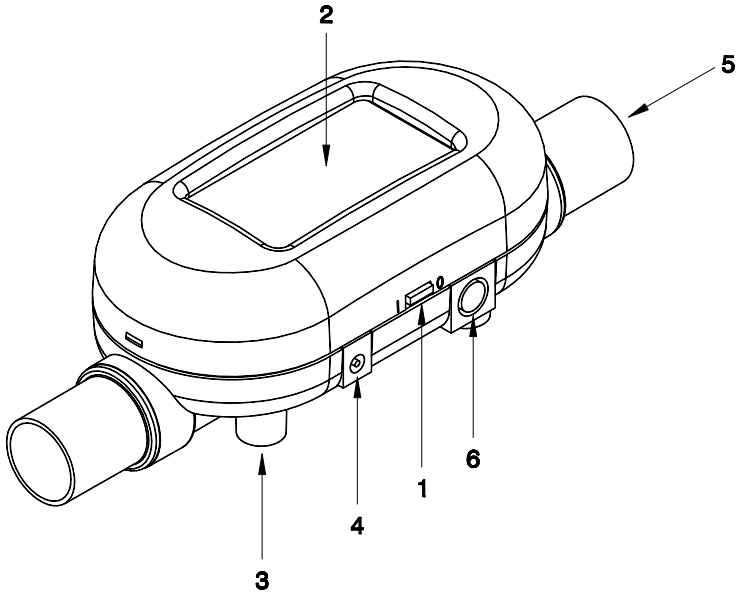

**Figure 1-1 Model 4040/4043/4045 Mass Flow Meter**

- |                         |   |
|-------------------------|---|
| 1. On/Off Switch        | 4. DC Power Input   |
| 2. Display              | 5. Flow Inlet   |
| 3. Mounting Inserts (2) | 6. Computer Serial Interface and<br>Analog Output and Optional<br>Power Input Connector |

# Chapter 2

## Setting-Up

### Supplying Power

The flow meter can be powered in one of two ways: through the power jack using the supplied AC adapter or through the mini-DIN connector. The DC power input connector is shown below along with the power requirements.

Power Supply: 7.5 VDC  $\pm$  1.5 V, 300 mA maximum

#### DC INPUT



When supplying power through the TSI-supplied interface cable, line up the arrow on the connector with the bottom side of the flow meter. Flow Meter connector pin-out designations are shown below.

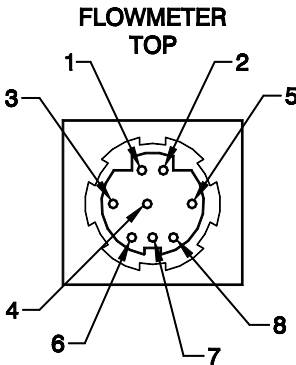

**Table 2.** List of Connector Pin-outs and Cable Color Code Designations

Pin	Function	Cable Color Code
1	Power Input (+)	Black
2	Power Ground (-)	Green
3	Analog Output (+)	Red
4	Analog Ground (-)	Brown
5	(no connection)	Blue
6	RS232 Receive (in)	White
7	RS232 Transmit (out)	Yellow
8	Logic Ground	Gray

## Connecting Filter and Flow Tubes

The Models 4040/4043/4045 have an exposed thermal flow sensor, which must be protected from foreign matter and particles in the gas flow. TSI® has supplied a filter, which should be connected to the inlet of the flow meter; however, any filter will work as long as it has a minimum efficiency of 99.9%.



### CAUTION

Always use a filter on the inlet of the flow meter. Failure to filter the gas flow may change the calibration and/or permanently damage the sensor.

**NOTE:** Flow direction is identified by the large arrow printed on the bottom side of the flow meter.

After attaching the filter, connect the flow tube, to the inlet, of the filter. Connecting a tube to the outlet of the flow meter will create back pressure. See [Appendix A](#) for flow meter accuracy specifications when operating at various pressures. In general, minimize back pressure on the flow meter to maintain higher accuracy.

## RS232 Configuration and Operation

Many flow meter operating parameters can be easily configured through the RS232 serial port. Likewise, the flow rate, temperature, pressure, and volume can be read through the serial port. Refer to the **Series 4000/4100 RS232 Serial Command Set** manual for a detailed description of the commands and command syntax.

**RS232 Settings:** Baud Rate..... 38.4 k  
Data Bits ..... 8  
Parity..... None  
Stop Bits ..... 1  
Flow Control..... None

**Table 3.** Changeable Operating Parameters

Function	Command
Select Gas Calibration (air, oxygen, mixture)	SG
Select Oxygen Concentration in Air (21% to 99%)	SGM
Select Standard or Volumetric Flow Measurement	SU
LCD Display Update Rate (controls averaging)	SUR
Select Data Update Rate for Analog Output	SSR
Set Analog Output Full-Scale Flow Rate Value	SAS
Set Analog Output Zero Value	SAZ

## Configuration Software

TSI® has several software utilities to help you communicate with your flow meter to change parameters and to obtain flow data. You can download the latest versions of these at no charge from our web site:

<https://tsi.com>

1. If you only want to change one or more of the operating parameters shown in Table 3 (above), the easiest way is to use the software utility called **“TSI setup.”** This uses convenient drop-down menus to help change these parameters. After you have made your changes, be sure to click on **“Send”** to store the changes in the flow meter’s memory.

The screenshot shows the TSIsetup utility window with the following parameters and controls:

- Gas: Air (dropdown menu)
- Sample Rate (ms): 10 (text input)
- Flow Units: Standard L/min (dropdown menu)
- Analog Span (L/min): 20 (text input)
- Analog Zero (mV): 0 (text input)
- Display Update Rate (ms): 500 (text input)
- Display Scroll Mode: Flow Only (dropdown menu)
- Buttons: Close, Default, Read, Send, Com Port, About, Help
- Serial Number: 41409941007
- Model Number: 4140
- Calibration Date: 12/11/00
- updates (checkbox)

2. If you want to communicate directly with the flow meter using the basic RS232 commands shown in the **Serial Command Set Manual**, you can use a terminal program. HyperTerminal® program is a common terminal program that is included with most versions of the Microsoft® operating system. You can download a document from our web site that helps you configure HyperTerminal® program. Download the document called **“Using HyperTerminal to communicate with TSI Flow Meters.”**

3. If you plan to develop a more sophisticated program for data collection and control using LabVIEW™ program, you can download a demonstration program called “**Real-time Demo Program**” and the source code “**Source Code for Real-time Demo Program.**” This program is intended to be a basic demonstration program and not a practical laboratory tool. It does, however, have a convenient implementation of the VOLUME measurement function that can be useful for basic tests.

# Chapter 3

## Operation

---

	<p style="text-align: center;"><b>CAUTION</b></p> <p>TSI® flow meters <b>ARE NOT</b> medical devices under FDA 510k and in no situation should they be utilized for human respiration measurements.</p>
---	---

### Overview

The Models 4040/4043/4045 Flow Meters measure mass flow rate, temperature and absolute pressure of the gas inside the flow tube. All measurements made by the Model 4040/4043/4045 are NIST traceable.

### ON/OFF Switch

Slide the switch to the ON position. The power switch is marked in the international symbols 'I' for *on* and 'O' for *off*. The flow meter will begin to simultaneously display flow rate, temperature and pressure.

### Warm-up Time

The flow meter will provide readings immediately upon power-up. Recommended warm-up time of the flow meter is 5 minutes.

### Flow Rate Measurement

Flow rate data can be obtained from the Models 4040/4043/4045 through the LCD display, RS232 serial port or the linearized analog output. The analog output is a 0 to 10 volt DC linear signal representing 0 to 300 Std L/min (Model 4043: 200 Std. L/min) (analog output scaling is user selectable). Refer to the RS232 Serial Command Set manual for instructions on how to obtain flow data through the serial port.

Gas calibrations (air, 100% nitrogen, 100% oxygen, or air/oxygen mixtures) can be selected through the RS232 serial port. Refer to the RS232 Serial Command Set manual for instructions on how to select gas calibrations. The LCD display will indicate the calibration being utilized, air or O<sub>2</sub>. When air/oxygen mixtures are being measured, the LCD display will illuminate both the air and oxygen symbols. When nitrogen is selected no gas type is displayed on the LCD.

Flow can be displayed in units of standard liters per minute (Std L/min\*) or in volumetric units of liters per minute (L/min). Refer to [Appendix B](#) for a description between the two measurements. Selecting between the two measurements is accomplished through the serial port. Refer to the RS232 Serial Command Set manual for instructions on how to select between flow units.

### **Temperature Measurement**

The Models 4040/4043/4045 have an independent temperature transducer in the flow tube to measure the gas temperature. The temperature sensor is used for temperature compensation of flow rate and for converting flow from standard to volumetric units. Temperature is displayed on the LCD and is available through the RS232 serial port in the units of degrees Celsius (°C).

---

**NOTE:** At low flow rates, the temperature inside of the flow tube will increase because of the heat generated by the thermal flow sensor. This effect is normal and the temperature of the incoming gas will be measured once flow resumes.

---

### **Pressure Measurement**

The Models 4040/4043/4045 measure absolute pressure near the outlet of the flow meter in the SI units of kilo-Pascals (kPa). Pressure measurements are required when converting from standard to volumetric flow. Absolute pressure measurements are displayed on the LCD display and are available through the RS232 serial port.

### **Volume Measurement**

The Models 4040/4043/4045 measure total volume by integrating flow over time. This is a calculated measurement performed by the flow meter and is only available using the RS232 serial port. Volume is not displayed on the LCD display. Refer to the Models 4040/4043/4045 RS232 Serial Command Set manual for instructions on using the volume function.

---

\*TSI® instruments defines standard conditions as 21.1°C (70° F) and 101.3 kPa (14.7 psia, 1 bar).



# Chapter 4

## Maintenance

---

### Flow Sensor

Periodically inspect the flow sensor by looking into the outlet of the flow meter. Remove dust, particles and fibers from the sensor, with clean, dry compressed air. The flow sensor will break if touched.

**Never run liquids through the flow meter and never touch the sensor with a brush.** Dust or other deposits on the flow sensor will degrade the 4040/4043/4045 flow meter's flow accuracy.

	<b>CAUTION</b>
	The flow meter must be switched off for cleaning. Only use clean, dry, compressed air when attempting to remove contamination from the sensor.

### Re-certification

To maintain a high degree of confidence in the measurements made by the Models 4040/4043/4045, TSI® recommends that you return the instrument to TSI® every 12 months for re-certification. For a nominal fee, we will recalibrate the unit and return it to you with a certificate of calibration and US National Institute of Standards Technology (NIST) traceability. This “annual checkup” assures you of consistently accurate readings; it is especially important in applications where strict calibration records must be maintained.

### Cases

If the instrument case or storage case needs cleaning, wipe it off with a soft cloth dipped in isopropyl alcohol or mild detergent. **NEVER** submerge the flow meter.

### Storage

When storing the flow meter, always cover the ends of flow tubes with the provided caps to prevent dust or other foreign matter from entering the tube.

*(This page intentionally left blank)*

# Chapter 5

## Troubleshooting

---

Table 4 lists the symptoms, possible causes, and recommended solutions for common problems encountered with the flow meter. If the symptom is not listed, or if none of the solutions solves the problem, please contact TSI® Customer Support at 1-800-680-1220 or 651-490-2860.

**Table 4.** Troubleshooting

Symptom	Possible Causes	Corrective Action
No display.	Unit not switched on.	Switch on the unit.
	No power to instrument.	Plug in AC adapter or check power source on mini-DIN connector.
Temperature reads high at low or zero flows.	Temperature sensor is being heated from the flow sensor.	This is normal. Once flow exceeds 1 Std L/min, the temperature will track the flowing gas temperature.
Flow readings fluctuate badly.	The flow is fluctuating.	Improve inlet conditions or increase display averaging time.
Display shows flows over-range with no flow passing through flow tube.	The sensor may be damaged or broken.	Return flow meter to <a href="#">TSI® for service</a> .

*(This page intentionally left blank)*

# Appendix A

## Specifications\*

<b>Flow Measurement</b>	
Measurement Range Models 4040/4045.....	0 to 300 Std L/min.
Model 4043 only.....	0 to 200 Std L/min.
Accuracy Air, O <sub>2</sub> .....	2% of reading or 0.05 Std L/min, whichever is greater.
N <sub>2</sub> , Air/O <sub>2</sub> mixtures .....	3% of reading or 0.1 Std L/min, whichever is greater, see note 1 below.
	Accuracy stated at standard conditions: 21.1°C and 101.3 kPa)
	See notes <b>2</b> through <b>6</b> below.
Resolution (Display).....	0.01 Std L/min between 0 and 90 Std L/min
	0.1 Std L/min between 90 and 300 Std L/min
Response .....	Less than 4 msec, 63% of final value at full scale flow
<b>Temperature Measurement</b>	
Measurement Range .....	0 to 50°C
Accuracy.....	±1°C, at flows greater than 1 L/min. See note <b>3</b> below.
Resolution (Display).....	0.1°C
Response .....	Less than 75 msec, 63% of final value for 20°C step change in temperature at full scale flow
<b>Static Pressure Measurement (Measured inside flow tube near the exit)</b>	
Measurement Range .....	50 to 199 kPa Absolute
Accuracy.....	±1 kPa, See note <b>8</b> below
Resolution (Display).....	0.1 kPa
Response .....	Less than 4 msec.
	63% of final value for 30 kPa step change
Over Pressure .....	620 kPa
<b>Burst Pressure</b>	
Tested to 690 kPa without rupture. Do <b>not</b> exceed 690 kPa.	
<b>Pressure Drop</b>	
See Chart.	
<b>Volume</b>	
Measurement Range .....	0.001 to 99.99 Liters
Accuracy.....	2% of Reading at flows greater than 2.5 Std L/min
	See notes <b>2</b> through <b>6</b> below.

<b>Instrument Temp. Range</b>	
Operation, Ambient .....	0 to 50°C
Storage, Ambient.....	-20 to 60°C
<b>Physical Dimensions</b>	
External Dimensions .....	See Diagram
Tube Adapters.....	Model 4040: 22 mm male ISO Taper
(Inlet & Outlet)	Model 4043: ½ inch straight
	Model 4045: ¾ inch straight
Weight .....	180 grams
Flow Body Material .....	PolyCarbonate
Mounting Threads .....	8-32, 0.25 in. (6 mm)
<b>Computer Interface</b>	
Connector.....	8 pin mini-DIN
Type .....	RS232 Serial
Baud Rate .....	38.4 k
Data Bits.....	8
Parity .....	None
Stop Bits.....	1
Flow Control .....	None
<b>Analog Output (Flow Only)</b>	
Range.....	0 to 10 V
Resolution .....	13 bit
Maximum Current.....	5 mA
Flow Accuracy .....	See note 7 below.
<b>Power</b>	
AC adapter or power supplied through mini-DIN	
7.5 VDC ± 1.5 V, 300 mA maximum	

**Notes:**

- 1 Nitrogen and Air/O<sub>2</sub> gas mixtures are corrections from the Air calibration.
- 2 Accuracy stated at standard conditions of 21.1°C and 101.3 kPa.
  - Add an additional 0.075% of reading per 1°C away from standard conditions when operating within the range of 0°C to 50°C.
  - Add an additional 0.015% of reading per 1 kPa above 101.3 kPa or
  - Add an additional 0.022% of reading per 1 kPa below 101.3 kPa when operating within the pressure range of 70 kPa to 170 kPa.
- 3 Accuracy stated with gas temperature and flow body temperature within ±10°C of one another.
- 4 Accuracy stated measuring dry gas (less than 10% R.H.).
- 5 Includes ±0.5% of reading repeatability.
- 6 Volumetric flow rate is calculated from the mass flow measurement. Add an additional 0.25% of reading to the flow accuracy to account for the uncertainty in measuring gas temperature and pressure.

- 7 For analog output, accuracy offset increases from 0.05 to 0.1 Std L/min. To achieve accuracy, analog zero needs to be changed from factory defaults to be 0.020V or higher. See [Appendix C](#).
- 8 Add uncertainty of 0.2 kPa for every 10°C away from 21.1°C.

*\*Specifications subject to change without notice.*

*(continued on next page)*

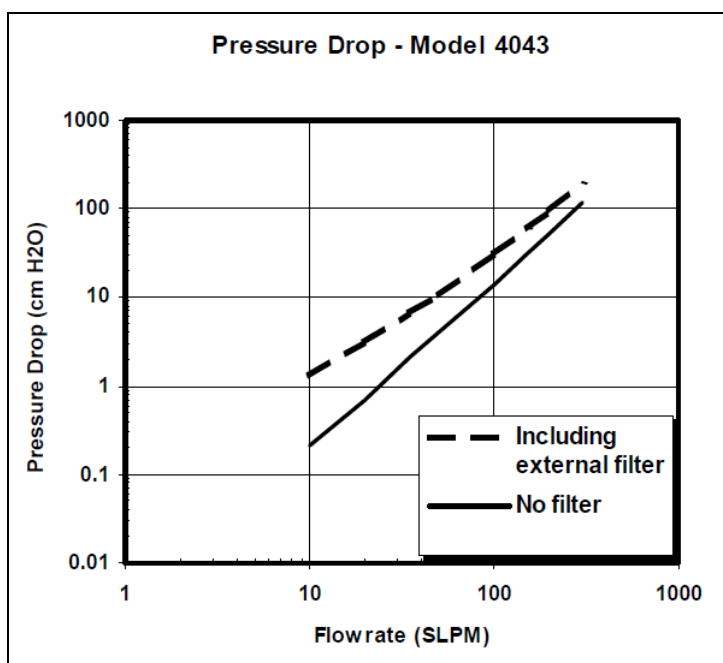
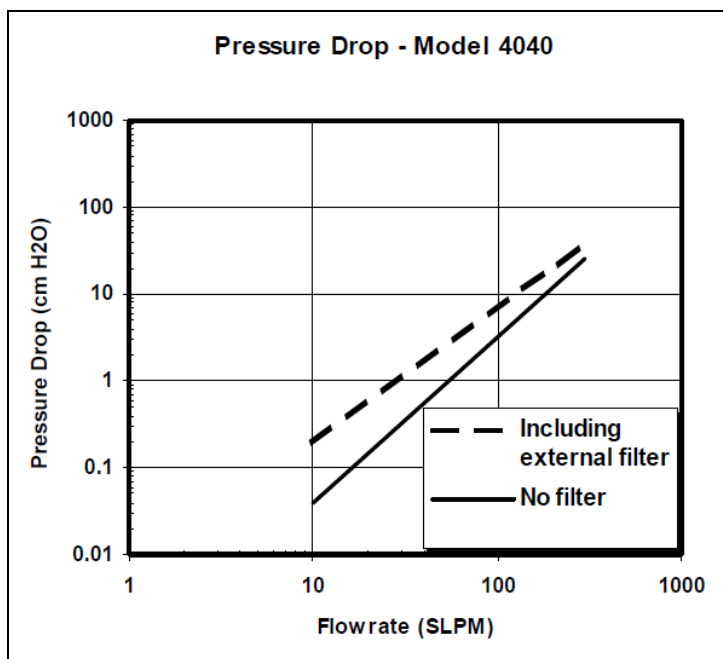



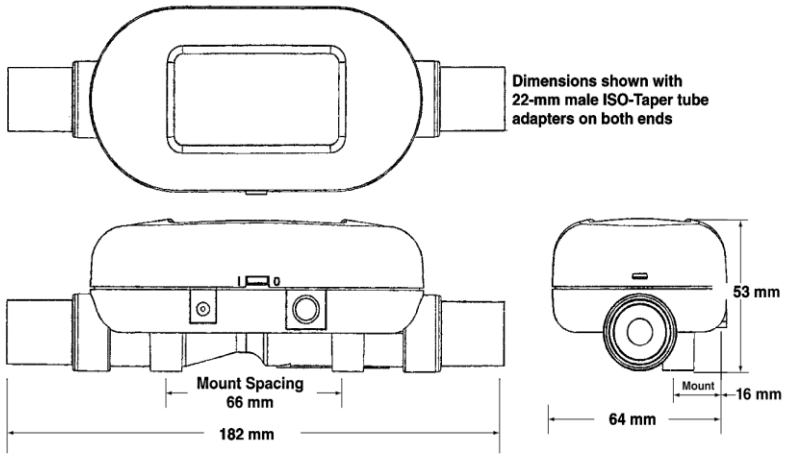
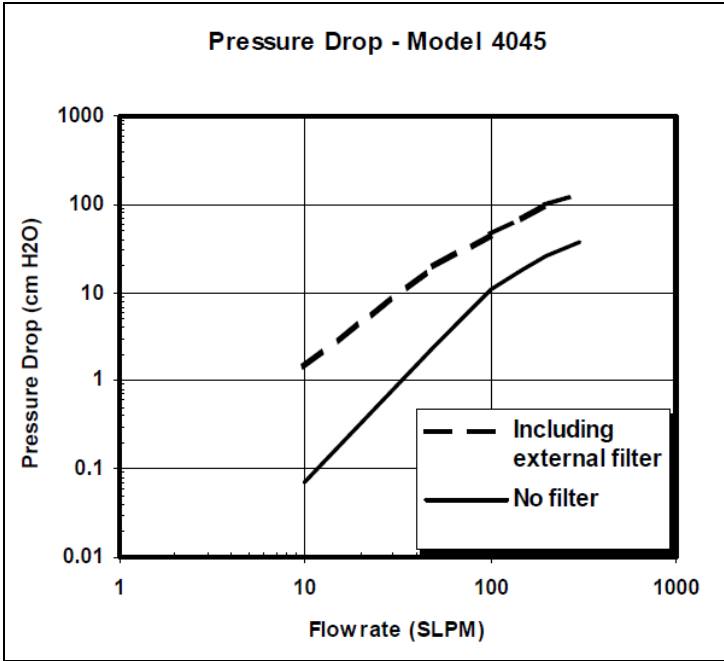

*(This page intentionally left blank)*

## Appendix B

### Standard Flow Rate vs. Volumetric Flow Rate

---

Since thermal flow sensors are sensitive to changes in air density and air velocity, all thermal flow meters indicate flow rates with reference to a set of standard conditions. For TSI® instruments, standard conditions are defined as 21.1° C (70° F) and 101.3 kPa (14.7 psia). Other manufacturers may use different values.

Standard flow rate is the flow rate the air would be moving if the temperature and pressure were at standard conditions. It is usually the most useful measure of airflow because it defines the heat-carrying capacity of the air.

Volumetric flow rate is the true volume flow of the gas exiting the flow meter.

In some instances, volumetric flow rate rather than standard flow rate may be of interest. To display volumetric flow rate, the Models 4040/4043/4045 will multiply the standard flow measurement by the following density correction factor:

$$\text{Volumetric Flow} = (\text{Standard Flow}) \left[ \frac{273.15 + T_m}{273.15 + 21.11} \right] \frac{101.3}{P_m}$$

Where

$T_m$  = Gas temperature measured in flow tube in units of degrees Celsius

$P_m$  = Absolute pressure measured in flow tube in units of kPa

To demonstrate the difference in output, consider the following.

Measured flow displays 100 Std L/min at 15C and 117kPa. The volumetric flow as calculated by the Models 4040/4043/4045 would be as follows.

$$\text{Volumetric Flow} = (100) \left[ \frac{273.15 + 15}{273.15 + 21.11} \right] \frac{101.3}{117} = 84.78 \text{ L / min}$$

*(This page intentionally left blank)*

# Appendix C

## Optimal Use of the 4000/4100 Series Analog Out Capability

---

### Introduction

TSI® Incorporated's 4000/4100 series flow meters have a feature that allows you to determine the flow rate based on a 0-10 Volt Analog out signal. This feature has programmable options that can improve its use accuracy.

### Function of the Analog Out Feature

The 4000/4100 series meter has an analog out circuit that outputs a voltage signal that is linearly proportional to the flow measurement displayed on the front screen. The voltage signal has a 0-10 volt range. This output is configurable so the user can change the voltage output at zero flow and at the span flow.

The factory defaults for the analog out are as follows:

- 0 volts at zero flow
- 10 volts at span flow (300 SLPM for 4000 Series meters, 20 SLPM for 4100 Series meters)

The graph below shows the factor default relationship. This relationship results in an easy conversion from voltage to flow.

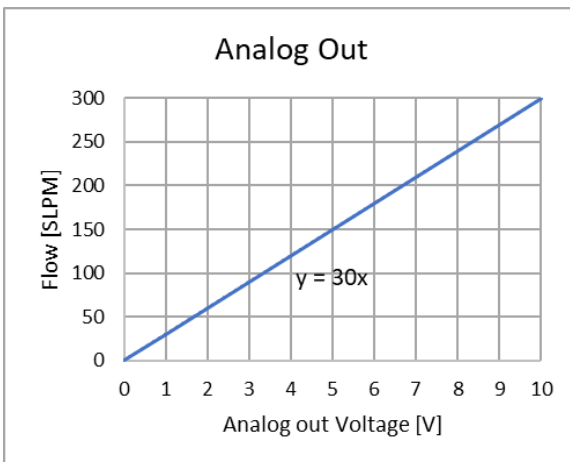

## Considerations When Needing to Read Zero and Low Flow Accurately

If the application requires accurate flow measurement at or near zero flows then it is recommended that the zero flow voltage be changed from its factory default of 0 volts to 100 mV. This is due to a slight offset of the ground voltage that could be interpreted as a low-level flow.

By setting 100 mV (0.1 V) to be the zero-flow voltage, this gets out of the region around 0 volts (ground) where the slight offset can shift the reading. The graphic below shows the change in zero voltage to move out of the ground region.

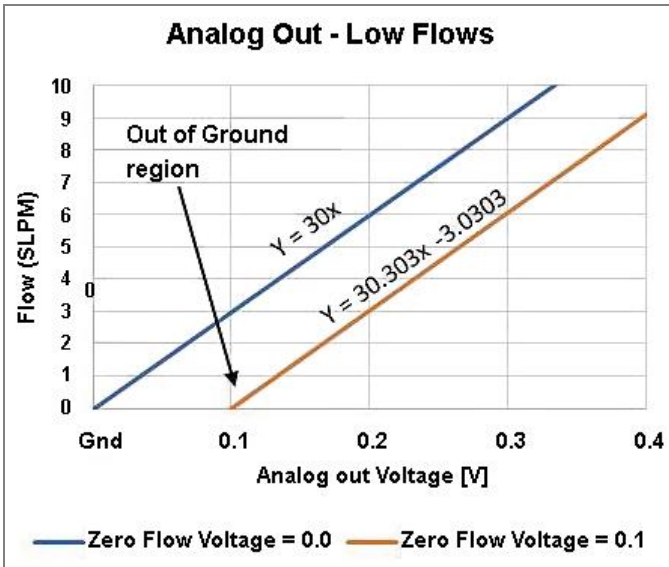

**NOTE:** The conversion equation changes if the zero is change to 100 mV.

## Considerations for Setting the Span Flow Voltage

If the application does not require the flow meter to read up to its span flow then it is recommended that the analog span be set to the maximum limit that is required by the application. This will make for a better voltage to flow conversion due to more resolution per change in measured flow. The

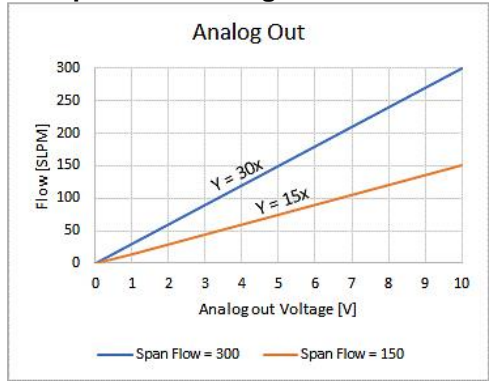

graphic compares examples with a span flow set to 300 SLPM (factory default for 4000 Series meters) and a 150 SLPM example.

For the factor default settings, each 1 SLPM change in flow will cause a 0.0333 change in voltage. If the application allows for the setting of 150 SLPM span, then for each 1 SLPM change in flow will cause a 0.0666 change in voltage. This will allow the voltage measurement device employed by the customer to be less precise.

## Process for Changing the Analog Zero and Span

The TSI® setup program, provided free of charge, makes changing the analog zero and span easy. The graphic below shows where to enter the analog zero and span in the TSI® setup program.

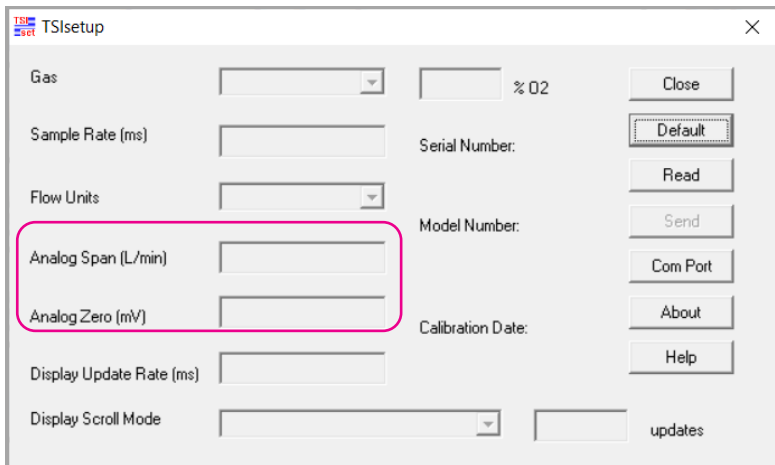

Reference the instrument manual for more details on how to use the TSI® setup program.



UNDERSTANDING, ACCELERATED

**TSI Incorporated** – Visit our website [www.tsi.com](http://www.tsi.com) for more information.

**USA** Tel: +1 800 680 1220

**UK** Tel: +44 149 4 459200

**France** Tel: +33 1 41 19 21 99

**Germany** Tel: +49 241 523030

**India** Tel: +91 80 67877200

**China** Tel: +86 10 8219 7688

**Singapore** Tel: +65 6595 6388

P/N 1980339 Rev L

©2021 TSI Incorporated

Printed in U.S.A.

