

## FEATURES

- Triaxial, digital output MEMS vibration sensing module**
- ±50 g measurement range**
- Ultralow output noise density, 26  $\mu\text{g}/\sqrt{\text{Hz}}$  (MTC mode)**
- Wide bandwidth: dc to 10 kHz within 3 dB flatness (RTS mode)**
- Embedded fast data sampling: 220 kSPS per axis**
- 6 digital FIR filters, 32 taps (coefficients), default options:**
  - High-pass filter cutoff frequencies: 1 kHz, 5 kHz, 10 kHz**
  - Low-pass filter cutoff frequencies: 1 kHz, 5 kHz, 10 kHz**
  - User configurable digital filter option (32 coefficients)**
- Spectral analysis through internal FFT**
  - Extended record length: 2048 bins per axis with user configurable bin sizes from 0.42 Hz to 53.7 Hz**
  - Manual or timer-based (automatic) triggering**
  - Windowing options: rectangular, Hanning, flat top**
  - FFT record averaging, configurable up to 255 records**
  - Spectral defined alarm monitoring, 6 alarms per axis**
- Time domain capture with statistical metrics**
  - Extended record length: 4096 samples per axis**
  - Mean, standard deviation, peak, crest factor, skewness, and kurtosis**
- Configurable alarm monitoring**
- Real-time data streaming**
  - 220 kSPS on each axis by default**
  - User programmable sample rates**
  - Burst mode communication with CRC-16 error checking**
- Storage: 10 data records for each axis**
- On demand self test with status flags**
- Sleep mode with external and timer driven wakeup**
- Digital temperature and power supply measurements**
- SPI-compatible serial interface**
- Identification registers: factory preprogrammed serial number, device ID, user programmable ID**
- Single-supply operation: 3.0 V to 3.6 V**
- Operating temperature range: -40°C to +105°C**
  - Automatic shutdown at 125°C (junction temperature)**
- 23.7 mm × 27.0 mm × 12.4 mm aluminum package**
  - 36 mm flexible, 14-pin connector interface**
  - Mass: 13 g**

## APPLICATIONS

- Vibration analysis
- CBM systems
- Machine health
- Instrumentation and diagnostics
- Safety shutoff sensing

Rev. A

[Document Feedback](#)

Information furnished by Analog Devices is believed to be accurate and reliable. However, no responsibility is assumed by Analog Devices for its use, nor for any infringements of patents or other rights of third parties that may result from its use. Specifications subject to change without notice. No license is granted by implication or otherwise under any patent or patent rights of Analog Devices. Trademarks and registered trademarks are the property of their respective owners.

## FUNCTIONAL BLOCK DIAGRAM

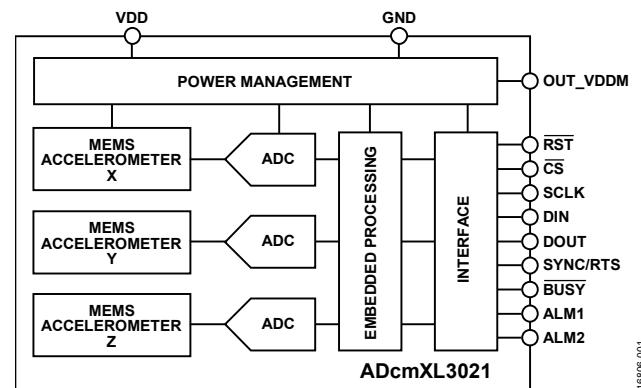

Figure 1.

## GENERAL DESCRIPTION

The ADcmXL3021 is a complete vibration sensing system that combines high performance vibration sensing (using micro-electromechanical systems (MEMS) accelerometers) with a variety of signal processing functions to simplify the development of smart sensor nodes in condition-based monitoring (CBM) systems. The typical ultralow noise density (26  $\mu\text{g}/\sqrt{\text{Hz}}$ ) in the MEMS accelerometers supports excellent resolution. The wide bandwidth (dc to 10 kHz within 3 dB flatness) enables tracking of key vibration signatures on many machine platforms.

The signal processing includes high speed data sampling (220 kSPS), 4096 time sample record lengths, filtering, windowing, fast Fourier transform (FFT), user configurable spectral or time statistic alarms, and error flags. The serial peripheral interface (SPI) provides access to a register structure that contains the vibration data and a wide range of user configurable functions.

The ADcmXL3021 is available in a 23.7 mm × 27.0 mm × 12.4 mm aluminum package with four mounting flanges to support installation with standard machine screws. This package provides consistent mechanical coupling to the core sensors over a broad frequency range. The electrical interface is through a 14-pin connector on a 36 mm flexible cable, which enables a wide range of location and orientation options for system mating connectors.

The ADcmXL3021 requires only a single, 3.3 V power supply and supports an operating temperature range of -40°C to +105°C.

**TABLE OF CONTENTS**

Features .....	1	Z_BUF/RSS_BUF, Buffer Access Register, Z-Axis.....	35
Applications.....	1	X_ANULL, X-AXIS Bias Calibration Register.....	36
Functional Block Diagram .....	1	Y_ANULL, Y-AXIS Bias Calibration Register .....	36
General Description .....	1	Z_ANULL, Z-AXIS Bias Calibration Register .....	36
Revision History .....	3	REC_CTRL, Recording Control .....	36
Specifications.....	4	RT_CTRL, Real Time Streaming Control .....	38
Timing Specifications .....	5	REC_PRD, Record Period.....	38
Absolute Maximum Ratings.....	7	ALM_F_LOW, Alarm Frequency Band .....	38
Thermal Resistance .....	7	ALM_F_HIGH, Alarm Frequency Band .....	38
ESD Caution.....	7	ALM_X_MAG1, Alarm Level 1 X-Axis.....	39
Pin Configuration and Function Descriptions.....	8	ALM_Y_MAG1, Alarm Level 1 Y-Axis.....	39
Typical Performance Characteristics .....	9	ALM_Z_MAG1, Alarm Level 1 Z-Axis .....	39
Theory of Operation .....	14	ALM_X_MAG2, Alarm Level 2 X-Axis.....	39
Core Sensors.....	14	ALM_Y_MAG2, Alarm Level 2 Y-Axis .....	40
Signal Processing .....	14	ALM_Z_MAG2, Alarm Level 2 Z-Axis .....	40
Modes of Operation .....	15	ALM_PNTR, Alarm Pointer.....	40
Data Recording Options.....	16	ALM_S_MAG Alarm Level .....	40
User Interface.....	19	ALM_CTRL, Alarm Control .....	40
Basic Operation.....	22	FILT_CTRL, Filter Control.....	41
Device Configuration .....	22	AVG_CNT, Decimation Control.....	41
Dual Memory Structure .....	22	DIAG_STAT, Status, and Error Flags.....	42
Power-Up Sequence .....	22	GLOB_CMD, Global Commands.....	42
Trigger.....	22	ALM_X_STAT, Alarm Status X-Axis .....	42
Sample Rate .....	23	ALM_Y_STAT, Alarm Status Y-Axis.....	43
Datapath Processing.....	23	ALM_Z_STAT, Alarm Status Z-axis.....	43
Spectral Alarms.....	25	ALM_X_PEAK, Alarm Peak Level X-Axis.....	43
Mechanical Mounting Recommendations.....	25	ALM_Y_PEAK, Alarm Peak Level Y-AXIS.....	43
User Register Memory Map .....	26	ALM_Z_PEAK, Alarm Peak Level Z-AXIS.....	43
User Register Details .....	32	TIME_STAMP_L and TIME_STAMP_H, Data Record Timestamp.....	44
PAGE_ID (Page Number) .....	32	DAY_REV, Day and Revision .....	44
TEMP_OUT (Internal Temperature) .....	32	YEAR_MON, Year and Month.....	44
SUPPLY_OUT (Power Supply Voltage) .....	32	PROD_ID, Product Identification .....	44
FFT_AVG1, Spectral Averaging .....	32	SERIAL_NUM, Serial Number .....	44
FFT_AVG2, Spectral Averaging .....	33	USER_SCRATCH .....	44
BUF_PNTR, Buffer Pointer .....	33	REC_FLASH_CNT, Record Flash Endurance .....	44
REC_PNTR, Record Pointer.....	34	MISC_CTRL, Miscellaneous Control .....	45
X_BUF, Buffer Access Register, X-Axis.....	34	REC_INFO1, Record Information.....	45
Y_BUF, Buffer Access Register, Y-Axis .....	35		

Record Information, REC\_INFO2 .....45  
 REC\_CNTR, Record Counter .....45  
 ALM\_X\_FREQ, Severe Alarm Frequency .....45  
 ALM\_Y\_FREQ, Severe Alarm Frequency .....45  
 ALM\_Z\_FREQ, Severe Alarm Frequency .....46  
 STAT\_PNTR, Statistic Result Pointer .....46  
 X\_STAT, Statistic Result X-Axis .....46  
 Y\_STAT, Statistic Result Y-Axis .....47  
 Z\_STAT, Statistic Result Z-Axis .....47

FUND\_FREQ, Fundamental Frequency .....47  
 FLASH\_CNT\_L, Flash Memory Endurance .....47  
 FLASH\_CNT\_U, Flash Memory Endurance .....48  
 FIR Filter Registers .....48  
 Applications Information .....49  
 Mechanical Interface .....49  
 Outline Dimensions .....50  
 Ordering Guide .....50

**REVISION HISTORY**

**3/2021—Rev. 0 to Rev. A**

Changes to Features Section ..... 1  
 Changed Error Parameter to Error Over Temperature  
 Parameter, Table 1 .....3  
 Changes to Table 2 .....5  
 Changes to Figure 5 Caption .....6  
 Deleted Figure 19; Renumbered Sequentially .....11  
 Changes to Figure 19 .....11  
 Changes to MTC Data Format Section .....17  
 Changes to Table 9 and RTS Data Format Section .....18  
 Delete Table 10; Renumbered Sequentially .....18  
 Changes to Table 20 .....26  
 Changes to Table 21 .....32  
 Changes to REC\_PNTR, Record Pointer Section and Table 40 .....34  
 Changes to X\_BUF, Buffer Access Register, X-Axis Section,  
 Table 44, and Table 46 .....35  
 Deleted Table 44 .....35  
 Changes to Real-Time Burst Mode Timeout Enabled Section .37  
 Added RT\_CTRL, Real-Time Streaming Control Section,  
 Table 56, and Table 57 .....38

Changes to Table 77 and Table 79 ..... 40  
 Deleted DIO\_CTRL, Digital Input/Output Line Control  
 Section, Table 83, and Table 84 ..... 40  
 Changes to Table 84 ..... 41  
 Changes to Table 88, Table 90, and Table 92 ..... 42  
 Changes to Table 94, Table 96, and Table 102 ..... 43  
 Changes to Table 104, Table 106, Table 108 to Table 112,  
 Table 114, and Table 118 ..... 44  
 Changed DATE\_REV, Day and Revision Section to DAY\_REV,  
 Day and Revision Section ..... 44  
 Added USER\_SCRATCH Section, Table 116, and Table 117 ...44  
 Changes to Table 120, Table 122, Table 124, Table 126,  
 Table 128, and Table 130 ..... 45  
 Changes to Table 132, Table 134, and Table 136 ..... 46  
 Changes to Table 141, Table 143, and Table 147 ..... 47  
 Changes to Table 148 and FIR Filter Design Guidelines ..... 48

**3/2019—Revision 0: Initial Version**

## SPECIFICATIONS

$T_A = 25^\circ\text{C}$ ,  $V_{DD} = 3.3\text{ V}$ , unless otherwise noted.

Table 1.

Parameter	Test Conditions/Comments	Min	Typ	Max	Unit
<b>ACCELEROMETERS</b>					
Measurement Range <sup>1</sup>			±50		<i>g</i>
Sensitivity					
FFT			0.9535		mg/LSB
Time Domain			1.907		mg/LSB
Error Over Temperature			±5		%
Nonlinearity	Best fit, straight line, full scale (FS) = ±50 <i>g</i>		±0.2	±1.25	%
Cross Axis Sensitivity			2		%
Alignment Error	With respect to package		2		Degrees
Offset Error over Temperature	$T_A = -40^\circ\text{C}$ to $+105^\circ\text{C}$		±5		<i>g</i>
Offset Temperature Coefficient	$T_A = -40^\circ\text{C}$ to $+105^\circ\text{C}$		34		mg/°C
Output Noise	Real-time streaming (RTS) mode		3.2		mg rms
Output Noise Density	100 Hz to 10 kHz, all axes, AVG_CNT = 0, MTC mode		26		μg/√Hz
Output Noise Density	1 Hz to 10 kHz, all axes, no filtering, RTS mode		32		μg/√Hz
3 dB Bandwidth	All axes	10,000			Hz
Sensor Resonant Frequency			21		kHz
<b>CONVERSION RATE</b>					
Clock Accuracy				220	kSPS
			3		%
<b>FUNCTIONAL TIMING</b>					
Factory Reset Time Recovery			130		ms
Start Up Time	Time from supply voltage reaching 3.0 V from power-down until ready for command		220		ms
Self Test Time			93		ms
<b>LOGIC INPUTS</b>					
Input High Voltage, $V_{INH}$		2.5			V
Input Low Voltage, $V_{INL}$				0.45	V
Logic 1 Input Current, $I_{INH}$	$V_{IH} = 3.3\text{ V}$		0.01	0.2	μA
Logic 0 Input Current, $I_{INL}$	$V_{IL} = 0\text{ V}$				
All Except $\overline{\text{RST}}$				100	μA
$\overline{\text{RST}}$			1		mA
Input Capacitance, $C_{IN}$			10		pF
<b>DIGITAL OUTPUTS</b>					
Output Voltage					
High, $V_{OH}$	$I_{OH} = -1\text{ mA}$	1.4			V
Low, $V_{OL}$	$I_{OL} = 1\text{ mA}$			0.4	V
Output Current					
High, $I_{OH}$	$I_{OH} = -1\text{ mA}$			2	mA
Low, $I_{OL}$	$I_{OL} = 1\text{ mA}$			2	mA
<b>FLASH MEMORY</b>					
Endurance <sup>2</sup>		10,000			Cycles
Data Retention <sup>3</sup>	$T_J = 85^\circ\text{C}$ , see Figure 52		10		Years
<b>THERMAL SHUTDOWN</b>					
Thermal Shutdown Threshold	$T_J$ rising		125		°C
Thermal Shutdown Hysteresis			15		°C

Parameter	Test Conditions/Comments	Min	Typ	Max	Unit
OUT_VDDM MONITOR OUTPUT Output Resistance	Logic output; logic high indicates good condition Logic low when internal temperature exceed allowed range	90	100	110	kΩ
POWER SUPPLY VOLTAGE Power Supply Current	Operating voltage range, VDD Operating mode, VDD = 3.0 V Operating mode, VDD = 3.3 V Operating mode, VDD = 3.6 V Sleep mode, VDD = 3.0 V Sleep mode, VDD = 3.3 V Sleep mode, VDD = 3.6 V	3.0	3.3 30.2 30.6 31.6 1 1.5 2.3	3.6	V mA mA mA mA mA mA

<sup>1</sup> The maximum range depends on the frequency of vibration.

<sup>2</sup> Endurance is qualified as per JEDEC Standard 22, Method A117 and measured at -40°C, +25°C, +85°C, and +125°C.

<sup>3</sup> Retention lifetime equivalent at junction temperature (T<sub>j</sub>) = 85°C as per JEDEC Standard 22, Method A117. Retention lifetime depends on junction temperature.

### TIMING SPECIFICATIONS

T<sub>c</sub> = 25°C, VDD = 3.3 V, unless otherwise noted.

Table 2.

Parameter	Description	Normal Mode			RTS Mode			Unit
		Min <sup>1</sup>	Typ	Max <sup>1</sup>	Min	Typ	Max <sup>1</sup>	
f <sub>SCLK</sub>	SCLK frequency	0.01		14	12.5 <sup>2</sup>		14	MHz
t <sub>STALL</sub>	Stall period between data bytes	16				N/A <sup>3</sup>		μs
t <sub>CLS</sub>	SCLK low period	35.7			35.7			ns
t <sub>CHS</sub>	SCLK high period	35.7			35.7			ns
t <sub>CS</sub>	CS to SCLK edge	35.7			35.7			ns
t <sub>DAV</sub>	DOUT valid after SCLK edge			20			20	ns
t <sub>DSU</sub>	DIN setup time before SCLK rising edge	6			6			ns
t <sub>DHD</sub>	DIN hold time after SCLK rising edge	8			8			ns
t <sub>DSOE</sub>	CS assertion to DOUT active			20	0		20	ns
t <sub>HD</sub>	SCLK edge to DOUT invalid			20			20	ns
t <sub>SFS</sub>	Last SCLK edge to CS deassertion	35.7			35.7			ns
t <sub>RTS_BUSY</sub>	RTS mode only, data out valid burst readout period end before BUSY rising edge for next burst		N/A		5			μs

<sup>1</sup> Guaranteed by design and characterization, but not tested in production.

<sup>2</sup> Assuming a sample rate of 220 kSPS. If in RTS mode the sample rate is reduced by using the RT\_CTRL register, f<sub>SCLK</sub> can be lower than 12.5 MHz. The minimum f<sub>SCLK</sub> is bound by the period of one RTS data frame read. If f<sub>SCLK</sub> is lowered further, and the entire RTS data frames are not read within a cycle, CRC errors may occur because SPI read out is not keeping up with the real-time data generation.

<sup>3</sup> N/A means not applicable. When using RTS mode, the stall period is not applicable.

### Timing Diagrams

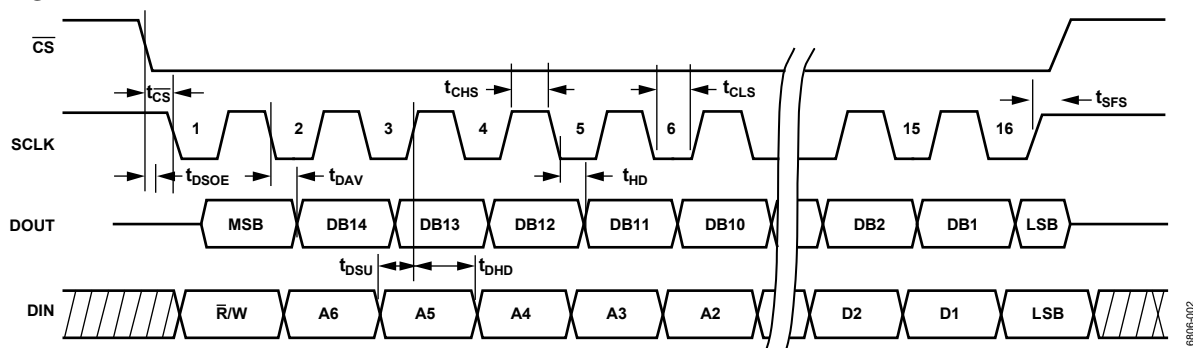

Figure 2. SPI Timing and Sequence

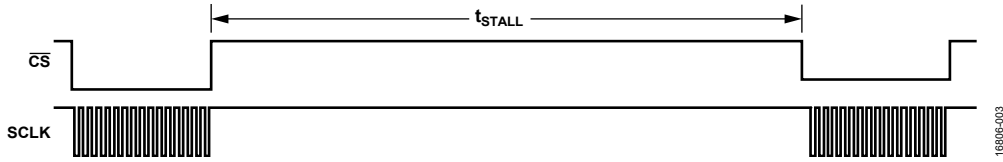

Figure 3. Stall Time (Does Not Apply to RTS Mode)

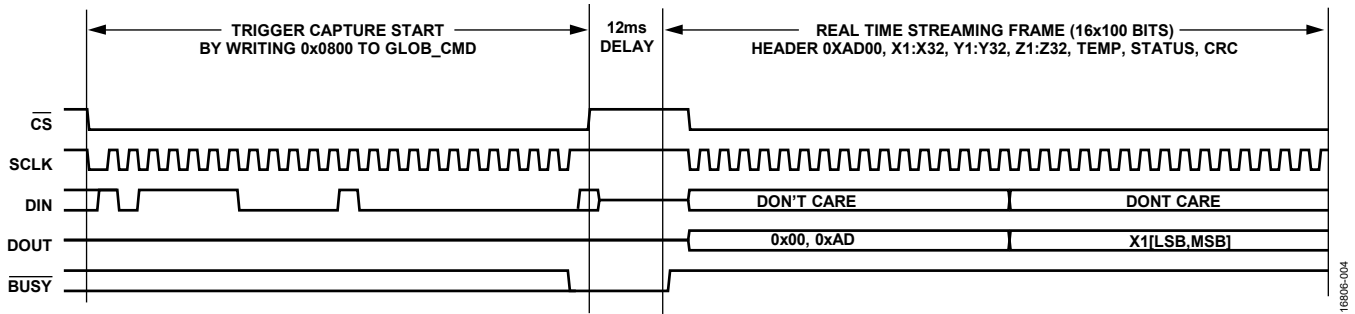

Figure 4. RTS Mode Timing Diagram (Assumes REC\_CTRL, Bits[1:0] = 0b11)

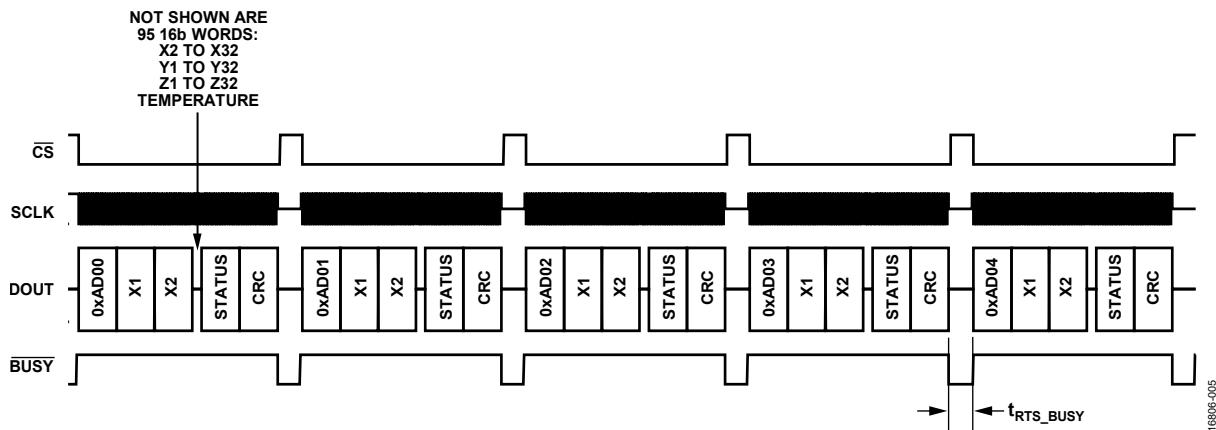

Figure 5. RTS Read Function Sequence Diagram, First Five Segments

## ABSOLUTE MAXIMUM RATINGS

Table 3.

Parameter	Rating
Acceleration	
Any Axis, Unpowered	2000 g
Any Axis, Powered	2000 g
VDD to GND	−0.3 V to +3.6 V
Digital Input Voltage to GND	−0.3 V to +3.6 V
Digital Output Voltage to GND	−0.3 V to +3.6 V
Temperature, $T_A$	
Operating Range	−40°C to +105°C
Storage Range	−65°C to +150°C

Stresses at or above those listed under Absolute Maximum Ratings may cause permanent damage to the product. This is a stress rating only; functional operation of the product at these or any other conditions above those indicated in the operational section of this specification is not implied. Operation beyond the maximum operating conditions for extended periods may affect product reliability.

## THERMAL RESISTANCE

Thermal performance is directly linked to printed circuit board (PCB) design and operating environment. Pay careful attention to PCB thermal design.

$\theta_{JA}$  is the natural convection junction to ambient thermal resistance measured in a one cubic foot sealed enclosure.

$\theta_{JC}$  is the junction to case thermal resistance.

The ADcmXL3021 is a multichip module, which includes many active components. The values in Table 4 identify the thermal response of the hottest component inside of the ADcmXL3021, with respect to the overall power dissipation of the module. This approach enables a simple method for predicting the temperature of the hottest junction, based on either ambient or case temperature.

For example, when  $T_A = 70^\circ\text{C}$ , under normal operation mode with a typical 34 mA current and 3.3 V supply voltage, the hottest junction temperature in the ADcmXL3021 is 77.3°C.

$$T_J = \theta_{JA} \times V_{DD} \times I_{DD} + 70^\circ\text{C}$$

$$T_J = 65.1^\circ\text{C}/\text{W} \times 3.3 \text{ V} \times 0.034 \text{ A} + 70^\circ\text{C}$$

$$T_J \approx 77.3^\circ\text{C}$$

where  $I_{DD}$  is the current consumption of the device.

Table 4. Thermal Resistance

Package Type	$\theta_{JA}$	$\theta_{JC}$
ML-14-7 <sup>1</sup>	65.1°C/W	33.2°C/W

<sup>1</sup> Thermal impedance simulated values come from a case with four machine screws at a size of M2.5 × 0.4 mm (torque = 25 inch-pounds). Secure the ADcmXL3021 to the PCB.

## ESD CAUTION



### ESD (electrostatic discharge) sensitive device.

Charged devices and circuit boards can discharge without detection. Although this product features patented or proprietary protection circuitry, damage may occur on devices subjected to high energy ESD. Therefore, proper ESD precautions should be taken to avoid performance degradation or loss of functionality.

## PIN CONFIGURATION AND FUNCTION DESCRIPTIONS

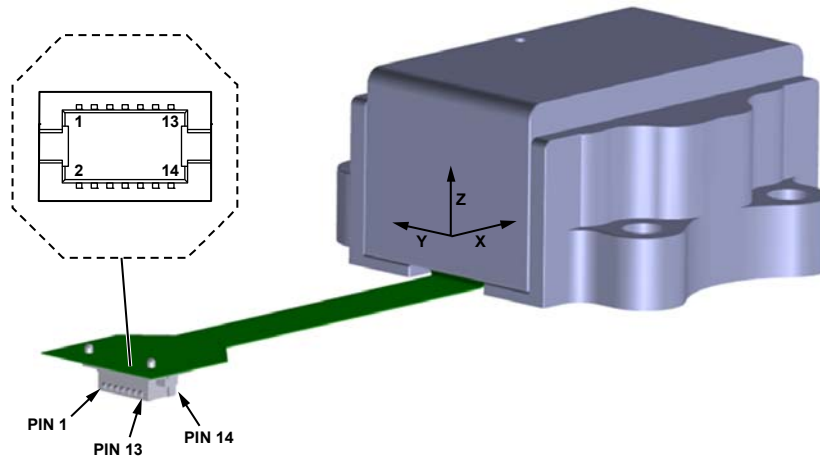

Figure 6. Pin Configuration

Table 5. Pin Function Descriptions

Pin No.	Mnemonic	Type	Description
1	GND	Supply	Ground.
2	ALM1	Output	Digital Output Only, Alarm 1 Output. This pin is configured by the ALM_CTRL register and is not used in real-time streaming mode.
3	SYNC/RTS	Input	Sync Function (SYNC)/RTS Burst Start/Stop (RTS). This pin is an digital input only, and is edge (not level) sensitive. This pin must be enabled in the MISC_CTRL register (Bit 12) before being used as an external trigger. The SYNC pulse width must be at least 50 ns. In MTC and MFFT modes, the SYNC pin acts as a manual trigger, this pin initiates a record capture event when a low to high transition is detected, equivalent to SPI Command 0x0800 to the GLOB_CMD register. In RTS and AFFT mode, when the logic level on this pin is high, conversion is active. When the logic level on this pin is low, conversion is stopped after the current data record is completed.
4	ALM2	Output	Digital Output Only, Alarm 2 Output. This pin is configured by the ALM_CTRL register and is not used in real-time streaming mode.
5	$\overline{\text{BUSY}}$	Output	Busy or Data Ready Indicator, Digital Output Only. In RTS mode, this pin is a logical output to indicate that data is ready and available for download. The logical state resets to logic low when data is loading to the output buffers. The pin is set high when data is ready for download. In other capture modes, the busy indicator identifies the state of the module processor and if it is available for external commands. When a command is executing, SPI access is not allowed and the device is in a busy state. After this process completes, whether a command or a record, the SPI is released and the BUSY pin is set to logic high state. Note that there is one exception to SPI port access while in the busy state: a capture can be terminated by writing the unique 16-bit escape code, 0x00E8, to the GLOB_CMD register.
6	OUT_VDDM	Output	Power Supply Monitor (Digital Output). This pin is logic low when temperature exceeds threshold and automatic shutdown occurs.
7	$\overline{\text{RST}}$	Input	Hardware Reset, Digital Input Only, Active Low. This pin enters the device in a known state by resetting the microcontroller. This pin also loads the user configurable parameters from flash memory.
8	VDD	Supply	Power Supply.
9	GND	Supply	Ground.
10	GND	Supply	Ground.
11	DIN	Input	SPI, Data Input Line.
12	DOUT	Output	SPI, Data Output. DOUT is an output when $\overline{\text{CS}}$ is low. When $\overline{\text{CS}}$ is high, DOUT is in a three-state, high impedance mode.
13	$\overline{\text{SCLK}}$	Input	SPI, Serial Clock.
14	$\overline{\text{CS}}$	Input	SPI, Chip Select.



### TYPICAL PERFORMANCE CHARACTERISTICS

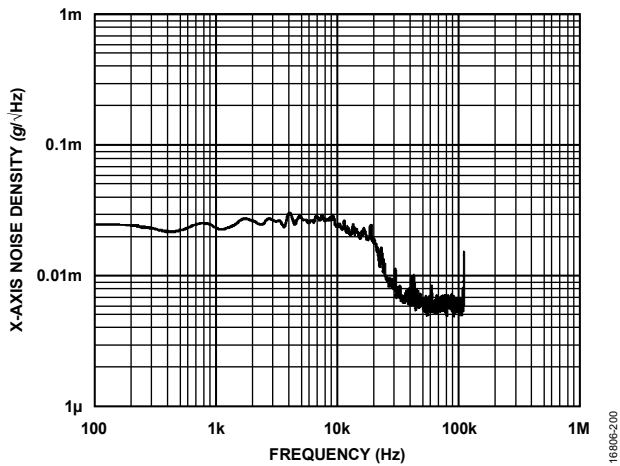

Figure 7. X-Axis Noise Density, Wideband, MTC, AVG\_CNT = 0

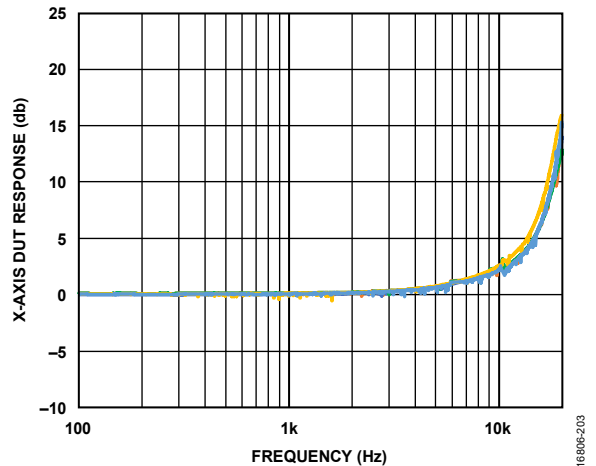

Figure 10. X-Axis Sine Sweep Response, RTS Mode

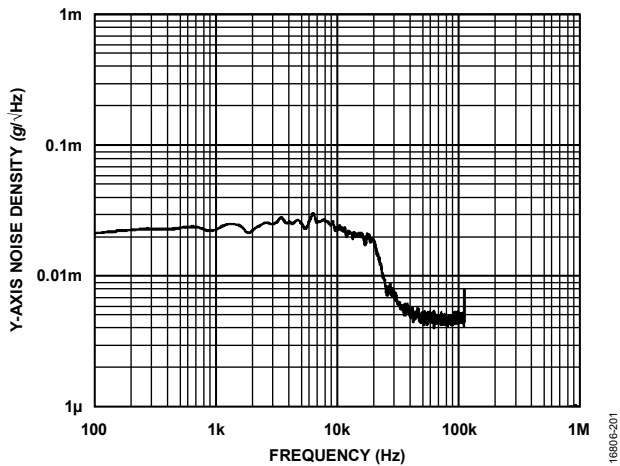

Figure 8. Y-Axis Noise Density, Wideband, MTC, AVG\_CNT = 0

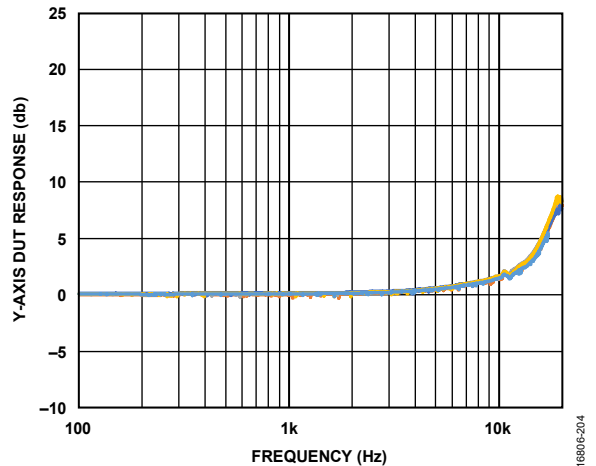

Figure 11. Y-Axis Sine Sweep Response, RTS Mode

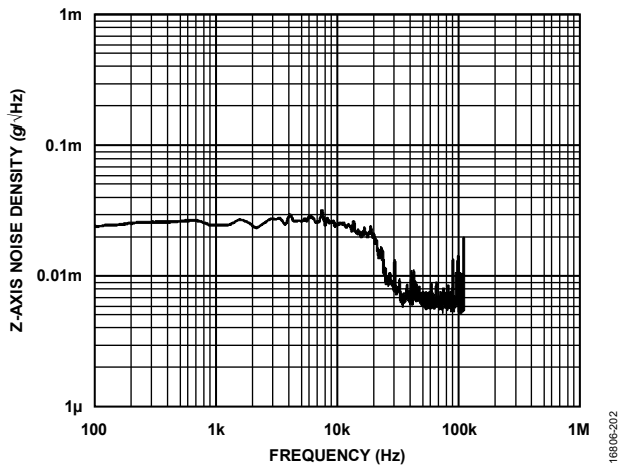

Figure 9. Z-Axis Noise Density, Wideband, MTC, AVG\_CNT = 0

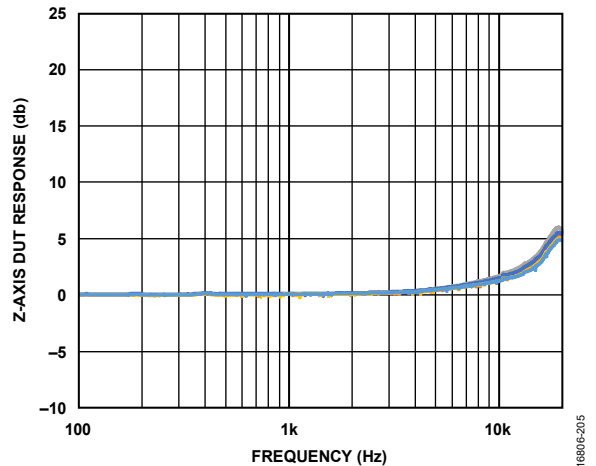

Figure 12. Z-Axis Sine Sweep Response, RTS Mode

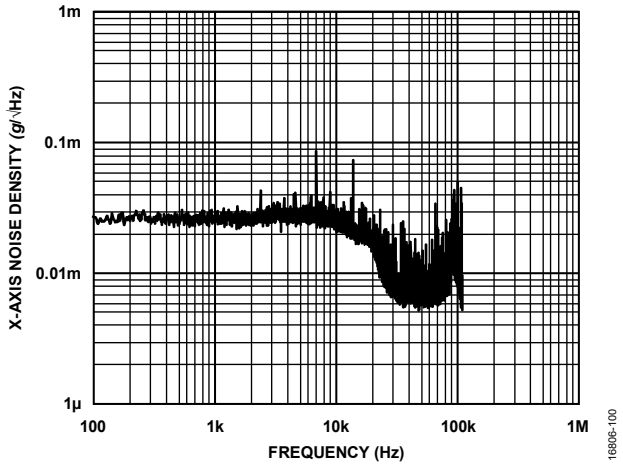

Figure 13. X-Axis Noise Density, Wideband, RTS Mode

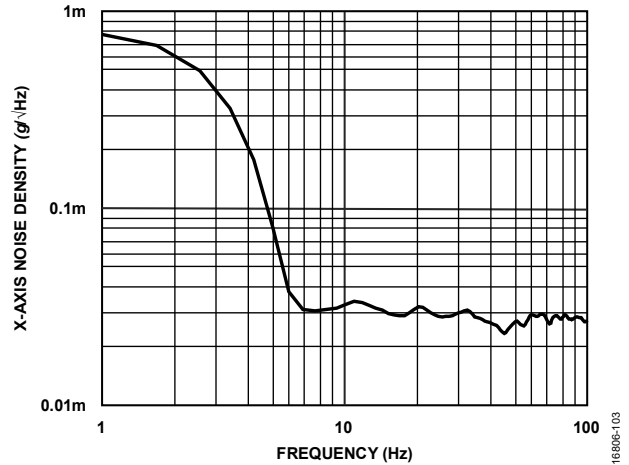

Figure 16. X-Axis Noise Density, Low Frequency, RTS Mode

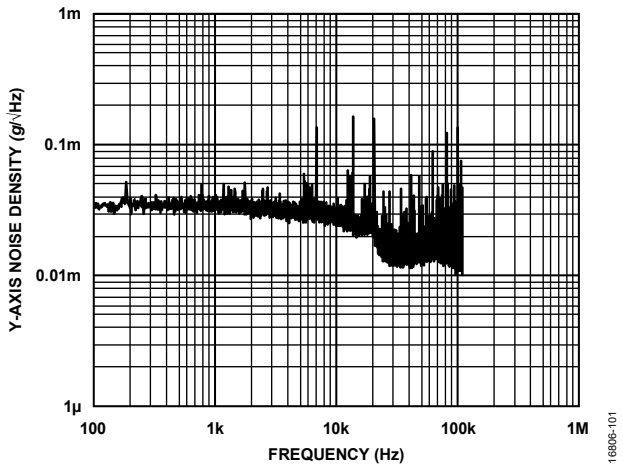

Figure 14. Y-Axis Noise Density, Wideband, RTS Mode

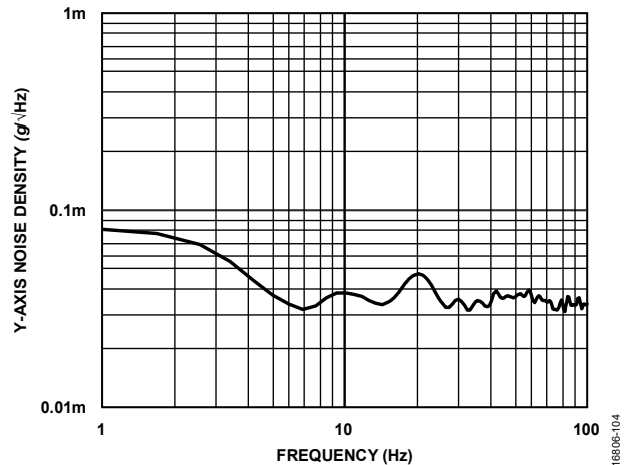

Figure 17. Y-Axis Noise Density, Low Frequency, RTS Mode

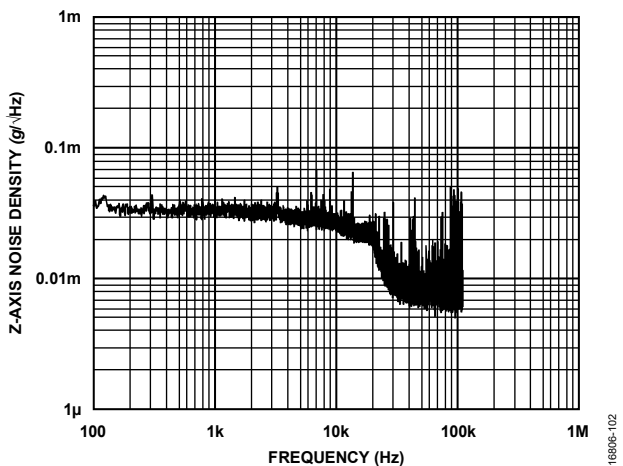

Figure 15. Z-Axis Noise Density, Wideband, RTS Mode

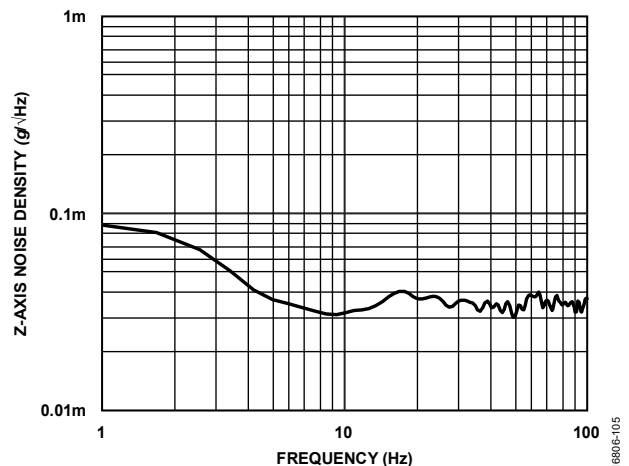

Figure 18. Z-Axis Noise Density, Low Frequency, RTS Mode

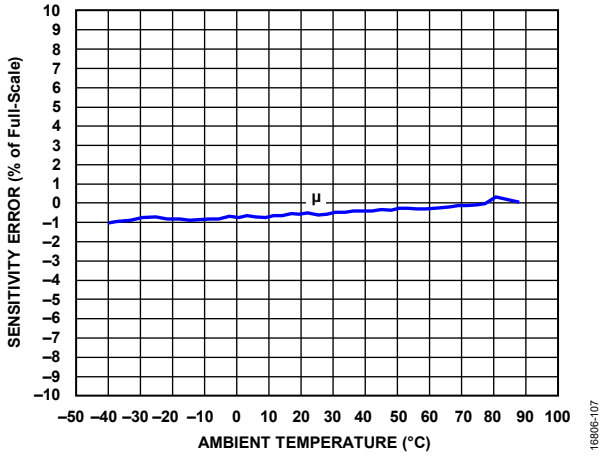

Figure 19. Sensitivity Error vs. Ambient Temperature, Normalized at 25°C

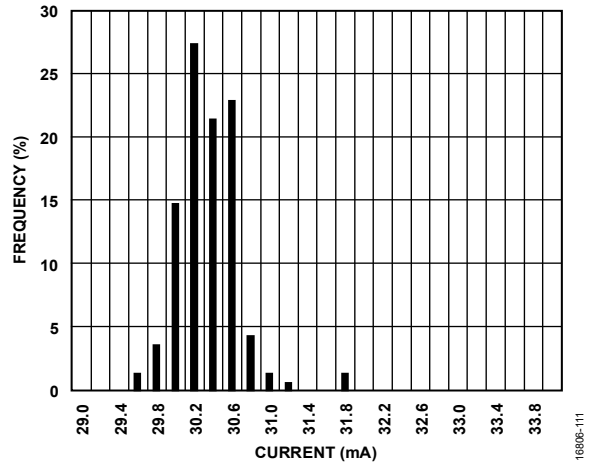

Figure 22. Operating Mode Current Distribution at 3.3 V Supply

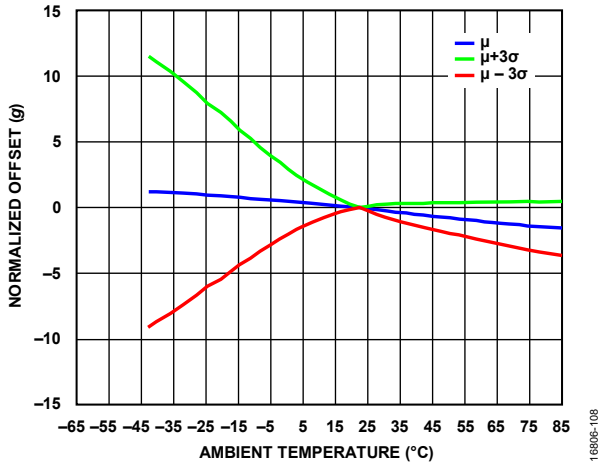

Figure 20. Offset vs. Temperature

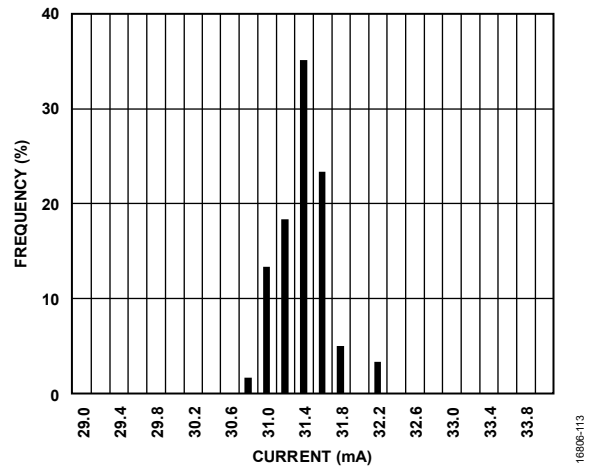

Figure 23. Operating Mode Current Distribution at 3.6 V Supply

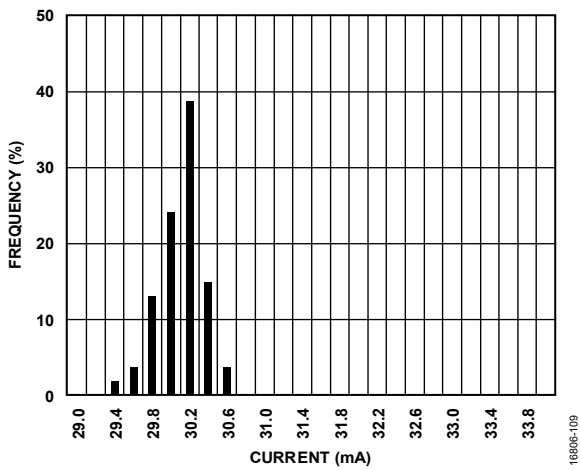

Figure 21. Operating Mode Current Distribution at 3.0 V Supply

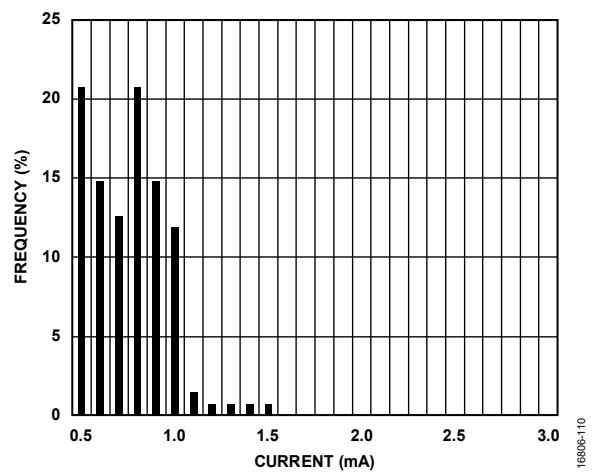

Figure 24. Sleep Mode Current Distribution at 3.0 V Supply

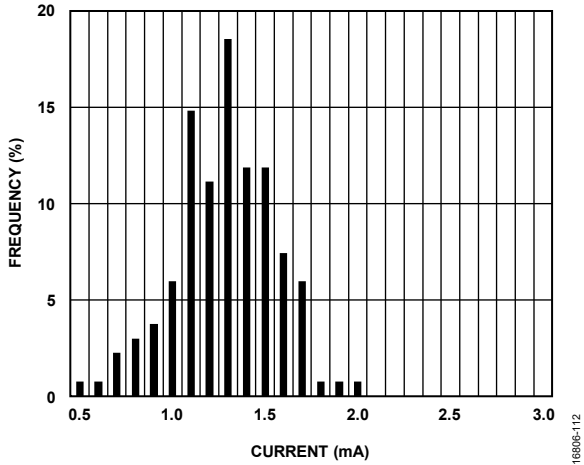

Figure 25. Sleep Mode Current Distribution at 3.3 V Supply

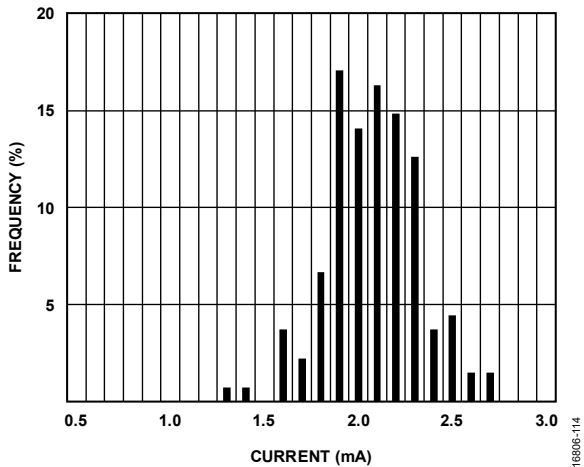

Figure 26. Sleep Mode Current Distribution at 3.6 V Supply

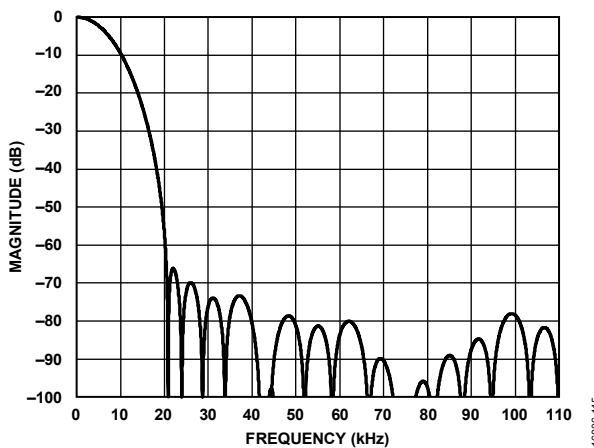

Figure 27. Digital Filter Frequency Response of the 1 kHz Low-Pass Filter

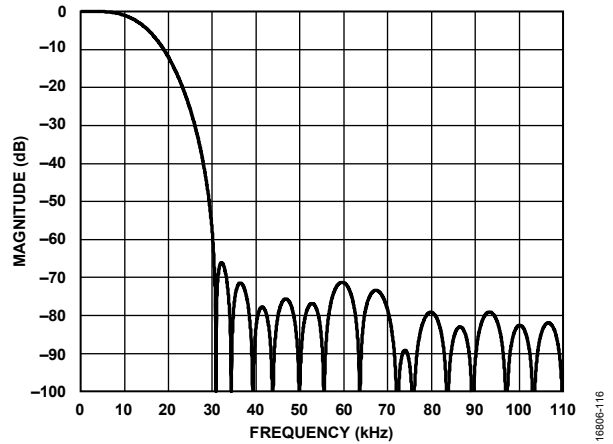

Figure 28. Digital Filter Frequency Response of the 5 kHz Low-Pass Filter

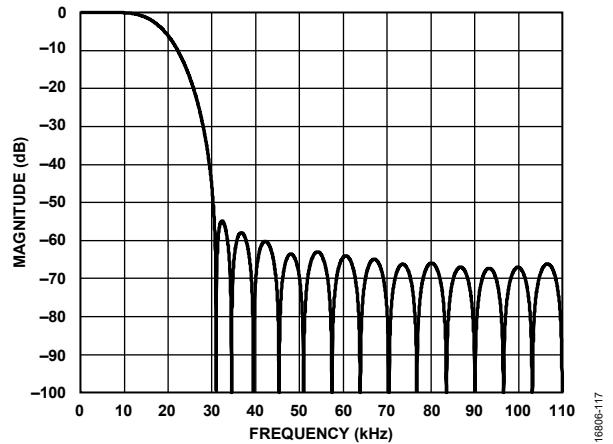

Figure 29. Digital Filter Frequency Response of the 10 kHz Low-Pass Filter

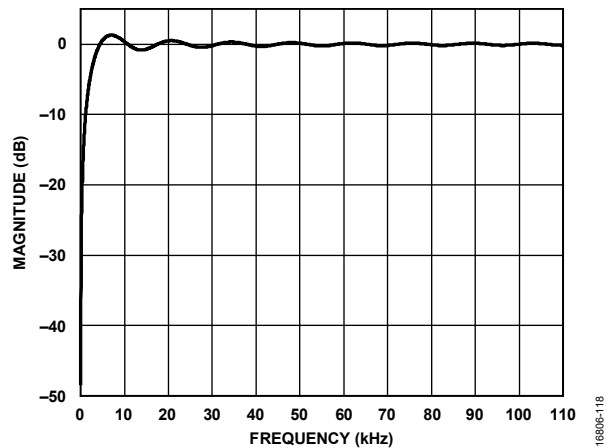

Figure 30. Digital Filter Frequency Response of the 1 kHz High-Pass Filter

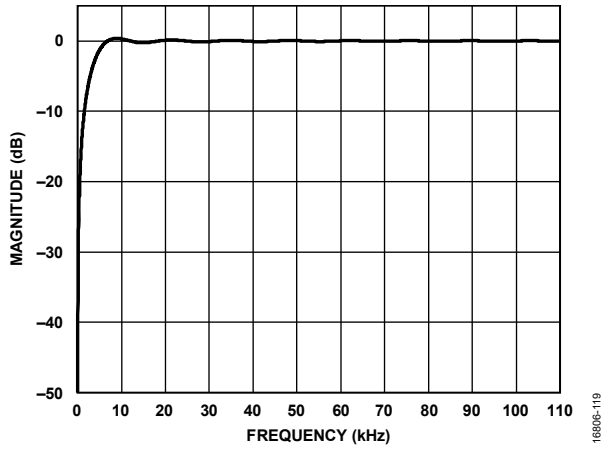

Figure 31. Digital Filter Frequency Response of the 5 kHz High-Pass Filter

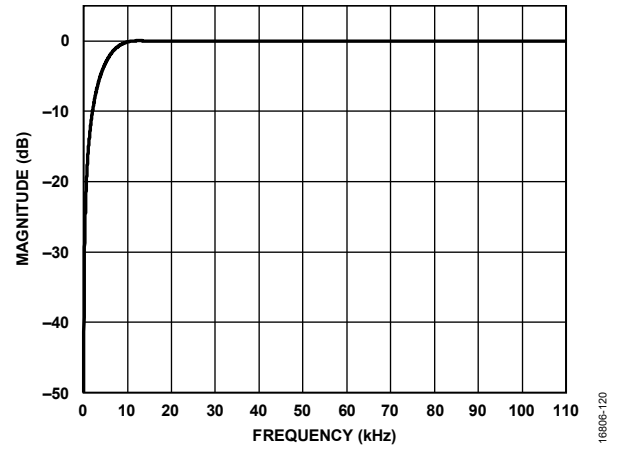

Figure 32. Digital Filter Frequency Response of the 10 kHz High-Pass Filter

## THEORY OF OPERATION

The ADcmXL3021 is a triaxial, vibration monitoring subsystem that includes wide bandwidth, low noise MEMS accelerometers, an analog-to-digital converter (ADC), high performance signal processing, data buffers, record storage, and a user interface that easily interfaces with most embedded processors. See Figure 33 for a basic signal chain. The subsystem is housed in an aluminum module that is mounted using four screws (accepts screw size M2.5) and is designed to be mechanically stable beyond 40 kHz. The combination of this mechanical mounting and oversampling ensures that aliasing artifacts are minimized.

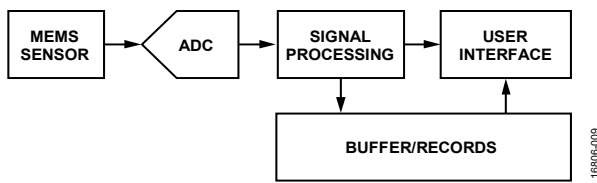

Figure 33. Basic Signal Chain

The ADcmXL3021 has a high operating input range of  $\pm 50 g$  and is suitable for vibration measurements in high bandwidth applications, such as vibration analysis systems that monitor and diagnose machine or system health. User configurable internal processing supports both time domain and frequency domain calculations.

The low noise and high frequency bandwidth enable the measurement of both repetitive vibration patterns and single shock events caused by small moving parts, such as internal bearings. The high  $g$  range provides the dynamic range to be used in high vibration environments, such as heating, ventilation, and air conditioning systems (HVAC), and heavy machine equipment. To achieve best performance, be aware of system noise, mounting, and signal conditioning for the particular application.

Proper mounting is required to ensure full mechanical transfer of vibration to accurately measure the desired vibration. A common technique for high frequency mechanical coupling is to use a combination of a threaded screw mount system and adhesive where possible. For lower frequencies (below the full capable bandwidth of the sensor), it is possible to use magnetic or adhesive mounting. Proper mounting techniques ensure accurate and repeatable results that are not influenced by measurement system mechanical resonances and/or damping at the desired frequencies, and represents an efficient and proper mechanical transfer to the system being monitored.

### CORE SENSORS

The ADcmXL3021 uses three [ADXL1002](#) MEMS accelerometers, with sensing axes configured to be mutually orthogonal to each other. Figure 34 is a simple mechanical diagram that shows how MEMS accelerometers translate linear acceleration to representative output signals.

The moving component of the sensor is a polysilicon surface-micromachined structure built on top of a silicon wafer. Polysilicon springs suspend the structure over the surface of the wafer and provide a resistance against acceleration forces.

Deflection of the structure is measured using differential capacitors that consist of independent fixed plates and plates attached to the moving mass. Acceleration deflects the structure and unbalances the differential capacitor, resulting in a sensor output with an amplitude proportional to acceleration. Phase sensitive demodulation determines the magnitude and polarity of the acceleration.

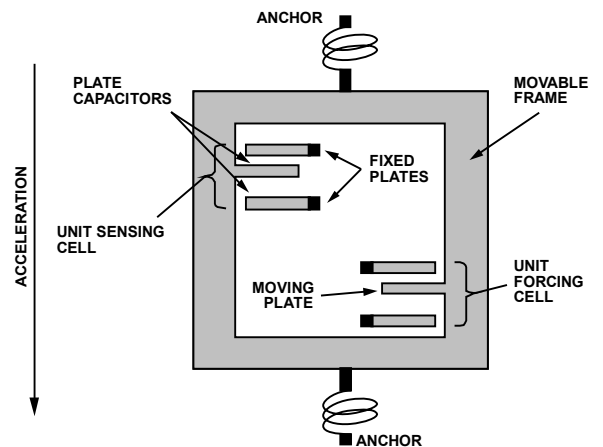

Figure 34. MEMS Sensor Diagram

### SIGNAL PROCESSING

The signal chain of the ADcmXL3021 includes wideband accelerometers to monitor three axes, a low-pass analog filter with a 13.5 kHz cutoff frequency, an oversampling ADC (sampling at 220 kSPS per axis), a microcontroller, and discrete components to provide a flexible vibration monitor subsystem that supports multiple processed output modes. There are four modes of operation. One mode of operation is the full rate real-time streaming (RTS) output. The three other modes include system level signal processing: manual FFT mode (MFFT), automatic FFT mode (AFFT), and manual time capture (MTC) mode. MTC mode supports 4096 consecutive time domain samples to which averaging, finite impulse response (FIR), and windowing signal processing can be enabled, along with the calculation of statistics, alarm configuring, and monitoring. In MTC mode, the raw time domain data is made available in register buffers for all three axes for the user to access and externally process.

In both FFT modes, manual fast Fourier transform (MFFT) and AFFT modes support the process of calculating an FFT of the current time domain record.

Finally, a continuous RTS mode bypasses all device digital computations and alarm monitoring, outputting real-time data over the SPI in burst data output format (see Figure 5).

**MODES OF OPERATION**

The ADcmXL3021 supports four different modes of operation: RTS mode, MTC mode, MFFT mode, and AFFT mode. Users can select the mode of operation by writing the corresponding code to the REC\_CTRL register, Bits[1:0] (see Table 55).

In three of these modes (MFFT, AFFT, and MTC), the ADcmXL3021 captures, analyzes, and stores vibration data in discrete events, known as capture events, and generates a record. Each capture event concludes with storing the data as configured in REC\_CTRL register in the user data buffers, which are accessible through the BUF\_PNTR register (see Table 36).

The two different FFT modes that produce vibration data in spectral terms are MFFT and AFFT. The difference between these two modes is the manner in which data capture and analysis starts. In MFFT mode, users trigger a capture event by an external digital signal or through a software command using the GLOB\_CMD register, Bit 11 (see Table 91). In AFFT mode, an internal timer automatically triggers additional spectral record captures without the need for an external trigger. Up to four different sample rate profiles can be selected for the modes to cycle through. The REC\_PRD register (see Table 59) contains the user configuration settings for the time that elapses between each capture event when operating in the AFFT mode.

**Manual Time Capture (MTC) Mode**

When operating in MTC mode, the ADcmXL3021 captures 4096 consecutive time domain samples. An offset null signal can be calculated and applied to the data using the command register option. Signal processing functions such as low-pass and high-pass FIR filtering and averaging can be applied. After digital processing is complete, the 4096 time domain sample data (per axis) record of vibration data is stored into the user data buffers, using the signal flow diagram shown in Figure 36.

Capturing is triggered by either a SPI write to the GLOB\_CMD register or by an external trigger. The ADcmXL3021 toggles the output BUSY when the data record is stored and the alarms are checked.

The decimation filter reduces the effective rate of stored data capture in the time record by averaging the sequential samples together and filtering out of band signal and noise. This filter has eight decimation rate settings (1, 2, 4, 8, 16, 32, 64, and 128) and can support up to four different settings. These time data records are time continuous captures with decimation filter acting on real time data from the ADC to produce 4096 samples (to produce the 4096 time domain samples requires  $2^N$  samples to be processed internally, where N is the average count value, AVG\_CNT). When more than one user configured sample record setting is in use, the ADcmXL3021 applies a single filter for each data record and cycles through all desired options, one for each data capture. Time statistic alarms can be configured for three levels of reporting: normal, critical, and warning. A record mode option allows all enabled time domain statistics to be stored, depending on user preference, and is configured by setting the record mode in Register REC\_CTRL, Bits[3:2] (Register 0x1A, 0x1B) = 0b10.

The output data can be configured to provide the root sum of squares (RSS) of all three axes or convert accelerometer data to equivalent velocity.

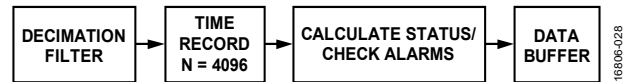

Figure 35. Signal Processing Diagram for Manual Time Capture (MTC) Mode

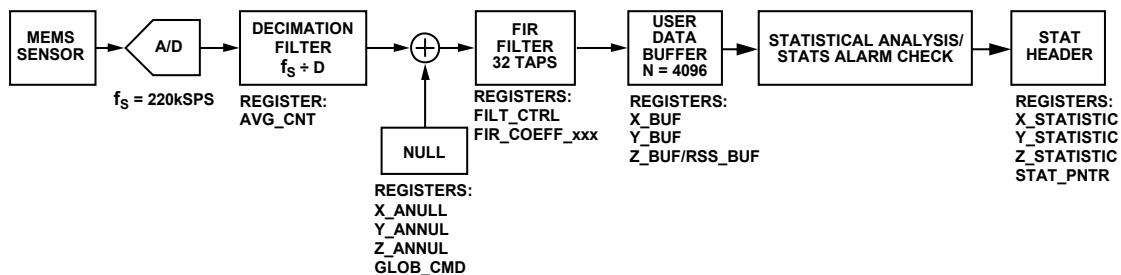

Figure 36. MTC Signal Flow Diagram

### MFFT Mode

MFFT mode can be used to manually trigger a capture to create a single FFT record with 2048 bins and allows various configuration options. The ADcmXL3021 has configurable high-pass and low-pass filters, decimation filtering, FFT averaging and spectral alarms. The ADcmXL3021 also has options to calculate velocity, apply windowing, and apply offset compensations. MFFT mode is configured by setting the record mode in Register REC\_CTRL, Bits[1:0] (Register 0x1A, 0x1B) = 0b00.

Processing steps collect 4096 consecutive time domain samples and filters the data similar to the MTC case. Additional windowing and FFT averaging can be enabled and configured using the 4096 sample burst captures. The ADcmXL3021 provides three different mathematical filtering options to processes the time record data, prior to performing an FFT, the filter options are rectangular, Hanning, or flat. See the REC\_CTRL register in Table 55 for more information on selecting the window option.

When a capture event is triggered by the user, the event follows the process flow diagram shown in Figure 37. The FIR filter has 32 coefficients and processes at the full internal ADC sample rate of 220 kSPS per axis. Users can select from one of six FIR filter bank options. Three of these filter banks have preset coefficients that provide low-pass responses to support half power bandwidths of 1 kHz, 5 kHz, and 10 kHz, respectively. The other three filter banks have preset coefficients that provide high-pass responses to support half power bandwidths of 1 kHz, 5 kHz, and 10 kHz filter. All six filter banks can be overwritten through user programming and stored to flash memory.

After the FIR filter is applied to the time domain data, if enabled, the data is decimated according to the AVG\_CNT setting until a full 4096 time sample capture fills the data buffer. This decimation produces a time record that is converted to a spectral record and averaged, depending on the FFT\_AVG1 or FFT\_AVG2 setting, as appropriate (see Figure 49 for the FFT capture datapath and appropriate registers).

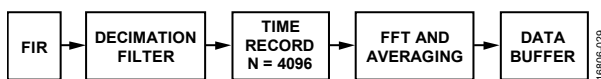

Figure 37. Signal Processing Diagram for FFT Modes

### AFFT Mode

AFFT mode is configured by setting the record mode in Register REC\_CTRL, Bits[1:0] (Register 0x1A, 0x1B) = 0b01. AFFT mode supports the same functionality as MFFT mode, except AFFT mode automatically advances and independently controls new capture events. New capture events are triggered periodically and are configured in the register map using REC\_PRD.

To save power for long off time durations, the device can be configured to sleep between auto captures using Bit 7 in the REC\_CTRL register.

### RTS Mode

RTS mode is configured by setting the record mode in Register REC\_CTRL, Bits[1:0] (Register 0x1A, 0x1B) = 0b11.

When operating in the RTS mode, the ADcmXL3021 samples each axis at a rate of 220 kSPS and makes this data available through a burst pattern via the SPI.

### DATA RECORDING OPTIONS

The ADcmXL3021 creates data records in FFT and MTC modes and supports three methods of data storage for each data record: immediate only mode, alarm triggered mode, and all mode. In MTC mode, the time domain statistics are stored and are not the time records.

When immediate only mode is selected, only the most recent capture data record is retained and accessible.

In alarm triggered mode, only data that triggered an alarm is stored. When an alarm event is triggered, the ADcmXL3021 stores the header registers and the FFT data to flash memory. Alarm triggered mode is helpful for continuous operation while minimally impacting the limited endurance of the flash memory. In the case of any alarm event, even on a single axis, all available axes are saved.

In all mode, each data record is stored. The data stored includes FFT header information and FFT data for all available axes. Up to 10 FFT records can be stored and retrieved.

The ADcmXL3021 samples, processes, and stores vibration data from three axes (x, y, and z) to the FFT or MTC data. In MTC mode, the record for each axis contains 4096 samples. In MFFT mode and AFFT mode, each record contains the 2048 bin FFT result for each accelerometer axis. Table 6 describes the registers that provide access to processed sensor data.

Table 6. Output Data Registers

Register	Address	Description
TEMP_OUT	0x02	Internal temperature measurement
SUPPLY_OUT	0x04	Internal power supply measurement
BUF_PNTR	0x0A	Data buffer index pointer
REC_PNTR	0x0C	FFT record index pointer
X_BUF	0x0E	X-axis accelerometer buffer
Y_BUF	0x10	Y-axis accelerometer buffer
Z_BUF	0x12	Z-axis accelerometer buffer
GLOB_CMD	0x3E	Global command register
TIME_STAMP_L	0x4C	Timestamp, lower word
TIME_STAMP_H	0x4E	Timestamp, upper word
REC_INFO1	0x66	FFT record header information
REC_INFO2	0x68	FFT record header information



**Reading Data from the Data Buffer**

After completing a spectral record and updating each data buffer, the ADcmXL3021 loads the first data sample from each data buffer to the x\_BUF registers (see Table 10, Table 11, and Table 12) and sets the buffer index pointer in the BUF\_PNTR register (see Table 7) to 0x0000. The index pointer determines which data samples load to the x\_BUF registers. For example, writing 0x009F to the BUF\_PNTR register (DIN = 0x8A9F, DIN = 0x8B00) causes the 160th sample in each data buffer location to load to the x\_BUF registers. The index pointer automatically increments with each x\_BUF read command, which causes the next set of capture data to load to each capture buffer register. This enables an efficient method for reading all 4096 time samples or 2048 FFT points in a record, using sequential read commands, without needing to manipulate the BUF\_PNTR register.

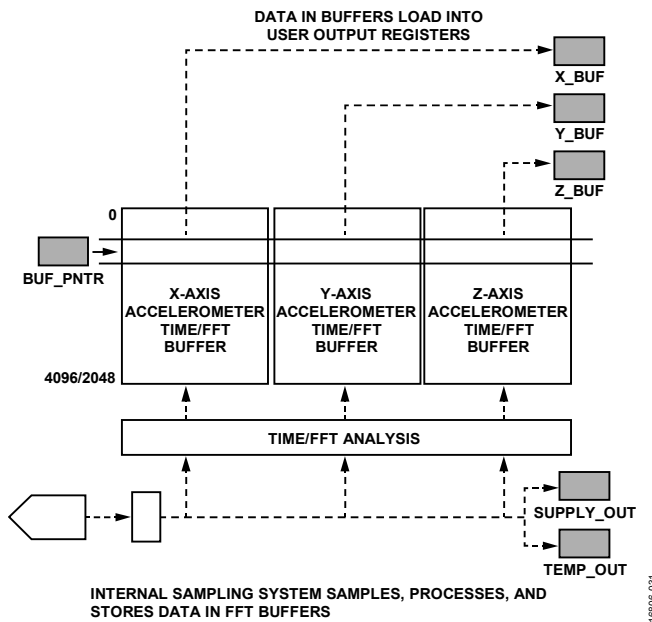

Figure 38. Data Buffer Structure and Operation

**Table 7. BUF\_PNTR (Base Address = 0x0A), Read/Write**

Bits	Description (Default = 0x0000)
[15:12]	Not used
[11:0]	Data bits; range = 0 to 2047 (FFT), 0 to 4095 (time)

**Accessing FFT Record Data**

Up to 10 FFT records can be stored in flash memory. The REC\_PNTR register (see Table 8) and GLOB\_CMD bit (Bit 13, see Figure 39) provide access to the FFT records.

The process when FFT averaging is enabled is as follows:

1. Initiate a capture.
2. Time domain samples are captured and filtered according to AVG\_CNT setting until 4096 time samples fill the buffer.
3. The FFT is calculated from the time samples in the buffer and the record is stored.

4. After the number of FFT averages is reached, all FFT records in memory are averaged and stored.
5. Alarms are checked, flags are set, and the data record is stored as per configuration
6. In either manual or automatic mode, the next sample rate option is set.
7. Finally, the BUSY signal is set.

Note that an FFT record is an FFT stored in flash, and an FFT capture is an FFT stored in RAM.

**Table 8. REC\_PNTR (Base Address = 0x0C), Read/Write**

Bits	Description (Default = 0x0000)
[12:8]	Time statistic record pointer address
[3:0]	FFT record number pointer address

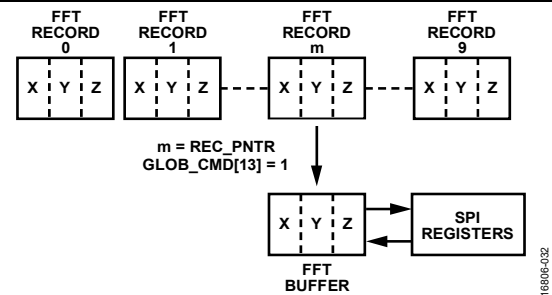

Figure 39. FFT Record Access

**MTC Data Format**

In MTC mode the X\_BUF, Y\_BUF, and Z\_BUF registers each contain a single time domain sample for the noted axis. When reading X\_BUF (as well as Y\_BUF and Z\_BUF), BUF\_PNTR automatically advances from 0 to 4095. The time domain data is 16-bit, two complement acceleration data by default with a resolution of 1 LSB = 1.907 mg. If velocity data is selected by setting REC\_CTRL, Bit 5 = 1, velocity data is stored in the buffer registers instead. Velocity data is calculated by integrating the acceleration data, its resolution and scale factor depend on the sample rate and AVG\_CNT value:

$$Velocity\ 1\ LSB = (2^{AVG\_CNT} / Sample\ Rate) \times 18.70\ mm/s$$

For instance, if the default sample rate is 220 kSPS and AVG\_CNT = 5, 1 LSB = 2.72 μm/sec.

Table 10, Table 11, and Table 12 list the bit assignments for the X\_BUF, Y\_BUF, and Z\_BUF registers. The acceleration data format depends on the record type setting in the REC\_CTRL register. Table 42 shows data formatting examples for the 16-bit, two complement format used in manual time mode.

In MTC mode, time domain statistic can be calculated by enabling Bit 6 in the REC\_CTRL register. The statistics value scales are calculated based on setting of accelerometer or velocity, and if RSS is enabled, all statistics are calculated based on the RSS values. The time domain statistics available are mean, standard deviation, peak, peak-to-peak, crest factor, kurtosis, and skewness.

The scale of all statistics are consistent with the data format selected (for example, 1 LSB = 1.907 mg for acceleration), except the crest factor, kurtosis, and skew, which require fractional numbers.

**Table 9. MTC Mode, 50 g Range, Data Format Examples**

Acceleration (mg) (1.907 mg/LSB)	LSB	Hex	Binary
+62486.7	+32,767	0x7FFF	0111 1111 1111 1111
+12498.5	+6554	0x199A	0001 1001 1001 1010
+3.9	+2	0x0002	0000 0000 0000 0010
+1.9	+1	0x0001	0000 0000 0000 0001
0	0	0x0000	0000 0000 0000 0000
-1.9	-1	0xFFFF	1111 1111 1111 1111
-3.8	-2	0xFFFE	1111 1111 1111 1110
-12498.5	-6554	0xE666	1110 0110 0110 0110
-62488.6	-32,768	0x8000	1000 0000 0000 0000

If RSS calculation is enabled in MTC mode, the RSS of all three axes is placed in the Z\_BUF registers. X and y time domain data is still available in the respective buffers, but the contents of Z\_BUF are replaced with the RSS values. If RSS is enabled, the x-axis and y-axis alarms still apply to the respective axes, but the z-axis alarms apply to the RSS values.

**Table 10. X\_BUF (Base Address = 0x0E), Read Only**

Bits	Description (Default = 0x8000)
[15:0]	X-axis acceleration data buffer register. Format = twos complement (time), unsigned integer (FFT).

**Table 11. Y\_BUF (Base Address = 0x10), Read Only**

Bits	Description (Default = 0x8000)
[15:0]	Y-axis acceleration data buffer register. Format = twos complement (time), unsigned integer (FFT).

**Table 12. Z\_BUF (Base Address = 0x12), Read Only**

Bits	Description (Default = 0x8000)
[15:0]	Z-acceleration or RSS data buffer register. Format = twos complement (time), unsigned integer (FFT).

**FFT Data Format (for AFFT and MFFT modes)**

In both AFFT and MFFT modes, the X\_BUF, Y\_BUF, and Z\_BUF registers contain a calculated FFT bin magnitude. The values contained in buffer locations from 0 to 2047 represent the magnitude of frequency bins of size, depending on the AVG\_CNT value as shown in Table 19.

The magnitude (x) can be calculated from the value read by using the following equation:

$$x(I) = \left( \frac{\frac{X_{BUF[I]}}{2^{2048}}}{\text{Number of FFT Averages}} \right) \times 0.9535 \text{ mg}$$

This formula is consistent for the y and z buffer values. Table 13 and Table 43 show the data formatting examples for FFT mode conversions from the X\_BUF value to acceleration.

When reading the X\_BUF register (as well as Y\_BUF and Z\_BUF), BUF\_PNTR automatically advances from 0 to 2047. The FFT data is unsigned 16-bit data.

**Table 13. FFT Magnitude Conversion from Register Value, Data Format Examples**

FFT Buffer Read Value (Bits)	FFT Averages	Magnitude
0x0001	1	0.953823 mg
0x0002	1	0.954146 mg
0x00FF	1	1.039447 mg
0x7D00	1	48.18528 g
0x0001	2	0.476911 mg
0x0002	2	0.477073 mg
0x00FF	2	0.519724 mg
0x0005	4	0.238779 mg
0x05FF	4	0.400762 mg
0x7530	4	6.121809 g
0x00FF	8	0.129931 mg
0x7D00	8	6.02316 g
0x7D00	16	3.01158 g
0xAFCE	128	30.65768 g

**RTS Data Format**

In RTS mode, continuous data is burst out of the SPI interface. Each data frame consists of 32 samples each of x-, y-, and z-axis accelerometer data plus a frame header, temperature reading, status bits, and a 16-bit cyclical redundancy check (CRC) code. To calculate CRC, the CCITT-16 bit algorithm with an initial seed of 0xFFFF is used. Each data sample is 16-bit, twos complement acceleration data by default with a resolution of 1 LSB = 1.907 mg. It is important that the external host device is able to retrieve the burst data in a sufficient time allotment, which is approximately 135 μs per data frame. No internal corrections are applied to this data. Therefore, the data may deviate from the results of other capture modes. Data is unsigned and must be offset (subtract) by 0x8000 to obtain ±g (signed data).

When first entering RTS mode capture, the first eight samples are all 0s and the CRC for the first frame is invalid. Anytime a frame is skipped (not read), the subsequent frame CRC is invalid. It is recommended that the first frame be ignored and data for the second frame and all subsequent frames be used.

In RTS mode, the default sample rate is 220 kSPS. Users can set the decimation ratio or select from preset sample rates using the RT\_CTRL register according to Table 56 and Table 57.

Table 14 shows several examples of how to translate RTS data values, assuming nominal sensitivity and zero bias error.

**Table 14. RTS Mode Data Format Examples**

Acceleration (g)	LSB	Hex.	Binary
+62.532	65,535	0xFFFF	1111 1111 1111 1111
+50	58,967	0xE657	1110 0110 0101 0111
+0.003816	32,770	0x8002	1000 0000 0000 0010
+0.001908	32,769	0x8001	1000 0000 0000 0001
0	32,768	0x8000	1000 0000 0000 0000
-0.001908	32,767	0x7FFF	0111 1111 1111 1111
-0.003816	32,766	0x7FFE	0111 1111 1111 1110
-50	6567	0x19A7	0001 1001 1010 0111
-62.534	0	0x0000	0000 0000 0000 0000

**USER INTERFACE**

The user interface includes a number of important functions: a data communications port, a trigger input, a busy indicator, and two alarm indicator signals.

Data communication between an embedded processor (master) and the ADcmXL3021 takes place through the SPI, which includes the chip select (CS), serial clock (SCLK), data input (DIN), and data output (DOOUT) pins (see Table 5).

The SYNC/RTS (see Table 5) pin provides user triggering options in manual triggering modes. The alarm pins, ALM1 and ALM2, are configurable to alert the user of an event that exceeds a user defined threshold of a parameter.

The SYNC/RTS pin is used in RTS mode to support start and stop control over data capture and analysis operations. The BUSY pin (see Table 5) provides an indication of internal operation when the ADcmXL3021 is executing a command. This signal helps the master processor avoid SPI communication when the ADcmXL3021 cannot support a response and can trigger an external data acquisition after data capture and analysis events are complete.

The ADcmXL3021 uses an SPI for communication, which enables simple connection with most embedded processor platforms, as shown in Figure 40.

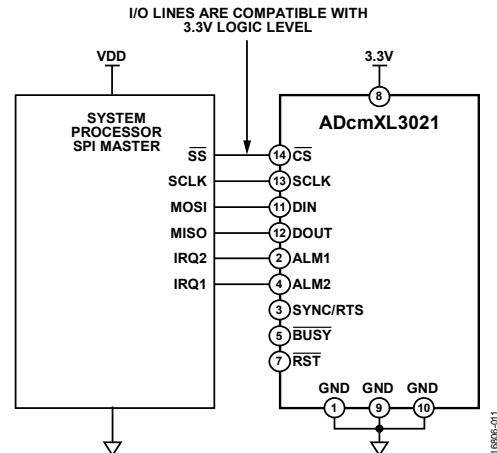

Figure 40. Electrical Hookup Diagram

The register structure uses a paged addressing scheme that contains seven pages, with each page containing 64 register locations. Each register is 16 bits wide, with each 2-byte word having its own unique address within the memory map of that page. The SPI port has access to one page at a time. Select the page to activate for SPI access by writing the corresponding code to the PAGE\_ID register. Read the PAGE\_ID register to determine which page is currently active. Table 15 displays the PAGE\_ID contents for each page and the basic functions. The PAGE\_ID register is located at Address 0x00 on each page.

**Table 15. User Register Page Assignments**

Page No.	PAGE_ID	Function
0	0x00	Configuration, data acquisition
1	0x01	FIR Filter Bank A
2	0x02	FIR Filter Bank B
3	0x03	FIR Filter Bank C
4	0x04	FIR Filter Bank D
5	0x05	FIR Filter Bank E
6	0x06	FIR Filter Bank F

The factory default configuration for the BUSY pin provides a busy indicator signal that transitions high when an event completes and data is available for user access and remains low during processing.

**Table 16. Generic Master Processor Pin Names and Functions**

Pin Name	Function
SS	Slave select
SCLK	Serial clock
MOSI	Master output, slave input
MISO	Master input, slave output
IRQ1, IRQ2	Interrupt request inputs (optional)

The ADcmXL3021 SPI supports full duplex serial communication (simultaneous transmit and receive) and uses the bit sequence shown in Figure 44. Table 17 shows a list of the most common settings that control the operation of SPI-compatible ports in most embedded processor platforms.

Embedded processors typically use control registers to configure serial ports for communicating with SPI slave devices, such as the ADcmXL3021. Table 17 lists settings that describe the SPI protocol of the ADcmXL3021. The initialization routine of the master processor typically establishes these settings using firmware commands to write them into the serial control registers.

Table 17. Generic Master Processor SPI Settings

Processor Setting	Description
Master	ADcmXL3021 operates as a slave.
SCLK Rate ≤ 14 MHz	Bit rate setting.
SPI Mode 3	Clock polarity/phase (CPOL = 1, CPHA = 1).
MSB First	Bit sequence.
16-Bit Mode	Shift register/data length.
Readout Formatting	Little Endian.

Table 20 lists user registers with lower byte addresses. Each register consists of two bytes. Each byte has a unique 7-bit address. Figure 41 relates the bits of each register to the upper and lower addresses.

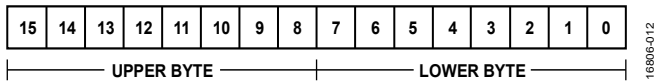

Figure 41. Generic Register Bit Definitions

Register Structure

All communication with the ADcmXL3021 involves accessing the user registers. The register structure contains both output data and control registers. The output data registers include the latest sensor data, alarm information, error flags, and identification data. The control register contained in Page 0 includes configurable options, such as time domain averaging, FFT averaging, filtering, alarm parameters, diagnostics, and data collection mode settings. Each user accessible register has two bytes (upper and lower), and each byte has a unique address. See Table 20 for a detailed list of all user registers, along with the corresponding addresses.

All communication between the ADcmXL3021 and an external processor involves either reading or writing these 16 bit user registers.

SPI Write Commands

User control registers govern many internal operations. The DIN bit sequence in Figure 44 provides a description to write to these registers. Each configuration register contains 16 bits (two bytes). Bits[7:0] contain the low byte, and Bits[15:8] contain the high byte of each register. Each byte has a unique address in the user register map (see Table 20). Updating the contents of a register requires writing both bytes in the following sequence: low byte first, high byte second. There are three parts to coding a SPI command (see Figure 44) that write a new byte of data to a register: the write bit (R/W = 1), the address of the byte [A6:A0], followed by the new data for that register address [D7:D0].

Figure 42 provides a coding example for writing 0x2345 to the FFT\_AVG1 register, the 0x8623 command writes 0x23 to Address 0x06 (lower byte) and the 0x8745 command writes 0x45 to Address 0x07 (upper byte).

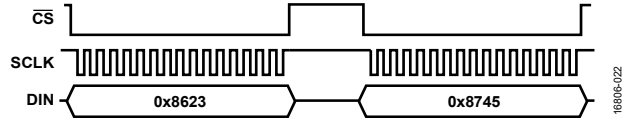

Figure 42. Single SPI Write Command

SPI Read Commands

A single register read requires two 16-bit SPI cycles that use the bit assignments shown in Figure 44. The beginning sequence sets R/W = 0 and communicates the target address (Bits[A6:A0]). Bits[DC7:DC0] are don't care bits for a read DIN sequence. DOUT clocks out the requested register contents during the second sequence. The second sequence can also use DIN to set up the next read.

Figure 43 provides an example that includes two register reads in succession. This example starts with DIN = 0x0C00 to request the contents of the REC\_PNTR register, and follows with 0x0E00, to request the contents of the X\_BUF register. The sequence in Figure 43 also shows the full duplex mode of operation, which means that the ADcmXL3021 can receive requests on DIN while also transmitting data out on DOUT within the same 16-bit SPI cycle.



Figure 43. SPI Multibyte Read Command Example

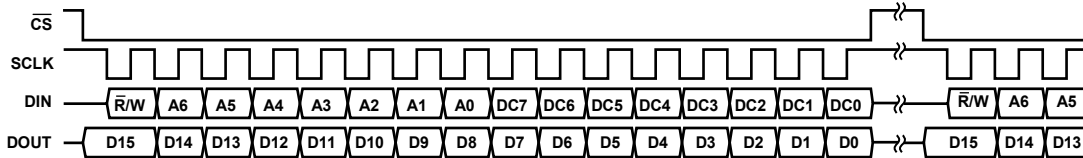

NOTES

1. DOUT BITS ARE PRODUCED ONLY WHEN THE PREVIOUS 16-BIT DIN SEQUENCE STARTS WITH R/W = 0.
2. WHEN CS IS HIGH, DOUT IS IN A THREE-STATE, HIGH IMPEDANCE MODE, WHICH ALLOWS MULTIFUNCTIONAL USE OF THE LINE FOR OTHER DEVICES.

Figure 44. SPI Communication, Multibyte Sequence

**Busy Signal**

The factory default configuration provides the user with a busy signal ( $\overline{\text{BUSY}}$ ), which pulses low when the output data registers are updating (see signal orientation of busy signal in Figure 45). In this configuration, connect  $\overline{\text{BUSY}}$  to an interrupt service pin on the embedded processor, which triggers data collection, when this signal pulses high.

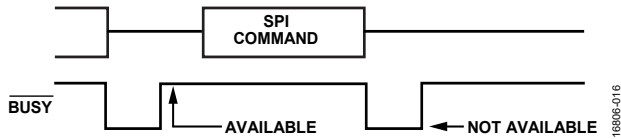

Figure 45. Busy Signal ( $\overline{\text{BUSY}}$ ) Orientation after SPI command

During the start-up and reset recovery processes, the  $\overline{\text{BUSY}}$  signal can exhibit some transient behavior before data production begins. Figure 45 provides an example of the  $\overline{\text{BUSY}}$  behavior during command processing. A low signal indicates SPI access is not available with the exception of the escape code that can terminate a capture. Figure 46 shows the  $\overline{\text{BUSY}}$  signal during power up.

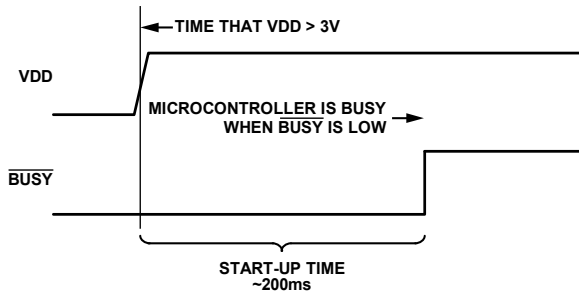

Figure 46.  $\overline{\text{BUSY}}$  Response During Startup

**RTS**

The RTS function provides a method for reading data (time domain acceleration data for each axis, temperature, status, and CRC code) that does not require a stall time between each 16-bit segment and only requires one command on the DIN line to initiate. System processors can execute this mode by reading each segment of data in the response, while holding the  $\overline{\text{CS}}$  line in a low state, until after reading the last 16-bit segment of data. If the  $\overline{\text{CS}}$  line goes high before the completion of all data acquisition, the data from that read request is lost.

The RTS burst contains 100 16 bits words (a header, including a incrementing counter, 32 x-axis samples, 32 y-axis samples, 32 z-axis samples, temperature, status, and CRC). The external SCLK rate must be between 12.5 MHz to 14 MHz to ensure the complete burst is read out before current data in the register buffer is overwritten. The maximum SCLK for RTS burst outputs is 14 MHz  $\pm$  1%. The minimum SCLK required to support the transfer is 12.5 MHz. The RTS burst response uses the sequencing diagrams shown in Figure 4 and Figure 5 and the data format shown in Table 18.

When first entering RTS mode capture, the first eight samples are all 0s and the CRC for the first frame is invalid. It is recommended that the first frame be ignored and that the data for the second frame and all subsequent frames be used.

**Table 18. RTS Data Format**

Byte Location in Output Dataset	2-Byte Value Represents
0	Fixed header: 0xccAD; where cc is an incrementing counter value from 0x00 to 0xFF, which returns to 0x00 after 0xFF
2	X-axis data (0) (oldest data from x-axis)
4	X-axis data (1)
6	X-axis data (2)
...	...
64	X-axis data (31)
66	Y-axis data (0) (oldest data from y-axis)
68	Y-axis data (1)
...	...
128	Y-axis data (31)
130	Z-axis data (0) (oldest data from z-axis)
132	Z-axis data (1)
134	Z-axis data (2)
...	...
192	Z-axis data (31)
194	Temperature
196	Status
198	CRC-16

## BASIC OPERATION

### DEVICE CONFIGURATION

Each register contains 16 bits (two bytes). Bits[7:0] contain the low byte and Bits[15:8] contain the high byte. Each byte has a unique address in the user register map (see Table 20). Updating the contents of a register requires writing to the low byte first and the high byte second. There are three parts to coding a SPI command, which writes a new byte of data to a register: the write bit ( $R/W = 1$ ), the 7-bit address code for the byte that this command is updating, and the 16 bits of new data for that location.

### DUAL MEMORY STRUCTURE

The ADcmXL3021 uses a dual memory structure (see Figure 47) with static random access memory (SRAM), supporting real-time operation and flash memory storing operational code and user configurable register settings. The manual flash update command (Bit 6 in the GLOB\_CMD register) provides a single-command method for storing user configuration settings to flash memory for automatic recall during the next power-on or reset recovery process. During power-on or reset recovery, the ADcmXL3021 performs a CRC on the SRAM and compares this result to a CRC computation from the same memory locations in flash memory. If this memory test fails, the ADcmXL3021 resets and boots up from the other flash memory location. The ADcmXL3021 provides an error flag for detecting when the backup flash memory supported the last power-on or reset recovery. Table 20 shows a memory map for the user registers in the ADcmXL3021, which includes flash backup support (indicated by yes or no in the flash column).

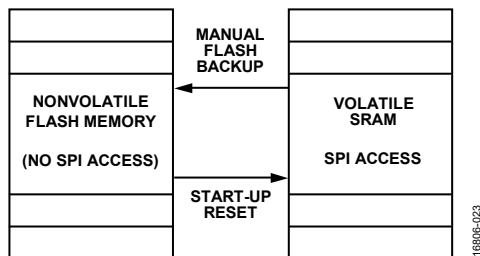

Figure 47. SRAM and Flash Memory Diagram

### POWER-UP SEQUENCE

The ADcmXL3021 requires only a single 3.3 V supply voltage and supports communication with most 3 V compliant embedded processor platforms using an SPI protocol. Avoid applying voltage to the SYNC/RTS, CS, SCLK, and DIN input pins until the proper supply voltage is applied to the module.

The power ramp from 0 V to 3.0 V must be monotonic. The module performs internal initialization, tests flash memory, and performs a sensor self test after powering on. No SPI access is allowed during this time. The module signals a completed initialization by setting the  $\overline{BUSY}$  pin logic high.

### TRIGGER

All modes, including RTS mode, require a trigger to start. AFFT mode and RTS mode also require a trigger to stop recording.

Start triggers arise either from using the SYNC/RTS digital input pin or by setting Bit 11 in the GLOB\_CMD register (see Table 91). If using the SYNC/RTS pin as a trigger, the user must set Bit 12 in the MISC\_CTRL register = 1 to enable this feature. While in RTS mode, during a valid capture period, normal SPI access is disabled until a valid stop is received.

The user can stop a capture in RTS mode in two ways: via a hardware pin or using software. The hardware pin method uses the RTS pin, which is enabled in Bit 12 of the MISC\_CTRL register. The software method requires the user to set Bit 15 in the REC\_CTRL register to 1, which enables timeout mode which must be configured prior to initiating a capture. In this case, RTS mode stops after 35 ms with no user supplied external readback clocks with  $\overline{CS}$  low. To restart RTS mode, use the normal start trigger options described in this data sheet.

To stop a capture in AFFT mode, the user must issue a stop command during a period when  $\overline{BUSY}$  is high ( $\overline{BUSY}$  is low when the device is configured for power saving mode and sleeps between captures) or by write an escape code to the device at any time. All other SPI writes are ignored. When the ADcmXL3021 is in between active collecting periods (as configured in the REC\_PRD register), setting Bit 11 in the GLOB\_CMD register (see Table 91) to 1 ( $DIN = 0xBF08$ ) interrupts the operation and the ADcmXL3021 returns to operating in the idle state. The REC\_PRD counter starts at the beginning of the capture and must be set to a period greater than the longest capture time if multiple rate options (Sample Rate 0 to Sample Rate 3) are enabled.

When operating in MFFT or MTC mode, the ADcmXL3021 operates in an idle state until it receives a command to start collecting data. When the ADcmXL3021 is in this idle state, setting Bit 11 in the GLOB\_CMD register (see Table 91) to 1 starts a data collection and processing event. An interruption of data collection and processing causes a loss of all data from the interrupted process. A positive pulse on the SYNC/RTS pin provides the same start function as raising Bit 11 in the GLOB\_CMD register when operating in MFFT mode.

In cases with many averages, a capture event can last an extended period with access to the SPI port (for example, when a device stays in a busy state). In this case, an escape code is used to terminate the active capture. The escape code is 0x00E8 and is written to the GLOB\_CMD register, using the two 16-bit sequence 0xBEE8, followed by 0xBF00 and repeat until  $\overline{BUSY}$  returns to a high logic state. An valid escape is also indicated in Bit 4 of the DIAG\_STAT register. After an escape is issued, any

data collected during the last capture is no longer valid. To continue capturing data, refer to the normal start trigger options.

**SAMPLE RATE**

RTS mode has a fixed sample rate of 220 kSPS. The output is streamed out in a burst data packet over the SPI communications port. After the device is configured for RTS mode, conversion starts and stops are controlled by the SYNC/RTS pin or by stopping SPI activity for a period of time (see Bit 15 of the REC\_CTRL register). RTS mode is unique in that, when configured, no additional processing is preformed and samples are output directly from the ADC without null, filter, or digital signal processing and alarms are not checked. A low-pass analog filter with a 13.5 kHz cutoff frequency is always in the datapath and, along with the high ADC sample rate, prevents aliasing.

For MTC mode, the sampling rate is always 220 kSPS and captures 4096 samples. The module can be configured to perform internal digital averaging.

For the null function (see Figure 36), the user can write offset correction values into the X\_ANULL register (see Table 49), the Y\_ANULL register (see Table 51), and the Z\_ANULL register (see Table 53). The user can also initiate the autonull command via Bit 0 in the GLOB\_CMD register (see Table 91), which automatically estimates the offset errors for each axis and writes correction values to the X\_ANULL register, Y\_ANULL register, and Z\_ANULL register. The autonull feature uses settings of SR3 to capture and calculate a correction value and requires time to complete.

The AVG\_CNT register allows the selection of the number of averages used in each capture for up to four sample rate options. The REC\_CTRL register selects which sample rate options are enabled. The number of averages determines the sample rate for each sample rate option by the following equation:

$$\text{Sample Rate} = 220 \text{ kHz} / 2^{\text{AVG\_CNT}[3:0]}$$

**Table 19. FFT Bin Sizes, Frequency Limits (Hz)**

AVG_CNT Setting (Averages)	Effective Sample Rate, f <sub>s</sub> (SPS)	Effective FFT Bin Size, f <sub>MIN</sub> (Hz)	Effective Maximum FFT Frequency, f <sub>MAX</sub> (Hz)
0 (1)	220000	53.71094	110000
1 (2)	110000	26.85547	55000
2 (4)	55000	13.42773	27500
3 (8)	27500	6.713867	13750
4 (16)	13750	3.356934	6875
5 (32)	6875	1.678467	3437.5
6 (64)	3437.5	0.839233	1718.75
7 (128)	1718.75	0.419617	859.375

In MFFT mode and AFFT mode, each FFT data record starts with a capture of 4096 time domain samples (after decimation, if enabled), as with MTC mode. The data is processed with the

null function and FIR filter after the decimation filter, as with MTC mode. An FFT calculation is performed on the data. This data is stored in user accessible buffer, in place of the time domain values, and spectral alarms are checked.

An important note is that the execution of the retrieve record with many FFT averages and a low sample rate may take minutes to hours to complete. Because the device turns off SPI interrupts during a recording the user cannot send a stop command. Instead, the device monitors the SPI receive buffer for the escape code, a SPI write of 0x00E8 to the GLOB\_CMD register, during the data capture portion of the recording. Therefore, the user can escape from a recording by writing 0x00E8 to the GLOB\_CMD register. It is recommended to write only 0x00E8 to the device, provide a small delay, and then monitor the busy indicator or poll the status register. Repeatedly send the 0x00E8 code and check the status register until the status register shows the escape flag and busy indicator/data ready flag.

**DATAPATH PROCESSING**

For RTS mode, there is no digital processing of data internal to the ADcmXL3021. Data is buffered internally to 32 sample packets that are burst output over the SPI interface.

For MTC mode, AFFT mode, and MFFT mode, the initial capture and processing procedure is the same, and is as follows:

1. Capture 4096 consecutive time domain samples at 220 kSPS.
2. If AVG\_CNT is enabled, apply the appropriate decimation filter. Continue to collect data until 4096 time sample buffer is filled.
3. Null data, if enabled.
4. Apply the FIR filter, if enabled.

If MTC mode is enabled, the remaining steps are required:

5. Calculate the statistic values enabled.
6. Check the statistics against alarm settings.
7. Write the statistic values to the data buffer.
8. If the RSS option is selected, the RSS of the axes is calculated on a time sample basis and replace the z-axis buffer values.
9. Calculate time domain statistics.
10. Check time domain alarms and set the alarm bit if appropriate.
11. Record statistic data according to the storage option selected.
12. Perform signal completion by setting the BUSY pin.

If AFFT or MFFT mode is enabled, the remaining steps occur after the initial capture and processing:

5. Calculate the FFT based on the AVG\_CNT setting.
6. Record data according to the storage option selected.
7. Check frequency domain alarms, set the alarm bit if appropriate.
8. Signal completion by setting the BUSY pin.

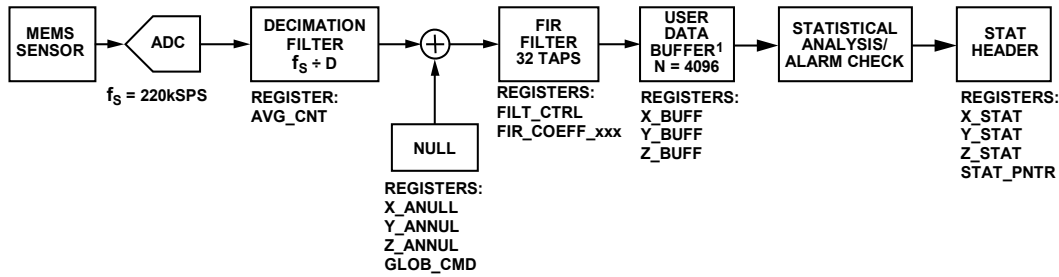

<sup>1</sup>OPTIONAL RSS OR VELOCITY CALCULATIONS APPLIED PRIOR TO USER BUFFER.

Figure 48. MTC Mode Datapath Processing

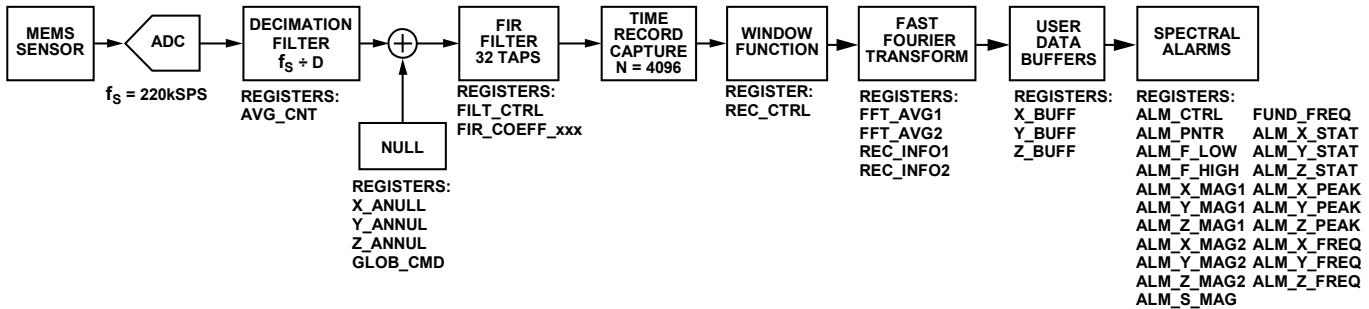

Figure 49. AFFT Mode and MFFT Mode Datapath Processing

After null corrections are applied, the data of each inertial sensor passes through an FIR filter (using the FILT\_CTRL register), decimation filter (using the AVG\_CNT register), and windowing filter (using the REC\_CTRL register), all of which have user configurable attributes.

The FIR filter includes six banks of coefficients with 32 taps each. The FILT\_CTRL register (see Table 83) provides the configuration options for the use of the FIR filters of each inertial sensor. Each FIR filter bank includes a preconfigured filter, but the user can design filters and write over these values using the register of each coefficient. Default filter configuration options are either low-pass or high-pass filters with cutoff frequencies of either 1 kHz, 5 kHz, or 10 kHz. Page 1 through Page 6 define the six sets of FIR filter coefficients. Each page is dedicated to a single filter. For example, Page 1 in the register map provides the details for the 1 kHz low-pass FIR filter. These filters represent typical cutoff frequencies for machine vibration monitoring applications.

**FIR Filter**

Six FIR filters are preprogrammed by default in memory and available for use. The coefficients for these filters are stored in Page 1 to Page 6 and provide selectable filter options for the 1 kHz, 5 kHz, or 10 kHz low-pass filter, and the 1 kHz, 5 kHz, or 10 kHz high-pass filter. Users can write and store custom filter setting by overwriting existing filter coefficients and saving these values to flash memory.

**Decimation**

Averaging options are available within the ADcmXL3021 and reduce the amount of data required to be transferred for a given

bandwidth while also reducing random noise impact on the signal to noise ratio. Decimation is set using the AVG\_CNT register and enabled in REC\_CTRL register. The decimation filter can be used when the module is configured for MTC, MFFT, or AFFT operation, but is not available in RTS mode. Table 87 shows selectable sample rates and resulting FFT bin width options.

MTC mode, AFFT mode, and MFFT mode can be configured to cycle automatically through up to four different AVG\_CNT settings (enabled in the REC\_CTRL register): SR0, SR1, SR2, and SR3.

When more than one sample rate option is enabled (REC\_CTRL register, Bit 8 through Bit 11, see Table 55), the device cycles through each one.

**Windowing**

There are three windowing options that can be applied to the time domain recording before the FFT is computed. The typical window for vibration monitoring is the Hanning window. This window is provided as a default. A Hanning window is optimal because it offers good amplitude resolution of the peaks between frequency bins and minimal broadening of the peak. The rectangular and flat top windows are also available because they are common windowing options for vibration monitoring. The rectangular window is a window of magnitude 1 providing a flat time domain response. The flat top window is advantageous because it can provide very accurate amplitudes with the disadvantage of significant broadening of the peaks. This window is useful when the magnitude accuracy of the peak is important.



## SPECTRAL ALARMS

When using MFFT mode or AFFT mode, six flexible alarms can be configured with settings for individual axes. There are 144 possible alarm configurations considering there are six alarm bands ( $\times 3$  axes  $\times 4$  sample rate options  $\times 2$  magnitude alarm levels).

The ALM\_PNTR register cycles through up to six alarm band configurations per capture. A lower frequency register (ALM\_F\_LOW) and an upper frequency register (ALM\_F\_HIGH) are set to define a bandwidth of interest. ALM\_X\_MAG1 and ALM\_X\_MAG2 define two levels of magnitude within the band set for the x-axis on which to base two triggers. These levels allow two warning levels for a trigger. Setting ALM\_CTRL allows the setting of enabling and disabling individual axes, two warning levels, the number of events required to trigger alarm, and the clearing options for the trigger alerts.

The alarm status is reported in the ALM\_X\_STAT register, the ALM\_Y\_STAT register, and the ALM\_Z\_STAT register. These registers show which alarm and axis caused the last alarm event. If the alarm is serviced immediately, REC\_INFO contains the last capture settings for additional information about the event. Based on the record mode (REC\_CTRL, Bits[2:3]) setting, up to 10 FFT capture records can be stored in memory.

When an alarm is triggered, the values in registers ALM\_X\_PEAK, ALM\_Y\_PEAK, and ALM\_Z\_PEAK represent the peak value. Only the values that triggered the alarm are stored when the measured value for the given conditions exceed the ALM\_X\_MAG1, ALM\_Y\_MAG1, ALM\_Z\_MAG1, ALM\_X\_MAG2, ALM\_Y\_MAG2, and ALM\_Z\_MAG2 threshold settings. The magnitude is in the resolution as configured by the FFT\_AVG setting for the specific capture.

The alarm frequency bin of the peak deviation point is reported in ALM\_X\_FREQ, ALM\_Y\_FREQ, and ALM\_Z\_FREQ. These results are in units of resolution (Hz), configured through the AVG\_CNT setting for the specific capture.

ALM\_X\_MAG1, ALM\_X\_MAG2, ALM\_X\_STAT, ALM\_X\_PEAK, and ALM\_X\_FREQ apply to the x-axis settings, and similar registers are available for the y-axis (ALM\_Y\_MAG1, ALM\_Y\_MAG2, ALM\_Y\_STAT, ALM\_Y\_PEAK, and ALM\_Y\_FREQ) and the z-axis (ALM\_Z\_MAG1, ALM\_Z\_MAG2, ALM\_Z\_STAT, ALM\_Z\_PEAK, and ALM\_Z\_FREQ).

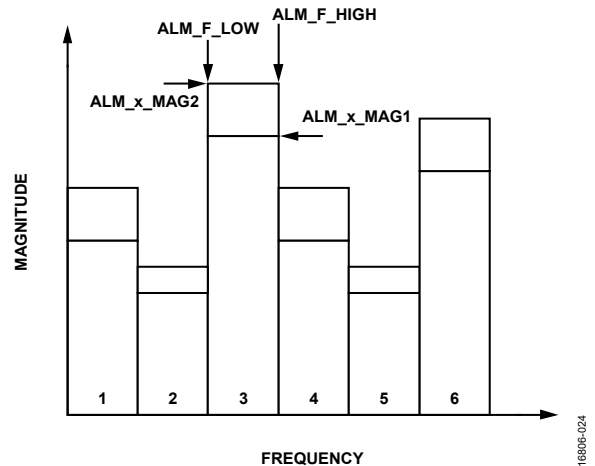

Figure 50. Spectral Alarm Band Registers

## MECHANICAL MOUNTING RECOMMENDATIONS

Mechanical mounting is critical to ensure the best transfer of vibration and avoiding resonances that may affect performance. The ADcmXL3021 module has four mounting holes integrated in the aluminum housing.

The mounting holes accept M2.5 screws to hold the module in place. Stainless steel screws torqued to about 25 inch-pounds are used for many of the characterization curves shown in the data sheet.

In some cases, when permanent mounting is an option, industrial epoxies or adhesives, such as cyanoacrylate adhesive, in addition to the mounting screws can be used to enhance mechanical coupling.

## USER REGISTER MEMORY MAP

Table 20. User Register Memory Map<sup>1</sup>

Register Name	R/W	Flash Backup	PAGE_ID	Address	Default	Register Description
PAGE_ID <sup>2</sup>	R/W	No	0x00	0x00, 0x01	0x0000	Page identifier
TEMP_OUT	R	No	0x00	0x02, 0x03	0x8000 <sup>3</sup>	Internal temperature
SUPPLY_OUT	R	No	0x00	0x04, 0x05	0x8000 <sup>3</sup>	Power supply voltage (VDD)
FFT_AVG1	R/W	Yes	0x00	0x06, 0x07	0x0108	FFT average settings (SR0, SR1)
FFT_AVG2	R/W	Yes	0x00	0x08, 0x09	0x0101	FFT average settings (SR2, SR3)
BUF_PNTR	R/W	No	0x00	0x0A, 0x0B	0x0000	Buffer address pointer
REC_PNTR	R/W	No	0x00	0x0C, 0x0D	0x0000	Data record pointer
X_BUF	R	No	0x00	0x0E, 0x0F	0x8000	Buffer data, x-axis
Y_BUF	R	No	0x00	0x10, 0x11	0x8000	Buffer data, y-axis
Z_BUF/RSS_BUF	R	No	0x00	0x12, 0x13	0x8000	Buffer data, z-axis or root sum square (RSS)
X_ANULL	R/W	Yes	0x00	0x14, 0x15	0x0000	Bias correction value (from auto null), x-axis
Y_ANULL	R/W	Yes	0x00	0x16, 0x17	0x0000	Bias correction value (from auto null), y-axis
Z_ANULL	R/W	Yes	0x00	0x18, 0x19	0x0000	Bias correction value (from auto null), z-axis
REC_CTRL	R/W	Yes	0x00	0x1A, 0x1B	0x1102	Record control register (mode of operation)
RT_CTRL	R/W	Yes	0x00	0x1C, 0x1D	0x0000	Real-time streaming control register
REC_PRD	R/W	Yes	0x00	0x1E, 0x1F	0x0000	Record period setting
ALM_F_LOW	R/W	Yes <sup>4</sup>	0x00	0x20, 0x21	0x0000	Spectral alarm band, low frequency setting
ALM_F_HIGH	R/W	Yes <sup>4</sup>	0x00	0x22, 0x23	0x0000	Spectral alarm band, high frequency setting
ALM_X_MAG1	R/W	Yes <sup>4</sup>	0x00	0x24, 0x25	0x0000	Spectral alarm band, Alarm Magnitude 1, x-axis
ALM_Y_MAG1	R/W	Yes <sup>4</sup>	0x00	0x26, 0x27	0x0000	Spectral alarm band, Alarm Magnitude 1, y-axis
ALM_Z_MAG1/ ALM_RSS1	R/W	Yes <sup>4</sup>	0x00	0x28, 0x29	0x0000	Spectral alarm band, Alarm Magnitude 1, z-axis or RSS Magnitude 1
ALM_X_MAG2	R/W	Yes <sup>4</sup>	0x00	0x2A, 0x2B	0x0000	Spectral alarm band, Alarm Magnitude 2, x-axis
ALM_Y_MAG2	R/W	Yes <sup>4</sup>	0x00	0x2C, 0x2D	0x0000	Spectral alarm band, Alarm Magnitude 2, y-axis
ALM_Z_MAG2/ ALM_RSS2	R/W	Yes <sup>4</sup>	0x00	0x2E, 0x2F	0x0000	Spectral alarm band, Alarm Magnitude 2, z-axis or RSS Magnitude 2
ALM_PNTR	R/W	No	0x00	0x30, 0x31	0x0000	Spectral alarm pointer
ALM_S_MAG	R/W	No	0x00	0x32, 0x33	0x0000	System alarm threshold setting
ALM_CTRL	R/W	Yes	0x00	0x34, 0x35	0x0080	Alarm control settings
Reserved	N/A	N/A	N/A	0x36, 0x37	0x0000	Not used
FILT_CTRL	R/W	Yes	0x00	0x38, 0x39	0x0000	Filter control settings
AVG_CNT	R/W	Yes	0x00	0x3A, 0x3B	0x0000	Sample rate settings (SR0, SR1, SR2, SR3)
DIAG_STAT	R	No	0x00	0x3C, 0x3D	0x0000	Diagnostic/status flags
GLOB_CMD	W	No	0x00	0x3E, 0x3F	0x0000	Global command triggers
ALM_X_STAT	R	Yes <sup>5</sup>	0x00	0x40, 0x41	0x0000	Alarm status register, x-axis
ALM_Y_STAT	R	Yes <sup>5</sup>	0x00	0x42, 0x43	0x0000	Alarm status register, y-axis
ALM_Z_STAT/ ALM_RSS_STAT	R	Yes <sup>5</sup>	0x00	0x44, 0x45	0x0000	Alarm status register, z-axis or RSS instead, if enabled
ALM_X_PEAK	R	Yes <sup>5</sup>	0x00	0x46, 0x47	0x0000	Alarm peak value, x-axis
ALM_Y_PEAK	R	Yes <sup>5</sup>	0x00	0x48, 0x49	0x0000	Alarm peak value, y-axis
ALM_Z_PEAK/ ALM_RSS_PEAK	R	Yes <sup>5</sup>	0x00	0x4A, 0x4B	0x0000	Alarm peak value, z-axis or RSS instead, if enabled
TIME_STAMP_L	R	N/A	0x00	0x4C, 0x4D	0x0000	Time stamp, lower word
TIME_STAMP_H	R	N/A	0x00	0x4E, 0x4F	0x0000	Time stamp, upper word
Reserved	N/A	N/A	0x00	0x50, 0x51	N/A	Reserved
DAY_REV	R	N/A	0x00	0x52, 0x53	N/A	Firmware revision and firmware day code
YEAR_MON	R	N/A	0x00	0x54, 0x55	N/A	Firmware date (month, year)

Register Name	R/W	Flash Backup	PAGE_ID	Address	Default	Register Description
PROD_ID	R	N/A	0x00	0x56, 0x57	0x0BCD	Product identification for ADcmXL3021 models, equals decimal 3021
SERIAL_NUM	R	N/A	0x00	0x58, 0x59	N/A	Serial number, lot-specific , unique per device
USER_SCRATCH	R/W	Yes	0x00	0x5A, 0x5B	N/A	Scratch register for user ID option
REC_FLASH_CNT	R	N/A	0x00	0x5C, 0x5D	N/A	Write counter for data record portion of flash memory
Reserved	N/A	N/A	0x00	0x5E to 0x63	N/A	Reserved
MISC_CTRL	R/W	No	0x00	0x64, 0x65	N/A	Miscellaneous control
REC_INFO1	R	Yes <sup>5</sup>	0x00	0x66, 0x67	0x0000	Record Information 1
REC_INFO2	R	Yes <sup>5</sup>	0x00	0x68, 0x69	0x0000	Record Information 2
REC_CNTR	R	Yes	0x00	0x6A, 0x6B	0x0000	Record counter
ALM_X_FREQ	R	Yes <sup>5</sup>	0x00	0x6C, 0x6D	0x0000	Frequency bin of most severe alarm, x-axis
ALM_Y_FREQ	R	Yes <sup>5</sup>	0x00	0x6E, 0x6F	0x0000	Frequency bin of most severe alarm, y-axis
ALM_Z_FREQ	R	Yes <sup>5</sup>	0x00	0x70, 0x71	0x0000	Frequency bin of most severe alarm, z-axis
STAT_PNTR	R/W	N/A	0x00	0x72, 0x73	0x0000	Pointer for time domain statistics
X_STAT	R	Yes <sup>5</sup>	0x00	0x74, 0x75	0x0000	Selected statistical value, x-axis
Y_STAT	R	Yes <sup>5</sup>	0x00	0x76, 0x77	0x0000	Selected statistical value, y-axis
Z_STAT	R	Yes <sup>5</sup>	0x00	0x78, 0x79	0x0000	Selected statistical value, z-axis
FUND_FREQ	R/W	Yes	0x00	0x7A, 0x7B	0x0000	Fundamental frequency setting
FLASH_CNT_L	R	N/A	0x00	0x7C, 0x7D	N/A	Flash access counter, lower 16 bits
FLASH_CNT_U	R	N/A	0x00	0x7E, 0x7F	0x0000	Flash access counter, upper 16 bits
PAGE_ID	R/W	No	0x01	0x00, 0x01	0x0001	Page identifier
FIR_COEF_A00	R/W	Yes	0x01	0x02, 0x03	0x0006	FIR Filter Bank A, Coefficient 0
FIR_COEF_A01	R/W	Yes	0x01	0x04, 0x05	0x0015	FIR Filter Bank A, Coefficient 1
FIR_COEF_A02	R/W	Yes	0x01	0x06, 0x07	0x0035	FIR Filter Bank A, Coefficient 2
FIR_COEF_A03	R/W	Yes	0x01	0x08, 0x09	0x006B	FIR Filter Bank A, Coefficient 3
FIR_COEF_A04	R/W	Yes	0x01	0x0A, 0x0B	0x00C1	FIR Filter Bank A, Coefficient 4
FIR_COEF_A05	R/W	Yes	0x01	0x0C, 0x0D	0x013C	FIR Filter Bank A, Coefficient 5
FIR_COEF_A06	R/W	Yes	0x01	0x0E, 0x0F	0x01E0	FIR Filter Bank A, Coefficient 6
FIR_COEF_A07	R/W	Yes	0x01	0x10, 0x11	0x02AE	FIR Filter Bank A, Coefficient 7
FIR_COEF_A08	R/W	Yes	0x01	0x12, 0x13	0x03A2	FIR Filter Bank A, Coefficient 8
FIR_COEF_A09	R/W	Yes	0x01	0x14, 0x15	0x04B3	FIR Filter Bank A, Coefficient 9
FIR_COEF_A10	R/W	Yes	0x01	0x16, 0x17	0x05D2	FIR Filter Bank A, Coefficient 10
FIR_COEF_A11	R/W	Yes	0x01	0x18, 0x19	0x06EE	FIR Filter Bank A, Coefficient 11
FIR_COEF_A12	R/W	Yes	0x01	0x1A, 0x1B	0x07F2	FIR Filter Bank A, Coefficient 12
FIR_COEF_A13	R/W	Yes	0x01	0x1C, 0x1D	0x08CB	FIR Filter Bank A, Coefficient 13
FIR_COEF_A14	R/W	Yes	0x01	0x1E, 0x1F	0x0967	FIR Filter Bank A, Coefficient 14
FIR_COEF_A15	R/W	Yes	0x01	0x20, 0x21	0x09B9	FIR Filter Bank A, Coefficient 15
FIR_COEF_A16	R/W	Yes	0x01	0x22, 0x23	0x09B9	FIR Filter Bank A, Coefficient 16
FIR_COEF_A17	R/W	Yes	0x01	0x24, 0x25	0x0967	FIR Filter Bank A, Coefficient 17
FIR_COEF_A18	R/W	Yes	0x01	0x26, 0x27	0x08CB	FIR Filter Bank A, Coefficient 18
FIR_COEF_A19	R/W	Yes	0x01	0x28, 0x29	0x07F2	FIR Filter Bank A, Coefficient 19
FIR_COEF_A20	R/W	Yes	0x01	0x2A, 0x2B	0x06EE	FIR Filter Bank A, Coefficient 20
FIR_COEF_A21	R/W	Yes	0x01	0x2C, 0x2D	0x05D2	FIR Filter Bank A, Coefficient 21
FIR_COEF_A22	R/W	Yes	0x01	0x2E, 0x2F	0x04B3	FIR Filter Bank A, Coefficient 22
FIR_COEF_A23	R/W	Yes	0x01	0x30, 0x31	0x03A2	FIR Filter Bank A, Coefficient 23
FIR_COEF_A24	R/W	Yes	0x01	0x32, 0x33	0x02AE	FIR Filter Bank A, Coefficient 24
FIR_COEF_A25	R/W	Yes	0x01	0x34, 0x35	0x01E0	FIR Filter Bank A, Coefficient 25
FIR_COEF_A26	R/W	Yes	0x01	0x36, 0x37	0x013C	FIR Filter Bank A, Coefficient 26
FIR_COEF_A27	R/W	Yes	0x01	0x38, 0x39	0x00C1	FIR Filter Bank A, Coefficient 27
FIR_COEF_A28	R/W	Yes	0x01	0x3A, 0x3B	0x006B	FIR Filter Bank A, Coefficient 28

Register Name	R/W	Flash Backup	PAGE_ID	Address	Default	Register Description
FIR_COEF_A29	R/W	Yes	0x01	0x3C, 0x3D	0x0035	FIR Filter Bank A, Coefficient 29
FIR_COEF_A30	R/W	Yes	0x01	0x3E, 0x3F	0x0015	FIR Filter Bank A, Coefficient 30
FIR_COEF_A31	R/W	Yes	0x01	0x40, 0x41	0x0006	FIR Filter Bank A, Coefficient 31
Reserved	N/A	N/A	0x01	0x42 to 0x7F	N/A	Reserved
PAGE_ID	R/W	No	0x02	0x00, 0x01	0x0002	Page identifier
FIR_COEF_B00	R/W	Yes	0x02	0x02, 0x03	0x0004	FIR Filter Bank B, Coefficient 0
FIR_COEF_B01	R/W	Yes	0x02	0x04, 0x05	0x0001	FIR Filter Bank B, Coefficient 1
FIR_COEF_B02	R/W	Yes	0x02	0x06, 0x07	0xFFEC	FIR Filter Bank B, Coefficient 2
FIR_COEF_B03	R/W	Yes	0x02	0x08, 0x09	0xFFB9	FIR Filter Bank B, Coefficient 3
FIR_COEF_B04	R/W	Yes	0x02	0x0A, 0x0B	0xFF62	FIR Filter Bank B, Coefficient 4
FIR_COEF_B05	R/W	Yes	0x02	0x0C, 0x0D	0xFFE1	FIR Filter Bank B, Coefficient 5
FIR_COEF_B06	R/W	Yes	0x02	0x0E, 0x0F	0xFE8C	FIR Filter Bank B, Coefficient 6
FIR_COEF_B07	R/W	Yes	0x02	0x10, 0x11	0xFE76	FIR Filter Bank B, Coefficient 7
FIR_COEF_B08	R/W	Yes	0x02	0x12, 0x13	0xFEFE	FIR Filter Bank B, Coefficient 8
FIR_COEF_B09	R/W	Yes	0x02	0x14, 0x15	0x006B	FIR Filter Bank B, Coefficient 9
FIR_COEF_B10	R/W	Yes	0x02	0x16, 0x17	0x02E1	FIR Filter Bank B, Coefficient 10
FIR_COEF_B11	R/W	Yes	0x02	0x18, 0x19	0x0645	FIR Filter Bank B, Coefficient 11
FIR_COEF_B12	R/W	Yes	0x02	0x1A, 0x1B	0x0A34	FIR Filter Bank B, Coefficient 12
FIR_COEF_B13	R/W	Yes	0x02	0x1C, 0x1D	0x0E13	FIR Filter Bank B, Coefficient 13
FIR_COEF_B14	R/W	Yes	0x02	0x1E, 0x1F	0x1130	FIR Filter Bank B, Coefficient 14
FIR_COEF_B15	R/W	Yes	0x02	0x20, 0x21	0x12EC	FIR Filter Bank B, Coefficient 15
FIR_COEF_B16	R/W	Yes	0x02	0x22, 0x23	0x12EC	FIR Filter Bank B, Coefficient 16
FIR_COEF_B17	R/W	Yes	0x02	0x24, 0x25	0x1130	FIR Filter Bank B, Coefficient 17
FIR_COEF_B18	R/W	Yes	0x02	0x26, 0x27	0x0E13	FIR Filter Bank B, Coefficient 18
FIR_COEF_B19	R/W	Yes	0x02	0x28, 0x29	0x0A34	FIR Filter Bank B, Coefficient 19
FIR_COEF_B20	R/W	Yes	0x02	0x2A, 0x2B	0x0645	FIR Filter Bank B, Coefficient 20
FIR_COEF_B21	R/W	Yes	0x02	0x2C, 0x2D	0x02E1	FIR Filter Bank B, Coefficient 21
FIR_COEF_B22	R/W	Yes	0x02	0x2E, 0x2F	0x006B	FIR Filter Bank B, Coefficient 22
FIR_COEF_B23	R/W	Yes	0x02	0x30, 0x31	0XFEFE	FIR Filter Bank B, Coefficient 23
FIR_COEF_B24	R/W	Yes	0x02	0x32, 0x33	0xFE76	FIR Filter Bank B, Coefficient 24
FIR_COEF_B25	R/W	Yes	0x02	0x34, 0x35	0XFE8C	FIR Filter Bank B, Coefficient 25
FIR_COEF_B26	R/W	Yes	0x02	0x36, 0x37	0xFFE1	FIR Filter Bank B, Coefficient 26
FIR_COEF_B27	R/W	Yes	0x02	0x38, 0x39	0xFF62	FIR Filter Bank B, Coefficient 27
FIR_COEF_B28	R/W	Yes	0x02	0x3A, 0x3B	0xFFB9	FIR Filter Bank B, Coefficient 28
FIR_COEF_B29	R/W	Yes	0x02	0x3C, 0x3D	0xFFEC	FIR Filter Bank B, Coefficient 29
FIR_COEF_B30	R/W	Yes	0x02	0x3E, 0x3F	0x0001	FIR Filter Bank B, Coefficient 30
FIR_COEF_B31	R/W	Yes	0x02	0x40, 0x41	0x0004	FIR Filter Bank B, Coefficient 31
Reserved	N/A	N/A	0x02	0x42 to 0x7F	N/A	Reserved
PAGE_ID	R/W	No	0x03	0x00, 0x01	0x0003	Page identifier
FIR_COEF_C00	R/W	Yes	0x03	0x02, 0x03	0x0025	FIR Filter Bank C, Coefficient 0
FIR_COEF_C01	R/W	Yes	0x03	0x04, 0x05	0x005A	FIR Filter Bank C, Coefficient 1
FIR_COEF_C02	R/W	Yes	0x03	0x06, 0x07	0x008F	FIR Filter Bank C, Coefficient 2
FIR_COEF_C03	R/W	Yes	0x03	0x08, 0x09	0x009A	FIR Filter Bank C, Coefficient 3
FIR_COEF_C04	R/W	Yes	0x03	0x0A, 0x0B	0x004D	FIR Filter Bank C, Coefficient 4
FIR_COEF_C05	R/W	Yes	0x03	0x0C, 0x0D	0xFF8D	FIR Filter Bank C, Coefficient 5
FIR_COEF_C06	R/W	Yes	0x03	0x0E, 0x0F	0xFE74	FIR Filter Bank C, Coefficient 6
FIR_COEF_C07	R/W	Yes	0x03	0x10, 0x11	0xFD5D	FIR Filter Bank C, Coefficient 7
FIR_COEF_C08	R/W	Yes	0x03	0x12, 0x13	0xFCDD	FIR Filter Bank C, Coefficient 8
FIR_COEF_C09	R/W	Yes	0x03	0x14, 0x15	0xFD97	FIR Filter Bank C, Coefficient 9
FIR_COEF_C10	R/W	Yes	0x03	0x16, 0x17	0x0003	FIR Filter Bank C, Coefficient 10

Register Name	R/W	Flash Backup	PAGE_ID	Address	Default	Register Description
FIR_COEF_C11	R/W	Yes	0x03	0x18, 0x19	0x0430	FIR Filter Bank C, Coefficient 11
FIR_COEF_C12	R/W	Yes	0x03	0x1A, 0x1B	0x09A2	FIR Filter Bank C, Coefficient 12
FIR_COEF_C13	R/W	Yes	0x03	0x1C, 0x1D	0x0F5F	FIR Filter Bank C, Coefficient 13
FIR_COEF_C14	R/W	Yes	0x03	0x1E, 0x1F	0x142C	FIR Filter Bank C, Coefficient 14
FIR_COEF_C15	R/W	Yes	0x03	0x20, 0x21	0x16E8	FIR Filter Bank C, Coefficient 15
FIR_COEF_C16	R/W	Yes	0x03	0x22, 0x23	0x16E8	FIR Filter Bank C, Coefficient 16
FIR_COEF_C17	R/W	Yes	0x03	0x24, 0x25	0x142C	FIR Filter Bank C, Coefficient 17
FIR_COEF_C18	R/W	Yes	0x03	0x26, 0x27	0x0F5F	FIR Filter Bank C, Coefficient 18
FIR_COEF_C19	R/W	Yes	0x03	0x28, 0x29	0x09A2	FIR Filter Bank C, Coefficient 19
FIR_COEF_C20	R/W	Yes	0x03	0x2A, 0x2B	0x0430	FIR Filter Bank C, Coefficient 20
FIR_COEF_C21	R/W	Yes	0x03	0x2C, 0x2D	0x0003	FIR Filter Bank C, Coefficient 21
FIR_COEF_C22	R/W	Yes	0x03	0x2E, 0x2F	0xFD97	FIR Filter Bank C, Coefficient 22
FIR_COEF_C23	R/W	Yes	0x03	0x30, 0x31	0xFCDD	FIR Filter Bank C, Coefficient 23
FIR_COEF_C24	R/W	Yes	0x03	0x32, 0x33	0xFD5D	FIR Filter Bank C, Coefficient 24
FIR_COEF_C25	R/W	Yes	0x03	0x34, 0x35	0xFE74	FIR Filter Bank C, Coefficient 25
FIR_COEF_C26	R/W	Yes	0x03	0x36, 0x37	0xFF8D	FIR Filter Bank C, Coefficient 26
FIR_COEF_C27	R/W	Yes	0x03	0x38, 0x39	0x004D	FIR Filter Bank C, Coefficient 27
FIR_COEF_C28	R/W	Yes	0x03	0x3A, 0x3B	0x009A	FIR Filter Bank C, Coefficient 28
FIR_COEF_C29	R/W	Yes	0x03	0x3C, 0x3D	0x008F	FIR Filter Bank C, Coefficient 29
FIR_COEF_C30	R/W	Yes	0x03	0x3E, 0x3F	0x005A	FIR Filter Bank C, Coefficient 30
FIR_COEF_C31	R/W	Yes	0x03	0x40, 0x41	0x0025	FIR Filter Bank C, Coefficient 31
Reserved	N/A	N/A	0x03	0x42 to 0x7F	N/A	Reserved
PAGE_ID	R/W	No	0x04	0x00, 0x01	0x0004	Page identifier
FIR_COEF_D00	R/W	Yes	0x04	0x02, 0x03	0xFD94	FIR Filter Bank D, Coefficient 0
FIR_COEF_D01	R/W	Yes	0x04	0x04, 0x05	0xFD62	FIR Filter Bank D, Coefficient 1
FIR_COEF_D02	R/W	Yes	0x04	0x06, 0x07	0xFD2A	FIR Filter Bank D, Coefficient 2
FIR_COEF_D03	R/W	Yes	0x04	0x08, 0x09	0xFCE8	FIR Filter Bank D, Coefficient 3
FIR_COEF_D04	R/W	Yes	0x04	0x0A, 0x0B	0xFC9C	FIR Filter Bank D, Coefficient 4
FIR_COEF_D05	R/W	Yes	0x04	0x0C, 0x0D	0xFC43	FIR Filter Bank D, Coefficient 5
FIR_COEF_D06	R/W	Yes	0x04	0x0E, 0x0F	0xFBD7	FIR Filter Bank D, Coefficient 6
FIR_COEF_D07	R/W	Yes	0x04	0x10, 0x11	0xFB52	FIR Filter Bank D, Coefficient 7
FIR_COEF_D08	R/W	Yes	0x04	0x12, 0x13	0xFAAB	FIR Filter Bank D, Coefficient 8
FIR_COEF_D09	R/W	Yes	0x04	0x14, 0x15	0xF9D2	FIR Filter Bank D, Coefficient 9
FIR_COEF_D10	R/W	Yes	0x04	0x16, 0x17	0xF8AB	FIR Filter Bank D, Coefficient 10
FIR_COEF_D11	R/W	Yes	0x04	0x18, 0x19	0xF702	FIR Filter Bank D, Coefficient 11
FIR_COEF_D12	R/W	Yes	0x04	0x1A, 0x1B	0xF468	FIR Filter Bank D, Coefficient 12
FIR_COEF_D13	R/W	Yes	0x04	0x1C, 0x1D	0xEFBC	FIR Filter Bank D, Coefficient 13
FIR_COEF_D14	R/W	Yes	0x04	0x1E, 0x1F	0xE4DC	FIR Filter Bank D, Coefficient 14
FIR_COEF_D15	R/W	Yes	0x04	0x20, 0x21	0xAE85	FIR Filter Bank D, Coefficient 15
FIR_COEF_D16	R/W	Yes	0x04	0x22, 0x23	0x517B	FIR Filter Bank D, Coefficient 16
FIR_COEF_D17	R/W	Yes	0x04	0x24, 0x25	0x1B24	FIR Filter Bank D, Coefficient 17
FIR_COEF_D18	R/W	Yes	0x04	0x26, 0x27	0x1044	FIR Filter Bank D, Coefficient 18
FIR_COEF_D19	R/W	Yes	0x04	0x28, 0x29	0x0B98	FIR Filter Bank D, Coefficient 19
FIR_COEF_D20	R/W	Yes	0x04	0x2A, 0x2B	0x08FE	FIR Filter Bank D, Coefficient 20
FIR_COEF_D21	R/W	Yes	0x04	0x2C, 0x2D	0x0755	FIR Filter Bank D, Coefficient 21
FIR_COEF_D22	R/W	Yes	0x04	0x2E, 0x2F	0x062E	FIR Filter Bank D, Coefficient 22
FIR_COEF_D23	R/W	Yes	0x04	0x30, 0x31	0x0555	FIR Filter Bank D, Coefficient 23
FIR_COEF_D24	R/W	Yes	0x04	0x32, 0x33	0x04AE	FIR Filter Bank D, Coefficient 24
FIR_COEF_D25	R/W	Yes	0x04	0x34, 0x35	0x0429	FIR Filter Bank D, Coefficient 25
FIR_COEF_D26	R/W	Yes	0x04	0x36, 0x37	0x03BD	FIR Filter Bank D, Coefficient 26

Register Name	R/W	Flash Backup	PAGE_ID	Address	Default	Register Description
FIR_COEF_D27	R/W	Yes	0x04	0x38, 0x39	0x0364	FIR Filter Bank D, Coefficient 27
FIR_COEF_D28	R/W	Yes	0x04	0x3A, 0x3B	0x0318	FIR Filter Bank D, Coefficient 28
FIR_COEF_D29	R/W	Yes	0x04	0x3C, 0x3D	0x02D6	FIR Filter Bank D, Coefficient 29
FIR_COEF_D30	R/W	Yes	0x04	0x3E, 0x3F	0x029E	FIR Filter Bank D, Coefficient 30
FIR_COEF_D31	R/W	Yes	0x04	0x40, 0x41	0x026C	FIR Filter Bank D, Coefficient 31
Reserved	N/A	N/A	0x04	0x42 to 0x7F	N/A	Reserved
PAGE_ID	R/W	No	0x05	0x00, 0x01	0x0005	Page identifier
FIR_COEF_E00	R/W	Yes	0x05	0x02, 0x03	0xFF2B	FIR Filter Bank E, Coefficient 0
FIR_COEF_E01	R/W	Yes	0x05	0x04, 0x05	0xFE0	FIR Filter Bank E, Coefficient 1
FIR_COEF_E02	R/W	Yes	0x05	0x06, 0x07	0xFEAA	FIR Filter Bank E, Coefficient 2
FIR_COEF_E03	R/W	Yes	0x05	0x08, 0x09	0xFE59	FIR Filter Bank E, Coefficient 3
FIR_COEF_E04	R/W	Yes	0x05	0x0A, 0x0B	0xFDFB	FIR Filter Bank E, Coefficient 4
FIR_COEF_E05	R/W	Yes	0x05	0x0C, 0x0D	0xFD8C	FIR Filter Bank E, Coefficient 5
FIR_COEF_E06	R/W	Yes	0x05	0x0E, 0x0F	0xFD09	FIR Filter Bank E, Coefficient 6
FIR_COEF_E07	R/W	Yes	0x05	0x10, 0x11	0xFC6B	FIR Filter Bank E, Coefficient 7
FIR_COEF_E08	R/W	Yes	0x05	0x12, 0x13	0xFBA8	FIR Filter Bank E, Coefficient 8
FIR_COEF_E09	R/W	Yes	0x05	0x14, 0x15	0xFAB1	FIR Filter Bank E, Coefficient 9
FIR_COEF_E10	R/W	Yes	0x05	0x16, 0x17	0xF96B	FIR Filter Bank E, Coefficient 10
FIR_COEF_E11	R/W	Yes	0x05	0x18, 0x19	0xF7A1	FIR Filter Bank E, Coefficient 11
FIR_COEF_E12	R/W	Yes	0x05	0x1A, 0x1B	0xF4E5	FIR Filter Bank E, Coefficient 12
FIR_COEF_E13	R/W	Yes	0x05	0x1C, 0x1D	0xF017	FIR Filter Bank E, Coefficient 13
FIR_COEF_E14	R/W	Yes	0x05	0x1E, 0x1F	0xE512	FIR Filter Bank E, Coefficient 14
FIR_COEF_E15	R/W	Yes	0x05	0x20, 0x21	0xAE97	FIR Filter Bank E, Coefficient 15
FIR_COEF_E16	R/W	Yes	0x05	0x22, 0x23	0x5169	FIR Filter Bank E, Coefficient 16
FIR_COEF_E17	R/W	Yes	0x05	0x24, 0x25	0x1AEE	FIR Filter Bank E, Coefficient 17
FIR_COEF_E18	R/W	Yes	0x05	0x26, 0x27	0x0FE9	FIR Filter Bank E, Coefficient 18
FIR_COEF_E19	R/W	Yes	0x05	0x28, 0x29	0x0B1B	FIR Filter Bank E, Coefficient 19
FIR_COEF_E20	R/W	Yes	0x05	0x2A, 0x2B	0x085F	FIR Filter Bank E, Coefficient 20
FIR_COEF_E21	R/W	Yes	0x05	0x2C, 0x2D	0x0695	FIR Filter Bank E, Coefficient 21
FIR_COEF_E22	R/W	Yes	0x05	0x2E, 0x2F	0x054F	FIR Filter Bank E, Coefficient 22
FIR_COEF_E23	R/W	Yes	0x05	0x30, 0x31	0x0458	FIR Filter Bank E, Coefficient 23
FIR_COEF_E24	R/W	Yes	0x05	0x32, 0x33	0x0395	FIR Filter Bank E, Coefficient 24
FIR_COEF_E25	R/W	Yes	0x05	0x34, 0x35	0x02F7	FIR Filter Bank E, Coefficient 25
FIR_COEF_E26	R/W	Yes	0x05	0x36, 0x37	0x0274	FIR Filter Bank E, Coefficient 26
FIR_COEF_E27	R/W	Yes	0x05	0x38, 0x39	0x0205	FIR Filter Bank E, Coefficient 27
FIR_COEF_E28	R/W	Yes	0x05	0x3A, 0x3B	0x01A7	FIR Filter Bank E, Coefficient 28
FIR_COEF_E29	R/W	Yes	0x05	0x3C, 0x3D	0x0156	FIR Filter Bank E, Coefficient 29
FIR_COEF_E30	R/W	Yes	0x05	0x3E, 0x3F	0x0110	FIR Filter Bank E, Coefficient 30
FIR_COEF_E31	R/W	Yes	0x05	0x40, 0x41	0x00D5	FIR Filter Bank E, Coefficient 31
Reserved	N/A	N/A	0x05	0x42 to 0x7F	N/A	Reserved
PAGE_ID	R/W	No	0x06	0x00, 0x01	0x0006	Page identifier
FIR_COEF_F00	R/W	Yes	0x06	0x02, 0x03	0xFFD9	FIR Filter Bank F, Coefficient 0
FIR_COEF_F01	R/W	Yes	0x06	0x04, 0x05	0xFFB9	FIR Filter Bank F, Coefficient 1
FIR_COEF_F02	R/W	Yes	0x06	0x06, 0x07	0xFF8C	FIR Filter Bank F, Coefficient 2
FIR_COEF_F03	R/W	Yes	0x06	0x08, 0x09	0xFF50	FIR Filter Bank F, Coefficient 3
FIR_COEF_F04	R/W	Yes	0x06	0x0A, 0x0B	0xFF02	FIR Filter Bank F, Coefficient 4
FIR_COEF_F05	R/W	Yes	0x06	0x0C, 0x0D	0xFE9E	FIR Filter Bank F, Coefficient 5
FIR_COEF_F06	R/W	Yes	0x06	0x0E, 0x0F	0xFE1F	FIR Filter Bank F, Coefficient 6
FIR_COEF_F07	R/W	Yes	0x06	0x10, 0x11	0xFD7D	FIR Filter Bank F, Coefficient 7
FIR_COEF_F08	R/W	Yes	0x06	0x12, 0x13	0xFCB0	FIR Filter Bank F, Coefficient 8

Register Name	R/W	Flash Backup	PAGE_ID	Address	Default	Register Description
FIR_COEF_F09	R/W	Yes	0x06	0x14, 0x15	0xFBA8	FIR Filter Bank F, Coefficient 9
FIR_COEF_F10	R/W	Yes	0x06	0x16, 0x17	0xFA49	FIR Filter Bank F, Coefficient 10
FIR_COEF_F11	R/W	Yes	0x06	0x18, 0x19	0xF861	FIR Filter Bank F, Coefficient 11
FIR_COEF_F12	R/W	Yes	0x06	0x1A, 0x1B	0xF581	FIR Filter Bank F, Coefficient 12
FIR_COEF_F13	R/W	Yes	0x06	0x1C, 0x1D	0xF089	FIR Filter Bank F, Coefficient 13
FIR_COEF_F14	R/W	Yes	0x06	0x1E, 0x1F	0xE558	FIR Filter Bank F, Coefficient 14
FIR_COEF_F15	R/W	Yes	0x06	0x20, 0x21	0xAEAF	FIR Filter Bank F, Coefficient 15
FIR_COEF_F16	R/W	Yes	0x06	0x22, 0x23	0x5151	FIR Filter Bank F, Coefficient 16
FIR_COEF_F17	R/W	Yes	0x06	0x24, 0x25	0x1AA8	FIR Filter Bank F, Coefficient 17
FIR_COEF_F18	R/W	Yes	0x06	0x26, 0x27	0x0F77	FIR Filter Bank F, Coefficient 18
FIR_COEF_F19	R/W	Yes	0x06	0x28, 0x29	0x0A7F	FIR Filter Bank F, Coefficient 19
FIR_COEF_F20	R/W	Yes	0x06	0x2A, 0x2B	0x079F	FIR Filter Bank F, Coefficient 20
FIR_COEF_F21	R/W	Yes	0x06	0x2C, 0x2D	0x05B7	FIR Filter Bank F, Coefficient 21
FIR_COEF_F22	R/W	Yes	0x06	0x2E, 0x2F	0x0458	FIR Filter Bank F, Coefficient 22
FIR_COEF_F23	R/W	Yes	0x06	0x30, 0x31	0x0350	FIR Filter Bank F, Coefficient 23
FIR_COEF_F24	R/W	Yes	0x06	0x32, 0x33	0x0283	FIR Filter Bank F, Coefficient 24
FIR_COEF_F25	R/W	Yes	0x06	0x34, 0x35	0x01E1	FIR Filter Bank F, Coefficient 25
FIR_COEF_F26	R/W	Yes	0x06	0x36, 0x37	0x0162	FIR Filter Bank F, Coefficient 26
FIR_COEF_F27	R/W	Yes	0x06	0x38, 0x39	0x00FE	FIR Filter Bank F, Coefficient 27
FIR_COEF_F28	R/W	Yes	0x06	0x3A, 0x3B	0x00B0	FIR Filter Bank F, Coefficient 28
FIR_COEF_F29	R/W	Yes	0x06	0x3C, 0x3D	0x0074	FIR Filter Bank F, Coefficient 29
FIR_COEF_F30	R/W	Yes	0x06	0x3E, 0x3F	0x0047	FIR Filter Bank F, Coefficient 30
FIR_COEF_F31	R/W	Yes	0x06	0x40, 0x41	0x0027	FIR Filter Bank F, Coefficient 31
Reserved	N/A	N/A	0x06	0x42 to 0x7F	N/A	Reserved

<sup>1</sup> N/A means not applicable.

<sup>2</sup> The PAGE\_ID register can be written to change the target register location, but does not change values on the defined page in the PAGE\_ID register.

<sup>3</sup> The default value is valid until the first capture event, when the measurement data replaces the default value.

<sup>4</sup> For registers that begin with ALM\_, values can be stored in flash but are not available for readback until ALM\_PNTR is set.

<sup>5</sup> Register values can be retrieved from records stored in flash by using record retrieve commands.

## USER REGISTER DETAILS

### PAGE\_ID (PAGE NUMBER)

The contents in the PAGE\_ID register (see Table 21 and Table 22) contain the current page setting. The ADcmXL3021 has output and control registers split over seven pages, numbered from zero to six. Page 1 to Page 6 are the configurable filter coefficients. Page 0 contains user registers for various configuration options and outputs.

As an example, write 0x8002 to select Page 2 for SPI-based user access. After the register map is pointed to Page 2, any register writes are used to configure the Filter Bank B coefficients. The ADcmXL3021 user register map (see Table 20) provides a functional summary of each page and the page assignments associated with each user accessible register.

**Table 21. PAGE\_ID Register Definition**

Page <sup>1</sup>	Addresses	Default	Access	Flash Backup
0x0000	0x00, 0x01	0x0000	R/W	No

<sup>1</sup> This register is located at Address 0x00 and Address 0x01 of each page.

**Table 22. PAGE\_ID Bit Descriptions**

Bits	Description
[15:0]	Page number, binary numerical format

### TEMP\_OUT (INTERNAL TEMPERATURE)

The TEMP\_OUT register (see Table 23 and Table 24) provides a measurement (uncalibrated) of the temperature inside of the unit at the conclusion of a data capture or analysis event, when the ADcmXL3021 is operating in the MFFT, AFFT, or MTC mode of operation (see Table 55). Table 25 shows several examples of the data format for the TEMP\_OUT register. The TEMP\_OUT value is related to the sensed temperature by the following relationship:

$$TEMP\_OUT = (Temperature - 460^{\circ}C) / (-0.46^{\circ}C/LSB)$$

**Table 23. TEMP\_OUT Register Definition**

Page	Addresses	Default	Access	Flash Backup
0x00	0x02, 0x03	0x8000 <sup>1</sup>	R	No

<sup>1</sup> The default value is valid until the first capture event, when the measurement data replaces the default value.

**Table 24. TEMP\_OUT Bit Definitions**

Bits	Description
[15:0]	Internal temperature data. Offset binary format is twos complement, 1 LSB = - 0.46°C and there is an offset of 460°C, except in RTC mode.

**Table 25. TEMP\_OUT Data Format Examples**

Temperature	Decimal	Hex	Binary
+105°C	772	0x0303	0000 0011 0000 0011
+60°C	870	0x0365	0000 0011 0110 0101
+20°C	957	0x03BC	0000 0011 1011 1100
+0°C	1000	0x03E8	0000 0011 1110 1000
-40°C	1087	0x043F	0000 0100 0011 1111

### SUPPLY\_OUT (POWER SUPPLY VOLTAGE)

The SUPPLY\_OUT register (see Table 26 and Table 27) provides a measurement (uncalibrated) of the voltage between the VDD and GND pins at the start of a data capture event, when the ADcmXL3021 is operating in the MFFT, AFFT, or MTC mode of operation (see Table 55). Table 28 shows several examples of the data format for the SUPPLY\_OUT register.

**Table 26. SUPPLY\_OUT Register Definition**

Page	Addresses	Default	Access	Flash Backup
0x00	0x04, 0x05	0x8000 <sup>1</sup>	R	No

<sup>1</sup> Default value is valid until the first capture event, when the measurement data replaces the default value

**Table 27. SUPPLY\_OUT Bit Descriptions**

Bits	Description
[15:12]	Do not use
[11:0]	Voltage between VDD and GND pins. 0x0000 = 0 V, 1 LSB = 3.22 mV.

**Table 28. Power Supply Data Format Examples**

Supply Level (V)	LSB	Hex	Binary
3.6	1117	0x45D	0100 0101 1101
3.3 + 0.003226	1025	0x401	0100 0000 0001
3.3	1024	0x400	0100 0000 0000
3.3 - 0.003226	1023	0x3FF	0011 1111 1111
3.0	930	0x3A2	0011 1010 0010

### FFT\_AVG1, SPECTRAL AVERAGING

The FFT\_AVG1 register (see Table 29 and Table 30) contains the user-configurable, spectral averaging settings for the SR0 and SR1 sample rate settings (see the AVG\_CNT register in Table 86). These settings determine the number of FFT records that the ADcmXL3021 averages when generating the final FFT result. When using the factory default value for the FFT\_AVG1 register, the FFT result for the sample rate, SR0, contains an average of eight separate FFT records. The FFT result for the SR1 sample rate contains a single FFT record (no spectral averaging).



Increasing the number of FFT averages increases the overall time for a record to be generated. The FFT averaging sequence is as follows: 4096 samples are measured, FFT on 4096 samples, Accumulate FFT result, repeat until the number of FFTs specified in FFT\_AVG1 or FFT\_AVG2 is reached. Then compute the average FFT, average power supply, and average temperature. The power supply and temperature are measured after the 4096 samples are captured each time and accumulated.

**Table 29. FFT\_AVG1 Register Definition**

Addresses	Default	Access	Flash Backup
0x06, 0x07	0x0108	R/W	Yes

**Table 30. FFT\_AVG1 Bit Descriptions**

Bits	Description
[15:8]	Number of records, SR1, 8 bit unsigned format, range: 1 to 255
[7:0]	Number of records, SR0, 8 bit unsigned format, range: 1 to 255

To eliminate averaging on both SR0 and SR1 settings, set FFT\_AVG1 = 0x0101 by using the following codes (in order) for the DIN serial string: 0x8601 and 0x8701. Table 31 shows three more examples of FFT\_AVG1 settings, along with the number of records that each setting corresponds to, that produces each FFT\_AVG1 value.

**Table 31. FFT\_AVG1 Formatting Examples**

FFT_AVG1 Value	Number of FFT Records	
	SR0	SR1
0x040C	12	4
0x0E1A	26	14
0xFF42	66	255

## FFT\_AVG2, SPECTRAL AVERAGING

The FFT\_AVG2 register (see Table 32 and Table 33) contains the user-configurable, spectral averaging settings for the SR2 and SR3 sample rate settings (see the AVG\_CNT register in Table 86). These settings determine the number of FFT records that the ADcmXL3021 averages when generating the final FFT result. When using the factory default value for the FFT\_AVG2 register, the FFT result for the SR2 and SR3 sample rates contains a single FFT record (no spectral averaging).

**Table 32. FFT\_AVG2 Register Definition**

Addresses	Default	Access	Flash Backup
0x08, 0x09	0x0101	R/W	Yes

**Table 33. FFT\_AVG2 Bit Descriptions**

Bits	Description
[15:8]	Number of records, SR3, 8 bit unsigned format, range: 1 to 255
[7:0]	Number of records, SR2, 8 bit unsigned format, range: 1 to 255

To configure the ADcmXL3021 to average two FFT records for both SR2 and SR3 settings, set FFT\_AVG2 = 0x0202 by using the following codes (in order) for the DIN serial string: 0x8802 and 0x8702. Table 34 shows three more examples of FFT\_AVG2 settings, along with the number of records that each setting correspond to, along with the DIN code sequence that produces each FFT\_AVG2 value.

**Table 34. FFT\_AVG2 Formatting Examples**

FFT_AVG2 Value	Number of FFT Records	
	SR2	SR3
0x0407	7	4
0x0D50	80	13
0x2FFA	250	47

## BUF\_PNTR, BUFFER POINTER

The BUF\_PNTR (see Table 35 and Table 36) controls the data sample that loads to the X\_BUF register (see Table 40), the Y\_BUF register (see Table 44), and the Z\_BUF/RSS\_BUF register (see Table 46), from the user data buffers. The BUF\_PNTR register contains 0x0000 at the conclusion of each capture event and increments with each read of the X\_BUF, Y\_BUF, or Z\_BUF/RSS\_BUF register. When BUF\_PNTR contains the maximum value (2047 or 4095, see Table 36), the next increment (caused by a read request of either X\_BUF, Y\_BUF, or Z\_BUF/RSS\_BUF) causes the value in the BUF\_PNTR register to wrap around to 0x0000. The depth of the user data buffer and, therefore, the range of numbers that BUF\_PNTR supports, depends on the mode of operation, according to the setting in the REC\_CTRL register, Bit0 and Bit 1 (see Table 55).

**Table 35. BUF\_PNTR Register Definition**

Addresses	Default	Access	Flash Backup
0x0A, 0x0B	0x0000	R/W	No

**Table 36. BUF\_PNTR Bit Descriptions**

Bits	Description
[15:12]	Set these bits to 0, when writing to this register
[11:0]	Buffer pointer value. Range = 0 to 2047 (in MFFT mode or AFFT mode). Range = 0 to 4095 (in MTC mode)

Writing a number to the BUF\_PNTR register causes that sample number for each user data buffer (x, y, and z) to load to the X\_BUF register, Y\_BUF register, and Z\_BUF/RSS\_BUF register. For example, using the following code sequence on DIN writes 0x031C to the BUF\_PNTR register: 0x8A1C and 0x8B03. This write causes sample pointer to x (796), y (796) and z (796) from each user data buffer to load to X\_BUF, Y\_BUF, and Z\_BUF/RSS\_BUF (see Figure 51).

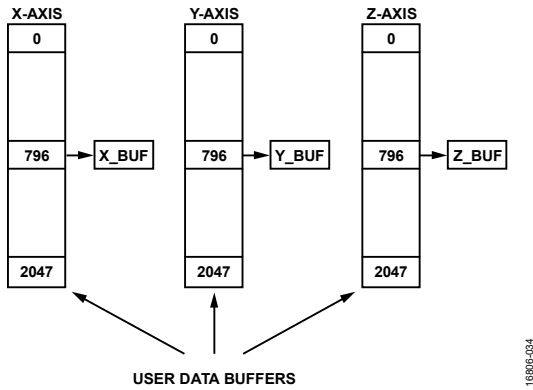

Figure 51. Register Activity, BUF\_PNTR = 0x031C (MFFT Mode or AFFT Mode)

**REC\_PNTR, RECORD POINTER**

The REC\_PNTR register (see Table 37 and Table 38) provides access to the statistical metrics from MTC capture events and spectral records from MFFT or AFFT capture events in the data storage bank. Each spectral analysis record in the data storage bank has a number from 0 to 9 that identifies the number to write to the REC\_PNTR register, Bits[3:0]. This write loads that spectral record to the user data buffers. After the data from the spectral record is in the user data buffers, the BUF\_PNTR register (see Table 36), X\_BUF register (see Table 41), Y\_BUF register (see Table 45), and Z\_RSS\_BUF register (see Table 47) provide access to the data in the specified data record through the SPI. For example, using the following DIN codes to set REC\_PNTR = 0x0007 causes Spectral Record 7 to load to the user data buffers. See Table 39 for additional examples.

Each statistical record in the data storage bank has a number from 0 through 31 that identifies the number to write to the REC\_PNTR register, Bits[12:8]. This write loads that statistical record to the user statistical buffers. After the data from a statistical record is in the user statistical buffers, the STAT\_PNTR register (see Table 135), X\_STAT register (see Table 137), Y\_STAT register (see Table 140), and Z\_STAT register (see Table 142) provides access to this data through the SPI. For example, using the following DIN codes to set REC\_PNTR = 0x0B00 causes Statistical Record 11 to load to the user statistical buffers: 0x8C00 and 0x8D0B. See Table 39 for additional examples.

**Table 37. REC\_PNTR Register Definition**

Addresses	Default	Access	Flash Backup
0x0C, 0x0D	0x0000	R/W	No

**Table 38. REC\_PNTR Bit Descriptions**

Bits	Description
[15:12]	Set these bits to 0 when writing to this register
[12:8]	Record number, statistics (from MTC mode only), range = 0 to 31
[7:4]	Set these bits to 0 when writing to this register
[3:0]	Record number, spectral records, range = 0 to 9 (from MFFT mode and AFFT mode only)

**Table 39. REC\_PNTR Example Use Cases**

DIN Codes	REC_PNTR Value	Description
0x8C05	0x0005	Spectral Record 5 loads to user data buffers.
0x8D0C	0x0C00	Statistical Record 12 loads to the user statistics buffer
0x8C03, 0x8D15	0x1503	Spectral Record 3 loads to user data buffers and Statistical Record 21 loads to the user statistics buffer.

**X\_BUF, BUFFER ACCESS REGISTER, X-AXIS**

The X\_BUF register (see Table 40 and Table 41) provides access to x-axis vibration data. When operating in MTC, MFFT, or AFFT mode, X\_BUF contains the x-axis data sample from the user data buffer, which the BUF\_PNTR register (see Table 36) commands. In RTS mode, data is streamed out from the SPI interface and registers data buffers are not used.

In modes other than RTS when data is stored, after a read of the upper byte and lower byte, the buffer automatically updates with the next data sample in the internal buffer, the BUF\_PNTR is autoincremented. For MTC mode, the buffer can support 4096 time domain samples and BUF\_PNTR can advance from 0 to 4095. For AFFT and MFFT mode, the buffer supports 2048 FFT bin values and BUF\_PNTR can advance from 0 to 2047.

**Table 40. X\_BUF Register Definition**

Addresses	Default <sup>1</sup>	Access	Flash Backup
0x0E, 0x0F	Not applicable	R	No

<sup>1</sup> The default value changes to 0x8000 when entering the first capture event and is only valid until completion of the first capture event or commencement of RTS mode.

**Table 41. X\_BUF Bit Descriptions**

Bits	Description
[15:0]	X-axis data

The numerical format of the data in X\_BUF depends on the mode of operation (see the REC\_CTRL register, Bits[1:0] in Table 55). When operating in MTC mode (REC\_CTRL, Bits[1:0] = 10), the data in the X\_BUF register uses a 16-bit, offset binary format, where 1 LSB represents ~0.001907 g. This format provides enough numerical range to support the measurement range (±50 g) and the maximum bias/offset from the core sensor. Table 42 shows several examples of how to translate these codes to the acceleration magnitude that they represent for MTC mode, assuming nominal sensitivity and zero bias error.

MTC mode data in the X\_BUF register uses a 16-bit, twos complement format, where 1 LSB represents ~0.001907 g. This format provides enough numerical range to support the measurement range (±50 g) and the maximum bias and offset from the core sensor. Table 42 shows several examples of how to translate these codes into the acceleration magnitude that they represent, assuming nominal sensitivity and zero bias error.

If velocity calculations are enabled using Bit 5 in the REC\_CTRL register, calculated velocity data is stored in place of default acceleration value.

**Table 42. MTC Mode Data Format Examples**

Acceleration (g)	LSB	Hex	Binary
+62.4867	+32,767	0x7FFF	0111 1111 1111 1111
+50	+26,219	0x666B	0110 0110 0110 1011
+0.003814	+2	0x0002	0000 0000 0000 0010
+0.001907	+1	0x0001	0000 0000 0000 0001
0	0	0x0000	0000 0000 0000 0000
-0.001907	-1	0xFFFF	1111 1111 1111 1111
-0.003814	-2	0xFFFE	1111 1111 1111 1110
-50	-26,220	0x9995	1001 1001 1001 0101
-62.4886	-32,768	0x8000	1000 0000 0000 0000

When operating in the FFT modes, either MFFT mode (REC\_CTRL1, Bits[1:0] = 00) or AFFT mode (REC\_CTRL, Bits[1:0] = 01), the X\_BUF register uses a 16-bit, unsigned binary format. Due to the increased resolution capability of FFT values because of averaging, converting the X\_BUF value to acceleration is accomplished using the following equation:

$$X \text{ (mg)} = \left( \frac{2^{\frac{X\_BUF}{2048}}}{\text{Number of FFT Averages}} \right) \times 0.9535 \text{ mg}$$

Table 43 shows the conversion from X\_BUF value to acceleration.

**Table 43. Spectral Analysis Data Format Examples**

Acceleration (mg)	X_BUF Value	Number of FFT Averages
62467.43	32767	1
6766.87	26200	1
1.02	200	1
0.95	1	1
64377.71	39000	8
3060.90	30000	8
0.12	8	8
0.95	2048	2
1.91	2048	1

**Y\_BUF, BUFFER ACCESS REGISTER, Y-AXIS**

The Y\_BUF register (see Table 44 and Table 45) provides access to y-axis vibration data. The numerical format of the data in Y\_BUF is the same as the format in the X\_BUF register, which depends on the mode of operation (see the REC\_CTRL register, Bits[1:0], in Table 55).

**Table 44. Y\_BUF Register Definition**

Addresses	Default <sup>1</sup>	Access	Flash Backup
0x10, 0x11	0x0000	R	No

<sup>1</sup> Default value is only valid until completion of the first capture event or commencement of RTS mode.

**Table 45. Y\_BUF Bit Descriptions**

Bits	Description
[15:0]	Y-axis data

**Z\_BUF/RSS\_BUF, BUFFER ACCESS REGISTER, Z-AXIS**

The Z\_BUF register is similar to the X\_BUF and Y\_BUF registers and provides a data storage location for z-axis data values. Optionally, this data can be replaced with an RSS value of all three axes in place of the z-axis data. To enable RSS calculations, set REC\_CTRL, Bit 4 to 1. Otherwise, the Z\_BUF register (see Table 37 and Table 38) provides access to z-axis vibration data.

When Bit 4 in the REC\_CTRL register = 1, the register provides access to vibration data that represents the RSS combination of all three axes. When the RSS value is reported, the number format is the same as the original data.

**Table 46. Z\_RSS\_BUF Register Definition**

Addresses	Default <sup>1</sup>	Access	Flash Backup
0x12, 0x13	0x0000	R	No

<sup>1</sup> Default value is only valid until completion of the first capture event or commencement of RTS mode.

**Table 47. Z\_BUF/RSS\_BUF Bit Descriptions**

Bits	Description
[15:0]	Z-axis data or RSS data for all three axes

The numerical format of the data in Z\_BUF/RSS\_BUF is the same as the format in the X\_BUF register, which depends on the mode of operation (see the REC\_CTRL register, Bits[1:0], in Table 55).

**X\_ANULL, X-AXIS BIAS CALIBRATION REGISTER**

The X\_ANULL register (see Table 48 and Table 49) contains the bias correction value for the x-axis accelerometer, which the auto-null command (see the GLOB\_CMD register, Bit 0, in Table 91) generates. The X\_ANULL register also supports write access, which enables users to write their own correction factors to the x-axis signal chain. The numerical format examples from Table 42 also apply to the X\_ANULL register. For example, writing the following codes to DIN sets X\_ANULL = 0x0064, which adjusts the offset of the x-axis signal chain by 100 LSB ( $\sim 0.1907 g = 1 g \div 524 \text{ LSBs} \times 100 \text{ LSBs}$ ): 0x9464 and 0x9500.

**Table 48. X\_ANULL Register Definition**

Addresses	Default	Access	Flash Backup
0x14, 0x15	0x0000	R/W	Yes

**Table 49. X\_ANULL Bit Descriptions**

Bits	Description
[15:0]	Bias correction factor, x-axis. Twos complement, 1 LSB = 0.001907 g.

The register is set to 0 at power-up, unless backed up in flash memory, which then loads the value saved in the flash memory. When an autonull command is issued, the null value for each axis is calculated from data collected from 4096 samples at the full internal data rate of 220 kSPS. The autonull command takes approximately 16 ms for all three axes, including data capture, calculations, and register setting.

**Y\_ANULL, Y-AXIS BIAS CALIBRATION REGISTER**

The Y\_ANULL register (see Table 50 and Table 51) contains the bias correction value for the y-axis accelerometer, which the auto-null command (see the GLOB\_CMD register, Bit 0, in Table 91) generates. The Y\_ANULL register also supports write access, which enables users to write their own correction factors to the y-axis signal chain. The numerical format examples from Table 42 also apply to the Y\_ANULL register. For example, writing the following codes to DIN sets Y\_ANULL = 0xFF9C, which adjusts the offset of the y-axis signal chain by  $-100 \text{ LSB}$  ( $\sim 0.1907 g = 1 g \div 524 \text{ LSBs} \times 100 \text{ LSBs}$ ): 0x969C and 0x97FF.

**Table 50. Y\_ANULL Register Definition**

Addresses	Default	Access	Flash Backup
0x16, 0x17	0x0000	R/W	Yes

**Table 51. Y\_ANULL Bit Descriptions**

Bits	Description
[15:0]	Bias correction factor, y-axis. Twos complement, 1 LSB = 0.001908 g.

**Z\_ANULL, Z-AXIS BIAS CALIBRATION REGISTER**

The Z\_ANULL register (see Table 52 and Table 53) contains the bias correction value for the z-axis accelerometer, which the auto-null command (see the GLOB\_CMD register, Bit 0, in Table 91) generates. The Z\_ANULL register also supports write access, which enables users to write their own correction factors to the z-axis signal chain. The numerical format examples from Table 42 also apply to the Z\_ANULL register. For example, writing the following codes to DIN sets Z\_ANULL = 0xFDDE, which adjusts the offset of the z-axis signal chain by  $-546 \text{ LSB}$  ( $\sim 1.042 g = 1 g \div 524 \text{ LSBs} \times 546 \text{ LSBs}$ ): 0x98DE and 0x99FD.

**Table 52. Z\_ANULL Register Definition**

Addresses	Default	Access	Flash Backup
0x18, 0x19	0x0000	R/W	Yes

**Table 53. Z\_ANULL Bit Descriptions**

Bits	Description
[15:0]	Bias correction factor, z-axis. Twos complement, 1 LSB = 0.001907 g.

**REC\_CTRL, RECORDING CONTROL**

The REC\_CTRL register (see Table 54 and Table 55) contains the configuration bits for a number of operational settings in the ADcmXL3021: mode of operation, record storage, power management, sample rates, and windowing.

**Table 54. REC\_CTRL Register Definitions**

Addresses	Default	Access	Flash Backup
0x1A, 0x1B	0x1102	R/W	Yes

**Table 55. REC\_CTRL Bit Descriptions**

Bits	Description
15	Real-time streaming timeout enable.
14	Not used.
[13:12]	Window setting (MFFT mode and AFFT modes only). 00 = rectangular. 01 = Hanning (default). 10 = flat top. 11 = not applicable.
11	SR3, Sample rate option 3 enable = 1, disable = 0. Sample rate = $220 \text{ kSPS} \div 2^{\text{AVG\_CNT}[15:12]}$ (see Table 86).
10	SR2, Sample rate option 2 enable = 1, disable = 0. Sample rate = $220 \text{ kSPS} \div 2^{\text{AVG\_CNT}[11:8]}$ (see Table 86).
9	SR1, Sample rate option 1 enable = 1, disable = 0. Sample rate = $220 \text{ kSPS} \div 2^{\text{AVG\_CNT}[7:4]}$ (see Table 86).
8	SR0, Sample rate option 0 enable = 1, disable = 0. Sample rate = $220 \text{ kSPS} \div 2^{\text{AVG\_CNT}[3:0]}$ (see Table 86).

Bits	Description
7	Automatic power-down between recordings (MFFT, AFFT, and MTC mode only). Requires a CS toggle to wake up. 0 = no power-down. 1 = power-down after data collection/processing.
6	Enable compute statistics in MTC mode.
5	Enable velocity calculations. 0 = acceleration. 1 = calculated velocity.
4	Calculate root sum square (MFFT, AFFT, and MTC modes only). The z-axis portion of the user data buffers contains a root sum square combination of all axes. 0 = disabled. The z-axis portion of the user data buffers contains only z-axis data. 1 = enabled.
[3:2]	Flash memory record storage method (MFFT, AFFT, MTC modes only). 00 = none. No record storage to flash memory, current data is available in SRAM until the next recording event is stored. 01 = alarm triggered. Record storage occurs when the vibration exceeds one of the configurable alarm settings. 10 = all. Record storage happens at the conclusion of each data collection and processing event. 11 = reserved.
[1:0]	Recording mode. 00 = MFFT mode. 01 = AFFT mode. 10 = MTC mode. 11 = RTS mode.

### Real-Time Burst Mode Timeout Enabled

Bit 15 in the REC\_CTRL register (see Table 55) contains the settings that independently disable RTS mode if the available data is not read. By default, RTS mode is enabled and disabled via the digital pin, RTS. If this bit is enabled, RTS mode is halted after failure to receive SCLK for more than 30 ms.

### Windowing

Bits[13:12] in the REC\_CTRL register (see Table 55) contain the settings for the window function that the ADcmXL3021 uses on the time domain data, prior to performing the FFT. The factory default setting for these bits (01) selects the Hanning window function. The other window options available are rectangular (setting 0b00), or flat top (setting 0b10).

### Spectral Record Selection

Bits[11:8] in the REC\_CTRL register (see Table 55) contain on and off settings for the four different sample rate options that are set using the AVG\_CNT register.

The sample rate selector bits (SR0, SR1, SR2, and SR3) are used when operating in MFFT, AFFT, or MTC mode. When only one of these bits is set to 1, every data capture event uses that sample rate setting. When two of the bits are set to 1, the ADcmXL3021 uses one of the sample rates for one data capture event, then switches to the other for the next capture event. When all four bits are set to 1, the ADcmXL3021 uses the sample rates in the following order, switching to a new sample rate for each new capture event: SR0, SR1, SR2, SR3, SR0, SR1, and so on.

### Automatic Power-Down

Bit 7 in the REC\_CTRL register (see Table 55) contains the setting for the automated power-down function when the ADcmXL3021 is operating in MFFT, AFFT, or MTC mode. When this bit is set to one, the ADcmXL3021 automatically powers down after completing data collection and processing. When this bit is set to zero, the ADcmXL3021 does not power down after completing data collection and processing functions. After the device is in sleep mode, a CS toggle is required to wake up before the next measurement can be used. If the device is powered down between records in AFFT mode, wake up occurs on its own before the next capture.

### Calculate MTC Statistics

Bit 6 in the REC\_CTRL register (see Table 55) contains the setting to enable statistic calculation on MTC records.

### Calculate Velocity

Bit 5 in the REC\_CTRL register (see Table 55) contains the setting to convert accelerometer data values to velocity values. When this bit is set to zero, the user data buffers contain linear acceleration data. When this bit is set to one, the user data buffers contain linear velocity data, which comes from integrating the acceleration data, with respect to time.

### Root Sum Square (RSS) Combination

Bit 4 in the REC\_CTRL register (see Table 55) contains the setting for the RSS function. When this bit is set to zero, the ADcmXL3021 processes data for each axis independently. When this bit is set to one, the ADcmXL3021 processes data as an RSS combination of all axes.

### Record Storage

Bits[3:2] in the REC\_CTRL register (see Table 55) contain the settings that determine when the ADcmXL3021 stores the result of an FFT capture event to a record location. The MISC\_CTRL register is used for storing time domain statistics.

### Recording Mode

Bits[1:0] in the REC\_CTRL register (see Table 55) establish the mode of operation. When operating in MTC mode, the ADcmXL3021 uses the signal flow diagram and user-accessible registers shown in Figure 35. When operating in AFFT and MFFT mode, the ADcmXL3021 uses the signal flow diagram and user-accessible registers shown in Figure 37.

**RT\_CTRL, REAL TIME STREAMING CONTROL**

The RT\_CTRL register (see Table 56 and Table 57) contains the configuration bits for the optional decimation setting for RTS mode. RT\_CTRL is also used to control sample rate options. The decimation or sample rate options are in effect only if Bit 7 is enabled.

**Table 56. RT\_CTRL Register Definitions**

Addresses	Default	Access	Flash Backup
0x1C, 0x1D	0x0000	R/W	Yes

**Table 57. RT\_CTRL Bit Descriptions**

Bits	Description
[15:8]	Not used.
7	Sample rate change enabled.
[6:4]	N: sets the decimation setting. The number of averages used for decimation can be calculated by $2^N$ .
3	Not used.
[2:0]	Sample rates include the following: 000 = 20 kSPS. 001 = 40 kSPS. 010 = 60 kSPS. 011 = 80 kSPS. 100 = 100 kSPS. 101 = 120 kSPS. 110 = 140 kSPS. 111 = 160 kSPS.

**REC\_PRD, RECORD PERIOD**

The REC\_PRD register (see Table 58 and Table 59) contains the settings for the timer function that the ADcmXL3021 uses when operating in AFFT mode.

**Table 58. REC\_PRD Register Definition**

Addresses	Default	Access	Flash Backup
0x1E, 0x1F	0x0000	R/W	Yes

**Table 59. REC\_PRD Bit Descriptions**

Bits	Description
[15:10]	Don't care
[9:8]	Scale for data bits: 00 = 1 second/LSB, 01 = 1 minute/LSB, 10 = 1 hour/LSB
[7:0]	Data bits, binary format; range = 0 to 255

Setting REC\_PRD is 0x0005, establishes a 5 sec setting for the time that elapses between the completion of one capture event and the beginning of the next capture event. Table 60 shows several more examples of configuration codes for the REC\_PRD register.

**Table 60. REC\_PRD Example Use Cases**

REC_PRD Value	Timer Value
0x0022	34 sec
0x010F	15 minutes
0x0218	24 hours

**ALM\_F\_LOW, ALARM FREQUENCY BAND**

Up to six individual spectral alarm bands can be specified with two magnitude alarm levels. The ALM\_PNTR register setting identifies which alarm is currently addressed and being configured. Spectral alarms apply when the ADcmXL3021 is operating in MFFT or AFFT mode and when the ALM\_F\_LOW register (see Table 61 and Table 62) contains the number of the lowest FFT bin, which is included in the spectral alarm setting that the ALM\_PNTR register (see Table 78) contains.

The value of ALR\_F\_LOW applies to the FFT spectral record. The exact frequency depends on AVG\_CNT register because this register setting reduces the full FFT bandwidth.

**Table 61. ALM\_F\_LOW Register Definition**

Addresses	Default	Access	Flash Backup
0x20, 0x21	0x0000	R/W	Yes

**Table 62. ALM\_F\_LOW Bit Descriptions**

Bits	Description
[15:12]	Don't care
[11:0]	Lower frequency, bin number; range = 0 to 2047

For example, when setting ALR\_F\_LOW = 0x0064, the lower frequency of the alarm band starts at bin 100. For example, if AVG\_CNT = 8, the lower frequency is set to 600 Hz ( $600 \text{ Hz} = (100 \text{ LSB} \times 220 \text{ kHz}/8)/4096$ ).

If AVG\_CNT = 2, the lower frequency is 2400 Hz if ALR\_F\_LOW = 0x0064.

**ALM\_F\_HIGH, ALARM FREQUENCY BAND**

When the ADcmXL3021 is operating in MFFT or AFFT mode, the ALM\_F\_HIGH register (see Table 63 and Table 64) contains the number of the highest FFT bin included in the spectral alarm setting. The ALM\_PNTR register (see Table 78) contains the information regarding which of the six alarms is being set.

**Table 63. ALM\_F\_HIGH Register Definition**

Addresses	Default	Access	Flash Backup
0x22, 0x23	0x0000	R/W	Yes

**Table 64. ALM\_F\_HIGH Bit Descriptions**

Bits	Description
[15:12]	Don't care
[11:0]	Upper frequency, bin number; range = 0 to 2047

The value of ALR\_F\_LOW applies to the FFT spectral record. The exact frequency depends on the AVG\_CNT register because this setting reduces the full FFT bandwidth.

For example, when setting ALR\_F\_LOW = 0x0064, the lower frequency of the alarm band starts at Bin 200. For example, if AVG\_CNT = 8, the lower frequency is set to 1200 Hz (1200 Hz = (200 LSB × 220 kHz/8)/4096).

If AVG\_CNT = 2, the lower frequency is 4800 Hz if ALR\_F\_LOW = 0x0064.

### ALM\_X\_MAG1, ALARM LEVEL 1 X-AXIS

The ALM\_X\_MAG1 register sets a magnitude limit for the x-axis in which to trigger an alarm warning. A second, higher trigger magnitude can be set in the ALM\_X\_MAG2 register and can be used to distinguish between a warning condition vs. a more critical condition. When the ADcmXL3021 is operating in MFFT or AFFT mode, the ALM\_X\_MAG1 register (see Table 65 and Table 66) contains the magnitude of the vibration on the x-axis, which triggers Alarm 1 for the spectral alarm setting contained in the ALM\_PNTR register (see Table 78). In this mode, the FFT band that is compared to the trigger magnitude limit is between ALM\_L\_LOW and ALM\_F\_HIGH.

When in MTC mode, this limit applies to the statistics of the time domain capture.

ALM\_X\_MAG1 can be used as a warning indicator and ALM\_X\_MAG2 as a critical alarm indicator. Set ALM\_X\_MAG2 to a greater or equal value as ALM\_X\_MAG1.

**Table 65. ALM\_X\_MAG1 Register Definition**

Addresses	Default	Access	Flash Backup
0x24, 0x25	0x0000	R/W	Yes

**Table 66. ALM\_X\_MAG1 Bit Descriptions**

Bits	Description
[15:0]	X-Axis Alarm Trigger Level 1

The data format in the ALM\_X\_MAG1 register is the same as the data format in the X\_BUF register. See Table 43 for several examples of this data format.

### ALM\_Y\_MAG1, ALARM LEVEL 1 Y-AXIS

The setting for the ALM\_Y\_MAG1 register is similar to the ALM\_X\_MAG1 setting, except that the ALM\_Y\_MAG1 limit applies to the y-axis. When the ADcmXL3021 operates in the MFFT or the AFFT mode, the ALM\_Y\_MAG12 (see Table 67 and Table 68) register contains the magnitude of the vibration on the y-axis, which triggers Alarm 1 for the spectral alarm setting that the ALM\_PNTR register (see Table 78) contains.

**Table 67. ALM\_Y\_MAG1 Register Definition**

Addresses	Default	Access	Flash Backup
0x26, 0x27	0x0000	R/W	Yes

**Table 68. ALM\_Y\_MAG1 Bit Descriptions**

Bits	Description
[15:0]	Y-axis Alarm Trigger Level 1

The data format in the ALM\_Y\_MAG1 register is the same as the data format in the Y\_BUF register.

### ALM\_Z\_MAG1, ALARM LEVEL 1 Z-AXIS

When the ADcmXL3021 is operating in MFFT or AFFT mode, the ALM\_Z\_MAG1 register (see Table 69 and Table 70) contains the magnitude of the vibration on the z-axis, which triggers Alarm 1 for the spectral alarm setting that the ALM\_PNTR register (see Table 78) contains.

When in MTC mode, this limit applies to the statistics of the time domain capture for the z-axis or the RSS value if RSS is enabled in the REC\_CTRL register.

**Table 69. ALM\_Z\_MAG1 Register Definition**

Addresses	Default	Access	Flash Backup
0x28, 0x29	0x0000	R/W	Yes

**Table 70. ALM\_Z\_MAG1 Bit Descriptions**

Bits	Description
[15:0]	Z-Axis Alarm Trigger Level 1

The data format in the ALM\_Z\_MAG1 register is the same as the data format in the X\_BUF register.

### ALM\_X\_MAG2, ALARM LEVEL 2 X-AXIS

When the ADcmXL3021 is operating in MFFT or AFFT mode, the ALM\_X\_MAG2 register (see Table 71 and Table 72) contains the magnitude of the vibration on the x-axis, which triggers Alarm 2 for the spectral alarm setting that the ALM\_PNTR register (see Table 78) contains. When in MTC mode, this limit applies to the statistics of the time domain capture.

**Table 71. ALM\_X\_MAG2 Register Definition**

Addresses	Default	Access	Flash Backup
0x2A, 0x2B	0x0000	R/W	Yes

**Table 72. ALM\_X\_MAG2 Bit Descriptions**

Bits	Description
[15:0]	X-Axis Alarm Trigger Level 2

The data format in the ALM\_X\_MAG2 register is the same as the data format in the X\_BUF register. See Table 43 for several examples of this data format.

The Alarm 2 magnitudes must be greater than or equal to Alarm 1.

**ALM\_Y\_MAG2, ALARM LEVEL 2 Y-AXIS**

When the ADcmXL3021 is operating in MFFT or AFFT mode, the ALM\_Y\_MAG2 register (see Table 73 and Table 74) contains the magnitude of the vibration on the y-axis, which triggers Alarm 2 for the spectral alarm setting that the ALM\_PNTR register (see Table 78) contains.

**Table 73. ALM\_Y\_MAG2 Register Definition**

Addresses	Default	Access	Flash Backup
0x2C, 0x2D	0x0000	R/W	Yes

**Table 74. ALM\_Y\_MAG2 Bit Descriptions**

Bits	Description
[15:0]	Y-Axis Alarm Trigger Level 2

The data format in the ALM\_Y\_MAG2 register is the same as the data format in the Y\_BUF register. See Table 43 for several examples of this data format.

**ALM\_Z\_MAG2, ALARM LEVEL 2 Z-AXIS**

When the ADcmXL3021 is operating in MFFT or AFFT mode, the ALM\_Z\_MAG2 register (see Table 75 and Table 76) contains the magnitude of the vibration on the z-axis, which triggers Alarm 2 for the spectral alarm setting that the ALM\_PNTR register (see Table 78) contains.

**Table 75. ALM\_Z\_MAG2 Register Definition**

Addresses	Default	Access	Flash Backup
0x2E, 0x2F	0x0000	R/W	Yes

**Table 76. ALM\_Z\_MAG2 Bit Descriptions**

Bits	Description
[15:0]	Z-Axis Alarm Trigger Level 2

The data format in the ALM\_Z\_MAG2 register is the same as the data format in the X\_BUF register. See Table 43 for several examples of this data format.

When in MTC mode, this limit applies to the statistics of the time domain capture for the z-axis or the RSS value if RSS is enabled in the REC\_CTRL register.

**ALM\_PNTR, ALARM POINTER**

When the ADcmXL3021 is operating in MFFT or AFFT mode, the ALM\_PNTR register (see Table 77 and Table 78) contains an alarm pointer that identifies a specific spectral alarm by sample rate (in Bits[9:8]) and spectral band number (in Bits[2:0]). Up to six alarms can be configured per sample rate setting.

**Table 77. ALM\_PNTR Register Definition**

Addresses	Default	Access	Flash Backup
0x30, 0x31	0x0000	R/W	No

**Table 78. ALM\_PNTR Bit Descriptions**

Bits	Description
[15:10]	Don't care
[9:8]	Indicates the sample rate setting for which Alarm x is defined 00 = SR0 01 = SR1 02 = SR2 03 = SR3
[7:3]	Don't care
[2:0]	Spectral band number (1, 2, 3, 4, 5, or 6)

Setting ALM\_PNTR = 0x0203 provides access to the settings for the spectral alarm, which is associated with Sample Rate SR2 and Spectral Band 3. The current attributes from this spectral alarm load to the ALM\_F\_LOW, ALM\_F\_HIGH, ALM\_X\_MAG1, ALM\_Y\_MAG1, ALM\_Z\_MAG1, ALM\_X\_MAG2, ALM\_Y\_MAG2, and ALM\_Z\_MAG2 registers. Writing to these registers changes each setting for the spectral alarm, which is associated with Sample Rate SR2 and Spectral Band 3 as well.

**ALM\_S\_MAG ALARM LEVEL**

The ALM\_S\_MAG register (see Table 79 and Table 80) contains the magnitude of the system alarm, which can monitor the temperature or power supply level according to Bits[5:4] in the ALM\_CTRL register (see Table 82).

**Table 79. ALM\_S\_MAG Register Definition**

Addresses	Default	Access	Flash Backup
0x32, 0x33	0x0000	R/W	No

**Table 80. ALM\_S\_MAG Bit Descriptions**

Bits	Description
[15:0]	System alarm setting

When Bit 4 in the ALM\_CTRL register is equal to zero, the ALM\_S\_MAG register uses the same data format as the SUPPLY\_OUT register (see Table 27 and Table 28). When Bit 4 in the ALM\_CTRL register is equal to one, the ALM\_S\_MAG register uses the same data format as the TEMP\_OUT register (see Table 24 and Table 25).

**ALM\_CTRL, ALARM CONTROL**

The ALM\_CTRL register (see Table 81 and Table 82) contains a number of configuration settings for the alarm function.

**Table 81. ALM\_CTRL Register Definition**

Addresses	Default	Access	Flash Backup
0x34, 0x35	0x0080	R/W	Yes



Table 82. ALM\_CTRL Bit Descriptions

Bits	Description
[15:13]	Don't care.
[12]	Disables automatic clearing of spectral alarm status bits upon a read of the status register.
[11:8]	Response delay, range = 0 to 15. Represents the number of spectral records for each spectral alarm before a spectral alarm flag is set high.
7	Latch DIAG_STAT error flags. Requires a clear status command (GLOB_CMD, Bit 4) to reset the flags to 0. 1 = enabled, 0 = disabled.
6	Enable Alarm 1 and Alarm 2 on ALM1 and ALM2, respectively.
5	System alarm polarity. 1 = trigger when less than ALM_S_MAG. 0 = trigger when greater than ALM_S_MAG.
4	System alarm selection. 1 = temperature, 0 = power supply.
3	System alarm: 1 = enabled, 0 = disabled.
2	Z-axis alarm: 1 = enabled, 0 = disabled.
1	Y-axis alarm: 1 = enabled, 0 = disabled.
0	X-axis alarm: 1 = enabled, 0 = disabled.

### FILT\_CTRL, FILTER CONTROL

The FILT\_CTRL register (see Table 83 and Table 84) provides configuration settings for the 32-tap, FIR filters. When the FILT\_CTRL pin contains the factory default value, the ADcmXL3021 does not use any of the FIR filters on any of the axes. Each axis has its own unique selection for one of the FIR filter bank. For example, set DIN = 0xB871, then set DIN = 0xB901 to write 0x0171 to the FILT\_CTRL register. This code (0x0171) selects Filter Bank 1 for the x-axis, Filter Bank 3 for the y-axis, and Filter Bank 5 for the z-axis.

Table 83. FILT\_CTRL Register Definition

Addresses	Default	Access	Flash Backup
0x38, 0x39	0x0000	R/W	Yes

Table 84. FILT\_CTRL Bit Descriptions

Bits	Description
[15:11]	Don't care
[10:8]	Z-axis FIR filter selection. 110: FIR Filter Bank F (high-pass filter, 10 kHz). 101: FIR Filter Bank E (high-pass filter, 5 kHz). 100: FIR Filter Bank D (high-pass filter, 1 kHz). 011: FIR Filter Bank C (low-pass filter, 10 kHz). 010: FIR Filter Bank B (low-pass filter, 5 kHz). 001: FIR Filter Bank A (low-pass filter, 1 kHz). 000: no FIR selection.
7	Reserved

Bits	Description
[6:4]	Y-axis FIR filter selection 110: FIR Filter Bank F (high-pass filter, 10 kHz) 101: FIR Filter Bank E (high-pass filter, 5 kHz) 100: FIR Filter Bank D (high-pass filter, 1 kHz) 011: FIR Filter Bank C (low-pass filter, 10 kHz) 010: FIR Filter Bank B (low-pass filter, 5 kHz) 001: FIR Filter Bank A (low-pass filter, 1 kHz) 000: no FIR selection
3	Reserved
[2:0]	X-axis FIR filter selection 110: FIR Filter Bank F (high-pass filter, 10 kHz) 101: FIR Filter Bank E (high-pass filter, 5 kHz) 100: FIR Filter Bank D (high-pass filter, 1 kHz) 011: FIR Filter Bank C (low-pass filter, 10 kHz) 010: FIR Filter Bank B (low-pass filter, 5 kHz) 001: FIR Filter Bank A (low-pass filter, 1 kHz) 000: no FIR selection

### AVG\_CNT, DECIMATION CONTROL

The AVG\_CNT register (see Table 85 and Table 86) provides four different sample rate settings (SR0, SR1, SR2, and SR3) that users can enable using Bits[11:8] in the REC\_CTRL register (see Table 55). These sample rate settings only apply to MFFT, AFFT, and MTC mode.

Table 85. AVG\_CNT Register Definition

Addresses	Default	Access	Flash Backup
0x3A, 0x3B	0x7421	R/W	Yes

Table 86. AVG\_CNT Bit Descriptions

Bits	Description
[15:12]	SR3 sample rate scale factor (1 to 7), SR3 sample rate = $2200000 \div 2^{AVG\_CNT[15:12]}$
[11:8]	SR2 sample rate scale factor (1 to 7), SR2 sample rate = $2200000 \div 2^{AVG\_CNT[11:8]}$
[7:4]	SR1 sample rate scale factor (1 to 7), SR1 sample rate = $2200000 \div 2^{AVG\_CNT[7:4]}$
[3:0]	SR0 sample rate scale factor (1 to 7), SR0 sample rate = $2200000 \div 2^{AVG\_CNT[3:0]}$

Each nibble in the AVG\_CNT register offers a setting for each sample rate setting: SR0, SR1, SR2, and SR3. The following formula demonstrates one of the sample rates (SR1) derived from the factory default value (0x7421) in the AVG\_CNT register:

$$SR1 = 220,000 \div 2^2 = 55,000 \text{ SPS}$$

To change one of the sample rate values, write the control value to the specific nibble in the AVG\_CNT register. For example, set DIN = 0xBB35 for set the upper byte of the AVG\_CNT register to 0x35, which causes the SR2 sample rate to be 27,500 SPS and the SR3 sample rate to be 6,875 SPS.

In MMFT and AFFT mode, the sample rate settings in the AVG\_CNT register influences the bin widths of each FFT result, which has an impact on the noise in each bin. Table 87 shows a list of SR0 sample rate settings (see the AVG\_CNT register, Bits[3:0]), along with the bin widths and noise predictions that come with those settings. The information in Table 87 also applies to the SR1 (AVG\_CNT register, Bits[7:4]), SR2 (AVG\_CNT register, Bits[11:8]), and SR3 (AVG\_CNT register, Bits[15:12]) settings as well.

**Table 87. SR0 Sample Rate Settings and Bin Widths**

AVG_CNT, Bits[3:0]	Sample Rate (SPS)	Bin Width (Hz)
0	Not applicable	Not applicable
1 (Default)	220000	53.8
2	110000	26.9
3	55000	13.4
4	27500	6.71
5	13750	3.35
6	6875	1.68
7	3438.5	0.839

## DIAG\_STAT, STATUS, AND ERROR FLAGS

The DIAG\_STAT (see Table 88 and Table 89) register contains a number of status flags.

**Table 88. DIAG\_STAT Register Definition**

Addresses	Default	Access	Flash Backup
0x3C, 0x3D	0x0000	R	No

**Table 89. DIAG\_STAT Bit Descriptions**

Bits	Description
15	Not used (don't care).
14	System alarm flag. The temperature or power supply exceeded the user configured alarm.
13	Z-axis, Spectral Alarm 2 flag.
12	Y-axis, Spectral Alarm 2 flag.
11	X-axis, Spectral Alarm 2 flag.
10	Z-axis, Spectral Alarm 1 flag.
9	Y-axis, Spectral Alarm 1 flag.
8	X-axis, Spectral Alarm 1 flag.
7	Data ready/busy indicator (0 = busy, 1 = data ready).
6	Flash test result, checksum flag (0 = no error, 1 = error).
5	Self test diagnostic error flag.
4	Recording escape flag. Indicates use of the SPI driven interruption command, 0x00E8. This flag is reset automatically after the first successful recording.
3	SPI communication failure (SCLKs $\neq$ even multiple of 16).
2	Flash update failure.
1	Power supply > 3.625 V.
0	Power supply < 2.975 V.

## GLOB\_CMD, GLOBAL COMMANDS

The GLOB\_CMD (see Table 90 and Table 91) register contains a number of global commands. To start any of these processes, set the corresponding bit to one. For example, set bit 0 to logic high to execute the autonull function and the bit self clears.

**Table 90. GLOB\_CMD Register Definition**

Addresses	Default	Access	Flash Backup
0x3E, 0x3F	0x0000	W	No

**Table 91. GLOB\_CMD Bit Descriptions**

Bits	Description
15	Clear autonull correction.
14	Retrieve spectral alarm band information from the ALM_PNTR setting.
13	Retrieve record data from flash memory.
12	Save spectral alarm band registers to flash memory.
11	Record start or stop.
10	Set BUF_PNTR = 0x0000.
9	Clear spectral alarm band registers from flash memory.
8	Clear all records.
7	Software reset.
6	Save registers to flash memory.
5	Flash test, compare sum of flash memory with factory value.
4	Clear DIAG_STAT register once.
3	Restore factory register settings and clear the capture buffers.
2	Self test. Executes the automatic self test method. If test does not pass, then the self test diagnostic flag is set in the status register (Bit 5).
1	Power-down (wake with $\overline{CS}$ toggle). Powers down sensor and puts embedded microcontroller in sleep mode. The device wakes up with a toggle of $\overline{CS}$ or if the automatic timer triggers a new capture (automatic mode).
0	Autonull.

## ALM\_X\_STAT, ALARM STATUS X-AXIS

The ALM\_X\_STAT (see Table 92 and Table 93) register contains status flags for each x-axis alarm.

**Table 92. ALM\_X\_STAT Register Definition**

Addresses	Default	Access	Flash Backup
0x40, 0x41	0x0000	R	Yes

**Table 93. ALM\_X\_STAT Bit Descriptions**

Bits	Description
15	Alarm 2 on Band 6; 1 = alarm set, 0 = no alarm
14	Alarm 1 on Band 6; 1 = alarm set, 0 = no alarm
13	Alarm 2 on Band 5; 1 = alarm set, 0 = no alarm
12	Alarm 1 on Band 5; 1 = alarm set, 0 = no alarm
11	Alarm 2 on Band 4; 1 = alarm set, 0 = no alarm
10	Alarm 1 on Band 4; 1 = alarm set, 0 = no alarm
9	Alarm 2 on Band 3; 1 = alarm set, 0 = no alarm

Bits	Description
8	Alarm 1 on Band 3; 1 = alarm set, 0 = no alarm
7	Alarm 2 on Band 2; 1 = alarm set, 0 = no alarm
6	Alarm 1 on Band 2; 1 = alarm set, 0 = no alarm
5	Alarm 2 on Band 1; 1 = alarm set, 0 = no alarm
4	Alarm 1 on Band 1; 1 = alarm set, 0 = no alarm
3	Not used
[2:0]	Alarm band containing the largest alarm delta from the most critical alarm; range = 1 to 6

### ALM\_Y\_STAT, ALARM STATUS Y-AXIS

The ALM\_Y\_STAT (see Table 94 and Table 95) register contains status flags for each y-axis alarm.

Table 94. ALM\_Y\_STAT Register Definition

Addresses	Default	Access	Flash Backup
0x42, 0x43	0x0000	R	Yes

Table 95. ALM\_Y\_STAT Bit Descriptions

Bits	Description
15	Alarm 2 on Band 6; 1 = alarm set, 0 = no alarm
14	Alarm 1 on Band 6; 1 = alarm set, 0 = no alarm
13	Alarm 2 on Band 5; 1 = alarm set, 0 = no alarm
12	Alarm 1 on Band 5; 1 = alarm set, 0 = no alarm
11	Alarm 2 on Band 4; 1 = alarm set, 0 = no alarm
10	Alarm 1 on Band 4; 1 = alarm set, 0 = no alarm
9	Alarm 2 on Band 3; 1 = alarm set, 0 = no alarm
8	Alarm 1 on Band 3; 1 = alarm set, 0 = no alarm
7	Alarm 2 on Band 2; 1 = alarm set, 0 = no alarm
6	Alarm 1 on Band 2; 1 = alarm set, 0 = no alarm
5	Alarm 2 on Band 1; 1 = alarm set, 0 = no alarm
4	Alarm 1 on Band 1; 1 = alarm set, 0 = no alarm
3	Not used
[2:0]	Most critical alarm condition, spectral band; range = 1 to 6

### ALM\_Z\_STAT, ALARM STATUS Z-AXIS

The ALM\_Z\_STAT (see Table 96 and Table 97) register contains status flags for each z-axis alarm.

Table 96. ALM\_Z\_STAT Register Definition

Addresses	Default	Access	Flash Backup
0x44, 0x45	0x0000	R	Yes

Table 97. ALM\_Z\_STAT Bit Descriptions

Bits	Description
15	Alarm 2 on Band 6; 1 = alarm set, 0 = no alarm
14	Alarm 1 on Band 6; 1 = alarm set, 0 = no alarm
13	Alarm 2 on Band 5; 1 = alarm set, 0 = no alarm
12	Alarm 1 on Band 5; 1 = alarm set, 0 = no alarm
11	Alarm 2 on Band 4; 1 = alarm set, 0 = no alarm
10	Alarm 1 on Band 4; 1 = alarm set, 0 = no alarm

Bits	Description
9	Alarm 2 on Band 3; 1 = alarm set, 0 = no alarm
8	Alarm 1 on Band 3; 1 = alarm set, 0 = no alarm
7	Alarm 2 on Band 2; 1 = alarm set, 0 = no alarm
6	Alarm 1 on Band 2; 1 = alarm set, 0 = no alarm
5	Alarm 2 on Band 1; 1 = alarm set, 0 = no alarm
4	Alarm 1 on Band 1; 1 = alarm set, 0 = no alarm
3	Not used
[2:0]	Most critical alarm condition, spectral band; range = 1 to 6

### ALM\_X\_PEAK, ALARM PEAK LEVEL X-AXIS

The ALM\_X\_PEAK (see Table 98 and Table 99) register contains the magnitude of the FFT bin, which contains the peak alarm value, for the x-axis.

Table 98. ALM\_X\_PEAK Register Definition

Addresses	Default	Access	Flash Backup
0x46, 0x47	0x0000	R	Yes

Table 99. ALM\_X\_PEAK Bit Descriptions

Bits	Description
[15:0]	Alarm peak, x-axis, accelerometer data format

### ALM\_Y\_PEAK, ALARM PEAK LEVEL Y-AXIS

The ALM\_Y\_PEAK (see Table 100 and Table 101) register contains the magnitude of the FFT bin, which contains the peak alarm value, for the y-axis.

Table 100. ALM\_Y\_PEAK Register Definition

Addresses	Default	Access	Flash Backup
0x48, 0x49	0x0000	R	Yes

Table 101. ALM\_Y\_PEAK Bit Descriptions

Bits	Description
[15:0]	Alarm peak, y-axis, accelerometer data format

### ALM\_Z\_PEAK, ALARM PEAK LEVEL Z-AXIS

The ALM\_Z\_PEAK (see Table 102 and Table 103) register contains the magnitude of the FFT bin, which contains the peak alarm value, for the z-axis.

Table 102. ALM\_Z\_PEAK Register Definition

Addresses	Default	Access	Flash Backup
0x4A, 0x4B	0x0000	R	Yes

Table 103. ALM\_Z\_PEAK Bit Descriptions

Bits	Description
[15:0]	Alarm peak, z-axis, accelerometer data format

## TIME\_STAMP\_L AND TIME\_STAMP\_H, DATA RECORD TIMESTAMP

The TIME\_STAMP\_L (see Table 104 and Table 105) and TIME\_STAMP\_H (see Table 106 and Table 107) registers contain a relative timestamp for the most recent data capture event.

**Table 104. TIME\_STAMP\_L Register Definition**

Addresses	Default	Access	Flash Backup
0x4C, 0x4D	0x0000	R	Not applicable

**Table 105. TIME\_STAMP\_L Bit Descriptions**

Bits	Description
[15:0]	Timestamp, seconds, lower word

**Table 106. TIME\_STAMP\_H Register Definition**

Addresses	Default	Access	Flash Backup
0x4E, 0x4F	0x0000	R	Not applicable

**Table 107. TIME\_STAMP\_H Bit Descriptions**

Bits	Description
[15:0]	Timestamp, seconds, upper word

## DAY\_REV, DAY AND REVISION

The DAY\_REV (see Table 108 and Table 109) contains part of the factory programming date (day) and the revision of the firmware.

**Table 108. DAY\_REV Register Definition**

Addresses	Default	Access	Flash Backup
0x52, 0x53	Not applicable	R	Not applicable

**Table 109. DAY\_REV Bit Descriptions**

Bits	Description
[15:12]	Day of the month, most significant digit
[11:8]	Day of the month, least significant digit
[7:4]	Firmware revision, most significant digit
[3:0]	Firmware revision, least significant digit

## YEAR\_MON, YEAR AND MONTH

The YEAR\_MON (see Table 110 and Table 111) contains the factory programming date (month and year).

**Table 110. YEAR\_MON Register Definition**

Addresses	Default	Access	Flash Backup
0x54, 0x55	Not applicable	R	Not applicable

**Table 111. YEAR\_MON Bit Descriptions**

Bits	Description
[15:12]	Year, most significant digit
[11:8]	Year, least significant digit
[7:4]	Month of the year, most significant digit
[3:0]	Month of the year, least significant digit

## PROD\_ID, PRODUCT IDENTIFICATION

The PROD\_ID (see Table 112 and Table 113) register contains the numerical portion of the model number.

**Table 112. PROD\_ID Register Definition**

Addresses	Default	Access	Flash Backup
0x56, 0x57	0x0BCD	R	Not applicable

**Table 113. PROD\_ID Bit Descriptions**

Bits	Description
[15:0]	Binary representation of the numerical portion of the model number: 0x0BCD = 3,021

## SERIAL\_NUM, SERIAL NUMBER

The SERIAL\_NUM (see Table 114 and Table 115) contains the serial number of the unit, within a particular manufacturing lot.

**Table 114. SERIAL\_NUM Register Definition**

Addresses	Default	Access	Flash Backup
0x58, 0x59	Not applicable	R	Not applicable

**Table 115. SERIAL\_NUM Bit Descriptions**

Bits	Description
[15:0]	Lot specific serial number

## USER\_SCRATCH

The USER\_SCRATCH register allows end users to store a device number to identify the sensor. The register is readable and writable. The last written value is nonvolatile, which allows data recovery upon reset.

**Table 116. USER\_SCRATCH Register Definition**

Addresses	Default	Access	Flash Backup
0x5A, 0x5B	Not applicable	R/W	Yes

**Table 117. USER\_SCRATCH Bit Descriptions**

Bits	Description
[15:0]	Optional user ID

## REC\_FLASH\_CNT, RECORD FLASH ENDURANCE

The REC\_FLASH\_CNT (see Table 118 and Table 119) provides a tool for tracking the endurance of the flash memory bank, which support the 10 record storage locations. The value in the REC\_FLASH\_CNT register increments after clearing the user record (GLOB\_CMD) and each time the record storage fills up (tenth location contains event data)

**Table 118. REC\_FLASH\_CNT Register Definition**

Addresses	Default	Access	Flash Backup
0x5C, 0x5D	Not applicable	R	Not applicable

**Table 119. REC\_FLASH\_CNT Bit Descriptions**

Bits	Description
[15:0]	Endurance counter for the record flash memory

**MISC\_CTRL, MISCELLANEOUS CONTROL**

The MISC\_CTRL register (see Table 120 and Table 121) enables the saving of MTC mode statistic values to memory, enable sensor self-test, and enable SYNC pin to external control.

**Table 120. MISC\_CTRL Register Definition**

Addresses	Default	Access	Flash Backup
0x64, 0x65	0x0000	R/W	No

**Table 121. MISC\_CTRL Bit Descriptions**

Bits	Description
[15:13]	Unused.
12	Enable sensitivity to SYNC pin to start a capture. Must be enabled for external trigger for manual capture modes.
11	Unused.
10	Transfers statistics record from flash memory to SRAM. REC_PNTR must point to the appropriate time domain statistic record.
9	Transfer statistics from SRAM to flash record.
8	Clear time domain statistics.
[7:4]	Unused.
3	Set self test on.
2	Clear self test.
[1:0]	Unused.

**REC\_INFO1, RECORD INFORMATION**

The REC\_INFO1 register (see Table 122 and Table 123) contains the sample rate (SRx), window function and FFT average settings associated with the spectral record in the user data buffer. The contents of this register are only relevant for results that come from MFFT and AFFT mode (see the REC\_CTRL register in Table 55).

**Table 122. REC\_INFO1 Register Definition**

Addresses	Default	Access	Flash Backup
0x66, 0x67	0x0000	R	Yes

**Table 123. REC\_INFO1 Bit Descriptions**

Bits	Description
[15:14]	Sample rate option. 00 = SR0. 01 = SR1. 10 = SR2. 11 = SR3.
[13:12]	Window setting. 00 = rectangular. 01 = Hanning. 10 = flat top. 11 = not applicable.
[11:8]	Not used (don't care).
[7:0]	FFT averages; range = 1 to 2047.

**RECORD INFORMATION, REC\_INFO2**

The REC\_INFO2 (see Table 124 and Table 125) register contains the contents of the AVG\_CNT register, which relate to the sample rate (SRx) in use for the spectral record in the user data buffer. The contents of this register are only relevant for results that come from MFFT and AFFT mode (see the REC\_CTRL register in Table 55).

**Table 124. REC\_INFO2 Register Definition**

Addresses	Default	Access	Flash Backup
0x68, 0x69	0x0000	R	Yes

**Table 125. REC\_INFO2 Bit Descriptions**

Bits	Description
[15:4]	Not used (don't care)
[3:0]	AVG_CNT setting

**REC\_CNTR, RECORD COUNTER**

The REC\_CNTR (see Table 126 and Table 127) register contains the record counter, which contains the number of records currently in use.

**Table 126. REC\_CNTR Register Definition**

Addresses	Default	Access	Flash Backup
0x6A, 0x6B	0x0000	R	Yes

**Table 127. REC\_CNTR Bit Descriptions**

Bits	Description
[15:4]	Not used
[3:0]	Record counter range: 0 through 9

**ALM\_X\_FREQ, SEVERE ALARM FREQUENCY**

The ALM\_X\_FREQ register (see Table 126 and Table 127) contains the frequency bin associated with the value in the ALM\_X\_PEAK (see Table 99) register.

**Table 128. ALM\_X\_FREQ Register Definition**

Addresses	Default	Access	Flash Backup
0x6C, 0x6D	0x0000	R	Yes

**Table 129. ALM\_X\_FREQ Bit Descriptions**

Bits	Description
[15:12]	Not used
[11:0]	Alarm frequency for x-axis peak alarm level, FFT bin number; range = 0 to 2047

**ALM\_Y\_FREQ, SEVERE ALARM FREQUENCY**

The ALM\_Y\_FREQ register (see Table 130 and Table 131) contains the frequency bin that is associated with the value in the ALM\_Y\_PEAK (see Table 101) register.

**Table 130. ALM\_Y\_FREQ Register Definition**

Addresses	Default	Access	Flash Backup
0x6E, 0x6F	0x0000	R	Yes

Table 131. ALM\_Y\_FREQ Bit Descriptions

Bits	Description
[15:12]	Not used
[11:0]	Alarm frequency for y-axis peak alarm level, FFT bin number; range = 0 to 2047

**ALM\_Z\_FREQ, SEVERE ALARM FREQUENCY**

The ALM\_Z\_FREQ register (see Table 132 and Table 132) contains the frequency bin that is associated with the value in the ALM\_X\_PEAK (see Table 103) register.

Table 132. ALM\_Z\_FREQ Register Definition

Addresses	Default	Access	Flash Backup
0x70, 0x71	0x0000	R	Yes

Table 133. ALM\_Z\_FREQ Bit Descriptions

Bits	Description
[15:12]	Not used
[11:0]	Alarm frequency for z-axis peak alarm level, FFT bin number; range = 0 to 2047

**STAT\_PNTR, STATISTIC RESULT POINTER**

The STAT\_PNTR register (see Table 134 and Table 135) controls which statistic loads to the X\_STAT register (see Table 137), Y\_STAT register (see Table 140), and Z\_STAT register (see Table 142). For example, set DIN = 0xF202 to write 0x02 to the lower byte of the STAT\_PNTR, which causes the Kurtosis results to load to X\_STAT, Y\_STAT, and Z\_STAT.

Table 134. STAT\_PNTR Register Definition

Addresses	Default	Access	Flash Backup
0x72, 0x73	0x0000	R/W	Not applicable

Table 135. STAT\_PNTR Bit Descriptions

Bits	Description
[15:3]	Don't care
[2:0]	110 = skewness 101 = Kurtosis 100 = crest factor 011 = peak-to-peak 010 = peak 001 = standard deviation 000 = mean value

**X\_STAT, STATISTIC RESULT X-AXIS**

The X\_STAT register (see Table 136 and Table 137) contains the x-axis statistical metric that represents the settings in the STAT\_PNTR register (see Table 135). The data format for this register depends on the metric that it contains. When the lower byte of the STAT\_PNTR register is equal to 0x00, 0x01, 0x02 or 0x03, the data format is the same as the X\_BUF register (MTC mode). See Table 41 and Table 42 for a definition and some examples of this data format. When the lower byte of the STAT\_PNTR register is equal to 0x01, 0x02, or 0x03, the X\_STAT register uses the binary coded decimal (BCD) format shown in Table 137. Table 138 shows numerical examples of this format.

Table 136. X\_STAT Register Definition

Addresses	Default	Access	Flash Backup
0x74, 0x75	0x0000	R	Yes

Table 137. X\_STAT Bit Descriptions for Crest Factor, Kurtosis and Skewness results

Bits	Description
[15:8]	Integer, offset binary format, 1 LSB = 1
[7:0]	Decimal, 1 LSB = 1/256 = 0.00390625

Table 138. Statistic Data Format Examples for Crest Factor, Kurtosis and Skewness results

Hex.	Integer	Decimal	Result
0x0000	0	0	0
0x0001	0	1/256 = 0.00390625	0.00390625
0x0002	0	2/256 = 0.0078125	0.0078125
0x000A	0	10/256 = 0.0390625	0.0390625
0x00FE	0	254/256 = 0.9921875	0.9921875
0x00FF	0	255/256 = 0.99609375	0.99609375
0x0100	1	0	1
0x016A	1	106/256 = 0.4140625	1.4140625
0x020A	2	10/256 = 0.0390625	2.0390625
0x069A	6	154/256 = 0.6015625	6.6015625
0x1AF2	26	242/256 = 0.9453125	26.9453125
0xFFFF	255	255/256 = 0.99609375	255.99609375

**Y\_STAT, STATISTIC RESULT Y-AXIS**

The Y\_STAT register (see Table 139 and Table 140) contains the y-axis statistical metric that represents the settings in the STAT\_PNTR register (see Table 135). The data format for this register depends on the metric that it contains. When the lower byte of the STAT\_PNTR register is equal to 0x00, 0x04, 0x05, or 0x06, the data format is the same as the Y\_BUF register (MTC mode). See Table 45 and Table 42 for a definition and some examples of this data format. When the lower byte of the STAT\_PNTR register is equal to 0x01, 0x02, or 0x03, the Y\_STAT register uses the binary coded decimal (BCD) format shown in Table 140. Table 138 provides some numerical examples of this format.

**Table 139. Y\_STAT Register Definition**

Addresses	Default	Access	Flash Backup
0x74, 0x75	0x0000	R	Yes

**Table 140. Y\_STAT Bit Descriptions for Crest Factor, Kurtosis and Skewness Results**

Bits	Description
[15:8]	Integer, offset binary format, 1 LSB = 1
[7:0]	Decimal, 1 LSB = 1/256 = 0.00390625

**Z\_STAT, STATISTIC RESULT Z-AXIS**

The Z\_STAT register (see Table 141 and Table 142) contains the z-axis statistical metric that represents the settings in the STAT\_PNTR register (see Table 135). The data format for this register depends on the metric that it contains. When the lower byte of the STAT\_PNTR register is equal to 0x00, 0x04, 0x05, or 0x06, the data format is the same as the Z\_BUF\_RSS register (MTC mode). See Table 47 and Table 42 for a definition and some examples of this data format. When the lower byte of the STAT\_PNTR register is equal to 0x01, 0x02, or 0x03, the Z\_STAT register uses the binary coded decimal (BCD) format shown in Table 140. Table 138 provides some numerical examples of this format.

**Table 141. Z\_STAT Register Definition**

Addresses	Default	Access	Flash Backup
0x78, 0x79	0x0000	R	Yes

**Table 142. Z\_STAT Bit Descriptions for Crest Factor, Kurtosis and Skewness results**

Bits	Description
[15:8]	Integer, offset binary format, 1 LSB = 1
[7:0]	Decimal, 1 LSB = 1/256 = 0.00390625

**FUND\_FREQ, FUNDAMENTAL FREQUENCY**

The FUND\_FREQ register (see Table 143 and Table 144) provides a simple way to configure the spectral alarms to monitor the fundamental vibration frequency on a platform, along with the subsequent harmonic frequencies. Table 145 provides the start and stop frequency settings for each alarm band, which automatically loads after writing to the upper byte of the FUND\_FREQ register, the units are Hz. Default is disabled.

**Table 143. FUND\_FREQ Register Definition**

Addresses	Default	Access	Flash Backup
0x7A, 0x7B	0x0000	R/W	Yes

**Table 144. FUND\_FREQ Bit Descriptions**

Bits	Description
[15:0]	Fundamental frequency setting, $f_f$ . Offset binary format, 1 LSB = 1 Hz. 0x0000 = no influence on alarm settings.

**Table 145. Statistic Data Format Examples**

Alarm Band	Start Frequency	Stop Frequency	Alarm 1 Level	Alarm 2 Level
1	$0.2 \times f_f$	$0.8 \times f_f$	$20\% \times 0.5 g$	$0.5 g$
2	$0.8 \times f_f$	$1.8 \times f_f$	$90\% \times 0.5 g$	$0.5 g$
3	$1.8 \times f_f$	$2.8 \times f_f$	$30\% \times 0.5 g$	$0.5 g$
4	$2.8 \times f_f$	$3.8 \times f_f$	$25\% \times 0.5 g$	$0.5 g$
5	$3.8 \times f_f$	$10.2 \times f_f$	$20\% \times 0.5 g$	$0.5 g$
6	$10.2 \times f_f$	$f_{MAX}$	$15\% \times 0.5 g$	$0.5 g$

**FLASH\_CNT\_L, FLASH MEMORY ENDURANCE**

FLASH\_CNT\_L (see Table 146 and Table 147) contains the lower 16 bits of a 32-bit counter. This counter tracks the total number of update cycles that the flash memory bank experiences.

**Table 146. FLASH\_CNT\_L Register Definition**

Addresses	Default	Access	Flash Backup
0x7C, 0x7D	Not applicable	R	Not applicable

**Table 147. FLASH\_CNT\_L Bit Descriptions**

Bits	Description
[15:0]	Flash update counter, lower word

**FLASH\_CNT\_U, FLASH MEMORY ENDURANCE**

The FLASH\_CNT\_U register (see Table 148 and Table 149) contains the upper 16 bits of a 32-bit counter. This counter tracks the total number of update cycles that the flash memory bank experiences.

**Table 148. FLASH\_CNT\_U Register Definition**

Addresses	Default	Access	Flash Backup
0x7E, 0x7F	0x0000	R	Not applicable

**Table 149. FLASH\_CNT\_U Bit Descriptions**

Bits	Description
[15:0]	Flash update counter, upper word

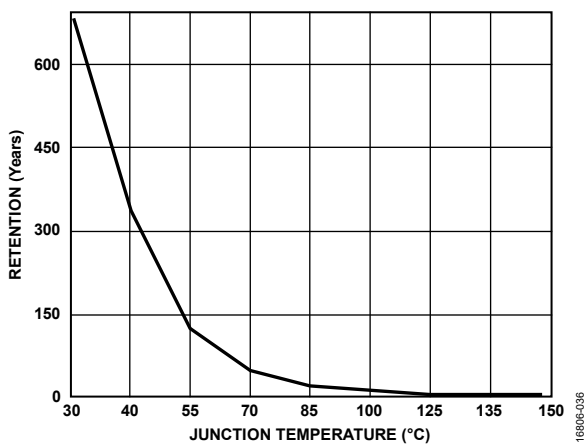

Figure 52. Flash/EE Memory Data Retention

**FIR FILTER REGISTERS**

The ADcmXL3021 signal chain includes a 32-tap, FIR filter. Register Page 1 through Register Page 6 provide user configuration access to the coefficients for six different FIR filter banks. The FILT\_CTRL (see Table 84) register controls the enabling of the FIR filters and allows the selection of the FIR filter banks. Each FIR filter bank features factory default filter designs, and each filter bank provides write access to support application specific filter designs. To access one of the FIR filter banks, write the corresponding page number to the PAGE\_ID register. For example, set DIN = 0x8003 to set PAGE\_ID = 0x0003, which provides access to FIR Filter Bank C. See Table 20 for a complete listing of the FIR coefficient addresses and pages.

By default, the following filters are preconfigured in the respective filter bank registers:

- Filter Band A is a 32 tap, low-pass filter at 1 kHz.
- Filter Band B is a 32 tap, low-pass filter at 5 kHz.
- Filter Band C is a 32 tap, low-pass filter at 10 kHz.
- Filter Band D is a 32 tap, high-pass filter at 1 kHz.
- Filter Band E is a 32 tap, high-pass filter at 5 kHz.
- Filter Band F is a 32 tap, high-pass filter at 10 kHz.

**FIR Filter Design Guidelines**

User defined, 32 tap digital filtering can be programmed and stored. This filter uses 16-bit coefficients. Register Page 1 through Register Page 6 contain filter bank coefficients for Filter A to Filter F, respectively. Each of the 32 coefficients has a 16-bit register. User filters (as well as other register settings) can be stored internally in the ADcmXL3021.

The numerical format for each coefficient is a 16-bit, two's complement signed value.

The 32 taps of the filter must sum to 0 to have unity gain. If values are summed as unsigned binary values, the summed value of 32,767 represents unity gain. By default, the FIR filters are designed to have a linear phase response up to 10 kHz.



## APPLICATIONS INFORMATION

### MECHANICAL INTERFACE

For the best performance, follow the guidelines described in this section when installing the ADcmXL3021 in a system.

Eliminate potential translational forces by aligning the module in a well defined orientation.

Use uniform mounting force on all four corners of the module.

Use all four mounting holes and M2.5 screws at a torque of 5 inch-pounds.

Additional mechanical adhesives (cyanoacrylate adhesive and epoxies such as Dymax 652A gel adhesive) can be used to, in some cases, improve mechanical coupling and frequency response. Application of these additional adhesives are mechanical design and processes dependent. Therefore, the application of these additional adhesives must be evaluated thoroughly during product development.

A minimum bend radius of the flex tail of 1 mm is allowed. At a lower bend radius, delamination or conductor failure may occur. The connector at the end of the flex tail is the DF12(3.0)-14DS-0.5V(86) from Hirose Electric Co. Ltd. The mating connector that must be used is the DF12(3.0)-14DP-0.5V(86) from Hirose Electric Co. Ltd.

OUTLINE DIMENSIONS

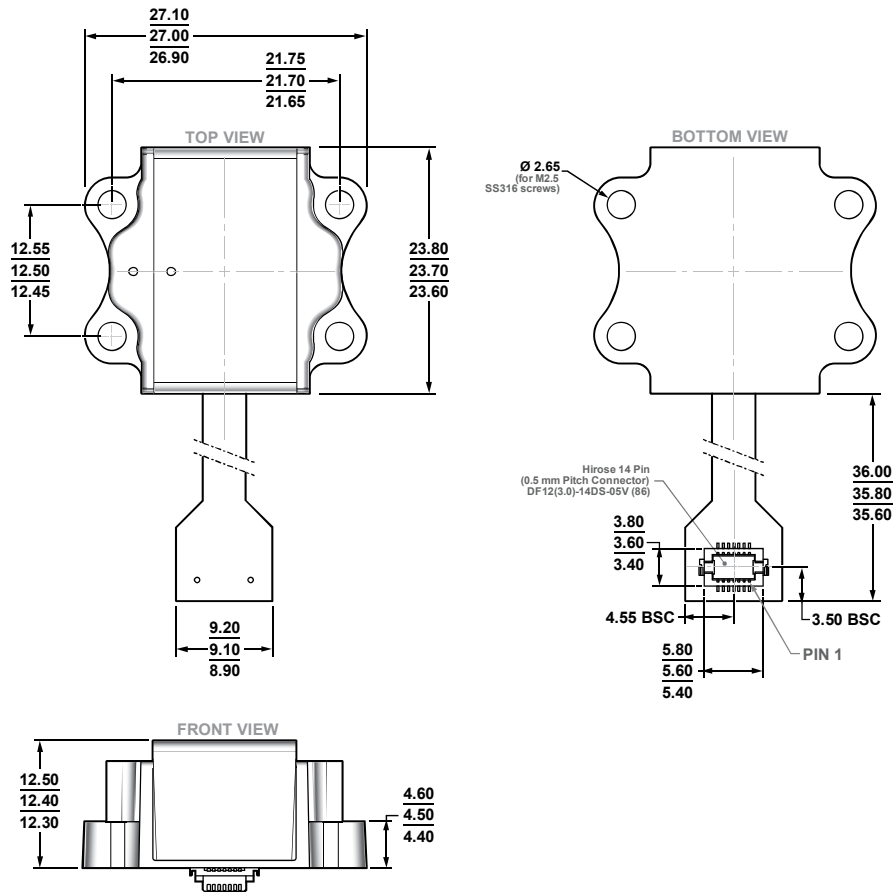

Figure 53. 14-Lead Module with Integrated Flex Connector [MODULE] (ML-14-7)  
Dimensions shown in millimeters

02-14-2019-B

ORDERING GUIDE

Model <sup>1</sup>	Temperature Range	g Range	Package Description	Package Option
ADcmXL3021BMLZ	-40°C to +105°C	±50 g	14-Lead Module with Integrated Flex Connector [MODULE]	ML-14-7
EVAL-ADCM			ADcmXL3021 Evaluation Kit	
ADCMXL_BRKOUT/PCBZ			ADcmXL3021 Breakout Interface Board	

<sup>1</sup> Z = RoHS-Compliant Part.