



Setting up your AT&T Internet



Choose 1 of 2 simple setup options

Option 1: Connecting with AT&T's Smart Home Manager



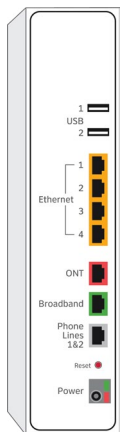

Option 2: Alternative setup method

Troubleshooting and additional information



Before you get started



Wi-Fi Gateway

-  **GREEN** cable
-  **YELLOW** Ethernet cable (optional)
-  **GRAY** cable (AT&T phone service)
-  **BLACK** Power supply (2 parts)

Make sure you've registered for your service.

-  Wait until 2 p.m. on your service activation date (located on your packing slip) to get started
-  Register your account to have an Access ID

Setting up your AT&T Internet

Option 1: Connecting with AT&T's Smart Home Manager

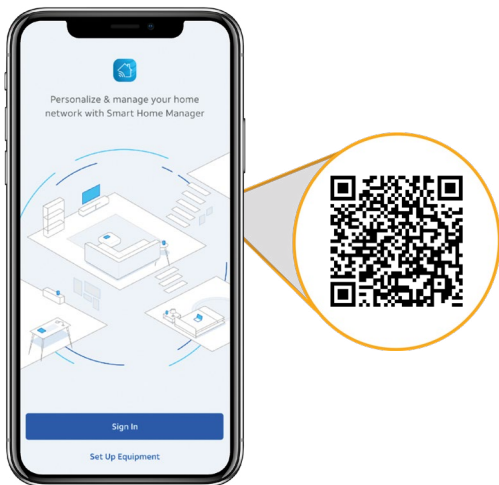

For quick download, open the camera on your smartphone and hold the camera over the QR code. After a few seconds, a notification will give you a link to open in your browser.

1.

Download the Smart Home Manager app from your app store or scan the QR code above with your smartphone.



Note: Wait until 2 p.m. on your service activation date (located on your packing slip) to get started.

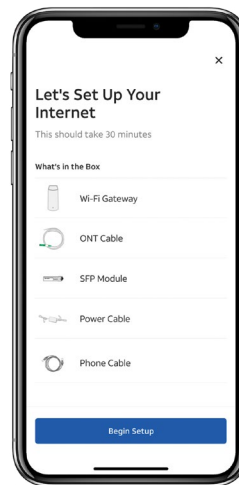

Tip: Control your home Wi-Fi network with the Smart Home Manager app. Do everything from troubleshooting to managing devices from almost anywhere.

2.

Follow the guided prompts to set up your home Wi-Fi. After that, you're ready to go.

Setting up your AT&T Internet

Option 2: Alternative setup method

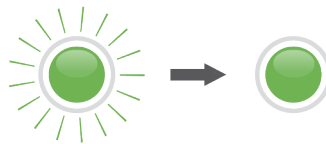
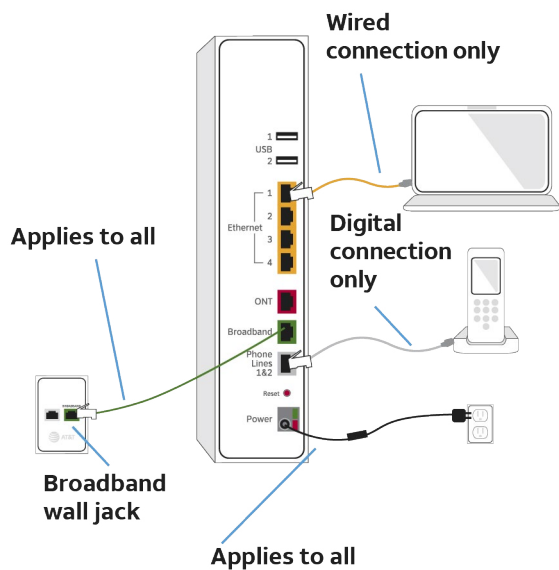

1.

Locate the AT&T broadband wall jack in your home (typically near the floor of the living room or closet).

Connect one end of the **GREEN** data cable to the wall broadband port and plug the other end into the gateway's broadband port.

Use the **BLACK** power supply cable to connect the gateway to a power outlet.



Note: Ensure all wires are connected properly by having them click into place.

2.

Power up and wait 10 minutes for the broadband and Service lights to turn solid green.



Note: If this doesn't happen, see the Troubleshooting section of this guide.

3.

To set up Wi-Fi® on your mobile device or computer, go to: **Settings > Select your Wi-Fi Network Name (SSID) >** enter the **12-character password** from the sticker on your gateway.

If you already registered, you are good to go.



Note: If registration doesn't start automatically, go to att.com/registration

Troubleshooting



Check your connections and the power. You can only install service on your service activation date (noted on your packing slip) after 2 p.m.



Power down, wait 15 seconds, then power back up. Allow up to 2 minutes for the lights to turn solid green.



This is a normal part of the power-up process. Do not unplug any cables during this time.



Check the lights and the GRAY cable. The broadband light and the Service light should be solid green, and the **GRAY** cable should be plugged into the Phone Line port on the gateway.

Need help? Don't sweat it.

If you get stuck during your setup, we're here to help you get up and running!



att.com/support



800.288.2020

Additional information

If your home phone service is provided through our fiber optic network, it needs electrical power to operate. Your gateway does not contain a battery backup so you should make sure you have one to keep you connected in the event of a power outage.

Go to att.com/batterybackup for more information.

Smart Home Manager app

Manage your account 24/7 from your mobile device.

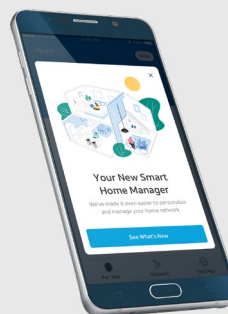

Accessibility support

Alternate format guides

Braille or large print: Call **800.288.2020** and request guide number **ATT170700942-3**. Accessible tagged PDF: Visit att.com/userguides

Telephone equipment for visual/hearing impaired

Phone: **800.772.3140**
TTY: **800.651.5111**
Compatible with any TTY/TDD devices with standard phone line.

¿Hablas español?

Para ver a esta guía en español, visita att.com/guias y haz clic en la pestaña Internet. Desplázate hacia abajo a donde dice "Guías de Reemplazo" y elije **ATT170700942-3**.

AT&T supports IPv6. Visit att.com/ipv6 to learn more.

© 2021 AT&T Intellectual Property. All rights reserved. AT&T and Globe logo are registered trademarks of AT&T Intellectual Property. All other marks are the property of their respective owners.