

User's Guide

Samsung Printer *Xpress*

M202x series

BASIC

This guide provides information concerning installation, basic operation and troubleshooting on windows.

ADVANCED

This guide provides information about the installation, advanced configuration, operation and troubleshooting on various OS environments.

Some features may not be available depending on models or countries.



1. Introduction

| | |
|-------------------------------|----|
| Key benefits | 4 |
| Features by models | 6 |
| Useful to know | 8 |
| About this user's guide | 9 |
| Safety information | 10 |
| Machine overview | 16 |
| Control panel overview | 19 |
| Turning on the machine | 21 |
| Installing the driver locally | 22 |
| Reinstalling the driver | 24 |



2. Learning the Basic Usage

| | |
|----------------|----|
| Media and tray | 26 |
| Basic printing | 35 |



3. Maintenance

| | |
|-----------------------------------|----|
| Ordering supplies and accessories | 39 |
| Available supplies | 40 |

| | |
|--|----|
| Storing the toner cartridge | 41 |
| Redistributing toner | 43 |
| Replacing the toner cartridge | 44 |
| Cleaning the machine | 46 |
| Tips for moving & storing your machine | 50 |



4. Troubleshooting

| | |
|------------------------------|----|
| Tips for avoiding paper jams | 52 |
| Clearing paper jams | 53 |
| Understanding the status LED | 56 |



5. Appendix

| | |
|------------------------|----|
| Specifications | 60 |
| Regulatory information | 69 |
| Copyright | 79 |



1. Introduction

This chapter provides information you need to know before using the machine.

- **Key benefits** 4
- **Features by models** 6
- **Useful to know** 8
- **About this user's guide** 9
- **Safety information** 10
- **Machine overview** 16
- **Control panel overview** 19
- **Turning on the machine** 21
- **Installing the driver locally** 22
- **Reinstalling the driver** 24



Key benefits

Environmentally friendly



- To save toner and paper, this machine supports the Eco feature (see "Easy Eco Driver" on page 148).
- To save paper, you can print multiple pages on a single sheet of paper (see "Using advanced print features" on page 133).
- To save paper, you can print on both sides of the paper (manual double-sided printing) (see "Using advanced print features" on page 133).
- To save electricity, this machine automatically conserves electricity by substantially reducing power consumption when not in use.
- We recommend using recycled paper for saving energy.

Print with excellent quality and speed



- You can print with a resolution of up to 1,200 x 1,200 dpi effective output.
- Fast, on-demand printing.
 - M202x series/M202xW series
 - For single-side printing, 20 ppm (A4) or 21 ppm (Letter).

- SL-M2024 series/SL-M2024W series
 - For single-side printing, 18 ppm (A4) or 19 ppm (Letter).

Convenience



- Simply touch your cell phone on the NFC tag on your printer and get the print job done (see "Using the NFC feature" on page 122).
- Samsung Easy Printer Manager is a program that monitors and informs you of the machine's status and allows you to customize the machine's settings (see "Using Samsung Easy Printer Manager" on page 151).
- Smart Update allows you to check for the latest software and install the latest version during the printer driver installation process. This is available only for Windows OS users.
- If you have Internet access, you can get help, support application, machine drivers, manuals, and order information from the Samsung website, www.samsung.com > find your product > Support or Downloads.

Key benefits

Wide range of functionality and application support



- Supports various paper sizes (see "Print media specifications" on page 62).
- Print watermark: You can customize your documents with words, such as "Confidential" (see "Using advanced print features" on page 133).
- Print posters: The text and pictures of each page of your document are magnified and printed across the multiple sheets of paper and can then be taped together to form a poster (see "Using advanced print features" on page 133).
- You can print in various operating systems (see "System requirements" on page 65).
- Your machine is equipped with a USB interface.

Supports various wireless network setting method



Wireless networking may not be available depending on the model (see "Features by models" on page 6).

- Using the WPS (Wi-Fi Protected Setup™) button
 - You can easily connect to a wireless network using the WPS button on the machine and the access point (a wireless router).
- Using the USB cable
 - You can connect and set various wireless network settings using a USB cable.
- Using the Wi-Fi Direct
 - You can conveniently print from your mobile device using the Wi-Fi or Wi-Fi Direct feature.



See "Introducing wireless set up methods" on page 94.

Features by models

Some features and optional goods may not be available depending on model or country.

Operating System

| Operating System | M202x series | M202xW series |
|------------------|--------------|---------------|
| Windows | • | • |
| Mac | • | • |
| Linux | • | • |
| Unix | | |

Software

| Software | M202x series | M202xW series |
|---------------------------------|--------------|---------------|
| PCL printer driver | | |
| SPL printer driver | • | • |
| PS printer driver | | |
| XPS printer driver ^a | | |
| Samsung Easy Printer Manager | • | • |
| SyncThru™ Web Service | | • |
| SyncThru™ Web Admin Service | | • |

Features by models

| Software | M202x series | M202xW series |
|-------------------------------------|--------------|---------------|
| Samsung Printer Status | ● | ● |
| Easy Eco Driver Anyweb Print | ● | ● |
| Easy Capture Manager | ● | ● |

a. For XPS driver, it is only supported for windows through the Samsung website (www.samsung.com)

Variety feature

| Features | M202x series | M202xW series |
|--|--------------|---------------|
| Hi-Speed USB 2.0 | ● | ● |
| Network Interface Ethernet 10/100 Base TX wired LAN | | |
| Network Interface 802.11b/g/n wireless LAN | | ● |
| NFC printing | | ● |
| IPv6 | | ● |
| Eco printing(Easy Eco Driver)^a | ● | ● |
| Wi-Fi Protected Setup™ (WPS) | | ● |
| Manual duplex (2-sided) printing | ● | ● |
| AirPrint | | ● |
| Google Cloud Print™ | | ● |

a. Setting the ECO settings is available from the windows driver.

(●: Included, Blank: Not available)

Useful to know



Where can I download the machine's driver?

- Visit www.samsung.com to download the latest machine's driver, and install it on your system.



Where can I purchase accessories or supplies?

- Inquire at a Samsung distributor or your retailer.
- Visit www.samsung.com/supplies. Select your country/region to view product service information.



The status LED flashes or remains constantly on.

- Turn the product off and on again.
- Check the meanings of LED indications in this manual and troubleshoot accordingly (see "Understanding the status LED" on page 56).



A paper jam has occurred.

- Open and close the top cover (see "Front view" on page 17).
- Check the instructions on removing jammed paper in this manual and troubleshoot accordingly (see "Clearing paper jams" on page 53).



Printouts are blurry.

- The toner level might be low or uneven. Shake the toner cartridge.
- Try a different print resolution setting.
- Replace the toner cartridge.



The machine does not print.

- Open the print queue list and remove the document from the list (see "Canceling a print job" on page 36).
- Remove the driver and install it again (see "Installing the driver locally" on page 22).
- Select your machine as your default machine in your Windows.

About this user's guide

This user's guide provides information for your basic understanding of the machine as well as detailed steps to explain machine usage.



- Read the safety information before using the machine.
- If you have a problem using the machine, refer to the troubleshooting chapter.
- Terms used in this user's guide are explained in the glossary chapter.
- All illustrations in this user's guide may differ from your machine depending on its options or model you purchased.
- The screenshots in this user's guide may differ from your machine depending on the machine's firmware/driver version.
- The procedures in this user's guide are mainly based on Windows 7.

Conventions

Some terms in this guide are used interchangeably, as below:

- Document is synonymous with original.
- Paper is synonymous with media, or print media.
- Machine refers to printer or MFP.

General icons



| Icon | Text | Description |
|---|----------------|--|
|  | Caution | Gives users information to protect the machine from possible mechanical damage or malfunction. |
|  | Note | Provides additional information or detailed specification of the machine function and feature. |

Safety information

These warnings and precautions are included to prevent injury to you and others, and to prevent any potential damage to your machine. Be sure to read and understand all of these instructions before using the machine. After reading this section, keep it in a safe place for future reference.

Important safety symbols

Explanation of all icons and signs used in this chapter

| | | |
|---|----------------|--|
|  | Warning | Hazards or unsafe practices that may result in severe personal injury or death. |
|  | Caution | Hazards or unsafe practices that may result in minor personal injury or property damage. |
|  | | Do not attempt. |

Operating environment

Warning



Do not use if the power cord is damaged or if the electrical outlet is not grounded.

This could result in electric shock or fire.



Do not place anything on top of the machine (water, small metal or heavy objects, candles, lit cigarettes, etc.).

This could result in electric shock or fire.

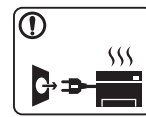

- If the machine gets overheated, it releases smoke, makes strange noises, or generates an odd odor, immediately turn off the power switch and unplug the machine.

- The user should be able to access the power outlet in case of emergencies that might require the user to pull the plug out.

This could result in electric shock or fire.



Do not bend, or place heavy objects on the power cord.

Stepping on or allowing the power cord to be crushed by a heavy object could result in electric shock or fire.







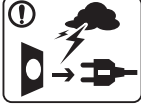

Do not remove the plug by pulling on the cord; do not handle the plug with wet hands.

This could result in electric shock or fire.





Safety information

Caution



| | |
|--|--|
|  | <p>During an electrical storm or for a period of non-operation, remove the power plug from the electrical outlet.</p> <p>This could result in electric shock or fire.</p> |
|  | <p>Be careful, the paper output area is hot.</p> <p>Burns could occur.</p> |
|  | <p>If the machine has been dropped, or if the cabinet appears damaged, unplug the machine from all interface connections and request assistance from qualified service personnel.</p> <p>Otherwise, this could result in electric shock or fire.</p> |
|  | <p>If the machine does not operate properly after these instructions have been followed, unplug the machine from all interface connections and request assistance from qualified service personnel.</p> <p>Otherwise, this could result in electric shock or fire.</p> |
|  | <p>If the plug does not easily enter the electrical outlet, do not attempt to force it in.</p> <p>Call an electrician to change the electrical outlet, or this could result in electric shock.</p> |
|  | <p>Do not allow pets to chew on the AC power, telephone or PC interface cords.</p> <p>This could result in electric shock or fire and/or injury to your pet.</p> |

Operating method

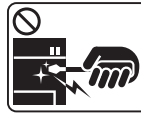
Caution

| | |
|---|--|
|  | <p>Do not forcefully pull the paper out during printing.</p> <p>It can cause damage to the machine.</p> |
|  | <p>Be careful not to put your hand between the machine and paper tray.</p> <p>You may get injured.</p> |
|  | <p>This machine's power reception device is the power cord.</p> <p>To switch off the power supply, remove the power cord from the electrical outlet.</p> |
|  | <p>Be care when replacing paper or removing jammed paper.</p> <p>New paper has sharp edges and can cause painful cuts.</p> |
|  | <p>When printing large quantities, the bottom part of the paper output area may get hot. Do not allow children to touch.</p> <p>Burns can occur.</p> |
|  | <p>When removing jammed paper, do not use tweezers or sharp metal objects.</p> <p>It can damage the machine.</p> |

Safety information

| | |
|--|---|
|  | Do not allow too many papers to stack up in the paper output tray. It can damage the machine. |
|  | Do not block or push objects into the ventilation opening. This could result in elevated component temperatures which can cause damage or fire. |
|  | Use of controls or adjustments or performance of procedures other than those specified herein may result in hazardous radiation exposure. |

Installation / Moving

Warning

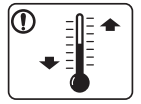
| | |
|--|---|
|  | Do not place the machine in an area with dust, humidity, or water leaks. This could result in electric shock or fire. |
|  | Place the machine in the environment where it meets the operating temperature and humidity specification. Otherwise, quality problems can occur and cause damage to the machine. See "General specifications" on page 60. |

Caution



Before moving the machine, turn the power off and disconnect all cords. The information below are only suggestions based on the units weight. If you have a medical condition that prevents you from lifting, do not lift the machine. Ask for help, and always use the appropriate amount of people to lift the device safely.

Then lift the machine:

- If the machine weighs under 20 kg (44.09 lbs), lift with 1 person.
- If the machine weighs 20 kg (44.09 lbs) - 40kg (88.18 lbs), lift with 2 people.
- If the machine weighs more than 40 kg (88.18 lbs), lift with 4 or more people.

The machine could fall, causing injury or machine damage.

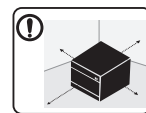

Choose a flat surface with enough space for ventilation to place the machine. Also consider the space required to open the cover and trays.

The place should be well-ventilated and be far from direct light, heat, and humidity.









When using the machine for a long period of time or printing a large number of pages in a non-ventilated space, it could pollute the air and be harmful to your health. Place the machine in a well-ventilated space or open a window to circulate the air periodically.



Do not place the machine on an unstable surface.

The machine could fall, causing injury or machine damage.

Safety information

| | |
|--|---|
|  | Use only No.26 AWG ^a or larger, telephone line cord, if necessary. Otherwise, it can cause damage to the machine. |
|  | Use the power cord supplied with your machine for safe operation. If you are using a cord which is longer than 2 meters (6 feet) with a 110 V machine, then the gauge should be 16 AWG or larger. Otherwise, it can cause damage to the machine, and could result in electric shock or fire. |
|  | Make sure you plug the power cord into a grounded electrical outlet. Otherwise, this could result in electric shock or fire. |
|  | Do not overload wall outlets and extension cords. This can diminish performance, and could result in electric shock or fire. |
|  | Do not put a cover over the machine or place it in an airtight location, such as a closet. If the machine is not well-ventilated, this could result in fire. |
|  | The machine should be connected to the power level which is specified on the label. If you are unsure and want to check the power level you are using, contact the electrical utility company. |

a. AWG: American Wire Gauge

Maintenance / Checking

Caution



Unplug this product from the wall outlet before cleaning the inside of the machine. Do not clean the machine with benzene, paint thinner or alcohol; do not spray water directly into the machine.

This could result in electric shock or fire.



When you are working inside the machine replacing supplies or cleaning the inside, do not operate the machine.

You could get injured.



Keep cleaning supplies away from children.



Children could get hurt.



Do not disassemble, repair or rebuild the machine by yourself.





It can damage the machine. Call a certified technician when the machine needs repairing.

Safety information

| | |
|--|---|
|  | <ul style="list-style-type: none">Do not remove any covers or guards that are fastened with screws.Fuser units should only be repaired by a certified service technician. Repair by non-certified technicians could result in fire or electric shock.The machine should only be repaired by a Samsung service technician. |
|  | <p>To clean and operate the machine, strictly follow the user's guide provided with the machine.</p> <p>Otherwise, you could damage the machine.</p> |
|  | <p>Keep the power cable and the contact surface of the plug clean from dust or water.</p> <p>Otherwise, this could result in electric shock or fire.</p> |

Supply usage

Caution

| | |
|---|--|
|  | <p>Do not disassemble the toner cartridge.</p> <p>Toner dust can be dangerous if inhaled or ingested.</p> |
|  | <p>Do not burn any of the supplies such as toner cartridge or fuser unit.</p> <p>This could cause an explosion or uncontrollable fire.</p> |
|  | <p>When storing supplies such as toner cartridges, keep them away from children.</p> <p>Toner dust can be dangerous if inhaled or ingested.</p> |
|  | <p>When changing the toner cartridge or removing jammed paper, be careful not to let toner dust touch your body or clothes.</p> <p>Toner dust can be dangerous if inhaled or ingested.</p> |
|  | <p>When toner gets on your clothing, do not use hot water to wash it.</p> <p>Hot water sets toner into fabric. Use cold water.</p> |

Safety information



Using recycled supplies, such as toner, can cause damage to the machine.

In case of damage due to the use of recycled supplies, a service fee will be charged.



For supplies that contain toner dust (toner cartridge, waste toner bottle, imaging unit, etc.) follow the instructions below.

- When disposing of the supplies, follow the instructions for disposal. Refer to the reseller for disposal instructions.
- Do not wash the supplies.
- For a waste toner bottle, do not reuse it after emptying the bottle.

If you do not follow the instructions above, it may cause machine malfunction and environmental pollution. The warranty does not cover damages caused by a user's carelessness.

Machine overview

Components

The actual component may differ from the illustration below. Some components may change depending on the circumstances.



Power cord

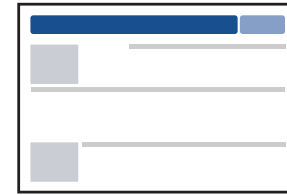

Quick installation guide

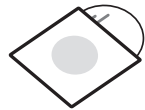

Software CD^a

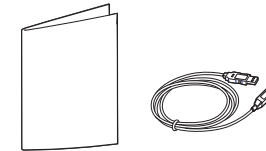

Misc. accessories^b

a. The software CD contains the printer drivers and software applications.

b. Miscellaneous accessories included with your machine may vary by country of purchase and specific model.

Machine overview

Front view



- This illustration may differ from your machine depending on its model.
- Some features and optional goods may not be available depending on model or country (see "Features by models" on page 6).

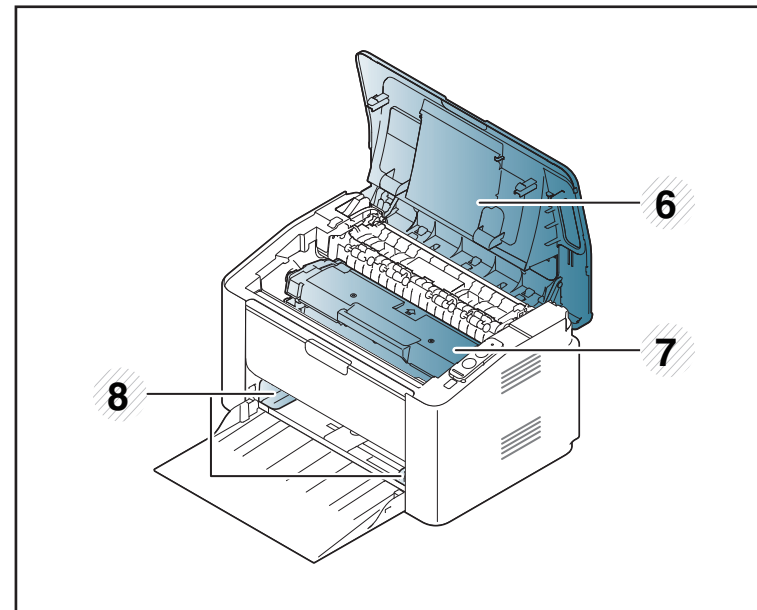
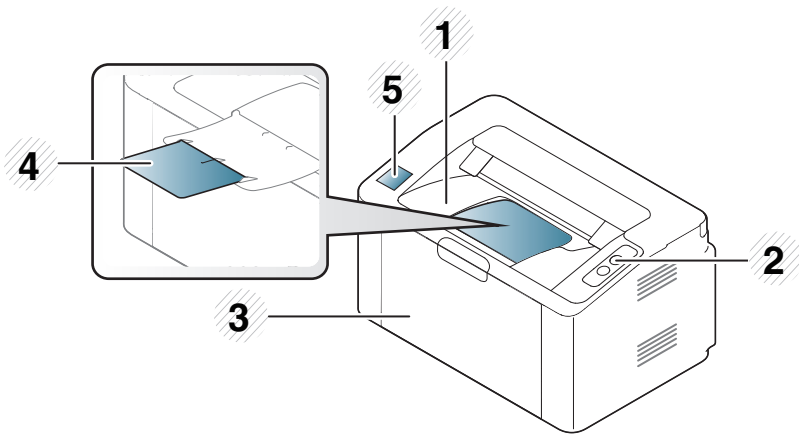

| | | | |
|---|----------------|---|---|
| 1 | Output tray | 5 | NFC (Near Field Communication) tag |
| 2 | Control panel | 6 | Top cover |
| 3 | Tray | 7 | Toner cartridge |
| 4 | Output support | 8 | Paper width guide |

Machine overview

Rear view



- This illustration may differ from your machine depending on its model.
- Some features and optional goods may not be available depending on model or country (see "Features by models" on page 6).

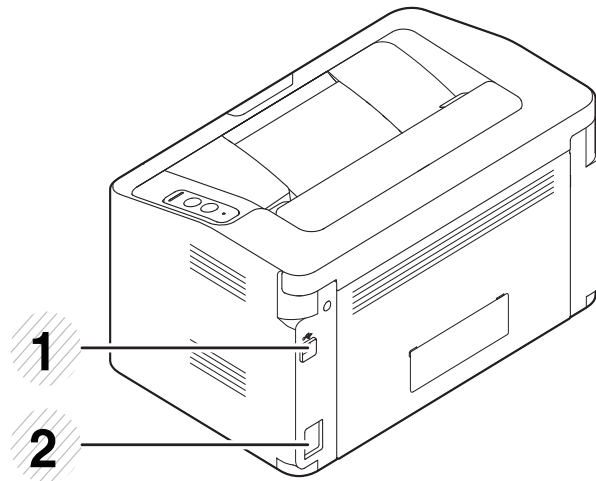

| | |
|---|------------------|
| 1 | USB port |
| 2 | Power receptacle |

Control panel overview



This control panel may differ from your machine depending on its model. There are various types of control panels.

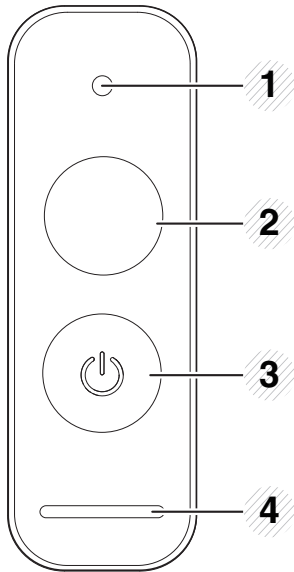

| | | | |
|---|--|-----------|--|
| 1 | | Toner LED | Shows the status of the toner (see "Status LED" on page 57). |
|---|--|-----------|--|

2



WPS^a

Configures the wireless network connection easily without a computer (see "Wireless network setup" on page 93).

- **Configuration sheet**
 - Press and hold this button for about 10 seconds until the green LED blinks slowly, and release.
- **Prints supplies info report / usage count report**
 - Press and hold this button for about 15 seconds until the green LED on, and release.
- **Manual print**
 - Press this button each time you load a sheet of paper in the tray if you have selected **Manual Feeder** for **Source** in your printer driver.

Control panel overview

2



**Print
screen^b**

- **Prints the screen**

- Press this button and the green LED will start blinking. If you want to print only the active screen, release the button when the green LED stops blinking. If you want to print the whole screen, release the button while it's blinking.



- **Print Screen** can only be used in the Windows and Mac operating systems.
- You can only use this function with USB-connected machine.
- When printing the active window/whole monitor screen using the print screen button, the machine may use more toner depending on what is being printed.
- You can only use this function if the machine's Easy Printer Manager program is installed if you are a Mac OS user, you need to enable **Screen Print Settings** from the Easy Printer Manager to use the Print Screen feature.

- **Configuration sheet**

- Press and hold this button for about 10 seconds until the green LED blinks slowly, and release.

- **Prints supplies info report / error report**

- Press and hold this button for about 15 seconds until the green LED on, and release.

- **Manual print**

- Press this button each time you load a sheet of paper in the tray if you have selected **Manual Feeder** for **Source** in your printer driver.

3



Power

You can turn the power off or wake the machine up from the sleep mode with this button.

4



**Status
LED**

Shows the status of your machine (see "Status LED" on page 57).

a. M202xW only.

b. M202x only.

Turning on the machine

- 1 Connect the machine to the electricity supply first.

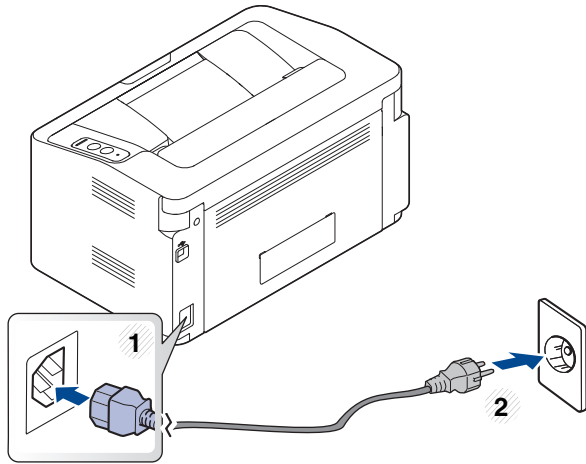

- 2 Press  (power) on the control panel.



If you want to turn the power off, press  (power) on the control panel.

Installing the driver locally

A locally connected machine is a machine directly attached to your computer using the cable.



- If you are a Mac or Linux OS user, refer to the "Software Installation" on page 83.
- The installation window in this User's Guide may differ depending on the machine and interface in use.
- Only use a USB cable no longer than 3 meters (118 inches).

Windows

- 1 Insert the supplied software CD into your CD-ROM drive.
If the installation window does not appear, click **Start > All programs > Accessories > Run**.
X:\Setup.exe replacing "X" with the letter, which represents your CD-ROM drive and click **OK**.
 - For Windows 8,
If the installation window does not appear, from **Charms**, select **Search > Apps** and search for **Run**. Type in X:\Setup.exe, replacing "X" with the letter that represents your CD-ROM drive and click **OK**. If "**Tap to choose what happens with this disc.**" pop-up window appears, click the window and select **Run Setup.exe**.
- 2 Review and accept the installation agreements in the installation window. Then, click **Next**.
- 3 Select **USB connection** on the **Printer Connection Type** screen. Then, click **Next**.
- 4 Follow the instructions in the installation window.

Installing the driver locally

From the Windows 8 Start Screen



- The V4 driver is automatically downloaded from the Windows Update if your computer is connected to the Internet. If not, you can manually download the V4 driver from Samsung website, www.samsung.com > find your product > Support or downloads.
- You can download Samsung Printer Experience app from the **Windows Store**. You need have a Microsoft account to use the Windows **Store**.
 - 1 From **Charms**, select **Search**.
 - 2 Click **Store**.
 - 3 Search and click **Samsung Printer Experience**.
 - 4 Click **Install**.
- If you install the driver using the supplied software CD, V4 driver is not installed. If you want to use the V4 driver in the **Desktop** screen, you can download from the Samsung website, www.samsung.com > find your product > Support or downloads.
- If you want to install Samsung's printer management tools, you need to install them using the supplied software CD .

- 1 Make sure that your computer is connected to the Internet and powered on.
- 2 Make sure that the machine is powered on.
- 3 Connect the computer and the machine with a USB cable.
The driver is automatically installed from the **Windows Update**.

Reinstalling the driver

If the printer driver does not work properly, follow the steps below to reinstall the driver.

Windows

- 1 Make sure that the machine is connected to your computer and powered on.
- 2 From the **Start** menu, select **Programs** or **All Programs** > **Samsung Printers** > **Uninstall Samsung Printer Software**.
 - For Windows 8,
 - 1 From Charms, select **Search** > **Apps**.
 - 2 Search and click **Control Panel**.
 - 3 Click **Programs and Features**.
 - 4 Right-click the driver you want to uninstall and select **Uninstall**.
 - 5 Follow the instructions in the window.
- 3 Follow the instructions in the installation window.
- 4 Insert the software CD into your CD-ROM drive and install the driver again (see "Installing the driver locally" on page 22).

From the Windows 8 Start Screen

- 1 Make sure that the machine is connected to your computer and powered on.
- 2 Click on the **Uninstall Samsung Printer Software** tile in the **Start** screen.
- 3 Follow the instructions in the window.



- If you cannot find a Samsung Printer Software tile, uninstall from the desktop screen mode.
- If you want to uninstall Samsung's printer management tools, from the **Start** screen, right-click the app > **Uninstall** > right-click the program you want to delete > **Uninstall** and follow the instruction in the window.



2. Learning the Basic Usage

After installation is complete, you may want to set the machine's default settings. Refer to the next section if you would like to set or change values.

- **Media and tray**
- **Basic printing**

26

35

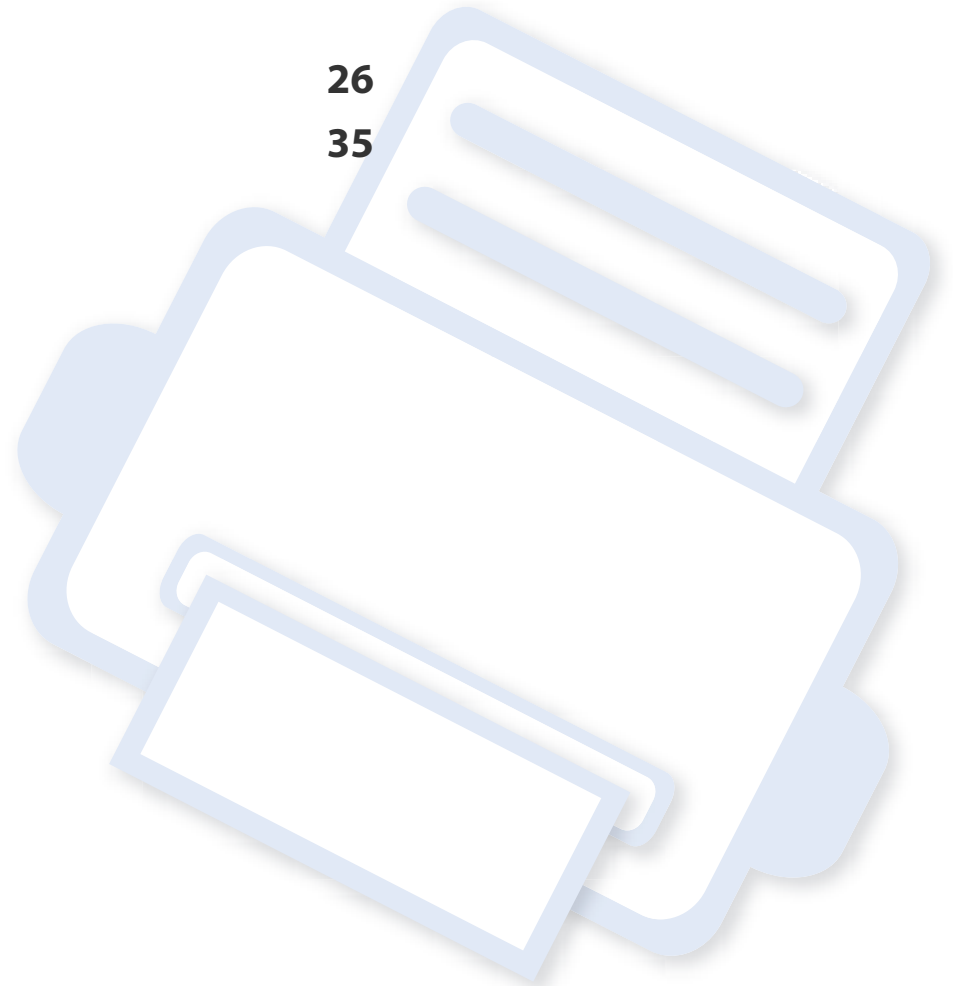

Media and tray

This chapter provides information on how to load print media into your machine.



- Using print media that does not meet these specifications may cause problems or require repairs. Such repairs are not covered by Samsung's warranty or service agreements.
- Make sure not to use the inkjet photo paper with this machine. It could cause damage to the machine.
- Using inflammable print media can cause a fire.
- Use designated print media (see "Print media specifications" on page 62).



The use of inflammable media or foreign materials left in the printer may lead to overheating of the unit and, in rare cases may cause a fire.

Tray overview

To change the size, you need to adjust the paper guide.

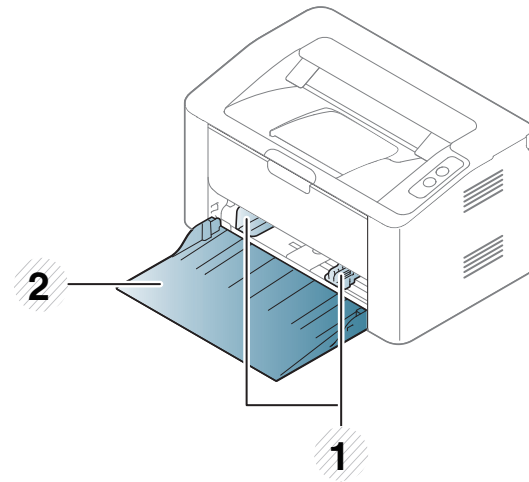

- 1 Paper width guide
- 2 Tray



If you do not adjust the guide, it may cause paper registration, image skew, or jamming of the paper.

Media and tray

Loading paper in the tray

- 1 Open the tray.

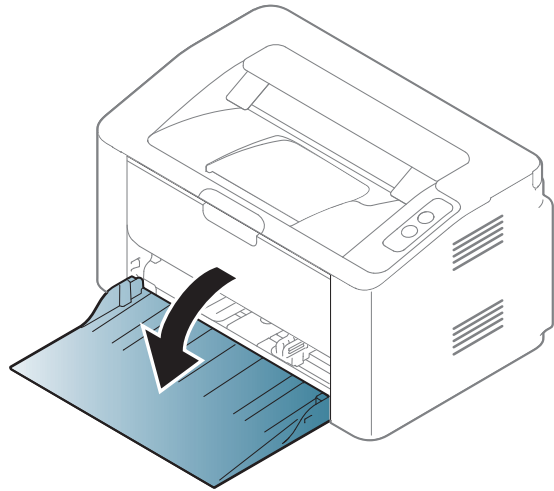

- 2 Flex or fan the edge of the paper stack to separate the pages before loading papers.

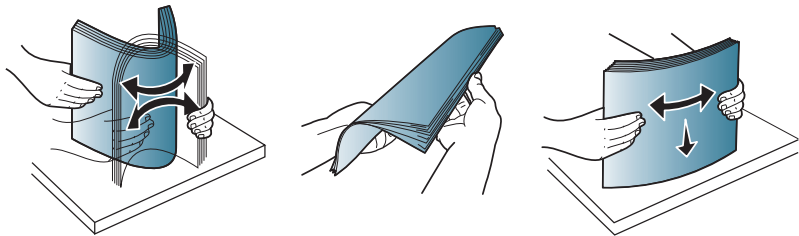

- 3 Adjust the tray size to the media size you are loading (see "Tray overview" on page 26). Then place the paper with the side you want to print facing up and open the output tray.

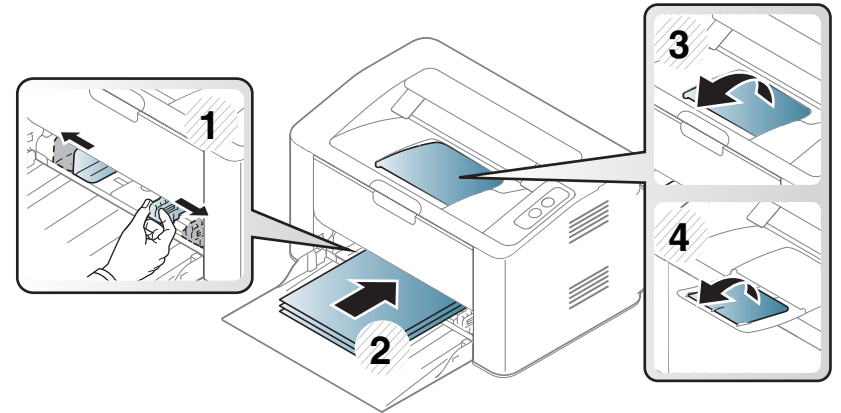

- 4 Squeeze the paper width guide and slide it to the edge of the paper stack without causing it to bend.

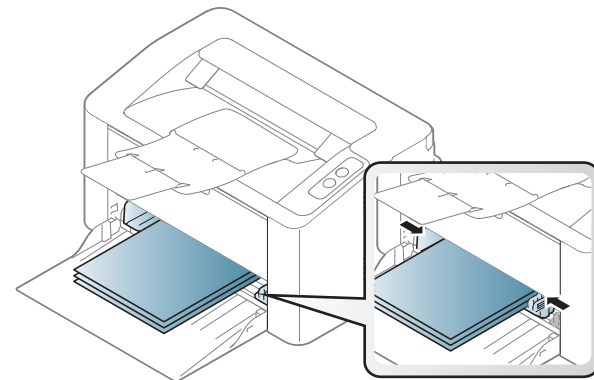

Media and tray



- Do not push the paper width guide too far causing the media to warp.
- If you do not adjust the paper width guide, it may cause paper jams.

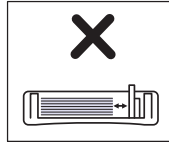
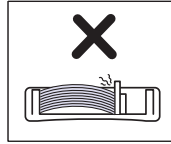
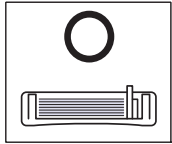

- Do not use a paper with a leading-edge curl, it may cause a paper jam or the paper can be wrinkled.

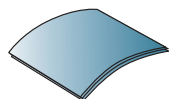
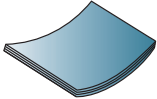
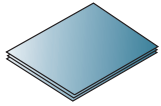

- 5 When you print a document, set the paper type and size for the tray (see "Setting the paper size and type" on page 34).



Media and tray

Manual feeding in the tray

The manual feeder can hold special sizes and types of print material, such as postcards, note cards, and envelopes (see "Print media specifications" on page 62).



Tips on using the manual feeder

- Load only one type, size and weight of print media at time in the manual feeder.
- If you select **Paper > Source > Manual Feeder** for the paper source in your software application, you need to press  (Print screen) or  (WPS) button each time you print a page and load only one type, size and weight of print media at a time on the manual tray.
- To prevent paper jams, do not add paper while printing when there is still paper in the manual feeder.
- Print media should be loaded face up with the top edge going into the manual feeder first and be placed in the center of the tray.
- To ensure printing quality and to prevent paper jams, only load the available paper (see "Print media specifications" on page 62).
- Flatten any curl on postcards, envelopes, and labels before loading them into the manual feeder.
- When printing on special media, you must follow the loading guidelines (see "Printing on special media" on page 30).

- When the machine is in a power save mode, the machine does not feed paper from the manual feeder. Wake up the machine by pressing the power button before using the manual feeder.

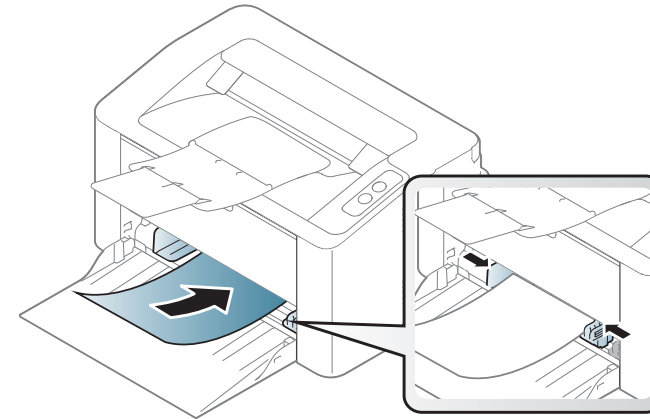

Media and tray

Printing on special media

The table below shows the special media usable in tray.

To change the paper setting set in the machine, from the **Printing preferences** window > **Paper** tab > **Paper Type** (see "Opening printing preferences" on page 36).



When using special media, we recommend you feed one sheet at a time (see "Print media specifications" on page 62).

To see for paper weights for each sheet, refer to "Print media specifications" on page 62.

| Types | Tray ^a |
|-----------|-------------------|
| Plain | ● |
| Thick | ● |
| Thin | ● |
| Bond | ● |
| Color | ● |
| CardStock | ● |
| Labels | ● |

| Types | Tray ^a |
|------------|-------------------|
| Envelope | ● |
| Preprinted | ● |
| Cotton | ● |
| Recycled | ● |
| Archive | ● |

a. The paper types available manual feeding in tray.

(●: Supported)

Media and tray

Envelope

Printing successfully on envelopes depends upon the quality of the envelopes.

To print an envelope, place it as shown in the following figure.

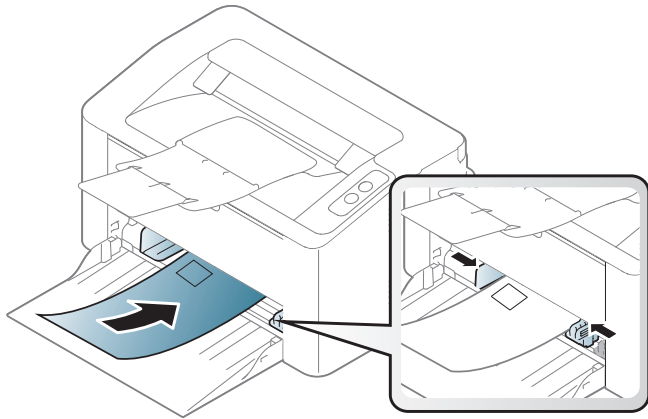

If you select **Envelope** from the **Printing Preferences** window, but the printed images get easily erased, select **Thick Envelope** and try printing again.

However, this might cause some noise when printing.

- When selecting envelopes, consider the following factors:
 - **Weight:** should not exceed 90 g/m² otherwise; jams may occur.
 - **Construction:** should lie flat with less than 6 mm curl and should not contain air.
 - **Condition:** should not be wrinkled, nicked, nor damaged.
 - **Temperature:** should resist the heat and pressure of the machine during operation.
- Use only well-constructed envelopes with sharp and well-creased folds.

- Do not use stamped envelopes.
- Do not use envelopes with clasps, snaps, windows, coated lining, self-adhesive seals, or other synthetic materials.
- Do not use damaged or poorly made envelopes.
- Be sure the seam at both ends of the envelope extends all the way to the corner of the envelope.

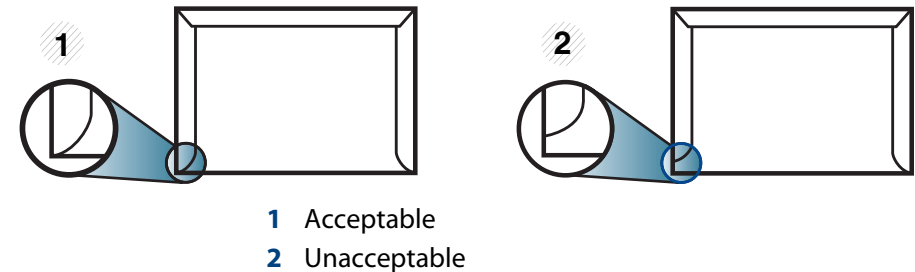

- Envelopes with a peel-off adhesive strip or with more than one flap that folds over to seal must use adhesives compatible with the machine's fusing temperature for 0.1 second (about 170°C (338 °F)). The extra flaps and strips might cause wrinkling, creasing, or jams, and may even damage the fuser.
- For the best print quality, position margins no closer than 15 mm from the edges of the envelope.
- Avoid printing over the area where the envelope's seams meet.

Media and tray

Labels

To avoid damaging the machine, use only labels designed for use in laser printers.

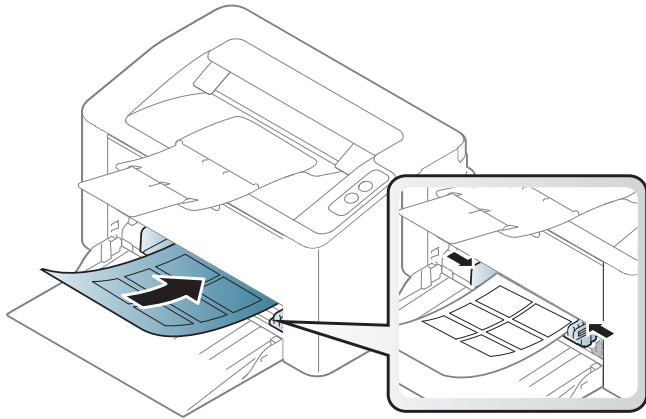

- When selecting labels, consider the following factors:
 - **Adhesives:** Should be stable at your machine's fusing temperature. Check your machine's specifications to view the fusing temperature (about 170°C (338°F)).
 - **Arrangement:** Only use labels with no exposed backing between them. Labels can peel off sheets that have spaces between the labels, causing serious jams.
 - **Curl:** Must lie flat with no more than 13 mm of curl in any direction.
 - **Condition:** Do not use labels with wrinkles, bubbles, or other indications of separation.

- Make sure that there is no exposed adhesive material between labels. Exposed areas can cause labels to peel off during printing, which can cause paper jams. Exposed adhesive can also cause damage to machine components.
- Do not run a sheet of labels through the machine more than once. The adhesive backing is designed for only a single pass through the machine.
- Do not use labels that are separating from the backing sheet or are wrinkled, bubbled, or otherwise damaged.

Card stock/ Custom-sized paper

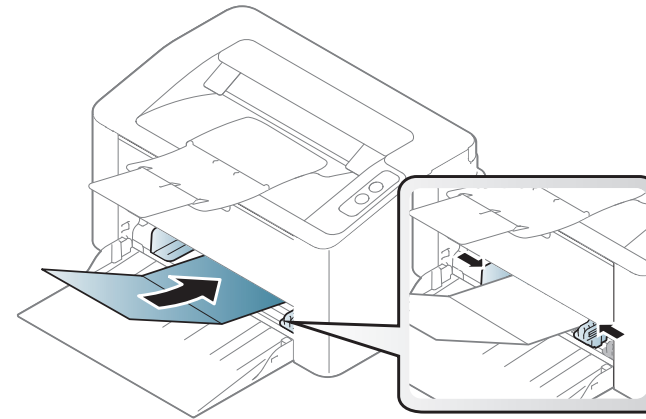

- In the software application, set margins at least 6.4 mm (0.25 inches) away from the edges of the material.

Media and tray

Preprinted paper

When loading preprinted paper, the printed side should be facing up with an uncurled edge at the front. If you experience problems with paper feeding, turn the paper around. Note that print quality is not guaranteed.

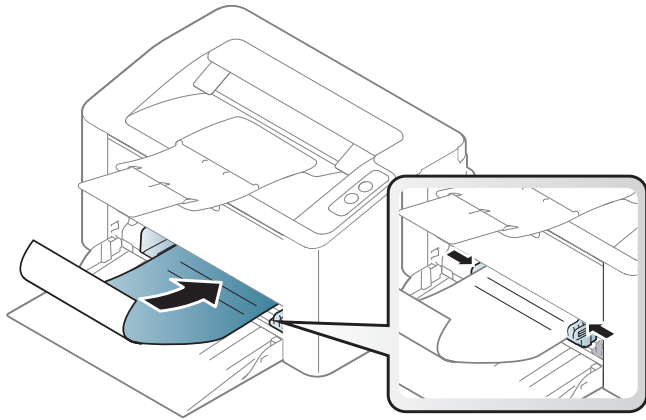

- Must be printed with heat-resistant ink that will not melt, vaporize, or release hazardous emissions when subjected to the machine's fusing temperature for 0.1 second (about 170°C (338°F)).
- Preprinted paper ink must be non-flammable and should not adversely affect machine rollers.
- Before you load preprinted paper, verify that the ink on the paper is dry. During the fusing process, wet ink can come off preprinted paper, reducing print quality.

Media and tray

Setting the paper size and type

After loading paper in the paper tray, set the paper size and type.

To change the paper setting set in the machine, from the **Printing preferences** window > **Paper** tab > **Paper Type** (see "Opening printing preferences" on page 36).



If you want to use special-sized paper such as billing paper, select **Custom** in the **Paper** tab in the **Printing Preferences** (see "Opening printing preferences" on page 36).

Basic printing



For special printing features, refer to the Advanced Guide (see "Using advanced print features" on page 133).

Printing



If you are a Mac or Linux user, refer to the "Mac printing" on page 140 or "Linux printing" on page 142.

The following **Printing Preferences** window is for Notepad in Windows 7.

- 1 Open the document you want to print.
- 2 Select **Print** from the **File** menu.

- 3 Select your machine from the **Select Printer** list.



- 4 The basic print settings including the number of copies and print range are selected within the **Print** window.



To take advantage of the advanced printing features, click **Properties** or **Preferences** from the **Print** window (see "Opening printing preferences" on page 36).

- 5 To start the print job, click **OK** or **Print** in the **Print** window.

Basic printing





Canceling a print job

If the print job is waiting in the print queue or print spooler, cancel the job as follows:

- You can access this window by simply double-clicking the machine icon () in the Windows task bar.

Opening printing preferences



- The **Printing Preferences** window that appears in this user's guide may differ depending on the machine in use. However, the composition of the **Printing Preferences** window is similar.
- When you select an option in **Printing Preferences**, you may see a warning mark  or . An  mark means you can select that certain option but it is not recommended, and an  mark means you cannot select that option due to the machine's setting or environment.

- 1 Open the document you want to print.
- 2 Select **Print** from the file menu.
- 3 Select your machine from the **Select Printer**.

- 4 Click **Properties** or **Preferences**.

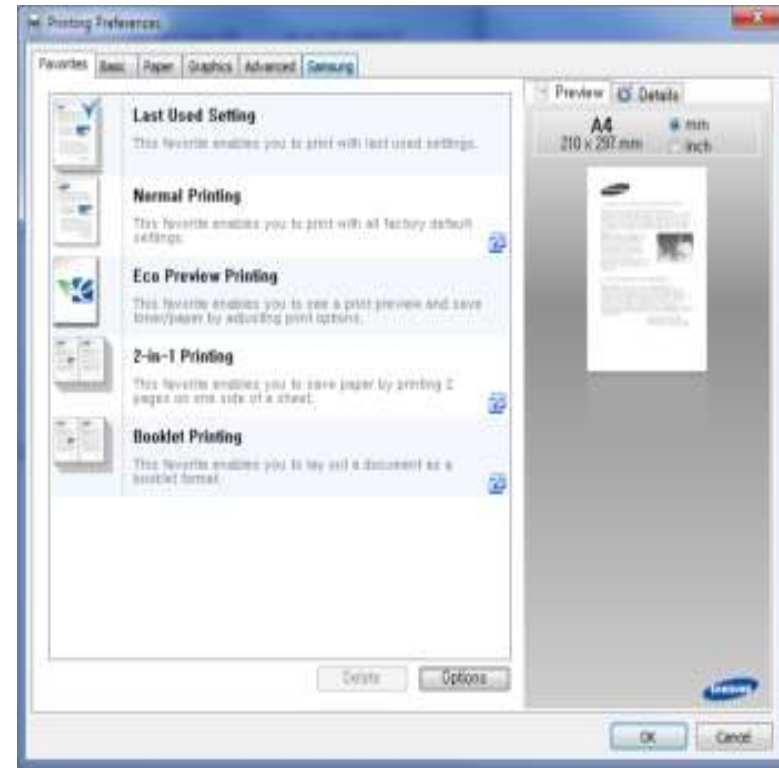

You can check the machine's current status using the **Printer Status** button (see "Using Samsung Printer Status" on page 154).

Basic printing

Using a favorite setting

The **Favorites** option, which is visible on each preferences tab except for the **Samsung** tab, allows you to save the current preferences for future use.

To save a **Favorites** item, follow these steps:

- 1 Change the settings as needed on each tab.
- 2 Enter a name for the item in the **Favorites** input box.
- 3 Click **Save**.
- 4 Enter name and description, and then select the desired icon.
- 5 Click **OK**. When you save **Favorites**, all current driver settings are saved.



To use a saved setting, select it in the **Favorites** tab. The machine is now set to print according to the settings you have selected.

To delete saved settings, select it in the **Favorites** tab and click **Delete**.

Using help

Click the option you want to know on the **Printing Preferences** window and press **F1** on your keyboard.

Eco printing

The **Eco** function cuts toner consumption and paper usage. The **Eco** function allows you to save print resources and lead you to eco-friendly printing.

To Eco Printing, click the below:

See "Easy Eco Driver" on page 148.



3. Maintenance

This chapter provides information about purchasing supplies, accessories and maintenance parts available for your machine.

- **Ordering supplies and accessories** 39
- **Available supplies** 40
- **Storing the toner cartridge** 41
- **Redistributing toner** 43
- **Replacing the toner cartridge** 44
- **Cleaning the machine** 46
- **Tips for moving & storing your machine** 50

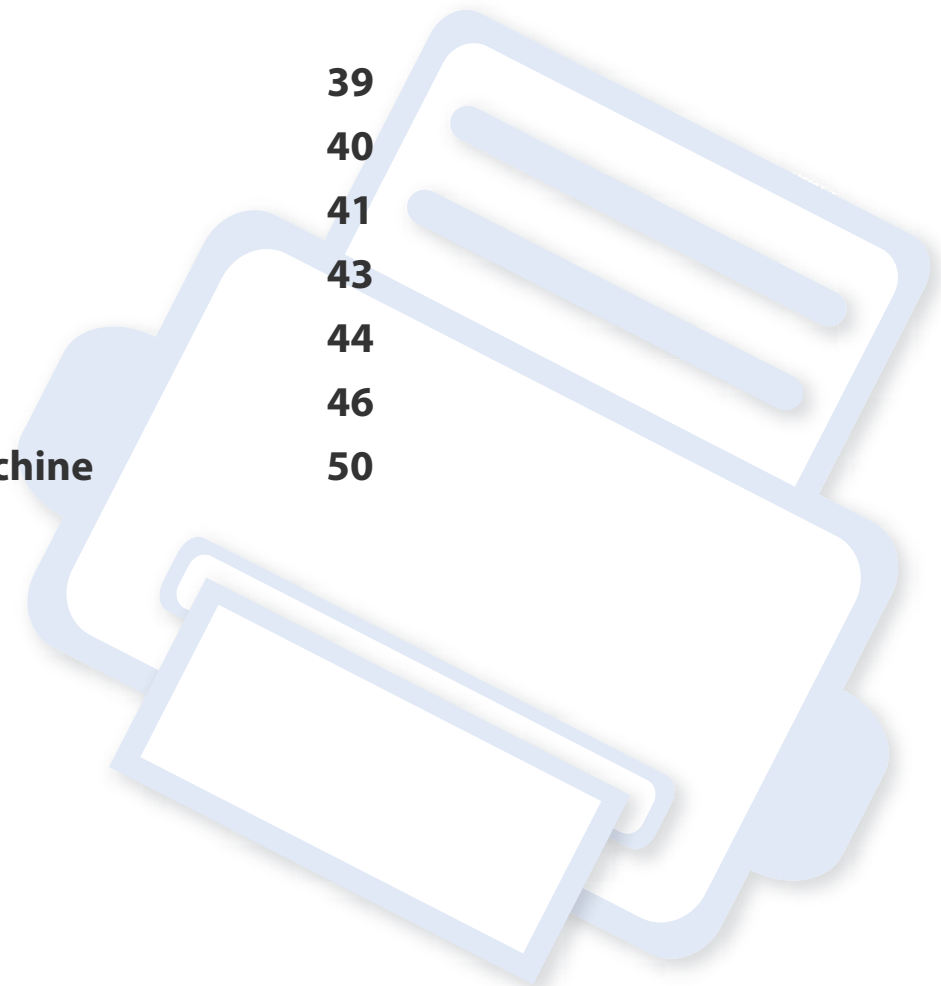

Ordering supplies and accessories



Available accessories may differ from country to country. Contact your sales representatives to obtain the list of available supplies, and maintenance parts.

To order Samsung-authorized supplies, accessories, and maintenance parts, contact your local Samsung dealer or the retailer where you purchased your machine. You can also visit www.samsung.com/supplies, and then select your country/region to obtain the contact information for service.

Available supplies

When supplies reach the end of their life spans, you can order the following types of supplies for your machine:

| Type | Average yield ^a | Part name |
|------------------------|----------------------------|-----------|
| Toner cartridge | Approx. 1,000 pages | MLT-D111S |

a. Declared yield value in accordance with ISO/IEC 19752.



Depending on the options, percentage of image area, and job mode used, the toner cartridge's lifespan may differ.



When purchasing new toner cartridges or other supplies, these must be purchased in the same country as the machine you are using. Otherwise, new toner cartridges or other supplies will be incompatible with your machine due to different configurations of toner cartridges and other supplies according to the specific country conditions.



Samsung does not recommend using non-genuine Samsung toner cartridge such as refilled or remanufactured toner. Samsung cannot guarantee non-genuine Samsung toner cartridge's quality. Service or repair required as a result of using non-genuine Samsung toner cartridges will not be covered under the machine's warranty.

Storing the toner cartridge

Toner cartridges contain components that are sensitive to light, temperature and humidity. Samsung suggests users follow these recommendations to ensure optimal performance, highest quality, and longest life from your new Samsung toner cartridge.

Store this cartridge in the same environment in which the printer will be used. This should be in controlled temperature and humidity conditions. The toner cartridge should remain in its original and unopened package until installation – if original packaging is not available, cover the top opening of the cartridge with paper and store in a dark cabinet.

Opening the cartridge package prior to use dramatically shortens its useful shelf and operating life. Do not store on the floor. If the toner cartridge is removed from the printer, follow the instructions below to store the toner cartridge properly.

- Store the cartridge inside the protective bag from the original package.
- Store lying flat (not standing on end) with the same side facing up as if it were installed in the machine.
- Do not store consumables in any of the following conditions:
 - Temperature greater than 40°C (104°F).
 - Humidity range less than 20% and greater than 80%.
 - An environment with extreme changes in humidity or temperature.
 - Direct sunlight or room light.
 - Dusty places.
 - A car for a long period of time.
 - An environment where corrosive gases are present.
 - An environment with salty air.

Storing the toner cartridge

Handling instructions

- Do not touch the surface of the photoconductive drum in the cartridge.
- Do not expose the cartridge to unnecessary vibrations or shock.
- Never manually rotate the drum, especially in the reverse direction; this can cause internal damage and toner spillage.

Toner cartridge usage

Samsung Electronics does not recommend or approve the use of non-Samsung brand toner cartridges in your printer including generic, store brand, refilled, or remanufactured toner cartridges.



Samsung's printer warranty does not cover damage to the machine caused by the use of a refilled, remanufactured, or non-Samsung brand toner cartridges.

Estimated cartridge life

Estimated cartridge life the life of the toner cartridge (or imaging unit) yield depends on the amount of toner that print jobs require. The actual print yield may vary depending on the print density of the pages you print on, operating environment, percentage of image area, printing interval, media type and/or media size. For example, if you print a lot of graphics, the consumption of the toner is higher and you may need to change the cartridge more often.

Redistributing toner

When the toner cartridge is near the end of its life:

- White streaks or light printing occurs and/or density variation side to side.
- The **Toner** LED blinks orange.

If this happens, you can temporarily improve print quality by redistributing the remaining toner in the cartridge. In some cases, white streaks or light printing will still occur even after you have redistributed the toner.



- Before opening the top cover, close the output support first.
- If toner gets on your clothing, wipe it off with a dry cloth and wash clothing in cold water. Hot water sets toner into fabric.

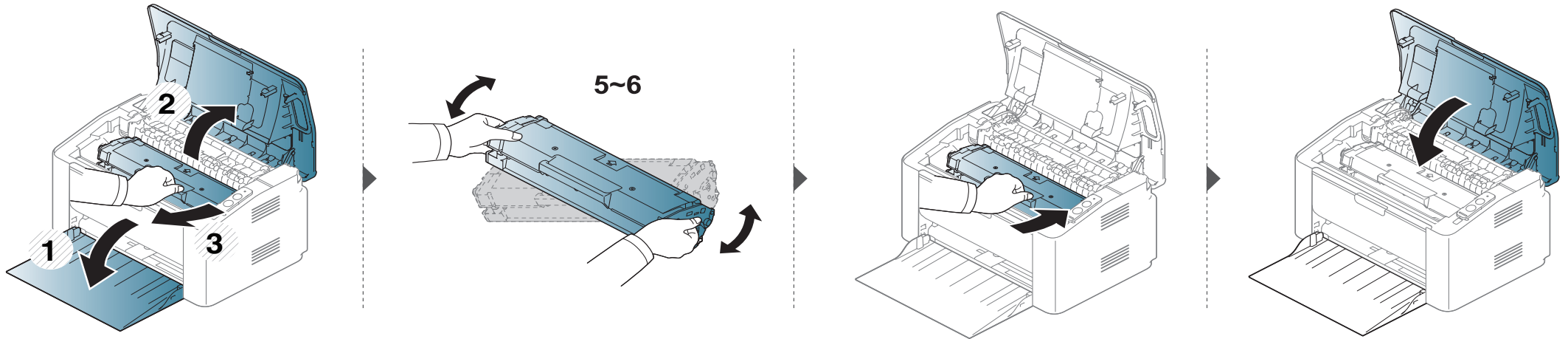

Replacing the toner cartridge

Toner cartridge



Click this link to open an animation about replacing a toner cartridge.



- Before opening the top cover, close the output support first.
- Do not use sharp objects such as a knife or scissors to open the toner cartridge package. They might scratch the drum of the cartridge.
- If toner gets on your clothing, wipe it off with a dry cloth and wash clothing in cold water. Hot water sets toner into fabric.
- Shake the toner cartridge thoroughly, it will increase the initial print quality.
- Do not touch the green underside of the toner cartridge. Use the handle on the cartridge to avoid touching this area.

Replacing the toner cartridge

When a toner cartridge has reached the end of life, the machine will stop printing.

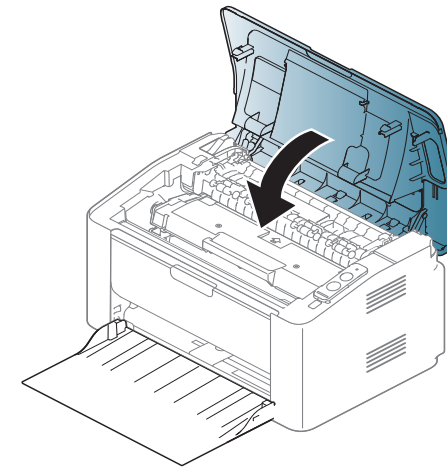
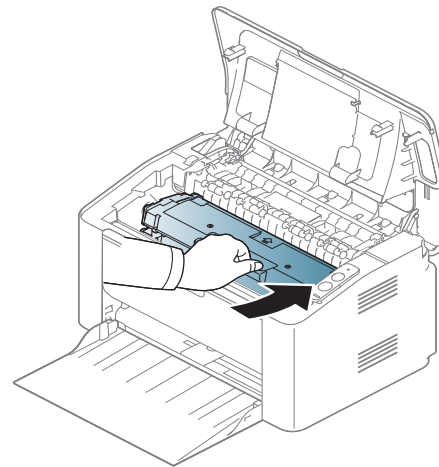
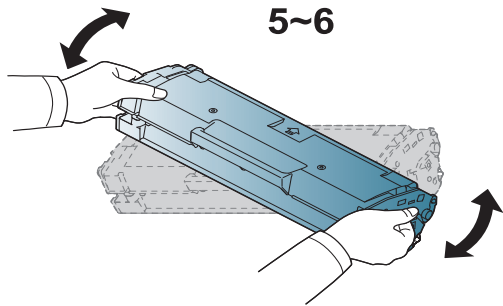
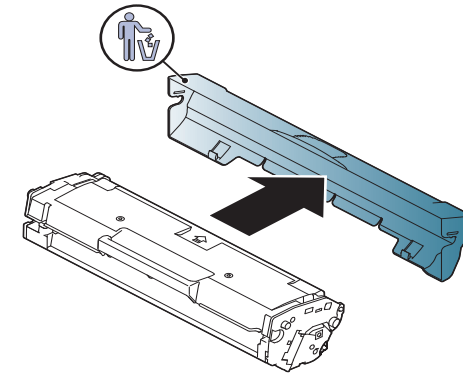
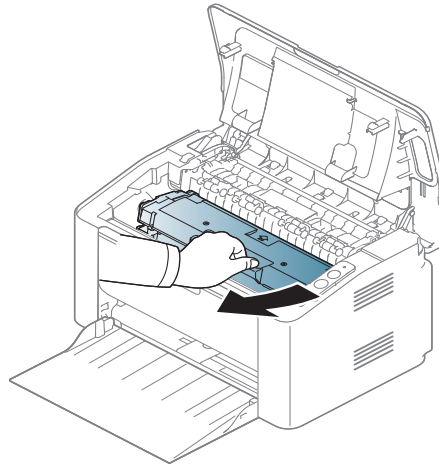
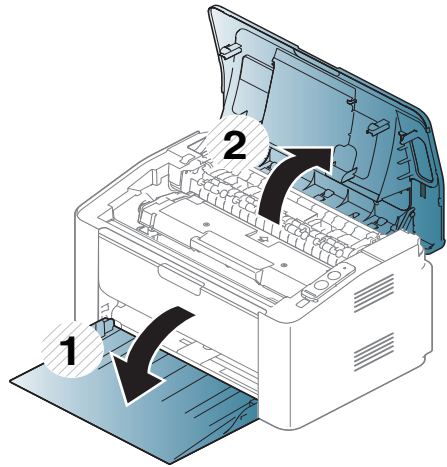

Cleaning the machine

If printing quality problems occur or if you use your machine in a dusty environment, you need to clean your machine regularly to keep it in the best printing condition and use your machine longer.



- Cleaning the cabinet of the machine with cleaning materials containing large amounts of alcohol, solvents, or other strong substances can discolor or distort the cabinet.
- If your machine or the surrounding area is contaminated with toner, we recommend you use a cloth or tissue dampened with water to clean it. If you use a vacuum cleaner, toner blows in the air and might be harmful to you.
- During the printing process, paper, toner, and dust particles can accumulate inside the machine. This buildup can cause print quality problems, such as toner specks or smearing. Cleaning the inside of the machine clears and reduces these problems.

Cleaning the outside

Clean the machine cabinet with a soft, lint-free cloth. Dampen the cloth slightly with water, but be careful not to let any water drip onto or into the machine.

Cleaning the machine

Cleaning the inside

During the printing process, paper, toner, and dust particles can accumulate inside the machine. This buildup can cause print quality problems, such as toner specks or smearing. Cleaning the inside of the machine clears and reduces these problems.



- Use a dry lint-free cloth to clean the machine.
- If your machine has a power switch, turn the power switch off before cleaning the machine.
- Before opening the top cover, close the output support first.

Cleaning the machine

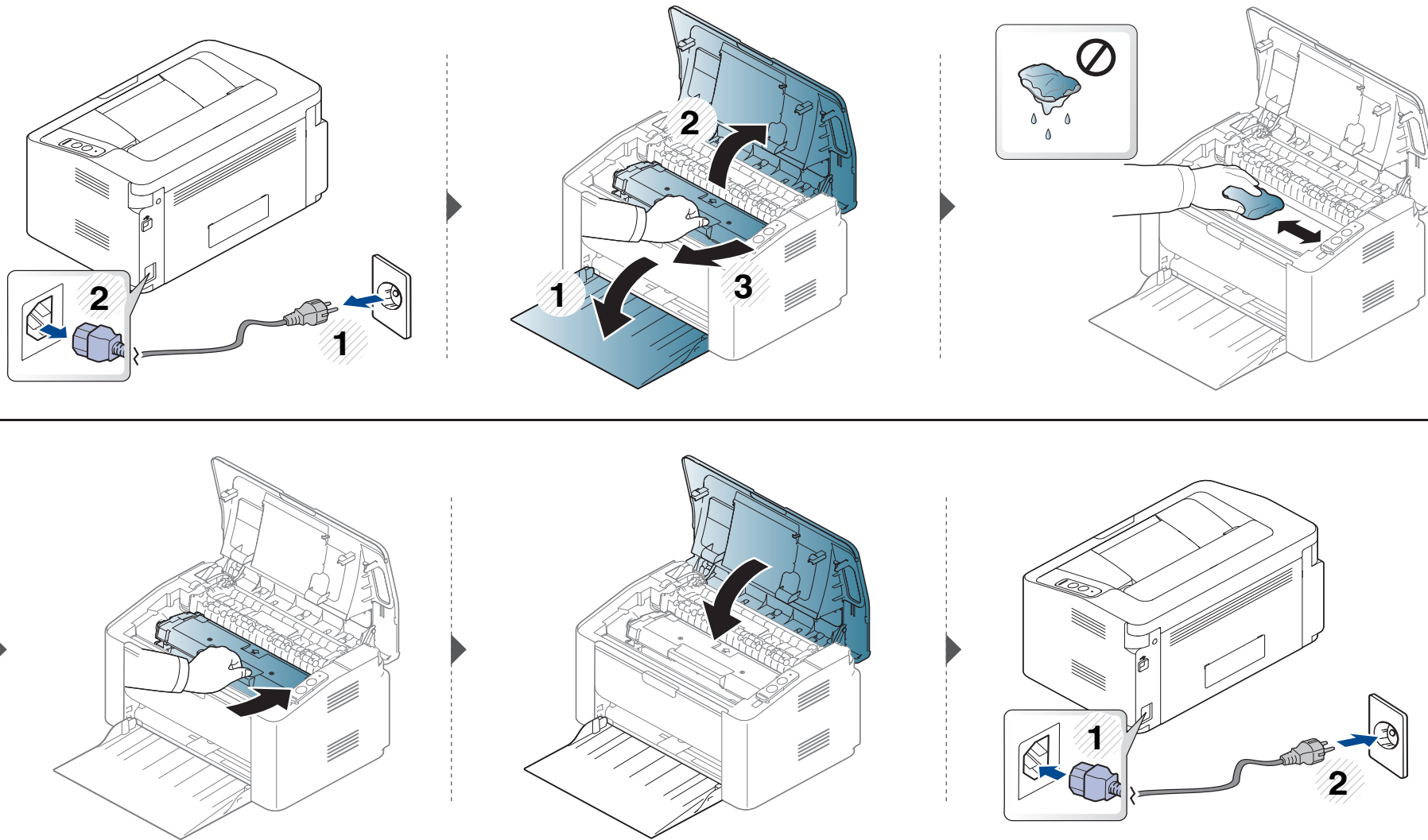

Cleaning the machine

Cleaning the pickup roller



- Use a dry lint-free cloth to clean the machine.
- If your machine has a power switch, turn the power switch off before cleaning the machine.

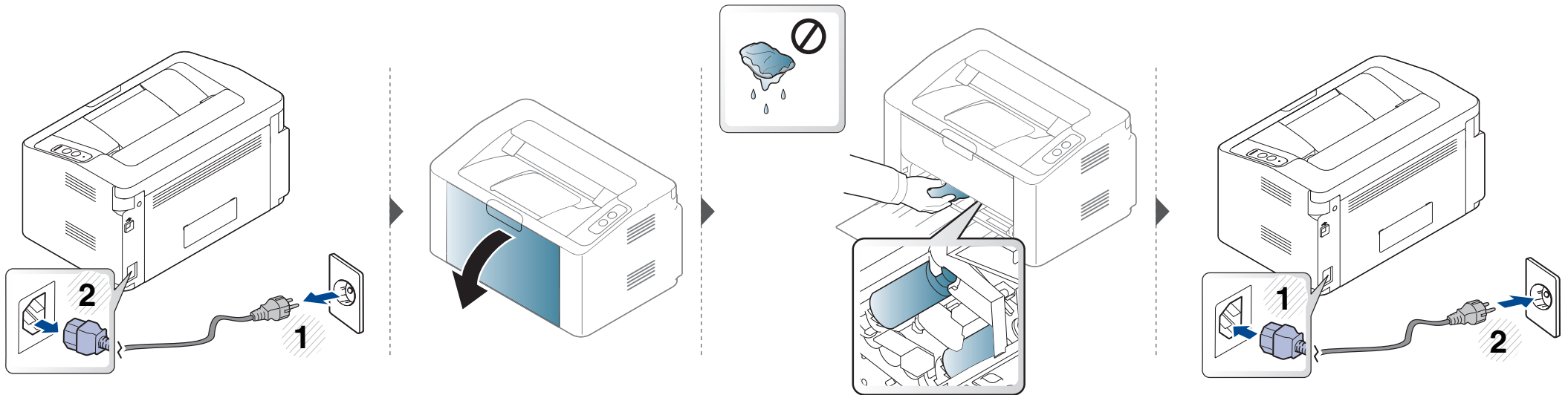

Tips for moving & storing your machine

- When moving the machine, do not tilt or turn it upside down. Otherwise, the inside of the machine may be contaminated by toner, which can cause damage to the machine or reduce print quality.
- When moving the machine, make sure at least two people are holding the machine securely.



4. Troubleshooting

This chapter gives helpful information for what to do if you encounter an error.

- **Tips for avoiding paper jams** 52
- **Clearing paper jams** 53
- **Understanding the status LED** 56



This chapter gives helpful information for what to do if you encounter an error. If your machine has a display screen, check the message on the display screen first to solve the error. If you cannot find a solution to your problem in this chapter, refer to the **Troubleshooting** chapter in the Advanced User's Guide (see "Troubleshooting" on page 162). If you cannot find a solution in the User's Guide or the problem persists, call for service.

Tips for avoiding paper jams

By selecting the correct media types, most paper jams can be avoided. To avoid paper jams, refer to the following guidelines:

- Ensure that the adjustable guides are positioned correctly (see "Tray overview" on page 26).
- Do not overload the tray. Ensure that the paper level is below the paper capacity mark on the inside of the tray.
- Do not remove paper from the tray while your machine is printing.
- Flex, fan, and straighten paper before loading.
- Do not use creased, damp, or highly curled paper.
- Do not mix paper types in a tray.
- Use only recommended print media (see "Print media specifications" on page 62).

Clearing paper jams

 To avoid tearing the paper, pull the jammed paper out slowly and gently.

In tray

 Click this link to open an animation about clearing a jam.

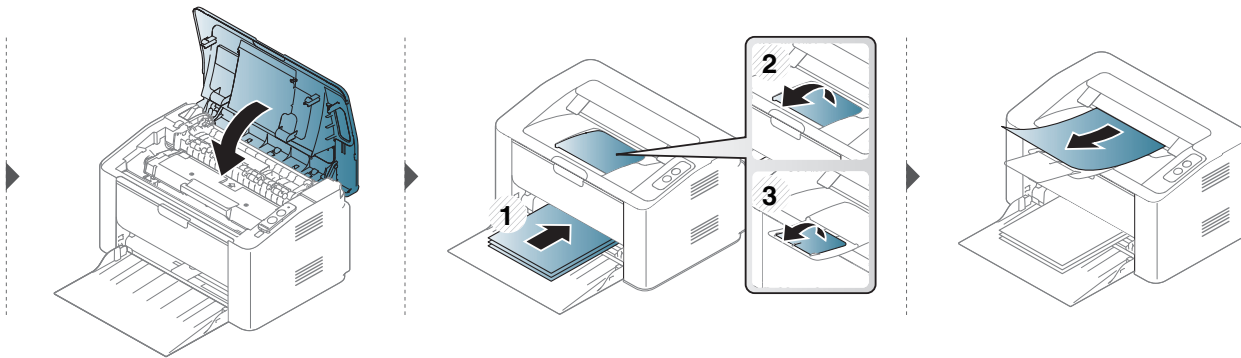
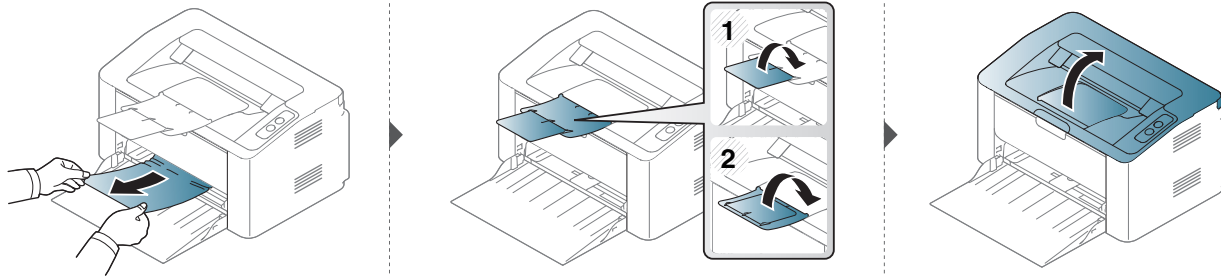

Clearing paper jams

Inside the machine



Click this link to open an animation about clearing a jam.



- The fuser area is hot. Take care when removing paper from the machine.
- Before opening the top cover, close the output support first.

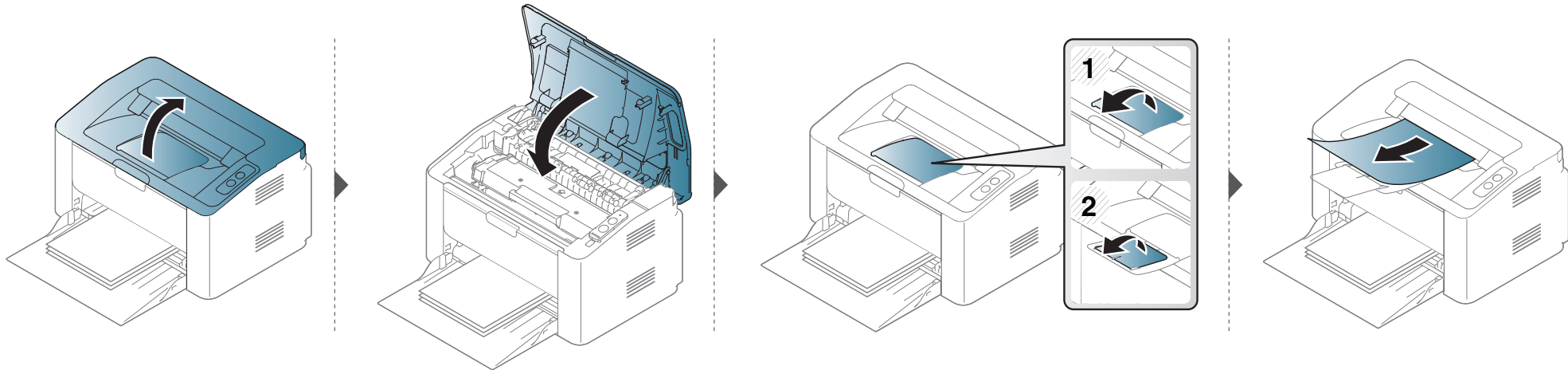

Clearing paper jams

If you do not see the paper in this area, stop and go to next step:

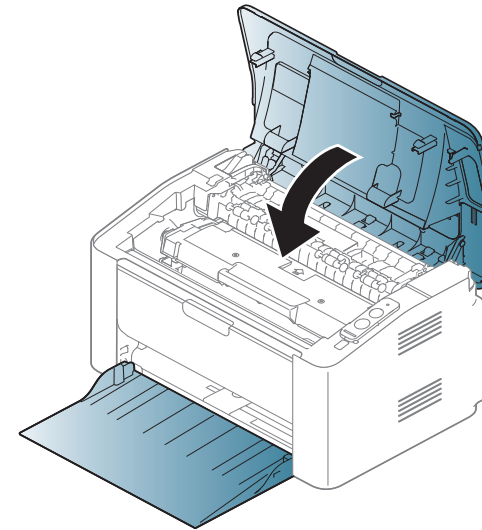
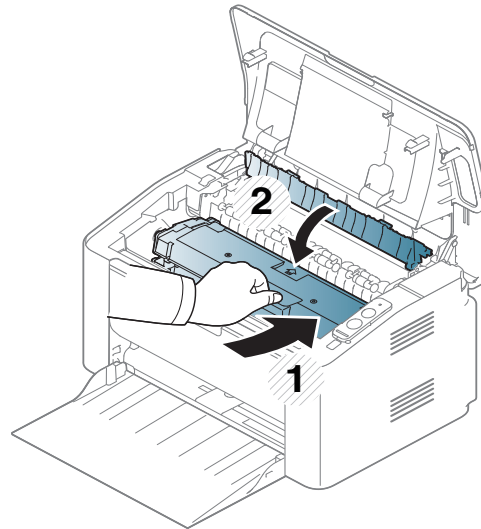
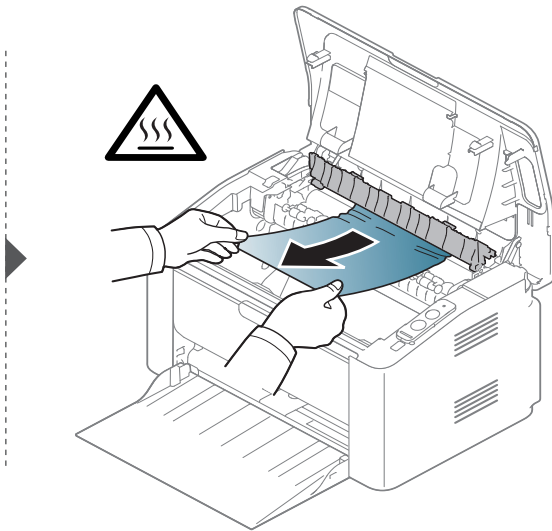
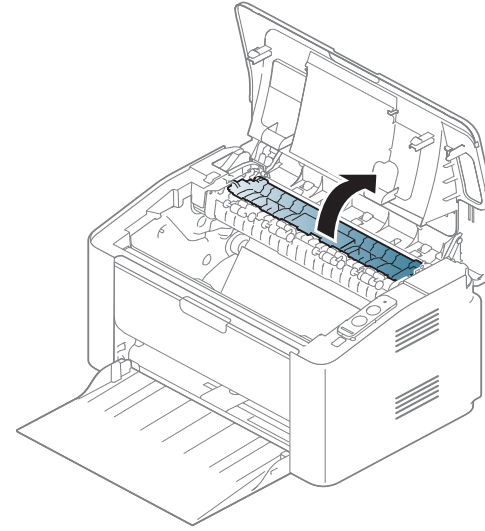
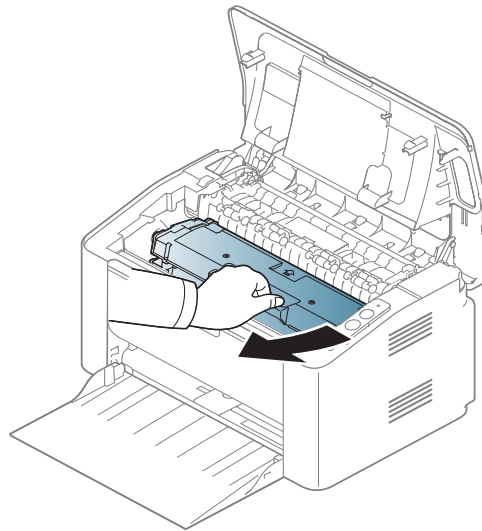
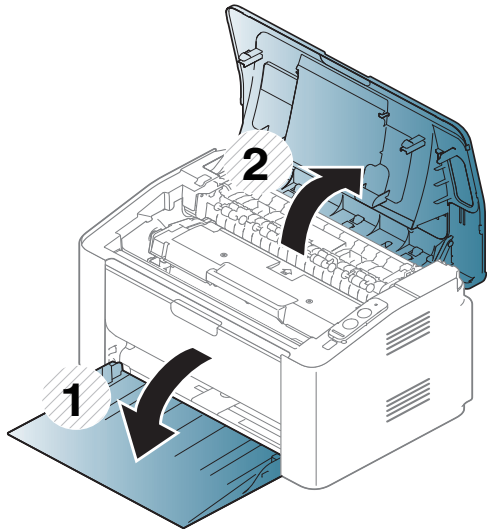

Understanding the status LED



The color of the LED indicates the machine's current status.



- Some LEDs may not be available depending on model or country.
- To resolve the error, look at the error message and its instructions from the troubleshooting part.
- You can also resolve the error with the guidelines from the Samsung Printer Status window or Smart Panel program window.
- If the problem persists, call a service representative.



Understanding the status LED

Status LED

| Status | | Description | |
|---|---------------|---------------------------------------|--|
|  (Status LED) | Off | The machine is off-line or save mode. | |
| | Green | Blinking | <ul style="list-style-type: none">• When the machine is receiving data and printing data.• When the backlight blinks rapidly, the machine is printing data. |
| | | On | The machine is on-line and can be used. |
| | Red | Blinking | Waiting for a  (Print screen) or  (WPS) button to be pressed for manual printing. |
| | | On | <ul style="list-style-type: none">• The cover is opened. Close the cover.• There is no paper in the tray when receiving or printing data. Load paper in the tray ("Loading paper in the tray" on page 27).• The machine has stopped due to a major error.• When the machine is manual and manual duplex printing. |
| | Orange | Blinking | Upgrading firmware. |
| | | On | A paper jam has occurred (see "Clearing paper jams" on page 53). |

Understanding the status LED

Toner LED/ WPS LED/ Power LED

| Status | | Description | |
|---|--------|-----------------|---|
|  (Toner LED) | Orange | Blinking | Small amount of toner is left in the cartridge. The estimated cartridge life of toner is close. Prepare a new cartridge for replacement. You may temporarily increase the printing quality by redistributing the toner (see "Redistributing toner" on page 43). |
| | | On | A toner cartridge has almost reached its estimated cartridge life ^a . It is recommended to replace the toner cartridge (see "Replacing the toner cartridge" on page 44). |
| | | Off | All toner cartridges are at normal capacity. |
|  (WPS LED) ^b | Blue | Blinking | The machine is connecting to a wireless network. |
| | | On | The machine is connected to a wireless network (see "Using the WPS button" on page 96). |
| | | Off | The machine is disconnected from a wireless network. |
|  (Power LED) | Blue | On | The machine is in power save mode. |
| | | Off | The machine is in ready mode or the machine's power is off. |

a. Estimated cartridge life means the expected or estimated toner cartridge life, which indicates the average capacity of print-outs and is designed pursuant to ISO/IEC 19752. The number of pages may be affected by operating environment, printing interval, graphics, media type and media size. Some amount of toner may remain in the cartridge even when red LED is on and the printer stops printing.

b. Wireless model only (see "Features by models" on page 6).



5. Appendix

This chapter provides product specifications and information concerning applicable regulations.

- **Specifications** 60
- **Regulatory information** 69
- **Copyright** 79

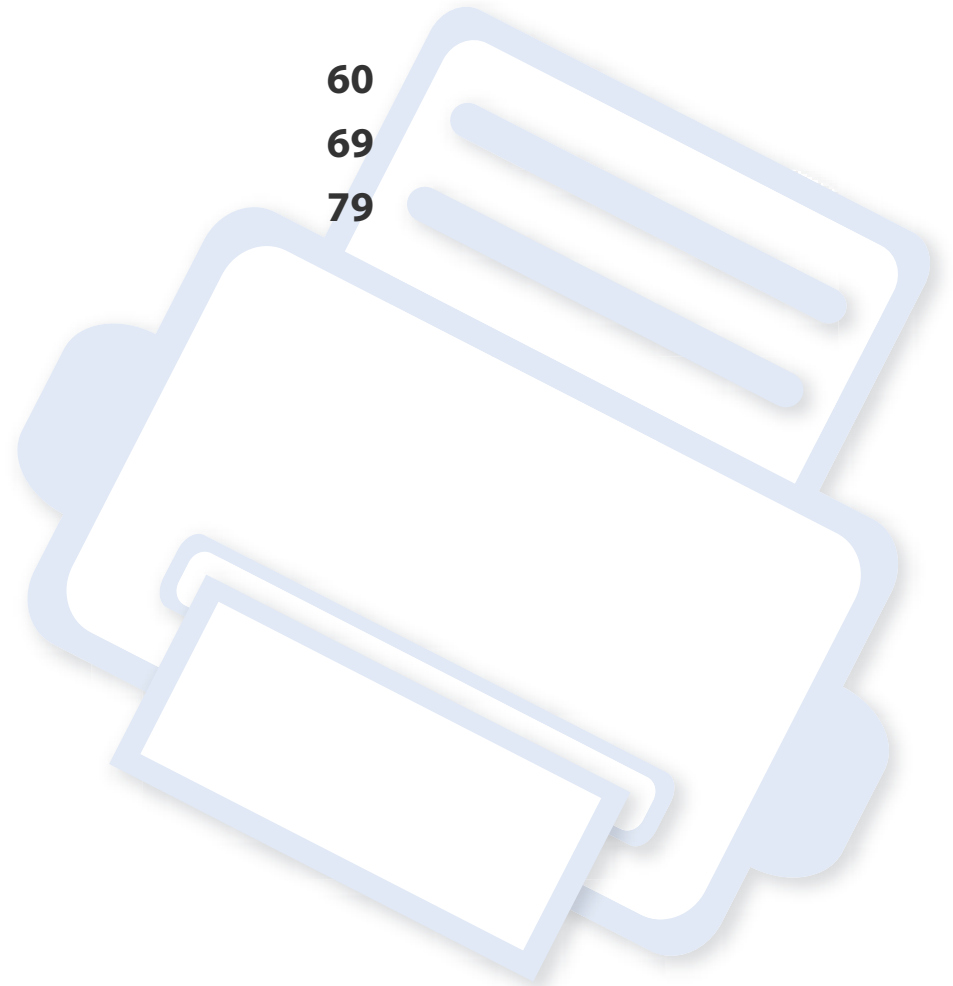

Specifications

General specifications



The specification values listed below are subject to change without notice. See www.samsung.com for possible changes in information.

| Items | | Description |
|---------------------------------|---------------------------------|---|
| Dimension | Width x Length x Height | 331 x 215 x 178 mm (13.03 x 8.46 x 7.01 inches) |
| Weight | Machine with consumables | 3.97 kg (8.75 lbs) |
| Noise Level^a | Ready mode | Less than 26 dB (A) |
| | Print mode | Less than 50 dB (A) |
| Temperature | Operation | 10 to 30 °C (50 to 86 °F) |
| | Storage (packed) | -20 to 40 °C (-4 to 104 °F) |
| Humidity | Operation | 20 to 80% RH |
| | Storage (packed) | 10 to 90% RH |
| Power rating^b | 110 volt models | AC 110 - 127 V |
| | 220 volt models | AC 220 - 240 V |

Specifications

| Items | | Description |
|-----------------------------|------------------------------------|---|
| Power consumption | Average operating mode | Less than 310 W |
| | Ready mode | Less than 30 W |
| | Power save mode^c | <ul style="list-style-type: none"> • M202x series: Less than 1.1 W • M202xW series: Less than 1.9 W (Wi-Fi Direct off :Less than 1.5 W) • M2020W/M2021W/M2024W: Less than 1.5 W |
| | Power off mode^d | Less than 0.45 W (0.1 W ^e) |
| Wireless^f | Module | SPW-B4319S |

a. Sound Pressure Level, ISO 7779. Configuration tested: basic machine installation, A4 paper, simplex printing. China only: If the equipment's noise is louder than 63 db (A), the equipment should be placed in region of relatively independent advice.

b. See the rating label on the machine for the correct voltage (V), frequency (hertz) and type of current (A) for your machine.

c. The power consumption of power save mode may be affected by machine's status, setting conditions, operating environment.

d. Power consumption can be completely avoided only when the power cable is not connected.

e. For the machine that has a power switch.

f. Wireless model only (see "Features by models" on page 6).

Specifications

Print media specifications

| Type | Size | Dimensions | Print media weight/Capacity ^a | |
|----------|-------------------------|------------------------------------|--|--|
| | | | Tray | Manual feeding in tray ^b |
| Plain | Letter | 216 x 279 mm (8.5 x 11 inches) | 71 to 85 g/m ² (19 to 23 lbs bond) • 150 sheets of 80 g/m ² (21 lbs bond) | 71 to 85 g/m ² (19 to 23 lbs bond) • 1 sheet |
| | Legal | 216 x 356 mm (8.5 x 14 inches) | | |
| | Folio | 216 x 330 mm (8.5 x 13 inches) | | |
| | A4 | 210 x 297 mm (8.27 x 11.69 inches) | | |
| | Oficio | 216 x 343 mm (8.5 x 13.5 inches) | | |
| | B5(JIS) | 182 x 257 mm (7.17 x 10.12 inches) | | |
| | B5(ISO) | 176 x 250 mm (6.93 x 9.84 inches) | | |
| | Executive | 184 x 267 mm (7.25 x 10.5 inches) | | |
| | A5 | 148 x 210 mm (5.83 x 8.27 inches) | | |
| Envelope | Monarch Envelope | 98 x 191 mm (3.87 x 7.5 inches) | 75 to 90 g/m ² (20 to 24 lbs bond) • 10 sheets | 75 to 90 g/m ² (20 to 24 lbs bond) • 1 sheet |
| | No 10 Envelope | 105 x 241 mm (4.12 x 9.5 inches) | | |
| | DL Envelope | 110 x 220 mm (4.33 x 8.66 inches) | | |
| | C5 Envelope | 162 x 229 mm (6.38 x 9.02 inches) | | |

Specifications

| Type | Size | Dimensions | Print media weight/Capacity ^a | |
|-------------------|-----------------------------------|----------------------------|---|---|
| | | | Tray | Manual feeding in tray ^b |
| Thick | Refer to the Plain section | Refer to the Plain section | 86 to 120 g/m ² (23 to 32 lbs bond) • 50 sheets of 120 g/m ² (32 lbs bond) | 86 to 120 g/m ² (23 to 32 lbs bond) • 1 sheet |
| Thin | Refer to the Plain section | Refer to the Plain section | 60 to 70 g/m ² (16 to 19 lbs bond) • 160 sheets of 60 g/m ² (16 lbs bond) | 60 to 70 g/m ² (16 to 19 lbs bond) • 1 sheet |
| Cotton | Refer to the Plain section | Refer to the Plain section | 75 to 90 g/m ² (20 to 24 lbs bond) • 150 sheets of 80 g/m ² (21 lbs bond) | 75 to 90 g/m ² (20 to 24 lbs bond) • 1 sheet |
| Color | Refer to the Plain section | Refer to the Plain section | 75 to 90 g/m ² (20 to 24 lbs bond) • 150 sheets of 80 g/m ² (21 lbs bond) | 75 to 90 g/m ² (20 to 24 lbs bond) • 1 sheet |
| Preprinted | Refer to the Plain section | Refer to the Plain section | 75 to 90 g/m ² (20 to 24 lbs bond) • 150 sheets of 80 g/m ² (21 lbs bond) | 75 to 90 g/m ² (20 to 24 lbs bond) • 1 sheet |
| Recycled | Refer to the Plain section | Refer to the Plain section | 60 to 90 g/m ² (16 to 24 lbs bond) • 150 sheets of 80 g/m ² (21 lbs bond) | 60 to 90 g/m ² (16 to 24 lbs bond) • 1 sheet |

Specifications

| Type | Size | Dimensions | Print media weight/Capacity ^a | |
|------------------------------|---|--------------------------------|--|--|
| | | | Tray | Manual feeding in tray ^b |
| Labels ^c | Letter, Legal, Oficio, Folio, A4, B5(JIS), B5(ISO), Executive, A5 | Refer to the Plain section | 120 to 150 g/m ² (32 to 40 lbs bond) • 10 sheets | 120 to 150 g/m ² (32 to 40 lbs bond) • 1 sheet |
| CardStock | Letter, Legal, Oficio, Folio, A4, B5(JIS), B5(ISO), Executive, A5, Postcard 4x6 | Refer to the Plain section | 121 to 163 g/m ² (32 to 43 lbs bond) • 10 sheets | 121 to 163 g/m ² (32 to 43 lbs bond) • 1 sheet |
| Bond | Refer to the Plain section | Refer to the Plain section | • 10 sheets | • 1 sheet |
| Archive | Refer to the Plain section | Refer to the Plain section | • 100 sheets | • 1 sheet |
| Minimum size (custom) | | 76 x 127 mm (3 x 5 inches) | 60 to 163 g/m ² (16 to 43 lbs bond) | |
| Maximum size (custom) | | 216 x 356 mm (8.5 x 14 inches) | | |

a. Maximum capacity may differ depending on media weight, thickness, and environmental conditions.

b. Feed one sheet at a time.

c. The smoothness of the labels used in this machine is 100 to 250 (sheffield). This means the numeric level of smoothness.

Specifications

System requirements

Microsoft® Windows®

| Operating system | Requirement (recommended) | | |
|--------------------------------|--|-----------------|-----------------|
| | CPU | RAM | free HDD space |
| Windows® XP | Intel® Pentium® III 933 MHz (Pentium IV 1 GHz) | 128 MB (256 MB) | 1.5 GB |
| Windows Server® 2003 | Intel® Pentium® III 933 MHz (Pentium IV 1 GHz) | 128 MB (512 MB) | 1.25 GB to 2 GB |
| Windows Server® 2008 | Intel® Pentium® IV 1 GHz (Pentium IV 2 GHz) | 512 MB (2 GB) | 10 GB |
| Windows Vista® | Intel® Pentium® IV 3 GHz | 512 MB (1 GB) | 15 GB |
| Windows® 7 | Intel® Pentium® IV 1 GHz 32-bit or 64-bit processor or higher | 1 GB (2 GB) | 16 GB |
| | <ul style="list-style-type: none">• Support for DirectX® 9 graphics with 128 MB memory (to enable the Aero theme).• DVD-R/W Drive | | |
| Windows Server® 2008 R2 | Intel® Pentium® IV 1.4 GHz (x64) or 1.4 GHz (x64) processors (2 GHz or faster) | 512 MB (2 GB) | 10 GB |
| Windows® 8 | Intel® Pentium® IV 1 GHz 32-bit or 64-bit processor or higher | 2 GB | 20 GB |
| Windows® 8.1 | <ul style="list-style-type: none">• Support for DirectX® 9 graphics with 128 MB memory (to enable the Aero theme).• DVD-R/W Drive | | |
| Windows Server® 2012 | Intel® Pentium® IV 1.4 GHz (x64) or 1.4 GHz (x64) processors (2 GHz or faster) | 512 MB (2 GB) | 32 GB |
| Windows Server® 2012 R2 | | | |

Specifications



- Internet Explorer 6.0 or higher is the minimum requirement for all Windows operating systems.
- Users who have administrator rights can install the software.
- **Windows Terminal Services** is compatible with your machine.

Mac

| Operating system | Requirements (Recommended) | | |
|-----------------------------|---|---------------|----------------|
| | CPU | RAM | Free HDD space |
| Mac OS X 10.5 | <ul style="list-style-type: none">• Intel® processors• 867 MHz or faster Power PC G4/ G5 | 512 MB (1 GB) | 1 GB |
| Mac OS X 10.6 | <ul style="list-style-type: none">• Intel® processors | 1 GB (2 GB) | 1 GB |
| Mac OS X 10.7 ~ 10.9 | <ul style="list-style-type: none">• Intel® processors | 2 GB | 4 GB |

Specifications

Linux

| Items | Requirements |
|-------------------------|--|
| Operating system | Red Hat Enterprise Linux 5, 6 Fedora 11, 12, 13, 14, 15, 16, 17, 18 openSUSE 11.0, 11.1, 11.2, 11.3, 11.4, 12.1, 12.2, 12.3 Ubuntu 10.04, 10.10, 11.04, 11.10, 12.04, 12.10 SUSE Linux Enterprise Desktop 10, 11 Debian 5.0, 6.0 Mint 13, 14 |
| CPU | Pentium IV 2.4GHz (Intel Core™2) |
| RAM | 512 MB (1 GB) |
| Free HDD space | 1 GB (2 GB) |

Specifications

Network environment



Wireless models only (see "Features by models" on page 6).

You need to set up the network protocols on the machine to use it as your network machine. The following table shows the network environments supported by the machine.

| Items | Specifications |
|---------------------------------|--|
| Network interface | <ul style="list-style-type: none">• 802.11b/g/n Wireless LAN (M202xW only) |
| Network operating system | <ul style="list-style-type: none">• Windows Server 2003 /Server 2008/XP/Vista/7/8/Server 2008 R2• Various Linux OS• Mac OS X 10.5 ~ 10.9 |
| Network protocols | <ul style="list-style-type: none">• TCP/IPv4• DHCP, BOOTP• DNS, WINS, Bonjour, SLP, UPnP• Standard TCP/IP Printing (RAW), LPR, IPP, WSD• SNMPv 1/2/3, HTTP, IPSec• TCP/IPv6 (DHCP, DNS, RAW, LPR, SNMPv 1/2/3, HTTP, IPSec) |
| Wireless security | <ul style="list-style-type: none">• Authentication: Open System, Shared Key, WPA Personal, WPA2 Personal (PSK)• Encryption: WEP64, WEP128, TKIP, AES |

Regulatory information

This machine is designed for a normal work environment and certified with several regulatory statements.

Laser safety statement

The printer is certified in the U.S. to conform to the requirements of DHHS 21 CFR, chapter 1 Subchapter J for Class I(1) laser products, and elsewhere is certified as a Class I laser product conforming to the requirements of IEC 60825-1 :2007.

Class I laser products are not considered to be hazardous. The laser system and printer are designed so there is never any human access to laser radiation above a Class I level during normal operation, user maintenance or prescribed service condition.

Warning

Never operate or service the printer with the protective cover removed from laser/scanner assembly. The reflected beam, although invisible, can damage your eyes.

When using this product, these basic safety precautions should always be followed to reduce risk of fire, electric shock, and injury to persons:



CAUTION - CLASS 3B, INVISIBLE LASER RADIATION WHEN OPEN, AVOID EXPOSURE TO THE BEAM.
DANGER - INVISIBLE LASER RADIATION WHEN OPEN, AVOID DIRECT EXPOSURE TO BEAM.
DANGER - KLASSE 3B, UNSICHTBARE LASERSTRAHLUNG, WENN OFFEN, STRAHLENAUSSETZUNG VERMEIDEN.
VORSICHT - UNSICHTBARE LASERSTRAHLUNG KLASSE 3 B, WENN ABDECKUNG GEÖFFNET, NICHT DEM STRAHL AUSSETZEN.
ATTENZIONE - CLASSE 3B, RADIAZIONI LASER INVISIBILI CON IL DISPOSITIVO APERTO, EVITARE L'ESPOSIZIONE AL RAGGIO.
PRECAUCIÓN - RADIACIÓN LÁSER INVISIBLE DE CLASE 3B PRESENTE AL ABRIR, EVITE LA EXPOSICIÓN AL HAZ.
PERIGO - CLASSE 3B, RADIAÇÃO LASER INVISÍVEL AO ABRIR, EVITE EXPOSIÇÃO DIRECTA AO FEIXE.
GEVAAR - KLASSE 3B, ONZICHTBARE LASERSTRALING INDIEN GEOPEND, VERMIJD BLOOTSTELLING AAN DE STRAAL.
ADVARSEL - KLASSE 3B, USYNLIG LASERSTRÅLING VED ÅBNING, UNDGÅ UDSÆTTELSE FOR STRÅLING.
ADVARSEL - KLASSE 3B, USYNLIG LASERSTRÅLING NÅR DEKSEL ÅPNES, UNNGÅ EKSPONERING FOR STRÅLEN.
VARNING - KLASSE 3B OSYNLIG LASERSTRÅLNING NÅR DENNA DEL ÄR ÖPPNAD, STRÅLEN ÄR FARLIG.
VAROITUS - LUOKAN 3B NÄKYMÄTTÖMÄLLE LASER-SÄTEILYÄ AVATTUNA, VÄLTÄ ALTISTUMISTA SÄTEELLE.
注意 - CLASS 3B。严禁打开，以免被不可见激光辐射泄漏灼伤
주의 - 열리면 등급 3B 비가시 레이저 방사선 이 방출됩니다. 광선에 노출을 피하십시오.

Ozone safety



This product's ozone emission rate is under 0.1 ppm. Because ozone is heavier than air, keep the product in a place with good ventilation.

Regulatory information

Power saver



This printer contains advanced energy conservation technology that reduces power consumption when it is not in active use.

When the printer does not receive data for an extended period of time, power consumption is automatically lowered.

ENERGY STAR and the ENERGY STAR mark are registered U.S. marks.

For more information on the ENERGY STAR program see <http://www.energystar.gov>

For ENERGY STAR certified models, the ENERGY STAR label will be on your machine. Check if your machine is ENERGY STAR certified.

China only

回收和再循环

为了保护环境，我们公司已经为废弃的产品建立了回收和再循环系统。我们会为您无偿提供回收同类废旧产品的服务。当您废弃您正在使用的产品时，请您及时与授权耗材更换中心取得联系，我们会及时为您提供服务。

Website : <http://www.samsung.com/cn/support/location/supportServiceLocation.do?page=SERVICE.LOCATION>

中国能效标识

| 型号 | 能效等级 | 典型能耗 (kW·h) |
|---------------|------|-------------|
| Xpress M2021 | 1 | 0.79 |
| Xpress M2021W | 1 | 0.85 |

依据国家标准 GB 25956-2010

Recycling



Recycle or dispose of the packaging material for this product in an environmentally responsible manner.

Regulatory information

Correct disposal of this product (Waste electrical & electronic equipment)

(Applicable in countries with separate collection systems)



This marking on the product, accessories or literature indicates that the product and its electronic accessories (e.g. charger, headset, USB cable) should not be disposed of with other household waste at the end of their working life. To prevent possible harm to the environment or human health from uncontrolled waste disposal, please separate these items from other types of waste and recycle them responsibly to promote the sustainable reuse of material resources.

Household users should contact either the retailer where they purchased this product, or their local government office, for details of where and how they can take these items for environmentally safe recycling.

Business users should contact their supplier and check the terms and conditions of the purchase contract. This product and its electronic accessories should not be mixed with other commercial wastes for disposal.

The United States of America only

Dispose unwanted electronics through an approved recycler. To find the nearest recycling location, go to our website: www.samsung.com/recyclingdirect Or call, (877) 278 - 0799

State of California Proposition 65 Warning (US Only)

The California Safe Drinking Water and Toxic Enforcement Act requires the Governor of California to publish a list of chemicals known to the State of California to cause cancer or reproductive toxicity and requires businesses to warn of potential exposure to such chemicals.

WARNING: This product contains chemicals known to the State of California to cause cancer, birth defects or other reproductive harm.
This appliance can cause low-level exposure to the chemicals, which can be minimized by operating the appliance in a well ventilated area.

Radio frequency emissions

FCC information to the user

This device complies with Part 15 of the FCC Rules. Operation is subject to the following two conditions:

- This device may not cause harmful interference, and
- This device must accept any interference received, including interference that may cause undesired operation.

Regulatory information

This equipment has been tested and found to comply with the limits for a Class B digital device, pursuant to Part 15 of the FCC Rules. These limits are designed to provide reasonable protection against harmful interference in a residential installation. This equipment generates, uses and can radiate radio frequency energy and, if not installed and used in accordance with the instructions, may cause harmful interference to radio communications. However, there is no guarantee that interference will not occur in a particular installation. If this equipment does cause harmful interference to radio or television reception, which can be determined by turning the equipment off and on, the user is encouraged to try to correct the interference by one or more of the following measures:

- Reorient or relocate the receiving antenna.
- Increase the separation between the equipment and receiver.
- Connect the equipment into an outlet on a circuit different from that to which the receiver is connected.
- Consult the dealer or experienced radio TV technician for help.



Change or modifications not expressly approved by the manufacturer responsible for compliance could void the user's authority to operate the equipment.

Canadian radio interference regulations

This digital apparatus does not exceed the Class B limits for radio noise emissions from digital apparatus as set out in the interference-causing equipment standard entitled "Digital Apparatus", ICES-003 of the Industry and Science Canada.

Cet appareil numérique respecte les limites de bruits radioélectriques applicables aux appareils numériques de Classe B prescrites dans la norme sur le matériel brouilleur: "Appareils Numériques", ICES-003 édictée par l'Industrie et Sciences Canada.

United states of america

Federal communications commission (FCC)

Intentional emitter per FCC Part 15

Low power, Radio LAN type devices (radio frequency (RF) wireless communication devices), operating in the 2.4 GHz/5 GHz Band, may be present (embedded) in your printer system. This section is only applicable if these devices are present. Refer to the system label to verify the presence of wireless devices.

Wireless devices that may be in your system are only qualified for use in the United States of America if an FCC ID number is on the system label.

Regulatory information

The FCC has set a general guideline of 20 cm (8 inches) separation between the device and the body, for use of a wireless device near the body (this does not include extremities). This device should be used more than 20 cm (8 inches) from the body when wireless devices are on. The power output of the wireless device (or devices), which may be embedded in your printer, is well below the RF exposure limits as set by the FCC.

This transmitter must not be collocated or operation in conjunction with any other antenna or transmitter.

Operation of this device is subject to the following two conditions: (1) This device may not cause harmful interference, and (2) this device must accept any interference received, including interference that may cause undesired operation of the device.



Wireless devices are not user serviceable. Do not modify them in any way. Modification to a wireless device will void the authorization to use it. Contact manufacturer for service.

FCC statement for wireless LAN use:



While installing and operating this transmitter and antenna combination the radio frequency exposure limit of 1 m W/cm² may be exceeded at distances close to the antenna installed. Therefore, the user must maintain a minimum distance of 20cm from the antenna at all times. This device cannot be collocated with another transmitter and transmitting antenna.

Russia/Kazakhstan/Belarus only



TOO «SAMSUNG ELECTRONICS KZ AND CENTRAL ASIA» (САМСУНГ ЭЛЕКТРОНИКС КЗ ЭНД ЦЕНТРАЛ ЭЙЖА)
Юридический адрес:
Республика Казахстан, город Алматы, пр. Аль Фараби, д. 36, 3,4 этажи



«SAMSUNG ELECTRONICS KZ AND CENTRAL ASIA» (САМСУНГ ЭЛЕКТРОНИКС КЗ ЭНД ЦЕНТРАЛ ЭЙЖА) ЖШС
Заңды мекен-жайы:
Қазақстан Республикасы, Алматы қ., Өл-Фараби даңғылы, 36, 3,4-қабаттар

Germany only

Das Gerät ist nicht für die Benutzung am Bildschirmarbeitsplatz gemäß BildscharbV vorgesehen.

Regulatory information

Turkey only

- RoHS
EEE Yönetmeliğine Uygundur.
This EEE is compliant with RoHS.
- Bu ürünün ortalama yaşam süresi 7 yıl, garanti süresi 2 yıldır.

Thai only

This telecommunication equipment conforms to NTC technical requirement.

Replacing the fitted plug (for UK only)

Important

The mains lead for this machine is fitted with a standard (BS 1363) 13 amp plug and has a 13 amp fuse. When you change or examine the fuse, you must re-fit the correct 13 amp fuse. You then need to replace the fuse cover. If you have lost the fuse cover, do not use the plug until you have another fuse cover.

Contact the people from you purchased the machine.

The 13 amp plug is the most widely used type in the UK and should be suitable. However, some buildings (mainly old ones) do not have normal 13 amp plug sockets. You need to buy a suitable plug adaptor. Do not remove the moulded plug.



If you cut off the moulded plug, get rid of it straight away. You cannot rewire the plug and you may receive an electric shock if you plug it into a socket.

Important warning:



You must earth this machine.

The wires in the mains lead have the following color code:

- **Green and Yellow:** Earth
- **Blue:** Neutral
- **Brown:** Live

If the wires in the mains lead do not match the colors marked in your plug, do the following:

You must connect the green and yellow wire to the pin marked by the letter “E” or by the safety ‘Earth symbol’ or colored green and yellow or green.

You must connect the blue wire to the pin which is marked with the letter “N” or colored black.

You must connect the brown wire to the pin which is marked with the letter “L” or colored red.

Regulatory information

You must have a 13 amp fuse in the plug, adaptor, or at the distribution board.

Declaration of conformity (European countries)

Approvals and Certifications

- Hereby, Samsung Electronics, declares that this [M202x series] is in compliance with the essential requirements and other relevant provisions of Low Voltage Directive (2006/95/EC), EMC Directive (2004/108/EC).
- Hereby, Samsung Electronics, declares that this [M202xW series] is in compliance with the essential requirements and other relevant provisions of R&TTE Directive 1999/5/EC.



The declaration of conformity may be consulted at www.samsung.com, go to Support > Download center and enter your printer (MFP) name to browse the EuDoC.

January 1, 1995: Council Directive 2006/95/EC Approximation of the laws of the member states related to low voltage equipment.

January 1, 1996: Council Directive 2004/108/EC, approximation of the laws of the Member States related to electromagnetic compatibility.

March 9, 1999: Council Directive 1999/5/EC on radio equipment and telecommunications terminal equipment and the mutual recognition of their conformity. A full declaration, defining the relevant Directives and referenced standards can be obtained from your Samsung Electronics Co., Ltd. representative.

EC Certification

Certification to 1999/5/EC Radio Equipment & Telecommunications Terminal Equipment Directive (FAX)

This Samsung product has been self-certified by Samsung for pan-European single terminal connection to the analogue public switched telephone network (PSTN) in accordance with Directive 1999/5/EC. The product has been designed to work with the national PSTNs and compatible PBXs of the European countries:

In the event of problems, you should contact the Euro QA Lab of Samsung Electronics Co., Ltd. in the first instance.

The product has been tested against TBR21. To assist in the use and application of terminal equipment which complies with this standard, the European Telecommunication Standards Institute (ETSI) has issued an advisory document (EG 201 121) which contains notes and additional requirements to ensure network compatibility of TBR21 terminals. The product has been designed against, and is fully compliant with, all of the relevant advisory notes contained in this document.

Regulatory information

European radio approval information (for products fitted with EU-approved radio devices)

Low power, Radio LAN type devices (radio frequency (RF) wireless communication devices), operating in the 2.4 GHz/5 GHz band, may be present (embedded) in your printer system which is intended for home or office use. This section is only applicable if these devices are present. Refer to the system label to verify the presence of wireless devices.



Wireless devices that may be in your system are only qualified for use in the European Union or associated areas if a CE mark is on the system label.

The power output of the wireless device or devices that may be embedded in your printer is well below the RF exposure limits as set by the European Commission through the R&TTE directive.

European states qualified under wireless approvals:

EU countries

European states with restrictions on use:

EU

EEA/EFTA countries

No limitations at this time

Regulatory compliance statements

Wireless guidance

Low power, Radio LAN type devices (radio frequency (RF) wireless communication devices), operating in the 2.4 GHz/5 GHz Band, may be present (embedded) in your printer system. The following section is a general overview of considerations while operating a wireless device.

Additional limitations, cautions, and concerns for specific countries are listed in the specific country sections (or country group sections). The wireless devices in your system are only qualified for use in the countries identified by the Radio Approval Marks on the system rating label. If the country you will be using the wireless device in, is not listed, contact your local Radio Approval agency for requirements. Wireless devices are closely regulated and use may not be allowed.

The power output of the wireless device or devices that may be embedded in your printer is well below the RF exposure limits as known at this time. Because the wireless devices (which may be embedded into your printer) emit less energy than is allowed in radio frequency safety standards and recommendations, manufacturer believes these devices are safe for use. Regardless of the power levels, care should be taken to minimize human contact during normal operation.

Regulatory information

As a general guideline, a separation of 20 cm (8 inches) between the wireless device and the body, for use of a wireless device near the body (this does not include extremities) is typical. This device should be used more than 20 cm (8 inches) from the body when wireless devices are on and transmitting.

This transmitter must not be collocated or operation in conjunction with any other antenna or transmitter.

Some circumstances require restrictions on wireless devices. Examples of common restrictions are listed below:



Radio frequency wireless communication can interfere with equipment on commercial aircraft. Current aviation regulations require wireless devices to be turned off while traveling in an airplane. IEEE 802.11 (also known as wireless Ethernet) and Bluetooth communication devices are examples of devices that provide wireless communication.



In environments where the risk of interference to other devices or services is harmful or perceived as harmful, the option to use a wireless device may be restricted or eliminated. Airports, Hospitals, and Oxygen or flammable gas laden atmospheres are limited examples where use of wireless devices may be restricted or eliminated. When in environments where you are uncertain of the sanction to use wireless devices, ask the applicable authority for authorization prior to use or turning on the wireless device.



Every country has different restrictions on the use of wireless devices. Since your system is equipped with a wireless device, when traveling between countries with your system, check with the local Radio Approval authorities prior to any move or trip for any restrictions on the use of a wireless device in the destination country.



If your system came equipped with an internal embedded wireless device, do not operate the wireless device unless all covers and shields are in place and the system is fully assembled.



Wireless devices are not user serviceable. Do not modify them in any way. Modification to a wireless device will void the authorization to use it. Contact manufacturer for service.



Only use drivers approved for the country in which the device will be used. See the manufacturer System Restoration Kit, or contact manufacturer Technical Support for additional information.

Israel only

מס' אישור אלחוטי של משרד התקשורת הוא 51-28466
אסור להחליף את האנטנה המקורית של המכשיר,
ולא לעשות בו כל שינוי טכני אחר.

Regulatory information

China only

产品中有毒有害物质或元素的名称及含量

| 部件名称 | 有毒有害物质或元素 | | | | | |
|---------------------|-----------|-----------|-----------|----------------------------|---------------|-----------------|
| | 铅 (Pb) | 汞 (Hg) | 镉 (Cd) | 六价铬 (Cr ⁶⁺) | 多溴联苯 (PBB) | 多溴联苯醚 (PBDE) |
| 塑料 | ○ | ○ | ○ | ○ | ○ | ○ |
| 金属 (机箱) | X | ○ | ○ | ○ | ○ | ○ |
| 印刷电路部件 (PCA) | X | ○ | ○ | ○ | ○ | ○ |
| 电缆 / 连接器 | X | ○ | ○ | ○ | ○ | ○ |
| 电源设备 | X | ○ | ○ | ○ | ○ | ○ |
| 电源线 | X | ○ | ○ | ○ | ○ | ○ |
| 机械部件 | X | ○ | ○ | ○ | ○ | ○ |
| 卡盒部件 | X | ○ | ○ | ○ | ○ | ○ |
| 定影部件 | X | ○ | ○ | ○ | ○ | ○ |
| 扫描仪部件 - CCD (如果有) | X | X | ○ | ○ | ○ | ○ |
| 扫描仪部件 - 其它 (如果有) | X | ○ | ○ | ○ | ○ | ○ |
| 印刷电路板部件 (PBA) | X | ○ | ○ | ○ | ○ | ○ |
| 墨粉 | ○ | ○ | ○ | ○ | ○ | ○ |
| 滚筒 | ○ | ○ | ○ | ○ | ○ | ○ |

○：表示该有毒有害物质在该部件所有均质材料中的含量均在 SJ/T 11363-2006 标准规定的限量要求以下。

X：表示该有毒有害物质至少在该部件的某一均质材料中的含量超出 SJ/T 11363-2006 标准规定的限量要求。

以上表为目前本产品含有有毒有害物质的信息。本信息由本公司的配套厂家提供，经本公司审核后而做成，本产品的部分部件含有有毒有害物质，这些部件是在现有科学技术水平下暂时无可替代物质，但三星电子将会一直为满足 SJ/T 11363-2006 标准而做不懈的努力。

Copyright

© 2013 Samsung Electronics Co., Ltd. All rights reserved.

This user's guide is provided for information purposes only. All information included herein is subject to change without notice.

Samsung Electronics is not responsible for any direct or indirect damages, arising from or related to use of this user's guide.

- Samsung and the Samsung logo are trademarks of Samsung Electronics Co., Ltd.
- Microsoft, Windows, Windows Vista, Windows 7, Windows 8 and Windows Server 2008 R2 are either registered trademarks or trademarks of Microsoft Corporation.
- Google, Picasa, Google Docs, Android and Gmail are either registered trademarks or trademarks of Google Inc.
- Google Cloud Print is a trademark of Google Inc.
- iPad, iPhone, iPod touch, Mac and Mac OS are trademarks of Apple Inc., registered in the U.S and other countries.
AirPrint and the AirPrint logo are trademarks of Apple Inc.
- All other brand or product names are trademarks of their respective companies or organizations.

Refer to the '**LICENSE.txt**' file in the provided CD-ROM for the open source license information.

REV. 4.00

User's Guide

Samsung Printer *Xpress*

M202x series

ADVANCED

This guide provides information about installation, advanced configuration, operation and troubleshooting on various OS environments.

Some features may not be available depending on models or countries.

BASIC

This guide provides information concerning installation, basic operation and troubleshooting on windows.

ADVANCED



1. Software Installation

| | |
|---------------------------------|----|
| Installation for Mac | 84 |
| Reinstallation for Mac | 85 |
| Installation for Linux | 86 |
| Reinstallation for Linux | 87 |



2. Using a Network-connected Machine

| | |
|--------------------------------|-----|
| Useful network programs | 89 |
| Wired network setup | 90 |
| IPv6 configuration | 91 |
| Wireless network setup | 93 |
| Samsung Mobile Print | 121 |
| Using the NFC feature | 122 |
| Google Cloud Print™ | 124 |
| AirPrint | 127 |



3. Special Features

| | |
|--|-----|
| Altitude adjustment | 130 |
| Changing the default print settings | 131 |
| Setting your machine as a default machine | 132 |
| Using advanced print features | 133 |
| Mac printing | 140 |
| Linux printing | 142 |



4. Useful Management Tools

| | |
|---|-----|
| Accessing management tools | 145 |
| Easy Capture Manager | 146 |
| Samsung AnyWeb Print | 147 |
| Easy Eco Driver | 148 |
| Using SyncThru™ Web Service | 149 |
| Using Samsung Easy Printer Manager | 151 |
| Using Samsung Printer Status | 154 |
| Using Samsung Printer Experience | 156 |



5. Troubleshooting

| | |
|--|------------|
| Paper feeding problems | 163 |
| Power and cable connecting problems | 164 |
| Printing problems | 165 |
| Printing quality problems | 169 |
| Operating system problems | 177 |



1. Software Installation

This chapter provides instructions for installing essential and helpful software for use in an environment where the machine is connected via a cable. A locally connected machine is a machine directly attached to your computer using the cable.

- **Installation for Mac** 84
- **Reinstallation for Mac** 85
- **Installation for Linux** 86
- **Reinstallation for Linux** 87



- If you are a Windows OS user, refer to the "Installing the driver locally" on page 22 for installing the machine's driver.
- Only use a USB cable no longer than 3 meter (118 inches).

Installation for Mac

1 Make sure that the machine is connected to your computer and powered on.

2 Insert the supplied software CD into your CD-ROM drive.

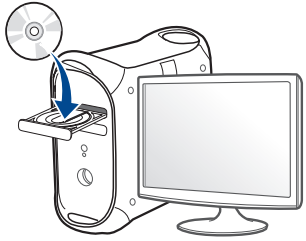

3 Double-click the CD-ROM icon that appears on your Mac desktop.

- For Mac OS X 10.8, double-click the CD-ROM that appears on **Finder**.

4 Double-click the **MAC_Installer** folder > **Installer OS X** icon.

5 Click **Continue**.

6 Read the license agreement and click **Continue**.

7 Click **Agree** to agree to the license agreement.

8 Click **Install**. All components necessary for machine operations will be installed.

If you click **Customize**, you can choose individual components to install.

9 Enter the password and click **OK**.

10 Select **USB Connected Printer** on the **Printer Connection Type** and click **Continue**.

11 Click **Add Printer** button to select your printer and add it to your printer list.

12 After the installation is finished, click **Close**.

Reinstallation for Mac

If the printer driver does not work properly, uninstall the driver and reinstall it.

- 1 Open the **Applications** folder > **Samsung** > **Printer Software Uninstaller**.
- 2 To uninstall printer software, click **Continue**.
- 3 Check the program you want to delete and click **Uninstall**.
- 4 Enter the password and click **OK**.
- 5 After the uninstallation is finished, click **Close**.



If a machine has already been added, delete it from the **Print Setup Utility** or **Print & Fax**.

Installation for Linux

You need to download Linux software packages from the Samsung website to install the printer software (<http://www.samsung.com> > find your product > Support or Downloads).

Installing the Unified Linux Driver



You must log in as a super user (root) to install the machine software. If you are not a super user, ask your system administrator.

- 1 Make sure that the machine is connected to your computer and powered on.
- 2 Copy **Unified Linux Driver** package to your system.
- 3 Open Terminal program and go to the folder that you copied the package to.
- 4 Extract the package.
- 5 Move to **uld** folder.
- 6 Execute **./install.sh** command (If you're not logged in as root, execute the command with **sudo** as **sudo ./install.sh**)
- 7 Proceed with installation.

- 8 When installation finished, launch printing utility(Go to **System** > **Administration** > **Printing** or execute **"system-config-printer"** command in Terminal program).
- 9 Click **Add** button.
- 10 Select your printer.
- 11 Click **Forward** button and add it to your system.

Reinstallation for Linux

If the printer driver does not work properly, uninstall the driver and reinstall it.

- 1 Open **Terminal** program.
- 2 Move to **uld** folder extracted from **Unified Linux Driver** package.
- 3 Execute "**./uninstall.sh**" command (If you're not logged in as root, execute the command with "**sudo**" as "**sudo ./uninstall.sh**")
- 4 Proceed with uninstallation.



2. Using a Network-connected Machine

This chapter gives you step-by-step instructions for setting up a network connected machine and software.

- **Useful network programs** 89
- **Wired network setup** 90
- **IPv6 configuration** 91
- **Wireless network setup** 93
- **Samsung Mobile Print** 121
- **Using the NFC feature** 122
- **Google Cloud Print™** 124
- **AirPrint** 127



Supported optional devices and features may differ according to your model (see "Features by models" on page 6).

Useful network programs

There are several programs available to setup the network settings easily in a network environment. For the network administrator especially, managing several machines on the network is possible.



- Before using the programs below, set the IP address first.
- Some features and optional goods may not be available depending on model or country (see "Features by models" on page 6).

SyncThru™ Web Service

The web server embedded on your network machine allows you to do the following tasks (see "IPv6 address configuration" on page 92):

- Check the supplies information and status.
- Customize machine settings.
- Configure the network parameters necessary for the machine to connect to various network environments.

SyncThru™ Web Admin Service

Web-based machine management solution for network administrators. SyncThru™ Web Admin Service provides you with an efficient way of managing network devices and lets you remotely monitor and troubleshoot network machines from any site with corporate Internet access.

- Download this program from <http://solution.samsungprinter.com>.

Wired network setup

Printing a network configuration report

You can print **Network Configuration Report** from the machine's control panel that will show the current machine's network settings. This will help you to set up a network.

- Press the  (WPS) button for more than 10 seconds on the control panel.

Using this **Network Configuration Report**, you can find your machine's MAC address and IP address.

For example:

- MAC Address: 00:15:99:41:A2:78
- IP Address: 165.254.192.192

IPv6 configuration



IPv6 is supported properly only in Windows Vista or higher.

In the IPv6 network environment, follow the next procedure to use the IPv6 address.

From the SyncThru™ Web Service

Activating IPv6

- 1 Access a web browser, such as Internet Explorer, from Windows. Enter the machine IP address (<http://xxx.xxx.xxx.xxx>) in the address field and press the Enter key or click **Go**.
- 2 If it's your first time logging into **SyncThru™ Web Service** you need to log-in as an administrator. Type in the below default ID and password. We recommend you to change the default password for security reasons.
 - **ID: admin**
 - **Password: sec00000**
- 3 When the **SyncThru™ Web Service** window opens, move the mouse cursor over the **Settings** of the top menu bar and then click **Network Settings**.

- 4 Click **TCP/IPv6** on the left pane of the website.
- 5 Check the **IPv6 Protocol** check box to activate IPv6.
- 6 Click the **Apply** button.
- 7 Turn the machine off and turn it on again.



- You can also set the DHCPv6.
- To manually set the IPv6 address:
Check the **Manual Address** check box. Then, the **Address/Prefix** text box is activated. Enter the rest of the address (e.g., :3FFE:10:88:194::**AAAA**. "A" is the hexadecimal 0 through 9, A through F).

IPv6 configuration

IPv6 address configuration

- 1 Start a web browser, such as Internet Explorer, that supports IPv6 addressing as a URL.
- 2 Select one of the IPv6 addresses (**Link-local Address, Stateless Address, Stateful Address, Manual Address**) from **Network Configuration Report** (see "Printing a network configuration report" on page 90).
 - **Link-local Address:** Self-configured local IPv6 address (Address starts with FE80).
 - **Stateless Address:** Automatically configured IPv6 address by a network router.
 - **Stateful Address:** IPv6 address configured by a DHCPv6 server.
 - **Manual Address:** Manually configured IPv6 address by a user.
- 3 Enter the IPv6 addresses (e.g.,: `http://[FE80::215:99FF:FE66:7701]`).



Address must be enclosed in '[']' brackets.

Wireless network setup



Make sure your machine supports wireless networking. Wireless networking may not be available depending on the model (see "Features by models" on page 6).

Getting started

Understanding your network type

Typically, you can only have one connection between your computer and the machine at a time.



Infrastructure mode

This is an environment generally used for homes and SOHOs (Small Office/ Home Office). This mode uses an access point to communicate with the wireless machine.



Ad hoc mode

This mode does not use an access point. The wireless computer and wireless machine communicate directly.

Wireless network name and Network Password

Wireless networks require higher security, so when an access point is first set up, a network name (SSID), the type of security used, and a Network Password are created for the network. Ask your network administrator about this information before proceeding with the machine installation.



Wireless network setup

Introducing wireless set up methods



You can set wireless settings either from the machine or the computer. Choose the setting method from the below table.

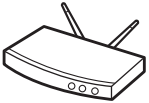

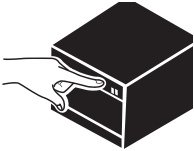
Some wireless network installation types may not be available depending on the model or country.

| Set up method | Connecting method | Description & Reference |
|---|--|---|
| With Access Point  | From the computer  | Windows user, see "Access point via USB cable" on page 99. Windows user, see "Access point without a USB cable (recommended)" on page 102. <ul style="list-style-type: none">• Mac user, see "Access point via USB cable" on page 107.• Mac user, see "Access point without a USB cable (recommended)" on page 109 |
| | From the machine's control panel  | <ul style="list-style-type: none">• See "Connecting in PBC mode" on page 97.• See "Connecting in PIN mode" on page 97. |

Wireless network setup

| Set up method | Connecting method | Description & Reference |
|---|--|---|
| Without Access Point  | From the computer | Windows user, see "Ad hoc via USB cable" on page 104. |
| | Ad-hoc  | Mac user, see "Ad hoc via USB cable" on page 112. |
| | Wi-Fi Direct setup | See "Setting up Wi-Fi Direct" on page 116. |
| | Wi-Fi Direct  | |



- If problems occur during wireless set up or driver installation, refer to the troubleshooting chapter (see "Troubleshooting" on page 117).
- It is strongly recommended that you set the password on Access Points. If you do not set the password on Access Points, they might be exposed to illegal access from unknown machines including PCs, smart phones and printers. Refer to the Access Point user' guide for password settings.

Wireless network setup

Using the WPS button

If your machine and an access point (or wireless router) support Wi-Fi Protected Setup™ (WPS), you can easily configure the wireless network settings by pressing the  (WPS) button on the control panel without a computer.





- If you want to use the wireless network using the infrastructure mode, make sure that the network cable is disconnected from the machine. Using the **WPS (PBC)** button or entering the PIN from the computer to connect to the access point (or wireless router) varies depending on the access point (or wireless router) you are using. Refer to the user's guide of the access point (or wireless router) you are using.
- When using the WPS button to set the wireless network, security settings may change. To prevent this, lock the WPS option for the current wireless security settings. The option name may differ depending on the access point (or wireless router) you are using.

Items to prepare

- Check if the access point (or wireless router) supports Wi-Fi Protected Setup™ (WPS).
- Check if your machine supports Wi-Fi Protected Setup™ (WPS).
- Networked computer (PIN mode only)

Choosing your type

There are two methods available to connect your machine to a wireless network using the  (WPS) button on the control panel.

The **Push Button Configuration (PBC)** method allows you to connect your machine to a wireless network by pressing both the  (WPS) button on the control panel of your machine and the WPS (PBC) button on a Wi-Fi Protected Setup™ WPS-enabled access point (or wireless router) respectively.

The **Personal Identification Number (PIN)** method helps you connect your machine to a wireless network by entering the supplied PIN information on a Wi-Fi Protected Setup™ WPS-enabled access point (or wireless router).

Factory default in your machine is **PBC** mode, which is recommended for a typical wireless network environment.

Wireless network setup

Connecting in PBC mode

- 1 Press and hold the  (WPS) button on the control panel for about 2 - 4 seconds until the status LED blinks quickly.

The machine starts connecting to the wireless network. The LED blinks slowly for up to two minutes until you press the PBC button on the access point (or wireless router).

- 2 Press the **WPS (PBC)** button on the access point (or wireless router).
 - a The light blinks fast on the WPS LED. The machine is connecting to the access point (or wireless router).
 - b When the machine is successfully connected to the wireless network, the WPS LED light stays on.
- 3 Insert the supplied software CD into your CD-ROM drive, and follow the instructions in the window to set up the wireless network.

Connecting in PIN mode

- 1 The network configuration report, including PIN, must be printed (see "Printing a network configuration report" on page 90).

In ready mode, Press and hold the  (WPS) button on the button formore than ten seconds on the control panel.

You can find your machine's PIN.

- 2 Press and hold the  (WPS) button on the control panel for more than 4 seconds until the status LED stays on.

The machine starts connecting to the access point (or wireless router).

- 3 You need to enter the eight-digit PIN within two minutes on the computer that is connected to the access point (or wireless router).

The LED blinks slowly for up to two minutes until you enter the eight-digit PIN.

The WPS LED blinks in the order below:

- a The light blinks fast on the WPS LED. The machine is connecting to the access point (or wireless router).
 - b When the machine is successfully connected to the wireless network, the WPS LED light stays on.
- 4 Insert the supplied software CD into your CD-ROM drive, and follow the instructions in the window to set up the wireless network.

Wireless network setup

Re-connecting to a network

When the wireless function is off, the machine automatically tries to re-connect to the access point (or wireless router) with the previously used wireless connection settings and address.



In the following cases, the machine automatically re-connects to the wireless network:

- The machine is turned off and on again.
- The access point (or wireless router) is turned off and on again.

Canceling the connection process

To cancel the wireless network connection when the machine is connecting to the wireless network, press and release the  (**Power**) button on the control panel. **You need to wait 2 minutes to re-connect to the wireless network.**

Disconnecting from a network

To disconnect the wireless network connection, press the  (WPS) button on the control panel for more than two seconds.

- **When the Wi-Fi network is in idle mode:** The machine is immediately disconnected from the wireless network and the WPS LED turns off.
- **When the Wi-Fi network is being used:** While the machine waits until the current job is finished, the light blinks fast on the WPS LED. Then, the wireless network connection is automatically disconnected and the WPS LED turns off.

Wireless network setup

Setup using Windows



Shortcut to the **Samsung Easy Wireless Setup** program without the CD: If you have installed the printer driver once, you can access the **Samsung Easy Wireless Setup** program without the CD (see "Accessing management tools" on page 145).

Access point via USB cable

Items to prepare

- Access point
- Network-connected computer
- Software CD that was provided with your machine
- A machine installed with a wireless network interface
- USB cable

Creating the infrastructure network

- 1 Check whether the USB cable is connected to the machine.
- 2 Turn on your computer, access point, and machine.

- 3 Insert the supplied software CD into your CD-ROM drive.

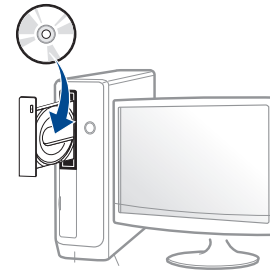

If the installation window does not appear, click **Start > All programs > Accessories > Run**.

X:\Setup.exe replacing "X" with the letter, which represents your CD-ROM drive and click **OK**.

- For Windows 8,
If the installation window does not appear, from **Charms**, select **Search > Apps** and search for **Run**. Type in X:\Setup.exe, replacing "X" with the letter that represents your CD-ROM drive and click **OK**.
If "**Tap to choose what happens with this disc.**" pop-up window appears, click the window and select **Run Setup.exe**.

- 4 Review and accept the installation agreements in the installation window. Then, click **Next**.

Wireless network setup

- 5 Select **Wireless network connection** on the **Printer Connection Type** screen. Then, click **Next**.



- 6 On the **Are you setting up your printer for the first time?** screen, select **Yes, I will set up my printer's wireless network**. Then, click **Next**.

If your printer is already connected on the network, select **No, my printer is already connected to my network**.

- 7 Select **Using a USB cable** on the **Select the Wireless Setup Method** screen. Then, click **Next**.



- 8 After searching, the window shows the wireless network devices. Select the name (SSID) of the access point you want to use and click **Next**.



If you cannot find the network name you want to choose, or if you want to set the wireless configuration manually, click **Advanced Setting**.

- **Enter the wireless Network Name:** Enter the SSID of the access point (SSID is case-sensitive).
- **Operation Mode:** Select **Infrastructure**.
- **Authentication:** Select an authentication type.
 - Open System:** Authentication is not used, and encryption may or may not be used, depending on the need for data security.
 - Shared Key:** Authentication is used. A device that has a proper WEP key can access the network.

Wireless network setup

WPA Personal or WPA2 Personal: Select this option to authenticate the print server based on a WPA Pre-Shared Key. This uses a shared secret key (generally called Pre Shared Key pass phrase), which is manually configured on the access point and each of its clients.

- **Encryption:** Select the encryption (None, WEP64, WEP128, TKIP, AES, TKIP AES).
- **Network Password:** Enter the encryption network password value.
- **Confirm Network Password:** Confirm the encryption network password value.
- **WEP Key Index:** If you are using WEP Encryption, select the appropriate **WEP Key Index**.



The wireless network security window appears when the access point has security settings.

Enter the Network Password of the access point (or router).

- 9 If your printer supports Wi-Fi Direct, the following screen appears. Click **Next**.



- Wi-Fi Direct option appears on the screen only if your printer supports this feature.
- Can start to build Wi-Fi Direct by using Samsung Easy Printer Manager (see "Setting up Wi-Fi Direct" on page 116).
- **Wi-Fi Direct Name:** The default Wi-Fi Direct Name is the model name and the maximum length is 22 characters.
- **Password setting** is the numeric string, and the size is 8 ~ 64 characters.

- 10 When the wireless network set up is completed, disconnect the USB cable between the computer and machine. Click **Next**.

Wireless network setup

11 Select the components to be installed.

12 Follow the instructions in the installation window.

Access point without a USB cable (recommended)

Items to prepare

- WiFi-enabled PC running Windows 7 or higher and an access point (router)
- Software CD that was provided with your machine
- A machine installed with a wireless network interface



While setting the wireless network, the machine uses PC's wireless LAN. You might not be able to connect to the Internet.

Creating the infrastructure network

1 Turn on your computer, access point, and machine.

2 Insert the supplied software CD into your CD-ROM drive.

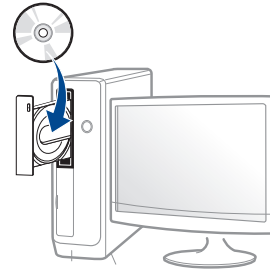

If the installation window does not appear, click **Start > All programs > Accessories > Run**.

X:\Setup.exe replacing "X" with the letter, which represents your CD-ROM drive and click **OK**.

- For Windows 8,

If the installation window does not appear, from **Charms**, select **Search > Apps** and search for **Run**. Type in X:\Setup.exe, replacing "X" with the letter that represents your CD-ROM drive and click **OK**.

If "**Tap to choose what happens with this disc.**" pop-up window appears, click the window and select **Run Setup.exe**.

3 Review and accept the installation agreements in the installation window. Then, click **Next**.

Wireless network setup

- 4 Select **Wireless network connection** on the **Printer Connection Type** screen. Then, click **Next**.



- 5 On the **Are you setting up your printer for the first time?** screen, select **Yes, I will set up my printer's wireless network**. Then, click **Next**.

If your printer is already connected on the network, select **No, my printer is already connected to my network**.

- 6 Select **Using a direct wireless connection** on the **Select the Wireless Setup Method** screen. Then, click **Next**.

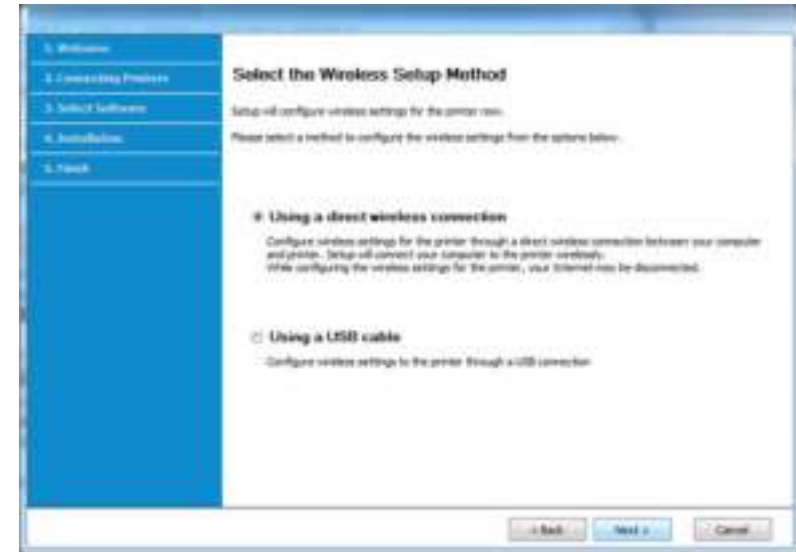

Even if your computer is running Windows 7 or higher, you cannot use this feature if your PC does not support wireless network. Set the wireless network using a USB cable (see "Access point via USB cable" on page 99).

Wireless network setup

If below screen appears, press the  (WPS) button from the control panel within 2 minutes.



7 When the wireless network set up is completed, click **Next**.

8 Follow the instructions in the installation window.

Ad hoc via USB cable

If you do not have an access point (AP), you may still connect the machine wirelessly to your computer by setting up an ad-hoc wireless network by following the simple steps below.

Items to prepare

- Network-connected computer
- Software CD that was provided with your machine
- A machine installed with a wireless network interface
- USB cable

Wireless network setup

Creating the ad hoc network in Windows

- 1 Turn on your computer and the wireless network machine.
- 2 Insert the supplied software CD into your CD-ROM drive.



If the installation window does not appear, click **Start > All programs > Accessories > Run**.

X:\Setup.exe replacing "X" with the letter, which represents your CD-ROM drive and click **OK**.

- For Windows 8,
 - If the installation window does not appear, from **Charms**, select **Search > Apps** and search for **Run**. Type in X:\Setup.exe, replacing "X" with the letter that represents your CD-ROM drive and click **OK**.
 - If "**Tap to choose what happens with this disc.**" pop-up window appears, click the window and select **Run Setup.exe**.
- 3 Review and accept the installation agreements in the installation window. Then, click **Next**.

- 4 Select **Wireless network connection** on the **Printer Connection Type** screen. Then, click **Next**.



- 5 On the **Are you setting up your printer for the first time?** screen, select **Yes, I will set up my printer's wireless network**. Then, click **Next**.
If your printer is already connected on the network, select **No, my printer is already connected to my network**.
- 6 Select **Using a USB cable** on the **Select the Wireless Setup Method** screen. Then, click **Next**.
- 7 After searching the wireless networks, a list of wireless networks your machine has searched appears. Click **Advanced Setting**.

Wireless network setup



- **Enter the wireless Network Name:** Enter the SSID name you want (SSID is case-sensitive).
- **Operation Mode:** Select ad hoc.
- **Channel:** Select the channel. (**Auto Setting** or 2412 MHz to 2467 MHz).
- **Authentication:** Select an authentication type.
Open System: Authentication is not used, and encryption may or may not be used, depending on the need for data security.
Shared Key: Authentication is used. A device that has a proper WEP key can access the network.
- **Encryption:** Select the encryption (None, WEP64, WEP128).
- **Network Password:** Enter the encryption network password value.
- **Confirm Network Password:** Confirm the encryption network password value.
- **WEP Key Index:** If you are using WEP Encryption, select the appropriate **WEP Key Index**.

The wireless network security window appears when the ad hoc network has security enabled.

Select **Open System** or **Shared Key** for the authentication and click **Next**.

- WEP (Wired Equivalent Privacy) is a security protocol preventing unauthorized access to your wireless network. WEP encrypts the data portion of each packet exchanged on a wireless network using a 64-bit or 128-bit WEP encryption key.

- 8 The window showing the wireless network setting appears. Check the settings and click **Next**.



Before entering the IP address for the machine, you must know the computer's network configuration information. If the computer's network configuration is set to DHCP, the wireless network setting should also be DHCP. Likewise, if the computer's network configuration is set to Static, the wireless network setting should also be Static.

If your computer is set to DHCP and you want to use the Static wireless network setting, you must contact the network administrator to get the static IP address.

- **For the DHCP method**

If the IP address assignment method is DHCP, check if DHCP is shown in the **Wireless Network Setting Confirm** window. If it shows Static, click **Change TCP/IP** to change the assignment method to **Receive IP address automatically (DHCP)**.

- **For the Static method**

If the IP address assignment method is Static, check if Static is shown in the **Wireless Network Setting Confirm** window. If it shows DHCP, click **Change TCP/IP** to enter the IP address and other network configuration values for the machine.

For example,

If the computer's network information is as shown follows:

- IP address: 169.254.133.42
- Subnet Mask: 255.255.0.0

Then, the machine's network information should be as below:

- IP address: 169.254.133.**43**
- Subnet Mask: 255.255.0.0 (Use the computer's subnet mask.)
- Gateway: 169.254.133.**1**

Wireless network setup

- 9 The **Wireless Network Setting Complete** window appears. Click **Next**.
- 10 When the wireless network settings are completed, disconnect the USB cable between the computer and machine. Click **Next**.
- 11 Follow the instructions in the installation window.

Setup using Mac

Access point via USB cable

Items to prepare

- Access point
- Network-connected printer
- Software CD that was provided with your machine
- A machine installed with a wireless network interface
- USB cable

- 1 Make sure that the machine is connected to your computer and powered on.
- 2 Insert the supplied software CD into your CD-ROM drive.

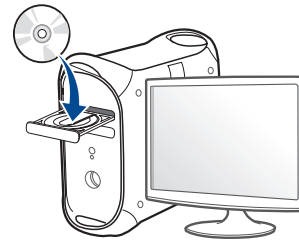

- 3 Double-click the CD-ROM icon that appears on your Mac desktop.
 - For Mac OS X 10.8, double-click the CD-ROM that appears on **Finder**.
- 4 Double-click the **MAC_Installer** folder > **Installer OS X** icon.
- 5 Click **Continue**.
- 6 Read the license agreement and click **Continue**.
- 7 Click **Agree** to agree to the license agreement.
- 8 Click **Install**. All components necessary for machine operations will be installed.
If you click **Customize**, you can choose individual components to install.
- 9 Enter the password and click **OK**.

Wireless network setup

- 10 Select **Configuration of Wireless network** on the **Printer Connection Type** and click **Continue**.

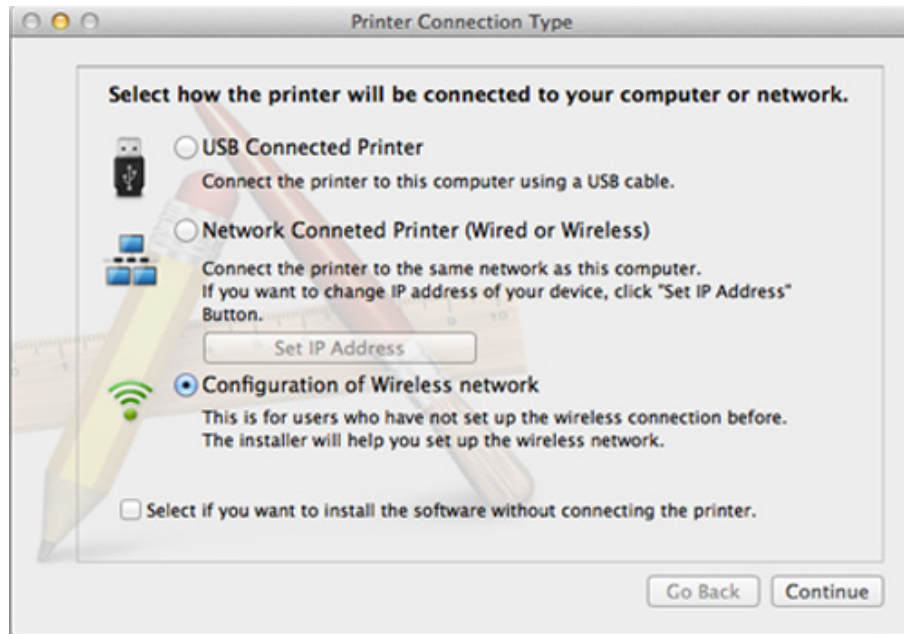

- 11 If **Wireless Settings** screen appears, select **Using a USB cable** and click **Next**.

If the screen does not appear, go to step 15.



Wireless network setup

- 12** After searching, the window shows the wireless network devices. Select the name (SSID) of the access point you want to use and click **Next**.



When you set the wireless configuration manually, click **Advanced Setting**.

- **Enter the wireless Network Name:** Enter the SSID of the access point (SSID is case-sensitive).
- **Operation Mode:** Select **Infrastructure**.
- **Authentication:** Select an authentication type.
Open System: Authentication is not used, and encryption may or may not be used, depending on the need for data security.
Shared Key: Authentication is used. A device that has a proper WEP key can access the network.
WPA Personal or WPA2 Personal: Select this option to authenticate the print server based on the WPA Pre-Shared Key. This uses a shared secret key (generally called Pre Shared Key pass phrase) that is manually configured on the access point and each of its clients.
- **Encryption:** Select the encryption. (None, WEP64, WEP128, TKIP, AES, TKIP, AES)
- **Network Password:** Enter the encryption network password value.
- **Confirm Network Password:** Confirm the encryption network password value.
- **WEP Key Index:** If you are using WEP Encryption, select the appropriate **WEP Key Index**.

The wireless network security window appears when the access point has security enabled.

Enter the Network Password of the access point (or router).

- 13** The window showing the wireless network setting appears. Check the settings and click **Next**.



- Wi-Fi Direct option appears on the screen only if your printer supports this feature.
- Can start to build Wi-Fi Direct by using Samsung Easy Printer Manager (see "Setting up Wi-Fi Direct" on page 116).
- **Wi-Fi Direct Name:** The default Wi-Fi Direct Name is the model name and the maximum length is 22 characters.
- **Password setting** is the numeric string, and the size is 8 ~ 64 characters.

- 14** The **Wireless Network Setting Complete** window appears. Click **Next**.

- 15** When the wireless network settings are completed, disconnect the USB cable between the computer and machine. Click **Next**.

Access point without a USB cable (recommended)

Items to prepare

- WiFi-enabled Mac running Mac OS 10.7 or higher and an access point (router)
- Software CD that was provided with your machine
- A machine installed with a wireless network interface

Wireless network setup

1 Make sure that the machine is connected to your computer and powered on.

2 Insert the supplied software CD into your CD-ROM drive.

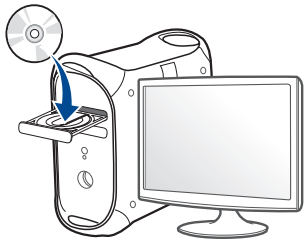

3 Double-click the CD-ROM icon that appears on your Mac desktop.

- For Mac OS X 10.8, double-click the CD-ROM that appears on **Finder**.

4 Double-click the **MAC_Installer** folder > **Installer OS X** icon.

5 Click **Continue**.

6 Read the license agreement and click **Continue**.

7 Click **Agree** to agree to the license agreement.

8 Click **Install**. All components necessary for machine operations will be installed.

If you click **Customize**, you can choose individual components to install.

9 Enter the password and click **OK**.

10 Select **Configuration of Wireless network** on the **Printer Connection Type** and click **Continue**.

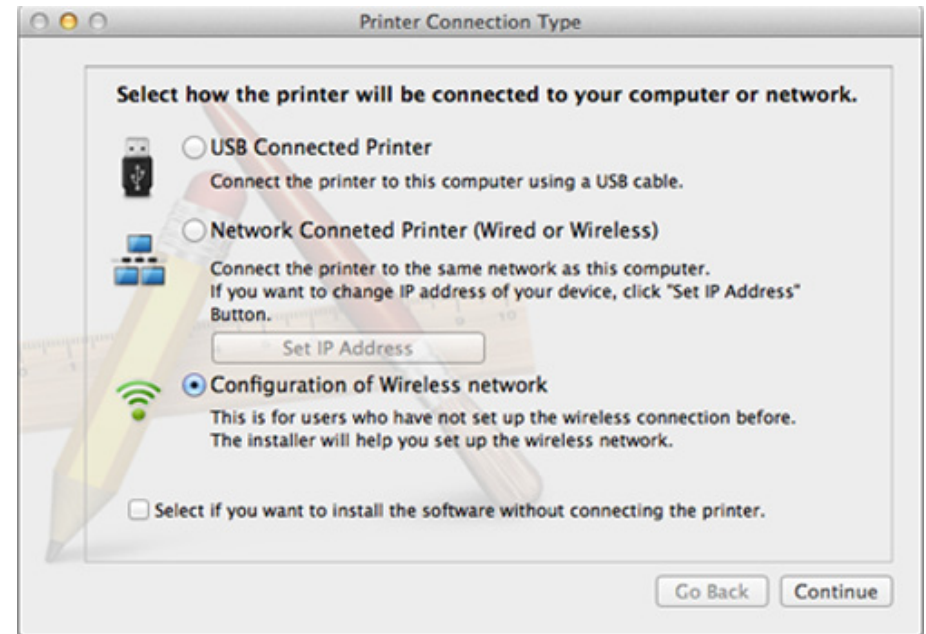

Wireless network setup

- 11** If **Wireless Settings** screen appears, select **Using a direct wireless connection** and click **Next**.

If the screen does not appear, go to step 13.



If below screen appears, press the  (WPS) button from the control panel within 2 minutes.



- 12** When the wireless network set up is completed, click **Next**.
- 13** After the installation is finished, click **Close**.

Wireless network setup

Ad hoc via USB cable

If you do not have an access point (AP), you may still connect the machine wirelessly to your computer by setting up an ad hoc wireless network by following these simple directions.

Items to prepare

- Network-connected computer
- Software CD that was provided with your machine
- A machine installed with a wireless network interface
- USB cable

Creating the ad hoc network in Mac

- 1 Make sure that the machine is connected to your computer and powered on.
- 2 Insert the supplied software CD into your CD-ROM drive.

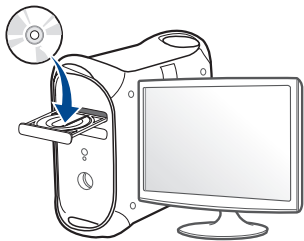

- 3 Double-click the CD-ROM icon that appears on your Mac desktop.
 - For Mac OS X 10.8, double-click the CD-ROM that appears on **Finder**.
- 4 Double-click the **MAC_Installer** folder > **Installer OS X** icon.
- 5 Click **Continue**.
- 6 Read the license agreement and click **Continue**.
- 7 Click **Agree** to agree to the license agreement.
- 8 Click **Install**. All components necessary for machine operations will be installed.

If you click **Customize**, you can choose individual components to install.
- 9 Enter the password and click **OK**.

Wireless network setup

- 10** Select **Configuration of Wireless network** on the **Printer Connection Type** and click **Continue**.

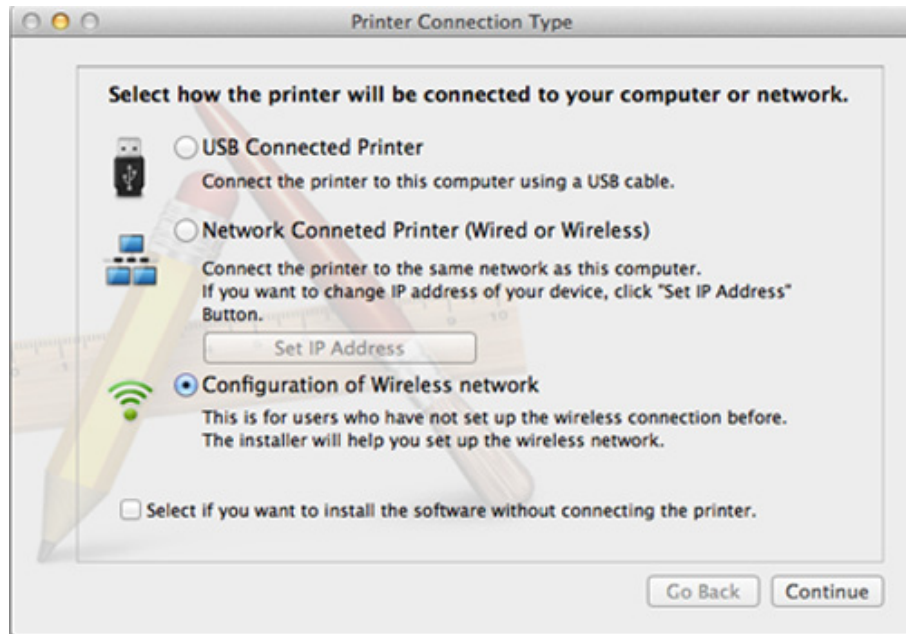

- 11** After searching the wireless networks, a list of wireless networks your machine has searched appears. Click **Advanced Setting**.



- **Enter the wireless Network Name:** Enter the SSID name (SSID is case-sensitive).
- **Operation Mode:** Select ad hoc.
- **Channel:** Select the channel (**Auto Setting** or 2412 MHz to 2467 MHz).
- **Authentication:** Select an authentication type.
 - **Open System:** Authentication is not used, and encryption may or may not be used, depending on the need for data security.
 - **Shared Key:** Authentication is used. A device that has a proper WEP key can access the network.
- **Encryption:** Select the encryption (None, WEP64, WEP128).
- **Network Password:** Enter the encryption network password value.
- **Confirm Network Password:** Confirm the encryption network password value.
- **WEP Key Index:** If you are using WEP Encryption, select the appropriate **WEP Key Index**.

The wireless network security window appears when the ad hoc network has security setting.

Select **Open System** or **Shared Key** for the authentication and click **Next**.

- WEP (Wired Equivalent Privacy) is a security protocol preventing unauthorized access to your wireless network. WEP encrypts the data portion of each packet exchanged on a wireless network using a 64-bit or 128-bit WEP encryption key.

Wireless network setup

- 12** The window showing the wireless network settings appears. Check the settings and click **Next**.



Before entering the IP address for the machine, you must know the computer's network configuration information. If the computer's network configuration is set to DHCP, the wireless network setting should also be DHCP. Likewise, if the computer's network configuration is set to Static, the wireless network setting should also be Static.

If your computer is set to DHCP and you want to use Static wireless network setting, you must contact the network administrator to get the static IP address.

- **For the DHCP method**

If the IP address assignment method is DHCP, check if DHCP is shown in the **Wireless Network Setting Confirm** window. If it shows Static, click **Change TCP/IP** to change the assignment method to **Receive IP address automatically (DHCP)**.

- **For the Static method**

If the IP address assignment method is Static, check if Static is shown in the **Wireless Network Setting Confirm** window. If it shows DHCP, click **Change TCP/IP** to enter the IP address and other network configuration values for the machine.

For example,

If the computer's network information is shown as follows:

- IP address: 169.254.133.42
- Subnet Mask: 255.255.0.0

Then, the machine's network information should be as shown below:

- IP address: 169.254.133.**43**

- Subnet Mask: 255.255.0.0 (Use the computer's subnet mask.)
- Gateway: 169.254.133.1

- 13** When the window that tells you that the network cable connection is confirmed appears, disconnect the network cable and click **Next**.

If the network cable is connected, it may have trouble finding the machine when configuring the wireless network.

- 14** The wireless network connects according to the network configuration.

- 15** Wireless network set up is completed. After installation is finished, click **Quit**.



After completing the wireless network connection, you need to install a machine driver to print from an application (see "Installation for Mac" on page 84).

Wireless network setup

Turning the Wi-Fi network on/off

- 1 Check whether the network cable is connected to the machine. If not, connect the machine with a standard network cable.
- 2 Start a web browser such as Internet Explorer, Safari, or Firefox and enter your machine's new IP address in the browser window.

For example,



- 3 Click **Login** on the upper right of the SyncThru™ Web Service website.
- 4 Type in the **ID** and **Password**, then click **Login**.
 - **ID: admin**
 - **Password: sec00000**
- 5 When the **SyncThru™ Web Service** window opens, click **Network Settings**.
- 6 Click **Wireless > Custom**.

You can also turn the Wi-Fi network on/off.

Setting the Wi-Fi Direct for mobile printing

Wi-Fi Direct is an easy-to-setup peer-to-peer connecting between method for your between a printer and mobile device that supports Wi-Fi Direct that provides a secure connection and better throughput than ad hoc mode.

With Wi-Fi Direct, you can connect your printer to a Wi-Fi Direct network while concurrently connecting to an access point, You can also use a wired network and a Wi-Fi Direct network simultaneously so multiple users can access and print documents both from Wi-Fi Direct and from a wired network.



- You cannot connect to the Internet through the mobile device in use Wi-Fi Direct.
- The supported protocol list may differ from your model, Wi-Fi Direct networks do NOT support IPv6, network filtering, IPSec, WINS, and SLP services.
- Up to four mobile devices can connect to Wi-Fi Direct at one time.

Wireless network setup

Setting up Wi-Fi Direct

You can enable Wi-Fi Direct feature by one of the following methods.

From the USB cable-connected computer(recommended)

- After the driver installation is complete, Samsung Easy Printer Manager can be set and changes in the Wi-Fi Direct can be made.



Samsung Easy Printer Manager is Available for Windows and Mac OS users only.

- From the **Start** menu, select **Programs** or **All Programs** > **Samsung Printers** > Samsung Easy Printer Manager > **Device Settings** > **Network**.
 - **Wi-Fi Direct On/Off:** Select **On** to enable.
 - **Device Name:** Enter the printer's name for searching for your printer on a wireless network. By default, the device name is the model name.
 - **IP Address:** Enter the IP address of the printer. This IP address is used only for the local network and not for the infrastructure wired or wireless network. We recommend using the default local IP address (the default local IP address of the printer for Wi-Fi Direct is 192.168.3.1)
 - **Group Owner:** Activate this option to assign the printer the Wi-Fi Direct group's owner. The **Group Owner** acts similar to a wireless access point. We recommend activating this option.

- **Network Password:** If your printer is a **Group Owner**, a **Network Password** is required for other mobile devices to connect to your printer. You can configure a Network Password yourself, or can remember the given Network Password that is randomly generated by default.

Setting up the mobile device

- After setting up Wi-Fi Direct from the printer, refer to the user manual of the mobile device you are using to set its Wi-Fi Direct.
- After setting up Wi-Fi Direct, you need to download the mobile printing application (For example: Samsung Mobile printer) to print from your smartphone.



- When you have found the printer you want to connect to from your mobile device, select the printer and the printer's LED will blink. Press the WPS button on the printer and it will be connected to your mobile device.
- If your mobile device does not support WPS, you need to enter the "Network Password" of a printer instead of pushing the WPS button.

Wireless network setup

Troubleshooting

Problems during setup or driver installation

Printers Not Found

- Your machine may not be turned on. Turn on your computer and the machine.
- USB cable is not connected between your computer and machine. Connect the machine to your computer using the USB cable.
- The machine does not support wireless networking. Check the machine's user's guide included on the software CD supplied with your machine and prepare a wireless network machine.

Connecting Failure - SSID Not Found

- The machine is unable to find the network name (SSID) you have selected or entered. Check the network name (SSID) on your access point and try connecting again.
- Your access point is not turned on. Turn on your access point.

Connecting Failure - Invalid Security

- Security is not configured correctly. Check the configured security on your access point and machine.

Connecting Failure - General Connection Error

- Your computer is not receiving a signal from your machine. Check the USB cable and your machine's power.

Connecting Failure - Connected Wired Network

- Your machine is connected with a wired network cable. Remove the wired network cable from your machine.

Connecting Failure - Assigning the IP address

- Cycle the power for the access point (or wireless router) and machine.

PC Connection Error

- The configured network address is unable to connect between your computer and machine.
 - For a DHCP network environment
The receives the IP address automatically (DHCP) when computer is configured to DHCP.



If the printing job is not working in DHCP mode, the problem may be caused by the automatically changed IP address. Compare the IP address between the product's IP address and the printer port's IP address.

How to compare:

- 1 Print the network information report of your printer, and then check the IP address (see "Printing a network configuration report" on page 90).

Wireless network setup

- 2 Check the printer port's IP address from your computer.
 - a Click the Windows **Start** menu.
 - For Windows 8, from the **Charms**, select **Search > Settings**.
 - b For Windows XP/Server 2003, select **Printer and Faxes**.
 - For Windows Server 2008/Vista, select **Control Panel > Hardware and Sound > Printers**.
 - For Windows Server 2008 R2, select **Control Panel > Hardware > Devices and Printers**.
 - For Windows 7/ Windows 8, select **Control Panel > Devices and Printers**.
 - c Right-click your machine.
 - d For Windows XP/2003/2008/Vista, press **Properties**.
For Windows 7/ Windows 8 or Windows Server 2008 R2, from context menus, select the **Printer properties**.
If **Printer properties** item has ► mark, you can select other printer drivers connected with selected printer.
 - e Click **Port** tab.
 - f Click **Configure Port..** button.
 - g Check if **Printer Name** or **IP Address:** is the IP address on the network configuration Sheet.
- 3 Change the printer port's IP address if it is different from the network information report's.
If you want to use the software installation CD to change the port IP, connect to a network printer. Then reconnect the IP address.

For example,

If the computer's network information is as shown below:

- IP address: 169.254.133.42
- Subnet Mask: 255.255.0.0

Then the machine's network information should be as below:

- IP address: 169.254.133.**43**
- Subnet Mask: 255.255.0.0 (Use the computer's subnet mask.)
- Gateway: 169.254.133.**1**

- For a Static network environment

The machine uses the static address when the computer is configured to static address.

Wireless network setup

Other problems

If problems occur while using the machine on a network, check the following:



For information on the access point (or wireless router), refer to its own user's guide.

- You cannot enable wired and wireless networks at the same time.
- Your computer, access point (or wireless router), or machine may not be turned on.
- Check the wireless reception around the machine. If the router is far from the machine or there is an obstacle, you might have difficulty receiving the signal.
- Cycle the power for the access point (or wireless router), machine, and computer. Sometimes cycling the power can recover network communication.
- Check whether firewall software (V3 or Norton) is blocking the communication.

If the computer and the machine are connected on the same network and it cannot be found when searching, firewall software might be blocking the communication. Refer to the user's guide for the software to turn it off and try searching for the machine again.

- Check whether the machine's IP address is allocated correctly. You can check the IP address by printing the network configuration report.

- Check whether the access point (or wireless router) has a configured security (password). If it has a password, refer to the access point (or wireless router) administrator.
- Check the machine's IP address. Reinstall the machine driver and change the settings to connect to the machine on the network. Due to the characteristics of DHCP, the allocated IP address could change if the machine is not used for a long time or if the access point has been reset.

Register the product's MAC address when you configure the DHCP server on the access point (or wireless router). Then you can always use the IP address that is set with the MAC address. You can identify the Mac address of your machine by printing a network configuration report (see "Printing a network configuration report" on page 90).

- Check the wireless environment. You might not be able to connect to the network in the infrastructure environment where you need to type in a user's information before connecting to the access point (or wireless router).
- This machine only supports IEEE 802.11 b/g/n and Wi-Fi. Other wireless communication types (e.g., Bluetooth) are not supported.
- When using the ad hoc mode, in operating systems such as Windows Vista, you might need to set the wireless connection setting every time you use the wireless machine.
- You cannot use infrastructure mode and ad hoc mode at the same time for Samsung wireless network machines.
- The machine is within the range of the wireless network.

Wireless network setup

- The machine is located away from obstacles that could block the wireless signal.

Remove any large metal objects between the access point (or wireless router) and the machine.

Make sure the machine and wireless access point (or wireless router) are not separated by poles, walls, or support columns containing metal or concrete.

- The machine is located away from other electronic devices that may interfere with the wireless signal.

Many devices can interfere with the wireless signal, including a microwave oven and some Bluetooth devices.

- Whenever the configuration of your access point (or wireless router) changes, you must do the product's wireless network setup again.
- The maximum number of device that can be connected via **Wi-Fi Direct** is 3.
- If **Wi-Fi Direct** is **ON**, this machine only supports IEEE 802.11 b/g.
- If the access point is set to work with the 802.11n standard only, it may not connect to your machine.

Samsung Mobile Print

What is Samsung Mobile Print?

Samsung Mobile Print is a free application that enables users to print photos, documents, and web pages directly from your smartphone or tablet. **Samsung Mobile Print** is not only compatible with your Android and iOS smart phones but also with your iPod Touch and tablet PC. It connects your mobile device to a network connected Samsung printer or to a wireless printer through a Wi-Fi access point. Installing a new driver or configuring network settings isn't necessary – just simply install the **Samsung Mobile Print** application, and it will automatically detect compatible Samsung printers. Besides printing photos, web pages, and PDFs, scanning is also supported. If you have Samsung multifunction printer, scan any document into a JPG, PDF, or PNG format for quick and easy viewing on your mobile device.

Downloading Samsung Mobile Print

To download **Samsung Mobile Print**, go to the application store (Samsung Apps, Play Store, App Store) on your mobile device, and just search for "**Samsung Mobile Print**." You can also visit iTunes for Apple devices on your computer.



Android



iOS

Supported Mobile OS

- Android OS 2.1 or higher
- iOS 4.0 or higher

Supported devices

- **iOS 4.0 or higher:** iPod Touch, iPhone, iPad
- **Android 2.3 or higher:** Galaxy series and Android mobile device

Using the NFC feature

The NFC(Near Field Communication) printer allows you to directly print/scan from your cell phone just by holding your cell phone over the NFC tag on your printer. It does not require installing print driver or connecting to an access point. You just need NFC supported cell phone. In order to use this feature, Samsung Mobile Print app needs to be installed on your cell phone.



- Depending on the material of the cell phone cover, NFC recognition may not work properly.
- Depending on the cell phone you are using, the transmission speed may differ.

Requirements

- NFC and Wi-Fi Direct enabled, Mobile Print app installed cell phone with Android OS 4.0 or higher.



Only Android OS 4.1 or higher will automatically enable the Wi-Fi Direct feature on your cell phone when you enable the NFC feature. We recommend you to upgrade your cell phone to Android OS 4.1 or higher to use the NFC feature.

- Wi-Fi Direct feature enabled printer. Wi-Fi Direct feature is enabled by default.

Printing

- 1 Check that NFC and Wi-Fi Direct features are enabled on your cell phone and Wi-Fi Direct feature is enabled on your printer (see "Setting up Wi-Fi Direct" on page 116).
- 2 Tag the NFC antenna on your cell phone (usually located on the back of the cell phone) over the NFC tag() on your printer.

Wait few seconds for Samsung Mobile Print app to start.

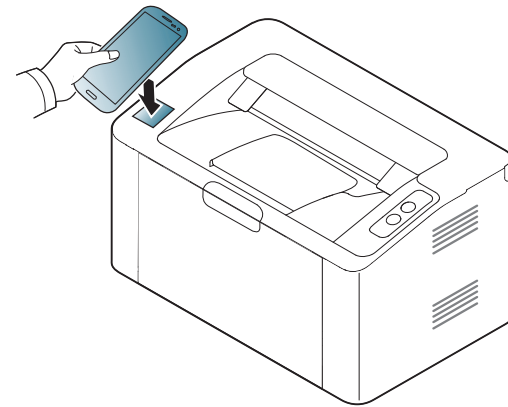

Using the NFC feature



- For some cell phones, NFC antenna might not be located at the back of the cell phone. Check the location of the NFC antenna on your cell phone before tagging.
- If error message about changed PIN number appears, enter a changed PIN number and press OK. Follow the instruction on the app screen to update the PIN number.
- If you do not have Samsung Mobile Print app installed on your cell phone, it automatically connects to Samsung Mobile Print app download page. Download the app and try again.



- For some cell phones, NFC antenna might not be located at the back of the cell phone. Check the location of the NFC antenna on your cell phone before tagging.
- If error message about changed PIN number appears, enter a changed PIN number and press OK. Follow the instruction on the app screen to update the PIN number.

3 Select the content you want to print.

If necessary, change the print option by pressing the .

4 Tag the NFC antenna on your cell phone(usually located on the back of the cell phone) over the NFC tag() on your printer.

Wait few seconds for the cell phone to connect to the printer.

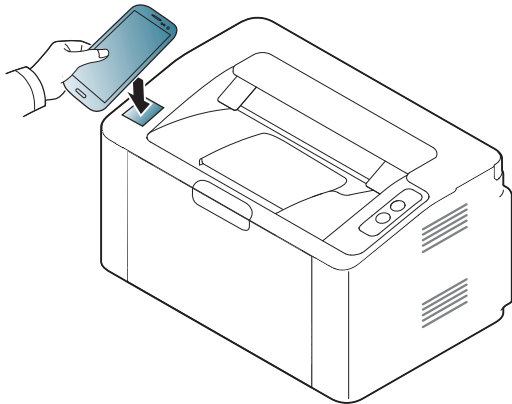

5 The printer starts printing.

Google Cloud Print™

Google Cloud Print™ is a service that allows you to print to a printer using your smart phone, tablet, or any other web-connected devices. Just register your Google account with the printer, and you are ready to use the Google Cloud Print™ service. You can print your document or email with Chrome OS, Chrome browser, or a Gmail™/ Google Docs™ application on your mobile device, so you don't need to install the printer driver on the mobile device. Refer to the Google website (<http://www.google.com/cloudprint/learn/> or <http://support.google.com/cloudprint>) for more information about Google Cloud Print™.

Registering your Google account to the printer



- Make sure the printer machine is turned on and connected to a wired or wireless network that has access to the Internet.
- You should create your Google account in the advance.

- 1 Open the Chrome browser.
- 2 Visit www.google.com.
- 3 Sign in to the Google website with your Gmail™ address.
- 4 Enter your printer's IP address in the address field and press the Enter key or click **Go**.

5 Click **Login** in the upper right corner of the SyncThru™ Web Service website.

6 If it's your first time logging into **SyncThru™ Web Service** you need to log-in as an administrator. Type in the below default **ID** and **Password**. We recommend you to change the default password for security reasons.

- **ID: admin**
- **Password: sec00000**



If the network environment is using a proxy server, you need to configure the proxy's IP and port number from **Settings > Network Settings > Google Cloud Print > Proxy Setting**. Contact your network service provider or network administrator for more information.

7 When the **SyncThru™ Web Service** window opens, click **Settings > Network Settings > Google Cloud Print**.

8 Enter your printer's name and description.

9 Click **Register**.
The confirmation pop-up window appears.



If you set the browser to block pop-ups, the confirmation window will not appear. Allow the site to show pop-ups.

Google Cloud Print™

10 Click **Finish printer registration**.

11 Click **Manage your printers**.

Now your printer is registered with Google Cloud Print™ service.

Google Cloud Print™-ready devices will appear in the list.

Printing with Google Cloud Print™

The printing procedure varies depending on the application or the device you are using. You can see the application list that supports Google Cloud Print™ service.



Make sure the printer is turned on and connected to a wired or wireless network that has access to the Internet.

Printing from an application on mobile device

The following steps are an example of using the Google Docs™ app from Android mobile phone.

1 Install the Cloud Print application on your mobile device.



If you do not have the application, download it from the application store such as Android Market or App Store.

2 Access the Google Docs™ application from your mobile device.

3 Tap the option  button of the document that you want to print.

4 Tap the send  button.

Google Cloud Print™

- 5 Tap the Cloud Print  button.
- 6 Set the printing options if you want.
- 7 Tap **Click here to Print**.

Printing from the Chrome browser

The following steps are an example of using the Chrome browser.

- 1 Run Chrome.
- 2 Open the document or email that you want to print.
- 3 Click the wrench icon  in the browser's top right corner.
- 4 Click **Print**. A new tab for printing appears.
- 5 Select **Print with Google Cloud Print**.
- 6 Click the **Print** button.

AirPrint



Only AirPrint certified machines can use the AirPrint feature. Check the box your machine came in for the AirPrint certified mark.



AirPrint allows you to wirelessly print directly from iPhone, iPad and iPod touch running the latest version of iOS.

Setting up AirPrint

Bonjour(mDNS) and IPP protocols are required on your machine to use the **AirPrint** feature. You can enable the **AirPrint** feature by one of the following methods.

- 1 Check whether the machine is connected to the network.
- 2 Start a web browser such as Internet Explorer, Safari, or Firefox and enter your machine's new IP address in the browser window.

For example,



- 3 Click **Login** in the upper right of the SyncThru™ Web Service website.

- 4 Type in the **ID** and **Password**, then click **Login**. Type in the below default ID and password. We recommend you to change the default password for security reasons.

- **ID: admin**
- **Password: sec00000**

- 5 When the SyncThru™ Web Service window opens, click **Settings > Network Settings**.

- 6 Click **Raw TCP/IP, LPR, IPP** or **mDNS**.

You can enable the IPP protocol or mDNS protocol.

AirPrint

Printing via AirPrint

For example, the iPad manual provides these instructions:

- 1 Open your email, photo, web page, or document you want to print.
- 2 Touch the action icon().
- 3 Select **your printer driver name** and option menu to set up.
- 4 Touch **Print** button. Print it out.



Cancelling print job: To cancel the printing job or view the print summary, click the print center icon () in multitasking area. You can click cancel in the print center.



3. Special Features

This chapter explains special printing features.

- **Altitude adjustment** 130
- **Changing the default print settings** 131
- **Setting your machine as a default machine** 132
- **Using advanced print features** 133
- **Mac printing** 140
- **Linux printing** 142



The procedures in this chapter are mainly based on Windows 7.

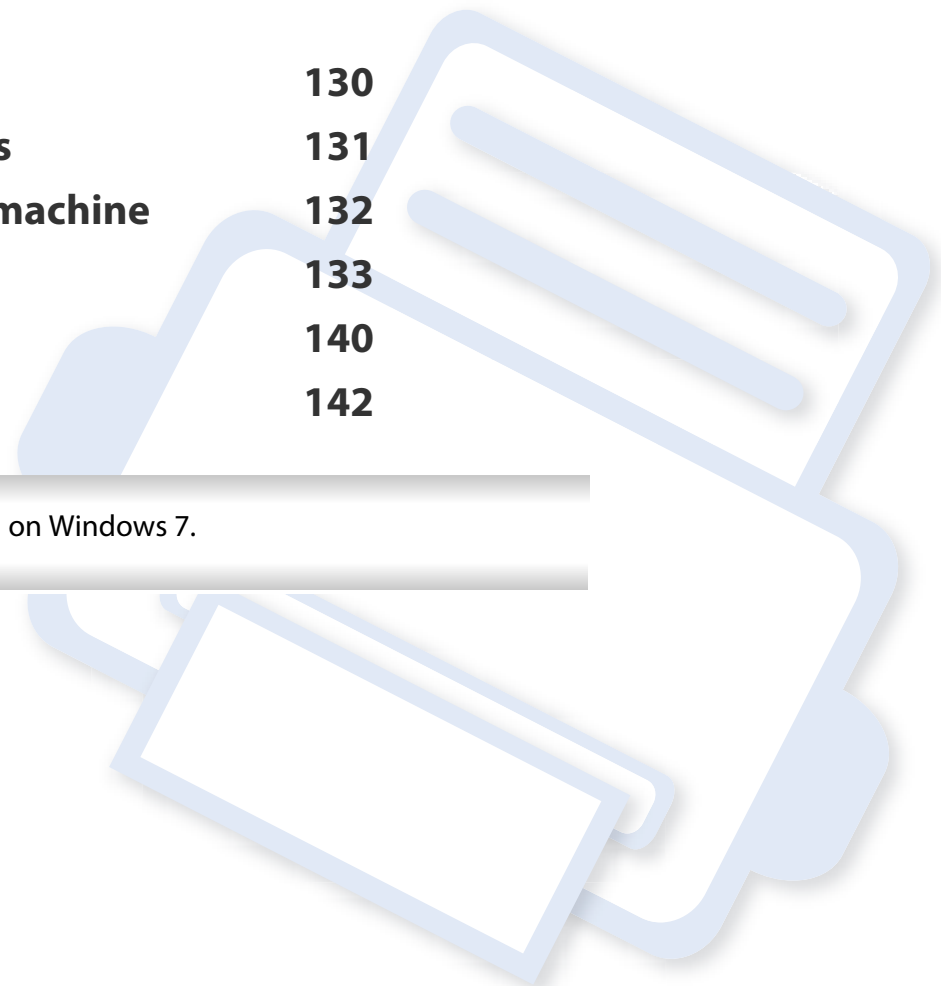

Altitude adjustment

Print quality is affected by atmospheric pressure, which is determined by the height of the machine above sea level. The following information will guide you on how to set your machine for the best print quality.

Before you set the altitude value, determine the altitude where you are.

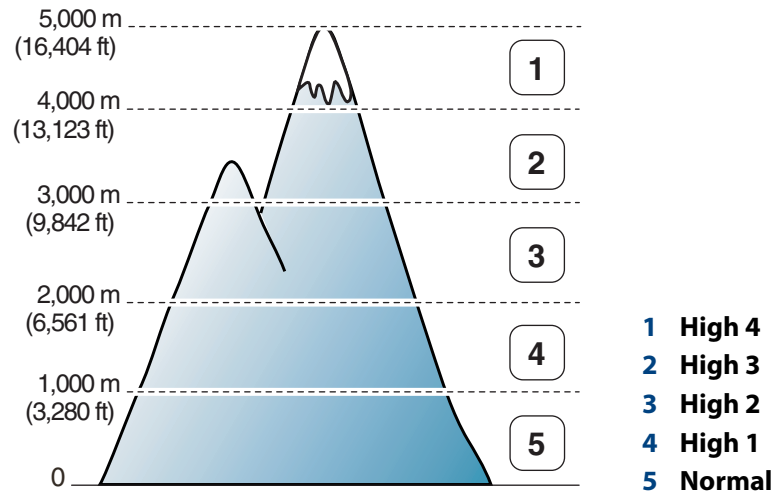

- For Windows and Mac users, see "Device Settings" on page 153.



If your machine is connected to the network, you can set the altitude via SyncThru™ Web Service (see "Using SyncThru™ Web Service" on page 149).

Changing the default print settings

- 1 Click the Windows **Start** menu.
 - For Windows 8, from the **Charms**, select **Search > Settings**.
- 2 For Windows XP/Server 2003, select **Printer and Faxes**.
 - For Windows Server 2008/Vista, select **Control Panel > Hardware and Sound > Printers**.
 - For Windows Server 2008 R2, select **Control Panel > Hardware > Devices and Printers**.
 - For Windows 7/ Windows 8, select **Control Panel > Devices and Printers**.
- 3 Right-click on your machine.
- 4 For Windows XP/Server 2003/Server 2008/Vista, select **Printing Preferences**.

For Windows 7/ Windows 8 or Windows Server 2008 R2, from context menus, select **Printing preferences**.

 If **Printing preferences** has a ►, you can select other printer drivers connected to the selected printer.

- 5 Change the settings on each tab.
- 6 Click **OK**.



If you want to change the settings for each print job, change it in **Printing Preferences**.

Setting your machine as a default machine

- 1 Click the Windows **Start** menu.
 - For Windows 8, from the **Charms**, select **Search** > **Settings**.
- 2 For Windows XP/Server 2003, select **Printer and Faxes**.
 - For Windows Server 2008/Vista, select **Control Panel** > **Hardware and Sound** > **Printers**.
 - For Windows Server 2008 R2, select **Control Panel** > **Hardware** > **Devices and Printers**.
 - For Windows 7/ Windows 8, select **Control Panel** > **Devices and Printers**.
- 3 Select your machine.
- 4 Right-click your machine and select **Set as Default Printer**.



For Windows 7/ Windows 8 or Windows Server 2008 R2, if **Set as default printer** has a ►, you can select other printer drivers connected to the selected printer.

Using advanced print features



- **XPS printer driver:** used to print XPS file format.
 - The XPS printer driver can be installed only on Windows Vista OS or higher.
 - Install optional memory when an XPS job does not print because the printer is out of memory.
 - For models that provide XPS driver from the Samsung website, <http://www.samsung.com> > find your product> Support or downloads.

2 Click **Print**.

3 Type in the destination path and the file name, and then click **OK**.
For example, **c:\Temp\file name**.



If you type in only the file name, the file is automatically saved in **My Documents**, **Documents and Settings**, or **Users**. The saved folder may differ, depending on your operating system or the application you are using.

Printing to a file (PRN)

You will sometimes need to save the print data as a file.

1 Check the **Print to file** box in the **Print** window.



Using advanced print features

Understanding special printer features

You can use advanced printing features when using your machine.





To take advantage of the printer features provided by your printer driver, click **Properties** or **Preferences** in the application's **Print** window to change the print settings. The machine name, that appears in the printer properties window may differ depending on the machine in use.



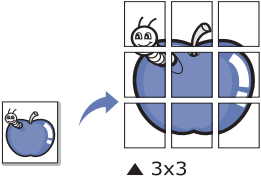
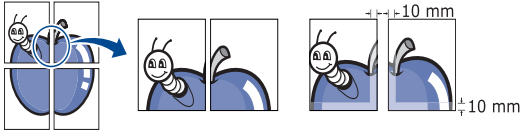
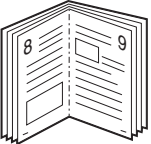

- Some menus may not appear on the display depending on options or models. If so, it is not applicable to your machine.
- Select the **Help** or click the  button from the window or press **F1** on your keyboard and click on any option you want to know about (see "Using help" on page 37).

| Item | Description |
|---|---|
| Multiple Pages per Side  | Selects the number of pages to print on a single sheet of paper. To print more than one page per sheet, the pages will be reduced in size and arranged in the order you specify. You can print up to 16 pages on one sheet. |

Using advanced print features

| Item | Description |
|--|---|
| <p data-bbox="51 316 259 344">Poster Printing</p>  | <p data-bbox="465 272 2190 344">Prints a single-page document onto 4 (Poster 2x2), 9 (Poster 3x3), or 16 (Poster 4x4) sheets of paper, for the purpose of pasting the sheets together to form one poster-size document.</p> <p data-bbox="465 368 2190 440">Select the Poster Overlap value. Specify Poster Overlap in millimeters or inches by selecting the radio button on the upper right of Basic tab to make it easier to paste the sheets together.</p>  |
| <p data-bbox="51 759 293 788">Booklet Printing^a</p>  | <p data-bbox="465 647 2175 719">Prints your document on both sides of a sheet of paper and arranges the pages so that the paper can be folded in half after printing to produce a booklet.</p> <p data-bbox="465 743 1800 772">If you want to make a booklet, you need to print on Letter, Legal, A4, US Folio, or Oficio sized print media.</p> <div data-bbox="483 823 2190 1082" style="background-color: #f0f0f0; padding: 10px;"><p data-bbox="488 855 2186 927"> The Booklet Printing option is not available for all paper sizes. Select the available paper Size option under the Paper tab to see what paper sizes are available.</p><p data-bbox="562 967 2181 1038">If you select an unavailable paper size, this option can be automatically canceled. Select only available paper (paper without  or  mark).</p></div> |

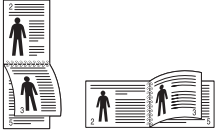
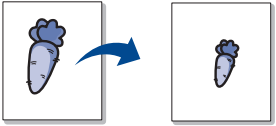

Using advanced print features

| Item | Description |
|--|---|
| Double-sided Printing (Manual)^a | <p>Print on both sides of a sheet of paper (duplex).</p> <div data-bbox="465 352 2197 644" style="background-color: #f0f0f0; padding: 10px;"><ul style="list-style-type: none">• You can use this feature with Letter, Legal, A4, US Folio or Oficio sized paper• If your machine does not have a duplex unit, you should complete the printing job manually. The machine prints every other page of the document first. After that, a message appears on your computer.• We recommend not to print on both sides of the special media, such as labels, envelopes, or thick paper. It may cause a paper jam or damage the machine.</div> <ul style="list-style-type: none">• Long Edge: This mode is the conventional layout used in bookbinding. • Short Edge: This mode is the conventional layout used in calendars.  |
| Paper Options  | <p>Changes the size of a document to appear larger or smaller on the printed page by entering in a percentage by which to enlarge or decrease the document.</p> |

Using advanced print features

| Item | Description |
|--|---|
| <p>Watermark</p>  | <p>The watermark option allows you to print text over an existing document. For example, you use it when you want to have large gray letters reading "DRAFT" or "CONFIDENTIAL" printed diagonally across the first page or all pages of a document.</p> |
| <p>Watermark (Creating a watermark)</p> | <ul style="list-style-type: none">a To change the print settings from your software application, access Printing Preferences.b Click the Advanced tab, select Edit from the Watermark drop-down list. The Edit Watermarks window appears.c Enter a text message in the Watermark Message box. You can enter up to 256 characters. The message displays in the preview window. |
| <p>Watermark (Editing a watermark)</p> | <ul style="list-style-type: none">a To change the print settings from your software application, access Printing Preferences.b Click the Advanced tab, select Edit from the Watermark drop-down list. The Edit Watermarks window appears.c Select the watermark you want to edit from the Current Watermarks list and change the watermark message and options.d Click Update to save the changes.e Click OK or Print until you exit the Print window. |
| <p>Watermark (Deleting a watermark)</p> | <ul style="list-style-type: none">a To change the print settings from your software application, access Printing Preferences.b Click the Advanced tab, select Edit from the Watermark drop-down list. The Edit Watermarks window appears.c Select the watermark you want to delete from the Current Watermarks list and click Delete.d Click OK or Print until you exit the Print window. |

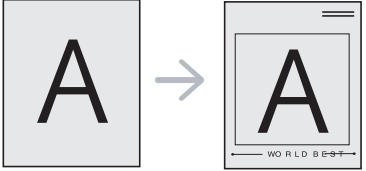
Using advanced print features

| Item | Description |
|--|--|
| <p>Overlay^a</p>  | <p>This option is available only when you use the PCL/SPL printer driver (see "Software" on page 6).</p> <p>An overlay is text and/or images stored in the computer hard disk drive (HDD) as a special file format that can be printed on any document. Overlays are often used to take the place of letterhead paper. Rather than using preprinted letterhead, you can create an overlay containing exactly the same information that is currently on your letterhead. To print a letter with your company's letterhead, you do not need to load preprinted letterhead paper in the machine: just print the letterhead overlay on your document.</p> <p>To use a page overlay, you must create a new page overlay containing your logo or image.</p> <div style="background-color: #f0f0f0; padding: 10px; border: 1px solid #ccc;"> <ul style="list-style-type: none">  • The overlay document size must be the same as the document you print with the overlay. Do not create an overlay with a watermark. • The resolution of the overlay document must be the same as that of the document you will print with the overlay. </div> |
| <p>Overlay (Creating a new page overlay)</p> | <ol style="list-style-type: none"> a To save the document as an overlay, access Printing Preferences. b Click the Advanced tab, and select Edit from the Text drop-down list. Edit Overlay window appears. c In the Edit Overlay window, click Create. d In the Save As window, type a name up to eight characters in the File name box. Select the destination path, if necessary (The default is C:\Formover). e Click Save. The name appears on the Overlay List. f Click OK or Print until you exit the Print window. The file is not printed. Instead, it is stored on your computer hard disk drive. |

Using advanced print features

| Item | Description |
|---|---|
| Overlay (Using a page overlay) | <ul style="list-style-type: none">a Click the Advanced tab.b Select the desired overlay from the Text drop-down list.c If the overlay file you want does not appear in the Text drop-down list, select Edit... from the list and click Load. Select the overlay file you want to use. If you have stored the overlay file you want to use in an external source, you can also load the file when you access the Open window. After you select the file, click Open. The file appears in the Overlay List box and is available for printing. Select the overlay from the Overlay List box.d If necessary, check Confirm Page Overlay When Printing box. If this box is checked, a message window appears each time you submit a document for printing, asking you to confirm printing an overlay on your document. If this box is not checked and an overlay has been selected, the overlay automatically prints with your document.e Click OK or Print until you exit the Print window. |
| Overlay (Deleting a page overlay) | <ul style="list-style-type: none">a In the Printing Preferences window, click the Advanced tab.b Select Edit in the Text drop down list.c Select the overlay you want to delete from the Overlay List box.d Click Delete.e When a confirming message window appears, click Yes.f Click OK or Print until you exit the Print window. You can delete page overlays that you no longer use. |

a. This option is not available when you use XPS driver.

Mac printing



Some features may not be available depending on models or options. It means that the features are not supported.

Printing a document

When you print with a Mac, you need to check the printer driver settings in each application you use. Follow the steps below to print from a Mac:

- 1 Open the document to print.
- 2 Open the **File** menu and click **Page Setup** (**Document Setup** in some applications).
- 3 Choose your paper size, orientation, scaling, other options, and make sure that your machine is selected. Click **OK**.
- 4 Open the **File** menu and click **Print**.
- 5 Choose the number of copies and indicate which pages to print.
- 6 Click **Print**.

Changing printer settings

You can use advanced printing features when using your machine.

Open an application and select **Print** from the **File** menu. The machine name, which appears in the printer properties window, may differ depending on the machine in use. Except for the name, the composition of the printer properties window is similar to the following.

Printing multiple pages on one sheet

You can print more than one page on a single sheet of paper. This feature provides a cost-effective way to print draft copies.

- 1 Open an application, and select **Print** from the **File** menu.
- 2 Select **Layout** from the drop-down list under **Orientation**. In the **Pages per Sheet** drop-down list, select the number of pages you want to print on one sheet of paper.
- 3 Select the other options to use.
- 4 Click **Print**.
The machine prints the selected number of pages to print on one sheet of paper.

Mac printing

Printing on both sides of the paper



Some features may not be available depending on models or options. It means that the features are not supported.

Before printing in the duplex mode, decide on which edge you will be binding your finished document. The binding options are, as follows:

- **Long-Edge Binding:** This option is the conventional layout used in book binding.
- **Short-Edge Binding:** This option is the type often used with calendars.

- 1 From your Mac application, select **Print** from the **File** menu.
- 2 Select **Layout** from the drop-down list under **Orientation**.
- 3 Select a binding orientation from the **Two-Sided** option.
- 4 Select the other options to use.
- 5 Click **Print** and the machine prints on both sides of the paper.



If you print more than 2 copies, the first copy and the second copy might print on the same sheet of paper. Avoid printing on both sides of paper when you are printing more than 1 copy.

Using help

Click the question mark on the bottom-left corner of the window and click on the topic you want to know about. A pop-up window appears with information about that option's feature, which is provided from the driver.



Linux printing



Some features may not be available depending on models or options. It means that the features are not supported.



Automatic/manual duplex printing may not be available depending on models. You can alternatively use the lp or lpr printing system or other applications for odd-even printing.

Printing from applications

There are a lot of Linux applications that allow you to print using Common UNIX Printing System (CUPS). You can print on your machine from any such application.

- 1 Open the document to print.
- 2 Open the **File** menu and click **Page Setup (Print Setup** in some applications).
- 3 Choose your paper size, orientation, and make sure that your machine is selected. Click Apply.
- 4 Open the File menu and click **Print**.
- 5 Select your machine to print.
- 6 Choose the number of copies and indicate which pages to print.
- 7 Change other printing options in each tab, if necessary.
- 8 Click **Print**.

Printing files

You can print text, image, pdf files on your machine using the standard **CUPS**, directly from the command line interface. The **CUPS** lp or lpr utility allows you to do that. You can print these files by using below command format.

```
"lp -d <printer name> -o <option> <file name>"
```

Please refer to lp or lpr man page on your system for more details.

Linux printing

Configuring Printer Properties

You can change the default printing options or connection type with Printing utility supplied by o/s.

- 1 Launch Printing utility(Go to **System > Administration > Printing** menu or execute "**system-config-printer**" command in Terminal program).
- 2 Select your printer and double-click it.
- 3 Change default printing options or connection type.
- 4 Click **Apply** button.



4. Useful Management Tools

This chapter introduces management tools provided to help you make full use of your machine.

- **Accessing management tools** 145
- **Samsung AnyWeb Print** 147
- **Easy Eco Driver** 148
- **Using SyncThru™ Web Service** 149
- **Using Samsung Easy Printer Manager** 151
- **Using Samsung Printer Status** 154
- **Using Samsung Printer Experience** 156



Accessing management tools

Samsung provides a variety of management tools for Samsung printers.

- 1 Make sure that the machine is connected to your computer and powered on.
- 2 From the **Start** menu, select **Programs** or **All Programs**.
•For Windows 8, from **Charms**, select **Search** > **Apps**.
- 3 Find **Samsung Printers**.
- 4 Under **Samsung Printers**, you can see installed management tools.
- 5 Click the management tool you want to use.



- After installing the driver, for some management tools, you can access them directly from the **Start** screen by clicking on the corresponding tile.
- For Windows 8, after installing the driver, for some management tools, you can access them directly from the **Start** screen by clicking on the corresponding tile.

Easy Capture Manager



Available for Windows OS users only.

Capture your screen and launch Easy Capture Manager by simply pressing the Print Screen key. Now you can easily print your captured screen as captured or edited.

Samsung AnyWeb Print



Available for Windows OS users only.

This tool helps you screen-capture, preview, scrap, and print Windows Internet Explorer pages more easily, than when you use an ordinary program.

Download the software from the Samsung website then unpack and install it: (<http://www.samsung.com> > find your product > Support or Downloads).

Easy Eco Driver



Available for Windows OS users only (see "Software" on page 6).

With the Easy Eco Driver, you can apply Eco features to save paper and toner before printing.

Easy Eco Driver also allows you simple editing such as removing images and texts, and more. You can save frequently used settings as a preset.

How to use:

- 1 Open a document to print.
- 2 Open **printing preference window** (see "Opening printing preferences" on page 36).
- 3 From the **Favorites** tab, select **Eco Printing Preview**.
- 4 Click **OK > Print** in the window. A preview window appears.
- 5 Select the options you want to apply to the document.
You can see the preview of the applied features.
- 6 Click **Print**.



If you want to run Easy Eco Driver every time you print, check **Start Easy Eco Driver before printing job** checkbox in the **Basic** tab of the printing preference window.

Using SyncThru™ Web Service



- Internet Explorer 6.0 or higher is the minimum requirement for SyncThru™ Web Service.
- SyncThru™ Web Service explanation in this user's guide may differ from your machine depending on its options or models.
- Network model only.

Accessing SyncThru™ Web Service

- 1 Access a web browser, such as Internet Explorer, from Windows.
Enter the machine IP address of your printer (<http://xxx.xxx.xxx.xxx>) in the address field and press the Enter key or click **Go**.
- 2 Your machine's embedded website opens.

Logging into SyncThru™ Web Service

Before configuring options in SyncThru™ Web Service, you need to log-in as an administrator. You can still use SyncThru™ Web Service without logging in but you won't have access to **Settings** tab and **Security** tab.

- 1 Click **Login** on the upper right of the SyncThru™ Web Service website.
- 2 Type in the **ID** and **Password** then click **Login**.
 - ID: admin**
 - Password: sec00000**

SyncThru™ Web Service overview



Information

Settings

Security

Maintenance



Some tabs may not appear depending on your model.

Information tab

This tab gives you general information about your machine. You can check things, such as remaining amount of toner. You can also print reports, such as an error report.

- **Active Alerts:** Shows the alerts that have occurred in the machine and their severity.
- **Supplies:** Shows how many pages are printed and amount of toner left in the cartridge.
- **Usage Counters:** Shows the usage count by print types

Using SyncThru™ Web Service

- **Current Settings:** Shows the machine's and network's information.
- **Print information:** Prints reports such as system related reports and font reports.

Settings tab

This tab allows you to set configurations provided by your machine and network. You need to log-in as an administrator to view this tab.

- **Machine Settings** tab: Sets options provided by your machine.
- **Network Settings** tab: Shows options for the network environment. Sets options such as TCP/IP and network protocols.

Security tab

This tab allows you to set system and network security information. You need to log-in as an administrator to view this tab.

- **System Security:** Sets the system administrator's information and also enables or disables machine features.
- **Network Security:** Sets settings for IPSec and IPv4/IPv6 filtering.

Maintenance tab

This tab allows you to maintain your machine by upgrading firmware and setting contact information for sending emails. You can also connect to Samsung website or download drivers by selecting the **Link** menu.

- **Firmware Upgrade:** Upgrade your machine's firmware.
- **Contact Information:** Shows the contact information.
- **Link:** Shows links to useful sites where you can download or check information.

Setting the system administrator's information

This setting is necessary for using the e-mail notification option.

- 1 Start a web browser, such as Internet Explorer, from Windows.
Enter the machine IP address (http://xxx.xxx.xxx.xxx) in the address field and press the Enter key or click **Go**.
- 2 Your machine's embedded website opens.
- 3 From the **Security** tab, select **System Security > System Administrator**
- 4 Enter the name of the administrator, phone number, location, and email address.
- 5 Click **Apply**.

Using Samsung Easy Printer Manager



- This feature may not be available depending on model or optional goods (see "Software" on page 6).
- Available for Windows and Mac OS users only (see "Software" on page 6).
- For Windows, Internet Explorer 6.0 or higher is the minimum requirement for Samsung Easy Printer Manager.

Samsung Easy Printer Manager is an application that combines Samsung machine settings into one location. Samsung Easy Printer Manager combines device settings as well as printing environments, settings/actions and launching. All of these features provide a gateway to conveniently use your Samsung machine. Samsung Easy Printer Manager provides two different user interfaces for the user to choose from: the basic user interface and the advanced user interface. Switching between the two interfaces is easy: just click a button.

Understanding Samsung Easy Printer Manager

To open the program:

For Windows,

Select **Start > Programs** or **All Programs > Samsung Printers > Samsung Easy Printer Manager**.

- For Windows 8, from **Charms**, select **Search > Apps > Samsung Printers > Samsung Easy Printer Manager**.

For Mac,

Open the **Applications** folder > **Samsung** folder > **Samsung Easy Printer Manager**.



The Samsung Easy Printer Manager interface is comprised of various basic sections as described in the table that follows:

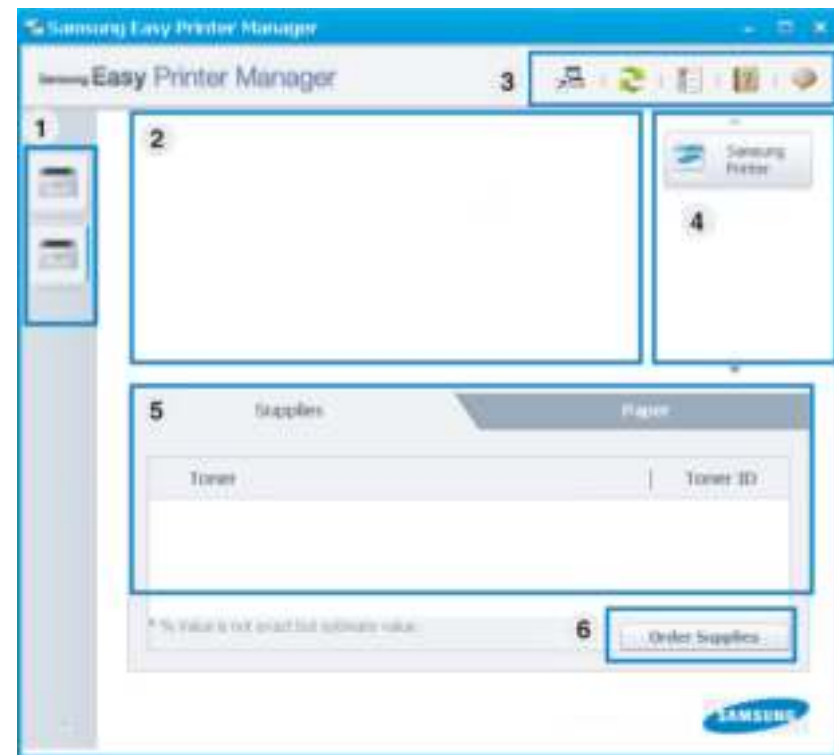

The screenshot may differ depending on operating system you are using.



Using Samsung Easy Printer Manager

| | | |
|---|-------------------------|--|
| 1 | Printer list | The Printer List displays printers installed on your computer and network printers added by network discovery (Windows only). |
| 2 | Printer information | <p>This area gives you general information about your machine. You can check information, such as the machine's model name, IP address (or Port name), and machine status.</p> <p> You can view the online User's Guide.</p> <p>Troubleshooting button: This button opens the Troubleshooting Guide when an error occurs. You can directly open the necessary section in the user's guide.</p> |
| 3 | Application information | <p>Includes links for changing to the advanced settings (switching UI), refresh, preference setting, summary, help, and about.</p> <p> The  button is used to change the user interface to the advanced settings user interface (see "Advanced settings user interface overview" on page 153).</p> |

| | | |
|---|----------------|--|
| 4 | Quick links | <p>Displays Quick links to machine specific functions. This section also includes links to applications in the advanced settings.</p> <p> If you connect your machine to a network, the SyncThru™ Web Service icon is enabled.</p> |
| 5 | Contents area | Displays information about the selected machine, remaining toner level, and paper. The information will vary based on the machine selected. Some machines do not have this feature. |
| 6 | Order supplies | Click on the Order button from the supply ordering window. You can order replacement toner cartridge(s) from online. |



Select the **Help** menu or click the  button from the window and click on any option you want to know about.

Using Samsung Easy Printer Manager

Advanced settings user interface overview

The advanced user interface is intended to be used by the person responsible for managing the network and machines.



Some menus may not appear in the display depending on options or models. If so, it is not applicable to your machine.

Device Settings

You can configure various machine settings such as machine setup, paper, layout, emulation, network, and print information.

Alert Settings (Windows only)

This menu includes settings related to error alerting.

- **Printer Alert:** Provides settings related to when alerts will be received.
- **Email Alert:** Provides options relating to receiving alerts via email.
- **Alert History:** Provides a history of device and toner related alerts.

Using Samsung Printer Status

The Samsung Printer Status is a program that monitors and informs you of the machine status.



- Available for Windows users.
- The Samsung Printer Status window and its contents shown in this user's guide may differ depending on the machine or operating system in use.
- Check the operating system(s) that are compatible with your machine (see "System requirements" on page 65).

Samsung Printer Status overview

If an error occurs while operating, you can check the error from the Samsung Printer Status. Samsung Printer Status is installed automatically when you install the machine software.

You can also launch Samsung Printer Status manually. Go to the **Printing Preferences**, click the **Basic** tab > **Printer Status** button.

These icons appear on the Windows task bar:

| Icon | Mean | Description |
|------|---------|---|
| | Normal | The machine is in ready mode and experiencing no errors or warnings. |
| | Warning | The machine is in a state where an error might occur in the future. For example, it might be in toner low status, which may lead to toner empty status. |
| | Error | The machine has at least one error. |

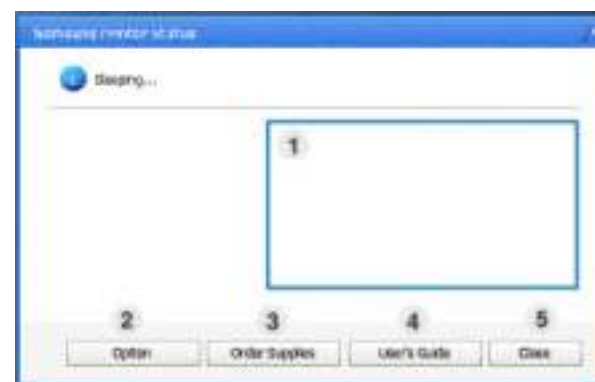

| | | |
|---|--------------------|---|
| 1 | Toner Level | You can view the level of toner remaining in each toner cartridge. The machine and the number of toner cartridge(s) shown in the above window may differ depending on the machine in use. Some machines do not have this feature. |
| 2 | Option | You can set Printing Job Alert related settings. |

Using Samsung Printer Status

| | | |
|---|-----------------------|--|
| 3 | Order Supplies | You can order replacement toner cartridge(s) from online. |
| 4 | User's Guide | <p>You can view the online User's Guide.</p> <div data-bbox="421 395 1084 639"> This button opens the Troubleshooting Guide when an error occurs. You can directly open the troubleshooting section in the user's guide.</div> |
| 5 | Close | Close the window. |

Using Samsung Printer Experience

Samsung Printer Experience is a Samsung application that combines Samsung machine settings and machine management into one location. You can set device settings, order supplies, open troubleshooting guides, visit Samsung's web site, and check connected machine information. This application will be automatically downloaded from the Windows **Store** if the machine is connected to a computer with an Internet connection.

Understanding the Samsung Printer Experience

To open the application,

From the **Start** screen, select the **Samsung Printer Experience** () tile.

The **Samsung Printer Experience** interface comprises various useful features as described in the following table:



The screenshot may differ depending on the model you are using.

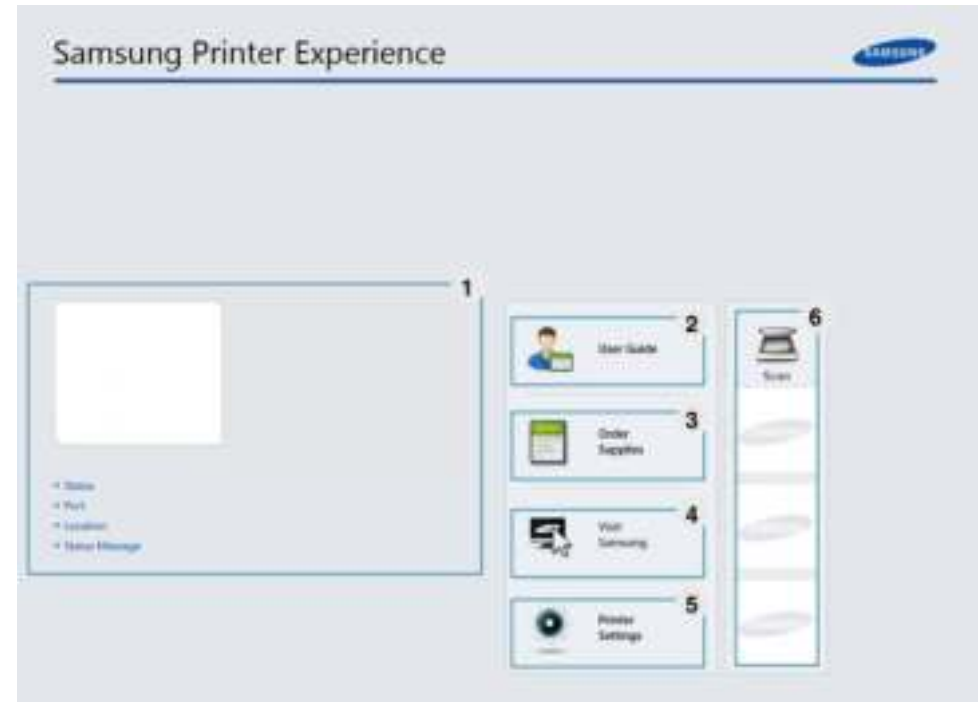

| | | |
|---|----------------------------|---|
| 1 | Printer Information | This area gives you general information about your machine. You can check information, such as the machine's status, location, IP address, and remaining toner level. |
|---|----------------------------|---|

Using Samsung Printer Experience

| | | |
|---|---|--|
| 2 | User Guide | You can view the online User's Guide. You need to be connected to the Internet to use this feature.  This button opens the Troubleshooting Guide when an error occurs. You can directly open the troubleshooting section in the user's guide. |
| 3 | Order Supplies | Click on this button to order replacement toner cartridges online. You need to be connected to the Internet to use this feature. |
| 4 | Visit Samsung | Links to Samsung printer website. You need to be connected to the Internet to use this feature. |
| 5 | Printer Settings | You can configure various machine settings such as machine setup, paper, layout, emulation, networking, and print information through SyncThru™ Web Service . Your machine needs to be connected to a network. This button will be disabled if your machine is connected via USB cable. |
| 6 | Device List & Latest Scanned Image | The scan list displays devices that supports Samsung Printer Experience . Under the device, you can see the latest scanned images. Your machine needs to be connected to a network to scan from here. This section is for the users with multi-functional printers. |

Adding/Deleting Printers

If you do not have any printer added to the **Samsung Printer Experience**, or if you want to add/delete a printer, follow the instructions below.



You can only add/delete network connected printers.

Adding a printer

- 1 From the **Charms**, select **Settings**.
Or, right-click the **Samsung Printer Experience** page and select **Settings**.
- 2 Select **Add Printer**
- 3 Select the printer you want to add.
You can see the added printer.



If you see  mark, you can also click  mark to add printers.

Using Samsung Printer Experience

Deleting a printer

- 1** From the **Charms**, select **Settings**.
Or, right-click the **Samsung Printer Experience** page and select **Settings**.
- 2** Select **Remove Printer**
- 3** Select the printer you want to delete.
- 4** Click **Yes**.
You can see that the deleted printer is removed from the screen.

Printing from Windows 8

This section explains common printing tasks from the **Start** screen.

Basic printing

- 1** Open the document to print.
- 2** From the **Charms**, select **Devices**.
- 3** Select your printer from the list
- 4** Select the printer settings, such as the number of copies and orientation.

Using Samsung Printer Experience

- 5 Click the **Print** button to start the print job.



Canceling a print job

If the printing job is waiting in the print queue or print spooler, cancel the job as follows:

- You can access this window by simply double-clicking the machine icon () in the Windows task bar.

Opening more settings



The screen may appear somewhat different depending on the model or options.

You can set up more printing parameters.

- 1 Open the document you want to print.
- 2 From the **Charms**, select **Devices**.
- 3 Select your printer from the list
- 4 Click **More settings**.

Using Samsung Printer Experience

Basic tab



Basic

This option allows you to choose the basic printing settings such as copies, orientation, and document type.

Eco settings

This option allows you to choose multiple pages per side to save media.

Advanced tab



Paper settings

This option allows you to set the basic paper handling specifications.

Layout settings

This option allows you to set the various ways to layout your documents.

Using Samsung Printer Experience

Security tab



Some features may not be available depending on the model or options. If this tab is not shown or disabled, it means that these features are not supported.

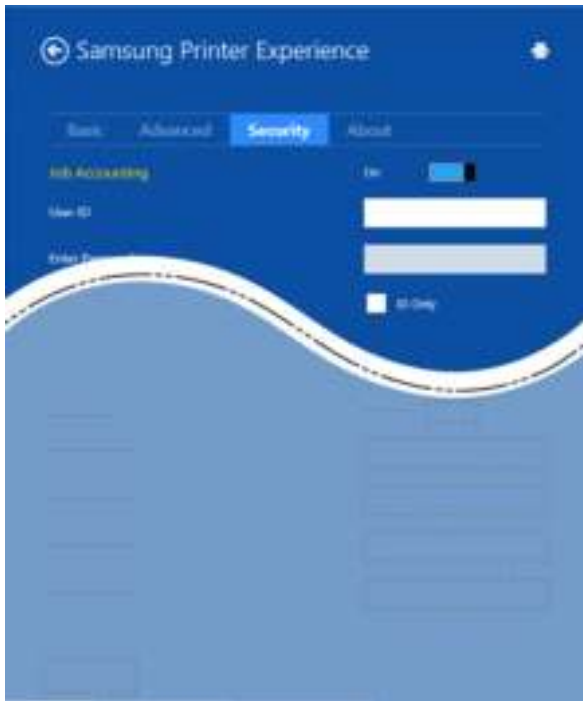

Job Accounting

This option allows you to print with the given permission.

Confidential Printing

This option is used for printing confidential documents. You need to enter a password to print using it.

Using the sharing feature

Samsung Printer Experience allows you to print from other applications installed on the computer using the sharing feature.



This feature is only available for printing jpeg, bmp, tiff, gif, and png file formats.

- 1 Select the content you want to print from other application.
- 2 From the **Charms**, select **Share > Samsung Printer Experience**.
- 3 Select the printer settings, such as the number of copies and orientation.
- 4 Click the **Print** button to start the print job.



5. Troubleshooting

This chapter gives helpful information for what to do if you encounter an error.

- **Paper feeding problems** 163
- **Power and cable connecting problems** 164
- **Printing problems** 165
- **Printing quality problems** 169
- **Operating system problems** 177

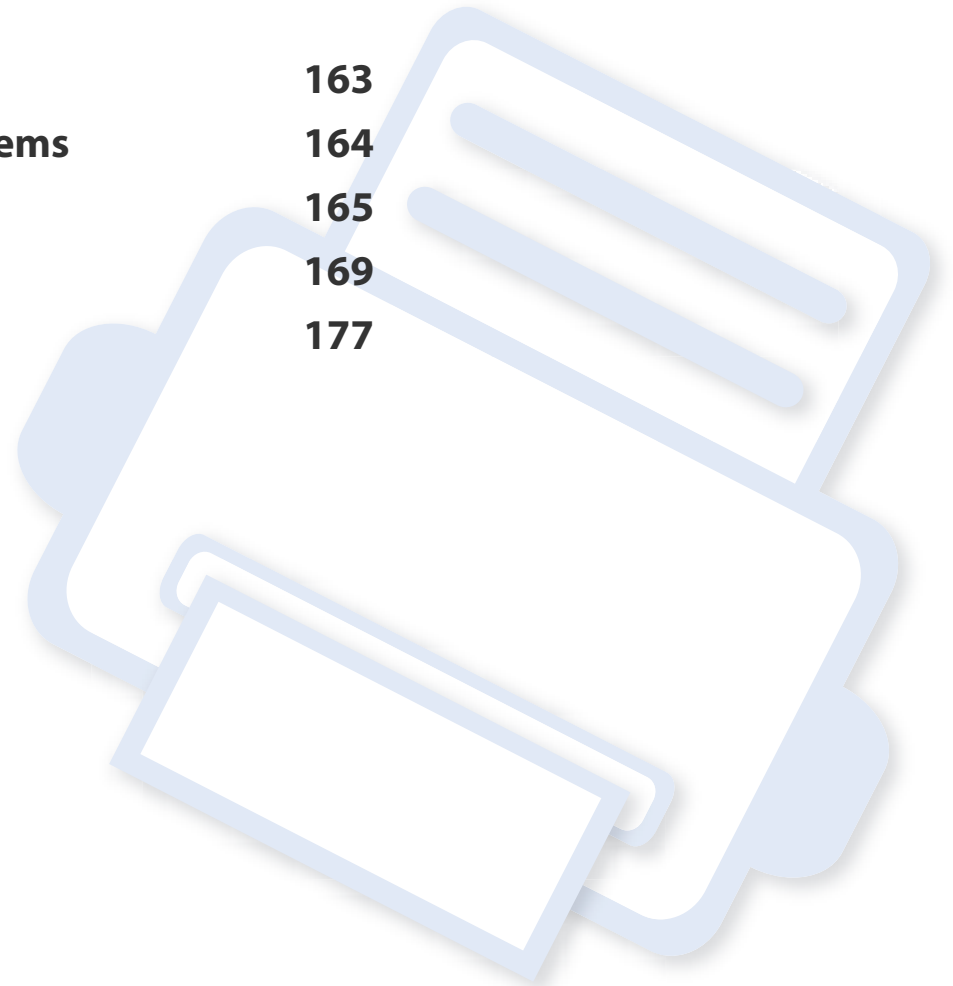

Paper feeding problems

| Condition | Suggested solutions |
|--|--|
| Paper jams during printing. | Clear the paper jam. |
| Paper sticks together. | <ul style="list-style-type: none">• Check the maximum paper capacity of the tray .• Make sure that you are using the correct type of paper.• Remove paper from the tray and flex or fan the paper.• Humid conditions may cause some paper to stick together. |
| Multiple sheets of paper do not feed. | Different types of paper may be stacked in the tray. Load paper of only one type, size, and weight. |
| Paper does not feed into the machine. | <ul style="list-style-type: none">• Remove any obstructions from inside the machine.• Paper has not been loaded correctly. Remove paper from the tray and reload it correctly.• There is too much paper in the tray. Remove excess paper from the tray.• The paper is too thick. Use only paper that meets the specifications required by the machine. |
| The paper keeps jamming. | <ul style="list-style-type: none">• There is too much paper in the tray. Remove excess paper from the tray. If you are printing on special materials, feed manually in the tray.• An incorrect type of paper is being used. Use only paper that meets the specifications required by the machine.• There may be debris inside the machine. Open the top cover and remove any debris. |
| Envelopes skew or fail to feed correctly. | Ensure that the paper guides are against both sides of the envelopes. |

Power and cable connecting problems

Power



Click this link to open an animation about solving power problems.

| Condition | Suggested solutions |
|--|--|
| The machine is not receiving power, or the connection cable between the computer and the machine is not connected properly. | <ul style="list-style-type: none">• Connect the machine to the electricity supply first and press the  (Power) button on the control panel.• Disconnect the machine's cable and reconnect it. |

Printing problems

| Condition | Possible cause | Suggested solutions |
|------------------------------------|---|--|
| The machine does not print. | The machine is not receiving power. | Check the power cord connections. Check the power switch and the power source. |
| | The machine is not selected as the default machine. | Select your machine as your default machine in Windows. |
| | Check the machine for the following: <ul style="list-style-type: none">• The top cover is not closed. Close the top cover.• Paper is jammed. Clear the paper jam (see "Clearing paper jams" on page 53).• No paper is loaded. Load paper (see "Loading paper in the tray" on page 27).• The toner cartridge is not installed. Install the toner cartridge (see "Replacing the toner cartridge" on page 44).• Make sure the protect cover and sheets are removed from the toner cartridge (see "Replacing the toner cartridge" on page 44). If a system error occurs, contact your service representative. | |
| | The connection cable between the computer and the machine is not connected properly. | Disconnect the machine cable and reconnect it (see "Rear view" on page 18). |
| | The connection cable between the computer and the machine is defective. | If possible, attach the cable to another computer that is working properly and print a job. You can also try using a different machine cable. |
| | The port setting is incorrect. | Check the Windows printer settings to make sure that the print job is sent to the correct port. If the computer has more than one port, make sure that the machine is attached to the correct one. |
| | The machine may be configured incorrectly. | Check the Printing Preferences to ensure that all of the print settings are correct. |

Printing problems

| Condition | Possible cause | Suggested solutions |
|---|---|---|
| The machine does not print. | The printer driver may be incorrectly installed. | Uninstall and reinstall the machine's driver. |
| | The machine is malfunctioning. | Check the display message on the control panel to see if the machine is indicating a system error. Contact a service representative. |
| | The document size is so big that the hard disk space of the computer is insufficient to access the print job. | Get more hard disk space and print the document again. |
| | The output tray is full. | Once the paper is removed from the output tray, the machine resumes printing. |
| The machine selects print materials from the wrong paper source. | The paper option that was selected in the Printing Preferences may be incorrect. | For many software applications, the paper source selection is found under the Paper tab within the Printing Preferences (see "Opening printing preferences" on page 36). Select the correct paper source. See the printer driver help screen (see "Using help" on page 37). |
| A print job is extremely slow. | The job may be very complex. | Reduce the complexity of the page or try adjusting the print quality settings. |
| Half the page is blank. | The page orientation setting may be incorrect. | Change the page orientation in your application (see "Opening printing preferences" on page 36). See the printer driver help screen (see "Using help" on page 37). |
| | The paper size and the paper size settings do not match. | Ensure that the paper size in the printer driver settings matches the paper in the tray. Or, ensure that the paper size in the printer driver settings matches the paper selection in the software application settings you use (see "Opening printing preferences" on page 36). |

Printing problems

| Condition | Possible cause | Suggested solutions |
|--|--|---|
| The machine prints, but the text is wrong, garbled, or incomplete. | The machine cable is loose or defective. | Disconnect the machine cable and reconnect. Try a print job that you have already printed successfully. If possible, attach the cable and the machine to another computer that you know works and try a print job. Finally, try a new machine cable. |
| | The wrong printer driver was selected. | Check the application's printer selection menu to ensure that your machine is selected. |
| | The software application is malfunctioning. | Try printing a job from another application. |
| | The operating system is malfunctioning. | Exit Windows and reboot the computer. Turn the machine off and back on again. |
| Pages print, but they are blank. | The toner cartridge is defective or out of toner. | Redistribute the toner, if necessary. If necessary, replace the toner cartridge. <ul style="list-style-type: none">• See "Redistributing toner" on page 43.• See "Replacing the toner cartridge" on page 44. |
| | The file may have blank pages. | Check the file to ensure that it does not contain blank pages. |
| | Some parts, such as the controller or the board, may be defective. | Contact a service representative. |
| The machine does not print PDF files correctly. Some parts of graphics, text, or illustrations are missing. | Incompatibility between the PDF file and the Acrobat products. | Printing the PDF file as an image may enable the file to print. Turn on Print As Image from the Acrobat printing options.  It will take longer to print when you print a PDF file as an image. |
| The print quality of photos is not good. Images are not clear. | The resolution of the photo is very low. | Reduce the photo size. If you increase the photo size in the software application, the resolution will be reduced. |

Printing problems

| Condition | Possible cause | Suggested solutions |
|---|---|--|
| Before printing, the machine emits vapor near the output tray. | Using damp/wet paper can cause vapor [white smoke] during printing. | This is not a problem, just keep printing. If you are bothered by the smoke [vapor], then replace the paper with fresh paper from an unopened ream. |
| The machine does not print special-sized paper, such as billing paper. | Paper size and paper size setting do not match. | Set the correct paper size in the Custom in Paper tab in Printing Preferences (see "Opening printing preferences" on page 36). |
| The printed billing paper is curled. | The paper type setting does not match. | Change the printer option and try again. Go to Printing Preferences , click Paper tab, and set type to Thick (see "Opening printing preferences" on page 36). |

Printing quality problems

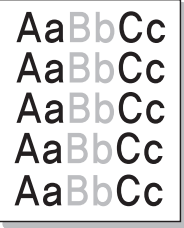
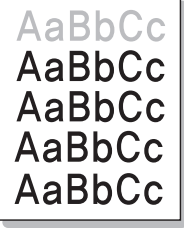

If the inside of the machine is dirty or paper has been loaded improperly, there might be a reduction in print quality. See the table below to clear the problem.

| Condition | Suggested Solutions |
|--|--|
| <p data-bbox="49 357 322 389">Light or faded print</p>  | <ul data-bbox="506 357 2190 751" style="list-style-type: none">• If a vertical white streak or faded area appears on the page, the toner supply is low. Install a new toner cartridge (see "Replacing the toner cartridge" on page 44).• The paper may not meet paper specifications; for example, the paper may be too moist or rough.• If the entire page is light, the print resolution setting is too low or the toner save mode is on. Adjust the print resolution and turn the toner save mode off. See the help screen of the printer driver.• A combination of faded or smeared defects may indicate that the toner cartridge needs cleaning. Clean the inside of your machine (see "Cleaning the machine" on page 46).• The surface of the LSU part inside the machine may be dirty. Clean the inside of your machine (see "Cleaning the machine" on page 46). If these steps do not correct the problem, contact a service representative. |
| <p data-bbox="49 786 472 903">The top half of the paper is printed lighter than the rest of the paper</p>  | <p data-bbox="506 786 1249 818">The toner might not adhere properly to this type of paper.</p> <ul data-bbox="506 842 2190 911" style="list-style-type: none">• Change the printer option and try again. Go to Printing Preferences, click the Paper tab, and set the paper type to Recycled (see "Opening printing preferences" on page 36). |

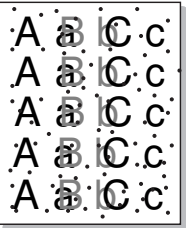
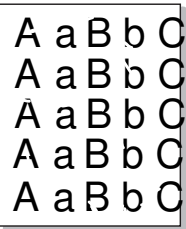
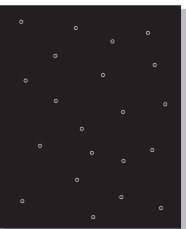
Printing quality problems

| Condition | Suggested Solutions |
|--|--|
| <p>Toner specks</p>  | <ul style="list-style-type: none">• The paper may not meet specifications; for example, the paper may be too moist or rough.• The transfer roller may be dirty. Clean the inside of your machine (see "Cleaning the machine" on page 46).• The paper path may need cleaning. Contact a service representative (see "Cleaning the machine" on page 46). |
| <p>Dropouts</p>  | <p>If faded areas, generally rounded, occur randomly on the page:</p> <ul style="list-style-type: none">• A single sheet of paper may be defective. Try reprinting the job.• The moisture content of the paper is uneven or the paper has moist spots on its surface. Try a different brand of paper.• The paper lot is bad. The manufacturing processes can cause some areas to reject toner. Try a different kind or brand of paper.• Change the printer option and try again. Go to Printing Preferences, click the Paper tab, and set type to Thick or Thicker (see "Opening printing preferences" on page 36). <p>If these steps do not correct the problem, contact a service representative.</p> |
| <p>White Spots</p>  | <p>If white spots appear on the page:</p> <ul style="list-style-type: none">• The paper is too rough and a lot of dirt from paper falls to the inner components within the machine, so the transfer roller may be dirty. Clean the inside of your machine (see "Cleaning the machine" on page 46).• The paper path may need cleaning. Clean the inside of your machine (see "Cleaning the machine" on page 46). <p>If these steps do not correct the problem, contact a service representative.</p> |

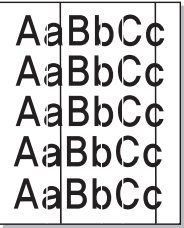
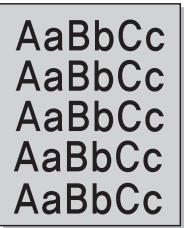
Printing quality problems

| Condition | Suggested Solutions |
|---|---|
| <p>Vertical lines</p>  | <p>If black vertical streaks appear on the page:</p> <ul style="list-style-type: none">• The surface (drum part) of the toner cartridge inside the machine has probably been scratched. Remove the toner cartridge and install a new one (see "Replacing the toner cartridge" on page 44). <p>If white vertical streaks appear on the page:</p> <ul style="list-style-type: none">• The surface of the LSU part inside the machine may be dirty. Clean the inside of your machine (see "Cleaning the machine" on page 46). If these steps do not correct the problem, contact a service representative. |
| <p>Black background</p>  | <p>If the amount of background shading becomes unacceptable:</p> <ul style="list-style-type: none">• Change to a lighter weight paper.• Check the environmental conditions: very dry conditions or a high level of humidity (higher than 80% RH) can increase the amount of background shading.• Remove the old toner cartridge and install a new one (see "Replacing the toner cartridge" on page 44).• Thoroughly redistribute the toner (see "Redistributing toner" on page 43). |
| <p>Toner smear</p>  | <ul style="list-style-type: none">• Clean the inside of the machine (see "Replacing the toner cartridge" on page 44).• Check the paper type and quality.• Remove the toner cartridge and install a new one (see "Replacing the toner cartridge" on page 44). |

Printing quality problems

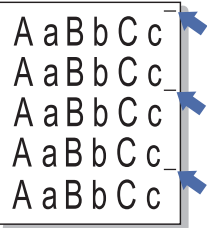
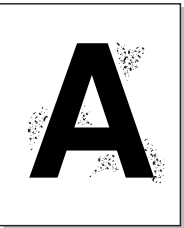
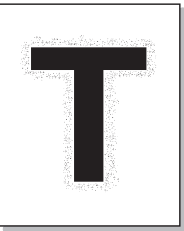
| Condition | Suggested Solutions |
|--|--|
| <p data-bbox="51 272 405 304">Vertical repetitive defects</p>  | <p data-bbox="506 272 1473 304">If marks repeatedly appear on the printed side of the page at even intervals:</p> <ul data-bbox="506 328 2190 544" style="list-style-type: none"><li data-bbox="506 328 2190 400">• The toner cartridge may be damaged. If you still have the same problem, remove the toner cartridge and, install a new one (see "Replacing the toner cartridge" on page 44).<li data-bbox="506 416 2190 488">• Parts of the machine may have toner on them. If the defects occur on the back of the page, the problem will likely correct itself after a few more pages.<li data-bbox="506 504 1462 544">• The fusing assembly may be damaged. Contact a service representative. |
| <p data-bbox="51 612 322 644">Background scatter</p>  | <p data-bbox="506 612 1621 644">Background scatter results from bits of toner randomly distributed on the printed page.</p> <ul data-bbox="506 668 2190 1054" style="list-style-type: none"><li data-bbox="506 668 2190 740">• The paper may be too damp. Try printing with a different batch of paper. Do not open packages of paper until necessary so that the paper does not absorb too much moisture.<li data-bbox="506 756 2190 876">• If background scatter occurs on an envelope, change the printing layout to avoid printing over areas that have overlapping seams on the reverse side. Printing on seams can cause problems. Or select Thick Envelope from the Printing Preferences window (see "Opening printing preferences" on page 36).<li data-bbox="506 892 2190 1011">• If background scatter covers the entire surface area of a printed page, adjust the print resolution through your software application or in Printing Preferences (see "Opening printing preferences" on page 36). Ensure the correct paper type is selected. For example: If Thicker Paper is selected, but Plain actually used, an overcharging can occur causing this copy quality problem.<li data-bbox="506 1027 1872 1054">• If you are using a new toner cartridge, redistribute the toner first (see "Redistributing toner" on page 43). |
| <p data-bbox="51 1086 479 1158">Toner particles are around bold characters or pictures</p>  | <p data-bbox="506 1086 1249 1118">The toner might not adhere properly to this type of paper.</p> <ul data-bbox="506 1142 2190 1302" style="list-style-type: none"><li data-bbox="506 1142 2190 1214">• Change the printer option and try again. Go to Printing Preferences, click the Paper tab, and set the paper type to Recycled (see "Opening printing preferences" on page 36).<li data-bbox="506 1230 2190 1302">• Ensure the correct paper type is selected. For example: If Thicker Paper is selected, but Plain actually used, an overcharging can occur causing this copy quality problem. |

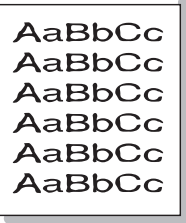
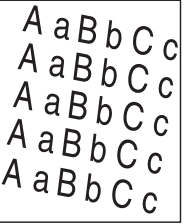
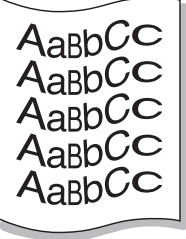

Printing quality problems

| Condition | Suggested Solutions |
|--|--|
| <p data-bbox="49 272 353 304">Misformed characters</p>  | <ul data-bbox="504 272 2072 304" style="list-style-type: none">• If characters are improperly formed and producing hollow images, the paper stock may be too slick. Try different paper. |
| <p data-bbox="49 608 203 639">Page skew</p>  | <ul data-bbox="504 608 1518 743" style="list-style-type: none">• Ensure that the paper is loaded properly.• Check the paper type and quality.• Ensure that the guides are not too tight or too loose against the paper stack. |
| <p data-bbox="49 951 226 983">Curl or wave</p>  | <ul data-bbox="504 951 1727 1086" style="list-style-type: none">• Ensure that the paper is loaded properly.• Check the paper type and quality. Both high temperature and humidity can cause paper curl.• Turn the stack of paper over in the tray. Also try rotating the paper 180° in the tray. |

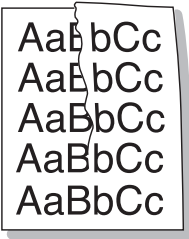
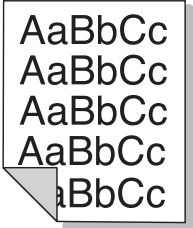
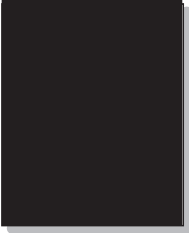
Printing quality problems

| Condition | Suggested Solutions |
|---|--|
| <p data-bbox="49 272 318 304">Wrinkles or creases</p>  | <ul data-bbox="504 272 1599 411" style="list-style-type: none">• Ensure that the paper is loaded properly.• Check the paper type and quality.• Turn the stack of paper over in the tray. Also try rotating the paper 180° in the tray. |
| <p data-bbox="49 619 412 651">Back of printouts are dirty</p>  | <ul data-bbox="504 619 1787 651" style="list-style-type: none">• Check for leaking toner. Clean the inside of the machine (see "Cleaning the machine" on page 46). |
| <p data-bbox="49 986 405 1018">Solid color or black pages</p>  | <ul data-bbox="504 986 2159 1161" style="list-style-type: none">• The toner cartridge may not be installed properly. Remove the cartridge and reinsert it.• The toner cartridge may be defective. Remove the toner cartridge and install a new one (see "Replacing the toner cartridge" on page 44).• The machine may require repairing. Contact a service representative. |

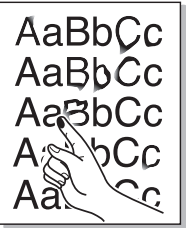
Printing quality problems

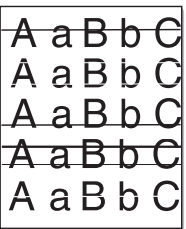
| Condition | Suggested Solutions |
|---|---|
| <p>Loose toner</p>  | <ul style="list-style-type: none">• Clean the inside of the machine (see "Cleaning the machine" on page 46).• Check the paper type and quality.• Remove the toner cartridge and then, install a new one (see "Replacing the toner cartridge" on page 44). <p>If the problem persists, the machine may require repair. Contact a service representative.</p> |
| <p>Character voids</p>  | <p>Character voids are white areas within parts of characters that should be solid black:</p> <ul style="list-style-type: none">• You may be printing on the wrong surface of the paper. Remove the paper and turn it around.• The paper may not meet paper specifications. |
| <p>Horizontal stripes</p>  | <p>If horizontally aligned black streaks or smears appear:</p> <ul style="list-style-type: none">• The toner cartridge may be installed improperly. Remove the cartridge and reinsert it.• The toner cartridge may be defective. Remove the toner cartridge and install a new one (see "Replacing the toner cartridge" on page 44). <p>If the problem persists, the machine may require repairing. Contact a service representative.</p> |

Printing quality problems

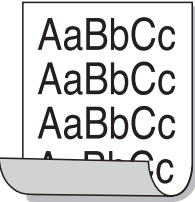
| Condition | Suggested Solutions |
|--|---|
| <p>Curl</p>  | <p>If the printed paper is curled or paper does not feed into the machine:</p> <ul style="list-style-type: none">• Turn the stack of paper over in the tray. Also try rotating the paper 180° in the tray.• Change the printer's paper option and try again. Go to Printing Preferences, click the Paper tab, and set type to Thin (see "Opening printing preferences" on page 36). |
| <ul style="list-style-type: none">• An unknown image repetitively appears on a few sheets• Loose toner• Light print or contamination occurs | <p>Your machine is probably being used at an altitude of 1,000 m (3,281 ft) or above. The high altitude may affect the print quality, such as loose toner or light imaging. Change the altitude setting for your machine (See "Altitude adjustment" on page 130).</p> |

Operating system problems

Common Windows problems

| Condition | Suggested solutions |
|--|--|
| “File in Use” message appears during installation. | Exit all software applications. Remove all software from the startup group, then restart Windows. Reinstall the printer driver. |
| “General Protection Fault”, “Exception OE”, “Spool 32”, or “Illegal Operation” messages appear. | Close all other applications, reboot Windows and try printing again. |
| “Fail To Print”, “A printer timeout error occurred” message appear. | These messages may appear during printing. Just keep waiting until the machine finishes printing. If the message appears in ready mode or after printing has completed, check the connection and/or whether an error has occurred. |
| Samsung Printer Experience is not shown when you click more settings . | Samsung Printer Experience is not installed. Download the app. from the Windows Store and install it. |
| Machine information is not displayed when you click the device in the Devices and Printers . | Check the Printer properties . Click the Ports tab. (Control Panel > Devices and Printers > Right-click on your printer icon and select Printer properties) If the port is set to File or LPT, uncheck them and select TCP/IP, USB, or WSD. |



Refer to the Microsoft Windows User’s Guide that came with your computer for further information on Windows error messages.

Operating system problems

Common Mac problems

| Condition | Suggested solutions |
|--|--|
| The machine does not print PDF files correctly. Some parts of graphics, text, or illustrations are missing. | <p>Printing the PDF file as an image may enable the file to print. Turn on Print As Image from the Acrobat printing options.</p> <p> It will take longer to print when you print a PDF file as an image.</p> |
| Some letters are not displayed normally during cover page printing. | <p>Mac OS cannot create the font while printing the cover page. The English alphabet and numbers are displayed normally on the cover page.</p> |
| When printing a document in Mac with Acrobat Reader 6.0 or higher, colors print incorrectly. | <p>Make sure that the resolution setting in your machine driver matches the one in Acrobat Reader.</p> |



Refer to the Mac User's Guide that came with your computer for further information on Mac error messages.

Operating system problems

Common Linux problems

| Condition | Suggested solutions |
|---|---|
| Printing with more than 2 copies does not work. | The problem occurs on Ubuntu 12.04 due to problem in standard CUPS filter 'pdftops' (actual output point it out exactly) and it has been fixed already. Updating 'cups-filters' package from version 1.0.17 to version 1.0.18 fixes the problem ('pdftops' is a part of 'cups-filters' package). |
| Printing PDF files does not work. | The problem occurs on openSUSE 12.3 and it has some problem in standard CUPS filter 'pdftops' that may affect certain PDF documents (it seems this issue relates somehow to fonts used in PDF). Due to this problem, incorrect Postscript is generated and device failed to print it. We are waiting for the patch. |
| Unchecking collate option in Print dialog does not work. | For some distributions, GNOME Print Dialog has an issue handling collate option. As workaround, set the default value of collate option to 'False' using system's Printing utility(execute "system-config-printer" in Terminal program). |
| Printing always works with duplex. | This duplex issue was in Ubuntu 9.10 cups package and was already fixed in security updates for this package, starting from cups version 1.4.1-5ubuntu2.2 |



Refer to the Linux User's Guide that came with your computer for further information on Linux error messages.

Contact SAMSUNG worldwide

If you have any comments or questions regarding Samsung products, contact the Samsung customer care center.

| Country/Region | Customer Care Center | WebSite |
|-------------------|------------------------------------|---|
| ANGOLA | 91-726-7864 | www.samsung.com |
| ARGENTINA | 0800-333-3733 | www.samsung.com |
| ARMENIA | 0-800-05-555 | www.samsung.com |
| AUSTRALIA | 1300 362 603 | www.samsung.com |
| AUSTRIA | 0810-SAMSUNG (7267864, € 0.07/min) | www.samsung.com |
| AZERBAIJAN | 088-55-55-555 | www.samsung.com |
| BAHRAIN | 8000-4726 | www.samsung.com/ae (English) www.samsung.com/ ae_ar (Arabic) |
| BELARUS | 810-800-500-55-500 | www.samsung.com |
| BELGIUM | 02-201-24-18 | www.samsung.com/be (Dutch) www.samsung.com/ be_fr (French) |
| BOLIVIA | 800-10-7260 | www.samsung.com |
| BOSNIA | 051 133 1999 | www.samsung.com |

| Country/Region | Customer Care Center | WebSite |
|-----------------------|--|---|
| BOTSWANA | 0800-726-000 | www.samsung.com |
| BRAZIL | 0800-124-421 4004-0000 | www.samsung.com |
| BULGARIA | 07001 33 11 , normal tariff | www.samsung.com |
| CAMEROON | 7095- 0077 | www.samsung.com |
| CANADA | 1-800-SAMSUNG (726-7864) | www.samsung.com/ca (English) www.samsung.com/ ca_fr (French) |
| CHILE | 800-SAMSUNG (726-7864) From mobile 02-24 82 82 00 | www.samsung.com/cl |
| CHINA | 400-810-5858 | www.samsung.com |
| COLOMBIA | 01-8000112112 Bogotá: 6001272 | www.samsung.com/co |
| COSTA RICA | 0-800-507-7267 | www.samsung.com/ latin (Spanish) www.samsung.com/ latin_en (English) |
| CROATIA | 062 SAMSUNG (062 726 786) | www.samsung.com |
| Cote D' Ivoire | 8000 0077 | www.samsung.com |

Contact SAMSUNG worldwide

| Country/Region | Customer Care Center | WebSite |
|--------------------|---|---|
| CYPRUS | 8009 4000 only from landline(+30) 210 6897691 from mobile and land line | www.samsung.com |
| CZECH | 800-SAMSUNG (800-726786) | www.samsung.com |
| DENMARK | 70 70 19 70 | www.samsung.com |
| DOMINICA | 1-800-751-2676 | www.samsung.com/ latin (Spanish) www.samsung.com/ latin_en (English) |
| ECUADOR | 1-800-10-7267 | www.samsung.com/ latin (Spanish) www.samsung.com/ latin_en (English) |
| EGYPT | 08000-726786 | www.samsung.com |
| EIRE | 0818 717100 | www.samsung.com |
| EL SALVADOR | 800-6225 | www.samsung.com/ latin (Spanish) www.samsung.com/ latin_en (English) |
| ESTONIA | 800-7267 | www.samsung.com/ee |
| FINLAND | 030-6227 515 | www.samsung.com |
| FRANCE | 01 48 63 00 00 | www.samsung.com/fr |

| Country/Region | Customer Care Center | WebSite |
|------------------|--|---|
| GERMANY | 0180 5 SAMSUNG bzw.0180 5 7267864* (*0,14 €/Min. aus dem dt. Festnetz, aus dem Mobilfunk max. 0,42 €/Min.) | www.samsung.com |
| GEORGIA | 8-800-555-555 | www.samsung.com |
| GHANA | 0800-10077 0302-200077 | www.samsung.com |
| GREECE | 80111-SAMSUNG (80111 726 7864) only from land line(+30) 210 6897691 from mobile and land line | www.samsung.com |
| GUATEMALA | 1-800-299-0013 | www.samsung.com/ latin (Spanish) www.samsung.com/ latin_en (English) |
| HONDURAS | 800-27919267 | www.samsung.com/ latin (Spanish) www.samsung.com/ latin_en (English) |
| HONG KONG | (852) 3698-4698 | www.samsung.com/hk (Chinese) www.samsung.com/ hk_en (English) |

Contact SAMSUNG worldwide

| Country/Region | Customer Care Center | WebSite |
|-------------------|---------------------------------|---|
| HUNGARY | 06-80-SAMSUNG (726-7864) | www.samsung.com |
| INDIA | 1800 3000 8282 1800 266 8282 | www.samsung.com/in |
| INDONESIA | 0800-112-8888 021-5699-7777 | www.samsung.com/id |
| IRAN | 021-8255 | www.samsung.com |
| ITALIA | 800-SAMSUNG (726-7864) | www.samsung.com |
| JAMAICA | 1-800-234-7267 | www.samsung.com |
| JAPAN | 0120-327-527 | www.samsung.com |
| JORDAN | 800-22273 065777444 | www.samsung.com/ Levant (English) |
| KAZAKHSTAN | 8-10-800-500-55-500 (GSM:7799) | www.samsung.com |
| KENYA | 0800 724 000 | www.samsung.com |
| KUWAIT | 183-2255 (183-CALL) | www.samsung.com/ae (English) www.samsung.com/ ae_ar (Arabic) |
| KYRGYZSTAN | 00-800-500-55-500 | www.samsung.com |
| LATVIA | 8000-7267 | www.samsung.com/lv |
| LITHUANIA | 8-800-77777 | www.samsung.com/lt |

| Country/Region | Customer Care Center | WebSite |
|--------------------|---|---|
| LUXEMBURG | 261 03 710 | www.samsung.com |
| MALAYSIA | 1800-88-9999 | www.samsung.com/ my |
| MEXICO | 01-800-SAMSUNG (726-7864) | www.samsung.com |
| MOLDOVA | 0-800-614-40 | www.samsung.com |
| MONGOLIA | +7-800-555-55-55 | www.samsung.com |
| MONTENEGRO | 020 405 888 | www.samsung.com |
| MOROCCO | 080 100 2255 | www.samsung.com |
| NAMIBIA | 8197267864 | www.samsung.com |
| NIGERIA | 0800-726-7864 | www.samsung.com |
| NETHERLANDS | 0900-SAMSUNG (0900-7267864) (€ 0,10/min) | www.samsung.com |
| NEW ZEALAND | 0800 SAMSUNG (0800 726 786) | www.samsung.com |
| NICARAGUA | 00-1800-5077267 | www.samsung.com/ latin (Spanish) www.samsung.com/ latin_en (English) |
| NORWAY | 815-56 480 | www.samsung.com |

Contact SAMSUNG worldwide

| Country/Region | Customer Care Center | WebSite |
|--------------------|---|---|
| OMAN | 800-SAMSUNG (726-7864) | www.samsung.com/ae (English) www.samsung.com/ae_ar (Arabic) |
| PANAMA | 800-7267 | www.samsung.com/latin (Spanish) www.samsung.com/latin_en (English) |
| PARAGUAY | 98005210001 | www.samsung.com |
| PERU | 0-800-777-08 (Only from landline) 336-8686 (From HHP & landline) | www.samsung.com |
| PHILIPPINES | 1-800-10-SAMSUNG(726-7864) for PLDT 1-800-3-SAMSUNG(726-7864) for Digitel 1-800-8-SAMSUNG(726-7864) for Globe 02-5805777 | www.samsung.com/ph |

| Country/Region | Customer Care Center | WebSite |
|---------------------|--|--|
| POLAND | 0 801-1SAMSUNG(172-678) * lub +48 22 607-93-33 ** * (całkowity koszt połączenia jak za 1 impuls według taryfy operatora) ** (koszt połączenia według taryfy operatora) | www.samsung.com/pl |
| PORTUGAL | 808 20-SAMSUNG (808 20 7267) | www.samsung.com |
| PUERTO RICO | 1-800-682-3180 | www.samsung.com |
| QATAR | 800-2255 (800-CALL) | www.samsung.com/ae (English) www.samsung.com/ae_ar (Arabic) |
| ROMANIA | 08008 SAMSUNG (08008 726 7864)TOLL FREE No. | www.samsung.com |
| RUSSIA | 800-00-0077 | www.samsung.com |
| SAUDI ARABIA | 9200-21230 | www.samsung.com/sa (Arabic) |
| SENEGAL | 8-800-555-55-55 | www.samsung.com |
| SERBIA | +381 11 321 6899 (old number still active 0700 7267864) | www.samsung.com |
| SINGAPORE | 1800-SAMSUNG (726-7864) | www.samsung.com |

Contact SAMSUNG worldwide

| Country/Region | Customer Care Center | WebSite |
|------------------------------|--------------------------------------|--|
| SLOVAKIA | 0800 - SAMSUNG(0800-726 786) | www.samsung.com |
| SOUTH AFRICA | 0860 SAMSUNG (726-7864) | www.samsung.com |
| SPAIN | 902-1-SAMSUNG(902 172 678) | www.samsung.com |
| SWEDEN | 0771 726 7864 (SAMSUNG) | www.samsung.com |
| SWITZERLAND | 0848-SAMSUNG (7267864, CHF 0.08/min) | www.samsung.com/ch www.samsung.com/ ch_fr/ |
| SYRIA | 18252273 | www.samsung.com/ Levant (English) |
| TADJIKISTAN | 8-10-800-500-55-500 | www.samsung.com |
| TAIWAN | 0800-329-999 0266-026-066 | www.samsung.com |
| TANZANIA | 0685 88 99 00 | www.samsung.com |
| THAILAND | 1800-29-3232 02-689-3232 | www.samsung.com/th |
| TRINIDAD & TOBAGO | 1-800-SAMSUNG (726-7864) | www.samsung.com |
| TURKEY | 444 77 11 | www.samsung.com |
| U.A.E | 800-SAMSUNG (726-7864) | www.samsung.com |
| U.K | 0330 SAMSUNG (726-7864) | www.samsung.com |

| Country/Region | Customer Care Center | WebSite |
|-------------------|--------------------------|--|
| U.S.A | 1-800-SAMSUNG (726-7864) | www.samsung.com |
| UGANDA | 0800 300 300 | www.samsung.com |
| UKRAINE | 0-800-502-000 | www.samsung.com/ua (Ukrainian) www.samsung.com/ ua_ru (Russian) |
| URUGUAY | 40543733 | www.samsung.com |
| UZBEKISTAN | 8-10-800-500-55-500 | www.samsung.com |
| VENEZUELA | 0-800-100-5303 | www.samsung.com |
| VIETNAM | 1 800 588 889 | www.samsung.com |
| ZAMBIA | 211350370 | www.samsung.com |



The following glossary helps you get familiar with the product by understanding the terminologies commonly used with printing as well as mentioned in this user's guide.

802.11

802.11 is a set of standards for wireless local area network (WLAN) communication, developed by the IEEE LAN/MAN Standards Committee (IEEE 802).

802.11b/g/n

802.11b/g/n can share same hardware and use the 2.4 GHz band. 802.11b supports bandwidth up to 11 Mbps, 802.11n supports bandwidth up to 150 Mbps. 802.11b/g/n devices may occasionally suffer interference from microwave ovens, cordless telephones, and Bluetooth devices.

Access point

Access Point or Wireless Access Point (AP or WAP) is a device that connects wireless communication devices together on wireless local area networks (WLAN), and acts as a central transmitter and receiver of WLAN radio signals.

ADF

An Automatic Document Feeder (ADF) is a scanning unit that will automatically feed an original sheet of paper so that the machine can scan some amount of the paper at once.

AppleTalk

AppleTalk is a proprietary suite of protocols developed by Apple, Inc for computer networking. It was included in the original Macintosh (1984) and is now deprecated by Apple in favor of TCP/IP networking.

BIT Depth

A computer graphics term describing the number of bits used to represent the color of a single pixel in a bitmapped image. Higher color depth gives a broader range of distinct colors. As the number of bits increases, the number of possible colors becomes impractically large for a color map. 1-bit color is commonly called as monochrome or black and white.

BMP

A bitmapped graphics format used internally by the Microsoft Windows graphics subsystem (GDI), and used commonly as a simple graphics file format on that platform.

BOOTP

Bootstrap Protocol. A network protocol used by a network client to obtain its IP address automatically. This is usually done in the bootstrap process of computers or operating systems running on them. The BOOTP servers assign the IP address from a pool of addresses to each client. BOOTP enables 'diskless workstation' computers to obtain an IP address prior to loading any advanced operating system.

CCD

Charge Coupled Device (CCD) is a hardware which enables the scan job. CCD Locking mechanism is also used to hold the CCD module to prevent any damage when you move the machine.

Collation

Collation is a process of printing a multiple-copy job in sets. When collation is selected, the device prints an entire set before printing additional copies.

Control Panel

A control panel is a flat, typically vertical, area where control or monitoring instruments are displayed. They are typically found in front of the machine.

Coverage

It is the printing term used for a toner usage measurement on printing. For example, 5% coverage means that an A4 sided paper has about 5% image or text on it. So, if the paper or original has complicated images or lots of text on it, the coverage will be higher and at the same time, a toner usage will be as much as the coverage.

CSV

Comma Separated Values (CSV). A type of file format, CSV is used to exchange data between disparate applications. The file format, as it is used in Microsoft Excel, has become a de facto standard throughout the industry, even among non-Microsoft platforms.

DADF

A Duplex Automatic Document Feeder (DADF) is a scanning unit that will automatically feed and turn over an original sheet of paper so that the machine can scan on both sides of the paper.

Default

The value or setting that is in effect when taking a printer out of its box state, reset, or initialized.

DHCP

A Dynamic Host Configuration Protocol (DHCP) is a client-server networking protocol. A DHCP server provides configuration parameters specific to the DHCP client host requesting, generally, information required by the client host to participate on an IP network. DHCP also provides a mechanism for allocation of IP addresses to client hosts.

DIMM

Dual Inline Memory Module (DIMM), a small circuit board that holds memory. DIMM stores all the data within the machine like printing data, received fax data.

DLNA

The Digital Living Network Alliance (DLNA) is a standard that allows devices on a home network to share information with each other across the network.

DNS

The Domain Name Server (DNS) is a system that stores information associated with domain names in a distributed database on networks, such as the Internet.

Dot Matrix Printer

A dot matrix printer refers to a type of computer printer with a print head that runs back and forth on the page and prints by impact, striking an ink-soaked cloth ribbon against the paper, much like a typewriter.

DPI

Dots Per Inch (DPI) is a measurement of resolution that is used for scanning and printing. Generally, higher DPI results in a higher resolution, more visible detail in the image, and a larger file size.

DRPD

Distinctive Ring Pattern Detection. Distinctive Ring is a telephone company service which enables a user to use a single telephone line to answer several different telephone numbers.

Duplex

A mechanism that will automatically turn over a sheet of paper so that the machine can print (or scan) on both sides of the paper. A printer equipped with a Duplex Unit can print on both sides of paper during one print cycle.

Duty Cycle

Duty cycle is the page quantity which does not affect printer performance for a month. Generally the printer has the lifespan limitation such as pages per year. The lifespan means the average capacity of print-outs, usually within the warranty period. For example, if the duty cycle is 48,000 pages per month assuming 20 working days, a printer limits 2,400 pages a day.

ECM

Error Correction Mode (ECM) is an optional transmission mode built into Class 1 fax machines or fax modems. It automatically detects and corrects errors in the fax transmission process that are sometimes caused by telephone line noise.

Emulation

Emulation is a technique of one machine obtaining the same results as another.

An emulator duplicates the functions of one system with a different system, so that the second system behaves like the first system. Emulation focuses on exact reproduction of external behavior, which is in contrast to simulation, which concerns an abstract model of the system being simulated, often considering its internal state.

Ethernet

Ethernet is a frame-based computer networking technology for local area networks (LANs). It defines wiring and signaling for the physical layer, and frame formats and protocols for the media access control (MAC)/data link layer of the OSI model. Ethernet is mostly standardized as IEEE 802.3. It has become the most widespread LAN technology in use during the 1990s to the present.

EtherTalk

A suite of protocols developed by Apple Computer for computer networking. It was included in the original Macintosh (1984) and is now deprecated by Apple in favor of TCP/IP networking.

FDI

Foreign Device Interface (FDI) is a card installed inside the machine to allow a third party device such as a coin operated device or a card reader. Those devices allow the pay-for-print service on your machine.

FTP

A File Transfer Protocol (FTP) is a commonly used protocol for exchanging files over any network that supports the TCP/IP protocol (such as the Internet or an intranet).

Fuser Unit

The part of a laser printer that fuses the toner onto the print media. It consists of a heat roller and a pressure roller. After toner is transferred onto the paper, the fuser unit applies heat and pressure to ensure that the toner stays on the paper permanently, which is why paper is warm when it comes out of a laser printer.

Gateway

A connection between computer networks, or between a computer network and a telephone line. It is very popular, as it is a computer or a network that allows access to another computer or network.

Grayscale

A shades of gray that represent light and dark portions of an image when color images are converted to grayscale; colors are represented by various shades of gray.

Halftone

An image type that simulates grayscale by varying the number of dots. Highly colored areas consist of a large number of dots, while lighter areas consist of a smaller number of dots.

HDD

Hard Disk Drive (HDD), commonly referred to as a hard drive or hard disk, is a non-volatile storage device which stores digitally-encoded data on rapidly rotating platters with magnetic surfaces.

IEEE

The Institute of Electrical and Electronics Engineers (IEEE) is an international non-profit, professional organization for the advancement of technology related to electricity.

IEEE 1284

The 1284 parallel port standard was developed by the Institute of Electrical and Electronics Engineers (IEEE). The term "1284-B" refers to a specific connector type on the end of the parallel cable that attaches to the peripheral (for example, a printer).

Intranet

A private network that uses Internet Protocols, network connectivity, and possibly the public telecommunication system to securely share part of an organization's information or operations with its employees. Sometimes the term refers only to the most visible service, the internal website.

IP address

An Internet Protocol (IP) address is a unique number that devices use in order to identify and communicate with each other on a network utilizing the Internet Protocol standard.

IPM

The Images Per Minute (IPM) is a way of measuring the speed of a printer. An IPM rate indicates the number of single-sided sheets a printer can complete within one minute.

IPP

The Internet Printing Protocol (IPP) defines a standard protocol for printing as well as managing print jobs, media size, resolution, and so forth. IPP can be used locally or over the Internet to hundreds of printers, and also supports access control, authentication, and encryption, making it a much more capable and secure printing solution than older ones.

IPX/SPX

IPX/SPX stands for Internet Packet Exchange/Sequenced Packet Exchange. It is a networking protocol used by the Novell NetWare operating systems. IPX and SPX both provide connection services similar to TCP/IP, with the IPX protocol having similarities to IP, and SPX having similarities to TCP. IPX/SPX was primarily designed for local area networks (LANs), and is a very efficient protocol for this purpose (typically its performance exceeds that of TCP/IP on a LAN).

ISO

The International Organization for Standardization (ISO) is an international standard-setting body composed of representatives from national standards bodies. It produces world-wide industrial and commercial standards.

ITU-T

The International Telecommunication Union is an international organization established to standardize and regulate international radio and telecommunications. Its main tasks include standardization, allocation of the radio spectrum, and organizing interconnection arrangements between different countries to allow international phone calls. A -T out of ITU-T indicates telecommunication.

ITU-T No. 1 chart

Standardized test chart published by ITU-T for document facsimile transmissions.

JBIG

Joint Bi-level Image Experts Group (JBIG) is an image compression standard with no loss of accuracy or quality, which was designed for compression of binary images, particularly for faxes, but can also be used on other images.

JPEG

Joint Photographic Experts Group (JPEG) is a most commonly used standard method of lossy compression for photographic images. It is the format used for storing and transmitting photographs on the World Wide Web.

LDAP

The Lightweight Directory Access Protocol (LDAP) is a networking protocol for querying and modifying directory services running over TCP/IP.

LED

A Light-Emitting Diode (LED) is a semiconductor device that indicates the status of a machine.

MAC address

Media Access Control (MAC) address is a unique identifier associated with a network adapter. MAC address is a unique 48-bit identifier usually written as 12 hexadecimal characters grouped in pairs (e. g., 00-00-0c-34-11-4e). This address is usually hard-coded into a Network Interface Card (NIC) by its manufacturer, and used as an aid for routers trying to locate machines on large networks.

MFP

Multi Function Peripheral (MFP) is an office machine that includes the following functionality in one physical body, so as to have a printer, a copier, a fax, a scanner and etc.

MH

Modified Huffman (MH) is a compression method for decreasing the amount of data that needs to be transmitted between the fax machines to transfer the image recommended by ITU-T T.4. MH is a codebook-based run-length encoding scheme optimized to efficiently compress white space. As most faxes consist mostly of white space, this minimizes the transmission time of most faxes.

MMR

Modified Modified READ (MMR) is a compression method recommended by ITU-T T.6.

Modem

A device that modulates a carrier signal to encode digital information, and also demodulates such a carrier signal to decode transmitted information.

MR

Modified Read (MR) is a compression method recommended by ITU-T T.4. MR encodes the first scanned line using MH. The next line is compared to the first, the differences determined, and then the differences are encoded and transmitted.

NetWare

A network operating system developed by Novell, Inc. It initially used cooperative multitasking to run various services on a PC, and the network protocols were based on the archetypal Xerox XNS stack. Today NetWare supports TCP/IP as well as IPX/SPX.

OPC

Organic Photo Conductor (OPC) is a mechanism that makes a virtual image for print using a laser beam emitted from a laser printer, and it is usually green or rust colored and has a cylinder shape.

An imaging unit containing a drum slowly wears the drum surface by its usage in the printer, and it should be replaced appropriately since it gets worn from contact with the cartridge development brush, cleaning mechanism, and paper.

Originals

The first example of something, such as a document, photograph or text, etc, which is copied, reproduced or translated to produce others, but which is not itself copied or derived from something else.

OSI

Open Systems Interconnection (OSI) is a model developed by the International Organization for Standardization (ISO) for communications. OSI offers a standard, modular approach to network design that divides the required set of complex functions into manageable, self-contained, functional layers. The layers are, from top to bottom, Application, Presentation, Session, Transport, Network, Data Link and Physical.

PABX

A private automatic branch exchange (PABX) is an automatic telephone switching system within a private enterprise.

PCL

Printer Command Language (PCL) is a Page Description Language (PDL) developed by HP as a printer protocol and has become an industry standard. Originally developed for early inkjet printers, PCL has been released in varying levels for thermal, dot matrix printer, and laser printers.

PDF

Portable Document Format (PDF) is a proprietary file format developed by Adobe Systems for representing two dimensional documents in a device independent and resolution independent format.

PostScript

PostScript (PS) is a page description language and programming language used primarily in the electronic and desktop publishing areas. - that is run in an interpreter to generate an image.

Printer Driver

A program used to send commands and transfer data from the computer to the printer.

Print Media

The media like paper, envelopes, labels, and transparencies which can be used in a printer, a scanner, a fax or, a copier.

PPM

Pages Per Minute (PPM) is a method of measurement for determining how fast a printer works, meaning the number of pages a printer can produce in one minute.

PRN file

An interface for a device driver, this allows software to interact with the device driver using standard input/output system calls, which simplifies many tasks.

Protocol

A convention or standard that controls or enables the connection, communication, and data transfer between two computing endpoints.

PS

See PostScript.

PSTN

The Public-Switched Telephone Network (PSTN) is the network of the world's public circuit-switched telephone networks which, on industrial premises, is usually routed through the switchboard.

RADIUS

Remote Authentication Dial In User Service (RADIUS) is a protocol for remote user authentication and accounting. RADIUS enables centralized management of authentication data such as usernames and passwords using an AAA (authentication, authorization, and accounting) concept to manage network access.

Resolution

The sharpness of an image, measured in Dots Per Inch (DPI). The higher the dpi, the greater the resolution.

SMB

Server Message Block (SMB) is a network protocol mainly applied to share files, printers, serial ports, and miscellaneous communications between nodes on a network. It also provides an authenticated Inter-process communication mechanism.

SMTP

Simple Mail Transfer Protocol (SMTP) is the standard for e-mail transmissions across the Internet. SMTP is a relatively simple, text-based protocol, where one or more recipients of a message are specified, and then the message text is transferred. It is a client-server protocol, where the client transmits an email message to the server.

SSID

Service Set Identifier (SSID) is a name of a wireless local area network (WLAN). All wireless devices in a WLAN use the same SSID in order to communicate with each other. The SSIDs are case-sensitive and have a maximum length of 32 characters.

Subnet Mask

The subnet mask is used in conjunction with the network address to determine which part of the address is the network address and which part is the host address.

TCP/IP

The Transmission Control Protocol (TCP) and the Internet Protocol (IP); the set of communications protocols that implement the protocol stack on which the Internet and most commercial networks run.

TCR

Transmission Confirmation Report (TCR) provides details of each transmission such as job status, transmission result and number of pages sent. This report can be set to print after each job or only after failed transmissions.

TIFF

Tagged Image File Format (TIFF) is a variable-resolution bitmapped image format. TIFF describes image data that typically come from scanners. TIFF images make use of tags, keywords defining the characteristics of the image that is included in the file. This flexible and platform-independent format can be used for pictures that have been made by various image processing applications.

Toner Cartridge

A kind of bottle or container used in a machine like a printer which contains toner. Toner is a powder used in laser printers and photocopiers, which forms the text and images on the printed paper. Toner can be fused by by a combination of heat/pressure from the fuser, causing it to bind to the fibers in the paper.

TWAIN

An industry standard for scanners and software. By using a TWAIN-compliant scanner with a TWAIN-compliant program, a scan can be initiated from within the program. It is an image capture API for Microsoft Windows and Apple Macintosh operating systems.

UNC Path

Uniform Naming Convention (UNC) is a standard way to access network shares in Window NT and other Microsoft products. The format of a UNC path is:
\\<servername>\<sharename>\<Additional directory>

URL

Uniform Resource Locator (URL) is the global address of documents and resources on the Internet. The first part of the address indicates what protocol to use, the second part specifies the IP address or the domain name where the resource is located.

USB

Universal Serial Bus (USB) is a standard that was developed by the USB Implementers Forum, Inc., to connect computers and peripherals. Unlike the parallel port, USB is designed to concurrently connect a single computer USB port to multiple peripherals.

Watermark

A watermark is a recognizable image or pattern in paper that appears lighter when viewed by transmitted light. Watermarks were first introduced in Bologna, Italy in 1282; they have been used by papermakers to identify their product, and also on postage stamps, currency, and other government documents to discourage counterfeiting.

WEP

Wired Equivalent Privacy (WEP) is a security protocol specified in IEEE 802.11 to provide the same level of security as that of a wired LAN. WEP provides security by encrypting data over radio so that it is protected as it is transmitted from one end point to another.

WIA

Windows Imaging Architecture (WIA) is an imaging architecture that is originally introduced in Windows Me and Windows XP. A scan can be initiated from within these operating systems by using a WIA-compliant scanner.

WPA

Wi-Fi Protected Access (WPA) is a class of systems to secure wireless (Wi-Fi) computer networks, which was created to improve upon the security features of WEP.

WPA-PSK

WPA-PSK (WPA Pre-Shared Key) is special mode of WPA for small business or home users. A shared key, or password, is configured in the wireless access point (WAP) and any wireless laptop or desktop devices. WPA-PSK generates a unique key for each session between a wireless client and the associated WAP for more advanced security.

WPS

The Wi-Fi Protected Setup (WPS) is a standard for establishing a wireless home network. If your wireless access point supports WPS, you can configure the wireless network connection easily without a computer.

XPS

XML Paper Specification (XPS) is a specification for a Page Description Language (PDL) and a new document format, which has benefits for portable document and electronic document, developed by Microsoft. It is an XML-based specification, based on a new print path and a vector-based device-independent document format.

Index

A

| | |
|------------------|-----|
| accessing | |
| management tools | 145 |
| AirPrint | 127 |
| AnyWeb Print | 147 |

C

| | |
|--------------------|----|
| cleaning | |
| inside | 47 |
| outside | 46 |
| pickup roller | 49 |
| cleaning a machine | 46 |
| control panel | 19 |
| convention | 9 |

E

| | |
|--------------|----|
| eco printing | 37 |
|--------------|----|

F

| | |
|----------------------------------|----|
| favorites settings, for printing | 37 |
| features | 4 |
| print media feature | 62 |
| front view | 17 |

G

| | |
|-----------------------|-----|
| general icons | 9 |
| glossary | 185 |
| google cloud printing | 124 |

J

| | |
|------------------------------|----|
| jam | |
| clearing paper | 53 |
| tips for avoiding paper jams | 52 |

L

| | |
|---|----------|
| Linux | |
| common Linux problems | 179 |
| driver installation for USB cable connected | 86, 87 |
| printer properties | 143, 142 |

loading

| | |
|---|--------|
| paper in manual feeder/multi-purpose tray | 29, 27 |
| special media | 30 |

local

| | |
|---------------------|--------|
| driver installation | 22, 24 |
|---------------------|--------|

M

| | |
|---|--------|
| Macintosh | |
| common Macintosh problems | 178 |
| driver installation for USB cable connected | 84, 85 |
| printing | 140 |
| system requirements | 66 |
| manual feeder/multi-purpose tray | |
| tips on using | 29 |
| using special media | 30 |

N

| | |
|------------------------|--------|
| network | |
| installing environment | 68, 89 |
| IPv6 configuration | 91 |
| wireless network setup | 93 |

N-up printing

| | |
|-----------|-----|
| Macintosh | 140 |
|-----------|-----|

O

| | |
|------------------|-----|
| overlay printing | |
| create | 138 |
| delete | 139 |
| print | 139 |

Index

| | |
|--------------------------------------|-----|
| P | |
| placing a machine | |
| adjusting the altitude | 130 |
| print | |
| mobile OS | 121 |
| print media | |
| card stock | 32 |
| envelope | 31 |
| labels | 32 |
| output support | 62 |
| preprinted paper | 33 |
| special media | 30 |
| printer preferences | |
| Linux | 143 |
| Printer Status | |
| general information | 154 |
| Printing | 35 |
| printing | |
| changing the default print settings | 131 |
| Linux | 142 |
| Macintosh | 140 |
| multiple pages on one sheet of paper | |
| Macintosh | 140 |
| printing a document | |

| | |
|----------------------------|--------------------|
| Windows | 35 |
| Macintosh | 141 |
| 133 | |
| printing a document | |
| Linux | 142 |
| Macintosh | 140 |
| problems | |
| paper feeding problems | 163, 164, 165, 169 |
| R | |
| rear view | 18 |
| regulatory information | 69 |
| S | |
| safety | |
| information | 10 |
| symbols | 10 |
| samsung printer experience | 156 |
| service contact numbers | 180 |
| special print features | 129 |
| specifications | 60 |
| print media | 62 |
| stop button | 20 |
| supplies | |

| | |
|---|--------|
| available supplies | 40 |
| estimated toner cartridge life | 42 |
| ordering | 40 |
| replacing toner cartridge | 44 |
| SyncThru Web Service | |
| general information | 149 |
| T | |
| toner cartridge | |
| estimated life | 42 |
| handling instructions | 42 |
| non-Samsung and refilled | 42, 44 |
| redistributing toner | 43, 44 |
| storing | 41 |
| tray | |
| adjusting the width and length | 26 |
| changing the tray size | 26 |
| loading paper in manual feeder/multi-purpose tray | 29 |
| U | |
| understanding the status LED | 56 |
| Unix | |
| system requirements | 67 |

Index

USB cable

- driver installation 84, 86, 85, 87
- using help 37, 141

W

watermark

- create 137
- delete 137
- edit 137

Windows

- common Windows problems 177
- driver installation for USB cable connected
22, 24
- system requirements 65

wireless

- ad hoc mode 93
- Infrastructure mode 93
- USB cable 99, 102
- WPS (the machine does not have a display
screen)
 - PBC 97