

FLUIDMASTER® PRO45U FILL VALVE INSTALLATION INSTRUCTIONS



30800 Rancho Viejo Road, San Juan Capistrano, CA 92675
www.FluidmasterPRO.com • 800-631-2011
 Contact Fluidmaster for troubleshooting help or visit www.FluidmasterPRO.com
 M-F 5:30 am - 5:00 pm PST.

WARNING

DO NOT USE IN-TANK DROP-IN TOILET BOWL CLEANERS CONTAINING BLEACH OR CHLORINE. Use of such products will: (1) **RESULT IN DAMAGE** to tank components and **MAY CAUSE FLOODING** and **PROPERTY DAMAGE** and (2) **VOID FLUIDMASTER WARRANTY.** Fluidmaster Flush 'n Sparkle Toilet Bowl Cleaning System is recommended for those choosing to use in-tank bowl cleaners and **WILL NOT VOID** the FLUIDMASTER WARRANTY because it will not damage the components. **DO NOT** overtighten nuts or tank/bowl may crack. Always use quality Fluidmaster parts when installing or repairing. Fluidmaster will not be responsible or liable for use of non-Fluidmaster parts during installation or repair.

LIMITED SEVEN-YEAR EXPRESS WARRANTY

Subject to the "Exclusions" set forth below, Fluidmaster Inc. promises to the consumer to repair, or at the option of Fluidmaster Inc. to replace any part of this plumbing product which proves to be defective in workmanship or materials under normal use for seven years from the date of purchase. All costs of removal, transportation and reinstallation to obtain warranty service shall be paid by the consumer. During this "Limited Seven Year Express Warranty," Fluidmaster Inc. will provide, subject to the "Exclusions" section set forth below, all replacement parts free of charge, necessary to correct such defects. This "Limited Seven Year Warranty" is null and void if this plumbing product has not been installed and maintained in accordance with all written instructions accompanying the product, and if non-Fluidmaster inc. parts are used in installation.

EXCLUSIONS: FLUIDMASTER INC. SHALL NOT BE LIABLE FOR INCIDENTAL OR CONSEQUENTIAL DAMAGES, INCLUDING COSTS OF INSTALLATION, WATER DAMAGE, PERSONAL INJURY OR FOR ANY DAMAGES RESULTING FROM ABUSE OR MISUSE OF THE PRODUCT, FROM OVERTIGHTENING OR FROM FAILURE TO INSTALL OR MAINTAIN THIS PLUMBING PRODUCT IN ACCORDANCE WITH THE WRITTEN INSTRUCTIONS, INCLUDING USE OF NON-FLUIDMASTER PARTS. DO NOT USE IN-TANK DROP-IN TOILET BOWL CLEANERS CONTAINING BLEACH OR CHLORINE. USE OF SUCH PRODUCTS WILL RESULT IN DAMAGE TO TANK COMPONENTS AND MAY CAUSE FLOODING AND PROPERTY DAMAGE. USE OF SUCH PRODUCTS WILL VOID THIS WARRANTY.

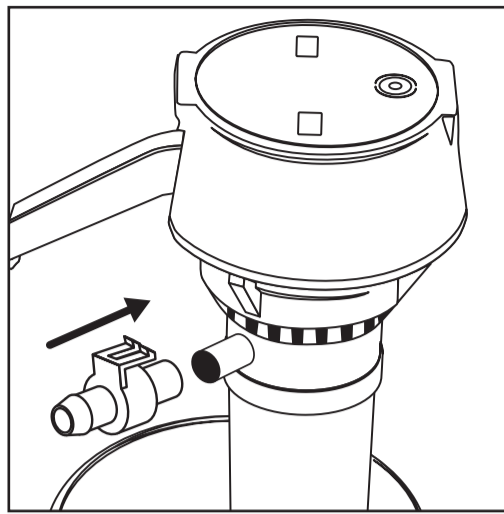

Figure 1

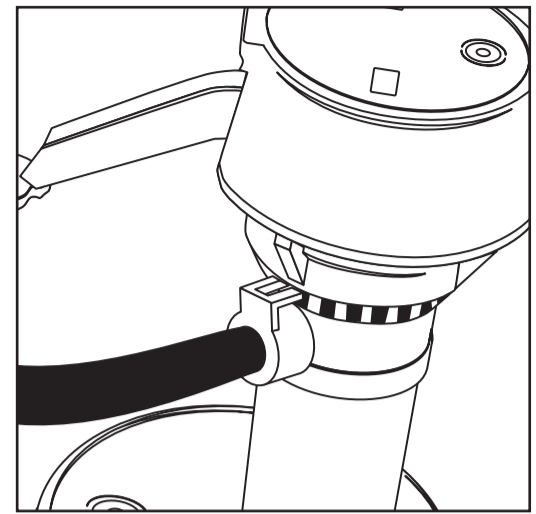
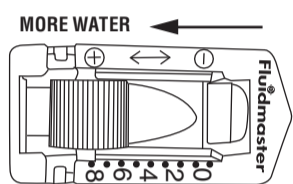

Figure 2

The PRO45U is designed to allow precise setting of the toilet tank refill rate to meet the original factory performance specifications for an optimal flush.

Select the proper insert and firmly press it into the refill port as shown in Figure 1. Be sure to press firmly on the insert until the top hooks engage as shown in Figure 2. To determine which of the seven custom refill diverter inserts to use, refer to the following charts. If you do not see the toilet you are working on listed, see the box at the bottom of this page for instructions:



To increase water, adjust roller to the next highest number.

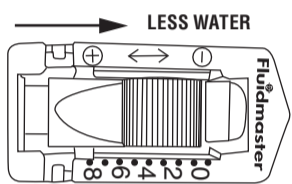

To decrease water, adjust roller to the next lowest number.

NOTE: Press down on roller, then adjust.

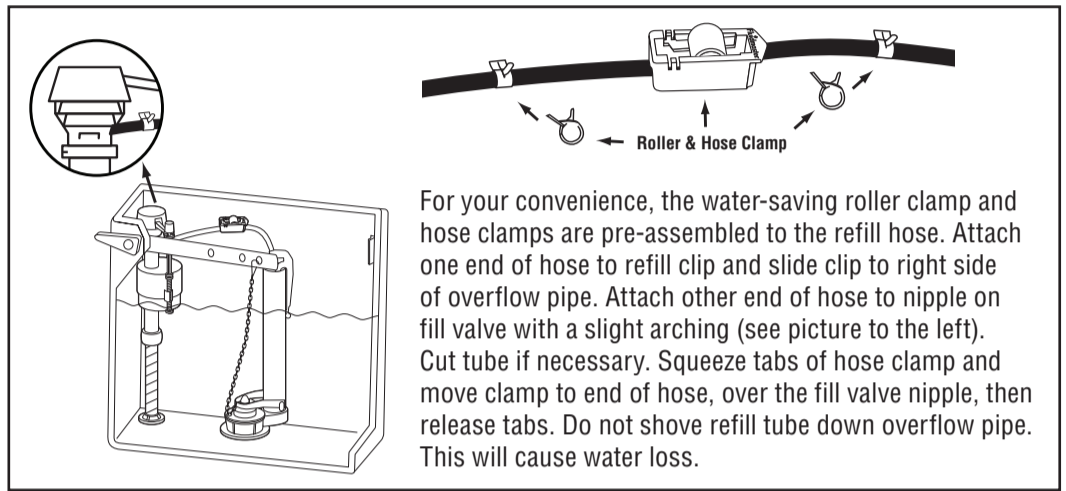

For your convenience, the water-saving roller clamp and hose clamps are pre-assembled to the refill hose. Attach one end of hose to refill clip and slide clip to right side of overflow pipe. Attach other end of hose to nipple on fill valve with a slight arching (see picture to the left). Cut tube if necessary. Squeeze tabs of hose clamp and move clamp to end of hose, over the fill valve nipple, then release tabs. Do not shove refill tube down overflow pipe. This will cause water loss.

Choose 1 of 7 included refill diverter inserts to meet factory spec

Designed to meet specifications for refill percentages on all toilets.

(From older 5 gallon per flush toilets to newer 1.0 GPF high efficiency toilets.)

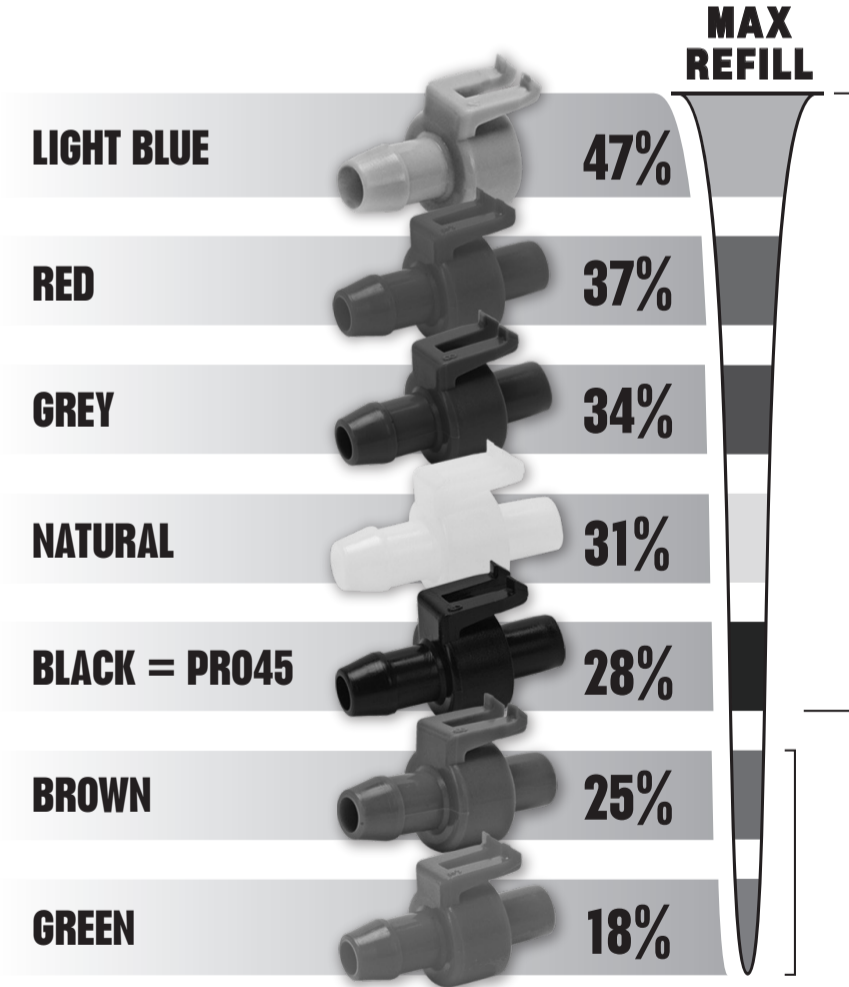

For all other toilets, loosely insert the GREEN refill diverter insert and install the fill valve. After flushing the toilet, if the bowl appears to be full but continues to fill, use the water-saving refill adjuster located on the refill tube to decrease the amount of water flowing down the overflow tube until the water level is correct. If the bowl does not fill completely to its previous level, replace the GREEN insert with the BROWN insert. If the bowl still does not fill, replace the BROWN insert with the BLACK insert. If it still continues to happen, replace the BLACK insert with the NATURAL insert. If the bowl is still not filling completely, replace the NATURAL insert with the GREY insert. If there is still too little water in the bowl then replace the GREY insert with the RED insert. If there is still too little water in the bowl, then replace the RED insert with the LIGHT BLUE insert and snap insert into place.

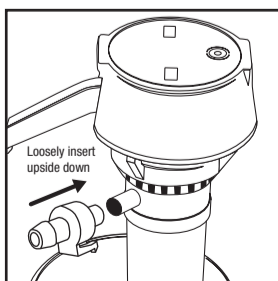

AMERICAN STANDARD			
TOILET MODEL	MODEL #	TANK MODEL #	INSERT COLOR
Cadet 3 Concealed Trapway Flowise RF ADA (HET)	Internet # 202810954	2988.101.020	Brown
Cadet 3 Concealed Trap Flowise RF ADA (12" rough-in) (HET)	2794.104	4000.104	Brown
Cadet 3 Concealed Trap FloWise RH (EL) ADA (HET)	2989.101.020	4000.101	Brown
Cadet 3 FloWise Round, (HET)	Internet # 202963992; THD SKU # 241417	2880128ST.020	Green
Cadet 3 FloWise RF ADA (HET)	3377.128ST	4021N	Green
Cadet 3 ADA EL (HET)	2887.216	4339	Red
Compact Cadet 3 Flowise ADA RH EL	2403.128.020, 2403.128, 2568.128 and 2403.500	N/A	Black
Compact Cadet 3 (EL) ADA	2403.500; 2568.500	N/A	Black
Cadet 3 Dual Flush	2886.216	4339.216	Grey
Champion 4 Max Performance Elongated (HET)	2586.128ST	4215A	Brown
Champion 4 Max RH (EL) ADA (HET)	231AA.104 & 2586.128ST	4215A.104	Brown
Champion 4 RH (EL) Toilet-To-Go 12" rough-in 2pc ADA	THD Model # 2002.014.020 Internet # 202499461	4215A	Brown
Champion 4 Max (EL) ADA (HET)	2586.128ST, Internet # 203182005, THD SKU: 615356	4215A.101	Brown
Champion Pro (EL) ADA Single Flush (HET)	211AA.104	4225A.104	Green
Champion Pro (EL) ADA 12" rough-in (HET)	211AA.104.020	4225A.104	Green
Eco-Fusion Siphonic Dual Flush RH (EL)	3380.216.020	4349.216	Green
Eljer Diplomat EL ADA	091-3275NST	4021	Green
H2Option Eco-Fusion Dual Flush (EL)	2887.216	4339, 4348, 4349	Green
H2Option RF ADA 12" Rough-in Dual Flush	2888.216	4339.216	Red

AQUA SOURCE			
TOILET MODEL	MODEL #	TANK MODEL #	INSERT COLOR
Elongated (HET)	AT1203-00	N/A	Green

CAPIZZI			
TOILET MODEL	MODEL #	TANK MODEL #	INSERT COLOR
Thor 3" RF Single Flush (HET)	6800	6	Brown

CRANE			
TOILET MODEL	MODEL #	TANK MODEL #	INSERT COLOR
Galaxy Cranada RF	3782	3742	Green

DELTA			
TOILET MODEL	MODEL #	TANK MODEL #	INSERT COLOR
Prelude (RD) (HET)	C41901-WH, THD SKU: 794603	RP71179	Green
Prelude (EL) (HET)	C43901-WH, THD SKU: 794636	RP71179	Brown
Corrente Elongated ADA (HET)	C43904-WH	RP71192	Brown

ELJER			
TOILET MODEL	MODEL #	TANK MODEL #	INSERT COLOR
Diplomat (EL) ADA Single Flush 12" Rough-in	091-3275	4021.416	Green

FERGUSON			
TOILET MODEL	MODEL #	TANK MODEL #	INSERT COLOR
Mirabelle RF ADA (HET)	-	MIRBD200	Brown
ProFlo RF (DISCONTINUED)	-	PF1400HEWH/ PF5112HEWH	Green
ProFlo RD Single Flush (HET)	-	PF1400HE	Green

GERBER			
TOILET MODEL	MODEL #	TANK MODEL #	INSERT COLOR
Viper Elongated Dual Flush Bowl (B)	21-512	28-590	Light Blue
Viper ErgoHeight Bowl (C)	21-512	EH28-590 (Pedestal flush valve)	Light Blue

GLACIER BAY			
TOILET MODEL	MODEL #	TANK MODEL #	INSERT COLOR
Glacier Bay EO Dual Flush Elongated	N2316	215-583	Natural
Glacier Bay (EL) ADA	N2316, THD SKU: 215-583	N2316T by Niagara	Green
Glacier Bay (EL) ADA 12" rough-in (HET)	THD SKU 331-725	135-428	Green
Glacier Bay; Round	340995	N2428T	Brown
Glacier Bay All-In-One (EL) ADA (HET)	669-706	135-438T-IN (insulated by Niagara)	Green
Glacier Bay; All In One	135-428	140-911	Green
Glacier Bay (EL) ADA	N2316, THD SKU: 215-583, 569-919	N2316T by Niagara	Brown
Glacier Bay by Niagara Dual Flush (EL) ADA 12" rough in (HET)	635-678	N2430T	Brown
Glacier Bay All-In-One Dual Flush (EL) ADA	215-583	N2316T	Green

JACUZZI			
TOILET MODEL	MODEL #	TANK MODEL #	INSERT COLOR
(Lowe's) Perfecta Round	Jacuzzi SKU EZ33959	EZ33959	Natural
Era (EL) ADA	Jacuzzi SKU BK37959	N/A	Brown
Perfecta RF ADA (Toilet in a Box)	Jacuzzi SKU: EZ33959	EZ33	Natural
Perfecta	(0130294 / EZ33959)	EZ33	Natural

KOHLER			
TOILET MODEL	MODEL #	TANK MODEL #	INSERT COLOR
Cavata; 45989-0 Dual Flush (EL) ADA	K-45989	4137	Light Blue
Cimarron (EL) ADA (HET)	K-3609: SOLD AS: K-11451 (THD), K-11813 (Lowe's) & K-11823	4421	Green
Cimarron Class 6 (EL) ADA	K-3589	4418	Black
Karsten Dual Force EL	402028	402023	Green
Sterling Stinson EL (HET) Single Flush	402076; 404702	402091	Green
Sterling Windham (HET) Single Flush	402215-0	404515	Green
Wellworth Classic Complete Solution (HET) 2pc Round	K-11464-0	K-4436	Red
Wellworth Classic (HET)	K-11498; K-3575; K-11498	K4436	Grey
Wellworth Classic (EL) (HET)	K-3575; K-11498	4436	Grey
Wellworth (EL)	K-3948	4841	Grey

LAMOSA VORTENS			
TOILET MODEL	MODEL #	TANK MODEL #	INSERT COLOR
Wc Delfos Dual Flush Elongated	3130 -V	N/A	Green
Pegasus Tulip EL (HET)	-	3427	Green
Rhoda EL ADA (HET)	3123-3436	3436 V	Green
Vienna RF DF (HET)	3208-3420	3420	Green
Vienna RF DF	3208-3436	3436-V	Green
Vienna ELX DF	(Vienna ELX) 3113-3420 (Vienna ELX - DF) 3113-3436	3420	Green
Vienna ELX Single Flush	3113	3436-SPS	Green
Murano (EL) ADA (HET) (Bowl #2)	3140-3425	3425 10" Tank	Green
Murano (EL) (HET) (Bowl #5)	3147-3425	3425 10" Tank	Green
Murano RF (HET); (Bowl #1)	3219-3425	3425	Green

LORETTO			
TOILET MODEL	MODEL #	TANK MODEL #	INSERT COLOR
Hurricane RF (HET)	3140-3473	3473	Green
Hurricane Toilet (HET)	(Loretto EL ADA) 3140-3475 (Superio EL ADA) 3140-3475	3475	Green

MANSFIELD			
TOILET MODEL	MODEL #	TANK MODEL #	INSERT COLOR
Alto (EL) ADA 12" rough in (HET)	413710007	3121	Green
Magnum (EL)	722	N/A	Green
Pro Fit 2, SmartPak Complete Toilet Kit (EL) 12" rough-in (HET) OR Alto (EL) 12" rough in ADA (HET)	4135	3121	Green
Pro Fit 2, SmartPak Complete Toilet Kit (EL) 12" rough-in (HET) OR Alto (EL) 12" rough in ADA (HET)	4135-3121	3121	Green
Summit Dual Flush Elongated Front	4382CTK	3386	Black

PENGUIN			
TOILET MODEL	MODEL #	TANK MODEL #	INSERT COLOR
Rough In WaterSense (EL) ADA (HET) Overflow Protection	524	577	Brown
524 (EL) ADA 12" rough-in (HET)	524	524	Brown

TOTO			
TOILET MODEL	MODEL #	TANK MODEL #	INSERT COLOR
Aquia II EL	CST416M	ST416M	Green
Aquia III (EL)	CST464M	ST464M	Green
ECO Drake (EL) 2pc Single Flush (HET)	CST744E(G)	ST743E ST43E	Brown
Drake II (EL) ADA; (Formerly Gwyneth Two-Piece) (HET)	CST454CEF(G)	ST454E #1 - Drake II	Black
Drake II (EL) ADA; (Formerly Gwyneth Two-Piece) (HET)	CST454CEF(G)	ST454E#1 - Drake II / Vespin II	Black