



2021 FIAT® 500X OWNER'S MANUAL

This Owner's Manual illustrates and describes the operation of features and equipment that are either standard or optional on this vehicle. This manual may also include a description of features and equipment that are no longer available or were not ordered on this vehicle. Please disregard any features and equipment described in this manual that are not on this vehicle. FCA US LLC reserves the right to make changes in design and specifications, and/or make additions to or improvements to its products without imposing any obligation upon itself to install them on products previously manufactured.

With respect to any vehicles sold in Canada, the name FCA US LLC shall be deemed to be deleted and the name FCA Canada Inc. used in substitution therefore.

This Owner's Manual is intended to familiarize you with the important features of your vehicle. Your most up-to-date Owner's Manual, Navigation/Uconnect manuals and Warranty Booklet can be found by visiting the website on the back cover.

U.S. Residents: If you are the first registered retail owner of your vehicle, you may obtain a complimentary printed copy of the Warranty Booklet by calling **1-888-242-6342** or by contacting your dealer. Replacement kits can be purchased by visiting **www.techauthority.com**.

Canadian Residents: If you are the first registered retail owner of your vehicle, you may obtain a complimentary printed copy of the Warranty Booklet or purchase a replacement kit by calling **1-800-387-1143** or by contacting your dealer.

 **WARNING:** Operating, servicing and maintaining a passenger vehicle or off-highway motor vehicle can expose you to chemicals including engine exhaust, carbon monoxide, phthalates, and lead, which are known to the State of California to cause cancer and birth defects or other reproductive harm. To minimize exposure, avoid breathing exhaust, do not idle the engine except as necessary, service your vehicle in a well-ventilated area and wear gloves or wash your hands frequently when servicing your vehicle. For more information go to **www.P65Warnings.ca.gov/passenger-vehicle**.



TABLE OF CONTENTS

1	INTRODUCTION.....	7
2	GETTING TO KNOW YOUR VEHICLE	13
3	GETTING TO KNOW YOUR INSTRUMENT PANEL	62
4	STARTING AND OPERATING	78
5	MULTIMEDIA	119
6	SAFETY	170
7	IN CASE OF EMERGENCY	215
8	SERVICING AND MAINTENANCE	230
9	TECHNICAL SPECIFICATIONS	282
10	CUSTOMER ASSISTANCE	287
11	INDEX.....	292

1

2

3

4

5

6

7

8

9

10

11

INTRODUCTION

SYMBOLS KEY	8
ROLLOVER WARNING	8
VEHICLE MODIFICATIONS/ALTERATIONS	9
SYMBOL GLOSSARY	9

GETTING TO KNOW YOUR VEHICLE

KEYS	13
Key Fob	13
SENTRY KEY	15
IGNITION SWITCH	16
Keyless Enter 'n Go™ Ignition	16
REMOTE START — IF EQUIPPED	17
How To Use Remote Start.....	17
To Exit Remote Start Mode.....	18
Remote Start Front Defrost Activation — If Equipped.....	18
Remote Start Comfort Systems — If Equipped	18
Remote Start Windshield Wiper De-Icer And Rear Defrost Activation — If Equipped.....	19
Remote Start Cancel Message — If Equipped.....	19
VEHICLE SECURITY SYSTEM — IF EQUIPPED	19
To Arm The System	20
To Disarm The System	20
Disabling	20

DOORS	20
Manual Door Locks	20
Power Door Locks	21
Keyless Enter 'n Go™ — Passive Entry (If Equipped).....	22
Automatic Door Locks — If Equipped	24
Child-Protection Door Lock System — Rear Doors.....	24
STEERING WHEEL	25
Manual Tilt/Telescoping Steering Column	25
Heated Steering Wheel — If Equipped	25
SEATS	25
Manual Adjustment (Front Seats).....	26
Manual Adjustment (Rear Seats).....	27
Power Adjustment Front Seats — If Equipped.....	28
Heated Seats — If Equipped	29
Head Restraints	30
UCONNECT VOICE RECOGNITION	32
Introducing Voice Recognition.....	32
Get Started	32
Basic Voice Commands	32
Additional Information	32
MIRRORS	33
Inside Rearview Mirror.....	33
Illuminated Vanity Mirrors — If Equipped	33
Outside Mirrors	34
Power Mirrors	34
Folding Mirror	34
Power Folding Mirrors — If Equipped	35
Heated Mirrors — If Equipped.....	35

EXTERIOR LIGHTS	35
Headlight Switch	35
Daytime Running Lights (DRLs) — If Equipped	36
High Beams	36
Flash-To-Pass	36
Automatic Headlights — If Equipped	36
Parking Lights.....	37
Headlight Time Delay	37
Front Fog Lights — If Equipped	37
Turn Signals.....	37
Lane Change Assist	38
Courtesy Lights/Approaching Lights.....	38
INTERIOR LIGHTS	38
Front Courtesy Light.....	38
Cargo Area Lights	39
WINDSHIELD WIPERS AND WASHERS	40
Windshield Wiper Operation	40
Rain Sensing Wipers — If Equipped	40
Rear Window Wiper/Washer	41
Windshield Wiper De-Icer — If Equipped	42
CLIMATE CONTROLS	42
Automatic Climate Control Descriptions And Functions.....	42
Manual Climate Control Descriptions And Functions	45
Automatic Temperature Control (ATC)	47
Climate Voice Recognition.....	48
Operating Tips	48



INTERIOR STORAGE AND EQUIPMENT	50
Storage.....	50
Sun Visors “Slide-On-Rod”	50
USB/Media Player Control.....	51
Power Outlets	51
Cigar Lighter — If Equipped	52
Ashtray — If Equipped	52
Grab Handles.....	53
WINDOWS	53
Power Window Controls.....	53
SUNROOF — IF EQUIPPED	55
Opening And Closing The Sunroof.....	55
Pinch Protect Feature	55
Venting Sunroof.....	55
Sun Shade	55
Sunroof Maintenance	55
Emergency Operation.....	56
Power Sunroof Relearn Procedure.....	56
HOOD	56
To Open The Hood.....	56
To Close The Hood	57
LIFTGATE	58
To Unlock/Open The Liftgate.....	58
Lock/Close The Liftgate.....	58
Cargo Area Features	59
ROOF LUGGAGE RACK — IF EQUIPPED	61

GETTING TO KNOW YOUR INSTRUMENT PANEL

INSTRUMENT CLUSTER	62
Instrument Cluster Descriptions	63
INSTRUMENT CLUSTER DISPLAY	63
Instrument Cluster Display Control Buttons...63	
Engine Oil Change Reset — If Equipped	64
Instrument Cluster Display Main Menu	64
WARNING LIGHTS AND MESSAGES	68
Red Warning Lights.....	68
Yellow Warning Lights.....	71
Yellow Indicator Lights.....	74
Green Indicator Lights	75
White Indicator Lights.....	75
Blue Indicator Lights	76
Gray Indicator Lights	76
ONBOARD DIAGNOSTIC SYSTEM — OBD II	76
Onboard Diagnostic System (OBD II) Cybersecurity	76
EMISSIONS INSPECTION AND MAINTENANCE PROGRAMS	77

STARTING AND OPERATING

STARTING THE ENGINE	78
Tip Start Feature	78
If Engine Fails To Start	78
Cold Weather Operation	79
Extended Park Starting.....	79
After Starting — Warming Up The Engine	79
Stopping The Engine.....	79
Turbocharger “Cool Down” — If Equipped	80
ENGINE BREAK-IN RECOMMENDATIONS	80
ELECTRIC PARK BRAKE (EPB)	80
Auto Park Brake	82
SafeHold.....	82
Brake Service Mode.....	82
AUTOMATIC TRANSMISSION	83
Gear Selector.....	84
Gear Ranges.....	84
Transmission Limp Home Mode	87
Ignition Park Interlock.....	87
Brake Transmission Shift Interlock (BTSI) System	87
ALL-WHEEL DRIVE (AWD) — IF EQUIPPED	88
DYNAMIC SELECTOR — IF EQUIPPED	88
Warning Messages.....	88
ELECTRIC POWER STEERING	88

STOP/START SYSTEM	89	VEHICLE LOADING	110	UCONNECT MODES	137
Automatic Mode	89	Certification Label.....	110	Steering Wheel Audio Controls	137
Possible Reasons The Engine Does Not		TRAILER TOWING	111	Radio Mode	137
Autostop.....	89	Common Towing Definitions.....	111	Media Mode	146
To Start The Engine While In Autostop		Trailer Hitch Classification.....	112	Phone Mode	148
Mode	90	Trailer Towing Weights (Maximum Trailer		ANDROID AUTO™ & APPLE CARPLAY® —	
To Manually Turn Off The Stop/Start		Weight Ratings).....	113	IF EQUIPPED	158
System	90	Trailer And Tongue Weight.....	113	Android Auto™ 	158
To Manually Turn On The Stop/Start		Towing Requirements	113	Apple CarPlay® 	160
System	90	Towing Tips	115	Android Auto™ And Apple CarPlay® Tips	
System Malfunction	90	RECREATIONAL TOWING (BEHIND		And Tricks	162
CRUISE CONTROL SYSTEMS — IF EQUIPPED	91	MOTORHOME)	116	NAVIGATION MODE — IF EQUIPPED	162
Cruise Control — If Equipped	91	Towing This Vehicle Behind Another		Navigation Main Menu	162
Adaptive Cruise Control (ACC) —		Vehicle	116	Navigating A Route.....	164
If Equipped.....	92	DRIVING TIPS	117	Search.....	164
FRONT/REAR PARK ASSIST — IF EQUIPPED	101	Driving On Slippery Surfaces.....	117	Current Route.....	165
Park Assist Sensors.....	101	Driving Through Water	117	My Places.....	167
Park Assist Warning Display.....	101	MULTIMEDIA		Parking.....	167
Park Assist Display	101	UCONNECT SYSTEMS	119	Gas Stations.....	168
Enabling And Disabling Park Assist.....	104	CYBERSECURITY	119	Settings.....	168
Service The Park Assist System	104	UCONNECT SETTINGS	120	RADIO OPERATION AND MOBILE PHONES	169
Cleaning The Park Assist System.....	104	Customer Programmable Features.....	120	Regulatory And Safety Information.....	169
Park Assist System Usage Precautions	104	UCONNECT INTRODUCTION	134	SAFETY	
LANESENSE — IF EQUIPPED	105	System Overview	134	SAFETY FEATURES	170
LaneSense Operation	105	Drag & Drop Menu Bar	136	Anti-Lock Brake System (ABS)	170
Turning LaneSense On Or Off.....	106	Safety And General Information.....	136	Electronic Brake Control (EBC) System	171
LaneSense Warning Message.....	106				
Changing LaneSense Status	108				
PARKVIEW REAR BACK UP CAMERA	108				
ADDING FUEL	109				

AUXILIARY DRIVING SYSTEMS	174	TIRE SERVICE KIT — IF EQUIPPED	220	VEHICLE MAINTENANCE	237
Blind Spot Monitoring (BSM) —		Tire Service Kit Storage	220	Engine Oil	237
If Equipped	174	Tire Service Kit Components And		Engine Oil Filter	238
Full Brake Control System With Mitigation..	179	Operation	220	Engine Air Cleaner Filter	238
Tire Pressure Monitoring System (TPMS)	182	Tire Service Kit Usage Precautions.....	221	Accessory Drive Belt Inspection.....	238
OCCUPANT RESTRAINT SYSTEMS	184	Replacing The Sealant.....	222	Air Conditioner Maintenance.....	239
Occupant Restraint Systems	184	JUMP STARTING	222	Body Lubrication	239
Important Safety Precautions.....	185	Preparations For Jump Start	222	Windshield Wiper Blades.....	240
Seat Belt Systems	185	Jump Starting Procedure	223	Exhaust System	241
Supplemental Restraint Systems (SRS)	191	IF YOUR ENGINE OVERHEATS	224	Cooling System.....	242
Child Restraints	201	GEAR SELECTOR OVERRIDE	225	Brake System	245
SAFETY TIPS	211	FREELING A STUCK VEHICLE	225	Automatic Transmission	246
Transporting Passengers.....	211	TOWING A DISABLED VEHICLE	226	FUSES	246
Transporting Pets	212	All-Wheel Drive (AWD) Models	226	BULB REPLACEMENT.....	253
Safety Checks You Should Make Inside		Tow Eye Usage — If Equipped	227	TIRES	262
The Vehicle	212	ENHANCED ACCIDENT RESPONSE SYSTEM		Tire Safety Information	262
Periodic Safety Checks You Should Make		(EARS)	229	Tires — General Information	269
Outside The Vehicle	213	EVENT DATA RECORDER (EDR)	229	Tire Types.....	272
Exhaust Gas	213	SERVICING AND MAINTENANCE		Spare Tires — If Equipped.....	273
Carbon Monoxide Warnings	214	SCHEDULED MAINTENANCE	230	Wheel And Wheel Trim Care.....	275
IN CASE OF EMERGENCY		Maintenance Plan	231	Snow Traction Devices	276
HAZARD WARNING FLASHERS	215	ENGINE COMPARTMENT	235	Tire Rotation Recommendations	277
JACKING AND TIRE CHANGING	215	1.3L Turbo Engine.....	235	DEPARTMENT OF TRANSPORTATION	
Preparations For Jacking	215	Checking Oil Level.....	236	UNIFORM TIRE QUALITY GRADES	278
Jack Location/Spare Tire Stowage —		Adding Washer Fluid	236	Treadwear.....	278
If Equipped.....	216	Maintenance-Free Battery	236	Traction Grades.....	278
Jacking Instructions	217	Pressure Washing	237	Temperature Grades.....	278
				STORING THE VEHICLE	279

BODYWORK	279	FLUID CAPACITIES	285	WARRANTY INFORMATION	288
Protection From Atmospheric Agents	279	ENGINE FLUIDS AND LUBRICANTS	286	MOPAR® PARTS	289
Body And Underbody Maintenance.....	279	CHASSIS FLUIDS AND LUBRICANTS	286	REPORTING SAFETY DEFECTS	289
Preserving The Bodywork	279			In The 50 United States And	
INTERIORS	280	CUSTOMER ASSISTANCE		Washington, D.C.....	289
Seats And Fabric Parts.....	280	SUGGESTIONS FOR OBTAINING SERVICE		In Canada	289
Plastic And Coated Parts	281	FOR YOUR VEHICLE	287	PUBLICATION ORDER FORMS	289
Leather Surfaces.....	281	Prepare For The Appointment	287	GENERAL INFORMATION	290
Glass Surfaces	281	Prepare A List	287		
		Be Reasonable With Requests.....	287		
TECHNICAL SPECIFICATIONS		IF YOU NEED ASSISTANCE	287		
VEHICLE IDENTIFICATION NUMBER (VIN)	282	FCA US LLC Customer Center.....	287		
BRAKE SYSTEM	282	FCA Canada Inc. Customer Center.....	287		
WHEEL AND TIRE TORQUE SPECIFICATIONS ..	282	Mexico.....	287		
Torque Specifications	282	Puerto Rico And U.S. Virgin Islands.....	288		
FUEL REQUIREMENTS	283	Customer Assistance For The Hearing Or			
1.3L Turbo Engine	283	Speech Impaired			
Reformulated Gasoline	283	(TDD/TTY)	288		
Materials Added To Fuel	283	Service Contract	288		
Gasoline/Oxygenate Blends	284				
Do Not Use E-85 In Non-Flex Fuel					
Vehicles.....	284				
CNG And LP Fuel System Modifications	284				
Methylcyclopentadienyl Manganese					
Tricarbonyl (MMT) In Gasoline.....	284				
Fuel System Cautions	285				

INTRODUCTION



Dear Customer,

Congratulations on the purchase of your new FIAT® vehicle. Be assured that it represents precision workmanship, distinctive styling, and high quality. This Owner's Manual has been prepared with the assistance of service and engineering specialists to acquaint you with the operation and maintenance of your vehicle. It is supplemented by customer-oriented documents. Within this information, you will find a description of the services that FCA US LLC offers to its customers as well as the details of the terms and conditions for maintaining its validity. Please take the time to read all of these publications carefully before driving your vehicle for the first time. Following the instructions, recommendations, tips, and important warnings in this manual will help ensure safe and enjoyable operation of your vehicle.

This Owner's Manual describes all versions of this vehicle. Options and equipment dedicated to specific markets or versions are not expressly indicated in the text. Therefore, you should only consider the information that is related to the trim level, engine, and version that you have purchased. Any content introduced throughout the Owner's Information, which may or may not be applicable to your vehicle, will be identified with the wording "If Equipped". All data contained in this publication are intended to help you use your vehicle in the best possible way. FCA US LLC aims at a constant improvement of the vehicles produced. For this reason, it reserves the right to make changes to the model described for technical and/or commercial reasons. For further information, contact an authorized dealer.

When it comes to service, remember that authorized dealers know your vehicle best, have factory-trained technicians and genuine Mopar® parts, and care about your satisfaction.

SYMBOLS KEY

WARNING!	These statements are against operating procedures that could result in a collision, bodily injury and/or death.
CAUTION!	These statements are against procedures that could result in damage to your vehicle.
NOTE:	A suggestion which will improve installation, operation, and reliability. If not followed, may result in damage.
TIP:	General ideas/solutions/suggestions on easier use of the product or functionality.
PAGE REFERENCE ARROW 	Follow this reference for additional information on a particular feature.
FOOTNOTE 	Supplementary and relevant information pertaining to the topic.

If you do not read this entire Owner's Manual, you may miss important information. Observe all Cautions and Warnings.

ROLLOVER WARNING

Utility vehicles have a significantly higher rollover rate than other types of vehicles. This vehicle has a higher ground clearance and a higher center of gravity than many passenger vehicles. It is capable of performing better in a wide variety of off-road applications. Driven in an unsafe manner, all vehicles can go out of control. Because of the higher center of gravity, if this vehicle is out of control it may roll over while some other vehicles may not.

Do not attempt sharp turns, abrupt maneuvers, or other unsafe driving actions that can cause loss of vehicle control. Failure to operate this vehicle safely may result in a collision, rollover of the vehicle, and severe or fatal injury. Drive carefully.

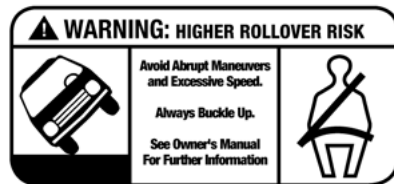

808re010

Rollover Warning Label

Failure to use the driver and passenger seat belts provided is a major cause of severe or fatal injury. In fact, the U.S. government notes that the universal use of existing seat belts could cut the highway death toll by 10,000 or more each year and could reduce disabling injuries by two million annually. In a rollover crash, an unbelted person is significantly more likely to die than a person wearing a seat belt. Always buckle up.

VEHICLE MODIFICATIONS/ALTERATIONS

WARNING!



Any modifications or alterations to this vehicle could seriously affect its roadworthiness and safety and may lead to a collision resulting in serious injury or death.









SYMBOL GLOSSARY



Some car components have colored labels with symbols indicating precautions to be observed when using this component. It is important to follow all warnings when operating your vehicle. See below for the definition of each symbol ↪ page 68.





NOTE:









Warning and Indicator lights are different based upon equipment options and current vehicle status. Some telltales are optional and may not appear.





Red Warning Lights	
	Air Bag Warning Light ↪ page 68
	Brake Warning Light ↪ page 69
	Battery Charge Warning Light ↪ page 69



Red Warning Lights	
	Coolant Temperature Warning Light ↪ page 69
	Door Open Warning Light ↪ page 70
	Electric Power Steering (EPS) Fault Warning Light ↪ page 70
	Electronic Throttle Control (ETC) Warning Light ↪ page 70
	Hood Open Warning Light ↪ page 70
	Oil Pressure Warning Light ↪ page 70
	Seat Belt Reminder Warning Light ↪ page 70
	Transmission Fault Warning Light ↪ page 70





Red Warning Lights	
	Vehicle Security Warning Light ⇨ page 70
	Trunk Open Warning Light ⇨ page 71



Yellow Warning Lights	
	Adaptive Cruise Control (ACC) Fault Warning Light ⇨ page 71
	Anti-Lock Brake System (ABS) Warning Light ⇨ page 71
	Audio System Failure Light ⇨ page 71
	Electronic Park Brake Warning Light ⇨ page 71
	Electronic Stability Control (ESC) Active Warning Light ⇨ page 71





Yellow Warning Lights	
	Electronic Stability Control (ESC) OFF Warning Light ⇨ page 71
	Drive Mode System Overheating ⇨ page 71
	Exterior Light Failure Indicator Light ⇨ page 72
	Loose Fuel Filler Cap Warning Light ⇨ page 72
	Low Fuel Warning Light ⇨ page 72
	LaneSense Warning Light ⇨ page 72
	Service LaneSense Warning Light ⇨ page 72
	Engine Check/Malfunction Indicator Warning Light (MIL) ⇨ page 72



Yellow Warning Lights	
	Service Warning Light ⇨ page 73
	Service Stop/Start System Warning Light ⇨ page 73
	Tire Pressure Monitoring System (TPMS) Warning Light ⇨ page 73
	Transmission Temperature Warning Light ⇨ page 74

Yellow Indicator Lights	
	Exterior Bulb Failure Indicator Light ⇨ page 74
	Full Brake Control System Indicator Light ⇨ page 74
	Full Brake Control System Off Indicator Light ⇨ page 74

Yellow Indicator Lights	
	Fuel Cutoff Failure Light ⇨ page 74
	Fuel Cutoff Indicator Light ⇨ page 74
	Fuel Level Sensor Failure ⇨ page 74
	Icy Road Condition Indicator Light ⇨ page 74
	Immobilizer Fail/VPS Electrical Alarm Indicator Light ⇨ page 75

Green Indicator Lights	
	Cruise Control Set Indicator Light ⇨ page 75
	Front Fog Indicator Light ⇨ page 75

Green Indicator Lights	
	LaneSense Indicator Light ↪ page 75
	Parking/Headlight On Indicator Light ↪ page 75
	Stop/Start Active Indicator Light ↪ page 75
	Turn Signal Indicator Lights ↪ page 75

White Indicator Lights	
	LaneSense Indicator Light ↪ page 75
	Light Sensor Failure ↪ page 75
	Speed Warning Indicator Light ↪ page 75

Blue Indicator Lights	
	High Beam Indicator Light ↪ page 76

Gray Indicator Lights	
	Cruise Control Ready/Canceled Indicator Light ↪ page 76

GETTING TO KNOW YOUR VEHICLE

KEYS

KEY FOB

Your vehicle is equipped with a key fob which supports Passive Entry, Remote Keyless Entry (RKE), Keyless Enter 'n Go™ (if equipped), and Remote Start (if equipped). The key fob allows you to lock or unlock the doors and liftgate or activate the Panic Alarm from distances up to approximately 66 ft (20 m). The key fob does not need to be pointed at the vehicle to activate the system. The key fob also contains an emergency key, which is stored in the rear of the key fob.

NOTE:

The key fob's wireless signal may be blocked if the key fob is located next to a mobile phone, laptop, or other electronic device. This may result in poor performance.

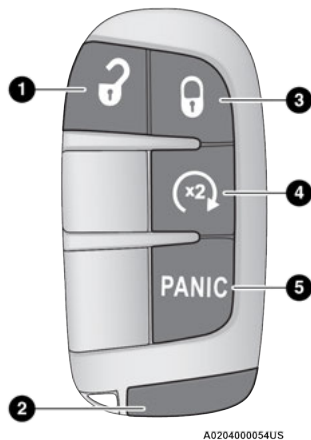

Keyless Ignition Key Fob

- 1 – Unlock
- 2 – Emergency Key
- 3 – Lock
- 4 – Remote Start
- 5 – PANIC

In case the ignition switch does not change with the push of a button, the key fob may have a low or fully depleted battery. A low key fob battery can be verified by referring to the instrument cluster, which will display directions to follow ↻ page 290.

2

To Unlock/Lock The Doors And Liftgate

Push and release the unlock button on the key fob once to unlock the driver's door, or twice within five seconds to unlock all the doors and the liftgate. To lock all the doors and the liftgate, push the lock button once.

When the doors are unlocked, the turn signals will flash and the illuminated entry system will be activated. When the doors are locked, the turn signals will flash and the horn will chirp.

NOTE:

If the vehicle is unlocked by a key fob, and no door is opened within 60 seconds, the vehicle will relock and if equipped, the security system will arm.

All doors can be programmed to unlock on the first push of the unlock button within Uconnect Settings ↻ page 120.

Replacing The Battery In The Key Fob

The recommended replacement battery is one CR2032 battery.

NOTE:

- Customers are recommended to use a battery obtained from Mopar®. Aftermarket coin battery dimensions may not meet the original OEM coin battery dimensions.
- Perchlorate Material – special handling may apply. See www.dtsc.ca.gov/hazardouswaste/perchlorate for further information.
- Do not touch the battery terminals that are on the back housing or the printed circuit board.

1. Remove the emergency key (2) by sliding the emergency key release (1) on the back of the key fob and pulling the emergency key out with your other hand.

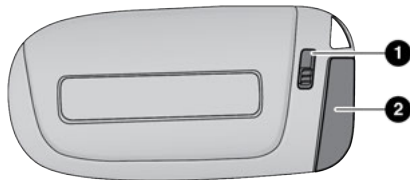

A0204000087US

Emergency Key Removal

- 1 – Emergency Key Release Button
- 2 – Emergency Key

2. Separate the key fob halves using a #2 flat blade screwdriver or a coin, and gently pry the two halves of the key fob apart. Make sure not to damage the seal during removal.

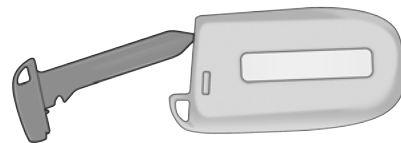

A0204000053US

Emergency Key Removal

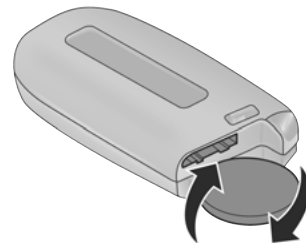

M0304000167US

Separating Case With A Coin



Key Fob Battery Replacement

- Remove the back cover to access and replace the battery. When replacing the battery, match the (+) sign on the battery to the (+) sign on the inside of the battery clip, located on the back cover. Avoid touching the new battery with your fingers. Skin oils may cause battery deterioration. If you touch a battery, clean it with rubbing alcohol.
- To assemble the key fob case, snap the two halves together.

WARNING!

- The integrated key fob contains a coin cell battery. Do not ingest the battery; there is a chemical burn hazard. If the coin cell battery is swallowed, it can cause severe internal burns in just two hours and can lead to death.

(Continued)

WARNING!

- If you think a battery may have been swallowed or placed inside any part of the body, seek immediate medical attention.
- Keep new and used batteries away from children. If the battery compartment does not close securely, stop using the product and keep it away from children.

Programming And Requesting Additional Key Fobs

Programming the key fob may be performed by an authorized dealer.

NOTE:

- Once a key fob is programmed to a vehicle, it cannot be repurposed and reprogrammed to another vehicle.
- Only key fobs that are programmed to the vehicle electronics can be used to start and operate the vehicle.

WARNING!

- Always remove the key fobs from the vehicle and lock all doors when leaving the vehicle unattended.
- Always remember to place the ignition in the OFF position.

Duplication of key fobs may be performed at an authorized dealer. This procedure consists of programming a blank key fob to the vehicle electronics. A blank key fob is one that has never been programmed.

NOTE:

- When having the Sentry Key Immobilizer system serviced, bring all vehicle keys with you to an authorized dealer.
- Keys must be ordered to the correct key cut to match the vehicle locks.

SENTRY KEY

The Sentry Key Immobilizer system prevents unauthorized vehicle operation by disabling the engine. The system does not need to be armed or activated. Operation is automatic, regardless of whether the vehicle is locked or unlocked.

The system uses a key fob, keyless push button ignition and a Radio Frequency (RF) receiver to prevent unauthorized vehicle operation. Therefore, only key fobs that are programmed to the vehicle can be used to start and operate the vehicle. The system will shut the engine off in two seconds if an incorrect key fob is used to start the engine.

After placing the ignition switch in the ON/RUN position, the Vehicle Security Light will turn on for three seconds for a bulb check. If the light remains on after the bulb check, it indicates that there is a

problem with the electronics. In addition, if the light begins to flash after the bulb check, it indicates that someone used an invalid key fob to start the engine. Either of these conditions will result in the engine being shut off after two seconds.

If the Vehicle Security Light turns on during normal vehicle operation (vehicle running for longer than 10 seconds), it indicates that there is a fault in the electronics. Should this occur, have the vehicle serviced as soon as possible by an authorized dealer.

CAUTION!

The Sentry Key Immobilizer system is not compatible with some aftermarket remote starting systems. Use of these systems may result in vehicle starting problems and loss of security protection.

All of the key fobs provided with your new vehicle have been programmed to the vehicle electronics
 ↪ page 290.

IGNITION SWITCH

KEYLESS ENTER 'N GO™ IGNITION

This feature allows the driver to operate the ignition switch with the push of a button as long as the key fob is in the passenger compartment.

The START/STOP ignition button has three operating positions. These positions are OFF, ON, and RUN.

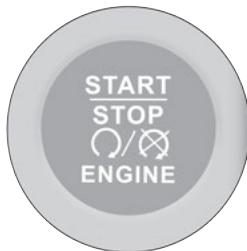

M0305000046US

START/STOP Ignition Button

The push button ignition can be placed in the following positions:

OFF

- The engine is stopped.
- No electrical devices are available.

ON

- The vehicle is not running.
- Some electrical devices (power locks, alarm, etc.) are still available.

RUN

- Driving mode.
- All the electrical devices are available (e.g. climate controls, heated seats, etc.).

NOTE:

The vehicle will not start if the key fob is located inside the cargo area and the liftgate is opened.

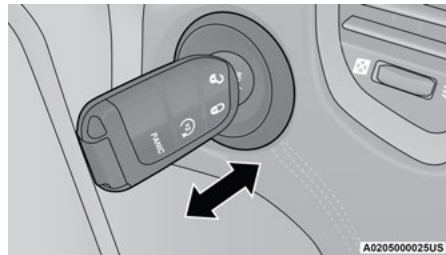

A0205000025US

Backup Starting Method

NOTE:

If the ignition switch does not change with the push of a button, the key fob may have a low or depleted battery. In this situation, a back up method can be used to operate the ignition switch. Put the nose

side (side opposite of the emergency key) of the key fob against the START/STOP ignition button and push to operate the ignition switch.

WARNING!

- When leaving the vehicle, always remove the key fob from the vehicle and lock your vehicle.
- Never leave children alone in a vehicle, or with access to an unlocked vehicle.
- Allowing children to be in a vehicle unattended is dangerous for a number of reasons. A child or others could be seriously or fatally injured. Children should be warned not to touch the parking brake, brake pedal or the gear selector.
- Do not leave the key fob in or near the vehicle, or in a location accessible to children, and do not leave the ignition in the ON or RUN position. A child could operate power windows, other controls, or move the vehicle.
- Do not leave children or animals inside parked vehicles in hot weather. Interior heat buildup may cause serious injury or death.

CAUTION!

An unlocked vehicle is an invitation for thieves. Always remove key fob from the vehicle and lock all doors when leaving the vehicle unattended.

NOTE:

For more information on proper engine starting procedures, see ↪ page 78.

REMOTE START — IF EQUIPPED



This system uses the key fob to start the engine conveniently from outside the vehicle while still maintaining security.

The system has a range of approximately 328 ft (100 m).

Remote Start is used to defrost windows in cold weather, and to reach a comfortable climate in all ambient conditions before the driver enters the vehicle.

NOTE:

Obstructions between the vehicle and key fob may reduce this range.

WARNING!

- Do not start or run an engine in a closed garage or confined area. Exhaust gas contains Carbon Monoxide (CO) which is odorless and colorless. Carbon Monoxide is poisonous and can cause serious injury or death when inhaled.
- Keep key fobs away from children. Operation of the Remote Start system, windows, door locks or other controls could cause serious injury or death.

2

HOW TO USE REMOTE START

Push and release the Remote Start button on the key fob twice within five seconds. The vehicle doors will lock, the parking lights will flash, and the horn will chirp twice (if programmed). Then, the engine will start, and the vehicle will remain in the Remote Start mode for a 15 minute cycle. Pushing the Remote Start button a third time shuts the engine off.

- With Remote Start, the engine will only run for 15 minutes.
- If an engine fault is present or fuel level is low, the vehicle will start and then shut down in 10 seconds.

- The parking lights will turn on and remain on during Remote Start mode.
- For security, power window and power sunroof operation (if equipped) are disabled when the vehicle is in the Remote Start mode.
- The ignition must be placed in the ON/RUN position before the Remote Start sequence can be repeated for a third cycle.

All of the following conditions must be met before the engine will remote start:

- Gear Selector in PARK
- Doors closed
- Hood closed
- Liftgate closed
- Hazard switch off
- Brake switch inactive (brake pedal not pressed)
- Battery at an acceptable charge level
- PANIC button not pushed
- System not disabled from previous Remote Start event
- Vehicle Security Light flashing
- Ignition in OFF position
- Fuel level meets minimum requirement
- Vehicle Security system is not signaling an intrusion
- Malfunction Indicator Light is not illuminated

WARNING!

- Do not start or run an engine in a closed garage or confined area. Exhaust gas contains Carbon Monoxide (CO) which is odorless and colorless. Carbon Monoxide is poisonous and can cause serious injury or death when inhaled.
- Keep key fobs away from children. Operation of the Remote Start system, windows, door locks or other controls could cause serious injury or death.

To Exit Remote Start Mode

To drive the vehicle after starting the Remote Start system, push and release the START/STOP ignition button while pressing the brake pedal prior to the end of the 15 minute cycle.

The Remote Start system will turn the engine off with another push and release of the Remote Start button on the key fob, or if the engine is allowed to run for the entire 15 minute cycle. Once the ignition is placed in the ON/RUN position, the climate controls will resume the previously set operations (temperature, blower control, etc.).

NOTE:

- For vehicles equipped with the Keyless Enter 'n Go™ — Passive Entry feature, the

message “Remote Start Active — Push Start Button” will display in the instrument cluster display until you push the START/STOP ignition button.

- To avoid unintentional shutdowns, the system will disable for two seconds after receiving a valid Remote Start request.

REMOTE START FRONT DEFROST ACTIVATION — IF EQUIPPED

When Remote Start is active, and the outside ambient temperature is 40°F (4.5°C) or below, the system will automatically activate front defrost for 15 minutes or less. The time is dependent on the ambient temperature. Once the timer expires, the system will automatically adjust the settings depending on ambient conditions. See “Remote Start Comfort Systems — If Equipped” in the next section for detailed operation.

REMOTE START COMFORT SYSTEMS — IF EQUIPPED

When Remote Start is activated, the front and rear defrost will automatically turn on in cold weather. The heated steering wheel and driver heated seat feature will turn on if selected in the comfort menu screen within Uconnect Settings ↗ page 120. In warm weather, the driver vented seat feature will automatically turn on when Remote Start is activated and is selected in the comfort menu

screen. The vehicle will adjust the climate control settings depending on the outside ambient temperature.

Automatic Temperature Control (ATC) — If Equipped

The climate controls will be automatically adjusted to the optimal temperature and mode settings depending on the outside ambient temperature. This will occur until the ignition is placed in the ON/RUN position where the climate controls will resume their previous settings.

Manual Temperature Control (MTC) — If Equipped

- In ambient temperatures at 40°F (4.5°C) or below, the climate settings will default to maximum heat, with fresh air entering the cabin. If the front defrost timer expires, the vehicle will enter Mix Mode.
- In ambient temperatures from 40°F (4.5°C) to 78°F (26°C), the climate settings will be based on the last settings selected by the driver.
- In ambient temperatures at 78°F (26°C) or above, the climate settings will default to MAX A/C, Bi-Level Mode, with Recirculation on.

For more information on ATC, MTC, and climate control settings, see ↗ page 42.

NOTE:

These features will stay on through the duration of Remote Start until the ignition is placed in the ON/RUN position. The climate control settings will change if manually adjusted by the driver while the vehicle is in Remote Start mode, and exit automatic override. This includes the OFF button on the climate controls, which will turn the system off.

REMOTE START WINDSHIELD WIPER DE-ICER AND REAR DEFROST ACTIVATION — IF EQUIPPED

When Remote Start is active and the outside ambient temperature is less than 40°F (4.4°C), the Windshield Wiper De-Icer and the Rear Defrost will be enabled. Exiting Remote Start will resume its previous operation. If the Windshield Wiper De-Icer was active, the timer and operation will continue.

REMOTE START CANCEL MESSAGE — IF EQUIPPED

The following messages will display in the instrument cluster if the vehicle fails to remote start or exits Remote Start prematurely:

- Remote Start Cancelled — Door Open
- Remote Start Cancelled — Hood Open
- Remote Start Cancelled — Fuel Low

- Remote Start Cancelled — Liftgate Open
- Remote Start Cancelled — Too Cold
- Remote Start Cancelled — Time Expired
- Remote Start Disabled — Start Vehicle To Reset

The message will stay active until the ignition is placed in the ON/RUN position.

2

VEHICLE SECURITY SYSTEM — IF EQUIPPED

The Vehicle Security system monitors the vehicle doors, hood, liftgate, and the Keyless Enter 'n Go™ Ignition for unauthorized operation. While the Vehicle Security system is armed, interior switches for door locks and liftgate release are disabled. If something triggers the alarm, the Vehicle Security system will provide the following audible and visible signals:

- The horn will pulse
- The turn signals will flash
- The Vehicle Security Light in the instrument cluster will flash

To ARM THE SYSTEM

Follow these steps to arm the Vehicle Security system:

1. Make sure the vehicle's ignition is placed in the OFF position.
2. Perform one of the following methods to lock the vehicle:
 - Push the lock button on the interior power door lock switch with the driver and/or passenger door open.
 - Push the lock button on the exterior Passive Entry door handle with a valid key fob available in the same exterior zone ↪ page 22.
 - Push the lock button on the key fob.
3. If any doors are open, close them.

To DISARM THE SYSTEM

The Vehicle Security system can be disarmed using any of the following methods:

- Push the unlock button on the key fob.
- Grab the Passive Entry door handle to unlock the door ↪ page 22.
- Cycle the ignition out of the OFF position to disarm the system.

NOTE:

- The driver's door key cylinder cannot arm or disarm the Vehicle Security system.
- The Vehicle Security system remains armed during liftgate entry. If someone enters the vehicle through the liftgate and opens any door, the alarm will sound.
- When the Vehicle Security system is armed, the interior power door lock switches will not unlock the doors.

The Vehicle Security system is designed to protect your vehicle. However, you can create conditions where the system will give you a false alarm. If one of the previously described arming sequences has occurred, the Vehicle Security system will arm, regardless of whether you are in the vehicle or not. If you remain in the vehicle and open a door, the alarm will sound. If this occurs, disarm the Vehicle Security system.

If the Vehicle Security system is armed and the battery becomes disconnected, the Vehicle Security system will remain armed when the battery is reconnected; the exterior lights will flash, and the horn will sound. If this occurs, disarm the Vehicle Security system.

DISABLING

To completely disable the alarm (e.g. in the case of long inactivity of the car), lock the doors by turning the emergency key in the exterior door lock cylinder.

NOTE:

If the batteries in the key fob discharge in the event of a failure to the system or to switch off the alarm, place the ignition in the ON/RUN position.

DOORS

MANUAL DOOR LOCKS

To lock each door from the inside, rotate the door lock button on each door trim panel forward. To unlock the doors from the inside, pull the inside door handle to the first detent or rotate the door lock button until the lock symbol is no longer visible.

If the lock symbol is visible when the door is shut, the door will lock. Therefore, make sure the key fob is not inside the vehicle before closing the door.

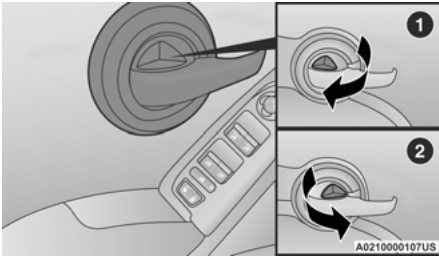
**Manual Lock/Unlock Switch**

- 1 – Door Unlocked
2 – Door Locked

NOTE:

The manual lock knob unlocks each individual door separately.

WARNING!

- When exiting the vehicle, always remove the key fob from the vehicle and lock your vehicle.
- Never leave children alone in a vehicle, or with access to an unlocked vehicle.

(Continued)

WARNING!

- Allowing children to be in a vehicle unattended is dangerous for a number of reasons. A child or others could be seriously or fatally injured. Children should be warned not to touch the parking brake, brake pedal or the gear selector.
- Do not leave the key fob in or near the vehicle, or in a location accessible to children, and do not leave the Keyless Enter 'n Go™ Ignition in the ON/RUN position. A child could operate power windows, other controls, or move the vehicle.
- Do not leave children or animals inside parked vehicles in hot weather. Interior heat buildup may cause serious injury or death.

CAUTION!

An unlocked car is an invitation. Always remove the key from the ignition and lock all doors when leaving the vehicle unattended.

POWER DOOR LOCKS

The power door lock switches are located on each front door panel. Push the switch to lock or unlock the doors and liftgate.

Push the lock button on the driver or passenger door trim panel to lock the doors.

With the doors locked, push the unlock button to unlock the doors.

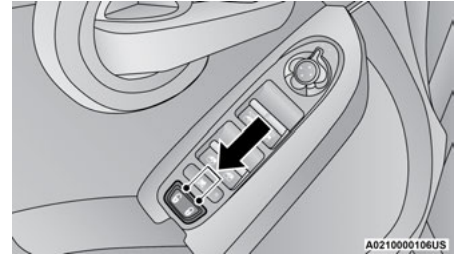
**Power Lock/Unlock Switch**

The doors can also be locked and unlocked with the Keyless Enter 'n Go™ – Passive Entry system (if equipped).

KEYLESS ENTER 'N GO™ — PASSIVE ENTRY (IF EQUIPPED)

The Passive Entry system is an enhancement to the vehicle's Remote Keyless Entry system and a feature of Keyless Enter 'n Go™. This feature allows you to lock and unlock the vehicle's door(s) without having to push the key fob lock or unlock buttons.

NOTE:

- Passive Entry may be programmed on/off through Uconnect Settings ↪ page 120.
- The key fob may not be detected by the vehicle Passive Entry system if it is located next to a mobile phone, laptop, or other electronic device; these devices may interfere with the key fob's wireless signal and prevent the Passive Entry system from locking and unlocking the vehicle.
- If wearing gloves, or if it has been raining/snowing on the Passive Entry door handle, the unlock sensitivity can be affected, resulting in a slower response time.
- If the vehicle is unlocked by the Passive Entry door handle, and no door goes ajar within 60 seconds, the vehicle will relock and if equipped, the Vehicle Security system will arm.

To Unlock From The Driver Or Passenger Side

With a valid Passive Entry key fob within 5 ft (1.5 m) of the door handle, grab the handle to unlock the vehicle. Grabbing the driver's door handle will unlock the driver door automatically. Grabbing the passenger door handle will unlock all doors and the liftgate automatically.

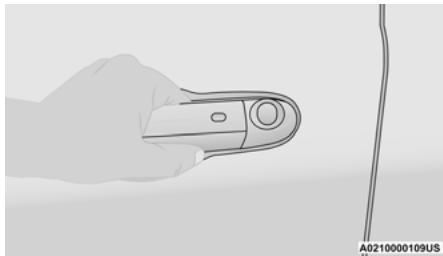

Grab The Door Handle To Unlock

NOTE:

- Either the driver door only or all doors will unlock when you grab hold of the front driver's door handle, depending on the selected setting in the Uconnect system ↪ page 120.
- All doors will unlock when the front passenger door handle is grabbed regardless of the driver's door unlock preference setting.

Frequency Operated Button Integrated Key (FOBIK-Safe)

To minimize the possibility of unintentionally locking a Passive Entry key fob inside your vehicle, the Passive Entry system is equipped with an automatic door unlock feature.

FOBIK-Safe only executes in vehicles with Passive Entry. There are three situations that trigger a FOBIK-Safe search in any Passive Entry vehicle:

- A lock request is made by a valid Passive Entry key fob while a door is ajar.
- A lock request is made by the Passive Entry door handle while a door is ajar.
- A lock request is made by the door panel switch while the door is ajar.

When any of these situations occur, after all ajar doors are shut, the FOBIK-Safe search will be executed. If it detects a Passive Entry key fob inside the car, and it does not detect any Passive Entry key fobs outside the car, then the car will unlock and alert the customer.

NOTE:

The vehicle will only unlock the doors when a valid Passive Entry key fob is detected inside the vehicle, and no valid Passive Entry key fob is detected outside the vehicle. The vehicle will not unlock the doors when any of the following conditions are met:

- The doors are manually locked using the door lock knobs.
- There is a valid Passive Entry key fob outside the vehicle and within 5 ft (1.5 m) of either Passive Entry door handle.

To Lock The Vehicle's Doors And Liftgate

With one of the vehicle's Passive Entry key fobs within 5 ft (1.5 m) of either front door handles, pushing the Passive Entry lock button will lock the vehicle.

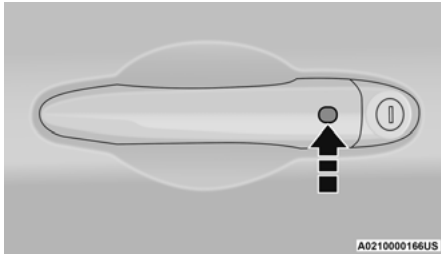
**Push The Door Handle Button To Lock****NOTE:**

DO NOT grab the door handle, when pushing the door handle lock button. This could unlock the door(s).

**DO NOT Grab The Door Handle When Locking****NOTE:**

- After pushing the door handle button, you must wait two seconds before you can lock or unlock the doors, using any Passive Entry door handle. This is to allow you to check if the vehicle is locked by pulling the door handle without the vehicle unlocking.
- The Passive Entry system will not operate if the key fob battery is depleted.

The vehicle doors can also be locked by using the lock button located on the vehicle's interior door panel.

To Unlock/Enter The Liftgate

The liftgate Passive Entry unlock feature is built into the electronic liftgate release. With a valid Passive Entry key fob within 3 ft (1.0 m) of the liftgate, push the electronic liftgate release to open.

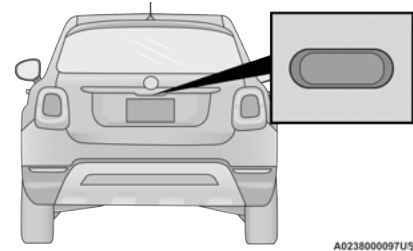
**Electronic Liftgate Release****NOTE:**

The liftgate will either unlock along with the vehicle doors, or it will need to be unlocked by pushing the electronic liftgate release, depending on the selected setting in the Uconnect system
 ⇨ page 120.

To Lock The Liftgate

With a valid Passive Entry key fob within 3 ft (1.0 m) of the liftgate, push the Passive Entry lock button located to the right of electronic liftgate release.

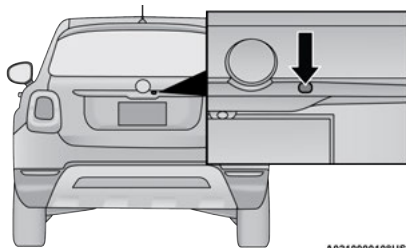

Liftgate Passive Entry Lock Button

NOTE:

The liftgate Passive Entry lock button will lock all doors and the liftgate.

Activation/Deactivation Of Keyless Enter 'n Go™

Keyless Enter 'n Go™ can be activated or deactivated through the instrument cluster display or through the Uconnect system ↪ page 290.

AUTOMATIC DOOR LOCKS — IF EQUIPPED

When the auto door lock feature is enabled, if all of the doors are closed properly, the door locks will

lock automatically when the vehicle's speed exceeds 12 mph (20 km/h). The auto door lock feature is enabled/disabled within Uconnect Settings ↪ page 120.

CHILD-PROTECTION DOOR LOCK SYSTEM — REAR DOORS

To provide a safer environment for small children riding in the rear seats, the rear doors are equipped with a Child-Protection Door Lock system.

To use the system, open each rear door, use a flat blade screwdriver (or emergency key) and rotate the dial to the lock or unlock position. When the system on a door is engaged, that door can only be opened by using the outside door handle even if the inside door lock is in the unlocked position.

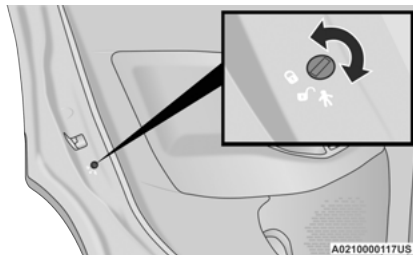

Child-Protection Door Lock Location

NOTE:

- When the Child-Protection Door Lock system is engaged, the door can only be opened by using the outside door handle even though the inside door lock is in the unlocked position.
- After disengaging the Child-Protection Door Lock system, always test the door from the inside to make certain it is in the unlocked position.
- After engaging the Child-Protection Door Lock system, always test the door from the inside to make certain it is in the locked position.
- For emergency exit with the system engaged, rotate the lock button to the unlocked position, roll down the window, and open the door with the outside door handle.

WARNING!

Avoid trapping anyone in a vehicle in a collision. Remember that the rear doors can only be opened from the outside when the Child-Protection locks are engaged.

NOTE:

Always use this device when carrying children. After engaging the child lock on both rear doors, check for effective engagement by trying to open a door with the internal handle. Once the Child-Protection Door Lock system is engaged, it is

impossible to open the doors from inside the vehicle. Before getting out of the vehicle, be sure to check that there is no one left inside.

STEERING WHEEL

MANUAL TILT/TELESCOPING STEERING COLUMN

This feature allows you to tilt the steering column upward or downward. It also allows you to lengthen or shorten the steering column. The tilt/telescoping lever is located below the steering wheel at the end of the steering column.



Tilt/Telescoping Lever

To unlock the steering column, push the tilt/telescoping lever downward (toward the floor). To tilt the steering column, move the steering wheel upward or downward as desired. To lengthen or

shorten the steering column, pull the steering wheel outward or push it inward as desired.

To lock the steering column in position, pull the tilt/telescoping lever upward until fully engaged.

WARNING!

Do not adjust the steering column while driving. Adjusting the steering column while driving or driving with the steering column unlocked, could cause the driver to lose control of the vehicle. Failure to follow this warning may result in serious injury or death.

HEATED STEERING WHEEL — IF EQUIPPED

The steering wheel contains a heating element that helps warm your hands in cold weather. The heated steering wheel has only one temperature setting. Once the heated steering wheel switch  has been turned on, it will operate for an average of 80 minutes or more before automatically shutting off. This time may vary depending on the environmental temperature. The heated steering wheel can shut off early or may not turn on when the steering wheel is already warm. The heated steering wheel control button is located on the center of the instrument panel below the climate controls.

For information on use with the Remote Start system, see  page 18.

WARNING!

- Persons who are unable to feel pain to the skin because of advanced age, chronic illness, diabetes, spinal cord injury, medication, alcohol use, exhaustion, or other physical conditions must exercise care when using the steering wheel heater. It may cause burns even at low temperatures, especially if used for long periods.
- Do not place anything on the steering wheel that insulates against heat, such as a blanket or steering wheel covers of any type and material. This may cause the steering wheel heater to overheat.

2

SEATS

Seats are a part of the Occupant Restraint system of the vehicle.

WARNING!

- It is dangerous to ride in a cargo area, inside or outside of a vehicle. In a collision, people riding in these areas are more likely to be seriously injured or killed.

(Continued)

WARNING!

- Do not allow people to ride in any area of your vehicle that is not equipped with seats and seat belts. In a collision, people riding in these areas are more likely to be seriously injured or killed.
- Be sure everyone in your vehicle is in a seat and using a seat belt properly.

MANUAL ADJUSTMENT (FRONT SEATS)**WARNING!**

- Adjusting a seat while the vehicle is moving is dangerous. The sudden movement of the seat could cause you to lose control. The seat belt might not be adjusted properly and you could be injured. Adjust the seat only while the vehicle is parked.
- Do not ride with the seatback reclined so that the shoulder belt is no longer resting against your chest. In a collision you could slide under the seat belt and be seriously or even fatally injured. Use the recliner only when the vehicle is parked.

Manual Front Seat Forward/Rearward Adjustment

Some models may be equipped with manual seats. The seat can be adjusted forward or rearward by using a bar located by the front of the seat cushion, near the floor.

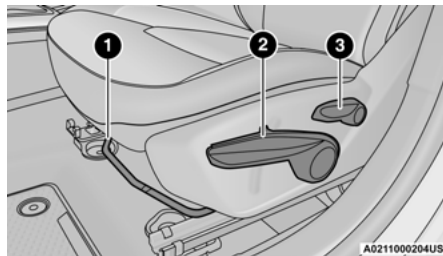
**Manual Seat Adjustment Levers**

- 1 — Forward/Rearward Adjustment Bar
- 2 — Seat Height Adjustment Lever (If Equipped)
- 3 — Recline Lever

While sitting in the seat, lift up on the bar located under the seat cushion and move the seat forward or rearward. Release the bar once you have reached the desired position. Then, using body pressure, move forward and rearward on the seat to be sure that the seat adjusters have latched.

WARNING!

- Adjusting a seat while driving may be dangerous. Moving a seat while driving could result in loss of control which could cause a collision and serious injury or death.
- Seats should be adjusted before fastening the seat belts and while the vehicle is parked. Serious injury or death could result from a poorly adjusted seat belt.

Height Adjustment — If Equipped

The front driver and passenger seats height can be raised or lowered by using a lever, located on the outboard side of the seat. Pull upward on the lever to raise the seat height or push downward on the lever to lower the seat height.

Recline Adjustment

To adjust the seatback, lift the lever located on the outboard side of the seat, lean back to the desired position and release the lever. To return the seatback, lift the lever, lean forward and release the lever.

MANUAL ADJUSTMENT (REAR SEATS)

WARNING!

Do not pile luggage or cargo higher than the top of the seatback. This could impair visibility or become a dangerous projectile in a sudden stop or collision.

Manual Folding Second Row Seat

The manual folding split rear seat increases the storage of the rear cargo area.

NOTE:

- Prior to folding the rear seat down, it may be necessary to position the front seat to its mid-track position. Be sure that the front seats are fully upright and positioned forward, this will allow the rear seat to fold down easily.
- You may experience deformation in the seat cushion from the seat belt buckles if the seats are left folded for an extended period of time. This is normal and by simply unfolding the seats to the open position, over time the seat cushion will return to its normal shape.

WARNING!

- It is extremely dangerous to ride in a cargo area, inside or outside of a vehicle. In a collision, people riding in these areas are more likely to be seriously injured or killed.
- Do not allow people to ride in any area of your vehicle that is not equipped with seats and seat belts.
- Be sure everyone in your vehicle is in a seat and using a seat belt properly.

Cargo Area Enlargement

Folding both sides of the rear seat provides additional storage in the rear cargo area.

Proceed as follows:

1. Remove the rear shelf (if equipped).
2. Fully lower the rear seat head restraints.
3. Move the safety belts to the outboard side of the seat.
4. Pull the seatback release lever to fold both sides of the rear seatbacks completely forward.

Partial Enlargement Of The Cargo Area

Enlargement of the left side of the cargo area allows you to carry a single passenger on the right side of the rear seat, while the enlargement of the right side allows you to carry two passengers.

Proceed as follows:

1. Remove the rear shelf (if equipped).
2. Fully lower the rear seat head restraints.
3. Move the safety belts to the outboard side of the seat and rest them on the seat belt guide.
4. Pull the seatback release lever to fold the left or right rear seatback completely forward.

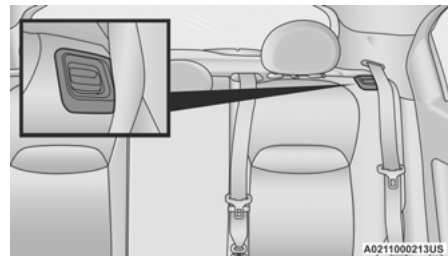

Seatback Release Lever

Seatback Repositioning

NOTE:

If interference from the cargo area prevents the seatback from fully locking, you will have difficulty returning the seat to its proper position.

1. Move the safety belts to the seat belt guides on the top edge of the seat to ensure the seatbacks properly latch.
2. Lift the seatbacks, pushing them back until they lock on both the latches. Verify the red notches are no longer visible on the release lever. If the red notches are visible, the seatback is not secure.

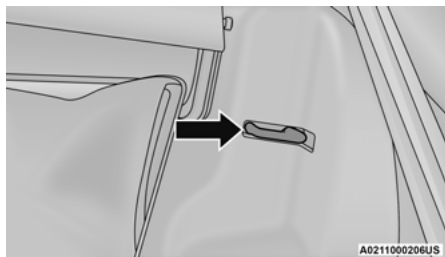

Rear Seat Latch

WARNING!

Be certain that the seatback is securely locked into position. If the seatback is not securely locked into position the seat will not provide the proper stability for child seats and/or passengers. An improperly latched seat could cause serious injury.

POWER ADJUSTMENT FRONT SEATS — IF EQUIPPED

The power seat switches are located on the outboard side of the seat.

Use the switch to move the seat up/down, forward/rearward, tilt if equipped and to set the angle of the seatback.

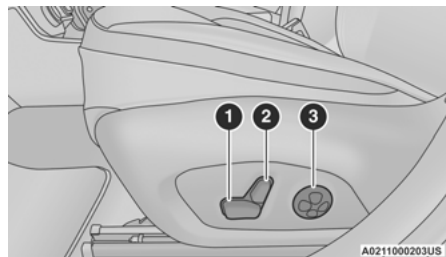

Power Seat Switches

- 1 — Power Seat Switch
- 2 — Power Recline Switch
- 3 — Power Lumbar Switch

Adjusting The Seat Forward Or Rearward

The seat can be adjusted both forward and rearward by using the power seat switch. The seat will move in the direction of the switch. Release the switch when the desired position has been reached.

Adjusting The Seat Up Or Down

The height of the seats can be adjusted up or down by using the power seat switch. The seat will move in the direction of the switch. Release the switch when the desired position is reached.

Tilting The Seat Up Or Down

The angle of the seat cushion can be adjusted up or down using the power seat switch. The front of the seat cushion will move in the direction of the switch. Release the switch when the desired position has been reached.

Reclining The Seatback

Push the seat recliner switch forward or rearward. The seatback will move in the direction of the switch. Release the switch when the desired position has been reached.

WARNING!

- Adjusting a seat while driving may be dangerous. Moving a seat while driving could result in loss of control which could cause a collision and serious injury or death.
- Seats should be adjusted before fastening the seat belts and while the vehicle is parked. Serious injury or death could result from a poorly adjusted seat belt.

(Continued)

WARNING!

- Do not ride with the seatback reclined so that the shoulder belt is no longer resting against your chest. In a collision you could slide under the seat belt, which could result in serious injury or death.

CAUTION!

Do not place any article under a power seat or impede its ability to move as it may cause damage to the seat controls. Seat travel may become limited if movement is stopped by an obstruction in the seat's path.

Power Lumbar — If Equipped

Vehicles equipped with power driver or passenger seats may also be equipped with power lumbar. The power lumbar switch is located on the outboard side of the power seat. Push the switch forward to increase the lumbar support. Push the switch rearward to decrease the lumbar support. Pushing upward or downward on the switch will raise and lower the position of the support.

NOTE:



The power lumbar adjustment knob can only be used when the ignition is in the ON/RUN position and for 20 minutes after the ignition is placed in

the OFF position. The device will automatically be deactivated when the ignition is in the OFF position if the vehicle is locked from the outside.

HEATED SEATS — IF EQUIPPED

The heated seat switches are located on the instrument panel.

You can choose between two heating levels:

- Push the heated seat button  once to turn the HI setting on.
- Push the heated seat button  a second time to turn the LO setting on.
- Push the heated seat button  a third time to turn the heating elements off.

If the HI-level setting is selected, the system will automatically switch to LO-level after approximately 145 minutes of continuous operation. At that time, the display will change from HI to LO, indicating the change. The LO-level setting will turn off automatically after approximately 60 minutes.

NOTE:

The engine must be running for the heated seats to operate.

For information on use with the Remote Start system, see  page 18.

WARNING!

- Persons who are unable to feel pain to the skin because of advanced age, chronic illness, diabetes, spinal cord injury, medication, alcohol use, exhaustion or other physical condition must exercise care when using the seat heater. It may cause burns even at low temperatures, especially if used for long periods of time.
- Do not place anything on the seat or seatback that insulates against heat, such as a blanket or cushion. This may cause the seat heater to overheat. Sitting in a seat that has been overheated could cause serious burns due to the increased surface temperature of the seat.

HEAD RESTRAINTS

Head restraints are designed to reduce the risk of injury by restricting head movement in the event of a rear impact. Head restraints should be adjusted so that the top of the head restraint is located above the top of your ear.

WARNING!

- All occupants, including the driver, should not operate a vehicle or sit in a vehicle's seat until the head restraints are placed in their proper positions in order to minimize the risk of neck injury in the event of a crash.
- Head restraints should never be adjusted while the vehicle is in motion. Driving a vehicle with the head restraints improperly adjusted or removed could cause serious injury or death in the event of a collision.

Front Adjustment

Your vehicle is equipped with driver and passenger head restraints.

To raise the head restraint, pull upward on the head restraint. To lower the head restraint, push the adjustment button, located on the base of the head restraint, and push downward on the head restraint.

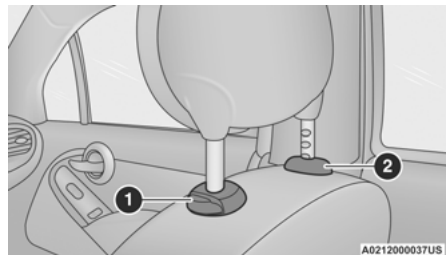
**Front Head Restraint**

- 1 – Adjustment Button
2 – Release Button

Rear Adjustment

Your vehicle is equipped with two outboard head restraints and one center head restraint for its rear passengers. The rear head restraints can be raised or lowered. When the center seat is being occupied, the head restraint should be in the raised position. When there are no occupants in the center seat, the head restraint can be lowered for maximum visibility for the driver.

To raise the head restraint, pull upward on the head restraint. To lower the head restraint, push the adjustment button, located at the base of the head restraint, and push downward on the head restraint.

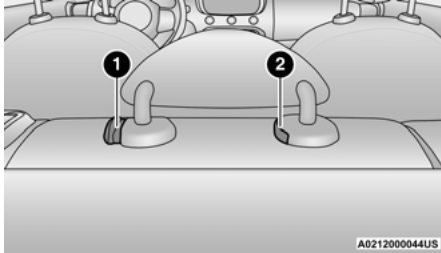

Rear Head Restraint

1 – Adjustment Button

2 – Release Button

Front Removal

To remove the head restraint recline the backrest of the seat to avoid interference with the roof. Raise the head restraint as far as it can go then push the release button and adjustment button at the base of each post while pulling the head restraint up. To reinstall the head restraint, put the head restraint posts into the holes and push downward. Then adjust it to the appropriate height.

NOTE:

Do not reposition the head restraint 180 degrees to the incorrect position in an attempt to gain additional clearance to the back of the head.

WARNING!

- A loose head restraint thrown forward in a collision or hard stop could cause serious injury or death to occupants of the vehicle. Always securely stow removed head restraints in a location outside the occupant compartment.
- ALL the head restraints MUST be reinstalled in the vehicle to properly protect the occupants. Follow the reinstallation instructions above prior to operating the vehicle or occupying a seat.

NOTE:

Do not reposition the head restraint 180 degrees to the incorrect position in an attempt to gain additional clearance to the back of the head.

WARNING!

- A loose head restraint thrown forward in a collision or hard stop could cause serious injury or death to occupants of the vehicle. Always securely stow removed head restraints in a location outside the occupant compartment.
- ALL the head restraints MUST be reinstalled in the vehicle to properly protect the occupants. Follow the reinstallation instructions above prior to operating the vehicle or occupying a seat.

Rear Removal

To remove the head restraint, raise it as far as it can go then push the release button and adjustment button at the base of each post while pulling the head restraint up. To reinstall the head restraint, put the head restraint posts into the holes and push downward. Then adjust it to the appropriate height.

UCONNECT VOICE RECOGNITION

INTRODUCING VOICE RECOGNITION

Start using Uconnect Voice Recognition with these helpful quick tips. It provides the key Voice Commands and tips you need to know to control your vehicle's Voice Recognition (VR) system.

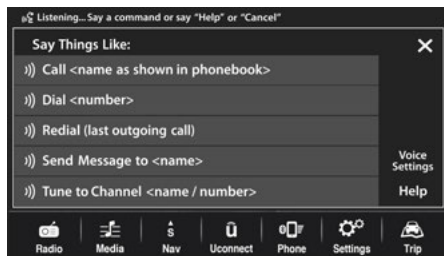

Uconnect 4/4 NAV With 7-inch Display

GET STARTED

The VR button is used to activate /deactivate your Voice Recognition system.

Helpful hints for using Voice Recognition:

- Reduce background noise. Wind noise and passenger conversations are examples of noise that may impact recognition.
- Speak clearly at a normal pace and volume while facing straight ahead.

- Each time you give a Voice Command, first push the VR button, wait until after the beep, then say your Voice Command.
- You can interrupt the help message or system prompts by pushing the VR button and saying a Voice Command from the current category.



Uconnect Voice Command Buttons

- 1 – Push To Start Or Answer A Phone Call And Send Or Receive A Text
- 2 – Push The Voice Recognition Button To Begin Radio, Media, And Climate Functions

BASIC VOICE COMMANDS

The basic Voice Commands below can be given at any point while using your Uconnect system.

Push the VR button (🎤). After the beep, say:

- **“Cancel”** to stop a current voice session.
- **“Help”** to hear a list of suggested Voice Commands.
- **“Repeat”** to listen to the system prompts again.

Notice the visual cues that inform you of your Voice Recognition system's status.

ADDITIONAL INFORMATION

© 2021 FCA US LLC. All rights reserved. Mopar and Uconnect are registered trademarks and Mopar Owner Connect is a trademark of FCA US LLC. Android™ is a trademark of Google Inc. SiriusXM® and all related marks and logos are trademarks of SiriusXM® Radio Inc. 📄 page 290.

For Uconnect system support, call 1-877-855-8400 (24 hours a day 7 days a week) or visit DriveUconnect.com (US) or DriveUconnect.ca (Canada).

MIRRORS

INSIDE REARVIEW MIRROR

Manual Mirror — If Equipped

The mirror can be adjusted up, down, left, and right. The mirror should be adjusted to center on the view through the rear window. Headlight glare from vehicles behind you can be reduced by moving the lever under the mirror to the night position (toward the rear of the vehicle). The mirror should be adjusted while the lever under the mirror is set in the day position (toward the windshield).

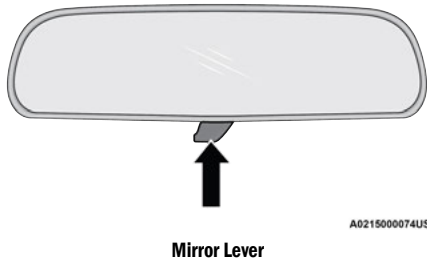

Automatic Dimming Mirror — If Equipped

This mirror automatically adjusts for headlight glare from vehicles behind you. You can turn the feature on or off by pushing the button at the base of the mirror. A light to the left of the button will illuminate to indicate when the dimming feature is activated. The sensor to the right of the button does not illuminate.

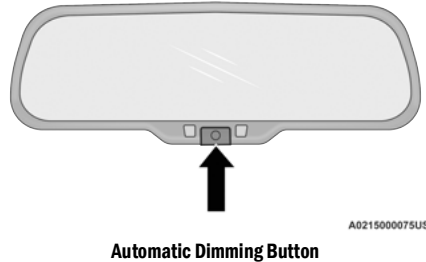

NOTE:

This feature is disabled when the vehicle is in REVERSE.

ILLUMINATED VANITY MIRRORS — IF EQUIPPED

An illuminated vanity mirror is located on each sun visor. To use the mirror, rotate the sun visor down and swing the mirror cover upward. The lights will turn on automatically. Closing the mirror cover will turn the light off.

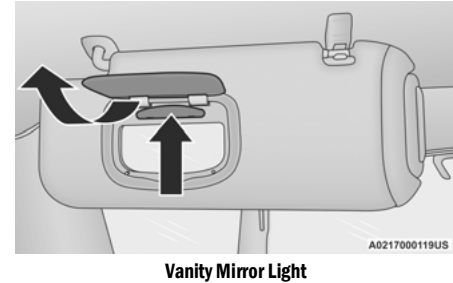

OUTSIDE MIRRORS

The outside mirror(s) can be adjusted to the center of the adjacent lane of traffic to achieve the optimal view.

WARNING!

Vehicles and other objects seen in an outside convex mirror will look smaller and farther away than they really are. Relying too much on side convex mirrors could cause you to collide with another vehicle or other object. Use your inside mirror when judging the size or distance of a vehicle seen in a side convex mirror.

POWER MIRRORS

The power mirror switch is located on the driver's door trim panel.

To adjust the mirror, rotate the mirror selection switch to the left or to the right and then push the mirror adjustment switch in the four directions indicated by arrows.

NOTE:

- To adjust the power mirrors, the ignition must be in the ON/RUN position.
- Once the mirror is adjusted, rotate the control to the neutral position to avoid accidental movements.
- The power mirror switches will remain active for up to three minutes after the ignition is placed in the OFF position. Opening either front door will cancel this feature.

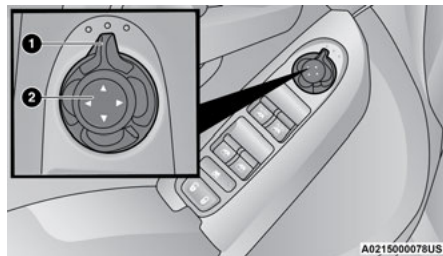

Power Mirror Switch

- 1 – Mirror Selector Switch
- 2 – Mirror Adjustment Switch

FOLDING MIRROR

The exterior mirrors are hinged to allow the mirror to pivot forward or rearward to help avoid damage. The mirror has three detent positions: full forward, normal and full rearward.

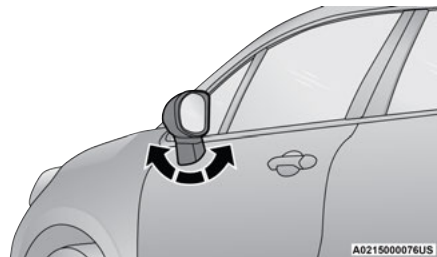

Folding Exterior Mirror

POWER FOLDING MIRRORS — IF EQUIPPED

If equipped, the outside mirrors can be folded using the power folding mirror switch, located on the driver's door trim panel. The power mirror switch will operate with the ignition in the ON/RUN position, and for three minutes after the ignition is placed in the OFF position. This feature will disable if either front door is opened.

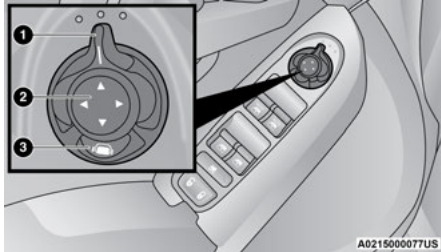

Power Folding Mirror Switch

- 1 — Mirror Selector Switch
- 2 — Mirror Adjustment Switch
- 3 — Power Folding Mirror Switch

To fold the outside mirrors, push the power folding mirror switch. Push the switch a second time to unfold the mirrors to the driving position. Any push of the power folding mirror switch will reverse the operation.



Power Folding Mirrors

NOTE:

The outside mirrors must always be in the unfolded position when the vehicle is in motion, except when driving through narrow locations.

Automatic Power Folding Mirrors

When the Automatic Fold Mirrors feature is enabled, the exterior mirrors will fold in when exiting the vehicle (the ignition is OFF, all doors are closed, and the doors are locked).

- If the exterior mirrors were auto-folded, they will unfold when the ignition is placed in the ON position or when the doors are unlocked.
- If the exterior mirrors were manually folded, they will not automatically unfold.

NOTE:

The Automatic Fold/Unfold Mirrors feature can be turned on and off using the Uconnect system ↪ page 120.

HEATED MIRRORS — IF EQUIPPED



These mirrors are heated to melt frost or ice. This feature will be activated whenever you turn on the rear window defroster (if equipped) ↪ page 42.

EXTERIOR LIGHTS

HEADLIGHT SWITCH

The headlight switch is located on the left side of the instrument panel. The headlight switch controls the operation of the headlights, parking lights, daytime running lights, fog lights and the dimming of the instrument cluster and interior lighting.

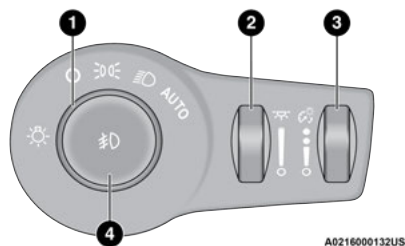

Headlight Switch

A0216000132US

- 1 – Rotate Headlight Control
- 2 – Ambient Lighting Control
- 3 – Instrument Panel Dimmer Control
- 4 – Front Fog Light Switch

Turning on the headlights will illuminate the instrument cluster and the controls located on the instrument panel.

NOTE:

On vehicles sold in Canada, both the rear position lights and Daytime Running Lights (DRLs) will turn on when the headlight switch is rotated to the O (off) position.

DAYTIME RUNNING LIGHTS (DRLs) — IF EQUIPPED

The Daytime Running Lights (DRLs), if enabled through Uconnect Settings, will turn on when the ignition is placed in the ON/RUN position and the park brake is not applied.

NOTE:

- For vehicles sold in Canada, the Daytime Running Lights will automatically deactivate when the front fog lights are turned on.
- On some vehicles, the Daytime Running Lights may deactivate, or reduce intensity, on one side of the vehicle (when a turn signal is activated on that side), or on both sides of the vehicle (when the hazard warning lights are activated).

HIGH BEAMS

To activate the high beam headlights, push the multifunction lever forward (toward the front of the vehicle), and an indicator will illuminate in the instrument cluster display.

To deactivate the high beam headlights, pull the multifunction lever rearward (toward the rear of the vehicle).

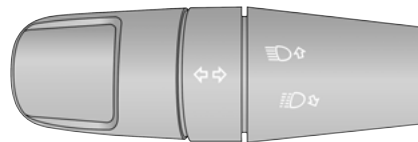

A0216000146US

High Beam And Turn Signal Controls

NOTE:

The headlights must be on for the high beams to activate.

FLASH-TO-PASS

You can signal another vehicle with your headlights by lightly pulling the multifunction lever toward you. This will cause the high beam headlights to turn on, and remain on, until the lever is released.

AUTOMATIC HEADLIGHTS — IF EQUIPPED

This system automatically turns the headlights on or off according to ambient light levels. To turn the system on, rotate the headlight switch clockwise to the last detent (AUTO position) for automatic headlight operation. To turn the automatic system off, move the headlight switch out of the AUTO position.

NOTE:

The ignition must be in the ON/RUN or START position before the headlights will come on in the automatic mode.

Light Sensor

The light sensor is equipped with an infrared LED, located on the windshield. It detects changes in light intensity outside the vehicle, based on the sensitivity of light set by using the Menu on the display or on the Uconnect system.

The higher the sensitivity, the lesser the amount of external light required for controlling the lighting.

PARKING LIGHTS

Rotate the headlight switch to the first position to turn on the parking lights. The parking light indicator in the cluster will illuminate.

HEADLIGHT TIME DELAY

This feature provides the safety of headlight illumination for up to 90 seconds when leaving your vehicle in an unlit area.

The time delay of the headlights is programmable between 0, 30, 60 and 90 seconds within Uconnect Settings ↗ page 120.

Headlight Delay Activation

To activate the delay feature, place the ignition in the OFF position while the headlights are still on. Then, turn off the headlights within two minutes.

The delay interval begins when the headlight switch is turned off.

Headlight Delay Deactivation

The feature is disabled by turning on the headlights, the parking lights or by placing the ignition in the ON/RUN position.

If you shut off the lights before the ignition is turned on, they will turn off in the normal manner.

NOTE:

The lights must be turned off within two minutes of placing the ignition in the OFF position to activate this feature.

FRONT FOG LIGHTS — IF EQUIPPED

The front fog light switch is built into the headlight switch.

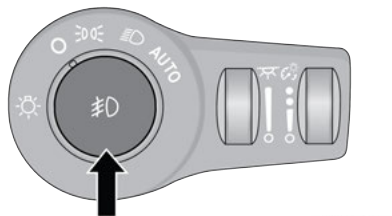

Front Fog Light Switch

To activate the front fog lights, turn on the parking lights or the low beam headlights and push the fog light button on the headlight switch. To turn off the front fog lights, push the headlight switch a second time or turn off the headlight switch.

An indicator light in the instrument cluster illuminates when the fog lights are turned on.

NOTE:

- The fog lights will operate with the low beam headlights or parking lights on. Selecting the high beam headlights will turn off the fog lights.
- The fog lights also function as cornering lights. Therefore there will be times when only one light is on.
- If the ignition is placed in the OFF position with the fog lights on, they will remain on when the ignition is placed back in the ON/RUN position.
- For vehicles sold in Canada, if the selector is moved to the parking lights position and the front fog lights are activated, the DRL will be deactivated and the front parking lights will be activated. Once the front fog lights are deactivated, the DRL will be activated again.

TURN SIGNALS

Move the multifunction lever up or down to activate the turn signals. The arrows on each side of the instrument cluster display flash to show proper operation.

LANE CHANGE ASSIST

Lightly push the multifunction lever up or down, without moving beyond the detent, and the turn signal will flash five times then automatically turn off.

COURTESY LIGHTS/APPROACHING LIGHTS

The courtesy lights feature allows you to activate the low beam, parking lights, and side marker lights for 25 seconds when the vehicle is unlocked. The courtesy lights feature can be activated or deactivated through the Uconnect Settings. When a door is open with the feature active, the activation of the lights is extended for 10 seconds. The feature is disabled when the vehicle is locked or when the ignition is placed in the ON/RUN position.

INTERIOR LIGHTS

FRONT COURTESY LIGHT

The courtesy lights will automatically turn on when the door is open or closed. The light switches in the overhead console are for reading lamps.

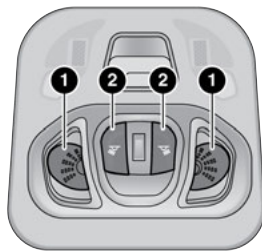

Front Courtesy/Reading Lights

A0217000117US

- 1 – Courtesy/Reading Lights
- 2 – Light Switches

Push the driver or passenger light switch to operate the reading lamps individually.

NOTE:

- Before exiting the vehicle, make sure that the interior lights are turned off. This will prevent the battery from discharging once the doors are closed.
- If a light is left on it will automatically be turned off after approximately 15 minutes after the ignition is in the OFF position.

Dome Light Timing

The dome light will automatically illuminate when the doors are unlocked, the doors are opened or after the doors are closed.

Timing Entering The Vehicle

The dome lights illuminate in the following ways:

- When the doors are unlocked, the dome light will illuminate for approximately 27 seconds.
- When one of the doors is opened, the dome light will illuminate for approximately three minutes.
- When the doors are closed, the dome light will automatically shut off after approximately 27 seconds.

NOTE:

The timing stops once the ignition is placed in the ON/RUN position.

The dome light will turn off under any of the following conditions:

- The dome light is disabled when the ignition is placed in the ON/RUN position.
- The dome lights will turn off automatically when the doors are locked.
- The dome lights will automatically turn off after approximately 15 minutes of inactivity to preserve the battery.

Timing Exiting The Vehicle

The dome light will illuminate under the following conditions when the ignition is placed in the OFF position:

- The dome light will illuminate for 27 seconds after the key is removed from the vehicle.
- The opening of one of the doors (approximately three minutes).
- After closing a door (approximately 27 seconds).

The dome light timing is disabled when the doors are locked.

Dimmer Controls

Rotate the ambient dimmer control upward or downward to increase or decrease the brightness of the ambient light located in the overhead console, lower instrument panel lights, and cubby bin lights.

With the parking lights or headlights on, rotate the instrument panel dimmer control upward or downward to increase or decrease the brightness of the instrument panel. At the top detent of the instrument panel dimmer, all the interior lights will also illuminate. At the bottom most setting of the thumb wheel, all the interior lights will be turned to their lowest dimmable setting.

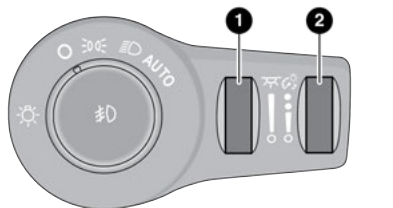

A0217000120US

Headlight Switch

- 1 – Ambient Light Control (If Equipped)
- 2 – Instrument Panel Dimmer

Rear Dome Light – If Equipped

Push the switch on the rear dome light once to turn the light on, the light will remain on at all times. Push the switch a second time to turn the light off, the light will remain off until a door is opened.

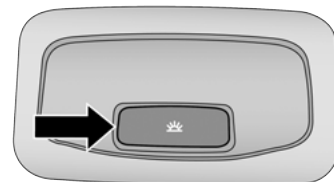

A0217000118US

Rear Dome Light On/Off Switch

Retractable Roof Lights

For vehicles equipped with a retractable roof, there are two interior lights located below the grab handles of the rear doors.

The lights come on by opening any of the doors.

CARGO AREA LIGHTS

An interior light is located on the left side panel in the cargo area.

This light automatically turns on/off when the liftgate is opened and closed, regardless of the position of the ignition.

NOTE:

In order to preserve the life of the battery, the light will turn off after 15 minutes.

WINDSHIELD WIPERS AND WASHERS

The windshield wiper/washer controls are located on the lever on the right side of the steering column. The front wipers are operated by rotating a switch, located on the end of the lever.



A0218000035US

Windshield Wiper Lever

CAUTION!

Always remove any buildup of snow that prevents the windshield wiper blades from returning to the “park” position. If the windshield wiper switch is turned off, and the blades cannot return to the “park” position, damage to the wiper motor may occur.

WINDSHIELD WIPER OPERATION

Rotate the windshield wiper knob to one of the first two detent positions for intermittent settings, the third detent for low wiper operation and the fourth for high wiper operation.

Windshield Washers

To use the washer, pull the lever toward you and hold. If the lever is pulled while in the intermittent setting, the wipers will turn on and operate for several wipe cycles after the lever is released, and then resume the intermittent interval previously selected.

If the lever is pulled while the wipers are in the off position, the wipers will operate for several wipe cycles, then turn off.

WARNING!

Sudden loss of visibility through the windshield could lead to a collision. You might not see other vehicles or other obstacles. To avoid sudden icing of the windshield during freezing weather, warm the windshield with the defroster before and during windshield washer use.

Mist

Push the lever upward to the Mist position and release for a single wiping cycle.

NOTE:

The Mist feature does not activate the washer pump; therefore, no washer fluid will be sprayed on the windshield. The wash function must be used in order to spray the windshield with washer fluid.

For information on wiper care and replacement, see ↻ page 240.

RAIN SENSING WIPERS — IF EQUIPPED

This feature senses moisture on the windshield and automatically activates the wipers. Rotate the end of the multifunction lever to one of two detent positions for intermittent settings to activate this feature.

NOTE:

If the end of the multifunction lever rotates from the 0 (off) position to the first intermittent setting or from the first intermittent setting to the second intermittent setting, the wipers will perform a round up to clean the windshield.

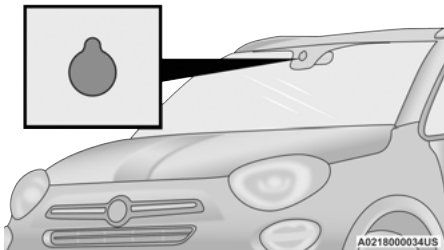

Rain Sensor Location

The sensitivity of the system can be adjusted with the multifunction lever. Wiper delay position one is the least sensitive, and wiper delay position two is the most sensitive. Place the wiper switch in the 0 (off) position when not using the system.

NOTE:

- The Rain Sensing feature will not operate when the wiper switch is in the low or high-speed position.
- The Rain Sensing feature may not function properly when ice or dried salt water is present on the windshield.
- Use of Rain-X or products containing wax or silicone may reduce Rain Sensing performance.
- The Rain Sensing feature can be turned on and off through Uconnect Settings → page 120.

The Rain Sensing system has protection features for the wiper blades and arms, and will not operate under the following conditions:

- **Low Ambient Temperature** — When the ignition is first placed in the ON/RUN position, the Rain Sensing system will not operate until the wiper switch is moved, vehicle speed is greater than 0 mph (0 km/h), or the outside temperature is greater than 32 °F (0 °C).
- **Transmission In NEUTRAL Position** — When the ignition is in the ON/RUN position, and the automatic transmission is in the NEUTRAL position, the Rain Sensing system will not operate until the wiper switch is moved, vehicle speed is greater than 3 mph (5 km/h), or the gear selector is moved out of the NEUTRAL position.
- **Remote Start Mode Inhibit** — On vehicles equipped with the Remote Start system, Rain Sensing wipers are not operational when the vehicle is in the Remote Start mode. Once the operator is in the vehicle and has placed the ignition switch in the ON/RUN position, rain sensing wiper operation can resume, if it has been selected, and no other inhibit conditions exist.
- **Rain Sensing Wipers — Inhibition** — When the user changes the ignition position from OFF to ON/RUN with the windshield wiper lever already in the intermittent position, no wipe cycle is performed for safety reasons. This temporary

inhibition avoids accidental activations of the wiping (e.g. during the hand washing of the windshield, blocking the blades in ice/snow conditions).

The user can activate the Rain Sensing Wipers in three ways:

- Moving the lever from the 0 (off) position to the intermittent positions.
- One Mist command actuation.
- The vehicle speed exceeds 3 mph (5 km/h) and the rain sensor detects the presence of rain.

REAR WINDOW WIPER/WASHER

The rear wiper/washer controls are located on the windshield wiper lever on the right side of the steering column. The rear wiper/washer is operated by rotating a switch, located at the middle of the lever.

NOTE:

If the front wiper is moving and the vehicle is shifted in REVERSE, the rear wiper will perform one round up to clean the rear window.



Rotate the center portion of the lever upward to the first detent for intermittent operation and to the second detent for continuous rear wiper operation.



To use the washer, push the lever forward and hold while spray is desired. If the lever is pushed while in the intermittent setting, the wiper will turn on and operate for several wipe cycles after the end of the lever is released, and then resume the intermittent interval previously selected.

NOTE:

As a protective measure, the pump will stop if the switch is held for more than 30 seconds. Once the lever is released, the pump will resume normal operation.

If the lever is pushed while the wiper is in the off position, the wiper will operate for several wipe cycles, then turn off.

If the rear wiper is operating when the ignition is placed in the OFF position, the wiper will automatically return to the “park” position.

CAUTION!

Failure to follow these cautions can cause damage to the heating elements:

- Use care when washing the inside of the rear window. Do not use abrasive window cleaners on the interior surface of the window. Use a soft cloth and a mild washing solution, wiping parallel to the heating elements. Labels can be peeled off after soaking with warm water.

(Continued)

CAUTION!

- Do not use scrapers, sharp instruments, or abrasive window cleaners on the interior surface of the window.
- Keep all objects a safe distance from the window.

WINDSHIELD WIPER DE-ICER — IF EQUIPPED

Your vehicle may be equipped with a Windshield Wiper De-Icer feature that may be activated under the following conditions:

- **Activation By Rear Defrost** — The Windshield Wiper De-Icer will be activated automatically when the rear defrost is turned on and the ambient temperature is below 40 °F (4.4 °C).
- **Activation By Remote Start Operation** — When Remote Start is active and the outside ambient temperature is less than 40 °F (4.4 °C), the Windshield Wiper De-Icer will be enabled. Exiting Remote Start will resume its previous operation. If the Windshield Wiper De-Icer was active, the timer and operation will continue.

CLIMATE CONTROLS

The Climate Control system allows you to regulate the temperature, air flow, and direction of air

circulating throughout the vehicle. The controls are located on the touchscreen (if equipped) and on the instrument panel below the radio.

AUTOMATIC CLIMATE CONTROL DESCRIPTIONS AND FUNCTIONS

Automatic Climate Controls

MAX A/C Setting

MAX A/C sets the system for maximum cooling performance. Rotate the driver temperature control adjust knob counterclockwise for MAX A/C. Both driver and passenger temperature displays will show MAX A/C LO. In MAX A/C, the blower speed and mode position can be adjusted to desired user settings. Pressing other settings will cause the MAX A/C operation to switch to the selected setting and MAX A/C to exit.

A/C Button



Push the A/C Control Button to change the current setting. The A/C indicator illuminates when A/C is on. Pushing the AUTO control button will cause the A/C operation to change to AUTO mode and the A/C indicator will turn off.

The Air Conditioning (A/C) button allows the operator to manually activate or deactivate the air conditioning system. When the air conditioning system is turned on, cool dehumidified air will flow through the outlets into the cabin. For improved fuel economy, press the A/C button to turn off the air conditioning and manually adjust the blower and airflow mode settings. Also, make sure to select only Panel, Bi-Level, or Floor modes.

NOTE:

If your air conditioning performance seems lower than expected, check the front of the A/C condenser (located in front of the radiator), for an accumulation of dirt or insects. Clean with a gentle water spray from the front of the radiator and through the condenser.

SYNC Button



Push the Sync button to toggle the Sync feature on/off. The Sync indicator illuminates when Sync is on. Sync synchronizes the passenger temperature setting with the driver temperature setting.

Changing the passenger temperature setting while in Sync mode will automatically exit this feature and return to the separate management of air temperatures in the two zones.

Recirculation Button



Press and release this button to change the system between Recirculation mode and outside air mode. The Recirculation indicator illuminates when Recirculation is on. Recirculation can be used when outside conditions such as smoke, odors, dust, or high humidity are present. Recirculation can be used in all modes. Recirculation may be unavailable if conditions exist that could create fogging on the inside of the windshield. Continuous use of the Recirculation mode may make the inside air stuffy and window fogging may occur. Extended use of this mode is not recommended.

In cold weather, use of Recirculation mode may lead to excessive window fogging. The Recirculation feature may be unavailable if conditions exist that could create fogging on the inside of the windshield.

AUTO Button



Set your desired temperature and press AUTO. AUTO will achieve and maintain your desired temperature by automatically adjusting the blower speed and air distribution. AUTO mode is highly

recommended for efficiency. Push the button on the faceplate to turn AUTO on. The AUTO indicator illuminates when AUTO is on. Toggling this function will cause the system to switch between manual mode and automatic mode ↪ page 47.

MAX Defrost Button



Push the MAX Defrost button to change the current airflow setting to Defrost mode. The MAX Defrost indicator illuminates when MAX Defrost is on.

Performing this function will cause the automatic climate controls to change to manual mode. The blower speed increases to full (all LEDs on) when MAX Defrost mode is selected, the air conditioning compressor is turned on (LED on), both driver and passenger temperature controls are set to (HI), defrost mode is selected (LED on), rear defroster is turned on (LED on) and the air recirculation is turned off (LED off). If the MAX Defrost mode is turned off, the climate system will return to the previous setting.

Rear Defrost Button



Push the Rear Defrost button to turn on the rear window defroster and the heated outside mirrors (if equipped). The Rear Defrost indicator illuminates when the rear window defroster is on. The rear window defroster automatically turns off after 20 minutes.

CAUTION!

Failure to follow these cautions can cause damage to the heating elements:

- Use care when washing the inside of the rear window. Do not use abrasive window cleaners on the interior surface of the window. Use a soft cloth and a mild washing solution, wiping parallel to the heating elements. Labels can be peeled off after soaking with warm water.
- Do not use scrapers, sharp instruments, or abrasive window cleaners on the interior surface of the window.
- Keep all objects a safe distance from the window.

Driver And Passenger Temperature Knobs

The passenger temperature knob provides the passenger with independent temperature control. The driver temperature knob provides the driver with independent temperature control. Rotate the adjustment knob to set the desired temperature.



Rotating the temperature knob clockwise increases the temperature.



Rotating the temperature knob counterclockwise decreases the temperature.

The set temperature is shown on the display.

Turning the temperature knob completely in one direction or the other activates the HI (maximum heating) or LO (maximum cooling) functions shown in the display, respectively. Rotate the driver temperature knob fully counterclockwise for maximum A/C (LO).

To deactivate these functions, turn the temperature knob to the desired temperature.

NOTE:

Rotating the passenger temperature control knob while in Sync mode will automatically exit Sync.

Blower Control Knob

Blower Control is used to regulate the amount of air forced through the Climate Control system. Adjusting the blower will cause automatic mode to switch to manual operation. The speeds can be selected by rotating the Blower Control adjustment knob.

Mode Control

Select Mode by pressing one of the Mode buttons to change the airflow distribution mode. The airflow distribution mode can be adjusted so air comes from the instrument panel outlets, floor outlets, defrost outlets and demist outlets.

Front Defrost Button

Push and release the button on the faceplate to change the current airflow setting to Defrost mode. The Front Defrost indicator illuminates when Front Defrost is on. Air comes from the windshield and side window demist outlets. When the defrost button is selected, the blower level may increase. Use Defrost mode with maximum temperature settings for best windshield and side window defrosting and defogging. When toggling the front defrost mode button, the Climate Control system will return to the previous setting.

Panel Mode

Air comes from the outlets in the instrument panel. Each of these outlets can be individually adjusted to direct the flow of air. The air vanes of the center outlets and outboard outlets can be moved up and down or side to side to regulate airflow direction. There is a shut-off wheel located below the air vanes to shut off or adjust the amount of airflow from these outlets.

Floor Mode

Air comes from the floor outlets. A slight amount of air is directed through the defrost and side window demister outlets.

Bi-Level Mode



Bi-Level Mode is obtained by pressing both the Panel Mode button and the Floor Mode button, activating them both. Air comes from the instrument panel outlets and floor outlets. A slight amount of air is directed through the defrost and side window demister outlets.

NOTE:

Bi-Level Mode is designed under comfort conditions to provide cooler air out of the panel outlets and warmer air from the floor outlets.

Mix Mode



Mix Mode is obtained by pressing both the Windshield Mode button and the Floor Mode button, activating them both. Air is directed through the floor, defrost, and side window demister outlets. This setting works best in cold or snowy conditions that require extra heat to the windshield. This setting is good for maintaining comfort while reducing moisture on the windshield.

Hi-Level Mode



Hi-Level Mode is obtained by pushing the Defrost Mode button and the Panel Mode button. Air comes from the instrument panel outlets and the defrost outlets. A

slight amount of air is directed through the side window demister outlets.

Tri-Level Mode



Tri-Level Mode is obtained by pressing the Defrost Mode button, the Panel Mode button, and the Floor Mode button. Air comes from the instrument panel outlets, the defrost outlets, and floor outlets. A slight amount of air is directed through the side window demister outlets.

Climate Control Power Button



Press and release the Climate Control Power button to turn the Climate Control on/off.

MANUAL CLIMATE CONTROL DESCRIPTIONS AND FUNCTIONS

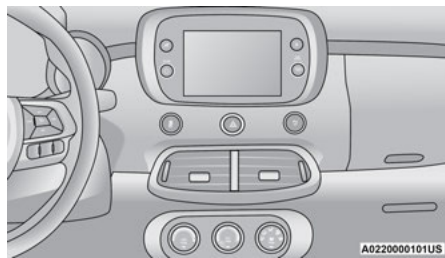

Manual Climate Controls

MAX A/C Setting



Set the temperature control knob to the MAX A/C setting to change the current setting to the coldest output of air. Moving the temperature control knob away from the MAX A/C setting causes the MAX A/C operation to exit.

A/C Button



Push the A/C button to engage the Air Conditioning (A/C). The A/C indicator illuminates when A/C is on.

NOTE:

- For Manual Climate Controls, if the system is in Mix, Floor or Defrost Mode, the A/C can be turned off, but the A/C system shall remain active to prevent fogging of the windows.
- If fog or mist appears on the windshield or side glass, select Defrost mode, and increase blower speed if needed.
- If your air conditioning performance seems lower than expected, check the front of the A/C condenser (located in front of the radiator), for an accumulation of dirt or insects. Clean with a gentle water spray from the front of the radiator and through the condenser.

Recirculation Button



Push the Recirculation button to change the system between recirculation mode and outside air mode. The Recirculation indicator and the A/C indicator illuminate when the Recirculation button is pressed. Recirculation can be used when outside conditions, such as smoke, odors, dust, or humidity are present. Recirculation can be used in all modes except for Defrost. Recirculation may be unavailable if conditions exist that could create fogging on the inside of the windshield. The A/C can be deselected manually without disturbing the mode control selection. Continuous use of the Recirculation mode may make the inside air stuffy and window fogging may occur. Extended use of this mode is not recommended.

On systems with Manual Climate Controls, if equipped, the Recirculation mode is not allowed in Defrost mode to improve window clearing operation. Recirculation is disabled automatically if this mode is selected. Attempting to use Recirculation while in this mode causes the LED in the control button to blink and then turns off.

Front Defrost Setting



Turn the mode control knob to the Front Defrost mode setting. Air comes from the windshield and side window demist outlets. When the defrost button is selected, the blower level may increase. Use

Defrost mode with maximum temperature settings for best windshield and side window defrosting and defogging.

Rear Defrost Button



Push and release the Rear Defrost Control button to turn on the rear window defroster and the heated outside mirrors (if equipped). The Rear Defrost indicator illuminates when the rear window defroster is on. The rear window defroster automatically turns off after 20 minutes.

CAUTION!

Failure to follow these cautions can cause damage to the heating elements:

- Use care when washing the inside of the rear window. Do not use abrasive window cleaners on the interior surface of the window. Use a soft cloth and a mild washing solution, wiping parallel to the heating elements. Labels can be peeled off after soaking with warm water.
- Do not use scrapers, sharp instruments, or abrasive window cleaners on the interior surface of the window.
- Keep all objects a safe distance from the window.

Temperature Control

Temperature Control regulates the temperature of the air forced through the climate system.



The temperature increases as you turn the temperature control knob clockwise.



The temperature decreases as you turn the temperature control knob counterclockwise.

Blower Control



Blower Control regulates the amount of air forced through the climate control system. There are seven blower speeds available. The blower speed increases as you turn the blower control knob clockwise from the lowest blower setting. The blower speed decreases as you turn the blower control knob counterclockwise.

Mode Control



Turn the mode control knob to adjust airflow distribution. The airflow distribution mode can be adjusted so air comes from the instrument panel outlets, floor outlets, defrost outlets and demist outlets.

Panel Mode



Air comes from the outlets in the instrument panel. Each of these outlets can be individually adjusted to direct the flow of air. The air vanes of the center outlets and outboard outlets can be moved up and down or side to side to regulate airflow direction. There is a shut-off wheel located below the air vanes to shut off or adjust the amount of airflow from these outlets.

Bi-Level Mode



Air comes from the instrument panel outlets and floor outlets. A slight amount of air is directed through the defrost and side window demister outlets.

NOTE:

Bi-Level mode is designed under comfort conditions to provide cooler air out of the panel outlets and warmer air from the floor outlets.

Floor Mode



Air comes from the floor outlets. A slight amount of air is directed through the defrost and side window demister outlets.

Mix Mode



Air comes from the floor, defrost, and side window demister outlets. This setting works best in cold or snowy conditions that require extra heat to the windshield. This setting is good for maintaining comfort while reducing moisture on the windshield.

Climate Control OFF



To turn the Climate Controls off, turn the blower control knob to the OFF (O) position.

AUTOMATIC TEMPERATURE CONTROL (ATC)

Automatic Operation

1. Push the AUTO button on the front ATC panel and the word "AUTO" will illuminate in the front ATC display, along with two temperatures for the driver and front passenger. The system will then automatically regulate the amount of airflow.
2. Adjust the temperature you would like the system to maintain, by adjusting the driver, and passenger temperatures. Once the

desired temperature is displayed, the system will achieve and automatically maintain that comfort level.

3. When the system is set up for your comfort level, it is not necessary to change the settings. You will experience the greatest efficiency by simply allowing the system to function automatically.

NOTE:

It is not necessary to move the temperature settings. The system automatically adjusts the temperature, mode, and fan speed to provide comfort as quickly as possible.

To provide you with maximum comfort in the automatic mode, during cold start-ups, the blower fan will remain on low until the engine warms up. The fan will engage immediately if the Defrost mode is selected, or by changing the front blower knob setting.

Manual Operation Override

This system offers a full complement of manual override features. The AUTO symbol in the front ATC display will be turned off when the system is being used in the manual mode.

CLIMATE VOICE RECOGNITION

Adjust vehicle temperatures hands-free and keep everyone comfortable while you keep moving ahead. (If vehicle is equipped with climate control.)

Push the VR button . After the beep, say one of the following commands:

- “Set the driver temperature to 70 degrees”
- “Set the passenger temperature to 70 degrees”

Did You Know: Voice Command for Climate may only be used to adjust the interior temperature of your vehicle. Voice Command will not work to adjust the heated seats or steering wheel if equipped.

OPERATING TIPS

NOTE:

Refer to the chart at the end of this section for suggested control settings for various weather conditions.

Summer Operation

The engine cooling system must be protected with a high-quality antifreeze coolant to provide proper corrosion protection and to protect against engine overheating. OAT coolant (conforming to MS.90032) is recommended.

Winter Operation

To ensure the best possible heater and defroster performance, make sure the engine cooling system is functioning properly and the proper amount, type, and concentration of coolant is used. Use of the Air Recirculation mode during Winter months is not recommended, because it may cause window fogging.

Vacation/Storage

For information on maintaining the Climate Control system when the vehicle is being stored for an extended period of time, see  page 279.

Window Fogging

Vehicle windows tend to fog on the inside in mild, rainy, and/or humid weather. To clear the windows, select Defrost or Mix mode and increase the front blower speed. Do not use the Recirculation mode without A/C for long periods, as fogging may occur.

Outside Air Intake

Make sure the air intake, located directly in front of the windshield, is free of obstructions, such as leaves. Leaves collected in the air intake may reduce airflow, and if they enter the air distribution box, they could plug the water drains. In Winter months, make sure the air intake is clear of ice, slush, and snow.

Cabin Air Filter

The Climate Control system filters out dust and pollen from the air. Contact an authorized dealer to service your cabin air filter, and to have it replaced when needed.

System Maintenance

In Winter, the Climate Control system must be turned on at least once a month for approximately 10 minutes.

Have the system inspected at an authorized dealer before the summer.

NOTE:

The system uses R-1234yf (refrigerant) which does not pollute the environment in the event of accidental leakage. Under no circumstances is the use of R-134a (refrigerant) allowed.

Rapid Window Demisting (MAX-Defrost Function)

Push the MAX-defrost button to activate (LED on) the windshield and side window demisting function.

The Climate Control system carries out the following operations:

- Turns on the air conditioning compressor when environmental conditions are suitable
- Turns air recirculation off

- Sets blower fan to the maximum speed and displays the fan speed (Blower Control Indicator LED illuminated)
- Directs air flow to windshield and front side window diffusers
- Activates the heated rear window defrost
- Activates the heated windshield (if equipped)

When the function is activated, the AUTO button LED turns off. With the function activated, the only possible manual adjustments are pushing the A/C control button, adjusting the fan speed and turning the heated rear window off.

When the Recirculation Control or AUTO buttons are pushed, the Climate Control system will deactivate the Front Defrost (MAX-DEF) function.

Selecting the footwell/windshield or only windshield distribution activates the Climate Control system compressor and the air recirculation is set to outside air intake.

This logic guarantees optimum visibility at the windows. Max-defrost is also available in manual mode.

Climate Control System Compressor

Push the A/C Control button to activate/deactivate the compressor (activation is indicated by the LED on the button turning on).







The system remembers that the compressor has been turned off, even after the engine has stopped.

Pushing the A/C button will stop AUTO mode (AUTO LED will turn off). To restore automatic control of compressor, push the AUTO button again.

NOTE:

With the compressor off, air cannot be introduced to the passenger compartment with a temperature lower than the outside temperature. Under certain environmental conditions, windows could fog rapidly since the air is not dehumidified.

Operating Tips Chart

WEATHER	CONTROL SETTINGS
Hot Weather And Vehicle Interior Is Very Hot	Set the mode control to  (Panel Mode), ^{MAX} (MAX A/C) on, and blower on high. Roll down the windows for a minute to flush out the hot air. Adjust the controls as needed to achieve comfort.
Warm Weather	Turn ^{A/C} (A/C) on and set the mode control to  (Panel Mode).
Cool Sunny	Operate in  (Bi-Level Mode).
Cool & Humid Conditions	Set the mode control to  (Mix Mode) and turn ^{A/C} (A/C) on to keep windows clear.
Cold Weather	Set the mode control to  (Floor Mode). If windshield fogging starts to occur, move the control to  (Mix Mode).

INTERIOR STORAGE AND EQUIPMENT

STORAGE

Glove Compartments

The glove compartments are located on the passenger side of the instrument panel.

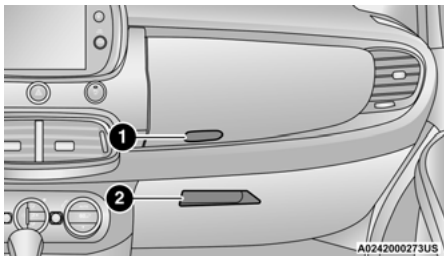

Glove Compartments

- 1 – Upper Glove Compartment Release Button
2 – Lower Glove Compartment Release Handle

To open the upper compartment, push in the button located on the bottom side of the upper door. The door will automatically open.

To close the upper compartment, push downward on the door's surface to latch the door closed.

To open the lower glove compartment, pull outward on the latch and lower the glove compartment door.

NOTE:

- Do not insert objects in the glove compartments that will not allow the compartment to fully close.
- The glove compartments should be completely closed while the vehicle is in motion.

Front Armrest

The front armrest is located between the front seats.

If your vehicle is equipped with an adjustable armrest, the armrest can be adjusted by moving it in the direction indicated by the arrows.

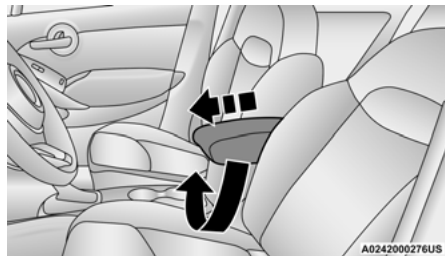

Front Armrest Handle

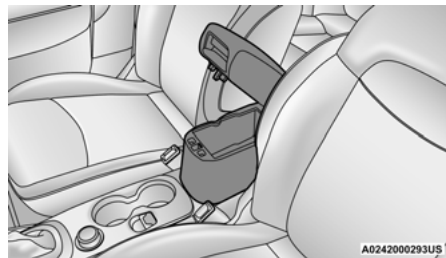

Storage Compartment

Push the storage handle and lift up the armrest to access the storage compartment.

WARNING!

Do not operate this vehicle with a console compartment lid in the open position. Driving with the console compartment lid open may result in injury in a collision.

SUN VISORS “SLIDE-ON-ROD”

Sun visors are located on both sides of the rearview mirror. The visors can be lowered or moved to the side to help block sunlight from entering the windshield or door glass.

To move the sun visor against the driver or passenger door glass, remove the sun visor from the hook and turn it toward the side window.

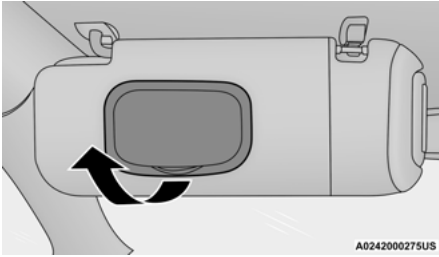
**Sun Visor Mirror Cover**

The visors also have illuminated vanity mirrors to allow use in low light conditions.

Lift upward on the mirror cover to access the mirror.

Extendible Sun Visor

To extend the sun visor, proceed as follows:

1. Place the sun visor against the door glass by detaching it from the hook and turning it toward the side window.
2. Slide the visor.
3. Slide out the sun visor extender.

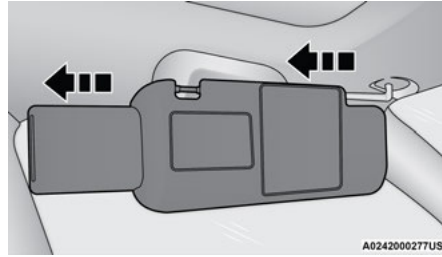
**Fully Extended Sun Visor**

USB/MEDIA PLAYER CONTROL

Located below the heating ventilation and air conditioning controls is the front USB ports.

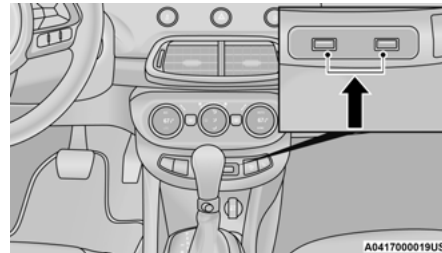
**Front USB Ports**

This feature allows an external device to be plugged into the USB port.

Rear Center Console USB Port

A third, charge only USB port is located on the back of the center console.

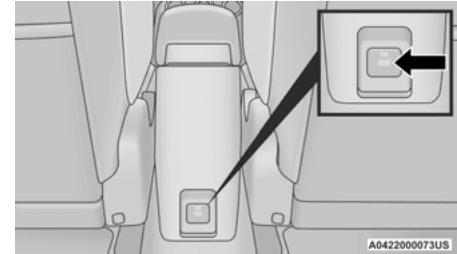
**Rear Center Console USB Port – If Equipped**

NOTE:

Depending on vehicle configuration, the USB port may be charge only or media file capable.

POWER OUTLETS

There is one 12 Volt (13 Amp) power outlet in this vehicle, located under the climate controls. This power outlet can power mobile phones, electronics and other low power devices.

This power outlet is located in front of the gear selector.

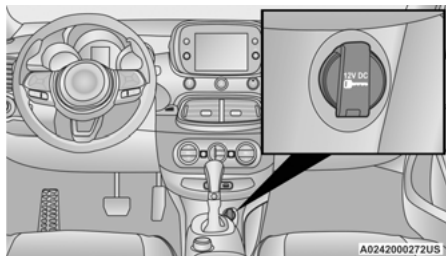
**12 Volt Power Outlet****NOTE:**

The power outlet can be changed to “battery” powered at all times by switching the power outlet Engine Compartment Fuses/Distribution Unit fuse from location F84 to F23.

NOTE:

- Do not exceed the maximum power of 160 Watts (13 Amps) at 12 Volts. If the 160 Watt (13 Amp) power rating is exceeded, the fuse protecting the system will need to be replaced.
- Power outlets are designed for accessory plugs only. Do not insert any other object in the power outlet as this will damage the outlet and blow the fuse. Improper use of the power outlet can cause damage not covered by your new vehicle warranty.

Power Outlet Fuse Location:

F84 Fuse 20A Yellow Instrument Panel Power Outlet.

CIGAR LIGHTER — IF EQUIPPED

The cigar lighter is located on the instrument panel, below the climate controls. To activate the cigar lighter, push and release the knob. After a few seconds the knob automatically returns to its initial position, and the cigar lighter is ready for use.

WARNING!

When the cigar lighter is in use it becomes very hot. To avoid serious injury, handle the cigar lighter with care. Always check that the cigar lighter has turned off.

NOTE:

- Always check that the cigar lighter is switched off.
- Do not connect devices with power higher than 180 W to the socket. Do not damage the socket by using unsuitable adapters.

ASHTRAY — IF EQUIPPED**NOTE:**

Ashtrays can be purchased at an authorized dealer through Mopar® parts.

The ashtray is a plastic container that can be placed into one of the cup holders.

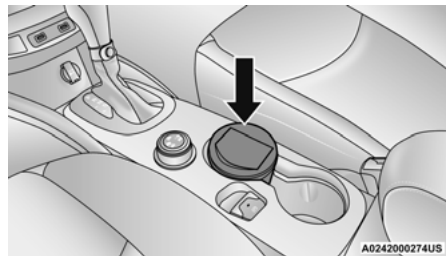
**Ashtray Location**

GRAB HANDLES

The grab handles are located immediately above the doors. The rear handles are equipped with hooks for dress hangers.

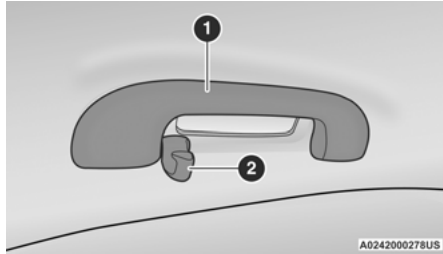

Rear Grab Handle Assembly

- 1 – Grab Handle
- 2 – Hook

WINDOWS

POWER WINDOW CONTROLS

The window controls on the driver's door control all the door windows.

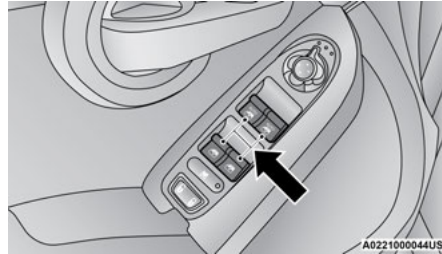

Power Window Switches

The passenger door windows can also be operated by using the single window controls on the passenger door trim panel. The window controls will operate only when the ignition is in the ON/RUN position.

NOTE:

The power window switches will remain active for up to three minutes after the ignition is placed in the OFF position. Opening either front door will cancel this feature.

WARNING!

Never leave children unattended in a vehicle, and do not let children play with power windows. Do not leave the key fob in or near the vehicle, or in a location accessible to children, and do not leave the Keyless Enter 'n Go™ Ignition in the ON/RUN position. Occupants, particularly unattended children, can become entrapped by the windows while operating the power window switches. Such entrapment may result in serious injury or death.

2

Automatic Window Features

Auto-Down Feature

The driver and front passenger door power window switches have an Auto-Down feature. Push the window switch down for a short period of time, then release, and the window will go down automatically.

To stop the window from going all the way down during the Auto-Down operation, pull up or push down on the switch briefly when the window has reached the desired position.

Auto-Up Feature With Anti-Pinch Protection

Lift the window switch up for a short period of time and release; the window will go up automatically.

To stop the window from going all the way up during the Auto-Up operation, pull up or push down on the switch briefly.

To close the window part way, lift the window switch briefly and release it when you want the window to stop.

If the window runs into any obstacle during auto-closure, it will reverse direction and then go back down. Remove the obstacle and use the window switch again to close the window.

NOTE:

Any impact due to rough road conditions may trigger the auto-reverse function unexpectedly during auto-closure. If this happens, pull the switch lightly and hold to close the window manually.

WARNING!

There is no auto-reverse protection when the window is almost closed. To avoid personal injury be sure to clear your arms, hands, fingers and all objects from the window path before closing.

Reset Auto-Up

Should the Auto-Up feature be interrupted and stop working, the feature will need to be reset. To reset Auto-Up:

1. Pull the window switch up to close the window completely and continue to hold the switch up for an additional two seconds after the window is closed.
2. Push the window switch down firmly to open the window completely and continue to hold the switch down for an additional two seconds after the window is fully open.

NOTE:

All doors must be closed before beginning the Auto-Up reset procedure.

Window Lockout Switch

The window lockout switch on the driver's door trim panel allows you to disable the window controls on the rear passenger doors. To disable the window controls, push and release the window lockout button (the indicator light on the switch will turn on). To enable the window controls, push and release the window lockout switch again (the indicator light on the switch will turn off).

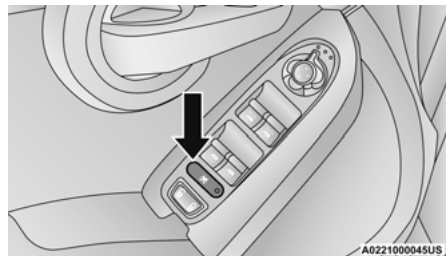

Window Lockout Switch

Wind Buffeting

Wind buffeting can be described as the perception of pressure on the ears or a helicopter-type sound in the ears. Your vehicle may exhibit wind buffeting with the windows down, or the sunroof (if equipped) in certain open or partially open positions. This is a normal occurrence and can be minimized. If the buffeting occurs with the rear windows open, open the front and rear windows together to minimize the buffeting. If the buffeting occurs with the sunroof open, adjust the sunroof opening to minimize the buffeting or open any window.

SUNROOF — IF EQUIPPED

The sunroof has two glass panels (the front one is operational and the rear one fixed) and is equipped with two manual operated sunshades, front and rear.

The power sunroof can be operated only when the ignition is placed in ON/RUN.

The power sunroof switches are located in the overhead console.

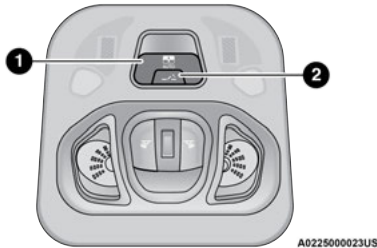

Operation Switch

- 1 — Front Panel Open/Close Switch
2 — Front Panel Vent Switch

WARNING!

- Never leave children alone in a vehicle, or with access to an unlocked vehicle. Never leave the key fob in or near the vehicle or in a location accessible to children. Occupants, particularly unattended children, can become entrapped by the power sunroof while operating the power sunroof switch. Such entrapment may result in serious injury or death.
- In a collision, there is greater risk of being thrown from a vehicle with an open sunroof. You could also be seriously injured or killed. Always fasten your seat belt properly and make sure all passengers are properly secured too.
- Do not allow small children to operate the sunroof. Never allow your fingers, other body parts, or any object to project through the sunroof opening. Injury may result.

OPENING AND CLOSING THE SUNROOF

To retract the front panel to the open position, push the open/close switch and the sunroof will fully open. The sunroof can be stopped in any position by pushing the switch a second time while is opening.

To close the front panel completely, pull the open/close switch from the open position. The sunroof can be stopped in any position by pulling the sunroof switch a second time while it is closing.

PINCH PROTECT FEATURE

This feature will detect an obstruction in the opening of the sunroof during Express Close operation. If an obstruction in the path of the sunroof is detected, the sunroof will automatically retract. Remove the obstruction if this occurs.

VENTING SUNROOF

To vent the sunroof, push the vent switch.

NOTE:

The vent switch has the automatic function only at the opening of the sunroof. During the closing of the sunroof, the switch must be held until closed.

SUN SHADE

The two sun shades are manually operated and can be adjusted in any position.

SUNROOF MAINTENANCE

Use only a non-abrasive cleaner and a soft cloth to clean the glass panel. Periodically check for and clear out any debris that may have collected in the tracks.

EMERGENCY OPERATION

If the power sunroof switch fails, the sunroof can be operated manually as follows:

1. Remove the protective cap located on the inner lining.
2. Remove the Allen Key that is supplied in the tool bag in the cargo area.
3. Insert the Allen Key into the key hole and turn it clockwise to open the roof or counter-clockwise to close.

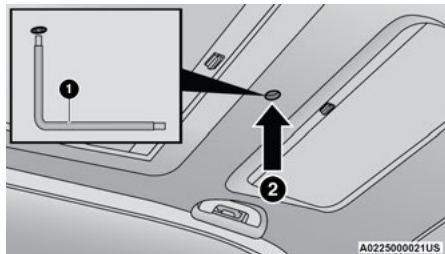

Emergency Key And Key Hole

- 1 – Allen Key
2 – Key Hole

CAUTION!

- When refitting sunroof, be careful to avoid fingers, scarves, ties and items of clothing from getting caught under the panel.
- Do not open the roof in the presence of snow or ice. There is risk of damage.

POWER SUNROOF RELEARN PROCEDURE

As a result of any abnormal behavior of the roof or as a result of an emergency operation, and you must relearn the automatic operation of the sunroof.

Proceed as follows:

1. Push the open/close button to move the roof in the fully closed position.
2. Place the ignition in the OFF position and wait for at least 10 seconds.
3. Place the ignition in the ON/RUN position.
4. Pull the open/close button and hold it for at least 10 seconds, after which you should feel the mechanical stop of the electric motor of the roof.

5. Within five seconds, pull to close and hold the open/close button, the roof makes a complete cycle of opening and closing automatically (to indicate that the relearn procedure has been successful). If this does not happen and you need to repeat the procedure from the beginning.

HOOD

To Open The Hood

To open the hood, two latches must be released.

1. Pull the release lever located underneath the driver's side of the instrument panel.

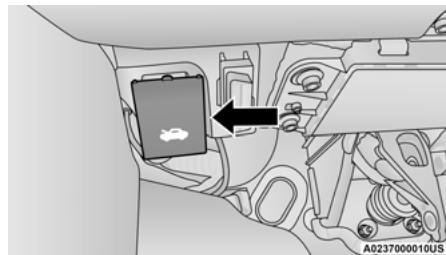

Hood Release Lever

2. Move to the outside of the vehicle and push the safety latch release lever toward the passenger side of the vehicle. The hood release lever is located behind the center front edge of the hood.

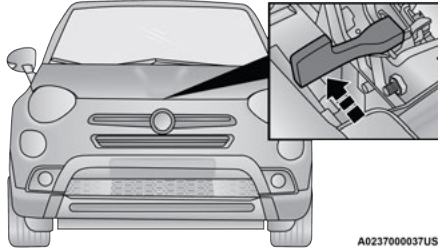

Safety Latch Release Lever Location

3. Remove the support rod from the locking tab and insert it into the seat located on the underside of the hood. Be sure the rod is locked into position.

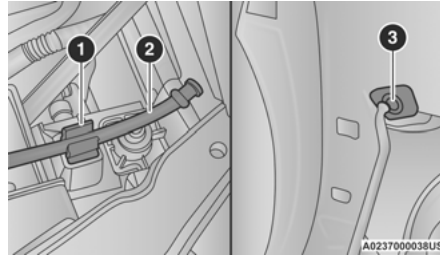

Hood Prop System

- 1 – Locking Tab
- 2 – Support Rod
- 3 – Support Rod Seat

To CLOSE THE HOOD

1. Hold up the hood with one hand and with the other hand remove the support rod from its seat and reinsert it into the locking tab.
2. Lower the hood to approximately 12 inches (30 cm) from the engine compartment and drop it. Make sure that the hood is completely closed.

WARNING!

Be sure the hood is fully latched before driving your vehicle. If the hood is not fully latched, it could open when the vehicle is in motion and block your vision. Failure to follow this warning could result in serious injury or death.

2

CAUTION!

To prevent possible damage, do not slam the hood to close it. Lower hood to approximately 12 inches (30 cm) and drop the hood to close. Make sure hood is fully closed for both latches. Never drive vehicle unless hood is fully closed, with both latches engaged.

LIFTGATE

TO UNLOCK/OPEN THE LIFTGATE

To unlock the liftgate from the outside, push the electronic liftgate release and pull the liftgate open with one fluid motion.

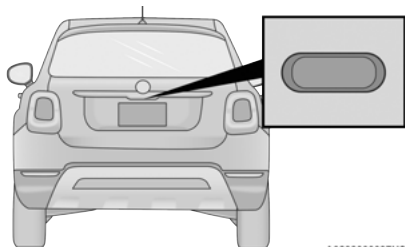

Electronic Liftgate Release

When opening the door, the interior dome light will illuminate. The interior dome light will turn off automatically by closing the liftgate ↪ page 38.

If the liftgate is left open, the interior dome light will shut off after a few minutes to conserve battery life.

Emergency Opening

Proceed as follows:

1. Lower the headrests and fold the seatbacks.

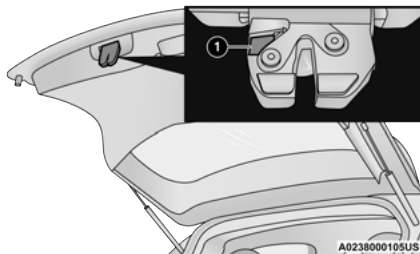

1 – Yellow Tab

2. Using the supplied screwdriver (located under cargo floor in tool kit), remove the yellow tab from the liftgate latching mechanism.
3. With the yellow tab removed, insert the screwdriver into the now open release tab slot to trigger the release of the liftgate.

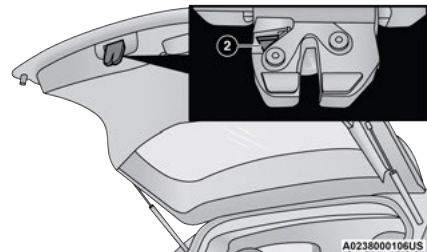

2 – Release Tab Slot

LOCK/CLOSE THE LIFTGATE

Grab the liftgate closing handle and lower the liftgate.

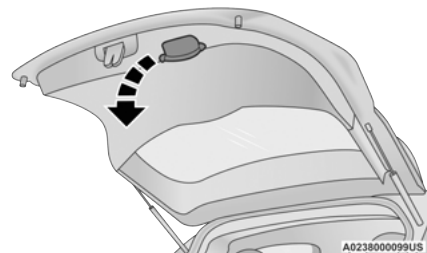

Liftgate Closing Handle

NOTE:

Before closing the liftgate, make sure to be in possession of the key because the liftgate will be locked automatically.

CARGO AREA FEATURES**Removable Rear Shelf – If Equipped**

To remove rear shelf, proceed as follows:

1. Disconnect the two links that support the shelf at the eyelets.

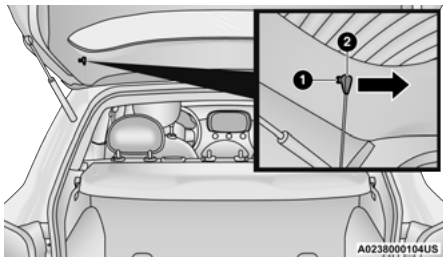

Rear Shelf Support Links

- 1 – Eyelets
- 2 – Links

2. Lift the rear part of the overhead luggage shelf.
3. Clear the pins placed outside of the shelf, and then remove the rear shelf pulling it upwards.
4. The rear shelf can be stored in the cargo area, or behind the front seatbacks.

Cargo Load Floor – If Equipped

The vehicle is equipped with a load floor that can be adjusted as needed.

Position 1 (Lowered Position):

This position allows you to make the load floor flat for ease of loading/unloading objects from the cargo area. This position also makes it possible to use the space below as another compartment for storing fragile or smaller objects.

Position 2 (Elevated Position):

When the rear seatbacks and front passenger seat are folded flat, it creates space for objects of long dimensions. This position is recommended only when transporting objects, then move the load floor back to position 1.

NOTE:

With a full size spare, the floor will be at the elevated position.

Access To The Loading Floor

To access the double load compartment, proceed as follows:

1. Lift up on the load floor handle.

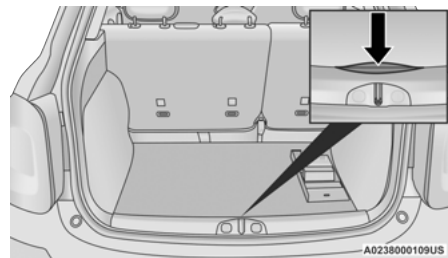

Load Floor Handle

2. Place the desired objects inside the compartment.

3. Reposition the load floor.

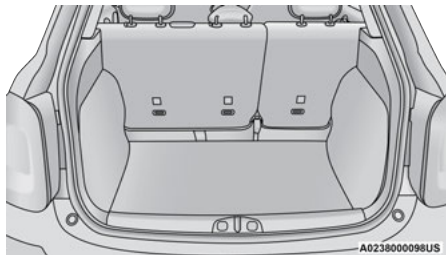

Cargo Area Storage

CAUTION!

The load floor must be arranged in a central position with respect to cargo area.

Displacement Load Floor

To position the load from the lower to the upper position, proceed as follows:

1. Grab the load floor handle and lift up the load floor.
2. Correctly place the load floor on the side panel guides and on the rear cross member.

Access To Tire Service Kit Or Spare Tire

To access the Tire Service Kit or spare tire and container carrier, proceed as follows:

1. Grab the load floor handle and remove the floor.
2. Pull the tab and lift up on the carpet.

Anchoring Of The Load

The cargo tie-downs, located on the trim panels around the cargo area floor, should be used to safely secure loads when the vehicle is moving.

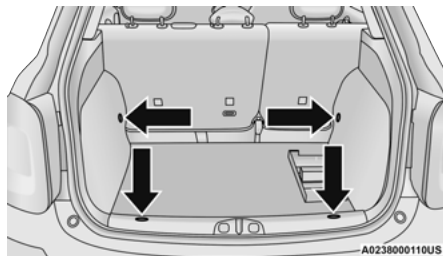

Tie-Downs

Cargo Box — If Equipped

The cargo area contains a preformed cargo box that can be used for the storage of objects that allows you to obtain a uniform level when loading.

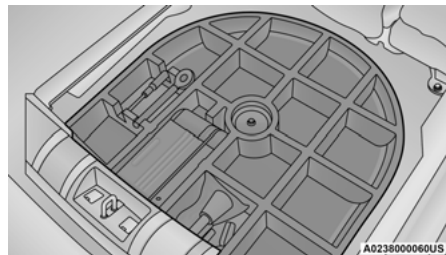

Cargo Box

NOTE:

The cargo box is sized for a maximum capacity of distributed weight equal to 242 lb (110 kg).

ROOF LUGGAGE RACK — IF EQUIPPED

Your vehicle may be equipped with a Roof Luggage Rack for transporting accessories.

Crossbars should always be used whenever cargo is placed on the Roof Luggage Rack. Check the straps frequently to be sure that the load remains securely attached.

NOTE:

Crossbars can be purchased at an authorized dealer through Mopar® parts. External racks do not increase the total load carrying capacity of the vehicle. Be sure that the total occupant and luggage load inside the vehicle, plus the load on the Roof Luggage Rack, do not exceed the maximum vehicle load capacity.

The load carried on the roof, when equipped with a Roof Luggage Rack, must not exceed 110 lb (50 kg), and it should be uniformly distributed over the cargo area.

Do not use the sunroof when using the crossbars.

WARNING!

Cargo must be securely tied down before driving your vehicle. Improperly secured loads can fly off the vehicle, particularly at high speeds, resulting in personal injury or property damage. Follow the roof rack cautions when carrying cargo on your roof rack.

CAUTION!

- To avoid damage to the Roof Luggage Rack and vehicle, do not exceed the maximum roof rack load capacity. Always distribute heavy loads as evenly as possible and secure the load appropriately.
- Long loads, which extend over the windshield, such as wood panels or surfboards, should be secured to both the front and rear of the vehicle.
- Place a blanket or other protection between the surface of the roof and the load.
- Travel at reduced speeds and turn corners carefully when carrying large or heavy loads on the roof rack. Wind forces, due to natural causes or nearby truck traffic, can add sudden upward lift. This is especially true on large flat loads and may result in damage to the cargo or your vehicle.

GETTING TO KNOW YOUR INSTRUMENT PANEL

INSTRUMENT CLUSTER

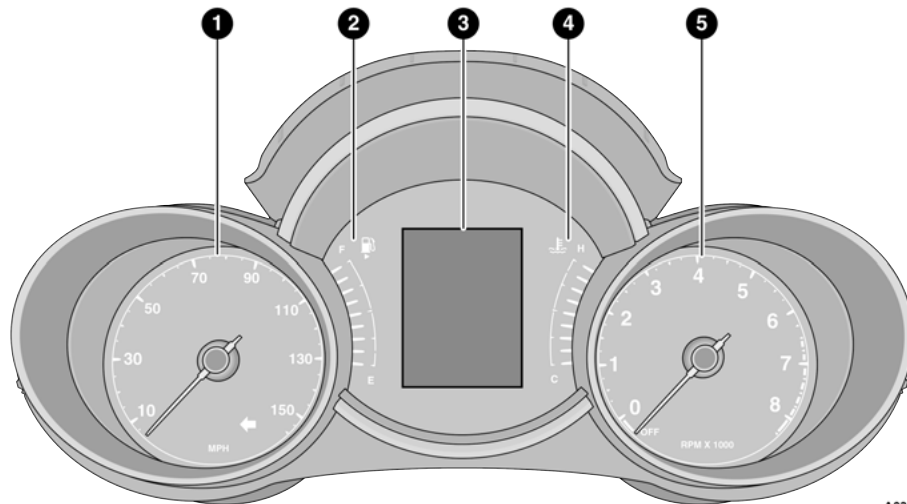

A0301000243US

Instrument Cluster

NOTE:

The illumination of the graphics on the instrument cluster may vary according to the version (Monocolor or Color display).

INSTRUMENT CLUSTER DESCRIPTIONS

1. Speedometer
 - Indicates the speed of the car.
2. Fuel Level Gauge
 - The fuel gauge in the instrument panel indicates the amount of fuel left in the tank.
 - The light comes on, together with a chime and the display of a message in the instrument cluster display, when the gas tank has 1.5 to 2 gallons (5 to 7 liters) of fuel remaining.
3. Instrument Cluster Display
 - The vehicle can be equipped with multi functional instrument cluster display which offers useful information to the driver.
 - With the ignition in the OFF position (and the key removed, for vehicles with a mechanical key), opening/closing of a door will activate the instrument cluster display for viewing, and display the total miles or kilometers in the odometer.
4. Engine Coolant Temperature
 - The temperature gauge on the instrument panel displays the temperature of the engine coolant and starts providing indications when the coolant temperature exceeds approximately 122°F (50°C). In

the normal use of the car, the temperature gauge can move in different directions based on the use of the car. The light comes on, together with a chime and the display of a message in the instrument cluster display, to indicate an excessive increase in the temperature of the engine coolant. Stop the engine and contact an authorized dealer.

5. Tachometer
 - Indicates the engine speed in Revolutions Per Minute (RPM x 1000).

INSTRUMENT CLUSTER DISPLAY

The vehicle is equipped with multi functional instrument cluster display which offers useful information to the driver. With the ignition in the OFF position (and the key removed, for vehicles with a mechanical key), opening/closing of a door will activate the instrument cluster display for viewing, and display the total miles or kilometers in the odometer. The instrument cluster display is designed to display important information about the vehicle's systems and features. Using a driver interactive display located on the instrument panel, your instrument cluster display can show you how systems are working and give you warnings when they aren't. The steering wheel mounted controls allow you to scroll through and enter the main menus and submenus. You can

access the specific information you want and make selections and adjustments.

INSTRUMENT CLUSTER DISPLAY CONTROL BUTTONS

The system allows the driver to select information by pushing the following buttons mounted on the steering wheel:

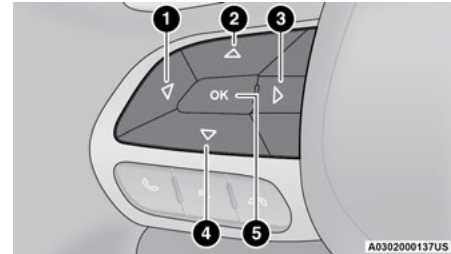

Instrument Cluster Display Control Buttons

- 1 — Left Arrow Button
- 2 — Up Arrow Button
- 3 — Right Arrow Button
- 4 — Down Arrow Button
- 5 — OK Button

The instrument cluster display features a driver interactive display that is located in the instrument cluster. Pushing the controls on the left side of the steering wheel allows the driver to select vehicle information and Personal Settings.

- Push the **back/left** ◀ arrow button to access the information screens or submenu screens of a main menu item.
- Push the **up** ▲ arrow button to scroll upward through the main menus and submenus (Speedometer, Trip, Drive Mode Selector, Vehicle Info, Driver Assist, Audio, Phone, Navigation, Messages, Settings).
- Push the **right** ▶ arrow button to access the information screens or submenu screens of a main menu item.
- Push the **down** ▼ arrow button to scroll downward through the main menu and submenus (Speedometer, Trip, Drive Mode Selector, Vehicle Info, Driver Assist, Audio, Phone, Navigation, Messages, Settings).
- Push the **OK** button to access/select the information screens or submenu screens of a main menu item. Push and hold the **OK** button for two seconds to reset displayed/selected features that can be reset.

ENGINE OIL CHANGE RESET — IF EQUIPPED

Your vehicle may be equipped with an engine oil change indicator system. The “Change Engine Oil” message will display in the instrument cluster display. The engine oil change indicator system is duty cycle based, which means the engine oil change interval may fluctuate, dependent upon your personal driving style.

Unless reset, this message will continue to display each time you turn the ignition switch to the ON/RUN position. To reset the oil change indicator system (after performing the scheduled maintenance), refer to the following procedure.

1. Turn the ignition switch to the ON position (do not start the engine).
2. Fully push the accelerator pedal slowly, three times, within 10 seconds.
3. Turn the ignition switch to the OFF position.

NOTE:

If the indicator message illuminates when you start the vehicle, the oil change indicator system did not reset. If necessary, repeat this procedure.

INSTRUMENT CLUSTER DISPLAY MAIN MENU

The Main Menu is composed of several options that can be selected using the control buttons above.

NOTE:

- The display mode of the menu items varies depending on the type of display.
- For some items, a submenu is provided.
- In the Uconnect system, some items on the menu are not shown on the instrument cluster display ⇨ page 63.

Instrument Cluster Display Menu/ Submenu Items

The Menu is composed of the following items:

- Speedometer
- Trip
 - Current Trip
 - Trip A
 - Trip B
- Drive Mode — If Equipped
 - Auto Mode
 - Sport Mode
 - All Weather Mode

- Vehicle Info
 - Tire Pressure
 - Oil Temperature
 - Battery Voltage
- Driver Assist — If Equipped
 - Lane Departure Warning
- Audio
- Phone — If Equipped
- Navigation
- Messages
- Settings — If Equipped
 - Display
 - Units
 - Clock and Date
 - Security
 - Safety & Assistance
 - Lights
 - Doors & Locks
 - Engine OFF Procedure — If Equipped
 - Stop/Start — If Equipped

Speedometer

View and change the speedometer scale from mph to km/h (km/h to mph).

Trip

This instrument cluster display menu item allows you to view and select information about the "Trip Computer":

- Instantaneous info
 - View the distance to empty (miles or km).
 - View the instantaneous consumption (mpg, or l/ 100km or km/l).
- Trip A
 - View Trip A distance (miles or km).
 - View travel time A (hours/minutes/seconds).
 - View average consumption A (mpg, or l/ 100km or km/l).
 - View average speed A (mph or km/h).
- Trip B
 - View Trip B distance (miles or km).
 - View travel time B (hours/minutes/seconds).
 - View average consumption B (mpg, or l/ 100km or km/l).
 - View average speed B (mph or km/h).

Drive Mode Selector

This instrument cluster display menu/submenu items allows you to view and select information about the "Drive Mode".

Vehicle Info

Push and release the **up** Δ or **down** ∇ arrow button until "Vehicle Info" is highlighted in the instrument cluster display. Push and release the **right** \triangleright arrow button and Coolant Temp will be displayed. Push the **right** \triangleright or **left** \triangleleft arrow button to scroll through the following information displays:

- Tire pressure
 - View the information relating to the Tire Pressure Monitoring System (TPMS) (if equipped).
- Oil Temperature
 - View the engine oil temperature.
- Battery Voltage
 - View the voltage value (state of charge) of the battery.

Driver Assist — If Equipped

This menu item allows you to change the settings (Notice LaneSense and Intensity LaneSense) relating to the LaneSense system (if equipped):

- Notice LaneSense

By selecting this function, you can select the "readiness" of LaneSense, choosing between the options "Near," "Medium," or "Far."

- Intensity LaneSense

Using this function, you can select the force applied to the steering wheel to keep the car in the roadway through the electrical drive system due to LaneSense.

Audio

This menu item allows you to view the instrument cluster display and the information present on the display of the Uconnect system.

The information displayed is:

- "Radio (AM or FM)": view Radio Station Name (if equipped), frequency, and graphical icon.
- MP3: title display or song number playing.
- USB: title display or song number playing.
- Ipod: display the song title and graphic element.
- Bluetooth@: displays the song title and a graphic element.

- SAT: displays the station name and a graphic element.

- APP: displays strings and a graphic element.

Phone — If Equipped

This menu displays the current status of a phone connected to the vehicle via Bluetooth@.

If no phone is connected, the menu will not function when the **OK** button is pushed. Otherwise, if a phone is connected, push the **OK** button to enter the menu. The following items will display:

- Recent calls: displays a list of the last 10 calls.
- SMS reader: displays the last 10 text messages and if they are read or unread.
- Favorite numbers: displays a maximum of six favorite numbers.

Navigation

If activated, this menu item will display navigation status and directions.

Messages (Stored)

This menu item allows you to display the information messages/malfunction stored.

The background color of the display varies according to the priorities of the failure:

- Failed Messages with low priority display in yellow.
- Failed Messages with high priority display in red.

Settings — If Equipped

This menu item allows you to change the settings for the following:

- Display
- Units
- Clock and Date
- Security
- Safety and Assistance
- Lights
- Doors and Locks
- Engine OFF Procedure — If Equipped

Display

By selecting "Display," you can access the following settings:

- Screen Setup: Allows you to configure the display screen.
- Language: Allows you to select the language in which to display the information/warnings.
- Automatic Reset Trip B: Allows you to set the options to reset the Trip B (never, always, every two hours or every eight hours).
- Phone Repetition: Allows you to select "On" or "Off". The instrument cluster display can also display the information concerning phone mode. The information that can be displayed is the connection status of the mobile phone

(phone connected or disconnected), the active telephone calls/incoming/on hold, and the management of double calls (first incoming second waiting, etc.).

- Navigation Repetition: Allows you to select "On" or "Off" on the instrument cluster display, information relating to the navigation mode.

Units

By selecting the item "Units Of Measure," you can select the unit of measure used in the display.

Possible options are:

- US
- Metric
- Custom

Clock And Date

By selecting the item "clock and date," you can adjust the clock.

Possible options are:

- Set Time: Adjust hours/minutes.
- Set Format: Adjust the time format "12h" (12 hours) or "24h" (24 hours).
- Set Date: Adjust day/month/year.

Security

By selecting the item "Security," you can make the following adjustments:

- Speed Warning: Set the vehicle speed limit (mph or km/h), which the driver is notified through a visual and acoustic signaling (display of a message and a symbol on the display).
- Seat Belt Buzzer: This function is only viewable when the Seat Belt Reminder (SBR) system is active.
- Hill Start Assist: Activation/Deactivation of the Hill Start Assist system.

Safety And Assistance — If Equipped

By selecting the item "Safety & Assistance," you can make the following adjustments:

- Full Brake Control — If Equipped: A selection of operating modes of the Full Brake Control system.
- Full Brake Control Sensitivity — If Equipped: A selection of the "readiness" of intervention of the Full Brake Control system, based on the distance to the obstacle.
- Park Assist — If Equipped: A selection of the type of information provided by Park Assist.
- Park Assist Vol. — If Equipped: A selection of the volume of acoustic signals provided by Park Assist.

- Rain Sensing Wipers — If Equipped: Enabling/disabling the automatic operation of wipers in the event of rain.
- LaneSense Warning — If Equipped: A selection of the "readiness" of intervention of LaneSense.
- Warning Buzzer Volume — If Equipped: Increase or decrease the volume of the buzzer by selecting "Low", "Medium", or "High".
- Maintenance Brakes — If Equipped: Activation of the procedure to carry out braking system maintenance.
- Auto Park Brake — If Equipped: Enable/disable auto-insertion of the Electric Parking Brake.

Lights — If Equipped

By selecting the item "Lights," you can make the following adjustments:

- Headlight Off Delay: Set the delay for headlight shutoff after engine shutoff.
- Headlight Sensitivity: Adjust the sensitivity of headlight brightness.
- Interior Ambient Lights: Increase or decrease the brightness of the Interior Ambient Lights.
- Greeting Lights: Enable/disable the vehicle's Greeting Lights.
- Auto High Beam: Activate/deactivate the automatic main beam headlights — If Equipped.

- Daytime Lights: Activate/deactivate the daytime running lights.
- Cornering Lights: Activate/deactivate the cornering lights — If Equipped.

Doors And Locks — If Equipped

By selecting the item "Doors & Locks," you can make the following adjustments:



- Auto Door Lock: Activate/deactivate the automatic locking of the doors with the vehicle moving.
- Auto Unlock On Exit: Automatic unlocking of the doors when exiting the vehicle.
- Flash Light With Lock: Activate the direction indicators when closing the doors.
- Sound Horn With Lock: Activate/deactivate the horn when pushing the lock button on the Remote Keyless Entry. The options are "Off," "First Press," and "Second Press."
- Horn With Remote Start: Activate/deactivate the horn at the Remote Starting of the engine with the Remote Keyless Entry.
- Remote Door Unlock Without Passive Entry: Allows you to choose whether to unlock all the doors or only the driver's side door on the first push of the unlock button on the Remote Keyless Entry.
- Door Unlock With Passive Entry: Allows you to open the driver door only on the first push of the

unlock button on the Remote Keyless Entry or using the passive entry handles on the doors or liftgates.

- Passive Entry — If Equipped: Activate the automatic locking of the doors.
- Engine OFF Procedure — If Equipped: Allows you to turn off the engine from the instrument cluster in the event of an ignition switch failure. Instructions for turning off the engine via the instrument cluster display controls will display in the instrument cluster.

Stop/Start — If Equipped

Automatically stops the engine during a vehicle stop under the right conditions to reduce fuel consumption.

Push and release the **up**  or **down**  arrow button until the Stop/Start menu title is displayed in the instrument cluster. This menu shows messages related to Stop/Start. Only one message can be viewed at a time until the condition is cleared.

When the Stop/Start is engaged (and the engine is off), the associated hardware indicator light is turned on. When the Stop/Start button on the central stack is pushed, a Stop/Start status message will appear in the instrument cluster display.

WARNING LIGHTS AND MESSAGES

The warning/indicator lights will illuminate in the instrument panel together with a dedicated message and/or acoustic signal when applicable. These indications are indicative and precautionary and as such must not be considered as exhaustive and/or alternative to the information contained in the Owner's Manual, which you are advised to read carefully in all cases. Always refer to the information in this chapter in the event of a failure indication. All active telltales will display first if applicable. The system check menu may appear different based upon equipment options and current vehicle status. Some telltales are optional and may not appear.

RED WARNING LIGHTS

Air Bag Warning Light



This warning light will illuminate to indicate a fault with the air bag, and will turn on for four to eight seconds as a bulb check when the ignition is placed in the ON/RUN position. This light will illuminate with a single chime when a fault with the air bag has been detected, it will stay on until the fault is cleared. If the light is either not on during startup, stays on, or turns on while driving, have the system inspected at an authorized dealer as soon as possible.

Brake Warning Light

BRAKE This warning light monitors various brake functions, including brake fluid level and parking brake application. If the brake light turns on it may indicate that the parking brake is applied, that the brake fluid level is low, or that there is a problem with the Anti-Lock Brake System reservoir.

If the light remains on when the parking brake has been disengaged, and the fluid level is at the full mark on the master cylinder reservoir, it indicates a possible brake hydraulic system malfunction or that a problem with the Brake Booster has been detected by the Anti-Lock Brake System (ABS) / Electronic Stability Control (ESC) system. In this case, the light will remain on until the condition has been corrected. If the problem is related to the brake booster, the ABS pump will run when applying the brake, and a brake pedal pulsation may be felt during each stop.

The dual brake system provides a reserve braking capacity in the event of a failure to a portion of the hydraulic system. A leak in either half of the dual brake system is indicated by the Brake Warning Light, which will turn on when the brake fluid level in the master cylinder has dropped below a specified level.

The light will remain on until the cause is corrected.

NOTE:

The light may flash momentarily during sharp cornering maneuvers, which change fluid level conditions. The vehicle should have service performed, and the brake fluid level checked. If brake failure is indicated, immediate repair is necessary.

WARNING!

Driving a vehicle with the red brake light on is dangerous. Part of the brake system may have failed. It will take longer to stop the vehicle. You could have a collision. Have the vehicle checked immediately.

Vehicles equipped with the Anti-Lock Brake System (ABS) are also equipped with Electronic Brake Force Distribution (EBD). In the event of an EBD failure, the Brake Warning Light will turn on along with the ABS Light. Immediate repair to the ABS system is required.

Operation of the Brake Warning Light can be checked by turning the ignition switch from the OFF position to the ON/RUN position. The light should illuminate for approximately two seconds. The light should then turn off unless the parking brake is applied or a brake fault is detected. If the light does not illuminate, have the light inspected by an authorized dealer.

The light also will turn on when the parking brake is applied with the ignition switch in the ON/RUN position.

NOTE:

This light shows only that the parking brake is applied. It does not show the degree of brake application.

Battery Charge Warning Light



This warning light will illuminate when the battery is not charging properly. If it stays on while the engine is running, there may be a malfunction with the charging system.

Contact an authorized dealer as soon as possible.

This indicates a possible problem with the electrical system or a related component.

Coolant Temperature Warning Light



This light warns of an overheated engine condition. If the light turns on while driving, safely pull over and stop the vehicle. If the Air Conditioning (A/C) system is on, turn it off.

Also, shift the transmission into NEUTRAL and idle the vehicle. If the temperature reading does not return to normal, turn the engine off immediately and call for service.

NOTE:

As the coolant temperature gauge approaches "H", this indicator will illuminate and a single chime will sound.

Door Open Warning Light



This indicator will illuminate when one or more door(s) are not fully closed.

NOTE:

If the vehicle is moving and a door is opened, there will also be a single chime.

Electric Power Steering (EPS) Fault Warning Light



This warning light will turn on when there's a fault with the EPS system
 ↪ page 88.

WARNING!

Continued operation with reduced assist could pose a safety risk to yourself and others. Service should be obtained as soon as possible.

Electronic Throttle Control (ETC) Warning Light



This warning light will illuminate to indicate a problem with the ETC system. If a problem is detected while the vehicle is running, the light will either stay on or flash depending on the nature of the problem.

Cycle the ignition when the vehicle is safely and completely stopped and the transmission is placed in the PARK position. The light should turn off. If

the light remains on with the vehicle running, your vehicle will usually be drivable; however, see an authorized dealer for service as soon as possible.

NOTE:

This light may turn on if the accelerator and brake pedals are pressed at the same time.

If the light continues to flash when the vehicle is running, immediate service is required and you may experience reduced performance, an elevated/rough idle, or engine stall and your vehicle may require towing. The light will come on when the ignition is placed in the ON/RUN position and remain on briefly as a bulb check. If the light does not come on during starting, have the system checked by an authorized dealer.

Hood Open Warning Light — If Equipped



This warning light will illuminate when the hood is left open and not fully closed.

Oil Pressure Warning Light



This warning light will illuminate to indicate low engine oil pressure. If the light turns on while driving, stop the vehicle, shut off the engine as soon as possible, and contact an authorized dealer. A chime will sound when this light turns on.

Do not operate the vehicle until the cause is corrected. This light does not indicate how much oil is in the engine. The engine oil level must be checked under the hood.

Seat Belt Reminder Warning Light



This warning light indicates when the driver or passenger seat belt is unbuckled. When the ignition is first placed in the ON/RUN position and if the driver's seat belt is unbuckled, a chime will sound and the light will turn on. When driving, if the driver or front passenger seat belt remains unbuckled, the Seat Belt Reminder Light will flash or remain on continuously and a chime will sound ↪ page 184.

Transmission Fault Warning Light



This light will illuminate (together with a message in the instrument cluster display and a buzzer) to indicate a transmission fault. Contact an authorized dealer if the message remains after restarting the engine.

Vehicle Security Warning Light — If Equipped



This light will flash at a fast rate for approximately 15 seconds when the vehicle security system is arming, and then will flash slowly until the vehicle is disarmed.

Trunk Open Warning Light



This indicator will illuminate when the trunk is open and not fully closed.

YELLOW WARNING LIGHTS

Adaptive Cruise Control (ACC) Fault Warning Light — If Equipped



This warning light will illuminate to indicate a fault in the ACC system. Contact a local authorized dealer for service → page 92.

Anti-Lock Brake System (ABS) Warning Light



This warning light monitors the ABS. The light will turn on when the ignition is placed in the ON/RUN position and may stay on for as long as four seconds.

If the ABS light remains on or turns on while driving, then the Anti-Lock portion of the brake system is not functioning and service is required as soon as possible. However, the conventional brake system will continue to operate normally, assuming the Brake Warning Light is not also on.

If the ABS light does not turn on when the ignition is placed in the ON/RUN position, have the brake system inspected by an authorized dealer.

Audio System Failure Light — If Equipped



This light will illuminate to report a failure of the Audio System. Contact an authorized dealership as soon as possible.

Electronic Park Brake Warning Light



This warning light will illuminate to indicate the Electronic Park Brake is not functioning properly and service is required. Contact an authorized dealer.

Electronic Stability Control (ESC) Active Warning Light — If Equipped



This warning light will indicate when the ESC system is Active. The ESC Indicator Light in the instrument cluster will come on when the ignition is placed in the ON/RUN position, and when ESC is activated. It should go out with the engine running. If the ESC Indicator Light comes on continuously with the engine running, a malfunction has been detected in the ESC system. If this warning light remains on after several ignition cycles, and the vehicle has been driven several miles (kilometers) at speeds greater than 30 mph (48 km/h), see an authorized dealer as soon as possible to have the problem diagnosed and corrected.

- The ESC OFF Indicator Light and the ESC Indicator Light come on momentarily each time the ignition is placed in the ON/RUN position.
- The ESC system will make buzzing or clicking sounds when it is active. This is normal; the sounds will stop when ESC becomes inactive.
- This light will come on when the vehicle is in an ESC event.

Electronic Stability Control (ESC) OFF Warning Light — If Equipped



This warning light indicates the ESC is off. Each time the ignition is turned to ON/RUN, the ESC system will be on, even if it was turned off previously.

Drive Mode System Overheating



This symbol appears, together with a dedicated message on the display, in case of overheating of the Drive Mode Selector system. In these conditions, the Drive Mode Selector system can still be used to select the required driving mode, but the mode will be engaged only when the system cools down.

The symbol will stay on for as long as the overheating condition persists.

External Light Failure Indicator Light — If Equipped



The External Light Failure Indicator will come on when a failure to one of the following lights is detected:

- Direction Indicators
- Backup Lights
- Parking Lights
- Daytime Running Lights
- License Plate Lights

The failure relating to these lights could be:

- One or more blown bulbs
- A blown protection fuse
- A break in the electrical connection

Loose Fuel Filler Cap Warning Light — If Equipped



This warning light will illuminate when the fuel filler cap is loose. Properly close the filler cap to disengage the light. If the light does not turn off, please see an authorized dealer.

Low Fuel Warning Light



When the fuel level reaches approximately 1.3–1.8 gal (5–7 L) this light will turn on, and remain on until fuel is added.

LaneSense Warning Light — If Equipped



The LaneSense Warning Light will be solid yellow when the vehicle is approaching a lane marker. The warning light will flash when the vehicle is crossing the lane marker → page 105.

Service LaneSense Warning Light — If Equipped



This warning light will illuminate when the LaneSense system is not operating and requires service. Please see an authorized dealer.

Engine Check/Malfunction Indicator Warning Light (MIL)



The Engine Check/Malfunction Indicator Light (MIL) is a part of an Onboard Diagnostic System called OBD II that monitors engine and automatic transmission control systems. This warning light will illuminate when the ignition is in the ON/RUN position before engine start. If the bulb does not come on when turning the ignition switch from OFF to ON/RUN, have the condition checked promptly.

Certain conditions, such as a loose or missing gas cap, poor quality fuel, etc., may illuminate the light after engine start. The vehicle should be serviced if the light stays on through several typical driving

styles. In most situations, the vehicle will drive normally and will not require towing.

When the engine is running, the MIL may flash to alert serious conditions that could lead to immediate loss of power or severe catalytic converter damage. The vehicle should be serviced by an authorized dealer as soon as possible if this occurs.

WARNING!

A malfunctioning catalytic converter, as referenced above, can reach higher temperatures than in normal operating conditions. This can cause a fire if you drive slowly or park over flammable substances such as dry plants, wood, cardboard, etc. This could result in death or serious injury to the driver, occupants or others.

CAUTION!

Prolonged driving with the Malfunction Indicator Light (MIL) on could cause damage to the vehicle control system. It also could affect fuel economy and driveability. If the MIL is flashing, severe catalytic converter damage and power loss will soon occur. Immediate service is required.

Service Warning Light – If Equipped



The “Maintenance Plan” includes vehicle maintenance at fixed intervals. For further information ↪ page 230. This message is displayed automatically along with the warning light when the key is turned to RUN - 1,242 miles (2,000 km) or 30 days before these deadlines, and reappears every time the key is turned to RUN. The indication will appear in miles or kilometers according to the “Unit Of Measurement” settings. When the next scheduled service is approaching and the key is turned to RUN, the word “Service” will appear on the display, followed by the number of miles or kilometers left. Contact an authorized dealership. The operations in the “Maintenance Plan” will be performed and the message will be reset.

Service Stop / Start System Warning Light – If Equipped



This warning light will illuminate when the Stop/Start system is not functioning properly and service is required. Contact an authorized dealer for service.

Tire Pressure Monitoring System (TPMS) Warning Light



The warning light switches on and a message is displayed to indicate that the tire pressure is lower than the recommended value and/or that slow

pressure loss is occurring. In these cases, optimal tire duration and fuel consumption may not be guaranteed.

Should one or more tires be in the condition mentioned above, the display will show the indications corresponding to each tire.

CAUTION!

Do not continue driving with one or more flat tires as handling may be compromised. Stop the vehicle, avoiding sharp braking and steering. If a tire puncture occurs, repair immediately using the dedicated tire repair kit and contact an authorized dealer as soon as possible.

Each tire, including the spare (if provided), should be checked monthly when cold and inflated to the inflation pressure recommended by the vehicle manufacturer on the vehicle placard or tire inflation pressure label. If your vehicle has tires of a different size than the size indicated on the vehicle placard or tire inflation pressure label, you should determine the proper tire inflation pressure for those tires.

As an added safety feature, your vehicle has been equipped with a TPMS that illuminates a low tire pressure telltale when one or more of your tires is significantly underinflated. Accordingly, when the low tire pressure telltale illuminates, you should stop and check your tires as soon as possible, and

inflate them to the proper pressure. Driving on a significantly underinflated tire causes the tire to overheat and can lead to tire failure. Underinflation also reduces fuel efficiency and tire tread life, and may affect the vehicle’s handling and stopping ability.

Please note that the TPMS is not a substitute for proper tire maintenance, and it is the driver’s responsibility to maintain correct tire pressure, even if underinflation has not reached the level to trigger illumination of the TPMS low tire pressure telltale.

Your vehicle has also been equipped with a TPMS malfunction indicator to indicate when the system is not operating properly. The TPMS malfunction indicator is combined with the low tire pressure telltale. When the system detects a malfunction, the telltale will flash for approximately one minute and then remain continuously illuminated. This sequence will continue upon subsequent vehicle start-ups as long as the malfunction exists. When the malfunction indicator is illuminated, the system may not be able to detect or signal low tire pressure as intended. TPMS malfunctions may occur for a variety of reasons, including the installation of replacement or alternate tires or wheels on the vehicle that prevent the TPMS from functioning properly. Always check the TPMS malfunction telltale after replacing one or more tires or wheels on your vehicle to ensure that the

replacement or alternate tires and wheels allow the TPMS to continue to function properly.

CAUTION!

The TPMS has been optimized for the original equipment tires and wheels. TPMS pressures and warning have been established for the tire size equipped on your vehicle. Undesirable system operation or sensor damage may result when using replacement equipment that is not of the same size, type, and/or style. Aftermarket wheels can cause sensor damage. Using aftermarket tire sealants may cause the Tire Pressure Monitoring System (TPMS) sensor to become inoperable. After using an aftermarket tire sealant it is recommended that you take your vehicle to an authorized dealer to have your sensor function checked.

Transmission Temperature Warning Light



This light indicates that the transmission fluid temperature is running hot. This may occur with severe usage, such as trailer towing. If this light turns on, safely pull over and stop the vehicle. Then, shift the transmission into PARK and run the engine at idle or slightly higher until the light turns off.

WARNING!

If you continue operating the vehicle when the Transmission Temperature Warning Light is illuminated you could cause the fluid to boil over, come in contact with hot engine or exhaust components and cause a fire.

CAUTION!

Continuous driving with the Transmission Temperature Warning Light illuminated will eventually cause severe transmission damage or transmission failure.

YELLOW INDICATOR LIGHTS

Exterior Bulb Failure Indicator Light — If Equipped



This light will illuminate when there is a malfunction in one of the exterior bulbs.

Full Brake Control System Indicator Light — If Equipped



This telltale will turn on to warn you of a possible collision with the vehicle in front of you.

Full Brake Control System Off Indicator Light — If Equipped



This indicator light illuminates to indicate that the Full Brake Control System is off.

Fuel Cutoff Failure Light — If Equipped



This light will illuminate if there is a fuel cutoff failure. If this light illuminates, take it to an authorized dealer and have them inspect it.

Fuel Cutoff Indicator Light — If Equipped



This telltale will illuminate after an accident has occurred, and the system has shut the fuel off.

Fuel Level Sensor Failure



This light illuminates when there is a fuel level sensor failure. If this light illuminates, take it to an authorized dealer and have them inspect it.

Icy Road Condition Indicator Light — If Equipped



This light will illuminate during an icy road condition.

Immobilizer Fail / VPS Electrical Alarm Indicator Light



This telltale will illuminate when the vehicle security system system has detected an attempt to break into the vehicle.

NOTE:

After cycling the ignition to the ON/RUN position, the Vehicle Security Warning Light could illuminate if a problem with the system is detected. This condition will result in the engine being shut off after two seconds.

GREEN INDICATOR LIGHTS

Cruise Control Set Indicator Light



This light will turn on when the cruise control is set to the desired speed
 ↪ page 91.

Front Fog Indicator Light — If Equipped



This indicator light will illuminate when the front fog lights are on.

LaneSense Indicator Light — If Equipped



The LaneSense indicator light illuminates solid green when both lane markings have been detected and the system is “armed” and ready to provide visual and

torque warnings if an unintentional lane departure occurs ↪ page 105.

Parking / Headlight On Indicator Light



This indicator light will illuminate when the parking lights or headlights are turned on.

Stop/Start Active Indicator Light — If Equipped



This indicator light will illuminate when the Stop/Start function is in “Autostop” mode.

Turn Signal Indicator Lights



When the left or right turn signal is activated, the turn signal indicator will flash independently and the corresponding exterior turn signal lamps will flash. Turn signals can be activated when the multifunction lever is moved down (left) or up (right).

NOTE:

- A continuous chime will sound if the vehicle is driven more than 1 mile (1.6 km) with either turn signal on.
- Check for an inoperative outside light bulb if either indicator flashes at a rapid rate.

WHITE INDICATOR LIGHTS

LaneSense Indicator Light — If Equipped



When the LaneSense system is ON, but not armed, the LaneSense indicator light illuminates solid white. This occurs when only left, right, or neither lane line has been detected. If a single lane line is detected, the system is ready to provide only visual warnings if an unintentional lane departure occurs on the detected lane line ↪ page 105.

Light Sensor Failure



This light illuminates when there is light sensor failure. If this light illuminates, have an authorized dealer inspect it.

Speed Warning Indicator Light — If Equipped



The indicator light will illuminate white along with a notification text message (Speed Warning Set to XX followed by unit). When the set speed is exceeded, a single chime will sound along with pop up message of “Speed Warning Exceeded.” Speed Warning can be turned on and off in the instrument cluster display.

The number “55” is only an example of a speed that can be set.

BLUE INDICATOR LIGHTS

High Beam Indicator Light



This indicator light will illuminate to indicate that the high beam headlights are on. With the low beams activated, push the multifunction lever forward (toward the front of the vehicle) to turn on the high beams. Pull the multifunction lever rearward (toward the rear of the vehicle) to turn off the high beams. If the high beams are off, pull the lever toward you for a temporary high beam on, "flash to pass" scenario.

GRAY INDICATOR LIGHTS

Cruise Control Ready/Canceled Indicator Light



This light will turn on when the cruise control has been turned on, but not set, or canceled by the driver → page 91.

ONBOARD DIAGNOSTIC SYSTEM — OBD II

Your vehicle is equipped with a sophisticated Onboard Diagnostic system called OBD II. This system monitors the performance of the emissions, engine, and transmission control systems. When these systems are operating properly, your vehicle will provide excellent performance and fuel economy, as well as engine emissions well within current government regulations.

If any of these systems require service, the OBD II system will turn on the Malfunction Indicator Light (MIL). It will also store diagnostic codes and other information to assist your service technician in making repairs. Although your vehicle will usually be drivable and not need towing, see an authorized dealer for service as soon as possible.

CAUTION!

- Prolonged driving with the MIL on could cause further damage to the emission control system. It could also affect fuel economy and driveability. The vehicle must be serviced before any emissions tests can be performed.
- If the MIL is flashing while the vehicle is running, severe catalytic converter damage and power loss will soon occur. Immediate service is required.

ONBOARD DIAGNOSTIC SYSTEM (OBD II) CYBERSECURITY

Your vehicle is required to have an OBD II and a connection port to allow access to information related to the performance of your emissions controls. Authorized service technicians may need to access this information to assist with the diagnosis and service of your vehicle and emissions system → page 119.

WARNING!

- ONLY an authorized service technician should connect equipment to the OBD II connection port in order to read the VIN, diagnose, or service your vehicle.
- If unauthorized equipment is connected to the OBD II connection port, such as a driver-behavior tracking device, it may:
 - Be possible that vehicle systems, including safety related systems, could be impaired or a loss of vehicle control could occur that may result in an accident involving serious injury or death.
 - Access, or allow others to access, information stored in your vehicle systems, including personal information.

EMISSIONS INSPECTION AND MAINTENANCE PROGRAMS

In some localities, it may be a legal requirement to pass an inspection of your vehicle's emissions control system. Failure to pass could prevent vehicle registration.



For states that require an Inspection and Maintenance (I/M), this check verifies the Malfunction Indicator Light (MIL) is functioning and is not on when the engine is running, and that the OBD II system is ready for testing.

Normally, the OBD II system will be ready. The OBD II system may **not** be ready if your vehicle was recently serviced, recently had a depleted battery or a battery replacement. If the OBD II system should be determined not ready for the I/M test, your vehicle may fail the test.

Your vehicle has a simple ignition actuated test, which you can use prior to going to the test station. To check if your vehicle's OBD II system is ready, you must do the following:

1. Cycle the ignition switch to the ON position, but do not crank or start the engine.

NOTE:

If you crank or start the engine, you will have to start this test over.

2. As soon as you cycle the ignition switch to the ON position, you will see the Malfunction Indicator Light (MIL) symbol come on as part of a normal bulb check.
3. Approximately 15 seconds later, one of two things will happen:
 - The MIL will flash for about 10 seconds and then return to being fully illuminated until you turn OFF the ignition or start the engine. This means that your vehicle's OBD II system is **not ready** and you should **not** proceed to the I/M station.
 - The MIL will not flash at all and will remain fully illuminated until you place the ignition in the off position or start the engine. This means that your vehicle's OBD II system is **ready** and you can proceed to the I/M station.

If your OBD II system is **not ready**, you should see an authorized dealer or repair facility. If your vehicle was recently serviced or had a battery failure or replacement, you may need to do nothing more than drive your vehicle as you normally would in order for your OBD II system to update. A recheck with the above test routine may then indicate that the system is **now ready**.

Regardless of whether your vehicle's OBD II system is ready or not, if the MIL is illuminated during normal vehicle operation you should have your vehicle serviced before going to the I/M station. The I/M station can fail your vehicle because the MIL is on with the engine running.

STARTING AND OPERATING

STARTING THE ENGINE

Before starting your vehicle, adjust your seat, adjust the inside and outside mirrors, fasten your seat belt, and if present, instruct all other occupants to buckle their seat belts.

WARNING!

- Never leave children alone in a vehicle, or with access to an unlocked vehicle.
- Allowing children to be in a vehicle unattended is dangerous for a number of reasons. A child or others could be seriously or fatally injured. Children should be warned not to touch the parking brake, brake pedal or the gear selector.
- Do not leave the key fob in or near the vehicle (or in a location accessible to children), and do not leave the ignition in the ON or RUN mode. A child could operate power windows, other controls, or move the vehicle.

Start the engine with the gear selector in the NEUTRAL or PARK position. Apply the brake before shifting to any driving range.

Proceed as follows:

1. Set the Electric Park Brake (EPB) and put the gear selector in the PARK or NEUTRAL position.
2. Press on the brake pedal, without pressing the accelerator.
3. Place the ignition in the RUN mode and release it as soon as the engine is started.
4. If the engine does not start, place the ignition in the OFF mode and wait 10-15 seconds before attempting to restart the engine.

TIP START FEATURE

Do not press the accelerator. Place the ignition switch briefly in the RUN mode and release it. The starter motor will continue to run but will automatically disengage when the engine is running.

IF ENGINE FAILS TO START

If the engine fails to start after you have followed the "Normal Starting" or "Cold Weather Operation" procedure, and has not experienced an extended park condition as identified in "Extended Park Starting" procedure it may be flooded. Push the accelerator pedal all the way to the floor and hold

it there. Crank the engine for no more than 15 seconds. This should clear any excess fuel in case the engine is flooded. Leave the ignition in RUN mode, release the accelerator pedal and repeat the "Normal Starting" procedure.

WARNING!

- Never pour fuel or other flammable liquid into the throttle body air inlet opening in an attempt to start the vehicle. This could result in flash fire causing serious personal injury.
- Do not attempt to push or tow your vehicle to get it started. Vehicles equipped with an automatic transmission cannot be started this way. Unburned fuel could enter the catalytic converter and once the engine has started, ignite and damage the converter and vehicle.
- If the vehicle has a discharged battery, booster cables may be used to obtain a start from a booster battery or the battery in another vehicle. This type of start can be dangerous if done improperly ↪ page 222.

CAUTION!

To prevent damage to the starter, do not continuously crank the engine for more than 25 seconds at a time. Wait 60 seconds before trying again.

COLD WEATHER OPERATION

To ensure reliable starting under extreme cold conditions an externally powered electric block heater (if equipped) is required below -20°F (-29°C).

To prevent possible engine damage while starting at low temperatures, this vehicle will inhibit engine cranking when the ambient temperature is less than -20°F (-29°C), and the oil temperature sensor reading indicates an engine block heater has not been used. The message “Plug in Engine Heater” will be displayed in the instrument cluster when the ambient temperature is below -4°F (-20°C) at the time the engine is shut off as a reminder to avoid possible crank delays at the next cold start.

EXTENDED PARK STARTING**NOTE:**

Extended Park condition occurs when the vehicle has not been started or driven for at least 30 days.

1. Install a battery charger or jumper cables to the battery to ensure a full battery charge during the crank cycle.
2. Place the ignition in the START mode and release it when the engine starts.
3. If the engine fails to start within 10 to 15 seconds, place the ignition in the OFF mode, wait 5 seconds to allow the starter to cool, then repeat the Extended Park Starting procedure.
4. If the engine fails to start after 8 attempts, allow the starter to cool for at least 10 minutes, then repeat the procedure.

CAUTION!

To prevent damage to the starter, do not crank continuously for more than 10 seconds at a time. Wait 10 to 15 seconds before trying again.

AFTER STARTING — WARMING UP THE ENGINE

Proceed as follows:

- Travel slowly, letting the engine run at a reduced RPM, without accelerating suddenly.
- It is recommended to wait until the engine coolant temperature gauge starts to rise for maximum performance.

STOPPING THE ENGINE

To shut off the engine with vehicle speed greater than 5 mph (8 km/h), you must push and hold the ignition or push the ENGINE START/STOP button three times consecutively within a few seconds. The engine will shut down, and the ignition will be placed in the RUN position.

Turning off the car (place the ignition from the RUN mode to the OFF mode), the power supply to the accessories are maintained for a period of three minutes.

NOTE:

If the vehicle fails to shut off using the ignition
 ⇨ page 63.

Opening the driver side door with the ignition in RUN will sound a short chime that reminds the driver to place the ignition to OFF.

When the ignition is in the OFF mode, the window switches remains active for three minutes.

Opening a front door will cancel this function.

After severe driving, idle the engine to allow the temperature inside the engine compartment to cool before shutting off the engine.

TURBOCHARGER “COOL DOWN” — IF EQUIPPED

This vehicle is equipped with an after-run pump to cool the turbocharger after the engine is shut off. Depending on the type of driving and the amount of cargo, the pump will run for up to 10 minutes after the engine has been shut off to circulate coolant through the turbocharger. Although the pump is rubber-mounted for quiet operation, it is normal to hear it running during this time.

ENGINE BREAK-IN RECOMMENDATIONS

A long break-in period is not required for the engine and drivetrain (transmission and axle) in your vehicle.

Drive moderately during the first 300 miles (500 km). After the initial 60 miles (100 km), speeds up to 50 or 55 mph (80 or 90 km/h) are desirable.

While cruising, brief full-throttle acceleration within the limits of local traffic laws contributes to a good

break-in. Wide-open throttle acceleration in low gear can be detrimental and should be avoided.

The engine oil installed in the engine at the factory is a high-quality energy conserving type lubricant. Oil changes should be consistent with anticipated climate conditions under which vehicle operations will occur. For the recommended viscosity and quality grades ↗ page 286.

CAUTION!

Never use Non-Detergent Oil or Straight Mineral Oil in the engine or damage may result.

NOTE:

A new engine may consume some oil during its first few thousand miles (kilometers) of operation. This should be considered a normal part of the break-in and not interpreted as a problem.

ELECTRIC PARK BRAKE (EPB)

Your vehicle is equipped with an EPB that offers simple operation, and some additional features that make the parking brake more convenient and useful.

The parking brake is primarily intended to prevent the vehicle from rolling while parked. Before leaving the vehicle, make sure that the parking brake is applied. Also, be certain to leave the transmission in PARK.

The EPB switch is located in the center console.

You can engage the EPB in two ways;

- Manually, by pulling up on the EPB switch momentarily to apply.
- Automatically, by enabling the Auto Park Brake feature in the Customer Programmable Features section of the Uconnect Settings.



Electric Park Brake Switch

To apply the EPB manually, pull up on the switch momentarily. You may hear a sound from the back of the vehicle while the EPB engages. Once the parking brake is fully engaged, the Brake Warning Light in the instrument cluster and an indicator on the switch will illuminate. If your foot is on the brake pedal while you apply the EPB, you may notice a small amount of brake pedal movement. The EPB can be applied even when the ignition is in the OFF mode however, it can only be released when the ignition is in the RUN mode.

NOTE:

The EPB fault lamp will illuminate if the EPB switch is held for longer than 60 seconds in either the released or applied position. The light will extinguish upon releasing the switch.

If the Auto Park Brake feature is enabled, the EPB will automatically engage whenever the transmission is moved into PARK when the ignition switch is in the STOP/OFF position. If your foot is on the brake pedal, you may notice a small amount of brake pedal movement while the EPB is engaging.

The EPB will be automatically released if the driver's seat belt is buckled (in case of automatic transmission) and driver's intention to start (in forward or reverse direction) is recognized by the system

To release the EPB manually, the ignition must be in the RUN mode. Put your foot on the brake pedal, then push the EPB switch down momentarily. You may hear a sound from the back of the car while the parking brake disengages. You may also notice a small amount of movement in the brake pedal. Once the EPB is fully disengaged, the Brake Warning Light in the instrument cluster and the LED indicator on the switch will extinguish.

NOTE:

When parking on a hill, it is important to turn the front wheels toward the curb on a downhill grade and away from the curb on an uphill grade. Apply the EPB before placing the gear selector in PARK,

otherwise the load on the transmission locking mechanism may make it difficult to move the gear selector out of PARK. The EPB should always be applied whenever the driver is not in the vehicle.

WARNING!

- When exiting the vehicle, always remove the key fob from the vehicle and lock your vehicle.
- Never leave children alone in a vehicle, or with access to an unlocked vehicle. Allowing children to be in a vehicle unattended is dangerous for a number of reasons. A child or others could be seriously or fatally injured. Children should be warned not to touch the parking brake, brake pedal or the transmission gear selector.
- Do not leave the key fob in or near the vehicle (or in a location accessible to children), and do not leave the ignition in the ON or RUN mode. A child could operate power windows, other controls, or move the vehicle.
- Be sure the parking brake is fully disengaged before driving; failure to do so can lead to brake failure and a collision.

(Continued)

WARNING!

- Always fully apply the parking brake when leaving your vehicle, or it may roll and cause damage or injury. Also be certain to leave the transmission in PARK. Failure to do so may allow the vehicle to roll and cause damage or injury.

CAUTION!

If the Brake System Warning Light remains on with the parking brake released, a brake system malfunction is indicated. Have the brake system serviced by an authorized dealer immediately.

If exceptional circumstances should make it necessary to engage the EPB while the vehicle is in motion, maintain upward pressure on the EPB switch for as long as engagement is desired. The brake warning lamp could illuminate in case of the hydraulic system is not available. The rear stop lamps will also be illuminated automatically while the vehicle remains in motion.

To disengage the EPB while the vehicle is in motion, release the switch. If the vehicle is brought to a complete stop using the EPB, when the vehicle reaches approximately 1.9 mph (3 km/h) the EPB will remain engaged.

WARNING!

Driving the vehicle with the parking brake engaged, or repeated use of the parking brake to slow the vehicle may cause serious damage to the brake system. Be sure the parking brake is fully disengaged before driving; failure to do so can lead to brake failure and a collision.

In the unlikely event of a malfunction of the EPB system, a yellow EPB fault lamp will illuminate. This may be accompanied by the Brake Warning Light flashing. In this status, some EPB functionalities may be deactivated. In this event, urgent service of the EPB system is required. Do not rely on the EPB to hold the vehicle stationary.

AUTO PARK BRAKE

The EPB can be programmed to be applied automatically whenever the vehicle speed is below 1.9 mph (3 km/h) and the automatic transmission is placed in PARK whenever the ignition is in the OFF mode. Auto Park Brake is enabled and disabled by customer selection through the Customer Programmable Features section of the Uconnect Settings.

Any single Auto Park Brake application can be bypassed by pushing the EPB switch to the release position while the transmission is placed in PARK and the ignition is in the RUN mode. In some cases,

if the ignition is cycled from ON/RUN to OFF and the gear selector is not firmly locked in the PARK position, EPB applies automatically even if Auto Park Brake has been previously disabled.

SAFEHOLD

SafeHold is a safety feature of the EPB system that will engage the parking brake automatically if the vehicle is left unsecured while the ignition switch is in the RUN mode.

The EPB will automatically engage if all of the following conditions are met:

- Vehicle speed is below 1.9 mph (3 km/h).
- There is no attempt to press the brake pedal or accelerator pedal.
- The seat belt is unbuckled.
- The driver door is open.
- The vehicle is not in the PARK position.

SafeHold can be temporarily bypassed by pushing the EPB switch while the driver door is open and the brake pedal is pressed. Once manually bypassed, SafeHold will be enabled again once the vehicle reaches 12 mph (20 km/h) or the ignition is cycled to the OFF mode and back to RUN mode.

BRAKE SERVICE MODE

We recommend having your brakes serviced by an authorized dealer. You should only make repairs for which you have the knowledge and the right equipment. You should only enter Brake Service Mode during brake service.

When servicing your rear brakes, it may be necessary for you or your technician to push the rear piston into the rear caliper bore. With the EPB system, this can only be done after retracting the EPB actuator. The actuator retraction can be done easily by entering the Brake Service Mode. This menu based system will guide you through the steps necessary to retract the EPB actuator in order to perform rear brake service.

Service Mode has requirements that must be met in order to be activated:

- The vehicle must be at a standstill.
- The parking brake must be disabled.
- The transmission must be in PARK or NEUTRAL.
- The EPB switch not activated.
- The ignition is in the ON/RUN mode.
- The brake pedal not pressed.

While in service mode, the EPB fault lamp will flash continuously while the ignition is placed in the ON position.

NOTE:

A dedicated message will appear in the instrument cluster if Brake Service Mode cannot be activated.

When brake service work is complete, the following steps must be followed to reset the parking brake system to normal operation:

- Ensure the vehicle is at a standstill.
- Press the brake pedal with moderate force.
- Apply the EPB switch.

NOTE:

A dedicated message will appear in the instrument cluster if Brake Service Mode cannot be deactivated.

WARNING!

You can be badly injured working on or around a motor vehicle. Do only that service work for which you have the knowledge and the right equipment. If you have any doubt about your ability to perform a service job, take your vehicle to a competent mechanic.

AUTOMATIC TRANSMISSION**NOTE:**

You must press and hold the brake pedal while shifting out of PARK.

The transmission gear range (PRND) is displayed both beside the gear selector and in the

instrument cluster. To select a gear range, push the lock button on the gear selector and move the lever rearward or forward. You must also press the brake pedal to shift the transmission out of PARK (or NEUTRAL, when the vehicle is stopped or moving at low speeds). Select the DRIVE range for normal driving.

WARNING!

- It is dangerous to shift out of PARK or NEUTRAL if the engine speed is higher than idle speed. If your foot is not firmly pressing the brake pedal, the vehicle could accelerate quickly forward or in reverse. You could lose control of the vehicle and hit someone or something. Only shift into gear when the engine is idling normally and your foot is firmly pressing the brake pedal.
- Unintended movement of a vehicle could injure those in or near the vehicle. As with all vehicles, you should never exit a vehicle while the engine is running. Before exiting a vehicle, always come to a complete stop, then apply the parking brake, shift the transmission into PARK, and turn the ignition OFF. When the ignition is in the OFF mode, the transmission is locked in PARK, securing the vehicle against unwanted movement.

(Continued)

WARNING!

- When exiting the vehicle, always make sure the ignition is in the OFF mode, remove the key fob from the vehicle, and lock the vehicle.
- Never leave children alone in a vehicle, or with access to an unlocked vehicle. Allowing children to be in a vehicle unattended is dangerous for a number of reasons. A child or others could be seriously or fatally injured. Children should be warned not to touch the parking brake, brake pedal or the transmission gear selector.
- Do not leave the key fob in or near the vehicle (or in a location accessible to children), and do not leave the ignition in the ON or RUN mode. A child could operate power windows, other controls, or move the vehicle.

CAUTION!

- Shift into or out of PARK or REVERSE only after the vehicle has come to a complete stop.
- Do not shift between PARK, REVERSE, NEUTRAL, or DRIVE when the engine is above idle speed.
- Before shifting into any gear, make sure your foot is firmly pressing the brake pedal.

GEAR SELECTOR

The transmission gear selector has PARK, REVERSE, NEUTRAL, DRIVE, and AutoStick (+/-) shift positions. Manual shifts can be made using the AutoStick shift control. Toggling the gear selector forward (-) or rearward (+) while in the AutoStick position (beside the DRIVE position) will manually select the transmission gear, and will display the current gear in the instrument cluster as 1, 2, 3, etc.

NOTE:

If the gear selector cannot be moved to the PARK, REVERSE, or NEUTRAL position (when pushed forward) it is probably in the AutoStick (+/-) position (beside the DRIVE position). In AutoStick mode, the transmission gear (1, 2, 3, etc.) is displayed in the instrument cluster. Move the gear selector to the right (into the DRIVE [D] position) for access to PARK, REVERSE, and NEUTRAL.

The electronically-controlled transmission adapts its shift schedule based on driver inputs, along with environmental and road conditions. The transmission electronics are self-calibrating; therefore, the first few shifts on a new vehicle may be somewhat abrupt. This is a normal condition, and precision shifts will develop within a few hundred miles (kilometers).

The nine-speed transmission has been developed to meet the needs of current and future FWD/AWD

vehicles. Software and calibration is refined to optimize the customer's driving experience and fuel economy. By design, some vehicle and driveline combinations utilize 9th gear only in very specific driving situations and conditions.

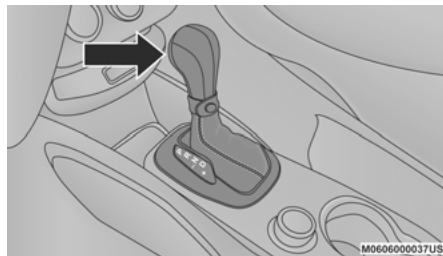

Gear Selector Lock Button

Only shift from DRIVE to PARK or REVERSE when the accelerator pedal is released and the vehicle is stopped. Be sure to keep your foot on the brake pedal when shifting between these gears.

Do not press the accelerator pedal when shifting from PARK or NEUTRAL into another gear range.

CAUTION!

After selecting any gear range, wait a moment to allow the selected gear to engage before accelerating. This is especially important when the engine is cold.

GEAR RANGES

PARK (P)

The engine can be started in this range. Never attempt to use PARK while the vehicle is in motion.

When parking on a hill, apply the EPB before shifting the transmission to PARK, otherwise the load on the transmission locking mechanism may make it difficult to move the gear selector out of PARK. As an added precaution, turn the front wheels toward the curb on a downhill grade and away from the curb on an uphill grade.

When exiting the vehicle, always:

- Apply the parking brake.
- Shift the transmission into PARK.
- Turn the engine off.
- Remove the key fob.

WARNING!

- Never use the PARK position as a substitute for the parking brake. Always apply the parking brake fully when exiting the vehicle to guard against vehicle movement and possible injury or damage.

(Continued)

WARNING!

- Your vehicle could move and injure you and others if it is not in PARK. Check by trying to move the transmission gear selector out of PARK with the brake pedal released. Make sure the transmission is in PARK before exiting the vehicle.
- It is dangerous to shift out of PARK or NEUTRAL if the engine speed is higher than idle speed. If your foot is not firmly pressing the brake pedal, the vehicle could accelerate quickly forward or in reverse. You could lose control of the vehicle and hit someone or something. Only shift into gear when the engine is idling normally and your foot is firmly pressing the brake pedal.
- Unintended movement of a vehicle could injure those in or near the vehicle. As with all vehicles, you should never exit a vehicle while the engine is running. Before exiting a vehicle, always come to a complete stop, then apply the parking brake, shift the transmission into PARK, and turn the ignition OFF. When the ignition is in the OFF mode, the transmission is locked in PARK, securing the vehicle against unwanted movement.

*(Continued)***WARNING!**

- When exiting the vehicle, always make sure the ignition is in the OFF mode, remove the key fob from the vehicle, and lock the vehicle.
- Never leave children alone in a vehicle, or with access to an unlocked vehicle. Allowing children to be in a vehicle unattended is dangerous for a number of reasons. A child or others could be seriously or fatally injured. Children should be warned not to touch the parking brake, brake pedal or the transmission gear selector.
- Do not leave the key fob in or near the vehicle (or in a location accessible to children), and do not leave the ignition in the ON or RUN mode. A child could operate power windows, other controls, or move the vehicle.

CAUTION!

- Before moving the transmission gear selector out of PARK, you must turn the ignition to the ON/RUN mode, and also press the brake pedal. Otherwise, damage to the gear selector could result.
- DO NOT race the engine when shifting from PARK or NEUTRAL into another gear range, as this can damage the drivetrain.

The following indicators should be used to ensure that you have properly engaged the transmission into the PARK position:

- When shifting into PARK, push the lock button on the gear selector, and firmly move the gear selector all the way forward until it stops and is fully seated.
- Look at the transmission gear position display and verify that it indicates the PARK position (P), and is not blinking.
- With the brake pedal released, verify that the gear selector will not move out of PARK.

REVERSE (R)

This range is for moving the vehicle backward. Shift into REVERSE only after the vehicle has come to a complete stop.

NEUTRAL (N)

Use this range when the vehicle is standing for prolonged periods with the engine running. The engine may be started in this range. Apply the Electric Park Brake and shift the transmission into PARK if you must exit the vehicle.

WARNING!

Do not coast in NEUTRAL and never turn off the ignition to coast down a hill. These are unsafe practices that limit your response to changing traffic or road conditions. You might lose control of the vehicle and have a collision.

CAUTION!

Towing the vehicle, coasting, or driving for any other reason with the transmission in NEUTRAL can cause severe transmission damage.

For Recreational Towing ↪ page 116.

For Towing A Disabled Vehicle ↪ page 226.

DRIVE (D)

This range should be used for most city and highway driving. It provides the smoothest upshifts and downshifts, and the best fuel economy. The transmission automatically upshifts through all forward gears.

When frequent transmission shifting occurs (such as when operating the vehicle under heavy loading conditions, in hilly terrain, traveling into strong head winds or while towing a heavy trailer), use the AutoStick shift control to select a lower gear. Under these conditions, using a lower gear will improve

performance and extend transmission life by reducing excessive shifting and heat buildup.

If the transmission temperature exceeds normal operating limits, the transmission controller may modify the transmission shift schedule, reduce engine torque, and/or expand the range of torque converter clutch engagement. This is done to prevent transmission damage due to overheating.

If the transmission becomes extremely hot, the “Transmission Temperature Warning Light” may illuminate and the transmission may operate differently until the transmission cools down.

During cold temperatures, transmission operation may be modified depending on engine and transmission temperature as well as vehicle speed. This feature improves warm up time of the engine and transmission to achieve maximum efficiency. Engagement of the torque converter clutch, and shifts into EIGHTH or NINTH gear, are inhibited until the transmission fluid is warm. Normal operation will resume once the transmission temperature has risen to a suitable level.

AutoStick

AutoStick is a driver-interactive transmission feature providing manual shift control, giving you more control of the vehicle. AutoStick allows you to maximize engine braking, eliminate undesirable upshifts and downshifts, and improve overall vehicle performance. This system can also provide

you with more control during passing, city driving, cold slippery conditions, mountain driving, trailer towing and many other situations.

Operation

When the gear selector is in the AutoStick position (beside the DRIVE position), it can be moved forward and rearward. This allows the driver to manually select the transmission gear being used. Moving the gear selector forward (-) triggers a downshift, and rearward (+) an upshift. The current gear is displayed in the instrument cluster.

NOTE:

In AutoStick mode, the transmission will only shift up or down when the driver moves the gear selector rearward (+) or forward (-), except as described below.

- The transmission will automatically upshift from FIRST to SECOND when necessary to prevent engine overspeed.
- The transmission will automatically downshift as the vehicle slows (to prevent engine lugging) and will display the current gear.
- The transmission will automatically downshift to FIRST or SECOND gear (depending on model) when coming to a stop. After a stop, the driver should manually upshift (+) the transmission as the vehicle is accelerated.

- You can start out (from a stop) in FIRST or SECOND gear. Starting out in SECOND gear can be helpful in snow or icy conditions. Tap the gear selector forward or rearward to select the desired gear after the vehicle is brought to a stop.
- If a requested downshift would cause the engine to overspeed, that shift will not occur.
- The system will ignore attempts to upshift at too low of a vehicle speed.
- Avoid using Cruise Control when AutoStick is engaged because the transmission will not shift automatically.
- Transmission shifting will be more noticeable when AutoStick is enabled.
- The system may revert to automatic shift mode if a fault or overheat condition is detected.

To disengage AutoStick mode, return the gear selector to the DRIVE position. You can shift in or out of the AutoStick position at any time without taking your foot off the accelerator pedal.

WARNING!

Do not downshift for additional engine braking on a slippery surface. The drive wheels could lose their grip and the vehicle could skid, causing a collision or personal injury.

TRANSMISSION LIMP HOME MODE

Transmission function is electronically monitored for abnormal conditions. If a condition is detected that could result in transmission damage, Transmission Limp Home Mode is activated. In this mode, the transmission may operate only in a fixed gear, or may remain in NEUTRAL. The Malfunction Indicator Light (MIL) may be illuminated. Limp Home Mode may allow the vehicle to be driven to an authorized dealer for service without damaging the transmission.

In the event of a momentary problem, the transmission can be reset to regain all forward gears by performing the following steps:

1. Stop the vehicle.
2. Shift the transmission into PARK.
3. Turn the ignition OFF.
4. Wait approximately 10 seconds.
5. Restart the engine.
6. Shift into the desired gear range. If the problem is no longer detected, the transmission will return to normal operation.

NOTE:

Even if the transmission can be reset, we recommend that you visit an authorized dealer at your earliest possible convenience. An authorized dealer has diagnostic equipment to assess the condition of your transmission. If the transmission cannot be reset, authorized dealer service is required.

IGNITION PARK INTERLOCK

This vehicle is equipped with an Ignition Park Interlock, which requires the transmission to be in PARK before the ignition can be turned to the OFF mode. Also, the transmission is locked in PARK whenever the ignition is in the OFF mode.

BRAKE TRANSMISSION SHIFT INTERLOCK (BTSI) SYSTEM

This vehicle is equipped with a BTSI that holds the transmission gear selector in PARK unless the brakes are applied. To shift the transmission out of PARK, the ignition must be in the RUN mode (engine running or not) and the brake pedal must be pressed.

The brake pedal must also be pressed before pushing the button on the gear selector to shift from NEUTRAL into DRIVE or REVERSE when the vehicle is stopped or moving at low speeds.

ALL-WHEEL DRIVE (AWD) — IF EQUIPPED

This feature provides on-demand All-Wheel Drive (AWD). The system is automatic with no driver inputs or additional driving skills required. Under normal driving conditions, the front wheels provide most of the traction. If the front wheels begin to lose traction, power is shifted automatically to the rear wheels. The greater the front wheel traction loss, the greater the power transfer to the rear wheels.

Additionally, on dry pavement under heavy throttle input (where one may have no wheel spin), torque will be sent to the rear in a preemptive effort to improve vehicle launch and performance characteristics.

CAUTION!

All wheels must have the same size and type tires. Unequal tire sizes must not be used. Unequal tire size may cause failure of the power transfer unit.

DYNAMIC SELECTOR — IF EQUIPPED

The Dynamic Selector combines the capabilities of the vehicle control systems, along with driver input, to provide the best performance in all driving conditions.

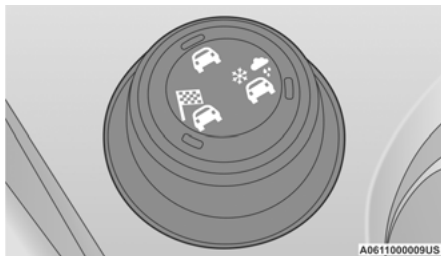

Dynamic Selector Switch

The Dynamic Selector consists of the following positions:

Auto Mode – This mode is designed for comfort and safety in normal driving conditions. In versions equipped with All-Wheel Drive, this mode also reduces fuel consumption by automatically altering the distribution of torque between the front and rear axle.

All Weather Mode – This mode offers increased traction control and stability control for low traction conditions such as driving on a dirt road or off-road as well as wet and slippery roads.

Sport Mode – This mode is designed to increase steering feedback to the driver with a slight increase in effort and changes the transmission shift schedules for more aggressive shifting. This

driving mode is useful while driving on twisty roads where more steering precision is desired in spirited cornering.

WARNING MESSAGES

In the event of a system fault, the system automatically defaults to “Auto” mode and a message will appear in the instrument cluster display.

For further information ↪ page 63.

ELECTRIC POWER STEERING

The electric power steering system will provide increased vehicle response and ease of maneuverability. The power steering system adapts to different driving conditions.

WARNING!

Continued operation with reduced assist could pose a safety risk to yourself and others. Service should be obtained as soon as possible.

If the “SERVICE POWER STEERING” OR “POWER STEERING ASSIST OFF - SERVICE SYSTEM” message and a steering wheel icon are displayed on the instrument cluster screen, it indicates that the vehicle needs to be taken to the dealer for service. It is likely the vehicle has lost power steering assistance ↪ page 63.

NOTE:

- Even if the power steering assistance is no longer operational, it is still possible to steer the vehicle. Under these conditions there will be a substantial increase in steering effort, especially at low speeds and during parking maneuvers.
- If the condition persists, see an authorized dealer for service.

STOP/START SYSTEM

The Stop/Start function was developed to reduce fuel consumption. The system will stop the engine automatically during a vehicle stop if the required conditions are met. Releasing the brake pedal or pressing the accelerator pedal will automatically restart the engine.

AUTOMATIC MODE

The Stop/Start feature is enabled after every normal customer engine start. At that time, the system will go into STOP/START READY and if all other conditions are met, can go into a STOP/START AUTOSTOP ACTIVE "Autostop" mode.

To Activate The Autostop Mode, The Following Must Occur:

- The system must be in STOP/START READY state. A STOP/START READY message will be displayed in the instrument cluster display within the Stop/Start section → page 63.
- The vehicle must be completely stopped.
- The gear selector must be in a forward gear and the brake pedal pressed.

The engine will shut down, the tachometer will move to the zero position and the Stop/Start telltale will illuminate indicating you are in Autostop. Customer settings will be maintained upon return to an engine running condition.

POSSIBLE REASONS THE ENGINE DOES NOT AUTOSTOP

Prior to engine shut down, the system will check many safety and comfort conditions to see if they are fulfilled. Detailed information about the operation of the Stop/Start system may be viewed in the instrument cluster display Stop/Start Screen. In the following situations the engine will not stop:

- Driver's seat belt is not buckled.
- Driver's door is not closed.
- Battery temperature is too warm or cold.

- Battery charge is low.
- The vehicle is on a steep grade.
- Cabin heating or cooling is in process and an acceptable cabin temperature has not been achieved.
- HVAC is set to full defrost mode at a high blower speed.
- HVAC set to MAX A/C.
- Engine has not reached normal operating temperature.
- The transmission is not in a forward gear.
- Hood is open.
- Vehicle is in 4WD Low transfer case mode (if equipped with 4WD).
- Brake pedal is not pressed with sufficient pressure with vehicle in DRIVE position.
- Accelerator pedal input.
- Engine temp too high.
- 5 mph (8 km/h) threshold not achieved from previous AUTOSTOP.
- Steering angle beyond threshold.

It may be possible for the vehicle to be driven several times without the Stop/Start system going into a STOP/START READY state under more extreme conditions of the items listed above.

TO START THE ENGINE WHILE IN AUTOSTOP MODE

While in a forward gear, the engine will start when the brake pedal is released or the throttle pedal is pressed. The transmission will automatically re-engage upon engine restart.

Conditions That Will Cause The Engine To Start Automatically While In Autostop Mode:

- The transmission gear selector is moved out of DRIVE except in the PARK and NEUTRAL position.
- To maintain cabin temperature comfort.
- HVAC is set to full defrost mode.
- HVAC system temperature or fan speed is manually adjusted.
- Battery voltage drops too low.
- Low brake vacuum (e.g. after several brake pedal applications).
- Stop/Start OFF switch is pushed.
- A Stop/Start system error occurs.
- 4WD system is put into 4WD Low mode (if equipped with 4WD).

Conditions That Force An Application Of The Electric Park Brake While In Autostop Mode:

- The driver's door is open and brake pedal released.
- The driver's door is open and the driver's seat belt is unbuckled.
- The engine hood has been opened.
- A Stop/Start system error occurs.

If the Electric Park Brake is applied with the engine off, the engine may require a manual restart and the Electric Park Brake may require a manual release (press brake pedal and push Electric Park Brake switch) ↪ page 63.

TO MANUALLY TURN OFF THE STOP/START SYSTEM

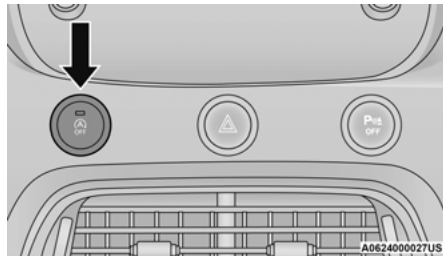

Stop/Start OFF Switch

Push the Stop/Start OFF switch (located on the switch bank). The light on the switch will illuminate. The “STOP/START OFF” message will appear in the instrument cluster display and the Autostop mode will be disabled ↪ page 63.

NOTE:

The Stop/Start system will reset itself back to an ON condition every time the ignition is turned off and back on.

TO MANUALLY TURN ON THE STOP/START SYSTEM

Push the Stop/Start OFF switch (located on the switch bank). The light on the switch will turn off.

SYSTEM MALFUNCTION

If there is a malfunction in the Stop/Start system, the system will not shut down the engine. A “SERVICE STOP/START SYSTEM” message will appear in the instrument cluster display ↪ page 63.

If the “SERVICE STOP/START SYSTEM” message appears in the instrument cluster display, have the system checked by an authorized dealer.

CRUISE CONTROL SYSTEMS — IF EQUIPPED

Your vehicle may be equipped with the Cruise Control system, or the Adaptive Cruise Control (ACC) system:

- Cruise Control will keep your vehicle at a constant preset speed.
- Adaptive Cruise Control (ACC) will adjust the vehicle speed up to the preset speed to maintain a distance with the vehicle ahead.

NOTE:

- In vehicles equipped with ACC, if ACC is not enabled, Fixed Speed Cruise Control will not detect vehicles directly ahead of you. Always be aware of the feature selected.
- Only one Cruise Control feature can operate at a time. For example, if Fixed Speed Cruise Control is enabled, Adaptive Cruise Control will be unavailable, and vice versa.

CRUISE CONTROL — IF EQUIPPED

When engaged, the Cruise Control takes over accelerator operations at speeds greater than 20 mph (32 km/h).

The Cruise Control buttons are located on the right side of the steering wheel.

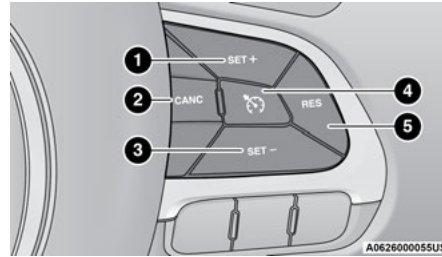

Cruise Control Buttons

- 1 — SET (+)/Accel
- 2 — CANCEL/Cancel
- 3 — SET (-)/Decel
- 4 — On/Off
- 5 — RES/Resume

WARNING!

Cruise Control can be dangerous where the system cannot maintain a constant speed. Your vehicle could go too fast for the conditions, and you could lose control and have an accident. Do not use Cruise Control in heavy traffic or on roads that are winding, icy, snow-covered or slippery.

To Activate

Push the on/off button to activate the Cruise Control. The cruise indicator light in the instrument cluster display will illuminate. To turn the system off, push the on/off button a second time. The cruise indicator light will turn off. The system should be turned off when not in use.

WARNING!

Leaving the Cruise Control system on when not in use is dangerous. You could accidentally set the system or cause it to go faster than you want. You could lose control and have an accident. Always ensure the system is off when you are not using it.

4

To Set A Desired Speed

Turn the Cruise Control on. When the vehicle has reached the desired speed, push the SET (+) or SET (-) button and release. Release the accelerator and the vehicle will operate at the selected speed. A cruise indicator light, along with set speed will also appear and stay on in the instrument cluster when the speed is set.

To Vary The Speed Setting

To Increase Or Decrease The Set Speed

When the Cruise Control is set, you can increase speed by pushing the SET (+) button, or decrease speed by pushing the SET (-) button.

U.S. Speed (mph)

- Pushing the SET (+), or SET (-) button once will result in a 1 mph speed adjustment. Each subsequent tap of the button results in an adjustment of 1 mph.
- If the button is continually pushed, the set speed will continue to adjust until the button is released, then the new set speed will be established.

Metric Speed (km/h)

- Pushing the SET (+), or SET (-) button once will result in a 1 km/h speed adjustment. Each subsequent tap of the button results in an adjustment of 1 km/h.
- If the button is continually pushed, the set speed will continue to adjust until the button is released, then the new set speed will be established.

To Accelerate For Passing

Press the accelerator as you would normally. When the pedal is released, the vehicle will return to the set speed.

USING CRUISE CONTROL ON HILLS

The transmission may downshift on hills to maintain the vehicle set speed.

The Cruise Control system maintains speed up and down hills. A slight speed change on moderate hills is normal. On steep hills, a greater speed loss or gain may occur so it may be preferable to drive without Cruise Control.

WARNING!

Cruise Control can be dangerous where the system cannot maintain a constant speed. Your vehicle could go too fast for the conditions, and you could lose control and have an accident. Do not use Cruise Control in heavy traffic or on roads that are winding, icy, snow-covered or slippery.

To Resume Speed

To resume a previously set speed, push the RES button and release. Resume can be used at any speed above 20 mph (32 km/h).

Deactivation

A tap on the brake pedal, pushing the CANC button, ESC intervention, brake control mitigation, Electronic Park Brake intervention, or normal brake pressure while slowing the vehicle will deactivate the Cruise Control without erasing the set speed from memory.

Pushing the on/off button or placing the ignition in the OFF position erases the set speed from memory.

ADAPTIVE CRUISE CONTROL (ACC) — IF EQUIPPED

Adaptive Cruise Control (ACC) increases the driving convenience provided by cruise control while traveling on highways and major roadways. However, it is not a safety system and not designed to prevent collisions. Cruise Control function performs differently if your vehicle is not equipped with ACC ↗ page 91.

ACC will allow you to keep Cruise Control engaged in light to moderate traffic conditions without the constant need to reset your speed. ACC utilizes a radar sensor and a forward facing camera designed to detect a vehicle directly ahead of you to maintain a set speed.

NOTE:

- If the ACC sensor detects a vehicle ahead, ACC will apply limited braking or accelerate (not to exceed the original set speed) automatically to maintain a preset following distance, while matching the speed of the vehicle ahead.
- Any chassis/suspension or tire size modifications to the vehicle will affect the performance of the Adaptive Cruise Control and Forward Collision Warning system.
- Fixed Speed Cruise Control (ACC not enabled) will not detect vehicles directly ahead of you. Always be aware of the feature selected → page 290.

WARNING!

- Adaptive Cruise Control (ACC) is a convenience system. It is not a substitute for active driver involvement. It is always the driver's responsibility to be attentive of road, traffic, and weather conditions, vehicle speed, distance to the vehicle ahead; and, most importantly, brake operation to ensure safe operation of the vehicle under all road conditions. Your complete attention is always required while driving to maintain safe control of your vehicle. Failure to follow these warnings can result in a collision and death or serious personal injury.

*(Continued)***WARNING!**

- The ACC system:
 - Does not react to pedestrians, oncoming vehicles, and stationary objects (e.g., a stopped vehicle in a traffic jam or a disabled vehicle).
 - Cannot take street, traffic, and weather conditions into account, and may be limited upon adverse sight distance conditions.
 - Does not always fully recognize complex driving conditions, which can result in wrong or missing distance warnings.

You should turn the ACC system off:

- When driving in fog, heavy rain, heavy snow, sleet, heavy traffic, and complex driving situations (i.e., in highway construction zones).
- When entering a turn lane or highway off ramp; when driving on roads that are winding, icy, snow-covered, slippery, or have steep uphill or downhill slopes.
- When towing a trailer up or down steep slopes.
- When circumstances do not allow safe driving at a constant speed.

Adaptive Cruise Control (ACC) Operation

The Cruise Control buttons (located on the right side of the steering wheel) operate the ACC system.

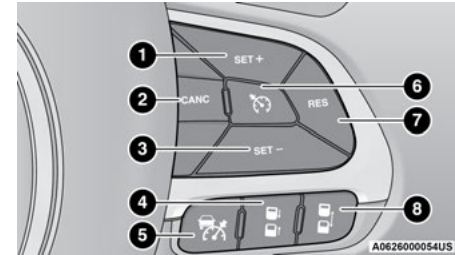
**Adaptive Cruise Control Buttons**

- 1 — SET (+)/Accel
- 2 — CANC/Cancel
- 3 — SET (-)/Decel
- 4 — Distance Setting Decrease
- 5 — Adaptive Cruise Control (ACC) On/Off
- 6 — Fixed Speed Cruise Control On/Off
- 7 — RES/Resume
- 8 — Distance Setting Increase

Adaptive Cruise Control (ACC) Menu

The instrument cluster display shows the current ACC system settings. The information it displays depends on ACC system status.

Push the Adaptive Cruise Control (ACC) on/off button until one of the following shows in the instrument cluster display:

Adaptive Cruise Control Off

When ACC is deactivated, the display will read “Adaptive Cruise Control Off.”

Adaptive Cruise Control Ready

When ACC is activated but the vehicle speed setting has not been selected, the display will read “Adaptive Cruise Control Ready.”

Adaptive Cruise Control Set

When the SET (+) or the SET (-) button is pushed, the display will read “ACC SET.”

When ACC is set, the set speed will appear in the instrument cluster display.

The ACC screen may display once again if any of the following ACC activity occurs:

- System Cancel
 - Driver Override
 - System Off
 - ACC Proximity Warning
 - ACC Unavailable Warning
- The instrument cluster display will return to the last display selected after five seconds of no ACC display activity.

Activating Adaptive Cruise Control (ACC)

The minimum set speed for the ACC system is 20 mph (32 km/h).

When the system is turned on and in the ready state, the instrument cluster display will read “ACC Ready.”

When the system is off, the instrument cluster display will read “Adaptive Cruise Control (ACC) Off.”

NOTE:

You cannot engage ACC under the following conditions:

- When in 4WD Low
- When the brakes are applied
- When the parking brake is applied
- When the automatic transmission is in PARK, REVERSE or NEUTRAL
- When the vehicle speed is below the minimum speed range
- When the brakes are overheated
- When the Electronic Stability Control (ESC), Anti-Lock Brake System (ABS), or other stability control systems are operating or have just operated
- During automatic braking by the Full Brake Control system (if equipped)
- When Cruise Control is activated

To Activate/Deactivate

Push and release the Adaptive Cruise Control (ACC) on/off button. The ACC menu in the instrument cluster display will read “ACC Ready.”

To turn the system off, push and release the Adaptive Cruise Control (ACC) on/off button again. At this time, the system will turn off and the instrument cluster display will read “Adaptive Cruise Control (ACC) Off.”

WARNING!

Leaving the Adaptive Cruise Control (ACC) system on when not in use is dangerous. You could accidentally set the system or cause it to go faster than you want. You could lose control and have a collision. Always ensure the system is off when you are not using it.

To Set A Desired ACC Speed

When the vehicle reaches the speed desired, push the SET (+) button or the SET (-) button and release. The instrument cluster display will show the set speed.

NOTE:

Fixed Speed Cruise Control can be used without ACC enabled. To change between the different modes, push the ACC on/off button which turns the ACC and the Fixed Speed Cruise Control off. Pushing the Fixed Speed Cruise Control on/off button will result in turning on (changing to) Fixed Speed Cruise Control mode.

WARNING!

In Fixed Speed Cruise Control mode, the system will not react to vehicles ahead. In addition, the proximity warning does not activate and no alarm will sound even if you are too close to the vehicle ahead since neither the presence of the vehicle ahead nor the vehicle-to-vehicle distance is detected. Be sure to maintain a safe distance between your vehicle and the vehicle ahead. Always be aware which mode is selected.

ACC or Fixed Speed Cruise Control is set when the vehicle speed is above 20 mph (32 km/h), the set speed shall be the current speed of the vehicle. Neither system cannot be set below 20 mph (32 km/h).

NOTE:

- Keeping your foot on the accelerator pedal can cause the vehicle to continue to accelerate beyond the set speed. If this occurs, the message "Adaptive Cruise Control Override" will display in the instrument cluster display.
- If you continue to accelerate beyond the set speed while ACC is enabled, the system will not be controlling the distance between your vehicle and the vehicle ahead. The vehicle speed will only be determined by the position of the accelerator pedal.

To Cancel

The following conditions cancel the system:

- The brake pedal is applied.
- The CANC button is pushed.
- An Anti-Lock Brake System (ABS) event occurs.
- The gear selector is removed from the DRIVE position.
- The braking temperature exceeds normal range (overheated).
- The Electronic Stability Control/Traction Control System (ESC/TCS) activates.
- The vehicle parking brake is applied.
- The driver switches ESC to Full Off mode.

To Turn Off

The system will turn off and erase the set speed in memory if:

- The Adaptive Cruise Control (ACC) on/off button is pushed.
- The Fixed Speed Cruise Control on/off button is pushed.
- The ignition is placed in the OFF position.

To Resume Speed

If there is a set speed in the memory, push the RES button and then remove your foot from the accelerator pedal. The instrument cluster display will show the last set speed.

ACC or Fixed Speed Cruise Control can only be resumed at speeds above 20 mph (32 km/h).

NOTE:

ACC cannot be resumed if there is a stationary vehicle in front of your vehicle in close proximity.

WARNING!

The Resume function should only be used if traffic and road conditions permit. Resuming a set speed that is too high or too low for prevailing traffic and road conditions could cause the vehicle to accelerate or decelerate too sharply for safe operation. Failure to follow these warnings can result in a collision and death or serious personal injury.

To Vary The Speed Setting

To Increase Or Decrease The Set Speed

After setting a speed, you can increase the set speed by pushing the SET (+) button, or decrease speed by pushing the SET (-) button.

U.S. Speed (mph)

- Pushing the SET (+), or SET (-) button once will result in a 1 mph speed adjustment. Each subsequent tap of the button results in an adjustment of 1 mph.
- If the button is continually pushed, the set speed will continue to adjust in 5 mph increments until the button is released. The new set speed is reflected in the instrument cluster display.

Metric Speed (km/h)

- Pushing the SET (+), or SET (-) button once will result in a 1 km/h speed adjustment. Each subsequent tap of the button results in an adjustment of 1 km/h.
- If the button is continually pushed, the set speed will continue to adjust in 10 km/h increments until the button is released. The new set speed is reflected in the instrument cluster display.

NOTE:

When you override and push the SET (+) button or SET (-) button, the new set speed will be the current speed of the vehicle.

When ACC Is Active:

- When you use the SET (-) button to decelerate, if the engine's braking power does not slow the vehicle sufficiently to reach the set speed, the brake system will automatically slow the vehicle.
- The ACC system maintains set speed when driving uphill and downhill. However, a slight speed change on moderate hills is normal. In addition, downshifting may occur while climbing uphill or descending downhill. This is normal operation and necessary to maintain set speed. When driving uphill and downhill, the ACC system will cancel if the braking temperature exceeds normal range (overheated).
- If Sport mode is chosen on the Dynamic Selector, the ACC system will switch to Sport mode. The system will become more reactive in case of acceleration.

Setting The Following Distance In ACC

The specified following distance for ACC can be set by varying the distance setting between four bars (longest), three bars (long), two bars (medium) and one bar (short). Using this distance setting and the vehicle speed, ACC calculates and sets the distance to the vehicle ahead. This distance setting will show in the instrument cluster display.

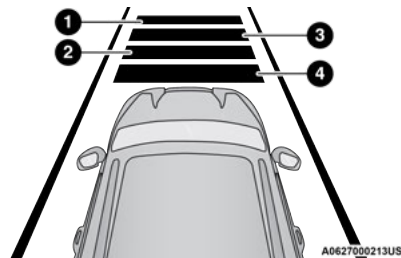

Distance Settings

- 1 — Longest Distance Setting (Four Bars)
- 2 — Medium Distance Setting (Two Bars)
- 3 — Long Distance Setting (Three Bars)
- 4 — Short Distance Setting (One Bar)

To increase the distance setting, push the Distance Increase button and release. Each time the button is pushed, the distance setting increases by one bar (longer).

If there is no vehicle ahead, the vehicle will maintain the set speed. If a slower moving vehicle is detected in the same lane, the instrument cluster display will show the ACC Set With Target Detected Light. The system adjusts vehicle speed automatically to maintain the distance setting, regardless of the set speed.

The vehicle will then maintain the set distance until:

- The vehicle ahead accelerates to a speed above the set speed.
- The vehicle ahead moves out of your lane or view of the sensor.
- The distance setting is changed.
- The system disengages → page 94.

The maximum braking applied by ACC is limited; however, the driver can always apply the brakes manually, if necessary.

NOTE:

The brake lights will illuminate whenever the ACC system applies the brakes.

A Proximity Warning will alert the driver if ACC predicts that its maximum braking level is not sufficient to maintain the set distance. If this

occurs, a visual alert “BRAKE!” will appear in the instrument cluster display and a chime will sound while ACC continues to apply its maximum braking capacity.

NOTE:

The “BRAKE!” screen in the instrument cluster display is a warning for the driver to take action and does not necessarily mean that the Full Brake Control system is applying the brakes automatically.

Overtake Aid

When driving with ACC engaged and following a vehicle, the system will provide an additional acceleration up to the ACC set speed to assist in passing the vehicle. This additional acceleration is triggered when the driver utilizes the left turn signal and will only be active when passing on the left hand side.

Display Warnings And Maintenance

“FRONT RADAR SENSOR TEMPORARILY BLOCKED” WARNING

The “ACC Front Radar Sensor Temporarily Blocked” warning will display and a chime will sound when conditions temporarily limit system performance.

This most often occurs at times of poor visibility, such as in snow or heavy rain. The ACC system may also become temporarily blinded due to

obstructions, such as mud, dirt or ice. In these cases, the instrument cluster display will read “ACC/FCW Unavailable Wipe Front Radar Sensor” and the system will deactivate.

The “ACC Front Radar Sensor Temporarily Blocked” message can sometimes be displayed while driving in highly reflective areas (i.e. ice and snow, or tunnels with reflective tiles). The ACC system will recover after the vehicle has left these areas. Under rare conditions, when the radar is not tracking any vehicles or objects in its path this warning may temporarily occur.

NOTE:

If the “ACC Front Radar Sensor Temporarily Blocked” warning is active, Fixed Speed Cruise Control is still available.

If weather conditions are not a factor, the driver should examine the sensor. It may require cleaning or removal of an obstruction. The sensor is located in the center of the vehicle behind the lower grille.

To keep the ACC System operating properly, it is important to note the following maintenance items:

- Always keep the sensor clean. Carefully wipe the sensor lens with a soft cloth. Do not use solvents or abrasive substances.
- Do not remove any screws from the sensor. Doing so could cause an ACC system malfunction or failure and require a sensor realignment.

- If the sensor or front end of the vehicle is damaged due to a collision, see an authorized dealer for service.
- Do not attach or install any accessories near the sensor, including transparent material or aftermarket grilles. Doing so could cause an ACC system failure or malfunction.

When the condition that deactivated the system is no longer present, the system will return to the “Adaptive Cruise Control Off” state and will resume function by simply reactivating it.

NOTE:

- If the “ACC Front Radar Sensor Temporarily Blocked” message occurs frequently (e.g. more than once on every trip) without any snow, rain, mud, or other obstruction, have the radar sensor realigned at an authorized dealer.
- Installing a snow plow, front-end protector, an aftermarket grille or modifying the grille is not recommended. Doing so may block the sensor and inhibit ACC/Full Brake Control System operation.

“CLEAN FRONT WINDSHIELD” WARNING

The “ACC/FCW Limited Functionality Wipe Front Windshield” warning will display when conditions temporarily limit system performance. This most often occurs at times of poor visibility, such as in snow or heavy rain and fog. The ACC system may

also become temporarily blinded due to obstructions, such as mud, dirt, or ice on windshield and fog on the inside of glass. In these cases, the instrument cluster display will read “ACC/FCW Limited Functionality Wipe Front Windshield” and the system will have degraded performance.

The “ACC/FCW Limited Functionality Wipe Front Windshield” message can sometimes be displayed while driving in adverse weather conditions. The ACC/Full Brake Control system will recover after the vehicle has left these areas. Under rare conditions, when the camera is not tracking any vehicles or objects in its path this warning may temporarily occur.

If weather conditions are not a factor, the driver should examine the windshield and the camera located on the back side of the inside rear view mirror. They may require cleaning or removal of an obstruction.

When the condition that created limited functionality is no longer present, the system will return to full functionality.

NOTE:

If the “ACC/FCW Limited Functionality Wipe Front Windshield” message occurs frequently (e.g. more than once on every trip) without any snow, rain, mud, or other obstruction, have the windshield and forward facing camera inspected at an authorized dealer.

SERVICE ACC/FCW WARNING

If the system turns off, and the instrument cluster display reads “ACC/FCW Limited Functionality Frontal Camera Service Required” or “Cruise Control Service Required”, there may be an internal system fault or a temporary malfunction that limits ACC functionality. Although the vehicle is still drivable under normal conditions, ACC will be temporarily unavailable. If this occurs, try activating ACC again later, following an ignition cycle. If the problem persists, see an authorized dealer.

Precautions While Driving With ACC

In certain driving situations, ACC may have detection issues. In these cases, ACC may brake late or unexpectedly. The driver needs to stay alert and may need to intervene. The following are examples of these types of situations:

TOWING A TRAILER

Towing a trailer is not recommended when using ACC.

OFFSET DRIVING

ACC may not detect a vehicle in the same lane that is offset from your direct line of travel, or a vehicle merging in from a side lane. There may not be sufficient distance to the vehicle ahead. The offset vehicle may move in and out of the line of travel, which can cause your vehicle to brake or accelerate unexpectedly.

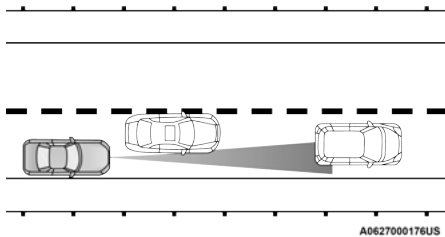

A0627000176US

Offset Driving Condition Example

TURNS AND BENDS

When driving on a curve with ACC engaged, the system may decrease the vehicle speed and acceleration for stability reasons, with no target vehicle detected. Once the vehicle is out of the curve the system will resume your original set speed. This is a part of normal ACC system functionality.

NOTE:

On tight turns ACC performance may be limited. The driver must maintain control of the vehicle, remain alert, and be ready to apply the brakes if needed.

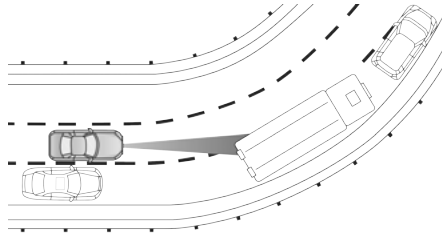

A0627000177US

Turn Or Bend Example

USING ACC ON HILLS

When driving on hills, ACC may not detect a vehicle in your lane. Depending on the speed, vehicle load, traffic conditions, and the steepness of the hills, ACC performance may be limited.

NOTE:

The driver must maintain control of the vehicle, remain alert, and be ready to apply the brakes if needed.

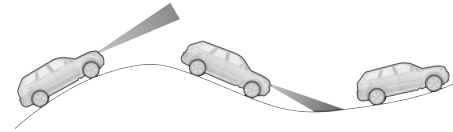

A0627000175US

ACC Hill Example

LANE CHANGING

ACC may not detect a vehicle until it is completely in the lane in which you are traveling. In the illustration shown, ACC has not yet detected the vehicle changing lanes and it may not detect the vehicle until it's too late for the ACC system to take action. ACC may not detect a vehicle until it is completely in the lane. There may not be sufficient distance to the lane-changing vehicle. Always be attentive and ready to apply the brakes if necessary.

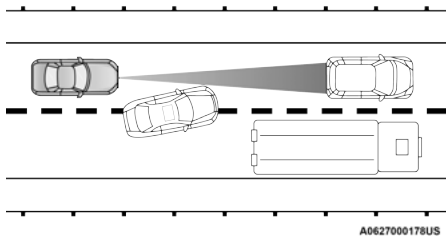

Lane Changing Example

NARROW VEHICLES

Some narrow vehicles traveling near the outer edges of the lane or edging into the lane are not detected until they have moved fully into the lane. There may not be sufficient distance to the vehicle ahead.

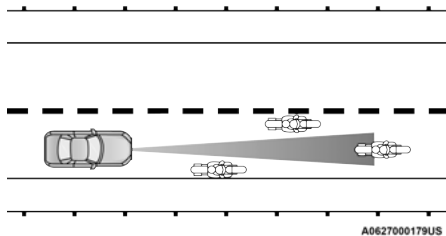

Narrow Vehicle Example

STATIONARY OBJECTS AND VEHICLES

ACC does not react to stationary objects and stationary vehicles. For example, ACC will not react in situations where the vehicle you are following exits your lane and the vehicle ahead is stopped in your lane. Always be attentive and ready to apply the brakes if necessary.

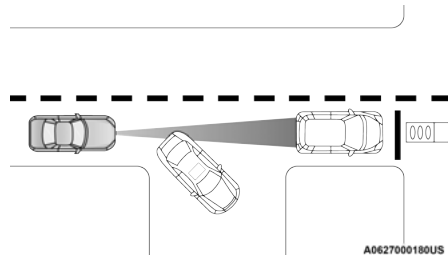

Stationary Object And Stationary Vehicle Example

FRONT/REAR PARK ASSIST — IF EQUIPPED

The Park Assist system provides visual and audible indications of the distance between the rear and/or front fascia/bumper and a detected obstacle when backing up or moving forward (e.g. during a parking maneuver).

For limitations of this system and recommendations, see ↪ page 104.

Park Assist will retain the last system state (enabled or disabled) from the last ignition cycle when the ignition is changed to the ON/RUN position.

Park Assist is active when the gear selector is shifted to REVERSE or to a forward gear and an obstacle is detected, as long as the system is on. When the gear selector shifted to NEUTRAL (or PARK in case of automatic gearbox), the system becomes inactive. When the vehicle is moving forward, the system will remain active until the vehicle speed remains below approximately 11 mph (18 km/h). Reducing the speed approximately below 9 mph (15 km/h), the system will come back active. When the vehicle is moving in REVERSE, the system will remain active as long as the speed remains below the maximum operating speed of 7 mph (11 km/h). When the maximum speed limit is exceeded, the system is disabled and the Park Assist switch LED will illuminate. The system will become active again if the vehicle speed reduces below approximately 6 mph (9 km/h).

PARK ASSIST SENSORS

The four Park Assist sensors, located in the rear fascia/bumper, monitor the area behind the vehicle that is within the sensors' field of view. The sensors can detect obstacles from approximately 12 inches (30 cm) up to 59 inches (150 cm) from the rear fascia/bumper in the horizontal direction, depending on the location, type and orientation of the obstacle.

The four Park Assist sensors, located in the front fascia/bumper (if equipped), monitor the area in front of the vehicle that is within the sensors' field of view. The sensors can detect obstacles from approximately 12 inches (30 cm) up to 39 inches (100 cm) from the front fascia/bumper in the horizontal direction, depending on the location, type and orientation of the obstacle.

PARK ASSIST WARNING DISPLAY

The Park Assist Warning screen will only be displayed if "Sound and Display" is selected from the Uconnect system ↪ page 120.

The Park Assist Warning screen is located within the instrument cluster display. It provides visual warnings to indicate the distance between the rear fascia/bumper and/or front fascia/bumper and the detected obstacle ↪ page 63.

PARK ASSIST DISPLAY

The Park Assist warning screen will be displayed when an obstacle is detected while the vehicle is in DRIVE or REVERSE, as long as the vehicle speed is below 7 mph (11 km/h) when in REVERSE and below 11 mph (18 km/h) when in DRIVE. When the vehicle is in REVERSE, the Park Assist warning screen will always be displayed.

The system will indicate a detected obstacle by showing a single arc in the left and/or right front or rear regions based on the object's distance and location relative to the vehicle.

If an object is detected in the left and/or right front or rear region, the display will show a single arc in the left and/or right front or rear region and the system will produce a tone. As the vehicle moves closer to the object, the display will show the single arc moving closer to the vehicle and the tone will change from a single 1/2 second tone to slow, to fast, to continuous.

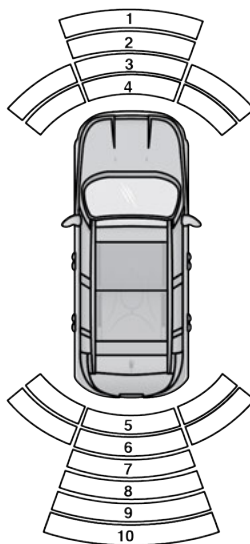

A0629000267US

Front/ Rear/Side ParkSense Arcs

- 1 – No Tone/Solid Arc
- 2 – No Tone/Flashing Arc
- 3 – Fast Tone/Flashing Arc
- 4 – Continuous Tone/Flashing Arc
- 5 – Continuous Tone/Flashing Arc

- 6 – Fast Tone/Flashing Arc
- 7 – Fast Tone/Flashing Arc
- 8 – Slow Tone/Solid Arc
- 9 – Slow Tone/Solid Arc
- 10 – 1/2 Second Tone/Solid Arc

The vehicle is close to the obstacle when the warning display shows one flashing arc and sounds a continuous tone. The following charts show the warning alert operation when the system is detecting an obstacle:

WARNING ALERTS FOR REAR							
Rear Distance (inches/cm)	Greater than 59 inches (150 cm)	59-52 inches (150-130 cm)	52-41 inches (130-105 cm)	41-34 inches (105-85 cm)	34-24 inches (85-60 cm)	24-12 inches (60-30 cm)	Less than 12 inches (30 cm)
Arcs – Left	None	None	None	None	None	6th Flashing	5th Flashing
Arcs – Center	None	10th Solid	9th Solid	8th Solid	7th Flashing	6th Flashing	5th Flashing
Arcs – Right	None	None	None	None	None	6th Flashing	5th Flashing
Audible Alert Chime	None	Single, 1/2 second, audible chime is heard	Audible chime increases as the object gets closer to the vehicle				Continuous
Radio Volume Reduced	No	Yes					

4

WARNING ALERTS FOR FRONT					
Front Distance (inches/cm)	Greater than 39 inches (100 cm)	39-32 inches (100-80 cm)	32-24 inches (80-60 cm)	24-12 inches (60-30 cm)	Less than 12 inches (30 cm)
Arcs – Left	None	None	None	3rd Flashing	4th Flashing
Arcs – Center	None	1st Solid	2nd Flashing	3rd Flashing	4th Flashing
Arcs – Right	None	None	None	3rd Flashing	4th Flashing
Audible Alert Chime	None	None	None	Audible chime increases as the object gets close to the vehicle	Continuous
Radio Volume Reduced	No			Yes	

NOTE:

Park Assist will reduce the volume of the radio, if on, when the system is sounding an audible tone.

Front Park Assist Audible Alerts

Park Assist will turn off the Front Park Assist audible alert (chime) after approximately three seconds when an obstacle has been detected, the vehicle is stationary, and brake pedal is applied. If the obstacle has been detected within less than 12 inches (30 cm), then the Park Assist will not turn off the Front Park Assist audible alert.

Adjustable Chime Volume Settings

Front and Rear chime volume settings can be selected from the Customer-Programmable Features section of the Uconnect system
 ↪ page 120.

If the Uconnect system is equipped, chime volume settings will not be accessible from the instrument cluster display.

The chime volume settings include low, medium, and high.

Park Assist will retain its last known configuration state through ignition cycles.

ENABLING AND DISABLING PARK ASSIST



Park Assist can be enabled and disabled with the Park Assist switch, located on the switch panel below the Uconnect display.

When the Park Assist switch is pushed to disable the system, the instrument cluster display will show the "Park Assist Disabled" message for approximately five seconds
 ↪ page 63.

The Park Assist switch LED will be on when the Park Assist system is disabled or requires service. The Park Assist switch LED will be off when the system is enabled. If the Park Assist switch is pushed, and the system requires service, the Park Assist switch LED will blink momentarily, and then the LED will be on.

SERVICE THE PARK ASSIST SYSTEM

During vehicle start up, when the Park Assist System has detected a faulted condition, the instrument cluster display will actuate a single chime, once per ignition cycle, and it will show the "PARK ASSIST UNAVAILABLE WIPE REAR SENSORS", "PARK ASSIST UNAVAILABLE WIPE FRONT SENSORS", or the "PARK ASSIST UNAVAILABLE SERVICE REQUIRED" message for five seconds.

If "PARK ASSIST UNAVAILABLE WIPE REAR SENSORS" or "PARK ASSIST UNAVAILABLE WIPE FRONT SENSORS" appears in the instrument cluster display make sure the outer surface and the underside of the rear fascia/bumper and/or front fascia/bumper is clean and clear of snow, ice, mud, dirt or other obstruction and then cycle the ignition. If the message continues to appear see an authorized dealer.

If the "PARK ASSIST UNAVAILABLE SERVICE REQUIRED" message appears in the instrument cluster display, see an authorized dealer.

CLEANING THE PARK ASSIST SYSTEM

Clean the Park Assist sensors with water, car wash soap and a soft cloth. Do not use rough or hard cloths. Do not scratch or poke the sensors. Otherwise, you could damage the sensors.

PARK ASSIST SYSTEM USAGE PRECAUTIONS

NOTE:

- Ensure that the outer surface and the underside of the front and rear fascia/bumper are clean and clear of snow, ice, mud, dirt or other obstruction to keep the Park Assist system operating properly.
- Jackhammers, large trucks, and other vibrations could affect the performance of Rear Park Assist.
- Clean the Park Assist sensors regularly, taking care not to scratch or damage them. The sensors must not be covered with ice, snow, slush, mud, dirt or debris. Failure to do so can result in the system not working properly. The Park Assist system might not detect an obstacle behind the fascia/bumper, or it could provide a false indication that an obstacle is behind the fascia/bumper.

- Objects such as bicycle carriers, etc., must not be placed within 12 inches (30 cm) from the rear fascia/bumper while driving the vehicle. Failure to do so can result in the system misinterpreting a close object as a sensor problem, causing a failure indication to be displayed in the instrument cluster.

WARNING!

- Drivers must be careful when backing up even when using Park Assist. Always check carefully behind your vehicle, look behind you, and be sure to check for pedestrians, animals, other vehicles, obstructions, and blind spots before backing up. You are responsible for safety and must continue to pay attention to your surroundings. Failure to do so can result in serious injury or death.
- Before using Park Assist, it is strongly recommended that the ball mount and hitch ball assembly be disconnected from the vehicle when the vehicle is not used for towing. Failure to do so can result in injury or damage to vehicles or obstacles because the hitch ball will be much closer to the obstacle than the rear fascia when the vehicle sounds the continuous tone. Also, the sensors could detect the ball mount and hitch ball assembly, depending on its size and shape, giving a false indication that an obstacle is behind the vehicle.

CAUTION!

- Park Assist is only a parking aid and it is unable to recognize every obstacle, including small obstacles. Parking curbs might be temporarily detected or not detected at all. Obstacles located above or below the sensors will not be detected when they are in close proximity.
- The vehicle must be driven slowly when using Park Assist in order to be able to stop in time when an obstacle is detected. It is recommended that the driver looks over his/her shoulder when using Park Assist.

If it is necessary to keep the trailer hitch and hitch ball assembly mounted for a long period, it is possible to filter out the trailer hitch and hitch ball assembly presence within the sensor's field of view. The filtering operation must be performed only by an authorized dealer.

LANESENSE — IF EQUIPPED

LANESENSE OPERATION

The LaneSense system is operational at speeds above 37 mph (60 km/h) and below 112 mph (180 km/h). The LaneSense system uses a forward looking camera to detect lane markings

and measure vehicle position within the lane boundaries.

When both lane markings are detected and the driver drifts out of the lane (no turn signal applied), the LaneSense system provides a haptic warning in the form of torque applied to the steering wheel to prompt the driver to remain within the lane boundaries. If the driver continues to drift out of the lane, the LaneSense system provides a visual warning through the instrument cluster display to prompt the driver to remain within the lane boundaries.

The driver may manually override the haptic warning by applying force to the steering wheel at any time.

When only a single lane marking is detected and the driver drifts across the lane marking (no turn signal applied), the LaneSense system provides a visual warning through the instrument cluster display to prompt the driver to remain within the lane. When only a single lane marking is detected, a haptic (torque) warning will not be provided.

NOTE:

When operating conditions have been met, the LaneSense system will monitor if the driver's hands are on the steering wheel and provides an audible warning to the driver if removed. The system will cancel if the driver does not return their hands to the wheel.

TURNING LANESENSE ON OR OFF



The LaneSense button is located on the end of the turn signal stalk, located on the left side of the steering column.

To turn the LaneSense system on, push the LaneSense button once. A “Lane Sense On” message is shown in the instrument cluster display.

To turn the LaneSense system off, push the LaneSense button once.

NOTE:

The LaneSense system will retain the last system state (on or off) from the last ignition cycle when the ignition is changed to the ON/RUN position.

LANESENSE WARNING MESSAGE

The LaneSense system will indicate the current lane drift condition through the instrument cluster display.

When the LaneSense system is on, the lane lines are gray when both of the lane boundaries have not been detected and the LaneSense telltale is solid white.

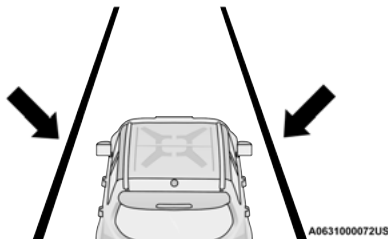

System On (Gray Lines/White Telltale)

Left Lane Departure — Only Left Lane Detected

- When the LaneSense system is on, the LaneSense telltale is solid white when only the left lane marking has been detected and the system is ready to provide visual warnings in the instrument cluster display if a lane departure occurs.
- When the LaneSense system senses the lane has been approached and is in a lane departure situation, the left lane line flashes yellow (on/off), and the LaneSense telltale changes from solid white to flashing yellow.

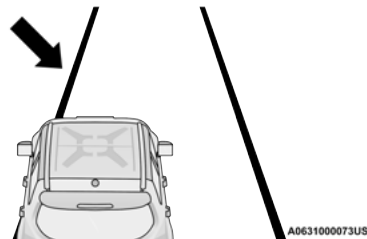

**Lane Approached
(Flashing Yellow Line/Flashing Yellow Telltale)**

NOTE:

The LaneSense system operates with similar behavior for a right lane departure when only the right lane marking has been detected.

Left Lane Departure — Both Lanes Detected

- When the LaneSense system is on, the lane lines turn from gray to white to indicate that both of the lane markings have been detected. The LaneSense telltale is solid green when both lane markings have been detected and the system is “armed” to provide visual warnings in the instrument cluster display and a torque warning in the steering wheel if a lane departure occurs.

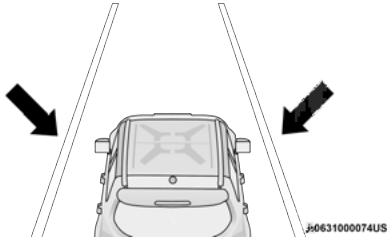

Lanes Sensed (White Lines/Green Telltale)

- When the LaneSense system senses a lane drift situation, the left lane line turns solid yellow. The LaneSense telltale changes from solid green to solid yellow. At this time torque is applied to the steering wheel in the opposite direction of the lane boundary.

For example: If approaching the left side of the lane the steering wheel will turn to the right.

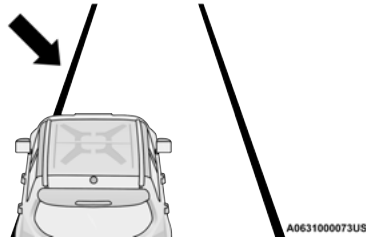

Lane Sensed (Solid Yellow Line/Solid Yellow Telltale)

- When the LaneSense system senses the lane has been approached and is in a lane departure situation, the left lane line flashes yellow (on/off). The LaneSense telltale changes from solid yellow to flashing yellow. At this time torque is applied to the steering wheel in the opposite direction of the lane boundary.

For example: If approaching the left side of the lane the steering wheel will turn to the right.

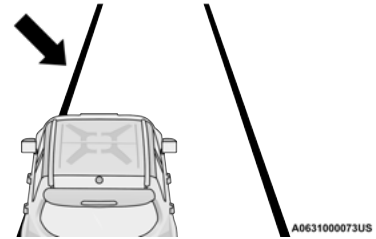

**Lane Approached
(Flashing Yellow Line/Flashing Yellow Telltale)**

NOTE:

The LaneSense system operates with similar behavior for a right lane departure.

CHANGING LANESENSE STATUS

The LaneSense system has settings to adjust the intensity of the torque warning and the warning zone sensitivity (early/late) that you can configure through the Uconnect system screen → page 120.

NOTE:

- When enabled the system operates above 37 mph (60 km/h) and below 112 mph (180 km/h).
- Use of the turn signal suppresses the warnings.
- The system will not apply torque to the steering wheel whenever a safety system engages. (Anti-Lock Brakes, Traction Control System, Electronic Stability Control, Full Brake Control system, etc.).

PARKVIEW REAR BACK UP CAMERA

The ParkView Rear Back Up Camera allows you to see an on-screen image of the rear surroundings of your vehicle when the gear selector is put into REVERSE. The image will be displayed on the touchscreen display along with a note to “Check Entire Surroundings” across the top of the screen. After five seconds this note will disappear. The ParkView camera is located on the rear of the vehicle above the rear license plate.

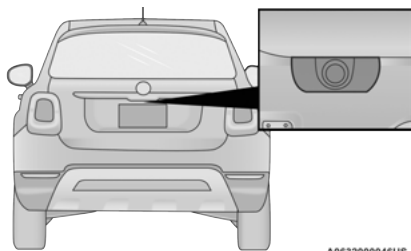

Back Up Camera Location

When the vehicle is shifted out of REVERSE (with camera delay turned off), the rear camera mode is exited and the navigation or audio screen appears again.

When the vehicle is shifted out of REVERSE (with camera delay turned on), the camera image will continue to be displayed for up to 10 seconds unless the vehicle speed exceeds 8 mph (13 km/h), the vehicle is shifted into PARK, or the ignition is placed in the OFF position.

A touchscreen button to disable the camera is available when the vehicle is not in REVERSE. Display of the camera image after shifting out of REVERSE can be disabled via Uconnect Settings.

When enabled, active guidelines are overlaid on the image to illustrate the width of the vehicle and its projected backup path based on the steering wheel position.

Different colored zones indicate the distance to the rear of the vehicle.

The following table shows the approximate distances for each zone:

Zone	Distance To The Rear Of The Vehicle
Red	0 - 1 ft (0 - 30 cm)
Yellow	1 ft - 3 ft (30 cm - 1 m)
Green	3 ft or greater (1 m or greater)

NOTE:

If snow, ice, mud, or any foreign substance builds up on the camera lens, clean the lens, rinse with water, and dry with a soft cloth. Do not cover the lens.

WARNING!

Drivers must be careful when backing up even when using the ParkView Rear Back Up Camera. Always check carefully behind your vehicle, and be sure to check for pedestrians, animals, other vehicles, obstructions, or blind spots before backing up. You are responsible for the safety of your surroundings and must continue to pay attention while backing up. Failure to do so can result in serious injury or death.

CAUTION!

- To avoid vehicle damage, ParkView should only be used as a parking aid. The ParkView camera is unable to view every obstacle or object in your drive path.
- To avoid vehicle damage, the vehicle must be driven slowly when using ParkView to be able to stop in time when an obstacle is seen. It is recommended that the driver look frequently over his/her shoulder when using ParkView.

ADDING FUEL

The Capless Fuel system uses a flapper placed at the filler pipe of the fuel tank; it opens and closes automatically upon insertion/extraction of the fuel nozzle.

The Capless Fuel system is designed so that it prevents the filling of an incorrect type of fuel.

Opening The Door

For filling, proceed as follows:

1. Open the door by pulling the tab outwards.

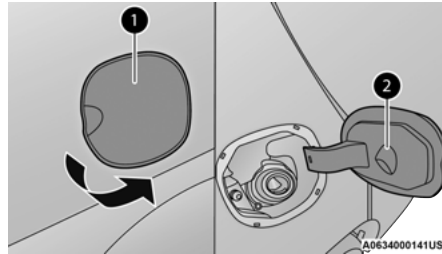
**Filler Door**

- 1 – Fuel Filler Door
- 2 – Dust Cover

2. Insert the fuel nozzle in the filler pipe and proceed with filling the fuel tank.

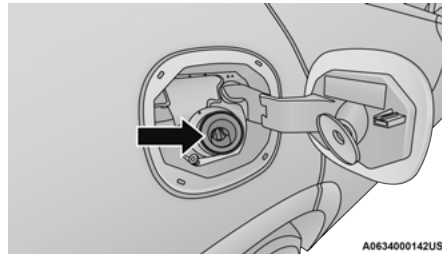
**Filler Pipe**

3. Before removing the nozzle, wait at least 10 seconds to allow the fuel to flow inside of the tank.
4. Pull the nozzle from the filler pipe and then close the door.

WARNING!

- Do not affix objects/plugs to the end of the filler neck other than what is provided on the car.
- The use of objects/plugs do not comply with the vehicle and may cause pressure increases inside the tank, creating dangerous conditions.
- Do not approach the neck of the tank with open flames or lit cigarettes its an extreme fire hazard. Also, avoid close contact with the filler pipe with your face, do not inhale harmful vapors.
- Do not use your mobile phone in the vicinity of the pump fuel nozzle, it can be a possible risk of fire.

VEHICLE LOADING

CERTIFICATION LABEL

As required by National Highway Traffic Safety Administration regulations, your vehicle has a certification label affixed to the driver's side door or pillar ↪ page 266.

This label contains the month and year of manufacture, Gross Vehicle Weight Rating (GVWR), Gross Axle Weight Rating (GAWR) front and rear, and Vehicle Identification Number (VIN). A Month-Day-Hour (MDH) number is included on this label and indicates the Month, Day and Hour of manufacture. The bar code that appears on the bottom of the label is your VIN.

Gross Vehicle Weight Rating (GVWR)

The GVWR is the total permissible weight of your vehicle including driver, passengers, vehicle, options and cargo. The label also specifies maximum capacities of front and rear axle systems (GAWR). Total load must be limited so GVWR and front and rear GAWR are not exceeded.

Payload

The payload of a vehicle is defined as the allowable load weight a truck can carry, including the weight of the driver, all passengers, options and cargo.

Gross Axle Weight Rating (GAWR)

The GAWR is the maximum permissible load on the front and rear axles. The load must be distributed in the cargo area so that the GAWR of each axle is not exceeded.

Each axle GAWR is determined by the components in the system with the lowest load carrying capacity (axle, springs, tires or wheels). Heavier axles or suspension components sometimes specified by purchasers for increased durability does not necessarily increase the vehicle's GVWR.

Tire Size

The tire size on the Vehicle Certification Label represents the actual tire size on your vehicle. Replacement tires must be equal to the load capacity of this tire size.

Rim Size

This is the rim size that is appropriate for the tire size listed.

Inflation Pressure

This is the cold tire inflation pressure for your vehicle for all loading conditions up to full GAWR.

Curb Weight

The curb weight of a vehicle is defined as the total weight of the vehicle with all fluids, including vehicle fuel, at full capacity conditions, and with no occupants or cargo loaded into the vehicle. The

front and rear curb weight values are determined by weighing your vehicle on a commercial scale before any occupants or cargo are added.

Loading

The actual total weight and the weight of the front and rear of your vehicle at the ground can best be determined by weighing it when it is loaded and ready for operation.

The entire vehicle should first be weighed on a commercial scale to ensure that the GVWR has not been exceeded. The weight on the front and rear of the vehicle should then be determined separately to be sure that the load is properly distributed over the front and rear axle. Weighing the vehicle may show that the GAWR of either the front or rear axles has been exceeded but the total load is within the specified GVWR. If so, weight must be shifted from front to rear or rear to front as appropriate until the specified weight limitations are met. Store the heavier items down low and be sure that the weight is distributed equally. Stow all loose items securely before driving.

Improper weight distributions can have an adverse effect on the way your vehicle steers and handles and the way the brakes operate.

CAUTION!

Do not load your vehicle any heavier than the GVWR or the maximum front and rear GAWR. If you do, parts on your vehicle can break, or it can change the way your vehicle handles. This could cause you to lose control. Also overloading can shorten the life of your vehicle.

TRAILER TOWING

In this section you will find safety tips and information on limits to the type of towing you can reasonably do with your vehicle. Before towing a trailer, carefully review this information to tow your load as efficiently and safely as possible.

To maintain the New Vehicle Limited Warranty coverage, follow the requirements and recommendations in this manual concerning vehicles used for trailer towing.

COMMON TOWING DEFINITIONS

The following trailer towing related definitions will assist you in understanding the following information:

Gross Vehicle Weight Rating (GVWR)

The GVWR is the total allowable weight of your vehicle. This includes driver, passengers, cargo and tongue weight. The total load must be limited so that you do not exceed the GVWR ↪ page 110.

Gross Trailer Weight (GTW)

The GTW is the weight of the trailer plus the weight of all cargo, consumables and equipment (permanent or temporary) loaded in or on the trailer in its "loaded and ready for operation" condition.

The recommended way to measure GTW is to put your fully loaded trailer on a vehicle scale. The entire weight of the trailer must be supported by the scale.

Gross Combination Weight Rating (GCWR)

The GCWR is the total allowable weight of your vehicle and trailer when weighed in combination.

Gross Axle Weight Rating (GAWR)

The GAWR is the maximum capacity of the front and rear axles. Distribute the load over the front and rear axles evenly. Make sure that you do not exceed either front or rear GAWR ↪ page 110.

WARNING!

It is important that you do not exceed the maximum front or rear GAWR. A dangerous driving condition can result if either rating is exceeded.

Tongue Weight (TW)

The TW is the downward force exerted on the hitch ball by the trailer. You must consider this as part of the load on your vehicle.

Frontal Area

The frontal area is the maximum height multiplied by the maximum width of the front of a trailer.

Trailer Sway Control — Mechanical

The trailer sway control is a telescoping link that can be installed between the hitch receiver and the trailer tongue that typically provides adjustable friction associated with the telescoping motion to dampen any unwanted trailer swaying motions while traveling.

Weight-Carrying Hitch

A weight-carrying hitch supports the trailer tongue weight, just as if it were luggage located at a hitch ball or some other connecting point of the vehicle. These kinds of hitches are commonly used to tow small and medium sized trailers.

Weight-Distributing Hitch

A weight-distributing system works by applying leverage through spring (load) bars. They are typically used for heavier loads to distribute trailer tongue weight to the tow vehicle's front axle and

the trailer axle(s). When used in accordance with the manufacturer's directions, it provides for a more level ride, offering more consistent steering and brake control thereby enhancing towing safety. The addition of a friction/hydraulic sway control also dampens sway caused by traffic and crosswinds and contributes positively to tow vehicle and trailer stability. Trailer sway control and a weight distributing (load equalizing) hitch are recommended for heavier Tongue Weights (TW) and may be required depending on vehicle and trailer configuration/loading to comply with Gross Axle Weight Rating (GAWR) requirements.

WARNING!

- An improperly adjusted Weight Distributing Hitch system may reduce handling, stability, braking performance, and could result in a collision.
- Weight Distributing Systems may not be compatible with Surge Brake Couplers. Consult with your hitch and trailer manufacturer or a reputable Recreational Vehicle dealer for additional information.

TRAILER HITCH CLASSIFICATION

The following chart provides the industry standard for the maximum trailer weight a given trailer hitch class can tow and should be used to assist you in selecting the correct trailer hitch for your intended towing condition.

Trailer Hitch Classification Definitions	
Class	Max. Trailer Hitch Industry Standards
Class I - Light Duty	2,000 lb (907 kg)
Class II - Medium Duty	3,500 lb (1,587 kg)
Class III - Heavy Duty	6,000 lb (2,722 kg)
Class IV - Extra Heavy Duty	10,000 lb (4,535 kg)

Refer to the "Trailer Towing Weights (Maximum Trailer Weight Ratings)" chart for the Maximum Gross Trailer Weight (GTW) towable for your given drivetrain.

All trailer hitches should be professionally installed on your vehicle.

TRAILER TOWING WEIGHTS (MAXIMUM TRAILER WEIGHT RATINGS)

The following chart provides the maximum trailer weight ratings towable for your given drivetrain.

Engine	Maximum GTW	Maximum Trailer TW (See Note)
1.3L Turbo AWD	2,000 lb (906 kg) with braked trailer	200 lb (90 kg)

Refer to local laws for maximum trailer towing speeds.

NOTE:

The trailer tongue weight must be considered as part of the combined weight of occupants and cargo and should never exceed the weight referenced on the Tire and Loading Information placard ↪ page 262.

TRAILER AND TONGUE WEIGHT

Never exceed the maximum tongue weight stamped on your bumper or trailer hitch.

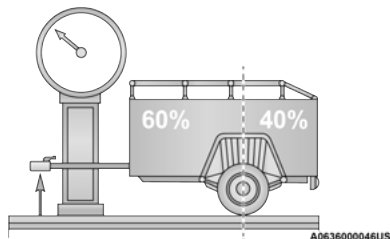

Weight Distribution

Consider the following items when computing the weight on the rear axle of the vehicle:

- The tongue weight of the trailer.
- The weight of any other type of cargo or equipment put in or on your vehicle.
- The weight of the driver and all passengers.

NOTE:

Remember that everything put into or on the trailer adds to the load on your vehicle. Also, additional factory-installed options or dealer-installed options must be considered as part of the total load on your vehicle. Refer to the tire and loading information placard for the maximum combined weight of occupants and cargo for your vehicle.

TOWING REQUIREMENTS

To promote proper break-in of your new vehicle drivetrain components, the following guidelines are recommended:

WARNING!

Improper towing can lead to a collision. Follow these guidelines to make your trailer towing as safe as possible:

- Make certain that the load is secured in the trailer and that it will not shift during travel. When trailering cargo that is not fully secured, dynamic load shifts can occur that may be difficult for the driver to control. You could lose control of your vehicle and have a collision.

(Continued)

WARNING!

- When hauling cargo, or towing a trailer, do not overload your vehicle or trailer. Overloading can cause a loss of control, poor performance, or damage to brakes, axle, engine, transmission, steering, suspension, chassis structure, or tires.
- Safety chains must always be used between your vehicle and trailer. Always connect the chains to the frame or hook retainers of the vehicle hitch. Cross the chains under the trailer tongue and allow enough slack for turning corners.
- Vehicles with trailers should not be parked on a grade. When parking, apply the parking brake on the tow vehicle. Put the tow vehicle transmission in PARK. Always block or "chock" the trailer wheels.
- GCWR must not be exceeded.
- Total weight must be distributed between the tow vehicle and the trailer such that the following four ratings are not exceeded:
 - GVWR
 - GTW
 - GAWR
 - Tongue weight rating for the trailer hitch utilized.

CAUTION!

- Do not tow a trailer at all during the first 500 miles (805 km) the new vehicle is driven. The engine, axle or other parts could be damaged.
- Then, during the first 500 miles (805 km) that a trailer is towed, do not drive over 50 mph (80 km/h) and do not make starts at full throttle. This helps the engine and other parts of the vehicle wear in at the heavier loads.

Towing Requirements — Tires

- Do not attempt to tow a trailer while using a compact spare tire.
- Proper tire inflation pressures are essential to the safe and satisfactory operation of your vehicle ⇨ page 269.
- Check the trailer tires for proper tire inflation pressures before trailer usage.
- Check for signs of tire wear or visible tire damage before towing a trailer ⇨ page 269.
- For the proper tire replacement procedures ⇨ page 269. Replacing tires with a higher load carrying capacity will not increase the vehicle's GVWR and GAWR limits.

Towing Requirements — Trailer Brakes

- Do **not** interconnect the hydraulic brake system or vacuum system of your vehicle with that of the trailer. This could cause inadequate braking and possible personal injury.
- An electronically actuated trailer brake controller is required when towing a trailer with electronically actuated brakes. When towing a trailer equipped with a hydraulic surge actuated brake system, an electronic brake controller is not required.
- Trailer brakes are recommended for trailers over 1,000 lb (453 kg) and required for trailers in excess of 2,000 lb (907 kg).

WARNING!

- Do not connect trailer brakes to your vehicle's hydraulic brake lines. It can overload your brake system and cause it to fail. You might not have brakes when you need them and could have a collision.
- Towing any trailer will increase your stopping distance. When towing you should allow for additional space between your vehicle and the vehicle in front of you. Failure to do so could result in a collision.

CAUTION!

If the trailer weighs more than 1,000 lb (453 kg) loaded, it should have its own brakes and they should be of adequate capacity. Failure to do this could lead to accelerated brake lining wear, higher brake pedal effort, and longer stopping distances.

Towing Requirements – Trailer Lights And Wiring (If Equipped)

Whenever you pull a trailer, regardless of the trailer size, stoplights and turn signals on the trailer are required for motoring safety.

The Trailer Tow Package may include a four- and seven-pin wiring harness. Use a factory approved trailer harness and connector.

NOTE:

Do not cut or splice wiring into the vehicles wiring harness.

The electrical connections are all complete to the vehicle but you must mate the harness to a trailer connector. Refer to the following illustrations.

NOTE:

- Disconnect trailer wiring connector from the vehicle before launching a boat (or any other device plugged into vehicle's electrical connect) into water.
- Be sure to reconnect after clear from water area.

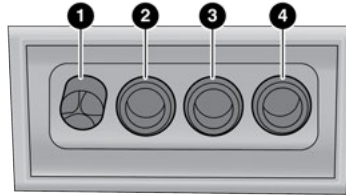

M0636000043US

Four-Pin Connector

- 1 – Ground
- 2 – Park
- 3 – Left Stop/Turn
- 4 – Right Stop/Turn

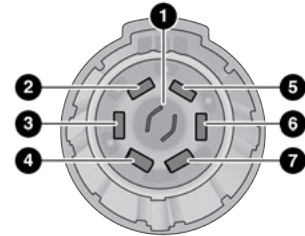

A0636000085US

Seven-Pin Connector

- 1 – Backup Lamps
- 2 – Running Lamps
- 3 – Left Stop/Turn
- 4 – Ground
- 5 – Battery
- 6 – Right Stop/Turn
- 7 – Electric Brakes

TOWING TIPS

Before towing, practice turning, stopping, and backing the trailer in an area located away from heavy traffic.

Automatic Transmission — If Equipped

Select the DRIVE range when towing. The transmission controls include a drive strategy to avoid frequent shifting when towing. However, if frequent shifting does occur while in DRIVE, you can use the AutoStick shift control to manually select a lower gear.

NOTE:

Using a lower gear while operating the vehicle under heavy loading conditions will improve performance and extend transmission life by reducing excessive shifting and heat build up. This action will also provide better engine braking.

AutoStick

- When using the AutoStick shift control, select the highest gear that allows for adequate performance and avoids frequent downshifts. For example, choose “5” if the desired speed can be maintained. Choose “4” or “3” if needed to maintain the desired speed.
- To prevent excess heat generation, avoid continuous driving at high RPM. Reduce vehicle speed as necessary to avoid extended driving at high RPM. Return to a higher gear or vehicle speed when grade and road conditions allow.

Cruise Control — If Equipped

- Do not use in hilly terrain or with heavy loads.
- When using the Cruise Control, if you experience speed drops greater than 10 mph (16 km/h), disengage until you can get back to cruising speed.
- Use Cruise Control in flat terrain and with light loads to maximize fuel efficiency.

RECREATIONAL TOWING (BEHIND MOTORHOME)

TOWING THIS VEHICLE BEHIND ANOTHER VEHICLE

Towing Condition	Wheels Off The Ground	All-Wheel Drive (AWD)
Flat Tow	NONE	NOT ALLOWED
Dolly Tow	REAR	NOT ALLOWED
	FRONT	
On Trailer	ALL	OK

NOTE:

When towing your vehicle, always follow applicable state and provincial laws. Contact state and provincial Highway Safety offices for additional details.

NOTE:

You must ensure that the Auto Park Brake feature is disabled before towing this vehicle, to avoid inadvertent Electric Park Brake engagement. The Auto Park Brake feature is enabled or disabled via the Customer Programmable Features in the Uconnect Settings.

All-Wheel Drive (AWD) Models

Recreational towing (with all four wheels on the ground, or using a towing dolly) is NOT ALLOWED. This vehicle may be towed on a flatbed or vehicle trailer provided all four wheels are OFF the ground.

CAUTION!

Towing this vehicle with ANY of its wheels on the ground can cause severe transmission and/or power transfer unit damage. Damage from improper towing is not covered under the New Vehicle Limited Warranty.

DRIVING TIPS

DRIVING ON SLIPPERY SURFACES

Information in this section will aid in safe controlled launches in adverse conditions.

Acceleration

Rapid acceleration on snow covered, wet, or other slippery surfaces may cause the driving wheels to pull erratically to the right or left. This phenomenon occurs when there is a difference in the surface traction under the front (driving) wheels.

WARNING!

Rapid acceleration on slippery surfaces is dangerous. Unequal traction can cause sudden pulling of the front wheels. You could lose control of the vehicle and possibly have a collision. Accelerate slowly and carefully whenever there is likely to be poor traction (ice, snow, wet, mud, loose sand, etc.).

Traction

When driving on wet or slushy roads, it is possible for a wedge of water to build up between the tire and road surface. This is hydroplaning and may cause partial or complete loss of vehicle control and stopping ability. To reduce this possibility, the following precautions should be observed:

- Slow down during rainstorms or when the roads are slushy.
- Slow down if the road has standing water or puddles.
- Replace the tires when tread wear indicators first become visible.
- Keep tires properly inflated.
- Maintain sufficient distance between your vehicle and the vehicle in front of you to avoid a collision in a sudden stop.

DRIVING THROUGH WATER

Driving through water more than a few inches/centimeters deep will require extra caution to ensure safety and prevent damage to your vehicle.

Flowing/Rising Water

WARNING!

Do not drive on or across a road or path where water is flowing and/or rising (as in storm run-off). Flowing water can wear away the road or path's surface and cause your vehicle to sink into deeper water. Furthermore, flowing and/or rising water can carry your vehicle away swiftly. Failure to follow this warning may result in injuries that are serious or fatal to you, your passengers, and others around you.

Shallow Standing Water

Although your vehicle is capable of driving through shallow standing water, consider the following Cautions and Warnings before doing so.

WARNING!

- Driving through standing water limits your vehicle's traction capabilities. Do not exceed 5 mph (8 km/h) when driving through standing water.
- Driving through standing water limits your vehicle's braking capabilities, which increases stopping distances. Therefore, after driving through standing water, drive slowly and lightly press on the brake pedal several times to dry the brakes.
- Failure to follow these warnings may result in injuries that are serious or fatal to you, your passengers, and others around you.

CAUTION!

- Always check the depth of the standing water before driving through it. Never drive through standing water that is deeper than the bottom of the tire rims mounted on the vehicle.

(Continued)

CAUTION!

- Determine the condition of the road or the path that is under water and if there are any obstacles in the way before driving through the standing water.
- Do not exceed 5 mph (8 km/h) when driving through standing water. This will minimize wave effects.
- Driving through standing water may cause damage to your vehicle's drivetrain components. Always inspect your vehicle's fluids (i.e., engine oil, transmission, axle, etc.) for signs of contamination (i.e., fluid that is milky or foamy in appearance) after driving through standing water. Do not continue to operate the vehicle if any fluid appears contaminated, as this may result in further damage. Such damage is not covered by the New Vehicle Limited Warranty.
- Getting water inside your vehicle's engine can cause it to lock up and stall out, and cause serious internal damage to the engine. Such damage is not covered by the New Vehicle Limited Warranty.

MULTIMEDIA

UCONNECT SYSTEMS

For detailed information about your Uconnect 4/4 NAV With 7-inch Display system → page 134.

NOTE:

Uconnect screen images are for illustration purposes only and may not reflect exact software for your vehicle.

CYBERSECURITY

Your vehicle may be a connected vehicle and may be equipped with both wired and wireless networks. These networks allow your vehicle to send and receive information. This information allows systems and features in your vehicle to function properly.

Your vehicle may be equipped with certain security features to reduce the risk of unauthorized and unlawful access to vehicle systems and wireless communications. Vehicle software technology continues to evolve over time and FCA US LLC, working with its suppliers, evaluates and takes appropriate steps as needed. Similar to a computer or other devices, your vehicle may require software updates to improve the usability and performance of your systems or to reduce the potential risk of unauthorized and unlawful access to your vehicle systems.

The risk of unauthorized and unlawful access to your vehicle systems may still exist, even if the most recent version of vehicle software (such as Uconnect software) is installed.

WARNING!

- It is not possible to know or to predict all of the possible outcomes if your vehicle's systems are breached. It may be possible that vehicle systems, including safety related systems, could be impaired or a loss of vehicle control could occur that may result in an accident involving serious injury or death.
- ONLY insert media (e.g., USB or CD) into your vehicle if it came from a trusted source. Media of unknown origin could possibly contain malicious software, and if installed in your vehicle, it may increase the possibility for vehicle systems to be breached.
- As always, if you experience unusual vehicle behavior, take your vehicle to your nearest authorized dealer immediately.

NOTE:

- FCA US LLC or an authorized dealer may contact you directly regarding software updates.
- To help further improve vehicle security and minimize the potential risk of a security breach, vehicle owners should:
 - Routinely check www.driveuconnect.com (US Residents) or www.driveuconnect.ca (Canadian Residents) to learn about available Uconnect software updates.
 - Only connect and use trusted media devices (e.g. personal mobile phones, USBs, CDs).

Privacy of any wireless and wired communications cannot be assured. Third parties may unlawfully intercept information and private communications without your consent. For further information, refer to “Data Collection & Privacy” in your Uconnect Owner’s Manual Supplement or “Onboard Diagnostic System (OBD II) Cybersecurity”

➔ page 76.

UCONNECT SETTINGS**CUSTOMER PROGRAMMABLE FEATURES****Uconnect 4/4 NAV Touchscreen And Faceplate Buttons**

- 1 — Buttons On The Touchscreen
- 2 — Buttons On The Faceplate

For the Uconnect 4/4 NAV With 7-inch Display

Press the **U** Apps button, then press the Settings button on the touchscreen to display the menu setting screen. In this mode, the Uconnect system allows you to access programmable features.

NOTE:

- Only one touchscreen area may be selected at a time.
- Depending on the vehicle’s options, feature settings may vary.

When making a selection, only press one button at a time to enter the desired menu. Once in the desired menu, press and release the preferred setting option until a check mark appears next to the setting, showing that setting has been selected. Once the setting is complete, press the X button on the touchscreen to close out of the settings screen. Pressing the Up or Down Arrow button on the right side of the screen will allow you to toggle up or down through the available settings.

Language

When the Language button is pressed on the touchscreen, the system displays the different language options. Once an option is selected, the system will display in the chosen language. The available setting is:

NOTE:

Depending on the vehicle's options, feature settings may vary.

Setting Name	Description
Language	This setting will change the language of the Uconnect system. The available languages are English, Français, and Español.

Display

After pressing the Display button on the touchscreen, the following settings will be available:

NOTE:

Depending on the vehicle's options, feature settings may vary.

Setting Name	Description
Display Mode	This setting will allow you to set the brightness manually or have the system set it automatically. The "Auto" setting has the system automatically adjust the display brightness. The "Manual" setting will allow the user to adjust the brightness of the display.
Display Brightness With Headlights ON	This setting will allow you to set the brightness when the headlights are on. To access this setting, Display Mode must be set to Manual. The "+" setting will increase the brightness; the "-" will decrease the brightness.

Setting Name	Description
Display Brightness With Headlights OFF	This setting will allow you to set the brightness when the headlights are off. To access this setting, Display Mode must be set to Manual. The "+" setting will increase the brightness; the "-" will decrease the brightness.
Touchscreen Beep	This setting will allow you to adjust the touchscreen beep. The setting options are "On" and "Off".

Units

When the Units button is pressed on the touchscreen, the system displays the different measurement options. The selected unit of measurement will display in the instrument cluster display and Navigation system (if equipped). The available settings are:

NOTE:

Depending on the vehicle's options, feature settings may vary.

Setting Name	Description
US	This setting will change the unit of measurement on the display to US.
Metric	This setting will change the unit of measurement on the display to Metric.
Custom	This setting changes the "Distance" (mi or km), "Fuel Consumption" (MPG [US], MPG [UK], L/100 km, or km/L), "Pressure" (psi, kPa, or bar), and "Temperature" (°C or °F) units of measurement independently.

Voice

When the Voice button is pressed on the touchscreen, the system displays the options related to the vehicle's Voice Recognition feature.

NOTE:

Depending on the vehicle's options, feature settings may vary.

Setting Name	Description
Voice Response Length	This setting will change the response length for the Voice Recognition system. The "Brief" setting provides a shortened audio description from the system. The "Detailed" setting provides the full audio description from the system.
Show Command List	This setting will allow you to turn the Command List on or off. The "Always" setting will always show the Command List. The "With Help" setting will show the Command List and provide a brief description of what the command does. The "Never" setting will turn the Command List off.

5

Clock

When the Clock button is pressed on the touchscreen, the system displays the different options related to the vehicle's internal clock.

NOTE:

Depending on the vehicle's options, feature settings may vary.

Setting Name	Description
Sync Time With GPS	This setting will sync the time to the GPS receiver in the system. The system will control the time via the GPS location.
Time Format	This setting will allow you to set the time format (AM/PM). Sync Time With GPS must be off for this setting to be available. The "12 hrs" setting will set the time to a 12-hour format. The "24 hrs" setting will set the time to a 24-hour format.

Setting Name	Description
Set Time Hours	This setting will allow you to set the hours. Sync Time With GPS must be off for this setting to be available. The "+" setting will increase the hours. The "-" setting will decrease the hours.
Set Time Minutes	This setting will allow you to set the minutes. Sync Time With GPS must be off for this setting to be available. The "+" setting will increase the minutes. The "-" setting will decrease the minutes.
Show Time in Status Bar	This setting will place the time in the radio's status bar.
Set Date	This setting will allow you to set the date.

Safety & Driving Assistance

After pressing the Safety & Driving Assistance button on the touchscreen, the following settings will be available:

NOTE:

Depending on the vehicle's options, feature settings may vary.

Setting Name	Description
Brake Control	Brake Control System includes Advanced Brake Assist (ABA). The ABA applies additional brake pressure when the driver requests insufficient brake pressure to avoid a potential frontal collision. When the "Only Warning" option is selected, a chime sounds alerting you of a possible collision with the vehicle in front of you and more brake pressure is needed. When the "Warning + Active Braking" option is selected, it applies the brakes to slow your vehicle in case of a potential forward collision and sounds an audible chime to alert you. Changing the Brake Control System status to "Off" prevents the system from warning you of a possible collision with the vehicle in front of you.

Setting Name	Description
Brake Control Sensitivity	The Full Brake Control System Sensitivity setting determines at what relative distance the vehicle directly in front of you needs to be at before the system warns you of a possible collision, based on the option selected. "Far" gives you the most amount of reaction time, whereas "Near" gives you the least amount of reaction time, based on the distance between the two vehicles.
LaneSense Warning	The LaneSense Warning setting determines at what distance the Lane Control system warns you, through steering wheel feedback, of a possible lane departure.
LaneSense Strength	This feature allows you to set the lane control strength to "Low", "Med", or "High".
Park Assist	The Park Assist system setting scans for objects behind the vehicle when the transmission gear selector is in REVERSE and the vehicle speed is less than 7 mph (11 km/h), when enabled. It provides an alert (audible and/or visual) to indicate the proximity to other objects. The system can be enabled with "Sound Only" or "Sound + Display."
Front Park Assist Volume	This setting will allow you to adjust the Front Park Assist Volume to "Low", "Medium", or "High".
Rear Park Assist Volume	This setting will allow you to adjust the Rear Park Assist Volume to "Low", "Medium", or "High".

Setting Name	Description
Blind Spot Assist	When the Blind Spot Assist feature is selected, the Blind Spot Monitor (BSM) system is activated and shows a visual alert in the outside mirrors, or it shows a visual alert in the outside mirrors and sounds an audible alert when the turn signal is on. When “Off” is selected, the BSM system is deactivated. If your vehicle has experienced any damage in the area where the sensor is located, even if the fascia/bumper is not damaged, the sensor may have become misaligned. Take your vehicle to an authorized dealer to verify sensor alignment. A sensor that is misaligned results in the BSM not operating to specification.
Rear View Camera Delay	The Rear View Camera Delay setting determines whether or not the screen displays the rear view image with dynamic grid lines for up to 10 seconds after the vehicle is shifted out of REVERSE. This delay is canceled if the vehicle’s speed exceeds 8 mph (13 km/h), the transmission is shifted into PARK, or the ignition is switched to the OFF position.
Active Rear View Camera Guidelines	The Active Rear View Camera Guidelines feature overlays the Rear View Camera image with active, or dynamic, grid lines to help illustrate the width of the vehicle and its projected backup path, based on the steering wheel position when the option is checked. A dashed center line overlay indicates the center of the vehicle to assist with parking or aligning to a hitch/receiver.
Rain Sensing Wipers	This setting will allow you to turn the rain sensing wipers on or off.

Mirrors – If Equipped

After pressing the Mirrors button on the touchscreen, the following setting will be available:

NOTE:

Depending on the vehicle's options, feature settings may vary.

Setting Name	Description
Auto Folding Side Mirrors	This setting will allow you to turn the auto folding side mirrors on or off.

Brakes

After pressing the Brakes button on the touchscreen, the following settings will be available:

NOTE:

Depending on the vehicle's options, feature settings may vary.

Setting Name	Description
Brake Service	Selecting the Brake Service feature will display a pop-up asking whether or not you would like to retract the park brakes for system service.
Auto Park Brake	This setting will allow you to turn the auto park brake on or off.

Lights

After pressing the Lights button on the touchscreen, the following settings will be available:

NOTE:

Depending on the vehicle's options, feature settings may vary.

Setting Name	Description
Interior Ambient Lights	When this feature is selected, it allows the adjustment of the brightness of the interior ambient lighting.
Headlight Sensitivity	This setting will allow you to adjust the headlight sensitivity to minimum sensitivity, medium sensitivity, or maximum sensitivity.
Headlight Off Delay	This setting will allow you to set the headlight off delay to "0", "30", "60", or "90" seconds.
Greeting Lights	This setting will allow you to turn the greeting lights on or off.
High Beam Control	This setting will allow you to turn the high beam control on or off.
Daytime Running Lights	When the Daytime Running Lights feature is selected, the daytime running lights can be turned on or off. This feature is only available if allowed by law in the country of the vehicle purchase.
Cornering Lights	When this feature is selected, if the steering wheel rotation angle is large or the turn signal indicators are on, a light (incorporated in the fog light) turns on, on the relevant side to improve visibility at night.
Flash Lights With Lock	This setting will allow you to turn the flash lights with lock on or off.

Doors & Locks

After pressing the Doors & Locks button on the touchscreen, the following settings will be available:

NOTE:

Depending on the vehicle's options, feature settings may vary.

Setting Name	Description
Auto Door Locks	When this feature is selected, all doors will lock automatically when the vehicle reaches a speed of 15 mph (24 km/h).
Auto Unlock On Exit	When the Auto Unlock On Exit feature is selected, all doors will unlock when the vehicle is stopped and the transmission is in the PARK or NEUTRAL position and the driver's door is opened.
Flash Lights With Lock	This setting will allow you to turn the flash lights with lock on or off.
Sound Horn With Lock	This setting will allow you to turn the horn with lock feature off, on 1st press, or on 2nd press.
Sound Horn With Remote Start	This setting will allow you to turn horn with remote start on or off.
Keyless Entry	This features allows you to lock and unlock the vehicle's door(s) without having to press the key fob lock or unlock buttons.
Remote Door Unlock	<ul style="list-style-type: none"> When "Driver" is programmed, only the driver's door will unlock on the first push of the key fob Unlock button; you must push the key fob Unlock button twice to unlock the passengers' door. When "All" is programmed, all of the doors will unlock on the first press of the key fob Unlock button. If "All" is programmed, all doors will unlock no matter which Passive Entry equipped door handle is grasped. If "Driver" is programmed, only the driver's door will unlock when the driver's door is grabbed. Touching the handle more than once will only result in the driver's door unlocking. If the driver's door is opened, the interior door lock/unlock switch can be used to unlock all doors (or use key fob).

Seats & Comfort/Auto-On Comfort Systems

When the Seats & Comfort/Auto-On Comfort Systems button is pressed on the touchscreen, the system displays the option related to the vehicle's comfort systems when remote start has been activated or the vehicle has been started.

NOTE:

Depending on the vehicle's options, feature settings may vary.

Setting Name	Description
Auto-On Driver Heat Seat & Steering Wheel	This setting will activate the vehicle's comfort system and heated seats (if equipped) or heated steering wheel (if equipped) when the vehicle is remote started or ignition is started. The "Off" setting will not activate the comfort systems. The "Remote Start" setting will only activate the comfort systems when using Remote Start. The "All Start" setting will activate the comfort systems whenever the vehicle is started.

Audio

When the Audio button is pressed on the touchscreen, the system displays options related to the vehicle's sound system. These settings can change the audio location within the vehicle, adjust the bass or treble levels, and auto-play settings from an audio device or smartphone.

NOTE:

Depending on the vehicle's options, feature settings may vary.

Setting Name	Description
Balance/Fade	This setting will adjust audio levels from specific speakers in the front/back and left/right of the vehicle. The Speaker icon can be moved to set audio location.
Equalizer	This setting will adjust the "Bass", "Mid", and "Treble" ranges of the audio.

Setting Name	Description
Speed Adjusted Volume	This setting will adjust audio volume as speeds increase. At a higher setting, the volume will increase more as the vehicle speeds up. The available settings are "Off", "1", "2", and "3".
AUX Volume Offset	This setting will tune the audio levels from a device connected through the AUX port. The available settings are "+" and "-".
Auto Play	This setting will automatically begin playing audio from a connected device.
Surround Sound	This setting will turn the Surround Sound system on or off.
Loudness	This setting will improve sound quality at lower volumes when enabled.
Auto-On Radio	This setting will have the radio automatically turn on when the vehicle is in ON/RUN or will recall whether it was on or off at last ignition OFF. The available options are "On", "Off", and "Last Recall".

Engine Off Options

When the Engine Off Options button is pressed on the touchscreen, the system will display settings concerning electronics during vehicle shut off.

NOTE:

Depending on the vehicle's options, feature settings may vary.

Setting Name	Description
Headlight Off Delay	This setting will allow you to set the amount of time the headlights remain on after the vehicle has been turned off. The "+" will increase the amount of time. The "-" will decrease the amount of time.
Radio Off Delay	This setting will keep the radio on after the vehicle has been shut off. The available options are "0 MIN" and "20 MIN"

Phone/Bluetooth®**WARNING!**

Any voice commanded system should be used only in safe driving conditions following all applicable laws. Your attention should be focused on safely operating the vehicle. Failure to do so may result in a collision causing serious injury or death.

When the Phone/Bluetooth® button is pressed on the touchscreen, the system displays the options related to Bluetooth® connectivity from an external audio device or smartphone. The list of paired audio devices or smartphones can be accessed from this menu.

NOTE:

Depending on the vehicle's options, feature settings may vary.

Setting Name	Description
Do Not Disturb	This setting will open the "Do Not Disturb" settings menu. The settings are "Auto Reply" (both, text, call), "Auto Reply Message" (custom, default), and "Custom Auto Reply Message" (create message).
Paired Phones And Audio Devices	This setting will show the list of paired phones and audio devices.
Phone Pop-ups Displayed In Cluster	This setting will activate phone message pop-ups in the Instrument Cluster Display.

SiriusXM® Setup – If Equipped

NOTE:

A subscription to SiriusXM® satellite radio is required for these settings to be functional.

When the SiriusXM® Setup button is pressed on the touchscreen, the system displays options related to SiriusXM® satellite radio. These settings can be used to skip specific radio channels and restart favorite songs from the beginning.

NOTE:

Depending on the vehicle's options, feature settings may vary.

Setting Name	Description
Tune Start	This setting will play the current song from the beginning when you tune to a music channel using one of the 12 presets.
Channel Skip	This setting allows you to set channels that you wish to skip. A channel list will display of the skipped channels.
Subscription Info	This menu provides SiriusXM® subscription information. SiriusXM® Travel Link is a separate subscription.

Restore Settings

When the Restore Settings button is pressed on the touchscreen, the system will display the setting related to resetting the system back to its default.

NOTE:

Depending on the vehicle's options, feature settings may vary.

Setting Name	Description
Restore Settings	When this feature is selected, it will reset Display, Clock, Audio, and Radio Settings to their default.

Clear Personal Data

When the Clear Personal Data button is pressed on the touchscreen, the system will display the option to clear personal data saved to the system.

NOTE:

Depending on the vehicle's options, feature settings may vary.

Setting Name	Description
Clear Personal Data	When this feature is selected, it will remove personal data including Bluetooth® devices and presets.

UCONNECT INTRODUCTION

SYSTEM OVERVIEW







Uconnect 4/4 NAV With 7-inch Display

- 1 – Radio Button
- 2 – Media Button
- 3 – Climate Button
- 4 – Apps Button
- 5 – Nav Button
- 6 – Phone Button
- 7 – Settings Button

NOTE:

Uconnect screen images are for illustration purposes only and may not reflect exact software for your vehicle.

Feature	Description
Radio/Media	Press the Radio button or Media button to enter Radio Mode/Media Mode and access the radio functions and external audio sources ↪ page 137.
Phone	Press the Phone button to enter Phone Mode and access the hands-free phone system ↪ page 148.
Settings	Press the Settings button to access the Uconnect Settings ↪ page 120.
	Push the Enter/Browse button on the faceplate to accept a highlighted selection on the screen. Rotate the Tune/Scroll rotary knob to scroll through a list or tune a radio station.
	Push the Screen Off button on the faceplate to turn the screen on or off.
	Push the Mute button on the faceplate to turn the audio of the radio system off. Push it again to turn the audio back on.
	Rotate the rotary knob to adjust the volume. Push the Volume & On/Off button on the faceplate to turn the system on or off.
Controls	Press the Controls button to access vehicle-specific features like heated seats and steering wheel.
Apps	Press the Apps button to access a list of the available Uconnect apps.
Climate	Press the Climate button to enter Climate Mode and access the climate control functions ↪ page 42.

DRAG & DROP MENU BAR

The Uconnect features and services in the main menu bar are easily customized for your preference. Simply follow these steps:

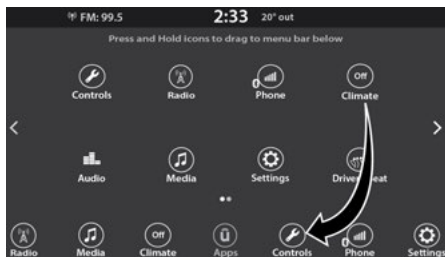

Uconnect 4 With 7-inch Display Drag & Drop

1. Press the Apps  button to open the App screen.
2. Press and hold, then drag the selected app to replace an existing shortcut in the main menu bar.

NOTE:

This feature is only available if the vehicle is in PARK.

SAFETY AND GENERAL INFORMATION

Safety Guidelines

WARNING!

ALWAYS drive safely with your hands on the steering wheel. You have full responsibility and assume all risks related to the use of the Uconnect features and applications in this vehicle. Only use Uconnect when it is safe to do so. Failure to do so may result in an accident involving serious injury or death.

Please read this manual carefully before using the system. It contains instructions on how to use the system in a safe and effective manner.

Do NOT attach any object to the touchscreen. Doing so can result in damage to the touchscreen.

Please read and follow these safety precautions. Failure to do so may result in injury or property damage.

- Glance at the screen only when safe to do so. If prolonged viewing of the screen is required, park in a safe location and set the parking brake.
- Stop use immediately if a problem occurs. Failure to do so may cause injury or damage to the product. See an authorized dealer for repair.

- Ensure the volume level of the system is set to a level that still allows you to hear outside traffic and emergency vehicles.

Safe Usage Of The Uconnect System

- The Uconnect system is a sophisticated electronic device. Do not let young children use the system.
- Permanent hearing loss may occur if you play your music or sound system at loud volumes. Exercise caution when setting the volume on the system.
- Keep drinks, rain and other sources of moisture away from the system. Besides damage to the system, moisture can cause electric shocks as with any electronic device.

NOTE:

Many features of this system are speed dependent. For your own safety, it is not possible to use some of the touchscreen features while the vehicle is in motion.

Care And Maintenance

- Do not press the touchscreen with any hard or sharp objects (pen, USB stick, jewelry, etc.), which could scratch the surface.
- Do not spray any liquid or chemicals directly on the screen! Use a clean and dry microfiber lens cleaning cloth in order to clean the touchscreen.
- If necessary, use a lint-free cloth dampened with a cleaning solution, such as isopropyl alcohol or

an isopropyl alcohol and water solution ratio of 50:50. Be sure to follow the solvent manufacturer's precautions and directions ↗ page 290.

UCONNECT MODES

STEERING WHEEL AUDIO CONTROLS

The remote sound system controls are located on the rear surface of the steering wheel at the three and nine o'clock positions.



Remote Sound System Controls

The right-hand control is a rocker-type switch with a push button in the center and controls the volume and mode of the sound system. Pushing the top of the rocker switch will increase the volume, and pushing the bottom of the rocker switch will decrease the volume.

Pushing the center button will make the radio switch between the various modes available (AM/FM/SXM or Media, etc.).

The left-hand control is a rocker-type switch with a push button in the center. The function of the left-hand control is different depending on which mode you are in.

The following describes the left-hand control operation in each mode:

Radio Operation

Pushing the top of the switch will Seek Up for the next available station and pushing the bottom of the switch will Seek Down for the next available station.

The button located in the center of the left-hand control will tune to the next preset station that you have programmed in the radio presets.

Media Mode

Pushing the top of the switch skips to the next track on the selected media (AUX/USB/Bluetooth®). Pushing the switch up twice will go forward two tracks. Pushing the bottom switch goes to the beginning of the current track, or the beginning of the previous track if it is within eight seconds after the current track begins to play. Double pressing the bottom button switch will skip to the previous track if it is after eight seconds into the current track.

RADIO MODE

Radio Controls

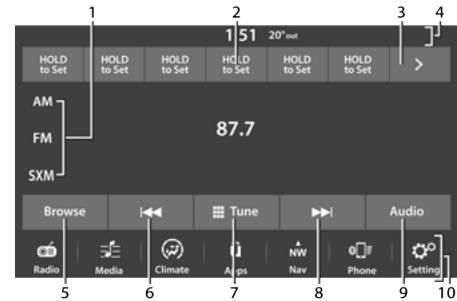

Uconnect 4/4 NAV With 7-inch Display

- 1 — Radio Bands
- 2 — Preset Radio Stations
- 3 — View Next Preset Radio Stations
- 4 — Status Bar
- 5 — Browse Button
- 6 — Seek Down ◀◀
- 7 — Tune Button
- 8 — Seek Up ▶▶
- 9 — Audio Settings
- 10 — Bottom Menu Bar

The radio is equipped with the following modes:

- AM
- FM
- SiriusXM® Satellite Radio (if equipped)

Press the Radio button on the touchscreen to enter the Radio Mode. The different tuner modes, AM, FM, and SXM, can then be selected by pressing the corresponding buttons in Radio Mode.

Volume & On/Off Control

Push the Volume & On/Off control knob to turn on and off the Uconnect system.

The electronic volume control turns continuously (360 degrees) in either direction, without stopping. Turning the Volume & On/Off control knob clockwise increases the volume, and counterclockwise decreases it.

When the audio system is turned on, the sound will be set at the same volume level as last played.

Mute Button

Push the Mute button to mute or unmute the system.

Tune/Scroll Control

Turn the rotary Tune/Scroll control knob clockwise to increase or counterclockwise to decrease the radio station frequency. Push the Enter/Browse button to choose a selection.

Seek

The Seek Up and Down functions are activated by pressing the double arrow buttons on the touchscreen to the right and left of the radio station display or by pressing the left steering wheel audio control button up or down.

Seek Up ►► and Seek Down ◀◀

Press and release the Seek Up ►► or Seek Down ◀◀ button to tune the radio to the next available station or channel. During a Seek Up/Down function, if the radio reaches the starting station after passing through the entire band two times, the radio will stop at the station where it began.

Fast Seek Up ►► and Fast Seek Down ◀◀

Press, hold, and then release the Seek Up ►► or Seek Down ◀◀ button to advance the radio through the available stations or channels at a faster rate. The radio stops at the next available station or channel when the button on the touchscreen is released.

NOTE:

Pressing and holding either the Seek Up ►► or Seek Down ◀◀ button will scan the different frequency bands at a slower rate.

Direct Tune

Press the Tune button located at the bottom of the radio screen to directly tune to a desired radio station or channel.

Press the available number button on the touchscreen to begin selecting a desired station. Once a number has been entered, any numbers that are no longer possible (stations that cannot be reached) will become deactivated/grayed out.

Undo

You can backspace an entry by pressing the Back <X> button on the touchscreen.

GO

Once the last digit of a station has been entered, press “GO”. The Direct Tune screen will close, and the system will automatically tune to that station.

RADIO VOICE COMMANDS

Use your voice to quickly get to the AM, FM, or SiriusXM® Satellite Radio stations you would like to hear. (Subscription or included SiriusXM® Satellite Radio trial required.)

Push the VR button  on the steering wheel and wait for the beep to say a command. See some examples below.

- “Tune to ninety-five-point-five FM”
- “Tune to Satellite Channel Hits 1”

Did You Know: At any time, if you are not sure of what to say or want to learn a Voice Command, push the VR button  and say “**Help**”. The system provides you with a list of commands.

SiriusXM® Satellite Radio Mode — If Equipped



Uconnect 4/4 NAV With 7-inch Display Changing To SiriusXM®

SiriusXM® Satellite Radio uses direct satellite-to-receiver broadcasting technology to provide clear, coast-to-coast radio content. SiriusXM® is a subscription-based service.

Visit siriusxm.com/getallaccess or review your SiriusXM® Radio pamphlet in your Owner's Manual kit for more information.

SiriusXM® services require subscriptions, sold separately after the trial included with the new vehicle purchase. If you decide to continue your service at the end of your trial subscription, the plan you choose will automatically renew and bill at then-current rates until you call SiriusXM® at 866-635-2349 to cancel. See SiriusXM® Customer Agreement for complete terms at www.siriusxm.com (US) or www.siriusxm.ca (Canada).

All fees and programming subject to change. SiriusXM® satellite service is available only to those at least 18 and older in the 48 contiguous US and D.C. Our SiriusXM® satellite service is also available in Canada and Puerto Rico (with coverage limitations). SiriusXM® Internet radio service is available throughout their satellite service area and in AK. © 2021 SiriusXM® Radio Inc. SiriusXM® and all related marks and logos are trademarks of SiriusXM® Radio Inc.

This functionality is only available for radios equipped with a Satellite receiver. In order to receive satellite radio, the vehicle needs to be outside with a clear view to the sky.

If the screen shows “Acquiring Signal”, you might have to change the vehicle's position in order to receive a signal. In most cases, the satellite radio does not receive a signal in underground parking garages or tunnels.

No Subscription

Radios equipped with a Satellite receiver require a subscription to the SiriusXM® Service. When the radio does not have the necessary subscription, the radio is able to receive the Preview channel only.

Acquiring SiriusXM® Subscription

To activate the SiriusXM® Satellite Radio subscription, US visit siriusxm.com/getallaccess or call: 1-800-643-2112

Canada visit <https://www.siriusxm.ca/> or call: 1-888-539-7474.

NOTE:

You will need to provide the SiriusXM® ID (RID) located at the bottom of the Channel 0 screen. The Satellite Mode is activated by a press of the SXM button on the touchscreen.

When in Satellite Mode:

- The SXM button on the touchscreen is highlighted.
- The SiriusXM® Presets are displayed at the top of the screen.
- The SiriusXM® Channel Number is displayed in the center.
- The Program Information is displayed at the bottom of the Channel Number.
- The SiriusXM® function buttons are displayed below the Program Information.

Tuning is done by operating the Tune Knob or by Direct Tune, similar to other Radio Bands.

In addition to the tuning operation functions common to all radio modes, the replay, Traffic/Weather button, and Favorite button functions are available in SiriusXM® Mode.



**Uconnect 4/4 NAV With 7-inch Display SiriusXM®
Satellite Radio**





- 1 – Browse Button
- 2 – Replay Button
- 3 – Seek Down Button ◀◀
- 4 – Direct Tune Button
- 5 – Seek Up Button ▶▶
- 6 – Audio Settings Button

REPLAY

The replay function provides a means to store and replay up to 22 minutes of music audio and 48 minutes of talk radio. Once the channel is switched, content in replay memory is lost.

Press the Replay button on the touchscreen. The Play/Pause, Rewind/Forward and Live buttons will display at the top of the screen, along with the replay time.

You can exit by pressing the Replay button on the touchscreen any time during the Replay Mode.

Play/Pause		Press the Pause/Play button on the touchscreen to pause the playing of live or rewind content at any time. Play can be resumed by pressing the Pause/Play button again on the touchscreen.
Rewind		Press the Rewind button on the touchscreen to rewind the content in steps of five seconds. Pressing the Rewind button on the touchscreen for more than two seconds rewinds the content. The radio begins playing the content at the point at which the press is released.
Forward		Each press of the Forward button on the touchscreen forwards the content in steps of five seconds. Forwarding of the content can only be done when the content is previously rewind, and therefore, cannot be done for live content. A continuous press of the Forward button on the touchscreen also forwards the content. The radio begins playing the content at the point at which the press is release.
Live		Press the Live button on the touchscreen to resume the playing of live content.

FAVORITES

Press the Favorites button on the touchscreen to activate the favorites menu, which will time out within 20 seconds in absence of user interaction.

You can exit the Favorites Menu by a press of the X button, or by pressing anywhere outside the favorites box.

The favorites feature enables you to set a favorite artist or song that is currently playing. The radio then uses this information to alert you when either the favorite artist or song is being played at any time by any of the SiriusXM® Channels.

The maximum number of favorites that can be stored in the Radio is 50.

Favorite Artist: While the song is playing, to set a favorite artist, press the Favorites button on the touchscreen and then the Add Fav Artist button on the touchscreen.

Favorite Song: While the song is playing, to set a favorite song, press the Favorites button on the touchscreen and then the Add Fav Song button on the touchscreen.

BROWSE IN SXM

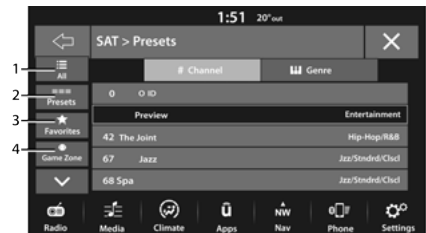
**Uconnect 4/4 NAV With 7-inch Display Browse Button**

- 1 — All Button
- 2 — Presets Button
- 3 — Favorites Button
- 4 — Game Zone Button

Press the Browse button on the touchscreen to edit Presets, Favorites, Game Zone, and Jump settings, along with providing the SiriusXM® Channel List.

This Screen contains many submenus. You can exit submenus to return to a parent menu by pressing the Back arrow.

All

Press the All button on the Browse Screen. When pressing the All button, the following categories become available:

- **Channel List:** Press the Channel List to display all the SiriusXM® Channel Numbers. You can scroll the Channel List by pressing the Up and Down arrows, located on the right side of the screen. Scrolling can also be done by operating the Tune/Scroll knob.
- **Genre List:** Press the Genre button on the touchscreen to display a list of Genres. You can select any desired Genre by pressing the Genre List. The radio tunes to a channel with the content in the selected Genre.

Presets — If Equipped

Press the Presets button (if equipped) located at the left of the Browse screen.

You can scroll the Presets list by pressing the Up and Down arrows located at the right side of the screen. Scrolling can also be done by operating the Tune/Scroll knob.

Preset Selection

A preset can be selected by pressing any of the listed Presets, or by pushing the Enter/Browse button on the Tune/Scroll knob to select the currently highlighted Preset. When selected, the radio tunes to the station stored in the Preset.

Deleting A Preset

A preset can be deleted in the Presets Browse screen by pressing the Trash Can icon for the corresponding preset.

Favorites

Press the Favorites button on the Browse screen.

The Favorites menu provides a means to edit the Favorites list and to configure the Alert Settings, along with providing a list of Channels currently airing any of the items in the Favorites list.

You can scroll the Favorites list by pressing the Up and Down arrows located at the right side of the screen. Scrolling can also be done by operating the Tune/Scroll knob as well.

On-Air

Press the On-Air tab at the top of the screen. The On-Air list provides a list of favorite Channels currently airing any of the items in the Selections list, and pressing any of the items in the list tunes the radio to that channel.

Remove Favorites

Press the Remove Favorites tab at the top of the screen. Press the Delete All button on the touchscreen to delete all of the Favorites or press the Trash Can icon next to the Favorite to be deleted.

Alert Settings

Press the Alert Settings tab at the top of the Favorites screen. The Alert Settings menu allows you to choose from a visual alert or audible and visual alert when one of your favorites is airing on any of the SiriusXM® channels.

Game Zone

Press the Game Zone button, located at the left of the Browse screen. This feature provides you with the ability to select teams, edit the selection, and set alerts.

On-Air

Press the On-Air tab at the top of the screen. The On-Air list provides a list of Channels currently airing any of the items in the Selections list, and pressing any of the items in the list tunes the radio to that channel.

Select Team — If Equipped

Press the Select Team button on the touchscreen to activate the League Scroll list. Press the chosen league and a scroll list of all teams within the league will appear, then you can select a team by pressing the corresponding box. A check mark appears for all teams that are chosen.

Remove Selection/Trash Can Icon

Press the Remove Selection tab at the top of the screen. Press the Delete All button on the touchscreen to delete all of the selections or press the Trash Can icon next to the selection to be deleted.

Alert Settings

Press the Alert Setting tab at the top of the screen. The Alert Settings menu allows you to choose from “Alert me to on-air games upon start” or “Alert upon score update” or both when one or more of your selections is airing on any of the SiriusXM® channels.

Traffic & Weather — If Equipped

Press the Traffic & Weather button at the top of the screen and select a specific city to view traffic and weather reports around the area you have selected.

Tune Start

Tune Start begins playing the current song from the beginning when you tune to a music channel using one of the 12 presets. This feature occurs the first time the preset is selected during that current song.

Setting Presets



Uconnect 4/4 NAV With 7-inch Display Radio Presets

The Presets are available for all Radio Modes, and are activated by pressing any of the Preset buttons, located at the top of the screen.

When you are on a station that you wish to save as a preset, press and hold the numbered button on the touchscreen for more than two seconds.

The Radio stores up to 12 presets in each of the Radio Modes.

A total of six presets will appear on the screen. You can switch between the radio presets list by pressing the Arrow button located in the upper right of the radio touchscreen.

PRESET FEATURES — IF EQUIPPED

Browse In AM/FM

When in either AM or FM, the Browse Screen provides a means to edit the Presets List and is entered by pushing the Enter/Browse button.

Scrolling Preset List

Once in the Browse Presets screen, you can scroll the preset list by rotation of the Tune/Scroll knob or by pressing the Up and Down Arrow button, located on the right of the screen.

Preset Selection From List

A preset can be selected by pressing any of the listed Presets, or by pushing the Enter/Browse button on the Tune/Scroll knob to select the currently highlighted Preset.

When selected, the radio tunes to the station stored in the Presets.

Deleting Presets

A preset can be deleted in the Presets Browse screen by pressing the Trash Can icon for the corresponding preset.

Return To Main Radio Screen

You can return to the Main Radio Screen by pressing the X button or the Back Arrow button when in the Browse Presets screen.

Audio Settings

Press the Audio button within the settings main menu to activate the Audio Settings screen.

The audio settings can also be accessed on the Radio Mode screen by pressing the Audio button. You can return to the Radio screen by pressing the X button.



Uconnect 4/4 NAV With 7-inch Display

- 1 — Balance/Fade
- 2 — Equalizer
- 3 — Speed Adjusted Volume
- 4 — Surround Sound
- 5 — Loudness
- 6 — AUX Volume Offset
- 7 — Radio Off With Door

Audio Setting	Description
Balance/Fade	Press the Balance/Fade button on the touchscreen to balance audio between the front speakers or fade the audio between the rear and front speakers. Press the Front, Rear, Left or Right button or press and drag the red Speaker icon to adjust the Balance/Fade.
Equalizer	Press the + or – button or press and drag the level bar to increase or decrease each of the equalizer bands. The level value, which spans between plus or minus nine, is displayed at the top of each of the bands.

Audio Setting	Description
Speed Adjusted Volume	The Speed Adjusted Volume is adjusted by selecting from “Off”, “1”, “2”, and “3”. This alters the automatic adjustment of the audio volume with variation to vehicle speed. Volume increases automatically as speed increases to compensate for normal road noise.
Surround Sound – If Equipped	When Surround Sound is on, you can hear audio coming from every direction as in a movie theatre or home theatre system.
Loudness – If Equipped	When Loudness is on, the sound quality at lower volumes improves.
AUX Volume Offset – If Equipped	The AUX Volume Offset is adjusted by pressing + and – buttons. This alters the AUX input audio volume. The level value, which spans between plus or minus three, is displayed above the adjustment bar.
Auto Play – If Equipped	The Auto Play feature begins playing music as soon as a USB Media device is connected to one of the vehicle’s Media USB ports, when it is turned on. Press “Off” to turn the setting off.
Radio Off With Door – If Equipped	The Radio Off With Door feature, when activated, keeps the radio on until the driver or passenger door is opened or when the Radio Off Delay selected time has expired.

MEDIA MODE

Operating Media Mode

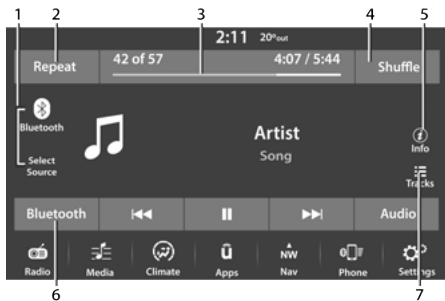

Uconnect 4/4 NAV With 7-inch Display Operating Media Mode

- 1 — Select Source
- 2 — Repeat
- 3 — Track Time
- 4 — Shuffle
- 5 — Info
- 6 — Bluetooth®
- 7 — Tracks

Audio Source Selection

Once in Media Mode, press the Source or Source Select button on the touchscreen and the desired mode button on the touchscreen. USB, AUX, and Bluetooth® are the Media sources available. When available, you can select the Browse button on the touchscreen to be given these options:

- Now Playing
- Artists
- Albums
- Genres
- Songs
- Playlists
- Folders

You can press the Source, Pause/Play, or the Info button on the touchscreen for artist information on the current song playing.

Types of Media Modes

USB MODE

Overview

USB Mode is entered by either inserting a USB device into the USB port or by selecting the USB button on the left side of the touchscreen or the Source Select/Select Source button, and then selecting USB 1 or 2 (if equipped).

BLUETOOTH® MODE

Overview

Bluetooth® Streaming Audio or Bluetooth® Mode is entered by pairing a Bluetooth® device, containing music, to the Uconnect system.

Before proceeding, the Bluetooth® device must be paired to the Uconnect Phone to communicate with the Uconnect system.

To access Bluetooth® Mode, press the Bluetooth® button on the left side of the touchscreen or under the Source Select/Select Source button (if equipped).

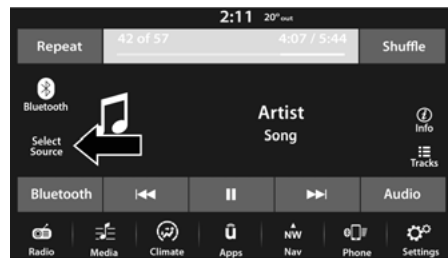

Uconnect 4/4 NAV With 7-inch Display Select Source

AUX MODE

Overview

Auxiliary Mode (AUX) is entered by inserting an AUX device using a cable with a 3.5 mm audio jack into the AUX port or by pressing the AUX button on the left side of the touchscreen or under the Source Select button (if equipped).

To insert an Auxiliary device, gently insert the Auxiliary device cable into the AUX port. If you insert an Auxiliary device with the ignition and the radio on, the unit will switch to AUX Mode and begin to play.

Controlling The Auxiliary Device

The control of the Auxiliary device (e.g., selecting playlists, play, fast forward, etc.) cannot be provided by the radio; use the device controls instead. Adjust the volume with the Volume button, Volume/Mute rotary knob, or the On/Off rotary knob, or with the volume of the attached device.

NOTE:

The radio unit is acting as the amplifier for audio output from the Auxiliary device. Therefore, if the volume control on the Auxiliary device is set too low, there will be insufficient audio signal for the radio unit to play the music on the device.

Seek Up ►► / Seek Down ◀◀

In USB Mode, press the Seek Up button on the touchscreen for the next selection on the USB

device. Press and release the Seek Down button on the touchscreen to return to the beginning of the current selection, or to return to the beginning of the previous selection if the USB device is within the first three seconds of the current selection.

In Bluetooth® Mode, press and release the Seek Up button on the touchscreen for the next selection on the Bluetooth® device. Press and release the Seek Down button on the touchscreen to return to the beginning of the current selection, or return to the beginning of the previous selection if the Bluetooth® device is within the first second of the current selection.

Browse

In USB Mode, press the Browse button on the touchscreen to display the browse window. In USB Mode, the left side of the browse window displays a list of ways you can browse through the contents of the USB device. If supported by the device, you can browse by Folder, Artist, Playlist, Album, Song, etc. Press the desired button on the touchscreen on the left side of the screen. The center of the browse window shows items and its sub-functions, which can be scrolled through by pressing the Up and Down buttons to the right. The Tune/Scroll knob can also be used to scroll.

Media Mode

In USB Mode, press the Media button on the touchscreen to select the desired audio source: USB.

In Bluetooth® Mode, press the Media button on the touchscreen to select the desired audio source: Bluetooth®.

In AUX Mode, press the Media button on the touchscreen to select the desired audio source: AUX.

Repeat

In USB Mode, press the Repeat button on the touchscreen to toggle the repeat functionality. The Repeat button on the touchscreen is highlighted when active. The Radio will continue to play the current track, repeatedly, as long as the repeat is active. Press the Repeat button again to enter Repeat All. The radio will continue to play all the current tracks, repeatedly, as long as the repeat function is active. To cancel Repeat, press the Repeat button a third time.

Shuffle

In USB Mode, press the Shuffle button on the touchscreen to play the selections on the USB device in random order to provide an interesting change of pace. Press the Shuffle button on the touchscreen a second time to turn this feature off.

Audio

Audio settings can be accessed by pressing the Audio button ⇨ page 137.

Info

In both Disc and USB Modes, press the Info button on the touchscreen to display the current track information. Press the Info or X button on the touchscreen a second time to cancel this feature.

Tracks

In both Disc and USB Modes, press the Tracks button on the touchscreen to display a pop-up with the Song List. The song currently playing is indicated by an arrow and lines above and below the song title. When in the Tracks List screen you can rotate the Tune/Scroll knob to highlight a track (indicated by the line above and below the track name) and then push the Enter/Browse knob to start playing that track.

In Bluetooth® Mode, if the Bluetooth® device supports this feature, press the Tracks button on the touchscreen to display a pop-up with the Song List. The currently playing song is indicated by a red arrow and lines above and below the song title.

Pressing the Tracks button on the touchscreen while the pop-up is displayed will close the pop-up.

MEDIA VOICE COMMANDS

Uconnect offers connections via USB, Bluetooth®, and auxiliary (AUX) ports. Voice operation is only available for connected USB and AUX devices.

Push the VR button  located on the steering wheel. After the beep, say one of the following commands and follow the prompts to switch your media source or choose an artist.

- “Change source to Bluetooth®”
- “Change source to AUX”
- “Change source to USB”
- “Play artist Beethoven”; “Play album Greatest Hits”; “Play song Moonlight Sonata”; “Play genre Classical”

Did You Know: Press the Browse button on the touchscreen to see all of the music on your USB device. Your Voice Command must match exactly how the artist, album, song, and genre information is displayed.

PHONE MODE

Overview

Uconnect Phone is a voice-activated, hands-free, in-vehicle communications system. It allows you to dial a phone number with your mobile phone.

The feature supports the following:

Voice Activated Features

- Hands-Free dialing via Voice (“Call John Smith Mobile” or “Dial 248-555-1212”).
- Hands-Free text-to-speech listening of your incoming SMS messages.

- Hands-Free Text Message Replying: Forward one of 18 predefined SMS messages to incoming calls/text messages.
- Redialing last dialed numbers (“Redial”).
- Calling Back the last incoming call number (“Call Back”).
- Viewing call logs on screen (“Show Incoming Calls,” “Show Outgoing Calls,” “Show Missed Calls,” or “Show Recent Calls”).
- Searching Contacts phone number (“Search for John Smith Mobile”).

Screen Activated Features

- Dialing via Keypad using touchscreen.
- Viewing and Calling contacts from Phonebooks displayed on the touchscreen.
- Setting Favorite Contact phone numbers so they are easily accessible on the Main Phone screen.
- Viewing and Calling contacts from Recent Call logs.
- Reviewing your recent Incoming SMS Messages.
- Pairing up to 10 phones/audio devices for easy access to connect to them quickly.

NOTE:

Your phone must be capable of SMS messaging via Bluetooth® for messaging features to work properly.

Your mobile phone's audio is transmitted through your vehicle's audio system; the system will automatically mute your radio when using the Uconnect Phone.

For Uconnect customer support:

- US visit UconnectPhone.com or call 877-855-8400
- Canada visit UconnectPhone.com or call 800-465-2001 (English) or (French) call 800-387-9983

Uconnect Phone allows you to transfer calls between the system and your mobile phone as you enter or exit your vehicle and enables you to mute the system's microphone for private conversation.

WARNING!

ALWAYS drive safely with your hands on the steering wheel. You have full responsibility and assume all risks related to the use of the Uconnect features and applications in this vehicle. Only use Uconnect when it is safe to do so. Failure to do so may result in an accident involving serious injury or death.

The Phone feature is driven through your Bluetooth® "Hands-Free Profile" mobile phone. Uconnect features Bluetooth® technology — the global standard that enables different electronic devices to connect to each other without wires or a docking station. Ensure your phone is turned on with Bluetooth® active and has been paired to the Uconnect system. Up to 10 mobile phones or audio devices are allowed to be linked to the system. Only one linked (or paired) mobile phone and one audio device can be used with the system at a time.

Phone Button

The Phone button  on your steering wheel is used to get into the Phone Mode and make calls, show recent, incoming or outgoing calls, view phonebook, etc. When you press the button you will hear a BEEP. The BEEP is your signal to give a command.

Voice Command Button

The Voice Command button  on your steering wheel is only used for "barge in" and when you are already in a call or want to make another call.

The button on your steering wheel is also used to access the Voice Commands for the Uconnect Voice Command features if your vehicle is equipped.

Phone Operation**OPERATION**

Voice commands can be used to operate the Uconnect Phone and to navigate its menu structure. Voice commands are required after most Uconnect Phone prompts. There are two general methods for how Voice Command works:

1. Say compound commands like "Call John Smith mobile".
2. Say the individual commands and allow the system to guide you to complete the task.

You will be prompted for a specific command and then guided through the available options.

- Prior to giving a voice command, one must wait for the beep, which follows the "Listen" prompt or another prompt.
- For certain operations, compound commands can be used. For example, instead of saying "Call" and then "John Smith" and then "mobile", the following compound command can be said: "Call John Smith mobile."
- For each feature explanation in this section, only the compound command form of the voice command is given. You can also break the commands into parts and say each part of the command when you are asked for it. For example, you can use the compound command form voice

command “Search for John Smith,” or you can break the compound command form into two voice commands: “Search Contacts” and when asked, “John Smith.” Please remember, the Uconnect Phone works best when you talk in a normal conversational tone, as if speaking to someone sitting a few feet/meters away from you.

NATURAL SPEECH

Your Uconnect Phone Voice system uses a Natural Language Voice Recognition (VR) engine.

Natural speech allows the user to speak commands in phrases or complete sentences. The system filters out certain non-word utterances and sounds such as “ah” and “eh.” The system handles fill-in words such as “I would like to”.

The system handles multiple inputs in the same phrase or sentence such as “make a phone call” and “to Kelly Smith”. For multiple inputs in the same phrase or sentence, the system identifies the topic or context and provides the associated follow-up prompt such as “Who do you want to call?” in the case where a phone call was requested but the specific name was not recognized.

The system utilizes continuous dialog. When the system requires more information from the user, it will ask a question to which the user can respond without pushing the Voice Command button on the steering wheel.

HELP COMMAND

If you need assistance at any prompt, or if you want to know your options at any prompt, say “Help” following the beep.

To activate the Uconnect Phone from idle, simply push the Phone button (if active) on your steering wheel and say a command or say “Help”. All Phone sessions begin with a push of the VR button or the Phone button on the touchscreen.

CANCEL COMMAND

At any prompt, after the beep, you can say “Cancel” and you will be returned to the main menu.

You can also push the VR button or Phone button on your steering wheel when the system is listening for a command and be returned to the main or previous menu.

PAIR (LINK) UCONNECT PHONE TO A MOBILE PHONE

Use this QR code to access your digital experience.

To begin using your Uconnect Phone, you must pair your compatible Bluetooth®-enabled mobile phone. Mobile phone pairing is the process of establishing a wireless connection between a cellular phone and the Uconnect system.



To complete the pairing process, you will need to reference your mobile phone’s manual. Please visit UconnectPhone.com for complete mobile phone compatibility information.



Uconnect 4/4 NAV With 7-inch Display

NOTE:

- You must have Bluetooth® enabled on your phone to complete this procedure.
- The vehicle must be in PARK or at a standstill.

Follow the steps below to pair your phone:

1. Place the ignition in the ACC or ON/RUN position.
2. Press the Phone button.

NOTE:

- If there are no phones currently connected with the system, a pop-up will appear asking if you would like to pair a mobile phone.
 - This pop-up only appears when the user enters Phone Mode and no other device(s) have previously been paired. If the system has a phone previously paired, even if no phone is currently connected with the system, this pop-up will not appear.
3. Select “Yes” to begin the pairing process.
 4. Search for available devices on your Bluetooth®-enabled mobile phone.
 - Press the Settings button on your mobile phone.
 - Select “Bluetooth®” and ensure it is enabled. Once enabled, the mobile phone will begin to search for Bluetooth® connections.

NOTE:

During the pairing procedure, you may receive a pop-up on your touchscreen asking you to make sure the PIN on the touchscreen matches the PIN from the pop-up on your mobile phone.

5. If “No” is selected, and you still would like to pair a mobile phone, press the Pairing or Settings button from the Uconnect Phone main screen.
 - Press the Paired Phones button.
 - Search for available devices on your Bluetooth®-enabled mobile phone (see below). When prompted on the phone, select “Uconnect” and accept the connection request.
6. Uconnect Phone will display an in-progress screen while the system is connecting.
7. When your mobile phone finds the Uconnect system, select “Uconnect.”
8. When prompted on the mobile phone, accept the connection request from Uconnect.
9. When the pairing process has successfully completed, the system will prompt you to choose whether or not this is your favorite phone. Selecting “Yes” will make this phone the highest priority. This phone will take precedence over other paired phones within range and will connect to the Uconnect system automatically when entering the vehicle. Only one mobile phone and/or one Bluetooth® audio device can be connected to the Uconnect system at a time. If “No” is selected, simply select “Uconnect” from the mobile

phone/audio device Bluetooth® screen, and the Uconnect system will reconnect to the Bluetooth® device.

NOTE:

For phones which are not made a favorite, the phone priority is determined by the order in which it was paired. The most recent phone paired will have the higher priority.

NOTE:

During the pairing procedure, you may receive a pop-up on your mobile phone for the Uconnect system to access your “messages” and “contacts”. Selecting “Ok” or “Allow” will sync your contacts with the Uconnect system.

You can also use the following VR command to bring up the Paired Phone screen from any screen on the radio:

- “Show Paired Phones”

NOTE:

Software updates on your phone or the Uconnect system may interfere with the Bluetooth® connection. If this happens, simply repeat the pairing process. However, first make sure to delete the device from the list of phones on your Uconnect system. Next, be sure to remove Uconnect from the list of devices in your phone’s Bluetooth® settings.

PAIR A BLUETOOTH® STREAMING AUDIO DEVICE

1. Press the Media button on the touchscreen to begin.
2. Change the source to “Bluetooth®”.
3. Press the Bluetooth® button on the touchscreen to display the Paired Audio Devices screen.
4. Press the Add Device button on the touchscreen.

NOTE:

If there is no device currently connected with the system, a pop-up will appear.

5. Search for available devices on your Bluetooth®-enabled audio device. When prompted on the device, confirm the PIN shown on the Uconnect screen.
6. Uconnect Phone will display an in-process screen while the system is connecting.
7. When the pairing process has successfully completed, the system will prompt you to choose whether or not this is your favorite device. Selecting “Yes” will make this device the highest priority. This device will take precedence over other paired devices within range.

NOTE:

For devices which are not made a favorite, the device priority is determined by the order in which it was paired. The most recent device paired will have the higher priority.

You can also use a following VR command to bring up a list of paired audio devices:

- “Show Paired Phones”

CONNECTING TO A PARTICULAR MOBILE PHONE OR AUDIO DEVICE AFTER PAIRING

Uconnect Phone will automatically connect to the highest priority paired phone and/or Audio Device within range. If you need to choose a particular phone or audio device follow these steps:

1. Press the Settings button on the touchscreen.
2. Press the Paired Phones/Audio Sources buttons.
3. Press to select the particular phone or the particular audio device. A pop-up menu will appear; press “Connect Phone”.
4. Press the X to exit out of the Settings screen.

DISCONNECTING OR DELETING A PHONE OR AUDIO DEVICE

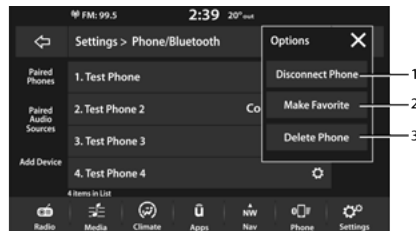

Uconnect 4/4 NAV With 7-inch Display

- 1 — Disconnect Device Or Disconnect Phone
- 2 — Make Favorite
- 3 — Delete Device/Phone

1. Press the Uconnect Phone Pairing or Settings button.
2. Press the Paired Phones/Audio Sources buttons.
3. Press the Settings button located to the right of the device name for a different phone or audio device than the currently connected device or press the preferred Connected Phone from the list.

4. The option's pop-up will be displayed.
5. Press the Disconnect Device or the Delete Device button on the touchscreen.
6. Press the X to exit out of the Settings screen.

MAKING A PHONE OR AUDIO DEVICE A FAVORITE

1. On the Paired Phone/Audio sources screen, press the Settings button located to the right of the device name for a different phone or audio device than the currently connected device or press the preferred "Connected Phone" from the list.
2. The option's pop-up will be displayed.
3. Press the Make Favorite button on the touchscreen; you will see the chosen device move to the top of the list.
4. Press the X to exit out of the Settings screen.

PHONEBOOK DOWNLOAD (AUTOMATIC PHONEBOOK TRANSFER FROM MOBILE PHONE) — IF EQUIPPED

If supported by your phone, Uconnect Phone has the ability to download contact names and number entries from the mobile phone's phonebook. Specific Bluetooth® Phones with Phonebook Access Profile may support this feature. Your mobile phone may receive a pop-up asking for permission for the Uconnect system to access your

messages and contacts. Selecting "Ok" or "Allow" will sync your contacts with the Uconnect system. See the Uconnect website, UconnectPhone.com, for supported phones.

- To call a name from a downloaded mobile phonebook, follow the procedure in the "Voice Command" in this section.
- Automatic download and update of a phonebook, if supported, begins as soon as the Bluetooth® wireless phone connection is made to the Uconnect Phone, for example, after you start the vehicle.
- A maximum of 5,000 contact names with four numbers per contact will be downloaded and updated every time a phone is connected to the Uconnect Phone.
- Depending on the maximum number of entries downloaded, there may be a short delay before the latest downloaded names can be used. Until then, if available, the previously downloaded phonebook is available for use.
- Only the phonebook of the currently connected mobile phone is accessible.
- This downloaded phonebook cannot be edited or deleted on the Uconnect Phone. These can only be edited on the mobile phone. The changes are transferred and updated to Uconnect Phone on the next phone connection.

MANAGING YOUR FAVORITES — IF EQUIPPED

There are two ways you can add an entry to your favorites:

1. After loading the mobile phonebook, press the Favorites button on the touchscreen, and then press one of the +Add Favorite Contact buttons that appears on the list.
2. After loading the mobile phonebook, select "Contacts" from the Phone main screen, and then select the appropriate number. Press the Down Arrow button next to the selected number to display the option's pop-up. In the pop-up, select "Add to Favorites".

NOTE:

If the Favorites list is full, you will be asked to remove an existing favorite.

TO REMOVE A FAVORITE — IF EQUIPPED

1. To remove a Favorite, select "Favorites" from the Phone main screen.
2. Next, select the Down Arrow icon next to the contact you want to remove from your favorites. This will bring up the options for that Favorite contact.
3. Deselect the Star icon to delete the Favorite.

Phone Call Features

The following features can be accessed through the Uconnect Phone if the feature(s) are available and supported by Bluetooth® on your mobile service plan. For example, if your mobile service plan provides three-way calling, this feature can be accessed through the Uconnect Phone. Check with your mobile service provider for the features that you have.

Listed below are the phone options with Uconnect:

- Redial
- Dial by pressing in the number
- Voice Commands (Dial by Saying a Name, Call by Saying a Phonebook Name, Redial or Call Back)
- Favorites
- Mobile Phonebook
- Recent Call Log
- SMS Message Viewer

CALL CONTROLS

The touchscreen allows you to control the following call features:



Uconnect 4/4 NAV With 7-inch Display

- 1 – Answer
- 2 – End
- 3 – Mute/Unmute
- 4 – Transfer
- 5 – Join Calls

Other phone call features include:

- End Call
- Hold/Unhold/Resume
- Swap two active calls

KEY PAD NUMBER ENTRY

1. Press the Phone button.
2. Press the Dial/Keypad button on the touchscreen.
3. The Touch-Tone screen will be displayed.
4. Use the numbered buttons on the touchscreens to enter the number and press “Dial/Call”.

RECENT CALLS – IF EQUIPPED

You may browse a list of the most recent of each of the following call types:

- All Calls
- Incoming Calls or Calls Received
- Outgoing Calls or Calls Made
- Missed Calls

These can be accessed by pressing the Recent Calls button on the phone main screen.

You can also push the VR button on your steering wheel and perform the above operation. For example, say “Show my incoming calls”.

ANSWER OR IGNORE AN INCOMING CALL — NO CALL CURRENTLY IN PROGRESS

When you receive a call on your mobile phone, the Uconnect Phone will interrupt the vehicle audio system. Push the Phone button on the steering wheel, press the Answer button on the touchscreen.

You can also press the Caller ID box to place the current call on hold or answer the incoming call.



Uconnect 4/4 NAV With 7-inch Display

- 1 — Answer Button
- 2 — Caller ID Box

ANSWER OR IGNORE AN INCOMING CALL — CALL CURRENTLY IN PROGRESS

If a call is currently in progress and you have another incoming call, you will hear the same network tones for call waiting that you normally hear when using your mobile phone. Push the Phone button on the steering wheel, press the Answer button on the touchscreen, or press the Caller ID box to place the current call on hold and answer the incoming call.

NOTE:

Phones that are compatible with the Uconnect system in the market today do not support rejecting an incoming call when another call is in progress. Therefore, the user can only answer an incoming call or ignore it.

DO NOT DISTURB

With Do Not Disturb, you can disable notifications from incoming calls and texts, allowing you to keep your eyes on the road and hands on the wheel. For your convenience, there is a counter display to keep track of your missed calls and text messages while Do Not Disturb is active.

Do Not Disturb can automatically reply with a text message, a call, or both when declining an incoming call and send it to voicemail.

Automatic reply messages can be:

- “I am driving right now, I will get back to you shortly”.
- Create a custom auto reply message up to 160 characters.

NOTE:

Only the first 25 characters can be seen on the touchscreen while typing a custom message.

While in Do Not Disturb, Conference Call can be selected so you can still place a second call without being interrupted by incoming calls.

NOTE:

- Reply with text message is not compatible with iPhones®.
- Auto reply with text message is only available on phones that support Bluetooth® Message Access Profile (MAP).

PLACE/RETRIEVE A CALL FROM HOLD

During an active call, press the Hold or Call On Hold button on the Phone main screen.

MAKING A SECOND CALL WHILE CURRENT CALL IS IN PROGRESS

You can place a call on hold by pressing the Hold button on the Phone main screen, then dial a number from the keypad (if supported by your mobile phone), recent calls, SMS Inbox or from the phonebooks.

TOGGLING BETWEEN CALLS



Uconnect 4 With 7-inch Display

If two calls are in progress (one active and one on hold), press the Swap Calls button on the phone main screen. Only one call can be placed on hold at a time.

You can also push the Phone button to toggle between the active and held phone call.

JOIN CALLS

When two calls are in progress (one active and one on hold), press the Join/Merge Calls button on the Phone main screen to combine all calls into a conference call.

CALL TERMINATION

To end a call in progress, momentarily press the End Call button on the touchscreen or the Phone End button on the steering wheel. Only the active call(s) will be terminated and if there is a call on hold, it will become the new active call.

REDIAL

Push the VR button  and after the “Listening” prompt and the following beep, say “Redial.”

The Uconnect Phone will call the last number that was dialed from your mobile phone.

CALL CONTINUATION

Call continuation is the progression of a phone call on the Uconnect Phone after the vehicle ignition has been switched to OFF.

NOTE:

The call will remain within the vehicle audio system until the phone becomes out of range for the Bluetooth® connection. It is recommended to press the Transfer button on the touchscreen when leaving the vehicle.

Advanced Phone Connectivity

TRANSFER CALL TO AND FROM MOBILE PHONE

The Uconnect Phone allows ongoing calls to be transferred from your mobile phone without terminating the call. To transfer an ongoing call from your connected mobile phone to the Uconnect Phone or vice versa, press the Transfer button on the Phone main screen.

Things You Should Know About Uconnect Phone

VOICE COMMAND

For the best performance:

- Always wait for the beep before speaking
- Speak normally, without pausing, just as you would speak to a person sitting a few feet/meters away from you
- Ensure that no one other than you is speaking during a voice command period
- Low-To-Medium Blower Setting
- Low-To-Medium Vehicle Speed
- Low Road Noise
- Smooth Road Surface
- Fully Closed Windows
- Dry Weather Conditions

WARNING!

ALWAYS drive safely with your hands on the wheel. You have full responsibility and assume all risks related to the use of the Uconnect features and applications in this vehicle. Only use Uconnect when it is safe to do so. Failure to do so may result in an accident involving serious injury or death.

Even though the system is designed for many languages and accents, the system may not always work for some.

NOTE:

It is recommended that you do not store names in your Favorites phonebook while the vehicle is in motion.

Number and name recognition rate is optimized when the entries are not similar. You can say “O” (letter “O”) for “0” (zero).

Even though international dialing for most number combinations is supported, some shortcut dialing number combinations may not be supported.

Audio Performance

Audio quality is maximized under:

- Low-To-Medium Blower Setting
- Low-To-Medium Vehicle Speed
- Low Road Noise

- Smooth Road Surface
- Fully Closed Windows
- Dry Weather Conditions
- Operation From The Driver's Seat

Performance such as audio clarity, echo, and loudness to a large degree rely on the phone and network, and not the Uconnect Phone.

Echo at the far end can sometimes be reduced by lowering the in-vehicle audio volume.

Phone Voice Commands



Making and answering hands-free phone calls is easy with Uconnect. When the Phonebook button is illuminated on your touchscreen, your system is ready. Check UconnectPhone.com for mobile phone compatibility and pairing instructions.

Push the Phone button  and wait for the beep to say a command. See some examples below:

- “**Call** John Smith”
- “**Dial** 123 456 7890”
- “**Redial**” (call previous outgoing phone number)
- “**Call back**” (call previously answered incoming phone number)

Did You Know: When providing a Voice Command, push the Phone button  and say “**Call**”, then pronounce the name **exactly** as it appears in your phonebook. When a contact has multiple phone numbers, you can say “**Call** John Smith **work**”.

Voice Text Reply – If Equipped

Uconnect can announce **incoming** text messages. Push the VR button  or Phone button  and say:

1. “**Listen**” to have the system read an incoming text message. (Must have compatible mobile phone paired to Uconnect system.)
2. “**Reply**” after an incoming text message has been read.

Listen to the Uconnect prompts. After the beep, repeat one of the predefined messages and follow the system prompts.

PRE-DEFINED VOICE TEXT REPLY RESPONSES

Yes.	Stuck in traffic.	See you later.
No.	Start without me.	I'll be late.
Okay.	Where are you?	I will be 5 <or 10, 15, 20, 25, 30, 45, 60> minutes late.
Call me.	Are you there yet?	

PRE-DEFINED VOICE TEXT REPLY RESPONSES		
I'll call you later.	I need directions.	See you in 5 <or 10, 15, 20, 25, 30, 45, 60> minutes.
I'm on my way.	Can't talk right now.	
I'm lost.		Thanks.

NOTE:

Only use the numbering listed in the provided table. Otherwise, the system will not transpose the message.

Did You Know: Your mobile phone must have the full implementation of the **Message Access Profile (MAP)** to take advantage of this feature. For details about MAP, visit UconnectPhone.com.

Apple® iPhone® iOS 6 or later supports reading **incoming** text messages only. For further information on how to enable this feature on your Apple® iPhone®, refer to your iPhone's® "User Manual".

Did You Know: Voice Text Reply is not compatible with iPhone®, but if your vehicle is equipped with Siri® Eyes Free, you can use your voice to send a text message.

Siri® Eyes Free — If Equipped

When used with your Apple® iPhone® connected to your vehicle via Bluetooth®, Siri lets you use your voice to send text messages, select media, place phone calls and much more. Siri uses your natural language to understand what you mean and responds back to confirm your requests. The system is designed to keep your eyes on the road and your hands on the wheel by letting Siri help you perform useful tasks.

To enable Siri, push and hold, then release the Uconnect Voice Recognition (VR) button on the steering wheel. After you hear a double beep, you can ask Siri to play podcasts and music, get directions, read text messages, and many other useful requests.

BLUETOOTH® COMMUNICATION LINK

Mobile phones may lose connection to the Uconnect Phone. When this happens, the connection can generally be re-established by restarting the mobile phone. Your mobile phone is recommended to remain in Bluetooth® ON mode.

POWER-UP

After switching the ignition key from OFF to either the ON/RUN or ACC position, or after a language change, you must wait at least 15 seconds prior to using the system ⇨ page 290.

ANDROID AUTO™ & APPLE CARPLAY® — IF EQUIPPED**ANDROID AUTO™**

Use this QR code to access your digital experience.



Android Auto™ is a feature of your Uconnect system, and your Android™ 6.0 or higher powered smartphone with a data plan, that allows you to project your smartphone and a number of its apps onto the touchscreen radio display. Android Auto™ brings you useful information, and organizes it into simple cards that appear just when they are needed. Android Auto™ can be used with speech technology, the steering wheel controls, the knobs and buttons on your radio faceplate, and the radio display's touchscreen to control many of your apps. To use Android Auto™, perform the following procedure:

NOTE:

Feature availability depends on your carrier and mobile phone manufacturer. Some Android Auto™ features may or may not be available in every region and/or language.

1. Download the Android Auto™ app from the Google Play store on your Android™-powered smartphone.

2. Connect your Android™-powered smartphone to one of the media USB ports in your vehicle. If the Android Auto™ app was not downloaded, the first time you plug your device in the app begins to download. Your vehicle should be in PARK the first time you use the app.

NOTE:

Be sure to use the factory-provided USB cable that came with your phone, as aftermarket cables may not work.

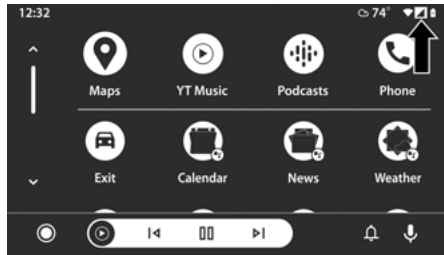

Android Auto™ And LTE Data Coverage

NOTE:

To use Android Auto™, make sure you are in an area with cellular coverage. Android Auto™ may use cellular data and your cellular coverage is shown in the upper right corner of the radio screen. Data plan rates apply.

3. Once the device is connected and recognized, the Phone icon on the drag & drop menu bar changes to the Android Auto™ icon.

NOTE:

Android Auto™ is set to launch immediately once a compatible device is connected. You can also launch it by pressing the Android Auto™ icon on the touchscreen.

Once Android Auto™ is up and running on your Uconnect system, the following features can be utilized using your smartphone's data plan:

- Google Maps™ for navigation
- Google Play Music, Spotify, iHeart Radio, etc. for music
- Hands-free calling and texting for communication
- Various compatible apps

Maps

 Push and hold the Voice Recognition (VR) button on the steering wheel until the beep or tap the Microphone icon to ask Google to take you to a desired destination by voice. You can also touch the Navigation icon in Android Auto™ to access other navigation apps.

While using Android Auto™, Google Maps™ provides voice-guided:

- Navigation
- Live traffic information
- Lane guidance

For further information, refer to www.android.com/auto/ (US) or https://www.android.com/intl/en_ca/auto (Canada).

For further information on the navigation function, please refer to <https://support.google.com/android> or <https://support.google.com/androidauto>.

Music

 Android Auto™ allows you to access and stream your favorite music with apps like YouTube Music, iHeartRadio, and Spotify. Using your smartphone's data plan, you can stream endless music on the road.

NOTE:

Music apps, playlists, and stations must be set up on your smartphone prior to using Android Auto™ for them to work with Android Auto™.

NOTE:

To see the track details for the music playing through Android Auto™, select the Uconnect system's media screen.

For further information, refer to <https://support.google.com/androidauto>.

Communication



With Android Auto™ connected, push and hold the VR button on the steering wheel to activate voice recognition specific to Android Auto™. This allows you to send and reply to text messages, have incoming text messages read out loud, and place and receive hands-free calls.

Apps

The Android Auto™ App displays all the compatible apps that are available to use with Android Auto™, every time it is launched. You must have the compatible app downloaded, and you must be signed in to the app through your mobile device for it to work with Android Auto™.

Refer to <https://play.google.com/store/apps> to see the latest list of available apps for Android Auto™.

Android Auto™ Voice Command

NOTE:

Feature availability depends on your carrier and mobile phone manufacturer. Some Android Auto™ features may or may not be available in every region and/or language.

Android Auto™ allows you to use your voice to interact with Android's™ best-in-class speech technology through your vehicle's voice recognition system, and use your smartphone's data plan to project your Android™-powered smartphone and a

number of its apps onto your Uconnect touchscreen. Connect your Android™ 6.0 or higher to one of the media USB ports, using the factory-provided USB cable, and press the new Android Auto™ icon that replaces your "Phone" icon on the main menu bar to begin Android Auto™. Push and hold the VR button on the steering wheel, or press and hold the "Microphone" icon within Android Auto™, to activate Android's™ VR, which recognizes natural voice commands, to use a list of your smartphone's features:

- Maps
- Music
- Phone
- Text Messages
- Additional Apps

NOTE:

- Requires compatible smartphone running Android™ 6.0 or higher and download app on Google Play. Android™, Android Auto™, and Google Play are trademarks of Google Inc. Android Auto™ may be downloaded automatically depending on the software version installed on your mobile device.
- To wirelessly use Android Auto™ on your car display, you need a compatible Android™ smartphone with an active data plan. You can check which smartphones are compatible at g.co/androidauto/requirements.

APPLE CARPLAY®

Use this QR code to access your digital experience.



Uconnect works seamlessly with Apple CarPlay®, the smarter, more secure way to use your iPhone® in the car, and stay focused on the road. Use your Uconnect Touchscreen display, the vehicle's knobs and controls, and your voice with Siri to get access to Apple Music®, Maps, Messages, and more.

NOTE:

Feature availability depends on your carrier and mobile phone manufacturer. Some Apple CarPlay® features may or may not be available in every region and/or language.

To use Apple CarPlay®, make sure you are using iPhone® 5 or later, have Siri enabled in Settings, ensure your iPhone® is unlocked for the very first connection only, and then use the following procedure:

1. Connect your iPhone® to one of the media USB ports in your vehicle.

NOTE:

Be sure to use the factory-provided Lightning cable that came with your phone, as aftermarket cables may not work.

- Once the device is connected and recognized, the Phone icon on the drag & drop menu bar changes to the Apple CarPlay® Icon.

NOTE:

Apple CarPlay® is set to launch immediately. You can also launch it by pressing the Apple CarPlay® icon on the touchscreen.

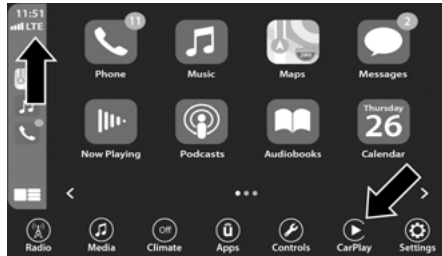

Apple CarPlay® And LTE Data Coverage

NOTE:

To use Apple CarPlay®, make sure that cellular data is turned on, and that you are in an area with cellular coverage. Your data and cellular coverage is shown on the left side of the radio screen. Data plan rates apply.

Once Apple CarPlay® is up and running on your Uconnect system, the following features can be utilized using your iPhone's® data plan:

- Phone
- Music
- Messages
- Maps

Phone

 With Apple CarPlay®, push and hold the VR button on the steering wheel to activate a Siri voice recognition session. You can also press and hold the Home button within Apple CarPlay® to start talking to Siri. This allows you to make calls or listen to voicemail as you normally would using Siri on your iPhone®.

NOTE:

Only temporarily pushing the VR button on the steering wheel launches a built-in Uconnect VR session, not a Siri session, and it will not function with Apple CarPlay®.

Music

 Apple CarPlay® allows you to access all your artists, playlists, and music from iTunes® or any third party application installed on your device. Using your iPhone's® data plan, you can also use select third party audio apps including music, news, sports, podcasts, and more.

Messages

 Push and hold the VR button on the steering wheel to activate a Siri voice recognition session. Apple CarPlay® allows you to use Siri to send or reply to text messages. Siri can also read incoming text messages, but drivers will not be able to read messages, as everything is done via voice.

Maps

 Push and hold the VR button on the steering wheel until the beep or tap the Microphone icon to ask Apple® Siri to take you to a desired destination by voice. You can also touch the Navigation icon in Apple CarPlay® to access Apple® Maps.

Apps

The Apple CarPlay® App plays all compatible apps that are available to use, every time it is launched. You must have the compatible app downloaded, and you must be signed in to the app through your mobile device for it to work with Apple CarPlay®.

Refer to <http://www.apple.com/ios/carplay> (US) or <https://www.apple.com/ca/ios/carplay> (Canada) to see the latest list of available apps for Apple CarPlay®.

Apple CarPlay® Voice Command

NOTE:

Feature availability depends on your carrier and mobile phone maker. Some Apple CarPlay® features may not be available in every region and/or language.

Apple CarPlay® allows you to use your voice to interact with Siri through your vehicle's voice recognition system, and use your smartphone's data plan to project your iPhone® and a number of its apps onto your Uconnect touchscreen. Connect your iPhone® 5 or higher to one of the media USB ports, using the factory-provided Lightning cable, and press the new Apple CarPlay® icon that replaces your "Phone" icon on the main menu bar to begin Apple CarPlay®. Push and hold the VR button on the steering wheel, or press and hold the Home button within Apple CarPlay®, to activate Siri, which recognizes natural voice commands to use a list of your iPhone's® features:

- Phone
- Music
- Messages
- Maps — If Equipped
- Additional Apps — If Equipped

NOTE:

Apple CarPlay® is a trademark of Apple® Inc. iPhone® is a trademark of Apple® Inc., registered in the US and other countries. Apple® terms of use and privacy statements apply.

ANDROID AUTO™ AND APPLE CARPLAY® TIPS AND TRICKS

Android Auto™ And Apple CarPlay® Automatic Bluetooth® Pairing

After connecting to Android Auto™ or Apple CarPlay® for the first time and undergoing the setup procedure, the smartphone pairs to the Uconnect system via Bluetooth® without any setup required every time it is within range, if Bluetooth® is turned on.

NOTE:

Apple CarPlay® uses a USB connection while Android Auto™ uses both USB and Bluetooth® connections to function. The connected device is unavailable to other devices when connected using Android Auto™ or Apple CarPlay®.

Multiple Devices Connecting To The Uconnect System — If Equipped

It is possible to have multiple devices connected to the Uconnect system. For example, if using Android Auto™/Apple CarPlay®, the connected device will be used to place hands-free phone calls or send hands-free text messages. However, another

device can also be paired to the Uconnect system, via Bluetooth®, as an audio source, so the passenger can stream music.

NOTE:

Apple CarPlay® and Android Auto™ can only be launched from the front and center console USB ports.







NAVIGATION MODE — IF EQUIPPED

NAVIGATION MAIN MENU

To access the Navigation system, press the Nav button on the touchscreen.



Navigation Main Menu

Search		Press to search for a Point Of Interest (POI) or specific address.
Current Route		Press to view and edit the current route. This menu option is only available when navigating to a destination.
My Places		Press to select from a list of saved destinations, including the saved Home address, Work address, and Recent destinations.
Parking		Press to open the map view with the nearest parking locations.
Gas Station		Press to open the map view with the nearest gas station locations.
Settings		Press to open up the settings menu and alter map and route settings.
Help		Press to open up the help menu.

NAVIGATING A ROUTE

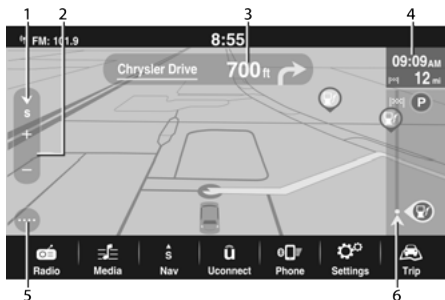

Navigation Route View

- 1 — Navigation View Button
- 2 — Zoom Button
- 3 — Next Turn Instructions
- 4 — Arrival Time and Distance
- 5 — Main Menu Button
- 6 — Points Of Interest On Route

Once a route is programmed, the map view will be displayed and highlight the route as a light blue bar. The route tracker is on the right side of the screen and shows the time and distance to the final destination. It also indicates stops and other points of interest along the way with icons that move closer as you near them. The direction distance is displayed at the top of the screen, and the main menu can be accessed at any time by pressing the Menu button: the four white dots in the bottom left-hand corner of the screen. The route will continue to display behind the menu as you travel along it.

SEARCH

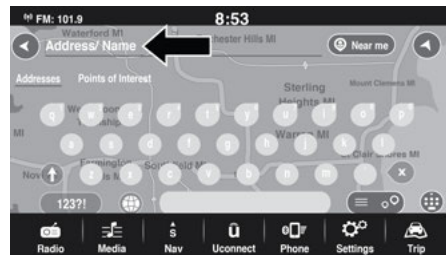

Search

To search for a destination and start navigation, follow these steps:

1. While in the Navigation Main Menu, press the Search button.
2. If searching using an address, begin typing the address on the keyboard. If searching the name of a destination, press “Point of Interest” first before typing.
3. Select the location from the list. The display will switch to the map view and will show the location of the selected destination.
4. Press the Navigate button — the red steering wheel icon — to begin navigating to the selected location.

NOTE:

Pressing the More button, the three dot icon, next to the Navigate button brings up the options to add the destination to the My Places menu, add the destination to the current route, and more. Within More, you can use the destination as a starting point and view information about the location.

CURRENT ROUTE



From the Navigation Main Menu, press the Current Route button on the touchscreen and select one of the following to adjust or change your current route.



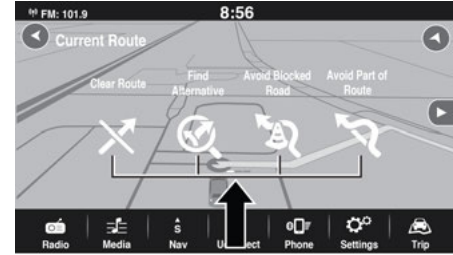



NOTE:

Current Route can only be selected from the Navigation Main Menu if the Navigation system is currently navigating to a destination.



Current Route Options

Clear Route		Press this button on the touchscreen to clear the current route from the Navigation system.
Change Route Type		Press this button on the touchscreen to change the current routes type to one of the below options: <ul style="list-style-type: none"> ● Fastest route: routes the vehicle to the destination using the roads that will take the least amount of time. ● Shortest route: routes the vehicle to the destination using the roads that will be the shortest amount of total distance traveled. ● Most eco-friendly route: routes the vehicle to the destination using the roads that will use the least amount of fuel. ● Avoid interstate highways: routes the vehicle to the destination avoiding all interstate highways.
Find Alternative		Press this button on the touchscreen to view an overhead view of your route, along with several others to choose from. Each with the time difference between your current route and these new ones. Select the colored button that corresponds to the new route you want to take.

Avoid Blocked Road		Press this button on the touchscreen to select a road you wish to avoid on your route that is blocked.
Avoid Part Of Route		Press this button on the touchscreen to bring up the list of directions for your current route. Select the part of the route you wish to avoid and the system will reroute the navigation track to your destination.
Avoid On This Route		Press this button on the touchscreen to select certain types of roads to avoid on your navigational route.
Show Instructions		Press this button on the touchscreen to view the directions of your route in list form.
Add Stop To Route		Press this button on the touchscreen to add an additional stop to your current route. Pressing the Search button will bring up the keyboard where you can type in the address or name of the destination you wish to add.
Reorder Stops		Press this button on the touchscreen to reorder the different stops on the current route.
Play Route Preview		Press this button on the touchscreen to begin a simulated preview of what your route will look like. The vehicle icon will begin traveling along your route until it reaches its destination. You can also end the preview by returning to the Current Route menu and selecting Stop Route Preview.

MY PLACES



My Places

From the Navigation Main Menu, press the My Places button on the touchscreen to display a list of saved destinations. The following destinations are selectable along with any other destinations that have been saved.

Home

Press the Home button to navigate to the saved Home destination. If no Home destination is saved, the Navigation system will ask you to search for the destination to save as your Home destination.

Work

Press the Work button to navigate to the saved Work destination. If no Work destination is saved, the Navigation system will ask you to search for the destination to save as your Work destination.

Recent Destinations

Press Recent Destinations button on the touchscreen to display a list of destinations the Navigation has recently routed to for you to select.

NOTE:

The Add and Edit List buttons allow you to add, remove, and reorder destinations that appear within the list.



Editing My Places

- 1 – Recent Destination Button
- 2 – Home Button

PARKING



Searching For Parking

From the Navigation Main Menu, press the Parking button on the touchscreen to bring up a view of your current location on the map. Within this map view, blue "P" icons will appear pointing out the locations of nearby parking lots. Press the desired parking lot icon to bring up the location, and select the steering wheel icon to navigate to it.

GAS STATIONS



Searching For Gas Stations



From the Navigation Main Menu, press the Gas Stations button on the touchscreen to bring up a view of your current location on the map. Within this map view, white “Gas Station” icons will appear pointing out the locations of nearby gas stations. Press the desired gas station icon to bring up its location, and select the steering wheel icon to navigate to it.





SETTINGS



Navigation Settings

From the Navigation Main Menu, press the Settings button to open up the Settings menu. The following Settings categories are selectable within the Settings Main Menu:

<p>Appearance</p>		<p>Press this button to adjust the appearance settings of the Navigation system. The appearance settings allow you to alter whether or not the system switches to night colors when it is dark, change the arrival information that is displayed, change what appears on the route (i.e. highway exits), when the system automatically zooms, and adjust the guidance view style from 3D, 2D and whether or not to show the 3D car icon.</p>
<p>Voices</p>		<p>Press this button to adjust what the Navigation system calls out while navigating. The voices settings allow you to turn on and off whether the system reads early instructions, sign information, road numbers, street names, and foreign street names out loud.</p>

Route Planning		Press this button to adjust the route planning features of the Navigation system. The route planning settings allow you to change whether or not the system will prompt you when a faster route is available, which type of route it should plan when setting one (i.e. fastest, shortest, most eco-friendly, or to avoid interstate highways), and what to avoid on every route.
Sounds & Warnings		Press this button to adjust how the Navigation system should warn you during a route. The sounds and warnings settings allows you to set the warning type the system will sound, and whether or not to warn you when the vehicle is traveling above the speed limit.
System		Press this button to reset the Navigation system. This will reset the Navigation to its factory setting and remove all saved data.
Help		Press the question mark icon to enter the Help menu. Within the Help menu, you may view the About page that display system information.

RADIO OPERATION AND MOBILE PHONES

Under certain conditions, the mobile phone being on in your vehicle can cause erratic or noisy performance from your radio. This condition may be lessened or eliminated by repositioning the mobile phone within the vehicle. This condition is not harmful to the radio. If your radio performance does not satisfactorily improve from repositioning the mobile phone, it is recommended that the volume be turned down or off during mobile phone operation when not using the Uconnect system.

REGULATORY AND SAFETY INFORMATION

US/CANADA

Exposure to Radio Frequency Radiation

The radiated output power of the internal wireless radio is far below the FCC and IC radio frequency exposure limits. Nevertheless, the wireless radio will be used in such a manner that the radio is 8 in (20 cm) or further from the human body.

The internal wireless radio operates within guidelines found in radio frequency safety

standards and recommendations, which reflect the consensus of the scientific community.

The radio manufacturer believes the internal wireless radio is safe for use by consumers. The level of energy emitted is far less than the electromagnetic energy emitted by wireless devices such as mobile phones. However, the use of wireless radios may be restricted in some situations or environments, such as aboard airplanes. If you are unsure of restrictions, you are encouraged to ask for authorization before turning on the wireless radio ↪ page 290.

SAFETY

SAFETY FEATURES

ANTI-LOCK BRAKE SYSTEM (ABS)

The ABS provides increased vehicle stability and brake performance under most braking conditions. The system automatically prevents wheel lock, and enhances vehicle control during braking.

The ABS performs a self-check cycle to ensure that the ABS is working properly each time the vehicle is started and driven. During this self-check, you may hear a slight clicking sound as well as some related motor noises.

The ABS is activated during braking when the system detects one or more wheels are beginning to lock. Road conditions such as ice, snow, gravel, bumps, railroad tracks, loose debris, or panic stops may increase the likelihood of ABS activation(s).

You also may experience the following normal characteristics when the ABS activates:

- The ABS motor noise or clicking sounds (you may continue to hear for a short time after the stop).
- Brake pedal pulsations.
- A slight drop of the brake pedal at the end of the stop.

The ABS is designed to function with the Original Equipment Manufacturer (OEM) tires. Modification may result in degraded ABS performance.

WARNING!

- The ABS contains sophisticated electronic equipment that may be susceptible to interference caused by improperly installed or high output radio transmitting equipment. This interference can cause possible loss of anti-lock braking capability. Installation of such equipment should be performed by qualified professionals.

(Continued)

WARNING!

- Pumping of the Anti-Lock Brakes will diminish their effectiveness and may lead to a collision. Pumping makes the stopping distance longer. Just press firmly on your brake pedal when you need to slow down or stop.
- The ABS cannot prevent the natural laws of physics from acting on the vehicle, nor can it increase braking or steering efficiency beyond that afforded by the condition of the vehicle brakes and tires or the traction afforded.
- The ABS cannot prevent collisions, including those resulting from excessive speed in turns, following another vehicle too closely, or hydroplaning.
- The capabilities of an ABS equipped vehicle must never be exploited in a reckless or dangerous manner that could jeopardize the user's safety or the safety of others.

Anti-Lock Brake System (ABS) Warning Light

The yellow ABS Warning Light will turn on when the ignition is placed in the ON/RUN mode and may stay on for as long as four seconds.

If the ABS Warning Light remains on or comes on while driving, it indicates that the anti-lock portion of the brake system is not functioning and that service is required. However, the conventional brake system will continue to operate normally if the ABS Warning Light is on.

If the ABS Warning Light is on, the brake system should be serviced as soon as possible to restore the benefits of Anti-Lock Brakes. If the ABS Warning Light does not come on when the ignition is placed in ON/RUN mode, have the light repaired as soon as possible.

ELECTRONIC BRAKE CONTROL (EBC) SYSTEM

Your vehicle is equipped with an advanced Electronic Brake Control (EBC) system. This system includes Anti-Lock Brake System (ABS), Brake Assist System (BAS), Dynamic Steering Torque (DST), Electronic Brake Force Distribution (EBD), Electronic Stability Control (ESC), Electronic Roll Mitigation (ERM), Hill Start Assist (HSA), and Traction Control System (TCS). These systems work

together to enhance both vehicle stability and control in various driving conditions.

Brake System Warning Light

The red Brake System Warning Light will turn on when the ignition is placed in the ON/RUN mode and may stay on for as long as four seconds.

If the Brake System Warning Light remains on or comes on while driving, it indicates that the brake system is not functioning properly and that immediate service is required. If the Brake System Warning Light does not come on when the ignition is placed in the ON/RUN mode, have the light repaired as soon as possible.

Brake Assist System (BAS)

The BAS is designed to optimize the vehicle's braking capability during emergency braking maneuvers. The system detects an emergency braking situation by sensing the rate and amount of brake application and then applies optimum pressure to the brakes. This can help reduce braking distances. The BAS complements the Anti-Lock Brake System (ABS). Applying the brakes very quickly results in the best BAS assistance. To receive the benefit of the system, you must apply continuous braking pressure during the stopping sequence (do not "pump" the brakes). Do not reduce brake pedal pressure unless braking is no longer desired. Once the brake pedal is released, the BAS is deactivated.

WARNING!

The Brake Assist System (BAS) cannot prevent the natural laws of physics from acting on the vehicle, nor can it increase the traction afforded by prevailing road conditions. BAS cannot prevent collisions, including those resulting from excessive speed in turns, driving on very slippery surfaces, or hydroplaning. The capabilities of a BAS-equipped vehicle must never be exploited in a reckless or dangerous manner, which could jeopardize the user's safety or the safety of others.

Dynamic Steering Torque (DST)

DST is a feature of the ESC and Electric Power Steering (EPS) modules that provides torque at the steering wheel for certain driving conditions in which the ESC module is detecting vehicle instability. The torque that the steering wheel receives is only meant to help the driver realize optimal steering behavior in order to reach/maintain vehicle stability. The only notification the driver receives that the feature is active is the torque applied to the steering wheel.

NOTE:

The DST feature is only meant to help the driver realize the correct course of action through small torques on the steering wheel, which means the effectiveness of the DST feature is highly dependent on the driver's sensitivity and overall reaction to the applied torque. It is very important to realize that this feature will not steer the vehicle, meaning the driver is still responsible for steering the vehicle.

Electronic Brake Force Distribution (EBD)

EBD manages the distribution of the braking torque between the front and rear axles by limiting braking pressure to the rear axle. This is done to prevent overslip of the rear wheels to avoid vehicle instability, and to prevent the rear axle from entering ABS before the front axle.

Electronic Roll Mitigation (ERM)

ERM anticipates the potential for wheel lift by monitoring the driver's steering wheel input and the speed of the vehicle. When ERM determines that the rate of change of the steering wheel angle and vehicle's speed are sufficient to potentially cause wheel lift, it then applies the appropriate brake and may also reduce engine power to lessen the chance that wheel lift will occur. ERM can only reduce the chance of wheel lift occurring during

severe or evasive driving maneuvers; it cannot prevent wheel lift due to other factors, such as road conditions, leaving the roadway, striking objects or other vehicles.

WARNING!

Many factors, such as vehicle loading, road conditions and driving conditions, influence the chance that wheel lift or rollover may occur. ERM cannot prevent all wheel lift or rollovers, especially those that involve leaving the roadway or striking objects or other vehicles. The capabilities of an ERM-equipped vehicle must never be exploited in a reckless or dangerous manner which could jeopardize the user's safety or the safety of others.

Electronic Stability Control (ESC)

ESC enhances directional control and stability of the vehicle under various driving conditions. ESC corrects for oversteering or understeering of the vehicle by applying the brake of the appropriate wheel(s) to counteract the above conditions. Engine power may also be reduced to help the vehicle maintain the desired path.

- Oversteer - when the vehicle is turning more than appropriate for the steering wheel position.
- Understeer - when the vehicle is turning less than appropriate for the steering wheel position.

ESC uses sensors in the vehicle to determine the vehicle path intended by the driver and compares it to the actual path of the vehicle. When the actual path does not match the intended path, ESC applies the brake of the appropriate wheel to assist in counteracting the oversteer or understeer condition.

The ESC Activation/Malfunction Indicator Light located in the instrument cluster will start to flash as soon as the ESC system becomes active. The ESC Activation/Malfunction Indicator Light also flashes when the TCS is active. If the ESC Activation/Malfunction Indicator Light begins to flash during acceleration, ease up on the accelerator and apply as little throttle as possible. Be sure to adapt your speed and driving to the prevailing road conditions.

WARNING!

- Electronic Stability Control (ESC) cannot prevent the natural laws of physics from acting on the vehicle, nor can it increase the traction afforded by prevailing road conditions. ESC cannot prevent accidents, including those resulting from excessive speed in turns, driving on very slippery surfaces, or hydroplaning. ESC also cannot prevent accidents resulting from loss of vehicle control due to inappropriate driver input for the conditions. Only a safe, attentive, and skillful driver can prevent accidents. The capabilities of an ESC equipped vehicle must never be exploited in a reckless or dangerous manner which could jeopardize the user's safety or the safety of others.
- Vehicle modifications, or failure to properly maintain your vehicle, may change the handling characteristics of your vehicle, and may negatively affect the performance of the ESC system. Changes to the steering system, suspension, braking system, tire type and size or wheel size may adversely affect ESC performance. Improperly inflated and unevenly worn tires may also degrade ESC performance. Any vehicle modification or poor vehicle maintenance that reduces the effectiveness of the ESC system can increase the risk of loss of vehicle control, vehicle rollover, personal injury and death.

ESC Operation Modes

To disable ESC and other active safety systems, follow the instruction below.

There are two operation modes of active safety systems on the vehicle:

- ESC On
- Partial Off

ESC On

All active safety systems are enabled. This is the normal operating mode when driving a vehicle.

This mode should be used in most driving conditions. The system will be in "ESC On" mode every time the engine is started

NOTE:

You are advised to select "Partial Off " mode only for specific driving requirements.

Partial Off

By pressing the ESC OFF button located below the radio screen when driving, the intervention of the ESC and TCS systems is limited to braking action on the single wheels.

The other systems remain enabled. Activation of this mode is indicated by the warning lamp on the instrument panel switching on (if equipped, together with a message on the display).

To restore "ESC On" operating mode, press the button below the radio screen again.

"ESC On" mode will automatically reactivate every time the engine is started.

NOTE:

When traveling on snowy roads with snow chains, it may be helpful to activate "Partial Off" mode: in these conditions, you can obtain better traction by slipping the drive wheels.

WARNING!

When in "Partial Off" mode, the TCS functionality of ESC, except for the limited slip feature described in the Traction Control System (TCS) section, has been disabled and the ESC OFF Indicator Light will be illuminated. When in "Partial Off" mode, the engine power reduction feature of TCS is disabled, and the enhanced vehicle stability offered by the ESC system is reduced.

Hill Start Assist (HSA)

HSA is designed to mitigate roll back from a complete stop while on an incline. If the driver releases the brake while stopped on an incline, HSA will continue to hold the brake pressure for a short period. If the driver does not apply the throttle before this time expires, the system will release brake pressure and the vehicle will roll down the hill as normal.

The following conditions must be met in order for HSA to activate:

- The feature must be enabled.
- The vehicle must be stopped.
- The parking brake must be off.
- The driver door must be closed.
- The vehicle must be on a sufficient grade.
- The gear selection must match vehicle uphill direction (i.e., vehicle facing uphill is in forward gear; vehicle backing uphill is in REVERSE gear).
- HSA will work in REVERSE gear and all forward gears. The system will not activate if the transmission is in PARK or NEUTRAL. For vehicles equipped with a manual transmission, if the clutch is pressed, HSA will remain active.

WARNING!

There may be situations where the Hill Start Assist (HSA) will not activate and slight rolling may occur, such as on minor hills or with a loaded vehicle, or while pulling a trailer. HSA is not a substitute for active driving involvement. It is always the driver's responsibility to be attentive to distance to other vehicles, people, and objects, and most importantly brake operation to ensure safe operation of the vehicle under all road conditions. Your complete attention is always required while driving to maintain safe control of your vehicle. Failure to follow these warnings can result in a collision or serious personal injury.

Disabling And Enabling HSA

This feature can be turned on or turned off. To change the current settings in the instrument cluster display see ↗ page 63.

Traction Control System (TCS)

The TCS monitors the amount of wheel spin of each of the driven wheels. If wheel spin is detected, the TCS may apply brake pressure to the spinning wheel(s) and/or reduce vehicle power to provide enhanced acceleration and stability. A feature of the TCS, Brake Limited Differential (BLD) functions similarly to a limited slip differential and controls the wheel spin across a driven axle. If one

wheel on a driven axle is spinning faster than the other, the system will apply the brake of the spinning wheel. This will allow more vehicle torque to be applied to the wheel that is not spinning. BLD may remain enabled even if TCS and ESC are in reduced modes.

AUXILIARY DRIVING SYSTEMS

BLIND SPOT MONITORING (BSM) — IF EQUIPPED

BSM uses two radar sensors, located inside the rear fascia/bumper, to detect highway licensable vehicles (automobiles, trucks, motorcycles, etc.) that enter the blind spot zones from the rear/front side of the vehicle.

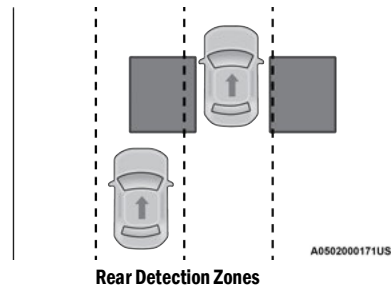

When the vehicle is started, the BSM Warning Light will momentarily illuminate in both outside rearview mirrors to let the driver know that the system is operational. The BSM system sensors operate when the vehicle is in any forward gear or REVERSE and enters standby mode when the vehicle is in PARK.

The BSM detection zone covers approximately one lane width on both sides of the vehicle, 10 ft (3 m). The zone length starts at the outside mirror and extends approximately 20 ft (6 m) beyond the rear fascia/bumper of the vehicle. The BSM system monitors the detection zones on both sides of the vehicle when the vehicle speed reaches approximately 6 mph (10 km/h) or higher and will alert the driver of vehicles in these areas.

NOTE:

- The BSM system DOES NOT alert the driver about rapidly approaching vehicles that are outside the detection zones.
- If a trailer is connected to the vehicle, it is necessary to deactivate BSM system manually by settings menu to avoid a misdetection
⇨ page 120.

The area on the rear fascia/bumper where the radar sensors are located must remain free of snow, ice, and dirt/road contamination so that the BSM system can function properly. Do not block the radar sensors located on the rear fascia/bumper with foreign objects (bumper stickers, bicycle racks, etc.).



Rear Sensor Locations

A0502000189US

The BSM system notifies the driver of objects in the detection zones by illuminating the BSM warning light located in the outside mirrors, in addition to sounding an audible (chime) alert (whenever the turn signal is activated) and reducing the radio volume ⇨ page 178.

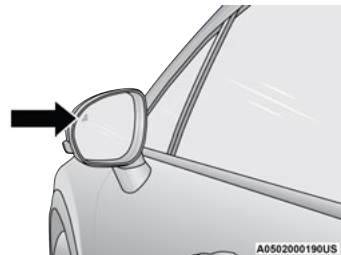

BSM Warning Light

The BSM system monitors the detection zone from three different entry points (side, rear, front) while driving to see if an alert is necessary. The BSM system will issue an alert during these types of zone entries.

Entering From The Side

Vehicles that move into your adjacent lanes from either side of the vehicle.

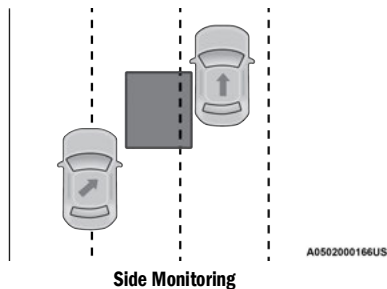

Entering From The Rear

Vehicles that come up from behind your vehicle on either side and enter the rear detection zone with a relative speed of less than 31 mph (50 km/h).

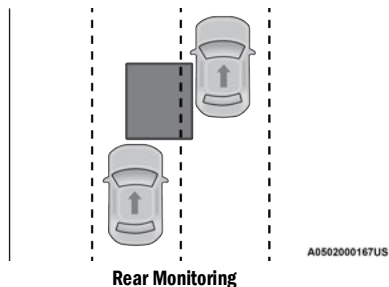

Overtaking Traffic

If you pass another vehicle slowly with a relative speed less than 15 mph (25 km/h) and the vehicle remains in the blind spot for approximately 1.5 seconds, the warning light will be illuminated. If the difference in speed between the two vehicles is greater than 15 mph (25 km/h), the warning light will not illuminate.

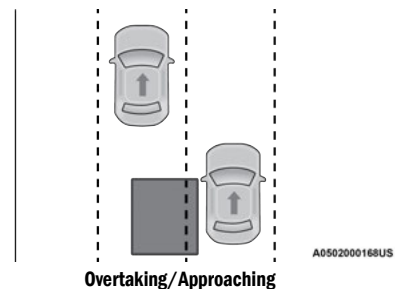

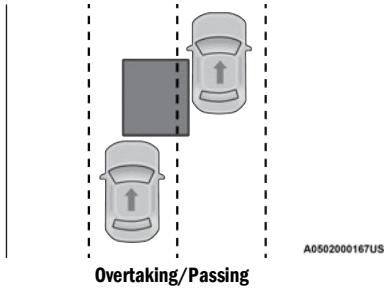

The BSM system is designed not to issue an alert on stationary objects such as guardrails, posts, walls, foliage, berms, etc. However, occasionally the system may alert on such objects. This is normal operation and your vehicle does not require service.

The BSM system will not alert you of objects that are traveling in the opposite direction of the vehicle in adjacent lanes → page 290.

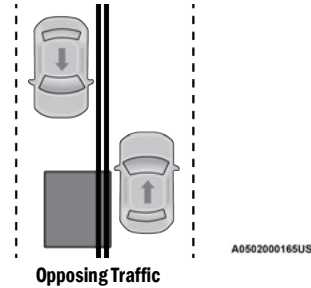

WARNING!

The Blind Spot Monitoring system is only an aid to help detect objects in the blind spot zones. The BSM system is not designed to detect pedestrians, bicyclists, or animals. Even if your vehicle is equipped with the BSM system, always check your vehicle's mirrors, glance over your shoulder, and use your turn signal before changing lanes. Failure to do so can result in serious injury or death.

Rear Cross Path (RCP)

RCP is intended to aid the driver when backing out of parking spaces where their vision of oncoming vehicles may be blocked. Proceed slowly and cautiously out of the parking space until the rear end of the vehicle is exposed. The RCP system will then have a clear view of the cross traffic and if an oncoming vehicle is detected, alert the driver.

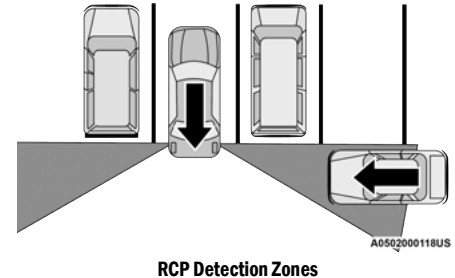

RCP monitors the rear detection zones on both sides of the vehicle, for objects that are moving toward the side of the vehicle with a minimum speed of approximately 1 mph (2 km/h), to objects moving a maximum of approximately 22 mph (35 km/h), such as in parking lot situations.

When RCP is on and the vehicle is in REVERSE, the driver is alerted using both the visual and audible alarms, including reducing the radio volume.

NOTE:

In a parking lot situation, oncoming vehicles can be blocked by vehicles parked on either side. If the sensors are blocked by other structures or vehicles, the system will not be able to alert the driver.

WARNING!

RCP is not a backup aid system. It is intended to be used to help a driver detect an oncoming vehicle in a parking lot situation. Drivers must be careful when backing up, even when using RCP. Always check carefully behind your vehicle, look behind you, and be sure to check for pedestrians, animals, other vehicles, obstructions, and blind spots before backing up. Failure to do so can result in serious injury or death.

Blind Spot Modes

Blind Spot has three selectable modes of operation that are available in the Uconnect system.

Blind Spot Alert Lights Only

When operating in Blind Spot Alert mode, the BSM system will provide a visual alert in the appropriate side view mirror based on a detected object. However, when the system is operating in Rear Cross Path (RCP) mode, the system will respond

with both visual and audible alerts when a detected object is present. Whenever an audible alert is requested, the radio is muted.

Blind Spot Alert Lights/Chime

When operating in Blind Spot Alert Lights/Chime mode, the BSM system will provide a visual alert in the appropriate side view mirror based on a detected object. If the turn signal is then activated, and it corresponds to an alert present on that side of the vehicle, an audible chime will also be sounded. Whenever a turn signal and detected object are present on the same side at the same time, both the visual and audible alerts will be issued. In addition to the audible alert, the radio (if on) will also be muted.

NOTE:

Whenever an audible alert is requested by the BSM system, the radio is also muted.

When the system is in RCP, the system will respond with both visual and audible alerts when a detected object is present. Whenever an audible alert is requested, the radio is also muted. Turn/hazard signal status is ignored; the RCP state always requests the chime.

Blind Spot Alert Off

When the BSM system is turned off, there will be no visual or audible alerts from either the BSM or RCP systems.

NOTE:

The BSM system will store the current operating mode when the vehicle is shut off. Each time the vehicle is started the previously stored mode will be recalled and used.

Blind Spot Monitoring Fault Warnings**Blinded Sensor**

In the case of a blinded sensor:

- BSM Mirror Warning Lights are turned on continuously.
- An instrument cluster message will display **“Blind Spot Monitoring Unavailable - Wipe Rear Bumper Corners.”**

NOTE:

The rear fascia/bumper must be clean and free of any obstructing debris.

System Not Available

In the case of the system being temporarily unavailable:

- BSM Mirror Warning Lights are turned on continuously.
- An instrument cluster message will display **“Blind Spot Monitoring Temporarily Unavailable.”**

In the case of the system being completely unavailable:

- A chime will turn on.
- An instrument cluster message will display **“Blind Spot Monitoring Unavailable - Service Required.”**

NOTE:

Vehicle must be taken to the nearest authorized dealer for service.

FULL BRAKE CONTROL SYSTEM WITH MITIGATION

The Full Brake Control system with Mitigation provides the driver with audible warnings, visual warnings (within the instrument cluster display), and may apply a brake jerk to warn the driver when it detects a potential frontal collision. The warnings and limited braking are intended to provide the driver with enough time to react, avoid or mitigate the potential collision.

NOTE:

- The Full Brake Control system monitors the information from the forward looking sensors as well as the Electronic Brake Controller (EBC), to calculate the probability of a forward collision. When the system determines that a forward

collision is probable, the driver will be provided with audible and visual warnings and may provide a brake jerk warning.

- If the driver does not take action based upon these progressive warnings, then the system will provide a limited level of active braking to help slow the vehicle and mitigate the potential forward collision. If the driver reacts to the warnings by braking and the system determines that the driver intends to avoid the collision by braking but has not applied sufficient brake force, the system will compensate and provide additional brake force as required.

After the end of the intervention of automatic braking, the transmission may remain in last gear stored: therefore the car could lurch forward, once the brakes release a few seconds later. If the Full Brake Control system event stops the vehicle completely, the system will hold the vehicle at standstill for two seconds and then release the brakes.

If a Full Brake Control system event begins at a speed below 26 mph (42 km/h), the system may provide the maximum braking possible to mitigate the potential forward collision. If the Full Brake Control system event stops the vehicle completely, the system will hold the vehicle at standstill for two seconds and then release the brakes.

BRAKE!

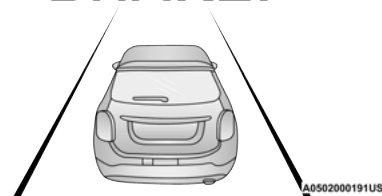

Full Brake Control system Message

When the system determines a collision with the vehicle in front of you is no longer probable, the warning message will be deactivated → page 290.

NOTE:

- The minimum speed for Full Brake Control system activation is 3 mph (5 km/h).
- The Full Brake Control system alerts may be triggered on objects other than vehicles such as guard rails or sign posts based on the course prediction. This is expected and is a part of normal Full Brake Control system activation and functionality.
- The Full Brake Control system is intended for on-road use only. If the vehicle is taken off-road, the Full Brake Control system should be deactivated to prevent unnecessary warnings to the surroundings.

WARNING!

The Full Brake Control System is not intended to avoid a collision on its own, nor can the Full Brake Control System detect every type of potential collision. The driver has the responsibility to avoid a collision by controlling the vehicle via braking and steering. Failure to follow this warning could lead to serious injury or death.

Turning Full Brake Control System On Or Off

The Full Brake Control system menu setting is located in the Uconnect Settings ↗ page 120.

NOTE:

The default status of Full Brake Control system is "Warning + Active Braking." This allows the system to warn you of a possible collision with the vehicle in front of you and enable the active braking.

- Changing the Full Brake Control system status to "Off" deactivates the system, so no warning or active braking will be available in case of a possible collision.
- Changing the Full Brake Control system status to "Only Warning" prevents the system from providing limited active braking, or additional brake support if the driver is not braking

adequately in the event of a potential frontal collision, but maintains the audible and visual warnings.

Changing the status of the system is only possible with the vehicle at a complete stop.

NOTE:

The Full Brake Control system state is not kept in memory from one key cycle to the next. If the system is turned off, it will turn on when the vehicle is restarted.

Changing Full Brake Control System Sensitivity

By changing the settings on the menu of the Uconnect system, you can change the sensitivity of the system by choosing one of the following three options: "Near", "Medium" or "Far" ↗ page 120.

The default option is "Medium". This setting provides that the system notify the driver of a possible accident with the vehicle ahead of it when the latter is at a standard distance, intermediate between the other two possible settings.

By setting the sensitivity of the system to "Far", the system will warn the driver of a possible accident with the vehicle in front when the latter is at a greater distance, giving you the chance to act on the brakes in a more limited and gradual way. This setting gives the driver the maximum possible time of reaction to prevent a possible accident.

By changing the option to "Near", the system will warn the driver of a possible accident with the vehicle ahead of it when the latter is a reduced distance. This setting offers a reaction time to the driver lower than the settings "Medium" and "Far", in the case of a potential accident, which will provide a more dynamic driving experience.

The setting of the sensitivity of the system is maintained in memory when the engine is switched off.

Full Brake Control System Limited Warning

If the instrument cluster display reads "Brake Control Limited Functionality" or "Brake Control Limited Functionality Clean Front Windshield" momentarily, there may be a condition that limits Full Brake Control system functionality. Although the vehicle is still drivable under normal conditions, the active braking may not be fully available. Once the condition that limited the system performance is no longer present, the system will return to its full performance state. If the problem persists, see an authorized dealer.

Service Full Brake Control System Warning

If the system turns off, and the instrument cluster display displays "Service Brake Control".

This indicates there is an internal system fault. Although the vehicle is still drivable under normal conditions, have the system checked by an authorized dealer.

“Brake Control Front Radar Sensor Temporarily Blocked” Warning

The “Brake Control Front Radar Sensor Temporarily Blocked” warning will display when conditions temporarily limit system performance. This most often occurs at times of poor visibility, such as in snow or heavy rain. The system may also become temporarily blinded due to obstructions, such as mud, dirt or ice. In these cases, the instrument cluster display will display “Brake Control Front Radar Sensor Temporarily Blocked” and the system will deactivate.

The “Brake Control Front Radar Sensor Temporarily Blocked” message can sometimes be displayed while driving in highly reflective areas (i.e. tunnels with reflective tiles, or ice and snow). The system will recover after the vehicle has left these areas. Under rare conditions, when the radar is not tracking any vehicles or objects in its path this warning may temporarily occur.

If weather conditions are not a factor, the driver should examine the sensor. It may require cleaning or removal of an obstruction. The sensor is located behind the lower grille. In absence of visible obstructions on the fascia/bumper, it could be necessary to wipe off the radar directly on the surface, after having the radar cover removed. It's recommended that an authorized dealer performs this operation.

NOTE:

- If the “Brake Control Front Radar Sensor Temporarily Blocked” message occurs frequently (e.g. more than once on every trip) without any snow, rain, mud, or other obstruction, have the radar sensor realigned at an authorized dealer.
- Installing a snow plow, front-end protector, an aftermarket grille or modifying the grille is not recommended. Doing so may block the sensor and inhibit Full Brake Control system operation.

Precautions While Driving With Full Brake Control System

In certain driving conditions, such as:

- Driving in the vicinity of a curve
- Small vehicles and/or not aligned to the lane
- Lane changing of other vehicles
- Passing of vehicles in an oncoming intersection

The intervention of the system could be unexpected or delayed. The driver must therefore always pay particular attention, while maintaining control of the car to drive in complete safety.

Driving In The Vicinity Of A Curve

Entering or exiting a large curve, the system could detect the presence of a vehicle that is in front of the car, but that does not reside in the same lane. In cases such as this, the system might respond.

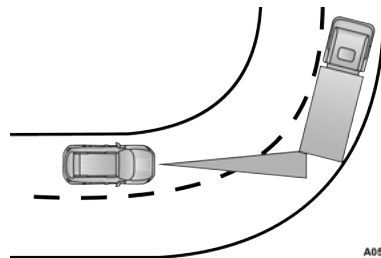

A0502000155US

Driving In The Vicinity Of A Curve

Small Vehicles And/Or Not Aligned To The Lane

The system is not able to detect the presence of vehicles that are in front of the car but placed outside the field of action of the radar sensor and could therefore not react in the presence of small vehicles such as bicycles or motorcycles.

6

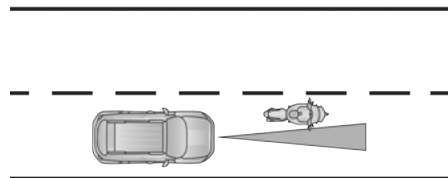

A0502000156US

Small Vehicles And/Or Not Aligned To The Lane

Lane Changing Of Other Vehicles

Vehicles that suddenly change lane, while standing in the traffic lane of their car and inside the field of action of the radar sensor may cause the intervention of the system.

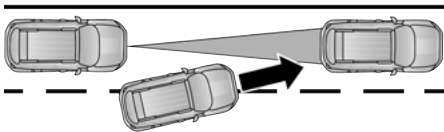

A0502000157US

Lane Changing Of Other Vehicles

Passing Of Vehicles In An Oncoming Intersection

The system could temporarily react to a vehicle that crossed the range of the radar sensor, in an oncoming intersection.

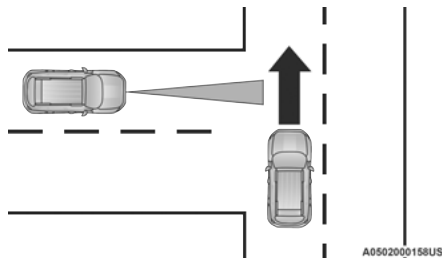

A0502000158US

Passing Of Vehicles In An Oncoming Intersection

TIRE PRESSURE MONITORING SYSTEM (TPMS)

The Tire Pressure Monitoring System (TPMS) will warn the driver of a low tire pressure based on the vehicle recommended cold tire pressure.

The tire pressure will vary with temperature by about 1 psi (7 kPa) for every 12° F (6.5° C). This means that when the outside temperature decreases, the tire pressure will decrease. Tire pressure should always be set based on cold inflation tire pressure. This is defined as the tire pressure after the vehicle has not been driven for at least three hours, or driven less than 1 mile (1.6 km) after a three hour period. The cold tire inflation pressure must not exceed the maximum inflation pressure molded into the tire sidewall. The tire pressure will also increase as the vehicle

is driven, this is normal and there should be no adjustment for this increased pressure.

See ⇨ page 269 on how to properly inflate the vehicle's tires.

The TPMS will warn the driver of a low tire pressure if the tire pressure falls below the low pressure warning limit for any reason, including low temperature effects, or natural pressure loss through the tire.

The TPMS will continue to warn the driver of low tire pressure as long as the condition exists, and will not turn off until the tire pressure is at or above the recommended cold tire pressure on the placard. Once the low tire pressure warning (Tire Pressure Monitoring System Warning Light) illuminates, you must increase the tire pressure to the recommended cold tire pressure in order for the Tire Pressure Monitoring System Warning Light to turn off. The system will automatically update and the Tire Pressure Monitoring System Warning Light will turn off once the system receives the updated tire pressures. The vehicle may need to be driven for up to 20 minutes above 15 mph (24 km/h) in order for the TPMS to receive this information.

For example, your vehicle may have a recommended cold (parked for more than three hours) tire pressure of 30 psi (207 kPa). If the ambient temperature is 68° F (20° C) and the measured tire pressure is 27 psi (186 kPa), a

temperature drop to 20° F (-7° C) will decrease the tire pressure to approximately 23 psi (159 kPa). This tire pressure is sufficiently low enough to turn on the Tire Pressure Monitoring System Warning Light. Driving the vehicle may cause the tire pressure to rise to approximately 27 psi (186 kPa), but the Tire Pressure Monitoring System Warning Light will still be on. In this situation, the Tire Pressure Monitoring System Warning Light will turn off only after the tires are inflated to the vehicle's recommended cold tire pressure value

➔ page 290.

CAUTION!

- The TPMS has been optimized for the original equipment tires and wheels. TPMS pressures and warnings have been established for the tire size equipped on your vehicle. Undesirable system operation or sensor damage may result when using replacement equipment that is not of the same size, type, and/or style. Aftermarket wheels can cause sensor damage. Using aftermarket tire sealants may cause the Tire Pressure Monitoring System (TPMS) sensor to become inoperable. After using an aftermarket tire sealant it is recommended that you take your vehicle to an authorized dealership to have your sensor function checked.

(Continued)

CAUTION!

- After inspecting or adjusting the tire pressure, always reinstall the valve stem cap. This will prevent moisture and dirt from entering the valve stem, which could damage the Tire Pressure Monitoring System sensor.

NOTE:

- The TPMS is not intended to replace normal tire care and maintenance, or to provide warning of a tire failure or condition.
- The TPMS should not be used as a tire pressure gauge while adjusting your tire pressure.
- Driving on a significantly underinflated tire causes the tire to overheat and can lead to tire failure. Underinflation also reduces fuel efficiency and tire tread life, and may affect the vehicle's handling and stopping ability.
- The TPMS is not a substitute for proper tire maintenance, and it is the driver's responsibility to maintain correct tire pressure using an accurate tire gauge, even if under-inflation has not reached the level to trigger illumination of the Tire Pressure Monitoring System Warning Light.
- Seasonal temperature changes will affect tire pressure, and the TPMS will monitor the actual tire pressure in the tire.

Base System



This is the TPMS warning indicator located in the instrument cluster.

The TPMS uses wireless technology with wheel rim mounted electronic sensors to monitor tire pressure levels. Sensors, mounted to each wheel as part of the valve stem, transmit tire pressure readings to the receiver module.

NOTE:

It is particularly important for you to check the tire pressure in all of the tires on your vehicle regularly and to maintain the proper pressure.

The TPMS consists of the following components:

- Receiver module.
- Four Tire Pressure Monitoring System sensors.
- Tire Pressure Monitoring System Warning Light.

TIRE PRESSURE MONITORING SYSTEM LOW PRESSURE WARNINGS

The Tire Pressure Monitoring System Warning Light will illuminate in the instrument cluster, an acoustic signal will be activated, and the "Check left or right front/rear tire" text message will display when one or more of the four active road tire pressures are low. Should this occur, you should stop as soon as possible, check the inflation pressure of each tire on your vehicle, and

inflate each tire to the vehicle's recommended cold placard pressure value. The system will automatically update and the Tire Pressure Monitoring Warning Light will extinguish once the updated tire pressures have been received. The vehicle may need to be driven for up to 20 minutes above 15 mph (24 km/h) to receive this information.

CHECK TPMS WARNINGS

The Tire Pressure Monitoring System Warning Light will flash on and off for 75 seconds and remain on solid when a system fault is detected, an audible chime will be activated and the "Service Tire Pressure Monitoring System" text message will display. If the ignition is cycled, this sequence will repeat providing the system fault still exists. The Tire Pressure Monitoring System Warning Light will turn off when the fault condition no longer exists. A system fault can occur with any of the following scenarios:

- Jamming due to electronic devices or driving next to facilities emitting the same radio frequencies as the TPMS sensors.
- Installing some form of aftermarket window tinting that affects radio wave signals.
- Snow or ice around the wheels or wheel housings.

- Using tire chains on the vehicle.
- Using wheels/tires not equipped with TPMS sensors.

NOTE:

Your vehicle may be equipped with a compact spare wheel and tire assembly.

- The compact spare tire does not have a Tire Pressure Monitoring System sensor. Therefore, the TPMS will not monitor the tire pressure in the compact spare tire.
- If you install the compact spare tire in place of a road tire that has a pressure below the low-pressure warning limit, upon the next ignition cycle, a chime will sound and the Tire Pressure Monitoring System Warning Light will still turn on due to the low tire.
- However, after driving the vehicle for up to 20 minutes above 15 mph (24 km/h), the Tire Pressure Monitoring System Warning Light will flash on and off for 75 seconds and then remain on solid.
- This occurs for each subsequent ignition cycle, a chime will sound and the Tire Pressure Monitoring System Warning Light will flash on and off for 75 seconds and then remain on solid.

- Once you repair or replace the original road tire and reinstall it on the vehicle in place of the compact spare tire, the TPMS will update automatically and the Tire Pressure Monitoring System Warning Light will turn off, as long as no tire pressure is below the low-pressure warning limit in any of the four active road tires. The vehicle may need to be driven for up to 20 minutes above 15 mph (24 km/h) in order for the TPMS to receive this information.

OCCUPANT RESTRAINT SYSTEMS

Some of the most important safety features in your vehicle are the restraint systems:

OCCUPANT RESTRAINT SYSTEMS

- Seat Belt Systems
- Supplemental Restraint Systems (SRS) Air Bags
- Child Restraints

Some of the safety features described in this section may be standard equipment on some models, or may be optional equipment on others. If you are not sure, ask an authorized dealer.

IMPORTANT SAFETY PRECAUTIONS

Please pay close attention to the information in this section. It tells you how to use your restraint system properly, to keep you and your passengers as safe as possible.

Here are some simple steps you can take to minimize the risk of harm from a deploying air bag:

1. Children 12 years old and under should always ride buckled up in the rear seat of a vehicle with a rear seat.
2. A child who is not big enough to wear the vehicle seat belt properly must be secured in the appropriate child restraint or belt-positioning booster seat in a rear seating position → page 201.
3. If a child from 2 to 12 years old (not in a rear-facing child restraint) must ride in the front passenger seat, move the seat as far back as possible and use the proper child restraint → page 201.
4. Never allow children to slide the shoulder belt behind them or under their arm.
5. You should read the instructions provided with your child restraint to make sure that you are using it properly.
6. All occupants should always wear their lap and shoulder belts properly.
7. The driver and front passenger seats should be moved back as far as practical to allow the front air bags room to inflate.
8. Do not lean against the door or window. If your vehicle has side air bags, and deployment occurs, the side air bags will inflate forcefully into the space between occupants and the door and occupants could be injured.
9. If the air bag system in this vehicle needs to be modified to accommodate a disabled person, see → page 287 for customer service contact information.

WARNING!

- Never place a rear-facing child restraint in front of an air bag. A deploying passenger front air bag can cause death or serious injury to a child 12 years or younger, including a child in a rear-facing child restraint.
- Never install a rear-facing child restraint in the front seat of a vehicle. Only use a rear-facing child restraint in the rear seat. If the vehicle does not have a rear seat, do not transport a rear-facing child restraint in that vehicle.

SEAT BELT SYSTEMS

Buckle up even though you are an excellent driver, even on short trips. Someone on the road may be a poor driver and could cause a collision that includes you. This can happen far away from home or on your own street.

Research has shown that seat belts save lives, and they can reduce the seriousness of injuries in a collision. Some of the worst injuries happen when people are thrown from the vehicle. Seat belts reduce the possibility of ejection and the risk of injury caused by striking the inside of the vehicle. Everyone in a motor vehicle should be belted at all times.

Enhanced Seat Belt Use Reminder System (BeltAlert)

Driver And Passenger BeltAlert — If Equipped

 BeltAlert is a feature intended to remind the driver and outboard front seat passenger (if equipped with outboard front passenger seat BeltAlert) to buckle their seat belts. The Belt Alert feature is active whenever the ignition switch is in the START or ON/RUN position.

Initial Indication

If the driver is unbuckled when the ignition switch is first in the START or ON/RUN position, a chime will signal for a few seconds. If the driver or outboard front seat passenger (if equipped with outboard front passenger seat BeltAlert) is unbuckled when the ignition switch is first in the START or ON/RUN position the Seat Belt Reminder Light will turn on and remain on until both outboard front seat belts are buckled. The outboard front passenger seat BeltAlert is not active when an outboard front passenger seat is unoccupied.

BeltAlert Warning Sequence

The BeltAlert warning sequence is activated when the vehicle is moving above a specified vehicle speed range and the driver or outboard front seat passenger is unbuckled (if equipped with outboard front passenger seat BeltAlert) (the outboard front passenger seat BeltAlert is not active when the outboard front passenger seat is unoccupied). The BeltAlert warning sequence starts by blinking the Seat Belt Reminder Light and sounding an intermittent chime. Once the BeltAlert warning sequence has completed, the Seat Belt Reminder Light will remain on until the seat belts are buckled. The BeltAlert warning sequence may repeat based on vehicle speed until the driver and occupied outboard front seat passenger seat belts are buckled. The driver should instruct all occupants to buckle their seat belts.

Change of Status

If the driver or outboard front seat passenger (if equipped with outboard front passenger seat BeltAlert) unbuckles their seat belt while the vehicle is traveling, the BeltAlert warning sequence will begin until the seat belts are buckled again.

The outboard front passenger seat BeltAlert is not active when the outboard front passenger seat is unoccupied. BeltAlert may be triggered when an animal or other items are placed on the outboard front passenger seat or when the seat is folded flat (if equipped). It is recommended that pets be restrained in the rear seat (if equipped) in pet harnesses or pet carriers that are secured by seat belts, and cargo is properly stowed.

BeltAlert can be activated or deactivated by an authorized dealer. FCA US LLC does not recommend deactivating BeltAlert.

NOTE:

If BeltAlert has been deactivated and the driver or outboard front seat passenger (if equipped with outboard front passenger seat BeltAlert) is unbuckled the Seat Belt Reminder Light will turn on and remain on until the driver and outboard front seat passenger seat belts are buckled.

Lap/Shoulder Belts

All seating positions in your vehicle are equipped with lap/shoulder belts.

The seat belt webbing retractor will lock only during very sudden stops or collisions. This feature allows the shoulder part of the seat belt to move freely with you under normal conditions. However, in a collision the seat belt will lock and reduce your risk of striking the inside of the vehicle or being thrown out of the vehicle.

WARNING!

- Relying on the air bags alone could lead to more severe injuries in a collision. The air bags work with your seat belt to restrain you properly. In some collisions, the air bags won't deploy at all. Always wear your seat belt even though you have air bags.
- In a collision, you and your passengers can suffer much greater injuries if you are not properly buckled up. You can strike the interior of your vehicle or other passengers, or you can be thrown out of the vehicle. Always be sure you and others in your vehicle are buckled up properly.

(Continued)

WARNING!

- It is dangerous to ride in a cargo area, inside or outside of a vehicle. In a collision, people riding in these areas are more likely to be seriously injured or killed.
- Do not allow people to ride in any area of your vehicle that is not equipped with seats and seat belts.
- Be sure everyone in your vehicle is in a seat and using a seat belt properly. Occupants, including the driver, should always wear their seat belts whether or not an air bag is also provided at their seating position to minimize the risk of severe injury or death in the event of a crash.
- Wearing your seat belt incorrectly could make your injuries in a collision much worse. You might suffer internal injuries, or you could even slide out of the seat belt. Follow these instructions to wear your seat belt safely and to keep your passengers safe, too.
- Two people should never be belted into a single seat belt. People belted together can crash into one another in a collision, hurting one another badly. Never use a lap/shoulder belt or a lap belt for more than one person, no matter what their size.

WARNING!

- A lap belt worn too high can increase the risk of injury in a collision. The seat belt forces won't be at the strong hip and pelvic bones, but across your abdomen. Always wear the lap part of your seat belt as low as possible and keep it snug.
- A twisted seat belt may not protect you properly. In a collision, it could even cut into you. Be sure the seat belt is flat against your body, without twists. If you can't straighten a seat belt in your vehicle, take it to an authorized dealer immediately and have it fixed.
- A seat belt that is buckled into the wrong buckle will not protect you properly. The lap portion could ride too high on your body, possibly causing internal injuries. Always buckle your seat belt into the buckle nearest you.
- A seat belt that is too loose will not protect you properly. In a sudden stop, you could move too far forward, increasing the possibility of injury. Wear your seat belt snugly.

*(Continued)***WARNING!**

- A seat belt that is worn under your arm is dangerous. Your body could strike the inside surfaces of the vehicle in a collision, increasing head and neck injury. A seat belt worn under the arm can cause internal injuries. Ribs aren't as strong as shoulder bones. Wear the seat belt over your shoulder so that your strongest bones will take the force in a collision.
- A shoulder belt placed behind you will not protect you from injury during a collision. You are more likely to hit your head in a collision if you do not wear your shoulder belt. The lap and shoulder belt are meant to be used together.
- A frayed or torn seat belt could rip apart in a collision and leave you with no protection. Inspect the seat belt system periodically, checking for cuts, frays, or loose parts. Damaged parts must be replaced immediately. Do not disassemble or modify the seat belt system. If your vehicle is involved in a collision, or if you have questions regarding seat belt or retractor conditions, take your vehicle to an authorized FCA dealer or authorized FCA Certified Collision Care Program facility for inspection.

Lap/Shoulder Belt Operating Instructions

1. Enter the vehicle and close the door. Sit back and adjust the seat.
2. The seat belt latch plate is above the back of the front seat, and next to your arm in the rear seat (for vehicles equipped with a rear seat). Grab the latch plate and pull out the seat belt. Slide the latch plate up the webbing as far as necessary to allow the seat belt to go around your lap.



Pulling Out The Latch Plate

3. When the seat belt is long enough to fit, insert the latch plate into the buckle until you hear a "click."



Inserting Latch Plate Into Buckle

4. Position the lap belt so that it is snug and lies low across your hips, below your abdomen. To remove slack in the lap belt portion, pull up on the shoulder belt. To loosen the lap belt if it is too tight, tilt the latch plate and pull on the lap belt. A snug seat belt reduces the risk of sliding under the seat belt in a collision.



Positioning The Lap Belt

5. Position the shoulder belt across the shoulder and chest with minimal, if any slack so that it is comfortable and not resting on your neck. The retractor will withdraw any slack in the shoulder belt.
6. To release the seat belt, push the red button on the buckle. The seat belt will automatically retract to its stowed position. If necessary, slide the latch plate down the webbing to allow the seat belt to retract fully.

Lap/Shoulder Belt Untwisting Procedure

Use the following procedure to untwist a twisted lap/shoulder belt.

1. Position the latch plate as close as possible to the anchor point.
2. At about 6 to 12 inches (15 to 30 cm) above the latch plate, grab and twist the seat belt webbing 180 degrees to create a fold that begins immediately above the latch plate.
3. Slide the latch plate upward over the folded webbing. The folded webbing must enter the slot at the top of the latch plate.
4. Continue to slide the latch plate up until it clears the folded webbing and the seat belt is no longer twisted.

Adjustable Upper Shoulder Belt Anchorage

In the driver and outboard front passenger seats, the top of the shoulder belt can be adjusted upward or downward to position the seat belt away from your neck. Push or squeeze the anchorage button to release the anchorage, and move it up or down to the position that serves you best.

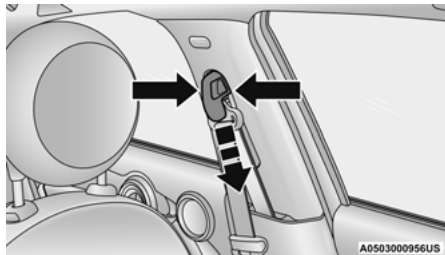

Adjustable Anchorage Up

As a guide, if you are shorter than average, you will prefer the shoulder belt anchorage in a lower position, and if you are taller than average, you will prefer the shoulder belt anchorage in a higher position. After you release the anchorage button, try to move it up or down to make sure that it is locked in position.

NOTE:

The adjustable upper shoulder belt anchorage is equipped with an Easy Up feature. This feature allows the shoulder belt anchorage to be adjusted in the upward position without pushing or squeezing the release button. To verify the shoulder belt anchorage is latched, pull downward on the shoulder belt anchorage until it is locked into position.

WARNING!

- Wearing your seat belt incorrectly could make your injuries in a collision much worse. You might suffer internal injuries, or you could even slide out of the seat belt. Follow these instructions to wear your seat belt safely and to keep your passengers safe, too.
- Position the shoulder belt across the shoulder and chest with minimal, if any slack so that it is comfortable and not resting on your neck. The retractor will withdraw any slack in the shoulder belt.
- Misadjustment of the seat belt could reduce the effectiveness of the safety belt in a crash.
- Always make all seat belt height adjustments when the vehicle is stationary.

Seat Belts And Pregnant Women

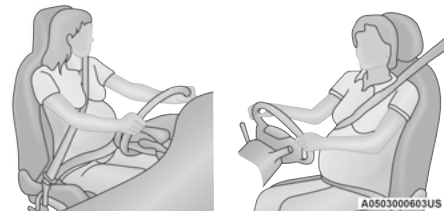

Seat Belts And Pregnant Women

Seat belts must be worn by all occupants including pregnant women: the risk of injury in the event of an accident is reduced for the mother and the unborn child if they are wearing a seat belt.

Position the lap belt snug and low below the abdomen and across the strong bones of the hips. Place the shoulder belt across the chest and away from the neck. Never place the shoulder belt behind the back or under the arm.

Seat Belt Pretensioner

The front outboard seat belt system is equipped with pretensioning devices that are designed to remove slack from the seat belt in the event of a collision. These devices may improve the performance of the seat belt by removing slack from the seat belt early in a collision. Pretensioners work for all size occupants, including those in child restraints.

NOTE:

These devices are not a substitute for proper seat belt placement by the occupant. The seat belt still must be worn snugly and positioned properly.

The pretensioners are triggered by the Occupant Restraint Controller (ORC). Like the air bags, the pretensioners are single use items. A deployed pretensioner or a deployed air bag must be replaced immediately.

Energy Management Feature

The front outboard seat belt system is equipped with an Energy Management feature that may help further reduce the risk of injury in the event of a collision. The seat belt system has a retractor assembly that is designed to release webbing in a controlled manner.

Switchable Automatic Locking Retractors (ALR)

The seat belts in the passenger seating positions are equipped with a Switchable Automatic Locking Retractor (ALR) which is used to secure a child restraint system → page 209.

The figure below illustrates the locking feature for each seating position.

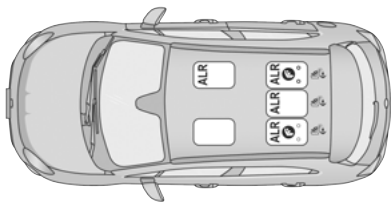

Switchable Automatic Locking Retractor (ALR) Locations

ALR — Switchable Automatic Locking Retractor

If the passenger seating position is equipped with an ALR and is being used for normal usage, only pull the seat belt webbing out far enough to comfortably wrap around the occupant's mid-section so as to not activate the ALR. If the ALR is activated, you will hear a clicking sound as the seat belt retracts. Allow the webbing to retract

completely in this case and then carefully pull out only the amount of webbing necessary to comfortably wrap around the occupant's mid-section. Slide the latch plate into the buckle until you hear a "click."

In Automatic Locking Mode, the shoulder belt is automatically pre-locked. The seat belt will still retract to remove any slack in the shoulder belt. Use the Automatic Locking Mode anytime a child restraint is installed in a seating position that has a seat belt with this feature. Children 12 years old and under should always be properly restrained in the rear seat of a vehicle with a rear seat.

WARNING!

- Never place a rear-facing child restraint in front of an air bag. A deploying passenger front air bag can cause death or serious injury to a child 12 years or younger, including a child in a rear-facing child restraint.
- Never install a rear-facing child restraint in the front seat of a vehicle. Only use a rear-facing child restraint in the rear seat. If the vehicle does not have a rear seat, do not transport a rear-facing child restraint in that vehicle.

How To Engage The Automatic Locking Mode

1. Buckle the combination lap and shoulder belt.
2. Grab the shoulder portion and pull downward until the entire seat belt is extracted.
3. Allow the seat belt to retract. As the seat belt retracts, you will hear a clicking sound. This indicates the seat belt is now in the Automatic Locking Mode.

How To Disengage The Automatic Locking Mode

Unbuckle the combination lap/shoulder belt and allow it to retract completely to disengage the Automatic Locking Mode and activate the vehicle sensitive (emergency) locking mode.

WARNING!

- The seat belt assembly must be replaced if the switchable Automatic Locking Retractor (ALR) feature or any other seat belt function is not working properly when checked according to the procedures in the Service Manual.
- Failure to replace the seat belt assembly could increase the risk of injury in collisions.

(Continued)

WARNING!

- Do not use the Automatic Locking Mode to restrain occupants who are wearing the seat belt or children who are using booster seats. The locked mode is only used to install rear-facing or forward-facing child restraints that have a harness for restraining the child.

SUPPLEMENTAL RESTRAINT SYSTEMS (SRS)

Some of the safety features described in this section may be standard equipment on some models, or may be optional equipment on others. If you are not sure, ask an authorized dealer.

The air bag system must be ready to protect you in a collision. The Occupant Restraint Controller (ORC) monitors the internal circuits and interconnecting wiring associated with the electrical Air Bag System Components. Your vehicle may be equipped with the following Air Bag System Components:

Air Bag System Components

- Occupant Restraint Controller (ORC)
- Air Bag Warning Light 
- Steering Wheel and Column
- Instrument Panel

- Knee Impact Bolsters
- Driver and Front Passenger Air Bags
- Seat Belt Buckle Switch
- Supplemental Side Air Bags
- Supplemental Knee Air Bags
- Front and Side Impact Sensors
- Seat Belt Pretensioners
- Seat Track Position Sensors

Air Bag Warning Light



The Occupant Restraint Controller (ORC) monitors the readiness of the electronic parts of the air bag system whenever the ignition switch is in the AVV/START or MAR/ACC/ON/RUN position. If the ignition switch is in the STOP/OFF/LOCK position the air bag system is not on and the air bags will not inflate.

The ORC contains a backup power supply system that may deploy the air bag system even if the battery loses power or it becomes disconnected prior to deployment.

The ORC turns on the Air Bag Warning Light in the instrument panel for approximately four to eight seconds for a self-check when the ignition switch is in the MAR/ACC/ON/RUN position. After the self-check, the Air Bag Warning Light will turn off. If the ORC detects a malfunction in any part of the system, it turns on the Air Bag Warning Light, either

momentarily or continuously. A single chime will sound to alert you if the light comes on again after initial startup.

The ORC also includes diagnostics that will illuminate the instrument panel Air Bag Warning Light if a malfunction is detected that could affect the air bag system. The diagnostics also record the nature of the malfunction. While the air bag system is designed to be maintenance free, if any of the following occurs, have an authorized dealer service the air bag system immediately.

- The Air Bag Warning Light does not come on during the four to eight seconds when the ignition switch is first in the MAR/ACC/ON/RUN position.
- The Air Bag Warning Light remains on after the four to eight-second interval.
- The Air Bag Warning Light comes on intermittently or remains on while driving.

NOTE:

If the speedometer, tachometer, or any engine related gauges are not working, the Occupant Restraint Controller (ORC) may also be disabled. In this condition the air bags may not be ready to inflate for your protection. Have an authorized dealer service the air bag system immediately.

WARNING!

Ignoring the Air Bag Warning Light in your instrument panel could mean you won't have the air bag system to protect you in a collision. If the light does not come on as a bulb check when the ignition is first turned on, stays on after you start the vehicle, or if it comes on as you drive, have an authorized dealer service the air bag system immediately.

Redundant Air Bag Warning Light



If a fault with the Air Bag Warning Light is detected, which could affect the Supplemental Restraint System (SRS), the Redundant Air Bag Warning Light will illuminate on the instrument panel. The Redundant Air Bag Warning Light will stay on until the fault is cleared. In addition, a single chime will sound to alert you that the Redundant Air Bag Warning Light has come on and a fault has been detected. If the Redundant Air Bag Warning Light comes on intermittently or remains on while driving have an authorized dealer service the vehicle immediately → page 68.

Front Air Bags

This vehicle has front air bags and lap/shoulder belts for both the driver and front passenger. The front air bags are a supplement to the seat belt restraint systems. The driver front air bag is mounted in the center of the steering wheel. The passenger front air bag is mounted in the instrument panel, above the glove compartment. The words "SRS AIRBAG" or "AIRBAG" are embossed on the air bag covers.

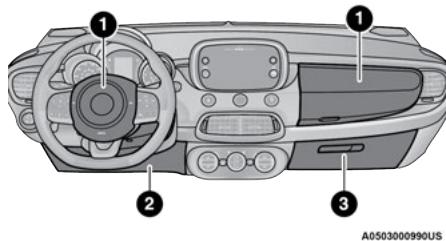

A0503000990US

Front Air Bag/Knee Impact Bolster Locations

- 1 — Driver And Passenger Front Air Bags
- 2 — Driver Knee Impact Bolster/Supplemental Driver Knee Air Bag
- 3 — Passenger Knee Impact Bolster

WARNING!

- Being too close to the steering wheel or instrument panel during front air bag deployment could cause serious injury, including death. Air bags need room to inflate. Sit back, comfortably extending your arms to reach the steering wheel or instrument panel.
- Never place a rear-facing child restraint in front of an air bag. A deploying passenger front air bag can cause death or serious injury to a child 12 years or younger, including a child in a rear-facing child restraint.
- Never install a rear-facing child restraint in the front seat of a vehicle. Only use a rear-facing child restraint in the rear seat. If the vehicle does not have a rear seat, do not transport a rear-facing child restraint in that vehicle.

Driver And Passenger Front Air Bag Features

The Advanced Front Air Bag system has multistage driver and front passenger air bags. This system provides output appropriate to the severity and type of collision as determined by the Occupant Restraint Controller (ORC), which may receive information from the front impact sensors (if equipped) or other system components.

The first stage inflator is triggered immediately during an impact that requires air bag deployment. A low energy output is used in less severe collisions. A higher energy output is used for more severe collisions.

This vehicle may be equipped with a driver and/or front passenger seat belt buckle switch that detects whether the driver or front passenger seat belt is buckled. The seat belt buckle switch may adjust the inflation rate of the Advanced Front Air Bags.

This vehicle may be equipped with driver and/or front passenger seat track position sensors that may adjust the inflation rate of the Advanced Front Air Bags based upon seat position.

WARNING!

- No objects should be placed over or near the air bag on the instrument panel or steering wheel because any such objects could cause harm if the vehicle is in a collision severe enough to cause the air bag to inflate.
- Do not put anything on or around the air bag covers or attempt to open them manually. You may damage the air bags and you could be injured because the air bags may no longer be functional. The protective covers for the air bag cushions are designed to open only when the air bags are inflating.

(Continued)

WARNING!

- Relying on the air bags alone could lead to more severe injuries in a collision. The air bags work with your seat belt to restrain you properly. In some collisions, air bags won't deploy at all. Always wear your seat belts even though you have air bags.

Front Air Bag Operation

Front Air Bags are designed to provide additional protection by supplementing the seat belts. Front air bags are not expected to reduce the risk of injury in rear, side, or rollover collisions. The front air bags will not deploy in all frontal collisions, including some that may produce substantial vehicle damage — for example, some pole collisions, truck underrides, and angle offset collisions.

On the other hand, depending on the type and location of impact, front air bags may deploy in crashes with little vehicle front-end damage but that produce a severe initial deceleration.

Because air bag sensors measure vehicle deceleration over time, vehicle speed and damage by themselves are not good indicators of whether or not an air bag should have deployed.

Seat belts are necessary for your protection in all collisions, and also are needed to help keep you in position, away from an inflating air bag.

When the Occupants Restraint Controller (ORC) detects a collision requiring the front air bags, it signals the inflator units. A large quantity of non-toxic gas is generated to inflate the front air bags.

The steering wheel hub trim cover and the upper passenger side of the instrument panel separate and fold out of the way as the air bags inflate to their full size. The front air bags fully inflate in less time than it takes to blink your eyes. The front air bags then quickly deflate while helping to restrain the driver and front passenger.

Knee Impact Bolsters

The Knee Impact Bolsters help protect the knees of the driver and front passenger, and position the front occupants for improved interaction with the front air bags.

WARNING!

- Do not drill, cut, or tamper with the knee impact bolsters in any way.
- Do not mount any accessories to the knee impact bolsters such as alarm lights, stereos, citizen band radios, etc.

Supplemental Driver Knee Air Bag

This vehicle is equipped with a Supplemental Driver Knee Air Bag mounted in the instrument panel below the steering column. The Supplemental Driver Knee Air Bag provides enhanced protection during a frontal impact by working together with the seat belts, pretensioners, and front air bags.

Supplemental Side Air Bags

Supplemental Seat-Mounted Side Air Bags (SABs)

This vehicle is equipped with Supplemental Seat-Mounted Side Air Bags (SABs).

Supplemental Seat-Mounted Side Air Bags (SABs) are located in the outboard side of the front seats. The SABs are marked with a “SRS AIRBAG” or “AIRBAG” on a label or on the seat trim on the outboard side of the seats.

The SABs may help to reduce the risk of occupant injury during certain side impacts, in addition to the injury reduction potential provided by the seat belts and body structure.

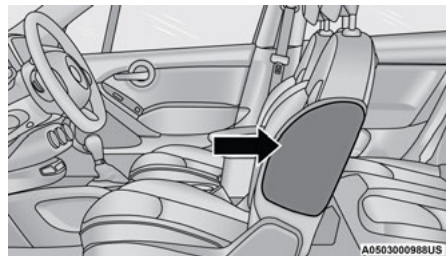

Front Supplemental Seat-Mounted Side Air Bag

When the SAB deploys, it opens the seam on the outboard side of the seatback's trim cover. The inflating SAB deploys through the seat seam into the space between the occupant and the door. The SAB moves at a very high speed and with such a high force that it could injure occupants if they are not seated properly, or if items are positioned in the area where the SAB inflates. Children are at an even greater risk of injury from a deploying air bag.

WARNING!

Do not use accessory seat covers or place objects between you and the Side Air Bags; the performance could be adversely affected and/or objects could be pushed into you, causing serious injury.

Supplemental Side Air Bag Inflatable Curtains (SABICs)

This vehicle is equipped with Supplemental Side Air Bag Inflatable Curtains (SABICs).

Supplemental Side Air Bag Inflatable Curtains (SABICs) are located above the side windows. The trim covering the SABICs is labeled “SRS AIRBAG” or “AIRBAG.”

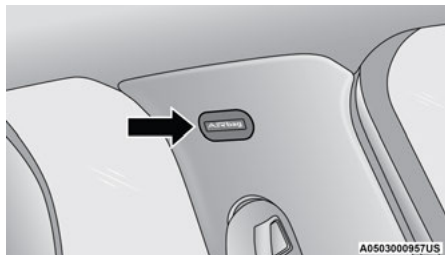

**Supplemental Side Air Bag Inflatable Curtain (SABIC)
Label Location**

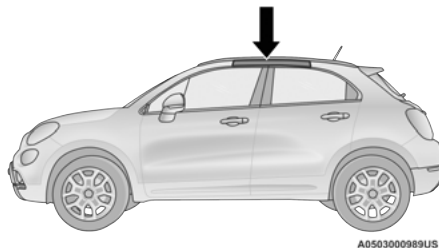

Supplemental Side Air Bag Inflatable Curtain (SABIC)

SABICs may help reduce the risk of head and other injuries to front and rear seat outboard occupants in certain side impacts, in addition to the injury reduction potential provided by the seat belts and body structure.

The SABIC deploys downward, covering the side windows. An inflating SABIC pushes the outside edge of the headliner out of the way and covers the window. The SABICs inflate with enough force to injure occupants if they are not belted and seated properly, or if items are positioned in the area where the SABICs inflate. Children are at an even greater risk of injury from a deploying air bag.

The SABICs may help reduce the risk of partial or complete ejection of vehicle occupants through side windows in certain side impact events.

WARNING!

- Do not mount equipment, or stack luggage or other cargo up high enough to block the deployment of the SABICs. The trim covering above the side windows where the SABIC and its deployment path are located should remain free from any obstructions.
- In order for the SABICs to work as intended, do not install any accessory items in your vehicle which could alter the roof. Do not add an after-market sunroof to your vehicle. Do not add roof racks that require permanent attachments (bolts or screws) for installation on the vehicle roof. Do not drill into the roof of the vehicle for any reason.

Side Impacts

The Side Air Bags are designed to activate in certain side impacts. The Occupant Restraint Controller (ORC) determines whether the deployment of the Side Air Bags in a particular impact event is appropriate, based on the severity and type of collision. The side impact sensors aid the ORC in determining the appropriate response to impact events. The system is calibrated to deploy the Side Air Bags on the impact side of the vehicle during impacts that require Side Air Bag occupant protection. In side impacts, the Side Air Bags deploy independently; a left side impact

deploys the left Side Air Bags only and a right-side impact deploys the right Side Air Bags only. Vehicle damage by itself is not a good indicator of whether or not Side Air Bags should have deployed.

The Side Air Bags will not deploy in all side collisions, including some collisions at certain angles, or some side collisions that do not impact the area of the passenger compartment. The Side Air Bags may deploy during angled or offset frontal collisions where the front air bags deploy.

Side Air Bags are a supplement to the seat belt restraint system. Side Air Bags deploy in less time than it takes to blink your eyes.

WARNING!

- Occupants, including children, who are up against or very close to Side Air Bags can be seriously injured or killed. Occupants, including children, should never lean on or sleep against the door, side windows, or area where the side air bags inflate, even if they are in an infant or child restraint.

(Continued)

WARNING!

- Seat belts (and child restraints where appropriate) are necessary for your protection in all collisions. They also help keep you in position, away from an inflating Side Air Bag. To get the best protection from the Side Air Bags, occupants must wear their seat belts properly and sit upright with their backs against the seats. Children must be properly restrained in a child restraint or booster seat that is appropriate for the size of the child.

WARNING!

- Side Air Bags need room to inflate. Do not lean against the door or window. Sit upright in the center of the seat.
- Being too close to the Side Air Bags during deployment could cause you to be severely injured or killed.
- Relying on the Side Air Bags alone could lead to more severe injuries in a collision. The Side Air Bags work with your seat belt to restrain you properly. In some collisions, Side Air Bags won't deploy at all. Always wear your seat belt even though you have Side Air Bags.

NOTE:

Air bag covers may not be obvious in the interior trim, but they will open during air bag deployment.

Rollover Events

Side Air Bags and seat belt pretensioners are designed to activate in certain rollover events. The Occupant Restraint Controller (ORC) determines whether deployment in a particular rollover event is appropriate, based on the severity and type of collision. Vehicle damage by itself is not a good indicator of whether or not Side Air Bags and seat belt pretensioners should have deployed.

The Side Air Bags and seat belt pretensioners will not deploy in all rollover events. The rollover sensing system determines if a rollover event may be in progress and whether deployment is appropriate. In the event the vehicle experiences a rollover or near rollover event, and deployment is appropriate, the rollover sensing system will deploy the side air bags and seat belt pretensioners on both sides of the vehicle.

The SABICs may help reduce the risk of partial or complete ejection of vehicle occupants through side windows in certain rollover or side impact events.

Air Bag System Components

NOTE:

The Occupant Restraint Controller (ORC) monitors the internal circuits and interconnecting wiring associated with electrical Air Bag System Components listed below:

- Occupant Restraint Controller (ORC)
- Air Bag Warning Light 
- Steering Wheel and Column
- Instrument Panel
- Knee Impact Bolsters
- Driver and Front Passenger Air Bags
- Seat Belt Buckle Switch
- Supplemental Side Air Bags
- Supplemental Knee Air Bags
- Front and Side Impact Sensors
- Seat Belt Pretensioners
- Seat Track Position Sensors

If A Deployment Occurs

The front air bags are designed to deflate immediately after deployment.

NOTE:

Front and/or side air bags will not deploy in all collisions. This does not mean something is wrong with the air bag system.

If you do have a collision which deploys the air bags, any or all of the following may occur:

- The air bag material may sometimes cause abrasions and/or skin reddening to the occupants as the air bags deploy and unfold. The abrasions are similar to friction rope burns or those you might get sliding along a carpet or gymnasium floor. They are not caused by contact with chemicals. They are not permanent and normally heal quickly. However, if you haven't healed significantly within a few days, or if you have any blistering, see your doctor immediately.
- As the air bags deflate, you may see some smoke-like particles. The particles are a normal by-product of the process that generates the non-toxic gas used for air bag inflation. These airborne particles may irritate the skin, eyes, nose, or throat. If you have skin or eye irritation, rinse the area with cool water. For nose or throat irritation, move to fresh air. If the irritation continues, see your doctor. If these particles settle on your clothing, follow the garment manufacturer's instructions for cleaning.

Do not drive your vehicle after the air bags have deployed. If you are involved in another collision, the air bags will not be in place to protect you.

WARNING!

Deployed air bags and seat belt pretensioners cannot protect you in another collision. Have the air bags, seat belt pretensioners, and the seat belt retractor assemblies replaced by an authorized dealer immediately. Also, have the Occupant Restraint Controller System serviced as well.

NOTE:

- Air bag covers may not be obvious in the interior trim, but they will open during air bag deployment.
- After any collision, the vehicle should be taken to an authorized dealer immediately.

Enhanced Accident Response System

In the event of an impact, if the communication network remains intact, and the power remains intact, depending on the nature of the event, the Occupant Restraint Controller (ORC) will determine whether to have the Enhanced Accident Response System perform the following functions:

- Cut off fuel to the engine (if equipped).
- Cut off battery power to the electric motor (if equipped).
- Flash hazard lights as long as the battery has power.

- Turn on the interior lights, which remain on as long as the battery has power or for 15 minutes from the intervention of the Enhanced Accident Response System.
- Unlock the power door locks.

Your vehicle may also be designed to perform any of these other functions in response to the Enhanced Accident Response System:

- Turn off the Fuel Filter Heater, Turn off the HVAC Blower Motor, Close the HVAC Circulation Door
- Cut off battery power to the:
 - Engine
 - Electric Motor (if equipped)
 - Electric power steering
 - Brake booster
 - Electric park brake

- Automatic transmission gear selector
- Horn
- Front wiper
- Headlamp washer pump

NOTE:

After an accident, remember to cycle the ignition to the STOP (OFF/LOCK) position and remove the key from the ignition switch to avoid draining the battery. Carefully check the vehicle for fuel leaks in the engine compartment and on the ground near the engine compartment and fuel tank before resetting the system and starting the engine. If there are no fuel leaks or damage to the vehicle electrical devices (e.g. headlights) after an accident, reset the system by following the procedure described below. If you have any doubt, contact an authorized dealer.

Enhanced Accident Response System Reset Procedure

After the event occurs, when the system is active, a message regarding fuel cutoff is displayed. Turn the ignition switch from ignition AVV/START or MAR/ACC/ON/RUN to ignition STOP/OFF/LOCK. Carefully check the vehicle for fuel leaks in the engine compartment and on the ground near the engine compartment and fuel tank before resetting the system and starting the engine.

Depending on the nature of the event the left and right turn signal lights, located in the instrument panel, may both be blinking and will continue to blink. In order to move your vehicle to the side of the road, you must follow the system reset procedure.

Customer Action	Customer Will See
NOTE: Each step MUST BE held for at least two seconds	
1. Turn ignition STOP/OFF/LOCK. (Turn Signal Switch Must be placed in Neutral State).	
2. Turn ignition MAR/ACC/ON/RUN.	Right turn light BLINKS. Left turn light is OFF.
3. Turn right turn signal switch ON.	Right turn light is ON SOLID. Left turn light BLINKS.

Customer Action	Customer Will See
NOTE: Each step MUST BE held for at least two seconds	
4. Place turn signal in neutral state.	Right turn light is OFF. Left turn light BLINKS.
5. Turn left turn signal switch ON.	Right turn light BLINKS. Left turn light is ON SOLID.
6. Place turn signal in neutral state.	Right turn light BLINKS. Left turn light is OFF.
7. Turn right turn signal switch ON.	Right turn light is ON SOLID. Left turn light BLINKS.
8. Place turn signal in neutral state.	Right turn light is OFF. Left turn light BLINKS.
9. Turn left turn signal switch ON.	Right turn light is ON SOLID. Left turn light is ON SOLID.
10. Turn left turn signal switch OFF. (Turn Signal Switch Must be placed in Neutral State).	Right turn light is OFF. Left turn light is OFF.
11. Turn ignition STOP/OFF/LOCK.	
12. Turn ignition MAR/ACC/ON/RUN. (Entire sequence needs to be completed within one minute or sequence will need to be repeated).	System is now reset and the engine may be started.
Turn hazard flashers OFF (Manually).	

If a reset procedure step is not completed within 60 seconds, then the turn signal lights will blink and the reset procedure must be performed again in order to be successful.

Maintaining Your Air Bag System

WARNING!

- Modifications to any part of the air bag system could cause it to fail when you need it. You could be injured if the air bag system is not there to protect you. Do not modify the components or wiring, including adding any kind of badges or stickers to the steering wheel hub trim cover or the upper passenger side of the instrument panel. Do not modify the front fascia/bumper, vehicle body structure, or add aftermarket side steps or running boards.
- It is dangerous to try to repair any part of the air bag system yourself. Be sure to tell anyone who works on your vehicle that it has an air bag system.

(Continued)

WARNING!

- Do not attempt to modify any part of your air bag system. The air bag may inflate accidentally or may not function properly if modifications are made. Take your vehicle to an authorized dealer for any air bag system service. If your seat, including your trim cover and cushion, needs to be serviced in any way (including removal or loosening/tightening of seat attachment bolts), take the vehicle to an authorized dealer. Only manufacturer approved seat accessories may be used. If it is necessary to modify the air bag system for persons with disabilities, contact an authorized dealer.

Event Data Recorder (EDR)

This vehicle is equipped with an event data recorder (EDR). The main purpose of an EDR is to record, in certain crash or near crash-like situations, such as an air bag deployment or hitting a road obstacle, data that will assist in understanding how a vehicle's systems performed. The EDR is designed to record data related to vehicle dynamics and safety systems for a short period of time, typically 30 seconds or less. The EDR in this vehicle is designed to record such data as:

- How various systems in your vehicle were operating;

- Whether or not the driver and passenger safety belts were buckled/fastened;
- How far (if at all) the driver was depressing the accelerator and/or brake pedal; and,
- How fast the vehicle was traveling.

These data can help provide a better understanding of the circumstances in which crashes and injuries occur.

NOTE:

EDR data are recorded by your vehicle only if a non-trivial crash situation occurs; no data are recorded by the EDR under normal driving conditions and no personal data (e.g., name, gender, age, and crash location) are recorded. However, other parties, such as law enforcement, could combine the EDR data with the type of personally identifying data routinely acquired during a crash investigation.

To read data recorded by an EDR, special equipment is required, and access to the vehicle or the EDR is needed. In addition to the vehicle manufacturer, other parties, such as law enforcement, that have the special equipment, can read the information if they have access to the vehicle or the EDR.

CHILD RESTRAINTS

Everyone in your vehicle needs to be buckled up at all times, including babies and children. Every state in the United States, and every Canadian province, requires that small children ride in proper restraint systems. This is the law, and you can be prosecuted for ignoring it.

Children 12 years or younger should ride properly buckled up in a rear seat, if available. According to crash statistics, children are safer when properly restrained in the rear seats rather than in the front.

WARNING!

In a collision, an unrestrained child can become a projectile inside the vehicle. The force required to hold even an infant on your lap could become so great that you could not hold the child, no matter how strong you are. The child and others could be badly injured or killed. Any child riding in your vehicle should be in a proper restraint for the child's size.

There are different sizes and types of restraints for children from newborn size to the child almost large enough for an adult safety belt. Always check the child seat Owner's Manual to make sure you have the correct seat for your child. Carefully read

and follow all the instructions and warnings in the child restraint Owner's Manual and on all the labels attached to the child restraint.

Before buying any restraint system, make sure that it has a label certifying that it meets all applicable Safety Standards. You should also make sure that you can install it in the vehicle where you will use it.

NOTE:

- For additional information, refer to <http://www.nhtsa.gov/parents-and-caregivers> or call 1-888-327-4236.
- Canadian residents should refer to Transport Canada's website for additional information: <http://www.tc.gc.ca/en/services/road/child-car-seat-safety.html>.

Summary Of Recommendations For Restraining Children In Vehicles

	Child Size, Height, Weight Or Age	Recommended Type Of Child Restraint
Infants and Toddlers	Children who are two years old or younger and who have not reached the height or weight limits of their child restraint	Either an Infant Carrier or a Convertible Child Restraint, facing rearward in a rear seat of the vehicle
Small Children	Children who are at least two years old or who have outgrown the height or weight limit of their rear-facing child restraint	Forward-Facing Child Restraint with a five-point Harness, facing forward in a rear seat of the vehicle

	Child Size, Height, Weight Or Age	Recommended Type Of Child Restraint
Larger Children	Children who have outgrown their forward-facing child restraint, but are too small to properly fit the vehicle's seat belt	Belt Positioning Booster Seat and the vehicle seat belt, seated in a rear seat of the vehicle
Children Too Large for Child Restraints	Children 12 years old or younger, who have outgrown the height or weight limit of their booster seat	Vehicle Seat Belt, seated in a rear seat of the vehicle

Infant And Child Restraints

Safety experts recommend that children ride rear-facing in the vehicle until they are two years old or until they reach either the height or weight limit of their rear-facing child restraint. Two types of child restraints can be used rear-facing: infant carriers and convertible child seats.

The infant carrier is only used rear-facing in the vehicle. It is recommended for children from birth until they reach the weight or height limit of the infant carrier. Convertible child seats can be used either rear-facing or forward-facing in the vehicle. Convertible child seats often have a higher weight limit in the rear-facing direction than infant carriers do, so they can be used rear-facing by children who have outgrown their infant carrier but are still less than at least two years old. Children should remain rear-facing until they reach the highest weight or height allowed by their convertible child seat.

WARNING!

- Never place a rear-facing child restraint in front of an air bag. A deploying passenger front air bag can cause death or serious injury to a child 12 years or younger, including a child in a rear-facing child restraint.
- Never install a rear-facing child restraint in the front seat of a vehicle. Only use a rear-facing child restraint in the rear seat. If the vehicle does not have a rear seat, do not transport a rear-facing child restraint in that vehicle.

Older Children And Child Restraints

Children who are two years old or who have outgrown their rear-facing convertible child seat can ride forward-facing in the vehicle. Forward-facing child seats and convertible child seats used in the forward-facing direction are for children who are over two years old or who have

outgrown the rear-facing weight or height limit of their rear-facing convertible child seat. Children should remain in a forward-facing child seat with a harness for as long as possible, up to the highest weight or height allowed by the child seat.

All children whose weight or height is above the forward-facing limit for the child seat should use a belt-positioning booster seat until the vehicle's seat belts fit properly. If the child cannot sit with knees bent over the vehicle's seat cushion while the child's back is against the seatback, they should use a belt-positioning booster seat. The child and belt-positioning booster seat are held in the vehicle by the seat belt.

WARNING!

- Improper installation can lead to failure of an infant or child restraint. It could come loose in a collision. The child could be badly injured or killed. Follow the child restraint manufacturer's directions exactly when installing an infant or child restraint.
- After a child restraint is installed in the vehicle, do not move the vehicle seat forward or rearward because it can loosen the child restraint attachments. Remove the child restraint before adjusting the vehicle seat position. When the vehicle seat has been adjusted, reinstall the child restraint.
- When your child restraint is not in use, secure it in the vehicle with the seat belt or LATCH anchorages, or remove it from the vehicle. Do not leave it loose in the vehicle. In a sudden stop or accident, it could strike the occupants or seatbacks and cause serious personal injury.

Children Too Large For Booster Seats

Children who are large enough to wear the shoulder belt comfortably, and whose legs are long enough to bend over the front of the seat when their back is against the seatback, should use the seat belt in a rear seat. Use this simple 5-step test to decide whether the child can use the vehicle's seat belt alone:

1. Can the child sit all the way back against the back of the vehicle seat?
2. Do the child's knees bend comfortably over the front of the vehicle seat – while the child is still sitting all the way back?
3. Does the shoulder belt cross the child's shoulder between the neck and arm?
4. Is the lap part of the belt as low as possible, touching the child's thighs and not the stomach?
5. Can the child stay seated like this for the whole trip?

If the answer to any of these questions was “no”, then the child still needs to use a booster seat in this vehicle. If the child is using the lap/shoulder belt, check seat belt fit periodically and make sure the seat belt buckle is latched. A child's squirming or slouching can move the belt out of position. If the shoulder belt contacts the face or neck, move the child closer to the center of the vehicle, or use a booster seat to position the seat belt on the child correctly.

WARNING!

Never allow a child to put the shoulder belt under an arm or behind their back. In a crash, the shoulder belt will not protect a child properly, which may result in serious injury or death. A child must always wear both the lap and shoulder portions of the seat belt correctly.

Recommendations For Attaching Child Restraints

Restraint Type	Combined Weight of the Child + Child Restraint	Use Any Attachment Method Shown With An "X" Below			
		LATCH – Lower Anchors Only	Seat Belt Only	LATCH – Lower Anchors + Top Tether Anchor	Seat Belt + Top Tether Anchor
Rear-Facing Child Restraint	Up to 65 lbs (29.5 kg)	X	X		
Rear-Facing Child Restraint	More than 65 lbs (29.5 kg)		X		
Forward-Facing Child Restraint	Up to 65 lbs (29.5 kg)			X	X
Forward-Facing Child Restraint	More than 65 lbs (29.5 kg)				X

Lower Anchors And Tethers For Children (LATCH) Restraint System



022668173

LATCH Label

Your vehicle is equipped with the child restraint anchorage system called LATCH, which stands for Lower Anchors and Tethers for Children. The LATCH system has three vehicle anchor points for installing LATCH-equipped child seats. There are two lower anchorages located at the back of the seat cushion where it meets the seatback and one top tether anchorage located behind the seating position. These anchorages are used to install LATCH-equipped child seats without using the vehicle's seat belts. Some seating positions may have a top tether anchorage but no lower anchorages. In these seating positions, the seat belt must be used with the top tether anchorage to install the child restraint. Please see the following table for more information.

LATCH Positions For Installing Child Restraints In This Vehicle

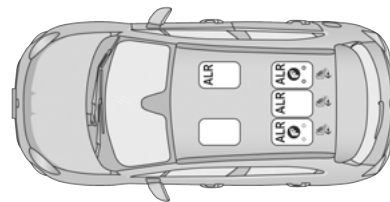

A0503000987US

LATCH Positions

 Lower Anchorage Symbol (2 Anchorages Per Seating Position)

 Top Tether Anchorage Symbol

Frequently Asked Questions About Installing Child Restraints With LATCH

What is the weight limit (child's weight + weight of the child restraint) for using the LATCH anchorage system to attach the child restraint?	65 lbs (29.5 kg)	Use the LATCH anchorage system until the combined weight of the child and the child restraint is 65 lbs (29.5 kg). Use the seat belt and tether anchor instead of the LATCH anchorage system once the combined weight is more than 65 lbs (29.5 kg).
Can the LATCH anchorages and the seat belt be used together to attach a rear-facing or forward-facing child restraint?	No	Do not use the seat belt when you use the LATCH anchorage system to attach a rear-facing or forward-facing child restraint. Booster seats may be attached to the LATCH anchorages if allowed by the booster seat manufacturer. See your booster seat owner's manual for more information.
Can a child seat be installed in the center position using the inner LATCH lower anchorages from the outboard seating positions?	No	Use the seat belt and tether anchor to install a child seat in the center seating position.
Can two child restraints be attached using a common lower LATCH anchorage?	No	Never "share" a LATCH anchorage with two or more child restraints. If the center position does not have dedicated LATCH lower anchorages, use the seat belt to install a child seat in the center position next to a child seat using the LATCH anchorages in an outboard position.
Can the rear-facing child restraint touch the back of the front passenger seat?	Yes	The child seat may touch the back of the front passenger seat if the child restraint manufacturer also allows contact. See your child restraint owner's manual for more information.
Can the rear head restraints be removed?	Yes	The head restraints can be removed in each seating position if they interfere with the installation of the child restraint  page 30.

Locating The LATCH Anchorages



The lower anchorages are round bars that are found at the rear of the seat cushion where it meets the seatback, below the anchorage symbols on the seatback. They are just visible when you lean into the rear seat to install the child restraint. You will easily feel them if you run your finger along the gap between the seatback and seat cushion.

They are just visible when you lean into the rear seat to install the child restraint. You will easily feel them if you run your finger along the gap between the seatback and seat cushion.

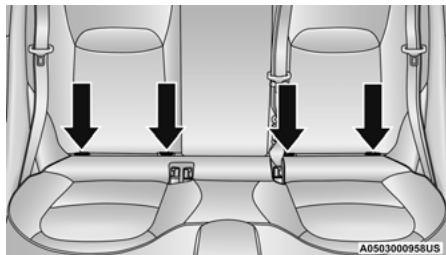

Lower Anchorage Location

Locating The Upper Tether Anchorages



There are tether strap anchorages behind each rear seating position located on the back of the seat.

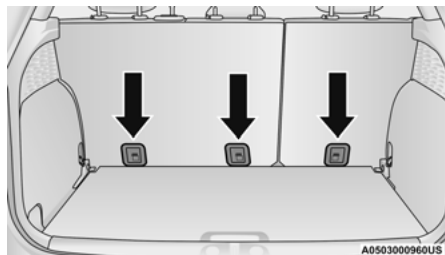

Tether Anchorage Locations

LATCH-compatible child restraint systems will be equipped with a rigid bar or a flexible strap on each side. Each will have a hook or connector to attach to the lower anchorage and a way to tighten the connection to the anchorage. Forward-facing child restraints and some rear-facing child restraints will also be equipped with a tether strap. The tether strap will have a hook at the end to attach to the top tether anchorage and a way to tighten the strap after it is attached to the anchorage.

Center Seat LATCH:

WARNING!

- Do not install a child restraint in the center position using the LATCH system. This position is not approved for installing child seats using the LATCH attachments. You must use the seat belt and tether anchor to install a child seat in the center seating position.
- Never use the same lower anchorage to attach more than one child restraint. See [page 208](#) for typical installation instructions.

Always follow the directions of the child restraint manufacturer when installing your child restraint. Not all child restraint systems will be installed as described here.

To Install A LATCH-Compatible Child Restraint

If the selected seating position has a Switchable Automatic Locking Retractor (ALR) seat belt, stow the seat belt, following the instructions below. See ⇨ page 209 to check what type of seat belt each seating position has.

1. Loosen the adjusters on the lower straps and on the tether strap of the child seat so that you can more easily attach the hooks or connectors to the vehicle anchorages.
2. Place the child seat between the lower anchorages for that seating position. If the second row seat can be reclined, you may recline the seat and/or raise the head restraint (if adjustable) to get a better fit. If the rear seat can be moved forward and rearward in the vehicle, you may wish to move it to its rear-most position to make room for the child seat. You may also move the front seat forward to allow more room for the child seat.
3. Attach the lower hooks or connectors of the child restraint to the lower anchorages in the selected seating position.

4. If the child restraint has a tether strap, connect it to the top tether anchorage. See ⇨ page 211 for directions to attach a tether anchor.
5. Tighten all of the straps as you push the child restraint rearward and downward into the seat. Remove slack in the straps according to the child restraint manufacturer's instructions.
6. Test that the child restraint is installed tightly by pulling back and forth on the child seat at the belt path. It should not move more than 1 inch (25.4 mm) in any direction.

How To Stow An Unused Switchable-ALR (ALR) Seat Belt:

When using the LATCH attaching system to install a child restraint, stow all ALR seat belts that are not being used by other occupants or being used to secure child restraints. An unused belt could injure a child if they play with it and accidentally lock the seat belt retractor. Before installing a child restraint using the LATCH system, buckle the seat belt behind the child restraint and out of the child's reach. If the buckled seat belt interferes with the child restraint installation, instead of buckling it behind the child restraint, route the seat belt through the child restraint belt path and then

buckle it. Do not lock the seat belt. Remind all children in the vehicle that the seat belts are not toys and that they should not play with them.

WARNING!

- Improper installation of a child restraint to the LATCH anchorages can lead to failure of the restraint. The child could be badly injured or killed. Follow the child restraint manufacturer's directions exactly when installing an infant or child restraint.
- Child restraint anchorages are designed to withstand only those loads imposed by correctly-fitted child restraints. Under no circumstances are they to be used for adult seat belts, harnesses, or for attaching other items or equipment to the vehicle.

Installing Child Restraints Using The Vehicle Seat Belt

Child restraint systems are designed to be secured in vehicle seats by lap belts or the lap belt portion of a lap/shoulder belt.

WARNING!

- Improper installation or failure to properly secure a child restraint can lead to failure of the restraint. The child could be badly injured or killed.
- Follow the child restraint manufacturer's directions exactly when installing an infant or child restraint.

The seat belts in the passenger seating positions are equipped with a Switchable Automatic Locking Retractor (ALR) that is designed to keep the lap portion of the seat belt tight around the child restraint so that it is not necessary to use a locking clip. The ALR retractor can be "switched" into a locked mode by pulling all of the webbing out of the retractor and then letting the webbing retract back into the retractor. If it is locked, the ALR will make a clicking noise while the webbing is pulled back into the retractor.

See the "Automatic Locking Mode" description ↗ page 190 for additional information on ALR.

Please see the table below and the following sections for more information.

Lap/Shoulder Belt Systems For Installing Child Restraints In This Vehicle

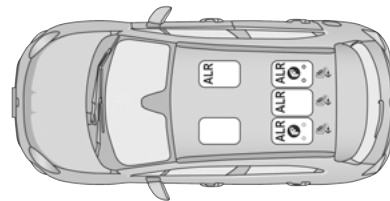

A0503000987US

Automatic Locking Retractor (ALR) Locations

ALR — Switchable Automatic Locking Retractor

 Top Tether Anchorage Symbol

6

Frequently Asked Questions About Installing Child Restraints With Seat Belts

What is the weight limit (child's weight + weight of the child restraint) for using the Tether Anchor with the seat belt to attach a forward facing child restraint?	Weight limit of the Child Restraint	Always use the tether anchor when using the seat belt to install a forward facing child restraint, up to the recommended weight limit of the child restraint.
Can the rear-facing child restraint touch the back of the front passenger seat?	Yes	Contact between the front passenger seat and the child restraint is allowed, if the child restraint manufacturer also allows contact.

Frequently Asked Questions About Installing Child Restraints With Seat Belts

Can the rear head restraints be removed?	Yes	The head restraints can be removed in each seating position if they interfere with the installation of the child restraint → page 30.
Can the buckle stalk be twisted to tighten the seat belt against the belt path of the child restraint?	No	Do not twist the buckle stalk in a seating position with an ALR retractor.

Installing A Child Restraint With A Switchable Automatic Locking Retractor (ALR):

Child restraint systems are designed to be secured in vehicle seats by lap belts or the lap belt portion of a lap/shoulder belt.

WARNING!

- Improper installation or failure to properly secure a child restraint can lead to failure of the restraint. The child could be badly injured or killed.
- Follow the child restraint manufacturer's directions exactly when installing an infant or child restraint.

1. Place the child seat in the center of the seating position. If the second row seat can be reclined, you may recline the seat and/or raise the head restraint (if adjustable) to get a

better fit. If the rear seat can be moved forward and rearward in the vehicle, you may wish to move it to its rear-most position to make room for the child seat. You may also move the front seat forward to allow more room for the child seat.

2. Pull enough of the seat belt webbing from the retractor to pass it through the belt path of the child restraint. Do not twist the belt webbing in the belt path.
3. Slide the latch plate into the buckle until you hear a "click."
4. Pull on the webbing to make the lap portion tight against the child seat.
5. To lock the seat belt, pull down on the shoulder part of the belt until you have pulled all the seat belt webbing out of the retractor. Then, allow the webbing to retract back into the retractor. As the webbing retracts, you will hear a clicking sound. This means the seat belt is now in the Automatic Locking mode.

6. Try to pull the webbing out of the retractor. If it is locked, you should not be able to pull out any webbing. If the retractor is not locked, repeat step 5.
7. Finally, pull up on any excess webbing to tighten the lap portion around the child restraint while you push the child restraint rearward and downward into the vehicle seat.
8. If the child restraint has a top tether strap and the seating position has a top tether anchorage, connect the tether strap to the anchorage and tighten the tether strap. See → page 211 for directions to attach a tether anchor.
9. Test that the child restraint is installed tightly by pulling back and forth on the child seat at the belt path. It should not move more than 1 inch (25.4 mm) in any direction.

Any seat belt system will loosen with time, so check the belt occasionally, and pull it tight if necessary.

Installing Child Restraints Using The Top Tether Anchorage:

WARNING!

Do not attach a tether strap for a rear-facing car seat to any location in front of the car seat, including the seat frame or a tether anchorage. Only attach the tether strap of a rear-facing car seat to the tether anchorage that is approved for that seating position, located behind the top of the vehicle seat. See  page 205 for the location of approved tether anchorages in your vehicle.

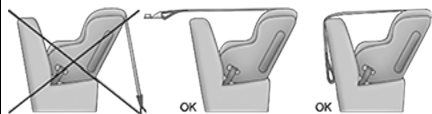

1. Look behind the seating position where you plan to install the child restraint to find the tether anchorage. You may need to move the seat forward to provide better access to the tether anchorage. If there is no top tether

anchorage for that seating position, move the child restraint to another position in the vehicle if one is available.

2. Route the tether strap to provide the most direct path for the strap between the anchor and the child seat. If your vehicle is equipped with adjustable rear head restraints, raise the head restraint, and where possible, route the tether strap under the head restraint and between the two posts. If not possible, lower the head restraint and pass the tether strap around the outboard side of the head restraint.
3. Attach the tether strap hook of the child restraint to the top tether anchorage as shown in the diagram.

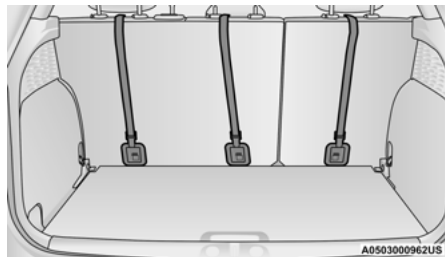

Tether Anchorage Locations

4. Remove slack in the tether strap according to the child restraint manufacturer's instructions.

WARNING!

- An incorrectly anchored tether strap could lead to increased head motion and possible injury to the child. Use only the anchorage position directly behind the child seat to secure a child restraint top tether strap.
- If your vehicle is equipped with a split rear seat, make sure the tether strap does not slip into the opening between the seatbacks as you remove slack in the strap.

SAFETY TIPS

TRANSPORTING PASSENGERS

NEVER TRANSPORT PASSENGERS IN THE CARGO AREA.

WARNING!

- Do not leave children or animals inside parked vehicles in hot weather. Interior heat build-up may cause serious injury or death.
- It is extremely dangerous to ride in a cargo area, inside or outside of a vehicle. In a collision, people riding in these areas are more likely to be seriously injured or killed.

(Continued)

WARNING!

- Do not allow people to ride in any area of your vehicle that is not equipped with seats and seat belts.
- Be sure everyone in your vehicle is in a seat and using a seat belt properly.

TRANSPORTING PETS

Air Bags deploying in the front seat could harm your pet. An unrestrained pet will be thrown about and possibly injured, or injure a passenger during panic braking or in a collision.

Pets should be restrained in the rear seat (if equipped) in pet harnesses or pet carriers that are secured by seat belts.

SAFETY CHECKS YOU SHOULD MAKE INSIDE THE VEHICLE**Seat Belts**

Inspect the seat belt system periodically, checking for cuts, frays, and loose parts. Damaged parts must be replaced immediately. Do not disassemble or modify the system.

If your vehicle is involved in a collision, or if you have questions regarding the seat belt or retractor conditions, take your vehicle to an authorized FCA

dealer or authorized FCA Certified Collision Care Program facility for inspection.

Air Bag Warning Light

The Air Bag Warning Light  will turn on for four to eight seconds as a bulb check when the ignition switch is first placed in the ON/RUN position. If the light is either not on during starting, stays on, or turns on while driving, have the system inspected at an authorized dealer as soon as possible. After the bulb check, this light will illuminate with a single chime when a fault with the Air Bag System has been detected. It will stay on until the fault is removed. If the light comes on intermittently or remains on while driving, have an authorized dealer service the vehicle immediately → page 184.

Defroster

Check operation by selecting the defrost mode and place the blower control on high speed. You should be able to feel the air directed against the windshield. See an authorized dealer for service if your defroster is inoperable.



Floor Mat Safety Information

Always use floor mats designed to fit your vehicle. Only use a floor mat that does not interfere with the operation of the accelerator, brake or clutch pedals. Only use a floor mat that is securely attached using the floor mat fasteners so it cannot slip out of position and interfere with the

accelerator, brake or clutch pedals or impair safe operation of your vehicle in other ways.

WARNING!

An improperly attached, damaged, folded, or stacked floor mat, or damaged floor mat fasteners may cause your floor mat to interfere with the accelerator, brake, or clutch pedals and cause a loss of vehicle control. To prevent SERIOUS INJURY or DEATH:

- ALWAYS securely attach  your floor mat using the floor mat fasteners. DO NOT install your floor mat upside down or turn your floor mat over. Lightly pull to confirm mat is secured using the floor mat fasteners on a regular basis.
- ALWAYS REMOVE THE EXISTING FLOOR MAT FROM THE VEHICLE  before installing any other floor mat. NEVER install or stack an additional floor mat on top of an existing floor mat.
- ONLY install floor mats designed to fit your vehicle. NEVER install a floor mat that cannot be properly attached and secured to your vehicle. If a floor mat needs to be replaced, only use a FCA approved floor mat for the specific make, model, and year of your vehicle.

(Continued)

WARNING!

- ONLY use the driver's side floor mat on the driver's side floor area. To check for interference, with the vehicle properly parked with the engine off, fully depress the accelerator, the brake, and the clutch pedal (if present) to check for interference. If your floor mat interferes with the operation of any pedal, or is not secure to the floor, remove the floor mat from the vehicle and place the floor mat in your trunk.
- ONLY use the passenger's side floor mat on the passenger's side floor area.
- ALWAYS make sure objects cannot fall or slide into the driver's side floor area when the vehicle is moving. Objects can become trapped under accelerator, brake, or clutch pedals and could cause a loss of vehicle control.
- NEVER place any objects under the floor mat (e.g., towels, keys, etc.). These objects could change the position of the floor mat and may cause interference with the accelerator, brake, or clutch pedals.

*(Continued)***WARNING!**

- If the vehicle carpet has been removed and re-installed, always properly attach carpet to the floor and check the floor mat fasteners are secure to the vehicle carpet. Fully depress each pedal to check for interference with the accelerator, brake, or clutch pedals then re-install the floor mats.
- It is recommended to only use mild soap and water to clean your floor mats. After cleaning, always check your floor mat has been properly installed and is secured to your vehicle using the floor mat fasteners by lightly pulling mat.

PERIODIC SAFETY CHECKS YOU SHOULD MAKE OUTSIDE THE VEHICLE**Tires**

Examine tires for excessive tread wear and uneven wear patterns. Check for stones, nails, glass, or other objects lodged in the tread or sidewall. Inspect the tread for cuts and cracks. Inspect sidewalls for cuts, cracks, and bulges. Check the lug nuts/bolt torque for tightness. Check the tires (including spare) for proper cold inflation pressure.

Lights

Have someone observe the operation of brake lights and exterior lights while you work the controls. Check turn signal and high beam indicator lights on the instrument panel.

Door Latches

Check for proper closing, latching, and locking.

Fluid Leaks

Check area under the vehicle after overnight parking for fuel, coolant, oil, or other fluid leaks. Also, if gasoline fumes are detected or if fuel or brake fluid leaks are suspected, the cause should be located and corrected immediately.

EXHAUST GAS**WARNING!**

Exhaust gases can injure or kill. They contain carbon monoxide (CO), which is colorless and odorless. Breathing it can make you unconscious and can eventually poison you. To avoid breathing (CO), follow these safety tips:

- Do not run the engine in a closed garage or in confined areas any longer than needed to move your vehicle in or out of the area.

(Continued)

WARNING!

- If you are required to drive with the trunk/lift-gate/rear doors open, make sure that all windows are closed and the climate control BLOWER switch is set at high speed. DO NOT use the recirculation mode.
- If it is necessary to sit in a parked vehicle with the engine running, adjust your heating or cooling controls to force outside air into the vehicle. Set the blower at high speed.

The best protection against carbon monoxide entry into the vehicle body is a properly maintained engine exhaust system.

Whenever a change is noticed in the sound of the exhaust system, when exhaust fumes can be detected inside the vehicle, or when the underside or rear of the vehicle is damaged, have an authorized dealer inspect the complete exhaust system and adjacent body areas for broken, damaged, deteriorated, or mispositioned parts. Open seams or loose connections could permit exhaust fumes to seep into the passenger compartment. In addition, inspect the exhaust system each time the vehicle is raised for lubrication or oil change. Replace as required.

CARBON MONOXIDE WARNINGS**WARNING!**

Carbon monoxide (CO) in exhaust gases is deadly. Follow the precautions below to prevent carbon monoxide poisoning:

- Do not inhale exhaust gases. They contain carbon monoxide, a colorless and odorless gas, which can kill. Never run the engine in a closed area, such as a garage, and never sit in a parked vehicle with the engine running for an extended period. If the vehicle is stopped in an open area with the engine running for more than a short period, adjust the ventilation system to force fresh, outside air into the vehicle.
- Guard against carbon monoxide with proper maintenance. Have the exhaust system inspected every time the vehicle is raised. Have any abnormal conditions repaired promptly. Until repaired, drive with all side windows fully open.

IN CASE OF EMERGENCY

HAZARD WARNING FLASHERS

The Hazard Warning Flashers button is located on the switch bank below the radio.

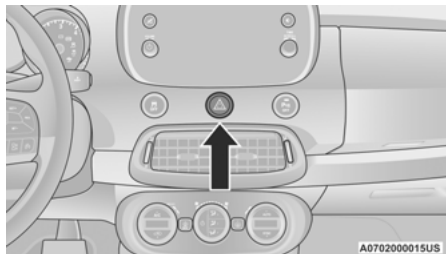

Hazard Warning Flasher Button

Push the button to turn on the Hazard Warning Flashers. When the button is activated, all directional turn signals will flash on and off to warn oncoming traffic of an emergency. Push the button a second time to turn off the Hazard Warning Flashers.

This is an emergency warning system and it should not be used when the vehicle is in motion. Use it when your vehicle is disabled and it is creating a safety hazard for other motorists.

When you must leave the vehicle to seek assistance, the Hazard Warning Flashers will continue to operate even though the ignition is placed in OFF mode.

NOTE:

With extended use the Hazard Warning Flashers may wear down your battery.

JACKING AND TIRE CHANGING

WARNING!

- Do not attempt to change a tire on the side of the vehicle close to moving traffic. Pull far enough off the road to avoid the danger of being hit when operating the jack or changing the wheel.
- Being under a jacked-up vehicle is dangerous. The vehicle could slip off the jack and fall on you. You could be crushed. Never put any part of your body under a vehicle that is on a jack. If you need to get under a raised vehicle, take it to a service center where it can be raised on a lift.
- Never start or run the engine while the vehicle is on a jack.

(Continued)

WARNING!

- The jack is designed to be used as a tool for changing tires only. The jack should not be used to lift the vehicle for service purposes. The vehicle should be jacked on a firm level surface only. Avoid ice or slippery areas.

PREPARATIONS FOR JACKING

1. Park on a firm, level surface. Avoid ice or slippery areas.

WARNING!

Do not attempt to change a tire on the side of the vehicle close to moving traffic. Pull far enough off the road to avoid being hit when operating the jack or changing the wheel.

2. Turn on the Hazard Warning Flashers.
3. Apply the Electric Park Brake.
4. Place the gear selector into PARK (P).
5. Turn the ignition to STOP mode.

- Block both the front and rear wheel diagonally opposite of each jacking position. For example, if the driver's front wheel is being changed, block the passenger's rear wheel.

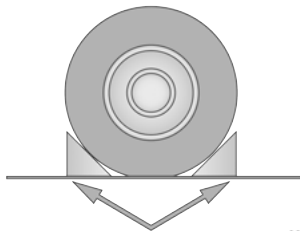
**Wheels Chocked**

A0707000523US

NOTE:

Passengers should not remain in the vehicle when the vehicle is being raised or lifted.

**JACK LOCATION/SPARE TIRE STORAGE
— IF EQUIPPED**

The jack and tools are located in the rear storage compartment, under the load floor.

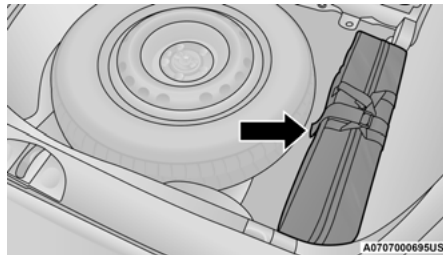
**Jack And Tools Location**

A0707000695US

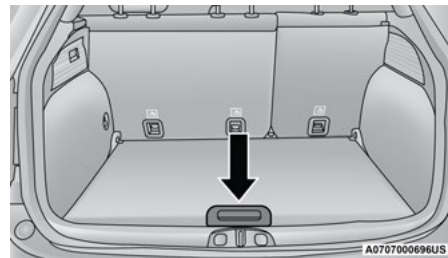
**Load Floor Handle**

A0707000696US

- Remove the fastener securing the spare tire.

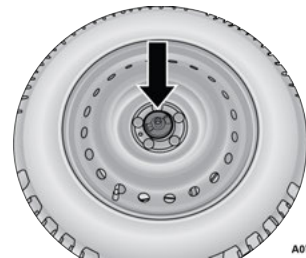
**Spare Tire Fastener**

A0707000432US

- Open the liftgate.
- Lift the access cover using the load floor handle.

4. Remove the jack, wheel bolt wrench, and wheel chocks (if equipped).

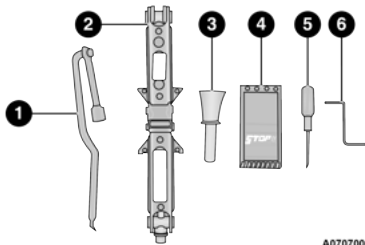

Jack And Tools

A0707000694US

- 1 – Wheel Bolt Wrench
 2 – Jack
 3 – Emergency Funnel
 4 – Wheel Chock (If Equipped)
 5 – Screwdriver
 6 – Emergency Allen Key

5. Remove the spare tire.

WARNING!

A loose tire or jack thrown forward in a collision or hard stop could endanger the occupants of the vehicle. Always stow the jack parts and the spare tire in the places provided. Have the deflated (flat) tire repaired or replaced immediately.

JACKING INSTRUCTIONS

WARNING!

Carefully follow these tire changing warnings to help prevent personal injury or damage to your vehicle:

- Always park on a firm, level surface as far from the edge of the roadway as possible before raising the vehicle.
- Turn on the Hazard Warning Flashers.
- Apply the parking brake and place an automatic transmission in PARK.
- Block the wheel diagonally opposite of the wheel to be raised.
- Never start or run the engine with the vehicle on a jack.

(Continued)

WARNING!

- Do not let anyone sit in the vehicle when it is on a jack.
- Do not get under the vehicle when it is on a jack. If you need to get under a raised vehicle, take it to a service center where it can be raised on a lift.
- Only use the jack in the positions indicated and for lifting this vehicle during a tire change.
- If working on or near a roadway, be extremely careful of motor traffic.
- To assure that spare tires, flat or inflated, are securely stowed, spares must be stowed with the valve stem facing the ground.

7



060600714

Jack Warning Label

CAUTION!

Do not attempt to raise the vehicle by jacking on locations other than those indicated in the Jacking Instructions for this vehicle.

1. Remove the spare tire, jack, and wheel bolt wrench.
2. If equipped with wheels where the center cap covers the wheel bolts, use the wheel bolt wrench to pry the center cap off carefully before raising the vehicle.
3. Before raising the vehicle, use the wheel bolt wrench to loosen, but not remove, the wheel bolts on the wheel with the flat tire. Turn the wheel bolts counterclockwise one turn while the wheel is still on the ground.

**Loosen The Wheel Bolt**

A0707000505US

NOTE:

Placement for the front and rear jacking locations are critical. See below images for proper jacking locations.

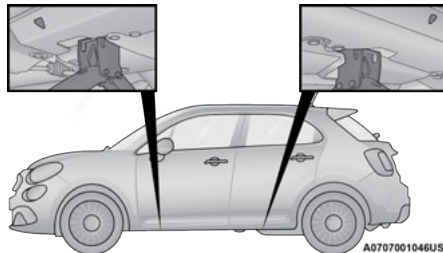
**Front And Rear Jacking Locations**

A0707001046US

4. Place the jack underneath the lift area that is closest to the flat tire. Turn the jack screw clockwise to firmly engage the jack saddle with the lift area of the sill flange, centering the jack saddle inside the cutout in the sill cladding.

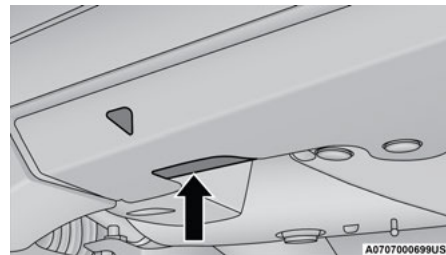
**Front Lifting Point**

A0707000699US

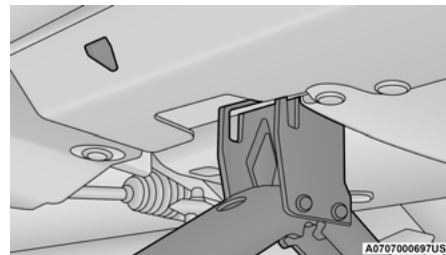
**Front Jacking Location**

A0707000697US

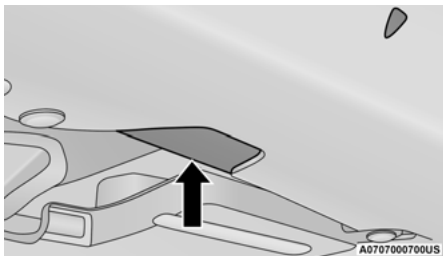

Rear Lifting Point

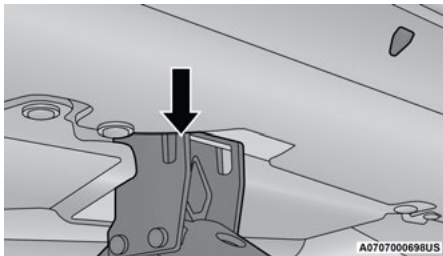

Rear Jacking Location

5. Raise the vehicle just enough to remove the flat tire.

WARNING!

Raising the vehicle higher than necessary can make the vehicle less stable. It could slip off the jack and hurt someone near it. Raise the vehicle only enough to remove the tire.

6. Remove the wheel bolts and tire.
7. Mount the spare tire.

CAUTION!

Be sure to mount the spare tire with the valve stem facing outward. The vehicle could be damaged if the spare tire is mounted incorrectly.

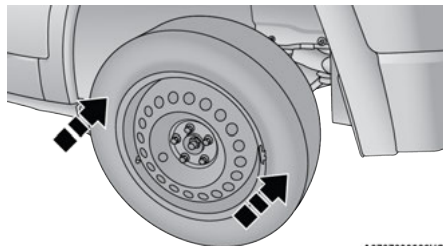

Mounting Spare Tire

NOTE:

For vehicles so equipped, do not attempt to install a center cap or wheel cover on the compact spare ↪ page 274.

8. Install the wheel bolts with the threaded end of the wheel bolt toward the wheel. Lightly tighten the wheel bolts.

WARNING!

To avoid the risk of forcing the vehicle off the jack, do not fully tighten the wheel bolts until the vehicle has been lowered. Failure to follow this warning may result in serious injury.

9. Lower the vehicle to the ground by turning the wheel bolt wrench counterclockwise.
10. Finish tightening the wheel bolts. Push down on the wrench while at the end of the handle for increased leverage. Tighten the wheel bolts in a star pattern until each wheel bolt has been tightened twice ↪ page 282.
11. Securely stow the jack, tools, chocks and flat tire.
12. After 25 miles (40 km) check the wheel bolt to ensure that all wheel bolts are properly seated against the wheel. If in doubt about the correct tightness, have them checked with a torque wrench by an authorized dealer or at a service station.

WARNING!

A loose tire or jack thrown forward in a collision or hard stop could endanger the occupants of the vehicle. Always stow the jack parts and the spare tire in the places provided. Have the deflated (flat) tire repaired or replaced immediately.

TIRE SERVICE KIT — IF EQUIPPED**TIRE SERVICE KIT STORAGE**

The Tire Service Kit is located in the rear storage compartment inside a storage container. Located inside the container are a screwdriver and the emergency fuel funnel. To access the Tire Service Kit open the liftgate and remove the load floor.

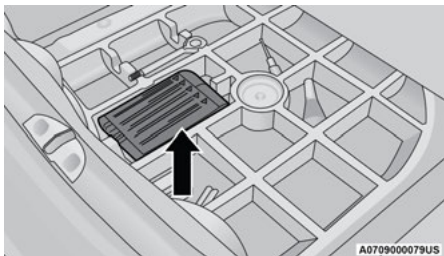
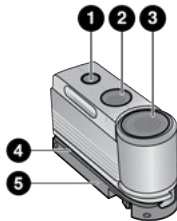
**Tire Service Kit Location****TIRE SERVICE KIT COMPONENTS AND OPERATION**

A0709000067US

Tire Service Kit Components

- 1 — Power Button
- 2 — Pressure Gauge
- 3 — Warning Label
- 4 — Sealant Hose (Clear)
- 5 — Power Plug (Located On Bottom Side Of Tire Service Kit)

If a tire is punctured, you can make a first emergency repair using the Tire Service Kit located in the rear storage compartment inside the storage container.

1. Remove the Tire Service Kit from the vehicle, take it out from the bag and place it near the punctured tire. Screw the clear flexible filling tube to the tire valve.
2. Insert the power plug into the vehicle power outlet socket. Start the vehicle engine.
3. Push the Tire Service Kit power button to the “I” position. The electric compressor will be turned on, sealant and air will inflate the tire. Minimum 26 psi (1.8 bar) of pressure should be reached within 20 minutes. If the pressure has not been reached turn off and remove the Tire Service Kit, drive the vehicle 30 feet (10 meters) back and forth, to better distribute the sealant inside the tire.
4. Attach the clear flexible filling tube of the compressor directly to the tire valve and repeat the inflation process.

When the correct pressure has been reached, start driving the vehicle to uniformly distribute the sealant inside the tire. After 10 minutes, stop and check the tire pressure. If the pressure is below 19 psi (1.3 bar), do not drive the vehicle, as the tire is too damaged, and contact the nearest authorized dealer.

WARNING!

Tire Service Kit is not a permanent flat tire repair. Have the tire inspected and repaired or replaced after using Tire Service Kit. Do not exceed 50 mph (80 km/h) until the tire is repaired or replaced. Failure to follow this warning can result in injuries that are serious or fatal to you, your passengers, and others around you. Have the tire checked as soon as possible at an authorized dealer.

NOTE:

The sealant is effective with external temperatures of between -40°F (-40°C) to 131°F (+55°C). The sealant has an expiry date. It is possible to repair tires which have been damaged on tread up to a diameter of 6mm. Show the cartridge and the label to the personnel charged with handling the tire treated with the tire repair kit.

If the pressure is at 19 psi (1.3 bar) or above repeat the inflation process to reach the correct tire pressure and continue driving.

5. Peel off the warning label from the bottle and place it on the dashboard as a reminder to the driver that the tire has been treated with Tire Service Kit.

WARNING!

The metal end fitting from Power Plug may get hot after use, so it should be handled carefully.

TIRE SERVICE KIT USAGE PRECAUTIONS**WARNING!**

- Do not attempt to seal a tire on the side of the vehicle closest to traffic. Pull far enough off the road to avoid the danger of being hit when using the Tire Service Kit.
- Do not use Tire Service Kit or drive the vehicle under the following circumstances:
 - If the puncture in the tire tread is approximately 1/4 inch (6 mm) or larger.
 - If the tire has any sidewall damage.
 - If the tire has any damage from driving with extremely low tire pressure.
 - If the tire has any damage from driving on a flat tire.
 - If the wheel has any damage.
 - If you are unsure of the condition of the tire or the wheel.

(Continued)

WARNING!

- Keep Tire Service Kit away from open flames or heat source.
- A loose Tire Service Kit thrown forward in a collision or hard stop could endanger the occupants of the vehicle. Always stow the Tire Service Kit in the place provided. Failure to follow these warnings can result in injuries that are serious or fatal to you, your passengers, and others around you.
- Take care not to allow the contents of Tire Service Kit to come in contact with hair, eyes, or clothing. Tire Service Kit sealant is harmful if inhaled, swallowed, or absorbed through the skin. It causes skin, eye, and respiratory irritation. Flush immediately with plenty of water if there is any contact with eyes or skin. Change clothing as soon as possible, if there is any contact with clothing.
- Tire Service Kit Sealant solution contains latex. In case of an allergic reaction or rash, consult a physician immediately. Keep Tire Service Kit out of reach of children. If swallowed, rinse mouth immediately with plenty of water and drink plenty of water. Do not induce vomiting! Consult a physician immediately.

REPLACING THE SEALANT

NOTE:

Replace the sealant canister prior to the expiration date at an authorized dealer.

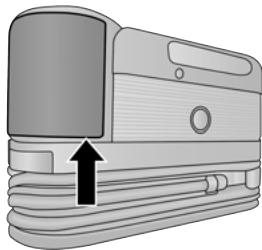

A0709000066US

Tire Service Kit Expiration Date Location

WARNING!

Store the sealant canister in its special compartment, away from sources of heat. Failure to follow this WARNING may result in sealant canister rupture and serious injury or death.

JUMP STARTING

If your vehicle has a discharged battery it can be jump started using a set of jumper cables and a battery in another vehicle or by using a portable battery booster pack. Jump starting can be dangerous if done improperly so please follow the procedures in this section carefully.

NOTE:

When using a portable battery booster pack follow the manufacturer's operating instructions and precautions.

WARNING!

Do not attempt jump starting if the battery is frozen. It could rupture or explode and cause personal injury.

CAUTION!

Do not use a portable battery booster pack or any other booster source with a system voltage greater than 12 Volts or damage to the battery, starter motor, alternator or electrical system may occur.

PREPARATIONS FOR JUMP START

The battery in your vehicle is located in the front of the engine compartment, behind the left headlight assembly.

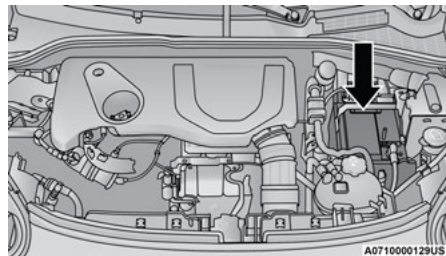

A0710000129US

Battery Location

NOTE:

The positive battery post may be covered with a protective cap. Lift up on the cap to gain access to the positive battery post. Do not jump off fuses.

Only jump directly off positive post which has a positive (+) symbol on or around the post.

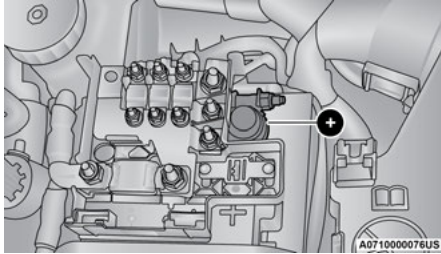

Positive (+) Battery Post

Follow the below steps to prepare for jump starting:

1. Turn off the heater, radio, and all electrical accessories.
2. Pull upward and remove the protective cover over the remote positive (+) battery post.

WARNING!

- Take care to avoid the radiator cooling fan whenever the hood is raised. It can start anytime the ignition switch is ON. You can be injured by moving fan blades.

(Continued)

WARNING!

- Remove any metal jewelry such as rings, watch bands and bracelets that could make an inadvertent electrical contact. You could be seriously injured.
- Batteries contain sulfuric acid that can burn your skin or eyes and generate hydrogen gas which is flammable and explosive. Keep open flames or sparks away from the battery.

JUMP STARTING PROCEDURE

WARNING!

Failure to follow this jump starting procedure could result in personal injury or property damage due to battery explosion.

CAUTION!

Failure to follow these procedures could result in damage to the charging system of the booster vehicle or the discharged vehicle.

Connecting The Jumper Cables

1. Connect the positive (+) end of the jumper cable to the positive (+) post of the discharged vehicle.
2. Connect the opposite end of the positive (+) jumper cable to the positive (+) post of the booster battery.
3. Connect the negative (-) end of the jumper cable to the negative (-) post of the booster battery.
4. Connect the opposite end of the negative (-) jumper cable to a good engine ground. A "ground" is an exposed metallic/unpainted part of the engine, frame or chassis, such as an accessory bracket or large bolt. The ground must be away from the battery and the fuel injection system.

WARNING!

Do not connect the jumper cable to the negative (-) post of the discharged battery. The resulting electrical spark could cause the battery to explode and could result in personal injury.

- Start the engine in the vehicle that has the booster battery, let the engine idle a few minutes, and then start the engine in the vehicle with the discharged battery.
- Once the engine is started, follow the disconnecting procedure below.

Disconnecting The Jumper Cables

- Disconnect the negative (-) end of the jumper cable from the engine ground of the vehicle with the discharged battery.
- Disconnect the opposite end of the negative (-) jumper cable from the negative (-) post of the booster battery.
- Disconnect the positive (+) end of the jumper cable from the positive (+) post of the booster battery.
- Disconnect the opposite end of the positive (+) jumper cable from the positive (+) post of the vehicle with the discharged battery.

If frequent jump starting is required to start your vehicle you should have the battery and charging system inspected at an authorized dealer.

CAUTION!

Accessories plugged into the vehicle power outlets draw power from the vehicle's battery, even when not in use (i.e., cellular devices, etc.). Eventually, if plugged in long enough without engine operation, the vehicle's battery will discharge sufficiently to degrade battery life and/or prevent the engine from starting.

IF YOUR ENGINE OVERHEATS

If the vehicle is overheating, it will need to be serviced by an authorized dealer.

In any of the following situations, you can reduce the potential for overheating your engine by taking the appropriate action.

- On the highways — slow down.
- In city traffic — while stopped, put transmission in NEUTRAL, but do not increase engine idle speed.

NOTE:

There are steps that you can take to slow down an impending overheat condition:

- If your Air Conditioner (A/C) is on, turn it off. The A/C system adds heat to the engine cooling system and turning the A/C off can help remove this heat.

- You can also turn the temperature control to maximum heat, the mode control to floor and the blower control to high. This allows the heater core to act as a supplement to the radiator and aids in removing heat from the engine cooling system.

CAUTION!

Driving with a hot cooling system could damage your vehicle. If the temperature gauge reads "H," pull over and stop the vehicle. Idle the vehicle with the air conditioner turned off until the pointer drops back into the normal range. If the pointer remains on the "H" and you hear continuous chimes, turn the engine off immediately and call for service.

WARNING!

You or others can be badly burned by hot engine coolant (antifreeze) or steam from your radiator. If you see or hear steam coming from under the hood, do not open the hood until the radiator has had time to cool. Never try to open a cooling system pressure cap when the radiator or coolant bottle is hot.

GEAR SELECTOR OVERRIDE

If a malfunction occurs and the gear selector cannot be moved out of the PARK position, you can use the following procedure to temporarily move the gear selector:

1. Turn the engine OFF.
2. Apply the Electric Park Brake.
3. Locate the bezel and boot assembly.

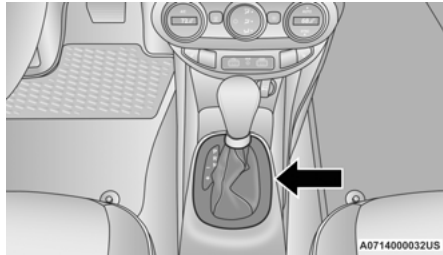

Gear Selector Bezel Location

4. Carefully separate the gear selector bezel and boot assembly from the center console.

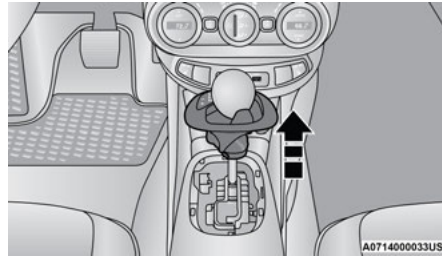

Removing Gear Selector Bezel

5. Press and maintain firm pressure on the brake pedal.
6. Insert a small screwdriver or similar tool down into the gear selector override access hole (at the right front corner of the gear selector assembly), and push and hold the override release lever down.

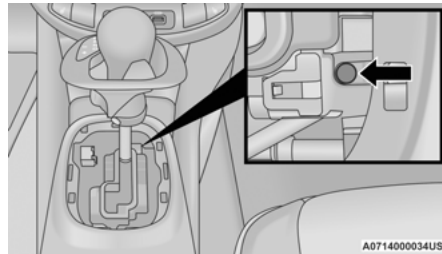

Gear Selector Override Location

7. Move the gear selector to the NEUTRAL position.
8. The vehicle may then be started in NEUTRAL.
9. Reinstall the gear selector bezel.

FREEING A STUCK VEHICLE

If your vehicle becomes stuck in mud, sand, or snow, it can often be moved using a rocking motion. Turn the steering wheel right and left to clear the area around the front wheels. Then shift back and forth between DRIVE (D) and REVERSE (R), while gently pressing the accelerator. Use the least amount of accelerator pedal pressure that will maintain the rocking motion, without spinning the wheels or racing the engine.

CAUTION!

- Racing the engine or spinning the wheels may lead to transmission overheating and failure. Allow the engine to idle with the transmission in NEUTRAL for at least one minute after every five rocking-motion cycles. This will minimize overheating and reduce the risk of clutch or transmission failure during prolonged efforts to free a stuck vehicle.

(Continued)

CAUTION!

- When “rocking” a stuck vehicle by shifting between DRIVE/SECOND gear and REVERSE, do not spin the wheels faster than 15 mph (24 km/h), or drivetrain damage may result.
- Revving the engine or spinning the wheels too fast may lead to transmission overheating and failure. It can also damage the tires. Do not spin the wheels above 30 mph (48 km/h) while in gear (no transmission shifting occurring).

Shifts between DRIVE and REVERSE can only be achieved at wheel speeds of 5 mph (8 km/h) or less. Whenever the transmission remains in NEUTRAL for more than two seconds, you must press the brake pedal to engage DRIVE or REVERSE.

NOTE:

Push the ESC OFF switch to place the Electronic Stability Control (ESC) system in “Partial OFF” mode, before rocking the vehicle ⇨ page 172. Once the vehicle has been freed, push the ESC OFF switch again to restore “ESC On” mode.

WARNING!

Fast spinning tires can be dangerous. Forces generated by excessive wheel speeds may cause damage, or even failure, of the axle and tires. A tire could explode and injure someone. Do not spin your vehicle's wheels faster than 30 mph (48 km/h) or for longer than 30 seconds continuously without stopping when you are stuck and do not let anyone near a spinning wheel, no matter what the speed.

TOWING A DISABLED VEHICLE

This section describes procedures for towing a disabled vehicle using a commercial towing service.

Towing Condition	Wheels OFF The Ground	ALL-WHEEL DRIVE
Flat Tow	NONE	NOT ALLOWED
Wheel Lift Or Dolly Tow	Rear	NOT ALLOWED
	Front	NOT ALLOWED
Flatbed	ALL	OK

This vehicle must be towed with all four wheels **OFF** the ground.

If you must use the accessories (wipers, defrosters, etc.) while being towed, the ignition must be in the RUN position.

If the key fob is unavailable or the vehicle's battery is discharged, find Instructions on shifting the transmission out of PARK in order to move the vehicle ⇨ page 225.

CAUTION!

- Do not use sling type equipment when towing. Vehicle damage may occur.
- When securing the vehicle to a flat bed truck, do not attach to front or rear suspension components. Damage to your vehicle may result from improper towing.

ALL-WHEEL DRIVE (AWD) MODELS

FCA US LLC requires towing with all four wheels **OFF** the ground. Acceptable methods are to tow the vehicle on a flatbed, or with one end of the vehicle raised and the opposite end on a towing dolly.

CAUTION!

- DO NOT tow this vehicle with ANY of its wheels on the ground. Damage to the drivetrain will result.
- Front or rear wheel lifts must not be used (if the remaining wheels are on the ground). Internal damage to the transmission or power transfer unit will occur if a front or rear wheel lift is used when towing.
- Towing this vehicle in violation of the above requirements can cause severe transmission and/or power transfer unit damage. Damage from improper towing is not covered under the New Vehicle Limited Warranty.

TOW EYE USAGE — IF EQUIPPED

Your vehicle is equipped with a tow eye that can be used to move a disabled vehicle.

When using a tow eye, be sure to follow the Tow Eye Usage Precautions below.

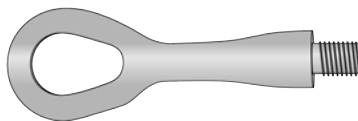

A0717000043US

Tow Eye**Tow Eye Usage Precautions****CAUTION!**

- The tow eye must only be used for roadside emergencies. Use with an appropriate device in accordance with highway code (a rigid bar or rope) to maneuver the vehicle in preparation for transport via a tow truck.
- The tow eye must not be used to move the vehicle off the road or where there are obstacles.
- Do not use the tow eyes for tow truck hookup or highway towing.
- Do not use the tow eye to free a stuck vehicle ↪ page 225.
- Damage to your vehicle may occur if these guidelines are not followed ↪ page 226.

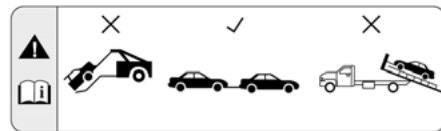

0614050352

Tow Eye Warning Label**WARNING!**

Stand clear of vehicles when pulling with tow eyes.

- Do not use a chain with a tow eye. Chains may break, causing serious injury or death.
- Do not use a tow strap with a tow eye. Tow straps may break or become disengaged, causing serious injury or death.
- Failure to follow proper tow eye usage may cause components to break resulting in serious injury or death.

Front Tow Eye Installation

The front tow eye receptacle is located behind an access door, located on the right side of the front fascia/bumper. To install the tow eye, open the access door using the vehicle key or a small screwdriver, and thread the tow eye into the receptacle.

Insert the wheel bolt wrench handle through the eye and tighten. The tow eye must be fully seated to the attaching bracket through the lower front fascia/bumper as shown. If the tow eye is not fully seated to the attaching bracket, the vehicle should not be towed.

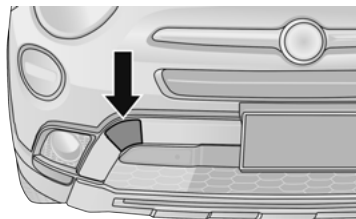

A0717000071US

Front Tow Eye Access Door

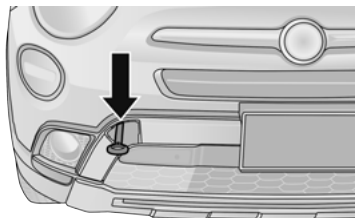

A0717000070US

Front Tow Eye Installed

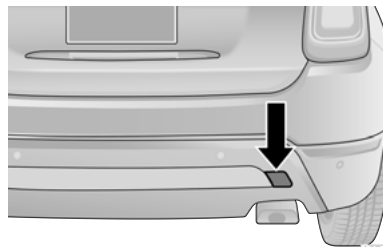

A0717000073US

Rear Tow Eye Access Door

Rear Tow Eye Installation

The rear tow eye receptacle is located behind a access door on the rear fascia/bumper.

To install the tow eye, open the access door using the vehicle key or a small screwdriver, and thread the tow eye into the receptacle.

Insert the wheel bolt wrench handle through the eye and tighten. The tow eye must be fully seated to the attaching bracket through the lower rear fascia/bumper. If the tow eye is not fully seated to the attaching bracket, the vehicle should not be towed.

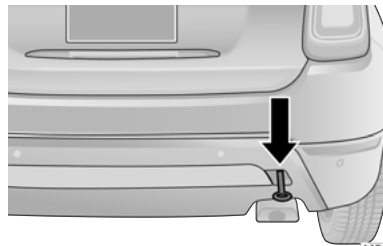

A0717000072US

Rear Tow Eye Installed

ENHANCED ACCIDENT RESPONSE SYSTEM (EARS)

This vehicle is equipped with an Enhanced Accident Response System.

This feature is a communication network that takes effect in the event of an impact → page 197.

EVENT DATA RECORDER (EDR)

This vehicle is equipped with an event data recorder (EDR). The main purpose of an EDR is to record data that will assist in understanding how a vehicle's systems performed under certain crash or near crash-like situations, such as an air bag deployment or hitting a road obstacle → page 200.

SERVICING AND MAINTENANCE

SCHEDULED MAINTENANCE

Your vehicle is equipped with an automatic oil change indicator system. The oil change indicator system will remind you that it is time to take your vehicle in for scheduled maintenance.

Based on engine operation conditions, the oil change indicator message will illuminate in the instrument cluster. This means that service is required for your vehicle. Operating conditions such as frequent short-trips, trailer tow and extremely hot or cold ambient temperatures will influence when the "Change Oil" or "Oil Change Required" message is displayed. Have your vehicle serviced as soon as possible, within the next 500 miles (805 km).

An authorized dealer will reset the oil change indicator message after completing the scheduled oil change.

NOTE:

Under no circumstances should oil change intervals exceed 10,000 miles (16,000 km), 12 months or 350 hours of engine run time, whichever comes first. The 350 hours of engine run or idle time is generally only a concern for fleet customers.

NOTE:

The Oil Change Indicator will not illuminate under these conditions.

Once A Month Or Before A Long Trip:

- Check engine oil level.
- Check windshield washer fluid level.
- Check the tire inflation pressures and look for unusual wear or damage.
- Check the fluid levels of the coolant reservoir, and brake master cylinder reservoir, and fill as needed.
- Check function of all interior and exterior lights.

MAINTENANCE PLAN

At Every Oil Change Interval As Indicated By Oil Change Indicator System:
Change oil and filter.
Inspect battery and clean and tighten terminals as required.
Inspect the CV/Universal joints.
Inspect brake pads, shoes, rotors, drums, and hoses.
Inspect engine cooling system protection and hoses.
Check and adjust hand brake.
Inspect exhaust system.
Inspect engine air cleaner filter if using in dusty or off-road conditions.

NOTE:

Using white lithium grease, lubricate the door hinge roller pivot joints twice a year to prevent premature wear.

Mileage or time passed (whichever comes first)	10,000	20,000	30,000	40,000	50,000	60,000	70,000	80,000	90,000	100,000	110,000	120,000	130,000	140,000	150,000
Or Years:	1	2	3	4	5	6	7	8	9	10	11	12	13	14	15
Or Kilometers:	16,000	32,000	48,000	64,000	80,000	96,000	112,000	128,000	144,000	160,000	176,000	192,000	208,000	224,000	240,000
Visually check the condition and wear of the front and rear brakes.	•	•	•	•	•	•	•	•	•	•	•	•	•	•	•
Check the front suspension, tie rods and replace if necessary.		•		•		•		•		•		•		•	
Inspect the CV/Universal joints.	•	•	•	•	•	•	•	•	•	•	•	•	•	•	•
Visual inspect the condition of the accessory drive belt.				•											
Check the tension of the accessory drive belt.		•								•					
Inspect and replace, if required, front end accessory drive belt, tensioner, and, idler pulley.								•							•
Inspect and replace PCV valve if necessary.										•					
Change engine oil and replace oil filter. ¹	In accordance with Oil Change Indicator System OR Severe Duty Mileage, whichever occurs first.														
Inspect the PTU fluid level.				•				•				•			
Inspect the rear differential fluid level.				•				•				•			
Replace spark plugs. ²				•				•				•			
Replace engine air cleaner filter. ³		•		•		•		•		•		•		•	

Mileage or time passed (whichever comes first)	10,000	20,000	30,000	40,000	50,000	60,000	70,000	80,000	90,000	100,000	110,000	120,000	130,000	140,000	150,000
Or Years:	1	2	3	4	5	6	7	8	9	10	11	12	13	14	15
Or Kilometers:	16,000	32,000	48,000	64,000	80,000	96,000	112,000	128,000	144,000	160,000	176,000	192,000	208,000	224,000	240,000
Replace brake fluid every two years.		•		•		•		•		•		•		•	
Replace cabin filter.	○	•	○	•	○	•	○	•	○	•	○	•	○	•	○
Flush and replace the engine coolant at 10 years or 150,000 miles (240,000 km) whichever comes first.										•					•

- The oil and oil filter replacement must be carried out when indicated by a warning light or message on the instrument panel, or in any case should not exceed 1 year or 10,000 miles (16,000 km).
- The spark plug change is distance based only, yearly intervals do not apply. The following are essential to ensure correct operation and prevent serious damage to the engine:
 - Only use spark plugs of the same make and type which are specially certified for such engines → page 286.
 - Strictly comply with the spark plug replacement interval given in the "Maintenance Plan" for spark plug replacement.
 - Contact an authorized dealer if you have any questions.
- The engine air cleaner filter should be inspected at every oil change if used in dusty areas.
 - Recommend replacement
 - Mandatory service

WARNING!

- You can be badly injured working on or around a motor vehicle. Do only service work for which you have the knowledge and the right equipment. If you have any doubt about your ability to perform a service job, take your vehicle to a competent mechanic.
- Failure to properly inspect and maintain your vehicle could result in a component malfunction and effect vehicle handling and performance. This could cause an accident.

ENGINE COMPARTMENT

1.3L TURBO ENGINE

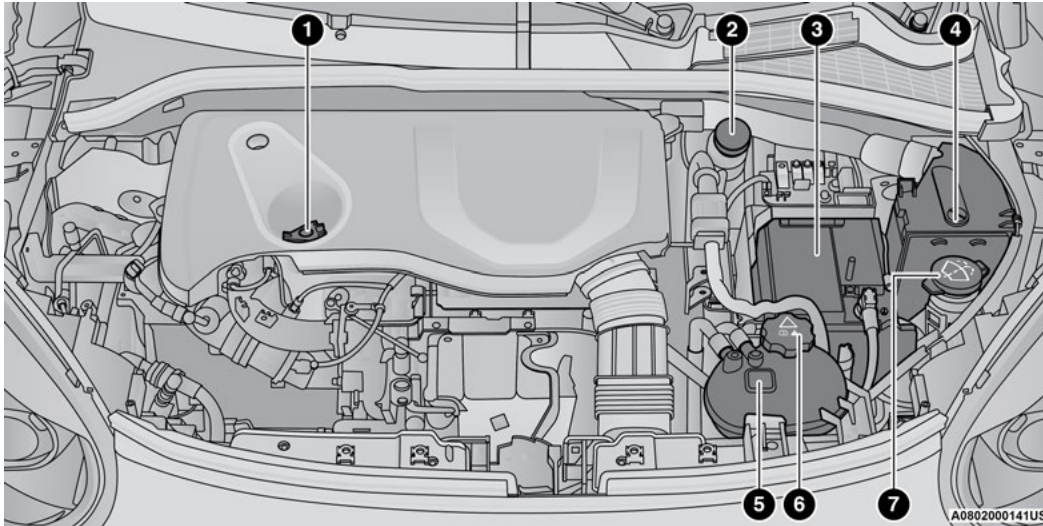

- 1 – Oil Fill Cap/Engine Oil Dipstick
- 2 – Brake Fluid Reservoir Cap
- 3 – Battery
- 4 – Power Distribution Center (Fuses)

- 5 – Engine Coolant Reservoir
- 6 – Engine Coolant Pressure Cap
- 7 – Washer Fluid Reservoir Cap

CHECKING OIL LEVEL

To ensure proper engine lubrication, the engine oil must be maintained at the correct level. Check the oil level at regular intervals, such as every fuel stop. The best time to check the engine oil level is about five minutes after a fully warmed up engine is shut off.

Checking the oil while the vehicle is on level ground will improve the accuracy of the oil level readings.

NOTE:

The dipstick is integral with the cap.

Engine Oil Cap/Dipstick Installation

Install the oil cap/dipstick aligning arrow on the cap with arrow on the engine cover and then screw the cap down.

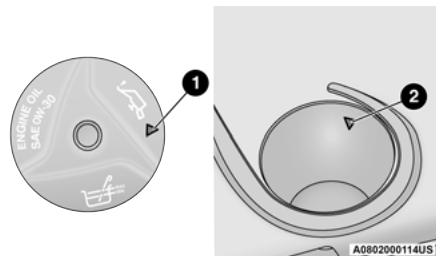

1 — Oil Cap/Dipstick Arrow

2 — Engine Cover Arrow

There are four possible dipstick types:

- Crosshatched zone.
- Crosshatched zone marked SAFE.
- Crosshatched zone marked with MIN at the low end of the range and MAX at the high end of the range.
- Crosshatched zone marked with dimples at the MIN and the MAX ends of the range.

NOTE:

Always maintain the oil level within the crosshatch markings on the dipstick.

Adding 1 quart (1 liter) of oil when the reading is at the low end of the dipstick range will raise the oil level to the high end of the range marking.

CAUTION!

Overfilling or underfilling the crankcase will cause aeration or loss of oil pressure. This could damage your engine.

ADDING WASHER FLUID

The windshield washer fluid reservoir is located in the engine compartment, and the fluid level should be checked at regular intervals. Fill the reservoir with windshield washer solvent (not engine coolant/ antifreeze) ↪ page 235.

WARNING!

Commercially available windshield washer solvents are flammable. They could ignite and burn you. Care must be exercised when filling or working around the washer solution.

MAINTENANCE-FREE BATTERY

Your vehicle is equipped with a maintenance-free battery. You will never have to add water, and periodic maintenance is not required.

WARNING!

- Battery fluid is a corrosive acid solution and can burn or even blind you. Do not allow battery fluid to contact your eyes, skin, or clothing. Do not lean over a battery when attaching clamps. If acid splashes in eyes or on skin, flush the area immediately with large amounts of water ↪ page 222.
- Battery gas is flammable and explosive. Keep flame or sparks away from the battery. Do not use a booster battery or any other booster source with an output greater than 12 Volts. Do not allow cable clamps to touch each other.

(Continued)

WARNING!

- Battery posts, terminals, and related accessories contain lead and lead compounds. Wash hands after handling.

CAUTION!

- It is essential when replacing the cables on the battery that the positive cable is attached to the positive post and the negative cable is attached to the negative post. Battery posts are marked positive (+) and negative (-) and are identified on the battery case. Cable clamps should be tight on the terminal posts and free of corrosion.
- If a “fast charger” is used while the battery is in the vehicle, disconnect both vehicle battery cables before connecting the charger to the battery. Do not use a “fast charger” to provide starting voltage.

PRESSURE WASHING

Cleaning the engine compartment with a high pressure washer is not recommended.

CAUTION!

Precautions have been taken to safeguard all parts and connections however, the pressures generated by these machines is such that complete protection against water ingress cannot be guaranteed.

VEHICLE MAINTENANCE

An authorized dealer has the qualified service personnel, special tools, and equipment to perform all service operations in an expert manner. Service Manuals are available which include detailed service information for your vehicle. Refer to these Service Manuals before attempting any procedure yourself.

NOTE:

Intentional tampering with emissions control systems may void your warranty and could result in civil penalties being assessed against you.

WARNING!

You can be badly injured working on or around a motor vehicle. Only do service work for which you have the knowledge and the proper equipment. If you have any doubt about your ability to perform a service job, take your vehicle to a competent mechanic.

ENGINE OIL**Engine Oil Selection**

For best performance and maximum protection for turbocharged engines under all types of operating conditions, the manufacturer recommends synthetic engine oils that are API Certified and meet the requirements of the manufacturer Material Standard MS-13340

American Petroleum Institute (API) Engine Oil Identification Symbol

This symbol means that the oil has been certified by the API. The manufacturer only recommends API Certified engine oils.

This symbol certifies 0W-20, 5W-20, 0W-30, 5W-30 and 10W-30 engine oils.

CAUTION!

Do not use chemical flushes in your engine oil as the chemicals can damage your engine. Such damage is not covered by the New Vehicle Limited Warranty.

Materials Added To Engine Oil

The manufacturer strongly recommends against the addition of any additives (other than leak detection dyes) to the engine oil. Engine oil is an engineered product and its performance may be impaired by supplemental additives.

Disposing Of Used Engine Oil And Oil Filters

Care should be taken in disposing of used engine oil and oil filters from your vehicle. Used oil and oil filters, indiscriminately discarded, can present a problem to the environment. Contact an authorized dealer, service station or governmental agency for advice on how and where used oil and oil filters can be safely discarded in your area.

ENGINE OIL FILTER

The engine oil filter should be replaced with a new filter at every engine oil change.

Engine Oil Filter Selection

A full-flow type disposable oil filter should be used for replacement. The quality of replacement filters varies considerably. Only high quality Mopar® certified filters should be used.

ENGINE AIR CLEANER FILTER

For the proper maintenance intervals ⇨ page 231.

WARNING!

The air induction system (air cleaner, hoses, etc.) can provide a measure of protection in the case of engine backfire. Do not remove the air induction system (air cleaner, hoses, etc.) unless such removal is necessary for repair or maintenance. Make sure that no one is near the engine compartment before starting the vehicle with the air induction system (air cleaner, hoses, etc.) removed. Failure to do so can result in serious personal injury.

Engine Air Cleaner Filter Selection

The quality of replacement filters varies considerably. Only high quality Mopar® certified filters should be used.

ACCESSORY DRIVE BELT INSPECTION**WARNING!**

- Do not attempt to inspect an accessory drive belt with vehicle running.
- When working near the radiator cooling fan, disconnect the fan motor lead. The fan is temperature controlled and can start at any time regardless of ignition mode. You could be injured by the moving fan blades.
- You can be badly injured working on or around a motor vehicle. Only do service work for which you have the knowledge and the proper equipment. If you have any doubt about your ability to perform a service job, take your vehicle to a competent mechanic.

When inspecting accessory drive belts, small cracks that run across ribbed surface of belt from rib to rib, are considered normal. These are not a reason to replace belt. However, cracks running along a rib (not across) are not normal. Any belt with cracks running along a rib must be replaced. Also have the belt replaced if it has excessive wear, frayed cords or severe glazing.

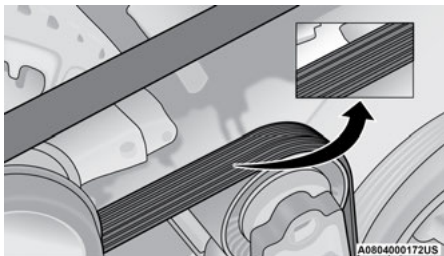

Accessory Belt (Serpentine Belt)

Conditions that would require replacement:

- Rib chunking (one or more ribs has separated from belt body)
- Rib or belt wear
- Longitudinal belt cracking (cracks between two ribs)
- Belt slips
- "Groove jumping" (belt does not maintain correct position on pulley)
- Belt broken (note: identify and correct problem before new belt is installed)
- Noise (objectionable squeal, squeak, or rumble is heard or felt while drive belt is in operation)

Some conditions can be caused by a faulty component such as a belt pulley. Belt pulleys should be carefully inspected for damage and proper alignment.

Belt replacement on some models requires the use of special tools, we recommend having your vehicle serviced at an authorized dealer.

AIR CONDITIONER MAINTENANCE

For best possible performance, your air conditioner should be checked and serviced by an authorized dealer at the start of each warm season. This service should include cleaning of the condenser fins and a performance test. Drive belt tension should also be checked at this time.

WARNING!

- Use only refrigerants and compressor lubricants approved by the manufacturer for your air conditioning system. Some unapproved refrigerants are flammable and can explode, injuring you. Other unapproved refrigerants or lubricants can cause the system to fail, requiring costly repairs. Refer to Warranty Information Book, located in your owner's information kit, for further warranty information.
- The air conditioning system contains refrigerant under high pressure. To avoid risk of personal injury or damage to the system, adding refrigerant or any repair requiring lines to be disconnected should be done by an experienced technician.

CAUTION!

Do not use chemical flushes in your air conditioning system as the chemicals can damage your air conditioning components. Such damage is not covered by the New Vehicle Limited Warranty.

Refrigerant Recovery And Recycling – R-1234yf

R-1234yf Air Conditioning Refrigerant is a hydrofluoroolefin (HFO) that is endorsed by the Environmental Protection Agency and is an ozone-friendly substance with a low global-warming potential. The manufacturer recommends that air conditioning service be performed by an authorized dealer using recovery and recycling equipment.

NOTE:

Use only manufacturer approved A/C system PAG compressor oil, and refrigerants.

Cabin Air Filter

See an authorized dealer for service.

BODY LUBRICATION

Locks and all body pivot points, including such items as seat tracks, door hinge pivot points and rollers, liftgate, tailgate, decklid, sliding doors and hood hinges, should be lubricated periodically with

a lithium based grease, such as Mopar® Spray White Lube to ensure quiet, easy operation and to protect against rust and wear. Prior to the application of any lubricant, the parts concerned should be wiped clean to remove dust and grit; after lubricating excess oil and grease should be removed. Particular attention should also be given to hood latching components to ensure proper function. When performing other underhood services, the hood latch, release mechanism and safety catch should be cleaned and lubricated.

The external lock cylinders should be lubricated twice a year, preferably in the Autumn and Spring. Apply a small amount of a high quality lubricant, such as Mopar® Lock Cylinder Lubricant directly into the lock cylinder.

WINDSHIELD WIPER BLADES

Clean the rubber edges of the wiper blades and the windshield periodically with a sponge or soft cloth and a mild nonabrasive cleaner. This will remove accumulations of salt or road film.

Operation of the wipers on dry glass for long periods may cause deterioration of the wiper blades. Always use washer fluid when using the wipers to remove salt or dirt from a dry windshield.

Avoid using the wiper blades to remove frost or ice from the windshield. Keep the blade rubber out of contact with petroleum products such as engine oil, gasoline, etc.

NOTE:

Life expectancy of wiper blades varies depending on geographical area and frequency of use. Poor performance of blades may be present with chattering, marks, water lines or wet spots. If any of these conditions are present, clean the wiper blades or replace as necessary.

The wiper blades and wiper arms should be inspected periodically, not just when wiper performance problems are experienced. This inspection should include the following points:

- Wear or uneven edges
- Foreign material
- Hardening or cracking
- Deformation or fatigue

If a wiper blade or wiper arm is damaged, replace the affected wiper arm or blade with a new unit. Do not attempt to repair a wiper arm or blade that is damaged.

Service Position Strategy

The service position allows the wiper blades to be placed in a position that allows the wiper blades to be easily changed.

To enable the Service Position Strategy, the wipers must be in the Park position before placing the ignition in the OFF mode.

Service Mode must be activated within two minutes after the ignition is placed in the OFF mode.

To have a correct activation of strategy, the Service Position command (anti-panic) must be active for at least half a second.

At every valid activation of Service Position command, the wiper blades are activated for 250 ms.

The Service Position command can be repeated several times to bring the blades into the desired position, up to a maximum of three times.

After three subsequent activations the strategy is disabled.

Function Deactivation:

The functionality is reset if:

- The ignition is turned to the RUN mode.
- Number of subsequent activations is three.
- Two minute timer has expired after placing the ignition OFF.

NOTE:

When turning the ignition ON, the blades will go into the parking position.

Front Wiper Blade Removal/Installation

1. Lift the front wiper arm upward to raise the wiper blade off of the windshield.
2. Push the release button on the arm of the wiper blade.
3. Push the wiper blade up and remove it.

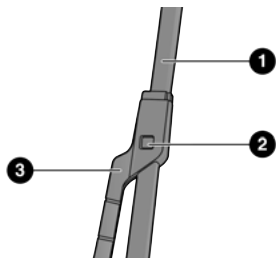

A0804000232US

- 1 — Wiper Blade
2 — Release Button
3 — Wiper Arm

4. Install the wiper blade and firmly push the wiper blade until it snaps into place.

Rear Wiper Blade Removal/Installation

1. Carefully lift the rear wiper arm upward to raise the wiper blade off of the liftgate glass.
2. Grab and hold the wiper arm closest to the wiper blade end while pushing the wiper blade towards the liftgate glass to unsnap the blade pivot pin from the wiper blade holder on the wiper arm.
3. Install the wiper blade pivot pin into the wiper blade holder at the end of the wiper arm, and firmly push the wiper blade until it snaps into place.

EXHAUST SYSTEM

The best protection against carbon monoxide entry into the vehicle body is a properly maintained engine exhaust system.

If you notice a change in the sound of the exhaust system; or if the exhaust fumes can be detected inside the vehicle; or when the underside or rear of the vehicle is damaged; have an authorized technician inspect the complete exhaust system and adjacent body areas for broken, damaged, deteriorated, or mispositioned parts. Open seams or loose connections could permit exhaust fumes to seep into the passenger compartment. In

addition, have the exhaust system inspected each time the vehicle is raised for lubrication or oil change. Replace as required.

WARNING!

- Exhaust gases can injure or kill. They contain carbon monoxide (CO), which is colorless and odorless. Breathing it can make you unconscious and can eventually poison you. To avoid breathing CO → page 213.
- A hot exhaust system can start a fire if you park over materials that can burn. Such materials might be grass or leaves coming into contact with your exhaust system. Do not park or operate your vehicle in areas where your exhaust system can contact anything that can burn.

CAUTION!

- The catalytic converter requires the use of unleaded fuel only. Leaded gasoline will destroy the effectiveness of the catalyst as an emissions control device and may seriously reduce engine performance and cause serious damage to the engine.

(Continued)

CAUTION!

- Damage to the catalytic converter can result if your vehicle is not kept in proper operating condition. In the event of engine malfunction, particularly involving engine misfire or other apparent loss of performance, have your vehicle serviced promptly. Continued operation of your vehicle with a severe malfunction could cause the converter to overheat, resulting in possible damage to the converter and vehicle.

Under normal operating conditions, the catalytic converter will not require maintenance. However, it is important to keep the engine properly tuned to ensure proper catalyst operation and prevent possible catalyst damage.

NOTE:

Intentional tampering with emissions control systems can result in civil penalties being assessed against you.

In unusual situations involving grossly malfunctioning engine operation, a scorching odor may suggest severe and abnormal catalyst overheating. If this occurs, stop the vehicle, turn off the engine and allow it to cool. Service, including a tune-up to manufacturer's specifications, should be obtained immediately.

To minimize the possibility of catalytic converter damage:

- Do not interrupt the ignition when the transmission is in gear and the vehicle is in motion.
- Do not try to start the vehicle by pushing or towing the vehicle.
- Do not idle the engine with any ignition components disconnected or removed, such as when diagnostic testing, or for prolonged periods during very rough idle or malfunctioning operating conditions.

COOLING SYSTEM**WARNING!**

- You or others can be badly burned by hot engine coolant (antifreeze) or steam from your radiator. If you see or hear steam coming from under the hood, do not open the hood until the radiator has had time to cool. Never open a cooling system pressure cap when the radiator or coolant bottle is hot.
- Keep hands, tools, clothing, and jewelry away from the radiator cooling fan when the hood is raised. The fan starts automatically and may start at any time, whether the engine is running or not.

(Continued)

WARNING!

- When working near the radiator cooling fan, disconnect the fan motor lead or turn the ignition to the OFF mode. The fan is temperature controlled and can start at any time the ignition is in the ON mode.

Engine Coolant Checks

Check the engine coolant (antifreeze) protection every 12 months (before the onset of freezing weather, where applicable). If the engine coolant is dirty, the system should be drained, flushed, and refilled with fresh Organic Additive Technology (OAT) coolant (conforming to MS.90032) by an authorized dealer. Check the front of the A/C condenser for any accumulation of bugs, leaves, etc. If dirty, clean by gently spraying water from a garden hose vertically down the face of the condenser.

Check the engine cooling system hoses for brittle rubber, cracking, tears, cuts, and tightness of the connection at the coolant recovery bottle and radiator. Inspect the entire system for leaks. **DO NOT REMOVE THE COOLANT PRESSURE CAP WHEN THE COOLING SYSTEM IS HOT.**

Cooling System — Drain, Flush And Refill

NOTE:

Some vehicles require special tools to add coolant properly. Failure to fill these systems properly could lead to severe internal engine damage. If any coolant is needed to be added to the system please contact an authorized dealer.

If the engine coolant (antifreeze) is dirty or contains visible sediment, have an authorized dealer clean and flush with Organic Additive Technology (OAT) coolant (conforming to MS.90032).

For the proper maintenance intervals → page 231.

Selection Of Coolant

For further information → page 286.

NOTE:

- Mixing of engine coolant (antifreeze) other than specified Organic Additive Technology (OAT) engine coolant, may result in engine damage and may decrease corrosion protection. OAT engine coolant is different and should not be mixed with Hybrid Organic Additive Technology (HOAT) engine coolant or any “globally compatible” coolant. If a non-OAT engine coolant is introduced into the cooling system in an emergency, the cooling system will need to be drained, flushed, and refilled with fresh OAT coolant (conforming to MS.90032), by an authorized dealer as soon as possible.

- Do not use water alone or alcohol-based engine coolant products. Do not use additional rust inhibitors or anti-rust products, as they may not be compatible with the radiator engine coolant and may plug the radiator.
- This vehicle has not been designed for use with propylene glycol-based engine coolant. Use of propylene glycol-based engine coolant is not recommended.
- Some vehicles require special tools to add coolant properly. Failure to fill these systems properly could lead to severe internal engine damage. If any coolant is needed to be added to the system please contact an authorized dealer.

Adding Coolant

Your vehicle has been built with an improved engine coolant (OAT coolant conforming to MS.90032) that allows extended maintenance intervals. This engine coolant (antifreeze) can be used up to ten years or 150,000 miles (240,000 km) before replacement. To prevent reducing this extended maintenance period, it is important that you use the same engine coolant (OAT coolant conforming to MS.90032) throughout the life of your vehicle.

Please review these recommendations for using Organic Additive Technology (OAT) engine coolant that meets the requirements of the manufacturer Material Standard MS.90032. When adding engine coolant:

- We recommend using Mopar® Antifreeze/Coolant 10 Year/150,000 Mile (240,000 km) Formula OAT that meets the requirements of the manufacturer Material Standard MS.90032.
- Mix a minimum solution of 50% OAT engine coolant that meets the requirements of the manufacturer Material Standard MS.90032 and distilled water. Use higher concentrations (not to exceed 70%) if temperatures below -34°F (-37°C) are anticipated. Please contact an authorized dealer for assistance.
- Use only high purity water such as distilled or deionized water when mixing the water/engine coolant solution. The use of lower quality water will reduce the amount of corrosion protection in the engine cooling system.

NOTE:

- It is the owner's responsibility to maintain the proper level of protection against freezing according to the temperatures occurring in the area where the vehicle is operated.
- Some vehicles require special tools to add coolant properly. Failure to fill these systems properly could lead to severe internal engine damage. If any coolant is needed to be added to the system, please contact a local authorized dealer.
- Mixing engine coolant types is not recommended and can result in cooling system

damage. If HOAT and OAT coolant are mixed in an emergency, have a authorized dealer drain, flush, and refill with OAT coolant (conforming to MS.90032) as soon as possible.

Cooling System Pressure Cap

The cap must be fully tightened to prevent loss of engine coolant (antifreeze), and to ensure that engine coolant will return to the radiator from the coolant expansion bottle/recovery tank (if equipped).

The cap should be inspected and cleaned if there is any accumulation of foreign material on the sealing surfaces.

WARNING!

- Do not open hot engine cooling system. Never add engine coolant (antifreeze) when the engine is overheated. Do not loosen or remove the cap to cool an overheated engine. Heat causes pressure to build up in the cooling system. To prevent scalding or injury, do not remove the pressure cap while the system is hot or under pressure.
- Do not use a pressure cap other than the one specified for your vehicle. Personal injury or engine damage may result.

Disposal Of Used Coolant

Used ethylene glycol-based coolant (antifreeze) is a regulated substance requiring proper disposal. Check with your local authorities to determine the disposal rules for your community. To prevent ingestion by animals or children, do not store ethylene glycol-based coolant in open containers or allow it to remain in puddles on the ground, clean up any ground spills immediately. If ingested by a child or pet, seek emergency assistance immediately.

Coolant Level

The coolant expansion bottle provides a quick visual method for determining that the coolant level is adequate. With the engine off and cold, the level of the coolant (antifreeze) in the bottle should be between the "MAX" and "MIN" lines marked on the bottle.

As long as the engine operating temperature is satisfactory, the coolant bottle need only be checked once a month.

When additional coolant is needed to maintain the proper level, it should be added to the coolant bottle. Do not overfill.

See an authorized dealer for service.

Cooling System Notes

NOTE:

When the vehicle is stopped after a few miles/kilometers of operation, you may observe vapor coming from the front of the engine compartment. This is normally a result of moisture from rain, snow, or high humidity accumulating on the radiator and being vaporized when the thermostat opens, allowing hot engine coolant (antifreeze) to enter the radiator.

If an examination of your engine compartment shows no evidence of radiator or hose leaks, the vehicle may be safely driven. The vapor will soon dissipate.

- Do not overfill the coolant expansion bottle.
- Check the coolant freeze point in the radiator and in the coolant expansion bottle. If engine coolant needs to be added, the contents of the coolant expansion bottle must also be protected against freezing.
- If frequent engine coolant additions are required, the cooling system should be pressure tested for leaks.
- Maintain engine coolant concentration at a minimum of 50% OAT coolant (conforming to MS.90032) and distilled water for proper corrosion protection of your engine which contains aluminum components.

- Make sure that the coolant expansion bottle overflow hoses are not kinked or obstructed.
- Keep the front of the radiator clean. If your vehicle is equipped with air conditioning, keep the front of the condenser clean.
- Do not change the thermostat for Summer or Winter operation. If replacement is ever necessary, install **ONLY** the correct type thermostat. Other designs may result in unsatisfactory engine cooling performance, poor gas mileage, and increased emissions.

BRAKE SYSTEM

In order to ensure brake system performance, all brake system components should be inspected periodically ↪ page 231.

WARNING!

Riding the brakes can lead to brake failure and possibly a collision. Driving with your foot resting or riding on the brake pedal can result in abnormally high brake temperatures, excessive lining wear, and possible brake damage. You would not have your full braking capacity in an emergency.

Brake Master Cylinder

The fluid level in the master cylinder should be checked when performing under hood services, or immediately if the “Brake Warning Light” is on.

Be sure to clean the top of the master cylinder area before removing the cap. If necessary, add fluid to bring the fluid level up to the requirements described on the brake fluid reservoir. Fluid level can be expected to fall as the brake pads wear. The brake fluid level should be checked when the pads are replaced. However, low fluid level may be caused by a leak and a checkup may be needed.

Use only manufacturer's recommended brake fluid ↪ page 286.

WARNING!

- Use only manufacturer's recommended brake fluid ↪ page 286. Using the wrong type of brake fluid can severely damage your brake system and/or impair its performance. The proper type of brake fluid for your vehicle is also identified on the original factory installed hydraulic master cylinder reservoir.

(Continued)

WARNING!

- To avoid contamination from foreign matter or moisture, use only new brake fluid or fluid that has been in a tightly closed container. Keep the master cylinder reservoir cap secured at all times. Brake fluid in an open container absorbs moisture from the air resulting in a lower boiling point. This may cause it to boil unexpectedly during hard or prolonged braking, resulting in sudden brake failure. This could result in a collision.
- Overfilling the brake fluid reservoir can result in spilling brake fluid on hot engine parts, causing the brake fluid to catch fire. Brake fluid can also damage painted and vinyl surfaces, care should be taken to avoid its contact with these surfaces.
- Do not allow petroleum based fluid to contaminate the brake fluid. Brake seal components could be damaged, causing partial or complete brake failure. This could result in a collision.

CAUTION!

Use of improper brake fluids will affect overall clutch system performance. Improper brake fluids may damage the clutch system resulting in loss of clutch function and the ability to shift the transmission.

AUTOMATIC TRANSMISSION

Special Additives

The manufacturer strongly recommends against using any special additives in the transmission. Automatic Transmission Fluid (ATF) is an engineered product and its performance may be impaired by supplemental additives. Therefore, do not add any fluid additives to the transmission. Avoid using transmission sealers as they may adversely affect seals.

CAUTION!

Do not use chemical flushes in your transmission as the chemicals can damage your transmission components. Such damage is not covered by the New Vehicle Limited Warranty.

Fluid Level Check

The fluid level is preset at the factory and does not require adjustment under normal operating conditions. Routine fluid level checks are not required, therefore the transmission has no dipstick. An authorized dealer can check your transmission fluid level using special service tools. If you notice fluid leakage or transmission malfunction, visit an authorized dealer immediately to have the transmission fluid level checked. Operating the vehicle with an improper fluid level can cause severe transmission damage.

CAUTION!

If a transmission fluid leak occurs, visit an authorized dealer immediately. Severe transmission damage may occur. An authorized dealer has the proper tools to adjust the fluid level accurately.

Fluid And Filter Changes

Under normal operating conditions, the fluid installed at the factory will provide satisfactory lubrication for the life of the vehicle.

Routine fluid and filter changes are not required. However, change the fluid and filter if the fluid becomes contaminated (with water, etc.), or if the transmission is disassembled for any reason.

Selection Of Lubricant

It is important to use the proper transmission fluid to ensure optimum transmission performance and life. Use the manufacturer specified transmission fluid ↗ page 286. It is important to maintain the transmission fluid at the correct level using the recommended fluid.

NOTE:

No chemical flushes should be used in any transmission; only the approved lubricant should be used.

CAUTION!

Using a transmission fluid other than the manufacturer recommended fluid may cause deterioration in transmission shift quality and/or torque converter shudder ↗ page 286.

FUSES

WARNING!

- When replacing a blown fuse, always use an appropriate replacement fuse with the same amp rating as the original fuse. Never replace a fuse with another fuse of higher amp rating. Never replace a blown fuse with metal wires or any other material. Failure to use proper fuses may result in serious personal injury, fire and/or property damage.
- Before replacing a fuse, make sure that the ignition is off and that all the other services are switched off and/or disengaged.
- If the replaced fuse blows again, contact an authorized dealer.
- If a general protection fuse for safety systems (air bag system, braking system), power unit systems (engine system, gearbox system), steering system or Body Control Module (BCM) blows, contact an authorized dealer.

General Information

The fuses protect electrical systems against excessive current.

When a device does not work, you must check the electrical circuit inside the fuse for a break/melt.

Also please be aware that when using power outlets for extended periods of time with the engine off may result in vehicle battery discharge.

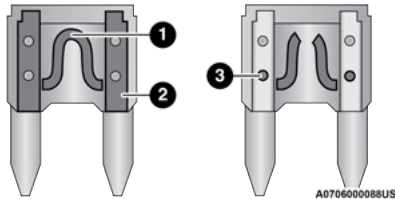

Blade Fuses

- 1 — Electrical Circuit
- 2 — Blade Fuse With Good Electrical Circuit
- 3 — Blade Fuse With Bad Electrical Circuit

Fuse Removal

To replace a fuse use the extractor attached to the fuse cover (located on the inside of the engine compartment fuse cover.)

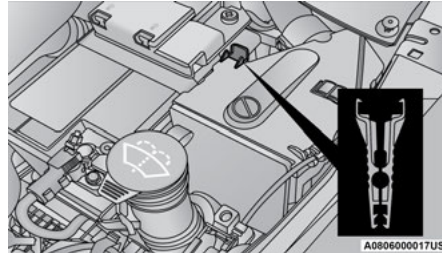

Fuse Extractor Location

Access To The Fuses

The fuses are grouped into four controllers located in the engine compartment, under the instrument panel and on the inside of the left side cargo trim panel.

Engine Compartment Fuses/Distribution Unit

The engine compartment fuse panel is part of the Body Control Module (BCM), located on the left side of the engine compartment.

NOTE:

See an authorized dealer for BCM fuse replacement.

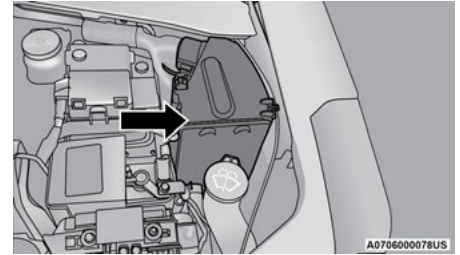

Engine Compartment Fuse Location

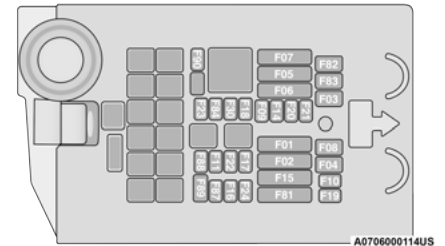

Engine Compartment Fuse Cavities

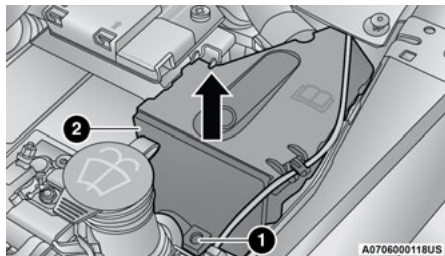
**Fuse Panel And Cover Location**

- 1 – Mounting Screw
2 – Fuse Cover

Removing Fuse Cover and Locking Screw

Proceed as follows:

1. Slowly turn the screw counterclockwise.
2. Slowly release the screw.
3. Remove the fuse cover by sliding it upward.

Mounting Fuse Cover and Locking Screw

Proceed as follows:

1. Properly secure the fuse cover to the box, slide completely from top to bottom.
2. Fully press the screw, using the special screwdriver supplied.
3. Slowly turn the screw clockwise.

4. Release the screw.

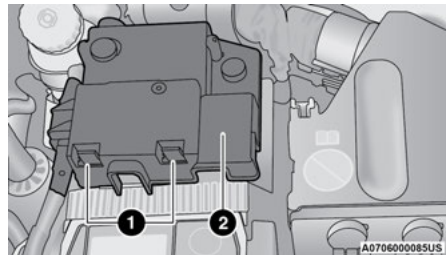
**Battery Fuse Cover Location**

- 1 – Fuse Cover Tabs
2 – Fuse Cover

Cavity	Maxi Fuse	Cartridge Fuse	Mini Fuse	Description
F01	70 Amp Tan	-	-	Module Body Computer
F02	60 Amp Blue	-	-	Module Body Computer, Rear Distribution Units
F03	-	20 Amp Blue	-	Controller Power Supply Body Computer
F04	-	30 Amp Pink	-	Brake Control Electronics Module
F05	70 Amp Tan	-	-	Electric Power-Assisted Steering
F06	70 Amp Tan	-	-	Engine Cooling fan
F08	-	30 Amp Pink	-	Automatic Transmission, GSM
F09	-	-	5 Amp Tan	Control Module Engine
F10	-	-	10 Amp Red	Horn

Cavity	Maxi Fuse	Cartridge Fuse	Mini Fuse	Description
F11	-	-	5 Amp Tan	Supply Secondary Loads
F14	-	-	7.5 Amp Brown	Pump Power "After run" AGS Supply
F15	40 Amp Orange	-	-	Brake Control Module Pump
F16	-	-	5 Amp Tan	Engine Control Module Power, Automatic Transmission
F17	-	-	30 Amp Green	Power Control Module Engine
F18	-	-	30 Amp Green	Power All-Wheel Drive
F19	-	-	7.5 Amp Brown	Air Conditioner Compressor
F20	-	-	5 Amp Tan	Electronic Power Four-Wheel Drive
F21	-	-	15 Amp Blue	Fuel Pump
F22	-	-	10 Amp Red	Supply Primary Loads
F23	-	-	20 Amp Yellow (Customer Installed)	Power Outlet (Battery Powered)
F24	-	-	15 Amp Blue	Electronic Unit Supply Automatic Transmission
F30	-	-	30 Amp Green	Heated Windshield - If Equipped
F83	-	40 Amp Green	-	Air Conditioning Fan
F84	-	-	20 Amp Yellow	Power Outlet (Ignition Powered)
F87	-	-	5 Amp Tan	Gear Selector Automatic Transmission
F88	-	-	7.5 Amp Brown	Heated Outside Mirrors
F89	-	30 Amp Pink	-	Heated Rear Window
F90	-	-	5 Amp Tan	IBS Sensor (Battery State of Charge)

Body Computer Fuse Center

The controller is located at the left side of the steering column at the bottom of the instrument panel.

For the fuse replacement see an authorized dealer.

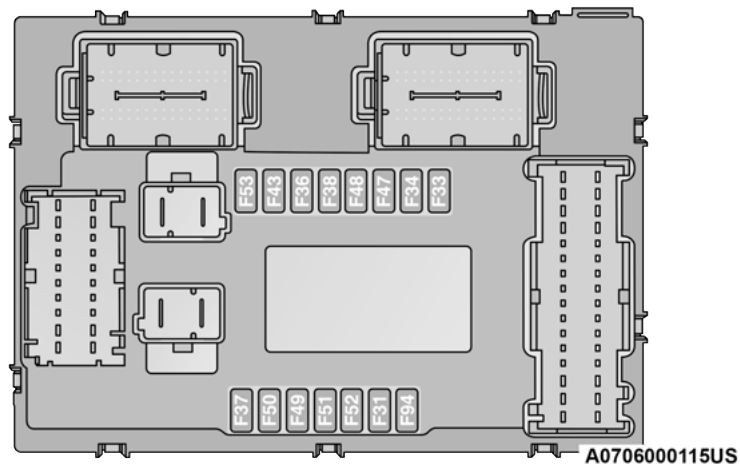

Body Controller Fuse Cavities

Cavity	Mini Fuse	Description
F31	7.5 Amp Brown	Fan Air Conditioning, Power Socket
F33	20 Amp Yellow	Power Window Front (Passenger Side)

F34	20 Amp Yellow	Power Window Front (Driver's Side)
F36	15 Amp Blue	Supply Uconnect System, Air Conditioning, USB Port, Rear lateral ceiling light in case of open roof, EOBD port
F37	10 Amp Red	System Power Forward Collision Warning Plus, All-Wheel Drive (AWD), IPC, Central stack switches, Brake Pedal Switch (NC)
F38	20 Amp Yellow	Central Locking
F42	7.5 Amp Brown	BSM - Brake Control Module, EPS - Electric Power-Assisted Steering
F43	20 Amp Yellow	Bi-directional Pump Washer
F47	20 Amp Yellow	Power Rear Window (Driver Side)
F48	20 Amp Yellow	Power Rear Window (Passenger Side)
F49	7.5 Amp Brown	Supply ParkSense, Spot Lights Front Dome, Internal Electocromic Mirror, Heated Front Seats, SGW, Sunroof Motor.
F50	7.5 Amp Brown	Supply Air Bag
F51	7.5 Amp Brown	Air Conditioning Compressor, Plaque Automatic Transmission, Rear Camera, Air Conditioning, LDW - Lane Departure Warning, ASS - Auxiliary Stack Switch, DSU - Drive Selector Unit, Reverse gear switch, side mirrors and rear window defrost
F53	7.5 Amp Brown	Supply IPC/Starter Device/System Keyless Enter 'n Go™, Brake Pedal Switch (NA), EPB - Electric Parking Brake

Rear Cargo Fuse/Relay Distribution Unit

To access the fuses, remove the access door from the left rear panel of the rear cargo area. Push on the left side of the access door to unhinge and remove.

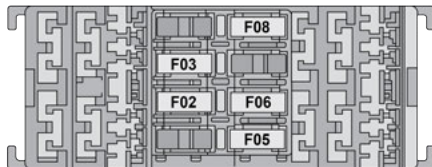

A0706000145US

Rear Cargo Fuse Cavities

Cavity	Mini Fuse	Description
F2	20 Amp Yellow	Audio System
F3	20 Amp Yellow	Electric Sunroof
F5	30 Amp Green	Power Seat (driver side)
F6	7.5 Amp Brown	Power Seat (driver side) Lumbar Adjustment
F8	20 Amp Yellow	Heating Front Seats

BULB REPLACEMENT

General Information

- Before you replace a bulb, check the contacts to be sure they are not oxidized.
- Replace the bulbs with the same type and wattage.
- After replacing a light bulb, always check the correct orientation.
- Before replacing a bulb that is not functioning, check that the fuse is intact.

NOTE:

Lens fogging can occur under certain atmospheric conditions. This will usually clear as atmospheric conditions change to allow the condensation to change back into a vapor. Turning the lamps on will usually accelerate the clearing process.

Replacement Bulbs

Interior Lamps	
Lamp Name	Lamp Number
Front Courtesy Light	C5W
Front Courtesy Lights (Sun Visors)	C5W
Rear Dome Light (Models Without Retractable Roof)	C5W
Rear Interior Lights (Models With Retractable Roof)	C5W
Interior Lights	W5W
Dome Light (Glove Compartment)	W5W

Exterior Lamps	
Lamp Name	Lamp Number
Low Beam/High Beam Headlamps	HIR2
Optional Low Beam/High Beam Headlamps	LED (Serviced at an authorized dealer)
Front Position/Daytime Running Lights (DRL)	LED (Serviced at an authorized dealer)
Front Direction Indicator Lamps	WY21W
Fog Lamps (Halogen)	H11
Fog Lamps (LED)	LED (Serviced at an authorized dealer)
Side Indicators (Side View Mirror)	WY5W
Side Marker	LED (Serviced at an authorized dealer)
Tail/Brake lights	LED (Serviced at an authorized dealer)
Turn Indicators	WY21W
Center High Mounted Stop Lamp (CHMSL)	LED (Serviced at an authorized dealer)
Reverse	P21W
License Plate Lamp	W5W

Replacing Exterior Bulbs

Headlamps

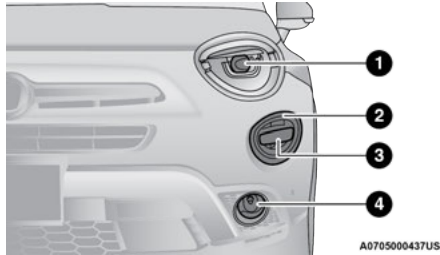

Front Lamps

- 1 – Headlamps
- 2 – Daytime Running Lamps
- 3 – Directional Indicators
- 4 – Fog Lamps – If Equipped

Hi/Lo Beam Light Halogen

See below steps for bulb replacement:

1. Open the engine compartment and remove the headlamp bulb cap.

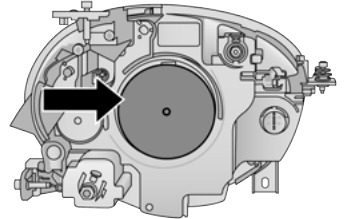

Headlamp Bulb Cap

2. Rotate the headlamp bulb socket counter-clockwise then pull outwards.

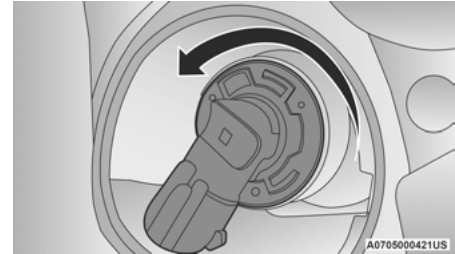

Headlamp Bulb Socket

3. Release the locking tab on the headlamp bulb connector and remove the bulb and socket.

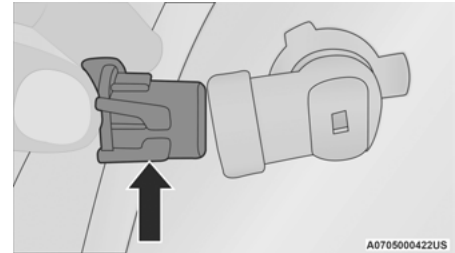

Headlamp Bulb Connector

4. Install the new headlamp bulb making sure it is properly locked.
5. Install the headlamp bulb and socket; align the tabs and turn it clockwise making sure it is properly locked.

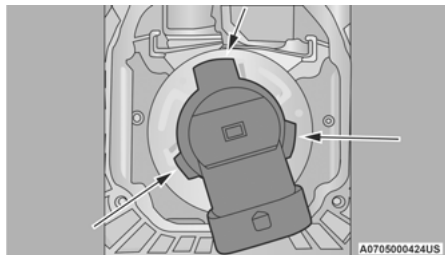

Headlamp Bulb Connector

WARNING!

Carry out the operation of replacing lamps only with the engine off. Also make sure that the engine is cold, to avoid the danger of burns.

LED Main Beam/Dipped Beam Headlights/Fog Lights – If Equipped

For replacing these bulbs, contact an authorized dealership.

Side Lights/Daytime Running Lights (DRL)

The side lights/Daytime Running Lights (DRL) are LED-type. To replace them, contact an authorized dealership.

Side Marker

Side marker lights are LED-type. For replacing these bulbs, contact an authorized dealer

Front Direction Indicator Lamp

See below steps for bulb replacement:

1. Turn the front wheels completely.
2. Use a suitable tool to remove the access door.

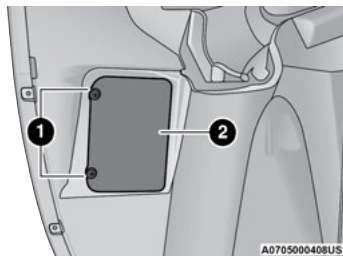

Light Access

- 1 – Screws
- 2 – Access Door

3. Turn the bulb and bulb holder assembly counterclockwise and then remove it sliding it outwards.
4. Replace the bayonet-fitted bulb.

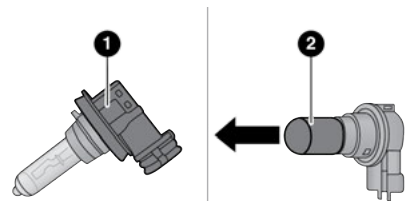

A0705000423US

Bulb Assembly

- 1 – Bulb Holder
- 2 – Bulb

5. Finally, refit the inspection door, fully tightening fixing screws.

Fog Lights (Halogen)

See below steps for bulb replacement:

1. Turn the front wheels completely.
2. Use a suitable tool to remove the access door.

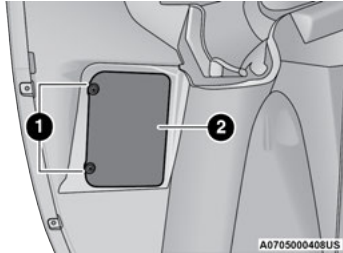

Fog Light Access

- 1 – Screws
2 – Access Door

3. Turn the bulb and bulb holder assembly counterclockwise and then remove it sliding it outwards.

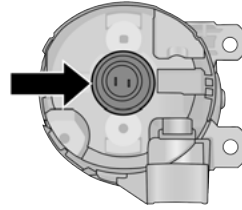

Fog Lamp Bulb Location

4. Replace the bayonet-fitted bulb.

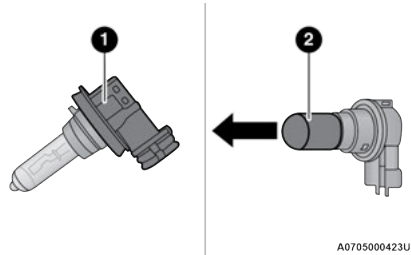

Bulb Assembly

- 1 – Bulb Holder
2 – Bulb

5. Finally, refit the inspection door, fully tightening fixing screws.

Side Indicators on External Rear View Mirrors – If Equipped

CAUTION!

The procedure is described as a guideline. For the replacement of the lamp it is recommended that you contact an authorized dealer.

See below steps for bulb replacement:

1. Remove the mirror cap on the outside rear view mirror.

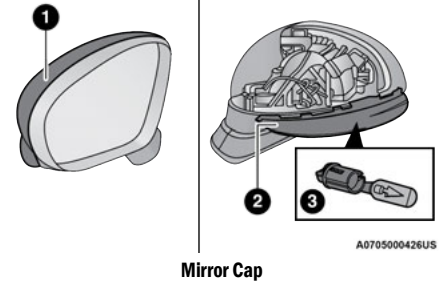

Mirror Cap

- 1 – Mirror Cover
2 – Side Indicator Lens
3 – Side Indicator Bulb Location

2. Remove the transparent lens assembly as shown.

- Remove the bulb socket and bulb from the transparent lens assembly by rotating the socket counterclockwise.
- Remove the bulb from the bulb socket by pulling the bulb straight out.
- Insert the new bulb, making sure that it is locked into place
- Reinstall the socket in to the transparent lens assembly.
- Reinstall the cover on the outside rear view mirror, making sure it is locked into place.

Rear Tail Lamps

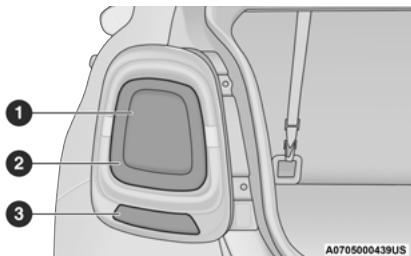

Tail Light

- 1 – Tail lights/Brake Lights
 2 – Direction indicator
 3 – REVERSE lights

Tail Lamps

The tail lights are LED-type. For replacing these bulbs, contact an authorized dealership.

Brake Lights

The brake lights are LED-type. For replacing these bulbs, contact an authorized dealership.

Side Marker

Side marker lights are LED-type. For replacing these bulbs, contact an authorized dealer

3rd Stop Lamp

The CHMSL is LED. For their replacement see an authorized dealer.

Reversing Light & Rear Direction Indicators

See below steps for bulb replacement:

- Open liftgate.
- Using a suitable tool, undo the two inboard screws, then release the light cluster from the respective pin fasteners pulling it carefully.

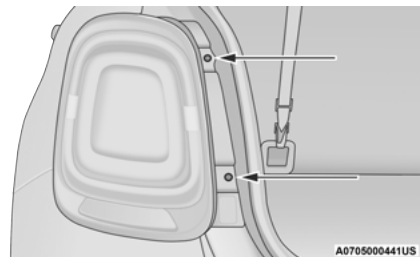

Tail Light Screws

- Disconnect the connector, then undo the two screws to access the bulbs.

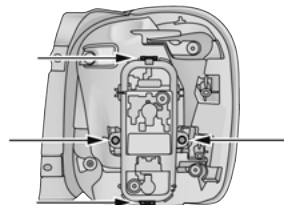

Tail Light Access

- Locate faulty bulb and press slightly and turn at the same time: counterclockwise to extract; clockwise to install.

5. Reposition the bulb holder assembly in the headlight body, proceed until you hear the tabs click.
6. Reinstall tail lamp assembly and close liftgate.

License Plate Lights

See below steps for bulb replacement:

To replace the bulbs proceed as follows:

1. Using a suitable tool remove the license plate lens.

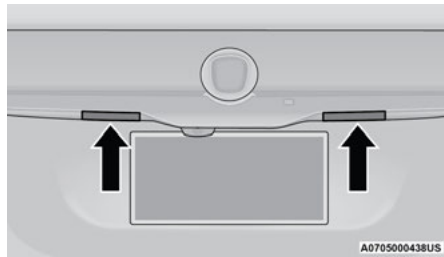

License Plate Light Location

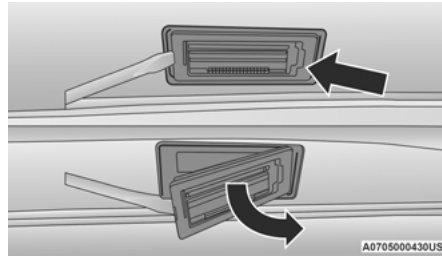

License Plate Light

2. Remove the bulbs from the individual side contacts.

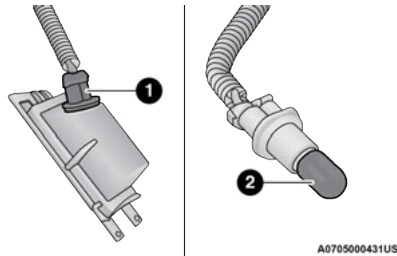

Lamp Assembly

- 1 – Bulb Holder
- 2 – Bulb

3. Insert the new bulbs, and ensure that they are properly locked between the contacts.
4. Reinstall the license plate lens.

NOTE:

If removal of the license plate lens using a suitable tool, be sure to cover the tip of the suitable with a cloth so no damage is done to the lenses or the vehicle paint.

Replacing Interior Bulbs

Front Courtesy Light

See below steps for bulb replacement:

1. Using a suitable tool remove the front courtesy light as shown.

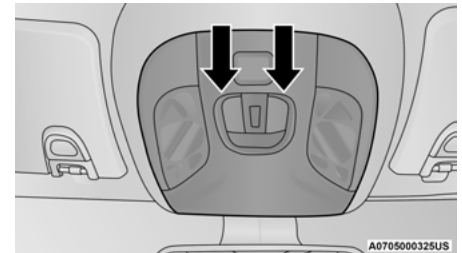

Front Courtesy Light Housing

2. Release the retainer clips and bulb housing as shown.

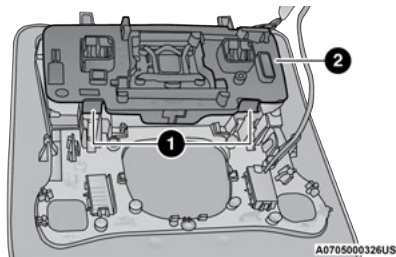

Front Courtesy Bulb Housing

- 1 – Retaining Clips
2 – Bulb Housing

3. Replace the bulbs by pulling straight out of bulb housing.

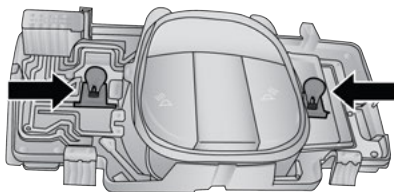

Front Courtesy Bulb Housing

4. Insert the new bulbs, making sure that they are properly locked.
5. Reassemble the bulb housing and courtesy light housing making sure that they are properly locked.
6. Install the front courtesy light making sure that it is properly locked.

Dome Light Vanity Mirror

See below steps for bulb replacement:

1. Lift the cover of the mirror and pull out the visor mirror light cover.
2. Replace the bulb, releasing it from the side contacts, and then insert the new bulb, making sure that it is properly locked between the contacts.

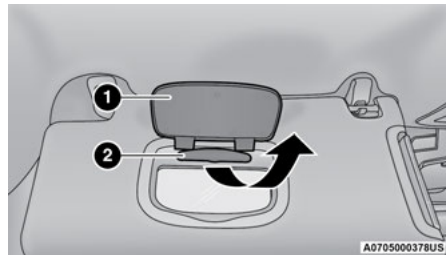

Visor Mirror Cover

- 1 – Visor Mirror Cover
2 – Visor Mirror Light

3. Reinstall the visor mirror light cover making sure that it is properly locked.
4. Finally lower the visor mirror cover to the mirror.

Dome Light Glove Compartment

See below steps for bulb replacement:

1. Open the glove compartment.
2. Place your fingers inside the light assembly, pull the bulb to replace it.

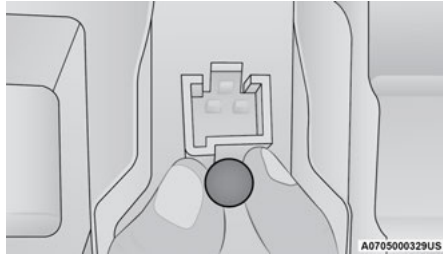

Bulb Removal/Installation

3. Insert the new bulb, making sure it is properly locked.

Rear Dome Light – Without Retractable Roof

See below steps for bulb replacement:

1. Using a suitable tool release the lamp assembly at both the ends.
2. Open the flap and replace the bulb.

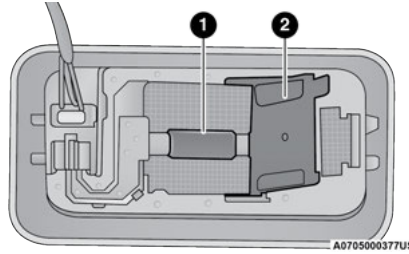

Rear Dome Light

- 1 – Bulb
2 – Flap

3. Insert the new bulb, locking it between the contacts.
4. Reinstall the dome light.

Dome Light

See below steps for bulb replacement:

1. Lower the handle in the direction shown remove the dome light.

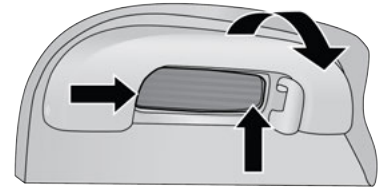

A0705000330US

Retractable Roof Light

2. Replace the bulb by removing it from the side contacts.

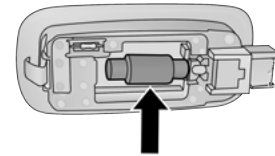

Bulb

A0703060322US

3. Insert the new bulb, locking it between the contacts.
4. Reinstall the dome light.

Interior Cargo Lights

See below steps for bulb replacement:

1. Open the luggage compartment and remove the dome light assembly.
2. Open the light cover and replace the bulb.

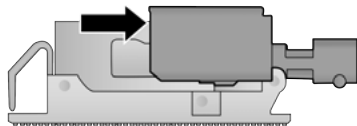

Light Cover

A0705000332US

3. Close the light cover over the bulb.
4. Reinstall the dome light in its correct position.

WARNING!

- Before proceeding with the lamp replacement, wait for the lamp to cool: **DANGER OF BURNS!**

(Continued)

WARNING!

- Modifications or repair of the electrical system performed incorrectly and without taking into account the technical characteristics can cause malfunctions with the risk of fire.
- Halogen lamps contain gas under pressure, in the event of breakage be careful of the projection of fragments of glass.
- Halogen lamps must be handled by touching only the metallic part. If the transparent bulb is in contact with the fingers, reduces the intensity of the emitted light and you can also affect the life of the lamp. In case of accidental contact, rub the bulb with a cloth dampened with alcohol and allow to dry.

TIRES

TIRE SAFETY INFORMATION

Tire safety information will cover aspects of the following information: Tire Markings, Tire Identification Numbers, Tire Terminology and Definitions, Tire Pressures, and Tire Loading.

Tire Markings

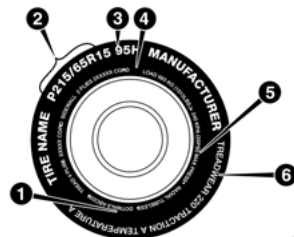

0601085396US

Tire Markings

- 1 – US DOT Safety Standards Code (TIN)
- 2 – Size Designation
- 3 – Service Description
- 4 – Maximum Load
- 5 – Maximum Pressure
- 6 – Treadwear, Traction and Temperature Grades

NOTE:

- P (Passenger) — Metric tire sizing is based on US design standards. P-Metric tires have the letter "P" molded into the sidewall preceding the size designation. Example: P215/65R15 95H.
- European — Metric tire sizing is based on European design standards. Tires designed to this standard have the tire size molded into the side-

wall beginning with the section width. The letter "P" is absent from this tire size designation.

Example: 215/65R15 96H.

- LT (Light Truck) — Metric tire sizing is based on US design standards. The size designation for LT-Metric tires is the same as for P-Metric tires except for the letters "LT" that are molded into the sidewall preceding the size designation. Example: LT235/85R16.

- Temporary spare tires are designed for temporary emergency use only. Temporary high pressure compact spare tires have the letter "T" or "S" molded into the sidewall preceding the size designation. Example: T145/80D18 103M.
- High flotation tire sizing is based on US design standards and it begins with the tire diameter molded into the sidewall. Example: 31x10.5 R15 LT.

TIRE SIZING CHART**EXAMPLE:**

Example Size Designation: P215/65R15XL 95H, 215/65R15 96H, LT235/85R16C, T145/80D18 103M, 31x10.5 R15 LT

P = Passenger car tire size based on US design standards, or

"....blank...." = Passenger car tire based on European design standards, or

LT = Light truck tire based on US design standards, or

T or S = Temporary spare tire or

31 = Overall diameter in inches (in)

215, 235, 145 = Section width in millimeters (mm)

65, 85, 80 = Aspect ratio in percent (%)

- Ratio of section height to section width of tire, or

10.5 = Section width in inches (in)

R = Construction code

- "R" means radial construction, or
- "D" means diagonal or bias construction

EXAMPLE:

15, 16, 18 = Rim diameter in inches (in)

Service Description:

95 = Load Index

- A numerical code associated with the maximum load a tire can carry

H = Speed Symbol

- A symbol indicating the range of speeds at which a tire can carry a load corresponding to its load index under certain operating conditions
- The maximum speed corresponding to the speed symbol should only be achieved under specified operating conditions (i.e., tire pressure, vehicle loading, road conditions, and posted speed limits)

Load Identification:

Absence of the following load identification symbols on the sidewall of the tire indicates a Standard Load (SL) tire:

- **XL** = Extra load (or reinforced) tire, or
- **LL** = Light load tire or
- **C, D, E, F, G** = Load range associated with the maximum load a tire can carry at a specified pressure

Maximum Load - Maximum load indicates the maximum load this tire is designed to carry

Maximum Pressure - Maximum pressure indicates the maximum permissible cold tire inflation pressure for this tire

Tire Identification Number (TIN)

The TIN may be found on one or both sides of the tire; however, the date code may only be on one side. Tires with white sidewalls will have the full TIN, including the date code, located on the white sidewall side of the tire. Look for the TIN on the outboard side of black sidewall tires as mounted on the vehicle. If the TIN is not found on the outboard side, then you will find it on the inboard side of the tire.

EXAMPLE:

DOT MA L9 ABCD 0301

DOT = Department of Transportation

- This symbol certifies that the tire is in compliance with the US Department of Transportation tire safety standards and is approved for highway use

MA = Code representing the tire manufacturing location (two digits)

L9 = Code representing the tire size (two digits)

ABCD = Code used by the tire manufacturer (one to four digits)

03 = Number representing the week in which the tire was manufactured (two digits)

- 03 means the 3rd week

01 = Number representing the year in which the tire was manufactured (two digits)

- 01 means the year 2001
- Prior to July 2000, tire manufacturers were only required to have one number to represent the year in which the tire was manufactured. Example: 031 could represent the 3rd week of 1981 or 1991

Tire Terminology And Definitions

Term	Definition
B-pillar	The vehicle B-pillar is the structural member of the body located behind the front door.
Cold Tire Inflation Pressure	Cold tire inflation pressure is defined as the tire pressure after the vehicle has not been driven for at least three hours, or driven less than 1 mile (1.6 km) after sitting for a minimum of three hours. Inflation pressure is measured in units of PSI (pounds per square inch) or kPa (kilopascals).
Maximum Inflation Pressure	The maximum inflation pressure is the maximum permissible cold tire inflation pressure for this tire. The maximum inflation pressure is molded into the sidewall.
Recommended Cold Tire Inflation Pressure	Vehicle manufacturer's recommended cold tire inflation pressure as shown on the tire placard.
Tire Placard	A label permanently attached to the vehicle describing the vehicle's loading capacity, the original equipment tire sizes and the recommended cold tire inflation pressures.

Tire Loading And Tire Pressure

NOTE:

The proper cold tire inflation pressure is listed on the driver's side B-pillar or the rear edge of the driver's side door.

Check the inflation pressure of each tire, including the spare tire (if equipped), at least monthly and inflate to the recommended pressure for your vehicle.

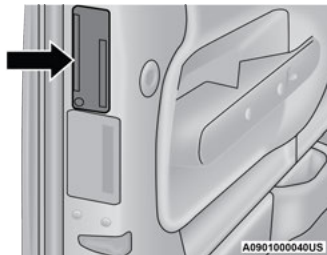

Example Tire Placard Location (Door)

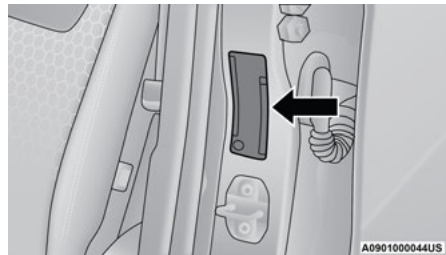

Example Tire Placard Location (B-pillar)

Tire And Loading Information Placard



811b5a9a

Tire And Loading Information Placard

This placard tells you important information about the:

1. Number of people that can be carried in the vehicle.
2. Total weight your vehicle can carry.
3. Tire size designed for your vehicle.
4. Cold tire inflation pressures for the front, rear, and spare tires.

Loading

The vehicle maximum load on the tire must not exceed the load carrying capacity of the tire on your vehicle. You will not exceed the tire's load carrying capacity if you adhere to the loading conditions,

tire size, and cold tire inflation pressures specified on the Tire and Loading Information placard
 ⇨ page 110.

NOTE:

Under a maximum loaded vehicle condition, Gross Axle Weight Rating (GAWR) for the front and rear axles must not be exceeded.

For further information on GAWR, vehicle loading, and trailer towing ⇨ page 110.

To determine the maximum loading conditions of your vehicle, locate the statement "The combined weight of occupants and cargo should never exceed XXX kg or XXX lbs." on the Tire and Loading Information placard. The combined weight of occupants, cargo/luggage and trailer tongue weight (if applicable) should never exceed the weight referenced here.

Steps For Determining Correct Load Limit—

(1) Locate the statement "The combined weight of occupants and cargo should never exceed XXX kg or XXX lbs." on your vehicle's placard.

(2) Determine the combined weight of the driver and passengers that will be riding in your vehicle.

(3) Subtract the combined weight of the driver and passengers from XXX kg or XXX lbs.

(4) The resulting figure equals the available amount of cargo and luggage load capacity. For example, if "XXX" amount equals 1400 lbs. and there will be five 150 lb passengers in your vehicle, the amount of available cargo and luggage load capacity is 650 lbs. (1400-750 (5x150) = 650 lbs.)

(5) Determine the combined weight of luggage and cargo being loaded on the vehicle. That weight may not safely exceed the available cargo and luggage load capacity calculated in Step 4.

(6) If your vehicle will be towing a trailer, load from your trailer will be transferred to your vehicle. Consult this manual to determine how this reduces the available cargo and luggage load capacity of your vehicle.

Metric Example For Load Limit

For example, if “XXX” amount equals 635 kg and there will be five 68 kg passengers in your vehicle, the amount of available cargo and luggage load capacity is 295 kg (635-340 (5x68) = 295 kg) as shown in step 4.

NOTE:

- If your vehicle will be towing a trailer, load from your trailer will be transferred to your vehicle. The following table shows examples on how to calculate total load, cargo/luggage, and towing capacities of your vehicle with varying seating configurations and number and size of occu-

pants. This table is for illustration purposes only and may not be accurate for the seating and load carry capacity of your vehicle.

- For the following example, the combined weight of occupants and cargo should never exceed 865 lb (392 kg).

Occupants			Combined weight of occupants and cargo from Tire Placard	MINUS	Combined Occupant's weight	=	AVAILABLE Cargo/Luggage and Trailer Tongue Weight
TOTAL	FRONT	REAR					
EXAMPLE 1			865 lbs	minus	670 lbs	=	195 lbs
5	2	3					
EXAMPLE 2			865 lbs	minus	540 lbs	=	325 lbs
3	2	1					
EXAMPLE 3			865 lbs	minus	400 lbs	=	465 lbs
2	2	0					

Occupant 1: 200 lbs
 Occupant 2: 130 lbs
 Occupant 3: 160 lbs
 Occupant 4: 100 lbs
 Occupant 5: 80 lbs
 TOTAL WEIGHT: 670 lbs

Occupant 1: 210 lbs
 Occupant 2: 180 lbs
 Occupant 3: 150 lbs
 TOTAL WEIGHT: 540 lbs

Occupant 1: 200 lbs
 Occupant 2: 200 lbs
 TOTAL WEIGHT: 400 lbs

WARNING!

Overloading of your tires is dangerous. Overloading can cause tire failure, affect vehicle handling, and increase your stopping distance. Use tires of the recommended load capacity for your vehicle. Never overload them.

TIRES — GENERAL INFORMATION**Tire Pressure**

Proper tire inflation pressure is essential to the safe and satisfactory operation of your vehicle. Four primary areas are affected by improper tire pressure:

- Safety
- Fuel Economy
- Tread Wear
- Ride Comfort and Vehicle Stability

Safety**WARNING!**

- Improperly inflated tires are dangerous and can cause collisions.
- Underinflation increases tire flexing and can result in overheating and tire failure.

(Continued)

WARNING!

- Overinflation reduces a tire's ability to cushion shock. Objects on the road and chuckholes can cause damage that result in tire failure.
- Overinflated or underinflated tires can affect vehicle handling and can fail suddenly, resulting in loss of vehicle control.
- Unequal tire pressures can cause steering problems. You could lose control of your vehicle.
- Unequal tire pressures from one side of the vehicle to the other can cause the vehicle to drift to the right or left.
- Always drive with each tire inflated to the recommended cold tire inflation pressure.

Both underinflation and overinflation affect the stability of the vehicle and can produce a feeling of sluggish response or over responsiveness in the steering.

NOTE:

- Unequal tire pressures from side to side may cause erratic and unpredictable steering response.
- Unequal tire pressure from side to side may cause the vehicle to drift left or right.

Fuel Economy

Underinflated tires will increase tire rolling resistance resulting in higher fuel consumption.

Tread Wear

Improper cold tire inflation pressures can cause abnormal wear patterns and reduced tread life, resulting in the need for earlier tire replacement.

Ride Comfort And Vehicle Stability

Proper tire inflation contributes to a comfortable ride. Overinflation produces a jarring and uncomfortable ride.

Tire Inflation Pressures

The proper cold tire inflation pressure is listed on the driver's side B-pillar or rear edge of the driver's side door.

At least once a month:

- Check and adjust tire pressure with a good quality pocket-type pressure gauge. Do not make a visual judgment when determining proper inflation. Tires may look properly inflated even when they are under-inflated.
- Inspect tires for signs of tire wear or visible damage.

CAUTION!

After inspecting or adjusting the tire pressure, always reinstall the valve stem cap. This will prevent moisture and dirt from entering the valve stem, which could damage the valve stem.

Inflation pressures specified on the placard are always “cold tire inflation pressure”. Cold tire inflation pressure is defined as the tire pressure after the vehicle has not been driven for at least three hours, or driven less than 1 mile (1.6 km) after sitting for a minimum of three hours. The cold tire inflation pressure must not exceed the maximum inflation pressure molded into the tire sidewall.

Check tire pressures more often if subject to a wide range of outdoor temperatures, as tire pressures vary with temperature changes.

Tire pressures change by approximately 1 psi (7 kPa) per 12 °F (7 °C) of air temperature change. Keep this in mind when checking tire pressure inside a garage, especially in the Winter.

Example: If garage temperature = 68 °F (20 °C) and the outside temperature = 32 °F (0 °C) then the cold tire inflation pressure should be increased by 3 psi (21 kPa), which equals 1 psi (7 kPa) for every 12 °F (7 °C) for this outside temperature condition.

Tire pressure may increase from 2 to 6 psi (13 to 40 kPa) during operation. DO NOT reduce this normal pressure build up or your tire pressure will be too low.

Tire Pressures For High Speed Operation

The manufacturer advocates driving at safe speeds and within posted speed limits. Where speed limits or conditions are such that the vehicle can be driven at high speeds, maintaining correct tire inflation pressure is very important. Increased tire pressure and reduced vehicle loading may be required for high-speed vehicle operation. Refer to an authorized tire dealer or original equipment vehicle dealer for recommended safe operating speeds, loading and cold tire inflation pressures.

WARNING!

High speed driving with your vehicle under maximum load is dangerous. The added strain on your tires could cause them to fail. You could have a serious collision. Do not drive a vehicle loaded to the maximum capacity at continuous speeds above 75 mph (120 km/h).

Radial Ply Tires**WARNING!**

Combining radial ply tires with other types of tires on your vehicle will cause your vehicle to handle poorly. The instability could cause a collision. Always use radial ply tires in sets of four. Never combine them with other types of tires.

Tire Repair

If your tire becomes damaged, it may be repaired if it meets the following criteria:

- The tire has not been driven on when flat.
- The damage is only on the tread section of your tire (sidewall damage is not repairable).
- The puncture is no greater than a ¼ of an inch (6 mm).

Consult an authorized tire dealer for tire repairs and additional information.

Damaged Run Flat tires, or Run Flat tires that have experienced a loss of pressure should be replaced immediately with another Run Flat tire of identical size and service description (Load Index and Speed Symbol). Replace the tire pressure sensor as well as it is not designed to be reused.

Run Flat Tires — If Equipped

Run Flat tires allow you the capability to drive 50 miles (80 km) at 50 mph (80 km/h) after a rapid loss of inflation pressure. This rapid loss of inflation is referred to as the Run Flat mode. A Run Flat mode occurs when the tire inflation pressure is of/or below 14 psi (96 kPa). Once a Run Flat tire reaches the Run Flat mode it has limited driving capabilities and needs to be replaced immediately. A Run Flat tire is not repairable. When a Run Flat tire is changed after driving with underinflated tire condition, please replace the TPM sensor as it is not designed to be reused when driven under Run Flat mode 14 psi (96 kPa) condition.

NOTE:

TPM Sensor must be replaced after driving the vehicle on a flat tire condition.

It is not recommended driving a vehicle loaded at full capacity or to tow a trailer while a tire is in the Run Flat mode.

See the tire pressure monitoring section for more information ↪ page 182.

Tire Spinning

When stuck in mud, sand, snow, or ice conditions, do not spin your vehicle's wheels above 30 mph (48 km/h) or for longer than 30 seconds continuously without stopping.

For further information ↪ page 225.

WARNING!

Fast spinning tires can be dangerous. Forces generated by excessive wheel speeds may cause tire damage or failure. A tire could explode and injure someone. Do not spin your vehicle's wheels faster than 30 mph (48 km/h) for more than 30 seconds continuously when you are stuck, and do not let anyone near a spinning wheel, no matter what the speed.

Tread Wear Indicators

Tread wear indicators are in the original equipment tires to help you in determining when your tires should be replaced.

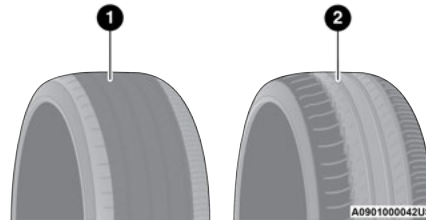

Tire Tread

1 — Worn Tire

2 — New Tire

These indicators are molded into the bottom of the tread grooves. They will appear as bands when the tread depth becomes a 1/16 of an inch (1.6 mm). When the tread is worn to the tread wear indicators, the tire should be replaced.

For further information ↪ page 272.

Life Of Tire

The service life of a tire is dependent upon varying factors including, but not limited to:

- Driving style.
- Tire pressure - Improper cold tire inflation pressures can cause uneven wear patterns to develop across the tire tread. These abnormal wear patterns will reduce tread life, resulting in the need for earlier tire replacement.
- Distance driven.
- Performance tires, tires with a speed rating of V or higher, and Summer tires typically have a reduced tread life. Rotation of these tires per the vehicle scheduled maintenance is highly recommended.

WARNING!

Tires and the spare tire should be replaced after six years, regardless of the remaining tread. Failure to follow this warning can result in sudden tire failure. You could lose control and have a collision resulting in serious injury or death.

NOTE:

Wheel valve stem must be replaced as well when installing new tires due to wear and tear in existing tires.

Keep dismounted tires in a cool, dry place with as little exposure to light as possible. Protect tires from contact with oil, grease, and gasoline.

Replacement Tires

The tires on your new vehicle provide a balance of many characteristics. They should be inspected regularly for wear and correct cold tire inflation pressures. The manufacturer strongly recommends that you use tires equivalent to the originals in size, quality and performance when replacement is needed ↗ page 271. Refer to the Tire and Loading Information placard or the Vehicle Certification Label for the size designation of your tire. The Load Index and Speed Symbol for your tire will be found on the original equipment tire sidewall.

See the Tire Sizing Chart example for more information relating to the Load Index and Speed Symbol of a tire ↗ page 263.

It is recommended to replace the two front tires or two rear tires as a pair. Replacing just one tire can seriously affect your vehicle's handling. If you ever replace a wheel, make sure that the wheel's specifications match those of the original wheels.

It is recommended you contact an authorized tire dealer or original equipment dealer with any questions you may have on tire specifications or capability. Failure to use equivalent replacement tires may adversely affect the safety, handling, and ride of your vehicle.

WARNING!

- Do not use a tire, wheel size, load rating, or speed rating other than that specified for your vehicle. Some combinations of unapproved tires and wheels may change suspension dimensions and performance characteristics, resulting in changes to steering, handling, and braking of your vehicle. This can cause unpredictable handling and stress to steering and suspension components. You could lose control and have a collision resulting in serious injury or death. Use only the tire and wheel sizes with load ratings approved for your vehicle.

(Continued)

WARNING!

- Never use a tire with a smaller load index or capacity, other than what was originally equipped on your vehicle. Using a tire with a smaller load index could result in tire overloading and failure. You could lose control and have a collision.
- Failure to equip your vehicle with tires having adequate speed capability can result in sudden tire failure and loss of vehicle control.

CAUTION!

Replacing original tires with tires of a different size may result in false speedometer and odometer readings.

TIRE TYPES**All Season Tires — If Equipped**

All Season tires provide traction for all seasons (Spring, Summer, Autumn, and Winter). Traction levels may vary between different all season tires. All season tires can be identified by the M+S, M&S, M/S or MS designation on the tire sidewall. Use all season tires only in sets of four; failure to do so may adversely affect the safety and handling of your vehicle.

Summer Or Three Season Tires — If Equipped

Summer tires provide traction in both wet and dry conditions, and are not intended to be driven in snow or on ice. If your vehicle is equipped with Summer tires, be aware these tires are not designed for Winter or cold driving conditions. Install Winter tires on your vehicle when ambient temperatures are less than 40°F (5°C) or if roads are covered with ice or snow. For more information, contact an authorized dealer.

Summer tires do not contain the all season designation or mountain/snowflake symbol on the tire sidewall. Use Summer tires only in sets of four; failure to do so may adversely affect the safety and handling of your vehicle.

WARNING!

Do not use Summer tires in snow/ice conditions. You could lose vehicle control, resulting in severe injury or death. Driving too fast for conditions also creates the possibility of loss of vehicle control.

Snow Tires

Some areas of the country require the use of snow tires during the Winter. Snow tires can be identified by a “mountain/snowflake” symbol on the tire sidewall.



If you need snow tires, select tires equivalent in size and type to the original equipment tires. Use snow tires only in sets of four; failure to do so may adversely affect the safety and handling of your vehicle.

Snow tires generally have lower speed ratings than what was originally equipped with your vehicle and should not be operated at sustained speeds over 75 mph (120 km/h). For speeds above 75 mph (120 km/h) refer to original equipment or an authorized tire dealer for recommended safe operating speeds, loading and cold tire inflation pressures.

While studded tires improve performance on ice, skid and traction capability on wet or dry surfaces may be poorer than that of non-studded tires. Some states prohibit studded tires; therefore, local laws should be checked before using these tire types.

SPARE TIRES — IF EQUIPPED

NOTE:

For vehicles equipped with Tire Service Kit instead of a spare tire, please refer to “Tire Service Kit” in “In Case Of Emergency” for further information.

CAUTION!

Because of the reduced ground clearance, do not take your vehicle through an automatic car wash with a compact or limited use temporary spare installed. Damage to the vehicle may result.

For restrictions when towing with a spare tire designated for temporary emergency use
 ⇨ page 114.

Spare Tire Matching Original Equipped Tire And Wheel — If Equipped

Your vehicle may be equipped with a spare tire and wheel equivalent in look and function to the original equipment tire and wheel found on the front or rear axle of your vehicle. This spare tire may be used in the tire rotation for your vehicle. If your vehicle has this option, refer to an authorized tire dealer for the recommended tire rotation pattern.

Compact Spare Tire — If Equipped

The compact spare is for temporary emergency use only. You can identify if your vehicle is equipped with a compact spare by looking at the spare tire description on the Tire and Loading Information Placard located on the driver's side door opening or on the sidewall of the tire. Compact spare tire descriptions begin with the letter "T" or "S" preceding the size designation. Example: T145/80D18 103M.

T, S = Temporary Spare Tire

Since this tire has limited tread life, the original equipment tire should be repaired (or replaced) and reinstalled on your vehicle at the first opportunity.

Do not install a wheel cover or attempt to mount a conventional tire on the compact spare wheel, since the wheel is designed specifically for the compact spare tire. Do not install more than one compact spare tire and wheel on the vehicle at any given time.

WARNING!

Compact and collapsible spares are for temporary emergency use only. With these spares, do not drive more than 50 mph (80 km/h). Temporary use spares have limited tread life. When the tread is worn to the tread wear indicators, the temporary use spare tire needs to be replaced. Be sure to follow the warnings, which apply to your spare. Failure to do so could result in spare tire failure and loss of vehicle control.

Collapsible Spare Tire — If Equipped

The collapsible spare is for temporary emergency use only. You can identify if your vehicle is equipped with a collapsible spare by looking at the spare tire description on the Tire and Loading Information Placard located on the driver's side door opening or on the sidewall of the tire.

Collapsible spare tire description example: 165/80-17 101P.

Since this tire has limited tread life, the original equipment tire should be repaired (or replaced) and reinstalled on your vehicle at the first opportunity.

Inflate collapsible tire only after the wheel is properly installed to the vehicle. Inflate the collapsible tire using the electric air pump before lowering the vehicle.

Do not install a wheel cover or attempt to mount a conventional tire on the collapsible spare wheel, since the wheel is designed specifically for the collapsible spare tire.

WARNING!

Compact and Collapsible spares are for temporary emergency use only. With these spares, do not drive more than 50 mph (80 km/h). Temporary use spares have limited tread life. When the tread is worn to the tread wear indicators, the temporary use spare tire needs to be replaced. Be sure to follow the warnings, which apply to your spare. Failure to do so could result in spare tire failure and loss of vehicle control.

Full Size Spare — If Equipped

The full size spare is for temporary emergency use only. This tire may look like the originally equipped tire on the front or rear axle of your vehicle, but it is not. This spare tire may have limited tread life. When the tread is worn to the tread wear indicators, the temporary use full size spare tire needs to be replaced. Since it is not the same as your original equipment tire, replace (or repair) the original equipment tire and reinstall on the vehicle at the first opportunity.

Limited Use Spare — If Equipped

The limited use spare tire is for temporary emergency use only. This tire is identified by a label located on the limited use spare wheel. This label contains the driving limitations for this spare. This tire may look like the original equipped tire on the front or rear axle of your vehicle, but it is not. Installation of this limited use spare tire affects vehicle handling. Since it is not the same as your original equipment tire, replace (or repair) the original equipment tire and reinstall on the vehicle at the first opportunity.

WARNING!

Limited use spares are for emergency use only. Installation of this limited use spare tire affects vehicle handling. With this tire, do not drive more than the speed listed on the limited use spare wheel. Keep inflated to the cold tire inflation pressures listed on your Tire and Loading Information Placard located on the driver's side B-pillar or the rear edge of the driver's side door. Replace (or repair) the original equipment tire at the first opportunity and reinstall it on your vehicle. Failure to do so could result in loss of vehicle control.

WHEEL AND WHEEL TRIM CARE

All wheels and wheel trim, especially aluminum and chrome plated wheels, should be cleaned regularly using mild (neutral Ph) soap and water to maintain their luster and to prevent corrosion. Wash wheels with the same soap solution recommended for the body of the vehicle and remember to always wash when the surfaces are not hot to the touch.

Your wheels are susceptible to deterioration caused by salt, sodium chloride, magnesium chloride, calcium chloride, etc., and other road chemicals used to melt ice or control dust on dirt roads. Use a soft cloth or sponge and mild soap to wipe away promptly. Do not use harsh chemicals or a stiff brush. They can damage the wheel's protective coating that helps keep them from corroding and tarnishing.

CAUTION!

Avoid products or automatic car washes that use acidic solutions or strong alkaline additives or harsh brushes. Many aftermarket wheel cleaners and automatic car washes may damage the wheel's protective finish. Such damage is not covered by the New Vehicle Limited Warranty. Only car wash soap, Mopar® Wheel Cleaner or equivalent is recommended.

When cleaning extremely dirty wheels including excessive brake dust, care must be taken in the selection of tire and wheel cleaning chemicals and equipment to prevent damage to the wheels. Mopar® Wheel Treatment or Mopar® Chrome Cleaner or their equivalent is recommended or select a non-abrasive, non-acidic cleaner for aluminum or chrome wheels.

CAUTION!

Do not use scouring pads, steel wool, a bristle brush, metal polishes or oven cleaner. These products may damage the wheel's protective finish. Such damage is not covered by the New Vehicle Limited Warranty. Only car wash soap, Mopar® Wheel Cleaner or equivalent is recommended.

NOTE:

If you intend parking or storing your vehicle for an extended period after cleaning the wheels with wheel cleaner, drive your vehicle and apply the brakes to remove the water droplets from the brake components. This activity will remove the

red rust on the brake rotors and prevent vehicle vibration when braking.

Dark Vapor Chrome, Black Satin Chrome, or Low Gloss Clear Coat Wheels**CAUTION!**

If your vehicle is equipped with these specialty wheels, **DO NOT USE** wheel cleaners, abrasives, or polishing compounds. They will permanently damage this finish and such damage is not covered by the New Vehicle Limited Warranty. **HAND WASH ONLY USING MILD SOAP AND WATER WITH A SOFT CLOTH.** Used on a regular basis; this is all that is required to maintain this finish.

SNOW TRACTION DEVICES

Use of traction devices require sufficient tire-to-body clearance. Due to limited clearance, the following snow traction devices are recommended. Follow these recommendations to guard against damage:

- Snow traction device must be of proper size for the tire, as recommended by the snow traction device manufacturer.
- No other tire sizes are recommended for use with the snow traction device.
- Please follow the table below for the recommended tire size, axle and snow traction device:

Trim Level	Axle	Tire/Wheel Size	Snow Traction Device (maximum projection beyond tire profile or equivalent)
ALL	Front	215/55R17 215/60R16	7 mm Cable Chain

WARNING!

Using tires of different size and type (M+S, Snow) between front and rear axles can cause unpredictable handling. You could lose control and have a collision.

CAUTION!

To avoid damage to your vehicle or tires, observe the following precautions:

- Because of restricted traction device clearance between tires and other suspension components, it is important that only traction devices in good condition are used. Broken devices can cause serious damage. Stop the vehicle immediately if noise occurs that could indicate device breakage. Remove the damaged parts of the device before further use.
- Install device as tightly as possible and then retighten after driving about ½ mile (0.8 km). Autosock traction devices do not require retightening.
- Do not exceed 30 mph (48 km/h).
- Drive cautiously and avoid severe turns and large bumps, especially with a loaded vehicle.
- Do not drive for a prolonged period on dry pavement.

(Continued)

CAUTION!

- Observe the traction device manufacturer's instructions on the method of installation, operating speed, and conditions for use. Always use the suggested operating speed of the device manufacturer's if it is less than 30 mph (48 km/h).
- Do not use traction devices on a compact spare tire.

TIRE ROTATION RECOMMENDATIONS

The tires on the front and rear of your vehicle operate at different loads and perform different steering, handling, and braking functions. For these reasons, they wear at unequal rates.

These effects can be reduced by timely rotation of tires. The benefits of rotation are especially worthwhile with aggressive tread designs such as those on On/Off Road type tires. Rotation will increase tread life, help to maintain mud, snow, and wet traction levels, and contribute to a smooth, quiet ride.

For the proper maintenance intervals ⇨ page 231. The reasons for any rapid or unusual wear should be corrected prior to rotation being performed.

The suggested rotation method is the "forward cross" shown in the following diagram. This rotation pattern does not apply to some directional tires that must not be reversed.

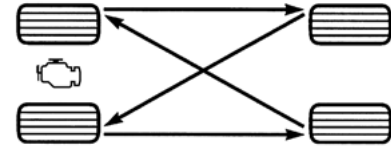

055707139

Tire Rotation (Forward Cross)**CAUTION!**

Proper operation of four-wheel drive vehicles depends on tires of equal size, type and circumference on each wheel. Any difference in tire size can cause damage to the power transfer unit. Tire rotation schedule should be followed to balance tire wear.

DEPARTMENT OF TRANSPORTATION UNIFORM TIRE QUALITY GRADES

The following tire grading categories were established by the National Highway Traffic Safety Administration. The specific grade rating assigned by the tire's manufacturer in each category is shown on the sidewall of the tires on your vehicle.

All passenger vehicle tires must conform to Federal safety requirements in addition to these grades.

TREADWEAR

The Treadwear grade is a comparative rating, based on the wear rate of the tire when tested under controlled conditions on a specified government test course. For example, a tire graded 150 would wear one and one-half times as well on the government course as a tire graded 100. The relative performance of tires depends upon the actual conditions of their use, however, and may depart significantly from the norm due to

variations in driving habits, service practices, and differences in road characteristics and climate.

TRACTION GRADES

The Traction grades, from highest to lowest, are AA, A, B, and C. These grades represent the tire's ability to stop on wet pavement, as measured under controlled conditions on specified government test surfaces of asphalt and concrete. A tire marked C may have poor traction performance.

WARNING!

The traction grade assigned to this tire is based on straight-ahead braking traction tests, and does not include acceleration, cornering, hydroplaning, or peak traction characteristics.

TEMPERATURE GRADES

The Temperature grades are A (the highest), B, and C, representing the tire's resistance to the generation of heat and its ability to dissipate heat, when tested

under controlled conditions on a specified indoor laboratory test wheel. Sustained high temperature can cause the material of the tire to degenerate and reduce tire life, and excessive temperature can lead to sudden tire failure. The grade C corresponds to a level of performance, which all passenger vehicle tires must meet under the Federal Motor Vehicle Safety Standard No. 109. Grades B and A represent higher levels of performance on the laboratory test wheel, than the minimum required by law.

WARNING!

The temperature grade for this tire is established for a tire that is properly inflated and not overloaded. Excessive speed, under-inflation, or excessive loading, either separately or in combination, can cause heat buildup and possible tire failure.

STORING THE VEHICLE

If you are storing your vehicle for more than three weeks, we recommend that you take the following steps to minimize the drain on your vehicle's battery:

- Disconnect the negative cable from battery.
- Any time you store your vehicle or keep it out of service (i.e., vacation) for two weeks or more, run the air conditioning system at idle for about five minutes in the fresh air and high blower setting. This will ensure adequate system lubrication to minimize the possibility of compressor damage when the system is started again.

NOTE:

When the vehicle has not been started or driven for at least 30 days, an Extended Park Start Procedure is required to start the vehicle → page 78.

BODYWORK

PROTECTION FROM ATMOSPHERIC AGENTS

Vehicle body care requirements vary according to geographic locations and usage. Chemicals that make roads passable in snow and ice and those that are sprayed on trees and road surfaces during other seasons are highly corrosive to the metal in your vehicle. Outside parking, which exposes your

vehicle to airborne contaminants, road surfaces on which the vehicle is operated, extreme hot or cold weather and other extreme conditions will have an adverse effect on paint, metal trim, and underbody protection.

The following maintenance recommendations will enable you to obtain maximum benefit from the corrosion resistance built into your vehicle.

What Causes Corrosion?

Corrosion is the result of deterioration or removal of paint and protective coatings from your vehicle.

The most common causes are:

- Road salt, dirt and moisture accumulation.
- Stone and gravel impact.
- Insects, tree sap and tar.
- Salt in the air near seacoast localities.
- Atmospheric fallout/industrial pollutants.

BODY AND UNDERBODY MAINTENANCE

Cleaning Headlights

Your vehicle is equipped with plastic headlights and fog lights that are lighter and less susceptible to stone breakage than glass headlights.

Plastic is not as scratch resistant as glass and therefore different lens cleaning procedures must be followed.

To minimize the possibility of scratching the lenses and reducing light output, avoid wiping with a dry cloth. To remove road dirt, wash with a mild soap solution followed by rinsing.

Do not use abrasive cleaning components, solvents, steel wool or other aggressive material to clean the lenses.

PRESERVING THE BODYWORK

Washing

- Wash your vehicle regularly. Always wash your vehicle in the shade using Mopar® Car Wash, or a mild car wash soap, and rinse the panels completely with water.
- If insects, tar, or other similar deposits have accumulated on your vehicle, use Mopar® Super Kleen Bug and Tar Remover to remove.
- Use a high quality cleaner wax, such as Mopar® Cleaner Wax to remove road film, stains and to protect your paint finish. Use precautions to not scratch the paint.
- Avoid using abrasive compounds and power buffing that may diminish the gloss or thin out the paint finish.

CAUTION!

- Do not use abrasive or strong cleaning materials such as steel wool or scouring powder that will scratch metal and painted surfaces.
- Use of power washers exceeding 1,200 psi (8,274 kPa) can result in damage or removal of paint and decals.

Special Care

- If you drive on salted or dusty roads or if you drive near the ocean, hose off the undercarriage at least once a month.
- It is important that the drain holes in the lower edges of the doors, rocker panels, and trunk be kept clear and open.
- If you detect any stone chips or scratches in the paint, touch them up immediately.
- If your vehicle is damaged due to a collision or similar cause that destroys the paint and protective coating, have your vehicle repaired as soon as possible.

- If you carry special cargo such as chemicals, fertilizers, de-icer salt, etc., be sure that such materials are well packaged and sealed.
- If a lot of driving is done on gravel roads, consider mud or stone shields behind each wheel.
- Use Mopar® Touch Up Paint on scratches as soon as possible. An authorized dealer has touch up paint to match the color of your vehicle.

INTERIORS**SEATS AND FABRIC PARTS**

Use Mopar® Total Clean to clean fabric upholstery and carpeting.

WARNING!

Do not use volatile solvents for cleaning purposes. Many are potentially flammable, and if used in closed areas they may cause respiratory harm.

Seat Belt Maintenance

Do not bleach, dye or clean the belts with chemical solvents or abrasive cleaners. This will weaken the fabric.

If the belts need cleaning, use a mild soap solution or lukewarm water. Do not remove the belts from the vehicle to wash them. Dry with a soft cloth.

Sun damage can also weaken the fabric. Replace the belts if they appear frayed or worn or if the buckles do not work properly.

WARNING!

A frayed or torn seat belt could rip apart in a collision and leave you with no protection. Inspect the seat belt system periodically, checking for cuts, frays, or loose parts. Damaged parts must be replaced immediately. Do not disassemble or modify the seat belt system. If your vehicle is involved in a collision, or if you have questions regarding seat belt or retractor conditions, take your vehicle to an authorized FCA dealer or authorized FCA Certified Collision Care Program facility for inspection.

PLASTIC AND COATED PARTS

Use Mopar® Total Clean to clean vinyl upholstery.

CAUTION!

- Direct contact of air fresheners, insect repellents, suntan lotions, or hand sanitizers to the plastic, painted, or decorated surfaces of the interior may cause permanent damage. Wipe away immediately.
- Damage caused by these type of products may not be covered by your New Vehicle Limited Warranty.

Cleaning Plastic Instrument Cluster

Lenses

The lenses in front of the instruments in this vehicle are molded in clear plastic. When cleaning the lenses, care must be taken to avoid scratching the plastic.

Clean with a wet soft cloth. A mild soap solution may be used, but do not use high alcohol content or abrasive cleaners. If soap is used, wipe clean with a clean damp cloth. Dry with a soft cloth.

LEATHER SURFACES

Mopar® Total Clean is specifically recommended for leather upholstery.

Your leather upholstery can be best preserved by regular cleaning with a damp soft cloth. Small particles of dirt can act as an abrasive and damage the leather upholstery and should be removed promptly with a damp cloth. Stubborn soils can be removed easily with a soft cloth and Mopar® Total Clean. Care should be taken to avoid soaking your leather upholstery with any liquid. Please do not use polishes, oils, cleaning fluids, solvents, detergents, or ammonia-based cleaners to clean your leather upholstery.

NOTE:

If equipped with light colored leather, it tends to show any foreign material, dirt, and fabric dye transfer more so than darker colors. The leather is designed for easy cleaning, and the manufacturer recommends Mopar® total care leather cleaner applied on a cloth to clean the leather seats as needed.

CAUTION!

Do not use Alcohol and Alcohol-based and/or Ketone based cleaning products to clean leather upholstery, as damage to the upholstery may result.

GLASS SURFACES

All glass surfaces should be cleaned on a regular basis with Mopar® Glass Cleaner, or any commercial household-type glass cleaner. Never use an abrasive type cleaner. Use caution when cleaning the inside rear window equipped with electric defrosters or windows equipped with radio antennas. Do not use scrapers or other sharp instruments that may scratch the elements.

When cleaning the rear view mirror, spray cleaner on the towel or cloth that you are using. Do not spray cleaner directly on the mirror.

TECHNICAL SPECIFICATIONS

VEHICLE IDENTIFICATION NUMBER (VIN)

The VIN is stamped on the plate illustrated, located on the left front corner of the instrument panel cover, visible from outside the vehicle through the windshield.

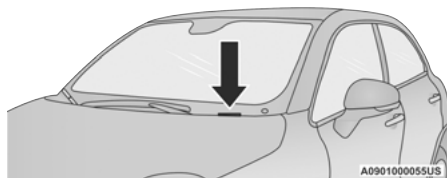

Windshield VIN Location

BRAKE SYSTEM

Your vehicle is equipped with dual hydraulic brake systems. If either of the two hydraulic systems loses normal capability, the remaining system will still function. However, there will be some loss of overall braking effectiveness. You may notice increased pedal travel during application, greater pedal force required to slow or stop, and potential activation of the Brake Warning Light.

In the event power assist is lost for any reason (i.e., repeated brake applications with the engine OFF) the brakes will still function. However, the effort required to brake the vehicle will be much greater than that required with the power system operating.

WHEEL AND TIRE TORQUE SPECIFICATIONS

Proper lug nut/bolt torque is very important to ensure that the wheel is properly mounted to the vehicle. Any time a wheel has been removed and reinstalled on the vehicle, the lug nuts/bolts should be torqued using a properly calibrated torque wrench using a six sided (hex) deep wall socket.

TORQUE SPECIFICATIONS

Lug Nut/Bolt Torque	**Lug Nut/Bolt Size	Lug Nut/Bolt Socket Size
89 Ft-Lb (120 N-m)	M12 x 1.25 x 25.5	17 mm

**Use only authorized dealer recommended lug nuts/bolts and clean or remove any dirt or oil before tightening. Inspect the wheel mounting surface prior to mounting the tire and remove any corrosion or loose particles.

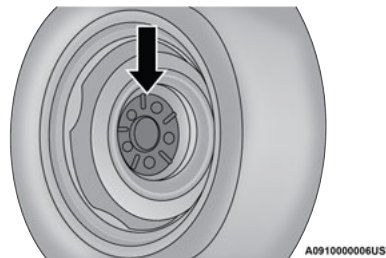

Wheel Mounting Surface

Tighten the lug nuts/bolts in a star pattern until each nut/bolt has been tightened twice.

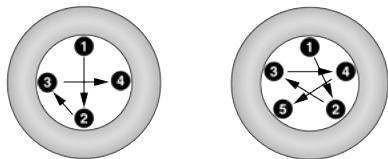

A0910000005US

Torque Patterns

After 25 miles (40 km) check the lug nut/bolt torque to be sure that all the lug nuts/bolts are properly tightened.

WARNING!

To avoid the risk of forcing the vehicle off the jack, do not tighten the lug nuts/bolts fully until the vehicle has been lowered. Failure to follow this warning may result in personal injury.

FUEL REQUIREMENTS

While operating on gasoline with the required octane number, hearing a light knocking sound from the engine is not a cause for concern. However, if the engine is heard making a heavy knocking sound, see an authorized dealer immediately. Use of gasoline with a lower than recommended octane number can cause engine failure and may void or not be covered by the New Vehicle Limited Warranty.

Poor quality gasoline can cause problems such as hard starting, stalling, and hesitations. If you experience these symptoms, try another brand of gasoline before considering service for the vehicle.

1.3L TURBO ENGINE

91 This engine is designed to meet all emission regulations and provide satisfactory fuel economy and performance when using high-quality unleaded regular gasoline having an octane rating of 87 using the (R+M)/2 method. For optimum performance and fuel economy the use of 91 octane or higher is recommended.

REFORMULATED GASOLINE

Many areas of the country require the use of cleaner burning gasoline referred to as “reformulated gasoline”. Reformulated gasoline

contains oxygenates and are specifically blended to reduce vehicle emissions and improve air quality.

The use of reformulated gasoline is recommended. Properly blended reformulated gasoline will provide improved performance and durability of engine and fuel system components.

MATERIALS ADDED TO FUEL

Besides using unleaded gasoline with the proper octane rating, gasolines that contain detergents, corrosion and stability additives are recommended. Using gasolines that have these additives will help improve fuel economy, reduce emissions, and maintain vehicle performance.

TOP TIER Detergent Gasoline Designated TOP TIER Detergent Gasoline contains a higher level of detergents to further aide in minimizing engine and fuel system deposits. When available, the usage of TOP TIER Detergent Gasoline is recommended. Visit www.toptiergas.com for a list of TOP TIER Detergent Gasoline Retailers.

Indiscriminate use of fuel system cleaning agents should be avoided. Many of these materials intended for gum and varnish removal may contain active solvents or similar ingredients. These can harm fuel system gasket and diaphragm materials.

GASOLINE/OXYGENATE BLENDS

Some fuel suppliers blend unleaded gasoline with oxygenates such as ethanol.

CAUTION!

DO NOT use E-85, gasoline containing methanol, or gasoline containing more than 15% ethanol (E-15). Use of these blends may result in starting and drivability problems, damage critical fuel system components, cause emissions to exceed the applicable standard, and/or cause the Malfunction Indicator Light to illuminate. Please observe pump labels as they should clearly communicate if a fuel contains greater than 15% ethanol (E-15).

Problems that result from using gasoline containing more than 15% ethanol (E-15) or gasoline containing methanol are not the responsibility of the manufacturer and may void or not be covered under New Vehicle Limited Warranty.

Do NOT Use E-85 In Non-Flex Fuel Vehicles

Non-Flex Fuel Vehicles (FFV) are compatible with gasoline containing up to 15% ethanol (E-15). Use of gasoline with higher ethanol content may void the New Vehicle Limited Warranty.

If a Non-FFV vehicle is inadvertently fueled with E-85 fuel, the engine will have some or all of these symptoms:

- Operate in a lean mode.
- OBD II Malfunction Indicator Light on.
- Poor engine performance.
- Poor cold start and cold drivability.
- Increased risk for fuel system component corrosion.

CNG AND LP FUEL SYSTEM MODIFICATIONS

Modifications that allow the engine to run on Compressed Natural Gas (CNG) or Liquid Propane (LP) may result in damage to the engine, emissions, and fuel system components. Problems that result from running CNG or LP are not the responsibility of the manufacturer and may void or not be covered under the New Vehicle Limited Warranty.

METHYLCYCLOPENTADIENYL MANGANESE TRICARBONYL (MMT) IN GASOLINE

MMT is a manganese-containing metallic additive that is blended into some gasoline to increase octane. Gasoline blended with MMT provides no performance advantage beyond gasoline of the same octane number without MMT. Gasoline blended with MMT reduces spark plug life and reduces emissions system performance in some vehicles. The manufacturer recommends that gasoline without MMT be used in your vehicle. The MMT content of gasoline may not be indicated on the gasoline pump; therefore, you should ask your gasoline retailer whether the gasoline contains MMT. MMT is prohibited in Federal and California reformulated gasoline.

FUEL SYSTEM CAUTIONS

CAUTION!

Follow these guidelines to maintain your vehicle's performance:

- The use of leaded gasoline is prohibited by Federal law. Using leaded gasoline can impair engine performance and damage the emissions control system.
- An out-of-tune engine or certain fuel or ignition malfunctions can cause the catalytic converter to overheat. If you notice a pungent burning odor or some light smoke, your engine may be out of tune or malfunctioning and may require immediate service. Contact an authorized dealer for service assistance.
- The use of fuel additives, which are now being sold as octane enhancers, is not recommended. Most of these products contain high concentrations of methanol. Fuel system damage or vehicle performance problems resulting from the use of such fuels or additives is not the responsibility of the manufacturer and may void or not be covered under the New Vehicle Limited Warranty.

NOTE:

Intentional tampering with the emissions control system can result in civil penalties being assessed against you.

FLUID CAPACITIES

	US	Metric
Fuel (Approximate)		
1.3L Turbo Engine	12.7 Gallons	48 Liters
Engine Oil With Filter		
1.3L Turbo Engine	4.8 Quarts	4.5 Liters
Cooling System *		
1.3L Turbo Engine	8.8 Quarts	8.3 Liters

* Includes heater and coolant recovery bottle filled to MAX level.

ENGINE FLUIDS AND LUBRICANTS

Component	Fluid, Lubricant, or Genuine Part
Engine Coolant	We recommend you use Mopar® Antifreeze/Coolant 10 Year/150,000 Mile (240,000 km) Formula OAT (Organic Additive Technology) or equivalent meeting the requirements of the manufacturer Material Standard MS.90032.
Engine Oil	We recommend you use SAE 0W-30 SN PLUS API Certified Synthetic Engine Oil, meeting the requirements of the manufacturer material standard MS.13340. Refer to your engine oil filler cap for correct SAE grade.
Engine Oil Filter	We recommend you use a Mopar® Engine Oil Filter. If a Mopar® Engine Oil Filter is unavailable, only use filters that meet or exceed SAE/USCAR-36 Filter Performance Requirements.
Fuel Selection	91 Octane (R+M)/2 Recommended, 87 Octane (R+M)/2 Acceptable, 0-15% Ethanol.

CHASSIS FLUIDS AND LUBRICANTS

Component	Fluid, Lubricant, or Genuine Part
Automatic Transmission	Use only Mopar® ZF 8 & 9 Speed ATF Automatic Transmission Fluid, or equivalent. Failure to use the correct fluid may affect the function or performance of your transmission.
Power Transfer Unit (PTU)	We recommend you use Mopar® Front Axle/PTU Synthetic Axle Lubricant SAE 75W-90 (API GL-5).
Rear Differential Module (RDM)	We recommend you use Mopar® Rear Axle/RDM Synthetic Axle Lubricant SAE 75W-90 (API GL-5).
Brake Master Cylinder	We recommend you use Mopar® DOT 4. If DOT 4 brake fluid is not available, then DOT 3 is acceptable. DOT 4 brake fluid must be changed every two years regardless of mileage.

CUSTOMER ASSISTANCE

SUGGESTIONS FOR OBTAINING SERVICE FOR YOUR VEHICLE

PREPARE FOR THE APPOINTMENT

All work to be performed may not be covered by the warranty. Discuss additional charges with the service manager. Keep a maintenance log of your vehicle's service history. This can often provide a clue to the current problem.

PREPARE A LIST

Make a written list of your vehicle's problems or the specific work you want done. If you've had an accident or work done that is not on your maintenance log, let the service advisor know.

BE REASONABLE WITH REQUESTS

If you list a number of items and you must have your vehicle by the end of the day, discuss the situation with the service advisor and list the items in order of priority. At many authorized dealers, you may obtain a rental at vehicle (additional charges may apply). If you need a rental, it is advisable to make these arrangements when you call for an appointment.

IF YOU NEED ASSISTANCE

FCA US LLC and its authorized dealers are vitally interested in your satisfaction. We want you to be happy with our products and services.

Warranty service must be done by an authorized dealer. We strongly recommend that you take the vehicle to an authorized dealer. They know your vehicle the best, and are most concerned that you get prompt and high quality service. FCA US LLC's authorized dealers have the facilities, factory-trained technicians, special tools, and the latest information to ensure the vehicle is fixed correctly and in a timely manner.

This is why you should always talk to an authorized dealer's service manager first. If for some reason you are still not satisfied, talk to the general manager or owner of the authorized dealer. They want to know if you need assistance. If an authorized dealer is unable to resolve the concern, you may contact the FCA US LLC's Customer Assistance center.

Any communication to FCA US LLC's customer center should include the following information:

- Owner's name and address
- Owner's telephone number (home, mobile and office)

- Authorized dealer name
- Vehicle Identification Number (VIN)
- Vehicle delivery date and mileage

FCA US LLC CUSTOMER CENTER

P.O. Box 21-8004

Auburn Hills, MI 48321-8004

Phone: (888) 242-6342

FCA CANADA INC. CUSTOMER CENTER

P.O. Box 1621

Windsor, Ontario N9A 4H6

Phone: (800) 465-2001 English /
(800) 387-9983 French

MEXICO

Av. Prolongacion Paseo de la Reforma, 1240

Sante Fe C.P. 05109

Mexico, D. F.

In Mexico City: 800-505-1300

Outside Mexico City: +(52)55 50817568

PUERTO RICO AND U.S. VIRGIN ISLANDS

FCA Caribbean LLC

P.O. Box 191857

San Juan 00919-1857

Phone: (888) 242-6342

Fax: (787) 782-3345

CUSTOMER ASSISTANCE FOR THE HEARING OR SPEECH IMPAIRED (TDD/TTY)

To assist customers who have hearing difficulties, FCA US LLC has installed special TDD (Telecommunication Devices for the Deaf) equipment at its customer center. Any hearing or speech impaired customer, who has access to a TDD or a conventional teletypewriter (TTY) in the United States, can communicate with FCA US LLC by dialing 1-800-380-2479.

Canadian residents with hearing difficulties that require assistance can use the special needs relay service offered by Bell Canada. For TTY teletypewriter users, dial 711 and for Voice callers, dial 1-800-855-0511 to connect with a Bell Relay Service operator.

SERVICE CONTRACT

You may have purchased a service contract for a vehicle to help protect you from the high cost of unexpected repairs after FCA US LLC's New Vehicle Limited Warranty expires. The Mopar® Vehicle Protection plans are the ONLY vehicle extended protection plans authorized, endorsed and backed by FCA US LLC to provide additional protection beyond your vehicle's warranty. If you purchased a Mopar® Vehicle Protection Plan, you will receive Plan Provisions and an Owner Identification Card in the mail within three weeks of the vehicle delivery date. If you have any questions about the service contract, call the FCA US LLC's Service Contract National Customer Hotline at 1-800-521-9922 (Canadian residents, call (800) 465-2001 English / (800) 387-9983 French).

FCA US LLC is not responsible for any service contract you may have purchased from another manufacturer. If you require service after the FCA US LLC New Vehicle Limited Warranty expires, please refer to the contract documents, and contact the person listed in those documents.

We appreciate that you have made a major investment when you purchased the vehicle. An authorized dealer has also made a major investment in facilities, tools, and training to assure that you are absolutely delighted with the ownership experience.

WARNING!

Engine exhaust (internal combustion engines only), some of its constituents, and certain vehicle components contain, or emit, chemicals known to the State of California to cause cancer and birth defects, or other reproductive harm. In addition, certain fluids contained in vehicles and certain products of component wear contain, or emit, chemicals known to the State of California to cause cancer and birth defects, or other reproductive harm.

WARRANTY INFORMATION

See the Warranty Information for the terms and provisions of FCA US LLC warranties applicable to this vehicle and market. Refer to www.mopar.com for further information.

See the Warranty Information for the terms and provisions of FCA Canada Inc. warranties applicable to this vehicle and market. Refer to www.owners.mopar.ca/en for further information.

Use this QR code to access your digital experience.



MOPAR® PARTS

Mopar® original equipment parts & accessories and factory filled fluids are available from an authorized dealer. They are recommended for your vehicle to keep it operating at its best and maintain its original condition.

REPORTING SAFETY DEFECTS

IN THE 50 UNITED STATES AND WASHINGTON, D.C.

If you believe that your vehicle has a defect that could cause a crash or cause injury or death, you should immediately inform the National Highway Traffic Safety Administration (NHTSA) in addition to notifying FCA US LLC.

If NHTSA receives similar complaints, it may open an investigation, and if it finds that a safety defect exists in a group of vehicles, it may order a recall and remedy campaign. However, NHTSA cannot become involved in individual problems between you, an authorized dealer or FCA US LLC.

To contact NHTSA, you may call the Vehicle Safety Hotline toll free at 1-888-327-4236 (TTY: 1-800-424-9153); or go to <http://www.safercar.gov>; or write to: Administrator, NHTSA, 1200 New Jersey Avenue, SE., West Building, Washington, D.C. 20590. You can also obtain other information about motor vehicle safety from <http://www.safercar.gov>.

IN CANADA

If you believe that your vehicle has a safety defect, you should contact the Customer Service Department immediately. Canadian customers who wish to report a safety defect to the Canadian government should contact Transport Canada, Motor Vehicle Defect Investigations and Recalls at 1-800-333-0510 or go to www.apps.tc.gc.ca/Saf-Sec-Sur/7/PCDB-BDPP.

PUBLICATION ORDER FORMS

To order the following manuals, you may use either the website or the phone numbers listed below.

Service Manuals

These comprehensive Service Manuals provide a complete working knowledge of the vehicle, system, and/or components and is written in straightforward language with illustrations, diagrams, and charts.

Diagnostic Procedure Manuals

Diagnostic Procedure Manuals are filled with diagrams, charts and detailed illustrations. These manuals make it easy to find and fix problems on computer-controlled vehicle systems and features. They show exactly how to find and correct problems, using step-by-step troubleshooting and drivability procedures, proven diagnostic tests and a complete list of all tools and equipment.

To order a hard copy of your Service or Diagnostic Procedure manuals, visit:

www.techauthority.com (US and Canada).

Owner's Manuals

These Owner's Manuals have been prepared with the assistance of service and engineering specialists to acquaint you with specific FCA vehicles.

To access your Owner's Information online, visit www.mopar.com/om (US) or www.owners.mopar.ca (Canada).

Or

Call Tech Authority toll free at:

- 1-800-890-4038 (US)

Owner's Manuals, Radio Manuals and Warranty Information Books can be ordered through Archway at:

- 1-800-387-1143 (Canada)

GENERAL INFORMATION

RADIO

The following regulatory statement applies to RADIO devices equipped in this vehicle:

FCC ID: Y70VP2RFP

IC: 7812H-VP2RFP

This device complies with Part 15 of the FCC Rules and with Innovation, Science and Economic Development Canada license-exempt RSS standard(s). Operation is subject to the following two conditions:

1. This device may not cause harmful interference, and
2. This device must accept any interference received, including interference that may cause undesired operation.

Le présent appareil est conforme aux CNR d'Innovation, Science and Economic Development applicables aux appareils radio exempts de licence. L'exploitation est autorisée aux deux conditions suivantes:

1. l'appareil ne doit pas produire de brouillage, et
2. l'utilisateur de l'appareil doit accepter tout brouillage radioélectrique subi, même si le brouillage est susceptible d'en compromettre le fonctionnement.

La operación de este equipo está sujeta a las siguientes dos condiciones:

1. es posible que este equipo o dispositivo no cause interferencia perjudicial y
2. este equipo o dispositivo debe aceptar cualquier interferencia, incluyendo la que pueda causar su operación no deseada.

RF Exposure Requirements

To comply with FCC RF exposure compliance requirements, the device must be installed and

operated to provide a separation distance of at least 20 cm from all persons.

This equipment complies with Canada radiation exposure limits set forth for an uncontrolled environment. This equipment should be installed and operated with minimum distance 20 cm between the radiator and your body.

Déclaration d'exposition aux radiations

Cet équipement est conforme aux limites d'exposition aux rayonnements ISSED établies pour un environnement non contrôlé. Cet équipement doit être installé et utilisé avec un minimum de 20 cm de distance entre la source de rayonnement et votre corps

NOTE:

Changes or modifications not expressly approved by the party responsible for compliance could void the user's authority to operate the equipment.

ACC and FCW

This device complies with Part 15 of the FCC Rules and with Industry Canada license-exempt RSS standard(s). Operation is subject to the following two conditions:

1. this device must not cause interference, and
2. this device must accept any interference, including interference that may cause undesired operation of the device.

Le présent appareil est conforme aux CNR d'Industrie Canada applicables aux appareils radio exempts de licence. L'exploitation est autorisée aux deux conditions suivantes:

1. l'appareil ne doit pas produire de brouillage, et
2. l'utilisateur de l'appareil doit accepter tout brouillage radioélectrique subi, même si le brouillage est susceptible d'en compromettre le fonctionnement.

This equipment has been tested and found to comply with the limits for a Class A digital device, pursuant to Part 15 of the FCC Rules. These limits are designed to provide reasonable protection against harmful interference when the equipment is operated in a commercial environment. This equipment generates, uses, and can radiate radio frequency energy and, if not installed and used in accordance with the instruction manual, may cause harmful interference to radio communications. Operation of this equipment in a residential area is likely to cause harmful interference in which case the user will be required to correct the interference at his own expense

RF Radiation Exposure Information

This equipment complies with FCC and IC radiation exposure limits set forth for an uncontrolled environment. This equipment should be installed and operated with a minimum distance of 20 cm between the radiator and your body. This transmitter must not be co-located or operating in conjunction with any other antenna or transmitter.

Cet équipement est conforme aux limites d'exposition aux rayonnements IC établies pour un environnement non contrôlé. Cet équipement doit être installé et utilisé avec un minimum de 20 cm de distance entre la source de rayonnement et votre corps. Ce transmetteur ne doit pas être placé au même endroit ou utiliser simultanément avec un autre transmetteur ou antenne.

BSM

This device complies with Part 15 of the FCC Rules and with Industry Canada's RSS - 310 . Operation is subject to the following two conditions:



1. this device may not cause harmful interference, and
2. this device must accept any interference received, including interference that may cause undesired operation.

Cet appareil est conforme au RSS - 310 d'Industrie Canada. Le fonctionnement est soumis à la condition que cet appareil ne provoque pas d'interférences nuisibles et accepte toute interférence, y compris les interférences susceptibles de provoquer un fonctionnement indésirable de l'appareil

CAUTION TO USERS

Changes or modifications not expressly approved by the party responsible for compliance could void the users authority to operate the equipment.

INDEX

- A**
- About Your Brakes 282
 - Adaptive Cruise Control (ACC) (Cruise Control)..... 92
 - Adding Engine Coolant (Antifreeze) 243
 - Adding Fuel..... 109
 - Adding Washing Fluid 236
 - Additives, Fuel 283
 - Advance Phone Connectivity 156
 - Air Bag 192
 - Air Bag Operation 193
 - Driver Knee Air Bag 194
 - Enhanced Accident Response 197, 229
 - Event Data Recorder (EDR) 229
 - Front Air Bag 192
 - If Deployment Occurs 197
 - Knee Impact Bolsters 194
 - Maintaining Your Air Bag System 200
 - Maintenance 200
 - Redundant Air Bag Warning Light 192
 - Side Air Bags 194
 - Transporting Pets 212
 - Air Bag Light 212
 - Air Cleaner, Engine (Engine Air Cleaner Filter) 238
 - Air Conditioner Maintenance 239
 - Air Conditioner Refrigerant 239
 - Air Conditioner System 239
 - Air Conditioning..... 43
 - Air Conditioning Filter..... 48, 239
 - Air Conditioning, Operating Tips..... 48
 - Air Filter 238
 - Air Pressure
 - Tires 269
 - Alarm
 - Arm The System 20
 - Disarm The System 20
 - Security Alarm 19, 70
 - All Wheel Drive (AWD) 88
 - Alterations/Modifications
 - Vehicle..... 9
 - Android Auto 158, 160
 - Android Auto™  158
 - Antifreeze (Engine Coolant) 243, 285
 - Disposal 244
 - Anti-Lock Brake System (ABS) 170
 - Anti-Lock Warning Light 71
 - Apple CarPlay..... 158, 162
 - Apple CarPlay®  160
 - Assist, Hill Start..... 174
 - Audio Settings..... 144
 - Audio Systems (Radio)..... 119
 - Auto Down Power Windows..... 53
 - Auto Up Power Windows 53
 - Automatic Door Locks 24
 - Automatic Headlights..... 36
 - Automatic Temperature Control (ATC)..... 47
 - Automatic Transmission..... 83, 246
 - Adding Fluid 246, 286
 - Fluid And Filter Change..... 246
 - Fluid Change..... 246
 - Fluid Level Check..... 246
 - Fluid Type 246, 286
 - Special Additives 246
 - Axle Fluid..... 286
 - Axle Lubrication 286
- B**
- Battery 69, 236
 - Charging System Light 69
 - Keyless Key Fob Replacement 14
 - Belts, Seat 212
 - Blind Spot Monitoring 174
 - Bluetooth
 - Connecting To A Particular Mobile Phone Or Audio Device After Pairing..... 152
 - Body Mechanism Lubrication..... 239
 - B-Pillar Location 266

Brake Assist System	171	Checks, Safety	211	Cooling System	242
Brake Control System, Electronic	171	Child Restraint	201	Adding Coolant (Antifreeze)	243
Brake Fluid	286	Child Restraints		Coolant Level	244
Brake System	245, 282	Booster Seats	203	Cooling Capacity	285
Anti-Lock (ABS).....	282	Child Seat Installation	210	Disposal Of Used Coolant	244
Fluid Check	286	How To Stow An unused ALR Seat Belt ...	208	Drain, Flush, And Refill	243
Master Cylinder	245	Infant And Child Restraints.....	202	Inspection	242, 244
Warning Light	69	LATCH Positions	205	Points To Remember	244
Brightness, Interior Lights.....	39	Locating The LATCH Anchorages	207	Pressure Cap	244
Bulbs, Light.....	213	Lower Anchors And Tethers For Children..	205	Radiator Cap.....	244
C		Older Children And Child Restraints	202	Selection Of Coolant	
Camera, Rear	108	Seating Positions.....	204	(Antifreeze).....	243, 285, 286
Capacities, Fluid	285	Cigar Lighter	52	Corrosion Protection	279
Caps, Filler		Clean Air Gasoline.....	283	Cruise Control (Speed Control).....	91
Oil (Engine).....	235	Cleaning		Cruise Light.....	75, 76
Radiator (Coolant Pressure)	244	Wheels	275	Customer Assistance	287
Car Washes	279	Climate Control.....	42	Customer Programmable Features	120
Carbon Monoxide Warning	213, 214	Clutch	245	Cybersecurity	119
CD.....	146	Fluid	245	D	
Cellular Phone	169	Coin Holder	50	Daytime Running Lights	36
Certification Label	110	Cold Weather Operation	79	Defroster, Rear Window	41
Chains, Tire.....	276	Compact Spare Tire	274	Defroster, Windshield	212
Chart, Tire Sizing.....	263	Console.....	50	De-Icer, Remote Start	19
Check Engine Light (Malfunction Indicator		Floor	50	Deleting A Phone.....	152
Light)	77	Contract, Service	288	Diagnostic System, Onboard	76
Checking Your Vehicle For Safety	211	Controls	137	Dimmer Switch	
		Cooling Pressure Cap (Radiator Cap).....	244	Headlight.....	36

Dipsticks		Electronic Stability Control (ESC)	172	Ethanol.....	284
Oil (Engine).....	236	Electronic Throttle Control Warning Light.....	70	Exhaust Gas Cautions	213, 214
Disabled Vehicle Towing	226	Emergency, In Case Of		Exhaust System	213, 241
Disc Drive	146	Hazard Warning Flasher	215	Exterior Lighting	35
Disconnecting.....	152	Jacking	215	Exterior Lights	35, 213
Disposal		Jump Starting	222		
Antifreeze (Engine Coolant).....	244	Overheating.....	224	F	
Disturb.....	155	Towing	226	Filters	
Door Ajar.....	70	Emission Control System Maintenance	77	Air Cleaner	238
Door Ajar Light.....	70	Engine.....	235	Air Conditioning	48, 239
Door Locks		Air Cleaner.....	238	Engine Oil	238, 286
Automatic.....	24	Break-In Recommendations	80	Engine Oil Disposal.....	238
Remote Keyless Entry	20	Checking Oil Level	236	Flashers	
Drag & Drop.....	136	Compartment	235	Hazard Warning.....	215
Driver Memory Presets	143	Coolant (Antifreeze).....	286	Turn Signals.....	37, 75, 213
Driver's Seat Back Tilt	25, 26	Cooling	242	Flash-To-Pass.....	36
Driving		Exhaust Gas Caution	213, 214	Flooded Engine Starting.....	78
Through Flowing, Rising, Or Shallow		Fails To Start	78	Floor Console	50
Standing Water	117	Flooded, Starting.....	78	Fluid Capacities	285
		Jump Starting	222	Fluid Leaks.....	213
E		Oil	237, 285, 286	Fluid Level Checks	
Electric Brake Control System	171	Oil Filler Cap	235	Engine Oil	236
Anti-Lock Brake System.....	170	Oil Filter	238	Fluid, Brake.....	286
Traction Control System	174	Oil Selection	237, 285	Fog Lights	37
Electric Park Brake	80	Overheating.....	224	Folding Rear Seats.....	25
Electric Parking Brake	80	Starting.....	78	Freeing A Stuck Vehicle.....	225
Electrical Outlet, Auxiliary (Power Outlet).....	51	Enhanced Accident Response		Front And Rear Park Assist System.....	101
Electrical Power Outlets.....	51	Feature	197, 229		

Fuel	283	Hazard Warning Flashers.....	215	Interior Lights.....	38
Adding.....	109	Head Restraints.....	30	Intermittent Wipers (Delay Wipers)	40
Additives	283	Headlights		iPod/USB/MP3 Control.....	51
Clean Air.....	283	Automatic.....	36		
Ethanol.....	284	Cleaning.....	279	J	
Gasoline.....	283	Delay.....	37	Jack Location	216
Gauge.....	72	High Beam/Low Beam Select Switch	36	Jack Operation	217
Materials Added.....	283	Lights On Reminder.....	37	Jacking Instructions	217
Methanol.....	284	Passing.....	36	Jump Starting.....	222
Octane Rating	283, 286	Switch.....	35		
Specifications.....	286	Time Delay.....	37	K	
Tank Capacity.....	285	Heated Mirrors.....	35	Key Fob	
Full Brake Control System	179	Heated Seats.....	29	Arm The Alarm	20
Fuses.....	246	High Beam/Low Beam Select (Dimmer)		Disarm The Alarm	20
		Switch.....	36	Keyless Entry	22
G		Hill Start Assist.....	174	Remote Keyless Entry.....	13
Gasoline, (Fuel)	283	Hitches		Key Fob Battery Service (Remote Keyless	
Gasoline, Clean Air	283	Trailer Towing.....	112	Entry)	14
Gasoline, Reformulated.....	283	Holder, Coin.....	50	Keyless Enter 'n Go™	
Gauges		Hood Prop.....	56	Passive Entry	22
Fuel.....	72	Hood Release	56	Passive Entry Programming.....	22
Gear Selector Override	225			Unlock From The Driver's Side.....	22
Glass Cleaning.....	281	I		Unlock From The Passenger's Side	22
Gross Axle Weight Rating.....	111	Ignition.....	16	Keyless Enter-N-Go	
GVWR	110	Switch.....	16	Enter The Trunk	22
		Inside Rearview Mirror.....	33	Lock The Vehicle's Doors.....	22, 129
H		Instrument Cluster	62	Remote Control.....	22
Hazard		Display.....	63	Keyless Entry	13
Driving Through Flowing, Rising, Or		Instrument Panel Lens Cleaning.....	281	Keys.....	13
Shallow Standing Water.....	117	Interior Appearance Care.....	280	Replacement	15

L		
Lane Change And Turn Signals.....	37	
Lane Change Assist.....	38	
LaneSense.....	105	
Lap/Shoulder Belts.....	186	
Latches.....	213	
Hood.....	56	
Leaks, Fluid.....	213	
Life Of Tires.....	271	
Liftgate.....	58	
Closing.....	58	
Opening.....	58	
Liftgate Window Wiper/Washer.....	41	
Light Bulbs.....	213	
Lighter.....		
Cigar.....	52	
Lights.....	213	
Adaptive Cruise Control.....	71	
Air Bag.....	212	
Audio System.....	71	
Automatic Headlights.....	36	
Brake Warning.....	69	
Coolant Temperature.....	69	
Cruise.....	75, 76	
Daytime Running.....	36	
Dimmer Switch, Headlight.....	36	
Drive Mode.....	71	
Electric Power Steering.....	70	
Electronic Park Brake.....	71	
Electronic Stability Control.....	71	
Exterior.....	35, 213	
Exterior Bulb.....	74	
External Light.....	72	
Fog.....	37, 75	
Fuel Cutoff.....	74	
Fuel Level.....	74	
Full Brake Control.....	74	
Hazard Warning Flasher.....	215	
Headlight Switch.....	35	
Headlights.....	35	
Headlights On Reminder.....	37	
High Beam.....	36, 76	
Hood Open.....	70	
Icy Road Condition.....	74	
Immobilizer Fail.....	75	
Instrument Cluster.....	35	
Intensity Control.....	39	
Interior.....	38	
LaneSense.....	72, 75	
Light Sensor.....	75	
Lights On Reminder.....	37	
Loose Fuel Filler Cap.....	72	
Malfunction Indicator (Check Engine).....	72	
Park.....	75	
Passing.....	36	
Seat Belt Reminder.....	70	
Security Alarm.....	70	
Service.....	73	
Service LaneSense.....	72	
Service Stop Start.....	73	
Speed.....	75	
StopStart Active.....	75	
Tire Pressure Monitoring (TPMS).....	182	
Transmission Fault.....	70	
Transmission Temperature.....	74	
Trunk Open.....	71	
Turn Signals.....	37, 75, 213	
Vanity Mirror.....	33	
Loading Vehicle.....	110	
Tires.....	266	
Locks.....		
Automatic Door.....	20	
Child Protection.....	24	
Low Tire Pressure System.....	182	
Lubrication, Body.....	239	
Lug Nuts/Bolts.....	282	
Luggage Carrier.....	61	
M		
Maintenance Free Battery.....	236	
Maintenance Schedule.....	230	
Malfunction Indicator Light (Check Engine).....	72	
Manual.....		
Service.....	289	
Master Cylinder.....		
Brakes.....	245	
Media Mode.....	146	
Methanol.....	284	
Mirrors.....	33	
Heated.....	35	

Outside.....	34
Rearview	33
Vanity	33
Modifications/Alterations	
Vehicle	9
Monitor, Tire Pressure System.....	182
Mopar Parts.....	289
MP3 Control	51

N

New Vehicle Break-In Period.....	80
----------------------------------	----

O

Occupant Restraints	184
Octane Rating, Gasoline (Fuel)	283, 286
Oil Change Indicator	64
Reset.....	64
Oil Filter, Change	238
Oil Filter, Selection.....	238
Oil Pressure Light	70
Oil, Engine	237, 286
Capacity	285
Checking	236
Dipstick.....	236
Disposal	238
Filter.....	238, 286
Filter Disposal	238
Identification Logo.....	237
Materials Added To	238
Pressure Warning Light	70

Recommendation	237, 285
Viscosity	285
Onboard Diagnostic System.....	76
Operating Precautions	76
Operator Manual	
Owner's Manual.....	289
Outside Rearview Mirrors	34
Overheating, Engine.....	224

P

Paint Care.....	279
Pair (Link) Uconnect Phone To A Mobile Phone 	150
Park Assist.....	101
Park Assist System, Front And Rear.....	101
Parking Brake	80
Personalized Main Menu Bar.....	136
Pets	212
Phone Mode	148
Pinch Protection	55
Placard, Tire And Loading Information.....	266
Power	
Brakes	282
Mirrors.....	34
Sunroof.....	55
Pregnant Women And Seat Belts.....	189
Preparation For Jacking	215
Presets	143

R

Radial Ply Tires.....	270
Radiator Cap (Coolant Pressure Cap).....	244
Radio	
Presets	143
Radio Controls	137
Radio Mode.....	137
Radio Operation	137, 169
Radio Remote Controls	137
Rain Sensitive Wiper System	40
Rear Camera	108
Rear Cross Path	177
Rear Seats, Folding.....	25
Rear Window Defroster	41
Rear Wiper/Washer	41
Recreational Towing.....	116
Reformulated Gasoline	283
Refrigerant.....	239
Release, Hood.....	56
Reminder, Lights On	37
Reminder, Seat Belt	185
Remote Control	
Starting System	17
Remote Keyless Entry	13
Arm The Alarm	20
Disarm The Alarm	20
Keyless Enter-N-Go.....	22
Remote Sound System (Radio) Control.....	137

Remote Starting			
Uconnect Customer Programmable			
Features.....	18		
Uconnect Settings.....	18		
Remote Starting System.....	17		
Replacement Keys.....	15		
Replacement Tires.....	272		
Reporting Safety Defects.....	289		
Restraints, Child.....	201		
Restraints, Head.....	30		
Roll Over Warning.....	8		
Roof Type Carrier.....	61		
Rotation, Tires.....	277		
S			
Safety.....	136		
Safety Checks Inside Vehicle.....	212		
Safety Checks Outside Vehicle.....	213		
Safety Defects, Reporting.....	289		
Safety Features.....	136		
Safety Information, Tire.....	262		
Safety Tips.....	211		
Safety, Exhaust Gas.....	213		
Satellite Radio.....	139		
Saved Radio Stations.....	143		
Schedule, Maintenance.....	230		
Seat Belt Reminder.....	70		
Seat Belts.....	185, 212		
Adjustable Shoulder Belt.....	189		
Adjustable Upper Shoulder Anchorage.....	189		
Adjustable Upper Shoulder Belt			
Anchorage.....	189		
Automatic Locking Retractor (ALR).....	190		
Child Restraints.....	201		
Front Seat.....	185, 186, 188		
Inspection.....	212		
Lap/Shoulder Belt Operation.....	188		
Lap/Shoulder Belt Untwisting.....	188		
Lap/Shoulder Belts.....	186		
Operating Instructions.....	188		
Pregnant Women.....	189		
Rear Seat.....	186		
Reminder.....	185		
Untwisting Procedure.....	188		
Seat Belts Maintenance.....	280		
Seats.....	25		
Adjustment.....	25, 26		
Heated.....	29		
Rear Folding.....	25		
Seatback Release.....	25, 26		
Tilting.....	25, 26		
Security Alarm.....	19, 70		
Arm The System.....	20		
Disarm The System.....	20		
Selection Of Coolant (Antifreeze).....	286		
Sentry Key Replacement.....	15		
Service Assistance.....	287		
Service Contract.....	288		
Service Manuals.....	289		
Settings.....	120		
Personal.....	120		
Settings, Audio.....	144		
Shift Lever Override.....	225		
Shoulder Belts.....	186		
Signals, Turn.....	37, 75, 213		
Sirius Satellite Radio.....	139		
Favorites.....	141		
Replay.....	140		
SiriusXM Satellite Radio			
Browse in SXM.....	142		
Favorites.....	141		
Replay.....	140		
Snow Chains (Tire Chains).....	276		
Snow Tires.....	273		
Spare Tires.....	273, 274, 275		
Specifications			
Fuel (Gasoline).....	286		
Oil.....	286		
Speed Control			
Distance Setting (ACC Only).....	92		
Mode Setting (ACC Only).....	92		
Resume.....	92		
Speed Control (Cruise Control).....	91		

Starting.....	78	Time Delay		Tread Wear Indicators	271
Button	16	Headlight.....	37	Wheel Nut Torque.....	282
Cold Weather	79	Tip Start	78	To Open Hood	56
Engine Fails To Start	78	Tire And Loading Information Placard.....	266	Tongue Weight/Trailer Weight	113
Remote	17	Tire Markings.....	262	Towing.....	111
Starting And Operating	78	Tire Safety Information	262	Disabled Vehicle.....	226
Starting Procedures.....	78	Tire Service Kit.....	220	Guide	113
Steering		Tires.....	213, 269, 273, 278	Recreational	116
Tilt Column	25	Aging (Life Of Tires)	271	Weight	113
Wheel, Heated.....	25	Air Pressure	269	Towing Behind A Motorhome	116
Wheel, Tilt	25	Chains	276	Towing Eyes	227
Steering Wheel Audio Controls	137	Changing	215	Traction.....	117
Steering Wheel Mounted Sound System	137	Compact Spare.....	274	Traction Control	174
Storage.....	50	General Information	269, 273	Trailer Towing.....	111
Storage, Vehicle.....	48	High Speed.....	270	Hitches	112
Store Radio Presets.....	143	Inflation Pressure.....	269	Minimum Requirements	113
Stuck, Freeing	225	Life Of Tires	271	Trailer And Tongue Weight.....	113
Sun Roof.....	55	Load Capacity.....	266, 267	Wiring	115
Closing	55	Pressure Monitoring System (TPMS) ..	73, 182	Trailer Towing Guide	113
Opening.....	55	Quality Grading.....	278	Trailer Weight.....	113
Sun Visor Extension.....	50	Radial	270	Transfer Case	
Supplemental Restraint System - Air Bag.....	192	Replacement	272	Fluid.....	286
Sway Control, Trailer.....	111	Rotation.....	277	Transmission	
System, Remote Starting	17	Safety	262, 269	Automatic	83, 246
		Sizes.....	263	Fluid.....	286
T		Snow Tires	273	Transporting Pets	212
Telescoping Steering Column	25	Spare Tires	273, 275	Tread Wear Indicators.....	271
Temperature Control, Automatic (ATC)	47	Spinning.....	271	Turn Signals	37, 75
Tilt Steering Column	25	Trailer Towing.....	114		

U

Uconnect	
Phone Call Features	154
Things You Should Know About Your Uconnect Phone.....	156
Uconnect Settings.....	18, 120
Uconnect Phone	150, 152
Answer Or Ignore An Incoming Call – Call Currently In Progress.....	155
Answer Or Ignore An Incoming Call – No Call Currently In Progress	155
Bluetooth Communication Link.....	158
Call Continuation.....	156
Call Controls.....	154
Call Termination	156
Cancel Command.....	150
Connecting To A Particular Mobile Phone Or Audio Device After Pairing	152
Help Command	150
Join Calls	156
Making A Phone Or Audio Device A Favorite.....	153
Making A Second Call While Current Call Is In Progress	156
Managing Your Favorites.....	153
Natural Speech	150
Operation	149
Overview.....	148

Pair (Link) Uconnect Phone To A Mobile Phone 	150
Pair A Bluetooth Streaming Audio Device...	152
Phonebook Download	153
Place/Retrieve A Call From Hold	155
Power-Up.....	158
Recent Calls	154
Redial	156
To Remove A Favorite.....	153
Toggling Between Calls.....	156
Touch-Tone Number Entry	154
Transfer Call To And From Mobile Phone.....	156
Voice Command	156
Uconnect Settings	
Customer Programmable Features.....	18, 120, 129
Passive Entry Programming.....	129
Uconnect System.....	134
Uniform Tire Quality Grades.....	278
Untwisting Procedure, Seat Belt	188
USB.....	51
V	
Vanity Mirrors	33
Vehicle Identification Number (VIN)	282
Vehicle Loading	110, 267
Vehicle Maintenance	237
Vehicle Modifications/Alterations.....	9

Vehicle Storage	48
Voice Command	32, 160, 162
Voice Recognition System (VR)	32

W

Warning Flashers, Hazard	215
Warnings, Roll Over.....	8
Warranty Information	288
Washer	
Adding Fluid	236
Washing Vehicle.....	279
Water	
Driving Through	117
Wheel And Wheel Tire Care.....	275
Wheel And Wheel Tire Trim	275
Wind Buffeting	54
Window Fogging.....	48
Windows	53
Windshield Defroster	212
Windshield Washers	40
Windshield Wiper Blades	240
Windshield Wipers	40
Wipers Blade Replacement.....	240
Wipers, Intermittent	40
Wipers, Rain Sensitive	40
Wrecker Towing.....	226

The driver's primary responsibility is the safe operation of the vehicle. Driving while distracted can result in loss of vehicle control, resulting in an accident and personal injury. FCA US LLC strongly recommends that the driver use extreme caution when using any device or feature that may take their attention off the road. Use of any electrical devices, such as cellular telephones, computers, portable radios, vehicle navigation or other devices, by the driver while the vehicle is moving is dangerous and could lead to a serious accident. Texting while driving is also dangerous and should never be done while the vehicle is moving. If you find yourself unable to devote your full attention to vehicle operation, pull off the road to a safe location and stop your vehicle. Some states or provinces prohibit the use of cellular telephones or texting while driving. It is always the driver's responsibility to comply with all local laws.

This Owner's Manual has been prepared to help you get acquainted with your new FIAT® brand vehicle and to provide a convenient reference source for common questions.

Not all features shown in this manual may apply to your vehicle. For additional information, visit www.mopar.com (U.S.), www.mopar.ca (Canada) or your local FIAT® brand dealer.

DRIVING AND ALCOHOL: Drunk driving is one of the most frequent causes of accidents. Your driving ability can be seriously impaired with blood alcohol levels far below the legal minimum. If you are drinking, don't drive. Ride with a designated non-drinking driver, call a cab, a friend or use public transportation.

WARNING

Driving after drinking can lead to an accident. Your perceptions are less sharp, your reflexes are slower and your judgment is impaired when you have been drinking. Never drink and then drive.





Whether it's providing information about specific product features, taking a tour through your vehicle's heritage, knowing what steps to take following an accident or scheduling your next appointment, we know you'll find the app an important extension of your FIAT® brand vehicle.

Simply download the app, select your make and model and enjoy the ride. To get this app, go directly to the App Store® or Google Play® Store and enter the search keyword "FIAT" (U.S. residents only).

U.S.



mopar.com/om

**DOWNLOAD A FREE ELECTRONIC COPY OF THE MOST
UP-TO-DATE OWNER'S MANUAL, UCONNECT AND
WARRANTY BOOKLETS**

Canada



owners.mopar.ca

fiatusa.com (U.S.) or fiatcanada.com/en (Canada)

©2021 FCA US LLC. All Rights Reserved. FIAT is a registered trademark of FCA Group Marketing S.p.A., used under license by FCA US LLC. App Store is a registered trademark of Apple Inc. Google Play Store is a registered trademark of Google.

First Edition V2
21_FD_OM_EN_USC