INSTALLATION INSTRUCTIONS

Bard Air Conditioning System



MEGA-TEC®
Wall-Mount
Air Conditioner



LC6000-200
Supervisory
Controller



Climate Control Solutions

Bard Manufacturing Company, Inc.
Bryan, Ohio 43506
www.bardhvac.com

Manual: 2100-705E
Supersedes: 2100-705D
Date: 7-6-21

CONTENTS

General Information	3
List of Necessary Materials/Tools	6
Site Preparation	7
Model Identification	7
New Shelter Installation vs. Retrofit Installation	7
Minimum Clearance	7
Clearance to Combustibles	8
Wall-Mount Unit Mounting	9
Mounting the Units	9
Wall-Mount Unit Wiring	14
Main Power Wiring	14
Unit Control Voltage Wiring	14
230/208V Wiring.....	14
460V Wiring.....	14
Crankcase Heater Start Up	18
Preliminary Start Up	19
Running in Orphan Mode	19
LC6000 Controller Installation	20
LC6000 Controller	21
Mounting the LC6000 Controller.....	21
Installing Remote Indoor Temperature/Humidity Sensor(s)	22
Installing Optional Outdoor Temperature/ Humidity Sensor.....	24

FIGURES AND TABLES

Figure 1	MEGA-TEC Model Nomenclature.....	6
Figure 2	Clearance Required for Service Access and Adequate Condenser Airflow	7
Figure 3	Unit Dimensions	8
Figure 4	Lifting Lug Plates	9
Figure 5	Mounting Instructions.....	10
Figure 6	Electric Heat Clearance	11
Figure 7	Wall Mounting Instructions.....	11
Figure 8	Wall Mounting Instructions.....	12
Figure 9	Common Wall Mounting Installations.....	13
Figure 10	WIRING: VAC Supply Wiring Landing Points..	14
Figure 11	Side Communication and Power Wire Entrances (Recommended)	17
Figure 12	Rear Communication and Power Wire Entrances (Optional).....	17
Figure 13	Cooling and Heating Setpoints.....	19
Figure 14	Typical LC6000-200 Component Location ...	20
Figure 15	LC6000 Fused Power Supply Terminal	21
Figure 16	Remote Indoor Temperature/Humidity Sensor Installation	22
Figure 17	Additional Remote Sensor Installation	23
Figure 18	Remote Outdoor Temperature/Humidity Sensor Installation	24
Figure 19	Emergency Off, Emergency Ventilation and Generator Run Connections.....	25
Figure 20	Communication Wiring (Daisy Chain).....	26
Figure 21	Communication Wiring (Alt. Method).....	26
Figure 22	Placement of Communication Filters.....	27
Figure 23	Communication Wiring: Termination at the Controller	28
Figure 24	Communication Wiring: Termination at the First Wall-Mount Unit	29
Figure 25	Communication Wiring: Termination at Additional Wall-Mount Units.....	30
Figure 26	LC6000 Controller Circuit Install	31
Figure 27	Controller Grounding Posts.....	31
Figure 28	WIRING: LC6000-200 Wiring Diagram.....	33
Figure 29	TEC-EYE Connection to Unit Control	34
Figure 30	TEC-EYE Display and Interface	34
Figure 31	Unit Configuration	35

Emergency Off, Emergency Vent and Generator Run Connections	25
Communication Wiring.....	26
Supply Wiring.....	31
System Set Up	34
TEC-EYE Hand-Held Diagnostic Tool	34
TEC-EYE Status Screen.....	35
Setting Up Wall-Mount Units for Operation	35
1. Address Each Wall-Mount Unit.....	35
2. Execute a Self Test on Each Unit	35
3. Clear Unit Alarm Logs on Each Unit	36
Setting Up LC6000 for Operation	36
4. Set LC Controller Date and Time	37
5. Configure Sensors.....	37
6. Enter Total Number of Units	40
7. Verify Units are Online	40
8. Select Economizer Type for Each Zone.....	40
9. Clear Controller Alarm Logs	41
10. Complete Installation	41
Additional Information	42
Menu Screens and Password Levels	42
Setpoints.....	43
Calibrating Sensors	43
A/C Circuit Information	45
Remote Indoor Temperature/Humidity Sensor Orientation	46

Figure 32	Executing Self Test.....	36
Figure 33	Clearing Unit Alarm Logs	36
Figure 34	LC6000 Controller Display and Interface	37
Figure 35	Setting Controller Date and Time	37
Figure 36	Enable/Disable Zone 1 Indoor Humidity Sensor	38
Figure 37	Enable/Disable Zone 2 Indoor Humidity Sensor	38
Figure 38	Enable/Disable Zone 3 Indoor Humidity Sensor	38
Figure 39	Enable/Disable Zone 1 Indoor Temperature Sensor	38
Figure 40	Enable/Disable Zone1 Remote Temperature Sensor	39
Figure 41	Enable/Disable Zone 2 Remote Temperature Sensor	39
Figure 42	Enable/Disable Zone 3 Remote Temperature Sensor	39
Figure 43	Enable/Disable Outdoor Air Humidity Sensor ..	40
Figure 44	Enable/Disable Outdoor Air Temperature Sensor	40
Figure 45	Total Units Displayed	40
Figure 46	Selecting Economizer Type.....	41
Figure 47	Clearing LC6000 Alarm Logs.....	41
Figure 48	Adjusting Sensor Offset Value.....	43
Figure 49	MEGA-TEC Refrigeration Circuits	45
Figure 50	Current Sensor Orientation	46
Figure 51	Earlier Sensor Orientation	46
Table 1	Minimum Clearances Required to Combustible Materials	8
Table 2A	Electrical Specifications – W***AP Series....	15
Table 2B	Electrical Specifications – W***AE Series....	16
Table 3	LC6000-200 Terminal Block Index	32
Table 4	LC6000/TEC-EYE Passwords (Default)	34
Table 5	TEC-EYE Menu Structure	42
Table 6	LC6000 Controller Menu Structure	42
Table 7	Unit Status Messages	44
Table 8	LC6000 Status Messages.....	45

GENERAL INFORMATION

Air Conditioning System

This Bard air conditioning system is comprised of MEGA-TEC wall-mounted air conditioners matched with an LC6000 supervisory controller or Bard PGD/PGDx stand-alone display. If only one wall-mounted air conditioner is being used, it can be matched with either the LC6000 supervisory controller or stand-alone controller (see **Single Unit Operation** on page 4 for information on the PGD and PGDx). If more than one wall mount is installed, the LC6000 controller must be matched with the air conditioning units. The wall-mount units are specifically engineered for telecom/motor control center rooms.

NOTE: The LC6000 supervisory controller or stand-alone display and MEGA-TEC wall-mount units are designed specifically to work together. The controller or stand-alone display cannot run other brands of systems, nor can other controllers run the MEGA-TEC wall-mount units. They are a complete system, and must be used together.

Controller

LC6000 controller and accessories shown below.

LC6000-200 Series Controller and Accessories Included with Controller



(1) LC6000 Programmable Logic Controller



(1) TEC-EYE™ Hand-Held Diagnostic Tool
Bard P/N 8301-059



(1) Remote Temperature/Humidity Sensor¹
Bard P/N 8403-079



(1) 35' 5-Wire 18 Gauge Shielded Cable



(2) Communication EMI Filters
Bard P/N 8301-055

NOTE: The 2-wire, 18 gauge shielded cable used to communicate between the controller and wall-mount units is not included and must be field supplied.

Optional Sensors:



Outside Air
Temperature/Humidity Sensor
Bard P/N 8301-090



Remote
Temperature/Humidity Sensor¹
Bard P/N 8403-079



Remote
Temperature Only Sensor
Bard P/N 8301-058

¹ One remote temperature/humidity sensor is included with the LC6000 controller. If the site in which the LC6000 controller will be used has more than one zone (maximum three zones), additional remote temperature/humidity sensors (one sensor per zone) will need to be purchased and installed in the additional zones. One additional temperature-only sensor (Bard P/N 8301-058) may also be used in Zone 1 but will also need to be purchased separately. Additional temperature/humidity sensors require field-supplied 5-wire 18 gauge shielded cable. Temperature-only sensors require field-supplied 2-wire 18 gauge shielded cable.

Wall-Mount Air Conditioner Units

MEGA-TEC units operate on VAC power. If equipped with an economizer, the units will supply 100% of rated cooling airflow in free cooling mode with ability to exhaust the same amount through the unit itself without any additional relief openings in the shelter.

MEGA-TEC units are fully charged with refrigerant and are available with optional electric heat and/or electric reheat dehumidification.

NOTE: 575V models take incoming field power and step-down secondary to 460V which supplies most components **except** compressors and electric heat which remain 575V. Reference wiring diagrams for more information.

NOTE: 400V models have only two stages of capacity rather than three and are identical in size. Take note of this when reading this manual.

Single Unit Operation

A PGD or PGDx stand-alone display can be used in place of the LC6000 controller when only one MEGA-TEC wall-mount air conditioner is being installed. If using a PGD or PGDx stand-alone display instead of the LC6000 controller, the alarm logging and remote communication capabilities of the LC6000 controller will not be available. See PGD manual 2100-734 or PGDx manual 2100-740 for information on installing and setting up a stand-alone display for single unit operation.

General

The equipment covered in this manual is to be installed by trained, experienced service and installation technicians.

The refrigerant system is completely assembled and charged. All internal wiring is complete.

The unit is designed for use with or without duct work. Flanges are provided for attaching the supply and return ducts.

These instructions explain the recommended method to install the air cooled self-contained unit and the electrical wiring connections to the unit.

These instructions and any instructions packaged with any separate equipment required to make up the entire air conditioning system should be carefully read before beginning the installation. Note particularly any tags and/or labels attached to the equipment.

While these instructions are intended as a general recommended guide, they do not supersede any national and/or local codes in any way. Authorities having jurisdiction should be consulted before the installation is made. See **Additional Publications** for information on codes and standards.

Sizing of systems for proposed installation should be based on heat loss and heat gain calculations made according to methods of Air Conditioning Contractors of America (ACCA). The supply flange should be installed in accordance with the *Standards of the National Fire Protection Association for the Installation of Air Conditioning and Ventilating Systems of Other Than Residence Type, NFPA No. 90A*, and *Residence Type Warm Air Heating and Air Conditioning Systems, NFPA No. 90B*. Where local regulations are at a variance with instructions, installer should adhere to local codes.

Shipping Damage

Upon receipt of equipment, the cartons should be checked for external signs of shipping damage. If damage is found, the receiving party must contact the last carrier immediately, preferably in writing, requesting inspection by the carrier's agent.

These units must remain in upright position at all times; do not lay on side. Do not stack units.

Additional Publications

These publications can help when installing the air conditioner. They can usually be found at the local library or purchased directly from the publisher. Be sure to consult the current edition of each standard.

National Electrical CodeANSI/NFPA 70

Standard for the Installation of Air Conditioning and Ventilating SystemsANSI/NFPA 90A

Standard for Warm Air Heating and Air Conditioning SystemsANSI/NFPA 90B

Load Calculation for Residential Winter and Summer Air Conditioning ACCA Manual J

For more information, contact these publishers:

Air Conditioning Contractors of America (ACCA)

1712 New Hampshire Ave. N.W.
Washington, DC 20009
Telephone: (202) 483-9370 Fax: (202) 234-4721

American National Standards Institute (ANSI)

11 West Street, 13th Floor
New York, NY 10036
Telephone: (212) 642-4900 Fax: (212) 302-1286

American Society of Heating, Refrigeration and Air Conditioning Engineers, Inc. (ASHRAE)

1791 Tullie Circle, N.E.
Atlanta, GA 30329-2305
Telephone: (404) 636-8400 Fax: (404) 321-5478

National Fire Protection Association (NFPA)

Batterymarch Park
P. O. Box 9101
Quincy, MA 02269-9901
Telephone: (800) 344-3555 Fax: (617) 984-7057

ANSI Z535.5 Definitions:

DANGER: Indicate[s] a hazardous situation which, if not avoided, will result in death or serious injury. The signal word “DANGER” is to be limited to the most extreme situations. DANGER [signs] should not be used for property damage hazards unless personal injury risk appropriate to these levels is also involved.

WARNING: Indicate[s] a hazardous situation which, if not avoided, could result in death or serious injury. WARNING [signs] should not be used for property damage hazards unless personal injury risk appropriate to this level is also involved.

CAUTION: Indicate[s] a hazardous situation which, if not avoided, could result in minor or moderate injury. CAUTION [signs] without a safety alert symbol may be used to alert against unsafe practices that can result in property damage only.

NOTICE: [this header is] preferred to address practices not related to personal injury. The safety alert symbol shall not be used with this signal word. As an alternative to “NOTICE” the word “CAUTION” without the safety alert symbol may be used to indicate a message not related to personal injury.



 **WARNING**

Electrical shock hazard.

Have a properly trained individual perform these tasks.

Failure to do so could result in electric shock or death.

 **WARNING**

Fire hazard.

Maintain minimum 1/4" clearance between the supply air duct and combustible materials in the first 3' of ducting.

Failure to do so could result in fire causing damage, injury or death.

 **WARNING**

Heavy item hazard.

Use more than one person to handle unit.

Failure to do so could result in unit damage or serious injury.

 **CAUTION**

Cut hazard.

Wear gloves to avoid contact with sharp edges.

Failure to do so could result in personal injury.

IMPORTANT

When connecting this product from a remote location, ensure that the network connection is secure and reliable.

LIST OF NECESSARY MATERIALS/TOOLS

Additional hardware and miscellaneous supplies are needed for installation. These items are field supplied and must be sourced before installation. This list also includes tools needed for installation.

List of Materials/Tools

- Personal protective equipment/safety devices/ anti-static wrist straps
- SG-10W supply grille and RG-10W return grille
- Field-fabricated sleeves (if necessary)
- Fasteners sufficient for mounting the units such as 5/16" diameter anchor/lag bolts
- 7/8" diameter washers
- Fasteners appropriate for the shelter wall construction to attach the controller to the wall
- Commercial grade outdoor silicone sealant
- Miscellaneous hand and power tools and jobsite or shop materials
- Lifting equipment with the necessary capacity and rigging to safely move/install the systems. The unit is supplied with lifting lug plates on each side at top of unit. Remount in upright position for use (see page 9).
- Electrical supplies
 - Various size circuit breakers for the shelter AC breaker box (see Tables 2A or 2B on pages 15 or 16)
 - High-voltage wire of various gauges (see Tables 2A or 2B)
 - 16 gauge minimum, 14 gauge maximum power wire to connect controller to shelter power source
 - 5-wire, 18 gauge shielded cable for remote temperature and humidity sensors (2-wire, 18 gauge shielded cable for temperature-only sensors)
 - Communication wire: 2-wire, 18 gauge, shielded with drain
 - 18 gauge non-shielded wire for connecting emergency off, emergency vent and/or generator relays, if applicable, to controller
 - CAT 6 Ethernet cable of field-determined length (for remote communication, if applicable)
 - 2 hole grounding lug (to be used with supplied 1/4" bolts and nuts for grounding controller box)
 - Miscellaneous electrical supplies including rigid/flexible conduit and fittings, 2" x 4" junction boxes (one per temperature/humidity sensor), wire connectors and supports

FIGURE 1
MEGA-TEC Wall-Mount Unit Model Nomenclature

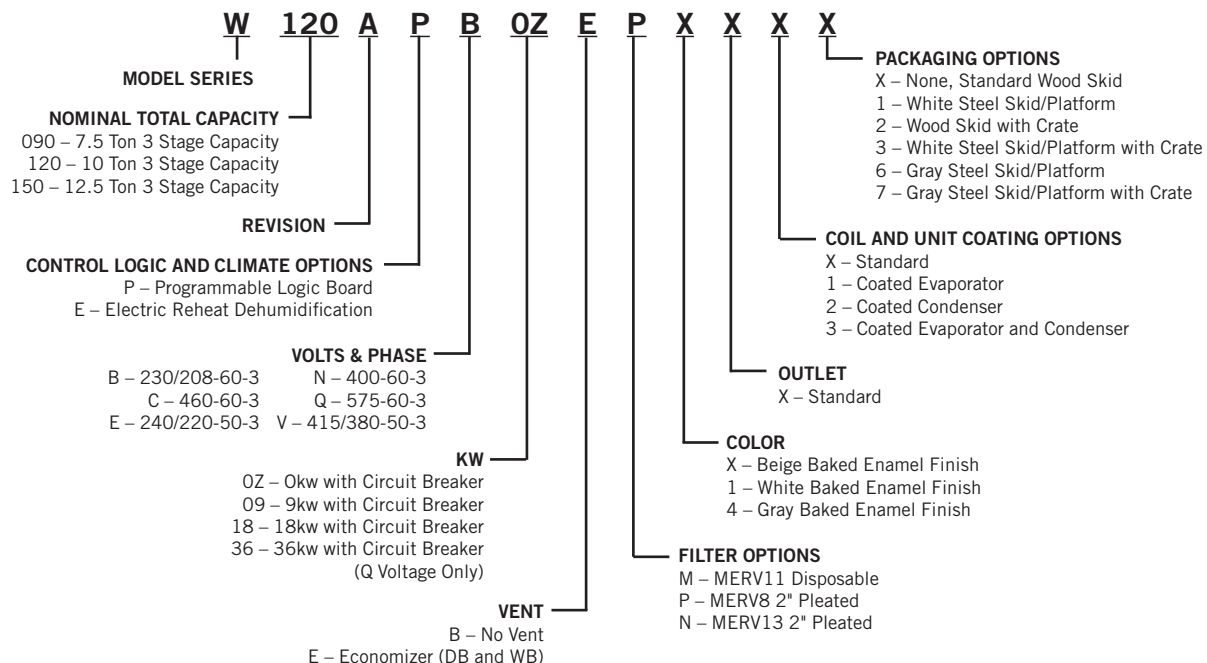

SITE PREPARATION

Model Identification

Identify the specific model using the model nomenclature information found in Figure 1 and the model/serial tag found on the unit. See Figure 3 on page 8 for dimensions and critical installation requirements.

New Shelter Installation vs. Retrofit Installation

These installation instructions cover both new shelter installations and retrofit installations. Each installation is unique and may require special accommodations and modifications. Although Bard Manufacturing follows a long-established tradition of manufacturing equipment using industry standard dimensions for building penetration, it is occasionally necessary to move or enlarge supply and return openings when replacing non-standardized equipment in a retrofit application.

Minimum Clearance

To maintain full service access and adequate condenser airflow, side-by-side installations require 28" of clearance between units for access to the economizer (20" of clearance between units without economizers) and proper airflow of the outdoor coil (see Figure 2). Additional clearance may be required to meet local or national codes.

Care should be taken to ensure that the recirculation and obstruction of condenser discharge air does not occur. Recirculation of condenser discharge air can be from either a single unit or multiple units. Any object such as shrubbery, a building or a large object can cause obstructions to the condenser discharge air. Recirculation or reduced airflow caused by obstructions will result in reduced capacity, possible unit pressure safety lockouts and reduced unit service life.

For units with blow through condensers, such as these wall-mount units, it is recommended there be a minimum distance of 10' between the front of the unit and any barrier or 20' between the fronts of two opposing (facing) units.

FIGURE 2
Clearance Required for Service Access and Adequate Condenser Airflow

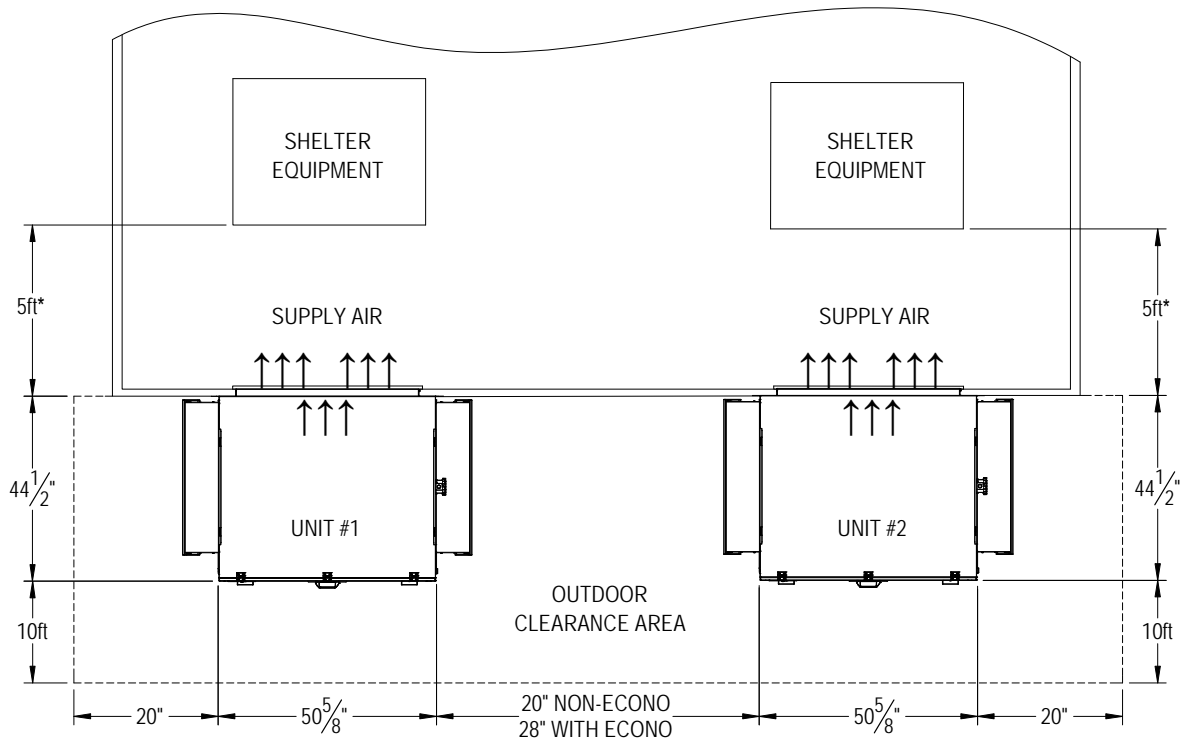

* Recommended distance between return air opening and equipment in room. Supply airstream must be able to provide adequate air circulation throughout the room.

MIS-3962

All national, state and local codes must be observed and followed during installation.

WALL-MOUNT UNIT MOUNTING

Mounting the Units

⚠ WARNING

Unit falling hazard.

Use only sufficiently rated mechanical lifting means with proper rigging to raise the unit for mounting.

Failure to follow this warning could result in injury or death.

NOTE: It may be best to spot some electrical knockouts (such as those located on the side and rear of the wall-mount unit) before units are mounted and access is unavailable or limited (see Figure 3 to locate pre-punched knockouts).

Heavy duty lifting lug plates are installed on each side of the unit to allow the unit to be lifted and installed on a structure. The plates must be removed and re-installed in upright position (see Figure 4) for use and can be removed after installation.

The filter access panel handle is shipped with the unit. Attach handle to front of filter access panel using the screws included with the handle as shown in Figure 4.

FIGURE 4
Lifting Lug Plates

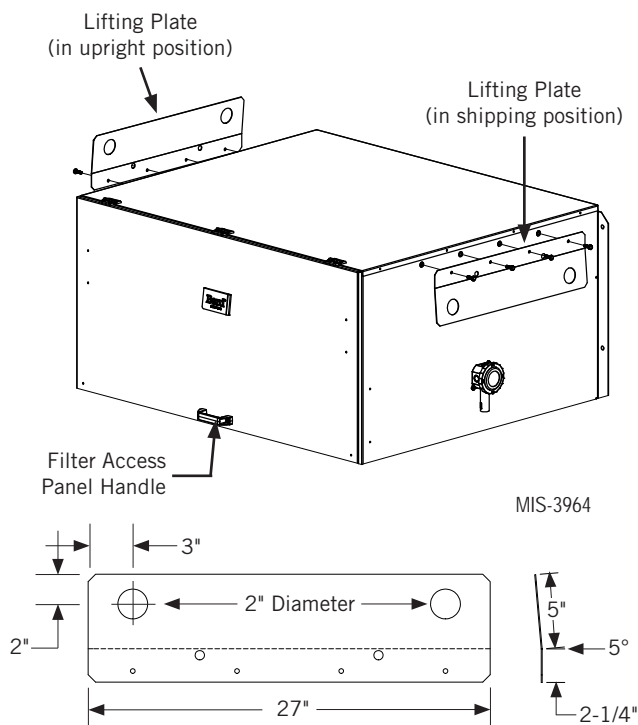

Two holes for the supply and return air openings must be cut through the wall as shown in Figure 5 on page 10. On wood frame walls, the wall construction must be strong and rigid enough to carry the weight of the unit without transmitting any unit vibration. All walls must be thoroughly inspected to ensure that they are capable of carrying the weight of the installed unit.

In retrofit (unit replacement) installations, the openings cut for the original equipment may not line up exactly with needs of this installation. Modifications may need to be made, such as increasing or decreasing the size of the wall cutouts. The existing bolt placement may not line up in which case the original bolts would need to be removed or cut away.

1. These units are secured by full-length mounting flanges built into the cabinet on each side which secure the unit to the outside wall surface.
2. The unit itself is suitable for 0" clearance, but the supply air duct flange and the first 3' of supply air duct require a minimum of 1/4" clearance to combustible material. See Figure 5 for details on opening sizes.
3. Locate and mark lag bolt locations and location for optional bottom mounting bracket, if desired (see Figure 5).
4. If desired, hook top rain flashing (attached to front-right of supply flange for shipping) under back bend of top.
5. Position unit in opening and secure with fasteners sufficient for the application such as 5/16" lag/ anchor/carriage bolts; use 7/8" diameter flat washers on the lag bolts. It is recommended that a bead of silicone caulking be placed behind the side mounting flanges.

NOTE: For economizer models, mount hoods after unit is installed so as to not block unit flange holes.

6. Secure optional rain flashing to wall and caulk across entire length of top (see Figure 5).
7. For additional mounting rigidity, the return air and supply air frames or collars can be drilled and screwed or welded to the structural wall itself (depending upon wall construction). Be sure to observe required clearance if combustible wall.
8. A plastic drain hose extends from each drain pan at the top of the unit down to the unit base. There are openings in the unit base for the drain hoses to pass through.

NOTE: Ensure hose doesn't kink inside of unit when pulling hose through holes in base. This could prevent proper drainage.

Additional openings exist in the condenser fan panel section for front drainage. In the event the drain hose is connected to a drain system of some type, it must be an open or vented type system to assure proper drainage.

FIGURE 5
Mounting Instructions

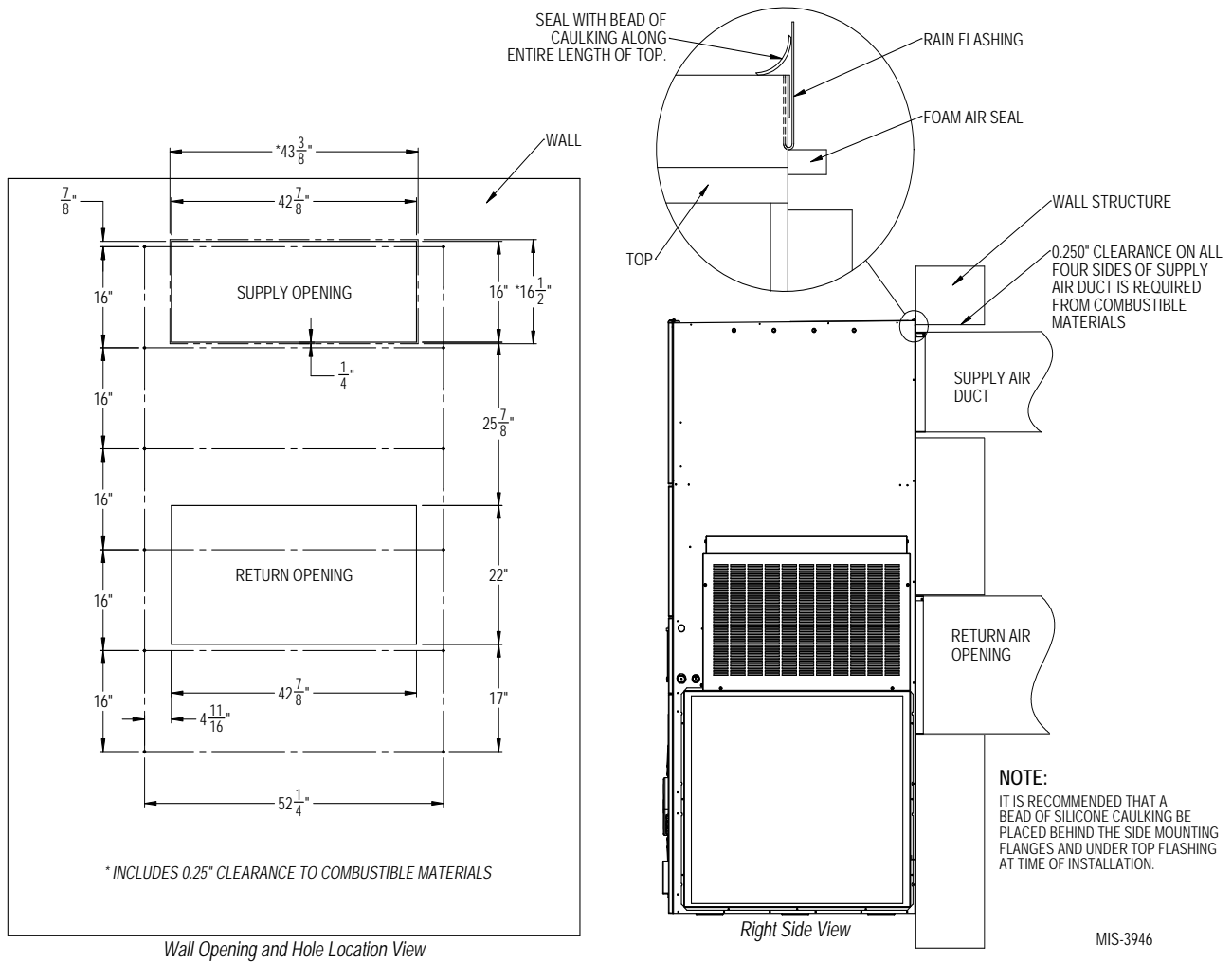

FIGURE 6
Electric Heat Clearance

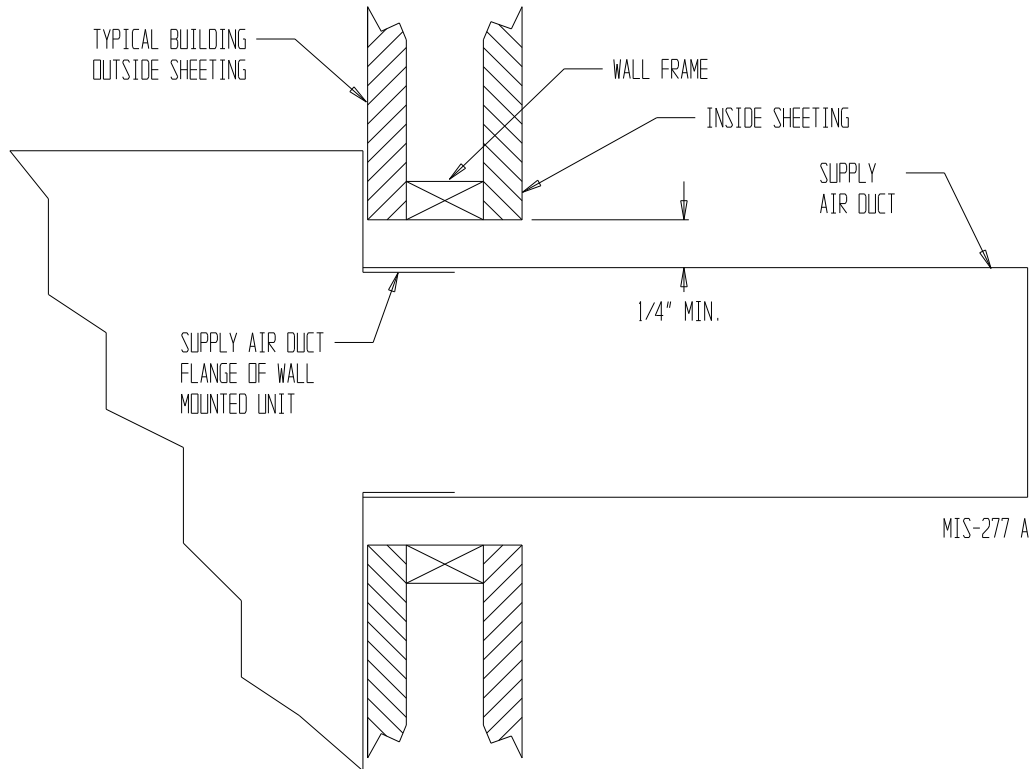

FIGURE 7
Wall Mounting Instructions

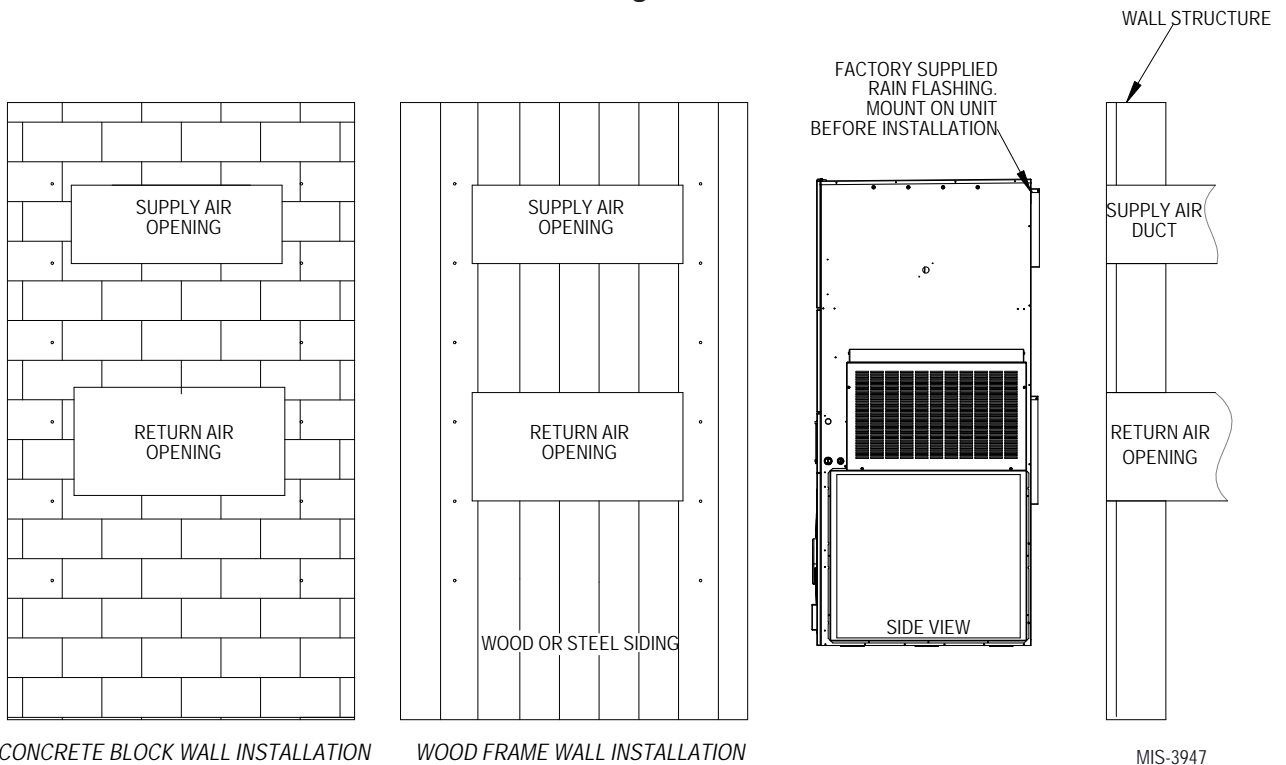

FIGURE 8
Wall Mounting Instructions

See Figure 3, Unit Dimensions,
for actual dimensions.

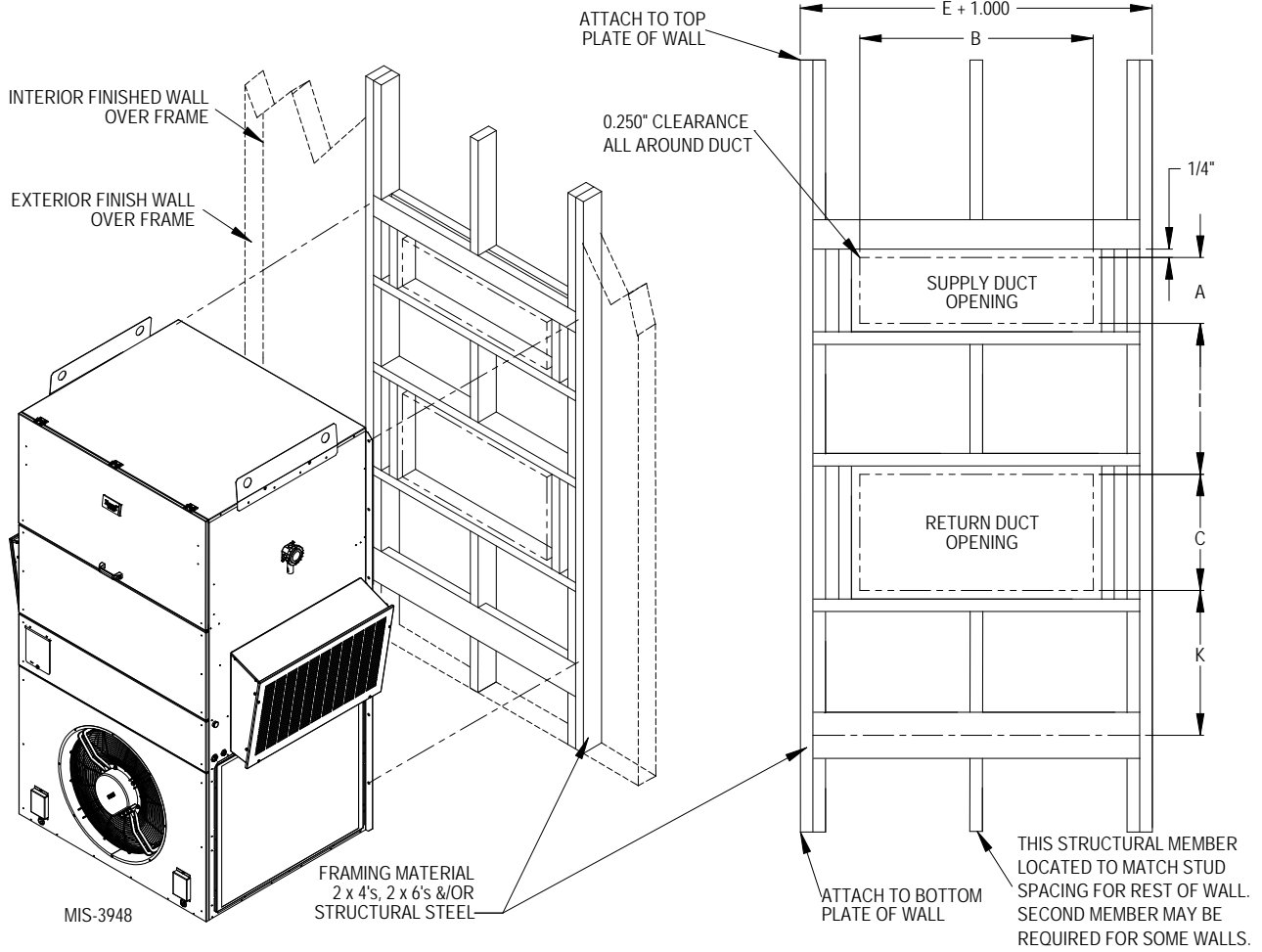
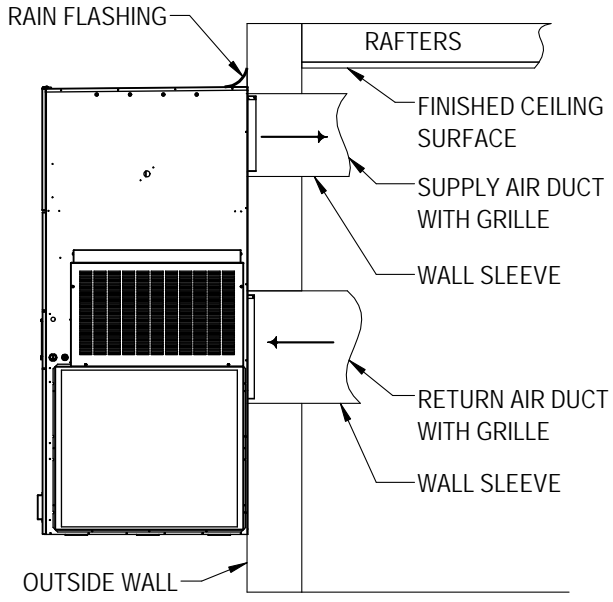
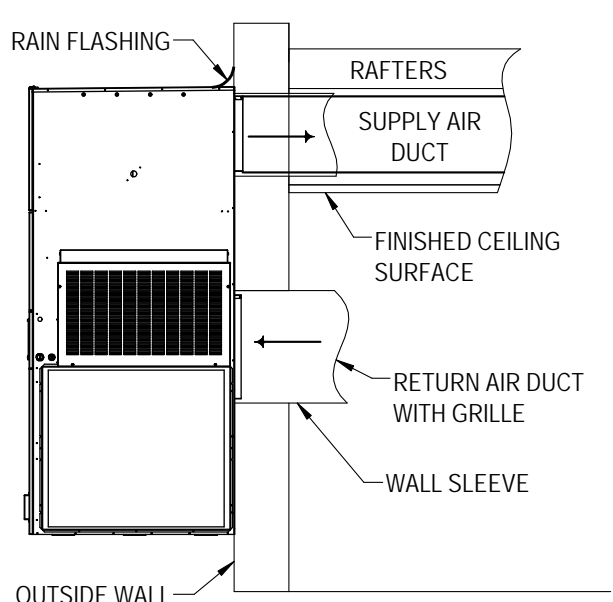

FIGURE 9
Common Wall Mounting Installations



FREE AIR-FLOW
 NO DUCT



DUCTED SUPPLY
 RETURN AT UNIT

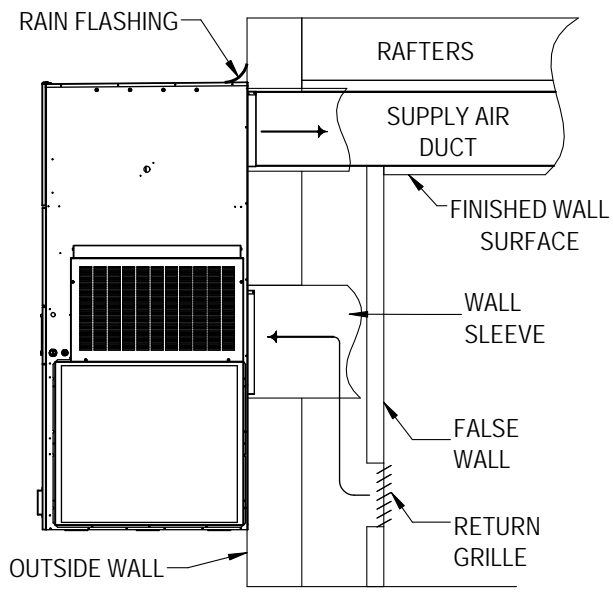

FALSE WALL INSTALLATION

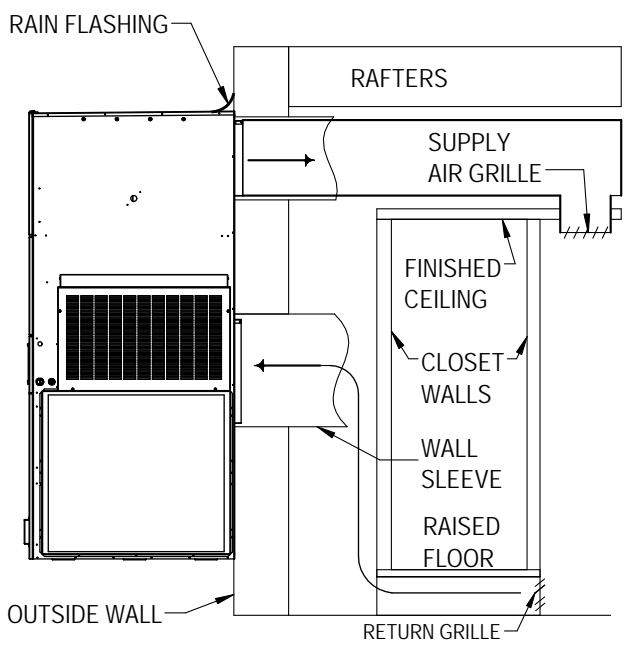

CLOSET INSTALLATION

MIS-3954

WALL-MOUNT UNIT WIRING

WARNING

Electrical shock hazard.

Have a properly trained individual perform these tasks.

Failure to do so could result in electric shock or death.

Main Power Wiring

Refer to the unit rating plate or Tables 2A or 2B for wire sizing information and maximum fuse or circuit breaker size. Each outdoor unit is marked with a “Minimum Circuit Ampacity”. The field wiring used must be sized to carry that amount of current. Depending on the installed KW of electric heat, there may be two field power circuits required. If this is the case, the unit rating plate will so indicate. All models are suitable only for connection with copper wire. Each unit and/or wiring diagram will be marked “Use Copper Conductors Only”. These instructions **must be** adhered to. Refer to the National Electrical Code (NEC) for complete current carrying capacity data on the various insulation grades of wiring material. All wiring must conform to NEC and all local codes.

The unit rating plate and Tables 2A and 2B list fuse and wire sizes (75°C copper) for all models including the most commonly used heater sizes. Also shown are the number of field power circuits required for the various models with heaters.

The unit rating plate lists a maximum circuit breaker or fuse that is to be used with the equipment. The correct size must be used for proper circuit protection and also to assure that there will be no nuisance tripping due to the momentary high starting current of the compressor motor.

The main unit circuit breaker disconnect access is located on the front panel of the unit.

Route all field power wires in channel under the control panel. See Figure 10 to reference VAC landing points.

Route wires into unit through recommended side entrances (see Figure 11 on page 17). Optional rear entry points are also available (see Figure 12 on page 17).

NOTE: *Field wires enter at bottom for line side connection.*

When running wires to unit from shelter, be careful to not place wiring and conduit where it will interfere with opening filter access doors.

FIGURE 10
VAC Supply Wiring Landing Points

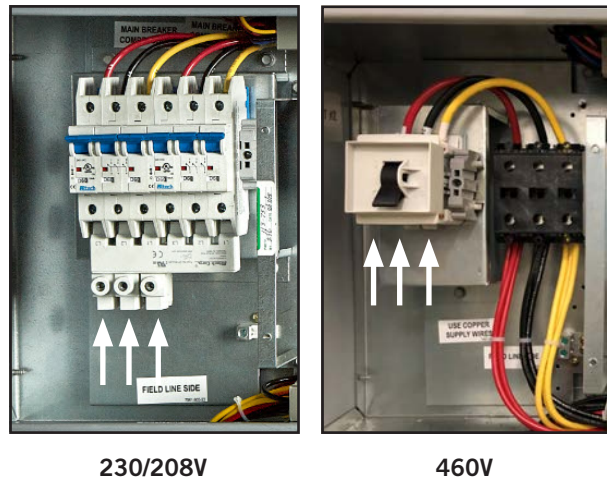

Unit Control Voltage Wiring

NOTE: *The voltage should be measured at the field power connection point in the unit and while the unit is operating at full load (maximum amperage operating condition).*

230/208V Wiring

230/208V 3 phase equipment use dual primary voltage transformers. All equipment leaves the factory wired on 240V tap. **It is very important that the correct voltage tap is used.** For 208V operation, reconnect from 240V to 208V tap. The acceptable operating voltage range for the 240 and 208V taps are: 240V tap (253 – 216) and 208 tap (220 – 197).

460V Wiring

460V 3 phase equipment use triple primary voltage transformers. All equipment leaves the factory wired on 480V tap. **It is very important that the correct voltage tap is used.** The acceptable operating voltage range for the 480V, 415V and 380V taps are: 480V tap (429 and above), 415 Tap (395 – 428) and 380 tap (below 395). For 400V N models, use the 415V tap.

NOTE: *575V models take incoming field power and step-down secondary to 460V which supplies most components **except** compressors and electric heat which remain 575V. Reference wiring diagrams for more information.*

For communication wiring, a 2-wire, 18 gauge color-coded shielded cable with drain is recommended.

TABLE 2A
Electrical Specifications – W*AP Series**

Model	Rated Volts & Phase	No. Field Power Circuits	Single Circuit				Dual Circuit										
			① Minimum Circuit Ampacity	② Maximum External Fuse or Ckt. Brkr.	③ Field Power Wire Size	④ Ground Wire	① Minimum Circuit Ampacity		② Maximum External Fuse or Ckt. Breaker		③ Field Power Wire Size		④ Ground Wire Size				
							Ckt. A	Ckt. B	Ckt. A	Ckt. B	Ckt. A	Ckt. B	Ckt. A	Ckt. B			
W090APB0Z B09 B18	230/208-60-3	1 1 1	46 46 59	60 60 60	8 8 6	10 10 10											
W090APC0Z C09 C18	460-60-3	1 1 1	21 21 30	30 30 35	10 10 8	10 10 10											
W090APE0Z E09 E18	220/200-50-3	1 1 1	46 46 59	60 60 60	8 8 6	10 10 10											
W090APQ0Z Q09 Q18 Q36	575-60-3	1 1 1 1	19 19 25 55	25 25 30 60	10 10 10 6	10 10 10 10											
W090APV0Z V07 V14	415-50-3	1 1 1	23 23 29	35 35 40	8 8 8	10 10 10											
W120APB0Z B09 B18	230/208-60-3	1 or 2 1 or 2 1 or 2	56 56 59	70 70 70	6 6 6	8 8 8	32 32 32	25 28 28	40 40 40	40 40 40	8 8 8	8 8 8	10 10 10	10 10 10			
W120APC0Z C09 C18	460-60-3	1 1 1	27 27 30	40 40 40	8 8 8	10 10 10											
W120APE0Z E09 E18	220/200-50-3	1 or 2 1 or 2 1 or 2	55 55 59	70 70 70	6 6 6	8 8 8	32 32 32	25 25 28	40 40 40	40 40 40	8 8 8	8 8 8	10 10 10	10 10 10			
W120APN0Z N09 N18	400-60-3	1 1 1	32 32 32	40 40 40	6 6 6	8 8 8											
W120APQ0Z Q09 Q18 Q36	575-60-3	1 1 1 1	24 24 27 57	35 35 35 60	8 8 8 6	10 10 10 10											
W120APV0Z V07 V14	415-50-3	1 1 1	27 27 30	40 40 40	8 8 8	10 10 10											
W150APB0Z B09 B18	230/208-60-3	1 or 2 1 or 2 1 or 2	67 67 67	80 80 80	4 4 4	8 8 8	39 39 39	34 34 37	50 50 50	40 40 40	8 8 8	8 8 8	10 10 10	10 10 10			
W150APC0Z C09 C18	460-60-3	1 1 1	32 32 32	40 40 40	8 8 8	10 10 10											
W150APE0Z E09 E18	220/200-50-3	1 or 2 1 or 2 1 or 2	67 67 67	80 80 80	4 4 4	8 8 8	39 39 39	29 29 29	40 50 50	40 40 40	8 8 8	8 8 8	10 10 10	10 10 10			
W150APN0Z N09 N18	400-60-3	1 1 1	34 34 34	40 40 40	8 8 8	10 10 10											
W150APQ0Z Q09 Q18 Q36	575-60-3	1 1 1 1	24 24 30 58	35 35 40 60	8 8 8 6	10 10 10 10											
W150APV0Z V07 V14	415-50-3	1 1 1	32 32 32	40 40 40	8 8 8	10 10 10											

① These “Minimum Circuit Ampacity” values are to be used for sizing the field power conductors. Refer to the National Electrical code (latest version), Article 310 for power conductor sizing. **CAUTION:** When more than one field power circuit is run through one conduit, the conductors must be derated. Pay special attention to note 8 of Table 310 regarding Ampacity Adjustment Factors when more than three (3) current carrying conductors are in a raceway.

② Maximum size of the time delay fuse or circuit breaker for protection of field wiring conductors.

③ Based on 75°C copper wire. All wiring must conform to the National Electrical Code and all local codes.

NOTE: The Maximum Overcurrent Protection (MOCP) value listed is the maximum value as per UL 1995 calculations for MOCP (branch-circuit conductor sizes in this chart are based on this MOCP). The actual factory-installed overcurrent protective device (circuit breaker) in this model may be lower than the maximum UL 1995 allowable MOCP value, but still above the UL 1995 minimum calculated value or Minimum Circuit Ampacity (MCA) listed.

IMPORTANT: While this electrical data is presented as a guide, it is important to electrically connect properly sized fuses and conductor wires in accordance with the National Electrical Code and all local codes.

TABLE 2B
Electrical Specifications – W*AE Series**

Model	Rated Volts & Phase	No. Field Power Circuits	Single Circuit				Dual Circuit							
			① Minimum Circuit Ampacity	② Maximum External Fuse or Ckt. Brkr.	③ Field Power Wire Size	④ Ground Wire	① Minimum Circuit Ampacity		② Maximum External Fuse or Ckt. Breaker		③ Field Power Wire Size		④ Ground Wire Size	
							Ckt. A	Ckt. B	Ckt. A	Ckt. B	Ckt. A	Ckt. B	Ckt. A	Ckt. B
W090AEB18	230/208-60-3	1 or 2	100	100	3	8	56	46	60	50	6	8	10	10
W090AEC18	460-60-3	1	53	60	6	10								
W090AEE18	220/200-50-3	1 or 2	100	100	3	8	56	46	60	50	6	8	10	10
W090AEQ18	575-60-3	1	43	45	8	10								
W090AEV14	415-50-3	1	53	60	6	10								
W120AEB18	230/208-60-3	1 or 2	110	120	2	6	59	52	60	60	6	6	10	10
W120AEC18	460-60-3	1	54	60	6	10								
W120AEE18	220/200-50-3	1 or 2	110	120	2	6	59	51	60	60	6	6	10	10
W120AEN18	400-60-3	1	45	50	8	10								
W120AEQ18	575-60-3	1	43	45	8	10								
W120AEV14	415-50-3	1	53	60	6	10								
W150AEB18	230/208-60-3	1 or 2	120	120	1	6	59	55	60	60	6	6	10	10
W150AEC18	460-60-3	1	54	60	6	10								
W150AEE18	220/200-50-3	1 or 2	113	120	2	6	51	59	60	60	6	6	10	10
W150AEN18	400-60-3	1	54	60	6	10								
W150AEQ18	575-60-3	1	43	45	8	10								
W150AEV14	415-50-3	1	53	60	6	10								

① These “Minimum Circuit Ampacity” values are to be used for sizing the field power conductors. Refer to the National Electrical code (latest version), Article 310 for power conductor sizing. **CAUTION:** When more than one field power circuit is run through one conduit, the conductors must be derated. Pay special attention to note 8 of Table 310 regarding Ampacity Adjustment Factors when more than three (3) current carrying conductors are in a raceway.

② Maximum size of the time delay fuse or circuit breaker for protection of field wiring conductors.

③ Based on 75°C copper wire. All wiring must conform to the National Electrical Code and all local codes.

NOTE: The Maximum Overcurrent Protection (MOCP) value listed is the maximum value as per UL 1995 calculations for MOCP (branch-circuit conductor sizes in this chart are based on this MOCP). The actual factory-installed overcurrent protective device (circuit breaker) in this model may be lower than the maximum UL 1995 allowable MOCP value, but still above the UL 1995 minimum calculated value or Minimum Circuit Ampacity (MCA) listed.

IMPORTANT: While this electrical data is presented as a guide, it is important to electrically connect properly sized fuses and conductor wires in accordance with the National Electrical Code and all local codes.

FIGURE 11
Side Communication and Power Wire Entrances (Recommended)

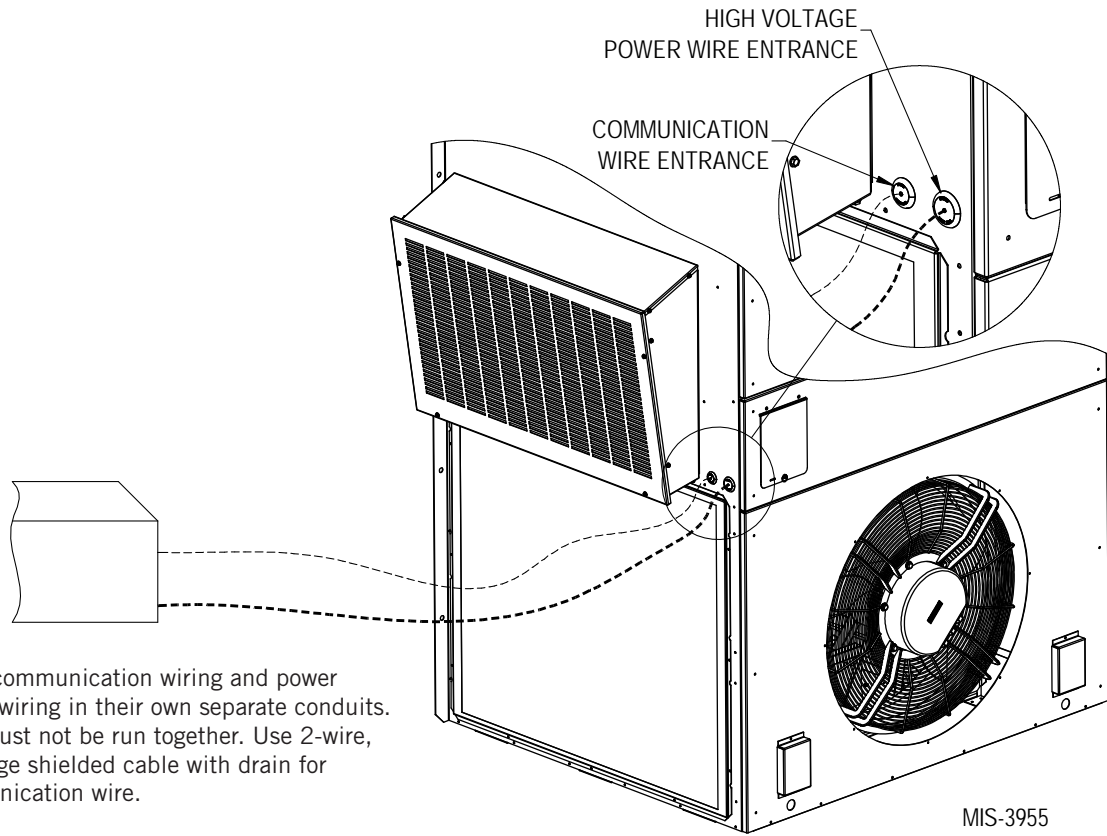

Route communication wiring and power supply wiring in their own separate conduits. They must not be run together. Use 2-wire, 18 gauge shielded cable with drain for communication wire.

FIGURE 12
Rear Communication and Power Wire Entrances (Optional)

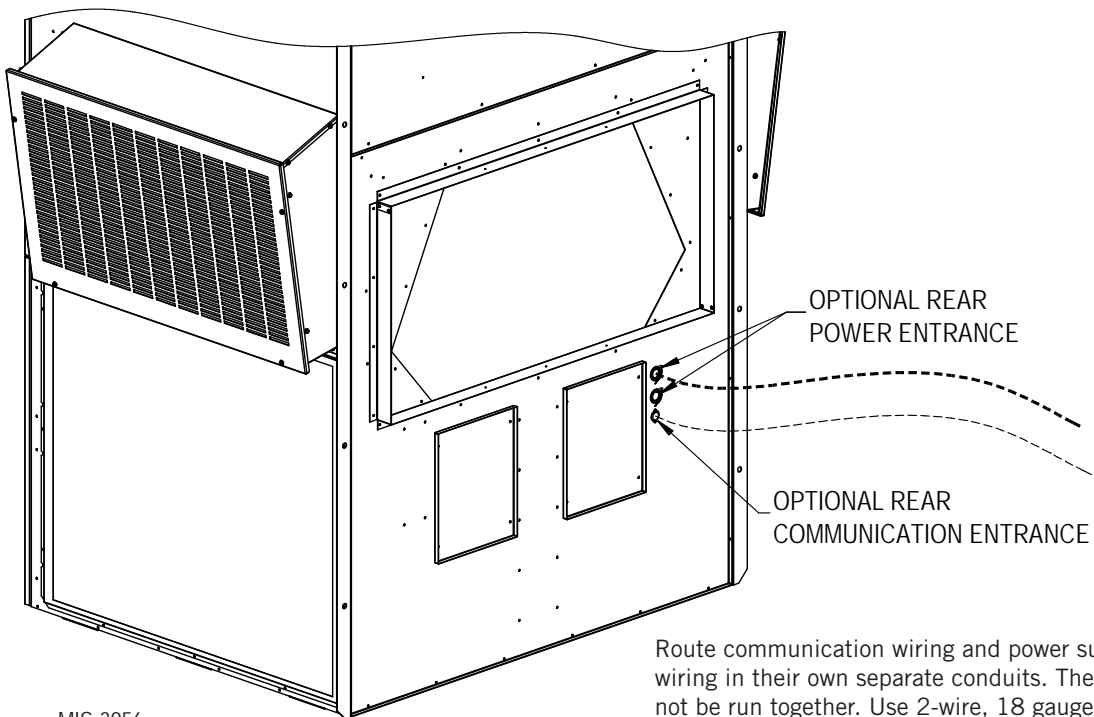

Route communication wiring and power supply wiring in their own separate conduits. They must not be run together. Use 2-wire, 18 gauge shielded cable with drain for communication wire.

MIS-3956

Crankcase Heater Start Up

All units covered in this manual are provided with compressor crankcase heat.

This crankcase heater is a band-type heater located around the bottom of the compressor. This heater is controlled by the crankcase heater relay. The heater is only energized when the compressor is not running.

Crankcase heat is essential to prevent liquid refrigerant from migrating to the compressor, preventing oil pump out on compressor start up and possible bearing or scroll vane failure due to compressing a liquid.

IMPORTANT: *The following procedure must be followed at initial start-up and at any time power has been removed for 12 hours or longer.*

To prevent compressor damage which may result from the presence of liquid refrigerant in the compressor crankcase:

1. Make certain the room thermostat is in the “off” position (the compressor is not to operate).
2. Apply power by closing the system disconnect switch. This energizes the compressor heater which evaporates the liquid refrigerant in the crankcase.
3. Allow 4 hours or 60 minutes per pound of refrigerant in the system as noted on the unit rating plate, whichever is greater.
4. After properly elapsed time, the thermostat may be set to operate the compressor.
5. **Do not open system disconnect switch except as required for safety while servicing.**

Running in Orphan Mode

With the AC breakers turned on, each MEGA-TEC wall-mount unit has the capability to run without the LC6000 controller connected—this feature is called orphan mode. This keeps the shelter between 60°F and 77°F (factory default settings) by the use of the factory-installed return air sensor in each wall-mount unit. In orphan mode, the wall unit uses a continuous blower setting to circulate room air into the return air inlet and uses the return air temperature sensor to control room temperature.

The wall-mount unit can be turned on and off with the TEC-EYE hand-held diagnostic tool. When ON is chosen, the wall-mount unit will heat or cool. When set to OFF using the TEC-EYE, the wall-mount unit will not heat, cool or ventilate.

To turn the unit on or off with TEC-EYE:

1. Connect the TEC-EYE diagnostic tool to the control board located in the unit.
2. Press MENU key to go to the Main Menu screen.
3. Press UP or DOWN keys and ENTER key to enter USER password 2000.
4. Press UP or DOWN keys to scroll to **On/Off**; press ENTER key.
5. Press UP or DOWN keys to change value from **ON** to **OFF** or from **OFF** to **ON**.
6. Press ESCAPE key several times to return to Main Menu screen.

To verify or change the wall-mount unit cooling and heating setpoints in orphan mode:

1. Connect the TEC-EYE diagnostic tool to the control board located in the unit.
2. From the Status screen, press UP or DOWN key until Quick Menu displays Setpoints (SET) icon. Press ENTER key.
3. Press ENTER key to scroll to the selected choice (see Figure 13).
4. Press UP or DOWN key on desired value until value displays correctly.
5. Press ENTER key to save and scroll to next parameter.
6. Press ESCAPE key until Main Menu screen is displayed.

FIGURE 13
Cooling and Heating Setpoints

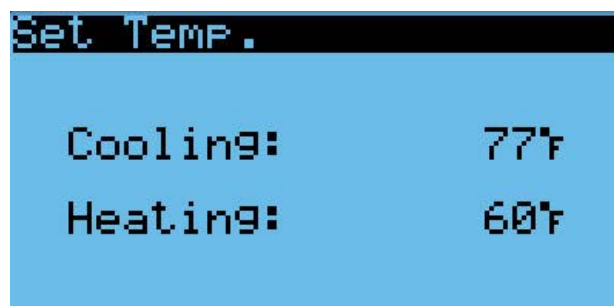

During installation, the ability to run in orphan mode allows deactivation of one of the existing, older wall-mount units, while keeping the shelter cool with the other unit still operating. Once the first of the Bard MEGA-TEC wall-mount units is installed, orphan mode can be enabled early in the installation—keeping the climate inside the shelter stable and the installers comfortable while the remainder of the older equipment is removed and the remaining Bard MEGA-TEC wall-mount units and LC6000 controller are installed.

Additionally, should any or all of the MEGA-TEC wall-mount units lose communication with the LC6000 controller (such as during maintenance), they will continue to serve the shelter's needs until a repair can be made.

LC6000 CONTROLLER INSTALLATION

FIGURE 14
Typical LC6000-200 Component Location

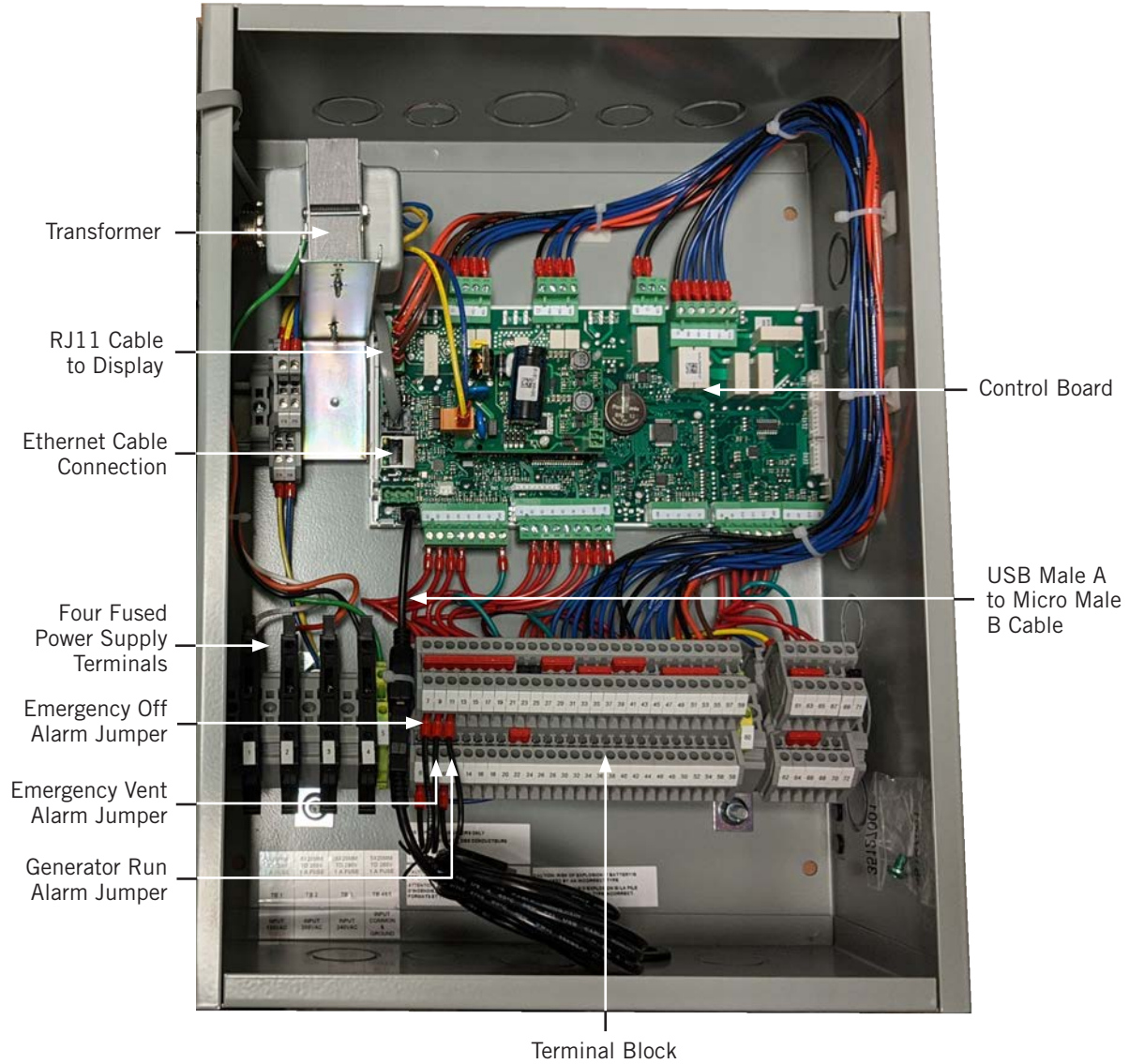

WARNING

Electrical shock hazard.

Disconnect VAC power supplies before servicing.

Failure to do so could result in electric shock or death.

IMPORTANT: When working with circuit board components, Bard recommends the use of an anti-static wrist strap to prevent static electricity shorts to electronic controls.

LC6000 Controller

The LC6000 controller is part of this air conditioning system. It is used to control up to fourteen (14) wall-mount air conditioners from one controller. The microprocessor control provides an easy-to-read interface with large LCD graphical display. It provides control for redundancy for the structure and equal wear on all units.

Conduit is recommended for all wiring. Route communication wiring and power supply wiring in their own separate conduits.

The LC6000 controller is not weatherproof and is intended for use in a weathertight structure.

Mounting the LC6000 Controller

The dimensions of the LC controller are 16" x 12" x 6".

Because the LC6000 controller utilizes a remote temperature sensor as opposed to one located in the controller box, the controller itself can be installed in any indoor location that is suitable, preferably at eye level. Four (4) mounting holes are provided for mounting to the wall and holes for conduit connections are provided in the base, sides and top of the controller.

The LC6000 controller includes four fused power supply terminals in the terminal block. Before connecting wires to the terminal block, confirm that the fuse in each of the four fuse holders is in the proper position (active) as shown in Figure 15.

FIGURE 15
LC6000 Fused Power Supply Terminal

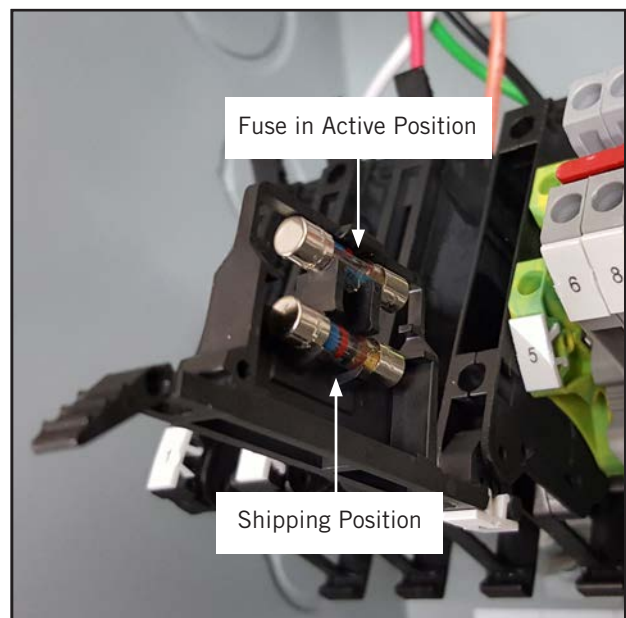

Installing Remote Indoor Temperature/Humidity Sensor(s)

One remote indoor temperature/humidity sensor and 35' of 18 gauge 5-conductor shielded cable is included with the controller. This sensor must be installed for proper operation. Mount the temperature/humidity sensor in a location least likely to be affected by open doors, rack-mounted fans, radiant heat sources, etc. Locating the sensor between both return grilles is often the best location, but every installation is unique. Location height should be approximately 60" above the floor. The sensor is best mounted on a 2" x 4" junction box and it is recommended that the cable be in conduit. Use shielded cable to connect to controller. The maximum cable length to connect the temperature/humidity sensor to the LC6000 is 98'.

FIGURE 16
Remote Indoor Temperature/Humidity Sensor Installation

1. Connect wires from the 18 gauge shielded cable to terminals #12, #13, #18, #19 and #22.

TB#	Wire Mark	Sensor	Description
18	B6	NTC OUT	Indoor Remote Sensor (Zone 1)
19	GND	NTC OUT	Ground
12	B2	OUT H	Remote Indoor Humidity Sensor: 0-1 VDC (Zone 1)
13	GND	M (GO)	Ground
22	+VDC	+ (G)	Power for B2

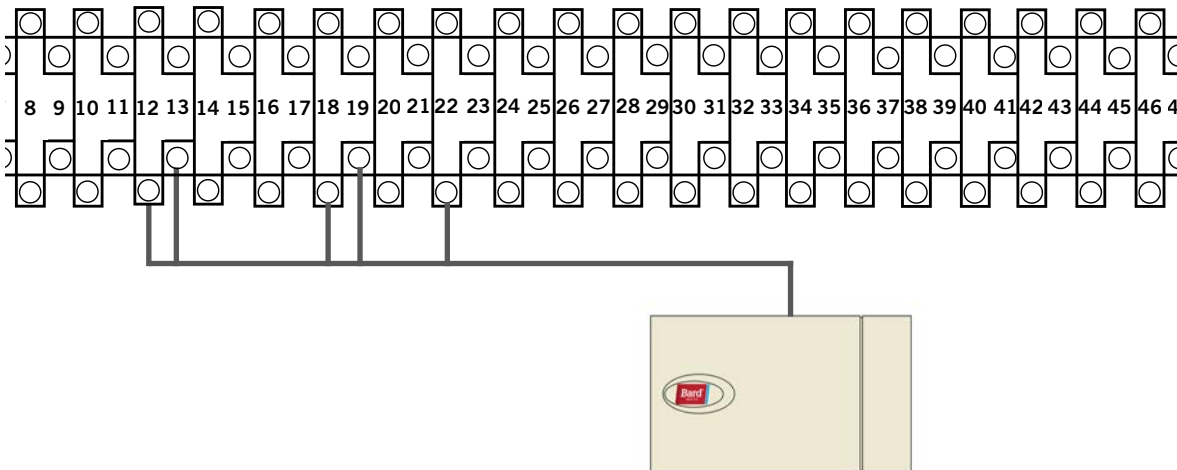

2. Connect the other end of the shielded cable to the sensor terminals. Be sure wires are connected to proper terminals as shown in table above.

Sensor jumpers need to be positioned for 0-1 V. With sensor oriented as shown in image to right, move both jumpers to right position (DP1 and DP2 set to OFF). **This applies to all indoor temperature/humidity sensors connected to the LC controller.** See illustration mounted inside of sensor cover for further detail on jumper position.

Earlier versions of this sensor may be mounted in a different orientation which would affect the positioning of the sensor jumpers. See page 45 for additional information on sensor orientation.

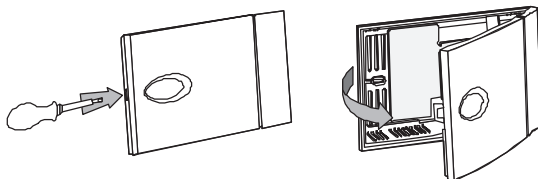
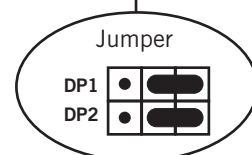
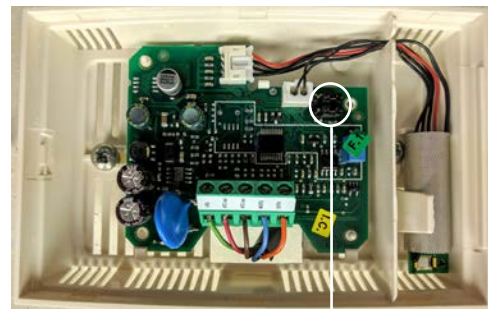

For proper operation, the remote indoor temperature/humidity sensor (and any additional sensors) must be configured properly with the controller as shown in Step 2 on page 22. An additional remote indoor temperature-only sensor can be purchased and installed in Zone 1. If the site in which the LC6000 controller will be used has more than one zone (maximum three zones per LC6000), additional remote temperature/humidity sensors (one per zone) will need to be purchased and installed in the additional zones. All installed sensors must be enabled in the controller menu (see **Configure Sensors** beginning on page 36).

FIGURE 17
Additional Remote Indoor Temperature and Temperature/Humidity Sensor Installation

One additional temperature sensor can be added to Zone 1 and additional temperature/humidity sensors may be added to Zones 2 and 3 (one per zone). **Be sure the sensors are connected to the proper terminals on the terminal block and sensor as listed below.** The maximum cable length to connect temperature or temperature/humidity sensors to the LC6000 is 98'.



Zone 1:
 Optional Remote Temperature Sensor
Terminals 20 & 21*

TB#	Wire Mark	Description
20	B7	Indoor Remote Sensor (Zone 1 – optional)
21	GND	Ground

* The two wire connections for the optional remote temperature sensor are not polarity sensitive.



Zone 2:
 Optional Remote Temperature/Humidity Sensor
Terminals 26, 27, 14, 15 & 23

IMPORTANT: Note jumper position in Figure 16

TB#	Wire Mark	Sensor	Description
26	B8	NTC OUT	Indoor Remote Sensor (Zone 2)
27	GND	NTC OUT	Ground
14	B3	OUT H	Remote Indoor Humidity Sensor: 0-1 VDC (Zone 2)
15	GND	M (GO)	Ground
23	+VDC	+ (G)	Power for B3



Zone 3:
 Optional Remote Temperature/Humidity Sensor
Terminals 28, 29, 16, 17 & 24

IMPORTANT: Note jumper position in Figure 16

TB#	Wire Mark	Sensor	Description
28	B9	NTC OUT	Indoor Remote Sensor (Zone 3)
29	GND	NTC OUT	Ground
16	B4	OUT H	Remote Indoor Humidity Sensor: 0-1 VDC (Zone 3)
17	GND	M (GO)	Ground
24	+VDC	+ (G)	Power for B4

Zones 2 and 3 can also use temperature-only sensors in place of the temperature/humidity sensors. Zone 2 will connect to TB# 26 and 27. Zone 3 will connect to TB# 28 and 29. The wire connections for the temperature-only sensors are not polarity sensitive.

Installing Optional Outdoor Temperature/Humidity Sensor

One optional outdoor temperature/humidity sensor (8301-090) can be installed. Follow the manufacturer's mounting instructions. Use 18 gauge 5-conductor shielded cable to connect to controller. The maximum cable length to connect the temperature/humidity sensor to the LC6000 is 98'.

FIGURE 18
Remote Outdoor Temperature/Humidity Sensor Installation

1. Connect wires from the 18 gauge shielded cable to terminals #65, #66, #67, #70 and #71.

TB#	Wire Mark	Sensor	Description
70	B12	4	Remote Outdoor Temperature Sensor
71	ND	5	Ground
67	B11	1	Remote Outdoor Humidity Sensor: 0-10 VDC
66	GND	3	Ground
65	+VDC	2	+VDC

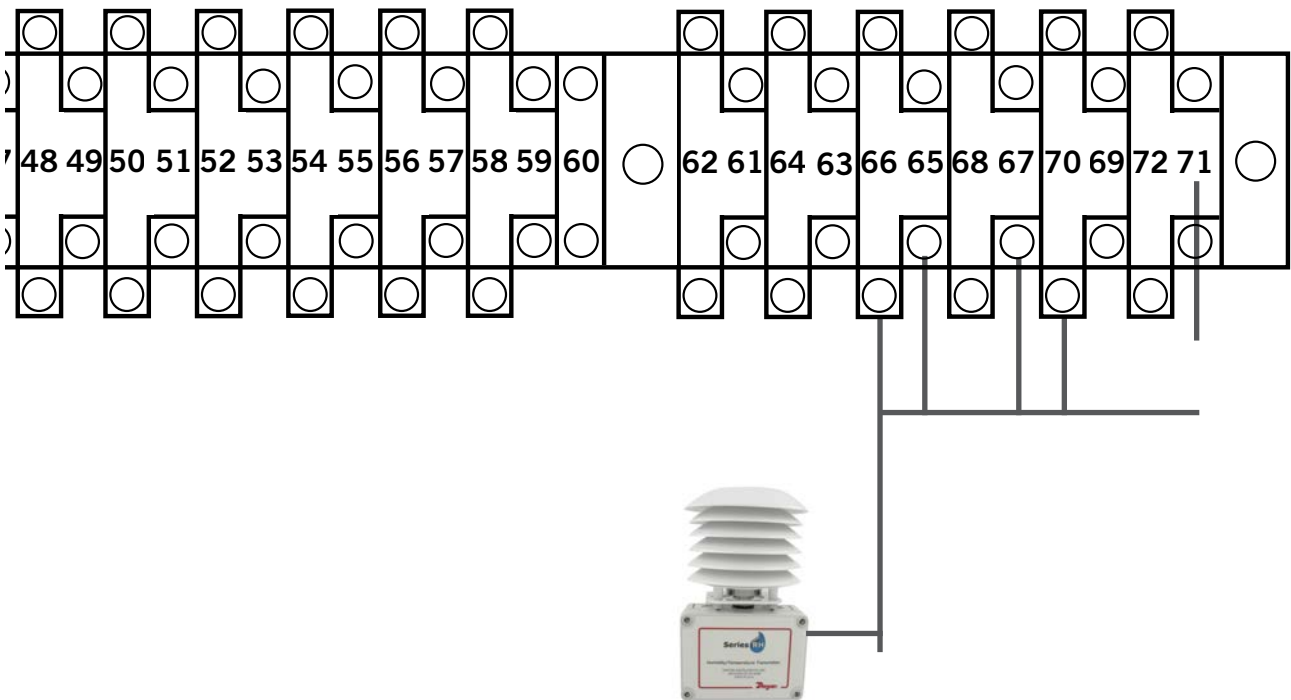

2. Connect the other end of the shielded cable to the sensor terminals. Be sure wires are connected to proper terminals as shown in table above.

Emergency Off, Emergency Ventilation and Generator Run Connections

The LC6000-200 controller is shipped with emergency off, emergency ventilation and generator run contacts. There are factory-installed jumpers across terminals #6 and #7 (emergency off), #8 and #9 (emergency ventilation) and #10 and #11 (generator run). Remove the factory-installed jumpers before making the connections.

FIGURE 19

LC6000-200 Series Connection for Emergency Off, Emergency Ventilation and Generator Run (If Applicable)

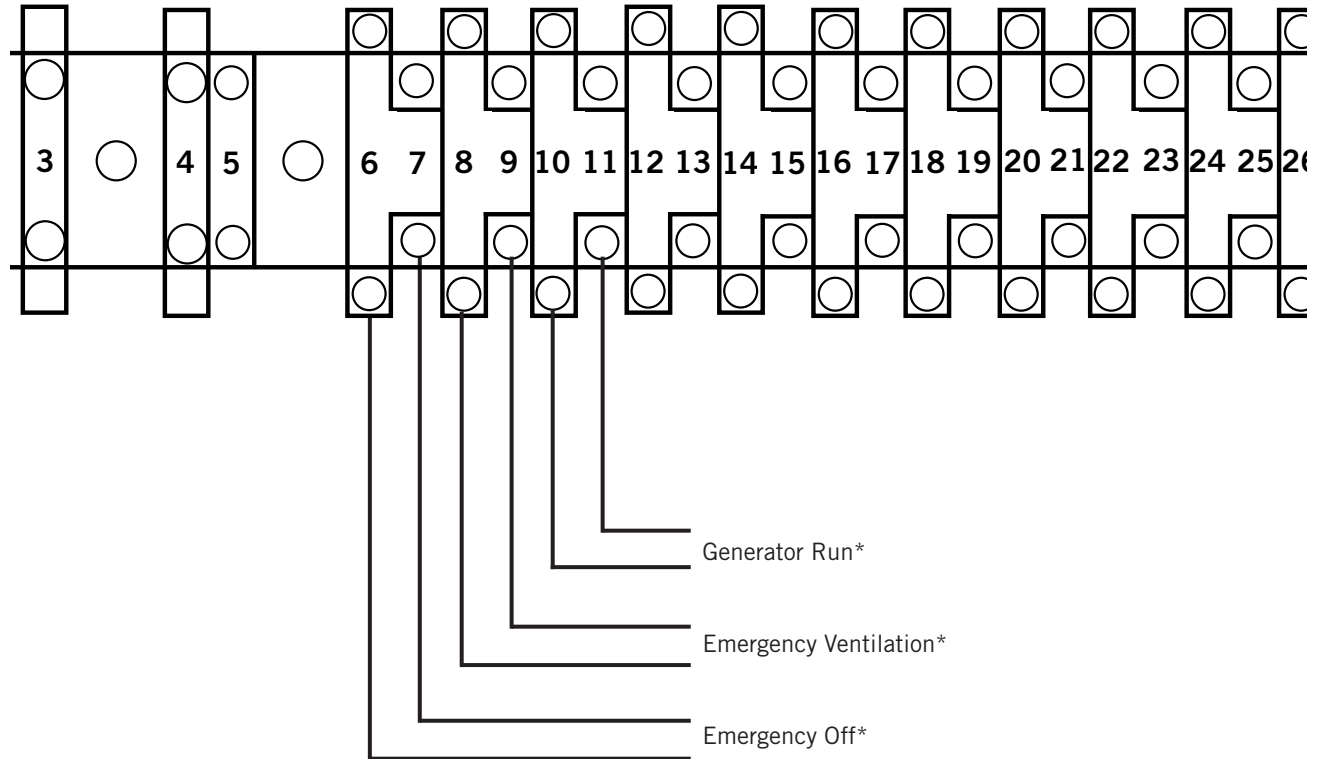

* Normally closed (NC) contacts required.

By default:
Closed = No Alarm
Open = Alarm

Communication Wiring

Connect the field-supplied communication wiring from the wall-mount units to the controller in the manner shown in Figures 20, 21 or 22. **The daisy chain does not need to follow the addressing order.** The communication wire should be 2-wire, 18 gauge shielded cable with drain. Any color can be used. Be sure to match "+" and "-" symbols on controller terminal blocks to prewired unit control terminal block (see Figures 24 and 25 on pages 29 and 30). Attach communication wire filters as shown in Figures 20, 21 or 22. **Do not run communication wiring in same conduit as supply wiring. Route communication wiring and power supply wiring in their own separate conduits.**

FIGURE 20
Communication Wiring (Daisy Chain Method)

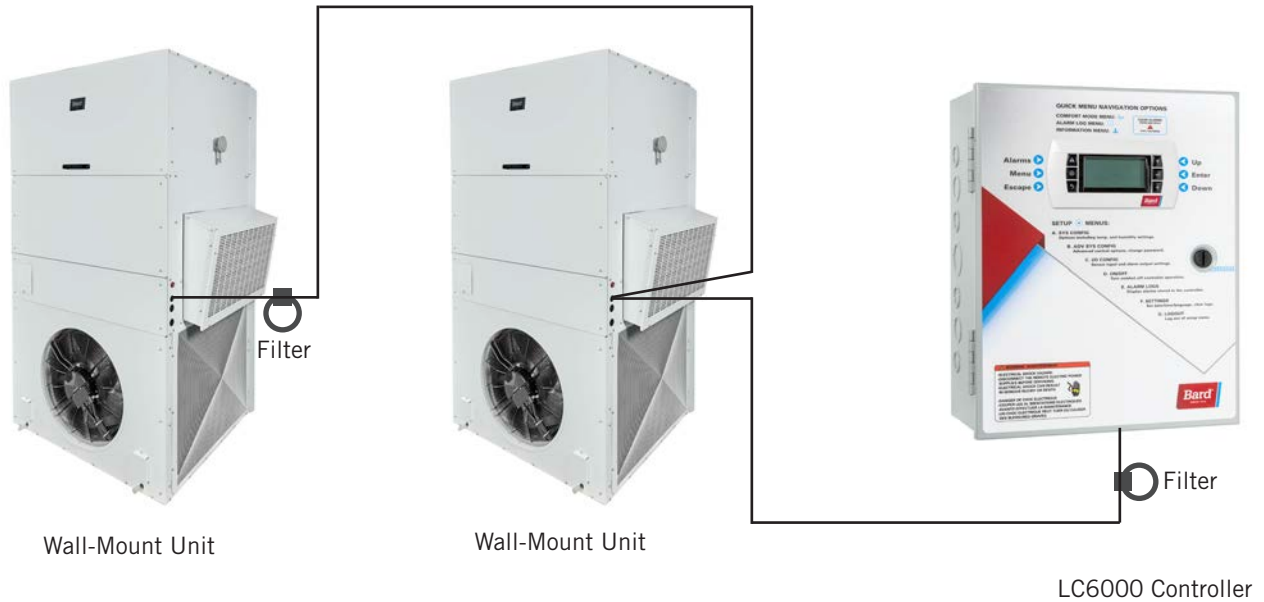

In addition to the "daisy chain" method of connecting the field-supplied communication wiring shown in Figure 20, the wall-mount units can also be connected in the manner shown in Figure 21. If connecting wall-units this way, be sure to place the communication wire filters in the positions shown in Figure 21. See Figure 22 for more information on the correct placement of the communication wire filters depending on the wiring method used.

FIGURE 21
Communication Wiring (Alternate Method)



FIGURE 22
Placement of Communication Wire Filters (Daisy Chain and Alternate Methods)

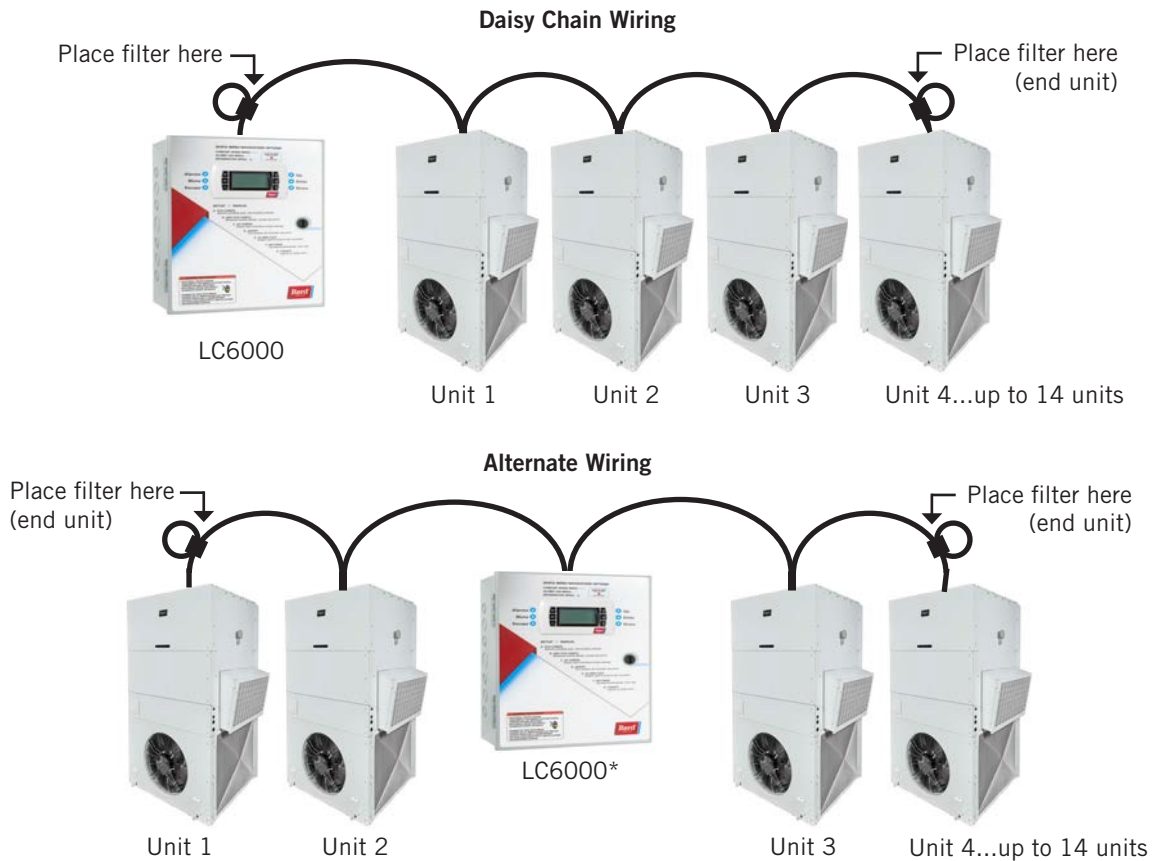

* LC6000 can be in any position other than start and end with filters placed on end units.

NOTE: Line filters can be on either the unit or controller, whichever device is on the end of the chain. No matter how many units there are, the two end devices will only have ONE communication cable, whereas the center devices will all have TWO (as shown above). Maximum two wires in each terminal. Filters go inside the unit or controller; shown out of unit above for identification only.

The steps outlined on the following pages show how to connect the field-supplied communication wiring using the daisy chain method shown in Figure 20. If using the alternate method (as shown in Figure 21), the connections to the controller and each wall-mount unit will be the same but the filters need to be placed in the positions shown in Figure 22.

FIGURE 23
Communication Wiring: Termination at the Controller

1. Using the field-provided shielded cable, make a small service loop after entering the controller and attach the provided EMI filter at the intersection of the loop.

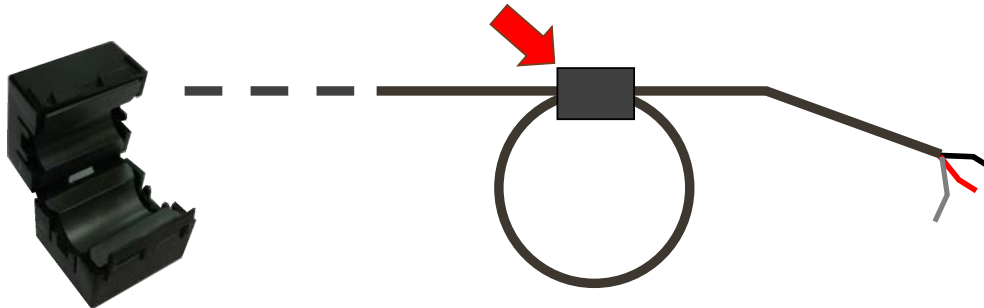

2. Connect one wire to terminal #56 (negative), the other wire to terminal #57 (positive) and the drain wire to ground terminal #60.

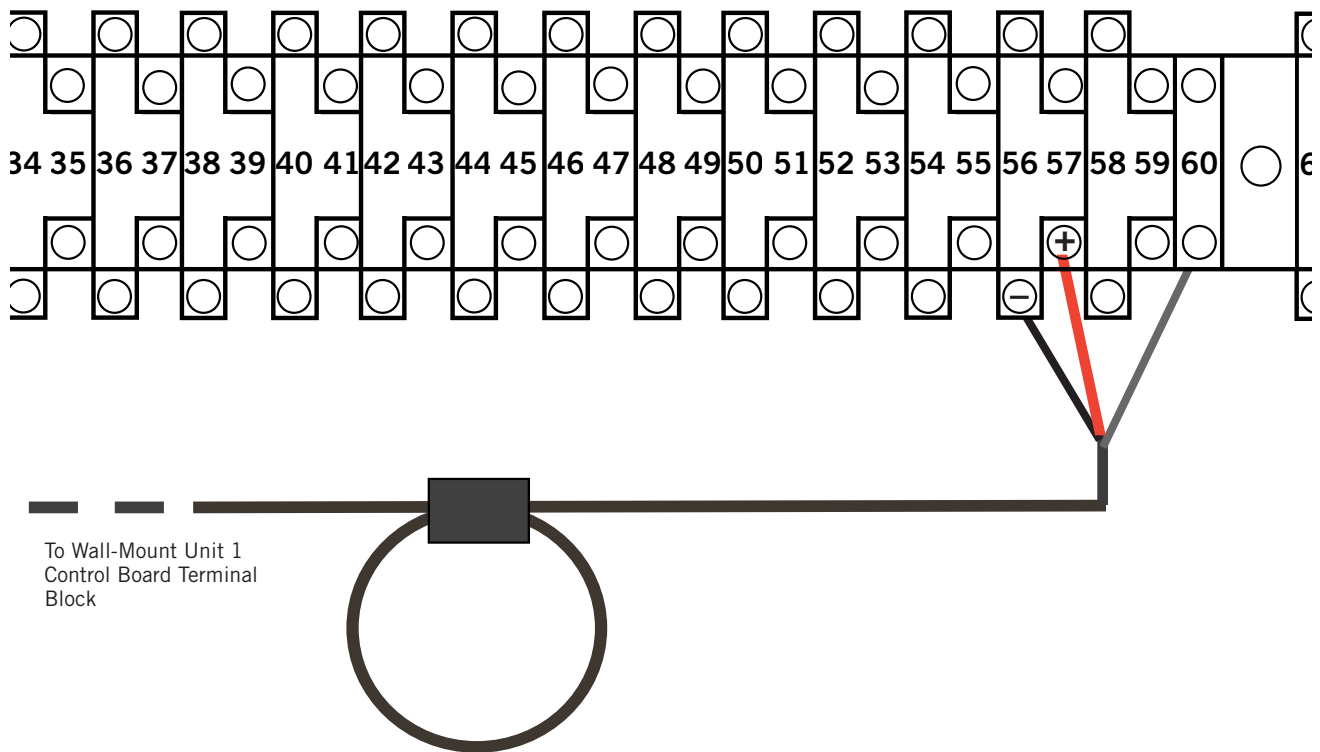
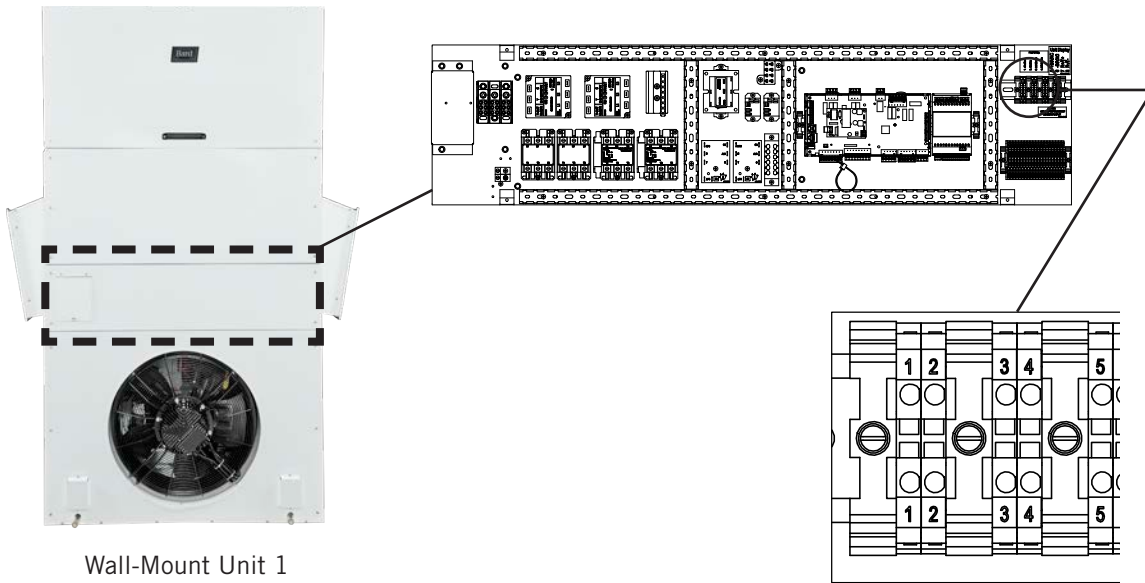

FIGURE 24
Communication Wiring: Termination at the First Wall-Mount Unit



Wall-Mount Unit 1

1. From the controller, extend the field-supplied shielded cable through a separate conduit and route to terminal #1 (positive) and terminal #2 (negative) on the upper terminal block next to the wall-mount control board on the unit control panel.

These connections are polarity-sensitive. Two-wire communication from control board is prewired to terminal block. Make sure to match "+" and "-" symbols on the Field Wiring label above the terminal block.

2. Connect the wires matching the terminal designations (+/-) of the Field Wiring label. Leave the drain wire loose.

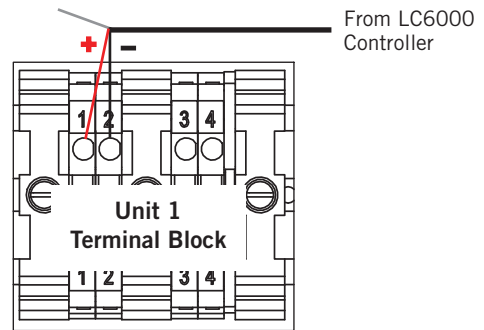

3. Connect another cable in a similar fashion ("daisy chain") to route in conduit to the second wall-mount unit. Connect both drain wires with wire nut. Maximum two wires per terminal.

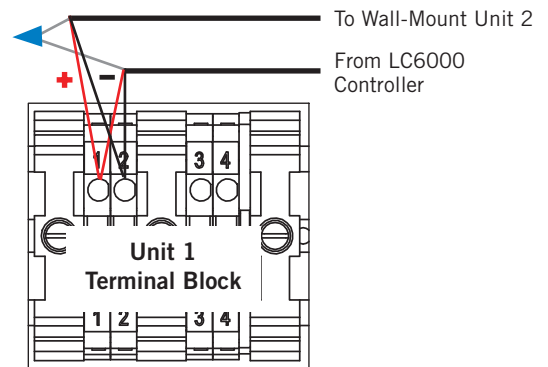
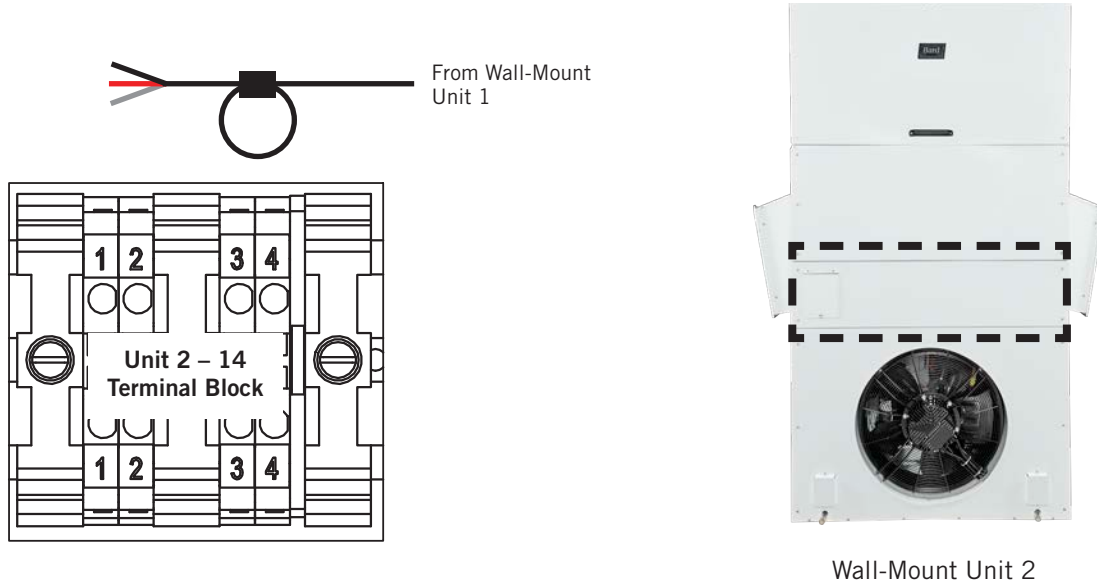
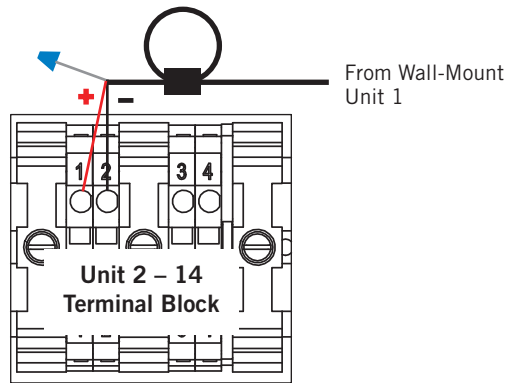

FIGURE 25
Communication Wiring: Termination at Additional Wall-Mount Units



1. Route the cable from the first wall-mount unit to the terminal block of the second wall-mount unit. If this is the last unit to be connected, make a small service loop and attach EMI filter as shown.

2. Connect the wires matching the terminal designations (+/-) on the Field Wiring label above the terminal block. Cap the loose drain with a wire nut or electrical tape.



3. Continue daisy chaining units by connecting "+" to "+", "-" to "-" and wire nutting drain together until last unit which is capped with a wire nut. **Attach EMI filter as shown above at last unit.** Up to 14 wall-mount units can be connected and controlled by one LC6000 controller.

NOTE: Terminals #3 and #4 are dry contacts to be used for the unit disable option.

WARNING: Do not apply voltage to daisy chain connection terminals #1 or #2 or terminals #3 or #4. If 24V or any voltage is applied to these terminals or to the daisy chain connection, board damage may occur.

Supply Wiring

The LC6000 controller is powered by 120, 208 or 230 volts from the shelter. Field-supplied supply wiring should be minimum 16 gauge, maximum 14 gauge (see Figure 26). A reliable earth ground must be connected in addition to any grounding from conduit. Grounding bolts and nuts are included with the controller for this purpose; a 2 hole grounding lug must be field supplied. Install as shown in Figure 27. **Failing to ground the controller box properly could result in damage to the equipment.**

FIGURE 26
LC6000 Controller Circuit Install

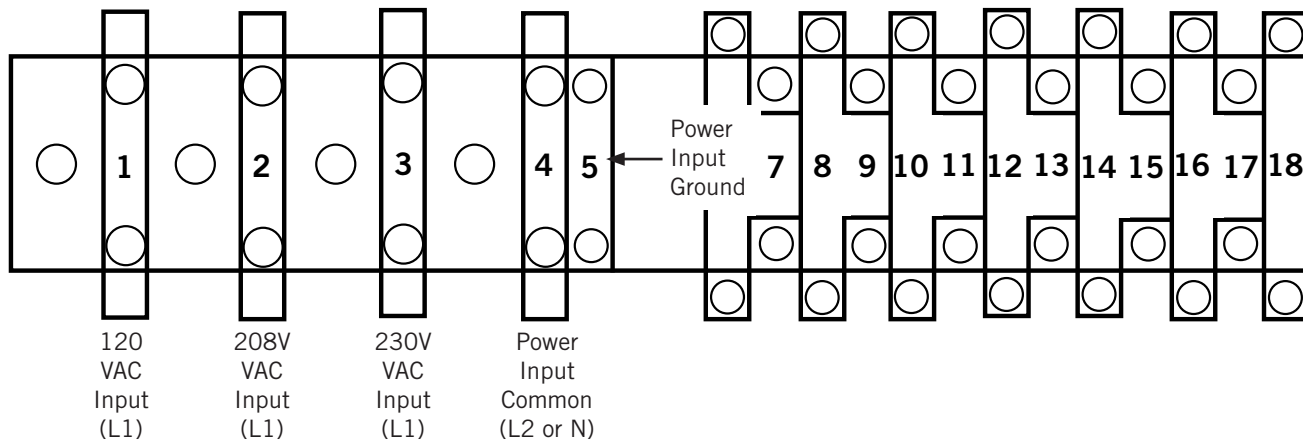
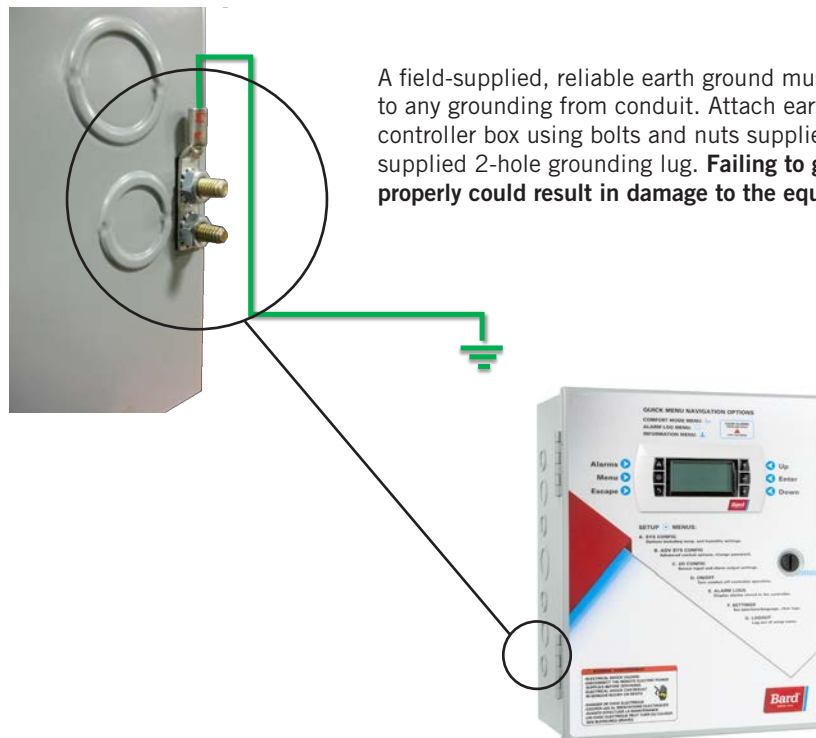

FIGURE 27
Controller Grounding Posts



A field-supplied, reliable earth ground must be connected in addition to any grounding from conduit. Attach earth ground to side of controller box using bolts and nuts supplied with controller and field-supplied 2-hole grounding lug. **Failing to ground the controller box properly could result in damage to the equipment.**

TABLE 3
LC6000-200 Terminal Block Index

TB#	Wire Mark	Description
1	-	120 VAC Input
2	-	208 VAC Input
3	-	230 VAC Input
4	-	Power Input Common
5	-	Power Input Ground
6	DI1	Emergency Off Input
7	GND	Emergency Off Common
8	DI2	Emergency Vent Input
9	GND	Emergency Vent Common
10	DI3	Generator Run Input
11	GND	Generator Run Common
12	B2	Zone 1 Indoor Remote Humidity Sensor
13	GND	Ground
14	B3	Zone 2 Indoor Remote Humidity Sensor
15	GND	Ground
16	B4	Zone 3 Indoor Remote Humidity Sensor
17	GND	Ground
18	B6	Zone 1 Indoor Temperature Sensor
19	GND	Ground
20	B7	Zone 1 Indoor Remote Temperature Sensor
21	GND	Ground
22	VDC+	Power for B2 (Z1 Humidity)
23	VDC+	Power for B3 (Z2 Humidity)
24	VDC+	Power for B4 (Z3 Humidity)
25	VDC+	Power for B10 (Pressure)
26	B8	Zone 2 Indoor Remote Temperature Sensor
27	GND	Ground
28	B9	Zone 3 Indoor Remote Temperature Sensor
29	GND	Ground
30	B10	Indoor Space Pressure
31	GND	Ground
32	NO1	Humidifier 1
33	C1	Common
34	NO2	Humidifier 2
35	C1	Common
36	NO3	Humidifier 3
37	C1	Common
38	NO4	Emergency Off Alarm

TB#	Wire Mark	Description
39	C4	Common
40	NO5	Emergency Vent Alarm
41	C4	Common
42	NO6	Generator Run Alarm
43	C4	Common
44	NO7	Indoor Humidity Alarm
45	C7	Common
46	NO8	High Indoor Temperature Alarm
47	C8	Common
48	NO9	Low Indoor Temperature Alarm
49	C8	Common
50	NO10	Zone 1 Unit Alarm
51	C8	Common
52	NO11	Zone 2 Unit Alarm
53	C8	Common
54	NO12	Zone 3 Unit Alarm
55	C8	Common
56	FB1R-	RS485 RX- / TX- (Fieldbus 1) UNIT CONNECTION
57	FB1R+	RS485 RX+ / TX+ (Fieldbus 1) UNIT CONNECTION
58	FB2R-	RS485 RX- / TX- (Fieldbus 2)
59	FB2R+	RS485 RX+ / TX+ (Fieldbus 2)
60	--	Power Input Ground
61	24 VAC+	24 VAC Supply
62	--	Not Used
63	24 VAC+	24 VAC Supply
64	24 VAC-	24 VAC Ground
65	24 VAC+	24 VAC Supply for Outdoor Humidity Sensor
66	24 VAC-	24 VAC Ground for Outdoor Humidity Sensor
67	B11	Signal for Outdoor Humidity Sensor
68	24 VAC+	24 VAC Supply
69	D14	Bard Guard Alarm Signal
70	B12	Signal for Outdoor Temperature Sensor
71	GND	Ground for Outdoor Temperature Sensor
72	GND	Ground for Bard Guard Alarm Signal
73	G	Orange Power Connector
74	24 VAC+	24 VAC Supply
75	G0	Orange Power Connector
76	24 VAC-	24 VAC Ground

FIGURE 28
LC6000-200 Wiring Diagram

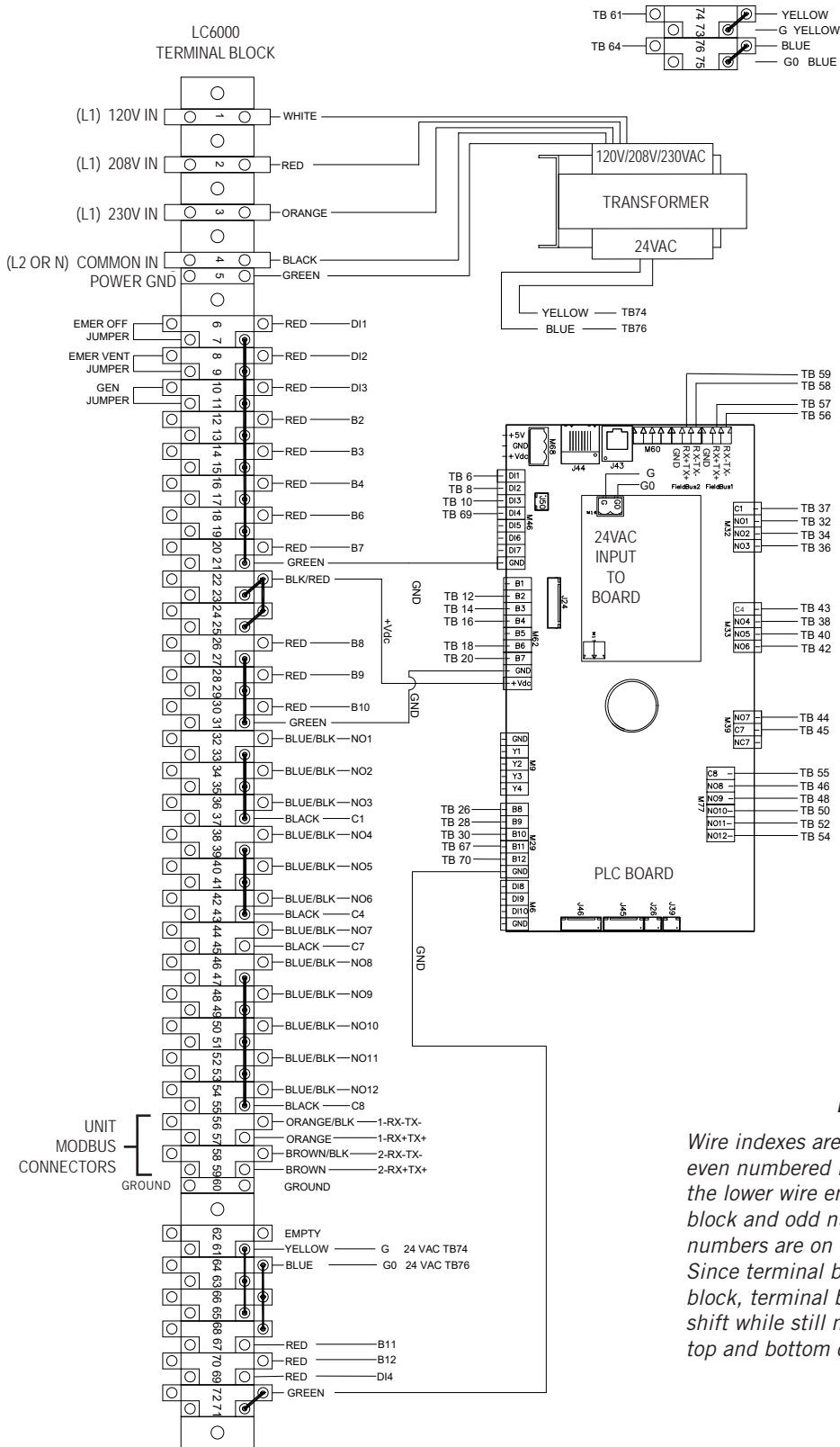

SYSTEM SET UP

NOTE: Screenshots shown in this manual reflect default settings (when applicable).

The LC6000 controller and TEC-EYE hand-held diagnostic tool will both be used to set up the Bard free cooling system (the TEC-EYE is only used to set up the wall-mount units). If installing a single MEGA-TEC wall-mount unit with a PGD or PGDx stand-alone display, refer to PGD manual 2100-734 or PGDx manual 2100-740 for information on setting up a stand-alone display for single unit operation.

TABLE 4
LC6000/TEC-EYE Passwords (Defaults)

User	2000
Technician	1313
Engineer	9254
Use UP or DOWN keys and ENTER key to enter password	

TEC-EYE Hand-Held Diagnostic Tool

The microprocessor control used in the MEGA-TEC wall-mount air conditioners allows for complete control and monitoring through the use of the provided TEC-EYE hand-held monitor.

The menu driven interface provides users the ability to scroll through two menu levels: Quick Menu and

Main Menu. The menus permit the user to easily view, control and configure the unit. See the latest version of MEGA-TEC Service Manual 2100-671 for more information on using the TEC-EYE.

The TEC-EYE connects to the wall-mount unit control board via an RJ11 modular connector as shown in Figure 29.

When not being used, the TEC-EYE hand-held diagnostic tool should be stored inside or near the LC6000 controller. Do not let the TEC-EYE leave the shelter.

FIGURE 29
TEC-EYE Connection to Unit Control

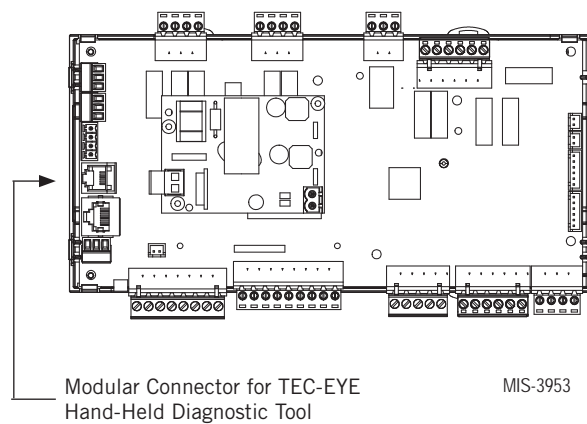
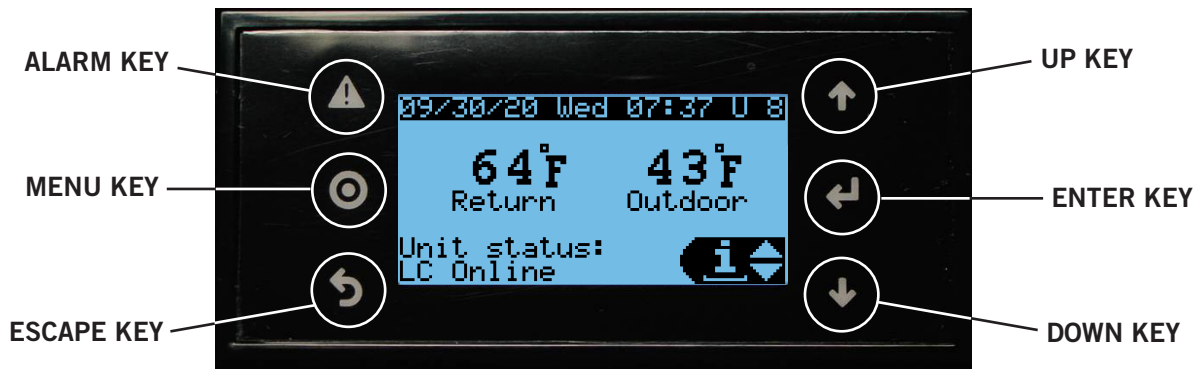

FIGURE 30
TEC-EYE (Bard P/N 8301-059) Display and Interface (Status Screen Shown)



ALARM KEY

Allows viewing of active alarms
Silences audible alarms
Resets active alarms

MENU KEY

Allows entry to Main Menu

ESCAPE KEY

Returns to previous menu level
Cancels a changed entry

UP KEY

Steps to next screen in the display menu
Changes (increases) the value of a modifiable field

ENTER KEY

Accepts current value of a modifiable field
Advances cursor

DOWN KEY

Steps back to previous screen in the display menu
Changes (decreases) the value of a modifiable field

TEC-EYE Status Screen

The Status screen is the default start-up screen and also the return screen after 5 minutes of no activity. The screen can be accessed any time by pressing the ESCAPE key repeatedly.

The wall-mount unit address is displayed in the upper right corner on the Status screen (see Figure 30). The Status screen also shows the current date, time, return air temperature, mixed air temperature, supply air temperature, outdoor air temperature and outdoor air humidity. Blower speed, condenser fan speed, damper position and unit status are also displayed. See Table 5 on page 42 for wall-mount unit status messages.

NOTICE

It is important to check the software version during installation to ensure that the latest version has been installed. Current software versions and installation instructions are available on the Bard website at <http://www.bardhvac.com/software-download/>

Setting Up Wall-Mount Units for Operation

The TEC-EYE hand-held diagnostic tool is needed to set up the wall-mount unit(s).

1. Address Each Wall-Mount Unit

Each unit must have a unique address for the system to operate correctly with the LC controller (Ex: 1, 2, 3, ...14 depending on the number of units). The unit only needs the address to be changed for the communication to work properly. The wall-mount unit address is displayed in the upper right corner on the Status screen on the TEC-EYE display (see Figure 30).

To change the unit address:

- 1) Press MENU key to access the Main Menu screen.
- 2) Press UP or DOWN keys and ENTER key to enter USER password 2000.
- 3) Press UP or DOWN keys to scroll to **Sys Config**; press ENTER key.
- 4) Press ENTER key to scroll to **Unit Address** (see Figure 31).
- 5) Press UP or DOWN keys to change the address to a value between 1 and 14.

NOTE: Each unit must have a unique address for the communication to work properly. Unit addresses

can only be used once per LC6000 regardless of number of zones. Bard also recommends physically labeling each unit for ease in identification.

FIGURE 31
Unit Configuration

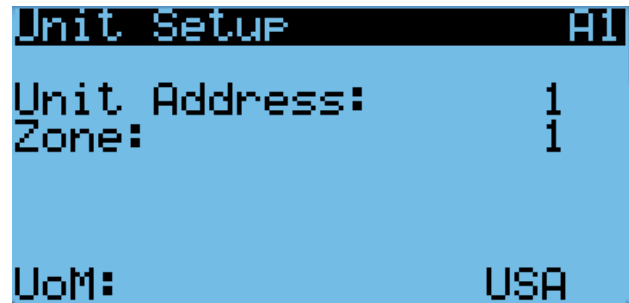

In addition to setting up the address, the user may also want to set the unit zone and unit of measure.

To change these settings:

- 1) Press MENU key to access the Main Menu screen.
- 2) Press UP or DOWN keys and ENTER key to enter USER password 2000.
- 3) Press UP or DOWN keys to scroll to **Sys Config**; press ENTER key.
- 4) Press ENTER key to scroll to **Unit Zone** (see Figure 31).
- 5) If desired, press UP or DOWN keys to change value to desired zone.
- 6) Press ENTER scroll to **UOM**.
- 7) If desired, press UP or DOWN keys to change the value from **USA** to **SI, NC, LON, CAN** or **UK**. Units are preconfigured for each selection.
- 8) Press ENTER key to save.

Basic wall unit parameter settings are now set and the unit is ready to communicate with the LC.

2. Execute a Self Test on Each Unit

Execute a self test on each unit to verify the equipment is functioning correctly. The self test parameters are not adjustable.

The self test will automatically skip sections of the test based on the model number entered into the controller. If position 10 of the model number is B (to indicate a blank off economizer option), the test steps associated with the economizer will be skipped. If positions 8 and 9 of the model number indicate a OZ (0 kW) option, test steps associated with heating will be skipped. If positions 8 and 9 indicate a O9 (9 kW) option, second stage heat tests will be skipped.

- 1) Press MENU key to access the Main Menu screen.
- 2) Press UP or DOWN keys and ENTER key to enter USER password 2000.
- 3) Press UP or DOWN keys to scroll to **Sys Config**; press ENTER key.
- 4) Press UP or DOWN keys to scroll to **Self Test A11** screen.
- 5) Press ENTER key to scroll to **Enable** parameter (see Figure 32).
- 6) Press UP or DOWN key to change value to **Yes**. The self test will begin.

FIGURE 32
Executing Self Test

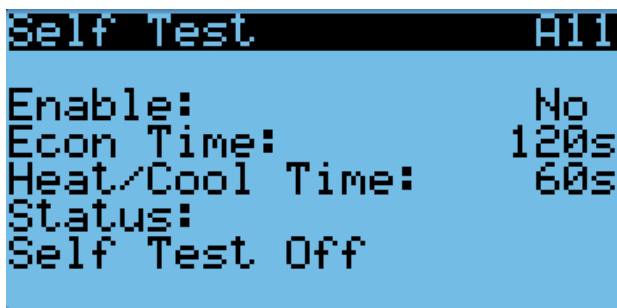

Self Test Parameter Descriptions

Damper Time: This is the time (in seconds) allowed for both the opening sequence and closing sequence.

Heat/Cool Time: This is the time (in seconds) allowed for cooling sequence and heating sequence.

Status: This will display what the unit is doing as the self test progresses. The following messages may appear:

- Self Test Off
- Initializing...
- Opening Economizer
- Closing Economizer
- Compressor 1 On
- Compressor 1 & 2 On
- C1 Full Load + C2 On
- Turning Comp. Off....
- Electric Heat 1 On
- Electric Heat 1 & 2 On
- Turning Heat Off...
- End

The unit will determine which items to test based on the unit model number.

3. Clear Unit Alarm Logs on Each Unit

The wall-mount unit may have generated some alarms during startup and should be cleared after installation.

To clear the wall-mount unit alarm logs:

- 1) Press MENU key to go to the Main Menu screen.
- 2) Use UP or DOWN keys and ENTER key to enter TECHNICIAN password 1313.
- 3) Press UP or DOWN keys to scroll to **Settings**; press ENTER key.
- 4) Press UP or DOWN keys to scroll to **Initialization**; press ENTER key.
- 5) Press UP or DOWN keys to scroll to **Initialization**; press ENTER key.
- 6) Press ENTER key to scroll to **Delete alarm logs?** (see Figure 33).
- 7) Press UP or DOWN key to change **NO** to **YES**.
- 8) Press ENTER key to clear all alarm logs.

FIGURE 33
Clearing Unit Alarm Logs

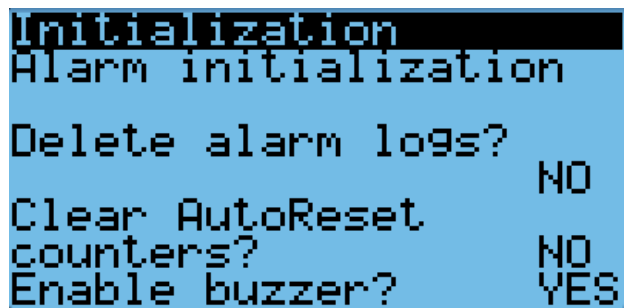

After each of the wall-mount units have been addressed, had a self test performed and had the alarm logs cleared, the rest of the system set up can proceed.

Setting Up LC6000 for Operation

The LC6000 controller will be used for the remaining steps in the set up process.

LC6000 Status Screen

The Status screen is the default start-up screen and also the return screen after 5 minutes of no activity on the LC6000. The screen can be accessed any time by pressing the ESCAPE key repeatedly.

The Status screen on the LC6000 displays the current date, time, unit displayed, zones and system status (see Figure 34).

FIGURE 34
LC6000 Controller Display and Interface (Status Screen Shown)

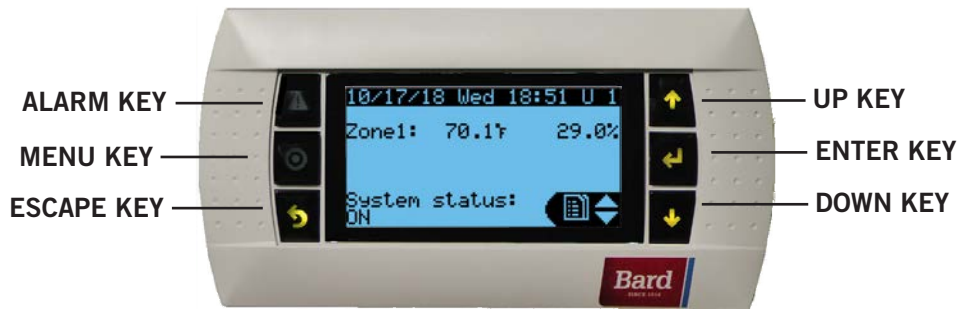

LC6000 interface key functions are the same as those shown for the TEC-EYE in Figure 30 on page 34.

4. Set LC Controller Date and Time

- 1) Press MENU key to access the Main Menu screen.
- 2) Use UP or DOWN keys and ENTER key to enter USER password 1313.
- 3) Press the UP or DOWN keys to scroll to the **Settings** menu; press ENTER key.
- 4) Press UP or DOWN keys to scroll to **Date/Time** menu; press ENTER key.
- 5) Press UP or DOWN keys to scroll to **Date/Time change**.
- 6) Press ENTER key to scroll to the desired value to be changed (see Figure 35).
- 7) Press UP or DOWN keys to change the value.
- 8) Press ENTER key to save and to scroll to top of screen.
- 9) Press UP or DOWN keys to scroll to **Timezone** (if applicable). Follow steps 6-8 to change timezone.
- 10) Press ESCAPE key several times to return to Main Menu screen.

NOTE: The LC6000 will sync the time and date configured to each of the wall-mount units once communication is established.

5. Configure Sensors

The system will need to be configured for the number of temperature and humidity sensors installed. The system is shipped with one combination temperature and humidity sensor. Additional combination sensors may be purchased or alternatively, temperature-only sensors may be purchased instead. The LC is capable of supporting up to four indoor temperature sensors (two in zone 1, one in zone 2 and one in zone 3), three indoor humidity sensors (one per zone), one outdoor temperature sensor and one outdoor humidity sensor. The system will need to be configured for the various configurations.

If necessary, the sensors could be calibrated at this time too. For information on calibrating the sensors (adjusting the offset), see page 42.

To enable/disable **Zone 1 Indoor Humidity**:

- 1) Press MENU key to go to the Main Menu screen.
- 2) Press UP or DOWN keys and ENTER key to enter USER password 2000.
- 3) Press UP or DOWN keys to scroll to **IO Config**; press ENTER key.
- 4) Press UP or DOWN keys to scroll to **Z1 Indoor Hum C4**.
- 5) Press ENTER key to scroll to **Enable** (see Figure 36 on page 38).
- 6) Press UP or DOWN key to change value to ON to enable sensor (or change value to OFF to disable sensor).

FIGURE 35
Setting Controller Date and Time



FIGURE 36
Enable/Disable Zone 1 Indoor Humidity Sensor



To enable/disable **Zone 2 Indoor Humidity**:

- 1) Press MENU key to go to the Main Menu screen.
- 2) Press UP or DOWN keys and ENTER key to enter USER password 2000.
- 3) Press UP or DOWN keys to scroll to **IO Config**; press ENTER key.
- 4) Press UP or DOWN keys to scroll to **Z2 Indoor Hum C5**.
- 5) Press ENTER key to scroll to **Enable** (see Figure 37).
- 6) Press UP or DOWN key to change value to ON to enable sensor (or change value to OFF to disable sensor).

FIGURE 37
Enable/Disable Zone 2 Indoor Humidity Sensor



To enable/disable **Zone 3 Indoor Humidity**:

- 1) Press MENU key to go to the Main Menu screen.
- 2) Press UP or DOWN keys and ENTER key to enter USER password 2000.
- 3) Press UP or DOWN keys to scroll to **IO Config**; press ENTER key.
- 4) Press UP or DOWN keys to scroll to **Z3 Indoor Hum C6**.

- 5) Press ENTER key to scroll to **Enable** (see Figure 38).
- 6) Press UP or DOWN key to change value to ON to enable sensor (or change value to OFF to disable sensor).

FIGURE 38
Enable/Disable Zone 3 Indoor Humidity Sensor



To enable/disable **Zone 1 Indoor Temperature**:

- 1) Press MENU key to go to the Main Menu screen.
- 2) Use UP or DOWN keys and ENTER key to enter USER password 2000.
- 3) Press UP or DOWN keys to scroll to **IO Config**; press ENTER key.
- 4) Press UP or DOWN keys to scroll to **Z1 Indoor Temp C7**.
- 5) Press ENTER key to scroll to **Enable** (see Figure 39).
- 6) Press UP or DOWN key to change value to ON to enable sensor (or change value to OFF to disable sensor).

FIGURE 39
Enable/Disable Zone 1 Indoor Temperature Sensor



To enable/disable **Zone 1 Remote Temperature**:

- 1) Press MENU key to go to the Main Menu screen.

- 2) Use UP or DOWN keys and ENTER key to enter USER password 2000.
- 3) Press UP or DOWN keys to scroll to **IO Config**; press ENTER key.
- 4) Press UP or DOWN keys to scroll to **Z1 Remote Temp C8**.
- 5) Press ENTER key to scroll to **Enable** (see Figure 40).
- 6) Press UP or DOWN key to change value to ON to enable sensor (or change value to OFF to disable sensor).

FIGURE 40
Enable/Disable Zone 1 Remote Temperature Sensor

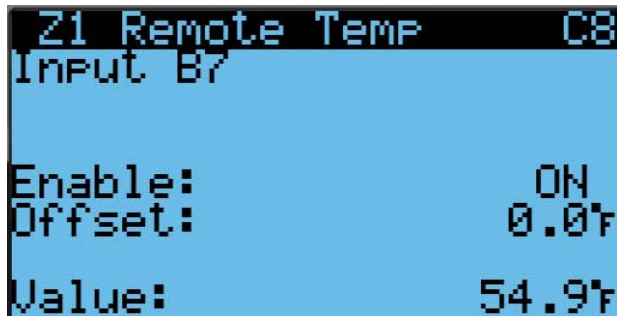

To enable/disable **Zone 2 Remote Temperature**:

- 1) Press MENU key to go to the Main Menu screen.
- 2) Use UP or DOWN keys and ENTER key to enter USER password 2000.
- 3) Press UP or DOWN keys to scroll to **IO Config**; press ENTER key.
- 4) Press UP or DOWN keys to scroll to **Z2 Remote Temp C9**.
- 5) Press ENTER key to scroll to **Enable** (see Figure 41).
- 6) Press UP or DOWN key to change value to ON to enable sensor (or change value to OFF to disable sensor).

FIGURE 41
Enable/Disable Zone 2 Remote Temperature Sensor

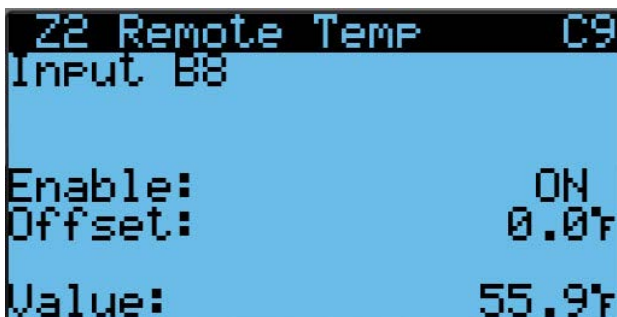

To enable/disable **Zone 3 Remote Temperature**:

- 1) Press MENU key to go to the Main Menu screen.
- 2) Use UP or DOWN keys and ENTER key to enter USER password 2000.
- 3) Press UP or DOWN keys to scroll to **IO Config**; press ENTER key.
- 4) Press UP or DOWN keys to scroll to **Z3 Remote Temp C10**.
- 5) Press ENTER key to scroll to **Enable** (see Figure 42).
- 6) Press UP or DOWN key to change value to ON to enable sensor (or change value to OFF to disable sensor).

FIGURE 42
Enable/Disable Zone 3 Remote Temperature Sensor

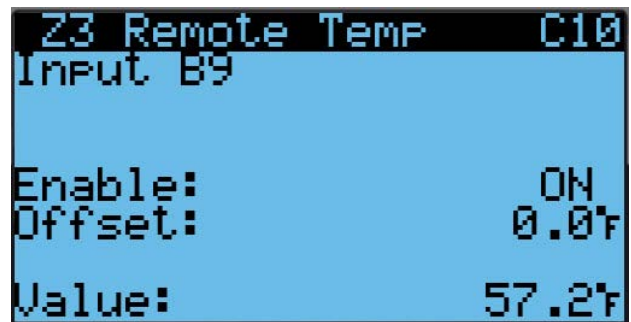

To enable/disable **Outdoor Air Humidity**:

- 1) Press MENU key to go to the Main Menu screen.
- 2) Use UP or DOWN keys and ENTER key to enter USER password 2000.
- 3) Press UP or DOWN keys to scroll to **IO Config**; press ENTER key.
- 4) Press UP or DOWN keys to scroll to **Outdoor Air Humid C11**.
- 5) Press ENTER key to scroll to **Enable** (see Figure 43 on page 40).
- 6) Press UP or DOWN key to change value to ON to enable sensor (or change value to OFF to disable sensor).

FIGURE 43
Enable/Disable Outdoor Air Humidity Sensor

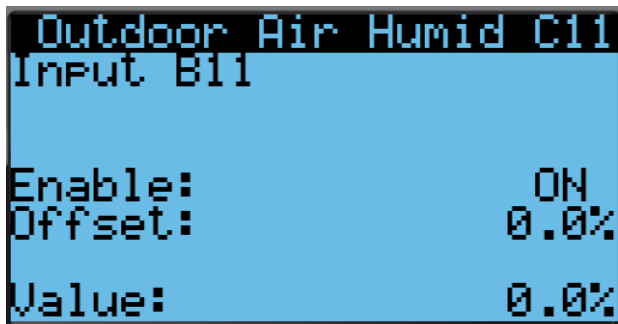

To enable/disable **Outdoor Air Temperature**:

- 1) Press MENU key to go to the Main Menu screen.
- 2) Use UP or DOWN keys and ENTER key to enter USER password 2000.
- 3) Press UP or DOWN keys to scroll to **IO Config**; press ENTER key.
- 4) Press UP or DOWN keys to scroll to **Outdoor Air Temp C12**.
- 5) Press ENTER key to scroll to **Enable** (see Figure 44).
- 6) Press UP or DOWN key to change value to ON to enable sensor (or change value to OFF to disable sensor).

FIGURE 44
Enable/Disable Outdoor Air Temperature

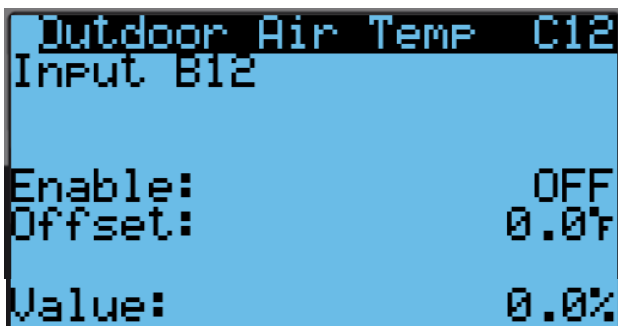

6. Enter Total Number of Units

- 1) Press MENU key to go to the Main Menu screen.
- 2) Press UP or DOWN keys and ENTER key to enter USER password 2000.
- 3) Press UP or DOWN keys to scroll to **Sys Config**; press ENTER key.
- 4) Press UP or DOWN keys to scroll to **General**; press enter key.

- 5) Press ENTER key to scroll to **Total Units** (see Figure 45).
- 6) Press UP or DOWN keys to adjust value to correct number of units.
- 7) Press ENTER key to save value.
- 8) Press the ESCAPE key several times to return to Main Menu screen.

FIGURE 45
Total Units Displayed

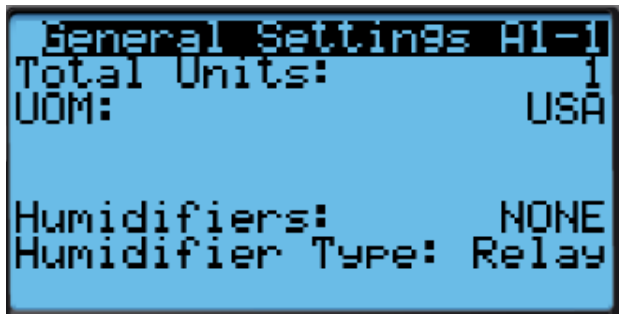

7. Verify Units Are Online

Once a unit is uniquely addressed, communication can be verified at the LC controller.

With the correct number of units set at the LC controller, each unit can be remotely viewed from the controller information screen.

To view these screens:

- 1) Press ESCAPE key to view the Status screen. (May need to be pressed more than once.)
- 2) Press UP or DOWN key until the Quick Menu in the lower right corner of the screen displays the Information icon (); press ENTER key.
- 3) Press UP or DOWN keys to scroll through the Information screens until the desired unit Information screen appears.

In addition to being able to remotely view the units, an alarm will be generated on the LC controller for units not communicating.

8. Select Economizer Type for Each Zone

Each zone can be configured to operate the economizers with different considerations. For more information on the different economizer choices, reference the most recent version of MEGA-TEC Service Instructions 2100-671.

The type of consideration can be set to none, dry bulb, temperature and humidity or enthalpy. These settings will be communicated to the wall units while connected to the LC6000 to ensure all units operate the same.

To select economizer type for each zone:

- 1) Press MENU key to go to the Main Menu screen.
- 2) Use UP or DOWN keys and ENTER key to enter password 1313.
- 3) Press UP or DOWN keys to scroll to **Sys Config**; press ENTER key.
- 4) Press UP or DOWN keys to scroll to **Zone 1**, **Zone 2** or **Zone 3**; press ENTER key.
- 5) Press UP or DOWN keys to scroll to **Zone FC Settings A2-4** (Zone 1), **Zone FC Settings A3-4** (Zone 2) or **Zone FC Settings A4-4** (Zone 3).
- 6) Press ENTER key to scroll to **Type** (see Figure 46).
- 7) Press UP or DOWN keys to change economizer type to **None**, **Drybulb**, **TempHum** or **Enthalpy**.
- 8) Press ENTER key to save.

FIGURE 46
Selecting Economizer Type

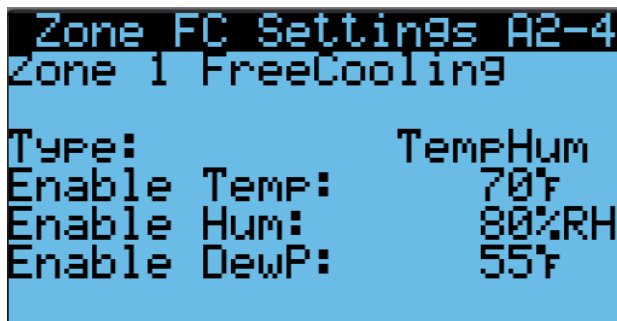

9. Clear Controller Alarm Logs

The LC6000 may have generated some alarms during startup and should be cleared after installation. Controller alarm logs must be cleared at time of installation.

To clear the LC controller alarm logs:

- 1) Press MENU key to go to the Main Menu screen.
- 2) Use UP or DOWN keys and ENTER key to enter USER password 2000.
- 3) Press UP or DOWN keys to scroll to **Settings**; press ENTER key.
- 4) Press UP or DOWN keys to scroll to **Initialization**; press ENTER key.
- 5) Press ENTER key to scroll to **Delete alarm logs?** (see Figure 47).
- 6) Press UP or DOWN key to value to **YES**; press ENTER key.
- 7) Press ESCAPE key several times to return to Main Menu screen.

FIGURE 47
Clearing LC6000 Alarm Logs

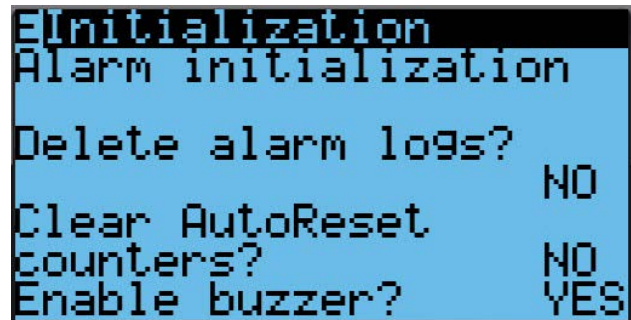

10. Complete Installation

Once all the installation steps have been completed, all alarms and alarm logs have been cleared and system verification and self test results were satisfactory, the installation can now be considered "complete".

Additional programming information can be found in MEGA-TEC Service Instructions 2100-671 and LC6000 Service Instructions 2100-669.

ADDITIONAL INFORMATION

Menu Screens and Password Levels

TABLE 5
TEC-EYE Menu Structure

Menu/Screen Structure	Password Level Required
<i>Quick Menu</i>	
Setpoints (Orphan Mode Temperature Control)	None
Information	None
Alarm Log	None
<i>Main Menu</i>	
System Config	User
Adv. Sys. Config	Technician
I/O Config	Technician
Digital Inputs	Technician
Digital Outputs	Technician
Analog Inputs	Technician
Analog Outputs	Technician
Fan/Blowers	Technician
Manual EEV	Technician
On/Off	User
Alarm Logs	User
Settings	--
Date/Time	Technician
Initialization	Technician
Change Passwords	Varies
Logout	--

TABLE 6
LC6000 Controller Menu Structure

Menu/Screen Structure	Password Level Required
<i>Quick Menu</i>	
Setpoints (Comfort Mode)	None
Information	None
System	None
Unit 1	None
Unit 2	None
Unit 3...14	None
Alarm Log	None
<i>Main Menu</i>	
System Config	User
Adv. Sys. Config	Technician
I/O Config	Technician
On/Off	User
Alarm Logs	User
Settings	--
Date/Time	Technician
Language	User
Network Config	Technician
Serial Config	Technician
Initialization	Varies
Logout	--

Setpoints

The LC6000 setpoints will determine the cooling and heating setpoints when *communicating with the wall-mount units*. The *unit* cooling and heating setpoints will determine the cooling and heating setpoints when *in orphan mode*. It is important to note that once the wall-mount unit establishes communication with the LC6000, the setpoints from the LC will override the wall-mount unit setpoints. If a unit returns to orphan mode after communicating with LC, it will operate with last communicated setpoints from the LC.

If at any time the unit(s) loses communication with the LC6000 controller, the unit(s) will go into orphan mode.

Calibrating Sensors

1. Press MENU key on LC controller interface to go to the Main Menu screen.
2. Use UP or DOWN keys and ENTER key to enter USER password 2000.
3. Press UP or DOWN keys to scroll to **I/O Config**; press ENTER key.
4. Press UP or DOWN keys to scroll to sensor to be adjusted.
5. Press ENTER key to scroll to **Offset** (see Figure 48).
6. Press UP or DOWN keys to add or subtract to the sensor offset value.
7. Press ENTER key to save.

FIGURE 48
Adjusting Sensor Offset Value



TABLE 7
Unit Status Messages

Message	Description
Orphan Mode	This message will be shown when unit is not connected to the LC or stand-alone display. The unit is not operating when this message is shown but is ready to heat or cool based on the return air temperature. Blower will run continuously in this mode.
Standalone Mode	This message will be shown when the unit is communicating with stand-alone display. The unit is not operating when this message is shown but is ready to heat or cool based on the display temperature sensor.
LC Online	This message will be shown when the unit is communicating with the LC6000. The unit is not operating when this message is shown but is ready to respond to any call or event from the LC.
Cont. Blower	The message will be shown when the unit has been commanded to run the blower continuously by the LC6000 or the stand-alone display.
Comfort Mode	This message will be shown when the unit has been put into comfort mode by the stand-alone display.
Freecooling	This message will be shown when the unit is utilizing the economizer to cool the space.
Passive Dehum	This message will be shown when the unit is connected to the LC6000 or stand-alone display and the economizer is disabled and blower speeds have been lowered to optimize moisture removal.
Cooling	This message will be shown when the unit is operating the air conditioning system to cool the space.
Heating	This message will be shown when the unit is operating the electric heaters to warm the space.
Optimized	This message will be shown when the unit is operating both the economizer and the air conditioning simultaneously to cool the space.
Active Dehum	This message will be shown when the unit is connected to the LC6000 or stand-alone display, no heating or cooling calls are required and the air conditioner and electric heat are being used together to remove moisture from the space.
Self Test	This message will be shown when the self test has been activated and component operations are being verified.
Off by Alarm	This message will be shown when the blower, fan or expansion module are no longer communicating with the main controller. Also, when unit disable, emergency off or no return sensor is detected in orphan mode.
Emergency Vent	This message will be shown when connected to a LC6000 and the emergency vent input is activated.
Emergency Cool	This message will be shown when the space temperature is above the high temperature setpoint. This can be active in orphan mode, stand-alone mode or when connected to the LC6000.
Emergency Off	This message will be shown when unit disable input is active, or when connected to LC6000 and emergency off input is active.
Off by LC	This message will be shown when connected to the LC6000 and the system is turned off.
Off by PGDx	This message will be shown when connected to the stand-alone display and the unit is turned off.
Off by Keyboard	This message will be shown when unit has been turned off at unit.
Model Invalid	This message will be shown when a valid model number is not entered into the controller.

TABLE 8
LC6000 Status Messages

Message	Description
On	The LC6000 is ready and functioning properly.
Off by BMS	The LC6000 is being turned off by the Building Management System through Modbus TCP/IP.
Off by Keyboard	The LC6000 is turned off using the (D. On/Off) Menu on the PGD. All communicating units will be inactive.
Comfort Mode	The LC6000 is set to Comfort Mode. This mode is used to temporarily override heating/cooling setpoints and maintain a default temperature of 72°F for 60 minutes.
Emergency Cooling	A high temperature has been sensed in one or more zones. All available units in that zone are sent a command for emergency cooling. (Refer to unit manual for emergency cooling sequence.)
Emergency Vent	Input signal from an external device at terminal DI2 (e.g., hydrogen detector). Units that are equipped with a ventilation option and configured will open the dampers at 100% with the blower at full speed.

A/C Circuit Information

MEGA-TEC Series wall-mounted air conditioners have two separate refrigeration circuits: Circuit 1 is the two stage system located on the left side of the unit and circuit 2 is the single stage system on the right side (see Figure 49).

NOTE: 400V models have only two stages of capacity rather than three and are identical in size. Take note of this when reading this manual.

For more information on the MEGA-TEC dual A/C circuits, see the latest version of Service Instructions 2100-671.

FIGURE 49
MEGA-TEC Refrigeration Circuits

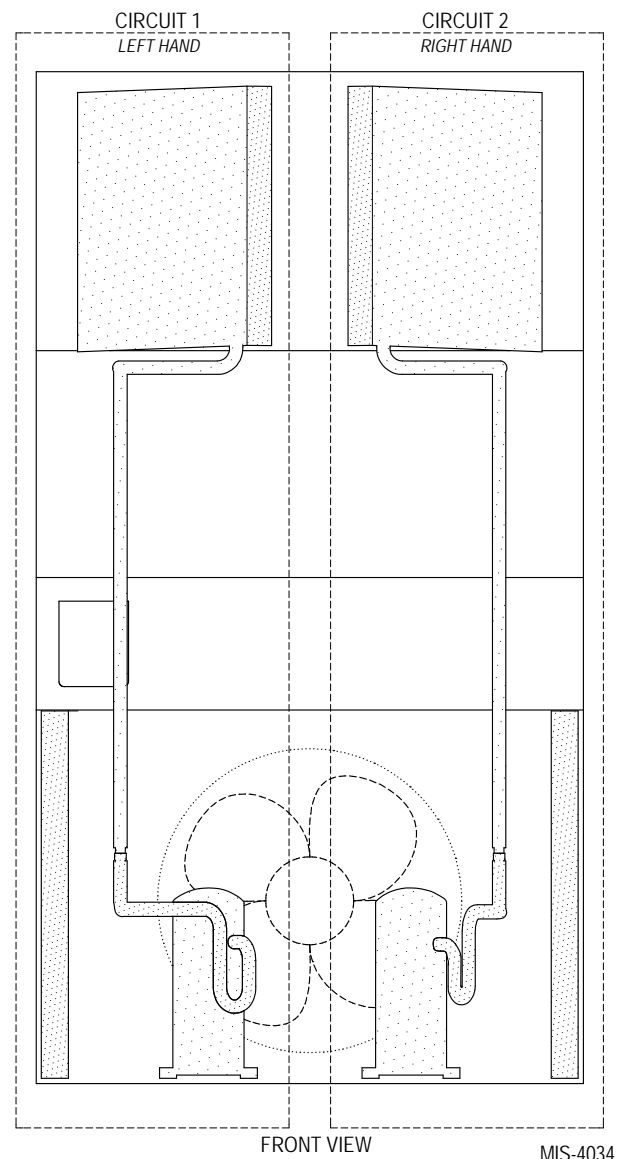

Remote Indoor Temperature/Humidity Sensor Orientation

Current versions of the remote indoor temperature/humidity sensor need to be installed with the shielded cable wires entering the bottom of the back of the sensor to connect to the sensor terminals (see Figure 50). Earlier versions of this sensor were installed so that the sensor wires entered through the top of the back of the sensor (see Figure 51). **The orientation of the sensor affects the position of the DP1/DP2 jumpers. Depending on how the sensor is installed, be sure to confirm that the jumpers are in the proper position for the 0-1 V setting as shown in the figures below.**

This applies to all indoor temperature/humidity sensors connected to the LC controller. See illustration mounted inside of sensor cover for further detail on jumper position.

FIGURE 50
Current Sensor Orientation
(Shielded Cable Wires Enter from Bottom)

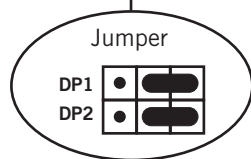
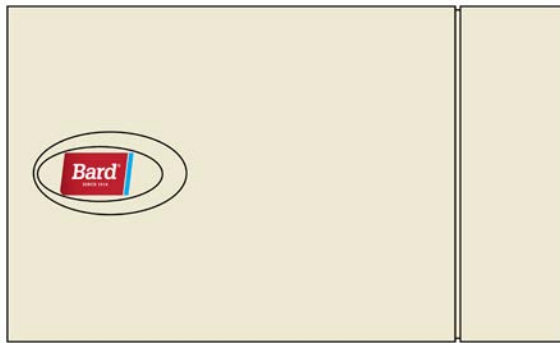

DP1 and DP2 Jumpers
 Positioned for 0-1V
 (Current Orientation)

FIGURE 51
Earlier Sensor Orientation
(Shielded Cable Wires Enter from Top)

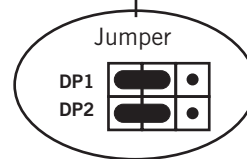
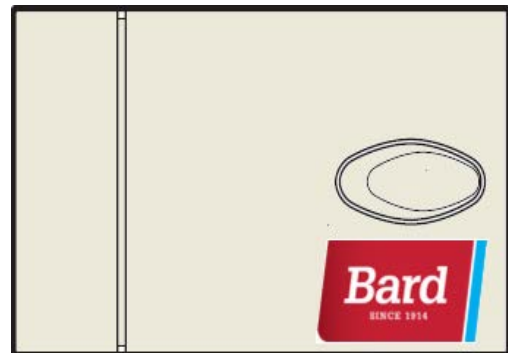

DP1 and DP2 Jumpers
 Positioned for 0-1V
 (Earlier Orientation)