



Digital – in the vehicle

Familiarize yourself with the contents of the Operator's Manual directly via the vehicle's multimedia system (menu item "Vehicle"). Start with the quick guide, discover your vehicle's highlights or broaden your knowledge with useful tips.



Vehicle document wallet

Here you can find comprehensive information about operating your vehicle and about services and warranties in printed form.



Digital – on the Internet

You can find the Operator's Manual on the Mercedes-Benz homepage.



Digital – as an App

The Mercedes-Benz Guides App is available free-of-charge in familiar App stores.



2905846200

Order no. P290 0026 13 Part no. 290 584 62 00
Edition A2019



Apple® iOS



Android™

Mercedes-Benz

Mercedes-AMG GT 4-door Coupe



Mercedes-AMG GT 4-door Coupe

Operator's Manual

Mercedes-Benz



Symbols

In this Operator's Manual, you will find the following symbols:

⚠ DANGER Danger due to not observing the warning notices

Warning notices draw your attention to hazards that may endanger your health or life, or the health or life of others.

▶ Please observe the warning notices in this manual.

🌿 ENVIRONMENTAL NOTE Environmental damage due to failure to observe environmental notes

Environmental notes include information on environmentally responsible behavior or environmentally responsible disposal.

▶ Observe environmental notes.

! NOTE Damage to property due to failure to observe notes on material damage

Notes on material damage inform you of risks which may lead to your vehicle being damaged.

▶ Observe notes on material damage.

i Useful instructions or further information that could be helpful to you.

▶ Instruction

(→ page) Further information on a topic

Display Information in the multifunction display/multimedia display

↗▶ Highest menu level, which is to be selected in the multimedia system

▶▶ Corresponding submenus, which are to be selected in the multimedia system

* Marks a cause

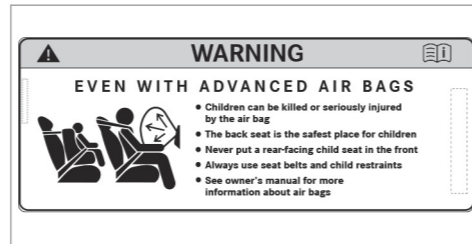

Example

⚠ WARNING Risk of injury or fatal injuries if the front passenger airbag is enabled

If the front passenger front airbag is enabled, a child on the front passenger seat may be struck by the front passenger airbag during an accident.

NEVER use a rearward-facing child restraint system on a seat with an **ENABLED FRONT AIRBAG, DEATH or SERIOUS INJURY** to the CHILD can occur.

Observe the "Children in the vehicle" section.

Publication details

Internet

Further information about Mercedes-Benz vehicles and about Daimler AG can be found on the following websites:

<http://www.mbusa.com> (USA only)

<http://www.mercedes-benz.ca> (Canada only)

Editorial office

©Daimler AG: Not to be reprinted, translated or otherwise reproduced, in whole or in part, without written permission from Daimler AG.

Vehicle manufacturer

Daimler AG

Mercedesstrasse 137

70327 Stuttgart

Germany

Welcome to the world of Mercedes-Benz

Before you first drive off, read this Operator's Manual carefully and familiarize yourself with your vehicle. For your own safety and a longer operating lifespan, follow the instructions and warning notices in this Operator's Manual. Disregarding them may lead to damage to the vehicle or personal injury.

Vehicle damage resulting from the disregard of the instructions is not covered by the Mercedes-Benz Limited Warranty.

The equipment or model designation of your vehicle may vary according to:

- Model
- Order
- National version
- Availability

Mercedes-Benz reserves the right to introduce changes in the following areas:

- Design
- Equipment
- Technical features

The equipment in your vehicle may therefore differ from that shown in the descriptions and illustrations.

The following are integral parts of the vehicle:

- Digital Operator's Manual
- Printed Operator's Manual
- Maintenance Booklet
- equipment-dependent Supplements

Keep these documents in the vehicle at all times. If you sell the vehicle, always pass all of the documents on to the new owner.

Mercedes-Benz USA, LLC

Mercedes-Benz Canada, Inc.

A Daimler Company

2905846200



At a glance	6	Limited Warranty	26	Seats and stowing	86
Cockpit	6	QR code for rescue card	27	Notes on the correct driver's seat position	86
Warning and indicator lamps	10	Data storage	27	Seats	87
Overhead control panel	12	Copyright	30	Steering wheel	95
Door control panel and seat adjustment	14			Easy entry and exit feature	96
Emergencies and breakdowns	16			Operating the memory function	97
				Stowage areas	98
Digital Operator's Manual	18	Occupant safety	32	Cup holder	105
Calling up the Digital Operator's Manual	18	Restraint system	32	Ashtray and cigarette lighter	107
		Seat belts	35	Sockets	108
		Airbags	39	Wireless charging of the mobile phone and connection with the exterior antenna ...	111
		PRE-SAFE® system	46	Installing/removing the floor mats	113
		Safely transporting children in the vehicle	48		
		Notes on pets in the vehicle	62		
General notes	19	Opening and closing	63	Light and visibility	115
Protecting the environment	19	SmartKey	63	Exterior lighting	115
Genuine Mercedes-Benz parts	20	Doors	68	Interior lighting	120
Operator's Manual	20	Cargo compartment	71	Windshield wiper and windshield washer system	121
Service and vehicle operation	21	Sun blind	77	Mirrors	123
Operating safety	22	Side windows	77	Operating the sun visors	126
Declaration of conformity for wireless vehicle components	24	Sliding sunroof	81	Infrared reflective windshield function	126
Diagnostics connection	24	Anti-theft protection	84		
Qualified specialist workshop	25				
Correct use of the vehicle	25				
Information on the REACH regulation	25				
Problems with your vehicle	26				
Reporting safety defects	26				

Climate control	128
Overview of climate control systems	128
Operating the climate control system	129

Driving and parking	135
Driving	135
DYNAMIC SELECT switch	147
Automatic transmission	149
Function of the 4MATIC	153
Refueling	154
Parking	156
Driving and driving safety systems	165
Vehicle towing instructions	223

Instrument Display and on-board computer	224
Instrument Display overview	224
Overview of the buttons on the steering wheel	225
Operating the on-board computer	225
Setting the design	227
Setting the additional value range	227
Overview of displays on the multifunction display	228

Adjusting the instrument lighting	229
Menus and submenus	229
Head-up Display	237

Voice Control System	240
Notes on operating safety	240
Operation	240
Using the Voice Control System effectively	242
Essential voice commands	242

Multimedia system	248
Overview and operation	248
System settings	257
AMG TRACK PACE	267
Fit & Healthy	271
Navigation	273
Telephone	298
Online and Internet functions	319
Media	325
Radio	338
Sound	342
Rear touchscreen	345

Maintenance and care	350
ASSYST PLUS service interval display	350
Engine compartment	351
Cleaning and care	357

Breakdown assistance	366
Emergency	366
Flat tire	366
Battery (vehicle)	372
Tow starting or towing away	377
Electrical fuses	382

Wheels and tires	386
Notes on noise or unusual handling characteristics	386
Notes on regularly inspecting wheels and tires	386
Notes on snow chains	387
Tire pressure	388
Loading the vehicle	393
Tire labeling	398
Definition of terms for tires and loading	403
Changing a wheel	406

Technical data	416
Notes on technical data	416
Vehicle electronics	416
Vehicle identification plate, VIN and engine number	418
Operating fluids	420
Vehicle data	426

Display messages and warning/indicator lamps	428
Display messages	428
Warning and indicator lamps	474

Index	488
--------------------	------------

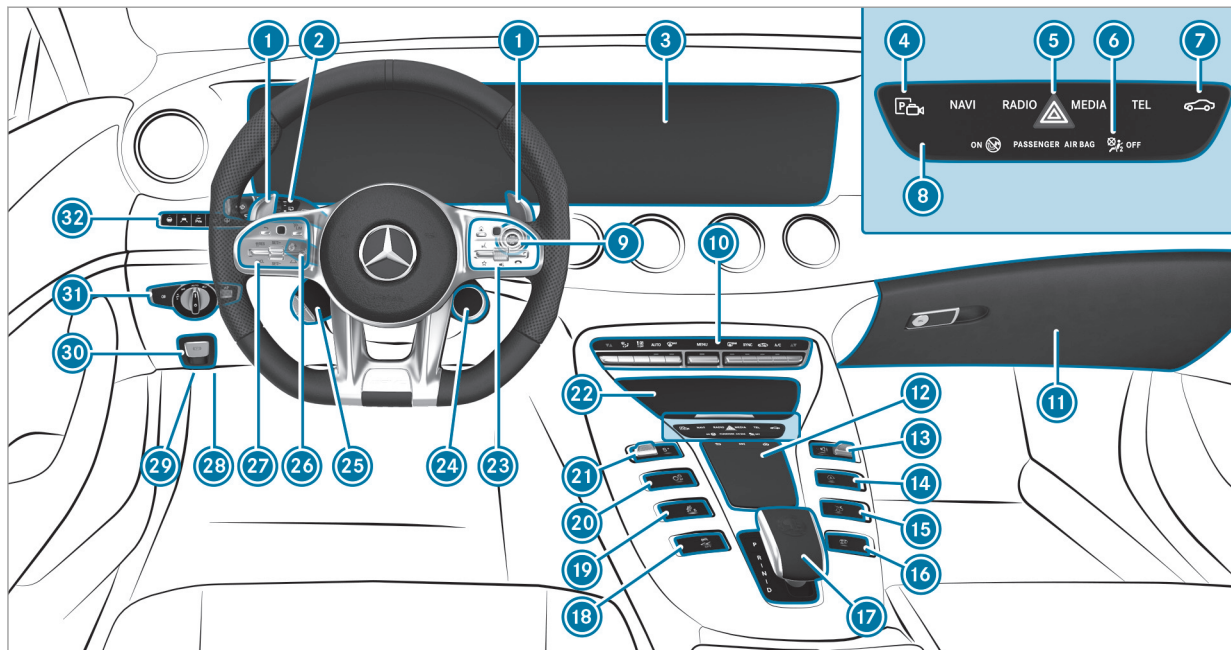

Left-hand-drive vehicles

①	Steering wheel paddle shifters	→	151	⑩	Climate control systems	→	129
②	Combination switch	→	116	⑪	Glove box	→	100
③	Multimedia system display	→	248	⑫	Control elements for the multimedia system	→	248
④	Active Parking Assist	→	211	⑬	Control knob for volume and switches sound on/off	→	248
⑤	Hazard warning lamps	→	117		Switches the multimedia system on/off	→	248
⑥	PASSENGER AIR BAG indicator lamp	→	44	⑭	ECO start/stop function	→	142
⑦	Calls up vehicle functions	→	253	⑮	Adjusts the rear wing	→	193
⑧	Control panel for the multimedia system	→	249	⑯	AMG Performance exhaust system	→	146
⑨	Start/stop button	→	136	⑰	AMG E-SELECT selector lever	→	149
				⑱	Activates/deactivates ESP®	→	167
				⑲	AMG adaptive sport suspension system	→	195
				⑳	Manual gearshifting (permanent setting)	→	151
				㉑	DYNAMIC SELECT switch	→	147
				㉒	Stowage compartment	→	100
				㉓	Control panel for the multimedia system (steering wheel)	→	225
				㉔	AMG DRIVE UNIT actuator	→	193
				㉕	AMG DRIVE UNIT buttons	→	193
				㉖	Adjusts the steering wheel	→	95
					Switches the steering wheel heater on or off	→	96
				㉗	Control panel for the on-board computer	→	225
					Operates cruise control	→	176
					Operates Active Distance Assist DISTRONIC	→	179
				㉘	Diagnostics connection	→	24







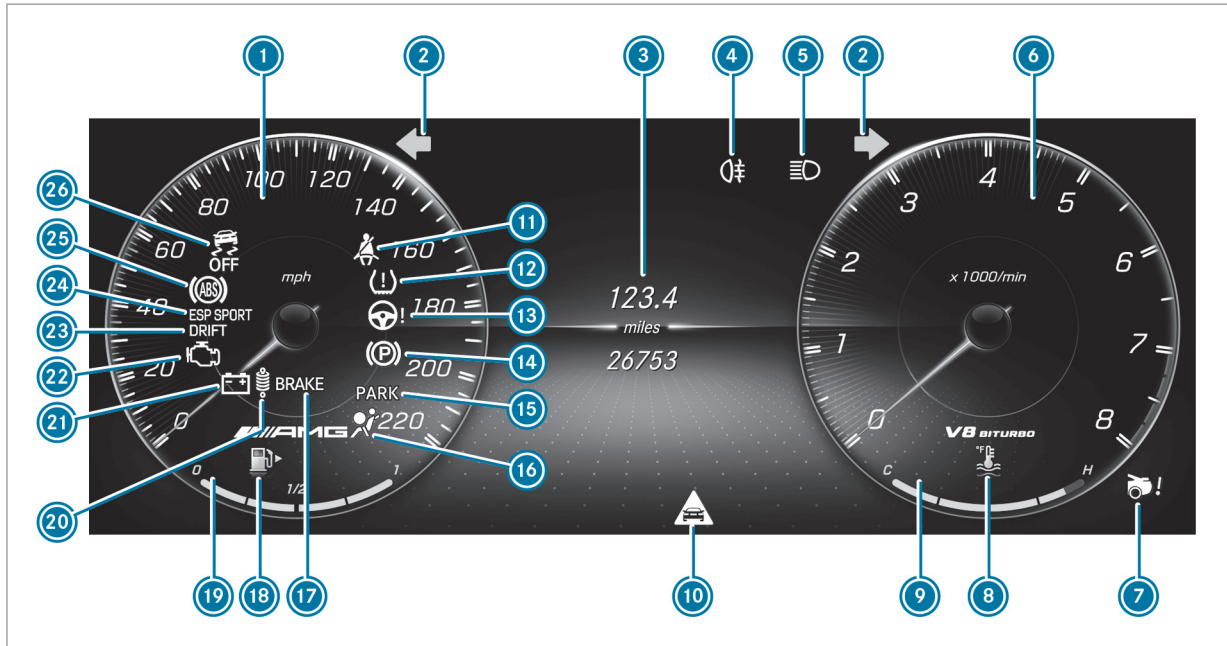

















8 At a glance - Cockpit

29	Opens the hood	→	351
30	Electric parking brake	→	162
31	Light switch	→	115
32	Control panel for:		
	Active Steering Assist	→	185







	Active Lane Keeping Assist	→	222
	Parking Assist PARKTRONIC	→	203
	Head-up Display	→	238
	Rear window roller sunblind	→	77
	Sets the vehicle level	→	198

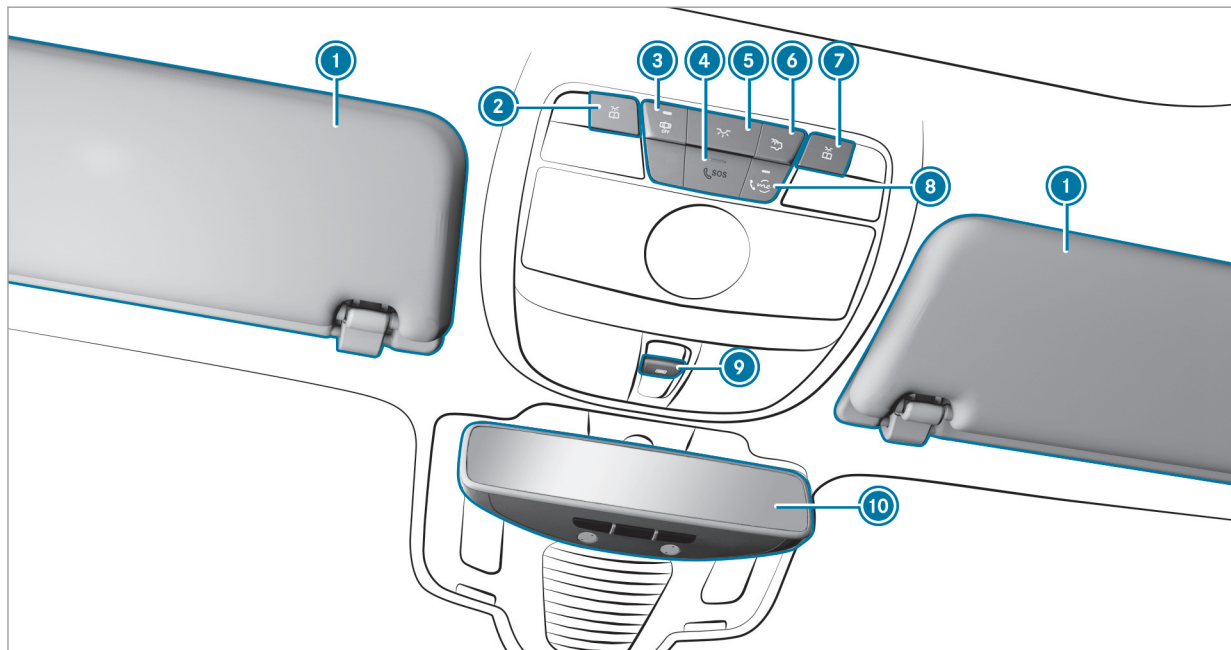





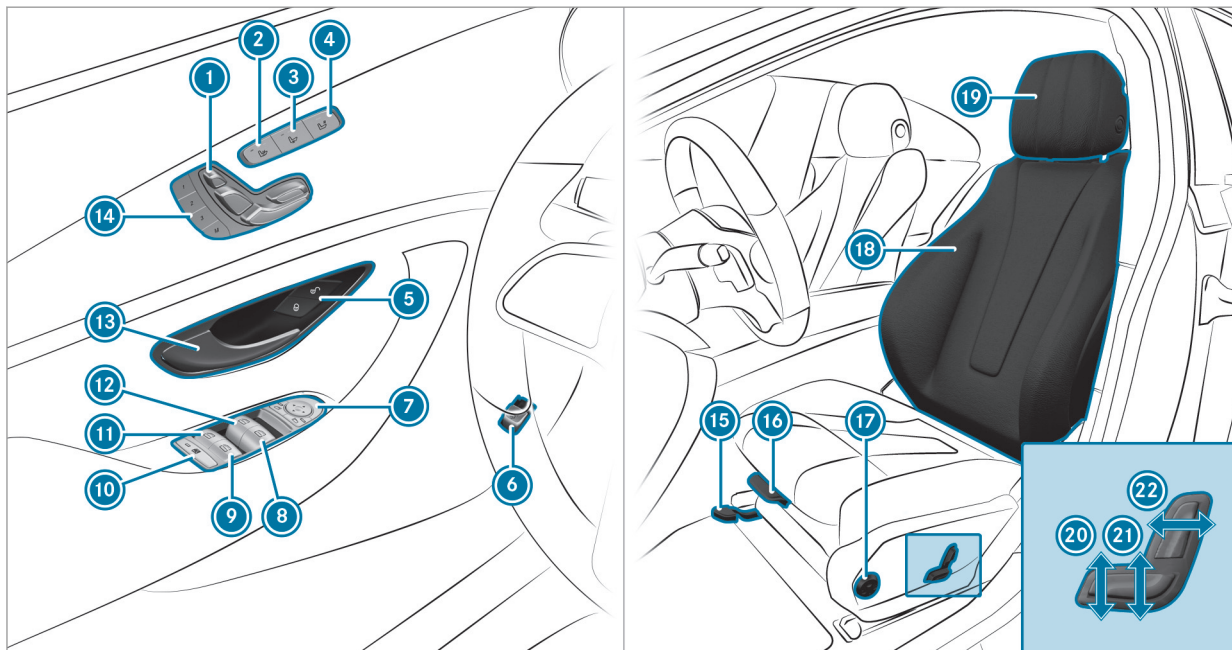

Instrument Display

①	Speedometer	→	224	 USA only	
②	  Turn signal lights	→	116	 Canada only	
③	Multifunction display	→	228	⑩⑥  Restraint system	→ 33
④	 Rear fog light	→	116	⑩⑦ Brakes (red)	→ 475
⑤	 High beam	→	116	 USA only	
	 Low beam	→	115	 Canada only	
	 Parking lights	→	115	⑩⑧  Fuel reserve with fuel filler flap location indicator	→ 483
⑥	Tachometer	→	224	⑩⑨ Fuel level indicator	
⑦	Rear wing	→	194	⑩⑩  AMG adaptive sport suspension system	→ 482
⑧	 Coolant too hot/cold	→	483	⑩⑪  Electrical malfunction	→ 483
⑨	Coolant temperature gauge	→	224	⑩⑫  Check Engine	→ 483
⑩	 Distance warning	→	482	⑩⑬ DRIFT MODE	→ 191
⑪	 Seat belt not fastened	→	481	⑩⑭   ESP SPORT	→ 475
⑫	 Tire pressure monitoring system	→	486	⑩⑮  ABS malfunctioning	→ 475
⑬	 Power-assisted steering malfunctioning	→	482	⑩⑯  ESP [®] OFF	→ 475
⑭	 Electric parking brake (yellow)	→	475		
⑮	Electric parking brake applied (red)	→	475		



①	Sun visors	→	126	⑥	 Switches the rear interior lighting on/off	→	120
②	 Switches the left-hand reading lamp on/off	→	120	⑦	 Switches the right-hand reading lamp on/off	→	120
③	 Switches automatic light control on/off	→	120	⑧	Service call button (Mercedes me connect)	→	315
④	SOS emergency call system (Mercedes-Benz emergency call system)	→	315	⑨	 Opens/closes the sliding sunroof	→	81
⑤	 Switches the front interior lighting on/off	→	120	⑩	Inside rearview mirror	→	124



①	Adjusts the seats electrically	→	89	⑫	 Opens/closes the left side window	→	77
②	Switches the seat heater on/off	→	93	⑬	Opens the door	→	68
③	Switches the seat ventilation on/off	→	95	⑭	Operates the memory function	→	97
④	Adjusts the front passenger seat from the driver's seat	→	89	⑮	Sets the seat fore-and-aft position	→	87
⑤	  Locks/unlocks the vehicle	→	68	⑯	Adjusts the seat cushion length	→	87
⑥	Opens/closes the tailgate	→	71	⑰	Adjusts the 4-way lumbar support	→	87
⑦	Operates the outside mirrors	→	123	⑱	Seat adjustment using the multimedia system	→	92
⑧	 Opens/closes the right side window	→	77	⑲	Adjusts the head restraints	→	90
⑨	 Opens/closes the rear right side window	→	77	⑳	Adjusts the seat cushion inclination	→	87
⑩	Child safety lock for the rear side windows	→	61	㉑	Adjusts the seat height	→	87
⑪	 Opens/closes the rear left side window	→	77	㉒	Adjusts the seat backrest inclination	→	87

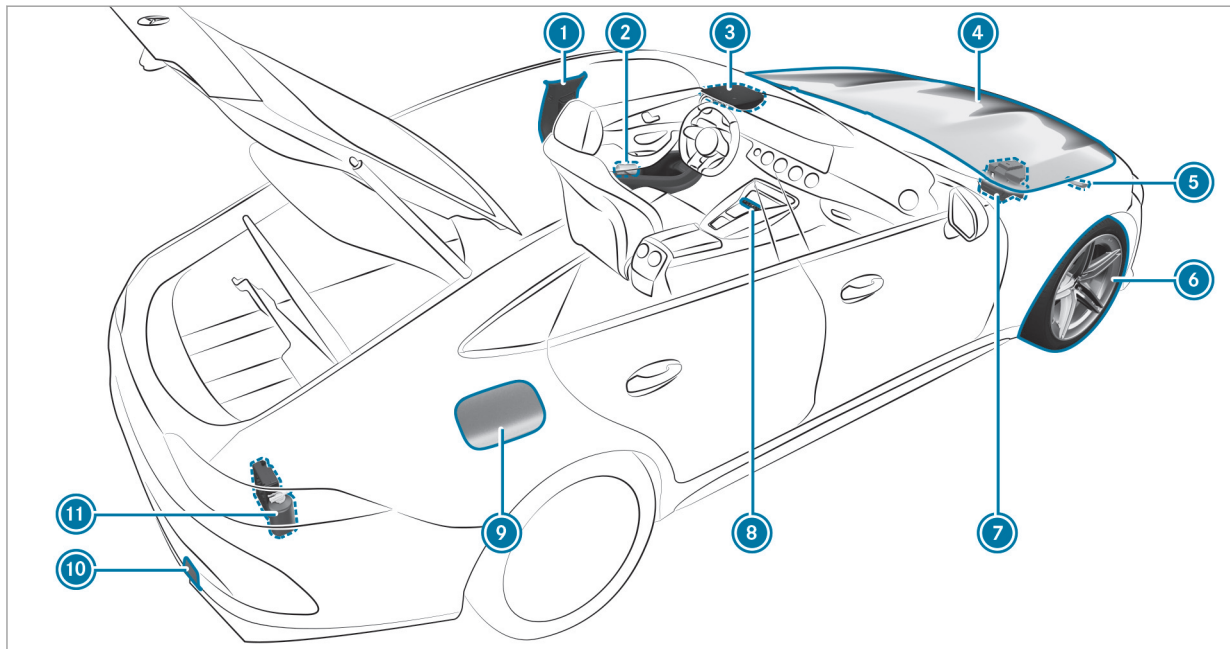

① QR code for accessing the rescue card	→	27	⑦ Jump-starting	→	376
② Safety vests	→	366	⑧ Hazard warning lamps	→	117
③ Buttons for the SOS emergency call system and breakdown assistance call	→	315	⑨ Fuel filler flap with instruction labels for tire pressure, fuel type and QR code for accessing the rescue card	→	154
④ To check and top up operating fluids	→	420	⑩ To tow-start and tow away	→	377
⑤ To tow-start and tow away	→	377	⑪ TIREFIT kit	→	368
⑥ Flat tire	→	366			

Calling up the Digital Operator's Manual

Multimedia system:

➔ Vehicle ➔ ⓘ Operator's Manual

▶ Select a menu item.

In addition, you can also call up the Operator's Manual within a main function (e.g. via [Navigation Info](#)).

The Digital Operator's Manual describes the function and operation of the vehicle and the multimedia system.

For safety reasons, the Digital Operator's Manual is deactivated while driving.



The Digital Operator's Manual contains the following menu items:

- **Search:** allows you to search precisely for keywords.
- **Quick start:** provides you with important information so that you can start using your vehicle immediately.
- **Tips:** provides tips on how to use your vehicle in certain situations.
- **Messages:** provides you with further information about the messages in the instrument cluster.
- **Bookmarks:** provides you with a list of all the bookmarks you have stored yourself.

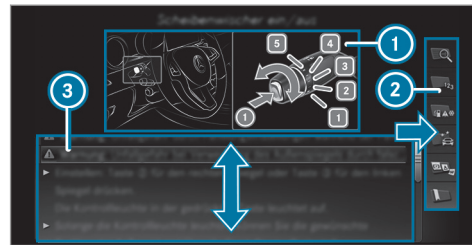

- ① Picture
- ② Menu
- ③ Navigation window

Some sections of the Digital Operator's Manual, such as warnings, can be made visible by highlighting and pressing them.

- ⓘ The Operator's Manual can also be found in the Mercedes-Benz Guides app in all common app stores.

Protecting the environment

 **ENVIRONMENTAL NOTE** Environmental damage due to operating conditions and personal driving style

The pollutant emission of your vehicle is directly related to the way you operate your vehicle.

You can help to protect the environment by operating your vehicle in an environmentally responsible manner. Please observe the following recommendations on operating conditions and personal driving style.

Operating conditions:

- ▶ Make sure that the tire pressure is correct.
- ▶ Do not carry any unnecessary weight (e.g. roof luggage racks once you no longer need them).
- ▶ Adhere to the service intervals. A regularly serviced vehicle will contribute to environmental protection.

- ▶ Always have maintenance work carried out at a qualified specialist workshop.

Personal driving style:

- ▶ Do not depress the accelerator pedal when starting the engine.
- ▶ Do not warm up the engine while the vehicle is stationary.
- ▶ Drive carefully and maintain a suitable distance from the vehicle in front.
- ▶ Avoid frequent, sudden acceleration and braking.
- ▶ Change gear in good time and use each gear only up to $\frac{2}{3}$ of its maximum engine speed.
- ▶ Switch off the engine in stationary traffic, e.g. by using the ECO start/stop function.
- ▶ Drive fuel-efficiently. Observe the ECO display for a fuel-efficient driving style.

 **ENVIRONMENTAL NOTE** Environmental pollution caused by irresponsible disposal of the high-voltage battery

A high-voltage battery contains materials which are harmful to the environment.

- ▶ Dispose of defective high-voltage batteries at a qualified specialist workshop.

Environmental issues and recommendations:

It is recommended that you re-use or recycle materials instead of just disposing of them.

The relevant environmental guidelines and regulations serve to protect the environment and must be strictly observed.

Genuine Mercedes-Benz parts



ENVIRONMENTAL NOTE Environmental damage caused by not using recycled/reconditioned components

Daimler AG offers recycled/reconditioned components and parts with the same quality as new parts. The same entitlement from the Limited Warranty is valid as for new parts.

- ▶ Use recycled/reconditioned components and parts from Daimler AG.



NOTE Impairment of the operating efficiency of the restraint systems from installing accessory parts or from repairs or welding

Airbags and Emergency Tensioning Devices, as well as control units and sensors for the restraint systems, may be installed in the following areas of your vehicle:

- Doors
- Door pillars

- Door sills
 - Seats
 - Cockpit
 - Instrument cluster
 - Center console
 - Lateral roof frame
- ▶ Do not install accessory parts such as audio systems in these areas.
 - ▶ Do not carry out repairs or welding.
 - ▶ Have aftermarket installation of accessories carried out at a qualified specialist workshop.

You could jeopardize the operating safety of your vehicle if you use parts, tires and wheels as well as accessories relevant to safety which have not been approved by Mercedes-Benz. Safety-relevant systems, e.g. the brake system, may malfunction. Only use Mercedes-Benz Genuine Parts or parts of equal quality. Only use tires, wheels and accessories that have been specifically approved for your vehicle model.

Mercedes-Benz Genuine Parts are subject to strict quality control. Each part has been specially developed, manufactured or selected for Mercedes-Benz vehicles and fine-tuned for them. Therefore, only Mercedes-Benz Genuine Parts should be used.

More than 300,000 different Mercedes-Benz Genuine Parts are available for Mercedes-Benz models.

All authorized Mercedes-Benz Centers maintain a supply of Mercedes-Benz Genuine Parts for necessary service and repair work. In addition, strategically located parts delivery centers provide for quick and reliable parts service.

Always specify the vehicle identification number (VIN) (→ page 418) when ordering Mercedes-Benz Genuine Parts.

Operator's Manual

This Operator's Manual describes all models and all standard and optional equipment available for your vehicle at the time of this Operator's Manual going to press. Country-specific differences are possible. Note that your vehicle may not be

equipped with all features described. This is also the case for systems and functions relevant to safety. Therefore, the equipment on your vehicle may differ from that in the descriptions and illustrations.

The original purchase agreement for your vehicle contains a list of all of the systems in your vehicle.

Should you have any questions concerning equipment and operation, please consult an authorized Mercedes-Benz Center.

The Operator's Manual and Maintenance Booklet are important documents and should be kept in the vehicle.

Service and vehicle operation

Vehicle operation outside the USA or Canada

When you are abroad with your vehicle, observe the following points:

- service points or replacement parts may not be available immediately.

- unleaded fuel may not be available for vehicles with a catalytic converter. Leaded fuel may cause damage to the catalytic converter.
- the fuel may have an extremely low octane number. Unsuitable fuel can cause engine damage.

Some Mercedes-Benz models are available in Europe through our European Delivery Program. For more information, please consult an authorized Mercedes-Benz service center, or write to one of the following address:

in the USA:

Mercedes-Benz USA, LLC
European Delivery Department
One Mercedes-Benz Drive
Sandy Springs, GA 30328

in Canada:

Mercedes-Benz Canada, Inc.
European Delivery Department
98 Vanderhoof Avenue
Toronto, Ontario M4G 4C9

Maintenance

Your customer advisor confirms the service in the service report.

Roadside Assistance

The Mercedes-Benz Roadside Assistance Program offers technical help in the case of a breakdown. Your calls to the toll-free Roadside Assistance Hotline are answered by our agents 24 hours a day, 365 days a year.

1-800-FOR-MERCEdes (1-800-367-6372) (USA)
1-800-387-0100 (Canada)

You can find further information in the Mercedes-Benz Roadside Assistance Program brochure (USA) or the "Roadside Assistance" section in the maintenance and warranty information booklet (Canada). You will find both in the vehicle document wallet.

Change of address or change of ownership

In the event of a change of address, please send us the "Notification of address change" in the

Service and Guarantee booklet or simply call the Mercedes-Benz Customer Assistance Center (USA) on the hotline number 1-800-FOR-MERCEdes (1-800-367-6372) or Customer Service (Canada) on 1-800-387-0100. We can then reach you in a timely fashion, if necessary.

If you sell your Mercedes, please leave all literature in the vehicle so that it is available to the next owner. If you have purchased a used vehicle, please send us the "Notice of Purchase of Used Car" in the Service and Guarantee booklet or simply call the Mercedes-Benz Customer Assistance Center (USA) at the hotline number 1-800-FOR-MERCEdes (1-800-367-6372) or Customer Service (Canada) at 1-800-387-0100.

Operating safety

⚠ WARNING Risk of accident due to malfunctions or system failures

If you do not have the prescribed service/maintenance work or any required repairs

carried out, this could result in malfunctions or system failures.

- ▶ Always have the prescribed service/maintenance work as well any required repairs carried out at a qualified specialist workshop.

⚠ WARNING Risk of accident or injury due to incorrect modification of electronic components and parts

Modification to electronic components, their software or wiring could impair their function and/or the function of other networked component parts. In particular, systems relevant to safety could also be affected.

As a result, these may no longer function properly and/or jeopardize the operating safety of the vehicle.

- ▶ Never tamper with the vehicle's wiring, electronic components or software.
- ▶ You should have all work on electrical and electronic components carried out at a qualified specialist workshop.

⚠ WARNING Risk of fire due to flammable materials on hot parts of the exhaust system

Flammable material such as leaves, grass or twigs may ignite if they come into contact with hot parts of the exhaust system.

- ▶ When driving on unpaved roads or off-road, regularly check the vehicle underside.
- ▶ Remove trapped plants or other flammable material.
- ▶ If there is damage, consult a qualified specialist workshop immediately.

! NOTE Damage to the vehicle

In the following situations, in particular, there is a risk of damage to the vehicle:

- The vehicle becomes grounded, e.g. on a high curb or an unpaved road

- The vehicle is driven too fast over an obstacle, e.g. a curb, speed bump or pot-hole
- A heavy object strikes the underbody or chassis components

In situations such as this, the body, the underbody, chassis components, wheels or tires could be damaged without the damage being visible. Components damaged in this way can unexpectedly fail or, in the case of an accident, may not absorb the loads that arise as intended.

If the underbody paneling is damaged, flammable materials such as leaves, grass or twigs can collect between the underbody and the underbody paneling. These materials may ignite if they come into contact with hot parts on the exhaust system.

- ▶ Have the vehicle checked and repaired immediately at a qualified specialist workshop.

or

- ▶ If driving safety is impaired while continuing your journey, pull over and stop the vehicle immediately in accordance with the traffic conditions, and contact a qualified specialist workshop.

Vehicles with a 48 V on-board electrical system (EQ Boost technology)

⚠ DANGER Risk of fatal injury by touching damaged high-voltage components

Vehicles with a 48 V on-board electrical system contain individual high-voltage components. These high-voltage components are under high voltage.

If you modify component parts of these high-voltage components or touch damaged component parts, you may be electrocuted.

High voltage components may be damaged in an accident, although the damage may not be visible.

- ▶ Never perform modifications to component parts of high-voltage components.

- ▶ Never touch damaged component parts of high-voltage components.
- ▶ Never touch component parts of high-voltage components after an accident.

Vehicles with a 48 V on-board electrical system contain high voltage components. These components are marked with a high voltage label:



All work on high voltage components must be carried out at a qualified specialist workshop.

Declaration of conformity for wireless vehicle components

USA: "The wireless devices of this vehicle comply with Part 15 of the FCC Rules. Operation is subject to the following two conditions: 1) These devices may not cause harmful interference, and 2) These devices must accept any interference received, including interference that may cause undesired operation. Changes or modifications not expressly approved by the party responsible for compliance could void the user's authority to operate the equipment."

Canada: "The wireless devices of this vehicle comply with Industry Canada license-exempt RSS standard(s). Operation is subject to the following two conditions: (1) These devices may not cause interference, and (2) These devices must accept any interference, including interference that may cause undesired operation of the device."

USA: "Wireless charging system for mobile devices (Model: D-WMI2015A): this device complies with Part 18 of the FCC Rules."

The name and address of the responsible party is:

Continental Automotive Systems US Inc.
2400 Executive Hills Drive
Auburn Hills, MI 48326-2980
United States of America

Diagnostics connection

The diagnostics connection is only intended for the connection of diagnostic devices at a qualified specialist workshop.

⚠ WARNING Risk of accident due to connecting devices to the diagnostics connection

If you connect equipment to a diagnostics connection in the vehicle, it may affect the operation of vehicle systems.

As a result, the operating safety of the vehicle could be affected.

- ▶ Only connect equipment to a diagnostics connection in the vehicle which is

approved for your vehicle by Mercedes-Benz.

⚠ WARNING Risk of accident due to objects in the driver's footwell

Objects in the driver's footwell may impede pedal travel or block a depressed pedal. This jeopardizes the operating and road safety of the vehicle.

- ▶ Stow all objects in the vehicle securely so that they cannot get into the driver's footwell.
- ▶ Always install the floor mats securely and as prescribed in order to ensure that there is always sufficient room for the pedals.
- ▶ Do not use loose floor mats and do not place floor mats on top of one another.

! **NOTE** Battery discharging from using devices connected to the diagnostics connection

Using devices at the diagnostics connection drains the battery.

- ▶ Check the charge level of the battery.
- ▶ If the charge level is low, charge the battery, e.g. by driving a considerable distance.

Connecting equipment to the diagnostics connection can lead to emissions monitoring information being reset, for example. This may lead to the vehicle failing to meet the requirements of the next emissions inspection during the main inspection.

Qualified specialist workshop

An authorized Mercedes-Benz Center is a qualified specialist workshop. It has the necessary special skills, tools and qualifications to correctly carry out the work required on your vehi-

cle. This particularly applies to safety-relevant works.

For the following, always have your vehicle checked at an authorized Mercedes-Benz Center:

- safety-relevant works
- service and maintenance work
- repair work
- modifications as well as installations and conversions
- work on electronic components

Mercedes-AMG recommends a Mercedes-Benz service center.

Correct use of the vehicle

If you remove any warning stickers, you or others could fail to recognize certain dangers. Leave warning stickers in position.

When using the vehicle, observe the following information:

- the safety notes in this manual

- technical data for the vehicle
- traffic rules and regulations
- laws and safety standards pertaining to motor vehicles

Information on the REACH regulation

The REACH Regulation (Regulation (EC) No. 1907/2006, Article 33) stipulates an information obligation for substances of very high concern (SVHC).

Daimler AG is acting to the best of its knowledge to avoid the use and application of these SVHCs and to enable the customer to handle these substances safely. According to supplier information and internal product information of Daimler AG, SVHCs are known which are more than 0.1 percent by weight in individual products of this vehicle.

Further information can be found at:

- <http://www.daimler.com/reach>
- <http://www.daimler.com/reach/en>

Problems with your vehicle

If you should experience a problem with your vehicle, particularly one that you believe may affect its safe operation, we urge you to contact an authorized Mercedes-Benz Center immediately to have the problem diagnosed and rectified. If the problem is not resolved to your satisfaction, please discuss the problem again with an authorized Mercedes-Benz Center or, if necessary, contact us at one of the following addresses:

In the USA:

Mercedes-Benz USA, LLC
Customer Assistance Center
One Mercedes-Benz Drive
Sandy Springs, GA 30328

In Canada:

Mercedes-Benz Canada, Inc.
Customer Relations Department
98 Vanderhoof Avenue
Toronto, Ontario M4G 4C9

Reporting safety defects

USA only:

The following text is published as required of manufacturers under Title 49, Code of U.S. Federal Regulations, Part 575 pursuant to the "National Traffic and Motor Vehicle Safety Act of 1966".

If you believe that your vehicle has a defect which could cause a crash or could cause injury or death, you should immediately inform the National Highway Traffic Safety Administration (NHTSA) in addition to notifying Mercedes-Benz USA, LLC.

If NHTSA receives similar complaints, it may open an investigation, and if it finds that a safety defect exists in a group of vehicles, it may order a recall and remedy campaign. However, NHTSA cannot become involved in individual problems between you, your dealer, or Mercedes-Benz USA, LLC.

To contact NHTSA, you may call the Vehicle Safety Hotline toll-free at 1-888-327-4236 (TTY: 1-800-424-9153) (inside the USA); go to <http://www.safercar.gov>; or write to: Adminis-

trator, NHTSA, 400 Seventh Street, SW., Washington, DC 20590, USA.

Further information on vehicle safety can be found at: <http://www.safercar.gov>

Limited Warranty

! **NOTE** Damage to the vehicle arising from violation of these operating instructions.

Damage to the vehicle can arise from violation of these operating instructions.

This damage is not covered either by the Mercedes-Benz implied warranty or by the New- or Used-Vehicle Warranty.

▶ Follow the instructions in these operating instructions on proper operation of your vehicle as well as on possible vehicle damage.

QR code for rescue card

The QR code is secured in the fuel filler flap and on the opposite side on the B-pillar. In the event of an accident, rescue services can use the QR code to quickly find the appropriate rescue card for your vehicle. The current rescue card contains the most important information about your vehicle in a compact form, e.g. the routing of the electric lines.

Further information can be obtained at <http://www.mercedes-benz.de/qrcode>.

Data storage

Electronic control units

Electronic control units are installed in your vehicle. Some of these are necessary for the safe operation of your vehicle, while some assist you when driving (driver assistance systems). In addition, your vehicle provides comfort and entertainment functions, which are also made possible by electronic control units.

Electronic control units contain data memories which can temporarily or permanently store

technical information about the vehicle's operating state, component loads, maintenance requirements and technical events or malfunctions.

In general, this information documents the state of a component part, a module, a system or the surroundings such as:

- operating states of system components (e.g. fluid levels, battery status, tire pressure)
- status messages concerning the vehicle or its individual components (e.g. number of wheel revolutions/speed, longitudinal acceleration, lateral acceleration, display of fastened seat belts)
- malfunctions or defects in important system components (e.g. lights, brakes)
- information on events leading to vehicle damage
- system reactions in special driving situations (e.g. airbag deployment, intervention of stability control systems)
- ambient conditions (e.g. temperature, rain sensor)

In addition to providing the actual control unit function, this data assists the manufacturer in detecting and rectifying malfunctions and optimizing vehicle functions. The majority of this data is temporary and is only processed in the vehicle itself. Only a small portion of the data is stored in the event or malfunction memory.

When your vehicle is serviced, technical data from the vehicle can be read out by service network employees (e.g. workshops, manufacturers) or third parties (e.g. breakdown services). Services include repair services, maintenance processes, warranty claims and quality assurance measures, for example. The read out is performed via the legally prescribed port for the diagnostics connection in the vehicle. The respective service network locations or third parties collect, process and use the data. They document technical statuses of the vehicle, assist in finding malfunctions and improving quality and are transmitted to the manufacturer, if necessary. Furthermore, the manufacturer is subject to product liability. For this, the manufacturer requires technical data from vehicles.

Malfunction memories in the vehicle can be reset by a service outlet as part of repair or maintenance work.

Depending on the selected equipment, you can import data into vehicle convenience and infotainment functions yourself.

This includes, for example:

- multimedia data such as music, films or photos for playback in an integrated multimedia system
- address book data for use in connection with an integrated hands-free system or an integrated navigation system
- entered navigation destinations
- data about the use of Internet services

This data can be saved locally in the vehicle or it is located on a device which you have connected to the vehicle (e.g. smartphone, USB flash drive or MP3 player). If this data is stored in the vehicle, you can delete it at any time. This data is sent to third parties only at your request, particularly when you use online services in accordance with the settings that you have selected.

You can store or change convenience settings/individualization in the vehicle at any time.

Depending on the equipment, this includes, for example:

- settings for the seat and steering wheel positions
- suspension and climate control settings
- customizations such as interior lighting

If your vehicle is accordingly equipped, you can connect your smartphone or another mobile end device to the vehicle. You can control this by means of the control elements integrated in the vehicle. Images and audio from the smartphone can be output via the multimedia system. Certain information is simultaneously transferred to your smartphone.

Depending on the type of integration, this can include:

- general vehicle data
- position data

This allows you to use selected apps on your smartphone, such as navigation or music play-

back. There is no further interaction between the smartphone and the vehicle; in particular, vehicle data is not directly accessible. Which type of further data processing occurs is determined by the provider of the specific app used. Which settings you can make, if any, depends on the specific app and the operating system of your smartphone.

Online services

Wireless network connection

If your vehicle has a wireless network connection, it enables data to be exchanged between your vehicle and additional systems. The wireless network connection is enabled via the vehicle's transmission and reception unit or via connected mobile end devices (e.g. smartphones). Online functions can be used via the wireless network connection. This includes online services and applications/apps provided by the manufacturer or other providers.

Manufacturer's services

Regarding online services of the manufacturer, the individual functions are described by the

manufacturer in a suitable place (e.g. Operator's Manual, website of the manufacturer) along with the relevant data protection information. Personal data may be used for the provision of online services. Data is exchanged via a secure connection, e.g. the manufacturer's designated IT systems. Personal data is collected, processed and used via the provision of services exclusively on the basis of legal permissions or with prior consent.

The services and functions (sometimes subject to a fee) can usually be activated or deactivated. In some cases, this also applies to the entire vehicle's data connection. This excludes, in particular, legally prescribed functions and services.

Third party services

If it is possible to use online services from other providers, these services are subject to the data protection and terms of use of the responsible provider. The manufacturer has no influence on the content exchanged.

Please inquire, therefore, about the type, scope and purpose of the collection and use of per-

sonal data as part of third party services from their respective provider.

COMAND/mbrace

If the vehicle is equipped with COMAND or mbrace, additional data about the vehicle's operation, the use of the vehicle in certain situations, and the location of the vehicle may be compiled through COMAND or the mbrace system.

For additional information please refer to the chapter Multimedia system and/or the mbrace Terms and Conditions.

Event data recorders

USA only:

This vehicle is equipped with an event data recorder (EDR). The main purpose of an EDR is to record, in certain crash or near crash-like situations, such as an airbag deployment or hitting a road obstacle, data that will assist in understanding how a vehicle's systems performed. The EDR is designed to record data related to

vehicle dynamics and safety systems for a short period of time, typically 30 seconds or less.

The EDR in this vehicle is designed to record such data as:

- How various systems in your vehicle were operating
- Whether or not the driver and front passenger seat belts were buckled/fastened
- How far (if at all) the driver was depressing the accelerator and/or brake pedal and
- How fast the vehicle was traveling

This data can help provide a better understanding of the circumstances in which accidents and injuries occur. NOTE: EDR data is recorded by your vehicle only if a non-trivial crash situation occurs; no data is recorded by the EDR under normal driving conditions and no personal data (e.g. name, gender, age and accident location) is recorded. However, other parties, such as law enforcement, could combine EDR data with the type of personally identifying data routinely acquired during a crash investigation.

Access to the vehicle and/or the EDR is needed to read data that is recorded by the EDR, and special equipment is required. In addition to the vehicle manufacturer, other parties that have the special equipment, such as law enforcement, can read the information by accessing the vehicle or the EDR.

EDR data may be used in civil and criminal matters as a tool in accident reconstruction, accident claims and vehicle safety. Since the Crash Data Retrieval (CDR) tool that is used to extract data from the EDR is commercially available, Mercedes-Benz USA, LLC ("MBUSA") expressly disclaims any and all liability arising from the extraction of this information by unauthorized Mercedes-Benz personnel.

MBUSA will not share EDR data with others without the consent of the vehicle owner or, if the vehicle is leased, without the consent of the lessee. Exceptions to this representation include responses to subpoenas by law enforcement; by federal, state or local government; in connection with or arising out of litigation involving MBUSA or its subsidiaries and affiliates; or, as required by law.

Warning: the EDR is a component of the Restraint System Module. Tampering with, altering, modifying or removing the EDR component may result in a malfunction of the Restraint System Module and other systems.

State laws or regulations regarding EDRs that conflict with federal regulation are pre-empted. This means that in the event of such conflict, the federal regulation governs. As of February 2013, 13 states have enacted laws relating to EDRs.

Copyright

Free and open source software

Information on free and open source software licenses for your vehicle's software can be found on the data storage medium in your vehicle document wallet and on the Internet together with updates:

<http://www.mercedes-benz.com/opensource>

Registered trademarks

- Bluetooth® is a registered trademark of Bluetooth SIG Inc.
- DTS™ is a registered trademark of DTS, Inc.
- Dolby® and MLP™ are registered trademarks of DOLBY Laboratories.
- BabySmart™, ESP® and PRE-SAFE® are registered trademarks of Daimler AG.
- HomeLink® is a registered trademark of Johnson Controls.
- iPod® and iTunes® are registered trademarks of Apple Inc.
- Burmester® is a registered trademark of Burmester Audiosysteme GmbH.
- Microsoft® and Windows Media® are registered trademarks of Microsoft Corporation.
- SIRIUS® is a registered trademark of Sirius XM Radio Inc.
- HD Radio™ is a registered trademark of iBiquity Digital Corporation.

- Gracernote® is a registered trademark of Gracernote, Inc.
- ZAGATSurvey® and related brands are registered trademarks of ZagatSurvey, LLC.

Restraint system

Protection provided by the restraint system

The restraint system comprises the following components:

- Seat belt system
- Airbags
- Child restraint system
- Child seat securing systems

The restraint system can reduce the risk of vehicle occupants coming into contact with parts of the vehicle's interior in the event of an accident. The restraint system can also reduce the forces to which vehicle occupants are subjected in the event of an accident.

Only a seat belt which is worn correctly can provide the intended level of protection. Depending on the detected accident situation, Emergency Tensioning Devices and/or airbags supplement a correctly worn seat belt. Emergency Tensioning Devices and/or airbags are not deployed in every accident.

For the restraint system to provide its full protection, each occupant must observe the following:

- Fasten the seat belt correctly.
- Be in an almost upright position with their back against the seat backrest.
- Sit with their feet resting on the floor, if possible.
- Always secure persons under 5 ft (1.50 m) tall in an additional restraint system suitable for Mercedes-Benz vehicles.

However, no system available today can completely eliminate injuries and fatalities in every accident situation. In particular, the seat belt and airbag generally do not protect against objects penetrating the vehicle from the outside. The risk of an injury resulting from airbag deployment also cannot be ruled out entirely.

Reduced restraint system protection

⚠ WARNING Risk of injury or death from modifications to the restraint system

The restraint system can no longer function correctly after alterations have been made.

The restraint system may then not protect the vehicle occupants as intended by failing in an accident or triggering unexpectedly, for example

- ▶ Never alter the parts of the restraint system.
- ▶ Never tamper with the wiring or any electronic component parts or their software.

If it is necessary to modify the vehicle to accommodate a person with disabilities, contact an authorized Mercedes-Benz Center for details.



USA only: for details, contact our Customer Assistance Center on 1-800-FOR-MERCEDES (1-800-367-6372).

Restraint system functionality

When the ignition is switched on, a self-test is performed, during which the  restraint system warning lamp lights up. It goes out no later than a few seconds after the vehicle is started. The components of the restraint system are then functional.

Malfunctioning restraint system

A malfunction has occurred in the restraint system if:

- the  restraint system warning lamp does not light up when the ignition is switched on
- the  restraint system warning lamp lights up continuously or repeatedly during a journey

⚠ WARNING Risk of injury or fatal injury due to a malfunction in the restraint system

If the restraint system is malfunctioning, restraint system components may be trig-

gered unintentionally or might not be triggered at all in the event of an accident. This may affect the Emergency Tensioning Device or airbag, for example.

- ▶ Have the restraint system checked and repaired immediately at a qualified specialist workshop.

Function of the restraint system in an accident

How the restraint system works is determined by the severity of the impact detected and the type of accident anticipated:

- Frontal impact
- Rear impact
- Side impact
- Rollover

The activation thresholds for the components of the restraint system are determined based on the evaluation of the sensor values measured at various points in the vehicle. This process is pre-emptive in nature. The triggering/deployment of

the components of the restraint system must take place in good time at the start of the collision.

Factors which can only be seen and measured after a collision has occurred do not play a decisive role in the deployment of an airbag. Nor do they provide an indication of airbag deployment.

The vehicle may be deformed significantly without an airbag being deployed. This is the case if only parts which are relatively easily deformed are affected and the rate of vehicle deceleration is not high. Conversely, an airbag may be deployed even though the vehicle suffers only minor deformation. If very rigid vehicle parts such as longitudinal members are hit, for example, this may result in sufficiently high levels of vehicle deceleration.

The components of the restraint system can be activated or deployed independently of each other:

Component	Detected deployment situation
Emergency Tensioning Devices	Frontal impact, rear impact, side impact, rollover
Driver's airbag, front passenger front airbag	Frontal impact
Knee airbag	Frontal impact
Side airbag	Side impact
Window curtain airbag	Side impact, rollover, frontal impact
PRE-SAFE® Impulse Side	Side impact

The front passenger front airbag can only be deployed in an accident if the PASSENGER AIR BAG OFF indicator lamp is off. If the front

passenger seat is occupied, make sure, both before and during the journey, that the status of the front passenger front airbag is correct (→ page 44).

⚠ WARNING Risk of burns from hot air bag components

The air bag parts are hot after an air bag has been deployed.

- ▶ Do not touch the air bag parts.
- ▶ Have a deployed air bag replaced at a qualified specialist workshop as soon as possible.

Mercedes-Benz recommends that you have the vehicle towed to a qualified specialist workshop after an accident. Take this into account, particularly if an Emergency Tensioning Device is triggered or an airbag deployed.

If the Emergency Tensioning Devices are triggered or an airbag is deployed, you will hear a bang, and a small amount of powder may also be released:

- The bang will not generally affect your hearing.
- In general, the powder released is not hazardous to health but may cause short-term breathing difficulties to persons suffering from asthma or other pulmonary conditions. Provided it is safe to do so, leave the vehicle immediately or open the window in order to prevent breathing difficulties.

Airbags and pyrotechnic Emergency Tensioning Devices contain perchlorate material, which may require special handling or environmental protection measures. National guidelines regarding waste disposal must be observed. In California, see <http://www.dtsc.ca.gov/HazardousWaste/Perchlorate/index.cfm>.

Seat belts

Protection provided by the seat belt

Always fasten your seat belt correctly before starting a journey. A seat belt can only provide the best level of protection if it is worn correctly.

⚠ WARNING Risk of injury or death due to incorrectly fastened seat belt

If the seat belt is not worn correctly, it cannot perform its intended protective function.

In addition, an incorrectly fastened seat belt can also cause injuries, for example, in the event of an accident or when braking or changing direction suddenly.

▶ Always ensure that all vehicle occupants have their seat belts fastened correctly and are sitting properly.

Always observe the instructions about the correct driver's seat position and adjusting the seat (→ page 86).

In order for the correctly worn seat belt to provide the intended level of protection, each vehicle occupant must observe the following information:

- The seat belt must not be twisted and must fit tightly and snugly across the body.
- The seat belt must be routed across the center of the shoulder and as low down across the hips as possible.
- The shoulder section of the seat belt should not touch your neck nor be routed under your arm or behind your back.
- Avoid wearing bulky clothing, e.g. a winter coat.
- Push the lap belt down as far as possible across your hips and pull tight with the shoulder section of the belt. Never route the lap belt across your abdomen.
- Never route the seat belt across sharp, pointed, abrasive or fragile objects.
- Only one person should use each seat belt at any one time. Never allow babies and children to travel sitting on the lap of another vehicle occupant.

- Never secure objects with a seat belt if the seat belt is also being used by one of the vehicle's occupants. Always observe the instructions for loading the vehicle when securing objects, luggage or loads (→ page 98).

Also ensure that no objects, e.g. a cushion, are ever placed between a person and the seat.

The seat belts on the following seats are equipped with a special seatbelt retractor:

- Front passenger seat
- Rear seats

Activate or deactivate the special seatbelt retractor (→ page 53).

If children are traveling in the vehicle, be sure to observe the instructions and safety notes on "Children in the vehicle" (→ page 49).

Reduced seat belt protection

⚠️ WARNING Risk of injury or death due to incorrect seat position

The seat belt does not offer the intended level of protection if you have not moved the seat backrest to an almost vertical position.

When braking or in the event of an accident, you could slide underneath the seat belt and sustain abdominal or neck injuries, for example.

- ▶ Adjust the seat properly before beginning your journey.
- ▶ Always ensure that the seat backrest is in an almost vertical position and that the shoulder section of your seat belt is routed across the center of your shoulder.

⚠️ WARNING Risk of injury or death when additional restraint systems are not used for persons with a smaller build

Persons under 5 ft (1.50 m) tall cannot wear the seat belt correctly without a suitable additional restraint system.

If the seat belt is not worn correctly, it cannot perform its intended protective function. In addition, an incorrectly fastened seat belt can also cause injuries, for example, in the event of an accident or when braking or changing direction suddenly.

- ▶ Always secure persons under 5 ft (1.50 m) tall in a suitable restraint system.

⚠️ WARNING Danger of injury or death due to blocked seat belt anchorages

The restraint effect of the seat belt is impaired if objects between the front seat and the door are blocking the movable seat belt anchorage on the front seat.

The seat belt may not then provide the proper protection.

- ▶ Before starting a journey, make sure that there are no objects between the front seat and the door.

⚠️ WARNING Risk of injury or death due to damaged or modified seat belts

Seat belts cannot provide protection in the following situations:

- If the seat belts are damaged, modified, extremely dirty, bleached or dyed
- If the seat belt buckle is damaged or extremely dirty
- If the Emergency Tensioning Devices, seat belt anchorages or seat belt retractors have been modified

Seat belts may be damaged in an accident, although the damage may not be visible, e.g. due to splinters of glass.

Modified or damaged seat belts may tear or fail, e.g. in an accident.

Modified Emergency Tensioning Devices can accidentally trigger or fail to function as intended.

- ▶ Never modify the seat belts, Emergency Tensioning Devices, seat belt anchorages or seat belt retractors.
- ▶ Make sure that the seat belts are undamaged, not worn and clean.
- ▶ Always have the seat belts checked immediately after an accident at a qualified specialist workshop.

Only use seat belts which have been approved for your vehicle by Mercedes-Benz.

The AMG sport seat and the AMG Performance seat are designed for the standard three-point seat belt. If you install a different multipoint seat belt, e.g. sport or racing seat belts, the restraint system cannot provide the intended level of protection.

Depending on the type of seat, there may be openings in the seat backrest. These openings have no function.

⚠ WARNING Risk of injury or fatal injury due to modified seat belt systems

If you feed seat belts through the opening in the seat backrest, the seat backrest may be damaged or may even break in the event of an accident.

- ▶ Only use the standard three-point seat belt.
- ▶ Never modify the seat belt system.

⚠ WARNING Risk of injury or death from deployed pyrotechnic Emergency Tensioning Devices

Pyrotechnic Emergency Tensioning Devices that have been deployed are no longer operational and are unable to perform their intended protective function.

- ▶ Therefore, have deployed pyrotechnic Emergency Tensioning Devices immediately replaced at a qualified specialist workshop.

Mercedes-Benz recommends that you have the vehicle towed to a qualified specialist workshop after an accident.

! NOTE Damage caused by trapping the seat belt

If an unused seat belt is not fully retracted, it may become trapped in the door or in the seat mechanism.

- ▶ Always ensure that an unused seat belt is fully retracted.

Fastening and adjusting the seat belts

If the seat belt is pulled quickly or sharply, the seat belt retractor locks. The seat belt strap cannot be pulled out any further.

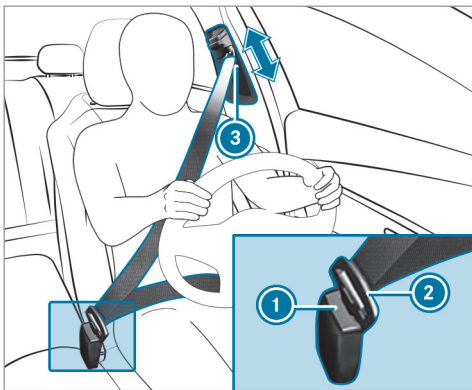

- ▶ Always engage seat belt tongue ② of the seat belt into seat belt buckle ① of the corresponding seat.
- ▶ Press and hold the seat belt outlet release and slide seat belt outlet ③ into the desired position.
- ▶ Let go of the seat belt outlet release and ensure that seat belt outlet ③ locks into position.

Vehicles with automatic front passenger front airbag shutoff:

! **NOTE** Deployment of the Emergency Tensioning Device and side air bag when the front passenger seat is unoccupied

If the seat belt tongue is engaged in the seat belt buckle of the unoccupied front passenger seat, the Emergency Tensioning Device and the side air bag may also deploy in the event of an accident along with other systems.

- ▶ Only one person should use each seat belt at any one time.

Vehicles without automatic front passenger front airbag shutoff:

! **NOTE** Deployment of the Emergency Tensioning Device when the front passenger seat is unoccupied

If the seat belt tongue is engaged in the seat belt buckle of the unoccupied front passenger seat, the Emergency Tensioning

Device may also deploy in the event of an accident along with other systems.

- ▶ Only one person should use each seat belt at any one time.

Seat belt adjustment function

Vehicles with PRE-SAFE®: If the front seat belt is not pulled tight across your body, the seat belt adjustment may automatically apply a certain tightening force. Do not hold the seat belt tightly while it is adjusting.

You can activate and deactivate the seat belt adjustment function using the multimedia system (→ page 39).

Releasing seat belts

- ▶ Press the release button in the seat belt buckle and guide the seat belt back with the seat belt tongue.

Activating/deactivating seat belt adjustment via the multimedia system

Multimedia system:

➔ Vehicle ➔  Vehicle Settings ➔ Belt Adjustment

▶ Activate or deactivate the function.

Seat belt warning function for the driver and front passenger

The  seat belt warning lamp in the Instrument Display is a reminder that all vehicle occupants must wear their seat belts correctly.

The  seat belt warning lamp lights up for six seconds every time the vehicle is started.

In addition, a warning tone may sound.

When the driver's and front passenger's doors are closed and the driver and front passenger have fastened their seat belts, the seat belt warning goes out.

In the following cases, the seat belt warning lights up during a journey if:

- The vehicle speed exceeds 15 mph (25 km/h) and the driver's or front passenger seat belt is not fastened.
- The driver or front passenger unfastens their seat belt while the vehicle is in motion.

Airbags

Overview of airbags

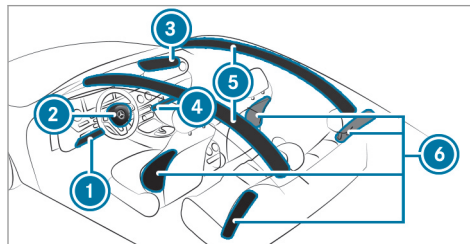

- ① Driver's knee bag
- ② Driver's airbag

- ③ Front passenger front airbag
- ④ Front passenger knee airbag
- ⑤ Window curtain airbag
- ⑥ Side airbag

The installation location of an airbag is identified by the AIRBAG symbol.

When enabled, an airbag can provide additional protection for the respective vehicle occupant.

Potential protection from each airbag:

Airbag	Potential protection for:
Knee airbag	Thigh, knee and lower leg
Driver's airbag, front passenger front airbag	Head and ribcage
Window curtain airbag	Head
Side airbag	Ribcage, also pelvis ¹⁾ for front seat occupants

¹⁾ AMG Performance seat: potential protection for the ribcage.

The front passenger front airbag can only be deployed in an accident if the PASSENGER AIR BAG OFF indicator lamp is off. If the front passenger seat is occupied, make sure, both before and during the journey, that the status of the front passenger front airbag is correct (→ page 44).

! **NOTE** Important points to remember if the front passenger seat is unoccupied

In an accident, the components of the restraint system may deploy unnecessarily on the front passenger side if:

- There are heavy objects on the front passenger seat.
- The seat belt tongue is engaged in the seat belt buckle of the front passenger seat and the front passenger seat is unoccupied.

▶ Stow objects in a suitable place.

▶ Only one person should use each seat belt at any one time.

Protection by the airbags

Depending on the accident situation, an airbag may supplement the protection offered by a correctly fastened seat belt.

! **WARNING** Risk of injury or death due to incorrect seat position

If you deviate from the correct seat position, the air bag cannot perform its intended protective function and deployment may even cause further injuries.

To avoid hazardous situations, always make sure that all vehicle occupants:

- Have their seat belt fastened correctly, including pregnant women.
- Are seated properly and that distance to the air bags is as large as possible.
- Observe the following information.

▶ Always make sure that there are no objects between the air bag and the vehicle occupant.

To avoid the risks resulting from the deployment of an airbag, each vehicle occupant must observe the following information:

- Before starting your journey, adjust your seat correctly; the driver's seat and front passenger seat should be moved as far back as possible.

When doing so, always observe the information on the correct driver's seat position (→ page 86).

- Only hold the steering wheel by the steering wheel rim. This allows the airbag to be fully deployed.
- Always lean against the seat backrest when the vehicle is in motion. Do not lean forwards or against the door or side window. You may otherwise be in the deployment area of the airbags.
- Always keep your feet on the floor. Do not put your feet on the cockpit, for example.

Your feet may otherwise be in the deployment area of the airbag.

- If children are traveling in the vehicle, observe the additional notes (→ page 49).
- Always stow and secure objects correctly.

Objects in the vehicle interior may prevent an airbag from functioning correctly. Each vehicle occupant must always make sure of the following:

- There are no people, animals or objects between the vehicle occupants and an airbag.
- There are no objects between the seat, door and door pillar (B-pillar).
- There are no hard objects, e.g. coat hangers, hanging on the grab handles or coat hooks.
- There are no accessory parts, such as PNDs (Personal Navigation Devices), mobile phones or cup holders attached to the vehicle within the deployment area of an airbag, e.g. on the cockpit, on doors, side windows or side paneling.

In addition, no connecting cable, tensioning strap or retaining strap may be routed through or attached in the deployment area of an airbag. Always observe the accessory manufacturer's installation instructions, in particular the information on suitable places for installation.

- There are no heavy, sharp-edged or fragile objects in the pockets of your clothing. Store such objects in a suitable place.

Limited protection from airbags

⚠ WARNING Risk of injury due to modifications to the airbag cover

If you modify the cover of an airbag or affix objects such as stickers to it, the airbag may no longer function correctly.

- ▶ Never modify the cover of an airbag and do not affix objects to it.

The installation location of an airbag is identified by the AIRBAG symbol (→ page 39).

⚠ WARNING Risk of injury or death due to the use of unsuitable seat covers

Unsuitable seat covers can obstruct or prevent the deployment of air bags integrated into the seats.

Consequently, the air bags cannot protect vehicle occupants as they are designed to do. In addition, operation of the automatic front passenger air bag shutoff may be restricted.

- ▶ You should only use seat covers that have been approved for the corresponding seats by Mercedes-Benz.

⚠ WARNING Risk of injury due to malfunctions of the sensors in the door paneling

Sensors to control the airbags are located in the doors. Modifications or work not performed correctly to the doors or door paneling, as well as damaged doors, can lead to the function of the sensors being impaired. The airbags might therefore not function properly any more.

Consequently, the airbags cannot protect vehicle occupants as they are designed to do.

- ▶ Never modify the doors or parts of the doors.
- ▶ Always have work on the doors or door paneling carried out at a qualified specialist workshop.

▲ WARNING Risk of injury due to deployed airbag

A deployed airbag no longer has a protective function and cannot protect as intended in the event of an accident.

- ▶ Have the vehicle towed to a qualified specialist workshop in order to have the deployed airbag replaced.

Have deployed airbags replaced immediately.

Status of the front passenger front airbag

Function of the automatic front passenger front airbag shutoff

The automatic front passenger front airbag shutoff is able to detect whether the front passenger seat is occupied by a person or a child restraint system. The front passenger front airbag and front passenger knee bag are then accordingly either enabled or deactivated.

When installing a child restraint system on the front passenger seat, always make sure of the following:

- Ensure that the child restraint system is positioned correctly (→ page 48).
- Always observe the child restraint system manufacturer's installation instructions.
- Never place objects, e.g. cushions, under or behind the child restraint system.
- Fully retract the seat cushion length adjustment.
- The entire base of the child restraint system must always rest on the seat cushion of the front passenger seat.

- The backrest of the forward-facing child restraint system must lie as flat as possible against the backrest of the front passenger seat.
- The child restraint system must not touch the roof or be put under strain by the head restraints. Adjust the seat backrest inclination and the head restraint setting accordingly.

▲ WARNING Risk of injury or death due to objects between the sitting surface and the child restraint system

Objects between the sitting surface and the child restraint system could affect the function of the automatic front passenger airbag shutoff.

This could result in the front passenger airbag not functioning as intended during an accident.

- ▶ Do not place any objects between the sitting surface and the child restraint system.

- ▶ The entire base of the child restraint system must always rest on the sitting surface of the front passenger seat.
- ▶ The backrest of the forward-facing child restraint system must, as far as possible, be resting on the seat backrest of the front passenger seat.
- ▶ Always comply with the child restraint system manufacturer's installation instructions.

A person on the front passenger seat must observe the following information:

- Fasten seat belts correctly (→ page 35).
- Sit in an almost upright seat position with their back against the seat backrest.
- Sit with their feet resting on the floor, if possible.

The front passenger front airbag may otherwise be deactivated by mistake, for example in the following situations:

- The front passenger transfers their weight by supporting themselves on a vehicle armrest.

- The front passenger sits in such a way that their weight is raised from the sitting surface.

⚠ WARNING Risk of injury or death due to deactivated front passenger airbag

If the PASSENGER AIR BAG OFF indicator lamp is lit, the front passenger airbag is disabled. It will not be deployed in the event of an accident and cannot perform its intended protective function.

A person in the front passenger seat could then, for example, come into contact with the vehicle interior, especially if the person is sitting too close to the cockpit.

If the front passenger seat is occupied, always ensure that:

- The classification of the person in the front passenger seat is correct and the front passenger airbag is enabled or disabled in accordance with the person in the front passenger seat.

- The front passenger seat has been moved as far back as possible.
 - The person is seated correctly.
- ▶ Ensure, both before and during the journey, that the status of the front passenger airbag is correct.

If the front passenger seat is occupied, the classification of the person or child restraint system on the front passenger seat takes place after the front passenger front airbag shutoff self-test. The PASSENGER AIR BAG indicator lamps display the status of the front passenger front airbag.

Always observe the notes on the function of the PASSENGER AIR BAG indicator lamps (→ page 44).

Function of the PASSENGER AIR BAG indicator lamps



Self-test of automatic front passenger front airbag shutoff

When the ignition is switched on, a self-test is performed during which the two PASSENGER AIR BAG ON and OFF indicator lamps light up simultaneously.

The status of the front passenger front airbag is displayed after the self-test:

- PASSENGER AIR BAG ON lights up for 60 seconds, subsequently both indicator lamps are off (PASSENGER AIR BAG ON and OFF): the front passenger front airbag is able to deploy in the event of an accident.
- PASSENGER AIR BAG OFF lights up continuously: the front passenger front airbag is disabled. It will then not be deployed in the event of an accident.

If the PASSENGER AIR BAG ON indicator lamp is off, only the PASSENGER AIR BAG OFF indicator lamp shows the status of the front passenger front airbag. The PASSENGER AIR BAG OFF indicator lamp may be lit continuously or be off.

If the PASSENGER AIR BAG OFF indicator lamp and the  restraint system warning lamp light up simultaneously, the front passenger seat may not be used. Also in this case, do not install a child restraint system on the front passenger seat. Have the automatic front passenger front airbag shutoff checked and repaired immediately at a qualified specialist workshop.

Status display

If the front passenger seat is occupied, ensure, both before and during the journey, that the status of the front passenger front airbag is correct for the current situation.

After installing a rearward-facing child restraint system on the front passenger seat: PASSENGER AIR BAG OFF must be lit continuously.

⚠ WARNING Risk of injury or death from using a rearward-facing child restraint system when the front passenger front airbag is enabled

If you secure a child in a rearward-facing child restraint system on the front passenger seat and the PASSENGER AIR BAG OFF indicator lamp is off, the front passenger airbag can deploy in the event of an accident.

The child could be struck by the airbag.

Always ensure that the front passenger airbag is deactivated. The PASSENGER AIR BAG OFF indicator lamp must be lit.

NEVER use a rearward-facing child restraint system on a seat protected by an ENABLED FRONT AIRBAG in front of it, DEATH or SERIOUS INJURY to the CHILD can occur.

When installing a child restraint system on the front passenger seat, observe the vehicle-specific information (→ page 59).

Depending on the child restraint system and the stature of the child, the PASSENGER AIR BAG OFF indicator lamp may be off. In this case, do not install the rearward-facing child restraint system on the front passenger seat.

Instead, install the rearward-facing child restraint system on a suitable rear seat.

After installing a forward-facing child restraint system on the front passenger seat: depending on the child restraint system and the stature of the child, PASSENGER AIR BAG OFF may be lit continuously or be off. Always observe the following information.

⚠ WARNING Risk of injury or death due to incorrect positioning of the forward-facing child restraint system

If you secure a child in a forward-facing child restraint system on the front passenger seat and you position the front passenger seat too close to the cockpit, in the event of an accident, the child could:

- Come into contact with the vehicle interior if the PASSENGER AIR BAG OFF indicator lamp is lit, for example.
- Be struck by the air bag if the PASSENGER AIR BAG OFF indicator lamp is off.

▶ Always move the front passenger seat as far back as possible and fully retract the seat cushion length adjustment. Always make sure that the shoulder belt strap is correctly routed from the seat belt outlet on the vehicle to the shoulder belt guide on the child restraint system. The shoulder belt strap must be routed forwards and downwards from the vehicle belt outlet. If necessary,

adjust the seat belt outlet and the front passenger seat accordingly.

▶ Always observe the child restraint system manufacturer's installation instructions.

When installing a child restraint system on the front passenger seat, observe the vehicle-specific information (→ page 59).

If a person is sitting on the front passenger seat: PASSENGER AIR BAG OFF may be lit continuously or be off, depending on the person's stature.

A person on the front passenger seat must always observe the following information:

- If the front passenger seat is occupied by an adult or a person with a stature corresponding to that of an adult, the PASSENGER AIR BAG OFF indicator lamp must be off. This indicates that the front passenger front air-bag is enabled.

If the PASSENGER AIR BAG OFF indicator lamp is lit continuously, an adult or person with a build corresponding to that of an adult

should not use the front passenger seat. Instead, they should use a rear seat.

- If the front passenger seat is occupied by a person of smaller stature (e.g. a teenager or small adult), the PASSENGER AIR BAG OFF indicator lamp either lights up continuously or remains off, depending on the result of the classification.
 - If the PASSENGER AIR BAG OFF indicator lamp is off: move the front passenger seat as far back as possible, or the person of smaller stature should use a rear seat.
 - If the PASSENGER AIR BAG OFF indicator lamp is lit continuously: the person of smaller stature should not use the front passenger seat.

⚠ WARNING Risk of injury or death when the PASSENGER AIR BAG OFF indicator lamp is lit

If the PASSENGER AIR BAG OFF indicator lamp remains lit after the system self-test, the front passenger air bag is deactivated. It

will not be deployed in the event of an accident. In this case, the front passenger air bag cannot perform its intended protective function, e.g. when a person is seated in the front passenger seat.

That person could, for example, come into contact with the vehicle interior, especially if the person is sitting too close to the cockpit.

If the front passenger seat is occupied, always ensure that:

- The classification of the person in the front passenger seat is correct and the front passenger air bag is enabled or deactivated in accordance with the person in the front passenger seat.
- The person is seated properly with a correctly fastened seat belt.
- The front passenger seat has been moved as far back as possible.

Be sure to also observe the following further related subjects:

- Child restraint system on the front passenger seat (→ page 59).

PRE-SAFE® system

PRE-SAFE® (anticipatory occupant protection)

PRE-SAFE® is able to detect certain critical driving situations and implement pre-emptive measures to protect the vehicle occupants.

PRE-SAFE® can implement the following measures independently of each other:

- Tightening the seat belts on the driver's seat and front passenger seat.
- Closing the side windows.
- **Vehicles with sliding sunroof:** Closing the sliding sunroof.
- **Vehicles with memory function:** Moving the front passenger seat to a more favorable seat position.

- **Vehicles with multicontour seat:** Increasing the air pressure in the seat side bolsters of the seat backrest.
- PRE-SAFE® Sound: provided that the multimedia system is switched on, generates a brief noise signal to stimulate the innate protective mechanism of a person's hearing.

! **NOTE** Damage caused by objects in the footwell or behind the seat

The automatic adjustment of the seat position may result in damage to the seat and/or the object.

► Stow objects in a suitable place.

Reversing the PRE-SAFE® system measures

If an accident did not occur, the pre-emptive measures that were taken are reversed.

You will need to perform certain settings yourself.

- If the seat belt pre-tensioning is not reduced, move the seat backrest back slightly. The locking mechanism releases.

Function of PRE-SAFE® PLUS (anticipatory occupant protection plus)

PRE-SAFE® PLUS can detect certain impacts, particularly an imminent rear impact, and take pre-emptive measures to protect the vehicle occupants. These measures cannot necessarily prevent an imminent impact.

PRE-SAFE® PLUS can implement the following measures independently of each other:

- Tightening the seat belts on the driver's seat and front passenger seat.
- Increasing brake pressure when the vehicle is stationary. This brake application is canceled automatically when the vehicle pulls away.

If an accident did not occur, the pre-emptive measures that were taken are reversed.

System limitations

The system will not initiate any action in the following situations:

- when backing up

The system will not initiate any braking application in the following situations:

- whilst driving
or
- when entering or exiting a parking space while using Active Parking Assist

Information on PRE-SAFE® Impulse Side

If an imminent side impact is detected, PRE-SAFE® Impulse Side can pre-emptively move the front seat vehicle occupant's upper body towards the center of the vehicle. It does this by rapidly inflating an air cushion in the outer seat side bolster of the seat backrest on the side on which the impact is anticipated. This increases the distance between the door and the vehicle occupant.

If PRE-SAFE® Impulse Side has been deployed or is faulty, the **PRE-SAFE Impulse Side Inoperative** See Operator's Manual display message appears (→ page 429).

Safely transporting children in the vehicle

Always observe when children are traveling in the vehicle

i Also strictly observe the safety notes for the specific situation. In this way you can recognize potential risks and avoid dangers if children are traveling in the vehicle (→ page 49).

Be diligent

Bear in mind that neglecting to secure a child in the child restraint system may have serious consequences. Always be diligent in securing a child carefully before every journey.

To improve protection for children younger than 12 years old or under 5 ft (1.50 m) in height, Mercedes-Benz recommends you observe the following information:

- Always secure the child in a child restraint system suitable for this Mercedes-Benz vehicle.
- The child restraint system must be appropriate to the age, weight and size of the child.
- The vehicle seat must be suitable for installing a child restraint system.

Accident statistics show that children secured in the rear seats are generally safer than children secured in the front seats. For this reason, Mercedes-Benz strongly advises that you install a child restraint system to a rear seat.

Generic term "child restraint system"

The generic term child restraint system is used in this Operator's Manual. A child restraint system is, for example:

- a baby car seat
- a rearward-facing child seat

- a forward-facing child seat
 - a child booster seat with a backrest and seat belt guide
- Mercedes-Benz recommends using a child booster seat with a backrest.

The child restraint system must be appropriate to the age, weight and size of the child.

Observing laws and legal requirements

Always observe the legal requirements when using a child restraint system in the vehicle.

Observing standards for child restraint systems

All child restraint systems must meet the following standards:

- U.S. Federal Motor Vehicle Safety Standards 213 and 225
- Canadian Motor Vehicle Safety Standards 213 and 210.2

Confirmation that the child restraint system complies with the standards can be found on an instruction label on the child restraint system. This confirmation can also be found in the instal-

lation instructions that are included with the child restraint system.

Detecting risks, avoiding danger

Securing systems for child restraint systems in the vehicle

Only use the following securing systems for child restraint systems:

- the LATCH-type (ISOFIX) mounting brackets
- the vehicle's seat belt system
- the Top Tether anchorages

Installing a LATCH-type (ISOFIX) child restraint system is preferred.

Simply attaching to the securing rings on the vehicle can reduce the risk of installing the child restraint system incorrectly.

When securing a child with the integrated seat belt of the LATCH-type (ISOFIX) child restraint system, always comply with the permissible gross weight for the child and child restraint system (→ page 54).

A booster seat may be necessary to achieve proper seat belt positioning for children over 40 lbs (18 kg) in weight or until they reach a height where a three-point seat belt can be installed properly without a booster seat.

Mercedes-Benz recommends a suitable child booster seat with a backrest and seat belt guide.

Advantage of a rearward-facing child restraint system

It is preferable to transport a baby or a small child in a suitable rearward-facing child restraint system. In this case, the child sits in the opposite direction to the direction of travel and faces backwards.

Babies and small children have comparatively weak neck muscles in relation to the size and weight of their head. The risk of injury to the cervical spine during an accident can be reduced in a rearward-facing child restraint system.

Always secure a child restraint system correctly

⚠ WARNING Risk of injury or death caused by incorrect installation of the child restraint system

If the child restraint system is incorrectly installed on a suitable seating position, it cannot perform its intended protective function.

The child cannot be restrained in the event of an accident, heavy braking or a sudden change of direction.

- ▶ Always comply with the manufacturer's installation instructions for the child restraint system and its correct use.
- ▶ Make sure that the entire base of the child restraint system always rests on the sitting surface of the seat.
- ▶ Never place objects under or behind the child restraint system, e.g. cushions.

- ▶ Always use child restraint systems with the original cover designed for them.
- ▶ Always replace damaged covers with genuine covers.

▲ WARNING Risk of injury or death from unsecured child restraint systems in the vehicle

If the child restraint system is not correctly installed or secured, it could release in the event of an accident, sudden braking or a sudden change in direction.

The child restraint system could be flung around and hit vehicle occupants.

- ▶ Always install child restraint systems correctly, even when not in use.
 - ▶ Always comply with the child restraint system manufacturer's installation instructions.
- Always observe the child restraint system manufacturer's installation and operating

instructions as well as the vehicle-specific information:

- Install the LATCH-type (ISOFIX) child restraint system to the rear seat (→ page 54).
- Secure the child restraint system with the seat belt on the rear seat (→ page 57).
- Secure the child restraint system with the seat belt on the front passenger seat (→ page 59). Observe the specific instructions for the rearward-facing and forward-facing child restraint systems (→ page 59).

If the front passenger seat is occupied, ensure, both before and during the journey, that the status of the front passenger front airbag is correct for the current situation (→ page 44).

- Observe the warning labels in the vehicle interior and on the child restraint system.
- Also secure Top Tether if present.

Do not modify the child restraint system

▲ WARNING Risk of injury due to modifications to the child restraint system

The child restraint system may no longer function as it is supposed to if you make modifications or attach objects to it, e.g. toys or unsuitable accessories. This poses an increased risk of injury!

Never modify the child restraint system. Only attach accessories which the manufacturer of the child restraint system has authorized especially for this child restraint system.

Only use child restraint systems which are in proper working condition

▲ WARNING Risk of injury or death caused by the use of damaged child restraint systems

Child restraint systems or their retaining systems that have been subjected to a load in an accident may then not be able to perform their intended protective function.

The child cannot be restrained in the event of an accident, heavy braking or a sudden change of direction.

- ▶ Always replace child restraint systems immediately that have been damaged or involved in an accident.
- ▶ Have the securing systems for the child restraint systems checked at a qualified specialist workshop before installing a child restraint system again.

Avoiding direct sunlight

⚠ WARNING Risk of burns when the child seat is exposed to direct sunlight

If the child restraint system is exposed to direct sunlight or heat, parts could heat up. Children could suffer burns from these parts, particularly on metallic parts of the child restraint system.

- ▶ Always make sure that the child restraint system is not exposed to direct sunlight.

- ▶ Protect it with a blanket, for example.
- ▶ If the child restraint system has been exposed to direct sunlight, allow it to cool before securing a child into it.
- ▶ Never leave children unattended in the vehicle.

Observe when stopping or parking

⚠ WARNING Risk of accident and injury due to children left unattended in the vehicle

If you leave children unattended in the vehicle, they may be able to set the vehicle in motion, for example by:

- Releasing the parking brake.
- Shifting the automatic transmission out of park position **P**.
- Starting the engine.

In addition, they may operate vehicle equipment and become trapped.

- ▶ Never leave children unattended in the vehicle.
- ▶ When leaving the vehicle, always take the SmartKey with you and lock the vehicle.



⚠ WARNING Risk of fatal injury due to exposure to extreme heat or cold in the vehicle

If people – particularly children – are exposed to extreme temperatures over an extended period of time, there is a risk of serious or even fatal injury.

- ▶ Never leave anyone – particularly children – unattended in the vehicle.
- ▶ Never leave animals in the vehicle unattended.

Overview of suitable seats in the vehicle for installing a child restraint system

Securing systems for child restraint systems

Vehicle seat		
Left/right rear seat	<p>Preferred securing system:</p> <p> LATCH-type (ISOFIX) child seat securing system</p> <p> Also secure Top Tether if present (→ page 56)</p>	<p>Alternative securing system:</p> <ul style="list-style-type: none"> • Vehicle seat belt
Front passenger seat	<p>Securing system:</p> <ul style="list-style-type: none"> • Vehicle seat belt 	<p>Be sure to observe:</p> <ul style="list-style-type: none"> • If the front passenger seat is occupied, ensure, both before and during the journey, that the status of the front passenger front airbag is correct for the current situation (→ page 44). • Notes on automatic front passenger front airbag shutoff (→ page 42). • Adjust the seat backrest until it as straight as possible and adjust the seat cushion inclination as far as it will go (→ page 89).

Vehicle seat

Center rear seat

Securing system:

- Vehicle seat belt



Also secure Top Tether if present
(→ page 56)

Activating/deactivating the seat belt's special seatbelt retractor

⚠ WARNING Risk of injury or death if a seat belt is unfastened while the vehicle is in motion

If the seat belt is released while the vehicle is in motion, the child restraint system is no longer correctly secured. The child seat safety feature is deactivated and the seat belt is drawn in a bit by the inertia reel.

It is therefore not possible to engage the seat belt again.

- ▶ Pull over and stop the vehicle safely as soon as possible, paying attention to road and traffic conditions.
- ▶ Activate the child seat safety feature again and correctly secure the child restraint system.

Requirements

When enabled, the special seatbelt retractor ensures that the seat belts of the front passenger seat and rear seats do not slacken once the child restraint system is secured.

The seat belts on the following seats are equipped with a special seatbelt retractor:

- Front passenger seat

- Rear seats

Installing a child restraint system

- ▶ When installing a child restraint system, always observe the manufacturer's installation and operating instructions as well as the information in this Operator's Manual.
- ▶ Pull the seat belt smoothly from the seat belt outlet.
- ▶ Engage the seat belt tongue in the seat belt buckle.

Activating the special seatbelt retractor

- ▶ Pull the seat belt out fully and let the inertia reel retract it again. When the special seatbelt retractor is activated, you should hear a ratcheting sound.
- ▶ Push the child restraint system down until the seat belt sits tightly.

Deactivating the special seatbelt retractor

- ▶ Press the release button of the seat belt buckle.
- ▶ Hold the seat belt tongue and guide back to the seat belt outlet.

Installing the LATCH-type (ISOFIX) child restraint system on the rear seat**Installing the LATCH-type (ISOFIX) child restraint system on the rear seat**

⚠ WARNING Risk of injury if the rear bench seat/rear seat and seat backrest are not engaged

If the rear bench seat/rear seat and seat backrest are not engaged they could fold forwards, e.g. when braking suddenly or in the event of an accident.

- If this is the case, the vehicle occupant would be forced into the seat belt by the rear bench seat/rear seat or by the seat backrest. The seat belt cannot protect as intended and could result in additional injury.
- Objects or loads in the trunk/cargo compartment cannot be restrained by the seat backrest.

- ▶ Make sure that the seat backrest and the rear bench seat/rear seat are engaged before every trip.

If the seat backrest is not engaged and locked, this will be shown on the multifunction display on the instrument cluster.

⚠ WARNING Risk of injury or death if the permissible gross mass of the child and child restraint system together is exceeded

For LATCH-type (ISOFIX) child restraint systems in which the child is secured using the integrated seat belt integrated in the child restraint system, the permissible gross mass of the child and child restraint system is 73 lb (33 kg).

If the child and the child restraint system together weigh more than 73 lb (33 kg), the LATCH-type (ISOFIX) child restraint system with integrated seat belt does not offer sufficient protection. An excessive load may be placed on the LATCH-type (ISOFIX) child seat

attachments and the child may not be restrained in the event of an accident, for example.

- ▶ If the child and the child restraint system together weigh more than 73 lb (33 kg), only use a LATCH-type (ISOFIX) child restraint system which secures the child with the vehicle seat belt.
- ▶ Also secure the child restraint system with the Top Tether belt, if available.

Always comply with the information about the mass of the child restraint system:

- in the manufacturer's installation and operating instructions for the child restraint system used
- on a label on the child restraint system, if present

Regularly check that the permissible gross mass of the child and child restraint system is still complied with.

When installing a child restraint system, observe the following:

- ✓ Always observe the correct use and the suitability of the seats for attaching a child restraint system.
- ✓ Always comply with the manufacturer's installation and operating instructions for the child restraint system used.
- ✓ Make sure that the child's feet do not touch the front seat. If necessary, move the front seat forward slightly.



When installing a LATCH-type (ISOFIX) child restraint system, observe the following:

- ✓ **When using a baby car seat in Group 0/0+ and a rearward-facing child restraint system in Group I on a rear seat:** adjust the front seat so that it does not touch the child restraint system.
- ✓ **When using a forward-facing child restraint system in Group I:** remove the head restraint from the respective seat, if possible. In addition, the seat backrest of

the child restraint system must, as far as possible, lie flat against the backrest of the vehicle seat.

When you remove the child restraint system, install the head restraint again immediately and adjust all the head restraints correctly.

- ✓ For certain child restraint systems in weight group II or III, there may be restrictions in the maximum size setting, e.g. due to possible contact with the roof.
- ✓ The child restraint system must not be put under strain between the roof and the seat cushion and/or be installed facing the wrong direction. Where possible, adjust the seat cushion inclination accordingly.
- ✓ The child restraint system must not be put under strain by the head restraints. Adjust the head restraints accordingly.

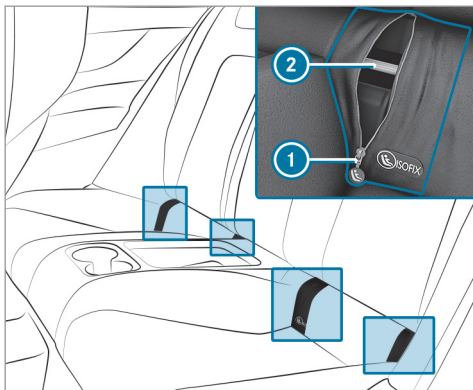

Before every trip, make sure that the LATCH-type (ISOFIX) child restraint system is engaged correctly in both mounting brackets in the vehicle.

! **NOTE** Be careful not to damage the seat belt for the center seat when installing the child restraint system

▶ Make sure that the seat belt is not trapped.

- ▶ Open the cover by using zipper ①.
- ▶ Carefully open the zip further.
- ▶ Attach the LATCH-type (ISOFIX) child restraint system to both mounting brackets ② in the vehicle.

Securing Top Tether

! **WARNING** Risk of injury or death if the rear seat backrests are not locked after installing Top Tether belts

If the rear seat backrests are not locked, they could fold forwards in the event of an accident or during braking or sudden changes of direction.

As a result, child restraint systems cannot perform their intended protective function. Rear seat backrests that are not locked can also cause additional injuries, e.g. in the event of an accident.

- ▶ Always lock rear seat backrests after installing Top Tether belts.
- ▶ Observe the lock verification indicator.

If the seat backrest is not engaged and locked, this will be shown on the multifunction display on the instrument cluster.



If the child restraint system is equipped with a Top Tether belt:

The risk of injury can be reduced by Top Tether. The Top Tether belt facilitates an additional connection between the child restraint system attached with LATCH-type (ISOFIX) and the vehicle.

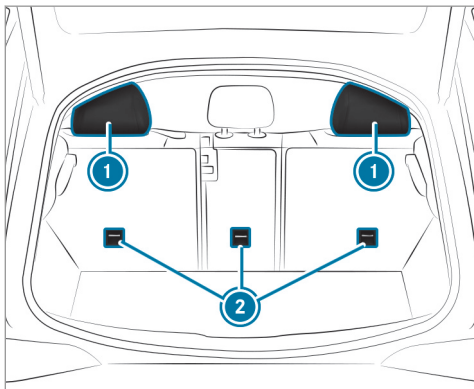

- ▶ If necessary, move head restraint ① upwards (→ page 91).
- ▶ Install the LATCH-type (ISOFIX) child restraint system with Top Tether. Always comply with the child restraint system manufacturer's installation instructions when doing so.

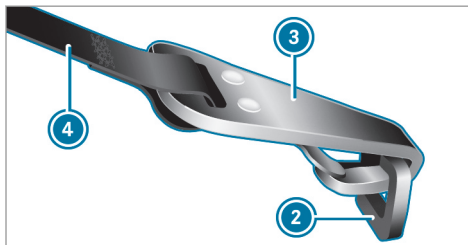

- ▶ Guide Top Tether belt ④ under head restraint ① between the two head restraint bars.
- ▶ Hook Top Tether hook ③ without twisting into Top Tether anchorage ②.
- ▶ Tension Top Tether belt ④. Always comply with the child restraint system manufacturer's installation instructions when doing so.
- ▶ If necessary, slide head restraint ① downwards (→ page 91). Make sure that you do not interfere with the correct routing of Top Tether belt ④.

Securing the child restraint system with the seat belt

Attaching the child restraint system with the seat belt on the rear seat

⚠ WARNING Risk of injury if the rear bench seat/rear seat and seat backrest are not engaged

If the rear bench seat/rear seat and seat backrest are not engaged they could fold forwards, e.g. when braking suddenly or in the event of an accident.

- If this is the case, the vehicle occupant would be forced into the seat belt by the rear bench seat/rear seat or by the seat backrest. The seat belt cannot protect as intended and could result in additional injury.
- Objects or loads in the trunk/cargo compartment cannot be restrained by the seat backrest.

- ▶ Make sure that the seat backrest and the rear bench seat/rear seat are engaged before every trip.

If the seat backrest is not engaged and locked, this will be shown on the multifunction display on the instrument cluster.

When installing a belt-secured child restraint system, observe the following:

- ✔ Always comply with the manufacturer's installation and operating instructions for the child restraint system used.
- ✔ **When using a category 0/0+ baby car seat and a category I rearward-facing child restraint system on a rear seat:** adjust the front seat so that the seat does not touch the child restraint system.
- ✔ **When using a category I forward-facing child restraint system:** remove the head restraint from the respective seat, if possible.

When you remove the child restraint system, install the head restraint again immedi-

ately and adjust all the head restraints correctly.

- ✔ The backrest of the forward-facing child restraint system must, as far as possible, be resting on the seat backrest of the rear seat.
- ✔ For certain child restraint systems in weight category II or III, there may be restrictions in the maximum size setting, e.g. due to possible contact with the roof.
- ✔ The child restraint system must not be put under strain between the roof and the seat cushion and/or be installed facing the wrong direction. Where possible, adjust the seat cushion inclination accordingly.
- ✔ The child restraint system must not be put under strain by the head restraints. Adjust the head restraints accordingly.
- ✔ Make sure that the child's feet do not touch the front seat. If necessary, move the front seat forward slightly.

The seat belts on the following seats are equipped with a special seatbelt retractor:

- Front passenger seat
- Rear seats

When enabled, the special seatbelt retractor ensures that the seat belts of the front passenger seat and rear seats do not slacken once the child restraint system is secured (→ page 53).

- ▶ Install the child restraint system. The entire base of the child restraint system must always rest on the sitting surface of the rear seat.
- ▶ Always make sure that the shoulder belt strap is correctly routed from the seat belt outlet of the vehicle to the shoulder belt guide on the child restraint system. The shoulder belt strap must be routed forwards and downwards from the seat belt outlet.

Notes on rearward-facing and forward-facing child restraint systems on the front passenger seat

⚠ WARNING Risk of injury or death from using a rearward-facing child restraint system when the front passenger front airbag is enabled

If you secure a child in a rearward-facing child restraint system on the front passenger seat and the PASSENGER AIR BAG OFF indicator lamp is off, the front passenger airbag can deploy in the event of an accident.

The child could be struck by the airbag.

Always ensure that the front passenger airbag is deactivated. The PASSENGER AIR BAG OFF indicator lamp must be lit.

NEVER use a rearward-facing child restraint system on a seat protected by an ENABLED FRONT AIRBAG in front of it, DEATH or SERIOUS INJURY to the CHILD can occur.

Observe the specific instructions for the rearward-facing and forward-facing child restraint systems (→ page 59).

Warning notice on the front passenger sun visor

Always observe the status of the front passenger front airbag on the PASSENGER AIR BAG OFF indicator lamp:

- When using a rearward-facing child restraint system on the front passenger seat, the front passenger front airbag must always be disabled. This is only the case if the PASSENGER AIR BAG OFF indicator lamp is lit continuously (→ page 44).
- If the PASSENGER AIR BAG OFF indicator lamp is out, the front passenger front airbag is enabled. The front passenger front airbag may deploy during an accident.

Securing the child restraint system with the seat belt on the front passenger seat

When installing a belt-secured child restraint system on the front passenger seat, always observe the following:

- ☑ Observe the child restraint system manufacturer's installation and operating instructions.
- ☑ When using a forward-facing child restraint system in Group I: remove the head restraint from the respective seat, if possible.
When you remove the child restraint system, install the head restraint again immediately and adjust all the head restraints correctly.
- ☑ The backrest of the forward-facing child restraint system must lie as flat as possible against the backrest of the front passenger seat.
- ☑ For certain child restraint systems in weight group II or III, there may be restrictions in the maximum size setting, e.g. due to possible contact with the roof.

- ✓ The child restraint system must not be put under strain between the roof and the seat cushion and/or be installed facing the wrong direction. Adjust the seat backrest inclination accordingly.
- ✓ The child restraint system must not be put under strain by the head restraints. Adjust the head restraints accordingly.
- ✓ Never place objects under or behind the child restraint system, e.g. cushions.

The seat belt on the front passenger side is equipped with a special seatbelt retractor.

When activated, the special seatbelt retractor ensures that the seat belt does not slacken once the child restraint system is secured (→ page 53).

- ▶ Set the front passenger seat as far back as possible and move the seat into the highest position.
- ▶ Fully retract the seat cushion length adjustment.
- ▶ Adjust the seat cushion inclination so that the front edge of the seat cushion is in the

highest position and the rear edge of the seat cushion is in the lowest position.

- ▶ Set the seat backrest to an almost vertical position.
- ▶ Install the child restraint system. The entire base of the child restraint system must always rest on the seat cushion of the front passenger seat.
- ▶ Always make sure that the shoulder belt strap is correctly routed from the seat belt outlet of the vehicle to the shoulder belt guide on the child restraint system. The shoulder belt strap must be routed forwards and downwards from the seat belt outlet.
- ▶ If necessary, adjust the seat belt outlet and the front passenger seat accordingly.

Child safety locks

Activating/deactivating the child safety lock for the rear doors

⚠ WARNING Risk of accident and injury due to children left unattended in the vehicle

If you leave children unattended in the vehicle, they may be able to set the vehicle in motion, for example by:

- Releasing the parking brake.
- Shifting the automatic transmission out of park position **P**.
- Starting the engine.

In addition, they may operate vehicle equipment and become trapped.

- ▶ Never leave children unattended in the vehicle.
- ▶ When leaving the vehicle, always take the SmartKey with you and lock the vehicle.

⚠ WARNING Risk of fatal injury due to exposure to extreme heat or cold in the vehicle

If people – particularly children – are exposed to extreme temperatures over an extended period of time, there is a risk of serious or even fatal injury.

- ▶ Never leave anyone – particularly children – unattended in the vehicle.
- ▶ Never leave animals in the vehicle unattended.

⚠ WARNING Risk of accident and injury due to children left unattended in the vehicle

When children are traveling in the vehicle, they could:

- open doors, thereby endangering other people or road users
- get out of the vehicle and be hit by traffic
- operate vehicle equipment and become trapped, for example

- ▶ When children are traveling in the vehicle, always activate the available child safety locks.
- ▶ Never leave children unattended in the vehicle.
- ▶ When leaving the vehicle, always take the key with you and lock the vehicle.

Child safety locks for the rear doors and the rear side windows are available. The child safety lock on the rear doors secures each door separately. The doors can no longer be opened from the inside.

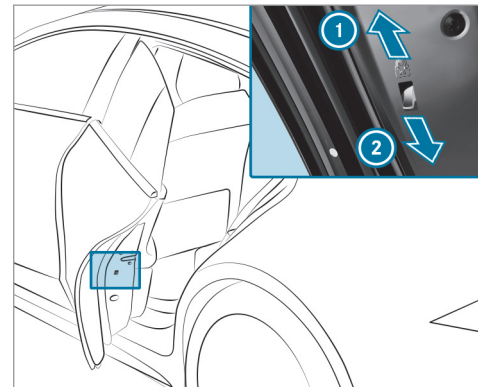

- ▶ Press the lever in direction ① (activate) or ② (deactivate).
- ▶ Make sure that the child safety locks are working properly.

Activating/deactivating the child safety lock for the rear passenger compartment side windows

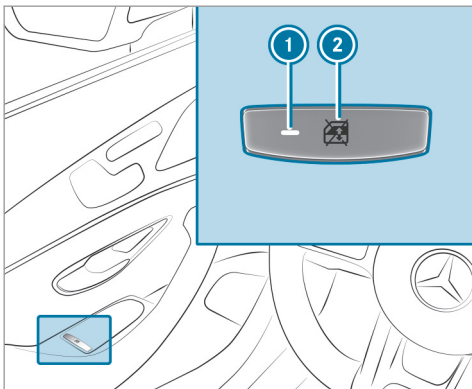

► **To activate/deactivate:** press button ②.

The rear passenger compartment side window can be opened or closed in the following cases:

- With indicator lamp ① lit: via the switch on the driver's door
- With indicator lamp ① off: via the switch on the corresponding rear passenger compartment door or driver's door

Notes on pets in the vehicle

⚠ WARNING Risk of accident and injury due to animals left unsecured or unattended in the vehicle

If you leave animals in the vehicle unattended or unsecured, they could possibly press down buttons or switches.

Thereby an animal may:

- activate vehicle equipment and become trapped, for example
- switch systems on or off and endanger other road users

Unsecured animals may be thrown around in the vehicle in the event of an accident or sudden steering and braking maneuver and injure vehicle occupants in the process.

- Never leave animals in the vehicle unattended.
- Always correctly secure animals while driving, for example using a suitable animal carrier.

SmartKey

Overview of SmartKey functions

⚠ WARNING Risk of accident and injury due to children left unattended in the vehicle

If children are left unattended in the vehicle, they could:

- Open doors, thereby endangering other persons or road users.
- Get out of the vehicle and be hit by oncoming traffic.
- Operate vehicle equipment and become trapped, for example.

In addition, children could also set the vehicle in motion, for example, by:

- Releasing the parking brake.
- Shifting the automatic transmission out of park position **P** or shifting manual transmission into neutral.
- Starting the engine

- ▶ When leaving the vehicle, always take the SmartKey with you and lock the vehicle.
- ▶ Never leave children and animals unattended in the vehicle.
- ▶ Keep the SmartKey out of reach of children.

! **NOTE** Damage to the key caused by magnetic fields

- ▶ Keep the key away from strong magnetic fields.

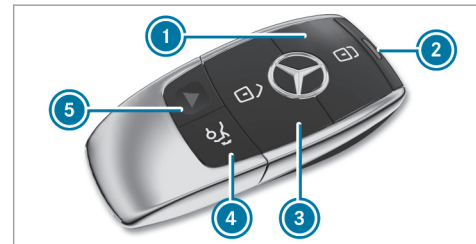



- ① Locks
 - ② Battery check lamp
 - ③ Unlocks
 - ④ Opens/closes the tailgate
 - ⑤ Panic alarm
- i** The SmartKey may vary from the one shown in the diagram, depending on the vehicle equipment.

The SmartKey locks and unlocks the following components:

- the doors
- the tailgate
- the fuel filler flap

If the vehicle is not opened within approximately 40 seconds after unlocking, it locks again. Anti-theft protection is activated again.

Do not keep the SmartKey together with electronic devices or metal objects. This can affect the SmartKey's functionality.

- ① If battery check lamp ② does not light up after pressing the  or  button, the battery is discharged.

Replacing the SmartKey battery (→ page 65).

Activating/deactivating the acoustic locking verification signal

Multimedia system:

↳ Vehicle ▶  Vehicle Settings ▶ Acoustic Lock

- ▶ Activate or deactivate the function.

Activating/deactivating the panic alarm

Requirements:

- ① The panic alarm function is only available in certain countries.
- The ignition is switched off.





- ▶ **To activate:** press button ① for approximately one second. A visual and audible alarm is triggered.
 - ▶ **To deactivate:** briefly press button ① again.
- or
- ▶ Press the start/stop button on the cockpit (the SmartKey is inside the vehicle).

Changing the unlocking settings

Possible unlocking functions of the SmartKey:

- Central unlocking
- Unlocking the driver's door and fuel filler flap

- ▶ **To switch between settings:** press the  and  buttons simultaneously for approximately six seconds until the battery check lamp flashes twice.

If the unlocking function for the driver's door and fuel filler flap has been selected:

- Pressing the  button a second time centrally unlocks the vehicle
- **Vehicles with KEYLESS-GO:** If you touch the inner surface of the door handle on the driver's door, only the driver's door and fuel filler flap are unlocked.

Deactivating the SmartKey functions

If you do not use the vehicle or a SmartKey for an extended period of time, you can reduce the energy consumption of the respective Smart-

Key . To do so, deactivate the SmartKey functions.

▶ **To deactivate:** press the  button on the SmartKey twice in quick succession. The battery check lamp of the SmartKey flashes twice briefly and lights up once.

▶ **To activate:** press any button on the SmartKey.

① When the vehicle is started with the SmartKey in the stowage compartment of the center console, the SmartKey functions are automatically activated (→ page 137).

Removing/inserting the emergency key

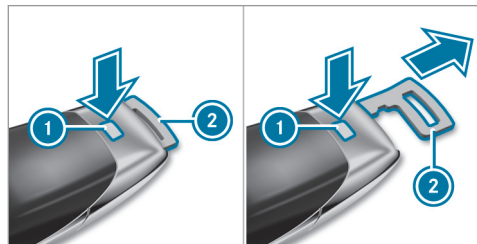

▶ **To remove:** press release button ①. Emergency key ② is pushed out slightly.

▶ Pull out emergency key ② until it engages in the intermediate position.

① You can use the intermediate position of emergency key ② to attach the SmartKey to a key ring.

▶ Press release button ① again and fully remove emergency key ②.

▶ **To insert:** press release button ①.

▶ Insert emergency key ② to the intermediate position or fully until it engages.

Replacing the SmartKey battery

⚠ DANGER Serious damage to health caused by swallowing batteries

Batteries contain toxic and corrosive substances. Swallowing batteries may cause serious damage to health.

There is a risk of fatal injury.

- ▶ Keep batteries out of the reach of children.
- ▶ If batteries are swallowed, seek medical attention immediately.

 **ENVIRONMENTAL NOTE** Environmental damage caused by improper disposal of batteries



Batteries contain pollutants. It is illegal to dispose of them with the household rubbish.



▶ Dispose of batteries in an environmentally responsible manner. Take discharged batteries to a qualified specialist workshop or to a collection point for used batteries.

Requirements:

- You require a CR 2032 3 V cell battery.

Mercedes-Benz recommends that you have the battery replaced at a qualified specialist workshop.

▶ Remove the emergency key (→ page 65).

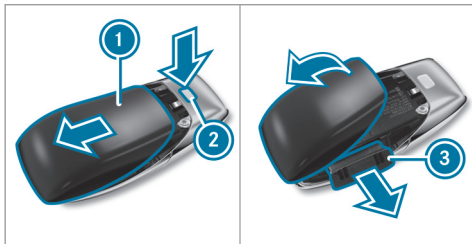

- ▶ Press release button (2) down fully and slide cover (1) in the direction of the arrow.
- ▶ Fold out cover (1) in the direction of the arrow and remove.
- ▶ Remove battery compartment (3) and take out the discharged battery.
- ▶ Insert the new battery into battery compartment (3). Observe the positive pole marking in the battery compartment and on the battery when doing this.
- ▶ Push in battery compartment (3).
- ▶ Re-attach cover (1) and push it until it engages.

Problems with the SmartKey

Problem	Possible causes/consequences and ▶ Solutions
<p>You can no longer lock or unlock the vehicle.</p>	<p>Possible causes are:</p> <ul style="list-style-type: none"> The SmartKey battery is discharged or nearly discharged. There is interference from a powerful radio signal source.

Problem	Possible causes/consequences and ► Solutions
	<ul style="list-style-type: none">• The SmartKey is defective.► Check the battery using the battery check lamp and replace if necessary (→ page 65).► Use the emergency key to lock or unlock (→ page 65).► Have the SmartKey checked at a qualified specialist workshop.
You have lost a SmartKey.	<ul style="list-style-type: none">► Have the SmartKey deactivated at a qualified specialist workshop.► If necessary, have the mechanical lock changed as well.

Doors

Unlocking and opening doors from the inside

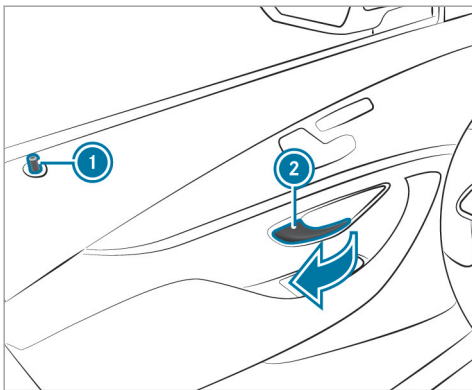

- ▶ **To unlock and open a front door:** pull door handle ②. Locking pin ① pops up when the door is unlocked.

- ▶ **To unlock a rear passenger compartment door:** pull the rear passenger compartment door handle. The locking pin pops up when the rear passenger compartment door is unlocked.
- ▶ **To open a rear passenger compartment door:** pull the rear passenger compartment door handle again.

Centrally locking and unlocking the vehicle from the inside

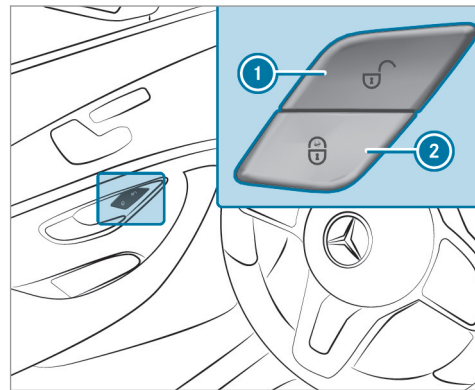

- ▶ **To unlock:** press button ①.
- ▶ **To lock:** press button ②.

This does not lock or unlock the fuel filler flap.

The vehicle is not unlocked:

- If you have locked the vehicle using the SmartKey.
- If you have locked the vehicle using KEYLESS-GO.

Locking/unlocking the vehicle with KEYLESS-GO

Requirements

- The SmartKey is outside the vehicle.
- The distance between the SmartKey and the vehicle does not exceed 3 ft (1 m).
- The driver's door and the door at which the door handle is used are closed.

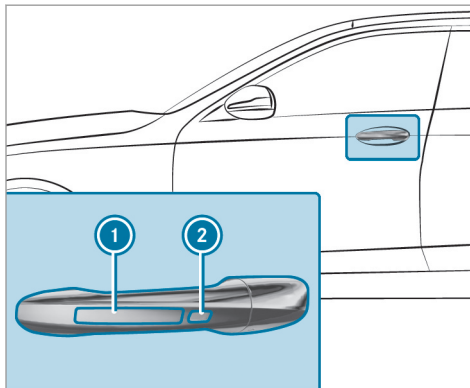

- ▶ **To unlock the vehicle:** touch the inner surface of the door handle.
- ▶ **To lock the vehicle:** touch sensor surface ① or ②.
- ▶ **Convenience closing:** touch recessed sensor surface ② until the closing procedure is complete.

① Further information on convenience closing (→ page 79).

If you open the tailgate from outside it is automatically unlocked.

Problems with KEYLESS-GO

Problem	Possible causes/consequences and ▶ Solutions
<p>You can no longer lock or unlock the vehicle using KEYLESS-GO.</p>	<p>Possible causes are:</p> <ul style="list-style-type: none"> • The SmartKey functions have been deactivated . • The SmartKey battery is discharged or nearly discharged. • There is interference from a powerful radio signal source.

Problem

Possible causes/consequences and ► Solutions

- The SmartKey is faulty.
- Activate the SmartKey functions (→ page 64).
- Check the battery using the battery check lamp and replace if necessary (→ page 65).
- Use the emergency key to unlock or lock the vehicle (→ page 65).
- Have the vehicle and SmartKey checked at a qualified specialist workshop.

Activating/deactivating the automatic locking feature

The vehicle is locked automatically when the ignition is switched on and the wheels are turning faster than walking pace.

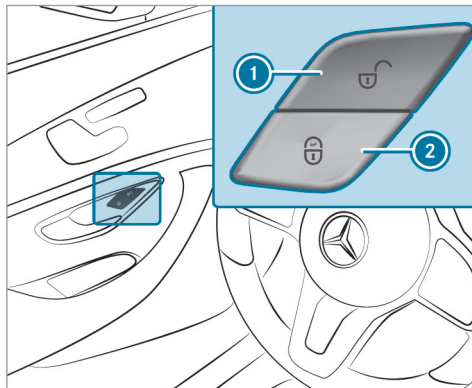

- **To activate:** press and hold button ② for approximately five seconds until an acoustic signal sounds.
- **To deactivate:** press and hold button ① for approximately five seconds until an acoustic signal sounds.

In the following situations, there is a danger of being locked out when the function is activated:

- While the vehicle is being tow started/ pushed.
- The vehicle is being tested on the dynamometer.

Locking/unlocking the driver's door with the emergency key

- i** If you wish to lock the vehicle entirely using the emergency key, first press the button for locking from the inside while the driver's door is open. Then proceed to lock the driver's door using the emergency key.

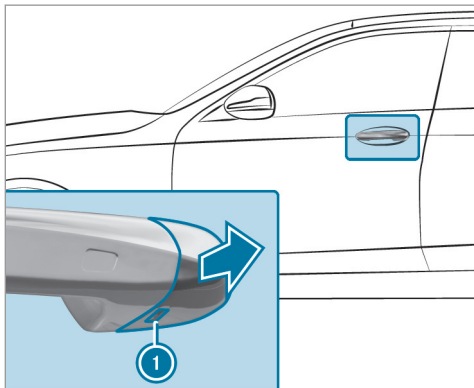

- ▶ Insert the emergency key as far as it will go into opening **1** in the cover.
- ▶ Pull and hold the door handle.
- ▶ Pull the cover on the emergency key as straight as possible away from the vehicle until it releases.
- ▶ Release the door handle.

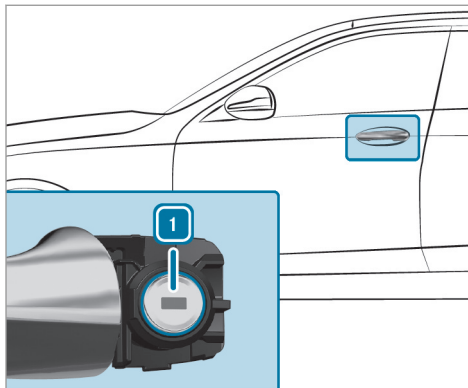

- ▶ **To unlock:** turn the emergency key counter-clockwise to position **1**.
- ▶ **To lock:** turn the emergency key clockwise to position **1**.
- ▶ Carefully press the cover onto the lock cylinder until it engages and is seated firmly.

Cargo compartment

Opening the tailgate

⚠ DANGER Risk of exhaust gas poisoning

Combustion engines emit poisonous exhaust gases such as carbon monoxide. Exhaust gases can enter the vehicle interior if the tailgate is open when the engine is running, especially if the vehicle is in motion.

- ▶ Always switch off the engine before opening the tailgate.
- ▶ Never drive with the tailgate open.

! **NOTE** Damage to the tailgate caused by obstacles above the vehicle

The tailgate swings rearwards and upwards when it is opened.

- ▶ Make sure that there is sufficient space behind and above the tailgate.

To open the tailgate, the following options are available:

- ▶ Pull on the handle for the tailgate in the bumper above the license plate.

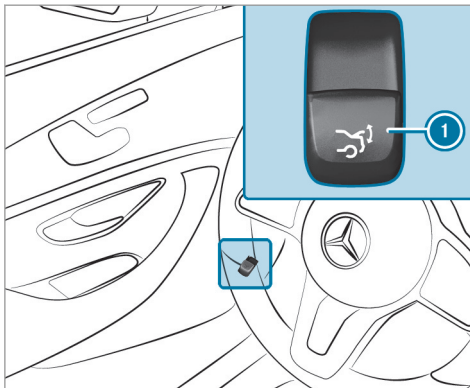

- ▶ Pull remote opening switch ① for the tailgate.
- ▶ Press and hold the  button on the SmartKey.
- ▶ **Vehicles with HANDS-FREE ACCESS:** Make a kicking movement with your foot below the bumper (→ page 75).

- ▶ For a tailgate stopped in an intermediate position, pull it upwards and release it as soon as it starts to open.

Closing the tailgate

! **WARNING** Risk of injury from unsecured items in the vehicle

If objects, luggage or loads are not secured or not secured sufficiently, they could slip, tip over or be thrown around and thereby hit vehicle occupants.

There is a risk of injury, particularly in the event of sudden braking or a sudden change in direction.

- ▶ Always stow objects in such a way that they cannot be thrown around.
- ▶ Before the journey, secure objects, luggage or loads against slipping or tipping over.

⚠ WARNING Risk of becoming trapped during automatic closing of the tailgate

Parts of the body could become trapped during automatic closing of the tailgate. Moreover, people, e.g. children, may be standing in the closing area or may enter the closing area during the closing process.

- ▶ Make sure that nobody is in the vicinity of the closing area during the closing process.

Use one of the following options to stop the closing process:

- Press the  button on the SmartKey.
- Press or pull the remote operating switch on the driver's door.
- Press the closing or locking button on the tailgate.
- Pull the tailgate handle.

Vehicles with HANDS-FREE ACCESS: It is also possible to stop the closing process by making a kicking movement with your foot below the rear bumper.

To close the tailgate, the following options are available:

- ▶ Pull the tailgate downwards slightly. Release it as soon as it begins to close.
- ▶ **Vehicles with HANDS-FREE ACCESS:** Make a kicking movement with your foot below the bumper (→ page 75).
- ▶ **Vehicles with KEYLESS-GO:** Press and hold the  button on the SmartKey (with the SmartKey in the vicinity of the vehicle).

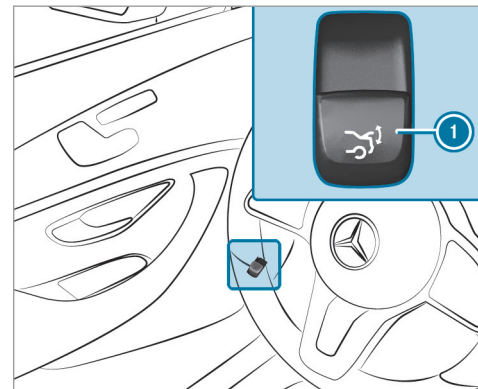

- ▶ Press remote operating switch ① for the tailgate.

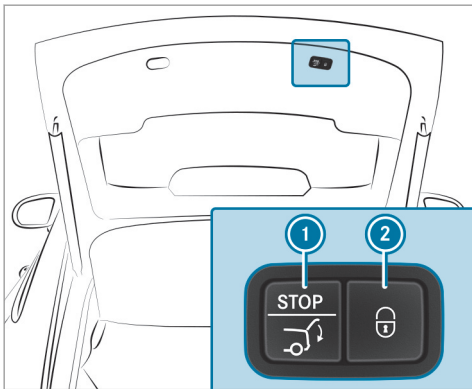

▶ Press closing button ① on the tailgate.

▶ **Vehicles with KEYLESS-GO:** Press locking button ② on the tailgate.

If a SmartKey is detected outside the vehicle, the tailgate will close and the vehicle will be locked.

Automatic reversing function for the tailgate

The tailgate is equipped with automatic obstacle detection with reversing function. If a solid

object blocks or restricts the tailgate when automatically closing, the tailgate automatically opens again slightly. Automatic obstacle detection with reversing function is only an aid. It is not a substitute for your attentiveness when you are closing the tailgate.

▶ When closing, make sure that no body parts are in the closing area.

⚠ WARNING Risk of becoming trapped despite the reversing function

The reversing function does not react:

- To soft, light and thin objects, e.g. fingers.
- Over the last $\frac{1}{3}$ in (8 mm) of the closing path.

In these situations in particular, the reversing function cannot prevent someone being trapped.

▶ When closing, make sure that no body parts are in the closing area.

If someone is trapped:

- Press the  button on the SmartKey, or
- Press or pull the remote operating switch on the driver's door, or
- Press the closing or locking button on the tailgate, or
- Pull the tailgate handle.

HANDS-FREE ACCESS function

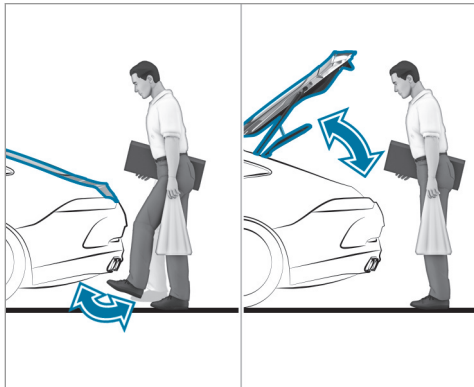

With HANDS-FREE ACCESS you can open, close or stop the closing process of the tailgate by performing a kicking movement under the rear bumper.

The kicking movement triggers the opening or closing process alternately.

Observe the notes when opening (→ page 71) and closing (→ page 72) the tailgate.

i Two warning tones sound when the tailgate is opening or closing.

⚠ WARNING Risk of burns caused by a hot exhaust system

The vehicle exhaust system can become very hot. If you use HANDS-FREE ACCESS, you could burn yourself by touching the exhaust system.

▶ Always ensure that you only make a kicking movement within the detection range of the sensors.

! **NOTE** Vehicle damage due to unintentional opening of the tailgate

- when using an automatic car wash
- when using a high pressure cleaner

▶ Deactivate KEYLESS-GO or make sure that the key located is at least 10 ft

(3 m) away from the vehicle in such situations.

When making the kicking movement, make sure that your feet are firmly on the ground, otherwise you could lose your balance, e.g. on ice.

Requirements:

- The SmartKey is behind the vehicle.
- Stand at least 12 in (30 cm) away from the vehicle while performing the kicking movement.
- Do not come into contact with the bumper while making the kicking movement.
- Do not carry out the kicking movement too slowly.
- The kicking movement must be towards the vehicle and back again.

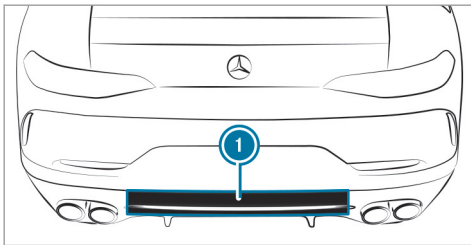

① Detection range of the sensors

If several consecutive kicking movements are not successful, wait ten seconds.

System limitations

The system may be impaired or may not function if:

- Snow or dirt, e.g. from road salt, covers the sensor area.
- The kicking movement is made using a prosthetic leg.

The tailgate can open or close unintentionally in the following situations:

- A person's arms or legs are moving in the sensor detection range, e.g. when polishing the vehicle or picking up objects.
- Objects are moved or placed behind the vehicle, e.g. tensioning straps or luggage.
- Clamping straps, tarps or other coverings are pulled over the bumper.
- A protective mat with a length reaching over the trunk sill down into the detection range of the sensors is used.
- The protective mat is not secured correctly.
- Work is being undertaken on the trailer hitch, on trailers or rear bicycle racks.

Deactivate the SmartKey functions (→ page 64) or do not carry the SmartKey about your person in such situations.

Limiting the opening angle of the tailgate

Activating the opening angle limiter

You can limit the opening angle of the tailgate in the top half of its opening range to approximately 8 in (20 cm) before the end position.

- ▶ Stop the opening procedure of the tailgate at the desired position.
- ▶ Press and hold the closing button in the tailgate until you hear a short acoustic signal. The opening angle limiter will be activated. The tailgate will then stop in the stored position when opened.

To open the tailgate fully, pull the handle on the outside of the tailgate again after it has stopped automatically.

Deactivating the opening angle limiter

- ▶ Press and hold the closing button in the tailgate until two short acoustic signals sound.

Unlocking the tailgate with the emergency key

- ▶ Fold the rear seat backrest forwards.

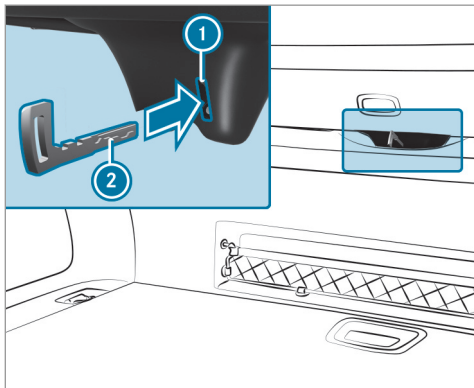

- ▶ Insert emergency key ② into opening ① in the trim and push it in. The tailgate will be unlocked.

Sun blind

Folding up or down the sun blind for the rear window

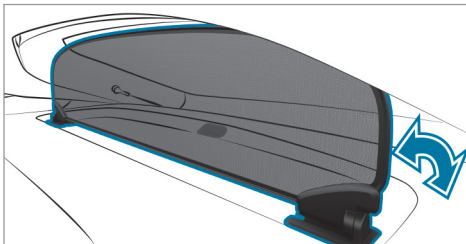

- ▶ Fold the sun blind up or down.
- ⓘ To fold the sun blind while the tailgate is open, unhook the cargo compartment cover in advance.

Side windows

Opening and closing the side windows

- ⚠ **WARNING** Risk of entrapment when opening a side window

When opening a side window, parts of the body could be drawn in or become trapped between the side window and window frame.

- ▶ When opening, make sure that nobody is touching the side window.
- ▶ If someone is trapped, release the button immediately or pull it in order to close the side window again.

- ⚠ **WARNING** Risk of becoming trapped when closing a side window

When closing a side window, body parts could be trapped in the closing area in the process.

- ▶ When closing, make sure that no body parts are in the closing area.

- ▶ If someone is trapped, release the button immediately or press the button in order to reopen the side window.

Requirements:

- The power supply or the ignition is switched on.

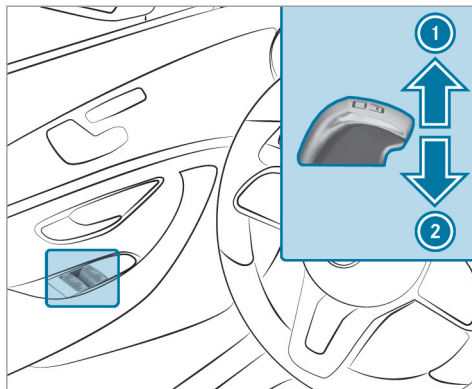

① Closes

② Opens

The buttons on the driver's door take precedence.

- ▶ **To start automatic operation:** press the  button beyond the point of resistance or pull and release it.

- ▶ **To interrupt automatic operation:** press or pull the  button again.

When the vehicle is switched off, the side windows can continue being operated.

The function is available for around five minutes or until a front door is opened.

Automatic reversing feature of the side windows

If an object blocks a side window during the closing process, the side window opens again automatically. The automatic reversing feature is only an aid and is not a substitute for your attentiveness.

- ▶ When closing, make sure that no body parts are in the closing area.

⚠ WARNING Risk of becoming trapped despite there being reversing protection on the side window

The reversing function does not react:

- To soft, light and thin objects, e.g. fingers
- During resetting

This means that the reverse function cannot prevent someone from becoming trapped in these situations.

- ▶ When closing, make sure that no body parts are in the closing area.
- ▶ If someone becomes trapped, press the  button to open the side window again.

Convenience opening (ventilating the vehicle before starting a journey)

⚠ WARNING Risk of entrapment when opening a side window

When opening a side window, parts of the body could be drawn in or become trapped between the side window and window frame.

- ▶ When opening, make sure that nobody is touching the side window.

▶ Release the button immediately if somebody becomes trapped.

- ▶ Press and hold the  button on the SmartKey.

The following functions are performed:

- The vehicle is unlocked.
- The side windows are opened.
- The sliding sunroof is opened.
- The seat ventilation of the driver's seat is switched on.

- ▶ **To interrupt convenience opening:** release the  button.

Convenience closing (closing the vehicle from outside)

⚠ WARNING Risk of entrapment caused by inadvertent convenience closing

When the convenience closing feature is operating, parts of the body could become

trapped in the closing area of the side window and the sliding sunroof.

- ▶ Observe the complete closing procedure when using convenience closing.
- ▶ When closing, make sure that no body parts are in the closing area.

- ▶ Press and hold the  button on the SmartKey.

The following functions are performed:

- The vehicle is locked.
- The side windows are closed.
- The sliding sunroof is closed.

- ▶ **To interrupt convenience closing:** release the  button.

i Convenience closing can also be operated with KEYLESS-GO (→ page 69).

Problems with the side windows

Problem

A side window cannot be closed and you cannot see the cause.

Possible causes/consequences and ► Solutions

- Check to see whether any objects are in the window guide.

⚠ WARNING Risk of becoming trapped or fatally injured if reversing protection is not activated

If you close a side window again immediately after it has been blocked or reset, the side window closes with increased or maximum force. The reversing feature is then not active.

Parts of the body could become trapped in the closing area in the process.

- Make sure that no parts of the body are in the closing area.
- To stop the closing process, release the button or press the button again to reopen the side window.

If a side window is obstructed during closing and reopens again slightly:

- Immediately after the window is blocked, pull the corresponding switch again until the side window has closed, and hold the switch for an additional second.
The side window will be closed with increased force.

If a side window is obstructed again during closing and reopens again slightly:

- Repeat the previous step.
The side window is closed without the automatic reversing function.

Problem

The side windows cannot be opened or closed using the convenience opening feature.

Possible causes/consequences and ► Solutions

The SmartKey battery is discharged or nearly discharged.

- Check the battery using the battery check lamp and replace if necessary (→ page 65).

Sliding sunroof**Opening and closing the sliding sunroof**

⚠ WARNING Risk of becoming trapped while opening and closing the sliding sunroof

During opening and closing, parts of the body could get caught in the sweep of the sliding sunroof.

- When opening or closing, make sure that no body parts are in the sweep.
- Release the button immediately if somebody becomes trapped.

or

- Press the button in any direction during the automatic opening/closing process. The opening/closing process is stopped.

⚠ WARNING Risk of becoming trapped if the sliding sunroof is operated by children

Children operating the sliding sunroof could get caught in the moving parts, particularly if unattended.

- Never leave children unattended in the vehicle.
- When leaving the vehicle, always take the key with you and lock the vehicle.

! NOTE Malfunction caused by snow and ice

Snow and ice may lead to a malfunction of the sliding sunroof.

- Only open the sliding sunroof if it is free of snow and ice.

! NOTE Damage caused by protruding objects

Objects that protrude from the sliding sunroof may damage the sealing strips.

- Do not allow anything to protrude from the sliding sunroof.

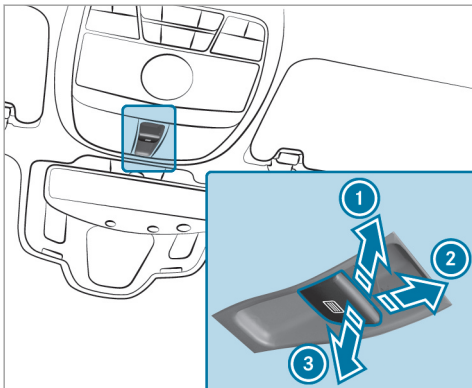

- ① Raises
- ② Opens
- ③ Closes/lowers

▶ **To start automatic operation:** press the  button beyond the point of resistance or pull and release it.

- ▶ **To interrupt automatic operation:** briefly press the  button in any direction. The opening/closing process is stopped.
- **Vehicles without a panoramic sliding sunroof:** The automatic opening and raising feature is available only when the sliding sunroof is closed.

Automatic reversing feature of the sliding sunroof

If there is an object obstructing the sliding sunroof during the closing process, the sliding sunroof will open again automatically. The automatic reversing feature is only an aid and is not a substitute for your attentiveness.

- ▶ When closing, make sure that no body parts are in the closing area.

⚠ WARNING Risk of entrapment even with the reversing function active

The reversing feature does not react in particular:

- To soft, light and thin objects, e.g. fingers
- Over the last 1/8 in (4 mm) of the closing path
- During resetting

This means that the reverse function cannot prevent someone from becoming trapped in these situations.

- ▶ When closing, make sure that no body parts are in the closing area.
- ▶ Release the button immediately if somebody becomes trapped.

or

- ▶ Briefly press the button in any direction during automatic operation. The closing process is stopped.

Problem

The sliding sunroof cannot be closed and you cannot see the cause.

Possible causes/consequences and ► Solutions

⚠ WARNING Risk of becoming trapped or fatal injury by closing the sliding sunroof again

If you close the sliding sunroof again immediately after it has been blocked or reset, the sliding sunroof closes with increased force.

Parts of the body could become trapped in the closing area in the process.

- Make sure that no parts of the body are in the closing area.
- Release the button immediately if somebody becomes trapped.

or

- Press the button in any direction during the automatic closing process.
The closing process is stopped.

If the sliding sunroof is obstructed during closing and reopens again slightly:

- Immediately after automatic reversing, pull and hold the  button down again to the point of resistance until the sliding sunroof is closed.
The sliding sunroof will be closed with increased force.



If the sliding sunroof is obstructed again and reopens again slightly:

- Repeat the previous step.
The sliding sunroof will be closed again with increased force.

Problem

Vehicles without a panoramic sliding sunroof: The sliding sunroof does not operate smoothly.

Possible causes/consequences and ► Solutions

- Push the  button up to the point of resistance until the sliding sunroof is fully open.
- Press the  button for another second.
- Close the sliding sunroof.

Anti-theft protection**Function of the immobilizer**

The immobilizer prevents your vehicle from being started without the correct SmartKey.

The immobilizer is automatically activated when the ignition is switched off and deactivated when the ignition is switched on.

When leaving the vehicle, always take the SmartKey with you and lock the vehicle. Anyone can start the engine if a valid SmartKey has been left inside the vehicle.

 In the event the engine cannot be started (yet the vehicle's starter battery is charged), the system is not operational. Contact an authorized Mercedes-Benz Center or call

1-800-FOR-MERCEdes (in the USA) or
1-800-387-0100 (in Canada).

ATA (anti-theft alarm system)**Function of the ATA system**

If the ATA system is armed, a visual and audible alarm is triggered in the following situations:

- when a door is opened
- when the tailgate is opened
- when the hood is opened

The ATA system is armed automatically after approximately ten seconds in the following situations:

- after locking the vehicle with the SmartKey
- after locking the vehicle using KEYLESS-GO

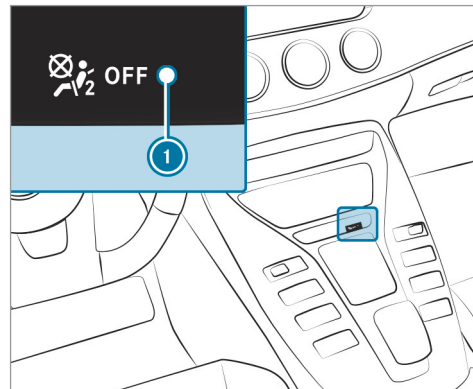

Indicator lamp  flashes when the ATA system is armed.

The ATA system is deactivated automatically in the following situations:

- after unlocking the vehicle with the SmartKey
- after pressing the start/stop button with the SmartKey in the stowage compartment (→ page 137)
- after unlocking the vehicle using KEYLESS-GO

 When the Mercedes-Benz emergency call system is active and the alarm stays on for more than 30 seconds, a message is automatically sent to the Customer Assistance Center (→ page 318).

Deactivating the ATA

 Press the ,  or  button on the SmartKey.

or

 Press the start/stop button with the SmartKey in the stowage compartment (→ page 137)

Deactivating the alarm using KEYLESS-GO:

 Grasp the outside door handle with the SmartKey outside the vehicle.

Notes on the correct driver's seat position

⚠ WARNING Risk of injury from adjusting the vehicle settings while the vehicle is in motion

You could lose control of the vehicle in the following situations:

- if you adjust the driver's seat, the head restraint, the steering wheel or the mirror while the vehicle is in motion
- if you fasten your seat belt while the vehicle is in motion

▶ Before starting the engine: adjust the driver's seat, the head restraint, the steering wheel or the mirror and fasten your seat belt.

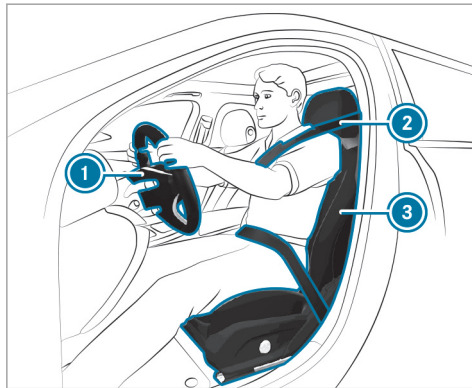

Ensure the following when adjusting the steering wheel ①, seat belt ② and driver's seat ③:

- you are as far away from the driver's airbag as possible
- you are sitting in an upright position
- your thighs are slightly supported by the seat cushion

- your legs are not fully extended and you can depress the pedals properly
- the back of your head is supported at eye level by the center of the head restraint
- you can hold the steering wheel with your arms slightly bent
- you can move your legs freely
- you can see all the displays on the instrument cluster clearly
- you have a good overview of the traffic conditions
- your seat belt is pulled snugly against your body and is routed across the center of your shoulder and across your hips in the pelvic area

Seats

Adjusting the front seat mechanically and electrically

⚠ WARNING Risk of becoming trapped if the seats are adjusted by children

Children could become trapped if they adjust the seats, particularly when unattended.

- ▶ When leaving the vehicle, always take the SmartKey with you and lock the vehicle.
- ▶ Never leave children unattended in the vehicle.

The seats can be adjusted when the ignition is switched off.

⚠ WARNING Risk of becoming trapped when adjusting the seats

When you adjust a seat, you or other vehicle occupants could become trapped, e.g. on the seat guide rail.

- ▶ When adjusting a seat, make sure that no one has any body parts in the sweep of the seat.

Observe the safety notes on "Airbags" and "Children in the vehicle".

⚠ WARNING Risk of accident due to the driver's seat not being engaged

If the driver's seat is not engaged, it could move unexpectedly while the vehicle is in motion.

This could cause you to lose control of the vehicle.

- ▶ Always make sure that the driver's seat is engaged before starting the vehicle.

⚠ WARNING Risk of becoming trapped if the seat height is adjusted carelessly

If you adjust the seat height carelessly, you or other vehicle occupants could be trapped and thereby injured.

Children in particular could accidentally press the electrical seat adjustment buttons and become trapped.

- ▶ While moving the seats, make sure that hands or other body parts do not get under the lever assembly of the seat adjustment system.

⚠ WARNING Risk of injury due to head restraints which are not installed or are adjusted incorrectly

If head restraints are not installed or are adjusted incorrectly, the head restraints cannot provide protection as intended.

There is an increased risk of injury in the head and neck area, e.g. in the event of an accident or when braking.

- ▶ Always drive with the head restraints installed.
- ▶ Before driving off, make sure for every vehicle occupant that the center of the head restraint supports the back of the head at about eye level.

Do not interchange the head restraints of the front and rear seats. Otherwise, you will not be able to adjust the height and angle of the head restraints correctly.

Adjust the head restraint fore-and-aft position so that it is as close as possible to the back of your head.

⚠ WARNING Risk of injury or death due to incorrect seat position

The seat belt does not offer the intended level of protection if you have not moved the seat backrest to an almost vertical position.

When braking or in the event of an accident, you could slide underneath the seat belt and sustain abdominal or neck injuries, for example.

- ▶ Adjust the seat properly before beginning your journey.
- ▶ Always ensure that the seat backrest is in an almost vertical position and that the shoulder section of your seat belt is routed across the center of your shoulder.

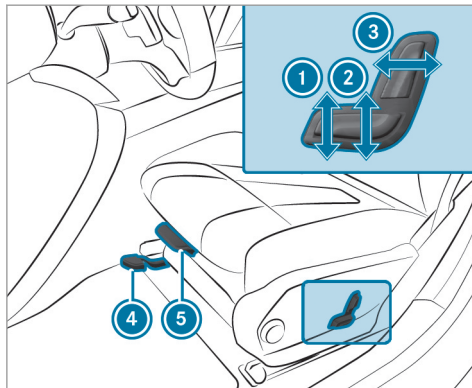

- ① Seat cushion inclination
- ② Seat height
- ③ Seat backrest inclination
- ④ Seat fore-and-aft position
- ⑤ Seat cushion length

▶ **To adjust the seat fore-and-aft position:** lift lever ④ and slide the seat into the desired position.

▶ Make sure that the seat is engaged in position.

▶ **To adjust the seat cushion length:** lift lever ⑤ and slide the front section of the seat cushion forwards or backwards.

Adjusting the front seat electrically

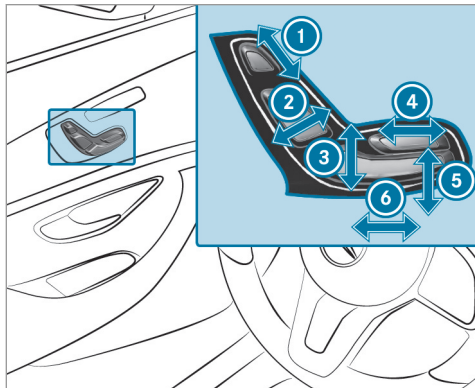

- ① Head restraint height
- ② Seat backrest inclination
- ③ Seat height
- ④ Seat cushion length
- ⑤ Seat cushion inclination
- ⑥ Seat fore-and-aft position

- ▶ Save the settings with the memory function (→ page 97).

Adjusting the front passenger seat electrically from the driver's seat

Requirements:

- The power supply is switched on

This function is available only in vehicles with an electrically adjustable front passenger seat.

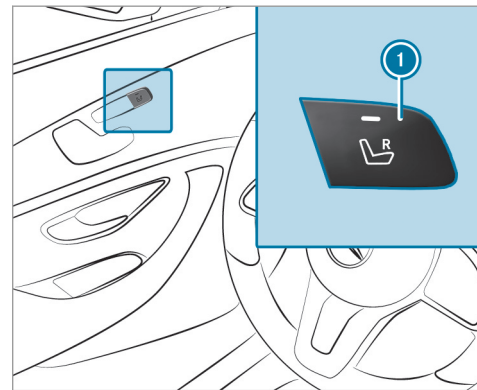

You can call up the following functions for the front passenger seat:

- Seat adjustment
- Seat heating
- Seat ventilation
- Memory function

- ▶ **To select the front passenger seat:** press button . When the indicator lamp lights up, the front passenger seat is selected.
- ▶ Adjust the front passenger seat using the buttons on the door control panel on the driver's side.

Adjusting the 4-way lumbar support

- ▶ Adjust the 4-way lumbar support via the multimedia system (→ page 92).

Adjusting the AMG Performance seat

To adjust the contour of the seat and for improved lateral support, you can adjust the front seats individually.

On the front passenger seat, you can adjust only the seat side bolsters of the seat backrest.

- ▶ Adjust the AMG Performance seat via the multimedia system (→ page 92).

Head restraints

Adjusting the front seat head restraints mechanically

- ▶ **WARNING** Risk of injury from adjusting the vehicle settings while the vehicle is in motion

You could lose control of the vehicle in the following situations:

- if you adjust the driver's seat, the head restraint, the steering wheel or the mirror while the vehicle is in motion
 - if you fasten your seat belt while the vehicle is in motion
- ▶ Before starting the engine: adjust the driver's seat, the head restraint, the steering wheel or the mirror and fasten your seat belt.

- ▶ **WARNING** Risk of injury due to head restraints which are not installed or are adjusted incorrectly

If head restraints are not installed or are adjusted incorrectly, the head restraints cannot provide protection as intended.

There is an increased risk of injury in the head and neck area, e.g. in the event of an accident or when braking.

- ▶ Always drive with the head restraints installed.
- ▶ Before driving off, make sure for every vehicle occupant that the center of the head restraint supports the back of the head at about eye level.

Do not interchange the head restraints of the front and rear seats. Otherwise, you will not be able to adjust the height and angle of the head restraints correctly.

Adjust the head restraint fore-and-aft position so that it is as close as possible to the back of your head.

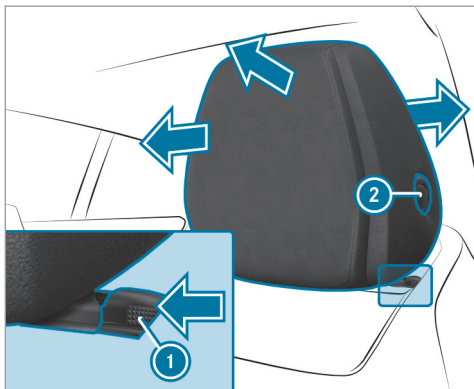

- ▶ **To raise:** pull the head restraint up.
- ▶ **To lower:** press release knob ① in the direction of the arrow and push the head restraint down.
- ▶ **To move forwards:** pull the head restraint forwards.
- ▶ **To move backwards:** press release knob ② and push the head restraint backwards.

Adjusting the head restraints of the rear seats mechanically

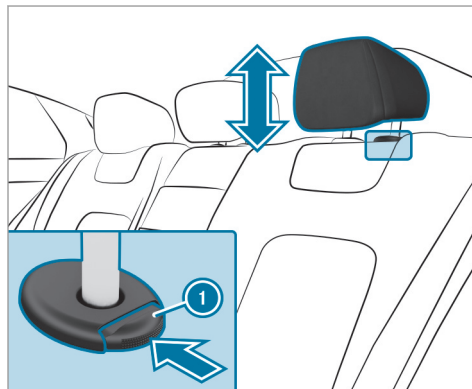

- ▶ **To raise:** pull the head restraint up.
- ▶ **To lower:** press release knob ① in the direction of the arrow and push the head restraint down.

Installing/removing the outer rear seat head restraints

Removing

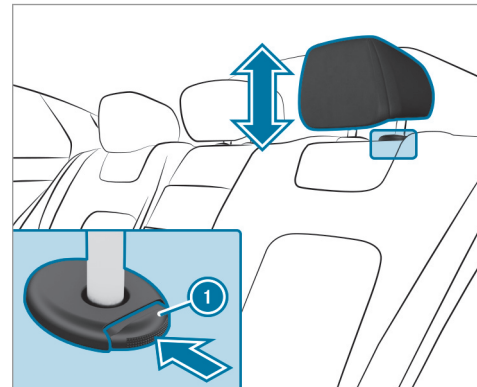

- ▶ Release the rear seat backrest and fold it forwards slightly.
- ▶ Pull the head restraint upwards as far as it will go.

- ▶ Push release knob  in the direction of the arrow and pull out the head restraint.

Installing

- ▶ Insert the head restraint such that the notches on the bar are on the left when viewed in the direction of travel.
- ▶ Push the head restraint down until you hear it engage in position.
- ▶ Fold the rear seat backrest back until it engages.

Configuring the seat settings

Multimedia system:

 Vehicle  Seats

- ▶ Select [Driver's Seat](#) or [Passenger Seat](#).

Adjusting the backrest side bolsters

- ▶ Select [Side Bolsters](#).
- ▶ Adjust the air cushions.

Adjusting the side bolsters of the driver's seat cushion (only vehicles with AMG Performance seat)

- ▶ Select [Lateral Support, Cush..](#)
- ▶ Adjust the air cushions.
-  This setting can only be made for the driver's seat. This setting is not available for the front passenger seat.

Adjusting the seat contour in the lumbar region of the seat backrest (lumbar)

- ▶ Select [Lumbar](#).
- ▶ Adjust the air cushions.

Memory function

- ▶ Save the seat settings with the memory function (→ page 97).

Setting automatic adjustment of the lateral support (active multicontour seat)

Multimedia system:

 Vehicle  Seats

With this function, the lateral support of the active multicontour seat is automatically adjusted to the driving and cornering dynamics of the vehicle.

- ▶ Select [Driver's Seat](#) or [Passenger Seat](#).
- ▶ Select [Dynamic Seat](#).
- ▶ **Select setting:** [Off](#), [Level 1](#) or [Level 2](#).

Overview of massage and workout programs

Massage program

The following programs can be selected:

- [Hot Relaxing Back](#)
- [Hot Relaxing Shoulder](#)
- [Activating Massage](#)
- [Classic Massage](#)
- [Wave Massage](#)

- Mobilizing Massage

Active Workout

The [Act. Workout Back](#) and [Act. Workout Cushion](#) programs require your active cooperation. Tensing and releasing also helps to improve blood flow to your muscles. Press against a pressure point as soon as you feel it.

Selecting the massage program for the front seats

Multimedia system:

↳ Vehicle ▶  Seats

- ▶ Select [Driver's Seat](#) or [Passenger](#).
- ▶ Select [Massage](#).
- ▶ Select a massage program.
The massage program runs for approximately 9 to 15 minutes, depending on the setting.
- ▶ **To set the massage intensity:** switch [High Intensity](#) on or off .

Resetting seat adjustments

Multimedia system:

↳ Vehicle ▶  Seats ▶ Reset

- ▶ Select [Yes](#) or [No](#).

Depending on whether the settings for the driver or front passenger seat are selected, only the selected seat can be reset.

Switching the seat heating on/off

⚠ WARNING Risk of burns due to repeatedly switching on the seat heating

Repeatedly switching on the seat heating can cause the seat cushion and seat backrest padding to become very hot.

The health of persons with limited temperature sensitivity or a limited ability to react to high temperatures may be affected or they may even suffer burn-like injuries.

- ▶ Do not repeatedly switch on the seat heating.

To protect against overheating, the seat heating may be temporarily deactivated after it is switched on repeatedly.

! **NOTE** Damage to the seats caused by objects or documents when the seat heater is switched on

When the seat heater is switched on, overheating can occur due to objects or documents placed on the seats e.g. seat cushions or child seats. This could cause damage to the seat surface.

- ▶ Make sure that no objects or documents are on the seats when the seat heater is switched on.

Requirements:

- The power supply is switched on

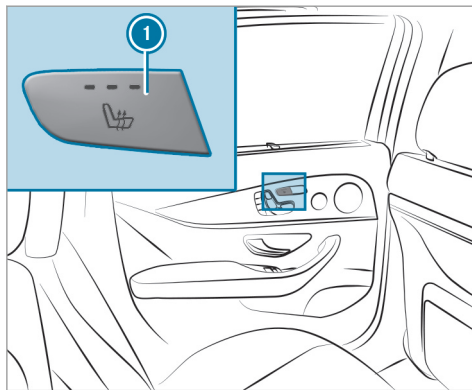
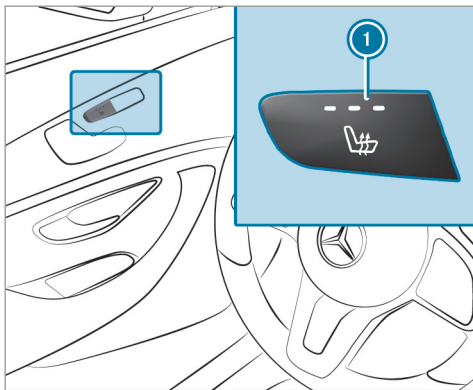

- ▶ **To switch on/increase the level:** press button ① repeatedly until the desired heating level is set. Depending on the heating level, up to three indicator lamps light up.

- ▶ **To switch off/reduce the level:** press button ① repeatedly until the desired heating level is set. If all indicator lamps are off, the seat heating is switched off.
- ⓘ The seat heating automatically switches down from the three heating levels after 8, 10 and 20 minutes until the seat heating is switched off.
- ⓘ Vehicles with the Warmth Comfort Package: you can heat the armrests in the door and the center console. You can also set the panel heating in the multimedia system (→ page 94).

Setting the panel heating

Multimedia system:

➔ Vehicle ➔  Vehicle Settings ➔ Panel Heating

When the seat heater is switched on, the armrests in the vehicle as well as the center console can be heated using this function.

Setting options

- ▶ Select **Front and Rear**, **Front Only**, **Rear Only** or **Off**.

Switching the seat ventilation on/off

Requirements:

- The power supply is switched on

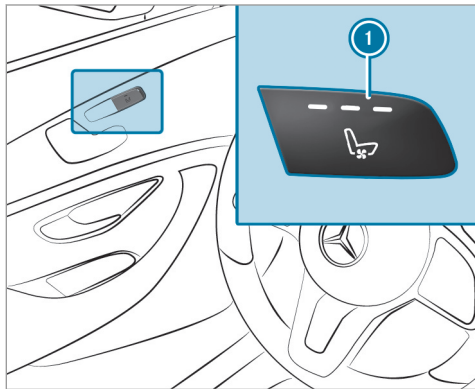

- ▶ **To switch on/increase the level:** press button ① repeatedly until the desired ventilation level is set. Depending on the ventilation level, up to three indicator lamps light up.
- ▶ **To switch off/reduce the level:** press button ① repeatedly until the desired ventilation level is set. If all indicator lamps are off, the seat ventilation is switched off.

Steering wheel

Adjusting the steering wheel electrically

The steering wheel can be adjusted when the power supply is switched off.

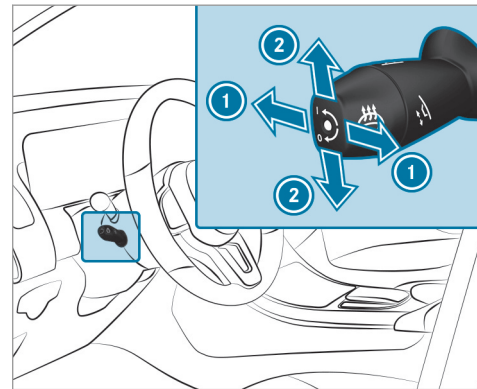

- ① Adjusts the distance to the steering wheel
- ② Adjusts the height
- ▶ Save the settings with the memory function (→ page 97).

Switching the steering wheel heater on or off

Requirements:

- The power supply or the ignition is switched on.

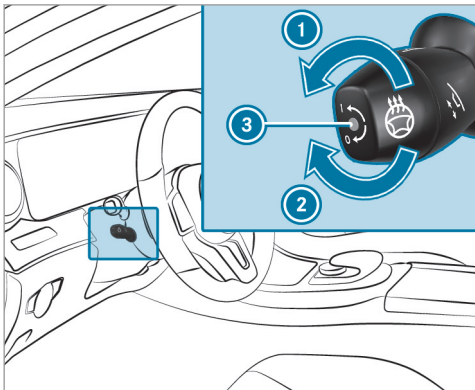

- ▶ **To switch on:** turn the lever in the direction of arrow ①. Indicator lamp ③ lights up.

- ▶ **To switch off:** turn the lever in the direction of arrow ②. Indicator lamp ③ goes out.

When you switch the ignition off, the steering wheel heater switches off.

Easy entry and exit feature

Using the easy entry and exit feature

- ⚠ **WARNING** Risk of accident when driving off while adjusting the easy exit feature

- If you drive off while the easy entry and exit feature is making adjustments, you could lose control of the vehicle.

- ▶ Always wait until the adjustment process is complete before driving off.

- ⚠ **WARNING** Risk of entrapment when adjusting the easy entry and exit feature

- When the easy entry and exit feature adjusts the steering wheel, you and other vehicle occupants – particularly children – could become trapped.

- ▶ - While the easy entry and exit feature is making adjustments, make sure that no one has any body parts in the sweep of the steering wheel.
- ▶ Move the adjustment lever of the steering wheel if there is a risk of becoming trapped by the steering wheel. The adjustment process is stopped.
- ▶ Never leave children unattended in the vehicle.
- ▶ When leaving the vehicle, always take the key with you and lock the vehicle.

Vehicles with memory function: You can stop the adjustment process by pressing one of the memory function position buttons.

If the easy entry and exit feature is active, the steering wheel will move upwards in the following situations:

- You switch the ignition off
- You open the driver's door when the ignition is switched on

The steering wheel moves back to the last drive position in the following cases:

- You switch the ignition on when the driver's door is closed
- You close the driver's door when the ignition is switched on

The last drive position is stored in the following situations:

- You switch the ignition off
- **Vehicles with memory function:** Save the seat settings via the memory function.

Vehicles with memory function: Press one of the memory function saved position buttons to stop the adjustment process.

Setting the easy entry and exit feature

Multimedia system:

→ Vehicle →  Vehicle Settings → Easy Entry/Exit

- ▶ Select **Steering Wheel & Seat, Steering Wheel Only** or **Off**.

Operating the memory function

⚠ WARNING Risk of an accident if the memory function is used while driving

If you use the memory function on the driver's side while driving, you could lose control of the vehicle as a result of the adjustments being made.

- ▶ Only use the memory function on the driver's side when the vehicle is stationary.

⚠ WARNING Risk of entrapment when setting the seat with the memory function

When the memory function adjusts the seat or steering wheel, you and other vehicle occupants – particularly children – could become trapped.

- ▶ During the setting procedure of the memory function, ensure that no body parts are in the sweep of the seat or the steering wheel.
- ▶ If somebody becomes trapped, immediately release the memory function position button. The adjustment process is stopped.

⚠ WARNING Risk of entrapment if the memory function is activated by children

Children could become trapped if they activate the memory function, particularly when unattended.

- ▶ Never leave children unattended in the vehicle.

- ▶ When leaving the vehicle, always take the key with you and lock the vehicle.

The memory function can be used when the ignition is switched off.

Storing

Seat adjustments for up to three people can be stored and called up using the memory function.

The following systems can be selected:

- Seat, backrest and head restraint
- Steering wheel
- Outside mirrors
- Head-up Display

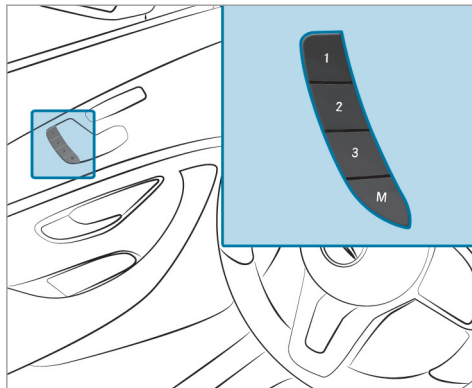

- ▶ Set the seat, the steering wheel, the Head-up Display and the outside mirrors to the desired position.
- ▶ Press memory button M together with one of preset position buttons 1, 2 or 3. An acoustic signal sounds. The settings are stored.
- ▶ **To call up:** press and hold the relevant preset position button 1, 2 or 3 until the front

seat, the steering wheel, Head-up Display and outside mirror are in the stored position.

Stowage areas

Notes on loading the vehicle

⚠ DANGER Risk of exhaust gas poisoning

Combustion engines emit poisonous exhaust gases such as carbon monoxide. Exhaust gases can enter the vehicle interior if the tailgate is open when the engine is running, especially if the vehicle is in motion.

- ▶ Always switch off the engine before opening the tailgate.
- ▶ Never drive with the tailgate open.

⚠ WARNING Risk of injury from unsecured items in the vehicle

If objects, luggage or loads are not secured or not secured sufficiently, they could slip, tip over or be thrown around and thereby hit vehicle occupants.

There is a risk of injury, particularly in the event of sudden braking or a sudden change in direction.

- ▶ Always stow objects in such a way that they cannot be thrown around.
- ▶ Before the journey, secure objects, luggage or loads against slipping or tipping over.

⚠ WARNING Risk of injury due to objects being stowed incorrectly

If you do not adequately stow objects in the vehicle interior, they could slip or be tossed around and thereby strike vehicle occupants. In addition, cup holders, open stowage spaces and mobile phone brackets cannot always restrain the objects they contain in the event of an accident.

There is a risk of injury, particularly in the event of sudden braking or a sudden change in direction.

- ▶ Always stow objects in such a way that they cannot be tossed about in these or similar situations.
- ▶ Always make sure that objects do not project from stowage spaces, parcel nets or stowage nets.
- ▶ Close the lockable stowage spaces before starting a journey.
- ▶ Stow and secure objects that are heavy, hard, pointed, sharp-edged, fragile or too large in the cargo compartment.

⚠ WARNING Risk of burning from the tailpipe or tailpipe trim

The tailpipe and tailpipe trim can become very hot. If you come into contact with these car parts, you could burn yourself.

- ▶ Always be particularly careful when in the vicinity of the tailpipe and tailpipe trims and supervise children very closely when in this area.
- ▶ Before any contact, allow the car parts to cool down.

The driving characteristics of your vehicle are dependent on the distribution of the load within the vehicle. You should bear the following in mind when loading the vehicle:

- never exceed the permissible gross mass or the gross axle weight rating for the vehicle (including occupants). The values are specified on the vehicle identification plate on the vehicle's B-pillar.
- the load must not protrude above the upper edge of the seat backrests.
- always place the load behind unoccupied seats if possible.
- secure the load using the tie-down eyes and distribute the load evenly.

Stowage spaces in the vehicle interior

Overview of the front stowage compartments

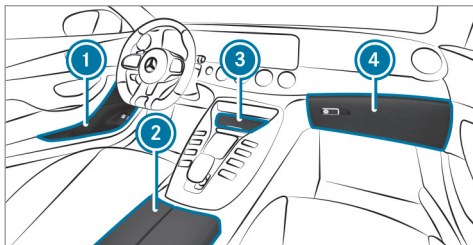

- ① Stowage compartment in the doors
- ② Stowage compartment in the armrest with a multimedia and USB connection
- ③ Stowage compartment in the front center console with a USB connection
- ④ Glove box

Locking and unlocking the glove box

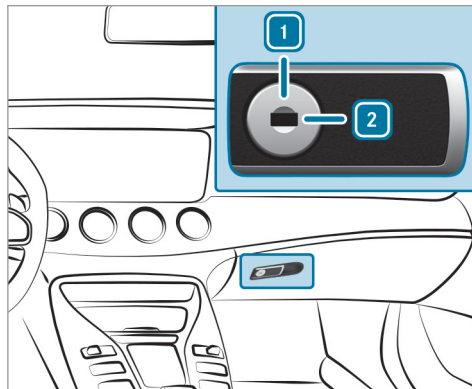

- ▶ Turn the emergency key a quarter turn clockwise ② (to lock) or counter-clockwise ① (to unlock).

Opening the eyeglasses compartment

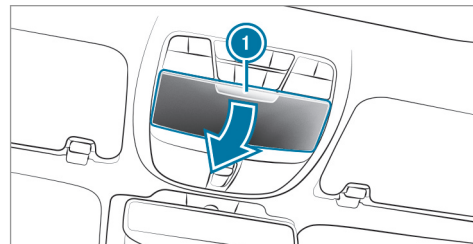

- ▶ Press button ①.

Opening the stowage compartment in the rear armrest

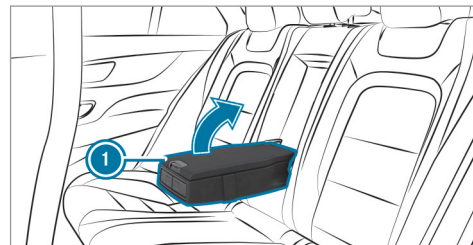

- ▶ Press release catch ① and swing the cover of the armrest upwards.

Through-loading feature in the rear bench seat

Locking the release catch of the center rear seat backrest

Requirements:

- The left and center seat backrests are engaged and joined together.

Lock the center seat backrest release catch if you want to secure the cargo compartment from unauthorized access. The center seat backrest can then be folded forwards only together with the left seat backrest.

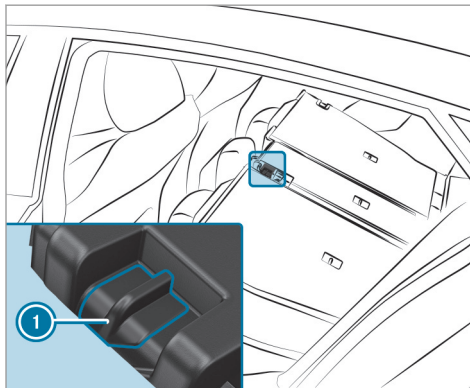

- ▶ Fold the center and left seat backrests forwards.
- ▶ **To lock:** slide catch ① upwards. The release catch of the center seat backrest will be locked.
- ▶ **To unlock:** slide catch ① downwards.

Securing the ski/snowboard bag in the cargo compartment

⚠ WARNING Risk of injury due to using the through-load ski bag incorrectly

The through-load ski bag in conjunction with the lashing straps cannot restrain any objects other than skis.

Vehicle occupants could be struck in the event of sudden braking or an accident in the following cases:

- if you transport other heavy or sharp-edged objects in the through-load ski bag
 - if you do not secure the through-load ski bag with the lashing straps
- ▶ Only store skis in the through-load ski bag.
 - ▶ Always secure the through-load ski bag with the lashing straps so that it cannot move around.

A maximum of four pairs of skis or two snowboards may be transported in the ski and snowboard bag.

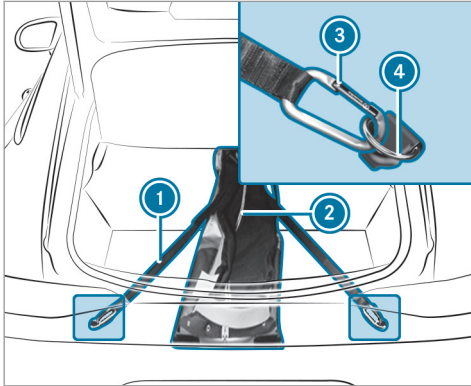

- ▶ Fold the center rear seat backrest forwards.
- ▶ Slide the ski and snowboard bag between the outer seat backrests into the rear passenger compartment.
- ▶ Open zip ②.

- ▶ Load the ski and snowboard bag with the skis or snowboards.
- ▶ Close zip ②.
- ▶ Pull the tensioning strap tight by the loose end.
- ▶ Cross lashing straps ①.
- ▶ Engage hooks ③ of lashing straps ① in tie-down eyes ④. Make sure that the fasteners of hooks ③ are facing upwards.

Overview of the tie-down eyes

Observe the notes on loading the vehicle (→ page 98).

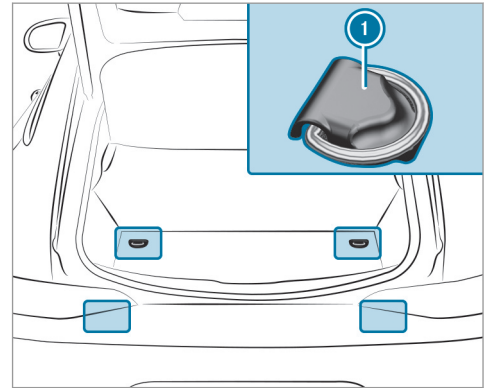

- ① Tie-down eyes

Overview of bag hooks

⚠ WARNING Risk of injury when using bag hooks with heavy objects

The bag hooks cannot restrain heavy objects or items of luggage.

Objects or items of luggage could be thrown around and thereby hit vehicle occupants when braking or abruptly changing directions.

- ▶ Only hang light objects on the bag hooks.
- ▶ Never hang hard, sharp-edged or fragile objects on the bag hooks.

Observe the notes on loading the vehicle (→ page 98).

The bag hooks can bear a maximum load of 6.6 lbs (3 kg). Do not use them to secure a load.

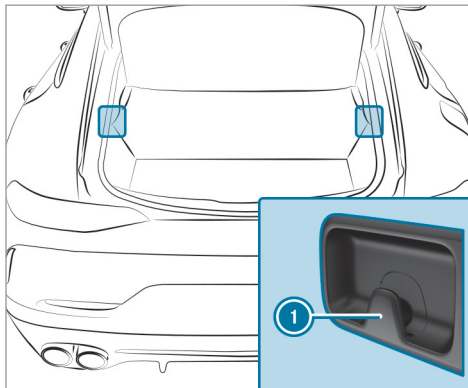

① Bag hook

EASY-PACK load-securing kit

Information on snap-in module for the cargo compartment (telescopic rods)

The EASY-PACK load-securing kit allows you to use your cargo compartment for a variety of pur-

poses. The components are located in the stowage space under the cargo compartment floor.

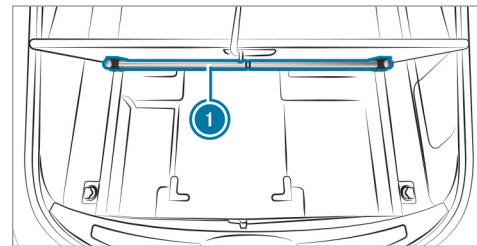

① Telescopic rod with mounting elements and holders

Installing a telescopic rod

⚠ WARNING Risk of injury due to an open cargo compartment floor

If you drive when the cargo compartment floor is open, objects could be thrown around and thereby strike vehicle occupants. There is a risk of injury, particularly in the event of

sudden braking or a sudden change in direction.

- ▶ Always close the cargo compartment floor before a journey.

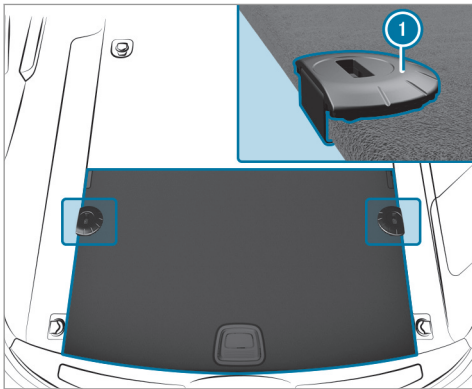

- ▶ Open the cargo compartment floor .
- ▶ Attach holders ① in the desired position to the side of the trunk floor.

- ▶ Close the cargo compartment floor.

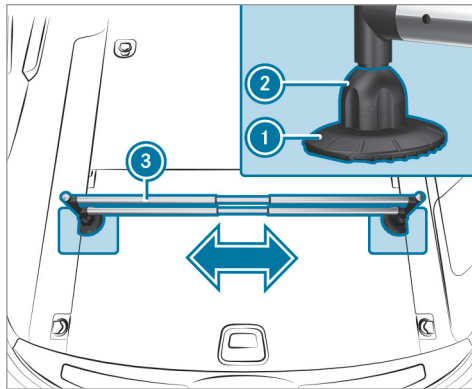

- ▶ Insert mounting elements ② into holders ① .
- ▶ Extend telescopic rod ③ .
- ▶ Insert telescopic rod ③ into mounting elements ② .
- ▶ Turn both mounting elements ② to  until you feel them engage.

Opening or closing the stowage space under the cargo compartment floor

⚠ WARNING Risk of injury due to an open cargo compartment floor

If you drive when the cargo compartment floor is open, objects could be thrown around and thereby strike vehicle occupants. There is a risk of injury, particularly in the event of sudden braking or a sudden change in direction.

- ▶ Always close the cargo compartment floor before a journey.

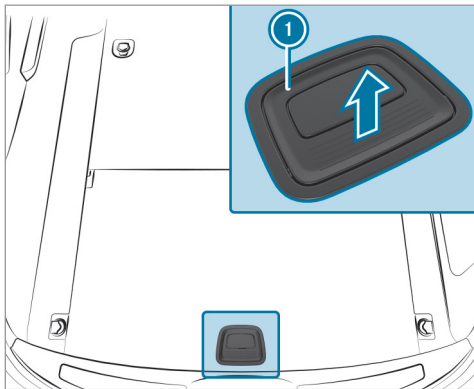

- ▶ **To open:** pull handle ① upwards.
- ▶ Lift the cargo compartment floor upwards using handle ①.
- ▶ **To close:** fold the cargo compartment floor down.

Cup holder

Installing the cup holder in or removing it from the center console (automatic transmission)

⚠ WARNING - Risk of accident or injury when using the cup holder while the vehicle is moving

The cup holder cannot secure containers while the vehicle is moving.

If you use a cup holder while the vehicle is moving, the container may be flung around and liquids may be spilled. The vehicle occupants may come into contact with the liquid and if it is hot, they could be scalded. You could be distracted from traffic conditions and you may lose control of the vehicle.

- ▶ Only use the cup holder when the vehicle is stationary.
- ▶ Only use the cup holder for containers of the right size.
- ▶ Close the container, particularly if the liquid is hot.

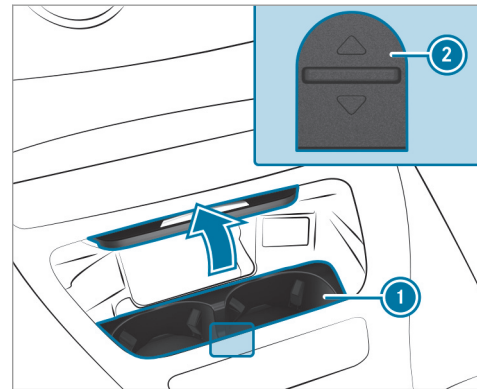

- ▶ **To remove:** slide catch ② forwards and pull out cup holder ①.
 - ▶ **To install:** insert cup holder ① and slide back catch ②.
- i** The cup holder rubber mat can be removed for cleaning, e.g. using clean, lukewarm water.

Opening or closing the cup holder in the rear armrest

! NOTE Damage to the rear armrest

When folded out, the rear armrest can be damaged by the weight of your body.

- ▶ Do not sit or support yourself on the rear armrest.

! NOTE Damage to the cup holder

When the rear armrest is folded back the cup holder could become damaged.

- ▶ Only fold the rear armrest back when the cup holder is closed.

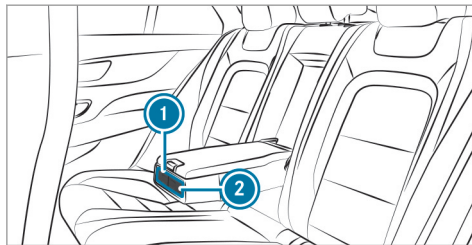

- ▶ **To open:** press cup holder ① or ②. Cup holder ① or ② extends automatically.
- ▶ **To close:** push cup holder ① or ② back until it engages.

Switching the cooling or heating function for the temperature-controlled cup holder on or off

When the heating function is used, the metal insert of the cup holder is heated. For this reason, you must not reach into the cup holder insert.

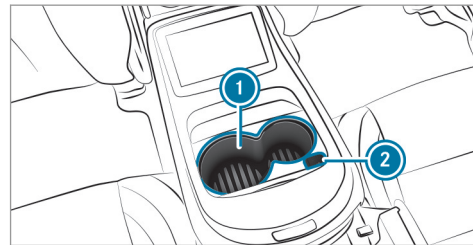

- ▶ **To switch on:** press button ② repeatedly until the blue (keep cool) or red (keep warm) indicator lamp on the button lights up.
 - ▶ **To switch off:** press button ② repeatedly until the indicator lamp on the button goes out.
- ⓘ Clean the removable rubber mat only with clear, lukewarm water, and clean cup holder ① only with a soft cloth.

Ashtray and cigarette lighter

Using the ashtray in the front center console

! **NOTE** Damage to the storage compartment under the ashtray

The storage compartment under the ashtray is not heat resistant and could be damaged if you rest a lit cigarette on it.

▶ Make sure that the ashtray is fully engaged.

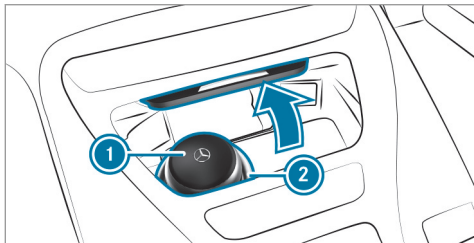

▶ **To open:** push up cover ② of the ashtray on its right or left side.

▶ **To remove the insert:** press insert ① upwards slightly and pull it out upwards.

▶ **To re-install the insert:** press insert ① into the holder until it engages.

Using the rear passenger compartment ashtray

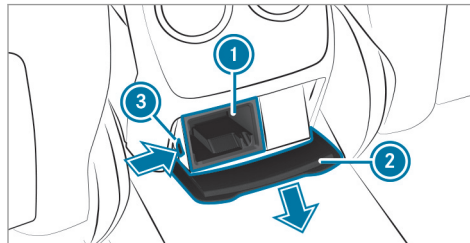

▶ **To open:** pull cover ② out by its top handle edge.

▶ **To remove the insert:** push ribbing ③ from the left side and pull insert ① upwards and out.

▶ **To install the insert:** install insert ① from above and press down on the holder until it engages.

Using the cigarette lighter in the front center console

! **WARNING** - Risk of fire and injury from hot cigarette lighter

You can burn yourself if you touch the hot heating element or the socket of the cigarette lighter.

In addition, flammable materials may ignite if:

- you drop the hot cigarette lighter
- a child holds the hot cigarette lighter to objects, for example

▶ Always hold the cigarette lighter by the knob.

▶ Always make sure that the cigarette lighter is out of reach of children.

- ▶ Never leave children unattended in the vehicle.

Requirements:

- The ignition is switched on.

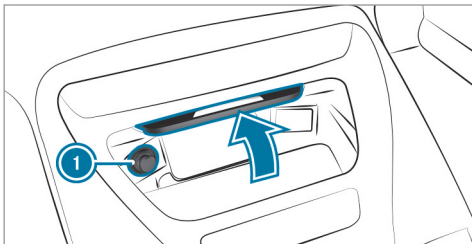

- ▶ Press in cigarette lighter ①. The cigarette lighter will pop out automatically when the heating element is red-hot.

Sockets

Using the 12 V socket in the front center console

Requirements:

- Only devices with up to a maximum of 180 watts (15 A) are permissible.

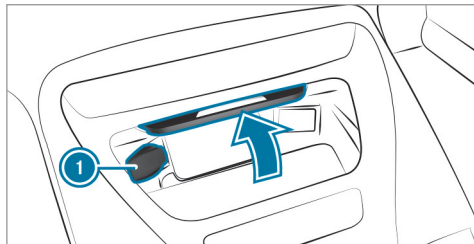

- ▶ Lift up socket cap ①.
- ▶ Insert the plug of the device.

If you have connected a device to the 12 V socket, leave the cover of the stowage compartment open.

Using the 12 V socket in the rear passenger compartment

Requirements:

- Only connect devices up to a maximum of 180 watts (15 A).

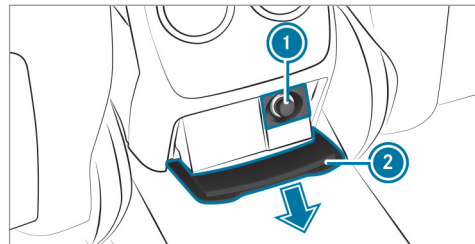

- ▶ Pull cover ② out by its top handle edge.
- ▶ Lift up the cap on socket ①.

Vehicles with luxury individual rear seats: the 12 V socket is in the stowage compartment in the center console.

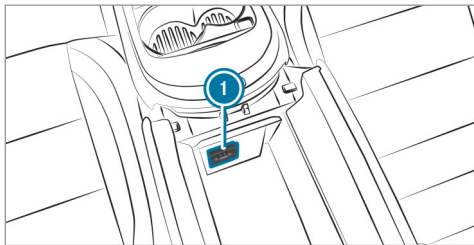

- ▶ Lift up the cap on socket ①.

Using the 115 V socket in the rear passenger compartment

⚠ DANGER Risk of fatal injury due to damaged connecting cables or sockets

If a suitable device is connected, the 115 V socket will be carrying a high voltage. If the connecting cable or the 115 V socket is pulled out of the trim or is damaged or wet, you could receive an electric shock.

- ▶ Only use dry and damage-free connecting cables.
- ▶ When the ignition is switched off, ensure that the 115 V socket is dry.
- ▶ If the 115 V socket is damaged or gets pulled out of the paneling, immediately have the socket checked or replaced at a qualified specialized workshop.
- ▶ Never plug the connecting cable into a 115 V socket that is damaged or has been pulled out of the trim.

⚠ DANGER Risk of fatal injury due to incorrect handling of the socket

You could receive an electric shock:

- if you reach into the socket.
 - if you insert unsuitable devices or objects into the socket.
- ▶ Do not reach into the socket.
 - ▶ Only connect suitable devices to the socket.

Requirements:

- Devices must be equipped with a suitable plug which conforms to the standards specific to the country you are in.
- Only devices up to a maximum of 150 W are permitted.
- Multiple sockets are not permitted.

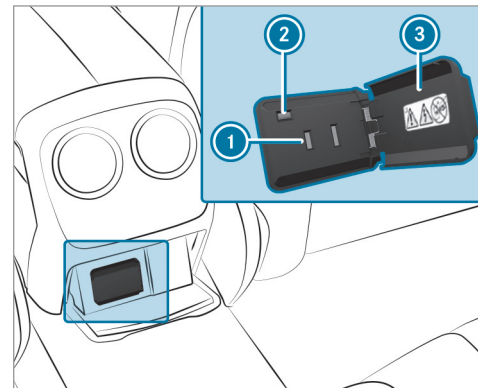

- ▶ Open flap ③.

- ▶ Insert the plug of the device into 115 V socket ①.
When the on-board electrical system voltage is sufficient, indicator lamp ② lights up.

Vehicles with luxury individual rear seats:
the 115 V socket is in the stowage compartment in the center console.

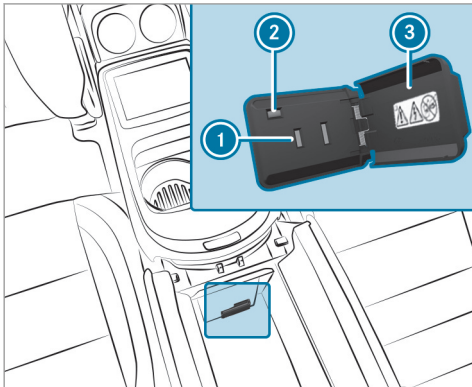

- ▶ Open flap ③.

- ▶ Insert the plug of the device into 115 V socket ①.
When the on-board electrical system voltage is sufficient, indicator lamp ② lights up.

Using the 12 V socket in the cargo compartment

Requirements:

- Only connect devices up to a maximum of 180 watts (15 A).

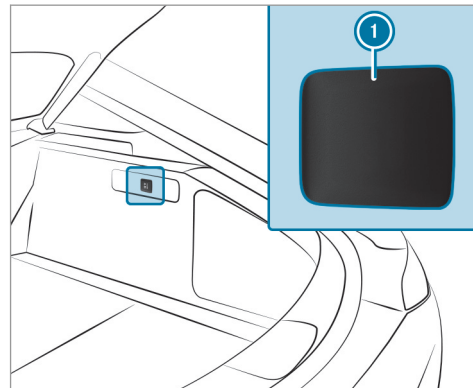

- ▶ Lift up cap ① of the socket and insert the plug of the device.

USB port in the rear passenger compartment

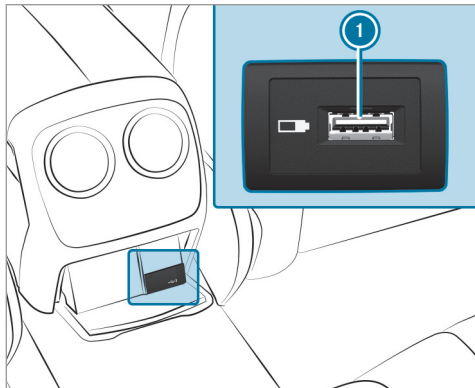

If the ignition is switched on you can charge a USB device, e.g. a mobile phone, at USB port ① using a suitable charging cable.

Vehicles with luxury individual rear seats: the USB port is in the stowage compartment in the center console.

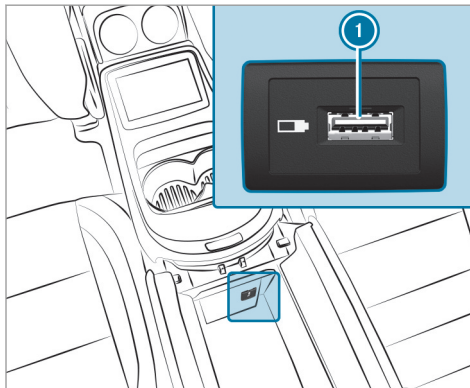

If the ignition is switched on you can charge a USB device, e.g. a mobile phone, at USB port ① using a suitable charging cable.

Wireless charging of the mobile phone and connection with the exterior antenna

Notes on wirelessly charging the mobile phone

⚠ WARNING Risk of injury due to objects being stowed incorrectly

If objects in the vehicle interior are stowed incorrectly, they can slide or be thrown around and hit vehicle occupants. In addition, cup holders, open stowage spaces and mobile phone receptacles cannot always retain all objects they contain.

There is a risk of injury, particularly in the event of sudden braking or a sudden change in direction.

- ▶ Always stow objects so that they cannot be thrown around in such situations.
- ▶ Always make sure that objects do not protrude from stowage spaces, luggage nets or stowage nets.

- ▶ Close the lockable stowage spaces before starting a journey.
- ▶ Always stow and secure heavy, hard, pointed, sharp-edged, fragile or bulky objects in the trunk/load compartment.

Observe the notes on loading the vehicle.

⚠ WARNING Risk of fire from placing objects in the mobile phone stowage compartment

If you place objects in the mobile phone stowage compartment, they may heat up excessively and even catch fire.

- ▶ Do not place additional objects, especially those made of metal, in the mobile phone stowage compartment.

! NOTE Damage to objects caused by placing them in the mobile phone stowage compartment

If objects are placed in the mobile phone stowage compartment, they may be damaged by electromagnetic fields.

- ▶ Do not place credit cards, storage media or other objects sensitive to electromagnetic fields in the mobile phone stowage compartment.

! NOTE Damage to the mobile phone stowage compartment caused by liquids

If liquids enter the mobile phone stowage compartment, the compartment may be damaged.

- ▶ Ensure that no liquids enter the mobile phone stowage compartment.

- Depending on the vehicle equipment, the mobile phone is connected to the vehicle's exterior antenna via the charging module.

- The charging function and wireless connection of the mobile phone to the vehicle's exterior antenna are only available if the ignition is switched on.
- Small mobile phones may not be able to be charged in every position of the mobile phone stowage compartment.
- Large mobile phones which do not rest flat in the mobile phone stowage compartment may not be able to be charged or connected with the vehicle's exterior antenna.
- The mobile phone may heat up during the charging process. This can also depend on the applications (apps) currently running.
- To ensure more efficient charging and connection with the vehicle's exterior antenna, remove the protective cover from the mobile phone. Protective covers which are designed for wireless charging are excluded.

Wireless charging of the mobile phone

Requirements:

- The mobile phone must be suitable for wireless charging (Qi-compatible mobile phone). You can find a list of Qi-compatible mobile phones at:
<http://www.mercedes-benz.com/connect>

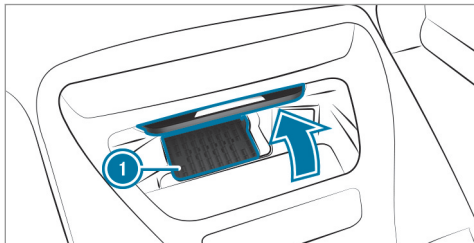

- Place the mobile phone as close to the center of mat ① as possible with the display facing upwards. When the charging symbol is shown in the multimedia system, the mobile phone is being charged.

Malfunctions during the charging process are shown in the multimedia system display.

- ① The mat can be removed for cleaning, e.g. using clean, lukewarm water.

Vehicles with luxury individual rear seats

You can charge a mobile phone in the stowage compartment in the center console.

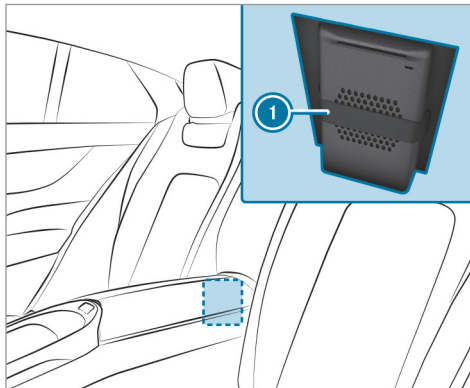

- ▶ Fasten the mobile phone behind rubber strap ①.

Installing/removing the floor mats

⚠ WARNING Risk of accident due to objects in the driver's footwell

Objects in the driver's footwell may impede pedal travel or block a depressed pedal. This jeopardizes the operating and road safety of the vehicle.

- ▶ Stow all objects in the vehicle securely so that they cannot get into the driver's footwell.
- ▶ Always install the floor mats securely and as prescribed in order to ensure that there is always sufficient room for the pedals.
- ▶ Do not use loose floor mats and do not place floor mats on top of one another.

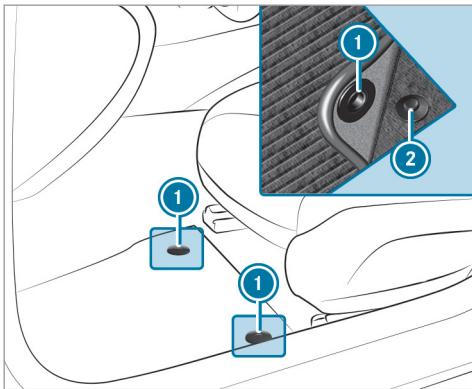

- ▶ **To install:** slide the seat backwards and lay the floor mat in the footwell.
- ▶ Press studs ① onto holders ②.
- ▶ Adjust the corresponding seat.
- ▶ **To remove:** pull the floor mat off holders ②.
- ▶ Remove the floor mat.

Exterior lighting

Information about lighting systems and your responsibility

The various lighting systems of the vehicle are only aids. The driver of the vehicle is responsible for correct vehicle illumination in accordance with the prevailing light and visibility conditions, legal requirements and traffic situation.

Light switch

Operating the light switch

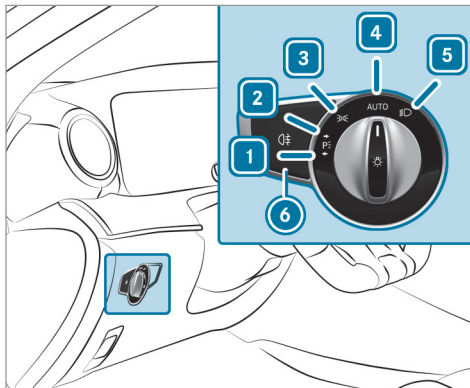

- 1 Left standing light
- 2 Right standing light
- 3 Parking lights and license plate lamp
- 4 **AUTO** Automatic driving lights (preferred light switch position)

- 5 Low beam/high beam
- 6 Switches the rear fog lights on or off

When low beam is activated, the indicator lamp for the parking lights is deactivated and replaced by the low beam indicator lamp.

▶ Always park your vehicle safely and in a well-lit area, in accordance with the relevant legal stipulations.

! **NOTE** Battery discharging by operating the standing lights

Operating the standing lights over a period of hours puts a strain on the battery.

▶ Where possible, switch on the right or left parking light.

In the case of severe battery discharging, the standing lights or parking lights are automatically switched off to facilitate the next engine start.

The exterior lighting (except standing and parking lights) switches off automatically when the driver's door is opened.

- Observe the notes on surround lighting (→ page 119).

Automatic driving lights function

The parking lights, low beam and daytime running lamps are switched on automatically depending on the ignition status and the ambient light.

⚠ WARNING Risk of accident when the low beam is switched off in poor visibility

When the light switch is set to **AUTO**, the low beam may not be switched on automatically if there is fog, snow or other causes of poor visibility such as spray.

- ▶ In such cases, turn the light switch to .

The automatic driving lights are only an aid. You are responsible for vehicle lighting.

Switching the rear fog lights on or off

Requirements:

- The light switch is in the  or **AUTO** position.

- ▶ Press the  button.

Please observe the country-specific laws on the use of rear fog lamps.



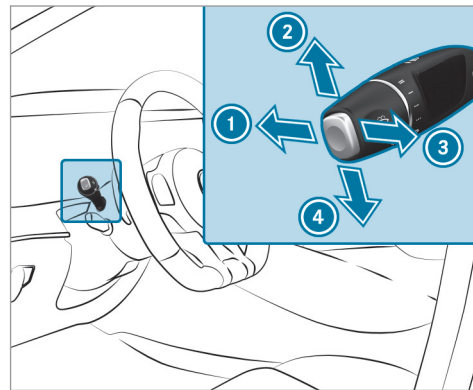

Operating the combination switch for the lights



- ① High-beam headlamps
- ② Turn signal, right
- ③ High-beam flasher
- ④ Turn signal, left

- ▶ Use the combination switch to activate the desired function.



High-beam headlamps



- ▶ **To switch on:** turn the light switch to the  or **AUTO** position.
- ▶ Press the combination switch beyond the point of resistance in the direction of arrow . When the high beam is activated, the indicator lamp for low beam  is deactivated and replaced by the indicator lamp for the high beam .
- ▶ **To switch off:** move the combination switch back to its starting position.

High-beam flasher

- ▶ Pull the combination switch in the direction of arrow .

Turn signals

- ▶ **To indicate briefly:** press the combination switch briefly to the point of resistance in the direction of arrow  or . The corresponding indicator will flash three times.

- ▶ **To indicate permanently:** press the combination switch beyond the point of resistance in the direction of arrow  or .

Vehicles with Active Lane Change Assist

The Active Lane Change Assist can:

- lengthen turn signal operation for the duration of the lane change if the driver has activated the indicator.
- automatically activate the turn signal indicator if the driver indicated to turn in that direction immediately beforehand but a lane change was not immediately possible.

Activating/deactivating the hazard warning lights

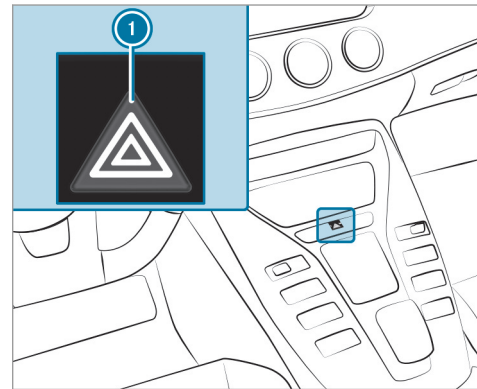

- ▶ Press button .

Cornering light

Cornering light function

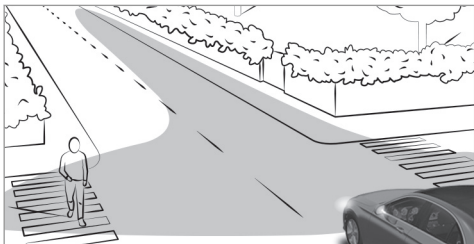

The cornering light improves the illumination of the roadway over a wide angle in the turning direction, enabling better visibility on tight bends, for example. It can be activated only when the low beam is switched on.

The function is active:

- At speeds below 25 mph (40 km/h) when the turn signal light is switched on or the steering wheel is turned

- At speeds between 25 mph (40 km/h) and 45 mph (70 km/h) when the steering wheel is turned

Traffic circle and intersection function: the cornering light is activated on both sides through an evaluation of the current GPS position of the vehicle. It remains active until after the vehicle has left the traffic circle or the intersection.

Adaptive Highbeam Assist

Adaptive Highbeam Assist function

⚠ WARNING Risk of accident despite Adaptive Highbeam Assist

Adaptive Highbeam Assist does not recognize the following road users:

- Road users without lights, e.g. pedestrians
- Road users with poor lighting, e.g. cyclists
- Road users whose lighting is obstructed, e.g. by a barrier

On very rare occasions, Adaptive Highbeam Assist may fail to recognize other road users with their own lighting, or may recognize them too late.

In these or similar situations, the automatic high beam is not deactivated or is activated despite the presence of other road users.

▶ Always observe the traffic carefully and switch off the high beam in good time.

Adaptive Highbeam Assist cannot take into account road, weather or traffic conditions.

Detection may be restricted:

- in poor visibility, e.g. fog, heavy rain or snow
- if there is dirt on the sensors or the sensors are obscured

Adaptive Highbeam Assist is only an aid. You are responsible for adjusting the vehicle's lighting to the prevailing light, visibility and traffic conditions.

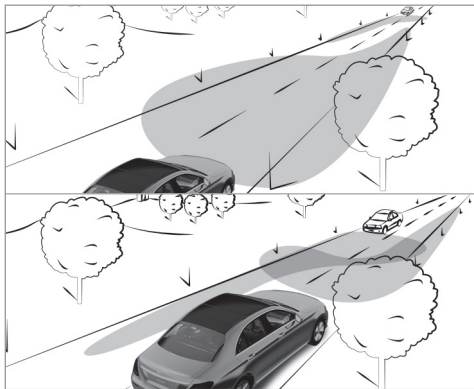

Adaptive Highbeam Assist switches automatically between:

- Low-beam headlamps
- High-beam headlamps

At speeds above 19 mph (30 km/h):

- If no other road users are detected, the high beam will be switched on automatically.

The high beam switches off automatically:

- At speeds below 16 mph (25 km/h).
- If other road users are detected.
- If street lighting is sufficient.

At speeds above approximately 31 mph (50 km/h):

- The headlamp range of the low beam is regulated automatically based on the distance to other road users.

The system's optical sensor is located behind the windshield near the overhead control panel.

Switching Adaptive Highbeam Assist on/off

- ▶ **To switch on:** turn the light switch to the **AUTO** position.
- ▶ Switch on the high beam using the combination switch. When the high beam is switched on automatically in the dark, the  indicator lamp on the multifunction display comes on.
- ▶ **To switch off:** switch off the high beam using the combination switch.

Switching the daytime running lamps on/off

Multimedia system:

 Vehicle ▶  Light Settings ▶ Day-time Run. Lights

▶ Activate or deactivate the function.

Setting the exterior lighting switch-off delay time

Multimedia system:

 Vehicle ▶  Light Settings ▶ Ext. Light Switch Off

▶ Set the switch-off delay time.

Setting the surround lighting

Multimedia system:

 Vehicle ▶  Light Settings ▶ Locator Lighting

▶ Activate or deactivate the function.

If the surround lighting is switched on, the exterior lighting remains lit for 40 seconds after the

vehicle is unlocked. When you start the vehicle, the surround lighting is deactivated and the automatic driving lights are activated.

Interior lighting

Adjusting the interior lighting

Front overhead control panel

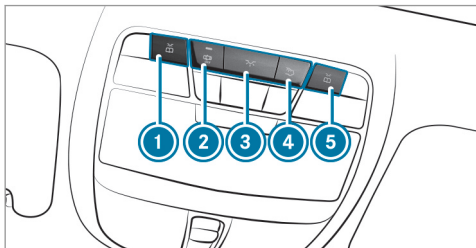

- ① Front left reading lamp
- ② Automatic interior lighting control
- ③ Front interior lighting
- ④ Rear interior lighting
- ⑤ Front right reading lamp

- ▶ **To switch on or off:** press button ① - ⑤ accordingly.

Control panel in the rear passenger compartment

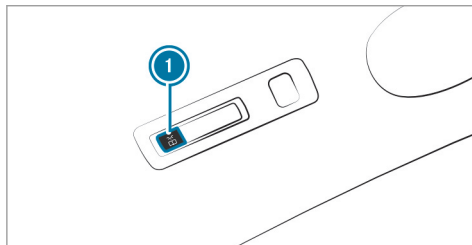

- ① Rear reading lamp

- ▶ **To switch on or off:** press button ①.

Adjusting the ambient lighting

Multimedia system:

➔ Vehicle ➔ Light Settings ➔ Ambient Light

Setting the color

- ▶ Select **Color**.
- ▶ Set a color.

Adjusting the brightness

- ▶ Select **Brightness**.
- ▶ Set a brightness value.

Activating the brightness for zones

- ▶ Select **Brightness Zones**.
- ▶ Activate or deactivate the function. The **Display**, **Front** and **Rear** zones can be set separately.

Activating multi-color lighting

- ▶ Select **Multi-color**.
- ▶ Activate or deactivate the function. There are ten preset color combinations available.

Activating multi-color animation

- ▶ Select **Multi-color Anim..**
- ▶ Activate or deactivate the function. The chosen color combination changes at predefined intervals.

Activating dependency on air conditioning settings

- ▶ Select **Climate.**
- ▶ Activate or deactivate the function. If changes are made to the temperature setting in the vehicle, the color of the ambient lighting changes briefly.

Activating welcome lighting

- ▶ Select **Welcome.**
- ▶ Activate or deactivate the function. When the vehicle is unlocked, a special interior lighting sequence runs.

Setting the interior lighting switch-off delay time

Multimedia system:

➔ **Vehicle** ➔  **Light Settings** ➔ **Int. Light Switch Off**

- ▶ Set the switch-off delay time.

Windshield wiper and windshield washer system

Switching the windshield wiper on/off

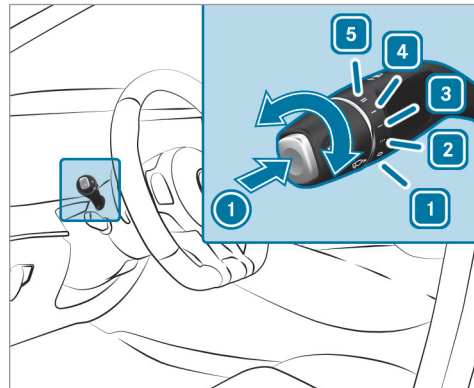



- 1** **0** Windshield wipers off
- 2** **...** Intermittent wiping, normal
- 3** **....** Intermittent wiping, frequent

4  Continuous wiping, slow

5  Continuous wiping, fast

▶ Turn the combination switch to the corresponding position 1 - 5.

▶ **Single wipe/washing:** push the button on the combination switch in the direction of arrow ①.

-  Single wipe
-  Wipes with washer fluid

Changing the windshield wiper blades

⚠ WARNING Risk of becoming trapped if the windshield wipers are switched on while wiper blades are being replaced

If the windshield wipers begin to move while you are changing the wiper blades, you can be trapped by the wiper arm.

- ▶ Always switch off the windshield wipers and the ignition before changing the wiper blades.

Moving the wiper arms to the change position

- ▶ Switch the ignition on and switch off again immediately.
- ▶ Within around 15 seconds, press the  button on the combination switch for approximately three seconds (→ page 121). The wiper arms will move into the change position.

Removing the wiper blades

- ▶ Fold the wiper arms away from the windshield.

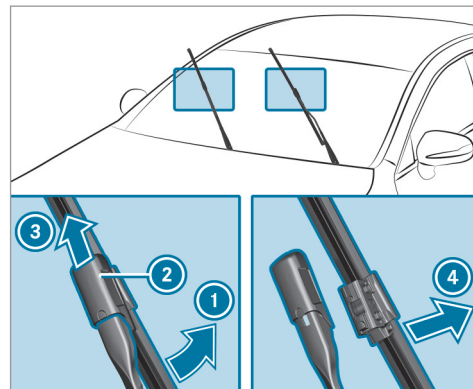

- ▶ Hold the wiper arm with one hand. With the other hand, turn the wiper blade in the direction of arrow ① away from the wiper arm as far as it will go.
- ▶ Slide catch ② in the direction of arrow ③ until it engages in the removal position.
- ▶ Remove the wiper blade from the wiper arm in the direction of arrow ④.

Installing the wiper blades

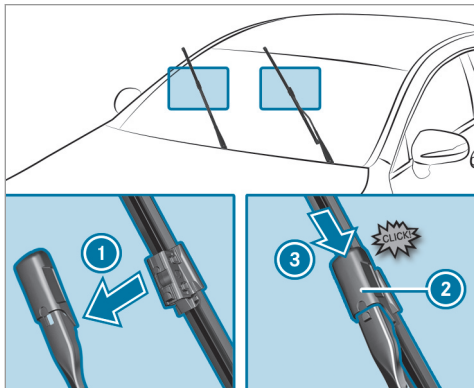

- ▶ Insert the new wiper blade into the wiper arm in the direction of arrow ①.
- ▶ Slide catch ② in the direction of arrow ③ until it engages in the locking position.
- ▶ Make sure that the wiper blade sits correctly.
- ▶ Fold the wiper arms back onto the windshield.

- ▶ Switch the ignition on.
- ▶ Press the  button on the combination switch (→ page 121). The wiper arms will move into the original position.

Maintenance display

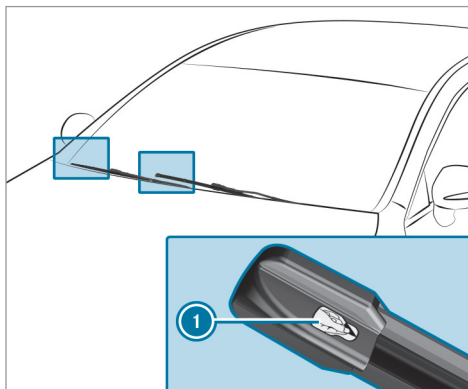

- ▶ Remove protective film ① from the maintenance display on the tip of the newly installed wiper blades.

If the color of the maintenance display changes from black to yellow, the wiper blades should be replaced.

- ① The duration until the color changes varies depending on the usage conditions.

Mirrors

Operating the outside mirrors

⚠ WARNING Risk of injury from adjusting the vehicle settings while the vehicle is in motion

You could lose control of the vehicle in the following situations:

- if you adjust the driver's seat, the head restraint, the steering wheel or the mirror while the vehicle is in motion
- if you fasten your seat belt while the vehicle is in motion

- ▶ Before starting the engine: adjust the driver's seat, the head restraint, the steering wheel or the mirror and fasten your seat belt.

⚠ WARNING Risk of accident due to misjudgment of distances when using the passenger mirror

The outside mirror on the front passenger side reflects objects on a smaller scale. The objects in view are in fact closer than they appear.

As a result, you may misjudge the distance between you and the road user driving behind you, for example, when changing lanes.

- ▶ Therefore, always look over your shoulder in order to ensure that you are aware of the actual distance between you and the road users driving behind you.

Folding the outside mirrors in/out

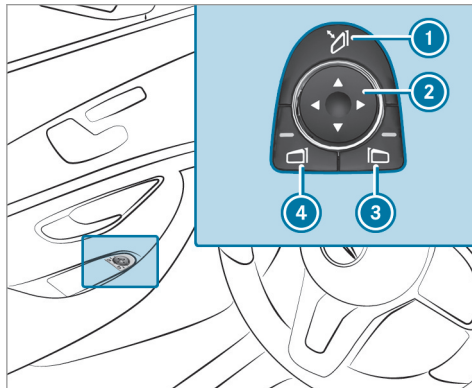

- ▶ Briefly press switch ①.

Resetting the outside mirrors

- ① If the battery has been disconnected or completely discharged, the outside mirrors must be reset. Only then will the automatic mirror folding function work properly.
- ▶ Briefly press switch ①.

Adjusting the outside mirrors

- ▶ Press buttons ③ or ④ to select the outside mirror to be adjusted.
- ▶ Press button ② to adjust the position of the mirror glass.

Engaging the outside mirrors

- ▶ Press and hold button ①. You will hear a click and the mirror will audibly engage in position. The outside mirror is set to the correct position.

Automatic anti-glare mirrors function

⚠ WARNING Risk of burns and poisoning due to the anti-glare mirror electrolyte

Electrolyte may escape if the glass in an automatic anti-glare mirror breaks.

The electrolyte is harmful and causes irritation. It must not come into contact with your skin, eyes, respiratory organs or clothing or be swallowed.

- ▶ If you come into contact with electrolyte, observe the following:
- Rinse the electrolyte from your skin and seek medical attention immediately.
 - If electrolyte comes into contact with your eyes, rinse them thoroughly with clean water and seek medical attention immediately.
 - If the electrolyte is swallowed, immediately rinse your mouth out thoroughly. Do not induce vomiting. Seek medical attention immediately.
 - Immediately change out of clothing which has come into contact with electrolyte.
 - If an allergic reaction occurs, seek medical attention immediately.

The inside rearview mirror and the outside mirror on the driver's side automatically go into anti-glare mode if light from a headlamp hits the sensor on the inside rearview mirror.

System limitations

The system does not go into anti-glare mode in the following situations:

- The engine is switched off
- Reverse gear is engaged
- The interior lighting is switched on

Function of the front-passenger outside mirror parking position

The parking position makes parking easier.

The front-passenger outside mirror tilts downwards and shows the rear wheel on the front-passenger side in the following situations:

- the parking position is stored (→ page 125)
- the passenger mirror is selected
- reverse gear is engaged

The front-passenger outside mirror moves back to its original position in the following situations:

- you shift the transmission to another transmission position
- at speeds greater than 9 mph (15 km/h)

- you press the button for the outside mirror on the driver's side

Storing the parking position of the front-passenger outside mirror using reverse gear

Storing

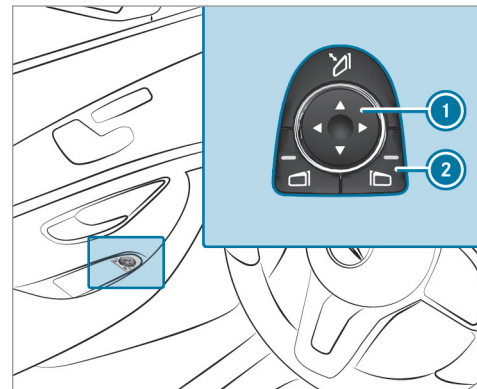

- ▶ Select the front-passenger outside mirror using button ②.
- ▶ Engage reverse gear.
- ▶ Move the front-passenger outside mirror into the desired parking position using button ①.

Calling up

- ▶ Select the front-passenger outside mirror using button ②.
- ▶ Engage reverse gear.
The front-passenger outside mirror will move to the stored parking position.

Activating/deactivating the automatic mirror folding function

Multimedia system:

↳ Vehicle ▶  Vehicle Settings ▶ Autom. Mirror Folding

- ▶ Activate or deactivate the function.

Operating the sun visors

Using the single sun visor

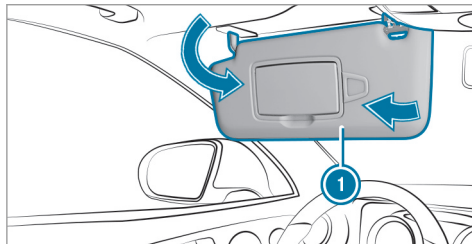

- ▶ **Glare from the front:** fold sun visor ① down.
- ▶ **Glare from the side:** swing sun visor ① to the side.

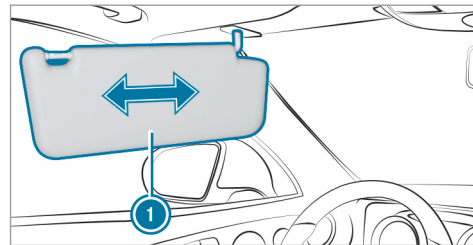

- ▶ Vehicles with an extendable sun visor: slide sun visor ① horizontally as required.

Infrared reflective windshield function

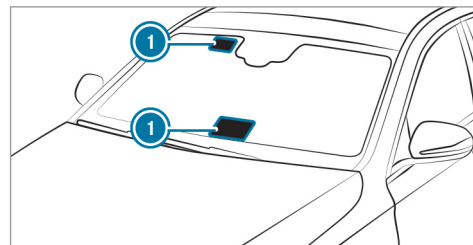

The infrared reflective windshield is coated and reduces the build-up of heat in the vehicle interior.

The coating shields the vehicle interior from radio waves up to the gigahertz range.

Radio-controlled equipment, such as toll systems, can only be mounted on areas of the windshield which are permeable to radio waves ① .

Areas permeable to radio waves ① are best visible from outside the vehicle when the windshield is illuminated using an external light source.

Overview of climate control systems

Notes on climate control

An interior air filter must always be used so that the air conditioning system, pollution level monitoring and the air filtering function work correctly. Make sure that the filter is installed correctly and the filter housing in the engine compartment is closed correctly using the cap and always tightly sealed when in operation. Use filters recommended and approved by Mercedes-Benz. Always have service work carried out at a qualified specialist workshop.

Overview of the control panel for dual-zone automatic climate control

The indicator lamps on the buttons indicate that the corresponding function is activated.

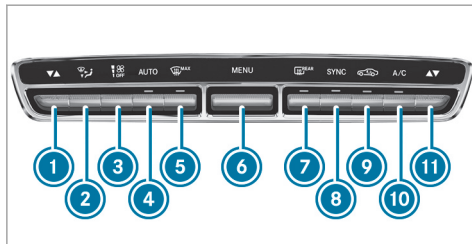

- ① Sets the temperature, left
- ② Sets the air distribution
- ③ Sets the airflow or switch off climate control
- ④ Sets climate control to automatic mode (→ page 130)
- ⑤ Defrosts the windshield
- ⑥ Calls up the air conditioning menu
- ⑦ Switches the rear window heater on/off
- ⑧ Activates or deactivates synchronization (→ page 130)
- ⑨ Switches air-recirculation mode on/off (→ page 131)

- ⑩ Switches the A/C function on/off (→ page 129)
- ⑪ Sets the temperature, right

Overview of the control panel for 3-zone automatic climate control

The indicator lamps on the buttons indicate that the corresponding function is activated.

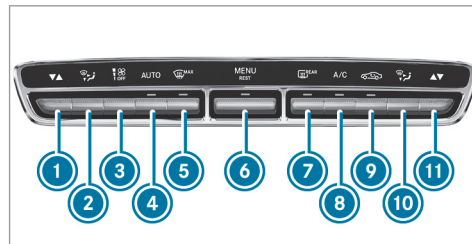

- ① Sets the temperature, left
- ② Sets the air distribution, left
- ③ Sets the airflow or switches off climate control

- ④ **AUTO** Sets climate control to automatic mode (→ page 130)
- ⑤ **MAX** Defrosts the windshield
- ⑥ **MENU REST** Calls up the air conditioning menu
Switches residual heat on/off (→ page 131)
- ⑦ **REAR** Switches the rear window heater on/off
- ⑧ **A/C** Switches the A/C function on/off (→ page 129)
- ⑨ **Recirculation** Switches air-recirculation mode on/off (→ page 131)
- ⑩ **Air distribution** Sets the air distribution, right
- ⑪ **Temperature** Sets the temperature, right

Rear operating unit

You can set the temperature for the entire rear passenger compartment using buttons ① or ③.

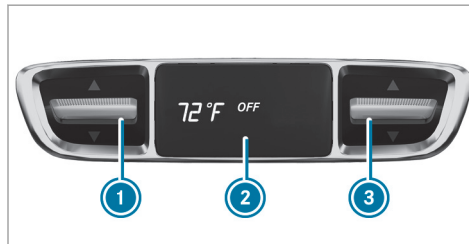

- ① Sets the temperature
- ② Display
- ③ Sets the temperature

Operating the climate control system

Switching climate control on/off

- ▶ **To switch on:** set the airflow to level 1 or higher using the **OFF** button.
- ▶ **To switch off:** set the airflow to level 0 using the **OFF** button.

- ⓘ If climate control is switched off, the windows may fog up more quickly. Switch off climate control only briefly.

Switching the A/C function on/off via the control panel

The A/C function heats, cools and dehumidifies the vehicle's interior air.

- ▶ Press the **A/C** button.

Switch off the A/C function only briefly otherwise the windows may fog up more quickly.

Condensation may drip from the underside of the vehicle when cooling mode is active. This is not a sign that there is a malfunction.

Activating/deactivating the A/C function via the multimedia system

Multimedia system:

- ▶ Vehicle ▶ **Climate Control** ▶ A/C



The A/C function heats, cools and dehumidifies the vehicle's interior air.

- ▶ Activate or deactivate the function.

Setting climate control to automatic mode

In automatic mode, the set temperature is controlled and maintained at a constant level by the air supply.

- ▶ Press the **AUTO** button.

- ▶ **To switch to manual mode:** press the  or  button.

Climate style

Climate style function

In automatic mode, you can select the following climate style settings for the driver's and front passenger areas:

- **FOCUS:** high airflow, slightly cooler setting
- **MEDIUM:** medium airflow, standard setting
- **DIFFUSE:** low airflow, slightly warmer and draft-free setting

Setting the climate style

Multimedia system:









↳ Vehicle ▶  Climate Control ▶ Climate Mode

- ▶ Select **FOCUS**, **MEDIUM** or **DIFFUSE**.

- ⓘ To feel the effect of the climate style, the **AUTO** function must be active (→ page 130).

Overview of the air distribution settings

The symbols on the display indicate which vents the airflow is being directed through:

-  defroster vents
-  center and side air vents
-  footwell vents
-  center, side and footwell vents
-  defroster and footwell vents
-  all vents
-  defroster, middle and side air vents
-  automatic air distribution

Activating/deactivating the climate control synchronization function via the control panel

The climate control can be operated centrally using the synchronization function. The temperature and air distribution setting for the driver side is adopted automatically for the front passenger side.

- ▶ Press the **SYNC** button.

The synchronization function is deactivated if the settings for one of the other climate zones are changed.

Activating or deactivating the climate control synchronization function using the multimedia system

Multimedia system:

↳ Vehicle ▶  Climate Control ▶ SYNC

The climate control can be controlled centrally using the synchronization function. The tempera-

ture setting is automatically adopted for all climate zones.

- ▶ Activate or deactivate the function.

Removing condensation from the windows

Windows fogged up on the inside

- ▶ Press the **AUTO** button.
- ▶ If the windows continue to fog up: press the  button.

Windows fogged up on the outside

- ▶ Switch on the windshield wipers.
- ▶ Press the **AUTO** button.

Switching air-recirculation mode on/off

- ▶ Press the  button.
The interior air will be recirculated.

Air-recirculation mode automatically switches to fresh air mode after some time.

- ⓘ If air-recirculation mode is switched on, the windows may fog up more quickly. Switch on air-recirculation mode only briefly.

Switching the residual heat on or off

Requirements:

- The vehicle is parked.

It is possible to make use of the residual heat from the engine to continue heating or ventilating the front compartment of the vehicle for approximately 30 minutes.

- ▶ **To switch on:** press the  button.

Residual heat is switched off automatically.

Activating/deactivating ionization

Multimedia system:

➔ Vehicle ➔  Climate Control ➔ Ionization

Ionization cleans and refreshes the interior air of the vehicle. The ionization of the interior air is odorless.

- ▶ Activate or deactivate the function.

Fragrance system

Setting the fragrance system

Requirements:

- Automatic climate control is activated.
- The glove box is closed.

Multimedia system:

➔ Vehicle ➔  Climate Control ➔ Air Freshener

The fragrance system distributes a pleasant fragrance throughout the vehicle interior from a flacon located in the glove box.

- ▶ **To set the intensity:** select **High**, **Medium**, **Low** or **Off**.

Inserting or removing the flacon of the fragrance system

⚠ WARNING Risk of injury from liquid perfume

If children open the flacon, they could drink the liquid perfume or it could come into contact with their eyes.

- ▶ Do not leave children unattended in the vehicle.
- ▶ Consult a doctor immediately if liquid perfume has been drunk.
- ▶ If liquid perfume comes into contact with your eyes or skin, rinse your eyes with clean water.
- ▶ If symptoms continue, consult a doctor.



ENVIRONMENTAL NOTE Environmental damage due to improper disposal of full flacons



Full flacons must not be disposed of with household waste.



Full flacons must be taken to a harmful substance collection point.

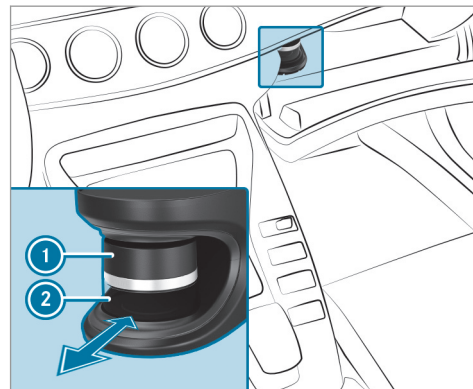

- ▶ **To insert:** slide flacon ② into the holder as far as it will go.
- ▶ **To remove:** pull out flacon ②.

If you do not use genuine Mercedes-Benz interior perfumes, observe the manufacturers' safety notices on the perfume packaging.

Dispose of the genuine Mercedes-Benz interior perfume flacon when it is empty and do not refill it.

Refillable flacon

- ▶ Unscrew cap ① of empty flacon ②.
- ▶ Fill flacon ② with a maximum of 0.5 fl. oz. (15 ml).
- ▶ Screw cap ① back onto flacon ②.

Always refill the empty refillable flacon with the same perfume. Observe the separate information sheet attached to the flacon.

Information on the windshield heater

The windshield heater is switched on automatically if the  button is activated.

After the vehicle is started, the windshield heater is switched on automatically as required.

Air vents

Adjusting the front air vents

⚠ WARNING - Danger of burns or frostbite due to being too close to the air vents

Very hot or very cold air can flow from the air vents.

This could result in burns or frostbite in the immediate vicinity of the air vents.

- ▶ Make sure that all vehicle occupants always maintain a sufficient distance to the air vents.
- ▶ If necessary, direct the airflow to another area of the vehicle interior.

To guarantee the flow of fresh air through the air vents into the vehicle interior, comply with the following:

- Always keep the vents and the ventilation grille in the vehicle interior free.
- Keep the air inlet free of deposits (→ page 356).

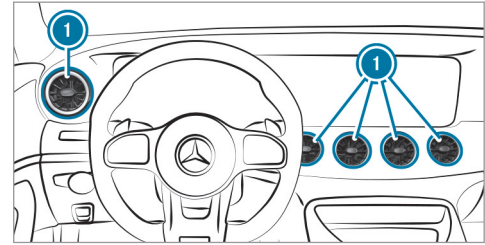

- ▶ **To open or close:** turn the center of air vent ① to the left or right as far as it will go.
- ▶ **To adjust the air direction:** hold air vent ① in the center and move it up or down or to the left or right.

Adjusting the rear air vents

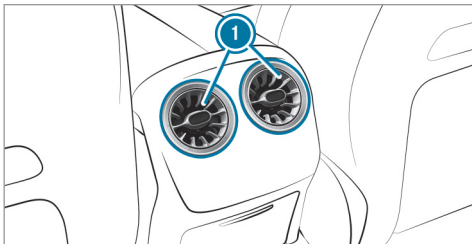

- ▶ **To open or close:** hold rear air vent ① in the center and turn it left (open) or right (closed) as far as it will go.
- ▶ **To adjust the air direction:** hold rear air vent ① in the center and move it up or down or to the left or right.

Opening or closing the air vent in the glove box

! **NOTE** Damage to temperature-sensitive objects in the glove box

Temperature-sensitive objects stored in the glove box may be damaged by the air vent located inside it.

- ▶ Close the air vent when you heat the vehicle.
- ▶ At high outside temperatures, open the air vent and switch on the A/C function.

The automatic climate control must be switched on to cool the glove box.

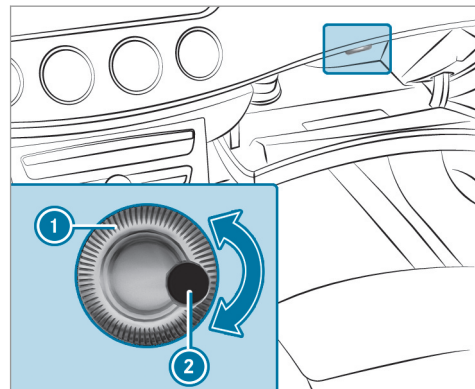

- ① Air vent controller
- ② Air vent

- ▶ **To open or close:** turn controller ① to the left or right.

Driving

Switching the power supply or ignition on without starting the engine

⚠ WARNING Risk of accident and injury due to children left unattended in the vehicle

If children are left unattended in the vehicle, they could:

- open doors, thereby endangering other persons or road users.
- get out of the vehicle and be hit by oncoming traffic.
- operate vehicle equipment and become trapped, for example.

In addition, children could also set the vehicle in motion, for example, by:

- releasing the parking brake.
- shifting the automatic transmission out of park position **P**.
- starting the engine

- ▶ Never leave children and animals unattended in the vehicle.
- ▶ When leaving the vehicle, always take the SmartKey with you and lock the vehicle.
- ▶ Keep the SmartKey out of the reach of children.

⚠ DANGER Risk of fatal injuries due to exhaust gases

Combustion engines emit poisonous exhaust gases such as carbon monoxide. Inhaling these exhaust gases is hazardous to health and can lead to poisoning.

- ▶ Never leave the engine running in an enclosed space without sufficient ventilation.

⚠ WARNING Risk of fire caused by flammable material on the exhaust system

Flammable materials brought in by either animals or environmental influences may ignite

if they come into contact with hot parts of the engine or exhaust system.

- ▶ Therefore, check regularly that there are no flammable materials in the engine compartment or on the exhaust system.

Requirements:

- The SmartKey is in the vehicle and is recognized.
- The brake pedal is not depressed.

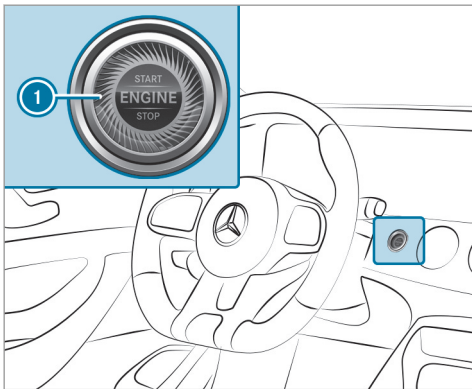

- ▶ **To switch on the power supply:** press button ① once. You can activate the windshield wipers, for example.

The power supply is switched off again if the following conditions are met:

- You open the driver's door.
- You press button ① twice.

- ▶ **To switch on the ignition:** press button ① twice. The indicator lamps in the instrument cluster light up.

The ignition is switched off again if one of the following conditions is met:

- You do not start the vehicle within 15 minutes and the transmission is in position **P** or the electric parking brake is applied.
- You press button ① once.

Starting the vehicle

Starting the vehicle with the start/stop button

Requirements:

- The SmartKey is in the vehicle and is recognized.
- ▶ Shift the transmission to position **P** or **N**.
- ▶ Depress the brake pedal and press button ① once.

- ▶ If the vehicle does not start: switch off non-essential consumers and press button ① once.
- ▶ If the vehicle still does not start and the [Place the Key in the Marked Space See Operator's Manual](#) display message also appears in the multifunction display: start the vehicle in emergency operation mode.

You can switch off the engine while driving by pressing button ① for about three seconds or by pressing button ① three times within a second. Be sure to observe the safety notes under "Driving tips".

Function of Emotion Start

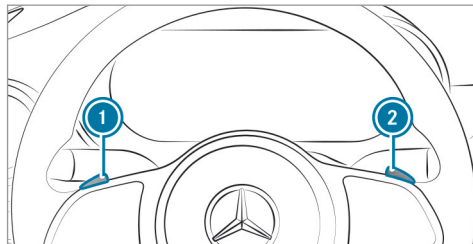

- ▶ Start the vehicle with the start/stop button (→ page 136) and simultaneously pull one of the steering wheel paddle shifters ① or ②.
 - The idle speed is increased briefly when starting the engine.
 - The exhaust gas flaps are opened (sporty characteristic) (→ page 146).

Starting the vehicle in emergency operation mode

If the vehicle does not start and the [Place the Key in the Marked Space See Operator's Manual](#) message appears in the multifunction display, you can start the vehicle in emergency operation mode.

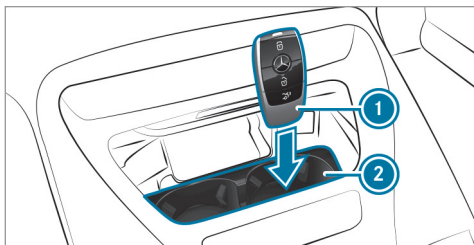

- ▶ Make sure that marked space ② is empty.
- ▶ Remove SmartKey ① from the key ring.
- ▶ Place SmartKey ① in marked space ②. The vehicle will start after a short time.

If you remove SmartKey ① from marked space ② the engine continues running. For further vehicle starts however, SmartKey ① must be located in marked space ② during the entire journey.

- ▶ Have the SmartKey ① checked at a qualified specialist workshop.

If the vehicle does not start:

- ▶ Place SmartKey ① in marked space ② and leave it there.
 - ▶ Depress the brake pedal and start the vehicle using the start/stop button.
- ⓘ You can also switch on the power supply or the ignition with the start/stop button.

Starting the vehicle via Remote Online services

Cooling or heating the vehicle interior before commencing your journey

ⓘ This function is not available in all countries. If you start the vehicle via your smartphone, the previously selected air conditioning adjustment is active.

Ensure the following before starting the engine:

- The legal stipulations in the area where your vehicle is parked allow engine starting via smartphone.
- It is safe to start and run the engine where your vehicle is parked.
- The fuel tank is sufficiently filled.
- The starter battery is sufficiently charged.

Charging the battery before commencing your journey

- ⓘ This function is not available in all countries.
- If the vehicle battery is discharged, you receive a message on your smartphone.

- You can then start the vehicle with the smartphone to charge the battery.
- The vehicle is automatically switched off after ten minutes.

Ensure the following before starting the engine:

- The legal stipulations in the area where your vehicle is parked allow engine starting via smartphone.
- It is safe to start and run the engine where your vehicle is parked.
- The fuel tank is sufficiently filled.

Starting the vehicle

⚠ WARNING Risk of crushing or entrapment due to unintentional starting of the engine

Limbs could be crushed or trapped if the engine is started unintentionally during service or maintenance work.

- ▶ Always secure the engine against unintentional starting before carrying out maintenance or repair work.

Requirements:

- Park position **P** is selected.
- The anti-theft alarm system is not activated.
- The panic alarm is not activated.
- The hazard warning lights are switched off.
- The hood is closed.
- The doors are closed and locked.
- The windows and sliding sunroof are closed.
- ▶ Start the vehicle using the smartphone:
 - After every vehicle start, the engine runs for ten minutes.
- You can carry out a maximum of two consecutive starting attempts. The vehicle must be started once with the SmartKey before trying to start the vehicle again with the smartphone.
- You can stop the vehicle again at any time.
- Further information can be found in the smartphone app.

Securing the engine against starting before carrying out maintenance or repair work:

- ▶ Switch on the hazard warning lights.
- or
- ▶ Unlock the doors.
- or
- ▶ Open a side window or the sliding sunroof.

Breaking-in notes

To preserve the engine during the first 1,000 miles (1,500 km):

- drive at varying road speeds and engine speeds.
- do not drive faster than 85 mph (140 km/h).
- only briefly allow the engine to reach a maximum engine speed of 4,500 rpm (4,500 rpm).
- drive the vehicle in drive program **C**.
- change gear before the tachometer needle is $\frac{2}{3}$ of the way to the red area of the tachometer.

- do not shift down a gear manually in order to brake.
- avoid overstraining the vehicle, e.g. driving at full throttle.
- do not depress the accelerator pedal past the pressure point (kickdown).
- only increase the engine speed gradually and accelerate the vehicle to full speed after 1,000 miles (1,500 km).

This also applies when the engine or parts of the drivetrain have been replaced.

Please also observe the following breaking-in notes:

- In certain driving and driving safety systems, the sensors adjust automatically while a certain distance is being driven after the vehicle has been delivered or after repairs. Full system effectiveness is not reached until the end of this teach-in process.
- Brakepads, brake discs and tires that are either new or have been replaced only achieve optimum braking effect and grip after several hundred kilometers of driving. Com-

pensate for the reduced braking effect by applying greater force to the brake pedal.

Notes on the locking differential

After a breaking-in period of 2000 miles (3000 km) the oil on the locking differential should be changed in a qualified specialist workshop. This oil change prolongs the service life of the locking differential.

Notes on driving

⚠ WARNING Risk of accident due to objects in the driver's footwell

Objects in the driver's footwell may impede pedal travel or block a depressed pedal.

This jeopardizes the operating and road safety of the vehicle.

- ▶ Stow all objects in the vehicle securely so that they cannot get into the driver's footwell.
- ▶ Always install the floor mats securely and as prescribed in order to ensure

that there is always sufficient room for the pedals.

- ▶ Do not use loose floor mats and do not place floor mats on top of one another.

⚠ WARNING Risk of accident due to unsuitable footwear

Operation of the pedals may be restricted due to unsuitable footwear such as:

- Shoes with platform soles
- Shoes with high heels
- Slippers

- ▶ When driving always wear suitable shoes in order to be able to operate the pedals safely.

⚠ WARNING Risk of accident when switching off the ignition when driving

If you switch off the ignition while driving, safety functions are restricted or no longer available. This may affect the power steering

system and the brake force boosting, for example.

You will then need to use considerably more force to steer and brake.

- ▶ Do not switch off the ignition while driving.

⚠ DANGER Risk of fatal injuries due to exhaust gases

Combustion engines emit poisonous exhaust gases such as carbon monoxide. Inhaling these exhaust gases is hazardous to health and can lead to poisoning.

- ▶ Never leave the engine running in an enclosed space without sufficient ventilation.

⚠ WARNING Risk of skidding and of an accident due to shifting down on slippery road surfaces

If you shift down on slippery road surfaces to increase the engine braking effect, the drive wheels may lose traction.

- ▶ Do not shift down on slippery road surfaces to increase the engine braking effect.

⚠ DANGER Risk of fatal injury due to poisonous exhaust gases

If the tailpipe is blocked or sufficient ventilation is not possible, poisonous exhaust gases such as carbon monoxide may enter the vehicle. This is the case if the vehicle gets stuck in snow, for example.

- ▶ Keep the tailpipe and the area around the vehicle free from snow when the engine or the stationary heater are running.
- ▶ Open a window on the windward side of the vehicle to ensure an adequate supply of fresh air.

⚠ WARNING Risk of accident and injury due to being under the influence of alcohol and drugs while driving

Driving when under the influence of alcohol and/or drugs is an extremely dangerous combination. Even small quantities of alcohol or drugs may affect your reflexes, perception and judgment.

The probability of a serious or even fatal accident greatly increases if you drive when under the influence of alcohol or drugs.

- ▶ Do not drink alcohol or take drugs while driving, and do not allow anyone to drive who has been drinking alcohol or taking drugs.

⚠ WARNING Risk of accident due to the brake system overheating

If you leave your foot on the brake pedal when driving, the brake system may overheat.

This increases the braking distance and the brake system may even fail.

- ▶ Never use the brake pedal as a footrest.
- ▶ Do not depress the brake pedal and the accelerator pedal at the same time while driving.

! **NOTE** Wearing out the brake linings by continuously depressing the brake pedal

- ▶ Do not depress the brake pedal continuously whilst driving.
- ▶ To use the braking effect of the engine, shift to a lower gear in good time.

! **NOTE** Damage to the drivetrain and engine when pulling away

- ▶ Do not warm up the engine while the vehicle is stationary. Pull away immediately.
- ▶ Avoid high engine speeds and driving at full throttle until the engine has reached its operating temperature.

! **NOTE** Damage to the catalytic converter due to non-combusted fuel

The engine is not running smoothly and is misfiring.

Non-combusted fuel may get into the catalytic converter.

- ▶ Only depress the accelerator pedal slightly.
- ▶ Have the cause rectified immediately at a qualified specialist workshop.

! **WARNING** Risk of accident due to incorrect gearshifting

If the engine speed is higher than the idle speed and you engage the transmission position **D** or **R**, the vehicle may accelerate sharply.

- ▶ If you engage the transmission position **D** or **R** always depress the brake pedal firmly and do not accelerate at the same time.

Limited braking effect on salt-treated roads:

- Due to salt build-up on the brake discs and brakepads, the braking distance can increase considerably or result in braking only on one side
- Maintain a much greater safe distance to the vehicle in front

To remove the layer of salt:

- Brake occasionally while paying attention to the traffic conditions
- Carefully depress the brake pedal at the end of the journey and when starting the next journey

Function of rear axle steering

Depending on the speed, rear axle steering adapts the track of the rear axle to the position of the front wheels. Together with the steering input of the front wheels, this results in greater mobility and improved stability.

Rear axle steering has the following characteristics:

- Reduced steering effort and turning radius, resulting in reduced parking effort
- Improved driving stability, e.g. on curves
- More direct steering, resulting in improved control of the vehicle

Tips for the AMG ceramic high-performance composite brake system

The brake system is designed for heavy loads. This may lead to noise when braking. This effect can also occur after washing the vehicle.

The noise depends on the following factors:

- Speed
- Brake force
- Environmental conditions, e.g. temperature and air humidity

- ① Have the brake system checked at a qualified specialist workshop after it has been subjected to extreme loads.

ECO start/stop function

Operation of the ECO start/stop function

All vehicles (except Mercedes-AMG GT 63 4MATIC+ and GT 63 S 4MATIC+)

The engine is switched off automatically in the following situations if all vehicle conditions for an automatic engine stop are met:

- you have selected drive program **C**.
- you brake the vehicle to a standstill in transmission position **D** or **N**.
- you engage transmission position **P**.
- you depress the brake pedal when driving at speeds below 15 mph (20 km/h).

The needle of the tachometer points to zero in the multifunction display.

The green **A** symbol appears in the multifunction display and in the display button when the vehicle is stationary.

If not all the vehicle conditions are met, the yellow **A** symbol appears in the multifunction display and in the display button.

The engine is restarted automatically if:

- you release the brake pedal in transmission position **D** when the HOLD function is not active.
- you engage transmission position **D** or **R**.
- you release the brake pedal, the vehicle is not in glide mode and it starts to move on a gentle downhill gradient at a speed below 2 mph (3 km/h).
- you depress the accelerator pedal.
- you permanently activate manual gearshifting.
- an automatic engine start is necessary.

If the engine was switched off by the ECO start/stop function and you leave the vehicle, a warning tone sounds. The [Vehicle Operational Switch the Ignition Off Before Exiting](#) display message also appears in the multifunction display. If you do not switch off the ignition, the ignition is automatically switched off after three minutes.

Mercedes-AMG GT 63 4MATIC+ and GT 63 S 4MATIC+

The engine is automatically switched off if the following conditions are met:

- you have selected drive program **C**.
- you brake the vehicle to a standstill in transmission position **D** or **N**.
- if all vehicle conditions for an automatic engine stop are met.

The green **A** symbol appears in the multifunction display and in the display button when the vehicle is stationary.

If not all the vehicle conditions are met, the yellow **A** symbol appears in the multifunction display and in the display button.

The engine is restarted automatically if:

- you release the brake pedal in transmission position **D** when the HOLD function is not active.
- you shift from transmission position **P**.
- you engage transmission position **D** or **R**.
- you depress the accelerator pedal.

- you permanently activate manual gearshifting.
- you pull the left-hand or right-hand steering wheel paddle shifter.
- an automatic engine start is necessary.

If the engine was switched off by the ECO start/stop function and you leave the vehicle, a warning tone sounds. The **Vehicle Operational Switch the Ignition Off Before Exiting** display message also appears in the multifunction display. If you do not switch off the ignition, the ignition is automatically switched off after three minutes.

Deactivating or activating the ECO start/stop function

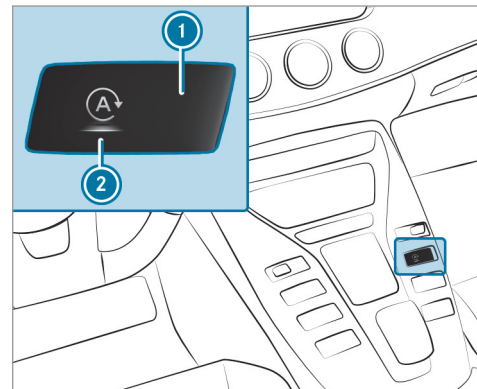

- ▶ Press display button **1**.

The display button indicates current status **2** of the ECO start/stop function:

- **A** OFF (red): deactivated
- **A** (green): activated
- **A** (yellow): inactive

- ⓘ Depending on the model and the vehicle equipment, the button may also be located at a different position in the center console.

ECO display function

The ECO display summarizes your driving characteristics from the start of the journey to its completion and assists you in achieving the most economical driving style.

You can influence consumption if you:

- drive with particular care
- drive the vehicle in drive program **C**
- observe the gearshift recommendations



The inner segment lights up and the outer segment fills up:

- ① moderate acceleration
- ② gentle deceleration and rolling
- ③ consistent speed

The inner segment does not light up and the outer segment empties:

- ① sporty acceleration
- ② heavy braking
- ③ fluctuations in speed

You have driven economically when:

- the three outer segments are completely filled simultaneously
- the ECO display lights up



The additional range achieved as a result of your driving style in comparison to a driver with a very sporty driving style is shown under **Bonus fr. Start**. The range displayed does not indicate a fixed reduction in consumption.

ECO Assist function

All vehicles (except Mercedes-AMG GT 63 4MATIC+ and GT 63 S 4MATIC+):

ECO Assist analyzes data for the vehicle's expected route. This allows the system to optimally adjust the driving style for the route ahead, save fuel and recuperate.

ECO Assist is available in the following drive programs:

-  **(Slippery)**
-  **(Comfort)**
-  **(Individual):** only with drive setting "Reduced" or "Moderate" (→ page 148)

If the system detects an event ahead, e.g. a speed limit or a traffic circle, it appears on the multifunction display.

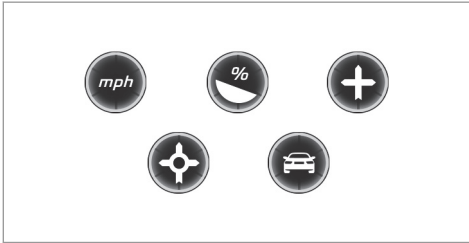

Available route results

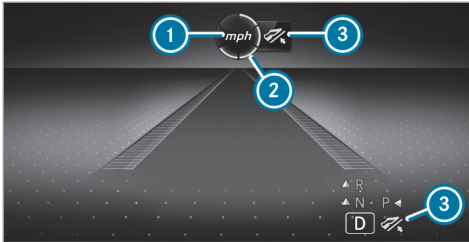

- ① Event ahead
- ② Distance to the event ahead
- ③ "Foot off the accelerator" prompt

A different number of segments ② will light up around the symbol depending on the distance to the event ahead:

- Few segments: the event ahead is near
- Many segments: the event ahead is further away

When the vehicle nears an event, ECO Assist will calculate the optimal speed for maximum fuel economy and recuperative energy based on the distance, speed and downhill gradient. "Foot off the accelerator" ③ symbol will appear on the multifunction display.

If the driver lifts off the accelerator pedal in good time, the remaining segments on the display will turn green until the event shown is reached. The drivetrain will be set for maximum fuel economy. In the **[I*]** drive program with drive setting "Reduced" or "Moderate", the vehicle will coast, with the combustion engine switched off if necessary.

If there is no response to "Foot off the accelerator" ③ prompt, the segments will remain white.

The event will be shown for a short time after it has been passed.

If the event involves a vehicle ahead and when the coast-down recommendation is given, all segments will immediately turn green once there is a response to "Foot off the accelerator" ③ prompt.

If the system does not intervene during the event ahead, nothing will be displayed. The system is passive.

In the **[C]** drive program, only the result "Vehicle ahead" is displayed.

System limitations

ECO Assist can function more precisely if the route is maintained when route guidance is active. The basic function is also available without active route guidance. Not all information and traffic situations can be foreseen. The quality depends on the map data.

ECO Assist is only an aid. The driver is responsible for keeping a safe distance to the vehicle in front, for vehicle speed and for braking in good time. The driver must be ready to brake at all

times irrespective of whether the system intervenes.

The system may be impaired or may not function in the following situations:

- If there is poor visibility, e.g. due to insufficient illumination of the road, highly variable shade conditions, or due to rain, snow, fog or heavy spray.
- If there is glare, e.g. from oncoming traffic, direct sunlight or reflections.
- If there is dirt on the windshield in the vicinity of the multifunction camera or the camera is fogged up, damaged or obscured.
- If the traffic signs are hard to detect, e.g. due to dirt or snow or insufficient lighting, or because they are covered.
- If the information on the navigation system's digital map is incorrect or out of date.
- If the signs are ambiguous, e.g. traffic signs on construction sites or in adjacent lanes.

Displaying ECO Assist

On-board computer:

- ➔ Assistance
- ▶ Select ECO Assist.

AMG Performance exhaust system

Function of the AMG Performance exhaust system

Changing the position of the exhaust gas flaps allows you to select the sound characteristics of the AMG Performance exhaust system:

- Closed exhaust gas flaps: comfort characteristic (balanced)
- Open exhaust gas flaps: sporty characteristic (powerful)

Operating the AMG Performance exhaust system

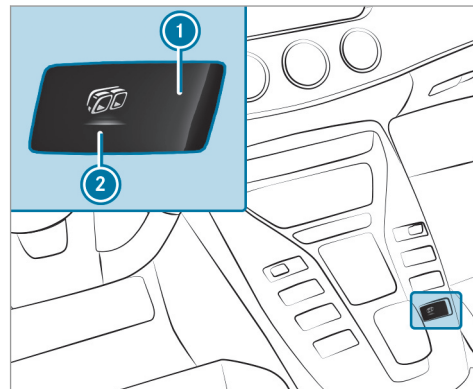

- ▶ Press display button ①.







The display button indicates the currently selected sound characteristic ②:



- Button symbol (blue): balanced
- Button symbol (red): powerful



DYNAMIC SELECT switch

Function of the DYNAMIC SELECT switch

Use the DYNAMIC SELECT switch to change between the following drive programs:

-  **(Slippery)**: optimized pulling away and driving characteristics in wintry and slippery road conditions
-  **(Individual)**: individual settings
-  **(Comfort)**: comfortable and economical driving style
-  **(Sport)**: sporty driving style
-  **(Sport Plus)**: particularly sporty driving style
-  **(RACE)**: driving like on a race track

 The drive program  **(RACE)** is available only for the Mercedes-AMG GT 63 S 4MATIC + model or for vehicles with AMG DYNAMIC PLUS package.



The  **(RACE)** drive program may not be used on normal roads.  **(RACE)** must only

be activated and used on dedicated race circuits, not on public roads.

Mercedes-AMG recommends selecting the drive program  when in city traffic or stop-and-go traffic.

Depending on the drive program selected, the following vehicle characteristics will change:

- Drive
 - Engine and transmission management
 - Active Distance Assist DISTRONIC
- AMG Dynamics
 - The four agility functions Basic, Advanced, Pro and Master are automatically selected depending on the drive program.
 - The steering, shift timing point, all-wheel drive and stabilization functions are adapted to the selected drive program.
 - When ESP® is activated, agility function Pro is selected in drive program  RACE. The Master function is automatically selected when ESP is deactivated.
- Position of the exhaust gas flaps

- Suspension
 - Steering
 - Availability of the ECO start/stop function
 - Availability of glide mode
 - The  **(RACE)** drive program has the following properties:
 - Manual gearshifting is activated automatically.
 - The vehicle exhibits driving characteristics suited for race circuits.
 - All vehicle systems are designed for maximum sportiness.
 - The chassis has a particularly tight suspension and damping system.
 - Glide mode is not available.
 - ECO start/stop function is not available.
 - The sporty sound characteristic of the exhaust system is activated.
-  You can call up vehicle characteristics via the Performance menu in the on-board computer

You can call up vehicle characteristics via the Performance menu in the on-board computer (→ page 230).

i You can also change the following vehicle characteristics using the buttons in the center console:

- Position of the exhaust gas flaps
- ECO start/stop function
- Suspension
- Manual gearshifting

Selecting the drive program

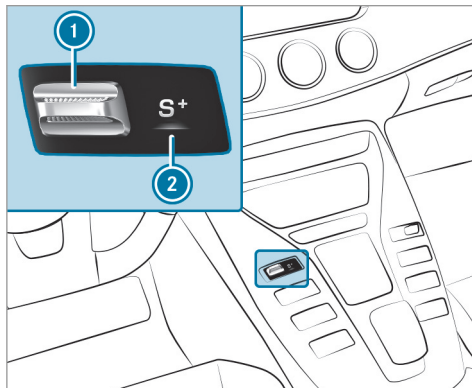

- ▶ Press DYNAMIC SELECT switch **1** forwards or backwards. The selected drive program appears in display **2** and in the multifunction display in the instrument cluster.

Configuring drive program I

Multimedia system:

↳ Vehicle ▶ DYNAMIC SELECT ▶ Individual

- ▶ Select the individual setting.

Switching the operation feedback for drive program on/off

Multimedia system:

↳ Vehicle ▶ DYNAMIC SELECT

- ▶ Switch **Notification for User** on or off . When this function is active, a corresponding message is shown in the media display when a drive program is selected with the DYNAMIC SELECT switch.

Displaying vehicle data

Multimedia system:

↳ Vehicle ▶ DYNAMIC SELECT

Displaying engine data

Multimedia system:

↳ Vehicle ▶  DYNAMIC SELECT

▶ Select Engine Data.

 The values for engine output and engine torque may deviate from the nominal values.

Items that can influence this are, for example:

- Sea level
- Fuel grade
- Outside temperature

Automatic transmission

E-SELECT selector lever

Function of the E-SELECT selector lever

 **WARNING** Risk of accident and injury due to children left unattended in the vehicle

If children are left unattended in the vehicle, they could:

- open doors, thereby endangering other persons or road users.
- get out of the vehicle and be hit by oncoming traffic.
- operate vehicle equipment and become trapped, for example.

In addition, children could also set the vehicle in motion, for example, by:

- releasing the parking brake.
- shifting the automatic transmission out of park position **P**.
- starting the engine

- ▶ Never leave children and animals unattended in the vehicle.
- ▶ When leaving the vehicle, always take the SmartKey with you and lock the vehicle.
- ▶ Keep the SmartKey out of the reach of children.

 **WARNING** Risk of accident due to incorrect gearshifting

If the engine speed is higher than the idle speed and you engage the transmission position **D** or **R**, the vehicle may accelerate sharply.

- ▶ If you engage the transmission position **D** or **R** always depress the brake pedal firmly and do not accelerate at the same time.

Use the E-SELECT selector lever to change the transmission position. The current transmission position is displayed in the multifunction display.

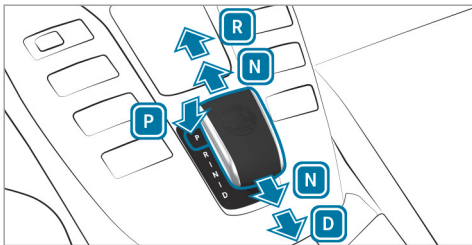

- P** Park position
- R** Reverse gear
- N** Neutral
- D** Drive position

Engaging reverse gear R

- ▶ Depress the brake pedal and push the E-SELECT selector lever upwards past the first point of resistance.
The transmission position display shows **R** in the multifunction display.

Engaging neutral N

- ▶ Depress the brake pedal and push the E-SELECT selector lever up or down to the first point of resistance.
The transmission position display shows **N** in the multifunction display.

Subsequently releasing the brake pedal will allow you to move the vehicle freely, e.g. to push it or tow it away.

If you want the automatic transmission to remain in neutral **N** even if the ignition is switched off:

- ▶ Start the vehicle.
 - ▶ Depress the brake pedal and engage neutral **N**.
 - ▶ Release the brake pedal.
 - ▶ Switch off the ignition.
- i** If you then exit the vehicle leaving the SmartKey in the vehicle, the automatic transmission remains in neutral **N**.

Engaging park position P

- ▶ Observe the notes on parking the vehicle (→ page 156).
- ▶ Depress the brake pedal until the vehicle is stationary.
- ▶ When the vehicle is stationary, press button **P**.
Park position is only engaged when the transmission position display **P** is shown in the multifunction display. If no transmission position display **P** appears, secure the vehicle to prevent it from rolling away.

Park position **P** is engaged automatically if one of the following conditions is met:

- you switch off the ignition when the vehicle is stationary and the transmission is in position **D** or **R**.
- you open the driver's door when the vehicle is stationary or when driving at a very low speed and the transmission is in position **D** or **R**.

- ⓘ To maneuver with an open driver's door, open the driver's door while stationary and engage transmission position **D** or **R** again.

Engaging drive position D

- ▶ Depress the brake pedal and pull the E-SELECT selector lever back past the first point of resistance.

The transmission position display shows **D** in the multifunction display.

When the automatic transmission is in transmission position **D**, it shifts the gears automatically. This depends on the following factors:

- The selected drive program
- The position of the accelerator pedal
- The driving speed

Double-clutch function

Double-clutch function is active when changing down in all drive programs. Double-clutch function reduces load change reactions and supports sporty driving. The acoustic perception of the

double-clutch function changes depending on the drive program.

Manual gearshifting

- ⚠ **WARNING** Risk of skidding and of an accident due to shifting down on slippery road surfaces

If you shift down on slippery road surfaces to increase the engine braking effect, the drive wheels may lose traction.

- ▶ Do not shift down on slippery road surfaces to increase the engine braking effect.

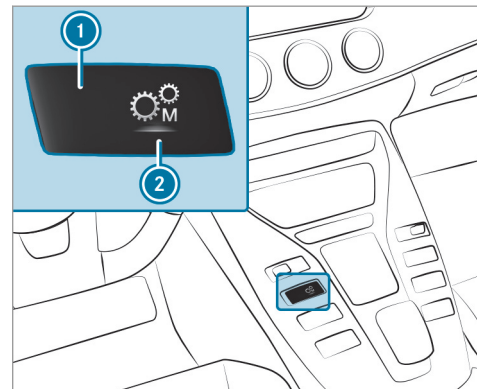

- ▶ **To activate/deactivate:** press display button ①.

The display button displays the currently selected gear setting ②:

- **M** (red): manual gearshifting
- **D** (blue): automatic transmission

When switching gears in the  (RACE) driving program, manual shifting is automatically activated.

- ① To permanently shift the gears manually in drive program  using the steering wheel paddle shifters, select the **M** (Manual) setting for the transmission.

! **NOTE** Damage to the engine due to shifting up too late

The automatic transmission does not shift up in manual mode even when the engine's limiting speed is reached.

The fuel supply is interrupted in order to prevent the engine from overrevving.

- ▶ Shift up before the engine speed reaches the red area in the tachometer.

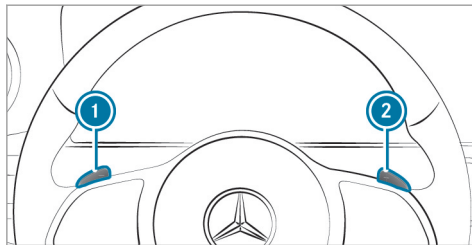

- ▶ **To shift up:** pull steering wheel paddle shifter ②.
- ▶ **To shift down:** pull steering wheel paddle shifter ①.

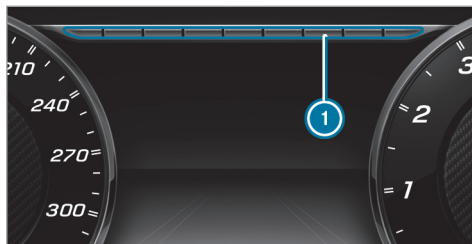

If the engine speed is too high or too low, you cannot change gear using the steering wheel paddle shifters. In this case, segment ① lights up red.

Gearshift recommendation

The gearshift recommendation assists you in adopting an economical driving style.

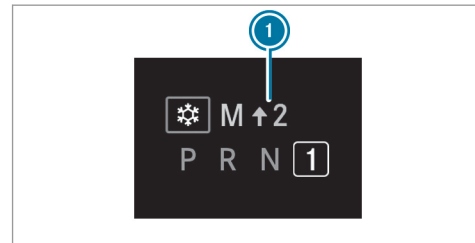

- ▶ If gearshift recommendation message ① is shown on the multifunction display, shift to the recommended gear.

- ⓘ Gearshift recommendation is active only if you have activated manual gearshifting with the button on the center console.

Using kickdown

- ▶ **Maximum acceleration:** depress the accelerator pedal beyond the pressure point.
- ⓘ If you have activated manual gearshifting with the button in the center console, the transmission does not react to the kickdown.

During kickdown, you cannot change gears using the steering wheel paddle shifters. The automatic transmission shifts up to the next gear when the maximum engine speed is reached to protect the engine from overrevving.

Glide mode function

With an anticipatory driving style, glide mode helps you to reduce fuel consumption.

Glide mode is characterized by the following:

- The combustion engine is disconnected from the drivetrain.
- The engine speed corresponds to the idle speed.
- The  symbol appears in the multifunction display.

Glide mode is activated if the following conditions are met:

- The ECO start/stop function is activated.
- Drive program  is selected with the drive setting "Moderate" or "Reduced".
- The speed is within a suitable range.
- The road's course is suitable, e.g. no steep uphill or downhill inclines or tight bends.
- **Mercedes-AMG GT 53 4MATIC+:** The charge level of the battery is sufficient.
- You are no longer depressing the accelerator or brake pedal.

Glide mode is deactivated again if one of the conditions is no longer met.

When Active Distance Assist DISTRONIC is active, glide mode is not available.

Function of the 4MATIC

4MATIC ensures that all four wheels are driven when needed. Together with ESP® and 4ETS, 4MATIC improves the traction of your vehicle whenever a driven wheel spins due to insufficient traction.

If you fail to adapt your driving style, 4MATIC can neither reduce the risk of an accident nor override the laws of physics. 4MATIC cannot take account of road, weather and traffic conditions. 4MATIC is only an aid. You are responsible for maintaining a safe distance from the vehicle in front, for vehicle speed, for braking in good time and for staying in lane.

- ⓘ In wintry road conditions, the maximum effect of 4MATIC can be achieved only if you use winter tires (M+S tires), with snow chains if necessary.

Refueling

Refueling the vehicle

⚠ WARNING Risk of fire or explosion from fuel

Fuels are highly flammable.

- ▶ Fire, open flames, smoking and creating sparks must be avoided.
- ▶ Switch off the ignition and, if it has been in use, switch off the stationary heater before you refuel your vehicle.

⚠ WARNING Risk of injury from fuels

Fuels are poisonous and hazardous to your health.

- ▶ Do not swallow fuel or let it come into contact with skin, eyes or clothing.
- ▶ Do not inhale fuel vapor.
- ▶ Keep children away from fuel.
- ▶ Keep doors and windows closed during the refueling process.

If you or other people come into contact with fuel, observe the following:

- ▶ Immediately rinse fuel off your skin with soap and water.
- ▶ If fuel comes into contact with your eyes, immediately rinse them thoroughly with clean water. Seek medical attention immediately.
- ▶ If you swallow fuel, seek medical attention immediately. Do not induce vomiting.
- ▶ Change immediately out of clothing that has come into contact with fuel.

⚠ WARNING Risk of fire or explosion from electrostatic charge

Electrostatic charge can create sparks and thereby ignite fuel vapors.

- ▶ Before you open the fuel filler cap or take hold of the pump nozzle, touch the metallic vehicle body. This discharges any electrostatic charge that may have built up.
- ▶ Do not get into the vehicle again during the refueling process. Otherwise, electrostatic charge could build up again.

! NOTE Damage caused by the wrong fuel

Vehicles with a gasoline engine:

Even small amounts of the wrong fuel could result in damage to the fuel system, the engine and the emission control system.

- ▶ The RON requirement is located in the fuel filler flap.
- ▶ Only refuel with low-sulfur unleaded fuel.

This fuel may contain up to 10% ethanol. Your vehicle is suitable for use with E10 fuel.

Never refuel using any of the following fuels:

- Diesel
- Gasoline with more than 10% ethanol by volume, e.g. E15, E85, E100
- Gasoline with more than 3% methanol by volume, e.g. M15, M30, M85, M100
- Gasoline with additives containing metal

If you accidentally refuel with the wrong fuel:

- ▶ Do not switch the ignition on.
- ▶ Consult a qualified specialist workshop.

! **NOTE** Do not use diesel to refuel vehicles with a gasoline engine.

If you accidentally refuel with the wrong fuel:

- Do not switch the ignition on. Otherwise fuel can enter the engine.

Even small amounts of the wrong fuel could result in damage to the fuel system and the engine. The repair costs are high.

- ▶ Consult a qualified specialist workshop.

- ▶ Have the fuel tank and fuel lines drained completely.

! **NOTE** Damage to the fuel system caused by overfilled fuel tanks.

- ▶ Only fill the fuel tank until the pump nozzle switches off.

! **NOTE** Fuel may spray out when you remove the fuel pump nozzle.

- ▶ Only fill the fuel tank until the pump nozzle switches off.

Requirements:

- The vehicle is unlocked.
- ⓘ Do not get into the vehicle again during the refueling process. Otherwise, electrostatic charge could build up again.

Observe the notes on operating fluids (→ page 420).

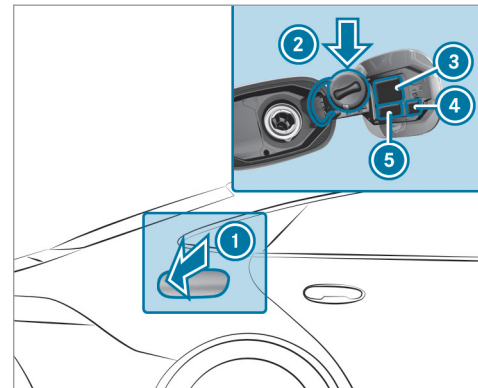

- ① Fuel filler flap
- ② Bracket for the fuel filler cap
- ③ Tire pressure table
- ④ QR code for rescue card
- ⑤ Fuel type

- ▶ Press fuel filler flap ①.
- ▶ Turn the fuel filler cap counter-clockwise and remove it.

- ▶ Insert the fuel filler cap into bracket ②.
- ▶ Completely insert the filler neck of the fuel pump nozzle into the tank, hook in place and refuel.
- ▶ Only fill the tank until the pump nozzle switches off.
- ▶ Replace the cap on the filler neck and turn clockwise until it engages audibly.
- ▶ Close the fuel filler flap.

Parking

Parking the vehicle

- ⚠ **WARNING** Risk of accident and injury caused by an insufficiently secured vehicle rolling away.

If the vehicle is not securely parked sufficiently, it can roll away in an uncontrolled way even at a slight downhill gradient.

- ▶ Ensure that the parked vehicle is always properly secured against rolling away as follows:

- On uphill or downhill gradients, turn the front wheels so that the vehicle rolls towards the curb if it starts moving.
- Apply the parking brake.
- Switch the transmission to position **P**.

- ⚠ **WARNING** Risk of fire caused by hot exhaust system parts

Flammable material such as leaves, grass or twigs may ignite if they come into contact with hot parts of the exhaust system or exhaust gas flow.

- ▶ Park the vehicle so that no flammable material can come into contact with hot vehicle components.
- ▶ In particular, do not park on dry grass-land or harvested grain fields.

- ⚠ **WARNING** Risk of accident and injury due to children left unattended in the vehicle

If you leave children unattended in the vehicle, they may be able to set the vehicle in motion, for example by:

- Releasing the parking brake.
- Shifting the automatic transmission out of park position **P**.
- Starting the engine.

In addition, they may operate vehicle equipment and become trapped.

- ▶ Never leave children unattended in the vehicle.
- ▶ When leaving the vehicle, always take the SmartKey with you and lock the vehicle.

! **NOTE** Damage to the vehicle due to it rolling away

- ▶ Always secure the vehicle against rolling away.

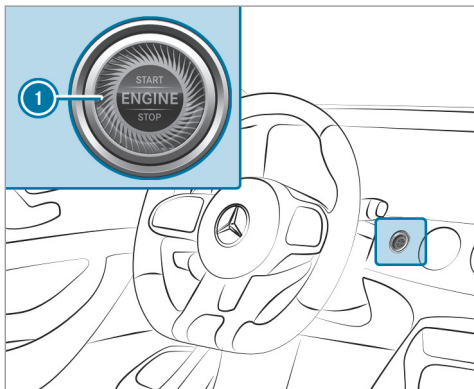

- ▶ Bring the vehicle to a standstill by applying the brake pedal.

- ▶ On uphill or downhill gradients, turn the front wheels so that the vehicle rolls towards the curb if it starts moving.
 - ▶ Apply the electric parking brake.
 - ▶ Engage transmission position **P** in a stationary vehicle with the brake pedal applied (→ page 150).
 - ▶ Switch off the engine and the ignition by pressing button **1**.
 - ▶ Release the service brake slowly.
 - ▶ Get out of the vehicle and lock it.
- i** When you park the vehicle, you can still operate the side windows and the sliding sunroof for approximately five minutes if the driver's door is closed.

Garage door opener

Programming buttons for the garage door opener

! **DANGER** Risk of fatal injuries due to exhaust gases

Combustion engines emit poisonous exhaust gases such as carbon monoxide. Inhaling these exhaust gases is hazardous to health and can lead to poisoning.

- ▶ Never leave the engine running in an enclosed space without sufficient ventilation.

! **WARNING** Risk of injury when opening or closing a door with the garage door opener

When you operate or program the door with the integrated garage door opener, people in the range of movement of the door may become trapped or struck by the door.

- ▶ When using the integrated garage door opener, always make sure that nobody

is within the range of movement of the door.

Only operate the following doors using the garage door opener:

- Doors with a safety stop and reversing feature.
- Doors which conform to the current U.S. safety standards.

Requirements:

- The vehicle has been parked outside the garage or outside the range of movement of the door.
 - The engine is switched off.
 - The ignition is switched on.
- i** The garage door opener function is always available when the ignition is switched on.

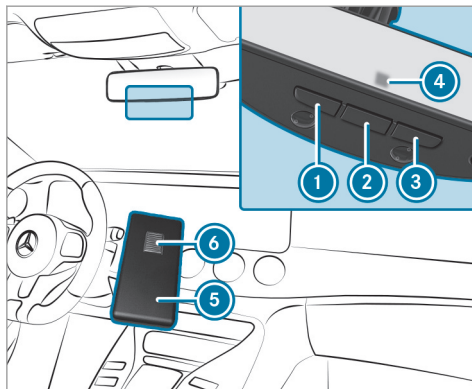

- ▶ Check if the transmitter frequency of the remote control has the frequency range of 280 to 868 MHz.

Radio equipment approval number:

- NZLMUAHL5 (USA)
- 4112A-MUAHL5 (Canada)

- ▶ Press and hold button **1**, **2** or **3** that you wish to program. Indicator lamp **4** flashes yellow.
- i** It can take up to 20 seconds before the indicator lamp flashes yellow.
- ▶ Release the previously pressed button. Indicator lamp **4** continues to flash yellow.
- ▶ Point remote control **5** from a distance of 1 in (1 cm) to 3 in (8 cm) towards buttons **1**, **2** or **3**.
- ▶ Press and hold button **6** of remote control **5** until:
 - Indicator lamp **4** lights up green continuously. Programming is complete.
 - Indicator lamp **4** flashes green. Programming was successful. Additionally, synchronization of the rolling code with the door system must also be carried out.
- ▶ If indicator lamp **4** does not light up or flash green: repeat the procedure.
- ▶ Release all of the buttons.

- ⓘ The remote control for the door drive is not included in the scope of delivery of the garage door opener.

Synchronizing the rolling code

Requirements:

- The door system uses a rolling code.
- The vehicle must be within range of the garage door or door drive.
- The vehicle as well as persons and objects, are located outside the range of movement of the door.

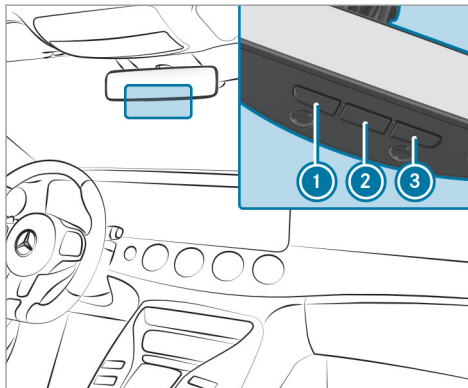

- ▶ Press the programming button on the door drive unit. Initiate the next step within approximately 30 seconds.
- ▶ Press previously programmed button ①, ② or ③ repeatedly, until the door closes. When the door closes, programming is completed.

- ⓘ Please also read the operating instructions for the door drive.

Troubleshooting when programming the remote control

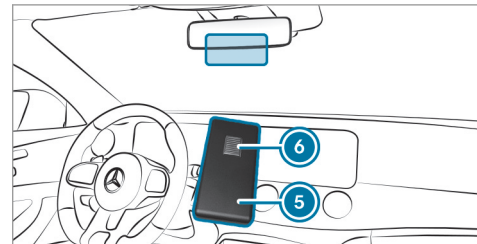

- ▶ Check if the transmitter frequency of remote control ⑤ is supported.
- ▶ Replace the batteries in remote control ⑤.
- ▶ Hold remote control ⑤ at various angles at a distance between 1 in (1 cm) to 3 in (8 cm) front of the inside rearview mirror. You should test every position for at least 25 seconds before trying another position.

- ▶ Hold remote control ⑤ at the same angles at various distances in front of the inside rearview mirror. You should test every position for at least 25 seconds before trying another position.
- ▶ Note that some remote controls transmit only for a limited period, press button ⑥ on remote control ⑤ again before transmission ends.
- ▶ Align the antenna line of the door opener unit with the remote control.

① Support and additional information on programming:

- On the toll free HomeLink® Hotline on 1-800-355-3515.
- On the Internet at <http://www.homelink.com/mercedes>.

Opening/closing a garage door

Requirements:

- The corresponding button is programmed to operate the door.

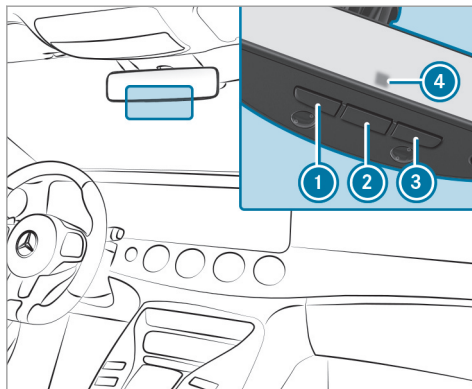

- ▶ Press and hold buttons ①, ② or ③ until the door opens or closes.
- ▶ If indicator lamp ④ flashes yellow after approximately 20 seconds: press and hold the previously pressed button again until the door opens or closes.

Clearing the garage door opener memory

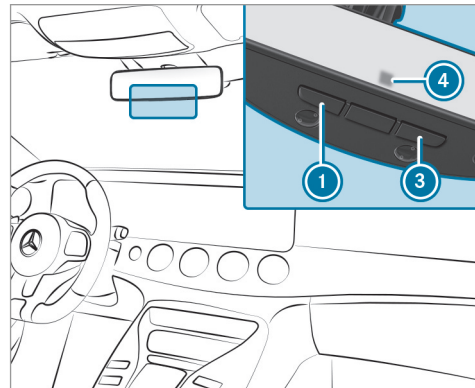

- ▶ Press and hold buttons ① and ③. Indicator lamp ④ lights up yellow.
- ▶ If indicator lamp ④ flashes green: release buttons ① and ③. The entire memory has been deleted.

Radio equipment approval numbers for the garage door opener

Radio equipment approval numbers



Brazil

Este equipamento opera em caráter secundário, isto é, não tem direito à proteção contra interferência prejudicial, mesmo de estações do mesmo tipo, e não pode causar interferência a sistemas operando em caráter primário.

Para maiores informações acessar www.anatel.gov.br

Radio equipment approval numbers

Country	Radio equipment approval number
Egypt	TAC.2511151293.WIR
Andorra	CE
Australia	R-NZ
Barbados	MED1578
Chile	2488/DFRS20576/F-74
European Union	CE
Gibraltar	CE
Iceland	CE
Jordan	TRC/LPD/2015/299
Canada	IC: 4112A-MUAHL5
Kuwait	CE
Liechtenstein	CE

Country	Radio equipment approval number
Mexico	RCPGEMU15-0448
Monaco	CE
New Zealand	R-NZ
Norway	CE
Russian Federation	Not required
Saudi Arabia	TA 10525
Switzerland	CE
South Africa	 TA-2015/1386

Country	Radio equipment approval number
Turkey	Not required
United Arab Emirates	ER41849/15 Dealer No: DA35176/14
United States	FCC ID: NZLNUAHL5

Further information on the declaration of conformity for wireless vehicle components (→ page 24).

Electric parking brake

Electric parking brake function (applying automatically)

⚠ WARNING Risk of accident and injury due to children left unattended in the vehicle

If you leave children unattended in the vehicle, they may be able to set the vehicle in motion, for example by:

- Releasing the parking brake.
- Shifting the automatic transmission out of park position **P**.
- Starting the engine.

In addition, they may operate vehicle equipment and become trapped.

- ▶ Never leave children unattended in the vehicle.
- ▶ When leaving the vehicle, always take the SmartKey with you and lock the vehicle.

The electric parking brake is applied if the transmission is in position **P** and one of the following conditions is fulfilled:

- The engine is switched off.
- The seat belt tongue is not inserted in the seat belt buckle of the driver's seat and the driver's door is opened.

i To prevent application: pull the handle of the electric parking brake.

In the following situations, the electric parking brake is also applied:

- Active Distance Assist DISTRONIC is bringing the vehicle to a standstill.
- The HOLD function is keeping the vehicle stationary.
- Active Parking Assist is keeping the vehicle stationary.

This is the case if one of the following conditions is also fulfilled:

- The engine is switched off.

- The seat belt tongue is not inserted in the seat belt buckle of the driver's seat and the driver's door is opened.
- There is a system malfunction.
- The power supply is insufficient.
- The vehicle is stationary for a lengthy period.

When the electric parking brake is applied, the red **PARK** (USA) or **(P)** (Canada) indicator lamp appears in the instrument cluster.

The electric parking brake is not automatically applied if the engine is switched off by the ECO start/stop function.

Electric parking brake function (releasing automatically)

The electric parking brake is released when the following conditions are fulfilled:

- The engine is running.
- The seat belt tongue is inserted into the seat belt buckle of the driver's seat.
- The transmission is in position **D** or **R** and you depress the accelerator pedal or you

shift from transmission position **P** to **D** or **R**.

If the seat belt tongue is not inserted into the seat belt buckle of the driver's seat, the following conditions must be fulfilled:

- The driver's door is closed.
- You move the transmission out of transmission position **P** or you have previously driven faster than 2 mph (3 km/h).

When the electric parking brake is released, the red **PARK** (USA) or **(P)** (Canada) indicator lamp in the instrument cluster goes out.

Applying/releasing the electric parking brake manually

Applying

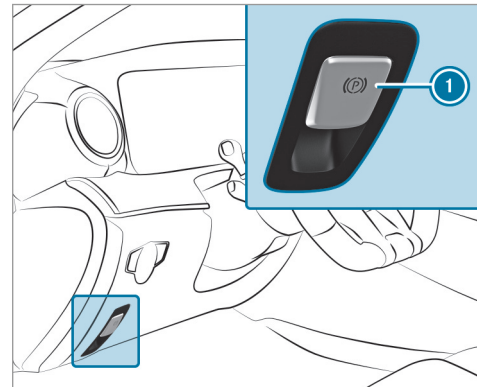

- ▶ Push handle ①. The red **PARK** (USA) or **(P)** (Canada) indicator lamp appears in the instrument cluster.

- ❗ The electric parking brake is only securely applied if the indicator lamp is lit continuously.

Releasing

- ▶ Switch the ignition on.
- ▶ Pull handle ①.
The red **PARK** (USA) or **(P)** (Canada) indicator lamp in the instrument cluster goes out.

Emergency braking

- ▶ Press and hold handle ①.
When the vehicle has been braked to a standstill, the electric parking brake is applied. The red **PARK** (USA) or **(P)** (Canada) indicator lamp appears in the instrument cluster.

Notes on parking the vehicle for an extended period

If you leave the vehicle parked for longer than four weeks, the disconnected battery may be damaged by deep discharge.

If you leave the vehicle parked for longer than six weeks, it may suffer disuse damage.

- ❗ Further information can be obtained at a qualified specialist workshop.

Standby mode (extension of the starter battery's period out of use)

Standby mode function

- ❗ This function is not available for all models.
If standby mode is activated, the vehicle can be parked for an extended period of time without losing power.

Standby mode is characterized by the following:

- the starter battery is preserved.
- the maximum non-operational time out of use is displayed in the multimedia system display.
- the connection to online services is interrupted.

If the following conditions are fulfilled, standby mode can be activated or deactivated using the multimedia system:

- the engine is switched off.
- the ignition is switched on.

Exceeding the vehicle's displayed non-operational time may cause inconvenience, i.e. it cannot be guaranteed that the starter battery will reliably start the engine.

The starter battery must be charged first in the following situations:

- the vehicle's non-operational time must be extended.
 - the **Battery Charge Insufficient for Standby Mode** message appears in the multimedia system display.
- ❗ Standby mode is automatically deactivated when the ignition is switched on.

Activating/deactivating standby mode

Multimedia system:

↳ Vehicle ▶  Vehicle Settings ▶ Standby Mode

-  This function is not available for all models.
- ▶ Activate or deactivate the function. When you activate the function, a prompt appears.
- ▶ Select **Yes**. Standby mode is activated.

Driving and driving safety systems

Driving systems and your responsibility

Your vehicle is equipped with driving systems which assist you in driving, parking and maneuvering the vehicle. The driving systems are aids and do not relieve you of your responsibility pertaining to road traffic law. Pay attention to the traffic conditions at all times and intervene when necessary. Be aware of the limitations regarding the safe use of these systems.

Function of the radar sensors

Some driving and driving safety systems use radar sensors to monitor the area in front of, behind or next to the vehicle (depending on the vehicle's equipment).

Depending on the vehicle's equipment, the radar sensors are integrated behind the bumpers and/or behind the Mercedes star. Keep these parts free of dirt, ice and slush (→ page 362). The sensors must not be covered, for example by cycle racks, overhanging loads, stickers, foil or foils to protect against stone chipping. In the event of damage to the bumpers or radiator grill, or following a collision impacting the bumpers or radiator grill, have the function of the radar sensors checked at a qualified specialist workshop. The driver assistance system may no longer work properly.

Overview of driving systems and driving safety systems

In this section, you will find information about the following driving systems and driving safety systems:

- 360° Camera (→ page 206)
- ABS (**A**nti-**l**ock **B**raking **S**ystem) (→ page 166)
- Active Distance Assist DISTRONIC (→ page 177)
- AMG adaptive sport suspension system (→ page 195)
- Active Brake Assist (→ page 170)
- Active Lane Keeping Assist (→ page 220)
- ATTENTION ASSIST (→ page 215)
- BAS (**B**rake **A**ssist **S**ystem) (→ page 166)
- Hill Start Assist
- DRIFT MODE (→ page 191)
- EBD (**E**lectronic **B**rake force **D**istribution) (→ page 170)

- ESP® (Electronic Stability Program) (→ page 167)
- Active Speed Limit Assist (→ page 180)
- HOLD function (→ page 189)
- STEER CONTROL (→ page 170)
- Active Steering Assist (→ page 183)
- Active Parking Assist (→ page 209)
- Parking Assist PARKTRONIC (→ page 200)
- Rear view camera (→ page 204)
- RACE START (→ page 190)
- Cruise control (→ page 175)
- Blind Spot Assist and Active Blind Spot Assist (→ page 218)
- Traffic Sign Assist (→ page 216)

Function of ABS (Anti-lock Braking System)

ABS regulates the brake pressure in critical driving situations:

- During braking, e.g. at full brake application or insufficient tire traction, the wheels are prevented from locking.

- Vehicle steerability while braking is ensured.

If ABS intervenes when braking, you will feel a pulsing in the brake pedal. The pulsating brake pedal can be an indication of hazardous road conditions and can serve as a reminder to take extra care while driving.

System limitations

- ABS is active from speeds of approx. 5 mph (8 km/h).
- ABS may be impaired or may not function if a malfunction has occurred and the yellow  ABS warning lamp lights up continuously in the instrument cluster after the engine is started.

Function of BAS (Brake Assist System)

⚠ WARNING Risk of an accident caused by a malfunction in BAS (Brake Assist System)

If BAS is malfunctioning, the braking distance in an emergency braking situation is increased.

 Depress the brake pedal with full force in emergency braking situations. ABS prevents the wheels from locking.

BAS supports your emergency braking situation with additional brake force.

If you depress the brake pedal quickly, BAS is activated:

- BAS automatically boosts the brake pressure.
- BAS can shorten the braking distance.
- ABS prevents the wheels from locking.

The brakes will function as usual once you release the brake pedal. BAS is deactivated.

Functions of ESP® (Electronic Stability Program)

⚠ WARNING Risk of skidding if ESP® is malfunctioning

If ESP® is malfunctioning, ESP® cannot carry out vehicle stabilization. In addition, other driving safety systems are switched off.

- ▶ Drive on carefully.
- ▶ Have ESP® checked at a qualified specialist workshop.

You can select between the following modes of ESP®:

- ESP® on
- ESP® SPORT
- ESP® off

Characteristics when ESP® is activated

ESP® monitors and improves driving stability and traction, particularly in the following situations:

- When pulling away on a wet or slippery roadway.
- When braking.
- In strong side winds when you are driving faster than 50 mph (80 km/h).

ESP® can stabilize the vehicle by intervening in the following ways:

- One or more wheels are braked.
- The engine output is adapted according to the situation.

ESP® is activated every time the engine is started regardless of whether ESP® was in ESP® SPORT or deactivated before the engine was switched off.

If the  ESP® warning lamp flashes in the instrument cluster, one or several vehicle wheels has reached its grip limit:

- Adapt the driving style to suit the prevailing road and weather conditions.
- Do not deactivate ESP® under any circumstances.
- Only depress the accelerator pedal as far as is necessary.

Characteristics when ESP® SPORT is activated

⚠ WARNING Risk of skidding if ESP® SPORT is used incorrectly

When you activate ESP® SPORT, there is an increased risk of skidding and having an accident.

- ▶ Activate ESP® SPORT only in the circumstances described below.

Select ESP® SPORT when the vehicle's own oversteering and understeering characteristics are desired, e.g on designated roads.

Driving with ESP® SPORT or with ESP® deactivated requires an extremely qualified and experienced driver.

When ESP® SPORT is activated, the  ESP® OFF warning lamp and the **ESP SPORT** message light up continuously in the instrument cluster.

If ESP® SPORT is activated and one or more wheels start to spin, the  ESP® warning lamp on the instrument cluster flashes. ESP® then only stabilizes the vehicle to a limited degree.

ESP® SPORT also has the following characteristics:

- ESP® only improves driving stability to a limited degree.
 - ETS/4ETS traction control is still active.
 - The engine's torque is only restricted to a limited degree and the drive wheels can spin.
- The spinning of the wheels results in a cutting action for better traction on loose surfaces.

- ESP® continues to provide assistance when the brakes are firmly applied.
- Crosswind Assist is no longer active.

Characteristics when ESP® is deactivated

 **WARNING** Risk of skidding if ESP® is deactivated



If you deactivate ESP®, ESP® cannot carry out vehicle stabilization.

 ESP® should only be deactivated in the following situations.

When ESP® is deactivated, the  ESP® OFF warning lamp and the **ESP OFF** message light up continuously in the instrument cluster.

- Driving stability will no longer be improved.
 - The drive wheels could spin.
 - ETS/4ETS traction control is still active.
 - Crosswind Assist is no longer active.
-  Even when ESP® is deactivated, you are still assisted by ESP® when braking hard.

It may be best to activate ESP® SPORT or deactivate ESP® in the following situations:

- When using snow chains.
 - In deep snow.
 - On sand or gravel.
-  Spinning the wheels results in a cutting action which provides better grip.
-  Activate ESP® as soon as the situations described above no longer apply. ESP® will otherwise not be able to stabilize the vehicle if the vehicle starts to skid or a wheel starts to spin.

If the  ESP® warning lamp lights up continuously even when ESP® is activated, ESP® is not available due to a malfunction.

Observe any information which may be displayed in the instrument cluster:

- Warning and indicator lamps (→ page 474)
- Display messages (→ page 428)

ETS/4ETS (Electronic Traction System)

ETS/4ETS traction control is part of ESP®.

ETS/4ETS can improve the vehicle's traction by intervening in the following ways:

- The drive wheels are braked individually if they spin.
- More drive torque is transferred to the wheel or wheels with traction.

Activating/deactivating ESP® (Electronic Stability Program)

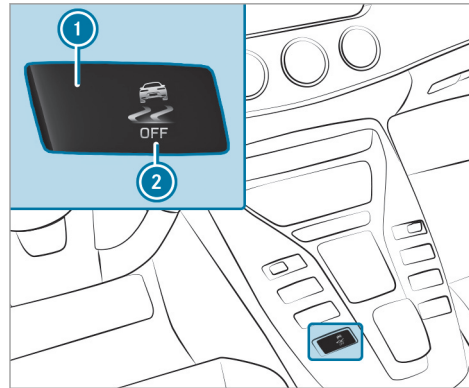

- ▶ **To activate ESP® SPORT:** press and hold display button ① until the road in button symbol ② lights up yellow. The ESP SPORT message is shown in the instrument cluster and the  and **ESP SPORT** warning lamps light up.

- ▶ **To deactivate ESP®:** press and hold display button ① until the road in button symbol ② lights up red. The ESP OFF message is shown in the instrument cluster and the  and **ESP OFF** warning lamps light up.
- ▶ **To activate ESP®:** press and hold display button ① until the road in button symbol ② lights up blue. The  and **ESP OFF** or **ESP SPORT** warning lamps in the instrument cluster go out.

When the  symbol ② is shown with a red ! on display button ①, ESP® is malfunctioning. Observe the information on warning lamps and display messages which may be shown in the instrument cluster.

Function of ESP® Crosswind Assist

ESP® Crosswind Assist detects sudden gusts of side wind and helps the driver to keep the vehicle in the lane:

- ESP® Crosswind Assist is active at vehicle speeds between 50 mph (80 km/h) and

125 mph (200 km/h) when driving straight ahead or cornering slightly.

- The vehicle is stabilized by means of individual brake application on one side.

Function of EBD (electronic brake force distribution)

EBD is characterized by the following:

- Monitoring and regulating the brake pressure on the rear wheels.
- Improved driving stability when braking, especially on bends.

Function of STEER CONTROL

STEER CONTROL helps you by transmitting a noticeable steering force to the steering wheel in the direction required for vehicle stabilization.

This steering recommendation is given particularly in the following situations:

- Both right wheels or both left wheels are on a wet or slippery road surface when you brake

- The vehicle starts to skid

System limitations

STEER CONTROL may be impaired or may not function in the following situations:

- ESP® is deactivated
- ESP® is malfunctioning
- The steering is malfunctioning

If ESP® is malfunctioning, you will be assisted further by the electric power steering.

Function of Active Brake Assist

Active Brake Assist consists of the following functions:

- Distance warning function
- Autonomous braking function
- Situation-dependent braking assistance
- **Vehicles with Driving Assistance Package:** Evasive Steering Assist

Active Brake Assist can help you to minimize the risk of a collision with vehicles or pedestrians or to reduce the effects of such a collision.

If Active Brake Assist has detected a risk of collision, a warning tone sounds and the  distance warning lamp lights up in the instrument cluster.

If you do not react to the warning, autonomous braking can be initiated in critical situations.

In especially critical situations, Active Brake Assist can initiate autonomous braking directly. In this case, the warning lamp and warning tone occur simultaneously with the braking application.

If you apply the brake yourself in a critical situation or apply the brake during autonomous braking, situation-dependent braking assistance occurs. The brake pressure increases up to maximum full-stop braking if necessary.



If autonomous braking or situation-dependent braking assistance has occurred, display ① appears in the multifunction display and then automatically goes out after a short time.

If the autonomous braking function or the situation-dependent braking assistance is triggered, additional preventive measures for occupant protection (PRE-SAFE®) may also be initiated.

⚠ WARNING Risk of an accident caused by limited detection performance of Active Brake Assist

Active Brake Assist cannot always clearly identify objects and complex traffic situations.

In such cases, Active Brake Assist might:

- Give a warning or brake without reason
- Not give a warning or not brake

▶ Always pay careful attention to the traffic situation; do not rely on Active Brake Assist alone. Active Brake Assist is only an aid. The driver is responsible for maintaining a suitable distance to the vehicle in front, vehicle speed and for braking in good time.

▶ Be prepared to brake or swerve if necessary.

Also observe the system limitations of Active Brake Assist.

The individual subfunctions are available in the following speed ranges:

Distance warning function

The distance warning function issues a warning at speeds:

- From approximately 4 mph (7 km/h), if your vehicle is critically close to a vehicle or pedestrian. An intermittent warning tone sounds and the  distance warning lamp lights up in the instrument cluster.

Brake immediately or take evasive action, provided it is safe to do so and the traffic situation allows this.

The distance warning function can aid you in the following situations with an intermittent warning tone and a warning lamp:

	Vehicles traveling in front	Stationary vehicles	Crossing vehicles	Moving pedestrians	Stationary pedestrians
Vehicles without Driving Assistance package	Up to approx. 155 mph (250 km/h)	Up to approx. 50 mph (80 km/h)	No reaction	Up to approx. 37 mph (60 km/h)	No reaction
Vehicles with Driving Assistance package	Up to approx. 155 mph (250 km/h)	Up to approx. 62 mph (100 km/h)	Up to approx. 43 mph (70 km/h)	Up to approx. 50 mph (80 km/h)	Up to approx. 43 mph (70 km/h)

Autonomous braking function

The autonomous braking function may intervene at speeds starting from approximately 4 mph (7 km/h) in the following situations:

	Vehicles traveling in front	Stationary vehicles	Crossing vehicles	Moving pedestrians	Stationary pedestrians
Vehicles without Driving Assistance package	Up to approx. 124 mph (200 km/h)	Up to approx. 31 mph (50 km/h)	No reaction	Up to approx. 37 mph (60 km/h)	No reaction
Vehicles with Driving Assistance package	Up to approx. 155 mph (250 km/h)	Up to approx. 62 mph (100 km/h)	Up to approx. 43 mph (70 km/h)	Up to approx. 43 mph (70 km/h)	Up to approx. 43 mph (70 km/h)

Situation-dependent braking assistance

Situation-dependent braking assistance may intervene at speeds starting from approximately 4 mph (7 km/h) in the following situations:

	Vehicles traveling in front	Stationary vehicles	Crossing vehicles	Moving pedestrians	Stationary pedestrians
Vehicles without Driving Assistance package	Up to approx. 155 mph (250 km/h)	Up to approx. 50 mph (80 km/h)	No reaction	Up to approx. 37 mph (60 km/h)	No reaction
Vehicles with Driving Assistance package	Up to approx. 155 mph (250 km/h)	Up to approx. 62 mph (100 km/h)	Up to approx. 43 mph (70 km/h)	Up to approx. 43 mph (70 km/h)	Up to approx. 43 mph (70 km/h)

Canceling a brake application of Active Brake Assist

You can cancel a brake application of Active Brake Assist at any time by:

- Fully depressing the accelerator pedal or with kickdown.
- Releasing the brake pedal.

Active Brake Assist may cancel the brake application when one of the following conditions is fulfilled:

- You maneuver to avoid the obstacle.

- There is no longer a risk of collision.
- An obstacle is no longer detected in front of your vehicle.

Evasive Steering Assist (only vehicles with Driving Assistance Package)

Evasive Steering Assist has the following characteristics:

- The ability to detect stationary or moving pedestrians
- Assistance through power-assisted steering if it detects a swerving maneuver

- Activation by an abrupt steering movement during a swerving maneuver
- Assistance during swerving and straightening of the vehicle
- Reaction from a speed of approximately 12 mph (20 km/h) up to a speed of approximately 43 mph (70 km/h)

You can prevent the assistance at any time by actively steering.

⚠ WARNING Risk of an accident despite Evasive Steering Assist

Evasive Steering Assist cannot always clearly identify objects and complex traffic situations.

In addition, the steering support of Evasive Steering Assist is generally not sufficient to avoid a collision.

In such cases Evasive Steering Assist can:

- give an unnecessary warning or provide assistance
 - not give a warning or not provide assistance
- ▶ Always pay careful attention to the traffic situation; do not rely on Evasive Steering Assist alone.
- ▶ Be ready to brake and take evasive action if necessary.
- ▶ Prevent the assistance by actively steering in non-critical driving situations.

- ▶ Drive at an appropriate speed if pedestrians are close to the path of your vehicle.

System limitations

Full system performance is not available for a few seconds after switching on the ignition or after driving off.

The system may be impaired or may not function in the following situations:

- In snow, rain, fog, heavy spray, if there is glare, in direct sunlight or in greatly varying ambient light.
- If the sensors are dirty, fogged up, damaged or covered.
- If the sensors are impaired due to interference from other radar sources, e.g. strong radar reflections in parking garages.
- If a loss of tire pressure or a faulty tire has been detected and displayed.
- In complex traffic situations where objects cannot always be clearly identified.

- For pedestrians or vehicles if they move quickly into the sensor detection range.
- For pedestrians who are hidden by other objects.
- If the typical outline of a pedestrian cannot be distinguished from the background.
- If a pedestrian is not detected as such, e.g. due to special clothing or other objects.
- On bends with a tight radius.

Setting Active Brake Assist

Multimedia system:

↳ Vehicle ▶  Assistance ▶ Active Brake Assist

Vehicles without Driving Assistance Package: The settings can be made after starting the vehicle.

Vehicles with Driving Assistance Package: The settings can be made when the ignition is switched on.

The following settings are available:

- Early

- Medium
- Late

▶ Select a setting.

- ① Your selection is retained when the vehicle is next started.

Deactivating Active Brake Assist

- ① It is recommended that you always leave Active Brake Assist activated.

▶ Select **Off**.

The distance warning function and the autonomous braking function are deactivated.

Vehicles without Driving Assistance Package: When the vehicle is next started, the medium setting is automatically selected.

Vehicles with Driving Assistance Package: Evasive Steering Assist is not available. When the ignition is next started, the middle setting is selected automatically and Evasive Steering Assist is available.

- ① If Active Brake Assist is deactivated, the  symbol appears in the status bar of the multifunction display.

Speed control cruise control

Function of cruise control

Cruise control regulates the speed to the value selected by the driver.

If you accelerate to overtake, for example, the stored speed is not deleted. If you remove your foot from the accelerator pedal after overtaking, cruise control will resume speed regulation back to the stored speed.

Cruise control is operated using the corresponding steering wheel buttons. You can store any road speed above 15 mph (20 km/h) up to the maximum speed.

If you fail to adapt your driving style, cruise control can neither reduce the risk of an accident nor override the laws of physics. It cannot take into account road, weather or traffic conditions. Cruise control is only an aid. You are responsible for maintaining a safe distance to the vehicle in front, for vehicle speed, for braking in good time and for staying in lane.

Displays on the multifunction display

The status of cruise control and the stored speed are shown in the multifunction display.

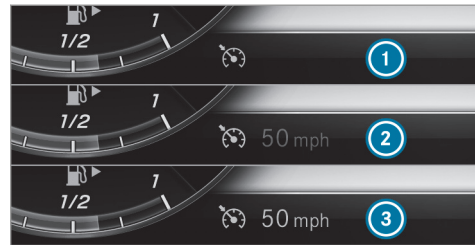

- ① Cruise control is selected
- ② Speed is saved, cruise control is deactivated
- ③ Speed is saved, cruise control is activated
- ① The segments between the stored speed and the end of the segment display light up in the speedometer.

System limitations

Cruise control may be unable to maintain the stored speed on uphill gradients. The stored speed is resumed when the gradient evens out.

Change into a lower gear in good time on long and steep downhill gradients. Take particular note of this when driving a laden vehicle. By

doing so, you will make use of the braking effect of the engine. This relieves the load on the brake system and prevents the brakes from overheating and wearing too quickly.

Do not use cruise control in the following situations:

- In traffic situations which require frequent changes of speed, e.g. in heavy traffic, on winding roads.
- On slippery roads. Accelerating can cause the drive wheels to lose traction and the vehicle could then skid.
- If you are driving when visibility is poor.

Operating cruise control

⚠ WARNING Risk of accident due to stored speed

If you call up the stored speed and this is lower than your current speed, the vehicle decelerates.

- ▶ Take into account the traffic situation before calling up the stored speed.

Requirements:

- ESP[®] must be activated, but not intervening.
- The driving speed is at least 15 mph (20 km/h).
- The transmission is in position **D**.

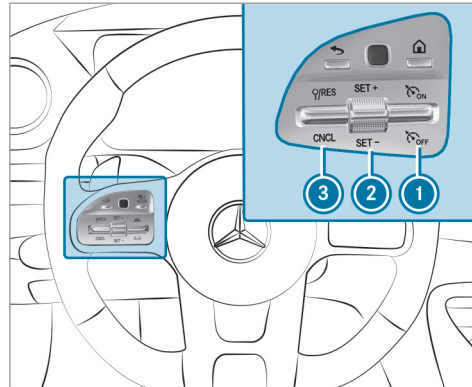

- ▶ **To activate cruise control:** press rocker switch **1** up.

- ▶ **To activate cruise control:** press rocker switch **2** up (SET+) or down (SET-).
- ▶ Remove your foot from the accelerator pedal. The current speed is stored and maintained by the vehicle.
- ▶ **To increase/reduce speed:** press rocker switch **2** up/down to the pressure point. The stored speed is increased or reduced by 1 mph (1 km/h).

or

- ▶ Press rocker switch **2** beyond the pressure point. The stored speed is increased or reduced by 5 mph (10 km/h).

or

- ▶ Accelerate the vehicle to the desired speed.
- ▶ Press rocker switch **2** up. If cruise control is activated and Traffic Sign Assist has detected a speed restriction sign with a maximum permissible speed and this is displayed in the instrument cluster:

▶ **To adopt the detected speed:** press rocker switch ③ up.

The maximum permissible speed shown by the traffic sign is stored and the vehicle maintains this speed.

▶ **To deactivate cruise control:** press rocker switch ③ (CNCL) down.

When cruise control is deactivated:

- Rocker switch ② (SET+) or (SET-) saves the currently driven speed and the vehicle maintains this speed.
- Rocker switch ③ (RES) calls up the speed last stored and the vehicle maintains this speed.

▶ **To deactivate cruise control:** press rocker switch ① down.

ⓘ If you brake, deactivate ESP® or if ESP® intervenes, cruise control is deactivated. When you switch off the vehicle, the last speed stored is cleared.

Active Distance Assist DISTRONIC

Function of Active Distance Assist DISTRONIC

Active Distance Assist DISTRONIC is only available for vehicles with the Driving Assistance Package.

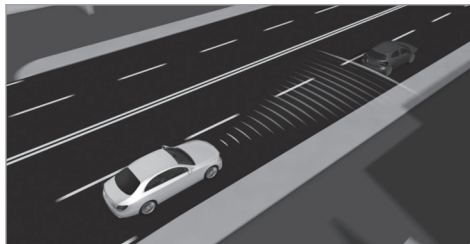

Active Distance Assist DISTRONIC maintains the set speed on free-flowing roads. If vehicles ahead are detected, the set distance is maintained, if necessary, until the vehicle comes to a halt. The vehicle accelerates or brakes depending on the distance to the vehicle in front and the set speed. The speed (in the range between 15 mph (20 km/h) and 130 mph (210 km/h))

and the distance to the vehicle ahead are set and saved on the steering wheel.

Other features of Active Distance Assist DISTRONIC:

- Adjusts the driving style depending on the selected drive program (fuel-saving, comfortable or dynamic) .
- Adjusts the driving style depending on the selected drive program (fuel-saving, comfortable or dynamic) (→ page 147).
- Reacts to stationary vehicles detected in urban speed ranges (except bicycles and motorcycles).
- Initiates acceleration to the stored speed if the turn signal indicator is switched on to change to the overtaking lane.
- Takes one-sided overtaking restrictions into account on highways or on multi-lane roads with separate roadways.

If the vehicle has been braked to a standstill on multi-lane, separate roadways by Active Distance Assist DISTRONIC, it can automatically follow the vehicle in front driving off again within

30 seconds. If a critical situation is detected when driving off, a visual and acoustic warning is given indicating that the driver must now take control of the vehicle. The vehicle is not accelerated any further.

Active Distance Assist DISTRONIC is only an aid. The driver is responsible for keeping a safe distance to the vehicle in front, for vehicle speed and for braking in good time.

System limitations

The system may be impaired or may not function in the following instances:

- In snow, rain, fog, heavy spray, if there is glare, in direct sunlight or in greatly varying ambient light.
- The windshield in the area of the camera is dirty, fogged up, damaged or covered.
- If the radar sensors are dirty or covered.
- On slippery roads, braking or accelerating can cause one or several wheels to lose traction and the vehicle could then skid.
- In parking garages or on roads with steep uphill or downhill gradients.

- Narrow vehicles, such as bicycles and motorcycles, are not detected.

Do not use Active Distance Assist DISTRONIC in these situations.

⚠ WARNING Risk of accident from acceleration or braking by Active Distance Assist DISTRONIC

Active Distance Assist DISTRONIC may accelerate or brake in the following cases, for example:

- If the vehicle pulls away using Active Distance Assist DISTRONIC.
- If the stored speed is called up and is considerably faster or slower than the currently driven speed.
- If Active Distance Assist DISTRONIC no longer detects a vehicle in front or does not react to relevant objects.

▶ Always carefully observe the traffic conditions and be ready to brake at all times.

▶ Take into account the traffic situation before calling up the stored speed.

⚠ WARNING Risk of accident due to insufficient deceleration by Active Distance Assist DISTRONIC

Active Distance Assist DISTRONIC brakes your vehicle with up to 50% of the maximum possible deceleration. If this deceleration is not sufficient, Active Distance Assist DISTRONIC alerts you with a visual and acoustic warning.

▶ In these cases, adjust your speed and keep a sufficient distance.

▶ Brake the vehicle yourself and/or take evasive action.

⚠ WARNING Risk of accident if detection function of Active Distance Assist DISTRONIC is impaired

Active Distance Assist DISTRONIC does not react or has a limited reaction:

- when driving on a different lane or when changing lanes
- to pedestrians, animals, bicycles or stationary vehicles, or unexpected obstacles
- to complex traffic conditions
- to oncoming vehicles and crossing traffic

As a result, Active Distance Assist DISTRONIC may neither give warnings nor intervene in such situations.

- ▶ Always observe the traffic conditions carefully and react accordingly.

Operating Active Distance Assist DISTRONIC

Requirements:

- The vehicle has been started.
- The electric parking brake is released.

- ESP® is activated and is not intervening.
- The transmission is in position **D**.
- All the doors are closed.
- Check of the radar sensor system has been successfully completed (vehicle traveling faster than 12 mph (20 km/h)).
- Parking Assist PARKTRONIC is not being used to park the vehicle or to exit from a parking space.
- The vehicle does not skid.

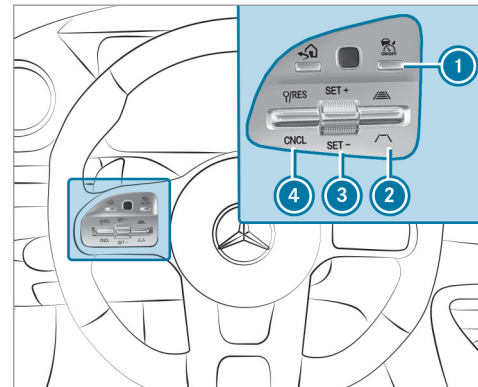

▶ **To activate/deactivate Active Distance Assist DISTRONIC:** press button **1**.

▶ **To activate Active Distance Assist DISTRONIC:** press rocker switch **3** up (SET +) or down (SET-), or press rocker switch **4** up. Remove your foot from the accelerator pedal.

The current speed is stored and maintained by the vehicle.

or

- ▶ **To activate Active Distance Assist DISTRONIC with a stored speed:** press rocker switch ④ up. Remove your foot from the accelerator pedal.

ⓘ If rocker switch ④ is pressed up twice while driving, Active Distance Assist DISTRONIC is activated with the speed restriction displayed in the instrument cluster.

- ▶ **To accept the displayed speed restriction when Active Distance Assist DISTRONIC is active:** press rocker switch ④ (RES) up. The speed limit displayed in the instrument cluster is adopted as the stored speed. The vehicle adapts its speed to that of the vehicle in front, but only up to the stored speed.

- ▶ **To pull away with Distance Assist DISTRONIC activated:** remove your foot from the brake pedal.

- ▶ Press rocker switch ④ (RES) up.

or

- ▶ Depress the accelerator pedal briefly and firmly. The functions of Active Distance Assist DISTRONIC continue to be carried out.

⚠ WARNING Risk of accident due to Active Distance Assist DISTRONIC still being activated when you leave the driver's seat

If you leave the driver's seat while the vehicle is being braked by Active Distance Assist DISTRONIC only, the vehicle can roll away.

- ▶ Always deactivate Active Distance Assist DISTRONIC and secure the vehicle to prevent it from rolling away before you leave the driver's seat.

- ▶ **To deactivate Active Distance Assist DISTRONIC:** press rocker switch ④ (CNCL) down.

- ▶ **To increase/reduce speed:** press rocker switch ③ up/down to the pressure point. The stored speed is increased or reduced by 1 mph (1 km/h).

or

- ▶ Press and hold rocker switch ③ up/down to the pressure point. The stored speed is increased or reduced in increments of 1 mph (1 km/h).

or

- ▶ Press rocker switch ③ beyond the pressure point. The stored speed is increased or reduced by 5 mph (10 km/h).

or

- ▶ Press rocker switch ③ beyond the pressure point and hold. The stored speed is increased or reduced in increments of 5 mph (10 km/h).
- ▶ **To increase or reduce the specified distance from the vehicle in front:** press rocker switch ② up or down.

Function of Active Speed Limit Assist

- ⓘ The availability of the following function is country-dependent.

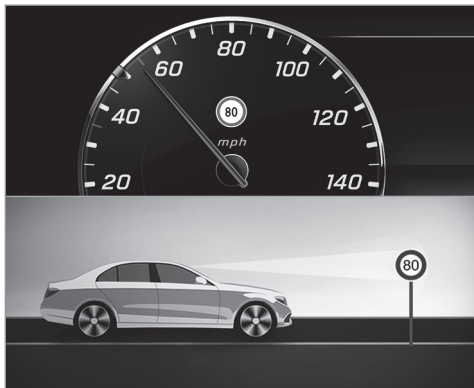

If a change in the speed limit is detected and Active Distance Assist DISTRONIC is activated, Active Distance Assist DISTRONIC adapts this new speed as the stored speed.

The driven speed is adjusted when the vehicle is level with the traffic sign at the latest. In the case of signs indicating entry into an urban area, the speed is adapted beforehand. The speed limit display in the Instrument Display is always

updated when the vehicle is level with the traffic sign.

If there is no speed restriction on an unlimited stretch of road (e.g. on a freeway), the recommended speed is adopted as the stored speed. The system uses the speed stored on an unlimited stretch of road as the recommended speed. If you do not alter the stored speed on an unlimited stretch of road, the recommended speed is 80 mph (130 km/h).

If Active Distance Assist DISTRONIC has been put into passive mode by pressing the accelerator pedal, only speed limits which are higher than the set speed are adopted.

Active Speed Limit Assist is only an aid. The driver is responsible for keeping a safe distance to the vehicle in front, for vehicle speed and for braking in good time. The maximum permissible speed also depends on factors such as the road surface and traffic conditions.

System limitations

Temporary speed restrictions (e.g. for a certain time or due to weather conditions) cannot be properly detected by the system. The maximum

permissible speed applying for a vehicle with a trailer is not detected by the system. In these situations you must adjust your speed yourself.

⚠ WARNING Risk of accident due to Active Speed Limit Assist adapting the vehicle's speed

The speed adopted by Active Speed Limit Assist may be too high or incorrect in some individual cases, such as:

- In the wet or in fog
 - When towing a trailer
- ▶ Ensure that the driven speed complies with traffic regulations.
- ▶ Adjust the driving speed to suit current traffic and weather conditions.

Function of route-based speed adaptation

i The availability of the following function is country-dependent.

When Distance Assist DISTRONIC is active, the function adjusts the speed depending on the

route events ahead. Depending on the drive program selected, the vehicle negotiates the route event ahead in a fuel-saving, comfortable or dynamic manner. When the route event has been passed, the vehicle accelerates again to the stored speed. The set distance to the vehicle in front, vehicles detected ahead and speed restrictions ahead are taken into account.

Route-based speed adjustment can be configured in the multimedia system (→ page 183).

Route events ahead are:

- Bends
- T-intersections, traffic circles and toll stations
- Turns and exits

i When the toll station is reached, Active Distance Assist DISTRONIC adopts the speed as the stored speed.

Also, the speed is reduced if the turn signal to change lanes is switched on and one of the following situations is detected:

- Turning off at intersections
- Driving on slowing-down lanes

- Driving on lanes adjacent to slowing-down lanes

The driver is responsible for choosing the right speed and observing other road users. This applies in particular to intersections, traffic circles and sets of traffic lights, as route-based speed adaptation does not brake the vehicle to a standstill.

When route guidance is active, the first speed adjustment is carried out automatically. If the turn signal indicator is switched on, the selected route is confirmed and further speed adjustment is activated.

Speed adjustment is canceled in the following cases:

- If the turn signal indicator is switched off before the route event.
- If the driver depresses the accelerator or brake pedal during the process.

System limitations

Route-based speed adaptation does not take right of way regulations into account. The driver

is responsible for complying with road traffic regulations and driving at a suitable speed.

In difficult conditions (e.g. unclear roads, narrow lanes, wet road surfaces, snow or ice) or when driving with a trailer, the speed adjustment made by the system may not always be suitable. In these situations the driver must intervene accordingly.

⚠ WARNING Risk of accident in spite of route-based speed adjustment

Route-based speed adjustment might malfunction or be temporarily unavailable in the following situations:

- If map data is not up to date or available
- If you do not follow the selected route guidance
- If the set route is re-planned
- In road construction areas
- When towing a trailer
- In bad weather or road conditions
- If the accelerator pedal is depressed

- ▶ Adjust the speed to the traffic situation.

Setting route-based speed adjustment

Requirements:

- Active Distance Assist DISTRONIC is activated.

Multimedia system:

↳ Vehicle ▶  Assistance ▶▶ Speed Adjustment

- ▶ Activate or deactivate the function.

Active Steering Assist

Function of Active Steering Assist

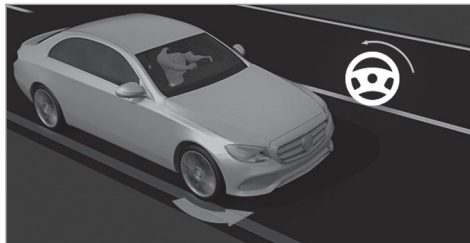

Active Steering Assist assists the driver at speeds up to 130 mph (210 km/h) and helps the driver to stay in the center of the lane by means of moderate steering interventions. The system orients itself using detected lane markings. Depending on the speed driven, Active Steering Assist uses the vehicles ahead as a reference. If the detection of lane markings and vehicles ahead is impaired, Active Steering Assist switches to passive mode. The system does not provide support in the form of steering interventions.

- The driver is required to keep their hands on the steering wheel at all times and be able to intervene at any time to correct the course of the vehicle and keep it in lane.
- The status of Active Steering Assist is displayed in the status bar of the multifunction display.

Steering and touch detection

The driver is required to keep their hands on the steering wheel at all times and to be able to intervene at any time. The driver must expect a change from active to passive mode or vice versa at any time.



If the system reaches a system limitation or the driver has not steered the vehicle for a considerable period of time or has removed their hands from the steering wheel, the system will, depending on the situation, first alert the driver with a visual warning. Display  appears in the multifunction display. If the driver still does not steer the vehicle, or has still not taken hold of the steering wheel, a repeated warning tone sounds in addition to the visual warning message to remind the driver to take control of the vehicle.

The warning message does not appear or disappears if one of the following conditions are met:

- The driver steers the vehicle.
- The driver presses a steering wheel button or operates Touch Control.

Active Steering Assist is only an aid. The driver is responsible for the distance to the vehicle in front, for vehicle speed, for braking in good time and for staying in lane. Before changing lanes, the driver must make sure that the neighboring lane is free (glance over the shoulder).

System limitations

Active Steering Assist has a limited steering torque for lateral guidance. In some cases, the steering intervention is not sufficient to keep the vehicle in the lane or to drive past exits. Active Steering Assist cannot provide the driver with steering assistance at traffic circles, T-intersections, intersections, toll stations or turns, for example.

The system may be impaired or may not function in the following instances:

- In snow, rain, fog, heavy spray, if there is glare, direct sunlight, greatly varying ambient light, reflections or strong shadows on the road.
- Insufficient road illumination.
- The windshield in the area of the camera is dirty, fogged up, damaged or covered.
- Absence of lane markings, or several unclear lane markings, or if the markings change rapidly.
- The distance to the vehicle in front is too small and the lane markings thus cannot be detected.

- The roadway is narrow and winding.
- Obstacles on the lane or projecting out into the lane.

The system does not provide assistance in the following conditions:

- On tight bends, traffic circles and when turning.
- When actively changing lane without switching on the turn signal.

 **WARNING** Risk of accident if Active Steering Assist unexpectedly stops functioning

If the system limitations of Active Steering Assist are reached there is no guarantee that the system will remain active or will keep the vehicle in lane.

- ▶ Always keep your hands on the steering wheel and observe the traffic carefully.
- ▶ Always steer the vehicle paying attention to traffic conditions.

⚠ WARNING Risk of accident if Active Steering Assist unexpectedly intervenes

A malfunction in the detection of lane markings and objects can occur.

This could cause unexpected steering intervention.

▶ Steer according to traffic conditions.

Activating Active Steering Assist

Requirements

- ESP® must be activated, but not intervening.
- Active Distance Assist DISTRONIC is activated.

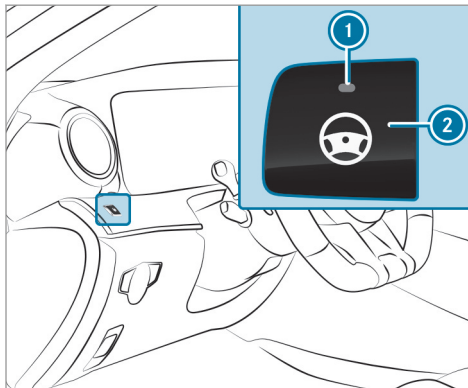

▶ If indicator lamp ① is off: press button ②.

Function of Active Lane Change Assist

i The following function is country-dependent and only available in conjunction with the Driving Assistance Package.

Active Lane Change Assist supports the driver when changing lanes by applying steering torque if the driver operates a turn signal.

Assistance when changing lanes is provided if all the following conditions are met:

- You are driving on a freeway or road with multiple lanes in the direction of travel.
- The neighboring lane is separated by a broken lane marking.
- No vehicle is detected in the adjacent lane.
- The driven speed is between 50 mph (80 km/h) and 110 mph (180 km/h).
- Active Lane Change Assist is switched on in the multimedia system.
- Active Steering Assist is switched on and active.



If no vehicle is detected in the adjacent lane and a lane change is permitted, the steering wheel symbol and the arrow are shown in green ②. The **Lane Change to the Left** message appears, for example. If Active Lane Change Assist has been activated with the turn signal indicator but a lane change is not immediately possible, the steering wheel symbol remains green and the arrow appears gray ①. When the lane change support starts, the turn signal indicator is automatically activated.

If the assistance graphic is active when you change lanes, an arrow also appears pointing towards the adjacent lane in the assistance graphic (→ page 187).

If a lane change is not possible, the arrow fades out after a few seconds and a new lane change must be initiated. An immediate lane change is only possible on freeway sections without speed limits.

If the system is impaired, Active Lane Change Assist may be canceled. If it is canceled, the **Lane Change Canceled** message appears in the multifunction display and a warning tone sounds.

⚠ WARNING Risk of accident from changing lane to an occupied adjacent lane

Lane Change Assist cannot always detect clearly if the adjacent lane is free.

The lane change might be initiated although the adjacent lane is not free.

- ▶ Before changing lanes, make sure that the neighboring lane is free and there is no danger to other road users.
- ▶ Monitor the lane change.

⚠ WARNING Risk of accident if Lane Change Assist unexpectedly stops functioning

If the system limitations for Lane Change Assist have been reached, there is no guarantee that the system will remain active.

Lane Change Assist cannot then assist you by applying steering torques.

- ▶ Always monitor the lane change and keep your hands on the steering wheel.

Observe the traffic conditions and steer and/or brake if necessary.

System limitations

The system limitations of Active Steering Assist apply to Active Lane Change Assist (→ page 183).

The system may also be impaired or may not function in the following situations:

- The sensors in the rear bumper are dirty, damaged or covered, for instance by a sticker or ice and snow.
- The exterior lighting shows a malfunction.

Activating/deactivating Active Lane Change Assist

Multimedia system:

↩ Vehicle ▶  Assistance

- ▶ Select **Lane Change Assist**.
- ▶ Activate or deactivate the function.

Function of Active Emergency Stop Assist

If the driver continues to ignore the warning to put their hands on the steering wheel, Active

Distance Assist DISTRONIC reduces the speed. If the driver still does not respond, the **Beginning Emergency Stop** message is shown in the multifunction display. The vehicle is decelerated in stages to a standstill. At speeds below 40 mph (60 km/h) the hazard warning lights switch on automatically.

When the vehicle is stationary, the following actions are carried out:

- The vehicle is secured with the electric parking brake
- Active Distance Assist DISTRONIC is ended
- The vehicle is unlocked
- If possible, an emergency call is placed to the Mercedes-Benz emergency call center

The driver can cancel the deceleration at any time by performing one of the following actions:

- Steering
- Depressing the brake or accelerator pedal
- Pressing a steering wheel button or operating Touch Control

- Activating or deactivating Active Distance Assist DISTRONIC

Overview of Active Distance Assist DISTRONIC displays in the instrument cluster

The assistance graphic and the status display show the status of the following functions in the instrument cluster:

- Active Distance Assist DISTRONIC
- Route-based speed adaptation
- Active Steering Assist

Assistant display

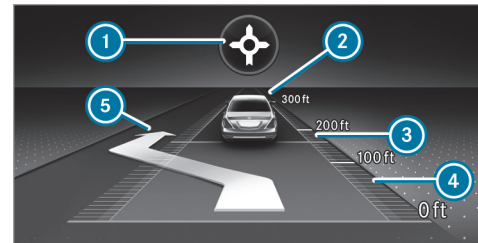

- 1 Route-based speed adaptation (type of route event)
- 2 Vehicle ahead
- 3 Distance indicator
- 4 Set specified distance
- 5 Active Lane Change Assist lane change display

Active Distance Assist DISTRONIC status display and route-based speed adaptation

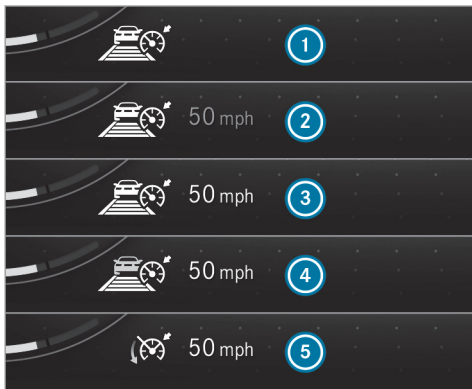

- ① Active Distance Assist DISTRONIC selected, set specified distance
- ② Active Distance Assist DISTRONIC deactivated, speed stored

- ③ Active Distance Assist DISTRONIC active, speed stored, no vehicle detected (bright vehicle symbol)
 - ④ Active Distance Assist DISTRONIC active, speed stored, vehicle detected (green vehicle symbol)
 - ⑤ Active Distance Assist DISTRONIC and route-based speed adaptation active, speed stored
- ① On highways or high-speed major roads, the green  vehicle symbol is displayed cyclically when the vehicle is ready to pull away.

Speedometer

The stored speed is highlighted on the speedometer. If the speed of the vehicle ahead or the speed adjustment is less than the stored speed due to the route event ahead, the segments in the speedometer light up. Activation or deactivation of Active Distance Assist DISTRONIC, as well as alterations in the stored speed and the distance to be maintained, are displayed in the individual control feedback of the multifunction display.

Active Steering Assist status display

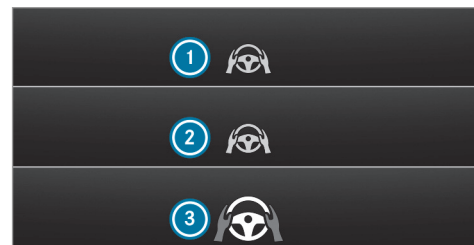

- ① Gray steering wheel: Active Steering Assist switched on and passive
- ② Green steering wheel: Active Steering Assist switched on and active
- ③ White steering wheel with red hands: transition from active to passive status (system limitation detected or prompt to the driver to actively confirm)

Hill start assist

Hill Start Assist holds the vehicle for a short time when pulling away on a hill under the following conditions:

- The transmission is in position **D** or **R**.
- The electric parking brake is released.

This gives you enough time to move your foot from the brake pedal to the accelerator pedal and depress it before the vehicle begins to roll away.

⚠ WARNING Risk of accident and injury due to the vehicle rolling away

After a short time, Hill Start Assist no longer holds the vehicle and it can roll away.

▶ Therefore, swiftly move your foot from the brake pedal to the accelerator pedal. Never attempt to leave the vehicle if it is being held by Hill Start Assist.

HOLD function

HOLD function

The HOLD function holds the vehicle at a standstill without requiring you to depress the brake pedal, e.g. while waiting in traffic.

System limitations

The HOLD function is only intended to provide assistance when driving and is not a sufficient means of safeguarding the vehicle against rolling away when stationary.

- The incline must not be greater than 30%.

Activating/deactivating the HOLD function

⚠ WARNING Risk of an accident due to the HOLD function being activated when you leave the vehicle

If you leave the vehicle while only the HOLD function is braking the vehicle, the vehicle can roll away in the following situations:

- If there is a malfunction in the system or in the power supply.

- If the HOLD function is deactivated by depressing the accelerator pedal or brake pedal, e.g. by a vehicle occupant.

▶ Always deactivate the HOLD function and secure the vehicle against rolling away before leaving the vehicle.

! NOTE Damage from automatic braking

If one of the following functions is switched on, the vehicle brakes automatically in certain situations:

- Active Brake Assist
- Active Distance Assist DISTRONIC
- HOLD function
- Active Parking Assist

To avoid damage to the vehicle, deactivate these systems in the following or similar situations:

- ▶ During towing
- ▶ In a car wash

Requirements:

- The vehicle is stationary.
- The driver's door is closed or the seat belt on the driver's side is fastened.
- The engine is running or has been automatically switched off by the ECO start/stop function.
- The electric parking brake is released.
- Active Distance Assist DISTRONIC is deactivated.
- The transmission is in position **D**, **R** or **N**.

Activating the HOLD function

- ▶ Depress the brake pedal and after a short time quickly depress further until the **HOLD** display appears in the multifunction display.
- ▶ Release the brake pedal.

Deactivating the HOLD function

- ▶ Depress the accelerator pedal to pull away.
- or
- ▶ Depress the brake pedal until the **HOLD** display disappears from the multifunction display.

The HOLD function is deactivated in the following situations:

- Active Distance Assist DISTRONIC is activated.
- The transmission is switched to position **P**.
- The vehicle is secured with the electric parking brake.

In the following situations, the vehicle is held by the transmission position **P** or by the electric parking brake:

- The seat belt is unfastened and the driver's door is opened.
- The drive system is switched off.
- There is a malfunction in the system or the power supply is insufficient.

RACE START**Function of RACE START**

- ⓘ RACE START is available only for the Mercedes-AMG GT 63 S 4MATIC+ model or for vehicles with AMG DYNAMIC PLUS package.

RACE START enables optimal vehicle acceleration from a standstill. For this, a suitably high-grip road surface is required, the tires and vehicle must also be in good condition.

- ⓘ RACE START is only available after the vehicle has been broken in (→ page 138).
- ⓘ RACE START may not be used on normal roads. RACE START must only be activated and used on dedicated race circuits, not on public roads. Be sure to read the safety notes and information on ESP® (→ page 167).

▲ WARNING Risk of skidding and having an accident from wheels spinning

When you use RACE START, individual wheels could spin and you could lose control of the vehicle.

Depending on the ESP® mode selected, there is an increased risk of skidding and having an accident.

- ▶ Make sure that no persons or obstacles are in the close vicinity of your vehicle.

Activating RACE START

You can activate RACE START under the following conditions:

- the doors, the hood and the tailgate are closed.
- the engine is running and the transmission and engine are at normal operating temperature.
- the steering wheel is in the straight-ahead position.
- the vehicle is on level ground.
- the vehicle is stationary, the brake pedal is depressed (left foot) and the parking brake is released.
- the transmission is in position **D**.
- the DRIFT MODE is deactivated.
- one of the drive programs **S**, **S+** or  is selected (→ page 147).

▶ Rapidly depress the accelerator pedal fully. The engine speed increases.

- ⓘ If the activation conditions are not fulfilled, RACE START cannot be activated. The **RACE**

START Not Possible See Operator's Manual message appears on the multifunction display.

▶ The **RACE START Release brake to start** message appears in the multifunction display.

- ⓘ In this phase you can adjust RACE START depending on the road conditions: you can vary the engine speed by pulling on one of the steering wheel paddle shifters. The segments in the multifunction display flicker rapidly.
- ⓘ If the brake pedal is not released after a short while, RACE START is canceled. The **RACE START Canceled** message appears on the multifunction display.

▶ Take your foot off the brake, but keep the accelerator pedal depressed. The vehicle pulls away at maximum acceleration. The **RACE START Active** message appears in the multifunction display.

RACE START is deactivated when the vehicle reaches a speed of approximately 31 mph (50 km/h).

RACE START is deactivated immediately if you release the accelerator pedal during RACE START or if any of the activation conditions are no longer fulfilled. The **RACE START Canceled** message appears on the multifunction display.

- ⓘ After using it several times in short succession, RACE START is unavailable until a certain distance has been driven.

DRIFT MODE

Functions of DRIFT MODE

- ⓘ The DRIFT MODE is available only for the Mercedes-AMG GT 63 S 4MATIC+ model or for vehicles with AMG DYNAMIC PLUS package.

DRIFT MODE enables intentional unstable movement (drifting) and oversteering of the vehicle. All activation conditions must be fulfilled for this (ESP® deactivated, for example).

- ⓘ Only a highly qualified and experienced driver should drive in DRIFT MODE. Be sure to read the safety notes and information on ESP® (→ page 167).

⚠ WARNING Risk of skidding and having an accident from wheels spinning

When you use DRIFT MODE, ESP® is not available. Individual wheels could spin and you could lose control of the vehicle.

There is an increased risk of skidding and having an accident.

- ▶ Do not use DRIFT MODE on normal roads.
- ▶ DRIFT MODE may only be activated and used on closed race circuits, not on public roads.
- ▶ Make sure that no persons or obstacles are in the close vicinity of your vehicle.

When DRIFT MODE is active, the vehicle drive occurs only at the rear and 4MATIC+ is deactivated.

From a speed of approximately 70 mph (115 km/h) up to 95 mph (150 km/h) 4MATIC+ is continuously reactivated. From a speed of 95 mph (150 km/h) 4MATIC+ is fully active again, ESP® however, remains deactivated.

Below a speed of 95 mph (150 km/h) to approximately 70 mph (115 km/h) 4MATIC+ is continuously deactivated again.

i DRIFT MODE is only available after the vehicle has been broken in (→ page 138).

Activating and deactivating DRIFT MODE

Requirements:

- ESP® is deactivated (→ page 169).
- drive program  (**RACE**) is selected (→ page 147).
- the doors, the hood and the tailgate are closed.
- the engine is running and the transmission and engine are at normal operating temperature.
- the transmission is in position **D**.

Activating DRIFT MODE

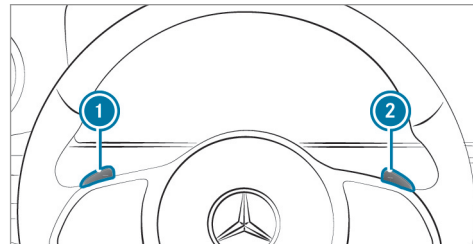

- ▶ Pull steering wheel paddle shifters **1** and **2** and hold for half a second. If all activation conditions are fulfilled, the instrument cluster displays the **DRIFT MODE Confirm: Paddle UP Cancel: Paddle DOWN** message and the **DRIFT** warning lamp flashes.
- ▶ **To cancel:** pull steering wheel paddle shifter **1**. The instrument cluster displays the message **DRIFT MODE Canceled** and the **DRIFT** warning lamp goes out.

- ▶ **To confirm:** pull steering wheel paddle shifter ②.
The instrument cluster shows the **DRIFT MODE Active** message and the **DRIFT** warning lamps lights up permanently.

Deactivating DRIFT MODE

- ▶ Pull steering wheel paddle shifters ① and ② and hold for half a second.
The **DRIFT MODE Active** message and the **DRIFT** warning lamp go out.

DRIFT MODE is automatically deactivated in the following situations:

- ESP® is activated.
- the drive program  (**RACE**) is switched off.
- the vehicle is switched off.
- automatic switch off is required by the vehicle.

Function of the AMG DRIVE UNIT

The **AMG DRIVE UNIT** is available only for the **Mercedes-AMG GT 63 S 4MATIC+** model

or for vehicles with **AMG DYNAMIC PLUS package**.

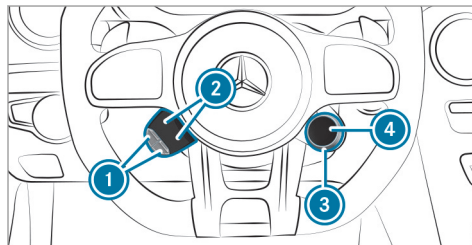

The AMG Drive Unit consists of two additional control elements on the steering wheel.

Using display buttons ②, you can decide which two functions you would like to operate with the left-hand AMG DRIVE UNIT control element. You can change between the available functions by pressing the respective display button.

You can select between the following functions:

- ESP® (→ page 167)
- AMG adaptive sport suspension system (→ page 195)

- AMG Performance exhaust system (→ page 146)
- ECO start/stop function (→ page 142)
- Manual gearshifting (→ page 151)
- Rear wing (→ page 193)

The selected functions are displayed in display buttons ②.

You can activate and deactivate and/or operate the selected functions by pressing buttons ①.

The selected functions remain stored even after a new engine start but are reset to their basic setting.

You can change between the drive programs with rotary adjuster ③. The selected drive program appears in display button ④. By pressing display button ④, you can directly access the  (**Individual**) drive program (→ page 147).

Rear wing

Function of the rear wing

The rear wing improves the vehicle's driving stability and automatically retracts and extends dur-

ing driving. Depending on the vehicle speed, it adopts different positions and thus adapts the vehicle's aerodynamics to the driving conditions.

Vehicles with the AMG aerodynamic package are equipped with a stationary rear wing (→ page 195).

If you drive at a speed greater than 50 mph (80 km/h), the rear wing will automatically extend.

If you drive at a speed lower than 50 mph (80 km/h), the rear wing will automatically retract.

You can retract and extend the rear wing manually for cleaning (→ page 194).

Extending/retracting the rear wing for cleaning

⚠ WARNING Risk of becoming trapped when extending and retracting the rear wing manually

When you extend or retract the rear wing manually, body parts may become trapped.

- ▶ Ensure that there are no people in the sweep of the rear wing when extending or retracting the rear wing.
- ▶ If someone becomes trapped during retraction of the rear wing, press the display button again immediately. The rear wing will then extend again.

! NOTE Damage to the rear wing when washing the vehicle in a car wash

If the rear wing is extended, it may be damaged when the vehicle is washed in a car wash.

- ▶ Only extend the rear wing if washing the car by hand.
- ▶ Before entering a car wash, ensure that the rear wing is retracted.

Requirements:

- The ignition is switched on.
- The tailgate is closed.

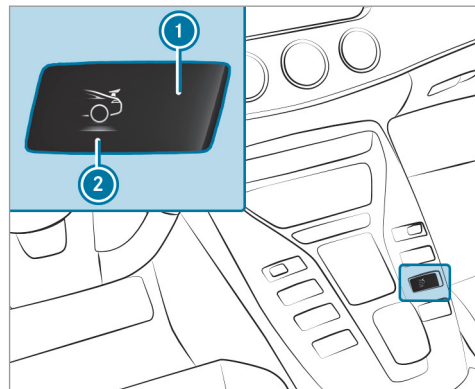

- ▶ **To extend/retract:** press display button ①. The rear wing extends or retracts completely. Display button symbol ② and its color indicate the following positions of the rear wing:
 - Rear wing retracted (blue)
 - Rear wing extended in different positions (red)
 - Rear wing extending or retracting (yellow)

If you press display button ① again during retraction, the rear wing will extend again.

The different positions of the rear wing are also shown on the instrument cluster.

Adjusting the fixed rear wing

Requirements

A socket wrench and a releasable, medium-strength screw lock are available.

Vehicles with the AMG aerodynamic package are installed with a fixed rear wing.

The rear wing improves the rear axle output and, therefore, the vehicle's driving stability. You can move the rear wing into an inclined and a flat position.

When you move the rear wing into the inclined position, the rear axle output and the air resistance increases.

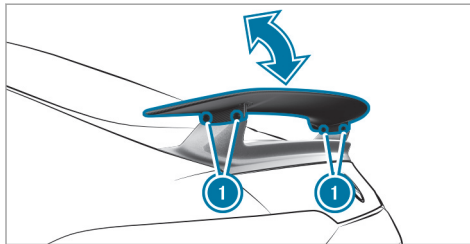

- ▶ Release screws ① with a socket wrench.
- ▶ Tilt the rear wing as far as it will go, upwards in an inclined position, or downwards in a flat position.
- ▶ Furnish screws ① with a releasable, medium-strength screw lock and tighten them.

Specified tightening torque: 7.5 lb-ft (10 Nm).

AMG adaptive sport suspension system

Function of the AMG adaptive sport suspension system

Characteristics of the AMG adaptive sport suspension system

The AMG adaptive sport suspension system is an electronically controlled damping system for improved driving comfort and increased driving safety.

The damping is adjusted individually to each wheel and depends on the following factors:

- The driving style, e.g. sporty
- The road condition, e.g. bumps.
- The individual selection of "Sport", "Sport Plus" or "Comfort"

AMG adaptive sport suspension system comprises:

- Electronically controlled damping system
- ADS PLUS (Adaptive Damping System with constant damping force adjustment).
- DYNAMIC SELECT switch
- Suspension tuning button.

Characteristics of AMG adaptive sport suspension system + (air suspension)

AMG adaptive sport suspension system + is an air suspension system with variable damping for improved driving characteristics. The all-round level control system ensures the best possible suspension and constant ground clearance, even with a laden vehicle. When driving at speed, the vehicle is lowered automatically to improve driving safety and to reduce fuel consumption. You also have the option of manually adjusting the vehicle level.

The damping is tuned individually for each wheel and is affected by the following factors:





- The driving style, e.g. sporty
- The road condition, e.g. bumps.
- The individual selection of "Sport", "Sport Plus" or "Comfort"

AMG adaptive sport suspension system + comprises:

- Air suspension with variable spring rate and automatic level control

- Speed-dependent lowering to reduce fuel consumption.
- Manually selectable high-level setting for greater ground clearance.
- ADS PLUS (Adaptive Damping System with constant damping force adjustment).
- DYNAMIC SELECT switch and level button.
- Suspension tuning button.

Characteristics of each drive program (vehicles with AMG adaptive sport suspension system + only)

Drive program	Characteristics
 (Slippery)  (Comfort)	<ul style="list-style-type: none"> • The suspension tuning is comfortable. • The vehicle is set to the normal level. • When driving at speeds of above 130 mph (210 km/h) the vehicle is lowered. • When driving at speeds below 75 mph (120 km/h) the vehicle is raised again. • 4MATIC+ is dynamically synchronized.
 (Sport)	<ul style="list-style-type: none"> • The suspension tuning is firmer. • The vehicle is set to the normal level. • When driving at speeds of above 130 mph (210 km/h) the vehicle is lowered. • When driving at speeds below 75 mph (120 km/h) the vehicle is raised again. • 4MATIC+ is dynamically synchronized.
 (Sport Plus)  (RACE)	<ul style="list-style-type: none"> • The suspension tuning is even firmer. • The vehicle is set to the low level. • The vehicle is not lowered any further if you are traveling at higher speeds. • 4MATIC+ is more dynamically synchronized.

 The mode can also be set using the DYNAMIC SELECT switch. To do this, the

same suspension tuning must be selected for the AMG adaptive sport suspension system and the DYNAMIC SELECT switch.

- ① When the vehicle is started again, the "Comfort" setting is activated automatically.

Selecting the suspension setting

In "Comfort" mode, the driving characteristics of your vehicle are comfortable. Select this suspension setting if you prefer a comfortable driving style.

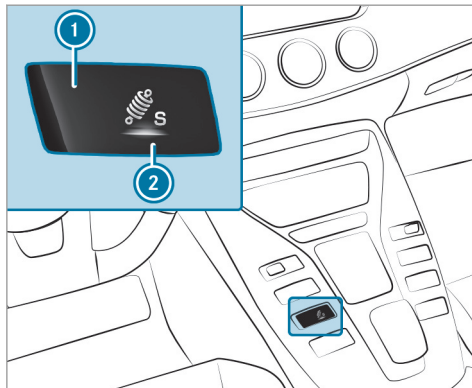

"Sport" driving mode ensures a firmer suspension tuning. Select this suspension setting when employing a sporty driving style, e.g. on winding country roads.

"Sport Plus" driving mode ensures a very firm suspension tuning.



- ▶ Press display button ①.

The display button shows currently selected suspension setting ②:

-  **C** (blue): Comfort
-  **S** (yellow): Sport
-  **S+** (red): Sport Plus

The selected suspension setting is shown in the multifunction display as a message:

- **AMG Suspension System COMFORT**
- **AMG Suspension System SPORT**
- **AMG Suspension System SPORT +**

Setting the vehicle level

⚠ WARNING Risk of accident because vehicle level is too high

If you drive at a higher vehicle level, the driving characteristics may be impaired due to the higher vehicle center of gravity.

The vehicle can drift outwards, for example, when steering or cornering.

- ▶ Always choose a vehicle level which is suited to the driving style and the road surface conditions.

⚠ WARNING Risk of entrapment from vehicle lowering

When lowering the vehicle, people could become trapped if their limbs are between the vehicle body and the tires or underneath the vehicle.

- ▶ Make sure no one is underneath the vehicle or in the immediate vicinity of the wheel arches when you lower the vehicle.

⚠ WARNING Risk of entrapment from vehicle lowering

Vehicles with AIR BODY CONTROL or level control system: When you unload luggage or leave the vehicle, the vehicle first rises slightly and then returns to the set level shortly afterwards.

You or anyone else in the vicinity of the wheel arches or the underbody could thus become trapped.

The vehicle can also be lowered after being locked.

- ▶ When leaving the vehicle, make sure that nobody is in the vicinity of the wheel arches or the underbody.

This function is only available for vehicles with AMG adaptive sport suspension system + (air suspension) (→ page 195).

Requirements:

- The vehicle has been started.
- The vehicle must not be moving faster than 40 mph (65 km/h).

Raising the vehicle

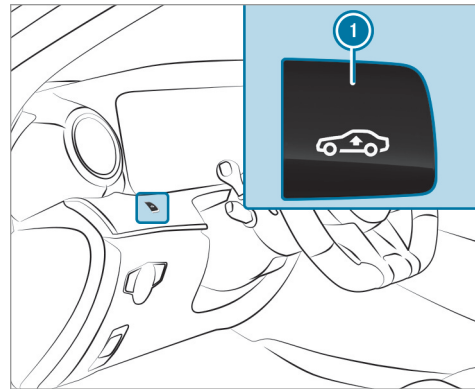

- ▶ Press button ①.
The vehicle is raised to the high level.

Your selection is saved.

The vehicle is lowered again in the following situations:

- When driving faster than 75 mph (120 km/h).

- When driving between 50 mph (80 km/h) and 75 mph (120 km/h) for approximately three minutes.
- After selecting a drive program using the DYNAMIC SELECT switch.

The vehicle is adjusted to the height of the last active drive program.

Lowering the vehicle

- ▶ Press button ①.
The vehicle is adjusted to the height of the last active drive program.

Parking Assist PARKTRONIC

Function of Parking Assist PARKTRONIC

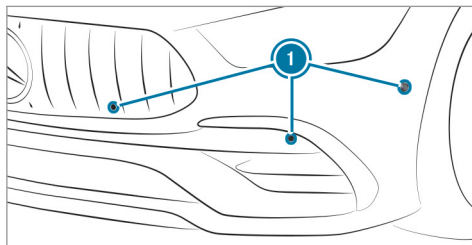

Parking Assist PARKTRONIC is an electronic parking assistance system with ultrasound. It monitors the area around your vehicle using six sensors ① in the front bumper and six sensors in the rear bumper. Parking Assist PARKTRONIC shows you the distance between your vehicle and a detected obstacle visually and audibly.

Parking Assist PARKTRONIC is only an aid. It is not a substitute for your attention to the surroundings. The responsibility for safe maneuvering and parking remains with you. Make sure that there are no persons, animals or objects in

the maneuvering area while maneuvering and parking in/exiting parking spaces.

In the standard setting, an intermittent warning tone sounds from a distance of approximately 1.0 ft (0.3 m) to an obstacle in front and approximately 3.3 ft (1.0 m) to an obstacle behind. A continuous tone sounds from a distance of approximately 0.7 ft (0.2 m). Using the **Warn early** setting in the multimedia system, the warning tones for front and side impact protection can also be set to sound at a greater distance of approximately 3.3 ft (1.0 m) (→ page 203).

- ① The **Warn early** setting is always active at the rear of the vehicle.

If Parking Assist PARKTRONIC is deactivated, Active Parking Assist is unavailable.

Parking Assist PARKTRONIC display in the multimedia system



Vehicles with Active Parking Assist without a 360° Camera



Vehicles with Active Parking Assist and a 360° Camera

If Active Parking Assist is deactivated and an obstacle is detected in the path of the vehicle, a pop-up window for Parking Assist PARKTRONIC ① appears in the multimedia system at speeds below 6 mph (10 km/h).

System limitations

Parking Assist PARKTRONIC does not necessarily take into account the following obstacles:

- Obstacles below the detection range, e.g. persons, animals or objects.

- Obstacles above the detection range, e.g. overhanging loads, overhangs or loading ramps of trucks.

The sensors must be free of dirt, ice and slush. Otherwise, they may not function correctly. Clean the sensors regularly, taking care not to scratch or damage them.

Function of the passive side impact protection

Passive side impact protection is an additional Parking Assist PARKTRONIC function which warns the driver about obstacles at the side of the vehicle. A warning is issued when obstacles are detected between the front and rear detection range. In order for an object on the side to be detected, the sensors in the front and rear bumper must first detect the object while you are driving past it.

During the parking procedure or maneuvering, objects are detected as the vehicle drives past. If you steer in the direction of a detected obstacle and there is a risk of a lateral collision, a warning is issued. The segments on the sides

light up yellow or red, depending on the distance to the obstacle.

Segment color depending on distance

Color	Lateral distance in cm
Yellow	Approx. 30 - 60
Red	Approx. < 30

In order for lateral front or rear segments to be displayed, the vehicle must first travel a distance of at least half of the vehicle length. Once the vehicle has traveled the length of the vehicle, all of the lateral front and rear segments can be displayed.

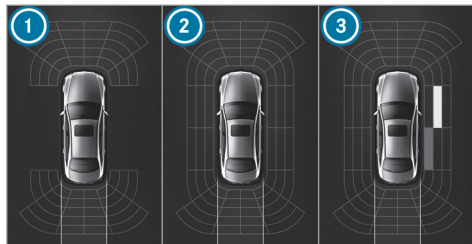

Vehicles without 360° Camera

- ① Parking Assist PARKTRONIC is only operational in the front and rear
- ② Parking Assist PARKTRONIC is operational and can also warn the driver about obstacles at the side of the vehicle
- ③ Obstacle detected at the front right (yellow) and rear (red)

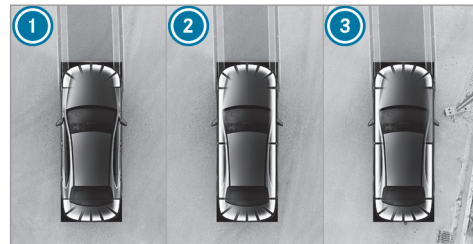

Vehicles with 360° Camera

- ① Parking Assist PARKTRONIC is only operational in the front and rear
- ② Parking Assist PARKTRONIC is operational and can also warn the driver about obstacles at the side of the vehicle
- ③ Obstacle detected at the front right (red)

Saved obstacles on the sides are deleted in the following situations, for example:

- You park the vehicle and switch off the ignition.
- You open the doors.

After the engine is restarted, obstacles must be detected again before a new warning can be issued.

System limitations

The system limitations for Parking Assist PARKTRONIC apply for passive side impact protection.

The following objects are not detected, for example:

- Pedestrians who approach the vehicle from the side
- Objects placed next to the vehicle

Deactivating/activating Parking Assist PARKTRONIC

! **NOTE** Risk of an accident from objects at close range

Parking Assist PARKTRONIC may not detect certain objects at close range.

- ▶ When parking or maneuvering the vehicle, pay particular attention to any objects which are above or below the sensors, e.g. flower pots or drawbars.

The vehicle or other objects could otherwise be damaged.

If indicator lamp ❶ is not lit, Parking Assist PARKTRONIC is active. If the indicator lamp is lit or the  symbol appears in the multifunction display, Parking Assist PARKTRONIC is not active.

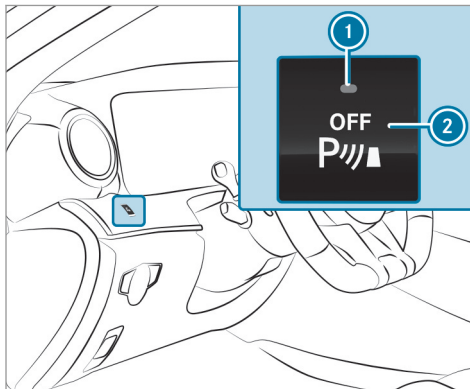

- ▶ Press button ❷.

- ❶ Depending on the vehicle's equipment, the button may also be located in the center console.
- ❶ Parking Assist PARKTRONIC is automatically activated when the vehicle is started.

Adjusting the warning tones of Parking Assist PARKTRONIC

Multimedia system:

➔ Vehicle ➔  Assistance ➔ Camera & Parking ➔ Set Warning Tones

Adjusting the volume of the warning tones

- ▶ Select **Warning Tone Volume**.
- ▶ Set a value.

Adjusting the pitch of the warning tones

- ▶ Select **Warning Tone Pitch**.
- ▶ Set a value.

Specifying the starting point for the warning tones

You can specify whether the Parking Assist PARKTRONIC warning tones should commence when the vehicle is further away from an obstacle.

- ▶ Select **Warn Early**.
- ▶ Activate or deactivate the function.

Activating/deactivating audio fadeout

You can specify whether the volume of a media source in the multimedia system is to be reduced when Parking Assist PARKTRONIC gives an audible warning.

- ▶ Select **Audio Fadeout During Warning Tones**.
- ▶ Activate or deactivate the function.

Reversing camera

Function of the rear view camera

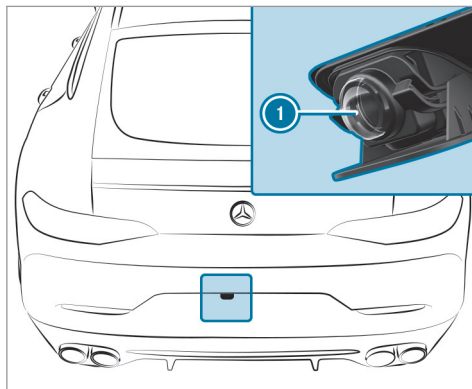

If you have activated the function in the multimedia system, the image from rear view camera ① is shown in the multimedia system display when reverse gear is selected. Dynamic guide lines show the path the vehicle will take with the steering wheel in its current position. This helps

you to orient yourself and to avoid obstacles when backing up.

The rear view camera is only an aid. It is not a substitute for your attention to the surroundings. The responsibility for safe maneuvering and parking remains with you. Make sure that there are no persons, animals or objects etc. in the maneuvering area while maneuvering and parking.

You can select from the following views:

- Normal view
- Wide-angle view
- Trailer view

The area behind the vehicle is displayed as a mirror image, as in the inside rearview mirror.

The following camera views are available in the multimedia system:

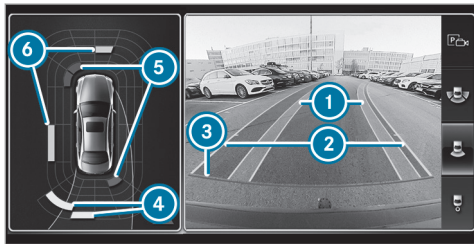

Normal view

- ① Yellow lane marking the course the tires will take at the current steering wheel angle (dynamic)
- ② Yellow guide line, vehicle width (driven surface) depending on the current steering wheel angle (dynamic)
- ③ Red guide line at a distance of approximately 12 in (0.3 m) from the rear area
- ④ Yellow warning display of Parking Assist PARKTRONIC: obstacles are at a distance of between approximately 2.0 ft (0.6 m) and 3.3 ft (1.0 m)

- ⑤ Red warning display of Parking Assist PARKTRONIC: obstacles are very close (approximately 1.0 ft (0.3 m) or less)
 - ⑥ Orange warning display of Parking Assist PARKTRONIC: obstacles are a medium distance away (between approximately 1.0 ft (0.3 m) and 2.0 ft (0.6 m))
- ⓘ If the entire system fails, the inner segments of the warning display are shown in red. The indicator lamp on the PARKTRONIC button lights up and the  symbol appears in the multifunction display.

If the system fails at the rear:

- The rear segments are shown in red when backing up.
- The rear segments are hidden when driving forwards.

When Active Parking Assist is active, the lanes are displayed in green.

If Parking Assist PARKTRONIC is deactivated, the warning display fades out.



Wide-angle view

System limitations

The rear view camera will not function or will only partially function in the following situations:

- There is heavy rain, snow or fog.
- The ambient light conditions are poor, e.g. at night.
- The camera lens is obstructed, dirty or fogged up. Observe the notes on cleaning the rear view camera (→ page 362).
- The camera or rear of your vehicle is damaged. In this case, have the camera and its

position and setting checked at a qualified specialist workshop.

The field of vision and other functions of the rear view camera may be restricted due to additional accessories on the rear of the vehicle (e.g. license plate bracket or bicycle rack).

- ⓘ The display contrast may be impaired due to incident sunlight or other light sources. In this case, pay particular attention.
- ⓘ Have the display repaired or replaced if, for example, pixel errors considerably restrict its use.

360° camera

Function of the 360° Camera

The 360° Camera is a system that consists of four cameras. The cameras cover the immediate vehicle surroundings. The system assists you, e.g. when parking or at exits with reduced visibility.

The 360° Camera is only an aid. It is not a substitute for your attention to the surroundings. The responsibility for safe maneuvering and

parking remains with you. Make sure that there are no persons, animals or objects etc. in the maneuvering area while maneuvering and parking.

The system evaluates images from the following cameras:

- Rear view camera
- Front camera
- Two side cameras in the outside mirrors

Views of the 360° Camera

You can select from different views:



- ① Wide-angle view, front
- ② Top view with image from the front camera
- ③ Top view with images from the side cameras in the outside mirrors
- ④ Wide-angle view, rear
- ⑤ Top view with image from the rear view camera
- ⑥ Top view with trailer view (if trailer hitch is installed)

Top view



- ① Lane indicating the route the vehicle will take with the steering wheel in its current position
- ② Yellow warning display of Parking Assist PARKTRONIC: obstacles at a distance of approximately 3.3 ft (1.0 m) or less
- ③ Your vehicle from above

If the distance to the object lessens, the color of warning display ② changes:

- From approx. 3.3 ft (1.0 m): yellow
- From approx. 2.0 ft (0.6 m): orange
- From approx. 1.0 ft (0.3 m): red

When Parking Assist PARKTRONIC is operational and no object is detected, the segments of the warning display are shown in gray.

- ⓘ If the entire system fails, the segments of the warning display are shown in red and the  symbol appears in the multifunction display in the instrument cluster.

If the system fails at the rear, the display of the segments changes as follows:

- The rear segments are shown in red when backing up.
- The rear segments are hidden when driving forwards.

If Parking Assist PARKTRONIC is deactivated, the warning display fades out.

Guide lines

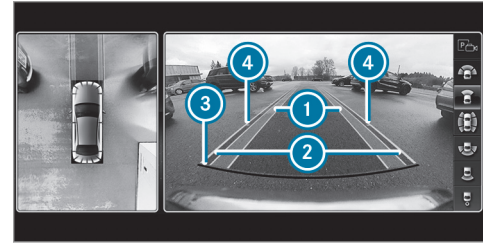

- ① Yellow lane marking the course the tires will take at the current steering wheel angle (dynamic)
 - ② Yellow guide line, vehicle width (driven surface) depending on the current steering wheel angle (dynamic)
 - ③ Red guide line at a distance of approximately 12 in (0.3 m) from the rear area
 - ④ Mark at a distance of approx. 3.3 ft (1.0 m)
- ⓘ When Active Parking Assist is active, lanes ① are displayed in green.

The guide lines in the multimedia system display show the distances to your vehicle. The distances apply to road level.

Side view of the mirror cameras

The sides of the vehicle can be seen in this view.

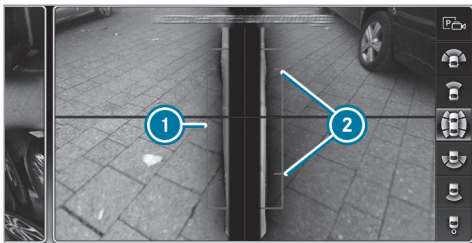

- ① Guide line of external vehicle dimensions with outside mirrors folded out
- ② Marker of the wheel contact points

System failure

If there is no operational readiness, the following message appears in the multimedia system:



System limitations

The 360° Camera will not function or will only partially function in the following situations:

- The doors are open.
- The side mirrors are folded in.
- There is heavy rain, snow or fog.
- The ambient light conditions are poor, e.g. at night.
- The camera lens is obstructed, dirty or fogged up.
- Cameras, or vehicle components in which the cameras are installed, are damaged. In this event, have the cameras, their positions

and their setting checked at a qualified specialist workshop.

- ① Do not use the 360° Camera under such circumstances. You could otherwise injure others or collide with objects when parking the vehicle.

If the vehicle is carrying a heavy load, leaving the standard height can result in inaccuracies in the guide lines and in the display of the generated images, depending on technical conditions.

The field of vision and other functions of the camera system may be restricted due to additional attachments on the vehicle (e.g. license plate bracket, bicycle rack).

- ① The contrast of the display may be impaired by abrupt direct sunlight or by other light sources, e.g. when driving out of a garage. In this case, pay particular attention.
- ① Have the display repaired or replaced if, for example, pixel errors considerably restrict its use.

See the notes on cleaning the 360° Camera (→ page 362).

Selecting a view for the 360° Camera

Requirements:

- The **Auto. Rear View Cam.** function is selected in the multimedia system.

- ▶ Engage reverse gear.
- ▶ In the multimedia system, select the desired view.

Opening the camera cover of the rear view camera

Multimedia system:

↳ **Vehicle** ▶  **Assistance** ▶ **Camera & Parking**

- ▶ Select **Open Camera Cover**.

- ⓘ The camera cover closes automatically after some time or after an ignition cycle.

Setting the camera as a favorite



You can call up the camera view directly in the multimedia system by setting it as a favorite.

- ▶ Press the  button on the control element.
The main functions are displayed.

- ▶ Navigate downwards twice.
The Favorites menu appears.
- ▶ Select **New Favorite**.
- ▶ Select **Vehicle**.
- ▶ Select **Camera**.

Active Parking Assist

Function of Active Parking Assist

Active Parking Assist is an electronic parking assistance system which uses ultrasound and is automatically activated during forward travel. The system is operational at speeds of up to approximately 22 mph (35 km/h). When all the conditions are fulfilled, the  symbol appears in the multifunction display in the instrument cluster and the system automatically searches for and measures parking spaces on both sides of the vehicle parallel and perpendicular to the direction of travel. If Active Parking Assist is activated, suitable parking spaces are shown in the display of the multimedia system. The  symbol appears in the display of the multimedia system. The arrows show on which side of the roadway free parking spaces are located.

The parking space and, if necessary, the parking direction can be selected as desired. Active Parking Assist calculates a suitable vehicle path and assists you in parking and exiting the parking space.

Active Parking Assist supports by changing gear, accelerating, braking and steering the vehicle.

Active Parking Assist is only an aid. It is not a substitute for your attention to the surroundings. The responsibility for safe maneuvering and parking remains with you. Make sure that no persons, animals or objects etc. are in the maneuvering range.

Active Parking Assist is canceled if, among other things, one of the following actions is carried out:

- You deactivate Parking Assist PARKTRONIC.
- You deactivate Active Parking Assist.
- You begin steering.
- You apply the parking brake.
- You engage transmission position **P**.
- ESP[®] intervenes.

- You open the doors or the trunk lid while driving.

System limitations

Objects located above or below the detection range of Active Parking Assist are not detected when the parking space is being measured. These are also not taken into account when the parking maneuver is calculated, e.g. overhanging loads, overhangs or loading ramps of trucks or the boundaries of parking spaces. In some circumstances, Active Parking Assist may therefore guide you into the parking space prematurely.

⚠ WARNING Risk of accident due to objects located above or below the detection range of Active Parking Assist

If there are objects above or below the detection range, the following situations may arise:

- Active Parking Assist may steer too early.
- **Vehicles with automatic transmission:** The vehicle may not stop in front of these objects.

This could cause a collision.

▶ In these situations, do not use Active Parking Assist.

Snowfall or heavy rain may lead to a parking space being measured inaccurately. Parking spaces that are partially occupied by trailer drawbars might not be identified as such or be measured incorrectly. Only use Active Parking Assist on level, high-grip ground.

Do not use Active Parking Assist in the following situations:

- In extreme weather conditions such as ice, packed snow or in heavy rain.
- If you are transporting a load that protrudes beyond the vehicle.
- If the parking space is on a steep downhill or uphill gradient.
- If you have installed snow chains.

Active Parking Assist may also display parking spaces that are not suitable for parking, e.g.:

- Parking spaces where parking is prohibited.

- Parking spaces on unsuitable surfaces.

Active Parking Assist will not assist you with parking spaces at right angles to the direction of travel in the following situations:

- If two parking spaces are located immediately next to each other.
- If the parking space is directly next to a low obstacle such as a curb.

Active Parking Assist will not assist you with parking spaces parallel or at right angles to the direction of travel in the following situations:

- If the parking space is on a curb.
- If the parking space is bordered by an obstacle, e.g. a tree, a post or a trailer.

Parking with Active Parking Assist

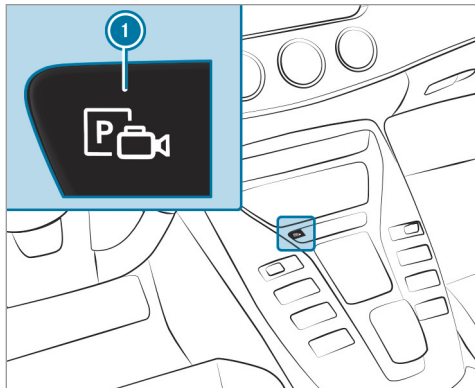

- ▶ Press button ①.



The Active Parking Assist view appears on the multimedia system display. Area ② displays detected parking spaces ④ and vehicle path ③.

- ① Vehicle path ③ shown on the multimedia system display may differ from the actual vehicle path.
- ▶ If you have driven past a parking space: bring the vehicle to a standstill.
- ▶ Select desired parking space ④.

- ▶ Where necessary, select the parking direction: forwards or reverse. Vehicle path ③ is shown, depending on selected parking space ④ and the parking direction.

- ▶ Confirm selected parking space ④.

- ① The turn signal indicator is switched on automatically when the parking procedure begins. The turn signal indicator is switched off automatically when you switch to **D**.

You are responsible for selecting the turn signal in accordance with the traffic conditions. If necessary, select the turn signal accordingly.

⚠ WARNING Risk of accident due to vehicle swinging out while parking or pulling out of a parking space

While parking or exiting a parking space, the vehicle swings out and can drive onto areas of the oncoming lane.

This could cause you to collide with objects or other road users.

- ▶ Pay attention to objects and other road users.
- ▶ Where necessary, stop the vehicle or cancel the parking procedure with Active Parking Assist.

- ▶ If, for example, the **Please Engage Reverse Gear** message appears in the multimedia system display: select the corresponding transmission position. The vehicle drives into the selected parking space.

On completion of the parking procedure, the **Parking Assist Finished, Take Control of Vehicle** display message appears. Further maneuvering may still be necessary.

- ▶ After completion of the parking procedure, safeguard the vehicle against rolling away. When required by legal requirements or local conditions: turn the wheels towards the curb.

i You can stop the vehicle and change the transmission position during the parking procedure. The system then calculates a new vehicle path. The parking procedure can

then be continued. If no new vehicle path is available, the transmission position will be changed again. If the vehicle has not yet reached the parking space, the parking procedure will be canceled, should a gear be changed.

Exiting a parking space with Active Parking Assist

Requirements:

- The vehicle has been parked with Active Parking Assist.

Please note that you are responsible for the vehicle and surroundings during the entire parking procedure.

- ▶ Start the vehicle.

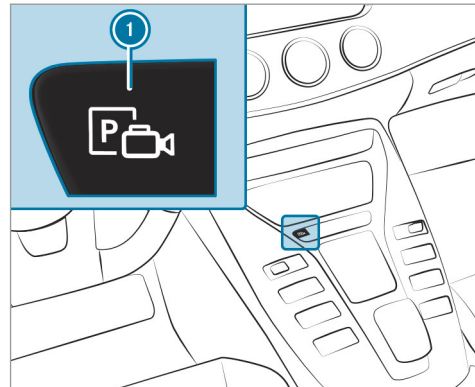

- ▶ Press button **1**. The Active Parking Assist view appears on the multimedia system display.



- ▶ If the vehicle has been parked at right angles to the direction of travel: in area ②, select direction of travel ③.
- ① The vehicle path shown on the multimedia system display may differ from the actual vehicle path.
- ▶ Confirm direction of exit ③ to drive out of the parking space.
- ① The turn signal indicator is switched on automatically when the exit the parking space procedure begins.

You are responsible for selecting the turn signal in accordance with the traffic conditions. If necessary, select the turn signal accordingly.

⚠ WARNING Risk of accident due to vehicle swinging out while parking or pulling out of a parking space

While parking or exiting a parking space, the vehicle swings out and can drive onto areas of the oncoming lane.

This could cause you to collide with objects or other road users.

- ▶ Pay attention to objects and other road users.
- ▶ Where necessary, stop the vehicle or cancel the parking procedure with Active Parking Assist.

- ▶ If, for example, the **Please Engage Forward Gear** message appears in the multimedia sys-

tem display: select the corresponding transmission position.
The vehicle moves out of the parking space. The turn signal indicator is switched off automatically.



Example: vehicles with 360° Camera

After the exiting procedure has been completed, the **Parking Assist Finished, Take Control of Vehicle** message appears in the display of the multimedia system. A warning tone and display ④ in the display of the multimedia system prompt you to take over control of the vehicle. You have to accelerate, brake, steer and change gear yourself again.

Function of Drive Away Assist

Drive Away Assist can reduce the severity of an impact when pulling away. If an obstacle is detected in the direction of travel, the vehicle's speed is briefly reduced to approx. 1 mph (2 km/h). If a critical situation is detected, the **LIM** symbol appears on the camera image of the multimedia system.

⚠ WARNING Risk of accident caused by limited detection performance of Drive Away Assist

Drive Away Assist cannot always clearly identify objects and traffic situations.

In such cases, Drive Away Assist might:

- Warn you without reason and limit the vehicle speed.
- Not warn you or not limit the vehicle speed.

▶ Always pay careful attention to the traffic situation; do not rely on Drive Away Assist alone.

▶ Be prepared to brake or swerve as necessary, provided the traffic situation permits and that it is safe to take evasive action.

Drive Away Assist is only an aid. It is not a substitute for your attention to the surroundings. The responsibility for safe maneuvering and parking remains with you. Make sure that no persons, animals or objects etc. are in the maneuvering range.

A risk of a collision may arise in the following situations, for example:

- If the driver mixes up the accelerator and brake pedals.
- If the wrong gear is selected.

The Drive Away Assist function is active under the following conditions:

- If Parking Assist PARKTRONIC is activated.
- Every time the gear is changed to **R** or **D** when the vehicle is at a standstill.
- If the detected obstacle is less than approx. 3.3 ft (1.0 m) away.

- If the maneuvering assistance function is activated in the multimedia system.

System limitations

Drive Away Assist is not available on inclines.

Function of Cross Traffic Alert

i Also read the instructions on Blind Spot Assist (→ page 218).

Vehicles with Blind Spot Assist: drivers can also be warned of any crossing traffic when backing up out of a parking space. If a critical situation is detected, symbol **1** appears in the multimedia system display. If the driver does not respond to the warning, the vehicle's brakes can be applied automatically. To do this, the function uses the radar sensors in the bumper. The area adjacent to the vehicle is continually monitored.

If the radar sensors are obstructed by vehicles or other objects, detection is not possible.

The Cross Traffic Alert function is active under the following conditions:

- If Blind Spot Assist is activated.
- If the vehicle is backing up at walking pace.

- If the maneuvering assistance function is activated in the multimedia system.

System limitations

Deactivating/activating maneuvering assistance

Multimedia system:

↳ Vehicle ▶▶  Assistance ▶▶ Camera & Parking ▶▶ Maneuvering Assist.

- ▶ Activate or deactivate the function.
- ⓘ Maneuvering assistance must be active for the function of Drive Away Assist (→ page 214).

ATTENTION ASSIST

Function of ATTENTION ASSIST

ATTENTION ASSIST assists you on long, monotonous journeys, e.g. on highways and trunk roads. If ATTENTION ASSIST detects indicators of fatigue or increasing lapses in concentration on the part of the driver, it suggests taking a break.

ATTENTION ASSIST is only an aid. It cannot always detect fatigue or lapses in concentration

in time. The system is not a substitute for a well-rested and attentive driver. On long journeys, take regular breaks in good time that allow for adequate recuperation.

You can choose between two settings.

- **Standard:** normal system sensitivity.
- **Sensitive:** higher system sensitivity. The driver is warned earlier and the attention level detected by ATTENTION ASSIST is adapted accordingly.

If drowsiness or increasing lapses in concentration are detected, the **ATTENTION ASSIST: Take a Break!** warning appears in the Instrument Display. You can acknowledge the message and take a break if necessary. If you do not take a break and ATTENTION ASSIST continues to detect increasing lapses in concentration, you will be warned again after a minimum of 15 minutes.

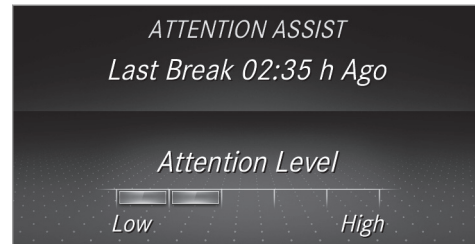

You can have the following status information for ATTENTION ASSIST displayed in the assistance menu of the on-board computer:

- The length of the journey since the last break.
- The attention level determined by ATTENTION ASSIST.

If ATTENTION ASSIST is unable to calculate the attention level and cannot issue a warning, the **System Suspended** message appears.

If a warning is given in the Instrument Display, the multimedia system offers to search for a rest area. You can select a rest area and start naviga-

tion to this rest area. This function can be activated and deactivated in the multimedia system.

If ATTENTION ASSIST is deactivated, the  symbol appears in the assistance graphic in the Instrument Display when the engine is running. ATTENTION ASSIST is activated automatically when the engine is re-started. The last selected sensitivity level remains stored.

System limitations

ATTENTION ASSIST is active in the 37 mph (60 km/h) to 124 mph (200 km/h) speed range.

The functionality of ATTENTION ASSIST is restricted, and warnings may be delayed or not occur at all in the following situations:

- If you have been driving for less than approximately 30 minutes.
- If the road condition is poor (uneven road surface or potholes).
- If there is a strong side wind.
- If you adopt a sporty driving style (high cornering speeds or high rates of acceleration).
- If the Steering Assist function of Active Distance Assist DISTRONIC is active.

- If the time has been set incorrectly.
- In active driving situations, if you change lanes and vary your speed frequently.

The ATTENTION ASSIST tiredness or alertness assessment is deleted and restarted when continuing the journey in the following situations:

- If you switch off the engine.
- If you unfasten your seat belt and open the driver's door (e.g. changing drivers or taking a break).

Setting ATTENTION ASSIST

Multimedia system:

 **Vehicle**   **Assistance**  **ATTENTION ASSIST**

Setting options

 Select **Standard**, **Sensitive** or **Off**.

Suggesting a rest area

 Select **Suggest Rest Area**.

 Activate or deactivate the function . If ATTENTION ASSIST detects fatigue or increasing lack of attention, it suggests a rest area in the vicinity.

 **Select a suggested rest area:** you are guided to the selected rest area.

Traffic Sign Assist

Function of Traffic Sign Assist

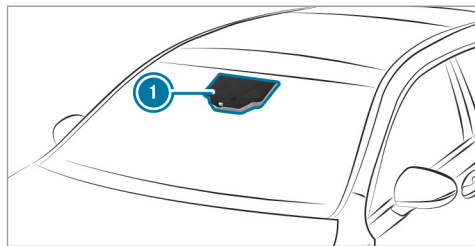

Traffic Sign Assist detects traffic signs with multifunction camera . It assists you by displaying detected speed limits and overtaking restric-

tions in the instrument cluster and optionally in the head-up display.

Since Traffic Sign Assist also uses the data stored in the navigation system, it can update the display in the following situations without detecting traffic signs:

- When the vehicle changes roads, e.g. free-way entry or exit road.
- When a village or city boundary is passed which is stored in the digital map.

The camera also detects traffic signs with a restriction indicated by an additional sign (e.g. in wet conditions).

Traffic Sign Assist is only an aid. The driver is responsible for keeping a safe distance to the vehicle in front, for vehicle speed and for braking in good time. The maximum permissible speed also depends on factors such as the road surface and traffic conditions.

Warning when the maximum permissible speed is exceeded

The system can warn you if you unintentionally exceed the maximum permissible speed. To do

this, you can specify in the multimedia system by how much the maximum permissible speed can be exceeded before a warning is issued. You can specify whether the warning is to be just a visual warning or an acoustic one as well.

Display in the Instrument Display

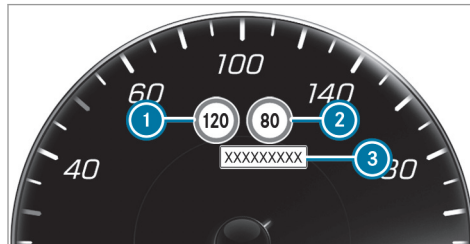

Instrument Display in the Widescreen Cockpit

- ① Permissible speed
- ② Permissible speed when there is a restriction
- ③ Additional sign with restriction (e.g. in wet conditions)



Traffic Sign Assist is not available in all countries. If it is unavailable, display ① is shown in the speedometer.

System limitations

The system may be impaired or may not function in the following situations:

- If there is poor visibility, e.g. due to insufficient illumination of the road, if there are highly variable shade conditions or in rain, snow, fog or heavy spray.
- If there is glare, e.g. from oncoming traffic, direct sunlight or reflections.

- If the windshield in the area of the multifunction camera is dirty, or if the camera is fogged up, damaged or covered.
- If the traffic signs are hard to detect, e.g. due to dirt or snow, or because they are covered or due to insufficient lighting.
- If the information in the navigation system's digital map is incorrect or out-of-date.
- If the signs are ambiguous, e.g. traffic signs on construction sites or in adjacent lanes.
- If you turn sharply, you may pass traffic signs that are outside the camera's field of vision.

Setting Traffic Sign Assist

Multimedia system:

➔ Vehicle ➔  Assistance ➔ Traffic Sign Assist

Displaying detected traffic signs in the media display

- ▶ Select **Display in COMAND**.
- ▶ Activate or deactivate the function.
- ⓘ When DISTRONIC, cruise control or the variable limiter are activated, the speed detected

can be manually adopted as the speed limit (→ page 179).

Adjusting the type of warning

- ▶ Select **Visual & Audible**, **Visual** or **None**.

Adjusting the warning threshold

This value determines the speed at which a warning is issued when exceeded.

- ▶ Select **Warning Threshold**.
- ▶ Set the desired speed.

Blind Spot Assist and Active Blind Spot Assist

Function of Blind Spot Assist and Active Blind Spot Assist

Blind Spot Assist uses two lateral, rear-facing radar sensors to monitor the area up to 130 ft (40 m) behind your vehicle and 10 ft (3 m) directly next to your vehicle.

If a vehicle is detected at speeds above approximately 8 mph (12 km/h) and this vehicle subsequently enters the monitoring range directly next

to your vehicle, the warning lamp in the outside mirror lights up red.

If a vehicle is detected close to your vehicle in the lateral monitoring range and you switch on the turn signal indicator in the corresponding direction, a warning tone sounds once. The red warning lamp in the outside mirror flashes. If the turn signal indicator remains switched on, all other detected vehicles are indicated only by the flashing of the red warning lamp.

If you overtake a vehicle quickly, no warning is given.

⚠ WARNING Risk of accident despite Blind Spot Assist

Blind Spot Assist does not react to vehicles approaching and overtaking you at a greatly different speed.

As a result, Blind Spot Assist cannot warn drivers in this situation.

- ▶ Always pay careful attention to the traffic situation and maintain a safe distance at the side of the vehicle.

Blind Spot Assist and Active Blind Spot Assist are only aids. They may fail to detect some vehicles and are no substitute for attentive driving. Always ensure that there is sufficient distance to the side for other road users and obstacles.

System limitations

The system may be limited in the following situations:

- The sensors are dirty or covered.
- Poor visibility, e.g. due to fog, heavy rain, snow or spray.
- Narrow vehicles, e.g. bicycles, are within the monitoring range.

Warnings may be issued in error when driving close to crash barriers or similar solid lane borders. Warnings may be interrupted when driving alongside long vehicles, for example trucks, for a prolonged time.

Blind Spot Assist is not operational when reverse gear is engaged.

Function of brake application (Active Blind Spot Assist)

The brake application function is only available for vehicles with a Driving Assistance Package.

If Active Blind Spot Assist detects a risk of a side impact in the monitoring range, a course-correcting brake application is carried out. This is designed to help you avoid a collision.

The course-correcting brake application is available in the speed range between approximately 20 mph (30 km/h) and 125 mph (200 km/h).

⚠ WARNING Risk of accident despite brake application of Active Blind Spot Assist

A course-correcting brake application cannot always prevent a collision.

- ▶ Always steer, brake or accelerate yourself, especially if Active Blind Spot Assist warns you or makes a course-correcting brake application.
- ▶ Always maintain a safe distance at the sides.

⚠ WARNING Risk of accident despite Active Blind Spot Assist

Active Blind Spot Assist does not react to the following:

- If vehicles overtake too closely on the side, placing them in the blind spot area
- Vehicles approaching and overtaking you at a greatly different speed

As a result, Active Blind Spot Assist may neither give warnings nor intervene in such situations.

- ▶ Always pay careful attention to the traffic situation and maintain a safe distance at the side of the vehicle.



If a course-correcting brake application occurs, the red warning lamp flashes in the outside mirror and a warning tone sounds. In addition, display ① indicating the danger of a side collision appears in the multifunction display.

In rare cases, the system may make an inappropriate brake application. This brake application may be interrupted at any time if you steer slightly in the opposite direction or accelerate.

System limitations

Either a course-correcting brake application appropriate to the driving situation, or none at all, may occur in the following situations:

- Vehicles or obstacles, e.g. crash barriers, are located on both sides of your vehicle.
- A vehicle approaches too closely on the side.
- You have adopted a sporty driving style with high cornering speeds.
- You brake or accelerate significantly.
- A driving safety system intervenes, e.g. ESP® or Active Brake Assist.
- ESP® is deactivated
- A loss of tire pressure or a faulty tire is detected.

Activating/deactivating Blind Spot Assist or Active Blind Spot Assist

Multimedia system:

Vehicle ► Assistance ► Blind Spot Assist

► Activate or deactivate the function.

Active Lane Keeping Assist

Function of Active Lane Keeping Assist

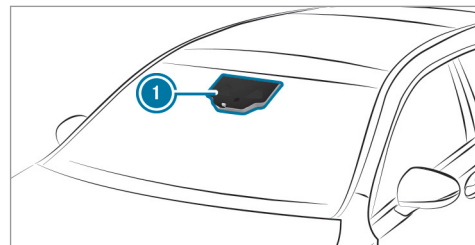

Active Lane Keeping Assist monitors the area in front of your vehicle by means of multifunction camera ①. It serves to protect you against unintentionally leaving your lane. You will be warned by vibration pulses in the steering wheel and guided by a course-correcting brake application back into your lane.

You are warned by vibration pulses in the steering wheel in the following circumstances:

- Active Lane Keeping Assist detects a lane marking.

- A front wheel drives over this lane marking.

You will also be guided back into your lane by means of a course-correcting brake application if the following conditions are met:

- Active Lane Keeping Assist detects lane markings on both edges of the lane.
- A front wheel drives over a solid lane marking.

You can activate or deactivate the Active Lane Keeping Assist warning.

Active Lane Keeping Assist can neither reduce the risk of an accident if you fail to adapt your driving style nor override the laws of physics. It cannot take into account road, weather or traffic conditions. Active Lane Keeping Assist is only an aid. You are responsible for maintaining a safe distance to the vehicle in front, for vehicle speed, for braking in good time and for staying in lane.

Active Lane Keeping Assist can bring the vehicle back into the lane with a lane-correcting brake application. In the case of a broken lane marking being detected, a brake application will only be

made if a vehicle has been detected in the adjacent lane. Oncoming traffic can be detected.

Vehicles with Driving Assistance package or Driving Assistance Plus package: overtaking vehicles and vehicles in adjacent lanes can also be detected.

Active Lane Keeping Assist is available in the speed range between 40 mph (60 km/h) and 120 mph (200 km/h).

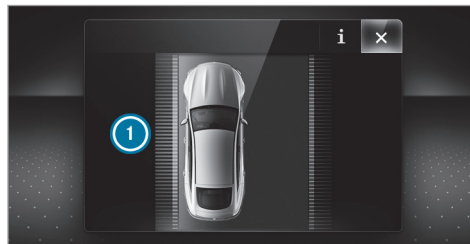

If a lane-correcting brake application occurs, display ① appears in the multifunction display.

System limitations

No lane-correcting brake application occurs in the following situations:

- You clearly and actively steer, brake or accelerate.
- You have switched on the turn signal indicator (situation-dependent).
- A driving safety system intervenes, such as ESP®, Active Brake Assist or Active Blind Spot Assist.
- You have adopted a sporty driving style with high cornering speeds or high rates of acceleration.
- When ESP® is deactivated.
- If a loss of tire pressure or a faulty tire has been detected and displayed.

The system may be impaired or may not function in the following situations:

- If there is poor visibility, e.g. due to insufficient illumination of the road, if there are highly variable shade conditions or in rain, snow, fog or heavy spray.

- If there is glare, e.g. from oncoming traffic, the sun or reflections.
- If the windshield in the area of the multifunction camera is dirty, or if the camera is fogged up, damaged or covered.
- If there are no lane markings, or several unclear lane markings are present for one lane, e.g. around roadworks.
- If the lane markings are worn, dark or covered.
- If the distance to the vehicle in front is too short and thus the lane markings cannot be detected.
- If the lane markings change quickly, e.g. lanes branch off, cross one another or merge.
- If the roadway is very narrow and winding.

Vehicles with Driving Assistance package or Driving Assistance Plus package: Active Lane Keeping Assist uses radar sensors to monitor several areas around the vehicle. If the radar sensors in the rear bumper are dirty or covered with snow, the system may be impaired or may

not function. If an obstacle in the lane in which you are driving has been detected, no lane-correcting brake application occurs.

Activating Active Lane Keeping Assist

⚠ WARNING Risk of accident despite Active Lane Keeping Assist warning

A lane-correcting brake application cannot always bring the vehicle back into the original lane.

- ▶ Always steer, brake or accelerate yourself, especially if Active Lane Keeping Assist warns you or makes a lane-correcting brake application.

⚠ WARNING Risk of accident despite intervention of Active Lane Keeping Assist

Active Lane Keeping Assist does not detect traffic conditions or road users. In very rare cases, the system may make an inappropriate brake application, e.g. after intentionally driving over a solid lane marking.

The brake application can be interrupted at any time if you steer slightly in the opposite direction.

- ▶ Always make sure that there is sufficient distance to the side for other traffic or obstacles.

⚠ WARNING Risk of accident despite Lane Keeping Assist

Lane Keeping Assist cannot always clearly detect lane markings.

In such cases, Lane Keeping Assist can:

- give an unnecessary warning
 - not give a warning
- ▶ Always pay particular attention to the traffic situation and keep within the lane, especially if Active Lane Keeping Assist alerts you.

Observe the system limitations of Active Lane Keeping Assist.

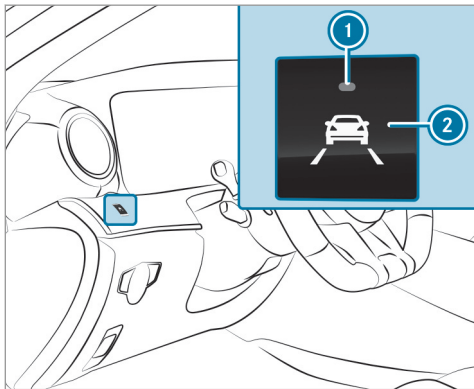

- ▶ Press button ②.

If indicator lamp ① lights up, Lane Keeping Assist is activated, the lane markings are shown as light in the assistance graphic. When Lane Keeping Assist is active and the lane markings are shown in green in the assistance graphic.

- ① Depending on the country, you may have to press and hold the button to deactivate.

Sensitivity of Active Lane Keeping Assist

- ① The availability of the following function is country-dependent.

With the standard or sensitive setting, you can adjust the sensitivity of Active Lane Keeping Assist. In the sensitive setting, there are additional situations in which Active Lane Keeping Assist intervenes. The likelihood of intervention is therefore higher.

Setting the sensitivity of Active Lane Keeping Assist

Multimedia system:

↳ Vehicle ▶ Assistance ▶ Act. Lane Keep. Assist

- ▶ Select a setting.

Activating/deactivating the warning

- ▶ Switch Lane Depart. Warning on or off .
You do not receive any warning when leaving a lane if the lane keeping warning system is deactivated.

Vehicle towing instructions

The vehicle is not suitable for the use of tow-bar systems, which are used for flat towing or dinghy towing, for example. Attaching and using tow-bar systems can lead to damage on the vehicle. When towing a vehicle with tow-bar systems, safe, dynamic driving behavior of the towing vehicle and the vehicle being towed is not guaranteed. The vehicle-trailer combination can swerve from side to side. Comply with the permitted towing methods (→ page 377) and the instructions for towing with both axles on the ground (→ page 379).

Instrument Display overview

⚠ WARNING Risk of accident due to an instrument display malfunction

If the Instrument Display has failed or malfunctioned, you may not recognize function restrictions applying to safety relevant systems.

The operating safety of your vehicle may be impaired.

- ▶ Drive on carefully.
- ▶ Have the vehicle checked immediately at a qualified specialist workshop.

If the operating safety of your vehicle is impaired, park the vehicle safely as soon as possible. Contact a qualified specialist workshop.

Instrument Display

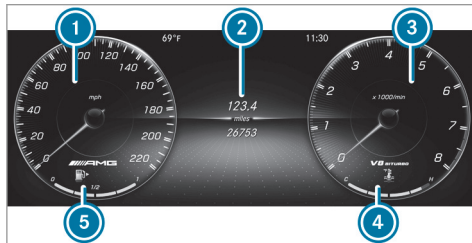

- ① Speedometer
- ② Multifunction display
- ③ Example: area for additional values
- ④ Mercedes-AMG GT 43/GT 53:
EQ Boost display
Mercedes-AMG GT 63:
Coolant temperature gauge
- ⑤ Fuel level and fuel filler flap location indicator
- ① Further display content can be shown on display ③ for additional values (→ page 227).

The segments on speedometer ① indicate the system status for the following:

- Cruise control(→ page 175)
- Active Distance Assist DISTRONIC(→ page 177)

! NOTE Engine damage due to excessively high engine speeds

The engine will be damaged if you drive with the engine in the overrevving range.

- ▶ Do not drive with the engine in the overrevving range.

The fuel supply is interrupted to protect the engine when the red mark on tachometer ③ (overrevving range) is reached.

During normal operating conditions, coolant temperature display ④ may rise to the red mark.

⚠ WARNING Danger of burns when opening the hood

If you open the hood when the engine has overheated or during a fire in the engine compartment, you could come into contact with hot gases or other escaping operating fluids.

- ▶ Before opening the hood, allow the engine to cool down.
- ▶ In the event of a fire in the engine compartment, keep the hood closed and call the fire service.

EQ Boost display



- POWER ① shows the electrical drive support as a percentage.
- CHARGE ② shows the electric motor's recuperation power performance as a percentage.

Overview of the buttons on the steering wheel

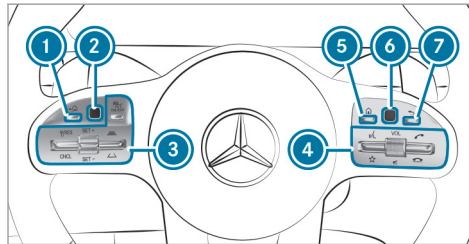

- ① Back/Home button (press and hold), on-board computer
- ② Touch Control, on-board computer
- ③ Control panel for cruise control or Active Distance Assist DISTRONIC

- ④ Control panel for multimedia system:
 - LINGUATRONIC or voice control system
 - Displays favorites
 - VOL: control knob, adjusts the volume or switches the sound off (press)
 - Makes/accepts a call
 - Rejects/ends a call
- ⑤ Calls up the home screen
- ⑥ Touch Control multimedia system
- ⑦ Back button (press and hold)

Operating the on-board computer

⚠ WARNING Risk of distraction from information systems and communications equipment

If you operate information and communication equipment integrated in the vehicle when driving, you will be distracted from the traffic situation. This could also cause you to lose control of the vehicle.

- ▶ Only operate this equipment when the traffic situation permits.
- ▶ If you cannot be sure of this, stop the vehicle whilst paying attention to road and traffic conditions and operate the equipment with the vehicle stationary.

Observe the legal requirements for the country in which you are currently driving when operating the on-board computer.

- ① The on-board computer displays appear on the multifunction display (→ page 228).

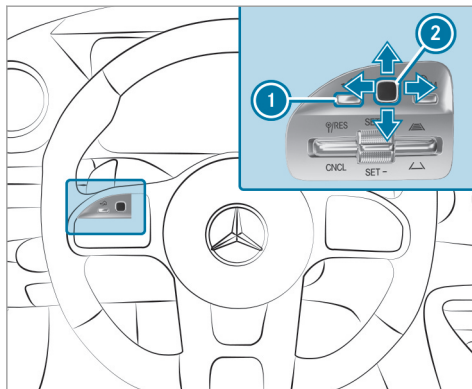

The on-board computer can be operated using the left-hand Touch Control ② and left-hand back/home button ①.

When the on-board computer is being operated, different acoustic signals sound as operating feedback, e.g. when the end of a list is reached or when scrolling through a list.

The following menus are available:

- Service

- Assistance
- Performance
- Trip
- Navigation
- Radio
- Media
- Phone
- HUD

Vehicles with an Instrument Display (standard) only: If you select the **Performance** menu, the upshift bar will appear on the multifunction display.

The menu can be called up from the menu bar on the multifunction display.

- ▶ **To call up the menu bar:** press back button on the left ① until the menu bar is displayed.

- ① **Vehicles without Active Distance Assist DISTRONIC:** press the  button to call up the menu bar of the on-board computer.



- ▶ **To scroll in the menu bar:** swipe left or right on left-hand Touch Control ②.
- ▶ **To call up a menu or confirm the selection:** press left-hand Touch Control ②.
- ▶ **To scroll through displays or lists on the menu:** swipe upwards or downwards on left-hand Touch Control ②.
- ▶ **To call up a submenu or confirm the selection:** press left-hand Touch Control ②.
- ▶ **To exit a submenu:** press back button on the left ①.

Setting the design

On-board computer:

➔ Designs

① This function is only available for vehicles with a Widescreen Cockpit.

The following designs can be selected:

- Classic
- Sport
- Supersport

- ▶ **To select a design:** swipe upwards or downwards on the left-hand Touch Control.
- ▶ Press the left-hand Touch Control. The Instrument Display is shown in the selected design.

Setting the additional value range



Example: G-meter

- ① Additional value range
- ② Index points

- ▶ **To select display content:** swipe to the right on the left-hand Touch Control.
- ▶ Swipe upwards or downwards on the left-hand Touch Control to select display content. When display content is selected, additional value range ① is briefly highlighted. Index points ② display the selected list item.

The following content can be displayed in Mercedes-AMG vehicles:





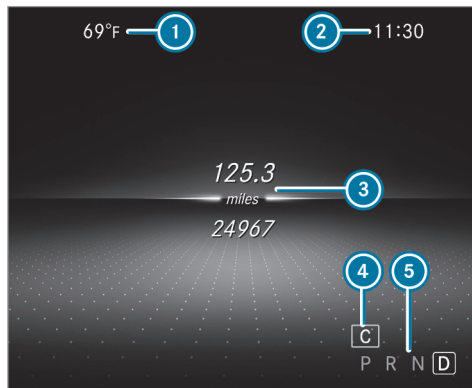





- Tachometer/date
- G-meter
- Engine data
- AMG TRACK PACE
- Warm-up
- Trip computer
- Navigation

Overview of displays on the multifunction display



- ① Outside temperature
- ② Time
- ③ Display section
- ④ Drive program
- ⑤ Transmission position

Further displays on the multifunction display:

-  Active Parking Assist activated (→ page 211)
-  Parking Assist PARKTRONIC deactivated (→ page 203)
-  Cruise control (→ page 175)
-  Active Distance Assist DISTRONIC (→ page 177)
-  Active Steering Assist (→ page 183)
-  ECO start/stop function
-  **Mercedes-AMG GT 43/53:** operational readiness established
-  **Mercedes-AMG GT 63:** 4-cylinder operation
-  HOLD function (→ page 189)
-  Adaptive Highbeam Assist (→ page 118)

Vehicles with Traffic Sign Assist: Detected instructions and traffic signs (→ page 216).

Adjusting the instrument lighting

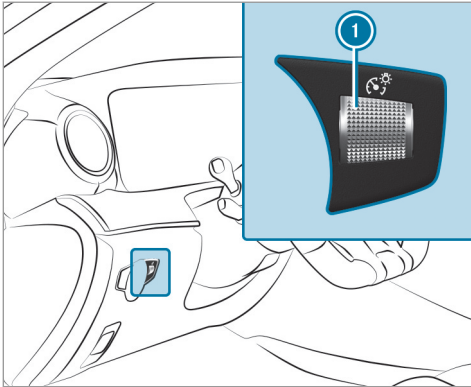

- ▶ Turn brightness control ① up or down. The lighting of the Instrument Display and in the control elements of the vehicle interior is adjusted.

Menus and submenus

Functions on the Service menu of the on-board computer

On-board computer:

↳ Service

- ▶ **To select the function:** swipe upwards or downwards on the left-hand Touch Control.
- ▶ Press the left-hand Touch Control.

Functions on the **Service** menu:

- Message memory (→ page 428)
- **Tires:**
 - Checking the tire pressure with the tire pressure monitoring system (→ page 392)
 - Restarting the tire pressure monitoring system (→ page 393)
- **ASSYST PLUS:** calls up the service due date (→ page 350)
- **Vehicles with a Widescreen Cockpit:** **Coolant:** Coolant temperature display
- **Engine Oil Level:** engine oil level

Calling up the assistant display

On-board computer:

↳ Assistance

The following displays are available on the assistant display menu:

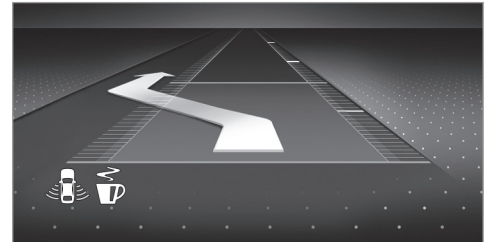

- Assistant display
- Attention level (→ page 215)

- ▶ **To switch between the displays:** swipe upwards or downwards on the left-hand Touch Control.



Status displays on the assistant display:

-  ATTENTION ASSIST: deactivated

- Light lane markings: Active Lane Keeping Assist enabled
- Green lane markings: Active Lane Keeping Assist active
-  Gray radar waves next to vehicle: Blind Spot Assist or Active Blind Spot Assist enabled
-  Green radar waves next to vehicle: Blind Spot Assist or Active Blind Spot Assist active
- Active Distance Assist DISTRONIC displays (→ page 177)

- G-meter
- Engine data
- **Vehicles without AMG TRACK PACE:** RACE-TIMER (→ page 231)

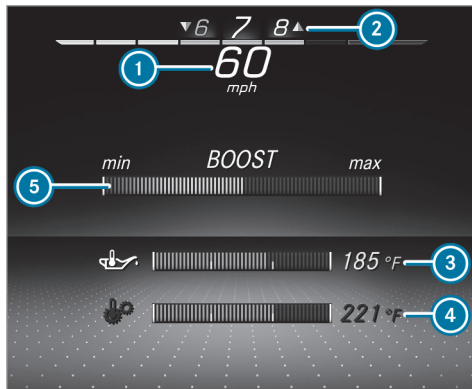

Example: warm-up

- ① Digital speedometer
- ② Gear display
- ③ Engine oil temperature

- ④ Transmission oil temperature
- ⑤ Boost pressure

If the engine or transmission is not at operating temperature, the multifunction display shows temperature ③ or ④ in blue. Avoid using the full engine power output during this time.

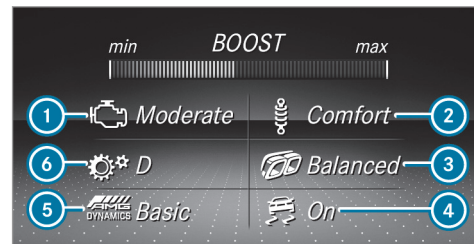

SETUP in Mercedes-AMG GT vehicles (example)

- ① Drive system setting:
Reduced/Moderate/Sport/Dynamic/Race
- ② Suspension tuning:
Comfort/Sport/Sport+
- ③ Exhaust system:
Balanced/Powerful

Calling up displays on the Performance menu

On-board computer:

 Performance

 **To select a display:** swipe upwards or downwards on the left-hand Touch Control.

Displays on the Performance menu:

- Warm-up
- SETUP

- ④ ESP®:
On/Sport/Off
- ⑤ AMG Dynamics:
Basic/Advanced/Pro/Master
- ⑥ Transmission position
D/M

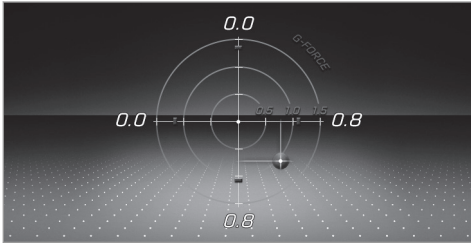

Example: G-meter

While the vehicle is in motion, the G-meter shows the forces that are exerted on the vehicle occupants both laterally and in the direction of travel. The maximum values appear in red in the coordinate system.

- ▶ **To reset the G-meter:** press the left-hand Touch Control.
- ▶ Select **Yes**.
- ▶ Press the left-hand Touch Control.

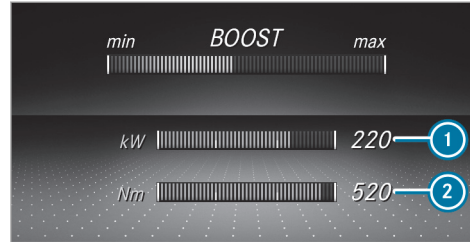

Example: engine data

- ① Current power output
- ② Current torque

When current power ① or current torque ② achieves the maximum value, the digital value is briefly stationary. The bar display continues.

Displaying and starting RACETIMER in the Performance menu

On-board computer:

➔ Performance

The following functions are possible in RACE-TIMER:

- Selecting and starting displays
- Stopping
- Starting a new lap
- Displaying lap statistics
- Resetting

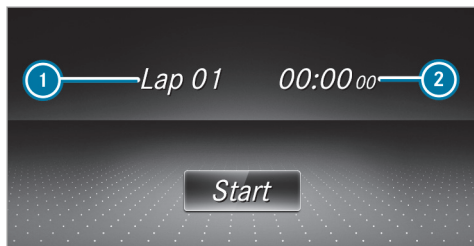

- ① Lap
- ② Lap time

RACETIMER is intended only for use on designated race tracks. Do not use the function on public roads.

- ▶ **To select a display and start:** swipe up or down on the left-hand Touch Control.
- ▶ Press the left-hand Touch Control.
- ▶ Select **Start** and press the left-hand Touch Control.
- ▶ **To stop:** select **Stop** and press the left-hand Touch Control.

- ▶ **To start a new lap:** after the first stored lap, press the left-hand Touch Control.
- ▶ Select **New Lap**.
A maximum of 32 laps may be stored.

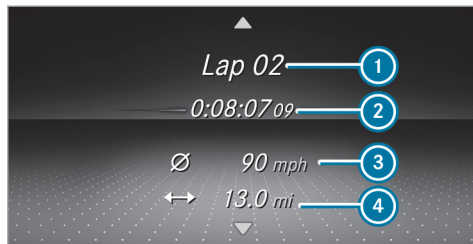

Example: RACETIMER

- ① Lap
 - ② Elapsed time
 - ③ Average speed
 - ④ Distance covered
- ▶ **To display the lap statistics:** after at least two stored laps, press the left-hand Touch Control.

- ▶ Select **Lap List**.
The lap statistics will be displayed.
- ▶ Display the statistics of the next lap by swiping up or down on the left-hand Touch Control.
The fastest lap is indicated by flashing symbol ①.
- ▶ **To reset:** stop RACETIMER and press the left-hand Touch Control.
- ▶ Select **Reset** and press the left-hand Touch Control.
All laps will be deleted.

Calling up displays on the trip menu

On-board computer:

- ▶ **Trip**
- ① You can view information about the journey in the left-hand area of the instrument display.
- ▶ **To select a display:** swipe upwards or downwards on the left-hand Touch Control.

Displays on the **Trip** menu:

- Standard display
- Range and current fuel consumption
If there is only a small amount of fuel left in the fuel tank, the display will show a vehicle being refueled instead of the range.
- ECO display (→ page 144)
- Trip computer **From Start** and **From Reset**
- Digital speedometer

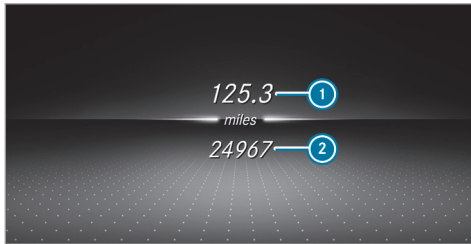

Example: standard display

- ① Trip distance
- ② Total distance



Example: trip computer

- ① Total distance
- ② Driving time
- ③ Average speed
- ④ Average fuel consumption

Resetting values on the trip menu of the on-board computer

On-board computer:



- ① The spelling on the main menu displayed may differ. Therefore, observe the menu

overview for the Instrument Display (→ page 225).

You can reset the values of the following functions:

- Trip distance
- Trip computer **From Start** and **From Reset**
- ECO display (→ page 144)

- ▶ **To select the function to be reset:** swipe upwards or downwards on the left-hand Touch Control.
- ▶ Press the left-hand Touch Control.
- ▶ Select **Yes**.
- ▶ Press the left-hand Touch Control.

If you press and hold the left-hand Touch Control, the values of the function will be reset immediately.

Calling up navigation instructions on the on-board computer

On-board computer:

➔ Navigation



Example: no change of direction announced

- ① Distance to the next change of direction
- ② Distance to the next destination
- ③ Estimated arrival time at next destination
- ④ Current road

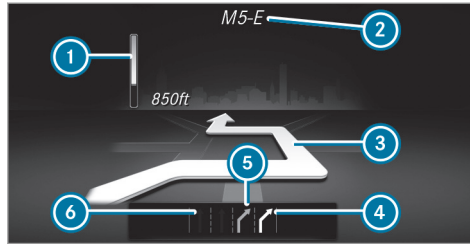

Example: change of direction announced

- ① Distance to the change of direction
- ② Road to which the change of direction leads
- ③ Change-of-direction symbol
- ④ Recommended lane (white)
- ⑤ Possible lane
- ⑥ Lane not recommended (dark gray)

Further possible displays on the [Navigation](#) menu:

- **Direction of Travel:** display of direction of travel and road currently being traveled on.
- **New Route...** or **Calculating Route...:** a new route is being calculated.

- **Road Not Mapped:** the road is unknown, e.g. for newly built roads.
- **No Route:** no route could be calculated to the selected destination.
- **Off Map:** the map for the current location is not available.
- **Area of Destination Reached:** you have reached the area of destination.
- 📍: you have reached the destination or an intermediate destination.

▶ **To exit the menu:** press the back button on the left.

Vehicles with the COMAND multimedia system: You can also start navigation to one of the recent destinations on the [Navigation](#) menu:

▶ Press the left-hand Touch Control.

▶ **To select a destination:** swipe upwards or downwards on the left-hand Touch Control.

▶ Press the left-hand Touch Control. Route guidance is started.

If route guidance has already been activated, a request will appear asking whether you wish to end the current route guidance.

- ▶ Select **Yes**.
- ▶ Press the left-hand Touch Control. Route guidance is started.

Selecting radio stations using the on-board computer

On-board computer:

↳ Radio

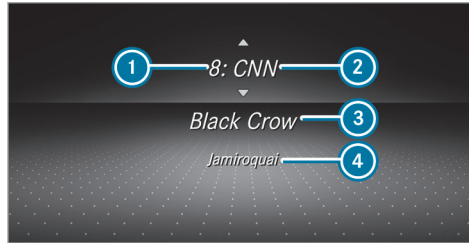

- ① Memory preset
- ② Channel name
- ③ Name of track
- ④ Name of artist

When you select a station from the memory presets, the preset will appear next to the station name. When you select a saved station in the frequency range, an asterisk will appear next to the station name.

- ▶ **To select a radio station:** swipe upwards or downwards on the left-hand Touch Control.

Selecting the frequency range or memory preset

- ▶ Press the left-hand Touch Control.
- ▶ **To select the frequency range/station preset:** swipe upwards or downwards on the left-hand Touch Control.
- ▶ Press the left-hand Touch Control.

Media playback using the on-board computer

On-board computer:

→ Media

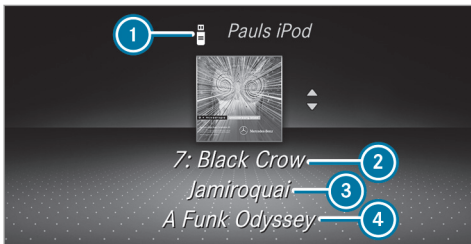

- ① Media source
- ② Track number and current track
- ③ Name of artist
- ④ Name of album

▶ **To change tracks on an active media source:** swipe upwards or downwards on the left-hand Touch Control.

Changing a media source

- ▶ Press the left-hand Touch Control.
- ▶ **To select a media source:** swipe upwards or downwards on the left-hand Touch Control.
- ▶ Press the left-hand Touch Control.

Dialing telephone numbers using the on-board computer

⚠ WARNING Risk of distraction from information systems and communications equipment

If you operate information and communication equipment integrated in the vehicle when driving, you will be distracted from the traffic situation. This could also cause you to lose control of the vehicle.

- ▶ Only operate this equipment when the traffic situation permits.
- ▶ If you cannot be sure of this, stop the vehicle whilst paying attention to road

and traffic conditions and operate the equipment with the vehicle stationary.

When telephoning, you must observe the legal requirements for the country in which you are currently driving.

Requirements:

- The mobile phone is connected to the multimedia system.

On-board computer:

→ Phone

Vehicles with the COMAND multimedia system: The most recent telephone calls (dialed, received and missed calls) are displayed on the **Phone** menu.

- ▶ **To select an entry:** swipe upwards or downwards on the left-hand Touch Control.
- ▶ Press the left-hand Touch Control.
If there is only one telephone number saved to an entry: the telephone number is selected.
- ▶ **If there are multiple telephone numbers saved to an entry:** swipe upwards or down-

wards on the left-hand touch control to select the desired telephone number.



- ▶ Press the left-hand Touch Control. The telephone number will be dialed.



The following displays may appear instead of the telephone numbers dialed:

- **Please Wait...:** the application is starting. If a Bluetooth® connection to the mobile phone is not established, the menu for authorizing and connecting a mobile phone will be displayed on the multimedia system (→ page 301).
- **Updating data...:** the call list is being updated.
- **Importing Contacts...:** contacts are being imported from the mobile phone or a storage medium.

Accepting/rejecting a call

Vehicles with Head-up Display: when you receive a call, the **Incoming Call** message will appear on the Head-up Display.

- ▶ Swipe upwards or downwards on the left-hand Touch Control and select  (Accept) or  (Reject).
- ▶ Press the left-hand Touch Control.

You may accept/reject the call using button  or  on the steering wheel.

Adjusting the Head-up Display settings on the on-board computer

On-board computer:



The following Head-up Display settings can be adjusted:

- Position
- Brightness
- Display Content

- ▶ **To select a setting:** swipe upwards or downwards on the left-hand Touch Control.
- ▶ Press the left-hand Touch Control.
- ▶ **To adjust a value:** swipe upwards or downwards on the left-hand Touch Control.

- ▶ Press the left-hand Touch Control.



- ① Setting currently selected
- ② Digital speedometer
- ③ Traffic Sign Assist
- ④ Navigation displays

Head-up Display

Function of the Head-up Display

The Head-up Display projects into the driver's field of vision:

- Information from the navigation system

- Information from the driver assistance systems
- Some warning messages

Display elements

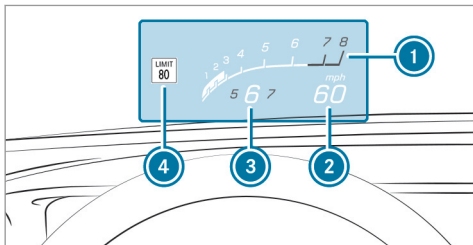

- 1 Current engine speed
- 2 Current speed
- 3 Currently selected gear, gearshift options with manual shifting
- 4 Detected instructions and traffic signs

Depending on the vehicle's equipment, you can select further AMG displays in addition to the standard displays on the [Display Content](#) menu.

If you select RACETIMER, the Head-up Display will show the lap and lap time.

In vehicles with AMG TRACK PACE, you can display further content depending on the setting, e.g.:

- Speed and gear indicator
- Lap and sector times
- Acceleration and braking
- Graphic track layouts

When you receive a call, the  Incoming Call message will appear on the Head-up Display.

In audio mode, the station name or track will be shown temporarily when the audio source is being actively operated.

System limitations

The visibility is influenced by the following conditions:

- Seat position
- The positioning of the display image
- Light conditions
- Wet roads

- Objects on the display cover
- Polarization in sunglasses

- i** In extreme sunlight, sections of the display may appear washed out. You can correct this by switching the Head-up Display off and on again.

Switching the Head-up Display on/off

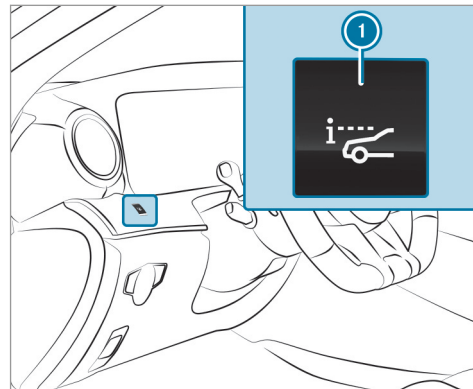

▶ Press button ①.

Notes on operating safety

⚠ WARNING Risk of distraction from information systems and communications equipment

If you operate information and communication equipment integrated in the vehicle when driving, you will be distracted from the traffic situation. This could also cause you to lose control of the vehicle.

- ▶ Only operate this equipment when the traffic situation permits.
- ▶ If you cannot be sure of this, stop the vehicle whilst paying attention to road and traffic conditions and operate the equipment with the vehicle stationary.

⚠ WARNING Risk of distraction from operating mobile communication equipment while the vehicle is in motion

If you operate mobile communication equipment when driving, you will be distracted

from the traffic situation. This could also cause you to lose control of the vehicle.

- ▶ Only operate this equipment when the vehicle is stationary.

For your own safety, always observe the following points when operating mobile communications equipment and especially your voice control system:



- Observe the legal requirements for the country in which you are driving.
- While driving, only operate mobile communications equipment and your voice control system when the traffic conditions permit it. You may otherwise be distracted from the traffic conditions and cause an accident, injuring yourself and others.
- If you use the voice control system in an emergency your voice can change and your telephone call, e.g. an emergency call, can thereby be unnecessarily delayed.
- Familiarize yourself with the voice control system functions before starting the journey.

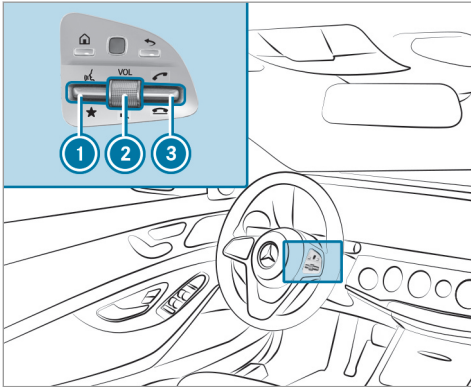

Operation

Overview of operating the multifunction steering wheel

The Voice Control System is operational approximately thirty seconds after the ignition is switched on.



- ① Press the rocker switch up:  starts the Voice Control System
- ② Press the control knob:  switches the sound off or on (ends the Voice Control System)
Turn the control knob up/down: increases/decreases the volume

- ③ Press the rocker switch up:  makes/accepts a call
Press the rocker switch down:  rejects/ends a call (ends the Voice Control System)

Conducting a dialog with the Voice Control System

- ▶ **To start or continue a dialog:** on the multi-function steering wheel, press the  rocker switch up.
You can say a voice command after an acoustic signal.
- ▶ **To correct an entry:** say the Correction voice command.
- ▶ **To select an entry from the selection list:** say the line number or the contents.
- ▶ **To browse the selection list:** say the Next or Back voice command.
- ▶ **To interrupt the dialog:** say the Pause voice command.
- ▶ **To cancel the dialog:** say the Cancel voice command.

Operable functions

You can use the Voice Control System to operate the following equipment depending on the features:

- Telephone
- Text messages
- Navigation
- Address book
- Radio
- Audio (memory card, Media Interface, USB and Bluetooth® audio)
- Vehicle

Overview of types of voice commands

A distinction is made between the following voice commands:

- **Global voice commands** can be said at any time and regardless of the current application, e.g. the voice commands Navigate to, Call or Text message to.

- **Application-specific voice commands** are only available for the active application.

Information on the language setting

You can change the language of the Voice Control System via the system language settings. If the set system language is not supported by the Voice Control System, English will be selected.

The Voice Control System is available in English, French, Portuguese and Spanish.

Using the Voice Control System effectively

Features of audible help functions

You receive information and help for:

- **For optimum operation:** say the brief instruction voice command.
- **Current application:** on the multifunction steering wheel, press the  rocker switch up and say the Help voice command.
- **Continued dialog:** say the Help voice command during a voice dialog.

- **Specific function:** say voice commands for the desired function, e.g. Help telephone.

Notes on how to improve speech quality

If the Voice Control System does not understand you:

- only operate the Voice Control System from the driver's seat.
- say the voice commands coherently and clearly, but do not exaggerate the words.
- avoid loud noises that cause interference while making a voice command entry, e.g. the blower.

A voice tag in the address book is not recognized:

- only create sensible address book entries in the system/mobile phone, e.g. enter surname and first name in the correct field.
- do not use any abbreviations, unnecessary spaces or special characters.

If a station list entry is not recognized:

- say the Read out station list voice command.

Essential voice commands

Overview of switch voice commands

Switch voice commands can be used to open certain applications. The voice command selection can be used regardless of the application that is currently active.

Overview of navigation voice commands

Using navigation voice commands, you can enter POIs or conventional addresses as well as directly change important navigation settings.

Overview of telephone voice commands

You can use the telephone voice commands to make phone calls or search through the address book.

Telephone voice commands

Voice command	Function
Call <Name>	Makes a phone call. All address book names are available.
Search for contact <Name>	Searches for and displays a contact. All address book names are available.
Outgoing calls	Displays the last call
Redial	Selects the last phone number dialed

Overview of radio voice commands

Radio voice commands can also be used when the radio application is running in the background.

Radio voice commands

Voice command	Function
Station <Name>	To call up receivable or saved stations
<Frequency>	To enter a frequency directly
Next station	To switch to the next available station

Voice command	Function
Previous station	To switch to the previous station
Save station	To save a station in the station list
Show station list	To display the names of all receivable stations
Read out station list	To listen to the names of all receivable stations
Traffic information on Traffic information off	To switch the traffic information service on/off
Radio info on Radio info off	To switch the current station information on/off

Overview of media player voice commands

Media player voice commands can also be used when the media player is running in the background.

Media player voice commands

Voice command	Function
Play <Tracks> Play <Albums> Play <Artists> Play<Composers> Play <Genres> Play <Playlists>	The names of all available tracks, albums, artists, composers, genres or playlists are accepted during the search.
Media search <Track> Media search <Albums> Media search <Artists> Media search <Composers> Media search <Genres> Media search <Playlists>	The names of all available tracks, albums, artists, composers, genres or playlists are accepted during the search.

Voice command	Function
Show all albums Show all artists Show all composers Show all genres Show all tracks Show all playlists	Available albums, artists, composers, genres, tracks or playlists are searched for.
Next track	To select the next track
Previous track	To select the previous track
Random track list on Random track list off	To switch the random track list on/off

Overview of message voice commands

Text messages can be created, edited and listened to using the message voice commands.

Message voice commands

Voice command	Function
Text message to <Name>	To create a message. All address book names are available.
Reply	To reply to a message
Forward text message	To forward a message

Overview of vehicle voice commands

You can use the vehicle voice commands to directly call up the corresponding menus for the vehicle settings.

Overview and operation

Overview of the multimedia system

⚠ WARNING Risk of distraction from information systems and communications equipment

If you operate information and communication equipment integrated in the vehicle when driving, you will be distracted from the traffic situation. This could also cause you to lose control of the vehicle.

- ▶ Only operate this equipment when the traffic situation permits.
- ▶ If you cannot be sure of this, stop the vehicle whilst paying attention to road and traffic conditions and operate the equipment with the vehicle stationary.

You must observe the legal requirements for the country in which you are currently driving when operating the multimedia system.

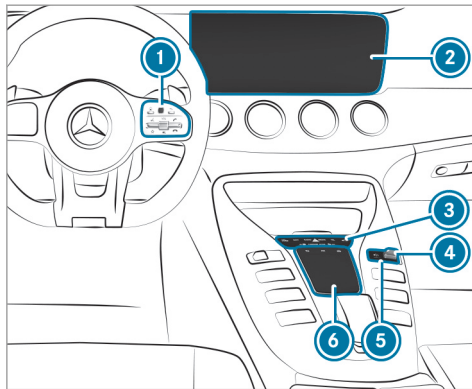

Equipment with touchpad

- ① Touch Control
Multimedia system button group on the steering wheel (→ page 225)
- ② Media display
- ③ Main function button group (→ page 253)
- ④ Press the rocker switch up or down: increases or decreases the volume

- ⑤ Display button shows volume, current volume when setting the volume or mute
Press the display button: switches the multimedia system on/off
- ⑥ Touchpad

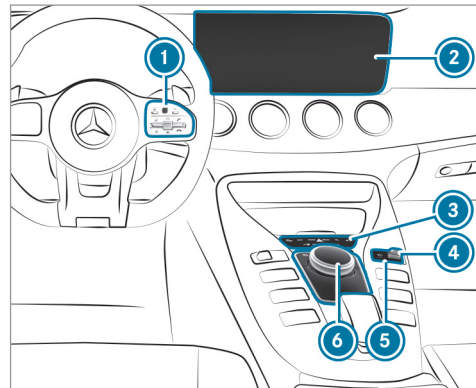

Equipment with controller

- ① Touch Control

Multimedia system button group on the steering wheel (→ page 225)

- ② Media display
- ③ Main function button group (→ page 253)
- ④ Press the rocker switch up or down: increases or decreases the volume
- ⑤ Display button shows volume, current volume when setting the volume or mute
Press the display button: switches the multimedia system on/off
- ⑥ Controller

Notes on the media display

! NOTE Scratches on the display

The display has a highly sensitive, high-gloss surface. There is a risk of it becoming scratched.

- ▶ Avoid touching the display.
- ▶ Observe the notes on cleaning.

Observe the notes on caring for the interior (→ page 364).

Automatic temperature-controlled switch-off feature: if the temperature is too high, the brightness is initially reduced automatically. The display may then switch off completely for a while.

- ⓘ If you are wearing polarized sunglasses, it may be difficult to read the display.

Central control elements overview

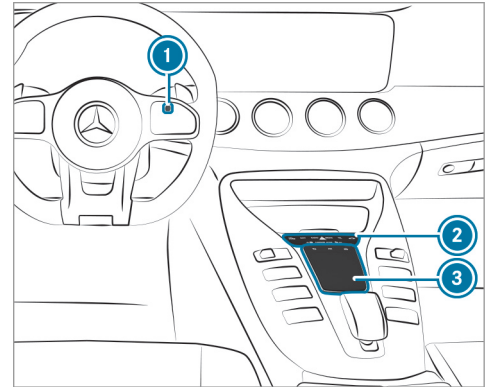

Touchpad equipment

- ① Touch Control
- ② Main function button group
- ③ Touchpad

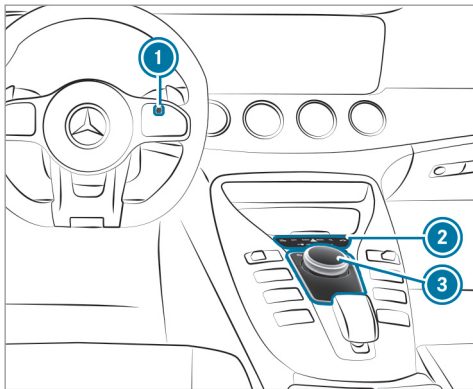

Controller equipment

- ① Touch Control
- ② Main function button group
- ③ Controller

Touch Control

Operating Touch Control

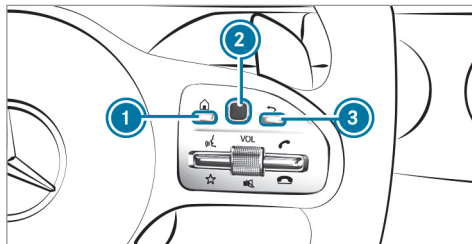

▶ **To call up main functions:** press button ①.

or

▶ Press and hold button ③.

▶ **To call up favorites:** press button ①.

▶ Swipe down on Touch Control ②.

▶ **To open a list:** press Touch Control ②.

▶ **To close a list:** press button ③.

or

▶ Swipe right on Touch Control ②.

▶ **To select a menu item:** swipe up, down, left or right on Touch Control ②.

▶ Press Touch Control ②.

▶ **To move the digital map:** swipe in any direction.

Setting the sensitivity for the Touch Control
Multimedia system:

↳ System ▶▶  Input ▶▶ Touch Control Sensitivity



▶ Select **Fast**, **Medium** or **Slow**.

Operating the controller



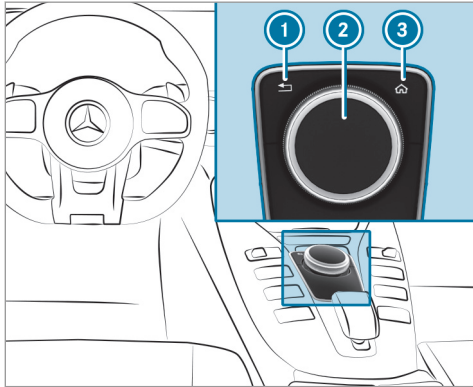

Requirements:

- The multimedia system is equipped with a controller.



- ①  button
Press briefly: returns to the previous display
Press and hold: calls up main functions
- ② Controller
- ③  button
Calls up main functions and favorites

Controller operating options:

- ▶ Turn  counter-clockwise or clockwise.
- ▶ Slide  left or right.
- ▶ Slide  up or down.
- ▶ Slide  diagonally.
- ▶ Press  briefly or press and hold.



Touchpad

Operating the touchpad

Requirements:

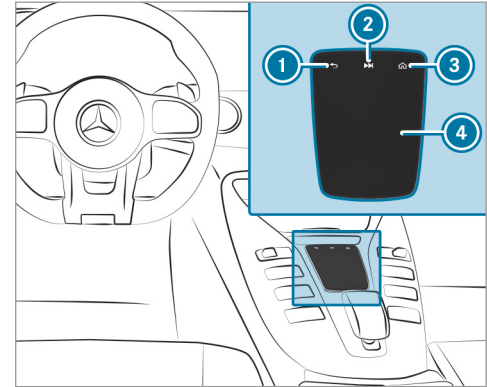
- The multimedia system is equipped with a touchpad.



- ①  button
Press briefly: returns to the previous display
Press and hold: calls up main functions
- ②  button
Calls up the control menu of the last active audio source
- ③  button

Calls up main functions and favorites

④ Touchpad

You can navigate in menus and lists via touch-sensitive surface ④ by using a **single-finger swipe**.

- ▶ **To open or close lists:** swipe left or right.
- ▶ **To select the menu item:** swipe up, down, left or right.
- ▶ Press touchpad ④.
- ▶ **To move the digital map:** swipe in any direction.

Use the following functions with a two-finger swipe:

- ▶ **To call up main functions and favorites:** swipe down with two fingers. The swipe must start in the upper area of the touchpad.
- ▶ **To zoom in and out of the map:** move two fingers together or apart.
- ▶ **To call up the control menu of the last active audio source:** swipe up with two fingers. The swipe must start in the lower area of the touchpad.

Setting the sensitivity for the touchpad

Multimedia system:

↳ System ▶  Input

- ▶ Select **Touchpad Sensitivity**.
- ▶ Select **Fast**, **Medium** or **Slow**.
- ▶ **To set the pressure sensitivity:** switch **Touchpad Tap** on or off . If the function is switched on , a tap on the touchpad is enough to select a menu item.

Handwriting recognition: switching the read-aloud function on/off

Multimedia system:

↳ System ▶  Audio ▶ System Feedback

- ▶ Switch **Read Out Handwriting Recognition** on or off .

Activating/deactivating haptic operating feedback on the touchpad

Multimedia system:

↳ System ▶  Input

The function supports you when making entries on the touchpad and when selecting menus.

- ▶ Switch **Haptic Operating Feedback** on or off . When the function is activated, a tactile feedback in the form of a vibration is effected when the touchpad is operated.

Selecting a station and track using the touchpad

- ▶ Press the  button on the touchpad.
- or

- ▶ Swipe up with two fingers. The swipe must start in the lower area of the touchpad. The control menu appears for the audio source that was last selected.
- ▶ Use one finger to swipe up or down. Radio: the previous or the next station is set. Media source: the previous or the next music track is selected.

- ▶ **To hide the control menu:** swipe down with two fingers. The swipe must start in the upper area of the touchpad.

Main functions

Calling up the main functions

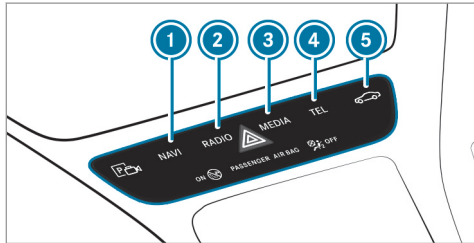

- ① **NAVI** button
Calls up navigation
- ② **RADIO** button
Calls up the radio
- ③ **MEDIA** button
Calls up media

- ④ **TEL** button
Calls up the telephone
- ⑤ **Vehicle** button
Sets vehicle functions

- ▶ Alternatively: press the  button on the Touch Control or touchpad (if available). The main functions are displayed.
- ▶ Select the main function.

Favorites

Overview of favorites

Favorites offer you quick access to frequently used applications. It is possible to create 20 favorites in total.

The following functions are available:

- add **pre-defined favorites** from the following categories (→ page 253):
 - Navigation
 - Entertainment
 - Phone
 - Connect

- Vehicle
- System Settings

- add **your own favorites** (→ page 253)
- rename favorites (→ page 254).
- move favorites (→ page 254).
- delete favorites (→ page 254).
- reset all favorites (→ page 254)

Calling up favorites

- ▶ Press the  button. The main functions are displayed.
- ▶ Navigate downwards once. Navigating means:
 - Swiping on the Touch Control or the touchpad

Leaving the favorites menu

- ▶ Press the  button.

Adding favorites

Adding predefined favorites

- ▶ Press the  button. The main functions are displayed.

- ▶ Navigate downwards twice.
The Favorites menu appears.
- ▶ Select **New Favorite**.
The categories are displayed.
- ▶ Select a category.
The favorites are displayed.
- ▶ Select a favorite.
- ▶ Store the favorite at the desired position.
If a favorite has already been added at this position, it will be overwritten.

Example: adding your own favorites

- ▶ Select **Vehicle**.
- ▶ Select **Full Screen: Consumption**.
- ▶ Press and hold the  button until the favorites are displayed.
- ▶ Store the favorite at the desired position.

If **No function available for saving** is shown, the selected function cannot be added.

Renaming favorites

- ▶ Press the  button.
The main functions are displayed.

- ▶ Navigate downwards once.
- ▶ Select a favorite.
- ▶ Navigate downwards once.
The Favorites menu appears.
- ▶ Select **Rename**.
- ▶ Enter the characters.
- ▶ **To confirm the entry:** select .

Moving favorites

- ▶ Press the  button.
The main functions are displayed.
- ▶ Navigate downwards once.
- ▶ Select a favorite.
- ▶ Navigate downwards once.
The Favorites menu appears.
- ▶ Select **Move**.
- ▶ Move the favorite to the desired position.
If a favorite has already been added at this position, it will be overwritten.

Deleting favorites

- ▶ Press the  button.
The main functions are displayed.

- ▶ Navigate downwards once.
- ▶ Select a favorite.
- ▶ Navigate downwards once.
The Favorites menu appears.
- ▶ **To delete:** select **Delete**.
- ▶ Select **Yes**.
- ▶ **To restore all favorites:** select **Reset All**.
A prompt appears.
- ▶ Select **Yes**.
The favorites are reset to the factory settings.

Switches the sound on/off

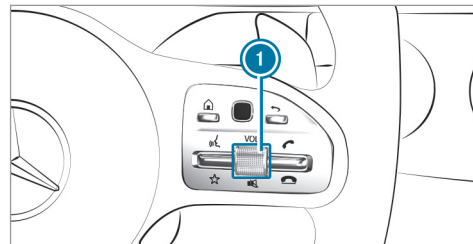

- ▶ **To mute:** press volume control ①.

The  symbol appears in the status line of the media display.

You will also hear traffic announcements and navigation announcements even when the sound is muted.

- ▶ **To switch on:** change the media source or turn volume control ①.

Adjusting the volume

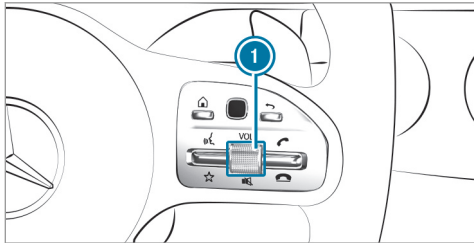

On the multifunction steering wheel

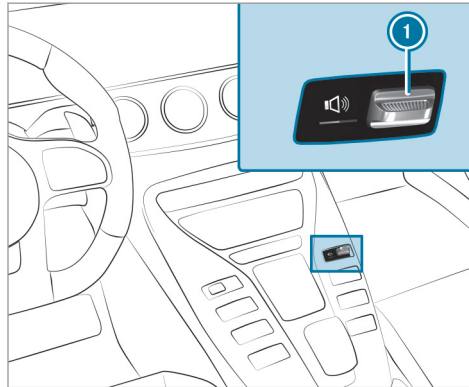

On the multimedia system

- ▶ **On the multifunction steering wheel:** turn volume control ①.

The volume of the current radio or media source is set. The volume of other audio sources can be adjusted separately.

Adjust this in the following situations:

- during a traffic announcement

- during a navigation announcement
The volume of the navigation announcement changes in accordance with the volume of the current media source.
- during a telephone call
- when entering or exiting a parking space while using Active Parking Assist

- ▶ **On the multimedia system:** press rocker switch ① up or down.

The volume is increased or reduced.

When adjusting the volume, the display button to the left of the rocker switch shows the current volume.

or

- ▶ Select **System** in the multimedia system.
- ▶ Select **Audio**.
- ▶ Select a volume setting.
- ▶ Set the volume.

Entering characters

Using the character input function

⚠ WARNING Risk of distraction from information systems and communications equipment

If you operate information and communication equipment integrated in the vehicle when driving, you will be distracted from the traffic situation. This could also cause you to lose control of the vehicle.

- ▶ Only operate this equipment when the traffic situation permits.
- ▶ If you cannot be sure of this, stop the vehicle whilst paying attention to road and traffic conditions and operate the equipment with the vehicle stationary.

You must observe the legal requirements for the country in which you are currently driving when operating the multimedia system.

Use the character input function in the following situations, for example:

- Renaming a favourite
- Entering a POI or address
- Making a phone call

The following functions are available:

- Selecting a character in the character bar
- Writing a character on the touchpad

Character input can be started with a control element and resumed with another.

The multimedia system is equipped with either a touchpad or controller.

▶ **On the Touch Control and controller (if available):** select the characters in the character bar.

Depending on the target entry, the following characters are available:

- The full set of characters is shown
- Only those characters which are useful for the current input string are shown

Other characters are grayed out.

▶ **On the touchpad (if available):** select the characters in the character bar.

or

▶ Write the characters on the touch-sensitive surface of the touchpad. Handwriting recognition supports you by means of character suggestions and a read-aloud function.

Examples of character entry:

- Renaming a favourite
- Entering a POI or an address using free or step-by-step search
- Entering a web address

Entering characters on the touchpad

Requirements:

- The entered or selected character should be read out: the handwriting recognition read-aloud function is switched on (→ page 252).

Example: renaming favorites

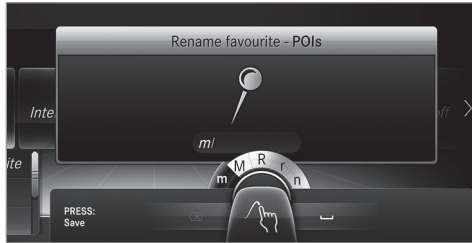

- ▶ Call up the "Renaming favorites" function (→ page 254).
- ▶ **To enter a character:** use your finger to write characters on the touchpad. The character is entered in the input line. If different interpretations are possible, character suggestions are displayed.
- ▶ **To select a character suggestion:** swipe up or down on the touchpad.
- ▶ Resume character input.
- ▶ **To enter a space:** swipe right when the cursor is located in the input line.

- ▶ **To delete a character:** swipe left when the cursor is located in the input line.
- ▶ **To confirm the entry:** press the touchpad.
- ▶ **To finish character entry:** swipe upwards.

or

- ▶ Press the  button.

Example: entering a destination (navigation)

- ▶ Enter the POI or address (→ page 274).

System settings

Display

Configuring display settings

Multimedia system:

- ↳ System ▶  Display and Designs

Setting the display brightness

- ▶ Select [Display Brightness](#).
- ▶ Select a brightness value.

Switching the display off/on

- ▶ **Off:** select [Display Off](#).

- ▶ **On:** press a button, , for example.

Display design

- ▶ Select [Day/Night Design](#).
- ▶ Select [Automatic](#), [Day Design](#) or [Night Design](#).

Additional display area

Depending on the vehicle, various items of additional information can be shown. The additional display area comprises the left-hand or right-hand third of the display.

- ▶ Select [Additional Disp. Area](#).

The following display content can be selected:

- [Dynamic](#)
- [Navigation Map](#)
- [Consumption](#)
- [Time and Date](#)

Time and date

Setting the time and date automatically

Multimedia system:

→ System ▶  Time and Date

- ▶ Deactivate **Manual Time Adjustment**. The time and date are set automatically for the selected time zone and summer time option.

 The correct time is required for the following functions:

- Route guidance with time-dependent traffic guidance.
- Calculation of expected time of arrival.

Setting the time zone

Multimedia system:

→ System ▶  Time and Date ▶ Time Zone:

The list of countries is displayed.

- ▶ Select a country •. Depending on the country, time zones are displayed.

- ▶ Select a time zone. The time zone set is displayed after **Time Zone:**.

Setting summer time

The **Automatic Daylight Saving Time** and **Daylight Saving Time** options cannot be selected in all countries.

Multimedia system:

→ System ▶  Time and Date

Automatically

- ▶ Switch **Automatic Daylight Saving Time** on or off .

Manually

- ▶ Deactivate **Automatic Daylight Saving Time**.
- ▶ Select **Daylight Saving Time**.
- ▶ Select **On** or **Off**.

Setting the time and date format

Multimedia system:

→ System ▶  Time and Date ▶ Set Format

- ▶ Set the date and time format •.

Setting the time manually

Requirements:

- The **Manual Time Adjustment** function is switched on.

Multimedia system:

→ System ▶  Time and Date ▶ Set Time

- ▶ Set the hours.
- ▶ Navigate to the right to set the minutes.
- ▶ Set the minutes.
- ▶ Confirm changes when exiting the menu.

The date is set automatically via GPS.

Connectivity

Switching transmission of the vehicle position on/off

Multimedia system:

→ System ▶  Connectivity

▶ Select **Transmit Vehicle Pos..**

▶ Activate or deactivate the function.

Bluetooth®

Information about Bluetooth®

Bluetooth® technology is a standard for short-range wireless data transfer up to approximately 32.8 ft (10 m).

You can use Bluetooth® to connect your mobile phone to the multimedia system and use the following functions, for example:

- hands-free system with access to the following options:
 - contacts (→ page 305)
 - call lists (→ page 308)
 - text messages

- Internet connection
- listening to music via Bluetooth® audio (→ page 335)
- transferring business cards (vCards) into the vehicle

Bluetooth® is a registered trademark of Bluetooth Special Interest Group (SIG) Inc.

 Internet connection via Bluetooth® is not available in all countries.

Activating/deactivating Bluetooth®

Requirements

To switch off Bluetooth®:

- Apple CarPlay™ is not active.

Multimedia system:

→ System ▶  Connectivity

▶ Activate or deactivate Bluetooth®.

If Android Auto is active, a prompt appears asking whether Bluetooth® should be deactivated.

▶ Select **Yes**.

Android Auto is closed and Bluetooth® is deactivated.

Wi-Fi

Wi-Fi connection overview

You can use Wi-Fi to establish a connection with a Wi-Fi network and to access the Internet or other network devices.

The following connection options are available:

- Wi-Fi connection
 - The Wi-Fi connection to a Wi-Fi-capable device, e.g. the customer's mobile phone or a tablet PC is established.
- Multimedia system as a Wi-Fi hotspot
 - Using this function, a tablet PC or notebook can be connected, for example.

To establish a connection, you can use the following methods:

- WPS PIN
 - The connection to a secure Wi-Fi network is made via a PIN.

- WPS PBC

The connection to a secure Wi-Fi network is made by pressing a button (push button).

- Security key

The connection to a secure Wi-Fi network is made via a security key.

Setting up Wi-Fi

Requirements:

- The device to be connected supports one of the three means of connection described (→ page 259).

Multimedia system:

→ System ▶  Connectivity

Activating/deactivating Wi-Fi

- ▶ Switch **Wi-Fi** on or off . If **Wi-Fi** is deactivated , communication via Wi-Fi to all devices is interrupted. This also means that a connection to the HERMES communication module cannot be established. Then functions such as dynamic route guidance with Live Traffic Information are not available.

Connecting the multimedia system with a device via Wi-Fi

This function is available if a HERMES communication module is not installed.

The type of connection established must be selected on the multimedia system and on the device to be connected.

- ▶  The connection procedure may differ depending on the device. Follow the instructions that are shown in the display. Further information (see the manufacturer's operating instructions).

- ▶ Select **Internet Settings**.
- ▶ Select **Search for Wi-Fi Networks**.

Using a security key



- ▶ Select a Wi-Fi network in the list.
- ▶ Have the security key displayed on the device to be connected (see the manufacturer's operating instructions).
- ▶ Enter this security key on the multimedia system.
- ▶ Confirm the entry with **OK**.

- ▶  All devices support a security key as a means of connection.



Using a WPS PIN

- ▶ Highlight a Wi-Fi network in the list.
- ▶ Select  **Connect via WPS PIN Input**. The multimedia system generates an eight-digit PIN.
- ▶ Enter this PIN on the device to be connected.
- ▶ Confirm the entry.

Using a button

- ▶  This function is only available in a Wi-Fi frequency of 2.4 GHz.
- ▶ Highlight a Wi-Fi network in the list.
- ▶ Select  **Connect via WPS PBC**.
- ▶ Select "Connect via WPS PBC" in the options on the device to be connected.
- ▶ Press the WPS button on the device to be connected.
- ▶ Select **Continue** in the multimedia system.

Device has already been connected:

- ▶ **To automatically connect:** highlight a Wi-Fi network in the list.
- ▶ Activate  **Connect Automatically** .
- ▶ **To connect:** highlight a Wi-Fi network in the list.
- ▶ Select  **Connect**.
The connection is established again. These functions are possible when the device has already been connected to the Wi-Fi network.

Setting up a Wi-Fi hotspot

Multimedia system:

 System ▶  Connectivity

Configuring the multimedia system as a Wi-Fi hotspot

The type of connection established depends on the device to be connected. The function must be supported by the multimedia system and by the device to be connected. The type of connection established must be selected on the multimedia system and on the device to be connected.

- ▶ Select **Set Up Hotspot**.
- ▶ Highlight **Connect Device to Vehicle Hotspot**.

Generating a WPS PIN

- ▶ Select  **Connect via WPS PIN Generation**.
- ▶ Enter the PIN shown in the media display on the device to be connected and confirm.

Connecting using a WPS PIN

- ▶ Select  **Connect via WPS PIN Input**.
- ▶ Select **Enter WPS PIN**.
- ▶ Enter the PIN that is shown on the external device's display on the multimedia system.
- ▶ Select **Continue**.

Connecting using a button

Requirements

- This function is only available in a Wi-Fi frequency of 2.4 GHz.
- ▶ Select  **Connect via WPS PBC**.
- ▶ Press the WPS button on the device to be connected or select **Connect**.

- ▶ Select **Continue** in the multimedia system.

Connecting using a security key

- ▶ Select **Connect Device to Vehicle Hotspot**. A security key is displayed.
- ▶ Select the vehicle from the device to be connected. The vehicle is displayed with the SSID **MB Hotspot XXXXX**.
- ▶ Enter the security key which is shown in the media display on the device to be connected.
- ▶ Confirm the entry.

Generating a new security key:

- ▶ Select **Set Up Hotspot**.
- ▶ Select **Generate Security Key**. A connection will be established with the newly created security key.
- ▶ **To save a security key:** select **Save**.
When a new security key is saved, all existing Wi-Fi connections are then disconnected. If the Wi-Fi connections are being re-established, the new security key must be entered.

Managing COMAND Touch devices

Requirements:

- The COMAND Touch app is installed on the external device (e.g. tablet or smartphone).
- Wi-Fi is activated (→ page 260) and the multimedia system is configured as a Wi-Fi hot-spot (→ page 261).

Multimedia system:

↳ System ▶ COMAND Touch

Connecting and authorizing a new device

- ▶ Select [Authorize a New Device](#).
- ▶ Select [Connect New Device](#).
- ▶ Enter the security key in the external device. The [Please start COMAND Touch on your device and follow the instructions](#). message appears.
- ▶ Select [Continue](#).
- ▶ [Accept](#) the connection request from the new device.
- ▶ Enter the PIN shown on the external device. The device is authorized.

Authorizing a connected device

- ▶ Select [Authorize a New Device](#).
The devices already connected are displayed.
- ▶ Select [Continue Using Connected Devices](#). The [Please start COMAND Touch on your device and follow the instructions](#). message appears.
- ▶ Select [Continue](#).
- ▶ The connection request from the device [Accept](#).
- ▶ Enter the PIN shown on the external device. The device is authorized.

De-authorizing the device

- ▶ Select an authorized device from the list. A prompt will appear asking whether you would like to de-authorize the selected device.
- ▶ Select [Yes](#).
The device is de-authorized.

Activating/deactivating child safety lock

Multimedia system:

↳ System ▶ Parental Control

Locking an external device

- ▶ Select an external device.
- ▶ Select [Lock](#).
The device connected via the COMAND Touch app is locked or unlocked .

System language

Notes on the system language

This function allows you to determine the language for the menu displays and the navigation announcements. The selected language affects the characters available for entry. The navigation announcements are not available in all languages. If a language is not available, the navigation announcements will be in English.

Setting the system language

Multimedia system:

↳ System ▶▶ Language

- ▶ Set the language.

Setting the distance unit

Multimedia system:

↳ System ▶▶  Units

- ▶ Select km or mi.
- ▶ In the multifunction display of the Instrument Display, switch the **Additional Speedometer** display on .

Data import and export

Data import/export function

The following functions are possible:

- Transferring data from one system or vehicle to another system or vehicle.
- Creating a backup copy of your personal data and loading it again.

- Protecting your personal data against unwanted export with PIN protection.

-  Please note that the NTFS file system is not supported. The FAT32 file system is recommended.

Importing/exporting data

 **NOTE** Loss of data due to premature removal

▶ Do not remove the data storage medium when data is being exported.

Mercedes-Benz is not liable for any loss of data.

Requirements:

- The vehicle is stationary.
- The ignition is switched on or the vehicle has been started.
- The SD card is inserted (→ page 326) or the USB device is connected (→ page 329).

Multimedia system:

↳ System ▶▶ System Backup

- ▶ Select **Import Data** or **Export Data**.

Importing

- ▶ Select a data storage medium. A prompt appears asking whether you really wish to overwrite the current data. If data originates from another vehicle, this is recognized during data reading.

The multimedia system is restarted once the data has been imported.

-  Current vehicle settings can be edited after the import.

Exporting

If PIN protection is activated, your PIN is requested.

- ▶ Enter the four-digit PIN.
- ▶ Select a data storage medium. The data is exported. The data export may take several minutes.

Activating/deactivating PIN protection

Multimedia system:

↳ System ▶▶ PIN Protection

Setting the PIN

- ▶ Select **Set PIN**.
- ▶ Enter a four-digit PIN.
- ▶ Enter the four-digit PIN again.
If both PINs match, PIN protection is active.

Changing the PIN

Requirements

- A current PIN must be set.

- ▶ Select **Change Settings**.
- ▶ Enter the current PIN.
- ▶ Select **Change PIN**.
- ▶ Set a new PIN.

Activating PIN protection for data export

- ▶ Select **Change Settings**.
Confirm with the PIN.

- ▶ Select **Protect Data Export**.
Activate or deactivate the function.

Unblocking the PIN

Requirements:

- There is an Internet connection.
- A Mercedes me account exists at <http://www.mercedes.me>.
- The **Personalization** service is active (→ page 265).

If the PIN has been entered incorrectly three times, the PIN will be blocked. You can have a single-use password sent to you via the Mercedes me connect online portal to reset the PIN protection.

- ▶ Select **Unblock PIN**.
- ▶ Enter the single-use password.
PIN protection is reset, and you can set a new PIN.
- ⓘ Alternatively, you can have PIN protection reset at an authorized Mercedes-Benz Center.

User profile

Setting a user profile

Multimedia system:

↳ System ▶▶  Personalization

Displaying a user profile when starting

If this function is active, a prompt appears when starting the system asking which user profile to use.

- ▶ Select **Display Profile Selection after Start**.
- ▶ Activate or deactivate the function.

Selecting a user profile

- ▶ Select **Guest Profile** or individual profile ●.
- ⓘ Some settings from the user profile are only loaded when the vehicle is stationary or when the ignition is switched on.

Automatic synchronization

Each time the ignition is switched off or on, the individual user profiles are synchronized on the multimedia system and on the server. This ensures that the latest user profiles are always available.

- ▶ Select **Automatic Synchronization**.
- ▶ Activate or deactivate the function.
- ⓘ For more information about importing/exporting user profiles .

Creating a user profile

Multimedia system:

↳ System ▶  Personalization ▶ Create Profile

- ▶ Enter a name.
- ▶ Select .

The following information is saved in the user profile, for example:

- System settings
- Settings in the TV tuner's channel list
- Navigation and traffic information

The settings differ depending on the vehicle equipment.

Setting user profile options

Multimedia system:

↳ System ▶  Personalization

- ▶ Highlight a profile.
- ▶ Select options.

The following options are available:

- **Rename**
 - **Delete**
 - **Reset**
- ⓘ The guest profile cannot be deleted or renamed.

Software update

Information on software updates

The multimedia system provides a message when an update is available.

Depending on the source, you can perform various updates:

Software update

Source of the update	Update type
Updates via mobile phone	Navigation map, system updates, Digital Operator's Manual
Updates via an external storage medium, e.g. a USB flash drive	Navigation maps

- ⓘ Updates via mobile phone require an active Internet connection for the vehicle. This is not available in all countries. For further information on connecting to the Internet, see (→ page 319).

Advantages of updating software

Thanks to the software update, your vehicle status is up-to-date.

In order to constantly improve the quality of our services you will receive future updates for your multimedia system, the Mercedes me connect services and your vehicle's communication module. These will conveniently be sent to you via

the mobile phone connection in your vehicle and, as an option, installed automatically. You can monitor the status of your updates on the Mercedes me portal and find information about potential innovations.

Your advantages at a glance:

- conveniently receive software updates via the mobile phone network
- improves the quality and availability of Mercedes me connect services
- keeps your multimedia system and communication module up-to-date

Further information about software updates can be found at <http://me.mercedes-benz.com>

Performing a software update

Requirements:

- There is an Internet connection (→ page 319).
- **For automatic updates:** your vehicle has a permanently installed communication module.

Multimedia system:

↳ System ▶▶ Software Update

Automatic update

- ▶ Switch **Automatic Online Update** on . Updates are performed.
The current status of the updates is displayed.

Manual update

- ▶ Deactivate **Automatic Online Update**.
- ▶ Select an update from the list and start the update.

Activating the software update

- ▶ Restart the system.

Function of important system updates

Important system updates may be necessary for the security of your multimedia system's data. Please install these updates, or else the security of your multimedia system cannot be ensured.

- ⓘ If automatic software updates are activated, the system updates will be downloaded automatically (→ page 266).

As soon as an update is available for download, a corresponding message appears on the media display.

You have the following selection options:

- **Download**
The update will be downloaded in the background.
- **Details**
Information about the pending system update is displayed.
- **Later**
The update can be downloaded manually at a later time (→ page 266).

If the download is completed and the update is ready for installation, you will be informed of this after the next ignition cycle, for example.

- ⓘ Park the vehicle safely in a suitable location before starting the installation.

Requirements for the installation:

- The ignition is switched on.
- The engine is not running.

- Notes and warnings have been read and accepted.
- The parking brake is applied.

If all requirements are met, the update will be installed. The multimedia system cannot be operated while the update is being installed and vehicle functions are restricted.

If errors should occur during the installation, the multimedia system automatically attempts to restore the previous version. If restoration of the previous version is not possible, a symbol appears on the center console display. Please consult a qualified specialist workshop to resolve the problem.

Reset function

Multimedia system:

↳ System ▶ Reset

Personal data is deleted, for example:

- Station presets
- Connected mobile phones

▶ Select **Yes**.

If PIN protection is activated, a prompt appears asking if you also wish to restore this to the factory settings during a reset.

▶ Select **Yes**.

▶ Enter the current PIN.
The PIN is reset.

or

▶ Select **No**.

The current PIN stays the same after resetting.

i If you have forgotten your PIN, an authorized Mercedes-Benz Center can deactivate the PIN protection for you.

A prompt appears again asking whether you really wish to reset.

▶ Select **Yes**.

The multimedia system is reset to the factory settings.

AMG TRACK PACE

General information

With AMG TRACK PACE, the driving characteristics on race tracks can be analyzed and optimized. You can drive previously stored race tracks (e.g. Hockenheimring) or new tracks can be recorded and stored. The driven lap times are stored for every track. These can be analyzed and compared to other lap times to achieve the best possible race results. Additionally, acceleration and braking procedures can be measured and stored.

Setting Track Race

Multimedia system:

↳ Vehicle ▶ TRACK PACE ▶ Track Race

Recording a track

▶ Select **New track**.

▶ At the desired starting point, select **Start**. The track recording starts at this point. During track recording, sectors can be set to determine intervals.

- ▶ To finish track recording, select **Stop** or cross the starting line again.
- ▶ Enter the weather and the track name.

Searching by track name

- ▶ Select **All tracks**.
- ▶ Select  **Search**.
- ▶ Enter the track name.
Tracks with the searched name are displayed.

Measuring the time on the track

- ▶ Select **Timekeeping**.
An overview of nearby tracks appears.
The distance and direction to the starting line of the track is displayed.
- ▶ Select the desired track.
If you have already driven on this track, you can select a driven time as a reference time.

Timekeeping begins automatically when the starting line has been crossed.

- ❗ When **Zoom** is selected, the track display can be switched from 2D to 3D.

Displaying the analysis

- ▶ Select **Lap times**.
An overview of all the driven times appears.
- ▶ Select a track.
The following data is displayed:
 - Lap and sector times
 - Average and top speed
 - Driver
 - Vehicle
 - Date
 - Weather
- ▶ Select a desired lap.
The analysis is displayed.

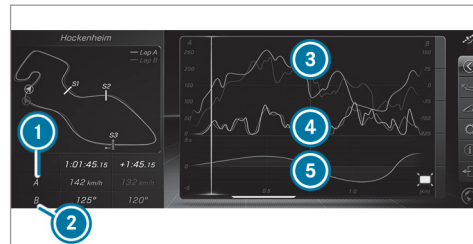

- ❶ Parameter 1 (e.g. speed)
 - ❷ Parameter 2 (e.g. steering angle)
 - ❸ Speed trend (Parameter 1)
 - ❹ Steering angle trend (Parameter 2)
 - ❺ Time difference between lap A and B (only when two laps are selected).
- ❗ The following values can be set for parameters 1 and 2, for example:
- Speed
 - Longitudinal/lateral acceleration
 - Steering angle
 - Engine speed

- Engine oil/tire temperature

Based on the analysis you can check and optimize driving characteristics for any position on the track.

Exporting tracks or races (USB)

- ▶ Select **All tracks**.
An overview of all stored tracks and races appears.
- ▶ Highlight desired tracks or races.
- ▶ Select  Options.
- ▶ Select **Export**.
The selected tracks or races can be exported to a USB storage device connected to the vehicle.

Editing tracks and recordings

- ▶ Select **All tracks**.
- ▶ Highlight the desired track.
- ▶ Select  options.
- ▶ Select **Rename** or **Delete**.

or

- ▶ Select a track.

- ▶ Highlight the desired recording.
- ▶ Select  options.
- ▶ Select **Weather** or **Delete**.

Setting Drag Race

Multimedia system:

 **Vehicle** ▶ **TRACK PACE** ▶ **Drag Race**

Measuring acceleration

- ▶ Select **Acceleration**.
Measurement begins when the vehicle accelerates. Measurement is incremental, in steps of 30 mph (50 km/h) up to a maximum of 180 mph (300 km/h) or up to the set top speed.
Measurement can be stopped early by selecting **Stop** or by stopping the vehicle.

Quarter-mile race

- ▶ Select **Quarter Mile**.
Timing runs until a mile has been traveled or to the set end distance.

Measurement can be stopped early by selecting **Stop** or by stopping the vehicle.

Manual start for acceleration and quarter-mile race

- ▶ Select **Acceleration** or **Quarter Mile**.
- ▶ Select **Manual start**.
Three red traffic lights appear one after the other. The reaction time measurement starts when they change to green at the same time. The reaction time is displayed as soon as you drive off. If you drive off too early, the message **Jump start** will appear and acceleration or quarter mile measurement will be canceled.

Measuring braking

- ▶ Select **Braking**.
- ▶ Select **Start Record**.
Measurement is incremental, in steps of 30 mph (50 km/h) to a standstill. If the braking procedure is started e.g. at a speed of 99 mph (160 km/h), measurement starts as soon as 90 mph (150 km/h) has been reached.

Storing and calling up measurement values

When a measurement has been completed or canceled, the measured time can be stored.

- ▶ After a measurement, select **Save measurement?** .

The stored measurements can be displayed via the **History** menu item.

Editing measurements

- ▶ Select **History**.
 - ▶ Highlight the desired measurement.
 - ▶ Select  options.
 - ▶ Select **Weather** or **Delete**.
- i** The measurements can be displayed by category, e.g. acceleration measurements, by applying a filter.

Calling up the telemetry display

Multimedia system:

↳ **Vehicle** ▶ **TRACK PACE** ▶ **Telemetry**

The telemetry display shows current vehicle data as a digital value and as a diagram. Up to four

parameters can be selected that are to be shown in the display.

For example:

- Engine speed
 - Wheel angle
 - Speed
 - Steering angle
- ▶ Set the desired parameters.
 - ▶ Set the time.
The set parameters are evaluated in the diagram for the time set.
- i** The time can range from a minimum of 30 seconds to a maximum of 20 minutes.

Configuring AMG TRACK PACE

Requirements

To use the TRACK PACE app:

- the TRACK PACE app is installed on the mobile end device.
- the mobile end device is connected to the multimedia system via Wi-Fi.

Multimedia system:

↳ **Vehicle** ▶ **TRACK PACE** ▶ **Options**

Setting driver profiles

- ▶ Select **Driver Profile**.
 - ▶ Create a new driver profile.
- or
- ▶ Select an existing driver profile.
The driver profile is activated.
- i** Tracks, laps and times driven are assigned to the active driver profile while driving. For an exact evaluation of your driving style, you should always drive with an active driver profile.

Displaying driver profile statistics

- ▶ Select **Driver Profile**.
 - ▶ Select the desired profile.
- The following information is displayed for the selected driver profile:
- driving time
 - track driven

- number of Track Races, Drag Races and laps driven
- maximum speed

Connecting a mobile device via the TRACK PACE app

The TRACK PACE app makes it possible to record videos and to synchronize them with stored tracks.

- ▶ Select the [TRACK PACE App](#).
Already authorized devices are displayed in the list.
- ▶ Select [Authorize new device](#).
Available devices are displayed.
- ▶ Start the TRACK PACE app on the device to be connected and follow the instructions.
- ▶ Confirm the authorization prompt.
- ▶ Enter the code displayed on the device.
The device is authorized.

or

- ▶ Select a device that is already authorized.
The device is de-authorized.

Setting the TRACK PACE display in the head-up display

- ▶ Select [HUD Contents](#).
- ▶ Activate or deactivate the desired contents.
The contents in the Head-up Display are adapted.
- ⓘ For further information on the Head-up Display, see (→ page 237) (→ page 238).

Setting acoustic feedback

- ▶ Select [Acoustic feedback](#).
The following settings are available:
 - [Loud](#)
 - [Medium](#)
 - [Quiet](#)

- [Off](#)
- ▶ Select a setting.

Activating/deactivating additional information

- ▶ Activate or deactivate [Display help](#).

When additional information is activated, popups provide information on the individual menus.

- ▶ Confirm popups with [OK](#) or select [Do not display](#).

Calling up information

- ▶ Select [Info](#).
The following information is displayed:
 - Software version
 - Memory used
 - Total number of tracks saved
 - Total number of races driven

ENERGIZING comfort program overview**Program overview**

Program	Function
Refresh	Can make targeted changes to the interior climate to refresh vehicle occupants. Cooling airflow and ionization purify the air. The vehicle interior is illuminated with cool colors and the seats are ventilated.
Warmth	Can increase the comfort level of the occupants. The vehicle's panel, seat and steering wheel heater produce a cozy warmth. The air is purified using ionization and a pleasant fragrance is released. The vehicle interior is illuminated with warm lighting.
Vitality	Can counteract fatigue in monotonous driving situations. Fast-paced music and a vitalizing massage provide invigorating stimulation for the vehicle occupants. The air is purified using ionization and a pleasant fragrance is released. The vehicle interior is illuminated in a stimulating hue and the seat is ventilated.
Pleasure	Can promote a positive mood in the occupants. Moderately fast music is played and a massage program is activated. The air is purified using ionization and a pleasant fragrance is released. The vehicle interior is illuminated with amicable lighting.
Well being	Can aid the physical and mental relaxation of occupants. A back massage combined with local warmth provide relaxation. The air is purified using ionization and a pleasant fragrance is released. The music player plays selections of calming music and the vehicle interior is illuminated with pleasant lighting.
Training	Can counteract the onset of muscle tension, limbs falling asleep or stress with targeted relaxation or stimulation exercises. The exercises are demonstrated in short videos. The air is purified using ionization and a pleasant fragrance is released. The vehicle interior is illuminated with lighting appropriate to the exercise.

- i** Please note that the available programs and the associated functions are dependent on your vehicle equipment. Depending on your equipment, fewer functions may be available.

Starting the ENERGIZING comfort program

Requirements:

- The ignition is switched on.
- i** ENERGIZING comfort is available approximately five minutes after starting the multimedia system.

Multimedia system:

➔ Vehicle ➔ ENERGIZING Comfort

Selecting a seat

- Select **Seat Selection**.
- Select the desired seat or **All Seats** .

Starting a program

- Select **Refresh, Warmth, Vitality, Enjoyment** or **Well-being**.

The selected program will run for ten minutes.

Configuring a program

- Call up further options  for the desired program.
- Switch the functions included in the program on or off .

Starting training

- Select **Training**.
 - Select **Muscle Relaxation, Muscle Stimulation** or **Balance**.
The selected training video starts and is displayed in the media display.
 - Select **Full Screen: Video**.
The training video is displayed in full screen.
- i** For more information on pausing or skipping through videos, see (→ page 329).

If, during an active program, a function requirement is no longer met, a corresponding message appears. The active program is canceled.

Navigation

Switching navigation on

Multimedia system:

➔ Navigation

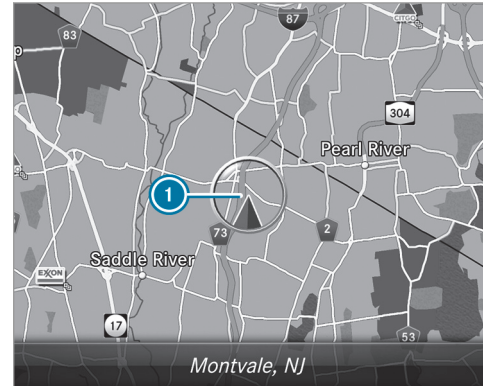

- Alternatively: press the **NAVI** button.
The map appears and shows current vehicle position **1**.

- ❗ If a climate control setting is changed, a climate bar appears briefly.

Showing/hiding the navigation menu

Requirements:

- The map displays the current vehicle position.

Multimedia system:

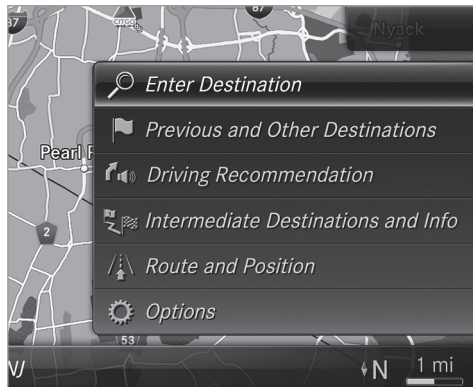

- ▶ **To show:** swipe left on the touchpad or the Touch Control.

or

- ▶ Slide the controller to the left.
- ▶ **To hide:** swipe right on the touchpad or the Touch Control.

or

- ▶ Slide the controller to the right.

- ❗ To show or hide lower menu levels, swipe or slide to the left or right as many times as necessary.

Destination entry

Entering a POI or address

⚠ WARNING Risk of distraction from information systems and communications equipment

If you operate information and communication equipment integrated in the vehicle when driving, you will be distracted from the traffic situation. This could also cause you to lose control of the vehicle.

- ▶ Only operate this equipment when the traffic situation permits.
- ▶ If you cannot be sure of this, stop the vehicle whilst paying attention to road

and traffic conditions and operate the equipment with the vehicle stationary.

You must observe the legal requirements for the country in which you are currently driving when operating the multimedia system.

Requirements:

- **For the online search:** Mercedes me connect is available.
- You have a user account for the Mercedes me portal.
- The service is available.
- The service has been activated at an authorized Mercedes-Benz Center.

Further information can be found at: <http://www.mercedes.me>

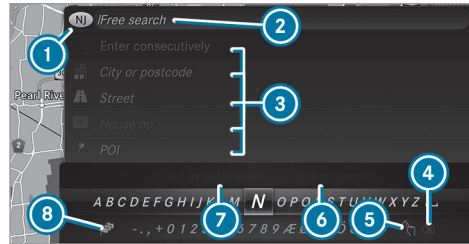

Multimedia system:

Navigation





- ▶ Show the navigation menu.
- ▶ Select  **Enter Destination** . The state or province in which the vehicle is located is set ① . There are two available methods of destination entry:
 - Free search ②
 - Search step-by-step ③

Method 1: free search

- ▶ Enter the POI or address in ② . The entries can be made in any order. During destination entry, suggestions are made by the multimedia system. A selection of destinations appears in a list. Enter these address elements, for example:
 - City, street, house number
 - Street, city
 - ZIP code
 - POI name
 - POI category, e.g. **Gas Station**
 - City, POI name
- ▶ **To switch to handwriting recognition:** select  ⑤ .
- ▶ Write the character on the touchpad.
- ▶ **To switch to character selection:** press the  button.

or

▶ Press the touchpad.

▶ **To delete an entry:** select   (if available).

Use the following options:

- Press briefly: deletes the last character entered or the last suggestion adopted.
- Press and hold: deletes the entire entry.

▶ **To set the language:** select .

▶ Select the language.

 This function is useful for countries in which several character sets are supported. An example is Russia, which uses Cyrillic and Latin characters.

▶ **To call up the online search function:**

select  [Online Search](#).

Once an Internet connection is established, a list appears. It shows online destinations related to the previous entry.

Online destinations are provided by the Internet service provider.

▶ Select the online destination.

or

▶ Enter the online destination or a 3 word address in the input line.

 Enter a 3 word address (→ page 280).
Online search is not available in all countries.

▶ **To call up the list:** press the  button.

or

▶ If the top line of the character bar is highlighted, navigate upwards.

▶ Select the destination in the list.

▶ **To adopt a destination:** select  [Select Destination](#).

If there are several listings for a destination, a list appears.

▶ Select the destination.

The destination address is shown.

Method 2: search step-by-step

▶ Press .

or

▶ If the top line of the character bar is highlighted, navigate upwards.

The character bar is hidden. [City or ZIP](#) is highlighted. Additional entry fields, e.g. for [POI](#), are available.

▶ Select [City or ZIP](#).

The character bar appears.

▶ Enter the city or the ZIP code.

During destination entry, suggestions are made by the multimedia system. A selection of destinations appears in a list.

The address entries can be made in any order, for example:

- [City or ZIP](#), [Street](#), [House No.](#)
Enter an intersecting street, if available.
- [Street](#), [City or ZIP](#)
- [POI](#), e.g. [Gas Station](#), [City or ZIP](#)

 During destination entry, use the following functions:

- Switching to handwriting recognition
- Switching to character selection
- Deleting an entry

An entry, e.g. **POI**, can be deleted with  in a step-by-step search. Navigate to the left to do so.

- Calling up the online search function (if available)
- Calling up a list

The functions are described in the free search.

- ▶ **To change the state/province:** select the state or the province.
- ▶ Enter the state or the province. You only need to enter the first character.
- ▶ Select the state or the province in the list.
- ▶ **To change the country:** select the country.
- ▶ Enter the country. You only need to enter the first character.
- ▶ Select the country on the list.
- ▶ **To adopt a destination:** select **Select Destination**.
If there are several listings for a destination, a distance-orientated list appears.

- ▶ Select the destination.
The destination address is shown.

Selecting previous destinations

Multimedia system:

 **Navigation** ▶▶  **Previous and Other Destinations**

- ▶ Select **Previous Destinations**.
- ▶ Select the destination.
The destination address is shown.
- or
- ▶ If favourites have been saved already (→ page 289), select **From My Favorites**.
- ▶ Select the favourite.
The destination address is shown.

Selecting a POI

Multimedia system:

 **Navigation** ▶▶  **Previous and Other Destinations** ▶▶ **POIs**



- ▶ Select the category.
or

- ▶ Select **All Categories** and the category.
If route guidance is not active: the search begins in the vicinity of the current vehicle position. The list is sorted by distance in ascending order.

The POIs show the following information:

- name of POI
- linear distance to the POI
- the direction of the linear distance to the POI (arrow) is displayed when searching for the vehicle's current position
- ▶ Select the POI.
- ▶ **Route guidance is active:** select the search position prior to choosing a POI.
- ▶ If intermediate destinations are set, these can also be selected as the search position after selecting **Near Destination**.

Filtering displays for POIs

- ▶ Enter the search term in  **Search:**.
The results list shows relevant POIs.
- ▶ Select .
The first POI in the list is highlighted.

- ▶ Select the POI.

Example: setting the search position for the parking category during active route guidance

- ▶ Select [In the Vicinity](#), [Near Destination](#) or [Along the Route](#).
The list shows the located POIs or opens an overview of the route destination after selecting [Near Destination](#).
- ▶ Select the POI.
- ▶ Select [Near Destination](#): select the intermediate destination or the destination.

Starting an automatic gas station search

Requirements:

- The automatic gas station search is activated (→ page 283).

Driving situation

Route guidance is active. The fuel level in the fuel tank reaches the reserve fuel level.

The [Reserve Fuel Do you want to start a search for surrounding gas stations?](#) message is shown.

- ▶ Select [Yes](#).
The automatic gas station search begins. The available gas stations along the route or in the vicinity of the vehicle's current position are displayed.
- ▶ Select the gas station.
The address of the gas station is displayed.
- ▶ If route guidance is not active, select [Start Route Guidance](#).
The selected gas station is set as the destination. Route guidance begins.

or

- ▶ If route guidance is active, select [Start New Route Guidance](#) or [Set as Next Way Point](#).
[Start New Route Guidance](#): the selected gas station is set as a new destination. The previous destinations and intermediate destinations are deleted. Route guidance to the gas station begins.
[Set as Next Way Point](#): the selected gas station is set as the next intermediate destination. Route guidance begins.

- ▶ **If there are already four intermediate destinations:** select [Yes](#) in the prompt.
The selected gas station is entered into position 1 of the intermediate destinations menu. Intermediate destination 4 is deleted. Route guidance begins.

Entering an intermediate destination

Requirements:

- A destination is entered.

Multimedia system:

 [Navigation](#)  [Way Points and Info](#)

- ▶ Select [Search for Way Point](#).
 - ▶ Enter the intermediate destination as a POI or address (→ page 274).
 - ▶ Select the intermediate destination.
 - ▶ Select [Set as Destination](#).
- or
- ▶ Select an intermediate destination using  [Enter Destination](#) during route guidance.
 - ▶ Select [Set as Next Way Point](#) after entering the destination.



Editing intermediate destinations

Requirements:

- A destination is entered.

Multimedia system:

 [Navigation](#)  [Way Points and Info](#)

- ▶ **To change the order of destinations:** highlight the destination or the intermediate destination.
- ▶ Select  [Move](#).
- ▶ Move the intermediate destination to the desired position.
- ▶ Press the Touch Control, the controller or the touchpad.
- ▶ **To call up the map:** highlight the destination or the intermediate destination.
- ▶ Select  [Map](#).
- ▶ Move the map (→ page 293).
- ▶ Select destination on the map (→ page 280).
- ▶ **To delete a destination:** highlight the destination or the intermediate destination.
- ▶ Select  [Delete](#).

Calculating a route with intermediate destinations

Requirements:

- The destination and at least one intermediate destination have been entered.

Multimedia system:

 [Navigation](#)  [Way Points and Info](#)

- ▶ Select [Start New Route Guidance](#).
The route is calculated with the set intermediate destinations.

Selecting a contact for destination entry

Requirements:

- A mobile phone is connected to the multimedia system (→ page 301).

Multimedia system:

 [Navigation](#)  [Previous and Other Destinations](#)  [Contacts](#)

- ▶ Select the contact.
The contact details are displayed.
- ▶ Select the address.

Filtering displays for contacts

- ▶ Enter a name or telephone number, for example, into the search field.
- ▶ Select .
- ▶ The first contact in the list is highlighted.
- ▶ Select the contact.
- ▶ Select the address.

Entering geo-coordinates

Multimedia system:

 [Navigation](#)  [Previous and Other Destinations](#)  [Geo-coordinates](#)

- ▶ Enter geo-coordinates as latitude and longitude coordinates in degrees, minutes and seconds.
The map shows the position.
- ▶ Confirm the entry.
- ▶ **To calculate a route:** select [Start Route Guidance](#).
- ▶ If a route has already been created, select [Start New Route Guidance](#) or [Set as Way Point](#).

Entering the destination as a 3 word address

Requirements:

- Searching for a destination using 3 word addresses is possible in the online search (→ page 274).
- There is an Internet connection.

 Searching for a destination using 3 word addresses is not possible in all countries.

Multimedia system:

 **Navigation**  **Enter Destination**

- ▶ Select **Online Search**.
- ▶ Enter the destination address as a 3 word address. Separate each of the words with a full stop.
The search results are displayed.
- ▶ Select the destination in the list.
The destination address is shown. The route can be calculated.

 3 word addresses from what3words are an alternative addressing system for multilingual georeferencing of global locations with a resolution of three meters. Using this grid,

locations on the Earth's surface are included which do not have a building address such as street and house number, for example.

The Empire State Building in New York has the following language dependent 3 word address, for example:

- English: **parade.help.bleat**
- French: **commun.verbe.bisquer**
- Spanish: **suertes.diga.pesca**

3 word addresses are unique, easy to remember and suffice for most routine applications.

The bidirectional conversion of 3 word addresses can be carried out here:

- at the website <http://what3words.com>
- in the what3words apps

Selecting a destination on the map

Multimedia system:

 **Navigation**  **Options**

- ▶ Select **Map Menu**.

or

- ▶ If the map is displayed in full screen mode, press the central control element.
The map menu appears.

- ▶ Select "move map" in map menu  (→ page 292).

- ▶ Swipe in any direction on the Touch Control or touchpad.

or

- ▶ Slide the controller in any direction.
The map moves in the corresponding direction under the crosshair. The more you move your finger away from the starting position on the touchpad, the faster the map moves.
- ▶ Press the Touch Control, the controller or the touchpad.

If several destinations are located around the crosshair, a list shows the available POIs and roads.

If a destination is located exactly on the crosshair, the destination address is displayed.

- ▶ Select the destination in the list.
The destination address is shown.

Setting the map orientation to 2D or 3D

- ▶ Highlight [Map Orientation: 2D/3D](#).
- ▶ Press the Touch Control, the touchpad or the controller.
The map will be displayed in the selected map orientation.

Showing traffic messages in the vicinity of the map

- ▶ Select [Traffic Messages for the Vicinity](#).
The map appears.
- ▶ Swipe left or right on the touchpad.

or

- ▶ Slide the controller to the left or right.
The previous or next traffic incident is highlighted on the map. Information on the traffic incident is displayed.

Showing POIs in the vicinity of the map

- ▶ Select [POIs in the Vicinity](#).
- ▶ Swipe left or right on the touchpad.

or

- ▶ Slide the controller to the left or right.
The previous or next POI is highlighted on the map. The name or the address is shown.
- ▶ **To filter the display by POI category:**
swipe down on the Touch Control or the touchpad.

or

- ▶ Slide the controller down.
- ▶ Select the POI category.
- ⓘ [User Defined](#) allows personal POI symbols to be selected (→ page 294).

Route

Calculating a route

Requirements:

- The destination has been entered.
- The destination address is shown.
- ▶ If route guidance is not active, select [Start Route Guidance](#).
The route to the destination is calculated. The map shows the route. Route guidance then begins.





or

- ▶ If route guidance is active, select [Start New Route Guidance](#) or [Set as Next Way Point](#).
[Start New Route Guidance](#): the selected destination address is set as a new destination. The previous destinations and intermediate destinations are deleted. Route guidance to the new destination begins.
[Set as Next Way Point](#): the selected destination address is set as the next intermediate destination. Route guidance begins.

Taking alternative routes into consideration

- ▶ Select an alternative route (→ page 283).

Other menu functions

- ▶ **To save the destination:** select  [Store in "Previous Destinations"](#).
- ▶ **To display on the map:** select  [Map](#).
- ▶ **To call a telephone number:** select  [Call](#).
- ▶ **To call up an Internet address:** select  [www](#) (if available).

Selecting a route type

Multimedia system:

 Navigation  Route and Position

▶ Select [Route Settings](#).

▶ Select the route type.

A route has already been created: the route is calculated on the basis of the new route type.

A route has not been created: the next route is calculated on the basis of the new route type.

You can choose from the following route types:

- [Eco Route](#)

An economical route is calculated. The journey time may be somewhat longer than for quicker routes.

The symbol for the current vehicle position is displayed in green.

- [Fast Route](#)

A route with a quick journey time is calculated.

- [Short Route](#)

A route with a short driving distance is calculated.

[Automatic Traffic Jam Avoidance](#) can be switched on or off for these route types. If [Automatic Traffic Jam Avoidance](#) is switched on, [Ask in the Event of Traffic Jam Avoidance](#) can be selected.

The [Automatic Traffic Jam Avoidance](#) and [Ask in the Event of Traffic Jam Avoidance](#) settings are not available in every country.

The settings enable the following:

- [Automatic Traffic Jam Avoidance](#)

The route is calculated with the currently set route type.

Traffic reports via Live Traffic Information are taken into account.

Live Traffic Information is not available in all countries.

- [Ask in the Event of Traffic Jam Avoidance](#)

A prompt appears when a new route is detected with a shorter journey time based on traffic reports. You can continue to use the current route or use the dynamic route instead.

Selecting route options

Multimedia system:

 Navigation  Route and Position  Avoid Options

Avoiding areas

▶ Select [Areas](#) (→ page 295).

Avoiding highways, ferries, motorail trains, tunnels, unpaved roads

▶ Select or deselect avoid option.

Using toll roads

▶ Select [Use Toll Roads](#).

▶ Select [Cash](#) or [Electronic Billing](#) or [Off](#). The route takes into account roads that require the payment of a usage fee (toll).

If [Off](#) is selected, toll roads are not taken into account.

The selected route options cannot always be implemented. Therefore, a route may include a ferry, for instance, even though the avoid [Ferries](#) option is enabled. A message appears and you will hear a corresponding message.

Using carpool lanes

- ▶ Select **Number of Occupants in the Vehicle**.
- ▶ Select number.
When using carpool lanes, observe the applicable legal requirements as well as any conditions pertaining to when and where such lanes may be used. Carpool lanes may only be used if certain conditions are met.

These route options are not available in every country.

Selecting notifications

Multimedia system:

↳ **Navigation** ▶  **Options** ▶ **Announcements**

- ▶ Switch an announcement on or off .
- You can choose from the following announcements:
- **Announce Traffic Warnings**
This function is not available in all countries.
 - **Announce Street Names**

The multimedia system announces the names of the roads that will follow the upcoming change of direction.

This function is not available in all countries and languages.

Displaying destination information

Requirements:

- A destination is entered.

Multimedia system:

↳ **Navigation**

- ▶ Select **Way Points and Info**.

The following information is displayed:

- Intermediate destinations and destination
The route can also include up to four intermediate destinations.
- Name, address
- Remaining driving distance
- Time of arrival

Selecting an alternative route

Multimedia system:

↳ **Navigation** ▶  **Route and Position**

- ▶ Select **Alternative Route**.
The routes are displayed in accordance with the setting made in the route settings.
The currently selected route is shown with a dark blue line.
- ▶ Select the alternative route.

Switching the automatic gas station search on/off

Multimedia system:

↳ **Navigation** ▶  **Options**

- ▶ Switch **Reserve Fuel** on or off .
- Switched on : when the fuel reserve level is reached, a prompt appears asking whether you want to start searching for gas stations.

Using automatic gas station search

Requirements:

The automatic gas station search is activated (→ page 283).

The prompt **Reserve Fuel Do you want to start a search for surrounding gas stations?** appears.

- ▶ Select **Yes**.
The automatic gas station search begins. The available gas stations along the route or in the vicinity are displayed.
- ▶ Select the gas station.
- ▶ When there is no route, the gas station is set as the destination.

or

- ▶ When there is a route, the gas station is set as the next intermediate destination.

Starting the automatic service station search

Requirements:

- ATTENTION ASSIST and the **Suggest Rest Area** function are activated (→ page 216).

Driving situation

The **ATTENTION ASSIST Do you want to search for a rest area?** message is shown.

- ▶ Select **Yes**.
The service station search starts. The available service stations along the route or in the vicinity of the vehicle's current position are displayed.
- ▶ Select the service station.
The service station address is displayed.
- ▶ If route guidance is not active, select **Start Route Guidance**.
The selected service station is set as a destination. Route guidance begins.

or

- ▶ If route guidance is active, select **Start New Route Guidance** or **Set as Next Way Point**.
Start New Route Guidance: the selected service station is set as a new destination. The previous destination and all intermediate destinations are deleted. Route guidance to the service station begins.
Set as Next Way Point: the selected service station is set as the next intermediate destination. Route guidance begins.

Route guidance

Notes on route guidance

⚠ WARNING Risk of distraction from operating integrated communication equipment while the vehicle is in motion

If you operate communication equipment integrated in the vehicle when driving, you will be distracted from the traffic situation. This could also cause you to lose control of the vehicle.

- ▶ Only operate this equipment when the traffic situation permits.
- ▶ If you cannot be sure of this, stop the vehicle whilst paying attention to road and traffic conditions and operate the equipment with the vehicle stationary.

You must observe the legal requirements for the country in which you are currently driving when operating the multimedia system. Route guidance begins once a route has been calculated.

The road and traffic rules and regulations always have priority over multimedia system driving instructions.

The following driving instructions can be used:

- Navigation announcements
- Route guidance displays
- Lane recommendations

If you do not follow the driving instructions or if you leave the calculated route, a new route is calculated automatically.

Driving instructions may differ from the actual road and traffic conditions if:

- The route is diverted
- The direction of a one-way street has been changed

For this reason, you must always observe road and traffic rules and regulations during your journey as well as the prevailing traffic conditions.

The route may differ from the ideal route due to the following:

- Roadworks

- Incomplete digital map data

Notes on GPS reception

The correct function of the navigation system depends amongst other things on GPS reception. In certain situations GPS reception can be impaired, defective or even not possible, e.g. in tunnels or in parking garages.

Changing direction overview



There are three phases when changing direction:

- Preparation phase

If there is enough time between the changes of direction, the multimedia system prepares you for the upcoming change of direction. A navigation announcement is issued, e.g. "Prepare to turn right".

The map appears in full-screen mode.

- Announcement phase

The multimedia system announces the upcoming change of direction, e.g. by announcing "Turn right in 300 ft (100 m)".

The display is split into two parts. The map is displayed on the left; on the right, there is a detailed image of the intersection or a 3D image of the upcoming change of direction.

- Change-of-direction phase

The multimedia system announces the imminent change of direction, e.g. by announcing "Now turn right".

The display is split into two parts.

The vehicle has successfully changed direction when the light-color bar on the right

drops down to 0 feet (0 m) and the current vehicle position symbol has reached the highlighted change-of-direction point.

When the change of direction is complete, the map appears in full-screen mode.

- Changes of direction are also shown in the Instrument Display.

Lane recommendations overview

This display appears for multi-lane roads.

If the digital map contains the relevant data, the multimedia system can display lane recommendations for the next two changes of direction.



- ① Recommended lane
- ② Possible lane
- ③ Lanes not recommended

The following lanes are displayed:

- Recommended lane ①
In this lane, you will be able to complete both the next change of direction and the one after that.

- Possible lane ②
In this lane, you will only be able to complete the next change of direction.
- Lane not recommended ③
In this lane, you will not be able to complete the next change of direction without changing lane.

During the change of direction, new lanes may be added.

- Lane recommendations can also be displayed in the Instrument Display and in the Head-up Display.

Overview of destination reached

Once the destination is reached, you will see the  checkered flag. Route guidance is finished.

When an intermediate destination has been reached, you will see the intermediate destination flag with the number of your  intermediate destination. After this, route guidance is continued.

Switching navigation announcements on/off

Requirements:

- A route has already been created.
- Route guidance is active.

▶ **To switch off:** press the volume control on the multifunction steering wheel during a navigation announcement (→ page 254). The **Voice Guidance has been deactivated.** message appears.

or

▶ Show the navigation menu (→ page 274).

▶ Select  **Voice Guidance** .
The symbol changes to .

▶ **To activate:** select  **Voice Guidance** .
The current navigation announcement is played.

- ⓘ In the following situations, navigation announcements are switched on automatically:
- A new route guidance is started.
 - The route is recalculated.

- ⓘ You can add and call up this function as a favourite under **Voice Guidance On/Off**.

Switching navigation announcements on/off during a phone call

- ▶ Select **System**.
- ▶ Select  **Audio** .
- ▶ Select **Navigation and Traffic Announcements**.
- ▶ Switch **Voice Guidance During Call** on or off .

Adjusting the volume of navigation announcements

Requirements:

- A route has already been created.
- Route guidance is active.

On the multifunction steering wheel or on the multimedia system

- ▶ Turn the volume control on the multifunction steering wheel during a navigation announcement.

or

- ▶ During a navigation announcement press the volume rocker switch on the center console up or down (→ page 255).

- ⓘ In the following situations, the volume is raised to the minimum volume or lowered to the maximum volume:
- A new route guidance is started.
 - The route is recalculated.
- ⓘ The minimum volume can be individually set at an authorized Mercedes-Benz Center.

Via system settings

- ▶ Select **System**.
- ▶ Select  **Audio**.
- ▶ Select **Navigation and Traffic Announcements**.
- ▶ Select **Voice Guidance Volume**.
- ▶ Set the volume.

Switching audio fadeout on/off during navigation announcements

- ▶ Select **System**.
- ▶ Select  **Audio**.

- ▶ Select [Navigation and Traffic Announcements](#).
- ▶ Switch [Audio Fadeout During Voice Guidance](#) on or off .



Repeating navigation announcements

Requirements:

- A route has already been created.
- Route guidance is active.

Multimedia system:

↳ [Navigation](#)

- ▶ Select  [Voice Guidance](#).
 - ▶ Select  [Voice Guidance](#).
The current navigation announcement is repeated.
-  You can add and call up this function as a favorite under [Repeat Voice Guidance](#).

Canceling route guidance

Requirements:

- A route has already been created.
- Route guidance is active.

Multimedia system:

↳ [Navigation](#)

- ▶ Select  [Cancel Route Guidance](#).

Overview of route guidance to an off-road destination

Off-road destination: the destination is within the digital map. However, the map contains no roads that lead to the destination.

You can enter off-road destinations on the map. Route guidance guides you for as long as possible with navigation announcements and displays on roads that are known to the multimedia system.

Shortly before you reach the last known position on the map, you will hear the "Please follow the direction arrow" announcement. The display shows a direction arrow and the linear distance to the destination.

Overview of route guidance from an off-road location to a destination

Off-road position: the current vehicle position is located within the digital map on roads that are not available.

When route guidance begins the following displays appear:

- The [Road Not Mapped](#) message is shown.
- A direction arrow showing the linear direction to the POI.

When the vehicle is back on a road known to the multimedia system, route guidance continues as normal.

Overview of off-road status during route guidance

Due to roadworks, for example, there may be differences between the data on the digital map and the actual course of the road. In such cases, the multimedia system will temporarily be unable to locate the vehicle's current position on the digital map. The vehicle is off-road.

When the vehicle is off-road, the following displays are shown:

- the [Road Not Mapped](#) message
- a direction arrow showing the linear direction to the POI

When the vehicle is back on a road known to the multimedia system, route guidance continues as normal.

Destination

Saving the current vehicle position

Multimedia system:

Navigation

- ▶ If the map is displayed in full screen mode, press the central control element. The map menu appears.
- ▶ Select  on the map menu (→ page 292). The current vehicle position is saved to the "Previous destinations" memory.

Storing a map position

Multimedia system:

Navigation

The map is in full-screen mode.



- ▶ Select "move map" in map menu  (→ page 292).



- ▶ Select a position on the map. If multiple entries are available for a map position, a list appears.
- ▶ Highlight an entry.
- ▶ Select  **Store in "Previous Destinations"**. The map position is saved to the "Previous destinations" memory.

Editing the previous destinations

Multimedia system:

Navigation ▶▶ Previous and Other Destinations ▶▶ Previous Destinations

- ▶ Highlight one of the previous destinations.
- ▶ **To save as a favorite:** select  **Save My Favorite**. The favorites are displayed.
- ▶ Move the favorite to the desired position. If a favorite has already been added at this position, it will be overwritten.
- ▶ **To save as "Home" address:** select  **Save as "Home"**.

- ▶ **To save as "Work" address:** select  **Save as "Work"**.
- ▶ **To delete a single or all destinations:** select  **Delete** or **Delete All**. A prompt appears.
- ▶ Select **Yes**.
- ▶ **To display destination information:** select  **Details**.

Using external destinations and routes

External destinations and routes can be received from the following sources:

- Mercedes-Benz Apps
- door-to-door navigation with Companion app (USA)
-  Received destinations are saved in the previous destinations.

A prompt appears on the media display.

- ▶ **A destination has been received without picture information:** select **Yes**.

- ▶ If route guidance is not active, select **Start Route Guidance**.
The route to the destination is calculated. The map shows the route. Route guidance then begins.

or

- ▶ If route guidance is active, select **Start New Route Guidance** or **Set as Next Way Point**.
Start New Route Guidance: the received destination address is set as a new destination. The previous destinations and intermediate destinations are deleted. Route guidance to the new destination begins.
Set as Next Way Point: the received destination address is set as the next intermediate destination. Route guidance begins.
- ▶ **A destination has been received with picture information:** select **Start Route Guidance**.
Route guidance starts.
- ▶ **A route has been received:** select **Start Route Guid. from Beginning of Route**.

or

- ▶ Select **Start Route Guidance from Current Position**.
Route guidance starts from the selected position.

Route guidance with current traffic reports

Traffic information overview

Traffic reports are received using Live Traffic Information and are used for route guidance.

This service is unavailable in some countries.

There may be differences between the traffic reports received and the actual road and traffic conditions.

Important information on Live Traffic Information:

- Current traffic reports are received via the Internet connection.
- The traffic situation is updated at short, regular intervals.
- The subscription information shows the status (→ page 290).

Information on the vehicle's position is regularly sent to Daimler AG. The data is immediately rendered anonymous by Daimler AG and forwarded to the traffic data provider. Using this data, traffic reports relevant to the vehicle's position are sent to the vehicle. The vehicle acts as a sensor for the flow of traffic and helps to improve the quality of the traffic reports.

If you do not wish to transmit your vehicle position, you can have this service deactivated at an authorized Mercedes-Benz Center.

Displaying subscription information

Requirements:

- The vehicle is equipped with Live Traffic Information.

Multimedia system:

 **Navigation**  **Options**

The subscription expiration date is automatically displayed:

- one month before the expiration date.
- one week before the expiration date.
- on the expiration date.

▶ **To display manually:** select [Live Traffic Subscription Info](#).

Depending on the status, one of the following messages appears:

- the period of validity for the subscription is displayed.
- the subscription has expired.

ⓘ The subscription can be extended:

- at an authorized Mercedes-Benz Center
- via an MB Info call to the Mercedes-Benz Customer Assistance Center

Displaying the traffic map

Requirements:

- For Live Traffic Information: the vehicle is equipped with a communication module featuring an activated, integrated SIM card.
- When the vehicle is started, the communication module automatically establishes an Internet connection. Traffic information is made available shortly afterwards.

Multimedia system:

↳ [Navigation](#) ▶  [Options](#) ▶ [Map Menu](#)

▶ Activate  .

The traffic map shows the following information, for example:

- traffic incidents, for example:
 - roadworks
 - road blocks
 - warning messages

The symbols for traffic incidents are displayed in color (on the route) or gray (off the route).

- traffic flow information:
 - traffic jam (red line)
 - slow-moving traffic (orange line)
 - heavy traffic (yellow line)
 - free-flowing traffic (green line)
- display for traffic delays on the route lasting at least one minute

- warning message symbols:

-  symbol
- additional road safety notes when approaching a traffic incident, e.g. the end of a traffic jam

If the vehicle approaches a danger area on the route, a warning message is displayed on the map. A warning message may also be issued (→ page 292).

Displaying traffic incidents

Multimedia system:

↳ [Navigation](#) ▶  [Options](#) ▶ [Map Content](#)

▶ Activate [Traffic Incidents](#).
Roadworks, road blocks, local area reports (e.g. fog) and warning messages are displayed.

Activating free flow and traffic display

▶ Activate [Free Flowing Traffic](#) and [Traffic Delays](#).

- i** The traffic delay is displayed for the current route. Traffic delays lasting one minute or longer are taken into consideration.

Displaying details

- ▶ Displays the traffic map (→ page 291).

- ▶ Moves the map (→ page 293).

- ▶ When a traffic report symbol is under the crosshair, press on the central control element.

The traffic report details are displayed.

or

- ▶ Press on the central control element.

- ▶ Select **Information on Traffic Reports**.

The map shows the traffic report symbols in the vicinity.

Traffic report information is displayed in the status line:

- Traffic report symbol
- Reason for the traffic report, e.g. traffic congestion
- Warning message (highlighted in red)

- ▶ **To select a traffic report symbol:** select **Next** or **Previous**.

- ▶ Press on the central control element.
The traffic report details are displayed.

Issuing hazard warnings

Multimedia system:

Navigation ▶  **Options** ▶ **Announcements**

- ▶ Activate **Announce Traffic Warnings**.
Warning messages are issued and tailbacks which pose a risk are announced.

Map and compass

Map and compass overview

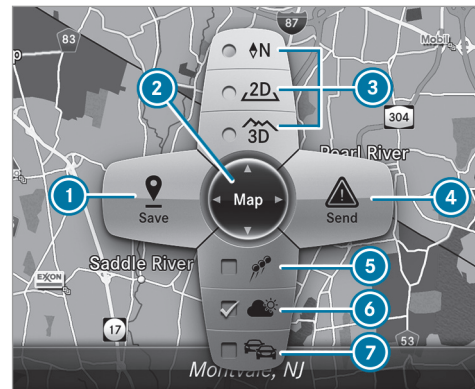

- ① Saves the current vehicle position
- ② Moves the map
- ③ Selects the map orientation and map view
- ④ Selects the function depending on the equipment:
 - Sends a hazard warning via Car-to-X.

- Filters the display of POIs in the vicinity according to POI category
- ⑤ Switches the display of personal POI symbols on the map on or off
- ⑥ Switches one of the following displays on or off depending on the equipment:
 - Weather information
 - Satellite map
 - Traffic incidents
- ⑦ Switches the traffic map display on or off

The map and satellite images are shown in globe projection. This allows for a realistic map display in all map scales. The map uses elevation modeling.

Depending on the map data, important buildings in many cities are depicted realistically on the map in small map scales (e.g. 1/32 mi (20 m), 1/16 mi (50 m)). Other buildings are shown as models.

- ① You can set the unit of measurement of the map scale (→ page 263).

If online information is available, fuel prices and the availability of parking spaces in parking garages are displayed, for example.

- ① Requirements:
 - Mercedes me connect is available.
 - You have a user account for the Mercedes me portal.
 - The service has been activated at an authorized Mercedes-Benz Center.

Further information can be found at: <http://www.mercedes.me>

- ① The online information is not available in all countries.

If **Display in COMAND** is activated in Traffic Sign Assist (→ page 218), speed limits and overtaking restrictions are displayed on the map.

- ① Company logos displayed on the map are trademarks of the respective companies and used solely for the purpose of indicating the locations of these companies. The use of such logos on the map does not indicate approval of, support of or advertising by

these companies for the navigation system itself.

Setting the map scale

Requirements:

- The map is shown.

Multimedia system:

→ Navigation

- ① You can set the unit of measurement of the map scale (→ page 263).

Moving the map

Multimedia system:

→ Navigation → ⚙ Options → Map Menu

- ▶ Alternatively, if the map is displayed in full screen mode, press the central control element. The map menu appears.
- ▶ Select "Move map" in map menu ② (→ page 292).

Selecting the map orientation

Multimedia system:

Navigation ► Options ► Map Menu

Alternatively, if the map is displayed in full screen mode, press the central control element.

The map menu appears.

In map menu , select **N**, **2D** or **3D**(→ page 292).

- **N**: the 2D map view is displayed so that north is always at the top.
- **2D**: the 2D map view is aligned to the direction of travel.
- **3D**: the 3D map view is aligned to the direction of travel.

Selecting POI symbols

Multimedia system:

Navigation ► Options ► Map Content

Select **POI Symbols**.

The • dot indicates the current setting.

Standard displays symbols of predefined categories on the map.

User Defined allows you to personally select the symbols for the available categories.

None switches the display off.

Select a setting.

User Defined: select categories. The POI symbols of the selected categories are displayed or not displayed .

Selecting the display of text information in the map

Multimedia system:

Navigation ► Options ► Text Information

Select text information.

Current Street shows the street you are currently driving on at the bottom of the display.

When the map is moved, the following information appears under the crosshair:

- Street name
- POI name
- Area name

Geo-coordinates displays the following information:

- Longitude and latitude
- Elevation

The elevation shown may deviate from the actual elevation.

- Number of satellites from which a signal can be received

When the map is moved, this information does not appear.

Climate Control displays the current climate control settings.

None switches the display off.

Displaying the next intersecting street

Requirements:

- Route guidance is not active.

Multimedia system:

Navigation ► Options



Activate **Next Intersecting Street**.

The name of the next intersecting street will be displayed at the upper edge of the display.

Displaying the map version

Multimedia system:

 Navigation   Options

-  Select [Map Version](#).
-  Select [Details](#).

 Information about new versions of the digital map can be obtained from an authorized Mercedes-Benz Center.

Overview of avoiding an area

You can define areas along a route that you would like to avoid.



The route can include an area that is to be avoided in the following situations:



- the destination is located in an area that is to be avoided
- if freeways are located within the area that is to be avoided
Freeways are always taken into account for the route.
- there is no sensible alternative route

Avoiding a new area

Multimedia system:

 Navigation   Route and Position  Avoid Options  Areas



-  Select [Avoid New Area](#).
 -  **To search for an area via the map:** select [Using Map](#).
 -  Move the map
- or

-  **To search for an area using an address:** select [Address Entry](#).
-  Enter the address.
-  Select [Select Destination](#).
The map appears.

Changing an area

Multimedia system:

 Navigation   Route and Position  Avoid Options  Areas



-  Highlight an area in the list.
-  Select  [Edit](#).



Moving the area on the map

-  Swipe in any direction on the Touch Control or touchpad.
- or

-  Slide the controller in any direction.

Changing the size of the area

-  **To start:** press the Touch Control, the touchpad or the controller.
 -  **To change:** swipe up or down on the Touch Control or the touchpad.
- or

-  Slide the controller up or down.
-  **To stop:** press the Touch Control, the touchpad or the controller.

Taking the area for the route into account

-  Avoid an area in the list.
If route guidance is active, a new route is calculated.
If there is no route yet, the setting is carried over to the next route guidance.





The route can include an area that is to be avoided in the following cases:

- the destination is located in an area that is to be avoided.
- if freeways are located within the area that is to be avoided.
Freeways are always taken into account for the route.
- there is no sensible alternative route.

Deleting one or all areas

Multimedia system:

 Navigation **»»**  Route and Position **»»** Avoid Options **»»** Areas

-  Highlight an area in the list.
-  Select  Delete or  Delete All.
-  Confirm the prompt with **Yes**.
One or all areas are deleted.

Map data update overview

Updating at the authorized Mercedes-Benz Center

The digital maps generated by the map software become outdated in the same way as conventional road maps. Optimal route guidance can only be provided by the navigation system in conjunction with the most up-to-date map data. Information about new versions of the digital map can be obtained from an authorized Mercedes-Benz Center.

You can receive updates to the digital map there.

Online map update

The online map update service from Mercedes me connect can be used to update map data.

 The online map update service is not available in all countries.

The following options are available for the update:

- the automatic map update updates map data for one region.

For automatic map updates [Automatic Online Update](#) must be activated in the system settings (→ page 266).

- the manual map update updates map data for several or all regions.

Further information on the online map update is available at an authorized Mercedes-Benz Center or at <http://www.mercedes.me>.

Further information on updates: http://manuals.daimler.com/baix/cars/connectme/en_GB/index.html.

Overview of map data

Your vehicle is supplied with map data at the factory. Depending on the country, map data for your region is either pre-installed or the map data is supplied on a data storage medium.

If the map data on your vehicle has been installed at the factory and you wish to reinstall it, you do not need to enter the activation code.

For map data that you have purchased in the form of a data storage medium, you must enter the accompanying activation code.

- i** If you save the map data on a data storage medium with the online map update service, no entry is required. The activation code is stored on the data storage medium during the downloading process.

Observe the following when entering the activation code:

- The activation code can be used for one vehicle
- The activation code is not transferable
- The activation code has six digits

In the event of the following problems, please contact an authorized Mercedes-Benz Center:

- The multimedia system does not accept the activation code
- You have lost the activation code

Displaying the compass

Multimedia system:

Navigation ►  Route and Position

► Select **Compass**.

The compass display shows the following information:

- the current direction of travel with bearing (360° format) and compass direction
- longitude and latitude coordinates in degrees, minutes and seconds
- height (rounded)
- number of GPS satellites from which a signal can be received

Setting the map scale automatically

Multimedia system:

Navigation ►  Options

The map scale is set automatically depending on your driving speed.

For journeys in cities with detailed city models, a map view from the driver's perspective is used.

► Switch **Auto Zoom** on or off .

- i** The automatically selected map scale can be changed manually for a short time. The setting is reset automatically after a few seconds.

Displaying the satellite map

Multimedia system:

Navigation ►  Options ► Map Content

► Switch **Satellite Map** on or off .

or

► If satellite map display  is available in the map menu, switch it on or off (→ page 292).

Switched on : satellite maps are displayed in map scales of 2 mi (2 km).

Switched off : satellite maps are not displayed in map scales from 2 mi (2 km) to 10 mi (10 km).

- i** Satellite maps for these map scales are not available in all countries.

Displaying weather information

Requirements:

- Mercedes me connect is available.
- You have a user account for the Mercedes me portal.
- The service is available.
- The service has been activated at an authorized Mercedes-Benz Center.

Further information can be found at: <http://www.mercedes.me>

Multimedia system:

Navigation ► Options ► Map Content

► Activate **Weather Information** .

or

► If weather information display  is available in the map menu, activate (→ page 292) it.

Current weather information is displayed on the navigation map, e.g. temperature or cloud cover.

 Weather information is not available in all countries.

Calling up the Digital Operator's Manual (navigation)

Calling up information on navigation

Multimedia system:

Navigation ►  Options ► Navigation Info

► Select the topic.

Telephone

Telephony

Notes on telephony

 **WARNING** Risk of distraction from operating integrated communication equipment while the vehicle is in motion

If you operate communication equipment integrated in the vehicle when driving, you will be distracted from the traffic situation.

This could also cause you to lose control of the vehicle.

- Only operate this equipment when the traffic situation permits.
- If you cannot be sure of this, stop the vehicle whilst paying attention to road and traffic conditions and operate the equipment with the vehicle stationary.

 **WARNING** Risk of distraction from operating mobile communication equipment while the vehicle is in motion

If you operate mobile communication equipment when driving, you will be distracted from the traffic situation. This could also cause you to lose control of the vehicle.

- Only operate this equipment when the vehicle is stationary.

You must observe the legal requirements for the country in which you are currently driving when operating mobile communication equipment in the vehicle.

Further information can be obtained from an authorized Mercedes-Benz Center or at: <http://www.mercedes-benz.com/connect>.

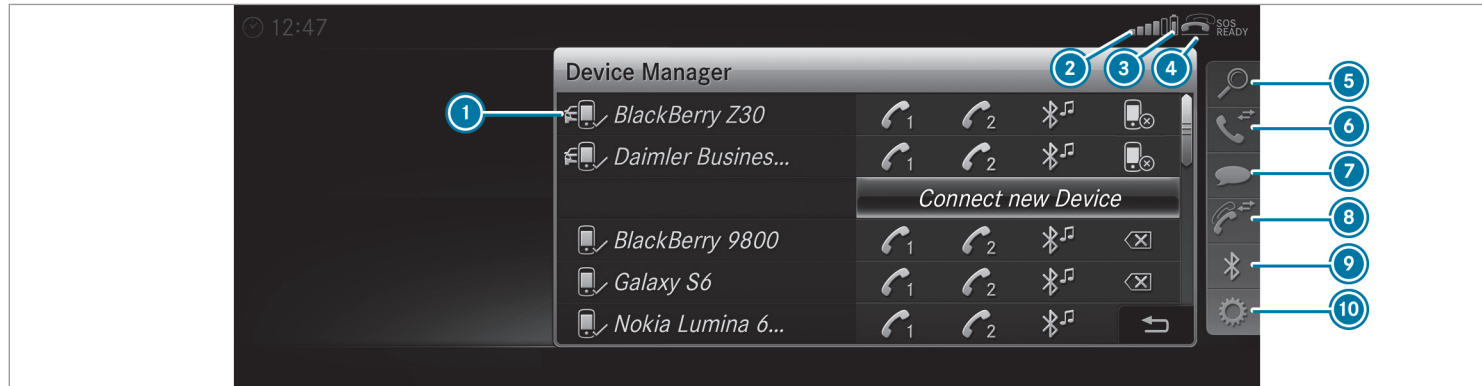

Telephone menu overview



❶ Bluetooth® device name of the currently connected mobile phone

❷ Signal strength of the mobile phone network for the currently connected and selected mobile phone

❸ Battery status of the currently connected and selected mobile phone

- ④  (telephone ready) or  (call active)
- ⑤ **Contacts** (→ page 305)
- ⑥ **Recent Calls** (→ page 308)

Symbols ① to ④ are not shown until after a mobile phone has been connected to the multimedia system. The symbols depend on your mobile phone and your mobile phone network provider.

Bluetooth® profile overview

Bluetooth® profile of the mobile phone	Function
PBAP (Phone Book Access Profile)	Contacts are automatically displayed in the multimedia system
MAP (Message Access Profile)	Message functions can be used

- ⑦ **Text Message**
- ⑧ One mobile phone connected: **Active Call**.

Telephony operating modes overview

Depending on your equipment, the following telephony operating modes are available:

- A mobile phone is connected to the multimedia system via Bluetooth® (→ page 301).
- Two mobile phones are connected with the multimedia system via Bluetooth® (two phone mode) (→ page 301).

Information on telephony

The following situations can lead to the call being disconnected while the vehicle is in motion:

- There is insufficient network coverage in the area
- You move from one GSM or UMTS transmitter/receiver area (cell) into another and no communication channels are free

Two mobile phones connected: changes view between telephone 1 and 2 or **Active Call**

- ⑨ **Devices** (→ page 301)
- ⑩ **Options**

- The SIM card used is not compatible with the network available
- A mobile phone with "Twincard" is logged into the network with the second SIM card at the same time

The multimedia system supports calls in HD Voice® for improved speech quality. A requirement for this is that the mobile phone and the mobile phone network provider of the person you are calling support HD Voice®.

Depending on the quality of the connection, the voice quality may fluctuate.

Connecting a mobile phone (Bluetooth® telephony)

Requirements:

- Bluetooth® is activated on the mobile phone (see the manufacturer's operating instructions).
- Bluetooth® is activated on the multimedia system (→ page 259).

Multimedia system:

↳ Phone ▶▶ ⌘ Devices

Searching for a mobile phone

- ▶ Select [Connect New Device](#).
- ▶ Select [Start Search on System](#).
The available mobile phones are displayed. If a new mobile phone is found, it is indicated by the  symbol.

Connecting a mobile phone (authorization using Secure Simple Pairing)

- ▶ Select the mobile phone.
A code is displayed in the multimedia system and on the mobile phone.

- ▶ **If the codes match:** confirm the code on the mobile phone.

Connecting a mobile phone (authorization by entering a passkey)

- ▶ Select the mobile phone.
- ▶ Choose a one to sixteen-digit number combination as a passkey.
- ▶ **On the multimedia system:** enter the passkey and select .
- ▶ **On the mobile phone:** enter the passkey again and confirm.
- ⓘ Up to 15 mobile phones can be authorized on the multimedia system.
Authorized mobile phones are reconnected automatically.

Connecting a second mobile phone (two phone mode)

Requirements:

- At least one mobile phone is already connected to the multimedia system via Bluetooth®.

Multimedia system:

↳ Phone ▶▶ ⌘ Devices

- ▶ Select [Connect New Device](#).
- ▶ Select [Start Search on System](#).
The available mobile phones are displayed.
- ▶ Select the mobile phone.
- ▶ Answer the [How would you like to connect the new device?](#) prompt.
- ▶ **To replace the currently connected mobile phone:** select [Phone 1](#).
The currently connected mobile phone is replaced by the new mobile phone.
- or
- ▶ **To connect the second mobile phone:** select [Phone 2](#).
The new mobile phone is connected as [Phone 2](#). If two mobile phones have already been connected, the second telephone is replaced by the new mobile phone.
- or
- ▶ **To use the mobile phone as an audio source:** select [Audio Source](#) (→ page 335).

- ❗ A mobile phone can be operated both as an audio source as well as telephone in parallel.
- ❗ It is possible at any future point to change the type of connection for the mobile phone already connected and to set this as **Phone 1**, **Phone 2** or **Audio Source** (→ page 302).

Functions of the mobile phone in two phone mode

Functions overview

Mobile phone in the foreground	Mobile phone in the background
Full range of functions	Incoming calls

Interchanging mobile phones (two phone mode)

Requirements:

- The mobile phones are authorized (→ page 301).

Multimedia system:

→ Phone → Bluetooth Devices

- ▶ In the device overview, select a mobile phone which has already been authorized and set as **Phone 1** or **Phone 2**.

After interchanging the mobile phones, the mobile phone in the foreground is replaced by the mobile phone in the background.

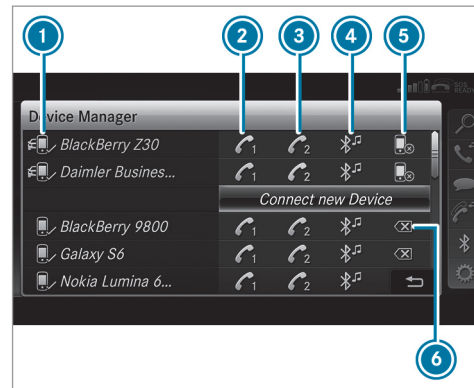

- ❶ Bluetooth® device name of the currently connected mobile phone
- ❷ Connects a mobile phone as **Phone 1**
- ❸ Connects a mobile phone as **Phone 2**
- ❹ Connects a mobile phone as **Audio Source**
- ❺ Disconnecting a mobile phone(→ page 303)
- ❻ De-authorizing a mobile phone(→ page 303)

- ⓘ If a new mobile phone is connected and defined as **Phone 1**, for example, this overwrites the previously connected mobile phone in the foreground of the system.

Disconnecting a mobile phone

Multimedia system:

➔ Phone ➔ ⌘ Devices

- ▶ Select the  symbol in the line of the mobile phone.
The disconnection of the mobile phone takes place without a confirmation prompt. The mobile phone remains authorized in the system.

De-authorizing a mobile phone

Multimedia system:

➔ Phone ➔ ⌘ Devices

- ▶ Select the  symbol in the line of the mobile phone.
- ▶ Answer the confirmation prompt with **Yes**.
The mobile phone is deauthorized and deleted from the system.

Information on Near Field Communication (NFC)

NFC enables short-range wireless data transfer or (re)connection of a mobile phone with the multimedia system.

The following functions are available without having authorized a mobile phone:

- Transferring a URL to be viewed in the multimedia system (see the manufacturer's operating instructions).
- Setting up the vehicle's Wi-Fi access data via the system settings (→ page 261).

Further information can be found at: <http://www.mercedes-benz.com/connect>

Using the mobile phone with Near Field Communication (NFC)

Requirements:

- NFC is activated on the mobile phone (see the manufacturer's operating instructions)
- The mobile phone's screen is switched on and unlocked (see the manufacturer's operating instructions)

- ▶ **To connect a mobile phone:** hold the NFC area of the mobile phone (see manufacturer's operating instructions) on mat or place the mobile phone on it.

The mobile phone is connected to the multimedia system.

- ▶ **To change a mobile phone:** hold the NFC area of the mobile phone (see manufacturer's operating instructions) on the mat or place the mobile phone on it.
If the mobile phone has already been authorized on the multimedia system, it is now connected.

If the mobile phone is authorized on the multimedia system for the first time, it is connected after confirming the mobile phone instructions (see the manufacturer's operating instructions).

Further information can be found at: <http://www.mercedes-benz.com/connect>

Setting the reception and transmission volume

Requirements:

- A mobile phone is authorized (→ page 301).

Multimedia system:

☛ Phone >>  Options >> Phone

This function ensures optimal language quality.

- ▶ Select **Reception Volume** or **Transmission Volume**.
- ▶ Set the volume.

Further information on the recommended reception and transmission volume: <http://www.mercedes-benz.com/connect>

Adjusting the call and ringtone volume

Multimedia system:

☛ System >>  Audio >> Phone

- ▶ Select **Call Volume** or **Ringtone Volume**.
- ▶ Set the volume.

Starting/stopping mobile phone voice recognition

Requirements:

- The mobile phone is connected to the multimedia system (→ page 301).

Starting mobile phone voice recognition

- ▶ Press and hold the  button on the multi-function steering wheel for more than one second.
You can use mobile phone voice recognition.

Stopping mobile phone voice recognition

- ▶ Press the  or  button on the multi-function steering wheel.

Calls

Using the telephone

Multimedia system:

☛ Phone >>  Contacts

Making a call

- ▶ Select **Numerical Keypad**.

- ▶ Enter the number.
- ▶ Select .
- ▶ The call is made.

Accepting a call

- ▶ Select **Accept**.

Rejecting a call

- ▶ Select **Reject**.

Ending a call

- ▶ Select .

Activating functions during a call

- ▶ To show all functions, navigate down.

The following functions are available during a call:

- **End Call**
- **Make Additional Call**
- **Keyboard** (show to send DTMF tones)
- Switch **Mute Mic** on or off .
- **Private Mode** (an active call in hands-free mode is transferred over to the telephone)

Conducting calls with several participants

Requirements:

- There is an active call (→ page 304).
- Another call is being made.

Switching between calls

- ▶ Select call ●.
The selected call is active. The other call is on hold.

Activating or ending a call on hold

- ▶ Select [Continue Call](#) or [End Call](#).

Conducting a conference call

- ▶ Select [Create Conference Call](#) in the telephone menu.
The new participant is included in the conference call.

Ending an active call

- ▶ Select .
- ⓘ On some mobile phones, the call on hold is activated as soon as the active call is ended.

Accepting/rejecting a waiting call

Requirements:

- There is an active call (→ page 304).

If you receive a call while already in a call, a message is displayed. An acoustic signal also sounds.

- ▶ Select [Accept](#).
The incoming call is active.
If only one mobile phone is connected with the multimedia system, the previous call will be put on hold.
If during a call you accept a call with the other mobile phone when in two phone mode then the existing call is ended.
- ▶ Select [Reject](#).
- ⓘ This function and behavior depends on your mobile phone network provider and the mobile phone (see the manufacturer's operating instructions).

Contacts

Information about the contacts menu

The contacts menu contains all contacts from existing data sources, e.g. mobile phone or memory card. You can store up to 6,000 contacts.

Depending on the data source, you have the following number of contacts:

- Permanently saved contacts: 3,000 entries
- Contacts loaded from the mobile phone: 3,000 entries

From the contacts menu, you can perform the following actions:

- Using the telephone
 - Calling a contact (→ page 307)
 - Calling a new number (→ page 304)
- Navigation (→ page 279)
- Compose messages (→ page 309)

If a mobile phone is connected to the multimedia system (→ page 301) and automatic calling up (→ page 306) is activated, the mobile phone's contacts are displayed in the address book.

Downloading mobile phone contacts

Multimedia system:

 Phone **»»**  Options **»»** Contacts

Automatically

- ▶ Switch [Synchronize Contacts Automatically](#) on .

Manually

- ▶ Deactivate [Synchronize Contacts Automatically](#).
- ▶ Select [Synchronize Contacts](#).

Calling up contacts

Multimedia system:

 Phone **»»**  Contacts

Depending on the character set, the following options can be used to search for contacts:

- Searching by initials
- Searching by name
- Searching by phone number

- ▶ Enter characters into the search field. A selection of possible contacts appears. Entering more characters into the search field narrows down the number of possible selections.

- ▶ Select the contact.

A contact can contain the following details:

- Phone numbers
- Navigation addresses
- Geo-coordinates
- Internet address

Editing the format of a contact's name

Multimedia system:

 Phone **»»**  Options **»»** [Contacts](#) **»»** [Name Format](#)



The following options are available:



- [Last Name, First Name](#)
- [Last Name First Name](#)
- [First Name Last Name](#)

- ▶ Select an option.

Overview of importing contacts

Contacts from various sources



Source	Requirements
 Memory card	The SD memory card is inserted.
 USB device	The USB device is inserted in the USB port.

Source	Requirements
 Bluetooth® connection	<p>If the sending of vCards via Bluetooth® is supported, vCards can be received on mobile phones or netbooks, for example.</p> <p>Bluetooth® is activated in the multimedia system and on the respective device (see the manufacturer's operating instructions).</p>
 Mobile phone	The mobile phone is connected to the multimedia system.

Importing contacts into the contacts menu

Multimedia system:







 Phone   Options  Contacts

-  Select **Import**.
-  Select an option.

Saving a mobile phone contact

Multimedia system:



 Phone   Contacts

-  Select the mobile phone contact .
-  Select .
-  Select **Save to Vehicle**.
The contact saved in the multimedia system is identified by the  symbol.

Calling a contact

Multimedia system:



 Phone   Contacts

-  Enter characters into the search field.
-  Select the contact.
-  Select the telephone number.
The number is dialed.

Selecting further options in the contacts menu

Multimedia system:

 Phone   Contacts

-  Select a contact.
-  Select .

Depending on the stored data, the following options are available:







- **Call**
 - **Send Text Message**
 - **Show Website** (if an Internet address has been stored)
 - **Navigate** (if an address has been stored)
 - **Save My Favorite**
 - **Send DTMF Tones** (for a number with DTMF tones)
-  Select an option.

Deleting a contact

Multimedia system:

 Phone   Contacts

You can delete contacts stored in the vehicle.

-  Search for the contact.
-  Select the contact.
-  Select .
-  Select **Delete Contact**.
-  Select **Yes**.

Call list

Call list overview

Depending on whether your mobile phone supports the PBAP Bluetooth® profile or not, this can have different effects on the presentation and functions of the call list.

If the PBAP Bluetooth® profile is supported, the effects are as follows:

- The call lists from the mobile phone are displayed in the multimedia system.
- When connecting the mobile phone, you may have to confirm the connection for the PBAP Bluetooth® profile.

If the PBAP Bluetooth® profile is not supported, the effects are as follows:

- The multimedia system generates its own call lists.
- The call list is not synchronized with the call lists in the mobile phone.

Making a call from the call list

Multimedia system:

 Phone   Recent Calls

- ▶ Select a number.
The call is made.

Text messages

Overview of text message functions

If the connected mobile phone supports the MAP Bluetooth® profile, the text message functions can be used on the multimedia system. You can obtain further information about settings and supported functions of Bluetooth®-capable mobile phones from an authorized Mercedes-Benz Center or at: <http://www.mercedes-benz.com/connect>

Some mobile phones require further settings after being connected to the multimedia system (see manufacturer's operating instructions).



New messages are identified by the  symbol in the media display and an audible signal.

Depending on the mobile phone, the multimedia system only displays new incoming text messages or the 100 newest text messages.

Configuring the text messages displayed

Multimedia system:

 Phone   Options  Text Message  Message Display

- ▶ Select .
- A menu with the following options is shown:
 - [All Messages](#)
 - [New and Unread Messages](#)
 - [New Messages](#)
 - [Off](#) (The text messages are not displayed automatically.)
- ▶ Select an option.
-  The setting may not be active until the mobile phone is reconnected.

Reading text messages

Multimedia system:

Phone >> Text Message

Reading a text message

- Select a text message.
The message text is displayed.

Using the read-aloud function

- Select a text message.
- Select **Read Aloud**.
The text message is read aloud.

Composing and sending a text message

Multimedia system:

Phone >> Text Message

- Select **Write New Text Message**.

Adding a recipient

- Select **Press to Add Recipient**.
- Select the contact.

Dictating text

- Select **Press to Dictate**.

- To start the dictation function:** press on the central control element.
The app for the dictation function is loaded.
If there was no prior Internet connection, a connection is now established.

- Say the message.
The dictation ends automatically after you have finished speaking.

After the voice message has been processed, it is shown as text.

- To replace a message:** select **Replace message**.
The text that has been dictated and shown on the display is reset and can be dictated again.

Editing text

- Select the word.
- To call up the correction menu:** press on the central control element.
The following options are available:
 - Adjusting the capitalization of words (if supported by the character set)

- Expanding the choice of words
- Deleting the selection
- Recording a new dictation
- To leave the menu:** select **Done**.

Sending text messages

- Select **Send Text Message**.

Replying to a text message

Multimedia system:

Phone >> Text Message

- Open the text message.
- Select .
- Select **Reply**.

Calling a text message sender

Multimedia system:

Phone >> Text Message

- Open the text message.
- Select .
- Select **Call Sender**.

Deleting text messages

Multimedia system:

☛ Phone ▶▶  Text Message

▶ Select .

▶ **To delete a text message:** select **Delete**.

▶ **Outbox**

or

▶ Select **Drafts**.

Mercedes-Benz link

Overview of Mercedes-Benz Link

Using Mercedes-Benz Link, various functions and selected mobile phone apps can be transferred to the media display.

The Mercedes-Benz Link control box supplementary equipment is required for this. You can obtain this at an authorized Mercedes-Benz Center.

 The Mercedes-Benz Link control box uses the Android operating system.

 The service provider is responsible for these apps and the services and content connected to it.

Connecting Mercedes-Benz Link with the multimedia system

▶ Connect the Mercedes-Benz Link control box with the  USB port of the multimedia connection unit using a suitable connecting cable.

 A suitable connecting cable is available separately at an authorized Mercedes-Benz Center.

Using Mercedes-Benz Link

Requirements:

- The Mercedes-Benz Link control box is connected with the multimedia system using the  USB port.

Multimedia system:

☛ **Connect**

▶ Select **Mercedes-Benz Link**.

▶ Select **MB Link**.

The mobile phone functions and apps are available and shown on the media display.

You can find more information in the Mercedes-Benz Link control box operating instructions.

Ending Mercedes-Benz Link

Multimedia system:

☛ **Connect** ▶▶ **Mercedes-Benz Link**

▶ Select **Disconnect**.

The connection is ended.

The mobile phone continues to be supplied with electricity.

or

▶ Disconnect the connecting cable between the Mercedes-Benz Link control box and the multimedia system.

 Mercedes-Benz recommends disconnecting the connecting cable only when the vehicle is stationary.

Apple CarPlay™

Overview of Apple CarPlay™

⚠ WARNING Risk of distraction from information systems and communications equipment

If you operate information and communication equipment integrated in the vehicle when driving, you will be distracted from the traffic situation. This could also cause you to lose control of the vehicle.

- ▶ Only operate this equipment when the traffic situation permits.
- ▶ If you cannot be sure of this, stop the vehicle whilst paying attention to road and traffic conditions and operate the equipment with the vehicle stationary.

You must observe the legal requirements for the country in which you are currently driving when operating the multimedia system. iPhone® functions can be used via the multimedia system using Apple CarPlay™. They are operated using the central control element or the

Siri® voice-operated control system. You can activate the voice-operated control system by pressing and holding the  button on the multifunction steering wheel.

When using Apple CarPlay™ via the voice-operated control system, the multimedia system can still be operated via the Voice Control System (→ page 240).

Only one mobile phone at a time can be connected via Apple CarPlay™ to the multimedia system.

The availability of Apple CarPlay™ may vary according to the country.

The service provider is responsible for this application and the services and content connected to it.

Information on Apple CarPlay™

While using Apple CarPlay™ various functions of the multimedia system, e.g. telephony or the media sources Bluetooth® audio and iPod®, are unavailable.

Only one route guidance can be active at a time. If route guidance is active on the multimedia sys-

tem, it is closed when route guidance is started on the mobile phone.

Connecting an iPhone® via Apple CarPlay™

Requirements:

- Apple® operating system version iOS 8.3 or above is installed on the iPhone®.
- There is an Internet connection for the full range of functions for Apple CarPlay™.
- The iPhone® is connected to the multimedia system via the USB port  using a suitable cable (→ page 329).

Multimedia system:

 **Connect**  **Apple CarPlay**

Setting automatic or manual start

A message appears when connected for the first time.

- ▶ **Automatic start:** select **Automatically**. **Start Automatically** is activated .

Apple CarPlay™ will now start immediately after the iPhone® is connected to the multimedia system using a USB cable.



- ▶ **Manual start:** select [Manually](#).
- ▶ Select the iPhone® in the device list.

Accepting/rejecting the data protection regulations

A message with the data protection regulations appears.

- ▶ Select [Accept & Start](#).
- or
- ▶ Select [Decline & End](#).

Exiting Apple CarPlay™

- ▶ Press the  button on the multifunction steering wheel, for example.
-  If Apple CarPlay™ was not displayed in the foreground before disconnecting, the application starts in the background when reconnected. You can call up Apple CarPlay™ in the main menu.

Calling up Apple CarPlay™ sound settings

Multimedia system:

- ↳ [Connect](#) ▶ [Apple CarPlay](#) ▶ [Sound](#)
- ▶ Select the tone menu (→ page 342).

Ending Apple CarPlay™

Multimedia system:

↳ [Connect](#) ▶ [Apple CarPlay](#)

- ▶ Select [Disconnect](#).
The connection is ended.
The mobile phone continues to be supplied with electricity.
- or
- ▶ Disconnect the connecting cable between the mobile phone and multimedia system. Mercedes-Benz recommends disconnecting the connecting cable only when the vehicle is stationary.

Android Auto

Android Auto overview

 **WARNING** Risk of distraction from information systems and communications equipment

If you operate information and communication equipment integrated in the vehicle

when driving, you will be distracted from the traffic situation. This could also cause you to lose control of the vehicle.

- ▶ Only operate this equipment when the traffic situation permits.
- ▶ If you cannot be sure of this, stop the vehicle whilst paying attention to road and traffic conditions and operate the equipment with the vehicle stationary.

You must observe the legal requirements for the country in which you are currently driving when operating the multimedia system. Mobile phone functions can be used with Android Auto using the Android operating system on the multimedia system. It is operated using the central control element or the voice control. You can activate the voice-operated control system by pressing and holding the  button on the multifunction steering wheel.

When using Android Auto via the voice-operated control system, the multimedia system can still be operated via the Voice Control System (→ page 240).

Only one mobile phone at a time can be connected via Android Auto to the multimedia system.

The availability of Android Auto and Android Auto Apps may vary according to the country.

The service provider is responsible for this application and the services and content connected to it.

Information on Android Auto

While using Android Auto, various functions of the multimedia system, for example the media source Bluetooth® audio, are not available.

Only one route guidance can be active at a time. If route guidance is active on the multimedia system, it is closed when route guidance is started on the mobile phone.

Connecting a mobile phone via Android Auto

Requirements:

- The first activation of Android Auto on the multimedia system must be carried out when the vehicle is stationary for safety reasons.
- The mobile phone supports Android Auto from Android 5.0.

- The Android Auto app is installed on the mobile phone.
- In order to use the telephone functions, the mobile phone must be connected to the multimedia system via Bluetooth® (→ page 301). If there was no prior Internet connection, this is established with the use of the mobile phone with Android Auto.
- The mobile phone is connected to the multimedia system via the USB port  using a suitable cable (→ page 329).
- There is an Internet connection for the full range of functions for Android Auto.

Multimedia system:

 [Connect](#)  [Android Auto](#)

- ▶ Select the mobile phone from the device list.

Accepting/rejecting the data protection regulations

A message with the data protection regulations appears.

- ▶ Select [Accept & Start](#).

or

- ▶ Select [Decline & End](#).

Activating automatic start

- ▶ Select [Start Automatically](#) .

Starting manually

- ▶ Select the mobile phone from the device list.

Exiting Android Auto

- ▶ Press the  button on the multifunction steering wheel, for example.

- ⓘ If Android Auto was not displayed in the foreground before disconnecting, the application starts in the background when reconnected. You can call up Android Auto in the main menu.

Calling up the Android Auto sound settings

Multimedia system:

 [Connect](#)  [Android Auto](#)  [Sound](#)

- ▶ Select the tone menu (→ page 342).

Ending Android Auto

Multimedia system:

↪ [Connect](#) ▶ [Android Auto](#)

▶ Select [Disconnect](#).

The connection is ended.

The mobile phone continues to be supplied with electricity.

or

▶ Disconnect the connecting cable between the mobile phone and multimedia system. Mercedes-Benz recommends disconnecting the connecting cable only when the vehicle is stationary.

[Transferred vehicle data with Android Auto and Apple CarPlay™](#)

Overview of transferred vehicle data

When using Android Auto or Apple CarPlay™, certain vehicle data is transferred to the mobile phone. This enables you to get the best out of selected mobile phone services. Vehicle data is not directly accessible.

The following system information is transmitted:

- Software release of the multimedia system
- System ID (anonymised)

The transfer of this data is used to optimize communication between the vehicle and the mobile phone.

To do this, and to assign several vehicles to the mobile phone, a vehicle identifier is randomly generated.

This has no connection to the vehicle identification number (VIN) and is deleted when the multimedia system is reset (→ page 267).

The following driving status data is transmitted:

- Transmission position engaged
- Distinction between parked, standstill, rolling and driving
- Day/night mode of the instrument cluster

The transfer of this data is used to alter how content is displayed to correspond to the driving situation.

The following position data is transmitted:

- Coordinates
- Speed
- Compass direction
- Acceleration direction

This data is only transferred while the navigation system is active in order to improve it (e.g. so it can continue functioning when in a tunnel).

[Mercedes me connect](#)

Notes on Mercedes me connect

Mercedes me connect provides the following services:

- Accident and breakdown management (me button)
- Concierge Service (when the service is activated), appointment requests or similar (me button)
- Mercedes-Benz emergency call system (SOS button)

The Mercedes-Benz Customer Center and the Mercedes-Benz emergency call center are available for you around the clock.

The me button and the emergency call system can be found on the vehicle's overhead control panel (→ page 315).

You can also call the Mercedes-Benz Customer Center using the multimedia system (→ page 315).

Please note that Mercedes me connect is a Mercedes-Benz service. In emergencies, always call the national emergency services first using the standard national emergency service phone numbers. In emergencies, you can also use the Mercedes-Benz emergency call system (→ page 317).

Observe the conditions of use for Mercedes me connect and other services. These can be obtained in the Mercedes me portal: <https://me.secure.mercedes-benz.com>

Calling the Mercedes-Benz Customer Center using the multimedia system

Requirements:

- You have access to a GSM network.
- The contract partner's GSM network coverage is available in the respective region.
- The ignition is switched on so that vehicle data can be transferred automatically.

Multimedia system:

☞ Phone ☞  Contacts

- ▶ Call **Mercedes me connect**. The call is made.

Then, you can select a service and be connected to a specialist at the Mercedes-Benz Customer Center.

Making a call via the overhead control panel

Requirements:

- You have access to a GSM network.
- The contract partner's GSM network coverage is available in the respective region.

- The ignition is switched on so that vehicle data can be transferred automatically.

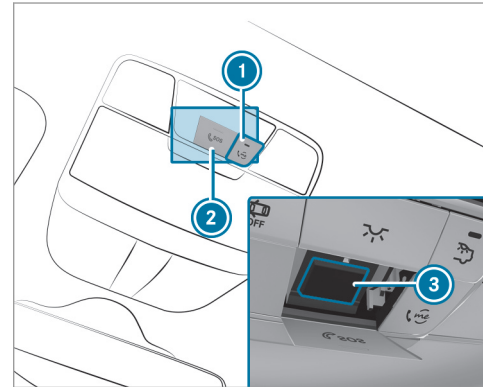

- ① Service call button (me button)
- ② SOS button cover
- ③ SOS button

▶ **To make a service call:** press button ①.

▶ **To make an emergency call:** press SOS button cover ② briefly to open.

▶ Press and hold SOS button ③ for at least one second.

If a service call is active, an emergency call can still be triggered. This has priority over all other active calls.

Service calls are only possible if a mobile phone network is available.

Information about the service call using the me button

A call to the Mercedes-Benz Customer Center has been initiated via the me button in the overhead control panel or the multimedia system.

In the event of a breakdown, you will get support:

- A qualified Mercedes-Benz technician provides breakdown assistance on site and/or the vehicle will be towed to the nearest authorized Mercedes-Benz Center.

You may be charged for these services.

You can find information on the following topics:

- Activation of Mercedes me connect
- Operating the vehicle
- Nearest authorized Mercedes-Benz Center
- Other products and services from Mercedes-Benz

Data is transferred during the connection to the Mercedes-Benz Customer Center (→ page 317).

Information on Mercedes me connect accident management

The Mercedes me connect accident management is an extension of the Mercedes-Benz emergency call system (→ page 317).

An emergency call is made to the Mercedes-Benz emergency call center after an accident:

- A voice connection is made to a contact person at the Mercedes-Benz emergency call center.
- If necessary, the contact person at the Mercedes-Benz emergency call center forwards the call to Mercedes me connect accident management.

Forwarding the call is not possible in all countries.

- If necessary, the vehicle will be towed to an authorized Mercedes-Benz Center.

Arranging a service appointment via Mercedes me connect

If you have activated the maintenance management service, relevant vehicle data is transferred automatically to the Mercedes-Benz Customer Center. You will then receive individual recommendations regarding the maintenance of your vehicle.

Regardless of whether you have consented to the maintenance management service, the multimedia system reminds you after a certain amount of time that a service is due. A prompt appears asking if you would like to make an appointment.

▶ **To arrange a service appointment:** select **Call**.

After your agreement the vehicle data is sent and a Mercedes-Benz Customer Center employee deals with your appointment. The

information is then sent to your desired service outlet.

This service outlet will then contact you within 24 hours.

- ① If you select **Later** after the service message appears, the message is hidden and reappears after a certain period of time.

Transferred data during a service call

Observe the conditions of use for Mercedes me connect and other services. These can be obtained in the Mercedes me portal: <https://me.secure.mercedes-benz.com>

When you make a service call via Mercedes me connect, data will be transmitted.

The following data is transmitted if a service call is made via Mercedes me connect:

- Vehicle identification number
- Reason for the initiation of the call

Mercedes-Benz emergency call system

Information on the Mercedes-Benz emergency call system

The Mercedes-Benz emergency call system only functions in areas where mobile phone coverage is available from the wireless service providers. Insufficient network coverage from the wireless service providers may result in an emergency call not being transmitted.

The Mercedes-Benz emergency call system is available for at least ten years starting from the manufacturing date.

The ignition must be switched on before an automatic emergency call can be made.

- ① The Mercedes-Benz emergency call system is activated at the factory.
- ① If you would like to deactivate the Mercedes-Benz emergency call system, please contact your dealership. If ownership of a vehicle changes, e.g. because the vehicle concerned is sold, the previous owner (i.e. the person selling the vehicle) must inform the new owner or contract partner (i.e. the person

buying the vehicle) that the Mercedes-Benz emergency call system is deactivated.

Overview of the Mercedes-Benz emergency call system

The Mercedes-Benz emergency call system can help to decisively reduce the time between an accident and the arrival of emergency services at the site of the accident. It helps locate an accident site in places that are difficult to access.

The emergency call can be made automatically (→ page 318) or manually (→ page 318). Only make emergency calls if you or others are in need of rescue. Do not make an emergency call in the event of a breakdown or a similar situation.

Displays in the media display:

SOS READY: emergency call available

SOS NOT READY: the ignition is not on or there is a malfunction with the emergency call system.

During an active emergency call,  appears in the display.

You can find more information on the regional availability of the Mercedes-Benz emergency call system at: http://www.mercedes-benz.com/connect_ecall.

 If there is a malfunction in the emergency call system (e.g. a malfunction with the speaker, microphone, airbag, SOS button), a corresponding message appears in the multifunction display of the instrument cluster.

Triggering an automatic emergency call

Requirements:

- The ignition is switched on.
- The starter battery is sufficiently charged.

If restraint systems such as airbags or Emergency Tensioning Devices have been activated after an accident, the Mercedes-Benz emergency call system may automatically initiate an emergency call.

The emergency call has been made:

- A voice connection is made to the Mercedes-Benz emergency call center.

- A message with accident data is transmitted to the Mercedes-Benz emergency call center. The Mercedes-Benz emergency call center can transmit the vehicle position data to one of the emergency call centers.
- In certain situations data is also transmitted in the voice channel to the Mercedes-Benz emergency call center. This allows measures for rescue, recovery or towing to an authorized Mercedes-Benz Center to be initiated quickly.

The SOS button in the overhead control panel flashes until the emergency call is finished.

It is not possible to immediately end an automatic emergency call.

If no connection can be made to the emergency services either, a corresponding message appears in the display.

 Dial the local emergency number on your mobile phone.

If an emergency call has been initiated:

- Remain in the vehicle if the road and traffic conditions permit you to do so until a voice

connection is established with the emergency call center service provider.

- On the basis of the call, the service provider decides whether it is necessary to call rescue teams and/or the police to the accident site.

Triggering a manual emergency call

 Press and hold the SOS button in the overhead control panel for at least one second.

The emergency call has been made:

- A voice connection is made to the Mercedes-Benz emergency call center.
- Remain in the vehicle if the road and traffic conditions permit you to do so until a voice connection is established with the emergency call center service provider.
- On the basis of the call, the service provider decides whether it is necessary to call rescue teams and/or the police to the accident site.
- A message with accident data is transmitted to the Mercedes-Benz emergency call center.

The Mercedes-Benz emergency call center can transmit the vehicle position data to one of the emergency call centers.

- In certain situations data is also transmitted in the voice channel to the Mercedes-Benz emergency call center.

This allows measures for rescue, recovery or towing to an authorized Mercedes-Benz Center to be initiated quickly.

If no connection can be made to the emergency services either, a corresponding message appears in the media display.

- ▶ Dial the local emergency number on your mobile phone.

Ending an unintentional emergency call

- ▶ Select  on the multifunction steering wheel.

Data transfer of the Mercedes-Benz emergency call system

The following data is transmitted to the Mercedes-Benz emergency call center:

- the vehicle's GPS position data

- the last GPS position data on the route (a few hundred meters before the incident)
- direction of travel
- vehicle identification number
- the vehicle drive type
- the estimated number of people in the vehicle
- whether Mercedes me connect is available or not
- whether the emergency call was initiated manually or automatically
- the time of the accident
- the language setting on the multimedia system

For accident clarification purposes, the following measures can be taken up to an hour after the emergency call has been initiated:

- the current vehicle position can be called up
- a voice connection to the vehicle occupants can be established

Online and Internet functions

Internet connection

Information on connecting to the Internet

⚠ WARNING Risk of distraction from information systems and communications equipment

If you operate information and communication equipment integrated in the vehicle when driving, you will be distracted from the traffic situation. This could also cause you to lose control of the vehicle.

- ▶ Only operate this equipment when the traffic situation permits.
- ▶ If you cannot be sure of this, stop the vehicle whilst paying attention to road and traffic conditions and operate the equipment with the vehicle stationary.

You must observe the legal requirements for the country in which you are currently driving when operating the multimedia system.

⚠ WARNING Risk of distraction from operating mobile communication equipment while the vehicle is in motion

If you operate mobile communication equipment when driving, you will be distracted from the traffic situation. This could also cause you to lose control of the vehicle.

▶ Only operate this equipment when the vehicle is stationary.

You must observe the legal requirements for the country in which you are currently driving when operating mobile communication equipment in the vehicle.

The Internet functions can only be used to a limited degree whilst driving.

Function of the communication module

On vehicles with a built-in communication module, the Internet connection is established via an integrated SIM card.

To use Internet access via the communication module the following conditions must be met:

- The vehicle is equipped with a permanently installed communication module.
- Mercedes me connect is active and ready for operation.
- Mercedes me connect is activated for Internet access.
- Data volume via Mercedes me connect is available.

If the data volume limit is reached, the availability of Mercedes me connect services is limited. The data volume must be purchased via Mercedes me connect. Contact an authorized Mercedes-Benz Center to find out whether it is possible to purchase data volume in your country.

Establishing an Internet connection

Multimedia system:

➡ **Connect**

▶ For example, select  **Browser**.

- ① The multimedia system usually establishes the Internet connection automatically. If the multimedia system is not connected to the Internet, the Internet connection is established when an Internet application is used.
- ① The availability of web browsers is country-dependent.

Connection status

Connection status overview



- ① Display of existing connection

Displaying the connection status

Multimedia system:

➔ System ➔  Connectivity

▶ Select **Internet Status**.

 In the case of a connection via the communication module the following status information is shown:

- Type of network
- Status online/offline

Mercedes-Benz Apps

Calling up Mercedes-Benz Apps

Requirements:

- The registration for the use of Mercedes-Benz Apps has been completed.
- The general terms and conditions have been confirmed.

Multimedia system:

➔ Connect ➔  Mercedes-Benz Apps

▶ Select an app.

 The available features are country-dependent.
License fees may be applicable.

Operating Mercedes-Benz Apps using voice control

Requirements:

- The registration for the use of Mercedes-Benz Apps has been completed.
- The general terms and conditions have been confirmed.

The  symbol indicates that a Mercedes-Benz app can be used via voice control.

▶ Select a Mercedes-Benz app.
The app menu is displayed.

▶ **To use voice control:** select  **Language**.

▶ Say the question or command.

 Voice control is not available in all countries and languages.

Web browser

Calling up a web page

 **WARNING** Risk of distraction from information systems and communications equipment

If you operate information and communication equipment integrated in the vehicle when driving, you will be distracted from the traffic situation. This could also cause you to lose control of the vehicle.

- ▶ Only operate this equipment when the traffic situation permits.
- ▶ If you cannot be sure of this, stop the vehicle whilst paying attention to road and traffic conditions and operate the equipment with the vehicle stationary.

You must observe the legal requirements for the country in which you are currently driving when operating the multimedia system.

Multimedia system:

↪ Con-
nect ▶▶  Browser ▶▶  Enter URL

▶ Enter a web address.

 The function is country-dependent.

▶ **To finish the entry and call up the website:** select  .

Showing/hiding the web browser menu

If you call up a website by selecting a link, for example, the web browser menu is hidden.







▶ **To show/hide:** press the  button.

 The web browser supports video playback.

 No websites or videos are displayed while the vehicle is in motion.

Web browser overview



-  URL entry
-  Bookmarks
-  Web page, back
-  Web page, forwards
-  Options
-  Closes the browser

Calling up web browser options

Multimedia system:

↪ Con-
nect ▶▶  Browser ▶▶  Options

The following functions are available:

- Refresh Page/Cancel
- Zoom
- Browser Settings
- Delete Browser Data

▶ Select an option.

▶ Make the desired changes to the settings.

Calling up the web browser settings

Multimedia system:

↪ Con-
nect ▶▶  Browser ▶▶  Options ▶▶ Bro
wser Settings

The following functions are available:

- Block Pop-Ups
- Activate Javascript
- Allow Cookies

- ▶ Activate or deactivate the function.

Deleting browser data

Multimedia system:

↳ Connect ▶▶  Browser ▶▶  Options ▶▶ Delete Browser Data

The following options are available:

- All
- Cache
- Cookies
- Entered URLs
- Form Data

- ▶ Select an option.
- ▶ Select Yes.

Managing bookmarks

Multimedia system:

↳ Connect ▶▶  Browser ▶▶  Bookmarks

Selecting a bookmark

- ▶ Select an entry.

Creating a bookmark

- ▶ Select Add New Bookmark.
- ▶ Enter a URL and a name.
- ▶ Select .

Editing a bookmark

- ▶ Highlight a bookmark.
- ▶ Select .
- ▶ Select Edit.
- ▶ Enter a URL and a name.
- ▶ Select .

Deleting a bookmark

- ▶ Highlight a bookmark.
- ▶ Select .
- ▶ Select Delete.
- ▶ Select Yes.

Closing the browser

Multimedia system:

↳ Connect ▶▶  Browser
▶ Select Close Browser.

Internet radio

Calling up Internet radio

Requirements:

- The Internet radio service is activated.
- The data volume is available.
Depending on the country, data volume may need to be purchased.
- A fast Internet connection for data transmission free of interference.
The services are country-dependent.
For more information, consult an authorized Mercedes-Benz Center.

Multimedia system:

↳ Connect ▶▶  Radio Source

- ▶ Select TuneIn Radio.
The Internet radio display appears. The last station set starts playing.

- ⓘ The connection quality depends on the local mobile phone reception.

Internet radio overview

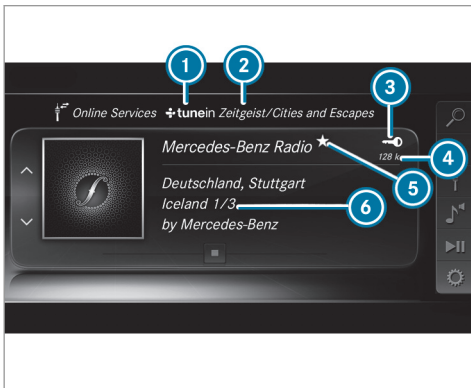

- 1 Internet radio provider
- 2 Selected category
- 3 Display (if connected to private user account)
- 4 Data transfer rate
- 5 Current station is stored as a favorite
- 6 Additional information on the current station

Selecting and connecting Internet radio stations

Multimedia system:

Radio >> Radio Source >> TuneIn
Radio >> Search

- ▶ Select a category.
- ▶ Select a station.
The connection is established automatically.

or

- ▶ Select **Enter Address or POI**.
- ▶ Enter a station name using the entry field.

i A relatively large volume of data can be transmitted when using Internet radio.

Saving/deleting an Internet radio station as a favorite

Multimedia system:

Radio >> Radio Source >> TuneIn
Radio

- ▶ Select a station.

- ▶ Press and hold the central control element until an audible signal sounds.
The **★** symbol appears by the station name.

- ▶ Select **★** **Favorites**.
The list of saved favorite stations appears.

or

- ▶ Create an account for the online provider (TuneIn radio) and then log in on the multimedia system.
Your favorites are imported to the multimedia system.

Deleting favorites

- ▶ Select **★** **Favorites**.
- ▶ Select a station.
- ▶ Press and hold the central control element until an audible signal sounds.
The **★** symbol by the station name disappears.

Setting Internet radio options

Multimedia system:

 Radio
  Radio Source
  TuneIn
  Options

The following options are available:

- **Select Stream:** select the stream quality.
- **Login to TuneIn Account:** log in to your TuneIn user account.
- **Log Out of Account:** log out of your TuneIn user account.

 Select an option.

Media

Audio mode

Information on the audio mode

 **WARNING** Risk of distraction when handling data storage media

If you handle a data storage medium while driving, your attention is diverted from the

traffic conditions. This could also cause you to lose control of the vehicle.

 Only handle a data storage medium when the vehicle is stationary.

Permissible file systems:

- FAT32
- exFAT
- NTFS

Permissible data storage medium:

- SD card
- USB storage device
- iPod®/iPhone®
- MTP devices
- Bluetooth® audio equipment

 Observe the following notes:

- The multimedia system supports a total of up to 50,000 files.
- Data storage media up to 2 TB are supported (32-bit address space).

Supported formats:

- MP3
- WMA
- AAC
- WAV
- FLAC
- ALAC

 Observe the following notes:

- Due to the large variety of available music files regarding encoders, sampling rates and data rates, playback cannot always be guaranteed.
- Due to the wide range of USB devices available on the market, playback cannot be guaranteed for all USB devices.
- Copy-protected music files or DRM encrypted files cannot be played back.
- MP3 players must support Media Transfer Protocol (MTP).



Manufactured under license from Dolby Laboratories. Dolby, Dolby Audio and the double-D symbol are trademarks of Dolby Laboratories.



Gracenote, the Gracenote logo and logotype, "Powered by Gracenote", MusicID and Playlist Plus are either registered trademarks or trademarks of Gracenote, Inc. in the United States and/or other countries.

Notes on copyright

Audio files that you create or reproduce yourself for playback are generally subject to copyright protection. In many countries, reproductions, even for private use, are not permitted without the prior consent of the copyright holder. Make sure that you know about the applicable copyright regulations and that you comply with these.

Activating media mode

Multimedia system:

➤ [Media](#) ➤  [Media Sources](#)

- ▶ Select a media source.
- ▶ Playable music files are played back.

Inserting/removing an SD card

⚠ DANGER Risk of fatal injury from swallowing SD cards

SD cards are small parts.

They could be swallowed and lead to choking.

- ▶ Keep SD cards out of the reach of children.
- ▶ Seek medical attention immediately if an SD card has been swallowed.

! NOTE Damage due to high temperatures

High temperatures may damage the SD card.

- ▶ Remove the SD card after use and take it out of the vehicle.

Multimedia system:

↳ Media ▶▶  Media Sources ▶▶ Mem.
Card

Inserting

The multimedia connection unit is located in the stowage compartment under the armrest.

- ▶ Insert the SD memory card into the SD card slot until it engages. The side with the contacts must face downwards.
Playable music files are played back.

Removing

- ▶ Press the SD card.
- ▶ Remove the SD card.

Overview of the audio mode

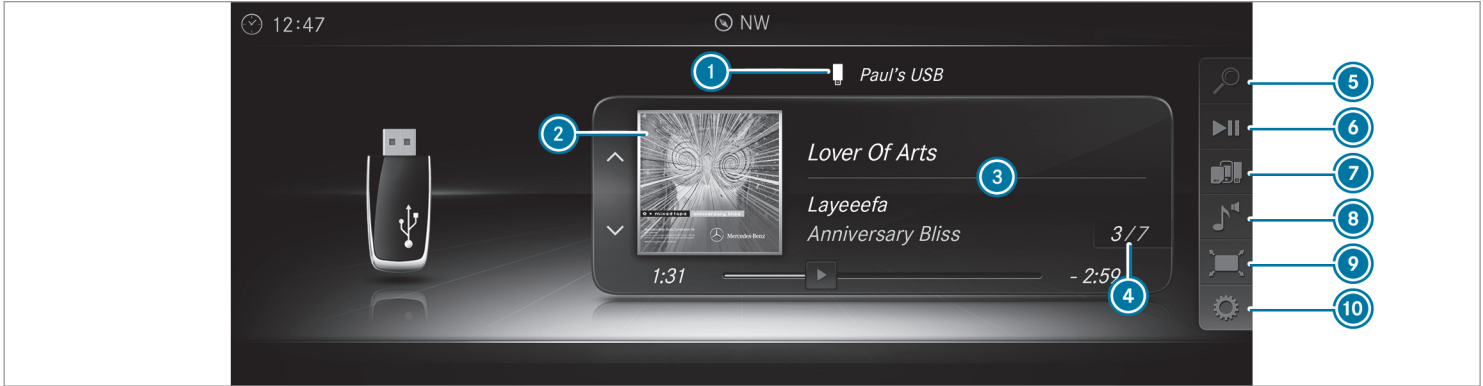

① Active data storage medium

② Album cover

③ Track, artist, album

④ Track number and number of tracks in the track list

⑤ Search

⑥ Playback Control

⑦ Media Sources

⑧ Sound

⑨ Full Screen (for video playback)

⑩ Options

Connecting USB devices

! **NOTE** Damage caused by high temperatures

High temperatures can damage USB devices.

- ▶ Remove the USB device after use and take it out of the vehicle.

The multimedia connection unit is found in the stowage compartment under the armrest and has two USB ports. Depending on the vehicle's equipment, additional USB ports can be found in the stowage compartment of the center console and in the rear passenger compartment.

- ▶ Connect the USB device to the USB port. Playable music files are played back only if the corresponding media display is activated.
- i** Use the USB port identified by  to use Apple CarPlay™ and Android Auto.
- i** Depending on the vehicle equipment there is an additional USB port in the rear passenger compartment. Ports that are labeled with a battery symbol can only be used to charge USB devices.

Selecting a track in the media playback

Multimedia system:

↳ **Media**

Selecting a track by skipping to a track

- ▶ **To skip backwards or forwards to a track:** navigate up or down.

Selecting a track using the current track list

- ▶ Select .
- ▶ Select **Current Track List**.
- ▶ Select a track.

Selecting playback options

Multimedia system:

↳ **Media** ▶  **Options**

Playing back similar tracks

- ▶ Select **Play Similar Tracks**.
A track list with similar tracks is created and played back.

Playback mode



- ▶ Select **Random Mode - Current Playlist**.
The current track list is played in random order.
- ▶ Select **Random Mode - Current Medium**.
All tracks on the active data storage medium are played in random order.
- ▶ Select **Normal Track Sequence**.
The current track list is played in the order it appears on the data storage medium.

Controlling media playback

Multimedia system:

↳ **Media** ▶  **Playback Control**

A bar with playback controls is shown.

- ▶ **To pause playback:** press the touchpad.
The  symbol is displayed.
- ▶ **To resume playback:** press the touchpad again.
The  symbol is displayed.

To fast forward/rewind

- ▶ To move  on the timeline: swipe left or right on the touchpad.

To hide the playback controls

- ▶ Press the  button.

Video mode

Switching to video mode

Multimedia system:

 Media  Media Sources

- ▶ Select a data storage medium.
- ▶ Search for and select video files or playlists with video files.
Playable video files are played back.

The multimedia system supports the following formats:

- MPEG
 - AVI, DivX, MKV
 - MP4, M4V
 - WMV
-  If the vehicle is traveling faster than 3 mph (5 km/h) the television picture is hidden from the driver. If available, the channel and program information is continuously displayed.
Due to the large variety of available video files regarding encoders, sampling rates and

data transfer rates, playback cannot be guaranteed.

Videos up to FullHD (1920x1080) are supported.

Copy-protected video files or DRM (Digital Rights Management) encrypted files cannot be played back.

Overview of video mode

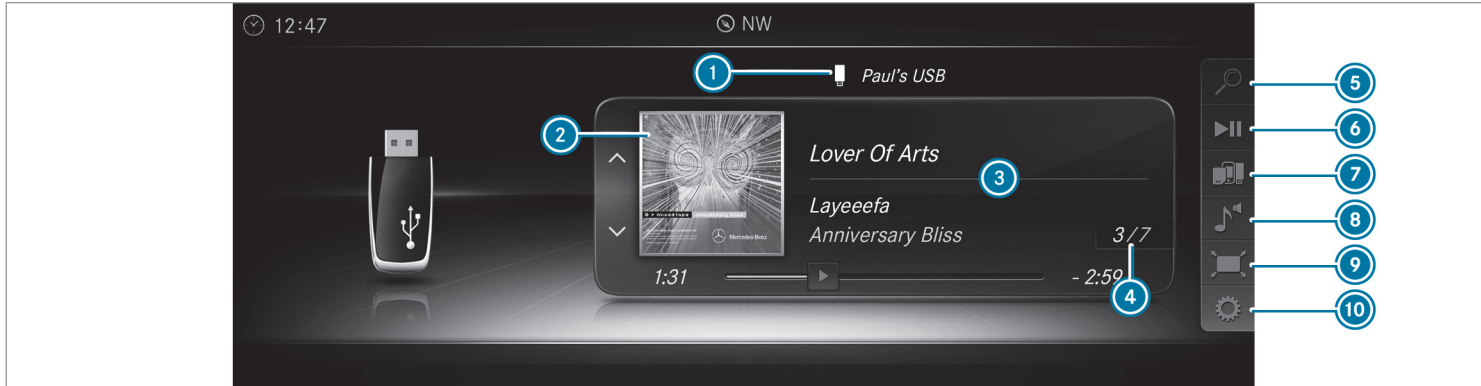

① Active data storage medium

② Album cover

③ Track, artist, album

④ Track number and number of tracks in the track list

⑤ Search

⑥ Playback Control

⑦ Media Sources

⑧ Sound

⑨ Full Screen (for video playback)

⑩ Options

Activating/deactivating full-screen mode

Multimedia system:

↳ Media ▶  Media Sources

▶ Select a data storage medium.
Playable video files are played back.

▶ **To activate full-screen mode:** select  Full Screen.

▶ **To deactivate full-screen mode:** press the touchpad.

Changing video settings

Multimedia system:

↳ Media ▶  Options ▶ Picture Format

The following picture formats are available:

- Automatic
- 16:9
- 4:3
- Zoom

▶ Select a picture format.

Adjusting the brightness manually

If the [Automatic](#) picture format is switched off, you can adjust the brightness yourself.

- ▶ Select [Brightness](#).
- ▶ Adjust the brightness.

Media search

Starting the media search

Multimedia system:

↳ Media ▶  Search

Depending on the connected media sources and files, the following categories are listed:

- [Current Track List](#)
- [Keyword Search](#)
- [Playlists](#)
- [Artists](#)
- [Albums](#)
- [Tracks](#)
- [Folders](#)
- [Music Genres](#)
- [Year](#)

- [Composers](#)
- [Videos](#)
- [Podcasts](#) (Apple® devices)
- [Audiobooks](#) (Apple® devices)

▶ Select a category.

 The categories are available as soon as the entire media content has been read in and analyzed.

Media Interface

Information about the Media Interface

Media Interface is a universal interface for the connection of mobile audio equipment. The multimedia system has two USB ports. The USB ports are located in the stowage compartment under the armrest.

Supported devices

The Media Interface allows you to connect the following data storage media:

- iPod®
- iPhone®

- MP3 player
- USB devices

For details and a list of supported devices, visit our website at <http://www.mercedes-benz.com/connect>. Follow the instructions in the "Media Interface" section.

Switching to Media Interface

Multimedia system:

 Media   Media Sources

- ▶ Connect a data storage medium to the USB port (→ page 329).

- ▶ Select a media device.
Playable music files are played back.

Overview of Media Interface

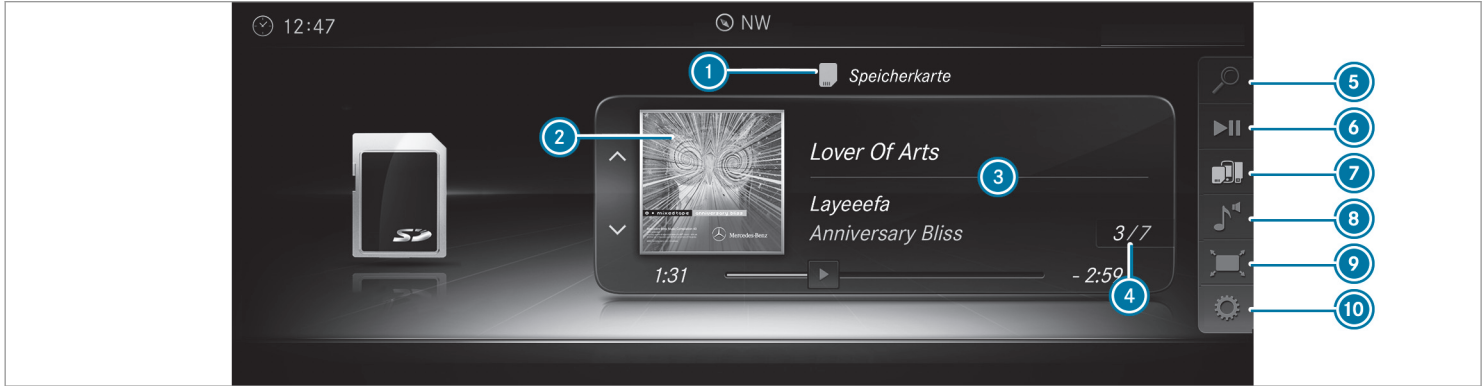

① Active data storage medium

② Album cover

③ Artist, track and album

④ Track number and number of tracks in the track list

⑤ Search

⑥ Playback Control

⑦ Media Sources

⑧ Sound

⑨ Full Screen (video playback only)

⑩ Options

Bluetooth® audio

Information about Bluetooth® audio

Before using your Bluetooth® audio equipment with the multimedia system for the first time, you will need to authorize it (→ page 336).

Bluetooth® audio overview

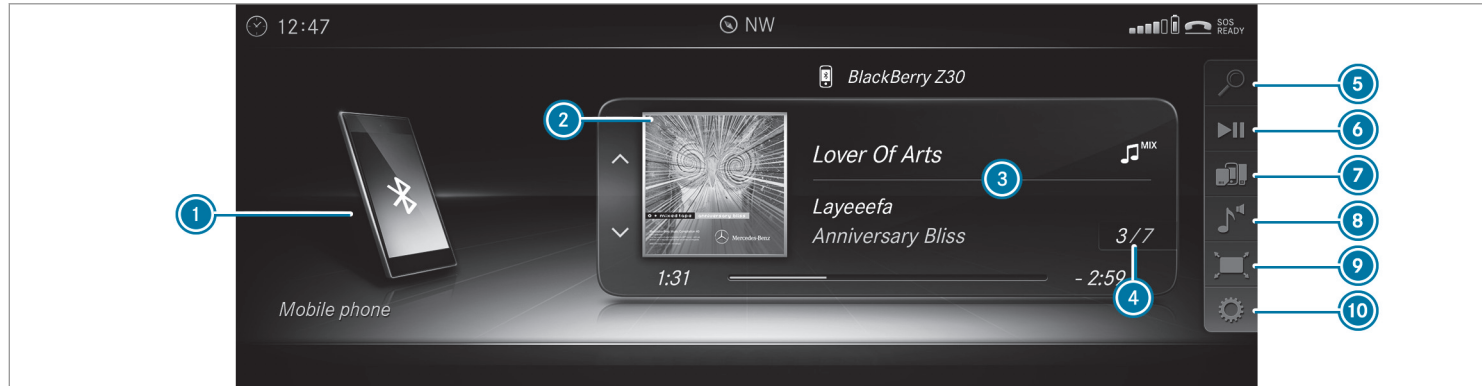

- ① Active data storage medium
- ② Album cover

- ③ Track, artist, album

- ④ Track number and number of tracks in the track list

- 5 Search
- 6 Playback Control

Searching for and authorizing a Bluetooth® audio device

Requirements:

- Bluetooth® is activated on the multimedia system and audio equipment (→ page 259).
- The audio equipment supports the Bluetooth® audio profiles A2DP and AVRCP.
- The audio equipment is "visible" for other devices.

Multimedia system:

↳ Media ▶▶  Media Sources ▶▶  Bluetooth Audio

Authorizing a new Bluetooth® audio device

- ▶ Select .
- ▶ Select **Add New Bluetooth Audio Device**.
- ▶ Select **Start Search on System**.
Detected audio equipment is displayed in the device list.

- 7 Media Sources
- 8 Sound

- ▶ Select a Bluetooth® audio device. Authorization starts. A code is displayed on the multimedia system and on the mobile phone.
- ▶ If the codes are identical, confirm on the audio equipment. The audio equipment is connected and playback starts.

Selecting previously authorized Bluetooth® audio equipment

- ▶ Select .
- ▶ Select a Bluetooth® audio device.

Establishing a connection from the Bluetooth® audio equipment

The Bluetooth® device name of the multimedia system is **MB BLUETOOTH XXXXX**.

- ▶ Select **Search from Device**.

- 9 Full Screen (video playback only)
- 10 Options

- ▶ Start the authorization on the audio equipment (see manufacturer's operating instructions). A code is displayed on the multimedia system and on the mobile phone.
- ▶ Confirm on both devices if the codes are identical. The audio equipment is connected and playback starts.

With some audio equipment, playback must be initially started on the device itself so that the multimedia system can play the audio files.

- ⓘ Device-specific information on authorizing and connecting Bluetooth®-capable mobile phones can be obtained at <http://www.mercedes-benz.com/connect> or from an authorized Mercedes-Benz Center.

Activating Bluetooth® audio

Multimedia system:

↳ Media ▶▶  Media Sources

- ▶ Select  Bluetooth Audio.
The multimedia system activates the connected Bluetooth® audio equipment.

Selecting the music player on the Bluetooth® audio device

Multimedia system:

↳ Media ▶▶ 

- ▶ Select the **Bluetooth Audio Players** category. If multiple music players are present on the Bluetooth® audio equipment a list appears.
 - ▶ Select a music player. Playback starts.
- ⓘ The function is not supported by every mobile phone.

Searching for a music track on the Bluetooth® audio device

Multimedia system:

↳ Media ▶▶  Media Sources ▶▶  Bluetooth Audio

- ▶ Select .
 - ▶ Select a category. A track list appears.
 - ▶ Select a track.
- ⓘ The function is only available when the mobile phone and the music player selected on the mobile phone support this function.

Switching Bluetooth® audio equipment via NFC

Requirements:

- Observe the notes on using NFC (→ page 303).
- The Bluetooth® audio overview is displayed (→ page 335).

- ▶ Lightly press the NFC area on the mobile phone (see the manufacturer's operating instructions).
If the mobile phone has already been authorized on the multimedia system as Bluetooth® audio equipment, it is now connected.
If the mobile phone is authorized on the multimedia system as Bluetooth® audio equipment for the first time, it is connected after confirming the instructions for the mobile phone (see the manufacturer's operating instructions).

Disconnecting Bluetooth® audio equipment

Multimedia system:

↳ Phone ▶▶  Media Sources

- ▶ Select the  symbol in the line of the mobile phone.
The disconnection of the mobile phone takes place without a confirmation prompt. The mobile phone remains authorized in the system.

Radio

Switching on the radio

Multimedia system:

↳ Radio

- Alternatively: press the  button. The radio display appears. You will hear the last station played on the last frequency band selected.

Switching the HD Radio function on/off

Multimedia system:

↳ Radio >>  Options >> HD Radio



- Switch the function on or off .

i HD Radio Technology manufactured under license from iBiquity Digital Corporation. U.S. and Foreign Patents. HD Radio™ and the HD, HD Radio and "Arc" logos are proprietary trademarks of iBiquity Digital Corp.

Setting the waveband

Multimedia system:

↳ Radio >>  Radio Source

HD Radio FM HD Radio AM and SiriusXM Radio can be selected.

- Select a frequency band.

Selecting a radio station

Multimedia system:

↳ Radio

- Navigate up or down.

Calling up the radio station list

Multimedia system:

↳ Radio >> 

- Select a station.

Searching for radio stations using station names or direct frequency entry

Multimedia system:

↳ Radio >>  >> 

- Enter a station name or frequency.
- Select  . Results are displayed.
- Select a station.

Storing radio stations



Multimedia system:

↳ Radio >>  Presets

- Select Store Current Station in the Presets.

Activating/deactivating radio text

Multimedia system:

 Radio   Options  Display Radio Text Information

 Activate or deactivate the function.

Satellite radio

Information on the satellite radio

SIRIUS XM[®] satellite radio offers more than 175 digital-quality radio channels providing 100% commercial-free music, sports, news and entertainment, for example. SIRIUS XM satellite radio employs a fleet of high-performance satellites to broadcast around the clock throughout the USA and Canada. The satellite radio program is available for a monthly fee. Information about this can be obtained from a Sirius XM[®] Service Center and at <http://www.siriusxm.com> (USA) or <http://www.siriusxm.ca> (Canada).

 Sirius, XM and all related marks and logos are trademarks of Sirius XM Radio Inc. and

its subsidiaries. All other marks, channel names and logos are the property of their respective owners. All rights reserved.

Satellite radio restrictions

Satellite radio mode may be temporarily unavailable or interrupted for a variety of reasons. These include environmental or topographical conditions beyond the control of Mercedes-Benz USA, LLC. Thus, operation at certain locations may not be possible.





Registering satellite radio

Requirements:

- Satellite radio equipment
- Registration with a satellite radio provider
- If registration is not included when purchasing the system, your credit card details will be required to activate your account

Multimedia system:

 Radio   Radio Source  SiriusXM Radio   Options

-  Select **Service Information**. The service information screen appears showing the radio ID and the current subscription status.
-  Establish a telephone connection.
-  Follow the service staff's instructions. The activation process may take up to ten minutes.
-  You can also have the satellite service activated online. To do so, please visit <http://www.siriusxm.com> (USA) or <http://www.siriusxm.ca> (Canada).

Switching on satellite radio

Multimedia system:

 Radio   Radio Source

 Select **SiriusXM Radio**.

Overview of the satellite radio

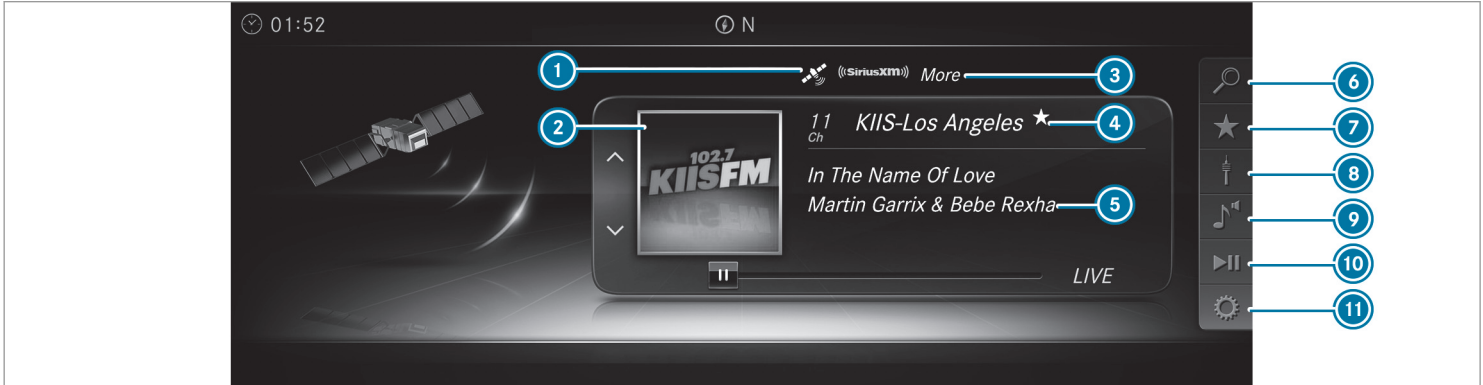

- 1 Active frequency band
- 2 Logo or album art (if available)
- 3 Category
- 4 Channel name

- 5 Channel information
- 6 SiriusXM Radio Channels
- 7 Presets
- 8 Radio Source

- 9 Sound
- 10 Playback Control
- 11 Options

Selecting a satellite radio category

Multimedia system:

➤ Radio ➤  Radio Source ➤ SiriusXM Radio ➤  SiriusXM Radio Channels ➤ Category

- ▶ Select a category.

Selecting a satellite radio channel

Multimedia system:

➤ Radio ➤  Radio Source ➤ SiriusXM Radio

- ▶ Navigate up or down.

Displaying EPG information for the current channel



Multimedia system:

➤ Radio ➤  Radio Source ➤ SiriusXM Radio ➤  Options

- ▶ Select EPG Information about Current Channel.

Setting parental control for radio

Multimedia system:

➤ Radio ➤  Radio Source ➤ SiriusXM Radio ➤  Options ➤ Parental Control

- ▶ Activate the function .
- ▶ Determine a four-digit character sequence and select  **ok**.
All channels with adult content are locked.

Unlocking a channel

- ▶ Enter the four-digit character sequence and select  **ok**.
All channels with adult content are unlocked.

Music and sport alerts function

This function enables you to program an alert for your favorite artists, tracks or sporting events. Music alerts can be saved whilst a track is being played and sport alerts can be saved during a live game. You can also specify sport alerts via the menu option. The system then continuously searches through all the channels. If a match is found with a stored alert, you will be informed.

Setting music and sport alerts

Multimedia system:

➤ Radio ➤  Radio Source ➤ SiriusXM Radio ➤  Options ➤ Alert for Artist, Song & Sporting Event

Setting a music alert

- ▶ Select **Add New Alert**.

or

- ▶ Select **Manage Artist & Song Alerts**.
- ▶ Select  **Options**.

The following options are available:

- **Mark This Entry**
- **Unmark This Entry**
- **Mark All Entries**
- **Unmark All Entries**
- **Delete This Entry**
- **Delete All Entries**
- ▶ Select an option.

▶ **Activate Artist & Song Alerts** .

The alert is set for the current artist or track. If a match is found, a prompt appears asking whether you wish to change to the station.

Setting a sport alert▶ Select **Add New Alert**.

or

▶ Select **Manage Sports Alerts**.▶ Select **Select New Alerts**.

or

▶ Select **Edit Alerts**.

▶ Select a team from a league.

▶ **Activate Sports Alerts** .**Information on Smart Favorites and Tune Start**

Stations in the station presets can be added as Smart Favorites. Smart Favorites stations are automatically saved to temporary storage in the background. If you change to a Smart Favorites station, you can replay, pause or actively skip forward or back to broadcasts which you have missed. If Tune Start is activated and you change to another Smart Favorites station, the music

track currently playing on the station is automatically restarted from the beginning of the track.

Activating/deactivating TuneStart

Multimedia system:

↳ **Radio** ▶  **Options** ▶ **TuneStart**

▶ **Activate** or **deactivate** the function.

Controlling playback

Multimedia system:

↳ **Radio** ▶  **Playback Control**

You can pause the playback of the current station or skip forward or backward in the timeline. This leaves live mode to access the internal temporary storage.

▶ **To pause playback:** select .

▶ **To return to live mode:** navigate to the end of the timeline.

Displaying satellite radio service information

Multimedia system:

↳ **Radio** ▶  **Radio Source** ▶ **SiriusXM Radio** ▶  **Options**

▶ Select **Service Information**.

Sound**Tone settings****Information about the sound system**

The sound system has a total output of 100 W and is equipped with seven speakers. It is available for all functions in the radio and media modes.

Calling up the sound menu

Multimedia system:

↳ **Media** ▶  **Sound**

The following functions are available:

- **Equalizer**
- **Balance and Fader**
- **Automatic Volume Adjustment**
- **Other Sound Settings**

▶ Select a sound menu.

Adjusting treble, mid-range and bass settings

Multimedia system:

➤ Media ▶▶  Sound ▶▶ Equalizer

- ▶ Select **Treble**, **Mid Range** or **Bass**.
- ▶ Change the settings.

Activating/deactivating automatic volume adjustment

Multimedia system:

➤ Media ▶▶  Sound ▶▶ Automatic Volume Adjustment

Automatic volume adjustment compensates for differing volumes when changing between audio sources.

- ▶ Activate or deactivate the function.

Adjusting the balance/fader

Multimedia system:

➤ Media ▶▶  Sound ▶▶ Balance and Fader

- ▶ Adjust the balance and fader.
- ▶ **To exit the menu:** press the  button.

Burmester® surround sound system

Information about the Burmester® surround sound system

The Burmester® surround sound system has a total output of 590 W and is equipped with 13 speakers. It is available for all functions in the radio and media modes.

Calling up the sound menu in the Burmester® surround sound system

Multimedia system:

➤ Media ▶▶  Sound

The following functions are available:

- Equalizer
 - Balance and Fader
 - Automatic Volume Adjustment
 - Surround Sound
 - Sound Focus
 - Other Sound Settings
- ▶ Select a function.

Adjusting the treble, mid and bass settings on the Burmester® surround sound system

Multimedia system:

➤ Media ▶▶  Sound ▶▶ Equalizer

- ▶ Select **Treble**, **Mid Range** or **Bass**.
- ▶ Set the desired values.

Activating/deactivating volume adjustment in the Burmester® surround sound system

Multimedia system:

➤ Media ▶▶  Sound ▶▶ Automatic Volume Adjustment

Automatic volume adjustment compensates for differing volumes when changing between audio sources.

- ▶ Activate or deactivate the function.

Adjusting the balance/fader in the Burmester® surround sound system

Multimedia system:

➤ Media ▶▶  Sound ▶▶ Balance and Fader

- ▶ Adjust the balance and fader.

▶ **To exit the menu:** press the  button.

Switching surround sound on/off in the Burmester® surround sound system

Multimedia system:

▶  Media ▶  Sound ▶ Surround Sound

▶ Activate or deactivate the function.

Adjusting the sound focus in the Burmester® surround sound system

Multimedia system:

▶  Media ▶  Sound ▶ Sound Focus

▶ Adjust the sound focus.

Burmester® high-end 3D surround sound system

Information on the Burmester® high-end 3D surround sound system

The Burmester® high-end 3D surround sound system has a total output of 1,450 watts and is equipped with 23 speakers. It is available for all functions in the radio and media modes.

Calling up the sound menu in the Burmester® high-end 3D surround sound system

Multimedia system:

▶  Media ▶  Sound

The following functions are available:

- Equalizer
- Balance and Fader
- Automatic Volume Adjustment
- VIP Seat (seat-based sound optimization)
- Sound Profiles
- Other Sound Settings

▶ Select a sound menu.

Adjusting the treble, mid-range and bass settings on the Burmester® high-end 3D surround sound system

Multimedia system:



▶  Media ▶  Sound ▶ Equalizer

▶ Select Treble, Mid Range or Bass.

▶ Set the desired values.

Activating/deactivating volume adjustment in the Burmester® high-end 3D surround sound system

Multimedia system:

▶  Media ▶  Sound ▶ Automatic Volume Adjustment

Automatic volume adjustment compensates for differing volumes when changing between audio sources.

▶ Activate or deactivate the function.

Adjusting the balance/fader in the Burmester® high-end 3D surround sound system

Multimedia system:

▶  Media ▶  Sound ▶ Balance and Fader

▶ Adjust the balance and fader.

▶ **To exit the menu:** press the  button.

Adjusting the seat-based sound optimization in the Burmester® high-end 3D surround sound system

Multimedia system:

↳ Media ▶▶  Sound ▶▶ VIP Seat

This setting optimizes the sound playback for the selected seat position.

- ▶ Activate the function .
- ▶ Select a seat position.

Selecting the sound profile in the Burmester® high-end 3D surround sound system

Multimedia system:

↳ Media ▶▶  Sound ▶▶ Sound Profiles

The following profiles are available:

- Pure
 - Easy Listening
 - Live
 - Surround
 - 3D-Sound
- ▶ Select a sound profile.

Rear touchscreen

Using the basic functions

The rear touchscreen is in the center console in the rear passenger compartment.

 Mercedes-Benz is constantly updating its vehicles to the state of the art.

Mercedes-Benz therefore reserves the right to introduce changes in the following areas:

- Design
- Equipment
- Technical features

The equipment in your vehicle may therefore differ from that shown in the descriptions and illustrations.

Please consult an authorized Mercedes-Benz Center should you have any questions.

▶ **To switch on the rear passenger compartment touchscreen:** start the vehicle. The main menu appears.

The status line is at the top. The functions are displayed in the middle. The climate control bar is at the bottom.



Depending on the vehicle equipment, the following functions are available:

- AMG (three menus)
- Vehicle (two menus)
- Media (three to five menus)
- System settings (four menus)
- Air conditioning adjustment in the climate control bar

The touchscreen is operated by swiping with one finger and pressing the displayed symbol. You can switch between functions by swiping with two fingers.



- ▶ **To call up a function:** select [Vehicle](#), for example, in the main menu.
- ▶ **To call up the menu for a function:** swipe left or right on the display.

or

- ▶ Press  or .
- ▶ **To switch function:** in any menu, swipe left or right with two fingers. The last menu set for the next or previous function appears.

Displays and functions in the status line

The date, time and current settings are displayed.

- ▶ **To call up the main menu:** in any menu, select  in the status line.
- ▶ **To increase/decrease volume:** select - or + in the status line.
- ▶ **To switch sound off/on:** select the speaker symbol in the status line.
- ▶ **To switch the display off:** press and hold  until the display is deactivated.

or

- ▶ Swipe down from the top of the touchscreen with one finger.
- ▶ **To switch the display on:** swipe from the very bottom of the touchscreen upward with one finger.

or

- ▶ Swipe left or right on the touchscreen using one finger.

or



- ▶ Tap the touchscreen twice in rapid succession.
- or
- ▶ Simultaneously press left and right on the top of the touchscreen.

AMG rear passenger compartment

Displaying AMG engine data

Rear touchscreen:



- ▶ **Engine Data** should be selected. The current engine output, transmission oil temperature and the temperature of the coolant are shown on the touchscreen.
-  The **AMG** menu has the three functions **Engine Data**, **Dynamic Data** and **Vehicle Data**. You can change between the functions with a swipe to the left or right or by pressing on  or .

Displaying AMG dynamic data

Rear touchscreen:



- ▶ **Dynamic Data** should be selected. The lateral and longitudinal acceleration as well as the currently selected drive program are shown.

Displaying AMG vehicle data

Rear touchscreen:



- ▶ Select **Vehicle Data**. The vehicle level, the currently selected drive program and the ratio of speed and brake force are shown.

Vehicle rear



Adjusting the ambient lighting

Rear touchscreen:



- ▶ **To select an area in the vehicle:** press an area. The selected area, e.g. **Front**, is displayed.

If no area is selected then the settings apply for the whole vehicle.

- ▶ **To set the intensity:** move the control knob between 0 and 10.
 - ▶ **To set the color:** move the control knob to the color range.
The color is displayed on the right next to the color range.
64 colors are available.
 - ▶ **To select a multi-color program:** switch on **Multi-color** .
 - ▶ Select a program from the list, e.g. **Sun yellow**.
 - ▶ **To select effects and scenarios:** swipe right or press on .
 - ▶ Switch on **Multi-color Animation**, **Welcome** or **Climate** .
-  The selection of effects can also be made in the system settings.

Setting the roller sunshade

Requirements:

- The vehicle is equipped with a panoramic sliding sunroof.
- The sliding sunroof is closed using the switch in the overhead control panel (→ page 81).

Rear touchscreen:

 **Vehicle** ▶▶ **Sunshade**

- ▶ **To open or close the roller sunshade:** move the slide control.





Rear media

Operating the media player

Rear touchscreen:

 **Media** ▶▶ **Media Player**

The functions depend on the audio source that is currently selected.

- ▶ **To start playback:** select .
- ▶ **To pause playback:** select .
- ▶ **To select the next/previous track or radio station:** select  or .

- ▶ **To select a playback option:** set the playback option via the MIX symbols.

- Normal track sequence
Both symbols are deactivated (white).
- Random track sequence from current folder
The left-hand symbol is activated (yellow).
- Random track sequence from current data storage medium
The right-hand symbol is activated (yellow).

- ▶ **To select a track position:** move the control knob to the playback bar.

Media player shortcut

- ▶ In any menu, swipe up from the bottom of the touchscreen with one finger.
- ▶ Use the functions described above.

Adjusting the equalizer

Rear touchscreen:

↳ Media ▶▶ Equalizer

- ▶ **To adjust the treble, mid and bass:** move the control knob between **-10** and **10**.

Setting the balance and fader

Rear touchscreen:

↳ Media ▶▶ Balance and Fader

- ▶ **To set the balance:** move the control knob from left to right.
- ▶ **To set the fader:** move the control knob from front to back.

Setting the sound focus (premium sound system)

Rear touchscreen:

↳ Media ▶▶ Sound Focus

- ▶ Switch **Sound Focus** on or off .
- ▶ **To set sound focus:** select **Front Only**, **Rear Only** or **All Seats**.

Setting seat-specific sound optimization (high-end sound system)

Rear touchscreen:

↳ Media ▶▶ VIP Seat

The setting optimizes the sound playback for the selected seat position.

- ▶ Select a seat position.
The following seat positions are available:
 - **Driver**
 - **Front Passenger**
 - **Rear Left**
 - **Rear Right**
- ▶ **To deactivate sound optimization:** select **Off**.

Selecting a sound profile (high-end sound system)

Rear touchscreen:

↳ Media ▶▶ Sound Profiles

- ▶ Select the sound profile.
The following profiles are available:
 - **Pure**

- **Easy Listening**
- **Live**
- **Surround**
- **3D sound**

Rear system settings

Setting the language

Rear touchscreen:

↳ Sys. Settings ▶▶ Language

- ▶ Set the language.

Setting the display brightness

Rear touchscreen:

↳ Sys. Settings ▶▶ Display Brightness

- ▶ Move the control knob between **- 5** (dark) and **5** (light).

Setting the display lock

Rear touchscreen:

↳ Sys. Settings ▶▶ Auto Lock

You can set the time at which the display locks if it is not being used.

- ▶ Move the control knob between **1 min** and **5 min**.

Resetting system settings

Rear touchscreen:

- ▶ **Sys. Settings** ▶ **System Reset**

You can reset the settings to factory settings. Personal settings are deleted when doing so.

- ▶ Select **Reset**.
A prompt appears.
- ▶ Select **Yes**.

Rear climate control

Switching the climate control function on/off

The climate control function can be switched on/off in the climate control bar. The climate control bar appears in all menus.

- ▶ Select **ON** or **OFF** in the climate control bar.

Setting the temperature

You can set the temperature in the climate control bar. The climate control bar appears in all menus.

- ▶ Select the current temperature value, e.g. **LO**.
- ▶ Move the control knob between **LO** and **HI**.

Setting the airflow

You can set the airflow in the climate control bar or set it to automatic mode. The climate control bar appears in all menus.

- ▶ Select the current airflow .
 - ▶ Move the control knob between **1** and **7**.
- or
- ▶ Select **AUTO**.

Setting the perfume atomizer

You can set the perfume atomizer in the climate control bar. The climate control bar appears in all menus.

- ▶ Select the current setting for the perfume atomizer.
 - ▶ Select the intensity **High**, **Medium** or **Low**.
- or
- ▶ Select **Off**.

Switching ionization on/off

Ionization can be switched on/off in the climate control bar. The climate control bar appears in all menus.

You can use the ionization function to purify the air in the vehicle interior and attain an improved interior climate.

Ionization can only be operated when the automatic climate control is switched on. The air vent in the rear passenger compartment must be open.

- ▶ Select the current setting for ionization.
- ▶ Select **Auto** or **Off**.

ASSYST PLUS service interval display

Function of the ASSYST PLUS service interval display

The ASSYST PLUS service interval display on the instrument display provides information on the remaining time or distance before the next service due date.

You can hide this service message using the back button on the left-hand side of the steering wheel.

Depending on how the vehicle is used, the ASSYST service interval display may shorten the service interval, e.g. in the following cases:

- Mainly short-distance driving
- When the engine is often left idling for long periods
- In the event of frequent cold start phases

Mercedes-Benz recommends avoiding such operating conditions.

You can obtain further information concerning the servicing of your vehicle from a qualified

specialist workshop, e.g. an authorized Mercedes-Benz Center.

Displaying the service due date

On-board computer:

↪ Service ▶ ASSYST PLUS

The next service due date is displayed.

▶ **To exit the display:** press the back button on the left-hand side of the steering wheel.

Make sure to observe the following further related subject:

- Operating the on-board computer (→ page 225).

Information on regular maintenance work

! **NOTE** Premature wear through failure to observe service due dates

Service work which is not carried out at the right time or incompletely can lead to increased wear and damage to the vehicle.

- ▶ Always observe the prescribed service intervals.
- ▶ Always have the prescribed service work carried out at a qualified specialist workshop.

Special service requirements

The prescribed service interval is based on normal operation of the vehicle. Maintenance work will need to be performed more often if the vehicle is operated under arduous conditions or increased loads.

The ASSYST PLUS service interval display is only an aid. The driver of the vehicle bears responsibility as regards to whether maintenance work needs to be performed more often than specified based on the actual operating conditions and/or loads.

Examples of arduous operating conditions:

- regular city driving with frequent intermediate stops
- mainly short-distance driving

- frequent operation in mountainous terrain or on poor road surfaces
- when the engine is often left idling for long periods
- operation in particularly dusty conditions and/or if air-recirculation mode is frequently used

In these or similar operating conditions, have the interior air filter, engine air cleaner, engine oil and oil filter etc. changed more frequently. The tires must be checked more frequently if the vehicle is operated under increased loads. Further information can be obtained at a qualified specialist workshop.

Battery disconnection periods

The ASSYST PLUS service interval display can only calculate the service due date when the battery is connected.

- ▶ Note down the service due date displayed on the instrument display before disconnecting the battery (→ page 350).

Engine compartment

Opening/closing the hood

- ⚠ **WARNING** Risk of accident if the engine hood is unlatched while driving

An unlocked engine hood may open up when the vehicle is in motion and block your view.

- ▶ Never unlatch the engine hood while driving.
- ▶ Before every trip, ensure that the engine hood is latched.

- ⚠ **WARNING** Risk of accident and injury when opening and closing the engine hood

When opening or closing the engine hood, it may suddenly drop into the end position.

There is a risk of injury for anyone in the engine hood's range of movement.

- ▶ Only open or close the engine hood when there are no persons in the engine hood's range of movement.

- ⚠ **WARNING** Danger of burns when opening the hood

If you open the hood when the engine has overheated or during a fire in the engine compartment, you could come into contact with hot gases or other escaping operating fluids.

- ▶ Before opening the hood, allow the engine to cool down.
- ▶ In the event of a fire in the engine compartment, keep the hood closed and call the fire service.

- ⚠ **WARNING** Risk of injury due to moving parts

Certain components in the engine compartment may continue to move or suddenly move again even after the ignition has been switched off, e.g. the cooler fan.

Make sure of the following before performing tasks in the engine compartment:

- ▶ Switch the ignition off.

- ▶ Never touch the danger zone surrounding moving component parts, e.g. the rotation area of the fan.
- ▶ Remove jewelry and watches.
- ▶ Keep items of clothing and hair away from moving parts.

⚠ WARNING Risk of injury from touching component parts under voltage

The ignition system and the fuel injection system work under high voltage. If you touch component parts which are under voltage, you could receive an electric shock.

- ▶ Never touch component parts of the ignition system or the fuel injection system when the ignition is switched on.

⚠ WARNING Risk of burns from hot component parts in the engine compartment

Certain component parts in the engine compartment can be very hot, e.g. the engine, the cooler and parts of the exhaust system.

- ▶ Let the engine cool down and only touch the component parts described as follows.

⚠ WARNING Risk of injury from using the windshield wipers while the engine hood is open

When the engine hood is open and the windshield wipers are set in motion, you can be trapped by the wiper linkage.

- ▶ Always switch off the windshield wipers and ignition before opening the engine hood.

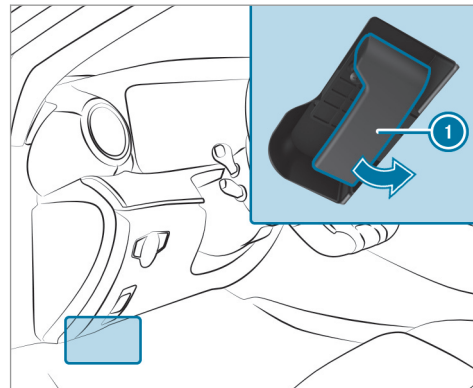

- ▶ **To open:** pull lever ① to release the hood.

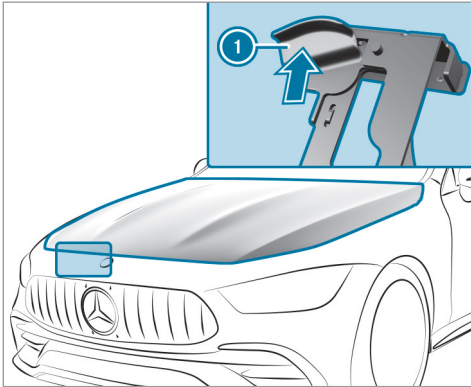

- ▶ Push handle ① of the hood catch upwards and lift the hood by approximately 15 in (40 cm).
- ▶ **To close:** lower the hood and press it firmly into the lock with both hands.
- ▶ If the hood can be lifted a little bit more, repeat the procedure until it engages correctly.

Engine oil

Checking the engine oil level using the on-board computer

Requirements

The engine oil level is determined during driving. Determining the engine oil level can take up to 30 minutes with a normal driving style and even longer with an active driving style.

In order to receive a result as quickly as possible:

- Warm up the engine
- Park the vehicle on a level surface
- Leave the engine running at idling speed

On-board computer:

↪ Service ▶▶ Engine Oil Level

You will see one of the following messages on the multifunction display:

- **Measuring Engine Oil Level...:** measurement of the oil level is not yet possible.
- ▶ Repeat the request after a maximum of 30 minutes driving.

- **Engine Oil Level OK** and the bar display for indicating the oil level on the multifunction display is green and is between "min" and "max": the oil level is correct.
- **Engine Oil Level Add 1.0 l** and the bar display for indicating the oil level on the multifunction display is orange and is below "min":
 - ▶ Add 1.1 US qt (1 l) engine oil.
- **Reduce Engine Oil Level** and the bar display for indicating the oil level on the multifunction display is orange and is above "max":
 - ▶ Drain off excess engine oil that has been added. Consult a qualified specialist workshop.
- **For Engine Oil Level Switch Ignition On:**
 - ▶ Switch on the ignition to check the engine oil level.
- **Engine Oil Level System Inoperative:** sensor faulty or not inserted.
 - ▶ Consult a qualified specialist workshop.
- **Engine Oil Level System Currently Unavail.:**

- ▶ Close the hood.

Adding engine oil

- ⚠ WARNING** Risk of burns from hot component parts in the engine compartment

Certain component parts in the engine compartment can be very hot, e.g. the engine, the cooler and parts of the exhaust system.

- ▶ Let the engine cool down and only touch the component parts described as follows.

- ⚠ WARNING** Risk of fire and injury from engine oil

If engine oil comes into contact with hot component parts in the engine compartment, it may ignite.

- ▶ Make sure that no engine oil is spilled next to the filler opening.
- ▶ Allow the engine to cool off and thoroughly clean the engine oil from component parts before starting the vehicle.

- ! NOTE** Engine damage caused by an incorrect oil filter, incorrect oil or additives

- ▶ Do not use engine oils or oil filters which do not correspond to the specifications explicitly prescribed for the service intervals.
- ▶ Do not alter the engine oil or oil filter in order to achieve longer change intervals than prescribed.
- ▶ Do not use additives.
- ▶ Follow the instructions in the service interval display regarding the oil change.

- ! NOTE** Damage caused by topping up too much engine oil

- Adding too much engine oil can cause damage to the engine or the catalytic converter.
- ▶ Have excess engine oil removed at a qualified specialist workshop.

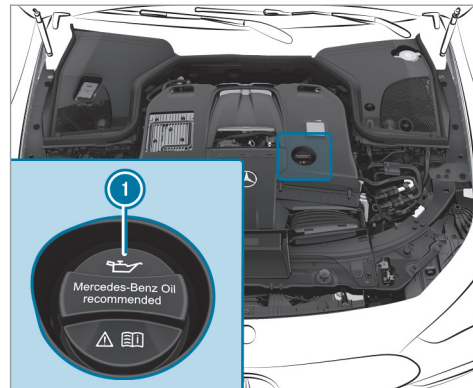

Mercedes-AMG GT 63 4MATIC+ and Mercedes-AMG GT 63 S 4MATIC+

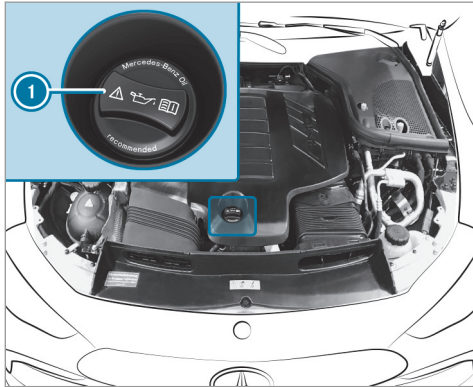

Mercedes-AMG GT 43, Mercedes-AMG GT 43 4MATIC+ and Mercedes-AMG GT 53 4MATIC+

- ▶ Turn cap ① counter-clockwise and remove it.
- ▶ Add engine oil.
- ▶ Replace cap ① and turn it clockwise as far as it will go.
- ▶ Check the oil level again (→ page 353).

Checking coolant level

⚠ WARNING Risk of burns from hot component parts in the engine compartment

Certain component parts in the engine compartment can be very hot, e.g. the engine, the cooler and parts of the exhaust system.

- ▶ Let the engine cool down and only touch the component parts described as follows.

⚠ WARNING Risk of scalding from hot coolant

The engine cooling system is pressurized, particularly when the engine is warm. If you open the cap, you could be scalded by hot coolant spraying out.

- ▶ Let the engine cool down before opening the cap.
- ▶ When opening the cap, wear protective gloves and safety glasses.
- ▶ Open the cap slowly to release pressure.

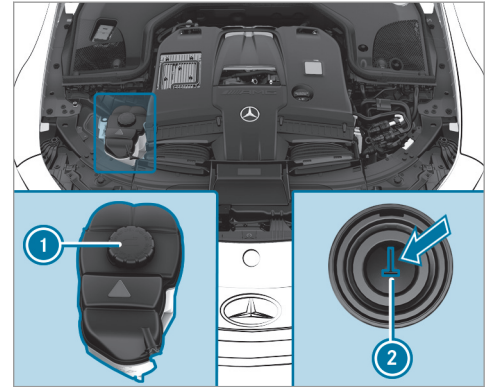

- ▶ Park the vehicle on a level surface.
- ▶ Check the coolant temperature display in the instrument cluster. The coolant temperature must be below 158 °F (70 °C).
- ▶ Slowly turn cap ① counter-clockwise to relieve overpressure.

- ▶ Continue turning cap ① counter-clockwise and remove it.

The coolant level is correct:

- If the engine is cold, up to marker bar ②
 - If the engine is warm, up to 0.6 in (1.5 cm) over marker bar ②
- ▶ If necessary, add coolant that has been approved for Mercedes-Benz.
- Further information on coolant (→ page 424).

Adding washer fluid to the windshield washer system

- ⚠ **WARNING** Risk of burns from hot component parts in the engine compartment

Certain component parts in the engine compartment can be very hot, e.g. the engine, the cooler and parts of the exhaust system.

- ▶ Let the engine cool down and only touch the component parts described as follows.

- ⚠ **WARNING** Danger of burns when opening the hood

If you open the hood when the engine has overheated or during a fire in the engine compartment, you could come into contact with hot gases or other escaping operating fluids.

- ▶ Before opening the hood, allow the engine to cool down.
- ▶ In the event of a fire in the engine compartment, keep the hood closed and call the fire service.

- ⚠ **WARNING** - Risk of fire and injury from windshield washer concentrate

Windshield washer concentrate is highly flammable. It could ignite if it comes into contact with hot engine component parts or the exhaust system.

- ▶ Make sure that no windshield washer concentrate spills out next to the filler opening.

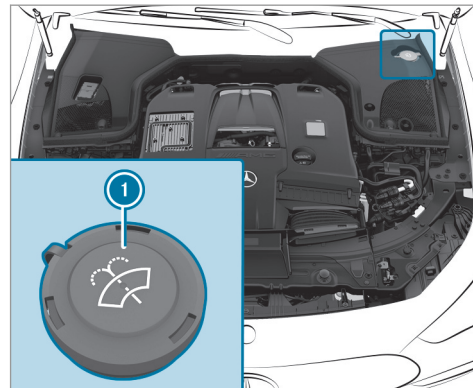

- ▶ Remove cap ① by the tab.
- ▶ Add washer fluid.

Keeping the air-water duct free

- ▶ Keep the area between the hood and the windshield free of deposits, e.g. ice, snow and leaves.

Cleaning and care

Information on washing the vehicle in a car wash

⚠ WARNING Risk of accident due to reduced braking effect after washing the vehicle

The braking effect is reduced after washing the vehicle.

▶ After the vehicle has been washed, brake carefully while paying attention to the traffic conditions until the braking effect has been fully restored.

To avoid damage to your vehicle when using a car wash, ensure the following beforehand:

- Active Distance Assist DISTRONIC and the HOLD function are deactivated.
- the 360° Camera or the rear view camera is switched off.
- the extendable rear wing is completely retracted.

- the side windows and sliding sunroof are completely closed.
 - the blower for the ventilation/heating is switched off.
 - the windshield wiper switch is in position **0**.
 - the SmartKey is at a minimum distance of 10 ft (3 m) away from the vehicle, otherwise the tailgate could open unintentionally.
 - in car washes with a conveyor system: neutral **N** is engaged.
- i** In car washes with a conveyor system: if you would like to leave the vehicle while it is being washed, make sure the SmartKey is located in the vehicle. The **P** gear is otherwise automatically engaged.
- i** If, after the car wash, you remove the wax from the windshield and wiper rubbers, this will prevent smearing and reduce wiper noise.

Information on using a power washer

⚠ WARNING Risk of accident when using high-pressure cleaning equipment with round-spray nozzles

The water jet from a round-spray nozzle (dirt grinder) may cause damage to tires and suspension components that is not visible.

Components damaged in this way may fail unexpectedly.

- ▶ Do not use high-pressure cleaning equipment with round-spray nozzles to clean your vehicle.
- ▶ Damaged tires or suspension components must be replaced immediately.

To avoid damage to your vehicle, observe the following when using a power washer:

- Keep the SmartKey at least 10 ft (3 m) away from the vehicle. Otherwise the tailgate could open unintentionally.
- Maintain a distance of at least 11.8 in (30 cm) to the vehicle.

- **Vehicles with decorative foil:** parts of your vehicle are covered with a decorative foil. Maintain a distance of at least 27.6 in (70 cm) between the foil-covered parts of the vehicle and the nozzle of the power washer. Move the power washer nozzle around whilst cleaning. The water temperature of the power washer must not exceed 124 °F (60 °C).
- Observe the information on the correct distance in the equipment manufacturer's operating instructions.

- Do not point the nozzle of the power washer directly at sensitive parts such as tires, slits, electrical components, batteries, light bulbs and ventilation slots.

Washing the vehicle by hand

Observe the legal requirements, e.g. in a number of countries, washing by hand is only permitted in specially designated wash bays.

- ▶ Use a mild cleaning agent, e.g. car shampoo.

- ▶ Wash the vehicle with lukewarm water using a soft car sponge. When doing so, do not expose the vehicle to direct sunlight.
- ▶ Carefully hose the vehicle off with water and dry using a chamois. Take care not to point the water jet directly towards the air inlet grille.

Notes on paintwork/matte finish paintwork care

Observe the following information:

	Cleaning and care	Avoiding paintwork damage
Paintwork	<ul style="list-style-type: none">• Insect remains: soak with insect remover and rinse off the treated areas afterwards.• Bird droppings: soak with water and rinse off afterwards.• Tree resin, oils, fuels and greases: remove by rubbing gently with a cloth soaked in petroleum ether or lighter fluid.• Coolant and brake fluid: remove with a damp cloth and clean water.• Tar stains: use tar remover.• Wax: use silicone remover.	<ul style="list-style-type: none">• Do not attach stickers, films or similar.• Remove dirt immediately, where possible.

Cleaning and care		Avoiding paintwork damage
Matte finish	<ul style="list-style-type: none">• Only use care products approved for Mercedes-Benz.	<ul style="list-style-type: none">• Do not polish the vehicle and alloy wheels.• Only use car washes that correspond to the latest engineering standards.• Do not use car wash programs with a final hot wax treatment.• Do not use paint cleaners, buffing or polishing products, gloss preservers, e.g. wax.• Always have paintwork repairs carried out at a qualified specialist workshop.

Notes on cleaning decorative foils

Observe the notes on matte finish care in the chapter "Notes on paintwork/matte finish paint-

work care" (→ page 359). They also apply to matte decorative foils.

Observe the following information:

Cleaning	Avoiding damage to the decorative foil
<ul style="list-style-type: none"> • For cleaning, use plenty of water and a mild cleaning agent without additives or abrasive substances, e.g. a car shampoo approved for Mercedes-Benz. • Remove dirt immediately, where possible, whilst avoiding rubbing too hard. There is otherwise a risk of damaging the decorative foil irreparably. • If there is dirt on the finish or if the decorative foil is dull: use the Paint Cleaner recommended and approved for Mercedes-Benz. • Insect remains: soak with insect remover and rinse off the treated areas afterwards. • Bird droppings: soak with water and rinse off afterwards. • To prevent water stains, dry a foil-wrapped vehicle with a soft, absorbent cloth after every car wash. 	<ul style="list-style-type: none"> • The service life and color of decorative foils are impaired by: <ul style="list-style-type: none"> - sunlight - temperature, e.g. hot air blower - weather conditions - stone chippings and dirt - chemical cleaning agents - oily products • Do not use polish on matte decorative foil. Polishing will have the effect of shining the foil-wrapped surface. • Do not treat matte or structured decorative foils with wax. Permanent stains may occur.

Scratches, corrosive deposits, areas affected by corrosion and damage caused by incorrect care cannot always be completely repaired. In such cases, visit a qualified specialist workshop.

You can obtain more information on care and cleaning products from the manufacturer.

In the case of foil-wrapped surfaces, optical differences may occur between the surfaces that were not protected by a decorative foil after removing a decorative foil.

 Have work or repairs to decorative foils carried out at a qualified specialist workshop, e.g. in an authorized Mercedes-Benz Center.

Notes on care of vehicle parts

⚠ WARNING Risk of entrapment if the windshield wipers are switched on while the windshield is being cleaned

If the windshield wipers are set in motion while you are cleaning the windshield or wiper blades, you can be trapped by the wiper arm.

▶ Always switch off the windshield wipers and the ignition before cleaning the windshield or wiper blades.

⚠ WARNING Risk of burning from the tailpipe or tailpipe trim

The tailpipe and tailpipe trim can become very hot. If you come into contact with these car parts, you could burn yourself.

▶ Always be particularly careful when in the vicinity of the tailpipe and tailpipe trims and supervise children very closely when in this area.

▶ Before any contact, allow the car parts to cool down.

Observe the following information:

	Notes on cleaning and care	Avoiding vehicle damage
Wheels/rims	Use water and acid-free wheel cleaners.	<ul style="list-style-type: none"> Do not use acidic wheel cleaners to remove brake dust. This could damage wheel bolts and brake components. To avoid corrosion of the brake discs and brakepads, drive the vehicle for a few minutes after cleaning before parking it. The brake discs and brakepads warm up and dry out.
Windows	Clean the windows on the inside and outside using a damp cloth and cleaning agents recommended by Mercedes-Benz.	Do not use dry cloths or abrasive or solvent-based cleaning agents to clean the inside of windows.
Wiper blades	Fold out the wiper blades and clean them using a damp cloth.	Do not clean the wiper blades too often.

	Notes on cleaning and care	Avoiding vehicle damage
Exterior lighting	Clean the lenses with a wet sponge and mild cleaning agent, e.g. car shampoo.	Only use cleaning agents or cleaning cloths that are suitable for plastic lenses.
Sensors	Clean the sensors in the front and rear bumper and in the radiator grill with a soft cloth and car shampoo.	When using a power washer, maintain a minimum distance of 11.8 in (30 cm).
Rear view camera and 360° Camera	<ul style="list-style-type: none"> • Open the camera cover with the multimedia system (→ page 209) . • Use clean water and a soft cloth to clean the camera lens. 	Do not use a power washer.
Extendable rear wing	<ul style="list-style-type: none"> • Extend the rear wing when washing by hand (→ page 194). • Clean the rear wing with a soft car sponge and mild cleaning agent, e.g. car shampoo. • Retract the rear wing completely after drying (→ page 194). 	Do not use a power washer.
Tailpipes	Clean with cleaning agents recommended by Mercedes-Benz, particularly in the winter and after washing the vehicle.	Do not use acidic cleaning agents.

Notes on care of the interior

⚠ WARNING Risk of injury from plastic parts breaking off after the use of solvent-based care products

Care and cleaning products containing solvents can cause surfaces in the cockpit to become porous.

When the airbags are deployed, plastic parts may break away.

- ▶ Do not use any care or cleaning products containing solvents to clean the cockpit.

⚠ WARNING Risk of injury or death from bleached seat belts

Bleaching or dyeing seat belts can severely weaken them.

This can, for example, cause seat belts to tear or fail in an accident.

- ▶ Never bleach or dye seat belts.

Observe the following information:

	Cleaning and care	Avoiding vehicle damage
Seat belts	Clean with lukewarm and soapy water.	<ul style="list-style-type: none"> • Do not use chemical cleaning agents. • Do not dry seat belts by heating them to over 176 °F (80 °C) or exposing them to direct sunlight.
Display	Clean the surface carefully with a microfiber cloth and a suitable display care product (TFT LCD).	<ul style="list-style-type: none"> • Switch off the display and let it cool down. • Do not use any other cleaning products.
Plastic trim	<ul style="list-style-type: none"> • Clean with a damp microfiber cloth. • For heavy soiling: use care product recommended for Mercedes-Benz. 	<ul style="list-style-type: none"> • Do not attach stickers, films or similar materials. • Do not allow cosmetics, insect repellent or sun cream to come in contact with the plastic trim.

Cleaning and care		Avoiding vehicle damage
Real wood/trim inserts	<ul style="list-style-type: none"> • Clean with a microfiber cloth. • Black piano-lacquer look: clean with a damp cloth and soapy water. • For heavy soiling: use care product recommended for Mercedes-Benz. 	Do not use solvent-based cleaning agents, polishes or waxes.
Headliner	Clean with a brush or dry shampoo.	
Carpet	Use carpet and textile cleaning agents recommended for Mercedes-Benz.	
Genuine leather seat covers	<ul style="list-style-type: none"> • Clean with a damp cloth and then wipe with a dry cloth. • Leather care: use leather care agents that have been recommended for Mercedes-Benz. 	Do not allow the leather to become too damp. Do not use a microfiber cloth.
DINAMICA seat covers	Clean with a damp cloth.	Do not use a microfiber cloth.
Imitation leather seat covers	Clean with a damp cloth and 1% soapy water.	Do not use a microfiber cloth.
Cloth seat covers	Clean with a damp microfiber cloth and 1% soapy water and allow to dry.	

Emergency

Removing the safety vest

The safety vests are located in the safety vest compartments in the driver's and front passenger door stowage compartments.

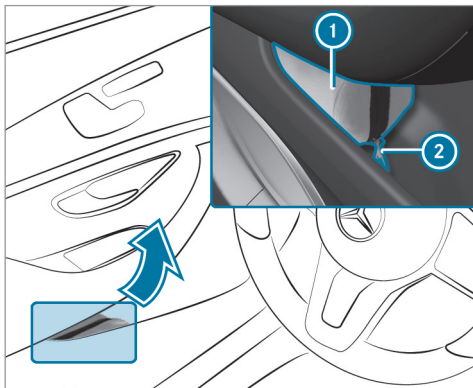

To remove: pull out safety vest bag ① by loop ②.

▶ Open safety vest bag ① and pull out the safety vest.

ⓘ There are also safety vest compartments in the rear door stowage compartments in which safety vests can be stored.

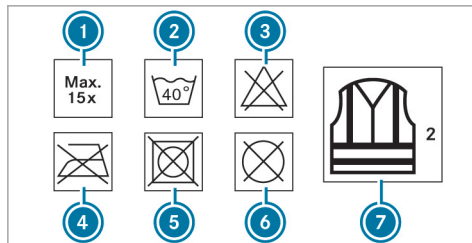

- ① Maximum number of washes
- ② Maximum wash temperature
- ③ Do not bleach
- ④ Do not iron
- ⑤ Do not tumble dry
- ⑥ Do not dry clean
- ⑦ Class 2 safety vest

The requirements defined by the legal standard are only fulfilled if the safety vest is the correct size and is fully closed.

The safety vest must be replaced in the following situations:

- The reflective strips are damaged or dirty
- The maximum permissible number of washes is exceeded
- The fluorescence has faded

Flat tire

Notes on flat tires

⚠ WARNING Risk of accident due to a flat tire

A flat tire severely affects the driving characteristics as well as the steering and braking of the vehicle.

Tires without run-flat characteristics:

- ▶ Do not drive on with a flat tire.
- ▶ Change the flat tire immediately with an emergency spare wheel or spare wheel.

Alternatively, consult a qualified specialist workshop.

Tires with run-flat characteristics:

- ▶ Observe the information and warning notes on MOExtended tires (run-flat tires).

In the event of a flat tire, the following options are available depending on your vehicle's equipment:

- **Vehicles with MOExtended tires:** it is possible to continue the journey for a short period of time. Make sure you observe the notes on MOExtended tires (run-flat tire) (→ page 367).
- **Vehicles with a TIREFIT kit:** you can repair the tires so that it is possible to continue the journey for a short period of time. To do this, use the TIREFIT kit (→ page 368).
- **Vehicles with Mercedes me connect:** you can make a call for Roadside Assistance via the overhead control panel in the case of a breakdown (→ page 315).

- **All vehicles:** change the wheel (→ page 410).

Notes on MOExtended tires (run-flat tire)

⚠ WARNING Risk of accident when driving in limp-home mode

When driving in emergency mode the handling characteristics are impaired. e.g. when cornering, when accelerating strongly and when braking.

- ▶ Do not exceed the permissible maximum speed for MOExtended tires.
- ▶ Avoid any abrupt steering and driving maneuvers as well as driving over obstacles (curbs, pot holes, off-road). This applies, in particular, to a loaded vehicle.
- ▶ Stop driving in the emergency mode if you notice:
 - banging noise
 - vehicle vibration

- smoke which smells like rubber
- continuous ESP® intervention
- cracks in tire side walls

- ▶ After driving in emergency mode have the rims checked by a qualified specialist workshop with regard to their further use.
- ▶ The defective tire must be replaced in every case.

With MOExtended tires (run-flat tire), you can continue to drive your vehicle even if there is a total loss of pressure in one or more tires. However, the tire affected must not show any clearly visible damage.

You can recognize MOExtended tires by the MOExtended marking which appears on the side wall of the tire.

Vehicles with tire pressure monitoring system: MOExtended tires may only be used in conjunction with an activated tire pressure monitoring system.

If a pressure loss warning message appears in the multifunction display:

- Check the tire for damage.
- If driving on, observe the following notes.

Driving distance possible in limp-home mode after the pressure loss warning:

Load condition	Driving distance possible in limp-home mode
Partially laden	50 miles (80 km)
Fully laden	19 miles (30 km)

- The driving distance possible in limp-home mode may vary depending on the driving style.
- Maximum permissible speed 50 mph (80 km/h).

If a tire has gone flat and cannot be replaced with an MOExtended tire, you can use a standard tire as a temporary measure.

TIREFIT kit storage location

The TIREFIT kit is located under the cargo compartment floor.

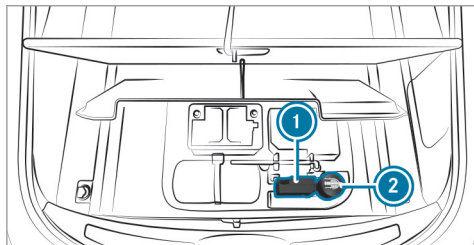

- ① Tire inflation compressor
- ② Tire sealant bottle

Using the TIREFIT kit

Requirements

Required tools:

- Tire sealant bottle
- TIREFIT sticker

- Tire inflation compressor
- Gloves (depending on the vehicle equipment)

TIREFIT kit storage location: (→ page 368)

You can use TIREFIT tire sealant to seal perforation damage of up to 0.16 in (4 mm), particularly those in the tire contact surface. You can use TIREFIT in outside temperatures down to -4°F (-20°C).

⚠ WARNING Risk of accident when using tire sealant.

In the following situations, the tire sealant is unable to provide sufficient breakdown assistance, as it is unable to seal the tire properly:

- There are cuts or punctures in the tire larger than those previously mentioned.
 - The wheel rim is damaged.
 - You have driven at a very low tire pressure or on a flat tire.
- ▶ Do not continue driving.
▶ Consult a qualified specialist workshop.

⚠ WARNING Risk of injury and poisoning from tire sealant

The tire sealant is harmful and causes irritation. Do not allow it to come into contact with the skin, eyes or clothing, and do not swallow it. Do not inhale tire sealant fumes. Keep the tire sealant away from children.

If you come into contact with the tire sealant, observe the following:

- ▶ Rinse off the tire sealant from your skin immediately using water.
- ▶ If tire sealant gets into your eyes, thoroughly rinse out the eyes using clean water.
- ▶ If tire sealant has been swallowed, immediately rinse out the mouth thoroughly and drink plenty of water. Do not induce vomiting and seek medical attention immediately.
- ▶ Change out of any clothes contaminated with tire sealant immediately.
- ▶ If allergic reactions occur, seek medical attention immediately.

! NOTE Overheating due to the tire inflation compressor running too long

- ▶ Do not run the tire inflation compressor for longer than ten minutes without interruption.

Comply with the manufacturer's safety notes on the sticker on the tire inflation compressor.

Have the tire sealant bottle replaced in a qualified specialist workshop every five years.

- ▶ Do not remove any foreign objects which have entered the tire.

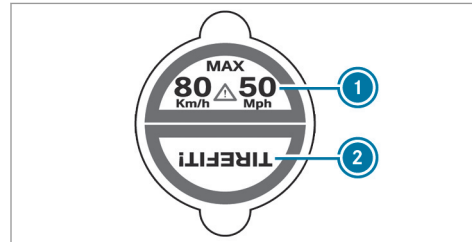

- ▶ Affix part ① of the TIREFIT sticker to the instrument cluster within the driver's field of vision.
- ▶ Affix part ② of the TIREFIT sticker near the valve on the wheel with the defective tire.

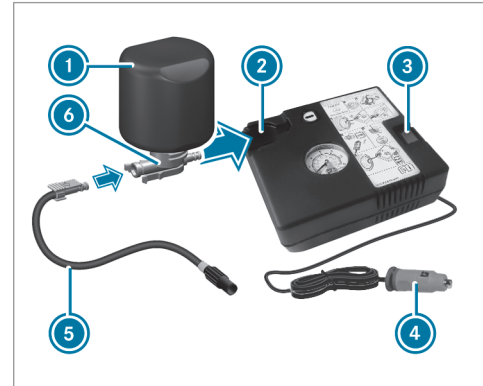

- ▶ Pull plug ④ with the cable and hose ⑤ out of the tire inflation compressor housing.

- ▶ Push the plug of hose ⑤ into flange ⑥ of tire sealant bottle ① until the plug engages.
- ▶ Place tire sealant bottle ① head downwards into recess ② of the tire inflation compressor.

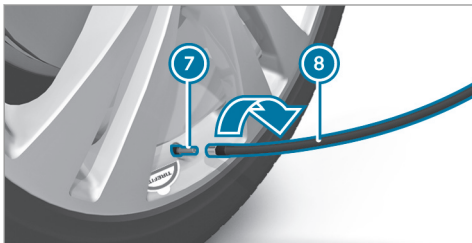

- ▶ Remove the valve cap from valve ⑦ on the defective tire.
- ▶ Screw filling hose ⑧ onto valve ⑦.
- ▶ Insert plug ④ into a 12 V socket in your vehicle.
- ▶ Switch the ignition on.

- ▶ Press on and off switch ③ on the tire inflation compressor. The tire inflation compressor is switched on. The tire is inflated. First, tire sealant is pumped into the tire. The pressure may briefly rise to approximately 500 kPa (5 bar/73 psi).

Do not switch off the tire inflation compressor during this phase.

- ▶ Let the tire inflation compressor run for a maximum of ten minutes. The tire should then have attained a tire pressure of at least 200 kPa (2.0 bar/29 psi).

If tire sealant leaks out, make sure you clean the affected area as quickly as possible. It is preferable to use clear water.

If you get tire sealant on your clothing, have it cleaned as soon as possible with perchloroethylene.

If, after ten minutes, a tire pressure of 200 kPa (2.0 bar/29 psi) has not been achieved:

- ▶ Switch off the tire inflation compressor.
- ▶ Unscrew the filling hose from the valve of the defective tire.

Please note that tire sealant may leak out when unscrewing the filling hose.

- ▶ Drive forwards or reverse very slowly for approximately 33 ft (10 m).
- ▶ Pump up the tire again. After a maximum of ten minutes the tire pressure must be at least 200 kPa (2.0 bar/29 psi).

⚠ WARNING Risk of accident due to the specified tire pressure not being reached

If the specified tire pressure is not reached after the specified time, the tire is too badly damaged. The tire sealant cannot repair the tire in this instance.

Damaged tires and a tire pressure that is too low can significantly impair braking and handling characteristics.

- ▶ Do not continue driving.
- ▶ Consult a qualified specialist workshop.

If, after ten minutes, a tire pressure of 200 kPa (2.0 bar/29 psi) has been achieved:

- ▶ Switch off the tire inflation compressor.
- ▶ Unscrew the filling hose from the valve of the defective tire.

⚠ WARNING Risk of accident from driving with sealed tires

A tire temporarily sealed with tire sealant impairs driving characteristics and is not suitable for higher speeds.

- ▶ Adapt your driving style accordingly and drive carefully.
- ▶ Do not exceed the maximum speed limit with a tire that has been repaired using tire sealant.

- ▶ Observe the maximum permissible speed for a tire sealed with tire sealant 50 mph (80 km/h).
- ▶ Affix the upper section of the TIREFIT sticker to the instrument cluster in a location where it will be easily seen by the driver.

! **NOTE** Staining caused by leaking tire sealant

After use, excess tire sealant may leak out from the filling hose.

- ▶ Therefore, place the filling hose in the plastic bag that contained the TIREFIT kit.

🔥 ENVIRONMENTAL NOTE Environmental pollution caused by environmentally irresponsible disposal

Tire sealant contains pollutants.

- ▶ Have the tire sealant bottle disposed of professionally, e.g. at an authorized Mercedes-Benz Center.

- ▶ Stow the tire sealant bottle and the tire inflation compressor.

▶ Pull away immediately.

- ▶ Stop driving after approximately ten minutes and check the tire pressure using the tire inflation compressor.
The tire pressure must now be at least 130 kPa (1.3 bar/ 19 psi).

⚠ WARNING Risk of accident due to the specified tire pressure not being reached

If the specified tire pressure is not reached after a brief drive, the tire is too badly damaged. The tire sealant cannot repair the tire in this instance.

Damaged tires and tire pressure that is too low can significantly impair the braking properties and the handling characteristics.

- ▶ Do not continue driving.
- ▶ Consult a qualified specialist workshop.

In cases such as the one mentioned above, contact an authorized Mercedes-Benz Center. Or

call 1-800-FOR-MERCEdes (in the USA) or 1-800-387-0100 (in Canada).

- ▶ Correct the tire pressure if it is still at least 130 kPa (1.3 bar/19 psi). See the Tire and Loading Information placard on the driver's side B-pillar or the tire pressure table in the fuel filler flap for values.
- ▶ **To increase the tire pressure:** switch on the tire inflation compressor.

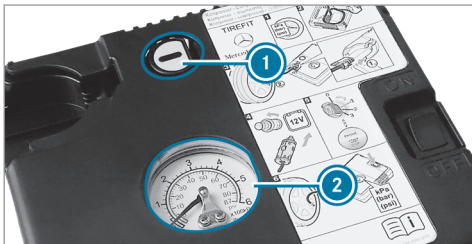

- ▶ **To reduce the tire pressure:** press pressure release button ① next to manometer ②.

- ▶ When the tire pressure is correct, unscrew the filling hose from the valve of the sealed tire.
- ▶ Screw the valve cap onto the valve of the sealed tire.
- ▶ Pull the tire sealant bottle out of the tire inflation compressor. The filling hose stays on the tire sealant bottle.
- ▶ Drive to the nearest qualified specialist workshop and have the tire, tire sealant bottle and filling hose replaced there.

Battery (vehicle)

Notes on the 12 V battery

⚠ WARNING Risk of an accident due to work carried out incorrectly on the battery

Work carried out incorrectly on the battery can, for example, lead to a short circuit. This can lead to function restrictions in safety-rel-

evant systems, for example the lighting system, ABS (anti-lock braking system) or ESP® (Electronic Stability Program). The operating safety of your vehicle may be restricted.

You could lose control of the vehicle in the following situations:

- when braking
- in the event of abrupt steering maneuvers and/or when the vehicle's speed is not adapted to the road conditions

- ▶ In the event of a short circuit or a similar incident, contact a qualified specialist workshop immediately.
- ▶ Do not continue driving.
- ▶ Always have work on the battery carried out at a qualified specialist workshop.

- Further information on ABS (→ page 166)
- Further information on ESP®

For safety reasons, Mercedes-Benz recommends that you only use batteries which have been tested and approved for your vehicle by Mercedes-

Benz. These batteries provide increased impact protection to prevent vehicle occupants from suffering acid burns should the battery be damaged in the event of an accident.

All vehicles except vehicles with a lithium-ion battery

⚠ WARNING Risk of explosion due to electrostatic charge

Electrostatic charge can cause sparks which may ignite the highly flammable gas mixture in the battery.

- ▶ To discharge any electrostatic charge that may have built up, touch the metal vehicle body before handling the battery.

The highly flammable gas mixture is created while the battery is charging and during starting assistance.

⚠ WARNING Danger of chemical burns from the battery acid

Battery acid is caustic.

- ▶ Avoid contact with the skin, eyes or clothing.
- ▶ Do not lean over the battery.
- ▶ Do not inhale battery gases.
- ▶ Keep children away from the battery.
- ▶ Immediately rinse battery acid off thoroughly with plenty of clean water and seek medical attention immediately.

All vehicles

🔥 ENVIRONMENTAL NOTE Environmental damage caused by improper disposal of batteries



Batteries contain pollutants. It is illegal to dispose of them with the household rubbish.



Dispose of batteries in an environmentally responsible manner. Take discharged batteries to a qualified specialist workshop or to a collection point for used batteries.

If you have to disconnect the 12 V battery, contact a qualified specialist workshop.

Comply with safety notes and take protective measures when handling batteries.



Risk of explosion.



Fire, open flames and smoking are prohibited when handling the battery. Avoid creating sparks.



Electrolyte or battery acid is corrosive. Avoid contact with the skin, eyes or clothing. Wear suitable protective clothing, in particular gloves, an

apron and a face mask. Immediately rinse electrolyte or acid splashes off with clean water. Consult a doctor if necessary.



Wear safety glasses.



Keep children away.



Observe this Operator's Manual.

Observe the following if you do not intend to use the vehicle over an extended period of time:

- Activate standby mode.
- Alternatively: connect the battery to a battery charger approved by Mercedes-Benz or consult a qualified specialist workshop to disconnect the battery.

Notes on starting assistance and on charging the 12 V battery

Vehicles with a lithium-ion battery

When charging the battery and during starting assistance, always use the jump-start connection point in the engine compartment.

! **NOTE** Damage to the battery from over-voltage

When charging using a battery charger without a maximum charging voltage, the battery or the on-board electronics may be damaged.

- ▶ Only use battery chargers with a maximum charging voltage of 14.4 V.

All other vehicles

When charging the battery and during starting assistance, always use the jump-start connection point in the engine compartment.

! **NOTE** Damaging the battery through overvoltage

When charging using a battery charger without a maximum charging voltage, the battery or the vehicle electronics may be damaged.

- ▶ Only use battery chargers with a maximum charging voltage of 14.8 V.

! **WARNING** Risk of explosion from hydrogen gas igniting

A battery generates hydrogen gas during the charging process. If there is a short circuit or sparks start to form, there is a danger of the hydrogen gas igniting.

- ▶ Make sure that the positive terminal of the connected battery does not come into contact with vehicle parts.
- ▶ Never place metal objects or tools on a battery.
- ▶ When connecting and disconnecting the battery, you must observe the described order for the battery clamps.

- ▶ When giving starting assistance, always make sure that you only connect battery terminals with identical polarity.
- ▶ During starting assistance, you must observe the described order for connecting and disconnecting the jumper cables.
- ▶ Do not connect or disconnect the battery clamps while the engine is running.

⚠ WARNING Risk of explosion during charging process and starting assistance

During the charging process and starting assistance, the battery may release an explosive gas mixture.

- ▶ Avoid fire, open flames, creating sparks and smoking.
- ▶ Make sure that there is sufficient ventilation during the charging process and during starting assistance.
- ▶ Do not lean over a battery.

⚠ WARNING Risk of explosion from a frozen battery

A discharged battery may freeze at temperatures slightly above or below freezing point. During starting assistance or battery charging, battery gas may be released.

- ▶ Always thaw a frozen battery out first before charging it or performing starting assistance.

If the indicator/warning lamps in the instrument cluster do not light up at low temperatures, it is very likely that the discharged battery has frozen. In this case you may neither jump-start the vehicle nor charge the battery.

The service life of a battery that has been thawed may be dramatically shortened. The starting characteristics may be impaired, especially at low temperatures.

It is recommended that you have a thawed battery checked at a qualified specialist workshop.

All vehicles

! NOTE Damage caused by numerous or extended attempts to start the engine

Numerous or extended attempts to start the engine may damage the catalytic converter due to non-combusted fuel.

- ▶ Avoid numerous and extended attempts to start the engine.

Observe the following points during starting assistance and when charging the battery:

- Only use undamaged jumper cables/charging cables with a sufficient cross-section and insulated terminal clamps.
- Non-insulated parts of the terminal clamps must not come into contact with other metal parts while the jumper cable/charging cable is connected to the battery/jump-start connection point.
- The jumper cable/charging cable must not come into contact with any parts which may move when the engine is running.

- Always make sure that neither you nor the battery is electrostatically charged.
- Keep away from fire and open flames.
- Do not lean over the battery.

Observe the additional following points when charging the battery:

- Only use battery chargers tested and approved for Mercedes-Benz.
- Read the battery charger's operating instructions before charging the battery.

Observe the additional following points during starting assistance:

- Starting assistance may only be provided using batteries with a nominal voltage of 12 V.
- The vehicles must not touch.
- **Gasoline engine:** Only accept starting assistance if the engine and exhaust system are cold.

Starting assistance and charging the 12 V battery

Requirements:

- The vehicle is secured with the electric parking brake.
- **Vehicles with automatic transmission:** The transmission is in position **P**.
- The ignition and all electrical consumers are switched off.
- The hood is open.

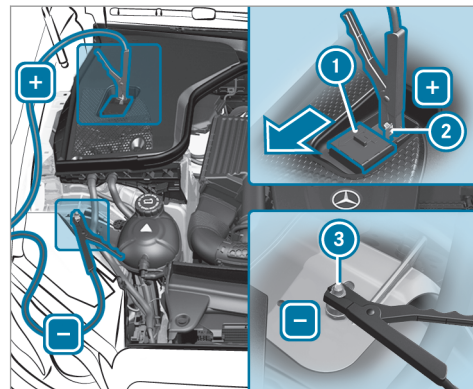

- ▶ Slide cover ① of positive clamp ② on the jump-starting connection point in the direction of the arrow.
- ▶ Connect positive clamp ② on your vehicle to the positive pole of the donor battery using the jumper cable/charging cable. Always begin with positive clamp ② on your own vehicle first.

- ▶ **During starting assistance:** start the engine of the donor vehicle and run at idle speed.
- ▶ Connect the negative pole of the donor battery and ground point ③ of your own vehicle by using the jumper cable/charging cable. Begin with the donor battery first.
- ▶ **During starting assistance:** start the engine of your own vehicle.
- ▶ **During the charging process:** start the charging process.
- ▶ **During starting assistance:** let the engines run for several minutes.
- ▶ **During starting assistance:** before disconnecting the jumper cable, switch on an electrical consumer in your own vehicle, e.g. the rear window heater or lighting.

When the starting assistance/charging process is complete, perform the following steps:

- ▶ First, remove the jumper cable/charging cable from ground point ③ and the negative pole of the donor battery, then from positive clamp ② and the positive pole of the donor

battery. Begin each time with the contacts on your own vehicle first.

- ▶ After removing the jumper cable/charging cable, close cover ① of positive clamp ②.

Further information can be obtained at a qualified specialist workshop.

Replacing the 12 V battery

- ▶ Observe the notes on the 12 V battery (→ page 372).

Mercedes-Benz recommends that you have the 12 V battery replaced at a qualified specialist workshop, e.g. at an authorized Mercedes-Benz Center.

Observe the following notes if you want to replace the battery yourself:

- Always replace a defective battery with a battery which meets the specific vehicle requirements.

The vehicle is equipped with an AGM technology battery (Absorbent Glass Mat) or a lithium-ion battery. Full vehicle functionality is

only guaranteed with an AGM battery or lithium-ion battery. For safety reasons, Mercedes-Benz recommends that you only use batteries which have been tested and approved for your vehicle by Mercedes-Benz.

- Carry over detachable parts, such as vent hoses, elbow fitting or terminal covers, from the battery being replaced.
- Make sure that the vent hose is always connected to the original opening on the side of the battery.
Install any existing or supplied cell caps. Otherwise, gases or battery acid could escape.
- Make sure that detachable parts are reconnected in the same way.

Tow starting or towing away

Permitted towing methods



Mercedes-Benz recommends transporting your vehicle in the case of a breakdown, rather than towing it away.

For towing, use a tow rope or tow bar with both axles on the ground. Do not use tow bar systems.

! **NOTE** Damage to the vehicle due to towing away incorrectly

▶ Observe the instructions and notes on towing away.

Permitted towing methods

Vehicle equipment/towing method	 Both axles on the ground	 Front axle raised	 Rear axle raised
Vehicles with automatic transmission	Yes, maximum 31 miles (50 km) at 31 mph (50 km/h)	No	Yes, if the steering wheel is fixed in the center position with a steering wheel lock.
4MATIC vehicles	Yes, maximum 31 miles (50 km) at 31 mph (50 km/h)	No	No

Towing with a raised axle: towing should be performed by a towing company.

Towing the vehicle with both axles on the ground

- ▶ Observe the notes on the permitted towing methods (→ page 377).
- ▶ Make sure that the battery is connected and charged.

Observe the following points when the battery is discharged:

- The engine cannot be started
 - The electric parking brake cannot be released or applied
 - **Vehicles with automatic transmission:** The automatic transmission cannot be shifted to position **N** or **P**.
- i** **Vehicles with automatic transmission:** If the automatic transmission cannot be shifted to position **N**, or the multifunction display in the instrument cluster does not show anything, have the vehicle transported away (→ page 380). A towing vehicle with lifting equipment is required for vehicle transportation.

! **NOTE** Damage due to towing away at excessively high speeds or over long distances

The drivetrain could be damaged when towing at excessively high speeds or over long distances.

- ▶ A towing speed of 30 mph (50 km/h) must not be exceeded.
- ▶ A towing distance of 30 miles (50 km) must not be exceeded.

! **WARNING** Risk of accident when towing a vehicle which is too heavy

If the vehicle being tow-started or towed away is heavier than the permissible gross mass of your vehicle, the following situations can occur:

- The towing eye may become detached.
 - The vehicle/trailer combination may swerve or even overturn.
- ▶ If another vehicle is tow-started or towed away, its weight must not exceed

the permissible gross mass of your own vehicle.

If a vehicle must be tow started or towed away, its permissible gross mass must not exceed the permissible gross mass of the towing vehicle.

- ▶ Information on the permissible gross mass of the vehicle can be found on the vehicle identification plate (→ page 418).
- ▶ **Vehicles with automatic transmission:** Do not open the driver's door or front passenger door, otherwise the automatic transmission automatically shifts to position **P**.
- ▶ Installing the towing eye (→ page 381).
- ▶ Fasten the tow bar.

! **NOTE** Damage due to incorrect connection

- ▶ Only connect the tow rope or tow bar to the towing eyes.
- ▶ Deactivating the automatic locking mechanism (→ page 70).

- ▶ Do not activate the HOLD function.
- ▶ Deactivate Active Brake Assist (→ page 174).
- ▶ **Vehicles with automatic transmission:** Shift the automatic transmission to position **N**.
- ▶ Release the electric parking brake.

⚠ WARNING Risk of accident due to limited safety-related functions during the towing process

Safety-related functions are limited or no longer available in the following situations:

- the ignition is switched off.
- the brake system or power steering system is malfunctioning.
- the energy supply or the on-board electrical system is malfunctioning.

When your vehicle is then towed away, significantly more effort may be required to steer and brake than is normally required.

- ▶ Use a tow bar.

- ▶ Make sure that the steering wheel can move freely, before towing the vehicle away.

! **NOTE** Damage due to excessive tractive power

If you pull away sharply, the tractive power may be too high and the vehicles could be damaged.

- ▶ Pull away slowly and smoothly.

Loading the vehicle for transport

- ▶ Observe the notes on towing away (→ page 379).
- ▶ Connect the tow bar to the towing eye in order to load the vehicle.
- ▶ **Vehicles with automatic transmission:** Shift the automatic transmission to position **N**.
- ▶ **Vehicles with automatic transmission:** The automatic transmission may be locked

in position **P** in the event of damage to the electrical system. To shift to **N**, provide the on-board electrical system with power (→ page 376).

- ▶ Load the vehicle onto the transporter.
- ▶ **Vehicles with automatic transmission:** Shift the automatic transmission to position **P**.
- ▶ Use the electric parking brake to secure the vehicle against rolling away.
- ▶ Only secure the vehicle by the wheels.

Vehicles with ADS PLUS (Adaptive Damping System PLUS)

⚠ WARNING Risk of an accident when transporting vehicles with Adaptive Damping System PLUS

The reduced damping forces on the vehicle being transported can cause the vehicle/trailer combination to start to swing.

As a result, when transporting vehicles with the Adaptive Damping System PLUS, the

vehicle/trailer combination may start to skid. Consequently, you could lose control of your vehicle.

- ▶ When transporting, ensure that:
 - The vehicle has been loaded onto the transporter correctly
 - The vehicle is secured at all four wheels with suitable tensioning straps
 - The maximum permissible speed of 35 mph (60 km/h) is not exceeded when transporting

! **NOTE** Damage to the vehicle from securing it incorrectly

- ▶ After loading, the vehicle must be secured at all four wheels. Otherwise, the vehicle could be damaged.
- ▶ A minimum distance of 8 in (20 cm) up and 4 in (10 cm) down must be kept to the transport platform.

- ▶ Secure the vehicle on all four wheels after loading.

4MATIC vehicles/vehicles with automatic transmission

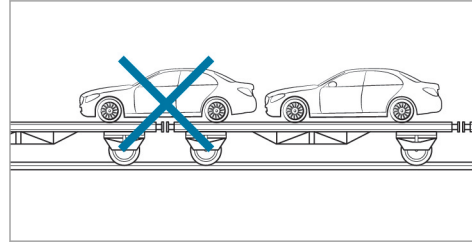

- ▶ Make sure that the front and rear axles come to rest on the same transportation vehicle.

! **NOTE** Damage to the drivetrain due to incorrect positioning

- ▶ Do not position the vehicle above the connection point of the transport vehicle.

Towing eye storage location

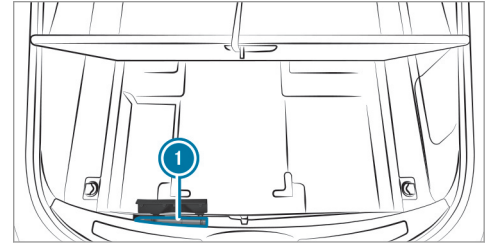

The towing eye is under the cargo compartment floor under cover ①.

Installing the towing eye

- ▶ **To remove the front towing eye:** pull out cover ①.
- ▶ **To remove the rear towing eye:** press the mark on cover ① inwards and remove.
- ▶ Screw in the towing eye clockwise as far as it will go and tighten.

- ❗ Make sure that cover ❶ engages in the bumper when you remove the towing eye.

❗ **NOTE** Damage due to incorrect use of the towing eye

When a towing eye is used to recover a vehicle, the vehicle may be damaged in the process.

- ▶ Only use the towing eye to tow away or tow start the vehicle.

Tow starting the vehicle (emergency engine start)

Vehicles with automatic transmission

❗ **NOTE** Damage to the automatic transmission due to tow starting

The automatic transmission may be damaged in the process of tow starting vehicles with automatic transmission.

- ▶ Vehicles with automatic transmission must not be tow started.

- ▶ Vehicles with automatic transmission must not be tow-started.

Electrical fuses

Notes on electrical fuses

⚠ **WARNING** Risk of accident and injury due to overloaded lines

If you manipulate or bridge a faulty fuse or if you replace it with a fuse with a higher amperage, the electric line could be overloaded.

This could result in a fire.

- ▶ Always replace faulty fuses with specified new fuses containing the correct amperage.

❗ **NOTE** Damage due to incorrect fuses

Electrical components or systems may be damaged by incorrect fuses, or their functionality may be significantly impaired.

- ▶ Only use fuses that have been approved by Mercedes-Benz and which have the correct fuse rating.

Blown fuses must be replaced with fuses of the same rating, which you can recognize by the color and fuse rating. The fuse ratings and further information to be observed are listed in the fuse assignment diagram.

Fuse assignment diagram: on the fuse box in the cargo compartment (→ page 384).

❗ **NOTE** Damage or malfunctions caused by moisture

Moisture may cause damage to the electrical system or cause it to malfunction.

- ▶ When the fuse box is open, make sure that no moisture can enter the fuse box.
- ▶ When closing the fuse box, make sure that the seal of the lid is positioned correctly on the fuse box.

If the newly inserted fuse also blows, have the cause traced and rectified at a qualified specialist workshop, e.g. an authorized Mercedes-Benz Center.

Ensure the following before replacing a fuse:

- The vehicle is secured against rolling away.
- All electrical consumers are switched off.
- The ignition is switched off.

The electrical fuses are located in various fuse boxes:

- Fuse box in the engine compartment on the driver's side (→ page 383)
- Fuse box on the driver's side of the cockpit (→ page 384)
- Fuse box in the front passenger footwell (→ page 384)
- Fuse box in the cargo compartment on the right-hand side of the vehicle, when viewed in the direction of travel (→ page 384)

Opening and closing the fuse box in the engine compartment

Requirements:

- You need a dry cloth and a screwdriver.

Observe the notes on electrical fuses (→ page 382).

Opening

⚠ WARNING Risk of injury from using the windshield wipers while the engine hood is open

When the engine hood is open and the windshield wipers are set in motion, you can be trapped by the wiper linkage.

▶ Always switch off the windshield wipers and ignition before opening the engine hood.

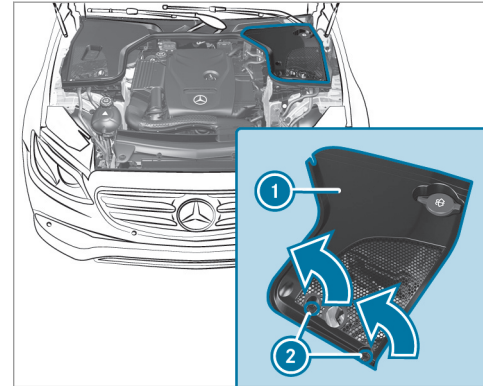

- ▶ Turn clip ② on cover ① a quarter-turn to the left.
- ▶ Pull cover ① upwards in the direction of the arrow.

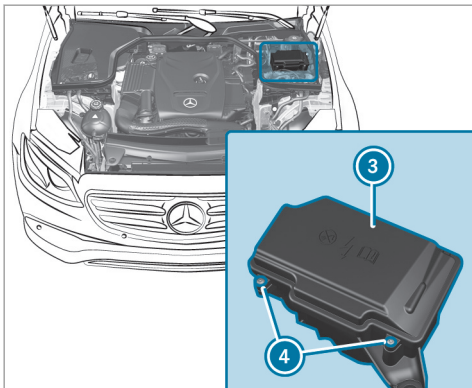

- ▶ Remove any existing moisture from the fuse box using a dry cloth.
- ▶ Loosen screws ④, remove fuse box lid ③ from the top.

Closing

- ▶ Check whether the seal is positioned correctly in lid ③.

- ▶ Insert lid ③ into the bracket at the rear of the fuse box.
- ▶ Fold down lid ③ of the fuse box and tighten screws ④.
- ▶ Insert cover ① on both sides.
- ▶ Turn clip ② on cover ① one quarter-turn to the right.
- ▶ Close the hood.

Opening and closing the fuse box in the cockpit

The fuse box is on the side of the dashboard under a cover.

- ▶ Contact an authorized Mercedes-Benz Center for further information.

Opening and closing the fuse box in the front passenger footwell

Observe the notes on electrical fuses (→ page 382).

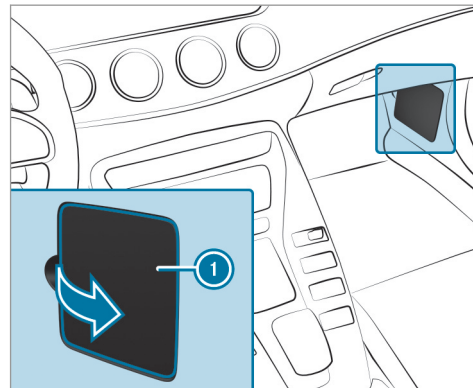

- ▶ Open cover ① in the direction of the arrow and remove it.

Opening and closing the fuse box in the cargo compartment

Observe the notes on electrical fuses (→ page 382).

- ▶ Open the cargo compartment floor .

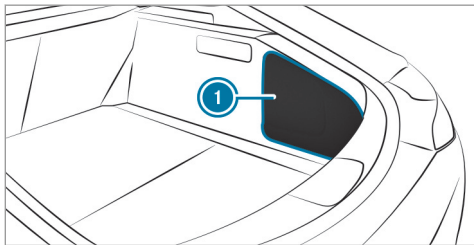

▶ Remove cover ①.

The fuse allocation chart is on the side of the fuse box.

Notes on noise or unusual handling characteristics

While driving, pay attention to vibrations, noises and unusual handling characteristics, e.g. pulling to one side. This may indicate that the wheels or tires are damaged. If you suspect that a tire is defective, reduce your speed immediately. Stop the vehicle as soon as possible to check the wheels and tires for damage. Hidden tire damage could also be causing the unusual handling characteristics. If you find no signs of damage, have the tires and wheels checked at a qualified specialist workshop.

Notes on regularly inspecting wheels and tires

⚠ WARNING Risk of accident from damaged tires

Damaged tires can cause tire pressure loss. As a result, you could lose control of your vehicle.

▶ Check the tires regularly for signs of damage and replace any damaged tires immediately.

⚠ WARNING Risk of aquaplaning due to insufficient tire tread

Insufficient tire tread will result in reduced tire grip. The tire tread is no longer able to dissipate water.

This means that in heavy rain or slush the risk of hydroplaning is increased, in particular if vehicle speed is not adapted to suit the conditions.

If the tire pressure is too high or too low, tires may exhibit different levels of wear at different locations on the tire contact surface.

▶ Thus, you should regularly check the tread depth and the condition of the tire contact surface across the entire width of all tires.

Minimum tread depth for:

- Summer tires: $\frac{1}{8}$ in (3 mm)
- M+S tires: $\frac{1}{6}$ in (4 mm)

▶ For safety reasons, replace the tires before the legally prescribed limit for the minimum tread depth is reached.

Carry out the following checks on all wheels regularly, at least once a month or as required, e.g. prior to a long journey or driving off-road:

- Check the tire pressure (→ page 388).
- Visually inspect tires and wheels for damage.
- Check the valve caps.

The valves must be protected against moisture and dirt by the valve caps approved especially for your vehicle by Mercedes-Benz.

- Visual check of the tire tread depth and the tire contact surface across the entire width.

The minimum tread depth for summer tires is $\frac{1}{8}$ in (3 mm) and for winter tires $\frac{1}{6}$ in (4 mm).

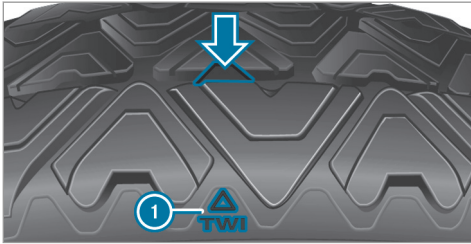

Six marks ① show where the bar indicators (arrow) are integrated into the tire tread. They are visible once a tread depth of approximately $\frac{1}{16}$ in (1.6 mm) has been reached.

Notes on snow chains

⚠ WARNING Risk of accident due to incorrect mounting of snow chains

If you have mounted snow chains to the front wheels, the snow chains may drag against the vehicle body or chassis components.

This could cause damage to the vehicle or the tires.

- ▶ Never mount snow chains on the front wheels.
- ▶ Only mount snow chains on the rear wheels in pairs.

! **NOTE** Damage to the wheel trim from mounted snow chains

If snow chains are mounted to steel wheels, the wheel trims can be damaged.

- ▶ Remove the wheel trims of steel wheels before mounting snow chains.

Observe the following notes when using snow chains:

- Snow chains are only permissible for certain wheel/tire combinations. You can obtain information about this from an authorized Mercedes-Benz Center.
- For safety reasons, only use snow chains that have been specifically approved for your

vehicle by Mercedes-Benz, or snow chains with the same quality standard.

- If snow chains are installed, the maximum permissible speed is 30 mph (50 km/h).
 - **Vehicles with Active Parking Assist:** Do not use Active Parking Assist when snow chains are installed.
 - **Vehicles with level control:** If snow chains are installed, only drive at raised vehicle level.
- ① You can deactivate ESP® to pull away . This allows the wheels to spin, achieving an increased driving force.

Tire pressure

Notes on tire pressure

⚠ WARNING Risk of accident due to insufficient or excessive tire pressure

Underinflated or overinflated tires pose the following risks:

- The tires may burst, especially as the load and vehicle speed increase.
 - The tires may wear excessively and/or unevenly, which may greatly impair tire traction.
 - The driving characteristics, as well as steering and braking, may be greatly impaired.
- ▶ Comply with the recommended tire pressure and check the tire pressure of all tires including the spare wheel regularly:
- at least once a month
 - when the load changes

- before embarking on a longer journey
 - if operating conditions change, e.g. off-road driving
- ▶ Adjust the tire pressure as necessary.

Driving with tire pressure that is too high or too low can:

- Shorten the service life of the tires.
- Cause increased tire damage.
- Adversely affect driving characteristics and thus driving safety, e.g. due to hydroplaning.

⚠ WARNING Risk of an accident due to insufficient tire pressure

Tires with pressure that is too low can overheat and burst as a result.

In addition, they also suffer from excessive and/or irregular wear, which can significantly impair the braking properties and the handling characteristics.

▶ Avoid excessively low tire pressures in all the tires, including the spare wheel.

Tire pressure which is too low can cause:

- Tire defects as a result of overheating
- Impaired handling characteristics
- Irregular wear
- Increased fuel consumption

⚠ WARNING Risk of accident from excessive tire pressure

Tires with excessively high pressure can burst because they are damaged more easily by highway fill, pot holes etc.

In addition, they also suffer from irregular wear, which can significantly impair the braking properties and the handling characteristics.

▶ Avoid excessively high tire pressures in all the tires, including the spare wheel.

Excessively high tire pressure can result in:

- Increased braking distance
- Impaired handling characteristics
- Irregular wear

- Impaired driving comfort
- Susceptibility to damage

⚠ WARNING Risk of accident caused by repeated drop in tire pressure

If the tire pressure drops repeatedly, the wheel, valve or tire may be damaged.

Insufficient tire pressure can cause the tires to burst.

- ▶ Inspect the tire for signs of foreign objects.
- ▶ Check whether the wheel or valve has a leak.
- ▶ If you are unable to rectify the damage, contact a qualified specialist workshop.

You can find information on tire pressure for the vehicle's factory-installed tires on the following labels:

- Tire and Loading Information placard on the B-pillar of your vehicle (→ page 393).
- Tire pressure table on the inside of the fuel filler flap (→ page 389).

Observe the maximum tire pressure (→ page 400).

Use a suitable tire pressure gauge to check the tire pressure. The outer appearance of a tire does not permit any reliable conclusion about the tire pressure.

Vehicles with a tire pressure monitoring system: You can also check the tire pressure using the on-board computer.

Only correct tire pressure when the tires are cold. Conditions for cold tires:

- The vehicle has been parked with the tires out of direct sunlight for at least three hours.
- The vehicle has traveled less than 1 mile (1.6 km).

A rise in the tire temperature of 18 °F (10 °C) increases the tire pressure by approx. 10 kPa (0.1 bar/1.5 psi). Take this into account when checking the tire pressure of warm tires.

The tire pressure recommended for increased load/speed in the tire pressure table can affect the ride comfort.

⚠ WARNING Risk of accident from unsuitable accessories on the tire valves

If you mount unsuitable accessories onto tire valves, the tire valves may be overloaded and malfunction, which can cause tire pressure loss. Tire pressure monitoring systems for retrofitting will cause the tire valve to remain open. This can also result in tire pressure loss.

- ▶ Only screw standard valve caps or valve caps specifically approved by Mercedes-Benz for your vehicle onto the tire valve.

Tire pressure table

The tire pressure table is on the inside of the fuel filler flap.

- ⓘ The data shown in the images is example data.

COLD TIRE PRESSURE			
normal load			A 213 584 00 15
maximum load			
Warm tires up to: + 4 psi			
1234567			

The tire pressure table shows the recommended tire pressure for all tires approved for this vehicle. The recommended tire pressures apply for cold tires under various operating conditions, i.e. loading and/or speed of the vehicle.

If one or more tire sizes precede a tire pressure, the tire pressure information following is only valid for those tire sizes.

The load conditions "partially laden" and "fully laden" are defined in the table for different numbers of passengers and amounts of luggage. The actual number of seats may differ from this.

		100 kPa = 1 bar			
		kPa ↓ psi		kPa ↓ psi	
R18					
R19					
M+S					

Some tire pressure tables only show the rim diameter instead of the complete tire size, e.g. **R18**. The rim diameter is part of the tire size and can be found on the tire side wall (→ page 401).

Be sure to also observe the following further related subjects:

- Notes on tire pressure (→ page 388)
- Tire and Loading Information placard (→ page 393)

- Maximum tire pressure (→ page 400)

Checking tire pressures manually

- ▶ Read the tire pressure for the current operating conditions from the Tire and Loading Information placard or the tire pressure table. Observe the notes on tire pressure.
- ▶ Remove the valve cap of the tire to be checked.
- ▶ Press the tire pressure gauge securely onto the valve.
- ▶ Read the tire pressure.
- ▶ If the tire pressure is lower than the recommended value, increase the tire pressure to the recommended value.
- ▶ If the tire pressure is higher than the recommended value, release air. To do so, press down the metal pin in the valve, e.g. using the tip of a pen for example. Then check the tire pressure again using the tire pressure gauge.
- ▶ Screw the valve cap onto the valve.

Further related subjects:

- Notes on tire pressure (→ page 388)
- Tire pressure table (→ page 389)
- Tire and Loading Information placard (→ page 393)

Tire pressure monitoring system

Function of the tire pressure monitoring system

⚠ DANGER Risk of accident due to incorrect tire pressure

Every tire, including the spare (if provided), should be checked when cold at least once a month and inflated to the pressure recommended by the vehicle manufacturer (see Tire and Loading Information placard on the B-pillar on the driver's side or the tire pressure label on the inside of the fuel filler flap of your vehicle). If your vehicle has tires of a different size than the size indicated on the Tire and Loading Information placard or the

tire pressure table, you need to determine the proper tire pressure for those tires.

As an added safety feature, your vehicle has been equipped with a tire pressure monitoring system (TPMS) that illuminates a low tire pressure indicator lamp when one or more of your tires are significantly underinflated. Accordingly, if the low tire pressure indicator lamp lights up, you should stop and check your tires as soon as possible, and inflate them to the proper pressure. Driving on a significantly underinflated tire causes the tire to overheat and can lead to tire failure. Underinflation also increases fuel consumption and reduces tire tread life, and may affect the vehicle's handling and braking ability. Please note that the TPMS is not a substitute for proper tire maintenance, and it is the driver's responsibility to maintain correct tire pressure, even if underinflation has not reached the level to trigger illumination of the TPMS low tire pressure indicator lamp.

Your vehicle has also been equipped with a TPMS malfunction indicator to indicate when

the system is not operating properly. The TPMS malfunction indicator is combined with the low tire pressure indicator lamp. When the system detects a malfunction, the indicator lamp will flash for approximately a minute and then remain continuously illuminated. This sequence will continue upon subsequent vehicle start-ups as long as the malfunction exists.

When the malfunction indicator is illuminated, the system may not be able to detect or signal low tire pressure as intended. TPMS malfunctions may occur for a variety of reasons, including the installation of incompatible replacement or alternate tires or wheels on the vehicle that prevent the TPMS from functioning properly.

Always check the TPMS malfunction warning lamp after replacing one or more tires or wheels on your vehicle to ensure that the replacement or alternate tires and wheels allow the TPMS to continue to function properly.

The system checks the tire pressure and the tire temperature of the tires installed on the vehicle by means of a tire pressure sensor.

New tire pressure sensors, e.g. in winter tires, are automatically taught-in during the first journey they are used.

The tire pressure and the tire temperature appear in the multifunction display (→ page 392).

If there is a substantial pressure loss or if the tire temperature is excessive, you will be warned in the following ways:

- via display messages (→ page 458)
- via the  warning lamp in the instrument cluster (→ page 486)

The tire pressure monitoring system is only an aid. It is the driver's responsibility to set the tire pressure to the recommended cold tire pressure suitable for the operating situation. Set the tire pressure for cold tires using a tire pressure gauge. Note that the correct tire pressure for the current operating situation must first be taught-in to the tire pressure monitoring system.

In most cases, the tire pressure monitoring system will automatically update the new reference values after you have changed the tire pressure. You can, however, also update the reference values by restarting the tire pressure monitoring system manually (→ page 393).

System limitations

The system may be impaired or may not function in the following situations:

- If the tire pressure is set incorrectly
- If there is a sudden pressure loss caused, for example, by a foreign object penetrating the tire
- If there is a malfunction caused by another radio signal source

Make sure to observe the following further related subject:

- Notes on tire pressure (→ page 388)

Checking the tire pressure with the tire pressure monitoring system

Requirements:

- The ignition is switched on.

On-board computer:

➔ [Service](#) ➔ [Tires](#)

One of the following displays appears:

- Current tire pressure and tire temperature of the individual wheels:

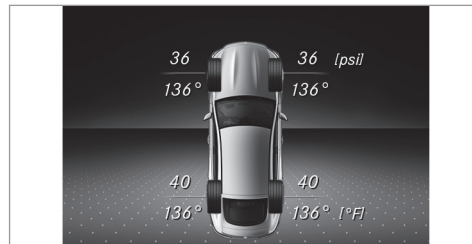

- [Tire pressure will be displayed after driving a few minutes](#)
 - [Tire Pressure Monitor Active](#): the teach-in process of the system is not yet complete. The tire pressures are already being monitored.
- ▶ Compare the tire pressure with the recommended tire pressure for the current operat-

ing condition (→ page 389). Observe the notes on tire temperature (→ page 388).

- ① The values displayed in the multifunction display may deviate from those of the tire pressure gauge as they refer to sea level. At high altitudes, the tire pressure values indicated by a pressure gauge are higher than those shown by the on-board computer. In this case, do not reduce the tire pressure.

Make sure to observe the following further related subject:

- Notes on tire pressure (→ page 388)

Restarting the tire pressure monitoring system

Requirements:

- The recommended tire pressure is correctly set for the respective operating status on each of the four wheels (→ page 388).

Restart the tire pressure monitoring system in the following situations:

- The tire pressure has changed.

- The wheels or tires have been changed or newly installed.

On-board computer:

↪ [Service](#) ▶ [Tires](#)

- ▶ Swipe downwards on the Touch Control on the left-hand side of the steering wheel. The [Use Current Pressures as New Reference Values?](#) message is shown in the multifunction display.
- ▶ To begin restart, press the Touch Control on the left-hand side of the steering wheel. The [Tire Press. Monitor Restarted](#) message is shown in the multifunction display.
Current warning messages are deleted and the  yellow warning lamp goes out.
After you have been driving for a few minutes, the system checks whether the current tire pressures are within the specified range. The current tire pressures are then accepted as reference values and monitored.

Make sure to observe the following further related subject:

- Notes on tire pressure (→ page 388)

Radio equipment approval of the tire pressure monitoring system

Radio equipment approval numbers

Country	Radio type approval number
Canada	IC: 2546A-AG5SP4
USA	FCC ID: MRXAG5SP4 FCC ID: MRXMFR

Further information on the declaration of conformity for wireless vehicle components (→ page 24).

Loading the vehicle

Notes on Tire and Loading Information placard

⚠ WARNING Risk of accident from overloaded tires

Overloaded tires may overheat and burst as a consequence. Overloaded tires can also

impair the steering and handling characteristics and lead to brake failure.

- ▶ Observe the load-bearing capacity of the tires.
- ▶ The load-bearing capacity must be at least half the gross axle weight rating of the vehicle.
- ▶ Never overload the tires by exceeding the maximum load.

The Tire and Loading Information placard is on the B-pillar on the driver's side of the vehicle.

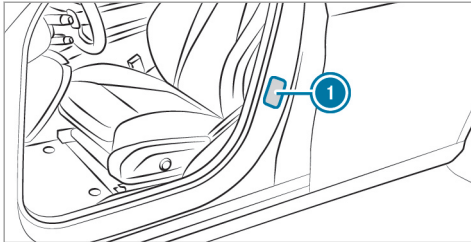

① Tire and Loading Information placard

TIRE AND LOADING INFORMATION RENSEIGNEMENTS POUR LES PNEUS ET LE CHARGEMENT				
SEATING CAPACITY NOMBRE DE PLACES	TOTAL 7	FRONT AVANT 2	MIDDLE MI EU 3	REAR ARRIÈRE 2
The combined weight of occupants and cargo should never exceed Le poids total des occupants et du chargement ne doit jamais dépasser		XXX kg or XXX lbs.* kg ou lb.*		
TIRE PNEU	SIZE DIMENSIONS	COLD TIRE PRESSURE PRESSION DES PNEUS À FROID		SEE OWNER'S MANUAL FOR ADDITIONAL INFORMATION VOIR LE MANUEL DE L'USAGER POUR PLUS DE RENSEIGNEMENTS
FRONT AVANT	255/40 ZR18 99Y XL	200 KPA, 29 PSI		
REAR ARRIÈRE	285/35 ZR18 101Y XL	200 KPA, 29 PSI		
SPARE DE SECOURS	175/55-18 95P	420 KPA, 60 PSI		

① The data shown in the illustration is example data.

The Tire and Loading Information placard shows:

- Maximum number of seats ② according to the maximum number of people permitted to travel in the vehicle.
- Maximum permissible load ③ comprises the gross weight of all vehicle occupants, load and luggage.

- Recommended tire pressures ① for cold tires. The recommended tire pressures are valid for the maximum permissible load and up to the maximum permissible vehicle speed.

Please also note:

- Information on permissible weights and loads on the vehicle identification plate (→ page 418).
- Information on tire pressure in the tire pressure table (→ page 389).

Further related subjects:

- Determining the maximum permissible load (→ page 394)
- Notes on tire pressure (→ page 388).

Determining the maximum permissible load

The following steps have been developed as required of all manufacturers under Title 49, Code of U.S. Federal Regulations, Part 575, pursuant to the "National Traffic and Motor Vehicle Safety Act of 1966".

- ▶ **Step 1:** locate the statement "The combined weight of occupants and load should never exceed XXX kg or XXX lbs." ("The combined weight of occupants and load should never exceed XXX kg or XXX lbs.") on your vehicle's Tire and Loading Information placard.
- ▶ **Step 2:** determine the combined weight of the driver and passengers that will be traveling in your vehicle.
- ▶ **Step 3:** subtract the combined weight of the driver and passengers from XXX kg or XXX lbs.
- ▶ **Step 4:** the resulting figure equals the permissible cargo and luggage load capacity. For example: If "XXX" equals 1400 lbs and there are five occupants in your vehicle with a weight of 150 lbs each, the maximum cargo and luggage load capacity is 650 lbs (1400 - 750 (5 x 150) = 650 lbs).
- ▶ **Step 5:** determine the combined weight of luggage and load that the vehicle will be car-

rying. For safety reasons, this weight may not safely exceed the available cargo and luggage load capacity calculated in step 4.

Even if you have calculated the total load carefully, you should still make sure that the maximum permissible gross mass and the maximum permissible axle load of your vehicle are not exceeded. Details can be found on the vehicle identification plate.

- ▶ Have your loaded vehicle – including driver, occupants and load – weighed on a vehicle weighbridge. The measured values may not exceed the maximum permissible values stated on the vehicle identification plate.

Further related subjects:

- Calculation example for determining the maximum load (→ page 395)
- Tire and Loading Information placard (→ page 393)

- Tire pressure table (→ page 389)
- Vehicle identification plate

Calculation example for determining the maximum load

The following table shows examples of how to calculate total and load capacities with varying seating configurations and different numbers and sizes of occupants. The following examples use a maximum load of 1500 lbs (680 kg). **This is for illustration purposes only.** Make sure you are using the actual load limit for your vehicle stated on your vehicle's Tire and Loading Information placard (→ page 393).

The higher the weight of all the occupants, the smaller the maximum load for luggage.

Step 1

	Example 1	Example 2
Combined maximum weight of occupants and load (data from the Tire and Loading Information placard)	1500 lbs (680 kg)	1500 lbs (680 kg)

Step 2

	Example 1	Example 2
Number of people in the vehicle (driver and occupants)	5	1
Distribution of the occupants	Front: 2 Rear: 3	Front: 1
Weight of occupants	Occupant 1: 150 lbs (68 kg) Occupant 2: 180 lbs (82 kg) Occupant 3: 160 lbs (73 kg) Occupant 4: 140 lbs (63 kg) Occupant 5: 120 lbs (54 kg)	Occupant 1: 200 lbs (91 kg)
Total weight of all occupants	750 lbs (340 kg)	200 lbs (91 kg)

Step 3

	Example 1	Example 2
Permissible load (maximum gross vehicle weight rating from the Tire and Loading Information placard minus the gross weight of all occupants)	1500 lbs (680 kg) - 750 lbs (340 kg) = 750 lbs (340 kg)	1500 lbs (680 kg) - 200 lbs (91 kg) = 1300 lbs (589 kg)

Tire labeling

Overview of tire labeling

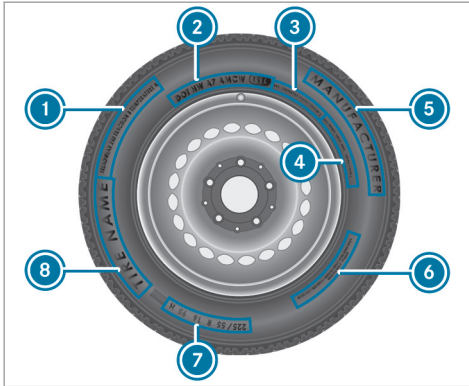

- ① Uniform Tire Quality Grading Standard (→ page 398)
- ② DOT, Tire Identification Number (→ page 399)
- ③ Maximum tire load (→ page 400)
- ④ Maximum tire pressure (→ page 400)

- ⑤ Manufacturer
- ⑥ Characteristics of the tire (→ page 401)
- ⑦ Tire size designation, load-bearing capacity, speed rating and load index (→ page 401)
- ⑧ Tire name
- ⓘ The data shown in the image is example data.

Tire Quality Grading

In accordance with the US Department of Transportation's "Uniform Tire Quality Grading Standards", tire manufacturers are required to grade their tires on the basis of the following three performance factors:

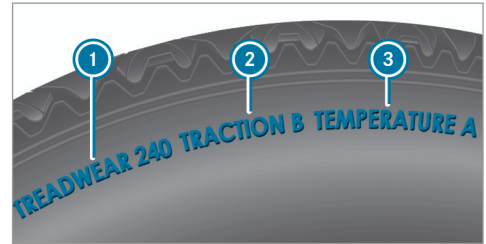

- ① Tread wear grade
- ② Traction grade
- ③ Temperature grade
- ⓘ The data shown in the image is example data.
- ⓘ The classification is not legally stipulated for Canada, but it is generally stated.

Tread wear grade

The tread wear grade is a comparative rating based on the wear rate of the tire when tested under controlled conditions on a specified test track of the US Department of Transportation. For example, a tire graded 150 would wear one

and one-half times as well on the government test track as a tire graded 100.

The relative performance of tires depends upon the actual conditions of their use, however, and may depart significantly from the norm due to variations in driving habits, service practices and differences in road characteristics and climate conditions.

Traction grade

⚠ DANGER Risk of accident due to inadequate traction

The traction grade assigned to this tire is based on straight-ahead braking traction tests, and does not include either acceleration, cornering, hydroplaning or peak traction characteristics.

- ▶ Always adapt your driving style and drive at a speed to suit the prevailing traffic and weather conditions.

! NOTE Damage to the drivetrain from wheelspin

- ▶ Avoid wheelspin.

The traction grades – from highest to lowest – are AA, A, B and C. Those grades represent the tire's ability to stop on wet pavement as measured under controlled conditions on specified government test surfaces made of asphalt and concrete.

Temperature grade

⚠ WARNING Risk of accident from tire overheating and tire failure

The temperature grade for this tire is established for a tire that is properly inflated and not overloaded. Excessive speed, underinflation, or excessive loading, either separately or in combination, can cause excessive heat build-up and possible tire failure.

- ▶ Observe the recommended tire pressures and regularly check the tire pres-

sure of all tires including the spare wheel.

- ▶ Adjust the tire pressure as necessary.

The temperature grades are A (the highest), B and C. They represent the tire's resistance to the generation of heat and its ability to dissipate heat when tested under controlled conditions on a specified indoor laboratory test wheel. Sustained high temperature can cause the material of the tire to degenerate and reduce tire life, and excessive temperature can lead to sudden tire failure. Grade C corresponds to a level of performance which all passenger car tires must meet under the requirements of the US Department of Transportation.

DOT, Tire Identification Number (TIN)

US tire regulations stipulate that every tire manufacturer or retreader must imprint a TIN in or on the side wall of each tire produced.

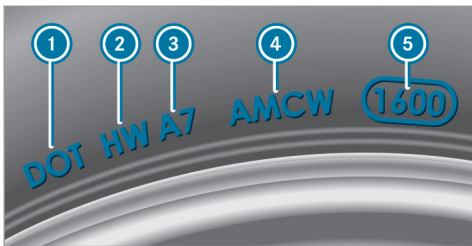

i The data shown in the image is example data.

The TIN is a unique identification number to identify tires and comprises the following:

- **DOT (Department of Transportation):** tire symbol marks **1** indicating that the tire complies with the requirements of the US Department of Transportation.
- **Manufacturer identification code:** manufacturer identification code **2** contains details of the tire manufacturer. New tires have a code with two symbols. Retreaded tires have a code with four symbols. Further information on retreaded tires (→ page 406).

- **Tire size:** identifier **3** describes the tire size.
- **Tire type code:** tire type code **4** can be used by the manufacturer as a code to describe specific characteristics of the tire.
- **Manufacturing date:** manufacturing date **5** provides information about the age of a tire. The 1st and 2nd positions represent the calendar week and the 3rd and 4th positions state the year of manufacture (e.g. "3208" represents the 32nd week of 2008).

Information on the maximum tire load



i The data shown in the image is example data.

Maximum tire load **1** is the maximum permissible weight for which the tire is approved.

Do not overload the tires by exceeding the specified load limit. The maximum permissible load can be found on the vehicle's Tire and Loading Information placard on the B-pillar on the driver's side (→ page 393).

Specifications for maximum tire pressure

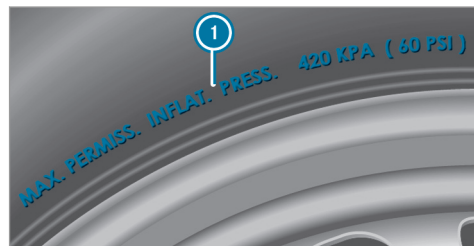

i The data shown in the image is example data.

Never exceed maximum tire pressure ❶ specified for the tire.

Information on tire characteristics

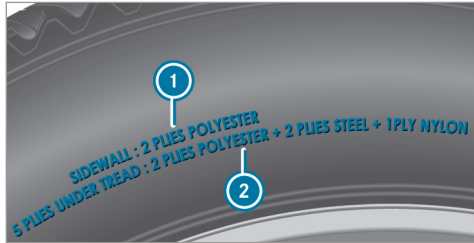

❶ The data shown in the image is example data.

This information describes the type of tire cord and the number of layers in side wall ❶ and under tire tread ❷.

Tire size designation, load-bearing capacity, speed rating and load index

⚠ WARNING Risk of injury through exceeding the specified tire load rating or the permissible speed rating

Exceeding the specified tire load rating or the permissible speed rating may lead to tire damage and to the tires bursting.

- ▶ Therefore, only use tire types and sizes approved for your vehicle model.
- ▶ Observe the tire load rating and speed rating required for your vehicle.

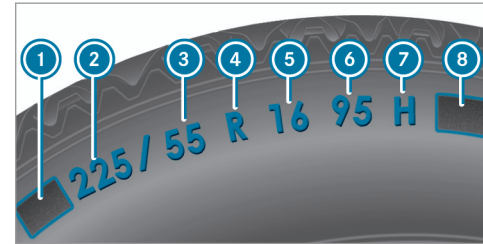

- ❶ Preceding letter
- ❷ Nominal tire width in millimeters
- ❸ Aspect ratio in %
- ❹ Tire code
- ❺ Rim diameter
- ❻ Load-bearing index
- ❼ Speed rating
- ❽ Load index

❶ The data shown in the image is example data.

Information about reading tire data can be obtained from any qualified specialist workshop.

Preceding letter ①:

- Without: passenger vehicle tires according to European manufacturing standards.
- "P": passenger vehicle tires according to US manufacturing standards.
- "LT": light truck tires according to US manufacturing standards.
- "T": compact emergency spare wheels with high tire pressure that are only designed for temporary use in an emergency.

Aspect ratio ③:

Ratio between tire height and tire width in percent (tire height divided by tire width).

Tire code ④ (tire type):

- "R" radial tire
- "D": bias ply tire
- "B": bias belted tires
- "ZR": radial tire with a maximum speed above 149 mph (240 km/h) (optional)

Rim diameter ⑤:

The diameter of the bead seat (not the diameter of the rim flange). The rim diameter is specified in inches (in).

Load-bearing index ⑥:

Numerical code that specifies the maximum load-bearing capacity of a tire (e.g. "91" corresponds to 1356 lbs (615 kg)).

The load-bearing capacity of the tire must be at least half the permissible axle load of your vehicle. Do not overload the tires by exceeding the specified load limit.

See also:

- Maximum permissible load on the Tire and Loading Information placard (→ page 393)
- Maximum tire load (→ page 400)
- Load index

Speed rating ⑦:

Specifies the approved maximum speed of the tire.

- ① An electronic speed limiter prevents your vehicle from exceeding a speed of 130 mph (210 km/h).

Make sure that your tires have the required speed rating. You can obtain information on the required speed rating from an authorized Mercedes-Benz Center.

Summer tires

Index	Speed rating
Q	up to 100 mph (160 km/h)
R	up to 106 mph (170 km/h)
S	up to 112 mph (180 km/h)
T	up to 118 mph (190 km/h)
H	up to 130 mph (210 km/h)
V	up to 149 mph (240 km/h)
W	up to 168 mph (270 km/h)
Y	up to 186 mph (300 km/h)

Index	Speed rating
ZR...Y ¹	up to 186 mph (300 km/h)
ZR...(..Y) ¹	over 186 mph (300 km/h)
ZR ¹	over 149 mph (240 km/h)

- Specifying the speed rating as the "ZR" index in tire code ④ is optional for tires up to 186 mph (300 km/h).
- If your tire code ④ includes "ZR" and there is no speed rating ⑦, find out what the maximum speed is from the tire manufacturer.
- If load-bearing index ⑥ and speed rating ⑦ are in brackets, the maximum speed rating of your tire is above 186 mph (300 km/h). To find out the maximum speed, ask the tire manufacturer.

All-weather tires and winter tires

Index	Speed rating
Q M+S ²	up to 100 mph (160 km/h)
T M+S ²	up to 118 mph (190 km/h)
H M+S ²	up to 130 mph (210 km/h)
V M+S ²	up to 149 mph (240 km/h)

Winter tires bear the  snowflake symbol and fulfill the requirements of the Rubber Manufacturers Association (RMA) and the Rubber Association of Canada (RAC) regarding the tire traction on snow.

Load index ⑧:

- No specification given: standard load (SL) tire
- "XL" or "Extra Load": extra load tire or reinforced tire
- "Light Load": light load tire

- "C", "D", "E": a load range that depends on the maximum load that the tire can carry at a certain pressure

Definition of terms for tires and loading

Tire structure and characteristics: describes the number of layers or the number of rubber-coated belts in the tire contact surface and the tire wall. These are made of steel, nylon, polyester and other materials.

Bar: metric unit for tire pressure. 14.5038 pounds per square inch (psi) and 100 kilopascal (kPa) is the equivalent of one bar.

DOT (Department of Transportation): DOT-marked tires fulfill the requirements of the US Department of Transportation.

Average weight of the vehicle occupants: the number of vehicle occupants for which the vehicle is designed, multiplied by 150 lb (68 kg).

¹ "ZR" stated in the tire code.

² Or "M+S  " for winter tires

Uniform Tire Quality Grading Standards: a uniform standard to grade the quality of tires with regard to tread quality, tire traction and temperature characteristics. The quality grading assessment is made by the manufacturer following specifications from the U.S. government. The quality grade of a tire is imprinted on the side wall of the tire.

Recommended tire pressure: the recommended tire pressure is the tire pressure specified for the tires mounted to the vehicle at the factory.

The tire and information table contains the recommended tire pressures for cold tires, the maximum permissible load and the maximum permissible vehicle speed.

The tire pressure table contains the recommended tire pressures for cold tires under various operating conditions, i.e. loading and/or speed of the vehicle.

Increased vehicle weight due to optional equipment: the combined weight of all standard and optional equipment available for the vehicle,

regardless of whether it is actually installed on the vehicle or not.

Rim: the part of the wheel on which the tire is installed.

GAWR (Gross Axle Weight Rating): the GAWR is the maximum permissible axle load. The actual load on an axle must never exceed the gross axle weight rating. The gross axle weight rating can be found on the vehicle identification plate on the B-pillar on the driver's side.

Speed rating: the speed rating is part of the tire identification. It specifies the speed range for which a tire is approved.

GVW (Gross Vehicle Weight): the gross vehicle weight comprises the weight of the vehicle including fuel, tools, the spare wheel, accessories installed, occupants, luggage and the trailer drawbar noseweight, if applicable. The gross vehicle weight must not exceed the gross vehicle weight rating GVWR as specified on the vehicle identification plate on the B-pillar on the driver's side.

GVWR (Gross Vehicle Weight Rating): the GVWR is the maximum permitted gross weight

of the fully laden vehicle (weight of the vehicle including all accessories, occupants, fuel, luggage and the trailer drawbar noseweight if applicable). The gross vehicle weight rating is specified on the vehicle identification plate on the B-pillar on the driver's side.

Maximum weight of the laden vehicle: the maximum weight is the sum of the curb weight of the vehicle, the weight of the accessories, the maximum load and the weight of optional equipment installed at the factory.

Kilopascal (kPa): metric unit for tire pressure. 6.9 kPa corresponds to 1 psi. Another unit for tire pressure is bar. 100 kilopascal (kPa) equals 1 bar.

Load index: in addition to the load-bearing index, the load index may also be imprinted on the side wall of the tire. This specifies the load-bearing capacity of the tire more precisely.

Curb weight: the weight of a vehicle with standard equipment including the maximum capacity of fuel, oil and coolant. It also includes the air conditioning system and optional equipment if

these are installed on the vehicle, but does not include passengers or luggage.

Maximum tire load: the maximum tire load is the maximum permissible weight in kilograms or lbs for which a tire is approved.

Maximum permissible tire pressure: maximum permissible tire pressure for one tire.

Maximum load on one tire: maximum load on one tire. This is calculated by dividing the maximum axle load of one axle by two.

PSI (pounds per square inch): standard unit of measurement for tire pressure.

Aspect ratio: ratio between tire height and tire width in percent.

Tire pressure: pressure inside the tire applying an outward force to every square inch of the tire. The tire pressure is specified in pounds per square inch (psi), in kilopascals (kPa) or in bar. The tire pressure should only be corrected when the tires are cold.

Cold tire pressure: the tires are cold when the vehicle has been parked for at least 3 hours

without direct sunlight on the tires or the vehicle has been driven for less than 1 mile (1.6 km).

Tire contact surface: the part of the tire that comes into contact with the road.

Tire bead: the purpose of the tire bead is to ensure that the tire sits securely on the wheel rim. There are several wire cores in the tire bead to prevent the tire from changing length on the wheel rim.

Side wall: the part of the tire between the tread and the tire bead.

Weight of optional equipment: the combined weight of the optional equipment weighing more than the replaced standard parts and more than 5 lbs (2.3 kg). This optional equipment, such as high-performance brakes, level control system, a roof luggage rack or high-performance batteries, is not included in the curb weight and the weight of the accessories.

TIN (Tire Identification Number): a unique identification number which can be used by a tire manufacturer to identify tires, for example, in a product recall, and thus identify the purchasers. The TIN is made up of the manufactur-

er's identity code, tire size, tire type code and the manufacturing date.

Load-bearing index: the load-bearing index is a code that contains the maximum load-bearing capacity of a tire.

Traction: traction is the grip resulting from friction between the tires and the road surface.

Wear indicator: narrow bars (tread wear bars) that are distributed over the tire contact surface. If the tire tread is level with the bars, the wear limit of 1/16 in (1.6 mm) has been reached.

Distribution of vehicle occupants: distribution of vehicle occupants over designated seat positions in a vehicle.

Maximum permissible payload weight: nominal load and luggage load plus 150 lb (68 kg) multiplied by the number of seats in the vehicle.

Changing a wheel

Notes on selecting, installing and replacing tires

You can ask for information regarding permitted wheel/tire combinations at an authorized Mercedes-Benz Center.

⚠ WARNING Risk of accident due to incorrect dimensions of wheels and tires

If wheels and tires of the wrong size are installed, the wheel brakes or wheel suspension components may be damaged.

▶ Always replace wheels and tires with those that fulfill the specifications of the original part.

When replacing wheels, make sure to fit the correct:

- Designation
- Model

When replacing tires, make sure to install the correct:

- Designation
- Manufacturer
- Model

⚠ WARNING Risk of injury through exceeding the specified tire load rating or the permissible speed rating

Exceeding the specified tire load rating or the permissible speed rating may lead to tire damage and to the tires bursting.

- ▶ Therefore, only use tire types and sizes approved for your vehicle model.
- ▶ Observe the tire load rating and speed rating required for your vehicle.

! NOTE Vehicle and tire damage through tire types and sizes that have not been approved

For safety reasons, only use tires, wheels and accessories which have been specially approved by Mercedes-Benz for your vehicle.

These tires are specially adapted to the control systems, such as ABS, ESP® and 4MATIC, and marked as follows:

- MO = Mercedes-Benz Original
- MOE = Mercedes-Benz Original Extended (run-flat tire only for certain wheels)
- MO1 = Mercedes-Benz Original (only certain AMG tires)

Certain characteristics, such as handling, vehicle noise emissions, fuel consumption, etc. may otherwise be adversely affected. Furthermore, other tire sizes could result in the tires rubbing against the body and axle components when loaded. This could result in damage to the tire or the vehicle.

Only use tires, wheels and accessories that have been checked and recommended by Mercedes-Benz.

! **NOTE** Risk to driving safety from retreaded tires

Retreaded tires are neither tested nor recommended by Mercedes-Benz, since previous damage cannot always be detected on retreaded tires.

For this reason driving safety cannot be guaranteed.

- ▶ Do not use used tires if you have no information about their previous usage.

! **NOTE** Possible damage to wheels or tires when driving over obstacles

Large wheels have a lower tire section width. The lower the tire section width, the greater is the risk of damage to wheels or tires when driving over obstacles.

- ▶ Avoid obstacles or drive particularly carefully.

! **NOTE** Damage to electronic component parts from the use of tire-mounting tools

Vehicles with a tire pressure monitoring system: Electronic component parts are located in the wheel. Tire-mounting tools should not be used in the area of the valve.

This could otherwise damage the electronic component parts.

- ▶ Have the tires changed at a qualified specialist workshop only.

! **NOTE** Damage to summer tires at low ambient temperatures

At low ambient temperatures, tears could form when driving with summer tires, causing permanent damage to the tires.

- ▶ At temperatures below 45 °F (7 °C), use M+S tires .

Accessory parts that are not approved for your vehicle by Mercedes-Benz or are not being used correctly can impair the operating safety.

Before purchasing and using non-approved accessories, visit a qualified specialist workshop and inquire about:

- Suitability
- Legal stipulations
- Factory recommendations

! **WARNING** Risk of accident with high performance tires

The special tire tread in combination with the optimized tire compound means that the risk of skidding or hydroplaning on wet roads is increased.

In addition, the tire grip is greatly reduced at a low outside temperature and tire running temperature.

- ▶ Switch on the ESP® and adapt your driving style accordingly.
- ▶ Use M+S tire at outside temperatures of less than 10 °C (50 °F).

Observe the following when selecting, installing and replacing tires:

- Only use tires and wheels of the same type (summer tires, winter tires, MOExtended tires) and the same make.
- Only install wheels of the same size on one axle (left and right).
It is only permissible to install a different wheel size in the event of a flat tire in order to drive to the specialist workshop.
- Only install tires of the correct size onto the wheels.
- **Vehicles with a tire pressure monitoring system:** All installed wheels must be equipped with functioning sensors for the tire pressure monitoring system.
- At temperatures below 45 °F (7 °C), use winter tires or all-season tires marked M+S for all wheels.

Winter tires bearing the  snowflake symbol in addition to the M+S marking provide the best possible grip in wintry road conditions.

- For M+S tires, only use tires with the same tread.
- Observe the maximum permissible speed for the M+S tires installed.
If this is below the vehicle's maximum speed, this must be indicated by an appropriate label in the driver's field of vision.
- Break in new tires at moderate speeds for the first 60 miles (100 km).
- Replace the tires after six years at the latest, regardless of wear.
- **When replacing with tires that do not feature run-flat characteristics:** vehicles with MOExtended tires are not equipped with a TIREFIT kit at the factory. Equip the vehicle with a TIREFIT kit after replacing with tires that do not feature run-flat characteristics, e.g. winter tires.

For more information on wheels and tires, contact a qualified specialist workshop.

Be sure to also observe the following further related subjects:

- Notes on tire pressure (→ page 388)

- Tire and Loading Information placard (→ page 393)
- Tire size designation, load-bearing capacity, speed rating and load index (→ page 401)
- Tire pressure table (→ page 389)

⚠ WARNING Risk of accident caused by non-approved tire types

If you use tire types that have not been adapted to changes made to the factory speed limit, this can have the following consequences:

- The tires do not exhibit the required quality characteristics and are not suitable for high speeds or the relevant driving dynamics.
- The tires wear unevenly and could, therefore, affect the roadworthiness of the vehicle.
- ABS, ESP® and cruise control operation are restricted.

This can jeopardize road safety.

- ▶ Only use tire types that have been approved for the maximum road speed set and the vehicle.

Notes on rotating wheels

⚠ WARNING Risk of injury through different wheel sizes

Interchanging the front and rear wheels if the wheels or tires have different dimensions may severely impair the driving characteristics.

The wheel brakes or wheel suspension components may also be damaged.

- ▶ Rotate front and rear wheels only if the wheels and tires are of the same dimensions.

The wear patterns on the front and rear wheels differ:

- Front wheels wear more on the shoulder of the tire

- Rear wheels wear more in the center of the tire

On vehicles that have the same size front and rear wheels, rotate the wheels according to the intervals in the tire manufacturer's warranty book in your vehicle documents. If this is not available, rotate the tires every 3,000 to 6,000 miles (5,000 to 10,000 km), depending on the wear. Ensure that the direction of rotation is maintained.

It is imperative to observe the instructions and safety notes on "Wheel change" when doing so.

Notes on storing wheels

- After removing wheels, store them in a cool, dry and preferably dark place.
- Protect the tires from contact with oil, grease or fuel.

Overview of the tire-change tool kit

Apart from some country-specific variants, vehicles are not equipped with a tire-change tool kit.

For more information on which tire-change tools are required and approved for performing a wheel change on your vehicle, consult a qualified specialist workshop.

You require the following tools, for instance, to change a wheel:

- Jack
- Chock
- Lug wrench
- Alignment bolt

The tire-change tool kit is located in tool bag **①** in the cargo compartment.

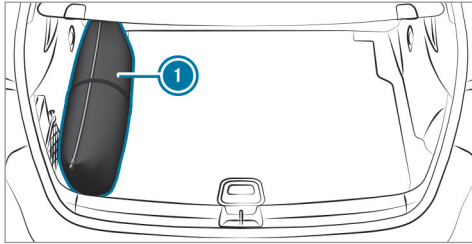

① Tool bag

Tool bag ① contains:

- Jack
- Gloves
- Lug wrench
- Alignment bolt
- Folding chock
- Ratchet for jack

Setting up the folding chock

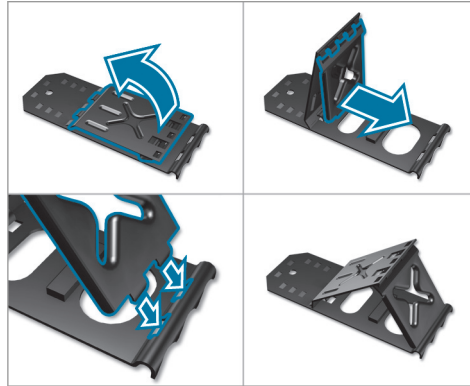

Preparing the vehicle for a wheel change

Requirements:

- The required tire-change tool is available. If your vehicle is not equipped with the tire-change tool kit, consult a qualified specialist workshop to find out about suitable tools.

- The vehicle is not on a slope.
 - The vehicle is on solid, non-slippery and level ground.
- ▶ Apply the electric parking brake manually.
 - ▶ Move the front wheels to the straight-ahead position.
 - ▶ **Vehicles with automatic transmission:** Shift into position **P**.
 - ▶ **Vehicles with level control system:** Set the normal vehicle level .
 - ▶ Switch off the engine.
 - ▶ Make sure that the engine cannot be started.
 - ▶ Place chocks or other suitable items under the front and rear of the wheel that is diagonally opposite the wheel you wish to change.
 - ▶ Remove the hub caps if necessary (→ page 411).
 - ▶ Raise the vehicle (→ page 411).

Removing and installing hub caps

Requirements:

- The vehicle is prepared for a wheel change (→ page 410).

Plastic hub cap

- To remove:** turn the center cover of the hub cap counter-clockwise and remove the hub cap.
- To install:** make sure that the center cover of the hub cap is turned counter-clockwise.
- Position the hub cap and turn the center cover clockwise until the hub cap engages physically and audibly.

Aluminum hub cap

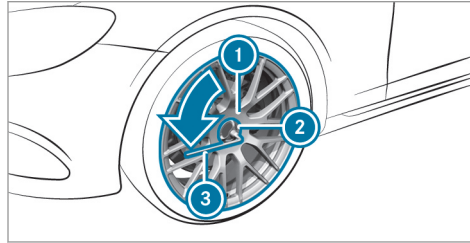

- To remove:** position socket ② on hub cap ①.
- i* The socket can be found in the tire-change tool kit.
- Position wheel wrench ③ on socket ②.
- Using wheel wrench ③, turn hub cap ① counter-clockwise and remove it.
- To install:** position hub cap ① and turn until it is completely flush with the wheel.
- Position socket ② on hub cap ①.

- Attach wheel wrench ③ to socket ② and tighten the hub cap clockwise.
Specified tightening torque: 20 lb-ft (27 Nm).
- Raise the vehicle (→ page 411).

Raising the vehicle when changing a wheel

Requirements:

- There are no persons in the vehicle.
- The vehicle has been prepared for a wheel change (→ page 410).
- The hub caps have been removed (→ page 411).

Important notes on using the jack:

- Only use the vehicle-specific jack that has been tested and approved by Mercedes-Benz to raise the vehicle.
- The jack is only designed for raising and holding the vehicle for a short time while a wheel is being changed and not for maintenance work under the vehicle.

- The jack must be placed on a firm, flat and non-slip surface. If necessary, use a large, flat, load-bearing, non-slip underlay.
- The foot of the jack must be positioned vertically under the jacking point.

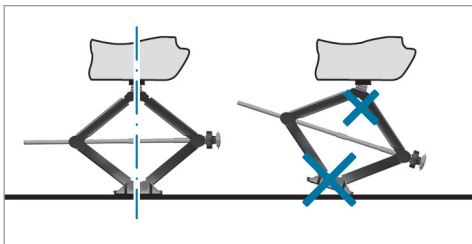

Rules of conduct when the vehicle is raised:

- Never place your hands or feet under the vehicle.
- Do not lie under the vehicle.
- Do not start the engine and do not release the electric parking brake.
- Do not open or close any doors or the tail-gate.

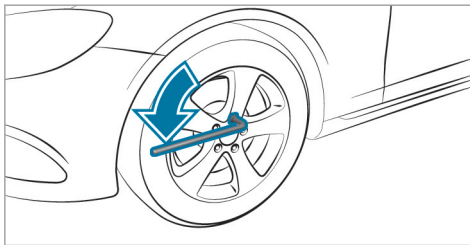

- ▶ Using the lug wrench, loosen the wheel bolts on the wheel you wish to change by about one full turn. Do not unscrew the bolts completely.

Position of jack support points

⚠ WARNING Risk of injury from incorrect positioning of the jack

If you do not position the jack correctly at the appropriate jacking point of the vehicle, the jack could tip with the vehicle raised.

- ▶ Only position the jack at the appropriate jacking point of the vehicle. The base of the jack must be positioned ver-

tically under the jacking point of the vehicle.

! **NOTE** Vehicle damage from the jack

If you do not position the jack correctly at the appropriate jack support point of the vehicle, the jack could tip over with the vehicle raised.

- ▶ The jack is designed exclusively for jacking up the vehicle at the jack support points.

- ▶ Take the ratchet wrench out of the tire-change tool kit and place it on the hexagon nut of the jack so that the letters "AUF" are visible.

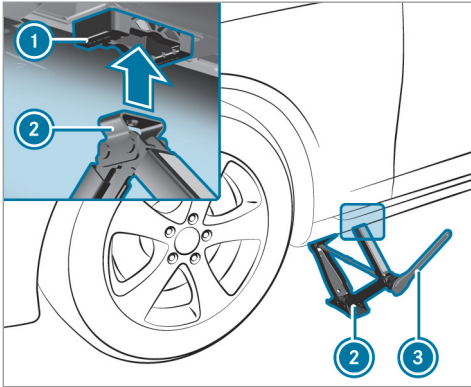

- ▶ Position jack ② at jack support point ①.
- ▶ Turn ratchet wrench ③ clockwise until jack ② sits completely on jack support point ① and the base of the jack lies evenly on the ground.
- ▶ Continue to turn ratchet wrench ③ until the tire is raised a maximum of 1.2 in (3 cm) off the ground.
- ▶ Loosen and remove the wheel (→ page 413).

Removing a wheel

Requirements:

- The vehicle is raised (→ page 411).

Vehicles with AMG ceramic high-performance composite braking system:

- ! **NOTE** Damage to the ceramic brake disk when changing a wheel

Mercedes-AMG vehicles with ceramic brake disks: during removal and repositioning of the wheel, the wheel rim may strike the ceramic brake disk and damage it.

- ▶ Take particular care.
- ▶ Ask another person for assistance or use a second centering pin.

When changing a wheel, avoid applying any force to the brake discs, since this could impair the level of comfort when braking.

- ! **NOTE** Damage to threading from dirt on wheel bolts

- ▶ Do not place wheel bolts in sand or on a dirty surface.

- ▶ Unscrew the uppermost wheel bolt completely.

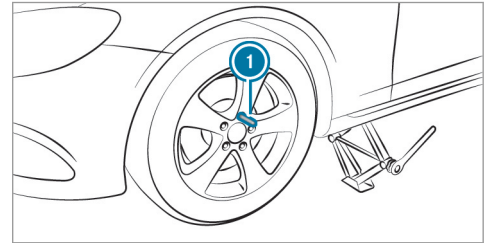

- ▶ Screw alignment bolt ① instead of the wheel bolt into the threading.
- ▶ Unscrew the remaining wheel bolts fully.
- ▶ Remove the wheel.
- ▶ Install the new wheel (→ page 414).

Mounting a new wheel

Requirements:

- The wheel is removed (→ page 413).

⚠ WARNING Risk of accident from losing a wheel

Oiled, greased or damaged wheel bolt/wheel nut threads or wheel hub/wheel mounting bolt threads can cause the wheel bolts/wheel nuts to come loose.

As a result, you could lose a wheel while driving.

- ▶ Never oil or grease the threads.
- ▶ In the event of damage to the threads, contact a qualified specialist workshop immediately.
- ▶ Have the damaged wheel bolts or damaged hub threads replaced.
- ▶ Do not continue driving.

- ▶ Observe the information on the choice of tires (→ page 406).

For tires with a specified direction of rotation, an arrow on the side wall of the tire indicates the correct direction of rotation. Observe the direction of rotation when installing.

⚠ NOTE Damage to the ceramic brake disk when changing a wheel

Mercedes-AMG vehicles with ceramic brake disks: during removal and repositioning of the wheel, the wheel rim may strike the ceramic brake disk and damage it.

- ▶ Take particular care.
- ▶ Ask another person for assistance or use a second centering pin.

- ▶ Slide the wheel to be mounted onto the alignment bolt and push it on.

⚠ WARNING Risk of injury from tightening wheel bolts and nuts

If you tighten the wheel bolts or wheel nuts when the vehicle is raised, the jack could tip.

- ▶ Only tighten wheel bolts or wheel nuts when the vehicle is on the ground.

- ▶ Be sure to observe the instructions and safety notes on "Changing a wheel" (→ page 406).
- ▶ For safety reasons, only use wheel bolts which have been approved by Mercedes-Benz and for the wheel in question.

⚠ NOTE Damage to paintwork of the wheel rim when screwing on the first wheel bolt

If the wheel has too much play when screwing in the first wheel bolt, the wheel rim paint can be damaged.

- ▶ Press the wheel firmly against the wheel hub when screwing on the first wheel bolt.

- ▶ Tighten the wheel bolts evenly in a diagonal pattern in the order indicated until they are finger-tight.
- ▶ Unscrew the alignment bolt.

- ▶ Tighten the last wheel bolt until it is finger-tight.
- ▶ Lower the vehicle (→ page 415).

Lowering the vehicle after a wheel change

Requirements:

- The new wheel has been installed (→ page 414).
- ▶ Place the ratchet wrench onto the hexagon nut of the jack so that the lettering "AB" is visible.
- ▶ **To lower the vehicle:** turn the ratchet wrench of the jack counter-clockwise.

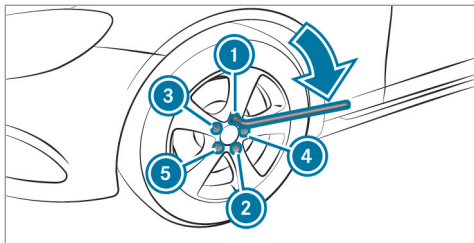

- ▶ Tighten the wheel bolts evenly in a diagonal pattern in the order indicated (1 to 5).
Specified tightening torque: 111 lb-ft (150 Nm).

⚠ WARNING Risk of injury through incorrect tightening torque

The wheels could come loose if the wheel bolts or wheel nuts are not tightened to the prescribed tightening torque.

- ▶ Make sure the wheel bolts or wheel nuts are tightened to the prescribed tightening torque.
- ▶ If you are not sure, do not move the vehicle. Consult a qualified specialist workshop and have the tightening torque checked immediately.

- ▶ Check the tire pressure of the newly mounted wheel and adjust accordingly.
- ▶ **Vehicles with a tire pressure monitoring system:** Restart the tire pressure monitoring system (→ page 393).

Make sure to observe the following further related subject:

- Notes on tire pressure (→ page 388)

Notes on technical data

The data stated only applies to vehicles with standard equipment. You can obtain further information from an authorized Mercedes-Benz Center.

Vehicle electronics

Two-way radios

Notes on installing two-way radios

⚠ WARNING Risk of accident due to improper work on two-way radios

The electromagnetic radiation from two-way radios can interfere with the on-board electronics if RF transmitters are manipulated or retrofitted incorrectly.

This could jeopardize the operating safety of the vehicle.

- ▶ You should have all work on electrical and electronic components carried out at a qualified specialist workshop.

⚠ WARNING Risk of accident from incorrect operation of two-way radios

If you operate two-way radios incorrectly in the vehicle, the electromagnetic radiation could interfere with the on-board electronics, e.g.:

- if the two-way radio is not connected to an exterior antenna
- if the exterior antenna is not correctly mounted or is not of low reflection

This could jeopardize the operating safety of the vehicle.

- ▶ Have the low-reflection exterior antenna installed at a qualified specialist workshop.
- ▶ When operating two-way radios in the vehicle, always connect them to the low-reflection exterior antenna.

! NOTE Invalidation of the operating permit due to failure to comply with the instructions for installation and use

The operating permit may be invalidated if the instructions for installation and use of two-way radios are not observed.

- ▶ Only use approved frequency bands.
- ▶ Observe the maximum permissible output power in these frequency bands.
- ▶ Only use approved antenna positions.

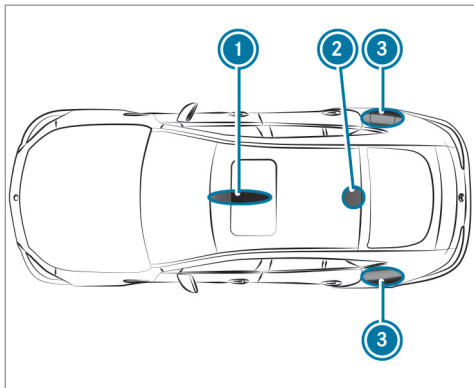

- ① Front roof area
- ② Rear roof area
- ③ Rear fenders

On the rear fenders, it is recommended that you install the antenna on the side of the vehicle closest to the center of the road.

Use Technical Specification ISO/TS 21609 (Road Vehicles - "EMCs for installation of aftermarket

radio frequency transmitting equipment") when retrofitting two-way radios. Comply with the legal requirements for detachable parts.

If your vehicle has installations for two-way radio equipment, use the power supply and antenna connectors provided in the pre-installation. Be sure to observe the manufacturer's supplements when installing.

Two-way radio transmission output

The maximum transmission output (PEAK) at the base of the antenna must not exceed the values in the following table.

Frequency band and maximum transmission output

Frequency band	Maximum transmission output
Short wave 3 - 54 MHz	(100 W)
4 m waveband 74 - 88 MHz	(30 W)

Frequency band	Maximum transmission output
2 m waveband 144 - 174 MHz	(50 W)
trunked radio system/Tetra 380 - 460 MHz	(10 W)
70 cm waveband 420 - 450 MHz	(35 W)
Two-way radio (2G/3G/4G)	(10 W)

The following devices can be used in the vehicle without restrictions:

- two-way radios with a maximum transmission output of up to 100 mW
- two-way radios with transmitter frequencies in the 380 - 410 MHz frequency band and a maximum transmission output of up to 2 W (trunked radio system/Tetra)
- mobile phones (2G/3G/4G)

There are no restrictions when positioning the antenna on the outside of the vehicle for the following wavebands:

- trunked radio system/Tetra
- 70 cm waveband
- 2G/3G/4G

Vehicle identification plate, VIN and engine number

Vehicle identification plate

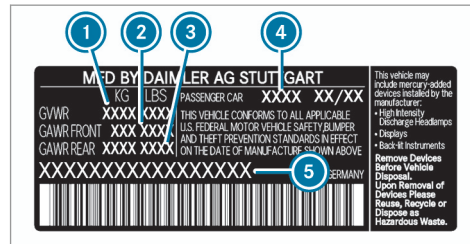
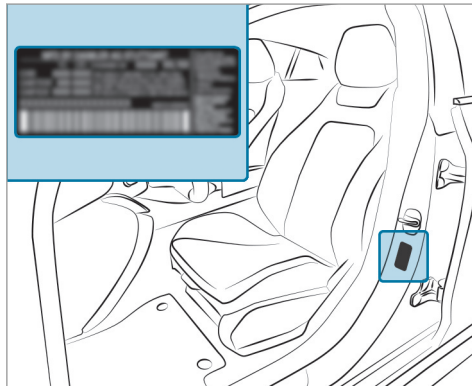

Vehicle identification plate (USA only)

- 1 Permissible gross weight
- 2 Permissible front axle load
- 3 Permissible rear axle load
- 4 Paint code
- 5 VIN (vehicle identification number)

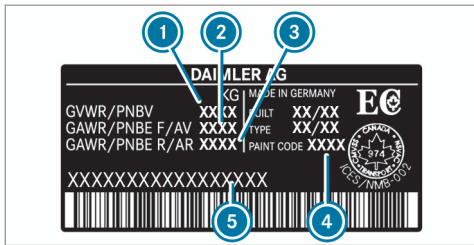

Vehicle identification plate (Canada only)

- ① Permissible gross weight
- ② Permissible front axle load
- ③ Permissible rear axle load
- ④ Paint code
- ⑤ VIN (vehicle identification number)

The permissible gross vehicle weight is made up of the vehicle weight, all vehicle occupants, the fuel and the load. The maximum gross axle weight rating is the maximum weight that can be carried on one axle (front or rear axle).

Never exceed the permissible gross vehicle weight or the maximum gross axle weight rating for the front or rear axle.

VIN in front of the right-hand front seat

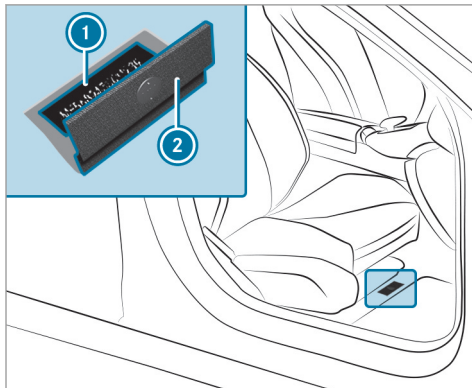

- ① Imprinted VIN (vehicle identification number)
- ② Floor covering

Additional plates

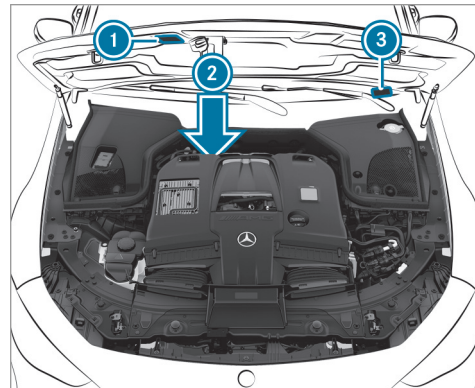

- ① Plate with information about emissions testing, including confirmation of emissions guidelines at the U.S. federal level as well as for California
- ② Imprinted engine number stamped into the crankcase

- ③ VIN (vehicle identification number) as a label at the lower edge of the windshield

Operating fluids

Notes on operating fluids

⚠ WARNING Risk of injury from operating fluids harmful to your health

Operating fluids may be poisonous and harmful to your health.

- ▶ Observe the text on the original containers when using, storing or disposing of operating fluids.
- ▶ Always store operating fluids sealed in their original containers.
- ▶ Always keep children away from operating fluids.



ENVIRONMENTAL NOTE Environmental pollution caused by environmentally irresponsible disposal

- ▶ Dispose of operating fluids in an environmentally responsible manner.

Operating fluids include the following:

- Fuels
- Lubricants
- Coolant
- Brake fluid
- Windshield washer fluid
- Climate control system refrigerant

Only use products approved by Mercedes-Benz. Damage caused by the use of products that have not been approved is not covered by the Mercedes-Benz warranty or goodwill gestures.

You can identify operating fluids approved by Mercedes-Benz by the following inscriptions on the container:

- MB-Freigabe (e.g. MB-Freigabe 229.51)

- MB-Approval (e.g. MB-Approval 229.51)

Further information on approved operating fluids is available at the following locations:

- In the Mercedes-Benz Specifications for Operating Fluids by entering the designation
 - At <http://bevo.mercedes-benz.com>
 - In the Mercedes-Benz BeVo App
- At a qualified specialist workshop

⚠ WARNING Risk of fire or explosion from fuel

Fuels are highly flammable.

- ▶ Fire, open flames, smoking and creating sparks must be avoided.
- ▶ Switch off the ignition and, if it has been in use, switch off the stationary heater before you refuel your vehicle.

⚠ WARNING Risk of injury from fuels

Fuels are poisonous and hazardous to your health.

- ▶ Do not swallow fuel or let it come into contact with skin, eyes or clothing.
- ▶ Do not inhale fuel vapor.
- ▶ Keep children away from fuel.
- ▶ Keep doors and windows closed during the refueling process.

If you or other people come into contact with fuel, observe the following:

- ▶ Immediately rinse fuel off your skin with soap and water.
- ▶ If fuel comes into contact with your eyes, immediately rinse them thoroughly with clean water. Seek medical attention immediately.
- ▶ If you swallow fuel, seek medical attention immediately. Do not induce vomiting.
- ▶ Change immediately out of clothing that has come into contact with fuel.

Fuel

Notes on fuel grade

Observe the notes on operating fluids (→ page 420).

! NOTE Damage caused by the wrong fuel

Even small amounts of the wrong fuel could result in damage to the fuel system, the engine and the emission control system.

- ▶ Only refuel with low-sulfur unleaded fuel.

This fuel may contain up to 10% ethanol by volume. Your vehicle is suitable for use with E10 fuel.

Never refuel with one of the following fuels:

- Diesel
- Gasoline with more than 10% ethanol by volume, e.g. E15, E85, E100
- Gasoline with more than 3% methanol by volume, e.g. M15, M30, M85, M100
- Gasoline with additives containing metal

If you have accidentally refueled with the wrong fuel:

- ▶ Do not switch on the ignition.
- ▶ Consult a qualified specialist workshop.

If the available fuel is not sufficiently low in sulfur, this can produce unpleasant odors.

Only refuel using unleaded premium grade gasoline with at least 91 AKI/95 RON.

As a temporary measure, if the recommended fuel is not available, you may also use unleaded regular gasoline which has at least the octane number specified in the instruction label in the fuel filler flap (→ page 154). This may reduce engine performance and increase fuel consumption.

Never refuel using gasoline with an even lower RON.

! **NOTE** Premature wear caused by unleaded regular gasoline

Unleaded regular gasoline can cause the engine to wear more quickly and impair longevity and performance.

If unleaded premium grade gasoline is unavailable and you have to refuel using unleaded regular gasoline:

- ▶ Only fill the fuel tank to half full with unleaded regular gasoline and refill as soon as possible with unleaded premium grade gasoline.
- ▶ Do not drive at the maximum speed.
- ▶ Avoid sudden acceleration and engine speeds over 3,000 rpm.

Further information on fuel is available at the following locations:

- at a gas station
- at a qualified specialist workshop
- USA only: at <http://www.mbusa.com>

Information on additives in gasoline

Observe the notes on operating fluids (→ page 420).

! **NOTE** Damage from use of unsuitable additives

Even small amounts of the wrong additive may lead to malfunctions occurring.

- ▶ Only add cleaning additives recommended by Mercedes-Benz to the fuel.

Mercedes-Benz recommends that you use fuel brands that have additives.

In some countries, the fuel available may not have sufficient additives. Residue could build up in the fuel injection system as a result. In this case, in consultation with an authorized Mercedes-Benz Center, the fuel may be mixed with the cleaning additive recommended by Mercedes-Benz. Be sure to observe the notes and mixing ratios specified on the container.

Tank content and fuel reserve

Capacity

Model	Total capacity
All models	21.1 gal (80.0 liters)
Model	Of which reserve
All models	3.1 gal (12.0 liters)

Engine oil

Notes on engine oil

Observe the notes on operating fluids (→ page 420).



! **NOTE** Engine damage caused by an incorrect oil filter, incorrect oil or additives

- ▶ Do not use engine oils or oil filters other than those which meet the specifications necessary for the prescribed service intervals.
- ▶ Do not alter the engine oil or oil filter in order to achieve longer change intervals than prescribed.
- ▶ Do not use additives.
- ▶ Have the engine oil changed after the prescribed intervals.

Mercedes-Benz recommends that you have the oil change carried out at a qualified specialist workshop.

Further information on engine oil and oil filters is available at the following locations:

- In the Mercedes-Benz Specifications for Operating Fluids by entering the designation:
 - At <http://bevo.mercedes-benz.com>
 - In the Mercedes-Benz BeVo app

- at a qualified specialist workshop

Quality and capacity of engine oil

MB-Freigabe or MB-Approval

Model	MB-Freigabe or MB-Approval
Mercedes-AMG GT 53 4MATIC+	229.51, 229.52, 229.61, 229.71
All other models	229.5, 229.51

Mercedes-AMG GT 63 4MATIC+, GT 63 S

4MATIC+: only use engine oils of viscosity class SAE 0W-40 or SAE 5W-40.

The following values refer to an oil change, including the oil filter.

Capacity

Model	Capacity
Mercedes-AMG GT 53 4MATIC+	9.0 US qt (8.5 liters)
All other models	9.5 US qt (9.0 liters)

Notes on brake fluid

Observe the notes on operating fluids (→ page 420).

! **WARNING** Risk of an accident due to vapor pockets forming in the brake system

The brake fluid constantly absorbs moisture from the air. This lowers the boiling point of the brake fluid. If the boiling point is too low, vapor pockets may form in the brake system when the brakes are applied hard.

This causes the braking effect to be impaired.

- ▶ Have the brake fluid renewed at the specified intervals.

Have the brake fluid regularly replaced at a qualified specialist workshop.

Only use brake fluid approved by Mercedes-Benz according to MB-Freigabe or MB-Approval 331.0.

You can obtain further information on brake fluid in the following places:

- in the Mercedes-Benz Specifications for Operating Fluids
 - at <http://bevo.mercedes-benz.com>
 - in the Mercedes-Benz BeVo App
- at a qualified specialist workshop

Coolant

Notes on coolant

Observe the notes on operating fluids (→ page 420).

⚠ WARNING - Risk of fire and injury from antifreeze

If antifreeze comes into contact with hot component parts in the engine compartment, it may ignite.

- ▶ Allow the engine to cool down before adding antifreeze.
- ▶ Make sure that no antifreeze spills out next to the filler opening.

▶ Thoroughly clean off any antifreeze from component parts before starting the vehicle.

! NOTE Damage caused by incorrect coolant

▶ Only add coolant that has been pre-mixed with the required antifreeze protection.

Information on coolant is available at the following locations:

- In the Mercedes-Benz Specification for Operating Fluids 310.1
 - At <http://bevo.mercedes-benz.com>
 - In the Mercedes-Benz BeVo app
- At a qualified specialist workshop

! NOTE Overheating at high outside temperatures

If an inappropriate coolant is used, the engine cooling system is not sufficiently pro-

ected against overheating and corrosion at high outside temperatures.

- ▶ Always use coolant approved by Mercedes-Benz.
- ▶ Observe the instructions in the Mercedes-Benz Specifications for Operating Fluids 310.1.

Have the coolant regularly replaced at a qualified specialist workshop.

The proportion of corrosion inhibitor/antifreeze concentrate in the engine cooling system should be:

- A minimum of 50% (antifreeze protection down to approximately -35 °F (-37 °C))
- A maximum of 55% (antifreeze protection down to -49 °F (-45 °C))

Coolant capacity

Capacity

Model	Capacity
Mercedes-AMG GT 53 4MATIC+	14.8 US qt (14.0 liters)
All other models	16.2 US qt (15.3 liters)

Notes on windshield washer fluid

Observe the notes on operating fluids (→ page 420).

⚠ WARNING - Risk of fire and injury from windshield washer concentrate

Windshield washer concentrate is highly flammable. It could ignite if it comes into contact with hot engine component parts or the exhaust system.

▶ Make sure that no windshield washer concentrate spills out next to the filler opening.

! **NOTE** Damage to the exterior lighting due to unsuitable windshield washer fluid

Unsuitable windshield washer fluid may damage the plastic surface of the exterior lighting.

▶ Only use windshield washer fluid which is also suitable for use on plastic surfaces, e.g. MB SummerFit or MB WinterFit.

! **NOTE** Blocked spray nozzles caused by mixing windshield washer fluids

▶ Do not mix MB SummerFit and MB WinterFit with other windshield washer fluids.

Do not use distilled or de-ionized water as the fill level sensor may be triggered erroneously.

Recommended windshield washer fluid:

- Above freezing point: e.g. MB SummerFit
- Below freezing point: e.g. MB WinterFit

For the correct mixing ratio, refer to the information on the antifreeze container.

Mix the washer fluid with the windshield washer fluid all year round.

Refrigerant

Notes on refrigerants

Observe the notes on operating fluids (→ page 420).

! **NOTE** Damage due to incorrect refrigerant

If a non-approved refrigerant is used, the climate control system may be damaged.

▶ Only use the refrigerant R-134a

! **NOTE** Damage to the climate control system due to incorrect refrigerant compressor oil

▶ Only use refrigerant compressor oil that has been approved by Mercedes-Benz.

- ▶ Do not mix the approved refrigerant compressor oil with a different refrigerant compressor oil.

Work on the climate control system may only be carried out by a qualified specialist workshop. All applicable regulations, as well as SAE standard J639, must be adhered to.

The instruction label on the climate control system for the refrigerant type and the refrigerant compressor oil is located on the inside of the hood.

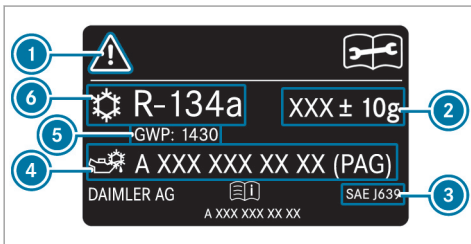

- ① Symbols for hazard and service information
② Refrigerant filling capacity

- ③ Applicable standards
④ PAG oil part number
⑤ GWP (Global Warming Potential) of the refrigerant used
⑥ Refrigerant type

Symbols ① advise you about the following:

- Possible dangers
- Having service work carried out at a qualified specialist workshop only

Refrigerant filling capacity

Filling capacity for refrigerant and PAG oil

Model	Refrigerant
All models	22.2 ± 0.4 oz (630 ± 10 g)
Model	PAG oil
Mercedes-AMG GT 53 4MATIC+	4.2 ± 0.4 oz (120 ± 10 g)
All other models	2.8 ± 0.4 oz (80 ± 10 g)

Vehicle data

Vehicle dimensions

The heights specified may vary as a result of the following factors:

- Tires
- Load
- Condition of the suspension
- Optional equipment

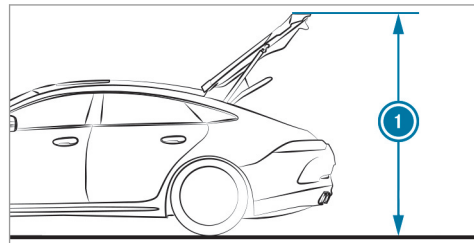

Height when opened

Model	 Height when opened
Mercedes-AMG GT 53 4MATIC+	77.0 in (1956 mm)
Mercedes-AMG GT 63 4MATIC+	76.3 in (1939 mm)
Mercedes-AMG GT 63 S 4MATIC+	76.5 in (1943 mm)

Vehicle dimensions

All models	
Vehicle width including outside mirrors	81.5 in (2069 mm)
Wheelbase	116.2 in (2951 mm)
Turning radius	41.3 ft (12.60 m)

Model	Vehicle length
Mercedes-AMG GT 53 4MATIC+	199.2 in (5059 mm)
Mercedes-AMG GT 63 4MATIC+	199.2 in (5060 mm)
Mercedes-AMG GT 63 S 4MATIC+	199.2 in (5060 mm)
Model	Vehicle height
Mercedes-AMG GT 53 4MATIC+	57.3 in (1455 mm)
Mercedes-AMG GT 63 4MATIC+	56.8 in (1442 mm)
Mercedes-AMG GT 63 S 4MATIC+	57.0 in (1447 mm)

Weights and loads

Note that items of optional equipment increase the curb weight and reduce the payload.

Roof load

All models	
Maximum roof load	220 lb (100 kg)

Display messages

Introduction

Notes on display messages

Display messages appear on the multifunction display.

Display messages with graphic symbols are simplified in the Operator's Manual and may differ from the symbols on the multifunction display. The multifunction display shows high-priority display messages in red. Certain display messages are accompanied by a warning tone.



Please respond in accordance with the display messages and follow the additional notes in this Operator's Manual.

For some display messages, a symbol is also shown:

-  Further information

-  Hide display message

You can select the desired symbol by swiping left or right on the left-hand Touch Control.

Press the  symbol to show further information on the multifunction display. Press the  symbol to hide the display message.

You can hide low-priority display messages by pressing the  button or the left-hand Touch Control. The display messages are then stored in the message memory.

Rectify the cause of a display message as quickly as possible.

High-priority display messages cannot be hidden. The multifunction display shows these display messages continuously until the cause of the message has been rectified.

Calling up stored display messages

On-board computer:



 **Service**  **1 Message**

If there are no display messages, **No Messages** appears on the multifunction display.

- ▶ Scroll through the display messages by swiping upwards or downwards on the left-hand Touch Control.
- ▶ **To exit the message memory:** press the  button.

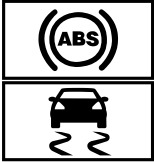

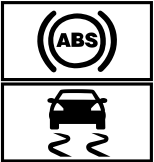

Safety systems



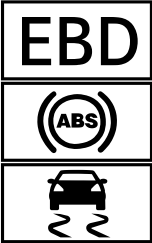



Display messages	Possible causes/consequences and ► Solutions
<div data-bbox="130 239 327 448">  </div> <p data-bbox="118 456 445 519">Currently Unavailable See Operator's Manual</p>	<p data-bbox="527 236 1902 384">* ABS and ESP[®] are temporarily unavailable. Other driving systems and driving safety systems may also be temporarily unavailable. The brake system continues to operate normally. The braking distance in an emergency braking situation can increase.</p> <div data-bbox="553 410 1984 715" style="background-color: #f0f0f0; padding: 10px;"> <p data-bbox="574 420 1412 453">▲ WARNING Risk of skidding if ABS and ESP[®] are malfunctioning</p> <p data-bbox="574 474 1909 536">If ABS and ESP[®] are malfunctioning, the wheels could lock when braking and ESP[®] cannot carry out vehicle stabilization.</p> <p data-bbox="574 552 1954 614">The steering capability and braking characteristics are thus severely impaired. The braking distance in an emergency braking situation can increase. In addition, other driving safety systems are switched off.</p> <ul data-bbox="574 629 1565 702" style="list-style-type: none"> ▶ Drive on carefully. ▶ Have ABS and ESP[®] checked immediately at a qualified specialist workshop. </div> <ul data-bbox="553 738 1964 845" style="list-style-type: none"> ▶ Carefully drive on a suitable stretch of road, making slight steering movements at a speed above 19 mph (30 km/h). ▶ If the display message does not disappear, consult a qualified specialist workshop immediately. Drive carefully.









Display messages	Possible causes/consequences and ► Solutions
 <p data-bbox="57 408 394 464">Inoperative See Operator's Manual</p>	<p data-bbox="466 184 915 218">* ABS and ESP[®] are malfunctioning.</p> <p data-bbox="492 232 1375 266">Other driving systems and driving safety systems may also malfunction.</p> <p data-bbox="492 273 1841 332">The brake system continues to operate normally. The braking distance in an emergency braking situation can increase.</p> <div data-bbox="492 360 1923 667" style="border: 1px solid gray; padding: 10px;"> <p data-bbox="517 370 1351 405">▲ WARNING Risk of skidding if ABS and ESP[®] are malfunctioning</p> <p data-bbox="513 422 1845 487">If ABS and ESP[®] are malfunctioning, the wheels could lock when braking and ESP[®] cannot carry out vehicle stabilization.</p> <p data-bbox="513 501 1892 566">The steering capability and braking characteristics are thus severely impaired. The braking distance in an emergency braking situation can increase. In addition, other driving safety systems are switched off.</p> <ul style="list-style-type: none"> <li data-bbox="513 578 778 612">► Drive on carefully. <li data-bbox="513 622 1500 656">► Have ABS and ESP[®] checked immediately at a qualified specialist workshop. </div> <ul style="list-style-type: none"> <li data-bbox="492 687 758 722">► Drive on carefully. <li data-bbox="492 732 1142 766">► Visit a qualified specialist workshop immediately.
 <p data-bbox="57 894 380 950">Currently Unavailable See Operator's Manual</p>	<p data-bbox="466 777 887 811">* ESP[®] is temporarily unavailable.</p> <p data-bbox="492 821 1375 855">Other driving systems and driving safety systems may also malfunction.</p>

Display messages	Possible causes/consequences and ► Solutions
	<p>▲ WARNING Risk of skidding if ESP® is malfunctioning</p> <p>If ESP® is malfunctioning, ESP® cannot carry out vehicle stabilization. In addition, other driving safety systems are switched off.</p> <ul style="list-style-type: none"> ▶ Drive on carefully. ▶ Have ESP® checked at a qualified specialist workshop. <p>► Carefully drive on a suitable stretch of road, making slight steering movements at a speed above 19 mph (30 km/h).</p> <p>► If the display message does not disappear, consult a qualified specialist workshop immediately. Drive carefully.</p>
 <p>Inoperative See Operator's Manual</p>	<p>* ESP® is malfunctioning</p> <p>Other driving systems and driving safety systems may also malfunction.</p> <p>The brake system continues to operate normally. The braking distance in an emergency braking situation can increase.</p> <p>▲ WARNING Risk of skidding if ESP® is malfunctioning</p> <p>If ESP® is malfunctioning, ESP® cannot carry out vehicle stabilization. In addition, other driving safety systems are switched off.</p> <ul style="list-style-type: none"> ▶ Drive on carefully. ▶ Have ESP® checked at a qualified specialist workshop.

Display messages	Possible causes/consequences and ► Solutions
 <p data-bbox="57 591 394 650">Inoperative See Operator's Manual</p>	<ul style="list-style-type: none"> ► Drive on carefully. ► Visit a qualified specialist workshop immediately. <p data-bbox="466 265 1377 339">* EBD, ABS and ESP® are malfunctioning. Other driving systems and driving safety systems may also malfunction.</p> <div style="background-color: #f0f0f0; padding: 5px; border: 1px solid #ccc;"> <p data-bbox="517 370 1420 408">▲ WARNING Risk of skidding if EBD, ABS and ESP® are malfunctioning</p> <p data-bbox="511 427 1890 487">If EBD, ABS and ESP® are malfunctioning, the wheels can lock when braking and ESP® cannot carry out vehicle stabilization.</p> <p data-bbox="511 503 1890 563">The steering capability and braking characteristics are thus severely impaired. The braking distance in an emergency braking situation can increase. In addition, other driving safety systems are switched off.</p> <ul style="list-style-type: none"> ► Drive on carefully. ► Have the brake system checked immediately at a qualified specialist workshop. </div> <ul style="list-style-type: none"> ► Drive on carefully. ► Visit a qualified specialist workshop immediately.
<p data-bbox="57 785 363 845">Radar Sensors Dirty See Operator's Manual</p>	<p data-bbox="466 778 1283 806">* The radar sensor system is malfunctioning. Possible causes are:</p> <ul style="list-style-type: none"> • Dirt on the sensors • Heavy rain or snow • Extended country driving without other traffic, e.g. in the desert





Display messages	Possible causes/consequences and ► Solutions
	<p>Driving systems and driving safety systems may be malfunctioning or temporarily unavailable.</p> <p>Once the cause of the problem is no longer present, driving systems and driving safety systems will be available again.</p> <p>If the display message does not disappear:</p> <ul style="list-style-type: none"> ► Pull over and stop the vehicle safely as soon as possible, paying attention to road and traffic conditions. ► Clean all sensors (→ page 362). ► Restart the engine.
<div data-bbox="130 469 324 572" data-label="Image"></div> <p data-bbox="130 583 257 612">(USA only)</p> <div data-bbox="130 627 324 731" data-label="Image"></div> <p data-bbox="130 741 298 770">(Canada only)</p> <p data-bbox="120 781 447 842">Turn On the Ignition to Release the Parking Brake</p>	<p>* The red  (USA only) or  (Canada only) indicator lamp is lit.</p> <p>You have attempted to release the electric parking brake with the ignition switched off.</p> <ul style="list-style-type: none"> ► Switch the ignition on.
<div data-bbox="130 862 324 966" data-label="Image"></div>	<p>* The red  (USA only) or  (Canada only) indicator lamp flashes.</p> <p>The electric parking brake is applied while you are driving:</p> <ul style="list-style-type: none"> • A condition for automatic release of the electric parking brake is not fulfilled (→ page 163).



Display messages	Possible causes/consequences and ► Solutions
<p>(USA only)</p>  <p>(Canada only)</p> <p>Please Release Parking Brake</p>	<ul style="list-style-type: none"> • You are performing emergency braking using the electric parking brake (→ page 164). ► Check that the conditions for automatic release of the electric parking brake are fulfilled. ► Release the electric parking brake manually.
 <p>(USA only)</p>  <p>(Canada only)</p> <p>Parking Brake See Operator's Manual</p>	<p>* The yellow  indicator lamp is lit. The electric parking brake is malfunctioning.</p> <p>To apply:</p> <ul style="list-style-type: none"> ► Switch off the ignition and switch it back on. ► Apply the electric parking brake manually (→ page 163). <p>If it is not possible to apply the electric parking brake:</p> <ul style="list-style-type: none"> ► Visit a qualified specialist workshop. ► Where necessary, also safeguard the parked vehicle against rolling away. <p>The yellow  and the red  (USA only) or  (Canada only) indicator lamps are lit. The electric parking brake is malfunctioning.</p> <p>To release:</p> <ul style="list-style-type: none"> ► Switch off the ignition and switch it back on. ► Release the electric parking brake manually (→ page 163).

Display messages	Possible causes/consequences and ► Solutions
	<p>or</p> <ul style="list-style-type: none"> ► Release the electric parking brake automatically (→ page 163). <p>If it is still not possible to release the electric parking brake:</p> <ul style="list-style-type: none"> ► Do not continue driving under any circumstances. Consult a qualified specialist workshop. <p>The yellow  indicator lamp is lit and the red  (USA only) or  (Canada only) indicator lamp is flashing. The electric parking brake is malfunctioning.</p> <p>The electric parking brake could not be applied or released.</p> <ul style="list-style-type: none"> ► Switch off the ignition and switch it back on. <p>To apply:</p> <ul style="list-style-type: none"> ► Release and then apply the electric parking brake manually (→ page 163). <p>To release:</p> <ul style="list-style-type: none"> ► Apply and then release the electric parking brake manually. <p>If the electric parking brake cannot be applied or the red  (USA only) or  (Canada only) indicator lamp continues to flash:</p> <ul style="list-style-type: none"> ► Do not continue driving under any circumstances. Consult a qualified specialist workshop. ► Where necessary, also safeguard the parked vehicle against rolling away. <p>The yellow  indicator lamp is on and the red  indicator lamp (USA only) or the  indicator lamp (Canada only) flashes for approximately ten seconds after the electric parking brake has been applied or released. It then remains lit or goes out. The electric parking brake is malfunctioning.</p>

Display messages	Possible causes/consequences and ► Solutions
	<p>If the battery charge level is too low:</p> <ul style="list-style-type: none">► Charge the battery. <p>To apply:</p> <ul style="list-style-type: none">► Switch off the ignition. The electric parking brake is applied automatically. <p>If the electric parking brake should not be applied, e.g. when washing the vehicle in an automatic car wash or when having the vehicle towed, leave the ignition switched on. This does not include having the vehicle towed with the rear axle raised.</p> <p>If the electric parking brake is not applied automatically:</p> <ul style="list-style-type: none">► Switch off the ignition and switch it back on.► Release and then apply the electric parking brake manually (→ page 163). <p>If it is still not possible to apply the electric parking brake:</p> <ul style="list-style-type: none">► Visit a qualified specialist workshop.► Where necessary, also safeguard the parked vehicle against rolling away. <p>To release:</p> <ul style="list-style-type: none">► If the conditions for automatic release are fulfilled and the electric parking brake is not released automatically, release the electric parking brake manually (→ page 163).

Display messages	Possible causes/consequences and ► Solutions
<div data-bbox="132 267 329 370" data-label="Image"> </div> <p data-bbox="124 379 253 410">(USA only)</p> <div data-bbox="132 425 329 529" data-label="Image"> </div> <p data-bbox="124 537 294 568">(Canada only)</p> <p data-bbox="124 581 421 607">Check Brake Fluid Level</p>	<p data-bbox="553 177 1295 203">If it is still not possible to release the electric parking brake:</p> <ul style="list-style-type: none"> <li data-bbox="553 218 1712 244">► Do not continue driving under any circumstances. Consult a qualified specialist workshop. <p data-bbox="529 265 1275 291">* There is insufficient brake fluid in the brake fluid reservoir.</p> <div data-bbox="553 317 1984 581" data-label="Complex-Block" style="border: 1px solid gray; padding: 5px;"> <p data-bbox="578 327 1346 353">▲ WARNING Risk of an accident due to low brake fluid level</p> <p data-bbox="578 379 1815 405">If the brake fluid level is too low, the braking effect and the braking characteristics may be impaired.</p> <ul style="list-style-type: none"> <li data-bbox="578 420 1902 477">► Pull over and stop the vehicle safely as soon as possible, paying attention to road and traffic conditions. Do not continue driving under any circumstances. <li data-bbox="578 493 1111 519">► Consult a qualified specialist workshop. <li data-bbox="578 534 901 560">► Do not add brake fluid. </div> <ul style="list-style-type: none"> <li data-bbox="553 601 1974 658">► Pull over and stop the vehicle safely as soon as possible, paying attention to road and traffic conditions. Do not continue driving under any circumstances. <li data-bbox="553 674 880 700">► Do not add brake fluid. <li data-bbox="553 715 1085 741">► Consult a qualified specialist workshop.
<p data-bbox="124 778 404 835">Check Brake Pads See Operator's Manual</p>	<p data-bbox="529 767 1099 793">* The brake pads have reached the wear limit.</p> <div data-bbox="553 819 1984 966" data-label="Complex-Block" style="border: 1px solid gray; padding: 5px;"> <p data-bbox="578 829 1367 855">▲ WARNING Risk of accident due to restricted braking power</p> <p data-bbox="578 881 1674 907">When the brake pads have reached their wear limit, the braking power may be restricted.</p> <ul style="list-style-type: none"> <li data-bbox="578 923 844 948">► Drive on carefully. </div>

Display messages	Possible causes/consequences and ► Solutions
	<p>► Have the brake system checked immediately at a qualified specialist workshop.</p> <p>► Visit a qualified specialist workshop.</p>
 <p>SRS Malfunction Service Required</p>	<p>* The restraint system is defective (→ page 33).</p> <p>⚠ WARNING Risk of injury or fatal injury due to a malfunction in the restraint system</p> <p>If the restraint system is malfunctioning, restraint system components may be triggered unintentionally or might not be triggered at all in the event of an accident. This may affect the Emergency Tensioning Device or airbag, for example.</p> <p>► Have the restraint system checked and repaired immediately at a qualified specialist workshop.</p> <p>Detection of a restraint system malfunction:</p> <ul style="list-style-type: none"> • The  restraint system warning lamp does not light up when the ignition is switched on. • The  restraint system warning lamp lights up continuously or repeatedly during a journey. <p>► Visit a qualified specialist workshop immediately.</p>
 <p>Front Left Malfunction Service Required (Example)</p>	<p>* The corresponding restraint system is malfunctioning (→ page 33).</p> <p>⚠ WARNING Risk of injury or fatal injury due to a malfunction in the restraint system</p> <p>If the restraint system is malfunctioning, restraint system components may be triggered unintentionally or might not be triggered at all in the event of an accident. This may affect the Emergency Tensioning Device or airbag, for example.</p>

Display messages	Possible causes/consequences and ► Solutions
	<p>► Have the restraint system checked and repaired immediately at a qualified specialist workshop.</p> <p>Detection of a restraint system malfunction:</p> <ul style="list-style-type: none"> • The  restraint system warning lamp does not light up when the ignition is switched on. • The  restraint system warning lamp lights up continuously or repeatedly during a journey. <p>► Visit a qualified specialist workshop immediately.</p>
 <p>Left Side Curtain Airbag Malfunction Service Required (Example)</p>	<p>* The corresponding window curtain airbag is malfunctioning (→ page 33).</p> <p>⚠ WARNING Risk of injury or fatal injury due to malfunctions in the window airbag</p> <p>If the window airbag is malfunctioning, it might be triggered unintentionally or might not be triggered at all in the event of an accident with high deceleration.</p> <p>► Have the window airbag checked and repaired immediately at a qualified specialist workshop.</p> <p>► Visit a qualified specialist workshop immediately.</p>
<p>Front Passenger Airbag Enabled See Operator's Manual</p>	<p>* The front passenger airbag and knee airbags are enabled during the journey:</p> <ul style="list-style-type: none"> • even when a child, a small adult or an object weighing less than the system weight threshold is located on the front passenger seat • even when the front passenger seat is not occupied <p>The system may detect objects or forces that are adding to the weight applied to the seat.</p>



Display messages	Possible causes/consequences and ► Solutions
	<p>▲ WARNING Risk of injury or fatal injury when using a child restraint system while the front passenger air bag is enabled</p> <p>If you secure a child in a child restraint system on the front passenger seat and the front passenger air bag is enabled, the front passenger air bag can deploy in the event of an accident. The child could be struck by the air bag.</p> <p>► Ensure, both before and during the journey, that the status of the front passenger air bag is correct.</p> <p>NEVER use a rearward facing child restraint on a seat protected by an ACTIVE FRONT AIR BAG; DEATH or SERIOUS INJURY to the CHILD can occur.</p> <p>► Pull over and stop the vehicle safely as soon as possible, paying attention to road and traffic conditions.</p> <p>► Check the status of the automatic front passenger airbag shutoff (→ page 44).</p> <p>► If necessary, consult a qualified specialist workshop immediately.</p>
<p>Front Passenger Airbag Disabled See Operator's Manual</p>	<p>* The front passenger airbag and the knee airbag are deactivated, although an adult or a person with an adult stature is on the front passenger seat. If additional forces are applied to the seat, the weight the system detects may be too low.</p> <p>▲ WARNING Risk of injury or fatal injury due to a disabled front passenger airbag</p> <p>If the front passenger airbag is disabled, the front passenger airbag will not be deployed in the event of an accident and cannot perform its intended protective function.</p>

Display messages	Possible causes/consequences and ► Solutions
	<p>A person in the front passenger seat could then, for example, come into contact with the vehicle's interior, especially if the person is sitting too close to the cockpit.</p> <ul style="list-style-type: none"> ► Make sure, both before and during the journey, that the status of the front passenger airbag is correct. ► Pull over and stop the vehicle safely as soon as possible, paying attention to road and traffic conditions. ► Check the status of the automatic front passenger airbag shutoff (→ page 44). ► If necessary, consult a qualified specialist workshop immediately.
<p>Active Brake Assist Functions Limited See Operator's Manual</p>	<p>* Vehicles with Driving Assistance Package: Active Brake Assist with cross-traffic function, Evasive Steering Assist or PRE-SAFE® PLUS is malfunctioning.</p> <p>Vehicles without Driving Assistance Package: Active Brake Assist is malfunctioning.</p> <ul style="list-style-type: none"> ► Visit a qualified specialist workshop.
<p>Active Brake Assist Functions Currently Limited See Operator's Manual</p>	<p>* Vehicles with the Driving Assistance Package: Active Brake Assist with cross-traffic function, Evasive Steering Assist or PRE-SAFE® PLUS are temporarily unavailable or only partially available.</p> <p>Vehicles without the Driving Assistance package: Active Brake Assist is temporarily unavailable.</p> <p>The ambient conditions are outside the system limits .</p> <ul style="list-style-type: none"> ► Drive on. As soon as the ambient conditions are within the system limits, the system will become available again. ► If the display message does not disappear, stop the vehicle while paying attention to road and traffic conditions and restart the engine.
	<p>* PRE-SAFE® functions are malfunctioning.</p>



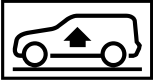
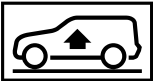

Display messages	Possible causes/consequences and ► Solutions
PRE-SAFE Inoperative See Operator's Manual	<ul style="list-style-type: none"> ► Visit a qualified specialist workshop.
PRE-SAFE Impulse Side Inoperative See Operator's Manual	<p>* PRE-SAFE® Impulse Side is malfunctioning or inoperative after having already been triggered.</p> <ul style="list-style-type: none"> ► Visit a qualified specialist workshop.
Mercedes me connect Services Limited See Operator's Manual	<p>* Service limited. At least one of the main functions of the Mercedes me connect system is malfunctioning.</p> <ul style="list-style-type: none"> ► Observe the notes on the diagnostics connection (→ page 24). ► Visit a qualified specialist workshop.
 Inoperative	<p>* At least one main function of the Mercedes me connect system or of the SOS emergency call system is malfunctioning.</p> <ul style="list-style-type: none"> ► Visit a qualified specialist workshop.

Driving systems

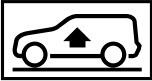
Display messages	Possible causes/consequences and ► Solutions
	<p>* ATTENTION ASSIST has detected fatigue or an increasing lack of concentration on the part of the driver (→ page 215).</p> <ul style="list-style-type: none"> ► If necessary, take a break.

Display messages	Possible causes/consequences and ► Solutions
<p>ATTENTION ASSIST: Take a Break!</p>	
 <p>ATTENTION ASSIST Inoperative</p>	<ul style="list-style-type: none"> * ATTENTION ASSIST is malfunctioning. <ul style="list-style-type: none"> ► Visit a qualified specialist workshop.
 <p>Lowering</p>	<ul style="list-style-type: none"> * The vehicle level may be lowered for the following reasons: <ul style="list-style-type: none"> • You have selected a different drive program. • You have exceeded a critical speed. • You have changed the vehicle level by pressing a button.
 <p>Vehicle Rising</p>	<ul style="list-style-type: none"> * Your vehicle is adjusting to the level you have selected.
 <p>Vehicle Rising Please Wait</p>	<ul style="list-style-type: none"> * The vehicle level is too low. The vehicle will be raised to the selected vehicle level. <ul style="list-style-type: none"> ► Wait until the display message disappears before pulling away.





Display messages	Possible causes/consequences and ► Solutions
 <p data-bbox="57 301 369 360">Stop Vehicle Too Low</p>	<p data-bbox="466 184 1242 215">* You have pulled away despite the vehicle level being too low.</p> <ul style="list-style-type: none"> <li data-bbox="492 228 1821 288">► Pull over and stop the vehicle safely as soon as possible, paying attention to road and traffic conditions. The vehicle will be raised to the selected vehicle level. <li data-bbox="492 301 1310 332">► Wait until the display message disappears before pulling away. <p data-bbox="492 363 1888 425">If the display message does not disappear and a warning tone also sounds, AIR BODY CONTROL+ is malfunctioning:</p> <ul style="list-style-type: none"> <li data-bbox="492 439 1774 470">► Do not drive faster than 50 mph (80 km/h) and consult a qualified specialist workshop immediately. <div data-bbox="492 503 1919 684" style="border: 1px solid gray; padding: 5px;"> <p data-bbox="519 513 1810 544">! NOTE The tires of the front axle or the front fenders could be damaged by large steering movements</p> <ul style="list-style-type: none"> <li data-bbox="513 565 1504 596">► Avoid large steering movements while driving and listen for scraping sounds. <li data-bbox="513 607 1862 669">► If you hear scraping sounds, pull over and stop the vehicle safely, paying attention to road and traffic conditions, and set a higher vehicle level if possible. </div> <ul style="list-style-type: none"> <li data-bbox="492 705 1177 767">► Set a higher vehicle level (→ page 198). Depending on the malfunction, the vehicle is raised.
<p data-bbox="57 793 288 824">Drive More Slowly</p>	<p data-bbox="466 785 1146 816">* You are driving too fast for the selected vehicle level.</p> <ul style="list-style-type: none"> <li data-bbox="492 829 1733 860">► In order to adjust the vehicle level, you must not drive at speeds greater than 37 mph (60 km/h). <li data-bbox="492 871 1882 933">► In order to adjust the vehicle level during trailer operation, you must not drive at speeds greater than 19 mph (30 km/h).

Display messages	Possible causes/consequences and ► Solutions
 Malfunction Drive at Max. 50 mph	<ul style="list-style-type: none"> * The AMG adaptive sport suspension system is malfunctioning. The vehicle's handling characteristics may be affected. <ul style="list-style-type: none"> ► Do not drive at speeds greater than 50 mph (80 km/h). ► Visit a qualified specialist workshop.
 Active Steering Assist Currently Unavailable See Operator's Manual	<ul style="list-style-type: none"> * Active Steering Assist is temporarily unavailable. The ambient conditions are outside the system limits (→ page 183). <ul style="list-style-type: none"> ► Drive on. As soon as the ambient conditions are within the system limits, the system will become available again. ► If necessary, clean the windshield in the camera's field of vision. ► Check the tire pressure if necessary.
 Active Steering Assist Inoperative	<ul style="list-style-type: none"> * Active Steering Assist is malfunctioning. Active Distance Assist DISTRONIC remains available. <ul style="list-style-type: none"> ► Visit a qualified specialist workshop.
	<ul style="list-style-type: none"> * Active Steering Assist has reached its system limits. <ul style="list-style-type: none"> ► Take over the steering and drive on in accordance with the traffic conditions.

Display messages	Possible causes/consequences and ► Solutions
<p>Active Lane Keeping Assist Currently Unavailable See Operator's Manual</p>	<p>* Active Lane Keeping Assist is temporarily unavailable. The ambient conditions are outside the system limits (→ page 220).</p> <p>► Drive on. As soon as the ambient conditions are within the system limits, the system will become available again.</p>
<p>Active Lane Keeping Assist Inoperative</p>	<p>* Active Lane Keeping Assist is malfunctioning.</p> <p>► Visit a qualified specialist workshop.</p>
<p>Active Lane Keeping Assist Camera View Restricted See Operator's Manual</p>	<p>* The camera view is restricted. Possible causes are:</p> <ul style="list-style-type: none"> • Dirt on the windshield in the camera's field of vision • Heavy rain, snow or fog <p>Driving systems and driving safety systems may be malfunctioning or temporarily unavailable. Once the cause of the problem is no longer present, driving systems and driving safety systems will be available again.</p> <p>If the display message does not disappear:</p> <p>► Pull over and stop the vehicle safely as soon as possible, paying attention to road and traffic conditions.</p> <p>► Clean the windshield.</p>
<p>Blind Spot Assist Currently Unavailable See Operator's Manual</p>	<p>* Blind Spot Assist is temporarily unavailable. The system limits have been reached (→ page 218).</p>

Display messages	Possible causes/consequences and ► Solutions
	<ul style="list-style-type: none"> ► Drive on. Once the cause of the problem is no longer present, the system will be available again. or ► If the display message does not disappear, stop the vehicle while paying attention to road and traffic conditions and restart the engine. ► If necessary, clean the rear bumper. If the bumper is extremely dirty, the sensors in the bumper may be malfunctioning.
Blind Spot Assist Inoperative	<ul style="list-style-type: none"> * Blind Spot Assist is malfunctioning. ► Visit a qualified specialist workshop.
Blind Spot Assist Not Available When Towing a Trailer See Operator's Manual	<ul style="list-style-type: none"> * When you establish the electrical connection to the trailer, Blind Spot Assist is unavailable. ► Press the left-hand Touch Control and acknowledge the display message.
Active Blind Spot Assist Currently Unavailable See Operator's Manual	<ul style="list-style-type: none"> * Active Blind Spot Assist is temporarily unavailable. The system limits have been reached (→ page 218). ► Drive on. Once the cause of the problem is no longer present, the system will be available again. ► If the display message does not disappear, stop the vehicle while paying attention to road and traffic conditions and restart the engine.
Active Blind Spot Assist Inoperative	<ul style="list-style-type: none"> * Active Blind Spot Assist is malfunctioning. ► Visit a qualified specialist workshop.

Display messages	Possible causes/consequences and ► Solutions
Active Blind Spot Asst. Not Available When Towing a Trailer See Operator's Manual	<p>* When you establish the electrical connection to the trailer, Active Blind Spot Assist is unavailable.</p> <ul style="list-style-type: none"> ► Press the left-hand Touch Control and acknowledge the display message.
Active Parking Assist and PARKTRONIC Inoperative See Operator's Manual	<p>* Active Parking Assist and Parking Assist PARKTRONIC are malfunctioning.</p> <ul style="list-style-type: none"> ► Stop the vehicle, paying attention to road and traffic conditions, and restart the engine. ► If the display message continues to be displayed, consult a qualified specialist workshop.
Traffic Sign Assist Currently Unavailable See Operator's Manual	<p>* Traffic Sign Assist is temporarily unavailable.</p> <ul style="list-style-type: none"> ► Drive on. <p>Once the cause of the problem is no longer present, the system will be available again.</p>
Traffic Sign Assist Camera View Restricted See Operator's Manual	<p>* The camera view is restricted. Possible causes are:</p> <ul style="list-style-type: none"> • Dirt on the windshield in the camera's field of vision • Heavy rain, snow or fog <p>Driving systems and driving safety systems may be malfunctioning or temporarily unavailable.</p> <p>Once the cause of the problem is no longer present, driving systems and driving safety systems will be available again.</p> <p>If the display message does not disappear:</p> <ul style="list-style-type: none"> ► Pull over and stop the vehicle safely as soon as possible, paying attention to road and traffic conditions. ► Clean the windshield.



Display messages	Possible causes/consequences and ► Solutions
Traffic Sign Assist Inoperative	<ul style="list-style-type: none"> * Traffic Sign Assist is malfunctioning. <ul style="list-style-type: none"> ► Visit a qualified specialist workshop.
 <p>Off</p>	<ul style="list-style-type: none"> * The HOLD function is deactivated because the vehicle is skidding or a condition for activation is not met. <ul style="list-style-type: none"> ► Reactivate the HOLD function later or check the activation conditions for the HOLD function (→ page 189).
 <p>Off</p>	<ul style="list-style-type: none"> * Active Distance Assist DISTRONIC was deactivated. If a warning tone also sounds, the Active Distance Assist DISTRONIC has deactivated automatically (→ page 179).
 <p>--- mph</p>	<ul style="list-style-type: none"> * Active Distance Assist DISTRONIC cannot be activated as not all activation conditions have been fulfilled. <ul style="list-style-type: none"> ► Comply with the activation conditions of Active Distance Assist DISTRONIC (→ page 179).
 <p>Suspended</p>	<ul style="list-style-type: none"> * If you activate the accelerator pedal beyond the Active Distance Assist DISTRONIC setting, the system will be put into passive mode (→ page 187).
	<ul style="list-style-type: none"> * Active Distance Assist DISTRONIC is temporarily unavailable.

Display messages	Possible causes/consequences and ► Solutions
Active Distance Assist Currently Unavailable See Operator's Manual	<p>The ambient conditions are outside the system limits (→ page 177).</p> <ul style="list-style-type: none"> ► Drive on. As soon as the ambient conditions are within the system limits, the system will become available again.
Active Distance Assist Inoperative	<ul style="list-style-type: none"> * Active Distance Assist DISTRONIC is malfunctioning. Other driving systems and driving safety systems may also malfunction. ► Visit a qualified specialist workshop.
Active Distance Assist Now Available	<ul style="list-style-type: none"> * Active Distance Assist DISTRONIC is operational again and can be activated (→ page 179).
<div data-bbox="67 513 263 617" data-label="Image"> </div> <p data-bbox="57 627 165 655">--- mph</p>	<ul style="list-style-type: none"> * Cruise control cannot be activated as not all activation conditions are fulfilled. ► Observe the activation conditions for cruise control (→ page 176).
Cruise Control Off	<ul style="list-style-type: none"> * Cruise control has been deactivated. If there is an additional warning tone, cruise control has been deactivated automatically (→ page 175).
Cruise Control Inoperative	<ul style="list-style-type: none"> * Cruise control is malfunctioning. ► Visit a qualified specialist workshop.
RACE START Not Possible See Operator's Manual	<ul style="list-style-type: none"> * Possible causes are: <ul style="list-style-type: none"> • The conditions for activation are not met (→ page 191).

Display messages	Possible causes/consequences and ► Solutions
<p>RACE START Canceled</p>	<p>* Possible causes are:</p> <ul style="list-style-type: none"> • You released the accelerator pedal during RACESTART. • You depressed the brake pedal during RACESTART. <p>You can try RACESTART again at the next start.</p>



Engine

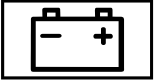
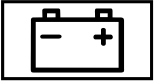
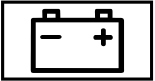

Display messages	Possible causes/consequences and ► Solutions
<p>Check Coolant Level See Operator's Manual</p>	<p>* The coolant level is too low.</p> <div style="border: 1px solid gray; padding: 5px; margin: 5px 0;"> <p>! NOTE Engine damage due to insufficient coolant</p> <p>► Avoid long journeys with insufficient coolant.</p> </div> <p>► Add coolant (→ page 355).</p>
<div style="text-align: center;">  </div> <p>Coolant Too Hot Stop Vehicle Turn Engine Off</p>	<p>* The coolant is too hot.</p> <p>► Pull over and stop the vehicle safely and switch off the engine, paying attention to road and traffic conditions.</p>





Display messages	Possible causes/consequences and ► Solutions
	<p>▲ WARNING Danger of burns when opening the hood</p> <p>If you open the hood when the engine has overheated or during a fire in the engine compartment, you could come into contact with hot gases or other escaping operating fluids.</p> <ul style="list-style-type: none"> ▶ Before opening the hood, allow the engine to cool down. ▶ In the event of a fire in the engine compartment, keep the hood closed and call the fire service. <ul style="list-style-type: none"> ▶ Wait until the engine has cooled down. ▶ Make sure that the air supply to the radiator is not obstructed. ▶ Avoiding high loads on the engine, drive to the nearest qualified specialist workshop. In doing so, ensure that the coolant temperature display remains below the red marking.
	<ul style="list-style-type: none"> * The fan motor is defective. ▶ Avoiding high loads on the engine, drive to the nearest qualified specialist workshop. In doing so, ensure that the coolant temperature display remains below the red marking.
 <p>See Operator's Manual</p>	<ul style="list-style-type: none"> * The battery is not being charged. <p>! NOTE Possible engine damage if you continue driving</p> <ul style="list-style-type: none"> ▶ Do not continue driving under any circumstances. ▶ Consult a qualified specialist workshop. <ul style="list-style-type: none"> ▶ Pull over and stop the vehicle safely and switch off the engine, paying attention to road and traffic conditions.

Display messages	Possible causes/consequences and ► Solutions
 <p data-bbox="118 336 429 398">Stop Vehicle See Operator's Manual</p>	<ul style="list-style-type: none"> <li data-bbox="553 177 1089 208">► Consult a qualified specialist workshop. <p data-bbox="527 220 1516 251">* The battery is no longer being charged and the battery charge level is too low.</p> <div data-bbox="553 275 1984 422" style="border: 1px solid black; padding: 5px;"> <p data-bbox="578 285 1291 317">! NOTE Possible engine damage if you continue driving</p> <ul style="list-style-type: none"> <li data-bbox="578 337 1236 368">► Do not continue driving under any circumstances. <li data-bbox="578 379 1109 410">► Consult a qualified specialist workshop. </div> <ul style="list-style-type: none"> <li data-bbox="553 443 1974 510">► Pull over and stop the vehicle safely as soon as possible, paying attention to road and traffic conditions. Do not continue driving under any circumstances. <li data-bbox="553 521 868 552">► Switch off the engine. <li data-bbox="553 562 1089 593">► Consult a qualified specialist workshop.
 <p data-bbox="118 723 429 785">12 V Battery See Operator's Manual</p>	<p data-bbox="527 607 1246 638">* The engine is off and the battery charge level is too low.</p> <ul style="list-style-type: none"> <li data-bbox="553 648 1261 679">► Switch off electrical consumers that are not required. <li data-bbox="553 689 1508 757">► Leave the engine running for a few minutes, or drive for a longer distance. The battery will charge. <p data-bbox="553 757 1896 788">If the message appears while the engine is running, this indicates an on-board electrical system malfunction.</p> <ul style="list-style-type: none"> <li data-bbox="553 798 1048 829">► Visit a qualified specialist workshop.
	<p data-bbox="527 845 983 876">* The battery charge level is too low.</p> <ul style="list-style-type: none"> <li data-bbox="553 886 1974 954">► Pull over and stop the vehicle safely as soon as possible, paying attention to road and traffic conditions. Do not continue driving under any circumstances.

Display messages	Possible causes/consequences and ► Solutions
<p>Stop Vehicle Leave Engine Running</p>	<ul style="list-style-type: none"> ► Leave the engine running. ► Wait until the display message disappears before pulling away.
<div data-bbox="67 262 263 365" data-label="Image"> </div> <p>48 V Battery See Operator's Manual</p>	<ul style="list-style-type: none"> * The 48 V system is malfunctioning. Convenience functions may be restricted. <ul style="list-style-type: none"> ► Visit a qualified specialist workshop immediately.
<p>Cannot Start Engine See Operator's Manual</p>	<ul style="list-style-type: none"> * The charge level of the 48 V battery is too low. You can no longer start the engine. <ul style="list-style-type: none"> ► Switch off electrical consumers that are not required. ► Connect a suitable charger approved by Mercedes-Benz with sufficient charge output to the jump-start connection point of the 12 V battery (→ page 376). The 48 V battery is charged via the voltage converter in the vehicle.
<p>Engine Can Now Be Started</p>	<ul style="list-style-type: none"> * The 48 V battery has been charged automatically via the voltage converter. <ul style="list-style-type: none"> ► Start the engine and drive the vehicle for a while to charge the 12 V battery and the 48 V battery.
<div data-bbox="67 738 263 842" data-label="Image"> </div> <p>Please Wait Charging High-voltage Battery...</p>	<ul style="list-style-type: none"> * The 48 V battery is discharged. You have switched on the ignition while the 12 V battery is being charged with a suitable charger or while another vehicle is providing starting assistance. The discharged 48 V battery is charged automatically via the voltage converter. After a few minutes, the Engine Can Now Be Started display message is shown on the multifunction display. <ul style="list-style-type: none"> ► Start the engine.



Display messages	Possible causes/consequences and ► Solutions
	<ul style="list-style-type: none"> ► Drive the vehicle for a while to charge the 12 V battery and the 48 V battery after disconnecting the charger from the vehicle. <p>If the Engine Can Now Be Started display message does not appear after a few minutes:</p> <ul style="list-style-type: none"> ► Try to start the engine again. ► If the engine does not start, consult a qualified specialist workshop.
 <p data-bbox="118 515 437 578">Check Engine Oil At Next Refueling</p>	<p data-bbox="527 401 1228 428">* The engine oil level has dropped to the minimum level.</p> <div data-bbox="553 453 1984 560" style="border: 1px solid black; padding: 5px;"> <p data-bbox="574 464 1459 495">! NOTE Engine damage caused by driving with insufficient engine oil</p> <ul style="list-style-type: none"> ► Avoid long journeys with insufficient engine oil. </div> <ul style="list-style-type: none"> ► Check the engine oil level when next refueling. <p data-bbox="553 636 915 663">Add engine oil (→ page 354).</p> <p data-bbox="553 677 977 704">Notes on engine oil (→ page 422).</p>
 <p data-bbox="118 837 445 899">Engine Oil Level Low Stop Vehicle Turn Engine Off</p>	<p data-bbox="527 723 1071 750">* Display message only for certain engines:</p> <p data-bbox="553 764 927 791">The engine oil level is too low.</p> <div data-bbox="553 816 1984 923" style="border: 1px solid black; padding: 5px;"> <p data-bbox="574 826 1459 857">! NOTE Engine damage caused by driving with insufficient engine oil</p> <ul style="list-style-type: none"> ► Avoid long journeys with insufficient engine oil. </div>

Display messages	Possible causes/consequences and ► Solutions
	<ul style="list-style-type: none"> ► Pull over and stop the vehicle safely as soon as possible, paying attention to road and traffic conditions. Do not continue driving under any circumstances. ► Switch off the engine. ► Add 1.1 US qt (1 l) engine oil. ► Check the engine oil level. <p>Top up engine oil (→ page 354). Notes on engine oil (→ page 422).</p>
 <p data-bbox="57 591 398 619">Engine Oil Reduce Oil Level</p>	<p>* Display message only for certain engines: The engine oil level is too high.</p> <div data-bbox="492 570 1917 622" style="border: 1px solid black; padding: 5px;"> <p>! NOTE Engine damage caused by driving with excess engine oil</p> </div> <div data-bbox="492 625 1917 677" style="border: 1px solid black; padding: 5px;"> <p>► Avoid long journeys with excess engine oil.</p> </div> <ul style="list-style-type: none"> ► Consult a qualified specialist workshop immediately and have the engine oil siphoned off.
 <p data-bbox="57 860 363 919">Engine Oil Pressure Stop Switch Off Engine</p>	<p>* Display message only for certain engines: The engine oil pressure is too low.</p> <div data-bbox="492 840 1917 891" style="border: 1px solid black; padding: 5px;"> <p>! NOTE Engine damage caused by driving with insufficient engine oil pressure</p> </div> <div data-bbox="492 895 1917 946" style="border: 1px solid black; padding: 5px;"> <p>► Avoid driving with insufficient engine oil pressure.</p> </div>



Display messages	Possible causes/consequences and ► Solutions
	<ul style="list-style-type: none"> ► Pull over and stop the vehicle safely as soon as possible, paying attention to road and traffic conditions. Do not continue driving under any circumstances. ► Consult a qualified specialist workshop.
 <p>Engine Oil Level Cannot Be Measured</p>	<ul style="list-style-type: none"> * The electrical connection to the oil level sensor is interrupted or the oil level sensor is defective. ► Visit a qualified specialist workshop.
 <p>Fuel Level Low</p>	<ul style="list-style-type: none"> * The fuel supply has dropped into the reserve range. ► Refuel.
 <p>Gas Cap Loose</p>	<ul style="list-style-type: none"> * There has been pressure loss in the fuel system. The fuel filler cap is not closed correctly or the fuel system is leaking. ► Close the fuel filler cap. ► If the fuel filler cap was already properly closed: consult a qualified specialist workshop.
	<ul style="list-style-type: none"> * Display message only for certain engines: The engine oil level has dropped to the minimum level.

Display messages	Possible causes/consequences and ► Solutions
<p>Check Engine Oil Level (Add 1 quart)</p>	<div data-bbox="492 174 1923 282" style="border: 1px solid black; padding: 5px;"> <p>! NOTE Engine damage caused by driving with insufficient engine oil</p> <p>► Avoid long journeys with insufficient engine oil.</p> </div> <p>► When next refueling, add 1 quart of engine oil.</p> <p>Top up engine oil (→ page 354).</p> <p>Notes on engine oil (→ page 422).</p>

Tires





Display messages	Possible causes/consequences and ► Solutions
 <p>Please Correct Tire Pressure</p>	<p>* The tire pressure is too low in at least one of the tires, or the tire pressure difference between the wheels is too great.</p> <p>► Check the tire pressure and add air, if necessary.</p> <p>► When the tire pressure is correct, restart the tire pressure monitoring system (→ page 393).</p>
 <p>Check Tires</p>	<p>* The tire pressure in one or more tires has dropped significantly. The wheel position is displayed.</p>



Display messages	Possible causes/consequences and ► Solutions
	<p>▲ WARNING Risk of an accident due to insufficient tire pressure</p> <p>Tire pressures that are too low pose the following hazards:</p> <ul style="list-style-type: none"> • The tires may burst, especially as the load and vehicle speed increase. • The tires may wear excessively and/or unevenly, which may greatly impair tire traction. • The driving characteristics, as well as steering and braking, may be greatly impaired. <p>You could then lose control of the vehicle.</p> <ul style="list-style-type: none"> ► Observe the recommended tire pressure. ► Adjust the tire pressure if necessary. <p>► Stop the vehicle, paying attention to road and traffic conditions.</p> <p>► Check the tire pressure (→ page 388) and the tires.</p>
 <p>Warning Tire Malfunction</p>	<p>* The tire pressure in one or more tires has dropped suddenly. The wheel position is displayed.</p> <p>▲ WARNING Risk of an accident from driving with a flat tire</p> <p>Flat tires are dangerous in the following ways:</p> <ul style="list-style-type: none"> • The tires can overheat and cause a fire. • The driving characteristics, as well as steering and braking, may be greatly impaired. <p>You could then lose control of the vehicle.</p>

Display messages	Possible causes/consequences and ► Solutions
	<ul style="list-style-type: none"> ► Do not drive with a flat tire. ► Observe the notes on flat tires. <p>Notes on flat tires (→ page 366).</p> <ul style="list-style-type: none"> ► Stop the vehicle, paying attention to road and traffic conditions. ► Check the tires.
 <p>Tire Press. Monitor Currently Unavailable</p>	<ul style="list-style-type: none"> * There is interference from a powerful radio signal source. As a result, no signals from the tire pressure sensors are received. The tire pressure monitoring system is temporarily unavailable. <ul style="list-style-type: none"> ► Drive on. ► The tire pressure monitoring system restarts automatically as soon as the cause has been rectified.
 <p>Wheel Sensor(s) Missing</p>	<ul style="list-style-type: none"> * The tire pressure sensor signal is missing from one or more tire(s). The pressure of the affected tire is not displayed. <ul style="list-style-type: none"> ► Have the defective tire pressure sensor replaced at a qualified specialist workshop.
 <p>Tire Pressure Monitor Inoperative No Wheel Sensors</p>	<ul style="list-style-type: none"> * The wheels installed do not have suitable tire pressure sensors. The tire pressure monitoring system is deactivated. <ul style="list-style-type: none"> ► Install wheels with suitable tire pressure sensors.



Display messages	Possible causes/consequences and ► Solutions
<div data-bbox="130 187 327 291" data-label="Image"> </div> <p data-bbox="118 301 472 360">Tire Press. Monitor Inoperative</p>	<p data-bbox="527 184 1156 215">* The tire pressure monitoring system is defective.</p> <div data-bbox="553 239 1984 459" data-label="Complex-Block"> <p data-bbox="574 246 1821 280">▲ WARNING There is a risk of an accident if the tire pressure monitoring system is malfunctioning</p> <p data-bbox="574 298 1964 360">If the tire pressure monitoring system is malfunctioning, it is not able to issue a warning if there is pressure loss in one or more of the tires.</p> <p data-bbox="574 373 1723 405">Underinflated tires may, for example, impair the driving, steering and braking characteristics.</p> <p data-bbox="574 418 1671 449">► Have the tire pressure monitoring system checked at a qualified specialist workshop.</p> </div> <p data-bbox="553 480 1048 511">► Visit a qualified specialist workshop.</p>
<p data-bbox="118 536 333 567">Tires Overheated</p>	<p data-bbox="527 526 1974 588">* At least one tire is overheating. The affected tires are displayed in red. At temperatures close to the limit value, the tires are displayed in yellow.</p> <p data-bbox="553 601 823 632">► Drive more slowly.</p>
<p data-bbox="118 655 327 686">Decrease Speed</p>	<p data-bbox="527 645 1974 707">* At least one tire is overheating. The affected tires are displayed in red. At temperatures close to the limit value, the tires are displayed in yellow.</p> <div data-bbox="553 731 1984 878" data-label="Complex-Block"> <p data-bbox="574 738 1432 772">▲ WARNING Risk of an accident from driving with overheated tires</p> <p data-bbox="574 790 1263 821">Overheated tires may burst, particularly at high speeds.</p> <p data-bbox="574 835 1140 866">► Reduce speed so that the tires cool down.</p> </div> <p data-bbox="553 897 1120 928">► Reduce speed so that the tires cool down.</p>

SmartKey

Display messages	Possible causes/consequences and ► Solutions
 <p data-bbox="57 350 282 379">Obtain a New Key</p>	<ul style="list-style-type: none"> <li data-bbox="461 236 942 265">* The SmartKey needs to be replaced. <li data-bbox="492 277 983 306">► Visit a qualified specialist workshop.
 <p data-bbox="57 512 308 541">Replace Key Battery</p>	<ul style="list-style-type: none"> <li data-bbox="461 401 942 430">* The SmartKey battery is discharged. <li data-bbox="492 443 942 472">► Replace the battery (→ page 65).
 <p data-bbox="57 675 333 704">Don't Forget Your Key</p>	<ul style="list-style-type: none"> <li data-bbox="461 564 1913 593">* A warning tone also sounds. This message reminds you to take your SmartKey with you when you leave the vehicle.
 <p data-bbox="57 838 369 896">Key Not Detected (white display message)</p>	<ul style="list-style-type: none"> <li data-bbox="461 727 962 756">* The SmartKey is currently undetected. <li data-bbox="492 768 1167 797">► Change the location of the SmartKey in the vehicle. <li data-bbox="492 810 1882 839">► If the SmartKey is still not recognized, start the engine with the SmartKey in the marked space (→ page 137).



Display messages	Possible causes/consequences and ► Solutions
 <p data-bbox="118 301 461 363">Key Not Detected (red display message)</p>	<p data-bbox="527 184 1430 215">* The SmartKey cannot be detected and may no longer be in the vehicle.</p> <p data-bbox="551 225 1430 256">The SmartKey is no longer in the vehicle and you switch off the engine:</p> <ul data-bbox="562 270 1052 342" style="list-style-type: none"> <li data-bbox="562 270 1032 301">• You can no longer start the engine. <li data-bbox="562 311 1052 342">• You cannot centrally lock the vehicle. <p data-bbox="551 363 1124 394">► Ensure that the SmartKey is in the vehicle.</p> <p data-bbox="551 425 1655 456">If the SmartKey detection function has a malfunction due to a strong radio signal source:</p> <ul data-bbox="551 467 1880 539" style="list-style-type: none"> <li data-bbox="551 467 1880 498">► Pull over and stop the vehicle safely as soon as possible, paying attention to road and traffic conditions. <li data-bbox="551 508 1798 539">► Place the SmartKey in the marked space for starting the engine with the SmartKey (→ page 137).
 <p data-bbox="118 674 449 767">Place the Key in the Marked Space See Operator's Manual</p>	<p data-bbox="527 560 1185 591">* The SmartKey detection function is malfunctioning.</p> <ul data-bbox="551 601 1349 674" style="list-style-type: none"> <li data-bbox="551 601 1236 632">► Change the location of the SmartKey in the vehicle. <li data-bbox="551 643 1349 674">► Start the vehicle with the SmartKey in the slot (→ page 137).



Vehicle

Display messages	Possible causes/consequences and ► Solutions
 <p data-bbox="57 350 396 446">Vehicle Operational Switch the Ignition Off Before Exiting</p>	<ul style="list-style-type: none"> <li data-bbox="466 236 1255 263">* You are leaving the vehicle when it is in a ready-to-drive state. <ul style="list-style-type: none"> <li data-bbox="492 277 1902 339">► When leaving the vehicle, switch off the ignition, secure the vehicle against rolling away and take the SmartKey with you. <li data-bbox="492 354 1902 446">► If you do not leave the vehicle, switch off the electrical consumers, e.g. the seat heating. Otherwise, the 12-V battery may discharge and it will then be possible to start the vehicle only using a donor battery (starting assistance).
 <p data-bbox="57 581 390 640">Operation Only Possible in Transmission Position P</p>	<ul style="list-style-type: none"> <li data-bbox="466 467 1704 494">* You have attempted to displace the ball coupling and the transmission is in position R, N or D. <ul style="list-style-type: none"> <li data-bbox="492 508 846 535">► Depress the brake pedal. <li data-bbox="492 550 997 577">► Shift the transmission to position P.
<p data-bbox="57 667 390 760">Driver's Door Open & Transmission Not in P Risk of Vehicle Rolling Away</p>	<ul style="list-style-type: none"> <li data-bbox="466 659 1535 686">* The driver's door is not fully closed and the transmission is in position R, N or D. <ul style="list-style-type: none"> <li data-bbox="492 701 1330 728">► Shift the transmission to position P when you park the vehicle.
<p data-bbox="57 788 390 850">N Permanently Active Risk of Rolling Away</p>	<ul style="list-style-type: none"> <li data-bbox="466 781 1733 808">* While the vehicle is rolling or while you are driving, the transmission has been shifted to position N. <ul style="list-style-type: none"> <li data-bbox="492 822 1841 849">► Depress the brake pedal to stop and, when the vehicle is stationary, shift the transmission to position P. <li data-bbox="492 864 1391 890">► To continue your journey, shift the transmission to position D or R.
	<ul style="list-style-type: none"> <li data-bbox="466 912 1794 939">* You have attempted to shift the transmission out of position P or N into another transmission position.

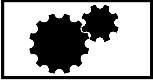

Display messages	Possible causes/consequences and ► Solutions
To Deselect P or N, Depress Brake and Start Engine	<ul style="list-style-type: none"> ► Depress the brake pedal. ► Start the engine.
Apply Brake to Shift from 'P'	<ul style="list-style-type: none"> * You have attempted to shift the transmission out of position P and into another transmission position. ► Depress the brake pedal.
Only Shift to 'P' when Vehicle is Stationary	<ul style="list-style-type: none"> * The transmission can only be shifted to position P when the vehicle is stationary.
To Engage Transmiss. Position R First Depress the Brake	<ul style="list-style-type: none"> * You have tried to switch to transmission position R. ► Depress the brake pedal. ► Switch the transmission to position R.
Service Required Do Not Shift Gears Visit Dealer	<ul style="list-style-type: none"> * The transmission is malfunctioning. The transmission position can no longer be shifted. ► When the transmission is in position D, consult a qualified specialist workshop and do not change the transmission position. ► For all other transmission positions, park the vehicle safely. ► Consult a qualified specialist workshop or breakdown service.
Reversing Not Possible Service Required	<ul style="list-style-type: none"> * The transmission is malfunctioning. Reverse gear can no longer be engaged. ► Visit a qualified specialist workshop.
Transmission Malfunction Stop	<ul style="list-style-type: none"> * The transmission is malfunctioning. The transmission shifts to position N automatically. ► Pull over and stop the vehicle safely as soon as possible, paying attention to road and traffic conditions.

Display messages	Possible causes/consequences and ► Solutions
	<ul style="list-style-type: none"> ► Switch the transmission to position P. ► Consult a qualified specialist workshop.
Auxiliary Battery Malfunction	<ul style="list-style-type: none"> * The auxiliary battery for the transmission is no longer being charged. ► Visit a qualified specialist workshop. ► Until then, manually set the transmission to position P before you switch off the engine. ► Before leaving the vehicle, apply the electric parking brake.
Stop Vehicle Leave Engine Running Wait Transmission Cooling	<ul style="list-style-type: none"> * The transmission is overheating. Pulling away may be temporarily impaired or not possible. ► Pull over and stop the vehicle safely as soon as possible, paying attention to road and traffic conditions. Do not continue driving under any circumstances. ► Leave the engine running. ► Wait until the display message disappears before pulling away.
 Transmission Oil Cooling Malfunction	<ul style="list-style-type: none"> * The transmission's coolant pump is defective. The transmission may overheat. ► Select the Performance menu in the on-board computer and check the transmission oil temperature (→ page 230). ► Avoid a high load with a dynamic driving style. ► If transmission oil temperatures are below 248 °F (120 °C), continue driving to the nearest qualified specialist workshop.

Display messages	Possible causes/consequences and ► Solutions
 <p data-bbox="118 302 392 362">Trans. Oil Overheated Drive on with Care</p>	<ul style="list-style-type: none"> * Transmission position M and the temporary manual driving program are no longer available. The engine power is reduced depending on the overheating. <ul style="list-style-type: none"> ► Let the transmission oil cool down by driving defensively until the display message goes out.
<p data-bbox="118 389 459 482">Electronic Rear Axle Differential Lock Currently Unavailable</p>	<ul style="list-style-type: none"> * The motor of the electronic rear axle locking differential is overheating. <ul style="list-style-type: none"> ► Let the electronic rear axle locking differential cool down by driving defensively.
<p data-bbox="118 508 459 570">Electronic Rear Axle Differential Lock Inoperative</p>	<ul style="list-style-type: none"> * The electronic rear axle locking differential is inoperative. <ul style="list-style-type: none"> ► Visit a qualified specialist workshop.
 <p data-bbox="118 703 449 796">Steering Malfunction Stop Immediately See Operator's Manual</p>	<ul style="list-style-type: none"> * The steering is malfunctioning Steering capability is considerably impaired. <div style="border: 1px solid gray; padding: 5px; margin-top: 10px;"> <p data-bbox="578 650 1371 684">⚠ WARNING Risk of accident if steering capability is impaired</p> <p data-bbox="578 700 1692 731">If the steering does not function as intended, the vehicle's operating safety is jeopardized.</p> <ul style="list-style-type: none"> ► Pull over and stop the vehicle safely as soon as possible, paying attention to road and traffic conditions. Do not continue driving under any circumstances. ► Consult a qualified specialist workshop. </div> <ul style="list-style-type: none"> ► Pull over and stop the vehicle safely as soon as possible, paying attention to road and traffic conditions. Do not continue driving under any circumstances.



Display messages	Possible causes/consequences and ► Solutions
 <p>Rear Axle Steering Malfunction Service Required</p>	<ul style="list-style-type: none"> ► Consult a qualified specialist workshop. <p>* The rear axle steering is malfunctioning. The rear axle has no steering capability. When driving in a straight line, the steering wheel may tilt.</p> <ul style="list-style-type: none"> ► Continue driving carefully at a changed speed. ► Visit a qualified specialist workshop immediately.
 <p>Steering Malfunction Increased Physical Effort See Operator's Manual</p>	<p>* The power assistance for the steering is malfunctioning.</p> <div style="background-color: #e0e0e0; padding: 5px; margin: 10px 0;"> <p>⚠ WARNING Risk of an accident due to altered steering characteristics</p> <p>If the power assistance of the steering fails partially or completely, you will need to use more force to steer.</p> <ul style="list-style-type: none"> ► If safe steering is possible, drive on carefully. ► Visit or consult a qualified specialist workshop immediately. </div> <ul style="list-style-type: none"> ► If safe steering is possible, drive on carefully. ► Visit or consult a qualified specialist workshop immediately.
 <p>Rear Axle Steering Currently Unavailable</p>	<p>* The rear axle steering is temporarily unavailable. The turning circle may enlarge.</p> <ul style="list-style-type: none"> ► Stop the vehicle, paying attention to road and traffic conditions, and restart the engine. <p>If the display message does not disappear:</p> <ul style="list-style-type: none"> ► Drive on carefully.





Display messages	Possible causes/consequences and ► Solutions
<p>Rear Spoiler Inoperative Limit ### mph</p>	<ul style="list-style-type: none"> ► Visit a qualified specialist workshop. <p>* The vehicle's speed is limited to the value displayed. Therefore, the rear wing cannot reach the end position during extension and only extends as far as is possible.</p> <p>If extension of the rear wing is blocked, e.g. by ice:</p> <ul style="list-style-type: none"> ► Ensure that the cause of the blockage has been removed. ► Switch off the engine and lock the vehicle. ► Start the vehicle after a few minutes. The rear wing moves to the initial position. <p>If the problem persists or the cause cannot be detected:</p> <ul style="list-style-type: none"> ► Visit a qualified specialist workshop.
<p>Rear Spoiler Control System Inoperative</p>	<p>* The rear wing cannot reach the end position during retraction and extends again if possible.</p> <p>If retraction of the rear wing is blocked, e.g. by ice:</p> <ul style="list-style-type: none"> ► Ensure that the cause of the blockage has been removed. ► Switch off the engine and lock the vehicle. ► Start the vehicle after a few minutes. The rear wing moves to the initial position. <p>If the problem persists or the cause cannot be detected:</p> <ul style="list-style-type: none"> ► Visit a qualified specialist workshop.



Display messages	Possible causes/consequences and ► Solutions
	<p>* The hood is open.</p> <p>▲ WARNING Risk of accident if the engine hood is unlatched while driving</p> <p>An unlocked engine hood may open up when the vehicle is in motion and block your view.</p> <ul style="list-style-type: none"> ▶ Never unlatch the engine hood while driving. ▶ Before every trip, ensure that the engine hood is latched. <ul style="list-style-type: none"> ▶ Stop the vehicle immediately, paying attention to road and traffic conditions. ▶ Close the hood.
	<p>* At least one door is open.</p> <ul style="list-style-type: none"> ▶ Close all doors.
	<p>* The tailgate is open.</p> <p>▲ DANGER Risk of exhaust gas poisoning</p> <p>Combustion engines emit poisonous exhaust gases such as carbon monoxide. Exhaust gases can enter the vehicle interior if the tailgate is open when the engine is running, especially if the vehicle is in motion.</p> <ul style="list-style-type: none"> ▶ Always switch off the engine before opening the tailgate. ▶ Never drive with the tailgate open. <ul style="list-style-type: none"> ▶ Close the tailgate.

Display messages	Possible causes/consequences and ► Solutions
 <p data-bbox="118 301 369 327">Check Washer Fluid</p>	<ul style="list-style-type: none"> <li data-bbox="527 184 1596 215">* The washer fluid level in the washer fluid reservoir has dropped below the minimum. <li data-bbox="553 225 989 256">► Add washer fluid (→ page 356).

Lights

Display messages	Possible causes/consequences and ► Solutions
 <p data-bbox="118 618 322 681">Check Left Low Beam (Example)</p>	<ul style="list-style-type: none"> <li data-bbox="527 501 1091 532">* The corresponding light source is defective. <li data-bbox="553 542 819 573">► Drive on carefully. <li data-bbox="553 584 1208 615">► Visit a qualified specialist workshop immediately. <li data-bbox="553 625 1984 687">ⓘ LED light bulbs: the display message for the corresponding lamp appears only when all the light-emitting diodes in the lamp have failed.
 <p data-bbox="118 824 457 886">Active Headlamps Inoperative</p>	<ul style="list-style-type: none"> <li data-bbox="527 707 997 738">* The active headlamps are defective. <li data-bbox="553 749 1050 780">► Visit a qualified specialist workshop.

Display messages	Possible causes/consequences and ► Solutions
 <p data-bbox="57 301 396 360">Intell. Light System Inoperative</p>	<ul style="list-style-type: none"><li data-bbox="466 184 1907 249">* The Intelligent Light System is defective. The lighting system continues to function properly without the functions of the Intelligent Light System.<ul style="list-style-type: none"><li data-bbox="492 260 983 291">► Visit a qualified specialist workshop.
 <p data-bbox="57 496 355 555">Malfunction See Operator's Manual</p>	<ul style="list-style-type: none"><li data-bbox="466 379 895 410">* The exterior lighting is defective.<ul style="list-style-type: none"><li data-bbox="492 420 983 451">► Visit a qualified specialist workshop.
 <p data-bbox="57 691 396 750">Automatic Headlamp Mode Inoperative</p>	<ul style="list-style-type: none"><li data-bbox="466 573 846 605">* The light sensor is defective.<ul style="list-style-type: none"><li data-bbox="492 615 983 646">► Visit a qualified specialist workshop.
 <p data-bbox="57 885 273 906">Switch Off Lights</p>	<ul style="list-style-type: none"><li data-bbox="466 768 1259 799">* You are leaving the vehicle and the lights are still switched on.<ul style="list-style-type: none"><li data-bbox="492 810 1054 841">► Turn the light switch to the AUTO position.

Display messages	Possible causes/consequences and ► Solutions
 <p data-bbox="118 301 396 329">Switch On Headlamps</p>	<p data-bbox="519 184 1116 212">* You are driving without low-beam headlamps.</p> <ul style="list-style-type: none"> <li data-bbox="549 228 1220 256">► Turn the light switch to the  or AUTO position.
<p data-bbox="118 355 449 417">Adaptive Highbeam Assist Inoperative</p>	<p data-bbox="519 344 1103 372">* Adaptive Highbeam Assist is malfunctioning.</p> <ul style="list-style-type: none"> <li data-bbox="549 389 1046 417">► Visit a qualified specialist workshop.
<p data-bbox="118 443 449 536">Adaptive Highbeam Assist Currently Unavailable See Operator's Manual</p>	<p data-bbox="519 433 1208 505">* Adaptive Highbeam Assist is temporarily unavailable. The system limits have been reached (→ page 118).</p> <ul style="list-style-type: none"> <li data-bbox="549 522 1972 614">► Drive on. Once the cause of the problem is no longer present, the system will be available again. The Adaptive Highbeam Assist Now Available display message appears.
<p data-bbox="118 640 449 733">Adaptive Highbeam Assist Camera View Restricted See Operator's Manual</p>	<p data-bbox="519 629 1185 657">* The camera view is restricted. Possible causes are:</p> <ul style="list-style-type: none"> <li data-bbox="560 674 1242 702">• Dirt on the windshield in the camera's field of vision <li data-bbox="560 718 889 746">• Heavy rain, snow or fog <p data-bbox="549 769 1710 797">Driving systems and driving safety systems may be malfunctioning or temporarily unavailable.</p> <p data-bbox="549 814 1937 873">Once the cause of the problem is no longer present, driving systems and driving safety systems will be available again.</p> <p data-bbox="549 889 1083 917">If the display message does not disappear:</p> <ul style="list-style-type: none"> <li data-bbox="549 934 1882 962">► Pull over and stop the vehicle safely as soon as possible, paying attention to road and traffic conditions.

Display messages

Possible causes/consequences and ► Solutions

- Clean the windshield.

Warning and indicator lamps

Overview of warning and indicator lamps

Some systems will perform a self-test when the ignition is switched on. Some warning and indicator lamps may briefly light up or flash. This behavior is non-critical. These warning and indicator lamps indicate a malfunction only if they light up or flash after the engine has been started or during a journey.

Instrument Display

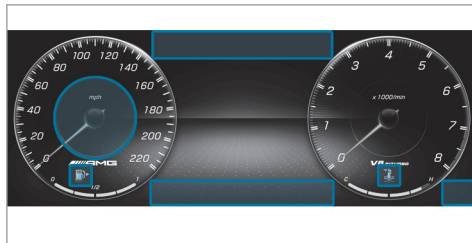



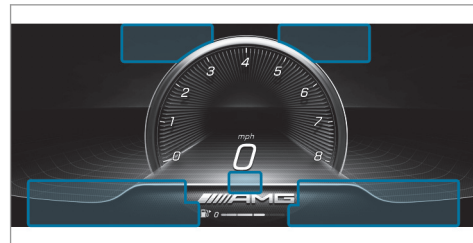





















Supersport setting





If you select the Supersport display setting, the positions of the indicator lamps on the Instrument Display will change.



Warning and indicator lamps:



-  Low beam (→ page 115)
-  Parking lights (→ page 115)
-  High beam (→ page 116)
-   Turn signal light (→ page 116)

	Rear fog light (→ page 115)		ABS malfunctioning (→ page 475)		Electrical malfunction (→ page 483)
	Restraint system (→ page 475)		ESP® (→ page 475)		Fuel reserve with fuel filler flap location indicator (→ page 483) (→ page 483)
	Seat belt not fastened (→ page 481)		ESP® OFF (→ page 475)		Coolant too hot/cold (→ page 483)
	USA: brakes (red) (→ page 475)		ESP® SPORT (→ page 475)		Tire pressure monitoring system (→ page 486)
	Canada: brakes (red) (→ page 475)		Distance warning (→ page 482)		
	Electric parking brake (yellow) (→ page 475)		Power-assisted steering malfunctioning (→ page 482)		
	USA: electric parking brake applied (red) (→ page 475)		AMG adaptive sport suspension system malfunctioning (→ page 482)		
	Canada: electric parking brake applied (red) (→ page 475)		Check Engine (→ page 483)		



Safety systems

Warning/indicator lamp	Possible causes/consequences and ► Solutions
 <p>Brake warning lamp (USA)</p> 	<p>The red brake system warning lamp is lit while the engine is running.</p> <p>Possible causes are:</p> <ul style="list-style-type: none"> • The brake force boosting is malfunctioning and the braking characteristics may be affected. • There is insufficient brake fluid in the brake fluid reservoir.

Warning/indicator lamp	Possible causes/consequences and ► Solutions
Brakes warning lamp (Canada)	<p data-bbox="457 184 1917 225">  WARNING Risk of accident and injury if brake force boosting is malfunctioning </p> <p data-bbox="457 236 1917 298"> If brake force boosting is malfunctioning, increased brake pedal force may be necessary for braking. The braking characteristics may be impaired. The braking distance can increase in emergency braking situations. </p> <ul data-bbox="457 308 1917 391" style="list-style-type: none"> <li data-bbox="457 308 1917 344">▶ Stop in a safe location immediately. Do not continue driving. <li data-bbox="457 355 1917 391">▶ Consult a qualified specialist workshop. <p data-bbox="457 427 1917 469">  WARNING Risk of an accident due to low brake fluid level </p> <p data-bbox="457 479 1917 510"> If the brake fluid level is too low, the braking effect and the braking characteristics may be impaired. </p> <ul data-bbox="457 521 1917 676" style="list-style-type: none"> <li data-bbox="457 521 1917 583">▶ Pull over and stop the vehicle safely as soon as possible, paying attention to road and traffic conditions. Do not continue driving under any circumstances. <li data-bbox="457 593 1917 629">▶ Consult a qualified specialist workshop. <li data-bbox="457 640 1917 676">▶ Do not add brake fluid. <ul data-bbox="441 702 1917 852" style="list-style-type: none"> <li data-bbox="441 702 1917 769">▶ Pull over and stop the vehicle safely as soon as possible, paying attention to road and traffic conditions. Do not continue driving under any circumstances. <li data-bbox="441 780 1917 816">▶ Observe the messages on the multifunction display. <li data-bbox="441 826 1917 852">▶ Consult a qualified specialist workshop.
<div data-bbox="69 871 261 971" style="border: 2px solid black; padding: 5px; text-align: center; font-weight: bold; font-size: 1.5em;">PARK</div>	<p data-bbox="441 866 1927 928">The red electric parking brake indicator lamp flashes or is lit. The yellow indicator lamp is also lit if the electric parking brake malfunctions.</p> <ul data-bbox="441 938 1927 975" style="list-style-type: none"> <li data-bbox="441 938 1927 975">▶ Observe the messages on the multifunction display.

Warning/indicator lamp	Possible causes/consequences and ► Solutions
<p>Red indicator lamp, electric parking brake applied (USA only)</p>  <p>Red indicator lamp, electric parking brake applied (Canada only)</p>  <p>Yellow electric parking brake indicator lamp is malfunctioning</p>	
 <p>ABS warning lamp</p>	<p>The yellow ABS warning lamp is lit while the engine is running. ABS is malfunctioning.</p> <p>If there is an additional warning tone, EBD is malfunctioning.</p> <p>Other driving systems and driving safety systems may also malfunction.</p>



Warning/indicator lamp	Possible causes/consequences and ► Solutions
	<p>▲ WARNING There is risk of skidding if EBD or ABS is malfunctioning</p> <p>If EBD or ABS is malfunctioning, the wheels could lock when braking</p> <p>The steering capability and braking characteristics are thus severely impaired. The braking distance in an emergency braking situation can increase. In addition, other driving safety systems are switched off.</p> <ul style="list-style-type: none"> ▶ Drive on carefully. ▶ Have the brake system checked immediately at a qualified specialist workshop. <ul style="list-style-type: none"> ▶ Drive on carefully. ▶ Observe the messages on the multifunction display. ▶ Visit a qualified specialist workshop.
 <p>ESP® OFF indicator lamp</p>	<p>The yellow ESP® OFF warning lamp is lit while the engine is running.</p> <p>ESP® is deactivated.</p> <ul style="list-style-type: none"> ▶ Observe the notes on deactivating ESP® (→ page 167).

Warning/indicator lamp	Possible causes/consequences and ► Solutions
 <p data-bbox="118 513 466 542">ESP® SPORT indicator lamp</p>	<p data-bbox="502 187 1160 218">ESP® SPORT is activated while the engine is running.</p> <p data-bbox="502 232 1533 263">When ESP® SPORT is activated, ESP® stabilizes the vehicle only to a limited extent.</p> <div data-bbox="502 288 1984 443" style="border: 1px solid gray; padding: 5px;"> <p data-bbox="519 298 1340 332">▲ WARNING Risk of skidding if ESP® SPORT is used incorrectly</p> <p data-bbox="519 353 1688 384">When you activate ESP® SPORT, there is an increased risk of skidding and having an accident.</p> <ul style="list-style-type: none"> <li data-bbox="519 397 1377 428">▶ Activate ESP® SPORT only in the circumstances described below. </div> <p data-bbox="502 464 1279 498">► Observe the notes on activating ESP® SPORT(→ page 167).</p>
 <p data-bbox="118 677 457 708">ESP® warning lamp flashes</p>	<p data-bbox="502 562 1351 593">The yellow ESP® warning lamp flashes while the vehicle is in motion.</p> <p data-bbox="502 607 1336 638">At least one wheel and tire assembly has reached its traction limit .</p> <p data-bbox="502 651 1340 682">► Adapt your driving style to suit the road and weather conditions.</p>
 <p data-bbox="118 843 437 906">ESP® warning lamp lights up</p>	<p data-bbox="502 728 1289 759">The yellow ESP® warning lamp is lit while the engine is running.</p> <p data-bbox="502 772 793 803">ESP® is malfunctioning</p> <p data-bbox="502 817 1389 848">Other driving systems and driving safety systems may also malfunction.</p>



Warning/indicator lamp	Possible causes/consequences and ► Solutions
	<p data-bbox="457 184 1173 221">▲ WARNING Risk of skidding if ESP® is malfunctioning</p> <p data-bbox="457 240 1872 302">If ESP® is malfunctioning, ESP® cannot carry out vehicle stabilization. In addition, other driving safety systems are switched off.</p> <ul data-bbox="457 319 1181 395" style="list-style-type: none"> <li data-bbox="457 319 731 350">► Drive on carefully. <li data-bbox="457 360 1181 395">► Have ESP® checked at a qualified specialist workshop. <ul data-bbox="437 428 1124 547" style="list-style-type: none"> <li data-bbox="437 428 707 459">► Drive on carefully. <li data-bbox="437 470 1124 501">► Observe the messages on the multifunction display. <li data-bbox="437 511 936 547">► Visit a qualified specialist workshop.
 <p data-bbox="57 675 374 737">Restraint system warning lamp</p>	<p data-bbox="437 561 1324 634">The red restraint system warning lamp is lit while the engine is running. The restraint system is defective (→ page 32).</p> <p data-bbox="457 665 1541 702">▲ WARNING Risk of injury or fatal injury due to a malfunction in the restraint system</p> <p data-bbox="457 716 1896 810">If the restraint system is malfunctioning, restraint system components may be triggered unintentionally or might not be triggered at all in the event of an accident. This may affect the Emergency Tensioning Device or airbag, for example.</p> <ul data-bbox="457 826 1684 857" style="list-style-type: none"> <li data-bbox="457 826 1684 857">► Have the restraint system checked and repaired immediately at a qualified specialist workshop. <ul data-bbox="437 888 1124 970" style="list-style-type: none"> <li data-bbox="437 888 707 919">► Drive on carefully. <li data-bbox="437 930 1124 970">► Observe the messages on the multifunction display.

Warning/indicator lamp	Possible causes/consequences and ► Solutions
	<ul style="list-style-type: none"> ► Visit a qualified specialist workshop immediately.

Seat belts

Warning/indicator lamp	Possible causes/consequences and ► Solutions
 <p data-bbox="118 493 410 555">Seat belt warning lamp lights up</p>	<p data-bbox="500 376 1590 407">The red seat belt warning lamp will light up for six seconds once the engine has started.</p> <p data-bbox="500 418 983 449">In addition, a warning tone may sound.</p> <p data-bbox="500 461 1645 492">The seat belt warning lamp reminds the driver and front passenger to fasten their seat belts.</p> <ul style="list-style-type: none"> <li data-bbox="500 503 977 534">► Fasten your seat belt (→ page 37). <p data-bbox="500 556 1712 587">If you have placed objects on the front passenger seat, the seat belt warning lamp may remain lit.</p>
 <p data-bbox="118 721 410 783">Seat belt warning lamp flashes</p>	<p data-bbox="500 602 1500 634">The red seat belt warning lamp flashes and an intermittent warning tone sounds.</p> <p data-bbox="500 645 1631 676">The driver or front passenger has not fastened their seat belt while the vehicle is in motion.</p> <ul style="list-style-type: none"> <li data-bbox="500 687 968 718">► Fasten your seat belt(→ page 37). <li data-bbox="500 720 1079 751">There are objects on the front passenger seat. <li data-bbox="500 762 1177 793">► Remove the objects from the front passenger seat.

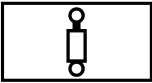
Driving systems

Warning/indicator lamp	Possible causes/consequences and ► Solutions
 <p data-bbox="57 350 378 381">Suspension warning lamp</p>	<p data-bbox="441 236 1318 308">The yellow AMG adaptive sport suspension system warning lamp is on. There is a malfunction in the AMG adaptive sport suspension system.</p> <ul data-bbox="441 319 1124 350" style="list-style-type: none"> ► Observe the messages on the multifunction display.
 <p data-bbox="57 508 378 570">Warning lamp for distance warning function</p>	<p data-bbox="441 399 1563 508">The red distance warning lamp lights up while the vehicle is in motion. The distance to the vehicle in front is too small for the speed selected. If there is an additional warning tone, you are approaching an obstacle at too high a speed.</p> <ul data-bbox="441 519 909 591" style="list-style-type: none"> ► Be prepared to brake immediately. ► Increase the distance. <p data-bbox="441 617 690 648">Active Brake Assist .</p>



Vehicle

Warning/indicator lamp	Possible causes/consequences and ► Solutions
	<p data-bbox="441 822 1400 895">The red power steering system warning lamp is lit while the engine is running. The power-assisted steering or the steering itself is malfunctioning.</p>

Warning/indicator lamp	Possible causes/consequences and ► Solutions
Power steering system warning lamp	<p data-bbox="523 184 1320 218">▲ WARNING Risk of accident if steering capability is impaired</p> <p data-bbox="523 236 1637 270">If the steering does not function as intended, the vehicle's operating safety is jeopardized.</p> <ul style="list-style-type: none"> <li data-bbox="523 280 1896 342">► Pull over and stop the vehicle safely as soon as possible, paying attention to road and traffic conditions. Do not continue driving under any circumstances. <li data-bbox="523 353 1058 387">► Consult a qualified specialist workshop. <p data-bbox="502 418 1187 452">► Observe the messages on the multifunction display.</p>

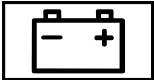

Engine

Warning/indicator lamp	Possible causes/consequences and ► Solutions
 <p data-bbox="118 733 437 795">Engine diagnosis warning lamp</p>	<p data-bbox="502 619 1391 653">The yellow Check Engine warning lamp is lit while the engine is running.</p> <p data-bbox="502 664 1504 698">A malfunction has occurred in the engine, the exhaust system or the fuel system.</p> <p data-bbox="502 708 1586 742">The emission limit values may be exceeded and the engine may be in emergency mode.</p> <p data-bbox="502 753 1974 815">In some states, legal requirements stipulate that you must immediately consult a qualified specialist workshop as soon as the yellow Check Engine warning lamp lights up.</p> <p data-bbox="502 825 1541 859">► Have the vehicle checked as soon as possible at a qualified specialist workshop.</p>
	<p data-bbox="502 868 1116 902">The red electrical malfunction warning lamp is lit.</p> <p data-bbox="502 912 977 946">There is a malfunction in the electrics.</p>

Warning/indicator lamp	Possible causes/consequences and ► Solutions
Electrical malfunction warning lamp	► Observe the messages on the multifunction display.
 <p>Fuel reserve warning lamp</p>	<p>The yellow fuel reserve warning lamp lights up while driving. There has been pressure loss in the fuel system. The fuel filler cap is not closed correctly or the fuel system is leaking.</p> <p>► Close the fuel filler cap.</p> <p>If the fuel filler cap has already been closed correctly:</p> <p>► Visit a qualified specialist workshop.</p>
 <p>Fuel reserve warning lamp</p>	<p>The yellow fuel reserve warning lamp is lit while the engine is running. The fuel supply has dropped into the reserve range.</p> <p>► Refuel.</p>
 <p>Coolant warning lamp</p>	<p>The red coolant warning lamp is lit while the engine is running. Possible causes are:</p> <ul style="list-style-type: none"> • The temperature sensor is malfunctioning • The coolant level is too low • The air supply to the radiator is obstructed • The radiator fan is defective <p>If there is an additional warning tone, the coolant temperature has exceeded the maximum permissible temperature.</p>

Warning/indicator lamp	Possible causes/consequences and ► Solutions
	<p data-bbox="523 184 1218 218">▲ WARNING Danger of burns when opening the hood</p> <p data-bbox="523 236 1937 298">If you open the hood when the engine has overheated or during a fire in the engine compartment, you could come into contact with hot gases or other escaping operating fluids.</p> <ul data-bbox="523 311 1745 384" style="list-style-type: none"><li data-bbox="523 311 1263 342">▶ Before opening the hood, allow the engine to cool down.<li data-bbox="523 353 1745 384">▶ In the event of a fire in the engine compartment, keep the hood closed and call the fire service. <p data-bbox="523 418 1943 480">▶ Pull over and stop the vehicle safely and switch off the engine, paying attention to road and traffic conditions. Do not continue driving under any circumstances.</p> <p data-bbox="523 494 1187 525">▶ Observe the messages on the multifunction display.</p> <p data-bbox="523 547 1479 578">If the coolant temperature display is at the lower end of the temperature scale:</p> <ul data-bbox="523 591 1943 861" style="list-style-type: none"><li data-bbox="523 591 1038 622">▶ Consult a qualified specialist workshop. <p data-bbox="523 636 533 656">or</p> <ul data-bbox="523 674 1943 861" style="list-style-type: none"><li data-bbox="523 674 1561 705">▶ Exit the vehicle and keep a safe distance from it until the engine has cooled down.<li data-bbox="523 718 1024 750">▶ Check the coolant level (→ page 355).<li data-bbox="523 763 1316 794">▶ Make sure that the air supply to the radiator is not obstructed.<li data-bbox="523 808 1943 861">▶ Avoiding high loads on the engine, drive to the nearest qualified specialist workshop. In doing so, ensure that the coolant temperature display remains below the red area.

Tires

Warning/indicator lamp	Possible causes/consequences and ► Solutions
 <p data-bbox="57 350 398 446">Tire pressure monitoring system warning lamp lights up</p>	<p data-bbox="443 236 1612 308">The yellow tire pressure monitoring system warning lamp (pressure loss/malfunction) is lit. The tire pressure monitoring system has detected tire pressure loss in at least one of the tires.</p> <div data-bbox="443 329 1923 381" style="background-color: #e0e0e0; padding: 5px;"> <p data-bbox="457 339 1289 370">⚠ WARNING Risk of an accident due to insufficient tire pressure</p> </div> <p data-bbox="461 391 1187 422">Tire pressures that are too low pose the following hazards:</p> <ul data-bbox="472 433 1586 550" style="list-style-type: none"> <li data-bbox="472 433 1375 464">• The tires may burst, especially as the load and vehicle speed increase. <li data-bbox="472 474 1586 505">• The tires may wear excessively and/or unevenly, which may greatly impair tire traction. <li data-bbox="472 515 1549 547">• The driving characteristics, as well as steering and braking, may be greatly impaired. <p data-bbox="461 570 983 601">You could then lose control of the vehicle.</p> <ul data-bbox="461 612 1017 684" style="list-style-type: none"> <li data-bbox="461 612 1017 643">► Observe the recommended tire pressure. <li data-bbox="461 653 962 684">► Adjust the tire pressure if necessary.
	<p data-bbox="443 809 1876 871">The yellow tire pressure monitoring system warning lamp (pressure loss/malfunction) flashes for approximately one minute and then remains lit.</p> <p data-bbox="443 881 1044 912">The tire pressure monitoring system is defective.</p>

Warning/indicator lamp	Possible causes/consequences and ► Solutions
Tire pressure monitoring system warning lamp flashes	<p data-bbox="519 184 1970 218">▲ WARNING There is a risk of an accident if the tire pressure monitoring system is malfunctioning</p> <p data-bbox="519 236 1970 296">If the tire pressure monitoring system is malfunctioning, it is not able to issue a warning if there is pressure loss in one or more of the tires.</p> <p data-bbox="519 311 1671 342">Underinflated tires may, for example, impair the driving, steering and braking characteristics.</p> <ul data-bbox="519 353 1616 384" style="list-style-type: none">► Have the tire pressure monitoring system checked at a qualified specialist workshop. <p data-bbox="498 420 997 446">► Visit a qualified specialist workshop.</p>

- 1, 2, 3 ...**
- 4MATIC** 153
Function 153
- 12 V battery**
see Battery (vehicle)
- 12 V socket**
see Socket (12 V)
- 48 V on-board electrical system**
Operating safety 22
- 115 V socket**
see Socket (115 V)
- 360° Camera** 206
Care 362
Function 206
Opening the camera cover (rear view camera) 209
Selecting a view 209
Setting favorites 209
- A**
- A/C function**
Activating/deactivating (multimedia system) 129
- Switching on/off (control panel) 129
- ABS (Anti-lock Braking System)** 166
- Acceleration**
see Kickdown
- Acoustic locking verification signal**
Activating/deactivating 64
- Activating/deactivating automatic volume adjustment**
Burmester® surround sound system ... 343
- Active Blind Spot Assist** 218
Brake application 219
Function 218
Switching on/off 220
System limitations 218
- Active Brake Assist**
Function/notes 170
Setting 174
- Active Distance Assist DISTRONIC** 177
Active Emergency Stop Assist 186
Active Lane Change Assist 185
Calling up a speed 179
Displays in the Instrument Display 187
Function 177
- Increasing/decreasing speed 179
Requirements 179
Route-based speed adaptation 181
Steering wheel buttons 179
Storing a speed 179
Switching off/deactivating 179
Switching on/activating 179
System limitations 177
- Active Emergency Stop Assist** 186
- Active Lane Change Assist** 185
Activating/deactivating 186
Function 185
- Active Lane Keeping Assist** 220
Activating/deactivating 222
Activating/deactivating the warning ... 223
Function 220
Sensitivity (function/notes) 223
Setting the sensitivity 223
System limitations 220
- Active Parking Assist** 209
Cross Traffic Alert 214
Drive Away Assist 214
Exiting a parking space 212
Function 209

- Maneuvering assistance 215
- Parking 211
- System limitations 209
- Active Service System PLUS**
- ASSYST PLUS 350
- Active Speed Limit Assist** 180
- Display 180
- Function 180
- Active Steering Assist** 183
- Activating/deactivating 185
- Active Emergency Stop Assist 186
- Active Lane Change Assist 185
- Displays in the Instrument Display 187
- Function 183
- System limitations 183
- Adaptive cruise control**
- see Active Distance Assist DISTRONIC
- Adaptive Highbeam Assist**
- Function 118
- Switching on/off 119
- Additional value range**
- Setting display content 227
- Additives** 422
- Engine oil 422
- Fuel 422
- Additives (engine oil)**
- see Additives
- Additives (fuel)**
- see Fuel
- Address book**
- see Contacts
- Adjusting the balance/fader**
- Burmester® high-end 3D surround sound system 344
- Burmester® surround sound system ... 343
- Rear touchscreen 348
- Adjusting the bass, mid-range and treble**
- Burmester® high-end 3D surround sound system 344
- Adjusting the mid-range, treble and bass**
- Burmester® high-end 3D surround sound system 344
- Adjusting the sound focus**
- Burmester® surround sound system ... 344
- Adjusting the sound optimization**
- Burmester® high-end 3D surround sound system 345
- Adjusting treble, mid-range and bass settings**
- Burmester® high-end 3D surround sound system 344
- Burmester® surround sound system ... 343
- After-sales service center**
- see ASSYST PLUS
- Air bag**
- Reduced protection 41
- Air conditioning system**
- see Climate control
- Air distribution**
- Setting 128
- Air freshener system**
- see Perfume atomizer
- Air inlet**
- see Air-water duct

- Air pressure**
see Tire pressure
- Air vents** 133
Adjusting (front) 133
Adjusting (rear) 134
Glove box 134
- Air vents**
see Air vents
- Air-recirculation mode** 131
- Air-water duct** 356
Keeping free 356
- Airbag** 39
Activation 33
Front airbag (driver, front passenger) ... 39
Installation locations 39
Knee airbag 39
Overview 39
PASSENGER AIR BAG indicator lamp 44
Protection 40
Side airbag 39
Window curtain airbag 39
- Airflow**
Setting 128
- Alarm**
see Panic alarm
- Alarm system**
see ATA (anti-theft alarm system)
- All-wheel drive**
see 4MATIC
- Alternative route**
see Route
- Ambiance light**
Setting (multimedia system) 120
- Ambient lighting**
Setting (rear touchscreen) 346
- AMG**
DRIVE UNIT 193
Steering-wheel buttons 193
- AMG adaptive sport suspension system**
Selecting the suspension setting 198
Setting 198
Suspension 195
- AMG ceramic high-performance composite brake system** 142
- AMG DRIVE UNIT**
see AMG Performance steering wheel
- AMG dynamic data**
Displaying (rear touchscreen) 346
- AMG engine data**
Displaying (rear touchscreen) 346
- AMG Performance adjustable exhaust system** 146
Function 146
Operating 146
- AMG performance seat**
Setting 90
- AMG Performance steering wheel** 193
- AMG TRACK PACE**
Configuring 270
Drag Race 269
General information 267
Telemetry display 270
Track Race 267
- AMG vehicle data**
Displaying (rear touchscreen) 346
- Android Auto** 312
Connecting a mobile phone 313

- Ending 314
- Information 313
- Overview 312
- Sound settings 313
- Transferred vehicle data 314
- Animals**
 - Pets in the vehicle 62
- Anti-lock braking system**
 - see ABS (Anti-lock Braking System)
- Anti-skid chains**
 - see Snow chains
- Anti-theft alarm system**
 - see ATA (anti-theft alarm system)
- Anti-theft protection**
 - Immobilizer 84
- Anti-theft protection**
 - see ATA (anti-theft alarm system)
- Anticipatory occupant protection**
 - see PRE-SAFE® (anticipatory occupant protection)
 - see PRE-SAFE® PLUS (anticipatory occupant protection plus)
- Apple CarPlay™** 311
 - Connecting an iPhone® 311
 - Ending 312
 - Notes 311
 - Overview 311
 - Sound settings 312
 - Transferred vehicle data 314
- Ashtray**
 - Front center console 107
 - Rear passenger compartment 107
- Assistance systems**
 - see Driving safety system
- Assistant display**
 - Menu (on-board computer) 229
- ASSYST PLUS** 350
 - Battery disconnection periods 351
 - Displaying the service due date 350
 - Function/notes 350
 - Regular maintenance work 350
 - Special service requirements 350
- ATA (anti-theft alarm system)** 84
 - Deactivating the alarm 85
 - Function 84
- ATTENTION ASSIST** 215, 216
 - Function 215
 - Setting 216
 - System limitations 215
- Attention assistant**
 - see ATTENTION ASSIST
- Audio mode**
 - Activating media mode 326
 - Connecting USB devices 329
 - Copyrights 326
 - Information 325
 - Inserting/removing an SD card 326
 - Media search 332
 - Overview 328
 - Pause and playback function 329
 - Selecting a track 329
 - Selecting playback options 329
 - Track list 329
- Authorized Mercedes-Benz Center**
 - see Qualified specialist workshop
- Authorized workshop**
 - see Qualified specialist workshop
- Automatic distance control**
 - see Active Distance Assist DISTRONIC



- Automatic driving lights** 116
- Automatic engine start (ECO start/stop function)** 142
- Automatic engine stop (ECO start/stop function)** 142
- Automatic front passenger front airbag shutoff** 42, 44
- Function of the automatic front passenger front airbag shutoff 42
 - PASSENGER AIR BAG indicator lamp 44
- Automatic front passenger front airbag shutoff**
- see Automatic front passenger front airbag shutoff
- Automatic lateral support adjustment**
- Setting 92
- Automatic mirror folding function**
- Activating/deactivating 126
- Automatic transmission**
- Double-clutch function 151
 - Drive program display 148
 - Drive programs 147
 - DYNAMIC SELECT switch 147
- E-SELECT selector lever 149
 - Engaging drive position 151
 - Engaging neutral 150
 - Engaging park position 150
 - Engaging reverse gear 150
 - Kickdown 153
 - Manual gearshifting 151
 - Oil temperature (on-board computer, Performance menu) 230
 - Steering wheel paddle shifters 151
 - Transmission position display 149
 - Transmission positions 149
- B**
- Bag hook** 102
- BAS (Brake Assist System)** 166
- Battery**
- Charging (Remote Online) 137
 - SmartKey 65
- Battery**
- see Battery (vehicle)
- Battery (vehicle)** 377
- Charging 376
 - Notes 372
- Notes (starting assistance and charging) 374
 - Replacing 377
 - Starting assistance 376
- Belt**
- see Seat belt
- Blind Spot Assist** 218
- Function 218
 - Switching on/off 220
 - System limitations 218
- Blower**
- see Climate control
- Bluetooth®** 259
- Activating/deactivating 259
 - Information 259
- Bluetooth® audio**
- Activating 337
 - De-authorizing (de-registering) the device 337
 - Information 335
 - Overview 335
 - Searching for a track 337
 - Searching for and authorizing the device 336









- Selecting a music player 337
 - Switching device via NFC 337
 - Boost pressure (on-board computer, Performance menu) 230**
 - Brake Assist System**
see BAS (Brake Assist System)
 - Brake fluid**
Notes 423
 - Brake force distribution**
EBD (electronic brake force distribution) 170
 - Brakes**
ABS (Anti-lock Braking System) 166
 - Active Brake Assist 170
 - AMG ceramic high-performance composite brake system 142
 - BAS (Brake Assist System) 166
 - Driving tips 139
 - EBD (electronic brake force distribution) 170
 - HOLD function 189
 - Limited braking effect (salt-treated roads) 139
 - New/replaced brakepads/brake discs 138
 - Notes on breaking-in a new vehicle 138
 - Braking assistance**
see BAS (Brake Assist System)
 - Breakdown**
Changing a wheel 410
 - Overview of the help functions 16
 - Roadside Assistance 21
 - Tow-starting 382
 - Towing away 379
 - Transporting the vehicle 380
 - Breakdown**
see Flat tire
 - Burmester® high-end 3D surround sound system**
Adjusting the balance/fader 344
 - Adjusting the sound optimization 345
 - Adjusting treble, mid-range and bass settings 344
 - Automatic volume adjustment 344
 - Calling up the sound menu 344
 - Information 344
 - Selecting the sound profile 345
 - Burmester® surround sound system 343**
Adjusting the balance/fader 343
 - Adjusting the sound focus 344
 - Adjusting treble, mid-range and bass settings 343
 - Automatic volume adjustment 343
 - Calling up the sound menu 343
 - Information 343
 - Switching the surround sound on/off 344
 - Buttons**
Steering wheel 225
- C
- Call list**
Making a call 308
 - Overview 308
 - Calling up the sound menu**
Burmester® high-end 3D surround sound system 344
 - Burmester® surround sound system ... 343
 - Calls 304**
Accepting 304
 - Activating functions during a call 304

























- Calls with several participants 305
- Declining 304
- Ending a call 304
- Incoming call during an existing call 305
- Making 304
- Via the overhead control panel
(Mercedes me connect) 315
- Camera**
 see 360° Camera
 see Rear view camera
- Car key**
 see SmartKey
- Car wash**
 see Care
- Car wash (care)** 357
- Care** 364
 - Air-water duct 356
 - Automatic car wash 357
 - Carpet 364
 - Decorative foil 360
 - Display 364
 - Exterior lighting 362
 - Headliner 364
 - Matte finish 359
 - Paintwork 359
 - Plastic trim 364
 - Power washer 357
 - Real wood/trim elements 364
 - Rear view camera/360° Camera 362
 - Rear wing (extendable) 362
 - Seat belts 364
 - Seat cover 364
 - Sensors 362
 - Tailpipes 362
 - Washing by hand 358
 - Wheels/rims 362
 - Windows 362
 - Wiper blades 362
- Cargo compartment floor**
 Opening/closing 104
- Cargo tie-down rings** 102
- Carpet (Care)** 364
- Change of address** 21
- Change of ownership** 21
- Changing a wheel**
 Preparation 410
 Raising the vehicle 411
- Changing gears** 151
 - Manually 151
- Changing hub caps** 411
- Character entry**
 Function/notes 256
 On the touchpad 256
- Charging**
 Battery (vehicle) 376
 USB port 111
- Child safety lock**
 Activating/deactivating (multimedia
 system) 262
 Rear door 60
 Rear side windows 61
- Child seat**
 Attaching (notes) 52
 Basic instructions 48
 Front passenger seat (notes) 59
 LATCH-type (ISOFIX) (installing) 54
 Notes on risks and dangers 49
 Securing on the front passenger seat 59
 Securing on the rear seat 57
 Top Tether 56























- Children**
 - Avoiding dangers in the vehicle 49
 - Basic instructions 48
 - Special seat belt retractor 53
- Chock** 409
 - Storage location 409
- Chock**
 - see Chock
- Cigarette lighter**
 - Front center console 107
- Cleaning**
 - see Care
- Climate control** 128
 - 3-zone automatic climate control panel 128
 - Activating/deactivating 129
 - Activating/deactivating the A/C function (control panel) 129
 - Activating/deactivating the A/C function (multimedia system) 129
 - Activating/deactivating the synchronization function (control panel) 130
 - Activating/deactivating the synchronization function (multimedia system) 130
 - Air distribution settings 130
 - Air-recirculation mode 131
 - Automatic control 130
 - Climate style function 130
 - Control panel for dual-zone automatic climate control 128
 - Defrosting the windshield 128
 - Filling capacity for PAG oil 426
 - Front air vents 133
 - Glove box air vent 134
 - Inserting/removing the flacon (fragrance system) 132
 - Ionization 131
 - Note 128
 - Rear air vents 134
 - Rear operating unit 128
 - Refrigerant 425
 - Refrigerant filling capacity 426
 - Removing condensation from the windows 131
 - Residual heat 131
 - Setting fragrancing (rear touchscreen) 349
 - Setting temperature (rear touchscreen) 349
 - Setting the air distribution 128
 - Setting the airflow 128
 - Setting the climate style 130
 - Setting the fragrance system 131
 - Setting the temperature 128
 - Switching ionization on/off (rear touchscreen) 349
 - Switching the climate control function on/off (rear touchscreen) 349
 - Switching the rear window defroster on/off 128
 - Ventilating the vehicle (convenience opening) 79
 - Windshield heater 133
- Climate style**
 - Function 130
 - Setting 130
- Cockpit** 6
 - Overview 6
- Coffee cup symbol**
 - see ATTENTION ASSIST









- COMAND**
see Multimedia system
- COMAND Touch**
Managing devices 262
- Combination switch** 116
- Compass** 297
- Computer**
see On-board computer
- Connection status**
Displaying 321
Overview 320
- Connectivity**
Switching transmission of the vehicle position on/off 259
- Contacts** 305
Calling up 306
Deleting 307
Downloading (from mobile phone) 306
Importing 307
Importing (overview) 306
Information 305
Making a call 307
Name format 306
- Options 307
Storing 307
- Controller**
Operating 250
- Convenience closing feature** 79
- Convenience opening** 79
- Coolant (engine)**
Check level 355
Filling capacity 425
Notes 424
- Cooling**
see Climate control
- Copyright**
Licenses 30
Trademarks 30
- Cornering light function** 118
- Cross Traffic Alert** 214
- Crosswind Assist**
Function/notes 169
- Cruise control** 175
Buttons 176
Calling up a speed 176
- Function 175
Requirements: 176
Selecting 176
Setting a speed 176
Storing a speed 176
Switching off 176
Switching on 176
System limitations 175
- Cup holder**
Rear passenger compartment 106
Switching the cooling/heating function on/off 106
- Cup holder in the center console**
Installing/removing (automatic transmission) 105
- Customer Assistance Center (CAC)** 26
- Customer Relations Department** 26
- D**
- Dashboard**
see Cockpit
- Dashboard lighting**
see Instrument cluster lighting

- Data acquisition**
 - Vehicle 27
- Data import/export** 263
 - Function/notes 263
 - Importing/exporting 263
- Data storage**
 - Electronic control units 27
 - Online services 28
 - Vehicle 27
- Date**
 - Setting the time and date automatically 258
- Daytime running lamp mode**
 - see Daytime running lights
- Daytime running lights** 119
 - Switching on/off 119
- Deactivating the alarm (ATA)** 85
- Dealership**
 - see Qualified specialist workshop
- Declaration of conformity**
 - Wireless vehicle components 24
- Decorative foil (cleaning instructions)** 360
- Definitions (tires and loading)** 403
- Designs**
 - Menu (on-board computer) 227
- Destination** 289
 - Editing intermediate destinations 279
 - Editing the previous destinations 289
 - External 289
 - Saving (current vehicle position) 289
 - Saving as global favorite 289
 - Storing a map position 289
- Destination entry** 274
 - Entering 3 word addresses 280
 - Entering a POI or address 274
 - Entering an intermediate destination ... 278
 - Entering geo-coordinates 279
 - Selecting a contact 279
 - Selecting a POI 277
 - Selecting from the map 280
 - Selecting previous destinations 277
- Detecting inattentiveness**
 - see ATTENTION ASSIST
- Diagnostics connection** 24
- Differential lock**
 - see Rear axle locking differential
- Digital Operator's Manual** 18
- Digital speedometer** 232
- Dinghy towing**
 - see Tow-bar system
- Display**
 - Care 364
 - Setting brightness (rear touchscreen) 348
- Display (multimedia system)**
 - Settings 257
- Display (on-board computer)**
 - Displays on the multifunction display .. 228
- Display content**
 - Setting the additional value range 227
- Display message** 428
 - Calling up (on-board computer) 428
 - Notes 428
- Display messages**
 -  --- mph 450
 -  --- mph 449
 -  12 V Battery See Operator's Manual 453

- Active Blind Spot Assist Currently Unavailable See Operator's Manual 447
- Active Blind Spot Assist Inoperative 447
- Active Blind Spot Asst. Not Available When Towing a Trailer See Operator's Manual 448
- Active Brake Assist Functions Currently Limited See Operator's Manual 441
- Active Brake Assist Functions Limited See Operator's Manual 441
- Active Distance Assist Currently Unavailable See Operator's Manual 449
- Active Distance Assist Inoperative 450
- Active Distance Assist Now Available 450
-  Active Headlamps Inoperative 471
- Active Lane Keeping Assist Camera View Restricted See Operator's Manual 446
- Active Lane Keeping Assist Currently Unavailable See Operator's Manual 446
- Active Lane Keeping Assist Inoperative 446
- Active Parking Assist and PARKTRONIC Inoperative See Operator's Manual 448
- Active Steering Assist Currently Unavailable See Operator's Manual 445
- Active Steering Assist Inoperative 445
- Adaptive Highbeam Assist Camera View Restricted See Operator's Manual 473
- Adaptive Highbeam Assist Currently Unavailable See Operator's Manual 473
- Adaptive Highbeam Assist Inoperative 473
- Apply Brake to Shift from 'P' 465
-  ATTENTION ASSIST Inoperative ... 443
-  ATTENTION ASSIST: Take a Break! 442
-  Automatic Headlamp Mode Inoperative 472
- Auxiliary Battery Malfunction 466
- Blind Spot Assist Currently Unavailable See Operator's Manual 446
- Blind Spot Assist Inoperative 447
- Blind Spot Assist Not Available When Towing a Trailer See Operator's Manual 447
-  Check Brake Fluid Level 437
- Check Coolant Level See Operator's Manual 451
-  Check Engine Oil At Next Refueling 455
-  Check Engine Oil Level (Add 1 quart) 457
-  Check Left Low Beam (Example) 471

- | | | |
|--|---|---|
|  Check Tires 458 |  Engine Oil Level Cannot Be Measured 457 |  Inoperative See Operator's Manual 432 |
|  Check Washer Fluid 471 |  Engine Oil Level Low Stop Vehicle Turn Engine Off 455 |  Inoperative 442 |
|  Coolant Too Hot Stop Vehicle Turn Engine Off 451 |  Engine Oil Pressure Stop Switch Off Engine 456 |  Intell. Light System Inoperative ... 472 |
| Cruise Control Inoperative 450 |  Engine Oil Reduce Oil Level 456 |  Key Not Detected (white display message) 462 |
| Cruise Control Off 450 |  Front Left Malfunction Service Required (Example) 438 |  Key Not Detected (red display message) 463 |
|  Currently Unavailable See Operator's Manual 429 | Front Passenger Airbag Disabled See Operator's Manual 440 |  Left Side Curtain Airbag Malfunction Service Required (Example) ... 439 |
|  Currently Unavailable See Operator's Manual 430 | Front Passenger Airbag Enabled See Operator's Manual 439 |  Lowering 443 |
| Decrease Speed 461 |  Fuel Level Low 457 | Malfunction Drive at Max. 50 mph 445 |
|  Don't Forget Your Key 462 |  Gas Cap Loose 457 |  Malfunction See Operator's Manual 472 |
| Drive More Slowly 444 |  Inoperative See Operator's Manual 430 | Mercedes me connect Services Limited See Operator's Manual 442 |
| Driver's Door Open & Transmission Not in P Risk of Vehicle Rolling Away .. 464 |  Inoperative See Operator's Manual 431 | N Permanently Active Risk of Rolling Away 464 |
| Electronic Rear Axle Differential Lock Currently Unavailable 467 | |  Obtain a New Key 462 |
| Electronic Rear Axle Differential Lock Inoperative 467 | |  Off 449 |

 Off 449	 Rear Axle Steering Malfunction Service Required 468	Stop Vehicle Leave Engine Running Wait Transmission Cooling 466
Only Shift to 'P' when Vehicle is Sta- tionary 465	Rear Spoiler Control System Inopera- tive 469	 Stop Vehicle Leave Engine Run- ning 453
 Operation Only Possible in Transmission Position P 464	Rear Spoiler Inoperative Limit ### mph 469	 Stop Vehicle See Operator's Manual 453
 Parking Brake See Operator's Manual 434	 Replace Key Battery 462	 Stop Vehicle Vehicle Too Low 444
 Place the Key in the Marked Space See Operator's Manual 463	Reversing Not Possible Service Required 465	 Suspended 449
 Please Correct Tire Pressure 458	 See Operator's Manual 452	 Switch Off Lights 472
 Please Release Parking Brake 433	Service Required Do Not Shift Gears Visit Dealer 465	 Switch On Headlamps 473
PRE-SAFE Impulse Side Inoperative See Operator's Manual 442	 SRS Malfunction Service Required 438	 Tire Press. Monitor Currently Unavailable 460
PRE-SAFE Inoperative See Opera- tor's Manual 441	 Steering Malfunction Increased Physical Effort See Operator's Man- ual 468	 Tire Press. Monitor Inoperative 461
Radar Sensors Dirty See Operator's Manual 432	 Steering Malfunction Stop Immediately See Operator's Manual 467	 Tire Pressure Monitor Inopera- tive No Wheel Sensors 460
 Rear Axle Steering Currently Unavailable 468		Tires Overheated 461
		To Deselect P or N, Depress Brake and Start Engine 464
		To Engage Transmiss. Position R First Depress the Brake 465

- Traffic Sign Assist Camera View
 Restricted See Operator's Manual 448
 Traffic Sign Assist Currently Unavailable See Operator's Manual 448
 Traffic Sign Assist Inoperative 449
-  Trans. Oil Overheated Drive on with Care 467
 Transmission Malfunction Stop 465
-  Transmission Oil Cooling Malfunction 466
-  Turn On the Ignition to Release the Parking Brake 433
-  Vehicle Operational Switch the Ignition Off Before Exiting 464
-  Vehicle Rising Please Wait 443
-  Vehicle Rising 443
-  Warning Tire Malfunction 459
-  Wheel Sensor(s) Missing 460
- Display on the windshield**
 see Head-up Display
- Distance control**
 see Active Distance Assist DISTRONIC
- Distance recorder**
 see Trip distance
- DISTRONIC**
 see Active Distance Assist DISTRONIC
- Door**
 Child safety lock (rear door) 60
 Locking (emergency key) 71
 Opening (from the inside) 68
 Unlocking (emergency key) 71
 Unlocking (from the inside) 68
- Door control panel** 14
- DOT, Tire Identification Number (TIN)** ... 399
- Double-clutch function** 151
- Drag Race**
 Setting 269
- Drawbar**
 see Tow-bar system
- DRIFT MODE**
 Activation conditions 192
 Function 191
 Switching off 192
- Switching on 192
- Drinking and driving** 139
- Drive Away Assist** 214
- Drive position**
 Engaging 151
- Drive program display** 148
- Drive programs**
 see DYNAMIC SELECT
- Driver's seat**
 see Seat
- Driving lights**
 see Automatic driving lights
- Driving safety system** 165
 ABS (Anti-lock Braking System) 166
 Active Brake Assist 170
 BAS (Brake Assist System) 166
 EBD (electronic brake force distribution) 170
 ESP® (Electronic Stability Program) 167
 ESP® Crosswind Assist 169
 Overview 165
 Radar sensors 165
 Responsibility 165

- | | | | | | |
|--|-----|--|-----|--|----------|
| STEER CONTROL | 170 | Drinking and driving | 139 | E10 | 421 |
| Driving system | | General driving tips | 139 | Easy entry feature | |
| AMG adaptive sport suspension sys-
tem | 195 | Notes on breaking-in a new vehicle | 138 | Function/notes | 96 |
| Driving system | | Drowsiness detection | | Setting | 97 |
| see 360° Camera | | see ATTENTION ASSIST | | Easy exit feature | |
| see Active Blind Spot Assist | | DYNAMIC SELECT | 147 | Function/notes | 96 |
| see Active Distance Assist DISTRONIC | | Configuring drive program I | 148 | Setting | 97 |
| see Active Emergency Stop Assist | | Displaying engine data | 149 | EASY-PACK load-securing kit | 103 |
| see Active Lane Change Assist | | Displaying vehicle data | 148 | Installing/removing the telescopic
rod | 103 |
| see Active Lane Keeping Assist | | Drive program display | 148 | Notes | 103 |
| see Active Parking Assist | | Drive programs | 147 | EBD (electronic brake force distribu-
tion) | |
| see Active Speed Limit Assist | | Function | 147 | Function/notes | 170 |
| see Active Steering Assist | | Operating (DYNAMIC SELECT switch)
..... | 148 | ECO Assist | |
| see ATTENTION ASSIST | | Selecting the drive program | 148 | Displaying | 146 |
| see Blind Spot Assist | | Showing operation feedback | 148 | Function/notes | 144 |
| see Cruise control | | | | ECO display | |
| see Driving safety system | | | | Function | 144 |
| see HOLD function | | | | Resetting | 233 |
| see Parking Assist PARKTRONIC | | | | ECO start/stop function | 142, 143 |
| see Rear view camera | | | | Automatic engine start | 142 |
| see Traffic Sign Assist | | | | Automatic engine stop | 142 |
| Driving tips | | | | | |
| AMG ceramic high-performance
composite brake system | 142 | | | | |

E

- | | |
|---|-----|
| E-SELECT selector lever | 149 |
| Engaging drive position | 151 |
| Engaging neutral | 150 |
| Engaging park position | 150 |
| Engaging park position automatically .. | 150 |
| Engaging reverse gear | 150 |
| Function | 149 |

- Method of operation 142
Switching off/on 143
- Electric parking brake** 162
Applying automatically 162
Applying or releasing manually 163
Emergency braking 164
Releasing automatically 163
- Electronics** 416
- Emergency**
Overview of the help functions 16
Reflective safety vest 366
- Emergency braking** 164
- Emergency braking**
see BAS (Brake Assist System)
- Emergency call system**
see Mercedes-Benz emergency call system
- Emergency engine start** 382
- Emergency key**
Locking a door 71
Unlocking a door 71
- Emergency operation mode**
Starting the vehicle 137
- Emergency Tensioning Devices**
Activation 33
- Emotion Start**
Starting the vehicle 136
- ENERGIZING comfort**
Overview of programs 272
Starting the program 273
- Engine**
ECO start/stop function 142
Engine number 418
Starting (emergency operation mode) 137
Starting (Remote Online) 138
Starting (start/stop button) 136
Starting assistance 376
Switching off (start/stop button) 156
- Engine data**
Displaying 149
- Engine number** 418
- Engine oil** 354
Additives 422
Capacity 423
Checking the oil level using the on-board computer 353
- MB-Freigabe or MB-Approval 423
Quality 423
Temperature (on-board computer, Performance menu) 230
Topping up 354
- EQ boost**
Operating safety 22
- Equalizer**
Setting (rear touchscreen) 348
- ESP®**
Crosswind Assist 169
- ESP® (Electronic Stability Program)**
Activating/deactivating 169
ESP® SPORT 167
Function/notes 167
Status display (on-board computer, Performance menu) 230
- ESP® SPORT**
Function/notes 167
- Exterior lighting**
Care 362
- Exterior lighting**
see Lights

- Exterior mirrors** 123, 124
- Anti-glare mode (automatic) 124
 - Automatic mirror folding function 126
 - Folding in/out 123
 - Operating the memory function 97
 - Parking position 125
 - Setting 123
- External device**
- Locking (child safety lock) 262
- Eyeglasses compartment** 100
- F**
- Fatigue detection**
- see ATTENTION ASSIST
- Favorites**
- Adding 253
 - Calling up 253
 - Deleting 254
 - Moving 254
 - Overview 253
 - Renaming 254
- Flacon**
- Inserting/removing 132
- Flat tire** 366
- Changing a wheel 410
 - MOExtended tires 367
 - Notes 366
 - TIREFIT kit 368
- Flat towing**
- see Tow-bar system
- Floor mats** 113
- Foil covering** 165
- Fragrance**
- see Perfume atomizer
- Free software** 30
- Frequencies**
- Two-way radio 417
- Frequency band**
- Dialing (on-board computer) 235
- Front airbag (driver, front passenger)** 39
- Front passenger seat**
- Adjusting from the driver's seat 89
- Fuel** 422
- Additives 422
 - E10 421
- Fuel reserve 422
- Gasoline 421
 - Quality (gasoline) 421
 - Refueling 154
 - sulfur content 421
 - Tank content 422
- Fuel consumption**
- On-board computer 232
- Function seat**
- see Door control panel
- Fuses** 382
- Before replacing a fuse 382
 - Dashboard fuse box 384
 - Fuse assignment diagram 382
 - Fuse box in the cargo compartment 384
 - Fuse box in the engine compartment .. 383
 - Fuse box in the front-passenger foot-well 384
 - Notes 382
- Fuses**
- see Fuses

G	
G-meter (on-board computer, Performance menu)	230
Garage door opener	
Clearing the memory	160
Opening or closing the door	160
Programming buttons	157
Radio equipment approval numbers	160
Resolving problems	159
Synchronizing the rolling code	159
Gas station search	
Starting automatic search	278
Switching automatic search on/off	283
Using automatic search	283
Gasoline	421
Gear display (on-board computer, Performance menu)	230
Gearshift recommendation	152
Genuine parts	20
Glide mode	153
Glove box	
Air vent	134
Locking/unlocking	100
H	
Handbrake	
see Electric parking brake	
Handling characteristics (unusual)	386
HANDS-FREE ACCESS	75
Hazard warning lights	117
Head restraint	
Front (adjusting mechanically)	90
Rear (installing/removing)	91
Rear passenger compartment (adjusting)	91
Head-up Display	237
Adjusting display elements (on-board computer)	237
Adjusting the brightness (on-board computer)	237
Function	237
Menu (on-board computer)	237
Operating the memory function	97
Setting the position (on-board computer)	237
Switching on/off	238

Headliner (care)	364
Heating	
see Climate control	
High beam	
Switching on/off	116
High-beam flasher	116
High-beam headlamps	
Adaptive Highbeam Assist	118
Hill start assist	189
HOLD function	
Function/notes	189
Switching on/off	189
Hood	
Opening/closing	351
Hotspot	
Setting up (Wi-Fi)	261
I	
Identification plate	
Engine	418
Refrigerant	425
Vehicle	418

- Ignition**
 - Switching on (Start/Stop button) 135
- Ignition key**
 - see SmartKey
- Immobilizer** 84
- Indicator lamps**
 - see Warning/indicator lamps
- Individual drive program**
 - Configuring 148
 - Selecting 148
- Inside rearview mirror**
 - see Exterior mirrors
- Instrument cluster**
 - see Instrument Display
- Instrument cluster lighting** 229
- Instrument Display** 224
 - Adjusting the lighting 229
 - Function/notes 224
 - Instrument cluster 10
 - Setting the additional value range 227
 - Warning/indicator lamps 474
- Intelligent Light System**
 - Adaptive Highbeam Assist 118
 - Cornering light function 118
- Interior lighting** 120
 - Ambiance light 120
 - Reading light 120
 - Setting 120
 - Switch-off delay time 121
- Intermediate destination**
 - Calculating a route with intermediate destinations 279
 - Entering 278
 - Modifying 279
 - Starting an automatic gas station search 278
 - Starting the automatic service station search 284
- Internet**
 - Calling up a web page 321
 - Closing the browser 323
 - Deleting a bookmark 323
 - Deleting browser data 323
 - Managing bookmarks 323
- Internet connection**
 - Connection status 320
 - Displaying the connection status 321
- Establishing 320
- Information 319
- Restrictions 319
- Via communication module 320
- Internet radio**
 - Calling up 323
 - Deleting stations 324
 - Logging out 325
 - Overview 324
 - Registering 325
 - Saving stations 324
 - Selecting and connecting to a station 324
 - Selecting stream 325
 - Setting options 325
 - Terms of use 325
- Ionization**
 - Activating/deactivating (multimedia system) 131
 - Switching on/off (rear touchscreen) ... 349
- iPhone®**
 - see Apple CarPlay™
 - see Mercedes-Benz Link

J	
Jack	
Storage location	409
Jump-start connection	376
General notes	374
Notes	374
K	
KEYLESS-GO	
Locking the vehicle	69
Problem	69
Unlocking setting	64
Unlocking the vehicle	69
Kickdown	153
Using	153
Knee airbag	39
L	
Labeling (tires)	
see Tire labeling	
Laden	
see EASY-PACK load-securing kit	
Lamp	
see Interior lighting	
Lamps (Instrument Display)	
see Warning/indicator lamps	
Lane detection (automatic)	
see Active Lane Keeping Assist	
Lane Keeping Assist	
see Active Lane Keeping Assist	
Language	262
Notes	262
Setting	263
Setting (rear touchscreen)	348
LATCH-type (ISOFIX) child seat securing system	
Installing	54
Light switch	
Overview	115
Lighting	
see Interior lighting	
see Lights	
Lights	115
Adaptive Highbeam Assist	118
Adjusting the instrument lighting	229

Automatic driving lights	116
Combination switch	116
Cornering light function	118
Hazard warning lights	117
High beam	116
High-beam flasher	116
Light switch	115
Low-beam headlamps	115
Parking lights	115
Rear fog lamp	115
Responsibility for lighting systems	115
Setting the surround lighting	119
Standing lights	115
Turn signals	116
Limited Warranty	
Vehicle	26
Limiting the opening angle (tailgate)	76
Live Traffic Information	
Displaying subscription information	290
Displaying the traffic map	291
Displaying traffic incidents	291
Extending a subscription	290
Issuing hazard alerts	292
Load index (tires)	401

- Load-bearing capacity (tires)** 401
- Loading** 102
- Bag hook 102
 - Cargo tie-down rings 102
 - Definitions 403
 - Notes 98
 - Stowage space underneath the cargo compartment floor 104
- Loading guidelines** 98
- Loading information table** 393
- Loads**
- Securing 98
- Locator lighting**
- see Surround lighting
- Locking differential**
- see Rear axle locking differential
- Locking/unlocking**
- Activating/deactivating the automatic locking feature 70
 - Emergency key 71
 - KEYLESS-GO 69
 - Opening the tailgate 71
- Unlocking and opening doors from the inside 68
- Low-beam headlamps**
- Switching on/off 115
- Lubricant additives**
- see Additives
- Luggage**
- Securing 98
- Lumbar support**
- see Lumbar support (4-way)
- Lumbar support (4-way)** 87, 90
- M**
- Maintenance**
- Menu (on-board computer) 229
 - Vehicle 21
- Maintenance**
- see ASSYST PLUS
- Malfunction**
- Restraint system 33
- Malfunction message**
- see Display message
- Map** 291, 292, 293
- Avoiding an area 295
 - Avoiding an area (overview) 295
 - Changing an area 295
 - Deleting an area 296
 - Displaying the compass 297
 - Displaying the map version 295
 - Displaying the next intersecting street 294
 - Displaying the satellite map 297
 - Displaying the traffic map 291
 - Displaying weather information 298
 - Map data 296
 - Moving 293
 - Overview 292
 - Selecting POI symbols 294
 - Selecting text information 294
 - Selecting the map orientation 294
 - Setting the map scale 293
 - Setting the map scale automatically 297
 - Updating 296
- Map and compass**
- Overview 292
- Massage program**
- Overview 92

Resetting the settings	93	Media playback		Head-up Display	237
Massage programs		Operating (on-board computer)	236	Maintenance	229
Selecting the front seats	93	Media player		Media	236
Matte finish (cleaning instructions)	359	Operating (rear touchscreen)	347	Navigation	234
Maximum load rating	400	Media search		Overview	225
Maximum permissible load		Starting	332	Performance	230
Calculation example	395	Media source		Radio	235
Determining	394	Selecting (on-board computer)	236	Telephone	236
Maximum tire pressure	400	Memory function		Trip	232
Mechanical key		Head-up Display – Calling up stored		Mercedes me connect	315
Inserting/removing	65	settings	97	Accident management	316
Unlocking the tailgate	76	Head-up Display – Storing settings	97	Calling the Mercedes-Benz Customer	
Media		Operating	97	Center	315
Menu (on-board computer)	236	Outside mirrors – Calling up stored		Information	314
Searching	332	settings	97	Making a call via the overhead con-	
Media display		Outside mirrors – Storing settings	97	trol panel	315
Notes	249	Seat – Calling up stored settings	97	Service call with the me button	316
Media Interface		Seat – Storing settings	97	Service message	316
Activating	333	Steering wheel – Calling up saved		Transferred data	317
Information	332	settings	97	Mercedes-Benz Apps	
Overview	334	Steering wheel – Saving settings	97	Calling up	321
Media mode		Menu (on-board computer)		Using voice control	321
Activating	326	Assistant display	229	Mercedes-Benz emergency call sys-	
		Designs	227	tem	317
				Automatic emergency call	318

- Information 317
- Manual emergency call 318
- Overview 317
- Transferred data 319
- Mercedes-Benz Link** 310
 - Connecting 310
 - Ending 310
 - Overview 310
 - Using 310
- Message (multifunction display)**
 - see Display message
- Message memory** 428
- Messages**
 - Voice commands (Voice Control System) 246
- Messages**
 - see Text messages
- Mirrors**
 - see Exterior mirrors
- Mobile phone**
 - Wireless charging 113
- Mobile phone**
 - see Android Auto
 - see Apple CarPlay™
 - see Mercedes-Benz Link
 - see Second telephone
 - see Telephone
- Mobile phone voice recognition**
 - Starting 304
 - Stopping 304
- Model series**
 - see Vehicle identification plate
- MOExtended tires** 367
- Multifunction display**
 - Overview of displays 228
- Multifunction steering wheel**
 - Overview of buttons 225
- Multifunction steering wheel**
 - see Steering wheel
- Multimedia system** 248
 - Activating/deactivating standby mode 165
 - Adjusts the volume 255
 - Central control elements 249
 - Configuring display settings 257
- ENERGIZING comfort program overview 272
- Favorites 253
- Main functions 253
- Overview 248
- Restoring the factory settings 267
- Standby mode function 164
- Starting the ENERGIZING comfort program 273
- Switching the sound on or off 254

N

Navigation

- Calling up the Digital Operator's Manual 298
- Menu (on-board computer) 234
- Showing/hiding the menu 274
- Switching on 273
- Updating the map data 296
- Voice commands (Voice Control System) 242

Navigation

- see Destination
- see Destination entry
- see Map

- see Route
- see Route guidance
- see Traffic information
- Navigation announcements**
 - Activating/deactivating 287
 - Adjusting the volume 287
 - Repeating 288
 - Switching audio fadeout on/off 287
- Navigation messages**
 - On-board computer 234
- Near Field Communication (NFC)** 303
 - Connecting the mobile phone to the multimedia system 303
 - Information 303
 - Switching Bluetooth® audio equipment 337
 - Switching mobile phones 303
 - Using a mobile phone 303
- Neutral**
 - Engaging 150
- NFC**
 - see Near Field Communication (NFC)
- Non-operational time**
 - Activating/deactivating standby mode 165
 - Standby mode function 164
- Notes on breaking-in a new vehicle** 138
- O**
- Occupant safety**
 - Pets in the vehicle 62
- Occupant safety**
 - see Airbag
 - see Automatic front passenger front airbag shutoff
 - see PRE-SAFE® (anticipatory occupant protection)
 - see PRE-SAFE® Impulse Side
 - see PRE-SAFE® PLUS (anticipatory occupant protection plus)
 - see Restraint system
 - see Seat belt
- Odometer**
 - see Total distance
- Oil**
 - see Engine oil
- On-board computer** 225
 - Assistance graphic menu 229
 - Displaying the service due date 350
 - Head-up Display menu 237
 - Media menu 236
 - Menu designs 227
 - Menu overview 225
 - Multifunction display 228
 - Navigation system menu 234
 - Operating 225
 - Performance menu 230
 - Radio menu 235
 - Service menu 229
 - Telephone menu 236
 - Trip menu 232
- On-board diagnostics interface**
 - see Diagnostics connection
- Open-source software** 30
- Opening the tailgate using your foot**
 - see HANDS-FREE ACCESS
- Operating fluids**
 - Additives (fuel) 422
 - Brake fluid 423
 - Coolant (engine) 424

- Engine oil 422
 - Fuel (gasoline) 421
 - Notes 420
 - Refrigerant (air conditioning system) ... 425
 - Windshield washer fluid 425
 - Operating safety**
 - 48 V on-board electrical system 22
 - Declaration of conformity (wireless vehicle components) 24
 - EQ boost 22
 - Information 22
 - Operating system**
 - see On-board computer
 - Operator's Manual**
 - Vehicle equipment 20
 - Operator's Manual (digital)** 18
 - Overhead control panel**
 - Making calls (Mercedes me connect) .. 315
 - Overview 12
- P**
- Paint code** 418
 - Paintwork (cleaning instructions)** 359
 - Panel heating**
 - Setting 94
 - Panic alarm** 64
 - Activating/deactivating 64
 - Park position**
 - Engaging 150
 - Selecting automatically 150
 - Parking**
 - see Electric parking brake
 - Parking aid**
 - see Parking Assist PARKTRONIC
 - Parking Assist PARKTRONIC** 200
 - Activating 203
 - Adjusting warning tones 203
 - Function 200
 - Side impact protection 201
 - Switching off 203
 - System limitations 200
 - Parking assistance systems**
 - see Active Parking Assist
 - Parking brake**
 - see Electric parking brake
 - Parking for an extended period** 164
 - Parking lights** 115
 - Parking position**
 - Exterior mirrors 125
 - Storing the position of the front-passenger outside mirror using reverse gear 125
 - PASSENGER AIR BAG status display**
 - see Automatic front passenger front airbag shutoff
 - Payload**
 - Calculation example 395
 - Determining the maximum 394
 - Performance (on-board computer, Performance menu)** 230
 - Perfume**
 - see Perfume atomizer
 - Perfume atomizer** 132
 - Inserting/removing the flacon 132
 - Setting 131
 - Setting (rear touchscreen) 349
 - Perfume vial**
 - see Perfume atomizer
 - Permitted towing methods** 377

Personalization	
see User profile	
Pets in the vehicle	62
Phone book	
see Contacts	
Picture formats	
see Video mode	
Picture settings	
see Video mode	
PIN protection	
Activating/deactivating	264
Plastic trim (Care)	364
Playback options	
Selecting	329
POI	
Selecting	277
POI symbols	
Selecting	294
Power output (on-board computer, Performance menu)	230
Power supply	
Switching on (Start/Stop button)	135

Power washer (care)	357
Power windows	
see Side windows	
PRE-SAFE® (anticipatory occupant protection)	46
Function	46
PRE-SAFE® Sound	46
Reversing measures	47
PRE-SAFE® Impulse Side	47
Activation	33
Function	47
PRE-SAFE® PLUS (anticipatory occupant protection plus)	47
Function	47
Reversing measures	47
Preventative occupant protection system	
see PRE-SAFE® (anticipatory occupant protection)	
Previous destinations	
Selecting	277
Protecting the environment	
Notes	19

Q

QR code	
Rescue card	27
Qualified specialist workshop	25

R

RACE START	
Activating	191
Activation conditions	191
Function	190
RACETIMER (on-board computer, Performance menu)	231
Radar sensors	165
Radio	
Activating/deactivating radio text	339
Calling up the station list	338
Direct frequency entry	338
Displaying information	339
Displaying radio text	339
Menu (on-board computer)	235
Searching for stations	338
Setting a channel	338
Setting the waveband	338

- Storing radio stations 338
- Switching on 338
- Switching the HD radio function on/off 338
- Voice commands (Voice Control System) 243
- Radio stations**
 - Dialing (on-board computer) 235
- Range**
 - Displaying 232
- REACH regulation** 25
- Reading light**
 - see Interior lighting
- Real wood (Care)** 364
- Rear axle locking differential** 139
- Rear axle steering** 141
- Rear door (child safety lock)** 60
- Rear fender**
 - Retracting/extending 194
- Rear fog lamp** 115
 - Switching on/off 116
- Rear spoiler**
 - see Rear wing
- Rear touchscreen**
 - Adjusting the ambient lighting 346
 - Adjusting the equalizer 348
 - Displaying AMG dynamic data 346
 - Displaying AMG engine data 346
 - Displaying AMG vehicle data 346
 - Operating the media player 347
 - Resetting system settings 349
 - Selecting a sound profile (high-end sound system) 348
 - Setting seat-specific sound optimization (high-end sound system) 348
 - Setting the airflow 349
 - Setting the balance and fader 348
 - Setting the display brightness 348
 - Setting the display lock 348
 - Setting the language 348
 - Setting the perfume atomizer 349
 - Setting the sound focus (premium sound system) 348
 - Setting the sunshade 347
 - Setting the temperature 349
 - Switching ionization on/off 349
- Switching the climate control function on/off 349
- Using the basic functions 345
- Rear view camera** 204
 - Care 362
 - Function 204
 - Opening the camera cover (360° Camera) 209
 - Setting favorites (360° Camera) 209
- Rear window**
 - Sun protection 77
- Rear window defroster** 128
- Rear wing** 193
 - Care 362
 - Function/notes 193
 - Setting 195
- Reflective safety vest** 366
- Refrigerant (air conditioning system)**
 - Notes 425
- Refueling**
 - Refueling the vehicle 154
- Remote Online**
 - Charging the battery 137

- Cooling or heating the vehicle interior 137
 - Starting the vehicle 138
 - Reporting malfunctions relevant to safety** 26
 - Rescue card** 27
 - Reserve**
 - Fuel 422
 - Reset function (multimedia system)** 267
 - Residual heat** 131
 - Restoring (factory settings)**
 - see Reset function (multimedia system)
 - Restraint system** 32
 - Basic instructions for children 48
 - Function in an accident 33
 - Functionality 33
 - Malfunction 33
 - Protection 32
 - Reduced protection 32
 - Self-test 33
 - Warning lamp 33
 - Reverse gear**
 - Engaging 150
 - Rims (Care)** 362
 - Roadside Assistance** 21
 - Roadside Assistance call**
 - see Mercedes me connect
 - Roll away protection**
 - see HOLD function
 - Roof load** 427
 - Route** 281, 283
 - Calculating 281
 - Displaying destination information 283
 - External 289
 - Planning 278
 - Selecting a type 282
 - Selecting an alternative route 283
 - Selecting notifications 283
 - Selecting options 282
 - Starting the automatic service station search 284
 - Switching the automatic gas station search on/off 283
 - Using automatic gas station search 283
 - With intermediate destinations 279
 - Route guidance** 284
 - Canceling 288
 - Changing direction 285
 - Destination reached 286
 - From an off-road location 288
 - Lane recommendations 286
 - Notes 284
 - Off-road 288
 - To an off-road destination 288
 - Route-based speed adaptation**
 - Displays in the Instrument Display 187
 - Function 181
 - Route-based speed adjustment**
 - Setting 183
 - Run-flat characteristics**
 - MOExtended tires 367
- S
- Safety systems**
 - see Driving safety system
 - Satellite map** 297
 - Satellite radio**
 - Activating/deactivating TuneStart 342
 - Displaying EPG information 341
 - Displaying service information 342
 - Information 339

- Information about Smart Favorites and TuneStart 342
- Logging in 339
- Music and sport alerts function 341
- Overview 340
- Pause and playback function 342
- Restrictions 339
- Selecting a category 341
- Selecting a channel 341
- Setting music and sport alerts 341
- Setting the parental control 341
- Switching on 339
- SD card**
 - Inserting/removing 326
- Seat** 86
 - 4-way lumbar support 87, 90
 - Adjusting (electrically) 89
 - Adjusting (Seat Comfort) 87
 - Backrest (rear) locking 101
 - Correct driver's seat position 86
 - Massage program overview 92
 - Operating the memory function 97
 - Panel heating 94
 - Resetting the settings 93
 - Setting automatic lateral support adjustment 92
 - Setting options 14
 - Workout program overview 92
- Seat adjustment**
 - Configuring 92
- Seat belt** 35
 - Protection 35
- Seat belt adjustment**
 - Activating/deactivating 39
 - Function 38
- Seat belt warning**
 - see Seat belts
- Seat belts** 39
 - Activating/deactivating seat belt adjustment 39
 - Adjusting the height 37
 - Care 364
 - Fastening 37
 - Reduced protection 36
 - Releasing 38
 - Seat belt adjustment (function) 38
 - Warning lamp 39
- Seat cover (Care)** 364
- Seat heating**
 - Activating/deactivating 93
- Seat ventilation**
 - Switching on/off 95
- Second telephone** 301, 302
 - Connecting 301
 - Features 302
- Selecting a gear**
 - see Changing gears
- Selecting the sound profile**
 - Burmester® high-end 3D surround sound system 345
- Selector lever**
 - see E-SELECT selector lever
- Self-test**
 - Automatic front passenger front air-bag shutoff 44
- Sensors (Care)** 362
- Service center**
 - see Qualified specialist workshop
- Service interval display**
 - see ASSYST PLUS

- Service station search**
 - Starting automatic search 284
- Setting a speed**
 - see Cruise control
- Setting summer time** 258
- Setting the date format** 258
- Setting the distance unit** 263
- Setting the map scale**
 - see Map
- SETUP (on-board computer, Performance menu)** 230
- Shift paddles**
 - see Steering wheel paddle shifters
- Shifting gears**
 - Gearshift recommendation 152
- Short messages**
 - see Text messages
- Side airbag** 39
- Side impact protection** 201
- Side windows** 77
 - Child safety lock in the rear passenger compartment 61
- Closing 77
- Closing using the SmartKey 79
- Convenience closing feature 79
- Convenience opening 79
- Opening 77
- Opening with the SmartKey 79
- Problem 80
- Size designation (tires)** 401
- Ski/snowboard bag** 101
- Sliding sunroof**
 - Closing 81
 - Closing using the SmartKey 79
 - Opening 81
 - Opening with the SmartKey 79
 - Problem 82
- SmartKey** 63
 - Acoustic locking verification signal 64
 - Battery 65
 - Energy consumption 64
 - Features 63
 - Key ring attachment 65
 - Mechanical key 65
 - Overview 63
 - Panic alarm 64
- Closing 66
- Unlocking setting 64
- SmartKey functions**
 - Deactivating 64
- Smartphone**
 - see Android Auto
 - see Apple CarPlay™
 - see Mercedes-Benz Link
 - see Telephone
- Snow chains** 387
- Socket (12 V)** 108
 - Cargo compartment 110
 - Front center console 108
 - Rear passenger compartment 108
- Socket (115 V)** 109
 - Rear passenger compartment 109
- Software update** 265
 - Important system updates 266
 - Information 265
 - Performing 266
- Sound**
 - PRE-SAFE® Sound 46
 - Wheels and tires 386

- Sound**
 see Burmester® surround sound system
 see Sound settings
- Sound focus (premium sound system)**
 Setting (rear touchscreen) 348
- Sound optimization (high-end sound system)**
 Seat-specific setting (rear touchscreen) 348
- Sound profile (high-end sound system)**
 Selecting (rear touchscreen) 348
- Sound settings** 342
 Adjusting the balance/fader 343
 Adjusting treble, mid-range and bass settings 343
 Automatic volume adjustment 343
 Calls up the sound menu 342
 Information 342
- Special seat belt retractor** 53
- Specialist workshop** 25
- Speech dialog system**
 see Voice Control System
- Speed index (tires)** 401
- Speedometer**
 Digital 232
- Sports exhaust**
 see AMG Performance adjustable exhaust system
- Standby mode**
 Activating/deactivating 165
 Function 164
- Standing lights** 115
- Start/Stop button**
 Parking the vehicle 156
 Starting the vehicle 136
 Switching on the power supply or ignition 135
- Start/stop function**
 see ECO start/stop function
- Starting assistance**
 see Jump-start connection
- Starting the engine**
 see Vehicle
- Starting-off aid**
 see Hill start assist
- Station**
 Direct frequency entry 338
 Searching 338
 Setting 338
 Storing 338
- Station list**
 Calling up 338
- STEER CONTROL**
 Function/notes 170
- Steering wheel** 225
 Adjusting (electrically) 95
 Buttons 225
 Operating the memory function 97
 Steering wheel heater 96
- Steering wheel heater**
 Switching on/off 96
- Steering wheel paddle shifters** 151
- Stowage areas**
 see Loading
 see Stowage compartment
- Stowage compartment** 100
 Armrest 100
 Center console 100

- Door 100
 - Eyeglasses compartment 100
 - Glove box 100
 - Rear armrest 100
 - Stowage compartments**
 - see Loading
 - see Stowage compartment
 - Stowage space underneath the cargo compartment floor** 104
 - Sulfur content** 421
 - Sun blind**
 - Rear window 77
 - Sun visor**
 - Operating 126
 - Sunshade**
 - Setting (rear touchscreen) 347
 - Surround lighting** 119
 - Setting 119
 - Surround View**
 - see 360° Camera
 - Suspension**
 - AMG adaptive sport suspension system 195
 - Selecting the suspension setting 198
 - Setting the suspension level 198
 - Suspension level**
 - Setting 198
 - SVHC (substances of very high concern)** 25
 - Switch-off delay time**
 - Exterior 119
 - Interior 121
 - Switching the surround sound on/off**
 - Burmester® surround sound system ... 344
 - Synchronization function**
 - Activating/deactivating (multimedia system) 130
 - Switching on/off (control panel) 130
 - System settings**
 - Activating/deactivating PIN protection 264
 - Reset function (multimedia system) 267
 - Resetting (rear touchscreen) 349
 - Setting the distance unit 263
 - Setting the time and date automatically 258
 - Setting the time zone 258
 - Setting the time/date format 258
 - Switching transmission of the vehicle position on/off 259
 - System settings**
 - see Bluetooth®
 - see Data import/export
 - see Language
 - see Software update
 - see Wi-Fi
- T
- Tailgate** 71
 - Closing 72
 - HANDS-FREE ACCESS 75
 - Limiting the opening angle 76
 - Opening 71
 - Opening dimensions 426
 - Unlocking (mechanical key) 76
 - Tailpipes (Care)** 362
 - Tank content**
 - Fuel 422
 - Reserve (fuel) 422
 - Technical data**
 - Information 416

- Tire pressure monitor 393
- Vehicle identification plate 418
- Telemetry display**
- Calling up 270
- Telephone** 236, 299
- Activating functions during a call 304
- Call and ringtone volume 304
- Calls with several participants 305
- Connecting a mobile phone (Near Field Communication (NFC)) 303
- Connecting a mobile phone (Pass-key) 301
- Connecting a mobile phone (Secure Simple Pairing) 301
- De-authorizing a mobile phone 303
- Disconnecting a mobile phone 303
- Importing contacts 307
- Importing contacts (overview) 306
- Incoming call during an existing call 305
- Information 300
- Interchanging mobile phones 302
- Menu (on-board computer) 236
- Mobile phone voice recognition 304
- Notes 298
- Operating modes 300
- Reception and transmission volume 304
- Switching mobile phones (Near Field Communication (NFC)) 303
- Telephone menu overview 299
- Telephone operation 304
- Using Near Field Communication (NFC) 303
- Voice commands (Voice Control System) 242
- Wireless charging (mobile phone) 113
- Telephone**
- see Second telephone
- Telephone number**
- Dialing (on-board computer) 236
- Telephony operating modes**
- Bluetooth® Telephony 300
- Telephony operating modes**
- see Second telephone
- Temperature** 128
- Engine oil (on-board computer, Performance menu) 230
- Setting (rear touchscreen) 349
- Transmission oil (on-board computer, Performance menu) 230
- Temperature grade** 398
- Text messages** 308
- Calling a message sender 309
- Changing folders 310
- Composing 309
- Configuring the displayed text messages 308
- Deleting 310
- Drafts 310
- Notes 308
- Options 310
- Outbox 310
- Read-aloud function 309
- Reading 309
- Replying 309
- Sending 309
- Voice commands (Voice Control System) 246
- Time**
- Manual time setting 258
- Setting summer time 258
- Setting the time and date automatically 258
- Setting the time zone 258
- Setting the time/date format 258

- TIN (Tire Identification Number)** 399
- Tire and Loading Information placard** ... 393
- Tire characteristics** 401
- Tire inflation compressor**
see TIREFIT kit
- Tire information table** 393
- Tire labeling** 398
 - Characteristics 401
 - DOT, Tire Identification Number (TIN)
..... 399
 - Load index 401
 - Load-bearing capacity 401
 - Maximum tire load 400
 - Maximum tire pressure 400
 - Overview 398
 - Speed rating 401
 - Temperature grade 398
 - Tire Quality Grading 398
 - Tire size designation 401
 - Traction grade 398
 - Tread wear grade 398
- Tire load (maximum)** 400
- Tire pressure** 389, 390
 - Checking (manually) 390
 - Checking (tire pressure monitoring
system) 392
 - Maximum 400
 - Notes 388
 - Restarting the tire pressure monitor-
ing system 393
 - Tire pressure monitoring system
(function) 391
 - Tire pressure table 389
 - TIREFIT kit 368
- Tire pressure monitor**
 - Restarting 393
 - Technical data 393
- Tire pressure monitoring system**
 - Checking the tire pressure 392
 - Checking the tire temperature 392
 - Function 391
- Tire pressure table** 389
- Tire Quality Grading** 398
- Tire temperature**
 - Checking (tire pressure monitoring
system) 392
- Tire pressure monitoring system
(function) 391
- Tire tread** 386
- Tire-change tool kit**
 - Overview 409
- TIREFIT kit** 368
 - Storage location 368
 - Using 368
- Tires**
 - Changing hub caps 411
 - Characteristics 401
 - Checking 386
 - Checking the tire pressure (man-
ually) 390
 - Checking the tire pressure (tire pres-
sure monitoring system) 392
 - Definitions 403
 - DOT, Tire Identification Number (TIN)
..... 399
 - Flat tire 366
 - Installing 414
 - Load index 401
 - Load-bearing capacity 401
 - Maximum tire load 400

- Maximum tire pressure 400
- MOExtended tires 367
- Noise 386
- Notes on installing 406
- Overview of tire labeling 398
- Removing 413
- Replacing 406, 410
- Restarting the tire pressure monitoring system 393
- Rotating 409
- Selection 406
- Snow chains 387
- Speed rating 401
- Storing 409
- Temperature grade 398
- Tire and Loading Information placard 393
- Tire pressure (notes) 388
- Tire pressure monitoring system (function) 391
- Tire pressure table 389
- Tire Quality Grading 398
- Tire size designation 401
- TIREFIT kit 368
- Traction grade 398
- Tread wear grade 398
- Unusual handling characteristics 386
- Tool**
see Vehicle tool kit
- Top Tether** 56
- Torque (on-board computer, Performance menu)** 230
- Total distance** 232
Displaying 232
- Touch Control**
On-board computer 225
Operating 250
Setting the sensitivity 250
- Touchpad**
Activating/deactivating haptic operation feedback 252
Operating 251
Reading the handwriting recognition aloud 252
Selecting a station and track 252
Setting the sensitivity 252
- Tow-bar system** 223
- Tow-starting** 382
- Towing away** 379
- Towing eye**
Installing 381
Storage location 381
- Towing methods** 377
- Track**
Selecting (audio mode) 329
- Track Race**
Setting 267
- Traction grade** 398
- Traffic information** 290
Displaying the traffic map 291
Displaying traffic incidents 291
Extending a Live Traffic Information subscription 290
Issuing hazard warnings 292
Live Traffic Information 290
Overview 290
- Traffic map**
see Map
- Traffic Sign Assist** 216
Function/notes 216
Setting 218
System limitations 216

Transferred vehicle data	
Android Auto	314
Apple CarPlay™	314
Transmission position display	149
Transporting	
Vehicle	380
Tread wear grade	398
Trim element (Care)	364
Trip	
Menu (on-board computer)	232
Trip computer	
Displaying	232
Resetting	233
Trip distance	232
Displaying	232
Resetting	233
Trip odometer	
see Trip distance	
Trunk lid	
see Tailgate	
Turn signal indicator	
see Turn signals	

Turn signals	116
Switching on/off	116
Two phone mode	
see Second telephone	
Two-way radios	
Frequencies	417
Notes on installation	416
Transmission output (maximum)	417























U

Units of measurement	
Setting	263
Unlocking setting	64
USB devices	
Connecting	329
USB port	111
User profile	264
Creating	265
Options	265
Setting	264
Using the telephone	
see Calls	

V

Vehicle	137
Activating/deactivating standby mode	165
Correct use	25
Data acquisition	27
Data storage	27
Diagnostics connection	24
Equipment	20
Limited Warranty	26
Locking (automatically)	70
Locking (from the inside)	68
Locking (KEYLESS-GO)	69
Locking/unlocking (emergency key)	71
Lowering	415
Maintenance	21
Parking for an extended period	164
Problem notification	26
QR code rescue card	27
Qualified specialist workshop	25
Raising	411
REACH regulation	25
Standby mode function	164
Starting (emergency operation mode)	137

- Starting (Emotion Start) 136
- Starting (Remote Online) 138
- Starting (start/stop button) 136
- Switching off (start/stop button) 156
- Towing 223
- Unlocking (from the inside) 68
- Unlocking (KEYLESS-GO) 69
- Ventilating (convenience opening) 79
- Voice commands (Voice Control System) 247
- Vehicle data**
 - Displaying (DYNAMIC SELECT) 148
 - Roof load 427
 - Transferring to Android Auto™ 314
 - Transferring to Apple CarPlay™ 314
 - Turning radius 426
 - Vehicle height 426
 - Vehicle length 426
 - Vehicle width 426
 - Wheelbase 426
- Vehicle data storage**
 - COMAND/mbrace 29
 - Event data recorders 29
- Vehicle dimensions** 426
- Vehicle electronics**
 - Notes 416
 - Two-way radios 416
- Vehicle identification number**
 - see VIN
- Vehicle identification plate** 418
 - Paint code 418
 - VIN 418
- Vehicle interior**
 - Cooling or heating (Remote Online) 137
- Vehicle key**
 - see SmartKey
- Vehicle maintenance**
 - see ASSYST PLUS
- Vehicle operation**
 - Outside the USA or Canada 21
- Vehicle position**
 - Switching transmission on/off 259
- Vehicle tool kit** 368
 - TIREFIT kit 368
 - Towing eye 381
- Ventilating**
 - Convenience opening 79
- Ventilation**
 - see Climate control
- Vents**
 - see Air vents
- Video mode** 332
 - Activating 330
 - Activating/deactivating full-screen mode 332
 - Overview 331
 - Settings 332
- VIN** 418
 - Identification plate 418
 - Seat 418
 - Windshield 418
- Vision**
 - Removing condensation from the windows 131
 - Windshield heater 133
- Voice command types (Voice Control System)** 241
- Voice Control System** 240
 - Application specific voice commands .. 241
 - Audible help functions 242
 - Global voice commands 241

- Improving speech quality 242
 - Language setting 242
 - Media player voice commands 244
 - Message voice commands 246
 - Multifunction steering wheel (operating) 240
 - Navigation voice commands 242
 - Operable functions 241
 - Operating safety 240
 - Radio voice commands 243
 - Switch voice commands 242
 - Telephone voice controls 242
 - Text message voice commands 246
 - Types of voice commands 241
 - Vehicle voice commands 247
 - Voice prompting 241
- Voice control system**
see Voice Control System
- W**
- Warm-up (on-board computer, Performance menu) 230**
 - Warning lamps**
see Warning/indicator lamps
 - Warning system**
see ATA (anti-theft alarm system)
 - Warning/indicator lamp**
 -  ABS warning lamp 477
 -  Brake warning lamp (USA) 475
 -  Brakes warning lamp (Canada) 475
 -  Coolant warning lamp 484
 -  Electrical malfunction warning lamp 483
 -  Engine diagnosis warning lamp ... 483
 -  ESP® OFF indicator lamp 478
 -  ESP® SPORT indicator lamp 479
 -  ESP® warning lamp flashes 479
 -  ESP® warning lamp lights up 479
 -  Fuel reserve warning lamp 484
 -  Power steering system warning lamp 482
 -  Red indicator lamp, electric parking brake applied (Canada only) 476
 -  Red indicator lamp, electric parking brake applied (USA only) 476
 -  Restraint system warning lamp ... 480
 -  Seat belt warning lamp flashes 481
 -  Seat belt warning lamp lights up 481
 -  Suspension warning lamp 482
 -  Tire pressure monitoring system warning lamp flashes 486
 -  Tire pressure monitoring system warning lamp lights up 486
 -  Warning lamp for distance warning function 482
 -  Yellow electric parking brake indicator lamp is malfunctioning 476
- Warning/indicator lamps 474**
 Overview 474
 PASSENGER AIR BAG 44
- Warranty 26**
- Washer fluid**
see Windshield washer fluid

- Washing by hand (care)** 358
- Water tank**
 - see Air-water duct
- Weather information** 298
- Web browser**
 - Calling up a web page 321
 - Calling up options 322
 - Calling up the settings 322
 - Deleting a bookmark 323
 - Deleting browser data 323
 - Ending 323
 - Managing bookmarks 323
 - Overview 322
 - Showing/hiding the menu 321
- Website**
 - Calling up 321
 - Showing/hiding the web browser menu 321
- Wheel change**
 - Lowering the vehicle 415
 - Mounting a new wheel 414
 - Removing a wheel 413
 - Removing/installing hub caps 411
- Wheel rotation** 409
- Wheels**
 - Care 362
 - Changing hub caps 411
 - Checking 386
 - Checking the tire pressure (manually) 390
 - Checking the tire pressure (tire pressure monitoring system) 392
 - Definitions 403
 - DOT, Tire Identification Number (TIN) 399
 - Flat tire 366
 - Installing 414
 - Load index 401
 - Load-bearing capacity 401
 - Maximum tire load 400
 - Maximum tire pressure 400
 - MOExtended tires 367
 - Noise 386
 - Notes on installing 406
 - Overview of tire labeling 398
 - Removing 413
 - Replacing 406, 410
 - Restarting the tire pressure monitoring system 393
 - Rotating 409
 - Selection 406
 - Snow chains 387
 - Speed rating 401
 - Storing 409
 - Temperature grade 398
 - Tire and Loading Information placard 393
 - Tire characteristics 401
 - Tire pressure (notes) 388
 - Tire pressure monitoring system (function) 391
 - Tire pressure table 389
 - Tire Quality Grading 398
 - Tire size designation 401
 - TIREFIT kit 368
 - Traction grade 398
 - Tread wear grade 398
 - Unusual handling characteristics 386
- Wi-Fi** 259
 - Overview 259
 - Setting 260
 - Setting up a hotspot 261
- Window curtain airbag** 39
- Windows**
 - see Side windows

- Windows (Care)** 362
- Windshield** 122, 128
 - Defrosting 128
 - Infrared reflective 126
 - Replacing the wiper blades 122
- Windshield**
 - see Windshield
- Windshield heater** 133
- Windshield heating**
 - see Windshield heater
- Windshield washer fluid** 425
 - Notes 425
- Windshield washer system**
 - Topping up 356
- Windshield wipers**
 - Activating/deactivating 121
 - Replacing the wiper blades 122
- Winter operation**
 - Snow chains 387
- Wiper blades**
 - Care 362
 - Replacing 122
- Wireless charging**
 - Function/notes 111
 - Mobile phone 113
- Wireless vehicle components**
 - Declaration of conformity 24
- Workout program**
 - Overview 92
- Workshop**
 - see Qualified specialist workshop

