

MANUAL

VX680



Verifone®

Verifone®

Verifone Finland Oy

Vantaankoskentie 14
01670 Vantaa

www.verifone.fi
point@point.fi

Switch: 09 477 433 0
Fax: 09 436 24 90

Our opening hours on weekdays are 8-16

Sales:
09 477 433 40
myynti@point.fi

Accessories:
09 477 433 44
tarviketilaukset@point.fi

Order processing:
09 477 433 43
tilaustenkasittely@point.fi

Maintenance:
09 477 433 70
huolto@point.fi

Customer service:
0600 01 02 03 (1,31 € / min)
weekdays: 8 – 21
Saturdays: 9 – 18
Sundays: 12 – 18
asiakaspalvelu@point.fi

Invoicing / Lindorff:
02 2700 390
weekdays: 8 – 20
Saturdays: 10 – 15
laskutus@lindorff.fi



INDEX:

1. BEFORE USE.....	5
1.1 Important.....	5
1.2 PA-DSS –Standard	5
1.3 Terminal structure	6
1.4 Technical data	7
1.5 Connecting the cables.....	8
1.6 Battery	9
1.7 SIM-card.....	10
1.8 Touchscreen.....	10
1.9 Stylus	10
1.10 Using the menus	11
1.11 Letters and special characters	11
1.12 Terminal start-up and shutdown.....	11
1.13 Switching the paper.....	12
1.14 Testing the connection	12
2. SETTINGS	13
2.1 Terminal settings.....	13
2.2 Parameter printing	13
2.3 Batch time	13
2.4 Cashier number	13
2.5 Time and date settings	13
2.6 Fixed IP-address	14
2.7 Power options.....	14
2.8 Contrast	14
2.9 Sounds	14
2.10 GPRS APN.....	15
2.11 WIFI settings.....	15
2.12 Audit log IP	15
3. DOWNLOADS	16
3.1 Downloading applications.....	16
3.2 Parameter downloading.....	16
4. DAILY USE	17
4.1 Transactions.....	17
4.1.1 Chip card transactions	17
4.1.2 Swipe card transactions	17



4.1.3 Contactless card transactions.....	18
4.1.4 Reversal	18
4.1.5 External reversal	18
4.1.6 Manual entry	19
4.1.7 Receipt copy.....	19
4.1.8 Refund.....	19
4.1.9 Cash back.....	20
4.2 Online transactions	20
4.2.1 General information on online transactions.....	20
4.2.2 Online batch.....	20
4.2.3 Verifone reporting.....	21
4.3 Reports and bank connection	21
4.3.1 Print batch	21
4.3.2 Monthly report	21
4.3.3 Send Batch.....	22
4.3.4 Blacklist.....	22
4.3.5 Issue report.....	22
4.3.6 Issue acknowledgment	24
4.3.7 Report explanations	24
5. SPECIAL FUNCTIONS.....	26
5.1 Cash receipt	26
5.2 Extra amount	27
5.3 VAT	27
5.4 Mandatory authorization	27
5.5 Invoice	27
5.6 Preauthorization	28
5.7 Multicashier version.....	30
6. EXTRA VERSIONS	31
6.1 Multiuser version	31
6.2 Taxi version	31
6.3 Product version	32
7. TROUBLE SHOOTING	36
7.1 Notifications on the screen	36
7.2 Notifications on the receipt.....	36
7.3 Other exceptions.....	37
7.4 Service.....	38



1. BEFORE USE

1.1 Important

NOTE! If these instructions are not followed and the terminal is damaged it will void the warranty!

- Protect the power cord and modem. If they are damaged they are not to be used anymore.
- The terminal is not waterproof or dustproof, and is intended for indoor use only.
- The warranty of the terminal will void if it is exposed to water or dust.
- Do not use the terminal next to water or moist areas.
- Do not use below 0°C degrees.
- Never place anything inside the chip slot or connection ports that are not meant there. This might seriously damage the terminal.
- If the terminal is damaged contact Verifone's maintenance service. Never try to fix the terminal by yourself.
- Use only appropriate paper with the terminal's printer. Poor quality paper can jam the printer and create excessive paper dust.
- Never use thinner, trichloroethylene, or ketone-based solvents- they may cause deterioration of plastic or rubber parts. Do not spray cleaners or other solutions directly onto the keypad.
- Always shut down the terminal before removing the battery.
- Disconnecting the power during a transaction may cause transaction data files not yet stored in terminal memory to be lost.
- The terminal's Li-ion –battery is not hazardous waste. Do not dispose the battery with combustible wastes. The battery should be recycled with other hazardous wastes or delivered to the terminal supplier for disposal.

1.2 PA-DSS –Standard

The purpose of the PA-DSS –standard is to help software suppliers develop, according to the PCI-DSS requirements, payment solutions which do not save forbidden card information such as the CVV2 or the PIN-code.

Companies must use solutions for card payment processing that are approved according to the PCI-DSS –standard.

For the latest version of the Verifone PA-DSS Implementation Guide, go to <http://www.verifone.fi/manuals>



1.3 Terminal structure

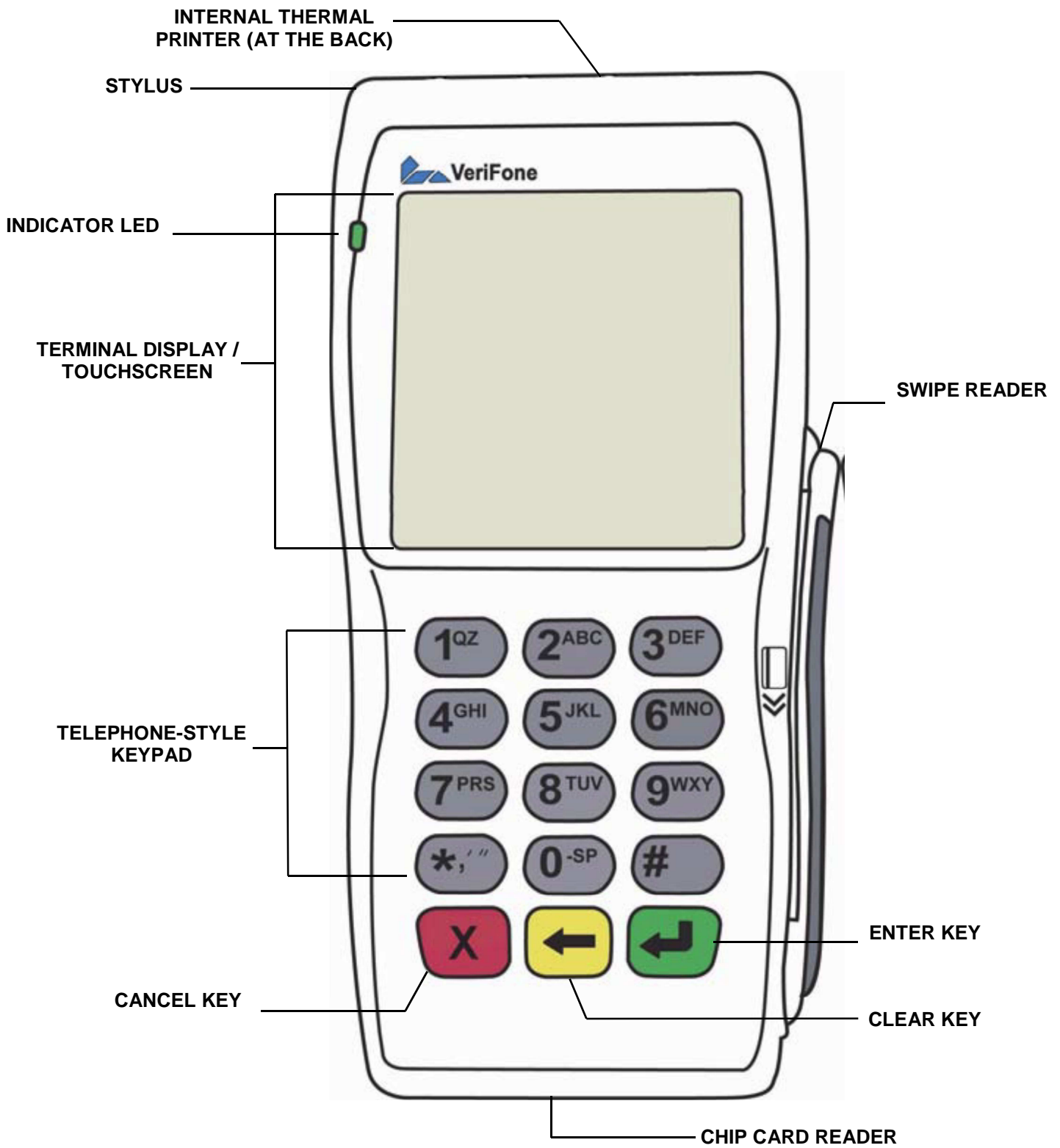

1.4 Technical data

Processor:	400 MHz ARM11, 32-bit RISC processor
Memory:	192 MB (128 MB Flash, 64 MB SDRAM) standard, can exceed up to 500 MB. Optional micro SD Flash memory card
Display:	240 x 320 pixel color TFT (QVGA) supports up to 26 lines x 26 characters 8 soft-function keys and 4 screen-addressable keys via resistive touch screen
Swipe card reader:	Triple track (tracks 1, 2, 3), high coercivity, bi-directional
Chip card reader:	ISO 7816, 1.8V, 3V, 5V; synchronous and asynchronous cards EMV Approved
SAM-card readers:	3 Security Access Modules (SAMs)
Keypad:	3 x 4 numeric keypad, plus screen addressable keys can be simulated on resistive touch screen
Peripheral Ports:	Single multi-port connector, which supports RS-232, USB Host, USB Slave, and Integrated Charging
Connection:	3G or WLAN
Printer:	Integrated thermal with graphics capabilities, 18 lines per second, 22, 32, or 42 columns. Paper roll width 40mm, diameter 40 mm.
Security:	3DES, Master/session and DUKPT key management; PED approved, SSL, WPA
Battery:	1800 mA lithium-Ion Smart
Physical:	Length 17.2 cm, max width 8.2 cm, height 6.2 cm, weight 477 g



1.5 Connecting the cables



WLAN terminal: Connect the adapter to the main power cord, the power cord to the power supply and the plug to the electrical outlet. The adapter is connected at the bottom of the terminal into the left port.

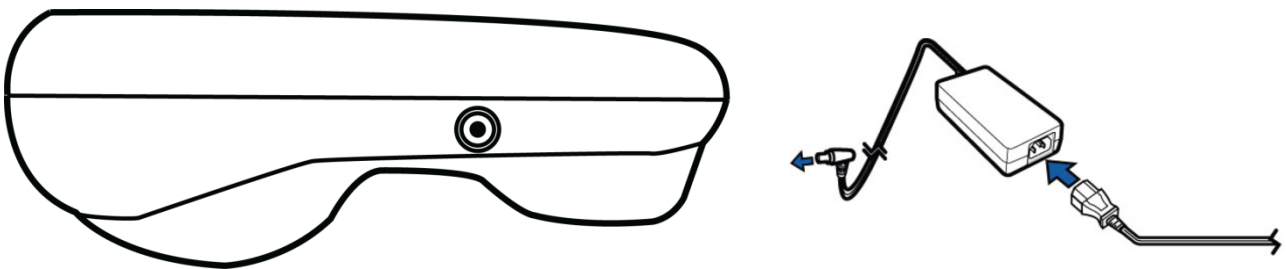

3G terminal: Connect the power cord into the port at the left side of the terminal.



1.6 Battery

The battery is attached by placing it on its slot and pressing it downwards.

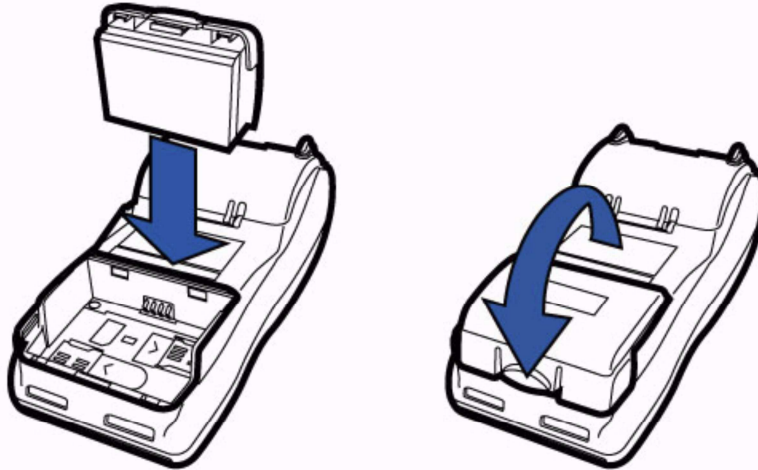

To remove the battery, press the locking tab and pull the battery from its slot.

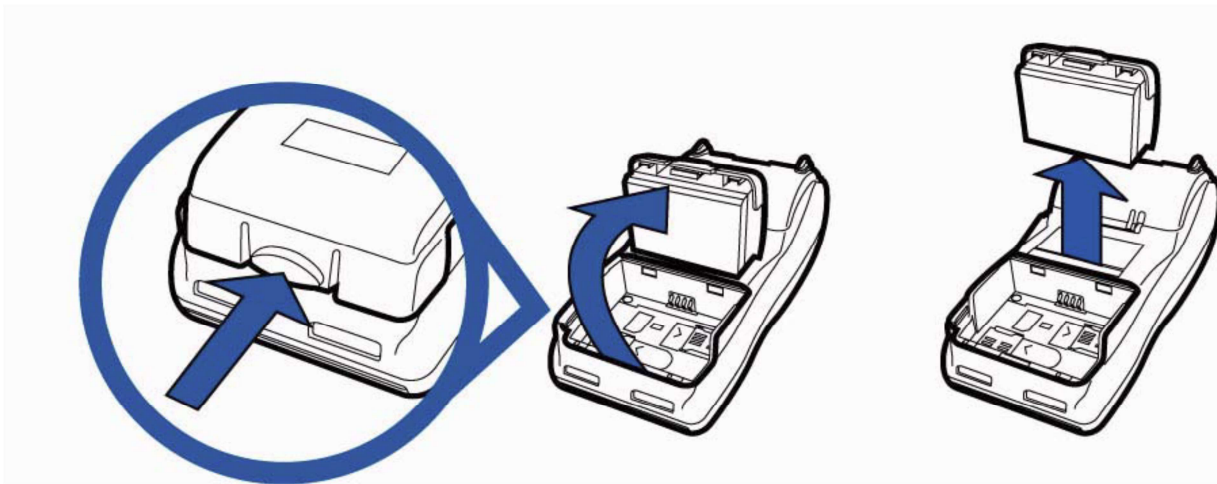

When the power cord is connected to the terminal, the battery image on the top right corner of the screen has a charge icon. When the power cord is unplugged the icon disappears. The terminal starts charging the battery when it is connected to the power cord. When the battery is charging, the LED-indicator blinks as an orange light. When the battery is fully charged the LED-light turns green. When the battery is almost empty the light turns red. The terminal can be connected to the power cord at all times; this does not affect the battery. It is recommended to keep the terminal connected to the power cord during night time. This will charge the battery so that it is fully charged at the start of the next work day, and also ensure the success of possible automatic batch sendings during the night.



1.7 SIM-card

Terminals which use 3G-connection have a SIM-card. Before inserting the SIM-card inside the terminal, disable the PIN-code query.

The SIM-card operator's APN information is inserted to the GPRS APN menu in the terminal. The APN information is set to INTERNET by default, change this if needed.

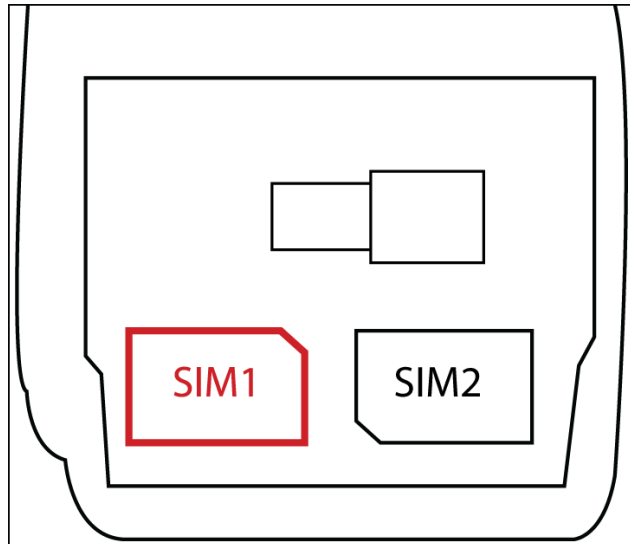

The SIM-card is placed to SIM1-slot beneath the battery so that the chip is facing down and the folded corner points upwards.

1.8 Touchscreen

The terminal has a touchscreen, which allows selecting menus directly from the screen. Enter- and cancel-functions can be selected directly from the screen or by pressing the particular key.

1.9 Stylus

The terminal comes with a stylus, which eases the selection of on screen menus. The stylus is located inside the left top corner of the terminal.

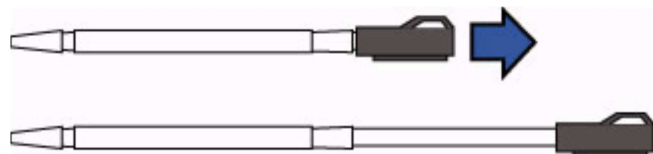
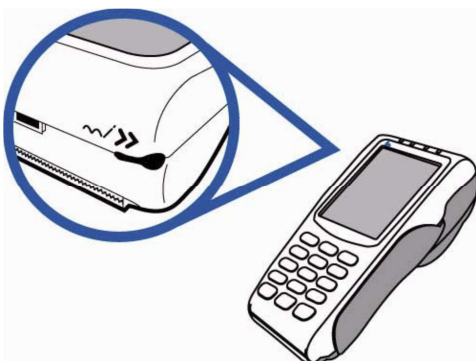

1.10 Using the menus

To see the terminal's various settings and functions, press the desired menu icon from the screen. To scroll inside the menu's press the arrow keys from the screen, or numbers 1 and 3 from the keypad. To select a particular function or setting, press its text field from the screen. A function is selected by pressing the enter key from the screen or from the keypad. To view the previous display, press the cancel key from the screen or from the keypad. To get to the main screen, press the cancel key several times. When selecting Reports or Settings the terminal asks to press enter.

1.11 Letters and special characters

To insert letters and special characters press the number with the desired character until the appropriate character appears. To switch capital letters into lower case letters, press the arrow up icon from the screen.

1= Q Z .
2= A B C
3= D E F
4= G H I
5= J K L
6= M N O
7= P R S
8= T U V
9= W X Y
0= - space +
*= , ' "
#= ! : ; @ = & / \ % \$ _

1.12 Terminal start-up and shutdown

The terminal is switched on by pressing the Enter key for a while or by connecting it to the power cord. To shutdown the terminal press the Cancel key until the terminal shuts down.

NOTE! The terminal will not shutdown if the power cord is connected.



1.13 Switching the paper

- Pull the printer covers eject button upwards, so that it opens.
- Remove the previous paper roll from the printer tray.
- Place the new paper roll so that the paper moves from the bottom of the roll towards the front edge.
- Leave a small amount of paper to extend outside the printer door.
- Close the printer cover.
- The terminal informs "PAPER INSERTED PRESS ANY KEY". Press any key to continue.

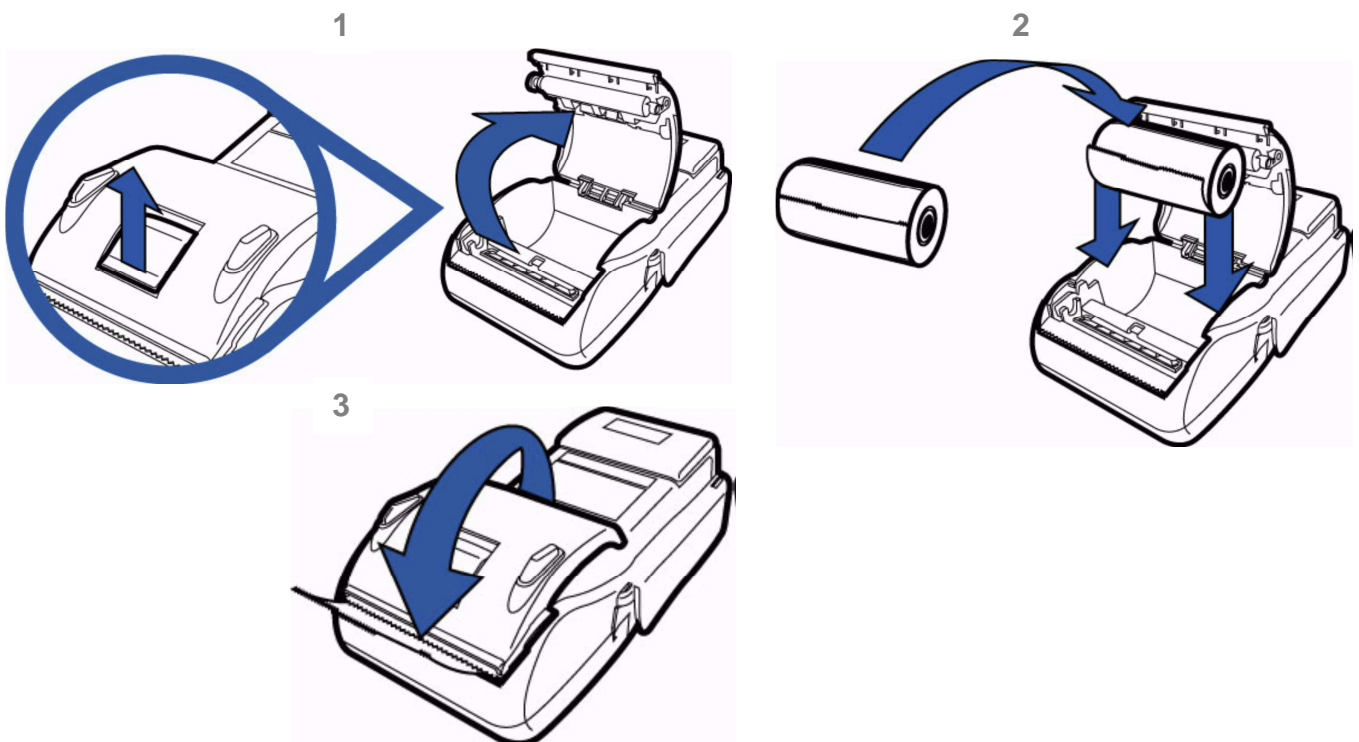

1.14 Testing the connection

The upper right corner of the display shows the strength of the connection. The signal can be refreshed by pressing keys # and 6 on the main display.

NOTE! If the signal bars are grey, the connection is missing. In these cases restart your terminal and test the connection again. If the problem is repeated, contact your connection provider about the problem.

From the main display, select the Reports menu by pressing its icon. After this, press enter and select SEND BATCH. The screen informs DIALING. If the terminal successfully connects, the text CONNECTED appears on screen. A white bar and the text RECEIVING are displayed on screen. The bar turns gradually black as the batch sending progresses. The terminal downloads the blacklist and other required card information files from the bank.

After this, the terminal is ready for use.



2. SETTINGS

2.1 Terminal settings

To get to the terminals setting menu, select the Settings icon from the screen and press Enter. Some of the listed settings are explained in later sections. The sections are marked in brackets. From the Settings menu choose EDIT.

BATCH TIME (2.3)	Batch sending time
CASHIER NUMBER (2.4)	Terminal's cashier number
TCP/IP PARAMETERS	DHCP / FIXED IP
LANGUAGE	Terminal's language (FIN/SWE/ENG)
EXTRA AMOUNT (5.2)	Extra amount settings
CASH RECEIPT (5.1)	YES / NO
POWER OPTIONS (2.7)	Terminal's power settings
AUTH. MANDATORY (5.4)	YES/ NO
TIME SETTINGS (2.5)	Time and date settings
VAT (5.3)	YES / NO/FIXED VAT
MULTICASHIER VER (5.7)	YES / NO
SOUND (2.9)	ON / OFF
CONTRAST (2.8)	Settings for the screen's brightness
AUDIT LOG IP (2.12)	

2.2 Parameter printing

Select the Settings menu and press Enter. Choose PRINT and PAREMETERS.

The terminal prints out the parameters list, which shows the technical settings of the terminal. This list is good to save.

2.3 Batch time

The terminal will send the batch automatically if you have set a sending time to the setting. Sending time can be at any time. We recommend that the time is after the closing time. Even hours are not recommended (e.g. 2100).

If you do not want to use the automatic sending time, set it to be at 9999. The batch must then be sent manually.

To set the sending time, choose BATCH TIME from the EDIT menu. Type on the screen the sending time that you want with four digits (e.g. 0315).

2.4 Cashier number

If you have in use more than one terminal, it is important to specify each terminal by their cashier number. The cashier number is printed on every receipt so that it is easy to discover which transaction has been done with which terminal in any problem cases. From the EDIT menu, choose CASHIER NUMBER. Type on the screen the cashier number that you want for the terminal with three digits (e.g. 001).

2.5 Time and date settings



Select TIME SETTINGS from the EDIT menu.
Choose ADJUST CLOCK.
Select the information you want to change, type in the new value and press Enter.

2.6 Fixed IP-address

If the terminal uses WLAN-connection, fixed IP-addresses might have to be defined to the terminal. Select TCP/IP PARAMETERS from the EDIT menu and choose FIXED IP.

Activate IP address = the IP-address for the terminal
Default gateway = Default gateway
SUBNET MASK = Subnet mask
DNS 1 / DNS 2 = Terminal does not use DNS addresses

2.7 Power options

Select POWER OPTIONS from the EDIT menu.

Shut down timer = Time it takes that the terminal automatically shuts down. The time is indicated in seconds (e.g. 180 = 3 min.) The terminal does not shutdown if it is connected to the power cord. If the sleep timer is enabled the terminal also will not shut down. If you want to disable the shut down timer, type 0 as the value.

Online bat percent = minimum battery reserve that the terminal requires to work. This is indicated in percentage (e.g. 20).

Screen saver = Time it takes that the terminal's screen saver appears. This is indicated in minutes. The screen saver will not appear, if the terminal is connected to the power cord. If you want to disable the screen saver, type 0 as the value.

2.8 Contrast

You can adjust the screen's contrast from the CONTRAST-settings with the minus and plus icons. Select the Menu icon from the screen and choose CONTRAST.

2.9 Sounds

To disable the terminal's button sounds, select SOUND from the EDIT menu and choose OFF.



2.10 GPRS APN

NOTE! To change the GPRS APN information you need the terminal's daily password. To get the password go to Verifone reporting or contact Verifone's customer service.

Press the SETTINGS icon and input the daily password.
Press enter and choose EDIT
Choose GPRS APN and input your operator's APN information.

2.11 WIFI settings

NOTE! To change the WIFI information you need the terminal's daily password. To get the password go to Verifone reporting or contact Verifone's customer service.

Press the SETTINGS icon and input the daily password.
Press enter and choose EDIT
Choose WLAN PARAMS

SSID = Network's name
WEP KEY = Network's password
WEP MODE = WPA or WPA2 **NOTE! The terminal doesn't support other encryptions!**
CHANNEL = Number for the channel in use

FIND WIFI NETWORKS = The terminal seeks all available networks from the area and lists them on the display. After choosing a network the terminal asks for the WEP KEY. Input the correct wep key and press enter. The terminal connects to the chosen network.

PRINT PARAMS = The terminal prints out the configured WIFI settings.

2.12 Audit log IP

With the audit log IP-function, your payment terminal sends log information to a desired IP-address. The terminal logs include error and update information etc. from the payment terminal.

To input your desired IP-address, select the Settings icon from the screen and press enter.
Choose Edit, and select Audit log IP.
Input the IP-address; to get a dot, press 1 repeatedly until the correct character is on the display.



3. DOWNLOADS

3.1 Downloading applications

NOTE! The terminal should be kept still and connected to the power cord during the entire download. It is not advised to download the terminal e.g. in a moving vehicle. This might disrupt the download.

Send the batch from the terminal before downloading.

To send the batch, select the Reports icon from the screen, press Enter and choose SEND BATCH.

Select the Settings icon from the screen and press Enter.

Choose APP. DOWNLOAD

Select APP + PARAMS or ONLY APPLICATION

The terminal downloads the application. A white bar appears on the screen, which gradually turns black as the download progresses.

NOTE! Parameters must be downloaded to the terminal after the application download has ended. Guides for parameter downloading are listed below.

3.2 Parameter downloading

Select the Settings icon from the screen and press Enter.

Choose DOWNLOAD

Choose FROM LOADPOINT

Choose PHONE

The terminal downloads the parameters. A white bar appears on the screen, which gradually turns black as the download progresses. The terminal prints on the paper "SUCCESSFUL PARAMETERS DOWNLOAD".

NOTE! After downloading the parameters, the terminal must connect to the bank. Select Reports from the screen, press Enter and choose SEND BATCH.



4. DAILY USE

4.1 Transactions

4.1.1 Chip card transactions

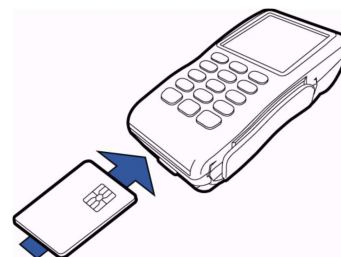

ENTER AMOUNT: Type the precise amount, including the cents, and press Enter.

INSERT/SWIPE OR PRESENT CARD: Insert the card into the chip reader, located at the front of the terminal, with the chip side facing up.

CREDIT / DEBIT: Customer selects the payment method.

ENTER PIN: Customer types the PIN-code and presses Enter.

NOTE! You can pass the PIN-code by pressing Enter. In this case the responsibility of the transaction is yours.

The terminal prints out the merchant's receipt and asks to print the customer's receipt. Press Enter if you wish to print out the customer's receipt. Otherwise, press Cancel.

If the PIN-code was entered, the customer does not need to sign the receipt. The terminal will remind you to check the customer's ID, if the transaction exceeds 50,00€ (depending on the card used). Press Enter, check the ID and write the last 4 digits of the social security number and which ID was checked to the receipt.

REMOVE CARD: Take the card from the chip card reader.

NOTE! The card must be in the reader during the entire transaction. Otherwise the transaction is cancelled.

4.1.2 Swipe card transactions

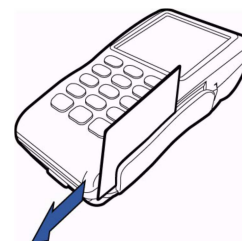

ENTER AMOUNT: Type the precise amount, including the cents, and press Enter.

INSERT/SWIPE OR PRESENT CARD: Swipe the card from the magnetic reader.

CREDIT / DEBIT: Choose the payment method

The terminal prints out the merchant's receipt and asks to print the customer's receipt. Press Enter if you wish to print out the customer's receipt. Otherwise, press Cancel.

The terminal will remind you to check the customer's ID, if the transaction exceeds 50,00€ (depending on the card used). Press Enter, check the ID and write the last 4 digits of the social security number and which ID was checked to the receipt.



4.1.3 Contactless card transactions

ENTER AMOUNT: Type the precise amount, and press Enter.

INSERT/SWIPE OR PRESENT CARD: Place the card on top of the display.

CREDIT / DEBIT: Choose the payment method

The terminal prints out the merchant's receipt and asks to print the customer's receipt. Press Enter if you wish to print out the customer's receipt. Otherwise, press Cancel.

Contactless cards have a floor limit for contactless transactions that is defined by the card company. When the limit is exceeded the terminal asks to insert the card into the chip reader. In these cases the transaction is done with the chip reader.

NOTE! The reversal of a contactless card transaction is not possible, if it has not been authorized. In these cases the terminal will inform NOT ALLOWED. If you wish to void an unauthorized transaction you should use the refund function for the transaction (4.1.8).

4.1.4 Reversal

NOTE! A reversal can only be done to a transaction that is still in the terminals memory.

Press the Menu icon from the screen and choose REVERSAL.

ENTER RECEIPT NUMBER: The terminal suggests the number of the last transaction. Accept by pressing Enter. Otherwise, type the wanted receipt number and press Enter.

The terminal informs CANCELLATION APPROVED, prints out the merchant's receipt and asks to print out the customer's receipt. Press Enter if you wish to print out the customer's receipt. Otherwise, press Cancel.

TRANSACTION DOESN'T EXIST: The receipt number is incorrectly typed or the transaction has been sent forward from the terminal.

4.1.5 External reversal

NOTE! External reversals cannot be performed without the card that the transaction has been made with.

With the external reversal you can void a transaction that has been made with another terminal. This requires that the terminals are linked to Verifone reporting.

Select the Menu icon from the screen and choose External reversal.

ENTER RECEIPT NUMBER: Type the transaction's receipt number. This is found on the receipt.

INPUT SN: Enter the serial number of the terminal, in which the transaction has been made. The serial number is located at the back side of the terminal, next to the bar code after initials S/N.

TRANSACTION TIME HHMM?: Type the time of the transaction (hours:minutes). This is found on the receipt.

PLEASE INSERT CARD: Insert the card that the transaction has been made with into the chip reader. The terminal connects and voids the transaction. The terminal informs CANCELLATION APPROVED.



The terminal prints out the merchant's receipt and asks to print the customer's receipt. Press Enter if you wish to print out the customer's receipt. Otherwise, press Cancel.

4.1.6 Manual entry

In order to manually type a card number during a transaction, press the * key when the terminal informs INSERT/SWIPE OR PRESENT CARD.

CARD NUMBER: Type the card number and press Enter

EXPIRY DATE: Type the card's expiry date and press Enter

CREDIT / DEBIT: Choose the payment method.

ENTER AMOUNT: Type the complete amount and press Enter .

DIAL YES / NO: If you want the terminal to make an automatic authentication for the transaction choose YES

NOTE! Manually entered transactions must be authenticated

If you pass the authentication by choosing NO the terminal will ask for authentication code. Call to the authorization centre and ask for an authentication code. Type in the code given to you and press Enter. You can pass this by typing 9999. In this case the responsibility of the transaction is on the company.

The terminal prints out the merchant's receipt and asks to print the customer's receipt. Press Enter if you wish to print out the customer's receipt. Otherwise, press Cancel.

The terminal will remind you to check the customer's ID, if the transaction exceeds 50,00€ (depending on the card used). Press Enter, check the ID and write the last 4 digits of the social security number and which ID was checked to the receipt.

NOT ALLOWED: The transaction is not allowed with the card type

4.1.7 Receipt copy

Select the Menu icon and choose PRINT COPY.

RECEIPT NUMBER: The terminal suggests the number of the last transaction. Accept by pressing Enter. Otherwise, type the wanted receipt number and press Enter.

The terminal prints out a copy.

4.1.8 Refund

You can make a refund at any time. If you need to undo a transaction at the same day use the REVERSAL instead

NOTE! It is not allowed to make a return for a bank card.

Select the Menu icon and choose REFUND

ENTER AMOUNT: Type the complete amount and press Enter

INSERT/SWIPE OR TAP CARD: Insert the card into the chip reader, swipe the card or place the card on top of the display



CREDIT / DEBIT: Choose the payment method.

The terminal prints out the merchant's receipt and asks to print the customer's receipt. Press Enter if you wish to print out the customer's receipt. Otherwise, press Cancel.

If the PIN-code was entered, the customer does not need to sign the receipt. The terminal will remind you to check the customer's ID, if the transaction exceeds 50,00€ (depending on the card used). Press Enter, check the ID and write the last 4 digits of the social security number and which ID was checked to the receipt.

Refund without the card: Press the * key when the terminal asks to insert the card. The terminal asks for the card number and expiry date. The terminal will inform NOT ALLOWED if the card does not allow manual entry.

4.1.9 Cash back

Cash back is a function that allows customers to withdraw cash from the cash register during a transaction. This action is possible with a credit- or debit card and always requires a transaction. Only withdrawing cash is not possible with the cash back-function.

Press the MENU icon and select CASH BACK

PAYMENT AMOUNT: Type the sum of the transaction and press Enter.

CASH BACK AMOUNT: Type the sum of the cash withdraw and press Enter.

The terminal prints out receipts, which display separately the payment and cash back amounts. Always check the customer's ID during a cash back transaction

4.2 Online transactions

4.2.1 General information on online transactions

Online batch is a function which sends information on each payment transaction to the real-time database of the Verifone reporting service. This is to prevent the loss of information from the payment terminal.

4.2.2 Online batch

During possible connection problems payment transactions cannot be sent forward after they have been made. The online batch gathers the successful transactions to the terminal's memory

Online batch settings enable you to choose the maximum sum and number of transactions in the terminal memory. After the maximum is reached from either limit, the transactions must be sent forward before taking new transactions.

- ONLINE QUEUE AMOUNT = The maximum sum of the transactions in queue. After this amount is reached, the terminal will send all of the transactions in queue (e.g. 2,000 euros).

- ONLINE QUEUE COUNT = The maximum number of the transactions in queue. After this number is reached, the terminal will send all of the transactions in queue (e.g. 20).

The largest possible sum is 999999,99 €. The largest possible number is 40.

NOTE! If you wish to edit these settings, please contact Verifone's customer service



4.2.3 Verifone reporting

Verifone reporting is a transaction collecting system by Verifone, which enables companies to monitor their centralized money flow. The service offers a customer-specific website that makes the centralized management possible for companies. Verifone reporting gathers transactions from terminals into different groups determined by the customer. The transactions are sent from the service to the customer's bank every day. The banks payments appear in the company's account with the Verifone reporting group names. A group-specific reference can be determined for the bank payments. This makes it easier for financial management programs to target specific payments.

A customer needs only one contract to enable all their terminals to be linked to Verifone reporting. Terminals linked to the service do not require installment of PATU-keys from the bank. The customer-specific websites for the system are encrypted with the same method as online bank services. The connection between a client's web browser and Verifone reporting is encrypted (https). Users log in to the service with three different identification information's: username, fixed password and a variable password from a password list.

For further information about Verifone reporting, contact Verifone's sales department:

Tel: **+358 (0)9 477 43340**

E-mail: **myynti@point.fi**

4.3 Reports and bank connection

4.3.1 Print batch

Select the Reports icon from the screen and press Enter.

Choose PRINT BATCH.

The terminal prints out a report of the current days transactions. Different card types are grouped separately on the receipt. The terminal resets the report after sending the batch from the terminal.

4.3.2 Monthly report

The monthly report can also be used as a shift report. The report gathers information of the transactions until the monthly report is reset.

NOTE! The report must always be printed before being reset.

Printing the monthly report:

Select the Reports icon and press Enter.

Select MONTHLY REPORT.

Select again MONTHLY REPORT.

The terminal prints out the report.

Resetting the monthly report:

Select the Reports icon and press Enter.

Select MONTHLY REPORT.

Select RESET REPORT



The terminal resets the report.

4.3.3 Send Batch

The terminal automatically sends the batch, if you have installed a sending time to the settings. You can also send the batch manually, for example if the automatic batch sending has not succeeded.

NOTE! The automatic batch sending does not work, if the terminal is turned off.

Select the Reports menu from the screen and press Enter.
Choose SEND BATCH.

The terminal prints out the report and connects to Verifone reporting. The terminal sends the transactions, retrieves the necessary files: return report, EMV keys, AID and BIN tables, and the blacklist.

If the batch sending is ok, the terminal prints out "BATCH SENDING OK". This text does not appear if there are no transactions on the report.

NOTE! The merchant has the duty to check that the accounting is correct with the report "LÄHETYSERÄRAPORTTI" and the return report "MAKSUPÄÄTEPALAUTE".

4.3.4 Blacklist

The terminal updates the blacklist automatically during the batch sending. You can also download the blacklist manually if it is missing from the terminal.

Select the Settings menu from the screen and press Enter.
Choose DOWNLOAD
Choose FROM HOST
Choose BLACKLIST and select FULL or UPDATE.

FULL = Terminal downloads the full blacklist
UPDATE = Terminal updates the blacklist

The terminal connects to Verifone reporting and downloads the blacklist from the bank. The terminal prints out to the receipt the amount of cards on the blacklist.

4.3.5 Issue report

The terminal sends all transactions forward from its memory to Verifone reporting. From this service the batches are forwarded daily to the chosen bank or acquiring company. If any problems occur during the forwarding of the batches, the terminal will print out information about the situations on an issue report. In order to save paper, the terminal will print out 20 issues at the most.

Here are listed all the types of issues that can be printed on the issue report, and also the proper actions that will fix the problem. The issue report will be printed from the terminal during a batch sending until the issues are acknowledged or fixed. The term "batch receiver" refers to the bank or credit card company to which the batch is forwarded from Verifone reporting.



NOTE! Once an issue is acknowledged, it cannot be in any cases sent again. Acknowledging an issue is always the responsibility of the Merchant.

PENDING = The batch is waiting to be forwarded to its receiver
Actions = No actions required. The batch will be automatically forwarded.

OLD TRANSACTIONS = Over 20 days old transactions have been sent to Verifone reporting.
Actions = The batch can be forwarded by Verifone. Contact Verifone's customer service. If the transactions have already been processed through other ways, the issues can be acknowledged from Verifone reporting or from the terminal.

SENT TO BANK FAILED = Sending of the batch to the receiver has failed.
Actions = Contact the batch receiver (bank / credit card company) and check why the sending has failed. If the batch must be sent again, it will be done by Verifone. Please contact Verifone's customer service. If the batch has been processed in the bank, the issue can be acknowledged from Verifone reporting or from the terminal.

NOT SENT, CONTAINS DUPLICATES = The batch has not been sent forward because it contains duplicate material.
Actions = Contact your own bank and check the duplicates that the batch contains. If the batch must be sent again, it will be done by Verifone. Please contact Verifone's customer service about the issue. If the batch has been processed through other ways, the issue can be acknowledged from Verifone reporting or from the terminal.

SENT TO BANK, REPORT OVERDUE = The batch has been forwarded to the receiver, but the report has been delayed.
Actions = Contact the batch receiver and confirm that the batch has been successfully received. Acknowledge the issues from Verifone reporting or from the terminal.

ALL REJECTED = The batch has been rejected by the receiver
Actions = Contact the batch receiver and check why the batch has been rejected. If the batch needs to be sent again, it will be done by Verifone. Please contact Verifone's customer service. If the batch has already been processed through other ways, the issue can be acknowledged from Verifone reporting or from the terminal.

PARTLY REJECTED = Part of the transactions that the batch contains have been rejected by the receiver.
Actions = Contact the batch receiver and check why the batch has been partially rejected. When the batch has been processed the issue can be rejected from Verifone reporting or from the terminal.

MISMATCH IN PAYMENT = The batch sum does not match with the bank statement.
Actions = Contact your bank and acknowledge the issue from Verifone reporting or from the terminal.

PAYMENT OVERDUE = Payment to the bank account has been delayed.
Actions = Contact your own bank and acknowledge the issues from Verifone reporting or from the terminal.



4.3.6 Issue acknowledgment

Press reports and Enter.
Choose ISSUE REPORT.
Select ACKNOWLEDGE ISSUE.
ISSUE ID: Type in the four-digit number that is next to the issue and press Enter.
The terminal connects to Verifone reporting, acknowledges the issue and displays on the screen ISSUE ACKNOWLEDGED.

If the acknowledgment fails, the screen displays COULD NOT ACKNOWLEDGE ISSUE.

**NOTE! Once an issue is acknowledged, it cannot be in any cases sent again.
Acknowledging an issue is always the responsibility of the Merchant.**

4.3.7 Report explanations

The batch report lists transactions by their card type. After this the report shows the total count of transactions and their total amount.

SENT TO TCS: The total count and amount of transactions that are sent to Verifone reporting as online transactions

NOT SENT TO TCS: The total count and amount of transactions that have not been sent to Verifone reporting as online transactions.

YHTEENSÄ: The total count and amount of all the transactions in the terminal's memory.

BATCH SENDING OK: the batch sending is ok.

MAKSUPAATEPALAUTE: Acknowledgement of the previous batch by the acquirer. This is printed if the batch has been received and forwarded by the acquirer. This does not come on weekends and bank holidays, or if the terminal has not been in use.

AID TABLE, BIN TABLE and KEYS: These are updated if they have been changed.

KIELTOLUETTELO: this shows the amount of cards on the blacklist.

4.4 Authorization notifications

When a transaction is declined at the authorization centre a declining code is printed on the receipt. This code tells you the reason why it has been declined. The transaction is declined by a notification given by the bank or the credit card company.

000-099

Accepted



000	Accepted
001	Check ID
002	Accepted for partial amount
003	Accepted (VIP)
005	Accepted, account type defined by the card donor
006	Accepted for partial amount, account type defined by the card donor
007	Accepted, chip update

100-199

100	Declined
101	Card is no longer valid
102	Suspected card counterfeit
103	Cashier, call recipient
104	Limited card
105	Cashier, call recipients' security department
106	Exceeds PIN-code attempts
107	Cashier, call the card donor
108	Cashier, check the card donors' special terms, make a manual authorization
109	False payment recipients' identifier
110	False amount
111	False card number
112	PIN-code required
113	Commission not accepted
114	False account type
115	Required action not supported
116	Not enough allowance
117	False PIN
118	Unknown card
119	Transaction is not allowed for card holder
120	Transaction is not allowed for payment terminal
121	Exceeds withdrawals floor limit
122	Security violation
123	Exceeds withdrawals time limit (too often)
124	Crown violation
125	Card is not valid yet
126	False PIN block
127	False PIN length
128	False PIN key synchronization
129	Suspected abuse

200-299

200	Declined
201	Card expired
202	Suspected card counterfeit
203	Cashier, contact the recipient
204	Limited card
205	Cashier, contact recipients' security department
206	Exceeds PIN-code attempts
207	Special situation



208	Extinct card
209	Stolen card
210	Suspected abuse
300	Successful
306	Unsuccessful
307	unsuccessful, form fault
400	Declined. Accepted revocation of authorization, try again

900-999

System error, authorization not successful

902	False transaction
903	Do the transaction again
904	Form fault, try again
905	Unable to route the transaction to recipient
906	Temporary usage brake in the card donors system
907	No connection to the card donor
908	Unable to route the message
909	System error
910	Unable to connect to the card donor
911	Unable to connect to the card donor
912	Card donor not available
913	Dual transaction sending
914	The original transaction cannot be traced
915	Control error, card donors' system temporarily unavailable
916	MAC-error
917	MAC-synchronization error
918	Data transfer keys not available
919	Encryption keys' synchronization error
920	Security program error, try again
921	Security program error, no transaction
922	Unknown message number
923	Transaction is being processed
930	Payment terminal error, date error

1Z3	Unable to connect to authorization centre, try again
0Y1	Offline accepted, no authorization
0Y3	Offline accepted, unsuccessful authorization
1Z1	Offline declined

5. SPECIAL FUNCTIONS

5.1 Cash receipt

Cash receipt is used when a customer pays with cash and a receipt is wanted from the terminal. Cash receipts are also seen on batch reports.

Cash receipt is activated from the Settings menu (2.1).



Making a cash receipt sale:

Select the Menu icon from the screen
Choose CASH RECEIPT
Select CASH RECEIPT SALE
ENTER AMOUNT: Enter the complete amount and press Enter.
VAT RATE %: Select the VAT percent.

The terminal prints out the merchant's receipt and asks to print the customer's receipt. Press Enter if you wish to print out the customer's receipt. Otherwise, press Cancel.

Voiding a cash receipt sale:

Select the Menu icon from the screen
Choose CASH RECEIPT
Choose CASH RECEIPT VOID
ENTER AMOUNT: Enter the complete amount and press Enter.

The terminal prints out the merchant's receipt and asks to print the customer's receipt. Press Enter if you wish to print out the customer's receipt. Otherwise, press Cancel.

5.2 Extra amount

Extra amount is used for example in restaurants when a customer wishes to leave tip for the waiter.

The Extra amount is activated from the Settings menu (2.1).
The terminal asks to input the extra amount during the card transactions.

5.3 VAT

VAT is activated from the Settings menu (2.1).
YES = the terminal asks the VAT-rate during transactions. Select this if you are using various VAT-rates.
NO = VAT is not in use.
FIXED VAT = Terminal will not ask for the VAT-rate during transactions. Select this if you are using a specific VAT-rate for all transactions.

When VAT is activated, the terminal prints out specified VAT-details on transaction receipts.

5.4 Mandatory authorization

Mandatory authorization is activated from the Settings menu (2.1). When the mandatory authorization is activated, the terminal automatically authenticates all transactions regardless of the amount or the card type.

5.5 Invoice

The invoice works in the same way as a cash receipt, except that the text INVOICE is printed on the receipt instead of CASH RECEIPT.



Making an invoice:

Press the Menu button from the screen.
Choose INVOICE.
Choose INVOICE again.
ENTER AMOUNT: Enter the complete amount and press Enter.

The terminal prints out the merchant's receipt and asks to print the customer's receipt. Press Enter if you wish to print out the customer's receipt. Otherwise, press Cancel.

Voiding an invoice:

Press the Menu button from the screen.
Choose INVOICE.
Choose VOID INVOICE
ENTER AMOUNT: Enter the complete amount and press Enter.

The terminal prints out the merchant's receipt and asks to print the customer's receipt. Press Enter if you wish to print out the customer's receipt. Otherwise, press Cancel.

5.6 Preauthorization

Preauthorization enables to perform a provision for a credit card, which can later be charged or reversed.

1. New preauthorization

Menu -> Preauthorization -> New pre-auth

Input the reference number if in use, otherwise press enter.

Insert or swipe card

Enter amount and press enter

ENTER PIN: Customer types the PIN-code and presses Enter.

The terminal performs a provision for the credit card, prints out the merchant's receipt and asks to print the customer's receipt. Press Enter if you wish to print out the customer's receipt. Otherwise, press Cancel.

NOTE! Preauthorizations cannot be done using contactless payment

2. Ending the preauthorization

Preauthorizations can be charged or reversed. The sum of the preauthorization can also be changed.

Menu -> Preauthorization -> Finalize pre-auth

a) Reversal pre-auth

Insert or swipe card

The card number can be typed by pressing the * key, preauthorization ID can be typed by pressing the # key. The preauthorization ID number is found on the receipt.



The terminal asks for the reference number if used. Input the reference number and press enter. If the reference number is used for multiple preauthorizations, select the correct preauthorization ID. If the preauthorization did not use a reference number, press enter.

If multiple preauthorizations have been made with the same credit card, select the correct preauthorization ID.

The terminal performs a reversal for the preauthorization, prints out the merchant's receipt and asks to print the customer's receipt. Press Enter if you wish to print out the customer's receipt. Otherwise, press Cancel.

b) Charge pre-auth

Insert or swipe card

The card number can be typed by pressing the * key, preauthorization ID can be typed by pressing the # key. The preauthorization ID is found on the receipt.

The terminal asks for the reference number if used. Input the reference number and press enter. If the reference number is used for multiple preauthorizations, select the correct preauthorization ID. If the preauthorization did not use a reference number, press enter.

If multiple preauthorizations have been made with the same credit card, select the correct preauthorization ID.

Amount: The terminal shows the preauthorization's amount. This can be changed by pressing the yellow-key. Accept the amount by pressing enter.

Amount not changed:

The terminal prints out the merchant's receipt and asks to print the customer's receipt. Press Enter or Cancel.

Amount is greater than preauth:

The terminal asks if the payment is done using the same card.

To do this, press enter. If the payment is done with multiple cards press cancel. The terminal asks to insert or swipe card, after which the customer types the PIN-code and presses Enter.

The terminal prints out separate merchant receipts from the preauth amount and the extra amount. The terminal asks to print the customer's receipt. Press Enter or Cancel.

If the charge has been started by typing the reference number or preauthorization ID, the whole amount is charged from the same credit card.

Amount is smaller than preauth:

The terminal prints out separate merchant receipt's from the reversed and charged amounts. The terminal asks to print the customer's receipt. Press Enter or Cancel.

NOTE! The terminal informs "failed" if there are no preauthorizations with the card.

3. Free reference



Menu -> Preauthorization -> Free reference

If you wish to use reference numbers with preauthorizations press Enter.

When references are in use, the terminal asks to type the number during preauthorizations. The reference number is found on preauthorization receipts at FREE REFERENCE.

You can type numbers, letters and special characters on references.

To type letters or special characters, press the selected key until the correct character appears.

To switch from upper to lower case letters, press the arrow up icon from the screen.

1= Q Z .

2= A B C

3= D E F

4= G H I

5= J K L

6= M N O

7= P R S

8= T U V

9= W X Y

0= - space +

*= , ' "

#= ! : ; @ = & / \ % \$ _

5.7 Multicashier version

Multicashier version is activated from the settings menu (2.1).

The terminal asks for a cashier number during transactions. Input a number between 1-99.

The cashier number is printed on transaction receipts, and can be used to specify payments from different salespersons.



6. EXTRA VERSIONS

6.1 Multiuser version

The multiuser version allows several users to take transactions with one terminal so that the batches can be sent to various bank accounts. In order to update your terminal to this version, please contact Verifone.

Printing the user list

Press Settings, enter and choose Print.

Select Users.

The terminal prints a list of the terminal users. This list shows the user numbers, receipt texts and merchant numbers.

Multiuser transactions

Enter amount: Type the transaction price and press enter.

User number: Type your user number and press enter.

Please insert or swipe card: Insert the chip card to the reader or swipe the card.

CREDIT / DEBIT: Choose the payment method.

ENTER PIN: Customer types the PIN-code and presses Enter.

The terminal prints out the merchant's receipt and asks to print the customer's receipt. Press Enter if you wish to print out the customer's receipt. Otherwise, press Cancel.

The terminal will remind you to check the customer's ID, if the transaction exceeds 50,00€ (depending on the card used). Press Enter, check the ID and write the last 4 digits of the social security number and which ID was checked to the receipt.

Multiuser reports

Daily and monthly multiuser reports are similar to normal reports, except that multiuser reports specify every user's transactions separately.

6.2 Taxi version

The taxi version is activated by Verifone.

Taxi version settings:

TAXI -> Setup

SWITCH COM

Choose COM6 if the terminal is attached to the taximeter.

BACKLIGHT

On = The backlight is always active.

Off = The backlight is never active (display is dim)

Auto näyttö on = The backlight dims when the terminal is not used. The light activates from enter.

Auto näyttö off = The display turns completely off when the terminal is not used. The backlight is activated by pressing enter.



PORT SPEED

1200 bps / 9600 bps, select the supported speed of your taximeter

SELECT TARGET

MITAX / HALDA, select your taximeter.

Cash payment:

TAXI -> Cash payment

Enter amount: input the total amount and press enter.

The terminal prints out receipts of the transaction.

Void cash payment:

TAXI -> Void cash payment

Enter amount: input the total amount and press enter.

The terminal prints out receipts of the transaction.

Invoice:

TAXI -> Invoice

Enter amount: input the total amount and press enter.

The terminal prints out receipts of the transaction.

Void invoice:

Taxi -> Void invoice

Enter amount: input the total amount and press enter.

The terminal prints out receipts of the transaction.

Taxi- and Turku-card batch:

Reports -> Taxi trans

The terminal sends the Taxi-card batch

Reports -> Turku batch

The terminal sends the Turku-card batch

6.3 Product version

Product version allows you to define products for your terminal. In this version receipts print out details of the sold products. This version can replace receipts from cash registers. In order to update your terminal to this version, please contact Verifone.

Forming VAT-groups

Select Settings, press enter and choose Edit.

Navigate down with the arrow key and select Edit VAT group

The display shows the following:

- a) Add VAT group
- b) Edit VAT group
- c) Remove VAT group

a) Add VAT group

VAT group: Type the groups number (0-99) and press Enter.



Verifone Finland Oy

Vantaankoskentie 14 FI-01670 VANTAA | tel: +358 (0)9 477 4330 | fax: +358 (0)9 436 2490
www.verifone.fi

VAT%: Type the VAT percent and press Enter.

The display shows the group number and VAT percent. Accept this group by pressing enter; cancel by the cancel-key.

Add next VAT: If you wish to add a new group, press enter. Otherwise press cancel.

b) Edit VAT group

VAT group: Type the group number and press Enter.

VAT: Type a new VAT percent and press Enter.

The display shows the group number and VAT percent. Accept this group by pressing enter; cancel by the cancel-key.

Edit next VAT: If you wish to edit another group, press enter. Otherwise press cancel.

c) Remove VAT group

NOTE! You cannot remove a VAT-group if products are defined to the group. The products must be removed first in these cases.

VAT Group: Type the group number and press enter.

The terminal asks to confirm of the removal of the VAT group. To accept, press enter. Otherwise press cancel.

Delete next VAT: If you wish to remove another group, press enter. Otherwise, press cancel.

Forming product groups

Select Settings, press enter and choose Edit.

Navigate down with the arrow key and select Edit products

The display shows the following:

- a) Add product
- b) Edit product
- c) Remove product

a) Add product

Product id: type the products number (0-99) and press Enter.

Product name: Type the product name and press enter. To get letters, press repeatedly a number key until the correct character is on the screen. To get a lowercase letter, press the icon on the screen.

VAT group: Type the VAT group number and press enter.

Price: Type the price for the product, and enter. If the product does not have a fixed price, type 0.

The display shows the product name, VAT group and the price. Accept this by pressing enter; cancel by the cancel-key.

Add next product: If you wish to add another product, press enter. Otherwise, press cancel.

b) Edit product

Product id: type the products number and press Enter.

Product name: Change the name of the product if needed and press enter.

VAT group: Change the VAT group if needed and press enter.

Price: Change the price if needed and press enter.

The display shows the product name, VAT group and the price. Accept this by pressing enter; cancel by the cancel-key.

Edit next product: If you wish to edit another product, press enter. Otherwise, press cancel.

c) Remove product



NOTE! You cannot remove a product that is included in unsent transactions, or if you have not sent the batch.

Product id: Type the products number and press enter.

The display shows the product name, VAT group and the price. Accept the removal by pressing enter; cancel by the cancel-key.

Delete next product: If you wish to remove another product, press enter. Otherwise, press cancel.

Product and VAT group lists

To print product or VAT group lists, press Settings, enter and choose Print.

VAT groups: select Print VAT groups

Product groups: select Print products

Product transaction

Press the *-key (below 7)

Product id: Type the products number and press enter.

Units: Type the unit amount for this product and press enter.

Price per unit: Type the price for the product and press enter. If the product has a fixed price, this will show on the screen. This can be changed if needed.

The terminal shows the total unit amount and total price for the transaction. Press enter.

The following options are shown:

- a) Cash receipt – choose this, if the customer pays in cash.
- b) Make a payment? – Choose this, if the customer uses a payment card.
- c) Add next product? – Choose this, if you wish to sell multiple products.

The terminal prints out the receipts.

Reversal of a product transaction

Press Menu and select cash receipt.

Choose Cash receipt void

Add products: press enter and type the product number.

Units: Type the unit amount for this product and press enter.

Price per unit: Type the price for the product and press enter. If the product has a fixed price, this will show on the screen. This can be changed if needed.

The terminal shows the total unit amount and total price for the transaction. Press enter.

The following options are shown:

- a) Make a payment? – The terminal prints out the receipt.
- b) Add next product? – Choose this, if you wish to reverse multiple products.

The terminal prints out the receipts.

NOTE! If the transaction has been made with a payment card, the reversal must also be done to the card transaction.



Product reports

Report printing:

Press Reports, enter and choose product report.
Choose daily report.

The terminal prints out a report that lists the sold products, the amount of products, the total amount of sold products and the different VAT groups of the sales.

Resetting the report:

The terminal gathers transactions to the report until it is been reset. The report can be reset at any time.

Press Reports, enter and choose Product report.
Choose daily report and select reset report.
Choose yes.

The terminal prints out the product report and resets it.



7. TROUBLE SHOOTING

7.1 Notifications on the screen

NO SIM CARD = The terminal does not have a SIM-card inside, or the SIM-card is not properly placed. See instructions (1.7)

NO BATTERY = Check that the battery is firmly locked at its place. The terminal cannot connect or print receipts without the battery.

BLACKLIST MISSING = The blacklist is missing from the terminal. See instructions for downloading the blacklist (4.3.4).

USE MAG CARD = The terminal cannot read the card's chip. Use the magnetic strip reader.

USE CHIP = The card has an EMV-chip. Use the chip reader.

PIN LOCKED = The pin code of the card in use has been locked. It can be unlocked by contacting the card donor or by using the card on an atm.

APPLICATION LOCKED = The application on the card is locked. The card holder has to contact the card donor.

JÄSENLIKENUMERO PUUTTUU = The card is not included in the terminals card selection. It cannot be used. The terminal also might not have the AID and BIN-tables. Send the batch from the terminal (instructions 4.3.3).

SERVICE NOT ALLOWED FOR THIS CARD PRODUCT = The card in use is not included in the terminals card selection. It cannot be used.

NOT ALLOWED = The card is not permitted to make the transaction. For example manual entry with a Visa Electron is not allowed.

WRONG CARD = Check that the card in use is the correct card for the required transaction.

TRANS NOT FOUND = The transaction is not in the terminals memory, check the receipt number.

MAX LIMIT EXCEEDED = The amount of the transaction exceeds the maximum limit of the card in use.

WRONG PIN = Customer has typed the wrong PIN-code for the card.

DOWNLOAD NEEDED = The software needs to be downloaded to the terminal. Contact Verifone's customer service.

TAMPERING DETECTED = The terminal has suffered a knock or a power surge, which has caused it to go into a security lock mode. The terminal must be delivered to Verifone's maintenance service, where the security lock can be opened. See instructions, part 7.4.

7.2 Notifications on the receipt



CONNECTION ERROR = There is a problem with the connection. See part 7.3.

BATCH SENDING ERROR = There is a problem with the connection. See part 7.3.

"PYYTÄMÄÄNNE AINEISTOA EI OLE" = The acquirer does not have information ready of the previous batch sending. This is a normal situation after weekends or bank holidays.

"TAPAHTUMATIEDOSTO PUUTTUU" = The acquirer does not have information ready of the previous batch sending. This is a normal situation after weekends or bank holidays.

ERROR FILE NOT EXISTENT = The acquirer does not have information ready of the previous batch sending. This is a normal situation after weekends or bank holidays.

OTA YHTEYS NEUVONTAAN = Contact the acquirer.

7.3 Other exceptions

CONNECTION PROBLEM = Switch the terminal off and on and try to connect again. Check that the SIM-card is properly placed in its slot.

TERMINAL DOES NOT READ CARDS = Switch the terminal off and on and try again. The chip card reader might also be unclean. Clean the reader with a cleaning card and try again.

POWER IS OFF = Switch on the terminal by pressing the Enter-button for a while. The battery might also be empty and require charging.



7.4 Service

NOTE! Do not, under any circumstances, try to fix the terminal by yourself. The terminal should be always delivered to the maintenance service.

If you suspect that the terminal is damaged or broken, do the following:

- Pack the terminal firmly, so that it will not be damaged during the delivery.
- Attach a description of the problem and your contact information with the terminal. Attach also a notification if there are transactions in the terminal.
- You do not have to send the cables with the terminal unless you want them tested too.
- Send the terminal by post. The postage is always paid by the sender.
- Service address is:

**Verifone Finland Oy/
Maintenance**

**Vantaankoskentie 14
01670 Vantaa**



DESCRIPTION OF TERMINAL PROBLEM

COMPANY NAME: _____

CONTACT PERSON: _____

PHONE: _____

CAUSE OF PROBLEM: _____

HOW IS THE PROBLEM NOTICED?: _____

TERMINAL HAS UNSENT TRANSACTIONS IN MEMORY?

YES NO

OTHER REMARKS: _____
