

TM-U220

Technical Reference guide

EPSON

English

Rev. E
404455405

CAUTIONS

- ❑ This document shall apply only to the product(s) identified herein.
- ❑ No part of this document may be reproduced, stored in a retrieval system, or transmitted in any form or by any means, electronic, mechanical, photocopying, recording, or otherwise, without the prior written permission of Seiko Epson Corporation.
- ❑ The contents of this document are subject to change without notice. Please contact us for the latest information.
- ❑ While every precaution has been taken in the preparation of this document, Seiko Epson Corporation assumes no responsibility for errors or omissions.
- ❑ Neither is any liability assumed for damages resulting from the use of the information contained herein.
- ❑ Neither Seiko Epson Corporation nor its affiliates shall be liable to the purchaser of this product or third parties for damages, losses, costs, or expenses incurred by the purchaser or third parties as a result of: accident, misuse, or abuse of this product or unauthorized modifications, repairs, or alterations to this product, or (excluding the U.S.) failure to strictly comply with Seiko Epson Corporation's operating and maintenance instructions.
- ❑ Seiko Epson Corporation shall not be liable against any damages or problems arising from the use of any options or any consumable products other than those designated as Original EPSON Products or EPSON Approved Products by Seiko Epson Corporation.

TRADEMARKS

EPSON is a registered trademark of Seiko Epson Corporation.

Exceed Your Vision and ESC/POS are registered trademarks or trademarks of Seiko Epson Corporation.

Microsoft® and Windows® are registered trademarks or trademarks of Microsoft Corporation in the United States and other countries.

All other trademarks are the property of their respective owners and used for identification purpose only.

ESC/POS® Proprietary Command System

EPSON took the initiative by introducing ESC/POS, a proprietary POS printer command system including patented commands and enabling versatile POS system construction with high scalability. Compatible with all types of EPSON POS printers and displays, this proprietary control system also offers the flexibility to easily make future upgrades. Its popularity is worldwide.

About This Manual

Aim of the Manual

This manual was created to provide information on the TM-U220 printer for anyone who is developing hardware, installations, or programs. Programmers will also want to consult other documents.

Contents of the Manual

Chapter 1, "General Information."	General description of features plus specifications.
Chapter 2, "System Planning."	Contains introduction of control methods and each connection form.
Chapter 3, "Setup."	Contains information on such matters as DIP switches, memory switches, error processing for using TM-U220.
Chapter 4, "Troubleshooting."	Contains useful information for using.
Chapter 5, "Application Development Information."	Contains useful information for programming.
Chapter 6, "Notices for Replacement of the TM-U210/TM-U300."	Contains various notices and comparison information for using the TM-U220 as a replacement for the TM-U210/TM-U300.
Appendix A, "Comparison table for TM-U220/U210/U300."	Comparison table for replacing TM-U210/TM-U300 with the TM-U220.
Appendix B, "How to Install the Printer on a Wall with the WH-10."	Installation instructions.
Appendix C, "Power Supply Unit."	Describes the external dimensions and specifications of the power supply units.
Appendix D, "Character Code Table."	Contains the supported character tables.

Related Software and Documents

Related software and documents

Software/document name	Description
TM-U220 User's Manual	This provides basic handling procedures for the end user of the printer
TM-U220 Technical Reference Guide	This Manual
ESC/POS Application Programming Guide	This provides descriptions in Acrobat format of the commands used by each TM printer, along with sample programs and other information about the printers
EPSON OPOS ADK	This is a OCX driver
EPSON OPOS ADK Manual	This provides information for anyone who is programming using OPOS. This is included in the EPSON OPOS ADK
EPSON Advanced Printer Driver	This is a Windows driver
EPSON Advanced Printer Driver Manual	This provides information for anyone who is programming using the APD (EPSON Advanced Printer Driver)

Safety Precautions

EMC and Safety Standards Applied

Product Name: TM-U220A / TM-U220B / TM-U220D

Model Name: M188A / M188B / M188D

The following standards are applied only to the printers that are so labeled. (EMC is tested using the EPSON's power supply.)

Europe:

CE marking

Safety: TÜV (EN 60950)

North America:

EMI: FCC/ICES-003 Class A

Safety: UL60950/CSA C22.2

No. 60950

Japan:

EMI: VCCI Class A

Oceania:

EMC: AS/NZS 3548 Class B

WARNING

The connection of a non-shielded printer interface cable to this printer will invalidate the EMC standards of this device.

You are cautioned that changes or modifications not expressly approved by Seiko Epson could void your authority to operate the equipment.

CE Marking

The printer conforms to the following Directives and Norms

Directive 89/336/EEC

EN 55022 Class B

EN 55024

IEC 61000-4-2

IEC 61000-4-3

IEC 61000-4-4

IEC 61000-4-5

IEC 61000-4-6

IEC 61000-4-11

WARNING

M147C is a Class A product. In a domestic environment these products may cause radio interference in which case the user may be required to take adequate measures.

FCC Compliance Statement For American Users

This equipment has been tested and found to comply with the limits for a Class A digital device, pursuant to Part 15 of the FCC Rules. These limits are designed to provide reasonable protection against harmful interference when the equipment is operated in a commercial environment.

This equipment generates, uses, and can radiate radio frequency energy and, if not installed and used in accordance with the instruction manual, may cause harmful interference to radio communications.

Operation of this equipment in a residential area is likely to cause harmful interference, in which case the user will be required to correct the interference at his own expense.

For Canadian Users

This Class A digital apparatus complies with Canadian ICES-003.

GERÄUSCHPEGEL

Gemäß der Dritten Verordnung zum Gerätesicherheitsgesetz (Maschinenlärminformations- Verordnung-3. GSGV) ist der arbeitsplatzbezogene Geräusch-Emissionswert kleiner als 70 dB(A) (basierend auf ISO 7779).

Key to Symbols

The following symbols are used in the documentation for this product. See the specific warnings and cautions at appropriate points throughout this guide.



WARNING:

Warnings must be followed carefully to avoid serious bodily injury.



CAUTION:

Cautions must be observed to avoid minor injury to yourself or damage to your equipment.



Note:

Notes have important information and useful tips on the operation of your printer.

Safety Precautions

This section presents important information to ensure safe and effective use of this product. Please read this section carefully and store it in an accessible location.

WARNING:

- ❑ *Shut down your equipment immediately if it produces smoke, a strange odor, or unusual noise. Continued use may lead to fire or electric shock. Immediately unplug the equipment and contact your dealer or a Seiko Epson service center for advice.*
- ❑ *Never attempt to repair this product yourself. Improper repair work can be dangerous.*
- ❑ *Never disassemble or modify this product. Tampering with this product may result in injury, fire, or electric shock.*
- ❑ *Be sure to use the specified power source. Connection to an improper power source may cause fire or shock.*
- ❑ *Never insert or disconnect the power plug with wet hands. Doing so may result in severe shock.*
- ❑ *Do not allow foreign matter to fall into the equipment. Penetration of foreign objects may lead to fire or shock.*
- ❑ *If water or other liquid spills into this equipment, unplug the power cord immediately, and then contact your dealer or a Seiko Epson service center for advice. Continued usage may lead to fire or shock.*
- ❑ *Do not place multiple loads on the power outlet (wall outlet). Overloading the outlet may lead to fire.*
- ❑ *Always supply power directly from a standard domestic power outlet.*
- ❑ *Handle the power cord with care. Improper handling may lead to fire or shock.*
 - *Do not modify or attempt to repair the cord.*
 - *Do not place any object on top of the cord.*
 - *Avoid excessive bending, twisting, and pulling.*
 - *Do not place cord near heating equipment.*
 - *Check that the plug is clean before plugging it in.*
 - *Be sure to push the prongs all the way in.*
- ❑ *If the cord becomes damaged, obtain a replacement from your dealer or a Seiko Epson service center.*

CAUTION:

- ❑ *Do not connect cables other than as described in this manual. Different connections may cause equipment damage and burning.*
- ❑ *Be sure to set this equipment on a firm, stable, horizontal surface. Product may break or cause injury if it falls.*
- ❑ *Do not use in locations subject to high humidity or dust levels. Excessive humidity and dust may cause equipment damage, fire, or shock.*
- ❑ *Do not place heavy objects on top of this product. Never stand or lean on this product. Equipment may fall or collapse, causing breakage and possible injury.*
- ❑ *To ensure safety, please unplug this product prior to leaving it unused for an extended period.*
- ❑ *Do not touch either the thermal or the dot matrix print head or the paper feed motor. Wait for the heads and the motor to cool. The head and the motor can be very hot after printing for a long time. Touching them may cause burns.*

Contents

TM-U220 Technical Reference guide

Chapter 1 General Information

1.1 Features	1-1
1.1.1 General	1-1
1.1.2 Printer handling	1-1
1.1.3 Printing	1-1
1.1.4 Software	1-1
1.2 Product Structure	1-2
1.2.1 Printer types	1-2
1.2.2 Standard Parts Included with the Printer	1-2
1.2.3 Related materials for TM-U220	1-3
1.3 Consumables	1-4
1.3.1 Ribbons	1-4
1.3.2 Roll paper	1-4
1.4 Product Specifications Overview	1-5
1.5 Printing and paper Specifications	1-6
1.5.1 Autocutter (for Type A / B)	1-8
1.5.2 Paper Roll Supply	1-8
1.5.2.1 Paper Specifications	1-9
1.5.2.2 Printable Area	1-10
1.6 Other Specifications	1-12
1.6.1 EMI and Safety Standards Applied	1-12
1.6.1.1 Printer (TM-U220)	1-12
1.6.1.2 AC Adapter C (packaged in ANK model)	1-13
1.6.1.3 AC adapter (packaged in Multilingual model (PS-180))	1-13
1.6.2 Reliability	1-14
1.6.3 Environmental Conditions	1-14
1.6.4 Installation	1-15
1.7 External Dimensions and Mass	1-16
1.7.1 External Dimensions and Mass	1-16
1.7.1.1 Overview (Type A)	1-16
1.7.1.2 Overview (Type B)	1-17
1.7.1.3 Overview (Type D)	1-18

Chapter 2 System Planning

2.1 Control Method	2-1
2.1.1 Windows Driver (EPSON Advanced Printer Driver)	2-1
2.1.1.1 General Features of the EPSON Advanced Printer Driver	2-1
2.1.1.2 EPSON Advanced Printer Driver Components	2-2
2.1.1.3 EPSON Advanced Printer Driver Support Environment	2-2
2.1.2 EPSON OPOS ADK	2-3
2.1.2.1 General Features of EPSON OPOS ADK (OPOS Control)	2-3
2.1.2.2 EPSON OPOS ADK Contents	2-4
2.1.2.3 EPSON OPOS ADK Supported Environment	2-5
2.1.3 ESC/POS Command	2-5
2.1.4 How to Get a Driver	2-5
2.2 Connection Form and Cables	2-6
2.3 Serial Connection	2-6
2.3.1 Stand alone	2-7

2.3.2 Y-connection	2-7
2.3.3 Pass-through connections	2-8
2.4 Parallel Connection	2-8
2.5 USB connection	2-9
2.6 Ethernet connection	2-10

Chapter 3 Setup

3.1 Part Name and Basic Operation	3-1
3.1.1 Part name	3-1
3.1.1.1 Connectors	3-1
3.1.2 The Control Panel	3-2
3.1.2.1 LED	3-2
3.1.2.2 Control Panel Buttons	3-3
3.2 Setup Flow	3-4
3.3 Printer setup	3-6
3.3.1 Installing or Replacing the Ribbon Cassette	3-6
3.3.2 Installing the Roll Paper	3-7
3.3.2.1 Installing the Roll Paper for Type B, D	3-8
3.3.2.2 Installing the Roll Paper for Type A	3-9
3.3.2.3 Replacing the Roll Paper	3-12
3.3.3 Connecting the Power Supply Unit	3-13
3.3.3.1 Connecting procedure	3-13
3.4 Adjusting Various Settings	3-14
3.4.1 How to Confirm Current Settings	3-14
3.4.2 Adjusting the DIP Switches	3-15
3.4.2.1 When the letters are STD	3-15
3.4.2.2 Notes for DIP switch 2-1	3-17
3.4.3 Memory Switches	3-17
3.4.4 Memory Switch Setup Mode	3-19
3.4.4.1 Starting the memory switch setup mode	3-20
3.4.4.2 Ending memory switch setting mode	3-20
3.4.4.3 Operating procedure	3-21
3.4.5 Adjusting Roll paper width	3-24
3.4.6 Adjusting Position of Roll Paper Near End Detector	3-25
3.4.7 Connecting the Printer to the Host PC / POS Terminal	3-26
3.4.7.1 Serial Interface model	3-27
3.4.7.2 Parallel Interface Models	3-27
3.4.7.3 USB Interface Models	3-27
3.4.7.4 Ethernet interface	3-29
3.4.7.5 Connecting a Drawer	3-30
3.5 Install a Printer Driver in the Host PC / POS Terminal	3-30
3.5.1 OPOS	3-30
3.5.1.1 Install and Set up	3-30
3.5.1.2 Package contents of EPSON OPOS ADK	3-33
3.5.2 Advanced Printer Driver (APD)	3-34
3.5.2.1 Installing and Setting Up	3-34
3.6 Self Test	3-36
3.6.1 Self Test Procedure	3-36

Chapter 4 Troubleshooting

4.1 LED Blinking Pattern	4-1
4.1.1 Error Types	4-1
4.1.1.1 Errors that automatically recover	4-1
4.1.1.2 Recoverable Errors	4-2
4.1.1.3 Errors that are impossible to recover:	4-2
4.2 Removing a Paper Jam	4-3

4.3 Autocutter Jam	4-3
4.4 Printer Stops Printing / Printer Repeats Printing on a Line	4-4
4.5 Printer prints “?” or Incorrect Data With Serial Interface	4-7
4.6 Print Speed is Slow When Using Windows Printer Driver	4-7
4.7 Printer doesn’t cut roll paper with the autocutter	4-7
4.8 Hexadecimal Dump mode	4-7

Chapter 5 Application Development Information

5.1 Various Status Categories	5-1
5.1.1 Printer Status on APD	5-1
5.1.2 OPOS	5-2
5.1.2.1 Checking the printer state	5-2
5.1.2.2 Printer Errors and Status	5-3
5.1.2.3 ESC/POS commands	5-3
5.2 Cash Drawer Control	5-4
5.2.1 Advanced Printer Driver	5-4
5.2.1.1 Drawer Open	5-4
5.2.1.2 Checking Drawer Status	5-5
5.2.2 OPOS	5-5
5.2.2.1 Drawer Open/Close	5-5
5.2.2.2 Checking Drawer Status	5-5
5.2.3 ESC/POS	5-6
5.3 NV memory	5-6
5.4 NV Bit-image Printing	5-8
5.4.1 Advanced Printer Driver	5-8
5.4.1.1 How to print “NV Bit-image”	5-8
5.4.1.2 Printable bitmap format in APD	5-8
5.4.2 OPOS	5-8
5.4.2.1 Printing method	5-8
5.4.2.2 LetterQuality	5-9
5.4.2.3 Setting of printing position by escape sequence	5-9
5.4.2.4 Printable bitmap format in OPOS	5-9
5.4.3 ESC/POS command	5-9
5.5 Printing for journal used	5-10
5.6 FAQ List	5-10
5.6.1 Q. Drawer kick does not operate properly.	5-10
5.6.1.1 A. Drawer specifications differ, depending on the manufacturer and the part number.	5-10
5.6.2 Q. Unable to print a part of Page 0 in Visual Basic.	5-11
5.6.2.1 A. Follow the procedure	5-11

Chapter 6 Notices for Replacement of the TM-U210/TM-U300

6.1 For Replacement of the TM-U210	6-1
6.1.1 About printing format compatibility	6-1
6.1.1.1 Printing area	6-1
6.1.1.2 Characters	6-2
6.1.1.3 Cutting position from print start position	6-2
6.1.2 Cutting Method	6-3
6.1.3 Dimensions	6-4
6.1.4 Receive buffer size	6-4
6.1.4.1 Effect on the application when condition of buffer full is changed	6-4
6.1.4.2 Effect on the application in the condition of release full state ..	6-5
6.1.5 Accessories compatibility	6-5
6.1.5.1 Power supply unit	6-5

6.1.5.2 Consumable compatibility	6-5
6.1.6 Provided statuses	6-5
6.1.7 Use for Journal	6-7
6.1.8 New functions added	6-7
6.1.8.1 Wall hanging	6-7
6.1.8.2 NV bit-image	6-7
6.1.8.3 User NV memory	6-7
6.1.8.4 Memory Switch and memory switch setup mode	6-8
6.1.9 Driver compatibility	6-8
6.1.9.1 Advanced Printer Driver	6-8
6.1.9.2 OPOS	6-8
6.1.9.3 ESC/POS command (Direct control)	6-8
6.2 For Replacement of the TM-U300	6-8
6.2.1 About Printing format compatibility	6-8
6.2.1.1 Printing area	6-9
6.2.1.2 Characters	6-9
6.2.1.3 Cutting position from print start position	6-10
6.2.2 Cutting Method	6-11
6.2.3 Dimensions	6-11
6.2.4 Receive buffer size	6-11
6.2.4.1 Effect to the application when condition of buffer full is changed	6-12
6.2.4.2 Effect to the application when condition of release full state ..	6-12
6.2.5 Accessories compatibility	6-12
6.2.5.1 Power supply unit	6-12
6.2.5.2 Consumables compatibility	6-12
6.2.6 Provided statuses and detectors	6-13
6.2.6.1 Newly added Status	6-13
6.2.7 Use for Journal	6-13
6.2.8 Added new functions	6-13
6.2.8.1 Wall hanging	6-13
6.2.8.2 NV bit-image	6-13
6.2.8.3 User NV memory	6-13
6.2.8.4 Memory Switch and Memory Switch setting mode	6-13
6.2.9 Driver compatibility	6-13
6.2.9.1 Advanced Printer Driver	6-14
6.2.9.2 OPOS	6-14
6.2.10 ESC/POS command (Direct control)	6-14

Appendix A Comparison table for TM-U220/U210/U300

Appendix B How to Install the Printer on a Wall with the WH-10

B.1 The Procedure	B-1
B.1.1 Precautions	B-1
B.1.2 Unpacking	B-1
B.1.3 Installation	B-2
B.1.3.1 Installing the wall-mount	B-2
B.1.4 Affixing the operation panel sheet	B-2
B.1.5 Changing the roll-paper detector position	B-2
B.1.6 Installing the brackets	B-7
B.1.7 Mounting the printer on the wall	B-8
B.2 Exterior Overviews	B-9
B.2.1 TM-U220 (Type B)	B-9
B.2.2 TM-U220 (Type D)	B-10

Appendix C Character Code Table

C.1 Page 0 (PC437: USA, Standard Europe)	C-1
C.2 Page 1 (Katakana)	C-2
C.3 Page 2 (PC850: Multilingual)	C-3
C.4 Page 3 (PC860: Portuguese)	C-4
C.5 Page 4 (PC863: Canadian-French)	C-5
C.6 Page 5 (PC865: Nordic)	C-6
C.7 Page 6 (Hiragana)	C-7
C.8 Page 7 (One-pass printing Kanji characters)	C-8
C.9 Page 8 (One-pass printing Kanji characters)	C-9
C.10 Page 16 (WPC1252)	C-10
C.11 Page 17 (PC866: Cyrillic #2)	C-11
C.12 Page 18 (PC852: Latin2)	C-12
C.13 Page 19 (PC858: Euro)	C-13
C.14 Page 20 (Thai character code 42)	C-14
C.15 Page 21 (Thai character code 11)	C-15
C.16 Page 22 (Thai character code 13)	C-16
C.17 Page 23 (Thai character code 14)	C-17
C.18 Page 24 (Thai character code 16)	C-18
C.19 Page 25 (Thai character code 17)	C-19
C.20 Page 26 (Thai character code 18)	C-20
C.21 Page 254 (Blank page)	C-21
C.22 Page 255 (Blank page)	C-22
C.23 International Character Sets	C-23

Appendix D Power Supply Unit

D.1 AC Adapter C	D-1
D.1.1 Case specifications	D-1
D.2 PS-180	D-2
D.2.1 Case specifications	D-2
D.2.2 Usage cautions	D-2

Chapter 1

General Information

1.1 Features

The TM-U220 is a POS printer that can print receipt paper (paper roll).

The TM-U220 is designed to be compatible with existing systems built around a TM-U210.

1.1.1 General

- ❑ Compact and lightweight.
- ❑ 3 model types are provided. (See “Printer types” (page 1-2))
- ❑ Excellent reliability and long life due to adoption of a stepping motor both for moving the carriage and for paper feeding.
- ❑ Can be installed hanging on the wall with an optional hanging bracket (only for type B, D).

1.1.2 Printer handling

- ❑ Easy drop-in paper loading and easy maintenance
- ❑ Cable connectors are housed in the bottom of the printer.
- ❑ Built-in two drawer kickout interface connectors
- ❑ Built-in autocutter (for type A or B)
- ❑ Built-in take-up device (for type A)

1.1.3 Printing

- ❑ High-speed printing through logic-seeking control
- ❑ Two-color printing (black and red)
- ❑ Can print on various paper wide range (for type B or D: 76 / 69.5 / 57.5 mm)

1.1.4 Software

- ❑ Command protocol is based on the ESC/POS proprietary command system.
- ❑ OPOS ADK and Windows printer driver are available.
- ❑ Automatic status back (ASB) function that automatically transmits changes in printer status.

1.2 Product Structure

1.2.1 Printer types

TM-U220 has 3 model types: A, B, D. The features are as following.

	Type A	Type B	Type D
Two color printing	Yes	Yes	Yes
Autocutter	Yes	Yes	No
Take up device	Yes	No	No
paper width (mm)	76	76/ 69.5/ 57.5	76/ 69.5/ 57.5
wall hanging install	No	Yes	Yes
Supported language	Alphanumeric model: alphanumeric Multilingual model It supports alphanumeric and printing with one of the following: <ul style="list-style-type: none">• Japanese Kanji• Simplified Chinese• Traditional Chinese• Korean• Thai	Alphanumeric model: alphanumeric Multilingual model It supports alphanumeric and printing with one of the following: <ul style="list-style-type: none">• Japanese Kanji• Simplified Chinese• Traditional Chinese• Korean• Thai	Alphanumeric model: alphanumeric Multilingual model It supports alphanumeric and printing with one of the following: <ul style="list-style-type: none">• Japanese Kanji• Simplified Chinese• Traditional Chinese• Korean• Thai
Near end detector	Factory option	Factory option	Factory option

1.2.2 Standard Parts Included with the Printer

This printer is packed with the materials listed below.

- User's Manual
- Roll paper: 1 roll
- Power switch cover (using this cover enables you to prevent accidental turning off of the power)
- Exclusive ribbon cassette ERC-38(B/R)
- Power supply unit (May not be included with the printer)



Note:

The "AC Adapter. C" which is packed in the carton box of ANK model is not able to use for the Multilingual model.

*Multilingual means the printer model that can print any one of the following: Japanese Kanji, Simplified Chinese, Traditional Chinese, Thai characters, or Korean characters.

1.2.3 Related materials for TM-U220

TM-U220 has the related materials listed in the following table.

Category	Name	Description
Options	WH-10	This is an optional unit for installing the printer on a wall.
	DF-10	Affixing Velcro® tape
	DC-21	This is optional power supply cable to gain power from user's power supply.
	PS-180	EPSON power supply unit
	DM-D105/D205, DM-D106/DM-D206	Direct connection customer display (available only for some serial interface models and some USB models) (See the below NOTE also.)
	UB-S01/02, UB-P02II, UB-U01II/02II, UB-E01 etc...	Various interface boards. (Serial, Parallel, USB, Ethernet interface)
POS accessories	DM-D series	These are customer displays. (Line Display)
Consumables	Roll Paper	This is required to print.
	Ribbon Cassette	This is required to print.
Manuals	User's Manual	This manual is packed in the carton box.
	Technical Reference Guide	This Manual.
	FAQ about ESC/ POS command	This Manual is Quick Reference of ESC/POS command. and this has a simple sample program & Tips.
	ESC/POS Application Guide	This Manual is Command Reference Guide of ESC/POS command. and this has a supplement which has some sample programs & Tips.
Drivers (Windows environment)	OPOS ADK	This provides the OCX driver which is based upon OPOS. It has Manuals, sample programs, and TMFlogo utility.
	Advanced Printer Driver	This is a Windows Driver. This Driver has a Manual, Sample programs, and utilities to use the driver.
Utilities (Windows environment)	Memory Switch setting Utility	This is a utility to adjust the setting (Memory Switch) of this printer. See "Memory Switches" (page 3-17) for details.
	TMFlogo	This is a utility to store "NV bitmap" into this printer. It helps printing "NV bitmap."

Please contact your dealer to get these.



Note:

When you are using the TM-U220 with the "AC Adapter C" power unit, which is packed in the carton box of Alphanumeric model, the DM-D series can't get power from the TM-U220. If you want to provide power from the TM-U220 to a DM-D, you have to use "PS-180."

1.3 Consumables

1.3.1 Ribbons

This printer needs a ribbon cassette to print receipts. We provide 3 ribbon cassettes:

- ❑ EPSON ribbon cassette, ERC-38 (B) (Life: 3,000,000 characters / Color: Black)
- ❑ EPSON ribbon cassette, ERC-38 (P) (Life: 4,000,000 characters / Color: Purple)
- ❑ EPSON ribbon cassette, ERC-38 (B/R) (Life: 1,500,000 characters / Color: Black)
(Life: 750,000 characters / Color: Red)



Note:

These ribbon cassette life numbers are under the EPSON test conditions.

1.3.2 Roll paper

We provide roll paper and carbon roll paper with 1 copy for this printer. The widths are 76 mm, 69.5 mm, and 57.5 mm {3.00"/2.74"/2.26"}.

1.4 Product Specifications Overview

Print method	serial impact dot matrix
Paper width	76 mm / 69.5 mm / 57.5 mm {3.00"/2.74"/2.26"}
Cut type	There are 2 types. The type can be changed. Partial cut (cutting with one point on left edge left uncut) (standard factory settings) or Full cut (optional factory setting)
Character sets	95 alphanumeric, 48 international characters, Extended graphics: 128 × 12 pages. (15 tables for Japanese model) Multilingual character model supports printing with one of the following character sets: <ul style="list-style-type: none"> • Japanese Kanji (Two-pass printing font) (JIS X0208-1990): 6879 • Simplified Chinese (Two-pass printing font) (GB18030-2000): 28553 • Traditional Chinese (Two-pass printing font) (Big 5): 13494 • Korean (Two-pass printing font) (KS C5601 type): 8366 • Thai (Three-pass printing font) : 128 characters × 7 pages (133 character types)
Interface (compatible)	RS-232C / Bidirectional parallel Dealer options: USB, 10Base-T I/F
Buffer	Receive buffer: Selectable as 4KB or 40 bytes using a DIP switch 1-2. Non-volatile graphics data buffer: 128KB User NV memory: 8KB
Power supply	Power supplied by included AC adapter ANK model: AC Adapter.C or PS-180 (option) Multilingual model: PS-180
Operating voltage	24 VDC ± 7% (optional power supply: EPSON PS-180)
Power consumption (except for drawer kickout driving)	Operating: Mean: Alphanumeric model: Approximately 31W Multilingual* model: Approximately 38W Standby: Mean: Approximately 2.2W
Temperature	During operation: 0 °C to 50 °C {41°F to 122 °F}. (At 34 °C {93°F} or higher, there are humidity restrictions; refer to "Environmental Conditions" (page 1-14)
Humidity	During operation: 10 to 90% (no condensation) During storage: 10 to 90% (no condensation; excludes paper and ribbon)
Weight (mass)	Type A: Approximately 2.7 kg {5.94 lb} Type B: Approximately 2.5 kg {5.5 lb} Type D: Approximately 2.3 kg {5.06 lb}

*Multilingual means the printer model that can print any one of the following: Japanese Kanji, Simplified Chinese, Traditional Chinese, Thai characters, or Korean characters.

1.5 Printing and paper Specifications

Printing method:	Serial impact dot matrix
Head wire configuration:	9-pin serial configuration
Printing direction:	Bidirectional printing (logic seeking)
Print speed: *1	Approximately 4.7 lps (printing 40 columns per line at 16 cpi) Approximately 6.0 lps (printing 30 columns per line at 16 cpi, with 1/8" line spacing) (except data transmission and processing time)
Paper width:	76 mm / 69.5 mm / 57.5 mm {3.00"/2.74"/2.26"}
Printing width:	63.4 mm / 57 mm / 47.5 mm {2.50" / 2.24" / 1.87"} Dot positions depend on DIP switch setting. See the table "Dot width of Printable area" (page 1-7) for details.
Characters per line:	35 (font A), 40 (font B, default) (When using 76mm width paper)
Character spacing:	ANK: 3 half dots (default) or 2 half dots. Kanji: 2 half dots (default) or 0 half dots. Thai: 3 half dots (default) or 2 half dots. The spacing of ANK and Thai characters is selectable by DIP SW2-1. The spacing of Kanji characters is selectable by ESC/POS command.
Paper feed speed:	30 lps
Line spacing (default):	4.23 mm {1/6"}, programmable by control commands.
Number of characters:	95 alphanumeric, 48 international characters, Extended graphics: 128 × 12 pages. (15 tables for Japanese model) Multilingual character model supports printing with one of the following character sets: <ul style="list-style-type: none">• Japanese Kanji (Two-pass printing font) (JIS X0208-1990): 6879• Simplified Chinese (Two-pass printing font) (GB18030-2000): 28553• Traditional Chinese (Two-pass printing font) (Big 5): 13494• Korean Kanji (Two-pass printing font) (KS C5601 type): 8366• Thai (Three-pass printing font): 128 characters 7 pages (133 character types)
Character structure:	Font A: 9 × 9 Font B: 7 × 9 Kanji: 16 × 16 (Font B is the default)

*1 This printer adjusts print speed when it prints graphic data, etc.

The dot width of the printable area depends on DIP switch setting and paper width as shown in the following table.

Dot width of Printable area

Paper width	DIP SW2-1 setting	
	ON	OFF
76 mm	385 half dots	400 half dots
69.5 mm	360 half dots	360 half dots
57.5 mm	297 half dots	300 half dots

Character Dimensions, Characters Per Inch, Characters Per line

Character configuration			Character dimensions W x H	Dot spacing between characters	Paper width (mm) and Characters per line (cpl)			Characters per inch (cpi) (1 inch = 25.4 mm)
Horiz. x Vert.	Condition of DIP SW 2-1	Character type			76 mm	69.5 mm	57.5 mm	
7 x 9 (Font B) (default)	ON	ANK	1.2 x 3.1	2 half dots	42	40	33	17.8
		Graphic	1.6 x 3.1	0				
	OFF (default)	ANK	1.2 x 3.1	3 half dots	40	36	30	
		Graphic	1.7 x 3.1	0				
9 x 9 (Font A)	ON	ANK	1.6 x 3.1	2 half dots	35	32	27	14.5
		Graphic	1.9 x 3.1	0				
	OFF (default)	ANK	1.6 x 3.1	3 half dots	33	30	25	
		Graphic	2.0 x 3.1	0				
16 x 16 (Kanji font)	Regardless *	Kanji	2.7 x 2.7	2 half dots (default) *	22	20	16	8.9
				0 *	25	22	18	9.5
7 x 27 (Thai font)	ON	Thai character	1.2 x 9.5	2 half dots	42	40	33	17.8
	OFF (default)			3 half dots	40	36	30	16
9 x 27 (Thai font)	ON	Thai character	1.6 x 9.5	2 half dots	35	32	27	14.5
	OFF (default)			3 half dots	33	30	25	13.3

*: The dot spacing between Kanji character is selected by an ESC/POS command.

1.5.1 Autocutter (for Type A / B)

Cutting method: By separated-blade scissors

Cutting type: Partial cut (one point left uncut) (standard factory settings)
 Full cut (completely cut off) (optional factory setting)



Note:

It is recommended to feed approximately 2.116 mm or more in advance before printing to prevent dot displacement after cutting.

Changing between partial cut and full cut is not controlled by a software command.

The full cut setting is an optional factory setting.



CAUTION:

When the paper is cut completely (full cut) with the printer's horizontal installation, make sure to remove the cut paper, then perform the next cut. Never allow several pieces of the cut paper to remain in the paper exit because double cuts, paper jams, or autocutter error may occur because the cut paper drops into the paper path.

1.5.2 Paper Roll Supply

Supply method: Drop-in method

Paper roll end detection: Detection method: Mechanical microswitch
Detection position: Positioned within the paper path for the roll paper; detects the end of the roll paper

Near-end detector: Detection method: Mechanical microswitch

Inner diameter of the roll paper core: 10.5 to 12.5 mm

Near-end adjustment: Adjusting screw

Remaining amount: Fixed position

#1 approximately 8 mm

#2 approximately 5 mm

(The adjusting screw has two positions.)

See "Adjusting Position of Roll Paper Near End Detector" (page 3-25).

1.5.2.1 Paper Specifications

Paper feeding method:	Friction feed
Paper feed interval:	Initial setting: Approximately 4.23mm {1/6"} Can be set in units of approximately 0.18mm {1/144"} by ESC/POS command
Paper feed speed:	30 lps (approximately 4.99" /s) (during continuous feeding) [lps: lines per second]
Roll paper width:	76 ± 0.5 mm (3" ± 0.02") / 69.5 ± 0.5 mm (2.74" ± 0.02") / 57.5 ± 0.5 mm (2.26" ± 0.02")
Maximum diameter:	83 mm (3.27")
Core:	When there is no near-end detector, always be sure to use roll paper that is not glued to the core.
Normal paper specifications:	Paper thickness: 1 sheet: 0.06 to 0.085mm {0.0024 to 0.0033"} Weight: 52.3 to 64 g/m ² {14 to 17 lb} (45 to 55 kg/1000 sheets 1091 × 788mm)
Carbon paper specifications:	Number of copies: Original 1 sheet + one copy sheet Thickness: 0.05 to 0.08 mm {0.002 to 0.0031"} (thickness of one sheet); Recommended paper: Paper by Mitsubishi - Carbonless paper (blue) Top sheets: N40Hi (paper thickness: 0.06mm {0.0024"}, mass: 47.2 g/m ² {12.6 lb} Bottom sheet N60 (paper thickness: 0.08mm {0.0031"}, mass: 68.0 g/m ² {18 lb) The copying capability is affected by the ambient temperature, and is guaranteed for the temperature ranges of 5 - 50°C {41 - 122°F}.

1.5.2.2 Printable Area

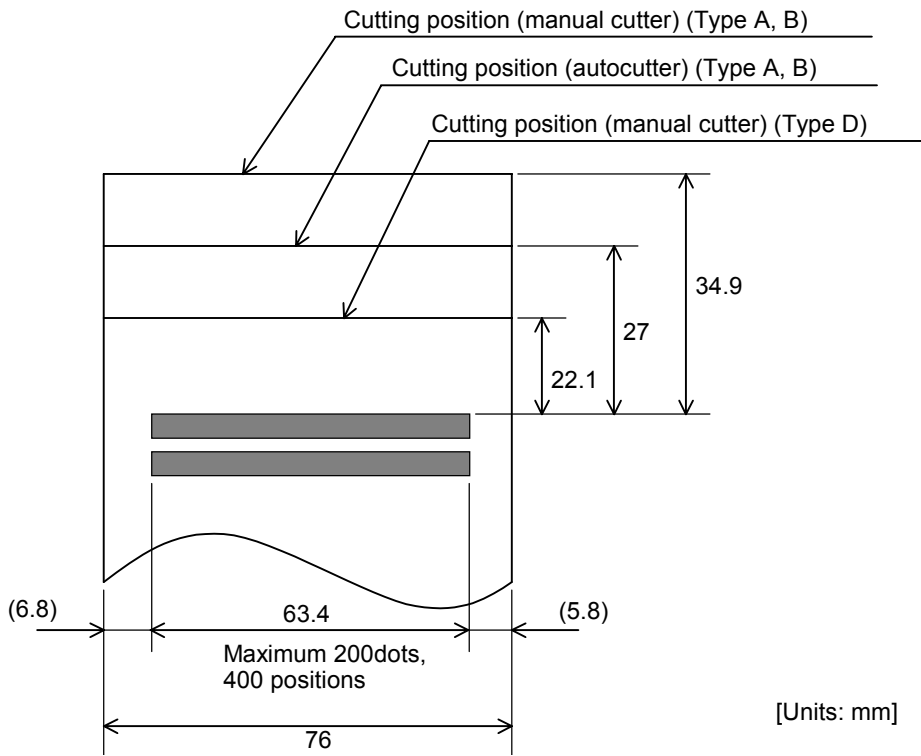

Printable area for 76mm width paper

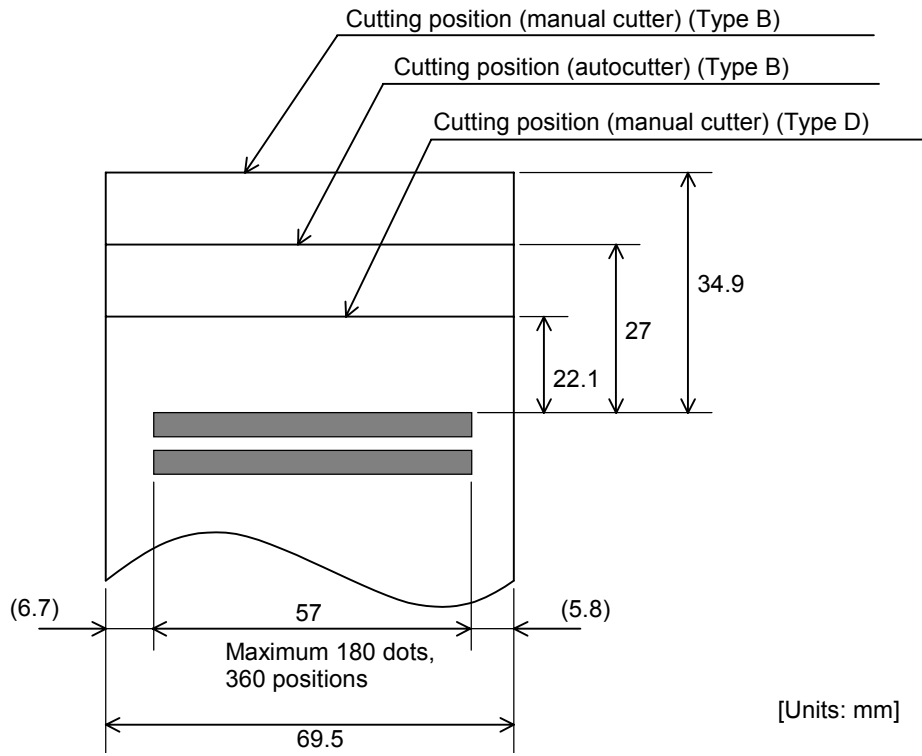

[Units: mm]

Printable area for 69.5mm width paper

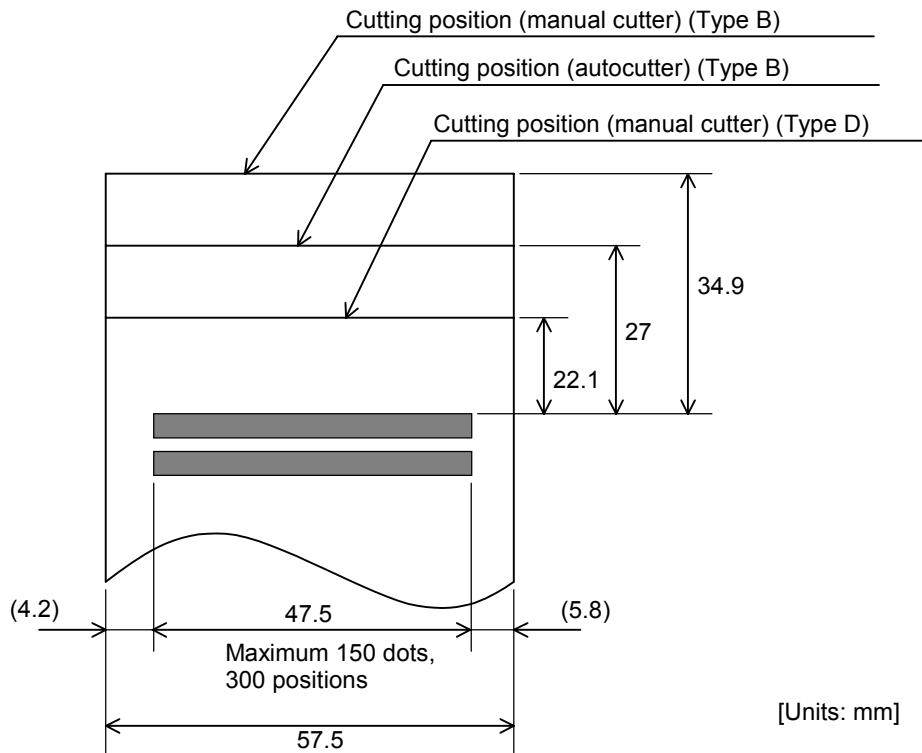

[Units: mm]

Printable area for 57.5mm width paper

1.6 Other Specifications

1.6.1 EMI and Safety Standards Applied

1.6.1.1 Printer (TM-U220)

EMC is Tested Using the EPSON's AC adapter.

Europe:

CE Marking Directive 89/336/EEC
 EN55022 Class B
 EN55024
 IEC 61000-4-2
 IEC 61000-4-3
 IEC 61000-4-4
 IEC 61000-4-5
 IEC 61000-4-6
 IEC 61000-4-11

North America:

Safety: EN 60950
 EMI: FCC/ICES-003 Class A
 Safety: UL60950/CSA C22.2 No. 60950

Japan:

EMI: VCCI Class A

Oceania:

EMC: AS/NZS 3548 Class B

1.6.1.2 AC Adapter C (packaged in ANK model)

Europe:	CE Marking Directive 89/336/EEC EN55022 Class B EN55024 IEC 61000-4-2 IEC 61000-4-3 IEC 61000-4-4 IEC 61000-4-5 IEC 61000-4-6 IEC 61000-4-11 EN61000-3-2 EN61000-3-3 Safety: EN 60950
North America:	Safety: UL1950/CSA C22.2 No. 950
Japan:	Electrical Appliance and Material Control Law
Oceania:	Safety: AS3260

1.6.1.3 AC adapter (packaged in Multilingual model (PS-180))

Europe:	CE Marking Directive 89/336/EEC EN55022 Class B EN55024 IEC61000-4-2 IEC61000-4-3 IEC61000-4-4 IEC61000-4-5 IEC61000-4-6 IEC61000-4-11 Safety Standard: EN60950
North America:	EMI: FCC Class A Safety Standards: UL1950-2TH-D3 C-UL
Japan:	EMI: VCCI Class 1 Safety Standards: Electrical Appliance and Material Control Law of Japan.

This unit meets EMI and EMC Standards, whether or not it is connected to an EPSON product.

1.6.2 Reliability

Life:	Mechanism: 7,500,000 lines
MTBF:	180,000 hours Failure is defined as a Random Failure occurring at the time of the Random Failure Period.
MCBF:	18,000,000 lines This is an average failure interval based on failures relating to Wearout and Random Failures up to the life of 7.5 million lines.
Print head life:	150 million characters (using an average of 2 dots/wire per character). (The printing pattern is EPSON test pattern).
Autocutter life:	800,000 cuts End of life is defined as the point at which the printer reaches the beginning of the wearout period.

1.6.3 Environmental Conditions

Temperature:	During operation: 0 °C to 50 °C {41°F to 122 °F}. (At 34 °C {93°F} or higher, there are humidity restrictions as listed below.)
Humidity:	During operation:10 to 90% (no condensation) During storage:10 to 90% (no condensation; excludes paper and ribbon)

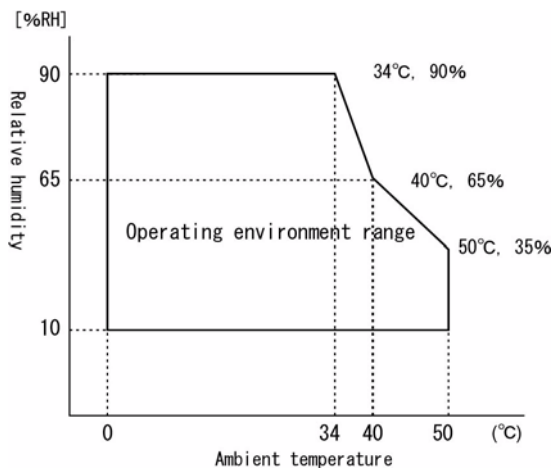

Operating temperature and humidity range

Vibration resistance:

When packed:
Frequency: 5 to 55 Hz
Acceleration: 19.6m/s² {2 G}
Sweep: 10 minutes (half cycle)
Duration: 1 hour
Directions: x, y, and z

No external or internal damage should be found after the vibration test, and the unit should operate normally.

Impact resistance:

When packed:
Package: EPSON standard package
Height: 60 cm (2 feet)
Directions: 1 corner, 3 edges, and 6 surfaces

No external or internal damage should be found after the drop test, and the unit should operate normally.

When unpacked:
Height: 5 cm (2")
Directions: Lift one edge and release it (for all 4 edges).

When the printer is not printing, no external or internal damage should be found after the drop test.

1.6.4 Installation

Install the printer horizontally as a basic position. The printer also must be installed so that it does not move or vibrate during paper cutting or the drawer kick-out operation. Velcro tape is available as an option.

The printer (Type B or D) can be also installed on a wall with the optional wall hanging bracket (WH-10).

1.7 External Dimensions and Mass

1.7.1 External Dimensions and Mass

Model type	External Dimensions			Mass
	Width	Height	Depth	
Type A	160 mm {Approximately 6.3"}	157.5 mm {Approximately 6.2"}	286 mm {Approximately 11.3"}	Approximately 2.7 kg {5.9 lb}
Type B	160 mm {Approximately 6.3"}	138.5 mm {Approximately 5.5"}	248 mm {Approximately 9.8"}	Approximately 2.5 kg {5.5 lb}
Type D	160 mm {Approximately 6.3"}	138.5 mm {Approximately 5.5"}	248 mm {Approximately 9.8"}	Approximately 2.5 kg {5.1 lb}

(All the numeric values are typical.)

Color: EPSON standard color (ECW, EDG)

1.7.1.1 Overview (Type A)

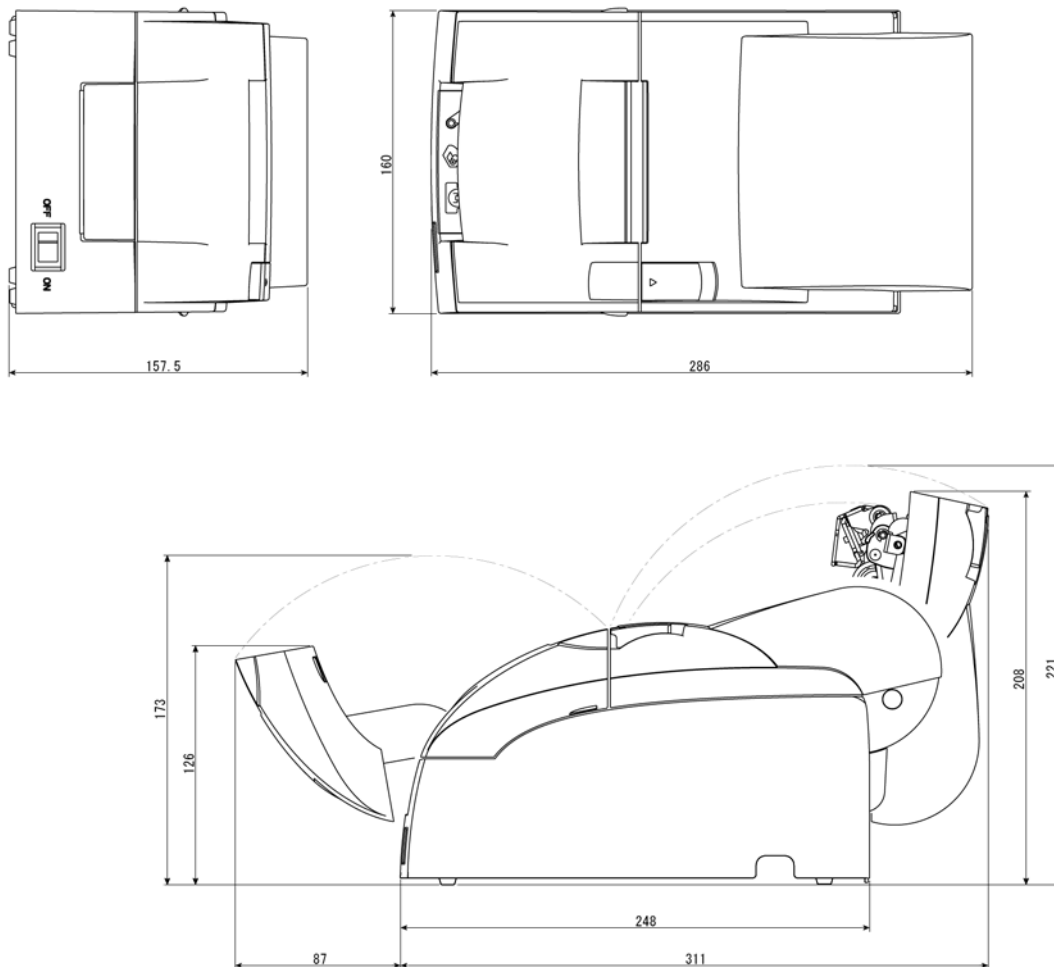

1.7.1.2 Overview (Type B)

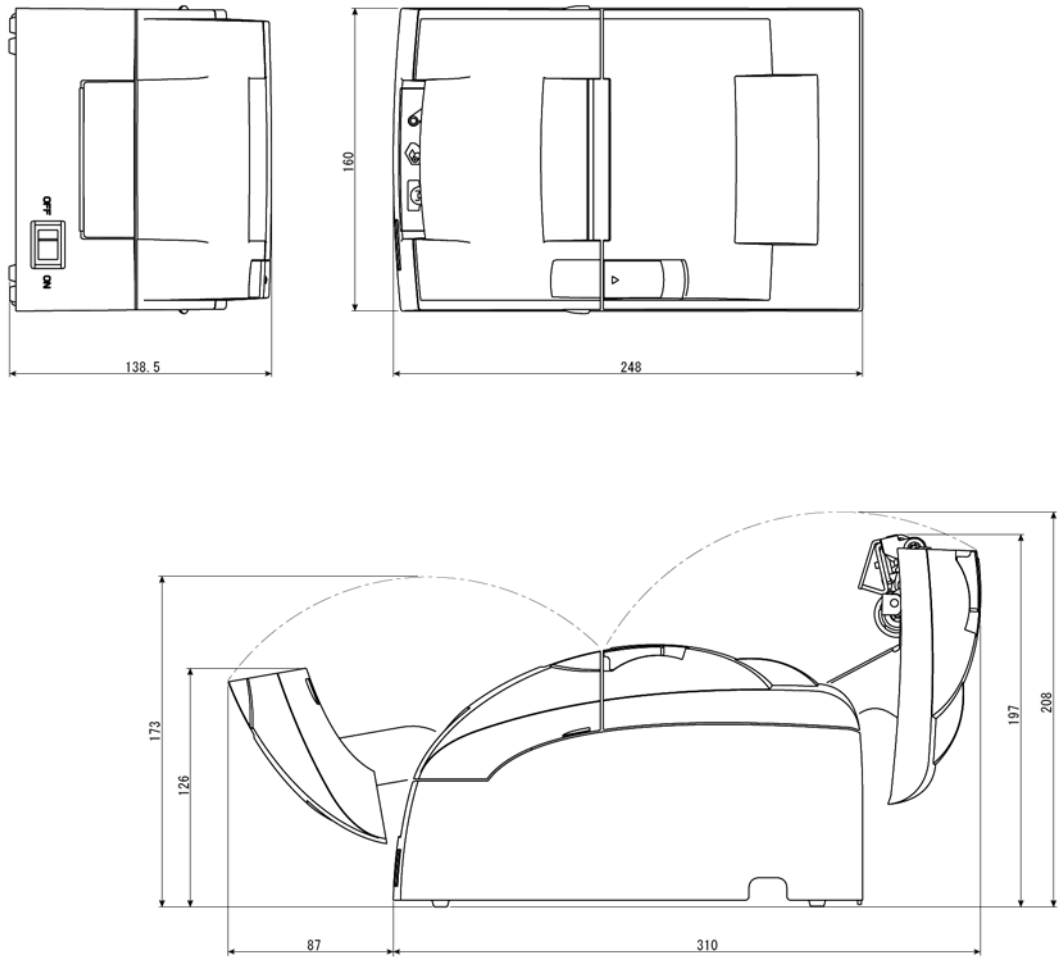

1.7.1.3 Overview (Type D)

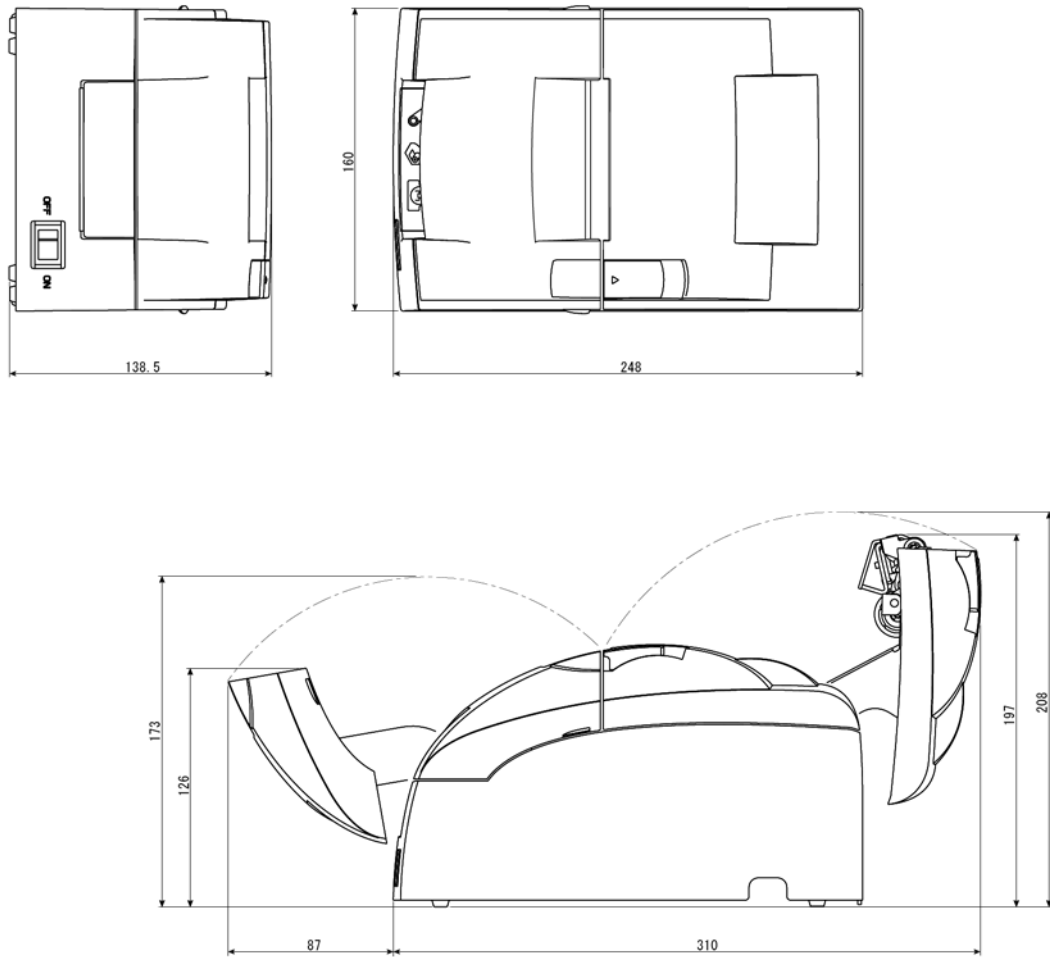

Chapter 2

System Planning

This section provides you information for system planning.

2.1 Control Method

A TM printer can print and be controlled using any of the following three methods:

1. Windows printer driver (EPSON Advanced Printer Driver)
2. EPSON OPOS ADK
3. ESC/POS commands

Depending on the driver or interface to be used, an IP setting tool for the Ethernet specification, a USB device driver, and a logo registration utility for printing (TMFlash logo utility) are provided.

See “How to Get a Driver” in this chapter.

2.1.1 Windows Driver (EPSON Advanced Printer Driver)

The EPSON Advanced Printer Driver is a method for controlling the TM printer in the same manner as the Windows standard printer driver.

2.1.1.1 General Features of the EPSON Advanced Printer Driver

The EPSON Advanced Printer Driver has the following features:

- ❑ Supplies the Windows printer driver for the TM printer, which enables printing through general Windows applications.
- ❑ Enables executing unique functions of the POS printer, such as paper cutting and drawer opening.
- ❑ Font type selection enables printing with the printer’s internal fonts.
- ❑ Enables obtaining the printer status by StatusAPI with a programming language such as VisualBasic. This makes it possible to have bi-directional communication with the TM printer under the Windows standard printer driver environment.



Note:

The statusAPI is the API for controlling the printer, which is supplied exclusively by EPSON. Using this enables obtaining printer status and transmitting ESC/POS commands.

2.1.1.2 EPSON Advanced Printer Driver Components

Installer recognizes PC environment in which the installation will be done and installs DLL files and software components necessary for operating automatically. Driver, sample program, or manual can be selected to be installed.

Driver

You can select a driver depending on the purpose of usage (installation can be done at the same time). Each has functions such as two-color printing, smoothing, continuous printing, and option selection for cutting method.

- Receipt: printing receipt
- Reduce35: reducing whole print display to fit it into the width of receipt paper and printing it

Sample program

Sample program for using the StatusAPI with Visual Basic and Visual C++ can be installed.

Manual

The following manuals can be installed:

- Driver: User's Manual
- Status API: Reference Manual

2.1.1.3 EPSON Advanced Printer Driver Support Environment

Supported interfaces

- Serial, Parallel, USB, Ethernet

Supported Operating Systems

Please refer to the Installation Guide included with the driver package.

Supported Development Languages

- Visual Basic
- VisualC++

Supported devices

(For detailed information on which devices can be used, see the release note for the driver.)

- EPSON receipt printer
- EPSON customer display

- EPSON cash drawer



Note:

The USB specification printer needs the USB driver and the Ethernet specification printer needs the IP setting utility in addition.

For detailed information, please contact your dealer or EPSON.

2.1.2 EPSON OPOS ADK

EPSON OPOS ADK supports the development environment necessary for OLE for Retail POS (OPOS) application development by OPOS Control proposed by the OPOS committee and supplies a printer driver (OCX) conforming to OPOS.

When developing an OPOS confirmed application, use the following control methods. EPSON OPOS ADK has the following features.

- ❑ EPSON OPOS ADK supports not only the OPOS Control (CO + SO) proposed by the OPOS committee but also totally supports the OPOS application development environment such as utilities for installation and setup, the contents necessary for development, such as sample programs and manuals, and also the function of Log when debugging, and silent installation, which enables easy installation for a targeted PC.
- ❑ EPSON OPOS ADK supports DirectIO with parameters for unique functions exclusively for TM printers by EPSON. Also the power notice function, offline buffer clear processing, and device irregular processing that has been taken into account by developers are supported by the driver; these can reduce the number of application steps.



Note:

For detailed information for the API functions, refer to “OLE for Retail POS Application Programmer’s Guide (APG)” issued by the OPOS committee.

2.1.2.1 General Features of EPSON OPOS ADK (OPOS Control)

OPOS Control included in EPSON OPOS ADK has the following features:

- ❑ Offers CO for each device class and SO for EPSON devices.
- ❑ Can use Direct IO with parameter
 - Acquires maintenance counter
 - Prints bit image for which NVRAM has already been registered
- ❑ Power on notice function (recovering automatically to the status before the power is turned off when turning on the power again)
- ❑ Offline buffer clear processing (deleting contents in print buffer at offline)
- ❑ Debugging function (trace function)

- Logs between an application and CO (for used API and its return value)
- Logs for device status (acquires causes for offline and errors in devices)

2.1.2.2 EPSON OPOS ADK Contents

Any installer later than EPSON OPOS ADK Ver2.10 supports the silent install function that can install the OPOS environment without a user interface, which offers easier installation. With this installer, OPOS Control for EPSON devices that are compatible with OPOS, manuals, utilities and sample programs described below can be installed.

❑ OPOS Control for EPSON devices

The following can be installed: CO, SO, header file for C++, header file for VB, TLB file for CO, or device information file.

❑ Manuals

- User's Guide (Environment construction manual: installation/uninstallation/usage of each utility)
- Application Development Guide (for OPOS compatible application developers: editions for common description and for each device)

❑ Utilities

- SetUpPOS Utility

Can select a device to be used, connection port and settings, such as paper width, monochrome/two-color (only for two-color supported devices) and print waiting time.

- TM Flash logo utility

Can register a bit map file to the printer and customer display.

- USB device driver

Required to connect a USB specification printer.

- Sample program

Sample programs in VB and VC++ can be installed.

2.1.2.3 EPSON OPOS ADK Supported Environment

- ❑ Supported interfaces
 - Serial, Parallel, USB, Ethernet
- ❑ Supported Operating Systems

Please refer to the Install Manual included with the driver package.
- ❑ Supported Development Languages
 - Visual Basic
 - VisualC++

2.1.3 ESC/POS Command

Print/control by ESC/POS commands is direct control for TM printers using the ESC/POS commands proposed by EPSON. Sending ESC/POS commands to the printer from an application enables direct control of the printer. For the detailed information regarding the ESC/POS commands, contact the dealer where you purchased the product.



Note:

USB specification printer needs the USB driver and the Ethernet specification printer needs the IP setting utility in addition.

2.1.4 How to Get a Driver

Please contact EPSON or your dealer about OPOS, APD, and ESC/POS.

2.2 Connection Form and Cables

2.3 Serial Connection

When the TM printer is connected to the host PC with a serial interface, the following connection forms are possible:

- Stand alone
- Y-connection
- Pass-through connection

Connections for usable serial cross cables are as follows:

Type A

D-Sub 25P(TM)			D-Sub 9P(PC)	
Pin No	Signal		Signal	Pin No
1	FG		DCD	1
2	TXD		TXD	3
3	RXD		RXD	2
20	DTR		DTR	4
6	DSR		DSR	6
4	RTS		RTS	7
5	CTS		CTS	8
7	GD		GD	5
25	RESET		RI/RESET	9

Type B

D-Sub 25P(TM)			D-Sub 9P(PC)	
Pin No	Signal		Signal	Pin No
1	FG		DCD	1
2	TXD		TXD	3
3	RXD		RXD	2
20	DTR		DTR	4
6	DSR		DSR	6
4	RTS		RTS	7
5	CTS		CTS	8
7	GD		GD	5
25	RESET		RI/RESET	9

The type of cable that should be used depends on the operation and the handshake method for the TM printer. You can operate the TM printer by Windows driver, OPOS, or ESC/POS commands. XON/XOFF, DTR/DSR, or RTS/CTS are available as handshake controls. See tables in following sections for the type cable for each connection.

2.3.1 Stand alone

Both TM printer and customer display (DM-D) are connected to the host PC via serial port.

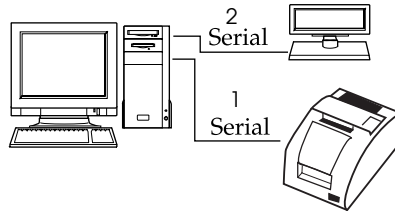

Application control setting		XON/XOFF (except OPOS)	DTR/DSR (DOS, OPOS, Visual C)	RTS/CTS (DOS, Windows driver, Visual C, Visual Basic, MSComm)
XON/XOFF	1	Type A or B	—	—
	2	DM-D500: A,B Other DM-D: not available	—	—
DTR/DSR	1	—	Type A or B	Type B
	2	—	Type A or B	Type B

2.3.2 Y-connection

TM printer is connected to the host PC via serial port and the customer display (DM-D) is connected to TM printer via a modular connector.

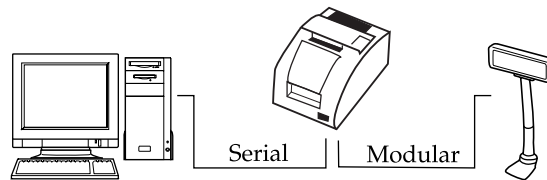

Application control setting		XON/XOFF (except OPOS)	DTR/DSR (DOS, OPOS, Visual C)	RTS/CTS (DOS, Windows driver, Visual C, Visual Basic, MSComm)
XON/XOFF		Not available	—	—
DTR/DSR		—	Type B (*)	Type B

(*) When RTS/CTS control is used between the TM and DM.

 **Note:**

When you would like to provide power from TM-U220 to a DM-D, you have to use "PS-180." The "AC Adapter C" can't provide power to a DM-D.

You need to use the UB-S09 interface when you use a modular connector.

On the DM-D (DM-D500 etc...) which has DIP switch to select Y-type connection, confirm that the DIP switch has been set "Y-type connection: Enable."

2.3.3 Pass-through connections

The TM printer is connected to the customer display (DM-D) via a serial port, and the DM-D is connected to the host PC via a serial port.



Note:

On the DM-D (DM-D500 etc...) which has a DIP switch to select Y-type connection, confirm that the DIP switch has been set to "Y-type connection: Disable."

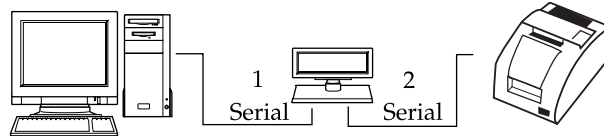

Application control		XON/XOFF (except OPOS)	DTR/DSR (DOS, OPOS, Visual C)	RTS/CTS (DOS, Windows driver, Visual C, Visual Basic, MSComm)
TM side control setting				
XON/XOFF		Not available	—	—
DTR/DSR	1	—	Type A or B	Type B
	2	—	Type A or B	Type A or B

2.4 Parallel Connection

The TM printer is connected to the host PC via a parallel interface board (UB-P02II). The customer display (DM-D) is connected to the host PC via a serial port.

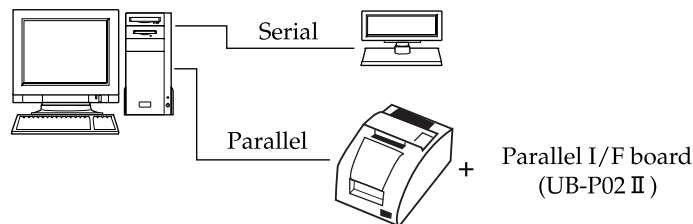

2.5 USB connection

The TM printer can be connected to the host PC via a USB connector, and other TM printers can be connected to the first printer via USB. (See “Changing the DIP Switch Settings” in Chapter 3 for DIP switch settings.)

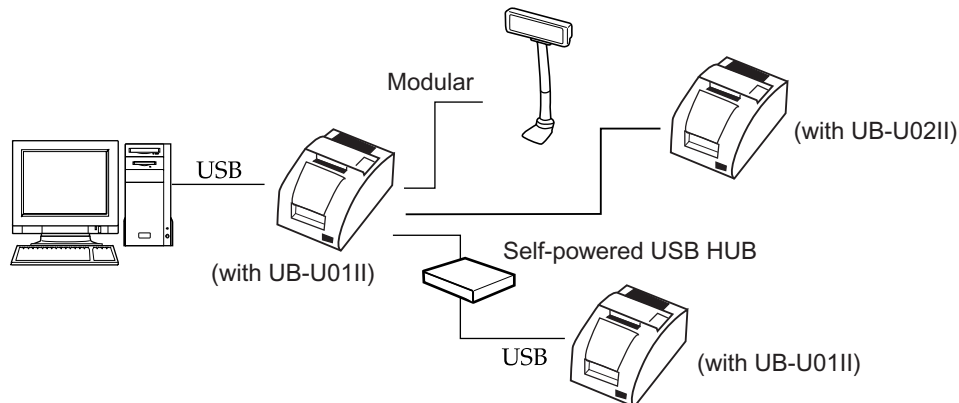

 **Note:**

UB-U011I has bus-powered USB HUB. Therefore This USB model printer can't be connected directly to other bus powered HUB (including other UB-U011I equipped TM printer) and bus-powered function whose current consumption is over 100mA. If you would like to connect other USB model TM printer with UB-U011I, use a self powered USB HUB as shown in the above figure.

When you would like to provide power from TM-U220 to a DM-D, you have to use "PS-180." The "AC Adapter C" can't provide power to a DM-D.

The host PC needs to have an installed "USB device driver" for using USB model TM printer. Please contact EPSON or your dealer about the USB device driver and the procedure for installing.

2.6 Ethernet connection

TM printers are connected to a network via a hub using an Ethernet cable.

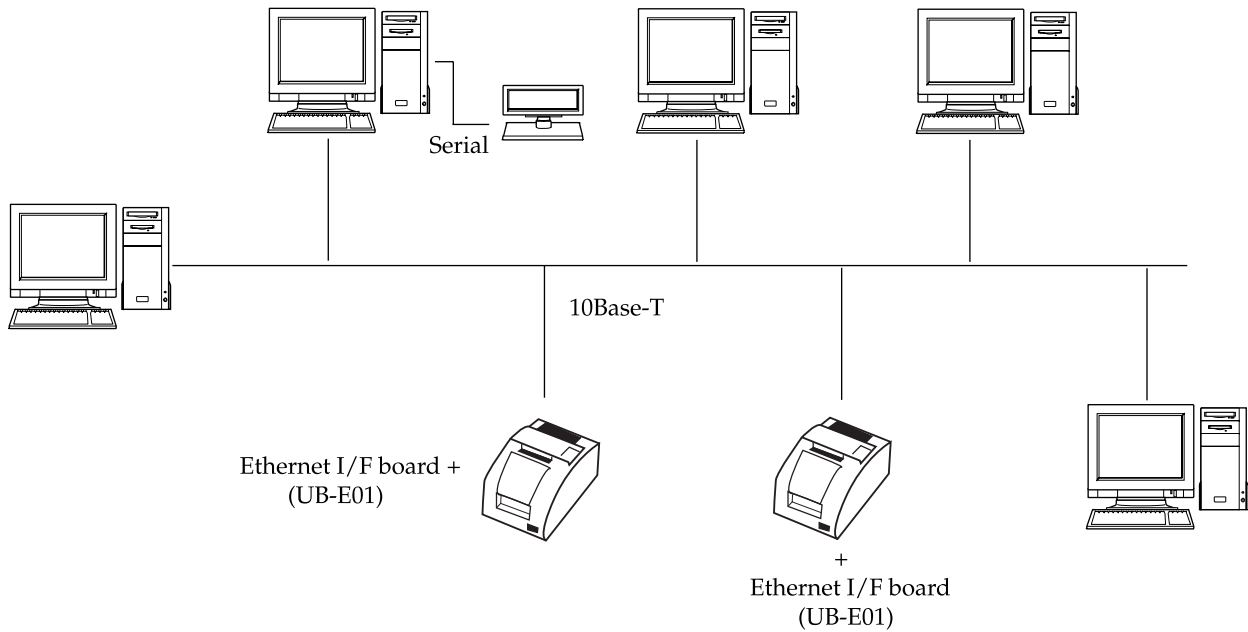

Note:

If the TM printer is connected to the host PC via an Ethernet interface, a DM-D cannot be connected to the TM printer.

We provide the IP address setup utility "EPSON TMNet WinConfig," for setting the IP address of the Ethernet model TM printer on the host PC. Please contact EPSON or your dealer about "EPSON TMNet WinConfig" and the procedure for installing.

Chapter 3

Setup

3.1 Part Name and Basic Operation

3.1.1 Part name

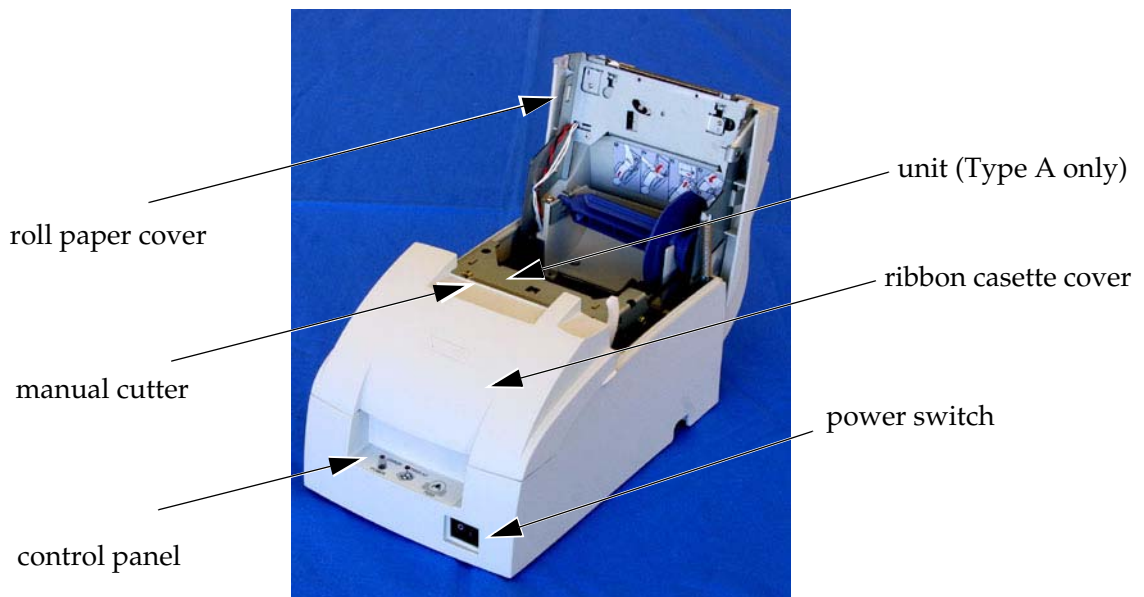

This figure is Type A.

3.1.1.1 Connectors

WARNING:

Do not connect a telephone line to the drawer kick-out connector or the display module connector; otherwise the printer and the telephone line may be damaged.

You can connect up to four cables to the printer. They all connect to the connector panel (on the bottom rear of the printer), which is shown below.

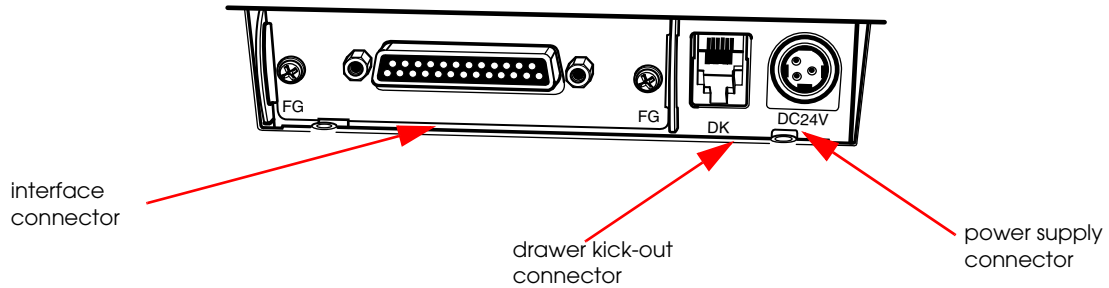

Note:

This illustration shows the serial interface model. The other interface connector looks slightly different.

3.1.2 The Control Panel

The control panel is shown below.

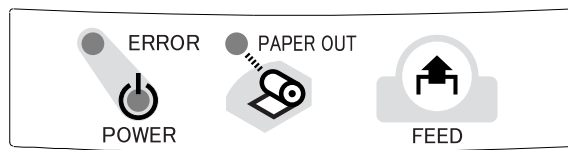

- POWER LED
- ERROR LED
- PAPER OUT LED
- FEED button

3.1.2.1 LED

POWER

- On: Power supply is stable.
- Off: Power supply is not stable.

ERROR

When this light is on but not blinking, it means that the printer is offline. Check to see if a cover is open. When this light is blinking, there is an error. See “LED Blinking Pattern” in Chapter 4.

PAPER OUT

On:	The roll paper near end (*1) or real end is detected.
Off:	Paper is loaded (normal condition).
Flashing:	Self-test waiting state for test print.



Note:

The roll paper near-end sensor is available as an factory option. If the printer is not equipped with the roll paper near-end sensor, the roll paper near-end is always detected as paper present. See "Adjusting Position of Roll Paper Near End Detector" (page 3-25) for information on adjusting the detector.

3.1.2.2 Control Panel Buttons

The control panel has paper button that you may have to use, although most paper handling functions will be handled by your software.

FEED

Use this button to feed roll paper or to start a roll paper self test. (See "Self Test Procedure" (page 3-36).)



Note:

The FEED button can be disabled by using an ESC/POS command. Refer to "ESC/POS Application Programming Guide" for details.

3.2 Setup Flow

You have to set up your printer to use it. And you can adjust some features by customizing them. This section describes the setup.

The set up flow of preparing to use printer is below.

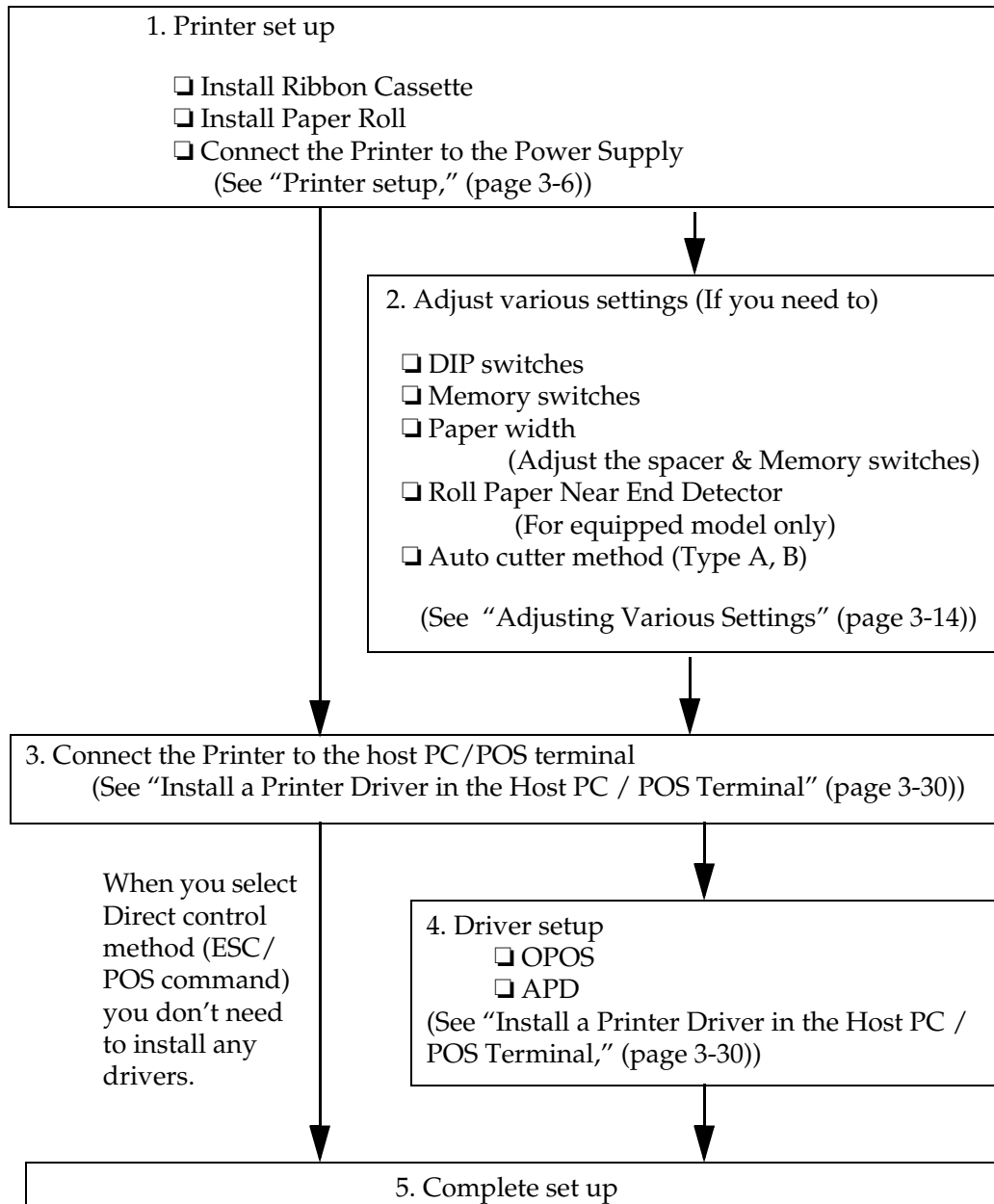



Note:

When you use OPOS (OCX driver from EPSON) or the Advanced Printer Driver, you need to install the driver. When you use ESC/POS commands, you don't have to install drivers. For information on these drivers, see "Control Method" (page 2-1) and "Install a Printer Driver in the Host PC / POS Terminal" (page 3-30).

This printer can be installed on a wall. See "How to Install the Printer on a Wall with the WH-10" in Appendix B for details.

The following sections describe the setup. The flow of preparing to use printer is listed below.

1. Printer setup
 - Install Ribbon Cassette
("Installing or Replacing the Ribbon Cassette" (page 3-6))
 - Install Paper Roll ("Installing the Roll Paper" (page 3-7))
 - Connect the Printer to the Power Supply
("Connecting the Power Supply Unit" (page 3-13))

2. Adjust various setting (If you need to)

When you use this printer with a serial interface, you have to adjust the communication settings. See "Adjusting the DIP Switches" (page 3-15) and "Memory Switches" (page 3-17) for how to set them.

- DIP switches ("Adjusting the DIP Switches" (page 3-15))
The DIP switches set serial communication conditions, busy condition, print column, receive buffer capacity, etc...
- Memory switches ("Memory Switches" (page 3-17))
The Memory switches set serial communication conditions, roll paper width, cover open status handling, etc...
- Paper width ("Adjusting Roll paper width" (page 3-24))
The paper width is set by the spacer & Memory switch setting.
- Roll Paper Near End Detector (For model equipped with the detector)
("Adjusting Position of Roll Paper Near End Detector" (page 3-25))

3. Connect the Printer to the Host PC/POS Terminal (and Cash Drawer)
("Connecting the Printer to the Host PC / POS Terminal" (page 3-26))
4. Driver set up (If you use driver)
("Install a Printer Driver in the Host PC / POS Terminal" (page 3-30))
5. Complete the setup

3.3 Printer setup

3.3.1 Installing or Replacing the Ribbon Cassette

EPSON recommends the use of genuine EPSON ribbon cassettes. Ribbon cassettes not manufactured by EPSON may cause damage to your printer that is not covered by EPSON's warranties.

To install the ribbon cassette for the first time or to replace a used ribbon, follow the steps below:

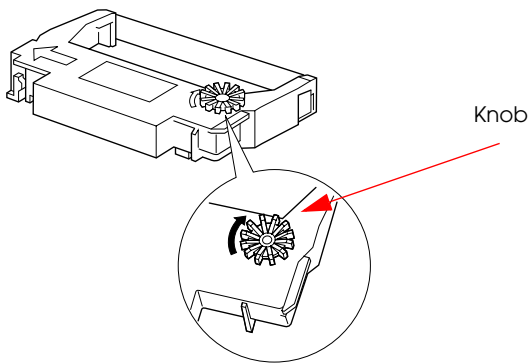

1. Unpack the ribbon cassette and turn the knob in the direction shown to take up any slack.

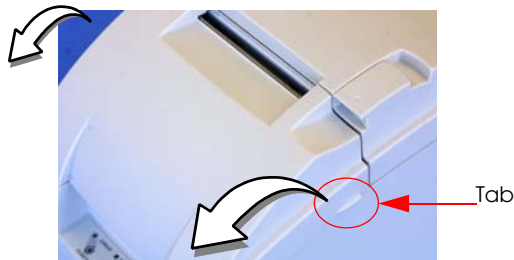

2. Open the ribbon cassette cover of the printer, using the tabs on each side of the cover.



3. Remove the old ribbon, if there is one.
4. Insert the new ribbon cassette as shown and push the ribbon cassette down until it clicks.



Note:

Make sure the ribbon is installed between the print head and the platen without wrinkles or creases.

5. Close the ribbon cassette cover of the printer.

3.3.2 Installing the Roll Paper

The installing procedure is little different between Type A and Type B, D.

 **CAUTION:**

Be sure to use roll paper that meets the specifications.

Be sure not to touch the manual cutter. Otherwise your fingers might be injured.

3.3.2.1 Installing the Roll Paper for Type B, D

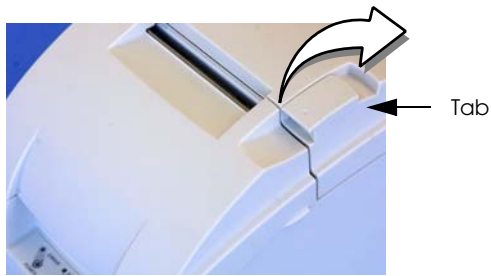

1. Using scissors, cut the leading edge of the roll paper, as shown in the left figure.

2. Turn on the printer and open the roll paper cover by using the tab, as shown in the left.

3. Insert the roll paper, as shown on the left.



Note:

Note the direction the paper comes off the roll, as shown below.

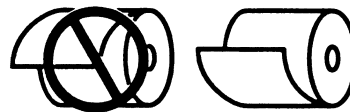

When using 2-ply roll paper, be sure that the top and bottom sheets are aligned at the paper exit. See the below illustration.



4. Close the roll paper cover.

3.3.2.2 Installing the Roll Paper for Type A

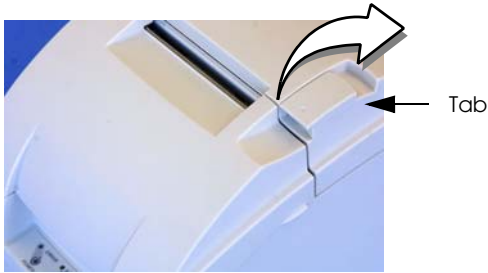

1. Using scissors, cut the leading edge of the roll paper, as shown in the left figure.

2. Turn on the printer and open the roll paper cover by using the tab, as shown in the left.



Note:

The printer feeds for 30 mm automatically if the roll paper cover is open. This is a normal operation to prevent the printer from damaging the paper when the roll paper cover is opened or closed.

Since the printer does not feed even if the roll paper cover is open when the printer is turned off, make sure not to pinch the paper when the cover is closed.

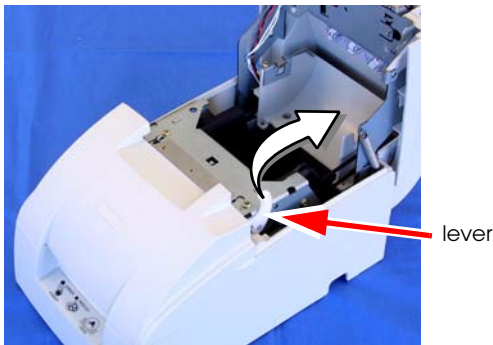

3. Open the unit by using the lever, as shown in the left.

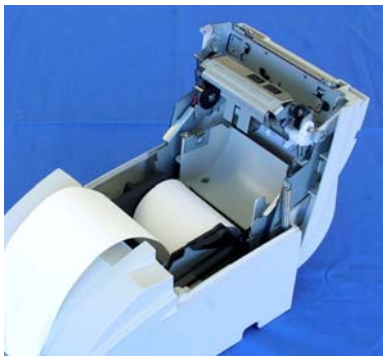

4. Insert the roll paper, as shown in the left.



Note:

Note the direction the paper comes off the roll, as shown in following

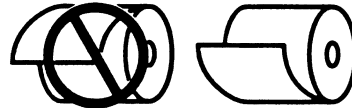

When using 2-ply roll paper, be sure that the top and bottom sheets are aligned at the paper exit. See below illustration.



5. Close the roll paper cover.
6. **If you are not using a take-up spool**, pull out a small amount of roll paper and close the roll paper cover; then tear off the paper with the manual cutter. You can skip steps 6 through 11.
7. When using 2-ply roll paper, pull out the roll paper to the bottom front of the printer as a guide, as shown in left.

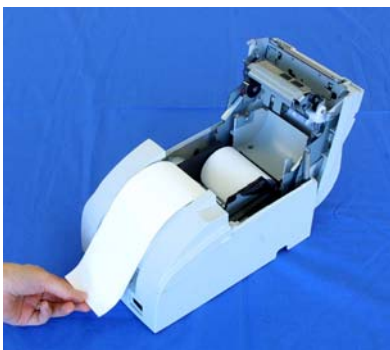

8. Close the unit, as shown in the left illustration.

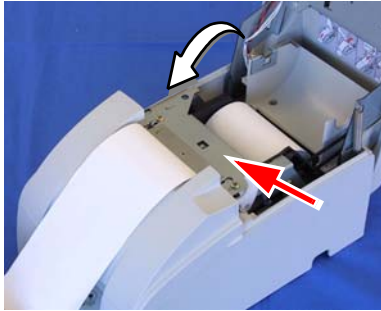

9. Insert the end of the bottom paper (journal paper) into the paper take-up spool, as shown in following.

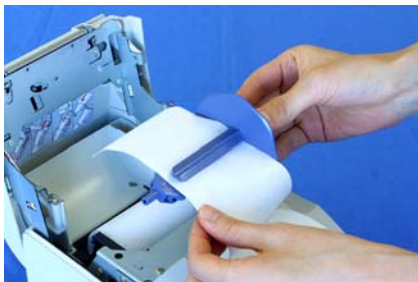

10. Insert the paper take-up spool in the printer. Be sure that the paper is aligned with the spool's flange, as shown.

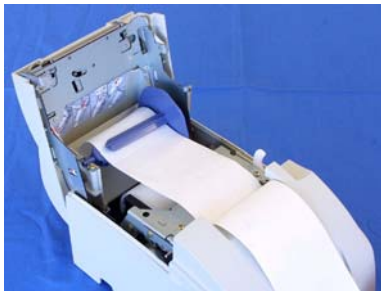

11. Feed the paper with the FEED button so that the paper is taken up by the spool.
12. Close the roll paper cover and tear off the roll paper with the manual cutter, as shown.





Note:

Since the printer does not feed even if the roll paper cover is open when the printer is turned off, make sure not to pinch the paper when the cover is closed.

Do not open the roll paper cover during printing or paper feeding.

When using the printer, be sure to cut the roll paper with the manual cutter after paper feeding is complete.

3.3.2.3 Replacing the Roll Paper

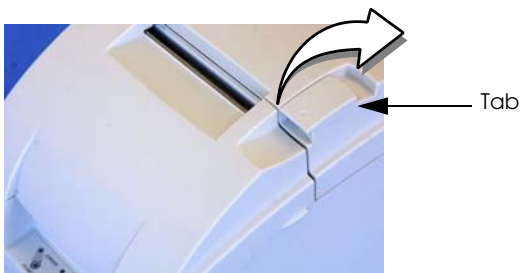

1. Turn on the printer and open the roll paper cover by using the tab, as shown.

2. Types B and D: Remove the used roll paper core.

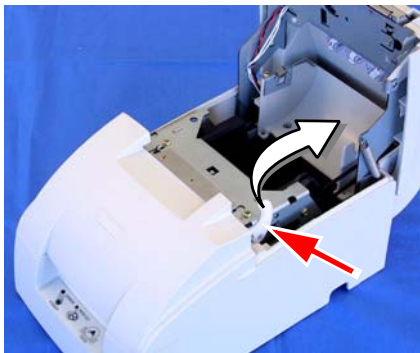

3. Type A only: Remove the take-up spool, and open the unit by using the unit open lever, as shown; then remove the used roll paper core.

4. Insert new roll paper. See the section "Installing the Roll Paper for Type A" (page 3-9).

3.3.3 Connecting the Power Supply Unit

Use the power supply or equivalent for your printer as listed below.

TM-U220 Alphanumeric model (Type A,B, D)	TM-U220 Multilingual model (Type A,B, D)
AC Adapter C (which is packed with ANK model) or PS-180 (Which is provided as option)	PS-180 (which is packed with Multilingual model)



Note:

The AC Adapter packed in the carton box of ANK model cannot be used for the Multilingual model.

The "AC adapter, C," which is packed with the alphanumeric model, cannot be used with the multilingual* model. Be sure to use the "PS-180" with the multilingual* model. If the "AC adapter, C," packed with the alphanumeric model, is connected to the multilingual* model by mistake, the printer might not operate correctly. For example, printing might stop before all the lines are printed or the printer might print the same line repeatedly.

*Multilingual means the printer model that can print any one of the following: Japanese Kanji, Simplified Chinese, Traditional Chinese, Thai characters, or Korean characters.



WARNING:

Make sure you use the AC Adapter C or EPSON PS-180 power supply or equivalent. Don't use the PA-#### or PB-#### power supply unit with TM-U220. Using an incorrect power supply may cause fire or electrical shock.



CAUTION:

When connecting or disconnecting the power supply from the printer, make sure the power supply is not plugged into an electrical outlet. Otherwise you may damage the power supply or the printer.

3.3.3.1 Connecting procedure

1. Make sure the printer's power switch is turned off and the power supply's power cord is unplugged from the electrical outlet.
2. Check the label on the power supply to make sure the voltage required by the power supply matches that of your electrical outlet.

3. Plug the power supply cord into the connector shown below.

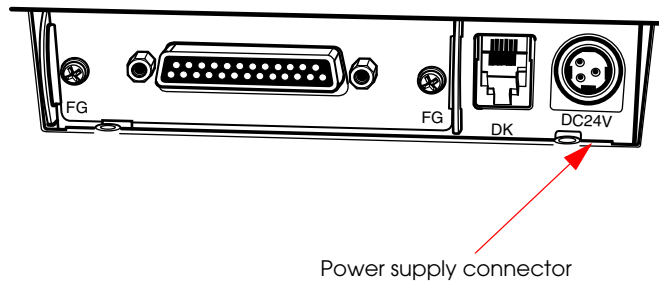

Note:

To remove the DC cable connector, make sure the power supply's power cord is unplugged; then grasp the connector and pull it straight out.

When you connect the power supply unit to the printer, we recommend to do a self test to confirm the operation. See "Self Test" (page 3-36) for details.

3.4 Adjusting Various Settings

This printer is able to be adjusted for the items below:

- DIP switch (communication condition, busy condition, print column, receive buffer capacity, etc...)
- Memory switch (serial communication conditions, roll paper width, cover open status handling, etc...)
- Roll paper width (76mm / 69.5mm / 59.5mm)
Adjusting the spacer & memory switch
- Position of roll paper near end detector

The current settings can be confirmed by a self test. (See "Self Test" (page 3-36).)



Note:

When you use serial interface model with 1200bps, 2400bps, or 19200bps, you have to adjust DIP switch "Serial interface selection" function and Memory switch "Serial communication condition".

When you adjust the items, we recommend to confirm the new setting. The confirmation is performed by running a self-test. See "Self Test Procedure" (page 3-36).

3.4.1 How to Confirm Current Settings

You can use a self-test to confirm the current settings. See "Self Test" on page 3-36.

3.4.2 Adjusting the DIP Switches

The printer has two sets of DIP switches. The function of the DIP switches is different for each interface model.

If you need to change settings, follow the steps below to make your changes:

CAUTION:

Turn off the power while removing the DIP switch cover to prevent an electric short, which can damage the printer.

Use a crosshead screwdriver to remove the screw holding the DIP switch cover.

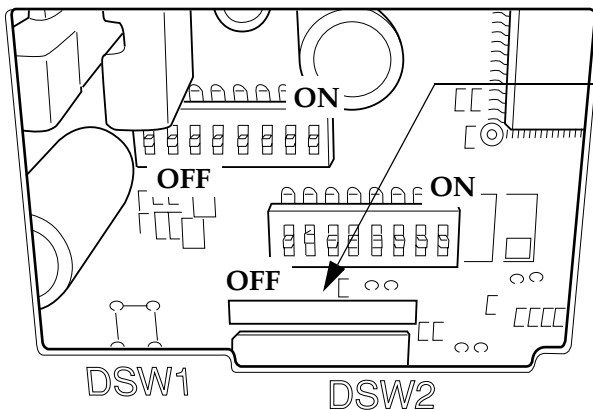

Look at the numbers and letters in the area indicated in the illustration. If the last letters are "STD", use the "STD" tables.

CAUTION:

Be sure to put back the DIP switch cover before using the printer.

Note:

The functions of the switches are shown in the following sections.

3.4.2.1 When the letters are STD

Serial model

(DIP Switch 1)

SW	Function	On	Off
1	Data receive error	Ignored	Prints "?"
2	Receive buffer capacity	40 bytes	4 KB
3	Handshaking	XON/XOFF	DTR/DSR
4	Word length	7 bits	8 bits
5	Parity check	Yes	No
6	Parity selection	Even	Odd
7	Transmission speed	4800 bps	9600 bps
8	BUSY condition	Receive buffer full	Receive buffer full or Offline

(DIP Switch 2)

SW	Function	On	Off
1	Print column	42/35	40/33
2	Reserved (Auto cutter enable/disable)	Type A, B Fixed to On	Type D Fixed to Off
3	Reserved	-	Fixed to Off
4	Serial interface selection	Memory switch	DIP switch
5	Reserved	-	Fixed to Off
6	Reserved	-	Fixed to Off
7	Pin 6 reset signal	Used	Not used
8	Pin 25 reset signal	Used	Not used

Parallel / USB / Ethernet model (Except serial)
(DIP Switch 1)

SW	Function	On	Off
1	Auto line feed	Enabled	Disabled
2	Receive buffer capacity	40 bytes	4 KB
3~7	Reserved	-	Fixed to Off
8	BUSY condition	Receive buffer full	Receive buffer full or Offline

(DIP Switch 2)

SW	Function	On	Off
1	Print column selection	42/35	40/33
2	Reserved (Auto cutter enable/disable)	Type A, B Fixed to On	Type D Fixed to Off
3~7	Reserved	-	Fixed to Off
8	Pin 31 reset signal	Used	Not used



Note:

See "Notes for DIP switch 2-1" (page 3-17) about the DIP SW 2-1 setting.

When you use serial interface model with 1200bps, 2400bps, or 19200bps, you have to adjust DIP switch "Serial interface selection" function and Memory switch "Serial communication condition".

3.4.2.2 Notes for DIP switch 2-1

The DIP switch 2-1 defines the print columns as listed in the following table.

Paper width	Character font	DIP switch 2-1 status	
		ON	OFF
76 mm	Font A (9 x 9)	35	33
	Font B (7 x 9)	42	40
69.5 mm	Font A (9 x 9)	32	30
	Font B (7 x 9)	40	36
57.5 mm	Font A (9 x 9)	27	25
	Font B (7 x 9)	33	30

Unit: cpl (Character per line)



Note:

The cpl of a Kanji character font is available to be changed by an ESC/POS command. (default: 22 cpl to 25cpl)

3.4.3 Memory Switches

This printer has “Memory switch” set which is software switches. Memory switch set has “Msw 2,” “Msw 8,” “Customize value,” “Serial communication condition.”

“Memory switch setting utility” can change the Memory switch set to ON or OFF as shown in the table below (default: all OFF):



Note:

The Memory switch is available to be changed by five methods:

- Memory switch setting utility
- Memory switch setup mode (there are limitations on what can be changed)
- Control from setupPOS (OPOS only, and there are limitations on what can be changed)
- Control from Windows driver (Advanced Printer Driver only, and there are limitations on what can be changed)
- Control from ESC/POS command

Some Memory switch settings can be changed by the “Memory switch setting mode.” See “Memory Switch Setup Mode” on page 3-19.

Settings of the memory switch are stored in the NV memory; therefore, even if the printer is turned off, the settings are maintained. Excessive use of this function may destroy the NV memory. As a guideline, do not use this function more than 10 times a day.

When you use OPOS or APD, generally you don’t need to adjust memory switch because OPOS or APD are able to set these items automatically.

When you replace a TM-U210 with a TM-U220, you should adjust the Msw 8-5 to OFF.

Memory Switch 2

SW	Function	On	Off
1	Reserved	-	Fixed to Off
2	Reserved	-	Fixed to Off
3	Selection of the character code system of the Simplified Chinese	GB2312	GB18030
4 ~ 8	Reserved	-	Fixed to Off



Note:

Msw 2-3:

The memory switch Msw 2-3 affects the Simplified Chinese model only.

Memory Switch 8

SW	Function	On	Off
1 ~ 4	Reserved	-	Fixed to Off
5	Selection of the cover open status	Cover open	Paper end
6	Reserved	-	Fixed to Off
7	Condition to release the BUSY in the receive buffer	Remaining 138 bytes	Remaining 256 bytes
8	Printer cover open during operation	Errors that can possibly recover	Errors that automatically recover



Note:

Msw 8-5:

When Off is selected, a bit of the "roll paper end sensor" in each status that is transmitted from the printer is changed every time the roll paper cover is open or closed. When On is selected, a bit of the "roll paper cover open / close" in each status that is transmitted from the printer is changed every time the roll paper cover is open or closed. When you replace a TM-U210 with a TM-U220, you should adjust the Msw 8-5 to Off.

Msw 8-8:

When Off is selected, a bit of the "automatic recoverable error" in each status that is transmitted from the printer is changed every time the roll paper cover is open. When On is selected, a bit of the "mechanical error" in each status that is transmitted from the printer is changed every time the roll paper cover is open.

The setting of Msw 8-5 and 8-8 can be set by "Memory switch setup mode." See "Memory Switch Setup Mode" on page 3-19.

Customize value

Function	Selectable value	
Roll paper width	57.5 mm	69.5 mm
	76 mm (default value)	--

 **Note:**

These setting can be set by “Memory switch setup mode.” See “Memory Switch Setup Mode” on page 3-19.

See “Adjusting Roll paper width” (page 3-24) also to adjust roll paper width.

Serial communication

Function	Selectable value	
baud rate	1200 bps	2400 bps
	4800 bps	9600 bps
	19200 bps	--
Parity	None	Odd
	Even	--
Handshake	DSR/DTR	XON/XOFF
Data length	7 bit	8 bit

 **Note:**

There are two methods, DIP switch and Memory switch, to adjust the serial communication conditions. DIP SW2 selects which is effective, DIP switch or Memory switch.

To enable the “Serial communication” setting, you have to adjust the “Serial interface selection” function of DIP switch 2 to “Memory switch.”

These settings can be set by “Memory switch setup mode.” See “Memory Switch Setup Mode” on page 3-19.

3.4.4 Memory Switch Setup Mode

The following items are specified in the memory switch setup mode:

- Basic Serial communication condition (Serial communication)
 - Transmission speed
 - Parity
 - Handshaking
 - Data length
- Receive buffer full release condition (Msw 8-7)
- Roll paper width (Customize value)
- Cover open status (Msw 8-5)

 **Note:**

All new settings will be lost if the power supply is turned off in the memory switch setup mode. Be sure to follow the proper procedure, and turn the power off at the correct time.

3.4.4.1 Starting the memory switch setup mode

Use the following procedure to start the memory switch setup mode.

1. Open the roll paper cover.
2. Turn the power on while pressing the paper FEED button.
3. Press the FEED button twice while POWER, ERROR, and PAPER OUT LEDs are lit.
4. Close the cover. The printer prints the enabled settings of the memory switches and instructions.
5. Follow the instructions to process the switch setup.



Note:

In the memory switch setup, the paper out LED may be flashing. The flashing time indicates "The times of FEED button is pressed before the roll paper cover is closed."

3.4.4.2 Ending memory switch setting mode

Once the setting is performed, the contents of the setting are stored. Then the printer initializes. When initialization is finished, the printer returns to normal operating mode.

3.4.4.3 Operating procedure

The procedures used for this process are described below.

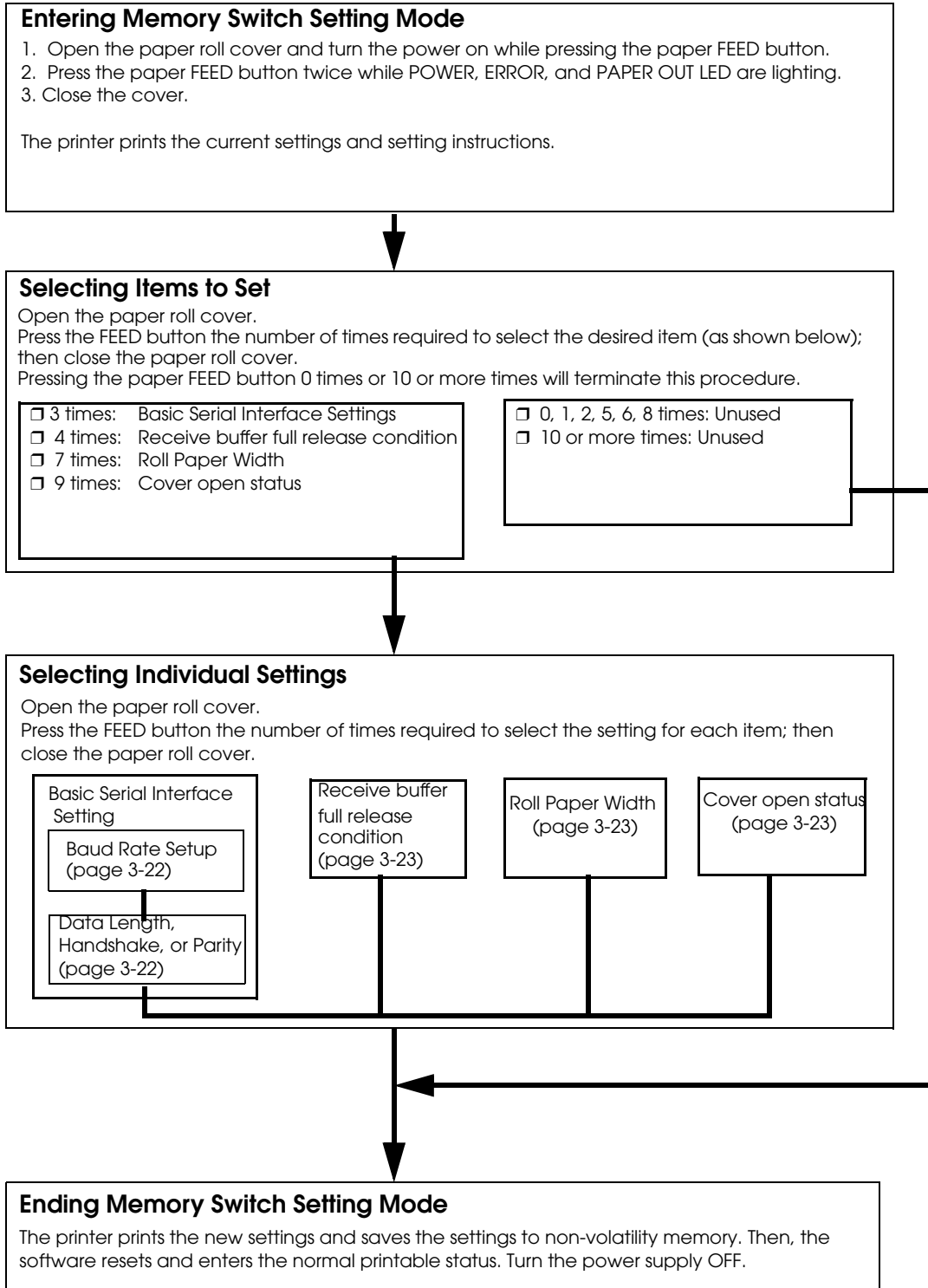

Selecting individual settings

❑ Basic serial interface setting

To select transmission conditions, first choose “Serial interface settings”; then select “Data length, handshake, or parity.”

Press the FEED button the number of times required to select the desired “Serial interface settings” used for transmission conditions.

Press FEED button	Setting selected
0 ~ 3 times:	No change
4 times:	19200 bps
5 times:	9600 bps
6 times:	4800 bps
7 times:	2400 bps
8 times:	1200 bps
9 or more times:	No change

bps: Indicates the number of transmitted bits per second (bps).

❑ Data length, handshake, or parity

Press the FEED button the number of times required to select the desired “Data length, handshake, or parity” setting used for transmission conditions.

Press FEED button	Setting selected		
	Data Length	Handshake	Parity
0 times:	No change		
1 time:	8 bits	DTR/DSR control	No parity
2 times:			Even
3 times:			Odd
4 times:		XON/XOFF control	No parity
5 times:			Even
6 times:			Odd
7 times:	7 bits	DTR/DSR control	No parity
8 times:			Even
9 times:			Odd
10 times:		XON/XOFF control	No parity
11 times:			Even
12 times:			Odd
13 or more times:	No change		

❑ Receive buffer full release condition

Press the FEED button the number of times required to select the desired receive buffer full release condition setting.

Press FEED button	Receive buffer full release condition
0 times:	No change
1 time:	256 bytes remain (Msw 8-7: Off)
2 times:	138 bytes remain (Msw 8-7: On)
3 or more times:	No change

❑ Paper width setting

Press the FEED button the number of times required to select the desired roll paper width setting (Customize value.)

Press FEED button	Selecting paper width
0 times:	No change
1 time:	76 mm
2 times:	69.5 mm
3 times:	58.5 mm
4 or more times:	No change

 **Note:**

See “Adjusting Roll paper width” (page 3-24) also to adjust roll paper width.

❑ Cover open status

Press the FEED button the number of times required to select the desired the mapping of cover open status setting.

Press FEED button	Setting selected
0 times:	No change
1 time:	Paper out (Msw 8-8: OFF)
2 times:	Cover open (Msw 8-8: ON)
3 or more times:	No change

3.4.5 Adjusting Roll paper width

The TM-U220 accommodates 76 mm {3"}, 69.5 mm {2.74"}, 57.5 mm {2.26"} wide paper rolls.



Note:

When you use a near-end detector equipped model, be sure not to pinch the lead wires of the near-end detector between the roll paper guide and the roll paper holder, and to push the lead wires inside so that the lead wire of the paper-end detector does not contact the motor gear.

When replacing the wires, be sure that the wires do not catch between the roll paper guide and the roll paper holder.

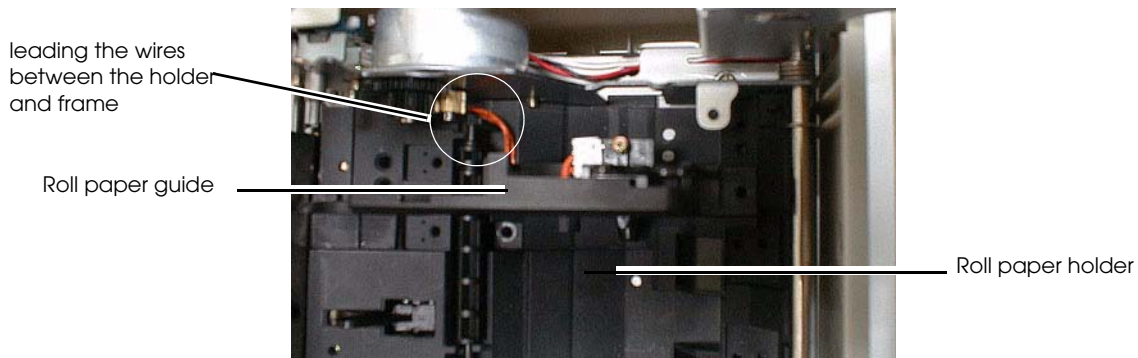

1. Make sure the power supply is disconnected.
2. Open the roll paper cover.
3. Take off the roll paper guide from the printer by loosening the two screws.

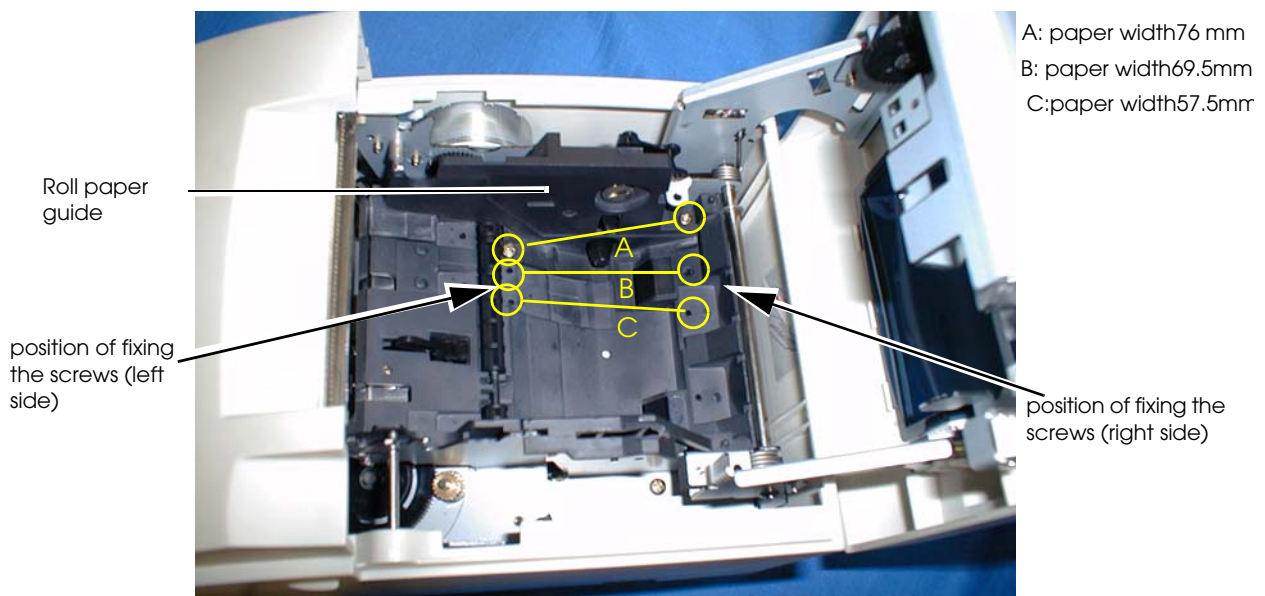

4. Push the roll paper guide on the appropriate width. (See figure above.)

5. Tighten the spacer with two screws included with the guide. (See figure above.)
6. Set the memory switch (customize value) for the paper width. (See “Memory Switches” (page 3-17))

3.4.6 Adjusting Position of Roll Paper Near End Detector

Below are two reasons for the roll paper to require an NE detector adjustment.

- ❑ To adjust the location of detection for the diameter of the roll paper core.
- ❑ To adjust the amount of remaining paper.

The procedure is as following.

1. Make sure the power supply is disconnected.
2. Open the roll paper cover, and remove the paper roll.
3. Loosen the detector adjustment screw with a coin or similar tool.
4. Adjust the detector by sliding the lever in the direction shown below.

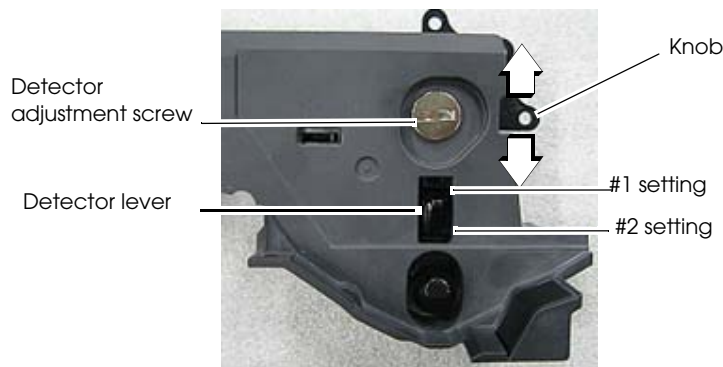

Seeing at outside for roll paper spacer

The table below shows the point at which the near-end detector is triggered. Note that this figure is a calculated value, and there may be some variations, depending on the printer.

Detection point of roll paper near-end

Detector position (attaching point of the detector adjustment lever)	Trigger point (included the thickness of paper roll core)
#1 setting	Approx. 8 mm
#2 setting	Approx. 5 mm

5. Tighten the detector adjustment screw.
6. Check to be sure that the detecting lever moves freely.

3.4.7 Connecting the Printer to the Host PC / POS Terminal

All cables are connected to the connector panel located on the lower rear side of the printer.

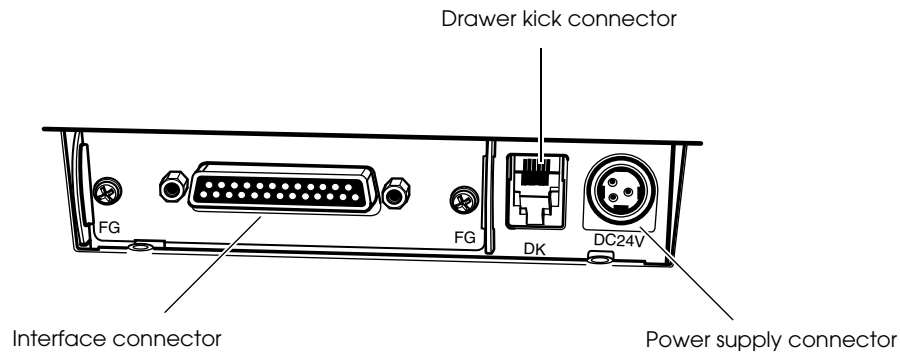

Connector panel



Note:

The figure above shows the connector panel for the serial interface model printer. The shape of the interface connector varies according to the type of interface used.

Be sure to turn off the power supply for both the printer and the host computer unit before connecting the various cables.

You need an appropriate serial, parallel, USB, or Ethernet interface cable to connect your computer to the printer. For the serial model, it is important that you use a null modem cable, not any other serial cable, and for the parallel model use an IEEE 1284 cable.

3.4.7.1 Serial Interface model

Before connecting any of the cables, make sure that both the printer and the host PC are turned off.

1. Plug the cable connector securely into the printer's interface connector.
2. If the cable connector has screws on it, tighten the screws on both sides of the connector.

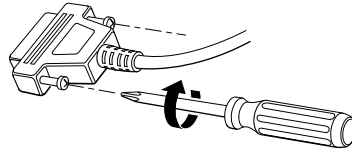

3. If your interface connector has a grounding wire, attach it to the printer using the screw labeled FG, which is next to the interface connector.
4. Attach the other end of the cable to the host PC.



Note:
 When using serial interface, you need to adjust serial communication using the DIP switches. See "Adjusting the DIP Switches" (page 3-15) for details.

When using serial interface, see "Serial Connection" in Chapter 2 also.

3.4.7.2 Parallel Interface Models

1. Press the connector on the end of the interface cable firmly into the interface connector on the connector panel.
2. Press down the clips on either side of the connector to lock it in place.
3. For interface cables equipped with a ground line, attach the ground line to the screw hole marked "FG" on the printer.
4. Connect the other end of the interface cable to the host computer.

3.4.7.3 USB Interface Models

1. Attach the locking wire saddle at the location shown in the figure below.
2. Hook the USB cable through the locking wire saddle, as shown in the figure below.



Note:

Hooking the USB cable through the locking wire saddle, as shown in the figure below, will prevent the cable from coming unplugged.

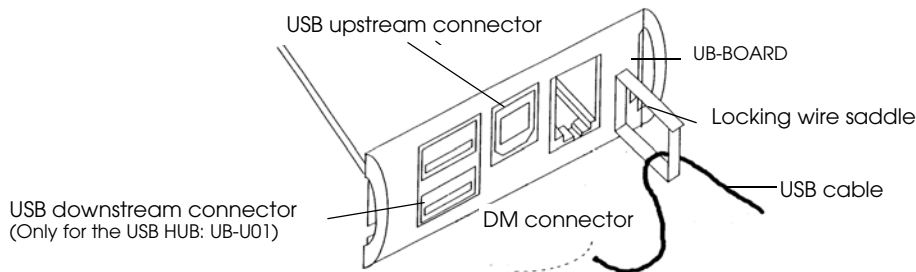

Attaching locking wire saddle

3. Connect the USB cable from the host computer to the USB upstream connector.
4. For models that have the UB-U01II installed, a maximum of two USB devices can be connected to the USB downstream connector.



Note:

The UB-U01 serves as a bus power-supply hub. Therefore, it is important to note that bus power supply hubs (including the UB-U01II) and bus power supply functions with power dissipation of 100 mA or more cannot be connected directly to the printer. (A UB-U02II can be directly connected to a UB-U01 hub.)

5. Install the UB-U01II/02II device driver on the host computer.



Note:

For information on how to obtain the required device drivers and their installation procedures, contact the nearest EPSON service center.

3.4.7.4 Ethernet interface

The following view shows the part names of the UB-E01.

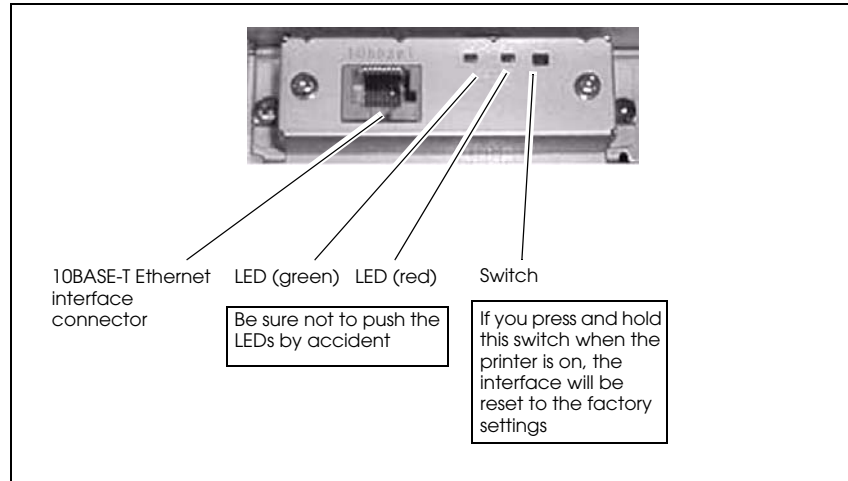

Before connecting any of the cables, make sure that both the printer and the host computer are turned off.

1. Make sure both the printer and the host computer are turned off.
2. Plug the 10BASE-T cable connector securely into the UB-E01's 10BASE-T Ethernet connector until you feel it click.

CAUTION:

Do not connect a telephone line, a display module cable, or a drawer kick-out cable to the UB-E01's 10BASE-T connector.

Note:

The display module connector on the TM printer cannot be used when the UB-E01 is installed.

3. Connect the power supply to the printer.

3.4.7.5 Connecting a Drawer

CAUTION:

Be sure to connect a drawer that meets printer specifications. Connecting a drawer of the wrong specifications may result in damage to both the drawer and the printer.

Never connect the telephone line to the drawer kick out connector (labeled "DK"). Doing so may result in damage to both the telephone line and the printer.

Never connect the drawer cable to the customer display connector (labeled "DM-D"). Doing so may result in damage to both the drawer cable and the printer.

1. Connect the drawer cable to the drawer kick out connector (labeled "DK") on the connector panel.

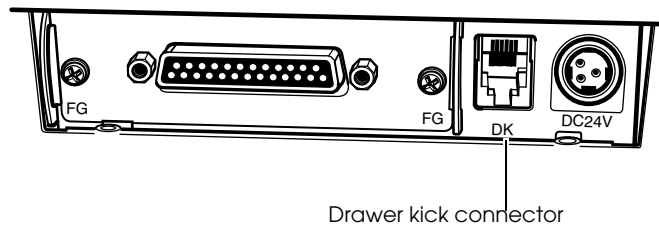

Connecting drawer

2. The connecting is finished.

3.5 Install a Printer Driver in the Host PC / POS Terminal

EPSON provides printer drivers for the TM-U220. The drivers are OPOS and Advanced Printer Driver (APD). They are for the Windows® environment.

3.5.1 OPOS

3.5.1.1 Install and Set up.

When you install and set up, please refer to the User's Manual, the file is automatically created at the installation of OPOS ADK.

Outline of install and Setup procedure is as follows.

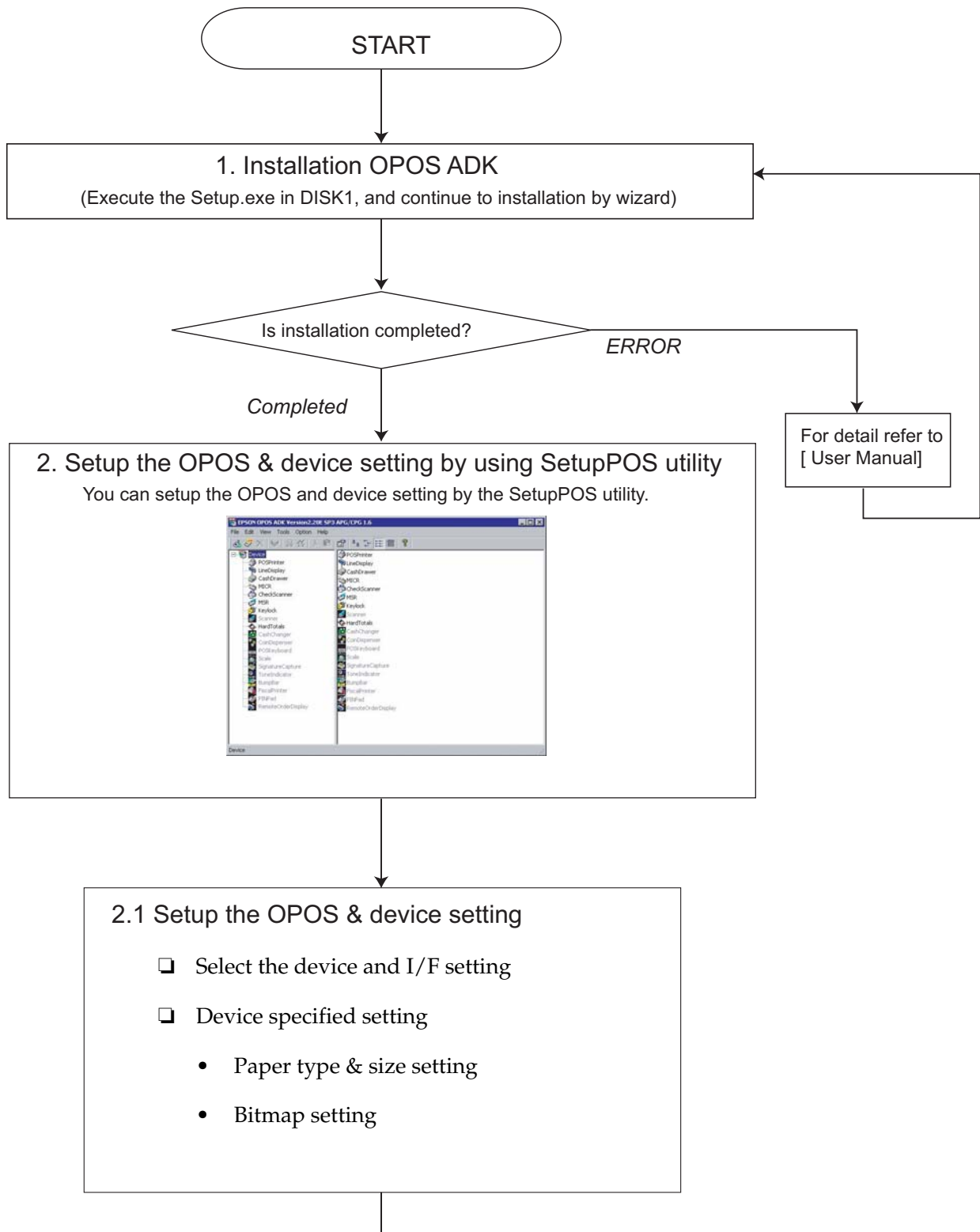

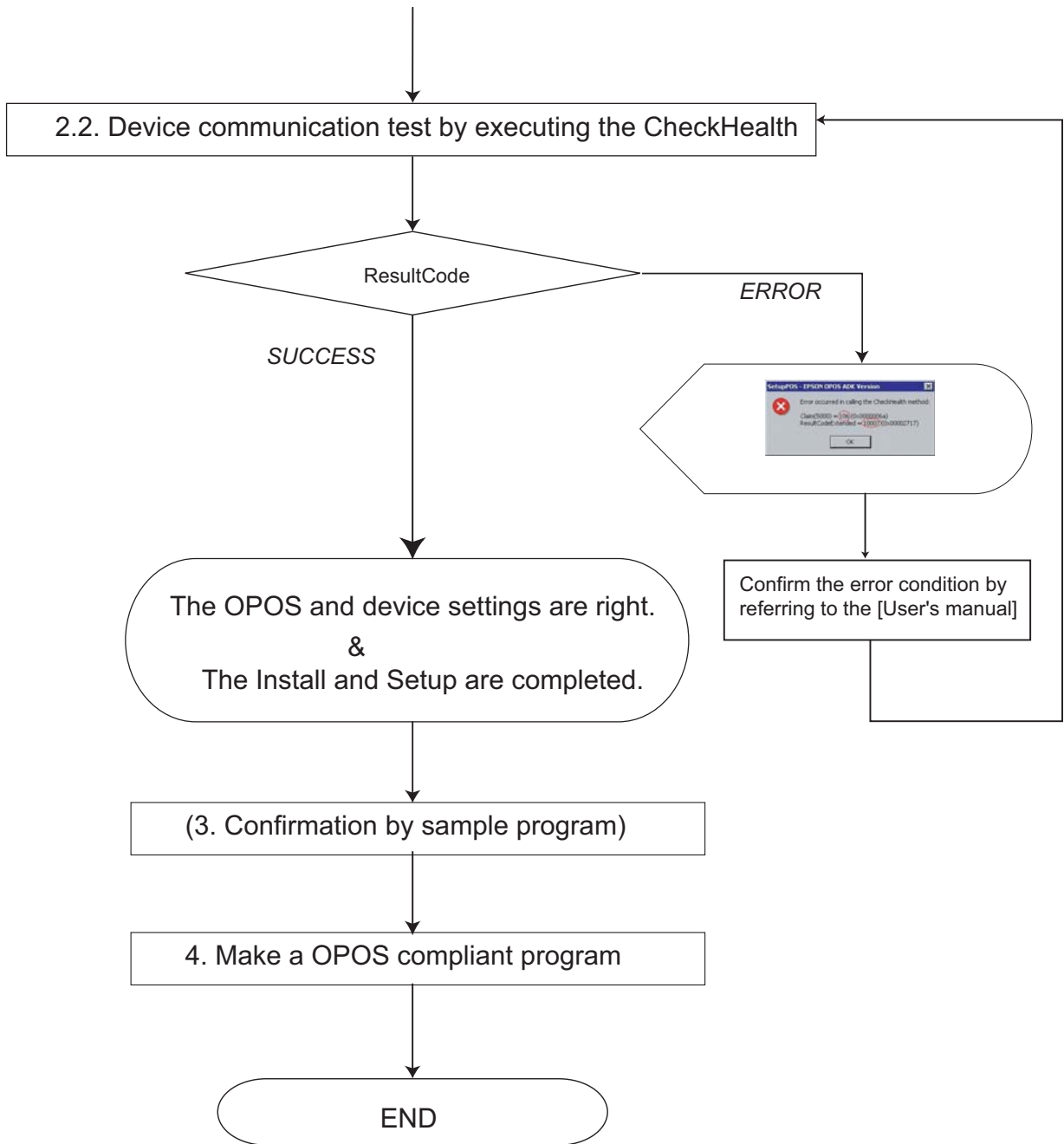

1. Installation.

Execute the Setup.exe in DISK1. and continue to installation by wizard.

2. Set up the device and environment.
 1. Set the device setting by using SetupPOS utility.
 - Select the device and I/F setting.
 - Device specified setting. (set the specified setting of the device)
 2. Execute the CheckHealth
Device communication test.
 - If you get "SUCCESS", the setting of the device is right.
 - If you get ResultCode (error), please re-check the device connection setting by following the User's Manual.

After performing the above procedure, please use an OPOS compliant program in your system.



Note:

Please refer to the sample program when you make a program.

OPOS ADK provides a sample program for each device class. The sample programs are intended as programs to serve as references for application developers. The ways to use the principal methods and properties for each device are introduced in the form of Visual Basic, Visual C++ programs. In this manual, it is introduced in the form of Visual Basic.

3.5.1.2 Package contents of EPSON OPOS ADK.

Package contents of EPSON OPOS ADK are same as that of the previous one.

- Installer
- SetupPOS Utility
- OPOS Controls
- Manual
 - User's Manual :Installation of the EPSON OPOS ADK, Configurations,and explanations of the attached tools.
 - ADG : Detailed information on the each device to support the development.

ADG for General :	General information on the development.
ADG for Common Information :	Common information to all the devices.
ADG for device class :	General information on the device class.
ADG for model :	Specific explanation on the device.
Sample program :	Information on the Sample Programs.

- Sample Program

Sample program for VB and VC (for each device class)

3.5.2 Advanced Printer Driver (APD)

3.5.2.1 Installing and Setting Up

When you install and set up the APD, please refer to the “EPSON Advanced Printer Driver Install Manual.” The Manual is a PDF file, which is provided with other manuals for the APD.

Outline of installation and setup procedure is as follows.

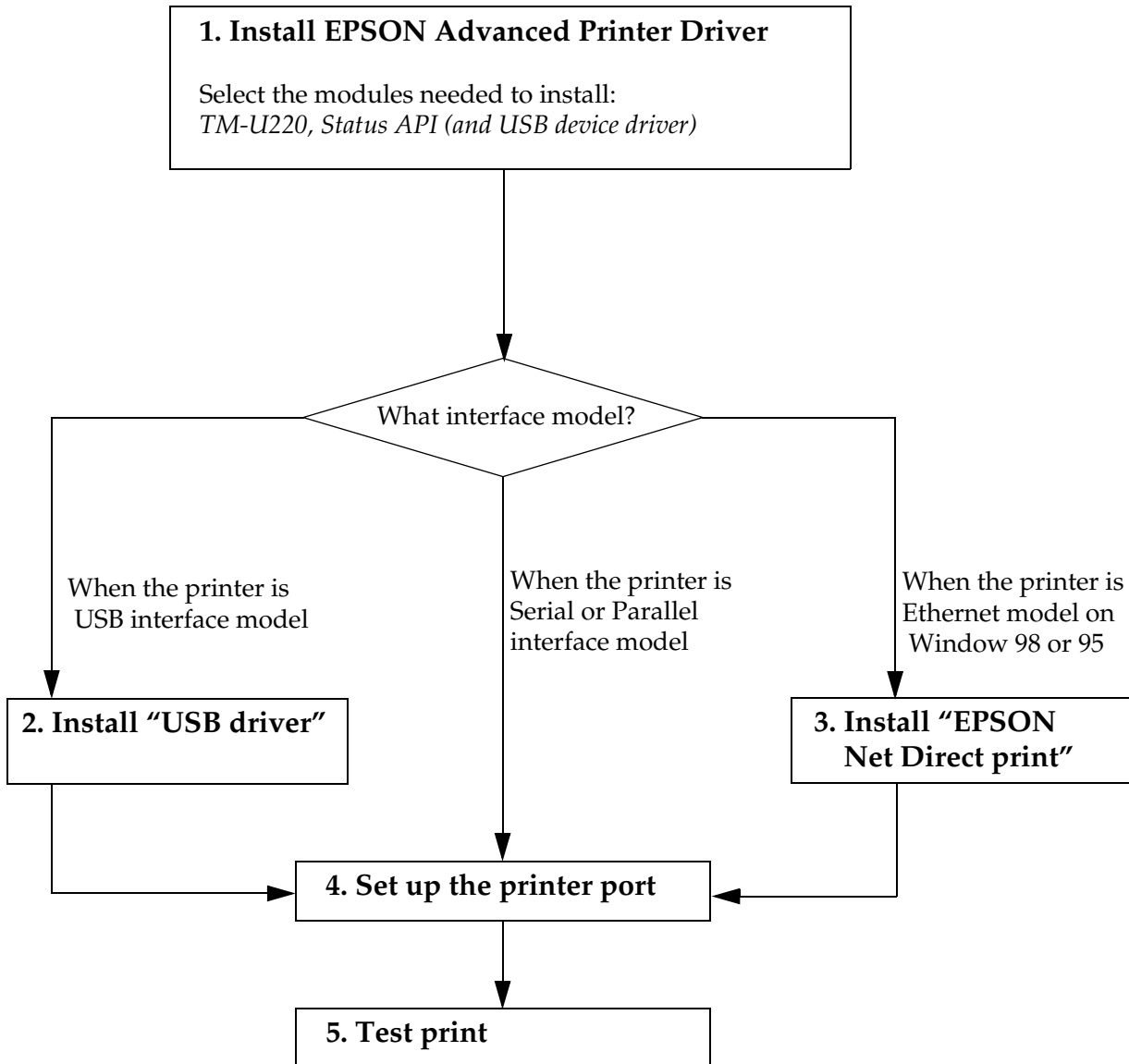

1. Install EPSON Advanced Printer Driver

Execute the installer “ADT###e.exe,” and select modules which you need. The recommended modules are shown below. Refer to the installation manual for details.

EPSON TM-U220 Receipt (76mm):	This module (printer driver) is required for printing on 76mm width receipt.
EPSON TM-U220 Receipt (69.5mm):	This module (printer driver) is required for printing on 69.5mm width receipt.
EPSON TM-U220 Receipt: (57.5mm)	This module (printer driver) is required for printing on 57.5mm width receipt.
Status API:	This module is required for monitoring the printer. This module provides API to monitor the printer’s status.
USB driver:	This module (device driver) is required for the USB interface model printer.



Note:

For the Manual, Sample program, and each utility, you have to download separately the ADT###e.exe.

2. Install “USB driver”

When you use a USB interface model printer, you need to install the “USB driver.” The procedure depends on the OS; therefore see the installation manual. If you aren’t using a USB interface model printer, you don’t need to install this module.

3. Install “EPSON Net Direct print”

When you use the Ethernet interface model printer with Windows98/95, you need to install “EPSON Net Direct print.” See the installation manual for details. If you aren’t using the Ethernet interface model printer, or aren’t using Windows 98/95, you don’t need to install this module.

4. Set up the printer port

After installing APD (and “USB driver” or “EPSON Net Direct print”) you need to adjust the printer port setting for the printer interface model. See the Installation manual and the User’s manual for details.



Note:

When you use the serial interface model printer, you need to adjust serial communication setting between printer and printer driver. See “Adjusting the DIP Switches” (page 3-15) and “Memory Switches” (page 3-17) for information on the settings.

5. Test print

Execute test print from the “property” of printer to confirm the setting. If the test print is not correct, please see the “Notes” on the “User’s Manual” and “Status API Reference Manual” to solve the your problem.



Note:

You can use the printer with sample program (written in Microsoft Visual Basic, Visual C++). The sample program is provided separately.

3.6 Self Test

The self test lets you know if your printer is operating properly. It checks the control circuits, printer mechanisms, print quality, control software version, and DIP switch settings.

This test is independent of any other equipment or software, so it is a good idea to run it when you first set up the printer and if you have any trouble. If the self tests work correctly, the problem is in the other equipment or the software, not the printer.

3.6.1 Self Test Procedure

1. Make sure the printer is turned off and the roll paper cover is closed properly.
2. While holding down the FEED button, turn on the printer using the switch on the front of the printer. The self test prints the printer settings and then prints the following, cuts the paper, and pauses. (The PAPER OUT light blinks.)

**If you want to continue SELF-TEST printing, Please press the
FEED button.**

3. Press the FEED button to continue printing. The printer prints a pattern using the built-in character set.
4. The self test automatically ends and cuts the paper after printing the following:

***** completed *****

The printer is ready to receive data as soon as it completes the self test.



Note:

If you want to pause the self test manually, press the FEED button. Press the FEED button again to continue the self test.

Chapter 4

Troubleshooting



This section describes general troubleshooting.

4.1 LED Blinking Pattern

4.1.1 Error Types

The printer stops all printer operations for the selected paper section, goes offline, and the ERROR LED blinks when an error is detected.

4.1.1.1 Errors that automatically recover

ERROR	Description	ERROR LED Blinking Pattern  160 ms	Recovery
Roll paper cover open error (when recoverable error is selected) (*1)	The roll paper cover is opened when printing.		Recovers automatically when the cover is closed.
Print head temperature error (*2)	The temperature of the print head is extremely high		Recovers automatically when the print head cools





 **Note:**

(*1) This conditions are selected by MSW 8-5, 8-8. When MSW 8-5 (mapping of the cover open status) is off, the error hasn't occurred but there is a "paper end error" instead. If MSW 8-8 is off, this error is handled as an automatically recoverable error.

(* 2) Print head temperature error is not abnormal.

4.1.1.2 Recoverable Errors

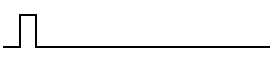
When a recoverable error occurs, after the cause of the error is removed, the printer can recover from the error by receiving an error recovery command without turning off the power:





ERROR	Description	ERROR LED Blinking Pattern  160 ms	Recovery
Paper roll cover open error (*1)	The roll paper cover is opened when printing.		Recovers by error recovery command with the cover closed
Autocutter error (Type A, B only)	The autocutter does not work correctly		Recovers by error recovery command. (See "Autocutter Jam" (page 4-3))
Home position detection error (This is "Mechanical error")	The home position cannot be detected due to a paper jam		Recovers by error recovery command

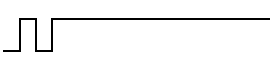

Note:

(*1) These conditions are selected by MSW 8-5 and 8-8. When MSW 8-5 (mapping of the cover open status) is OFF, the error does not occur and a "paper end error" occurs instead. If MSW 8-8 is ON, this error is handled as a recoverable error.

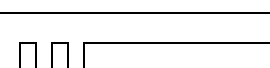
4.1.1.3 Errors that are impossible to recover:

ERROR	Description	ERROR LED Blinking Pattern  160 ms	Recovery
R/W error in memory or gate array	After R/W checking, the printer does not work correctly. Writing to, reading out, or erasing the NV memory for image scanning results does not work correctly.		Impossible to recover
High voltage error	The power supply voltage is extremely high		Impossible to recover
Low voltage error	The power supply voltage is extremely low		Impossible to recover
CPU execution error	The CPU executes an incorrect address or I/F board is not connected		Impossible to recover
Print head temperature detection circuit error	There is an abnormality in the print head temperature		Impossible to recover

4.2 Removing a Paper Jam

CAUTION:

Be sure not to touch the manual cutter. Otherwise your finger might be injured.

1. Turn the power off.
2. Open the roll paper cover by using the tab, as shown in the below illustration.
3. If you have a Type A printer, remove the take-up spool and open the unit by using the unit open lever, as shown in the illustration.

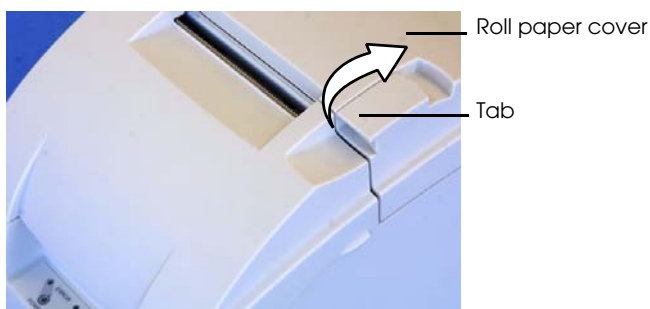

1. open the roll paper cover

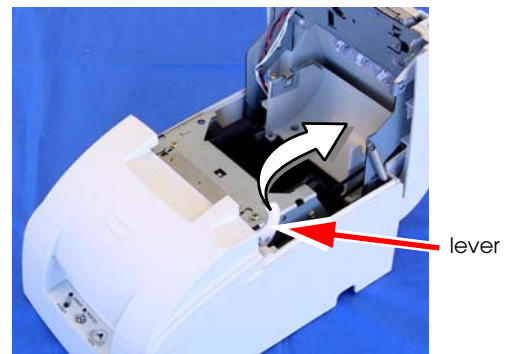

2. (only type A) open the unit

4. Remove the jammed paper.

Note:

When you turn the power off by mistake during the printing operation, the cutter blade may stop in the paper feed line. So the paper may not be fed in the first operation normally when you turn the power on. If the phenomenon happens again after removing the jammed paper, try the solution "Autocutter Jam" (page 4-3).

4.3 Autocutter Jam

If a foreign object such as a push pin or paper clip drops in the autocutter and causes the auto cutter to lock up, the printer enters an error state and begins the recovery operation automatically.

If the problem is not serious, the autocutter returns to its normal position without any intervention by the user.

If the autocutter does not return to its normal position by itself, follow the steps below to fix the problem:

1. Open the roll paper cover, and remove the jammed object if there is one.

2. Turn off the printer, and close the roll paper cover, and turn it back on. Then the cutter blade returns to the normal position. If you would like not to turn off the printer, send an error recovery command and initialize printer command instead.
3. If the cutter blade doesn't return to the normal position, return the cutter blade to the normal position by rotating the autocutter knob in the direction of the arrow. When it is returned to the normal position, a lever comes into the center of hole in the autocutter frame.

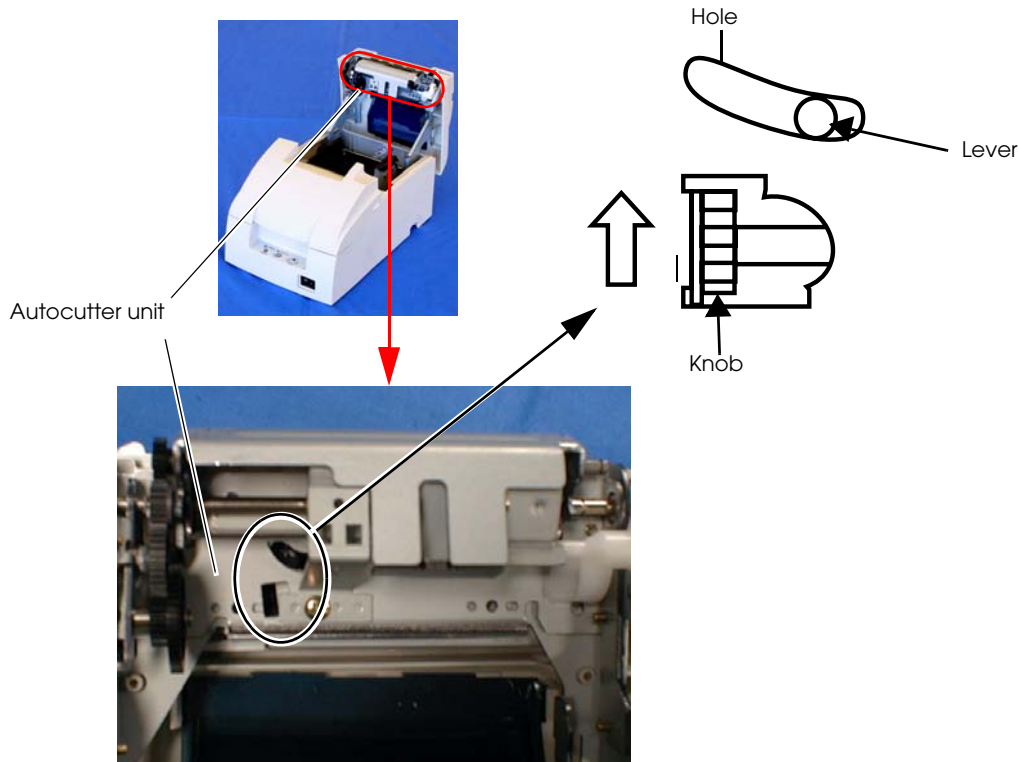

4. Close the roll paper cover.

4.4 Printer Stops Printing / Printer Repeats Printing on a Line

When you connect the wrong power supply unit, printer will not perform correctly. See below to determine which power supply unit should be connected to the printer.

TM-U220 Alphanumeric model (Type A,B, D)	TM-U220 Multilingual model (Type A,B, D)
AC Adapter C (which is packed with ANK model) or PS-180 (Which is provided as an option)	PS-180 (which is packed with the Multilingual model)



**Multilingual means the printer model that can print any one of the following: Japanese Kanji, Simplified Chinese, Traditional Chinese, Thai characters, or Korean characters.*

Use the self test to confirm what model of printer you have, and then use the correct power supply. (See "Self Test Procedure" (page 3-36) for how to run the self test.)

Alphanumeric model

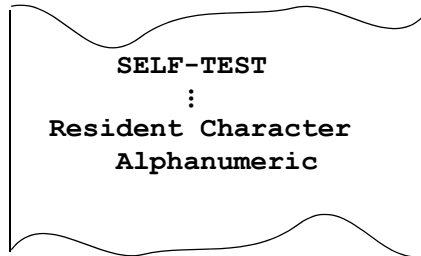

The following models are called Multilingual

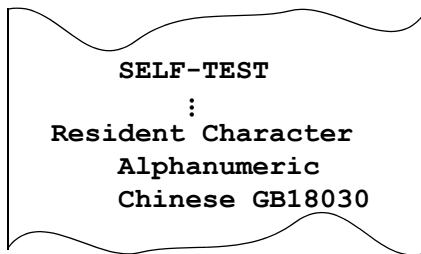

Simplified Chinese model

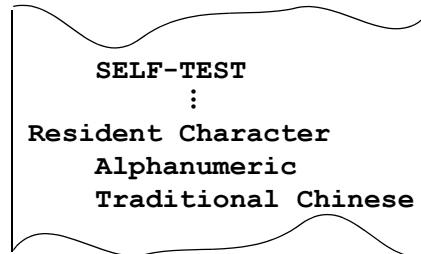

Traditional Chinese model

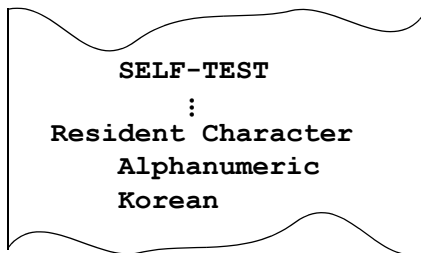

Korean model

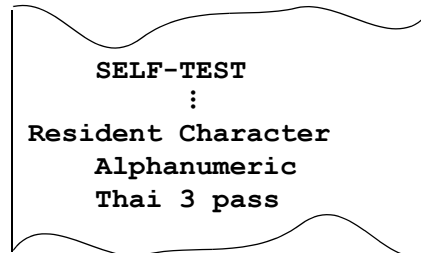

Thai model

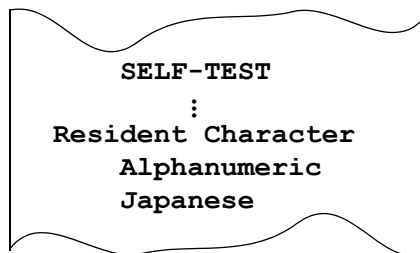

Japanese model

Result of SELF-TEST and printer model

4.5 Printer prints “?” or Incorrect Data With Serial Interface

If one of the following errors occurs during serial interface communication, the printer prints “?” or ignores the data, depending on the setting of DIP switch 1-1.

- Parity error
- Framing error
- Overrun error



Note:

For other errors, we recommend confirming the transmission setting of DIP switch 1-3: Handshaking.

4.6 Print Speed is Slow When Using Windows Printer Driver

When the printer prints a Windows font using the EPSON Advanced Printer Driver, the print speed is slow. To improve the print speed, use a printer font.

4.7 Printer doesn't cut roll paper with the autocutter

TM-U220 Type D does not have an autocutter unit. If you use the type D model, you can't use the autocutter function. Use the manual cutter.

4.8 Hexadecimal Dump mode

This feature allows experienced users to see exactly what data is coming to the printer. This can be useful in finding software problems. When you turn on the hex dump function, the printer prints all commands and other data in hexadecimal format, along with a guide section to help you find specific commands.

To use the hex dump feature, follow these steps:

1. After you make sure the printer is off, open the paper roll cover.
2. While you hold down the FEED button, turn on the printer.
3. Close the cover.

4. Run any software program that sends data to the printer. The printer prints "Hexadecimal Dump" and then all the codes it receives in a two-column format. The first column contains the hexadecimal codes and the second column gives the ASCII characters that correspond to the codes. Part of a hexadecimal dump is shown below:

Hexadecimal Dump

To terminate hexadecimal dump,
press FEED button three times.

```
1B 21 00 1B 26 02 40 40      . ! . . & . @ @  
1B 25 01 1B 63 34 00 1B      . % . . c 4 . .  
41 42 43 44 45 46 47 48      A B C D E F G H
```

- A period (.) is printed for each code that has no ASCII equivalent.
 - In hex dump mode all commands except real time ESC/POS commands are disabled.
5. Open the cover to set the printer offline so that it will print the last line.
 6. Close the cover and turn off the printer, press the FEED button three times, or reset the printer to turn off the hex dump mode.



Note:

The hexadecimal dump mode can't be used with OPOS or the APD.

Chapter 5

Application Development Information

This section contains usable information to develop POS systems that use this printer.

5.1 Various Status Categories

This printer is able to send various status reports to the host PC. This section describes about the kind of statuses and handling.

Status Categories	Description
Drawer kick connector pin status	Cash drawer is open or closed.
Roll Paper cover status	Roll paper cover is open or closed
Paper feeding button status	Paper feed button is pressed or not
Error status	Various error information (Off-line / On-line), (detail of the error; Mechanical error, autocutter error, auto-recovery error, unrecoverable error)
Paper remaining amount status	It provides status of paper remaining amount (Near-end or Paper end)



Note

Near-end status (paper remain status) is supported only by printers equipped with a near-end detector. The near-end detector is a factory option.

This printer has an Automatic status back (ASB) function that automatically transmits changes in printer status. It is available in any control method (APD, OPOS, ESC/POS command.)

The status format depends on each control method. Refer to each manual for detail.

The statuses are useful for the following situations.

- When an error status is sent to the host PC, the host PC can display an error message or solution message for operator.
- When "Paper near end" or "Paper end" status is sent to the host PC, the host PC can display a warning message for operator to replace roll paper.

5.1.1 Printer Status on APD

When you use APD to get printer's status, you have to install "Status API" and use it. Refer to "Status API User's Manual" and the sample program of Status API for details.

5.1.2 OPOS



Note

This section describes the summary of status handling. Refer to “OPOS ADK Application Development Guide General Functions” for details.

5.1.2.1 Checking the printer state

The state of the printer can be checked through properties supported by the printer. For example, if the user wants to check if the printer cover is open, the CoverOpen property can be used.

```
If OPOSPOSPrinter1.CoverOpen = True Then
    MsgBox "Cover is open!"
End If
```

This and many other events can also be checked by firing a StatusUpdateEvent.

```
[Event management]
Private Sub OPOSPOSPrinter1_StatusUpdateEvent(ByVal Data As Long)
    If Data = PTR_SUE_COVER_OPEN Then
        MsgBox "Cover is open!"
    End If
End Sub
```

StatusUpdateEvent can return information on the following items.

STATUS INFORMATION

PTR_SUE_COVER_OPEN	Cover is open.
PTR_SUE_COVER_OK	Cover is closed.
PTR_SUE_REC_EMPTY	Receipt paper is out.
PTR_SUE_REC_NEAREMPTY	Receipt paper is near the end. (The near end detector is factory option. When the printer does not have one, the status does not occur.)
PTR_SUE_REC_PAPEROK	Receipt paper is OK.
PTR_SUE_IDLE	Printer State is idle.

When the FlagWhenIdle property is set to TRUE, PTR_SUE_IDLE is sent to inform the application that the printer is idle. Other than when data is being sent, the printer is in an idle state, so if FlagWhenIdle is TRUE, an event will be fired when printing is finished. After the event is fired, FlagWhenIdle will be set to FALSE. By using this value, the information below can be found out.

*Finding out when multiple asynchronous print jobs have finished printing. When multiple asynchronous print jobs have been sent to the printer, it is possible to know when they have finished printing. After setting the AsyncMode property to TRUE and running the PrintNormal

method, change the FlagWhenIdle property to TRUE. When all data has finished printing, the printer becomes idle and a StatusUpdateEvent is fired to the application with the value of PTR_SUE_IDLE.

5.1.2.2 Printer Errors and Status

A change in printer status when asynchronous data is being sent is made available to the program by the firing of an ErrorEvent and StatusUpdateEvent. When the printer changes status while nothing is happening, the change is told to the program by a StatusUpdateEvent only.

As an example, assume that the printer cover becomes open. Usually, when data is not being sent to the printer and the cover is opened, a StatusUpdateEvent is fired to the application. After the AsyncMode property is set to TRUE and a method is used to print data, if the cover is opened while the data is being sent, the program is notified by an ErrorEvent. ErrorEvents are fired when the error has interrupted the data that is being sent. Only StatusUpdateEvent will fire when the error does not effect the data and the data will continue being sent as normal.

Reasons for the ErrorEvent being fired and the corresponding error names are listed below.

ResultCode/ ResultCodeExtended Reason

OPOS_E_ILLEGAL	There is an abnormality with the device. (Includes the following 1 error)
OPOS_E_EXTENDED	Error determined by the device's SO (Includes the following 4 errors)
OPOS_EPTR_COVER_OPEN	Cover is open.
OPOS_EPTR_REC_EMPTY	Receipt paper is empty.
OPOS_E_FAILURE	Hard error (Includes the following 6 errors).
OPOS_EPTR_UNRECOVERABLE	Error that cannot be recovered from.
OPOS_EPTR_CUTTER	Error with the auto cutter.
OPOS_EPTR_MECHANICAL	Mechanical error.
OPOS_EPTR_OVERHEAT	Head overheat error.
OPOS_EX_DEVBUSY	Device busy error.
OPOS_EPTR_REC_CARTRIDGE_REMOVED	Receipt cartridge is removed.
OPOS_EPTR_REC_CARTRIDGE_EMPTY	Receipt cartridge is empty.
OPOS_EPTR_REC_HEAD_CLEANING	Receipt head starts cleaning.

After an error occurs, more detailed information about the error can be obtained from the ErrorLevel, ErrorStation, and ErrorString properties.

5.1.2.3 ESC/POS commands

When you use ESC/POS commands to control the printer, you can get the status by using "status command" including Auto Status Back command (ASB.) Please refer to "ESC/POS APG."

5.2 Cash Drawer Control

5.2.1 Advanced Printer Driver

5.2.1.1 Drawer Open

When you control a drawer which is connected to this printer using APD, you have 2 methods to open the drawer. The first method is using "Control font," second is using "Status API."

Below is an example of a program (Visual Basic) to open a cash drawer using Control font.

```
'Execute open cash drawer1.  
Printer.Font.Name = "control"  
Printer.Print "A"           'This "A" means "open the drawer1 with 50msec pulse."
```

Below is an example of a program (Visual Basic) to open a cash drawer using Status API.

```
'call api to open the drawer1  
rtn = BiOpenDrawer(m_hApi, EPS_BI_DRAWER_1, EPS_BI_PULSE_100)  
'This calling means "open the drawer1 with 100msec pulse."
```

Note: Program needs to call "BiOpenMonPrinter" before calling "BiOpenDrawer."

5.2.1.2 Checking Drawer Status

You can get drawer status by using Status API. Below is examples of program which checks the drawer status.

```
'get the current printer status
rtn = BiGetStatus(m_hApi, getstatus)
If rtn < 0 Then
    ErrMsg (rtn) 'Error handling
    Exit Sub
End If

If (getstatus And ASB_DRAWER_KICK) = ASB_DRAWER_KICK Then
    MsgBox("Drawer is opened")    'Pin No.3 is high
Else
    MsgBox("Drawer is closed")
End If
```

There are the other checking method (Bi BiSetStatusBackFunction, BiSetStatusBackWnd) in Status API. Refer to the Status API User's Manual and the sample programs for detail.

5.2.2 OPOS

Programming examples of how to use API function relating to a Cash Drawer are shown below.

5.2.2.1 Drawer Open/Close

Using the OpenDrawer method opens the cash drawer. The DrawerOpened property can be used to check the current state of the drawer. To pause the program until the drawer is closed, the WaitForDrawerClose method is used.

Below is as example of a program to open and close a cash drawer.

```
If Not OPOSCashdrawer1.DrawerOpened Then
    OPOSCashdrawer1.OpenDrawer
    OPOSCashdrawer1.WaitForDrawerClose 10000, 1000, 100, 100
End If
```

5.2.2.2 Checking Drawer Status

There are methods other than explained in section 5.2.2.1 that can be used to check drawer status. A StatusUpdateEvent is fired whenever the drawer is opened or closed.

Below are examples of programs that use events to check if the drawer has been opened or closed.

[Main Program]

```
Global DrawerFlag As Boolean
If Not OPOSCashdrawer1.DrawerOpened Then
    DrawerFlag = True
OPOSCashdrawer1.OpenDrawer
    While (DrawerFlag = True)
        'This part uses timer management to check the status of DrawerFlag.
        DoEvents
    Wend
End If
```

[Event Management]

```
Private Sub OPOSCashdrawer1_StatusUpdateEvent(ByVal As Long)
    If Data = False Then
        DrawerFlag = False
    End If
End Sub
```

5.2.3 ESC/POS

When you drive a cash drawer which is connected to this printer, please refer to “FAQ about ESC/POS command.” About “FAQ about ESC/POS command,” please contact your dealer or EPSON.

5.3 NV memory

This printer has NV memory (Non-volatile). The data of NV memory remains after you turn off the power. The NV memory is available in two ways.

1. NV Bit-image

Please refer “NV Bit-image Printing” (page 5-8) for detail of the function.

2. User NV memory

There is free area in the NV memory that the user can use. You can use this free area for notations, to write other character information, or for many other purposes. The data remains after you turn off the power. Use ESC/POS commands to read and write this data. The following are examples of purposes.

- Date of the printer for maintenance
- ID definition for developer or POS system

**Note**

When you use User NV memory area by using OPOS or APD, you have to use "Direct I/O method" or "Control A font." Please contact EPSON or your dealer for details.

Note the following when writing to and erasing NV memory.

- ❑ The following restrictions apply when performing NV memory operations (including data storage and deletion).
 - The paper FEED button must not be used to feed paper.
 - The real-time command must not be executed.
 - The ASB status will not be sent, even when the ASB function is set to enabled.
- ❑ The printer sometimes enters the Busy state while data is written to NV memory. It is important not to send data from the host computer while the printer is in the Busy state, as it will be incapable of processing any received data.
- ❑ Frequent use of the functions for defining data to and deleting data from NV memory can damage the memory. As a rule in using the various commands, avoid writing to NV memory more than a 10 times per day.

5.4 NV Bit-image Printing

This printer has “NV Bit-image” Function. This function provides printing bit-image (e.g. a shop logo.) This function is available for any control method (APD, OPOS, ESC/POS command.)

EPSON provides a tool, “TMFLogo” that enables registration of a bitmap image in the NV memory of an EPSON TM series printer. The bitmap image in the NV memory can be printed with the printer by using each control method.

	Printable Size	Printing method
NV Bit-image	<width> Less than paper width.	<u>Store</u> Store bitmap to NVRAM by TMFLogo utility in device specific settings on the SetupPOS utility. If you store the bitmap in a NVRAM, it is not necessary to restore unless the NV memory is deleted.
	<height> There is a limitation Height length = NV memory Size / width length	<u>Print</u> Depends on each control method.



Note

The available NV memory size for the TM-U220 is 128KB.

Example: The NV memory can store 20 graphics data when the file size of a graphic is 6 KB.

5.4.1 Advanced Printer Driver

5.4.1.1 How to print “NV Bit-image”

APD prints a stored “NV Bit-image” by using “Control font.” See the User’s Manual of Advanced Printer Driver for detail.

5.4.1.2 Printable bitmap format in APD

The printable bitmap formats are formats that meet all the following condition.

- ❑ When using “NV Bit-image”
 - Depends on the TM Flogo utility. (.BMP format)

5.4.2 OPOS

EPSON OPOS ADK provides a tool, “TMFLogo” that enables registration of a bitmap image in the NVRAM of an EPSON TM series printer. The tool can be used from the device specific settings of the SetupPOS utility. The bitmap image in the NVRAM can be printed with a printer by using the DirectIO method. Concerning the available NVRAM size for the TM-U220, refer to the ADG for TM-U220 in the OPOS ADK.

5.4.2.1 Printing method

Print stored bitmap by DirectIO method.

- *Command : PTR_DI_PRINT_FLASH_BITMAP

The available NVRAM size for the TM-U220 is 128KB.

5.4.2.2 LetterQuality

It is possible to change the speed and quality of a bitmap by using the XXXLetterQuality property.

RecLetterQuality = TRUE 'print Receipt's bitmap in quality mode.

RecLetterQuality = FALSE 'print Receipt's bitmap in speed mode.

5.4.2.3 Setting of printing position by escape sequence

POS Printers support escape sequences that can be treated as printing data. The following commands are the escape sequence command for setting of printing position.

Name	Data	Remarks
Center	ESC cA	Aligns following text in the center.
Right justify	ESC rA	Aligns following text at the right.
Normal	ESC N	Restores printer characteristics to normal condition.



Note1: manner of "ESC | cA" and "ESC | rA"

Characteristics are reset at the end of each print method or by a "Normal" sequence, so these escape sequences cannot be used in the following manner.

```
OPOSPOSPrinter1.PrintNormal PTR_S_RECEIPT, Chr(&H1B) + "|cA" + "123"
OPOSPOSPrinter1.PrintNormal PTR_S_RECEIPT, "456" + Chr(13) + Chr(10)
```

The "123" characters will be printed in the center, but not under "456". When using a new method to print characters, it is necessary to add the desired escape sequence again.



Note2 : limitation of "ESC | cA" and "ESC | rA"

*During rotated printing mode (Left90, right90), these escape sequences will not work.

*These will not work if they are not the first character of a line.

*It is not possible to use these on PrintBitmap method.

5.4.2.4 Printable bitmap format in OPOS

The printable bitmap formats are formats that meet all the following conditions.

- BMP files
- Monochrome, 16-color (4 bit), 256-color (8 bit)
- Uncompressed

5.4.3 ESC/POS command

See "ESC/POS Application Programming Guide" about the method.

5.5 Printing for journal used

This printer can print on carbon paper (original + 1 copy.) This is available to use for journal. When you use this printer "Type A" model, you can take up the copied paper with Auto take-up unit. If you use this printer "Type B" model, you can cut each a receipt and the copy at same time.

A special control isn't required to use carbon paper; you can treat it as same as normal paper. However, when you use the Type A model with Auto take-up unit, you have to install carbon paper with Auto take-up unit. Please refer "Installing the Roll Paper for Type A" (page 3-9).

5.6 FAQ List

The questions shown in the list below begin with "Q" and their replies with "A."

1. Sentences beginning with "Q" provide information relating to a question or problem.
2. The instructions described in the "A" sentence answer the question or solve the problem.

5.6.1 Q. Drawer kick does not operate properly.

5.6.1.1 A. Drawer specifications differ, depending on the manufacturer and the part number.

We recommend to use a Drawer that is made by EPSON. These conditions also apply to any other devices that use the drawer kick-out connector. Any devices that do not satisfy all the following conditions must not be used.

[Conditions]

- A load must be provided between drawer kick-out connector pins 4 and 2 or between pins 4 and 5. (*1)
- When the drawer open/close signal is used, a switch must be provided between drawer kick-out connector pins 3 and 6. (*2)
- The resistance of the load must be 24 Ω or more, or the input current must be 1 A or less. (*3)
- Be sure to use drawer kick-out connector pin 4 (24 V power output) to drive the device. Never connect any other power supply to the drawer kick-out connector. (*4)

NOTES:

- (*1) Operating the printer with incorrectly installed devices voids the warranty.
- (*2) Connecting devices other than the drawer open/close switch voids the warranty.
- (*3) If a device with a resistance of less than 24 Ω or an input current of over 1 A is used, the resulting overcurrent may damage the device.
- (*4) Connecting a power supply other than that specified voids the warranty.

5.6.2 Q. Unable to print a part of Page 0 in Visual Basic.

Unable to print a part of Page 0 (for example **ä, ú, ë**) in Visual Basic.

5.6.2.1 A. Follow the procedure

When programming with Visual Basic, limitations prevent data from 81h through 9Fh and from E0h through FEh from being sent as characters. However, you can use the following procedure to send this data.

```
Dim Send_data(0) As Byte
Send_data(0) = &h81 '1 byte of sending data
MSComm1.Output = Send_data
```

Chapter 6

Notices for Replacement of the TM-U210/TM-U300

TM-U220 is designed to smoothly replace the TM-U210/TM-U300. This section gives answers to your questions.

6.1 For Replacement of the TM-U210

When you replace TM-U210 with the TM-U220, you have to set the memory switch [MemSW8-5: OFF (default)] and [MemSW 8-8: OFF (default)] to get the same status provided by the TM-U210. See "6.1.6 Provided statuses (6-5 page)" for details.

6.1.1 About printing format compatibility

The TM-U220 can provide almost the same printing result as the TM-U210. This section describes the reasons, which are printing area compatibility, character compatibility, and top margin compatibility (cutting position.)

6.1.1.1 Printing area

The TM-U220 has almost the same printing area as TM-U210 as shown in the following table and figures. Therefore, the TM-U220 can print same contents as the TM-U210 without adjusting any original control sources.

Printing areaitem	TM-U210 (Type A,B,D)	TM-U220 (Type A,B, D) (when 76mm paper using)
Print width	63.34mm (200dots, 400 position)	63.34mm (200dots,400position)
Left margin	(5.9mm)	6.8mm
Right margin	(6.76mm)	5.8mm

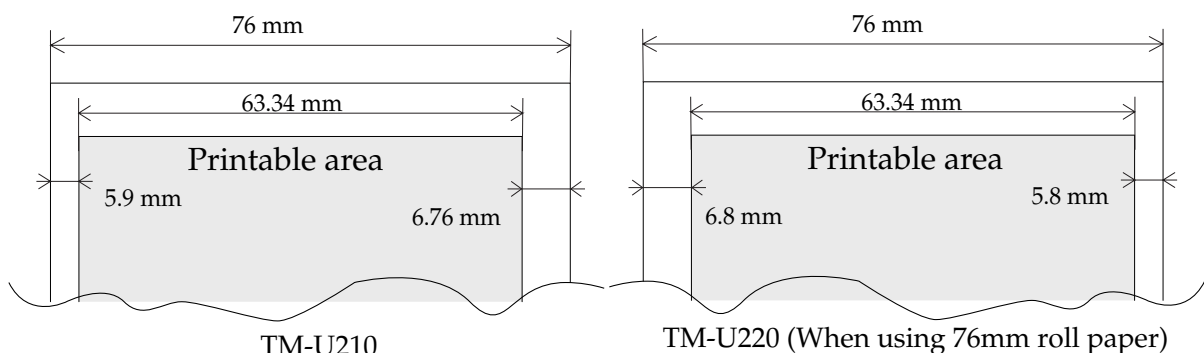

These values are reference values

Printing area and margins

6.1.1.2 Characters

TM-U220 has almost the same character spec as the TM-U210. Therefore, the TM-U220 can print the same contents as the TM-U210 without adjusting any original control sources.

Character spec		TM-U210 (Type A,B,D)	TM-U220 (Type A,B, D)
Character par line (CPI)	Font A (9 x 9)	33 (35) cpl	33 (35) cpl
	Font B (7 x 9)	40 (42) cpl	40 (42) cpl
	Kanji (16 x 16)	25 (22) cpl	25 (22) cpl
Character width	Font A (9 x 9)	1.6 x 3.1	1.6 x 3.1
	Font B (7 x 9)	1.2 x 3.1	1.2 x 3.1
	Kanji (16 x 16)	2.7 x 2.7	2.7 x 2.7
Character configuration		Code page 0 to 8, and 19 to 26	Code page 0 to 8, and 19 to 26 and code page 16, 17, 18



Note:

The character per line for Font A, B can be changed by DIP SW2-1.

The cpl for the Kanji character font can be changed by anESC/POS command. (default:22cpl to 25cpl)

6.1.1.3 Cutting position from print start position

TM-U220 has same distance between the auto cut position and the print start position as the TM-U210. Therefore the top margin is the same as the previous one when you replace the TM-U210 with the TM-U220 with autocutter. In other cases, please refer the table and figures below.

Cutting position	TM-U210 (Type A,B,D)	TM-U220 (Type A,B, D)
Autocutting position to print start position	27mm	27mm
Manual cut position to print start position	20.2mm	Type D: 22.1mm TypeA,B: 34.9mm
Cutting method of partial cut	one point left uncut position at center position. (Type A, B only)	one point left uncut position at right position. (Type A, B only)

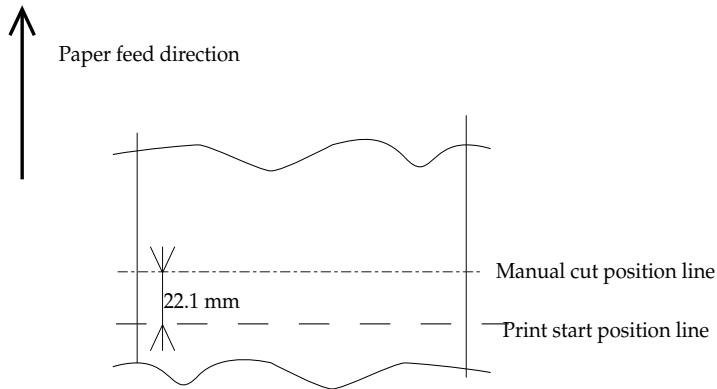

TM-U210 (Type A, B, D)

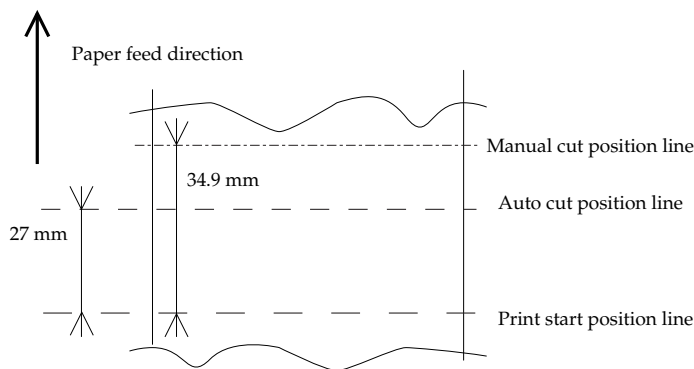

TM-U220 (Type A, B)
(When using 76mm roll paper)

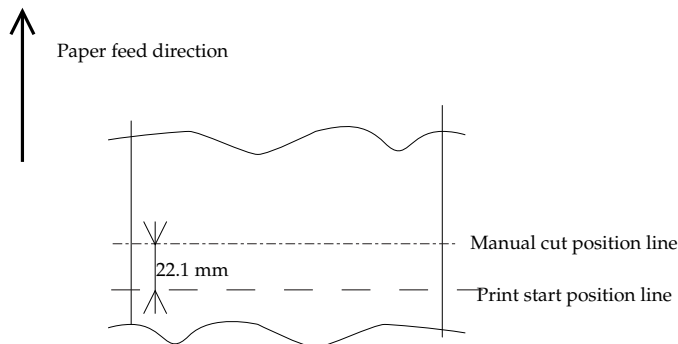

TM-U220 (Type D)
(When using 76mm roll paper)

These values are reference values

6.1.2 Cutting Method

The partial cut method for the TM-U220 (Type A, B) is a little different from the TM-U210. The TM-U210 always uses the partial cut method. The partial cut method is one point left uncut at the center position, so the method is different from that of the TM-U220 in respect to the uncut position. The TM-U220 leaves the right position uncut in the partial cut.

6.1.3 Dimensions

Some dimensions of the TM-U220 are smaller than those of the TM-U210 except Type D. Therefore, the TM-U220 Type A and B printers can be installed in the same space as the TM-U210 Type A and B.

		TM-U210	TM-U220
Dimensions (W x D x H) (Unit: mm)	Type A	160 x 295 x 160	160 x 286 x 158
	Type B	160 x 248 x 150	160 x 248 x 139
	Type D	160 x 248 x 133	160 x 248 x 139

See “1.7.1 External Dimensions and Mass (1-16 page)” for details.

6.1.4 Receive buffer size

This topic is for serial model.

The receive buffer size of the TM-U220 can be changed as shown in the following table.

Product	Receive buffer capacity	Condition of buffer full	Condition of release full state	Byte number from buffer full to release full state
TM-U210	40 bytes (DIP SW1-2 is On) (ANK: DIP SW1-2 is Off) 1K bytes (Multilingual: DIP SW1-2 is Off) 512 bytes	Buffer space is 16 bytes	Buffer space is 26 bytes	10 bytes
TM-U220	40 bytes (DIP SW1-2 is On)	Buffer space is 16 bytes	Buffer space is 26 bytes	10 bytes (Regardless of MemSW8-7)
	4K bytes (DIP SW1-2 is Off) (default)	Buffer space is 128 bytes	Buffer space is 256 bytes	128 bytes (MemSW8-7:OFF) (default)
		Buffer space is 128 bytes	Buffer space is 138 bytes	10 bytes (MemSW8-7: ON)



Note:

The receive buffer of TM-U210 may cause lost data at bufferfull state when there is no FIFO setting, or the FIFO setting is larger than 16 bytes. However, the TM-U220 will have enough remaining receive buffer space to prevent data loss at bufferfull state when DIP SW1-2 is Off regardless of the setting of MemSW 8-7.

The “Byte number from buffer full to release full state” is larger than TM-U210. It is for improvement. However, you should pay attention to the following:

6.1.4.1 Effect on the application when condition of buffer full is changed

The time from buffer empty to buffer full becomes longer. However, there are no cases in which the Host PC watches the time. Therefore, there should be no problem.

6.1.4.2 Effect on the application in the condition of release full state

The time from buffer full to releasing full state becomes longer than for the TM-U210. There is a possibility that the application gets a time-out. For countermeasure, Memory switch [MemSW8-7] assigned for selection of buffer-full release condition, 256 bytes (default) of 138 bytes. Therefore when the time-out occurs, set the memory switch [MemSW8-7] on.

6.1.5 Accessories compatibility

TM-U220 can use same consumables as the TM-U210. However, the power supply unit isn't compatible. The following sections describe these.

6.1.5.1 Power supply unit

The TM-U220 can't use the power supply unit of TM-U210 (PA-#### or PB-####.) The TM-U220 can use the power supply units only as described in the following table.

TM-U220 ANK model (Type A,B, D)	TM-U220 Multilingual model (Type A,B, D)
AC Adapter C (which is packed with ANK model) or PS-180 (Which is provided as option)	PS-180 (which is packed with Multilingual model)

 **CAUTION:**

Don't use the PA-#### or PB-#### power supply unit with TM-U220. Connection to an improper power source may cause fire or shock.

6.1.5.2 Consumable compatibility

TM-U220 can use same consumables as the TM-U210 except the carbon roll paper. (original + 2 copies. TM-U220 can't print on carbon roll paper with 2 copies.)

Consumables	TM-U210 (Type A,B,D)	TM-U220 (Type A,B, D)
Ribbon cassette	ERC-38 (B), (P), (B/R)	ERC-38 (B), (P), (B/R)

6.1.6 Provided statuses

TM-U220 has same statuses as TM-U210; in addition, the TM-U220 has the following status added. About the purpose of these, see "5.1 Various Status Categories (5-1 page)."

- Roll paper cover open/close status (and detector)

When you replace the TM-U210 with the TM-U220, you have to set the Memory switch as described below. These settings make the TM-U220 have almost the same as behavior as the TM-U210 statuses.

- Msw 8-5 "Cover open status mapping" : OFF
(Default: Paper end status)
- Msw 8-8 "Error select when cover is opened during printing": OFF
(Default: Auto recover error)

See the next tables for the behavior.

The status behavior is as following two tables.

Printer status bit	U210			
	Off-line	Paper-out LED	Waiting on-line recovery	Cover open
Operation when paper-end				
1) Paper end occurs.	OFF line	ON	OFF	--
2) Operator opens the cover for setting a paper roll.	OFF line	ON	OFF	--
3) Operator installed paper roll then closed cover.	OFF line	OFF	waiting on-line recover	--
4) Type B,D: Operator pressed FEED SW when paper out LED blinks. Type A: After approx.500msec. passed.	On line	OFF	OFF	--

This printer doesn't have cover open sensor. Therefore, there are no status.

ASB(Auto Status Back) notification does not occur because status did not change.

ASB(Auto Status Back) notification occurs because status is changed.

Printer status bit	U220 (Msw 8-5: OFF)				U220 (Msw 8-5: ON)			
	Off-line	Paper-out LED	Waiting on-line recovery	Cover open	Off-line	Paper-out LED	Waiting on-line recovery	Cover open
Operation when paper-end								
1) Paper end occurs.	OFF line	ON	--	OFF	OFF line	ON	--	OFF
2) Operator opens the cover for setting a paper roll.	OFF line	ON	--	<u>OFF</u>	OFF line	ON	--	<u>ON</u>
3) Operator installed paper roll then closed cover.	On line	OFF	--	OFF	On line	OFF	--	OFF

This "Cover open" means;
Off: Cover is closed
On: Cover is opened

The mapping of cover open status is as following two tables.

Printer status bit	U210			
	Off-line	Paper-out LED	Waiting on-line	Cover open
Operation when paper-end				
Operation when cover open				
Cover open	OFF	OFF	OFF	--
Cover close	OFF	OFF	OFF	--

Printer status bit	U220 (Msw 8-5: OFF)				U220 (Msw 8-5: ON)			
	Off-line	Paper-out LED	Waiting on-line	Cover open	Off-line	Paper-out	Waiting on-line	Cover open
Operation when paper-end								
Cover open	OFF	<u>ON</u>	--	<u>OFF</u>	OFF	<u>OFF</u>	--	<u>ON</u>
Cover close	OFF	OFF	--	OFF	OFF	OFF	--	OFF

You don't have to be afraid when you use the printer with OPOS or Advanced Printer Driver (APD) and you set the memory switch as [MemSW 8-5: OFF], [MemSW 8-8: OFF]. Because the status behavior normally doesn't affect your application.

When you use the printer with ESC/POS commands (when you control printer without any driver), read the sentences below:

The TM-U210 uses the "waiting on-line recover" bit in ASB status (the bit may indicate "0" or "1"); however, the TM-U220 does not use the bit (the bit is always "0"). Because the TM-U220 recovers to online when the cover is closed (cover is closed is detected by the cover open detector.) Therefore, if your application program watches the bit, confirm that it doesn't affect the performing of program.

By the way, the ASB data transmitted timing of TM-U220 is same as TM-U210. You don't have to be afraid when your application program doesn't watch the bit.



Note:

The "waiting on-line recover" is a status which is constructed by a bit in ASB (Auto Status Back) data. The status is for telling that the printer is not prepared to print (roll paper cover isn't closed, etc...) to the host PC. The status tells that the preparation done by the host PC is canceled. This status is canceled by action of the FEED button or host PC. These canceling actions must be executed after the roll paper is installed and roll paper cover is closed.

The "waiting on-line recover" bit of TM-U220 is always "0," because the TM-U220 can tell "ready for printing (roll paper is installed and roll paper cover is closed)" to the host PC.

6.1.7 Use for Journal

TM-U220 Type A is able to be used for journal as TM-U210 (Type A.) However, notice following item when you replace the TM-U210 with the TM-U220.

- ❑ TM-U210 (Type D) can print on carbon roll paper with 2 copies; however, the TM-U220 can print on carbon roll paper with 1 copies, not 2 copies.

6.1.8 New functions added

6.1.8.1 Wall hanging

The TM-U220 can be installed on a wall. The installing requires an option, the "WH-10."

6.1.8.2 NV bit-image

The TM-U220 can print bit-images on roll paper. See "5.4 NV Bit-image Printing (5-8 page)" for details.

6.1.8.3 User NV memory

The TM-U220 can store some text data. See "5.3 NV memory (5-6 page)" for details.

6.1.8.4 Memory Switch and memory switch setup mode

The TM-U220 has a Memory switch which is a software DIP switch. The memory switch setup mode is for adjusting the memory switches by printer only (No host PC needed.) See “3.4.3 Memory Switches (3-17 page)” and “3.4.4 Memory Switch Setup Mode (3-19 page)” for detail.

6.1.9 Driver compatibility

This section informs you the compatibility and notices for replacing.

6.1.9.1 Advanced Printer Driver

The TM-U220 has compatibility with the TM-U210 in APD. Therefore, the TM-U210 Advanced Printer Driver can drive the TM-U220. However, the print margin is little different from the original output, and the TM-U210 driver can't use NV memory functions. See “6.1.1 About printing format compatibility (6-1 page)” and “6.1.8 New functions added (6-7 page)” for the differences.

6.1.9.2 OPOS

TM-U220 has compatibility with the TM-U210 in OPOS. Therefore, the TM-U210 OPOS can drive the TM-U220. However, the print margin is a little different from the original output, and the TM-U210 driver can't use NV memory functions. See “6.1.1 About printing format compatibility (6-1 page)” and “6.1.8 New functions added (6-7 page)” for the differences.

6.1.9.3 ESC/POS command (Direct control)

The TM-U220 has compatibility with the TM-U210 in ESC/POS commands. Therefore, a program source for the TM-U210 can drive the TM-U220. However, the print margin is a little different from original output. See “6.1.1 About printing format compatibility (6-1 page)” for the difference.

6.2 For Replacement of the TM-U300

6.2.1 About Printing format compatibility

The TM-U220 can print almost the same printing result as the TM-U210/TM-U300. This section describes the reasons which are printing area compatibility, character compatibility, and top margin compatibility (cutting position.)

6.2.1.1 Printing area

The TM-U220 has almost the same printing area as the TM-U300 as shown in the following table and figures. Therefore, the TM-U220 can print same contents as the TM-U300 without any adjustment of original control sources.

Printing areaitem	TM-U300 (Type A,B, C, D)	TM-U220 (Type A,B, D) (when 76mm paper using)
Print width	63.5mm (200dots, 400 position)	63.34mm (200dots,400position)
Left margin	6mm	6.8mm
Right margin	6.5mm	5.8mm

This value is reference value.

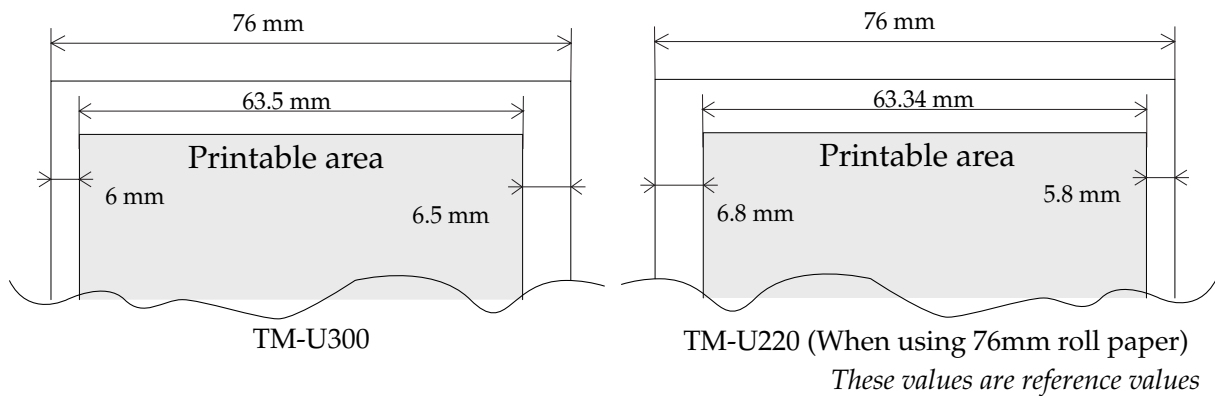

Printing area and margins

6.2.1.2 Characters

The TM-U220 has almost the same character spec as the TM-U300. Therefore, the TM-U220 can print the same contents as the TM-U300 without adjusting any original control sources.

Character spec		TM-U300 (Type A,B, C, D)	TM-U220 (Type A,B, D)
Character per line (CPI)	Font A (9 x 9)	33 cpl	33 (35) cpl
	Font B (7 x 9)	40 cpl	40 (42) cpl
	Kanji (16 x 16)	25 (22) cpl	25 (22) cpl
Character width	Font A (9 x 9)	1.6 x 3.1	1.6 x 3.1
	Font B (7 x 9)	1.2 x 3.1	1.2 x 3.1
	Kanji (16 x 16)	2.7 x 2.7	2.7 x 2.7
Character configuration		Code page 0 to 5	Code page 0 to 8, and 19 to 26 and code page 16, 17, 18



Note:

The character per line for Font A, B can be changed by DIP SW2-1.

The cpl of the Kanji character font can be changed by ESC/POS command. (default:22cpl to 25cpl)

6.2.1.3 Cutting position from print start position

The TM-U220 has almost the same distance from the auto cut position to the print start position as the TM-U300. Therefore the top margin is same as previous one when you replace the TM-U300 with the TM-U220 with an autocutter. In other cases, please refer the table and figures below.

Cutting position	TM-U300 (Type A,B, C, D)	TM-U220 (Type A,B, D)
A/C position to print start position	36mm	27mm
Manual cut position to print start position	26mm (type A, B) 28mm (type C, D)	Type D: 22.1mm Type A,B: 34.9mm

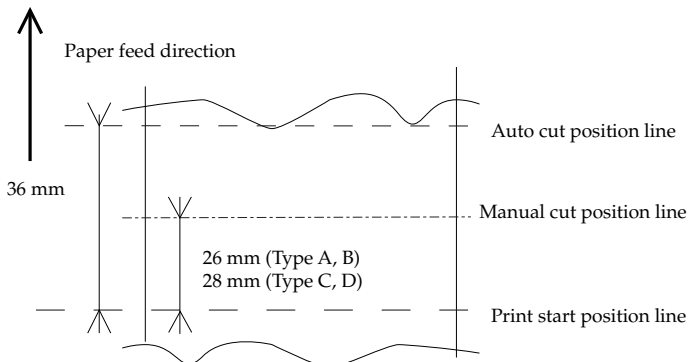

TM-U300 (Type A, B, C, D)

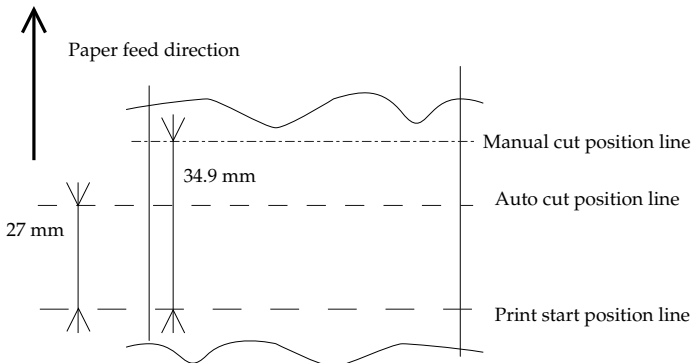

TM-U220 (Type A, B)
(When using 76mm roll paper)

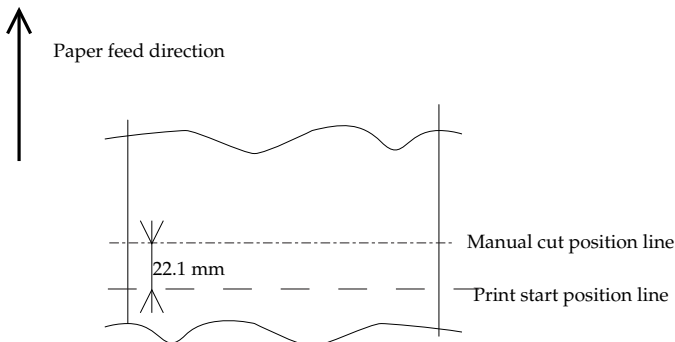

TM-U220 (Type D)
(When using 76mm roll paper)

These values are reference value

6.2.2 Cutting Method

The TM-U300 can select the partial cut method from Driver or ESC/POS command control. There are two partial cut methods, one is three points left method, the other is one point left uncut.

The TM-U220 allows you to select Partial cut (one point is left uncut at the right position) or Full cut (optional factory setting). These cannot be selected using the driver or with ESC/POS commands.

6.2.3 Dimensions

Some dimensions of the TM-U220 are smaller than those of the TM-U300 except Type D. Therefore, the TM-U220 can be installed in the same space as a TM-U300.

		TM-U300	TM-U220
Dimensions (W x D x H)	Type A:	170 x 288 x 183	160 x 286 x 158
	Type B:	170 x 253 x 148	160 x 248 x 139
	Type C:	158 x 295 x 145	--
	Type D:	158 x 235 x 125	160 x 248 x 139

See "1.7.1 External Dimensions and Mass (1-16 page)" for details.

6.2.4 Receive buffer size

This topic is for serial model.

The receive buffer size of the TM-U220 can be changed as shown in the following table.

Product	Receive buffer capacity	Condition of buffer full	Condition of release full state	Byte number from buffer full to release full state
TM-U300	40 bytes (DIP SW1-2 is On) (ANK: DIP SW1-2 is Off) 1K bytes (Multilingual: DIP SW1-2 is Off) 512 bytes	Buffer space is 10 bytes	Buffer space is 20 bytes	10 bytes
TM-U220	40 bytes (DIP SW1-2 is On)	Buffer space is 16 bytes	Buffer space is 26 bytes	10 bytes (Regardless of MemSW8-7)
	4K bytes (DIP SW1-2 is Off) (default)	Buffer space is 128 bytes	Buffer space is 256 bytes	128 bytes (MemSW8-7:OFF) (default)
		Buffer space is 128 bytes	Buffer space is 138 bytes	10 bytes (MemSW8-7: ON)



Note:

The receive buffer of TM-U300 may cause lost data at bufferfull state when there is no FIFO setting, or the FIFO setting is larger than 10 bytes. However, the TM-U220 will have enough remaining receive buffer space to prevent data loss at bufferfull state when DIP SW1-2 is Off regardless of the setting of MemSW 8-7.

The “Byte number from buffer full to release full state” is larger than TM-U300. It is for improvement.

However, you should pay attention to the following:

6.2.4.1 Effect to the application when condition of buffer full is changed

The time from buffer empty to buffer full becomes longer. However, there are no cases in which the host PC watches the time; therefore, there should be no problem.

6.2.4.2 Effect to the application when condition of release full state

The time from buffer full to releasing full state becomes longer than for the TM-U300. There is a possibility that the application gets a time-out. For countermeasure, Memory switch [MemSW8-7] is assigned for selection of buffer-full release condition, 256 bytes (default) of 138 bytes. Therefore when the time-out occurs, set the memory switch [MemSW8-7] to on.

6.2.5 Accessories compatibility

TM-U220 can use same consumables as the TM-U300. However, the power supply unit isn’t compatible. The following sections describe these.

6.2.5.1 Power supply unit

TM-U220 can’t use the power supply unit of TM-U300 (PA-#### or PB-####.) The TM-U220 can use the power supply units only as described in the following table.

TM-U220 ANK model (Type A, B, D)	TM-U220 Multilingual model (Type A, B, D)
AC Adapter C (which is packed with ANK model) or PS-180 (Which is provided as option)	PS-180 (which is packed with Multilingual model)



CAUTION:

Don’t use the PA-#### or PB-#### power supply unit with TM-U220. Connection to an improper power source may cause fire or shock.

6.2.5.2 Consumables compatibility

TM-U220 can use same consumables as the TM-U300 except a carbon roll paper (original + 2 copies. The TM-U220 can’t print on carbon roll paper with 2 copies.)

Consumables	TM-U300 (Type A, B, C, D)	TM-U220 (Type A, B, D)
Ribbon cassette	ERC-38 (P), (B/R)	ERC-38 (B), (P), (B/R)

6.2.6 Provided statuses and detectors

TM-U220 has same statuses as TM-U210/TM-U300. In addition, the TM-U220 has new statuses. The following sections describe them.

6.2.6.1 Newly added Status

The following statuses have been added for the TM-U220. About the use of these statuses , see “5.1 Various Status Categories (5-1 page).”

- Roll paper cover open/close status
- Roll paper near-end status (When equipped with a near-end detector [Factory option])

6.2.7 Use for Journal

TM-U220 Type A is able to be used for journal as TM-U300 (Type A, C.) However, notice the following item when you replace the TM-300 with the TM-U220.

- The TM-U300 can print on carbon roll paper with 2 copies; however, the TM-U220 can print carbon roll paper with 1 copies, not 2 copies.

6.2.8 Added new functions

6.2.8.1 Wall hanging

The TM-U220 can be installed on a wall. The installation requires an option, the “WH-10.”

6.2.8.2 NV bit-image

The TM-U220 can print bit-image on roll paper. See “5.4 NV Bit-image Printing (5-8 page)” for detail.

6.2.8.3 User NV memory

The TM-U220 can store some text data. See “5.3 NV memory (5-6 page)” for detail.

6.2.8.4 Memory Switch and Memory Switch setting mode

The TM-U220 has a memory switch ,which is a software DIP switch. The memory switch setting mode is for adjustingt the memory switches by printer only (No need for a host PC.) See “3.4.3 Memory Switches (3-17 page)” and “3.4.4 Memory Switch Setup Mode (3-19 page)” for details.

6.2.9 Driver compatibility

This section informs you the compatibility and notices for replacing.

6.2.9.1 Advanced Printer Driver

The TM-U220 does not have compatibility with the TM-U300 in the Advanced Printer Driver (APD). Therefore, the TM-U300 APD can't drive the TM-U220. However, you can print almost the same output as the TM-U300 APD by using the TM-U220 APD. The print margin is little different from original output. See "6.2.1 About Printing format compatibility (6-8 page)" for the difference.

6.2.9.2 OPOS

TM-U220 does not have compatibility with the TM-U210/TM-U300 in OPOS. Therefore, TM-U210/TM-U300 OPOS can't drive TM-U220. However, you can replace the printer module easily in OPOS. You only have to change the printer device to TM-U210 from other printer.

About the difference of print margin, see "6.2.1 About Printing format compatibility (6-8 page)."

6.2.10 ESC/POS command (Direct control)

The TM-U220 has some compatibility with the TM-U300 in ESC/POS commands. Therefore, a program source for the TM-U300 may drive the TM-U220. See also "6.2.1 About Printing format compatibility (6-8 page)" for the difference of print margin.

Appendix A

Comparison table for TM-U220/U210/U300

		TM-U300 (Type A, B, C, D)	TM-U210 (Type A, B, D)	TM-U220 (Type A, B, D)	
Print specification	Print method	Serial 9 pin Bi-direction, logical seeking		<==	
	Print speed	Approx. 3.5 lines/sec.(40 column, 16cpi)		"Approx. 4.7 lines/sec. (76mm, 40column, 16cpi, 1/6 inch line feed) Approx. 6.0 lines/sec.(57.5mm, 30column, 16cpi, 1/8 inch line feed)"	
	2 color printing	possible	possible	<==	
	Character per line	Font A (9 x 9)	33 cpl	33 (35) cpl	<==
		Font B (7 x 9)	40 cpl	40 (42) cpl	<==
		Kanji (16 x 16)	25 (22) cpl	25 (22) cpl	<==
	Character width	Font A (9 x 9)	1.6 x 3.1	1.6 x 3.1	<==
		Font B (7 x 9)	1.2 x 3.1	1.2 x 3.1	<==
		Kanji (16 x 16)	2.7 x 2.7	2.7 x 2.7	<==
	Character configuration	Code page 0 to 5	Code page 0 to 8, and 19 to 26	Code page 0 to 8, and 19 to 26 and code page 16, 17, 18	
Ribbon cassette	ERC-38 (P), (B/R)	ERC-38 (B), (P), (B/R)	<==		

		TM-U300 (Type A, B, C, D)	TM-U210 (Type A, B, D)	TM-U220 (Type A, B, D)
Paper supply functions	Roll Paper install method	Paper roll holding shaft	Paper roll drop in	<==
	Paper roll setting	Auto-loading	Auto-loading	1-2-3 setting
	Paper end detector	Yes	Yes	<==
	Paper near-end detector	Yes	Option	Factory option.
	Cover open detector	Yes	No	Yes
	Validation detector	Yes (Option for type C, D)	No Validation function	<==
	Paper feed method	Friction feed	Friction feed	<==
	Paper feed length	Default 4.23mm(1/6 inches); changeable by command	Default 4.23mm(1/6 inches); changeable by command	<==
	Paper feed speed	25 lines/sec	25 lines/sec	30 lines/sec
Paper specification	Paper roll dimensions	Paper width:76mm, Roll diameter: max.83mm	Paper width:76mm, Roll diameter: max.83mm	Paper width: 76mm (Type A) 76mm / 69.5mm / 57.5mm (Type B, D) Roll diameter: max 83mm
	Normal paper	Paper thickness: 0.06 ~ 0.085mm	Paper thickness: 0.06 ~ 0.085mm	<==
	Carbon paper	Number of copies Original + 1 copies Original + 2 copies (at temperature approx. 25C°) (Copy mode need to be set by command)	Original + 1 copies Original + 2 copies (type D only)	Original + 1 copies (for all type A, B, D)
	Validation paper	Type C, D only	Not supported	<==

		TM-U300 (Type A, B, C, D)	TM-U210 (Type A, B, D)	TM-U220 (Type A, B, D)	
Take up unit		Auto-take up (type A, C)	Auto-take up (type A)	<==	
Autocutter (type A/B)		Full cut / partial cut; selectable by command	Partial cut (one point left uncut at center position)	Partial cut or full cut (optional factory setting) (Partial cut: one point left uncut at right position.)	
Print area	A/C position to print start position	36mm	27mm	<==	
	Manual cut position to print start position	26mm (type A, B)	20.2mm	34.9mm (Type A, B)	
		28mm (type C, D)		22.1mm (Type D)	
	Print width	63.5mm (200dots, 400 position)	63.34mm (200dots, 400 position)	76: 63.34mm(200dots,400position), 69.5: 57mm(180,360), 57.5:47.5mm(150,300)	
	Left margin	(6mm)	(5.9mm)	76: 6.8mm, 69.5: 6.7mm, 57.5: 4.2mm	
Right margin	Approx. 6.5mm	(6.76mm)	76: 5.8mm, 69.5: 5.8mm, 57.5: 5.8mm		
Internal buffer	Receive buffer	ANK model	1K bytes / 40 bytes: selectable	1K bytes / 40 bytes: selectable	4K bytes / 40 bytes: selectable
		Multi-language model	512 bytes / 40 bytes; selectable	512 bytes / 40 bytes; selectable	4K bytes / 40 bytes: selectable
	NV bit image	ANK model	No	No	128K bytes
		Multi-language model	No	No	128K bytes
	User NV memory	ANK model	No	No	8K bytes
		Multi-language model	No	No	8K bytes

		TM-U300 (Type A, B, C, D)	TM-U210 (Type A, B, D)	TM-U220 (Type A, B, D)
Applicable Power supply unit	For North America	PA-6509 or PB-6509	PB-6509	For ANK model: AC Adapter C which is in carton box. or PS-180 For Multi-language model: PS-180.
	For Europe (Germany)	PA-6510 or PB-6510	PB-6510	
	For Europe (U.K.)	PA-6511 or PB-6511	PA-6511	
	Australia	PA-6513 or PB-6513	PA-6513	
Dimensions (W x D x H)		Type A; 170 x 288 x 183	Type A; 160 x 295 x 160	Type A: 160x286x158
		Type B: 170 x 253 x 148	Type B: 160 x 248 x 150	Type B: 160x248x139,
		Type C; 158 x 295 x 145	--	--
		Type D; 158 x 235 x 125	Type D; 160 x 248 x 133	Type D: 160 x 248 x 139 Printer tray of IR option can be used.
Burn-resistant grade of case		V-0	V-0	V-0
Install		Horizontal (max. slant 15 degree) and Wall hanging possible.(Type B, D)	Horizontal (max. slant 15 degree)	Horizontal (max. slant 15 degree) and Wall hanging possible.(Type B, D)

Appendix B

How to Install the Printer on a Wall with the WH-10

WH-10 is a option for the TM printer series, with it you can install a TM-U220 on a wall. This section describes how to install wall hanging TM-U220. See the “WH-10 installation Manual” for details.

B.1 The Procedure

B.1.1 Precautions

- ❑ Static electricity may cause cut paper to adhere to the printer case.
(This static electricity will not affect the operation of the printer.)

B.1.2 Unpacking

Open the package and confirm that it contains all of the parts listed in the illustration. If any parts are missing or damaged, please contact your dealer for assistance.

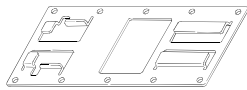

wall-mount (note: screws for wall-mount not included; see the installation section.)

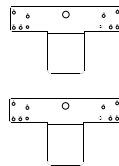

brackets (2 pieces)



control panel sheets
Please attach the appropriate sheet.



installation manual

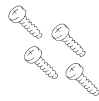

screws for brackets (3×12)
(4 pieces)



screws (3×10)



screws (3×6) (5 pieces)
Note: 4 of the screws are used for attaching the brackets

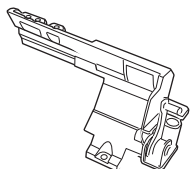

roll paper holder for hanging bracket

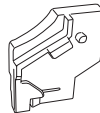

cam

Note:

Other parts are packed for other TM printer series.

Depending on the conditions during storage and shipping, some rust may form around the edges of the wall-mount or brackets. This may be removed with sandpaper.

B.1.3 Installation

Before installation, be sure that the printer and all equipment connected to the printer is turned off. Detach all cables from the body of the printer.

B.1.3.1 Installing the wall-mount

CAUTION:

The weight of the printer is approx. 2.5 kg for the TM-U220 Type B, and approx. 2.3 kg for the TM-U220 Type D. In order to insure that the wall-mount can properly support the weight of the printer, please secure it with screws appropriate to the type of wall the wall-mount is installed on. A screw with 4 mm diameter and length of 12 mm or more is recommended. The thickness of the wall should be 10 mm or more.

Be sure to fasten the wall-mount securely to the wall with a screw in each of the ten holes.

Before attaching the wall-mount, make sure enough space remains around the printer.

Make sure that there is enough space for opening the printer cover.

Attach the wall-mount to the wall in the position illustrated to the right (with the area marked A at the top), and fasten securely with ten screws. These screws are not included; please use screws appropriate to the type of wall being used.

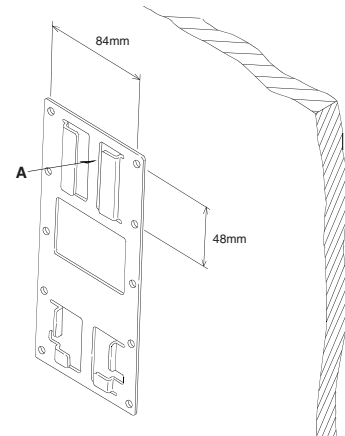

B.1.4 Affixing the operation panel sheet

When you mount the printer on the wall, the operation panel on the printer will be upside down. Therefore, operation panel sheets in the correct direction for wall mounting have been enclosed.

Align the FEED switch mark on the operation panel sheet with the FEED switch mark on the printer operation panel and affix the operation panel sheet to the printer.

B.1.5 Changing the roll-paper detector position

Two types of screws are used with the WH-10: 3×6 and 3×10. The longest screw (3×12) will not be used.

1. Open the roll paper cover.
For a model that does not have a roll-paper near-end detector and does not need a change in paper width, jump to step 7. For a model that does not have a roll-paper near-end detector and needs a change in paper width, jump to step 3

- Loosen the detector adjustment screw a little bit by using a tool such as a coin and then loosen the screw gently by hand as until it stops. It must not be removed completely.

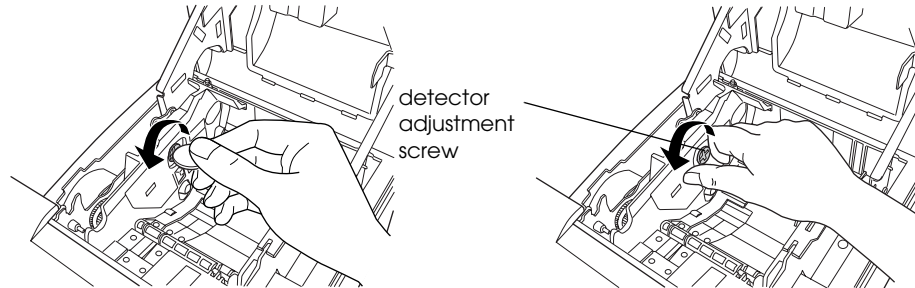

- Remove the two screws of the roll paper guide.

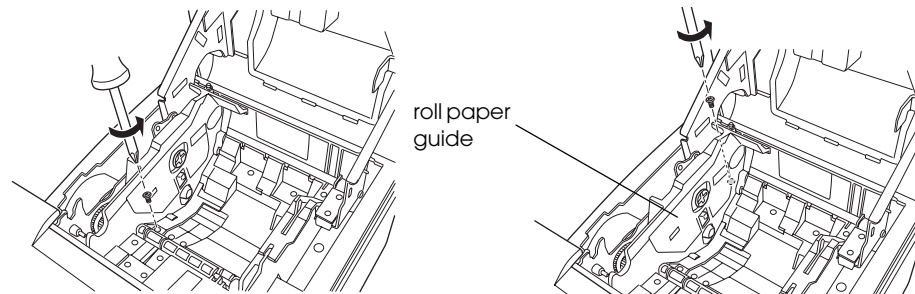

For a model that does not have a roll paper near-end detector , jump to step 6.

- Rotate the detector lever on the roll paper guide to change its direction.

 **Note:**

After the direction of the detector lever is changed, be sure that the cable is connected to the connector firmly.

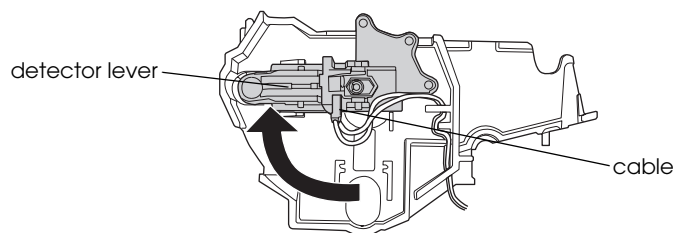

- Tighten the detector adjustment screw.
- Align the hole on the roll paper guide with the hole on the roll paper holder to match your roll paper width and then tighten the screw (3×10).

 **Note:**

You will not use one of the two screws that have been removed when the roll paper guide is removed. Please store it as an extra screw in case you need it.

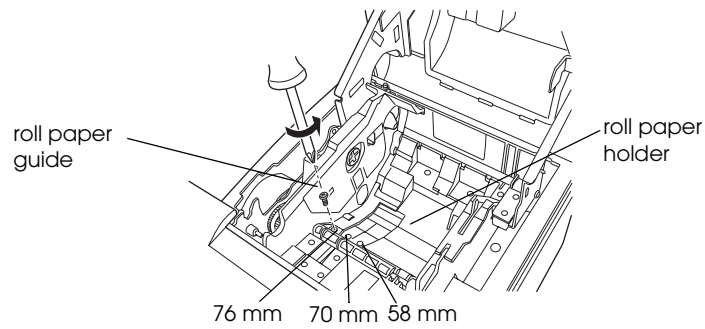

7. Align the hole on the roll paper holder for hanging bracket with the dowel on the roll paper guide. (For a model that needs a change of paper width, the hole to be used will be different to match your roll paper width.)

Putting the screw (3×6) in the hole on the roll paper holder for hanging bracket makes it easier for you to tighten the screw in the next step.

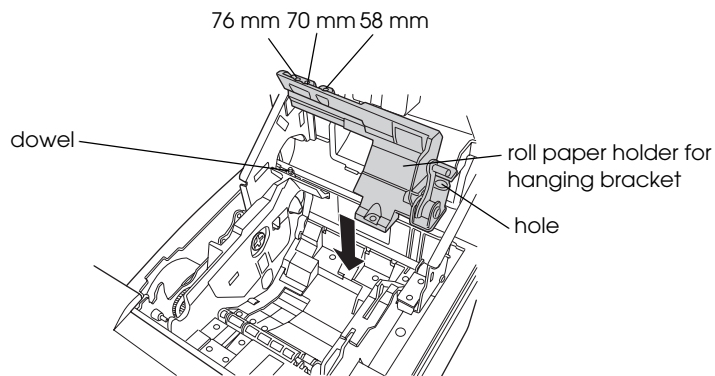

8. Tighten the screw (3×6) to fix the roll paper holder for hanging bracket and the base frame.

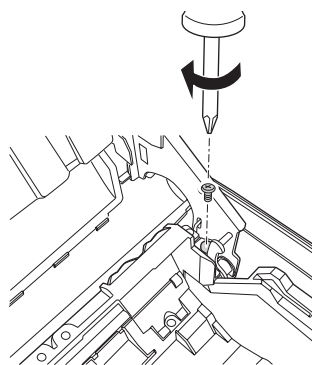

9. Tighten the screw (3×10) to fix the roll paper holder for hanging bracket and the roll paper holder.

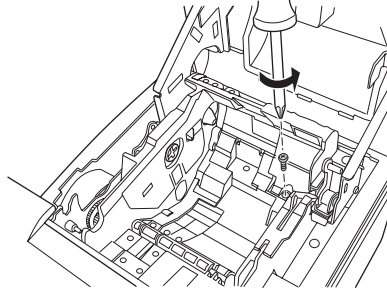

10. Check that the brake arm is up as shown in the illustration below.

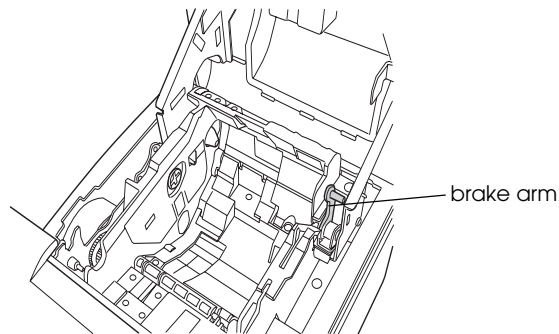

⚠ CAUTION:

Do not move the brake arm until the roll paper holder for hanging bracket is attached onto the base frame. Otherwise the arm part will be damaged.

11. Insert the dowel of the cam into the hole of the platen frame.

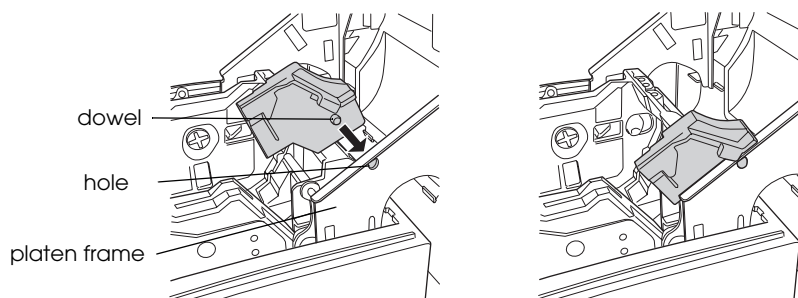

12. While you make sure the pin of the brake arm is in the groove on the inner side of the cam, rotate the cam along with the surface of the platen frame in the direction indicated by the arrow until it clicks into position.

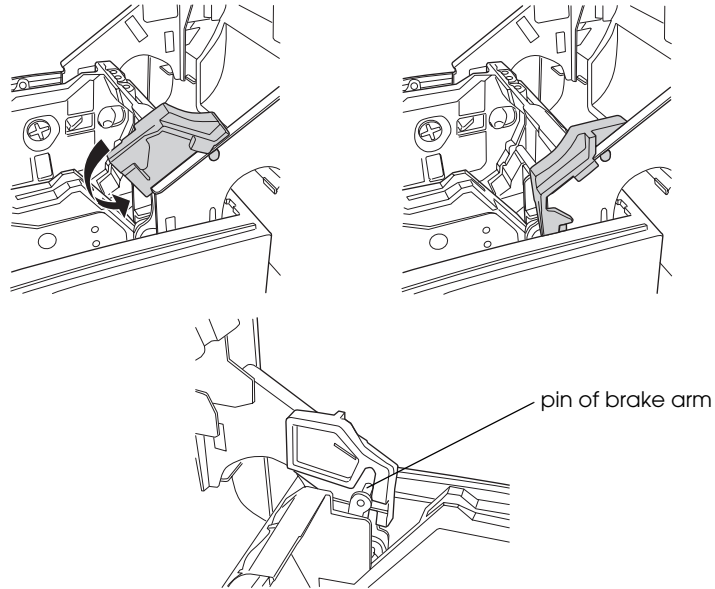

13. Close the printer cover.



Note:

When closing the cover, push the middle of the printer indicated by the circle in the illustration below.

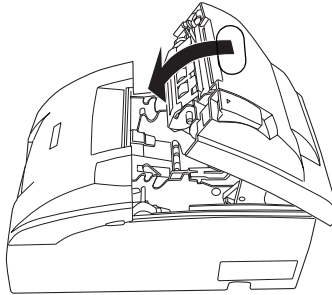

14. Turn the printer over and then put it on a packing box as a platform horizontally.

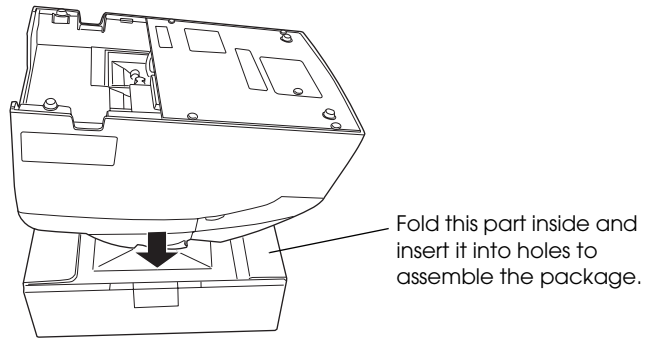

15. See the "Installing the Brackets" section for attaching the brackets.

Removing the cam

While you push the cam through the hole on the platen frame with a pointed tool such as tweezers, rotate the cam in the upper direction to remove it.

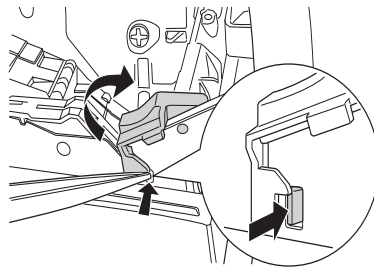

B.1.6 Installing the brackets

Four different sets of screw holes are found on each bracket. Each hole is identified by a number; be sure to use the holes indicated in the instructions.

Attach the upper bracket to the holes numbered "2" and the lower bracket to the holes numbered "1" using the screws (3×6).

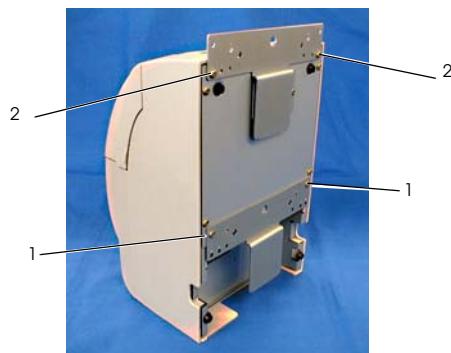

B.1.7 Mounting the printer on the wall



CAUTION:

When mounting the printer, make sure that the wall-mount is securely fastened to the wall.

When the brackets are attached properly for the TM-U220B/U220D, the printer's operation panel will be on the top and the connector side on the bottom. If this is not the case, please see the installing the brackets section and reattach the brackets in the proper position.

Slide the brackets into the slots of the wall-mount, starting with the top bracket.

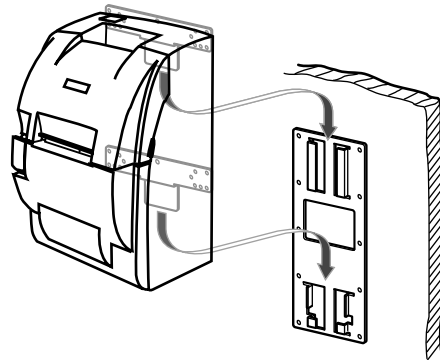

B.2 Exterior Overviews

B.2.1 TM-U220 (Type B)

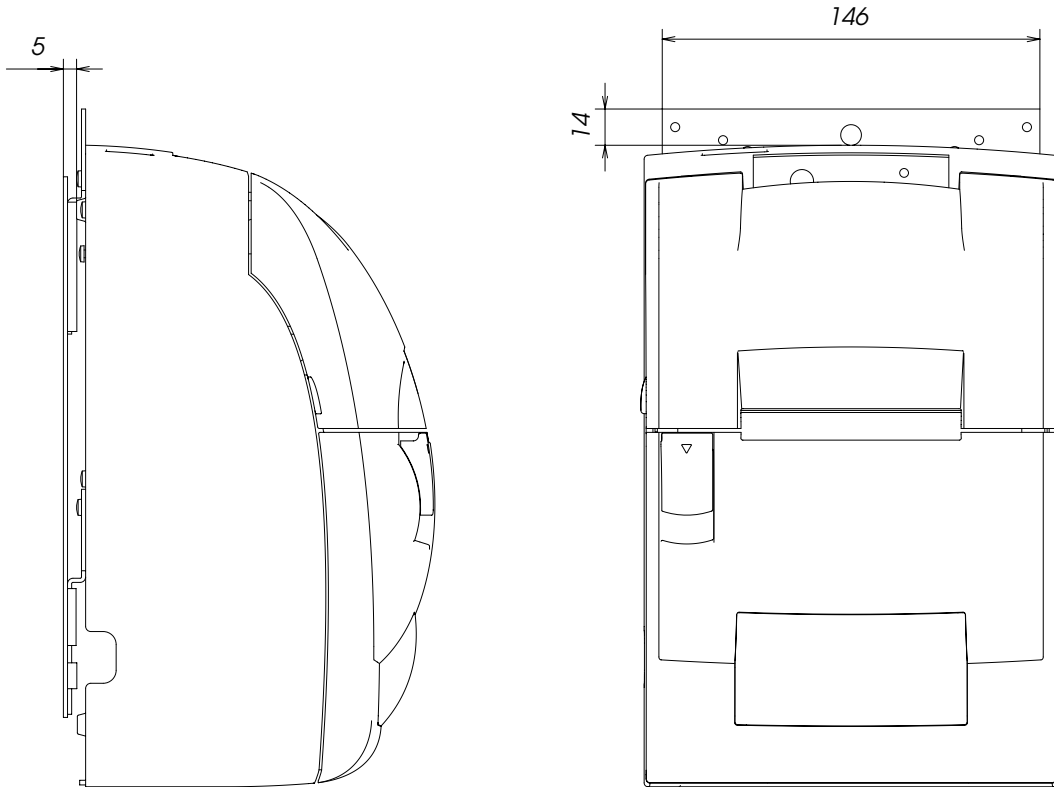

B.2.2 TM-U220 (Type D)

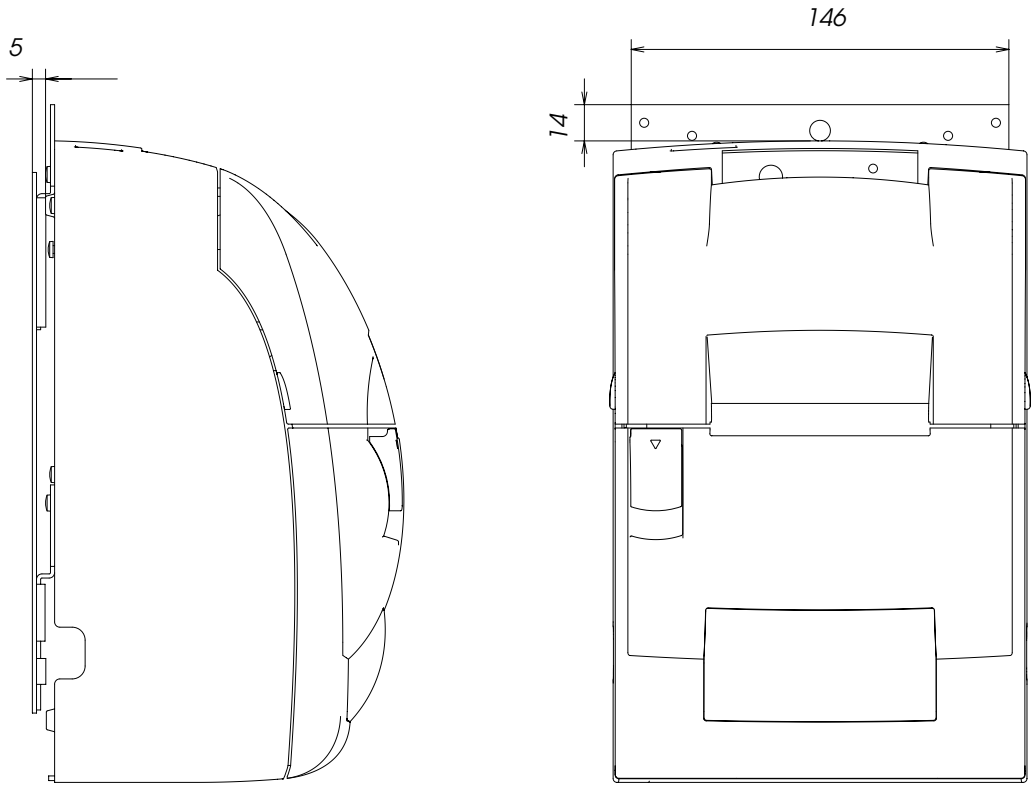

Appendix C

Character Code Table

C.1 Page 0 (PC437: USA, Standard Europe)

(International character set: when U.S. is selected.)

HEX	O	I	2	3	4	5	6	7	8	9	A	B	C	D	E	F
0000	NUL															
0001	DLE	SP	!	"	#	\$	%	&	'	()	*	+	,	-	.
0002	XON		1	2	3	4	5	6	7	8	9	:	;	<	=	>
0003			A	B	C	D	E	F	G	H	I	J	K	L	M	N
0004																
0005																
0006																
0007																
0008																
0009																
1010	LF															
1011	ESC															
1100	FF	FS														
1101	CR	GS														
1110																
1111																

C.2 Page 1 (Katakana)

	HEX	8	9	A	B	C	D	E	F
HEX	BIN	1000	1001	1010	1011	1100	1101	1110	1111
0	0000	┌ 128	┌ 144	SP 160	一 176	夕 192	ミ 208	二 224	× 240
1	0001	┌ 129	┌ 145	。○ 161	ア 177	チ 193	ム 209	ト 225	円 241
2	0010	┌ 130	┌ 146	「 162	イ 178	ツ 194	メ 210	≠ 226	年 242
3	0011	┌ 131	┌ 147	」 163	ウ 179	テ 195	モ 211	≠ 227	月 243
4	0100	┌ 132	┌ 148	、 164	エ 180	ト 196	ヤ 212	▲ 228	日 244
5	0101	┌ 133	┌ 149	・ 165	オ 181	ナ 197	ユ 213	▲ 229	時 245
6	0110	┌ 134	┌ 150	ヲ 166	カ 182	ニ 198	ヨ 214	▼ 230	分 246
7	0111	┌ 135	┌ 151	ア 167	キ 183	ヌ 199	ラ 215	▼ 231	秒 247
8	1000	┌ 136	┌ 152	「 168	ク 184	ネ 200	リ 216	♠ 232	〒 248
9	1001	┌ 137	┌ 153	「 169	ケ 185	ノ 201	ル 217	♥ 233	市 249
A	1010	┌ 138	┌ 154	「 170	コ 186	ハ 202	レ 218	◆ 234	区 250
B	1011	┌ 139	┌ 155	」 171	サ 187	ヒ 203	ロ 219	♣ 235	町 251
C	1100	┌ 140	┌ 156	「 172	シ 188	フ 204	ワ 220	● 236	村 252
D	1101	┌ 141	┌ 157	「 173	ス 189	ヘ 205	ン 221	○ 237	人 253
E	1110	┌ 142	┌ 158	「 174	セ 190	ホ 206	・ 222	／ 238	☼ 254
F	1111	┌ 143	┌ 159	「 175	ソ 191	マ 207	・ 223	＼ 239	SP 255

C.3 Page 2 (PC850: Multilingual)

	HEX	8	9	A	B	C	D	E	F
HEX	BIN	1000	1001	1010	1011	1100	1101	1110	1111
0	0000	Ç 128	É 144	á 160	☒ 176	┌ 192	ð 208	Ó 224	— 240
1	0001	ü 129	æ 145	í 161	☒ 177	└ 193	Ð 209	ß 225	± 241
2	0010	é 130	Æ 146	ó 162	☒ 178	┘ 194	Ê 210	Ô 226	= 242
3	0011	â 131	ô 147	ú 163	 179	┘ 195	Ë 211	Ò 227	³ / ₄ 243
4	0100	ä 132	ö 148	ñ 164	┘ 180	— 196	È 212	õ 228	¶ 244
5	0101	à 133	ò 149	Ñ 165	Á 181	┘ 197	ı 213	Õ 229	§ 245
6	0110	â 134	û 150	a 166	Â 182	ã 198	Í 214	µ 230	÷ 246
7	0111	ç 135	ù 151	o 167	À 183	Ã 199	Î 215	þ 231	· 247
8	1000	ê 136	ÿ 152	ı 168	© 184	┌ 200	İ 216	þ 232	° 248
9	1001	ë 137	Ö 153	® 169	┘ 185	┘ 201	┘ 217	Ú 233	¨ 249
A	1010	è 138	Ü 154	┘ 170	 186	┘ 202	┘ 218	Û 234	· 250
B	1011	ï 139	ø 155	¹ / ₂ 171	┘ 187	┘ 203	■ 219	Ù 235	¹ / ₂ 251
C	1100	î 140	£ 156	¹ / ₄ 172	┘ 188	┘ 204	■ 220	Ý 236	³ / ₄ 252
D	1101	ì 141	Ø 157	ı 173	¢ 189	= 205	ı 221	Ý 237	² / ₃ 253
E	1110	Ä 142	× 158	« 174	¥ 190	┘ 206	İ 222	— 238	■ 254
F	1111	Å 143	f 159	» 175	┘ 191	▣ 207	■ 223	’ 239	SP 255

C.4 Page 3 (PC860: Portuguese)

	HEX	8	9	A	B	C	D	E	F
HEX	BIN	1000	1001	1010	1011	1100	1101	1110	1111
0	0000	Ç <small>128</small>	É <small>144</small>	á <small>160</small>	☼ <small>176</small>	┌ <small>192</small>	└ <small>208</small>	α <small>224</small>	≡ <small>240</small>
1	0001	ü <small>129</small>	À <small>145</small>	í <small>161</small>	☼ <small>177</small>	└ <small>193</small>	┘ <small>209</small>	β <small>225</small>	≠ <small>241</small>
2	0010	é <small>130</small>	È <small>146</small>	ó <small>162</small>	☼ <small>178</small>	┘ <small>194</small>	┘ <small>210</small>	Γ <small>226</small>	≥ <small>242</small>
3	0011	â <small>131</small>	ô <small>147</small>	ú <small>163</small>	<small>179</small>	┘ <small>195</small>	┌ <small>211</small>	π <small>227</small>	≤ <small>243</small>
4	0100	ã <small>132</small>	õ <small>148</small>	ñ <small>164</small>	┘ <small>180</small>	— <small>196</small>	┌ <small>212</small>	Σ <small>228</small>	∫ <small>244</small>
5	0101	à <small>133</small>	ò <small>149</small>	Ñ <small>165</small>	┘ <small>181</small>	┘ <small>197</small>	┘ <small>213</small>	σ <small>229</small>	∫ <small>245</small>
6	0110	Á <small>134</small>	Ú <small>150</small>	a <small>166</small>	┘ <small>182</small>	┘ <small>198</small>	┘ <small>214</small>	μ <small>230</small>	÷ <small>246</small>
7	0111	ç <small>135</small>	ù <small>151</small>	o <small>167</small>	┘ <small>183</small>	┘ <small>199</small>	┘ <small>215</small>	τ <small>231</small>	≈ <small>247</small>
8	1000	ê <small>136</small>	ì <small>152</small>	¿ <small>168</small>	┘ <small>184</small>	┌ <small>200</small>	┘ <small>216</small>	Φ <small>232</small>	° <small>248</small>
9	1001	Ê <small>137</small>	Õ <small>153</small>	Ò <small>169</small>	┘ <small>185</small>	┘ <small>201</small>	┘ <small>217</small>	θ <small>233</small>	• <small>249</small>
A	1010	è <small>138</small>	Ü <small>154</small>	¬ <small>170</small>	<small>186</small>	└ <small>202</small>	┘ <small>218</small>	Ω <small>234</small>	· <small>250</small>
B	1011	í <small>139</small>	ç <small>155</small>	½ <small>171</small>	┘ <small>187</small>	┘ <small>203</small>	■ <small>219</small>	δ <small>235</small>	√ <small>251</small>
C	1100	Ô <small>140</small>	£ <small>156</small>	¼ <small>172</small>	┘ <small>188</small>	┘ <small>204</small>	■ <small>220</small>	∞ <small>236</small>	n <small>252</small>
D	1101	ì <small>141</small>	Ù <small>157</small>	¡ <small>173</small>	┘ <small>189</small>	<small>205</small>	■ <small>221</small>	ø <small>237</small>	² <small>253</small>
E	1110	Ã <small>142</small>	Þ <small>158</small>	« <small>174</small>	┘ <small>190</small>	┘ <small>206</small>	■ <small>222</small>	∈ <small>238</small>	■ <small>254</small>
F	1111	Â <small>143</small>	Ó <small>159</small>	» <small>175</small>	┘ <small>191</small>	└ <small>207</small>	■ <small>223</small>	∩ <small>239</small>	SP <small>255</small>

C.5 Page 4 (PC863: Canadian-French)

	HEX	8	9	A	B	C	D	E	F
HEX	BIN	1000	1001	1010	1011	1100	1101	1110	1111
0	0000	Ç 128	É 144	Ï 160	Ë 176	Ï 192	Ï 208	ɑ 224	≡ 240
1	0001	Û 129	È 145	Ï 161	Ë 177	Ï 193	Ï 209	β 225	± 241
2	0010	é 130	Ê 146	ó 162	Ë 178	Ï 194	Ï 210	Γ 226	≥ 242
3	0011	â 131	ô 147	ú 163	Ï 179	Ï 195	Ï 211	π 227	≤ 243
4	0100	Â 132	Ë 148	¨ 164	Ï 180	Ï 196	Ï 212	Σ 228	∫ 244
5	0101	à 133	ï 149	· 165	Ï 181	Ï 197	Ï 213	σ 229	∫ 245
6	0110	¶ 134	û 150	³ 166	Ï 182	Ï 198	Ï 214	μ 230	÷ 246
7	0111	ç 135	ù 151	— 167	Ï 183	Ï 199	Ï 215	τ 231	≈ 247
8	1000	ê 136	ɑ 152	î 168	Ï 184	Ï 200	Ï 216	Φ 232	° 248
9	1001	ë 137	Ô 153	Ï 169	Ï 185	Ï 201	Ï 217	θ 233	· 249
A	1010	è 138	Û 154	Ï 170	Ï 186	Ï 202	Ï 218	Ω 234	· 250
B	1011	ï 139	¢ 155	½ 171	Ï 187	Ï 203	■ 219	δ 235	√ 251
C	1100	î 140	£ 156	¼ 172	Ï 188	Ï 204	■ 220	∞ 236	n 252
D	1101	= 141	Û 157	¾ 173	Ï 189	Ï 205	■ 221	∅ 237	² 253
E	1110	À 142	Û 158	« 174	Ï 190	Ï 206	■ 222	∈ 238	■ 254
F	1111	§ 143	f 159	» 175	Ï 191	Ï 207	■ 223	∩ 239	SP 255

C.6 Page 5 (PC865: Nordic)

	HEX	8	9	A	B	C	D	E	F
HEX	BIN	1000	1001	1010	1011	1100	1101	1110	1111
0	0000	Ç 128	É 144	á 160	☒ 176	┘ 192	┘ 208	α 224	≡ 240
1	0001	ü 129	æ 145	í 161	☒ 177	┘ 193	┘ 209	β 225	± 241
2	0010	é 130	Æ 146	ó 162	☒ 178	┘ 194	┘ 210	Γ 226	≥ 242
3	0011	â 131	ô 147	ú 163	 179	┘ 195	┘ 211	π 227	≤ 243
4	0100	ä 132	ö 148	ñ 164	┘ 180	— 196	┘ 212	Σ 228	ƒ 244
5	0101	à 133	ò 149	Ñ 165	┘ 181	┘ 197	┘ 213	σ 229	Ј 245
6	0110	å 134	û 150	а 166	┘ 182	┘ 198	┘ 214	μ 230	÷ 246
7	0111	ç 135	ù 151	о 167	┘ 183	┘ 199	┘ 215	τ 231	≈ 247
8	1000	ê 136	ÿ 152	ı 168	┘ 184	┘ 200	┘ 216	Φ 232	° 248
9	1001	ë 137	Ö 153	┘ 169	┘ 185	┘ 201	┘ 217	θ 233	• 249
A	1010	è 138	Ü 154	┘ 170	 186	┘ 202	┘ 218	Ω 234	· 250
B	1011	ï 139	ø 155	½ 171	┘ 187	┘ 203	■ 219	δ 235	√ 251
C	1100	î 140	£ 156	¼ 172	┘ 188	┘ 204	■ 220	∞ 236	n 252
D	1101	ì 141	Ø 157	ı 173	┘ 189	== 205	■ 221	ø 237	² 253
E	1110	Ä 142	Pt 158	« 174	┘ 190	┘ 206	■ 222	€ 238	■ 254
F	1111	Å 143	f 159	α 175	┘ 191	┘ 207	■ 223	∩ 239	SP 255

C.7 Page 6 (Hiragana)

This page is available on the Japanese model only.

	HEX	8	9	A	B	C	D	E	F
HEX	BIN	1000	1001	1010	1011	1100	1101	1110	1111
0	0000	礎 128	本 144	SP 160	一 176	た 192	み 208	過 224	換 240
1	0001	129	145	。 161	あ 177	ち 193	む 209	225	241
2	0010	除 130	荷 146	「 162	い 178	つ 194	め 210	足 226	攻 242
3	0011	131	147	」 163	う 179	て 195	も 211	227	243
4	0100	定 132	特 148	、 164	え 180	と 196	や 212	利 228	産 244
5	0101	133	149	・ 165	お 181	な 197	ゆ 213	229	245
6	0110	信 134	越 150	を 166	か 182	に 198	よ 214	用 230	打 246
7	0111	135	151	あ 167	き 183	ぬ 199	ら 215	231	247
8	1000	緑 136	他 152	い 168	く 184	ね 200	り 216	移 232	納 248
9	1001	137	153	う 169	け 185	の 201	る 217	233	249
A	1010	科 138	社 154	え 170	こ 186	は 202	れ 218	下 234	変 250
B	1011	139	155	お 171	さ 187	ひ 203	ろ 219	235	251
C	1100	目 140	瓶 156	や 172	し 188	ふ 204	わ 220	加 236	誂 252
D	1101	141	157	ゆ 173	す 189	へ 205	ん 221	237	253
E	1110	々 142	奉 158	よ 174	せ 190	ほ 206	ゝ 222	解 238	件 254
F	1111	143	159	っ 175	そ 191	ま 207	。 223	239	255

C.8 Page 7 (One-pass printing Kanji characters)

This page is available on the Japanese model only.

	HEX	8	9	A	B	C	D	E	F
HEX	BIN	1000	1001	1010	1011	1100	1101	1110	1111
0	0000	日 128	会 144	水 160	受 176	点 192	課 208	買 224	非 240
1	0001	129	145	161	177	193	209	225	241
2	0010	扱 130	客 146	木 162	前 178	中 194	証 210	号 226	承 242
3	0011	131	147	163	179	195	211	227	243
4	0100	外 132	券 148	土 164	残 180	内 196	組 212	有 228	送 244
5	0101	133	149	165	181	197	213	229	245
6	0110	額 134	回 150	振 166	止 182	部 198	店 214	期 230	一 246
7	0111	135	151	167	183	199	215	231	247
8	1000	割 136	在 152	数 168	純 184	別 200	認 216	限 232	棄 248
9	1001	137	153	169	185	201	217	233	249
A	1010	検 138	算 154	精 170	替 186	戻 202	廃 218	頭 234	累 250
B	1011	139	155	171	187	203	219	235	251
C	1100	高 140	上 156	銭 172	代 188	門 204	両 220	差 236	違 252
D	1101	141	157	173	189	205	221	237	253
E	1110	価 142	火 158	総 174	値 190	料 206	効 222	括 238	番 254
F	1111	143	159	175	191	207	223	239	255

C.9 Page 8 (One-pass printing Kanji characters)

















































This page is available on the Japanese model only.

	HEX	8	9	A	B	C	D	E	F
HEX	BIN	1000	1001	1010	1011	1100	1101	1110	1111
0	0000	訂 128	計 144	払 160	売 176	名 192	次 208	万 224	室 240
1	0001	129	145	161	177	193	209	225	241
2	0010	正 130	小 146	掛 162	取 178	個 194	不 210	責 226	商 242
3	0011	131	147	163	179	195	211	227	243
4	0100	品 132	金 148	入 164	係 180	領 196	枚 212	終 228	人 244
5	0101	133	149	165	181	197	213	229	245
6	0110	円 134	現 150	貸 166	未 182	収 198	誤 214	了 230	大 246
7	0111	135	151	167	183	199	215	231	247
8	1000	種 136	釣 152	出 168	消 184	予 200	休 216	免 232	安 248
9	1001	137	153	169	185	201	217	233	249
A	1010	担 138	預 154	支 170	費 186	約 202	契 218	伝 234	仕 250
B	1011	139	155	171	187	203	219	235	251
C	1100	当 140	税 156	単 172	年 188	込 204	開 220	自 236	控 252
D	1101	141	157	173	189	205	221	237	253
E	1110	合 142	引 158	返 174	月 190	明 206	閉 222	設 238	基 254
F	1111	143	159	175	191	207	223	239	255

C.10 Page 16 (WPC1252)

	HEX	8	9	A	B	C	D	E	F
HEX	BIN	1000	1001	1010	1011	1100	1101	1110	1111
0	0000	€ 128	SP 144	SP 160	° 176	À 192	Ð 208	à 224	ð 240
1	0001	SP 129	‘ 145	í 161	± 177	Á 193	Ñ 209	á 225	ñ 241
2	0010	, 130	, 146	¢ 162	² 178	Â 194	Ò 210	â 226	ò 242
3	0011	f 131	“ 147	£ 163	³ 179	Ã 195	Ó 211	ã 227	ó 243
4	0100	” 132	” 148	¤ 164	´ 180	Ä 196	Ô 212	ä 228	ô 244
5	0101	… 133	· 149	¥ 165	µ 181	Å 197	Õ 213	å 229	õ 245
6	0110	† 134	— 150	 166	¶ 182	Æ 198	Ö 214	æ 230	ö 246
7	0111	‡ 135	— 151	§ 167	· 183	Ç 199	× 215	ç 231	+ 247
8	1000	^ 136	~ 152	¨ 168	¸ 184	È 200	Ø 216	è 232	ø 248
9	1001	‰ 137	™ 153	© 169	¹ 185	É 201	Ù 217	é 233	ù 249
A	1010	Š 138	š 154	ª 170	º 186	Ê 202	Ú 218	ê 234	ú 250
B	1011	‹ 139	› 155	« 171	» 187	Ë 203	Û 219	ë 235	û 251
C	1100	Œ 140	œ 156	¬ 172	^{1/4} 188	Ì 204	Ü 220	ì 236	ü 252
D	1101	SP 141	SP 157	- 173	^{1/2} 189	Í 205	Ý 221	í 237	ý 253
E	1110	Ž 142	ž 158	® 174	^{3/4} 190	Î 206	Þ 222	î 238	þ 254
F	1111	SP 143	Ÿ 159	— 175	¿ 191	Ï 207	ß 223	ï 239	ÿ 255

C.11 Page 17 (PC866: Cyrillic #2)

	HEX	8	9	A	B	C	D	E	F
HEX	BIN	1000	1001	1010	1011	1100	1101	1110	1111
0	0000	А 128	Р 144	а 160	 176	 192	 208	р 224	Ё 240
1	0001	Б 129	С 145	б 161	 177	 193	 209	с 225	ё 241
2	0010	В 130	Т 146	в 162	 178	 194	 210	т 226	ѐ 242
3	0011	Г 131	У 147	г 163	 179	 195	 211	у 227	ѓ 243
4	0100	Д 132	Ф 148	д 164	 180	 196	 212	ф 228	є 244
5	0101	Е 133	Х 149	е 165	 181	 197	 213	х 229	ѕ 245
6	0110	Ж 134	Ц 150	ж 166	 182	 198	 214	ц 230	і 246
7	0111	З 135	Ч 151	з 167	 183	 199	 215	ч 231	ї 247
8	1000	И 136	Ш 152	и 168	 184	 200	 216	ш 232	ј 248
9	1001	Й 137	Щ 153	й 169	 185	 201	 217	щ 233	љ 249
A	1010	К 138	Ъ 154	к 170	 186	 202	 218	ъ 234	њ 250
B	1011	Л 139	Ы 155	л 171	 187	 203	 219	ы 235	ћ 251
C	1100	М 140	Ь 156	м 172	 188	 204	 220	ь 236	№ ² 252
D	1101	Н 141	Э 157	н 173	 189	 205	 221	э 237	ќ 253
E	1110	О 142	Ю 158	о 174	 190	 206	 222	ю 238	 254
F	1111	П 143	Я 159	п 175	 191	 207	 223	я 239	SP 255

C.12 Page 18 (PC852: Latin2)

	HEX	8	9	A	B	C	D	E	F
HEX	BIN	1000	1001	1010	1011	1100	1101	1110	1111
0	0000	Ç 128	É 144	á 160	☐ 176	☐ 192	d 208	Ó 224	- 240
1	0001	ü 129	Í 145	í 161	■ 177	☐ 193	Đ 209	ß 225	” 241
2	0010	é 130	Í 146	ó 162	■ 178	☐ 194	Ď 210	Ô 226	‘ 242
3	0011	â 131	ô 147	ú 163	☐ 179	☐ 195	Ě 211	Ň 227	ˇ 243
4	0100	ä 132	ö 148	À 164	☐ 180	☐ 196	ď 212	ń 228	ˇ 244
5	0101	û 133	Ĺ 149	ą 165	Á 181	☐ 197	Ň 213	ň 229	§ 245
6	0110	ć 134	ĩ 150	Ż 166	Â 182	Ă 198	í 214	Š 230	÷ 246
7	0111	ç 135	Ś 151	ż 167	Ě 183	ǎ 199	î 215	š 231	· 247
8	1000	ì 136	ś 152	Ę 168	Ş 184	☐ 200	ě 216	Ŕ 232	° 248
9	1001	ë 137	Ö 153	e 169	☐ 185	☐ 201	☐ 217	Ú 233	” 249
A	1010	Ö 138	Ü 154	170	☐ 186	☐ 202	☐ 218	ř 234	· 250
B	1011	ö 139	Ť 155	ź 171	☐ 187	☐ 203	■ 219	Ů 235	ů 251
C	1100	î 140	ť 156	Č 172	☐ 188	☐ 204	■ 220	ý 236	Ř 252
D	1101	Ž 141	Ł 157	ś 173	Ż 189	☐ 205	Ť 221	Ý 237	ř 253
E	1110	Ä 142	× 158	« 174	ž 190	☐ 206	Ů 222	ţ 238	■ 254
F	1111	Ć 143	č 159	» 175	☐ 191	☐ 207	■ 223	’ 239	SP 255

C.13 Page 19 (PC858: Euro)

	HEX	8	9	A	B	C	D	E	F
HEX	BIN	1000	1001	1010	1011	1100	1101	1110	1111
0	0000	Ç 128	É 144	á 160	⌘ 176	⌚ 192	Đ 208	Ó 224	— 240
1	0001	ü 129	æ 145	í 161	⌘ 177	⌚ 193	Đ 209	ß 225	± 241
2	0010	é 130	Æ 146	ó 162	⌘ 178	⌚ 194	Ê 210	Ô 226	= 242
3	0011	â 131	ô 147	ú 163	 179	⌚ 195	Ë 211	Ò 227	³ / ₄ 243
4	0100	ä 132	ö 148	ñ 164	⌚ 180	— 196	È 212	õ 228	¶ 244
5	0101	à 133	ò 149	Ñ 165	Á 181	⌚ 197	€ 213	Ö 229	§ 245
6	0110	å 134	û 150	ä 166	Â 182	ã 198	í 214	µ 230	÷ 246
7	0111	ç 135	ù 151	ó 167	À 183	Ã 199	î 215	þ 231	· 247
8	1000	ê 136	ÿ 152	¿ 168	© 184	⌚ 200	Ï 216	þ 232	° 248
9	1001	ë 137	Ö 153	® 169	⌚ 185	⌚ 201	⌚ 217	Ú 233	¨ 249
A	1010	è 138	Ü 154	⌚ 170	 186	⌚ 202	⌚ 218	Û 234	· 250
B	1011	ï 139	ø 155	¹ / ₂ 171	⌚ 187	⌚ 203	■ 219	Ü 235	¹ 251
C	1100	î 140	£ 156	¹ / ₄ 172	⌚ 188	⌚ 204	■ 220	Ý 236	³ 252
D	1101	ì 141	Ø 157	ì 173	¢ 189	= 205	ì 221	Ý 237	² 253
E	1110	Ä 142	× 158	« 174	¥ 190	⌚ 206	ì 222	— 238	■ 254
F	1111	Å 143	f 159	» 175	⌚ 191	⌚ 207	■ 223	' 239	SP 255

C.14 Page 20 (Thai character code 42)

This page is available on the Thai model only.

	8	9	A	B	C	D	E	F
0	ร	๐		ฌ	ย	ไ	.	D3
1	๗	๑	ก	ฌ	จ	แ	๘	D+
2	L	๒	ข	ด	ถ	โ	๙	D๐
3	J	๓	ค	ต	ฉ	ใ	+	D-
4		๔	ฆ	ถ	ว	ไ	๘	D๕
5	-	๕	ง	ท	ศ	๗	.	D3
6	†	๖	จ	ฉ	ษ	๙	๐-	D+
7	†	๗	ฉ	น	ส	๐	๐๕	D-
8	⊥	๘	ข	บ	ห	๘	๐3	D๕
9	T	๙	ช	ป	ฬ	D	๐+	D3
A	†	๐	ฌ	ผ	อ	D	๕-	D+
B	■	ค	ฉ	ผ	ช	D	๕๕	D-
C	←	๓	ฉ	ฬ	๕	D	๕3	D๕
D	↑	๑	ฉ	ฬ	ฉ	๕	๕+	D3
E	→	๔	ฌ	ฉ	๗	๐	D-	D+
F	↓	ไ	ก	ม	๗	๘	D๕	

C.15 Page 21 (Thai character code 11)

This page is available on the Thai model only.

	8	9	A	B	C	D	E	F
0	๕-	๕+	ใ	๕	ภ	๕	ใ	๐
1	๕๕	๕-	ก	ท	ม	๕	แ	๑
2	๕๖	๕๕	บ	ฆ	ย	า	โ	๒
3	๕+	๕๖	บ	ณ	ร	า	ใ	๓
4	๕-	๕+	ค	ค	ถ	๕	ใ	๔
5	๕๕	๐	ค	ค	ล	๕	า	๕
6	๕๖	๐๕	ม	ถ	ภ	๕	า	๖
7	๕+	๐๖	ง	ท	ว	๕	๕	๗
8	๕๐	๐+	จ	อ	ศ	๐	.	๘
9	๕-	๐	ฉ	น	ช	๕	๕	๙
A	๕๕	๐	ช	บ	ส	.	๕	๐
B	๕๖	L	ช	ป	ท	-	+	๑
C	๕+	J	ณ	ผ	พ	๕	๕	๒
D	๕-	I	ณ	ผ	อ	T	๐	๓
E	๕๕	๕	ณ	พ	อ	๕	๐	๔
F	๕๖	๕	ณ	พ	๕	๕	๐	

C.16 Page 22 (Thai character code 13)

This page is available on the Thai model only.

	8	9	A	B	C	D	E	F
0		๒-		ฐ	ภ	๕	เ	๐
1	๖	๒๕	ก	ท	ม	๖	แ	๑
2	๕๕	๒๖	ป	ฌ	ย	๗	โ	๒
3	๕๖	๒๗	บ	ฉ	ร	๘	ใ	๓
4	๕๗		ค	ด	ถ	๙	ไ	๔
5		๒-	ค	ด	ฉ	๑	๗	๕
6	๐	๒๕	ฆ	ถ	ภ	๒	๘	๖
7	๐๕	๒๖	ง	ท	ว	๓	๙	๗
8	๐๖	๒๗	จ	ธ	ศ	๔	.	๘
9	๐๗		ฉ	น	ษ	๕	๖	๙
A		๒-	ช	บ	ส	.	๗	๐
B	๒-	๒๕	ช	บ	ห	๑	๘	๑
C	๒๕	๒๖	ฉ	ฝ	ฬ	๒	๙	←
D	๒๖	๒๗	ฉ	ฝ	อ	๓	๐	↑
E	๒๗		ฉ	ฝ	ฮ	๔	๑	→
F	๒๘		ฉ	ฝ	๙	๕	๒	↓

C.17 Page 23 (Thai character code 14)

This page is available on the Thai model only.

	8	9	A	B	C	D	E	F
0	ร	น		ฐ	ภ	๕	เ	๐
1	๖	๑	ก	ท	ม	๖	แ	๑
2	๗	๕	บ	ฒ	ย	๗	โ	๒
3	๘	๕๕	ข	ณ	ร	๘	ใ	๓
4	๙	๕๖	ค	ด	ถ	๙	ไ	๔
5	-	๕๗	ค	ด	ฉ	๐	๗	๕
6	๑	๕๘	ฆ	ถ	ภ	๑	๗	๖
7	๒	๕๙	ง	ท	ว	๒	๙	๗
8	๓	๕๐	จ	ฉ	ศ	๓	.	๘
9	๔	๕๑	ฉ	น	ช	๔	๖	๙
A	๕	๕๒	ช	บ	ส	๕	๖	๐
B	■	๕๓	ช	บ	ห	๕๓	๗	๕๓
C	๐	๕๔	ฉ	ฝ	ฬ	๕๔	๘	๕๔
D	๐๕	๕๕	ฉ	ฝ	อ	๕๕	๐	๕๕
E	๐๖	๕๖	ฉ	ฝ	ฮ	๕๖	๑	๕๖
F	๐๗	๕๗	ฉ	ฝ	๙	๕๗	๑	๕๗

C.18 Page 24 (Thai character code 16)

This page is available on the Thai model only.

	8	9	A	B	C	D	E	F
0	ร	โ		ฐ	ภ	ะ	เ	๐
1	๖	ใ	ก	ท	ม	ุ	แ	๑
2	๗	ุ	บ	ฌ	ย	า	๖	๒
3	๘	ะ	บ	ฌ	ร	า	๑	๓
4		ะ	ค	ด	ถ	๖	๖	๔
5	-	๖	ค	ด	ล	๖	๖	๕
6	๗	๖	ฆ	ถ	ภ	๖	๖	๖
7	๗	๖	ง	ท	ว	๖	๖	๗
8	๗	๖	จ	ช	ศ	๖	.	๘
9	๗	๖	ฉ	น	ษ	๖	๖	๙
A	๗	๖	ช	บ	ส	.	๖	๙
B	■	๖	ช	บ	ท	๖	+	๖
C	←	๖	ฌ	ฬ	ฬ	๖	๖	๖
D	↑	๖	ฌ	ฬ	อ	๖	๐	๖
E	→	๖	ฌ	ฬ	ฮ	๖	๖	๖
F	↓	๖	ฌ	ฬ	๖	๖	๖	

C.19 Page 25 (Thai character code 17)

This page is available on the Thai model only.

	8	9	A	B	C	D	E	F
0	๘	๙		๘	๙	๘	๙	๘
1	๘	๙	๘	๙	๘	๙	๘	๙
2	๘	๙	๘	๙	๘	๙	๘	๙
3	๘	๙	๘	๙	๘	๙	๘	๙
4	๘	๙	๘	๙	๘	๙	๘	๙
5	๘	๙	๘	๙	๘	๙	๘	๙
6	๘	๙	๘	๙	๘	๙	๘	๙
7	๘	๙	๘	๙	๘	๙	๘	๙
8	๘	๙	๘	๙	๘	๙	๘	๙
9	๘	๙	๘	๙	๘	๙	๘	๙
A	๘	๙	๘	๙	๘	๙	๘	๙
B	๘	๙	๘	๙	๘	๙	๘	๙
C	๘	๙	๘	๙	๘	๙	๘	๙
D	๘	๙	๘	๙	๘	๙	๘	๙
E	๘	๙	๘	๙	๘	๙	๘	๙
F	๘	๙	๘	๙	๘	๙	๘	๙

C.20 Page 26 (Thai character code 18)

This page is available on the Thai model only.

	8	9	A	B	C	D	E	F
0	ร	ร		ฐ	ภ	๕๕	เ	๐
1	๖	๖	ก	ท	ม	๕	แ	๑
2	๗	๕-	บ	ฒ	ย	๖	โ	๒
3	๘	๕๕	ป	ฒ	ร	๖	ใ	๓
4	๙	๕๕	ค	ด	ถ	๖	ไ	๔
5	-	๕+	ค	ด	ถ	๖	๖	๕
6	๑	๖-	ฆ	ถ	ภ	๖	๖	๖
7	๒	๖๕	ง	ท	ว	๖	๕	๗
8	๓	๖๕	จ	ช	ศ	๖	.	๘
9	๔	๖+	ฉ	น	ษ	๕	๕	๙
A	๕	๖๕	ช	บ	ส	.	๕	๕
B	■	๖-	ช	บ	ห	๖-	+	๖-
C	←	๖๕	ฒ	ฒ	ฬ	๖๕	๕	๖๕
D	↑	๖๕	ฒ	ฒ	อ	๖๕	๐	๖๕
E	→	๖+	ฒ	ฒ	ฮ	๖+	๕	๖+
F	↓	๖	ฒ	ฒ	๖	๖	๐	

C.21 Page 254 (Blank page)

HEX	HEX	8	9	A	B	C	D	E	F
HEX	BIN	1000	1001	1010	1011	1100	1101	1110	1111
0	0000	SP 128	SP 144	SP 160	SP 176	SP 192	SP 208	SP 224	SP 240
1	0001	SP 129	SP 145	SP 161	SP 177	SP 193	SP 209	SP 225	SP 241
2	0010	SP 130	SP 146	SP 162	SP 178	SP 194	SP 210	SP 226	SP 242
3	0011	SP 131	SP 147	SP 163	SP 179	SP 195	SP 211	SP 227	SP 243
4	0100	SP 132	SP 148	SP 164	SP 180	SP 196	SP 212	SP 228	SP 244
5	0101	SP 133	SP 149	SP 165	SP 181	SP 197	SP 213	SP 229	SP 245
6	0110	SP 134	SP 150	SP 166	SP 182	SP 198	SP 214	SP 230	SP 246
7	0111	SP 135	SP 151	SP 167	SP 183	SP 199	SP 215	SP 231	SP 247
8	1000	SP 136	SP 152	SP 168	SP 184	SP 200	SP 216	SP 232	SP 248
9	1001	SP 137	SP 153	SP 169	SP 185	SP 201	SP 217	SP 233	SP 249
A	1010	SP 138	SP 154	SP 170	SP 186	SP 202	SP 218	SP 234	SP 250
B	1011	SP 139	SP 155	SP 171	SP 187	SP 203	SP 219	SP 235	SP 251
C	1100	SP 140	SP 156	SP 172	SP 188	SP 204	SP 220	SP 236	SP 252
D	1101	SP 141	SP 157	SP 173	SP 189	SP 205	SP 221	SP 237	SP 253
E	1110	SP 142	SP 158	SP 174	SP 190	SP 206	SP 222	SP 238	SP 254
F	1111	SP 143	SP 159	SP 175	SP 191	SP 207	SP 223	SP 239	SP 255

C.22 Page 255 (Blank page)

HEX	BIN	8	9	A	B	C	D	E	F
HEX	BIN	1000	1001	1010	1011	1100	1101	1110	1111
0	0000	SP 128	SP 144	SP 160	SP 176	SP 192	SP 208	SP 224	SP 240
1	0001	SP 129	SP 145	SP 161	SP 177	SP 193	SP 209	SP 225	SP 241
2	0010	SP 130	SP 146	SP 162	SP 178	SP 194	SP 210	SP 226	SP 242
3	0011	SP 131	SP 147	SP 163	SP 179	SP 195	SP 211	SP 227	SP 243
4	0100	SP 132	SP 148	SP 164	SP 180	SP 196	SP 212	SP 228	SP 244
5	0101	SP 133	SP 149	SP 165	SP 181	SP 197	SP 213	SP 229	SP 245
6	0110	SP 134	SP 150	SP 166	SP 182	SP 198	SP 214	SP 230	SP 246
7	0111	SP 135	SP 151	SP 167	SP 183	SP 199	SP 215	SP 231	SP 247
8	1000	SP 136	SP 152	SP 168	SP 184	SP 200	SP 216	SP 232	SP 248
9	1001	SP 137	SP 153	SP 169	SP 185	SP 201	SP 217	SP 233	SP 249
A	1010	SP 138	SP 154	SP 170	SP 186	SP 202	SP 218	SP 234	SP 250
B	1011	SP 139	SP 155	SP 171	SP 187	SP 203	SP 219	SP 235	SP 251
C	1100	SP 140	SP 156	SP 172	SP 188	SP 204	SP 220	SP 236	SP 252
D	1101	SP 141	SP 157	SP 173	SP 189	SP 205	SP 221	SP 237	SP 253
E	1110	SP 142	SP 158	SP 174	SP 190	SP 206	SP 222	SP 238	SP 254
F	1111	SP 143	SP 159	SP 175	SP 191	SP 207	SP 223	SP 239	SP 255

C.23 International Character Sets

Country	ASCII code (hexadecimal number)											
	23	24	40	5B	5C	5D	5E	60	7B	7C	7D	7E
U.S.	#	\$	@	[\]	^	`	{		}	~
France	#	\$	à	°	ç	§	^	`	é	ù	è	¨
Germany	#	\$	§	Ä	Ö	Ü	^	`	ä	ö	ü	ß
UK	£	\$	@	[\]	^	`	{		}	~
Denmark I	#	\$	@	Æ	Ø	Å	^	`	æ	ø	å	~
Sweden	#	\$	É	Ä	Ö	Å	Ü	é	ä	ö	å	ü
Italy	#	\$	@	°	\	é	^	ù	à	ò	è	ì
Spain I	Pt	\$	@	i	Ñ	¿	^	`	¨	ñ	}	~
Japan	#	\$	@	[¥]	^	`	{		}	~
Norway	#	¤	É	Æ	Ø	Å	Ü	é	æ	ø	å	ü
Denmark II	#	\$	É	Æ	Ø	Å	Ü	é	æ	ø	å	ü
Spain II	#	\$	á	i	Ñ	¿	é	`	í	ñ	ó	ú
Latin America	#	\$	á	i	Ñ	¿	é	ü	í	ñ	ó	ú
Korea	#	\$	@	[₩]	^	`	{		}	~

Appendix D

Power Supply Unit

D.1 AC Adapter C

This power supply unit can be used with the TM-U220 ANK model only. When you use any other model of the TM-U220, please use PS-180.

D.1.1 Case specifications

- ❑ Size: 54 mm(D) × 114 mm(L) × 36 mm(H)
{2.13 (D) × 4.49 (L) × 1.42" (H)}
(excluding projections) Refer to the figure below.
- ❑ Mass: Approx. 0.4kg (excluding the AC cable)
- ❑ Material: Flame-resistance grade: V0
- ❑ Color: Black (matte)

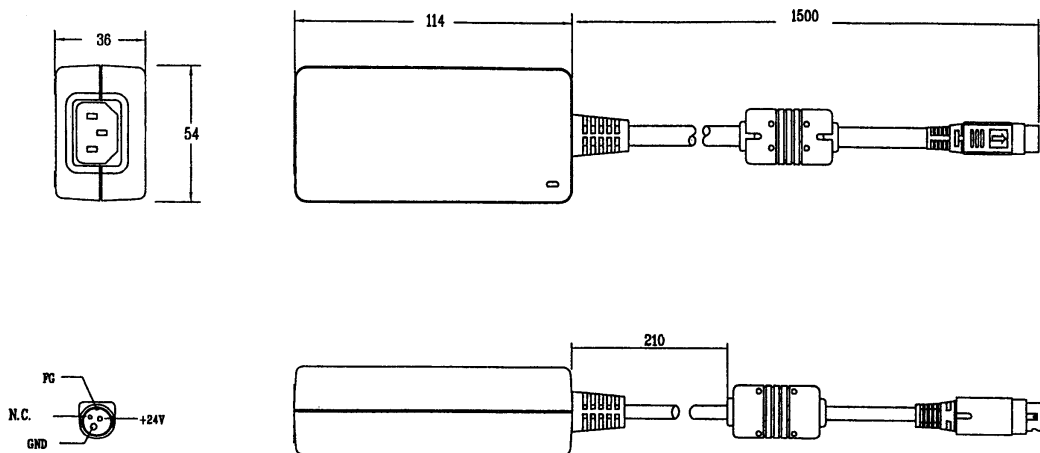

Case specifications

D.2 PS-180

This power supply unit can be used with all models of the TM-U220.

D.2.1 Case specifications

- ❑ Size: 68 mm(D) × 136 mm(L) × 32 mm(H)
{2.68 (D) × 5.35 (L) × 1.26" (H)}
(excluding projections) Refer to the figure below.
- ❑ Mass: Approx. 0.4kg (excluding the AC cable)
- ❑ Material: Flame-resistance grade: V0
- ❑ Color: Black (matte)

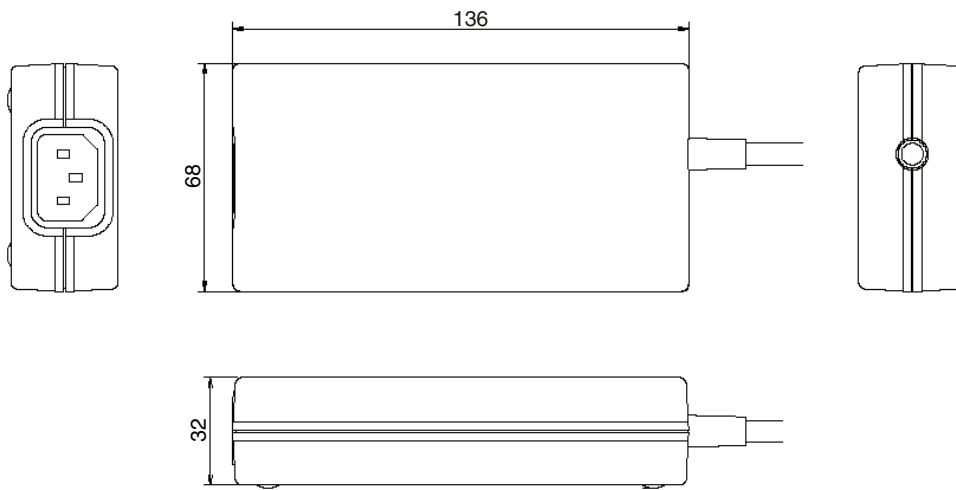

Case specifications

D.2.2 Usage cautions

- ❑ AC cable Select an AC cable that satisfies the following conditions
 - Product safety standards
 - Plug with PE terminal
- ❑ Ground connection Ground certainly for safety