

SIEMENS

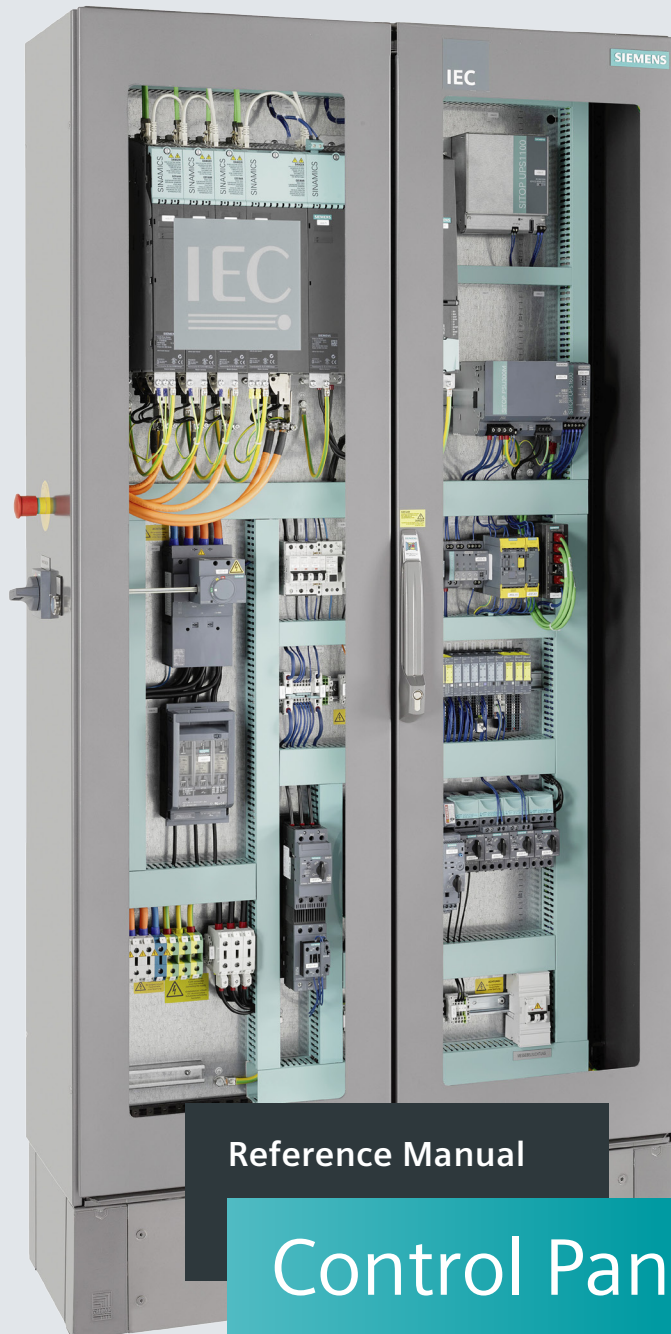

Reference Manual

Control Panels

Compliant with IEC Standards and European Directives



[siemens.com/panelbuilding](https://www.siemens.com/panelbuilding)

Industrial Controls

Control Panels compliant with IEC Standards and European Directives

Reference Manual

Preface

Introduction

1

Scope of this documentation

2

Organizations and standards

3

Markings and symbols for market access

4

Control engineering - definition of terms and fundamental principles

5

Electrical equipment

6

Devices in the control panel and the machine environment

7

Use of IE2 and IE3 motors

8

Engineering support with data and tools

A

European directives and CE marking for industrial and machine control panels

B

Legal information

Warning notice system

This manual contains notices you have to observe in order to ensure your personal safety, as well as to prevent damage to property. The notices referring to your personal safety are highlighted in the manual by a safety alert symbol, notices referring only to property damage have no safety alert symbol. These notices shown below are graded according to the degree of danger.

DANGER

indicates that death or severe personal injury **will** result if proper precautions are not taken.

WARNING

indicates that death or severe personal injury **may** result if proper precautions are not taken.

CAUTION

indicates that minor personal injury can result if proper precautions are not taken.

NOTICE

indicates that property damage can result if proper precautions are not taken.

If more than one degree of danger is present, the warning notice representing the highest degree of danger will be used. A notice warning of injury to persons with a safety alert symbol may also include a warning relating to property damage.

Qualified Personnel

The product/system described in this documentation may be operated only by **personnel qualified** for the specific task in accordance with the relevant documentation, in particular its warning notices and safety instructions. Qualified personnel are those who, based on their training and experience, are capable of identifying risks and avoiding potential hazards when working with these products/systems.

Proper use of Siemens products

Note the following:

WARNING

Siemens products may only be used for the applications described in the catalog and in the relevant technical documentation. If products and components from other manufacturers are used, these must be recommended or approved by Siemens. Proper transport, storage, installation, assembly, commissioning, operation and maintenance are required to ensure that the products operate safely and without any problems. The permissible ambient conditions must be complied with. The information in the relevant documentation must be observed.

Trademarks

All names identified by ® are registered trademarks of Siemens AG. The remaining trademarks in this publication may be trademarks whose use by third parties for their own purposes could violate the rights of the owner.

Disclaimer of Liability

We have reviewed the contents of this publication to ensure consistency with the hardware and software described. Since variance cannot be precluded entirely, we cannot guarantee full consistency. However, the information in this publication is reviewed regularly and any necessary corrections are included in subsequent editions.

Preface

Disclaimer/Terms of Use

The information herein is provided as a general reference regarding the use of Siemens products in generic applications. This information is provided without warranty.

It is your responsibility to ensure that you are correctly using/servicing all Siemens products properly in your specific application. Although we strive to maintain accurate and up-to-date information, there is no guarantee that the information provided herein is accurate or applies to your specific situation.

If you use the information provided herein in your specific application, please double check its accuracy and applicability and be advised that you are using this information at your own risk.

Change history

The 10/2017 edition of this reference manual contains corrections and additions that are essentially based on changes in IEC 60204-1 Edition 6.0.

- Extensively revised: Chapter 6 Electrical equipment
- New: Chapter 6.9.4.3 Verification of short-circuit withstand strength

Authors

Martin Berger

Staatlich geprüfter Techniker (state-certified technician)

Application consulting and business development for control panel engineering and low-voltage controls and distribution

Email: bergermartin@siemens.com

Wolfgang Christ

(Dipl. Ing.) Power Engineering

Industrial applications for medium and low-voltage systems in international IEC business segment

Email: christ.wolfgang@siemens.com

Gerhard Flierl

(Dipl. Ing.) Electrical Engineering / Business Administration

Application consulting and business development for control panel engineering and low-voltage controls and distribution

Email: gerhard.flierl@siemens.com

Ralph Neumann

(Dipl. Ing.) Electrical Engineering / Automation Technology

Development / configuring of electrical systems and implementation of electrical switchgear designs for machine tools

Email: ralph.neumann@siemens.com

Marcel Schulz

Application consulting and business development for digital engineering

Email: marcel.schulz@siemens.com

Table of contents

	Preface	5
1	Introduction.....	21
2	Scope of this documentation.....	23
3	Organizations and standards	25
3.1	Organizations	25
3.2	Standards.....	30
3.3	The control panel - does the Machinery Directive or the Low Voltage Directive apply?	37
4	Markings and symbols for market access	39
5	Control engineering - definition of terms and fundamental principles.....	45
5.1	Safety rules	46
5.2	Types of grounding system.....	47
5.3	Rated... ..	49
5.4	Current.....	50
5.5	Degree of protection of enclosures.....	52
5.6	Touch protection for electrical equipment.....	55
5.7	Degree of pollution.....	58
5.8	Clearance and creepage distance	59
5.9	Overvoltage category	60
5.10	Selectivity	61
5.11	Utilization categories.....	62
5.12	Switch disconnectors and circuit breakers	64
5.13	Selection of the electrical characteristics of circuit breakers	66
5.14	Trip classes.....	67
5.15	Comparison of electrical characteristics	69
5.16	Insulation.....	70
5.17	Classes	71
5.18	Rated diversity factor	75
5.19	Motor duty types	76

6	Electrical equipment	81
6.1	Interface agreements between customer and manufacturer	81
6.2	Incoming supply conductor termination and supply disconnecting device	82
6.2.1	Incoming supply conductor termination	82
6.2.2	Supply disconnecting (isolating) device	86
6.2.3	Excepted circuits	93
6.2.4	Devices for removal of power for prevention of unexpected start-up	95
6.2.5	Devices for isolating electrical equipment	98
6.2.6	Protection against unauthorized, inadvertent and/or mistaken connection	99
6.3	Protection against electric shock	101
6.3.1	Basic protection	102
6.3.2	Fault protection	110
6.3.3	Protection by PELV (protective extra-low voltage)	117
6.4	Design and protection of equipment	118
6.4.1	Overcurrent protection	119
6.4.1.1	Arrangement of overcurrent protective devices	121
6.4.1.2	Initial symmetrical short-circuit current	127
6.4.1.3	Selection of overcurrent protective devices	133
6.4.1.4	Selection of control devices	135
6.4.1.5	Conductor dimensioning	139
6.4.1.6	Practical example	147
6.4.1.7	Control circuit	153
6.4.2	Protection of motors against overheating	154
6.4.3	Protection against abnormal temperatures	156
6.4.4	Protection against the effects of supply interruption or voltage dip followed by voltage recovery	156
6.4.5	Motor overspeed protection	156
6.4.6	Ground fault/residual current protection	156
6.4.7	Phase sequence monitoring	157
6.4.8	Protection against overvoltages due to lightning and to switching surges	157
6.5	Equipotential bonding	158
6.5.1	Protective bonding	158
6.5.2	Functional bonding	168
6.6	Conductors and cables	169
6.6.1	Classification	169
6.6.2	Conductor types	171
6.6.3	Selection criteria	174
6.7	Warning signs and markings	176
6.7.1	Functional identification	178
6.7.2	Marking of equipment	179
6.8	Wiring practices	183
6.8.1	Identification of cables	189
6.8.2	Wiring inside control panels	192
6.9	Testing and verifications	194
6.9.1	Requirements of IEC 60204-1	195
6.9.1.1	Visual inspection (mandatory)	195
6.9.1.2	Verification of conditions for protection by automatic disconnection of supply (mandatory)	195

6.9.1.3	Verification of the continuity of the protective bonding circuit.....	196
6.9.1.4	Fault loop impedance verification and suitability of the associated overcurrent protective device	196
6.9.1.5	Determination of the disconnecting time by comparison	200
6.9.1.6	Insulation resistance test (optional)	202
6.9.1.7	Voltage test (optional)	203
6.9.1.8	Protection against residual voltages (optional)	204
6.9.1.9	Functional tests (optional)	204
6.9.1.10	Retesting (optional)	205
6.9.2	Requirements of verifications from the IEC 61439 series of standards	205
6.9.2.1	Overview of design and routine verifications from IEC 61439-1	206
6.9.3	Detailed description of design verifications relating to construction	208
6.9.3.1	Strength of materials and parts	208
6.9.3.2	Degree of protection of enclosures	209
6.9.3.3	Clearances and creepage distances	210
6.9.3.4	Protection against electric shock and integrity of protective circuits	210
6.9.3.5	Incorporation of switching devices and components	211
6.9.3.6	Internal electrical circuits and connections	212
6.9.3.7	Terminals for external conductors	212
6.9.4	Detailed description of design verifications relating to performance	213
6.9.4.1	Dielectric properties	213
6.9.4.2	Verification of temperature rise	215
6.9.4.3	Verification of short-circuit withstand strength	216
6.9.4.4	Electromagnetic compatibility	224
6.9.4.5	Mechanical operation	225
6.9.5	Overview of routine verifications	226
6.9.6	Detailed description of routine verifications relating to the constructional requirement	227
6.9.6.1	Degree of protection of enclosures	227
6.9.6.2	Clearances and creepage distances	227
6.9.6.3	Protection against electric shock and integrity of protective circuits	228
6.9.6.4	Incorporation of switching devices and components	228
6.9.6.5	Internal electrical circuits	229
6.9.6.6	Terminals for external conductors	229
6.9.6.7	Mechanical operation	230
6.9.7	Detailed description of routine verifications relating to performance	230
6.9.7.1	Dielectric properties	230
6.9.7.2	Wiring, operational performance and function	231
6.9.8	Documentation of verifications	231
7	Devices in the control panel and the machine environment	233
7.1	Main circuit - motor starter protectors/circuit breakers	234
7.2	Main circuit - molded case circuit breakers	239
7.3	Main circuit - contactors	242
7.4	Main circuit - motor starters	245
7.4.1	SIRIUS 3RM1 motor starters	246
7.4.2	SIRIUS 3RA6 compact starters	247
7.4.3	SIRIUS ET 200SP motor starters	249
7.4.4	SIRIUS ET 200pro motor starters	251
7.4.5	SIRIUS M200D motor starters	252
7.4.6	SIRIUS MCU motor starters	253

7.5	Main circuit - soft starters	255
7.6	Main circuit - frequency converters	261
7.6.1	SINAMICS V	262
7.6.2	SINAMICS G	264
7.6.3	SINAMICS S	267
7.7	Main circuit - solid-state switching devices	269
7.8	Control circuit - SITOP power supplies	271
7.9	Control circuit - SIMOCODE	272
7.10	Control circuit - safety relays	275
7.10.1	Safety relays	275
7.10.2	Evaluating	277
7.10.2.1	Output expansions for the 3SK family	280
7.10.2.2	Expansion units for the 3SK1 Advanced family	281
7.10.2.3	Diagnostics for the 3SK2 family	281
7.10.3	Reacting	282
7.11	Control circuit - command and signaling devices	283
7.12	Control circuit - function relays	285
7.13	Control circuit - position switches	290
7.14	Control circuit - signaling columns	293
7.15	Control circuit - AS-Interface	295
8	Use of IE2 and IE3 motors	299
8.1	Normative and legal requirements	299
8.1.1	Efficiency classes for IEC motors	299
8.1.2	Exceptions in the EU Regulation	301
8.2	IE3 motors	302
8.2.1	Properties	302
8.2.2	Siemens IE3 motors	304
8.3	Use of switching devices and protective equipment with IE3 motors	305
8.3.1	Motor starter protectors	305
8.3.2	Soft starters	306
A	Engineering support with data and tools	309
A.1	Engineering in the company	309
A.1.1	Optimization of internal and external cooperation	310
A.1.2	Integrated data management	312
A.2	Data for the engineering system	313
A.2.1	Overview of CAD and CAE data	313
A.2.2	Product master data	314
A.2.3	CAE / CAD / Graphic data	314
A.2.4	Documentation	317
A.2.5	Supplementary data for the digital twin	319
A.3	Selection aids and engineering software	320
A.3.1	Acquisition of information	320
A.3.1.1	Getting an overview of the product	320

A.3.1.2	Finding out the product details.....	321
A.3.1.3	Choosing the product.....	322
A.3.1.4	Obtaining data for the engineering system.....	326
A.3.1.5	Getting help and support.....	327
A.3.1.6	Creating documentation.....	329
B	European directives and CE marking for industrial and machine control panels.....	331
B.1	Scope of application of relevant directives.....	331
B.2	Harmonized standards.....	333
B.3	Technical documentation.....	337
B.4	Declaration of conformity.....	338
B.5	CE marking.....	339
B.6	Risk analysis and assessment.....	340
B.7	Scope of applicability for IEC60335.....	343
B.8	Websites.....	347
	Glossary.....	349
	Index.....	355

Tables

Table 3- 1	Selection of harmonized standards.....	36
Table 5- 1	Degree of pollution	58
Table 5- 2	Utilization category - suitability for selectivity.....	62
Table 5- 3	Utilization categories for switch disconnectors	63
Table 5- 4	Trip classes of overload relays.....	67
Table 5- 5	Comparing characteristics from the plant to characteristics of the fuse/switching device.....	69
Table 5- 6	Comparing characteristics from the plant to characteristics of circuit breakers.....	69
Table 5- 7	Values of assumed loading	75
Table 5- 8	Duty type S1: Continuous duty	76
Table 5- 9	Duty type S2: Short-time duty	77
Table 5- 10	Duty type S3: Intermittent periodic duty without starting.....	78
Table 6- 1	Minimum cross-sectional area of copper protective conductors.....	85
Table 6- 2	Maximum disconnecting times for TN systems.....	113
Table 6- 3	Excerpt from the product data sheet of the molded case circuit breaker 3VA2110-5HL36-	117
Table 6- 4	Rated currents and initial symmetrical short-circuit currents	128
Table 6- 5	Example of current-carrying capacity.....	140
Table 6- 6	Methods of installation - examples.....	141
Table 6- 7	Ambient temperature correction factors.....	141
Table 6- 8	Grouping correction factors.....	142
Table 6- 9	Derating factors.....	143
Table 6- 10	Admissible cable lengths - voltage drop across copper conductor.....	145
Table 6- 11	Admissible cable lengths - voltage drop across aluminum conductor	146
Table 6- 12	Minimum cross-sectional area of copper protective conductors.....	163
Table 6- 13	Standards applicable to cables and conductors	170
Table 6- 14	Conductor types	171
Table 6- 15	Examples of commonly used cable types.....	172
Table 6- 16	Type code (selection) - example H07RR-F3G1.5.....	173
Table 6- 17	Temperature limits for accessible parts of surfaces of electrical equipment	177
Table 6- 18	Examples of functional identification from IEC 60417	179
Table 6- 19	Main conductors of size S00 with M3 combination screws.....	184
Table 6- 20	Main conductors of size S00	184
Table 6- 21	Maximum disconnecting times for TN systems.....	200
Table 6- 22	References values for maximum cable length.....	202
Table 6- 23	Overview of design verifications	206

Table 6- 24	Overview of design verifications and permissible alternatives	207
Table 6- 25	Verifications for enclosures.....	209
Table 6- 26	Temperature rise verification methods	215
Table 6- 27	Overview of routine verifications	226
Table 8- 1	New efficiency classes for induction motors	300
Table 8- 2	Affected motors	300
Table A- 1	CAX data and formats	313
Table A- 2	Siemens engineering software.....	320
Table A- 3	Detail pages – control panels.....	321
Table A- 4	Detail pages – power distribution.....	321
Table A- 5	Design and dimensioning tools.....	324
Table A- 6	Product configurators.....	324
Table A- 7	mySupport.....	328
Table B- 1	Harmonized CE Directives, Publication 2014	332
Table B- 2	A, B and C Type standards - description	336
Table B- 3	IEC member states (in 2016).....	343
Table B- 4	CENELEC members (in 2016).....	346
Table B- 5	Links to organizations	347
Table B- 6	Links to standards and directives	347
Table B- 7	European network for market surveillance, databases.....	348

Figures

Figure 3-1	Important standards and the countries/regions in which they apply.....	25
Figure 3-2	Standardization (Germany as example)	26
Figure 3-3	European Economic Area with EFTA and other countries	28
Figure 3-4	Development and publication of harmonized standards.....	29
Figure 3-5	Legal standard	31
Figure 3-6	German interest groups for electrical engineering standardization projects.....	32
Figure 3-7	Development of a standard (Germany as example).....	32
Figure 3-8	Excerpt from the Official Journal of the European Union.....	33
Figure 3-9	Excerpt from the Official Journal for the European Low Voltage Directive (2014/35/EU)	34
Figure 3-10	Recommended application of standards.....	38
Figure 4-1	Example: Countries and economic regions which require test and administrative marks.....	39
Figure 4-2	Meaning of EU directives and legal consequences	40
Figure 4-3	Example: Rating plate with CE, CCC and EAC markings	42
Figure 5-1	TN-C-S system.....	47
Figure 5-2	IT system.....	48
Figure 5-3	TT system (N conductor as required)	48
Figure 5-4	Oscillogram of a short-circuit disconnection by a fuse.....	51
Figure 5-5	Degree of protection provided by enclosures: International Protection	52
Figure 5-6	Test finger (dimensions in mm).....	56
Figure 5-7	Parts dangerous to touch, dimensions in mm.....	57
Figure 5-8	Clearance	59
Figure 5-9	Creepage distance	59
Figure 5-10	Transient and temporary overvoltage	60
Figure 5-11	Example: Tripping characteristics.....	68
Figure 5-12	SELV	73
Figure 5-13	PELV	74
Figure 5-14	FELV	74
Figure 5-15	Calculation of average heating effect.....	79
Figure 6-1	Defining boundaries between areas of responsibility of user and supplier.....	82
Figure 6-2	Separate terminals for neutral conductor and protective conductor	84
Figure 6-3	Example: Labeling of terminal for the external protective conductor	85
Figure 6-4	Selection of Siemens switch disconnectors compliant with IEC 60947-3.....	87
Figure 6-5	Selection of Siemens circuit breakers compliant with IEC 60947-2.....	87
Figure 6-6	Examples of external operating means (handles) for supply disconnecting devices	88
Figure 6-7	Example: Dimensioning of supply disconnecting device / main disconnect.....	89

Figure 6-8	Installation height for operating means of the supply disconnecting device.....	92
Figure 6-9	Supply disconnecting device for excepted circuit	93
Figure 6-10	Example: Warning label	94
Figure 6-11	Example: Device for removal of power for prevention of unexpected start-up.....	95
Figure 6-12	Example: Device with plug-in fuses	96
Figure 6-13	Example: Contactor as device for removal of power for prevention of unexpected start-up	97
Figure 6-14	Padlock to prevent reconnection	99
Figure 6-15	Lockable door-coupling rotary operating mechanism of a 3VA... molded case circuit breaker	99
Figure 6-16	Protective measures in accordance with IEC 60364-4-41.....	101
Figure 6-17	Motor starter with appropriate enclosure for use in the field.....	103
Figure 6-18	Control panel with appropriate enclosure	103
Figure 6-19	Control panel locked by means of a key or by screw connections	104
Figure 6-20	Opening a control panel with a door lock interlocked with the supply disconnecting device	104
Figure 6-21	Using a tool to open a control panel with a door lock interlocked with the supply disconnecting device.....	105
Figure 6-22	Labeling of components that are still live even though the supply disconnecting device is open	106
Figure 6-23	Removal of cable insulation by destruction	107
Figure 6-24	Cable freely installed on cable rack	107
Figure 6-25	Cable installed in cable duct	108
Figure 6-26	Example: Warning notice to protect against residual voltages	108
Figure 6-27	Example: Touch voltage 115 V with one protective conductor (standard installation)	112
Figure 6-28	Example: Touch voltage 50 V with 2 protective conductors	112
Figure 6-29	Example: Hand-held class I equipment and residual current protective devices	114
Figure 6-30	Example: Reducing the current-carrying capacity of conductors	122
Figure 6-31	Design of overcurrent protective devices according to the maximum prospective short- circuit current at the incoming supply point.....	124
Figure 6-32	Prospective short-circuit value at the incoming supply point to the machine	126
Figure 6-33	Example: Short-circuit attenuation as a function of cable length and cross-sectional area	129
Figure 6-34	Example: Influence of the cable length and cross-sectional area	130
Figure 6-35	Largest possible and smallest possible short-circuit in the machine.....	131
Figure 6-36	Excerpt from the Siemens SIMARIS Design software, comparison of I_{kmin} at 20 m and 100 m cable length.....	131
Figure 6-37	Example: Type of coordination 1	137
Figure 6-38	Example: Type of coordination 2	138

Figure 6-39	Parameters of conductors and protective devices.....	143
Figure 6-40	Tripping characteristic of 3RV2021-4EA10 circuit breaker (excerpt from SIMARIS curves).....	149
Figure 6-41	Let-through energy characteristic of 3RV2021-4EA10 motor starter protector (excerpt from SIMARIS curves)	150
Figure 6-42	Maximum cable length for a voltage drop of maximum 5 %	151
Figure 6-43	Assessment of the smallest possible short-circuit (excerpt from SIMARIS design)	152
Figure 6-44	Comparison between "current-dependent" and "temperature-dependent" overtemperature protection.....	155
Figure 6-45	Examples: Components of the protective bonding circuit.....	158
Figure 6-46	Example: Protective conductor as a braided ribbon cable.....	160
Figure 6-47	Example: Location at the bottom of the control panel.....	160
Figure 6-48	Example: Protective conductor with GREEN-AND-YELLOW insulation	160
Figure 6-49	Example: Symbol IEC 60417-5019.....	161
Figure 6-50	Example: Bicolor combination GREEN-AND-YELLOW at the end of the grounding bar	161
Figure 6-51	Example: Grounding of frequency converters on the mounting plate.....	165
Figure 6-52	Symbol in accordance with IEC 60417-5020: Frame or chassis	168
Figure 6-53	Example: PVC sheathed cable with three copper cores, cross-sectional area 1.5 mm ²	172
Figure 6-54	Symbol ISO 7010-W012	176
Figure 6-55	Symbol ISO 7010-W017	177
Figure 6-56	SIRIUS ACT pushbuttons and indicator lights from Siemens.....	178
Figure 6-57	Functional identification on operator controls	178
Figure 6-58	Functional identification next to operator controls	178
Figure 6-59	Example: Nameplate for control panel.....	181
Figure 6-60	Example: Nameplate according to IEC 60204-1 and IEC 61439-1	182
Figure 6-61	Example: Reference designations on various items of equipment in the control panel	182
Figure 6-62	Example: End sleeve	185
Figure 6-63	Example: Use of end sleeves at clamping points on equipment	185
Figure 6-64	Example: Marking of terminals.....	186
Figure 6-65	Example: Separate routing of 24 V and 230 V/400 V circuits.....	188
Figure 6-66	Example: Identification of single wires and equipment.....	189
Figure 6-67	Example: Marking with the symbol IEC 60417-5019	190
Figure 6-68	Example: Marking with GREEN-AND-YELLOW at the end of the protective conductor busbar	190
Figure 6-69	Symbol IEC 60417-5021	191
Figure 6-70	Example: Installation in doors with flexible cables.....	193
Figure 6-71	Typical arrangement for fault loop impedance (Z _S) measurement in TN systems.....	198

Figure 6-72	Typical arrangement for fault loop impedance (Z_s) measurement for power drive system circuits in TN systems	198
Figure 6-73	Example: 3RV20314JB10 tripping characteristic (excerpt from SIMARIS curves)	201
Figure 6-74	EU Declaration of Conformity for SIVACON enclosure	208
Figure 6-75	Example: Alteration of the degree of protection by installation of a component.....	209
Figure 6-76	Example: Data sheet for contactor, degree of pollution 3 (normal in industrial environments)	210
Figure 6-77	Symbol IEC 60417-5019.....	212
Figure 6-78	Source: IEC 61439-1, Table 13: Short-circuit verification by comparison with a reference design: check list.....	218
Figure 6-79	Example: Tested reference designs from SIOS	219
Figure 6-80	I_{cw} or $I_{cc} \leq 10$ kA.....	221
Figure 6-81	Cut-off current (let-through current) $I_c \leq 17$ kA.....	222
Figure 6-82	Let-through current characteristic for 3RV2 motor starter protector (excerpt from SIMARIS curves)	223
Figure 6-83	Exceptions for auxiliary circuits.....	224
Figure 6-84	Symbol IEC 60417-5019.....	229
Figure 7-1	Motor starter protectors for motor protection, sizes S00/S0	234
Figure 7-2	Motor starter protectors for motor protection with overload relay function, sizes S00/S0 and S2.....	235
Figure 7-3	Circuit breakers according to UL 489, sizes S00/S0 and S3.....	236
Figure 7-4	Motor feeders with 3RV2917 infeed system	237
Figure 7-5	3VA1 and 3VA2 molded case circuit breakers	240
Figure 7-6	Extensive scope of functions thanks to large portfolio of accessories.....	241
Figure 7-7	Contactors for switching motors, sizes S00, S0, S2 and S3	242
Figure 7-8	Contactors for resistive loads.....	243
Figure 7-9	Capacitor contactors	243
Figure 7-10	SIRIUS 3RM1 motor starters in the control panel.....	246
Figure 7-11	Compact starter with the integrated functionality of a motor starter protector, contactor and electronic overload relay	248
Figure 7-12	Individual compact starters or combined with associated infeed system and AS-i interfacing.....	248
Figure 7-13	3RK1308 motor starter in the ET 200SP I/O system.....	250
Figure 7-14	ET 200pro motor starter: Isolator module, Standard starter and High-Feature starter mounted on a wide module rack.....	252
Figure 7-15	SIRIUS M200D motor starter family	253

Figure 7-16	Soft starters for standard applications without integral overload protection, sizes S00, S0, S2 and S3.....	256
Figure 7-17	Soft starters for standard applications with integral overload protection, sizes S0, S2, S3, S6 and S12	257
Figure 7-18	Soft starters for High-Feature applications, various sizes	259
Figure 7-19	Selection aid for soft starters (excerpt from Siemens Catalog IC 10).....	260
Figure 7-20	SINAMICS drive family - usage types.....	261
Figure 7-21	SINAMICS V20, frame sizes FSA to FSE.....	263
Figure 7-22	SINAMICS V90	264
Figure 7-23	SINAMICS G120 built-in devices	265
Figure 7-24	Frequency converters from the SINAMICS G range	266
Figure 7-25	SINAMICS S110	267
Figure 7-26	SINAMICS S120 built-in devices	268
Figure 7-27	Solid-state relays.....	269
Figure 7-28	Solid-state contactors.....	270
Figure 7-29	Function modules for load monitoring (Basic, Extended), heating current monitoring, power controllers and power regulators for heaters	270
Figure 7-30	SITOP Family Control Cabinet.....	271
Figure 7-31	SIMOCODE pro S and SIMOCODE pro V.....	273
Figure 7-32	Overview of SIMOCODE pro S and SIMOCODE pro V functions.....	274
Figure 7-33	Functional safety	275
Figure 7-34	Protective door monitoring to SIL 3 or PL e with a 3SK1 safety relay	276
Figure 7-35	Narrow and wide 3SK2 basic unit.....	279
Figure 7-36	SIRIUS 3RM1 motor starters - space saving.....	280
Figure 7-37	Diagnostics display 3RK3611-3AA00	281
Figure 7-38	Easy to use	284
Figure 7-39	Simple configuring with the SIRIUS ACT Configurator	284
Figure 7-40	Area of application of SIRIUS relays.....	285
Figure 7-41	Overview of the area of application of monitoring relays	286
Figure 7-42	Line and voltage monitoring relays	287
Figure 7-43	3UG4 and 3RR2 monitoring relays.....	287
Figure 7-44	Monitoring relays for monitoring residual currents.....	288
Figure 7-45	Monitoring relays for insulation monitoring	288
Figure 7-46	3RS10 / 3RS11 temperature monitoring relays (digitally adjustable).....	289
Figure 7-47	Easy plug-in method for fast replacement of actuator heads	290
Figure 7-48	SIRIUS 3SE63 non-contact safety switches, RFID	291

Figure 7-49	Standard and supplementary ranges in the new 3SE66/67 design.....	292
Figure 7-50	8WD signaling columns and integrated signal lamps	294
Figure 7-51	Configuration of an AS-i network – connecting sensors with minimum effort: standard and fail-safe.....	296
Figure 7-52	Mounting and connecting an AS-i field module to the AS-i cable.....	297
Figure 7-53	AS-i master in the SIMATIC ET 200SP and intelligent AS-i master station with ET 200SP CPU	298
Figure A-1	Distribution of costs for designing a new control panel.	309
Figure A-2	Data synchronization	312
Figure A-3	Example: Dimension drawing of a motor feeder combination (motor starter protector and contactor)	315
Figure A-4	Example: 3D model of a motor feeder combination (motor starter protector and contactor)	315
Figure A-5	Example: Circuit diagram of a SITOP power supply.....	316
Figure A-6	Product selection using software	323
Figure A-7	Siemens Industry Mall.....	325
Figure B-1	Example: Horizontal and vertical standards	331
Figure B-2	Low voltage Directive 2014/35/EU (LVD)	334
Figure B-3	Machinery Directive 2006/42/EC (MD)	335
Figure B-4	A, B and C Type standards - overview	336
Figure B-5	Blue Guide	339
Figure B-6	Process of risk assessment and risk reduction.....	341
Figure B-7	Flowchart for plant modifications	342

Introduction

Target group

This reference manual is intended for the following target groups:

- Plant manufacturers
- Industrial control panel builders
- Machine builders
- Electrical system planners

The information in this manual is intended as an aid to users in practical issues concerning the planning, manufacture and operation of electronic low-voltage switchgear and controlgear assemblies.

Typical circuit diagrams and interpretations of standards and directives

The typical circuit diagrams and interpretations of standards and directives are not binding and do not claim to be complete regarding configuration, equipment or any other eventuality. They are not customer-specific solutions, but simply provide assistance with typical tasks.

Every user is responsible for the correct operation of the products described.

The typical circuit diagrams and interpretations of standards and directives do not relieve you of your responsibility to ensure safe handling when using, installing, operating, and maintaining electrical equipment. By using these typical circuit diagrams and interpretations of standards and directives, you acknowledge that Siemens cannot be held liable for possible damage beyond the scope of the liability outlined above. We reserve the right to make changes and revisions to these typical circuit diagrams and interpretations of standards and directives without prior announcement.

Information about the sources used

A few of the tables and texts in this reference manual have been taken from the latest editions of regulations, standards, directives and codes that were valid at the time of preparation of the manual. All users shall always check whether the information quoted from these sources is still up to date and applicable or not.

The information in this manual will rarely be sufficient to attain compliance with EU legislation, approval, listing, certification, or authorization. Detailed knowledge of the corresponding regulations is needed for this.

The concepts and terms which appear in the manual are explained in the glossary.

Standards

The manual is based on European directives and international IEC standards. Most of the rules and regulations discussed in the document originate from the following sources:

- Low Voltage Directive 2014/35/EU
- Machinery Directive 2006/42/EC
- EMC Directive 2014/30/EU
- IEC 60364 series (DIN VDE 0100 series) (the version of each standard valid at the time of preparation of this manual)
- IEC 60204-1 (2016, modified)
- IEC 61439 series (DIN EN 61439 series) (the version of each standard valid at the time of preparation of this reference manual)

The standards and directives listed above do not specify the necessary details for many types of application. To meet the needs of the manufacturer, this reference manual therefore makes liberal use of provisions from other relevant standards and regulations. The applications described here are generally recognized practices.

Industrial control panels and equipment for machinery manufactured for and circulated in the international IEC market shall comply with the relevant regulations as a minimum requirement. The aim of this document is to help manufacturers and their suppliers to comply with the applicable standards and directives.

Every manufacturer is responsible for ensuring that the product he/she places on the market fulfills the relevant safety objectives. Within the European Economic Area, this is achieved by ensuring compliance of the product with the relevant directive. A manufacturer certifies conformity with the applicable directives by a CE marking and an EU Declaration of Conformity. Conformity with directives can be presumed by ensuring compliance with harmonized standards. It is the responsibility of the manufacturer to decide which directive and harmonized standards apply to a particular product.

Acceptance testing by an independent certification institute is not mandatory within the European Economic Area.

Scope of this documentation

This reference manual focuses mainly on the design of electrical equipment for machinery, in other words, on control panels and switchgear and controlgear assemblies for general use, and general electrical equipment for industrial machinery and systems according to standards IEC 60204-1 and IEC 61439-1/-2. In many respects, the primary standards series IEC 60364 also applies and is therefore discussed.

Since some chapters of this reference manual are based on specifications from standards, the area of application is, accordingly, based on these standards as well. Details about the scope of the primarily relevant standards IEC 60204-1, IEC 61439-1/-2 and the IEC 60364 series can be found in chapter Standards (Page 30).

This manual does not discuss the following subjects: safety of machinery, functional safety of safety-related electronic equipment or systems, devices or protective systems in potentially explosive areas, explosion protection or electromagnetic compatibility.

This reference manual cannot and should not be regarded as a substitute for the required standards. Instead, it attempts to give practical explanations of passages from these standards based on examples and background information. Electrical equipment cannot be designed to conform to standards unless the relevant standards are applied to the design.

Organizations and standards

3.1 Organizations

This chapter provides an overview of existing European and international standardization bodies and institutes, and explains how they work together to draw up standards and directives. The technical implementation of this reference manual is based on the publication and implementation of directives, regulations and standards adopted within the European Union and internationally.

Global standards

The map below shows the countries/regions of the world in which important global standards are valid:

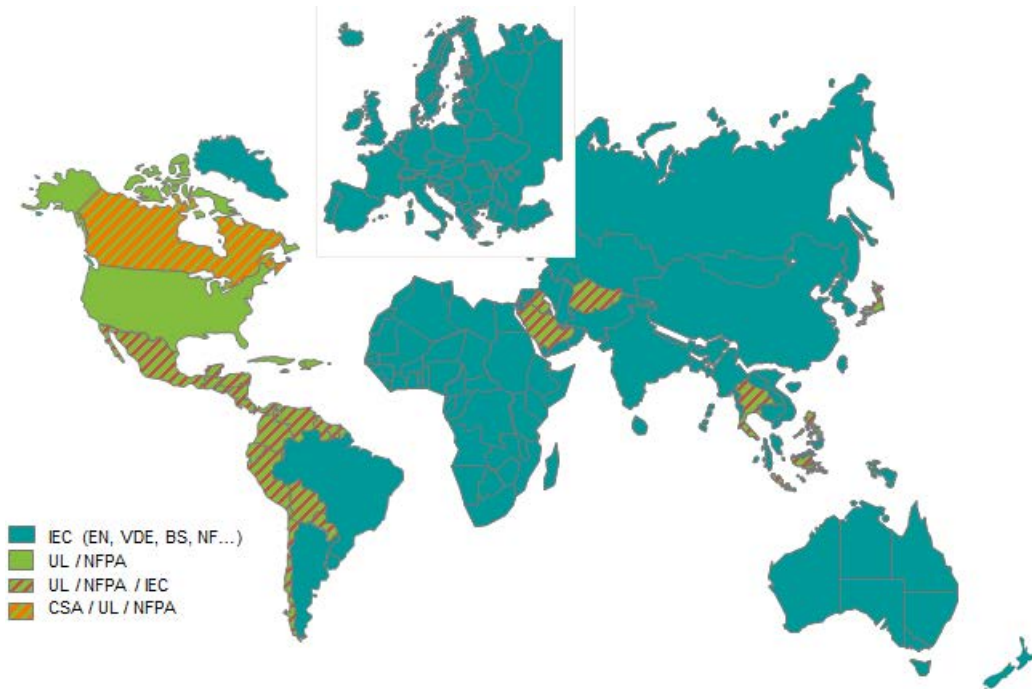

Figure 3-1 Important standards and the countries/regions in which they apply

Further information about North American standards can be found in the Siemens guide "Industrial Control Panels and Electrical Equipment of Industrial Machinery for North America".

Organizations and committees

Listed below are the organizations and committees that have been nominated to publish technical specifications and standards for application internationally and in the European Economic Area. The official publication languages are French, English and German.

IEC

German: *Internationale Elektrotechnische Kommission*

English: *International Electrotechnical Commission*

83 states were members of the International Electrotechnical Commission in 2016. These "National Committees" nominate their experts from industry, government agencies, trade associations and scientific institutions to participate in the electrotechnical standardization and conformity assessment work performed by the **IEC**. A list of the member states organized in the IEC can be found in the appendix (Page 343).

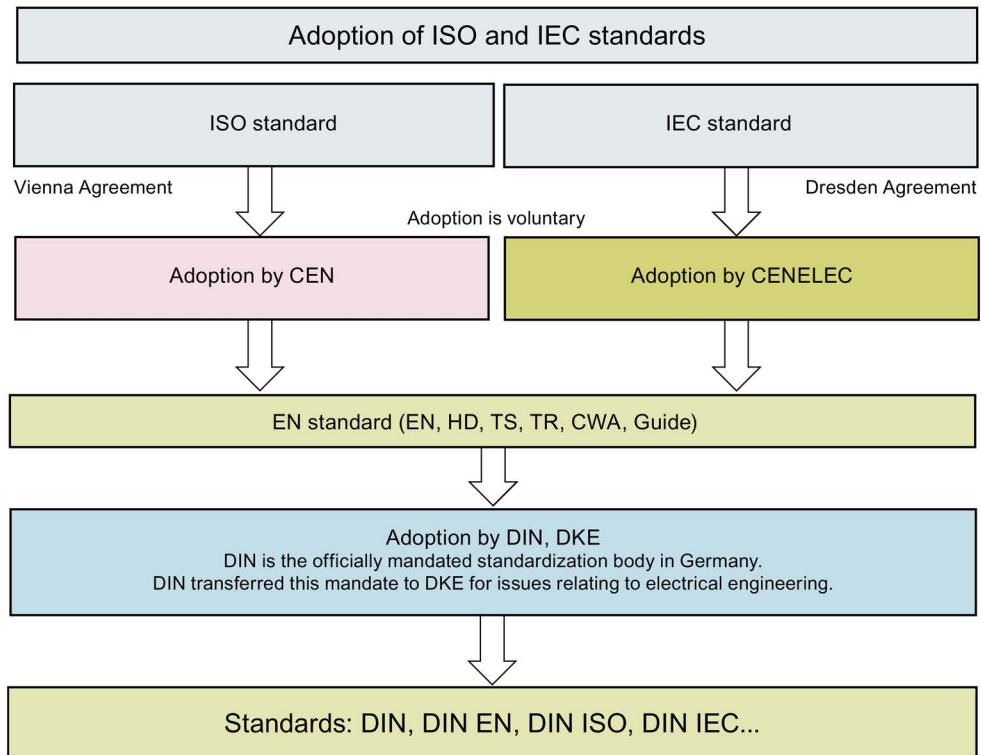

- DIN German Institute for Standardization
- DKE German Commission for Electrical, Electronic and Information Technologies
- ISO International Organization for Standardization
- EN European Norm
- HD Harmonized Document
- Types of published results (ISO):
- TS Technical Specification
- TR Technical Report

Figure 3-2 Standardization (Germany as example)

Interest groups

ZVEI, ZVEH, VDMA, CAPIEL (EU) are major associations that assist their members with the interpretation of standards. These associations are not directly involved in the standardization process, but members of the associations may well be members of standardization committees.

- IECEE or CEE

German: *Internationale Kommission für die Regelung der Zulassung elektrischer Ausrüstungen*

English: *International Commission on Rules for the approval of Electrical Equipment*

The IEC uses the name IECEE to refer to *Conformity Testing and Certification of Electrotechnical Equipment and Components*. This body comprises a large number of certification institutes and test laboratories and was integrated into the IEC in 1985. A list of the member states organized in IECEE can be found in the appendix (Page 343).

The CEN is the largest of the three major European standards organizations for all technical sectors. CENELEC (electrotechnical standards) and ETSI (telecommunications standards) are the other two standards organizations charged with developing standards for all 27 member states of the European Union.

- CEN

German: Europäisches Komitee für Normung

English: European Committee for Standardization

- CENELEC

German: Europäisches Komitee für Elektrotechnische Normung

English: European Committee for Electrotechnical Standardisation

- ETSI

German: Europäisches Institut für Telekommunikationsnormen

English: European Telecommunications Standards Institute

Scope of the EU directives

The standards that are developed by the standards organizations and then published by CENELEC are then also valid in the three EFTA member states Iceland, Liechtenstein and Norway, and in the other member states of the European Economic Area (EEA) Switzerland, Turkey, Andorra, San Marino and Monaco. The standards are also valid in the overseas dependent territories Guadeloupe, French Guiana, Martinique, Réunion, Saint-Barthélemy, Saint-Martin, the Azores, Madeira and the Canary Islands.



Figure 3-3 European Economic Area with EFTA and other countries

Development and publication of harmonized standards

The three European standards organizations are mandated by the European Commission to develop harmonized standards.

The proposed standards are drafted on the basis of this mandate and largely based on IEC international standards.

The CENELEC as a European Committee for Electrotechnical Standardization brings together the national standards institutions of various countries. Owing to the large number of national standards institutions and the involvement of industry, government agencies, trade associations and scientific bodies, it is commonly the case that several voting proposals are developed and submitted to the European Commission for assessment. After these have been assessed, they are published as a "harmonized standard".

The country-specific committees for standards and national specifications are listed in the appendix (Page 347).

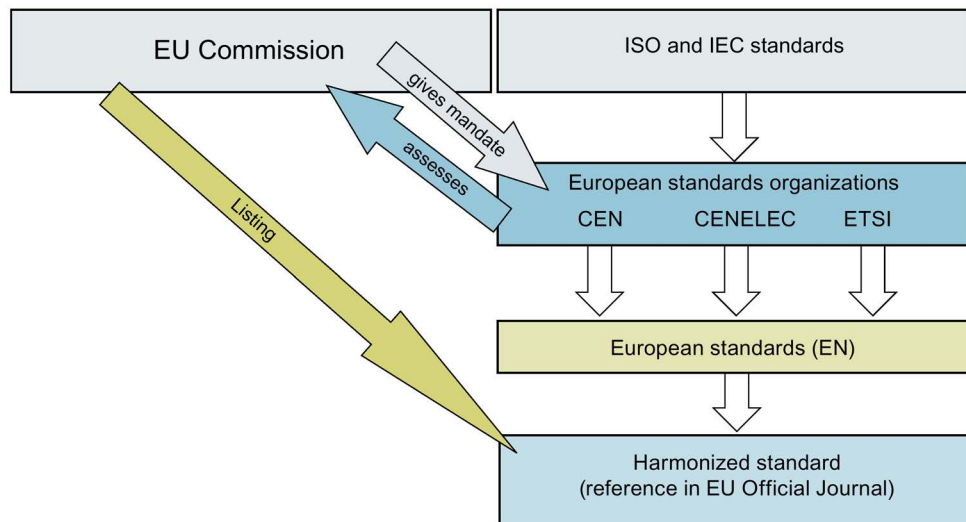

Figure 3-4 Development and publication of harmonized standards

The term "standard" for example is defined in DIN 820, Part 3 as: "Standardization is the systematic unification of material and immaterial subjects carried out by all stakeholders working in consensus for the benefit of society as a whole."

3.2 Standards

The following chapter explains the interrelationship between European directives and harmonized standards using the example of the Low Voltage Directive 2014/35/EU and the Machinery Directive 2006/42/EC.

Harmonized standards

EU directives are usually transposed by the member states of the European Economic Area into their own national legislation as binding product safety laws or regulations. For Germany, for example, the Machinery Directive 2006/42/EC is implemented in the 9th Product Safety Act for the protection of the health and safety of users.

As part of efforts to harmonize European directives, several new directives came into force in 2016. One of these directives - the Low Voltage Directive - was implemented in national law. The new version of the 1st Product Safety Act (Regulation on electrical equipment - 1st ProdSV) came into force on April 20, 2016.

Several directives may apply simultaneously to one product. If this is true for a particular product, all basic requirements of the relevant directives shall be fulfilled.

However, the directives simply define the basic requirements for averting risks without specifying the means by which solutions can be engineered. The technical standards provide guidance in fulfilling the basic requirements for averting risks for the operator and the product. EU standards are available to manufacturers as "harmonized European standards". The European Commission grants a mandate to CENELEC to develop these standards.

As a result of the New Approach to harmonizing standards launched in 1985, the concept of harmonized standards became a reality and was extended further in 2008 by the harmonization efforts encompassed in the "New legislative Framework" (NLF).

Directives, regulations, legislation and standards

Standards are used by product manufacturers as a guide for analyzing risks and meeting basic requirements. The list of applicable harmonized standards is published with the Official Journal for the relevant directive.

By contrast with the requirements in the directives, the standards are extremely precise with respect to technical details and reflect the state of the art as regards protection against hazards at the time of publication.

But application of these standards is still voluntary. In other words, unlike laws and regulations, standards are not binding. However, an obligation to apply them may arise as a result of legislation, administrative regulations or contractual commitments.

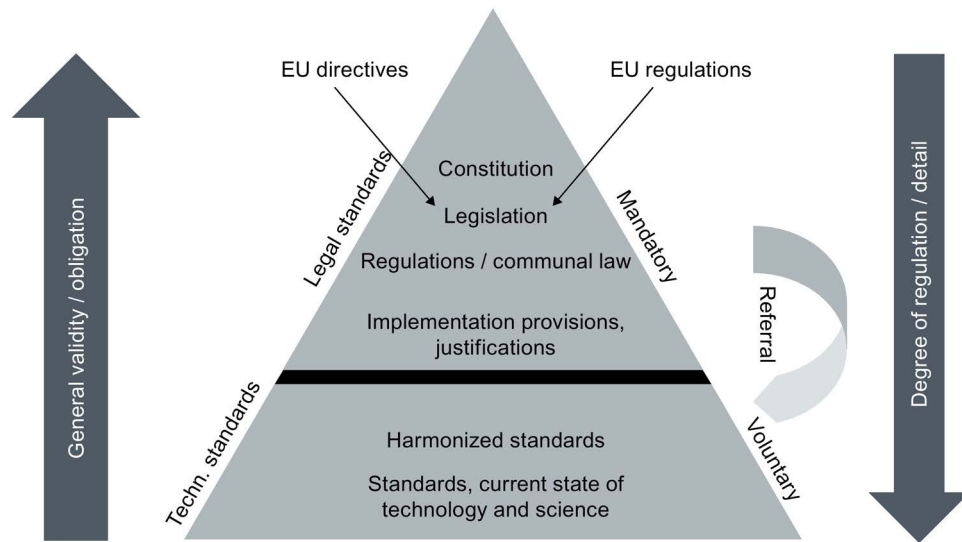

Figure 3-5 Legal standard

The members in the standards organizations are responsible for drafting standards. A total of 33 members are listed for CENELEC, see appendix (Page 346). These people bear the responsibility for developing and interpreting standards and safety regulations applicable to electrical and electronic products.

State of the art and acknowledged rule of technology

The definition in paragraph 1.4 "State of the art in EN 45020-2006 is as follows:

"Developed stage of technical capability at a given time as regards products, processes and services, based on the relevant consolidated findings of science, technology and experience"

"Acknowledged rule of technology" is defined in paragraph 1.5 as:

"technical provision acknowledged by a majority of representative experts as reflecting the **state of the art**"

German interest groups

The *Deutsche Kommission Elektrotechnik Elektronik Informationstechnik im DIN und VDE* (German Commission for Electrical, Electronic & Information Technologies of DIN and VDE) - or *DKE* for short – is responsible for the development of standards and safety specifications in the areas of electrical engineering, electronics, information technologies and telecommunications that are largely harmonized with European and global standards.

The *DKE* sends its experts to international commissions in order to represent German interests on standardization committees.



Figure 3-6 German interest groups for electrical engineering standardization projects

Development of a standard

The following diagram illustrates the process of developing a standard in Germany - from the moment it is initially proposed until the date of its publication.

Public experts (whether individuals or interest groups) have the option of submitting proposals for a specific standard either by personal or written application. The proposals are channeled and evaluated by the standardization committee.

During the consultation period (between 2 and 4 months depending on the standard), public experts can actively participate in drafting the standard, e.g. online via the DIN Standards Portal (<http://www.din.de/de/mitwirken/entwuerfe>). The responsible working committee evaluates comments submitted by experts and writes the manuscript. The unit "Process Quality Monitoring" then checks and finally publishes the standard.

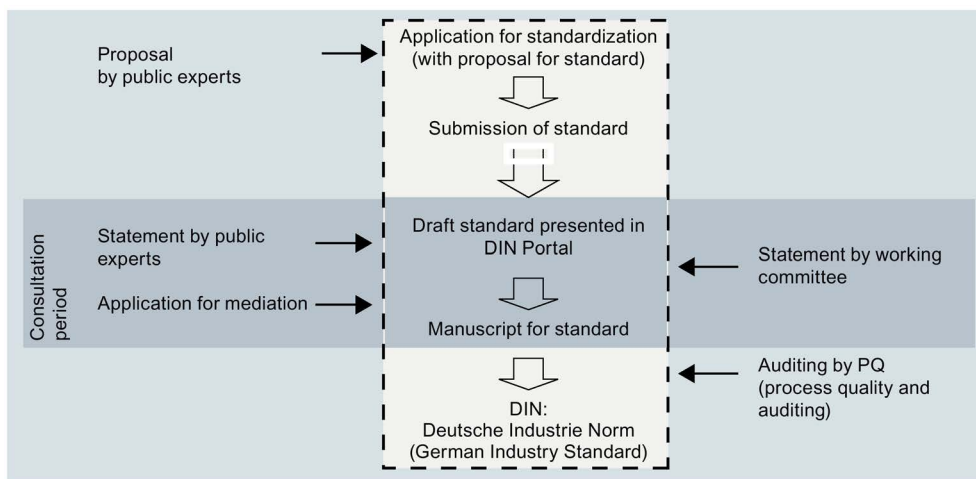

Figure 3-7 Development of a standard (Germany as example)

Details about the development of national, European and international standards can be found at the DIN (<https://www.din.de>) website.

Translation

The content of published regulations, standards or harmonization documents is translated into German from the original document. In the Federal Republic of Germany and in many other European states, the content of published regulations and recommendations are implemented in national laws and regulations by trade associations or legislators.

In Germany, DKE is responsible for translating content and transposing it into the DIN set of standards and the VDE regulatory standards. When standards are translated from the original text, the formulation from the original version is binding.

Publication of standards

The Official Journals that publish European directives list harmonized standards that make it possible to fulfill each respective directive's safety objectives (presumption of conformity). The manufacturer shall ensure that he/she applies the latest version of the standard.

Unlike the directive, the EU Official Journals are regularly updated and made available to download from the Internet.

You can find a selection of the current links for downloading directives and Official Journals free of charge in the appendix (Page 333).

Official Journal for the European Low Voltage Directive 2014/35/EU

Below is an excerpt from the Official Journal for the European Low Voltage Directive 2014/35/EU which explains the listed standards and how they should be used and interpreted.



Figure 3-8 Excerpt from the Official Journal of the European Union

3.2 Standards

C 249/62 EN Official Journal of the European Union 8.7.2016				
Commission communication in the framework of the implementation of Directive 2014/35/EU of the European Parliament and of the Council on the harmonisation of the laws of the Member States relating to the making available on the market of electrical equipment designed for use within certain voltage limits (Publication of titles and references of harmonised standards under Union harmonisation legislation) (Text with EEA relevance) (2016/C 249/03)				
ISO (*)	Reference and title of the standard (and reference document)	First publication OJ	Reference of superseded standard	Date of cessation of presumption of conformity of superseded standard Note 1
(1)	(2)	(3)	(4)	(5)
CEN	EN ISO 11252:2013 Lasers and laser-related equipment - Laser device - Minimum requirements for documentation (ISO 11252:2013)	This is the first publication		
Cenelec	EN 61243-3:2014 Live working - Voltage detectors - Part 3: Two-pole low-voltage type IEC 61243-3:2014	This is the first publication	EN 61243-3:2010 Note 2.1	13.11.2017
Cenelec	EN 61439-1:2011 Low-voltage switchgear and controlgear assemblies - Part 1: General rules IEC 61439-1:2011	This is the first publication	EN 61439-1:2009 Note 2.1	
Cenelec	EN 61439-2:2011 Low-voltage switchgear and controlgear assemblies - Part 2: Power switchgear and controlgear assemblies IEC 61439-2:2011	This is the first publication	EN 61439-2:2009 Note 2.1	
Cenelec	EN 61439-3:2012 Low-voltage switchgear and controlgear assemblies - Part 3: Distribution boards intended to be operated by ordinary persons (DBO) IEC 61439-3:2012	This is the first publication	EN 60439-3:1991 + A1:1994 + A2:2001 Note 2.1	

Source: European Commission, Official Journal OJ C 249 published on July 8, 2016

Figure 3-9 Excerpt from the Official Journal for the European Low Voltage Directive (2014/35/EU)

Proof of compliance with basic requirements

The advantage of complying with a harmonized European standard (that is published in at least one member state via the Official Journal) is that it can be presumed automatically that the basic requirements of the directive to which the standard refers have been fulfilled.

Product manufacturers are urgently advised to base their risk assessment on harmonized standards which provide useful guidance in performing effective risk analysis and meeting basic requirements.

If the manufacturer of a product decides against providing proof of compliance on the basis of "harmonized standards", then he/she is required to conduct a risk analysis to provide separate proof that the basic requirements of the EU directive have been fulfilled.

Although standards IEC 60204-1 and IEC 61439-1/-2 do not describe any specific methods of risk analysis, it is possible to manage most risks through consistent compliance with standards. You can find suitable risk analysis guidance with respect to low-voltage equipment in the CENELEC Guide 32 (Page 340) and in IEC 12100.

It may be necessary to use the services of a third party in some cases.

Special aspects of the Machinery Directive

According to paragraph 1.5.1 for the electricity supply of machinery in the Machinery Directive 2006/42/EC, the following generally applies with respect to risks due to other hazards:

"[...] Where machinery has an electricity supply, it shall be designed, constructed and equipped in such a way that all hazards of an electrical nature are or can be prevented. [...]"

As regards the hazards posed by electricity, the Machinery Directive specifically refers to the safety objectives of the Low Voltage Directive. In view of this fact, the electrical equipment of machinery is subject not only to the standards associated with the Machinery Directive, but also to those published for the Low Voltage Directive.

You can find a selection of the electrical and mechanical standards that are valid for the Machinery Directive 2006/42/EC and the Low Voltage Directive 2014/35/EU in the appendix (Page 331). IEC 61439 is listed in the Official Journal of the Low Voltage Directive, but not in the Machinery Directive.

Selection of harmonized standards

Excerpts from a number of important harmonized standards and the sections relevant to the safety of machinery and the electrical equipment of machines are given in the table below.

Table 3- 1 Selection of harmonized standards

European standard	German standard	International standard	Title
EN 60204-1	DIN EN 60204-1	IEC 60204-1	Safety of machinery – Electrical equipment of machines
EN 61439-1	DIN EN 61439-1	IEC 61439-1	Low-voltage switchgear and controlgear assemblies – General rules
EN 61439-2	DIN EN 61439-2	IEC 61439-2	Low-voltage switchgear and controlgear assemblies – Power switchgear and controlgear assemblies
HD 60364	DIN VDE 0100	IEC 60364	Low-voltage electrical installations – Parts 1 to 8
EN ISO 12100	DIN EN ISO 12100	ISO 12100	Safety of machinery – General principles for design – Risk assessment and risk reduction
EN ISO 13849	DIN EN ISO 13849	ISO 13849	Safety of machinery – Safety-related parts of control systems
EN 62061	DIN EN 62061	IEC 62061	Safety of machinery – Functional safety of safety-related electrical, electronic and programmable electronic control systems

See also

Scope of applicability for IEC EE (Page 343)

3.3 The control panel - does the Machinery Directive or the Low Voltage Directive apply?

The decision as to whether the electrical equipment of machines including the control panel falls within the scope of the Machinery Directive or the Low Voltage Directive has immediate implications for the manufacturer's obligations to provide proof with respect to technical documentation and the standards applied. For additional information about verification, refer to chapter Testing and verifications (Page 194).

Regardless of whether the control panel falls within the scope of the Machinery or the Low Voltage Directive, the general principles with respect to health and safety requirements shall be observed. The person who places the control panel on the market shall ensure that a risk assessment is carried out to determine the applicable health and safety requirements. The party who will bear responsibility for performing the risk assessment of the control panel shall be agreed in advance between the machine manufacturer and the control panel manufacturer.

Statement regarding safety of electrical machinery

The *German Commission for Electrical, Electronic & Information Technologies of DIN and VDE* (DKE) published a statement regarding the application of DIN EN 60204-1, DIN EN 61439-1 and DIN EN 61439-2 in relation to the safety of machinery and the installation of electrical equipment of machines.

In their summary, DKE stated the following:

"The application of DIN EN 60204-1 allows the declaration of conformity with the relevant essential requirements of the Machinery Directive or the Low Voltage Directive (presumption of conformity for the requirements of Annex I to the Machinery Directive listed in Annex ZZ). As a result of risk assessment, manufacturers of switchgear may use technical rules, e.g. those given in DIN EN 61439-1 or DIN EN 61439-2, as an additional aid for design (e.g. consideration of heat and short-circuit).

However, the exclusive use of DIN EN 61439-1 and DIN EN 61439-2 is not sufficient for the safety of machinery.

The use of DIN EN 60204-1 is sufficient for the declaration of conformity of switchgear assemblies which are part of the electrical equipment of machines."

The full wording of the statement DKE/K 225 of November 3, 2014 can be read under the following link (<https://www.dke.de/de/normen-standards/normen-anwenden/installationstechnik-anlagen-geraete-und-maschinen>).

Recommendation

Note

In accordance with the statement DKE/K 225, we recommend that the contents of standards EN 60204-1 and EN 61439-1/-2 are used to analyze the risks pertaining to electrical safety within the framework of the risk assessment for the electrical equipment of machinery and the relevant control panel.

The DKE statement refers to the German market. It is however recommended that the statement be observed worldwide within the context of IEC standards.

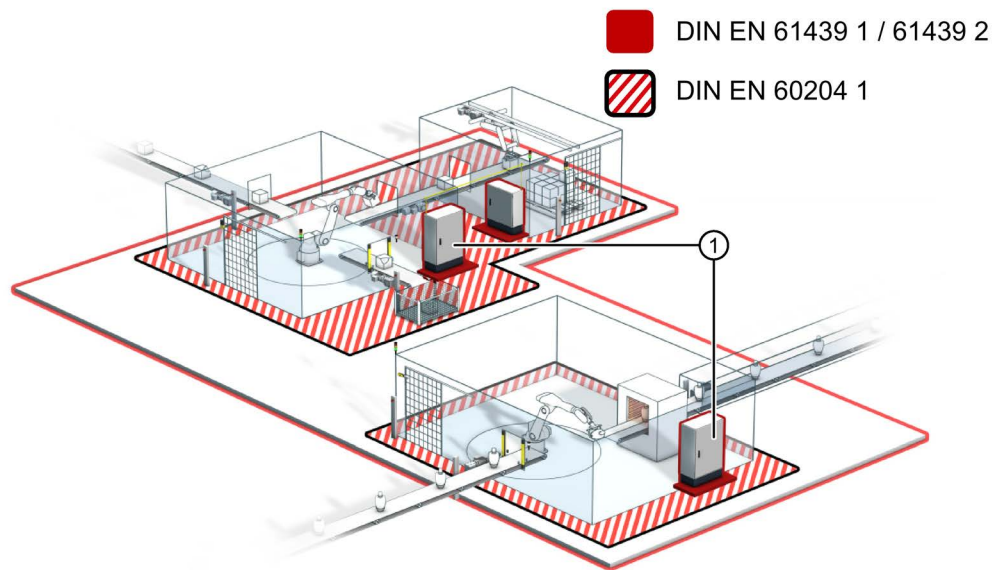

① Control panel

Figure 3-10 Recommended application of standards

Markings and symbols for market access

Product markings

This chapter provides an overview of the requirements and markings relating to products and product safety that are common in the European Economic Area (EEA) and on international markets.

Markings that allow products to gain market access are common. They are proof that the product complies with certain legal and technical regulations. Depending on the country, application or product, these markings can be mandatory or voluntary.

The following map shows a variety of countries color-coded according to international standards and economic regions which have specific requirements with respect to test and administrative marks.

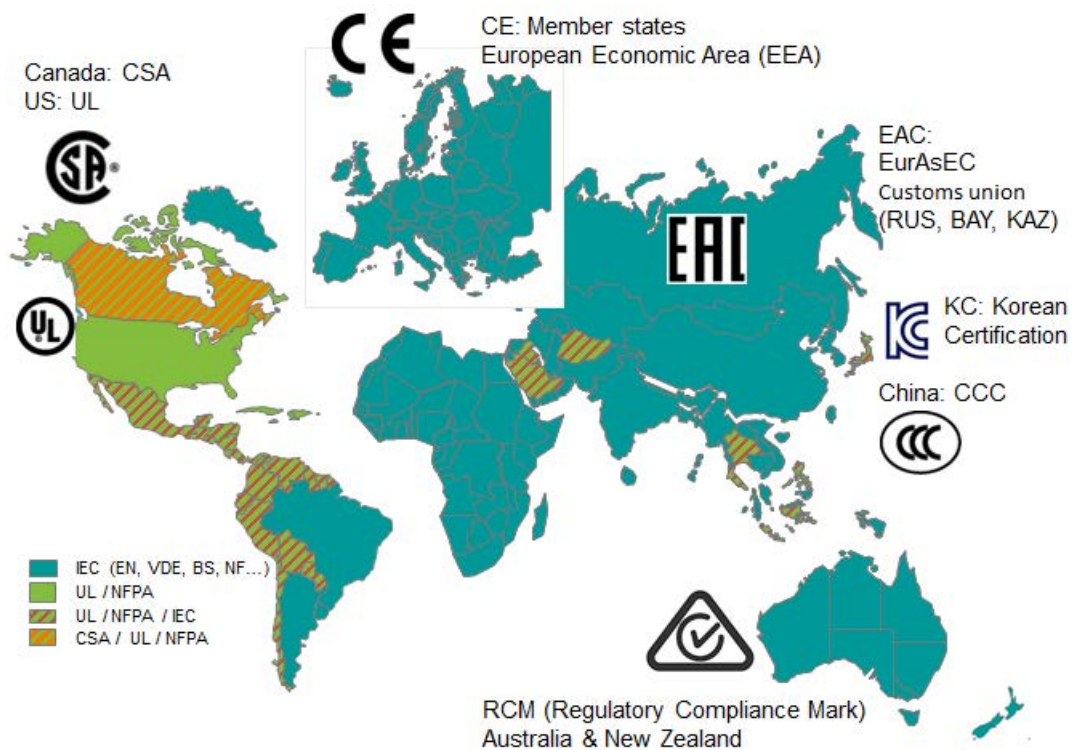

Figure 4-1 Example: Countries and economic regions which require test and administrative marks

Declaration of conformity and CE marking

The declaration of conformity and CE marking are mandatory for products placed on the market for the countries of the European Union, the member states of the European Economic Area including those countries who have signed up to the European Free Trade Agreement, the European overseas dependent territories, as well as Switzerland and Turkey. The consistent, obligatory implementation of EU legal provisions and the strict observance of the safety objectives defined in EU directives for the protection of the health and safety of users are the basis for the declaration of conformity and CE marking.

By affixing the CE marking to a product, the manufacturer declares that the product has been successfully assessed for conformity and that it legally complies with the basic requirements of the safety objectives defined in the relevant directive. Through compliance with the harmonized standards and legal provisions, the criteria for "presumption of conformity" are met, i.e. it is presumed that the product fulfils the safety objectives outlined in the directive.

The CE marking is important proof that a product conforms to EU legal provisions. It means that goods can move freely within the member states of the EEA regardless of whether the goods were manufactured inside or outside the EEA.

Irrespective of which of the 4 defined economic players (manufacturers, authorized representatives, importers and distributors) places a product on the market in the economic area, it is done within a uniform framework with general principles. The economic players are responsible for ensuring product conformity according to the appropriate EU directives for product safety. The obligations to be fulfilled by these players vary in terms of the burden they impose depending on the role of the player in the supply chain. Failure to consistently implement EU legal provisions or violations or shortcomings with respect to fulfillment of performance or function requirements can have serious consequences for the economic player or players and for the product placed on the market.

Implementation	Member states are responsible for execution of EU law	
Monitoring	<ul style="list-style-type: none"> - Market supervision by customs or factory inspectorate - Employers' liability insurance associations, factory inspectorate 	
Consequences	<ul style="list-style-type: none"> - Written warning, obligation to issue a warning, publication - Rework - Sales prohibition, withdrawal or recall - Penalty (fine and/or imprisonment depending on the directive and severity) 	
Networks	<ul style="list-style-type: none"> - European network of the market surveillance authority. Central databases for recording problem products. - RAPEX database and ICSMS database 	
	CE marking → implement conscientiously and professionally	

Figure 4-2 Meaning of EU directives and legal consequences

The European Union plays a leading role in international cooperation in relation to technical regulations, standardization and conformity assessment and in eliminating technical obstacles to free trade with products. Furthermore, as part of its neighborhood policy, the European Commission has sent clear signals that it wishes to cooperate more closely on trade, market access and regulatory structures with neighboring countries in the east and south of the EU.

Detailed information about the CE marking can be found in the "Blue Guide (<http://ec.europa.eu/DocsRoom/documents/12661?locale=de>) on the implementation of EU product rules 2016" (2016/C 272/01).

Test and administrative marks

A large number of test and administrative marks are in use outside of the EEA but within areas of the world in which IEC standards are applicable, for example, in Eastern and Southern Europe, the Middle East, Asia, China, Oceania and South America.

Note

Changes for the countries of the Customs Union (CU)

The Russian certification **GOST** or **GOST-R** is still valid for the Russian Federation, but is gradually being superseded by new technical rules and regulations. The GOST or GOST-R certification is not valid in the other countries in the Customs Union.

In the case of a declaration of conformity in accordance with the technical guidelines of the Customs Union, the GOST-R certification is not required and is replaced by the **EAC** certification.

People's Republic of China

The 3C or **CCC** (China Compulsory Certificate) certification was implemented in the People's Republic of China in 2002 and is designed to safeguard aspects of national safety and to protect people, animals and the environment. For products or product groups that require a China Compulsory Certificate (CCC), it is usual to carry out product-specific tests and manufacturer-specific audits.

As with the CE marking in the EEA, products which require a certificate may not be imported or sold or marketed within the scope of a business relationship in China without a CCC product label. Violations of CCC rules are normally penalized with fines.

Example

A range of different approval markings including CE, CCC and EAC are exhibited on the rating plate below:



Figure 4-3 Example: Rating plate with CE, CCC and EAC markings

Other countries

The obligation to label products varies from country to country and from product to product. Individual components such as contactors or frequency converters may well need to be marked, while a complete control panel, for example, might not need any certification at all. For this reason, it is advisable to clarify and possibly check requirements in these countries on a case-by-case basis with the customer depending on the product and the design of the control panel. For many countries, it has proven useful to carry out certification on an order-specific basis with the assistance of specialized service providers.

Additional test and administrative markings are used in the following countries and regions:

- **Eastern and Southern Europe**
Countries in the Customs Union: Russia, Belarus, Kazakhstan, Ukraine (other countries under discussion)
- **Middle East**
Kingdom of Saudi Arabia, Kuwait, United Arab Emirates, Qatar, Iraq and Kurdistan
- **Asia and Oceania**
China, Japan, South Korea, Australia

- **South America**

Panama, Ecuador, Columbia, Peru, Uruguay, Venezuela, Brazil, Argentina, Chile

- **North America**

North American Free Trade Agreement (NAFTA): USA, Canada, Mexico

You can find information about exporting to North America in our reference manual "Industrial Control Panels and Electrical Equipment of Industrial Machinery for North America" on the Internet (<http://www.siemens.com/schaltschrankbau>).

Irrespective of the regions mentioned above, we recommend that you investigate the current rules regarding test and administrative markings including the currently applicable standards **before** you deliver products to new economic areas.

Control engineering - definition of terms and fundamental principles

5

Important basic terms relating to switchgear manufacture and control engineering are briefly explained and illustrated by examples in this chapter. You can find further definitions in German, English and French in the online dictionary of the DKE (International Electrotechnical Vocabulary): DKE-IEV (<https://www2.dke.de/de/Online-Service/DKE-IEV/Seiten/IEV-Woerterbuch.aspx>)

Detailed explanations can be found in the documentation for the relevant products or in the relevant product standards or the application standards, e.g. IEC EN 60204-1 or IEC 61439-1.

5.1 Safety rules

All electrically skilled persons and electrically instructed persons shall be familiar with the five safety rules applicable to work on electrical installations. These rules shall always be observed.

5 safety rules

Definition according to DIN VDE 0105-100 / EN 50110-1:

All work on electrical installations shall be carried out by electrically skilled persons, or by persons who have received instruction in working on electrical installations, or under the supervision of one of the aforementioned. An installation or a section of an installation shall be released by the person charged with supervising the work after all five safety rules have been followed. Adherence with the specified rule sequence is essential.

1. Disconnect completely
2. Secure against re-connection
3. Verify absence of operating voltage
4. Carry out earthing and short-circuiting (exceptions may be made under certain circumstances)
5. Provide protection against adjacent live parts
(exceptions may be made under certain circumstances)

Skilled person (electrically)

Definition according to DIN EN 60204-1:

"Person with relevant education, knowledge and experience to enable him or her to analyze risks and to avoid hazards which electricity could create."

(Electrically) Instructed person

Definition according to DIN EN 60204-1:

"Person adequately advised by an electrically skilled person to enable him or her to avoid dangers which electricity may create."

5.2 Types of grounding system

TN-S system

T = Terra = directly grounded neutral
 N = low-resistance return conductor to transformer neutral point
 S = separate conductors for PE and N

Advantage: System conforms with EMC guidelines

Disadvantage: 5 conductors

TN-C system

T = Terra = directly grounded neutral
 N = low-impedance return conductor to transformer neutral point
 c = a "combined" conductor for PE and N = PEN

Advantage: Only 4 conductors

Disadvantage: Susceptible to electromagnetic interference because harmonics are discharged via the PEN which means that loads with N conductor are additionally stressed by harmonics.

TN-C-S system

With this system, a combined N and PE (PEN) conductor exits from the transformer, but at some point, the PEN conductor is split up into separate PE and N lines.

PEN is nonetheless the correct description for this PE because the neutral can be separated out of the combined conductor at any time. Once the neutral has been separated out of the combined conductor, it cannot be connected to the PEN again, i.e. it must be a "spur line"!

If a neutral conductor that had already been split from the PEN were reconnected to it, it would constitute a parallel connection with an incalculable impedance and thus also an incalculable short-circuit load. Furthermore, it can result in undesirable stray ("vagrant") currents.

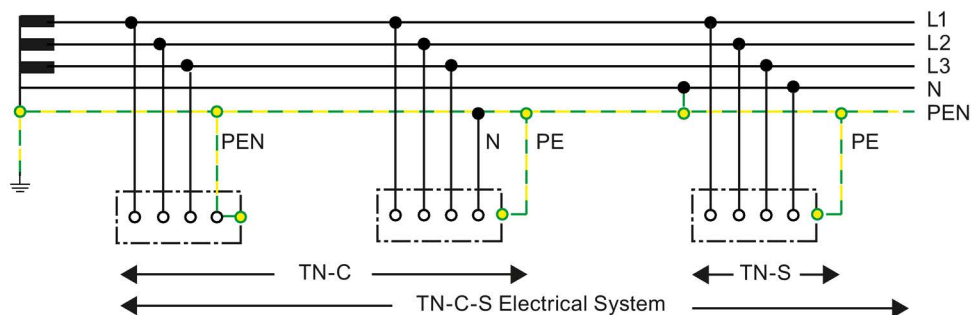

Figure 5-1 TN-C-S system

IT system

I = transformer neutral point isolated or with high-impedance ground connection
T = Terra = each item of equipment has separate low-impedance ground connection

Advantage: First fault = conductive connection from phase to enclosure does **not** cause disconnection.

Disadvantage: An additional monitoring system for detecting the first fault shall be installed.

Used, for example, in situations in which high availability of electrical installations is essential, e.g. in hospital operating theaters, potentially explosive atmospheres.

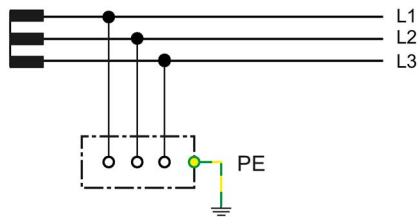

Figure 5-2 IT system

TT system

T = Terra = directly grounded neutral
T = Terra = each item of equipment has separate low-impedance ground connection

The PE connection is provided by a local ground electrode. When the transformer is located a long way from the equipment, the large number of series and parallel equivalent resistances of the ground produce a relatively low grounding resistance which means that this system has similar characteristics to a TN system.

Advantage: Only 3 conductors are required

Disadvantage: An effective system only when transformer is located a long way from consumers.

Used in low-voltage networks in areas in which the substation is located at a large distance from consumers, i.e. in rural localities.

Used in medium-voltage networks in conjunction with (overhead) power lines.

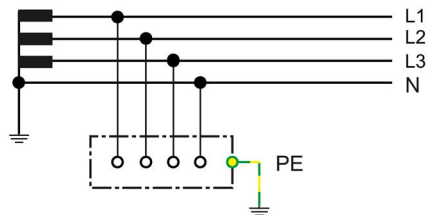

Figure 5-3 TT system (N conductor as required)

5.3 Rated...

Rated...

Whenever a term begins with or contains the word "rated...", it means that the circuit or the component concerned is designed to permanently withstand this value (see IEC 60204-1).

- Rated current
- Rated voltage
- Rated power
- Rated cross-sectional area
- Rated diversity factor RDF
- Rated short-time withstand current I_{cw}

5.4 Current...

Overcurrent

Current which exceeds the rated value.

For conductors and cables, the rated value is their current-carrying capacity.

The rated value for switchgear is the relevant rated current (I_{rated} or I_r).

Overload (of a circuit)

Time/current relationship in a circuit which is in excess of the rated full load when the circuit is not under a fault condition. (Source: IEC 60204-1)

Overload should not be used as a synonym for overcurrent.

Short-circuit current

Overcurrent resulting from a short circuit due to a fault or an incorrect connection in an electric circuit. (Source: IEC 441-11-07)

In this case, the magnitude of the current is significantly higher than the rated value.

Circuit under a fault condition; low-impedance connection between phase and PE / N

Earth fault current (US: Ground fault current)

Current flowing to earth due to an insulation fault. (Source: IEC 442-01-23)

Earth leakage current

Current flowing from the live parts of the installation to earth, in the absence of an insulation fault. (Source: IEC 442-01-24)

Cut-off current (let-through current)

Maximum instantaneous value of current attained during the breaking operation of a switching device or a fuse.

NOTE: This concept is of particular importance when the switching device or the fuse operates in such a manner that the prospective peak current of the circuit is not reached.
(Source: IEC 441-17-12)

If the prospective peak current of the circuit is not reached, the term "current limiting" is applied. In this case, the cut-off current i_D corresponds to the cut-off current actually attained. This is specified as a peak value.

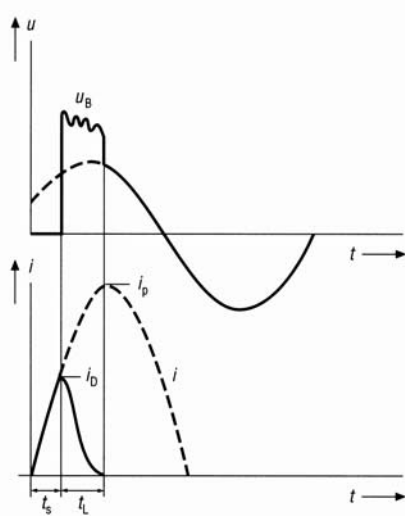

i_D : Cut-off current (let-through current)

i_p : Peak short-circuit current

t_s : Melting time

t_L : Arc quenching time

U_B : Arc voltage

Source: Siemens AG, Handbook Switching, Protection and Distribution in Low-Voltage Networks, 4th Edition 1997

Figure 5-4 Oscillogram of a short-circuit disconnection by a fuse

5.5 Degree of protection of enclosures

International Protection

The abbreviation IP stands for *International Protection*, but in English-speaking countries IP is also derived from "Ingress Protection".

IEC 60529 provides a detailed description of the degrees of protection provided by enclosures.

The letters IP are followed by 2 characteristic numerals, e.g. IP54:

- The first numeral defines the strength of the enclosure against the ingress of solid foreign objects (dust, contact by human body).
- The second numeral defines the strength of the enclosure against the ingress of water.

The following two letters are optional:

- The first letter defines the degree of protection against access to hazardous parts.
- The second letter defines test methods (access of test probes).

According to IEC 60529, additional letters are used in the following cases:

- When the actual protection against access to hazardous parts is higher than indicated by the first numeral.
- When only the protection against access to hazardous parts is specified and the first numeral is replaced by an X.

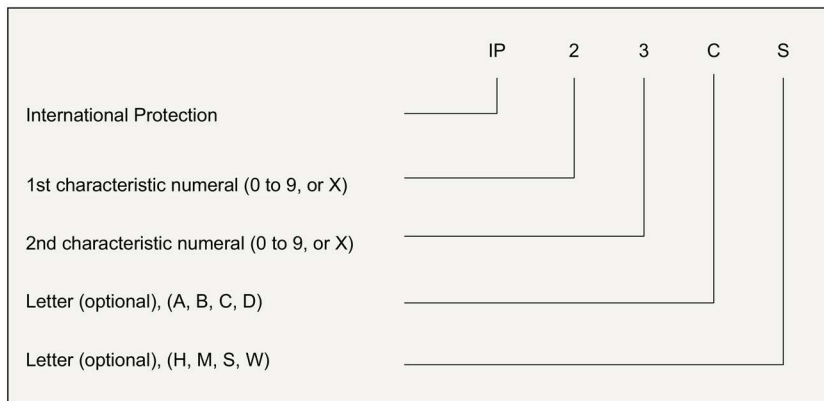

Figure 5-5 Degree of protection provided by enclosures: International Protection

Examples

IP54

- 5 = dust-protected. Ingress of dust is not totally prevented, but dust shall not penetrate in a quantity to interfere with satisfactory operation of the apparatus or to impair safety.
- 4 = protected against splashing water. Water splashed against the enclosure from any direction shall have no harmful effects.

This means that water may enter the enclosure, but it shall not cause any damage or safety hazards.

IPXXB

Protection against ingress of solid foreign objects and/or water is not required. The additional letter indicates, however, that access to hazardous parts is protected for incidental contact with fingers. This is generally referred to as "finger-safe".

Verification

Enclosures shall be tested in specially equipped laboratories to verify that they comply with the requirements for a particular degree of protection.

Recommendation

Enclosures that have already been tested in accordance with IEC 60529, (e.g. 8MF, ALPHA 3200, SIVACON) should be used.

Minimum degree of protection

IEC 60204-1 → IP22

IEC 61439-1 → IP2X

the front of an open switchgear and controlgear assembly
→ IPXXB

Installation of command and signaling devices in the door of a control panel, e.g. with IP54.

In order to maintain the degree of protection of the panel, the two numerals in the degree of protection of the equipment shall be equal to or higher than the numerals of the panel.

Examples:

- Panel IP54 and pushbutton IP44 → **not** possible because degree of protection of panel would then only be IP44
- Panel IP54 and pushbutton IP54 → OK, overall degree of protection IP54
- Panel IP54 and pushbutton IP65 → OK, overall degree of protection IP54

Conditions for accessing control panels and switchgear and controlgear assemblies

With key or tool

- Access only for electrically skilled persons, persons instructed in working on electrical installations.

Live parts which can be accessed, for example, during resetting or adjustment shall have at least IP2X (IPXXB), inside of door at least IP1X (IPXXA).

- **Disconnection of live parts**

- The parts shall be disconnected before the enclosure can be opened.
- It shall not be possible to open the door until the disconnecting device is open.
- It shall not be possible to close the disconnecting device unless the door is closed.
- All parts that remain live after the disconnecting device(s) has(have) been opened shall be protected against direct contact and labeled accordingly (at least IP2X / IPXXB).

This can be achieved, for example, by use of a door-coupling rotary operating mechanism.

Note

Exception

It shall be possible to make an exception for electrically skilled persons.

For information, see Chapter Basic protection (Page 102).

- **Without key, tool or disconnection**

- All live parts shall have at least IP2X (IP4X) or IPXXB (IPXXD).
- Covers can only be removed using tools.
- If it is possible to remove covers without using tools, the relevant live parts shall be disconnected automatically.

5.6 Touch protection for electrical equipment

EN 50274 "Low-voltage switchgear and controlgear assemblies - Protection against electric shock – Protection against unintentional direct contact with hazardous live parts" contains precise specifications with respect to touch protection including, for example, dimension drawings for test fingers.

Switchgear and controlgear assemblies that require occasional handling shall have touch protection:

- The touch protection in the area around the operator controls shall be "finger-safe".
- The touch protection in the rest of the panel shall be "safe from touch by back of the hand".

The touch protection measures are always tested on the horizontal (not from the side or at an angle from above).

Finger-safety

Standardized "test fingers" are used to test electrical equipment for finger-safety.

The purpose of this test is to ensure that nobody can access live parts with their fingers under normal conditions. This cannot be guaranteed, however, for parts used that are smaller than the "test finger".

Finger-safety measures are usually implemented in the direct vicinity of operator controls.

Safety from touch by back of hand

A standardized ball (diameter 50 mm) that is shaped like the back of a hand is used to test electrical equipment for this kind of safety.

The purpose of this test is to ensure that nobody can access live parts with the back of their hand under normal conditions. This **cannot** be guaranteed, however, for parts that are smaller, e.g. that can be accessed with a finger.

Safety measures to provide protection against access with the back of the hand are usually implemented adjacent to the finger-safe area or near parts which need to be exchanged (e.g. fuses).

Wire safety

Wire safety is calculated in 2 stages:

- Wires with a diameter of not less than 2.5 mm
- Wires with a diameter of not less than 1 mm

Wires with a diameter of not less than 1 mm are normally used for easily accessible, horizontal covers because this can provide reliable protection against contact between live components and "normal" wires used in the construction of switchgear and controlgear assemblies or "arm jewelry" (bracelets).

Example of the application of finger-safety

Finger-safety measures shall be implemented 30 mm around the pushbutton and to a depth of 80 mm.

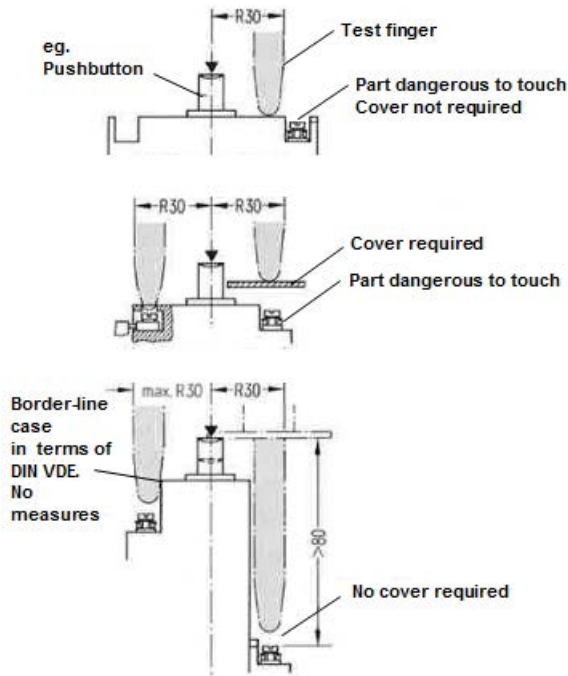

Source: Siemens AG, Handbook Switching, Protection and Distribution in Low-Voltage Networks, 4th Edition 1997

Figure 5-6 Test finger (dimensions in mm)

Example of the application of safety from touch by back of hand

The ball shall not make any contact with live parts.

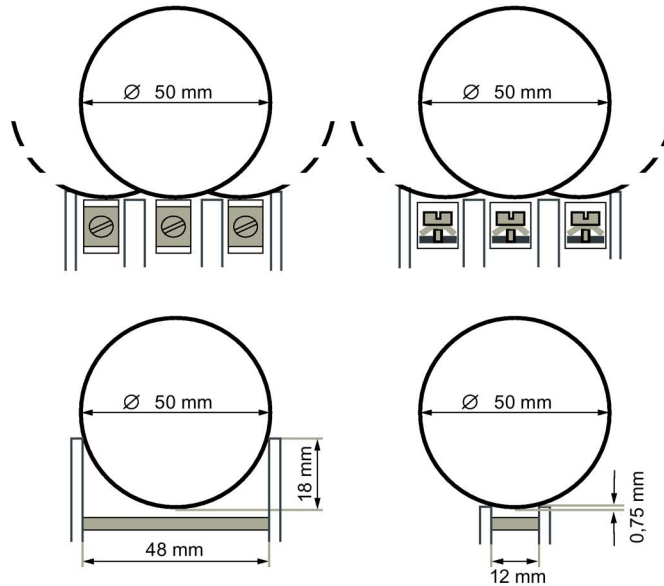

Figure 5-7 Parts dangerous to touch, dimensions in mm

5.7 Degree of pollution

The degree of pollution refers to the ambient conditions in which the switchgear or the control panel can operate.

For devices and components in an enclosure, the degree of pollution refers to the ambient conditions inside the enclosure.

The pollution degree is required in order to evaluate clearances and creepage distances. The higher the degree of pollution, the larger the clearances and creepage distances.

The degree of pollution always relates to the environment directly around the equipment.

Degree of pollution

The table describes the 4 degrees of pollution as defined by IEC 60664-1 and the areas to which they are usually assigned.

Degree of pollution 3 can be regarded as standard in industry.

Table 5- 1 Degree of pollution

Degree of pollution	Description	Areas	Minimum values of width X of grooves ¹
1	No pollution or only dry, non-conductive pollution occurs. The pollution has no influence.	Air-conditioned or clean, dry areas	0.25 mm
2	Only non-conductive pollution occurs except that occasionally a temporary conductivity caused by condensation is to be expected.	Residential, retail or commercial areas, precision mechanics workshops, laboratories, test stations, rooms used for medical purposes	1.0 mm
3	Conductive pollution occurs or dry, non-conductive pollution occurs which becomes conductive due to condensation which is to be expected.	Industrial companies , commercial and agricultural operations, unheated storage areas, workshops, boiler rooms	1.5 mm
4	Continuous conductivity occurs due to conductive dust, rain or other wet conditions.	Outdoor areas	2.5 mm

¹ Dimensions in accordance with IEC 61439-1, Annex F, Table F.1

5.8 Clearance and creepage distance

Clearance

"Shortest distance in air between two conductive parts" (Source: IEV 426-04-12)

Example

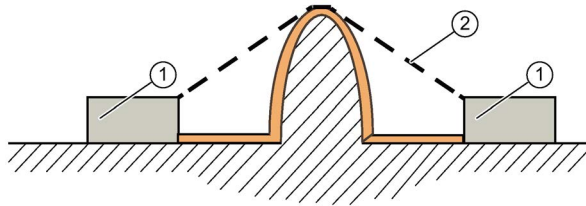

- ① Conductive parts
- ② Clearance between the two conductive parts

Figure 5-8 Clearance

Creepage distance

"Shortest distance along the surface of a solid insulating material between two conductive parts" (Source: IEV 151-15-50)

Example

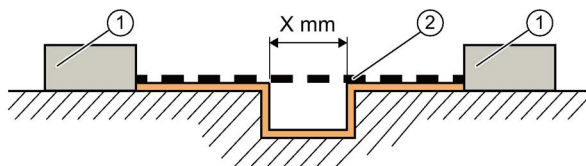

- ① Conductive parts
- ② Creepage distance between the two conductive parts

Figure 5-9 Creepage distance

The width of the groove depends on the degree of pollution.

- If the groove is narrower than the minimum width for the degree of pollution, it is regarded as non-existent, i.e. the dashed line is the distance.
- If the groove is of the minimum required width or larger, the distance is measured along the contour including the groove, i.e. the thick line is the distance.

5.9 Overvoltage category

"Numeral defining a transient overvoltage condition." (Source: IEC 581-21-02)

The overvoltage category depends on limiting (or controlling) the values of prospective transient overvoltages occurring in a circuit (or within an electrical system having different nominal voltages) and depending upon the means employed to influence the overvoltages.

Transient and temporary overvoltage

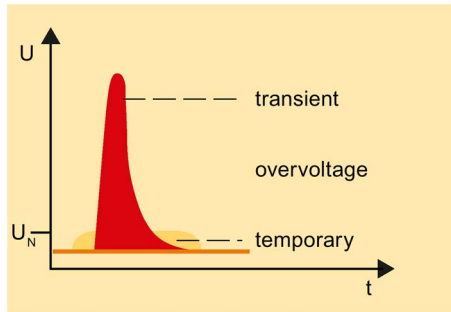

Figure 5-10 Transient and temporary overvoltage

Transient overvoltages

Transient overvoltages are characterized by their very short duration (normally in the milliseconds range), but very high magnitude (in the kilovolts range).

Overvoltage category III is the most common category for industrial equipment.

If a lower overvoltage category is required, this can be achieved by installing appropriate components such as surge arresters or line filters that block, absorb or discharge the overvoltage energy to reduce the transient overvoltage down to the relevant category.

Temporary overvoltages

Temporary overvoltages are characterized by their relatively long duration (in the seconds range), but relatively low magnitude (in the volts range).

Nominal voltage and rated impulse withstand voltage

Table G in EN 61439-1 or IEC 61439-1 shows the correlation between the nominal voltage of the supply system and the rated impulse withstand voltage of the equipment.

5.10 Selectivity

Selectivity

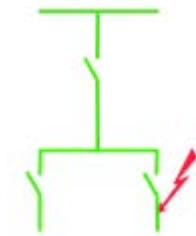

Selectivity

An installation with various levels of protective devices is said to operate "selectively" when a fault is cleared only by the protective device **installed immediately upstream of the fault location**.

In each case, the fault is cleared within the specified clearance time in accordance with the application / type of grounding system.

All of the other circuits **unaffected** by the fault remain operational.

Current selectivity

Current selectivity is achieved when the series-connected protective devices are selected and set in such a way that the fault is only ever cleared by the device located immediately upstream of the fault (without time delay).

Time selectivity

Time selectivity is achieved when all upstream protective devices delay tripping until the device immediately upstream of the fault trips.

Total selectivity

Total selectivity is achieved when the maximum possible short-circuit current trips only the device located immediately upstream of the fault, but does **not** trip any of the other upstream devices.

Partial selectivity, as of a specific current value

Partial selectivity is achieved when the upstream device trips at the same time as the device located upstream of the fault as soon as the fault current reaches a specific value. This value differs according to the device combination and shall be calculated separately for each configuration.

Selectivity limit

The selectivity limit is a "specific" fault current value (see "Partial selectivity") which, when exceeded, causes upstream protective devices to trip simultaneously.

5.11 Utilization categories

Utilization category according to IEC 60947-2

Table 5-2 Utilization category - suitability for selectivity

Utilization category	Suitability for selectivity
A	Circuit breakers not specifically intended for selectivity under short-circuit conditions with respect to other short-circuit protective devices in series on the load side, i.e. without an intentional short-time delay provided for selectivity under short-circuit conditions and therefore without a short-time withstand current rating according to 4.3.5.4.
B	Circuit breakers specifically intended for selectivity under short-circuit conditions with respect to other short-circuit protective devices in series on the load side, i.e. with an intentional short-time delay (which may be adjustable), provided for selectivity under short-circuit conditions. Such circuit breakers have a short-time withstand current rating according to 4.3.5.3. NOTE Selectivity is not necessarily ensured up to the ultimate short-circuit breaking capacity of the circuit breakers (for example in the case of operation of an instantaneous release), but at least up to the values specified in Table 3.
...	

Source: IEC 60947-2, excerpt from Table 4: Utilization categories; highlighting by author

Utilization categories for contactors

Utilization categories for contactors according to IEC 60947-4-1

Alternating current – selection

AC-1 Non-inductive or slightly inductive loads, resistance furnaces ($I_E = 1.5 \times$; $I_A = 1.5 \times$)

AC-2 Slip-ring motors: starting, switching off ($I_E = 4 \times$; $I_A = 4 \times$)

AC-3 Squirrel-cage motors: starting, switching off during operation ($I_E = 10 \times$; $I_A = 8 \times$)

AC-4 Squirrel-cage motors: starting, plugging, inching ($I_E = 12 \times$; $I_A = 10 \times$)

Direct current – selection

DC-1 Non-inductive or slightly inductive loads, resistance furnaces

DC-3 Shunt motors: starting, plugging, inching, dynamic braking of motors

DC-5 Series motors: starting, plugging, inching, dynamic braking of motors

DC-6 Switching of incandescent lamps

Utilization categories for contactor relays

Utilization categories for contactor relays according to IEC 60947-5-1

Alternating current

AC-12 Control of resistive loads and inductive loads with isolation by optocouplers

AC-13 Control of solid-state loads with transformer isolation

AC-14 Control of small electromagnetic loads (< 72 VA)

AC-15 Control of electromagnetic loads (> 72 VA)

DC current

DC-12 Control of resistive loads and solid-state loads with isolation by optocouplers

DC-13 Control of electromagnets

DC-14 Control of electromagnetic loads having economy resistors in circuit

Utilization categories for switch disconnectors

Utilization categories for switch disconnectors with and without fuses according to EN 60947-3

Table 5- 3 Utilization categories for switch disconnectors

Nature of current	Utilization categories		Typical applications
	Category A	Category B	
Alternating current	AC-20A*	AC-20B*	• Connecting and disconnecting under no-load conditions
	AC-21A	AC-21B	• Switching of resistive loads including moderate overloads
	AC-22A	AC-22B	• Switching of mixed resistive and inductive loads, including moderate overloads
	AC23-A	AC23-B	• Switching of motor loads or other highly inductive loads
Direct current	DC-20A*	DC-20B*	• Connecting and disconnecting under no-load conditions
	DC-21A	DC-21B	• Switching of resistive loads including moderate overloads
	DC-22A	DC-22B	• Switching of mixed resistive and inductive loads, including moderate overloads (e.g. shunt motors)
	DC23-A	DC23-B	• Switching of highly inductive loads (e.g. series motors)

* The use of these utilization categories is not permitted in the USA.

Source: EN 60947-3 Switch disconnectors with and without fuses, Table 2: Utilization categories

Category A = Frequent use; Category B = Occasional use

5.12 Switch disconnectors and circuit breakers

Non-automatic air circuit breakers

		<p>Same type of construction as a circuit breaker.</p> <p>Cannot be set if equipped with short-circuit release.</p> <p>Same equipment as a circuit breaker, e.g. remote operating mechanism, auxiliary release, auxiliary switch.</p>
--	--	---

Switch disconnector

		<p>Same type of construction as a circuit breaker, but without any protection functions. For this reason, a fuse / circuit breaker needs to be connected upstream.</p> <p>Same equipment as a circuit breaker, e.g. remote operating mechanism, auxiliary switch.</p>
--	--	---

Circuit breakers for starter assembly

		<p>Same type of construction as a circuit breaker, but only one (adjustable) short-circuit protection function, for adaptation to the destruction characteristic of the overload relay.</p> <p>The motor is protected against overload by the overload relay.</p> <p>Advantage: Clear signaling concept: Starter switch → short circuit / bistable relay → overload.</p>
--	--	--

Requirements of circuit breakers for line protection

		<p>Must trip within two hours at 1.3 x load. (This tripping time is one hour for devices up to 63 A).</p> <p>Must not trip within two hours at 1.05 x load.</p> <p>Usual setting ranges: Adjustability of the overload release is not necessary in most cases.</p> <p>Response values of the short-circuit releases $5 - 10 \cdot I_r$</p> <p>A selectivity evaluation makes sense for applications involving power distribution boards.</p>
--	--	---

Requirements of circuit breakers for motor protection

		<p>Must trip within two hours at 1.2 x load. (This tripping time is one hour for devices up to 63 A).</p> <p>Must not trip within two hours at 1.05 x load.</p> <p>Insensitivity to motor starting inrush current normally about 20 ms.</p> <p>Optional: Phase failure sensitivity to protect explosion-proof motors Temperature compensation (-20 °C ... +60 °C) Thermal memory (several starting attempts cause temperature rise in motor) → prompt restart conditionally possible, without thermal memory ⇒ long delay Adjustable trip class for adjusting breaker to motor's starting behavior.</p>
--	--	--

5.13 Selection of the electrical characteristics of circuit breakers

Below you will find a selection of the electrical characteristics of circuit breakers with the definitions according to EN 60947.

I_{cm} – Rated short-circuit making capacity (peak value)

Maximum prospective peak current that the switching device can connect.

I_{cw} – Rated short-time withstand current (r.m.s.)

Max. prospective short-circuit current that the switching device can conduct for a specific time period
(\Rightarrow thermal short-circuit withstand rating); e.g. $I_{cw} = 100 \text{ kA}, 0.5 \text{ s}$

I_{cu} – Rated ultimate short-circuit breaking capacity (r.m.s)

Test sequence III (I_{cu}): O - t - CO

The circuit breaker shall be capable of disconnecting this current **twice** without sustaining damage. **Thereafter** the circuit breaker shall **no longer** be operational and shall be replaced or repaired.

I_{cs} – Rated service ultimate short-circuit breaking capacity (r.m.s.)

Test sequence II (I_{cs}): O - t - CO - t - CO

The circuit breaker shall be capable of disconnecting this current **three times** without sustaining damage. Then, among other characteristics, the performance of the circuit breaker is tested, i.e. the circuit breaker shall **afterwards** be capable of conducting and also switching the **operational current** (at least once).

I_{cc} – Rated conditional short-circuit current

"The value of prospective short-circuit current, declared by the ASSEMBLY manufacturer that can be withstood for the total operating time (clearing time) of the short-circuit protective device (SCPD) under specified conditions

NOTE The short-circuit protective device may form an integral part of the ASSEMBLY or may be a separate unit." (Source: IEC 61439-1)

I_c – Cut-off current (let-through current)

"Maximum instantaneous value of current attained during the breaking operation of a switching device or a fuse.

NOTE This concept is of particular importance when the switching device or the fuse operates in such a manner that the prospective peak current of the circuit is not reached."
(Source: IEC 60050-441:2007, 441-17-12)

5.14 Trip classes

The trip classes according to IEC 60947-4-1 are intended to protect motors against inadmissible temperature rise in supply systems not affected by harmonics. They define the time intervals within which the protection equipment (overload release of a circuit breaker or overload relay) shall trip from the cold state in the case of a symmetrical, three-phase load. These protective devices shall trip the response thresholds in Section 8.2.1.5 of the standard, which represent a multiple value of the current setting. The response threshold is 7.2 times the current setting.

The trip classes in Table 2 of the standard apply in relation to the load connected to the motor and tolerance band E for electronic overload releases if stated by the manufacturer.

The class, e.g. CLASS 10, defines a starting behavior of the motor including a load between 4 and max. 10 seconds. A protection device with CLASS 10 therefore allows a starting behavior of the motor including load torque for a maximum of 10 seconds.

Table 5-4 Trip classes of overload relays

Trip class	Tripping time T_P under the condition specified in 8.2.1.5.1, Table 3 Column D ^a s	Tripping time T_P under the condition specified in 8.2.1.5.1, Table 3 Column D for tighter tolerances (tolerance band E) ^a s
...
5	$0.5 < T_P \leq 5$	$3 < T_P \leq 5$
10	$2 < T_P \leq 10$	-
10 A	$4 < T_P \leq 10$	$5 < T_P \leq 10$
20	$6 < T_P \leq 20$	$10 < T_P \leq 20$
30	$9 < T_P \leq 30$	$20 < T_P \leq 30$
40	-	$30 < T_P \leq 40$
^a The manufacturer shall add the letter E to trip classes to indicate compliance with the band E.		
...		

Source: IEC 60947-4-1, excerpt from Table 2: Trip classes of overload relays

Normal and heavy-duty starting

The graphic below illustrates the tripping times in relation to the tripping current with 3-pole loading from the cold state. CLASS 5 and CLASS 10 are often referred to as normal starting.

Siemens provides combinations for CLASS 20, CLASS 30 and CLASS 40 for applications where a higher starting current is required for a prolonged period. These trip classes are also referred to as "heavy-duty starting".

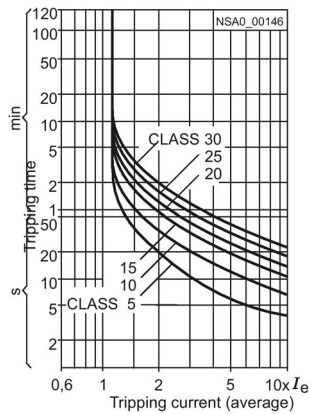

Source: Configuring the SIRIUS modular system, configuration manual, 09/2017

Figure 5-11 Example: Tripping characteristics

5.15 Comparison of electrical characteristics

Plant – fuses/switching devices

Table 5- 5 Comparing characteristics from the plant to characteristics of the fuse/switching device

Plant	Characteristic		Comments
	Fuse	Switching device	
$I_{k\max}''$	Rated breaking capacity	Rated conditional short-circuit current	R.m.s. value - rated conditional short-circuit current With respect to switching device, may depend on the type of application (load switching or merely isolation of equipment from supply).
$I_{k\min}''$	Characteristic	Unnecessary	Calculated at the end of the cable or directly upstream of the next protective device. The fuse shall also be capable of interrupting this short-circuit current within 5 seconds.
\hat{I}_P	Unnecessary	Rated short-circuit making capacity	Reference value for mechanical connections. Should be verified for switching devices (max. let-through value for fuses)
S^2k^2	Operating I^2t_A	Unnecessary	The fuse requires the operating I^2t_A to ensure that the short-circuit current can be safely interrupted (pre-arcing energy + arcing energy).
S^2k^2 conditional		\hat{I}_P	The short-circuit current through the fuse is limited to this value. It is necessary for the purposes of selectivity evaluation and can be used to dimension the downstream cables and devices.

The fuse values (incl. tolerances) have to exceed the system values.

Plant – circuit breaker

Table 5- 6 Comparing characteristics from the plant to characteristics of circuit breakers

Plant	Characteristic		Comments
		Circuit breakers	
$I_{k\max}''$		$I_{cu}; I_{cs}$	Determines the number of possible short-circuit interrupts.
$I_{k\min}''$		$I_i; I_d$	Current through the circuit breaker. When current selectivity is implemented, the setting value of the breaker (tolerance) should be lower than the plant value.
$I_{k\min}'' + \text{time}$		I_{cw}	Required for time-selectivity tasks. Determines the time period for which the circuit breaker can conduct the relevant short-circuit current.
\hat{I}_P		I_{cm}	Reference value for mechanical loading of the breaker and connections. This value determines the max. possible locking force of the breaker.
S^2k^2		$I^2t; \hat{I}_D$	Let-through current of the circuit breaker. Applies particularly to current-limiting circuit breakers.

The values of the breaker (incl. tolerances) shall be higher than the values from the plant.

5.16 Insulation

Exposed conductive part (of electrical equipment)

"Conductive part of equipment which can be touched and which is not normally live, but which can become live when basic insulation fails." (Source: IEV 826-12-10)

Basic insulation

"Insulation of hazardous live parts which provides basic protection"

NOTE: This concept does not apply to insulation used exclusively for functional purposes. (Source: IEV 195-06-06)

Supplementary insulation

"Independent insulation applied in addition to basic insulation, for fault protection. It shall be designed in the same way as basic insulation." (Source: IEV 195-06-07)

Double insulation

"Insulation comprising both basic insulation and supplementary insulation." (Source: IEV 195-06-08)

Basic protection

"Protection against electric shock under fault-free conditions." (Source: IEV 195-06-01)

Reinforced insulation

"Insulation of hazardous live parts which provides a degree of protection against electric shock equivalent to double insulation.



NOTE: Reinforced insulation may comprise several layers which cannot be tested singly as basic insulation or supplementary insulation." (Source: IEV 195-06-09)

5.17 Classes

Classes define measures that are designed to protect against electric shock. The classes for electrical equipment are specified in EN 61140 (in VDE 0140-1 for Germany).

Classes

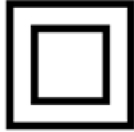
Class	Meaning
0	<p>No special protection against electric shock is provided apart from basic insulation.</p> <p>Equipment in this class cannot be connected to the protective bonding circuit. Shock protection shall be afforded by the installation environment of the equipment.</p> <p>Class 0 does not have a symbol or marking. It is planned to exclude class 0 from future releases of the international standard.</p> <p>Sale of equipment in class 0 is prohibited in some countries, e.g. in Germany and Austria.</p>
I Protective conductor	<p>All electrically conductive parts of the equipment enclosure (chassis) are connected to the protective bonding circuit of the permanent electrical installation that is at ground potential.</p> <p>Mobile devices in class I have a plug-and-socket connection with protective conductor contact. The connection to the protective conductor is designed such that the protective conductor is the first to be connected or last to be disconnected when the plug is inserted in or pulled out of the socket outlet. The entry point of the connecting cable into the device shall be equipped with a strain-relief mechanism; when the cable is ripped out, the protective conductor shall be the last to be interrupted.</p> <p>When a live conductor comes into contact with the enclosure connected to the protective conductor, it will normally cause a "short circuit to frame" that will trip the fuse, a circuit breaker or a residual-current-operated circuit breaker and so disconnect the circuit.</p> <p>Grounding without a special grounding conductor is sometimes a feature of older installations, i.e. the N and PE conductors are connected in the socket. This is now prohibited for new installations with conductors smaller than 10 mm² copper/16 mm² aluminum. In such cases, the N and PE conductors shall be routed separately.</p>

Class	Meaning
<p data-bbox="347 287 459 378">II Protective insulation</p> 	<p data-bbox="561 287 1374 378">Equipment in class II has reinforced or double insulation between the mains circuit and the output voltage or metal enclosure; it is not connected to the protective conductor.</p> <p data-bbox="561 385 1426 476">This measure is also known as "protective insulation". Even if the equipment has electrically conductive surfaces, it is protected against contact with live parts by two layers of insulating material.</p> <p data-bbox="561 483 1289 510">Mobile devices in class II do not have a plug with protective contact.</p> <p data-bbox="561 517 1370 608">Plugs without a protective contact are used to connect the equipment to the mains. Contoured plugs that look similar to shock-proof plugs are used in Germany for high currents.</p> <p data-bbox="561 614 1094 642">"Euro" plugs are used for low currents (up to 2 A).</p> <p data-bbox="561 649 1426 704">A "double square" symbol on an electrical device / enclosure indicates that it has protective insulation.</p>
<p data-bbox="347 717 373 744">III</p> 	<p data-bbox="561 717 1374 806">Class III equipment operates on safety extra-low voltage (SELV). In line-fed operation, it also requires reinforced or double insulation between the mains circuit and the output voltage.</p>

Further methods of protecting against direct contact

Another method of protecting humans and livestock against direct contact or indirect contact with live parts is to use suitable voltage sources:

- SELV
- PELV
- FELV

Note

SELV, PELV and FELV are described in detail in IEC 60364-4-41. IEC 60204-1 only refers to PELV. That means that PELV in the machine shall be set up according to the rules of IEC 60204-1. If SELV or FELV is to be implemented in the machine, this shall be done according to the rules of IEC 60364-4-41.

SELV (Safety Extra Low Voltage)

IEC 60364-4-41 describes SELV as safety extra-low voltage lower than 50 V (alternating voltage) or 120 V (direct voltage) generated by a safety transformer as defined by EN 61558-2-6. This also applies to power supply units with integral safety transformer.

Safety transformers are designed such that the HV and LV sides are electrically isolated from one another, i.e. so that parasitic voltages cannot be transferred between them.

The following current sources are also suitable if it has been ensured that the control circuit is safely isolated from the power circuit:

- An electrochemical current source (e.g. a battery) or another current source that is safely isolated from circuits with higher voltage (e.g. a generator driven by an internal combustion engine).
- Certain electronic devices constructed according to relevant standards and with which the voltage does not rise above the permitted values even as a result of the occurrence of a fault.
- Mobile low-voltage current sources (e.g. safety isolating transformers or motor generators) shall have double or reinforced insulation as defined by IEC 60364-4-41.

The low-voltage side is not grounded with SELV.

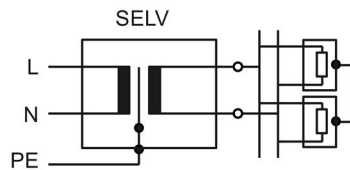

Safety transformer or equivalent power source
No connection to ground

Figure 5-12 SELV

According to IEC 60364-4-41, SELV can be regarded as effective protection against direct contact in dry environments provided that the voltage does not exceed 25 V AC or 60 V DC.

Note

Safety extra-low voltages drawn from batteries or accumulators comply with the requirements of class III without any additional measures.

PELV (Protective Extra Low Voltage)

Protective extra-low voltage with protective separation.

Similar concept to SELV, but the equipment is grounded on the secondary side.

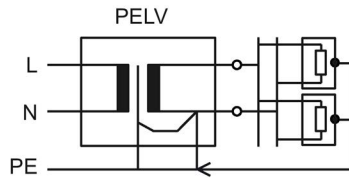

Figure 5-13 PELV

IEC 60204-1 describes PELV as protection against electric shock as follows:

- Rated voltage ≤ 25 V AC or 60 V DC in dry locations and when large area contact of live parts with the human body is not expected.
- ≤ 6 V AC or 15 V DC in all other cases.
- The PELV circuit shall be grounded.
- The PELV circuit shall be electrically separated from other live circuits. As a minimum, as with a safety isolating transformer (see IEC 61558-1 and IEC 61558-2-6)
- Physical separation of the conductors. Where this requirement is impracticable, suitable barriers shall be used for separating the conductors where there are circuits of varying voltage or all cables in the cable duct are approved for the highest occurring voltage.
- Plugs and socket-outlets shall not be capable of combination with other circuits.
- Power sources as with SELV

FELV (Functional Extra Low Voltage)

Functional extra-low voltage without protective separation.

Same voltage limits as for SELV, but no special requirements of the transformer or the power supply unit.

Used mostly for general control systems.

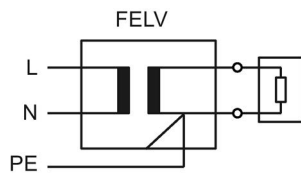

Not a safety power source.

Ground connection permitted.

Figure 5-14 FELV

5.18 Rated diversity factor

Rated diversity factor

According to IEC 61439-1, the rated diversity factor is "the per unit value of the rated current assigned by the ASSEMBLY manufacturer, to which outgoing circuits of an ASSEMBLY can be continuously and simultaneously loaded taking into account the mutual thermal influences."

In practice, however, it might not be nearly so easy to calculate the RDF value. In such cases, it is advisable for users to estimate the value themselves depending on the application.

One helpful guide is Table 101 in IEC 61439-2. The information in this table can be applied if no load values for the individual circuits are available, or if it contradicts what is already known about the intended application of the switchgear and controlgear assembly.

Table 5-7 Values of assumed loading

Type of load	Assumed loading factor
Distribution – 2 or 3 circuits	0.9
Distribution – 4 or 5 circuits	0.8
Distribution – 6 to 9 circuits	0.7
Distribution – 10 or more circuits	0.6
Electric actuator	0.2
Motors ≤ 100 kW	0.8
Motors > 100 kW	1

Source: IEC 61439-2, Table 101: Values of assumed loading

5.19 Motor duty types

Information about the duty types of motors under defined conditions.
The most common duty types are described below.

Continuous duty S1

Table 5-8 Duty type S1: Continuous duty

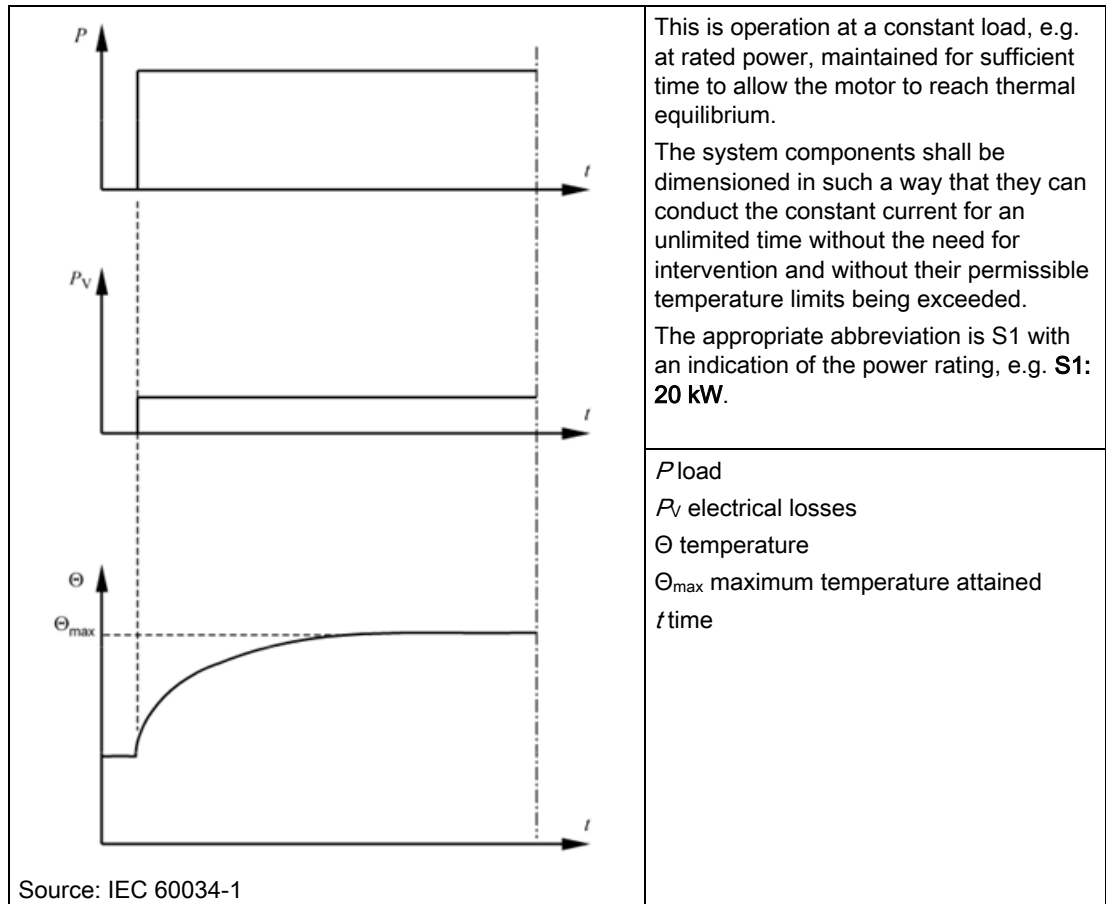

Short-time duty S2

Table 5- 9 Duty type S2: Short-time duty

<p>Source: IEC 60034-1</p>	<p>Duty type S2 refers to operation at a constant load for a given time, less than that required to reach thermal equilibrium, followed by a time de-energized and at rest of sufficient duration to re-establish machine temperatures within 2K of the coolant temperature.</p> <p>P load P_V electrical losses Θ temperature Θ_{max} maximum temperature attained t time Δt_P operation time at constant load</p>
----------------------------	--

Intermittent periodic duty S3

Table 5- 10 Duty type S3: Intermittent periodic duty without starting

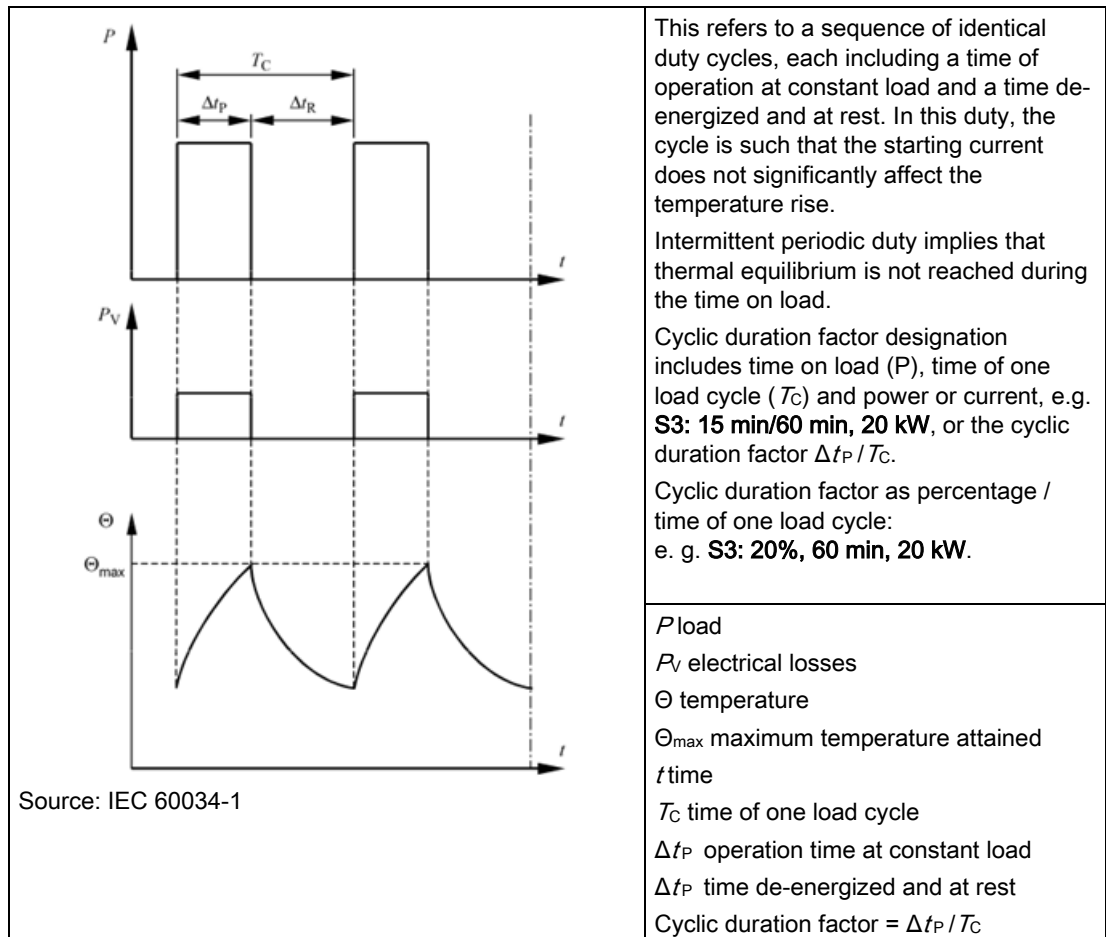

In accordance with EN 60034-1 (VDE 0530), the cycle time for motors in intermittent duty is 10 minutes unless otherwise agreed. This time of one load cycle shall be regarded in practice as the upper limit.

Periodic duty

In periodic duty with very short times de-energized and at rest, the thermally effective current may occasionally exceed the effective load current of the motor. This is generally the case if the period of operation and time de-energized and at rest of the motor are relatively short because the starting currents then affect the temperature rise.

Annex E (Figure E6) of IEC 61439-1 contains the following method of calculating this thermal equivalent.

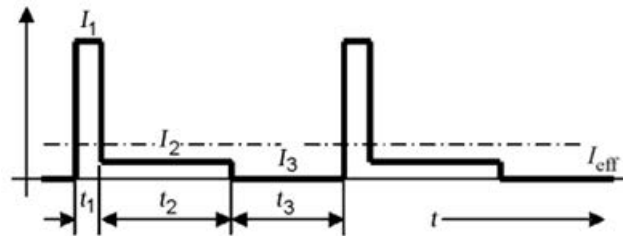

$$I_{\text{eff}} = \sqrt{\frac{I_1^2 \times t_1 + I_2^2 \times t_2 + I_3^2 \times t_3}{t_1 + t_2 + t_3}}$$

- t_1 Starting time at I_1
- t_2 Run time at I_2
- t_3 Interval time at $I_3 = 0$
- $t_1 + t_2 + t_3$ = cycle time

Figure 5-15 Calculation of average heating effect

Electrical equipment

6.1 Interface agreements between customer and manufacturer

The user and supplier shall come to an agreement about technical requirements before work commences on configuring and planning the electrical equipment.

Whether, for example, a control panel is dimensioned for a prospective short-circuit current of 10 kA or 50 kA, or whether it will be connected to a TN or an IT supply system, will have a significant impact on its design. The intended site of installation is also a crucial factor and will determine the degree of protection required for the panel. Harsh operating conditions (in factory workshops, for example) demand a higher degree of protection than would be needed in a clean electrical equipment room.

Recommendation: A detailed agreement about all interfaces should be worked out in advance!

Only when an agreement has been reached is it possible for the supplier:

- To draw up a quotation
- To plan the installation
- To construct a standard-compliant installation
- To fulfill the customer's expectations and needs

Both IEC 60204-1 (in Annex B) and IEC 61439-1 (in Annex C) contain specifications designed to facilitate the exchange of information in the form of questionnaires that are to be completed in advance by the customer.

6.2 Incoming supply conductor termination and supply disconnecting device

6.2.1 Incoming supply conductor termination

Areas of responsibility

The incoming supply conductor termination represents the power supply, i.e. the supply of electrical power, for the machine.

Unless otherwise agreed between the user and the machine supplier, the area of responsibility of the machine supplier begins at the point at which the machine is connected to the incoming supply, In other words, at the infeed terminal of the supply disconnecting device or, if provided, at upstream connecting terminals.

If a switch disconnecter without fuses is used as a supply disconnecting device, the outgoing cables at the supply disconnecting device will not have any protection. In this case, the supplier shall specify that the operator uses suitable fuses upstream of the control panel.

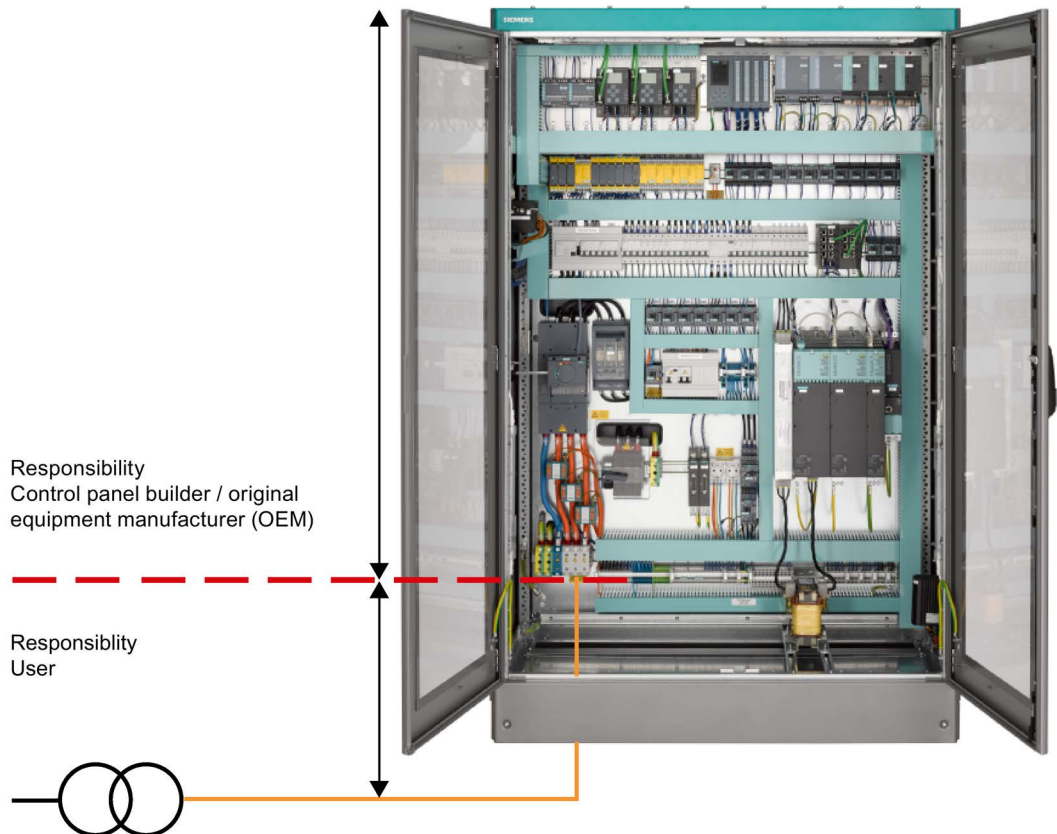

Figure 6-1 Defining boundaries between areas of responsibility of user and supplier

In order to reduce the risks associated with electrical installations, Chapter 5.1 of IEC 60204-1 recommends the use of only **one** incoming supply conductor wherever this is practicable.

Electrical equipment of a machine

Where another supply is necessary, e.g. for circuits that operate at a different voltage (control circuits, etc.), that supply should be derived, as far as is practicable, from devices that form part of the electrical equipment of the machine.

Depending on the complexity of the machinery, there may also be a need for more than one incoming supply conductor, for example, for large, complex machinery (e.g. optional generator operation, UPS systems). As a general rule, however, the number of supply conductors should be kept to the absolute necessary minimum.

If a neutral conductor is used, a separate insulated terminal labeled "N" shall be provided. Such a terminal can also be part of the supply disconnecting device. In this case, there shall be no connection between the neutral conductor and the protective bonding circuit inside the electrical equipment.

Note

Exception for TN-C and TN-C-S systems

A connection may be made between the neutral terminal and the PE terminal at the point of the connection of the electrical equipment to a TN-C or TN-C-S supply system.

6.2 Incoming supply conductor termination and supply disconnecting device

For types of grounding system (Page 47) in which an external protective conductor is routed to the machine, the protective conductor shall be connected to a terminal that is in the same terminal compartment as the associated line conductor terminals. The terminal for the external protective conductor shall be marked with "PE".

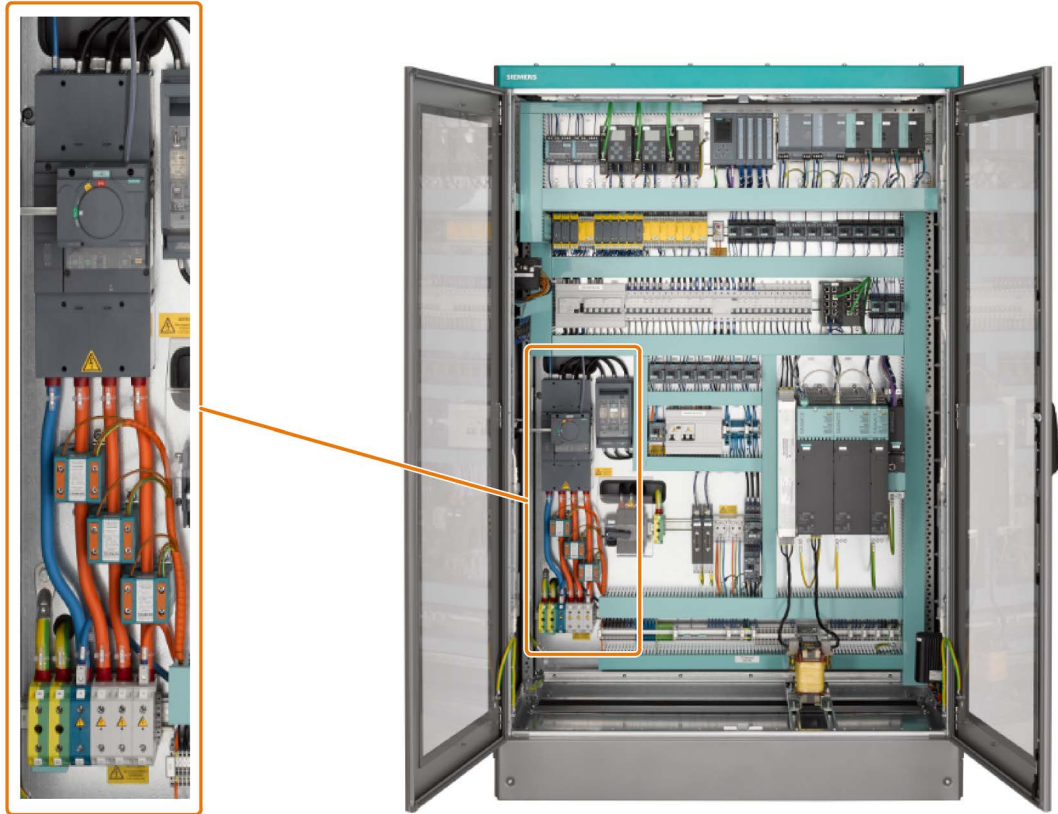

Figure 6-2 Separate terminals for neutral conductor and protective conductor

Protective conductor

Protective conductors made of copper require terminals dimensioned for a cross-sectional area specified in the table below.

Table 6- 1 Minimum cross-sectional area of copper protective conductors

Cross-sectional area of the conductor S (mm ²)	Minimum cross-sectional area of the corresponding copper protective conductor S_p (mm ²)
$S \leq 16$	S
$16 < S \leq 35$	16
$S > 35$	$S/2$

Source: IEC 60204-1, Table 1: Minimum cross-sectional area of copper protective conductors

External protective conductors of a material other than copper may be used if they have a cross-sectional area of at least 16 mm². Where a protective conductor of a material other than copper is used, the terminal size shall be selected to suit the cross-sectional area of the conductor and shall be suitable for the conductor material selected. You can find information about dimensioning aluminum protective conductors in the Chapter Protective bonding (Page 158).

The terminal for the external protective grounding system or the external protective conductor shall be labeled with the letters PE.

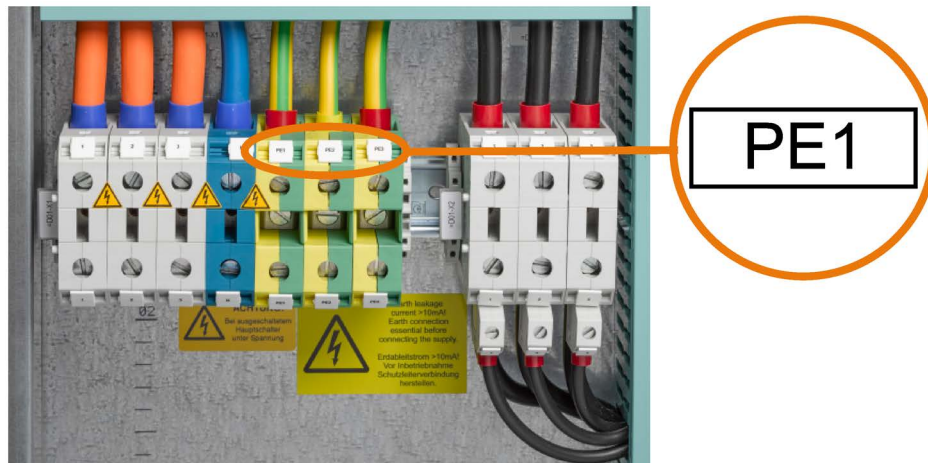

Figure 6-3 Example: Labeling of terminal for the external protective conductor

6.2.2 Supply disconnecting (isolating) device

Supply disconnecting (isolating) device

The purpose of the supply disconnecting device is to disconnect (isolate) a machine from the incoming supply when required. With the exclusion of some excepted circuits, the electrical equipment of the machine will be isolated from the supply when the supply disconnecting device is switched off. This may be necessary, for example, to allow maintenance work.

According to Chapter 5.3 of IEC 60204-1, supply disconnecting devices shall be provided for the following:

- For each incoming source of supply to one or more machines
- For each on-board power supply, e.g. for mobile machines

Note

Two or more supply disconnecting devices

Where two or more supply disconnecting devices are provided, protective interlocks to ensure their correct operation shall also be provided in order to prevent risks to the safety of personnel, or damage to the machine or to the work in progress.

Permissible types of supply disconnecting device

According to IEC 60204-1, it is permissible to use the following types of supply disconnecting device:

- According to IEC 60947-3: switch disconnecter, with or without fuses, for utilization category AC-23B or DC-23B
- According to IEC 60947-6-2: Control and protective switching devices with isolating properties
- According to IEC 60947-2: Circuit breakers suitable for isolation
- Any other switching devices that fulfill an IEC product standard, requirements placed on isolating devices and the appropriate utilization category and/or the stress requirements specified in the product standards.
- Plug/socket combinations for a flexible cable supply

Note

For further information, see Chapter SIRIUS 3RA6 compact starters (Page 247)

Supply disconnecting devices supplied by Siemens

Siemens offers a large portfolio of suitable supply disconnecting devices (Page 234).

Switch disconnectors compliant with IEC 60947-3

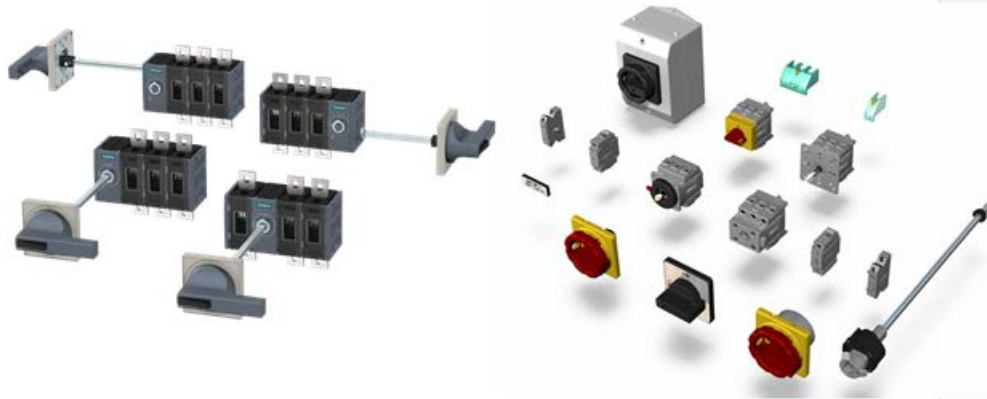

Figure 6-4 Selection of Siemens switch disconnectors compliant with IEC 60947-3

Circuit breakers compliant with IEC 60947-2:



Figure 6-5 Selection of Siemens circuit breakers compliant with IEC 60947-2

Rule

It shall have a visible position indicator that clearly shows whether the supply disconnecting device is ON or OFF.

The following conditions shall be fulfilled for this purpose:

- There shall only be one OFF position and one ON position.
- The OFF position is marked with "O" and the ON position with "I", or there shall be a visible contact gap.

Rule

The supply disconnecting device shall be accessible from outside the enclosure so that the machine can be shut down to allow work (maintenance, repair, etc.)

The supply disconnecting device shall meet the following requirements:

- It shall have an external operating means
- It shall be provided with a means permitting it to be locked in the OFF (isolated) position (against reclosure)
- It shall disconnect all live conductors of its power supply circuit

Example



Figure 6-6 Examples of external operating means (handles) for supply disconnecting devices

Note

The neutral conductor need not be disconnected by the supply disconnecting device if not required by the rules of the country concerned. See also Chapter Protection against overcurrent (Page 119).

If the supply disconnecting device is also required to fulfill an emergency stop function or an emergency switching off function, the externally accessible operating means shall be red against a yellow background.

Breaking capacity

It shall have a breaking capacity sufficient to interrupt the current of the largest motor when stalled together with the sum of all other loads. Not all connected loads need to be taken into account. It is sufficient to only consider the maximum number of loads that can be operated at the same time.

Note

Limitation of motor currents

Where motors are supplied by converters or similar solid-state switching devices, you should take the possible limitation of motor currents into account.

Example

Breaking capacity of supply disconnecting device \geq current of largest motor when stalled + the sum of all other loads = $6 \times 30 \text{ A} + 20 \text{ A} + 15 \text{ A} = 215 \text{ A}$

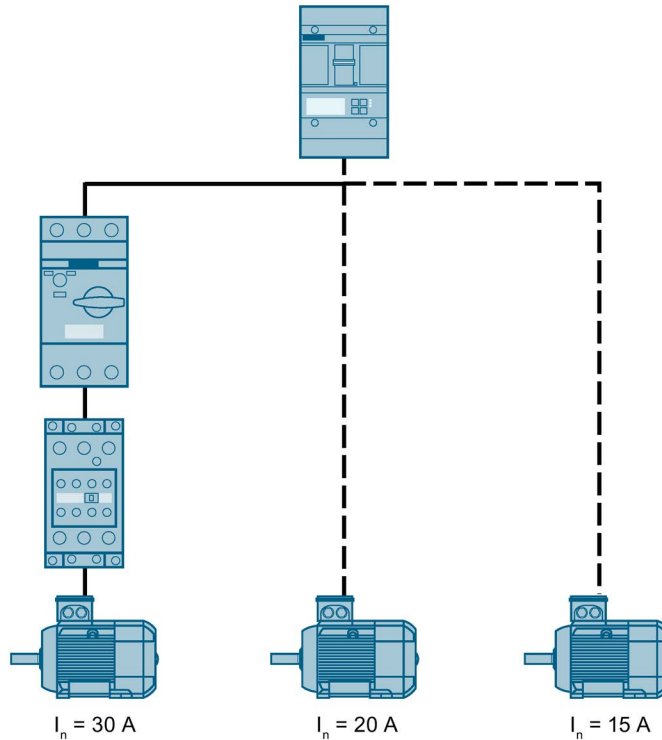

Figure 6-7 Example: Dimensioning of supply disconnecting device / main disconnect

Note**(Rated) breaking capacity \neq rated operational current**

The (rated) breaking capacity should not be confused with the rated operational current. With a circuit breaker, the (rated) breaking capacity is the maximum short-circuit current that can be disconnected. With a switch disconnecting device, a (rated) breaking capacity is also usually indicated on the data sheet.

Special requirements of plugs

When a plug/socket combination is used as a supply disconnecting device, one of the following conditions shall be fulfilled:

- It shall have an appropriate switching capability so that the plug can be removed from the socket under load.
- It shall be interlocked with a switching device with an appropriate breaking capacity

It shall have a breaking capacity sufficient to interrupt the current of the largest motor when stalled together with the sum of all other loads. The breaking capacity may be reduced by a rated diversity factor, if available.

If the switching device is electrically actuated (e.g. a contactor), it shall have an appropriate utilization category (Page 62).

Where motors are supplied by converters or similar solid-state switching devices, the possible limitation of motor currents should be taken into account.

Conditions for plug/socket combinations:

Plug/socket combinations shall also meet the following conditions:

- Plug/socket combinations shall be of such a design as to prevent unintentional contact with live parts at any time, including during insertion or removal of the connectors. They shall have a degree of protection of at least IP2X or IPXXB. PELV circuits are excepted from this requirement.
- Where socket combinations contain a contact for the protective bonding circuit, they shall have a first make last break protective bonding contact (grounding contact).
- Plug/socket combinations intended to be connected or disconnected during load conditions shall have sufficient load-breaking capacity. Where the plug/socket combination is rated at ≥ 30 A, it shall be interlocked with a switching device so that the connection or disconnection is possible only when the switching device is in the OFF position.
- Plug/socket combinations that are rated at > 16 A shall have a retaining means to prevent unintended or accidental disconnection.
- Where an unintended or accidental disconnection of plug/socket combinations can cause a hazardous situation, they shall be provided with a retaining means.
- Metallic housings of plug/socket combinations shall be connected to the protective bonding circuit.
- Plug/socket combinations that are not intended to be disconnected during load conditions shall have a retaining means to prevent unintended or accidental disconnection and shall be clearly marked that they are not intended to be disconnected under load.
- Where more than one plug/socket combination is provided in the same electrical equipment, the associated combinations shall be clearly identifiable. It is recommended that mechanical coding be used to prevent incorrect insertion.

- Plug/socket combinations used in control circuits shall fulfil the applicable requirements of IEC 61984.

Exception: In plug/socket combinations in accordance with IEC 60309-1, only those contacts shall be used for control circuits which are intended for those purposes. This exception does not apply to control circuits using high-frequency signals superimposed on the power circuits.

Note

Exceptions to the requirements

The requirements specified above do not apply to components or devices inside an enclosure, terminated by fixed plug/socket systems (no flexible cable), or components connected to a bus system by a plug/socket combination.

Operating means of the supply disconnecting device

The operating means of the supply disconnecting device shall be easily accessible and shall be external to the enclosure of the electrical equipment and located between 0.6 m and 1.9 m above the servicing level. Recommendation: An upper limit of 1.7 m.

Exception: Circuit breakers with a motorized operating mechanism need not be provided with a handle outside the electrical equipment enclosure where other means (e.g. pushbuttons) are provided to open the supply disconnecting device outside the enclosure.

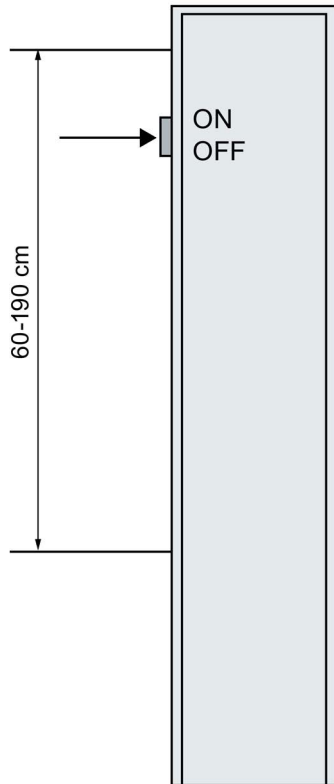

Figure 6-8 Installation height for operating means of the supply disconnecting device

See also

Types of grounding system (Page 47)

6.2.3 Excepted circuits

In many control panels, it is necessary to maintain the supply to certain circuits even when the supply disconnecting device is switched off. We refer to these as "excepted circuits".

These may include the following circuits:

- Lighting circuits for lighting needed during maintenance or repair
- Socket outlets for the exclusive connection of repair or maintenance tools and equipment (for example, hand drills, test equipment)
- Undervoltage protection circuits that are only provided for automatic tripping in the event of supply failure
- Circuits supplying equipment that should normally remain energized for correct operation (for example, temperature-controlled measuring devices, program storage devices).

Since excepted circuits also need to undergo maintenance from time to time (e.g. device replacement), it is recommended that such circuits be provided with their own disconnecting device.

Excepted circuit

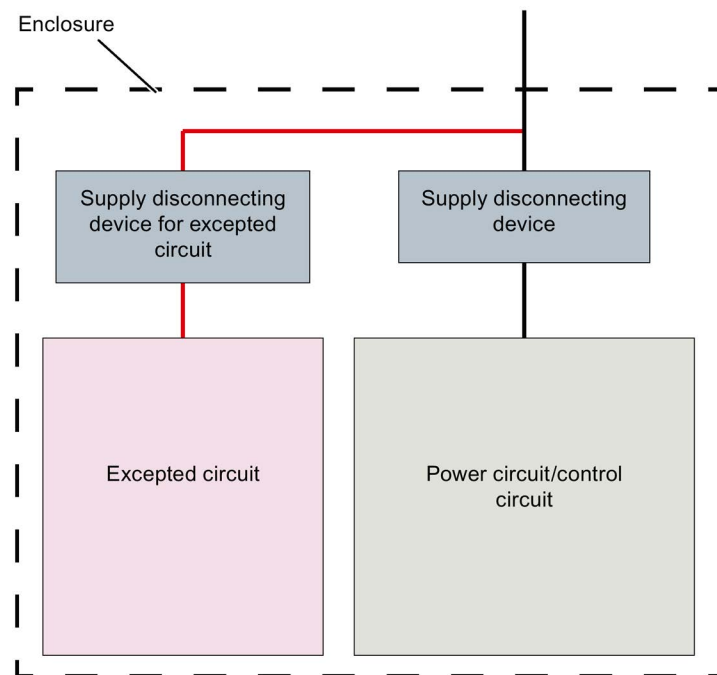

Figure 6-9 Supply disconnecting device for excepted circuit

Note: Control circuits supplied via another supply disconnecting device, regardless of whether that disconnecting device is located in the electrical equipment or in another machine or other electrical equipment, need not be disconnected by the supply disconnecting device of the electrical equipment.

Rules for circuits without supply disconnecting device

Permanent warning labels shall be appropriately placed in proximity to the supply disconnecting device for circuits that are not disconnected by the device.

Example

Warning label that states that the supply disconnecting device will not disconnect all circuits:



Figure 6-10 Example: Warning label

Furthermore, the maintenance manual shall also contain a statement drawing attention to the fact that the supply disconnecting device will not disconnect all circuits. In this case, it is advisable to name the affected circuits.

At least one of the following requirements shall be fulfilled for excepted circuits:

- A permanent warning label shall be affixed in the proximity of every excepted circuit.
- The excepted circuit shall be spatially separated from other circuits.
- The conductors shall be color-coded for easy identification (see Chapter Identification by color).

6.2.4 Devices for removal of power for prevention of unexpected start-up

Machines or parts of machines may often need to be serviced at regular intervals. To ensure that maintenance engineers can work in safety, it may be necessary to shut down the machine or parts of the machine.

In Chapters 5.4 and 5.5 of IEC 60204-1, a distinction is made between "Devices for removal of power for prevention of unexpected start-up" and "Devices for isolating electrical equipment (Page 98)".

Whenever a potentially **hazardous situation as a result of unexpected movement of a machine or part of a machine** can develop, suitable "Devices for removal of power for prevention of unexpected start-up" shall be provided.

This can be achieved by several methods, including by the supply disconnecting device itself. If only part of the machine needs to undergo maintenance while the rest remains in operation, it may be necessary to provide additional devices. Devices of this kind shall be placed in appropriate locations and be readily identifiable as to their purpose and function.



Figure 6-11 Example: Device for removal of power for prevention of unexpected start-up

Note

A permanent marking/label as to their purpose and function can also be affixed.

If a device for removal of power with isolation function is required, devices also approved as Supply disconnecting (isolating) device (Page 86) may be used.

Equipment with fuse links

Note

Disconnectors, plug-in fuses and isolating links may only be used in enclosed electrical operating areas to which only skilled persons have access.



Figure 6-12 Example: Device with plug-in fuses

If access is prohibited to all except skilled persons by the fact that the devices are installed in enclosed operating areas, then the devices in question can also be deployed as "devices for removal of power for prevention of unexpected start-up".

Background

An unqualified person cannot always tell which switch belongs to which piece of equipment, or may not be able to correctly interpret the relevant circuit diagram. Furthermore, the enclosed operating area will prevent unauthorized closure of disconnectors.

Devices without isolation function

Devices without isolation function may also be used. However, such devices may only be used for removal of power prior to inspections and adjustment work on non-electrical equipment, or for work on electrical equipment under the following conditions:

- There is no risk of electric shock or burns.
- The device for removal of power remains effective throughout the work.
- The work is of a minor nature which does not involve disturbing existing wiring of components.

Note

Devices without isolation function are, for example, a contactor de-energized by a control circuit or a power drive system (PDS, Power Drive System) with the function "Safe Torque Off" (STO, Safe Torque Off) in accordance with IEC 61800-5-2.

Example

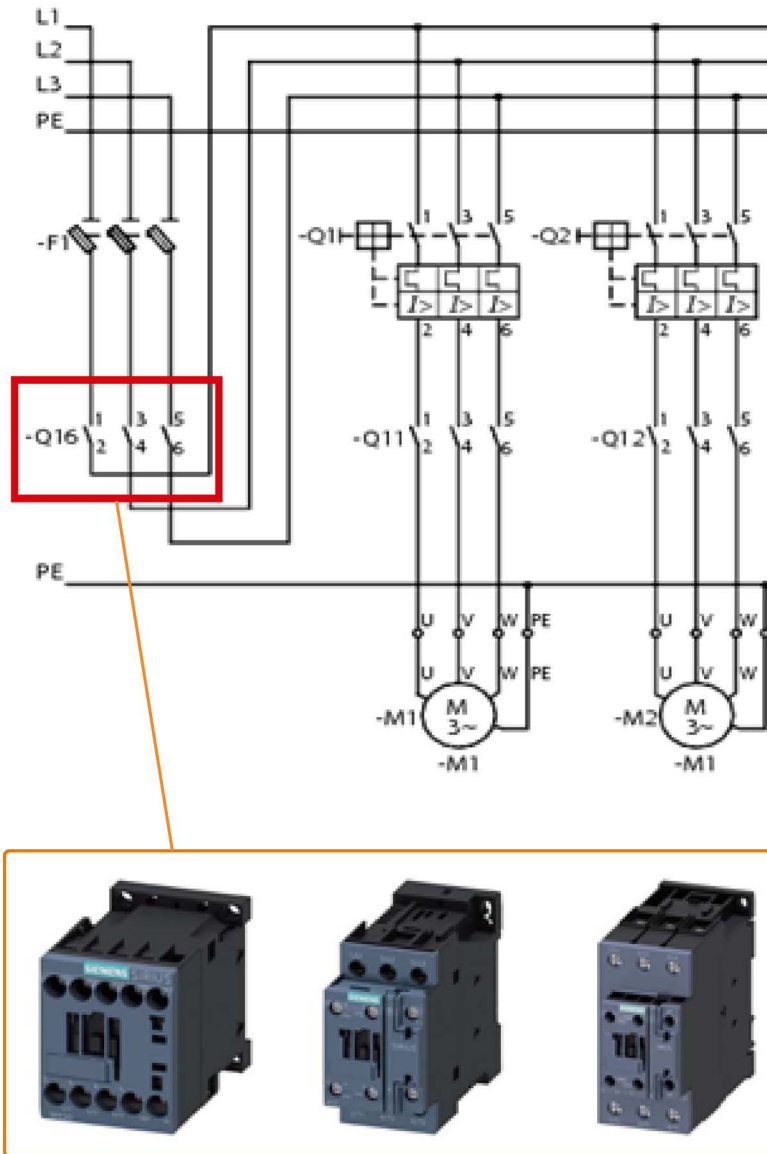

Figure 6-13 Example: Contactor as device for removal of power for prevention of unexpected start-up

6.2.5 Devices for isolating electrical equipment

Voltage poses another potential hazard. In other words, if the voltage itself is the agent which poses a potential hazard, devices for isolating electrical equipment or parts thereof shall be provided.

These devices shall meet the following conditions:

- They are easy to operate and access.
- They are suitable for the intended use.
- They are readily identifiable as to which part(s) or circuit(s) they serve.

The supply disconnecting device may, in some cases, be capable of acting as an isolating device. Separate isolating devices are required only when it is necessary to work on individual parts of the electrical equipment of a machine, or on one of a number of machines fed by a common wire system or conductor bar system or inductive power supply system.

Devices which also serve as a supply disconnecting device (Page 86) may be used.

Note

Disconnectors, withdrawable fuse links and withdrawable fuse isolating links shall always be located in an electrical operating area. Information to this effect shall be supplied with the electrical equipment.

Devices without isolation function shall not be used for this purpose.

6.2.6 Protection against unauthorized, inadvertent and/or mistaken connection

IEC 60204-1 describes in Chapter 5.6 that "Devices for removal of power for prevention of unexpected start-up" and "Devices for isolating electrical equipment" shall be equipped with means to secure them in the OFF position (disconnected state) in order to prevent reconnection if they are located outside an enclosed electrical operating area.

Examples



Figure 6-14 Padlock to prevent reconnection

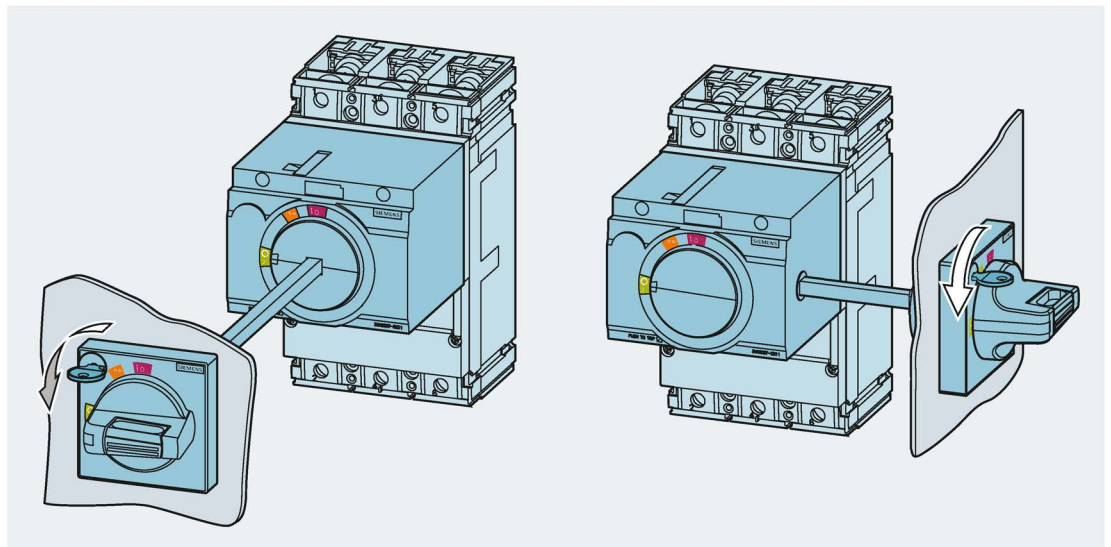

Figure 6-15 Lockable door-coupling rotary operating mechanism of a 3VA... molded case circuit breaker

Rule

Note

It shall not be possible to reconnect the device either locally or remotely.

6.2 Incoming supply conductor termination and supply disconnecting device

Other precautions against reconnection, e.g. warning notices or signs, may be sufficient for devices for removal of power situated inside an enclosed electrical operating area.

Plug/socket combinations need not be lockable if they can be kept under the immediate supervision of the person who is carrying out the work.

6.3 Protection against electric shock

General

Persons who work on or operate the electrical equipment of machines shall be appropriately protected against the associated risks. One of the essential hazards associated with this kind of equipment is the risk of electric shock. This risk shall be taken into account to the extent possible at the machine design phase and eliminated by the implementation of suitable measures.

Note

Hazardous touch voltage

Voltages of **> 50 V (alternating)** or **> 120 V (direct)** are deemed to pose a potentially fatal risk to healthy, adult human beings. Voltages of this magnitude are referred to as "hazardous touch voltage".

The measures described in this chapter shall be implemented if there are live parts in the machine at a voltage of at least **> 50 V (alternating)** or **> 120 V (direct)**.

Protective measures in accordance with IEC 60364-4-41

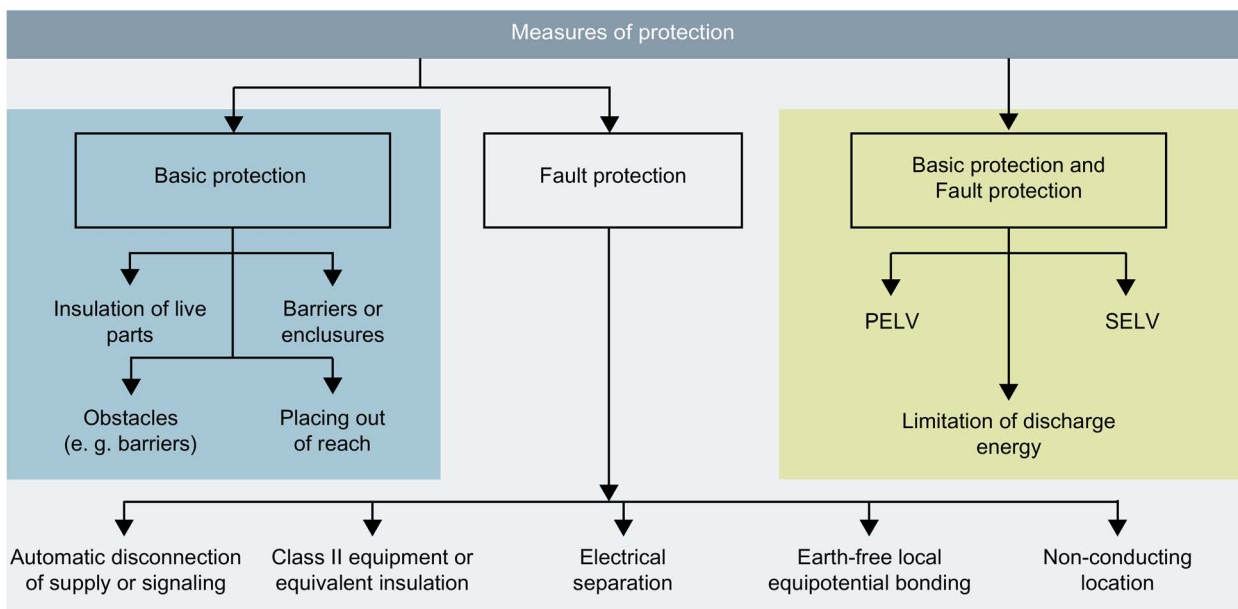

Figure 6-16 Protective measures in accordance with IEC 60364-4-41

Chapter 6 of IEC 60204-1 principally differentiates between:

- Basic protection (Page 102)
- Fault protection (Page 110)
- Protection by PELV (Page 117) (protective extra-low voltage)

6.3.1 Basic protection

Protection against direct contact includes protection by the following methods:

- Protection by enclosures
- Protection by insulation
- Protection against residual voltages if applicable

Note

If none of the above mentioned measures can be used due, for example, to the machine design, other measures as specified in IEC 60364-4-41 can also be implemented, such as

- Protection by barriers (covers)
 - Protection by placing out of reach or protection using obstacles
-

Equipment accessible to the general public, including children, shall be in an enclosure with protection against contact with live parts and correspond to degree of protection IP4X or IPXXD or shall be appropriately insulated.

Protection by enclosures

With the protection by enclosures method, all live parts shall be located inside the enclosure and the enclosure itself shall be suitable for the prevailing ambient conditions. The enclosure shall be at least "finger-safe" and have degree of protection IP2X or IPXXB.

When work (such as maintenance) is carried out on the control panel or machine, materials or tools used by the maintenance personnel are often placed down on readily accessible top surfaces of enclosures. In order to prevent such objects from accidentally falling into the enclosure, "top surfaces" of enclosures shall be "wire-safe" and have at least degree of protection IP4X or IPXXD.



Figure 6-17 Motor starter with appropriate enclosure for use in the field



Figure 6-18 Control panel with appropriate enclosure

Opening an enclosure shall only be possible under one of the following conditions:

- By use of a key or tool
- By disconnecting the equipment before the enclosure is opened
- Opening without the use of a key or tool and without disconnecting live parts

By use of a key or tool



Figure 6-19 Control panel locked by means of a key or by screw connections

Using this method it is possible to prevent all except skilled persons from accessing the panel. The keys to locked enclosures shall be left in the safekeeping of authorized skilled persons. In the case of enclosures that are screwed shut, personnel shall be clearly instructed that they may only be opened by electrically skilled persons.

Live parts, including those on the inside of doors, that can be adjusted or reset by suitable tools while the equipment is still connected to the power supply shall have at least degree of protection IP2X or IPXXB.

It is possible for people working on the equipment with the door open to accidentally come into contact with live parts integrated in the door with, for example, their arm or shoulder. Therefore all such live parts that cannot be adjusted or reset with suitable tools shall be at least "safe from touch by the back of the hand" and have at least degree of protection IP1X or IPXXA.

By disconnecting the equipment before the enclosure is opened

One method of achieving this, for example, is to ensure that the control panel remains locked while the supply disconnecting device is closed and can only be opened when the disconnecting device is also open. Reconnecting may only be possible when the door has been closed again.

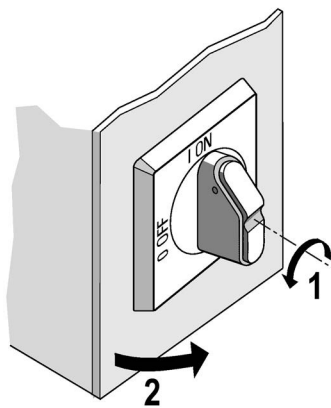

Figure 6-20 Opening a control panel with a door lock interlocked with the supply disconnecting device

Exceptions for electrically skilled persons

Since certain activities (e.g. measurements) need to be carried out on live equipment, it may be necessary for electrically skilled persons to open the control panel without disconnecting the power supply beforehand. For this reason, the standard stipulates an exception that allows the control panel to be opened with a key or tool while the supply disconnecting device is still closed.

This exception is subject to the following conditions:

- It is possible at all times to open the supply disconnecting device and lock it in the OFF position or otherwise prevent unauthorized closure of the disconnecting device.
- Upon closing of the door, the interlock shall be automatically restored.
- Live parts that are likely to be touched when resetting or adjusting devices intended for such operations (e.g. screwdrivers) while the equipment is still connected shall have at least degree of protection IP2X or IPXXB ("finger-safe"). This also applies to live parts on the inside of doors.
- Other live parts integrated in the door shall have at least degree of protection IP1X or IPXXA ("safe from touch by the back of the hand").
- Relevant information about the procedure for the defeat of the interlock shall be supplied with the equipment.

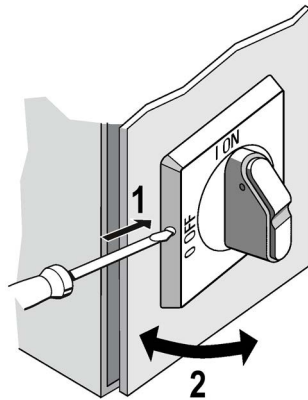

Figure 6-21 Using a tool to open a control panel with a door lock interlocked with the supply disconnecting device

Note

Electrically skilled persons and electrically instructed persons

The key or tool for opening the control panel when it is live shall only be used by electrically skilled persons or electrically instructed persons. Means shall be provided to restrict access to live parts to this group of people.

All parts that are still live after switching off the supply disconnecting device shall be protected against direct contact with at least degree of protection IP2X or IPXXB. Such parts shall be labeled with a warning sign.

Exceptions are

- Parts that can be live only because of connection to interlocking circuits and that are distinguished by color as potentially live
 - Supply terminals of a supply disconnecting device installed in a separate enclosure.
-



Figure 6-22 Labeling of components that are still live even though the supply disconnecting device is open

Opening without the use of a key or tool and without disconnecting live parts

Without the use of a key or tool and without disconnecting live parts, opening the enclosure shall only be possible if all live parts have at least degree of protection IP2X or IPXXB.

Alternative: All live parts that are protected by the barrier shall be disconnected automatically when the barrier is removed.

If this is achieved by the use of a barrier, it shall only be possible to remove the barrier by use of a tool.

Protection by insulation of active parts

It is also possible to insulate live parts. The insulation shall meet the following conditions:

- Live parts shall be completely covered with insulation.
- The insulation shall only be removable by destruction.
- The insulation shall be capable of withstanding the stresses to which it is subjected under normal operating conditions.

Note

These stresses may be mechanical, chemical, electrical and thermal in nature.

IEC 60204-1 generally considers paints, varnishes, lacquers and similar products alone to be inadequate as protection against electric shock.

Insulating tape that can be removed without destruction is not suitable.

Insulated cables, for example, are a common, well-documented practical example: There are cables that have a sufficiently rugged insulation that they can be freely installed along the machine frame or on cable racks. By contrast, other types of cable shall be installed in cable ducts or conduits because their insulation is not sufficiently strong to withstand the stresses to which freely installed cables are subjected. For further details, see also Chapter Wiring practices (Page 183).

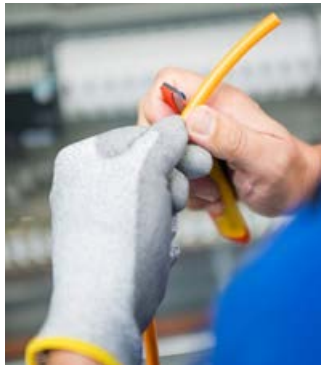

Figure 6-23 Removal of cable insulation by destruction



Figure 6-24 Cable freely installed on cable rack



Figure 6-25 Cable installed in cable duct

Protection where there are residual voltages

Live parts shall be discharged to ≤ 60 V within 5 seconds after the supply has been disconnected.

Note

Components with a stored charge of $\leq 60 \mu\text{C}$ are exempted from this requirement.

However, certain components (frequency converters, for example) cannot be discharged within this timeframe. In such cases, a durable warning notice shall be displayed at an easily visible location on or immediately adjacent to the enclosure that contains the live parts. The warning notice shall indicate the following:

- The type of hazard
 - The delay required until the enclosure may be opened
-

Note

Attachment of warning notices

The warning notice that is affixed to the components themselves by the manufacturers are not sufficient.

The control panel manufacturer shall always attach an additional warning notice to the control panel enclosure.

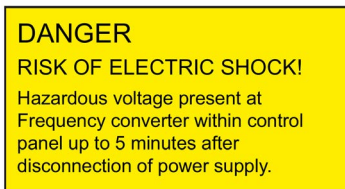

Figure 6-26 Example: Warning notice to protect against residual voltages

In the case of plugs, conductors that might be exposed by the withdrawal of the plug shall be discharged to ≤ 60 V within 1 second. If this is not possible, these conductors shall be protected to at least degree of protection IP2X or IPXXB, e.g. by sheaths. If neither the specified discharge time nor a degree of protection of at least IP2X or IPXXB can be achieved, additional switching devices or warning notices shall be provided.

If the equipment is accessible to the general public, which can also include children, warning notices are not sufficient. In this case, a degree of protection of at least IP4X or IPXXD is required.

Protection by barriers (covers)

This method may be used only in the case that protection by enclosure, protection by insulation or protection against residual voltages are not suitable options, e.g. due to the machine design.

IEC 60204-1 makes reference in Chapter 6.2.5 to IEC 60364-4-41. Annex A.2 of this standard states the following:

- Barriers and enclosures that provide protection against contact with live parts shall have at least degree of protection IP2X or IPXXB.¹
- Where materials can be placed down on the surfaces of barriers or enclosures, these surfaces shall have at least degree of protection IPXXD or IP4X.
- Barriers and enclosures shall be firmly secured in place and have sufficient stability to be able to maintain protection against contact with live parts in normal operation.
- Where it is necessary to remove barriers or enclosures, this shall be possible only
 - by the use of a key or tool, or
 - after disconnection of the supply to live parts against which the barriers or enclosures afford protection. Restoration of the supply shall only be possible if the barrier or enclosure has been closed again, or where an intermediate barrier with a degree of protection of at least IP2X or IPXXB is provided that can only be opened by a key or tool
- A warning label shall be affixed to the barrier or enclosure if items of equipment that retain dangerous electrical charges after they have been switched off are installed behind the barrier or enclosure. Small capacitors such as those used for arc extinction, for delaying the response of relays, etc. need not be considered dangerous.

Note 1

Where larger openings occur during the replacement of parts,

- suitable precautions shall be taken to prevent unintentional contact with live parts
- persons shall be made aware that live parts can be touched through the opening and should not be touched intentionally
- the opening shall be as small as possible to allow replacement of the parts

See also

Degree of protection of enclosures (Page 52)

6.3.2 Fault protection

Protection against indirect contact shall always be provided in cases where exposed conductive parts of the machinery may unexpectedly carry a hazardous touch voltage due to an insulation fault.

At least one of the following measures shall be applied for each circuit/part of electrical equipment which conducts hazardous touch voltage:

- Prevention of the occurrence of a hazardous touch voltage
- Automatic disconnection of the supply before the time of contact with a touch voltage can become hazardous

Prevention of the occurrence of a hazardous touch voltage

Chapter 6.3.2.1 of IEC 60204-1 describes two measures that prevent the occurrence of a hazardous touch voltage:

- Use of Class II components or components with equivalent insulation
- Protection by electrical separation

Class II or equivalent insulation

Class II components or components with equivalent insulation can be used in order to prevent the occurrence of hazardous touch voltages caused by faults in the basic insulation at accessible exposed conductive parts of the machinery.

This can be achieved by use of one or more of the following:

- Class II equipment or apparatus
- Switchgear or controlgear assemblies with total insulation
- Supplementary or reinforced insulation

Protection by electrical separation

Protection by electrical separation of individual circuits is intended to prevent contact with the exposed conductive parts of other circuits that may be energized by an insulation fault. It thus prevents the occurrence of a hazardous touch voltage

According to IEC 60364-4-41, Chapter 413.3, protection by electrical separation shall meet the following conditions:

1. Supply through a current source with at least simple separation and voltage ≤ 500 V.
2. Live parts shall not be connected at any point to other circuits, or to ground or to a protective conductor.
3. Flexible cables and cords shall be visible throughout any part of their length liable to mechanical damage.
4. The use of a separate cable and cord system is recommended.

Note

More than one item of current-using equipment

See IEC 60364-4-41, Annex C.3 for "Electrical separation for the supply of more than one item of current-using equipment"

Automatic disconnection of the power supply

Automatic disconnection of the power supply before the time of contact with a touch voltage can become hazardous

This is the protection measure most commonly applied in practice. Two essential parameters need to be considered:

1. The period of exposure to the touch voltage
2. The magnitude of the touch voltage

A hazardous touch voltage does not pose a danger to humans if it is disconnected within a sufficiently short time period.

Equipment that is not held by hand during operation

A disconnecting time of ≤ 5 seconds is considered to be sufficiently short for items of equipment that are not held by hand during operation. The risk that a person will touch the live machine part precisely in the disconnecting time window of up to 5 seconds is very low

Exceptions

In cases where this disconnecting time cannot be attained, the touch voltage shall be reduced to ≤ 50 V (alternating voltage) or ≤ 120 V (direct voltage). This can be achieved, for example, by provision of supplementary protective bonding.

Touch voltages in excess of 50 V can develop in standard installations:

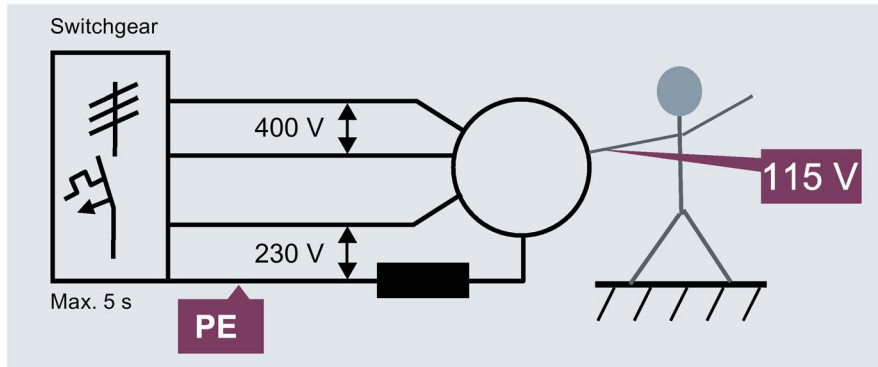

Figure 6-27 Example: Touch voltage 115 V with one protective conductor (standard installation)

The touch voltage can be lowered to ≤ 50 V by reducing the electrical resistance. This can be achieved, for example, by increasing the cross-sectional area of the protective conductor or connecting a protective bonding conductor in parallel (PA).

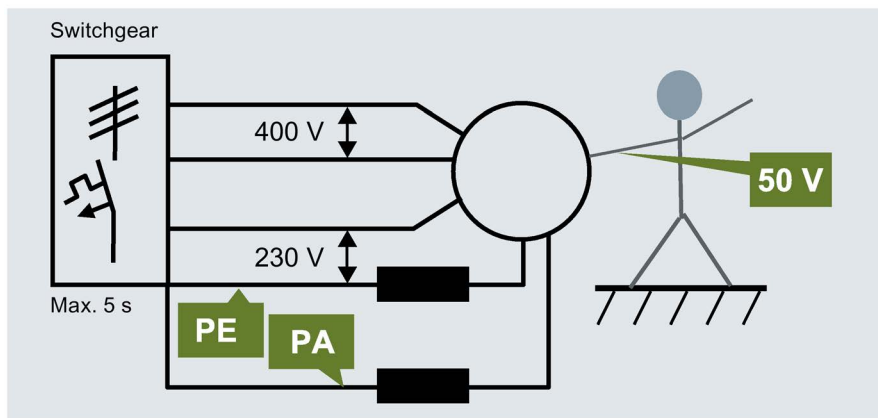

Figure 6-28 Example: Touch voltage 50 V with 2 protective conductors

Sufficient reduction of the touch voltage is assured if the impedance of the protective conductor system is not higher than:

$Z_{PE} \leq \frac{50}{U_0} \times Z_S$	<p>Z_{PE} = is the impedance of the protective bonding circuit somewhere on the machine or between simultaneously accessible exposed conductive parts and/or extraneous conductive parts.</p> <p>U_0 = nominal AC voltage to ground</p> <p>Z_S = is the impedance of the fault loop comprising the source, the live conductor up to the point of the fault and the protective conductor between the point of the fault and the source</p>
---	--

The prerequisite stated above can be confirmed by "checking the continuity of the protective bonding circuit" for measurement of the resistance R_{PE} . The prerequisite for protection is achieved when the measured value of R_{PE} is not higher than:

$R_{PE} \leq \frac{50}{I_{a(5s)}}$	<p>$I_{a(5s)}$ = current that causes automatic operation of the disconnecting protective device within 5 s</p> <p>R_{PE} = resistance of the protective bonding circuit between the PE terminal and the equipment, somewhere on the machine or between simultaneously accessible exposed conductive parts and/or extraneous conductive parts</p>
------------------------------------	--

Hand-held equipment

Circuits which supply hand-held class I devices or portable equipment (e.g. socket outlets on a machine for accessory equipment) shall be disconnected within a significantly faster time than 5 seconds. The table below specifies the required disconnecting times:

Table 6- 2 Maximum disconnecting times for TN systems

System	50V < U_0 ≤ 120V		120V < U_0 ≤ 230V		230V < U_0 ≤ 400V		U_0 > 400V	
	[s]		[s]		[s]		[s]	
	AC	DC	AC	DC	AC	DC	AC	DC
TN	0.8	Note 1	0.4	5	0.2	0.4	0.1	0.1

U_0 is the nominal AC voltage or nominal DC line to ground voltage

NOTE 1 Disconnection may be required for reasons other than protection against electric shock.

NOTE 2 For voltages which are within the tolerance band stated in IEC 60038, the disconnecting time appropriate to the nominal voltage applies.

NOTE 3 For intermediate values of voltage, the next higher value in the above table is to be used.

Source: IEC 60204-1, Table A.1: Maximum disconnecting times for TN systems

Since circuits cannot be reliably disconnected within these times when fuses, circuit breakers or miniature circuit breakers are used, supplementary measures are required in such cases, e.g. residual current protective devices.

Note

Sockets-outlets for accessories

According to IEC 60204-1, Chapter 15.1, residual current protective devices (RCD) with a rated residual current of $I_{\Delta n} \leq 30 \text{ mA}$ are explicitly required for circuits supplying socket-outlets for accessories with a nominal current of $\leq 20 \text{ A}$.

Example

Circuit with socket-outlet for hand-held class I equipment (drill, for example) and residual current protective devices:

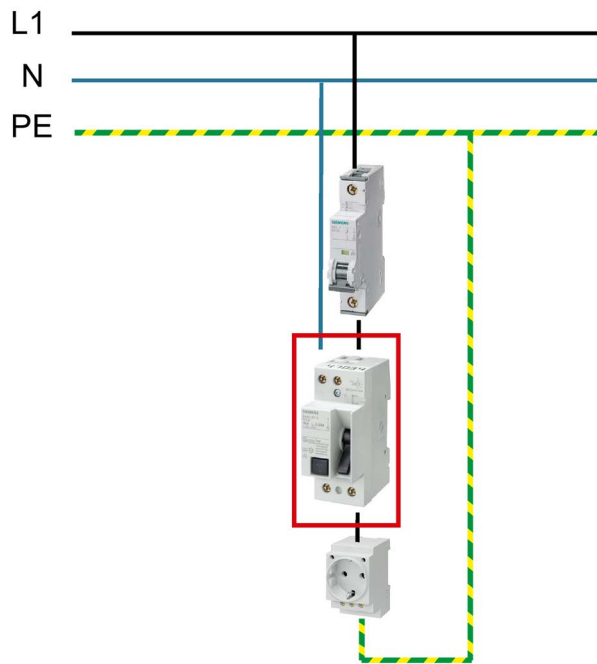

Figure 6-29 Example: Hand-held class I equipment and residual current protective devices

To ensure that the required disconnecting times are achieved, the following parameters shall be mutually coordinated:

- Type of grounding system (Page 47)
- Characteristics of the protective devices that detect insulation fault(s)
- Impedance of the protective bonding circuit (Page 196)

Type of grounding system

TN system

TN systems are the most common type of grounding system for industrial applications. With TN-S, TN-C or TN-C-S systems, exposed conductive parts are connected to the neutral point of the supply via a protective conductor. In other words, in the event of an insulation fault, the current increases very rapidly with the result that the required disconnecting time of ≤ 5 seconds for machine parts that are not held by hand during operation can easily be achieved by the use of fuses, circuit breakers or miniature circuit breakers.

TT system

In the unlikely case that an industrial environment is supplied by a TT system (although this does still occur in some countries), the exposed conductive parts are grounded directly at their location. In the event of an insulation fault, the location and the exposed conductive parts assume virtually the same potential (touch voltage $U \sim 0$ V). An insulation fault only becomes a ground fault, not a short circuit. This means that the fault current is low by comparison with a TN system. It is not generally possible to achieve disconnection within the specified time by means of fuses, circuit breakers or miniature circuit breakers. As a result, residual current protective devices normally need to be provided.

IT system

In IT systems, line conductors and any existing neutral conductors are isolated to ground or have a high-impedance ground connection under fault-free operating conditions. No hazardous shock currents flow when the first insulation fault occurs which means that the installation does not need to be shut down immediately. The advantage of this system is that the faulty part of the system can be identified and disconnected in a controlled fashion. To ensure that this particular advantage of the IT system can be exploited, an insulation monitoring device shall signal the occurrence of a fault.

IT systems are deployed in any situation where an installation shall not be shut down after a first insulation fault. Some typical examples include hospitals, installations in explosion protection zones or applications which require a high level of plant availability.

Note

Power drive system (PDS)

Where a power drive system is used, fault protection shall be provided for the circuits supplied by the converter. If this protection is not ensured by the converter, corresponding information from the converter manufacturer shall be heeded.

Frequency converters from the SINAMICS range of Siemens feature such functionality. For further information, see Main circuit - frequency converters (Page 261).

Fault loop impedance

To ensure that protective devices can trip within the specified time period, the fault loop impedance shall be such that the following condition is met:

$Z_s \times I_a \leq U_0$	<p>Z_s is the impedance of the fault loop comprising the source, the live conductor up to the point of the fault and the protective conductor between the point of the fault and the source</p> <p>I_a is the current that produces automatic disconnection of the protective device within the specified time</p> <p>U_0 is the nominal AC voltage to ground</p>
---------------------------	--

Since the measurements are taken at ambient temperature and at low currents, the increase in resistance of the conductors as a result of the increase in temperature due to the fault current shall be taken into account. The following condition applies:

$Z_s(n) \leq \frac{2}{3} \times \frac{U_0}{I_a}$	<p>$Z_s(n)$ = measured or calculated value of Z_s under normal conditions</p> <p>The value U_0 is generally known as a characteristic of the given type of grounding system.</p> <p>Example: TN-S system 400 V phase/phase → $U_0 = 230$ V phase/ground</p> <p>I_a is specified by the manufacturer of the protective device used. It is the minimum current that causes the short-circuit release of a protective device to respond.</p>
--	--

Note

Evaluation according to IEC 60364

If $Z_s(n) > 2/3 \times U_0/I_a$, a more precise assessment should be performed according to IEC 60364-6:2006, Annex C.61.3.6.2.

Example of a molded case circuit breaker

Table 6- 3 Excerpt from the product data sheet of the molded case circuit breaker 3VA2110-5HL36-

...

Adjustable parameters	
Adjustable response value current / I _g min.	40 A
Adjustable response value current / I _g min.	100 A
Adjustable response value current / I _g min.	0.5
Adjustable response value current / I _g min.	17
Short-term delayed / tripping switchable / I _{2t} =ON/OFF	No
Adjustable response value current / I _i min.	150 A
Adjustable response value current / I _i max.	1 200 A



Note

3VA2 molded case circuit breaker

The designation for the response current of the 3VA2 molded case circuit breaker is I_i. The designation for this current in IEC 60204-1 is I_a. Since the short-circuit release is adjustable, values are specified for I_i min. and I_i max.

The fault loop impedance Z_S is normally measured during commissioning of the machine. The value can also be calculated if necessary.

For additional information, please refer to Chapter Testing and verification in accordance with IEC 60204-1 (Page 194).

See also

Insulation (Page 70)

Classes (Page 71)

6.3.3 Protection by PELV (protective extra-low voltage)

The abbreviation "PELV" stands for "Protective Extra Low Voltage".

This type of circuit can be used to protect persons against electric shock from indirect contact, or from direct contact with a small contact surface.

For more information, see Chapter Definition of terms (Page 71).

6.4 Design and protection of equipment

Many factors influence the design and construction of machines, their control panels and other electrical equipment. These factors include the supply system and the physical environmental and operating conditions at the site of installation. The design not only needs to take fault-free operation under normal conditions into consideration, but also make provision for protecting the equipment against harmful effects under fault conditions.

Harmful effects

Harmful effects according to IEC 60204-1, chapter 7	Explanations of causes and remedies
<ul style="list-style-type: none">Overcurrent arising from a short-circuit or motor overload	Overcurrent protection (Page 119)
<ul style="list-style-type: none">Loss of cooling of motors	Protection of motors against overheating (Page 154)
<ul style="list-style-type: none">Abnormal temperature	Protection against abnormal temperatures (Page 156)
<ul style="list-style-type: none">Loss of or reduction in the supply voltage	Protection against the effects of supply interruption or voltage dip followed by voltage recovery (Page 156)
<ul style="list-style-type: none">Overspeed of machines/machine elements	Motor overspeed protection (Page 156)
<ul style="list-style-type: none">Ground fault/residual current	Ground fault/residual current protection (Page 156)
<ul style="list-style-type: none">Incorrect phase sequence	Phase sequence monitoring (Page 157)
<ul style="list-style-type: none">Overvoltage due to lightning and switching surges	Protection against overvoltages due to lightning and to switching surges (Page 157)

Risks at operating site

Note

Risk analysis

An appropriate risk analysis shall be carried out in order to identify the specific risks that exist at a given operating site. A clear interface agreement (Page 81) shall be reached between the manufacturer and the operator of the electrical equipment before a correct, reliable risk analysis can be carried out.

6.4.1 Overcurrent protection

Overcurrent is present in the electrical equipment whenever one or both of the following states exist:

- Current > rating of any component
- Current > current-carrying capacity of the conductors

Overcurrent can develop as the result of a short circuit, but can also be caused by motor overload.

The cables as well as the components in the electrical equipment shall be dimensioned accordingly and protected against overload. Overcurrent protection shall be provided in all live conductors.

Note

Neutral conductor

The neutral conductor is generally a live conductor and does not need to be disconnected or switched in TN-C-S and TN-S systems if the power utility declares that the neutral conductor has a reliable and sufficiently low-impedance connection to ground.

The neutral conductor is not regarded as having a sufficiently low-impedance connection to ground and shall therefore be disconnected or switched in Belgium, France, Portugal, Spain, Norway and Switzerland.

Disconnection of conductors

The following conductors may only be disconnected if all associated live conductors are also disconnected:

- Neutral conductors of AC power circuits
- Grounded conductors of DC power circuits
- Conductors of DC power circuits that are bonded to exposed conductive parts of mobile machines

If cross-sectional area of neutral conductor is \geq cross-sectional area of line conductor

Overcurrent detection and interruption of the neutral conductor is not necessary!

If cross-sectional area of neutral conductor is < cross-sectional area of line conductor

Multi-phase circuits (with line conductors > 16 mm² for copper and > 25 mm² for aluminum) may have neutral conductors with a smaller cross-sectional area if the following conditions are met simultaneously:

- Prospective current distributed symmetrically over line conductor and 3rd order harmonic and uneven multiple of the 3rd order harmonic $\leq 15\%$ of the line conductor current
- In the event of overcurrent, the neutral conductor is protected in accordance with the neutral conductor cross-sectional area. Overcurrent detection shall disconnect the line conductors, not necessarily the neutral conductor.
- Neutral conductor cross-sectional area shall be at least 16 mm² for copper or 25 mm² for aluminum.

Note

Neutral conductor according to IEC 61439-1

The reduced neutral conductor cross-sectional area can be reduced by up to 50 % of the line conductor cross-sectional area unless otherwise agreed between the manufacturer and the user. But not smaller than 16 mm².

Neutral conductors in IT systems (not recommended)

Overcurrent detection shall be provided for neutral conductors of each circuit!

→ Disconnection of all live conductors of the applicable circuit including the neutral conductor

This measure is not required in the following cases:

- If the neutral conductor under consideration is protected by a protective device on the supply side, e.g. at the infeed of the system.

Or

- If the circuit under consideration is protected by a residual current protective device (RCD) that has a rated residual current that is lower than or equal to 0.20 times the current-carrying capacity of the relevant neutral conductor and all live conductors of the relevant circuit including the neutral conductor are disconnected.

Note

Distributed neutral conductor

If a neutral conductor is routed with the other conductors to the load in an IT system, it is referred to as a distributed neutral conductor.

A neutral conductor is not permitted to be connected to ground in an IT system. A neutral conductor is not recommended because it is difficult to calculate the short circuit in this case and selection of protective devices then becomes more difficult.

6.4.1.1 Arrangement of overcurrent protective devices

Reduction in current-carrying capacity

If the current-carrying capacity of the conductors is reduced, e.g. due to a reduction in the cross-sectional area or some other modification, an overcurrent protective device shall be provided at the point at which the current-carrying capacity is reduced.

Exception if all the following conditions are met:

- Current-carrying capacity of the conductors \geq load current
- Appropriate overcurrent protection no further than 3 m after the point at which the current-carrying capacity is reduced.
- Protective installation of conductors so as to mitigate the risk of short circuits. For example, protected by an enclosure or a cable duct.

The cross-sectional area required to ensure the short-circuit withstand rating of the cable is calculated according to the following formula:

$$S \text{ (mm}^2\text{)} \geq \sqrt{\frac{I^2 \text{ (A)} \times t \text{ (s)}}{k^2}}$$

Example

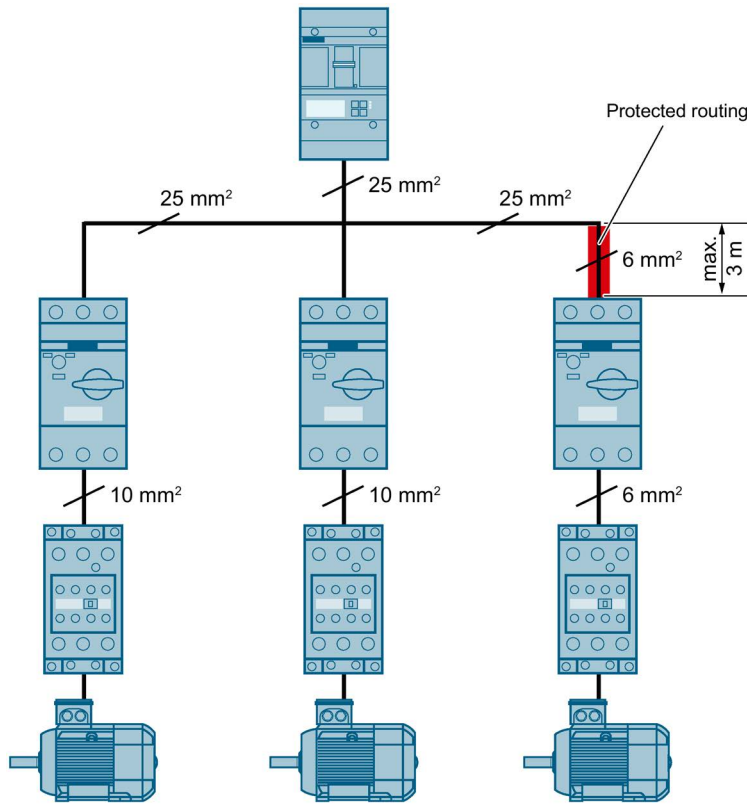

Figure 6-30 Example: Reducing the current-carrying capacity of conductors

Short-circuit current rating of electrical equipment

According to IEC 60204-1, Chapter 7.10, the short-circuit current rating of the electrical equipment is to be determined using design rules, calculations or tests.

The short-circuit current rating can be determined in compliance with IEC 61439-1, IEC 60909-0, IEC/TR 60909-1 or IEC/TR 61912-1, for example.

The process according to IEC 61439-1 is described in Chapter Detailed description of design verifications relating to construction (Page 208) of this reference manual.

Selection of overcurrent protective devices

Selection of overcurrent protective devices in accordance with IEC 60204-1, Chapter 7.2.9./10:

- The rated short-circuit breaking capacity shall be greater than or equal to the prospective short-circuit current at the point of installation.
- The rated current of fuses or the setting current of other overcurrent protective devices shall be selected as low as possible but adequate for the anticipated overload currents (e.g. during motor starting).
- Protection of switching devices against damage by overcurrents (e.g. against welding of the switching device contacts) shall be ensured.
- The current-carrying capacity of the protected conductors and the maximum disconnecting time of ≤ 5 seconds shall be ensured.

Note

Back-up protection

An overcurrent protective device with a lower rated breaking capacity can also be used. In this case, however, another overcurrent protective device with the required breaking capacity shall then be installed on the supply side of the one with the lower rated breaking capacity. The characteristic values shall be mutually coordinated in such a way that the let-through energy I^2t of the two series-connected devices shall not exceed the value that the load-side overcurrent protective device and the conductor it protects can withstand without sustaining damage.

IEC 60947-2, Annex A, describes 2 methods for verifying back-up protection:

- Verification by testing
- Verification by comparison of characteristics

Since verification by comparison of characteristics is difficult to perform in practice due to the method described in the standard, there is one remaining practical option, i.e. to apply tested combinations in accordance with the manufacturer's specifications.

Short-circuit current at the installation location

The electrical equipment shall be designed for both the highest possible short-circuit current and the lowest possible short-circuit current. The major factor here is the prospective short-circuit current.

Highest possible short-circuit current

If no separate supply terminals are used, the largest possible short-circuit that can occur within the control panel builder's area of responsibility (see Fig. 6-1 (Page 82)) is the 3-pole short-circuit on the outgoing side of the supply terminal or of the supply disconnecting device.

Calculating the maximum short-circuit values at the location in which the overcurrent protective devices are installed involves a significant amount of engineering work. Equipment manufacturers design most overcurrent protective devices for high short circuits. For this reason, it is common practice to dimension all overcurrent protective devices according to the prospective short-circuit current at the incoming supply point. Furthermore, overcurrent protective devices shall ensure the protection of control devices such as contactors or frequency converters against any damage. Siemens specifies the appropriate overcurrent protective devices in the relevant manuals of the control devices.

Example

Simplest method: Design every overcurrent protective device for 50 kA.

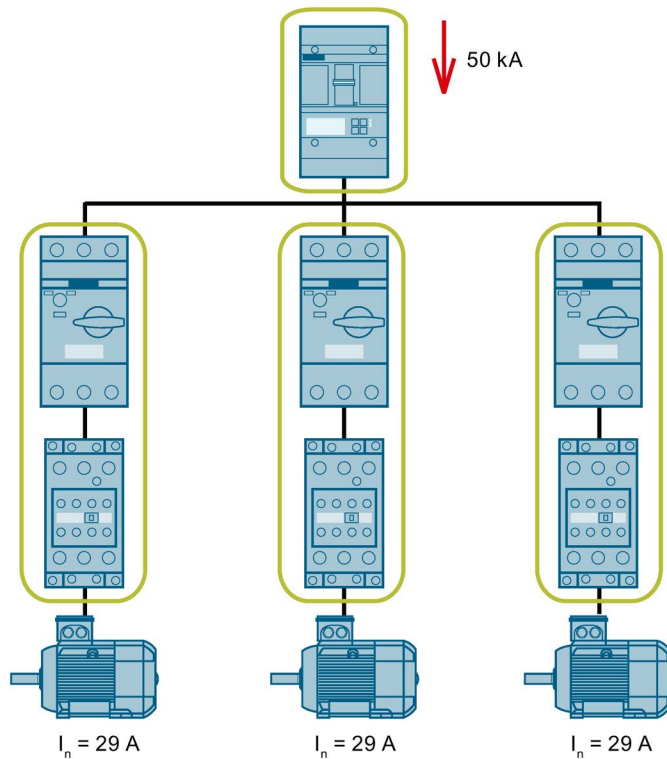

Figure 6-31 Design of overcurrent protective devices according to the maximum prospective short-circuit current at the incoming supply point.

Note

Consideration of additional currents

Where the short-circuit current from the supply to an overcurrent protective device can include additional currents (e.g. from motors, from power factor correction capacitors), those currents shall also taken into consideration.

For more information, see IEC 60909-0.

Prospective short-circuit current at the incoming supply point to the machine

The prospective short-circuit current at the incoming supply point to the machine is thus an **important input quantity for configuring** the control panel. This value shall also be agreed in advance with the operator of the machine. In the enquiry form in Annex B of IEC 60204-1, it is recommended that the **prospective** short-circuit current at the supply connection point of the electrical infeed is agreed.

The prospective short-circuit current at the incoming supply point to the machine is dependent on two factors:

1. The initial symmetrical short-circuit current of the supply transformer
2. The attenuation effect of the supply cable

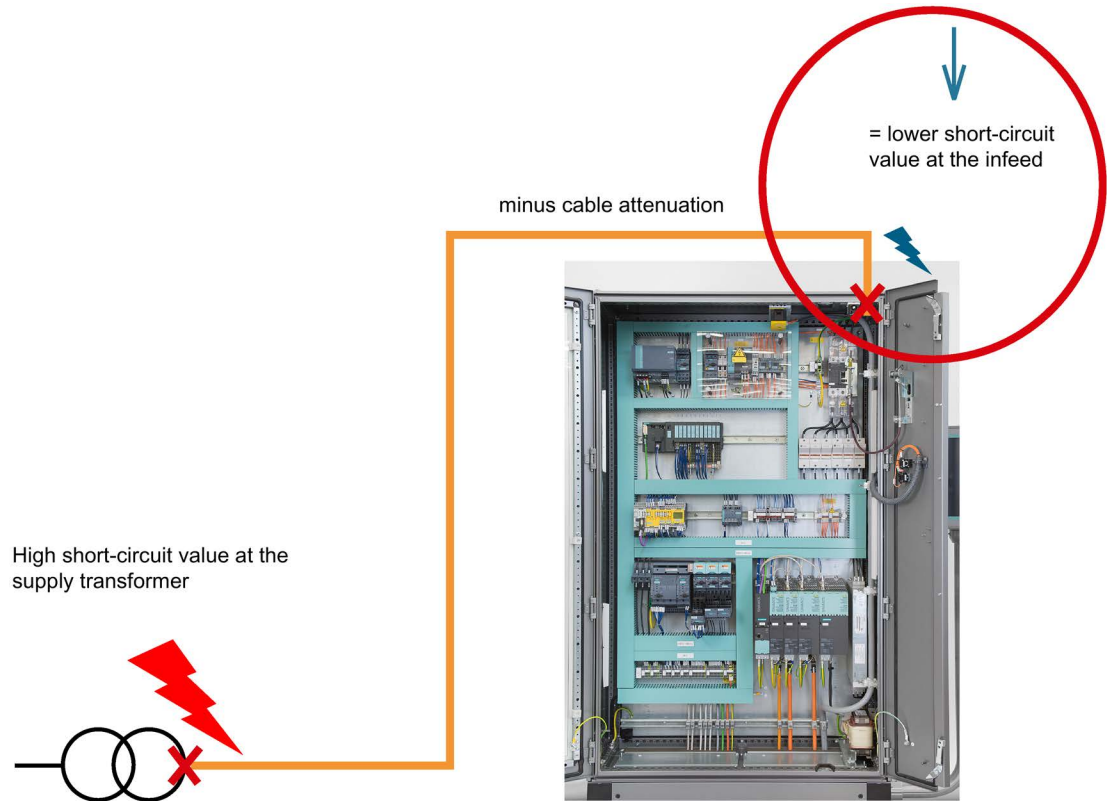

Prospective short-circuit value at the incoming supply point to the machine as a function of the maximum initial symmetrical short-circuit current on the secondary side of the supply transformer and the supply cable to the machine.

Figure 6-32 Prospective short-circuit value at the incoming supply point to the machine

See also

Incoming supply conductor termination (Page 82)

6.4.1.2 Initial symmetrical short-circuit current

Approximation formulas for current estimation

If there are no specified table values, you can estimate currents using approximation formulas.

The approximation for the rated transformer current is:

$$I_r = k \times S_T$$

The approximation for the initial symmetrical transformer short-circuit current is:

$$k'' = I_r / u_{kr}$$

Example

- Rated transformer power $S_T = 500$ kVA
- Voltage factor k
 - k = 1.45 A/kVA for a rated voltage of 400 V
 - k = 1.10 A/kVA for a rated voltage of 525 V
 - k = 8.40 A/kVA for a rated voltage of 690 V
- Rated short-circuit voltage $u_{kr} = 4\%$

→ the approximation values for $U_f = 400$ V are:

$$I_r = (1.45 \times 500) \text{ A} = 725 \text{ A}$$

$$k'' = (725 \times 100 / 4) \text{ A} = 18.125 \text{ kA}$$

Rated currents and initial symmetrical short-circuit currents

Rated currents and initial symmetrical short-circuit currents of three-phase distribution transformers with 50 to 3150 kVA

Table 6- 4 Rated currents and initial symmetrical short-circuit currents

Rated voltage U_{rT}	400/230 V, 50 Hz			525 V, 50 Hz			690/400 V, 50 Hz		
Rated value of the short-circuit voltage u_{kr}		4% ¹⁾	6% ²⁾		4% ¹⁾	6% ²⁾		4% ¹⁾	6% ²⁾
Rated power	Rated current I_r	Initial symmetrical short-circuit current I_k ³⁾		Rated current I_r	Initial symmetrical short-circuit current I_k ³⁾		Rated current I_r	Initial symmetrical short-circuit current I_k ³⁾	
[kVA]	[A]	[A]	[A]	[A]	[A]	[A]	[A]	[A]	[A]
50	72	1933	1306	55	1473	955	42	1116	754
100	144	3871	2612	110	2950	1990	84	2235	1508
160	230	6209	4192	176	4731	3194	133	3585	2420
200	288	7749	5239	220	5904	3992	167	4474	3025
250	360	9716	6552	275	7402	4992	209	5609	3783
315	455	12247	8259	346	9331	6292	262	7071	4768
400	578	15506	10492	440	11814	7994	335	8953	6058
500	722	19438	12020	550	14810	9158	418	11223	6939
630	910	24503	16193	693	18669	12338	525	14147	9349
800	1154	-	20992	880	-	15994	670	-	12120
1000	1444	-	26224	1100	-	19980	836	-	15140
1250	1805	-	32791	1375	-	24984	1046	-	18932
1600	2310	-	39818	1760	-	30338	1330	-	22989
2000	2887	-	52511	2200	-	40008	1674	-	30317
2500	3608	-	65547	2749	-	49941	2090	-	37844
3150	4550	-	82656	3470	-	62976	2640	-	47722

Source: Siemens AG, Totally Integrated Power, SIVACON S8 - Technical Planning Information, 10/2015

- 1) $u_{kr} = 4\%$, standardized according to DIN 42503 for $S_{rT} = 50 \dots 630$ kVA
- 2) $u_{kr} = 6\%$, standardized according to DIN 42511 for $S_{rT} = 100 \dots 1600$ kVA
- 3) I_k Prospective transformer initial symmetrical short-circuit current when connected to a system with unlimited short-circuit power in consideration of the voltage and correction factor of the transformer impedance in accordance with EN 60909 / DIN VDE 0102 (July 2002)

Attenuation effect of the supply cable

The attenuation effect of the supply cable also has a significant influence on the maximum possible short circuit at the incoming supply point to the machine. The length and the cross-sectional area of the cable play a decisive role. As a general rule, the longer the cable and the smaller the cross-sectional area, the greater the attenuation effect.

The diagram below demonstrates the short circuit at the end of the relevant supply cable as a function of the length and cross-sectional area of the cable for an initial symmetrical short-circuit current of 52.5 kA at the secondary terminal of the supply transformer. So, for example, the short-circuit current through a supply cable with a cross-sectional area of 70 mm² at its end is only around 25 kA after it has traveled 20 m through the cable.

Example

Short-circuit attenuation as a function of cable length and cross-sectional area

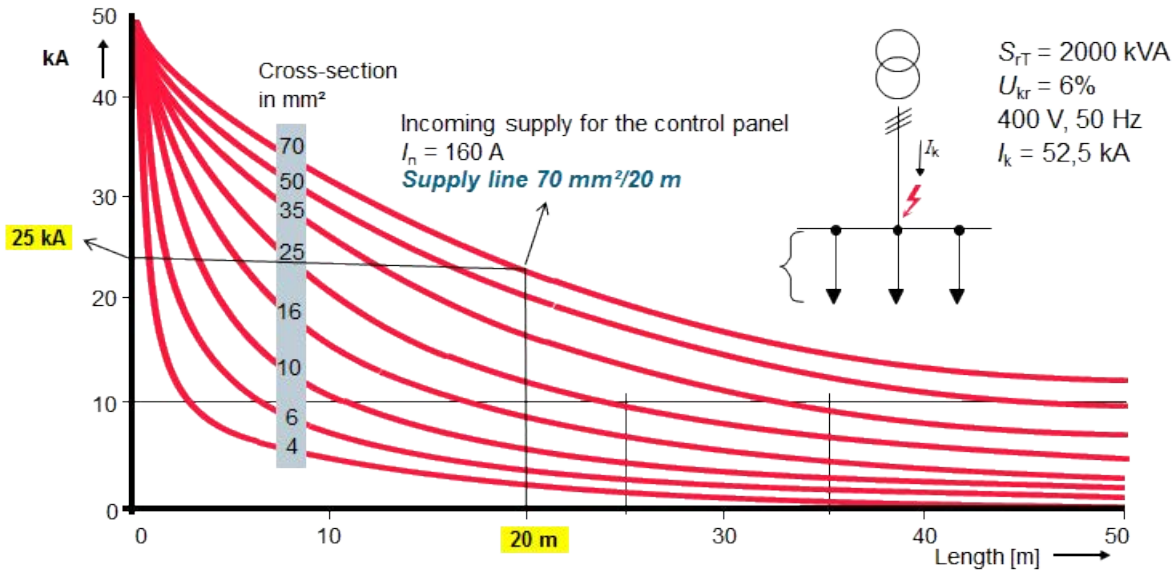

Figure 6-33 Example: Short-circuit attenuation as a function of cable length and cross-sectional area

Influence of the cable length and cross-sectional area

When calculating the short-circuit current at the incoming supply point to the machine, it is important to note that the cable length and cross-sectional area are more important factors than the initial symmetrical short-circuit current of the supply transformer.

For example, in the diagram on the left, the short-circuit current at the incoming supply point to the machine is 8.1 kA with an initial symmetrical short-circuit current of 16.2 kA. In the right-hand diagram, the initial symmetrical short-circuit current is 48.6 kA, the cable lengths and cross-sectional areas are the same as in the left-hand diagram, but the value at the incoming supply point to the machine is only slightly higher at 10.8 kA.

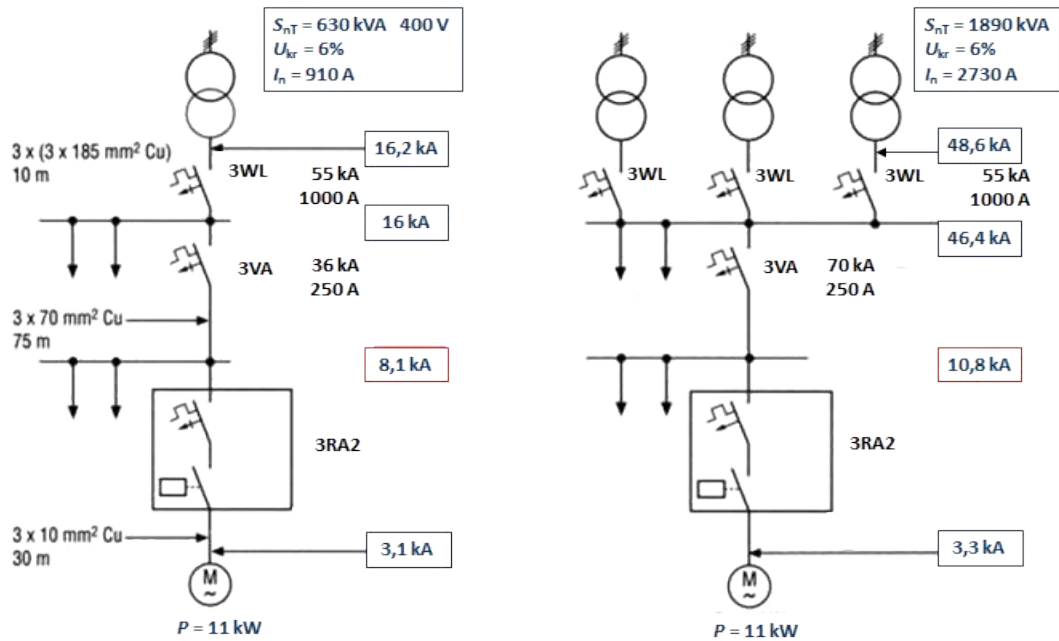

Figure 6-34 Example: Influence of the cable length and cross-sectional area

Note

Include a safety margin

When designing the short-circuit withstand rating of the control panel, it is advisable to include a safety margin of 10 to 20 % above the calculated value (around 9.3 kA in the left-hand example above).

Lowest possible short-circuit current

The lowest possible short-circuit that can occur is the single-pole short-circuit. The longer the supply cable to the short-circuit location and the smaller the cross-sectional area of the cable, the greater the fault loop impedance and the smaller the short-circuit that occurs. It is essential to ensure that the short-circuit release of the upstream protection device still responds. Otherwise, it may not be possible to comply with the required maximum disconnecting time of 5 seconds (see also Chapter Fault protection (Page 110)).

The fault loop impedance Z_s is normally measured during commissioning of the machine. The value can also be calculated if necessary. For additional information, please refer to Chapter Testing and verification (Page 194) in accordance with IEC 60204-1.

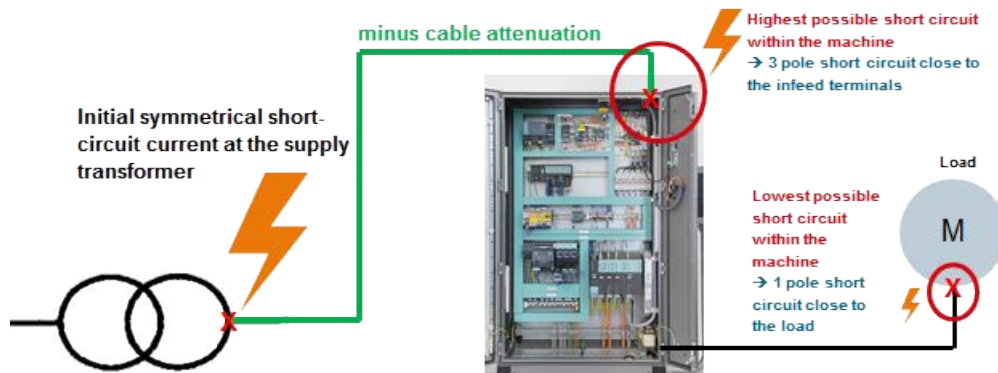

Figure 6-35 Largest possible and smallest possible short-circuit in the machine.

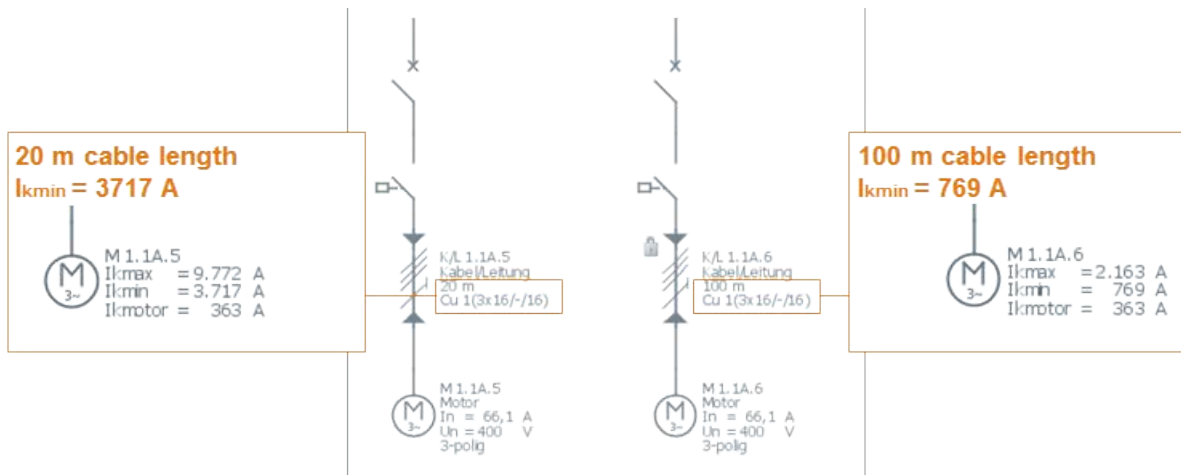

Figure 6-36 Excerpt from the Siemens SIMARIS Design software, comparison of I_{kmin} at 20 m and 100 m cable length

A motor starter protector with a non-adjustable overload release is no longer suitable for the example on the right. This triggers at 13x nominal voltage ($\pm 20\%$ tolerance). According to the nominal current I_n of the motor, a Siemens motor starter protector with a rated value of 73 A should be selected. However, at 949 A ($\pm 20\%$ tolerance) the response value of the short-circuit release is no longer suitable to disconnect within the required 5 seconds. One alternative here would be, for example, the SENTRON circuit breaker (article number 3VA2...). Some types feature an adjustable short-circuit release, with which the circuit breaker can be set to an appropriate response value. See also Chapter Main circuit - molded case circuit breakers (Page 239).

Conclusion

Since very long supply cables are often used at machine operating sites, the short-circuit currents at the incoming supply point to the machine are - by contrast with installations supplied by low-voltage power distribution boards - often only in the single-digit or in the low two-digit kA range. But it is entirely possible for high short-circuit currents to be present at machine supply points. For example, high short-circuit currents may often occur in the automotive or steel industries because of the high connected loads required for these applications.

Generally speaking, the operator should specify the maximum prospective short-circuit value at the incoming supply point to the machine. Since this value is frequently unknown, operators often demand an unnecessarily high short-circuit withstand rating for the control panel. **This can significantly increase the costs of the panel.** The information above can also be used as a guide in calculating the maximum prospective short-circuit current at the incoming supply point to the machine as well as the minimum short-circuit current at the loads.

The maximum prospective short-circuit current at the incoming supply point to the machine, the minimum short-circuit current at the loads as well as fault currents at the installation site of the other overcurrent protective devices can be easily calculated with the SIMARIS design (<http://www.siemens.com/SIMARIS>) software.

6.4.1.3 Selection of overcurrent protective devices

The overcurrent protective devices shall be dimensioned **according to the maximum and minimum short-circuit currents** at the incoming supply point to the machine.

Example

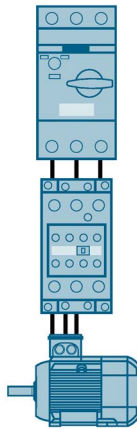

CIRCUIT-BREAKER SZ S0, FOR MOTOR PROTECTION, CLASS 10, A-RELEASE 27...32A, N-RELEASE 400A, SCREW CONNECTION, STANDARD SW. CAPACITY,

Protective and monitoring functions:

Trip class	Class 10
Design of the overload release	thermal
Operational short-circuit current breaking capacity (Ics) at AC	
<ul style="list-style-type: none"> • at 240 V rated value • at 400 V rated value • at 500 V rated value • at 690 V rated value 	100 kA 25 kA 5 kA 2 kA
Maximum short-circuit current breaking capacity (Icu)	
<ul style="list-style-type: none"> • at AC at 240 V rated value • at AC at 400 V rated value • at AC at 500 V rated value • at AC at 690 V rated value 	100 kA 55 kA 10 kA 4 kA

Excerpt from the data sheet of the Siemens 3RV2021-4EA10 motor starter protector

Selection of overcurrent protective device according to rated current / setting current of overcurrent protective devices

The rated current / setting current of overcurrent protective devices shall be as low as possible, but adequate for the anticipated overcurrents. It is therefore necessary to coordinate the tripping characteristic of the overcurrent protective device with the startup characteristic of the load. It goes without saying that a solution would not be sensible if the overcurrent protective device were to trip when a motor was switched on.

Example

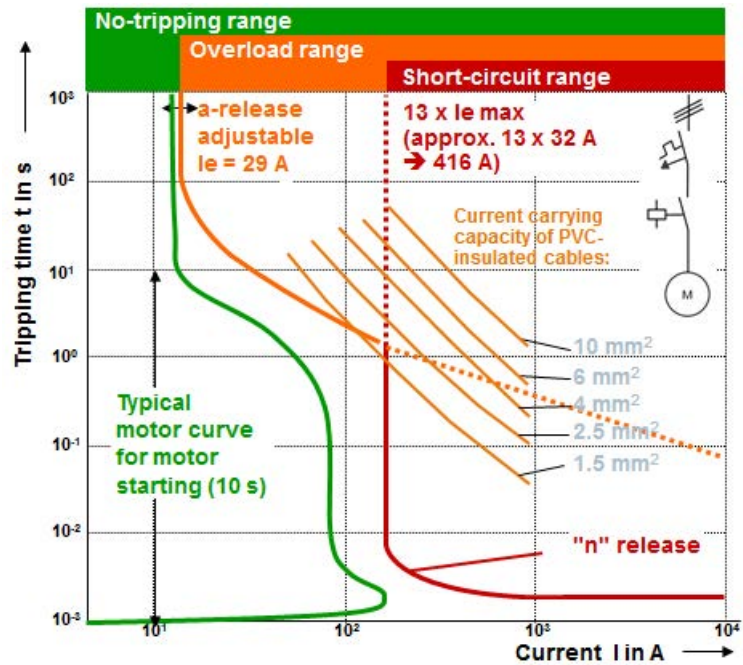
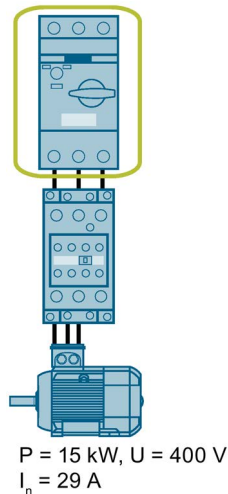

Comparison between the tripping characteristic of a 3RV20 motor starter protector and the startup characteristic of a 15 kW motor

IE3 and IE4 motors

Note

IE3 and IE4 motors can have higher starting currents than IE2 motors. In view of this fact, Siemens has implemented a comprehensive test program and upgraded its overcurrent protective devices. Overcurrent protective devices supplied by Siemens can be confidently deployed for IE3 and IE4 motors as well.

For information, see Chapter Use of IE2 and IE3 motors (Page 299).

6.4.1.4 Selection of control devices

Control devices shall also be dimensioned according to the power and nominal currents of the loads to be switched. Control devices shall be adequately protected against short circuits. Siemens specifies suitable protective devices for the relevant equipment in data sheets or configuration manuals.

Example

**CLASS 10, type of coordination 2,
short-circuit breaking capacity $I_k = 150$ kA**

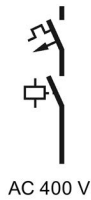

Standard three-phase motor 4-pole at 400 V AC		Motor starter protector Motor protection Maximum permitted setting range overload release			Contactor	Size
Standard output P	Motor current (guide value) I	IE1 / IE2 motors	IE3 / IE4 motors	Article No.	Article No.	
kW	A	A	A	Article No.	Article No.	
0.04	0.16	0.11 ... 0.16	0.11 ... 0.14	3RV2011-0AA10	3RT2015-1AP01	S00/S00
0.06	0.2	0.14 ... 0.20	0.14 ... 0.18	3RV2011-0BA10	3RT2015-1AP01	S00/S00
0.06	0.2	0.18 ... 0.25	0.18 ... 0.22	3RV2011-0CA10	3RT2015-1AP01	S00/S00
0.09	0.3	0.22 ... 0.32	0.22 ... 0.28	3RV2011-0DA10	3RT2015-1AP01	S00/S00
0.09	0.3	0.28 ... 0.40	0.28 ... 0.35	3RV2011-0EA10	3RT2015-1AP01	S00/S00
0.12	0.4	0.35 ... 0.50	0.35 ... 0.45	3RV2011-0FA10	3RT2015-1AP01	S00/S00
0.18	0.6	0.45 ... 0.63	0.45 ... 0.55	3RV2011-0GA10	3RT2015-1AP01	S00/S00
0.18	0.6	0.55 ... 0.80	0.55 ... 0.7	3RV2011-0HA10	3RT2015-1AP01	S00/S00
0.25	0.85	0.70 ... 1.00	0.7 ... 0.9	3RV2011-0JA10	3RT2015-1AP01	S00/S00
0.37	1.1	0.90 ... 1.25	0.9 ... 1.1	3RV2011-0KA10	3RT2015-1AP01	S00/S00
0.55	1.5	1.1 ... 1.6	1.1 ... 1.4	3RV2011-1AA10	3RT2015-1AP01	S00/S00
...						

Excerpt from the manual "Configuring SIRIUS Innovations"

Frame size	Rated power	Inverter article number	Article number		I _{max} ¹⁾	Control cabinet ²⁾
			Fuse	Circuit-breaker		
FSAA, FSA	0.55 kW	6SL3210-1KE11-8...	3NA3803	3RV2011-1JA.. or 3RV2021-1JA..	10 A	≥ 0.03 m³
	0.75 kW	6SL3210-1KE12-3...				
	1.1 kW	6SL3210-1KE13-2...				
	1.5 kW	6SL3210-1KE14-3...				
FSA	2.2 kW	6SL3210-1KE15-8...				
	3 kW	6SL3210-1KE17-5...	3NA3805	3RV2011-4AA.. or 3RV2021-4AA..	16 A	
FSA	4 kW	6SL3210-1KE18-8...				
	5.5 kW	6SL3210-1KE21-3...	3NA3812	3RV2021-4EA..	32 A	≥ 0.06 m³
FSB	7.5 kW	6SL3210-1KE21-7...				
	11 kW	6SL3210-1KE22-6...	3NA3822	3RV1041-4JA..	63 A	≥ 0.2 m³
FSC	15 kW	6SL3210-1KE23-2...				
	18.5 kW	6SL3210-1KE23-8...				



1) Maximum rated current of the protection device. You may also use protective devices 3NA38.. and 3RV with a lower rated current.
 2) Minimum volume of the control cabinet in which the inverter is installed. The restriction applies only for a protection with a circuit-breaker.

Excerpt from the Compact Operating Instructions "SINAMICS G120C low-voltage inverters"

Types of coordination according to IEC 60947

The types of coordination describe the foreseeable reaction of a switching device in the event of a short circuit.

IEC 60947-4-1 distinguishes between types of coordination "1" and "2" for motor starters and switching devices. Both types of coordination are based on the requirement that "(...) the contactor or starter shall cause no danger to persons or installation under short-circuit conditions".

Type of coordination 1

According to the aforementioned standard, the contactor or starter "(...) may not be suitable for further service without repair and replacement of parts."

For the machine this means:

- Contactor and/or overload relay is/are possibly defective.
 - Components may possibly be unsuitable for further service.
 - Operator and machine protection are unsafe in the event of continued service.
 - Functionality of components is uncertain.
- ⇒ The components should be replaced.

Advantage

- The costs of manufacturing the control panel are lower than with type of coordination 2 because smaller switching devices can be used.

Disadvantage

- Long downtimes
- High outlay for repairs

Type of coordination 2

According to the aforementioned standard, the contactor or starter "(...) shall be suitable for further service. The risk of contact welding is recognized, in which case, the manufacturer shall indicate the measures to be taken as regards the maintenance of the equipment." The instructions on maintenance shall describe how the permitted contact welds can be broken apart again.

Note

The coordination is at risk if the manufacturer's recommendations are not followed during use of a Short Circuit Protective Device (SCPD).

Advantage

- Short downtimes
- Low outlay for repairs

Disadvantage

- The costs of manufacturing the control panel are higher than with type of coordination 1 because larger switching devices shall be used.

Example of type of coordination 1

The size combination S00/S00 for motor starter protector/contactor is acceptable up to a motor current of 15.5 A for type of coordination 1.

CLASS 10, type of coordination 1,
short-circuit breaking capacity $I_k = 150$ kA



Standard three-phase motor 4-pole at 400 V AC ¹⁾		Motor starter protector Motor protection			Contactor ²⁾	Size
Standard output P	Motor current I	Maximum permitted setting range overload release				
		IE1 / IE2 motors	IE3 / IE4 motors	Article No.	Article No.	
kW	A	A	A			
0.04	0.16	0.11 ... 0.16	0.11 ... 0.14	3RV2011-0AA10	3RT2015-1AP01	S00/S00
0.06	0.2	0.14 ... 0.20	0.14 ... 0.18	3RV2011-0BA10	3RT2015-1AP01	S00/S00
0.06	0.2	0.18 ... 0.25	0.18 ... 0.22	3RV2011-0CA10	3RT2015-1AP01	S00/S00
0.09	0.3	0.22 ... 0.32	0.22 ... 0.28	3RV2011-0DA10	3RT2015-1AP01	S00/S00
0.09	0.3	0.28 ... 0.40	0.28 ... 0.35	3RV2011-0EA10	3RT2015-1AP01	S00/S00
0.12	0.4	0.35 ... 0.50	0.35 ... 0.45	3RV2011-0FA10	3RT2015-1AP01	S00/S00
0.18	0.6	0.45 ... 0.63	0.45 ... 0.55	3RV2011-0GA10	3RT2015-1AP01	S00/S00
0.18	0.6	0.55 ... 0.80	0.55 ... 0.7	3RV2011-0HA10	3RT2015-1AP01	S00/S00
0.25	0.85	0.70 ... 1.00	0.7 ... 0.9	3RV2011-0JA10	3RT2015-1AP01	S00/S00
0.37	1.1	0.90 ... 1.25	0.9 ... 1.1	3RV2011-0KA10	3RT2015-1AP01	S00/S00
0.55	1.5	1.1 ... 1.6	1.1 ... 1.4	3RV2011-1AA10	3RT2015-1AP01	S00/S00
0.75	1.9	1.4 ... 2.0	1.4 ... 1.8	3RV2011-1BA10	3RT2015-1AP01	S00/S00
0.75	1.9	1.8 ... 2.5	1.8 ... 2.2	3RV2011-1CA10	3RT2015-1AP01	S00/S00
1.1	2.7	2.2 ... 3.2	2.2 ... 2.8	3RV2011-1DA10	3RT2015-1AP01	S00/S00
1.5	3.6	2.8 ... 4.0	2.8 ... 3.5	3RV2011-1EA10	3RT2015-1AP01	S00/S00
1.5	3.6	3.5 ... 5.0	3.5 ... 4.5	3RV2011-1FA10	3RT2015-1AP01	S00/S00
2.2	5	4.5 ... 6.3	4.5 ... 5.5	3RV2011-1GA10	3RT2015-1AP01	S00/S00
3	6.5	5.5 ... 8.0	5.5 ... 7	3RV2011-1HA10	3RT2015-1AP01	S00/S00
4	8.5	7.0 ... 10.0	7 ... 9	3RV2011-1JA10	3RT2016-1AP01	S00/S00
5.5	11.5	9.0 ... 12.5	9 ... 10	3RV2011-1KA10	3RT2017-1AP01	S00/S00
7.5	15.5	10 ... 16	10 ... 13	3RV2011-4AA10	3RT2018-1AP01	S00/S00



Figure 6-37 Example: Type of coordination 1

Example of type of coordination 2

For type of coordination 2, the size combination S00/S0 for motor starter protector/contactor is needed for motor currents of 3.6 A and above.

CLASS 10, type of coordination 2, short-circuit breaking capacity $I_k = 150 \text{ kA}$



Standard three-phase motor 4-pole at 400 V AC ¹⁾		Motor starter protector Motor protection Maximum permitted setting range overload release		Article No.	Article No.	Size
Standard output P	Motor current (guide value) I	IE1 / IE2 motors	IE3 / IE4 motors			
kW	A	A	A	Article No.	Article No.	
0.04	0.16	0.11 ... 0.16	0.11 ... 0.14	3RV2011-0AA10	3RT2015-1AP01	S00/S00
0.06	0.2	0.14 ... 0.20	0.14 ... 0.18	3RV2011-0BA10	3RT2015-1AP01	S00/S00
0.06	0.2	0.18 ... 0.25	0.18 ... 0.22	3RV2011-0CA10	3RT2015-1AP01	S00/S00
0.09	0.3	0.22 ... 0.32	0.22 ... 0.28	3RV2011-0DA10	3RT2015-1AP01	S00/S00
0.09	0.3	0.28 ... 0.40	0.28 ... 0.35	3RV2011-0EA10	3RT2015-1AP01	S00/S00
0.12	0.4	0.35 ... 0.50	0.35 ... 0.45	3RV2011-0FA10	3RT2015-1AP01	S00/S00
0.18	0.6	0.45 ... 0.63	0.45 ... 0.55	3RV2011-0GA10	3RT2015-1AP01	S00/S00
0.18	0.6	0.55 ... 0.80	0.55 ... 0.7	3RV2011-0HA10	3RT2015-1AP01	S00/S00
0.25	0.85	0.70 ... 1.00	0.7 ... 0.9	3RV2011-0JA10	3RT2015-1AP01	S00/S00
0.37	1.1	0.90 ... 1.25	0.9 ... 1.1	3RV2011-0KA10	3RT2015-1AP01	S00/S00
0.55	1.5	1.1 ... 1.6	1.1 ... 1.4	3RV2011-1AA10	3RT2015-1AP01	S00/S00
0.75	1.9	1.4 ... 2.0	1.4 ... 1.8	3RV2011-1BA10	3RT2015-1AP01	S00/S00
0.75	1.9	1.8 ... 2.5	1.8 ... 2.2	3RV2011-1CA10	3RT2015-1AP01	S00/S00
1.1	2.7	2.2 ... 3.2	2.2 ... 2.8	3RV2011-1DA10	3RT2015-1AP01	S00/S00
1.5	3.6	2.8 ... 4.0	2.8 ... 3.5	3RV2011-1EA10	3RT2015-1AP01	S00/S00
1.5	3.6	3.5 ... 5.0	3.5 ... 4.5	3RV2011-1FA10	3RT2024-1AP00	S00/S0



Figure 6-38 Example: Type of coordination 2

Multiple function equipment – Control and protective switching devices (or equipment) - CPS

A CPS (Control and protective switching devices (or equipment)) may or may not consist of a single device, but is always rated as a unit.

According to IEC 60947-6-2, "A CPS is capable of making, carrying and breaking currents under normal conditions, including specified operating overload conditions". A CPS is capable of making, carrying for a specified time and breaking currents under specified abnormal conditions such as those of short-circuits.

Note

Continuity of service at all currents up to its rated service short-circuit current I_{cs} shall be possible.

In other words, the CPS can resume operation after the occurrence of an **overcurrent** under its specified conditions.

For the machine this means:

- Contactor and overload relay are suitable for continued service after a short circuit
- Operator and machine protection are assured
- Functionality is assured.
⇒ No damage occurs within the control panel.

Advantage

- **No** downtime, **no** outlay for repair of the CPS.
Motor could be restarted immediately again after a "reset" on the device (Auto/Manual).

See also

SIRIUS 3RA6 compact starters (Page 247)

6.4.1.5 Conductor dimensioning

Conductors and cables shall be designed such that they are capable of withstanding the operating conditions at the site of installation, e.g. voltage, current. These conditions also include external factors such as ambient temperature, and mechanical and chemical influences.

The following conditions shall be taken into consideration when the cross-sectional area is dimensioned:

- Current-carrying capacity during normal operation
- Overload condition
- Short-circuit condition
- Voltage drop

Current-carrying capacity during normal operation

The current-carrying capacity of conductors during normal operation is dependent on several factors:

- Insulating material
- Number of cores in a conductor
- Design
- Methods of installation
- Grouping
- Ambient temperature

Note

Current-carrying capacity during normal operation

Further details are described in IEC 60364-5-52 and in some national standards, or can be found in relevant manufacturer specifications.

The following table contains a typical example of the current-carrying capacity of PVC-insulated wiring in a steady-state condition between enclosures and individual items of equipment.

Table 6- 5 Example of current-carrying capacity

	B1	B2	C	E
Cross-sectional area (mm ²)	Current-carrying capacity I _z for three-phase circuits (A)			
0.75	8.6	8.5	9.8	10.4
1.0	10.3	10.1	11.7	12.4
1.5	13.5	13.1	15.2	16.1
2.5	18.3	17.4	21	22
4	24	23	28	30
6	31	30	36	37
10	44	40	50	52
16	59	54	66	70
25	77	70	84	88
35	96	86	104	110
50	117	103	125	133
70	149	130	160	171
95	180	156	194	207
120	208	179	225	240
Control circuit pairs				
0.2				
0.5	4.5	4.3	4.4	4.4
0.75	7.9	7.5	7.5	7.8
	9.5	9.0	9.5	10
...				

Source: IEC 60204-1, excerpt from Table 6: Examples of current-carrying capacity (I_z) of PVC-insulated copper conductors or cables under steady-state conditions in an ambient air temperature of +40 °C for different methods of installation

Method of installation

The current-carrying capacity according to Table 6 also depends on the method of installation. Chapter D.2.2 of IEC 60204-1 differentiates between methods of installation B1, B2, C and E.

Table 6- 6 Methods of installation - examples

Method of installation	Description	Example
B1	Conductors/single-core cables in conduit and cable trunking systems	
B2	Cables in conduit and cable trunking systems	
C	Cables on walls	
E	Cables on open cable trays	

Correction factors

Depending on the ambient air temperature, the load on the cable may be higher or lower than the value stated in Table 6 of the standard. Table D.1 shows the relevant correction factors for the ambient air temperature.

Table 6- 7 Ambient temperature correction factors

Ambient air temperature [°C]	Correction factor
30	1.15
35	1.08
40	1.00
45	0.91
50	0.82
...	...

Source: IEC 60204-1, excerpt from Table D.1: Correction factors for other ambient temperatures

No. of loaded circuits

The current-carrying capacity of the cable (I_z) also depends on the number of loaded circuits in the cable duct. Tables D.2 and D.3 of the standard show the relevant correction factors for so-called "Grouping".

Table 6- 8 Grouping correction factors

Methods of installation (...) (see Note 3)	Number of loaded circuits/cables			
	2	4	6	9
B1 (conductors or single-core cables) and B2 (multicore cables)	0.80	0.65	0.57	0.50
C, single layer with no gap between cables	0.85	0.75	0.72	0.70
E, single layer on one perforated tray without gap between cables	0.88	0.77	0.73	0.72
E, as before but with 2 to 3 trays, with a vertical spacing between each tray of 300 mm (see Note 4)	0.86	0.76	0.71	0.66
Control circuit pairs $\leq 0.5 \text{ mm}^2$ independent of methods of installation	0.76	0.57	0.48	0.40
<p>NOTE 1: These factors are applicable to:</p> <ul style="list-style-type: none"> – cables, all equally loaded, the circuit itself symmetrically loaded; – groups of circuits of insulated conductors or cables having the same allowable maximum operating temperature; <p>NOTE 2: The same factors are applied to:</p> <ul style="list-style-type: none"> – groups of two or three single-core cables; – multicore cables. <p>NOTE 3: Factors derived from IEC 60364-5-52:2009.</p> <p>...</p>				

Source: IEC 60204-1, excerpt from Table D.2: Derating factors for I_z for grouping

Note

Number of circuits

Table D.2 in the standard refers to the number of **circuits**, not to the number of conductors. With three-phase loads, for example, there would be six conductors with two three-phase circuits.

Table 6- 9 Derating factors

Number of loaded conductors or pairs	Conductors ($\geq 1 \text{ mm}^2$) (...)	Pairs (0.25 mm^2 to 0.75 mm^2)
1	-	1.0
3	1.0	0.5
5	0.75	0.39
7	0.65	0.34
...

Source: IEC 60204-1, excerpt from Table D.3: Derating factors for I_z for multicore cables up to 10 mm^2

Overload condition

To ensure that cables are adequately protected against overload, the following conditions shall be fulfilled:

1. $I_b \leq I_n \leq I_z$
2. $I_2 \leq 1.45 \times I_z$

I_b = current for which the circuit is designed

I_z = effective current-carrying capacity for continuous service according to method of installation, ambient temperature of cable and grouping

I_n = nominal current of protective device (setting current)

I_2 = the minimum current ensuring effective operation of the protective device within a specified time (manufacturer specification, e.g. tripping characteristic)

The diagram below illustrates the relationship between the parameters of conductors and the parameters of protective devices providing overload protection.

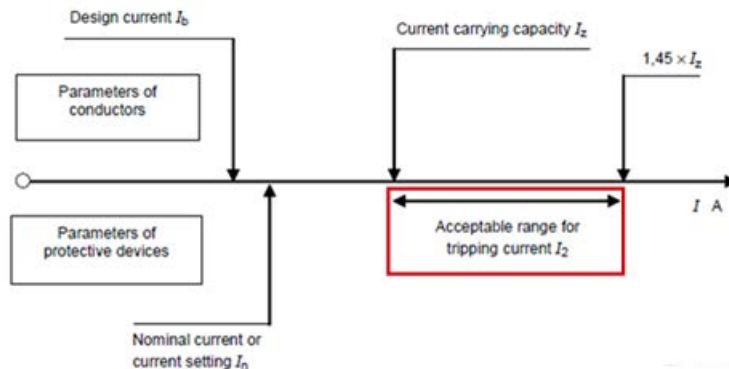

Source: IEC 60204-1, Figure D.2: Parameters of conductors and protective devices; highlighting by author

Figure 6-39 Parameters of conductors and protective devices

Short-circuit condition

All live conductors are required to be protected against short circuits so that any short-circuit current is interrupted before the conductor has reached the maximum allowable temperature. In practice, this is guaranteed in accordance with IEC 60204-1, Annex D, D.4, if the following formula is applied:

$$t = \left(k \times \frac{S \text{ (mm}^2\text{)}}{I \text{ (A)}} \right)^2$$

S = cross-sectional area

I = effective short-circuit current expressed for alternating current as the r.m.s. value

k = factor for copper conductors when insulated with the following material:

PVC 115, Rubber 141, SiR 132, XLPE 143, EPR 143

Note

Where can the factor k be found?

The factor k for some materials is described in Chapter D.4 of IEC 60204-1.

The factor is also specified by the cable manufacturer.

Voltage drop

The voltage drop from the point of supply of the machine up to the furthest load shall also be taken into account according to Chapter 12.5 of IEC 60204-1. Under normal operating conditions, the voltage drop shall not exceed 5% **in the power circuit**. In order to conform to this requirement, it may be necessary to use conductors with a larger cross-sectional area than that derived from Table 6 of the standard (see Table "Ambient temperature correction factors" in this reference manual).

Supplement 5 of DIN VDE 0100 describes a simple method for calculating the voltage drop. It can also be calculated by the SIMARIS design (<http://www.siemens.com/SIMARIS>) software.

The two tables below apply to the following cables for a specific voltage drop ΔU for three-phase current:

- Cables with NYY 0.6/1 kV copper conductors to DIN VDE 0271 (VDE 0271), or
- Cables with NAYY 0.6/1 kV aluminum conductors to DIN VDE 0271 (VDE 0271)

Nominal voltage $U_n = 400$ V, three-phase, 50 Hz

I_{max} shall be multiplied by a factor of 0.5 for single-phase AC circuits.

Table 6- 10 Admissible cable lengths - voltage drop across copper conductor

Conductor nominal cross-sectional area mm ²	Rated current I_l A	Voltage drop Δu in %				
		3	4	5	8	10
		Admissible length l_{max} in m				
1.5	6	95	127	159	254	318
1.5	10	57	76	95	152	190
1.5	16	35	47	59	95	119
1.5	20	28	38	47	76	95
1.5	25	22	30	38	61	76
2.5	10	93	124	155	249	311
2.5	16	58	77	97	155	194
2.5	20	46	62	77	124	155
2.5	25	37	49	62	99	124
2.5	32	29	38	48	77	97
4	16	94	126	158	253	316
4	20	75	101	126	202	253
4	25	60	81	101	162	202
4	32	47	63	79	126	158
4	40	37	50	63	101	126
4	50	30	40	50	81	101
6	20	114	152	190	304	381
6	25	91	121	152	243	304
6	32	71	95	119	190	238
6	40	57	76	95	152	190
6	50	45	60	76	121	152
6	63	36	48	60	96	120
10	25	153	204	255	408	510
10	32	119	159	199	318	398
10	40	95	127	159	255	318
...						

Source: DIN VDE 0100, supplement 5, excerpt from Table 4: "Admissible lengths of cables and cords for a specific voltage drop for copper conductors, values for four-core cables and cords 0.6/1kV" (NYY cable to DIN VDE 0271 (VDE 0271), NYM cable to DIN VDE 0250-204 (VDE 0250 Part 204))

Table 6- 11 Admissible cable lengths - voltage drop across aluminum conductor

Conductor nominal cross-sectional area mm ²	Rated current I _n A	Voltage drop Δu in %				
		3	4	5	8	10
		Admissible length l _{max} in m				
16	40	91	122	152	244	305
16	50	73	97	122	195	244
16	63	58	77	96	154	193
16	80	45	61	76	122	152
16	100	36	48	61	97	122
25	50	115	153	191	306	383
25	63	91	121	152	243	304
25	80	71	95	119	191	239
25	100	57	76	95	153	191
25	125	46	61	76	122	153
35	80	98	131	164	262	328
35	100	78	104	131	209	262
35	125	62	83	104	167	209
35	160	49	65	82	131	164
35	200	39	52	65	104	131
...						

Source: DIN VDE 0100, supplement 5, excerpt from Table 5: "Admissible lengths of cables or cords for a specific voltage drop for aluminum conductors, values for four-core NAYY cables to DIN VDE 0271 (VDE 0271) with nominal voltage 0.6/1kV"

The two tables list the safe, short, admissible cable lengths.

The table data are based on the following assumption:

Phase angle (j) of the rated current = impedance angle of cable or cord (L).

Refer to DIN VDE 0100, Supplement 5, for information about calculating the maximum admissible cable length for any current or voltage.

With regard to **control circuits**, please refer to the manufacturer's equipment operating instructions for the maximum admissible voltage drop taking inrush currents into account. The voltage drop within equipment, e.g. in overcurrent protective devices and switching devices, should also be taken into account.

6.4.1.6 Practical example

The information relating to selection of equipment on the previous pages is explained further by the following practical example.

Step 1: Selection of protection and switching devices from configuration manual

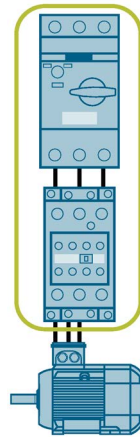

CLASS 10, type of coordination 2,
short-circuit breaking capacity $I_k = 150 \text{ kA}$



Standard three-phase motor 4-pole at 400 V AC ¹⁾		Motor starter protector Motor protection Maximum permitted setting range overload release		Contactor ²⁾	Size	
Standard output P	Motor current (guide value) I	IE1 / IE2 motors	IE3 / IE4 motors	Article No.	Article No.	
kW	A	A	A	Article No.	Article No.	
0.04	0.16	0.11 ... 0.16	0.11 ... 0.14	3RV2011-0AA10	3RT2015-1AP01	S00/S00
0.06	0.2	0.14 ... 0.20	0.14 ... 0.18	3RV2011-0BA10	3RT2015-1AP01	S00/S00
0.06	0.2	0.18 ... 0.25	0.18 ... 0.22	3RV2011-0CA10	3RT2015-1AP01	S00/S00
15	29	23 ... 28	23 ... 27	3RV2021-4NA10	3RT2027-1AP00	S0/S0
15	29	27 ... 32	27 ... 30 (up to 256 A starting current)	3RV2021-4EA10	3RT2027-1AP00	S0/S0

P = 15 kW, U = 400 V Excerpt from the manual "Configuring SIRIUS Innovations"
 $I_n = 29 \text{ A}$

Step 2: Dimensioning the cable

- According to current-carrying capacity during normal operation
- According to overload condition
- According to short-circuit condition

Dimensioning according to current-carrying capacity during normal operation

Assumption:

- Ambient air temperature = 45 °C
- No. of loaded circuits in cable duct = 2
- Method of installation of cable = B1 (single-core cable in cable duct)
- PVC cable

1. Selection of the cable in accordance with IEC 60204-1, Table 6 (Page 139)
→ 29 A for installation method B1 = 6 mm² (current-carrying capacity up to 31 A)
2. Consideration of correction factors
→ Correction factor ambient temperature in accordance with IEC 60204-1, Table D.1 (Page 139): 31 A × 0.91 = 28.21 A
→ Correction factor grouping in accordance with IEC 60204-1, Table D.2 (Page 139): 28.21 A × 0.8 = 22.57 A

Result:

A 6 mm² cross-sectional area is not sufficient to withstand the prevailing ambient conditions. For this reason, the same procedure has to be followed for the next larger cross-sectional area:

1. Selection of the cable in accordance with IEC 60204-1, Table 6
→ Next larger cross-sectional area for method of installation B1 = 10 mm² (current-carrying capacity up to 44 A)
2. Consideration of correction factors
→ Correction factor ambient temperature: 44 A × 0.91 = 40.04 A
→ Correction factor grouping: 40.04 A × 0.8 = 32.03 A

Cross-sectional area required according to current-carrying capacity during normal operation: ≥ 10 mm²

Dimensioning according to overload condition

1. $I_b \leq I_n \leq I_z \rightarrow 29 \text{ A (rated motor current)} \leq 29 \text{ A (see configuration manual)} \leq 32.03 \text{ A (see current-carrying capacity during normal operation)} \rightarrow$ **Condition 1 satisfied!**
2. $I_2 \leq 1.45 \times I_z \rightarrow 30.5 \text{ A (see circuit breaker tripping characteristic)} \leq 1.45 \times 32.03 \text{ A} \rightarrow 30.5 \text{ A} \leq 46.44 \text{ A} \rightarrow$ **Condition 2 satisfied!**

I_b = configured current of circuit

I_z = effective current-carrying capacity for continuous service according to method of installation

I_n = nominal current of the protective device (setting current)

I_2 = minimum current ensuring effective operation of the protective device within a specified time (manufacturer specification, e.g. tripping characteristic)

Tripping characteristics

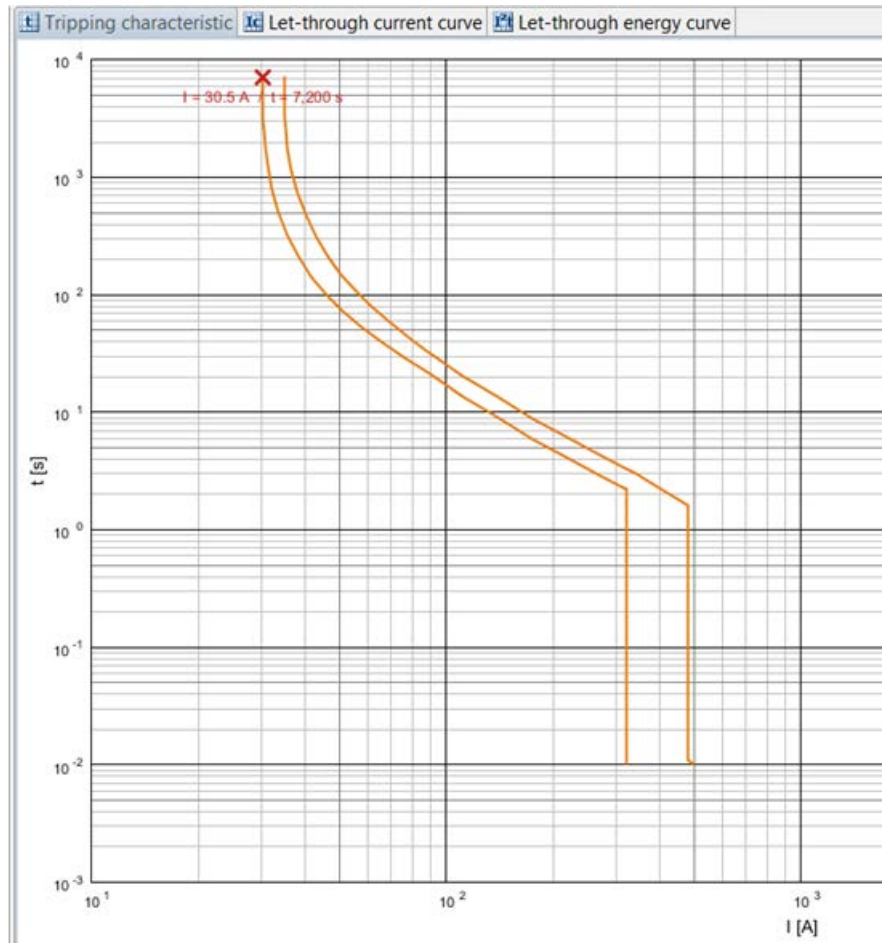

Figure 6-40 Tripping characteristic of 3RV2021-4EA10 circuit breaker (excerpt from SIMARIS curves)

Dimensioning according to short-circuit condition

Starting formula:

($t = \text{max. } 5 \text{ s}$)

$$t = \left(k \times \frac{S \text{ (mm}^2\text{)}}{I \text{ (A)}} \right)^2$$

Rearranged according to S

(cross-sectional area in mm^2):

$$S \text{ (mm}^2\text{)} \geq \sqrt{\frac{I^2 \text{ (A)} \times t \text{ (s)}}{k^2}}$$

$$S \text{ (mm}^2\text{)} \geq \sqrt{\frac{85600 \text{ (A}^2\text{s)}}{115^2}}$$

$$S \text{ (mm}^2\text{)} \geq 2,54 \text{ mm}^2$$

I^2t = let-through energy of the protective device → see circuit breaker let-through energy characteristic

k = factor for copper conductors when insulated with material → PVC = 115 (see above)

Cross-sectional area required according to short-circuit condition: $\geq 2.54 \text{ mm}^2$

→ suitable for use: at least 4 mm^2

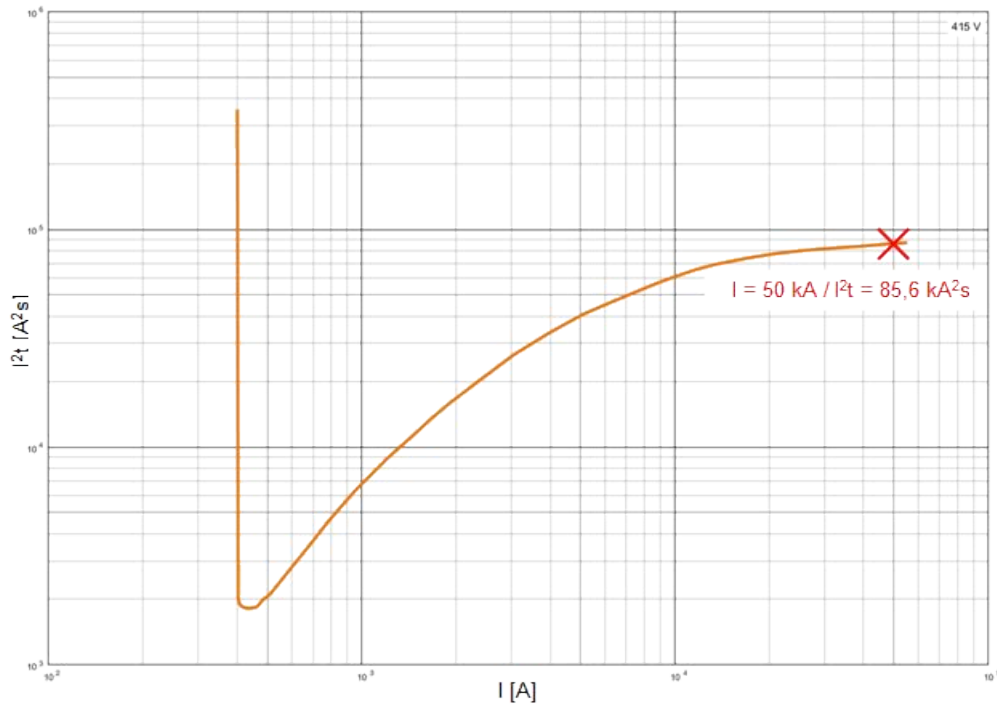
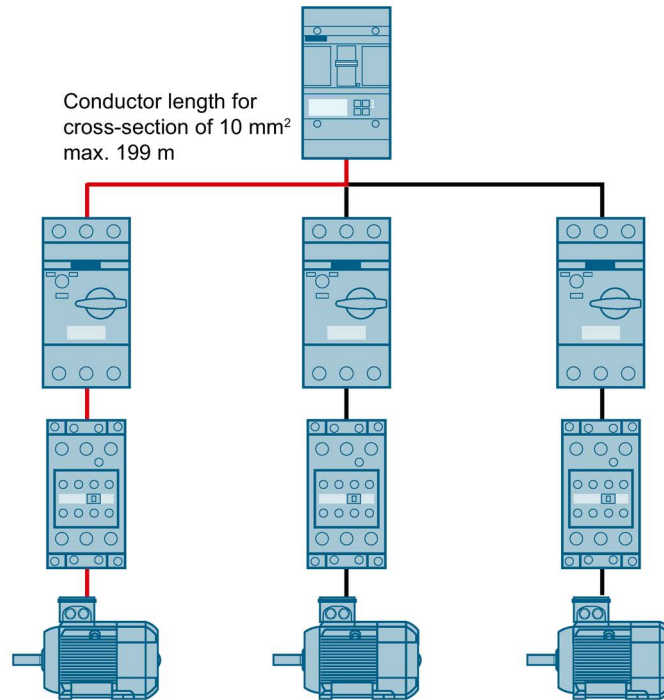

Figure 6-41 Let-through energy characteristic of 3RV2021-4EA10 motor starter protector (excerpt from SIMARIS curves)

Result

An examination of all conditions has revealed that the minimum required cross-sectional area is 10 mm^2 .

Assessment of the maximum admissible cable length according to voltage drop



Conductor length for cross-section of 10 mm² max. 199 m

P = 15 kW, U = 400 V
I_n = 29 A

Figure 6-42 Maximum cable length for a voltage drop of maximum 5 %

If cable lengths in excess of 199 m are required, the cross-sectional area shall be increased to 16 mm² (see table below).

Conductor cross section mm ²	Rated current I ₁ A	Voltage drop ΔU in %			
		3	4	5	8
		Admissible length l _{max} in m			
1,5	6	95	127	159	254
...					
10	25	153	204	255	408
10	32	119	159	199	318
10	40	95	127	159	255

Source: DIN VDE0100, Supplement 5, Table 4: Excerpt from the table "Admissible lengths of cables and cords for a specific voltage drop for copper conductors, values for four-core cables and cords 0.6/1kV"; highlighting by author with reference to example above

Assessment of smallest possible short-circuit with SIMARIS design

When the smallest possible short-circuit occurs, it shall be ensured in the machine that the upstream protective device trips within 5 seconds (see Chapter Initial symmetrical short-circuit current (Page 127) in the section "Smallest possible short-circuit".) This means that the residual current shall be at least sufficiently high to ensure that the short-circuit release responds. In the example described above, we use the Siemens SIMARIS design software to check whether this is the case.

Assumption: The cable length of the protective device to the load is 20 m

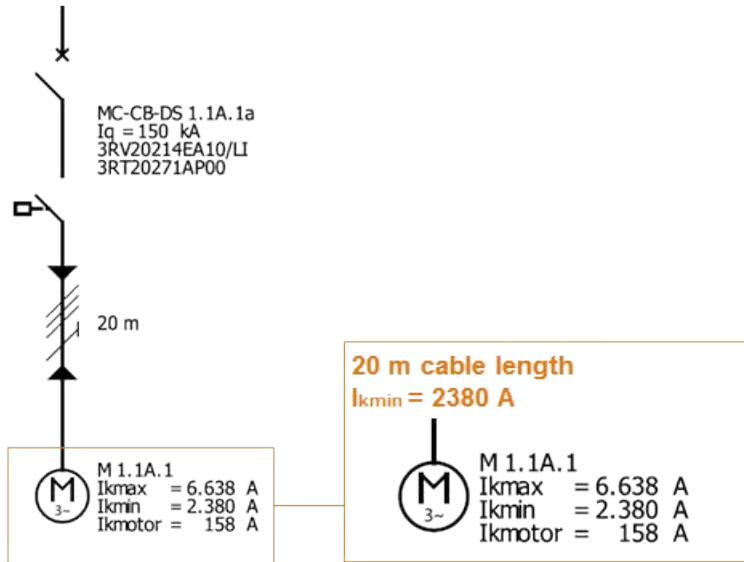

Figure 6-43 Assessment of the smallest possible short-circuit (excerpt from SIMARIS design)

The I_{kmin} at the load is 2380 A. According to the data sheet, the short-circuit release of the selected 3RV2021-4EA10 motor starter protector responds at 400 A or higher ($\pm 20\%$ tolerance) (see Chapter Selection of control devices (Page 135)).

→ **The configuration is therefore correct.**

6.4.1.7 Control circuit

The conductors of control circuits shall also be protected against overcurrent!
This applies to the following conductors:

- Conductors directly connected to the supply voltage
- Conductors that are supplied by a control transformer/DC current source

A overcurrent protective device shall be provided in all ungrounded conductors (phases).
This means:

- Grounded control circuit → 1-pole protection
- Ungrounded control circuit → 2-pole protection

Exception:

If the current supply limits the current below the current-carrying capacity of the conductors and current-carrying capacity of the connected equipment, overcurrent protection is not necessary.

Socket outlets and lighting circuits

Socket outlets for general applications and lighting circuits shall be equipped with overcurrent protection.

Overcurrent protection shall be provided for ungrounded conductors (phases).

Note

Sockets-outlets for accessories

According to IEC 60204-1, Chapter 15.1, residual current protective devices (RCD) with a rated residual current of $I_{\Delta n} \leq 30$ mA are explicitly required for circuits supplying socket-outlets for accessories with a nominal current of ≤ 20 A.

You will find further information in Chapter Protection against electric shock (Page 101).

Transformers

Transformers shall be protected in accordance with the manufacturer's specifications!

1. Unnecessary tripping due to inrush currents shall be avoided
2. Increasing the winding temperature above the permissible value of the transformer as a result of a short circuit on the secondary side shall be avoided
→ on the secondary side, protect as close to the transformer as possible!

Note

Transformer protection

Since transformers have higher inrush currents than motors, for example, Siemens offers "circuit breakers for transformer protection".

For more information, see Chapter Main circuit - motor starter protectors/circuit breakers (Page 234).

6.4.2 Protection of motors against overheating

According to IEC 60204-1, Chapter 7.3, protection of motors against overheating shall be provided for each motor rated at more than 0.5 kW.

Exception

In applications where an automatic interruption of the motor operation is unacceptable (for example fire pumps), a warning signal shall be issued.

Protection against overheating

Protection of motors against overheating can be achieved by:

- Overload protection (current-dependent)
- Overtemperature protection (temperature-dependent)
- Current-limiting protection

Note

Automatic restart

Automatic restarting of the motor after the operation of the overtemperature protective device shall be prevented where this can cause a hazardous situation or damage to the machine or work in progress.

Overload protection (current-dependent)

Overload protection shall be provided in every live conductor except neutral conductors.

However, where motor overload detection is not used simultaneously for protection of cables and conductors, e.g. due to the use of additional miniature circuit breakers, the number of motor overload detection devices may be reduced at the request of the operator.

Where motors with special duty ratings are required to start or brake frequently, it can be difficult to provide overload protection with a time constant comparable with that of the winding to be protected.

→ Appropriate protective devices designed to accommodate special duty motors or overtemperature protection may then become necessary!

Note

Overload protection

Overload protection is not required for motors that cannot be overloaded, e.g. because they are overdimensioned or protected by load measuring devices.

Overtemperature protection (temperature-dependent)

Overtemperature protection for motors is recommended:

- In situations where the cooling can be impaired, e.g. in dusty environments.
- For motors that cannot be overloaded (e.g. torque motors, motion drives that are either protected by mechanical overload protective devices or adequately dimensioned), where the possibility of overtemperature exists, e.g. due to reduced cooling.

Note

Overtemperature protection

Depending on the type of motor, protection under stalled rotor or loss of phase conditions is not always ensured by overtemperature protection.

→ Additional protection should then be provided!

The ideal situation is where overtemperature protection for the motor can be afforded by the overload device for protecting cables and conductors. However, if the risk analysis reveals risks that cannot be managed by the overload protective device for cables and conductors, it then becomes necessary to provide an additional overtemperature protective device.

Current-dependent (e.g. with overload relays)	● Full protection ○ Conditional protection ⊘ No protection	Temperature-dependent (temp. with PTCs)	
Increased motor losses during operation			
	● Overloading in continuous service	●	
	○ Excessively long starting and braking operations	●	
	○ Irregular intermittent operation	●	
	○ Excessively high switching frequency	●	
	Increased motor losses in the event of a fault		
	● Single-phase operation and current unbalance	●	
	● Voltage and frequency fluctuations	●	
	● Stalling of the rotor	●	
	Connecting to a braked motor		
	● of stator-critical motors	●	
● of rotor-critical motors	○		
Restricted cooling			
⊘ Increased ambient temperature	●		
⊘ Obstruction of coolant flow	●		
● Protection of the conductor in an overload		⊘	

Figure 6-44 Comparison between "current-dependent" and "temperature-dependent" overtemperature protection

6.4.3 Protection against abnormal temperatures

If abnormal temperatures can lead to hazardous situations, the equipment shall be protected accordingly.

6.4.4 Protection against the effects of supply interruption or voltage dip followed by voltage recovery

Where a power supply interruption or a voltage dip followed by voltage recovery can cause a hazardous situation or damage to the machine, suitable protection shall be provided according to IEC 60204-1, Chapter 7.5.

Where a brief voltage dip does not impair operation of the machine, a delayed undervoltage trip unit can be used.

No hazardous situations may arise on subsequent restoration of the voltage.

6.4.5 Motor overspeed protection

According to IEC 60204-1, Chapter 7.6, overspeed protection shall be provided where overspeeding can occur and could possibly cause a hazardous situation. The overspeed protection shall initiate appropriate control responses and shall prevent automatic restarting. It should operate in such a manner that the mechanical speed limit of the motor or its load is not exceeded.

Note

Motor overspeed protection

This protection can consist, for example, of a centrifugal switch or speed limit monitor.

6.4.6 Ground fault/residual current protection

In addition to the overcurrent protection provided, IEC 60204-1 states in Chapter 7.7 that ground fault/residual current protection can be provided. The aim here is to reduce damage to the equipment that is caused by ground fault currents less than the response threshold of overcurrent protection. The setting of the devices shall be as low as possible, consistent with correct operation of the equipment.

If fault currents with DC components are possible, an RCD of type B in accordance with IEC/TR 60755 can be required.

6.4.7 Phase sequence monitoring

According to IEC 60204-1, Chapter 7.8, protection shall be provided in cases where an incorrect phase sequence of the supply voltage can cause a hazardous situation or damage to the machine.

Conditions of use that can lead to an incorrect phase sequence include:

- A machine that is transferred from one supply to another
- A mobile machine with a facility for connection to an external power supply

6.4.8 Protection against overvoltages due to lightning and to switching surges

Cause and remedy

Lightning or switching surges can cause overvoltages.

According to IEC 60204-1, Chapter 7.9, protective devices can be provided to protect the equipment against the effects of overvoltages.

Where provided:

- Devices for the suppression of overvoltages due to lightning shall be connected to the incoming terminals of the supply disconnecting device.
- Devices for the suppression of overvoltages due to switching surges shall be connected as necessary for equipment requiring such protection.

Note

Information about the correct selection and installation of SPDs is given for example in IEC 60364-4-44, IEC 60364-5-53, IEC 61643-12, IEC 62305-1 and IEC 62305-4.

- Equipotential bonding of the machine, its electrical equipment and extraneous-conductive parts to a common bonding network of the building/site can help mitigate electromagnetic interference, including the effects of lightning, on the equipment.

More information

Note

Siemens portfolio of equipment for detecting harmful effects

Siemens offers a comprehensive portfolio of devices that are capable of detecting and controlling the hazards described above.

For additional information, see Chapter Devices in the control panel and the machine environment (Page 233).

6.5 Equipotential bonding

An integrated grounding system shall be implemented in order to protect personnel and equipment against electric shock. This is achieved by equalizing or minimizing differences in electrical potential (voltage). The electrical engineering term for this concept is "equipotential bonding". In Chapter 8 of IEC 60204-1, a differentiation is made between:

- Protective bonding (Page 158) and
- Functional bonding (Page 168)

6.5.1 Protective bonding

The purpose of protective bonding is to protect **persons in the event of an insulation failure**. Measures shall be taken to prevent parts of the machine that are de-energized in normal operation from becoming energized unexpectedly. The term "fault protection" is used in the standards to refer to such measures.

Protective bonding circuit

The protective bonding circuit consists of the interconnection of many different components. This unfortunately means that it is also a source of many potential faults since there are many possible weak points that can interrupt the continuity of the protective conductor. It is important to eliminate these weak points.

The protective bonding circuit of the electrical equipment comprises:

- PE terminals
- Protective conductors in the system
- Exposed conductive parts and conductive structural parts of the electrical equipment
- Conductive structural parts of the machine



Figure 6-45 Examples: Components of the protective bonding circuit

Note

On mobile machines with an on-board power supplies, the protective conductors of conductive structural parts of the electrical equipment, and those extraneous-conductive which form the structure of the machine shall all be connected to a protective bonding terminal. Where a mobile machine is also capable of being connected to an external incoming power supply, this protective bonding terminal shall be the connection point for the external protective conductor.

In the event of a ground fault, the protective bonding circuit shall be capable of withstanding extreme thermal and mechanical stresses, e.g. a short-circuit current.

The cross-sectional area of protective conductors that do not form part of a cable or that are not in a common enclosure with the live conductor shall not be less than:

- 2.5 mm² Cu or 16 mm² Al, **if protection** against mechanical damage is provided,
- 4 mm² Cu or 16 mm² Al, **if no protection** against mechanical damage is provided.

Note

The use of steel for a protective conductor is not excluded.

Protective conductors not forming part of a cable is considered to be mechanically protected if it is installed in a conduit, cable trunking system, or protected in a similar way.

The following conductive structural parts **do not need to be connected** to the protective bonding circuit:

- Structural parts of the electrical equipment that comply with class 2.
- Structural parts of the machine where all of the equipment corresponds to class 2.

Exposed conductive parts of the electrical equipment that protect against hazardous touch voltage by **electrical separation shall not be connected to the protective bonding circuit.**

Extraneous conductive parts of the equipment that protect against hazardous touch voltage by **electrical separation may not be connected to the protective bonding circuit.**

Exposed conductive parts that do not pose a risk to personnel do not need to be connected to the protective bonding circuit. This applies to:

- Exposed conductive parts that are too small to offer a large contact surface (< 50 × 50 mm).
- Exposed conductive parts that are located so that neither contact with live parts nor an insulation failure is possible.

Note

Exposed conductive parts that do not need to be connected to the protective bonding circuit

Screws, rivets, nameplates and parts inside enclosures need not be connected to the protective bonding circuit irrespective of their size.

Identification of the protective conductor / protective bonding conductor

The protective conductor / protective bonding conductor shall be readily distinguishable from other conductors. IEC 60204-1 describes the following possible identification methods:

- Shape
- Location
- Color

Examples:



Figure 6-46 Example: Protective conductor as a braided ribbon cable



Figure 6-47 Example: Location at the bottom of the control panel



Figure 6-48 Example: Protective conductor with GREEN-AND-YELLOW insulation

Note

Identification

Where the protective conductor can be identified **by its color alone**, the bicolor combination GREEN-AND-YELLOW shall be used throughout the **length of the conductor**. Conductors other than the protective conductor shall have a different color.

Exception

Where the protective conductor can be easily identified **by its shape, position or construction**, or where the insulated conductor is not readily accessible or is part of a multicore cable, color coding throughout its length is not necessary. However, the conductors shall then be clearly marked at the ends or in accessible locations.

The following options are permitted:

1. The letters PE
2. Graphical symbol according to IEC 60417-5019
3. Bicolor combination **GREEN-AND-YELLOW**



Figure 6-49 Example: Symbol IEC 60417-5019



Figure 6-50 Example: Bicolor combination GREEN-AND-YELLOW at the end of the grounding bar

Cross-sectional area of protective conductors

Copper is the preferred conductor material but it is not a mandatory requirement. If materials other than copper are used, the electrical resistance of the material used per unit length shall be less than or equal to the electrical resistance of copper. The minimum cross-sectional area of such conductors is 16 mm² to ensure mechanical durability.

Formulas for converting the cross-sectional area of protective conductors from copper to aluminum:

$$R_{Cu} \text{ (copper)} = R_{aW} \text{ (other material)}$$

$$\frac{\rho_{Cu} \times I_{Cu}}{A_{Cu}} = \frac{\rho_{aW} \times I_{aW}}{A_{aW}}$$

$$A_{aW} = \frac{\rho_{aW} \times I_{aW} \times A_{Cu}}{\rho_{Cu} \times I_{Cu}}$$

Since $I_{Cu} = I_{aW}$, this value is canceled out of the formula →

$$A_{aW} = \frac{\rho_{aW} \times A_{Cu}}{\rho_{Cu}}$$

- R = electrical resistance in Ω
- ρ = specific resistance in Ω × mm²/m
- A = conductor cross-sectional area in mm²
- l = length of cable in m

Example

What is the required cross-sectional area for a protective conductor made of aluminum if it is to replace a 10 mm² protective conductor made of copper?

(ρCu ~ 0.01721 Ω × mm²/m; ρAL ~ 0.0265 Ω × mm²/m)

$$A_{AL} = \frac{\rho_{AL} \times A_{Cu}}{\rho_{Cu}} = \frac{0,0265 \Omega \times \text{mm}^2/\text{m} \times 10 \text{ mm}^2}{0,01721 \Omega \times \text{mm}^2/\text{m}} = 15,40 \text{ mm}^2$$

→ **Minimum cross-sectional area of the aluminum protective conductor = 16 mm²**

The PE/PEN/N cross-sectional area of top hat or G-type rails can be found in the Annex Table A.1 of IEC 60947-7-2.

Requirements

The following requirements shall be fulfilled when metal enclosures, frames or mounting plates of the electrical equipment are connected to the protective bonding circuit:

- Protection against mechanical, chemical or electrochemical ageing shall be ensured by electrical continuity by means of construction or by suitable connection.
- The requirements according to IEC 60364-5-54:2011, Chapter 543.1 shall be fulfilled.
- It shall be possible to connect other protective conductors at predetermined tap-off points.

If the protective conductor used is made of copper, the minimum cross-sectional areas specified in IEC 60204-1, Table 1 shall be observed.

Table 6- 12 Minimum cross-sectional area of copper protective conductors

Cross-sectional area of line conductors S (mm ²)	Minimum cross-sectional area of the corresponding copper protective conductor S_p (mm ²)
$S \leq 16$	S
$16 < S \leq 35$	16
$S > 35$	$S/2$

Source IEC 60204-1, Table 1: Minimum cross-sectional area of copper protective conductors

The method in accordance with IEC 60364-5-54:2011, 543.1.2 can also be used to calculate the cross-sectional area of protective conductors.

Note

Further useful information from Siemens

The procedure recommended by IEC 60364-5-54, 543 is described in more detail in the manual "SINAMICS S120 Power units, Booksize format, Dimensioning the protective conductor". The manual is available to download (<https://support.industry.siemens.com/cs/ww/en/view/109738572>).

Note

Dimensioning of the protective conductor

The protective conductor shall always be dimensioned according to the largest live conductor that can cause an insulation fault. If, for example, the supply disconnecting device is installed on the mounting plate, the cross-sectional area of the incoming supply conductor is decisive because this has the largest cross-sectional area of any conductor near the mounting plate that can cause an insulation fault.

Example with conductors made of copper:

Cross-sectional area of incoming supply conductor = 70 mm² → cross-sectional area of protective conductor = at least 35 mm²

Properties of protective conductors

The protective conductor shall either

- be part of a multicore cable, or
- be in a common enclosure with the line conductors, or
- have a cross-sectional area of at least
 - 2.5 mm² Cu or 16 mm² Al, **if protection** against mechanical damage is provided,
 - 4 mm² Cu or 16 mm² Al, **if no protection** against mechanical damage is provided.

Note

Method of installation

A protective conductor not forming part of a multicore cable shall be installed in a conduit, in a cable trunking system or protected in a similar way.

The following parts of the machine and its electrical equipment shall be connected to the protective bonding circuit. However, they shall not be used as protective conductors:

- Conductive structural parts of the machine
- Metal cable ducts of flexible or rigid construction
- Metallic cable shields or armoring
- Metallic pipes containing flammable materials (e.g. gases, liquids or powder)
- Flexible or pliable metal conduits
- Constructional parts subject to mechanical stress in normal service
- Flexible metal parts such as support wires; cable trays or cable ladders.

Continuity of the protective bonding circuit

Where a part is removed for any reason (for example: routine maintenance), the protective bonding circuit for the remaining machine parts shall not be interrupted.

Recommendation: Point-to-point grounding

Note

Grounding of frequency converters

It may be meaningful to use a meshed grounding network in installations supplied by a frequency converter. A mesh-type grounding system, e.g. with ground connections on the mounting plate, and the short cable lengths over a large surface area that are associated with it, ensures effective discharge of noise due to low ground impedance. Furthermore, the differences in potential at ground potential are only minor.



Figure 6-51 Example: Grounding of frequency converters on the mounting plate

The current-carrying capacity of connection and bonding points shall be sufficiently stable and not be impaired by mechanical, chemical or electrochemical influences.

Frequent faults in practice are, among others, loose screwed joints or painted grounding points, e.g. inadvertently painted grounding bolts or absent contact washers.

Note

Aluminum or aluminum alloys

When aluminum or aluminum alloys are used, particular consideration shall be given to the possibility of electrolytic corrosion.

The continuity of the protective conductor shall be ensured wherever electrical equipment is fitted on exposed conductive parts such as lids, doors or cover plates. It is advisable to use a protective conductor. If this is not possible, fastenings, hinges or sliding contacts designed to have a low resistance shall be used.

Note

Verification of the continuity of the protective conductor is mandatory in accordance with IEC 60204-1. For more information, see Chapter Verification of the continuity of the protective bonding circuit (Page 196).

Where cables are exposed to damage, for example flexible trailing cables, the continuity of the conductors shall be ensured by means of appropriate measures, for example by monitoring.

Conductor wires, conductor bars or slip-ring assemblies that are part of the protective bonding circuit shall not carry current under normal operating conditions. This means that both the protective conductor (PE) and neutral conductor (N) shall have their own conductor wires or slip-ring. The continuity of the protective conductor (PE) shall be ensured by appropriate measures, e.g. by doubling the current collectors or monitoring the continuity.

Rule

Note

Protective bonding circuit

The protective bonding circuit shall never be interrupted. For this reason, it is not permissible to incorporate a switching device or an overcurrent protective device, e.g. circuit breaker, miniature circuit breaker, fuse, in the protective bonding circuit.

Exception

Links for test or measurement purposes that cannot be opened without the use of a tool and that are located in an enclosed electrical operating area.

Plug/socket combinations, removable current collectors or other devices that can interrupt the protective bonding circuit shall have a first make last break contact. This will ensure that the equipment is always effectively grounded while current is flowing.

→ **First ground and then contact, or disconnect first before interrupting the ground connection.**

The continuity of the protective conductor shall be easily comprehensible. The bonding points for protective conductors may only be used to connect protective conductors and shall be labeled/marked accordingly. Only one protective conductor may be connected per bonding point.

The following options are permitted:

- Symbol according to IEC 60417-5019 (preferred solution)
- Identification by the bicolor combination GREEN-**AND**-YELLOW

- Marking by the letters "PE" (mandatory for connection of the external protective conductor at the supply connection point, see Chapter "Incoming supply conductor termination and supply disconnecting device")
- Combination of the stated options

Examples:



Symbol IEC 60417-5019 Marking by the letters PE Identification by the bicolor combination GREEN-AND-YELLOW

Earth (ground) leakage currents

Some equipment such as electric variable-speed drive systems or information technology equipment causes ground leakage currents that normally flow via the protective conductor. If the protective bonding circuit were to be interrupted or have an excessively high resistance, ground leakage currents may cause hazardous touch voltages on parts of the machine and pose a potential electric shock hazard for users of the machine.

In order to minimize the risk of interruption of the protective bonding circuit, Chapter 8.2.6 of IEC 60204-1 stipulates that the protective bonding circuit shall be of a particularly rugged design. This means that equipment with ground leakage currents higher than 10 mA (AC or DC) shall satisfy one or several of the following conditions in each section of the protective bonding circuit:

- Completely enclosed within electrical equipment enclosures or otherwise protected against damage throughout its length.
- Cross-sectional area of protective conductor $\geq 10 \text{ mm}^2$ Cu or 16 mm^2 Al over the entire conductor length.
- If the cross-sectional area of the protective conductor is $< 10 \text{ mm}^2$ Cu or 16 mm^2 Al, a second protective conductor of at least the same cross-sectional area shall be provided up to the point at which the cross-sectional area of the protective conductor becomes $\geq 10 \text{ mm}^2$ Cu or 16 mm^2 Al.
- Automatic disconnection of the power supply in the event of loss of continuity of the protective conductor.
- Where a plug/socket combination is used, an industrial connector in accordance with the IEC 60309 series shall be provided. The protective conductor shall have a cross-sectional area of $\geq 2.5 \text{ mm}^2$ as part of a multicore cable.

A warning sign shall be provided adjacent to the PE terminal stating that a leakage current greater than 10 mA flows through the protective conductor. The machine documentation shall also contain information about the leakage current. A statement shall be given in the instructions for installation that the equipment shall be installed in accordance with the specified requirements.

Measures to reduce high leakage currents

High leakage currents can be reduced by connection to a dedicated supply transformer having separate windings. The secondary winding of the transformer and the exposed conductive parts shall be connected to the protective bonding circuit. Protective conductors between the secondary winding of the transformer and the equipment shall comply with the rules under "Ground leakage currents".

6.5.2 Functional bonding

Protection of the machine and electrical equipment

It may be necessary to implement functional bonding in order to prevent electrical equipment malfunctions. In an ideal situation, this protection is afforded by protective bonding. Functional bonding is normally achieved by a connection to the protective bonding circuit. Separate functional bonding may be necessary if the electrical disturbances on the protective bonding circuit are not sufficiently low to allow proper functioning of the machine and the electrical equipment. Functional bonding is often used to optimize the EMC performance of an electrical installation.

Functional bonding prevents the following phenomena:

- Insulation faults that impair the operation of the machine
- Electrical disturbances on sensitive electrical equipment
- Currents induced by lightning that can lead to the destruction of the electrical equipment

The connecting points for functional bonding should be marked or labeled using the following symbol:



Figure 6-52 Symbol in accordance with IEC 60417-5020: Frame or chassis

6.6 Conductors and cables

6.6.1 Classification

Definition of "conductor"

According to VDE 0100, Part 200, "conductor" is a general term for cables. The standard makes reference to IEC 60050-826 that defines "conductor" as follows under 826-1406: "Conductive part intended to carry a specified electric current" (IEV 195-01-07)

Classification according to standards

Wire types can be unambiguously and correctly classified as either a "cable" or a "conductor" only on the basis of the term applied to them in the relevant standards. For example, on the basis of the standards in the series DIN VDE 0250 (EN 57250) for conductors or in the series DIN VDE 0271 for plastic cables with PVC insulation.

Whether a conductor or a cable should be used for a particular application depends on its suitability, and its ability to withstand certain types of stress. This is defined in the standards pertaining to the installation of electrical equipment according to the safety requirements of the equipment in question.

General guide to classifying wire types

Cables

- Cables are only suitable for permanent installation, but not inside buildings.
- Cables always have a sheath made of plastic or rubber or metal.
- Cables have a nominal voltage of at least 0.6/1 kV.
- Cables may be installed indoors, outdoors, below ground and in water.

Exception: Cables with improved performance in the event of fire are **not** suitable for installation below ground or in water.

Conductors for permanent installation and flexible conductors

(for classification, refer also to DIN VDE 0298 Part 3)

- Flexible wire types are conductors even if they have a nominal voltage higher than 0.6/1 kV, i.e. this classification is not dependent on the conductor cross-sectional area (e.g. drum-wound conductors for excavators).
Flexible connecting leads at equipment are thus never "cables".
- Conductors for permanent installation in buildings are, for example, PVC-sheathed conductors or flat webbed building wires.
- Conductors may be installed or used indoors. Some conductors may also be used outdoors (e.g. certain types of rubber-sheathed conductors), but they must never be buried directly below ground.



Standards applicable to cables and conductors

Table 6- 13 Standards applicable to cables and conductors

German standard	European standard	Title
DIN VDE 0207	EN 50363	Insulating, sheathing and covering materials for low-voltage energy cables
DIN VDE 0250	EN 57250	Specifications for cables, wires and flexible cords for power installations
DIN VDE 0281	HD 21.1	Polyvinyl chloride insulated cables for power installations
DIN VDE 0282	HD 22.1	Rubber cables and flexible cords for power installations
DIN VDE 0293	EN 50334	Marking by inscription for the identification of cores of electric cables
DIN VDE 0295	EN 60228	Conductors of insulated cables for power installations
DIN VDE 0298 Part 3	No corresponding standard	Application of cables and flexible cords in power installations – (Part 3 "General requirements for cords" and Part 300 "Guidelines for harmonized flexible cords")
DIN VDE 0298 Part 4	No corresponding standard	Recommended current-carrying capacity for sheathed and nonsheathed cables for fixed wirings in and around buildings and for flexible cables and cords
DIN VDE 0472/0473	No corresponding standard	Testing of cables, wires and flexible cords

6.6.2 Conductor types

Table 6- 14 Conductor types

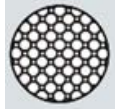
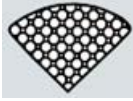
Type	Description	Round conductor	Sector-shaped conductor
Solid wire	Comprises 1 copper wire per cross-sectional area; not suitable for bending in operation, can be clamped in most terminals without additional treatment of the conductor end. Disadvantage: The larger the cross-sectional area, the more difficult it is to bend the conductor.		
Stranded wire	Multiple conductors per cross-sectional area, most common with large cross-sectional areas		
Finely stranded wire	Large number of conductors per cross-sectional area, most common with small cross-sectional areas, e.g. for duct wiring in control panels	-	-
Highly flexible conductor	Very large number of conductors per cross-sectional area, most common for applications involving mechanical movement	-	-
Single-conductor cable	1 conductor with two layers of insulation	-	-
Multi-conductor cable	Several individual conductors enclosed together by insulation	-	-

Example: PVC-sheathed cable NYM-J 3x1.5

"N" in the designation stands for "normalized (standardized)" cable according to DIN VDE 0250 (EN 57250).

"J" stands for a cable with a green-yellow protective conductor, "Y" for PVC insulation and "M" for stranded.



Figure 6-53 Example: PVC sheathed cable with three copper cores, cross-sectional area 1.5 mm²

Table 6- 15 Examples of commonly used cable types

Type code	Description
NYIF	Flat webbed building wire, for installation in dry rooms and under plaster; not suitable for installation directly below ground or in water
NYKY	Cable with plastic insulation and lead sheath, for all methods of installation indoors or outdoors, including installation directly below ground or in water Suitable for applications where cables might be exposed to solvents or other chemicals
NSSHÖU	Flexible rubber-sheathed cable, suitable for harsh conditions in commercial or industrial applications indoors or outdoors, but not for installation directly below ground or in water Also suitable for underground mining applications and in potentially explosive atmospheres

Harmonized and non-harmonized types

A distinction is made between cable types depending on whether they are harmonized or non-harmonized. Harmonized cables are manufactured in accordance with European standards ("H").

Non-harmonized cables are those that are recognized in accordance with national standards ("A"). A standardized marking based on letters and numbers (type code) makes it easier to select cables according to their type of construction, purpose and conductor cross-sectional area.

Table 6- 16 Type code (selection) - example H07RR-F3G1.5

Specifications	Marking	H	07	RR		-F	3	G	1.5
Type	Harmonized Nationally recognized	H A							
Rated voltage [V]	300/300 300/500 450/750		03 05 07						
Insulation for conductor and sheath	Ethylene propylene rubber Chloroprene rubber Polyurethane Natural and synthetic rubber Silicone rubber Polyvinyl chloride (PVC)			B N Q R S V					
Type of construction	Flat, fan-out Not fan-out				H H2				
Conductor type	Solid Stranded Finely stranded, permanently installed Finely stranded, flexible Very finely stranded Tinsel conductor					U R K F H Y			
No. of cores	1...n						n		
Protective conductor	Without GREEN-AND-YELLOW With GREEN-AND-YELLOW							X G	
Conductor cross-sectional area	0.5...500 mm ²								...

6.6.3 Selection criteria

Selection according to method of installation

- Frequent movement of cables
- Trailing cable
- No movement
- Door to switchgear and controlgear assembly / control panel and vice versa

Selection according to voltage specification

The nominal voltage of a cable is the voltage used to test the electrical properties of the cable. This means that the cable may not be connected to higher voltages.

According to DIN VDE 0298 and IEC 183, the nominal voltage is the ratio U_0/U .

U_0 is the nominal voltage between conductor and ground

U is the nominal voltage between the line conductors with three-phase current

$$U = \sqrt{3} \times U_0$$

Example

With a nominal voltage of $U_0/U = 0.6/1$ kV, the plastic insulation is rated for the voltage U_0 . These cables are thus suitable for use in single-phase systems

- with the nominal voltage $U_N = 2 U_0$ if both line conductors are insulated, or
- with the nominal voltage $U_N = U_0$ if one line conductor is grounded.

Selection according to connection to equipment

Another selection criterion is specified by the manufacturer. These specifications can normally be found in the product data sheets.

As part of the device approval process, the cables and their cross-sectional areas are determined according to the following criteria:

1. Short-circuit withstand rating

The combination of device and connected cables shall be capable of withstanding the short-time thermal and mechanical stresses imposed by the short-circuit current for which the device is to be approved.

The r.m.s. value of the short-circuit current is an equivalent for the thermal stress. The temperature reached as a result of this thermal stress shall not exceed the maximum short-time temperature of the cable.

The peak value of the short-circuit current is an equivalent for the mechanical stress; the connecting terminals and the specified torque shall be capable of keeping the connected conductors securely clamped when subjected to this stress.

2. The nominal current of the device

The combination of device and connected cables shall not exceed the maximum operating temperature of the cables, connecting terminals or the device when the nominal current is flowing continuously.

3. The mechanical construction of the device and the connection points at the devices

It is not possible to connect flexible busbars to some devices.

Causes:

- The forces transferred to the device by the copper ribbon cables during a short circuit are too high.
- Their operating temperature is too high.
- They are not clamped securely enough by the connecting terminals.

Note

Flexible connection bars

If you are using flexible connection bars, then compare their connection data with the data of the device!

6.7 Warning signs and markings

General requirements

Markings and warning signs shall be selected with respect to material, fastenings and quality such that they are sufficiently durable to withstand the physical environment at the site of installation. "Durable" in an industrial environment means a service life of 20 years or more.

Ambient conditions such as high temperatures, temperature fluctuations, UV radiation, moisture and salinity should be taken into consideration when fastening materials such as adhesives are selected.

Markings that are applied with paint cannot be regarded as durable as they can often be removed or overpainted when modernization work is carried out.

Many warning symbols are not always self-explanatory to operators of the equipment. It is therefore advisable to explain the meaning of the affixed warning signs in the relevant equipment manual.

Electric shock hazard

If it is not immediately obvious that an enclosure contains electrical equipment, appropriate markings shall be affixed to the enclosure.

The standard IEC 60204-1 provides the symbol ISO 7010-W012 for this purpose. The symbol shall be plainly visible on the enclosure door or the enclosure covers.



Figure 6-54 Symbol ISO 7010-W012

The symbol may be omitted if it is plainly visible as a result of other factors (notices or the presence of typical electrical devices) that the enclosure contains electrical equipment and will pose a shock hazard if the enclosure door is opened.

According to IEC 60204-1, the warning symbol may be omitted because it is obvious that an enclosure contains electrical equipment and shall be opened with a tool if one of the following conditions is fulfilled:

If one of the following conditions is fulfilled, IEC 60204-1 states that the warning symbol may be omitted because it is obvious that an enclosure contains electrical equipment:

- The enclosure contains a switching device that can be operated by an external operating means and handle, e.g. supply disconnecting devices.
- Entry of external cables into the enclosure make it clearly visible that the enclosure contains electrical equipment.
- The enclosure is fitted with built-on indicator lights, switches and pushbuttons that are the usual features of an operator-machine interface.

Enclosures containing electrical equipment that can also be opened without tools shall always display the warning symbol.

Exception

Enclosures that can only be opened after the supply disconnecting device has been moved to the "OFF" position so that the equipment is de-energized.

Hot surfaces hazard

Where a hot surfaces hazard exists, the primary consideration is to protect personnel. Parts of the installation can and may reach high temperatures during operation and thus pose a risk of causing skin burn injuries.

When the equipment is erected, suitable barriers or covers shall be provided so as to prevent accidental contact with hot surfaces and so reduce the risk associated with them.

Whether a warning notice is also required shall be determined according to the risk analysis for the installation / machine. The standards do not stipulate any limit temperatures at which a warning notice becomes mandatory.

IEC 60364-4-42 discusses the subject of admissible maximum temperatures above which measures shall be taken to prevent accidental contact with hot surfaces. For further details, see Table 42.1 in IEC 60364-4-42:

Table 6- 17 Temperature limits for accessible parts of surfaces of electrical equipment

Accessible parts	Material of accessible surfaces	Maximum temperatures °C
Hand-held means of operation	Metallic	55
	Non-metallic	65
Parts intended to be touched but not hand-held	Metallic	70
	Non-metallic	80
Parts which need not be touched for normal operation	Metallic	80
	Non-metallic	90

Source: IEC 60364-4-42, Table 42.1: Temperature limits in normal service for accessible parts of equipment within arm's reach

When a warning notice drawing attention to hot surfaces is provided, the symbol used shall match the symbol prescribed by ISO 7010-W017:



Figure 6-55 Symbol ISO 7010-W017

6.7.1 Functional identification

With respect to control devices and visual indicators, it is recommended to use standardized symbols for functional identification. The standardized symbols are defined in IEC 60417 and ISO 7000.

In the same way as warning notices, the symbols used to identify functions shall be explained in the operating instructions.

Examples of functional identification on and next to operator controls

Standard IEC 60204-1 stipulates that the functional identification shall be durable. It does not state, however, whether the identification should be on or next to the operator control.



Figure 6-56 SIRIUS ACT pushbuttons and indicator lights from Siemens







Figure 6-57 Functional identification on operator controls



Figure 6-58 Functional identification next to operator controls

Examples of functional identification from IEC 60417

Table 6- 18 Examples of functional identification from IEC 60417

				
Stand-by	"ON/OFF" push-push	Blower Fan	Battery	3 Phase alternating current with Neutral conductor

6.7.2 Marking of equipment

According to IEC 61439-1 and IEC 60204-1, control panels shall be provided with a nameplate. The nameplate does not need to be affixed to the outside of the enclosure, but can also be attached inside the enclosure.

The information on the nameplate is primarily intended for the installation engineer at the installation site so that he/she can check whether the equipment will function properly in the event of a fault (e.g. a short circuit). With small installations and machines, the information can be incorporated into the machine nameplate. With larger, more complex installations, the control panel should have its own nameplate or, where there are several control panels, the nameplate of each shall be displayed adjacent to the main incoming supply.

Requirements of IEC 60204-1 of the nameplate

According to IEC 60204-1, the nameplate shall include the following data:

- Name or company logo of manufacturer
- The certification marks that are required as a result of the laws applicable in the location at which the machine is operated, e.g. CE mark for Europe.
- Serial number, type designation or model, where applicable.
- Rated voltage, number of phases, and frequency (if AC voltage), and full-load current for each incoming supply
- Main document number, if applicable
- The information should be affixed near the power supply infeed.

Short-circuit withstand rating of the control panel

The control panel manufacturer shall ensure that the control panel has a sufficiently high short-circuit rating according to the data supplied by the operator. It is essential that the manufacturer and operator agree on the short-circuit rating at an early stage of the equipment planning and dimensioning process because this rating will not only affect the selection and dimensioning of overcurrent protective devices (e.g. circuit breakers, motor starter protectors, fuses), but also the rating of cables and control devices.

If the short-circuit power is higher than the short-circuit withstand rating of the control panel, overcurrent protective devices shall be connected upstream of the panel in order to reduce short-circuit currents and energy to the value for which the panel was originally rated.

Scenarios:

1. The supply conductor and the associated overcurrent protection are not supplied by the manufacturer

The supply conductor and the overcurrent protective device which protects the supply conductor do not fall within the scope of IEC 60204-1. Unless otherwise agreed, therefore, the required supply disconnecting device does not provide overcurrent protection for the supply conductor.

In this case, the manufacturer of the control panel shall specify the maximum permissible short-circuit rating / current. These parameters are often determined by the short-circuit breaking capacity of the smallest downstream short-circuit protective device.

2. The supply conductor and the associated overcurrent protection are supplied by the manufacturer

Since the supply conductor and associated overcurrent protective device do not fall within the scope of IEC 60204-1, it is essential that the operator and the manufacturer of the control panel come to an agreement about them in advance.

In this case, it is the supplier who is responsible for dimensioning the supply conductor correctly, for deciding whether the overcurrent protective devices need to operate selectively, and for specifying the maximum permissible short-circuit current of the supply system or the short-circuit breaking capacity of the overcurrent protective device for the supply conductor.

3. Supply disconnecting device provides overcurrent protection for the control panel

This applies if an overcurrent protective device such as a circuit breaker or a switch disconnecter with fuses is selected as a supply disconnecting device. In this case, the short-circuit breaking capacity of the supply disconnecting device shall be specified.

4. Supply disconnecting device does not provide overcurrent protection for the control panel

This applies if a component without integral overcurrent protection (such as a switch disconnecter without fuses) is used as a supply disconnecting device. In this case, the manufacturer of the control panel shall specify an overcurrent protection mechanism that shall be provided by the operator.

(See Chapter "Incoming supply conductor termination" (Page 82))

Requirements of IEC 61439-1 regarding the nameplate

According to IEC 61439-1, the nameplate shall include the following data:

- Name or trade mark of the manufacturer of the control panel
- Type designation or identification number, with which it is possible to obtain relevant information from the manufacturer of the control panel
- Means of identifying date of manufacture
- IEC 61439-X (the applicable part is to be specified)

Examples of nameplates



Figure 6-59 Example: Nameplate for control panel

AAA Mechanical Engineering, Sample Street, Sample Town		CE
Serial number	123456	
Operator	Customer	
Rated voltage	3 ~, 400 V/230 V AC	
Control voltage	24 V DC	
Frequency	50 Hz	
Rated current	300 A	
Documentation	Manual 1, Chapter ...	
Date of manufacture	DD.MM.YYYY	
Product complies with the standards	IEC 60204-1, IEC 61439-1/-2	

Figure 6-60 Example: Nameplate according to IEC 60204-1 and IEC 61439-1

Example of reference designations

In cases where an item of equipment needs to be replaced or removed during maintenance, the designation is marked on the item of equipment itself as well as on the mounting plate next to the equipment.

The structuring principles and reference designations are defined in standard IEC 81346-1.



Figure 6-61 Example: Reference designations on various items of equipment in the control panel

6.8 Wiring practices

Protection against accidental (self-) loosening

Protection against accidental loosening means that the prescribed contact pressure at the clamping point is permanently maintained even when, for example, the clamping point is exposed to mechanical stresses or temperature fluctuations.

Despite the withdrawal of the standard (DIN 128), it is still the common and correct practice to use spring lock washers in screw-type terminations.

As an optional alternative to screw-type terminals, it is possible to use spring-loaded terminals which use the spring force in the terminal to permanently maintain a constant contact pressure. This type of terminal is also maintenance-free.

Soldered connections

Soldered connections are permitted when solder cable lugs are used or when conductors with a small cross-sectional area are soldered to rings, e.g. in control circuits.

Where screw-type terminals are used or in situations where movement may occur between the soldered components, the standard prohibits soldering of the ends of stranded or finely stranded conductors.

In this case, the state-of-the-art solution is to use end sleeves.

Note

End sleeves

The equipment manufacturer's specifications should be consulted before a decision is made to use end sleeves. There are a large number of devices equipped with terminals which do not require the use of end sleeves even though the conductors used are finely or very finely stranded.

Example

End sleeves are to be used to connect finely stranded conductors on devices with screw-type terminals.

The use of end sleeves is optional for devices with spring-loaded terminals.

The "SIRIUS Modular System" system manual contains the following examples:

Conductor cross-sectional area specifications for screw-type connection systems:

Table 6- 19 Main conductors of size S00 with M3 combination screws

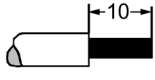
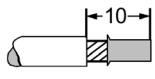
		Motor starter protectors/circuit breakers	Contactors	Overload relays ¹⁾ , current monitoring relays ¹⁾
Tool		Pozidriv size PZ 2, Ø 5 ... 6 mm		
Tightening torque		0.8 to 1.2 Nm		
Solid and stranded			2 x (0.5 ... 1.5) mm ²	2 x (0.5 ... 1.5) mm ²
		2 x (0.75 ... 2.5) mm ²	2 x (0.75 ... 2.5) mm ²	2 x (0.75 ... 2.5) mm ²
		Max. 2 x 4 mm ²	Max. 2 x 4 mm ²	Max. 2 x 4 mm ²
Finely stranded with end sleeve		2 x (0.5 ... 1.5) mm ²	2 x (0.5 ... 1.5) mm ²	2 x (0.5 ... 1.5) mm ²
		2 x (0.75 ... 2.5) mm ²	2 x (0.75 ... 2.5) mm ²	2 x (0.75 ... 2.5) mm ²

¹⁾ Only 1 conductor can be clamped on the stand-alone assembly support.

Conductor cross-sectional area specifications for spring-loaded connection systems:

Table 6- 20 Main conductors of size S00

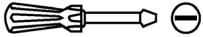
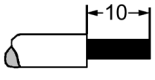
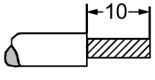
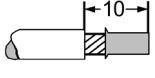
		Motor starter protectors/circuit breakers, contactors	Overload relays, current monitoring relays
Tool		Ø 3.0 x 0.5 (3RA2808-1A)	
Solid and stranded		2 x (0.5 to 4.0) mm ²	0.5 to 4.0 mm ²
Finely stranded without end sleeve		2 x (0.5 to 2.5) mm ²	0.5 to 2.5 mm ²
Finely stranded with end sleeve (DIN 46228 Part 1)		2 x (0.5 to 2.5) mm ²	0.5 to 2.5 mm ²

Example



Figure 6-62 Example: End sleeve



Figure 6-63 Example: Use of end sleeves at clamping points on equipment

Flexible conduits

Liquids can enter and possibly flow through flexible conduits in electrical installations. IEC 60204-1 therefore stipulates that the conduit shall be installed in such a way that liquids shall drain away from the fittings. If the cable shall be fed in from above so that liquid may flow onto the fitting, additional measures shall be taken to ensure that the liquid can drain away.

Marking of terminals

Terminals shall always be plainly marked on terminal blocks; the markings shall correspond with the identification used in the relevant documentation. A system of consecutive numbering is often used for this purpose, but functional identifiers such as "N" for the neutral conductor or L1 - L2 - L3 for the line conductors are also acceptable.

Where an incorrect electrical connection is identified as a source of risk and where this cannot be resolved by design measures, e.g. by providing equipment with a plug-in socket, the terminals shall be identified by numbers, numbers and letters, color or a combination of all three.



Figure 6-64 Example: Marking of terminals

Conductors of different circuits

When conductors of different circuits are installed in the same cable duct or as a single circuit in a cable, the following shall be noted:

- Measures shall be taken to prevent, for example, inductive and capacitive coupling between conductors.
- The insulation strength of all conductors shall be at least as high as the highest possible voltage of all circuits. If, for example, 400 V circuits are routed together with 24 V circuits, the insulation of the cables in the 24 V circuits shall be rated for at least 400 V. If insulation of the appropriate rating cannot be provided, some appropriate means shall be found to separate the cables, e.g. by installing separate cable ducts or providing a barrier between the circuits.

Note

The cables shall be rated for the phase-to-ground (U_0) voltage.

For example, the cables in a 400 V/230 V TN system would need to be rated for at least 230 V.

AC circuits and electromagnetic effects

If conductors of AC circuits are installed in ferromagnetic enclosures, all conductors, including the protective conductor of each circuit, shall be contained in the same enclosure. Where such conductors enter a ferrous enclosure they shall be arranged such that the conductors are not individually surrounded by ferromagnetic material.

Single-core cables armored with steel wire or steel tape should not be used for AC circuits.

Conductor and cable runs

Conductors and cables shall be run from terminal to terminal without splices or joints. This does not apply to plugs or sockets as these are not classed as "joints".

However, IEC 60204-1 also cites an exception in this case: Where it is impractical to provide adequate terminals, e.g. on mobile machines or machines having long flexible cables, it is permissible to use splices or joints.

Where it is anticipated that items of equipment will be connected and disconnected frequently, a sufficient extra length of cable shall be provided to avoid the subsequent need for joints and splices. When cables are connected and disconnected multiple times, they often sustain mechanical damage.

The conductors shall be protected against potential mechanical stresses, e.g. caused by pulling or pressure at the terminations. Suitable cable supports shall be provided.

When the conductors of a circuit are routed individually, the protective conductor for the circuit shall be positioned as close as possible to the live phase conductors. This will ensure that the protective conductor does not have a significantly higher impedance than the phase conductors. The impedance of the protective conductor could otherwise have a negative impact on the touch voltage in the event of a fault and on the disconnecting time where protection is provided by automatic disconnection.

Example



Figure 6-65 Example: Separate routing of 24 V and 230 V/400 V circuits

6.8.1 Identification of cables

General requirements

As a general requirement, it shall be possible to identify each conductor at the relevant termination in accordance with the information provided in the technical documentation. The standard therefore recommends that conductor identification is based on numbers, letters or color or a combination of all three. Where numbers are used, they shall be Arabic; letters shall be Roman.

The purpose of this measure is to minimize wiring errors during installation or during subsequent maintenance work or replacement of equipment.

According to the recommendations in the standard, various identification methods can be used, but these also have cost implications. For example, identifying every single termination as well as the cable would certainly be more expensive than using a color-coded cable. The standard therefore recommends that the supplier and operator work closely together to select a suitable cable identification system. This may ultimately have safety implications because the maintenance personnel at existing plants may be used to working with an established identification system and will be less likely to make errors if it is adopted for new equipment.

Example



Figure 6-66 Example: Identification of single wires and equipment

Identification of the protective conductor / protective bonding conductor

The protective conductor / protective bonding conductor shall be readily distinguishable from other conductors in the control panel by its marking, color, shape or location. The protective conductor is often identified by color in which case the bicolor combination GREEN-AND-YELLOW shall be used throughout the length of the conductor. This color combination shall not be used for any other cable and is strictly reserved for protective conductors.

If single-core or multicore cables in just one color are used, the above-mentioned rule need not be observed. In this case, only the ends of the cores of the protective conductor need to be marked, e.g. by wrapping them in colored tape.

If this type of marking is chosen, it shall be ensured that one of the colors covers at least 30 %, but not more than 70 % of the conductor surface over any 15 mm length. The remainder of the surface shall be covered by the other color.

If the protective conductor can be easily identified by its shape, position or construction, it does not need to be marked except at the ends of the cores or in locations where the conductor is accessible. The combination of letter "PE", the bicolor combination GREEN-AND-YELLOW or the graphical symbol 5019 from IEC 60417 shall be used for this purpose.

Examples



Figure 6-67 Example: Marking with the symbol IEC 60417-5019



Figure 6-68 Example: Marking with GREEN-AND-YELLOW at the end of the protective conductor busbar

Note

Protective bonding conductors can also be marked with the letters "PB" and/or with the IEC symbol IEC 60417-5021.



Figure 6-69 Symbol IEC 60417-5021

Identification of the neutral conductor

The color BLUE shall be used to identify the neutral conductor. In order to avoid any confusion with other circuits, it is recommended that the color LIGHT BLUE is used. Where color is the only option for identifying the neutral conductor, this color shall not be used for any other conductor to avoid any possible confusion.

Where the neutral conductor is a bare conductor, its color identification shall meet one of the following criteria:

- Colored by stripes, 15 to 100 mm wide, in each compartment or unit at each accessible location
- Colored throughout its length

In cases where the circuit does not include any neutral conductor, the color BLUE may also be used for other purposes.

Identification by color

IEC 60204-1 recommends the following colors for identifying conductors (with the exception of the protective and neutral conductors):

BLACK, BROWN, RED, ORANGE, YELLOW, GREEN, BLUE (including LIGHT BLUE), VIOLET, GRAY, WHITE, PINK, TURQUOISE

Note

Color coding is used for the purpose of differentiating between conductors; it does not identify any particular conductor or function.

Avoid using a single color to identify all sorts of different functions.

In large installations with many functions, the same colors are sometimes used for different functions. For example, the color BLUE (or LIGHT BLUE) is prescribed for the neutral conductor, for DC circuits and for the marking of intrinsically safe circuits in relation to explosion protection.

In this case, it is likely that identification by color alone would not be sufficient.

Where color is used to identify conductors, the standard recommends the following:

- **BLACK:** Power circuits, for AC and DC circuits
- **RED:** AC control circuits
- **BLUE:** DC control circuits
- **ORANGE:** Excepted circuits

Note

The color shall be applied along the entire length of the cable through either the color of the insulation, or by color markings at regular intervals and at each of the ends of the conductor.

Color coding may be implemented by using combinations of the colors listed above (see IEC 60757) - except for the color combination of GREEN and YELLOW as this could lead to confusion with the protective conductor.

6.8.2 Wiring inside control panels

It shall be ensured that conductors are held securely in position inside enclosures. This can be achieved by fastening them separately or by using non-metallic cable ducts; in the latter case, it is essential that the ducts are made of flame-retardant insulating material. We recommend that you seek confirmation from the manufacturer that the cable duct is really flame-retardant.

The space in new cable ducts should not be completely filled. On the one hand, this is for practical reasons, i.e. to leave enough space for any expansions or additional cabling required. On the other hand, the heat generated as a result of the heat losses of cables (particularly power circuit conductors) will then have a less harmful effect. It is advisable to discuss and agree the fill level of cable ducts with the operator of the plant.

If conductors or cables do not run in ducts, they shall be adequately supported.

Cables for door-mounted equipment or other movable components shall be flexible to allow them to move freely as often as required. These shall be supported on the stationary part as well as the mobile part to provide cable strain relief.

Example



Figure 6-70 Example: Installation in doors with flexible cables

Standard 60204-1 recommends that control panels should be planned such that where subsequent modifications to the wiring are required, these can be made from the front of the enclosure. Where this is not practicable, swingout panels shall be provided or, where a device is wired at the rear, an access door.

The interface between the external and internal wiring of the control panel shall take the form of terminal blocks or plugs and sockets. The following are excepted:

- Cables of power circuits which may have such a large cross-sectional area that they are difficult to install.
- Measuring circuits with a shield that it may be possible to interrupt by using terminal blocks or plug-in connectors.

For these two exceptions, it is admissible to connect the cable directly to the terminals of the equipment.

6.9 Testing and verifications

The testing and verifications described in this chapter are essentially based on the following standards:

- IEC 60204-1 – Electrical Equipment of Machines Part 1 – General Requirements
- IEC 61439-1 – Low-Voltage Switchgear and Controlgear Assemblies – Part 1 General Rules

In order to avoid contradictions and make it easier to use and understand these two standards, their requirements have been explained separately.

The electrical equipment of machines includes (depending on its complexity) a large number of products, product groups and interfaces to other electrical installations, e.g. control panels. These products and product groups in turn fall within the scope of other standards and are tested according to these. This should be taken into account during selection of tests and verifications so as to avoid contradictory results and, in some cases, obviate the need to repeat tests unnecessarily.

Important standards pertaining to other products and product groups:

- Single items of electrical equipment:

These are tested according to the relevant product standard.

Example: IEC 60947 series for low-voltage switchgear and controlgear

- Low-voltage switchgear and controlgear assemblies

The IEC 61439 series that describes verifications can be applied to these products.

Control panels that are designed for installation and the electrical equipment of machines also fall within the scope of this series of standards.

Purpose of the tests

- To ensure the proper functioning and the electrical safety of electrical equipment, particularly at the interfaces between components and assemblies.
- To identify assembly errors, wiring errors and inadmissible combinations of components.

Each of the verification procedures described in IEC 60204-1 is a routine test which shall be carried out on each individual machine and its electrical equipment. IEC 60204-1 does not discuss type tests.

Mandatory and voluntary tests

Some of the tests are mandatory and others voluntary. In other words, it is left to the discretion of the manufacturer to decide whether to conduct voluntary tests in addition to the mandatory tests for a specific application.

6.9.1 Requirements of IEC 60204-1

6.9.1.1 Visual inspection (mandatory)

A visual inspection shall be conducted for the purpose of ascertaining that the electrical equipment matches the description in the documentation.

This includes, for example, a thorough inspection of control panels focusing on the wiring and the completeness and correct use of the installed components to ensure that they match the information given in the documentation.

6.9.1.2 Verification of conditions for protection by automatic disconnection of supply (mandatory)

General information

Protection by automatic disconnection in the case of indirect contact under fault conditions is dependent on the fault current flowing through the protective conductor and reaching an amperage that is high enough to trip the upstream protective device within a maximum admissible time period.

To ensure that this protective mechanism works, the power supply system shall have a high enough short-circuit power and the overcurrent protective device shall have been selected correctly. See also Chapter Motor starter protectors/circuit breakers (Page 234).

EN 60204-1 describes the test methods for TN systems.
For TT and IT system test methods, see IEC 60364-6-61.

TN systems

The verification procedure for TN systems consists of two tests:

- Test 1: Verification of the continuity of the protective bonding circuit (Page 196)
- Test 2: Fault loop impedance verification and suitability of the associated overcurrent protective device (Page 196)

6.9.1.3 Verification of the continuity of the protective bonding circuit

This involves a resistance measurement conducted to determine whether there are any interruptions or high contact resistances in the protective bonding circuit. The measurement is taken between the PE terminal and parts of the protective bonding circuit. It is particularly important to perform the test on equipment that is installed at a long distance from the PE terminal and has a point-to-point connection to the protective conductor.

The voltage-current measurement method shall be used to measure the resistance. The resistance may be measured with a current of between 0.2 A and 10 A; the supply voltage shall not exceed 24 V AC or DC. The advantage of selecting higher currents is that the test results will be more accurate, particularly in cases where the resistance is expected to be low (with cables that are short, for example, and/or that also have a large cross-sectional area).

To avoid measuring errors, SELV sources should be selected to supply the measuring instrument since PELV sources are themselves grounded at one end and may therefore falsify the measurement result.

No specific resistance values are stipulated. However, the value should be within the expected range for the cross-sectional area and the material of the conductor since it is the purpose of the test to reveal possible assembly errors or interruptions.

Where residual current protective devices (RCDs) are used, their proper functioning shall be verified in accordance with the manufacturer's instructions. The intervals for verifying proper functioning shall be documented, e.g. in the maintenance instructions.

6.9.1.4 Fault loop impedance verification and suitability of the associated overcurrent protective device

The purpose of this verification is to prove that protection by automatic disconnection is actually afforded for the specific application. The precondition for successful protection is a short-circuit current that is sufficiently high to ensure that the overcurrent protective device trips within the required disconnecting time.

For this reason, close attention needs to be paid to two aspects during verification:

- Determination of the short-circuit current
- Determination of the disconnecting time by comparison of the calculated short-circuit current with the tripping characteristic of the upstream overcurrent protective device

Determination of the short-circuit current

The magnitude of the short-circuit current is determined by the following factors:

- The supply voltage of the source [V] (normally a transformer)
- The internal resistance of the source (this can be calculated from the short-circuit voltage u_k [%] when the source is a transformer).
- The existing line impedance [Ω] from the incoming supply point to the machine up to the transformer, and from the incoming supply point up to the relevant fault location.

Note: Information about resistance per unit length can often be requested from the manufacturer as a basis for calculating the impedance of cables and conductors. See also Chapter Protection of equipment (Page 127).

Due to the differences in cable length to potential fault sources, the verification should be conducted for each part of the machine that is provided with its own overcurrent protective device.

There are two alternative methods of determining the short-circuit current:

- Determination by calculation
- Determination by measurement

Determination by calculation

For this method, it is essential that all relevant data of the power supply are known. Cable and conductor resistances are normally specified in the technical data sheets supplied by the manufacturer.

Note

SIMARIS design

The SIMARIS design (<http://www.siemens.com/simaris>) software can be used, for example, to calculate and simulate the short-circuit power of transformers, cable lengths, voltage drops and protection by automatic disconnection.

Determination by measurement

The figures A.1 and A.2 in Annex A of IEC 60204-1 show a typical measurement arrangement. The test shall be performed using an instrument that complies with IEC 61557-3.

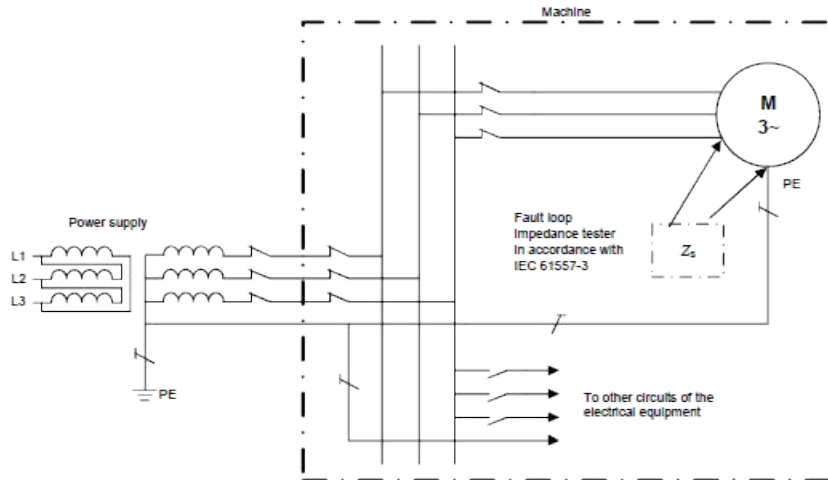

Source: IEC 60204-1, Annex A, Figure A.1

Figure 6-71 Typical arrangement for fault loop impedance (Z_s) measurement in TN systems

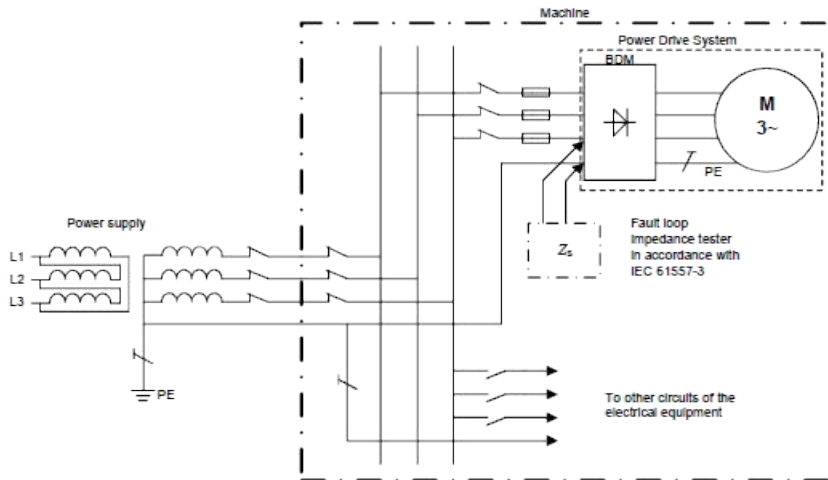

Source: IEC 60204-1, Annex A, Figure A.2

Figure 6-72 Typical arrangement for fault loop impedance (Z_s) measurement for power drive system circuits in TN systems

Note

Power drive system (PDS)

Where a power drive system is used, a confirmation shall be provided by the manufacturer that the setting values as well as the characteristic of the protective device comply with the information given and the values required of the power drive system.

Conclusion

The standard states that there are two equally valid alternatives for determining the short-circuit current, i.e. by calculation or by measurement. Which of these is the most practicable method should be decided on a case-by-case basis.

From a practical viewpoint however, the higher the short-circuit current needed to ensure reliable disconnection within the required time period, the less accurate the measurement results will be. There are certainly also instances in which the existing impedance cannot be calculated so that measurement is the only option.

Note

The machine / control panel manufacturer often cannot know the line-side fault loop impedance at the site of installation. For this reason, it is advisable for the manufacturer and operator to come to an agreement about the minimum required short-circuit current and/or the maximum permissible line-side fault loop impedance.

6.9.1.5 Determination of the disconnecting time by comparison

Determination of the disconnecting time by comparison of the calculated short-circuit current with the tripping characteristic of the upstream overcurrent protective device

The calculated short-circuit current in the fault loop must now be compared with the tripping characteristic of the relevant upstream protective device in order to determine the tripping time. For stationary, non-portable machines as defined by IEC 60204-1, the tripping time shall not exceed 5 seconds. For other devices such as class 1 hand-held equipment or portable equipment, the disconnecting times stated in Table A1 of IEC 60204-1 apply:

Table 6- 21 Maximum disconnecting times for TN systems

U_0^a V	Disconnecting time s
120	0.8
230	0.4
277	0.4
400	0.2
> 400	0.1

^a U_0 is the nominal AC r.m.s. voltage to ground.
NOTE 1 For voltages which are within the tolerance band stated in IEC 60038, the disconnecting time appropriate to the nominal voltage applies.
NOTE 2 For intermediate values of voltage, the next higher value in the above table must be used.

Source: IEC 60204-1, Table A.1: Maximum disconnecting times for TN systems

Example

Note

Documentation of tripping characteristics

The SIMARIS curves (<http://www.siemens.com/simaris>) software can be used to evaluate and document the tripping characteristics of many of the low-voltage protective switching devices supplied by Siemens.

```

Rated current In: 65 A
Number of poles: 3
Rated ultimate short-circuit breakin... 65 kA
Design of the overcurrent release a... TM
Protective functions: LI
Operating voltage: 415 V
Order number: 3RV20314JB10

```

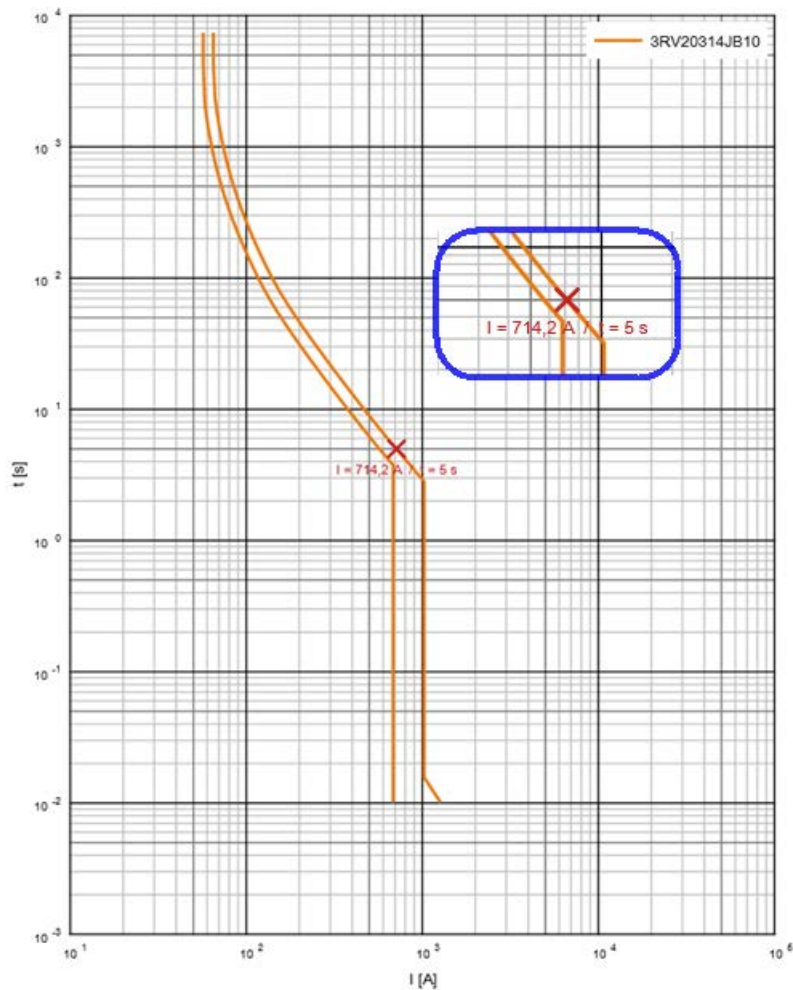

Figure 6-73 Example: 3RV20314JB10 tripping characteristic (excerpt from SIMARIS curves)

If it is impossible to guarantee tripping within the specified disconnecting times, one of the following two measures shall be implemented:

- Additional protective bonding to reduce the hazardous touch voltage to below 50 V.
- Selection of a faster overcurrent protective device in order to ensure disconnection within the required time period.

You will find further information in Chapter "Protection against electric shock", Section Fault protection (Page 110)

Conclusion

This comparison should always be performed for each feeder that contains an overcurrent protective device. For reasons of efficiency, however, it is in practice sufficient to carry out the comparison for only those circuits that are obviously critical. The longer the cable and the smaller its cross-sectional area, the higher the impedance and thus the longer the disconnecting time.

Reference values according to IEC 60204-1

As a guide to estimation, IEC 60204-1 also gives reference values for the maximum cable length from a protective device up to its load.

Table 6- 22 References values for maximum cable length

1 Impedance of the supply to the protective device	2 Cross- sectional area of conductors	3 Nominal rating or setting of the protective device I_N	4 Fuse disconnect time 5 s	5 Fuse disconnect time 0.4 s	6 Miniature circuit breaker char. B ⁴ $I_a = 5 \times I_N$ Disconnect time 0.1 s	7 Miniature circuit breaker char. C ⁶ $I_a = 10 \times I_N$ Disconnect time 0.1 s	8 Adjustable circuit breaker $I_a = 8 \times I_N$ Disconnect time 0.1 s
mΩ	mm ²	A	Maximum cable length in m from each protective device to its load				
500	1.5	16	97	53	76	30	28
500	2.5	20	115	57	94	34	36
500	4.0	25	135	66	114	35	38
400	6.0	32	145	59	133	40	42
...							

Source: IEC 60204-1, excerpt from Table 10: Examples of maximum cable length from each protective device to its load

Note

If the cables in a feeder are sufficiently protected against short circuits, the conditions for protection against electric shock for stationary equipment are also fulfilled because the maximum permissible disconnecting time in the event of a short circuit and for the purpose of protection against indirect contact is ≤ 5 seconds. This will be applicable to many applications.

However, it is not permitted to go the other way and assume that sufficient short-circuit protection is provided if the disconnecting time is ≤ 5 seconds.

6.9.1.6 Insulation resistance test (optional)

Purpose of the test

To ensure that no insulation faults have been caused due to ingress of contaminants during assembly of the installation.

Requirements of the test:

- Test voltage 500 V DC
- Measuring points between the power circuit conductors and the protective bonding circuit
- Measured value shall be $\geq 1 \text{ M}\Omega$ (according to IEC 61439-1, routine verification $\geq 1000 \text{ }\Omega/\text{V}$)

Testing may be carried out on individual sections of the complete electrical installation.

Exceptions

Lower minimum value for certain parts of electrical equipment are permitted, e.g. busbars or conductor wire systems. But not $< 50 \text{ k}\Omega$.

Any existing surge protection devices may

- be disconnected or
- be tested with a lower test voltage so that they are not tripped. However, not lower than the peak value of the upper limit of the supply voltage (phase to neutral).

6.9.1.7 Voltage test (optional)

Purpose of the test

To detect inadequate clearances, or weak points in the insulation caused, for example, by cable damage occurring during installation, spliced single cores when end sleeves are used, or metal chips embedded in the insulation.

Requirements of the test:

- Test device in accordance with IEC 61180-2
- Frequency: 50 Hz or 60 Hz
- Test voltage: 2 x rated voltage, but not $< 1000 \text{ V}$
- Measuring points between the power circuit conductors and the protective bonding circuit
- Test voltage shall be applied for approximately 1 second

Result

The requirements are met if there is no disruptive discharge.

Exceptions

- Components and devices that are not rated to withstand this test voltage shall be disconnected **before testing**.
- Components and devices that have been voltage tested according to their product standard may be disconnected during testing.

6.9.1.8 Protection against residual voltages (optional)

Purpose of the test

To ensure that the equipment complies with the limit values for direct contact stipulated in the standard at which direct contact is permitted, but is no longer dangerous.

Applicability of the test:

Residual voltages following disconnection of the power supply occur in equipment that contains capacitors. The test therefore only needs to be carried out if the electrical equipment includes devices that carry residual voltages. Examples of such equipment are electronic motor control devices, frequency converters, power factor correction equipment.

The manufacturer generally affixes a warning notice to most items of equipment that carry residual voltages. This generally specifies a wait time until the voltage has dropped to a safe level.

Requirements of the test:

- Determination of the discharge voltage by calculation

$$Q = C \times U$$

Q = electric charge in [coulomb]

C = capacitance in [F]

U = voltage in [V]

- Determination of the residual voltage and time by measurement

6.9.1.9 Functional tests (optional)

Purpose of the test

To verify the proper functioning of all operating equipment for normal operation and of the protective equipment.

The protective equipment includes:

- Residual current protective devices (RCD)
- Ground fault monitors
- Insulation monitors
- Safety interlocks
- Safety switches and monitors
- Emergency switching off / emergency stop for emergency operations
- Limit switches
- Failure of redundant equipment

6.9.1.10 Retesting (optional)

Purpose of the test

To ensure proper functioning of equipment after it has been replaced or modified.

Note

Periodic testing

Regular periodic tests are not covered by carrying out retesting!

Some periodic tests fall within the scope of other standards, e.g. periodic testing for safety functions or fulfillment of operator and accident prevention regulations by EN 50110-1/-2 (DIN VDE 0105-100) "Operation of electrical installations".

Note

Modifications which affect the machine's ability to function

When the machine is modified in significant ways which may influence its ability to function, new risks might arise or the nature of existing risks might change. In such cases, simple retesting is not sufficient. A new risk analysis shall be carried out and may potentially result in the need to adapt the entire machine or parts of it to ensure that they comply with new standards. This can only be assessed and decided on a case-by-case basis.

6.9.2 Requirements of verifications from the IEC 61439 series of standards

IEC 60204-1 is normally the leading standard applicable to control panels that operate in machine and plant environments. The IEC 61439 series of standards is designed primarily for switchboards and power distribution boards. Within its scope of application, however, it can also apply to machine control panels on the condition that the requirements stipulated in IEC 60204-1 are also taken into consideration.

A paragraph out of IEC 60204-1 (with additional text by the author) referring to the selection of tests and verifications is therefore cited below:

"4.2.2 Electrical equipment in compliance with the IEC 60439 series [superseded by IEC 61439 as of 11.2014]

The electrical equipment of the machine shall satisfy the safety requirements identified by the risk assessment of the machine. Depending upon the machine, its intended use and its electrical equipment, the designer may select parts of the electrical equipment of the machine that are in compliance with relevant parts of IEC 60439-1 / of the IEC 61439 series (see also Annex F)."

Conclusion

With respect to machine control panels, it is left to the discretion of the designer whether he/she conducts some or all of the verifications defined in IEC 61439-1 and -2.

The DKE (Deutsche Kommission Elektrotechnik Elektronik Informationstechnik (German Commission for Electrical, Electronic & Information Technologies)) has also clarified this in a statement (Page 37).

6.9.2.1 Overview of design and routine verifications from IEC 61439-1

Introduction

The design verification involves verification made on **samples** of an ASSEMBLY (refers to switchgear and controlgear assembly), or on parts of ASSEMBLIES.

The original manufacturer uses the design verification to verify whether the ASSEMBLY design conforms to the standard. A single design verification applies to all ASSEMBLIES of identical design.

Purpose

Verification of compliance with the general requirements of the IEC 61439-1 standard and the relevant IEC 61439-2 to IEC 61439-6 product standards

Overview of design verifications

The following table provides an overview of the design verifications. A distinction is made between design verifications that relate to the **construction** of an ASSEMBLY and those which influence the **performance** of the ASSEMBLY.

Table 6- 23 Overview of design verifications

1	Construction	2	Performance
1.1	Strength of materials and parts (Page 208)	2.1	Dielectric properties (Page 213) (for similar test, see also IEC 60204-1)
1.2	Degree of protection of enclosures (Page 227)	2.2	Verification of temperature rise (Page 215)
1.3	Clearances and creepage distances (Page 210)	2.3	Short-circuit withstand strength (Page 216)
1.4	Protection against electric shock and integrity of protective circuits (Page 210)	2.4	Electromagnetic compatibility (Page 224)
1.5	Incorporation of switching devices and components (Page 211)	2.5	Mechanical operation (Page 225)
1.6	Internal electrical circuits and connections (Page 212)		
1.7	Terminals for external conductors (Page 212)		

Verification procedure

Three equally valid alternative verification methods are defined:

- **Testing**
Tests made on a sample of an ASSEMBLY or on parts of ASSEMBLIES
- **Comparison**
Structured comparison of the proposed design or parts of an ASSEMBLY with a reference design verified by test
- **Assessment**
Design verification of strict design rules or calculations applied to a sample of an ASSEMBLY or to parts of ASSEMBLIES

Verification methods

It is always left to the discretion of the manufacturer to decide which of the verification methods should be applied and which are the most efficient in terms of time and cost. From the viewpoint of the user, the only important issue is whether the ASSEMBLY satisfies the requirements of the standard and whether this has been verified. However, it is not possible to apply all of the three possible alternative verification methods to some characteristics that need to be verified. These are listed in Annex D of IEC 61439-1.

The following table shows an overview of the design verifications and the permissible alternative verification methods.

Table 6- 24 Overview of design verifications and permissible alternatives

Characteristic to be verified	Verification options available		
	Testing	Comparison	Assessment
Strength of materials and parts	YES	NO	NO ¹
Degree of protection of enclosures	YES	NO	YES
Clearances	YES	NO	NO
Creepage distances	YES	NO	NO
Protection against electric shock and integrity of protective circuits	YES	NO ²	NO
Incorporation of switching devices and components	NO	NO	YES
Internal electrical circuits and connections	NO	NO	YES
Terminals for external conductors	NO	NO	YES
Dielectric properties	YES	NO	NO ³
Temperature rise limits	YES	YES	YES

Source: IEC 61439-1, Annex D; excerpt from Table D.1: List of design verifications to be performed

Exceptions (added by the author)

- 1 UV radiation/resistance to extraordinary heat/fire
- 2 Short-circuit withstand strength of the protective conductor
- 3 Surge voltage strength

6.9.3 Detailed description of design verifications relating to construction

6.9.3.1 Strength of materials and parts

Verification objective

Verification of the mechanical, electrical, and thermal suitability of materials and parts.

If an enclosure in accordance with IEC 62208 is used, no further "strength of materials" tests will be required!

Note

Tested enclosures

Siemens enclosures from the SIVACON sicube 8MF1 and 8MF2 range are already tested in accordance with IEC 62208.



Figure 6-74 EU Declaration of Conformity for SIVACON enclosure

Own design and own construction

In cases where an enclosure that is not in accordance with IEC 62208 is used, e.g. it is a manufacturer's own design and own construction, the following verifications shall be carried out to the extent that they are applicable:

Table 6- 25 Verifications for enclosures

Verifications	Applicable for
Corrosion resistance	For ferrous metallic enclosures
Properties of insulating materials	Thermal stability and resistance to exceptional heat
Resistance to ultra-violet (UV) radiation	For enclosures installed outdoors coated with insulating material. Exception: This test does not need to be performed if the original manufacturer can provide data from the material supplier showing the material satisfies the requirements in the same type and thickness or thinner.
Lifting	Optional, if requested
Impact test	Optional for power switchgear and controlgear assemblies according to IEC 61439-2, if requested.
Markings	Only for markings made by molding, pressing, engraving.

6.9.3.2 Degree of protection of enclosures

Verification objective

Verification that the enclosure is adequately protected against ingress of solid bodies and liquids.

The degree of protection (IP) does not need to be tested on enclosures already tested in accordance with IEC 62208.

External modifications shall not result in a deterioration of the degree of protection!

All other enclosures shall be tested in accordance with IEC 60529 Degrees of protection by enclosures (IP code).



Figure 6-75 Example: Alteration of the degree of protection by installation of a component

6.9.3.3 Clearances and creepage distances

Verification objective

To ensure dielectric properties are appropriate for installations where pollution (creepages) and excess voltage levels (clearances) are an issue.

Equipment such as switching devices and components incorporated in the ASSEMBLY shall fulfill the relevant product standard.

→ Degree of pollution (Page 58) and overvoltage class are stated in the data sheets. The clearances and creepage distances that correlate with these need not therefore be verified.

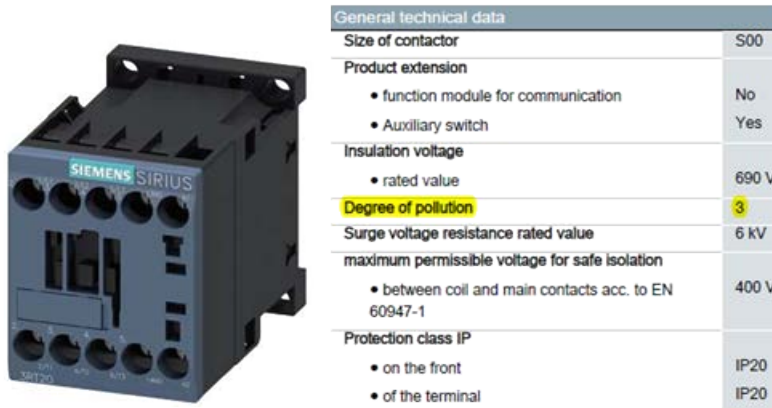

Figure 6-76 Example: Data sheet for contactor, degree of pollution 3 (normal in industrial environments)

6.9.3.4 Protection against electric shock and integrity of protective circuits

Verification objective

Effectiveness of protective function in the event of a fault

- Protection against the consequences of a fault within the ASSEMBLY
- Protection against the consequences of faults in external circuits supplied through the ASSEMBLY

With internal faults

Continuous connection of the protective conductor to the conductive parts in the ASSEMBLY (protection against internal faults)

- All conductive parts shall be connected to the protective conductor.
- Maximum resistance $R \leq 0.1 \Omega$ of the electrical circuit
- Verification using a resistance meter (AC or DC) at a minimum of 10 A; current flows from any exposed conductive part to the terminal for the external protective conductor.

With external faults

Short-circuit withstand strength of the protective circuit (protection against external faults)

Verification by comparison with a tested reference design

- Utilizing a check list (IEC 61439-1, Table 13): Fulfillment of requirements of items 1 to 6 and 8 to 10
- Utilizing calculation:
 - Equivalent to "Verification of the short-circuit withstand strength of busbar arrangements via comparison with a tested reference design"
 - Additional fulfillment of requirements of items 6 to 10 of the check list (IEC 61439-1, Table 13)
- Verification by testing short-circuit withstand strength to IEC 61439-1 §10.11.5.6 Testing of the protective circuit.

Note

There is no need to test electrical circuits that are excluded in terms of short-circuit withstand strength.

For condition, see design verifications, Short-circuit withstand strength (Page 216)

6.9.3.5 Incorporation of switching devices and components

Verification objective

Verification whether switching devices and components are installed in accordance with manufacturer specifications and are wired and accessible accordingly.

- Verification is based on an assessment of constructional requirements (IEC 61439-1 Chapter 8).
- The manufacturer specifications must be followed at the time of installation!

Example of specifications for electromagnetic compatibility

- Verification by inspection of the environment defined (A or B) with the incorporated switching devices and components that are relevant from the EMC perspective

or

- If necessary, confirmation by EMC testing.

You can find further information in the Siemens guide "Control panels – The EMC Directive 2014/30/EU in Practice" (<https://www.siemens.com/emc-guideline>).

6.9.3.6 Internal electrical circuits and connections

Verification objective

Verification by inspection of the internal electrical circuits and connections based on the constructional requirements

Constructional requirements for electrical circuits and connections inside assemblies

Particular consideration should be given to the following constructional features and parts in assemblies:

- Main circuit
- Auxiliary circuit
- Bare and insulated conductors
- Selection and installation of non-protected, live conductors to reduce the possibility of short-circuits
- Identification of the conductors of main and auxiliary circuits
- Identification of the protective conductor (PE, PEN) and neutral conductor (N) of the main circuits

6.9.3.7 Terminals for external conductors

Verification objective

Verification by inspection of the terminals for external conductors.

- Indication as to whether terminals are for connection of copper and/or aluminum conductors
- Unless otherwise agreed, copper cross-sectional areas (min. and max. terminals) shall be designed in accordance with Annex A (does not apply to circuits $I_{cn} \leq 1$ A and $U_{dc} \leq 120$ V or $U_{ac} \leq 50$ V).
- If aluminum terminals are used, agreement needs to be reached on the type, size, and terminal technology.
- Neutral conductor shall be at least 50 % of the line conductor cross-sectional area, but no less than 16 mm².
- Terminal cross-sectional area for external copper PE conductors in accordance with IEC 61439-1, Table 5
- Marking of terminals for external PE conductors with the following symbol:



Figure 6-77 Symbol IEC 60417-5019

The symbol can be omitted where the bicolor combination GREEN-AND-YELLOW is used to identify the PE conductor.

6.9.4 Detailed description of design verifications relating to performance

6.9.4.1 Dielectric properties

General

- Each circuit shall be designed to withstand the following overvoltages:
 - Temporary overvoltages
 - tested based on power-frequency withstand voltage
 - Transient overvoltages
 - tested based on impulse withstand voltage
- All electrical switching devices and components shall be connected.
Exception:
 - Devices designed for a lower test voltage.
 - Devices that induce a current flow (windings, measuring instruments, surge protection devices, etc.)

Power-frequency overvoltages

Verification objective

Verification that there are no insulation faults that would lead to a disruptive discharge in the event of power-frequency overvoltages.

Power-frequency withstand voltage (verification shall be based on testing!)

- Main, auxiliary and control circuits that are connected to the main circuit
 - Test according to IEC 61439-1, Table 8
- AC / DC control circuits that are not connected to the main circuit
 - Test according to IEC 61439-1, Table 9
- Test voltage applied at maximum 50 % of the final test value; increased progressively and maintained for at least 5 seconds up to a maximum of 7 seconds

Transient overvoltages of short duration

Verification objective

Verification that there are no insulation faults that would lead to a disruptive discharge in the event of transient (brief) overvoltages.

Impulse withstand voltage (verification based on testing or assessment!)

Verification by testing:

Impulse voltage generator with test voltage as per IEC 61439-1, Table 10

- 1.2/50 μ s impulse voltage
- Five times for each polarity at intervals of at least 1 second

1st alternative: Power-frequency voltage testing:

- Sinusoidal test voltage, output current ≥ 200 mA
- Value of test voltage as per IEC 61439-1, Table 10
- Applied once for at least 15 ms

2nd alternative: Testing with direct voltage:

- Test DC voltage, output current ≥ 200 mA
- Value of test voltage as per IEC 61439-1, Table 10
- Applied once for each polarity; $15 \text{ ms} \geq t \leq 100 \text{ ms}$

Verification by assessment:

- Clearances shall be at least **1.5 times the value in Table 1 of IEC 61439-1**.
- As an alternative to measuring clearances, the dimensions in the design drawing can be verified instead
- Switching devices and components shall be appropriate for the rated impulse withstand voltage U_{imp} .

Result:

- There shall be no disruptive discharge (insulation fault)
- The measuring instrument's overcurrent relay shall not trip.

6.9.4.2 Verification of temperature rise

Verification objective

Verification that the specified temperature rise limits for different parts of an ASSEMBLY are not exceeded. The temperature rise limits are stated in Table 6 of IEC 61439-1.

Verification methods

Three different verification methods can be used:

Table 6- 26 Temperature rise verification methods

Method	Up to 630 A	Up to 1600 A	Over 1600 A
Assessment	X	X ¹	X
Verification by comparison with a tested reference design	X	X	
Testing	X	X	X

¹ Restrictions on use of available methods

Note

- Depending on the nominal current of the ASSEMBLY, there are restrictions on which of the available verification methods can be used.
 - Testing is the only permissible method for verification of temperature rise on ASSEMBLIES with a rated frequency of higher than 60 Hz.
-

More information

Note

Tip

The verification by assessment method (calculation) is normally applied to control panels up to 1600 A.

With its free software SIMARIS therm (<http://www.siemens.com/simaristherm>), Siemens offers a convenient, standards-compliant software application which allows manufacturers to perform verification of temperature rise limit according to IEC 60890 in four easy steps.

Furthermore, the software contains the power loss data of more than 28,000 devices and also offers a tool for generating documentation that conforms to standards.

6.9.4.3 Verification of short-circuit withstand strength

General information

Control panels have to be designed and constructed in such a way that they are capable of withstanding thermal and dynamic stresses potentially caused by short-circuit currents up to the specified limit values under acceptable conditions.

Note

IEC 60204-1

Chapter 7.10 of the current IEC 60204-1 Edition 6.0 also stipulates that the rated short-circuit current rating of the electrical equipment shall be determined. This can be done by tests, the application of design rules, or by calculation.

The procedure can be based on the standard IEC 61439-1, IEC 60909-0, IEC/TR 60909-1 or IEC/TR 61912-1.

Suitable protection against short-circuit currents with overcurrent protective devices shall therefore be provided. The overcurrent protective devices are installed upstream of the control panels and can be located inside or outside them. Details of some overcurrent protective devices can be found in the Chapter Devices in the control panel and the machine environment (Page 233).

Verification

According to IEC 61439-1, the following methods can be used to verify the short-circuit withstand strength:

- Verification by testing (Page 217)
- Verification by comparison with a tested reference design (Page 218)

Verification by testing

Basis for the circuits to be verified

Regardless of how the verification of short-circuit withstand strength is performed, the basis for the circuits to be verified shall be by testing.

Testing can either be performed on the complete ASSEMBLY or on parts thereof.

When a test is performed for the circuits to be verified, care shall be taken to ensure that the most onerous variant of the ASSEMBLY is chosen. That is to say, where the highest stresses are generated or to be expected.

Note

This reference manual focuses on control panels for machinery and plants. In many cases, the number of identical control panels is limited. In fact, the control panel in question is often an individual, specific design for a particular type of machine or plant.

The amount of time and money invested in a short-circuit test is often unacceptable from an economic point of view .

We shall therefore not go into detail here regarding verification of short-circuit withstand strength.

Verification by comparison with a tested reference design

In addition to verification by testing, there is also the comparison with a tested reference design. This method of verification is particularly suitable when there are circuits in ASSEMBLIES that are similar in terms of design and dimensioning.

Comparison using a check list

A comparison based on questions can be conducted using a check list from the IEC 61439-1 standard. If all ten questions can be answered with "yes", no further verification is required.

Table 13 – Short-circuit verification by comparison with a reference design: check list (10.5.3.3, 10.11.3 and 10.11.4)

Item No.	Requirements to be considered	YES	NO
1	Is the short-circuit withstand rating of each circuit of the ASSEMBLY to be assessed, less than or equal to, that of the reference design?		
2	Is the cross-sectional dimensions of the busbars and connections of each circuit of the ASSEMBLY to be assessed, greater than or equal to, those of the reference design?		
3	Is the center line spacing of the busbars and connections of each circuit of the ASSEMBLY to be assessed, greater than or equal to, those of the reference design?		
4	Are the busbar supports of each circuit of the ASSEMBLY to be assessed of the same type, shape and material and have, the same or smaller center line spacing, along the length of the busbar as the reference design? And is the mounting structure for the busbar supports of the same design and mechanical strength?		
5	Are the material and the material properties of the conductors of each circuit of the ASSEMBLY to be assessed the same as those of the reference design?		
6	Are the short-circuit protective devices of each circuit of the ASSEMBLY to be assessed equivalent, that is of the same make and series ^a with the same or better limitation characteristics (I^2t , I_{pk}) based on the device manufacturer's data, and with the same arrangement as the reference design?		
7	Is the length of unprotected live conductors, in accordance with 8.6.4, of each non-protected circuit of the ASSEMBLY to be assessed less than or equal to those of the reference design?		
8	If the ASSEMBLY to be assessed includes an enclosure, did the reference design include an enclosure when verified by test?		
9	Is the enclosure of the ASSEMBLY to be assessed of the same design, type and have at least the same dimensions to that of the reference design?		
10	Are the compartments of each circuit of the ASSEMBLY to be assessed of the same mechanical design and at least the same dimensions as those of the reference design?		
<p>'YES' to all requirements – no further verification required.</p> <p>'NO' to any one requirement – further verification is required.</p>			
<p>^a Short-circuit protective devices of the same manufacturer but of a different series may be considered equivalent where the device manufacturer declares the performance characteristics to be the same or better in all relevant respects to the series used for verification, e.g. breaking capacity and limitation characteristics (I^2t, I_{pk}), and critical distances.</p>			

Figure 6-78 Source: IEC 61439-1, Table 13: Short-circuit verification by comparison with a reference design: check list

Reference designs

Note

Tested reference designs from Siemens

SIEMENS offers extensive, tested reference designs which can be used for the purpose of verification by means of comparison – regardless of the arrangement of the circuits of the actual ASSEMBLY.

The reference designs can be found in Siemens Industry Online Support (SIOS) (<http://www.siemens.com/sios>). They can be found using the search term "short-circuit withstand values as a function of minimum enclosure size according to IEC 61439-1".

Example

You will find the example of tested reference designs in SIOS. (<http://www.siemens.com/sios/84473032>)

Tabelle/ Table 2 Kurzschlusswerte in Abhängigkeit von der Mindestgehäusegröße Short circuit withstand values as a function of minimum enclosure size						
Frame Size	Circuit breaker Leistungsschalter		Short circuit withstand strength Kurzschlussfestigkeit		Minimum enclosure size Mindestgehäusegröße	Minimum volume
	Catalog No.	In max.	Ue	Short circuit current	H x B x T H x W x D	
S00	3RV1.11	12A	400V	50 kA	290mm X 290mm X 150 mm	12,6 dm ³
S0	3RV1.21	25A	400V	50 kA	290mm X 290mm X 150 mm	12,6 dm ³
S2	3RV1.31	50A	400V	50 kA	292mm X 152mm X 292 mm	12,6 dm ³
S3	3RV1.4	100A	400V	65 kA	500mm X 230mm X 250 mm	28,8 dm ³
S3	3RV1742	70A	400V	65 kA	500mm X 230mm X 250 mm	28,8 dm ³
S00	3RV2.11	16A	400V	55 kA	290mm X 290mm X 150 mm	12,6 dm ³
	3RV2711	15A	400V	55 kA	300mm X 320mm X 160 mm	15,4 dm ³
	3RV2811	15A	400V	55 kA	300mm X 320mm X 160 mm	15,4 dm ³
S0	3RV2.21	25A	400V	55 kA	290mm X 290mm X 150 mm	12,6 dm ³
	3RV2.21	32A	400V	50 kA	290mm X 290mm X 150 mm	12,6 dm ³
	3RV2.21	40A	400V	12 kA	290mm X 290mm X 150 mm	12,6 dm ³
	3RV2721	22A	400V	50 kA	300mm X 320mm X 160 mm	15,4 dm ³
	3RV2821	22A	400V	50 kA	300mm X 320mm X 160 mm	15,4 dm ³
S2	3RV2031	80A	400V	65 kA	605mm X 310mm X 205 mm	38,4 dm ³
	3RV2032		400V	100 kA		
S3	3RV2.41	100A	400V	65 kA	500mm X 230mm X 250 mm	28,8 dm ³
	3RV2.42		400V	100 kA		
	3RV2742	70A	400V	65 kA	500mm X 230mm X 250 mm	28,8 dm ³

Figure 6-79 Example: Tested reference designs from SIOS

Comparison with a tested reference design by means of calculation

Short-circuit withstand strength of busbar arrangements

Annex P of IEC 61439-1 describes a method for assessing the short-circuit withstand strength of busbar arrangements by means of calculation in the context of a comparison. In addition, the circuits of the ASSEMBLY shall satisfy the requirements of points 6, 8, 9 and 10 from the check list (Page 218) in Table 13 of IEC 61439-1.

Note

Testing by the manufacturer

In most cases, busbar arrangements in machinery and plant control panels have already been tested by the manufacturer of the busbar system. This reference manual therefore goes into no further detail regarding Annex P or the calculation method.

See also

Verification by comparison with a tested reference design (Page 218)

Exceptions to verification of short-circuit withstand strength

Alternative for individual control panels

In some cases, verifying the short-circuit withstand strength of circuits for ASSEMBLIES is time-consuming, and, under precisely defined circumstances, it may be possible to forego the procedure. This alternative may be an economic yet safe method of ensuring sufficient short-circuit withstand strength for individual control panels or small series of identical control panels.

The three exceptions are listed below:

- I_{cw} or $I_{cc} \leq 10$ kA
- Let-through current $I_c \leq 17$ kA
- Exceptions for auxiliary circuits

I_{cw} or $I_{cc} \leq 10$ kA

ASSEMBLIES having a rated short-time withstand current I_{cw} or a rated conditional short-circuit current I_{cc} with a root mean square value not exceeding 10 kA.

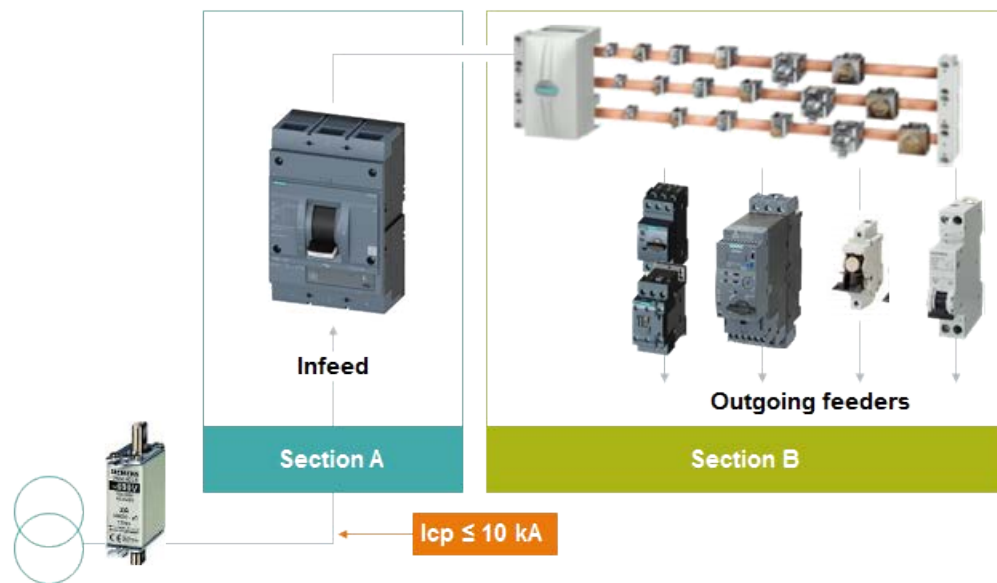

Figure 6-80 I_{cw} or $I_{cc} \leq 10$ kA

Cut-off current (let-through current) $I_c \leq 17$ kA

ASSEMBLIES, or circuits of ASSEMBLIES, protected by current-limiting devices having a cut-off current not exceeding 17 kA with the maximum allowable prospective short-circuit current at the terminals of the incoming circuit of the ASSEMBLY.

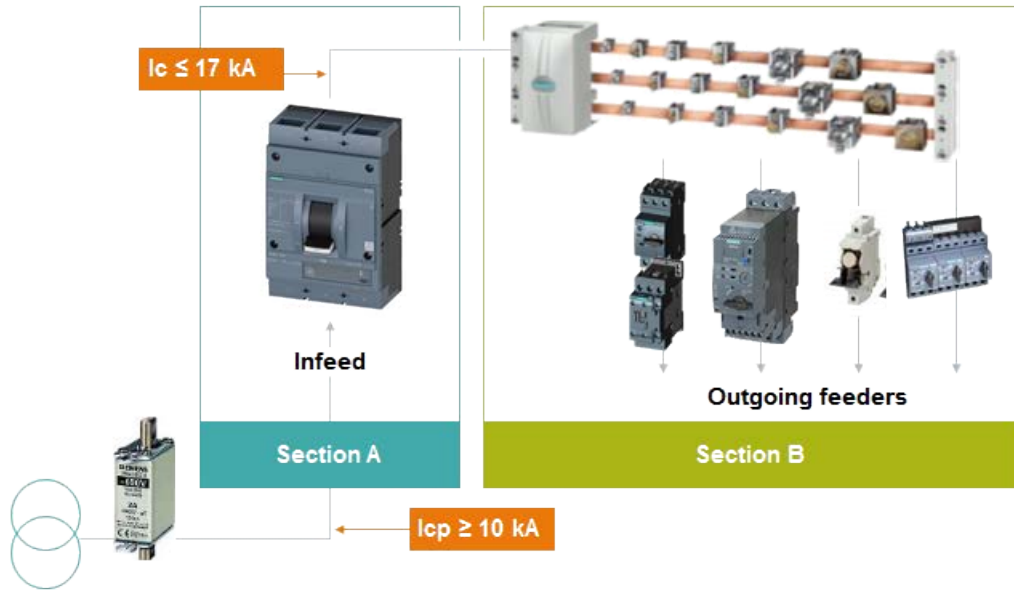

Figure 6-81 Cut-off current (let-through current) $I_c \leq 17$ kA

Overcurrent protective devices have a cut-off current $I_c \leq 17$ kA at each prospective short-circuit current $I_{CP} \geq 10$ kA.

Note

The standards do not specify an official symbol for let-through current. This guide uses the symbol I_c as used in SIMARIS curves.

Example of 3RV2 motor starter protector

Data:

3RV2021-4CA20 motor starter protector

Prospective short-circuit current $I_p = 50 \text{ kA}$

Result in accordance with SIMARIS curves: Let-through current of the motor starter protector: $I_c = 5.9 \text{ kA}$

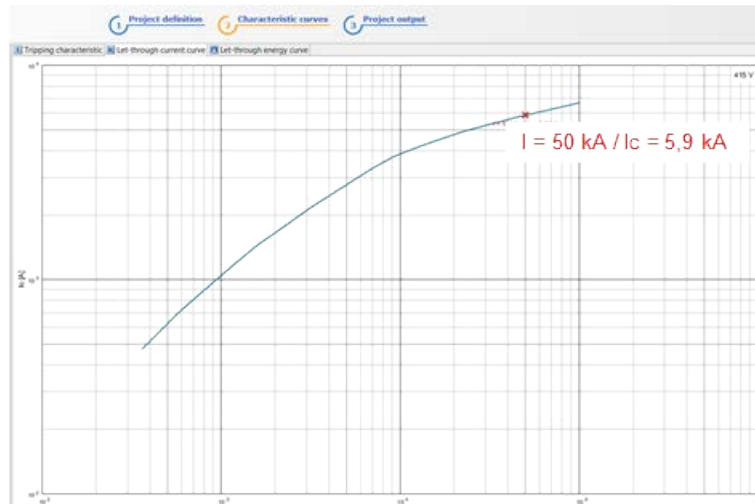

Figure 6-82 Let-through current characteristic for 3RV2 motor starter protector (excerpt from SIMARIS curves)

Note

Siemens' SIMARIS curves (<http://www.siemens.com/SIMARIS>) software is available free of charge and contains a large number of overcurrent protective devices with all important characteristics. The software can be used to determine and very simply document the let-through value for a particular short-circuit current.

Exceptions for auxiliary circuits

The following applies to auxiliary circuits:

- $U_N \geq 110 \text{ V}$, $P_N \leq 10 \text{ kVA}$ and $u_k \geq 4 \%$
- $U_N < 110 \text{ V}$, $P_N \leq 1.6 \text{ kVA}$ and $u_k \geq 4 \%$

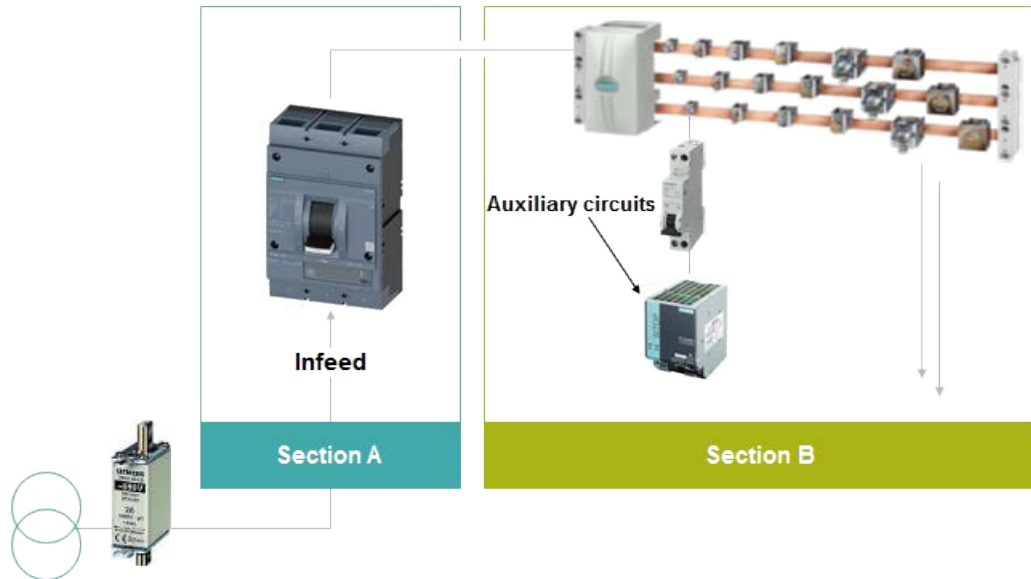

Figure 6-83 Exceptions for auxiliary circuits

6.9.4.4 Electromagnetic compatibility

You can find detailed information about conducting the design verification in the Siemens guide "Control panels – The EMC Directive 2014/30/EU in Practice"

(<https://www.siemens.com/emc-guideline>).

6.9.4.5 Mechanical operation

Verification objective

Verification of the proper functioning of devices which operate mechanically

Verification is based on actuation of the device. The required number of operating cycles is 200.

Result:

The effort required for operation after 200 operating cycles shall not be significantly higher than **before** the test and the operating conditions or the degree of protection shall not have been impaired.

Note

If the ASSEMBLY contains components that have already been tested according to the standards and regulations that specifically apply to them, it is not necessary to verify their mechanical operation again.

Exception

This does not apply if the originally intended mechanical operation of these components has been modified by their mounting.

6.9.5 Overview of routine verifications

The original manufacturer uses the routine verification to verify whether the ASSEMBLY design conforms to the standard.

Note

While a single **design verification** is valid for all ASSEMBLIES of the same design, the **routine verification** shall be performed on each individual ASSEMBLY.

The following table provides an overview of the routine verifications. A distinction is made between **constructional requirement (construction)** and **performance**

Table 6- 27 Overview of routine verifications

1	Constructional requirement	2	Performance
1.1	Degree of protection of enclosures (Page 227)	2.1	Dielectric properties (Page 230)
1.2	Clearances and creepage distances (Page 227)	2.2	Wiring, operational performance and function (Page 231)
1.3	Protection against electric shock and integrity of protective circuits (Page 228)		
1.4	Incorporation of switching devices and components (Page 228)		
1.5	Internal electrical circuits (Page 229)		
1.6	Terminals for external conductors (Page 229)		
1.7	Mechanical operation (Page 225)		

6.9.6 Detailed description of routine verifications relating to the constructional requirement

6.9.6.1 Degree of protection of enclosures

Visual inspection

Verification is based on a visual inspection.

- Verification of protection against mechanical influences (if required) as per test documentation
- Verification that the prescribed IP degree of protection for the enclosure or enclosure parts has been achieved

The degree of protection (Page 52) comprises two characteristic numerals:

1st characteristic numeral: Protection against touching live parts and ingress of solid foreign bodies

2nd characteristic numeral: Protection against the ingress of water

- Verification by visual inspection of the ASSEMBLY and the documentation

As far as removable parts and the associated loss of prescribed protection are concerned, the measures, marking, or agreements need to be checked in the documentation.

6.9.6.2 Clearances and creepage distances

Clearances

Visual inspection of clearances

- If clearances are visibly less than the values given in Table 1 of IEC 61439, an impulse voltage withstand test shall be performed.

See design verification Dielectric properties (Page 213).

Creepage distances

Visual inspection of creepage distances

- If the creepage distance cannot be accurately determined by visual inspection, verification shall be provided via physical measurements.

6.9.6.3 Protection against electric shock and integrity of protective circuits

Visual inspection

Visual inspection of required measures with respect to:

- Basic protection (protection against direct contact)
- Fault protection (protection against indirect contact)

Verification is based on

- Visual inspection of the protective circuits; the specifications for protective circuits shall be met.
- Screwed and bolted connections shall be checked on a random basis, e.g. correct tightness shall be verified.

6.9.6.4 Incorporation of switching devices and components

Visual inspection

Visual inspection to establish whether switching devices and components have been installed and marked as described in the manufacturer's documentation:

- Inserts and removable parts (e.g. removal only when de-energized)
- Selection of switching devices and components in accordance with the relevant IEC standards
- Installation in accordance with manufacturer specifications
- Accessibility as specified in standards or agreements
- Covers (excluding operator hazards)
- Direction of actuation and displays of switch positions (marking)
- Indicator lights and pushbuttons (colors)

6.9.6.5 Internal electrical circuits

Verification

- Random verification of connections to see whether these are tight enough.
- Special attention should be paid to screwed and bolted connections.
- Verification that conductors match the description in the manufacturer's documentation.

To be precise, this applies to:

- Main circuits (busbars, cross-sectional area of N and PEN conductors)
- Auxiliary circuits
- Bare and insulated conductors
- Selection and installation of non-protected, live conductors in terms of the probability of short circuits (**max. 3 m** conductor length before the next form of short-circuit protection)
- Marking of conductors in main and auxiliary circuits
- Marking of PE, PEN, and N connectors in main circuits

6.9.6.6 Terminals for external conductors

Verification

Verification of the quantity, type and marking of terminals based on the manufacturer's documentation for the ASSEMBLY.

Examples of verifications

- Number of conductors that can be connected to one terminal
- Type: Aluminum conductor and/or copper conductor
- Marking with symbol and/or bicolor combination GREEN-AND-YELLOW within the ASSEMBLY



Figure 6-84 Symbol IEC 60417-5019

6.9.6.7 Mechanical operation

Correct mechanical operation is verified by a visual inspection. The objective of this test is ensure that the prescribed measures for attaining the required degrees of protection are implemented.

Examples

Examples of possible visual inspections include the following:

- Are openings closed correctly, or is the equipment provided (e.g. ventilation openings, grilles, etc.) correctly installed?
- Are the doors for the ASSEMBLY functioning properly and correctly installed, e.g. doors hinged on left or right, locking system (key or tool)?
- Are the mechanical actuating elements functioning properly? This can apply, for example, to interlocks, actuating elements or locks.

6.9.7 Detailed description of routine verifications relating to performance

6.9.7.1 Dielectric properties

General

Testing of power-frequency insulation strength shall be performed for all circuits.

Test duration 1 second (not minimum 5 seconds to maximum of 7 seconds as for the design verification).

See design verification Dielectric properties (Page 213).

Exceptions

The test need not be carried out:

- On auxiliary circuits that are protected by a device rated for maximum 16 A.
- On auxiliary circuits that have already undergone a function test at the rated voltage.
- Alternative to testing for assemblies with a protective device up to maximum 250 A at the infeed:

Measurement of insulation resistance with at least 500 V DC

The insulation resistance shall measure $\geq 1000 \Omega/V$ between the circuits and the exposed conductive parts.

6.9.7.2 Wiring, operational performance and function

Marking and documentation

Verification that the markings and documentation of the ASSEMBLY are complete.

With complex assemblies, it is recommended that the wiring be inspected and that an electrical function test is carried out.

The test procedure and the number of tests depend on whether the ASSEMBLY has, for example, complicated interlocks, sequence control facilities, etc.

→ Decision of the manufacturer or an agreement between the manufacturer and the user

6.9.8 Documentation of verifications

In accordance with IEC 61439-1, a verification report shall be drawn up for recording verification data.

The wording of the following requirement in Chapter 10.1 of the standard is cited below:

"The reference designs, the number of assemblies or parts thereof used for verification, the selection of the verification method when applicable, and the order in which the verification is carried out shall be at the discretion of the original manufacturer.

The data used, calculations made, and comparison undertaken for the verification of assemblies shall be recorded in verification reports."

Devices in the control panel and the machine environment

7

General requirements

Machines and their control panels are deployed in many different industrial sectors under extremely diverse ambient conditions. Whether it is the mining or automotive industry, semiconductor manufacture, shipbuilding or the railway sector, each application places specific demands on machines and control panels. Machine and control panel manufacturers face many challenges in designing products that can meet these demands.

One major consideration is selection of the right components to install in the machine or control panel. In addition to suitability for the application in question, there are of course many other factors that play a decisive role in the selection of products. While a machine needs to meet the relevant requirements, it shall also be reasonably priced.

The total costs of a machine do not just comprise the material costs of the individual components. A significant proportion of the costs is also allocated to engineering (Page 309), design and documentation, as well as assembly and wiring. This means that the manufacturer not only needs a product portfolio of technically coordinated products, but also requires fast and easy access to all of the necessary technical data, documents and information.

Siemens product and system portfolio

In addition to a portfolio of fully coordinated products and systems that can meet all of the conventional requirements of today's industrial sectors, Siemens is also offering the corresponding data and tools. These help control panel and machine manufacturers to work faster, more flexibly and more efficiently, and allow them to optimize the overall quality of their products.

Some of Siemens products are discussed in more detail in the following chapters.

You can find precise product information on the Internet:

Information about control panel building	Link (http://www.siemens.com/panelbuilding)
Product information / Article numbers	Catalog IC10 (http://www.siemens.com/ic10) Industry Mall (http://www.siemens.com/industrymall)
Technical data	Siemens Industry Online Support SIOS (http://www.siemens.com/sios)

7.1 Main circuit - motor starter protectors/circuit breakers

Motor starter protectors and circuit breakers are used in general to protect motors or transformers against short circuits and overloading. Since fuseless technology is becoming ever more popular, circuit breakers and motor starter protectors are now widely used in all sectors. The advantage of motor starter protectors and circuit breakers is that they only need to be reset after a fault, but do not have to be replaced (like fuses).

Siemens offers the following variants of motor starter protector/circuit breaker:

- Motor starter protectors for motor protection
- Motor starter protectors for motor protection with overload relay function
- Motor starter protectors for starter combinations
- Motor starter protectors/circuit breakers for transformer protection
- Circuit breakers for the North American market
- Circuit breakers for line protection, see Chapter Molded case circuit breakers (Page 239)
- Motor starter protectors/circuit breakers as switch disconnectors

Motor starter protectors for motor protection (3RV20)

The Siemens range of motor starter protectors for motor protection are approved as motor starters according to IEC 60204-4-1 (standard for contactors and motor-starters – electromechanical contactors and motor-starters) and as circuit breakers according to IEC 60204-2 (standard for circuit breakers). They have a short-circuit and overload protection function.



Figure 7-1 Motor starter protectors for motor protection, sizes S00/S0

Motor starter protectors for motor protection with overload relay function (3RV21)

Overloads can sometimes occur during operation. For example, temporary sluggish movement of a conveyor belt due to a material blockage, resulting in overloading of the drive motor. In such cases, the overload relay function offers the advantage that the bimetallic switch in the side-mounted contact block trips and disconnects the power supply to the motor before the latching mechanism in the motor starter protector trips. This means that the motor starter protector remains in the "ON position" and the system can be restarted as soon as the bimetallic switch has cooled down. The fault does not need to be acknowledged locally.



Figure 7-2 Motor starter protectors for motor protection with overload relay function, sizes S00/S0 and S2

Motor starter protectors for starter combinations (3RV23)

Motor starter protectors for starter combinations do not have an integral overload release, but only a short-circuit release. In other words, the overload protection for the motor shall be implemented in some other way. For example, by the use of a frequency converter or a soft starter with integral overload protection, by an overload protection mechanism integrated in the motor, or by the use of an additional overload relay. All of these options offer the same advantages as motor starter protectors with an overload relay function. By combining them with an electronic overload relay, it is also possible to extend the current setting range (1:4) to beyond the range that is available, for example, when a thermal overload relay is used.

Motor starter protectors for starter protection look almost exactly the same as motor starter protectors for motor protection. The only difference is that they do not have the screw for adjusting the overload protection tripping current.

Motor starter protectors for transformer protection (3RV24)

Motor starter protectors for transformer protection are almost exactly the same as motor starter protectors for motor protection. The only difference is that the short-circuit release does not trip at 13× rated current (as with a motor starter protector for motor protection), but at around 20× rated current. The inrush current of transformers is often higher than the starting current of motors and would possibly cause a motor starter protector for motor protection to trip. These motor starter protectors look exactly the same as motor starter protectors for motor protection.

Circuit breakers for the North American market (3RV27/28)

Circuit breakers with the article number 3RV27/28 are approved as Circuit Breakers according to UL 489 for system protection and are usually only installed in control panels sold on the North American market. The 3RV27 trips at 13× rated current and is deployed as a general circuit breaker for system protection. The 3RV28 is a more suitable circuit breaker for protecting transformers because its tripping current corresponds to 20× rated current.

Since these circuit breakers are also circulated on the European market when they are sold to European customers who export their control panels to North America, they also need a CE marking in addition to their approval for the North American market. This means that they need to be approved according to a harmonized European standard. For this reason, these circuit breakers are also approved in accordance with IEC 60947-2. Some control panel manufacturers want all their panels to have a uniform design and therefore want only one product version for both the IEC and North American markets.

While other circuit breakers with the article numbers 3RV20/21/23/24 also have a UL/CSA approval, they are only approved in North America as "Manual Self-Protected Combination Motor Controllers according to UL 508 Type E" for motor protection and as "Manual Motor Controllers according to UL 508" as motor controllers.

You can find information about exporting to North America in our reference manual "Industrial Control Panels and Electrical Equipment of Industrial Machinery for North America" on the Internet (<https://www.siemens.com/UL508A>).



Figure 7-3 Circuit breakers according to UL 489, sizes S00/S0 and S3

Highlights

- **Siemens supplies four sizes to cover the motor current spectrum up to 100 A:**
 - Size S00 up to 16 A, width 45 mm
 - Size S0 up to 40 A, width 45 mm
 - Size S2 up to 80 A, width 55 mm
 - Size S3 up to 100 A, width 70 mm
- **Cost advantage**

It is often necessary to install expensive molded case circuit breakers to provide short-circuit protection for rated currents in excess of 65 A. Since the 3RV2 range of motor starter protectors/circuit breakers from Siemens cover current ratings up to 100 A, they can save money for the control panel manufacturer.

- **High short-circuit breaking capacity**

The motor starter protectors/circuit breakers are available with a range of different short-circuit breaking capacities. All of them have a short-circuit breaking capacity of 100 kA up to 100 A.

- **Spring-type terminals**

Sizes S00/S0 are also available with spring-type terminals and therefore offer significant advantages. These include, for example, time and cost savings thanks to fast assembly and commissioning, short setup times, easy wiring, as well as vibration and shock resistance even in harsh operating conditions.

- **Quick and easy installation with the 3RV2917 infeed system**

It is quick and easy to assemble motor starter protectors or motor starter protectors/contactors assemblies in conjunction with the 3RV2917 infeed system. A single connection for the infeed system supply cables and the simple operation of plugging the motor starter protectors into the infeed system make it particularly efficient in terms of time and cost. The infeed system can be used for sizes S00 and S0 and is available with screw terminals and spring-type terminals.



Figure 7-4 Motor feeders with 3RV2917 infeed system

Selection example

Lower power loss thanks to overload releases with overlapping setting ranges

Siemens offers motor starter protectors that have overload releases with overlapping setting ranges. For a motor with a nominal current of 15 A, it is possible to select between:

- Motor starter protector A, 10 to 16 A setting scale
- Motor starter protector B, 14 to 20 A setting scale

Motor starter protector B is recommended since its power loss is lower and it has a higher distance to the response limits.

The power loss of motor starter protector B is approximately 35 % lower than that of motor starter protector A.

With fully equipped control panels, this fact can influence the decision as to whether or not cooling equipment is required to manage heat radiation in the panel.

Response limits

The response limits of the short-circuit release always refer to the maximum setting value:

- In the case of motor starter protector A, the response value of the short-circuit release is 208 A (13×16 A).
With a setting value of 15 A, the distance to the response limit of the short-circuit release is 13.86 times the setting current ($208 \text{ A} : 15 \text{ A} = 13.86$).
- In the case of motor starter protector B, the response value of the short-circuit release is 260 A (13×20 A).
With a setting value of 15 A, the distance to the response limit of the short-circuit release is 17.33 times the setting current ($260 \text{ A} : 15 \text{ A} = 17.33$).

In the present example, the distance to the response limit of 13.86 times the setting current for motor starter protector A thus increases to 17.33 times the setting current for motor starter protector B.

More information

Motor starter protectors/circuit breakers from Siemens

Link (<http://www.siemens.com/sirius>)

See also

Motor starter protectors (Page 305)

7.2 Main circuit - molded case circuit breakers

3VA molded case circuit breakers

Molded case circuit breakers are used in power distribution systems and machine control panels for line, personnel and motor protection and for disconnecting loads. Molded case circuit breakers are very frequently used as supply disconnecting devices for machinery. Molded Case Circuit Breakers (MCCB) are also known as compact current limiting circuit breakers. They are described in product standard IEC 60947-2.

Selection criteria

A user shall at least know the following criteria in order to select the correct molded case circuit breaker:

1. For what purpose will the molded case circuit breaker be used: line (system) protection, motor protection, starter protection, as switch disconnecter?
2. Number of poles: 1 / 2 / 3 / 4 poles?
3. Desired mounting type: Fixed-mounting / plug-in technology / draw-out technology?
4. Nominal current for Siemens MCCBs: I_n (16 A to 1600 A)?
5. Breaking capacity I_{cu} ?
6. Required tripping method: Thermal-magnetic (TMTU = thermal magnetic trip unit) or electronic (ETU = electronic trip unit)? This criterion depends on requirements regarding selectivity and on the required setting options for protection parameters.
7. Communication: Will it be necessary to transmit data? If so, which data? What are the data for? Which bus system will be used? etc.

Molded case circuit breakers as line protection

The 3VA molded case circuit breaker is part of an extensive portfolio of line and generator protection products. All of the following benefits are combined in the MCCB, type 3VA:

- Thermal-magnetic trip unit (TMTU) in 2 sizes up to 250 A
- Smallest molded case circuit breaker (MCCB) on the market up to 160 A (at 70 kA, $I_{cu}=I_{cs}$)
- Electronic trip unit (ETU) in 3 sizes up to 1000 A
- Wide power range
- Small footprint
- Uniform accessories platform across all 3VA molded case circuit breakers
- Metering function integrated in the ETU 8-series
- Optional communication interface via PROFIBUS, PROFINET, Modbus TCP, Modbus RTU with the ETU 5-series and 8-series

Molded case circuit breakers as starter and motor protection

The 3VA molded case circuit breaker is also designed to protect starters and motors.

Advantages:

- Starter protection by thermal-magnetic trip unit (TMTU) and electronic trip unit (ETU), motor protection by electronic trip unit (ETU) alone
- Available combination tests: Motor protection, starter protection with overload relay and Simocode, soft starter, contactor assemblies for star-delta (wye-delta) start
- Integrated metering function with ETU860M
- Communication interface via PROFIBUS, PROFINET, Modbus TCP, Modbus RTU
- IE3 ready
- Wide power range
- Small footprint
- High flexibility thanks to large number of tripping methods

The ETU860M for motor protection offers the following additional functions:

- Protection against phase unbalance
- Stall protection
- No-load protection
- Integrated metering function
- Optional communication interface



Figure 7-5 3VA1 and 3VA2 molded case circuit breakers

Accessories

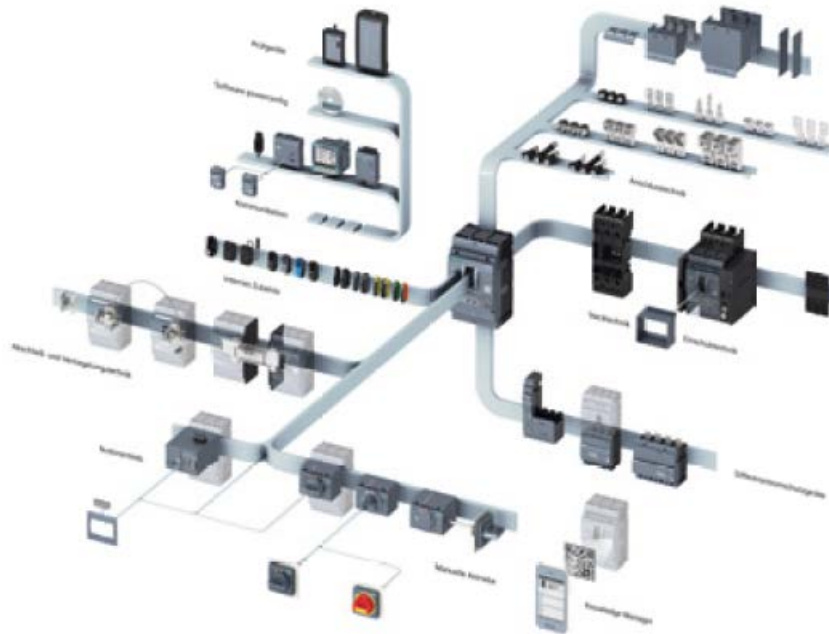

Figure 7-6 Extensive scope of functions thanks to large portfolio of accessories

More information

Molded case circuit breakers from Siemens

- Link (<http://www.siemens.com/SENTRON>)
- Catalog LV10 (<http://www.siemens.com/lv10>)

7.3 Main circuit - contactors

Contactors are used to connect and disconnect specific loads such as electric motors, heaters and power distribution transformers. Contactors are frequently used for these and other applications. They are still the device most commonly used to switch electric loads. For any application that does not require infinitely variable control of the motor speed, contactors are still the cheapest option. Contactors are commonly deployed in conjunction with frequency converters. They may be needed, for example, to galvanically isolate the motor from the power supply.

Contactors are used in virtually every industrial sector. In the power supply industry, for example, they are deployed in coal-fired and nuclear power plants, in the solar energy industry and in wind power stations. But contactors can also be found in the automotive industry, in trains, on ships, in sewage treatment plants, in the steel industry and in general machinery construction.

As a result of their diverse fields of application, contactors shall be capable of withstanding every conceivable kind of environment. From extremely hot conditions such as the desert, for example, to very cold climates in countries such as Siberia. Contactors are also suitable for use in the railway sector where controlled switching is essential even under high vibration and shock loads.

Siemens offers the following contactors:

- Contactors for switching motors
- Contactors for special applications (for resistive loads)
- Contactors for capacitive loads (capacitor contactors)
- Contactor relays

Contactors for switching motors (3RT20)

Switching electric motors on and off is the most common application for contactors. Motor contactors are designed to switch inductive loads such as induction motors.



Figure 7-7 Contactors for switching motors, sizes S00, S0, S2 and S3

Contactor for special applications (for resistive loads) (3RT23)

Components that convert electricity into heat are always switched on and off by contactors for resistive loads. Examples are: Electric heaters, heating tunnels used for drying paint in the automotive industry, heating systems in trains.



Figure 7-8 Contactors for resistive loads

Contactor for capacitive loads (capacitor contactors) (3RT26)

Capacitor contactors are often installed in transformer stations. Transformers or capacitors draw high currents during the precharging phase before they reach their normal operating state. The precharging resistors in the capacitor contactor limit the high precharging currents to prevent them from causing damage to the normal switching contacts. This means that capacitor contactors used for this kind of application have a significantly longer service life than normal motor contactors.

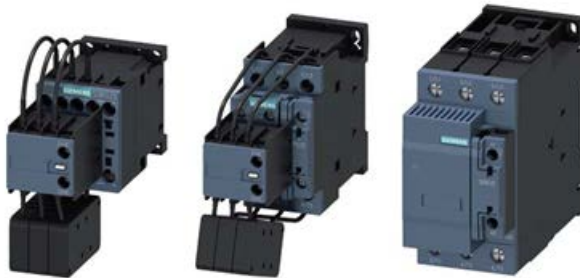

Figure 7-9 Capacitor contactors

Contactor relays (3RH21)

Contactor relays are used to distribute control signals. They are often chosen as a means of increasing the number of contacts in complex installations. This may become necessary, for example, if the line contactor does not have enough contacts. Unlike the line contactor, the contactor relay does not switch the load, but controls a line contactor that switches the load.

Highlights

- **Compact design, including units with high power ratings**

- Size S00 up to 7.5 kW, width 45 mm
- Size S0 up to 18.5 kW, width 45 mm
- Size S2 up to 37 kW, width 55 mm
- Size S3 up to 55 kW, width 70 mm

- **Cost and space savings**

Thanks to the compact design of the products, their footprint inside the control panel is significantly smaller than that of contactor relays supplied by other manufacturers. Furthermore, the SIRIUS system is characterized by its high degree of modularity and variability. Sizes S00/S0 are also available with spring-type terminals and therefore offer significant advantages such as time and cost savings thanks to fast assembly and commissioning, short setup times and easy wiring.

- **High short-circuit ratings**

Siemens contactors have high short-circuit ratings up to 150 kA that have been tested with various protective devices for types of coordination 1 and 2. Siemens has tested around 45,000 different combinations in total so that it can offer a wide range of product combinations.

- **Approval in accordance with the standard for railway applications IEC 60077**

Siemens is the first and to date the only manufacturer that has been granted approval for its contactors in accordance with IEC 60077 "Railway applications; Electric equipment for rolling stock".

- **Energy savings through UC coils**

Since 2009, Siemens has been offering contactors with so-called UC coils. UC stands for "universal current". These contactors are therefore suitable for AC as well as DC control circuits. UC contactors are extremely energy-efficient because they feature integrated electronics that ensure that the contactor reaches its steady state very quickly.

More information

Contactors from Siemens

Link (<http://www.siemens.com/sirius>)

7.4 Main circuit - motor starters

As their name suggests, motor starters are used to start motors. Motor starters also have other functions - to accelerate motors to their normal speed, to shut them down and to protect them against overloading when they are equipped with an appropriate protective circuit.

Siemens offers a range of different motor starters. Motor starters can be implemented by combining protective and switching devices. Examples are: Motor starter protector + contactor (+ overload relay in some cases) + motor starter protector + soft starter (+ overload relay in some cases). Motor starters are also available as complete units.

Motor starters as complete units are described in brief in this chapter in order to help users select the right unit for a given application.

Siemens motor starters

Motor starters for use in the control panel

- SIRIUS 3RM1 motor starters (Page 246)
- SIRIUS 3RA6 compact starters (Page 247)
- ET 200SP motor starters (Page 249)

Motor starters with high degree of protection for use in the field

- ET 200pro motor starters (Page 251)
- SIRIUS M200D motor starters (Page 252)
- SIRIUS MCU motor starters (Page 253)

7.4.1 SIRIUS 3RM1 motor starters

SIRIUS 3RM1 motor starters are compact, 22.5 mm-wide devices that combine a large number of functions in a single enclosure. They consist of combinations of relay contacts, power semiconductors (hybrid technology), and an electronic overload relay for operational switching of three-phase motors up to 3 kW (at 400 V) and resistive loads up to 10 A (at AC voltages to 500 V). The 3RM1 motor starters with overload protection and wide setting range are available as direct-on-line and reversing starters and as versions with safety-related shutdown up to SIL 3/PL e.

Product advantages

- Less space required in the control panel (20 to 80 %) thanks to high functional density, which also means reduced wiring and testing.
- Longer service life and reduced heat losses thanks to hybrid technology
- Lower overheads for stock keeping and configuration as a result of the wide setting range of the electronic overload release (up to 1:5)
- Fast wiring without tools for rigid conductors or conductors equipped with end sleeves thanks to spring-type terminals (Push-In)
- Safety-related shutdown in accordance with SIL 3/PL e by shutting down the control supply voltage without additional devices in the main circuit
- The motor starters can be ideally combined with 3SK safety relays for safety-related shutdown.
- Motor status feedback to the higher-level control system in the case of 3RM10 and 3RM12 motor starters in the 24 V DC version
- Virtually error-free wiring on the mains connection side and reduction in short-circuit protective devices by means of 3RM19 infeed system
- ATEX certification of the overload protection of the 3RM1 Failsafe motor starters: "Increased safety" type of protection EEx e according to ATEX directive 94/9/EC
- The 3RM1 motor starters can be used with highly energy-efficient IE3/IE4 motors.



Figure 7-10 SIRIUS 3RM1 motor starters in the control panel

7.4.2 SIRIUS 3RA6 compact starters

The SIRIUS 3RA6 compact starters are a generation of special load feeders with the integrated functionality of a motor starter protector, contactor and electronic overload relay. In addition, various functions of optional mountable accessories, e.g. auxiliary switches, surge suppressors, are already integrated in the SIRIUS compact starter.

SIRIUS compact starters can be used wherever standard three-phase motors or resistive loads up to 32 A (approx. 15 kW/400 V) are directly started or switched. They are available as direct-on-line or reversing starters.

A Siemens compact starter is approved as a CPS (Control and Protective Switching device) according to IEC 60947-6-2.

Product advantages

- **Very high operational reliability**

The high short-circuit breaking capacity and defined shutdown when the end of service life is reached mean that the SIRIUS compact starter achieves a very high level of operational reliability that would otherwise only be possible with considerable additional outlay. This sets it apart from devices with similar functionality.

- **Safe disconnection**

The auxiliary switches (NC contacts) of the 3RA6 compact starters are designed as mirror contacts. This enables their use for safe disconnection - e.g. EMERGENCY STOP up to SIL 1 (IEC 62061) or PL c (ISO 13849-1) or, if used in conjunction with an additional infeed contactor, up to SIL 3 (IEC 62061) or PL e (ISO 13849-1).

- **Communications integration with AS-Interface**

For the integration of communication via AS-Interface there is an AS-i add-on module available in several versions for mounting instead of the control circuit terminals on the SIRIUS compact starter. The design of the AS-i add-on module permits a group of up to 62 feeders with a total of four cables to be connected to the control system. This reduces wiring work considerably compared to the parallel wiring method.

- **Communications integration with IO-Link**

Up to four compact starters in IO-Link version (reversing and direct-on-line starters) can be connected together and conveniently linked to the IO-Link master through a standardized IO-Link connection. The SIRIUS 4SI electronic modules are used e.g. as IO-Link masters for connection to the SIMATIC ET 200S distributed I/O system.

The IO-Link connection enables a high density of information in the local range.

The diagnostics data of the process collected by the 3RA6 compact starter, e.g. short circuit, end of service life, limit position, etc., are not only indicated on the compact starter itself but also transmitted to the higher-level control system through IO-Link. Thanks to the optionally available operator panel, which can be installed in the control panel door, it is easy to control the 3RA6 compact starters with IO-Link from the control panel door.

- **Permanent wiring/easy replacement**

Using the SIRIUS infeed system for 3RA6 it is possible to carry out the wiring in advance without a compact starter needing to be connected. A compact starter is very easily replaced simply by pulling it out of the device without disconnecting the wiring. Even with screw connections or mounting on a standard mounting rail there is no need to disconnect any wiring (on account of the removable main and control circuit terminals) in order to replace a compact starter.

- **Consistent solution from the infeed to the motor feeder**

The SIRIUS infeed system for 3RA6 with integrated PE bar is offered as a user-friendly possibility of feeding in summation currents up to 100 A with a maximum conductor cross-sectional area of 70 mm² and connecting the motor cable directly without additional intermediate terminals.

Examples



Figure 7-11 Compact starter with the integrated functionality of a motor starter protector, contactor and electronic overload relay.



Figure 7-12 Individual compact starters or combined with associated infeed system and AS-i interfacing

7.4.3 SIRIUS ET 200SP motor starters

ET 200SP is a scalable, highly flexible and modular I/O system with IP20 degree of protection. As I/O modules, the ET 200SP motor starters are an integral part of this I/O system. They are switching and protection devices for single and three-phase loads and are available as direct-on-line or reversing starters.

Product advantages

- Fully integrated into the ET 200SP I/O system (including TIA Selection Tool and TIA Portal)
- Simple, integrated current value transmission
- Extensive parameterization by means of TIA Portal
- Increase of plant availability through fast replacement of units (easy mounting and plug-in technology)
- Longer service life and reduced heat losses thanks to hybrid technology
- Less space required in the control panel (20 to 80 %) as a result of greater functional density (direct-on-line and reversing starters in same width)
- Extensive diagnostics and information for preventive maintenance
- Parameterizable inputs via 3DI/LC control module
- Less wiring and testing required as a result of integrating several functions into a single device
- Lower overheads for stock keeping and configuration as a result of the wide setting range of the electronic overload release (up to 1:3)
- Technology has lower inherent power losses than speed-controlled drive systems, so that less cooling and smaller footprint are possible
- The ET 200SP motor starters can be used with highly energy-efficient IE3/IE4 motors.

Example

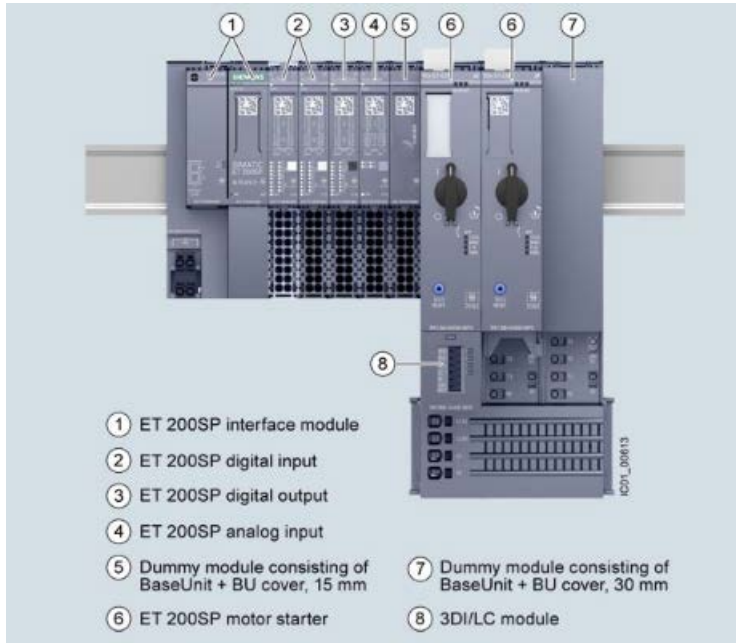

Figure 7-13 3RK1308 motor starter in the ET 200SP I/O system

7.4.4 SIRIUS ET 200pro motor starters

SIMATIC ET 200pro is the modular I/O system with high IP65/66/67 degree of protection for local operation without control panel. The ET 200pro motor starters with the high degree of protection IP65 are an integral part of ET 200pro.

Product advantages

- Only two variants up to 5.5 kW
- All settings can be parameterized by bus
- Comprehensive diagnostics messages
- Support for PROFIenergy
- Overload can be acknowledged by remote reset
- Current unbalance monitoring
- Stall protection
- EMERGENCY START function on overload
- Current value transmission by bus
- Current limit monitoring
- Full support of acyclic services
- Direct-on-line or reversing starter
- Power bus connection can be plugged in using Han Q4/2 plug-in connectors
- Motor feeder with Han Q8/0 connector
- Conductor cross-sectional area up to 6 x 4 mm²
- 25 A per segment (power looped through using jumper plug)
- In the Standard and High-Feature versions (with 4 DI onBoard)
- Electromechanical switching and electronic switching
- Electronic starter for direct starting or with integrated soft starter function
- Supplied with 400 V AC brake contact as an option
- Temperature sensor can be connected (Thermoclick or PTC type A)
- Provision of the motor current in PROFIenergy format to higher-level systems, motor current disconnection in dead times using PROFIenergy

Example



Figure 7-14 ET 200pro motor starter: Isolator module, Standard starter and High-Feature starter mounted on a wide module rack

7.4.5 SIRIUS M200D motor starters

The high degree of protection IP65 makes the M200D motor starters suitable in particular for use on extensive conveying systems such as are found in mail sorting centers, airports, automotive factories and the packing industry.

The SIRIUS motor starter variants M200D AS-i Basic and M200D AS-i Standard are available for implementing motor control with AS-Interface. They are available as direct-on-line or reversing starters.

Product advantages

- High plant availability through standardized plug-in capability of the main circuit, the communication equipment and the I/Os – relevant for installing and replacing devices
- Field installation close to motor thanks to the high degree of protection IP65
- The motor starters record the actual current flow for the parameterizable electronic motor overload protection. Reliable messages concerning the overshooting or undershooting of setpoint values for comprehensive motor protection. All motor protection functions can be defined by simple parameterization.
- Low stock levels and low order costs thanks to a wide setting range for the electronic motor protection of 1:10 (only two device versions up to 5.5 kW)
- The integrated wide current range enables a single device to cover numerous standard motors of different sizes
- Comprehensive offering of accessories, including ready-assembled cables
- The M200D motor starters can be installed in a few simple steps. The integrated plug-in technology significantly reduces wiring outlay: Preassembled cables can be plugged directly onto the motor starter module
- Easy and user-friendly installation because all versions have the same enclosure dimensions.

- Fast and user-friendly commissioning using optional manual local operation
- Increase of process speed through integrated functions such as "Quick Stop" and "Disable Quick Stop", e.g. at points and crossings
- Optional manual local control with momentary-contact and latching operation for easier commissioning and maintenance of the plant

Example



Figure 7-15 SIRIUS M200D motor starter family

7.4.6 SIRIUS MCU motor starters

The SIRIUS MCU (Motor Control Unit) motor starter family rounds off the bottom end of the SIRIUS motor starter range.

A system solution for the control of AC loads outside the control cabinet for operation in the field represents the application area for this motor starter series in a high degree of protection.

The MCU product range extends from simple motor control with I/O control from a central sub-distribution board to motor starters with AS-i communication for demanding tasks.

The MCU motor starters are completely pre-wired inside, have a high degree of protection and are designed for switching and protecting any AC loads. They are mostly used on standard three-phase motors in direct-on-line or reversing duty up to 5.5 kW at 400/500 V AC (electromechanical switching).

The motor and short-circuit protection integrated in the MCUs consists of an electromechanical switchgear and controlgear assembly and a motor starter protector unit for short-circuit protection.

Product advantages

- The high degree of protection IP55 on MCU motor starters in a plastic enclosure enables distributed configurations in the field and saves space in the local control panel.
- Comprehensive motor protection thanks to integrated overload and short-circuit protection with SIRIUS 3RV motor starter protectors/circuit breakers
- Cable connection by means of economical M screw (optionally with plug-in connection)
- Simple mounting for AS-i and external auxiliary voltage (24 V DC) by an M12 connection
- Status/diagnostics displays with built-in LEDs
- Manual operation: An integrated key-operated switch "MAN-0-AUTO" and a selector button for switching on, switching off and changing the direction of rotation for control purposes during commissioning or maintenance.
- Convenient control and monitoring through AS-Interface bus communication
- Rugged M12 connection system for the AS-i bus connection increases flexibility and prevents errors in the system configuration.

More information

Motor starters from Siemens

Link (<http://www.siemens.com/motorstarter>)

7.5 Main circuit - soft starters

Soft starters are an economical alternative to direct-on-line starters or star-delta (wye-delta) starters for starting three-phase motors in the control panel. Economical because they reduce unpleasant side effects such as mechanical impacts in the machine and mechanical components, or voltage dips in the power supply.

Soft starting protects plant components such as V-belts or gear units. Furthermore, some applications require motors to start softly so that they do not cause jerky movement of the drive system. To take just one example: Goods on a production conveyor belt shall not topple over which they certainly could do if the motor did not start smoothly. Soft starters are normally used to start pumps or fans, but they can also be deployed to start compressors, conveyor belts, agitators, or crushers for hard materials such as stone. To sum up, soft starters are particularly ideal for applications where the torque can suddenly surge when a motor is started directly on line.

Differences to contactors

With direct-on-line starting with a contactor, the starting current is generally 8 to 10 × rated current. In other words, the direct rise in the current causes jerky starting.

With a wye-delta contactor, the motor is started in two stages. The motor is started in a wye-connected circuit at approximately 30% of starting current. After an adjustable time period, the circuit is switched to a delta connection. After the motor has finished running up, the current drops to the operating point, i.e. to the normal nominal current which means that there is no longer any flow of excess current.

By contrast, a soft starter utilizes the integrated voltage ramp to limit the starting current to between 3 and 5.5 × rated current, gradually increasing the voltage until the current drops to the operating point and the motor is operating at normal rated current.

By comparison with a wye-delta contactor which necessarily comprises a combination of three contactors, a soft starter reduces the overall footprint by around 2/3. This completely eliminates the wiring work needed for a wye-delta starter. This is a particularly significant advantage for higher motor ratings which are only rarely available as fully wired solutions. Furthermore, the number of cables from the starter to the motor is reduced from six to three. Compact dimensions, short setup times, easy wiring and fast commissioning make themselves felt as clear-cut cost advantages.

Siemens soft starters

Siemens offers soft starters with a range of different functions

- Soft starters for standard applications without integral overload protection
- Soft starters for standard applications with integral overload protection
- Soft starters for High-Feature applications

Soft starters for standard applications without integral overload protection (3RW30)

The SIRIUS 3RW30 soft starters reduce the motor voltage through variable phase control and increase it in ramp-like mode from a selectable starting voltage up to mains voltage. During starting, these devices limit the torque as well as the current and prevent the shocks which arise during direct starts or wye-delta starts. In this way, mechanical loads and mains voltage dips can be reliably reduced.

The selectable start value means that the soft starters are adjusted individually to the requirements of the application in question. The SIRIUS 3RW30 soft starters are characterized above all by their small space requirements.

Integrated bypass contacts mean that no power losses occur at the power semiconductors (thyristors) after the motor has started up. This cuts down on heat losses, enabling a more compact design and making external bypass circuits superfluous.

The advantages at a glance

- Extremely compact designs
- Simple mounting and commissioning
- Soft starting with voltage ramp; the starting voltage setting range U_s is 40 to 100 % and the ramp time t_R can be set from 0 to 20 seconds.
- Integrated bypass contact system to minimize power loss
- Setting with two potentiometers
- Mains voltages 50/60 Hz, 200 to 480 V
- Two control voltage versions 24 V AC/DC and 110 to 230 V AC/DC
- Wide temperature range from -25 to +60 °C
- The built-in auxiliary contact ensures user-friendly control and possible further processing within the system.

It makes sense to combine SIRIUS 3RW30 soft starters with SIRIUS 3RV20 motor starter protectors.



Figure 7-16 Soft starters for standard applications without integral overload protection, sizes S00, S0, S2 and S3

Soft starters for standard applications with integral overload protection (3RW40)

The SIRIUS 3RW40 soft starters are characterized above all by their small space requirements. Integrated bypass contacts mean that no power losses occur at the power semiconductors (thyristors) after the motor has started up. This cuts down on heat losses, enabling a more compact design and making external bypass circuits superfluous.

At the same time this soft starter comes with additional integrated functions such as adjustable current limiting, motor overload and intrinsic device protection, and optional thermistor motor protection. The higher the motor rating, the more important these functions become because they make it unnecessary to purchase and install protection equipment such as overload relays. Internal intrinsic device protection prevents thermal overloading of the thyristors and the power section defects this can cause. As an option, the thyristors can also have semiconductor fuses to protect them against short circuits.

Thanks to integrated status monitoring and fault monitoring, this compact soft starter offers many different diagnostics options. Up to four LEDs and relay outputs permit differentiated monitoring and diagnostics of the operating mechanism by indicating the operating state as well as for example mains or phase failure, missing load, non-permissible tripping time/CLASS setting, thermal overloading or device faults. Soft starters rated up to 250 kW (at 400 V) for standard applications in three-phase networks are available. Extremely small sizes, low power losses and simple commissioning are just three of the many advantages of the SIRIUS 3RW40 soft starters.

The 3RW40 soft starter sizes S0 to S12 are suitable for starting explosion-proof motors with the "increased safety" type of protection EEx e.

The advantages at a glance

- SIRIUS 3RW40 soft starters have all the same advantages as the 3RW30 soft starters.
- Thanks to the adjustable current limiting, the SIRIUS 3RW40 soft starter helps to maintain the stability of the supply system.
- Thanks to the integrated motor overload protection according to IEC 60947-4-2 there is no need for an additional overload relay with the new soft starters.
 - Overload tripping times can be adjusted to different settings (CLASS 10, 15 and 20).
 - The motor overload protection can be deactivated if this function is to be performed by a different motor management control device, e.g. with PROFIBUS interface.
- Device versions with thermistor motor protection evaluation are available up to 55 kW.
- Wire break and short circuit in the sensor circuit cause immediate shutdown of the soft starter.



Figure 7-17 Soft starters for standard applications with integral overload protection, sizes S0, S2, S3, S6 and S12

Soft starters for High-Feature applications (3RW44)

In addition to soft starting and soft ramp-down, the solid-state SIRIUS 3RW44 soft starters provide numerous functions for higher-level requirements. They cover a performance range up to 710 kW (at 400 V) in the inline circuit and up to 1200 kW (at 400 V) in the inside-delta circuit.

The 3RW44 soft starters are characterized by a compact design for space-saving and clearly arranged control panel layouts. For optimized motor starting and stopping the innovative SIRIUS 3RW44 soft starters are an attractive alternative with considerable savings potential compared to applications with a frequency converter. The new torque control and adjustable current limiting enable the High-Feature soft starters to be used in nearly every conceivable task. They guarantee the reliable avoidance of sudden torque surges and current peaks during motor starting and stopping. This creates savings potential when calculating the size of the switchgear and when servicing the machinery installed. With the SIRIUS 3RW44 soft starter, savings can be made with respect to size and outlay, both for (In-Line) and (Inside-Delta) circuits.

The bypass contacts already integrated in the soft starter bypass the thyristors after a motor ramp-up is detected. This results in a further great reduction in the heat loss occurring during operation of the soft starter at rated value.

Combinations of various starting, operating and ramp-down possibilities ensure an optimum adaptation to the application-specific requirements. Operation and commissioning can be performed with the user-friendly keypad and a menu-prompted, multi-line graphic display with background lighting. Optimized motor ramp-up and ramp-down can be achieved quickly, easily and reliably by means of just a few settings with a previously selected language. Four-key operation and plain-text displays for each menu item guarantee full clarity during every phase of parameterization and operation.

The advantages at a glance

- Simple mounting and commissioning
- Simple integration in the motor feeder
- Soft starting with breakaway pulse, torque control or voltage ramp, with adjustable torque or current limiting as well as any combination of these, depending on load type
- Integrated bypass contact system to minimize power loss
- Various setting options in three separate parameter sets for the starting parameters such as starting torque, starting voltage, ramp-up and ramp-down time, and much more
- Ramp-up detection
- Inside-delta circuit for savings in terms of size and equipment costs
- Various ramp-down modes selectable: coasting down, torque-controlled ramp-down, pump stop, combined DC braking
- Electronic motor overload and intrinsic device protection
- Thermistor motor protection
- Keypad with a menu-prompted, multi-line graphic display with background lighting
- Interface for communication with the PC for more accurate setting of the parameters as well as for control and monitoring
- Display of operating states and fault messages
- Connection to PROFIBUS and PROFINET with optional PROFIBUS DP or PROFINET module



Figure 7-18 Soft starters for High-Feature applications, various sizes

Selection aid for soft starters



Application	SIRIUS 3RW30 Standard applications	SIRIUS 3RW40 Standard applications	SIRIUS 3RW44 High Feature applications
Normal starting (CLASS 10)			
Pumps	●	●	●
Pumps with special pump ramp-down (to prevent water hammer)			●
Heat pumps	●	●	●
Hydraulic pumps	○	●	●
Presses	○	●	●
Conveyor belts	○	●	●
Roller conveyors	○	●	●
Screw conveyors	○	●	●
Escalators		●	●
Piston compressors		●	●
Screw compressors		●	●
Small fans ¹⁾		●	●
Centrifugal blowers		●	●
Bow thrusters		●	●
Heavy starting (CLASS 20)			
Stirrers		○	●
Extruders		○	●
Lathes		○	●
Milling machines		○	●
Very heavy starting (CLASS 30)			
Large fans ²⁾			●
Circular saws/bandsaws			●
Centrifuges			●
Mills			●
Breakers			●

● Recommended soft starter
○ Possible soft starter

¹⁾ The mass inertia of the fan is <10 times the mass inertia of the motor.
²⁾ The mass inertia of the fan is ≥10 times the mass inertia of the motor.

Figure 7-19 Selection aid for soft starters (excerpt from Siemens Catalog IC 10)

More information

Soft starters from Siemens

- Link (<http://www.siemens.com/softstarter>)
- Selection aid Configurator (<http://www.siemens.com/sirius/configurators>)
- Simulation Tool for Soft Starters STS (<http://www.siemens.com/softstarter>)

7.6 Main circuit - frequency converters

It is easy to control the speed of motors that are supplied by frequency converters. Frequency converters are generally installed for applications that require speed control.

A diverse range of applications can be divided into four different application groups for which frequency converters are deployed:

- Pumping / ventilating / compressing → e.g. compressors, pumps, fans
- Movement → e.g. conveyors, hoists, stacker cranes
- Processing → e.g. shredders, mixers, winders
- Machining → e.g. machine tools (milling, turning and grinding machines)

Let us consider a practical example, e.g. a piping system through which a liquid is pumped. This application requires that the system pressure is kept stable. If, for example, a valve is opened and liquid is drained out, the pump shall work harder and this can be achieved by speed control effected by the frequency converter. Another example is a milling machine on which the speed of the milling tool needs, of course, to be individually adjustable.

A suitable frequency converter can be selected according to the complexity and performance requirements of the application.











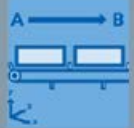

Application area		basic	SINAMICS performance	high
		SIMPLE	EFFICIENT	FLEXIBLE
	Pumping	 V series	 G series	 S series
	Ventilating			
	Compressing			
	Moving	 V series	 G series	 S series
	Processing	 G series		
	Machining	 S series		

Figure 7-20 SINAMICS drive family - usage types

Siemens frequency converters

Siemens can supply medium-voltage, low-voltage and DC converters.

The following low-voltage converters from the SINAMICS range are described in more detail below:

- SINAMICS V (Page 262) → **Basic**
- SINAMICS G (Page 264) → **Efficient**
- SINAMICS S (Page 267) → **Flexible**

7.6.1 SINAMICS V

SINAMICS V – for basic drive tasks

SINAMICS V units are designed to perform the basics - this is reflected in their hardware and their functionality. From the user's viewpoint, they are an extremely rugged and inexpensive. SINAMICS V is particularly suitable for applications that do not require any specialist drive knowledge.

SINAMICS V20 basic converters

The SINAMICS V20 compact Basic Performance frequency converter is a simple and cost-effective drive solution. SINAMICS V20 is characterized by short commissioning times, extremely simple handling, a rugged design and cost efficiency. The converter with its seven sizes covers the performance range from 0.12 kW to 30 kW.

The SINAMICS V20 frame sizes FSAA and FSAB for single-phase 230 V line operation are the smallest SINAMICS products. With a width of just 68 millimeters and a height of 142 millimeters, Siemens has substantially reduced the size of the SINAMICS V20 for motors with low powers. The units are optionally available with an integrated RFI suppression filter, enabling compliance with the radio interference limit values laid out in IEC 61800-3 category C1 when the device is installed in a control panel in accordance with EMC guidelines. Frame sizes FSAA and FSAB therefore satisfy the radio interference requirements for industrial applications as well as for use in residential and business environments, including commercial applications such as refrigerated counters, fitness equipment, ventilation systems, industrial washing machines, etc.

The converter can be operated and commissioned either by integrated application macros or by a wireless connection via an optional web server module. The SINAMICS V20 Smart Access web server module is simply plugged onto the converter. Handling the SINAMICS V20 becomes even easier if it is commissioned and operated by smartphone, tablet or laptop. Furthermore, the optional Parameter Loader module allows the writing of parameters directly into the converter even when this is not connected to the power supply.

The SINAMICS V20 is controlled either directly via the converter terminals or by means of USS/Modbus RTU control.

Various options are available which allow users to adapt the SINAMICS V20 to suit the application or their own individual requirements. These options include: external Basic Operator Panel, Parameter Loader, SD memory card, filters, braking resistors, etc.

These compact units are suitable for use in industrial applications such as pumps, fans, compressors and conveyor systems.

Advantages of SINAMICS V20

Simple installation

- Wall mounting and through-hole technology - two variants for direct adjacent mounting
- Integrated USS and Modbus RTU interfaces
- Integrated braking module for 7.5 kW to 30 kW
- Electromagnetic compatibility (EMC) according to Category C1/C2

Easy to use

- Parameter readout and cloning without power supply
- Simple commissioning, operation and diagnostics using the SINAMICS V20 Smart Access web server module
- Integrated connection and application macros
- Keep Running mode permits uninterrupted operation
- Extremely rugged thanks to wide voltage range, advanced cooling design and coated PCBs

Easy to save money

- ECO mode for U/f, U2/f; hibernation mode in idle state
- Integrated energy and water flow monitoring for pump applications
- High overload capability (HO) and low overload capability (LO) for frame size FSE



Figure 7-21 SINAMICS V20, frame sizes FSA to FSE

SINAMICS V90 basic servo drive system

The drive system comprises the SINAMICS V90 servo converter and the SIMOTICS S-1FL6 servomotor. The system features eight converter frame sizes and seven motor shaft heights to cover a performance range of 0.05 to 7.0 kW for operation in single-phase and three-phase networks. It can be integrated easily via PTI, PROFINET, USS or Modbus RTU. The SINAMICS V90 servo drive system enables a host of simple Motion Control tasks to be implemented cost-efficiently and conveniently with the focus being on dynamic motion and processing.

Advantages of SINAMICS V90

- Optimized servo performance
- Inexpensive
- Easy to use
- Safety Integrated (Safe Torque Off STO)
- Can be configured with SIMATIC controllers in the TIA Portal



Figure 7-22 SINAMICS V90

7.6.2 SINAMICS G

SINAMICS G – for maximum efficiency

Whether the application involves pumps, fans, compressors, conveyor belts, mixers, mills or extruders:

SINAMICS G converters are the perfect solution where the application places low to moderate demands on the dynamic response of the control system. They are based on the same platform as all the other products in the innovative SINAMICS system range.

SINAMICS G users enjoy the benefits of a control concept which is fully integrated but simple.

The SINAMICS G portfolio includes a range of different device versions with adaptable scope of functions to meet the requirements of any application. Whether the user requires a compact or a modular device, wishes to install it in a control panel or a distributed configuration or use Safety Integrated and energy saving functions, or buy a system with ready-integrated technology such as positioning functions, all of these options are available.

SINAMICS G120C built-in devices

The SINAMICS G range comprises an extensive portfolio of built-in devices, cabinet units, distributed converters and sector-specific converters for a variety of different applications.

SINAMICS G120C combines an especially compact design with high power density – and offers a well-balanced combination of features to address a wide range of applications. With seven frame sizes, SINAMICS G120C covers a power range from 0.55 kW to 132 kW.

- **Compact**
 - Space-saving design, even for power ratings up to 132 kW
 - Integrated input reactor and EMC filter
 - All frame sizes in side-by-side design without power reduction or current derating
- **Easy commissioning and operation**
 - Intuitive series commissioning, cloning function using BOP-2, IOP or SD card
 - Simple and fast software parameter assignment
- **Perfect integration**
 - Full integration of the drives into the TIA Portal system diagnostics
 - Use of the TIA Portal library concept guarantees simple reusability of the converters, including their parameters and hardware components.
- **Cutting-edge technology functions**
 - High torques at low frequency setpoints are possible thanks to energy-efficient, sensorless vector control
 - Due to the certified safety function Safe Torque Off which is integrated as standard, further external components can be omitted.
- **Reliable communication**
 - All standard bus systems such as PROFINET, EtherNet/IP, PROFIBUS and USS/Modbus RTU are supported.



Figure 7-23 SINAMICS G120 built-in devices

Modular converter from 0.55 to 250 kW

The second generation of the SINAMICS G120 from Siemens is a modular converter with a higher power density and space-saving size. This series of converters is available in three voltage variants for connection to 200 V, 400 V and 690 V networks.

Various Safety Integrated functions are supported depending on the converter version: STO (SIL 3, PL e, Kat. 3), SS1, SBC, SLS, SDI, SSM, all of them via PROFIsafe

The motor is controlled according to various control methods by the Control Unit. In addition to control functions, the Control Unit can also perform other tasks which can be adapted to the relevant application by parameterization.

The following Control Units are available for the SINAMICS G120:

- CU240E-2 series Control Unit - for standard applications in general machinery construction
- CU250S-2 series Control Unit - for high-performance applications in general machinery construction
- CU230P-2 series Control Unit - the specialist for pumps, fans and compressors

The converter is interfaced with a higher-level control system such as PROFINET, PROFIBUS, USS, Modbus, Ethernet IP or BACnet.

A broad spectrum of Power Modules for different drive requirements, for example, PM240-2 Power Modules have a braking chopper (four-quadrant applications) and are suitable for a large number of applications in general machinery construction. PM250 Power Modules are suitable for the same applications as the PM240. Any braking energy is directly fed back into the mains (four-quadrant applications - a braking chopper is not required).

More information

Further information about SINAMICS G, e.g. about the G110D/G110M/G120D distributed converters, the SINAMICS G130 and G150 built-in / cabinet units, and the SINAMICS G120P and SINAMICS G180 sector-specific converters can be found at link (<http://www.siemens.com/SINAMICS>).



Figure 7-24 Frequency converters from the SINAMICS G range

7.6.3 SINAMICS S

SINAMICS S – for complex applications

SINAMICS S converters have been specially developed for use in complex, highly dynamic machine and plant engineering applications – and to meet the demands of a broad range of Motion Control tasks. Products from this portfolio are available with power ratings ranging from 0.12 kW to 5700 kW and in many different construction types and frame sizes. An important feature is their consistently engineered design.

SINAMICS S110 basic servo

The SINAMICS S110 positioning drive with its integrated basic positioner (EPos) is recommended for applications involving machine axes that need to be positioned as quickly and accurately as possible. The basic positioner performs these positioning tasks and so relieves the load on the higher-level machine control system. As an alternative to EPos, the positioning drive can also function as a speed-controlled axis and receive setpoints via an analog input or a fieldbus interface (PROFIBUS, CAN, PROFINET). Furthermore, it can also control a wide range of integrated safety functions with on-board safety terminals without the need for additional complex circuitry. As a modular single-axis drive with servo functionality, the positioning drive covers a power range from 120 watts (230 V 1AC) to 90 kilowatts (400 V 3AC). It can be used to position synchronous servomotors as well as induction motors.

The SINAMICS S110 positioning drive is suitable for the following applications: Handling equipment, medical engineering (patient tables, for example), feeding and delivery systems, tracker systems (e.g. solar panels), tool changers, stacking units, automated assembly machines and laboratory automation.

Advantages of SINAMICS S110

- Easy positioning with synchronous and induction motors
- Integrated safety functions
- Simple commissioning thanks to the electronic rating plate in DRIVE CLiQ motors, as well as convenient commissioning using STARTER
- Automatic controller optimization using autotuning
- Interfacing with higher-level control systems using standard communication blocks and by Totally Integrated Automation (TIA)



Figure 7-25 SINAMICS S110

SINAMICS S120 built-in devices

The modular SINAMICS S120 drive is the modular system for high-performance Motion Control applications in industrial plant and machinery construction. Customized solutions can be implemented based on a wide range of components and functions that are optimally coordinated with one another. For instance, high-performance single-motor drives and coordinated drives (multi-axis applications) with vector or servo functionality.

The SINAMICS S120 is suitable for use in highly dynamic processes in many sectors: Packaging machines, plastics machines, textile machines, printing machines, paper machines, hoisting devices, handling and assembly systems, machine tools, conveyor systems, rolling mills, presses, test stands, drives on ships and drilling rigs.

Advantages of SINAMICS S120

- The servo and vector drive is a platform for modular plant and machine concepts that utilize digital communications
- Wide range of closed-loop control methods
- Integrated technology functions
- Integrated safety functions
- Integrated know-how protection
- Rational engineering and fast commissioning thanks to the SIZER (drive dimensioning) and STARTER (commissioning) tools
- Autoconfiguring and autotuning of the closed-loop control functions
- Standardized solutions easily implemented using Totally Integrated Automation (TIA)



Figure 7-26 SINAMICS S120 built-in devices

More information

Frequency converters from Siemens

Link (<http://www.siemens.com/SINAMICS>)

7.7 Main circuit - solid-state switching devices

Solid-state switching devices are generally used for loads that require a high switching frequency. These loads are resistive in most cases. Heating systems in machines (in injection molding machines or thermoformers, for example) are regulated by switching them on and off frequently. Solid-state switching devices are the right choice wherever strip heaters are used and the heating output needs to be regulated.

Solid-state switching devices are also used to switch motors with a high number of starts. Siemens is offering a range of devices with article number 3RF34 that have been specifically designed for this purpose.

Since solid-state switching devices do not have movable contacts, the switching operation does not involve any wearing parts. The control energy required is also low.

Siemens is offering two different types in 1- and 3-pole versions:

- Solid-state relays, and
- Solid-state contactors

Solid-state relays (3RF20/21/22)

Solid-state relays comprise only one switching element without built-on heat sink. It is meaningful to use solid-state relays if the application involves a machine containing a large number of resistive loads (such as an injection molding machine with many heating cartridges). In this instance, the advantage of solid-state relays is that all of them can be mounted on a large heat sink that only needs to be dimensioned once for all of the relays. The final footprint is therefore small.



Figure 7-27 Solid-state relays

Solid-state contactors (3RF23/24/34)

Solid-state contactors consist of one switching element with built-on heat sink. They are often deployed in machines that contain only a few heaters, for example, in packaging machines with just a few heating cartridges for sealing the packaging. Since solid-state contactors already have a built-on heat sink, they can be installed in control panels without the need to dimension a heat sink in advance.



Figure 7-28 Solid-state contactors

Advantages of Siemens solid-state switching devices

Siemens offers function modules as accessories that are capable of measuring current and so functioning as a load monitor. It is therefore possible, for example, to detect disturbances such as load interruption, power failure or severe damage to the solid-state switching device caused by short circuits and signal them to the control system. Other function modules are also capable of controlling or regulating the heat output.



Figure 7-29 Function modules for load monitoring (Basic, Extended), heating current monitoring, power controllers and power regulators for heaters

More information

Solid-state switching devices from Siemens

Link (<http://www.siemens.com/SIRIUS>)

7.8 Control circuit - SITOP power supplies

The SITOP power supplies from Siemens are mainly used for supplying DC circuits in industrial automation applications and in the manufacture of standard and special-purpose machines. SITOP smart is generally used in the manufacture of standard machines, while the SITOP modular 8200 and 8600 systems are generally deployed in the production of special-purpose machines.

The DC circuits in this case are mostly control circuits in the control panel that are used, for example, to supply automation systems, switchgear or signaling lamps. SITOP power supplies are also used to supply control circuits installed in or around machines to supply sensors or AS-i modules or, where DC motors are operated in the machine, to supply main circuits as well.

Advantages of SITOP power supplies

By virtue of their construction, design and cross-testing with other Siemens products, the SITOP power supplies fit seamlessly into the Siemens product environment – e.g. SIMATIC power supplies. The units are cooled on the left-hand side because this has no mounted components.

With their wide-range input, excellent performance under load and numerous certifications, SITOP power supplies ensure reliable operation of plants.

In addition to power supply units, the SITOP portfolio offers a range of perfectly coordinated additional modules which help to protect 24 V power supplies from disruptions on the primary and secondary sides. For example, UPS solutions for bridging short, medium and long-term supply interruptions, or the SITOP selectivity modules for providing short-circuit protection on the secondary side of the power supply.

The right power supply can be configured quickly and easily with the tool "SITOP Finder" or "SITOP Selection Tool".



Figure 7-30 SITOP Family Control Cabinet

More information

SITOP power supplies from Siemens

Link (<http://www.siemens.com/SITOP>)

7.9 Control circuit - SIMOCODE

SIMOCODE pro (3UF7) motor management system

In many industrial sectors, constant-speed drive solutions are indispensable. Industries such as oil/gas, chemicals/petrochemicals or the water/sewage treatment sector frequently use low-voltage three-phase induction motors that are operated directly on the grid. In many cases, the SIMOCODE pro motor management system is used either to fully exploit the diverse control functions or to further increase the availability of machines and plants by utilizing the protection and diagnostics capabilities of the system. This increases process quality and minimizes risks.

The biggest problem for automated processes is the extremely high cost of downtimes. These are costs that can easily be reduced or avoided altogether by preventing disturbances, by locating faults in the system before they can cause any damage and, if the worst comes to the worst, by eliminating them quickly using intelligent technology.

SIMOCODE pro supplies extensive motor data that can be used to improve the quality of process control.

The option of connecting SIMOCODE pro to PROFIBUS, PROFINET, Ethernet/IP or Modbus RTU means that all the necessary motor feeder data for process and plant operation can be made available anywhere in the world. This increases transparency and information density on a process-wide basis. Communication via Ethernet (PROFINET) offers special benefits here: Convenient access to diagnostics messages is possible via a standard Web browser, i.e. there is no need for any special software. In addition, individual access to measured values and data using HMI Panels or SCADA systems is possible via the integral, vendor-neutral OPC UA interface.

System redundancy with SIMOCODE pro

System redundancy offers PROFINET users in the process industry a number of clear advantages: increased plant availability and enhanced productivity. Because SIMOCODE pro supports the PROFINET system redundancy function.

- SIMOCODE pro motor management devices can be directly connected to high-availability systems such as SIMATIC S7-400 H, for example.
- Both subsystems communicate with the I/Os via PROFINET and exchange data with SIMOCODE pro.
- Plant operation is not interrupted by cable breaks or by component or subsystem failures: A control system has continuous access to the SIMOCODE pro field device.

Extensive spectrum of motor feeder features

- Multifunctional and electronic full motor protection that is independent of the automation system
- Safe shutdown of motors
- Integrated control functions
- Detailed operational, service and diagnostics data
- Open communication via PROFIBUS, PROFINET, Ethernet/IP or Modbus RTU
- Flexible, convenient software for device parameterization and diagnostics

SIMOCODE pro

SIMOCODE pro S – smart and compact.

The SIMOCODE pro S motor management system in a modern titanium-gray enclosure of slimline design measuring just 22.5 mm in width redefines the concept of an efficient, extremely compact, entry-level motor management device: The basic unit and multifunction module meet all the main demands of modern motor users with respect to control, monitoring and protection of a motor. From the most basic requirement, such as overload protection, all the way to motor feeders with direct-on-line starting, reversing starting, or star-delta (wye-delta) starting as well as thermistor motor protection and ground-fault monitoring, SIMOCODE pro S provides tailor-made solutions. SIMOCODE pro S can be simply connected to the controller via PROFIBUS.

SIMOCODE pro V – variable and intelligent

The SIMOCODE pro V motor management system offers a more diverse range of functions than the SIMOCODE pro S system. You can choose exactly those functions that you need for your motor feeder: In addition to the full range of functions available with SIMOCODE pro S, the SIMOCODE pro V basic unit combined with a maximum of five expansion modules offers numerous other useful functions such as voltage and active power detection, fail-safe shutdown and connection to PROFIBUS, PROFINET, Ethernet/IP or Modbus RTU.



Figure 7-31 SIMOCODE pro S and SIMOCODE pro V

Overview of SIMOCODE pro S and SIMOCODE pro V functions

SIMOCODE pro S	Functions	SIMOCODE pro V
●	Simple control functions (e.g. overload relay, direct-on-line start and reversing start, soft start*, star-delta*)	●
●	Protection functions (e.g. thermistor, overload, phase unbalance)	●
●	Basic monitoring functions (e.g. current limits, internal ground fault, downtimes)	●
●	Basic unit 4 inputs/2 outputs	●
	Basic unit with multifunction modules max. 8 inputs/4 outputs	
●	Basic unit 4 inputs/3 outputs	●
	Basic unit with digital modules max. 12 inputs/7 outputs	
●	Current measurement	●
●	External ground-fault monitoring	●
●	Temperature monitoring	●
●	I/O expansion, input voltage 24 V DC, 110–240 V AC/DC, monostable relay outputs	●
	Expanded control functions (e.g. pole-changing starter, positioner)	●
	Voltage / power measurement	●
	Analog value monitoring	●
	Safety-related shutdown	●
	I/O expansion, input voltage 24 V DC, 110–240 V AC/DC, bistable relay outputs	●

Figure 7-32 Overview of SIMOCODE pro S and SIMOCODE pro V functions

Convenient use of SIMOCODE pro in the motor control center

Thanks to the initialization module for SIMOCODE pro, the switchboard and the motor management system merge even more closely. With the withdrawable design frequently used in motor control centers, the initialization module is permanently integrated into the switchboard. Feeder-related parameter and address data are thus assigned specifically to this feeder. When replacing the withdrawable module with SIMOCODE pro, the new component is automatically initialized with the correct parameters. This makes manual programming following device replacement a thing of the past.

ATEX approval for operation in potentially explosive atmospheres

The SIRIUS SIMOCODE pro 3UF7 motor management system is certified for the protection of flame-proof motors in potentially explosive atmospheres.

It fulfills the requirements of the following certifications:

- ATEX Ex I (M2); equipment group I, category M2 (mining)
- ATEX Ex II (2) GD; equipment group II, category 2 in zone with gases and dusts

More information

SIMOCODE pro from Siemens

Link (<http://www.siemens.com/SIMOCODE>)

7.10 Control circuit - safety relays

7.10.1 Safety relays

Machine safety

Machine manufacturers and machine owners are required by law to ensure the safety of persons and the environment. In other words: Machines shall be safe and remain safe – regardless of whether they are new or used.

In addition to electrical safety which has been discussed in depth in this reference manual, it is absolutely essential that machines are also functionally safe.

Taking preventive measures to mitigate any risk posed by machinery is also an important economic consideration:

- Avoidance of direct consequential costs from personal injuries (for medical treatment, wages, and compensation)
- Avoidance of indirect consequential costs from injuries (e.g. fines because of failure to observe regulations, costs of repair)
- Increased productivity thanks to improved machine availability: fewer unplanned downtimes and smoother production operations
- Longer plant service life
- Improvement in global competitiveness thanks to increased exportability of machines

In order to make a machine safe, signals from appropriate sensors installed in and around the machine shall be detected and evaluated so that actuators can respond accordingly. This can be achieved only if components in and around the machine and in the control panel can interact with one another.



Figure 7-33 Functional safety

Detecting

Sensors, position switches and other command and signaling devices such as pushbuttons are used to detect events in and around the machine.

The example shown in the diagram is of two position switches which stop the machine when the door is opened.

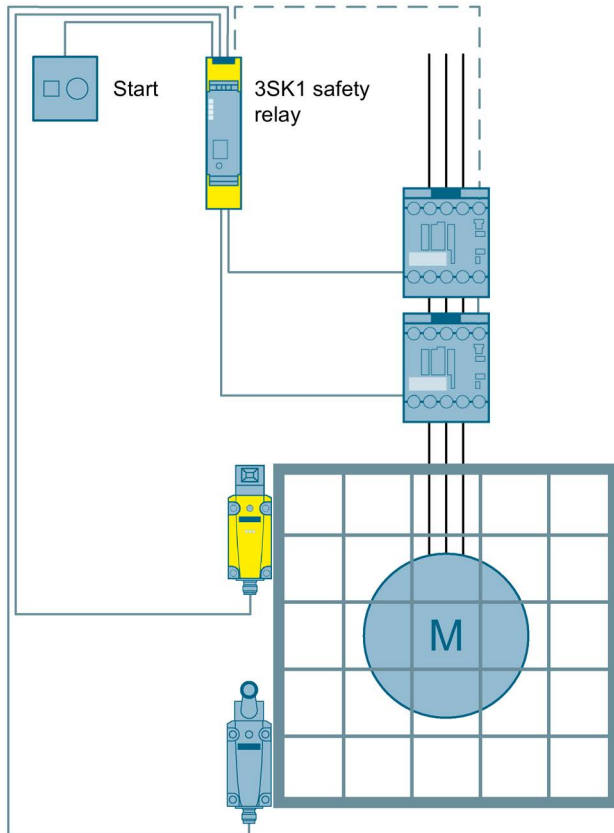

Figure 7-34 Protective door monitoring to SIL 3 or PL e with a 3SK1 safety relay

Another example is the EMERGENCY STOP button as an additional safety measure that is compulsory for every machine. For further information, refer to chapters Control circuit - position switches (Page 290) and Pushbuttons (Page 283).

Evaluating and reacting

See chapter Evaluating (Page 277)

See chapter Reacting (Page 282)

7.10.2 Evaluating

SIRIUS (3SK) safety relays

SIRIUS 3SK safety relays evaluate signals from sensors installed in or around the machine and initiate an appropriate response by the actuators, e.g. shutdown of a drive by a switching device, or signaling by a lamp.

The perfect interaction between safety relays, sensors and actuators makes it possible to create complete safety sequences that are not only exceptionally reliable, but also significantly faster, simpler and more economical. SIRIUS 3SK safety relays are certified in accordance with IEC 62061 (up to SIL_{CL} 3) and ISO 13849-1 (up to PL e).

The SIRIUS 3SK product portfolio is extremely streamlined. Regardless of whether the application involves the fail-safe monitoring of a mechanical or an electronic sensor, there are no major differences between the safety relays that can be used. Standard safety applications can be implemented quickly with safety relays from the 3SK1 range. 3SK2 devices are available for applications with more complex safety requirements.

3SK1 basic units

3SK1 basic units can be parameterized by means of DIP switches on the device. Operation of a sensor is always followed by fail-safe disabling of all outputs.

The essential differences between Standard and Advanced basic units are as follows:

- Degree of system modularity
- Reduced wiring thanks to device connectors

3SK1 Standard basic units

If the outputs on the Standard basic unit are not sufficient or if special switching capabilities are required, the output expansions can be flexibly combined to meet the individual requirements of the application. Thanks to the modular system design, adjustments can be made as required.

The Standard basic units are characterized by easy handling and they are available with relay and solid-state outputs.

They are simply connected to the sensors and actuators, after which the individual devices are wired. This is made particularly easy by the labeled terminal covers and the optimized working angle.

The basic unit can be parameterized for the individual sensors via the DIP switches.

3SK1 Advanced basic units

The 3SK1 Advanced basic units are a good choice for users who want a wider range of functions and an easier, more flexible method of implementing safety functions.

They offer all the same product features as the Standard basic units. Additional sensors can be connected via flexibly combinable input expansions. The Advanced basic units do not need to be interconnected by wiring, but are simply plugged into the unique design of device connector that is available for these units. This ensures rapid and comfortable installation without wiring errors.

The Advanced basic units are available with time delay that can be adjusted via a rotary coding switch.

3SK2 basic units

The new 3SK2 basic units are the perfect choice for applications with complex safety requirements. While the 3SK1 safety relays always ensure simultaneous fail-safe disabling of all outputs, the fail-safe outputs on the 3SK2 devices can be disabled individually.

The 3SK2 devices are easy to parameterize with the "SIRIUS Safety ES" software. Since the fail-safe outputs can be freely assigned, it is easy to parameterize assignments between sensors and outputs using the "drag and drop" method.

"SIRIUS Safety ES" also offers extensive support with commissioning and diagnostics.

Highlights of the 3SK2

- Powerful solid-state outputs that can be adjusted to various loads by parameterization
- Simple implementation of muting and protective door monitoring with tumbler
- Easy commissioning and diagnostics

Two variants of 3SK2 are available for plant concepts that require multiple safety functions to shut down sections of the plant selectively:

- The narrow, 22.5 mm-wide 3SK2 basic unit with up to 10 fail-safe inputs and 2 fail-safe solid-state outputs
- The 45 mm-wide 3SK2 basic unit with up to 20 fail-safe inputs and 4 fail-safe solid-state outputs

Two further safe output functions are provided for the two 3SK2 basic units by the device connectors.



Figure 7-35 Narrow and wide 3SK2 basic unit

A further highlight is the exchangeable memory module on the wide version of the 3SK2 basic unit. This helps to save time when a device is replaced. Furthermore, status and diagnostic messages on the device display reduce downtimes and assist with troubleshooting.

7.10.2.1 Output expansions for the 3SK family

SIRIUS 3RM1 Failsafe motor starters

Small motors up to 3 kW can be switched safely in the 3SK1 system.

Simply add the SIRIUS 3RM1 Failsafe motor starter to the 3SK basic unit. Because safety technology is merged with conventional control technology in the new SIRIUS 3RM1 Failsafe motor starters.

The motor starters are available as fail-safe direct-on-line and reversing starters. Motors combined with the safety relays are not only shut down safely, but also protected against overload. Furthermore, the motor starter works on low-wear and energy-efficient hybrid switching technology. Devices from the main and control circuits can thus simply be combined by device connectors to form an end-to-end safety relay system.

The advantages at a glance

- Saves on hardware.
- Saves on wiring, and so minimizes potential wiring errors.
- Creates more free space in the control panel.



Figure 7-36 SIRIUS 3RM1 motor starters - space saving

You will find further information about 3RM1 motor starters in chapter Motor starters (Page 245).

4RO output expansion

A 4RO contact expansion can be used to increase the number of outputs on the basic unit. This has 4 relay outputs for switching currents up to 5 A.

3RO output expansion

The contact expansion with three power relay outputs for switching high currents up to 10 A is available when special switching characteristics are required.

7.10.2.2 Expansion units for the 3SK1 Advanced family

Input expansion

If more than one sensor is required, it is only necessary to provide an input expansion rather than additional basic units.

The 24 V power supply supplies up to six components with voltage – whether basic units or input or output expansions. It covers all conventional global control voltages from 110 to 240 V AC/DC. This means that the safety relays can be deployed almost anywhere in the world.

7.10.2.3 Diagnostics for the 3SK2 family

Diagnostics display 3RK3611-3AA00

The diagnostic display 3RK3611-3AA00 provides assistance with troubleshooting in the event of outages. When combined with the 3SK2 device, it immediately indicates which sensor has operated. It also helps to locate plant faults. This saves time and costs.

The diagnostics display can also be used to read out and save configuring data from the 3SK2 devices. This also helps to save time when a device is replaced. Configuring data can also be copied without a PC/PG. This is particularly useful for the manufacture of standard machines.



Figure 7-37 Diagnostics display 3RK3611-3AA00

See also

Control circuit - signaling columns (Page 293)

7.10.3 Reacting

Reacting

Once a detected signal has been evaluated by the safety relays, an appropriate reaction is initiated, e.g. a motor or drive is shut down or stopped. Plant conditions are reliably indicated by the signaling columns supplied by Siemens.

Further information can be found in the chapters Contactors (Page 242), Motor starters (Page 245), Frequency converters (Page 261) and Signaling columns (Page 293).

More information

Safety relays from Siemens

Link (<http://www.siemens.com/safety>)

7.11 Control circuit - command and signaling devices

SIRIUS ACT (3SU1) pushbuttons and indicator lights

Command and signaling devices function as a human-machine interface and are used to control machines and display signals. In short, they provide a platform for communication between humans and machines. They are used, for example, to switch loads on and off, for EMERGENCY SWITCHING OFF and EMERGENCY STOP functions or to display operating states.

Since command and signaling devices are normally located in the field (i.e. outside the control panel) in an unprotected environment, they shall be capable of withstanding harsh environmental conditions and fulfill the relevant IP degree of protection. Since the devices are visible, they are also a feature of the machine design.

Thanks to the communication solutions provided by SIRIUS ACT, it is easy to combine command and signaling devices, HMI touch screens and industrial PCs,

which means that complex input stations can be set up without the need to invest extensive time and effort in wiring and engineering.

Advantages

The SIRIUS ACT pushbuttons and indicator lights from Siemens offer many advantages when it comes to meeting the requirements for a specific application:

- **Modern design**
 - Four design lines, one range of accessories
 - Ideal combination of design and function
 - Improved look of the system
- **Easy to use**
 - One-handed installation
 - No special tools needed
 - Anti-twist protection integrated in the holder
- **Extremely rugged**
 - IP69K as standard
 - Insensitive to dust, oil, caustic solutions and water
 - Design stability after many years of use
- **Flexible communication**
 - PROFINET, AS-i or IO-Link interfacing possible
 - Fast and direct connection to the control system
 - Integrated into the TIA Portal



Figure 7-38 Easy to use

Configuring with the SIRIUS ACT Configurator

- Easy processing with more than 10,000 article numbers
- Simple configuring of enclosure solutions
- Individual labeling with texts or customized images using an inscription tool
- User can save own configurations and use the "Configuration Identification Number (CIN)" to reuse them in subsequent projects



Figure 7-39 Simple configuring with the SIRIUS ACT Configurator

More information

SIRIUS ACT command and signaling devices from Siemens

- Link (<http://www.siemens.com/sirius-act>)
- SIRIUS ACT Configurator (<http://www.siemens.com/sirius-act/configurator>)

7.12 Control circuit - function relays

Function relays are used to monitor, control and switch loads and therefore provide a simple means of operating machines and plant in a straightforward, safe and purposeful manner.

The portfolio of SIRIUS relays offers all components required for motor feeder applications from a single source. Siemens can supply a suitable function relay whatever the application – whether timing or monitoring relays in various designs, especially narrow coupling relays, plug-in relays, low-noise power relays or analog signal converters.

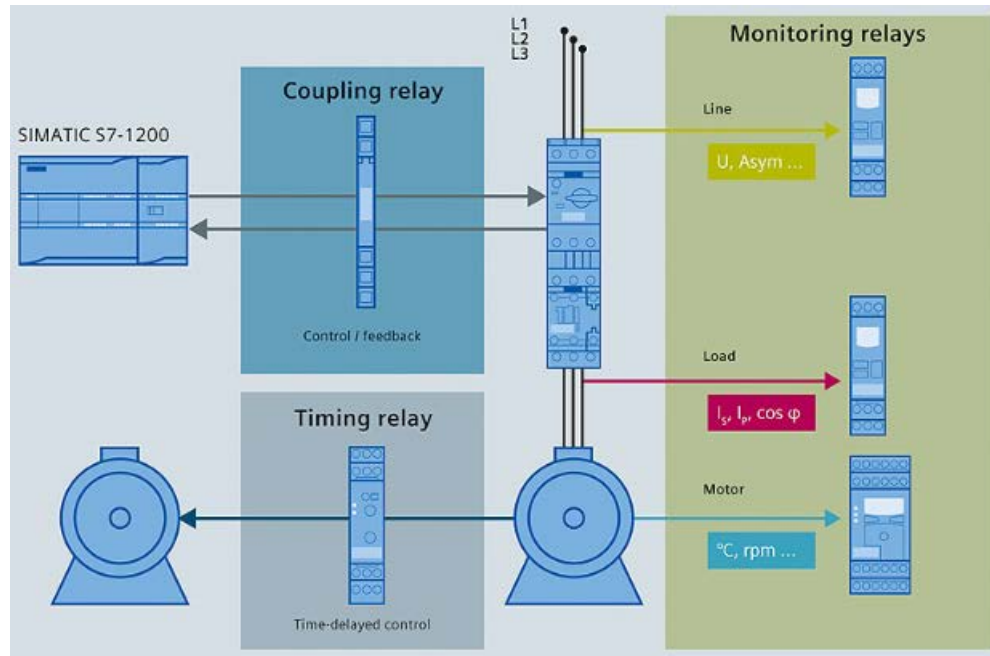

Figure 7-40 Area of application of SIRIUS relays

SIRIUS monitoring relays from Siemens

SIRIUS monitoring relays are used to monitor electrical variables (infeed) as well as mechanical parameters and temperatures. The following overview shows the range of different monitoring capabilities of SIRIUS monitoring relays.





Electrical parameters		Other parameters			
					
Infeed	Application monitoring	Mechanical parameters		Temperature	
Line and voltage	Power, power factor, insulation, fault current	Speed	Filling level	Thermistor	Thermocouple, resistance sensor
- Phase sequence and failure - Overvoltage or undervoltage	- Functionality of lamps and heating - Protection against overload - No-load monitoring - Belt slippage or breakage	- Conveyor belt - Chain drives	- Coolant and lubricant - Wastewater	- Heavy-duty start-up - Braking and reversing operation - Frequent switching	- Motor, waste gas and process temperature - Coolant

Figure 7-41 Overview of the area of application of monitoring relays

Electronic line and voltage monitoring relays (3UG451/461/463/481/483) for infeed monitoring

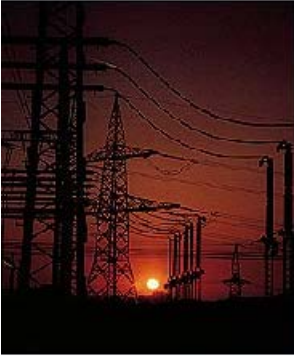
Electronic line and voltage monitoring relays can be used to monitor the voltage at the line infeed. It is therefore possible to react to phase sequence, phase failure or phase asymmetry. This kind of monitoring is a legal requirement in some sectors, e.g. for hoisting gear such as cranes or elevators. A crane that is operating on only two phases, for example, will only have half its normal lifting capacity which could lead to a serious accident in the worst-case scenario. Phase sequence monitoring prevents a crane from rotating in the wrong direction, or a compressor from suffering irreparable damage as a result of the wrong direction of rotation. This function is often particularly valuable for mobile devices. Furthermore, electronic line monitoring relays provide maximum protection in unstable networks. Line and voltage faults can be detected promptly before they have a chance to lead to more substantial damage.

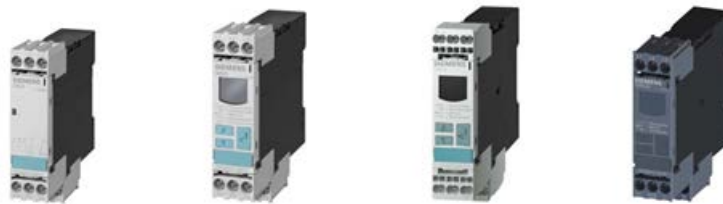

Figure 7-42 Line and voltage monitoring relays

Electronic current monitoring relays (3UG4621/22/41/4822/41 and 3RR21/22/24) for monitoring the application

Electronic current monitoring relays are used less to monitor motors, and far more often to monitor systems and driven loads. This function can be useful in detecting harmful effects that cannot be sensed by conventional protective devices such as motor starter protectors/circuit breakers or overload relays. A pump monitoring application is a good example. If the pump runs dry, there is a risk that it will overheat because the cooling effect of the pumped liquid has been lost. This condition cannot be detected by a motor starter protector/circuit breaker or overload relay. An electronic current monitoring relay set to monitor for undercurrent or power factor promptly detects that the pump is running dry and shuts it down before it can sustain any damage.



Figure 7-43 3UG4 and 3RR2 monitoring relays

Electronic residual-current monitoring relays (3UG4625 and 3UG4825) for application monitoring

Electronic residual-current monitoring relays are used to monitor systems in which fault currents can occur. There are many potential sources for faults (dust deposits, for example, or moisture, porous cables or capacitive fault currents) in and around machines which can lead to insulation problems over time and so create hazards in the machine environment. In order to prevent these kinds of hazards, it is advisable to use a 3UG4625 or 3UG4825 residual-current monitoring relay in combination with a 3UL23 summation current transformer.



Figure 7-44 Monitoring relays for monitoring residual currents

Electronic insulation monitoring relays (3UG458) for application monitoring

Electronic insulation monitoring relays are required to monitor the insulation resistance in ungrounded single or three-phase supply systems, i.e. in IT systems. A special feature of IT systems is that the fault current is low on the occurrence of a first single-pole short circuit which means that the plant can usually remain in operation. The short-circuit current would only flow during a second single-pole short circuit and trip the relevant protective device. IT systems are always provided in situations where high availability and supply security are important factors. In order to exploit this positive characteristic, it is essential that the insulation resistance is continuously monitored and that any detected insulation fault is rectified as quickly as possible. In industrial plants, this work can be done when the plant is out of operation anyway, for example, at weekends or at the end of a shift. This ensures that outages during normal production times are avoided and helps to keep the plant highly available. IT systems are often used in the chemical and automotive industries, in printing shops, in shipbuilding and the railway sector, and in mining and healthcare facilities.



Figure 7-45 Monitoring relays for insulation monitoring

Electronic relays for monitoring mechanical operation and temperature

System/line protection involves more than just the monitoring of electrical variables – it also requires further equipment to monitor parameters such as mechanical operation or temperature.

These include, for example, the monitoring of fill levels to prevent dry running, overflow or leakage. The monitoring of motor speed or overheating due to external factors should also be included in this list. Whether the issue is slippage or rupture of a belt drive, closed valves, blocked filters, defective fans, frequent or heavy starting: all of these conditions can cause damage to a machine, but are not reliably detected by an overload relay.

Siemens can supply appropriate monitoring relays to protect against these hazards:

- 3UG4501 level monitoring relay
- 3UG4651 and 3UG4851 speed monitoring relays
- 3RN2 thermistor motor protection relay for protection against overheating
- 3RS10/11 (analogically adjustable) plus 3RS10/11/20/21 and 3RS14/15 (digitally adjustable) temperature monitoring relays



Figure 7-46 3RS10 / 3RS11 temperature monitoring relays (digitally adjustable)

Coupling relays and signal converters

When controllers with their standard inputs/outputs reach their limits, coupling relays and signal converters come into their own. Siemens supplies a wide selection of coupling relays and signal converters for the electrical isolation of I/Os and PLC inputs and outputs, signal amplification or reproduction as well as conversion to different voltage levels or signal forms.

Timing relays

Timing relays are used wherever simple time-controlled processes are required. Timing relays are particularly important in conjunction with a control system. Whether the application involves staged starting of motors, fan run-on or control of star-delta (wye-delta) starts, SIRIUS timing relays are used for all time-delayed switching operations in open-loop control circuits, starting circuits, protection circuits, and closed-loop control circuits.

More information

Function relays from Siemens

Link (<http://www.siemens.com/relays>)

7.13 Control circuit - position switches

SIRIUS detecting devices

SIRIUS detecting devices are used to precisely measure motion sequences in machines and plants. Whether they are used to detect positions, limit the movement of specific machine components or incorporated in safety circuits, detecting devices shall be able to manage the wide range of information in the field, even under the harshest conditions. For seamless control Siemens offers an extensive range of mechanical and non-contact position and safety switches.

Mechanical position and safety switches (3SE5/3SF1)

A wealth of information is gathered in the machine environment. Reliable devices are needed to record information precisely. Position switches supplied by Siemens ensure reliable tripping in hazardous situations, even under harsh environmental conditions. In other words, they reliably shut down machines and plants in fault or hazard situations. The SIRIUS 3SE5 range of position switches includes complete units, but also modular designs which can easily be combined to create special solutions.

The advantages at a glance

- High degree of flexibility and low stock keeping costs thanks to modular design
- Large number of combination options thanks to various types of contact, roller and connector
- Position switches available in metal or plastic enclosure according to EN 50047 and EN 50041
- Variants for extreme environmental conditions such as enhanced corrosion protection or -40 °C versions
- Fast on-site diagnostics per LEDs
- ASIsafe electronics integrated in basic enclosure



Figure 7-47 Easy plug-in method for fast replacement of actuator heads

SIRIUS 3SE63 non-contact safety switches, RFID

The electronic non-contact safety switch for protective equipment is based on contactless RFID transponder technology and offers a high level of protection against interference, tampering and bypassing. The rugged, vibration-resistant safety switch has a plastic enclosure providing a high degree of protection up to IP69K that is resistant to detergents and designed for a long service life and use under extreme environmental conditions. It switches without wear and covers a wide range of applications, including protective covers, flaps and doors that are difficult to adjust or that open and close frequently.

Highlights

Reliable monitoring of protective equipment at the highest level of safety, even when several switches are connected in series.

The advantages at a glance

- High protection against interference and tampering thanks to diverse coding variants
- Highest level of safety because of compatibility with safety evaluation units such as SIMATIC SPS, SIRIUS 3SK1/2 or 3RK3
- Several RFID switches can be connected in the same safety circuit because they have integrated cross-circuit, open-circuit and external voltage monitoring functions.
- Low investment costs because only one switch pair is required for safety applications to PL e acc. to EN 13849-1 and SIL 3 acc. to IEC 61508/62061
- Long service life due to wear-free switching
- Increased plant availability thanks to extensive diagnostics functions
- Rugged and detergent-resistant: Degree of protection up to IP69K
- Optional magnetic catch (18N) – keeps doors and flaps securely closed so that they cannot be opened unintentionally
- Ideally used for metal-working machines and plants thanks to non-magnetic technology (RFID)
- Simple assembly and wiring:
 - Universal mounting holes: Can be mounted on both sides
 - Can be used as an end stop for small to medium-sized doors
 - Can be adjusted quickly via slotted holes because they have a larger switching displacement than mechanical switches and boundary detection by LED indication on the switch → improved mounting and sagging tolerance
 - Standard gauge and holes (as on the SIRIUS 3SE66/67 magnetically operated switches) makes replacement easier



Figure 7-48 SIRIUS 3SE63 non-contact safety switches, RFID

SIRIUS 3SE66/67 non-contact safety switches, magnetically operated

SIRIUS 3SE6 magnetically operated switches are designed for mounting on movable protective guards (e.g. hoods, hinged covers, doors). Evaluation is performed by means of a safety relay or through connection to a bus system. The 3SE66/67 non-contact, magnetically operated safety switches stand out due to their enclosed design with high degree of protection IP67. They are particularly suitable therefore for areas exposed to contamination, cleaning or disinfecting.

The advantages at a glance

- Tamper-proof protective door monitoring
- Small footprint thanks to compact dimensions
- SIL 3 and PL e can be achieved with a single switch pair in a safety circuit.



Figure 7-49 Standard and supplementary ranges in the new 3SE66/67 design

More information

SIRIUS detecting devices from Siemens

Link Safety (www.siemens.com/sirius-detecting)

7.14 Control circuit - signaling columns

Signaling columns and integrated signal lamps are deployed in all sectors for the visual and acoustic signaling of machine operating conditions. Signaling columns can display operating states ranging from fault condition to normal operation in many different applications including production lines, injection molding machines, placement machines for electronic components, and many others. Siemens offers signaling column components in a variety of different colors and with a diameter of 50 mm and 70 mm which can be freely combined to create columns comprising up to five elements.

While the lamps are available with integral LED, the user can also fit them with an incandescent lamp if required.

The following visual and acoustic variants are available:

- Continuous light
- Blinklight
- Rotating light
- Flashlight
- Siren (acoustic)
- Buzzer (acoustic)

The advantages at a glance

- Simple mounting and lamp replacement without tools
- Quick to assemble thanks to bayonet connection system
- AS-Interface adapter reduces wiring outlay
- LED technology:
 - Economical due to low power consumption
 - Insensitive to shocks and vibration
 - Long service life
- Extensive range of accessories, e.g.:
 - Labeling panel with standard labels
 - Mounting bracket
 - Adjustable-angle feet
- Switchover to external auxiliary voltage with an AS-i adapter element, and A/B technology which allows the connection of up to 64 slaves

Technical data

- Available in 24 V, 115 V AC and 230 V AC versions
- Versions with LED:
 - Long service life
100,000 hours with integrated LED with chip-on-board technology
50,000 hours with socketed LED
- Connection elements with screw terminals and cage-clamp terminals
- High degree of protection IP65 for 8WD44
- Ambient temperature -20 °C to +60 °C
- AS-Interface element in A/B technology with switchable auxiliary voltage (only 70 mm signaling columns)



Figure 7-50 8WD signaling columns and integrated signal lamps

More information

SIRIUS signaling columns and integrated signal lamps from Siemens

Link Safety (<http://www.siemens.com/sirius-commanding>)

7.15 Control circuit - AS-Interface

AS-Interface (AS-i)

If machines and plants are to be controlled safely and efficiently, it is essential that sensors, actuators and the PLC in the control panel can communicate effectively. With the conventional method of linking components by individual cables, the task of installing and connecting cables and subsequently maintaining them is time-consuming and expensive. If instead the sensors and actuators are linked to the control system via AS-Interface, significant savings in cabling materials, time and space can be achieved.

AS-i = simple

Only one cable is needed for data and power. Standard and safety-related components are similarly integrated. Fewer cables means less time spent on assembly and installation. The engineering process in the Totally Integrated Automation Portal (TIA Portal) is just as clever. In this case, the guiding principle is "drag & drop". With perfect diagnostic capabilities. Local maintenance and replacement of IP65 modules are just as easy thanks to connections that use the insulation piercing method and so can be disconnected quickly without interrupting the fieldbus.

AS-i = flexible

The two-wire cable can be flexibly installed – just like a normal electric power cable! Up to 62 slaves can be connected to each AS-i network over a length of up to 600 m (using repeaters or extension plugs).

Safety technology for small to large-scale applications is integrated in AS-i. The safe AS-i signals can be processed by a fail-safe control system (F-CPU) or used locally in the ASIsafe modular safety system for shutting down the plant.

AS-i = efficient

Each AS-i module is given a unique address. The slaves can be replaced in double-quick time when necessary and a new address is automatically assigned. Degree of protection IP65/67 is standard for AS-i – in other words, the components are rugged and stable even in harsh operating environments. And what happens if a slave fails? Thanks to highly perfected device and network diagnostic capabilities, the master can explain what has gone wrong and so make troubleshooting as easy as child's play.

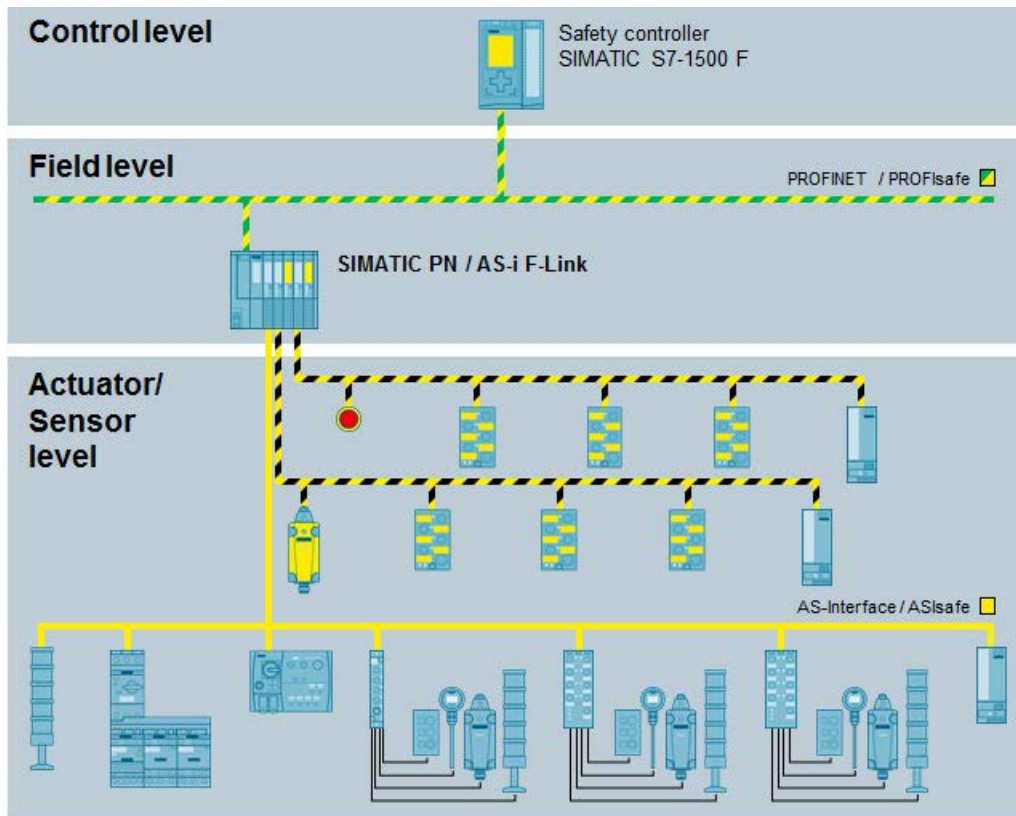

Figure 7-51 Configuration of an AS-i network – connecting sensors with minimum effort: standard and fail-safe

Advantages

- Very simple installation through piercing on unshielded two-wire cable
- Bus topology of any kind: line, star or tree
- Free positioning of components
- Sensors supplied via the bus cable
- Safety Integrated SIL 3 / PL e

Quantity structure

- 62 AS-i digital modules 4 DI / 4 DQ providing 248 digital inputs / 248 digital outputs, or analog modules
- 31 safe AS-i F-DI modules, 2-channel
- 200 m AS-i bus cable (with extension plug)
- Extension using repeaters, e.g. over 600 m length
- 5 ms cycle time for 31 AS-i digital modules

Installation and connection

Distances to sensors and actuators can be kept short by the use of AS-i modules with IP65 degree of protection that are simply snapped onto the AS-i cable at the required points directly in the machine. Cabling is kept to an absolute minimum.



Figure 7-52 Mounting and connecting an AS-i field module to the AS-i cable

AS-i master in the ET 200SP distributed I/O system

All the data collected from the AS-i bus in the machine converge in the AS-i master. The AS-i master can function as a PLC module, as a gateway to PROFINET or PROFIBUS, or as an I/O module in the SIMATIC ET 200SP system.

Modular configuration

A modular AS-i link to PROFINET or PROFIBUS can be set up with a minimal amount of effort:

- ET 200SP interface module IM155-6
- CM AS-i master ST
- Optional for safety applications: F-CM AS-i Safety ST

(The required ET 200SP BaseUnits are not included in the list.)

If an ET 200SP CPU or F-CPU is used instead of the ET 200SP interface module, the resulting controller is a high-performance system with AS-Interface connection in the compact format of the ET 200SP.

If the quantity framework of an AS-i network is not sufficient, multiple networks can be created by adding further ET 200SP modules, i.e. CM AS-i Master ST or F-CM AS-i Safety ST modules. It is of course possible to combine all other ET 200SP modules in order to add a further local input or output directly in the control panel when required.

Number of AS-i masters in the ET 200SP

Up to eight standard or five fail-safe AS-i networks can be operated on an ET 200SP interface module IM155-6PN ST. On an ET 200SP interface module IM155-6PN HF, it is even possible to operate up to 43 standard or 29 fail-safe AS-i networks.

Engineering

Graphic tools are used in the TIA Portal to engineer, program and diagnose the AS-i system in the ET 200SP. The TIA Portal provides a single engineering tool with common database with which standard and safety signals can be processed and stored in a project. In this way, the planner can keep a clear overview of the plant.

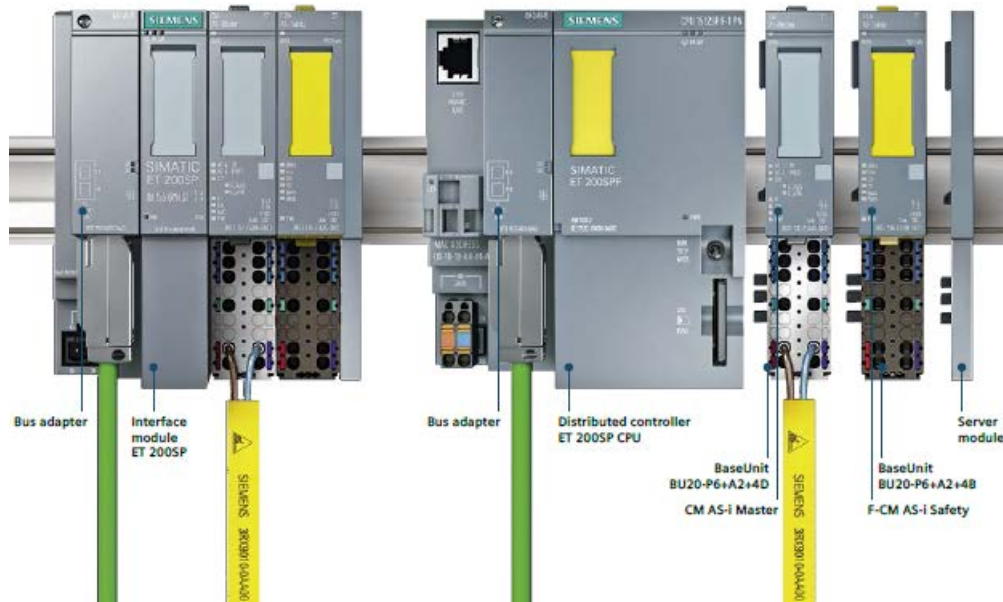

Figure 7-53 AS-i master in the SIMATIC ET 200SP and intelligent AS-i master station with ET 200SP CPU

More information

AS-Interface and ET 200SP

- Link (<http://www.siemens.com/as-interface>)
- Link (<http://www.siemens.com/et200sp>)

Use of IE2 and IE3 motors

8.1 Normative and legal requirements

8.1.1 Efficiency classes for IEC motors

Comprehensive laws have been introduced in the European Union with the objective of reducing energy consumption and therefore CO₂ emissions. EU Regulation 640/2009, amended by Commission Regulation 04/2014, concerns the energy consumption or energy efficiency of induction motors for mains operation in industrial environments. This Regulation is in force in all countries of the European Union.

Efficiency classes according to IEC 60034-30-1:2014

IEC 60034-30-1:2014 defines the efficiencies or efficiency classes in the power rating range from 0.12 kW to 1000 kW at 50 and 60 hertz: The standard specifies the motors to which it applies and which exceptions apply worldwide. The EU Regulation is based essentially on this standard.

In IEC 60034-30-1, new efficiency classes have been defined for induction motors (IE = International Efficiency):

- IE1 = Standard Efficiency (comparable with EFF2)
- IE2 = High Efficiency (comparable with EFF1)
- IE3 = Premium Efficiency
- IE4 = Super Premium Efficiency

Note

- The old European designations EFF3, EFF2 and EFF1 are currently still valid, but they will be gradually replaced by the new IE classes.
 - Problem-free 1:1 interchanging is possible thanks to specified standard sizes (especially the shaft heights).
-

The following changes became effective on the dates indicated:

Table 8- 1 New efficiency classes for induction motors

Since June 16, 2011	Compliance with the legally required minimum efficiency class IE2 for induction motors suitable for S1 duty in accordance with EU Regulation.
Since July 27, 2014	Commission Regulation 04/2014 amending EU Regulation 640/2009.
Since January 1, 2015	Compliance with the legally required minimum efficiency class IE3 for outputs from 7.5 kW to 375 kW or IE2 motor with frequency converter. ¹
From January 1, 2017	Compliance with the legally required minimum efficiency class IE3 for outputs from 0.75 kW to 375 kW or IE2 motor with frequency converter. ¹

¹ From an energy efficiency viewpoint, an IE3 motor is not equivalent to an IE2 motor with a frequency converter. In constant-speed applications, an IE3 motor with a motor starter is the most energy-efficient and economical solution. Frequency converters should only be used where the application requires speed control.

Scope of application

Table 8- 2 Affected motors

EU Regulations 640/2009 and 04/2014 based on standard IEC 60034-30	
Description	The EU Regulation is in force in every country of the EU. Losses are determined and the efficiency level therefore calculated in accordance with IEC 60034-2-1:2007.
Number of poles	2, 4, 6
Power range	0.75 to 375 kW
Level	IE1 - Standard Efficiency IE2 - High Efficiency IE3 - Premium Efficiency
Voltage	< 1000 volts, 50/60 Hz
Degree of protection	All
Validity	IEC 60030-1 standard, valid since March 2014; the EU Regulation has been in force since June 16, 2011. Manufacturers are no longer permitted to market IE1 motors within the European Economic Area.

8.1.2 Exceptions in the EU Regulation

According to the EU Regulations 640/2009 and 04/2014 (valid as of July 27, 2014), motors operated under the following conditions are excepted:

- At altitudes greater than 4000 m above sea level
- At ambient temperatures above 60 °C
- At ambient temperatures below -30 °C (any motor) or below 0 °C (water-cooled motor)
- Where the liquid coolant temperature at the inlet to a product is less than 0 °C or more than 32 °C;

Further exceptions

The following motors are excepted as they were prior to the amendment:

- Motors designed to be operated totally submerged in a liquid.
- Motors fully integrated into a product (e.g. a gearbox, pump, fan or compressor) whose energy efficiency cannot be measured independently of the product
- Motors that are specially designed for operation under the following conditions:
 - At maximum operating temperatures above 400 °C
 - In potentially explosive atmospheres in the context of Directive 94/9/EC of the European Parliament and of the Council
- Brake motors

Unaffected motors

- 8-pole motors
- Pole-changing motors
- Synchronous motors
- Motors that are suitable exclusively for duty types S2 to S9
- Single-phase motors

8.2 IE3 motors

8.2.1 Properties

As of January 2015, minimum efficiency class IE3 has been mandatory for power ratings between 7.5 kW and 375 kW. Alternatively, an IE2 motor with a frequency converter can be used.

Differences to IE2 motors

- IE3 motors are more efficient
- Lower rated currents
- Rising starting current
- Rising inrush current

IE3 motors are more efficient

The new IE3 motors are characterized by higher efficiency compared to the previous IE1 / IE2 motors. In the higher output range, IE1 or IE2 motors are already extremely efficient - the lower the output rating, the poorer the efficiency. For this reason, the legally required efficiency increase of the IE3 motors is higher in the lower performance range.

Lower rated currents

The required efficiency increase for IE3 motors is usually implemented using lower rated motor currents. In the low-end performance ranges, the required efficiency increase is greater and the deviation in the rated current is therefore greater here. The higher the performance, the lower the deviation of the rated currents compared with IE1 / IE2 motors.

Increasing starting current ratios

The higher the IE class, the higher the starting current ratios: ratio between starting current and rated current; steady state, locked rotor.

Change in starting current

Starting current = rated current × starting current ratio

In contrast to the starting current ratio, the starting current changes less. This effect is due to the lower rated current of the IE3 motors.

Example: Performance class 4 to 15 kW for IE3 compared to IE2

- The rated currents drop to 4.5 % on average.
- The starting current ratios rise by 13.5 %.
- The starting current increases by only 11.5 %.

Rising inrush current

The inrush current is a dynamic compensation event. It results from the following operations:

1. Connection of an inductive load (motor) to an AC system
2. Dynamic current transients in the motor
3. Saturation effects in the laminated cores of the motor

These occur during all starts (direct-on-line starting) and changeover operations (YD changeover). The highest currents usually occur in one or two phases in the first half-wave. The greatest influencing factor is the internal resistance.

Inrush current value

The inrush currents for IE1, IE2 and IE3 depend on the following factors in the respective application:

- Motor design
- Power supply conditions (especially the short-circuit rating of the transformer, and thus the voltage stability)
- Length and routing of the motor supply lines
- Starting phase angle in the respective phase
- Motor power output: the smaller the motor, the higher the inrush current

8.2.2 Siemens IE3 motors

IE3-compliant induction motors from Siemens are characterized by their reliability, long service life, and ruggedness. They are available with power ratings ranging from 0.5 kW to 375 kW in many standard versions:

Furthermore, they are uniformly designed in compliance with efficiency class IE3 for the scope of EU Regulation 640/2009 from 0.75 kW to 375 kW. The motors are well-suited to all applications in the manufacturing and process industries.

Siemens IE3 motors

The table below shows the range of IE3 motors offered by Siemens:

	General Purpose SIMOTICS GP	Severe Duty SIMOTICS SD	Explosion-proof SIMOTICS XP	Definite Purpose SIMOTICS DP	Transnorm SIMOTICS TN
Enclosure material	Aluminum	Gray cast iron	Aluminum or gray cast iron	Aluminum or gray cast iron	Gray cast iron
Power range	0.09 ... 45 kW	0.75 ... 315 kW	0.09 ... 1000 kW	0.37 ... 481 kW	200 ... 3500 kW
Legal requirements	Usually subject to the minimum efficiency classes from 750 W	Usually subject to the minimum efficiency classes	Are not subject to the minimum efficiency classes, but are available in IE3 for a wide range of areas	Are subject to the minimum efficiency classes in a wide range of areas (e.g. marine applications, smoke extraction)	Usually subject to the minimum efficiency classes up to 375 kW
Application areas and industries	Pumps, fans, compressors, and conveyor systems with especially low weight and high efficiency requirements	Pumps, fans, compressors, conveyor systems, marine and offshore applications, mixers, mills, extruders, rollers with special demands in terms of ruggedness, particularly in the chemical and petrochemical industries	For general industrial applications with special explosion protection requirements, e.g. in the process industry	Special motors for e.g. work and transport roller tables, dockside cranes Ventilation of tunnels, multi-story car parks, shopping malls, container terminals	Pumps, fans, compressors, mixers, extruders in the chemical and petrochemical industries, paper-making machines, mining, cement, steel industry, and marine applications including propulsion
Further information	SIMOTICS GP (http://www.siemens.com/simotics-gp)	SIMOTICS SD (http://www.siemens.com/simotics-sd)	SIMOTICS XP (http://www.siemens.com/simotics-xp)	SIMOTICS DP (http://www.siemens.com/simotics-dp)	SIMOTICS N-compact (http://www.siemens.com/simotics-n-compact)

More information

You can find information about Siemens IE3 motors on the Internet (<http://www.siemens.com/simotics>).

8.3 Use of switching devices and protective equipment with IE3 motors

8.3.1 Motor starter protectors

Short-circuit detection in systems with motor starter protectors

In the event of unusually high currents in the electrical installation, short-circuit detection serves to keep the thermal and dynamic load low and ensure safe shutdown. The response threshold shall be higher than the currents that a starting motor causes. The dimensioning of a system is influenced by the response value. The higher the response value, the larger the cross-sectional areas of the conductors to be protected shall be. This increases costs in the system and for the switching devices. This is why the response values have been adapted to the previously typical motor starting currents.

The drawback of the new, more efficient IE3 motors is that, on average, the starting currents and magnetization reversal currents (inrush currents) arising at the moment of switching on are considerably higher than those of previous generations of motors. The variance of starting and inrush currents is very wide. Motors with high values can therefore cause the motor starter protector to trip.

This leads to unintentional shutdown during motor starting. This "early tripping" can occur whenever the motor current is near the top of the motor starter protector's setting scale and a motor with a high inrush current is used.

Making and breaking capacity of motor starter protectors

Making and breaking capacity tests are conducted in compliance with the standard under three-phase AC loading with 10 to 8 times the rated current. In some cases, the starting and inrush currents of IE3 motors are significantly higher than these values. In isolated cases, current spikes that arise during starting can cause brief lifting of the contacts without triggering a breaking operation by short-circuit detection.

Where the motor is switched on by a contactor, for example, the motor starter protector's making/breaking capacity is irrelevant. In this case, the motor current is only carried. The current that can be carried without any problems is normally higher than the switching device's making/breaking capacity.

Rated motor current/setting scale

For motor protection, the motor's rated current shall be set on the setting scale of the motor starter protector. The new IE3 motors generally have lower rated currents. This can lead to situations in which a motor starter protector with a lower rated current has to be chosen for the same motor rating. Thus, the short-circuit detection response value also drops and can lead to tripping during motor starting.

The optimization of motor starter protectors for use on IE3 motors

The motor starter protectors have been modified as follows in relation to the higher motor starting currents and inrush currents:

- Increase in the lower short-circuit detection response tolerances without changes to the maximum values.
→ No change to system dimensioning
- Increase in the making / breaking capacity.
→ Largely avoids restrictions due to increased motor starting currents and inrush currents
- Adjustment of overload releases and setting scales of some versions of motor starter protector
→ Avoids use of smaller motor starter protectors due to lower rated motor currents

In the case of motors with very high starting and inrush currents, problems can still arise despite these modifications, e.g. undesired tripping on starting. It is recommended that motor starter protectors be selected such that the setting does not need to be made in the upper range of the setting scale. This reduces power loss in the device (cost saving and reduced temperature rise in the control panel) and increases the distance from the short-circuit releases' response limits.

Selection example

An example of how to select motor starter protectors can be found in chapter Main circuit - motor starter protectors/circuit breakers (Page 234).

8.3.2 Soft starters

Function

Soft starters limit the starting current and starting torque. This reliably prevents mechanical stress and mains voltage dips. The motor voltage is reduced using phase control and is increased from an adjustable starting voltage up to the line voltage within a specific ramp time.

The motor is adjusted to the load characteristic of the driven machine by means of stepless control of the voltage supply. With soft starters, the starting currents can be reduced in most applications to less than 50 % of the value for direct-on-line starting. If it is assumed that the starting currents are no more than 8 times the rated current, this results in a maximum of 4 times the starting current when starting with soft starters.

Special considerations for motors with high starting currents

For motors with high starting currents in particular, soft starters are especially suitable since the high starting currents are reduced to lower values and the supply network is therefore subject to a comparatively lower load.

Using soft starters to limit the starting current of motors with high starting currents can have different effects. This applies only if the other conditions for startup, such as the load conditions, do not change as well:

- **Case A**

Motors that have higher starting currents but also an improved torque curve can be started under comparable conditions under certain circumstances. In this case, it is not necessary to analyze the startup process any further because other aspects of starting rarely need to change under ideal conditions.

- **Case B**

Motors that consume higher starting currents but exhibit no changes in torque behavior in comparison to standard motors shall be provided with more energy during startup.

In Case B, the effects on startup shall be analyzed more closely:

the diagram shows how the startup current over time can change when motors with higher starting currents are used. A motor with normally high starting current ratios (5 to 8 times the rated motor current) is taken as the starting point.

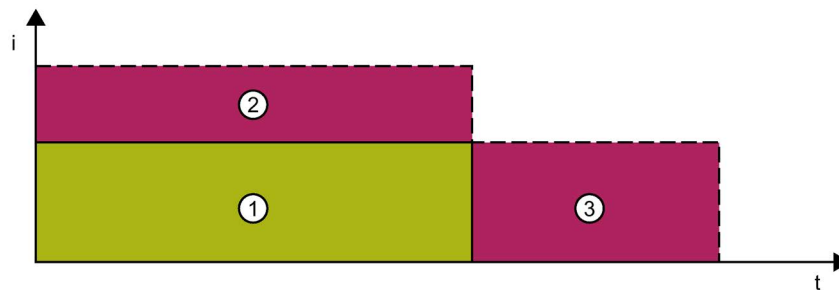

- ① Normal
- ② Starting current higher
- ③ Starting time longer

Startup diagram		Startup time	Starting current	Application
①	Normal condition	Normal	Normal	The resulting starting torque is sufficient for correct power-up of the motor.
②	Higher starting current	Normal	Higher	The resulting starting torque cannot be reduced any further because, for example, the acceleration resulting from a high load torque is not sufficient and the motor does not start up.
③	Longer starting time	Longer	Normal	The resulting starting torque can be reduced slightly further since sufficient acceleration is available.

Operation and settings

As described for Case B, the startup behavior changes especially when the starting current is increased but other motor parameters have only slightly changed. The achievable current limitations depend on the startup situation:

- If the acceleration torque is low, the current cannot be limited as it could be for motors with normal starting currents. In this case, therefore, higher starting current values shall be accepted. SIRIUS 3RW40 and 3RW44 soft starters with integrated motor protection permit current limiting values of up to 5.5 times the set motor current (I_e motor) depending on the version.
If this is not sufficient, higher values can be achieved by dispensing with the integrated motor protection.
- If a high acceleration torque is available, it is usually possible to achieve a current limit that is also achieved with motors with normal starting currents. In this case, starting merely takes longer because more energy is required for power-up. It is then only rarely necessary to change the setting parameters of the soft starter.
The dimensioning of the soft starter shall be checked.

Dimensioning of soft starters

Like motors with normally high starting currents, soft starters are essentially dimensioned according to the conditions of use:

A soft starter is selected that can handle the motor current during continuous duty and at startup depending on the installation altitude, ambient temperature, requirements of the application, starting currents and starting time. You will find further information about dimensioning in the catalogs and manuals.

For the correct dimensioning of soft starters for motors with high starting current ratios ($I/I_e \geq 8$), we recommend use of our "Simulation Tool for Soft Starters" (STS):

- Download (<http://support.automation.siemens.com/WW/view/en/101494917>)
- Readme (<http://support.automation.siemens.com/WW/view/en/101494773>)

More information

You can find further information about IE3 motors on the Internet (<http://www.siemens.com/ie3ready>).

See also

Main circuit - soft starters (Page 255)

Engineering support with data and tools

A.1 Engineering in the company

Meaning of the engineering process

The way in which new control panels are designed and constructed has changed a great deal in recent years. Electrical design engineers are supported in their daily work by modern software which they now regard as an essential tool. Tasks that used to be performed manually and took a relatively large amount of time and effort are now carried out automatically. Nonetheless, the design process is becoming increasingly complex. Influenced by new standards and directives, customer demands for detailed documentation or the wish to optimize aspects of assembly and production, the prorated costs of the electrical engineering design process and the amount of time and effort dedicated to it are growing.

The following diagram shows how the cost factors for the average control panel are distributed and compares the situation today to the prorated costs as they were around 15 years ago. The rise in the costs allocated to the engineering process is striking.

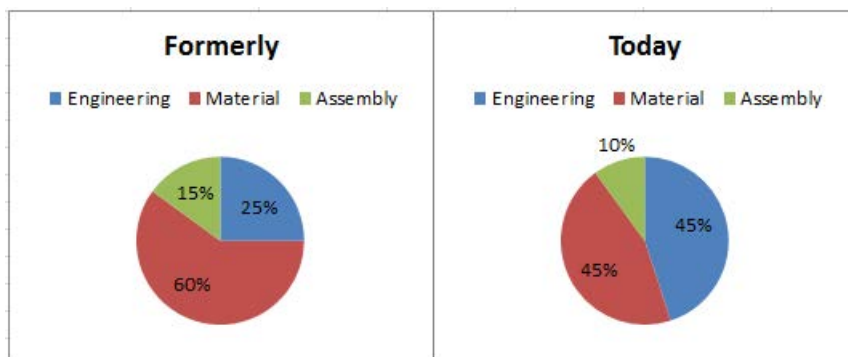

Source: Siemens AG

Figure A-1 Distribution of costs for designing a new control panel.

Engineering has become a core process. Optimized working is one of the key factors in reducing costs and remaining competitive.

Siemens not only offers a broad product portfolio for control panels, but can provide assistance at every stage of development of a new panel. This chapter contains a great deal of helpful information about the data and tools that are useful to electrical design engineers.

A.1.1 Optimization of internal and external cooperation

Important functions

Since design of electrical systems is a core process in developing a control panel, it shall be optimally integrated into the company. Flexible, efficient cooperation with other departments is just as important as the internal workflow in the design department itself. The overview below explains which functions need to be closely intermeshed:

Management / Procurement		Engineering		Production / Assembly
<ul style="list-style-type: none"> • Supplier contracts • Supply conditions • Price negotiations • Ordering process • Offer handling 	↔	<ul style="list-style-type: none"> • Mechanical construction • Automation programming • Electrical engineering • Simulation • Technical quality management 	↔	<ul style="list-style-type: none"> • Inventory control • Storage • Sheet metal processing • Assembly / Mounting • Wire preparation / wiring • Testing

Influence on costs and quality

The individual functions are often regarded and managed as independent entities. For example, it is not uncommon for the price to determine whether a new product is listed. On closer analysis of the situation, however, it is clear that many other factors have a direct influence on costs and quality.

- 1. Outlay for integration into a company's own Enterprise Resource Planning system (ERP)**
 Are all commercial data available (in electronic form)?
- 2. Outlay for integration into the engineering software**
 Are technical data available in electronic form?
 Are there suitable data available for the engineering system used?
 Is there sufficient documentation?
 Does the product have the certifications required (marine, UL, railway)?
 Can simulations be carried out with the available data?
 How high are the costs for integrating data?
- 3. Outlay for production/assembly**
 Are the devices easy to assemble/wire up?
 Do special tools need to be procured?
 Are the devices easy to handle, and are the device handling procedures known?

Support

In addition, attention needs to be paid to other factors that influence the costs of providing support and thus directly impact the satisfaction of the end customer.

1. Support

Which support options is the manufacturer offering?

How quick is the access to information?

2. Documentation

How easy is it to compile and supply individualized documentation?

In which languages is the documentation available?

Optimization

Attention should finally be paid to factors that influence overall optimization. The following overview shows a few examples:

Power loss data	<ul style="list-style-type: none"> • Can a thermal simulation simplify a heat test or even make such a test superfluous?
Connection data	<ul style="list-style-type: none"> • Virtual wiring possible in the engineering system • Simulation of the capacity utilization of cable ducts • Cable prefabrication possible • Automatic wiring possible • Reduction in wastage of cabling materials • Detailed documentation
Drilling plans	<ul style="list-style-type: none"> • Sheet metal can be processed automatically • Reduction in wastage • Detailed documentation
Classification data (ETIM / eCI@ss)	<ul style="list-style-type: none"> • Data management harmonization (commercial and technical) • Exchange of standardized data

A.1.2 Integrated data management

When a new product is created or changes are made to master data, it is important that the same set of information is available in all systems (ERP system, engineering software and Machine Execution System – MES). **To achieve this goal, it is always advisable to operate a cross-functional, integrated data management system.** Data are only entered once and then made available in digital form to all users (e.g. sales personnel, electrical design engineers, production supervisors). To ensure high-quality data integration, synchronization modules should be used that automatically distribute all data to other systems.

Integrated data landscape

A cross-functional, integrated data landscape is illustrated in the following example:

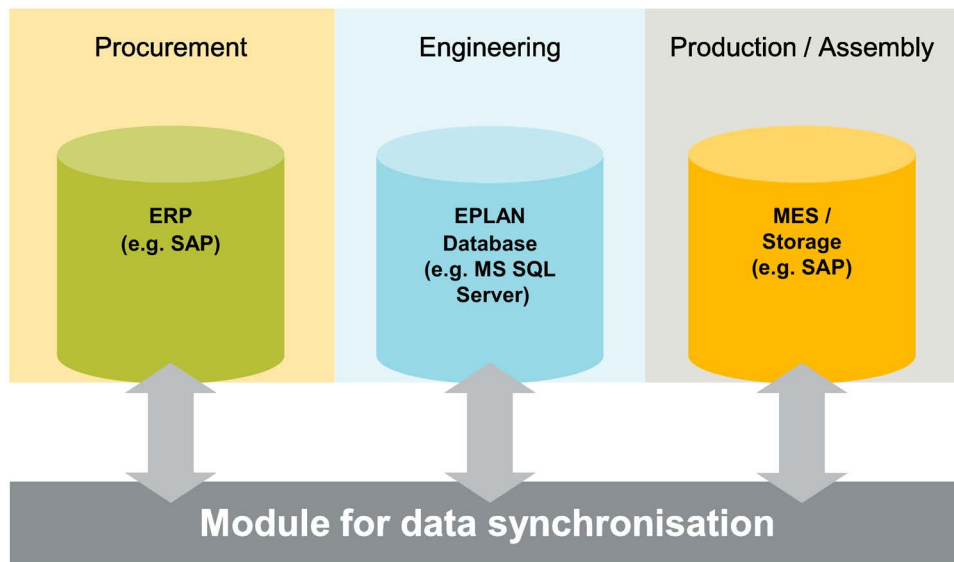

Figure A-2 Data synchronization

A system of this kind ensures that different data for an article are continuously and simultaneously accessible at all locations. For example, an electrical design engineer can create a new article and administer its technical data. The sales personnel enter any missing commercial data such as prices and delivery times which will then be available for use in calculations by the electrical design engineer.

These kinds of modules are often integrated as standard in commonly used ERP systems, engineering software packages (EPLAN, WSCAD) or production systems. They only need to be set up once in most cases.

A.2 Data for the engineering system

A.2.1 Overview of CAD and CAE data

The availability of product data for the planning software used is not only important, but essential in achieving a high-quality planning result. Siemens is offering a broad spectrum of CAD and CAE data (or "CAx data" for short) that can be imported directly into popular planning software packages.

CAx data

Table A- 1 CAx data and formats

CAx data		Formats
Product master data (Page 314)		
	• Commercial master data	eCI@ss / ETIM / CSV / XLSX
	• Technical master data	
Graphics / CAE data (Page 314)		
	• 2-dimensional drawings	DXF, DWG
	• 3D models	STEP
	• Circuit diagrams	DXF
	• EPLAN / WSCAD macros	EDZ / WSPKG
	• Product pictures	JPG / PNG / TIF
Documentation (Page 317)		
	• Data sheets	PDF
	• Manuals / operating instructions	PDF / XML
	• Characteristic curves	PDF / dynamic
	• Certificates	PDF
Supplementary data for the digital twin (Page 319)		
	• Power loss data	XLS
	• Connection data	ProPanel
	• Drilling plans	ProPanel Makro

These universal CAx data make it easy to integrate Siemens products into virtually any planning system. All data provided by Siemens are created according to defined rules and high quality standards. The data are therefore characterized by their consistently high quality and ease of use.

A.2.2 Product master data

Commercial data

These data are primarily intended for integration into a company's commercial system. They include important features such as product texts, article numbers, prices and classifications. Siemens supports the classification standards ETIM and eCl@ss. These ensure uniform structuring of all products (including those of other manufacturers) throughout the world.

Note

Download

Commercial data can be downloaded by means of the CAx Download Manager.

Technical data

Technical data are available in list format for every product. They are primarily intended to supply engineering or production systems. Depending on the type of product, technical data can be imported individually into the structure of the article database in the engineering system.

Note

Download

Technical data can be downloaded by means of the CAx Download Manager.

A.2.3 CAE / CAD / Graphic data

Note

Download

All graphic data can be downloaded from the following sources:

- Siemens Industry Mall (individual download)
 - Siemens image database (individual download)
 - CAx Download Manager (mass download)
-

2-dimensional drawing

A 2-dimensional drawing is a technical product drawing available in DXF or DWG format. It is often possible to import it directly into the planning system. The drawing contains the dimensions of a product. It can also be used as the basis for the control panel layout.

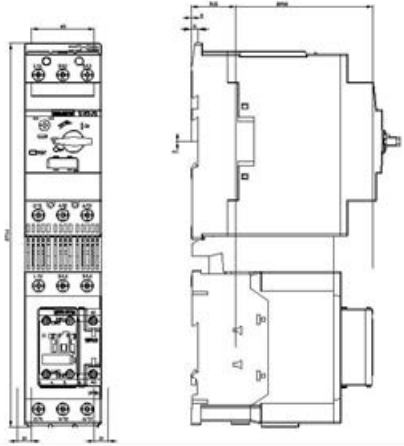

Figure A-3 Example: Dimension drawing of a motor feeder combination (motor starter protector and contactor)

3D model

The 3D model in STEP format can be imported into virtually any 3D-based engineering system. It can be used to create an extremely accurate virtual plan of the control panel. After a STEP file has been imported, it is generally necessary to carry out "finishing work". This includes: defining termination points, specifying drilling plans or choosing start and end points. Thanks to the 3D model, this finishing process is very easy. Siemens 3D models can also be downloaded as PDF preview versions (only possible in the Siemens image database). A 3D program is not required.



Figure A-4 Example: 3D model of a motor feeder combination (motor starter protector and contactor)

Circuit diagrams

A circuit diagram in DXF or DWG format contains an electrical circuit symbol for use in wiring plans. For its products, Siemens offers a circuit symbol standardized according to IEC. The circuit diagram is particularly useful for devices with symbols that are not included in the IEC standard symbol catalog. These include, for example, motor starters, controllers, soft starters or other complex devices.

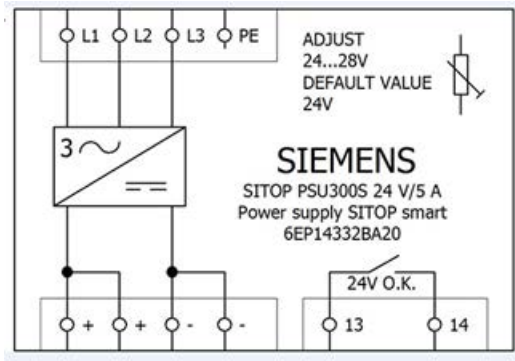

Figure A-5 Example: Circuit diagram of a SITOP power supply

EPLAN / WSCAD macro

Most popular engineering systems offer their own specially developed data formats for exchanging complete sets of article data. Siemens (currently) supports the data formats of EPLANElectric P8 (.EDZ) and WSCAD (.WSPKG). The file – often referred to as a "macro" – contains commercial, technical and graphic data. It often takes just a few mouse clicks to import the files into the software. These special macros can also be downloaded via the manufacturers' own data portals EPLAN Dataportal and wscaduniverse.com.

A.2.4 Documentation

Note

Download

All types of documentation can be downloaded from the following sources:

- CAx Download Manager (mass download)
 - Siemens Industry Online Support (individual download)
-

Operating instructions

Operating instructions are available for every article. They contain installation and connection instructions for the device concerned. The operating instructions are generally shipped with the product.

Manuals

SIEMENS makes a distinction between various types of manual. One type is the product manual that is created for each individual product family (e.g. SITOP, 3RT2 contactors or SIMATIC S7-1500). These contain all the relevant technical specifications as well as a description of various processes from installation to commissioning.

Another type is the system manual that describes the interaction between different components that are often combined with one another. For example, the SIRIUS Innovations system manual contains a lot of detailed information about combining contactors, motor starter protectors, overload relays and device connectors.

Characteristic curves

Characteristic curves are important parameters that help users to correctly select certain components such as motor starter protectors. There are various different types of characteristic curve:

- Tripping characteristic
- Let-through energy characteristic (I^2t characteristic)
- Let-through current characteristic

Note

Visualization and evaluation of characteristic curves

Many characteristic curves are stored in the SIMARIS curves (<http://www.siemens.com/SIMARIS>) software that can be downloaded free of charge.

This software displays characteristics with a high degree of precision and in any desired scale.

Certificates

Every control panel needs to be documented in full. The most important documents are the certificates for the products and product combinations used in the panel. By supplying certificates, it is possible to dispense with some of the special tests that normally need to be carried out by experts. All of the certificates offered by Siemens can be downloaded in PDF format from Industry Online Support.

Technical product data sheets

All of the important technical features of a product that are relevant for component selection are contained in the technical product data sheet. It is available in PDF format. The dimension drawing in the data sheet can be zoomed to the required size. It also contains references to all of the certificates issued for the product.

All product data sheets are available in the following 10 languages: German, English, French, Spanish, Italian, Portuguese, Dutch, Chinese, Russian and Turkish.

Note

Download

Technical product data sheets can be called up and downloaded from directly within the article view in the Industry Mall.

A.2.5 Supplementary data for the digital twin

The digital twin of a device or a product is the totality of all of the digital data that has been generated for that device or product. While a 3D model is a digital twin, it only describes the physical dimensions of a product. If the 3D model is combined with connection information such as coordinates, terminal designations and conductor cross-sectional areas, the result is a detailed twin which can be used not only to generate a 3D layout of a control panel, but also to create virtual wiring.

In the past, it was common practice to supply a large volume of technical data and 2D information for products. But the trend is now moving in favor of 3D. With 3D, for example, it is possible to plan a virtual design plus the equipment wiring with millimeter precision. Siemens is meeting this trend by supplying useful planning data.

Connection data / drilling plans

Connection data and drilling information are needed in order to plan a control panel and generate virtual wiring in 3D. Siemens is currently supplying these data in the form of ProPanel macros for EPLAN ProPanel.

Note

Siemens is continuously expanding its EPLAN ProPanel macros to include new products as soon as they become available.

Power loss data

The thermal analysis of a control panel is one of the most important risk analyses performed by control panel manufacturers. Many manufacturers offer stand-alone or integrated thermal calculation or simulation tools for this purpose. However, these tools can only be used if the precise power loss data of the equipment is known. A complete list of power loss data for the current ranges of Siemens products can be downloaded from Siemens Industry Online Support.

Siemens offers the SIMARIS therm (<http://www.siemens.com/simaristherm>) software for analyzing the heat balance of control panels.

A.3 Selection aids and engineering software

Products that are new and previously unused are often incorporated in new control panels. In many cases, the panel designer has to study new technologies and then select a system comprising individual components that will interact perfectly under ideal conditions. Compiling a selection of components is often a very time-consuming process and thus increases engineering costs. Furthermore, thanks to the necessity to comply with standards and directives, the task is becoming ever more complex and the designer might not have any easy solutions to hand.

Electronic selection aids and engineering software

In order to minimize the time and effort spent on this task and assist panel designers in the most effective way possible, Siemens is offering a large selection of electronic selection aids and engineering software that are mostly free of charge.

Table A- 2 Siemens engineering software

Getting an overview of the product (Page 320)	Which products and technologies can be used in the control panel?
Finding out the product details (Page 321)	Which capabilities and options are offered by a particular product range?
Choosing the product (Page 322)	What is the right method for designing and/or configuring products and systems?
Obtaining data for the engineering system (Page 326)	Which CAE data are available and where can they be downloaded?
Creating documentation (Page 329)	How can the necessary documents and individual manuals be obtained?
Getting help and support (Page 327)	How can technical support be accessed if there are any problems?

A.3.1 Acquisition of information

A.3.1.1 Getting an overview of the product

An overview of all equipment available for control panels and switchgear and controlgear assemblies can be found on the main website (<http://www.siemens.com/panel-building>).

All the major product ranges are listed under "Power distribution" and "Control panel".



A.3.1.2 Finding out the product details

Starting from the product overview, it is possible to navigate to a page containing a detailed description of the product range including information about types, versions and accessories. The detail pages can also be called directly.

Product ranges for control panels

Table A- 3 Detail pages – control panels

Controls	SIRIUS (http://www.siemens.com/SIRIUS)
Protection equipment	SENTRON (http://www.siemens.com/SENTRON)
Measuring devices	
Busbar trunking systems and cubicles	SIVACON (http://www.siemens.com/SIVACON) ALPHA (http://www.siemens.com/ALPHA)
Power supplies	SITOP (http://www.siemens.com/SITOP)
Frequency converters	SINAMICS (http://www.siemens.com/SINAMICS)
Controllers	SIMATIC (http://www.siemens.com/SIMATIC)
HMI	SIMATIC-HMI (http://www.siemens.com/SIMATIC-HMI)

Product ranges for power distribution

Table A- 4 Detail pages – power distribution

Low-voltage components	SENTRON (http://www.siemens.com/SENTRON) SIRIUS (http://www.siemens.com/SIRIUS)
Busbar trunking systems and cubicles	SIVACON (http://www.siemens.com/SIVACON) ALPHA (http://www.siemens.com/ALPHA)
SIMOSEC air-insulated switchgear	SIMOSEC (http://www.siemens.com/SIMOSEC)
Automation and metering	SICAM (http://www.siemens.com/SICAM)
Protection equipment	SIPROTEC (http://www.siemens.com/SIPROTEC)
Transformers <ul style="list-style-type: none"> • Dry-type transformers • Liquid-immersed distribution transformers 	Transformers Link (http://www.siemens.com/transformers)
Vacuum switching technology <ul style="list-style-type: none"> • Vacuum interrupters • Contactor/fuse combinations • Motor starter protectors • Switch disconnectors 	Medium voltage Link (http://www.siemens.com/mediumvoltage)

A.3.1.3 Choosing the product

There are a variety of different approaches to choosing the correct products. It is important to abide by various rules, particularly when it comes to switching and protection devices. SIEMENS offers software specially developed for this purpose.

The different approaches to choosing products are explained below:

1. Product design / product dimensioning

The dimensioning approach is used when important basic properties are not yet known. Standards-compliant calculations are performed on the basis of application parameter inputs during the design process. When all the calculations are complete, the software suggests products or provides information that can be used to select or configure a product.

2. Product configuration

The product configuration approach is used after the basic properties have been calculated, but certain product versions that are not yet fully defined or known are required for the application. The product configuration method generally identifies several products that are designed to operate and/or have been tested together. This also applies to configuration of accessories.

3. Product selection

The simple approach of selecting a product is used once the basic characteristics and product versions are already known, but the article number still has to be found. This applies, for example, if the short-circuit rating of a motor starter protector has already been calculated on the basis of the motor and cable length, and the required product variant (such as connection type or control voltage) has been determined.

Selection

The following overview illustrates which approach will lead to the right product:

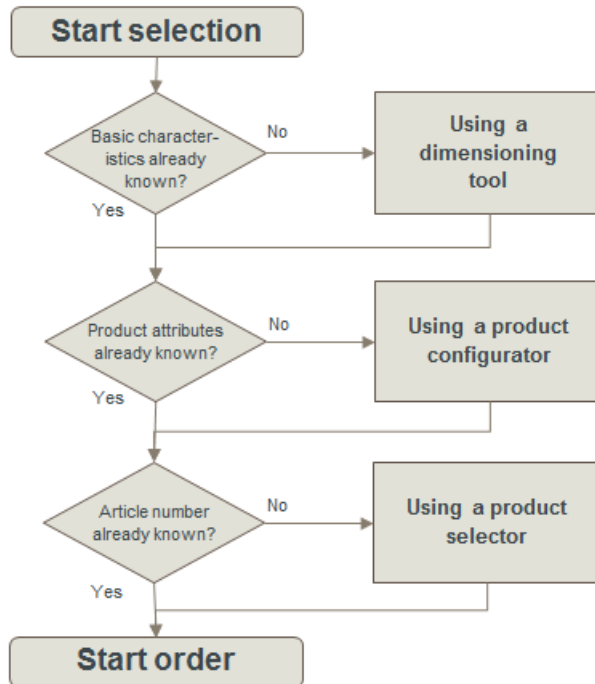

Figure A-6 Product selection using software

Design and dimensioning tools

SIEMENS offers design and dimensioning tools to help with the selection of products that are standards-compliant and suitable for the application in question. The following overview shows all of the main tools arranged according to their selection approach:

Table A- 5 Design and dimensioning tools

Mechanical load cycles Frequency converters Motors	SIZER (http://www.siemens.com/SIZER)
Energy efficiency Switching devices / soft starters Frequency converters	SINASAVE (http://www.siemens.com/SINASAVE)
Switching and protective equipment Short-circuit calculation Cable dimensioning Network dimensioning	SIMARIS design (http://www.siemens.com/SIMARIS)
Motor starter protectors Characteristic curves for protection equipment	SIMARIS curves (http://www.siemens.com/SIMARIS)
Soft starters	Simulation Tool for Soft Starters STS (http://www.siemens.com/softstarter) (Software tab)

Product configurators

Table A- 6 Product configurators

Drives • Configurator for drive technology	DT Configurator (http://www.siemens.com/dt-configurator)
Motors • Guided motor selection	Configurator (https://mall.industry.siemens.com/mall/en/de/Catalog/Configurators)
Converters/inverters • Guided inverter selection	(→ Drive Technology)
SIMATIC PLC, communication, AS-i / IO-Link / PROFINET	TIA Selection Tool TST (http://www.siemens.com/TST) (offline and Cloud version)
Molded case circuit breakers	3VA Configurator (http://www.siemens.com/lowvoltage/3va-configurator)

Pushbuttons and indicator lights	SIRIUS ACT Configurator (http://www.siemens.com/sirius-act/configurator)
Motor starters up to 5.5 kW, group branch circuits	Configurators (https://mall.industry.siemens.com/mall/en/de/Catalog/Configurators) (→ Low-Voltage Controls and Distribution)
• Configurator for 3RM1 motor starters	
Safety relays	
• Configurator for 3SK1 and modular safety system	
Load feeders up to 18.5 kW (switching and protective equipment combinations)	
Motor starter protectors	
• SIRIUS Innovations Configurator	

Product selection

Simple product selection via the Siemens Industry Mall (<http://www.siemens.com/industrymall>) is also an option. This is done by navigating through the product tree to the relevant product range in order to display the product list:

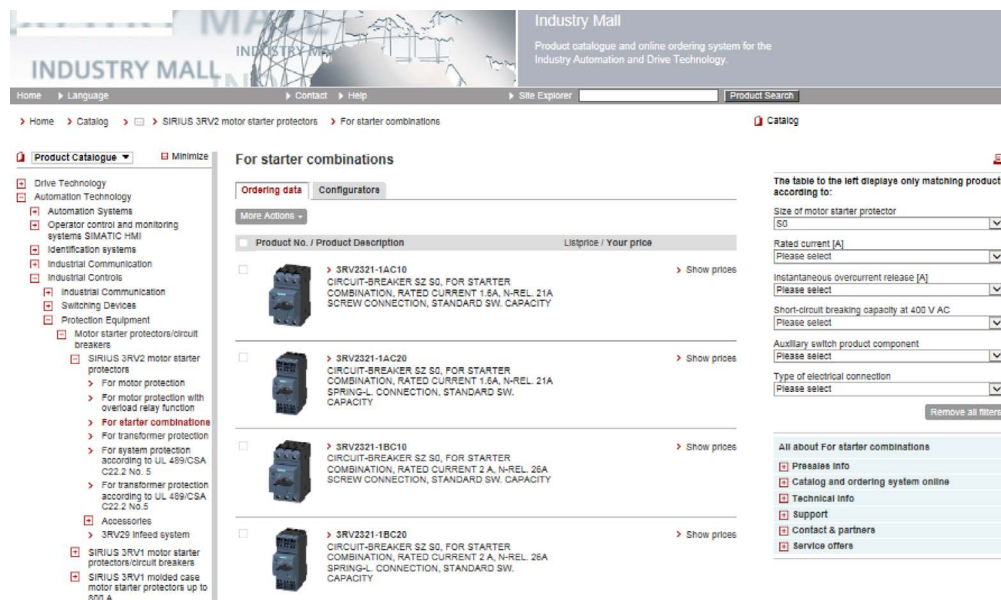

Figure A-7 Siemens Industry Mall

On the right-hand side, filters can be set up under "The table to the left displays only matching products according to:" When only a few products are still listed after filtering, the "Compare" button can be clicked to open a detail view which clearly displays the differences between products.

It is possible to use selection configurators (<http://www.siemens.com/configurators>) as an alternative to integrated product selection in the Siemens Industry Mall

A.3.1.4 Obtaining data for the engineering system

Appropriate data are needed for the engineering system (electrical design software) in order to generate an error-free, consistent electrical design. An overview of all of the available data can be found in chapter Data for the engineering system (Page 313).

CAX data can be downloaded by the following methods:

- From a CAE software data portal
- Mass download of CAX data (Page 327)
- Downloading individual CAX data (Page 326)

From a CAE software data portal

Siemens provides special data packages for downloading from the data portals of a number of CAE software producers: The data required for many products can therefore be directly imported into or exported out of the CAE software.

The following SIEMENS article data are available:

- For EPLAN Electric P8 and EPLAN Pro Panel in the EPLAN Data Portal (<http://www.eplandataportal.com>)
- For the WSCAD Suite in the wscaduniverse (<http://www.wscaduniverse.com>)

Downloading individual CAX data

The most important graphic data and the technical product data sheet can be found in the Siemens Industry Mall (<http://www.siemens.com/industrymall>).

3RT2015-1AB01



CONTACTOR, AC-3, 3KW/400V, 1NO, AC 24V, 50/60 HZ, 3-POLE, SZ S00 SCREW TERMINAL

List Price	> Show prices
Customer Price	> Show prices
DataSheet in PDF	PDF Download
Manuals, Certificates, FAQs...	↗ Service & Support

> Image gallery and Data for M-CAD and E-CAD (7)

The link to all available graphic data can be found under the product image in the detail view.

The technical product data sheet can be downloaded directly from the list to the right of the product image.

Documentation such as manuals, operating instructions and certificates are available in SIOS.

Mass download of CAx data

All of the data for several products can be downloaded simultaneously in a single package with the CAx Download Manager.

Use of the CAx Manager is always free, but a valid login for the Siemens Industry Online Support Portal is required.

CAx Download Manager

The CAx Download Manager (<http://www.siemens.com/cax>) can be accessed in the Siemens Industry Online Support Portal (SIOS) by selecting **mySupport** → **CAx Data**.

A click on the sub-link **CAx Data** → **CAx Download Manager** displays an overview of all previously generated download packages. This view is empty if a CAx data download package has not yet been generated.

A click on the second link **CAx Data** → **Set up new CAx download** generates a new and individualized download package. The CAx Download Manager wizard then guides the user through a step-by-step process of specifying the required data.

A detailed guide to using the CAx Download Manager can be called with the help function of the Siemens Industry Online Support Portal.

A.3.1.5 Getting help and support

Siemens Industry Online Support

The central contact point for all product queries is the Siemens Industry Online Support Portal – or SIOS (<http://www.siemens.com/sios>) for short.

The portal consists of the following areas:

- Product support
- Application examples
- Services
- Forum
- mySupport

Product support

An article number can be used to access all information such as certificates, manuals, operating instructions, FAQs, downloads and product information. Just enter an article number on the home page. An intelligent search filter then appears. This can be used to filter out any unwanted search results.

Application examples

A large database containing practical examples for all products can be accessed in the "Application examples" area. In most cases, detailed instructions for an application are displayed – from basic knowledge and configuration to finished program code that can be applied in customer projects.

Services

Special information and individual services can be accessed in the Services area. These include repair services, training services or spare parts services, for example.

Forum

It is possible to search for specific questions and answers, to post questions and take part in discussions in the forum. The forum in SIOS has a very large community which is overseen by moderators. Questions posted in the forum are very often answered directly by Siemens experts. Complete access to the forum is only granted after a user has registered free of charge in SIOS beforehand.

mySupport

The mySupport area of SIOS (<http://www.siemens.com/sios>) offers functions that can be customized by SIOS users. Use of the mySupport area is only available to users who have already registered and logged in (free service). The following overview shows the main functions:

Table A- 7 mySupport

Support Request	You can submit a request relating to a specific product to Siemens Technical Support. The support service is available 24/7 and will usually respond within 24 hours.
Products	You can create, administer and use personalized article lists to speed up searches for documentation in SIOS.
Notifications	You can configure this function to obtain updated information relating to specific subjects or new contents. Notifications are managed in this area.
Filter	Filters for searches in SIOS can be stored and called again at any time. This enables you to search for information selectively without having to enter the search criteria again. It is possible to set notifications for the filters so that you will be informed when new documents that match your search criteria are available.
Documentation	You can compile and manage your own documentation with this function.
CAX data	CAX data (3D, 2D, technical data, data sheets, macros, manuals, operating instructions) for several articles can be downloaded simultaneously.

More information

By selecting the "Help" link in the navigation bar of the portal, it is possible to display detailed instructions and videos for the currently selected SIOS page.

Instructions for using SIOS can be found in the HelpCenter (<https://support.industry.siemens.com/cs/helpcenter/de/index.htm>).

A.3.1.6 Creating documentation

The preparation of detailed and complete documentation during and at the end of a project in particular is compulsory and frequently involves a great deal of time and work. In many cases, it is necessary to search for and download many certificates, manuals and operating instructions on manufacturers' websites.

In the Siemens Industry Online Support (SIOS), Siemens offers two functions that speed up these searches and make it easier to compile documentation:

- Product lists
- MyDocumentationManager / documentation

Product lists

You can administer personalized or project-specific lists in SIOS under **mySupport** → **Products**.

Once you have created a new product list, you can add several Siemens article numbers to it. This is done by using the CAE software to evaluate all the articles and then copying and pasting them into your new product list. The list remains stored in your account.

You can use this list to search for documents in SIOS. The only search results then displayed are those which directly relate to the products on the product list.

MyDocumentationManager / documentation

The SIOS includes the function **mySupport** → **Documentation**.

With this function, you can compile your own personalized or project-specific documentation. You have to create a folder structure for documentation purposes first.

Once the structure has been defined, you can use your personal product list or the search functions in SIOS to search for documents. You can add any document or individual chapters to your personal library. By this method, you can gradually compile individual documentation.

The documentation is permanently stored in your profile. It is also possible to program automatic notifications which inform you of any changes to the contents of your library, for example, after publication of a new manual version.

In a final step, you export the documentation in PDF, XML or RTF format. Each document is assigned a unique revision number, a table of contents that is generated according to the documentation structure and a subject index.

All data can be stored and exported in a number of different languages.

Further information and a detailed guide to using the **mySupport** → **Documentation** function can be found in the help of the Siemens Industry Online Support Portal.

European directives and CE marking for industrial and machine control panels

B

B.1 Scope of application of relevant directives

Vertical and horizontal directives

If products fall within the scope of several EU directives, they shall fulfill the protection requirements of all the applicable directives. A distinction is made between horizontal and vertical EU directives.

Vertical directives are **product-specific** directives. They specially and comprehensively regulate product-specific protection requirements.

Horizontal directives govern **general** (common) **protection requirements** for products. They **apply across products**. Products may be exempted from product-specific and general protection requirements depending on the product type and the relevant directives.

Example

Examples of important vertical and horizontal directives for control engineering:

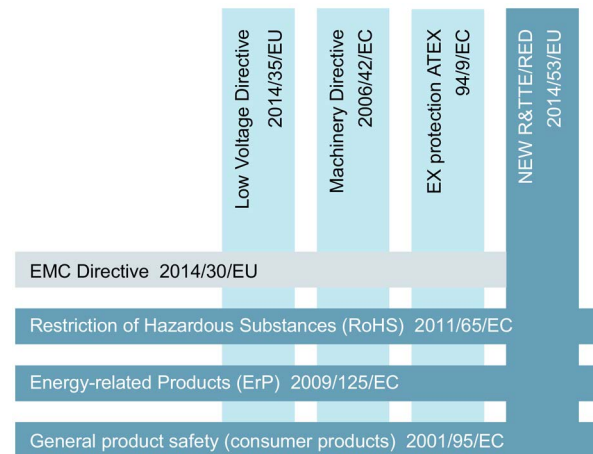

Figure B-1 Example: Horizontal and vertical standards

B.1 Scope of application of relevant directives

Recommendation

For marketing an industrial control panel in the EEA, it is advisable to pay particular attention to the Low Voltage Directive, the Machinery Directive and the EMC Directive.

The currently harmonized EU directives can be found on the website of the European Commission (<http://ec.europa.eu/growth/single-market/european-standards/harmonised-standards>).

The following table lists the EU directives applicable to low-voltage switchboards and/or industrial control panels for machinery that have been revised within the scope of the New Legislative Framework.

Table B- 1 Harmonized CE Directives, Publication 2014

Directive	"Old"	"New"	Effective date / valid as of
Low Voltage Directive (https://ec.europa.eu/growth/single-market/european-standards/harmonised-standards/low-voltage_en)	2006/95/EC	2014/35/EU	April 20, 2016
EMC Directive (http://eur-lex.europa.eu/legal-content/EN/TXT/?uri=uriserv:OJ.L_.2014.096.01.0079.01.ENG)	2004/108/EC	2014/30/EU	April 20, 2016
ATEX Directive	94/9/EC	2014/34/EU	April 20, 2016
Measuring Instruments Directive	2004/22/EC	2014/32/EU	April 20, 2016
Civil Explosives Directive	93/15/EC	2014/28/EU	April 20, 2016
Simple Pressure Vessels Directive	2009/105/EC	2014/29/EU	April 20, 2016
Lifts Directive	95/16/EC	2014/33/EU	April 20, 2016
Non-Automatic Weighing Instruments Directive	90/384/EC	2014/31/EU	April 20, 2016
Pressure Equipment Directive	97/23/EC	2014/68/EU	July 19, 2016
Radio Equipment Directive	99/5/EC	RED 2014/35/EU (Radio Equipment Directive)	June 13, 2016

The specified directives have been transposed into the national legislation of EU states and have been valid since the effective date. The "old" directives and the corresponding numbers of the directives may no longer be applied to new products placed on the market since the effective date of the new directive. Old directives may no longer be used for the purposes of conformity assessment or declaration of conformity, nor may they be mentioned in documentation.

The Machinery Directive has not yet been revised within the scope of the New Legislative Framework. This directive has been applicable without change since December 29, 2009: MRL-2006/42/EU (<http://eur-lex.europa.eu/legal-content/de/TXT/?uri=CELEX:32006L0042>).

B.2 Harmonized standards

Standards are used by product manufacturers as a guide for analyzing risks and meeting basic requirements. The list of applicable harmonized standards is published with the Official Journal for the relevant directive.

The Official Journals can be found on the website of the European Commission (<http://ec.europa.eu>).

Available EU directives

A list of available EU directives (dated February 2017) can be found on the website Harmonised Standards (http://ec.europa.eu/growth/single-market/european-standards/harmonised-standards_de).

Harmonised Standards

A harmonised standard is a European standard developed by a recognised European Standards Organisation: CEN, CENELEC, or ETSI. It is created following a request from the European Commission to one of these organisations. Manufacturers, other economic operators, or conformity assessment bodies can use harmonised standards to demonstrate that products, services, or processes comply with relevant EU legislation.

The references of harmonised standards must be published in the Official Journal of the European Union. The purpose of this website is to **provide access to the latest lists of references of harmonised standards** and other European standards published in the Official Journal of the European Union (OJEU).

References of harmonised standards and of other European standards published in the OJEU

Electric and electronic engineering

- ...
- Low Voltage (LVD) (https://ec.europa.eu/growth/single-market/european-standards/harmonised-standards/low-voltage_en)

...

Mechanical engineering and means of transport

- ...
- Machinery (MD) (https://ec.europa.eu/growth/single-market/european-standards/harmonised-standards/machinery_en)

Example

Below are excerpts from the webpages of the European Commission relating to the Low Voltage Directive and the Machinery Directive. The links lead to the current Official Journals in the relevant national languages.

Short name:	Low voltage (LVD)
Base:	Directive 2014/35/EU of the European Parliament and of the Council of 26 February 2014 on the harmonisation of the laws of the Member States relating to the making available on the market of electrical equipment designed for use within certain voltage limits (recast). Applicable from 20 April 2016. OJ L 96, 29 March 2014
Modification:	[-]
Directives repealed (applicable until 20 April 2016):	Directive 2006/95/EC of the European Parliament and of the Council of 12 December 2006 on the harmonisation of the laws of Member States relating to Electrical Equipment designed for use within certain voltage limits OJ L 374 of 27 December 2006
Guide for application:	<ul style="list-style-type: none"> • Guidance on CE marking for professionals • Low voltage directive - Guidelines on application and recommendations
Commission contact point:	Directorate-General for Internal Market, Industry, Entrepreneurship and SMEs Mr Luca Del Colombo, Tel +32 2 295 57 97 Email Webpage for electrical and electronic engineering industries
For information about the content and availability of European standards, please contact the European Standardisation Organisations .	

Source: European Commission > Growth > The European Single Market > European Standards > Harmonised Standards > Low voltage (LVD); February 2017

Figure B-2 Low voltage Directive 2014/35/EU (LVD)

Short name:	Machinery (MD)
Base:	Directive 2006/42/EC of the European Parliament and of the Council of 17 May 2006 on machinery, and amending Directive 95/16/EC (recast) OJ No L 157, 9 June 2006
Modification:	Regulation (EC) N° 569/2009 - adaptation to the regulatory procedure with scrutiny [OJ L 188, 18 July 2009] Directive 2009/127/EC amending Directive 2006/42/EC with regard to machinery for pesticide application [OJ L 310, 25 November 2009]
Guide for application:	Guidance on CE marking for professionals Guide to application of the Machinery Directive 2006/42/EC
Commission contact point:	Directorate-General for Internal Market, Industry, Entrepreneurship and SMEs Ms Felicia STOICA, Tel +32 2 295 67 79 Email Webpage on machinery
For information about the content and availability of European standards, please contact the European Standardisation Organisations	

Source: European Commission > Growth > The European Single Market > European Standards > Harmonised Standards > Machinery (MD); February 2017

Figure B-3 Machinery Directive 2006/42/EC (MD)

A, B and C Type standards

The harmonized standards of the Machinery Directive do not normally apply to just the control panel, but to the entire machine.

The standards are categorized as either A Type (few standards, not detailed), B Type or C Type (many standards, very detailed).

A Type standards	Design principles and basic concepts for machines		Basic safety standards
B Type standards	B1 standards General safety aspects	B2 standards Reference to special protective equipment	Group safety standards
C Type standards	Specific safety aspects of individual machines or machine categories		Machine safety standards / technical standard

Figure B-4 A, B and C Type standards - overview

Table B- 2 A, B and C Type standards - description

Description	Examples
A Type standards deal with basic concepts, design principles and general aspects that can be applied to machinery.	EN ISO 12100 "Safety of Machinery - General Design Principles - Risk Assessment and Minimizing Risks"
B Type standards deal with one safety aspect or one type of safeguard that can be used across a wide range of machinery.	B1 Type standard: EN 1037 "Safety of Machinery – Prevention of unexpected start up" B2 Type standard: EN 1088 "Safety of machinery – Interlocking devices associated with guards – principles for design and selection"
The machinery safety standards – also known as technical standards – of C Type deal with detailed safety requirements for a specific machine, or a family of identical machines.	EN 12717 "Safety of machine tools – drilling machines" EN ISO 10218 "Safety requirements for industrial robots"

B.3 Technical documentation

Requirements of the technical documentation

The manufacturer draws up the technical documentation for products that are delivered to the European Economic Area. Compliance of an electrical item of equipment with the applicable requirements can be evaluated on the basis of these documents.

The requirements for technical documentation that are defined in Annex III of the Low Voltage Directive 2014/35/EU are summarized below:

- A general description of the electrical equipment
- A conceptual design and manufacturing drawings and schemes of components, sub-assemblies, circuits, etc.
- Descriptions and explanations necessary for the understanding of those drawings and schemes and the operation of the electrical equipment.
The purpose of this requirement is to ensure that third parties can understand the aforementioned aspects of the equipment.
- A list of standards applied (in full or in part) or a description of the means by which the safety requirements of the directive have been satisfied.
- The results of the design calculations, the tests performed (e.g. also tests in compliance with IEC 60204-1 or type and routine verification in compliance with IEC 61439-1), etc.
- Test reports (available test reports from the manufacturer or third parties)

Storage

The manufacturer shall take all measures necessary so that the manufacturing process and its monitoring ensure compliance of the manufactured electrical equipment with the technical documentation.

The technical documentation shall be stored in an easily accessible location for at least 10 years by the manufacturer or by the economic players mentioned in Chapter 5 (e.g. in digital form as well). At the request of the authorities, the documentation shall be made available in a language that can be understood easily by the responsible national authority

Technical documentation in other economic regions

The requirements of technical documentation in other economic regions varies according to the country and product. The standards are specific to the country in question and may differ significantly from EU requirements in terms of their content and language requirements.

B.4 Declaration of conformity

Products that are delivered to the European Economic Area shall bear a CE marking. With the CE marking, a manufacturer certifies conformity with the applicable directives, e.g. the product falls within the scope of the Low Voltage Directive or the EMC Directive.

Declarations of conformity are also required in other economic regions. However, the requirements normally deviate from those of the EU and, in most regions, stipulate the support of a certification agency or product testing by a certified test laboratory.

The assessment of conformity process for products destined for sale in the European Economic Area essentially comprises 3 steps:

1. Compilation of the technical documentation including risk analysis and assessment, see Technical documentation (Page 337)
2. Preparation of the EU declaration of conformity
3. The CE marking

B.5 CE marking

Information about the general principles of the CE marking can be found in Regulation EC 765/2008 (<http://eur-lex.europa.eu/legal-content/DE/TXT/?qid=1476713993189&uri=CELEX:32008R0765>).

Detailed information about the CE marking can be found in the "Blue Guide (<http://ec.europa.eu/DocsRoom/documents/12661?locale=de>) on the implementation of EU product rules 2016" (2016/C 272/01).



Download links:

Original format. PDF format with official reference.

[BLUE GUIDE 2016 EN](#) (2 MB) [bg](#) [cs](#) [da](#) [de](#) [et](#) [el](#) [es](#) [fr](#) [hr](#) [it](#) [lv](#) [lt](#) [hu](#) [mt](#) [nl](#) [pl](#)
[pt](#) [ro](#) [sk](#) [sl](#) [fi](#) [sv](#)

Source: European Commission, <http://ec.europa.eu/DocsRoom/documents/12661?locale=de>; March 2, 2017

Figure B-5 Blue Guide

B.6 Risk analysis and assessment

Chapter 5 of the CENELEC GUIDE 32 "Guidelines for Safety Related Risk Assessment and Risk Reduction for Low Voltage Equipment" contains a detailed description of risk analysis methods.

The guidelines are available in English, French and German.

Link (ftp://ftp.cenelec.eu/CENELEC/Guides/CLC/32_CENELECGuide32.pdf)

Basic procedure

Basic risk analysis and assessment procedures

1. Risk analysis:

Determine the actual risk posed by the electrical equipment as defined, for example, in the Low Voltage Directive 2014/35/EU.

Equipment within certain voltage limits from 50 V AC to 1000 V AC and 75 V DC to 1500 V DC. The requirements mentioned thereafter may also apply to a complete electrical switchgear and controlgear assembly.

2. Risk assessment:

Determine the tolerable or acceptable residual risk in accordance with the application.

3. Implement measures in order to reduce the currently identifiable risk (as described in paragraph 1) to a level below the tolerable risk level.

4. Verify that the measures implemented have been successful. If it is determined that the measures have not been successful, the procedure shall be repeated as described in point 1.

5. On successful completion of the risk analysis and assessment, the measures that have been implemented and tested shall be appropriately documented. This record shall be stored with the other documentation for assessment in accordance with the Low Voltage Directive or possibly the Machinery Directive.

Flowchart

The flowchart below is based on the CENELEC Guide 32 and describes in schematic form the process for assessing and reducing risks:

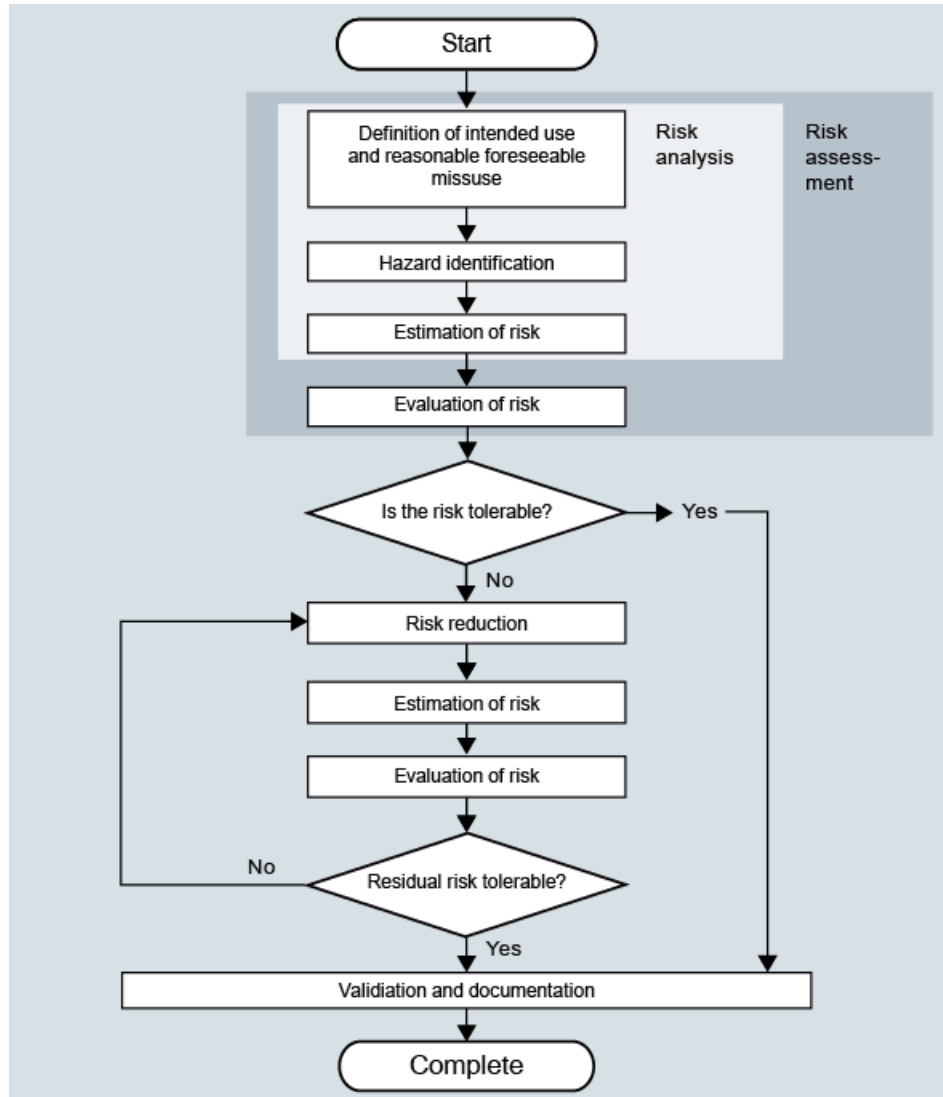

Figure B-6 Process of risk assessment and risk reduction

Substantial modifications to the plant

The risk analysis shall be performed again when substantial modifications or changes are made to the technical features of the plant.

The flowchart below provides a useful decision-making guide for determining whether modifications to existing plants are substantial enough to warrant another risk analysis.

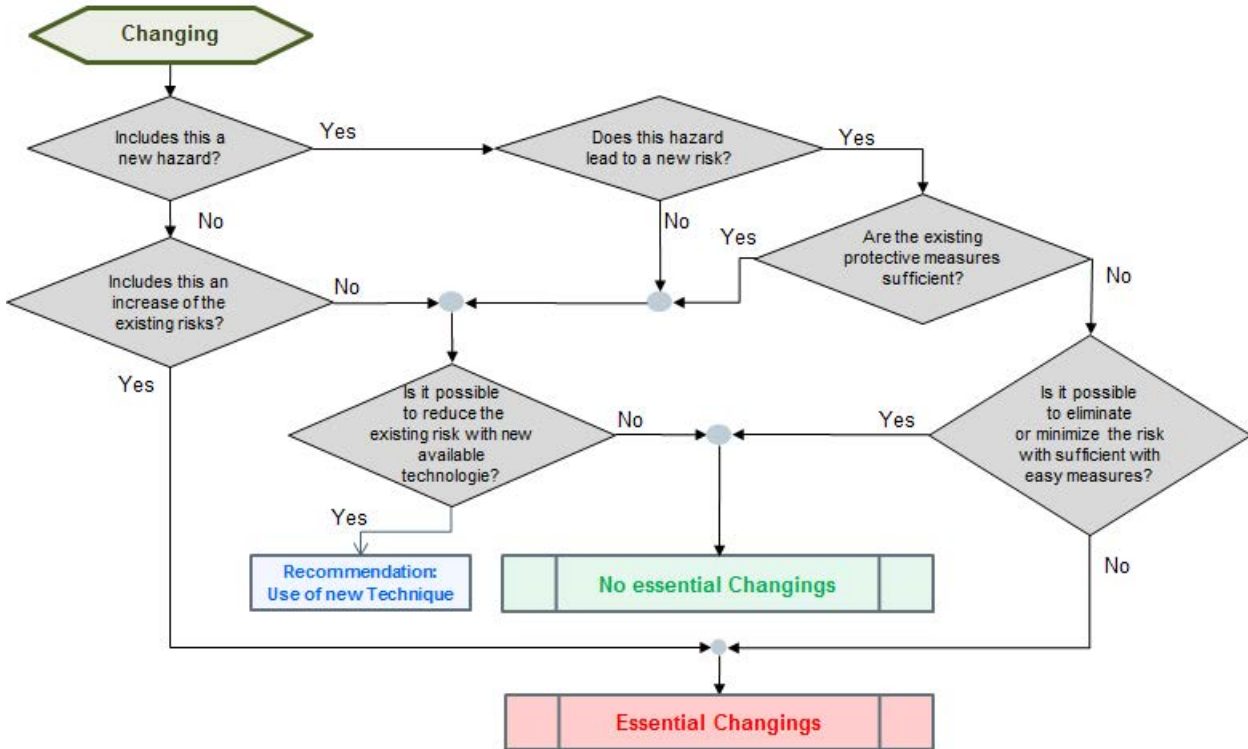

Figure B-7 Flowchart for plant modifications

B.7 Scope of applicability for IECEE

IEC member states

Table B- 3 IEC member states (in 2016)

Country	Code		Website
Albania	AL	**	http://www.dps.gov.al
Algeria	DZ	*	http://www.ianor.dz
Argentina	AR	*	http://www.aea.org.ar
Australia	AU	*	http://www.standards.org.au
Austria	AT	*	http://www.ove.at
Bahrain	BH	**	
Belarus	BY	*	http://www.gosstandart.gov.by
Belgium	BE	*	http://www.ceb-bec.be
Bosnia-Herzegovina	BA	**	http://www.bas.gov.ba/button_82.html
Brazil	BR	*	http://www.cobei.org.br
Bulgaria	BG	*	http://www.bds-bg.org
Canada	CA	*	http://www.scc.ca
Chile	CL	*	http://www.cornelec.cl
China	CN	*	http://www.sac.gov.cn
Colombia	CO	*	http://www.icontec.org
Croatia	HR	*	http://www.hzn.hr
Cuba	CU	**	-
Cyprus	CY	**	http://www.cys.org.cy
Czech Republic	CZ	*	http://www.unmz.cz/
Democratic People's Republic of Korea	KP	**	-
Denmark	DK	*	http://www.ds.dk
Egypt	EG	*	-
Estonia	EE	**	http://www.evs.ee
Finland	FI	*	http://www.sesko.fi
France	FR	*	http://www.afnor.org
Georgia	GE	**	http://www.geostm.ge
Germany	DE	*	http://www.dke.de
Greece	GR	*	http://www.elot.gr
Hungary	HU	*	http://www.mszt.hu
Iceland	IS	**	http://www.stadlar.is
India	IN	*	http://www.bis.org.in
Indonesia	ID	*	http://bsn.go.id
Iran	IR	*	http://www.inec.ir
Iraq	IQ	*	-
Ireland	IE	*	http://www.nsai.ie
Israel	IL	*	http://www.sii.org.il

B.7 Scope of applicability for IECCE

Country	Code		Website
Italy	IT	*	http://www.ceinorme.it
Japan	JP	*	http://www.jisc.go.jp/
Jordan	JO	**	http://www.jsmo.gov.jo
Kazakhstan	KZ	**	http://www.memst.kz
Kenya	KE	**	http://www.kebs.org
Korea, Republic of	KR	*	http://www.kats.go.kr/
Latvia	LV	**	http://www.lvs.lv
Libya	LY	*	http://www.lncsm.org.ly
Lithuania	LT	**	http://www.lsd.lt
Luxembourg	LU	*	http://www.portail-qualite.lu/
Malaysia	MY	*	http://www.jsm.gov.my
Malta	MT	**	http://www.mccaa.org.mt/
Mexico	MX	*	http://www.economia.gob.mx/?P=85
Moldova	MD	**	http://www.standard.md
Montenegro	ME	**	http://www.isme.me/
Morocco	MA	**	http://www.imanor.ma/
Netherlands	NL	*	http://www.nen.nl
New Zealand	NZ	*	http://www.standards.govt.nz/
Nigeria	NG	**	http://www.son.gov.ng
Norway	NO	*	http://www.nek.no
Oman	OM	*	-
Pakistan	PK	*	http://www.psqca.com.pk
Philippines, Rep. of the	PH	*	http://www.bps.dti.gov.ph
Poland	PL	*	http://www.pkn.pl
Portugal	PT	*	http://www.ipq.pt
Qatar	QA	*	-
Romania	RO	*	http://www.asro.ro
Russian Federation	RU	*	http://www.gost.ru
Saudi Arabia	SA	*	http://www.saso.gov.sa
Serbia	RS	*	http://www.iss.rs
Singapore	SG	*	http://www.spring.gov.sg/
Slovakia	SK	*	http://www.unms.sk
Slovenia	SI	*	http://www.sist.si
South Africa	ZA	*	http://www.sabs.co.za/
Spain	ES	*	http://www.aenor.es
Sri Lanka	LK	**	http://www.nsf.ac.lk
Sweden	SE	*	http://www.elstandard.se
Switzerland	CH	*	http://www.electrosuisse.ch
Thailand	TH	*	http://www.tisi.go.th
The Former Yugoslav Rep. of Macedonia	MK	**	http://www.isrm.gov.mk
Tunisia	TN	**	-

Country	Code		Website
Turkey	TR	*	http://www.tse.org.tr
Ukraine	UA	*	http://www.ukrndnc.org.ua/
United Arab Emirates	AE	*	http://www.esma.gov.ae
United Kingdom	GB	*	http://www.bsigroup.com
United States of America	US	*	http://www.ansi.org
Vietnam	VN	**	http://www.tcvn.gov.vn

* Full member

** Associate member

CENELEC members

Table B- 4 CENELEC members (in 2016)

Country	Code	Description	Website
Austria	OVE	Austrian Electrotechnical Association	www.ove.at
Belgium	CEB-BEC	Comité Electrotechnique Belge/Belgisch Elektrotechnisch Comité	www.ceb-bec.be
Bulgaria	BDS	Bulgarian Institute for Standardization	www.bds-bg.org
Croatia	HZN	Croatian Standards Institute	www.hzn.hr
Cyprus	CYS	Cyprus Organization for Standardisation	www.cys.org.cy
Czech Republic	UNMZ	Czech Office for Standards, Metrology and Testing	www.unmz.cz
Denmark	DS	Dansk Standard	www.ds.dk
Estonia	EVS	Estonian Centre for Standardisation	www.evs.ee
Finland	SESKO	Finnish Electrotechnical Standards Association	www.sesko.fi
Former Yugoslav Republic of Macedonia	ISRM	Standardization Institute of the Republic of Macedonia	www.isrm.gov.mk
France	AFNOR-FrSS-UTE	AFNOR-French Standardization System-UTE	www.ute-fr.com
Germany	DKE	German Commission for Electrical, Electronic and Information Technologies of DIN and VDE	www.dke.de
Greece	NQIS/ELOT	National Quality Infrastructure System	www.elot.gr
Hungary	MSZT	Hungarian Standards Institution	www.mszt.hu
Iceland	IST	Icelandic Standards	www.stadlar.is
Ireland	NSAI	National Standards Authority of Ireland	www.nsai.ie
Italy	CEI	Comitato Elettrotecnico Italiano	www.ceiweb.it
Latvia	LVS	Latvian Standard Ltd.	www.lvs.lv
Lithuania	LST	Lithuanian Standards Board	www.lsd.lt
Luxembourg	ILNAS	Organisme Luxembourgeois de Normalisation	www.portail-qualite.lu
Malta	MCCAA	The Malta Competition and Consumer Affairs Authority	www.mccaa.org.mt
Netherlands	NEC	Nederlands Elektrotechnisch Comité	www.nen.nl
Norway	NEK	Norsk Elektroteknisk Komite	www.nek.no
Poland	PKN	Polish Committee for Standardization	www.pkn.pl
Portugal	IPQ	Instituto Português da Qualidade	www.ipq.pt
Romania	ASRO	Romanian Standards Association	www.asro.ro
Slovakia	UNMS	Slovak Office of Standards Metrology and Testing	www.unms.sk
Slovenia	SIST	Slovenian Institute for Standardization	www.sist.si
Spain	AENOR	Asociación Española de Normalización y Certificación	www.aenor.es
Sweden	SEK	Svensk Elstandard	www.elstandard.se
Switzerland	Electrosuisse	Association for Electrical Engineering, Power and Information Technologies	www.electrosuisse.ch
Turkey	TSE	Turkish Standards Institution	www.tse.org.tr
United Kingdom	BSI	British Standards Institution	www.bsigroup.com

B.8 Websites

Links to standards organizations

Table B- 5 Links to organizations

IEC – International Electrotechnical Commission	http://www.iec.ch
ISO – International Organization for Standardization	http://www.iso.org
IECEE – System of Conformity Assessment for Electrotechnical Equipment and Components	http://members.iecee.org
CEN	http://www.cen.eu/Pages/default.aspx
CENELEC	https://www.cenelec.eu/
ETSI	http://www.etsi.org/
European Commission	http://ec.europa.eu
Euro-Lex	http://eur-lex.europa.eu/homepage.html
DKE – Deutsche Kommission für Elektrotechnik (German Commission for Electrical Engineering)	http://www.dke.de

Links to standards and directives

Organizations and publishing houses which provide information about standards and directives:

Table B- 6 Links to standards and directives

DIN – Deutsches Institut für Normung e. V. (German Institute for Standardization)	http://www.din.de
VDE – Verband der Elektrotechnik, Elektronik und Informationstechnik e. V. (Association for Electrical, Electronic and Information Technologies (Germany))	https://www.vde.com/de
VDE Verlag GmbH	https://www.vde-verlag.de
Beuth Verlag GmbH	http://www.beuth.de
Bayerisches Staatsministerium für Wirtschaft und Medien, Energie und Technologie (Bavarian State Ministry of Economy and Media, Energy and Technology)	https://www.stmwi.bayern.de
KAN – Kommission Arbeitsschutz und Normung (Commission for Occupational Health and Safety and Standardization)	https://www.kan.de/

European network for market surveillance, databases

Table B- 7 European network for market surveillance, databases

RAPEX database Rapid Alert System for dangerous non-food products	http://ec.europa.eu/consumers/safety/rapex/alerts/main/index.cfm?event=main.listNotifications
ICSMS database Internet-supported information and communication system for the pan-European market surveillance	https://webgate.ec.europa.eu/icsms/

Glossary

(Electrical) separation

"Protective measure in which hazardous live parts are insulated from all other electric circuits and parts, from local earth and from touch"

(Source: IEV 826-12-27)

Ambient temperature

Temperature of the air or another medium in which equipment is operated.

Example:

- Ambient temperature panel → outside = room temperature
- Ambient temperature contactor → inside = panel internal temperature

Assessment of conformity

The process of assessing whether specific requirements of a product, a process, a service, a system, a person or a location have been fulfilled.

Basic protection (previously: protection against direct contact)

"Protection against electric shock under fault-free conditions.

NOTE Basic protection is intended to prevent contact with live parts and generally corresponds to protection against direct contact."

(Source: IEC 61439-1, chapter 3.7.8)

Cable rack/cable ladder

"A shelf intended to receive cables which are usually arranged to run side by side"

(Source: IEV 605-02-29)

"Cable support consisting of a series of transverse supporting elements rigidly fixed to main longitudinal supporting members"

(Source: IEV 826-15-09)

Control panel

An electrical enclosure containing electrical components for controlling machines or parts of machines.

DIN

German Institute for Standardization

Economic players

Economic players in the context of EU regulations within the framework of the New Legislative Framework are manufacturers, authorized representatives, importers and distributors.

Authorized representative

Any natural or legal person established in the Community who has been authorized in writing by a manufacturer to act on his behalf in carrying out certain tasks.

Distributor

Any natural or legal person in the supply chain, other than the manufacturer or the importer, who makes a product available on the market.

Manufacturer

Any natural or legal person who manufactures electrical equipment or has electrical equipment designed or manufactured, and markets that equipment under his/her name or trade mark.

Importer

Any natural or legal person established in the European Union who places an item of electrical equipment from a third country on the Union market.

User

Entity who utilizes the machine and its associated electrical equipment (Source: IEC 60204-1, chapter 3.1.65)

Placing on the market

General: the supply of goods for sale or use

In the context of EU legislation: The first time a product is placed on the Union market.

Electrical operating area

"Room or location for electrical equipment to which access is intended to be restricted to skilled or instructed persons, by the opening of a door or the removal of a barrier without the use of a key or tool and which is clearly marked by appropriate warning signs."
(Source: IEC 60204-1, chapter 3.1.19)

Emergency stop

The emergency stop function is a functional safety measure that shall be implemented on machines that may pose a risk to personnel or machinery as a result of motion, heat, or similar. Emergency stop "merely" stops the hazardous motion.

Emergency switching off

The emergency switching off function is designed to provide electrical safety. This function switches off the supply of electrical power to the system.

Enclosed electrical operating area

"Room or location for electrical equipment to which access is intended to be restricted to skilled or instructed persons by the use of a key or tool to open a door, or remove a barrier, and which is clearly marked by appropriate warning signs."

(Source: IEC 60204-1, chapter 3.1.23)

Fault protection (previously: protection against indirect contact)

"Protection against electric shock under single-fault conditions (e.g. failure of basic insulation).

NOTE Fault protection generally corresponds to protection against indirect contact, mainly with regard to failure of basic insulation."

(Source: IEC 61439-1, chapter 3.7.10)

Harmonized standard

A standard elaborated on the basis of a request from the European Commission according to Article 6 of the relevant directive by one of the recognized European Standards Organizations stated in Annex I of Directive 98/34/EC and published in the Official Journal of the EU.

Indirect contact (fault protection)

Contact of persons or livestock with exposed conductive parts which have become live under fault conditions.

Initial symmetrical short-circuit current

"R.m.s. value of the AC symmetrical component of a prospective short-circuit current applicable at the instant of short circuit if the impedance remains at zero-time value"

(Source: IEC 60909-0, chapter 3.5)

Isolation, isolating function

Function intended to make dead for reasons of safety all or a discrete section of the electrical installation by separating the electrical installation or section from every source of electric energy.

(Source: IEC 826-17-01)

Low-voltage switchgear and controlgear assembly (short form: "ASSEMBLY")

"Combination of one or more low-voltage switching devices together with associated control, measuring, signaling, protective, regulating equipment, with all the internal electrical and mechanical interconnections and structural parts"
(Source: IEC 61439-1 - Terms)

Machinery/machine

"Assembly of linked parts or components, at least one of which moves, with the appropriate machine actuators, control and power circuits, joined together for a specific application, in particular for the processing, treatment, moving or packaging of a material.

The term "machinery" also covers an assembly of machines which, in order to achieve the same end, are arranged and controlled so that they function as an integral whole."
(Source: IEC 60204-1 - § Definitions)

Presumption of conformity

The presumption of conformity is a reversal of the burden of proof. A product complying with the relevant standards may be challenged, for example, by the market surveillance authority, only if actual evidence can be produced that the manufacturer has violated the requirements of the directives.

Prospective short-circuit current

"The r.m.s. value of the current which would flow if the supply conductors to the circuit are short-circuited by a conductor of negligible impedance located as near as practicable to the supply terminals of the ASSEMBLY."
(Source: IEC 61439-1, chapter 3.8.7)

Risk analysis

"systematic use of available information to identify hazards and to estimate the risk"
(Source: IEC 903-01-08)

Short-circuit current

"An over-current resulting from a short-circuit due to a fault or an incorrect connection in an electric circuit" (Source: IEC 441-11-07)

SIL (Safety Integrity Level)

Discrete level (one of three possibilities) for defining safety integrity specifications of safety-related control functions. Safety integrity level 3 is the highest possible level and level 1 the lowest.

Simultaneously accessible parts

"Conductors or conductive parts which can be touched simultaneously by a person or by an animal.

NOTE: Simultaneously accessible parts may be:

- live parts,
- exposed-conductive parts,
- extraneous-conductive parts,
- protective conductors,
- soil or conductive floor."

(Source: IEC 826-12-12)

Standardization

Definition according to DIN 820 – Part 3: "systematic unification of material and immaterial subjects carried out by all stakeholders working in consensus for the benefit of society as a whole"

State of the art

"Developed stage of technical capability at a given time as regards products, processes and services, based on the relevant consolidated findings of science, technology and experience.
(Source: IEC 901-01-04)

Supply disconnecting (isolating) device (main disconnect)

Every industrial machine that falls under the scope of IEC 60204-1 (VDE 0113, Part 1) shall be equipped with a supply disconnecting device that disconnects all electrical equipment from the network while cleaning, maintenance, and repair work is being carried out, as well as during long periods of downtime. Usually a switch which can be operated by hand that is stipulated for electrical or mechanical prevention of a hazard. The main disconnect can also function as an emergency switching off device. The actuator of this switch shall be red. If a background exists immediately around the actuator, then this background shall be colored yellow.

Switchgear and controlgear assembly

See "Low-voltage switchgear and controlgear assembly"

Switching capacity

Trip current of overcurrent protective devices such as circuit breakers or fuses.

Touch voltage

"Voltage between conductive parts when touched simultaneously by a person or an animal.

NOTE: The value of the effective touch voltage may be appreciably influenced by the impedance of the person or the animal in electric contact with these conductive parts."

(Source: IEC 826-11-05)

Utilization category

According to IEC 60947-4-1, the application area of and the load applied to motor starters can be identified by looking at the specified utilization category in conjunction with the specified rated operational current or the motor power and the rated voltage. An example is utilization category AC-53a for starting and switching off squirrel-cage motors.

Index

(

(Electrically) instructed person, 46

2

2-dimensional drawing, 315

3

3D model, 315

A

AC circuits

Wiring practices, 187

Access conditions

Control panel, 54

Acknowledged rule of technology, 31

Administrative mark, 41

Application examples

SIOS, 328

Approval markings, 42

Arc extinction, 109

Area of responsibility

Control panel builder, 82

User, 82

Assessment

Cable length according to voltage drop, 151

SIMARIS design, 152

Attenuation

Supply cable, 129

B

Back-up protection, 123

Basic insulation, 70

Basic protection, 70

Protection by enclosures, 103

Protection by insulation, 107

Protection where there are residual voltages, 108

Basic protection (protection against direct contact), 102

Bicolor combination GREEN-AND-YELLOW

Protective conductor, 161

Blue Guide, 41, 339

Breaking capacity, 88

Rated breaking capacity, 89

Breaking capacity of supply disconnecting device

Example, 89

C

Cable ducts, 192

Cable length

according to voltage drop, 151

Assessment of the maximum admissible cable length, 151

Correction factors, 141

Influence, 130

Cable rack, 107, 142

Cables / conductors

Selection, 174

CAD data, 313

CAE data, 313

Capacitor contactors, 243

CAPIEL (EU), 27

CAX data, 313

CAX Download Manager, 314

CCC, 41

CE marking, 40

CEE, 27

CEN, 27

CENELEC, 27

Members, 346

Certificates, 318

Certifications

EAC, 41

GOST, GOST-R, 41

Characteristic curves

Evaluation, 317

Visualization, 317

Characteristics

Circuit breakers, 66

Comparison, 69

Circuit breakers

Characteristics, 66

for line protection, 65

for motor protection, 65

for starter assembly, 64

Circuit diagram, 316

Circuits

Excepted circuits, 93

Load values, 75

- Maintenance manual, 94
 - Number, 142
 - Warning label, 94
 - Circuits without a supply disconnecting device
 - Rules, 94
 - Circuits without a supply disconnecting device
 - Warning label, 94
 - Circuits without a supply disconnecting device
 - Example, 94
 - Class II, 110
 - Classes, 71
 - Clearance, 59
 - Color
 - Conductors, 191
 - Command devices, 283
 - Comparing characteristics
 - Plant - circuit breaker, 69
 - Plant - fuses/switching devices, 69
 - Conditions
 - Plug/socket combinations, 90
 - Conductor dimensioning, 139
 - Current-carrying capacity, 147
 - Example, 147
 - Overload condition, 148
 - Short-circuit condition, 150
 - Tripping characteristics, 149
 - Conductor types, 171
 - Conductors
 - Color, 191
 - Current-carrying capacity, 140
 - Fastening, 192
 - harmonized types, 173
 - Conduits
 - Wiring practices, 185
 - Connection data, 319
 - Constructional requirements
 - Circuits, 212
 - Contactor relays, 243
 - Utilization categories, 63
 - Contactors, 242
 - Utilization categories, 62
 - Contactors for resistive loads, 243
 - Continuity
 - Protective bonding circuit, 196
 - Continuous duty S1, 76
 - Control circuit, 93
 - Voltage drop, 146
 - Control devices
 - Example, 135
 - Selection, 135
 - Control panel
 - Access conditions, 54
 - Nameplate, 179
 - Open, 105
 - Planning, 193
 - Protection by enclosures, 103
 - Short-circuit withstand rating, 180
 - Wiring, 193
 - Control panel builder
 - Area of responsibility, 82
 - Control panels
 - Product ranges, 321
 - Verification of short-circuit withstand strength, 216
 - Converters
 - SINAMICS G, 264
 - Copper conductor, 162
 - Minimum cross-sectional area, 163
 - Correction factors
 - Ambient temperature, 141
 - Grouping, 142
 - Coupling relay, 289
 - CPS, 138
 - Creepage distance, 59
 - Cross-sectional area of cable
 - Influence, 130
 - Current, 50
 - Current limiting, 51
 - Current monitoring relay, 287
 - Current selectivity, 61
 - Current-carrying capacity, 50
 - Conductors, 139
 - Example, 122
 - Reduction, 121
 - Customs Union (CU), 41
 - Cut-off current (let-through current), 51
 - Overcurrent protective devices, 222
- D**
- Declaration of Conformity, 40
 - Definition
 - (Electrically) instructed person, 46
 - Characteristics for circuit breakers, 66
 - Rated diversity factor, 75
 - Safety rules, 46
 - Skilled person (electrically), 46
 - Degree of pollution, 58
 - Degree of protection
 - Enclosure, 52
 - Examples, 53
 - Design tools, 324
 - Design verifications
 - Alternatives, 207
 - Overview, 206

- Determination
 - Short-circuit current, 197
- Device for removal of power
 - Example, 95
- Devices for removal of power, 99, 100
 - Maintenance, 95
- Diagnostics display, 281
- Digital twin, 319
- Dimensioning tools, 324
- DIN, 26
- Directives
 - Horizontal, 331
 - Vertical, 331
- Disconnecting time
 - Class 1 equipment, 200
 - in TN systems, 200
 - Machinery, 200
- DKE, 26, 32
- DKE statement, 37
- Documentation
 - CAX data, 313
 - Residual current protective device (RCD), 196
 - Tripping characteristic, 200
 - with SIMARIS curves, 200
- Double insulation, 70
- Drilling plans, 319
- Duty type
 - S1, 76
 - S2, 77
 - S3, 78

- E**
- EAC, 41
- Economic players, 40
- Efficiency, 299
- Efficiency classes, 299
- Electrical equipment
 - Requirements, 162
- Electrical equipment of a machine, 83
- Electrical operating areas
 - Disconnecter, 98
- Electrical voltage
 - Potential risks, 98
 - Supply disconnecting device, 98
- Electrically instructed persons, 106
- EN, 26
- Enclosed electrical operating area, 99
 - Disconnecter, 96
 - Protection against reconnection, 100
- Energy consumption, 299
- Energy efficiency, 299

- Engineering software, 320
- EPLAN, 316
- EPLAN ProPanel, 319
- Equipment with fuse links, 96
- ETSI, 27
- Example
 - Breaking capacity of supply disconnecting device, 89
 - Conductor cross-sections for screw-type connection systems, 184
 - Conductor cross-sections for spring-loaded connection systems, 184
 - Conductor dimensioning, 147
 - Converting the cross-sectional area, 162
 - Device for removal of power, 95
 - Device with plug-in fuses, 96
 - Dimensioning of supply disconnecting device / main disconnect, 89
 - End sleeve, 185
 - Method of installation, 141
 - Nameplate, 42
 - Overload release, 238
 - Protection against reconnection, 99
 - Reference designations, 182
 - SIMARIS curves, 200, 223
 - Supply disconnecting device, 88
 - Tested reference designs, 219
 - Tripping characteristic, 200
 - Wiring in the control panel, 193
 - Wiring practices, 188
- Excepted circuits
 - Maintenance work, 93
 - Supply disconnecting device, 93
- Exposed conductive part, 70
- External protective conductor
 - Labeling, 85

- F**
- Fastening
 - Conductors, 192
- Fault loop impedance
 - Measurement in TN systems, 198
- Fault protection
 - Protective bonding, 158
- Fault protection (protection in the event of indirect contact), 110
- FELV, 74
- Finger-safety, 55
- Flowchart
 - Modification to the plant, 342
 - Risk assessment, 341

Forum, 328
Frequency converters, 262
 Grounding, 165
 SINAMICS G, 264
Function relays, 285
Functional bonding, 168
Fuse links
 Equipment, 96

G

GOST, 41
Graphics / CAE data, 313
Ground fault current, 50
Ground leakage currents, 167
Grounding
 Frequency converters, 165

H

Hand-held equipment, 113
Harmful effects, 118
Harmonized standards, 30
 Selection, 36
Hazardous touch voltage, 111
HD, 26
Heavy-duty starting, 68
HelpCenter, 328

I

Ic
 Cut-off current (let-through current), 66
Icc
 Rated conditional short-circuit current, 66
Icm
 Rated short-circuit making capacity, 66
Ics
 Rated service ultimate short-circuit breaking capacity, 66
Icu
 Rated ultimate short-circuit breaking capacity, 66
Icw
 Rated short-time withstand current, 66
Identification
 Protective bonding conductor, 190
 Protective conductor, 160, 190
IE3 motors
 Efficiency, 302
IE3 motors from Siemens, 304

IEC, 26
 Member states, 343
IECEE, 27
Image database, 314
Impedances, 197
Incoming supply conductor termination, 82
Indicator lights, 283
Industry Online Support (SIOS), 327
Ingress Protection, 52
Initial symmetrical short-circuit current
 Approximation formulas, 127
 Transformer, 127
Insulation, 70
Insulation monitoring relays, 288
Insulation strength
 Testing, 230
Integrated signal lamps, 293
Interface agreement, 81
Intermittent periodic duty S3, 78
International Efficiency, 299
International Protection, 52
IP, 52
ISO, 26
Isolation function
 Devices without isolation function, 96
IT system, 48
 Neutral conductor, 120

L

Leakage current, 50
Leakage currents
 Reduction, 168
Line monitoring relays, 287
Line protection
 Molded case circuit breakers, 239
Live conductors, 119
Live parts
 Cover, 109
 Disconnection, 54
 Enclose, 109
 Insulate, 107
Low-voltage converters, 262

M

Machine
 Electrical equipment, 83
Machine safety
 Safety relays, 275

Machinery Directive
 Special aspect, 35
 Maintenance
 Ensuring safe maintenance, 95
 Maintenance instructions
 Residual current protective device, 196
 Maintenance work
 Excepted circuits, 93
 Supply disconnecting device, 86
 Manuals, 317
 Marking
 Protective conductor, 190
 Markings
 Requirements, 176
 Maximum temperature, 177
 MCCB, 239
 Measurement
 Fault loop impedance, 198
 Method of installation
 Examples, 141
 Minimum efficiency, 300
 Molded case circuit breakers
 Motor protection, 240
 Selection criteria, 239
 Starter protection, 240
 Monitoring relays, 287
 Motor contactors, 242
 Motor current
 Limitation, 88
 Motor management system
 SIMOCODE pro, 272
 Motor protection
 Molded case circuit breakers, 240
 Motor starter protector/circuit breaker, 234
 Motor starter protector/circuit breaker
 Motor protection, 234
 Selection, 234
 Selection example, 238
 Motor starter protectors
 IE3 motors, 306
 Making capacity/breaking capacity, 305
 Short-circuit detection, 305
 Motor starters, 245
 Motors
 Efficiency, 299
 MyDocumentationManager, 329
 mySupport, 328

N

Nameplate
 Example, 42, 181

 Requirements IEC 60204-1, 179
 Requirements IEC 61439-1, 181
 Neutral conductor, 119
 Color coding, 191
 IT system, 120
 New Approach, 30
 New legislative Framework, 30
 Nominal voltage, 60
 Non-automatic air circuit breakers, 64
 Normal starting, 68

O

Official Journal
 European Low Voltage Directive 2014/35/EU, 33
 Operating instructions, 317
 Overcurrent, 50, 119
 Overcurrent protection device
 Tripping characteristic, 200
 Overcurrent protective device
 Example, 133
 Selection, 134
 Overcurrent protective devices
 Cut-off current (let-through current), 222
 Selection, 123
 Overload, 50
 Overload condition
 Conductors, 143
 Overload protection
 current-dependent, 154
 Overspeed protection, 156
 Overtemperature protection
 Temperature-dependent, 155
 Overvoltage category, 60
 Overvoltages
 Protective devices, 157

P

Partial selectivity, 61
 PELV, 74, 117
 Periodic duty, 79
 Periodic testing, 205
 Phase sequence monitoring, 157
 Planning system
 with CAx data, 313
 Plant
 Modification, 342
 Plug/socket combinations
 Conditions, 90

- Plugs
 - Requirements, 90
- Position switches, 290
- Potential risks
 - Electrical voltage, 98
- Power distribution
 - Product ranges, 321
- Power drive system (PDS), 115
- Power loss data, 319
- Power supply
 - Automatic disconnection, 111
- Product data
 - CAX data, 313
- Product data sheets, 318
- Product lists, 329
- Product master data, 313
- Product ranges
 - Control panels, 321
 - Power distribution, 321
- Product support
 - SIOS, 327
- Prospective short-circuit current, 126
- Protection by barriers (covers), 109
- Protection by electrical separation, 110
- Protection by enclosures, 103
- Protection by insulation, 107
- Protection in the event of indirect contact, 110
- Protection where there are residual voltages, 108
- Protective bonding
 - Fault protection, 158
- Protective bonding circuit
 - Verification of continuity, 196
- Protective bonding circuit, 158
 - Continuity, 165
 - Rule, 166
- Protective bonding conductor
 - Identification, 190
- Protective conductor
 - Copper, 85
 - Cross-sectional area, 162
 - Dimensioning, 163
 - Identification, 160, 190
 - Minimum cross-sectional area, 85
 - Properties, 164
- Protective devices, 204
 - Overvoltages, 157
- Protective extra-low voltage, 117
- Protective grounding system
 - Labeling, 85
- Protective measures
 - Touch voltage, 101
- Pushbuttons, 283

R

- Rated current
 - Transformer, 127
- Rated diversity factor, 75, 75
- Rated impulse withstand voltage, 60
- Rated operational current, 89
- Rated service ultimate short-circuit breaking capacity, 66
- Rated short-circuit making capacity, 66
- Rated short-time withstand current, 66
- Rated ultimate short-circuit breaking capacity, 66
- Rated value, 50
- Rated..., 49
- Reference designations
 - Example, 182
- Reference designs
 - Example, 219
 - Tested reference designs from Siemens, 219
- Reinforced insulation, 70
- Requirements
 - Marking conductors, 189
 - Markings, 176
 - Plugs, 90
 - Warning signs, 176
- Residual current protective devices
 - Documentation, 196
- Residual voltages
 - Warning label, 108
- Residual-current monitoring relays, 288
- Resistance measurement, 196
- Retesting, 205
- Risk analysis, 118, 340
 - Procedure, 340
- Risk assessment, 340
 - Flowchart, 341
- Routine verification
 - Overview, 226
- Rule
 - Local reconnection, 99
 - Remote reconnection, 99
- Rules
 - Circuits without a supply disconnecting device, 94

S

- Safe Torque Off (STO), 96, 96
- Safety from touch by back of hand, 55
- Safety relay
 - Protective door monitoring, 276

- Safety relays
 - Machine safety, 275
 - SIRIUS 3SK, 277
- Safety rules, 46
- Safety switches, 290
- Scope, 23
- Securing against reconnection, 99
- Selection
 - Overcurrent protective devices, 123
 - Protective and switching device, 147
- Selection aids, 320
- Selection criteria
 - Cables / conductors, 174
 - Molded case circuit breakers, 239
- Selectivity, 61
- Selectivity limit, 61
- SELV, 73
- Services, 328
- Short circuit
 - Smallest possible short-circuit, 152
- Short-circuit attenuation
 - Example, 129
- Short-circuit condition, 144
- Short-circuit current, 50, 66
 - Determination, 197
 - Highest possible short-circuit current, 124
 - Incoming supply point to the machine, 126
 - Installation location, 124
 - Lowest possible short-circuit current, 131
 - Prospective short-circuit current, 126
- Short-circuit withstand rating
 - Control panel, 180
 - Scenarios, 180
- Short-time duty S2, 77
- Siemens
 - Image database, 314
 - Industry Mall, 314
- Siemens product pages, 321
- Signal converter, 289
- Signaling columns, 293
- Signaling devices, 283
- SIMARIS curves, 317
 - Example of let-through current characteristic, 223
 - Example of tripping characteristic, 200
 - Tripping characteristics, 149
- SIMARIS design
 - Assessment of smallest possible short-circuit, 152
- SIMARIS therm, 319
- SIMOCODE pro, 272
- SIOS
 - Application examples, 328
 - Forum, 328
 - HelpCenter, 328
 - mySupport, 328
 - Product support, 327
 - Services, 328
- SITOP, 271
- SITOP power supplies, 271
- Skilled person (electrically), 46, 106
- Soft starters, 255, 306
 - Dimensioning, 308
 - Function, 306
 - Settings, 308
- Software
 - Design and dimensioning, 324
 - Product configurators, 324
- Solid-state contactors, 269
- Solid-state relays, 269
- Solid-state switching devices
 - Solid-state contactors, 269
 - Solid-state relays, 269
- Standard
 - Definition, 29
- Standards
 - A Type, 336
 - B Type, 336
 - C Type, 336
 - Cables, 170
 - Conductors, 170
 - Global, 25
 - North America, 25
- Starter protection
 - Molded case circuit breakers, 240
- State of the art, 31
- Supplementary insulation, 70
- Supply cable
 - Attenuation, 129
- Supply disconnecting device
 - Circuit breakers compliant with IEC 60947-2, 87
 - Circuits, 93
 - Electrical voltage, 98
 - Emergency stop function, 88
 - Emergency switching off function, 88
 - Example, 88
 - Excepted circuits, 93, 93
 - Operating means, 88, 92
 - Permissible devices, 86
 - Purpose, 86
 - Rules, 87
 - Switch disconnectors compliant with IEC 60947-3, 87
- Switch disconnecter, 64
 - Utilization categories, 63

Switching devices
 Command and signaling devices, 283
 Contactors, 242
 Frequency converters, 262
 Function relays, 285
 Molded case circuit breakers, 239
 Motor starter protector/circuit breaker, 234
 Motor starters, 245
 Position switches, 290
 Power supplies, 271
 Safety relays, 275
 Safety switches, 290
 Signaling columns, 293
 SIMOCODE pro, 272
 Soft starters, 255
 Solid-state switching devices, 269

Symbol
 IEC 60417-5019, 190
 IEC 60417-5020, 168
 IEC 60417-5021, 191

T

Technical product data sheets, 318
 Temperature limits, 177
 Temperature rise limits, 215
 Temperatures
 Abnormal, 156
 Temporary overvoltage, 60
 Test mark, 41
 Test requirements
 Comparison, 194
 Time selectivity, 61
 Timing relays, 289
 TN systems
 Verification, 195
 TN-C system, 47
 TN-C-S system, 47
 TN-S system, 47
 Total selectivity, 61
 Touch protection, 55, 55
 Touch voltage, 101, 110
 TR, 26
 Transformer protection
 Motor starter protector/circuit breaker, 234
 Transient overvoltage, 60
 Trip classes
 Overload relay, 67
 Tripping characteristic
 Documentation, 200
 Overcurrent protection device, 200

Tripping characteristics
 SIMARIS curves, 149
 TS, 26
 TT system, 48
 Type code, 173
 Type of coordination 1
 Example, 137
 Type of coordination 2
 Example, 138
 Types of coordination
 IEC 60947, 136
 Types of grounding system, 47

U

Unexpected machine movement
 Devices for removal of power, 95
 User
 Area of responsibility, 82
 Utilization category, 62

V

VDMA, 27
 Verification methods, 207
 Verification of short-circuit withstand strength
 Exceptions, 221
 Visual inspection
 Control panel, 195
 Voltage dip, 156
 Voltage drop
 Control circuit, 146
 Power circuit, 144
 Voltage monitoring relays, 287
 Voltage recovery, 156

W

Warning notice
 Attach, 108
 Warning signs
 Requirements, 176
 Warning symbols, 176
 Wire safety, 55
 Wiring practices, 183
 AC circuits, 187
 Circuit, 187
 Conduits, 185
 Example of separate routing, 188
 Terminals, 188
 WSCAD, 316

Siemens AG
Digital Factory
Control Products
Postfach 23 55
90713 FUERTH
GERMANY

© Siemens AG 2017
Subject to change without prior notice

