

FlexPod Datacenter with Docker Enterprise Edition for Container Management

Design and Deployment Guide for FlexPod Datacenter with Docker Enterprise Edition for Container Management

Last Updated: April 28, 2017



About the Cisco Validated Design (CVD) Program

The CVD program consists of systems and solutions designed, tested, and documented to facilitate faster, more reliable, and more predictable customer deployments. For more information visit

<http://www.cisco.com/go/designzone>.

ALL DESIGNS, SPECIFICATIONS, STATEMENTS, INFORMATION, AND RECOMMENDATIONS (COLLECTIVELY, "DESIGNS") IN THIS MANUAL ARE PRESENTED "AS IS," WITH ALL FAULTS. CISCO AND ITS SUPPLIERS DISCLAIM ALL WARRANTIES, INCLUDING, WITHOUT LIMITATION, THE WARRANTY OF MERCHANTABILITY, FITNESS FOR A PARTICULAR PURPOSE AND NONINFRINGEMENT OR ARISING FROM A COURSE OF DEALING, USAGE, OR TRADE PRACTICE. IN NO EVENT SHALL CISCO OR ITS SUPPLIERS BE LIABLE FOR ANY INDIRECT, SPECIAL, CONSEQUENTIAL, OR INCIDENTAL DAMAGES, INCLUDING, WITHOUT LIMITATION, LOST PROFITS OR LOSS OR DAMAGE TO DATA ARISING OUT OF THE USE OR INABILITY TO USE THE DESIGNS, EVEN IF CISCO OR ITS SUPPLIERS HAVE BEEN ADVISED OF THE POSSIBILITY OF SUCH DAMAGES.

THE DESIGNS ARE SUBJECT TO CHANGE WITHOUT NOTICE. USERS ARE SOLELY RESPONSIBLE FOR THEIR APPLICATION OF THE DESIGNS. THE DESIGNS DO NOT CONSTITUTE THE TECHNICAL OR OTHER PROFESSIONAL ADVICE OF CISCO, ITS SUPPLIERS OR PARTNERS. USERS SHOULD CONSULT THEIR OWN TECHNICAL ADVISORS BEFORE IMPLEMENTING THE DESIGNS. RESULTS MAY VARY DEPENDING ON FACTORS NOT TESTED BY CISCO.

CCDE, CCENT, Cisco Eos, Cisco Lumin, Cisco Nexus, Cisco StadiumVision, Cisco TelePresence, Cisco WebEx, the Cisco logo, DCE, and Welcome to the Human Network are trademarks; Changing the Way We Work, Live, Play, and Learn and Cisco Store are service marks; and Access Registrar, Aironet, AsyncOS, Bringing the Meeting To You, Catalyst, CCDA, CCDP, CCIE, CCIP, CCNA, CCNP, CCSP, CCVP, Cisco, the Cisco Certified Internetwork Expert logo, Cisco IOS, Cisco Press, Cisco Systems, Cisco Systems Capital, the Cisco Systems logo, Cisco Unified Computing System (Cisco UCS), Cisco UCS B-Series Blade Servers, Cisco UCS C-Series Rack Servers, Cisco UCS S-Series Storage Servers, Cisco UCS Manager, Cisco UCS Management Software, Cisco Unified Fabric, Cisco Application Centric Infrastructure, Cisco Nexus 9000 Series, Cisco Nexus 7000 Series, Cisco Prime Data Center Network Manager, Cisco NX-OS Software, Cisco MDS Series, Cisco Unity, Collaboration Without Limitation, EtherFast, EtherSwitch, Event Center, Fast Step, Follow Me Browsing, FormShare, GigaDrive, HomeLink, Internet Quotient, IOS, iPhone, iQuick Study, LightStream, Linksys, MediaTone, MeetingPlace, MeetingPlace Chime Sound, MGX, Networkers, Networking Academy, Network Registrar, PCNow, PIX, PowerPanels, ProConnect, ScriptShare, SenderBase, SMARTnet, Spectrum Expert, StackWise, The Fastest Way to Increase Your Internet Quotient, TransPath, WebEx, and the WebEx logo are registered trademarks of Cisco Systems, Inc. and/or its affiliates in the United States and certain other countries.

All other trademarks mentioned in this document or website are the property of their respective owners. The use of the word partner does not imply a partnership relationship between Cisco and any other company. (0809R)

© 2017 Cisco Systems, Inc. All rights reserved.

Table of Contents

Executive Summary	8
Business Challenges	9
FlexPod System Overview	9
FlexPod Benefits	10
FlexPod: Cisco and NetApp Verified Architecture	10
FlexPod Design Principles	11
Implementation Overview	11
Highlights	11
Solution Benefits	12
Audience	12
Purpose of the Document	13
Solution Overview	14
Solution Components	15
Technology Overview	16
Cisco Unified Computing System	16
Cisco UCS Manager	17
Cisco UCS Fabric Interconnects	17
Cisco UCS 5108 Blade Server Chassis	17
Cisco UCS B200M4 Blade Server	18
Cisco UCS Fabric Extenders	18
Cisco VIC Interface Cards	18
Cisco UCS Differentiators	18
Cisco Nexus 9000 Switches	20
NetApp Storage Controllers	20
NetApp All Flash FAS	21
NetApp Data ONTAP	21
NetApp Storage Virtual Machines	22
NetApp Docker Volume Plugin (nDVP):	22
Storage Design practices:	22
Docker Enterprise Edition	23
Docker EE	25
Docker UCP	25
Docker Trusted Registry	28

Solution Design.....	31
Architectural Overview.....	31
Solution Deployment.....	33
Physical Topology.....	33
Deployment Hardware and Software	34
Deployment Hardware	34
Software Revisions	34
Configuration Guidelines.....	35
Physical Infrastructure.....	36
FlexPod Cabling	36
FlexPod Cisco Nexus Base	40
Set Up Initial Configuration	40
FlexPod Cisco Nexus Switch Configuration.....	42
Enable Licenses.....	42
Set Global Configurations	43
Create VLANs.....	43
Add NTP Distribution Interface.....	44
Add Individual Port Descriptions for Troubleshooting.....	44
Create Port Channels.....	46
Configure Port Channel Parameters.....	47
Configure Virtual Port Channels	48
Uplink into Existing Network Infrastructure.....	50
NetApp Storage Configuration	50
NetApp Hardware Universe	50
Controllers.....	50
Disk Shelves	50
ONTAP 9.0	51
Complete Configuration Worksheet	51
Configure ONTAP Nodes	51
Log In to the Cluster	63
Zero All Spare Disks	63
Set Onboard Unified Target Adapter 2 Port Personality	64
Set Auto-Revert on Cluster Management	65
Set Up Management Broadcast Domain	65
Set Up Service Processor Network Interface	65

Create Aggregates	65
Verify Storage Failover.....	66
Disable Flow Control on 10GE Ports	67
Disable Unused FCoE Capability on CNA Ports.....	67
Configure Network Time Protocol	68
Configure Simple Network Management Protocol.....	68
Configure AutoSupport	69
Enable Cisco Discovery Protocol	69
Create Broadcast Domains in Data ONTAP	69
Create Interface Groups	69
Create VLANs.....	69
Create Docker Infrastructure Storage Virtual Machine.....	70
Create Load-Sharing Mirrors of SVM Root Volume	70
Create Block Protocol (FC) Service.....	71
Configure HTTPS Access	71
Configure NFSv3	72
Create FlexVol Volumes.....	72
Create Boot LUNs.....	72
Create Docker Data LUNs.....	73
Schedule Deduplication	74
Create FCP LIFs.....	74
Create NFS LIFs.....	74
Add Infrastructure SVM Administrator.....	75
Create Broadcast Domain for Container Tenant A.....	75
Create VLAN Interfaces for Container Tenant A	75
Create Docker Tenant Storage Virtual Machine.....	75
Create Load-Sharing Mirrors of Tenant SVM Root Volume	76
Configure Secure Access to Cntr-TNT-A-SVM	76
Configure NFSv3 in Cntr-TNT-A-SVM.....	77
Create NFS LIFs in Cntr-TNT-A-SVM.....	78
Add Cntr-TNT-A-SVM Administrator and NetApp Volume Plugin (nDVP) User.....	78
Cisco UCS Direct Storage Connect Base Configuration	79
Perform Initial Setup of Cisco 6248UP Fabric Interconnects for FlexPod Environments.....	79
Cisco UCS Direct Storage Connect Setup	81
Upgrade Cisco UCS Manager Software to Version 3.1(2f)	81

Anonymous Reporting	81
Configure Cisco UCS Call Home.....	82
Place UCS Fabric Interconnects in Fiber Channel Switching Mode	82
Configure Unified Ports.....	83
Add Block of IP Addresses for KVM Access	85
Synchronize Cisco UCS to NTP.....	85
Edit Chassis Discovery Policy	87
Enable Server and Uplink Ports.....	87
Acknowledge Cisco UCS Chassis.....	88
Create Uplink Port Channels to Cisco Nexus Switches	89
Create a WWNN Pool for FC Boot.....	90
Create WWPN Pools.....	92
Create Storage VSANs	95
Assign VSANs to FC Storage Ports.....	97
Create vHBA Templates	98
Create SAN Connectivity Policy.....	100
Create MAC Address Pools	102
Create UUID Suffix Pool.....	104
Create Server Pool	105
Create VLANs.....	105
Modify Default Host Firmware Package	107
Set Jumbo Frames in Cisco UCS Fabric.....	108
Create Local Disk Configuration Policy (Optional)	109
Create Network Control Policy for Cisco Discovery Protocol (CDP) and Link Layer Discovery Protocol (LLDP)	110
Create Power Control Policy.....	111
Create Server Pool Qualification Policy (Optional).....	112
Create Server BIOS Policy	113
Update the Default Maintenance Policy.....	116
Create vNIC Templates.....	117
Create LAN Connectivity Policy	121
Create Boot Policy (FC Boot)	123
Create Service Profile Template (FC Boot).....	126
Create Service Profiles	133
Gather Necessary Information.....	134
Data ONTAP SAN Storage Setup	136

Create Igroups.....	136
Map LUNs to igroups.....	137
Installation of Red Hat Enterprise Linux Operating System.....	138
Docker Enterprise Edition Installation.....	154
Complete Host Networking Setup.....	155
Registering Nodes and Updating Host OS.....	158
Installing and Configuring Ansible.....	158
Installing NTP & Configuring Host OS System Clocks.....	163
Installing Cisco Virtual Interface Card (VIC) eNIC (Ethernet Network Interface Card) and fNIC Driver.....	165
Configuring Host OS Firewall for required ports.....	166
Installation of Docker Repo and Docker Engine.....	168
Configuring Docker CS Engine for Device-Mapper Driver in Direct LVM-Mode.....	169
Install and Configure Docker UCP Controller Nodes.....	173
Add UCP Replicas.....	174
Add UCP Nodes.....	175
Install and Configure DTR and its Replicas.....	176
Configure NetApp Docker Volume Plugin (nDVP).....	179
Validate Docker UCP and DTR Cluster.....	184
Solution Validation.....	186
Application Container Deployment.....	186
Container Networks.....	188
Deploying container/application container using overlay network.....	190
DTR Operations.....	196
Showing Container Survivability Using Docker Swarm.....	198
Storage Utilization using a non-admin DDE User.....	201
Summary.....	206
About Authors.....	207
Acknowledgements.....	207

Executive Summary

Docker is the world's leading software container platform for developers and IT operations to build, ship, and run distributed applications anywhere. With Microservices architecture shaping the next generation of IT, enterprises with large investments in monolithic applications are finding ways to adopt Docker as a strategy for modernizing their application architectures and keeping the organization competitive and cost effective. Containerization provides the agility, control, and portability that developers and IT operations require to build and deploy applications across any infrastructure. The Docker platform allows distributed applications to be easily composed into a lightweight application container that can change dynamically yet non-disruptively. This capability makes the applications portable across development, test, and production environments running on physical or virtual machines locally, in data centres, and across the networks of different cloud service providers.

Cisco Unified Computing System (UCS) is a next-generation Datacenter platform that unifies computing, networking, storage access, and virtualization into a single cohesive system, which makes Cisco UCS an ideal platform for Docker Enterprise Edition

In FlexPod with Docker Enterprise Edition, NetApp Docker Volume Plugin (nDVP) provides direct integration with the Docker ecosystem for NetApp's ONTAP, E-Series, and SolidFire storage platforms. The nDVP package supports the provisioning and management of storage resources from the storage platform to Docker hosts, with a robust framework for adding additional platforms in the future.

Figure 1. FlexPod Component Families

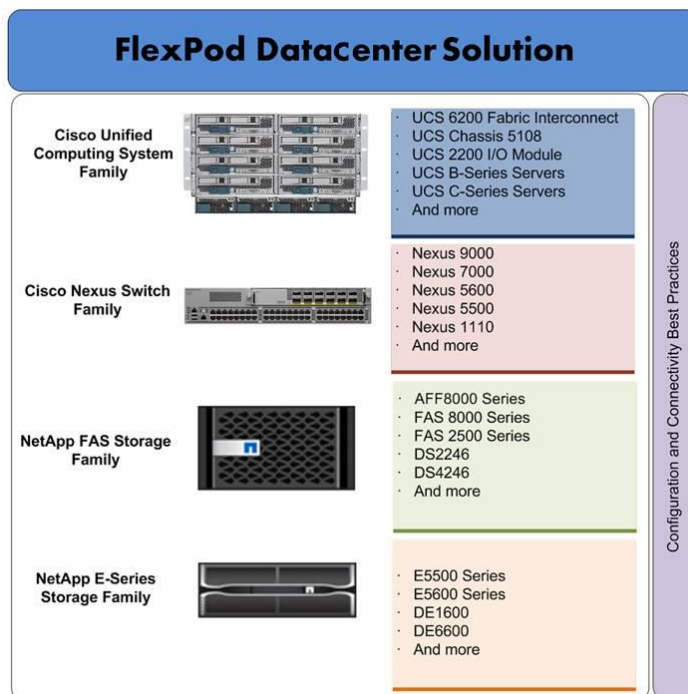

Business Challenges

Technological revolution has created new opportunities and challenges for businesses in this digital world. Many companies – small and big, new and old are using disruptive innovations such as Microservices architecture to quickly develop and deploy applications and services to rapidly adopt to changing markets and meet customer needs. These innovations also provide a path to modernize traditional business critical applications providing agility, flexibility and portability to reduce operational and management costs while improving performance and security. In order to keep up with new technologies or stay one step ahead, enterprises will have to overcome key challenges to accelerate product development, add value and compete better at lower cost.

Key Challenges:

- **Portability:** Applications have dependencies around OS versions, libraries, Java versions, etc. Any changes to these dependencies can break portability which means applications developed on a specific environment may behave differently on a production environment hosted on-premise or cloud. Changing code and rebuilding/testing code leads to delay in product or service offering and loss of market share.
- **Agility:** Enterprises have many legacy applications, tools and complex development process slowing innovation significantly as product release cycle takes days to weeks due to complex flow from development to production.
- **Resource Utilization:** Engineering and hardware resources in large enterprises are not used efficiently due to various organizations operating in silos. These silos that worked in the past are causing a huge overhead in development/release cycle and resource under-utilization as technology changes rapidly.
- **Policy Management:** Large enterprises have redundant processes and policies in place, and are reluctant to adopt new technologies due to fear of breaking compliance causing delays in new development/release cycle.

FlexPod System Overview

FlexPod is a best practice Datacenter architecture that includes these components:

- Cisco Unified Computing System (Cisco UCS)
- Cisco Nexus switches
- NetApp fabric-attached storage (FAS), AFF, and/or NetApp E-Series storage systems

These components are connected and configured according to best practices of both Cisco and NetApp, and provide the ideal platform for running a variety of enterprise workloads with confidence. As previously mentioned, the reference architecture covered in this document leverages the Cisco Nexus 9000 Series switch. One of the key benefits of FlexPod is the ability to maintain consistency at scaling, including scale up and scale out. Each of the component families shown in Figure 1 (Cisco Unified Computing System, Cisco Nexus, and NetApp storage systems) offers platform and resource options to scale the infrastructure up or down, while supporting the same features and functionality that are required under the configuration and connectivity best practices of FlexPod.

FlexPod Benefits

As customers transition toward shared infrastructure or cloud computing they face a number of challenges such as initial transition hiccups, return on investment (ROI) analysis, infrastructure management and future growth plan. The FlexPod architecture is designed to help with proven guidance and measurable value. By introducing standardization, FlexPod helps customers mitigate the risk and uncertainty involved in planning, designing, and implementing a new Datacenter infrastructure. The result is a more predictive and adaptable architecture capable of meeting and exceeding customers' IT demands.

FlexPod: Cisco and NetApp Verified Architecture

Cisco and NetApp have thoroughly validated and verified the FlexPod solution architecture and its many use cases while creating a portfolio of detailed documentation, information, and references to assist customers in transforming their Datacenters to this shared infrastructure model. This portfolio includes, but is not limited to the following items:

- Best practice architectural design
- Workload sizing and scaling guidance
- Implementation and deployment instructions
- Technical specifications (rules for FlexPod **configuration dos and don'ts**)
- Frequently asked questions (FAQs)
- Cisco Validated Designs (CVDs) and NetApp Verified Architectures (NVAs) focused on a variety of use cases

Cisco and NetApp have also built a robust and experienced support team focused on FlexPod solutions, from customer account and technical sales representatives to professional services and technical support engineers. The Co-operative Support Program by NetApp and Cisco, customers and channel service partners with direct access to technical experts who collaborate with cross vendors and have access to shared lab resources to resolve potential issues. FlexPod supports tight integration with virtualized and cloud infrastructures, making it a logical choice for long-term investment. The following IT initiatives are addressed by the FlexPod solution.

Integrated System

FlexPod is a pre-validated infrastructure that brings together compute, storage, and network to simplify, accelerate, and minimize the risk associated with Datacenter builds and application rollouts. These integrated systems provide a standardized approach in the Datacenter that facilitates staff expertise, application onboarding, and automation as well as operational efficiencies relating to compliance and certification.

Out of the Box Infrastructure High Availability

FlexPod is a highly available and scalable infrastructure that IT can evolve over time to support multiple physical and virtual application workloads. FlexPod has no single point of failure at any level, from the server through the network, to the storage. The fabric is fully redundant and scalable, and provides seamless traffic failover, should any individual component fail at the physical or virtual layer.

FlexPod Design Principles

FlexPod addresses four primary design principles:

- **Application availability:** Makes sure that services are accessible and ready to use.
- **Scalability:** Addresses increasing demands with appropriate resources.
- **Flexibility:** Provides new services or recovers resources without requiring infrastructure modifications.
- **Manageability:** Facilitates efficient infrastructure operations through open standards and APIs.

Implementation Overview

Docker Enterprise Edition solution is integrated and validated on Cisco UCS is implemented on Cisco UCS B-Series server and Cisco Nexus platforms. The NetApp AFF 8040 storage system is integrated with Docker EE using the NetApp Docker Volume Plugin (nDVP) to provide persistent storage for containers via NFS. Another NFS volume is mounted on all Docker Trusted Registry(DTR) nodes for storing Docker images in a private and on-prem trusted repository. To enable stateless computing boot LUNs are provisioned from the NetApp storage using Fibre Channel, and additional Fibre Channel LUNs are provisioned for container and image storage management (graph).

The architecture covers step by step install/configuration, provisioning process, and the solution testing required for CVD. The bare metal is installed manually; OS configuration and Docker EE install is automated through built-in Docker tools and Ansible. The end-to-end stack is tested for correctness (recommended software stack), performance, and scalability, high-availability and security policies. The containers will be deployed and managed by Docker (Universal Control Plane) UCP. This deployment guide contains detailed step by step instructions on setting up the complete stack and solution validation test results.

Highlights

- **Industry-Leading Converged Computing Infrastructure:** Cisco UCS blade servers enable customers to rapidly and efficiently deploy and manage compute, network and storage functions for containers. They enable customers to reduce IT costs through consolidation, manage more containers per computing node and make better use of infrastructure to provide an application container environment in real time.
- **Industry-Leading Container Application Infrastructure:** Docker EE brings container orchestration, management and security to the enterprise. It enables developers and system administrators to build, ship and run distributed applications anywhere.
- **Combined Use Cases**
 - **Microservice and cloud native application architecture:** Enables stateless application container deployment for specific business use needs
 - **Continuous integration and continuous deployment(CI/CD):** Enable developers to develop and test applications more quickly and within relevant environment
 - **DevOps:** Break down barriers between development and operations teams to improve delivery of applications for the business

- Big Data: Empower organizations to use big data analytics using small foot print applications at a very large scale numbers
 - Infrastructure optimization: Decrease infrastructure costs while increasing efficiency. The lightweight nature of containers and the absence of hypervisors and guest operating systems enables enterprises to optimize resource and eliminate licensing costs

Solution Benefits

The benefits of Docker Enterprise Edition on FlexPod include the following:

- Cisco UCS
 - Simplicity: Reduced Datacenter complexities through Cisco UCS converged infrastructure with a single management control plane for hardware lifecycle management
 - Rapid Deployment: Easily deploy and scale the solution
 - High Availability: Superior scalability and high-availability
 - Faster ROI: Better response with optimal ROI
- NetApp ONTAP
 - Ease of deployment: Simplified deployment and management across flash, disk, and cloud
 - Flexibility: Fast and agile solution deployment
 - Security: Data protection with flexible, built-in encryption
 - Performance: Leading TCO with flash efficiencies, performance, and scale.
- Docker Enterprise Edition
 - Agility: Gain the freedom to define environments and create and deploy applications quickly and easily, providing flexibility of IT operations that respond quickly to change
 - Control: Enable developers to own the code from the infrastructure to the application and quickly move from the build to the production environment. IT operations manageability features enable organizations to standardize, secure, and scale the operating environment
 - Portability: Docker Containers are self-contained and independent units that are portable between private infrastructure and public cloud environments without complexity or disruption
 - Security: Docker EE makes safer applications with usable security features with end to end encryption, integrated secrets management, image signing, and vulnerability monitoring

Audience

The audience for this document includes, but is not limited to, sales engineers, field consultants, professional services, IT managers, partner engineers, IT architects, and customers who want to take advantage of an infrastructure that is built to deliver IT efficiency and enable IT innovation. The reader of this document is

expected to have the necessary training and background to install and configure Red Hat Enterprise Linux, Cisco Unified Computing System (UCS) and Cisco Nexus Switches, NetApp storage as well as high level understanding of Docker Container components. External references are provided where applicable and it is recommended that the reader be familiar with these documents.

Readers are also expected to be familiar with the infrastructure, network and security policies of the customer installation.

Purpose of the Document

This document highlights the benefits of using Docker Enterprise Edition (EE) on FlexPod comprising of Cisco UCS infrastructure and NetApp ONTAP storage backend to efficiently deploy, scale, and manage a production-ready application container environment for enterprise customers. The goal of this document is to demonstrate the value that Cisco UCS brings to the data center, such as single-point hardware lifecycle management and highly available converged compute and network infrastructure for application container deployments using Docker EE.

Solution Overview

FlexPod solutions speed up IT operations today and create the modern technology foundation you need for initiatives like private cloud, big data, and desktop virtualization. With Cisco UCS Manager and Cisco Single Connect Technology, hardware is automatically configured by application-centric policies—ushering in a new era of speed, consistency, and simplicity for Datacenter operations. UCS brings the flexibility of virtualized systems to the physical world in a way no other server architecture can, lowering costs and improving your ROI.

Leveraging the centralized management of Cisco UCS Manager, this solution provides unified, embedded, policy-driven management to programmatically control server, network, and storage resources you can efficiently manage the scale-up/ -out infrastructure. Furthermore, Cisco Nexus - unified Fabric is a holistic network architecture comprising switching, security, and services that are designed for physical, virtual, and cloud environments. It uniquely integrates with servers, storage, and orchestration platforms for more efficient operations and greater scalability.

Cisco has partnered with Docker to provide Container Management solution to accelerate the IT transformation by enabling easy and faster deployments, greater flexibility of choice, business agility, efficiency, lower risk.

Docker has become the industry standard for developers and IT operations to build, ship and run distributed applications in bare-metal, virtualized and cloud environments. As organizations adopt public, private or Hybrid cloud, Docker makes it easy to move applications between on premise and cloud environments. Docker can significantly improve hardware resource utilization, accelerate application lifecycle and reduce overall cost by automating IT processes, and deploying dockerized application on-premise or cloud environment.

Docker EE delivers an integrated platform for developers and IT operations to collaborate in the enterprise software supply chain. Bringing security, policy and controls to the application lifecycle without sacrificing any agility or application portability. Docker EE integrates to enterprise business – from on-premises and VPC deployment models, open APIs and interfaces, to flexibility for supporting a wide variety of workflows.

Figure 2. Docker Enterprise Edition – Software Supply Chain Journey to CaaS

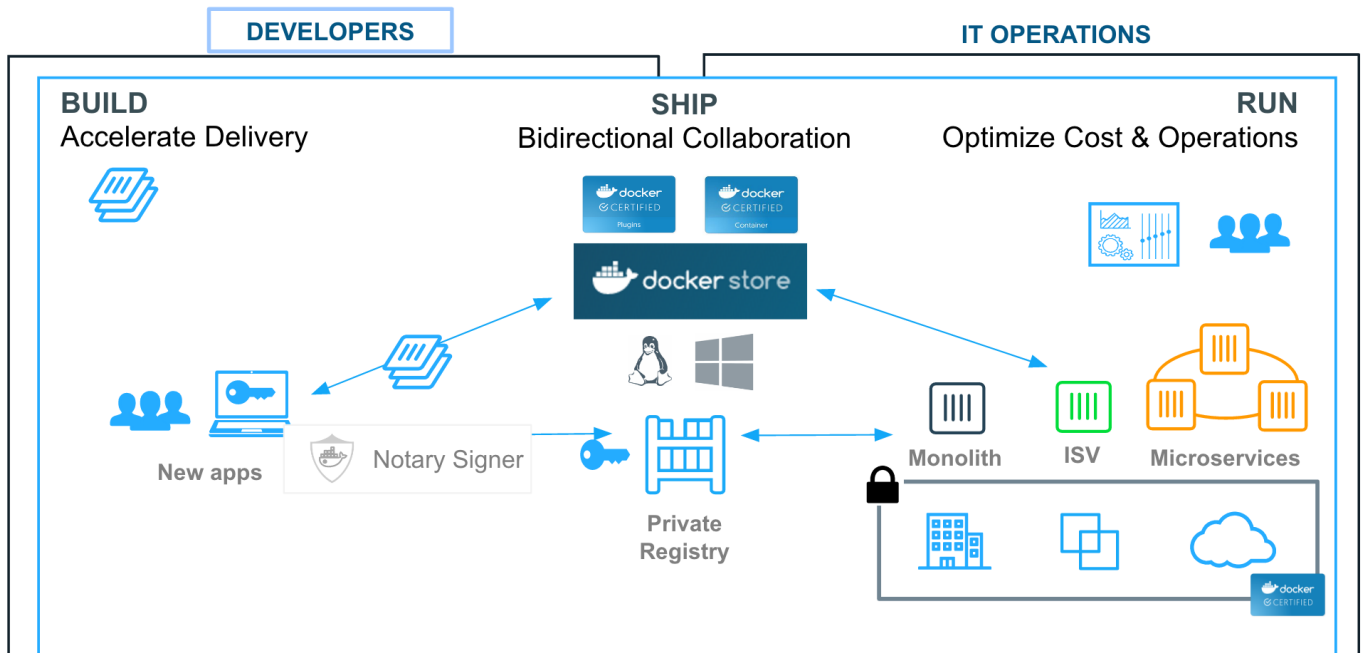

Solution Components

The solution offers redundant architecture from a compute, network, and storage perspective. The solution consists of the following key components:

- Cisco Unified Computing System (UCS)
- Cisco UCS Manager
- Cisco UCS 6248UP Fabric Interconnects
- Cisco 2204XP IO Module or Cisco UCS Fabric Extenders
- Cisco B200 M4 Servers
- Cisco VIC 1340
- Cisco Nexus 93180YC-EX Switches
- Docker Enterprise Edition (EE)
- Docker EE (Basic)
- Docker Universal Control Plane (UCP)
- Docker Trusted Repository (DTR)
- Red Hat Enterprise Linux 7.3
- NetApp AFF8040

Technology Overview

This section provides a brief introduction of the various hardware/ software components used in this solution.

Cisco Unified Computing System

The Cisco Unified Computing System is a next-generation solution for blade and rack server computing. The system integrates a low-latency, lossless 10 Gigabit Ethernet unified network fabric with enterprise-class, x86-architecture servers. The system is an integrated, scalable, multi-chassis platform in which all resources participate in a unified management domain. The Cisco Unified Computing System accelerates the delivery of new services simply, reliably, and securely through end-to-end provisioning and migration support for both virtualized and non-virtualized systems. Cisco Unified Computing System provides:

- Comprehensive Management
- Radical Simplification
- High Performance

The Cisco Unified Computing System consists of the following components:

- **Compute** - The system is based on an entirely new class of computing system that incorporates rack mount and blade servers based on Intel Xeon 2600 v3 Series Processors.
- **Network** - The system is integrated onto a low-latency, lossless, 10-Gbps unified network fabric. **This network foundation consolidates Local Area Networks (LAN's), Storage Area Networks (SANs),** and high-performance computing networks which are separate networks today. The unified fabric lowers costs by reducing the number of network adapters, switches, and cables, and by decreasing the power and cooling requirements.
- **Virtualization** - The system unleashes the full potential of virtualization by enhancing the scalability, performance, and operational control of virtual environments. Cisco security, policy enforcement, and diagnostic features are now extended into virtualized environments to better support changing business and IT requirements.
- **Storage access** - The system provides consolidated access to both SAN storage and Network Attached Storage (NAS) over the unified fabric. It is also an ideal system for Software defined Storage (SDS). Combining the benefits of single framework to manage both the compute and Storage servers in a single pane, Quality of Service (QOS) can be implemented if needed to inject IO throttling in the system. In addition, the server administrators can pre-assign storage-access policies to storage resources, for simplified storage connectivity and management leading to increased productivity.
- **Management** - the system uniquely integrates all system components to enable the entire solution to be managed as a single entity by the Cisco UCS Manager. The Cisco UCS Manager has an intuitive graphical user interface (GUI), a command-line interface (CLI), and a powerful scripting library module for Microsoft PowerShell built on a robust application programming interface (API) to manage all system configuration and operations.

Cisco Unified Computing System (Cisco UCS) fuses access layer networking and servers. This high-performance, next-generation server system provides a data center with a high degree of workload agility and scalability.

Cisco UCS Manager

Cisco Unified Computing System (UCS) Manager provides unified, embedded management for all software and hardware components in the Cisco UCS. Using Single Connect technology, it manages, controls, and administers multiple chassis for thousands of virtual machines. Administrators use the software to manage the entire Cisco Unified Computing System as a single logical entity through an intuitive GUI, a command-line interface (CLI), or an XML API. The Cisco UCS Manager resides on a pair of Cisco UCS 6200 Series Fabric Interconnects using a clustered, active-standby configuration for high-availability.

UCS Manager offers unified embedded management interface that integrates server, network, and storage. UCS Manager performs auto-discovery to detect inventory, manage, and provision system components that are added or changed. It offers comprehensive set of XML API for third part integration, exposes 9000 points of integration and facilitates custom development for automation, orchestration, and to achieve new levels of system visibility and control.

Service profiles benefit both virtualized and non-virtualized environments and increase the mobility of non-virtualized servers, such as when moving workloads from server to server or taking a server offline for service or upgrade. Profiles can also be used in conjunction with virtualization clusters to bring new resources online easily, complementing existing virtual machine mobility.

For more Cisco UCS Manager Information, refer to: <http://www.cisco.com/c/en/us/products/servers-unified-computing/ucs-manager/index.html>

Cisco UCS Fabric Interconnects

The Fabric interconnects provide a single point for connectivity and management for the entire system. Typically deployed as an active-**active pair, the system's fabric interconnects integrate all components into a** single, highly-available management domain controlled by Cisco UCS Manager. The fabric interconnects manage all I/O efficiently and securely at a single point, resulting in deterministic I/O latency regardless of a **server or virtual machine's topological location in the system.**

Cisco UCS 6200 Series Fabric Interconnects support the system's 80-Gbps unified fabric with low-latency, lossless, cut-through switching that supports IP, storage, and management traffic using a single set of cables. The fabric interconnects feature virtual interfaces that terminate both physical and virtual connections equivalently, establishing a virtualization-aware environment in which blade, rack servers, and virtual machines are interconnected using the same mechanisms. The Cisco UCS 6248UP is a 1-RU Fabric Interconnect that features up to 48 universal ports that can support 80 Gigabit Ethernet, Fiber Channel over Ethernet, or native Fiber Channel connectivity.

For more information, visit the following link: <http://www.cisco.com/c/en/us/products/servers-unified-computing/ucs-6200-series-fabric-interconnects/index.html>

Cisco UCS 5108 Blade Server Chassis

The Cisco UCS 5100 Series Blade Server Chassis is a crucial building block of the Cisco Unified Computing System, delivering a scalable and flexible blade server chassis. The Cisco UCS 5108 Blade Server Chassis is six rack units (6RU) high and can mount in an industry-standard 19-inch rack. A single chassis can house up to eight half-width Cisco UCS B-Series Blade Servers and can accommodate both half-width and full-width

blade form factors. Four single-phase, hot-swappable power supplies are accessible from the front of the chassis. These power supplies are 92 percent efficient and can be configured to support non-redundant, N+1 redundant and grid-redundant configurations. The rear of the chassis contains eight hot-swappable fans, four power connectors (one per power supply), and two I/O bays for Cisco UCS 2204XP or 2208XP Fabric Extenders. A passive mid-plane provides up to 40 Gbps of I/O bandwidth per server slot and up to 80 Gbps of I/O bandwidth for two slots. The chassis is capable of supporting future 80 Gigabit Ethernet standards.

For more information, please refer to the following link: <http://www.cisco.com/c/en/us/products/servers-unified-computing/ucs-5100-series-blade-server-chassis/index.html>

Cisco UCS B200M4 Blade Server

The enterprise-class **Cisco UCS B200 M4 blade server extends the capabilities of Cisco's Unified Computing System** portfolio in a half-width blade form factor. The Cisco UCS B200 M4 uses the power of the latest Intel® Xeon® E5-2600 v3 Series processor family CPUs with up to 768 GB of RAM (using 32 GB DIMMs), two solid-state drives (SSDs) or hard disk drives (HDDs), and up to 80 Gbps throughput connectivity. The UCS B200 M4 Blade Server mounts in a Cisco UCS 5100 Series blade server chassis or UCS Mini blade server chassis. It has 24 total slots for registered ECC DIMMs (RDIMMs) or load-reduced DIMMs (LR DIMMs) for up to 768 GB total memory capacity (B200 M4 configured with two CPUs using 32 GB DIMMs). It **supports one connector for Cisco's VIC 1340 or 1240 adapter**, which provides Ethernet and FCoE.

For more information, see: <http://www.cisco.com/c/en/us/products/servers-unified-computing/ucs-b200-m4-blade-server/index.html>

Cisco UCS Fabric Extenders

The Cisco UCS 2204XP Fabric Extender has four 10 Gigabit Ethernet, FCoE-capable, SFP+ ports that connect the blade chassis to the fabric interconnect. Each Cisco UCS 2204XP has sixteen 10 Gigabit Ethernet ports connected through the mid-plane to each half-width slot in the chassis. Typically configured in pairs for redundancy, two fabric extenders provide up to 80 Gbps of I/O to the chassis.

Cisco VIC Interface Cards

The Cisco UCS Virtual Interface Card (VIC) 1340 is a 2-port 40-Gbps Ethernet or dual 4 x 10-Gbps Ethernet, Fiber Channel over Ethernet (FCoE) capable modular LAN on motherboard (mLOM) designed exclusively for the M4 generation of Cisco UCS B-Series Blade Servers.

All the blade servers for both Controllers and Computes will have MLOM VIC 1340 card. Each blade will have a capacity of 40 Gb of network traffic. The underlying network interfaces like will share this MLOM card.

The Cisco UCS VIC 1340 enables a policy-based, stateless, agile server infrastructure that can present over 256 PCIe standards-compliant interfaces to the host that can be dynamically configured as either network interface cards (NICs) or host bus adapters (HBAs).

For more information, see:

<http://www.cisco.com/c/en/us/products/interfaces-modules/ucs-virtual-interface-card-1340/index.html>

Cisco UCS Differentiators

Cisco's Unified Compute System is revolutionizing the way servers are managed in data-center. Following are the unique differentiators of UCS and UCS Manager:

1. Embedded Management –In UCS, the servers are managed by the embedded firmware in the Fabric Interconnects, eliminating need for any external physical or virtual devices to manage the servers.
2. Unified Fabric –In UCS, from blade server chassis or rack servers to FI, there is a single Ethernet cable used for LAN, SAN and management traffic. This converged I/O results in reduced cables, SFPs and adapters – reducing capital and operational expenses of overall solution.
3. Auto Discovery –By simply inserting the blade server in the chassis or connecting rack server to the fabric interconnect, discovery and inventory of compute resource occurs automatically without any management intervention. The combination of unified fabric and auto-discovery enables the wire-once architecture of UCS, where compute capability of UCS can be extended easily while keeping the existing external connectivity to LAN, SAN and management networks.
4. Policy Based Resource Classification –Once a compute resource is discovered by UCS Manager, it can be automatically classified to a given resource pool based on policies defined. This capability is useful in multi-tenant cloud computing. This CVD showcases the policy based resource classification of UCS Manager.
5. Combined Rack and Blade Server Management –UCS Manager can manage B-Series blade servers and C-Series rack server under the same UCS domain. This feature, along with stateless computing makes compute resources truly hardware form factor agnostic.
6. Model based Management Architecture –UCS Manager Architecture and management database is model based and data driven. An open XML API is provided to operate on the management model. This enables easy and scalable integration of UCS Manager with other management systems.
7. Policies, Pools, Templates –The management approach in UCS Manager is based on defining policies, pools and templates, instead of cluttered configuration, which enables a simple, loosely coupled, data driven approach in managing compute, network and storage resources.
8. Loose Referential Integrity –In UCS Manager, a service profile, port profile or policies can refer to other policies or logical resources with loose referential integrity. A referred policy cannot exist at the time of authoring the referring policy or a referred policy can be deleted even though other policies are referring to it. This provides different subject matter experts to work independently from each-other. This provides great flexibility where different experts from different domains, such as network, storage, security, server and virtualization work together to accomplish a complex task.
9. Policy Resolution –In UCS Manager, a tree structure of organizational unit hierarchy can be created that mimics the real life tenants and/or organization relationships. Various policies, pools and templates can be defined at different levels of organization hierarchy. A policy referring to another policy by name is resolved in the organization hierarchy with closest policy match. If no policy with specific name is found in the hierarchy of the root organization, then special policy **named “default” is searched. This policy resolution practice enables automation friendly management APIs and provides great flexibility to owners of different organizations.**
10. Service Profiles and Stateless Computing –a service profile is a logical representation of a server, carrying its various identities and policies. This logical server can be assigned to any physical

compute resource as far as it meets the resource requirements. Stateless computing enables procurement of a server within minutes, which used to take days in legacy server management systems.

11. Built-in Multi-Tenancy Support –The combination of policies, pools and templates, loose referential integrity, policy resolution in organization hierarchy and a service profiles based approach to compute resources makes UCS Manager inherently friendly to multi-tenant environment typically observed in private and public clouds.
12. Extended Memory – the enterprise-class Cisco UCS B200 M4 blade server extends the capabilities of Cisco's **Unified Computing System portfolio in a half-width** blade form factor. The Cisco UCS B200 M4 harnesses the power of the latest Intel® Xeon® E5-2600 v3 Series processor family CPUs with up to 1536 GB of RAM (using 64 GB DIMMs) – allowing huge VM to physical server ratio required in many deployments, or allowing large memory operations required by certain architectures like Big-Data.
13. Virtualization Aware Network –VM-FEX technology makes the access network layer aware about host virtualization. This prevents domain pollution of compute and network domains with virtualization when virtual network is managed by port-**profiles defined by the network administrators'** team. VM-FEX also off-loads hypervisor CPU by performing switching in the hardware, thus allowing hypervisor CPU to do more virtualization related tasks. VM-FEX technology is well integrated with VMware vCenter, Linux KVM and Hyper-V SR-IOV to simplify cloud management.
14. Simplified QoS –Even though Fiber Channel and Ethernet are converged in UCS fabric, built-in support for QoS and lossless Ethernet makes it seamless. Network Quality of Service (QoS) is simplified in UCS Manager by representing all system classes in one GUI panel.

Cisco Nexus 9000 Switches

The Cisco Nexus 9000 Series delivers proven high performance and density, low latency, and exceptional power efficiency in a broad range of compact form factors. Operating in Cisco NX-OS Software mode or in Application Centric Infrastructure (ACI) mode, these switches are ideal for traditional or fully automated data center deployments.

The Cisco Nexus 9000 Series Switches offer both modular and fixed 10/40/100 Gigabit Ethernet switch configurations with scalability up to 30 Tbps of non-blocking performance with less than five-microsecond latency, 1152 10 Gbps or 288 40 Gbps non-blocking Layer 2 and Layer 3 Ethernet ports and wire speed VXLAN gateway, bridging, and routing

NetApp Storage Controllers

A storage system running Data ONTAP (also known as a storage controller) is the hardware device that receives and sends data from the host. Controller nodes are deployed in HA pairs, with these HA pairs participating in a single storage domain or cluster. This unit detects and gathers information about its own hardware configuration, the storage system components, the operational status, hardware failures, and other error conditions. A storage controller is redundantly connected to storage through disk shelves, which are the containers or device carriers that hold disks and associated hardware such as power supplies, connectivity interfaces, and cabling.

NetApp All Flash FAS

NetApp All Flash FAS addresses enterprise storage requirements with high performance, superior flexibility, and best-in-class data management. Built on the Data ONTAP storage operating system, All Flash FAS speeds up your business without compromising on efficiency, reliability, or the flexibility of your IT operations. As true enterprise-class, all-flash arrays, these systems accelerate, manage, and protect your business-critical data, now and in the future. With All Flash FAS systems, you can:

Accelerate the speed of business

- The storage operating system employs the NetApp WAFL® (Write Anywhere File Layout) system, which is natively enabled for flash media
- FlashEssentials enables consistent sub-millisecond latency and up to 4 million IOPS
- The All Flash FAS system delivers 4 to 12 times higher IOPS and 20 times faster response for databases than traditional hard disk drive HDD systems

Reduce costs while simplifying operations

- High performance enables server consolidation and can reduce database licensing costs by 50%
- **As the industry's only unified all-flash storage** that supports synchronous replication, All Flash FAS supports all your backup and recovery needs with a complete suite of integrated data-protection utilities
- Data-reduction technologies can deliver space savings of 5 to 10 times on average
 - Newly enhanced inline compression delivers near-zero performance effect. Incompressible data detection eliminates wasted cycles.
 - Always-on deduplication runs continuously in the background and provides additional space savings for use cases such as virtual desktop deployments
 - Inline zero-block deduplication accelerates VM provisioning by 20 to 30%
 - Advanced SSD partitioning increases usable capacity by almost 20%

Future-proof your investment with deployment flexibility

- All Flash FAS systems are ready for the data fabric. Data can move between the performance and capacity tiers on premises or in the cloud
- All Flash FAS offers application and ecosystem integration for virtual desktop integration VDI, database, and server virtualization
- Without silos, you can non-disruptively scale out and move workloads between flash and HDD within a cluster

NetApp Data ONTAP

With Data ONTAP, NetApp provides enterprise-ready, unified scale-out storage. Developed from a solid foundation of proven Data ONTAP technology and innovation, Data ONTAP is the basis for large virtualized shared storage infrastructures that are architected for non-disruptive operations over the system lifetime. Controller nodes are deployed in HA pairs in a single storage domain or cluster.

Data ONTAP scale-out is a way to respond to growth in a storage environment. As the storage environment grows, additional controllers are added seamlessly to the resource pool residing on a shared storage infrastructure. Host and client connections as well as datastores can move seamlessly and non-disruptively anywhere in the resource pool, so that existing workloads can be easily balanced over the available resources, and new workloads can be easily deployed. Technology refreshes (replacing disk shelves, adding or completely replacing storage controllers) are accomplished while the environment remains online and continues serving data. Data ONTAP is the first product to offer a complete scale-out solution, and it offers an adaptable, always-available storage infrastructure for today's highly virtualized environment.

NetApp Storage Virtual Machines

A cluster serves data through at least one and possibly multiple storage virtual machines (SVMs; formerly called vServers). An SVM is a logical abstraction that represents the set of physical resources of the cluster. Data volumes and network logical interfaces (LIFs) are created and assigned to an SVM and may reside on any node in the cluster to which the SVM has been given access. An SVM may own resources on multiple nodes concurrently, and those resources can be moved nondisruptively from one node to another. For example, a flexible volume can be non-disruptively moved to a new node and aggregate, or a data LIF can be transparently reassigned to a different physical network port. The SVM abstracts the cluster hardware and it is not tied to any specific physical hardware.

An SVM is capable of supporting multiple data protocols concurrently. Volumes within the SVM can be junctioned together to form a single NAS namespace, which makes all of an SVM's data available through a single share or mount point to NFS and CIFS clients. SVMs also support block-based protocols, and LUNs can be created and exported using iSCSI, Fiber Channel, or FCoE. Any or all of these data protocols may be configured for use within a given SVM.

Because it is a secure entity, an SVM is only aware of the resources that are assigned to it and has no knowledge of other SVMs and their respective resources. Each SVM operates as a separate and distinct entity with its own security domain. Tenants may manage the resources allocated to them through a delegated SVM administration account. Each SVM may connect to unique authentication zones such as Active Directory®, LDAP, or NIS.

NetApp Docker Volume Plugin (nDVP):

NetApp Docker Volume Plugin (nDVP) provides direct integration with Docker ecosystem for NetApp's ONTAP, E-Series and SolidFire storage platforms. nDVP runs like any other service on Docker hosts and provisions Docker volumes from storage platforms and presents them to Docker hosts. nDVP provisions both file based(NFS) and block storage(iSCSI) from ONTAP based storage platform. Note that in this implementation, only NFS provisioning was demonstrated.

With the latest release of Docker Engine (1.13 or 17.03) NetApp Docker Volume Plugin is available as a certified Docker plugin in the Docker store.

More information on nDVP and associated best practices can be found [here](#)

Storage Design practices:

Storage Virtual Machines enable multi-tenancy by providing storage resource isolation. NetApp recommends that each team in Docker EE uses a separate nDVP instance. The nDVP instance is configured with a separate SVM and appropriate `storagePrefix` parameter.

NetApp recommends active monitoring of volume count utilization to ensure that SVM or node volume count maximums aren't reached. Monitoring of capacity and volume count utilization is performed using [NetApp OnCommand Unified Manager](#) (OCUM).



When an application is deployed as a service in Docker EE, the resources (volumes etc.) associated with the service are managed directly through the application service lifecycle. For example, when a service is created the Docker volumes are created, similarly when a service is destroyed the associated Docker volumes are destroyed. However, Docker EE administrator needs to monitor for any dangling volumes that might exist. (Docker volumes not associated with any service and are no longer used).

Additionally, nDVP instances corresponding to different storage tiers can be configured. Parameters like aggregates used, thin provisioning and snapshot policy can be appropriately set in the nDVP configuration file corresponding to a storage class service.

For example, the following config corresponds a storage class Gold in a certain environment:

```
{
  "version": 1,
  "storageDriverName": "ontap-nas",
  "storagePrefix": "finance",
  "managementLIF": "192.168.91.11",
  "dataLIF": "192.168.93.11",
  "svm": "Cntr-TNT-A-SVM",
  "username": "ndvpuser",
  "password": "HlghV0lt",
  "aggregate": "aggr1_ssd",
  "spaceReserve": "none",
  "snapshotPolicy": "gold"
}
```



The aggr1_ssd contains all SSDs and a snapshot Policy gold already exists on ONTAP with a certain snapshot schedule

Docker Enterprise Edition

Docker - a containerization platform developed to simplify and standardize deployment in various environments. It is largely instrumental in spurring the adoption of this style of service design and management. Docker containers encapsulate all application components, such as dependencies and services. When all dependencies are encapsulated, applications become portable and can be dependably moved between development, test, and production environments. Docker makes container creation and management simple and integrates with many open source projects. Docker EE comprises an enterprise container orchestration, application management and enterprise-grade security.

Figure 3. Docker Enterprise Edition Platform



Docker EE includes leading Docker open source projects, commercial software, integrations with validated and supported configurations:

- Docker Engine for a robust container runtime
- Universal Control Plane (UCP) with embedded Swarm scheduler for integrated management and orchestration of the Docker environment
- Trusted Registry (DTR) for Docker image management, security, and collaboration
- Security must be a multi-layered approach; content Trust provides the ability to sign images with digital keys and then verify the signature of those images

Figure 4. High level Docker Enterprise Edition Architecture

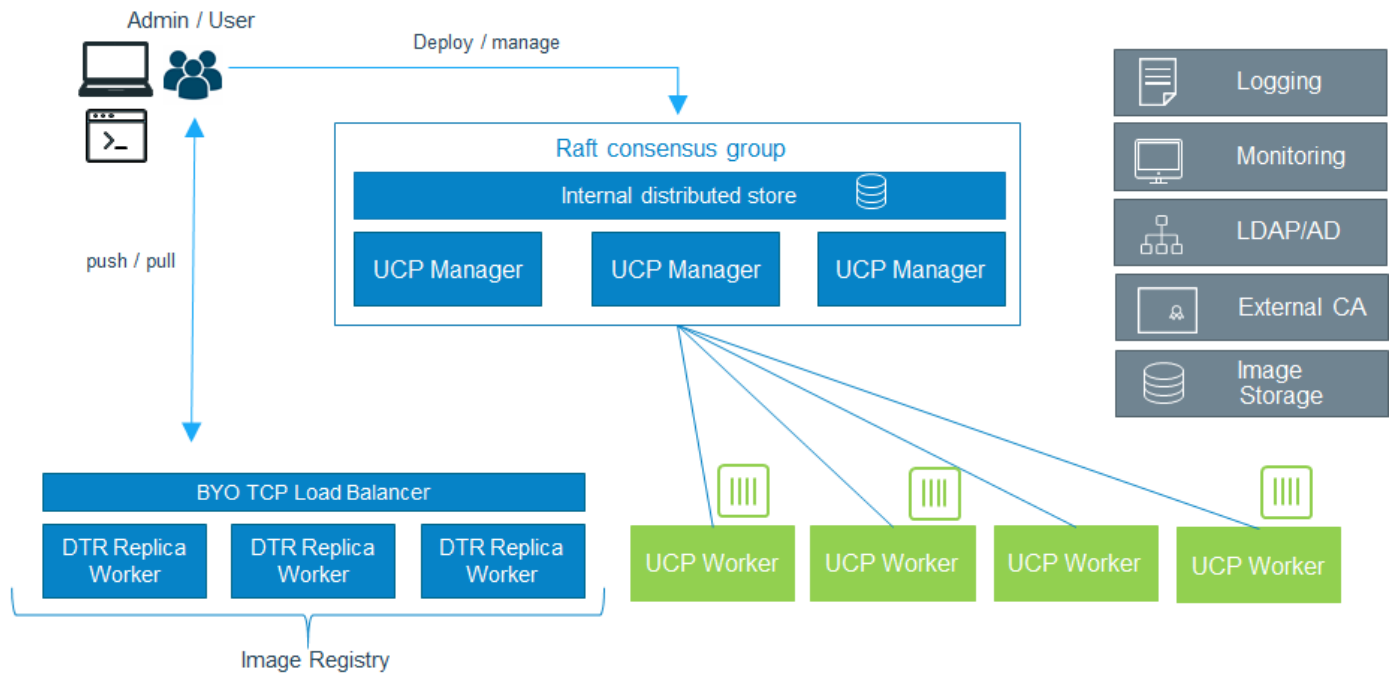

Docker EE

Docker EE (Basic) is the building block for the modern application platform for the enterprise. It's a lightweight container runtime and robust tooling that runs and build containers. Docker allows us to package the application code and dependencies together in an isolated container that shares the OS kernel on the host system. The in-host daemon communicates with Docker Client to execute commands to build, ship and run containers.

Docker UCP

Docker Universal Control Plane (Docker UCP) is an enterprise on premise solution that includes user management, resource management, clustering and orchestration that integrates with the existing enterprise LDAP/AD for High-Availability, security and compliance. Docker UCP enables IT operation teams to deploy and manage the containerized applications in production.

UCP is a containerized application, which provides enterprise-grade cluster management solution. It gets installed on Docker Engine on all the nodes which are designated as controller nodes. After installing first node with Docker Engine, UCP application is installed and the other nodes are joined to the first node to form a Docker swarm cluster.

Figure 5. Docker EE (Datacenter Cluster)

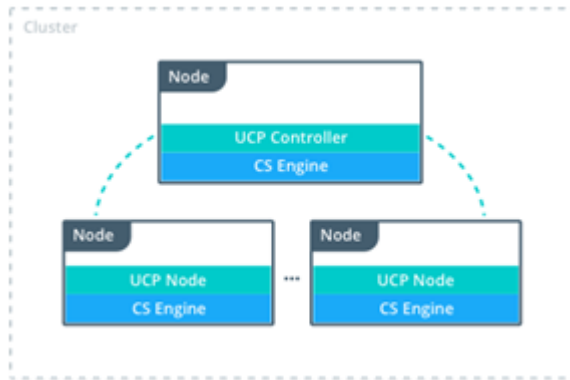

A Docker UCP cluster has two types of nodes:

- UCP Controller Node
- UCP Node

UCP Controller Node

Docker UCP controller node manages the cluster and provides persistent cluster configurations. Within controller nodes there are two categories of nodes – Master and Replicas. A first node which gets installed with UCP is treated as a Master Controller node. And controller nodes joining the master controller node are termed as Replica nodes. Controller nodes can take up application container workload as well. This is a configurable option available at the admin and user level.

Figure 6. Docker UCP Controller

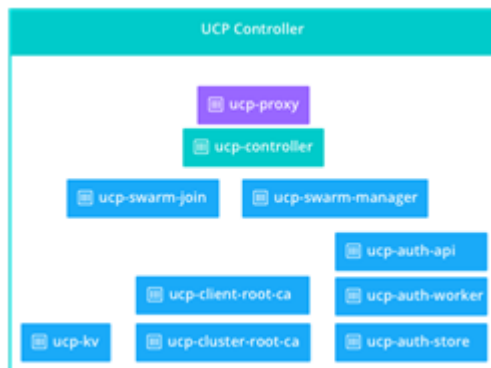

Table 1. Docker UCP Controller node containers and their description

Name	Description
ucp-proxy	A TLS proxy. It allows secure access to the local Docker Engine.
ucp-controller	The UCP application. It uses the key-value store for persisting configurations.
ucp-swarm-manager	Provides the clustering capabilities. It uses the key-value store for leader election, and keeping track of cluster members.

ucp-swarm-join	Heartbeat to record on the key-value store that this node is alive. If the node goes down, this heartbeat stops, and the node is removed from the cluster.
ucp-auth-api	The centralized API for identity and authentication used by UCP and DTR.
ucp-auth-worker	Performs scheduled LDAP synchronizations and cleans data on the ucp-auth-store.
ucp-auth-store	Stores authentication configurations, and data for users, organizations, and teams.
ucp-kv	Used to store the UCP configurations. Do not use it in your applications, since it's for the internal use only.
ucp-cluster-root-ca	A certificate authority to sign the certificates used when joining new nodes, and on administrator client bundles.
ucp-client-root-ca	A certificate authority to sign user bundles. Only used when UCP is installed without an external root CA.

Table 2. Following are the named volumes used by Docker UCP for persistent data

Node	Volume name	Location on host [var/lib/docker/volumes/]	Description
all	ucp-client-root-ca	ucp-client-root-ca/_data	The certificate and key for the UCP root CA. Do not create this volume if you are using your own certificates.
all	ucp-cluster-root-ca	ucp-cluster-root-ca/_data	The certificate and key for the Swarm root CA.
all	ucp-controller-client-certs	ucp-controller-client-certs/_data	The UCP Controller Swarm client certificates for the current node.
all	ucp-controller-server-certs	ucp-controller-server-certs/_data	The controller certificates for the UCP controllers web server.
all	ucp-kv	ucp-kv/_data	Key value store persistence.
all	ucp-kv-certs	ucp-kv-certs/_data	The Swarm KV client certificates for the current node (repeated on every node in the cluster).
all	ucp-node-certs	ucp-node-certs/_data	The Swarm certificates for the current node (repeated on every node in the cluster).

While installing Docker UCP these volumes get created with default volume driver. In our solution we have used Docker device-mapper driver in direct-lvm mode.

Docker Universal Control Plane works in high-availability mode. Adding replicas to first UCP Controller node makes the cluster HA ready. A minimum three node Controller cluster is needed to tolerate one node failure. Adding replica nodes to the cluster allows user request to get load-balanced across controller master and replica nodes.

Docker UCP does not include load-balancing services. It needs external load-balancer to balance user requests across all the controller nodes.

Docker UCP Node

Docker UCP nodes take the container workload. These are the nodes where containers get deployed. Nodes with Docker CS Engine join the existing UCP cluster. While joining the existing UCP Cluster the following containers get instantiated on the UCP node.

Figure 7. Containers on UCP node while joining the UCP cluster

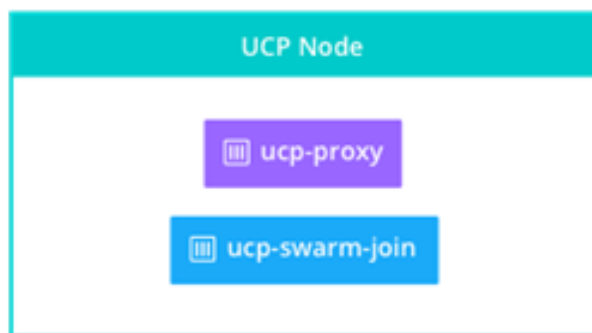

Table 3. Containers formed during UCP Node Join

Name	Description
ucp-proxy	A TLS proxy. It allows secure access to the local Docker Engine.
ucp-swarm-join	Heartbeat to record on the key-value store that this node is alive. If the node goes down, this heartbeat stops, and the node is dropped from the cluster.

Docker Trusted Registry

Docker Trusted Registry (DTR) is an enterprise-grade image storage solution from Docker. DTR gives enterprises the security and compliance to store and manage their Docker images on-premises or in their virtual private cloud (VPC). It has a built-in authentication mechanism; supports role based access control, and allows integration with LDAP and Active Directory.

DTR is part of the Docker Enterprise Edition Subscription which also includes, Universal Control Plane, and Engine. DTR is easy to deploy, configure and integrate with your existing infrastructure and application delivery workflows.

Docker Trusted Registry (DTR) is a dockerized application that runs a Docker Universal Control Plane cluster.

Table 4. With DTR installation the following containers are started

Name	Description
dtr-nginx-<replica_id>	Receives http and https requests and proxies them to other DTR components. By default it listens to ports 80 and 443 of the host.
dtr-api-<replica_id>	Executes the DTR business logic. It serves the DTR web application, and API.
dtr-registry-<replica_id>	Implements the functionality for pulling and pushing Docker images. It also handles how images are stored.
dtr-etcd-<replica_id>	A key-value store for persisting DTR configuration settings. Don't use it in your applications, since it's for internal use only.
dtr-rethinkdb-<replica_id>	A database for persisting repository metadata. Don't use it in your applications, since it's for internal use only.
dtr-jobrunner-<replica_id>	Runs cleanup jobs in the background
dtr-notary-signer-<replica_id>	Performs server-side timestamp and snapshot signing for content trust metadata
dtr-notary-server-<replica_id>	Receives, validates, and serves content trust metadata, and is consulted when pushing or pulling to DTR with content trust enabled

The communication between all DTR components is secured using TLS. Also, when installing DTR, two certificate authority (CA) are created. These CAs are used to create the certificates used by etcd and rethinkDB when communicating across nodes.

Table 5. Following networking gets created when DTR containers communicate with each other

Name	Type	Description
dtr-br	bridge	Allows containers on the same node to communicate with each other in a secure way.
dtr-ol	overlay	Allows containers running on different nodes to communicate. This network is used in high-availability installations, to allow etcd and rethinkDB containers to replicate their data.

Table 6. DTR uses following named volumes for persistent data

Volume name	Description
-------------	-------------

dtr-ca-<replica_id>	The volume where the private keys and certificates are stored so that containers can use TLS to communicate.
dtr-etcd-<replica_id>	The volume used by etcd to persist DTR configurations.
dtr-registry-<replica_id>	The volume where images are stored, if DTR is configured to store images on the local filesystem.
dtr-rethink-<replica_id>	The volume used by RethinkDB to persist DTR data, like users and repositories.
dtr-nfs-registry-<replica_id>	Docker images data, if DTR is configured to store images on NFS
dtr-notary-<replica_id>	Certificate and keys for the Notary components



For shared image repo, data between the DTR cluster 'dtr-registry/_data' can be NFS mounted for high-availability.

For load balancing and high-availability, multiple replicas of DTR are installed and get joined to form a cluster, within Docker EE UCP cluster. When joining new replicas to the cluster, we create new DTR instances that are running the same set of services. Any change to the state of an instance is replicated across all the other instances.

Figure 8. DTR Cluster behind load balancer

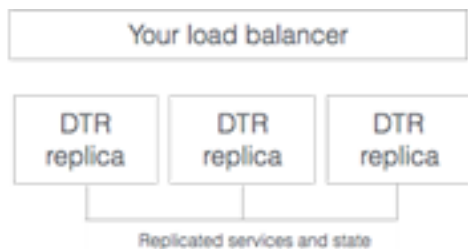

Having a DTR cluster with multiple replicas, allows us to:

- Load-balance user requests across the DTR replicas
- Keep the DTR cluster up and running when a replica fails

DTR does not provide a load balancing service. An on-premises or cloud-based load balancer is required to balance requests across multiple DTR replicas. Load balancer is required to be configured:

- On TCP ports 80 and 443
- On a TCP load balancer which does not terminate the HTTPS connections

Solution Design

This section provides an overview of the hardware and software components used in this solution, as well as the design factors to be considered in order to make the system work as a single, highly available solution

Architectural Overview

This solution consists of Cisco UCS B-Series servers, Cisco UCS Fabric Interconnects, Cisco Nexus TOR switches, and NetApp AFF8040 storage. The Docker Enterprise Edition is certified on Red Hat Enterprise Linux Operating System. Cisco UCS servers provide converged and highly available hardware platform centrally managed by Cisco UCS Manager software residing on Cisco Fabric Interconnects. As an important component of the Docker Enterprise Edition, Docker Universal Control Plane provides the redundancy and high-availability of the Docker Engine and management control plane. This solution holistically offers Container management for diverse application environment to be deployed in DevOps and Production use cases.

Compute nodes for Docker are configured to run on Cisco B-Series servers. In some cases, compute node resources could be shared between the control plane software stack and the container engine. Docker Universal Control Plane services are spread over three B-Series servers for providing management control plane redundancy and high-availability. DTR services and its replicas are configured to run on three dedicated B-Series servers as part of Docker EE.

The following figure illustrates the physical backend connectivity of the hardware components.

Figure 9. Cabling Diagram

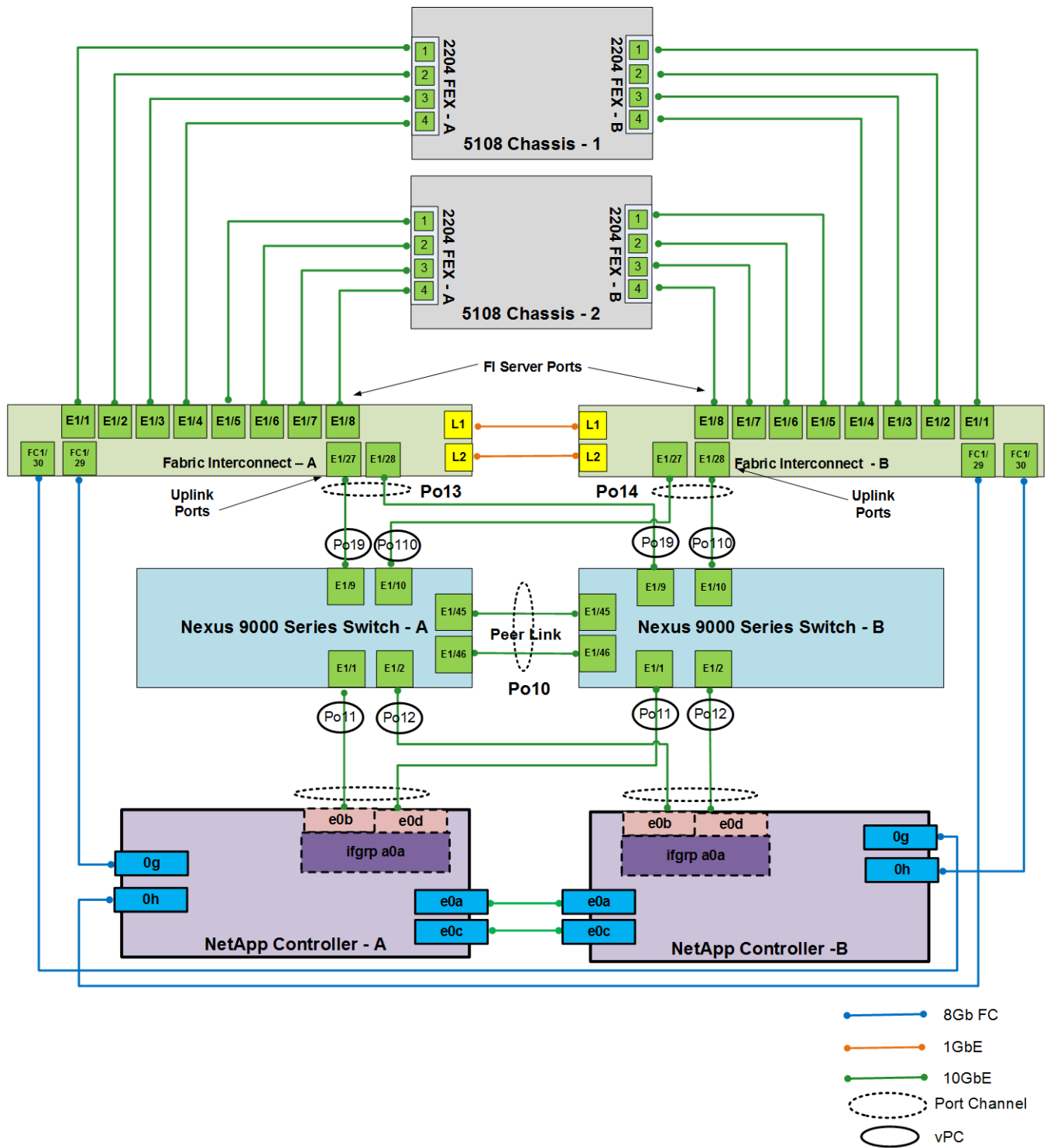

Solution Deployment

Physical Topology

Figure 10. FlexPod with Cisco UCS 6248 Fabric Interconnects and UCS Direct Connect SAN

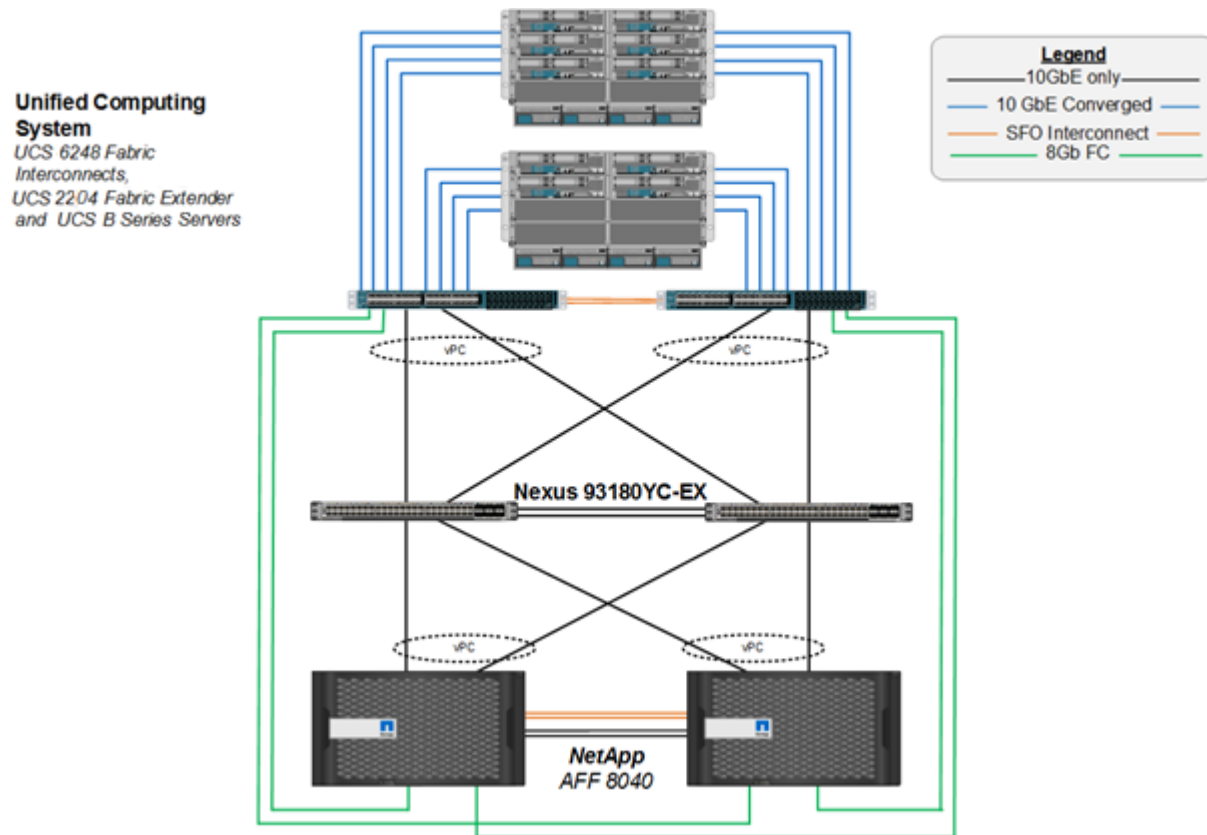

The reference hardware configuration includes:

- Two Cisco Nexus 93180YC-EX switches
- Two Cisco UCS 6248UP fabric interconnects
- One NetApp AFF8040 (HA pair) running Data ONTAP with Disk shelves and Solid State Drives (SSD)

Deployment Hardware and Software

Deployment Hardware

Table 7. Solution Component Details

Component	Model	Quantity	Comments
UCP Controller, UCP and DTR nodes	Cisco UCS B200 M4 Servers	10	CPU - 2 x E5-2660 V4 Memory - 16 x 16GB 2133 DIMM - total of 256G Network Card - 1x1340 VIC + Port Expander
Chassis	Cisco UCS 5108 Chassis	2	
IO Modules	Cisco UCS 2204XP Fabric Extenders	4	
Fabric Interconnects	Cisco UCS 6248UP Fabric Interconnects	2	
ToR Switches	Cisco Nexus 93180YC-EX Switches	2	

Software Revisions

Table 8 lists the software revisions for this solution.

Table 8. Software Revisions

Layer	Device	Image	Comments
Compute	Cisco UCS Fabric Interconnects 6200 and 6300 Series, UCS B-200 M4	3.1(2f)	Includes the Cisco UCS IOM-2208XP, and 2204XP Cisco UCS Manager, and Cisco UCS VIC 1340
	Cisco eNIC	2.3.0.30	
	Cisco fNIC	1.6.0.30	
Network	Cisco Nexus 9000 NX-OS	7.0(3)I4(5)	
Storage	NetApp AFF 8040	Data ONTAP 9.0	
Software	Cisco UCS Manager	3.1(2f)	

	Red Hat Enterprise Linux	7.3	
	Docker Universal Control Plane (UCP)	2.1.2	
	Docker Trusted Registry (DTR)	2.2.3	
	Docker EE (Basic)	17.03.1-ee-3	
	NetApp Docker Volume Plugin	1.4	

Configuration Guidelines

This document provides details for configuring a fully redundant, highly available configuration for a FlexPod unit with clustered Data ONTAP storage. Therefore, reference is made to which component is being configured with each step, either 01 or 02 or A and B. For example, node01 and node02 are used to identify the two NetApp storage controllers that are provisioned with this document, and Cisco Nexus A or Cisco Nexus B identifies the pair of Cisco Nexus switches that are configured. The Cisco UCS fabric interconnects are similarly configured. Additionally, this document details the steps for provisioning multiple Cisco UCS hosts, and these examples are identified as: Docker-Host-01, Docker-Host-02 to represent infrastructure and production hosts deployed to each of the fabric interconnects in this document. Finally, to indicate that you should include information pertinent to your environment in a given step, <text> appears as part of the command structure. See the following example for the network port vlan create command:

Usage:

```
network port vlan create ?
[-node] <nodename>           Node
{ [-vlan-name] {<netport>|<ifgrp>} VLAN Name
| -port {<netport>|<ifgrp>}   Associated Network Port
[-vlan-id] <integer> }       Network Switch VLAN Identifier
```

Example:

```
network port vlan -node <node01> -vlan-name i0a-<vlan id>
```

This document is intended to enable you to fully configure the customer environment. In this process, various steps require you to insert customer-specific naming conventions, IP addresses, and VLAN schemes, as well as to record appropriate MAC addresses. Table 3 lists the virtual machines (VMs) necessary for deployment as outlined in this guide. Table 9 describes the VLANs necessary for deployment as outlined in this guide.

Table 9. Necessary VLANs

VLAN Name	VLAN Purpose	ID Used in Validating This Document
Out of Band Mgmt	VLAN for out-of-band management interfaces	13

VLAN Name	VLAN Purpose	ID Used in Validating This Document
Container Mgmt	VLAN for in-band Container management interfaces	901
Native	VLAN to which untagged frames are assigned	2
Container Mgmt NFS	VLAN for Container Management NFS traffic	902
Container Tenant A NFS	VLAN for First Container Tenant NFS traffic	903

Table 9 lists the VLANs necessary for deployment as outlined in this document.

Physical Infrastructure

FlexPod Cabling

The information in this section is provided as a reference for cabling the physical equipment in a FlexPod environment. To simplify cabling requirements, the tables include both local and remote device and port locations.

The tables in this section contain the details for the prescribed and supported configuration of the NetApp AFF8040 running Data ONTAP 9.0



For any modifications of this prescribed architecture, consult the [NetApp Interoperability Matrix Tool](#) (IMT).

This document assumes that out-of-band management ports are plugged into an existing management infrastructure at the deployment site. These interfaces will be used in various configuration steps

Be sure to use the cabling directions in this section as a guide.

The NetApp storage controller and disk shelves should be connected according to best practices for the specific storage controller and disk shelves. For disk shelf cabling, refer to the Universal SAS and ACP Cabling Guide: https://library.netapp.com/ecm/ecm_get_file/ECMM1280392.

Table 10 through Table 15 provide the details of all the connections in use in the validation lab. Please use these tables as a reference.



In the lab used for this validation, both UCS 6248UP and UCS 6332-16UP Fabric Interconnects were used as noted in these tables.

Table 10. Cisco Nexus 9372-A Cabling Information

Local Device	Local Port	Connection	Remote Device	Remote Port
Cisco Nexus 93180YC-EX A	Eth1/1	10GbE	NetApp Controller 1	e0b
	Eth1/2	10GbE	NetApp Controller 2	e0b

Local Device	Local Port	Connection	Remote Device	Remote Port
	Eth1/9	10GbE	Cisco UCS 6248UP FI A	Eth1/27
	Eth1/10	10GbE	Cisco UCS 6248UP FI B	Eth1/27
	Eth1/45	10GbE	Cisco Nexus 93180 B	Eth1/45
	Eth1/46	10GbE	Cisco Nexus 93180 B	Eth1/46
	MGMT0	GbE	GbE management switch	Any



The vPC peer link shown here on 40 GbE ports 1/49 and 1/50 could also be placed on 10 GbE ports. It is recommended to make the total bandwidth of the vPC peer link at least 40 Gb/s if using 40 GbE ports in this architecture.

Table 11. Cisco Nexus 9372-B Cabling Information

Local Device	Local Port	Connection	Remote Device	Remote Port
Cisco Nexus 93180YC-EX B	Eth1/1	10GbE	NetApp Controller 1	e0d
	Eth1/2	10GbE	NetApp Controller 2	e0d
	Eth1/9	10GbE	Cisco UCS 6248UP FI A	Eth1/28
	Eth1/10	10GbE	Cisco UCS 6248UP FI B	Eth1/28
	Eth1/44	10GbE	Cisco Nexus 93180 A	Eth1/45
	Eth1/46	10GbE	Cisco Nexus 93180 A	Eth1/46
	MGMT0	GbE	GbE management switch	Any

Table 12. NetApp Controller-1 Cabling Information

Local Device	Local Port	Connection	Remote Device	Remote Port
NetApp controller 1	e0M	GbE	GbE management switch	Any

Local Device	Local Port	Connection	Remote Device	Remote Port
	e0i	GbE	GbE management switch	Any
	e0P	GbE	SAS shelves	ACP port
	e0a	10GbE	NetApp Controller 2	e0a
	e0b	10GbE	Cisco Nexus 93180 A	Eth1/1
	e0c	10GbE	NetApp Controller 2	e0c
	e0d	10GbE	Cisco Nexus 93180 B	Eth1/1
	0g	8Gb FC	For Direct Connect to UCS FI	FC1/29
	0h	8Gb FC	For Direct Connect to UCS FI	FC1/30



When the term e0M is used, the physical Ethernet port to which the table is referring is the port indicated by a wrench icon on the rear of the chassis.

Table 13. NetApp Controller-2 Cabling Information

Local Device	Local Port	Connection	Remote Device	Remote Port
NetApp controller 2	e0M	GbE	GbE management switch	Any
	e0i	GbE	GbE management switch	Any
	e0P	GbE	SAS shelves	ACP port
	e0a	10GbE	NetApp Controller 1	e0a
	e0b	10GbE	Cisco Nexus 93180 A	Eth1/2
	e0c	10GbE	NetApp Controller 1	e0c
	e0d	10GbE	Cisco Nexus 93180 B	Eth1/2
	0g	8Gb FC	For Direct Connect to UCS FI	FC1/29
	0h	8Gb FC	For Direct Connect to UCS FI	FC1/30

Table 14. Cisco UCS 6248UP Fabric Interconnect A Cabling Information

Local Device	Local Port	Connection	Remote Device	Remote Port
Cisco UCS fabric interconnect A	FC 1/29	8Gb FC	NetApp Controller 1	0g
	FC 1/30	8Gb FC	NetApp Controller 2	0g
	Eth1/1	10GbE	Cisco UCS Chassis 1 2204 FEX A	IOM 1/1
	Eth1/2	10GbE	Cisco UCS Chassis 1 2204 FEX A	IOM 1/2
	Eth1/3	10GbE	Cisco UCS Chassis 1 2204 FEX A	IOM 1/3
	Eth1/4	10GbE	Cisco UCS Chassis 1 2204 FEX A	IOM 1/4
	Eth1/5	10GbE	Cisco UCS Chassis 2 2208 FEX A	IOM 1/1
	Eth1/6	10GbE	Cisco UCS Chassis 2 2208 FEX A	IOM 1/2
	Eth1/7	10GbE	Cisco UCS Chassis 2 2208 FEX A	IOM 1/3
	Eth1/8	10GbE	Cisco UCS Chassis 2 2208 FEX A	IOM 1/4
	Eth1/27	10GbE	Cisco Nexus 93180 A	Eth1/9
	Eth1/28	10GbE	Cisco Nexus 93180 B	Eth1/9
	MGMT0	GbE	GbE management switch	Any
	L1	GbE	Cisco UCS 6248UP FI B	L1
	L2	GbE	Cisco UCS 6248UP FI B	L2

Table 15. Cisco UCS 6248UP Fabric Interconnect B Cabling Information

Local Device	Local Port	Connection	Remote Device	Remote Port
Cisco UCS fabric interconnect B	FC 1/29	8Gb FC	NetApp Controller 1	0h
	FC 1/30	8Gb FC	NetApp Controller 2	0h
	Eth1/1	10GbE	Cisco UCS Chassis 1 2204 FEX B	IOM 1/1
	Eth1/2	10GbE	Cisco UCS Chassis 1 2204 FEX B	IOM 1/2
	Eth1/3	10GbE	Cisco UCS Chassis 1 2204 FEX B	IOM 1/3

Local Device	Local Port	Connection	Remote Device	Remote Port
	Eth1/4	10GbE	Cisco UCS Chassis 1 2204 FEX B	IOM 1/4
	Eth1/5	10GbE	Cisco UCS Chassis 2 2208 FEX B	IOM 1/1
	Eth1/6	10GbE	Cisco UCS Chassis 2 2208 FEX B	IOM 1/2
	Eth1/7	10GbE	Cisco UCS Chassis 2 2208FEX B	IOM 1/3
	Eth1/8	10GbE	Cisco UCS Chassis 2 2208 FEX B	IOM 1/4
	Eth1/27	10GbE	Cisco Nexus 93180 A	Eth1/10
	Eth1/28	10GbE	Cisco Nexus 93180 B	Eth1/10
	MGMT0	GbE	GbE management switch	Any
	L1	GbE	Cisco UCS 6248UP FI B	L1
	L2	GbE	Cisco UCS 6248UP FI B	L2

FlexPod Cisco Nexus Base

The following procedures describe how to configure the Cisco Nexus switches for use in a base FlexPod environment. This procedure assumes the use of Nexus 9000 7.0(3)I4(5).



The following procedure includes setup of NTP distribution on the Container Management VLAN. The interface-vlan feature and ntp commands are used to set this up. This procedure also assumes the default VRF will be used to route the Container Management VLAN.

Set Up Initial Configuration

Cisco Nexus 93180YC-EX A

To set up the initial configuration for the Cisco Nexus A switch on <nexus-A-hostname>, complete the following steps:

1. Configure the switch.



On initial boot and connection to the serial or console port of the switch, the NX-OS setup should automatically start and attempt to enter Power on Auto Provisioning.

```
Abort Power on Auto Provisioning and continue with normal setup? (yes/no) [n]: yes
```

```
Do you want to enforce secure password standard (yes/no): yes
```

```
Enter the password for "admin": <password>
```

```
Confirm the password for "admin": <password>
```



```
Would you like to enter the basic configuration dialog (yes/no): yes
Create another login account (yes/no) [n]: Enter
Configure read-only SNMP community string (yes/no) [n]: Enter
Configure read-write SNMP community string (yes/no) [n]: Enter
Enter the switch name: <nexus-A-hostname>
Continue with Out-of-band (mgmt0) management configuration? (yes/no) [y]: Enter
Mgmt0 IPv4 address: <nexus-A-mgmt0-ip>
Mgmt0 IPv4 netmask: <nexus-A-mgmt0-netmask>
Configure the default gateway? (yes/no) [y]: Enter
IPv4 address of the default gateway: <nexus-A-mgmt0-gw>
Configure advanced IP options? (yes/no) [n]: Enter
Enable the telnet service? (yes/no) [n]: Enter
Enable the ssh service? (yes/no) [y]: Enter

Type of ssh key you would like to generate (dsa/rsa) [rsa]: Enter
Number of rsa key bits <1024-2048> [1024]: Enter
Configure the ntp server? (yes/no) [n]: y
NTP server IPv4 address: <global-ntp-server-ip>
Configure default interface layer (L3/L2) [L2]: Enter
Configure default switchport interface state (shut/noshut) [noshut]: shut
Configure CoPP system profile (strict/moderate/lenient/dense/skip) [strict]: Enter
Would you like to edit the configuration? (yes/no) [n]: Enter
2. Review the configuration summary before enabling the configuration.

Use this configuration and save it? (yes/no) [y]: Enter
```

Cisco Nexus 93180YC-EX B

To set up the initial configuration for the Cisco Nexus B switch on <nexus-B-hostname>, complete the following steps:

1. Configure the switch.



On initial boot and connection to the serial or console port of the switch, the NX-OS setup should automatically start and attempt to enter Power on Auto Provisioning.

```
Abort Power on Auto Provisioning and continue with normal setup? (yes/no) [n]: yes
```

```
Do you want to enforce secure password standard (yes/no): yes
```

```
Enter the password for "admin": <password>
```

```
Confirm the password for "admin": <password>

Would you like to enter the basic configuration dialog (yes/no): yes

Create another login account (yes/no) [n]: Enter

Configure read-only SNMP community string (yes/no) [n]: Enter

Configure read-write SNMP community string (yes/no) [n]: Enter

Enter the switch name: <nexus-B-hostname>

Continue with Out-of-band (mgmt0) management configuration? (yes/no) [y]: Enter

Mgmt0 IPv4 address: <nexus-B-mgmt0-ip>

Mgmt0 IPv4 netmask: <nexus-B-mgmt0-netmask>

Configure the default gateway? (yes/no) [y]: Enter

IPv4 address of the default gateway: <nexus-B-mgmt0-gw>

Configure advanced IP options? (yes/no) [n]: Enter

Enable the telnet service? (yes/no) [n]: Enter

Enable the ssh service? (yes/no) [y]: Enter

Type of ssh key you would like to generate (dsa/rsa) [rsa]: Enter

Number of rsa key bits <1024-2048> [1024]: Enter

Configure the ntp server? (yes/no) [n]: y

NTP server IPv4 address: <global-ntp-server-ip>

Configure default interface layer (L3/L2) [L2]: Enter

Configure default switchport interface state (shut/noshut) [noshut]: shut

Configure CoPP system profile (strict/moderate/lenient/dense/skip) [strict]: Enter

Would you like to edit the configuration? (yes/no) [n]: Enter

2. Review the configuration summary before enabling the configuration.

Use this configuration and save it? (yes/no) [y]: Enter
```

FlexPod Cisco Nexus Switch Configuration

Enable Licenses

Cisco Nexus 93180YC-EX A and Cisco Nexus 93180YC-EX B

To license the Cisco Nexus switches, complete the following steps:

1. Log in as admin.
2. Run the following commands:

```
config t
feature interface-vlan
feature lacp
feature vpc
feature lldp
feature nxapi
```

Set Global Configurations

Cisco Nexus 93180YC-EX A and Cisco Nexus 93180YC-EX B

To set global configurations, complete the following step on both switches:

Run the following commands to set global configurations:

```
spanning-tree port type network default
spanning-tree port type edge bpduguard default
spanning-tree port type edge bpdufilter default
port-channel load-balance src-dst l4port
ntp server <global-ntp-server-ip> use-vrf management
ntp master 3
ip route 0.0.0.0/0 <docker-vlan-gateway>
copy run start
```

Create VLANs

Cisco Nexus 93180YC-EX A and Cisco Nexus 93180YC-EX B

To create the necessary virtual local area networks (VLANs), complete the following step on both switches:

From the global configuration mode, run the following commands:

```
vlan <cntr-mgmt-vlan-id>
name Container-VLAN
exit
vlan <native-vlan-id>
name Native-VLAN
exit
vlan <cntr-mgmt-nfs-vlan-id>
name Cntr-MGMT-NFS-VLAN
exit
vlan <cntr-tnt-a-nfs-vlan-id>
```

```
name Cntr-TNT-A-NFS-VLAN
exit
```

Add NTP Distribution Interface

Cisco Nexus 93180YC-EX A

From the global configuration mode, run the following commands to add the NTP distribution IP in the Container Management VLAN:

```
ntp source <switch-a-ntp-ip>
interface Vlan<cntr-mgmt-vlan-id>
ip address <switch-a-ntp-ip>/<cntr-mgmt-vlan-netmask-length>
no shutdown
exit
```

Cisco Nexus 93180YC-EX B

From the global configuration mode, run the following commands to add the NTP distribution IP in the Container Management VLAN:

```
ntp source <switch-b-ntp-ip>
interface Vlan<cntr-mgmt-vlan-id>
ip address <switch-b-ntp-ip>/<cntr-mgmt-vlan-netmask-length>
no shutdown
exit
```

Add Individual Port Descriptions for Troubleshooting

Cisco Nexus 93180YC-EX A

To add individual port descriptions for troubleshooting activity and verification for switch A, complete the following step:



In this step and in further sections, configure the <ucs-6248-clustername> interface as appropriate to your deployment.

From the global configuration mode, run the following commands:

```
interface Eth1/1
description <st-node01>:e0b
exit
interface Eth1/2
description <st-node02>:e0b
exit
```

```
interface Eth1/9
description <ucs-6248-clustername>-a:1/27
exit

interface Eth1/10
description <ucs-6248-clustername>-b:1/27
exit

interface Eth1/45
description <nexus-B-hostname>:1/45
exit

interface Eth1/46
description <nexus-B-hostname>:1/46
exit
```

Cisco Nexus 93180YC-EX B

To add individual port descriptions for troubleshooting activity and verification for switch B, complete the following step:

From the global configuration mode, run the following commands:

```
interface Eth1/1
description <st-node01>:e0d
exit

interface Eth1/2
description <st-node02>:e0d
exit

interface Eth1/9
description <ucs-6248-clustername>-a:1/28
exit

interface Eth1/10
description <ucs-6248-clustername>-b:1/28
exit

interface Eth1/45
description <nexus-A-hostname>:1/45
exit

interface Eth1/46
description <nexus-A-hostname>:1/46
exit
```

Create Port Channels

Cisco Nexus 93180YC-EX A and Cisco Nexus 93180YC-EX B

To create the necessary port channels between devices, complete the following step on both switches:

From the global configuration mode, run the following commands:

```
interface Po10
description vPC peer-link
exit
interface Eth1/45-46
channel-group 10 mode active
no shutdown
exit
interface Po11
description <st-node01>
exit
interface Eth1/1
channel-group 11 mode active
no shutdown
exit
interface Po12
description <st-node02>
exit
interface Eth1/2
channel-group 12 mode active
no shutdown
exit
interface Po19
description <ucs-6248-clustername>-a
exit
interface Eth1/9
channel-group 19 mode active
no shutdown
exit
interface Po110
```

```
description <ucs-6248-clustername>-b
exit
interface Eth1/10
channel-group 110 mode active
no shutdown
exit
copy run start
```

Configure Port Channel Parameters

Cisco Nexus 93180YC-EX A and Cisco Nexus 93180YC-EX B

To configure port channel parameters, complete the following step on both switches:

From the global configuration mode, run the following commands:

```
interface Po10
switchport mode trunk
switchport trunk native vlan 2
switchport trunk allowed vlan <cntr-mgmt-vlan-id>,<cntr-mgmt-nfs-vlan-id>,<cntr-tnt-a-nfs-vlan-id>
spanning-tree port type network
exit
interface Po11
switchport mode trunk
switchport trunk native vlan 2
switchport trunk allowed vlan <cntr-mgmt-vlan-id>,<cntr-mgmt-nfs-vlan-id>,<cntr-tnt-a-nfs-vlan-id>
spanning-tree port type edge trunk
mtu 9216
exit
interface Po12
switchport mode trunk
switchport trunk native vlan 2
switchport trunk allowed vlan <cntr-mgmt-vlan-id>,<cntr-mgmt-nfs-vlan-id>,<cntr-tnt-a-nfs-vlan-id>
spanning-tree port type edge trunk
mtu 9216
exit
interface Po19
switchport mode trunk
```

```
switchport trunk native vlan 2
switchport trunk allowed vlan <cntr-mgmt-vlan-id>,<cntr-mgmt-nfs-vlan-id>,<cntr-tnt-a-nfs-vlan-id>
spanning-tree port type edge trunk
mtu 9216
exit
interface Po110
switchport mode trunk
switchport trunk native vlan 2
switchport trunk allowed vlan <cntr-mgmt-vlan-id>,<cntr-mgmt-nfs-vlan-id>,<cntr-tnt-a-nfs-vlan-id>
spanning-tree port type edge trunk
mtu 9216
exit
copy run start
```

Configure Virtual Port Channels

Cisco Nexus 93180YC-EX A

To configure virtual port channels (vPCs) for switch A, complete the following step:

From the global configuration mode, run the following commands:

```
vpc domain <nexus-vpc-domain-id>
role priority 10
peer-keepalive destination <nexus-B-mgmt0-ip> source <nexus-A-mgmt0-ip>
peer-switch
peer-gateway
auto-recovery
delay restore 150
exit
interface Po10
vpc peer-link
exit
interface Po11
vpc 11
exit
interface Po12
vpc 12
```



```
exit
interface Po19
vpc 19
exit
interface Po110
vpc 110
exit
copy run start
```

Cisco Nexus 93180YC-EX B

To configure vPCs for switch B, complete the following step:

From the global configuration mode, run the following commands.

```
vpc domain <nexus-vpc-domain-id>
role priority 20
peer-keepalive destination <nexus-A-mgmt0-ip> source <nexus-B-mgmt0-ip>
peer-switch
peer-gateway
auto-recovery
delay restore 150
exit
interface Po10
vpc peer-link
exit
interface Po11
vpc 11
exit
interface Po12
vpc 12
exit
interface Po19
vpc 19
exit
interface Po110
vpc 110
```

```
exit
```

```
copy run start
```

Uplink into Existing Network Infrastructure

Depending on the available network infrastructure, several methods and features can be used to uplink the FlexPod environment. If an existing Cisco Nexus environment is present, NetApp recommends using vPCs to uplink the Cisco Nexus 93190YC-EX switches included in the FlexPod environment into the infrastructure. The previously described procedures can be used to create an uplink vPC to the existing environment. Make sure to run copy run start to save the configuration on each switch after the configuration is completed.

NetApp Storage Configuration

See the following sections in the [Site Requirements Guide](#) for planning the physical location of the storage systems:

- Site Preparation
- System Connectivity Requirements
- Circuit Breaker, Power Outlet Balancing, System Cabinet Power Cord Plugs, and Console Pinout Requirements
- NetApp 80xx Series Systems

NetApp Hardware Universe

The NetApp Hardware Universe (HWU) application provides supported hardware and software components for any specific ONTAP version. It provides configuration information for all the NetApp storage appliances currently supported by ONTAP software. It also provides a table of component compatibilities.

Confirm that the hardware and software components that you would like to use are supported with the version of ONTAP that you plan to install by using the [HWU application](#) at the [NetApp Support](#) site. Access the [HWU](#) application to view the system configuration guides. Click the Controllers tab to view the compatibility between different version of ONTAP software and the NetApp storage appliances with your desired specifications. Alternatively, to compare components by storage appliance, click Compare Storage Systems.

Controllers

Follow the physical installation procedures for the controllers found in the [AFF8000 Series product documentation](#) at the [NetApp Support](#) site.

Disk Shelves

NetApp storage systems support a wide variety of disk shelves and disk drives. The complete list of [disk shelves](#) that are supported by the AFF 80xx is available at the [NetApp Support](#) site.

To use SAS disk shelves with NetApp storage controllers, refer to the [SAS Disk Shelves Universal SAS and ACP Cabling Guide](#) for proper cabling guidelines.

ONTAP 9.0

Complete Configuration Worksheet

Before running the setup script, complete the cluster setup worksheet from the [ONTAP 9 Software Setup Guide](#). You must have access to the [NetApp Support](#) site to open the cluster setup worksheet.

Configure ONTAP Nodes

Before running the setup script, review the configuration worksheets in the [ONTAP 9 Software Setup Guide](#) to learn about configuring ONTAP. Table 16 lists the information needed to configure two ONTAP nodes. Customize the cluster detail values with the information applicable to your deployment.

Table 16. ONTAP software installation prerequisites

Cluster Detail	Cluster Detail Value
Cluster Node01 IP address	<node01-mgmt-ip>
Cluster Node01 netmask	<node01-mgmt-mask>
Cluster Node01 gateway	<node01-mgmt-gateway>
Cluster Node02 IP address	<node02-mgmt-ip>
Cluster Node02 netmask	<node02-mgmt-mask>
Cluster Node02 gateway	<node02-mgmt-gateway>
Data ONTAP 9.0 URL	<url-boot-software>

Configure Node 01

To configure node 01, complete the following steps:

1. Connect to the storage system console port. You should see a Loader-A prompt. However, if the storage system is in a reboot loop, press Ctrl-C to exit the autoboot loop when you see this message:

```
Starting AUTOBOOT press Ctrl-C to abort...
```

2. Allow the system to boot up.

```
autoboot
```

3. Press Ctrl-C when prompted.



If ONTAP 9 is not the version of software being booted, continue with the following steps to install new software. If ONTAP 9 is the version being booted, select option 8 and *y* to reboot the node. Then continue with step 14.

4. To install new software, select option 7.

7

5. Enter `y` to perform an upgrade.

y

6. Select `e0M` for the network port you want to use for the download.

e0M

7. Enter `y` to reboot now.

y

8. Enter the IP address, netmask, and default gateway for `e0M` in their respective places.

<node01-mgmt-ip> <node01-mgmt-mask> <node01-mgmt-gateway>

9. Enter the URL where the software can be found.

This web server must be pingable.

<url-boot-software>

10. Press Enter for the user name, indicating no user name.

11. Enter `y` to set the newly installed software as the default to be used for subsequent reboots.

y

12. Enter `y` to reboot the node.

y

When installing new software, the system might perform firmware upgrades to the BIOS and adapter cards, causing reboots and possible stops at the Loader-A prompt. If these actions occur, the system might deviate from this procedure.

13. Press **Ctrl-C** when you see this message:

Press Ctrl-C for Boot Menu

14. Select option 4 for Clean Configuration and Initialize All Disks.

4

15. Enter `y` to zero disks, reset config, and install a new file system.

```
y
```

16. Enter `y` to erase all the data on the disks.

```
y
```

The initialization and creation of the root aggregate can take 90 minutes or more to complete, depending on the number and type of disks attached. When initialization is complete, the storage system reboots. Note that SSDs take considerably less time to initialize. You can continue with the node 02 configuration while the disks for node 01 are zeroing.

Configure Node 02

To configure node 02, complete the following steps:

1. Connect to the storage system console port. You should see a Loader-A prompt. However, if the storage system is in a reboot loop, press Ctrl-C to exit the autoboot loop when you see this message:

```
Starting AUTOBOOT press Ctrl-C to abort...
```

2. Allow the system to boot up.

```
autoboot
```

3. Press Ctrl-C when prompted.



If ONTAP 9 is not the version of software being booted, continue with the following steps to install new software. If ONTAP 9 is the version being booted, select option 8 and `y` to reboot the node. Then continue with step 14.

4. To install new software, select option 7.

```
7
```

5. Enter `y` to perform an upgrade.

```
y
```

6. Select `e0M` for the network port you want to use for the download.

```
e0M
```

7. Enter `y` to reboot now.

```
y
```

8. Enter the IP address, netmask, and default gateway for `e0M` in their respective places.

```
<node02-mgmt-ip> <node02-mgmt-mask> <node02-mgmt-gateway>
```

9. Enter the URL where the software can be found.



This web server must be pingable.

```
<url-boot-software>
```

10. Press Enter for the user name, indicating no user name.
11. Enter `y` to set the newly installed software as the default to be used for subsequent reboots.

```
y
```

12. Enter `y` to reboot the node.

```
y
```



When installing new software, the system might perform firmware upgrades to the BIOS and adapter cards, causing reboots and possible stops at the Loader-A prompt. If these actions occur, the system might deviate from this procedure.

13. Press **Ctrl-C** when you see this message:

```
Press Ctrl-C for Boot Menu
```

14. Select option 4 for Clean Configuration and Initialize All Disks.

```
4
```

15. Enter `y` to zero disks, reset config, and install a new file system.

```
y
```

16. Enter `y` to erase all the data on the disks.

```
y
```



The initialization and creation of the root aggregate can take 90 minutes or more to complete, depending on the number and type of disks attached. When initialization is complete, the storage system reboots. Note that SSDs take considerably less time to initialize.

Set Up Node

From a console port program attached to the storage controller A (node 01) console port, run the node setup script. This script appears when ONTAP 9 boots on the node for the first time.

1. Follow the prompts to set up node 01:

Welcome to node setup.

You can enter the following commands at any time:

"help" or "?" - if you want to have a question clarified,

"back" - if you want to change previously answered questions, and

"exit" or "quit" - if you want to quit the setup wizard.

Any changes you made before quitting will be saved.

To accept a default or omit a question, do not enter a value.

This system will send event messages and weekly reports to NetApp Technical Support.

To disable this feature, enter "autosupport modify -support disable" within 24 hours.

Enabling AutoSupport can significantly speed problem determination and resolution should a problem occur on your system.

For further information on AutoSupport, see:

<http://support.netapp.com/autosupport/>

Type yes to confirm and continue {yes}: yes

Enter the node management interface port [e0M]: Enter

Enter the node management interface IP address: <node01-mgmt-ip>

Enter the node management interface netmask: <node01-mgmt-mask>

Enter the node management interface default gateway: <node01-mgmt-gateway>

A node management interface on port e0M with IP address <node01-mgmt-ip> has been created

This node has its management address assigned and is ready for cluster setup.

To complete cluster setup after all nodes are ready, download and run the System Setup utility from the NetApp Support Site and use it to discover the configured nodes.

For System Setup, this node's management address is: <node01-mgmt-ip>.

Alternatively, you can use the "cluster setup" command to configure the cluster.

2. Press Enter and log in to the node with the admin user ID and no password.

3. At the node command prompt, enter the following commands to set HA mode for storage failover.



If the node responds that the HA mode was already set, then proceed with step 4.

```
::> storage failover modify -mode ha

Mode set to HA. Reboot node to activate HA.

::> system node reboot

Warning: Are you sure you want to reboot node "localhost"? {y|n}: y
```

4. After reboot, set up the node with the preassigned values.

```
Welcome to node setup.

You can enter the following commands at any time:

"help" or "?" - if you want to have a question clarified,
"back" - if you want to change previously answered questions, and
"exit" or "quit" - if you want to quit the setup wizard.

Any changes you made before quitting will be saved.

To accept a default or omit a question, do not enter a value.

Enter the node management interface port [e0M]: Enter
Enter the node management interface IP address [<node01-mgmt-ip>]: Enter
Enter the node management interface netmask [<node01-mgmt-mask>]: Enter
Enter the node management interface default gateway [<node01-mgmt-gateway>]: Enter

This node has its management address assigned and is ready for cluster setup.

To complete cluster setup after all nodes are ready, download and run the System Setup utility from the
NetApp Support Site and use it to discover the configured nodes.

For System Setup, this node's management address is: <node01-mgmt-ip>.
```

Alternatively, you can use the "cluster setup" command to configure the cluster.

5. Log in to the node as the admin user with no password.

Repeat this procedure for storage cluster node 02.

Create Cluster on Node 01

In ONTAP, the first node in the cluster performs the cluster create operation. All other nodes perform a cluster join operation. The first node in the cluster is considered node 01.

Table 17. Cluster `create` in ONTAP prerequisites

Cluster Detail	Cluster Detail Value
Cluster name	<clustername>
ONTAP base license	<cluster-base-license-key>
Cluster management IP address	<clustermgmt-ip>
Cluster management netmask	<clustermgmt-mask>
Cluster management gateway	<clustermgmt-gateway>
Cluster node01 IP address	<node01-mgmt-ip>
Cluster node01 netmask	<node01-mgmt-mask>
Cluster node01 gateway	<node01-mgmt-gateway>

1. Run the `cluster setup` command to start the Cluster Setup wizard.

```
cluster setup

Welcome to the cluster setup wizard.

You can enter the following commands at any time:

"help" or "?" - if you want to have a question clarified,

"back" - if you want to change previously answered questions, and

"exit" or "quit" - if you want to quit the cluster setup wizard.

Any changes you made before quitting will be saved.

You can return to cluster setup at any time by typing "cluster setup".

To accept a default or omit a question, do not enter a value.

Do you want to create a new cluster or join an existing cluster? {create, join}:
```



If a login prompt appears instead of the Cluster Setup wizard, start the wizard by logging in with the factory default settings and then enter the cluster setup command.

2. Run the following command to create a new cluster:

```
create
```

3. Enter `no` for the single-node cluster option.

```
Do you intend for this node to be used as a single node cluster? {yes, no} [no]: no
```

4. Enter `no` for a cluster network using network switches.

```
Will the cluster network be configured to use network switches? [yes]:no
```

5. The system defaults are displayed. Enter `yes` to use the system defaults. Use the following prompts to configure the cluster ports.

```
Existing cluster interface configuration found:
```

Port	MTU	IP	Netmask
e0a	9000	169.254.118.102	255.255.0.0
e0c	9000	169.254.191.92	255.255.0.0

```
Do you want to use this configuration? {yes, no} [yes]: no
```

```
System Defaults:
```

```
Private cluster network ports [e0a,e0c].
```

```
Cluster port MTU values will be set to 9000.
```

```
Cluster interface IP addresses will be automatically generated.
```

```
Do you want to use these defaults? {yes, no} [yes]: yes
```



If four ports are being used for the switchless cluster interconnect, enter `e0a`, `e0b`, `e0c`, and `e0d` for the private cluster network ports above.

6. The steps to create a cluster are displayed.

```
Enter the cluster administrators (username "admin") password: <password>  
Retype the password: <password>
```

```
It can take several minutes to create cluster interfaces...
```

```
Step 1 of 5: Create a Cluster
```

You can type "back", "exit", or "help" at any question.

```
Enter the cluster name: <clustername>
Enter the cluster base license key: <cluster-base-license-key>
Creating cluster <clustername>

Enter an additional license key []:<var-fcp-license>
```



The cluster is created. This can take a few minutes.



For this validated architecture, NetApp recommends installing license keys for NetApp SnapRestore® data recovery software, NetApp FlexClone® data replication technology, and the NetApp SnapManager® suite. In addition, install all required storage protocol licenses and all licenses that came with the AFF bundle. After you finish entering the license keys, press Enter.

```
Enter the cluster management interface port [e0e]: e0i
Enter the cluster management interface IP address: <clustermgmt-ip>
Enter the cluster management interface netmask: <clustermgmt-mask>
Enter the cluster management interface default gateway: <clustermgmt-gateway>
```

7. Enter the DNS domain name.

```
Enter the DNS domain names:<dns-domain-name>
Enter the name server IP addresses:<nameserver-ip>
```

If you have more than one name server IP address, separate the IP addresses with a comma.

8. Set up the node.

```
Where is the controller located []:<node-location>
Enter the node management interface port [e0M]: e0M
Enter the node management interface IP address [<node01-mgmt-ip>]: Enter
Enter the node management interface netmask [<node01-mgmt-mask>]: Enter
Enter the node management interface default gateway [<node01-mgmt-gateway>]: Enter
```

The node management interface has been modified to use port e0M with IP address <node01-mgmt-ip>.

This system will send event messages and weekly reports to NetApp Technical Support.

To disable this feature, enter "autosupport modify -support disable" within 24 hours.

Enabling AutoSupport can significantly speed problem determination and resolution should a problem occur on your system.

For further information on AutoSupport, please see: <http://support.netapp.com/autosupport/>

```
Press enter to continue: Enter
Cluster "<<var_clustername>>" has been created.
```

To complete cluster setup, you must join each additional node to the cluster by running "cluster setup" on each node.

Once all nodes have been joined to the cluster, see the Clustered Data ONTAP Software Setup Guide for information about additional system configuration tasks. You can find the Software Setup Guide on the NetApp Support Site.

To complete system configuration, you can use either OnCommand System Manager or the Data ONTAP command-line interface.

To access OnCommand System Manager, point your web browser to the cluster management IP address (<clustermgmt-ip>).

To access the command-line interface, connect to the cluster management IP address (for example, ssh admin@<clustermgmt-ip>).

<clustername>::>



The node management interface can be on the same subnet as the cluster management interface, or it can be on a different subnet. In this document, we assume that it is on the same subnet.

Join Node 02 to Cluster

The first node in the cluster performs the `cluster create` operation. All other nodes perform a `cluster join` operation. The first node in the cluster is considered node 01, and the node joining the cluster in this example is node 02.

Cluster `join` in ONTAP prerequisites

Cluster Detail	Cluster Detail Value
Cluster name	<clustername>
Cluster management IP address	<clustermgmt-ip>
Cluster node02 IP address	<node02-mgmt-ip>
Cluster node02 netmask	<node02-mgmt-mask>
Cluster node02 gateway	<node02-mgmt-gateway>

To join node 02 to the existing cluster, complete the following steps:

1. If prompted, enter `admin` in the login prompt.

```
admin
```

2. Run the `cluster setup` command to start the Cluster Setup wizard.

```
cluster setup
```

This node's storage failover partner is already a member of a cluster.

Storage failover partners must be members of the same cluster.

The cluster setup wizard will default to the cluster join dialog.

Welcome to the cluster setup wizard.

You can enter the following commands at any time:

"help" or "?" - if you want to have a question clarified,

"back" - if you want to change previously answered questions, and

"exit" or "quit" - if you want to quit the cluster setup wizard.

Any changes you made before quitting will be saved.

You can return to cluster setup at any time by typing "cluster setup".

To accept a default or omit a question, do not enter a value.

Do you want to create a new cluster or join an existing cluster?

```
{join}:
```



If a login prompt is displayed instead of the Cluster Setup wizard, start the wizard by logging in using the factory default settings, and then enter the cluster setup command.

3. Run the following command to join a cluster:

```
join
```

4. Data ONTAP detects the existing cluster and agrees to join the same cluster. Follow the prompts to join the cluster.

```
Existing cluster interface configuration found:
```

Port	MTU	IP	Netmask
e0a	9000	169.254.1.79	255.255.0.0
e0c	9000	169.254.100.157	255.255.0.0

```
Do you want to use this configuration? {yes, no} [yes]: no
```

```
System Defaults:
```

```
Private cluster network ports [e0a,e0c].
```

```
Cluster port MTU values will be set to 9000.
```

```
Cluster interface IP addresses will be automatically generated.
```



If four ports are being used for the switchless cluster interconnect, enter e0a, e0b, e0c, and e0d for the private cluster network ports above.

```
Do you want to use these defaults? {yes, no} [yes]:Enter
It can take several minutes to create cluster interfaces...
```

5. The steps to join a cluster are displayed.

```
Step 1 of 3: Join an Existing Cluster
```

```
You can type "back", "exit", or "help" at any question.
```

```
Enter the name of the cluster you would like to join [<clustername>]:Enter
Joining cluster <clustername>
```

```
Starting cluster support services ..
```

```
This node has joined the cluster <<var_clustername>>.
```

```
Step 2 of 3: Configure Storage Failover (SFO)
```

```
You can type "back", "exit", or "help" at any question.
```

```
SFO is enabled.
```

```
Step 3 of 3: Set Up the Node
```

```
You can type "back", "exit", or "help" at any question.
```

```
Notice: HA is configured in management.
```



The node should find the cluster name. Cluster joining can take a few minutes.

6. Set up the node.

```
Enter the node management interface port [e0M]: e0M
Enter the node management interface IP address [<node02-mgmt-ip>]: Enter
Enter the node management interface netmask [<node02-netmask>]: Enter
Enter the node management interface default gateway [<node02-gw>]: Enter
The node management interface has been modified to use port e0M with IP address <node02-mgmt-ip>.
```

This system will send event messages and weekly reports to NetApp Technical Support.

To disable this feature, enter "autosupport modify -support disable" within 24 hours.

Enabling AutoSupport can significantly speed problem determination and resolution should a problem occur on your system.

For further information on AutoSupport, please see: <http://support.netapp.com/autosupport/>

Press enter to continue: Enter

This node has been joined to cluster "<clustername>".

To complete cluster setup, you must join each additional node to the cluster by running "cluster setup" on each node.

Once all nodes have been joined to the cluster, see the Clustered Data ONTAP Software Setup Guide for information about additional system configuration tasks. You can find the Software Setup Guide on the NetApp Support Site.

To complete system configuration, you can use either OnCommand System Manager or the Data ONTAP command-line interface.

To access OnCommand System Manager, point your web browser to the cluster management IP address (<clustermgmt-ip>).

To access the command-line interface, connect to the cluster management IP address (for example, ssh admin@<clustermgmt-ip>).



The node management interface can be on the same subnet as the cluster management interface, or it can be on a different subnet. In this document, we assume that it is on the same subnet.

Log In to the Cluster

To log in to the cluster, complete the following steps:

1. Open an SSH connection to either the cluster IP or host name.
2. Log in to the admin user with the password you provided earlier.

Zero All Spare Disks

To zero all spare disks in the cluster, run the following command:

```
disk zerospares
```



Advanced Data Partitioning should have created a root partition and two data partitions on each SSD drive in an All Flash FAS configuration. Disk autoassign should have assigned one data partition to each node in an HA Pair. If a different disk assignment is required, disk autoassignment must be disabled on both nodes in the HA pair by running the `disk option modify` command. Spare partitions can then be moved from one node to another by running the `disk removeowner` and `disk assign` commands.

Set Onboard Unified Target Adapter 2 Port Personality

To set the personality of the onboard unified target adapter 2 (UTA2), complete the following steps:

1. Verify the Current Mode and Current Type properties of the ports by running the `ucadmin show` command.

```
ucadmin show

                Current  Current  Pending  Pending  Admin
Node           Adapter  Mode     Type     Mode     Type     Status
-----
<st-node01>
                0e     fc      target   -        -        online
<st-node01>
                0f     fc      target   -        -        online
<st-node01>
                0g     cna     target   -        -        online
<st-node01>
                0h     cna     target   -        -        online
<st-node02>
                0e     fc      target   -        -        online
<st-node02>
                0f     fc      target   -        -        online
<st-node02>
                0g     cna     target   -        -        online
<st-node02>
                0h     cna     target   -        -        online

8 entries were displayed.
```

2. Verify that the Current Mode and Current Type properties for all ports are set properly. Set ports used for Fibre Channel (FC) connectivity to mode `fc`; otherwise, set them to the mode `cna`. That includes FCoE ports, which should be set to the mode `cna`. The port type for all protocols should be set to `target`. Change the port personality with the following command:

```
ucadmin modify -node <home-node-of-the-port> -adapter <port-name> -mode {fc|cna} -type target
```



The ports must be offline to run this command. To take an adapter offline, run the `fcport adapter modify -node <home-node-of-the-port> -adapter <port-name> -state down com-`

mand. Ports must be converted in pairs (for example, 0e and 0f). After conversion, a reboot is required, and the ports must be brought back to the up state.

Set Auto-Revert on Cluster Management

To set the `auto-revert` parameter on the cluster management interface, complete the following step:



A storage virtual machine (SVM) is referred to as a Vserver (or `vserver`) in the GUI and CLI.

Run the following command:

```
network interface modify -vserver <clustername> -lif cluster_mgmt -auto-revert true
```

Set Up Management Broadcast Domain

By default, all network ports are included in the default broadcast domain. Network ports used for data services (for example, `e0b`, `e0d`, `e0g`, `e0h`, `e0j`, `e0k`, and `e0l`) should be removed from the default broadcast domain, leaving just the management network ports (`e0i` and `e0m`). To perform this task, run the following commands:

```
broadcast-domain remove-ports -broadcast-domain Default -ports <st-node01>:e0b,<st-node01>:e0d, <st-node01>:e0g,<st-node01>:e0h,<st-node01>:e0j,<st-node01>:e0k,<st-node01>:e0l,<st-node02>:e0b,<st-node02>:e0d,<st-node02>:e0g,<st-node02>:e0h,<st-node02>:e0j,<st-node02>:e0k,<st-node02>:e0l
broadcast-domain show
```

Set Up Service Processor Network Interface

To assign a static IPv4 address to the service processor on each node, run the following commands:

```
system service-processor network modify -node <st-node01> -address-family IPv4 -enable true -dhcp none -ip-address <node01-sp-ip> -netmask <node01-sp-mask> -gateway <node01-sp-gateway>
```

```
system service-processor network modify -node <st-node02> -address-family IPv4 -enable true -dhcp none -ip-address <node02-sp-ip> -netmask <node02-sp-mask> -gateway <node02-sp-gateway>
```



The service processor IP addresses should be in the same subnet as the node management IP addresses.

Create Aggregates

An aggregate containing the root volume is created during the ONTAP setup process. To create additional aggregates, determine the aggregate name, the node on which to create it, and the number of disks it contains.

To create new aggregates, complete the following steps:

1. Run the following commands:

```
aggr create -aggregate aggr1_node01 -node <st-node01> -diskcount <num-disks>
```

```
aggr create -aggregate aggr1_node02 -node <st-node02> -diskcount <num-disks>
```



You should have the minimum number of hot spare disks for hot spare disk partitions recommended for your aggregate



For all flash aggregates, you should have a minimum of one hot spare disk or disk partition. For nonflash homogenous aggregates, you should have a minimum of two hot spare disks or disk partitions. For Flash Pool aggregates, you should have a minimum of two hot spare disks or disk partitions for each disk type.



Start with five disks initially; you can add disks to an aggregate when additional storage is required. In an AFF configuration with a small number of SSDs, you might want to create an aggregate with all but one remaining disk (spare) assigned to the controller.



The aggregate cannot be created until disk zeroing completes. Run the `aggr show` command to display aggregate creation status. Do not proceed until both `aggr1_node1` and `aggr1_node2` are online.

2. Rename the root aggregate on node 01 to match the naming convention for this aggregate on node 02.

```
aggr show
aggr rename -aggregate aggr0 -newname <node01-rootaggrname>
```

Verify Storage Failover

To confirm that storage failover is enabled, run the following commands for a failover pair:

1. Verify the status of storage failover.

```
storage failover show
```



Both `<st-node01>` and `<st-node02>` must be capable of performing a takeover. Continue with step 3 if the nodes are capable of performing a takeover.

2. Enable failover on one of the two nodes.

```
storage failover modify -node <st-node01> -enabled true
```



Enabling failover on one node enables it for both nodes.

3. Verify the HA status for a two-node cluster.



This step is not applicable for clusters with more than two nodes.

```
cluster ha show
```

4. Continue with step 6 if high availability is configured.
5. Only enable HA mode for two-node clusters. Do not run this command for clusters with more than two nodes because it causes problems with failover.

```
cluster ha modify -configured true
Do you want to continue? {y|n}: y
```

6. Verify that hardware assist is correctly configured and, if needed, modify the partner IP address.

```
storage failover hwassist show
storage failover modify -hwassist-partner-ip <node02-mgmt-ip> -node <st-node01>
storage failover modify -hwassist-partner-ip <node01-mgmt-ip> -node <st-node02>
```

Disable Flow Control on 10GE Ports

NetApp recommends disabling flow control on all of the 10GbE and UTA2 ports that are connected to external devices. To disable flow control, complete the following steps:

1. Run the following commands to configure node 01:

```
network port modify -node <st-node01> -port e0b,e0d,e0e,e0f,e0g,e0h -flowcontrol-admin none
Warning: Changing the network port settings will cause a several second interruption in carrier.
Do you want to continue? {y|n}: y
```

2. Run the following commands to configure node 02:

```
network port modify -node <st-node02> -port e0b,e0d,e0e,e0f,e0g,e0h -flowcontrol-admin none
Warning: Changing the network port settings will cause a several second interruption in carrier.
Do you want to continue? {y|n}: y
network port show -fields flowcontrol-admin
```

Disable Unused FCoE Capability on CNA Ports

If a UTA2 port is set to CNA mode and is only expected to handle Ethernet data traffic (for example NFS), then the unused FCoE capability of the port should be disabled by setting the corresponding FCP adapter to state down with the fcp adapter modify command. Here are some examples:

```
fcp adapter modify -node <st-node01> -adapter 0g -state down
fcp adapter modify -node <st-node01> -adapter 0h -state down
fcp adapter modify -node <st-node02> -adapter 0g -state down
fcp adapter modify -node <st-node02> -adapter 0h -state down
fcp adapter show -fields state
```

Configure Network Time Protocol

To configure time synchronization on the cluster, complete the following steps:

1. Set the time zone for the cluster.

```
timezone <timezone>
```



For example, in the eastern United States, the time zone is `America/New_York`.

2. Set the date for the cluster.

```
date <ccyymmddhhmm.ss>
```



The format for the date is `<[Century][Year][Month][Day][Hour][Minute].[Second]>` (for example, `201309081735.17`).

3. Configure the Network Time Protocol (NTP) servers for the cluster.

```
cluster time-service ntp server create -server <switch-a-ntp-ip>
```

```
cluster time-service ntp server create -server <switch-b-ntp-ip>
```

Configure Simple Network Management Protocol

To configure the Simple Network Management Protocol (SNMP), complete the following steps:

1. Configure basic SNMP information, such as the location and contact. When polled, this information is visible as the `sysLocation` and `sysContact` variables in SNMP.

```
snmp contact <snmp-contact>
```

```
snmp location "<snmp-location>"
```

```
snmp init 1
```

```
options snmp.enable on
```

2. Configure SNMP traps to send to remote hosts, such as a DFM server or another fault management system.

```
snmp traphost add <oncommand-um-server-fqdn>
```

Configure SNMPv1 Access

To configure SNMPv1 access, set the shared, secret plain-text password (called a community):

```
snmp community add ro <snmp-community>
```

Configure AutoSupport

NetApp AutoSupport® sends support summary information to NetApp through HTTPS. To configure AutoSupport, run the following command:

```
system node autosupport modify -node * -state enable -mail-hosts <mailhost> -transport https -support enable -noteto <storage-admin-email>
```

Enable Cisco Discovery Protocol

To enable the Cisco Discovery Protocol (CDP) on the NetApp storage controllers, run the following command to enable CDP on ONTAP:

```
node run -node * options cdpd.enable on
```



To be effective, CDP must also be enabled on directly connected networking equipment such as switches and routers.

Create Broadcast Domains in Data ONTAP

To create a data broadcast domains for Container Management and NFS on ONTAP:

```
broadcast-domain create -broadcast-domain Cntr-MGMT -mtu 1500  
broadcast-domain create -broadcast-domain Cntr-MGMT-NFS -mtu 9000
```

Create Interface Groups

To create the LACP interface groups for the 10GbE data interfaces, run the following commands:

```
ifgrp create -node <st-node01> -ifgrp a0a -distr-func port -mode multimode_lacp  
ifgrp add-port -node <st-node01> -ifgrp a0a -port e0b  
ifgrp add-port -node <st-node01> -ifgrp a0a -port e0d  
  
ifgrp create -node <st-node02> -ifgrp a0a -distr-func port -mode multimode_lacp  
ifgrp add-port -node <st-node02> -ifgrp a0a -port e0b  
ifgrp add-port -node <st-node02> -ifgrp a0a -port e0d  
  
ifgrp show
```

Create VLANs

To create VLANs, create Container Management and NFS VLAN ports and add them to the appropriate broadcast domain:

```
network port modify -node <st-node01> -port a0a -mtu 9000  
network port modify -node <st-node02> -port a0a -mtu 9000  
  
network port vlan create -node <st-node01> -vlan-name a0a-<ctnr-mgmt-vlan-id>  
network port vlan create -node <st-node02> -vlan-name a0a-<ctnr-mgmt-vlan-id>  
network port vlan create -node <st-node01> -vlan-name a0a-<ctnr-mgmt-nfs-vlan-id>  
network port vlan create -node <st-node02> -vlan-name a0a-<ctnr-mgmt-nfs-vlan-id>
```

```
broadcast-domain add-ports -broadcast-domain Cntr-MGMT -ports <st-node01>:a0a-<ctnr-mgmt-vlan-id>, <st-  
node02>:a0a-<ctnr-mgmt-vlan-id>
```

```
broadcast-domain add-ports -broadcast-domain Cntr-NFS -ports <st-node01>:a0a-<ctnr-mgmt-nfs-vlan-id>, <st-  
node02>:a0a-<ctnr-mgmt-nfs-vlan-id>
```

Create Docker Infrastructure Storage Virtual Machine

To create an infrastructure SVM, complete the following steps:

1. Run the `vserver create` command.

```
vserver create -vserver Container-SVM -rootvolume rootvol -aggregate aggr1_node01 -rootvolume-security-style  
unix
```

2. Select the SVM data protocols to configure, keeping `fc` and `nfs`.

```
vserver remove-protocols -vserver Container-SVM -protocols iscsi,cifs,ndmp
```

3. Add the two data aggregates to the Container-SVM aggregate list.

```
vserver modify -vserver Container-SVM -aggr-list aggr1_node01,aggr1_node02
```

4. Enable and run the NFS protocol in the Container-SVM.

```
nfs create -vserver Container-SVM -udp disabled
```

Create Load-Sharing Mirrors of SVM Root Volume

To create a load-sharing mirror of an SVM root volume, complete the following steps:

1. Create a volume to be the load-sharing mirror of the infrastructure SVM root volume on each node.

```
volume create -vserver Container-SVM -volume rootvol_m01 -aggregate aggr1_node01 -size 1GB -type DP  
volume create -vserver Container-SVM -volume rootvol_m02 -aggregate aggr1_node02 -size 1GB -type DP
```

2. Create a job schedule to update the root volume mirror relationships every 15 minutes.

```
job schedule interval create -name 15min -minutes 15
```

3. Create the mirroring relationships.

```
snapmirror create -source-path Container-SVM:rootvol -destination-path Container-SVM:rootvol_m01 -type LS -  
schedule 15min
```

```
snapmirror create -source-path Container-SVM:rootvol -destination-path Container-SVM:rootvol_m02 -type LS -  
schedule 15min
```

4. Initialize the mirroring relationship.

```
snapmirror initialize-ls-set -source-path Container-SVM:rootvol  
snapmirror show
```

Create Block Protocol (FC) Service

Run the following command to create the FCP service on each SVM. This command also starts the FCP service and sets the WWN for the SVM.

```
fcv create -vserver Container-SVM
fcv show
```

Configure HTTPS Access

To configure secure access to the storage controller, complete the following steps:

1. Increase the privilege level to access the certificate commands.

```
set -privilege diag
Do you want to continue? {y|n}: y
```

2. Generally, a self-signed certificate is already in place. Verify the certificate, and obtain parameters (for example, <serial-number>) by running the following command:

```
security certificate show
```

3. For each SVM shown, the certificate common name should match the DNS FQDN of the SVM. Delete the two default certificates and replace them with either self-signed certificates or certificates from a certificate authority (CA). To delete the default certificates, run the following commands:

```
security certificate delete -vserver Container-SVM -common-name Container-SVM -ca Container-SVM -type server -serial <serial-number>
```



Deleting expired certificates before creating new certificates is a best practice. Run the `security certificate delete` command to delete expired certificates. In the following command, use TAB completion to select and delete each default certificate.

4. To generate and install self-signed certificates, run the following commands as one-time commands. Generate a server certificate for the Infra-SVM and the cluster SVM. Use TAB completion to aid in the completion of these commands.

```
security certificate create -common-name <cert-common-name> -type server -size 2048 -country <cert-country> -state <cert-state> -locality <cert-locality> -organization <cert-org> -unit <cert-unit> -email-addr <cert-email> -expire-days <cert-days> -protocol SSL -hash-function SHA256 -vserver Infra-SVM
```

5. To obtain the values for the parameters required in step 6 (<cert-ca> and <cert-serial>), run the `security certificate show` command.
6. Enable each certificate that was just created by using the `-server-enabled true` and `-client-enabled false` parameters. Use TAB completion to aid in the completion of these commands.

```
security ssl modify -vserver <clustername> -server-enabled true -client-enabled false -ca <cert-ca> -serial <cert-serial> -common-name <cert-common-name>
```



It is normal for some of these commands to return an error message stating that the entry does not exist.

7. Change back to the normal admin privilege level and set up the system to allow SVM logs to be available by web.

```
set -privilege admin  
  
vserver services web modify -name spi|ontapi|compat -vserver * -enabled true
```

Configure NFSv3

To configure NFSv3 on the SVM, complete the following steps:

1. Create a new rule for the infrastructure NFS subnet in the default export policy.

```
vserver export-policy rule create -vserver Container-SVM -policyname default -ruleindex 1 -protocol nfs -  
clientmatch <cntr-nfs-subnet-cidr> -rorule sys -rwrule sys -superuser sys -allow-suid false
```

2. Assign the FlexPod export policy to the infrastructure SVM root volume.

```
volume modify -vserver Container-SVM -volume rootvol -policy default
```

Create FlexVol Volumes

The following information is required to create a NetApp FlexVol® volume:

- The volume name
- The volume size
- The aggregate on which the volume exists

To create a FlexVol volume, run the following commands:

```
volume create -vserver Container-SVM -volume Linux_Boot -aggregate aggr1_node01 -size 1200GB -state online -  
policy default -space-guarantee none -percent-snapshot-space 0  
  
volume create -vserver Container-SVM -volume Docker_Data_LUNs -aggregate aggr1_node02 -size 3TB -state online  
-policy default -space-guarantee none -percent-snapshot-space 0  
  
volume create -vserver Container-SVM -volume DTR_NFS -aggregate aggr1_node01 -size 1TB -state online -policy  
default -junction-path /DTR-NFS -space-guarantee none -percent-snapshot-space 0  
  
snapmirror update-ls-set -source-path Container-SVM:rootvol
```

Create Boot LUNs

To create ten boot LUNs, run the following commands:

```

lun create -vserver Container-SVM -volume Linux_Boot -lun Docker_Host_01 -size 60GB -ostype linux -space-
reserve disabled
lun create -vserver Container-SVM -volume Linux_Boot -lun Docker_Host_02 -size 60GB -ostype linux -space-
reserve disabled

lun create -vserver Container-SVM -volume Linux_Boot -lun Docker_Host_03 -size 60GB -ostype linux -space-
reserve disabled

lun create -vserver Container-SVM -volume Linux_Boot -lun Docker_Host_04 -size 60GB -ostype linux -space-
reserve disabled

lun create -vserver Container-SVM -volume Linux_Boot -lun Docker_Host_05 -size 60GB -ostype linux -space-
reserve disabled

lun create -vserver Container-SVM -volume Linux_Boot -lun Docker_Host_06 -size 60GB -ostype linux -space-
reserve disabled

lun create -vserver Container-SVM -volume Linux_Boot -lun Docker_Host_07 -size 60GB -ostype linux -space-
reserve disabled

lun create -vserver Container-SVM -volume Linux_Boot -lun Docker_Host_08 -size 60GB -ostype linux -space-
reserve disabled

lun create -vserver Container-SVM -volume Linux_Boot -lun Docker_Host_09 -size 60GB -ostype linux -space-
reserve disabled

lun create -vserver Container-SVM -volume Linux_Boot -lun Docker_Host_10 -size 60GB -ostype linux -space-
reserve disabled

```

Create Docker Data LUNs

To create ten boot LUNs, run the following commands:

```

lun create -vserver Container-SVM -volume Docker_Data_LUNs -lun Docker_Host_01 -size 300GB -ostype linux -
space-reserve disabled
lun create -vserver Container-SVM -volume Docker_Data_LUNs -lun Docker_Host_02 -size 300GB -ostype linux -
space-reserve disabled

lun create -vserver Container-SVM -volume Docker_Data_LUNs -lun Docker_Host_03 -size 300GB -ostype linux -
space-reserve disabled

lun create -vserver Container-SVM -volume Docker_Data_LUNs -lun Docker_Host_04 -size 300GB -ostype linux -
space-reserve disabled

lun create -vserver Container-SVM -volume Docker_Data_LUNs -lun Docker_Host_05 -size 300GB -ostype linux -
space-reserve disabled

lun create -vserver Container-SVM -volume Docker_Data_LUNs -lun Docker_Host_06 -size 300GB -ostype linux -
space-reserve disabled

lun create -vserver Container-SVM -volume Docker_Data_LUNs -lun Docker_Host_07 -size 300GB -ostype linux -
space-reserve disabled

lun create -vserver Container-SVM -volume Docker_Data_LUNs -lun Docker_Host_08 -size 300GB -ostype linux -
space-reserve disabled

lun create -vserver Container-SVM -volume Docker_Data_LUNs -lun Docker_Host_09 -size 300GB -ostype linux -
space-reserve disabled

lun create -vserver Container-SVM -volume Docker_Data_LUNs -lun Docker_Host_10 -size 300GB -ostype linux -
space-reserve disabled

```

Schedule Deduplication

On NetApp All Flash FAS systems, deduplication is enabled by default. To schedule deduplication, complete the following steps:

After the volumes are created, assign a once-a-day deduplication schedule to all volumes.

```
efficiency modify -vserver Container-SVM -volume Linux_Boot -schedule sun-sat@0
efficiency modify -vserver Container-SVM -volume Docker_Data_LUNs -schedule sun-sat@0
efficiency modify -vserver Container-SVM -volume DTR_NFS -schedule sun-sat@0
```

Create FCP LIFs

Run the following commands to create four FCP LIFs (two on each node) per attached fabric interconnect:

```
network interface create -vserver Container-SVM -lif fcp_lif01a -role data -data-protocol fcp -home-node <st-
node01> -home-port 0e -status-admin up

network interface create -vserver Container-SVM -lif fcp_lif01b -role data -data-protocol fcp -home-node <st-
node01> -home-port 0f -status-admin up

network interface create -vserver Container-SVM -lif fcp_lif02a -role data -data-protocol fcp -home-node <st-
node02> -home-port 0e -status-admin up

network interface create -vserver Container-SVM -lif fcp_lif02b -role data -data-protocol fcp -home-node <st-
node02> -home-port 0f -status-admin up

network interface show
```

Create NFS LIFs

To create NFS LIFs, run the following commands:

```
network interface create -vserver Container-SVM -lif nfs_lif01 -role data -data-protocol nfs -home-node <st-
node01> -home-port a0a-<cntr-mgmt-nfs-vlan-id> -address <node01-cntr-mgmt-nfs-ip> -netmask <node01-cntr-mgmt-
nfs-mask> -status-admin up -failover-policy broadcast-domain-wide -firewall-policy data -auto-revert true

network interface create -vserver Container-SVM -lif nfs_lif02 -role data -data-protocol nfs -home-node <st-
node02> -home-port a0a-<cntr-mgmt-nfs-vlan-id> -address <node02-cntr-mgmt-nfs-ip> -netmask <node02-cntr-mgmt-
nfs-mask> -status-admin up -failover-policy broadcast-domain-wide -firewall-policy data -auto-revert true

network interface show
```

Add Infrastructure SVM Administrator

To add the infrastructure SVM administrator and SVM administration LIF in the out-of-band management network, complete the following steps:

1. Run the following commands:

```
network interface create -vserver Container-SVM -lif svm-mgmt -role data -data-protocol none -home-node <st-node02> -home-port a0a-<cntr-mgmt-vlan-id> -address <svm-mgmt-ip> -netmask <svm-mgmt-mask> -status-admin up -failover-policy broadcast-domain-wide -firewall-policy mgmt -auto-revert true
```

2. Create a default route to allow the SVM management interface to reach the outside world.

```
network route create -vserver Container-SVM -destination 0.0.0.0/0 -gateway <svm-mgmt-gateway>
```

```
network route show
```

3. Set a password for the SVM vsadmin user and unlock the user.

```
security login password -username vsadmin -vserver Container-SVM
Enter a new password: <password>
Enter it again: <password>
```

```
security login unlock -username vsadmin -vserver Container-SVM
```

Create Broadcast Domain for Container Tenant A

To create a data broadcast domain for the first Container Tenant and NFS on ONTAP:

```
broadcast-domain create -broadcast-domain Cntr-TNT-A-NFS -mtu 9000
```

Create VLAN Interfaces for Container Tenant A

To create VLAN interfaces for Container Tenant A and add them to the appropriate broadcast domain:

```
network port vlan create -node <st-node01> -vlan-name a0a-<cntr-tnt-a-nfs-vlan-id>
network port vlan create -node <st-node02> -vlan-name a0a-<cntr-tnt-a-nfs-vlan-id>

broadcast-domain add-ports -broadcast-domain Cntr-TNT-A-NFS -ports <st-node01>:a0a-<cntr-tnt-a-nfs-vlan-id>,
<st-node02>:a0a-<cntr-tnt-a-nfs-vlan-id>
```

Create Docker Tenant Storage Virtual Machine

To create a tenant SVM, complete the following steps:

1. Run the `vserver create` command.

```
vserver create -vserver Cntr-TNT-A-SVM -rootvolume rootvol -aggregate aggr1_node02 -rootvolume-security-style unix
```

2. Create a max volume limit on the tenant SVM (optional)

```
vserver modify -vserver Cntr-TNT-A-SVM -max-volumes 50
```



The max volumes allowed per SVM can be modified as per tenant's quota

3. Select the SVM data protocols to configure, keeping only nfs.

```
vserver remove-protocols -vserver Cntr-TNT-A-SVM -protocols iscsi,fcg,cifs,ndmp
```

4. Add the two data aggregates to the Container-SVM aggregate list.

```
vserver modify -vserver Cntr-TNT-A-SVM -aggr-list aggr1_node01,aggr1_node02
```

5. Enable and run the NFS protocol in the Cntr-TNT-A-SVM.

```
nfs create -vserver Cntr-TNT-A-SVM -udp disabled
```

Create Load-Sharing Mirrors of Tenant SVM Root Volume

To create a load-sharing mirror of an SVM root volume, complete the following steps:

1. Create a volume to be the load-sharing mirror of the infrastructure SVM root volume on each node.

```
volume create -vserver Cntr-TNT-A-SVM -volume rootvol_m01 -aggregate aggr1_node01 -size 1GB -type DP  
volume create -vserver Cntr-TNT-A-SVM -volume rootvol_m02 -aggregate aggr1_node02 -size 1GB -type DP
```

2. Create the mirroring relationships.

```
snapmirror create -source-path Cntr-TNT-A-SVM:rootvol -destination-path Cntr-TNT-A-SVM:rootvol_m01 -type LS -  
schedule 15min  
  
snapmirror create -source-path Container-SVM:rootvol -destination-path Cntr-TNT-A-SVM:rootvol_m02 -type LS -  
schedule 15min
```

3. Initialize the mirroring relationship.

```
snapmirror initialize-ls-set -source-path Cntr-TNT-A-SVM:rootvol  
snapmirror show
```

Configure Secure Access to Cntr-TNT-A-SVM

To configure secure access to the storage controller, complete the following steps:

1. Increase the privilege level to access the certificate commands.

```
set -privilege diag  
  
Do you want to continue? {y|n}: y
```

2. Generally, a self-signed certificate is already in place. Verify the certificate, and obtain parameters (for example, <serial-number>) by running the following command:

```
security certificate show
```

3. For each SVM shown, the certificate common name should match the DNS FQDN of the SVM. Delete the two default certificates and replace them with either self-signed certificates or certificates from a certificate authority (CA). To delete the default certificates, run the following commands:

```
security certificate delete -vserver Cntr-TNT-A-SVM -common-name <cert-common-name> -ca <cert-common-name>-  
type server -serial <serial-number>
```



Deleting expired certificates before creating new certificates is a best practice. Run the `security certificate delete` command to delete expired certificates. In the following command, use TAB completion to select and delete each default certificate.

4. To generate and install self-signed certificates, run the following commands as one-time commands. Generate a server certificate for the Infra-SVM and the cluster SVM. Use TAB completion to aid in the completion of these commands.

```
security certificate create -common-name <cert-common-name> -type server -size 2048 -country <cert-country>  
-state <cert-state> -locality <cert-locality> -organization <cert-org> -unit <cert-unit> -email-addr <cert-  
email> -expire-days <cert-days> -protocol SSL -hash-function SHA256 -vserver Cntr-TNT-A-SVM
```

5. To obtain the values for the parameters required in step 6 (<cert-ca> and <cert-serial>), run the `security certificate show` command.
6. Enable each certificate that was just created by using the `-server-enabled true` and `-client-enabled false` parameters. Use TAB completion to aid in the completion of these commands.

```
security ssl modify -vserver Cntr-TNT-A-SVM -server-enabled true -client-enabled false -ca <cert-ca> -serial  
<cert-serial> -common-name <cert-common-name>
```



It is normal for some of these commands to return an error message stating that the entry does not exist.

7. Change back to the normal admin privilege level and set up the system to allow SVM logs to be available by web.

```
set -privilege admin  
  
vserver services web modify -name spi|ontapi|compat -vserver * -enabled true
```

Configure NFSv3 in Cntr-TNT-A-SVM

To configure NFSv3 on the SVM, complete the following steps:

1. Create a new rule for the infrastructure NFS subnet in the default export policy.

```
vserver export-policy rule create -vserver Cntr-TNT-A-SVM -policyname default -ruleindex 1 -protocol nfs -clientmatch <cntr-tnt-a-nfs-subnet-cidr> -rorule sys -rwrule sys -superuser sys -allow-suid false
```

2. Assign the FlexPod export policy to the infrastructure SVM root volume.

```
volume modify -vserver Cntr-TNT-A-SVM -volume rootvol -policy default
```

Create NFS LIFs in Cntr-TNT-A-SVM

To create NFS LIFs, run the following commands:

```
network interface create -vserver Cntr-TNT-A-SVM -lif nfs_lif01 -role data -data-protocol nfs -home-node <st-node01> -home-port a0a-<cntr-tnt-a-nfs-vlan-id> -address <node01-cntr-tnt-a-nfs-ip> -netmask <node01-cntr-tnt-a-nfs-mask> -status-admin up -failover-policy broadcast-domain-wide -firewall-policy data -auto-revert true
```

```
network interface create -vserver Cntr-TNT-A-SVM -lif nfs_lif02 -role data -data-protocol nfs -home-node <st-node02> -home-port a0a-<cntr-tnt-a-nfs-vlan-id> -address <node02-cntr-tnt-a-nfs-ip> -netmask <node02-cntr-tnt-a-nfs-mask> -status-admin up -failover-policy broadcast-domain-wide -firewall-policy data -auto-revert true
```

```
network interface show
```

Add Cntr-TNT-A-SVM Administrator and NetApp Volume Plugin (nDVP) User

To add the Cntr-TNT-A-SVM administrator, nDCP user, and SVM administration LIF in the Container management network, complete the following steps:

1. Run the following commands:

```
network interface create -vserver Cntr-TNT-A-SVM -lif svm-mgmt -role data -data-protocol none -home-node <st-node02> -home-port a0a-<cntr-mgmt-vlan-id> -address <svm-mgmt-ip> -netmask <svm-mgmt-mask> -status-admin up -failover-policy broadcast-domain-wide -firewall-policy mgmt -auto-revert true
```

2. Create a default route to allow the SVM management interface to reach the outside world.

```
network route create -vserver Cntr-TNT-A-SVM -destination 0.0.0.0/0 -gateway <svm-mgmt-gateway>
```

```
network route show
```

3. Create a nDVP role

```
#Create a new nDVP role
security login role create -vserver Cntr-TNT-A-SVM -role ndvp_role -cmddirname DEFAULT -access none

#Grant nDVP permissions
security login role create -vserver Cntr-TNT-A-SVM -role ndvp_role -cmddirname "event generate-autosupport-log" -access all
security login role create -vserver Cntr-TNT-A-SVM -role ndvp_role -cmddirname "network interface" -access readonly
security login role create -vserver Cntr-TNT-A-SVM -role ndvp_role -cmddirname "version" -access readonly
security login role create -vserver Cntr-TNT-A-SVM -role ndvp_role -cmddirname "vserver" -access readonly
```

```
security login role create -vserver Cntr-TNT-A-SVM -role ndvp_role -cmddirname "vserver nfs show" -access readonly
security login role create -vserver Cntr-TNT-A-SVM -role ndvp_role -cmddirname "volume" -access all
```

4. Create a user specific to nDVP role and set the password.

```
security login create -user-or-group-name ndvp_user -application ontapi -authentication-method password -role ndvp_role -vserver Cntr-TNT-A-SVM
```

5. Unlock the ndvp_user.

```
security login unlock -username ndvp_user -vserver Cntr-TNT-A-SVM
```

6. Set a password for the vsadmin and unlock the user.

```
security login password -username vsadmin -vserver Cntr-TNT-A-SVM
```

```
Enter a new password: <password>
Enter it again: <password>
```

```
security login unlock -username vsadmin -vserver Cntr-TNT-A-SVM
```



ndvp_role ensures restricted access to ONTAP command directories, thereby allowing to run multiple workloads securely without needing administrative privileges.

Cisco UCS Direct Storage Connect Base Configuration

This FlexPod deployment will show configuration steps for the Cisco UCS 6248UP Fabric Interconnects (FI) in a design that will support Fibre Channel connectivity between the NetApp AFF and the FI.

This section contains the UCS deployment for when the Cisco UCS FI is used as the fiber channel SAN switch.

Perform Initial Setup of Cisco 6248UP Fabric Interconnects for FlexPod Environments

This section provides detailed procedures for configuring the Cisco Unified Computing System (Cisco UCS) for use in a FlexPod environment. The steps are necessary to provision the Cisco UCS B-Series and C-Series servers and should be followed precisely to avoid improper configuration.

Cisco UCS Fabric Interconnect A

To configure the Cisco UCS for use in a FlexPod environment, complete the following steps:

1. Connect to the console port on the first Cisco UCS fabric interconnect.

```
Enter the configuration method: gui
```

```
Physical switch Mgmt0 IP address: <ucsa-mgmt-ip>
```

```
Physical switch Mgmt0 IPv4 netmask: <ucsa-mgmt-mask>
```

```
IPv4 address of the default gateway: <ucsa-mgmt-gateway>
```

2. Using a supported web browser, connect to <https://<ucsa-mgmt-ip>>, accept the security prompts, and click the 'Express Setup' link under HTML.

3. Select Initial Setup and click Submit.
4. Select Enable clustering, Fabric A, and IPv4.
5. Fill in the Virtual IP Address with the UCS cluster IP.
6. Completely fill in the System setup section. For system name, use the overall UCS system name. For the Mgmt IP Address, use <ucs-mgmt-ip>.

Enable clustering
 Standalone mode
 Synchronize

Fabric Setup: Fabric A Fabric B

IPv4
 IPv6

Virtual IP Address: . . .

System setup

Enforce strong password?: Yes No

System name:

Admin Password: **Confirm Admin password:**

Mgmt IP Address: . . . **Mgmt IP Netmask:** . . .

Default Gateway: . . .

DNS Server IP: . . . **Domain Name :**

UCS Central managed environment

UCS Central IP: . . . **Shared Secret:**

7. Click Submit.

Cisco UCS Fabric Interconnect B

To configure the Cisco UCS for use in a FlexPod environment, complete the following steps:

1. Connect to the console port on the second Cisco UCS fabric interconnect.

Enter the configuration method: gui

Physical switch Mgmt0 IP address: <ucsb-mgmt-ip>

Physical switch Mgmt0 IPv4 netmask: <ucsb-mgmt-mask>

IPv4 address of the default gateway: <ucsb-mgmt-gateway>

2. Using a supported web browser, connect to <https://<ucsb-mgmt-ip>>, accept the security prompts, and click the 'Express Setup' link under HTML.
3. Under System setup, enter the Admin Password entered above and click Submit.
4. Enter <ucsb-mgmt-ip> for the Mgmt IP Address and click Submit.

Cisco UCS Direct Storage Connect Setup

Log in to Cisco UCS Manager

To log in to the Cisco Unified Computing System (UCS) environment, complete the following steps:

1. Open a web browser and navigate to the Cisco UCS fabric interconnect cluster address.



You may need to wait at least 5 minutes after configuring the second fabric interconnect for UCS Manager to come up.

2. Click the Launch UCS Manager link under HTML to launch Cisco UCS Manager.
3. If prompted to accept security certificates, accept as necessary.
4. When prompted, enter `admin` as the user name and enter the administrative password.
5. Click Login to log in to Cisco UCS Manager.

Upgrade Cisco UCS Manager Software to Version 3.1(2f)

This document assumes the use of Cisco UCS 3.1(2f). To upgrade the Cisco UCS Manager software and the Cisco UCS Fabric Interconnect software to version 3.1(2f), refer to [Cisco UCS Manager Install and Upgrade Guides](#).

Anonymous Reporting

To create anonymous reporting, complete the following step:

1. In the Anonymous Reporting window, select whether to send anonymous data to Cisco for improving future products. If you select Yes, enter the IP address of your SMTP Server. Click OK.

Anonymous Reporting

Cisco Systems, Inc. will be collecting feature configuration and usage statistics which will be sent to Cisco Smart Call Home server anonymously. This data helps us prioritize the features and improvements that will most benefit our customers.

If you decide to enable this feature in future, you can do so from the "Anonymous Reporting" in the Call Home settings under the Admin tab.

[View Sample Data](#)

Do you authorize the disclosure of this information to Cisco Smart CallHome?

Yes No

Don't show this message again.

OK

Cancel

Configure Cisco UCS Call Home

It is highly recommended by Cisco to configure Call Home in UCSM. Configuring Call Home will accelerate resolution of support cases. To configure Call Home, complete the following steps:

1. In Cisco UCS Manager, click Admin on the left.
2. Select All > Communication Management > Call Home.
3. Change the State to On.
4. Fill in all the fields according to your Management preferences and click Save Changes and OK to complete configuring Call Home.

Place UCS Fabric Interconnects in Fiber Channel Switching Mode

In order to use Fiber Channel Storage Ports for storage directly connected to the UCS fabric interconnects, the fabric interconnects must be changed from fiber channel end host mode to fiber channel switching mode.

To place the fabric interconnects in fiber channel switching mode, complete the following steps:

1. In Cisco UCS Manager, click Equipment on the left.
2. Select Equipment > Fabric Interconnects > Fabric Interconnect A (primary).
3. In the center pane, select Set FC Switching Mode. Click Yes and OK for the confirmation message.

4. Wait for both Fabric Interconnects to reboot by monitoring the console ports and log back into Cisco UCS Manager.

Configure Unified Ports

To set Unified Ports as Fibre Channel ports, the UCS Fabric Interconnects have a slider mechanism within the UCSM GUI interface. With the 6248UP, the port selection options will start from the right of the 32 fixed ports, or the right of the 16 ports of the expansion module, going down in contiguous increments of 2.

To enable the fiber channel ports, complete the following steps for the 6248UP:

1. In Cisco UCS Manager, click Equipment on the left.
2. Select Equipment > Fabric Interconnects > Fabric Interconnect A (primary)
3. Select Configure Unified Ports.
4. Click Yes on the pop-up window warning that changes to the fixed module will require a reboot of the fabric interconnect and changes to the expansion module will require a reboot of that module.
5. Configure the Fixed Module Ports from the subsequent Configure Fixed Module Ports pop-up window, or click on the Configure Expansion Module Ports button to select from expansion module ports.
6. Within either option, move the gray slider bar from the right to the left selecting ports in increments of two to set as FC ports.

Configure Unified Ports ? X

Instructions

The position of the slider determines the type of the ports.
All the ports to the left of the slider are Ethernet ports (Blue), while the ports to the right are Fibre Channel ports (Purple).

Port	Transport	If Role or Port Channel Membership	Desired If Role
Port 1	ether	Unconfigured	
Port 2	ether	Unconfigured	
Port 3	ether	Unconfigured	
Port 4	ether	Unconfigured	
Port 5	ether	Unconfigured	
Port 6	ether	Unconfigured	
Port 7	ether	Unconfigured	
Port 8	ether	Unconfigured	
Port 9	ether	Unconfigured	
Port 10	ether	Unconfigured	
Port 11	ether	Unconfigured	
Port 12	ether	Unconfigured	
Port 13	ether	Unconfigured	
Port 14	ether	Unconfigured	
Port 15	ether	Unconfigured	

7. Click Finish. Click Yes on the confirmation. Click OK.
8. Select Equipment > Fabric Interconnects > Fabric Interconnect B (subordinate)
9. Select Configure Unified Ports.
10. Click Yes on the pop-up window warning that changes to the fixed module will require a reboot of the fabric interconnect and changes to the expansion module will require a reboot of that module.
11. Configure the Fixed Module Ports from the subsequent Configure Fixed Module Ports pop-up window, or click on the Configure Expansion Module Ports button to select from expansion module ports.
12. Within either option move the gray slider bar from the right to the left selecting ports in increments of two to set as FC Uplinks.
13. Click Finish. Click Yes on the confirmation. Click OK.

14. If you reconfigured ports in the fixed module, wait for both the Fabric Interconnects to reboot by monitoring the console ports.
15. Log back into UCS Manager.

Add Block of IP Addresses for KVM Access

To create a block of IP addresses for in band server Keyboard, Video, Mouse (KVM) access in the Cisco UCS environment, complete the following steps:

1. In Cisco UCS Manager, click LAN on the left.
2. Expand Pools > root > IP Pools.
3. Right-click IP Pool ext-mgmt and select Create Block of IPv4 Addresses.
4. Enter the starting IP address of the block, number of IP addresses required, and the subnet mask and gateway information.

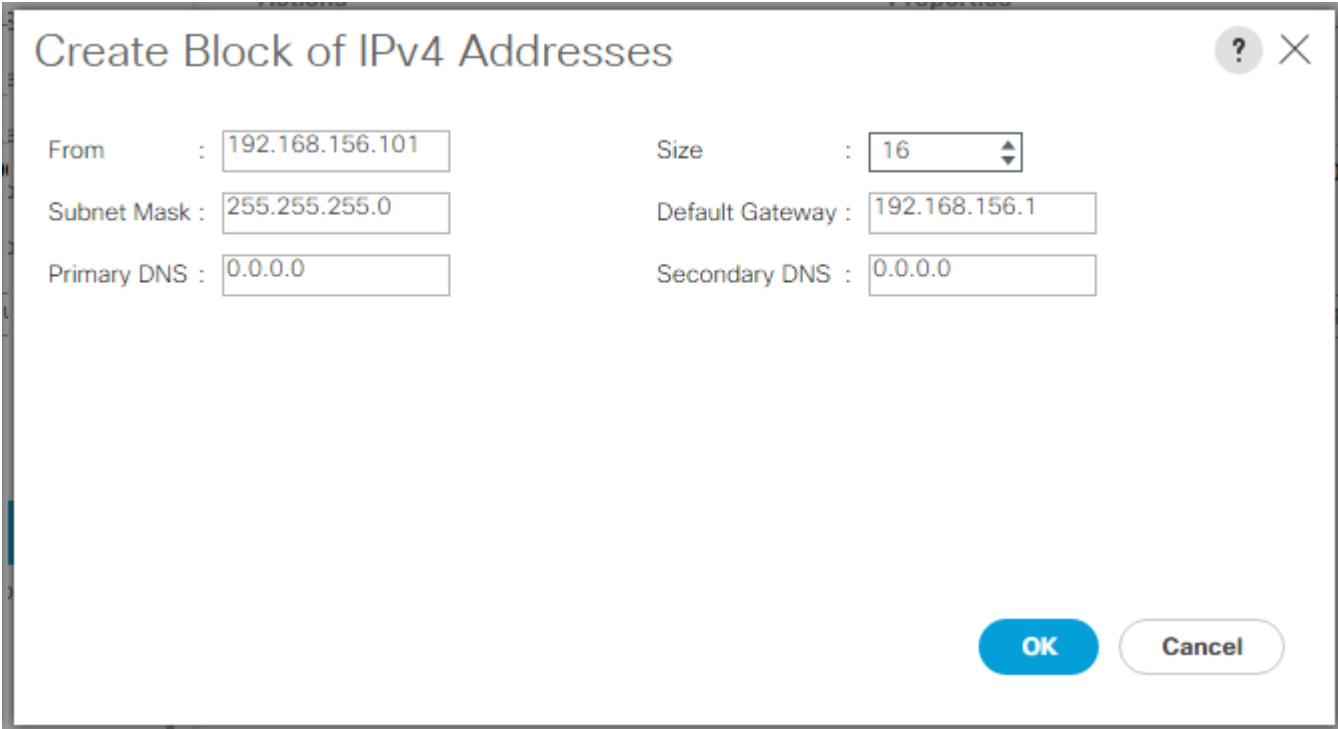

The screenshot shows a dialog box titled "Create Block of IPv4 Addresses". It has a question mark icon and a close button (X) in the top right corner. The dialog contains the following fields:

From :	<input type="text" value="192.168.156.101"/>	Size :	<input type="text" value="16"/>
Subnet Mask :	<input type="text" value="255.255.255.0"/>	Default Gateway :	<input type="text" value="192.168.156.1"/>
Primary DNS :	<input type="text" value="0.0.0.0"/>	Secondary DNS :	<input type="text" value="0.0.0.0"/>

At the bottom right, there are two buttons: "OK" (a blue button) and "Cancel" (a white button with a grey border).

5. Click OK to create the block.
6. Click OK in the confirmation message.

Synchronize Cisco UCS to NTP

To synchronize the Cisco UCS environment to the NTP servers in the Nexus 9372 switches, complete the following steps:

1. In Cisco UCS Manager, click Admin on the left.

2. Expand All > Time Zone Management.
3. Select Timezone.
4. In the Properties pane, select the appropriate time zone in the Time Zone pulldown.
5. Click Save Changes, and then click OK.
6. Click Add NTP Server.
7. Enter <switch-a-ntp-ip> and click OK. Click OK on the confirmation.

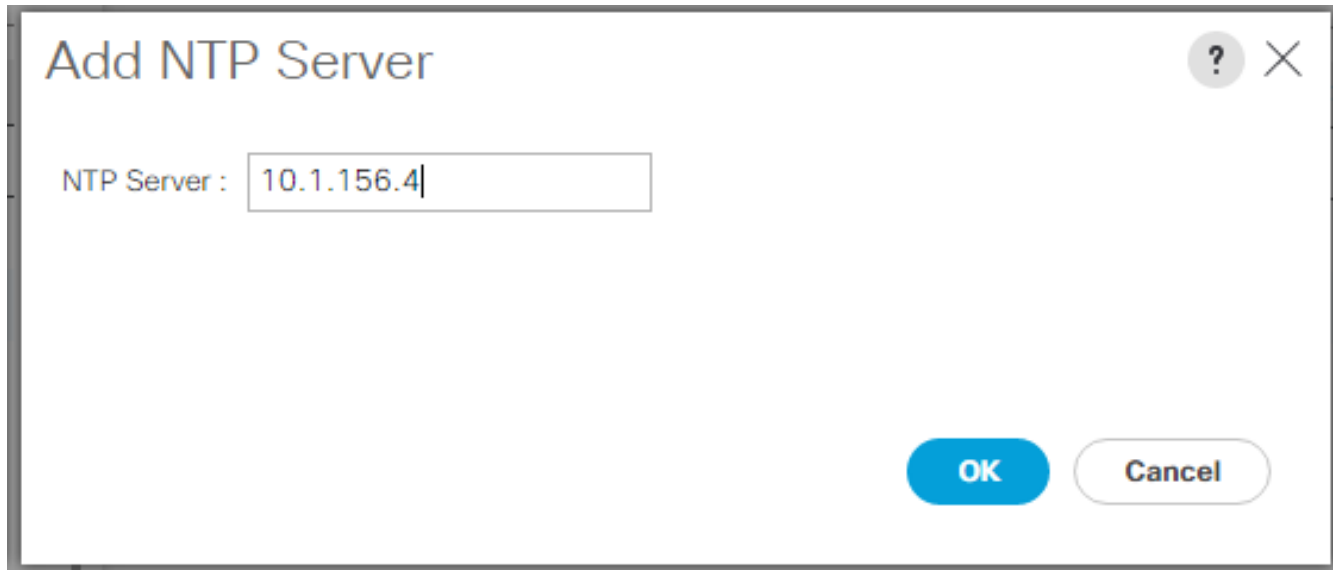

8. Click Add NTP Server.
9. Enter <switch-b-ntp-ip> and click OK. Click OK on the confirmation.

All / Time Zone Management / Timezone

General
Events

Actions

Add NTP Server

Properties

Time Zone : America/New_York (Eastern ▼)

NTP Servers

⌵ Advanced Filter
⬆ Export
🖨 Print

Name
NTP Server 10.1.156.4
NTP Server 10.1.156.5

Edit Chassis Discovery Policy

Setting the discovery policy simplifies the addition of B-Series Cisco UCS chassis and of additional fabric extenders for further C-Series connectivity. To modify the chassis discovery policy, complete the following steps:

1. In Cisco UCS Manager, click Equipment on the left and select Equipment in the second list.
2. In the right pane, click the Policies tab.
3. Under Global Policies, set the Chassis/FEX Discovery Policy to match the minimum number of uplink ports that are cabled between the chassis or fabric extenders (FEXes) and the fabric interconnects.
4. Set the Link Grouping Preference to Port Channel. If Backplane Speed Preference appears, leave it set at 40G. If the environment being setup contains a large amount of multicast traffic, set the Multicast Hardware Hash setting to Enabled.

Equipment

The screenshot shows the Cisco UCS Manager interface. At the top, there is a navigation bar with tabs: Fabric Interconnects, Servers, Thermal, Decommissioned, Firmware Management, Policies (selected), and Faults. Below this is a sub-navigation bar with tabs: Global Policies (selected), Autoconfig Policies, Server Inheritance Policies, Server Discovery Policies, SEL Policy, and Po. The main content area is titled "Chassis/FEX Discovery Policy" and contains three configuration fields:

- Action: A dropdown menu set to "2 Link".
- Link Grouping Preference: Radio buttons for "None" and "Port Channel" (selected).
- Multicast Hardware Hash: Radio buttons for "Disabled" (selected) and "Enabled".

5. Click Save Changes.
6. Click OK.

Enable Server and Uplink Ports

To enable server and uplink ports, complete the following steps:

1. In Cisco UCS Manager, click Equipment on the left.
2. Expand Equipment > Fabric Interconnects > Fabric Interconnect A (primary) > Fixed Module.
3. Expand Ethernet Ports.
4. Select the ports that are connected to the chassis, right-click them, and select **“Configure as Server Port.”**
5. Click Yes to confirm server ports and click OK.

6. Verify that the ports connected to the chassis are now configured as server ports and are in the Up state.
7. Select the ports that are connected to the Cisco Nexus switches, right-click them, and select Configure as Uplink Port.
8. Click Yes to confirm uplink ports and click OK.
9. Expand FC Ports under Fabric Interconnect A.
10. Select the ports that are connected to the NetApp storage controllers, right-click them, and select Configure as FC Storage Port.
11. Click Yes to confirm FC Storage ports and click OK.
12. Select any unused FC ports, right-click and select Disable. Select Yes and OK.
13. Select Equipment > Fabric Interconnects > Fabric Interconnect B (subordinate) > Fixed Module.
14. Expand Ethernet Ports.
15. Select the ports that are connected to the chassis, right-click them, and select Configure as Server Port.
16. Click Yes to confirm server ports and click OK.
17. Verify that the ports connected to the chassis are now configured as server ports and are in the Up state.
18. Select the ports that are connected to the Cisco Nexus switches, right-click them, and select Configure as Uplink Port.
19. Click Yes to confirm the uplink ports and click OK.
20. Expand FC Ports under Fabric Interconnect A.
21. Select the ports that are connected to the NetApp storage controllers, right-click them, and select Configure as FC Storage Port.
22. Click Yes to confirm FC Storage ports and click OK.
23. Select any unused FC ports, right-click and select Disable. Select Yes and OK.

Acknowledge Cisco UCS Chassis

To acknowledge all Cisco UCS chassis, complete the following steps:

1. In Cisco UCS Manager, click Equipment on the left.
2. Expand Chassis and select each chassis that is listed.
3. Right-click each chassis and select Acknowledge Chassis.

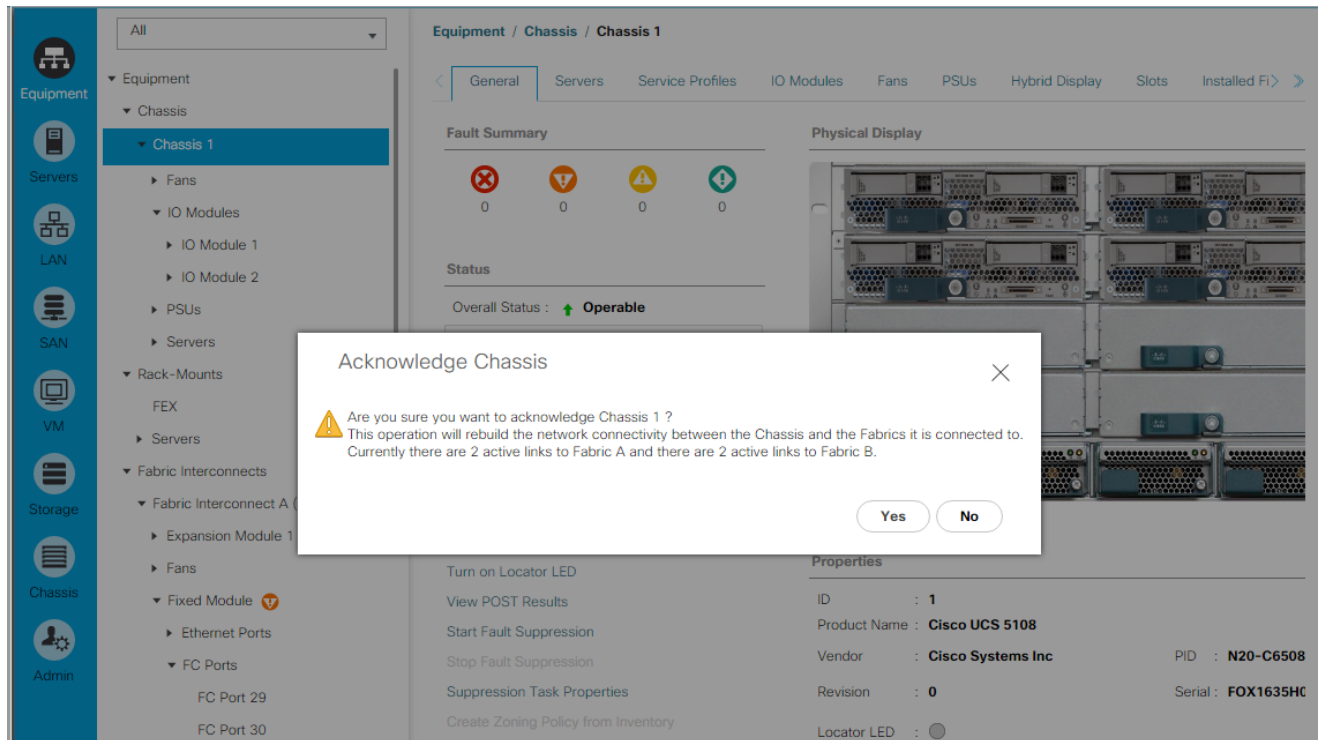

4. Click Yes and then click OK to complete acknowledging the chassis.

Create Uplink Port Channels to Cisco Nexus Switches

To configure the necessary port channels out of the Cisco UCS environment, complete the following steps:

1. In Cisco UCS Manager, click LAN on the left.



In this procedure, two port channels are created: one from fabric A to both Cisco Nexus switches and one from fabric B to both Cisco Nexus switches.

2. Under LAN > LAN Cloud, expand the Fabric A tree.
3. Right-click Port Channels.
4. Select Create Port Channel.
5. Enter a unique ID number for the port channel.
6. Enter `vPC-Nexus` as the name of the port channel.
7. Click Next.
8. Select the ports connected to the Nexus switches to be added to the port channel:
9. Click >> to add the ports to the port channel.
10. Click Finish to create the port channel.

11. Click OK.
12. In the navigation pane, under LAN > LAN Cloud, expand the fabric B tree.
13. Right-click Port Channels.
14. Select Create Port Channel.
15. Enter a unique ID for the port channel.
16. Enter vPC-Nexus as the name of the port channel.
17. Click Next.
18. Select the ports connected to the Nexus switches to be added to the port channel:
19. Click >> to add the ports to the port channel.
20. Click Finish to create the port channel.
21. Click OK.

Create a WWNN Pool for FC Boot

To configure the necessary WWNN pool for the Cisco UCS environment, complete the following steps on Cisco UCS Manager.

1. Select SAN on the left.
2. Select Pools > root.
3. Right-click WWNN Pools under the root organization.
4. Select Create WWNN Pool to create the WWNN pool.
5. Enter WWNN-Pool for the name of the WWNN pool.
6. Optional: Enter a description for the WWNN pool.
7. Select Sequential for Assignment Order.

Create WWNN Pool ? X

1 Define Name and Description

2 Add WWN Blocks

Name : WWNN-Pool

Description :

Assignment Order : Default Sequential

< Prev Next > Finish Cancel

8. Click Next.
9. Click Add.
10. Modify the From field as necessary for the UCS Environment.



Modifications of the WWNN block, as well as the WWPN and MAC Addresses, can convey identifying information for the UCS domain. Within the From field in our example, the 6th octet was changed from 00 to 48 to represent as identifying information for this being in the UCS 6248 in the 4th cabinet.



Also, when having multiple UCS domains sitting in adjacency, it is important that these blocks, the WWNN, WWPN, and MAC hold differing values between each set.

11. Specify a size of the WWNN block sufficient to support the available server resources.

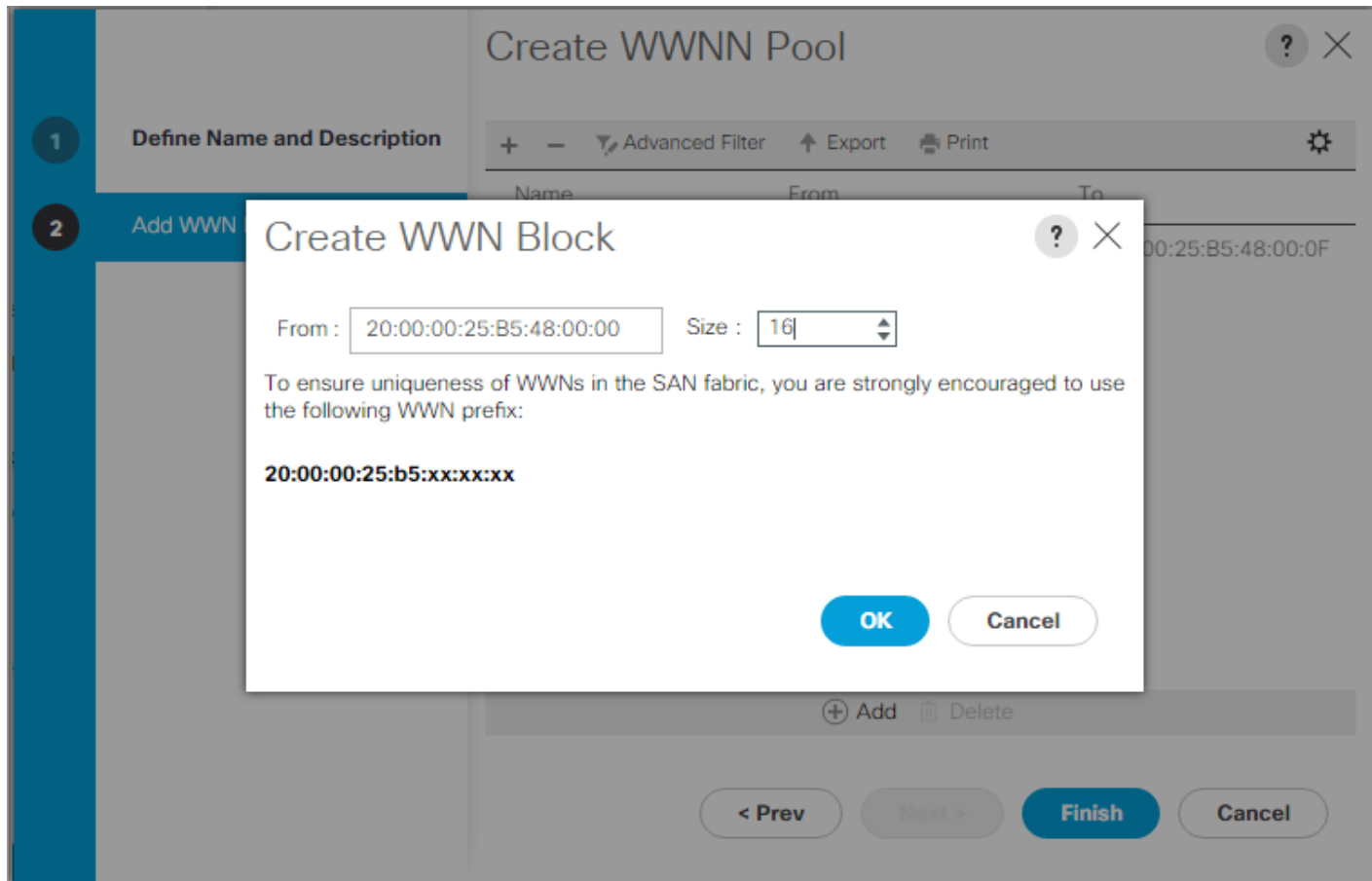

12. Click OK.

13. Click Finish and OK to complete creating the WWNN pool.

Create WWPN Pools

To configure the necessary WWPN pools for the Cisco UCS environment, complete the following steps:

1. In Cisco UCS Manager, click SAN on the left.
2. Select Pools > root.
3. In this procedure, two WWPN pools are created, one for each switching fabric.
4. Right-click WWPN Pools under the root organization.
5. Select Create WWPN Pool to create the WWPN pool.
6. Enter `WWPN-Pool1-A` as the name of the WWPN pool.
7. Optional: Enter a description for the WWPN pool.
8. Select Sequential for Assignment Order.

Create WWPN Pool

1 Define Name and Description

2 Add WWN Blocks

Name : WWPN-Pool-A

Description :

Assignment Order : Default Sequential

< Prev Next > Finish Cancel

9. Click Next.

10. Click Add.

11. Specify a starting WWPN.



For the FlexPod solution, the recommendation is to place 0A in the next-to-last octet of the starting WWPN to identify all of the WWPNs as fabric A addresses. Merging this with the pattern we used for the WWNN we see a WWPN block starting with 20:00:00:25:B5:48:0A:00.

12. Specify a size for the WWPN pool that is sufficient to support the available blade or server resources.

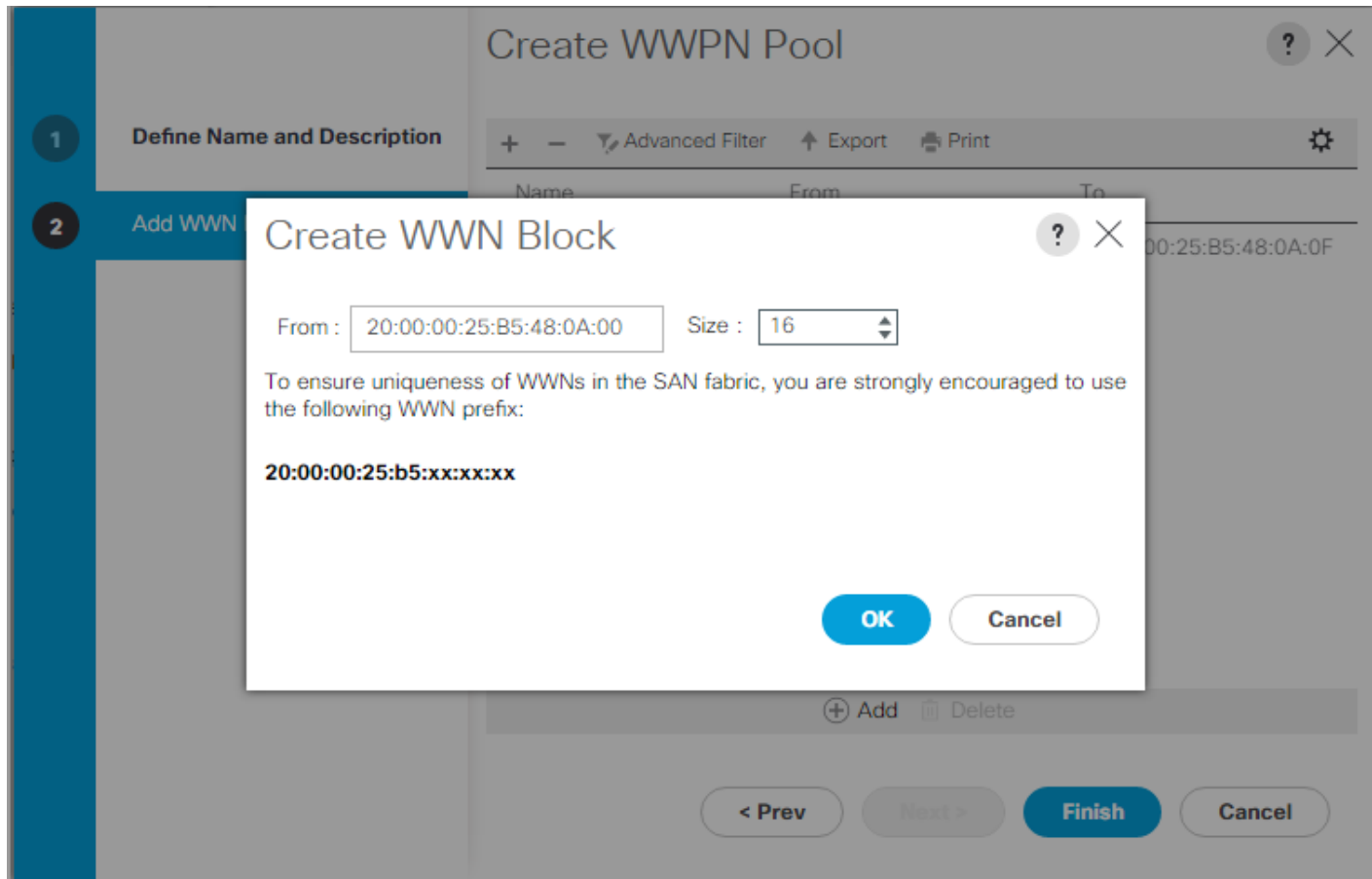

13. Click OK.
14. Click Finish.
15. In the confirmation message, click OK.
16. Right-click WWPN Pools under the root organization.
17. Select Create WWPN Pool to create the WWPN pool.
18. Enter `WWPN-Pool-B` as the name of the WWPN pool.
19. Optional: Enter a description for the WWPN pool.
20. Select Sequential for Assignment Order.
21. Click Next.
22. Click Add.
23. Specify a starting WWPN.



For the FlexPod solution, the recommendation is to place 0B in the next-to-last octet of the starting WWPN to identify all of the WWPNs as fabric A addresses. Merging this with the pattern we used for the WWNN we see a WWPN block starting with 20:00:00:25:B5:48:0B:00.

24. Specify a size for the WWPN address pool that is sufficient to support the available blade or server resources.
25. Click OK.
26. Click Finish.
27. In the confirmation message, click OK.

Create Storage VSANs

To configure the necessary virtual storage area networks (VSANs) for the Cisco UCS environment, complete the following steps:

1. In Cisco UCS Manager, click the SAN on the left.



In this procedure, two VSANs are created.

2. Select SAN > Storage Cloud.
3. Right-click VSANs.
4. Select Create Storage VSAN.
5. Enter `vsan-A` as the name of the VSAN to be used for Fabric A.
6. Set FC Zoning to Enabled.
7. Select Fabric A.
8. Enter a unique VSAN ID and a corresponding FCoE VLAN ID for Fabric A. It is recommended to use the same ID for both parameters and to use something other than 1.

Create Storage VSAN ? X

Name :

FC Zoning Settings

FC Zoning : Disabled Enabled

Do **NOT** enable local zoning if fabric interconnect is connected to an upstream FC/FCoE switch.

Common/Global Fabric A Fabric B Both Fabrics Configured Differently

You are creating a local VSAN in fabric A that maps to a VSAN ID that exists only in fabric A. A VLAN can be used to carry FCoE traffic and can be mapped to this VSAN.

Enter the VSAN ID that maps to this VSAN. Enter the VLAN ID that maps to this VSAN.

VSAN ID : FCoE VLAN :

9. Click OK, and then click OK again.
10. Under Storage Cloud, right-click VSANs.
11. Select Create Storage VSAN.
12. Enter `vsan-B` as the name of the VSAN to be used for Fabric B.
13. Set FC Zoning to Enabled.
14. Select Fabric B.
15. Enter a unique VSAN ID and a corresponding FCoE VLAN ID for Fabric B. It is recommended use the same ID for both parameters and to use something other than 1.

Create Storage VSAN ? X

Name :

FC Zoning Settings

FC Zoning : Disabled Enabled

Do **NOT** enable local zoning if fabric interconnect is connected to an upstream FC/FCoE switch.

Common/Global Fabric A Fabric B Both Fabrics Configured Differently

You are creating a local VSAN in fabric B that maps to a VSAN ID that exists only in fabric B. A VLAN can be used to carry FCoE traffic and can be mapped to this VSAN.

Enter the VSAN ID that maps to this VSAN. Enter the VLAN ID that maps to this VSAN.

VSAN ID : FCoE VLAN :

16. Click OK, and then click OK again.

Assign VSANs to FC Storage Ports

To assign storage VSANs to FC Storage Ports, complete the following steps:

1. In Cisco UCS Manager, click SAN on the left.
2. Select SAN > Storage Cloud.
3. Expand Fabric A and Storage FC Interfaces.
4. Select the first FC Interface.
5. For User Label, enter the storage controller name and port. Click Save Changes and OK.
6. Use the pulldown to select VSAN VSAN-A. Click Save Changes and OK.

General

Faults

Events

Actions

Enable Interface

Disable Interface

Properties

ID	: 29	Slot ID	: 1
Fabric ID	: A		
User Label	: <input type="text" value="d04-aff8040-01:0g"/>		
Port Type	: Physical	Network Type	: San
Transport Type	: Fc	Role	: Storage
Locale	: External	Port	: sys/switch-A
VSAN	: <input type="text" value="Fabric A/vsan VSAN-A"/>	Fill Pattern	: <input type="radio"/> Idle <input checked="" type="radio"/> A

7. Select the second FC Interface.
8. For User Label, enter the storage controller name and port. Click Save Changes and OK.
9. Use the pulldown to select VSAN VSAN-A. Click Save Changes and OK.
10. Expand Fabric B and Storage FC Interfaces.
11. Select the first FC Interface.
12. For User Label, enter the storage controller name and port. Click Save Changes and OK.
13. Use the pulldown to select VSAN VSAN-B. Click Save Changes and OK.
14. Select the second FC Interface.
15. For User Label, enter the storage controller name and port. Click Save Changes and OK.
16. Use the pulldown to select VSAN VSAN-B. Click Save Changes and OK.

Create vHBA Templates

To create the necessary virtual host bus adapter (vHBA) templates for the Cisco UCS environment, complete the following steps:

1. In Cisco UCS Manager, click SAN on the left.
2. Select Policies > root.
3. Right-click vHBA Templates.
4. Select Create vHBA Template.

5. Enter vHBA-Template-A as the vHBA template name.
6. Keep Fabric A selected.
7. Leave Redundancy Type set to No Redundancy.
8. Select VSAN-A.
9. Leave Initial Template as the Template Type.
10. Select WWPN-Pool-A as the WWPN Pool.
11. Click OK to create the vHBA template.
12. Click OK.

Create vHBA Template ? ×

Name : vHBA-Template-A

Description :

Fabric ID : A B

Redundancy

Redundancy Type : No Redundancy Primary Template Secondary Template

Select VSAN : VSAN-A Create VSAN

Template Type : Initial Template Updating Template

Max Data Field Size : 2048

WWPN Pool : WWPN-Pool-A(16/16) ▼

QoS Policy : <not set> ▼

Pin Group : <not set> ▼

Stats Threshold Policy : default ▼

13. Right-click vHBA Templates.

14. Select Create vHBA Template.
15. Enter vHBA-Template-B as the vHBA template name.
16. Leave Redundancy Type set to No Redundancy.
17. Select Fabric B as the Fabric ID.
18. Select VSAN-B.
19. Leave Initial Template as the Template Type.
20. Select WWPN-Pool-B as the WWPN Pool.
21. Click OK to create the vHBA template.
22. Click OK.

Create SAN Connectivity Policy

To configure the necessary Infrastructure SAN Connectivity Policy, complete the following steps:

1. In Cisco UCS Manager, click SAN on the left.
2. Select SAN > Policies > root.
3. Right-click SAN Connectivity Policies.
4. Select Create SAN Connectivity Policy.
5. Enter Cntr-FC-Boot as the name of the policy.
6. Select the previously created WWNN-Pool for the WWNN Assignment.
7. Click the Add button at the bottom to add a vHBA.
8. In the Create vHBA dialog box, enter Fabric-A as the name of the vHBA.
9. Select the Use vHBA Template checkbox.
10. In the vHBA Template list, select vHBA-Template-A.
11. In the Adapter Policy list, select Linux.

Create vHBA ? X

Name :

Use vHBA Template :

Redundancy Pair : Peer Name :

vHBA Template : Create vHBA Template

Adapter Performance Profile

Adapter Policy : Create Fibre Channel Adapter Policy

12. Click OK.
13. Click the Add button at the bottom to add a second vHBA.
14. In the Create vHBA dialog box, enter Fabric-B as the name of the vHBA.
15. Select the Use vHBA Template checkbox.
16. In the vHBA Template list, select vHBA-Template-B.
17. In the Adapter Policy list, select Linux
18. Click OK.

Create SAN Connectivity Policy ? X

Name :

Description :

A server is identified on a SAN by its World Wide Node Name (WWNN). Specify how the system should assign a WWNN to the server associated with this profile.

World Wide Node Name

WWNN Assignment:

Create WWNN Pool

The WWNN will be assigned from the selected pool.
The available/total WWNNs are displayed after the pool name.

Name	WWPN
▶ vHBA Fabric-B	Derived
▶ vHBA Fabric-A	Derived

19. Click OK to create the SAN Connectivity Policy.

20. Click OK to confirm creation.

Create MAC Address Pools

To configure the necessary MAC address pools for the Cisco UCS environment, complete the following steps:

1. In Cisco UCS Manager, click LAN on the left.
2. Select Pools > root.



In this procedure, two MAC address pools are created, one for each switching fabric.

3. Right-click MAC Pools under the root organization.
4. Select Create MAC Pool to create the MAC address pool.
5. Enter `MAC-Pool1-A` as the name of the MAC pool.
6. Optional: Enter a description for the MAC pool.

7. Select Sequential as the option for Assignment Order.
8. Click Next.
9. Click Add.
10. Specify a starting MAC address.



For the FlexPod solution, the recommendation is to place 0A in the next-to-last octet of the starting MAC address to identify all of the MAC addresses as fabric A addresses. In our example, we have carried forward the address also embedding the UCS domain number information giving us 00:25:B5:48:0A:00 as our first MAC address.

11. Specify a size for the MAC address pool that is sufficient to support the available blade or server resources, noting that up to 5 virtual network interfaces (vNICs) will be created on each server.

The screenshot shows the 'Create MAC Pool' wizard in a web interface. The current step is 'Add MAC Addresses'. A modal dialog is open with the title 'Create a Block of MAC Addresses'. It contains a form with 'First MAC Address' set to '00:25:B5:48:0A:00' and 'Size' set to '64'. Below the form, there is a warning message: 'To ensure uniqueness of MACs in the LAN fabric, you are strongly encouraged to use the following MAC prefix: 00:25:B5:xx:xx:xx'. The dialog has 'OK' and 'Cancel' buttons. The background wizard shows a table with columns 'Name', 'From', and 'To', and navigation buttons like '< Prev', 'Next >', 'Finish', and 'Cancel'.

12. Click OK.
13. Click Finish.

14. In the confirmation message, click OK.
15. Right-click MAC Pools under the root organization.
16. Select Create MAC Pool to create the MAC address pool.
17. Enter `MAC-Pool-B` as the name of the MAC pool.
18. Optional: Enter a description for the MAC pool.
19. Select Sequential as the option for Assignment Order.
20. Click Next.
21. Click Add.
22. Specify a starting MAC address.



For the FlexPod solution, it is recommended to place `0B` in the next to last octet of the starting MAC address to identify all the MAC addresses in this pool as fabric B addresses. Once again, we have carried forward in our example of also embedding the UCS domain number information giving us `00:25:B5:48:0B:00` as our first MAC address.

23. Specify a size for the MAC address pool that is sufficient to support the available blade or server resources.
24. Click OK.
25. Click Finish.
26. In the confirmation message, click OK.

Create UUID Suffix Pool

To configure the necessary universally unique identifier (UUID) suffix pool for the Cisco UCS environment, complete the following steps:

1. In Cisco UCS Manager, click Servers on the left.
2. Select Pools > root.
3. Right-click UUID Suffix Pools.
4. Select Create UUID Suffix Pool.
5. Enter `UUID-Pool` as the name of the UUID suffix pool.
6. Optional: Enter a description for the UUID suffix pool.
7. Keep the prefix at the derived option.

8. Select Sequential for the Assignment Order.
9. Click Next.
10. Click Add to add a block of UUIDs.
11. Keep the From field at the default setting.
12. Specify a size for the UUID block that is sufficient to support the available blade or server resources.
13. Click OK.
14. Click Finish.
15. Click OK.

Create Server Pool

To configure the necessary server pool for the Cisco UCS environment, complete the following steps:



Consider creating unique server pools to achieve the granularity that is required in your environment.

1. In Cisco UCS Manager, click Servers on the left.
2. Select Pools > root.
3. Right-click Server Pools.
4. Select Create Server Pool.
5. Enter `Container-Pool` as the name of the server pool.
6. Optional: Enter a description for the server pool.
7. Click Next.
8. Select ten (or more) servers to be used for this solution and click >> to add them to the `Container-Pool` server pool.
9. Click Finish.
10. Click OK.

Create VLANs

To configure the necessary virtual local area networks (VLANs) for the Cisco UCS environment, complete the following steps:

1. In Cisco UCS Manager, click LAN on the left.



In this procedure, four unique VLANs are created.

2. Select LAN > LAN Cloud.
3. Right-click VLANs.
4. Select Create VLANs.
5. Enter `Native-VLAN` as the name of the VLAN to be used as the native VLAN.
6. Keep the Common/Global option selected for the scope of the VLAN.
7. Enter the native VLAN ID.
8. Keep the Sharing Type as None.
9. Click OK, and then click OK again.

Create VLANs ? ×

VLAN Name/Prefix :

Multicast Policy Name : [Create Multicast Policy](#)

Common/Global Fabric A Fabric B Both Fabrics Configured Differently

You are creating global VLANs that map to the same VLAN IDs in all available fabrics.
Enter the range of VLAN IDs.(e.g. "2009-2019", "29,35,40-45", "23", "23,34-45")

VLAN IDs :

Sharing Type : None Primary Isolated Community

10. Expand the list of VLANs in the navigation pane, right-click the newly created `Native-VLAN` and select Set as Native VLAN.
11. Click Yes, and then click OK.

12. Right-click VLANs.
13. Select Create VLANs
14. Enter `Container-MGMT-VLAN` as the name of the VLAN to be used for management traffic.
15. Keep the Common/Global option selected for the scope of the VLAN.
16. Enter the Container management VLAN ID.
17. Keep the Sharing Type as None.
18. Click OK, and then click OK again.
19. Right-click VLANs.
20. Select Create VLANs.
21. Enter `Container-MGMT-NFS` as the name of the VLAN to be used for NFS.
22. Keep the Common/Global option selected for the scope of the VLAN.
23. Enter the Container MGMT NFS VLAN ID.
24. Keep the Sharing Type as None.
25. Click OK, and then click OK again.
26. Select Create VLANs.
27. Enter `Container-TNT-A-NFS` as the name of the VLAN to be used for NFS.
28. Keep the Common/Global option selected for the scope of the VLAN.
29. Enter the Container Tenant A NFS VLAN ID.
30. Keep the Sharing Type as None.
31. Click OK, and then click OK again.

Modify Default Host Firmware Package

Firmware management policies allow the administrator to select the corresponding packages for a given server configuration. These policies often include packages for adapter, BIOS, board controller, FC adapters, host bus adapter (HBA) option ROM, and storage controller properties.

To create a firmware management policy for a given server configuration in the Cisco UCS environment, complete the following steps:

1. In Cisco UCS Manager, click Servers on the left.
2. Select Policies > root.

3. Expand Host Firmware Packages.
4. Select default.
5. In the Actions pane, select Modify Package Versions.
6. Select the version 3.1(2e) for both the Blade and Rack Packages.

Modify Package Versions

Blade Package : 3.1(2e)B

Rack Package : 3.1(2e)C

Excluded Components:

- Adapter
- Host NIC Option ROM
- CIMC
- Board Controller
- Flex Flash Controller
- BIOS
- PSU
- SAS Expander
- Storage Controller Onboard Device
- Storage Device Bridge
- GPUs
- FC Adapters
- Local Disk
- HBA Option ROM

OK Apply Cancel Help

7. Click OK then OK again to modify the host firmware package.

Set Jumbo Frames in Cisco UCS Fabric

To configure jumbo frames and enable quality of service in the Cisco UCS fabric, complete the following steps:

1. In Cisco UCS Manager, click LAN on the left.
2. Select LAN > LAN Cloud > QoS System Class.
3. In the right pane, click the General tab.
4. On the Best Effort row, enter 9216 in the box under the MTU column.
5. Click Save Changes in the bottom of the window.
6. Click OK

LAN / LAN Cloud / QoS System Class

Priority	Enabled	CoS	Packet Drop	Weight	Weight (%)	MTU	Multicast Optimized
Platinum	<input type="checkbox"/>	5	<input type="checkbox"/>	10	N/A	normal	<input type="checkbox"/>
Gold	<input type="checkbox"/>	4	<input checked="" type="checkbox"/>	9	N/A	normal	<input type="checkbox"/>
Silver	<input type="checkbox"/>	2	<input checked="" type="checkbox"/>	8	N/A	normal	<input type="checkbox"/>
Bronze	<input type="checkbox"/>	1	<input checked="" type="checkbox"/>	7	N/A	normal	<input type="checkbox"/>
Best Effort	<input checked="" type="checkbox"/>	Any	<input checked="" type="checkbox"/>	5	50	9216	<input type="checkbox"/>
Fibre Channel	<input checked="" type="checkbox"/>	3	<input type="checkbox"/>	5	50	fc	N/A

Create Local Disk Configuration Policy (Optional)

A local disk configuration for the Cisco UCS environment is necessary if the servers in the environment do not have a local disk.



This policy should not be used on servers that contain local disks.

To create a local disk configuration policy, complete the following steps:

1. In Cisco UCS Manager, click Servers on the left.
2. Select Policies > root.
3. Right-click Local Disk Config Policies.
4. Select Create Local Disk Configuration Policy.
5. Enter SAN-Boot as the local disk configuration policy name.
6. Change the mode to No Local Storage.
7. Click OK to create the local disk configuration policy.

Create Local Disk Configuration Policy ? X

Name :

Description :

Mode :

FlexFlash

FlexFlash State : Disable Enable

If **FlexFlash State** is disabled, SD cards will become unavailable immediately.
Please ensure SD cards are not in use before disabling the FlexFlash State.

FlexFlash RAID Reporting State : Disable Enable

8. Click OK.

Create Network Control Policy for Cisco Discovery Protocol (CDP) and Link Layer Discovery Protocol (LLDP)

To create a network control policy that enables CDP and LLDP on virtual network ports, complete the following steps:

1. In Cisco UCS Manager, click LAN on the left.
2. Select Policies > root.
3. Right-click Network Control Policies.
4. Select Create Network Control Policy.

5. Enter Enable-CDP-LLDP as the policy name.
6. For CDP, select the Enabled option.
7. For LLDP, scroll down and select Enabled for both Transmit and Receive.
8. Click OK to create the network control policy.

Create Network Control Policy

CDP : Disabled Enabled

MAC Register Mode : Only Native Vlan All Host Vlans

Action on Uplink Fail : Link Down Warning

MAC Security

Forge : Allow Deny

LLDP

Transmit : Disabled Enabled

Receive : Disabled Enabled

OK **Cancel**

9. Click OK.

Create Power Control Policy

To create a power control policy for the Cisco UCS environment, complete the following steps:

1. In Cisco UCS Manager, click Servers tab on the left.
2. Select Policies > root.
3. Right-click Power Control Policies.
4. Select Create Power Control Policy.
5. Enter No-Power-Cap as the power control policy name.
6. Change the power capping setting to No Cap.
7. Click OK to create the power control policy.
8. Click OK.

Create Power Control Policy ? ×

Name :

Description :

Fan Speed Policy :

Power Capping

If you choose **cap**, the server is allocated a certain amount of power based on its priority within its power group. Priority values range from 1 to 10, with 1 being the highest priority. If you choose **no-cap**, the server is exempt from all power capping.

No Cap cap

Cisco UCS Manager only enforces power capping when the servers in a power group require more power than is currently available. With sufficient power, all servers run at full capacity regardless of their priority.

Create Server Pool Qualification Policy (Optional)

To create an optional server pool qualification policy for the Cisco UCS environment, complete the following steps:



This example creates a policy for Cisco UCS B-Series and Cisco UCS C-Series servers with the Intel E2660 v4 Xeon Broadwell processors.

1. In Cisco UCS Manager, click Servers on the left.
2. Select Policies > root.
3. Right-click Server Pool Policy Qualifications.
4. Select Create Server Pool Policy Qualification.
5. Name the policy `UCS-Broadwell`.
6. Select Create CPU/Cores Qualifications.
7. Select Xeon for the Processor/Architecture.

8. Enter UCS-CPU-E52660E as the PID.
9. Click OK to create the CPU/Core qualification.
10. Click OK to create the policy then OK for the confirmation.

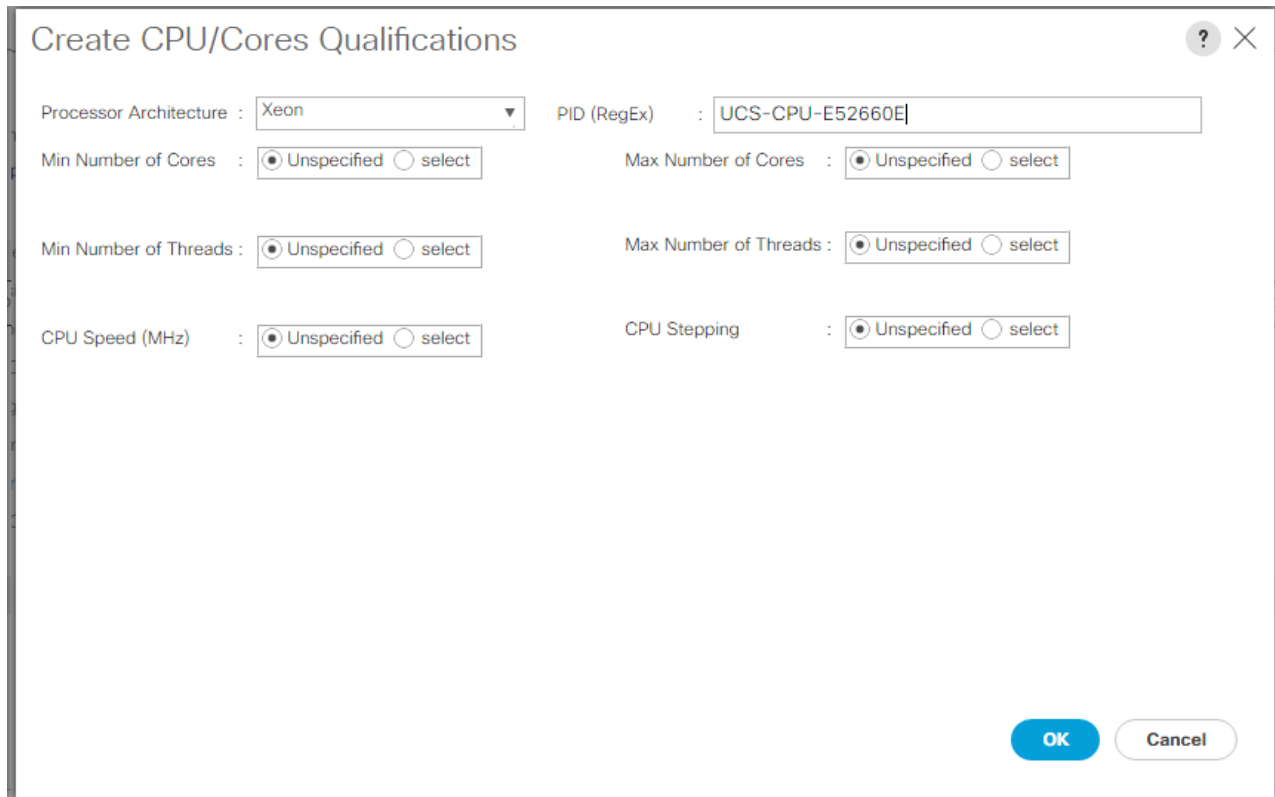

Create CPU/Cores Qualifications

Processor Architecture : Xeon PID (RegEx) : UCS-CPU-E52660E

Min Number of Cores : Unspecified select Max Number of Cores : Unspecified select

Min Number of Threads : Unspecified select Max Number of Threads : Unspecified select

CPU Speed (MHz) : Unspecified select CPU Stepping : Unspecified select

OK Cancel

Create Server BIOS Policy

To create a server BIOS policy for the Cisco UCS environment, complete the following steps:

1. In Cisco UCS Manager, click Servers on the left.
2. Select Policies > root.
3. Right-click BIOS Policies.
4. Select Create BIOS Policy.
5. Enter Cntr-Host as the BIOS policy name.
6. Change the Quiet Boot setting to disabled.

7. Change Consistent Device Naming to enabled.

The screenshot shows a 'Create BIOS Policy' window with a left-hand navigation pane and a main configuration area. The navigation pane lists 12 categories: 1 Main, 2 Processor, 3 Intel Directed IO, 4 RAS Memory, 5 Serial Port, 6 USB, 7 PCI, 8 QPI, 9 LOM and PCIe Slots, 10 Trusted Platform, 11 Graphics Configuration, and 12 Boot Options. The 'Main' category is currently selected. The main configuration area contains the following settings:

- Name: Cntr-Host
- Description: (empty)
- Reboot on BIOS Settings Change:
- Quiet Boot: disabled enabled Platform Default
- Post Error Pause: disabled enabled Platform Default
- Resume Ac On Power Loss: stay-off last-state reset Platform Default
- Front Panel Lockout: disabled enabled Platform Default
- Consistent Device Naming: disabled enabled Platform Default

At the bottom right, there are four buttons: '< Prev' (disabled), 'Next >' (disabled), 'Finish' (active), and 'Cancel'.

8. Click on the Processor tab on the left pane.

9. Set the following within the Processor tab.

10. Processor C state → disabled

11. Processor C1E → disabled

12. Processor C3 Report → disabled

13. Processor C7 Report → disabled

Create BIOS Policy

Turbo Boost	: <input type="radio"/> disabled <input type="radio"/> enabled <input checked="" type="radio"/> Platform Default
Enhanced Intel Speedstep	: <input type="radio"/> disabled <input type="radio"/> enabled <input checked="" type="radio"/> Platform Default
Hyper Threading	: <input type="radio"/> disabled <input type="radio"/> enabled <input checked="" type="radio"/> Platform Default
Core Multi Processing	: Platform Default
Execute Disabled Bit	: <input type="radio"/> disabled <input type="radio"/> enabled <input checked="" type="radio"/> Platform Default
Virtualization Technology (VT)	: <input type="radio"/> disabled <input type="radio"/> enabled <input checked="" type="radio"/> Platform Default
Hardware Pre-fetcher	: <input type="radio"/> disabled <input type="radio"/> enabled <input checked="" type="radio"/> Platform Default
Adjacent Cache Line Pre-fetcher	: <input type="radio"/> disabled <input type="radio"/> enabled <input checked="" type="radio"/> Platform Default
DCU Streamer Pre-fetch	: <input type="radio"/> disabled <input type="radio"/> enabled <input checked="" type="radio"/> Platform Default
DCU IP Pre-fetcher	: <input type="radio"/> disabled <input type="radio"/> enabled <input checked="" type="radio"/> Platform Default
Direct Cache Access	: <input type="radio"/> disabled <input type="radio"/> enabled <input type="radio"/> auto <input checked="" type="radio"/> Platform Default
Processor C State	: <input checked="" type="radio"/> disabled <input type="radio"/> enabled <input type="radio"/> Platform Default
Processor C1E	: <input checked="" type="radio"/> disabled <input type="radio"/> enabled <input type="radio"/> Platform Default
Processor C3 Report	: disabled
Processor C6 Report	: <input type="radio"/> disabled <input type="radio"/> enabled <input checked="" type="radio"/> Platform Default
Processor C7 Report	: disabled
Processor CMCI	: <input type="radio"/> enabled <input type="radio"/> disabled <input checked="" type="radio"/> Platform Default
CPU Performance	: Platform Default
Max Variable MTRR Setting	: <input type="radio"/> auto-max <input type="radio"/> 8 <input checked="" type="radio"/> Platform Default
Local X2 APIC	: <input type="radio"/> xapic <input type="radio"/> x2apic <input type="radio"/> auto <input checked="" type="radio"/> Platform Default

< Prev Next > Finish

14. Scroll down to the remaining Processor options, and select:

15. Energy Performance → performance

16. Frequency Floor Override → enabled

17. DRAM Clock Throttling → performance

Create BIOS Policy

Energy Performance	: performance
Frequency Floor Override	: <input type="radio"/> disabled <input checked="" type="radio"/> enabled <input type="radio"/> Platform Default
P-STATE Coordination	: <input type="radio"/> hw-all <input type="radio"/> sw-all <input type="radio"/> sw-any <input checked="" type="radio"/> Platform Default
DRAM Clock Throttling	: performance
Channel Interleaving	: Platform Default
Rank Interleaving	: Platform Default
Demand Scrub	: <input type="radio"/> disabled <input type="radio"/> enabled <input checked="" type="radio"/> Platform Default
Patrol Scrub	: <input type="radio"/> disabled <input type="radio"/> enabled <input checked="" type="radio"/> Platform Default
Altitude	: Platform Default
Package C State Limit	: Platform Default
CPU Hardware Power Management	: <input type="radio"/> disabled <input type="radio"/> hwpm-native-mode <input type="radio"/> hwpm-oob-mode <input checked="" type="radio"/> Platform Default
Energy Performance Tuning	: <input type="radio"/> os <input type="radio"/> bios <input checked="" type="radio"/> Platform Default
Workload Configuration	: <input type="radio"/> balanced <input type="radio"/> io-sensitive <input checked="" type="radio"/> Platform Default

< Prev Next > Finish

18. Click on the RAS memory option, and select:

19. LV DDR Mode → performance-mode

Create BIOS Policy

Memory RAS Config : Platform Default

NUMA : disabled enabled Platform Default

LV DDR Mode : power-saving-mode performance-mode auto Platform Default

DRAM Refresh Rate : Platform Default

DDR3 Voltage Selection : ddr3-1500mv ddr3-1350mv Platform Default

< Prev Next > **Finish** Cancel

20. Click Finish to create the BIOS policy

21. Click OK.

Update the Default Maintenance Policy

To update the default Maintenance Policy, complete the following steps:

1. In Cisco UCS Manager, click Servers on the left.
2. Select Policies > root.
3. Select Maintenance Policies > default.
4. Change the Reboot Policy to User Ack.
5. Click “On Next Boot” to delegate maintenance windows to server administrators.

General	Events
Actions <hr/> Delete Show Policy Usage Use Global	Properties <hr/> Name : default Description : <input type="text"/> Owner : Local Soft Shutdown Timer : <input type="text" value="150 Secs"/> Reboot Policy : <input type="radio"/> Immediate <input checked="" type="radio"/> User Ack <input type="radio"/> Timer Automatic <input checked="" type="checkbox"/> On Next Boot (Apply pending changes at next reboot.)

6. Click Save Changes.
7. Click OK to accept the change.

Create vNIC Templates

To create multiple virtual network interface card (vNIC) templates for the Cisco UCS environment, complete the following steps. A total of 3 vNIC Templates will be created.

Create Container Management vNIC

1. In Cisco UCS Manager, click LAN on the left.
2. Select Policies > root.
3. Right-click vNIC Templates.
4. Select Create vNIC Template.
5. Enter Cntr-Template as the vNIC template name.
6. Keep Fabric A selected.
7. Select the Enable Failover checkbox.
8. Leave Redundancy Type set at No Redundancy.
9. Under Target, make sure that only the Adapter checkbox is selected.
10. Select Updating Template as the Template Type.
11. Under VLANs, select the checkbox for Container-MGMT-VLAN.
12. Set Container-MGMT-VLAN as the native VLAN.
13. Select vNIC Name for the CDN Source.

14. For MTU, enter 1500.

15. In the MAC Pool list, select MAC-Pool-A.

16. In the Network Control Policy list, select Enable-CDP-LLDP.

Create vNIC Template

Template Type : Initial Template Updating Template

VLANs

Advanced Filter Export Print

Select	Name	Native VLAN
<input type="checkbox"/>	Container-MGMT-NFS	<input type="radio"/>
<input checked="" type="checkbox"/>	Container-MGMT-VLAN	<input checked="" type="radio"/>
<input type="checkbox"/>	Container-TNT-A-NFS	<input type="radio"/>
<input type="checkbox"/>	default	<input type="radio"/>
<input type="checkbox"/>	IB-MGMT	<input type="radio"/>
<input type="checkbox"/>	Infra-NFS	<input type="radio"/>

CDN Source : vNIC Name User Defined

MTU : 1500

MAC Pool : MAC-Pool-A(38/64) ▼

QoS Policy : <not set> ▼

Network Control Policy : Enable-CDP-LLDP ▼

Pin Group : <not set> ▼

Stats Threshold Policy : default ▼

Connection Policies

Dynamic vNIC usNIC VMQ

Dynamic vNIC Configuration Policy: []

OK Cancel

17. Click OK to create the vNIC template.

18. Click OK.

Create NFS vNICs

1. In Cisco UCS Manager, click LAN on the left.

2. Select Policies > root.

3. Right-click vNIC Templates.
4. Select Create vNIC Template.
5. Enter `Container-NFS-A` as the vNIC template name.
6. Keep Fabric A selected.
7. Do not select the Enable Failover checkbox.
8. Select Primary Template for Redundancy Type.
9. Leave the Peer Redundancy Template set to <not set>.
10. Under Target, make sure that only the Adapter checkbox is selected.
11. Select Updating Template as the Template Type.
12. Under VLANs, select the checkboxes for the `Container-MGMT-NFS` and `Container-TNT-A-NFS` VLANs.
13. Set the `Container-MGMT-NFS` VLAN as the Native VLAN.
14. Select `vNIC Name` for the CDN Source.
15. For MTU, enter 9000.
16. In the MAC Pool list, select `MAC-Pool-A`.
17. In the Network Control Policy list, select `Enable-CDP-LLDP`.

Create vNIC Template

Template Type : Initial Template Updating Template

VLANs

Advanced Filter Export Print

Select	Name	Native VLAN
<input checked="" type="checkbox"/>	Container-MGMT-NFS	<input checked="" type="radio"/>
<input type="checkbox"/>	Container-MGMT-VLAN	<input type="radio"/>
<input checked="" type="checkbox"/>	Container-TNT-A-NFS	<input type="radio"/>
<input type="checkbox"/>	default	<input type="radio"/>
<input type="checkbox"/>	IB-MGMT	<input type="radio"/>
<input type="checkbox"/>	Infra-NFS	<input type="radio"/>

CDN Source : vNIC Name User Defined

MTU : 9000

MAC Pool : MAC-Pool-A(38/64) ▼

QoS Policy : <not set> ▼

Network Control Policy : Enable-CDP-LLDP ▼

Pin Group : <not set> ▼

Stats Threshold Policy : default ▼

Connection Policies

Dynamic vNIC usNIC VMQ

Dynamic vNIC Connection Policy : <not set> ▼

OK Cancel

18. Click OK to create the vNIC template.

19. Click OK.

Repeat these equivalent steps for template Container-NFS-B:

1. Select LAN on the left.
2. Select Policies > root.
3. Right-click vNIC Templates.
4. Select Create vNIC Template

5. Enter `Container-NFS-B` as the vNIC template name.
6. Select Fabric B.
7. Do not select the Enable Failover checkbox.
8. Set Redundancy Type to Secondary Template.
9. Select `Container-NFA-A` for the Peer Redundancy Template.
10. In the MAC Pool list, select `MAC-Pool-B`. The MAC Pool is all that needs to be selected for the Secondary Template.
11. Click OK to create the vNIC template.
12. Click OK.

Create LAN Connectivity Policy

To configure the necessary Container LAN Connectivity Policy, complete the following steps:

1. In Cisco UCS Manager, click LAN on the left.
2. Select LAN > Policies > root.
3. Right-click LAN Connectivity Policies.
4. Select Create LAN Connectivity Policy.
5. Enter `Cntr-FC-Boot` as the name of the policy.
6. Click the upper Add button to add a vNIC.
7. In the Create vNIC dialog box, enter `eno1` as the name of the vNIC.
8. Select the Use vNIC Template checkbox.
9. In the vNIC Template list, select `Cntr-Template`.
10. In the Adapter Policy list, select Linux.
11. Click OK to add this vNIC to the policy.

Create vNIC ? X

Name :

Use vNIC Template :

Redundancy Pair :

Peer Name :

vNIC Template : ▼ [Create vNIC Template](#)

Adapter Performance Profile

Adapter Policy : ▼ [Create Ethernet Adapter Policy](#)

12. Click the upper Add button to add another vNIC to the policy.
13. In the Create vNIC box, enter eno2 as the name of the vNIC.
14. Select the Use vNIC Template checkbox.
15. In the vNIC Template list, select Container-NFS-A.
16. In the Adapter Policy list, select Linux.
17. Click OK to add the vNIC to the policy.
18. Click the upper Add button to add a vNIC.

19. In the Create vNIC dialog box, enter eno3 as the name of the vNIC.
20. Select the Use vNIC Template checkbox.
21. In the vNIC Template list, select Container-NFS-B.
22. In the Adapter Policy list, select Linux.
23. Click OK to add this vNIC to the policy.

Create LAN Connectivity Policy

Name :

Description :

Click **Add** to specify one or more vNICs that the server should use to connect to the LAN.

Name	MAC Address	Native VLAN
vNIC eno3	Derived	
vNIC eno2	Derived	
vNIC eno1	Derived	

[-] Delete [+ Add] [i] Modify

[+] Add iSCSI vNICs

OK Cancel

24. Click OK, then OK again to create the LAN Connectivity Policy.

Create Boot Policy (FC Boot)

This procedure applies to a Cisco UCS environment in which two FC logical interfaces (LIFs) are on cluster node 1 and two FC LIFs are on cluster node 2. One port from each cluster node is connected to each Cisco UCS Fabric Interconnect:

To create a boot policy for the Cisco UCS environment, complete the following steps:

1. In Cisco UCS Manager, click Servers on the left.
2. Select Policies > root.
3. Right-click Boot Policies.
4. Select Create Boot Policy.
5. Enter `Boot-FC-Cntr` as the name of the boot policy.
6. Optional: Enter a description for the boot policy.



Do not select the Reboot on Boot Order Change checkbox.

7. Keep the Reboot on Boot Order Change option cleared.
8. Expand the Local Devices drop-down menu and select `Add Remote CD/DVD`.
9. Expand the vHBAs drop-down menu and select `Add SAN Boot`.
10. Select the Primary Type.
11. Enter `Fabric-A` in the vHBA field.
12. Confirm that Primary is selected for the Type option.

Add SAN Boot ? X

vHBA :

Type : Primary Secondary Any

13. Click OK to add the SAN boot initiator.
14. From the vHBA expanded menu, select `Add SAN Boot Target`.
15. Keep 0 as the value for Boot Target LUN.

16. Enter the WWPN for `fc_p_lif01a` from the Container-SVM on the storage cluster.



To obtain this information, log in to the storage cluster and run the `network interface show - vserver Container-SVM` command.

17. Select Primary for the SAN boot target type.

Add SAN Boot Target ? X

Boot Target LUN :

Boot Target WWPN :

Type : Primary Secondary

OK Cancel

18. Click OK to add the SAN boot target.

19. From the vHBA drop-down menu, select Add SAN Boot Target.

20. Enter 0 as the value for Boot Target LUN.

21. Enter the WWPN for `fc_p_lif02a` from the Container-SVM on the storage cluster.

22. Click OK to add the SAN boot target.

23. From the vHBA expanded menu, select Add SAN Boot.

24. In the Add SAN Boot dialog box, enter `Fabric-B` in the vHBA box.

25. The SAN boot type should automatically be set to Secondary.

26. Click OK to add the SAN boot initiator.

27. From the vHBA drop-down menu, select Add SAN Boot Target.

28. Keep 0 as the value for Boot Target LUN.

29. Enter the WWPN for `fc_p_lif01b` from the Container-SVM on the storage cluster.

30. Select Primary for the SAN boot target type.
31. Click OK to add the SAN boot target.
32. From the vHBA drop-down menu, select Add SAN Boot Target.
33. Keep 0 as the value for Boot Target LUN.
34. Enter the WWPN for `fcp_1if02b` from the Container-SVM on the storage cluster.
35. Click OK to add the SAN boot target.

Create Boot Policy

Name :

Description :

Reboot on Boot Order Change :

Enforce vNIC/vHBA/iSCSI Name :

Boot Mode : Legacy Uefi

WARNINGS:
 The type (primary/secondary) does not indicate a boot order presence.
 The effective order of boot devices within the same device class (LAN/Storage/iSCSI) is determined by PCIe bus scan order.
 If **Enforce vNIC/vHBA/iSCSI Name** is selected and the vNIC/vHBA/iSCSI does not exist, a config error will be reported.
 If it is not selected, the vNICs/vHBAs are selected if they exist, otherwise the vNIC/vHBA with the lowest PCIe bus scan order is used.

Local Devices
vNICs
vHBAs
Add SAN Boot
Add SAN Boot Target
iSCSI vNICs
CIMC Mounted vMedia
EFI Shell

Boot Order

Name	Order	vNIC/vHBA	Type	WWN	LUN Na...	Slot Nu...	Boot Na...	Boot Path	Descript...
Rem...	1								
San	2								
S...		Fabric-A	Primary						
!			Primary	20:18:0...	0				
!			Second...	20:1A:0...	0				
S...		Fabric-B	Second...						

Move Up Move Down Delete

Set Uefi Boot Parameters

OK Cancel

36. Click OK, then click OK again to create the boot policy.

Create Service Profile Template (FC Boot)

In this procedure, one service profile template for Docker Container hosts is created for Fabric A boot.

To create the service profile template, complete the following steps:

1. In Cisco UCS Manager, click Servers on the left.
2. Select Service Profile Templates > root.

3. Right-click root.
4. Select Create Service Profile Template to open the Create Service Profile Template wizard.
5. Enter Docker-Host-FC-A as the name of the service profile template. This service profile template is configured to boot from storage node 1 on fabric A.
6. Select the “Updating Template” option.
7. Under UUID, select UUID_Pool as the UUID pool.

Create Service Profile Template

You must enter a name for the service profile template and specify the template type. You can also specify how a UUID will be assigned to this template and enter a description.

Name :

The template will be created in the following organization. Its name must be unique within this organization.
Where : **org-root**

The template will be created in the following organization. Its name must be unique within this organization.
Type : Initial Template Updating Template

Specify how the UUID will be assigned to the server associated with the service generated by this template.
UUID

UUID Assignment:

The UUID will be assigned from the selected pool.
The available/total UUIDs are displayed after the pool name.

Optionally enter a description for the profile. The description can contain information about when and where the service profile should be used.

< Prev Next > **Finish** Cancel

8. Click Next.

Configure Storage Provisioning

1. If you have servers with no physical disks, click on the Local Disk Configuration Policy and select the SAN-Boot Local Storage Policy. Otherwise, select the default Local Storage Policy.
2. Click Next.

Configure Networking Options

1. Keep the default setting for Dynamic vNIC Connection Policy.
2. Select the “Use Connectivity Policy” option to configure the LAN connectivity.

3. Select Cntr-FC-Boot from the LAN Connectivity Policy pull-down.
4. Leave Initiator Name Assignment at <not set>.

Create Service Profile Template ? ×

Optionally specify LAN configuration information.

Dynamic vNIC Connection Policy: ▼

[Create Dynamic vNIC Connection Policy](#)

How would you like to configure LAN connectivity?

Simple Expert No vNICs Use Connectivity Policy

LAN Connectivity Policy : ▼ [Create LAN Connectivity Policy](#)

Initiator Name

Initiator Name Assignment: ▼

[Create IQN Suffix Pool](#)

WARNING: The selected pool does not contain any available entities.
You can select it, but it is recommended that you add entities to it.

[< Prev](#) [Next >](#) [Finish](#) [Cancel](#)

5. Click Next.

Configure SAN Connectivity

1. Select the Use Connectivity Policy option for the “How would you like to configure SAN connectivity?” field.
2. Pick the Cntr-FC-Boot option from the SAN Connectivity Policy pull-down.

3. Click Next.

Configure Zoning Options

1. Set no Zoning options and click Next.



It is not necessary to set zoning options since FC Boot Targets are automatically zoned.

Configure vNIC/HBA Placement

1. In the “Select Placement” list, leave the placement policy as “Let System Perform Placement”.
2. Click Next.

Configure vMedia Policy

1. Do not select a vMedia Policy.
2. Click Next.

Configure Server Boot Order

1. Select `Boot-FC-Cntr` for Boot Policy.

Create Service Profile Template

Optionally specify the boot policy for this service profile template.

Select a boot policy.

Boot Policy: [Create Boot Policy](#)

Name : **Boot-FC-Cntr**
 Description :
 Reboot on Boot Order Change : **No**
 Enforce vNIC/vHBA/iSCSI Name : **Yes**
 Boot Mode : **Legacy**

WARNINGS:
 The type (primary/secondary) does not indicate a boot order presence.
 The effective order of boot devices within the same device class (LAN/Storage/iSCSI) is determined by PCIe bus scan order.
 If **Enforce vNIC/vHBA/iSCSI Name** is selected and the vNIC/vHBA/iSCSI does not exist, a config error will be reported.
 If it is not selected, the vNICs/vHBAs are selected if they exist, otherwise the vNIC/vHBA with the lowest PCIe bus scan order is used.

Boot Order

+ - Advanced Filter Export Print

Name	Order	vNIC/vH...	Type	WWN	LUN Name	Slot Num...	Boot Name	Boot Path	Description
Remo...	1								
San	2								
SA...		Fabric-A	Primary						
S			Primary	20:18:00...	0				
S			Secondary	20:1A:0...	0				
SA...		Fabric-B	Secondary						

[Create iSCSI vNIC](#) [Set iSCSI Boot Parameters](#) [Set UEFI Boot Parameters](#)

< Prev **Next >** **Finish** Cancel

2. Click Next to continue to the next section.

Configure Maintenance Policy

1. Change the Maintenance Policy to default.

Create Service Profile Template ? X

Specify how disruptive changes such as reboots, network interruptions, and firmware upgrades should be applied to the server associated with this service profile.

⊖ Maintenance Policy

Select a maintenance policy to include with this service profile or create a new maintenance policy that will be accessible to all service profiles.

Maintenance Policy: [Create Maintenance Policy](#)

Name	: default
Description	:
Soft Shutdown Timer	: 150 Secs
Reboot Policy	: User Ack

< Prev Next > **Finish** Cancel

2. Click Next.

Configure Server Assignment

To configure server assignment, complete the following steps:

1. In the Pool Assignment list, select `Container-Pool`.
2. Select Down as the power state to be applied when the profile is associated with the server.
3. **Optional: select “UCS-Broadwell” for the Server Pool Qualification.**
4. Expand Firmware Management at the bottom of the page and select the default policy

5. Click Next.

Configure Operational Policies

To configure the operational policies, complete the following steps:

1. In the BIOS Policy list, select **Cntr-Host**.
2. Expand Power Control Policy Configuration and select **No-Power-Cap** in the Power Control Policy list.

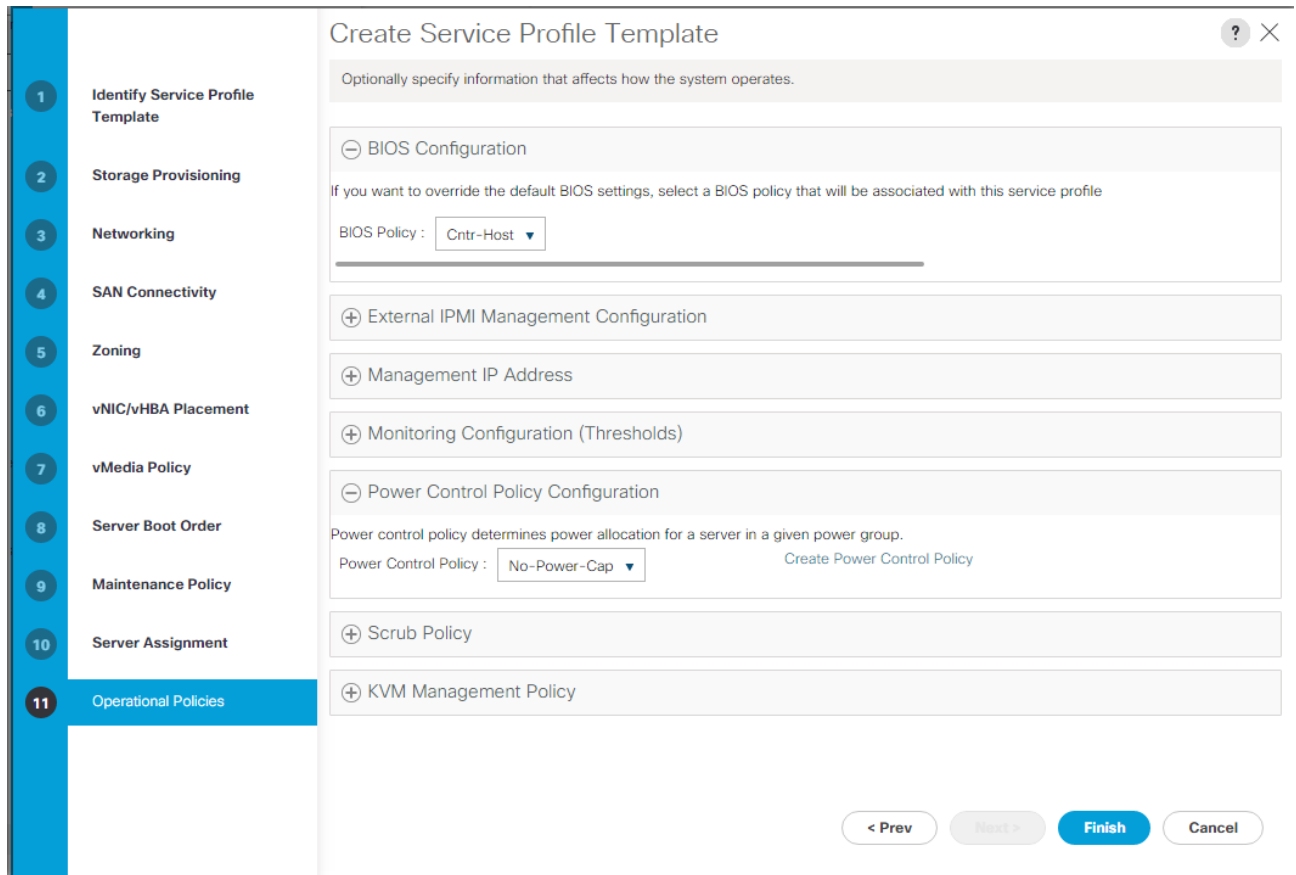

3. Click Finish to create the service profile template.
4. Click OK in the confirmation message.

Create Service Profiles

To create service profiles from the service profile template, complete the following steps:

1. Connect to UCS Manager, click Servers on the left.
2. Select Service Profile Templates > root > Service Template Docker-Host-FC-A.
3. Right-click Docker-Host-FC-A and select Create Service Profiles from Template.
4. Enter Docker-Host-0 as the service profile prefix.
5. Enter 1 as “Name Suffix Starting Number.”
6. Enter 9 as the “Number of Instances.”
7. Click OK to create the service profiles.

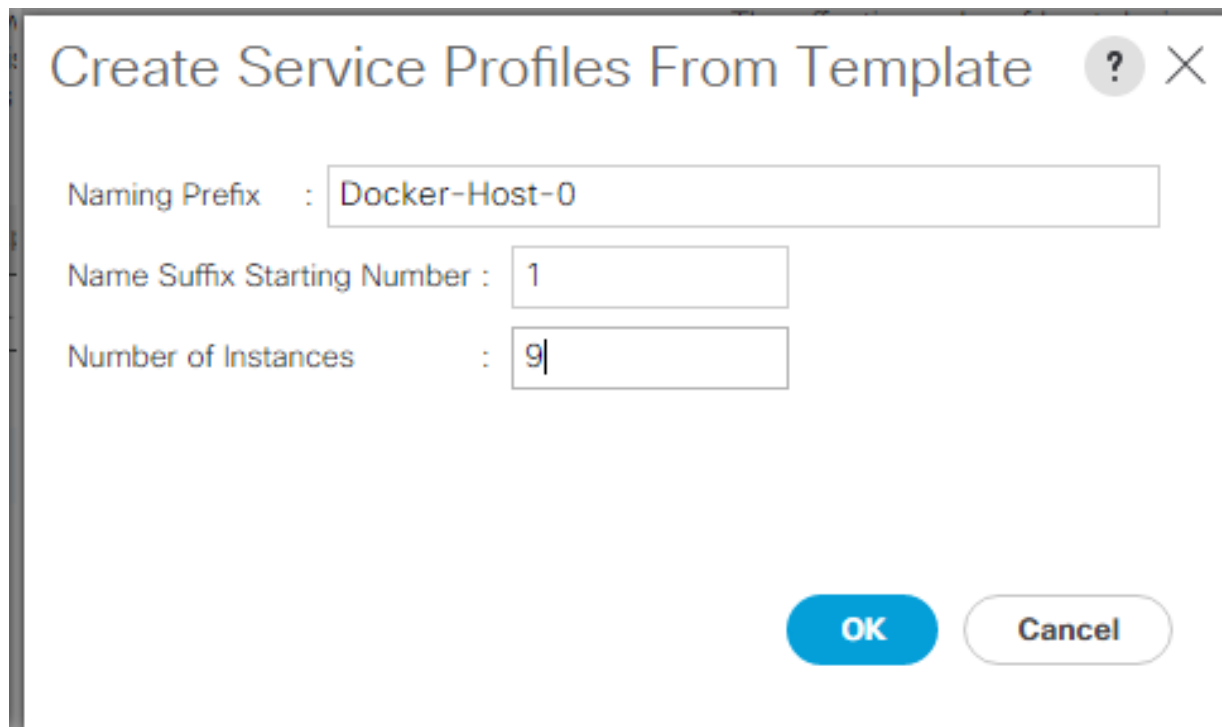

8. Click OK in the confirmation message.
9. Right-click Docker-Host-FC-A and select Create Service Profiles from Template.
10. Enter Docker-Host- as the service profile prefix.
11. Enter 10 as “Name Suffix Starting Number.”
12. Enter 1 as the “Number of Instances.”
13. Click OK to create the service profiles.
14. Click OK in the confirmation message.
15. Each Docker Node’s function can be entered in the Service Profile’s User Label field, for example, UCP-Ctrl-1.

Gather Necessary Information

After the Cisco UCS service profiles have been created, each infrastructure server in the environment will have a unique configuration. To proceed with the FlexPod deployment, specific information must be gathered from each Cisco UCS server and from the NetApp controllers. Insert the required information into Table 18 and Table 19.

Table 18. WWPNs from NetApp Storage

SVM	Target LIF WWPN (FC)
Container-SVM	fcp_lif01a

SVM	Target LIF WWPN (FC)
	fcp_lif01b
	fcp_lif02a
	fcp_lif02b



To obtain the FC WWPNs, run the network interface show command on the storage cluster management interface.

Table 19. FC WWPNs for fabric A and fabric B

Cisco UCS Service Profile Name	Initiator: WWPNs (FC)	Variables
Docker-Host-01		<docker-host-01-wwpna> <docker-host-01-wwpnb>
Docker-Host-02		<docker-host-02-wwpna> <docker-host-02-wwpnb>
Docker-Host-03		<docker-host-03-wwpna> <docker-host-03-wwpnb>
Docker-Host-04		<docker-host-04-wwpna> <docker-host-04-wwpnb>
Docker-Host-05		<docker-host-05-wwpna> <docker-host-05-wwpnb>
Docker-Host-06		<docker-host-06-wwpna> <docker-host-06-wwpnb>
Docker-Host-07		<docker-host-07-wwpna> <docker-host-07-wwpnb>
Docker-Host-08		<docker-host-08-wwpna> <docker-host-08-wwpnb>
Docker-Host-09		<docker-host-09-wwpna> <docker-host-09-wwpnb>

Cisco UCS Service Profile Name	Initiator: WWPNs (FC)	Variables
Docker-Host-10		<docker-host-10-wwpna> <docker-host-10-wwpnb>



To obtain the information on FC vHBA WWPN in Cisco UCS Manager GUI, go to Servers > Service Profiles > root. Click each service profile and then click the “Storage” tab, then “vHBAs” tab on the right. The WWPNs are displayed in the table at the bottom of the page.

Data ONTAP SAN Storage Setup

Create Igroups

Create igroups by entering the following commands from the cluster management node SSH connection:

```

igroup create -vserver Container-SVM -igroup Docker-Host-01 -protocol fcp -ostype linux -initiator <docker-host-01-wwpna>, <docker-host-01-wwpnb>

igroup create -vserver Container-SVM -igroup Docker-Host-02 -protocol fcp -ostype linux -initiator <docker-host-02-wwpna>, <docker-host-02-wwpnb>

igroup create -vserver Container-SVM -igroup Docker-Host-03 -protocol fcp -ostype linux -initiator <docker-host-03-wwpna>, <docker-host-03-wwpnb>

igroup create -vserver Container-SVM -igroup Docker-Host-04 -protocol fcp -ostype linux -initiator <docker-host-04-wwpna>, <docker-host-04-wwpnb>

igroup create -vserver Container-SVM -igroup Docker-Host-05 -protocol fcp -ostype linux -initiator <docker-host-05-wwpna>, <docker-host-05-wwpnb>

igroup create -vserver Container-SVM -igroup Docker-Host-06 -protocol fcp -ostype linux -initiator <docker-host-06-wwpna>, <docker-host-06-wwpnb>

igroup create -vserver Container-SVM -igroup Docker-Host-07 -protocol fcp -ostype linux -initiator <docker-host-07-wwpna>, <docker-host-07-wwpnb>

igroup create -vserver Container-SVM -igroup Docker-Host-08 -protocol fcp -ostype linux -initiator <docker-host-08-wwpna>, <docker-host-08-wwpnb>

igroup create -vserver Container-SVM -igroup Docker-Host-09 -protocol fcp -ostype linux -initiator <docker-host-09-wwpna>, <docker-host-09-wwpnb>

```



```
igroup create -vserver Container-SVM -igroup Docker-Host-10 -protocol fcp -ostype linux -initiator <docker-host-10-wwpna>, <docker-host-10-wwpnb>
```

Use the values listed in Table 12 and Table 13 for the WWPN information.

To view the igroups that were just created, type `igroup show`.

Map LUNs to igroups

From the storage cluster management SSH connection, enter the following commands:

```
lun map -vserver Container-SVM -volume Linux_Boot -lun Docker-Host-01 -igroup Docker-Host-01 -lun-id 0
lun map -vserver Container-SVM -volume Docker_Data_LUNs -lun Docker-Host-01 -igroup Docker-Host-01 -lun-id 1

lun map -vserver Container-SVM -volume Linux_Boot -lun Docker-Host-02 -igroup Docker-Host-02 -lun-id 0
lun map -vserver Container-SVM -volume Docker_Data_LUNs -lun Docker-Host-02 -igroup Docker-Host-02 -lun-id 1

lun map -vserver Container-SVM -volume Linux_Boot -lun Docker-Host-03 -igroup Docker-Host-03 -lun-id 0
lun map -vserver Container-SVM -volume Docker_Data_LUNs -lun Docker-Host-03 -igroup Docker-Host-03 -lun-id 1

lun map -vserver Container-SVM -volume Linux_Boot -lun Docker-Host-04 -igroup Docker-Host-04 -lun-id 0
lun map -vserver Container-SVM -volume Docker_Data_LUNs -lun Docker-Host-04 -igroup Docker-Host-04 -lun-id 1

lun map -vserver Container-SVM -volume Linux_Boot -lun Docker-Host-05 -igroup Docker-Host-05 -lun-id 0
lun map -vserver Container-SVM -volume Docker_Data_LUNs -lun Docker-Host-05 -igroup Docker-Host-05 -lun-id 1

lun map -vserver Container-SVM -volume Linux_Boot -lun Docker-Host-06 -igroup Docker-Host-06 -lun-id 0
lun map -vserver Container-SVM -volume Docker_Data_LUNs -lun Docker-Host-06 -igroup Docker-Host-06 -lun-id 1

lun map -vserver Container-SVM -volume Linux_Boot -lun Docker-Host-07 -igroup Docker-Host-07 -lun-id 0
lun map -vserver Container-SVM -volume Docker_Data_LUNs -lun Docker-Host-07 -igroup Docker-Host-07 -lun-id 1

lun map -vserver Container-SVM -volume Linux_Boot -lun Docker-Host-08 -igroup Docker-Host-08 -lun-id 0
lun map -vserver Container-SVM -volume Docker_Data_LUNs -lun Docker-Host-08 -igroup Docker-Host-08 -lun-id 1

lun map -vserver Container-SVM -volume Linux_Boot -lun Docker-Host-09 -igroup Docker-Host-09 -lun-id 0
lun map -vserver Container-SVM -volume Docker_Data_LUNs -lun Docker-Host-09 -igroup Docker-Host-09 -lun-id 1
```

```
lun map -vserver Container-SVM -volume Linux_Boot -lun Docker-Host-10 -igroup Docker-Host-10 -lun-id 0
lun map -vserver Container-SVM -volume Docker_Data_LUNs -lun Docker-Host-10 -igroup Docker-Host-10 -lun-id 1
```

Installation of Red Hat Enterprise Linux Operating System

After the service profile association, Red Hat Enterprise Linux 7.3 Operating System is installed on all the blade servers. The following section provides detailed procedure for installing Red Hat Linux 7.3 OS on the Boot-Lun created using UCSM Storage Profile.

Complete the following to install Red Hat Enterprise Linux 7.3 OS.

1. From Cisco UCS Manager, click Servers → Service Profiles
2. Select a node (for example, UCP-Ctrl-1) and click KVM Console.

The screenshot displays the Cisco UCS Manager web interface. On the left, a navigation sidebar includes categories like Equipment, Servers, LAN, SAN, VM, Storage, Chassis, and Admin. The 'Servers' category is expanded, showing a list of nodes including 'Docker-Host-01 (UCP-Ctrl-1)'. The main content area shows the configuration page for a service profile, with tabs for 'General', 'Storage', 'Network', and 'iSCSI vNI'. The 'General' tab is active, showing a 'Fault Summary' section with four status indicators (red X, orange triangle, yellow triangle, green circle) and a 'Status' section indicating 'Overall Status: OK'. A 'Status Details' button is visible below the status section. An 'Actions' section at the bottom lists various server management tasks such as 'Set Desired Power State', 'Boot Server', 'Shutdown Server', 'Reset', 'KVM Console >>', 'SSH to CIMC for SoL >>', 'Rename Service Profile', and 'Create a Clone'.

3. In the KVM Console select Virtual Media tab. From the drop-down menu select Activate Virtual Devices.

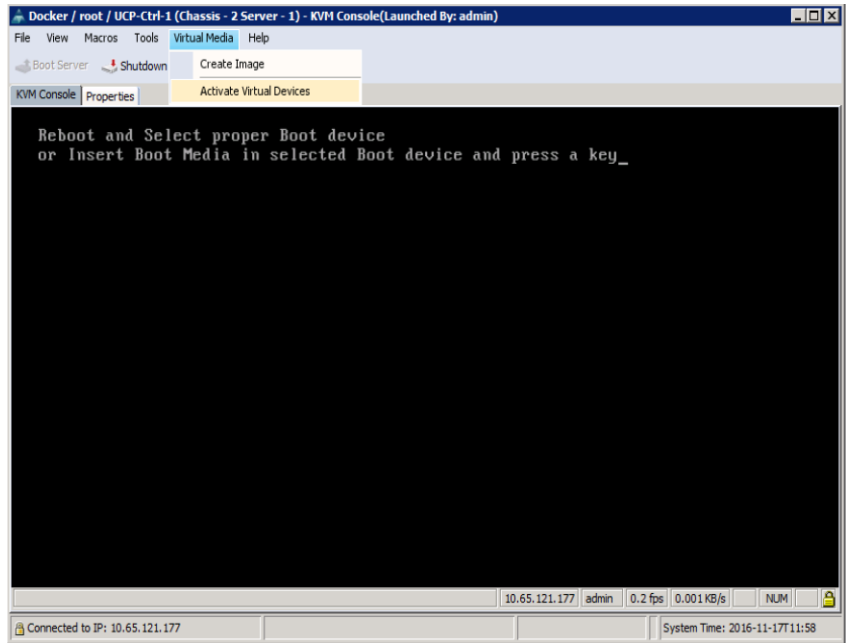

4. Once the virtual devices get activated, select Map CD/DVD option.

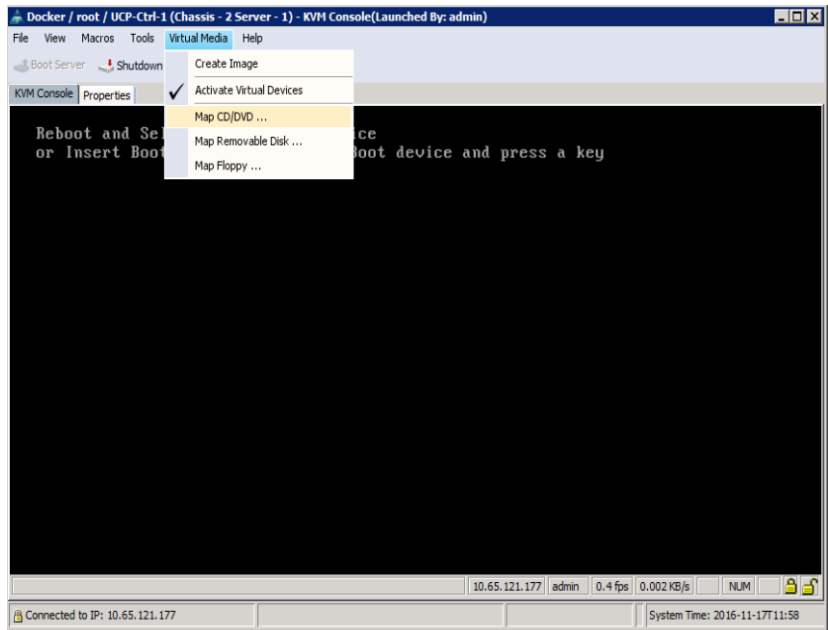

5. Click Browse to locate the Red Hat Enterprise Linux Server 7.3 installer ISO image file.

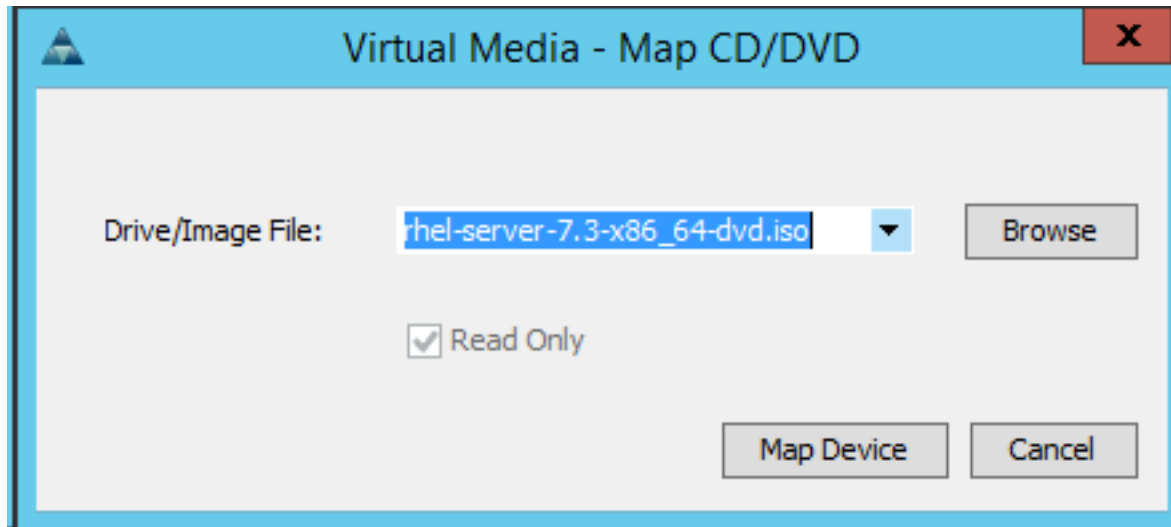

6. The image gets mapped to CD/DVD.
7. In the KVM window, select the KVM tab to monitor during boot.
8. In the KVM window, select the Macros > Static Macros > Ctrl-Alt-Del button in the upper left corner.
9. Click OK.
10. Click OK to reboot the system.
11. Select the option - Install Red Hat Enterprise Linux 7.3.

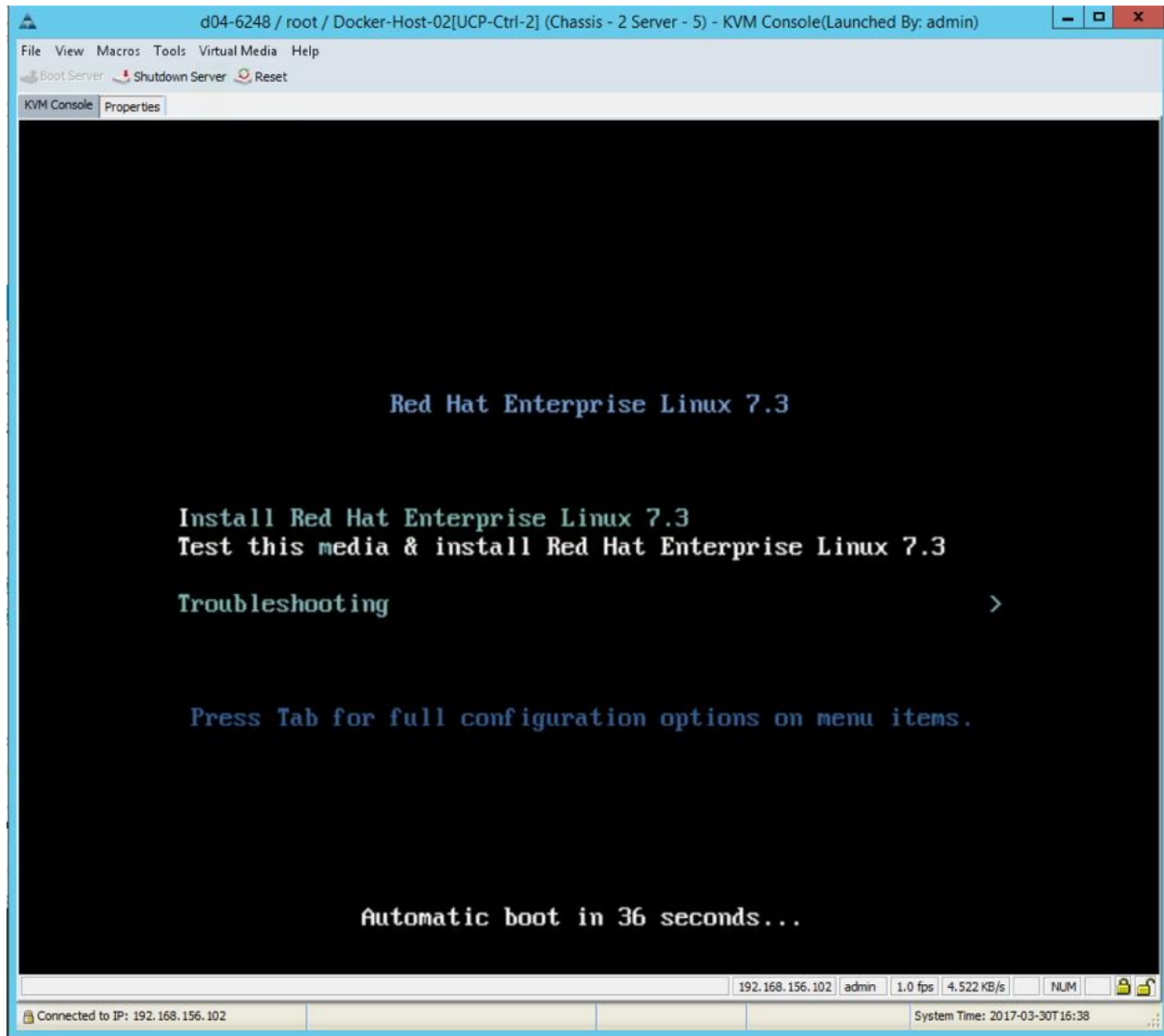

12. Select Language and Click Continue.

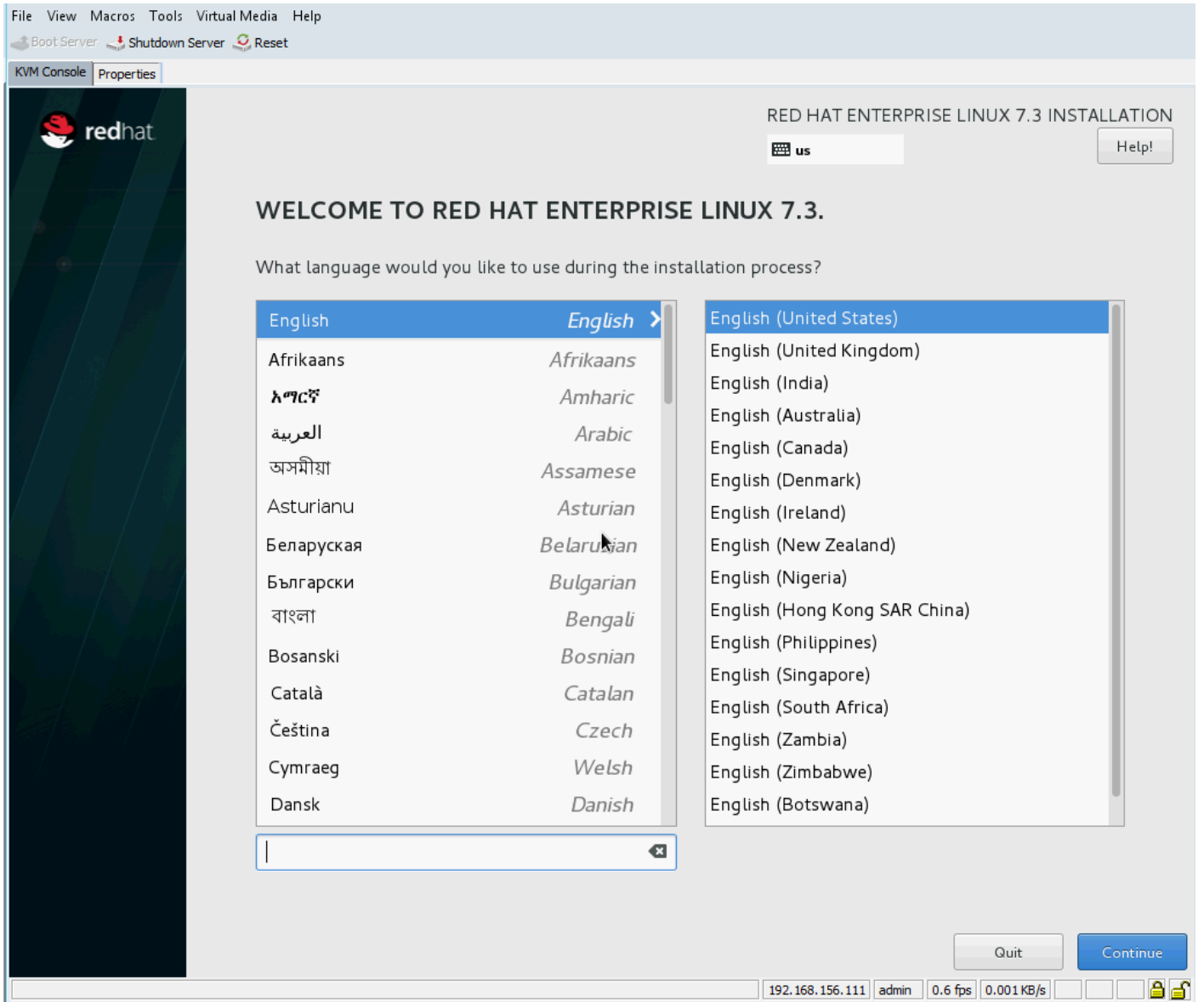

13. Click DATE & TIME.

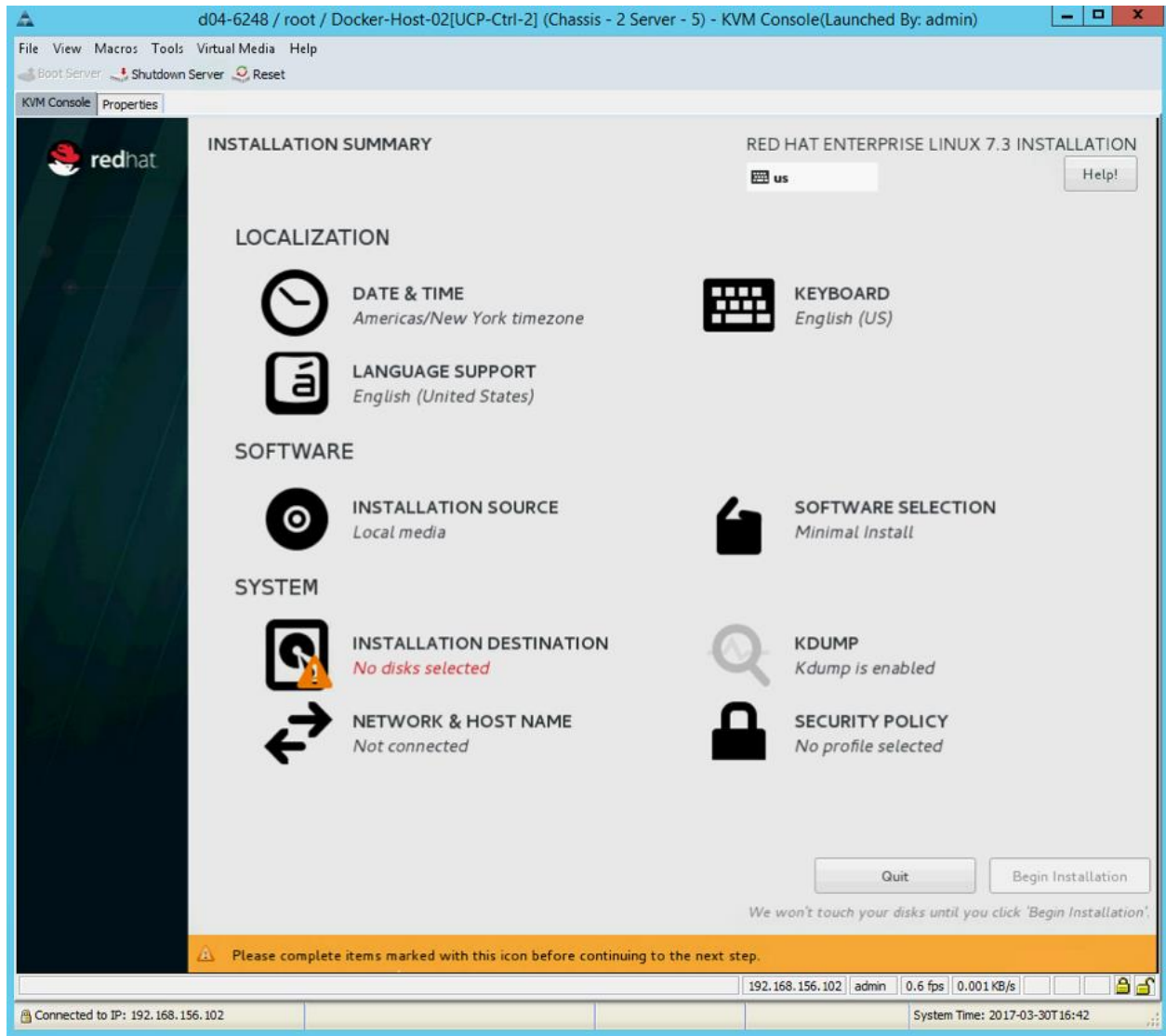

14. Select Region and City in DATE & TIME screen and Click Done.

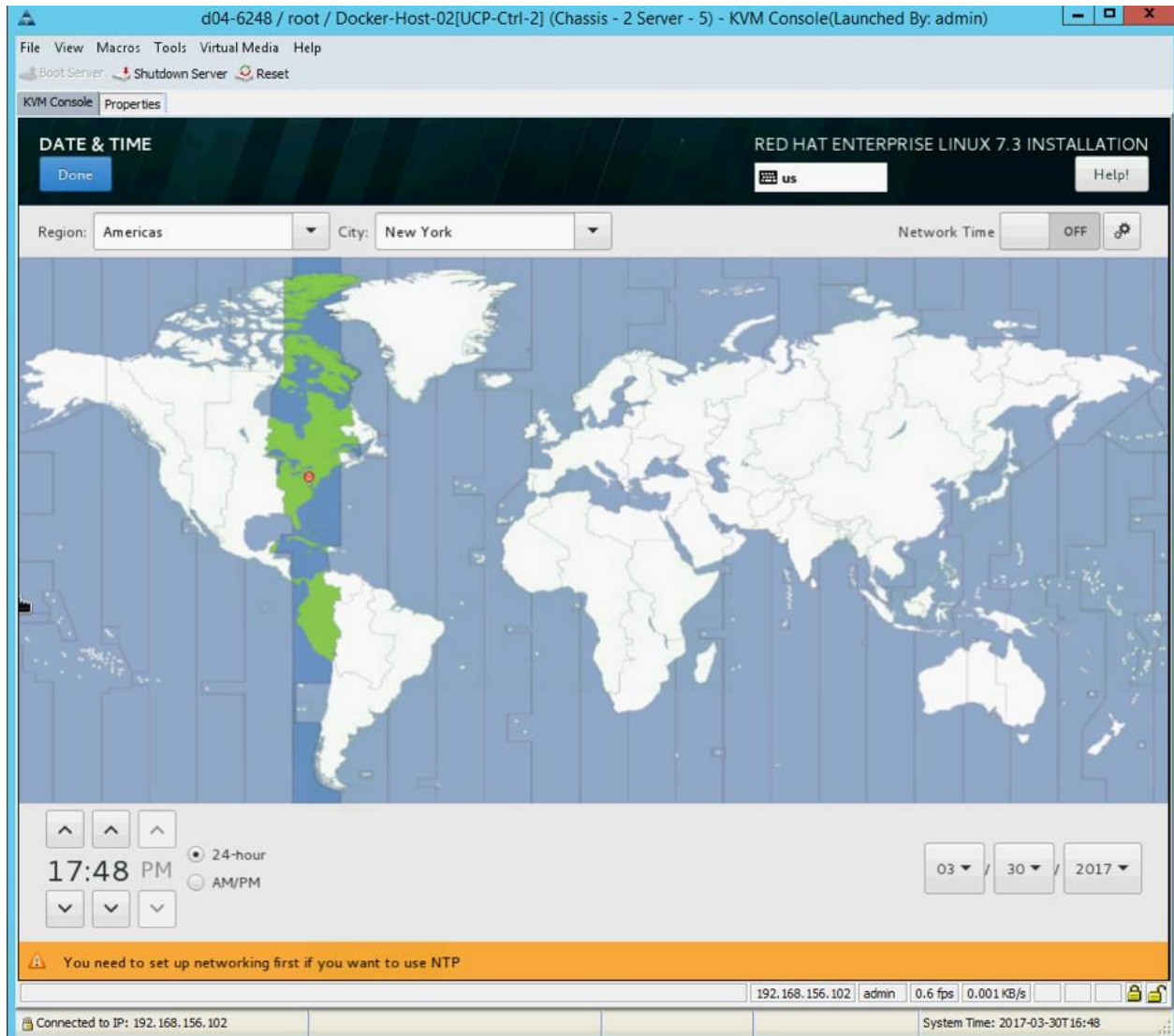

15. Click SOFTWARE SELECTION, select the option Server with GUI. Select the necessary add-ons for the selected environment. Click Done.

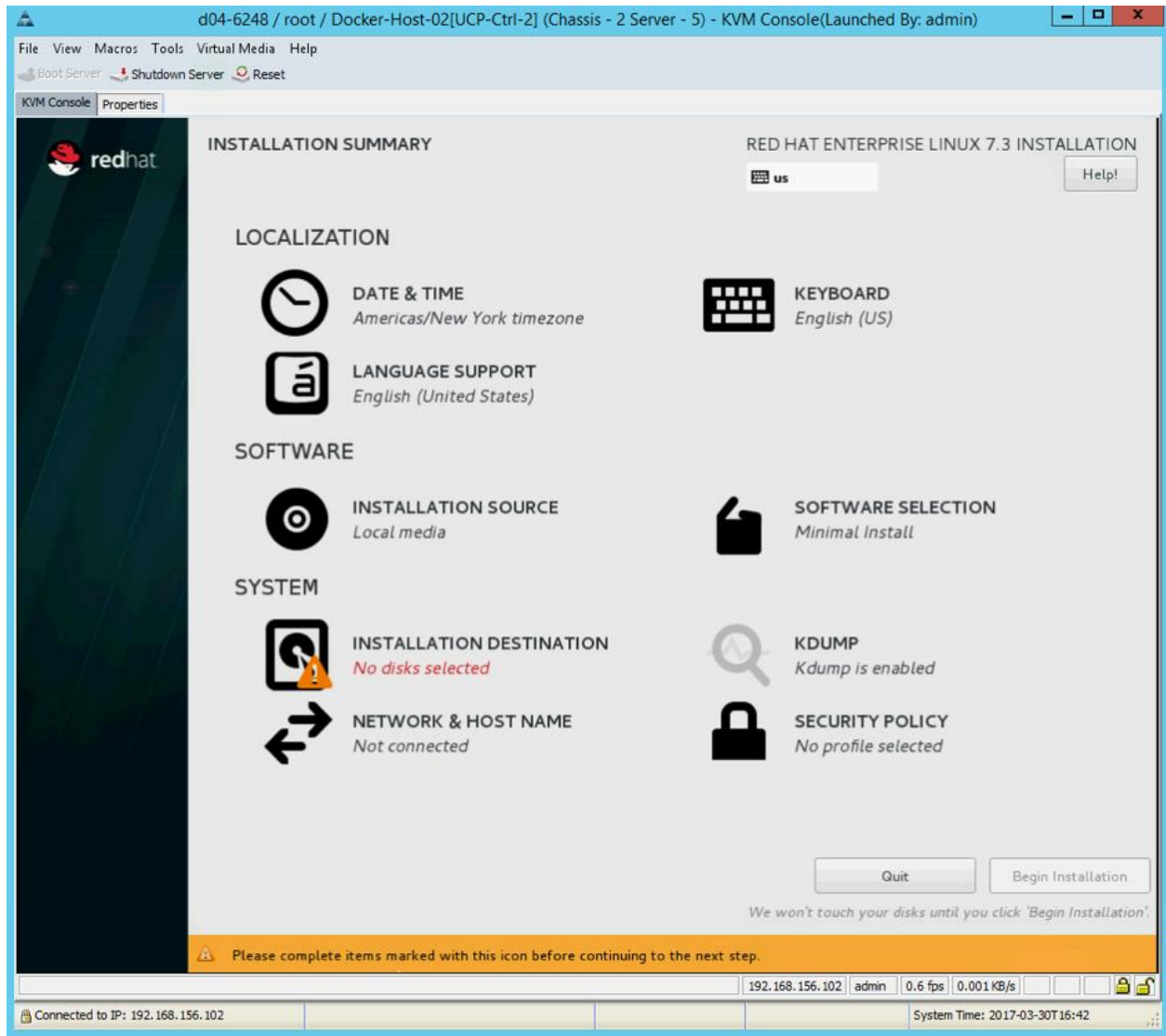

16. Select Server with GUI and check box Java Platform, Network File System Client, Compatibility Libraries, and Development Tools as shown below. Click Done.

Done

us

Help!

Base Environment

- Minimal Install**
Basic functionality.
- Infrastructure Server**
Server for operating network infrastructure services.
- File and Print Server**
File, print, and storage server for enterprises.
- Basic Web Server**
Server for serving static and dynamic internet content.
- Virtualization Host**
Minimal virtualization host.
- Server with GUI**
Server for operating network infrastructure services, with a GUI.

Add-Ons for Selected Environment

- RDMA-based InfiniBand and iWARP fabrics.
- Java Platform**
Java support for the Red Hat Enterprise Linux Server and Desktop Platforms.
- KDE**
The KDE Plasma Workspaces, a highly-configurable graphical user interface which includes a panel, desktop, system icons and desktop widgets, and many powerful KDE applications.
- Large Systems Performance**
Performance support tools for large systems.
- Load Balancer**
Load balancing support for network traffic.
- Mainframe Access**
Tools for accessing mainframe computing resources.
- MariaDB Database Server**
The MariaDB SQL database server, and associated packages.
- Network File System Client**
Enables the system to attach to network storage.
- Performance Tools**
Tools for diagnosing system and application-level performance problems.
- PostgreSQL Database Server**
The PostgreSQL SQL database server, and associated packages.
- Print Server**
Allows the system to act as a print server.
- Remote Management for Linux**
Remote management interface for Red Hat Enterprise Linux, including OpenLMI and SNMP.
- Virtualization Client**

Done

us

Help!

Base Environment

- Minimal Install**
Basic functionality.
- Infrastructure Server**
Server for operating network infrastructure services.
- File and Print Server**
File, print, and storage server for enterprises.
- Basic Web Server**
Server for serving static and dynamic internet content.
- Virtualization Host**
Minimal virtualization host.
- Server with GUI**
Server for operating network infrastructure services, with a GUI.

Add-Ons for Selected Environment

- MySQL Database Server**
The MariaDB SQL database server, and associated packages.
- Network File System Client**
Enables the system to attach to network storage.
- Performance Tools**
Tools for diagnosing system and application-level performance problems.
- PostgreSQL Database Server**
The PostgreSQL SQL database server, and associated packages.
- Print Server**
Allows the system to act as a print server.
- Remote Management for Linux**
Remote management interface for Red Hat Enterprise Linux, including OpenLMI and SNMP.
- Virtualization Client**
Clients for installing and managing virtualization instances.
- Virtualization Hypervisor**
Smallest possible virtualization host installation.
- Virtualization Tools**
Tools for offline virtual image management.
- Compatibility Libraries**
Compatibility libraries for applications built on previous versions of Red Hat Enterprise Linux.
- Development Tools**
A basic development environment.
- Security Tools**
Security tools for integrity and trust verification.
- Smart Card Support**
Support for using smart card authentication.

17. Click INSTALLATION DESTINATION.

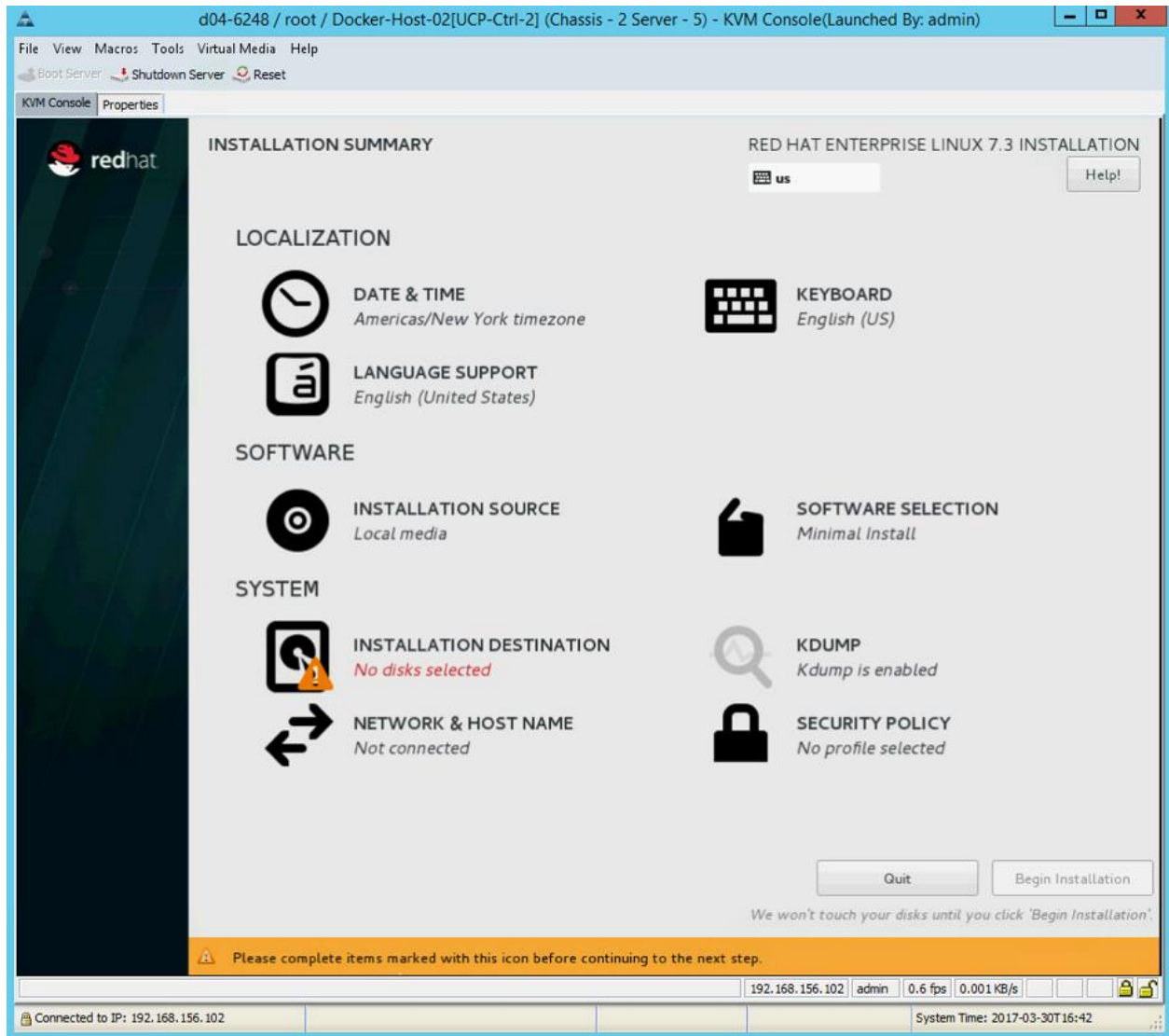

18. Under Specialized & Network Disks, select Add a disk.

19. Click Multipath Devices on INSTALLATION DESTINATION screen. Select 60 GiB LUN as shown. Click Done.

Done

us

Help!

Search **Multipath Devices** Other SAN Devices

Filter By: None

WWID	Capacity	Vendor	Interconnect	Paths
<input checked="" type="checkbox"/> 36:00:a0:98:03:83:03:44:a3:32:b4:97:95:46:57:23:1	60 GiB	NETAPP		sda sdc sde sdg
<input type="checkbox"/> 36:00:a0:98:03:83:03:44:a5:83:f4:97:17:85:83:46:5	300.04 GiB	NETAPP		sdb sdd sdf sdh

Add iSCSI Target... Add FCoE SAN... Refresh List

[1 storage device selected](#)

20. Click Done on device selection for installation destination.

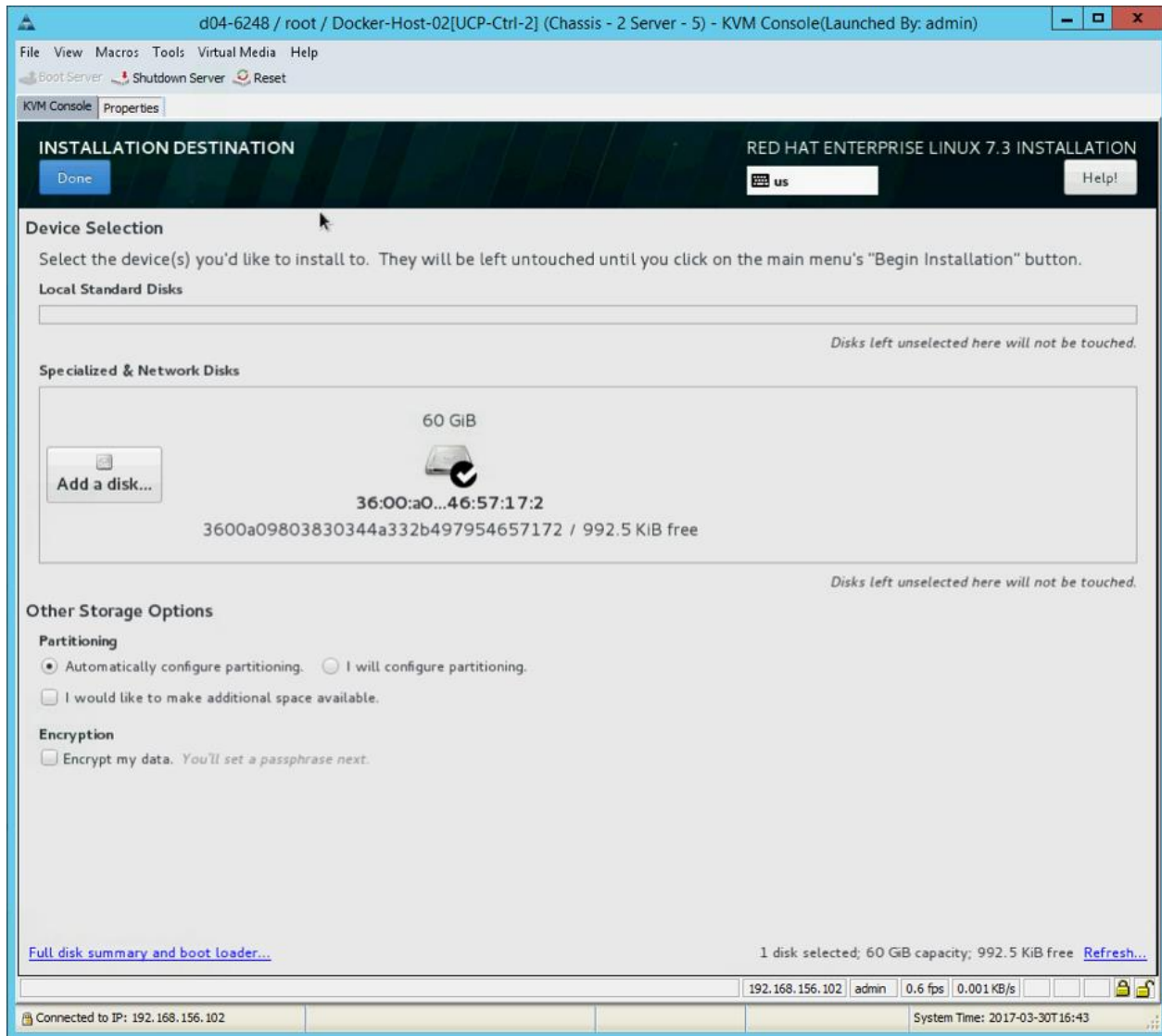

21. Click NETWORK & HOSTNAME. Select the Ethernet interface eno1 and enter the host name (for example, UCP-Ctrl-1.vikings.cisco.com). Click Configure. Enter an MTU of 1500. Select the IPv4 Settings tab, then the Manual Method. Click Add and enter the IPv4 address, subnet mask, gateway, DNS server IP, and the Search domain. Click Save. On the upper right, turn the connection on.

d04-6248 / root / Docker-Host-02[UCP-Ctrl-2] (Chassis - 2 Server - 5) - KVM Console(Launched By: admin)

File View Macros Tools Virtual Media Help

Boot Server Shutdown Server Reset

KVM Console Properties

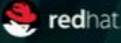



INSTALLATION SUMMARY

RED HAT ENTERPRISE LINUX 7.3 INSTALLATION

us Help!

LOCALIZATION

 **DATE & TIME**
Americas/New York timezone

 **KEYBOARD**
English (US)

 **LANGUAGE SUPPORT**
English (United States)

SOFTWARE

 **INSTALLATION SOURCE**
Local media

 **SOFTWARE SELECTION**
Minimal install

SYSTEM

 **INSTALLATION DESTINATION**
No disks selected

 **KDUMP**
Kdump is enabled

 **NETWORK & HOST NAME**
Not connected

 **SECURITY POLICY**
No profile selected

Quit Begin Installation

We won't touch your disks until you click 'Begin Installation'.

 Please complete items marked with this icon before continuing to the next step.

192.168.156.102 | admin | 0.6 fps | 0.001 KB/s

Connected to IP: 192.168.156.102 | System Time: 2017-03-30T16:42

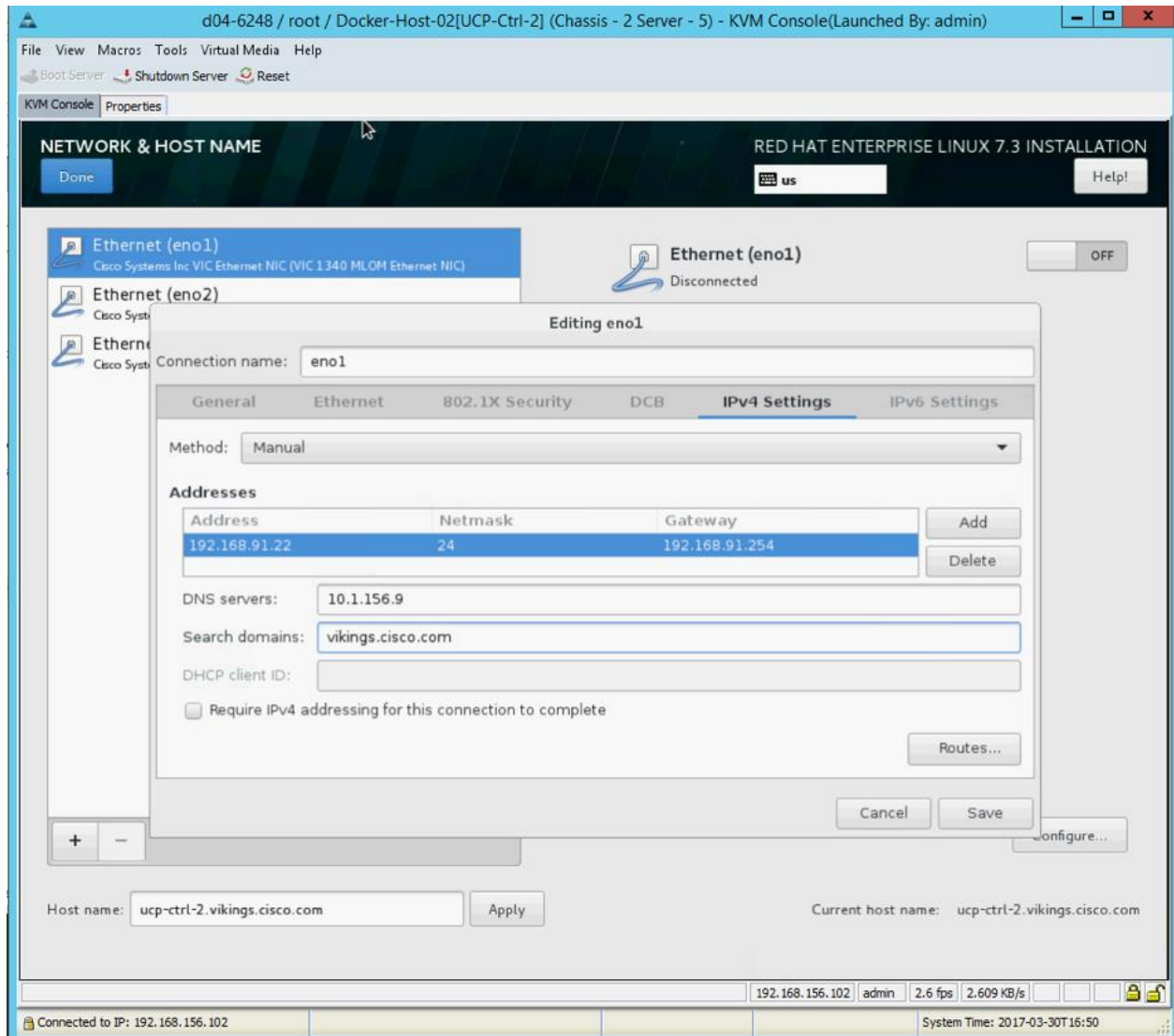

22. Click Done. And click Begin Installation.

23. While the installation is in progress, click Root Password to assert a password and then click User Creation to set user credentials. Click Done.

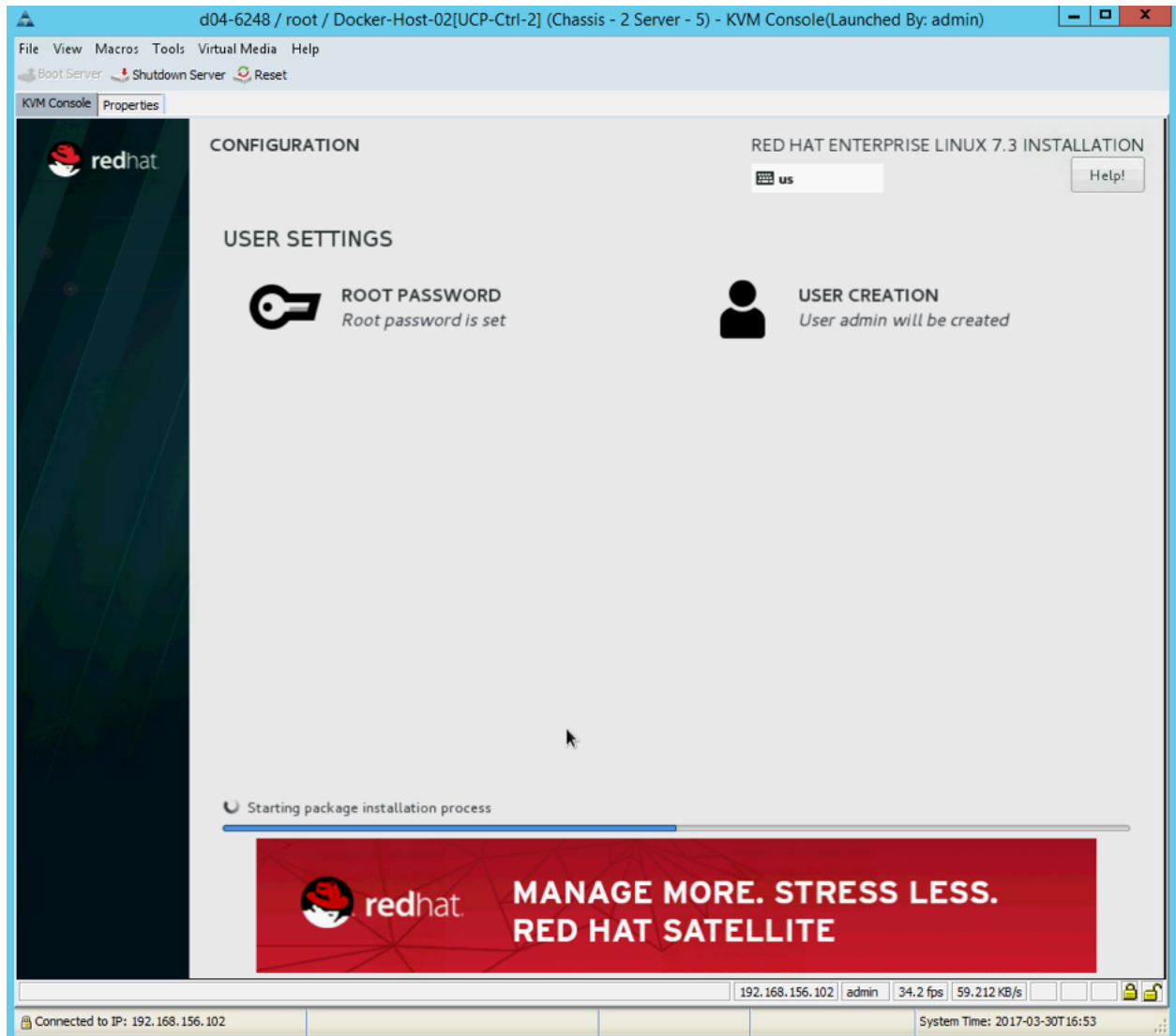

24. Once the installation is complete, upon prompting click Reboot.

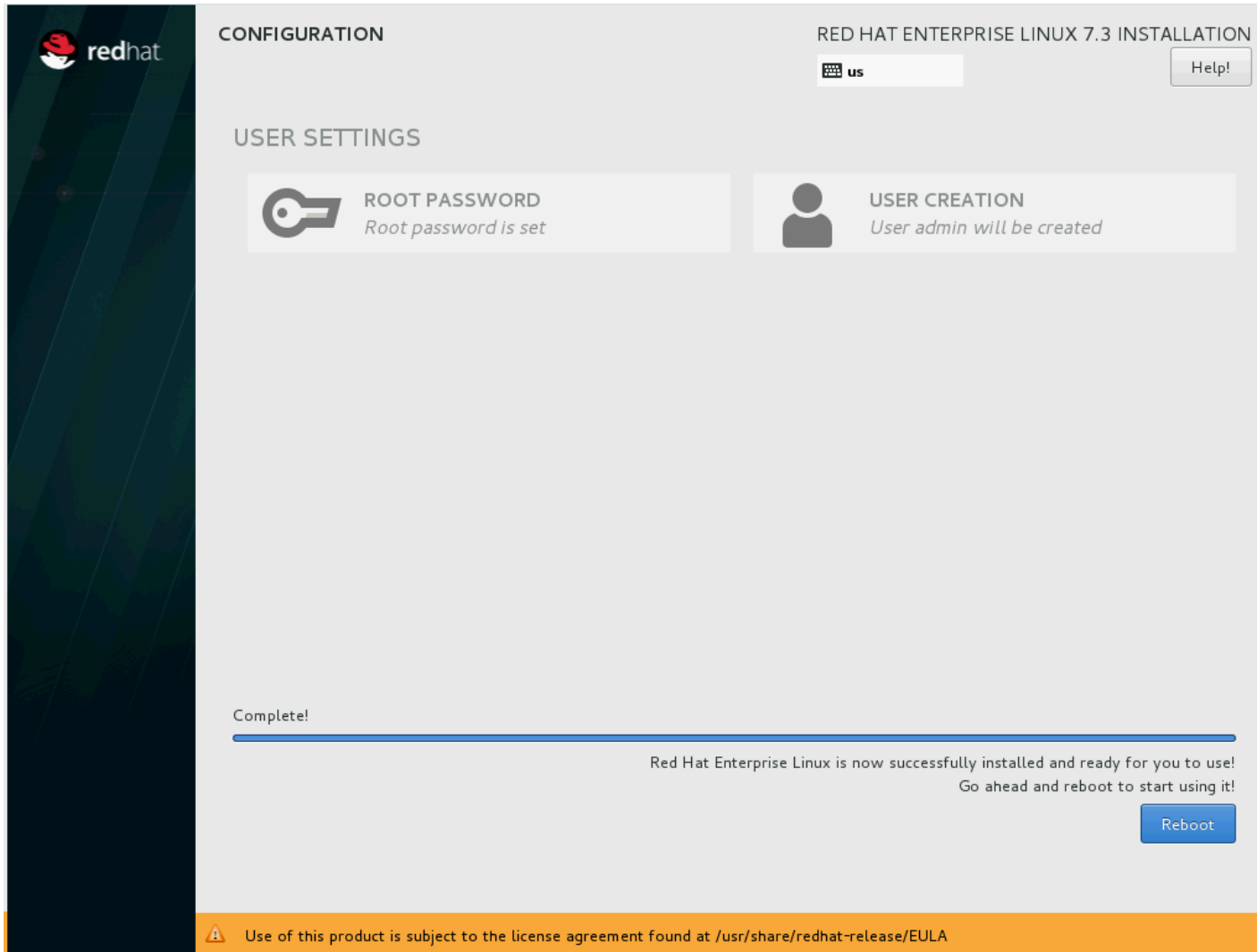

After the reboot, verify that interfaces are up and IP addresses are configured by running `# cat /etc/sysconfig/network-scripts/ifcfg-eno1`. If not configured, configure it either in RHEL GUI or via CLI in `/etc/sysconfig/network-scripts/ifcfg-eno1`

Docker Enterprise Edition Installation

Docker EE is a software subscription that includes 3 products:

- Docker EE (Basic)
- Docker Trusted Registry
- Docker Universal Control Plane

Both Docker UCP and DTR can be installed on-premises or on cloud as part of the installation of Docker EE on Cisco UCS blades running on a bare metal operating system. Operating system does not need any additional libraries or software stack. RHEL OS is sufficient to start and all the required software bits get installed as part of Docker Engine installation.

There are mainly 3 steps to bring up the entire DDC on a cluster of bare metal hosts. We are required to install OS followed by Docker Enterprise Edition. Support matrix for Docker EE includes RHEL 7.3 release. We have used the same in this solution.



We have used root login for the entire workflow for Docker EE platform bring-up. This can also be done using 'sudo'.

Complete Host Networking Setup

1. The network devices and IP network need to be setup on each Docker host. This can be done from the KVM console or from an ssh session as root, provided that the eno1 network interface was set up correctly during setup. Each node was equipped with three Cisco UCS virtual network interfaces (vNICs) in the UCS Service profile. The three vNICs are eno1, eno2, and eno3. Eno1 is connected to the Docker management network and is configured on Fabric A in the UCS with failover. Eno2 and eno3 are configured on Fabric A and Fabric B respectively and do not have failover configured. These interfaces are bonded to the bond0 interface. Bond0 uses adaptive load balancing (ALB) for non-switch aware link aggregation.
2. Log into each Docker host and setup up network configuration files in /etc/sysconfig/network-scripts for bond0 (the bonded Docker Management NFS interface), bond0.<cntr-tnt-a-nfs-vlan-id> (the VLAN interface for the first Tenant's NFS), eno1, eno2, and eno3. It is important to add the hardware address (MAC) to the eno1, eno2, and eno3 interface files. The MAC address can be obtained with the "ifconfig -a" command. Note also that bond0, bond0.<cntr-tnt-a-nfs-vlan-id>, eno2, and eno3 are configured with Jumbo frames (MTU 9000). Sample network files are shown below:

```
[root@ucp-ctrl-1 /]# ifconfig -a
eno1: flags=4163<UP,BROADCAST,RUNNING,MULTICAST> mtu 1500
    inet 192.168.91.21 netmask 255.255.255.0 broadcast 192.168.91.255
    inet6 fe80::1d27:1769:aeb2:7dfb prefixlen 64 scopeid 0x20<link>
    ether 00:25:b5:48:0a:0a txqueuelen 1000 (Ethernet)
    RX packets 578 bytes 56248 (54.9 KiB)
    RX errors 0 dropped 52 overruns 0 frame 0
    TX packets 143 bytes 19216 (18.7 KiB)
    TX errors 0 dropped 0 overruns 0 carrier 0 collisions 0

eno2: flags=4163<UP,BROADCAST,RUNNING,MULTICAST> mtu 9000
    ether 00:25:b5:48:0a:19 txqueuelen 1000 (Ethernet)
    RX packets 31 bytes 8369 (8.1 KiB)
    RX errors 0 dropped 27 overruns 0 frame 0
    TX packets 0 bytes 0 (0.0 B)
    TX errors 0 dropped 0 overruns 0 carrier 0 collisions 0

eno3: flags=4163<UP,BROADCAST,RUNNING,MULTICAST> mtu 9000
    ether 00:25:b5:48:0b:0f txqueuelen 1000 (Ethernet)
    RX packets 31 bytes 8369 (8.1 KiB)
    RX errors 0 dropped 27 overruns 0 frame 0
    TX packets 0 bytes 0 (0.0 B)
    TX errors 0 dropped 0 overruns 0 carrier 0 collisions 0

lo: flags=73<UP,LOOPBACK,RUNNING> mtu 65536
    inet 127.0.0.1 netmask 255.0.0.0
    inet6 ::1 prefixlen 128 scopeid 0x10<host>
    loop txqueuelen 1 (Local Loopback)
    RX packets 4 bytes 340 (340.0 B)
    RX errors 0 dropped 0 overruns 0 frame 0
    TX packets 4 bytes 340 (340.0 B)
    TX errors 0 dropped 0 overruns 0 carrier 0 collisions 0

[root@ucp-ctrl-1 /]# cat /etc/sysconfig/network-scripts/ifcfg-eno1
```

```
HWADDR="00:25:b5:48:0a:0a"
TYPE="Ethernet"
BOOTPROTO="none"
DEFROUTE="yes"
IPV4_FAILURE_FATAL="no"
IPV6INIT="no"
IPV6_AUTOCONF="yes"
IPV6_DEFROUTE="yes"
IPV6_FAILURE_FATAL="no"
IPV6_ADDR_GEN_MODE="stable-privacy"
NAME="eno1"
DEVICE="eno1"
ONBOOT="yes"
MTU="1500"
IPADDR="192.168.91.21"
PREFIX="24"
GATEWAY="192.168.91.254"
DNS1="10.1.156.9"
DOMAIN="vikings.cisco.com"
IPV6_PEERDNS="yes"
IPV6_PEERROUTES="yes"
IPV6_PRIVACY="no"
USERCTL="no"
NM_CONTROLLED="no"

[root@ucp-ctrl-1 /]# cat /etc/sysconfig/network-scripts/ifcfg-bond0
DEVICE="bond0"
NAME="bond0"
TYPE="bond"
BONDING_MASTER="yes"
BONDING_OPTS="mode=6 miimon=100"
USERCTL="no"
NM_CONTROLLED="no"
BOOTPROTO="none"
ONBOOT="yes"
IPADDR="192.168.92.21"
PREFIX="24"
IPV4_FAILURE_FATAL="no"
IPV6INIT="no"
MTU="9000"

[root@ucp-ctrl-1 /]# cat /etc/sysconfig/network-scripts/ifcfg-eno2
HWADDR="00:25:b5:48:0a:19"
DEVICE="eno2"
NAME="bond0-slave"
MASTER="bond0"
TYPE="Ethernet"
BOOTPROTO="none"
ONBOOT="yes"
NM_CONTROLLED="no"
SLAVE="yes"
MTU="9000"

[root@ucp-ctrl-1 /]# cat /etc/sysconfig/network-scripts/ifcfg-eno3
HWADDR="00:25:b5:48:0b:0f"
DEVICE="eno3"
NAME="bond0-slave"
MASTER="bond0"
TYPE="Ethernet"
BOOTPROTO="none"
ONBOOT="yes"
NM_CONTROLLED="no"
SLAVE="yes"
MTU="9000"

[root@ucp-ctrl-1 ~]# cat /etc/sysconfig/network-scripts/ifcfg-bond0.903
DEVICE="bond0.903"
BOOTPROTO="none"
ONPARENT="yes"
IPADDR="192.168.93.21"
PREFIX="24"
NETWORK="192.168.93.0"
VLAN="yes"
MTU="9000"
```

```
NM_CONTROLLED="no"
```

3. After the node networking files have been configured on each node, restart networking on the node:

```
service network restart
```

4. Verify that networking, including the bond0 interface is up and running:

```
[root@ucp-ctrl-1 /]# ifconfig -a
bond0: flags=5187<UP,BROADCAST,RUNNING,MASTER,MULTICAST> mtu 9000
    inet 192.168.92.21 netmask 255.255.255.0 broadcast 192.168.92.255
    inet6 fe80::225:b5ff:fe48:a19 prefixlen 64 scopeid 0x20<link>
    ether 00:25:b5:48:0a:19 txqueuelen 1000 (Ethernet)
    RX packets 1231 bytes 301590 (294.5 KiB)
    RX errors 0 dropped 285 overruns 0 frame 0
    TX packets 34128 bytes 2257106 (2.1 MiB)
    TX errors 0 dropped 0 overruns 0 carrier 0 collisions 0

bond0.903: flags=4163<UP,BROADCAST,RUNNING,MULTICAST> mtu 9000
    inet 192.168.93.21 netmask 255.255.255.0 broadcast 192.168.93.255
    inet6 fe80::225:b5ff:fe48:a19 prefixlen 64 scopeid 0x20<link>
    ether 00:25:b5:48:0a:19 txqueuelen 1000 (Ethernet)
    RX packets 43 bytes 7492 (7.3 KiB)
    RX errors 0 dropped 1 overruns 0 frame 0
    TX packets 25 bytes 3703 (3.6 KiB)
    TX errors 0 dropped 0 overruns 0 carrier 0 collisions 0

eno1: flags=4163<UP,BROADCAST,RUNNING,MULTICAST> mtu 1500
    inet 192.168.91.21 netmask 255.255.255.0 broadcast 192.168.91.255
    inet6 fe80::225:b5ff:fe48:a0a prefixlen 64 scopeid 0x20<link>
    ether 00:25:b5:48:0a:0a txqueuelen 1000 (Ethernet)
    RX packets 435014 bytes 36191755 (34.5 MiB)
    RX errors 0 dropped 580 overruns 0 frame 0
    TX packets 428348 bytes 28919792 (27.5 MiB)
    TX errors 0 dropped 0 overruns 0 carrier 0 collisions 0

eno2: flags=6211<UP,BROADCAST,RUNNING,SLAVE,MULTICAST> mtu 9000
    ether 00:25:b5:48:0a:19 txqueuelen 1000 (Ethernet)
    RX packets 615 bytes 151372 (147.8 KiB)
    RX errors 0 dropped 7 overruns 0 frame 0
    TX packets 17073 bytes 1129229 (1.0 MiB)
    TX errors 0 dropped 0 overruns 0 carrier 0 collisions 0

eno3: flags=6211<UP,BROADCAST,RUNNING,SLAVE,MULTICAST> mtu 9000
    ether 00:25:b5:48:0b:0f txqueuelen 1000 (Ethernet)
    RX packets 616 bytes 150338 (146.8 KiB)
    RX errors 0 dropped 8 overruns 0 frame 0
    TX packets 17055 bytes 1127877 (1.0 MiB)
    TX errors 0 dropped 0 overruns 0 carrier 0 collisions 0

lo: flags=73<UP,LOOPBACK,RUNNING> mtu 65536
    inet 127.0.0.1 netmask 255.0.0.0
    inet6 ::1 prefixlen 128 scopeid 0x10<host>
    loop txqueuelen 1 (Local Loopback)
    RX packets 331 bytes 181776 (177.5 KiB)
    RX errors 0 dropped 0 overruns 0 frame 0
    TX packets 331 bytes 181776 (177.5 KiB)
    TX errors 0 dropped 0 overruns 0 carrier 0 collisions 0
```



The virbr0 and virbr0-nic interfaces were present but were not shown in these illustrations.

Registering Nodes and Updating Host OS

1. After the first reboot of the nodes we need to subscribe the nodes to Red Hat Subscription Manager (RHSM) for getting the latest operating system software updates. This step requires a valid subscription license with Red Hat. These steps are to be performed on all the cluster nodes.

```
# subscription-manager register
```

2. Attach nodes to Red Hat Enterprise Linux Server product pool. You can also find the pools containing the required channels.

```
# subscription-manager list --available  
# subscription-manager attach --pool=<pool_id>
```

3. Set the RHEL release to 7.3 and verify it. All available releases can be found by running the following commands.

```
# subscription-manager release --list  
# subscription-manager release --set=7.3  
# subscription-manager release --show
```



In order to fix the updates of the operating system software to 7.3 release, we need to configure subscription-manager release set to 7.3, as noted above.

4. Disable all the software repos that gets attached automatically as part of system subscription. We need to enable only a specific set of repos for the stack by running the following:

```
# subscription-manager repos --disable=*  
# subscription-manager repos --enable rhel-7-server-rpms -enable rhel-7-server-optional-rpms -enable rhel-7-server-extras-rpms
```

5. Perform yum update on all the nodes:

```
# yum update -y
```

6. Reboot all the nodes.

Installing and Configuring Ansible

In order to speed up post installation tasks on a cluster consisting of 10 nodes, we have used an open source automation tool called Ansible. This powerful tool needs very few steps to configure nodes and get up and running. **This tool is not based on a 'server-client' model for executing automated tasks. Ansible tool can be installed through EPEL (Extra Packages for Enterprise Linux) repos.**

Ansible does not require a build host, any host with in a group of hosts subjected for post install configuration can take a role of Ansible controller node. Ansible controller node does not require any additional software or packages. It's the node from where we run Ansible commands/playbook for automated configuration of all the nodes including the controller nodes itself. Note that the controller node is also part of Docker EE. Steps to install and configure Ansible are listed below:

1. Generate and populate ssh key of the Ansible controller node to itself and rest of the nodes in the cluster. This is required for password-less ssh login to all the nodes in order to execute configuration tasks.

```
# ssh-keygen
```

```
[root@ucp-ctrl-1 ~]# ssh-keygen
Generating public/private rsa key pair.
Enter file in which to save the key (/root/.ssh/id_rsa):
Enter passphrase (empty for no passphrase):
Enter same passphrase again:
Your identification has been saved in /root/.ssh/id_rsa.
Your public key has been saved in /root/.ssh/id_rsa.pub.
The key fingerprint is:
0b:0a:21:b7:86:c2:7c:00:fc:89:59:9f:90:76:4e:d0 root@ucp-ctrl-1.vikings.cisco.co
m
The key's randomart image is:
+--[ RSA 2048 ]-----+
|o .+                |
|.. = E              |
|..O B .             |
|o*.,= +            |
|oo+. . S           |
|.... . . .         |
| . .                |
|                    |
+-----+

```

- Using 'ssh-copy-id' copy key is generated to all the nodes including control node:

```
# ssh-copy-id root@UCP-Ctrl-1
```

```
[root@UCP-Ctrl-1 ~]# ssh-copy-id root@UCP-Ctrl-1
The authenticity of host 'ucp-ctrl-1 (10.65.122.61)' can't be established.
ECDSA key fingerprint is 98:11:14:1c:5c:e2:93:fb:23:e9:d5:6f:5f:0b:2a:a1.
Are you sure you want to continue connecting (yes/no)? yes
/usr/bin/ssh-copy-id: INFO: attempting to log in with the new key(s), to filter out any that are already installed
/usr/bin/ssh-copy-id: INFO: 1 key(s) remain to be installed -- if you are prompted now it is to install the new keys
root@ucp-ctrl-1's password:

Number of key(s) added: 1

```

Now try logging into the machine, with: "ssh 'root@UCP-Ctrl-1'"
and check to make sure that only the key(s) you wanted were added.

```
[root@UCP-Ctrl-1 ~]# ssh-copy-id root@UCP-Ctrl-2
The authenticity of host 'ucp-ctrl-2 (10.65.122.62)' can't be established.
ECDSA key fingerprint is d5:5b:30:59:84:37:06:56:ab:1a:b3:9a:d7:74:85:62.
Are you sure you want to continue connecting (yes/no)? yes
/usr/bin/ssh-copy-id: INFO: attempting to log in with the new key(s), to filter out any that are already installed
/usr/bin/ssh-copy-id: INFO: 1 key(s) remain to be installed -- if you are prompted now it is to install the new keys
root@ucp-ctrl-2's password:

Number of key(s) added: 1

```

Now try logging into the machine, with: "ssh 'root@UCP-Ctrl-2'"
and check to make sure that only the key(s) you wanted were added.

```
[root@UCP-Ctrl-1 ~]# ssh-copy-id root@UCP-Ctrl-3
The authenticity of host 'ucp-ctrl-3 (10.65.122.63)' can't be established.
ECDSA key fingerprint is bc:00:dd:ac:72:22:30:fd:9b:46:12:9d:02:f5:14:44.
Are you sure you want to continue connecting (yes/no)? yes
/usr/bin/ssh-copy-id: INFO: attempting to log in with the new key(s), to filter out any that are already installed
/usr/bin/ssh-copy-id: INFO: 1 key(s) remain to be installed -- if you are prompted now it is to install the new keys
root@ucp-ctrl-3's password:

Number of key(s) added: 1

```

Now try logging into the machine, with: "ssh 'root@UCP-Ctrl-3'"
and check to make sure that only the key(s) you wanted were added.

- Install epel rpm, for which we have to download latest the 'epel' rpm for attaching epel repos to all the cluster nodes:

```
[root@UCP-Ctrl-1 ~]# ls -ltr
total 24
-rw-----. 1 root root 1852 Nov 18 12:46 anaconda-ks.cfg
-rw-----. 1 root root 1945 Nov 18 13:34 initial-setup-ks.cfg
-rw-r--r--. 1 root root 14612 Nov 19 22:51 epel-release-latest-7.noarch.rpm
[root@UCP-Ctrl-1 ~]# rpm -ivh epel-release-latest-7.noarch.rpm
warning: epel-release-latest-7.noarch.rpm: Header V3 RSA/SHA256 Signature, key ID 352c64e5: NOKEY
Preparing... ##### [100%]
Updating / installing...
 1:epel-release-7-8 ##### [100%]
[root@UCP-Ctrl-1 ~]#
```

```
# wget https://dl.fedoraproject.org/pub/epel/epel-release-latest-7.noarch.rpm
```



epel rpm can be downloaded from - <https://fedoraproject.org/wiki/EPEL>

4. Copy the rpms on the remaining nodes and install:

```
# for i in 22 23 24 25 26 27 28 29 30;do echo 192.168.91.$i;scp epel-release-latest-7.noarch.rpm 192.168.91.$i:/root;done
```

```
[root@ucp-ctrl-1 ~]# for i in 22 23 24 25 26 27 28 29 30;do echo 192.168.91.$i;scp epel-release-latest-7.noarch.rpm 192.168.91.$i:/root;done
192.168.91.22
epel-release-latest-7.noarch.rpm 100% 14KB 14.4KB/s 00:00
192.168.91.23
epel-release-latest-7.noarch.rpm 100% 14KB 14.4KB/s 00:00
192.168.91.24
epel-release-latest-7.noarch.rpm 100% 14KB 14.4KB/s 00:00
192.168.91.25
epel-release-latest-7.noarch.rpm 100% 14KB 14.4KB/s 00:00
192.168.91.26
epel-release-latest-7.noarch.rpm 100% 14KB 14.4KB/s 00:00
192.168.91.27
epel-release-latest-7.noarch.rpm 100% 14KB 14.4KB/s 00:00
192.168.91.28
epel-release-latest-7.noarch.rpm 100% 14KB 14.4KB/s 00:00
192.168.91.29
epel-release-latest-7.noarch.rpm 100% 14KB 14.4KB/s 00:00
192.168.91.30
epel-release-latest-7.noarch.rpm 100% 14KB 14.4KB/s 00:00
[root@ucp-ctrl-1 ~]#
```

5. Check for the available Ansible version, we have used version 2.2:

```
# rpm -i epel-release-latest-7.noarch.rpm
# yum info ansible
```



```

Available Packages
Name      : ansible
Arch     : noarch
Version  : 2.2.1.0
Release  : 1.el7
Size     : 4.6 M
Repo     : epel/x86_64
Summary  : SSH-based configuration management, deployment, and task execution system
URL      : http://ansible.com
License  : GPLv3+
Description :
: Ansible is a radically simple model-driven configuration management,
: multi-node deployment, and remote task execution system. Ansible works
: over SSH and does not require any software or daemons to be installed
: on remote nodes. Extension modules can be written in any language and
: are transferred to managed machines automatically.

[root@ucp-ctrl-1 ~]#

```

6. Install Ansible using yum on all the nodes as below:

```
# yum install -y ansible
```

7. If the nodes does not have FQDN as hostname, we will have to update the '/etc/hosts' file with all cluster node entries:



If the host name is added in DNS server, this step can be skipped. Try pinging server using their hostname to verify

```

[root@UCP-Ctrl-1 ~]# cat /etc/hosts
127.0.0.1 localhost localhost.localdomain localhost4 localhost4.localdomain4
::1 localhost localhost.localdomain localhost6 localhost6.localdomain6
10.65.122.61 UCP-Ctrl-1.cisco.com UCP-Ctrl-1
10.65.122.62 UCP-Ctrl-2.cisco.com UCP-Ctrl-2
10.65.122.63 UCP-Ctrl-3.cisco.com UCP-Ctrl-3
10.65.122.64 DDC-DTR-1.cisco.com DDC-DTR-1
10.65.122.65 DDC-DTR-2.cisco.com DDC-DTR-2
10.65.122.66 DDC-DTR-3.cisco.com DDC-DTR-3
10.65.122.67 UCP-Node-1.cisco.com UCP-Node-1
10.65.122.68 UCP-Node-2.cisco.com UCP-Node-2
10.65.122.69 UCP-Node-3.cisco.com UCP-Node-3
10.65.122.70 UCP-Node-4.cisco.com UCP-Node-4

```

8. Ansible relies on the concept of host groups, all the configuration tasks are targeted to specific group of hosts. Since all our nodes are similar in nature for software stack deployment, we created a single host group 'Docker', 'UCP', 'DTR', and 'NODE' as shown below:

```
# cat /etc/ansible/hosts | grep -A 23 Docker
```

```
[root@ucp-ctrl-1 ~]# cat /etc/ansible/hosts | grep -A 23 Docker
[Docker]
ucp-ctrl-2
ucp-ctrl-3
ddc-dtr-1
ddc-dtr-2
ddc-dtr-3
ucp-node-1
ucp-node-2
ucp-node-3
ucp-node-4
ucp-ctrl-1
[UCP]
ucp-ctrl-2
ucp-ctrl-3
ucp-ctrl-1
[DTR]
ddc-dtr-1
ddc-dtr-2
ddc-dtr-3
[NODE]
ucp-node-1
ucp-node-2
ucp-node-3
ucp-node-4
[root@ucp-ctrl-1 ~]# █
```



Note that in the Docker and UCP groups that ucp-ctrl-1 is listed last. This is done because most Ansible tasks are run from this node and it can run the commands on all the other nodes before running them on that node.

To run the other tasks specific to DTR nodes we created a host group for DTR nodes, as shown above.

1. Verify Ansible is configured correctly on all the nodes by using it's ICMP module, we can check if the nodes are reachable:

```
# ansible Docker -m "ping"
```

```
[root@ucp-ctrl-1 ~]# ansible Docker -m "ping"
ucp-ctrl-1 | SUCCESS => {
  "changed": false,
  "ping": "pong"
}
ucp-ctrl-2 | SUCCESS => {
  "changed": false,
  "ping": "pong"
}
ddc-dtr-1 | SUCCESS => {
  "changed": false,
  "ping": "pong"
}
```

2. Populate the /etc/hosts file on the remaining nodes from controller node:

```
# ansible Docker -m copy -a "src=/etc/hosts dest=/etc/hosts"
```

```
[root@UCP-Ctrl-1 ~]# ansible Docker -m copy -a "src=/etc/hosts dest=/etc/hosts"
UCP-Ctrl-1 | SUCCESS => {
  "changed": false,
  "checksum": "6e8aebbfble06d09dfd48fe448ee89a994f530cc",
  "dest": "/etc/hosts",
  "gid": 0,
  "group": "root",
  "mode": "0644",
  "owner": "root",
  "path": "/etc/hosts",
  "secontext": "system_u:object_r:net_conf_t:s0",
  "size": 602,
  "state": "file",
  "uid": 0
}
DDC-DTR-2 | SUCCESS => {
  "changed": true,
  "checksum": "6e8aebbfble06d09dfd48fe448ee89a994f530cc",
  "dest": "/etc/hosts",
  "gid": 0,
  "group": "root",
  "md5sum": "a68470d659f0952a7fe599b2990b2e23",
  "mode": "0644",
  "owner": "root",
  "secontext": "system_u:object_r:net_conf_t:s0",
  "size": 602,
  "src": "/root/.ansible/tmp/ansible-tmp-1479577631.2-119323327479829/source",
  "state": "file",
  "uid": 0
}
UCP-Ctrl-2 | SUCCESS => {
  "changed": true,
  "checksum": "6e8aebbfble06d09dfd48fe448ee89a994f530cc",
  "dest": "/etc/hosts",
  "gid": 0,
  "group": "root",
  "md5sum": "a68470d659f0952a7fe599b2990b2e23",
  "mode": "0644",
  "owner": "root",
  "secontext": "system_u:object_r:net_conf_t:s0",
  "size": 602,
  "src": "/root/.ansible/tmp/ansible-tmp-1479577631.2-253037475841184/source",
  "state": "file",
  "uid": 0
}
```

Installing NTP & Configuring Host OS System Clocks

1. Docker EE requires nodes participating in the cluster have their system time to be in sync with external source. We do this by installing NTP services and configuring it to remain in sync with the system time:

```
# ansible Docker -m yum -a "name=ntp state=present"
```



```
[root@UCP-Ctrl-1 ~]# ansible Docker -a "/usr/sbin/ntpdate -q 10.1.156.4"
UCP-Ctrl-2 | SUCCESS | rc=0 >>
server 10.1.156.4, stratum 3, offset -0.000828, delay 0.02600
30 Jan 15:31:53 ntpdate[50702]: adjust time server 10.1.156.4 offset -0.000828 sec

UCP-Ctrl-3 | SUCCESS | rc=0 >>
server 10.1.156.4, stratum 3, offset -13.126177, delay 0.02596
30 Jan 15:32:06 ntpdate[48405]: step time server 10.1.156.4 offset -13.126177 sec

UCP-Ctrl-1 | SUCCESS | rc=0 >>
server 10.1.156.4, stratum 3, offset -0.000718, delay 0.02591
30 Jan 15:31:53 ntpdate[51392]: adjust time server 10.1.156.4 offset -0.000718 sec

DDC-DTR-2 | SUCCESS | rc=0 >>
server 10.1.156.4, stratum 3, offset 12.271748, delay 0.02594
30 Jan 15:31:41 ntpdate[50505]: step time server 10.1.156.4 offset 12.271748 sec

DDC-DTR-1 | SUCCESS | rc=0 >>
server 10.1.156.4, stratum 3, offset -0.000814, delay 0.02596
30 Jan 15:31:53 ntpdate[11465]: adjust time server 10.1.156.4 offset -0.000814 sec
```

Installing Cisco Virtual Interface Card (VIC) eNIC (Ethernet Network Interface Card) and fNIC Driver

RHEL 7.3 comes with inbox eNIC and fNIC drivers for the Cisco VIC, but we need to update them to the latest corresponding versions for the UCS Manager release used in the solution. RPMs need to be extracted from the appropriate downloaded Cisco UCS B-Series Server Software bundle from cisco.com.

1. Installing of eNIC and fnic drivers can be done through rpm install and this requires host reboot.
2. Copy the two rpm files to the /tmp directory on UCP Controller 1.
3. Copy the rpm files to all the nodes using Ansible:

```
[root@UCP-Ctrl-1 ~]# ansible Docker -m copy -a "src=/tmp/kmod-enic-2.3.0.30-rhel7u3.el7.x86_64.rpm
dest=/root/kmod-enic-2.3.0.30-rhel7u3.el7.x86_64.rpm"
```

```
[root@UCP-Ctrl-1 ~]# ansible Docker -m copy -a "src=/tmp/kmod-fnic-1.6.0.30-rhel7u3.el7.x86_64.rpm
dest=/root/kmod-fnic-1.6.0.30-rhel7u3.el7.x86_64.rpm"
```

4. Use the yum module to install the eNIC and fnic driver rpm file on all node through Ansible:

```
[root@UCP-Ctrl-1 ~]# ansible Docker -m yum -a "name=/root/kmod-enic-2.3.0.30-rhel7u3.el7.x86_64.rpm
state=present"
```

```
[root@UCP-Ctrl-1 ~]# ansible Docker -m yum -a "name=/root/kmod-fnic-1.6.0.27-rhel7u3.el7.x86_64.rpm
state=present"
```

```

[root@UCP-Ctrl-1 ~]# ansible Docker -m yum -a "name=/root/kmod-enic-2.3.0.30-rhel7u2.el7.x86_64.rpm state=present"
DDC-DTR-1 | SUCCESS => {
  "changed": true,
  "msg": "",
  "rc": 0,
  "results": {
    "loaded plugins: langpacks, product-id, search-disabled-repos, subscription-\n          : manager\nExamining /root/kmod-enic-2.3.0.30-rhel7u2.el7.x86_64.rpm: kmod-enic-2.3.0.30-rhel7u2.el7.x86_64\nMarking /root/kmod-enic-2.3.0.30-rhel7u2.el7.x86_64.rpm to be installed\nResolving Dependencies\n--> Running transaction check\n--> Package kmod-enic.x86_64 0:2.3.0.30-rhel7u2.el7 will be installed\n--> Finished Dependency Resolution\n\nDependencies Resolved\n\n-----\nPackage Arch Version Repository Size\n-----\nInstalling:\n kmod-enic\n x86_64 2.3.0.30-rhel7u2.el7 /kmod-enic-2.3.0.30-rhel7u2.el7.x86_64 3.8 M\n\nTransaction Summary\n-----\n\nInstall 1 Package\n\nTotal size: 3.8 M\nInstalled size: 3.8 M\nDownloading packages:\nRunning transaction check\nRunning transaction test\nTransaction test succeeded\nRunning transaction\n Installing : kmod-enic-2.3.0.30-rhel7u2.el7.x86_64 1/1\n/sbin/dracut: line 640: warning: setlocale: LC_CTYPE: cannot change locale (); No such file or directory\n/sbin/dracut: line 640: warning: setlocale: LC_CTYPE: cannot change locale (); No such file or directory\n/sbin/dracut: line 640: warning: setlocale: LC_CTYPE: cannot change locale (); No such file or directory\n Verifying : kmod-enic-2.3.0.30-rhel7u2.el7.x86_64 1/1\n\nInstalled: \n kmod-enic.x86_64 0:2.3.0.30-rhel7u2.el7\n\nComplete!\n"}
UCP-Ctrl-2 | SUCCESS => {
  "changed": true,
  "msg": "",
  "rc": 0,
  "results": {
    "loaded plugins: langpacks, product-id, search-disabled-repos, subscription-\n          : manager\nExamining /root/kmod-enic-2.3.0.30-rhel7u2.el7.x86_64.rpm: kmod-enic-2.3.0.30-rhel7u2.el7.x86_64\nMarking /root/kmod-enic-2.3.0.30-rhel7u2.el7.x86_64.rpm to be installed\nResolving Dependencies\n--> Running transaction check\n--> Package kmod-enic.x86_64 0:2.3.0.30-rhel7u2.el7 will be installed\n--> Finished Dependency Resolution\n\nDependencies Resolved\n\n-----\nPackage Arch Version Repository Size\n-----\nInstalling:\n kmod-enic\n x86_64 2.3.0.30-rhel7u2.el7 /kmod-enic-2.3.0.30-rhel7u2.el7.x86_64 3.8 M\n\nTransaction Summary\n-----\n\nInstall 1 Package\n\nTotal size: 3.8 M\nInstalled size: 3.8 M\nDownloading packages:\nRunning transaction check\nRunning transaction test\nTransaction test succeeded\nRunning transaction\n Installing : kmod-enic-2.3.0.30-rhel7u2.el7.x86_64 1/1\n/sbin/dracut: line 640: warning: setlocale: LC_CTYPE: cannot change locale (); No such file or directory\n/sbin/dracut: line 640: warning: setlocale: LC_CTYPE: cannot change locale (); No such file or directory\n/sbin/dracut: line 640: warning: setlocale: LC_CTYPE: cannot change locale (); No such file or directory\n Verifying : kmod-enic-2.3.0.30-rhel7u2.el7.x86_64 1/1\n\nInstalled: \n kmod-enic.x86_64 0:2.3.0.30-rhel7u2.el7\n\nComplete!\n"}
UCP-Ctrl-1 | SUCCESS => {
  "changed": true,
  "msg": "",
  "rc": 0,
  "results": {
    "loaded plugins: langpacks, product-id, search-disabled-repos, subscription-\n          : manager\nExamining /root/kmod-enic-2.3.0.30-rhel7u2.el7.x86_64.rpm: kmod-enic-2.3.0.30-rhel7u2.el7.x86_64\nMarking /root/kmod-enic-2.3.0.30-rhel7u2.el7.x86_64.rpm to be installed\nResolving Dependencies\n--> Running transaction check\n--> Package kmod-enic.x86_64 0:2.3.0.30-rhel7u2.el7 will be installed\n--> Finished Dependency Resolution\n\nDependencies Resolved\n\n-----\nPackage Arch Version Repository Size\n-----\nInstalling:\n kmod-enic\n x86_64 2.3.0.30-rhel7u2.el7 /kmod-enic-2.3.0.30-rhel7u2.el7.x86_64 3.8 M\n\nTransaction Summary\n-----\n\nInstall 1 Package\n\nTotal size: 3.8 M\nInstalled size: 3.8 M\nDownloading packages:\nRunning transaction check\nRunning transaction test\nTransaction test succeeded\nRunning transaction\n Installing : kmod-enic-2.3.0.30-rhel7u2.el7.x86_64 1/1\n/sbin/dracut: line 640: warning: setlocale: LC_CTYPE: cannot change locale (); No such file or directory\n/sbin/dracut: line 640: warning: setlocale: LC_CTYPE: cannot change locale (); No such file or directory\n/sbin/dracut: line 640: warning: setlocale: LC_CTYPE: cannot change locale (); No such file or directory\n Verifying : kmod-enic-2.3.0.30-rhel7u2.el7.x86_64 1/1\n\nInstalled: \n kmod-enic.x86_64 0:2.3.0.30-rhel7u2.el7\n\nComplete!\n"}

```

5. Reboot all the nodes after installing the latest enic and fnic drivers:

```
[root@UCP-Ctrl-1 ~]# ansible Docker -a "/usr/sbin/shutdown -r +1"
```

Configuring Host OS Firewall for required ports

Docker EE requires some TCP and UDP ports to be opened to facilitate communication between its container infrastructure services running on cluster nodes. This needs to be done before installing Docker CS Engine and the Docker UCP. **For opening ports on hosts, 'firewall-cmd' is used for configuring 'firewalld-service' as shown below.** For every port type such as TCP and UDP, refer the table below to see the specific ports to be opened and then making them permanent on the host.

Table 20. TCP and UDP ports to be opened on hosts for Docker UCP

Hosts	Direction	Port	Purpose
controllers, nodes	in	TCP 443 (configurable)	Web app and CLI client access to UCP.
controllers, nodes	in	TCP 2375	Heartbeat for nodes, to ensure they are running.
controllers	in	TCP 2376 (configurable)	Swarm manager accepts requests from UCP controller.
controllers, nodes	in, out	TCP + UDP 4789	Overlay networking.
controllers, nodes	in, out	TCP + UDP 7946	Overlay networking.

controllers, nodes	in	TCP 12376	Proxy for TLS, provides access to UCP, Swarm, and Engine.
controller	in	TCP 12379	Internal node configuration, cluster configuration, and HA.
controller	in	TCP 12380	Internal node configuration, cluster configuration, and HA.
controller	in	TCP 12381	Proxy for TLS, provides access to UCP.
controller	in	TCP 12382	Manages TLS and requests from swarm manager.
controller	in	TCP 12383	Used by the authentication storage backend.
controller	in	TCP 12384	Used by authentication storage backend for replication across controllers.
controller	in	TCP 12385	The port where the authentication API is exposed.
controller	in	TCP 12386	Used by the authentication worker.

1. Run the following linux command to open firewall using ansible in all the hosts.

```
[root@UCP-Ctrl-1 ~]# ansible Docker -a "/usr/bin/firewall-cmd --permanent --zone=public --add-port=443/tcp"
[root@UCP-Ctrl-1 ~]# ansible Docker -a "/usr/bin/firewall-cmd --permanent --zone=public --add-port=2375-2376/tcp"
[root@UCP-Ctrl-1 ~]# ansible Docker -a "/usr/bin/firewall-cmd --permanent --zone=public --add-port=4789/udp"
[root@UCP-Ctrl-1 ~]# ansible Docker -a "/usr/bin/firewall-cmd --permanent --zone=public --add-port=4789/tcp"
[root@UCP-Ctrl-1 ~]# ansible Docker -a "/usr/bin/firewall-cmd --permanent --zone=public --add-port=12379-12385/tcp"
# ansible Docker -a "/usr/bin/firewall-cmd --permanent --zone=public --add-port=2377/tcp"
# ansible Docker -a "/usr/bin/firewall-cmd --permanent --zone=public --add-port=7946/tcp"
# ansible Docker -a "/usr/bin/firewall-cmd --permanent --zone=public --add-port=7946/udp"
# ansible Docker -a "/usr/bin/firewall-cmd --permanent --zone=public --add-port=12386/tcp"
# ansible Docker -a "/usr/bin/firewall-cmd --permanent --zone=public --add-port=12387/tcp"
# ansible Docker -a "/usr/bin/firewall-cmd --permanent --zone=public --add-port=12376/tcp"
```

2. Restart the firewall service as below:

```
[root@UCP-Ctrl-1 ~]# ansible Docker -a "/usr/bin/systemctl restart firewalld.service"
```

3. To confirm the list of ports opened run the following command as shown below:

```
[root@UCP-Ctrl-1 ~]# ansible Docker -a "/usr/bin/firewall-cmd --zone=public --list-all"
```

```
[root@UCP-Ctrl-1 ~]#
[root@UCP-Ctrl-1 ~]# ansible Docker -a "/usr/bin/firewall-cmd --zone=public --list-all"
UCP-Ctrl-3 | SUCCESS | rc=0 >>
public (default, active)
  interfaces: bond0 eno1
  sources:
  services: dhcpv6-client ssh
  ports: 443/tcp 4789/udp 12379-12385/tcp 2377/tcp 7946/udp 7946/tcp 4789/tcp 80/tcp 2375-2376/tcp 12386/tcp 12376/tcp
  masquerade: no
  forward-ports:
  icmp-blocks:
  rich rules:
```

Installation of Docker Repo and Docker Engine

Perform following steps to install Docker engine



Docker EE is supported on RHEL 7.2 or 7.3 64 bit.

1. Visit <https://store.docker.com/search?offering=enterprise&type=edition> and click Docker Enterprise Edition for Red Hat Enterprise Linux. Copy the URL to download your Edition.
2. Setup two yum repositories in /etc/yum/vars. Store your EE repository URL in /etc/yum/vars/dockerurl in all the hosts as below using ansible. Replace <DOCKER-EE-URL> with the URL you copied in the above step

```
[root@UCP-Ctrl-1 ~]# ansible Docker -a "sh -c 'echo "<DOCKER-EE-URL>" > /etc/yum/vars/dockerurl'"
```

3. Store your RHEL version in /etc/yum/vars/dockerosversion. Replace the <RHEL VERSION> with appropriate RHEL version string. For example, 7.3 in this case.

```
[root@UCP-Ctrl-1 ~]# ansible Docker -a "sh -c 'echo "<RHEL VERSION>" > /etc/yum/vars/dockerosversion'"
```

4. Install 'yum-utils' package which provides the yum-config-manager utility:

```
[root@UCP-Ctrl-1 ~]# ansible Docker -m yum -a "name=yum-utils state=present"
```

5. Use the following command to add the stable repository. Replace the <DOCKER-EE-URL>

```
[root@UCP-Ctrl-1 ~]# ansible Docker -a "yum-config-manager --add-repo <DOCKER-EE-URL>/docker-ee.repo"
```

6. Update the yum cache

```
[root@UCP-Ctrl-1 ~]# ansible Docker -a "yum makecache fast"
```

7. Install the Docker EE

```
[root@UCP-Ctrl-1 ~]# ansible Docker -a "yum -y install docker-ee"
```

8. Verify that all the nodes have Docker Engine installed successfully

```
[root@UCP-Ctrl-1 ~]# ansible Docker -a "/usr/bin/yum info docker-ee"
```



```
[root@ucp-ctrl-1 ~]# ansible Docker -a "/usr/bin/yum info docker-ee"
ucp-ctrl-3 | SUCCESS | rc=0 >>
Loaded plugins: langpacks, product-id, search-disabled-repos, subscription-
: manager
Installed Packages
Name      : docker-ee
Arch      : x86_64
Version   : 17.03.1.ee.3
Release   : 1.el7.centos
Size      : 65 M
Repo      : installed
From repo : docker-ee-stable-17.03
Summary   : The open-source application container engine
URL       : https://dockerproject.org
License   : ASL 2.0
Description : Docker is an open source project to build, ship and run any
: application as a lightweight container.
:
: Docker containers are both hardware-agnostic and
: platform-agnostic. This means they can run anywhere, from your
: laptop to the largest EC2 compute instance and everything in
: between - and they don't require you to use a particular language,
: framework or packaging system. That makes them great building
: blocks for deploying and scaling web apps, databases, and backend
: services without depending on a particular stack or provider.
```



Do not start the Docker daemon services as yet. We need to configure Docker device-mapper driver in direct LVM-Mode before starting the Docker daemon services.

Configuring Docker CS Engine for Device-Mapper Driver in Direct LVM-Mode

Device Mapper is a kernel-based framework that underpins many advanced volume management **technologies on Linux**. Docker's device-mapper storage driver leverages the thin provisioning and snapshotting capabilities of this framework for image and container management. The preferred configuration for production deployments is direct-lvm. This mode uses block devices to create the thin pool. The following procedure shows you how to configure a Docker host to use the device-mapper storage driver in a direct-lvm configuration.

Each node has 300 GB size LUN getting discovered as /dev/sdb. In this FlexPod environment, with multi-pathing, we have to use the device Id for this purpose.

In each node, perform the following steps:

1. Get the device id by running the following command:

```
[root@UCP-Ctrl-1 ~]# pvs -a
[root@UCP-Ctrl-1 ~]# lsblk
```

2. Create physical volume using the device id as shown in the below example and verify it using pvs -a command.

```
[root@UCP-Ctrl-1 ~]# pvcreate /dev/mapper/3600a09803830344a583f497178583377
```

3. Create a volume group named Docker using physical volume which we previously created:

```
[root@UCP-Ctrl-1 ~]# vgcreate Docker /dev/mapper/3600a09803830344a583f497178583377
```

4. Create a logical volume named thinpool and thinpoolmeta. In this example, the logical data is **95% of the 'Docker' volume group size. Leaving 5% free space allows for auto expanding of either the data or metadata if space runs low.**

```
[root@UCP-Ctrl-1 ~]# ansible Docker -a "/usr/sbin/lvcreate --wipesignatures y -n thinpool Docker -l 95%VG"
[root@UCP-Ctrl-1 ~]# ansible Docker -a "/usr/sbin/lvcreate --wipesignatures y -n thinpoolmeta Docker -l 5%VG"
```

5. Convert the pool to a thinpool:

```
[root@UCP-Ctrl-1 ~]# ansible Docker -a "/usr/sbin/lvconvert -y --zero n -c 512K --thinpool Docker/thinpool -poolmetadata Docker/thinpoolmeta"
```

6. Configure auto-execution of thin pool via lvm profile. **Specify 'thin_pool_autoextend_threshold' value. The value should be the percentage of space used before lvm attempts to autoextend the available space (100 = disabled). Modify the thin_pool_autoextend_percent for when thin pool autoextension occurs. The value's setting is the percentage of space to increase the thin pool (100 = disabled).** Docker-thinpool.profile should appear as below

```
[root@UCP-Ctrl-1 ~]# vi /etc/lvm/profile/docker-thinpool.profile

activation {
    thin_pool_autoextend_threshold=80
    thin_pool_autoextend_percent=20
}
```

7. Copy the docker-thinpool.profile to all the hosts.

```
# ansible Docker -m copy -a "src=/etc/lvm/profile/docker-thinpool.profile dest=/etc/lvm/profile/docker-thinpool.profile"
```

8. Apply the newly created lvm-profile

```
[root@UCP-Ctrl-1 ~]# ansible Docker -a "/usr/sbin/lvchange --metadataprofile docker-thinpool Docker/thinpool"
```

9. Verify lv is monitored in all the nodes through ansible

```
[root@UCP-Ctrl-1 ~]# ansible Docker -a "/usr/sbin/lvs -o+seg_monitor"
```

10. Configure Docker daemon with specific device-mapper options. Now that storage is configured we need to tell Docker daemon to use it. We do this by creating daemon.json file with the following configuration parameters and place it as /etc/docker/daemon.json. create a directory if /etc/docker does not exists.

```
# vi /etc/docker/daemon.json
{
  "storage-driver": "devicemapper",
  "storage-opts": [
    "dm.thinpooldev=/dev/mapper/Docker-thinpool",
    "dm.use_deferred_removal=true",
    "dm.use_deferred_deletion=true"
  ]
}
```

```
}
```

11. If /etc/docker does not exist, create it before-hand on all the nodes and copy the daemon.json:

```
[root@UCP-Ctrl-1 ~]# ansible Docker -a "/usr/bin/mkdir /etc/docker"
```

12. Copy /etc/docker/daemon.json to all the nodes using ansible as below:

```
[root@UCP-Ctrl-1 ~]# ansible Docker -m copy -a "src=/etc/docker/daemon.json dest=/etc/docker/daemon.json"
```

```
[root@UCP-Ctrl-1 ~]# ansible Docker -m copy -a "src=/etc/docker/daemon.json dest=/etc/docker/daemon.json"
UCP-Ctrl-1 | SUCCESS => {
  "changed": false,
  "checksum": "eaac4b28dcefa7d4326e8db898d4452a2812f6e5",
  "dest": "/etc/docker/daemon.json",
  "gid": 0,
  "group": "root",
  "mode": "0644",
  "owner": "root",
  "path": "/etc/docker/daemon.json",
  "secontext": "unconfined_u:object_r:etc_t:s0",
  "size": 191,
  "state": "file",
  "uid": 0
}
DDC-DTR-2 | SUCCESS => {
  "changed": true,
  "checksum": "eaac4b28dcefa7d4326e8db898d4452a2812f6e5",
  "dest": "/etc/docker/daemon.json",
  "gid": 0,
  "group": "root",
  "md5sum": "b796711c7ba52654a7b5d8e740a231d4",
  "mode": "0644",
  "owner": "root",
  "secontext": "system_u:object_r:docker_config_t:s0",
  "size": 191,
  "src": "/root/.ansible/tmp/ansible-tmp-1479804595.72-176691544304356/source",
  "state": "file",
  "uid": 0
}
UCP-Ctrl-2 | SUCCESS => {
  "changed": true,
  "checksum": "eaac4b28dcefa7d4326e8db898d4452a2812f6e5",
  "dest": "/etc/docker/daemon.json",
  "gid": 0,
  "group": "root",
  "md5sum": "b796711c7ba52654a7b5d8e740a231d4",
  "mode": "0644",
  "owner": "root",
  "secontext": "system_u:object_r:docker_config_t:s0",
  "size": 191,
  "src": "/root/.ansible/tmp/ansible-tmp-1479804595.73-272322441151302/source",
  "state": "file",
  "uid": 0
}
}
```

13. Enable Docker service and start the service on all the nodes:

```
[root@UCP-Ctrl-1 ~]# ansible Docker -a "/usr/bin/systemctl enable docker.service"
[root@UCP-Ctrl-1 ~]# ansible Docker -a "/usr/bin/systemctl start docker.service"
```

14. Verify that Docker service is up and running on all the nodes:

```
[root@UCP-Ctrl-1 ~]# ansible Docker -a "/usr/bin/systemctl status docker.service"
```

15. Verify that the Docker service is running with storage driver set to device-mapper:

```
[root@UCP-Ctrl-1 ~]# ansible Docker -a "/usr/bin/docker info"
```

```

[root@ucp-ctrl-1 ~]# ansible Docker -a "/usr/bin/docker info"
ucp-ctrl-1 | SUCCESS | rc=0 >>
Containers: 0
  Running: 0
  Paused: 0
  Stopped: 0
Images: 0
Server Version: 17.03.1-ee-3
Storage Driver: devicemapper
  Pool Name: Docker-thinpool
  Pool Blocksize: 524.3 kB
  Base Device Size: 10.74 GB
  Backing Filesystem: xfs
  Data file:
  Metadata file:
  Data Space Used: 19.92 MB
  Data Space Total: 306 GB
  Data Space Available: 306 GB
  Metadata Space Used: 380.9 kB
  Metadata Space Total: 3.221 GB
  Metadata Space Available: 3.221 GB
  Thin Pool Minimum Free Space: 30.6 GB
  Udev Sync Supported: true
  Deferred Removal Enabled: true
  Deferred Deletion Enabled: true
  Deferred Deleted Device Count: 0
  Library Version: 1.02.135-RHEL7 (2016-11-16)
Logging Driver: json-file

```

16. Check that the LVs are monitored as configured:

```
[root@UCP-Ctrl-1 ~]# journalctl -fu dm-event.service
```

```

[root@UCP-Ctrl-1 ~]#
[root@UCP-Ctrl-1 ~]# journalctl -fu dm-event.service
-- Logs begin at Fri 2017-01-27 10:33:06 EST. --
Jan 27 10:33:13 UCP-Ctrl-1.vikings.cisco.com systemd[1]: Started Device-mapper event daemon.
Jan 27 10:33:13 UCP-Ctrl-1.vikings.cisco.com systemd[1]: Starting Device-mapper event daemon...
Jan 27 10:33:13 UCP-Ctrl-1.vikings.cisco.com dmeventd[1720]: dmeventd ready for processing.
Jan 27 10:33:13 UCP-Ctrl-1.vikings.cisco.com lvm[1720]: Monitoring thin Docker-thinpool.

```

17. Before you begin to next step. Make sure there aren't any containers running on any of the cluster nodes:

```
[root@UCP-Ctrl-1 ~]# ansible Docker -a "/usr/bin/docker ps"
```

```
[root@UCP-Ctrl-1 ~]# ansible Docker -a "/usr/bin/docker ps"
DDC-DTR-2 | SUCCESS | rc=0 >>
CONTAINER ID          IMAGE                COMMAND             CREATED             STATUS              PORTS              NAMES
UCP-Ctrl-1 | SUCCESS | rc=0 >>
CONTAINER ID          IMAGE                COMMAND             CREATED             STATUS              PORTS              NAMES
DDC-DTR-1 | SUCCESS | rc=0 >>
CONTAINER ID          IMAGE                COMMAND             CREATED             STATUS              PORTS              NAMES
UCP-Ctrl-2 | SUCCESS | rc=0 >>
CONTAINER ID          IMAGE                COMMAND             CREATED             STATUS              PORTS              NAMES
UCP-Ctrl-3 | SUCCESS | rc=0 >>
CONTAINER ID          IMAGE                COMMAND             CREATED             STATUS              PORTS              NAMES
DDC-DTR-3 | SUCCESS | rc=0 >>
CONTAINER ID          IMAGE                COMMAND             CREATED             STATUS              PORTS              NAMES
UCP-Node-3 | SUCCESS | rc=0 >>
CONTAINER ID          IMAGE                COMMAND             CREATED             STATUS              PORTS              NAMES
UCP-Node-2 | SUCCESS | rc=0 >>
CONTAINER ID          IMAGE                COMMAND             CREATED             STATUS              PORTS              NAMES
UCP-Node-4 | SUCCESS | rc=0 >>
CONTAINER ID          IMAGE                COMMAND             CREATED             STATUS              PORTS              NAMES
UCP-Node-1 | SUCCESS | rc=0 >>
CONTAINER ID          IMAGE                COMMAND             CREATED             STATUS              PORTS              NAMES
```

18. With this all the cluster nodes are installed with Docker CS Engine and they are configured for installing Docker UCP and DTR services.

Install and Configure Docker UCP Controller Nodes

1. Docker UCP is a containerized application that requires Docker CS Engine 1.10.0 or above to run. Installation work flow is split into two steps. We identify the first UCP Controller node, install UCP on it and then start adding UCP Controller replicas and UCP Nodes. This way they form a large cluster running Docker EE. Docker Trusted Registry is again a containerized application running on one of the UCP nodes.
2. Docker UCP installation is one single command as shown below:

```
[root@UCP-Ctrl-1 ~]# docker run --rm -it --name ucp -v /var/run/docker.sock:/var/run/docker.sock docker/ucp
install -i --host-address 192.168.91.21
```

3. This command takes the following parameters:

- Container name: --name ucp
- UCP version tag: docker/ucp:<VERSION>



UCP release tagging is important, as we are specifically saying what version needed to be installed. Otherwise 'docker run' command will download and install the latest UCP version.

- UCP URL/Host address: --host-address <ip-address of the 1st Controller Node>
 - License file can also be specified with the -v parameter during install time such as -v <path>/docker_subscription.lic:/docker_subscription.lic
4. Check that the UCP web application is running. Open the browser and navigate to the address where UCP is installed

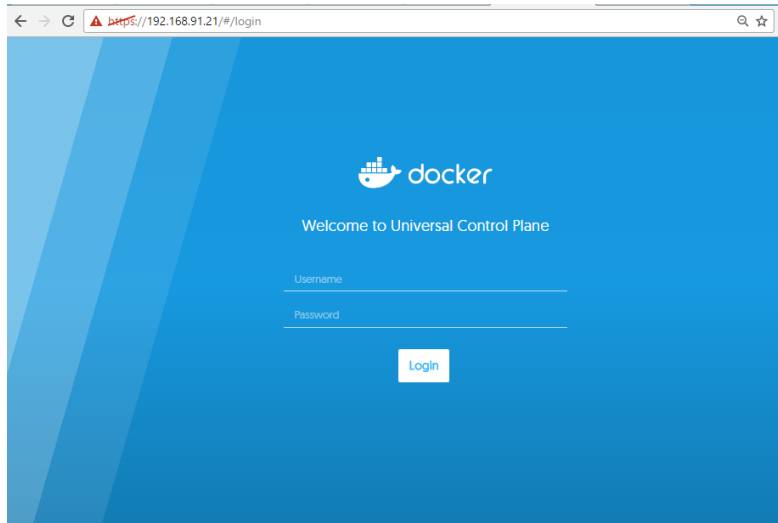

5. Now that UCP is installed. It is important to license it.

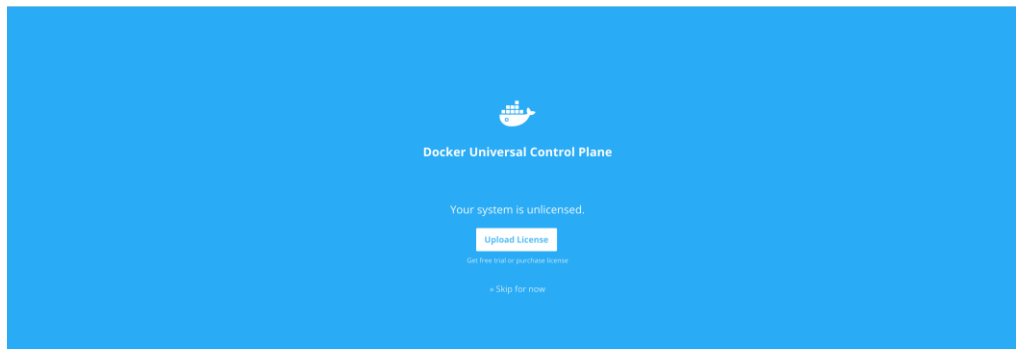

6. Follow the instruction to upload the license file by clicking 'upload License'. For more information of how to license your installation, please visit:
<https://store.docker.com/editions/enterprise/docker-ee-server-rhel/purchase>

Add UCP Replicas

1. Login to UCP controller GUI
2. Click Resource→Nodes→Add Node
3. Pop-up will show up. Click check box "Add node as a manager"
4. Copy docker swarm join command in the clip board as shown in Figure

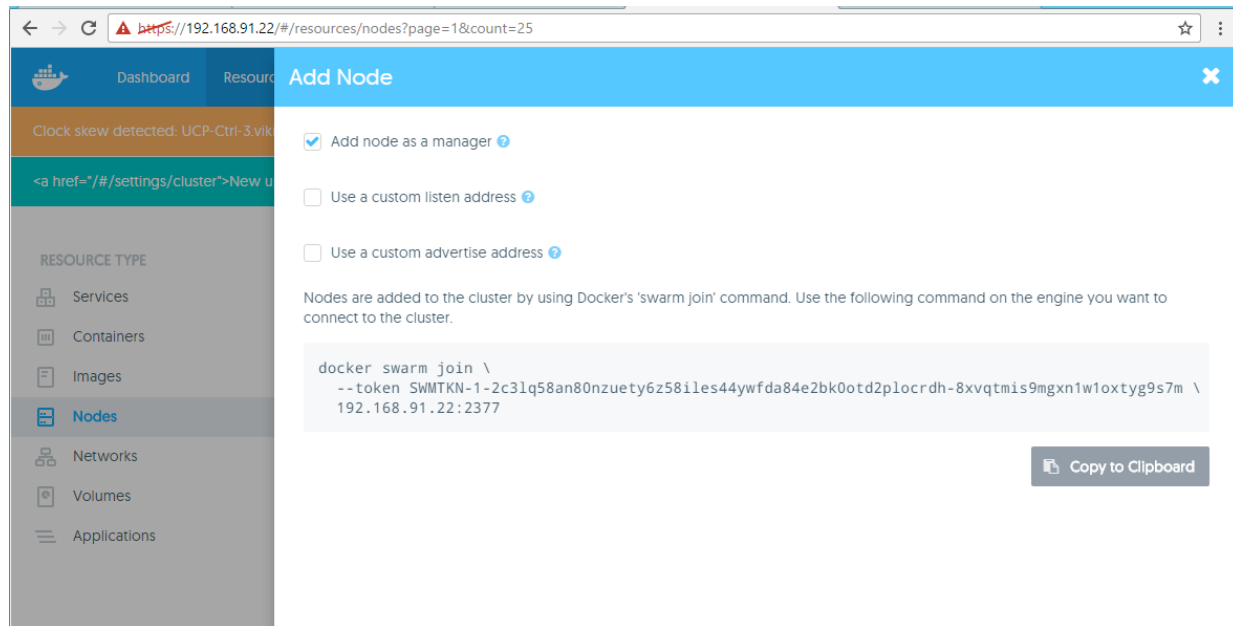

5. Login to the UCP Controller node and execute the docker swarm join command from the Clipboard to add the second UCP node
6. Repeat to add third UCP controller replica.
7. After the third node has joined we need to restart the Docker services on controller nodes one by one, starting from the first UCP controller node.
8. All the three nodes joins to form a cluster, Docker UCP dashboard will show three active managers.

Add UCP Nodes

In this step we will now continue to add rest of the 7 hosts to the newly formed cluster. Even the DTR nodes will be added as UCP worker nodes first. For all the remaining nodes, command will be same.

Perform the following steps to add worker nodes:

1. Login UCP controller
2. Click Resources→Nodes→+ Add Node
3. Leave everything unchecked.
4. Copy docker swarm join command to the Clipboard by clicking the “Copy to Clipboard” as shown

```
[root@UCP-Ctrl-1 ~]# ansible Docker -a "/usr/bin/systemctl restart firewalld.service"
```

- Execute the following on the first UCP controller node to install the DTR node

```
[root@UCP-Ctrl-1 ~]# docker run --rm -it docker/dtr install --ucp-url https://192.168.91.21:443 --ucp-node DDC-DTR-1.vikings.cisco.com --dtr-external-url 192.168.91.24 --ucp-username <UCP-USERNAME> --ucp-password <UCP-PASSWORD> --ucp-insecure-tls --nfs-storage-url nfs://192.168.92.11/DTR-NFS
```

- Following parameters are used in the command

- Specific DTR versioning tag - docker/dtr:<VERSION>. Specify docker/dtr for latest version
- UCP URL - 1st UCP Controller URL - --ucp-url https://<ip-address>
- UCP Node - --ucp-node <1st DTR Node FQDN>
- DTR External URL - --dtr-external-url <ip address of the 1st DTR Node>
- UCP CA Certs - --ucp-ca <cert file with path where we downloaded certs using curl>
- UCP Insecure Tls --ucp-insecure-tls <tells the installer to trust the certificates used by the UCP>
- NFS Storage URL

- Join other DTR Nodes as DTR replicas by using the replica id from the outcome of first DTR node. Run the following command in the UCP controller node. Nfs tag is not required for joining nodes.

```
[root@UCP-Ctrl-1 ~]# docker run --rm -it docker/dtr join --ucp-url https://192.168.91.21:443 --ucp-node DDC-DTR-2.vikings.cisco.com --existing-replica-id 75180d732196 --ucp-username <UCP-USERNAME> --ucp-password <UCP-PASSWORD> --ucp-insecure-tls
```



Here we added --existing-replica-id <id as provided at the of the first DTR Node addition>

- We will now add the DTR application to the third DTR Node:

```
[root@UCP-Ctrl-1 ~]# docker run --rm -it docker/dtr join --ucp-url https://192.168.91.21:443 --ucp-node DDC-DTR-3.vikings.cisco.com --existing-replica-id 75180d732196 --ucp-username <UCP_USERNAME> --ucp-password <UCP-PASSWORD> --ucp-insecure-tls
```

- Check that DTR containers running on DTR Nodes in UCP GUI.

Container ID	Image	Repository	Image Name
456b83e90ce2	ddc-dtr-3.vikings.cisco.com	dtr-scanningstore-d4f72ec2b7f0	docker/dtr-postgres:2.2.3
3cbb511d307b	ddc-dtr-3.vikings.cisco.com	dtr-notary-signer-d4f72ec2b7f0	docker/dtr-notary-signer:2.2.3
f24d038afe03	ddc-dtr-3.vikings.cisco.com	dtr-jobrunner-d4f72ec2b7f0	docker/dtr-jobrunner:2.2.3
767b8f52b6d0	ddc-dtr-3.vikings.cisco.com	dtr-nginx-d4f72ec2b7f0	docker/dtr-nginx:2.2.3
fae8c7e5181d	ddc-dtr-3.vikings.cisco.com	dtr-notary-server-d4f72ec2b7f0	docker/dtr-notary-server:2.2.3
dd9c59745b90	ddc-dtr-3.vikings.cisco.com	dtr-api-d4f72ec2b7f0	docker/dtr-api:2.2.3
855b6c8064c3	ddc-dtr-3.vikings.cisco.com	dtr-garant-d4f72ec2b7f0	docker/dtr-garant:2.2.3
3c47067b88c2	ddc-dtr-3.vikings.cisco.com	dtr-registry-d4f72ec2b7f0	docker/dtr-registry:2.2.3

8. Login to DTR URL (which is the first DTR Node ip address):

The screenshot shows the 'Settings > General' page in the Docker Trusted Registry Admin UI. The 'Domain' section is highlighted, showing the 'Load Balancer/Public Address' field set to '192.168.91.24'. Other sections visible include 'Updates' (Version 2.2.3, Check for updates toggle on) and 'License' (Tier: Security Scanning, Expires: April 3, 2017 at 4:52PM, License ID field, and Auto refresh license toggle on).



Docker recommends using external load balancer VIP address in Domain section shown in Figure. As external load balancer is out of scope in this solution, we have mentioned the first DTR node's ip address.

9. Next step is to configure NFS file system on all three DTR Nodes to have the shared access.

- Check nfs-utils is installed in DTR nodes. If not install nfs-utils using `# yum install nfs-utils`
- Open firewall ports for NFS services on DTR nodes only and restart firewalld service:

```
[root@UCP-Ctrl-1 ~]# ansible DTR -a "firewall-cmd --permanent --zone=public --add-service=nfs"
[root@UCP-Ctrl-1 ~]# ansible DTR -a "firewall-cmd --permanent --zone=public --add-service=mountd"
```

```
[root@UCP-Ctrl-1 ~]# ansible DTR -a "firewall-cmd --permanent --zone=public --add-service=rpc-bind"
[root@UCP-Ctrl-1 ~]# ansible DTR -a "systemctl restart firewalld.service"
```

10. NFS share is setup during DTR install and join commands. verify external NFS file share on all the three DTR Nodes as shown below:

```
[root@DDC-DTR-1 ~]# mount | grep DTR
```

```
[root@ddc-dtr-1 netappdvp]#
[root@ddc-dtr-1 netappdvp]# mount | grep dtr
:/DTR-NFS on /var/lib/docker/volumes/dtr-registry-nfs-a59161f366ed/_data type nfs (rw,relatime,sync,vers=3,rsize=65536,wsiz=65536,namlen=255,acregmin=0,acregmax=0,acdirmin=0,acdirmax=0,hard,proto=tcp,timeo=600,retrans=2,sec=sys,mountaddr=192.168.92.11,mountvers=3,mountproto=tcp,local_lock=none,addr=192.168.92.11)
[root@ddc-dtr-1 netappdvp]# █
```



NFS mount point should be /var/lib/docker/volumes/dtr-registry-nfs-<DTR Replica id>/_data

11. NFS storage back-end can also be verified in DTR GUI by clicking Settings→Storage as shown

← → C ⚠ Not secure | <https://192.168.91.24/admin/settings/storage>

docker trusted registry 🔍 Search

Settings > Storage

GENERAL **STORAGE** SECURITY GARBAGE COLLECTION

Set up your storage with a Manual form YAML file

Storage backend

Filesystem S3 Azure Swift Google Cloud Storage

Filesystem settings

Storage backend ⓘ - Where registry files will be stored
dtr-registry-nfs-a59161f366ed

Save

Configure NetApp Docker Volume Plugin (nDVP)

1. Perform the following steps to setup the NetApp Docker Volume Plugin (nDVP)
2. Verify that Docker version is 17.03 or above.

```
# docker --version
```

3. Create a location for the config files

```
[root@UCP-Ctrl-1 ~]# ansible Docker -a "mkdir -p /etc/netappdvp"
```

4. Create a configuration files

```
[root@UCP-Ctrl-1 netappdvp]# vi /etc/netappdvp/netapp-nas-tnt-a-01.json
{
  "version": 1,
  "storageDriverName": "ontap-nas",
  "storagePrefix": "netappdvp",
  "managementLIF": "192.168.91.11",
  "dataLIF": "192.168.93.11",
  "svm": "Cntr-TNT-A-SVM",
  "username": "ndvp_user",
  "password": "HlghV0lt",
  "aggregate": "aggr1_node01"
}

[root@UCP-Ctrl-1 netappdvp]# vi /etc/netappdvp/netapp-nas-tnt-a-02.json
{
  "version": 1,
  "storageDriverName": "ontap-nas",
  "storagePrefix": "netappdvp",
  "managementLIF": "192.168.91.11",
  "dataLIF": "192.168.93.12",
  "svm": "Cntr-TNT-A-SVM",
  "username": "ndvp_user",
  "password": "HlghV0lt",
  "aggregate": "aggr1_node02"
}
```



The above config creates nDVP instances using the default storage prefix name. The storagePrefix parameter in the configuration file can be modified as needed for monitoring and reporting. For example, a CRM team in the Docker EE would configure the storagePrefix parameter to “crm”. The FlexVols corresponding to the Docker volumes created using this nDVP instance would then have a prefix of “crm”.

5. Copy the .json configuration files to all the hosts as below

```
# ansible Docker -m copy -a "src=/etc/netappdvp/netapp-nas-tnt-a-01.json dest=/etc/netappdvp/netapp-nas-tnt-a-01.json"
# ansible Docker -m copy -a "src=/etc/netappdvp/netapp-nas-tnt-a-02.json dest=/etc/netappdvp/netapp-nas-tnt-a-02.json"
```

6. Start nDVP using the managed plugin system

```
# ansible Docker -a "docker plugin install store/netapp/ndvp-plugin:1.4.0 --alias netapp-nas-tnt-a-01 config=netapp-nas-tnt-a-01.json --grant-all-permissions"
# ansible Docker -a "docker plugin install store/netapp/ndvp-plugin:1.4.0 --alias netapp-nas-tnt-a-02 config=netapp-nas-tnt-a-02.json --grant-all-permissions"
```

```

1.4.0: Pulling from store/netapp/ndvp-plugin
379c219698bb: Verifying Checksum
379c219698bb: Download complete
Digest: sha256:3ad1d542924f887c10be8b36c543544ceae87f147a87fae3934c6b3a63f04dfa
Status: Downloaded newer image for store/netapp/ndvp-plugin:1.4.0
Installed plugin store/netapp/ndvp-plugin:1.4.0

ucp-node-3 | SUCCESS | rc=0 >>
1.4.0: Pulling from store/netapp/ndvp-plugin
379c219698bb: Verifying Checksum
379c219698bb: Download complete
Digest: sha256:3ad1d542924f887c10be8b36c543544ceae87f147a87fae3934c6b3a63f04dfa
Status: Downloaded newer image for store/netapp/ndvp-plugin:1.4.0
Installed plugin store/netapp/ndvp-plugin:1.4.0

ddc-dtr-3 | SUCCESS | rc=0 >>
1.4.0: Pulling from store/netapp/ndvp-plugin
379c219698bb: Verifying Checksum
379c219698bb: Download complete
Digest: sha256:3ad1d542924f887c10be8b36c543544ceae87f147a87fae3934c6b3a63f04dfa
Status: Downloaded newer image for store/netapp/ndvp-plugin:1.4.0
Installed plugin store/netapp/ndvp-plugin:1.4.0

[root@ucp-ctrl-1 netappdvp]# █

```

7. Verify that plugin has been install by the running the following command.

```
# docker plugin ls
```

```

[root@ucp-ctrl-1 netappdvp]# docker plugin ls
ID                NAME                DESCRIPTION
10a8896c64f1     netapp-nas-tnt-a-01:latest  nDVP - NetApp Docker Volume Pl
ugin true
ecfd1a30e33f     netapp-nas-tnt-a-crm:latest  nDVP - NetApp Docker Volume Pl
ugin true
80ea8fb2220e     netapp-nas-tnt-a-02:latest  nDVP - NetApp Docker Volume Pl
ugin true

```

8. After the service is started, volumes can be created and managed via Docker CLI

```

# docker volume create -d netapp-nas-tnt-a-01 --name demo_vol
# docker volume ls | grep demo_vol
# docker volume inspect demo_vol

```

```
[root@docker-mgmt ucp-cvd]#
[root@docker-mgmt ucp-cvd]# docker volume create -d netapp-nas-tnt-a-01 --name demo_vol
demo_vol
[root@docker-mgmt ucp-cvd]# docker volume inspect demo_vol
[
  {
    "Name": "demo_vol",
    "Driver": "netapp-nas-tnt-a-01:latest",
    "Mountpoint": "/var/lib/docker/plugins/1cd5cd00e8a8e855d335a35e925896bbb88e53980d2c16",
    "Labels": {},
    "Scope": "global"
  }
]
```

9. Below figure shows that volume is mounted in all the hosts and its mount point can be verified in the hosts at /var/lib/docker-volumes directory.

```
[root@docker-mgmt ucp-cvd]#
[root@docker-mgmt ucp-cvd]# docker volume ls | grep demo_vol
netapp-nas-tnt-a-01:latest demo_vol
netapp-nas-tnt-a-01:latest demo_vol
netapp-nas-tnt-a-01:latest demo_vol
netapp-nas-tnt-a-01:latest demo_vol
netapp-nas-tnt-a-01:latest demo_vol
netapp-nas-tnt-a-01:latest demo_vol
netapp-nas-tnt-a-01:latest demo_vol
netapp-nas-tnt-a-01:latest demo_vol
netapp-nas-tnt-a-01:latest demo_vol
netapp-nas-tnt-a-01:latest demo_vol
netapp-nas-tnt-a-01:latest demo_vol
[root@docker-mgmt ucp-cvd]#
```

10. Using NetApp's SVM CLI command via SSH we can verify that the volume is provisioned on NetApp storage through the plugin as shown in the figure.

```
# ssh vsadmin@192.168.91.11 volume show -volume *demo_vol* -fields volume,size
```

```
[root@docker-mgmt ucp-cvd]#
[root@docker-mgmt ucp-cvd]# ssh vsadmin@192.168.91.11 volume show -volume *demo_vol* -fields volume,size
Password:
vsadmin          volume          size
-----
Cntr-TNT-A-SVM netappdvpdemo_vol 1GB
[root@docker-mgmt ucp-cvd]#
```



For more information about NetApp Docker Volume Plugin (ndvp) visit [here](#). nDVP will also be covered as part of FlexPod Cooperative Support at a future date. Until then, please redirect any issues to the project GitHub [page](#) / the Slack channels for nDVP



Now create a container using the volume created above and place a data file in the volume

```
# docker run -itd --name demo-container --volume-driver netapp-nas-tnt-a-01 --volume demo_vol:/vol_01 busybox
# docker ps | grep demo
# docker exec demo-container touch /vol_01/Persistent-Data.txt
# docker exec demo-container ls /vol_01
```

```
[root@docker-mgmt ucp-cvd]#
[root@docker-mgmt ucp-cvd]# docker run -itd --name demo-container --volume-driver netapp-nas-tnt-a-01 --volume demo_vol:/vo
l_01 busybox
6810d147b32151037a71492a3ce1f86f0d9f58f33cd1934959966efd93045858
[root@docker-mgmt ucp-cvd]# docker ps | grep demo
6810d147b321      busybox          "sh"             Less than a second ago   Up 27 seconds
ucp-node-2.vikings.cisco.com/demo-container
[root@docker-mgmt ucp-cvd]# docker exec demo-container touch /vol_01/Persistent-Data.txt
[root@docker-mgmt ucp-cvd]# docker exec demo-container ls /vol_01
Persistent-Data.txt
[root@docker-mgmt ucp-cvd]#
```

11. Using an external, enterprise class, storage array for the application data is important for a number of reasons, not the least of which is data protection. Storage arrays are designed for high availability and to assure the integrity of the data being stored. The volume can also be cloned to setup development environment as mentioned in the following steps.

12. Clone the volume and mount it in all the host by running the following docker commands.

```
# docker volume create -d netapp-nas-tnt-a-01 --name demo_vol_clone -o from=demo_vol
# docker volume ls | grep demo_vol_clone
```

```
[root@docker-mgmt ~]# docker volume create -d netapp-nas-tnt-a-01 --name demo_vol_clone -o from=demo_vol
demo_vol_clone
[root@docker-mgmt ~]# docker volume ls | grep demo_vol_clone
netapp-nas-tnt-a-01      demo_vol_clone
[root@docker-mgmt ~]#
```

13. Notice that the cloned volume only appears once, this is intended behaviour. Once the volume is created and mounted, it can also be verified in storage array as shown below.

```
# ssh vsadmin@192.168.91.11 volume show -volume *demo_vol* -fields volume,clone-parent-name
```

```
[root@docker-mgmt ucp-cvd]# ssh vsadmin@192.168.91.11 volume show -volume *demo_vol* -fields volume,clone-parent-name
Password:
vsadmin@vsadmin:~$ volume show -volume *demo_vol* -fields volume,clone-parent-name
-----
Cntr-TNT-A-SVM netappdvpdemo_vol -
Cntr-TNT-A-SVM netappdvpdemo_vol_clone netappdvpdemo_vol
2 entries were displayed.
[vsadmin@vsadmin ~]$
```

14. Now create a container from the cloned volume and look for the added data in the cloned volume.

```
# docker run -itd --name demo-container-clone --volume-driver netapp-nas-tnt-a-01 --volume
demo_vol_clone:/vol_0 busybox
# docker ps | grep demo-container-clone
# docker exec demo-container-clone ls /vol_0
```

```
[root@docker-mgmt ~]# docker run -itd --name demo-container-clone --volume-driver netapp-nas-tnt-a-01 --volume demo_v
ol_clone:/vol_0 busybox
6a9c04cbf559b82ffb8f7eeef152c065efdd1cf0c37240486d575f831f9f8b3d
[root@docker-mgmt ~]# docker ps | grep demo-container-clone
6a9c04cbf559 busybox "sh" 3 seconds ago Up 8 seconds
UCP-Node-1.vikings.cisco.com/demo-container-clone
[root@docker-mgmt ~]# docker exec demo-container-clone ls /vol_0
Persistent-Data.txt
[root@docker-mgmt ~]#
```



Note that it is critical in this case to have the “volume-driver” field in the docker run command in order for the volume to be properly connected to the container.

Validate Docker UCP and DTR Cluster

This section validates the Docker UCP/DTR cluster deployment. To check the basic sanity follow these steps:

1. Run ‘docker ps’ to see the status of all infrastructure containers and DTR application containers. There should not be any stopped and/or exited containers:

```
[root@UCP-Ctrl-1 ~]# ansible docker -a "/usr/bin/docker ps"
UCP-Ctrl-1 | SUCCESS | rc=0 >>
CONTAINER ID        IMAGE               COMMAND             CREATED             STATUS              PORTS
a4671564145b       docker/ucp-controller:1.1.4   "/bin/controller serv"   36 hours ago       Up 26 hours        0.0.0.0:443->8080/tcp
ucp-controller
43a2d26e95a       docker/ucp-auth:1.1.4         "/usr/local/bin/enzi "   36 hours ago       Up 26 hours        0.0.0.0:12386->4443/tcp
ucp-auth-worker
d1502ab5ebef       docker/ucp-auth:1.1.4         "/usr/local/bin/enzi "   36 hours ago       Up 26 hours        0.0.0.0:12385->4443/tcp
ucp-auth-api
16cd735bc08f       docker/ucp-auth-storer:1.1.4   "rethinkdb --bind all"   36 hours ago       Up 26 hours        0.0.0.0:12383-12384->12383-12384/tcp
ucp-auth-stose
370accdb9c27       docker/ucp-cfsal:1.1.4        "/bin/cfsal serve -ad"   36 hours ago       Up 26 hours        8888/tcp, 0.0.0.0:12381->12381/tcp
ucp-cluster-root-na
82dud1907409       docker/ucp-cfsal:1.1.4        "/bin/cfsal serve -ad"   36 hours ago       Up 26 hours        8888/tcp, 0.0.0.0:12382->12382/tcp
ucp-client-root-na
afaf7b035119       docker/ucp-swarm:1.1.4        "/swarm manage --tlsv"   36 hours ago       Up 26 hours        0.0.0.0:2376->2375/tcp
ucp-swarm-manage
370cd99b7f66       docker/ucp-swarm:1.1.4        "/swarm join --discov"   36 hours ago       Up 26 hours        2375/tcp
ucp-swarm-join
347f7c1d6d3055       docker/ucp-proxy:1.1.4        "/bin/run"             36 hours ago       Up 26 hours        0.0.0.0:12376->2376/tcp
ucp-proxy
196563be0bb6       docker/ucp-etcd:1.1.4         "/bin/etcd --data-dir"   36 hours ago       Up 26 hours        2380/tcp, 4001/tcp, 7001/tcp, 0.0.0.0:12380->12380/tcp, 0.0.0.0:1237
9->2379/tcp
ucp-kv

UCP-DTR-2 | SUCCESS | rc=0 >>
CONTAINER ID        IMAGE               COMMAND             CREATED             STATUS              PORTS              NAMES
94ad6d6860c2       docker/dtr-nginx:2.0.3       "/init --skip-runit /"   14 hours ago       Up 14 hours        0.0.0.0:80->80/tcp, 0.0.0.0:443->443/tcp   dtr-nginx-c057c8974d24
18a074e82d26       docker/dtr-api:2.0.3         "/bin/server"           14 hours ago       Up 14 hours        80/tcp              dtr-api-c037c8974d24
0c4955d6db16       docker/dtr-registry:2.0.3    "/init --skip-runit /"   14 hours ago       Up 14 hours        5000/tcp            dtr-registry-c057c8974d24
74ea186e68f       docker/dtr-rethink:2.0.3     "start.sh"              14 hours ago       Up 14 hours        8080/tcp            dtr-rethinkdb-c057c8974d24
3cbfd295d4a       docker/ucp-swarm:1.1.4       "/swarm join --discov"   26 hours ago       Up 26 hours        2379-2380/tcp, 4001/tcp, 7001/tcp       dtr-etcd-c057c8974d24
374832af7231       docker/ucp-swarm:1.1.4       "/swarm join --discov"   26 hours ago       Up 26 hours        2375/tcp            ucpswarm-join
140856d1c4f7       docker/ucp-proxy:1.1.4       "/bin/run"              26 hours ago       Up 26 hours        0.0.0.0:12376->2376/tcp               ucps-proxy

UCP-DTR-1 | SUCCESS | rc=0 >>
CONTAINER ID        IMAGE               COMMAND             CREATED             STATUS              PORTS              NAMES
c98b13ba5a29       docker/dtr-nginx:2.0.3       "/init --skip-runit /"   15 hours ago       Up 15 hours        0.0.0.0:80->80/tcp, 0.0.0.0:443->443/tcp   dtr-nginx-ea5f0db3c5fb
3bda7a59191f       docker/dtr-api:2.0.3         "/bin/server"           15 hours ago       Up 15 hours        80/tcp              dtr-api-ea5f0db3c5fb
c0f97b63bac7       docker/dtr-registry:2.0.3    "/init --skip-runit /"   15 hours ago       Up 15 hours        5000/tcp            dtr-registry-ea5f0db3c5fb
30548242406f       docker/dtr-rethink:2.0.3     "start.sh"              15 hours ago       Up 15 hours        8080/tcp            dtr-rethinkdb-ea5f0db3c5fb
17c728020a39       docker/ucp-swarm:1.1.4       "/swarm join --discov"   26 hours ago       Up 26 hours        2379-2380/tcp, 4001/tcp, 7001/tcp       dtr-etcd-ea5f0db3c5fb
1c20e20be40f       docker/ucp-swarm:1.1.4       "/swarm join --discov"   26 hours ago       Up 26 hours        2375/tcp            ucpswarm-join
970bae8a067       docker/ucp-proxy:1.1.4       "/bin/run"              26 hours ago       Up 26 hours        0.0.0.0:12376->2376/tcp               ucps-proxy

UCP-Node-4 | SUCCESS | rc=0 >>
CONTAINER ID        IMAGE               COMMAND             CREATED             STATUS              PORTS              NAMES
32b3b7e5514f       docker/ucp-swarm:1.1.4       "/swarm join --discov"   26 hours ago       Up 26 hours        2375/tcp            ucpswarm-join
11c3222be8bf       docker/ucp-proxy:1.1.4       "/bin/run"              26 hours ago       Up 26 hours        0.0.0.0:12376->2376/tcp               ucps-proxy

UCP-Node-2 | SUCCESS | rc=0 >>
CONTAINER ID        IMAGE               COMMAND             CREATED             STATUS              PORTS              NAMES
4984eeabf239       docker/ucp-swarm:1.1.4       "/swarm join --discov"   26 hours ago       Up 26 hours        2375/tcp            ucpswarm-join
43a27493cb92       docker/ucp-proxy:1.1.4       "/bin/run"              26 hours ago       Up 26 hours        0.0.0.0:12376->2376/tcp               ucps-proxy

UCP-Node-1 | SUCCESS | rc=0 >>
CONTAINER ID        IMAGE               COMMAND             CREATED             STATUS              PORTS              NAMES
88b8793ce514       docker/ucp-swarm:1.1.4       "/swarm join --discov"   26 hours ago       Up 26 hours        2375/tcp            ucpswarm-join
81ed94d768a0       docker/ucp-proxy:1.1.4       "/bin/run"              26 hours ago       Up 26 hours        0.0.0.0:12376->2376/tcp               ucps-proxy

UCP-Node-3 | SUCCESS | rc=0 >>
CONTAINER ID        IMAGE               COMMAND             CREATED             STATUS              PORTS              NAMES
34fe4f989e53       docker/ucp-swarm:1.1.4       "/swarm join --discov"   26 hours ago       Up 26 hours        2375/tcp            ucpswarm-join
ab2c68059228       docker/ucp-proxy:1.1.4       "/bin/run"              26 hours ago       Up 26 hours        0.0.0.0:12376->2376/tcp               ucps-proxy
```

2. Verify the Docker device-mapper in direct-lvm mode is functioning correctly and containers are getting thin storage provisioned via Docker thinpool:

Solution Validation

Application Container Deployment

To validate this solution we have performed some feature functional tests, high-availability tests, stack scale-up and scale-down tests. Feature functional tests included routine container life-cycle management operations through Docker UCP client bundle and GUI. Basic operation covers, creating containers, start/stop of containers, killing containers, creating network, and using the created networks for running containers. Docker UCP client requires Docker Toolbox to be installed on mac or windows client machine. Docker Toolbox provides tools such as Docker Compose, Docker command line environment along with the others. The following test validation tasks were accomplished using these tools whenever required. Docker Toolbox can be obtained from below URLs:

- Docker Toolbox Overview - <https://docs.docker.com/toolbox/overview/>
- Docker for Mac or Windows - <https://www.docker.com/products/docker-toolbox>

Docker client bundle can be installed on a mac or windows box where Docker Toolbox has been installed. It can also be run on any of the UCP Controller, DTR or UCP nodes, without having to install the Docker Toolbox.

Procedure to install Docker client bundle is simple. Follow these steps to download the client bundle:

1. Download the client bundle from Docker UCP GUI by navigating to admin > Profile > Create a Client Bundle.

The screenshot shows a web browser window with the address bar displaying `https://192.168.91.21/#/user`. The dashboard has a blue header with navigation links: Dashboard, Resources, User Management, and Admin Settings. The main content area is divided into three sections:

- Change Password:** A form with three input fields labeled "CURRENT PASSWORD", "NEW PASSWORD", and "CONFIRM NEW PASSWORD". A blue "Change Password" button is located below the fields.
- Permissions:** A section with a "Default Permissions" tab and an "Admin" tab. Below the tabs, it states: "You do not currently belong to any teams where permission labels have been configured".
- Client Bundles:** A section with two blue buttons: "Create a Client Bundle" and "Add an Existing Public Key".

2. Client bundle can also be installed by running the following commands.

```
# AUTHTOKEN=$(curl -sk -d '{"username":"admin","password":"<PASSWORD>"}' https://192.168.91.21/auth/login |  
jq -r .auth_token)  
# mkdir ucp-cvd  
# cd ucp-cvd  
# curl -k -H "Authorization: Bearer $AUTHTOKEN" https://192.168.91.21/api/clientbundle -o bundle.zip
```

3. Unzip the client bundle zip file

```
# unzip bundle.zip
```

4. Set the environment variable by running the env.sh as follows

```
# eval $(<env.sh)
```

```
[root@docker-mgmt ucp-cvd]# curl -k -H "Authorization: Bearer $AUTHOKEN" https://192.168.91.21/api/clientbundle -o bundle.zip
  % Total    % Received % Xferd  Average Speed   Time    Time     Time  Current
                                 Dload  Upload   Total   Spent    Left   Speed
100 4893    100 4893    0     0    27782    0  --:--:--  --:--:--  --:--:-- 27960
[root@docker-mgmt ucp-cvd]# ls -ll
total 8
-rw-r--r--. 1 root root 4893 Apr  2 22:38 bundle.zip
[root@docker-mgmt ucp-cvd]# unzip bundle.zip
Archive:  bundle.zip
  extracting: ca.pem
  extracting: cert.pem
  extracting: key.pem
  extracting: cert.pub
  extracting: env.sh
  extracting: env.ps1
  extracting: env.cmd
[root@docker-mgmt ucp-cvd]#
```

5. Run docker info to see if client bundle is working.

```
# docker info
```

```
[root@docker-mgmt ucp-cvd]#
[root@docker-mgmt ucp-cvd]# docker info
Containers: 183
  Running: 73
  Paused: 0
  Stopped: 110
Images: 104
Server Version: ucp/2.0.1
Role: primary
Strategy: spread
Filters: health, port, containerslots, dependency, affinity, constraint
Nodes: 10
  DDC-DTR-1.vikings.cisco.com: 192.168.91.24:12376
    ID: VNAJ:MZIF:2DBD:A6F7:IA2G:F3YJ:F3YW:JUY2:D4LO:KAUJ:7RPN:ITNJ
    Status: Healthy
    Containers: 21 (10 Running, 0 Paused, 11 Stopped)
    Reserved CPUs: 0 / 58
    Reserved Memory: 0 B / 264.2 GiB
    Labels: kernelversion=3.10.0-327.36.3.el7.x86_64, operatingsystem=Red Hat Enterprise Linux, storagedriver=devicemapper
    UpdatedAt: 2017-02-01T00:19:10Z
    ServerVersion: 1.12.6-cs6
  DDC-DTR-3.vikings.cisco.com: 192.168.91.26:12376
    ID: EU02:BI4M:PBIT:TCIV:ELDM:VUG3:URKR:QQBS:7OU6:QU2Q:EOWF:DNJH
    Status: Healthy
    Containers: 20 (10 Running, 0 Paused, 10 Stopped)
    Reserved CPUs: 0 / 58
    Reserved Memory: 0 B / 264.2 GiB
    Labels: kernelversion=3.10.0-327.36.3.el7.x86_64, operatingsystem=Storage, storagedriver=devicemapper
    UpdatedAt: 2017-02-01T00:19:46Z
    ServerVersion: 1.12.6-cs6
  UCP-Ctrl-1.vikings.cisco.com: 192.168.91.21:12376
    ID: UMSU:UTQV:VUPN:CV4F:D4GX:KAUR:WSTB:VNSE:GSSV:BIBV:MIK3:7RC6
    Status: Healthy
    Containers: 19 (10 Running, 0 Paused, 9 Stopped)
    Reserved CPUs: 0 / 58
    Reserved Memory: 0 B / 264.2 GiB
    Labels: kernelversion=3.10.0-327.36.3.el7.x86_64, operatingsystem=Red Hat Enterprise Linux, storagedriver=devicemapper
    UpdatedAt: 2017-02-01T00:19:46Z
    ServerVersion: 1.12.6-cs6
  UCP-Ctrl-2.vikings.cisco.com: 192.168.91.22:12376
    ID: BSF5:P7BP:3MOL:4ZGL:JIXF:E4QK:HSAQ:VGPD:EH52:HVKZ:PZPQ:DH7N
    Status: Healthy
    Containers: 19 (10 Running, 0 Paused, 9 Stopped)
    Reserved CPUs: 0 / 58
```

6. Now you are good to use the client, as shown in above example. Setting up environment variable enables you to use your admin credential to connect to your deployed Docker EE. Once the environment is set, you can do all container management operations through Docker shell commands sitting outside the Docker UCP cluster itself.

Container Networks

There are various ways in which container-to-container and container-to-host connectivity is provided. This sub-section provides details on the container networking types supported for Docker containers:

- None - None is a simple mode of container networking. In this the deployed container receives a network stack, which lacks an external network interface; but does receive a loopback interface. This mode of container networking is mainly used for testing and staging a container and where container does not need external communications.
- Bridge - A Linux bridge provides a host internal network in which containers on the same host may communicate, but the IP address assigned to them are not accessible from outside of the host. Bridge networking leverages iptables for NAT and port-mapping thus providing single host networking. Bridge network is a default Docker network type, for example, docker0 is a bridge name where one end of a virtual network interface pair is connected between the bridge and the container. NAT is used to provide communication beyond the host. Bridge networking solves the problems of port-conflict and also solves performance over head associated using NAT. It also provides isolation to containers running on one host.

Figure 11. Bridge Network

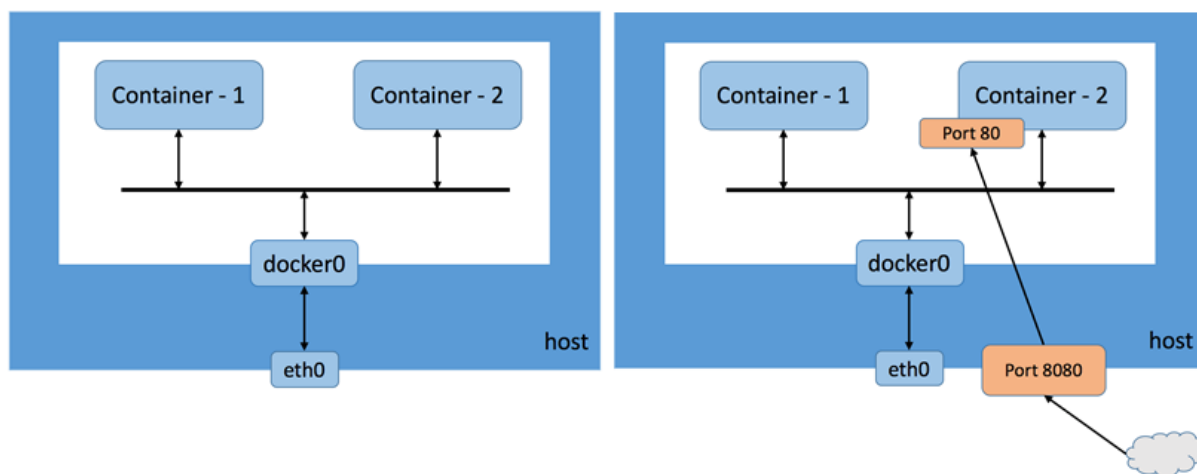

The first image in the figure shows how a bridge network communicates and the adjacent images shows how a service on Container-2 gets exposed to outside world via host port 8080 mapped to port 80 on the container.

- Host - In this type of network, a newly created container shares its network namespace with the host, providing higher performance and eliminating the need for NAT. The bottle-neck in this type of network is port-conflicts and since container has full-access to hosts interfaces it run into security risks.

Figure 12. Host Network

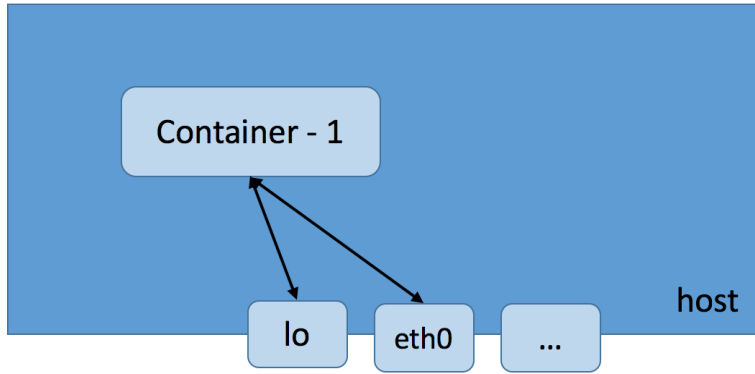

- Overlay – It uses networking tunnels to deliver communication across hosts. This allows containers to behave as if they are on the same host by tunneling network subnets from one host to the other. Essentially, it is like spanning one network across multiple hosts. VxLAN encapsulation is the tunneling choice for Docker libnetworks. Multi-host networking requires additional parameters when launching Docker daemon, as well as a key-value store. Overlay networks focus on the cross-host communication challenge. Containers on the same host that are connected to two different overlay networks cannot communicate with each other via local bridge – they are segmented from one another.

Figure 13. Overlay Network

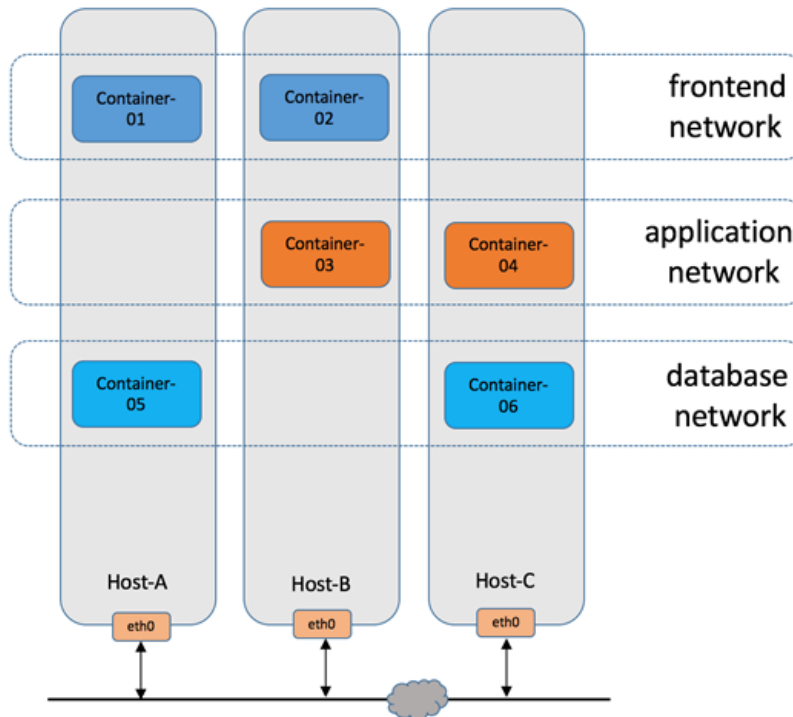

Deploying container/application container using overlay network

Follow these steps to deploy container/application container using overlay network:

1. Log in to any Linux machine with Docker UCP client bundle installed. To list out existing available networks, run the command 'docker network ls' as shown:

```
# docker network ls
```

```
[root@docker-mgmt ucp-cvd]#
[root@docker-mgmt ucp-cvd]# docker network ls
NETWORK ID          NAME                                                    DRIVER          SCOPE
f4eb17652653       ddc-dtr-1.vikings.cisco.com/bridge                   bridge         local
f5a5d534f0f9       ddc-dtr-1.vikings.cisco.com/docker_gwbridge          bridge         local
adcdb21cdd97       ddc-dtr-1.vikings.cisco.com/host                     host           local
e55e4848ee97       ddc-dtr-1.vikings.cisco.com/none                     null           local
9c81d9ab05f2       ddc-dtr-2.vikings.cisco.com/bridge                   bridge         local
1a6d7c965da8       ddc-dtr-2.vikings.cisco.com/docker_gwbridge          bridge         local
5b8b61e83e72       ddc-dtr-2.vikings.cisco.com/host                     host           local
1f8103d330d1       ddc-dtr-2.vikings.cisco.com/none                     null           local
b86f5c3b09b3       ddc-dtr-3.vikings.cisco.com/bridge                   bridge         local
0a22d6aa79bd       ddc-dtr-3.vikings.cisco.com/docker_gwbridge          bridge         local
4e596e41bec0       ddc-dtr-3.vikings.cisco.com/host                     host           local
79b446ae3245       ddc-dtr-3.vikings.cisco.com/none                     null           local
a71shcmcgmr2       dtr-ol                                                 overlay        swarm
ur3olvhza6e4       ingress                                                overlay        swarm
4b2d1ddbc9ce       ucp-ctrl-1.vikings.cisco.com/bridge                   bridge         local
269364480b98       ucp-ctrl-1.vikings.cisco.com/docker_gwbridge          bridge         local
16f57d50a45a       ucp-ctrl-1.vikings.cisco.com/host                     host           local
ea9fba83d669       ucp-ctrl-1.vikings.cisco.com/none                     null           local
6624d75afd8d       ucp-ctrl-2.vikings.cisco.com/bridge                   bridge         local
a347661b14e1       ucp-ctrl-2.vikings.cisco.com/docker_gwbridge          bridge         local
bc402a48c1af       ucp-ctrl-2.vikings.cisco.com/host                     host           local
0c561d9aaa52       ucp-ctrl-2.vikings.cisco.com/none                     null           local
6802aa85e356       ucp-ctrl-3.vikings.cisco.com/bridge                   bridge         local
```

2. For creating an overlay network, we need to specify the overlay driver and the network name as shown below:

```
# docker network create --driver overlay --subnet 10.0.2.0/24 my-multi-host-network --attachable
```



Docker Engine running in Swarm mode, you can create overlay attachable network on a manager node. --attachable option is not available in Docker client.

The 'docker network create' command requires driver, name of the network and the subnet. After creating the network we can verify its successful creation by listing available networks. The last column as shown in the screenshot above lists the scope of the network created, 'local' refers to the network created on the host locally, while 'global' scope tells network is created across all the nodes of the cluster.

3. To check the details of the created overlay network, we use 'docker inspect' command:

```
# docker network inspect my-multi-host-network
```

```
[root@docker-mgmt ucp-cvd]# docker network inspect my-multi-host-network
[
  {
    "Name": "my-multi-host-network",
    "Id": "5tdlg7wio0wultsk06jtl9ng",
    "Scope": "swarm",
    "Driver": "overlay",
    "EnableIPv6": false,
    "IPAM": {
      "Driver": "default",
      "Options": null,
      "Config": [
        {
          "Subnet": "10.0.2.0/24",
          "Gateway": "10.0.2.2"
        }
      ]
    },
    "Internal": false,
    "Attachable": true,
    "Containers": null,
    "Options": {
      "com.docker.network.driver.overlay.vxlanid_list": "263"
    },
    "Labels": null
  }
]
```

4. Deploy a container by running the following command

```
# docker volume create -d netapp-nas-tnt-a-01 --name my_busybox
# docker run -itd --name my-busybox-c1 --volume-driver netapp-nas-tnt-a-01 --volume my_busybox:/disk_01 --network my-multi-host-network busybox
```

Above command will provision container with the volume in NetApp NFS backend and attached it to the overlay network. Container volume specified in the docker run command can be verified in NetApp OnCommand System Manager as shown in the Figure by running the following command.

```
ssh vsadmin@192.168.91.11 volume show -volume *my_busybox -fields volume,clone-parent-name
```

```
[root@docker-mgmt ucp-cvd]#
[root@docker-mgmt ucp-cvd]# ssh vsadmin@192.168.91.11 volume show -volume *my_busybox -fields volume,clone-parent-name
Password:
vserver          volume          clone-parent-name
-----
Cntr-TNT-A-SVM netappdvpmymy_busybox -
[root@docker-mgmt ucp-cvd]# █
```

5. Create another container in different host to establish container communication.

```
# docker volume create -d netapp-nas-tnt-a-01 --name my_busybox_vol2
# docker run -itd --name my-busybox-c2 --volume-driver netapp-nas-tnt-a-01 --volume my_busybox_vol2:/disk_01 --network my-multi-host-network busybox
```

6. Run the docker ps command to see if the two containers are created in two different nodes as shown.

```
# docker ps | grep my-busybox
```



```
[root@docker-mgmt ucp-cvd]#
[root@docker-mgmt ucp-cvd]# docker ps | grep my-busybox
4c76764118b0      busybox          "sh"                Less than a second ago   Up 31 seconds
ucp-node-2.vikings.cisco.com/my-busybox-c2
bb714d5b1a1b     busybox          "sh"                4 minutes ago           Up 7 minutes
ucp-node-1.vikings.cisco.com/my-busybox-c1
[root@docker-mgmt ucp-cvd]#
```

- Let us check the network stack created inside the container to verify that the interface is plumbed correctly and it gets the ip address from the subnet we have specified earlier and the routes it is populated with. We use the command 'docker exec' to verify this:

```
docker exec my-busybox-c1 ifconfig
```

```
[root@docker-mgmt ucp-cvd]# docker exec my-busybox-c1 ifconfig
eth0      Link encap:Ethernet  HWaddr 02:42:0A:00:02:03
          inet addr:10.0.2.3  Bcast:0.0.0.0  Mask:255.255.255.0
          inet6 addr: fe80::42:aff:fe00:203/64 Scope:Link
          UP BROADCAST RUNNING MULTICAST  MTU:1450  Metric:1
          RX packets:15 errors:0 dropped:0 overruns:0 frame:0
          TX packets:8 errors:0 dropped:0 overruns:0 carrier:0
          collisions:0 txqueuelen:0
          RX bytes:1206 (1.1 KiB)  TX bytes:648 (648.0 B)

eth1      Link encap:Ethernet  HWaddr 02:42:AC:12:00:04
          inet addr:172.18.0.4  Bcast:0.0.0.0  Mask:255.255.0.0
          inet6 addr: fe80::42:acff:fe12:4/64 Scope:Link
          UP BROADCAST RUNNING MULTICAST  MTU:1500  Metric:1
          RX packets:8 errors:0 dropped:0 overruns:0 frame:0
          TX packets:8 errors:0 dropped:0 overruns:0 carrier:0
          collisions:0 txqueuelen:0
          RX bytes:648 (648.0 B)  TX bytes:648 (648.0 B)

lo        Link encap:Local Loopback
          inet addr:127.0.0.1  Mask:255.0.0.0
          inet6 addr: ::1/128 Scope:Host
          UP LOOPBACK RUNNING  MTU:65536  Metric:1
          RX packets:0 errors:0 dropped:0 overruns:0 frame:0
          TX packets:0 errors:0 dropped:0 overruns:0 carrier:0
          collisions:0 txqueuelen:0
          RX bytes:0 (0.0 B)  TX bytes:0 (0.0 B)

[root@docker-mgmt ucp-cvd]#
```

- From the above screen shot we see that the first container's ip address as 10.0.2.3. We will verify its reachability and make sure that it can ping the external gateway which is 10.0.2.2 from docker network inspect my-multi-host-network output.

```
# docker exec my-busybox-c1 ping 10.0.2.2
```

```
[root@docker-mgmt ucp-cvd]#
[root@docker-mgmt ucp-cvd]# docker exec my-busybox-c1 ping 10.0.2.2
PING 10.0.2.2 (10.0.2.2): 56 data bytes
64 bytes from 10.0.2.2: seq=0 ttl=64 time=0.086 ms
64 bytes from 10.0.2.2: seq=1 ttl=64 time=0.048 ms
64 bytes from 10.0.2.2: seq=2 ttl=64 time=0.073 ms
64 bytes from 10.0.2.2: seq=3 ttl=64 time=0.090 ms
^C
[root@docker-mgmt ucp-cvd]#
```

9. Now look at the ip address of the second container by running the following command.

```
# docker exec my-busybox-c2 ifconfig
```

```
[root@docker-mgmt ucp-cvd]# docker exec my-busybox-c2 ifconfig
eth0      Link encap:Ethernet  HWaddr 02:42:0A:00:02:04
          inet addr:10.0.2.4  Bcast:0.0.0.0  Mask:255.255.255.0
          inet6 addr: fe80::42:aff:fe00:204/64 Scope:Link
          UP BROADCAST RUNNING MULTICAST  MTU:1450  Metric:1
          RX packets:334 errors:0 dropped:0 overruns:0 frame:0
          TX packets:327 errors:0 dropped:0 overruns:0 carrier:0
          collisions:0 txqueuelen:0
          RX bytes:31908 (31.1 KiB)  TX bytes:31350 (30.6 KiB)

eth1      Link encap:Ethernet  HWaddr 02:42:AC:12:00:04
          inet addr:172.18.0.4  Bcast:0.0.0.0  Mask:255.255.0.0
          inet6 addr: fe80::42:acff:fe12:4/64 Scope:Link
          UP BROADCAST RUNNING MULTICAST  MTU:1500  Metric:1
          RX packets:8 errors:0 dropped:0 overruns:0 frame:0
          TX packets:8 errors:0 dropped:0 overruns:0 carrier:0
          collisions:0 txqueuelen:0
          RX bytes:648 (648.0 B)  TX bytes:648 (648.0 B)

lo        Link encap:Local Loopback
          inet addr:127.0.0.1  Mask:255.0.0.0
          inet6 addr: ::1/128 Scope:Host
          UP LOOPBACK RUNNING  MTU:65536  Metric:1
          RX packets:0 errors:0 dropped:0 overruns:0 frame:0
          TX packets:0 errors:0 dropped:0 overruns:0 carrier:0
          collisions:0 txqueuelen:0
          RX bytes:0 (0.0 B)  TX bytes:0 (0.0 B)
```

10. To verify if both the container communicates on an overlay network, run ping from container 1 to container 2 IP address which is 10.0.2.4. A successful ping is observed between the containers running in different hosts connected via overlay network.

```
# docker exec my-busybox-c1 ping 10.0.2.4
```

```
[root@docker-mgmt ucp-cvd]#
[root@docker-mgmt ucp-cvd]# docker exec my-busybox-c1 ping 10.0.2.4
PING 10.0.2.4 (10.0.2.4): 56 data bytes
64 bytes from 10.0.2.4: seq=0 ttl=64 time=0.297 ms
64 bytes from 10.0.2.4: seq=1 ttl=64 time=0.218 ms
64 bytes from 10.0.2.4: seq=2 ttl=64 time=0.287 ms
64 bytes from 10.0.2.4: seq=3 ttl=64 time=0.261 ms
^C
[root@docker-mgmt ucp-cvd]#
```

11. Deploy an application container for example 'nginx' with port-mapping done for httpd services, in order to access its web-service from the upstream network:

```
# docker volume create -d netapp-nas-tnt-a-01 --name nginx_vol_01
# docker run -itd --name Nginx-Overlay --volume-driver netapp-nas-tnt-a-01 --volume nginx_vol_01:/disk_01 --
network my-multi-host-network -p 5555:80 nginx
# docker ps | grep Nginx
```

```
[root@docker-mgmt ucp-cvd]#
[root@docker-mgmt ucp-cvd]# docker ps | grep Nginx
ae118a202c6f      nginx          "nginx -g 'daemon off"  Less than a second ago   Up 47 seconds      443/tcp
p, 192.168.91.30:5555->80/tcp
ucp-node-4.vikings.cisco.com/Nginx-Overlay
[root@docker-mgmt ucp-cvd]#
```

We have mapped port 5555 on the host to port 80 using '-p' port-mapper switch to deploy an 'nginx' container. We can see its deployed on our UCP-Node-3 host.

12. Open <https://192.168.91.21> in a web browser to login to the Docker UCP. The Resources tab shows the 'nginx' container being deployed:

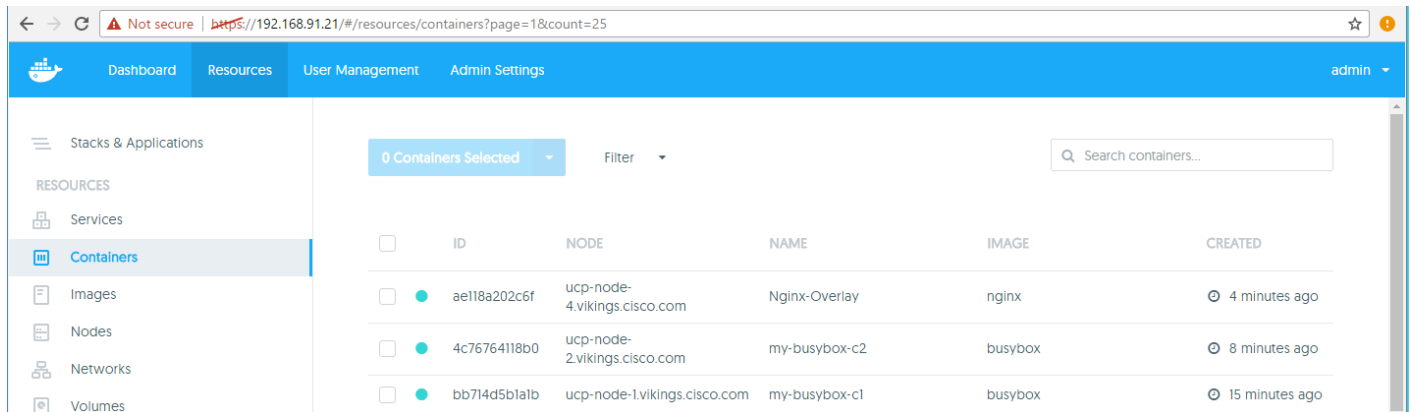

The screenshot shows the Docker UCP interface. The 'Resources' tab is active, displaying a table of containers. The table has columns for ID, NODE, NAME, IMAGE, and CREATED. Three containers are listed:

ID	NODE	NAME	IMAGE	CREATED
ae118a202c6f	ucp-node-4.vikings.cisco.com	Nginx-Overlay	nginx	4 minutes ago
4c76764118b0	ucp-node-2.vikings.cisco.com	my-busybox-c2	busybox	8 minutes ago
bb714d5b1ab	ucp-node-1.vikings.cisco.com	my-busybox-c1	busybox	15 minutes ago

13. Open 192.168.91.30:5555 in a web browser. With the port-mapping in place, we can reach our nginx web-server from outside world, by accessing the port#5555 as shown below:



The screenshot shows a web browser address bar with the URL 192.168.91.30:5555.

Welcome to nginx!

If you see this page, the nginx web server is successfully installed and working. Further configuration is required.

For online documentation and support please refer to nginx.org. Commercial support is available at nginx.com.

Thank you for using nginx.

DTR Operations

This section details about validating the Docker Trusted Registry workflow. As mentioned earlier, DTR provides a way to create a repository of Docker images used for container deployment locally for the enterprise. This eliminates the need for accessing external repos in public domain for downloading images for the containers. This option provides a better control on deploying images for the enterprise and secures application container environment.

1. Login to the DTR GUI and create a repository. In this example we have chosen 'busybox' as the repository:

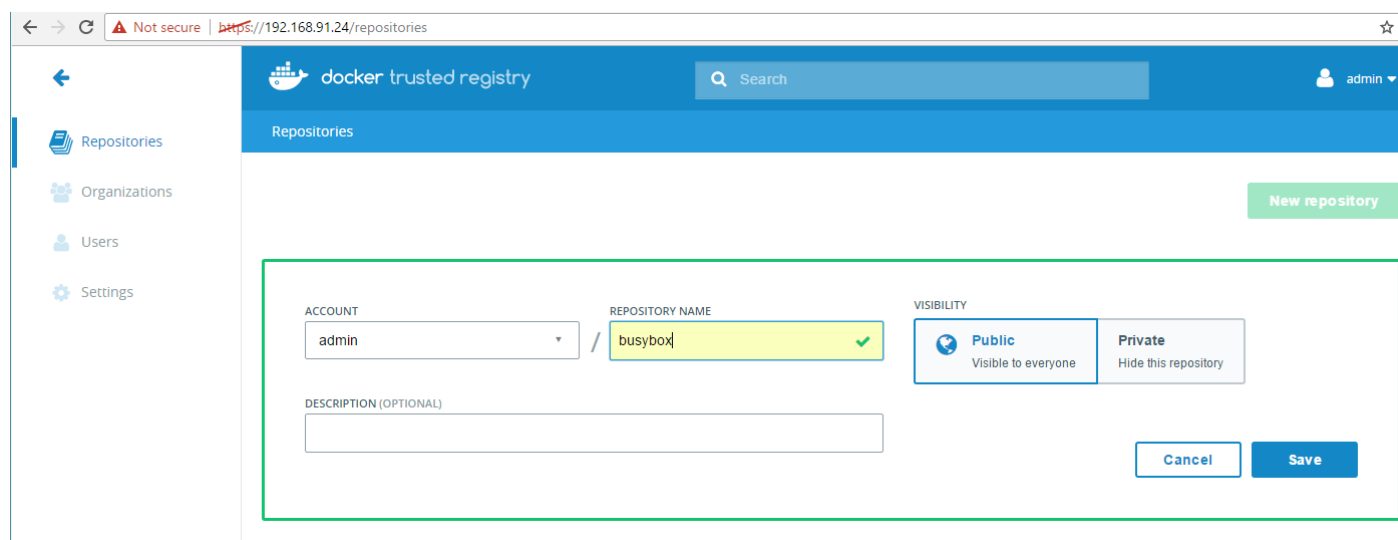

2. Download the sample Docker image (busybox) to the local host. Use 'docker pull' command to download the image from the Docker public repo:

```
# docker pull busybox
```

```
[root@docker-mgmt ucp-cvd]#  
[root@docker-mgmt ucp-cvd]# docker pull busybox  
Using default tag: latest  
DDC-DTR-3.vikings.cisco.com: Pulling busybox:latest... : downloaded  
UCP-Node-4.vikings.cisco.com: Pulling busybox:latest... : downloaded  
UCP-Node-3.vikings.cisco.com: Pulling busybox:latest... : downloaded  
UCP-Ctrl-1.vikings.cisco.com: Pulling busybox:latest... : downloaded  
UCP-Node-2.vikings.cisco.com: Pulling busybox:latest... : downloaded  
UCP-Ctrl-2.vikings.cisco.com: Pulling busybox:latest... : downloaded  
DDC-DTR-1.vikings.cisco.com: Pulling busybox:latest... : downloaded  
UCP-Ctrl-3.vikings.cisco.com: Pulling busybox:latest... : downloaded  
ddc-dtr-2.vikings.cisco.com: Pulling busybox:latest... : downloaded  
UCP-Node-1.vikings.cisco.com: Pulling busybox:latest... : downloaded  
[root@docker-mgmt ucp-cvd]#
```



The downloaded image gets pulled to all our cluster nodes as shown in the screenshot above. This enables us to run the container using this image on any of the host.

3. To list all the images that we have on the setup use 'docker image' command:

```
# docker images
```

4. Tag the image with version that we want to put in our DTR repo. Tags help in version control. So any dev changes to this image version will have an incremental version number and will be pushed to the DTR repo. This way we have an option to quickly upgrade and/or downgrade to the required version.

```
# docker tag busybox 192.168.91.24/admin/busybox:1.0  
# docker images
```

5. To push our tagged image to local DTR repository we need to log-in to the local DTR and push the image as shown below:

```
# docker login 192.168.91.24
```

```
[root@docker-mgmt ucp-cvd]#  
[root@docker-mgmt ucp-cvd]# docker login 192.168.91.24  
Username (docker): admin  
Password:  
Login Succeeded  
[root@docker-mgmt ucp-cvd]#
```

6. Push the image to DTR

```
# docker push 192.168.91.24/admin/busybox:1.0
```

```
[root@docker-mgmt ucp-cvd]#  
[root@docker-mgmt ucp-cvd]# docker push 192.168.91.24/admin/busybox:1.0  
The push refers to a repository [192.168.91.24/admin/busybox]  
c0de73ac9968: Pushed  
1.0: digest: sha256:68effe31a4ae8312e47f54bec52d1fc925908009ce7e6f734e1b54a4169081c5 size: 527  
[root@docker-mgmt ucp-cvd]#
```

7. Verify that the image was successfully pushed from the DTR dashboard:

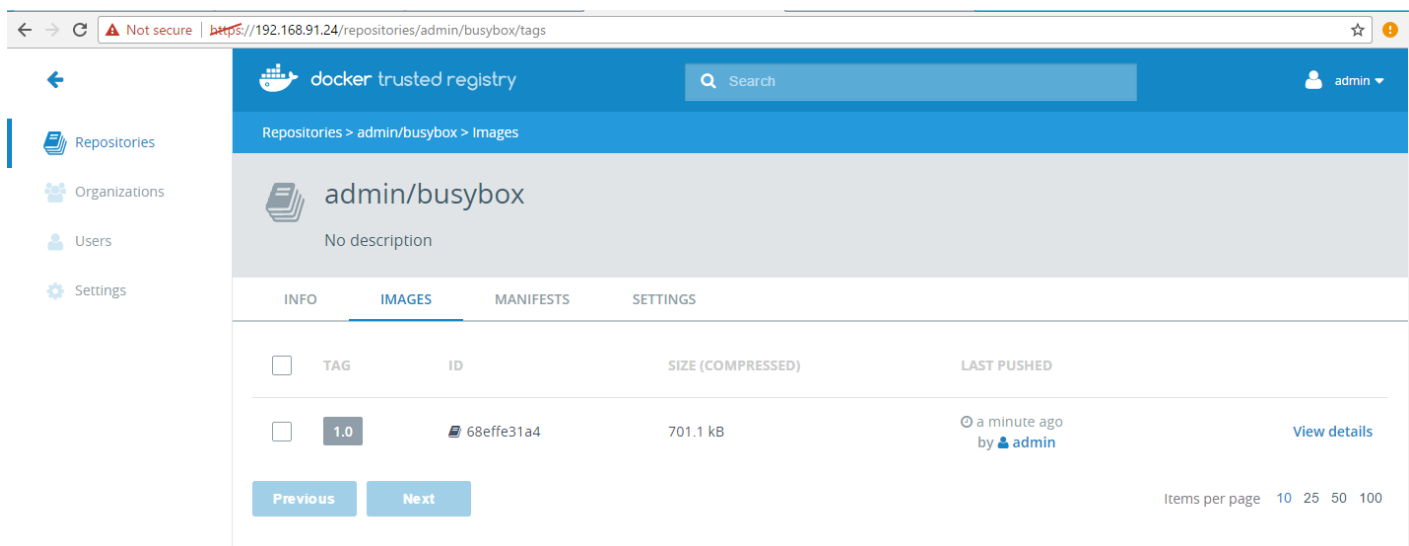

The screenshot shows the Docker Trusted Registry (DTR) dashboard. The browser address bar displays `https://192.168.91.24/repositories/admin/busybox/tags`. The page title is "docker trusted registry" and the user is logged in as "admin". The breadcrumb navigation shows "Repositories > admin/busybox > Images". The repository name is "admin/busybox" with the description "No description". The "IMAGES" tab is selected, showing a table of image tags.

<input type="checkbox"/>	TAG	ID	SIZE (COMPRESSED)	LAST PUSHED
<input type="checkbox"/>	1.0	68effe31a4	701.1 kB	a minute ago by admin View details

Navigation buttons: Previous, Next. Items per page: 10, 25, 50, 100.

- Click INFO tab to get the command to pull this image from the local repo for deployment:

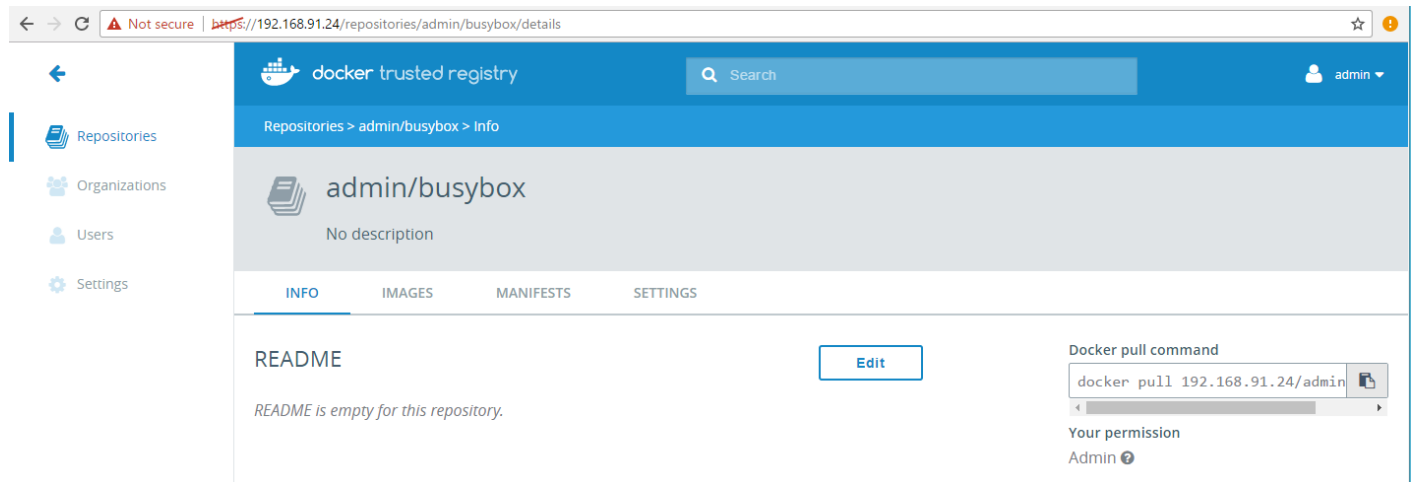

- Now validate the container deployment using local DTR image repo:

```
# docker run -it --name dtr-test-busybox 192.168.91.24/admin/busybox:1.0
```

```
[root@docker-mgmt ucp-cvd]# docker run -it --name dtr-test-busybox 192.168.91.24/admin/busybox:1.0
/ # ip a
1: lo: <LOOPBACK,UP,LOWER_UP> mtu 65536 qdisc noqueue qlen 1
    link/loopback 00:00:00:00:00:00 brd 00:00:00:00:00:00
    inet 127.0.0.1/8 scope host lo
        valid_lft forever preferred_lft forever
    inet6 ::1/128 scope host
        valid_lft forever preferred_lft forever
29: eth0@if30: <BROADCAST,MULTICAST,UP,LOWER_UP,M-DOWN> mtu 1500 qdisc noqueue
    link/ether 02:42:ac:11:00:03 brd ff:ff:ff:ff:ff:ff
    inet 172.17.0.3/16 scope global eth0
        valid_lft forever preferred_lft forever
    inet6 fe80::42:acff:fe11:3/64 scope link
        valid_lft forever preferred_lft forever
/ #
```

Showing Container Survivability Using Docker Swarm

If a container is created in the Docker Swarm using “docker service create” instead of “docker run”, the container has High Availability. If the node that the container is running on fails, the container and its persistent data volumes mapped with the NetApp Docker Volume Plugin will immediately be brought up on another node in the Swarm.

- Return to the demo-container created with docker volume demo_vol created earlier, and stop and remove the container.

```
# docker ps | grep demo-container
# docker stop demo-container
# docker rm demo-container
```

- Create a docker service with one replica and with demo_vol mapped into anNGINX instance. Check for the launch of the service.

```
# docker service create -p 5915:80 --name demo-svc --mount volume-driver=netapp-nas-tnt-a-01,source=demo_vol,destination=/usr/share/nginx/html/data nginx
# docker service ls
# docker ps | grep demo-svc
```

```
[root@docker-mgmt ucp-cvd]# docker service create -p 5915:80 --name demo-svc --mount volume-driver=netapp-nas-tnt-a-01,source=demo_vol,destination=/usr/share/nginx/html/data nginx
i0dh0ufp0b6tnylgoyli9hyzm
[root@docker-mgmt ucp-cvd]# docker service ls
ID                NAME          REPLICAS  IMAGE                                     COMMAND
i0dh0ufp0b6t     demo-svc      1/1       nginx:latest@sha256:e6693c20186f837fc393390135d8a598a96a833917917789d63766cab6c59582
y8590tkew87     ucp-agent    global    docker/ucp-agent:2.1.2@sha256:7988211f5491b5d2bcf4aa94e2655f4c26089543f918e85a9407101db12dde9d
[root@docker-mgmt ucp-cvd]# docker ps | grep demo-svc
83ed14dc8287     nginx@sha256:e6693c20186f837fc393390135d8a598a96a833917917789d63766cab6c59582   "nginx -g 'daemon off'"   Less than a second ago   Up 24 seconds
80/tcp, 443/tcp                                               ucp-node-2.vikings.cisco.com/demo-svc.1.jmmtm7avq2sajkts2m4tryito
[root@docker-mgmt ucp-cvd]#
```

3. Make sure the file added earlier is still in demo_vol.

```
# docker exec <container-id> ls /usr/share/nginx/html/data
```

```
[root@docker-mgmt ucp-cvd]# docker ps | grep demo-svc
83ed14dc8287     nginx@sha256:e6693c20186f837fc393390135d8a598a96a833917917789d63766cab6c59582   "nginx -g 'daemon off'"   Less than a second ago   Up 24 seconds
80/tcp, 443/tcp                                               ucp-node-2.vikings.cisco.com/demo-svc.1.jmmtm7avq2sajkts2m4tryito
[root@docker-mgmt ucp-cvd]# docker exec 83ed14dc8287 ls /usr/share/nginx/html/data
Persistent-Data.txt
[root@docker-mgmt ucp-cvd]#
```

4. Reboot the host the container is running on and verify that the container is brought up on another node.

```
# ssh root@ucp-node-1 reboot
# docker ps | grep demo-svc - Run this repeatedly until you see the second container running.
```

```

[root@docker-mgmt ucp-cvd]# ssh root@ucp-node-2 reboot
The authenticity of host 'ucp-node-2 (192.168.91.28)' can't be established.
ECDSA key fingerprint is c0:1d:84:7b:f9:f6:bc:b2:c6:56:2b:c1:0f:7e:15:c1.
Are you sure you want to continue connecting (yes/no)? yes
Warning: Permanently added 'ucp-node-2,192.168.91.28' (ECDSA) to the list of known hosts.
root@ucp-node-2's password:
Connection to ucp-node-2 closed by remote host.
[root@docker-mgmt ucp-cvd]# docker ps | grep demo-svc
0dc8685f10e4      nginx@sha256:e6693c20186f837fc393390135d8a598a96a83391791778
9d63766cab6c59582  "nginx -g 'daemon off'"   Less than a second ago   Up 48 seconds
                        80/tcp, 443/tcp
                        ucp-node-2.vikings.cisco.com/demo-svc.1.wx8t0tsuxwsm8wpjct23g71j1
83ed14dc8287      nginx@sha256:e6693c20186f837fc393390135d8a598a96a83391791778
9d63766cab6c59582  "nginx -g 'daemon off'"   About a minute ago      Up 4 minutes
                        80/tcp, 443/tcp
                        ucp-node-2.vikings.cisco.com/demo-svc.1.jmmtm7avq2sajkts2m4tryito
[root@docker-mgmt ucp-cvd]# █

```

5. Verify the persistent data in the new container.

```
# docker exec <new-container-id> ls /usr/share/nginx/html/data
```

```

[root@docker-mgmt ucp-cvd]# docker ps | grep demo-svc
0dc8685f10e4      nginx@sha256:e6693c20186f837fc393390135d8a598a96a83391791778
9d63766cab6c59582  "nginx -g 'daemon off'"   Less than a second ago   Up 48 seconds
                        80/tcp, 443/tcp
                        ucp-node-2.vikings.cisco.com/demo-svc.1.wx8t0tsuxwsm8wpjct23g71j1
83ed14dc8287      nginx@sha256:e6693c20186f837fc393390135d8a598a96a83391791778
9d63766cab6c59582  "nginx -g 'daemon off'"   About a minute ago      Up 4 minutes
                        80/tcp, 443/tcp
                        ucp-node-2.vikings.cisco.com/demo-svc.1.jmmtm7avq2sajkts2m4tryito
[root@docker-mgmt ucp-cvd]# docker exec 0dc8685f10e4 ls /usr/share/nginx/html/data
Persistent-Data.txt
[root@docker-mgmt ucp-cvd]# █
[root@docker-mgmt ucp-cvd]# docker ps | grep demo-svc
0dc8685f10e4      nginx@sha256:e6693c20186f837fc393390135d8a598a96a83391791778
9d63766cab6c59582  "nginx -g 'daemon off'"   Less than a second ago   Up 48 seconds
                        80/tcp, 443/tcp
                        ucp-node-2.vikings.cisco.com/demo-svc.1.wx8t0tsuxwsm8wpjct23g71j1
83ed14dc8287      nginx@sha256:e6693c20186f837fc393390135d8a598a96a83391791778
9d63766cab6c59582  "nginx -g 'daemon off'"   About a minute ago      Up 4 minutes
                        80/tcp, 443/tcp
                        ucp-node-2.vikings.cisco.com/demo-svc.1.jmmtm7avq2sajkts2m4tryito
[root@docker-mgmt ucp-cvd]# docker exec 0dc8685f10e4 ls /usr/share/nginx/html/data
Persistent-Data.txt
[root@docker-mgmt ucp-cvd]# █

```

Storage Utilization using a non-admin DDE User

Storage level isolation among multiple tenants is achieved through dedicated SVM associated per tenant. This allows us to limit the number of volumes, storage tiers, QoS on a per-tenant basis.

Create a following nDVP instance for a CRM team.

```
[root@ucp-ctrl-1 netappdvp]# vi netapp-nas-tnt-a-crm.json
{
  "version": 1,
  "storageDriverName": "ontap-nas",
  "storagePrefix": "crm",
  "managementLIF": "192.168.91.11",
  "dataLIF": "192.168.93.12",
  "svm": "Cntr-TNT-A-SVM",
  "username": "ndvp_user",
  "password": "H1ghV0lt",
  "aggregate": "aggr1_node02"
}
```

1. Copy the .json file to all the hosts using ansible as shown

```
# ansible Docker -m copy -a "src=/etc/netappdvp/netapp-nas-tnt-a-crm.json dest=/etc/netappdvp/netapp-nas-tnt-a-crm.json"
```

2. Include the nDVP instance into service file.

```
# ansible Docker -a "docker plugin install store/netapp/ndvp-plugin:1.4.0 --alias netapp-nas-tnt-a-crm config=netapp-nas-tnt-a-crm.json --grant-all-permissions"
```

```
[root@ucp-ctrl-1 ~]# ansible Docker -a "docker plugin install store/netapp/ndvp-plugin:1.4.0 --alias netapp-nas-tnt-a-crm config=netapp-nas-tnt-a-crm.json --grant-all-permissions"
ddc-dtr-1 | SUCCESS | rc=0 >>
1.4.0: Pulling from store/netapp/ndvp-plugin
379c219698bb: Verifying Checksum
379c219698bb: Download complete
Digest: sha256:3ad1d542924f887c10be8b36c543544ceae87f147a87fae3934c6b3a63f04dfa
Status: Downloaded newer image for store/netapp/ndvp-plugin:1.4.0
Installed plugin store/netapp/ndvp-plugin:1.4.0

ucp-ctrl-2 | SUCCESS | rc=0 >>
1.4.0: Pulling from store/netapp/ndvp-plugin
379c219698bb: Verifying Checksum
379c219698bb: Download complete
Digest: sha256:3ad1d542924f887c10be8b36c543544ceae87f147a87fae3934c6b3a63f04dfa
Status: Downloaded newer image for store/netapp/ndvp-plugin:1.4.0
Installed plugin store/netapp/ndvp-plugin:1.4.0
```

3. Login to the UCP control plane and create a new user "John Doe".

To create a new user, go to the UCP web UI, and navigate to the User Management page.

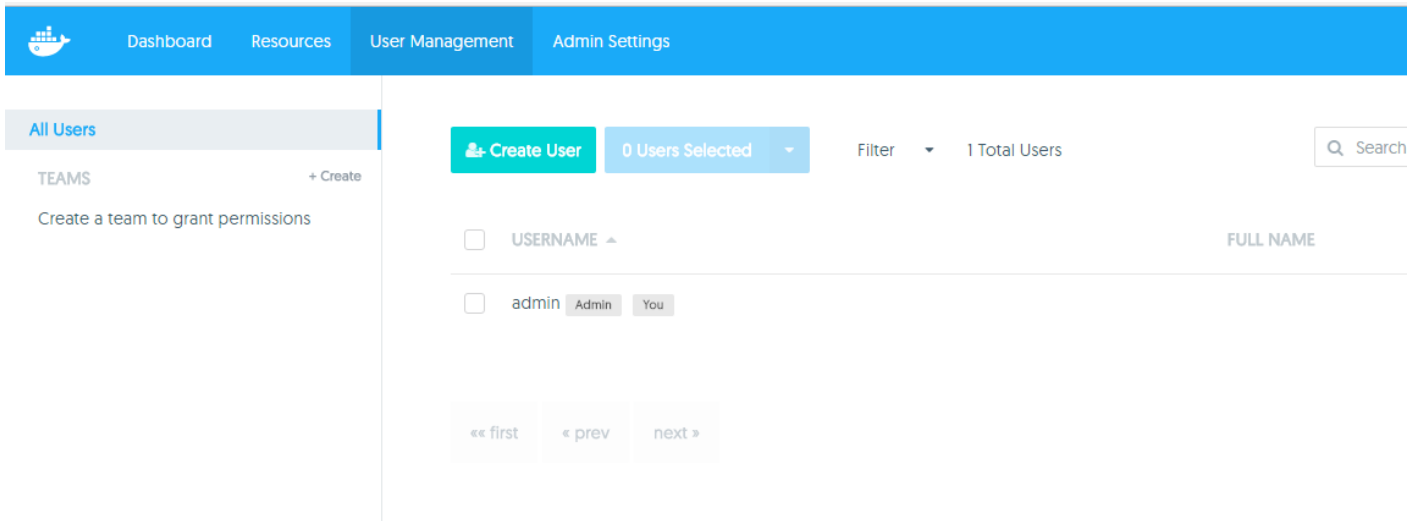

1. Create a new user for example "John Doe"

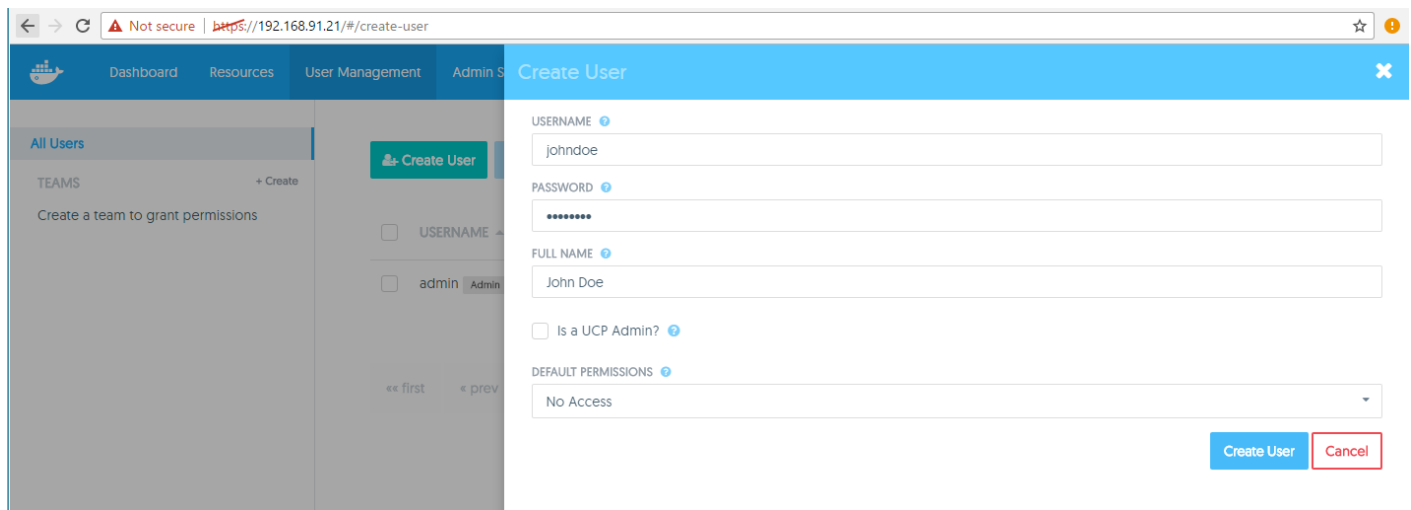

By default we don't assign any privileges to the user. We later create `com.docker.ucp.access.label` associated with different privileges in the team

2. Create a team CRM and add users

To create a new user, go to the UCP web UI, and navigate to the User Management page.

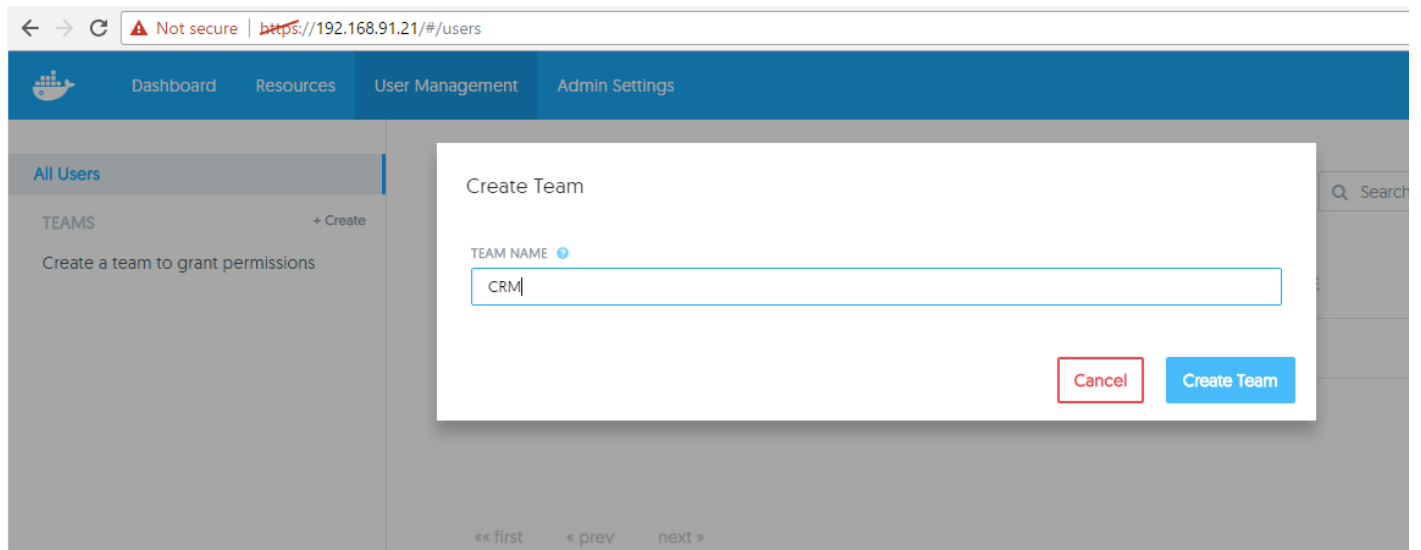

1. Add John Doe user to the CRM team.

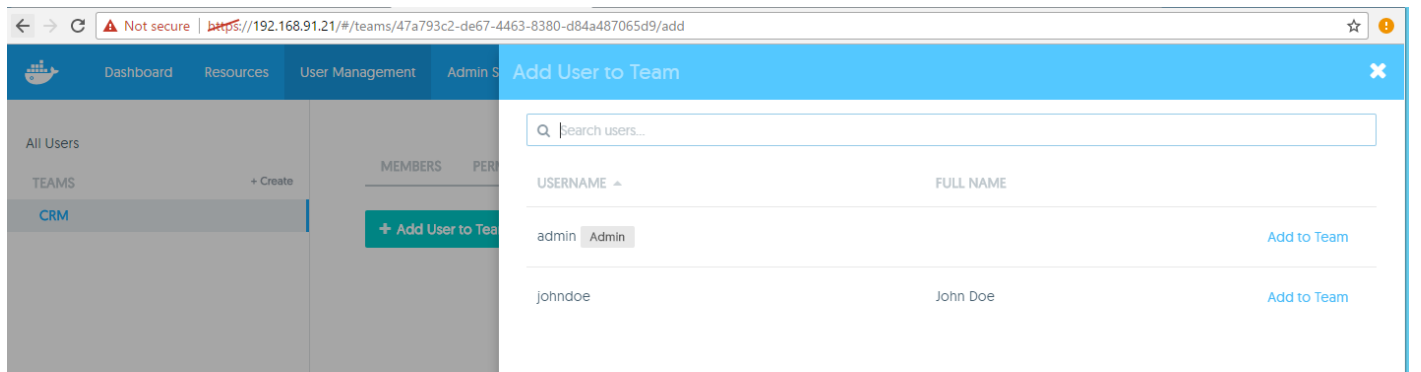

2. Click PERMISSIONS tab and assign a label with "Restricted Control" for the team CRM.

← → ↻ Not secure | https://192.168.91.21/#/teams/47a793c2-de67-4463-8380-d84a487065d9/permissions

Dashboard Resources User Management Admin Settings

All Users
TEAMS + Create
CRM

MEMBERS PERMISSIONS SETTINGS

+ Add Label

Add Label

LABEL ⓘ prod PERMISSION ⓘ Restricted Control

Cancel Add Label



The restricted control permission allows the user to view and create resources with this label.

3. Log in into UCP Control Plane as Jon Doe user and create a volume.

Create Volume ✕

NAME ⓘ
billing

PERMISSIONS LABEL [COM.DOCKER.UCP.ACCESS.LABEL] ⓘ
prod

DRIVER ⓘ
netapp-nas-tnt-a-crm

OPTIONS ⓘ
option=value space separated

Labels ⓘ

+ Add label

No labels defined

Create Cancel

4. Verify that the volume `crmbilling` is created on ONTAP.

The screenshot shows the NetApp OnCommand System Manager interface. The browser address bar displays the URL: `https://192.168.156.20/sysmgr/SysMgr.html#volume&svm=Cntr-TNT-A-SVM`. The page title is "NetApp OnCommand System Manager". The navigation menu includes "Dashboard", "LUNs", "SVMs", "Network", "Hardware and Diagnostics", "Protection", and "Configurations". The current page is "Volumes" for the SVM "Cntr-TNT-A-SVM".

Below the navigation menu, there is a toolbar with actions: Create, Edit, Delete, Clone, Status, Snapshot Copies, Resize, Storage Efficiency, Move, and Storage QoS. The main content area displays a table of volumes.

Name	Aggregate	Status	Thin Provisioned	% Used	Available Space	Total Sp
crmbilling	aggr1_node02	Online	Yes	5	972.57 MB	1 GB

Summary

The emergence of the Docker platform and the underlying support in the Linux and Windows has enabled a shift in the way that traditional applications are managed and new applications are designed and built, moving to more efficient micro services architectures. Microservices architectures are an approach to modernizing and building complex applications through small, independent components that communicate with each other over language-independent APIs.

The integration of Docker Enterprise Edition with the FlexPod converged infrastructure enabled through automation tools like UCS Python SDK and Ansible provides container application platform to get deployed and managed quickly at scale. It also provides a very good starting point for enterprise IT to make in-roads into DevOps and CI/CD model for application environment for quick business need turn around. By combining Docker setup with NetApp Clustered Data ONTAP, applications are robustly protected. Furthermore, NetApp Snapshot copies, Snap Mirror software, and FlexClone platform can also be leverage along with application integrated data protection and data management features.

FlexPod converged infrastructure and Docker Enterprise Edition container management solution can accelerate your IT transformation by enabling easier and faster deployments, greater flexibility, heightened business agility, increased efficiency with lowered risk and higher ROI for enterprise customers.

About Authors

Muhammad Afzal, Engineering Architect, Cisco Systems Inc.

Muhammad Afzal is an Engineering Architect and Technical Marketing Engineer at Cisco Systems in Cisco UCS Product Management and Datacenter Solutions Engineering. He is currently responsible for designing, developing, and producing validated converged architectures while working collaboratively with product partners. Previously, Afzal had been a lead architect for various cloud and data center solutions in Solution **Development Unit at Cisco. Prior to this, Afzal has been a Solutions Architect in Cisco's Advanced Services** group, where he worked closely with Cisco's large enterprise and service provider customers delivering data center and cloud solutions. Afzal holds an MBA in finance and a BS in computer engineering.

John George, Technical Marketing Engineer, Cisco Systems, Inc.

As part of the Cisco UCS team, John George is focused on designing, developing, and validating the FlexPod Integrated Infrastructure solution. John has worked on FlexPod for both Cisco and NetApp for over six years. John holds a Master's degree in computer engineering from Clemson University.

Amit Borulkar, Technical Marketing Engineer, NetApp, Inc.

Amit is a Technical Marketing Engineer with Converged Infrastructure Solutions at NetApp. He has a Master's degree in Computer Science from North Carolina State University. At NetApp, he focusses on OpenStack reference architectures, container orchestration and infrastructure automation with open source tools on FlexPod. While at NC State, his research interests included distributed systems and cloud computing.

Uday Shetty, Senior Software Engineer, Strategic Development, Docker, Inc.

Uday Shetty has more than 25+ years of experience in Enterprise Applications at Sun/Oracle and Docker, working with ISVs and Strategic Partners on new technology adoptions and **Reference Architectures. Uday's** expertise includes C/C++, Java, J2EE, Docker Enterprise Edition for on-premise and Docker EE templates for Cloud providers.

Acknowledgements

- Rajesh Kharya, Technical Leader, Cisco Systems, Inc.
- David Arnette, Sr. Technical Marketing Engineer, NetApp, Inc.
- Andrew Sullivan, Technical Marketing Engineer, NetApp, Inc.

