

Loop Station RC-5

Reference Manual



Getting Ready	2
Panel Descriptions	2
How the RC-5 Is Organized.....	3
Connecting the Equipment	4
Turning the Power On/Off	4
Creating a Loop Phrase	5
Recording	5
Record While Listening to the Rhythm Sound.....	6
Sounding a Rhythm.....	6
Setting the Tempo of Rhythm	6
Saving a Memory	7
Saving a Memory (WRITE)	7
Erasing Data from a Memory (CLEAR)	7
Editing a Memory	8
Editing the Settings of a Memory.....	8
Editing the Rhythm Settings	8
MEMORY parameters.....	9
Settings for the Entire RC-5 (SETUP)	12
SETUP parameters	12
Connecting a Computer via USB	16
Connecting the RC-5 and Computer	16
Backing-Up or Recovering Data	16
Controlling Devices via MIDI	17
MIDI Settings.....	17
Controlling an External MIDI Device from the RC-5.....	17
Controlling the RC-5 from an External MIDI Device.....	18
Connecting Two RC-5 Units	18
Appendix	19
Troubleshooting	19
Error Message List	20
Restoring the Factory Default Settings (Factory Reset).....	21
Changing the Battery	21
Main Specifications	22
IMPORTANT NOTES	23

Getting Ready

Panel Descriptions

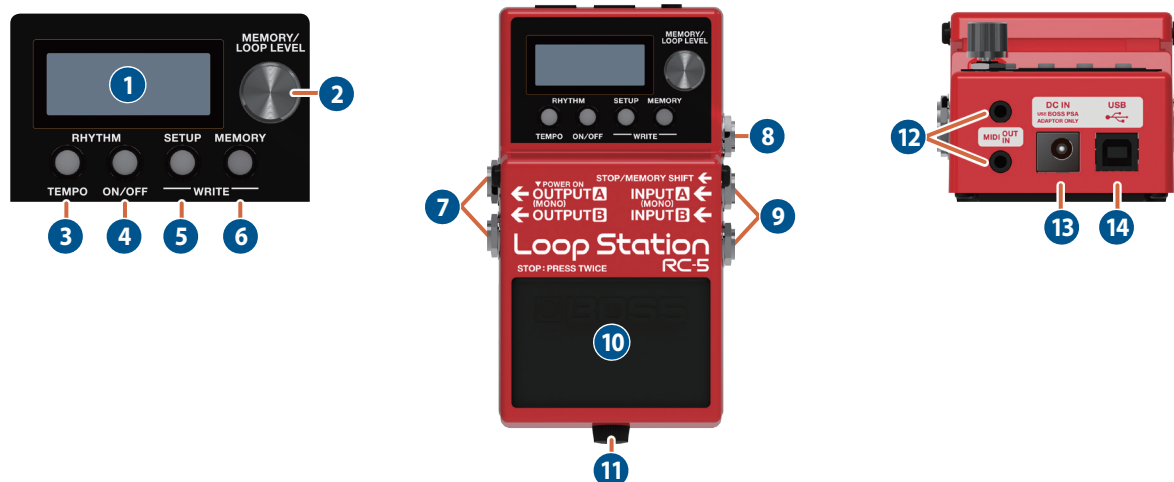

Name	Explanation													
1 Display	Shows various information of the RC-5. During recording/playback/overdubbing, the color of the screen changes according to the status. <table border="1"> <tr> <td>Lit blue</td> <td>No phrase</td> </tr> <tr> <td>Lit red</td> <td>Recording</td> </tr> <tr> <td>Lit green</td> <td>Playing</td> </tr> <tr> <td>Lit yellow</td> <td>Overdubbing</td> </tr> <tr> <td>Lit white</td> <td>Phrase exists</td> </tr> </table>	Lit blue	No phrase	Lit red	Recording	Lit green	Playing	Lit yellow	Overdubbing	Lit white	Phrase exists			
Lit blue	No phrase													
Lit red	Recording													
Lit green	Playing													
Lit yellow	Overdubbing													
Lit white	Phrase exists													
2 [MEMORY/LOOP LEVEL] knob	<table border="1"> <tr> <td rowspan="2">Play screen</td> <td>Turning</td> <td>Selects a memory (01–99) or adjusts the volume of the track (LOOP LEVEL).</td> </tr> <tr> <td>Pressing</td> <td>Switches between selecting a memory and adjusting the volume of the track (LOOP LEVEL).</td> </tr> <tr> <td rowspan="2">When editing</td> <td>Turning</td> <td>Selects a parameter or changes a value.</td> </tr> <tr> <td>Pressing</td> <td>Specifies the parameter to edit. Alternatively, confirms an operation.</td> </tr> <tr> <td colspan="2">Turn while pressing</td> <td>Changes a value in larger steps.</td> </tr> </table>	Play screen	Turning	Selects a memory (01–99) or adjusts the volume of the track (LOOP LEVEL).	Pressing	Switches between selecting a memory and adjusting the volume of the track (LOOP LEVEL).	When editing	Turning	Selects a parameter or changes a value.	Pressing	Specifies the parameter to edit. Alternatively, confirms an operation.	Turn while pressing		Changes a value in larger steps.
Play screen	Turning		Selects a memory (01–99) or adjusts the volume of the track (LOOP LEVEL).											
	Pressing	Switches between selecting a memory and adjusting the volume of the track (LOOP LEVEL).												
When editing	Turning	Selects a parameter or changes a value.												
	Pressing	Specifies the parameter to edit. Alternatively, confirms an operation.												
Turn while pressing		Changes a value in larger steps.												
3 RHYTHM [TEMPO] button	Press to specify the tempo of the rhythm. You can also set the tempo by pressing the button at the desired interval (tap tempo).													
4 RHYTHM [ON/OFF] button	The rhythm switches on (lit)/off (unlit)/ready to play rhythm (blink) each time you press the button. You can record while listening to a rhythm at the tempo you specify. Long press the button (two seconds or longer) to select rhythm settings mode.													
5 [SETUP] button	Lets you make settings that affect the entire RC-5 (the function of a footswitch or expression pedal connected to this unit, and system settings).													
6 [MEMORY] button	Lets you make settings related to loop playback and recording, rhythm settings, and memory name settings. If the track of the selected memory is already recorded, the button is lit green.													
By pressing the [SETUP] button and [MEMORY] button simultaneously, you can save a memory (write) or erase (clear) memory data.														
7 OUTPUT jacks A (MONO), B	Connect these jacks to your amp or monitor speakers. If you're using a mono setup, use only the A (MONO) jack. Even sound that is input in stereo is output in mono. * The OUTPUT A (MONO) jack doubles as the power switch. Power to the unit is turned on when you plug into the OUTPUT A (MONO) jack; the power is turned off when the cable is unplugged. When you are not using the unit, pull the plug out of the OUTPUT A (MONO) jack.													
8 STOP/MEMORY SHIFT jack	Connect a separately sold footswitch or expression pedal to this jack. This lets you control a variety of functions: you can use a footswitch to stop recording/playback/overdubbing or to switch memories, and you can use an expression pedal to operate various parameters. ➔ "Settings for the Entire RC-5 / CONTROL" (p. 13)													
9 INPUT jacks A (MONO), B	Connect your guitar/bass or effect unit to these jacks. * Use the A (MONO) jack and B jack when connecting a stereo-output effects unit. Use only the A (MONO) jack if you're using a mono source.													

Name	Explanation
10 Pedal switch	<p>This pedal switches you between phrase recording, playback, and overdubbing. Press the pedal twice in succession to stop playback.</p> <ul style="list-style-type: none"> • Hold down the pedal two seconds or longer during playback or overdubbing to Undo (cancel the recording or the last overdubbing). Hold down the switch once again for two seconds or longer to Redo (cancel the Undo). • Hold down the pedal two seconds or longer while stopped, the recorded phrase is cleared. <p>MEMO</p> <p>You can assign other functions to the pedal switch.</p> <p>➔ “Settings for the Entire RC-5 / CONTROL” (p. 13)</p>
11 Thumbscrew	<p>When this screw is loosened, the pedal will open, allowing you to change the battery.</p> <p>➔ “Changing the Battery” (p. 21)</p>
12 MIDI IN, OUT connectors	<p>Connect an external MIDI device here.</p> <p>To make these connections, use TRS/MIDI connecting cables (sold separately: BMIDI-5-35). This lets you control an external MIDI device from this unit via MIDI.</p>
13 DC IN jack	<p>Accepts connection of an AC Adaptor (PSA series; sold separately). By using an AC Adaptor, you can play without being concerned about how much battery power you have left.</p> <p>* Use only the specified AC adaptor (PSA-series).</p> <p>* If the AC adaptor is connected while a battery is installed, the power supply is drawn from the AC adaptor.</p>
14 USB port	<p>You can connect your computer here and use it to back up or recover data.</p>

How the RC-5 Is Organized

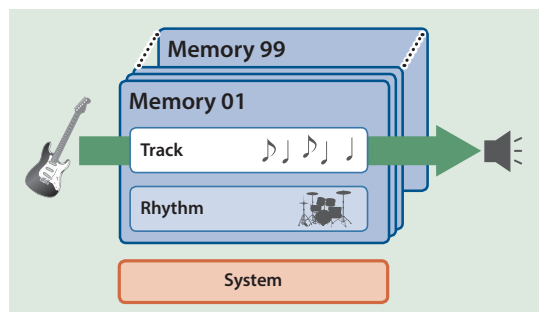

Track

Record and play back audio from an instrument such as guitar.

Rhythm

In addition to the track, the RC-5 can also play a “Rhythm.”

You can record while listening to a rhythm at the tempo you specify.

Memory

The one track, together with the “rhythm” settings, are collectively called a “memory.”

The RC-5 can store up to 99 memories.

System

Settings that are common to the entire RC-5, such as the display contrast adjustment and MIDI settings, are called “system settings.”

“Recording” versus “Overdubbing”

In this manual, we refer to the act of recording to an empty track for the first time as “recording.”

Any subsequent recordings that are made, which are added on top of the existing recording, we refer to as “overdubbing.”

Play screen

The screen that appears after you turn on the power is called the “Play screen.”

01 Memory
01

Connecting the Equipment

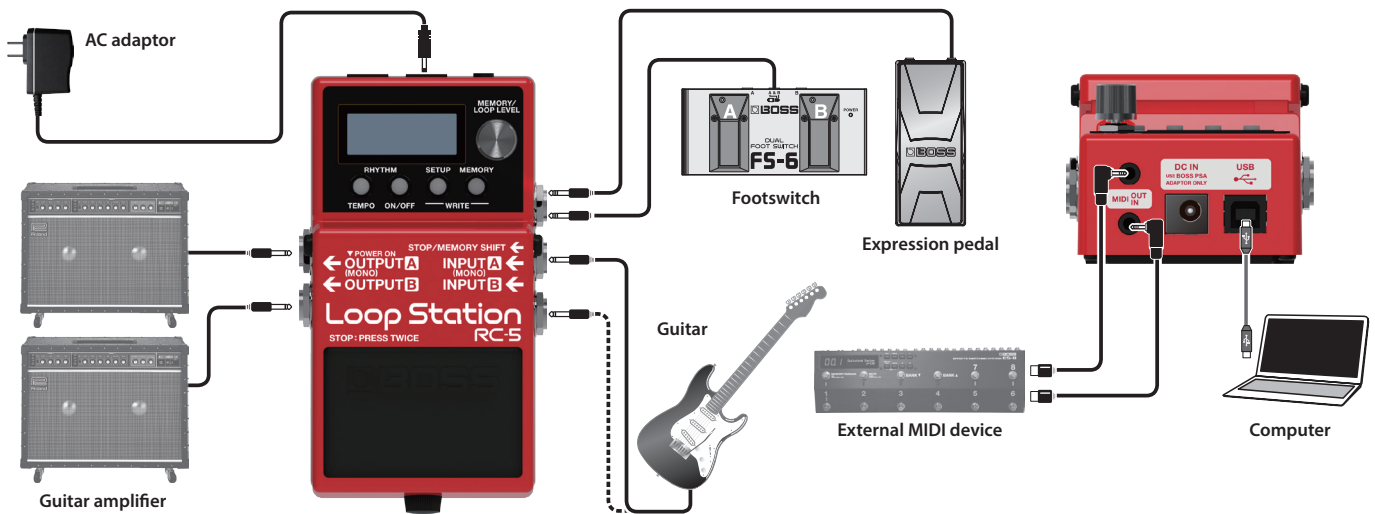

- To prevent malfunction and equipment failure, always turn down the volume, and turn off all the units before making any connections.
- Use only the specified expression pedal (FV-500H, FV-500L, EV-30, and Roland EV-5; sold separately). By connecting any other expression pedals, you risk causing malfunction and/or damage to the unit.

NOTE

When connecting an external pedal, you must turn off the power before connecting or disconnecting cables. Failure to observe this precaution will cause malfunctions.

Connecting a footswitch

Connect a footswitch or switches and set their mode/polarity switches by referring to the illustrations below.

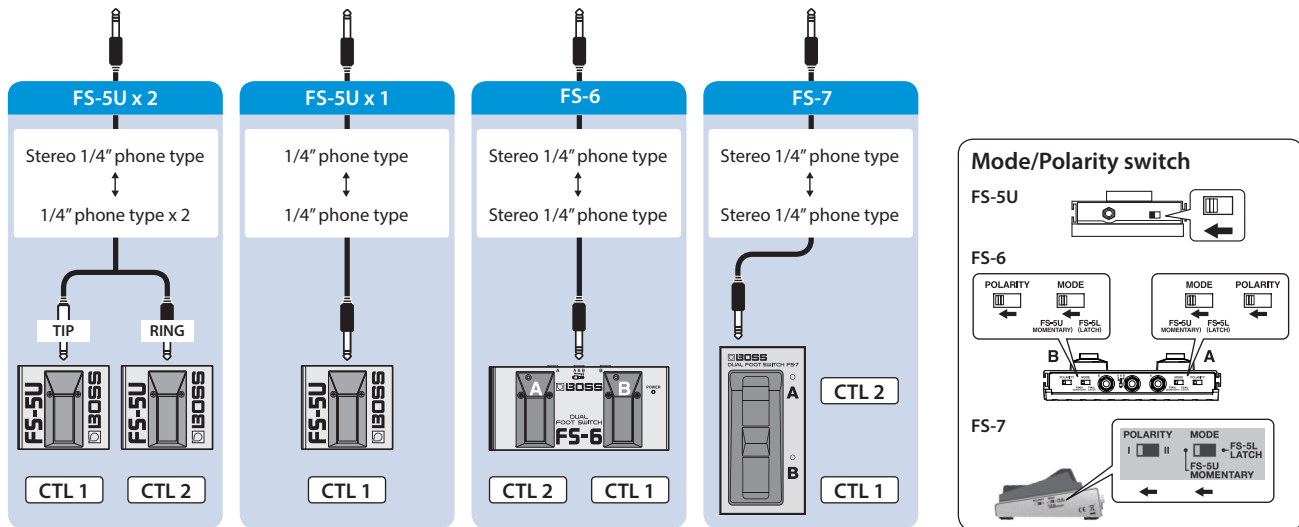

Turning the Power On/Off

The OUTPUT A (MONO) jack doubles as the power switch. Power to the unit is turned on when you plug into the OUTPUT A (MONO) jack; the power is turned off when the cable is unplugged. When you are not using the unit, pull the plug out of the OUTPUT A (MONO) jack.

* Before turning the unit on/off, always be sure to turn the volume down. Even with the volume turned down, you might hear some sound when switching the unit on/off. However, this is normal and does not indicate a malfunction.

When powering up: Turn on the power to your amp last.

When powering down: Turn off the power to your amp first.

Creating a Loop Phrase

Recording

Getting ready to record

Turn the [MEMORY/LOOP LEVEL] knob to select a memory.

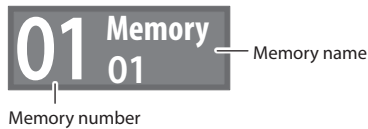

Screen	Status
Blue	Empty track
White	Track contains data

Basic operation

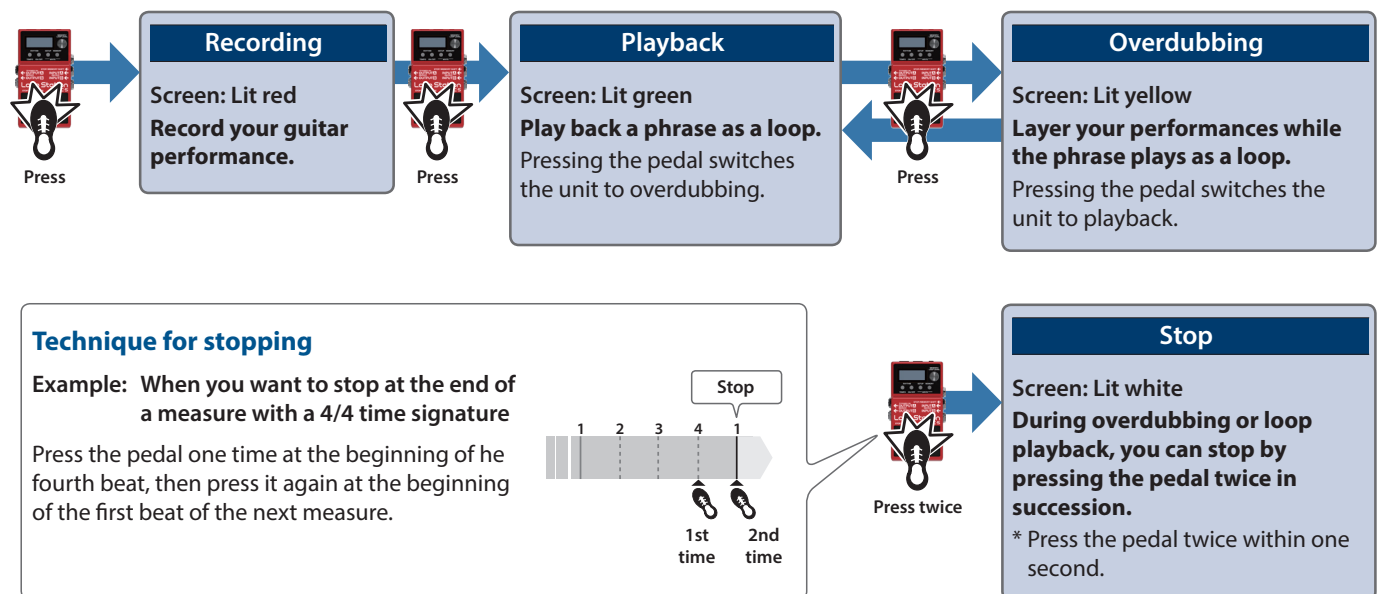

Undo/Redo

Hold down the pedal two seconds or longer during playback or overdubbing to Undo (cancel the recording or the last overdubbing). Hold down the switch once again for two seconds or longer to Redo (cancel the Undo).

Clear

Hold down the pedal two seconds or longer while stopped, the recorded phrase is cleared.

Record While Listening to the Rhythm Sound

In addition to the track, the RC-5 can also play a “Rhythm.”

By recording while you listen to a rhythm at the tempo you’ve specified, you can record at an accurate tempo.

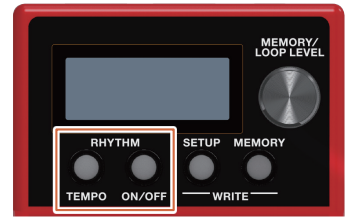

Sounding a Rhythm

1. Press the RHYTHM [ON/OFF] button.

The rhythm switches on (lit)/off (unlit)/ready to play rhythm (blink) each time you press the button.

- The specified tempo can be saved as a setting in memory.
➔ “Saving a Memory (WRITE)” (p. 7)
- You can specify the volume and type of rhythm, and how the rhythm plays.
➔ “Editing the Rhythm Settings” (p. 8)

Setting the Tempo of Rhythm

1. Press the RHYTHM [TEMPO] button.

The tempo setting screen appears.



2. While the tempo setting screen is shown, turn the [MEMORY/LOOP LEVEL] knob to set the tempo.

Value	40.0–300.0
-------	------------

Tap tempo

You can set the tempo by pressing a button at the desired interval.

1. Press the RHYTHM [TEMPO] button several times in time with the desired tempo.

MEMO

If you long press the RHYTHM [TEMPO] button (two seconds or longer), the tempo returns to the default value.

Saving a Memory

Saving a Memory (WRITE)

If you select a different memory or turn off the power after recording or editing the settings, the recorded content or edited settings will be lost. If you want to keep the data, you must save it.

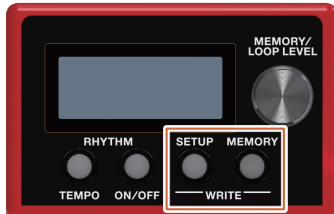

1. Press the [SETUP] button and [MEMORY] button simultaneously.

The UTILITY screen appears.



2. Turn the [MEMORY/LOOP LEVEL] knob to select "WRITE," and press the [MEMORY/LOOP LEVEL] knob.

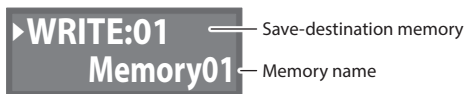

3. Turn the [MEMORY/LOOP LEVEL] knob to select the save-destination memory.

- You can skip this step if you want to save to the currently selected memory.
- If you decide to cancel, press one of the RHYTHM [TEMPO]–[MEMORY] buttons.

4. Press the [MEMORY/LOOP LEVEL] knob.

The memory will be saved.

- * Do not turn off the power while the "EXECUTING..." message is shown.

MEMO

You can assign a name to the memory. For details, refer to p. 11.

Erasing Data from a Memory (CLEAR)

You can erase the data that is saved in a memory, clearing that memory to an empty state.



1. Press the [SETUP] button and [MEMORY] button simultaneously.

The UTILITY screen appears.



2. Turn the [MEMORY/LOOP LEVEL] knob to select "CLEAR," and press the [MEMORY/LOOP LEVEL] knob.



3. Turn the [MEMORY/LOOP LEVEL] knob to select the memory that you want to clear.

- You can skip this step if you want to clear to the currently selected memory.
- If you decide to cancel, press one of the RHYTHM [TEMPO]–[MEMORY] buttons.

4. Press the [MEMORY/LOOP LEVEL] knob.

The memory will be cleared.

- * Do not turn off the power while the "EXECUTING..." message is shown.

Editing a Memory

Editing the Settings of a Memory

Here's how to edit the settings of each memory.

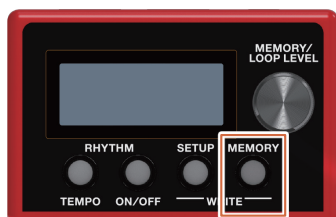

1. Select the memory that you want to edit.

2. Press the [MEMORY] button.

The memory settings screen appears.



3. Turn the [MEMORY/LOOP LEVEL] knob to select the item that you want to edit, and press the [MEMORY/LOOP LEVEL] knob.



4. Turn the [MEMORY/LOOP LEVEL] knob to select the parameter that you want to edit, and press the [MEMORY/LOOP LEVEL] knob.



5. Turn the [MEMORY/LOOP LEVEL] knob to change the value.

6. Press the [MEMORY] button to return to the play screen.

7. If you want to save the edited settings, execute the Write operation (p. 7).

Editing the Rhythm Settings

* Rhythm parameters can also be edited from the edit screens for a memory.

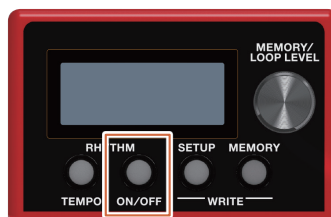

1. Select the memory for which you want to edit the rhythm settings.

2. Long press the RHYTHM [ON/OFF] button.

The rhythm settings screen appears.



3. Turn the [MEMORY/LOOP LEVEL] knob to select the parameter that you want to edit, and press the [MEMORY/LOOP LEVEL] knob.



4. Turn the [MEMORY/LOOP LEVEL] knob to change the value, and press the [MEMORY/LOOP LEVEL] knob.

5. Repeat steps 3–4 to edit the parameter that you want.

6. Long press the RHYTHM [ON/OFF] button to return to the play screen.

7. If you want to save the edited settings, execute the Write operation (p. 7).

MEMO

By executing the Write operation while in the rhythm play-standby or rhythm play condition, you can save/recall the memory as a "rhythm: on" memory.

MEMORY Parameters



LOOP

Parameter	Value (Bold: default)	Explanation
REVERSE	OFF , ON	Specifies conventional playback (OFF) or reverse playback (ON). * When REVERSE is set to "ON," you won't be able to switch to overdubbing after a recording has been completed.
1SHOT	Specifies whether the track playback will be one-shot or not one-shot (conventional loop playback).	
	OFF	Conventional loop playback.
	ON	The phrase will play only once from the beginning to the end of the track, and then stop automatically (One-Shot Playback). If you press the pedal switch during playback, playback will begin again from the beginning of the track (Retrigger Playback). Overdubbing cannot be carried out.
LEVEL	0– 100 –200	Adjusts the playback level of the track. * You can also use the [MEMORY/LOOP LEVEL] knob to adjust the playback level.
REC ACTION	Specifies the order in which record/playback/overdub are switched when you press the pedal switch.	
	REC->DUB	Operation will switch in the order of Recording → Overdubbing → Playback.
	REC->PLAY	Operation will switch in the order of Recording → Playback → Overdubbing.
DUB MODE	Specifies the overdubbing method.	
	OVERDUB	The new performance is layered onto the prerecorded track. If overdub is repeated, the next performance is layered on top of the previous material, allowing you to create an ensemble in a single track.
	REPLACE	Track with existing recordings is overwritten as new track is recorded over them. Overwriting takes places while the previously recorded track is played back, allowing you to achieve a kind of delay effect similar to that obtained from an effects processor.
AUTO REC	"AUTO REC" (auto record) starts recording when there is audio input from your guitar performance.	
	OFF	Recording will begin the instant you press the pedal switch.
	ON	The display shows that you have entered record standby mode when you press the pedal switch. Once you start playing, the display shows that you are now in recording mode, and recording begins.
START	Specifies whether playback starts with a fade-in or immediately when the track plays.	
	IMMEDIATE	Playback starts immediately.
	FADE IN	Playback starts while fading in. * You can use "FADE TIME" to specify the length of the fade-in.
STOP	Specifies how the track will stop when you press the pedal switch. * You can't overdub during the time until playback stops.	
	IMMEDIATE	Playback will stop immediately.
	FADE OUT	Playback will fade out and then stop. * You can use "FADE TIME" to specify the length of the fade-out.
	LOOP END	Playback will continue to the end of the loop, and then stop.
FADE TIME	♪, ♪, ♫, 1MEAS– 2MEAS –64MEAS	Specifies the fade-in/out time as a number of measures when START is set to "FADE IN" or STOP is set to "FADE OUT."
MEASURE	You can specify the number of measures for a track. When recording along with rhythm sounds, it's convenient to specify the number of measures before you record, so that looping will occur at the specified measure length, even if you don't operate the switch when you've finished recording.	
	FREE	The number of measures will be set automatically, corresponding to the length of the recording.
	1MEAS–	The number of measures will be set manually.

RHYTHM

Parameter	Value (Bold: default)	Explanation
LEVEL	0– 100 –200	Adjusts the volume of the rhythm.
REVERB	0– 30 –100	Adjusts the depth of the reverb applied to the rhythm.
PATTERN	Selects the rhythm pattern. SimpleBeat1 –4, GrooveBeat1–7, Rock1–4, Funk1–4, Shuffle1–5, Swing1–5, SideStick1–5, PercusBeat1–4, LatinBeat1–4, Conga1–3, Bossa1–2, Samba1–2, DanceBeat1–4, Metronome1–4, Blank	
VARIATION	A , B	Selects the rhythm pattern variation (A or B).
VAR.CHANGE	Specifies the timing at which the rhythm pattern variation is switched.	
	MEASURE	Play to the end of the measure and then switch.
	LOOP END	Play to the end of the loop and then switch.
KIT	Selects the drum kit that is used for rhythm playback.	
	Studio , Rock, Jazz, Brush, Cajon, R&B, 808+909	
BEAT	2/4– 4/4 –7/4, 5/8–15/8	Selects the rhythm beat. * You cannot change the beat after the track is recorded. Be sure to set this before recording.
START	Specifies how rhythm playback starts.	
	LOOP START	The rhythm plays when loop recording or playback starts.
	REC END	The rhythm plays when loop recording ends and switches to playback. This is useful if you want to perform without specifying a tempo, then start recording, and then play the loop in time with the rhythm when playback starts.
	BEFORE LOOP	The rhythm plays before loop recording or playback. The rhythm starts playing when you press the switch once, and recording/playback starts in time with the rhythm when you press the switch once again.
STOP	Specifies how rhythm playback stops.	
	OFF	The rhythm always continues playing. If you are performing in synchronization with an external MIDI device, you can keep the rhythm playing continuously to allow synchronized playback.
	LOOP STOP	The rhythm stops when the loop stops.
	REC END	The rhythm stops when loop recording ends. This is useful when you want to use the rhythm as a guide during recording.
REC COUNT	Specifies whether a count-in is heard for recording. * A count-in won't be sounded when a track or rhythm is being played back.	
	OFF	No count-in is played.
	1MEAS	Recording starts after a one-measure count-in is played.
PLAY COUNT	Specifies whether a count-in is heard for playback.	
	OFF	No count-in is played.
	1MEAS	Playback starts after a one-measure count-in is played.
FILL	OFF, ON	Specifies whether the rhythm plays with a fill-in (ON) or without a fill-in (OFF).
PART1–4	OFF, ON (PART1–3) OFF , ON (PART4)	For each of the four drum parts (PART 1–4) that make up the drum kit, these settings specify whether the drum sound is heard (ON) or not heard (OFF).
TONE LOW	–10– 0 –10	Adjusts the low-frequency tonal character of the rhythm sound.
TONE HIGH	–10– 0 –10	Adjusts the high-frequency tonal character of the rhythm sound.

NAME

Parameter	Value (Bold: default)	Explanation
NAME	Specifies the memory name. * Maximum of 12 characters	
	<ol style="list-style-type: none"> Turn the [MEMORY/LOOP LEVEL] knob to move the cursor to the position at which you want to enter a character, and then press the [MEMORY/LOOP LEVEL] knob.  Turn the [MEMORY/LOOP LEVEL] knob to select a character, and then press the [MEMORY/LOOP LEVEL] knob.  	

Settings for the Entire RC-5 (SETUP)

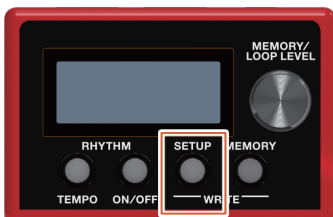

1. Press the [SETUP] button.

The SETUP screen appears.



2. Turn the [MEMORY/LOOP LEVEL] knob to select the item that you want to edit, and press the [MEMORY/LOOP LEVEL] knob.



3. Turn the [MEMORY/LOOP LEVEL] knob to select the parameter that you want to edit, and press the [MEMORY/LOOP LEVEL] knob.



4. Turn the [MEMORY/LOOP LEVEL] knob to change the value.

5. Press the [SETUP] button to return to the play screen.

SETUP Parameters

GENERAL

Parameter	Value (Bold: default)	Explanation
DISP CONT	1- 5 -10	Adjusts the display contrast.
DISP MODE	Specify what is shown in the screen during recording, playback, and overdubbing.	
	STATUS	Show "REC" during recording, "PLAY" during playback, and "DUB" during overdubbing
	POSITION	Show the progress of recording/playback/overdubbing
	STATUS+POS	Upper line: STATUS indication Lower line: POSITION indication
	NUMBER+POS	Upper line: Show the memory number Lower line: POSITION indication
	NAME+POS	Upper line: Show the memory name Lower line: POSITION indication
	BEAT+POS	Upper line: Show the time signature of the rhythm Lower line: POSITION indication
BEAT	Show the time signature of the rhythm	
M.EXT MIN	01 -99	Specify the extent in which memories can be switched (lower limit: MIN / upper limit: MAX).
M.EXT MAX	01- 99	
UNDO/REDO	Specify the timing at which undo/redo is executed. * This parameter is valid if a function that allows undo/redo by long pressing the switch is assigned as the PEDAL FUNC or CTL1-2 FUNC (p. 13) setting.	
	HOLD	Execute undo/redo while you hold down the switch.
	RELEASE	Execute undo/redo the moment you release the switch.

CONTROL

Parameter	Value (Bold: default)	Explanation
PEDAL FUNC CTL1 FUNC CTL2 FUNC		Specify the functions of the pedal switch, and a footswitch (CTL1, CTL2) connected to the STOP/MEMORY SHIFT jack.
	TRK REC/PLY	Switch between record/play/overdubbing for track. Long press (two seconds or longer) the switch during playback or overdubbing to Undo, long press the switch once again to Redo.
	TRK R/P/S	Switch between record/play/stop (press the switch twice) for track. Long press (two seconds or longer) the switch during recording or playback to Undo, long press the switch once again to Redo.
	TRK R/P/S(C) (PEDAL)	Switch between record/play/stop (press the switch twice) for track. Long press (two seconds or longer) the switch during recording or playback to Undo, long press the switch once again to Redo. Long press (two seconds or longer) the switch during stopped, the track is cleared.
	TRK MOM R/P	Put track in record/play only while you hold down the switch.
	TRK PLY/STP	Switch between play/stop for track.
	TRK P/S(CLR)	Switch between play/stop for track. Long press (two seconds or longer) the switch during recording or playback to Undo, long press the switch once again to Redo. Long press (two seconds or longer) the switch during stopped, the track is cleared.
	TRK STOP	Stop record/play for track.
	TRK STOP(TAP)	Stop record/play for track. Specify the tempo (tap tempo) by pressing the switch several times at the desired interval while stopped.
	TRK STOP(CLR) (CTL1)	Stop record/play for track. Long press (two seconds or longer) the switch during stopped, the track is cleared.
	TRK STOP(T/C)	Stop record/play for track. Specify the tempo (tap tempo) by pressing the switch several times at the desired interval while stopped. Long press (two seconds or longer) the switch during stopped, the track is cleared.
	TRK CLEAR	Clear the track.
	TRK UND/RED	Undo/redo recording or the most recent overdubbing for track.
	TRK REVERSE	Turn reverse play on/off for track.
	TAP TEMPO	Press the switch several times at the desired interval to specify the tempo. Long press the switch (two seconds or longer) to return to the previous tempo.
	RHYHTM P/S	Switch the rhythm between play/stop.
	RHYTHM PLAY	Play the rhythm.
	RHYTHM STOP	Stop playing the rhythm.
	MEMORY INC (CTL2)	Switch to the next memory.
	MEMORY DEC	Switch to the previous memory.
EXP FUNC		Specifies the function of an expression pedal connected to the STOP/MEMORY SHIFT jack.
	TRK LEVEL1	Control the volume of track (LOOP LEVEL) in the range of 0–200.
	TRK LEVEL2	Control the level in the range of 0–“maximum value,” with the LOOP LEVEL setting of track as the maximum value.
	TEMPO UP	Press the pedal to make the tempo faster.
	TEMPO DOWN	Press the pedal to make the tempo slower.
	RHYTHM LEV1	Control the “LEVEL” (p. 10) of memory/RHYTHM in the range of 0–200.
	RHYTHM LEV2	Control the level in the range of 0–“maximum value,” with the “LEVEL” setting of memory/RHYTHM as the maximum value.
	MEMORY LEV1	Control the “LEVEL” (p. 9) of memory/LOOP in the range of 0–200.
MEMORY LEV2	Control the level in the range of 0–“maximum value,” with the “LEVEL” setting of memory/LOOP as the maximum value.	

Settings for the Entire RC-5 (SETUP)

Parameter	Value (Bold: default)	Explanation
		This sets the functions that are controlled when a control change message (controller numbers 80–87) is received from an external MIDI device.
	OFF	No function is assigned.
	TRK PLY/STP	Switch between play/stop for track.
	TRK CLEAR	Clear the track.
	TRK UND/RED	Undo/redo recording or the most recent overdubbing for track.
	TRK REVERSE	Turn reverse play on/off for track.
	TRK LEVEL1	Control the volume of track (LOOP LEVEL) in the range of 0–200.
	TRK LEVEL2	Control the level in the range of 0–“maximum value,” with the LOOP LEVEL setting of track as the maximum value.
	TAP TEMPO	Press the switch several times at the desired interval to specify the tempo. Long press the switch (two seconds or longer) to return to the previous tempo.
	TEMPO UP	Press the pedal to make the tempo faster.
	TEMPO DOWN	Press the pedal to make the tempo slower.
	RHYHTM P/S	Switch the rhythm between play/stop.
	RHYTHM PLAY	Play the rhythm.
	RHYTHM STOP	Stop playing the rhythm.
	RHYTHM LEV1	Control the “LEVEL” (p. 10) of memory/RHYTHM in the range of 0–200.
	RHYTHM LEV2	Control the level in the range of 0–“maximum value,” with the “LEVEL” setting of memory/RHYTHM as the maximum value.
CC#80 FUNC	MEMORY INC	Switch to the next memory.
CC#81 FUNC	MEMORY DEC	Switch to the previous memory.
CC#82 FUNC	MEMORY LEV1	Control the “LEVEL” (p. 9) of memory/LOOP in the range of 0–200.
CC#83 FUNC	MEMORY LEV2	Control the level in the range of 0–“maximum value,” with the “LEVEL” setting of memory/LOOP as the maximum value.
CC#84 FUNC	TRK REVERSE	Control “REVERSE” of memory/LOOP.
CC#85 FUNC	TRK 1SHOT	Control “1SHOT” of memory/LOOP.
CC#86 FUNC	REC ACTION	Control “REC ACTION” of memory/LOOP.
CC#87 FUNC	DUB MODE	Control “DUB MODE” of memory/LOOP.
	AUTO REC	Control “AUTO REC” of memory/LOOP.
	TRK START	Control “START” of memory/LOOP.
	TRK STOP	Control “STOP” of memory/LOOP.
	FADE TIME	Control “FADE TIME” of memory/LOOP.
	REVERB	Control “REVERB” of memory/RHYTHM.
	PATTERN	Control “PATTERN” of memory/RHYTHM.
	VARIATION	Control “VARIATION” of memory/RHYTHM.
	VAR.CHANGE	Control “VAR.CHANGE” of memory/RHYTHM.
	KIT	Control “KIT” of memory/RHYTHM.
	RHY START	Control “START” of memory/RHYTHM.
	RHY STOP	Control “STOP” of memory/RHYTHM.
	REC COUNT	Control “REC COUNT” of memory/RHYTHM.
	PLAY COUNT	Control “PLAY COUNT” of memory/RHYTHM.
	RHY FILL	Control “FILL” of memory/RHYTHM.
	RHY PART1–4	Control “PART1”–“PART4” of memory/RHYTHM.
	TONE LOW	Control “TONE LOW” of memory/RHYTHM.
	TONE HIGH	Control “TONE HIGH” of memory/RHYTHM.

MIDI

Parameter	Value (Bold: default)	Explanation
RX CTL CH	1 –16	Specifies the receive channel for messages (control changes) that switch memories or control the RC-5.
OMNI	Specifies MIDI omni mode.	
	OFF	Messages will be received only on the channel specified by the RX CTL CH setting.
	ON	Messages are received via all MIDI channels, regardless of the RX CTL CH settings.
RX NOTE CH	1– 10 –16	Specifies the receive channel for note messages that play the RC-5's drum sounds.
TX CH	1–16, RX CTL	Specifies the MIDI transmit channel. If this is "RX CTL," the channel will be the same as the RX CTL CH.
SYNC CLOCK	Specifies the input to which the tempo clock is synchronized.	
	AUTO	The RC-5 will normally operate using its internal tempo, but will synchronize the tempo to MIDI clock if MIDI clock data is being input via the MIDI IN connector or the USB port. Choose the "AUTO" setting if using the RC-5 as a slave device. The priority order is MIDI>USB>internal clock.
	INTERNAL	The clock uses the tempo specified by the memory. Choose the "INTERNAL" setting if you don't want to synchronize the RC-5 to an external device.
	USB	Synchronize to the tempo from the USB port.
	MIDI	Synchronize to the tempo from the MIDI IN connector.
CLOCK OUT	OFF, ON	Specifies whether MIDI clock is transmitted (ON) or not transmitted (OFF).
SYNC START	Specifies what starts in synchronization when a MIDI start message is received.	
	OFF	Synchronized start does not occur.
	ALL	Track + rhythm
	RHYTHM	Rhythm
PC OUT	OFF, ON	Specifies whether program change messages are transmitted (ON) or not transmitted (OFF).
MIDI THRU USB THRU	Specifies the connector(s) from which MIDI messages received at the MIDI IN connector or the USB port are output.	
	OFF	MIDI messages are not output.
	MIDI OUT	Output from the MIDI OUT connector.
	USB OUT	Output from the USB port.
	USB/MIDI	Output from the USB port and the MIDI OUT connector.

STORAGE

Parameter	Value (Bold: default)	Explanation
STORAGE	OFF , CONNECT	Change this from the OFF setting when connecting the RC-5 via USB to your computer. When a connection with the computer is established, the message "CONNECTING..." appears.

F.RESET

Parameter	Value (Bold: default)	Explanation
F.RESET	Specifies the settings that will be returned to their factory-set state.	
	MEMORY	Memory 01–99
	SYSTEM	System settings
	MEM+SYS	Memory 01–99 and system settings

Connecting a Computer via USB

If the RC-5 is connected via USB to your computer, you'll be able to do the following.

- Back up the RC-5's data to your computer.
- Restore (recover) backed-up data from your computer to the RC-5.
- Use BOSS TONE STUDIO to import or back-up loop phrases (audio files).

To use BOSS TONE STUDIO

Access the following URL, and download BOSS TONE STUDIO.

➔ <https://www.boss.info/support/>

Connecting the RC-5 and Computer

1. Use a commercially available USB cable to connect the RC-5's  (USB) port to your computer's USB port.

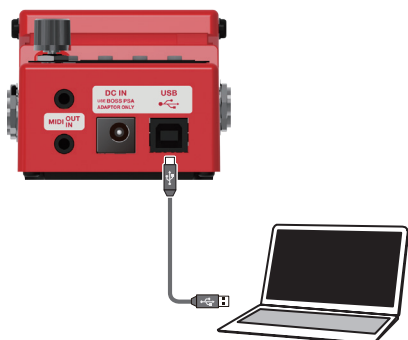

NOTE

- Use a USB cable that supports USB 2.0 Hi-Speed.
- This might not work correctly for some models of computer. Refer to the BOSS website for details on the operating systems that are supported.

Backing-Up or Recovering Data

1. Press the [SETUP] button.

The SETUP screen appears.



2. Turn the [MEMORY/LOOP LEVEL] knob to select "STORAGE," and press the [MEMORY/LOOP LEVEL] knob.



3. Turn the [MEMORY/LOOP LEVEL] knob to set "PREPARING...".

4. Use a USB cable to connect the RC-5's USB port to your computer's USB port.

When a connection with the computer is established, the message "CONNECTING..." appears.

* USB connection is not possible if the unit is not stopped, or if there is a phrase that has not been saved.

5. Open the BOSS RC-5 drive.

Windows

Within My Computer (or Computer), open "BOSS RC-5" (or Removable Disk).

Mac OS

On the desktop, open the "BOSS RC-5" icon.

6. Back-up or recover the data.

Backup

Copy the entire "ROLAND" folder from the BOSS RC-5 drive to your computer.

Recover

* When you execute this operation, the memory currently saved in the RC-5 disappears. Back up in advance.



In the BOSS RC-5 drive, delete the "ROLAND" folder, and then copy the backed-up "ROLAND" folder from the computer into the BOSS RC-5 drive.

NOTE

Do not delete the folders in the BOSS RC-5 drive other than when executing the recovery operation.

7. Eject the USB drive.

Windows

In the lower right of your screen, click the  icon →  icon, and then click "Eject BOSS RC-5."

Mac OS

Drag the "BOSS RC-5" icon to the trash ("Eject" icon).

Controlling Devices via MIDI

Connection

MIDI cables are connected to these connectors as needed.

Connector	Explanation
MIDI IN	Receives messages from another MIDI device.
MIDI OUT	Transmits messages from this device.

To make these connections, use TRS/MIDI connecting cables (sold separately: BMIDI-5-35).

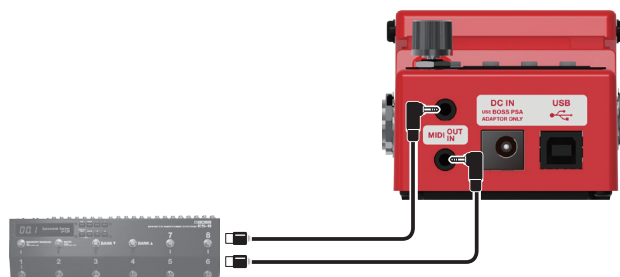

MIDI Settings

Use of MIDI requires that the MIDI channels be matched with those of the connected device. Data cannot be transmitted to, nor received from another MIDI device unless the MIDI channels are set properly.

For details on each of the MIDI setting parameters, refer to p. 15.

Controlling an External MIDI Device from the RC-5

Overview	Explanation
Transmitting tempo data and data for starting and stopping playback	
The RC-5's performance tempo data is transmitted to external MIDI devices as MIDI Clock.	<p>Setting an external MIDI device to the same tempo as the RC-5</p> <p>MIDI Clock messages are output from the RC-5 at all times. Set the external MIDI device beforehand so it is ready to receive MIDI Clock and MIDI Start and Stop messages. For details, refer to the owner's manual that came with the device.</p>
Playback start and stop operations with the RC-5's switches can be transmitted as MIDI Start and Stop messages.	<p>Transmitting Start/Stop</p> <p>A MIDI Start message is transmitted at the moment that recording or playback of the track begins, when tracks had been stopped. This message is also transmitted when an All Start is carried out. A MIDI Stop message is transmitted when tracks have stopped. This is also transmitted when All Stop is in carried out.</p> <p>* If you want MIDI synchronized performance to continue even after the track stops, set the RHYTHM parameter STOP (p. 10) to "OFF." * Track whose 1SHOT setting (p. 9) is "ON" will not transmit Start/Stop data.</p>
Transmitting Program Change messages	
When a memory is selected with the RC-5, a Program Change message corresponding to the selected memory number is transmitted simultaneously.	<p>Transmitting Program Change messages</p> <p>When memories are switched on the RC-5, a MIDI Program Change message is transmitted to the connected external MIDI device. You can transmit Program Change messages numbered 01 through 99, corresponding to the 99 individual memories 1–99.</p> <ul style="list-style-type: none"> • Set PC OUT (p. 15) to "ON" beforehand. • Program Change messages 100–128 cannot be transmitted. • Bank Select MIDI messages (Control Change #0, #32) cannot be transmitted.

Controlling the RC-5 from an External MIDI Device

Overview	Explanation
Receiving tempo data and data for starting and stopping playback	
The RC-5 will synchronize to the tempo of MIDI Clock data from an external MIDI device.	Setting the RC-5 to the same tempo as an external MIDI device Make settings on your external MIDI device so that it will transmit MIDI Clock and MIDI Start/Stop data. For details, refer to the owner's manual of your device. Set the RC-5's SYNC CLOCK to "AUTO" (p. 15). * You can't switch the tempo during recording.
Start/stop data will be received from an external MIDI device to play/stop the RC-5.	Receiving MIDI Start When MIDI Start (FA) is received, all tracks will play (All Start).
Switching memories	
The RC-5's memories switch simultaneously upon receipt of corresponding Program Change messages from external MIDI devices.	Switching memories You can switch the RC-5's memories with Program change messages from external MIDI devices. The RC-5 can receive program change messages numbered 01 through 99, corresponding to the 99 individual memories 1–99. * Program Change messages 100–128 cannot be received. * Even if received, Bank Select MIDI messages (Control Change #0, #32) are disregarded.
Receiving Control Change messages	
The RC-5 can be controlled using Control Change messages from external MIDI devices.	Receiving Control Change messages You can use Control Change messages from an external MIDI device to control functions that would be difficult to control using the RC-5's own controllers. Select the parameter you wish to control using the CONTROL settings from "CC#80 FUNC" to "CC#87 FUNC" (p. 14).

Connecting Two RC-5 Units

Two RC-5 units can be synchronized after connecting them together using a MIDI cable.

* To make this connection, use a stereo mini-plug ↔ stereo mini-plug cable.

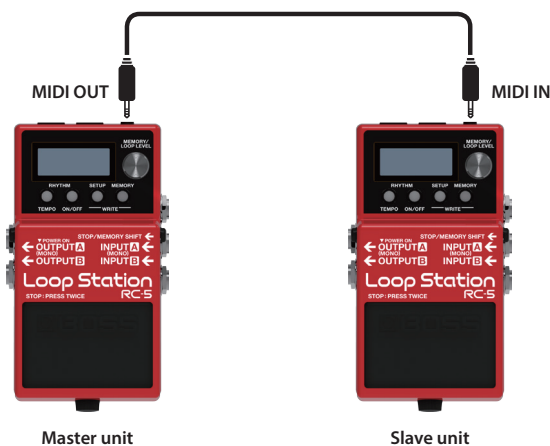

- Begin recording on the master RC-5 unit's tracks.
- The slave RC-5 unit starts in synchronization when the master RC-5 unit's track starts playing.
- The track on the slave unit plays back at the tempo set in the master unit's memory.

Appendix

Troubleshooting

Problem	Items to Check	Action
Problems with sound		
No sound/low volume	Is the RC-5 properly connected to other devices?	Check the connections to other devices (p. 4).
	Is the power to the connected amp or mixer not turned on, or is the volume turned down?	Check the settings for connected devices.
	Are the connection cables shorted?	Try replacing the connection cable.
	Is the track level set correctly?	Use the [MEMORY/LOOP LEVEL] knob to adjust the level.
		Check the "LEVEL" of memory/LOOP setting (p. 9). Check whether an external expression pedal might have been used to adjust the level (p. 13).
Has anything been recorded to the track?	Check the [MEMORY] button to see whether the track has been recorded. If the [MEMORY] button is unlit, nothing has been recorded.	
No rhythm sound	Is RHYTHM LEVEL set correctly?	Check the "LEVEL" of memory/RHYTHM setting (p. 10).
Sound is missing from the beginning and end of the recorded track	To prevent noise, a fade-in and a fade-out are applied at the beginning and end of a recording. In some cases, it may sound as if some of the sound has been left out.	
Problems with operation		
Memories not switching	Is something other than the Play screen appearing in the display?	You cannot switch memories while any screen other than the Play screen is displayed. Press the [MEMORY] button to return to the Play screen.
Recording/overdubbing stops before finishing	Is there insufficient memory remaining?	If memory is insufficient, clear any unneeded memories (p. 7) before recording or overdubbing.
Playback tempo not changing	Is recording or overdubbing in progress?	You cannot change the memory tempo during recording or overdubbing. Change the tempo while the performance is stopped or being played back.
	Is the RC-5 synchronized via MIDI?	If MIDI clock is being received via the MIDI IN connector or the USB port, the RC-5 will synchronize its tempo to MIDI clock. If you don't want to synchronize with an external device, set SYNC CLOCK to "INTERNAL" (p. 15).
MIDI messages not being transmitted/received	Could there be a short in the MIDI cable?	Try replacing the MIDI cable.
	Is the external MIDI device properly connected?	Check the connections to the external MIDI device.
	Are the MIDI channels matched to those of the external MIDI device?	Confirm that both devices are set to the same MIDI channels.
	If transmitting from the RC-5, have you made the necessary settings for transmission?	Check the TX CH (transmit channel) setting and the PC OUT (program change message transmit) on/off setting (p. 15).
Problems with USB		
Unable to communicate with computer	Is the USB cable properly connected?	Check the connection (p. 16).
	(If exchanging files via USB with your computer) Could "STORAGE" be OFF?	In the procedure "Backing-Up or Recovering Data" (p. 16), set STORAGE to "PREPARING...".
	Could you be editing a memory?	USB connection is not possible if there is an unsaved memory. Save the memory (p. 7), and then try USB connection again.

Error Message List

Message	Meaning	Action
LOOPER		
DATA DAMAGED	Data may have been damaged.	In the factory reset function (p. 21), choose "SYS+MEM" to return the RC-5 to its factory settings.
DATA READ ERR	A problem has occurred with the content of the RC-5's memory.	Consult your Roland dealer or local Roland Service.
DATA WRITE ERR		
DATA TOO LONG	Playback is not possible because the recording time or audio file is too long.	The recording time or audio file length must not exceed 1.5 hours.
DATA TOO SHORT	Playback is not possible because the recording time or audio file is too short.	The recording time or audio file length must be at least 0.1 seconds.
EVENT FULL	Further overdubbing is not possible.	Save the memory (p. 7).
MEMORY FULL	The recorded time of one track exceeded 1.5 hours (approximately). No further recording is possible on the current track.	Save the memory (p. 7). If you want to continue recording, select a different memory.
	The total recording time of all memories exceeded 13 hours (approximately). No further recording is possible.	Clear unneeded memories (p. 7).
NOT EMPTY	You are attempting to overwrite-save onto a memory in which a phrase is already recorded.	Either clear the currently selected memory (p. 7), or select an empty memory.
TEMPO TOO FAST	Since the track is being played at a much faster tempo than when it was recorded, it might not play back correctly.	Adjust the tempo.
TEMPO TOO SLOW	Since the track is being played at a much slower tempo than when it was recorded, it might not play back correctly.	
TOO BUSY	The RC-5 could not process the data completely.	Lower the performance tempo.
TOO BUSY OMSG	For "TOO BUSY OMSG": Since you attempted to apply the loop FX to a phrase that was set to a significantly slower tempo than when it was recorded, the data could not be processed quickly enough.	In the case of "TOO BUSY OMSG," return to the tempo that was used during recording.
		Save the current content to a memory. If this appears frequently, back up the data to your computer, then execute factory reset "SYS+MEM," and then recover the data (p. 21, p. 16).
UNDEFINED ERR	An error of unknown cause has occurred during recording, playback, or overdubbing.	Consult your Roland dealer or local Roland Service.
MIDI		
BUFFER FULL	An excessive volume of messages were received and could not be processed properly.	Reduce the number or size of MIDI messages transmitted to the RC-5.
OFFLINE	There is a problem with the MIDI cable connection.	Check to make sure the cable has not been disconnected and that there is no short in the cable.
Others		
BATTERY LOW	The battery has run down.	Replace the batteries, or use an AC adaptor.
BATTERY LOW!! STOP ALL	Because the battery has run down, the unit cannot function correctly. All operations of the RC-5 have stopped.	
MEMORY FULL	This unit's memory is insufficient. If this message appears, recording or overdubbing might end mid-way.	Clear unneeded memories (p. 7), and then try recording again.
STOP LOOPER	The operation is not possible during recording, playback, or overdubbing.	Stop before performing the operation.
STOP ALL	The operation is not possible during recording, playback, overdubbing, or rhythm playback.	Stop all of these before performing the operation.
STOP ALL&SAVE	The operation is not possible during recording, playback, overdubbing, or rhythm playback when there is also unsaved data.	Stop all of these, and then save the memory (p. 7).
UNSUPPORTED FILE	This audio file is unplayable.	Check the format of the audio file.
		To import an audio file into the RC-5, use "BOSS TONE STUDIO."

Restoring the Factory Default Settings (Factory Reset)

Not only can you return all of the settings to the values in effect when the RC-5 was shipped from the factory, you can also specify the items to be reset.

* When you execute "Factory Reset," the settings you made will be lost. In advance, back up important data to your computer.

1. Press the [SETUP] button.

The SETUP screen appears.



2. Turn the [MEMORY/LOOP LEVEL] knob to select "F.RESET," and press the [MEMORY/LOOP LEVEL] knob.



3. Turn the [MEMORY/LOOP LEVEL] knob to specify the settings that will be returned to their factory-set state, and press the [MEMORY/LOOP LEVEL] knob.

Value	Explanation
MEMORY	Memory 1-99
SYSTEM	System settings
MEM+SYS	Memory 1-99 and system settings

A confirmation message "ARE YOU OK?" appears.

* If you decide not to execute the factory reset, select "CANCEL" and press the [MEMORY/LOOP LEVEL] knob.

4. Turn the [MEMORY/LOOP LEVEL] knob to select "OK," and press the [MEMORY/LOOP LEVEL] knob.

The factory reset is executed.

* Do not turn off the power while the "EXECUTING..." message is shown.

Once the factory reset is complete, you are returned to the Play screen.

Changing the Battery

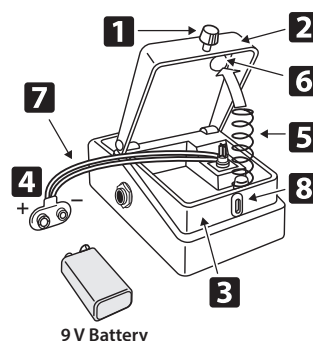

1. Hold down the pedal and loosen the thumbscrew **1**, then open the pedal **2** upward.

* The pedal can be opened without detaching the thumbscrew completely.

2. Remove the old battery from the battery housing **3**, and remove the battery snap **4** connected to it.

3. Connect the battery snap to the new battery, and place the battery inside the battery housing.

* Be sure to carefully observe the battery's polarity (+ versus -).

4. Slip the coil spring **5** onto the spring base **6** on the back of the pedal, and then close the pedal.

* Carefully avoid getting the battery snap cord **7** caught in the pedal, coil spring, and battery housing.

5. Insert the thumbscrew into the guide bush hole **8** and tighten it securely.

Main Specifications

Sampling Frequency	44.1 kHz	
AD/DA Conversion	32 bits	
Processing	32-bit floating point	
Recording/Playback	Number of Tracks: 1 Data Format: WAV (44.1 kHz, 32-bit float, stereo) Maximum Recording Time: Approx. 1.5 hours (1 track), Approx.13 hours (total of All memories)	
Rhythm Type	57 Patterns x 2 Variations	
Rhythm Kit	7 types	
Effect	Reverb (only for rhythm part)	
Memory	99	
Nominal Input Level	INPUT A/MONO, B: -20 dBu	
Input Impedance	INPUT A/MONO, B: 1 M Ω	
Nominal Output Level	OUTPUT A/MONO, B:-20 dBu	
Output Impedance	OUTPUT A/MONO, B: 1 k Ω	
Recommended Load Impedance	OUTPUT A/MONO, B: 10 k Ω or greater	
Bypass	Buffered bypass	
Display	Graphic LCD (96 x 32 dots, RGB backlit LCD)	
Connectors	NPUT A/MONO, B jacks: 1/4-inch phone type OUTPUT A/MONO, B jacks: 1/4-inch phone type STOP/MEMORY jack: 1/4-inch TRS phone type USB port: USB B type MIDI (IN, OUT) jacks: stereo miniature type DC IN jack	
Power Supply	Alkaline battery (9 V, 6LR61 or 6LF22) AC adaptor (PSA series: sold separately)	
Current Draw	170 mA	
Expected battery life under continuous use	These figures will vary depending on the actual conditions of use. Alkaline: Approx. 2 hours	
Dimensions	73 (W) x 129 (D) x 56 (H) mm 2-7/8 (W) x 5-1/8 (D) x 2-1/4 (H) inches	
Weight	(excluding battery) 405 g/15 oz	(including battery) 450 g/1 lb
Accessories	Owner's Manual Leaflet ("USING THE UNIT SAFELY," "IMPORTANT NOTES," and "Information") Alkaline battery (9 V, 6LR61 or 6LF22)	
Options (sold separately)	AC adaptor: PSA-S series Footswitch: FS-5U Dual Footswitch: FS-6, FS-7 Expression Pedal: FV-500H, FV-500L, EV-30, Roland EV-5 TRS/MIDI connecting cable: BMIDI-5-35	

* 0 dBu = 0.775 Vrms

* This document explains the specifications of the product at the time that the document was issued. For the latest information, refer to the Roland website.

IMPORTANT NOTES

Power Supply: Use of Batteries

- Batteries should always be installed or replaced before connecting any other devices. This way, you can prevent malfunction and damage.
- If operating this unit on batteries, please use alkaline batteries.
- Even if batteries are installed, the unit will turn off if you connect or disconnect the power cord from the AC outlet while the unit is turned on, or if you connect or disconnect the AC adaptor from the unit. When this occurs, unsaved data may be lost. You must turn off the power before you connect or disconnect the power cord or AC adaptor.

Repairs and Data

- Before sending the unit away for repairs, be sure to make a backup of the data stored within it; or you may prefer to write down the needed information. Although we will do our utmost to preserve the data stored in your unit when we carry out repairs, in some cases, such as when the memory section is physically damaged, restoration of the stored content may be impossible. Roland assumes no liability concerning the restoration of any stored content that has been lost.

Additional Precautions

- Any data stored within the unit can be lost as the result of equipment failure, incorrect operation, etc. To protect yourself against the irretrievable loss of data, try to make a habit of creating regular backups of the data you've stored in the unit.
- Roland assumes no liability concerning the restoration of any stored content that has been lost.
- Never strike or apply strong pressure to the display.
- When disposing of the packing carton or cushioning material in which this unit was packed, you must observe the waste disposal regulations that apply to your locality.
- Do not use connection cables that contain a built-in resistor.

Intellectual Property Right

- It is forbidden by law to make an audio recording, video recording, copy or revision of a third party's copyrighted work (musical work, video work, broadcast, live performance, or other work), whether in whole or in part, and distribute, sell, lease, perform or broadcast it without the permission of the copyright owner.
- Do not use this product for purposes that could infringe on a copyright held by a third party. We assume no responsibility whatsoever with regard to any infringements of third-party copyrights arising through your use of this product.
- The copyright of content in this product (the sound waveform data, style data, accompaniment patterns, phrase data, audio loops and image data) is reserved by Roland Corporation.
- Purchasers of this product are permitted to utilize said content (except song data such as Demo Songs) for the creating, performing, recording and distributing original musical works.
- Purchasers of this product are NOT permitted to extract said content in original or modified form, for the purpose of distributing recorded medium of said content or making them available on a computer network.
- This product contains eParts integrated software platform of eSOL Co., Ltd. eParts is a trademark of eSOL Co., Ltd. in Japan.
- This product includes third party open source software.
Copyright © 2009-2019 ARM Limited. All rights reserved.
Licensed under the Apache License, Version 2.0 (the "License");
You may obtain a copy of the License at
<http://www.apache.org/licenses/LICENSE-2.0>
Copyright © 2016, Freescale Semiconductor, Inc.
Copyright 2016-2019 NXP
All rights reserved.
Licensed under the BSD-3-Clause
You may obtain a copy of the License at
<https://opensource.org/licenses/BSD-3-Clause>
- Roland, BOSS, and LOOP STATION are either registered trademarks or trademarks of Roland Corporation in the United States and/or other countries.
- Company names and product names appearing in this document are registered trademarks or trademarks of their respective owners.

 **BOSS**