

9062

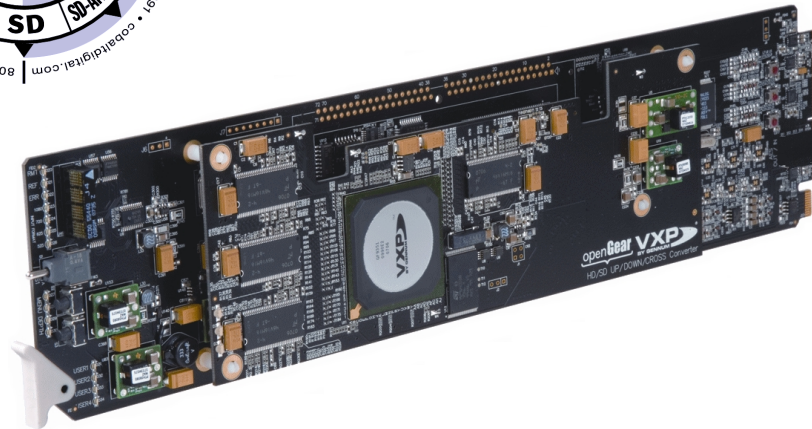

Up/Down/Cross Format Converter with HD/SD-SDI Input, Embedded Audio Support, Frame Sync, Timecode and Closed Caption Support

Product Manual



Cobalt Digital Inc.

2406 E. University Ave.
Urbana, IL 61802
Voice 217.344.1243 • Fax 217.344.1245
www.cobaltdigital.com

Copyright

©Copyright 2013, Cobalt Digital Inc. All Rights Reserved.

Duplication or distribution of this manual and any information contained within is strictly prohibited without the express written permission of Cobalt Digital Inc. This manual and any information contained within, may not be reproduced, distributed, or transmitted in any form, or by any means, for any purpose, without the express written permission of Cobalt Digital Inc. Reproduction or reverse engineering of software used in this device is prohibited.

Disclaimer

The information in this document has been carefully examined and is believed to be entirely reliable. However, no responsibility is assumed for inaccuracies. Furthermore, Cobalt Digital Inc. reserves the right to make changes to any products herein to improve readability, function, or design. Cobalt Digital Inc. does not assume any liability arising out of the application or use of any product or circuit described herein.

Trademark Information

Cobalt[®] is a registered trademark of Cobalt Digital Inc.

COMPASS[®] and **FUSION3G**[®] are registered trademarks of Cobalt Digital Inc.

openGear[®] is a registered trademark of Ross Video Limited. **DashBoard**[™] is a trademark of Ross Video Limited.

Dolby[®] is a registered trademark of Dolby Laboratories, Inc. Other product names or trademarks appearing in this manual are the property of their respective owners.

Linear Acoustic[®], **AEROMAX**[®] and **UPMAX**[®] are registered trademarks of Linear Acoustic, Inc. 2.0-to-5.1 audio upmixer licensed feature uses the **AutoMAX-II**[™] upmix algorithm provided under license from

Linear Acoustic Inc. **Linear Acoustic**, the "LA" symbol, **AutoMAX**, and **AutoMAX-II** are trademarks of Linear Acoustic Inc. All Rights Reserved.

Congratulations on choosing the Cobalt[®] 9062 Up/Down/Cross Format Converter with HD/SD-SDI Input, Embedded Audio Support and Frame Sync. The 9062 is part of a full line of modular processing and conversion gear for broadcast TV environments. The Cobalt Digital Inc. line includes video decoders and encoders, audio embedders and de-embedders, distribution amplifiers, format converters, remote control systems and much more. Should you have questions pertaining to the installation or operation of your 9062, please contact us at the contact information on the front cover.

Manual No.:	9062-OM
Document Version:	V4.6
Release Date:	September 24, 2013
Applicable for Firmware Version (or greater):	3314
Description of product/manual changes:	<ul style="list-style-type: none">- Revise manual for latest firmware build functionality.- Clarification of Framesync control descriptions.- Correction of minor errata.- Update manual to include latest available card options.

Table of Contents

Chapter 1	Introduction	1-1
	Overview	1-1
	9062 Card Software Versions and this Manual	1-2
	Cobalt Reference Guides	1-2
	Manual Conventions	1-3
	Warnings, Cautions, and Notes	1-3
	Labeling Symbol Definitions	1-4
	Safety Summary	1-4
	Warnings	1-4
	Cautions	1-4
	9062 Functional Description	1-5
	9062 Input/Output Formats	1-5
	Video Processor Description	1-7
	Audio Processor Description	1-12
	User Control Interface	1-15
	9062 Rear I/O Modules	1-17
	Audio and Video Formats Supported by the 9062	1-18
	Technical Specifications	1-19
	Warranty and Service Information	1-21
	Cobalt Digital Inc. Limited Warranty	1-21
	Contact Cobalt Digital Inc.	1-22
Chapter 2	Installation and Setup	2-1
	Overview	2-1
	Installing the 9062 Into a Frame Slot	2-1
	Installing a Rear I/O Module	2-3
	9062 Rear I/O Modules	2-5
	Setting Up 9062 Network Remote Control	2-6

Chapter 3	Operating Instructions	3-1
	Overview	3-1
	Control and Display Descriptions	3-1
	Function Submenu/Parameter Submenu Overview	3-2
	DashBoard™ User Interface	3-3
	Cobalt® Remote Control Panel User Interfaces	3-4
	Accessing the 9062 Card via Remote Control	3-5
	Accessing the 9062 Card Using DashBoard™	3-5
	Accessing the 9062 Card Using a Cobalt® Remote Control Panel	3-6
	Checking 9062 Card Information.....	3-7
	Ancillary Data Line Number Locations and Ranges	3-8
	9062 Function Submenu List and Descriptions	3-9
	Audio Input Controls	3-10
	Video Proc	3-11
	Scaler	3-12
	AFD	3-18
	Overlays	3-22
	Framesync	3-26
	Embedded Audio Group 1/2	3-31
	Embedded Audio Group 3/4	3-34
	Dolby Metadata	3-35
	Closed Captioning	3-36
	Timecode	3-38
	Tone Generator	3-42
	Audio Mixing	3-42
	Licensable Features	3-47
	Presets	3-47
	Troubleshooting	3-50
	Error and Failure Indicator Overview	3-50
	Basic Troubleshooting Checks.....	3-54
	9062 Processing Error Troubleshooting.....	3-55
	Troubleshooting Network/Remote Control Errors.....	3-57
	In Case of Problems	3-57

Introduction

Overview

This manual provides installation and operating instructions for the 9062 Up/Down/Cross Format Converter with HD/SD-SDI Input, Embedded Audio Support and Frame Sync card (also referred to herein as the 9062).

This manual consists of the following chapters:

- **Chapter 1, “Introduction”** – Provides information about this manual and what is covered. Also provides general information regarding the 9062.
- **Chapter 2, “Installation and Setup”** – Provides instructions for installing the 9062 in a frame, and optionally installing a 9062 Rear I/O Module.
- **Chapter 3, “Operating Instructions”** – Provides overviews of operating controls and instructions for using the 9062.

This chapter contains the following information:

- **9062 Card Software Versions and this Manual (p. 1-2)**
- **Manual Conventions (p. 1-3)**
- **Safety Summary (p. 1-4)**
- **9062 Functional Description (p. 1-5)**
- **Technical Specifications (p. 1-19)**
- **Warranty and Service Information (p. 1-21)**
- **Contact Cobalt Digital Inc. (p. 1-22)**

9062 Card Software Versions and this Manual

When applicable, Cobalt Digital Inc. provides for continual product enhancements through software updates. As such, functions described in this manual may pertain specifically to cards loaded with a particular software build.

The Software Version of your card can be checked by viewing the **Card Info** menu in DashBoard™. See Checking 9062 Card Information (p. 3-7) in Chapter 3, “Operating Instructions” for more information. You can then check our website for the latest software version currently released for the card as described below.

Check our website and proceed as follows if your card’s software does not match the latest version:

<p>Card Software earlier than latest version</p>	<p>Card is not loaded with the latest software. Not all functions and/or specified performance described in this manual may be available.</p> <p>You can update your card with new Update software by going to the Support>Firmware Downloads link at www.cobaltdigital.com. Download “Firmware Update Guide”, which provides simple instructions for downloading the latest firmware for your card onto your computer, and then uploading it to your card through DashBoard™.</p> <p>Software updates are field-installed without any need to remove the card from its frame.</p>
<p>Card Software newer than version in manual</p>	<p>A new manual is expediently released whenever a card’s software is updated and specifications and/or functionality have changed as compared to an earlier version (a new manual is not necessarily released if specifications and/or functionality have not changed). A manual earlier than a card’s software version may not completely or accurately describe all functions available for your card.</p> <p>If your card shows features not described in this manual, you can check for the latest manual (if applicable) and download it by going to the Support>Documents>Product Information and Manuals link at www.cobaltdigital.com.</p>

Cobalt Reference Guides

From the Cobalt® web home page, go to **Support>Documents>Reference Guides** for easy to use guides covering network remote control, card firmware updates, and other topics.

Manual Conventions

In this manual, display messages and connectors are shown using the exact name shown on the 9062 itself. Examples are provided below.

- Card-edge display messages are shown like this:



Ch01

- Connector names are shown like this: **SDI IN**

In this manual, the terms below are applicable as follows:

- **9062** refers to the 9062 Up/Down/Cross Format Converter with HD/SD-SDI Input, Embedded Audio Support and Frame Sync card.
- **Frame** refers to the HPF-9000, OG3-FR, 8321, or similar 20-slot frame that houses Cobalt® or other cards.
- **Device** and/or **Card** refers to a COMPASS™ card.
- **System** and/or **Video System** refers to the mix of interconnected production and terminal equipment in which the 9062 and other COMPASS™ cards operate.
- Functions and/or features that are available only as an option are denoted in this manual like this:



Option ➔

Warnings, Cautions, and Notes

Certain items in this manual are highlighted by special messages. The definitions are provided below.

Warnings

Warning messages indicate a possible hazard which, if not avoided, could result in personal injury or death.



Cautions

Caution messages indicate a problem or incorrect practice which, if not avoided, could result in improper operation or damage to the product.

Notes

Notes provide supplemental information to the accompanying text. Notes typically precede the text to which they apply.

Labeling Symbol Definitions

	Attention, consult accompanying documents.
	<p>Electronic device or assembly is susceptible to damage from an ESD event. Handle only using appropriate ESD prevention practices.</p> <p>If ESD wrist strap is not available, handle card only by edges and avoid contact with any connectors or components.</p>
	<p>Symbol (WEEE 2002/96/EC)</p> <p>For product disposal, ensure the following:</p> <ul style="list-style-type: none"> • Do not dispose of this product as unsorted municipal waste. • Collect this product separately. • Use collection and return systems available to you.

Safety Summary

Warnings

! WARNING !

To reduce risk of electric shock do not remove line voltage service barrier cover on frame equipment containing an AC power supply. **NO USER SERVICEABLE PARTS INSIDE. REFER SERVICING TO QUALIFIED SERVICE PERSONNEL.**

Cautions

CAUTION

This device is intended for environmentally controlled use only in appropriate video terminal equipment operating environments.

CAUTION

This product is intended to be a component product of an openGear® frame. Refer to the openGear® frame Owner's Manual for important safety instructions regarding the proper installation and safe operation of the frame as well as its component products.

CAUTION

Heat and power distribution requirements within a frame may dictate specific slot placement of cards. Cards with many heat-producing components should be arranged to avoid areas of excess heat build-up, particularly in frames using only convection cooling. The 9062 has a moderate power dissipation (24 W max.). As such, avoiding placing the card adjacent to other cards with similar dissipation values if possible.

CAUTION

If required, make certain Rear I/O Module(s) is installed before installing the 9062 into the frame slot. Damage to card and/or Rear I/O Module can occur if module installation is attempted with card already installed in slot.

CAUTION

If card resists fully engaging in rear I/O module mating connector, check for alignment and proper insertion in slot tracks. Damage to card and/or rear I/O module may occur if improper card insertion is attempted.

9062 Functional Description

Figure 1-1 shows a functional block diagram of the 9062. The 9062 format converter also includes embedded audio support and routing and a full video frame synchronizer. The 9062 also handles AFD code detection and processing, timecode insertion, and closed captioning support.

The video source can be either an HD or SD-SDI. The video can be up, down, or cross-converted to a different format, and aspect ratio can be corrected to provide proper output aspect.

Note: Some of the functions described below are available only when using the DashBoard™, or Cobalt® OGCP-9000 or OGCP-9000/CC Control Panels user interfaces. Refer to User Control Interface (p. 1-15) for user interface descriptions.

9062 Input/Output Formats

The 9062 provides the following inputs and outputs:

- **Inputs:**
 - **HD/SD-SDI IN** – dual-rate HD/SD-SDI input
- **Outputs:**
 - **HD/SD-SDI OUT** – four dual-rate HD/SD-SDI buffered video outputs
 - **RCK OUT** – four dual-rate HD/SD-SDI reclocked buffered video outputs
 - **RS-485** – RS485 Dolby® metadata output (with option +LTC, also provides RS-485 LTC I/O)

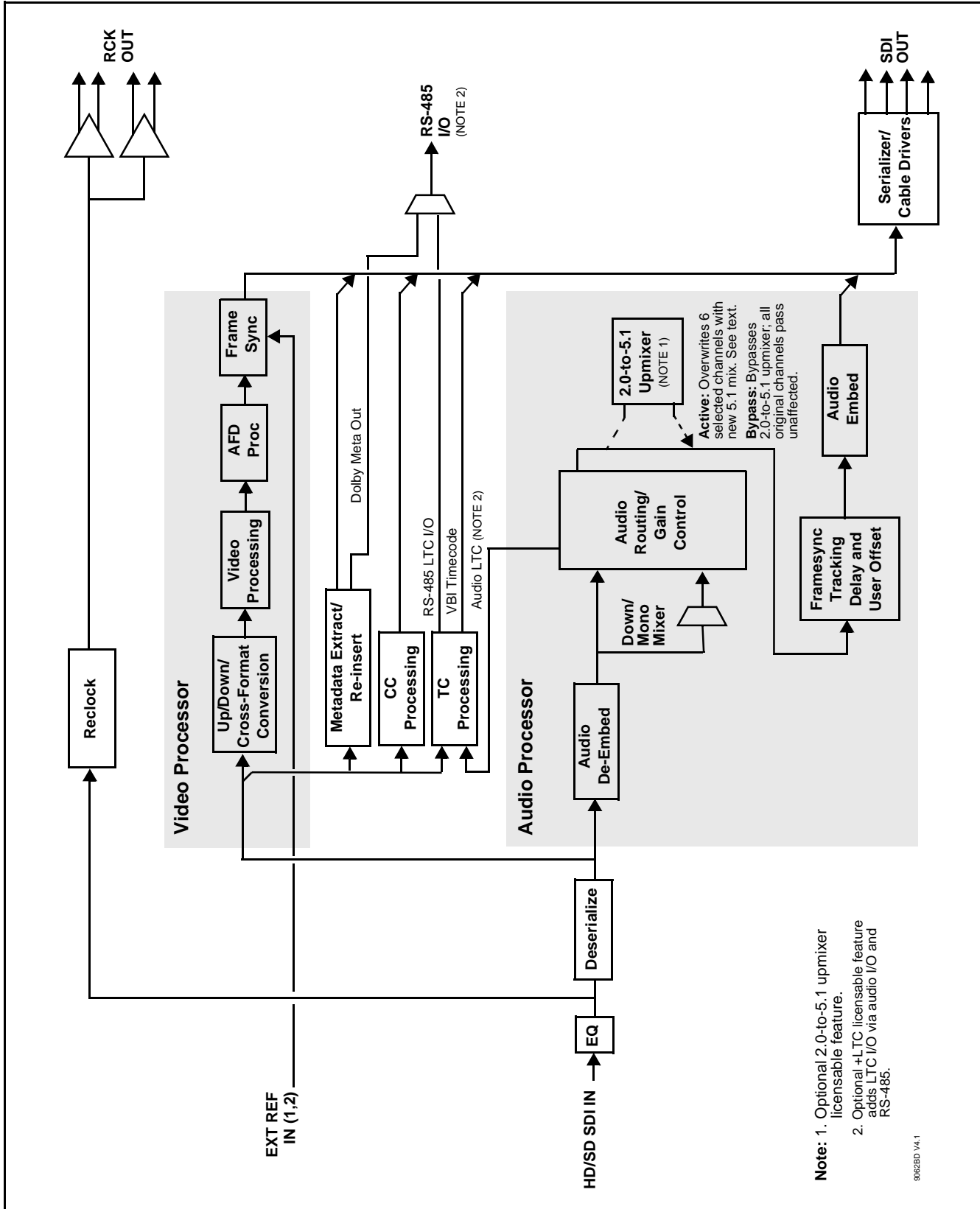

Figure 1-1 9062 Functional Block Diagram

Video Processor Description

The 9062 features a scaler that provides up, down, and cross-conversion using de-interlacing and motion adaptation for high quality up-conversions. The scaler also provides user-adjustable aspect ratio control and zoom control. Separate controls are provided for SD and HD inputs that allow the card to flexibly and independently handle mixed input formats. The 9062 video subsystem also provides the functions described below.

Video Processor

The 9062 provides full color processing control (luma gain and lift, chroma saturation, and color phase) of the output video.

Frame Sync Function

This function provides for frame sync control using either one of two external **EXT REF IN (1,2)** reference signals distributed with the card frame, or the input video as a frame sync reference. This function also allows horizontal and/or vertical offset to be added between the output video and the frame sync reference.

A video/audio delay offset function allows adding or reducing audio delay from the matching video delay. This function is useful for correcting lip sync problems when video and audio paths in the chain experience differing overall delays. A Reset Framesync function resets the frame sync following any horizontal or vertical offset changes, clearing any buffered audio and video and re-establishing the frame sync. The 9062 re-establishes video/audio sync following framesync changes by applying an offset in small, progressive amounts to provide a seamless, glitch-free retiming. A user-selectable hard resync function allows setting a threshold at which hard resync is applied if audio-video offset exceeds a selectable threshold. Hard resync provides fastest sync-up suitable for off-air manipulation. Conversely, a threshold setting that avoids hard resync allows glitch-free on-air manipulation. In the event of input video loss of signal, this function provides for disabling the video, going to a desired color raster, or freezing to the last intact frame (frame having valid SAV and EAV codes).

Scaler Function

The scaler function provides up, down, and cross-conversions between multiple standard SD and HD video formats, multiple frame rates, film frame rates, and cross-conversion between interlaced and progressive formats. Table 1-1 lists the 9062 conversion choices available for various input formats and frame rates.

When output video is set to 720p for either SD or HD video, the 720p output can be converted to 720p half-rate formats as listed in Table 1-1. When output video is set to 1080 film (1080p23.98) for either SD or HD inputs, the 9062 can convert the output to 1080PsF23.98 (segmented frame progressive). Both of these functions can be independently applied to either SD and/or HD video inputs.

Table 1-1 Scaler Function Conversions

Input Format	SD (NTSC/PAL)	720p	720p half-rate	720p (film rates)	1080i	1080p	1080p (film rates)	1080PsF (film rates)
525i 59.94	525i 59.94	720p 59.94	720p 29.97	720p 23.98 ₍₄₎	1080i 59.94	1080p 29.97	1080p 23.98 ₍₄₎	1080PsF 23.98 ₍₄₎
625i 50	625i 50	720p 50	720p 25	X	1080i 50	1080p 25	X	X
720p 60	X	720p 60	720p 30	720p 24 ₍₄₎	1080i 60	1080p 30	1080p 24 ₍₄₎	1080PsF 24 ₍₄₎
720p 59.94	525i 59.94	720p 59.94	720p 29.97	720p 23.98 ₍₄₎	1080i 59.94	1080p 29.97	1080p 23.98 ₍₄₎	1080PsF 23.98 ₍₄₎
720p 50	625i 50	720p 50	720p 25	X	1080i 50	1080p 25	X	X
720p 30	X	720p 60	720p 30	720p 24 ₍₅₎	1080i 60	1080p 30	1080p 24 ₍₅₎	1080PsF 24 ₍₅₎
720p 29.97	525i 59.94	720p 59.94	720p 29.97	720p 23.98 ₍₅₎	1080i 59.94	1080p 29.97	1080p 23.98 ₍₅₎	1080PsF 23.98 ₍₅₎
720p 25	625i 50	720p 50	720p 25	X	1080i 50	1080p 25	X	X
720p 24	X	720p 60	720p 30	720p 24	1080i 60	1080p 30	1080p 24	1080PsF 24
720p 23.98	525i 59.94	720p 59.94	720p 29.97	720p 23.98	1080i 59.94	1080p 29.97	1080p 23.98	1080PsF 23.98
1080i 60	X	720p 60	720p 30	720p 24 ₍₄₎	1080i 60	1080p 30	1080p 24 ₍₄₎	1080PsF 24 ₍₄₎
1080i 59.94	525i 59.94	720p 59.94	720p 29.97	720p 23.98 ₍₄₎	1080i 59.94	1080p 29.97	1080p 23.98 ₍₄₎	1080PsF 23.98 ₍₄₎
1080i 50	625i 50	720p 50	720p 25	X	1080i 50	1080p 25	X	X
1080p 30	X	720p 60	720p 30	720p 24 ₍₅₎	1080i 60	1080p 30	1080p 24 ₍₅₎	1080PsF 24 ₍₅₎
1080p 29.97	525i 59.94	720p 59.94	720p 29.97	720p 23.98 ₍₅₎	1080i 59.94	1080p 29.97	1080p 23.98 ₍₅₎	1080PsF 23.98 ₍₅₎
1080p 25	625i 50	720p 50	720p 25	X	1080i 50	1080p 25	X	X
1080p 24	X	720p 60	720p 30	720p 24	1080i 60	1080p 30	1080p 24	1080PsF 24
1080p 23.98	525i 59.94	720p 59.94	720p 29.97	720p 23.98	1080i 59.94	1080p 29.97	1080p 23.98	1080PsF 23.98
1080PsF 24	X	720p 60	720p 30	720p 24	1080i 60	1080p 30	1080p 24	1080PsF 24
1080PsF 23.98	525i 59.94	720p 59.94	720p 29.97	720p 23.98	1080i 59.94	1080p 29.97	1080p 23.98	1080PsF 23.98

- Notes:**
1. The drop-down list choice of "Same as Input" is used when no conversion is desired. For clarity, it is not redundantly listed here.
 2. "X" denotes conversions not available or invalid conversions.
 3. Interlaced formats rates listed are field rates. Progressive format rates listed are frame rates.
 4. If the original material does not have a proper 3-2 cadence suitable for conversion to film rates, the conversion reverts to standard de-interlacing. While this video can be converted to film rates, the resulting image motion will lack smoothness. Therefore, make certain interlaced video is appropriately constructed for 3-2 reverse pulldown when converting video to film rates. See 3-2 Pulldown Conversion and Considerations (p. 1-11).
 5. Formats using a 30/29.97 Hz progressive frame rate can be converted to a 24/23.98 Hz progressive frame rate, however some image motion irregularity will appear in the converted output.
 6. "NTSC" and "PAL" in this manual informally refer to 486i5994 and 575i50 SD-SDI video formats, respectively.

The scaler function also provides aspect ratio conversion that provides a choice from several standard aspect ratios. Additionally, user defined and "Follow AFD Settings" conversion can be applied. User defined settings allow custom user-defined H and V aspect ratio control. "Follow AFD Settings" sets the output aspect ratio to track with AFD (Active Format Description) settings embedded in the received video signal.

Timecode Processor

(See Figure 1-2.) This function provides for extraction of timecode data from the input video, and in turn re-insertion of timecode data into the output SDI. In this manner, timecode data can be preserved, even after format conversion. The function can monitor the SDI video input of the card for supported timecode formats, and then select and prioritize among SDI VITC, SDI ATC_VITC, and SDI ATC_LTC, and embedded audio LTC timecode sources. If the preferred format is detected, the preferred format is used by the card; if the preferred format is not detected, the card uses other formats (where available) as desired. The function also provides conversion between various timecode formats and provides independent insertion and line number controls for each SDI timecode output format.

Option ➤ Option +LTC allows bidirectional transfer and conversion between VBI formats over SDI and audio LTC, as well as RS-485 LTC. Audio LTC can be received or sent over a selected embedded channel.

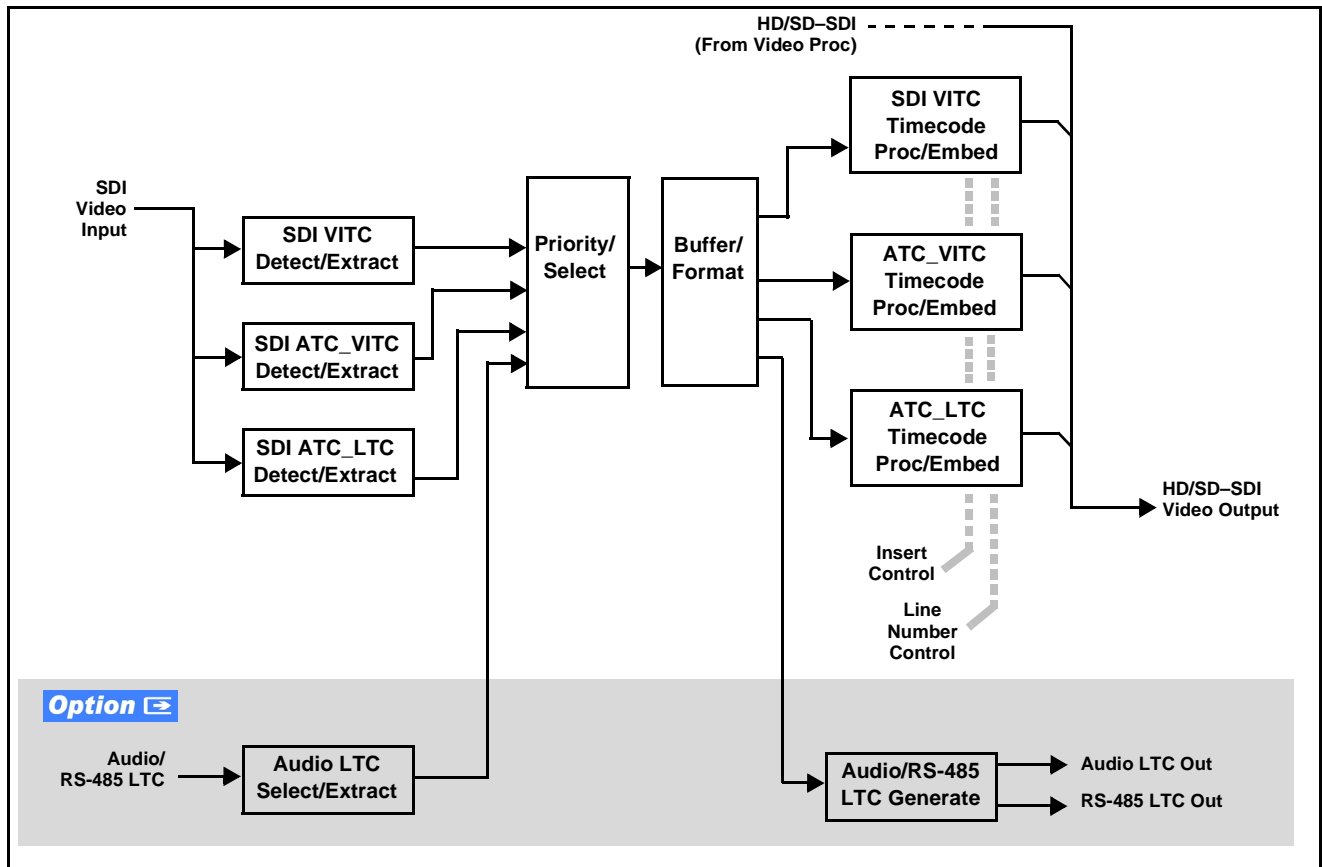

Figure 1-2 Timecode Processor

Closed Captioning Processor

This function provides support for closed captioning setup. The function allows the selection of the ancillary data line number where the ancillary closed caption data is outputted when the output is HD. When receiving HD-SDI, both CEA 608 and CEA 708 are supported, with CEA 608 and CEA 708 (containing CEA 608 packets) converted to line 21 closed captioning on outputs down-converted to SD (on up-convert of SD, only CEA 608 closed captioning is generated).

Dolby® Metadata Extractor/Re-inserter

This function extracts and preserves Dolby® metadata from the input SDI, and in turn allows the metadata to be re-inserted in the output SDI. This allows scaling and/or format conversions without losing Dolby® metadata. (The 9062 does not offer Dolby® decoding or encoding, but will pass Dolby® E and/or Dolby® Digital™ encoded signals and metadata intact.) The extracted metadata is buffered and then output on a user-selectable line number on the SDI output.

AFD Processor

This function provides aspect ratio controls and assignment of AFD codes to the SDI output video.

Using this function, aspect ratios in accordance with the standard 4-bit AFD codes can be applied to the output video. Additionally, custom aspect ratios can be independently defined for any of the AFD codes.

Separate, independent AFD controls are provided for both 16:9 coded and 4:3 coded frames.

This function also provides AFD-controlled ARC by checking for any existing AFD code within the received video input. If a code is present, the code is displayed. With the Scaler function **Aspect Ratio Conversion** set to **Follow AFD Settings**, the H and V settings corresponding to the received code are applied to the video by the 9062. The default, standard aspect ratio described by the AFD code can be applied, or custom horizontal/vertical scaling can be applied for a given code.

The function also allows the selection/changing of the AFD code and ancillary data line number for the outputted AFD code.

3-2 Pulldown Conversion and Considerations

Figure 1-3 depicts the 3-2 pulldown process used for conversions between progressive film video formats and interlaced video formats. (Although the term “3-2” is used here per convention, it is more accurately described as 2-3 per the diagram here and SMPTE definitions which stipulate that first film frame **A** be represented exclusively by 2 fields from the same frame). As shown in Figure 1-3, the term 2-3 is derived from the pattern, or *cadence*, in which four consecutive film video frames are converted into five consecutive interlaced video frames (i.e., 10 interlaced video fields). Odd and even interlaced fields are denoted in Figure 1-3 by “**O**” and “**E**” (for example, “**A_O**” and “**A_E**”). Note the considerations described in Figure 1-3 for converting to film rates.

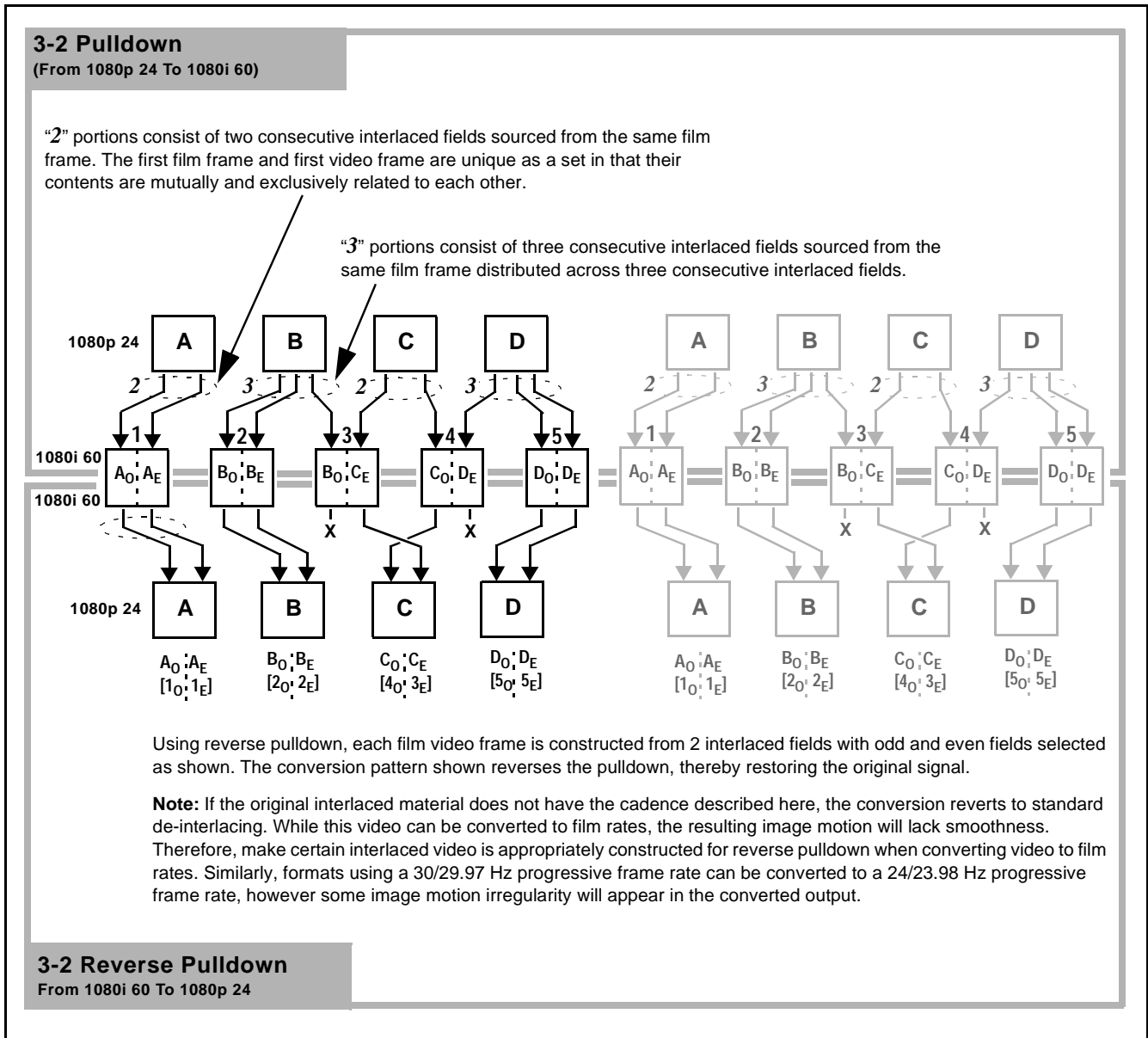

Figure 1-3 3-2 Pulldown and Reverse Pulldown

Audio Processor Description

The audio processor operates as an internal audio router. The router function chooses from the following inputs:

- 16 channels of embedded audio from the SDI video input
- Four independent internal tone generators (described below)
- Internal Down Mix and Mono Mixer outputs (described below)
- Digital silence (mute) setting

The router function provides up to 16 channels of embedded audio on the **SDI OUT** outputs. The router acts as a full audio cross point. Each of the 16 embedded output channels can receive signal from any one of the 16 embedded input channels, four internal tone generators, or several mixer outputs. Unused output channels can be mapped to a “Silence” source. Each output also provides gain adjustment and selectable polarity inversion.

Output audio rates are always 48 kHz locked to output video. (embedded audio must be nominally 48 kHz input; 32, 44.1, 96, and 192 kHz inputs are not compatible with the 9062.) Embedded output audio is always precisely synchronized with the output video.

As set with the default settings, the routing between embedded audio channels is basic 1-for-1 for the 16 embedded audio channels (with embedded Ch 1 being embedded to embedded Ch 1 at the SDI output, and so on). Other sources and/or destinations for each channel are selected using the card edge controls or a remote control system.

Audio Down Mix and Mono Mix Function

(See Figure 1-4.) The Audio Down Mixer function provides for the selection of any five embedded audio sources serving as Left (**L**), Right (**R**), Center (**C**), Left Surround (**Ls**), and Right Surround (**Rs**) individual signals to be multiplexed into stereo pair Down Mix Left (**DM-L**) and Down Mix Right (**DM-R**). The resulting stereo pair **DM-L** and **DM-R** can in turn be routed and processed just like any of the other audio sources described earlier.

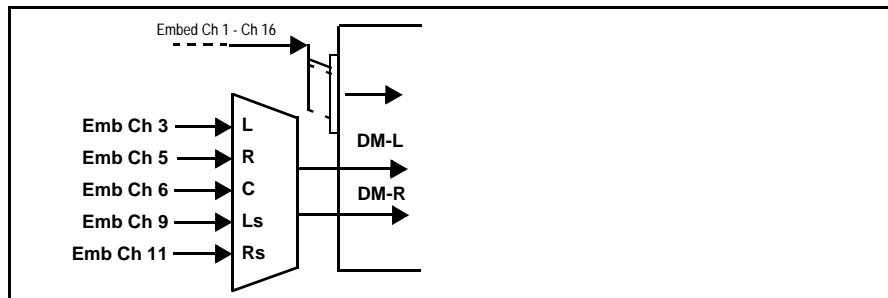

Figure 1-4 Audio Down Mix Functional Block Diagram with Example Sources

The Mono Mixer function (Figure 1-5) generates an additional mono-mixed channel from two selected embedded input channels serving as left and right inputs. The resulting mono mix channel is available as an audio source for any of the 16 destination embedded output channels.

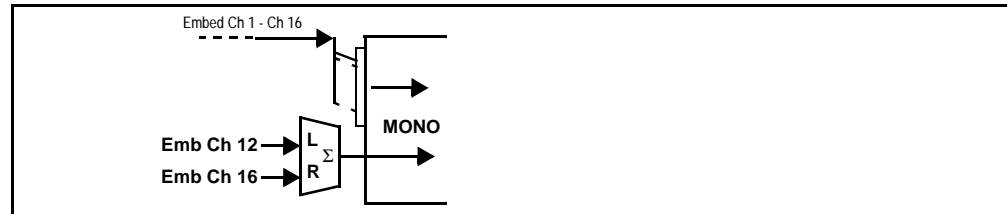

Figure 1-5 Audio Mono Mix Functional Block Diagram with Example Sources

2.0-to-5.1 Upmix Function Option

Note: Upmix function is an optional licensable feature. This function and its controls appear only when a license key is entered and activated. (This option (identified in Cobalt[®] price lists as **+UM**) can be purchased upon initial order, or field-activated using a key string which is sent to you when this option is purchased.)

The 2.0-to-5.1 upmixer function receives a normal PCM stereo pair from the Audio Routing/Gain Control function and upmixes the pair to provide 5.1 channels (Left (**L**), Right (**R**), Center (**C**), Low Frequency Effects (**LFE**), Left Surround (**Ls**), and Right Surround (**Rs**)). Whenever the upmixer is active, it overwrites the six selected channels with the new 5.1 upmix signals (including replacing the original source stereo **L** and **R** inputs with new **L** and **R** signals).

The 2.0-to-5.1 upmixer can be set to up mix in any of three modes: Always upmix, Bypass upmix, or Auto enable/bypass upmixing. The Auto upmixing mode looks at the signal levels on the selected channels and compares them to a selectable level threshold. It then determines whether or not to generate 5.1 upmixing from the stereo pair as follows:

- If the upmixer detects signal level **below** a selected threshold on **all four** of the selected channels designated as **C**, **LFE**, **Ls**, and **Rs**, this indicates to the upmixer that these channels are not carrying 5.1. In this case, the upmixer overwrites all six selected channels with the new 5.1 content.
- If the upmixer detects signal level **above** a selected threshold on **any** of the four selected channels designated as **C**, **LFE**, **Ls**, and **Rs**, this indicates to the upmixer that the channel(s) are already carrying viable 5.1 content. In this case, the upmixer is bypassed, allowing the original channels to pass unaffected.

The examples in Figure 1-6 show the automatic enable/disable up-mixing function applied to example selected channels **Emb Ch 1** thru **Emb Ch 6**. As shown and described, the processing is contingent upon the signal levels of the channels selected to carry the new 5.1 upmix relative to the selected threshold (in this example, -60 dBFS). Note also that this function is applied **after** the Audio Routing/Gain Control function.

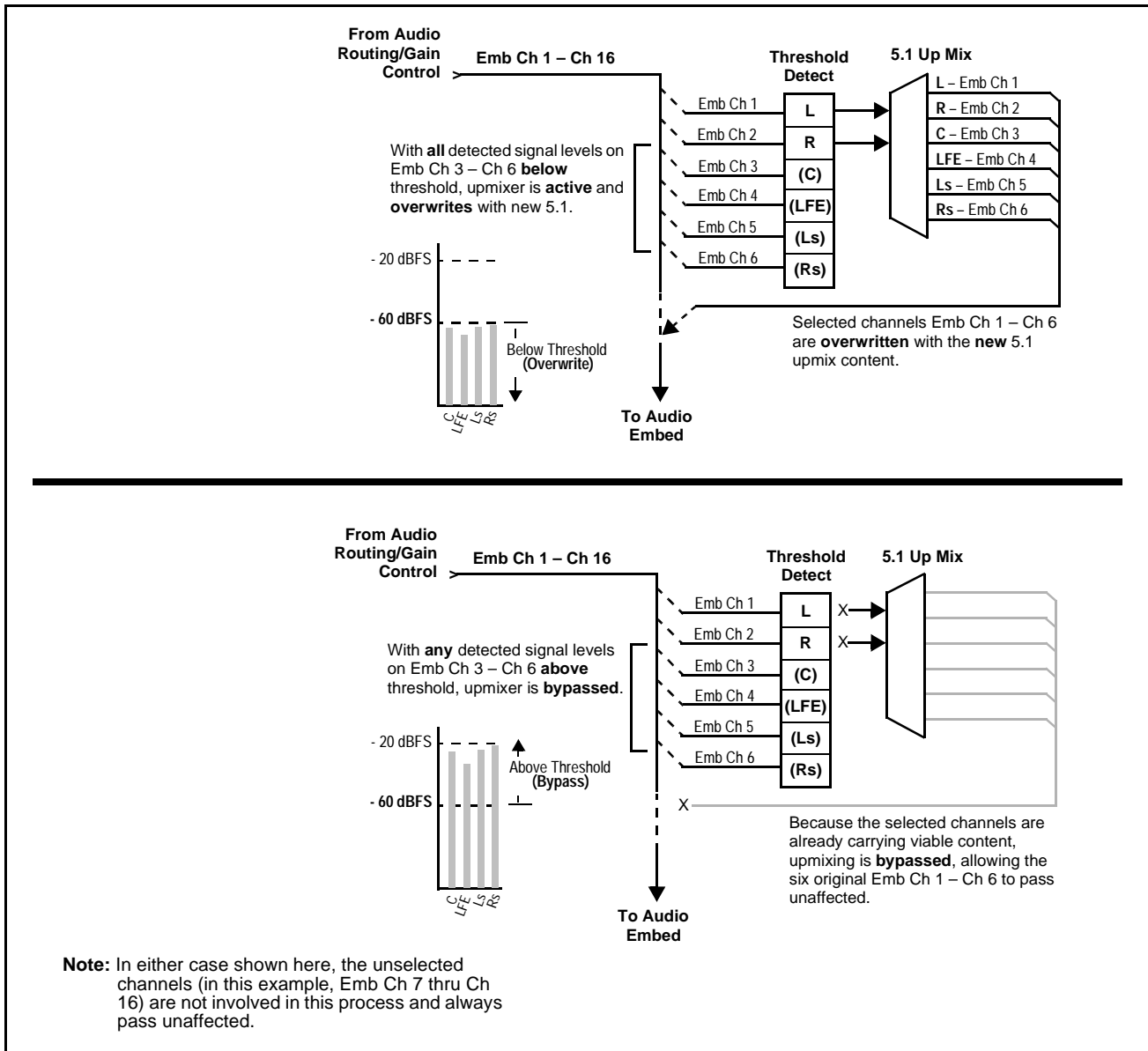

Figure 1-6 Up Mix Auto Enable/By-pass with Example Sources

Loudness Processor (Option +LP) **Option**

Note: Loudness processor function is an optional licensable feature. This function and its controls appear only when a license key is entered and activated. (This option (identified in Cobalt® price lists as **+LP**) can be purchased upon initial order, or field-activated using a key string which is sent to you when this option is purchased.)

If your card was purchased with option **+LP**, loudness processor manual supplement “5.1 and Stereo Loudness Processing Options for Compass® Cards (+LP51, +LP20) Manual Supplement” (OPT-SW-LP-MS) is included in your documentation package. Supplement OPT-SW-LP-MS can be downloaded from our website or requested using the Cobalt contact information in this manual.

Tone Generator Function

The 9062 contains four built-in tone generators (Tone Generator 1 thru Tone Generator 4). Each of the four tone generators can be set to a different frequency, and are available as audio sources for the embedded audio outputs. 18 discrete sine wave frequencies are available, ranging from 50 Hz to 16 kHz (default frequency is 1.0 kHz).

User Control Interface

Figure 1-7 shows the user control interface options for the 9062. These options are individually described below.

Note: All user control interfaces described here are cross-compatible and can operate together as desired. Where applicable, any control setting change made using a particular user interface is reflected on any other connected interface.

- **Built-in Card Edge User Interface** – Using the built-in card edge controls and display, card control settings can be set using a front panel menu which is described in Chapter 3, “Operating Instructions”.

Note: Some of the 9062 functions described in this manual are available only when using the DashBoard™, or Cobalt® OGCP-9000 or OGCP-9000/CC Remote Control Panel user interfaces.

- **DashBoard™ User Interface** – Using DashBoard™, the 9062 and other cards installed in openGear®¹ frames can be controlled from a computer and monitor.

DashBoard™ allows users to view all frames on a network with control and monitoring for all populated slots inside a frame. This simplifies the setup and use of numerous modules in a large installation and offers the ability to centralize monitoring. Cards define their controllable parameters to DashBoard™, so the control interface is always up to date.

1. openGear® is a registered trademark of Ross Video Limited. DashBoard™ is a trademark of Ross Video Limited.

The DashBoard™ software can be downloaded from the Cobalt Digital Inc. website: www.cobaltdigital.com (enter “DashBoard” in the search window). The DashBoard™ user interface is described in Chapter 3, “Operating Instructions”.

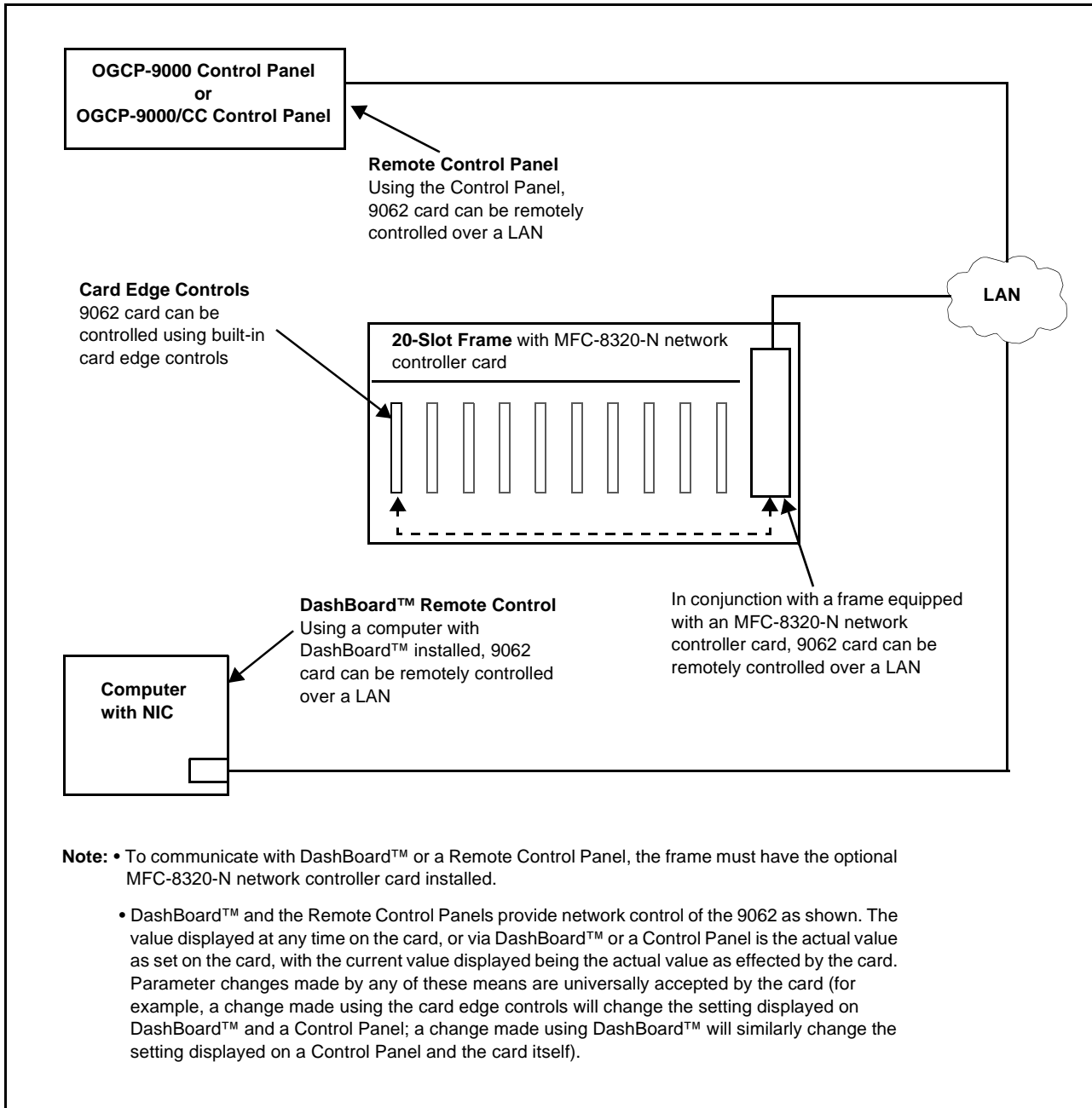

Figure 1-7 9062 User Control Interface

Note: If network remote control is to be used for the frame and the frame has not yet been set up for remote control, Cobalt® reference guide **Remote Control User Guide (PN 9000RCS-RM)** provides thorough information and step-by-step instructions for setting up network remote control of COMPASS™ cards using DashBoard™. (Cobalt® OGCP-9000 and OGCP-9000/CC Remote Control Panel product manuals have complete instructions for setting up remote control using a Remote Control Panel.)

Download a copy of this guide by clicking on the **Support>Documents>Reference Guides** link at www.cobaltdigital.com and then select DashBoard Remote Control Setup Guide as a download, or contact Cobalt® as listed in Contact Cobalt Digital Inc. (p. 1-22).

- **Cobalt® OGCP-9000 and OGCP-9000/CC Remote Control Panels** – The OGCP-9000 and OGCP-9000/CC Remote Control Panels conveniently and intuitively provide parameter monitor and control of the 9062 and other video and audio processing terminal equipment meeting the open-architecture Cobalt COMPASS™ cards for openGear™ standard.

In addition to circumventing the need for a computer to monitor and control signal processing cards, the Control Panels allow quick and intuitive access to hundreds of cards in a facility, and can monitor and allow adjustment of multiple parameters at one time.

The Remote Control Panels are totally compatible with the openGear™ control software DashBoard™; any changes made with either system are reflected on the other. The Remote Control Panel user interface is described in Chapter 3, “Operating Instructions”.

9062 Rear I/O Modules

The 9062 physically interfaces to system video connections at the rear of its frame using a Rear I/O Module.

All inputs and outputs shown in the 9062 Functional Block Diagram (Figure 1-1) enter and exit the card via the card edge backplane connector. The Rear I/O Module breaks out the 9062 card edge connections to BNC connectors that interface with other components and systems in the signal chain.

The full assortment of 9062 Rear I/O Modules is shown and described in 9062 Rear I/O Modules (p. 2-5) in Chapter 2, “Installation and Setup”.

Audio and Video Formats Supported by the 9062

The 9062 supports all current SMPTE standard SD and HD video formats. Table 1-2 lists and provides details regarding the audio and video formats supported by the 9062.

Table 1-2 Supported Audio and Video Formats

Item	Description/Specification	
Input / Output Video	Raster Structure:	Frame Rate ₍₁₎ :
	1080PsF	23.98; 24
	1080p	23.98; 24
	1080i ₍₁₎	25; 29.97; 30
	720p	23.98; 24; 25; 29.97; 30; 50; 59.94; 60
	486i ₍₁₎	29.97
	575i ₍₁₎	25
Embedded Audio	The 9062 supports all four groups (16 channels) of embedded audio at full 24-bit resolution in both SD (with extended data packets) and HD.	
(1) All rates displayed as frame rates; interlaced ("i") field rates are two times the rate value shown.		

Technical Specifications

Table 1-3 lists the technical specifications for the 9062 Up/Down/Cross Format Converter, Video/Audio In with Frame Sync card.

Table 1-3 Technical Specifications

Item	Characteristic
Part number, nomenclature	9062 Up/Down/Cross Format Converter with HD/SD-SDI Input, Embedded Audio Support and Frame Sync
Installation/usage environment	Intended for installation and usage in frame meeting openGear™ modular system definition.
Power consumption	< 24 Watts maximum
Environmental: Operating temperature: Relative humidity (operating or storage):	32° – 104° F (0° – 40° C) < 95%, non-condensing
Frame communication	10/100 Mbps Ethernet with Auto-MDIX.
Indicators	Card edge display and indicators as follows: <ul style="list-style-type: none"> • 4-character alphanumeric display • Status/Error LED indicator • Input Format LED indicator
Controls	Card edge switches as follows: <ul style="list-style-type: none"> • Menu Enter pushbutton switch • Menu exit pushbutton switch • Up/down selection toggle switch
Internal Tone Generators	Four built-in tone generators, each configurable for 18 discrete sine wave frequencies ranging from 50 Hz to 16 kHz. Generator source signal level is equivalent to -20 dBu.
Serial Digital Video Input	Data Rates Supported: SMPTE 292 HD-SDI: 1.485 Gbps or 1.485/1.001 Gbps SMPTE 259M-C SD-SDI: 270 Mbps Impedance: 75 Ω terminating Equalization (HD): 328 ft (100 m) Belden 1694A Equalization (SD): 1000 ft (305 m) Belden 1694A Return Loss: > 15 dB at 5 MHz – 1.485 GHz
Post-Processor Serial Digital Video Outputs	Number of Outputs: Four HD/SD-SDI BNC per IEC 60169-8 Amendment 2 Impedance: 75 Ω

Table 1-3 Technical Specifications — continued

Item	Characteristic
Post-Processor Serial Digital Video Outputs (cont.)	Return Loss: > 15 dB at 5 MHz – 270 MHz > 12 dB at 270 MHz – 1.485 GHz Signal Level: 800 mV \pm 10% DC Offset: 0 V \pm 50 mV Jitter (HD): < 0.15 UI (all outputs) Jitter (SD): < 0.10 UI (all outputs) Overshoot: < 0.2% of amplitude
Pre-Processor (Reclocked) Serial Digital Video Outputs	Number of Outputs: Four HD/SD-SDI BNC per IEC 60169-8 Amendment 2 Impedance: 75 Ω
Reference Video Input	Number of Inputs: Two non-terminating (looping) Frame Reference inputs Standards Supported (HD): 720p 24; 25; 29.97; 30; 50; 59.94 1080i 25; 29.97 1080p 23.98; 24; 25; 29.97; 30 1080p/sF 23.98; 24 Standards Supported (SD): 486i 29.97 (NTSC); 575i 25 (PAL) Signal Level: 1 Vp-p nominal Signal Type: Analog video sync (black burst or tri-level) Impedance: 75 Ω Return Loss: > 30 dB to 30 MHz Allowable Maximum DC on Ref Input: \pm 1.0 V

Warranty and Service Information

Cobalt Digital Inc. Limited Warranty

This product is warranted to be free from defects in material and workmanship for a period of five (5) years from the date of shipment to the original purchaser, except that 4000, 5000, 6000, 8000 series power supplies, and Dolby® modules (where applicable) are warranted to be free from defects in material and workmanship for a period of one (1) year.

Cobalt Digital Inc.'s ("Cobalt") sole obligation under this warranty shall be limited to, at its option, (i) the repair or (ii) replacement of the product, and the determination of whether a defect is covered under this limited warranty shall be made at the sole discretion of Cobalt.

This limited warranty applies only to the original end-purchaser of the product, and is not assignable or transferrable therefrom. This warranty is limited to defects in material and workmanship, and shall not apply to acts of God, accidents, or negligence on behalf of the purchaser, and shall be voided upon the misuse, abuse, alteration, or modification of the product. Only Cobalt authorized factory representatives are authorized to make repairs to the product, and any unauthorized attempt to repair this product shall immediately void the warranty. Please contact Cobalt Technical Support for more information.

To facilitate the resolution of warranty related issues, Cobalt recommends registering the product by completing and returning a product registration form. In the event of a warrantable defect, the purchaser shall notify Cobalt with a description of the problem, and Cobalt shall provide the purchaser with a Return Material Authorization ("RMA"). For return, defective products should be double boxed, and sufficiently protected, in the original packaging, or equivalent, and shipped to the Cobalt Factory Service Center, postage prepaid and insured for the purchase price. The purchaser should include the RMA number, description of the problem encountered, date purchased, name of dealer purchased from, and serial number with the shipment.

Cobalt Digital Inc. Factory Service Center

2406 E. University Avenue
Urbana, IL 61802 USA
www.cobaltdigital.com

Office: (217) 344-1243
Fax: (217) 344-1245
Email: info@cobaltdigital.com

THIS LIMITED WARRANTY IS EXPRESSLY IN LIEU OF ALL OTHER WARRANTIES EXPRESSED OR IMPLIED, INCLUDING THE WARRANTIES OF MERCHANTABILITY AND FITNESS FOR A PARTICULAR PURPOSE AND OF ALL OTHER OBLIGATIONS OR LIABILITIES ON COBALT'S PART. ANY SOFTWARE PROVIDED WITH, OR FOR USE WITH, THE PRODUCT IS PROVIDED "AS IS." THE BUYER OF THE PRODUCT ACKNOWLEDGES THAT NO OTHER REPRESENTATIONS WERE MADE OR RELIED UPON WITH RESPECT TO THE QUALITY AND FUNCTION OF THE GOODS HEREIN SOLD. COBALT PRODUCTS ARE NOT AUTHORIZED FOR USE IN LIFE SUPPORT APPLICATIONS.

COBALT'S LIABILITY, WHETHER IN CONTRACT, TORT, WARRANTY, OR OTHERWISE, IS LIMITED TO THE REPAIR OR REPLACEMENT, AT ITS OPTION, OF ANY DEFECTIVE PRODUCT, AND SHALL IN NO EVENT INCLUDE SPECIAL, INDIRECT, INCIDENTAL, OR CONSEQUENTIAL DAMAGES (INCLUDING LOST PROFITS), EVEN IF IT HAS BEEN ADVISED OF THE POSSIBILITY OF SUCH DAMAGES.

Contact Cobalt Digital Inc.

Feel free to contact our thorough and professional support representatives for any of the following:

- Name and address of your local dealer
- Product information and pricing
- Technical support
- Upcoming trade show information

Phone:	(217) 344-1243
Fax:	(217) 344-1245
Web:	www.cobaltdigital.com
General Information:	info@cobaltdigital.com
Technical Support:	support@cobaltdigital.com

Installation and Setup

Overview

This chapter contains the following information:

- Installing the 9062 Into a Frame Slot (p. 2-1)
- Installing a Rear I/O Module (p. 2-3)
- Setting Up 9062 Network Remote Control (p. 2-6)

Installing the 9062 Into a Frame Slot

CAUTION

Heat and power distribution requirements within a frame may dictate specific slot placement of cards. Cards with many heat-producing components should be arranged to avoid areas of excess heat build-up, particularly in frames using only convection cooling. The 9062 has a moderate power dissipation (24 W max.). As such, avoiding placing the card adjacent to other cards with similar dissipation values if possible.

CAUTION



This device contains semiconductor devices which are susceptible to serious damage from Electrostatic Discharge (ESD). ESD damage may not be immediately apparent and can affect the long-term reliability of the device.

Avoid handling circuit boards in high static environments such as carpeted areas, and when wearing synthetic fiber clothing. Always use proper ESD handling precautions and equipment when working on circuit boards and related equipment.

- Note:**
- If installing the 9062 in a slot already equipped with a suitable I/O module, proceed to card installation steps below.
 - If installing the 9062 in a slot with no rear I/O module, a Rear I/O Module is required before cabling can be connected. Refer to Installing a Rear I/O Module (p. 2-3) for rear I/O module installation procedure.

CAUTION

If required, make certain Rear I/O Module(s) is installed before installing the 9062 into the frame slot. Damage to card and/or Rear I/O Module can occur if module installation is attempted with card already installed in slot.

Note: Check the packaging in which the 9062 was shipped for any extra items such as a Rear I/O Module connection label. In some cases, this label is shipped with the card and to be installed on the Rear I/O connector bank corresponding to the slot location of the card.

Install the 9062 into a frame slot as follows:

1. Determine the slot in which the 9062 is to be installed.
2. Open the frame front access panel.
3. While holding the card by the card edges, align the card such that the plastic ejector tab is on the bottom.
4. Align the card with the top and bottom guides of the slot in which the card is being installed.
5. Gradually slide the card into the slot. When resistance is noticed, gently continue pushing the card until its rear printed circuit edge terminals engage fully into the rear I/O module mating connector.

CAUTION

If card resists fully engaging in rear I/O module mating connector, check for alignment and proper insertion in slot tracks. Damage to card and/or rear I/O module may occur if improper card insertion is attempted.

6. Verify that the card is fully engaged in rear I/O module mating connector.
7. Close the frame front access panel.
8. Connect the input and output cables as shown in 9062 Rear I/O Modules (p. 2-5).
9. Repeat steps 1 through 8 for other 9062 cards.

Note: External frame sync reference signals are received by the card over a reference bus on the card frame, and not on any card rear I/O module connectors. The frame has BNC connectors labeled **REF 1** and **REF 2** which receive the reference signal from an external source such as a house distribution.

Note: The 9062 BNC inputs are internally 75-ohm terminated. It is not necessary to terminate unused BNC inputs or outputs.

Note: To remove a card, press down on the ejector tab to unseat the card from the rear I/O module mating connector. Evenly draw the card from its slot.

10. If network remote control is to be used for the frame and the frame has not yet been set up for remote control, perform setup in accordance with Setting Up 9062 Network Remote Control (p. 2-6).

Note: If installing a card in a frame already equipped for, and connected to DashBoard™, no network setup is required for the card. The card will be discovered by DashBoard™ and be ready for use.

Installing a Rear I/O Module

Note: This procedure is applicable **only if a Rear I/O Module is not currently installed** in the slot where the 9062 is to be installed.

If installing the 9062 in a slot already equipped with a suitable I/O module, omit this procedure.

Install a Rear I/O Module as follows:

1. On the frame, determine the slot in which the 9062 is to be installed.
2. In the mounting area corresponding to the slot location, install Rear I/O Module as shown in Figure 2-1.

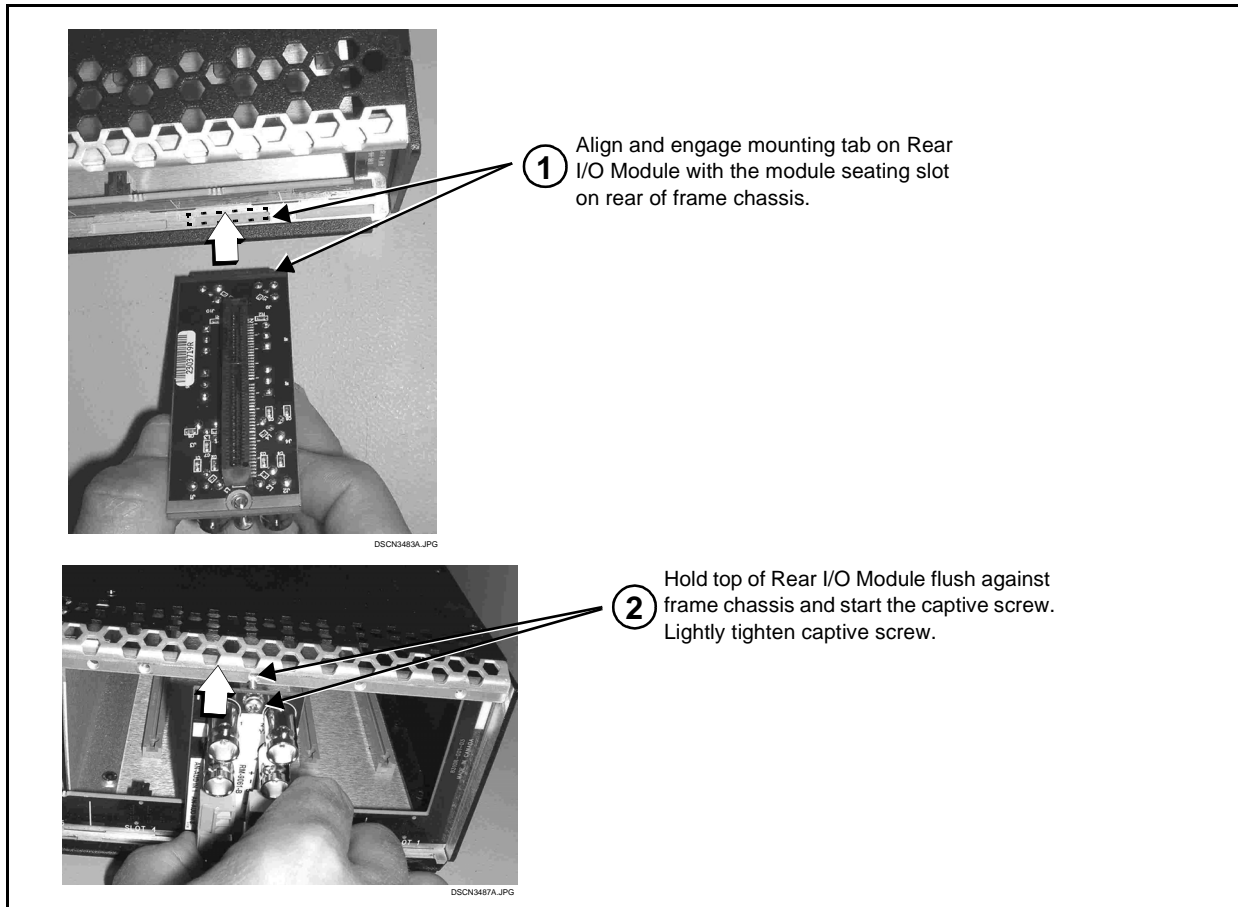

Figure 2-1 Rear I/O Module Installation

9062 Rear I/O Modules

Table 2-1 shows and describes the full assortment of Rear I/O Modules specifically for use with the 9062.

Notes: • Rear I/O Modules equipped with 3-wire Phoenix connectors are supplied with removable screw terminal block adapters. For clarity, the adapters are omitted in the drawings below.

Table 2-1 9062 Rear I/O Modules

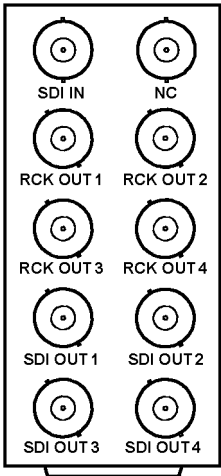
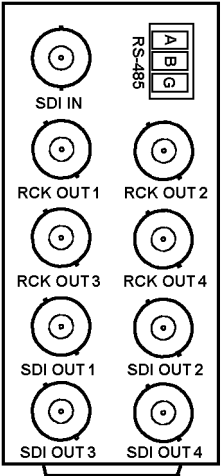
9062 Rear I/O Module	Description
<p>RM20-9062-A</p>  <p>The diagram shows a rear panel with ten circular connectors arranged in two columns of five. The left column contains: SDI IN, RCK OUT 1, RCK OUT 3, SDI OUT 1, and SDI OUT 3. The right column contains: NC, RCK OUT 2, RCK OUT 4, SDI OUT 2, and SDI OUT 4.</p>	<p>Provides the following connections:</p> <ul style="list-style-type: none"> • HD/SD-SDI coaxial input (SDI IN) • Four reclocked SDI input copies (RCK OUT 1- 4) • Four buffered SDI coaxial outputs (SDI OUT 1- 4)
<p>RM20-9062-B</p>  <p>The diagram shows a rear panel with ten circular connectors arranged in two columns of five. The left column contains: SDI IN, RCK OUT 1, RCK OUT 3, SDI OUT 1, and SDI OUT 3. The right column contains: RCK OUT 2, RCK OUT 4, SDI OUT 2, and SDI OUT 4. To the right of the connectors is a rectangular RS-485 connector with three pins labeled A, B, and G.</p>	<p>Provides the following connections:</p> <ul style="list-style-type: none"> • HD/SD-SDI coaxial input (SDI IN) • Four reclocked SDI input copies (RCK OUT 1- 4) • Four buffered SDI coaxial outputs (SDI OUT 1- 4) • RS-485 metadata output (RS-485) <p>Note: On card with +LTC option, this connector provides RS-485 LTC I/O as well as Dolby metadata output (selectable using card control).</p>

Setting Up 9062 Network Remote Control

Perform remote control setup in accordance with Cobalt® reference guide “Remote Control User Guide” (PN 9000RCS-RM).

- Note:**
- If network remote control is to be used for the frame and the frame has not yet been set up for remote control, Cobalt® reference guide **Remote Control User Guide (PN 9000RCS-RM)** provides thorough information and step-by-step instructions for setting up network remote control of COMPASS™ cards using DashBoard™. (Cobalt® OGCP-9000 and OGCP-9000/CC Remote Control Panel product manuals have complete instructions for setting up remote control using a Remote Control Panel.)
Download a copy of this guide by clicking on the **Support>Documents>Reference Guides** link at www.cobaltdigital.com and then select DashBoard Remote Control Setup Guide as a download, or contact Cobalt® as listed in Contact Cobalt Digital Inc. (p. 1-22).
 - If installing a card in a frame already equipped for, and connected to DashBoard™, no network setup is required for the card. The card will be discovered by DashBoard™ and be ready for use.

Operating Instructions

Overview

If you are already familiar with using DashBoard or a Cobalt Remote Control Panel to control Cobalt cards, please skip to 9062 Function Submenu List and Descriptions (p. 3-9).

This chapter contains the following information:

- Control and Display Descriptions (p. 3-1)
- Accessing the 9062 Card via Remote Control (p. 3-5)
- Checking 9062 Card Information (p. 3-7)
- Ancillary Data Line Number Locations and Ranges (p. 3-8)
- 9062 Function Submenu List and Descriptions (p. 3-9)
- Troubleshooting (p. 3-50)

Control and Display Descriptions

This section describes the user interface controls, indicators, and displays for using the 9062 card. The 9062 functions can be accessed and controlled using any of the user interfaces described here.

The format in which the 9062 functional controls, indicators, and displays appear and are used varies depending on the user interface being used. Regardless of the user interface being used, access to the 9062 functions (and the controls, indicators, and displays related to a particular function) follows a general arrangement of Function Submenus under which related controls can be accessed (as described in Function Submenu/Parameter Submenu Overview below).

Note: DashBoard™ and the Remote Control Panel provide greatly simplified user interfaces as compared to using the card edge controls. For this reason, **it is strongly recommended** that DashBoard™ or a Remote Control Panel be used for all card applications other than the most basic cases. Card edge control codes are not included in this manual. If card-edge control is to be used, obtain a copy of “Manual Supplement – Card-Edge Control Reference Master List and Instructions for Using Compass™ Card-edge (Local) Control Codes” (989CEC-MS.pdf) at www.cobaltdigital.com>Support>Documents>Reference Guides.

Note: When a setting is changed, settings displayed on DashBoard™ (or a Remote Control Panel) are the settings as effected by the card itself and reported back to the remote control; the value displayed at any time is the actual value as set on the card.

Function Submenu/Parameter Submenu Overview

The functions and related parameters available on the 9062 card are organized into function **submenus**, which consist of parameter groups as shown below.

Figure 3-1 shows how the 9062 card and its submenus are organized, and also provides an overview of how navigation is performed between cards, function submenus, and parameters.

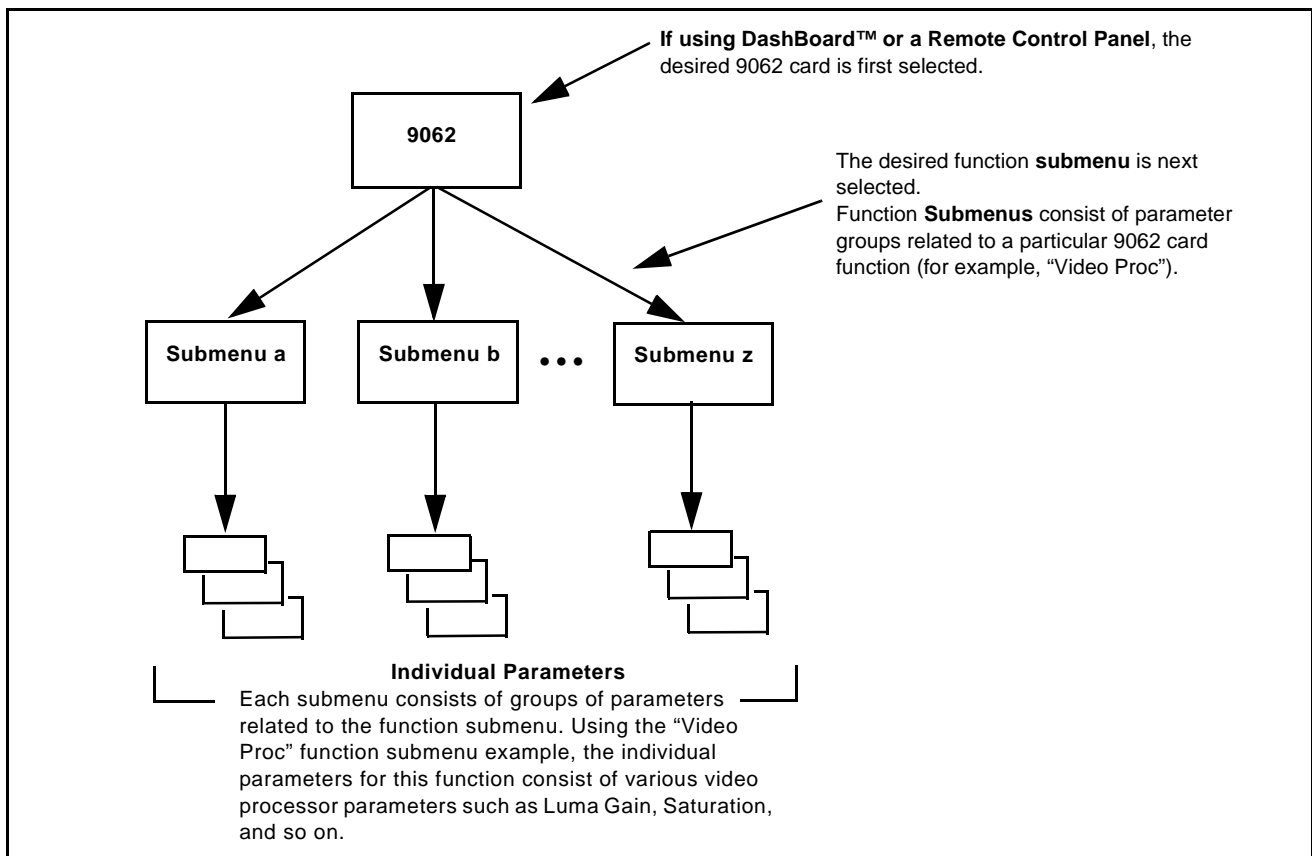

Figure 3-1 Function Submenu/Parameter Submenu Overview

DashBoard™ User Interface

(See Figure 3-2.) The card function submenus are organized in DashBoard™ using tabs. When a tab is selected, each parametric control or selection list item associated with the function is displayed. Scalar (numeric) parametric values can then be adjusted as desired using the GUI slider controls. Items in a list can then be selected using GUI drop-down lists. (In this manner, the setting effected using controls and selection lists displayed in DashBoard™ are comparable to the submenu items accessed and committed using the card edge controls.)

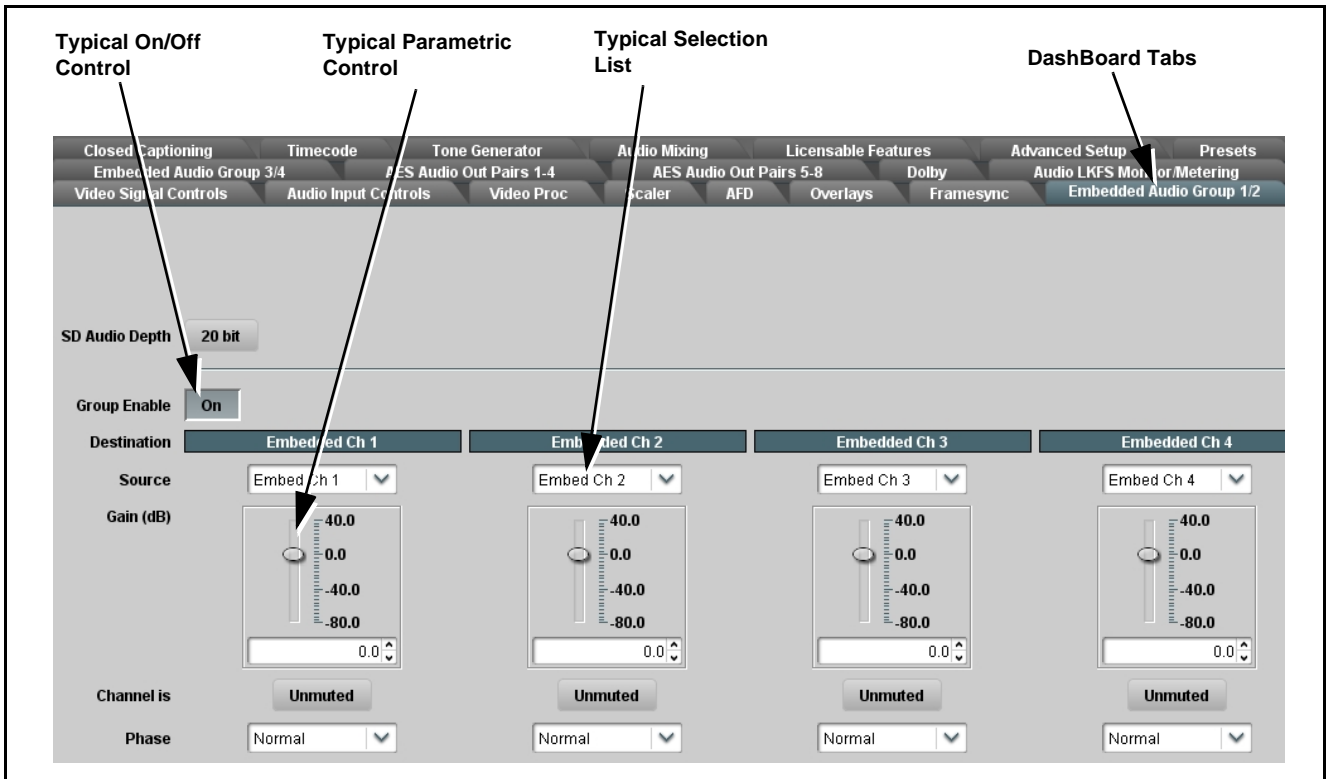

Figure 3-2 Typical DashBoard Tabs and Controls

Cobalt® Remote Control Panel User Interfaces

(See Figure 3-3.) Similar to the function submenu tabs using DashBoard™, the Remote Control Panels have a Select Submenu key that is used to display a list of function submenus. From this list, a control knob on the Control Panel is used to select a function from the list of displayed function submenu items.

When the desired function submenu is selected, each parametric control or selection list item associated with the function is displayed. Scalar (numeric) parametric values can then be adjusted as desired using the control knobs, which act like a potentiometer. Items in a list can then be selected using the control knobs which correspondingly act like a rotary switch. (In this manner, the setting effected using controls and selection lists displayed on the Control Panel are comparable to the submenu items accessed and committed using the 9062 card edge controls.)

Figure 3-3 shows accessing a function submenu and its parameters (in this example, “Video Proc”) using the Control Panel as compared to using the card edge controls.

Note: Refer to “OGCP-9000 Remote Control Panel User Manual” (PN OGCP-9000-OM) or “OGCP-9000/CC Remote Control Panel User Manual” (PN OGCP-9000/CC-OM) for complete instructions on using the Control Panels.



Figure 3-3 Remote Control Panel Setup of Example Video Proc Function Setup

Accessing the 9062 Card via Remote Control

Access the 9062 card using DashBoard™ or Cobalt® Remote Control Panel as described below.

Accessing the 9062 Card Using DashBoard™

1. On the computer connected to the frame LAN, open DashBoard™.
2. As shown below, in the left side Basic View Tree locate the Network Controller Card associated with the frame containing the 9062 card to be accessed (in this example, “MFC-8320-N SN: 00108053”).

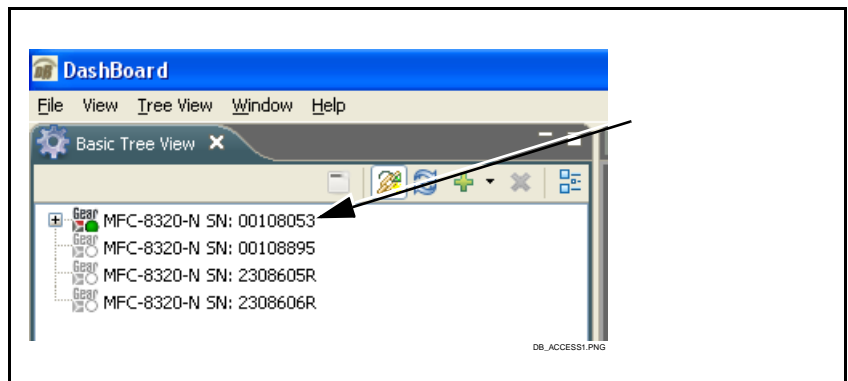

3. As shown below, expand the tree to access the cards within the frame. Click on the card to be accessed (in this example, “Slot 6: CDI-9062 RCVR21”).

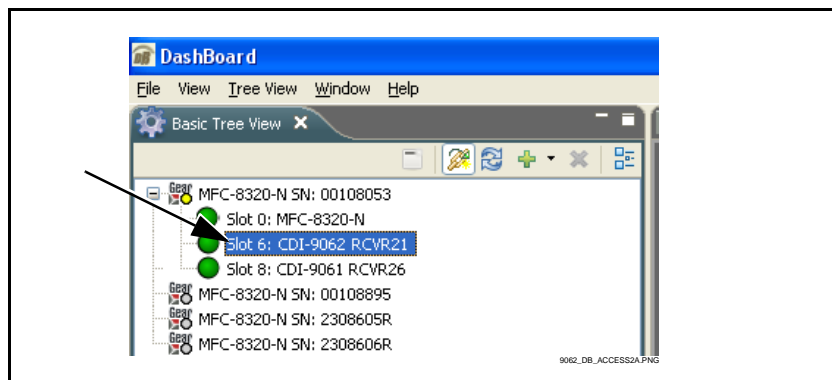

As shown on the next page, when the card is accessed in DashBoard™ its function submenu screen showing tabs for each function is displayed. (The particular submenu screen displayed is the previously displayed screen from the last time the card was accessed by DashBoard™).

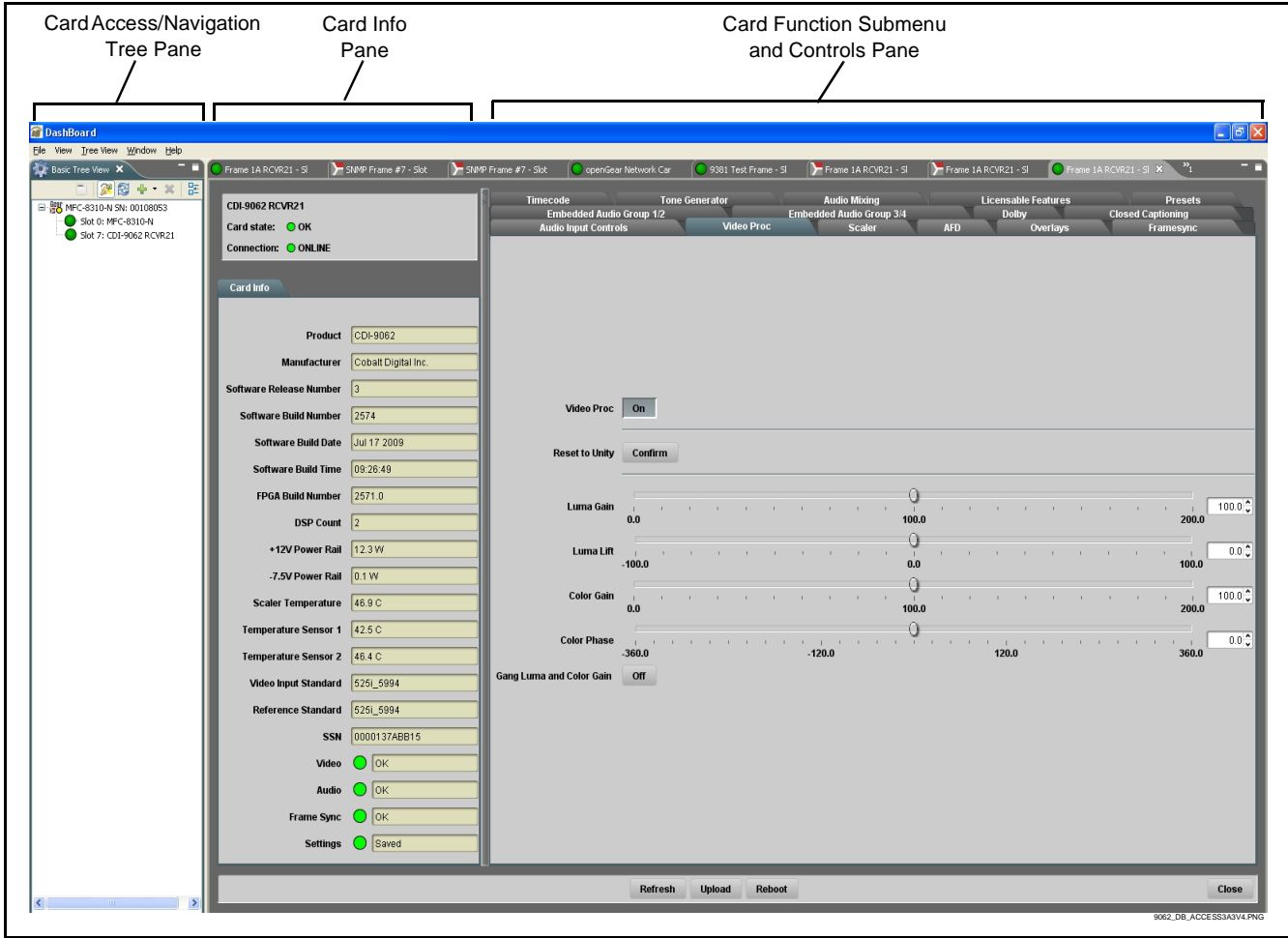

Accessing the 9062 Card Using a Cobalt® Remote Control Panel

Press the **Select Device** key and select a card as shown in the example below.

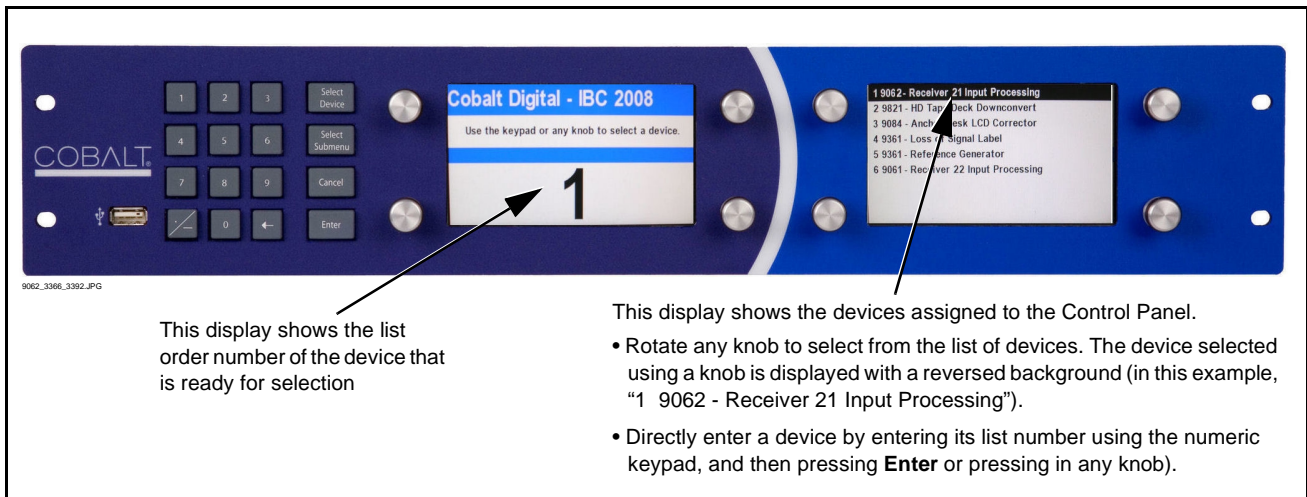

Checking 9062 Card Information

The operating status and software version the 9062 card can be checked using DashBoard™ or the card edge control user interface. Figure 3-4 shows and describes the 9062 card information screen using DashBoard™ and accessing card information using the card edge control user interface.

Note: Proper operating status in DashBoard™ is denoted by green icons for the status indicators shown in Figure 3-4. Yellow or red icons respectively indicate an alert or failure condition. Refer to Troubleshooting (p. 3-50) for corrective action.

The **Tree View** shows the cards seen by DashBoard™. In this example, Network Controller Card is hosting a 9062 card in slot 6.

Software Release Number and Software Build Number
Refer to these numbers to check that documentation (such as this manual) matches the card's Software Release Number and Software Build Number. Use these numbers also when communicating to Cobalt® regarding this card.

Power Consumption and Temperature Displays
This display shows the power consumed by the 9062 for both the +12V and -7.5V rails, as well as key device temperatures.

Status Displays
These displays show the status the signal being received by the 9062. Green Settings icon shows that any changes made on DashBoard™ are successfully saved on the card's memory.

CDI-9062 RCVR21	
Card state:	OK
Connection:	ONLINE
Card Info	
Product	CDI-9062
Manufacturer	Cobalt Digital Inc.
Software Release Number	3
Software Build Number	2574
Software Build Date	Jul 17 2009
Software Build Time	09:26:49
FPGA Build Number	2571.0
DSP Count	2
+12V Power Rail	12.3 W
-7.5V Power Rail	0.1 W
Scaler Temperature	46.9 C
Temperature Sensor 1	42.5 C
Temperature Sensor 2	46.4 C
Video Input Standard	525_L_5994
Reference Standard	525_L_5994
SSN	0000137ABB15
Video	OK
Audio	OK
Frame Sync	OK
Settings	Saved

Figure 3-4 9062 Card Info Utility

Ancillary Data Line Number Locations and Ranges

Table 3-1 lists typical default output video VANC line number locations for various ancillary data items that may be passed or handled by the card.

Table 3-1 Typical Ancillary Data Line Number Locations/Ranges

Item	Default Line No. / Range	
	SD	HD
AFD	12 (Note 2)	9 (Note 2)
ATC_VITC	13 (Note 2)	9/8 (Note 2)
ATC_LTC	—	10 (Note 2)
Dolby® Metadata	13 (Note 2)	13 (Note 2)
SDI VITC Waveform	14/16 (Note 2)	—
Closed Captioning	21 (locked)	10 (Note 2)

Notes:

- The card does not check for conflicts on a given line number. Make certain the selected line is available and carrying no other data.
- While range indicated by drop-down list on GUI may allow a particular range of choices, the actual range is automatically clamped (limited) to certain ranges to prevent inadvertent conflict with active picture area depending on video format. Limiting ranges for various output formats are as follows:

Format	Line No. Limiting	Format	Line No. Limiting	Format	Line No. Limiting
525i	12-19	720p	9-25	1080p	9-41
625i	9-22	1080i	9-20		

Because line number allocation is not standardized for all ancillary items, consideration should be given to all items when performing set-ups. Figure 3-5 shows an example of improper and corrected VANC allocation within an HD-SDI stream.

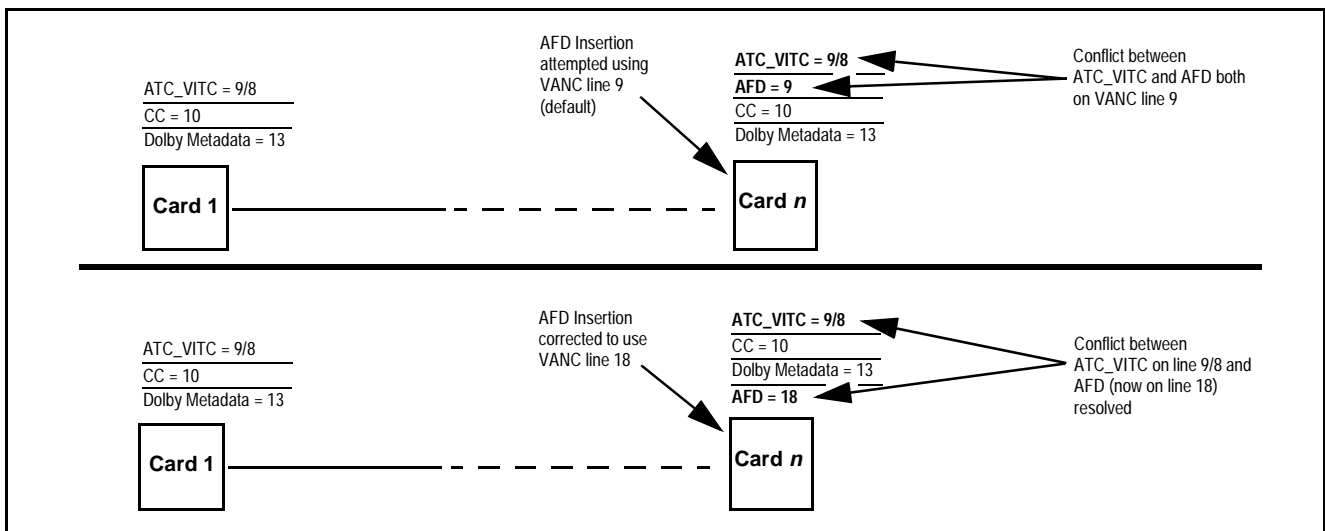



Figure 3-5 Example VANC Line Number Allocation Example

9062 Function Submenu List and Descriptions

Table 3-2 individually lists and describes each 9062 function submenu and its related list selections, controls, and parameters. Where helpful, examples showing usage of a function are also provided. Table 3-2 is primarily based upon using DashBoard™ to access each function and its corresponding submenus and parameters.

Note: All numeric (scalar) parameters displayed on DashBoard™ can be changed using the slider controls,  arrows, or by numeric keypad entry in the corresponding numeric field. (When using numeric keypad entry, add a return after the entry to commit the entry.)

On DashBoard™ itself and in Table 3-2, the function submenu items are organized using tabs as shown below.

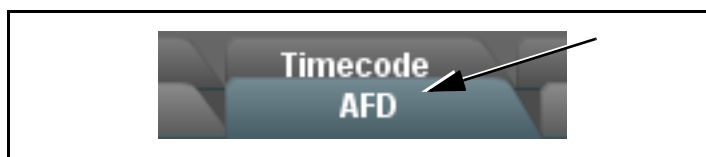

The table below provides a quick-reference to the page numbers where each function submenu item can be found.

Function Submenu Item	Page	Function Submenu Item	Page
Audio Input Controls	3-10	Dolby Metadata	3-35
Video Proc	3-11	Closed Captioning	3-36
Scaler	3-12	Timecode	3-38
AFD	3-18	Tone Generator	3-42
Overlays	3-22	Audio Mixing	3-42
Framesync	3-26	Licensable Features	3-47
Embedded Audio Group 1/2	3-31	Presets	3-47
Embedded Audio Group 3/4	3-34		

Table 3-2 9062 Function Submenu List



	<p>Displays signal status for the 16 embedded audio channels. Also provides global unity routing/parameter control resets.</p>
<p>• Status Displays</p> 	<p>Individual signal status displays embedded audio channels 1-16 as follows:</p> <ul style="list-style-type: none"> • Not Present: Indicates embedded channel does not contain recognized audio PCM data. Note: Channel displaying Not Present may still carry usable audio data with Unlocked being displayed due to invalid headers. • Present, Professional: Indicates embedded channel contains recognized audio PCM data. • Present, Consumer: Indicates embedded channel contains audio PCM data other than professional (for example, S/PDIF). • Present, Dolby E: Indicates embedded channel contains Dolby® E encoded data. • Present, Dolby Digital: Indicates embedded channel contains Dolby® Digital encoded data. Note: Dolby status displays shown to the left only occur for valid Dolby® signals meeting SMPTE 337M standard. <p>This card does not perform Dolby® processing on the signal. Although the card controls will appear to be usable for this signal tag, the signal is passed with 1-to-1 routing and all related gain and polarity controls set to unity.</p>
<p>• Embedded Unity Channel Selection</p> 	<p>Selects unity reset of Embedded Audio Group 1/2 and 3/4 controls and re-establishes default 1-to-1 routing as follows:</p> <ul style="list-style-type: none"> • Embedded: Routes Embedded Ch 1 thru Ch 16 as sources to destination channels Embedded Ch 1 thru Embedded Ch 16.
<p>• Apply Audio Channel Selection</p> 	<p>Applies embedded unity channel selection (as set in the above drop-down lists). To apply the selections, click the Confirm button. When Confirm is clicked, a Confirm? pop-up appears, requesting confirmation.</p> <ul style="list-style-type: none"> • Click Yes to proceed with the unity reset. • Click No to reject unity reset. <p>For any selection following confirm, the destination channel controls are default reset as follows:</p> <ul style="list-style-type: none"> • Gain is to unity • Phase control is set to Normal • Channel is set to Unmuted

Table 3-2 9062 Function Submenu List — continued





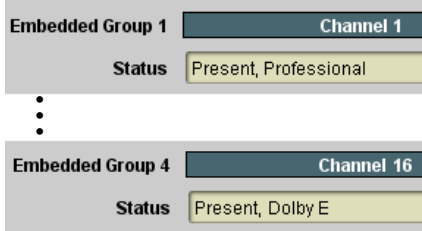

	<p>Provides the following Video Proc parametric controls.</p>
<ul style="list-style-type: none"> • Video Proc 	<p>Video Proc (On/Off) provides master on/off control of all Video Proc functions.</p> <ul style="list-style-type: none"> • When set to Off, Video Proc is bypassed. • When set to On, currently displayed parameter settings take effect.
<ul style="list-style-type: none"> • Reset to Unity 	<p>Reset to Unity provides unity reset control of all Video Proc functions. When Confirm is clicked, a Confirm? pop-up appears, requesting confirmation.</p> <ul style="list-style-type: none"> • Click Yes to proceed with the unity reset. • Click No to reject unity reset.
<ul style="list-style-type: none"> • Luma Gain 	<p>Adjusts gain percentage applied to Luma (Y channel). (0% to 200% range in 0.1% steps; unity = 100%)</p>
<ul style="list-style-type: none"> • Luma Lift 	<p>Adjusts lift applied to Luma (Y-channel). (-100% to 100% range in 0.1% steps; null = 0.0%)</p>
<ul style="list-style-type: none"> • Color Gain 	<p>Adjusts gain percentage (saturation) applied to Chroma (C-channel). (0% to 200% range in 0.1% steps; unity = 100%)</p>
<ul style="list-style-type: none"> • Color Phase 	<p>Adjusts phase angle applied to Chroma. (-360° to 360° range in 0.1° steps; null = 0°)</p>
<ul style="list-style-type: none"> • Gang Luma and Color Gain 	<p>When set to On, changing either the Luma Gain or Color Gain controls increases or decreases both the Luma and Chroma levels by equal amounts.</p>

Table 3-2 9062 Function Submenu List — continued

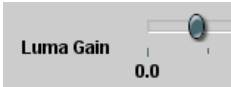

	<p>Provides video format up/down/cross-conversions and aspect ratio controls.</p>
<p>Note: Scaling and/or format conversion removes Dolby® metadata and ATC packets (if present). If Dolby® metadata is present and needs to be preserved, use the Dolby Metadata function tab to preserve and re-apply the metadata on the output SDI. Refer to Dolby Metadata function on page 3-35 for more information.</p>	
<p>• Scaler enable</p> 	<p>Enables or bypasses Scaler function as follows:</p> <ul style="list-style-type: none"> • Enabled: Provides Scaler functions for the received video input. • Bypassed: Received video input bypasses the Scaler functions.
<p>• Current Input Format</p> 	<p>Displays the input format of the video currently being received by the 9062 (for example, 1080p at 29.97 Hz frame rate as shown here).</p> <p>Note: Rates displayed for progressive formats are frame rates; rates displayed for interlaced formats are field rates.</p>
<p>• Current Output Format</p> 	<p>Displays the currently selected output format of the video currently being processed by the 9062 (for example, 1080p HD at 29.97 Hz frame rate as shown here). The output format displayed is the output present on the card's SDI OUT BNC connectors.</p> <p>Note: Output format shown in this display tracks with selection made in HD: Convert to or SD: Convert to drop-down lists. Output Format display only tracks with changes applicable to the currently received input format (for example, when currently receiving HD video, changes made in the SD: Convert to drop-down list have no effect on the Output Format display). Output format also tracks with any applicable Scaler functions that affect output format.</p> <p>Note: Rates displayed for progressive formats are frame rates; rates displayed for interlaced formats are field rates.</p>

Table 3-2 9062 Function Submenu List — continued

Scaler		(continued)						
Scaler Video Format Conversions								
<p>The Scaler HD: Convert to: and SD: Convert to: drop-down lists (as shown and described in the following pages) allows selection of up/down/cross-conversions (or no conversion) for various input formats. The table below lists the conversion choices available for various input formats and frame rates provided by the Scaler Convert to: function. Also shown are the resulting frame rates for the converted outputs.</p>								
Input Format	SD (NTSC/PAL)	720p	720p half-rate	720p (film rates)	1080i	1080p	1080p (film rates)	1080PsF (film rates)
525i 59.94	525i 59.94	720p 59.94	720p 29.97	720p 23.98 ₍₄₎	1080i 59.94	1080p 29.97	1080p 23.98 ₍₄₎	1080PsF 23.98 ₍₄₎
625i 50	625i 50	720p 50	720p 25	X	1080i 50	1080p 25	X	X
720p 60	X	720p 60	720p 30	720p 24 ₍₄₎	1080i 60	1080p 30	1080p 24 ₍₄₎	1080PsF 24 ₍₄₎
720p 59.94	525i 59.94	720p 59.94	720p 29.97	720p 23.98 ₍₄₎	1080i 59.94	1080p 29.97	1080p 23.98 ₍₄₎	1080PsF 23.98 ₍₄₎
720p 50	625i 50	720p 50	720p 25	X	1080i 50	1080p 25	X	X
720p 30	X	720p 60	720p 30	720p 24 ₍₅₎	1080i 60	1080p 30	1080p 24 ₍₅₎	1080PsF 24 ₍₅₎
720p 29.97	525i 59.94	720p 59.94	720p 29.97	720p 23.98 ₍₅₎	1080i 59.94	1080p 29.97	1080p 23.98 ₍₅₎	1080PsF 23.98 ₍₅₎
720p 25	625i 50	720p 50	720p 25	X	1080i 50	1080p 25	X	X
720p 24	X	720p 60	720p 30	720p 24	1080i 60	1080p 30	1080p 24	1080PsF 24
720p 23.98	525i 59.94	720p 59.94	720p 29.97	720p 23.98	1080i 59.94	1080p 29.97	1080p 23.98	1080PsF 23.98
1080i 60	X	720p 60	720p 30	720p 24 ₍₄₎	1080i 60	1080p 30	1080p 24 ₍₄₎	1080PsF 24 ₍₄₎
1080i 59.94	525i 59.94	720p 59.94	720p 29.97	720p 23.98 ₍₄₎	1080i 59.94	1080p 29.97	1080p 23.98 ₍₄₎	1080PsF 23.98 ₍₄₎
1080i 50	625i 50	720p 50	720p 25	X	1080i 50	1080p 25	X	X
1080p 30	X	720p 60	720p 30	720p 24 ₍₅₎	1080i 60	1080p 30	1080p 24 ₍₅₎	1080PsF 24 ₍₅₎
1080p 29.97	525i 59.94	720p 59.94	720p 29.97	720p 23.98 ₍₅₎	1080i 59.94	1080p 29.97	1080p 23.98 ₍₅₎	1080PsF 23.98 ₍₅₎
1080p 25	625i 50	720p 50	720p 25	X	1080i 50	1080p 25	X	X
1080p 24	X	720p 60	720p 30	720p 24	1080i 60	1080p 30	1080p 24	1080PsF 24
1080p 23.98	525i 59.94	720p 59.94	720p 29.97	720p 23.98	1080i 59.94	1080p 29.97	1080p 23.98	1080PsF 23.98
1080PsF 24	X	720p 60	720p 30	720p 24	1080i 60	1080p 30	1080p 24	1080PsF 24
1080PsF 23.98	525i 59.94	720p 59.94	720p 29.97	720p 23.98	1080i 59.94	1080p 29.97	1080p 23.98	1080PsF 23.98
<p>Notes: 1. The drop-down list choice of "Same as Input" is used when no conversion is desired. For clarity, it is not redundantly listed here.</p> <p>2. "X" denotes conversions not available or invalid conversions.</p> <p>3. Interlaced formats rates listed are field rates. Progressive format rates listed are frame rates.</p> <p>4. If the original material does not have a proper 3-2 cadence suitable for conversion to film rates, the conversion reverts to standard de-interlacing. While this video can be converted to film rates, the resulting image motion will lack smoothness. Therefore, make certain interlaced video is appropriately constructed for 3-2 reverse pull-down when converting video to film rates. (See 3-2 Pull-down Conversion and Considerations (p. 1-11) for more information.)</p> <p>5. Formats using a 30/29.97 Hz progressive frame rate can be converted to a 24/23.98 Hz progressive frame rate, however some image motion irregularity will appear in the converted output.</p>								

Table 3-2 9062 Function Submenu List — continued

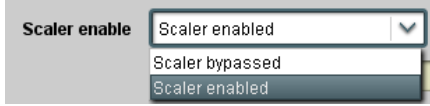

Scaler	(continued)
Note: HD: controls described below affect HD inputs ; SD: controls described below affect SD inputs .	
<p>• SD: Convert To</p> 	<p>When SD video input is received by the 9062, provides output format conversions, or re-aspecting to SD when SD is the detected input format as described below.</p> <ul style="list-style-type: none"> • SD (Same as input): Output follows currently received video input format, with Current Input Format and Current Output Format displays showing same selection. • 720p: Output is converted to 720p • 720 film: Output is converted to corresponding 720p film frame rate • 1080i: Output is converted to 1080i • 1080p: Output is converted to 1080p • 1080 film: Output is converted to corresponding 1080i film frame rate • Output Follows Reference In: Output tracks with format set in Reference Video Input <p>Note: Output Follows Reference In selection automatically sets the output format to that of the received reference signal input (this signal is distributed to the 9062 and other cards via a frame bus). In addition to extracting a frame sync and rate, this function determines the type of black burst (i.e., black burst or tri-level) and sets the output format to match.</p>
<p>• SD: Output Half-rate 720p</p> 	<p>When SD: Convert to drop-down list is set to 720p, converts output to 720p half-rate.</p> <p>Yes/No control functions as follows:</p> <ul style="list-style-type: none"> • No: Do not apply half-rate; leave output at standard frame rate • Yes: Output set at half- rate <p>Note: Half-rate outputs are available for the 720p frame rates listed under “720p” in the “Scaler Video Format Conversions” table on the previous page.</p>
<p>• SD: Output PsF</p> 	<p>When enabled (and with the output video is set to 1080 film), converts the output to 1080PsF (segmented frame progressive).</p>
<p>• SD: Aspect Ratio Conversion</p> 	<p>Selects between the standard preset Aspect Ratio Conversions (ARC) shown here, as well as User Defined and Follow AFD Settings.</p> <ul style="list-style-type: none"> • User Defined settings allow custom user-defined H and V aspect ratio control. • Follow AFD Settings sets the output aspect ratio to track with AFD settings performed in AFD (p. 3-18). <p>Note: This function is intended for aspect ratio adjustment of a particular signal without AFD considerations.</p> <ul style="list-style-type: none"> • If ARC is being used on a case-by-case basis for a particular signal, it is easier to use the Scaler ARC tools described here. • If AFD is to be used to set and apply a standard AFD code label for ARC, use Follow AFD Settings. Do not perform ARC here; instead, perform ARC as described in the AFD function description on page 3-18.

Table 3-2 9062 Function Submenu List — continued

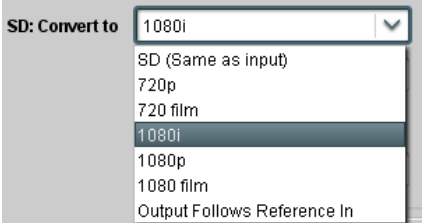
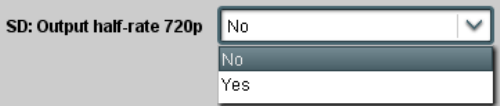

	(continued)
<ul style="list-style-type: none"> • SD: User-defined aspect ratio 	<p>(Horizontal) and (Vertical) controls adjust horizontal and vertical zoom percentage. Settings less than (<) 100% provide zoom-out; settings greater than (>) 100% provide zoom-in.</p> <p>(50% to 200% range in 0.1% steps; null = 100.0)</p>
<ul style="list-style-type: none"> • SD: Top line suppression 	<p>Selects the number of lines suppressed at the beginning of video. In this manner, the image is scaled proportionally to replace the top few lines suppressed using this control. When upconverting from SD to HD, using this control can hide unwanted closed caption or timecode data.</p> <p>(Range is 0 thru 10 lines.)</p>
<ul style="list-style-type: none"> • SD: Side pixel suppression 	<p>Selects the number of pixels at the left and right horizontal margins within the SAV and EAV portions of each line.</p> <p>(Range is 0 thru 20 pixels.)</p>
<ul style="list-style-type: none"> • HD: Convert To 	<p>When HD video input is received by the 9062, provides output format conversions listed below.</p> <ul style="list-style-type: none"> • HD (Same as input): Output follows currently received video input format, with Current Input Format and Current Output Format displays showing same selection. • SD (NTSC or PAL): Output is converted to 525i at 59.94 Hz frame rate or 625i at 50 Hz rate, as applicable. • 720p: Output is converted to 720p • 720 film: Output is converted to corresponding 720p film frame rate • 1080i: Output is converted to 1080i • 1080p: Output is converted to 1080p • 1080 film: Output is converted to corresponding 1080i film frame rate • Output Follows Reference In: Output tracks with format set in Reference Video Input <p>Note: Output Follows Reference In selection automatically sets the output format to that of the received reference signal input (this signal is distributed to the 9062 and other cards via a frame bus). In addition to extracting a frame sync and rate, this function determines the type of black burst (i.e., black burst or tri-level) and sets the output format to match.</p>
<ul style="list-style-type: none"> • HD: Output Half-rate 720p 	<p>When HD: Convert to drop-down list is set to 720p, converts output to 720p half-rate.</p> <p>Yes/No control functions as follows:</p> <ul style="list-style-type: none"> • No: Do not apply half-rate; leave output at standard frame rate • Yes: Output set at half-rate <p>Note: Half-rate outputs are available for the 720p frame rates listed under “720p” in the “Scaler Video Format Conversions” table on page 3-13.</p>

Table 3-2 9062 Function Submenu List — continued

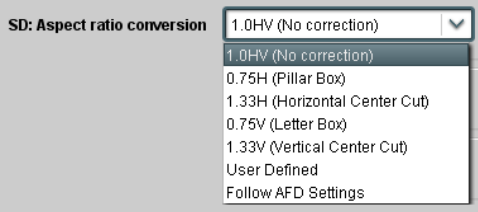

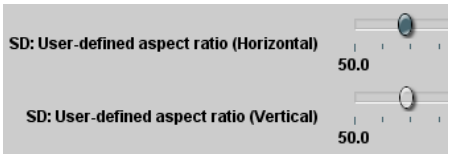

	(continued)
<ul style="list-style-type: none"> • HD: Output PsF 	<p>When enabled (and with the output video is set to 1080 film) converts output to 1080PsF (segmented frame progressive).</p>
<ul style="list-style-type: none"> • HD: Aspect Ratio Conversion 	<p>Selects between the standard preset Aspect Ratio Conversions (ARC) shown here, as well as User Defined and Follow AFD Settings.</p> <ul style="list-style-type: none"> • User Defined settings allow custom user-defined H and V aspect ratio control. • Follow AFD Settings sets the output aspect ratio to track with AFD settings performed in AFD (p. 3-18). <p>Note: This function is intended for aspect ratio adjustment of a particular signal without AFD considerations.</p> <ul style="list-style-type: none"> • If ARC is being used on a case-by-case basis for a particular signal, it is easier to use the Scaler ARC tools described here. • If AFD is to be used to set and apply a standard AFD code label for ARC, use Follow AFD Settings. Do not perform ARC here; instead, perform ARC as described in the AFD function description on page 3-18.
<ul style="list-style-type: none"> • HD: User-defined aspect ratio 	<p>(Horizontal) and (Vertical) controls adjust horizontal and vertical zoom percentage. Settings less than (<) 100% provide zoom-out; settings greater than (>) 100% provide zoom-in.</p> <p>(50% to 200% range in 0.1% steps; null = 100.0)</p>
<ul style="list-style-type: none"> • HD: Top line suppression 	<p>Selects the number of lines suppressed at the beginning of video. In this manner, the image is scaled proportionally to replace the top few lines suppressed using this control. When upconverting from SD to HD, using this control can hide unwanted closed caption or timecode data.</p> <p>(Range is 0 thru 10 lines.)</p>
<ul style="list-style-type: none"> • HD: Side pixel suppression 	<p>Selects the number of pixels at the left and right horizontal margins within the SAV and EAV portions of each line.</p> <p>(Range is 0 thru 20 pixels.)</p>
<ul style="list-style-type: none"> • Detail Enhancement Controls 	<p>Sharpness Level, Threshold, and Noise Reduction controls (individually described below) which can be used to tailor output video sharpness per program material and aesthetic preferences.</p> <p>Note: Detail Enhancement Controls apply to both SD and HD conversions.</p>

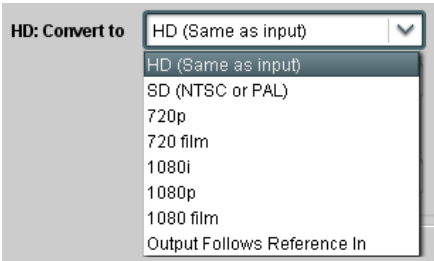
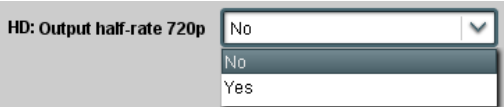
Table 3-2 9062 Function Submenu List — continued



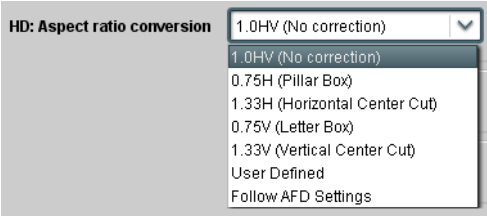
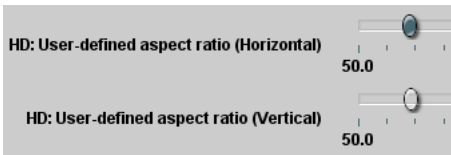

	(continued)
<ul style="list-style-type: none"> • Sharpness Level Control 	<p>Adjusts the aggressiveness of sharpening applied to MPEG video. Optimum setting results in overall perception of increased sharpness, while avoiding pattern noise artifacts.</p> <p>(Range is 0 thru 255)</p>
<ul style="list-style-type: none"> • Sharpness Threshold Control 	<p>Adjusts the point at which sharpening rules become active. Data below the threshold setting is passed unaffected.</p> <p>Higher settings allow for a more subtle sharpness enhancement (especially with content showing motion). Lower settings allow more content in general to be acted upon by the enhancement process.</p> <p>(Range is 0 thru 255)</p>
<ul style="list-style-type: none"> • Noise Reduction Control 	<p>Adjusts the amount of statistical low-pass filtering applied to the data. Using this control, regular pattern noise artifacts from the sharpening process can be reduced, resulting in subjectively smoother raster backgrounds and detail boundaries.</p> <p>(Range is 0 thru 63)</p>

Table 3-2 9062 Function Submenu List — continued





	<p>Allows assignment of AFD (Active Format Description) codes to the SDI output video, and allows unique ARC settings to be applied for each AFD code.</p> <p>When an appropriate AFD code is received by this card, this function can be used to apply the AFD-directed re-aspecting, resulting in a properly scaled and cropped image area.</p>
<div data-bbox="256 548 1365 1016"> <p>Without AFD</p> <p>NTSC-Coded (4:3) 1080i Video Signal → Up-Conversion to 16:9 → 1080i Video Signal with 16:9 uncorrected signal</p> <p>NTSC-Coded image on 16:9 display shows letterbox cropping</p>  <p>Uncorrected up-conversion results in "postage stamp" effect with both letterbox and sidebars visible on 16:9 display</p>  </div> <div data-bbox="256 1058 1365 1598"> <p>With AFD</p> <p>NTSC-Coded (4:3) 1080i Video Signal with 1010 AFD Code → 9062 with 1010 AFD Code Received and Applied → Up-Conversion to 16:9 → 1080i Video Signal with 16:9 corrected signal</p> <p>NTSC-Coded image on 16:9 display shows letterbox cropping</p>  <p>AFD Corrected up-conversion results in intended image area properly visible on 16:9 display</p>  </div>	

Table 3-2 9062 Function Submenu List — continued

	(continued)																												
<p>• Incoming AFD</p> 	<p>Displays incoming AFD setting as follows:</p> <ul style="list-style-type: none"> • If AFD code is present, one of the 11, four-bit AFD codes is displayed (as shown in the example to the left). Also displayed is the VANC line number of the incoming AFD code. • If no AFD setting is present in the video signal, No AFD Present is displayed. 																												
<p>• 16:9 Controls</p> 	<p>Individual user (custom) H Zoom, V Zoom, and AFD Output Code tools for the following 12 AFD codes/formats suited for 16:9 sources:</p> <table border="1" data-bbox="771 672 1412 1008"> <thead> <tr> <th>AFD Code⁽¹⁾</th> <th>Description</th> <th>AFD Code⁽¹⁾</th> <th>Description</th> </tr> </thead> <tbody> <tr> <td>–</td> <td>No code present</td> <td>1001</td> <td>4:3 (center)</td> </tr> <tr> <td>0000</td> <td>Undefined</td> <td>1010</td> <td>16:9 (image protected)⁽²⁾</td> </tr> <tr> <td>0010</td> <td>Full frame</td> <td>1011</td> <td>14:9 (center)</td> </tr> <tr> <td>0011</td> <td>4:3 (center)</td> <td>1101</td> <td>4:3 (with alternate 14:9 center)</td> </tr> <tr> <td>0100</td> <td>Box > 16:9 (center)</td> <td>1110</td> <td>16:9 (with alternate 14:9 center)⁽²⁾</td> </tr> <tr> <td>1000</td> <td>Full frame</td> <td>1111</td> <td>16:9 (with alternate 4:3 center)⁽²⁾</td> </tr> </tbody> </table> <p>1: AFD codes numbering and definitions conform to SMPTE 2016-1-2007. 2: Image Protected implies picture content that must not be cropped by conversion processes or display devices. Alternate center formats may have protected center areas, with areas outside of the protected area not containing mandatory content. Refer to SMPTE 2016-1-2007 for more information if needed.</p>	AFD Code ⁽¹⁾	Description	AFD Code ⁽¹⁾	Description	–	No code present	1001	4:3 (center)	0000	Undefined	1010	16:9 (image protected) ⁽²⁾	0010	Full frame	1011	14:9 (center)	0011	4:3 (center)	1101	4:3 (with alternate 14:9 center)	0100	Box > 16:9 (center)	1110	16:9 (with alternate 14:9 center) ⁽²⁾	1000	Full frame	1111	16:9 (with alternate 4:3 center) ⁽²⁾
AFD Code ⁽¹⁾	Description	AFD Code ⁽¹⁾	Description																										
–	No code present	1001	4:3 (center)																										
0000	Undefined	1010	16:9 (image protected) ⁽²⁾																										
0010	Full frame	1011	14:9 (center)																										
0011	4:3 (center)	1101	4:3 (with alternate 14:9 center)																										
0100	Box > 16:9 (center)	1110	16:9 (with alternate 14:9 center) ⁽²⁾																										
1000	Full frame	1111	16:9 (with alternate 4:3 center) ⁽²⁾																										
<p>• 4:3 Controls</p> 	<p>Individual user (custom) H Zoom, V Zoom, and AFD Output Code tools for the following 12 AFD codes/formats suited for 4:3 sources:</p> <table border="1" data-bbox="771 1270 1412 1585"> <thead> <tr> <th>AFD Code⁽¹⁾</th> <th>Description</th> <th>AFD Code⁽¹⁾</th> <th>Description</th> </tr> </thead> <tbody> <tr> <td>–</td> <td>No code present</td> <td>1001</td> <td>Full frame</td> </tr> <tr> <td>0000</td> <td>Undefined</td> <td>1010</td> <td>16:9 (center)</td> </tr> <tr> <td>0010</td> <td>Box 16:9 (top)</td> <td>1011</td> <td>14:9 (center)</td> </tr> <tr> <td>0011</td> <td>Box 14:9 (top)</td> <td>1101</td> <td>4:3 (with alternate 14:9 center)</td> </tr> <tr> <td>0100</td> <td>Box > 16:9 (center)</td> <td>1110</td> <td>16:9 (with alternate 14:9 center)⁽²⁾</td> </tr> <tr> <td>1000</td> <td>Full frame</td> <td>1111</td> <td>16:9 (with alternate 4:3 center)⁽²⁾</td> </tr> </tbody> </table> <p>1: AFD codes numbering and definitions conform to SMPTE 2016-1-2007. 2: Image Protected implies picture content that must not be cropped by conversion processes or display devices. Alternate center formats may have protected center areas, with areas outside of the protected area not containing mandatory content. Refer to SMPTE 2016-1-2007 for more information if needed.</p>	AFD Code ⁽¹⁾	Description	AFD Code ⁽¹⁾	Description	–	No code present	1001	Full frame	0000	Undefined	1010	16:9 (center)	0010	Box 16:9 (top)	1011	14:9 (center)	0011	Box 14:9 (top)	1101	4:3 (with alternate 14:9 center)	0100	Box > 16:9 (center)	1110	16:9 (with alternate 14:9 center) ⁽²⁾	1000	Full frame	1111	16:9 (with alternate 4:3 center) ⁽²⁾
AFD Code ⁽¹⁾	Description	AFD Code ⁽¹⁾	Description																										
–	No code present	1001	Full frame																										
0000	Undefined	1010	16:9 (center)																										
0010	Box 16:9 (top)	1011	14:9 (center)																										
0011	Box 14:9 (top)	1101	4:3 (with alternate 14:9 center)																										
0100	Box > 16:9 (center)	1110	16:9 (with alternate 14:9 center) ⁽²⁾																										
1000	Full frame	1111	16:9 (with alternate 4:3 center) ⁽²⁾																										

Table 3-2 9062 Function Submenu List — continued

	<p>(continued)</p>																				
<p>• H Zoom and V Zoom Controls</p> 	<p>Individual H Zoom and V Zoom controls for each of the 12 AFD code choices for both 4:3 and 16:9 coded input frames described above allow adjustment of horizontal and vertical zoom percentage for each AFD code.</p> <p>(50% to 200% range in 0.1% steps)</p> <p>Note: To apply H and V settings for a given AFD code using this card, Scaler Aspect Ratio Conversion must be set to Follow AFD Settings.</p> <p>Note: Default zoom percentages use the following rules:</p> <ul style="list-style-type: none"> • The default zoom percentages displayed when this function is accessed are the default percentages corresponding to the respective AFD standard ratio definitions (for example, default horizontal and vertical zoom percentages for 4:3 ratios are correspondingly 133% and 100%, yielding a 4:3 aspect ratio). In these cases, the null values for this definition are the default values shown. • In cases where a different aspect ratio is to be used for a given received aspect ratio, the default ratio displayed is the null value that results (assuming no H or V zoom modification). For example, for a 16:9 signal and settings set for a 1111 (15) AFD code (“16:9 with 4:3 protected image”), the respective displayed default H and V zoom settings of 100% and 75% protect the Protected Image Area. 																				
<p>• AFD Output Code</p> 	<p>Twelve drop-down lists that allow assignment of AFD codes to the 12 individual H Zoom and V Zoom tools described above.</p> <p>Note:</p> <ul style="list-style-type: none"> • The default AFD codes displayed when this function is accessed show the SMPTE AFD code most closely reflecting the aspect ratio when the corresponding default settings are applied. • An AFD Output Code setting has no effect on aspect on ARC performed by this card; it merely applies a selected AFD code to the output video. 																				
<table border="1" data-bbox="402 1440 1271 1633"> <thead> <tr> <th>AFD Code</th> <th>H Zoom (50.0-200.0)</th> <th>V Zoom (50.0-200.0)</th> <th>AFD Output Code</th> </tr> </thead> <tbody> <tr> <td>No AFD Present</td> <td>100.0</td> <td>75.0</td> <td>No AFD</td> </tr> <tr> <td>Undefined - 0000</td> <td>100.0</td> <td>75.0</td> <td>0000</td> </tr> <tr> <td>Full Frame - 0010</td> <td>100.0</td> <td>75.0</td> <td>1010</td> </tr> <tr> <td>4:3 (center) - 0011</td> <td>133.0</td> <td>100.0</td> <td>1000</td> </tr> </tbody> </table> <p>In this example, if a “0011” AFD code is received, the entered H Zoom and V Zoom values corresponding to AFD code 0011 are applied to the image (133.0% and 100.0%, respectively, in this example). The H Zoom and V Zoom values for any AFD code can be changed as desired. When the card Scaler Aspect Ratio Conversion is set to Follow AFD Settings, the H and V zoom values set here are applied to the output video.</p> <p>In this example, with the AFD Output Code drop-down set to 1000, if a 0011 code is received on the input, an AFD code of 1000 is outputted by the card. (Note that the assigned output code has no effect on ARC performed within this card.)</p>		AFD Code	H Zoom (50.0-200.0)	V Zoom (50.0-200.0)	AFD Output Code	No AFD Present	100.0	75.0	No AFD	Undefined - 0000	100.0	75.0	0000	Full Frame - 0010	100.0	75.0	1010	4:3 (center) - 0011	133.0	100.0	1000
AFD Code	H Zoom (50.0-200.0)	V Zoom (50.0-200.0)	AFD Output Code																		
No AFD Present	100.0	75.0	No AFD																		
Undefined - 0000	100.0	75.0	0000																		
Full Frame - 0010	100.0	75.0	1010																		
4:3 (center) - 0011	133.0	100.0	1000																		

Table 3-2 9062 Function Submenu List — continued

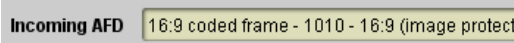
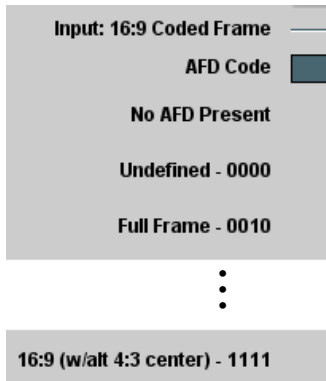
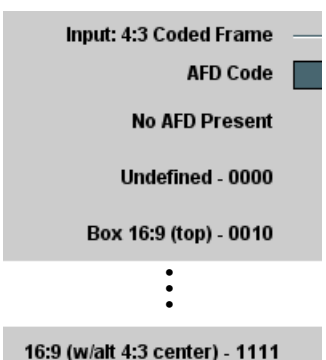

	(continued)
<ul style="list-style-type: none"> • Output Line 	<p>Allows selecting the line location of the AFD data within the video signal Ancillary Data space.</p> <p>(Range is 9 thru 41)</p> <p>Note:</p> <ul style="list-style-type: none"> • Although the output line drop-down will allow any choice within the 9 thru 41 range, the actual range is automatically clamped (limited) to certain ranges to prevent inadvertent conflict with active picture area depending on video format. See Ancillary Data Line Number Locations and Ranges (p. 3-8) for more information. • The card does not check for conflicts on a given line number. Make certain the selected line is available and carrying no other data.
<ul style="list-style-type: none"> • Restore Defaults 	<p>Restore Defaults provides default restore of all user settings described in the remainder of the AFD function description.</p> <p>When Confirm is clicked, a Confirm? pop-up appears, requesting confirmation.</p> <ul style="list-style-type: none"> • Click Yes to proceed with restore defaults. • Click No to reject restore defaults.

Table 3-2 9062 Function Submenu List — continued

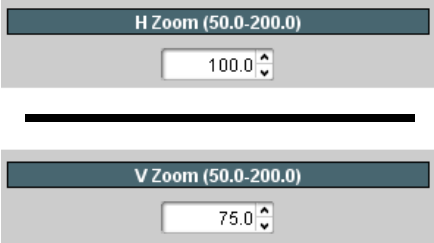
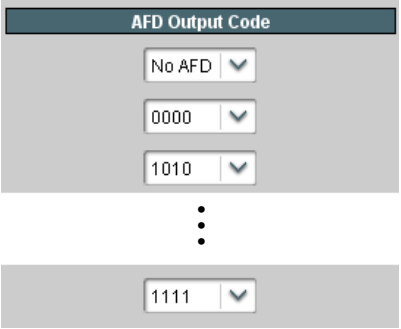



	<p>Allows Safe Action and/or Safe Title overlays to be added to the image. The overlays can be used to identify safe action and safe title areas within the image.</p>
<p>Note:</p> <ul style="list-style-type: none"> • Overlay markers using this function are for setup only. When enabled, these markers are embedded in the SDI video output signal and may appear in the image. Use this function only on preview video and not on-air video. Make certain any overlay tools are turned off when done. • Overlays are functional only when Scaler is enabled. • Multiple overlay markers described below can be simultaneously enabled as desired. 	
<p>• Safe Action Area</p> 	<p>When enabled (On), turns on the Safe Action Area overlay.</p>  <p>When enabled (On), outline shows Safe Action Area boundary. Color of boundary is selected using Color drop-down list.</p>
<p>• Safe Title Area</p> 	<p>When enabled (On), turns on the Safe Title Area overlay.</p>  <p>When enabled (On), outline shows Safe Title Area boundary. Color of boundary is selected using Color drop-down list.</p>

Table 3-2 9062 Function Submenu List — continued

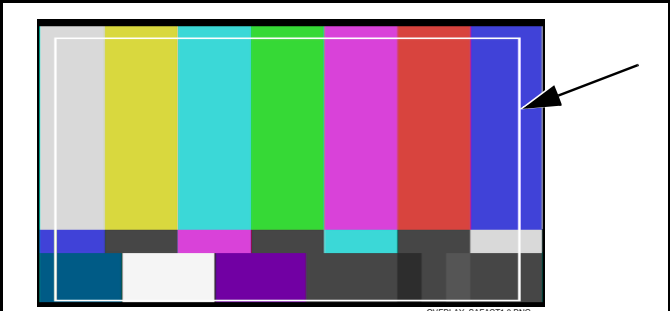

<div style="background-color: #333; color: white; padding: 5px; text-align: center; font-weight: bold;">Overlays</div>	(continued)
<p>• Safe Action/Title Area Color</p> 	<p>Selects the Safe Action and Safe Title overlay color from choices shown to the left.</p>
<p>• 0.75H Safe Action Area</p> 	<p>When enabled (On), turns on the 0.75H Safe Action Area overlay that shows the 4:3 safe area on a 16:9 image (i.e., the resulting safe area when the image is converted to 4:3).</p>  <p style="text-align: center; font-size: small;">OVERLAY_SAFACT_NORMW075.PNG</p> <p>Outline shows 0.75H Safe Action Area boundary. Color of boundary is selected using Color drop-down list.</p> <p>Note: If 0.75H (Pillar Box) is selected using the Aspect Ratio Conversion tool in the Scaler function, and Overlays Follow ARC is selected for this function, the overlays will be additionally reduced 0.75H beyond the standard 4:3 safe areas</p>

Table 3-2 9062 Function Submenu List — continued

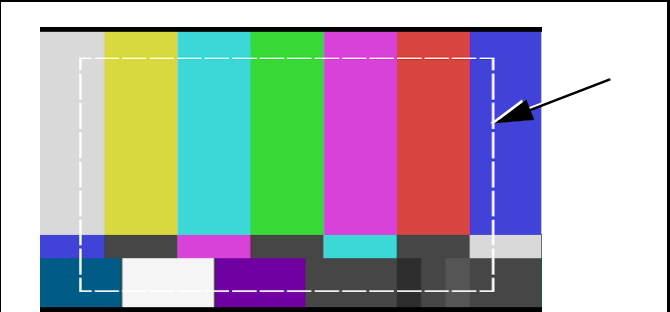
<div style="background-color: #333; color: white; padding: 5px; text-align: center; font-weight: bold;">Overlays</div>	(continued)
<ul style="list-style-type: none"> • 0.75H Safe Title Area <div style="border: 1px solid #ccc; padding: 5px; margin-top: 10px;"> 0.75H Safe Title Area <input type="checkbox" value="On"/> </div>	<p>When enabled (On), turns on the 0.75H Safe Title Area overlay that shows the 4:3 safe title area on a 16:9 image (i.e., resulting safe title area when the image is converted to 4:3).</p> <div style="border: 1px solid black; padding: 10px; margin: 10px 0;">  <p style="font-size: small; text-align: right;">OVERLAY_SAFELENORM075.PNG</p> </div> <p>Outline shows 0.75H Safe Title Area boundary. Color of boundary is selected using Color drop-down list.</p> <p>Note: If 0.75H (Pillar Box) is selected using the Aspect Ratio Conversion tool in the Scaler function, and Overlays Follow ARC is selected for this function, the overlays will be additionally reduced 0.75H beyond the standard 4:3 safe areas</p>
<ul style="list-style-type: none"> • 0.75H Safe Action/Title Area Color <div style="border: 1px solid #ccc; padding: 5px; margin-top: 10px;"> <p>Color White ▼</p> <ul style="list-style-type: none"> White Yellow Cyan Green Magenta Red Blue Black </div>	<p>Selects the 0.75H Safe Action and 0.75H Safe Title overlay color from choices shown to the left.</p>

Table 3-2 9062 Function Submenu List — continued

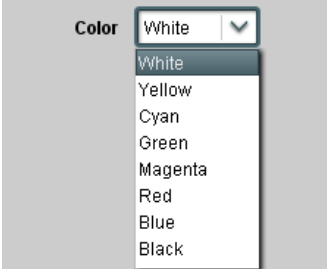
<div style="background-color: #333; color: white; padding: 5px; text-align: center; font-weight: bold;">Overlays</div>	<p style="text-align: center; font-weight: bold;">(continued)</p>
<p>• Center Cross</p> <div style="border: 1px solid #ccc; padding: 5px; margin-top: 10px;"> Center Cross <input checked="" type="checkbox" value="On"/> </div>	<p>When enabled (On), turns on the Center Cross overlay.</p> <div style="border: 1px solid black; padding: 10px; margin-top: 10px;">  <p style="font-size: small; text-align: right;">OVERLAY_CTRX.PNG</p> <p>Color of marker is selected using Color drop-down list.</p> </div>
<p>• Center Cross Color</p> <div style="border: 1px solid #ccc; padding: 5px; margin-top: 10px;"> Color White <ul style="list-style-type: none"> <li style="border: 1px solid #ccc; padding: 2px;">White <li style="border: 1px solid #ccc; padding: 2px;">Yellow <li style="border: 1px solid #ccc; padding: 2px;">Cyan <li style="border: 1px solid #ccc; padding: 2px;">Green <li style="border: 1px solid #ccc; padding: 2px;">Magenta <li style="border: 1px solid #ccc; padding: 2px;">Red <li style="border: 1px solid #ccc; padding: 2px;">Blue <li style="border: 1px solid #ccc; padding: 2px;">Black </div>	<p>Selects the Center Cross overlay color from choices shown to the left.</p>
<p>• Overlays Follow ARC</p> <div style="border: 1px solid #ccc; padding: 5px; margin-top: 10px;"> Overlays Follow ARC <input checked="" type="checkbox" value="On"/> </div>	<p>When enabled (On), overlays are resized along with the image in accordance with any ARC settings.</p> <p>Note: This choice functions only when a zoom-out is applied (settings less than 100%).</p>

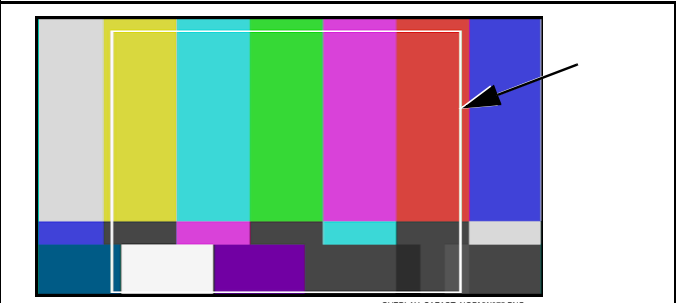
Table 3-2 9062 Function Submenu List — continued



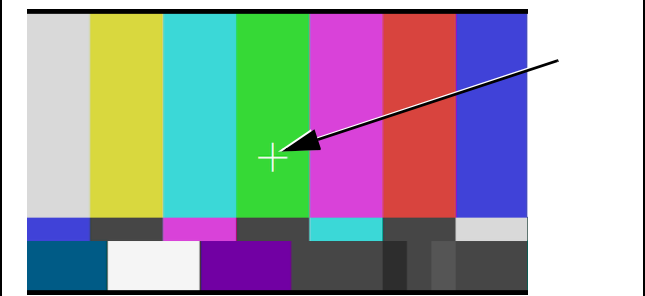

	<p>Provides video Frame Sync offset and audio re-sync tools.</p>
<p>• Framesync Enable</p> 	<p>Disables the Frame Sync function, or selects from choices below.</p> <ul style="list-style-type: none"> • Off: Video path bypasses frame sync entirely; output video timing tracks with input video timing. • Reference 1: Allows Frame Sync function to use external Reference 1 as the reference ("house") standard. • Reference 2: Allows Frame Sync function to use external Reference 2 as the reference ("house") standard. <p>Note: If Reference 1 or Reference 2 is selected and an appropriate external reference is not received, the  indication appears in the Card Info status portion of DashBoard™, indicating invalid frame sync reference error. (Additionally, the card edge ERR indicator illuminates indicating the same.) External reference signals Reference 1 and Reference 2 are distributed to the card and other cards via a frame bus.</p> <ul style="list-style-type: none"> • Input Video: Allows full framesync functionality (such as delay offset), but instead uses the input video signal as the reference standard. <p>Note: If Input Video is used for framesync, any timing instability on the input video will result in corresponding instability on the output video. This setting should only be used where syncing to input video is known to be reliable.</p> <ul style="list-style-type: none"> • Negative vertical or horizontal delay values (using the controls below) should not be used when using Input Video mode. This may result in image motion "jerkiness". To add an offset in this case, instead apply a positive value that results in the desired net offset.
<p>• Vertical Delay Control</p> 	<p>When Framesync is enabled, sets vertical delay (in number of lines of output video timing) between the output video and the frame sync reference.</p> <p>(Range is -1124 thru 1124 lines.)</p> <p>Note: Lines refer to lines in the output video format, and not to the reference format.</p>
<p>• Horizontal Delay Control</p> 	<p>When Framesync is enabled, sets (in μsec of output video timing) horizontal delay between the output video and the frame sync reference.</p> <p>(Range is -64.000 thru 64.000 μsec)</p> <p>Note: When an external framesync reference is used, the card will not produce a framesync reset until the variance between framesync reference and output video exceeds ± 2 clock periods. Therefore, a framesync reset will not result if offsets within this window are applied.</p> <p>To apply an offset/framesync reset within this window, first apply a relatively large offset, then apply the target smaller offset.</p> <p>Example: To apply a 1-period offset, first apply a 10-period positive offset and then apply a 9-period negative offset. This results in the target 1-period offset being applied to the output video.</p>

Table 3-2 9062 Function Submenu List — continued



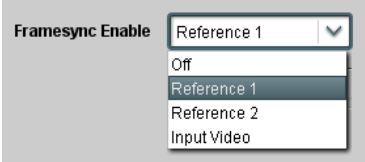

	(continued)
<ul style="list-style-type: none"> • Input Video Mode Fixed Delay Control 	<p>When Framesync is enabled and set to Input Video, allows adding video delay. This is useful when compensating for processes which result in large audio delays.</p> <p>(Range is 0.0000 thru 300.0 msec.)</p>
<ul style="list-style-type: none"> • Framesync Audio SRC On/Off Control 	<p>When Framesync is enabled and set to Input Video, allows disabling audio SRC. This is required if the card is to pass non-PCM audio such as Dolby® audio to downstream devices.</p>
<ul style="list-style-type: none"> • Minimum Latency Frames Control 	<p>When Framesync is enabled, specifies the smallest amount of latency allowed by the frame sync (latency measurement in output video frames). The frame sync will not output a frame unless the specified number of frames are captured in the buffer. The operational latency of the frame sync is always between the specified minimum latency and minimum latency plus one frame (not one field).</p> <p>(Maximum range is 0 to 32.)</p> <p>Note: Due to card memory limits, the maximum available Minimum Latency Frames is related to the output video format selected. For example, with a 525i59.94 output, the practical maximum limit is 13.</p> <p>When using this control, be sure to check the Framesync Status display as follows:</p>  <ul style="list-style-type: none"> • Latency frames selection within limits.  <ul style="list-style-type: none"> • Latency frames selection exceeds limits.

Table 3-2 9062 Function Submenu List — continued

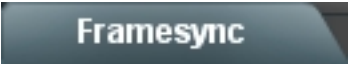

<div style="background-color: #333; color: white; padding: 5px; text-align: center; font-weight: bold;">Framesync</div>	(continued)
<p>• Audio Hard Resync Threshold Control</p> <div style="border: 1px solid #ccc; padding: 5px; margin-bottom: 10px;"> <p>Audio Hard Resync Threshold (Frames) 1.5</p>  </div> <p>With offset less than selected hard resync threshold, resync is progressively applied in many small steps to provide a seamless, glitch-free retiming. After the successive steps, the audio is synchronized with the video (in this example, 40 msec). (Progressive correction is applied at 1 msec/sec appr. rate.)</p> <div style="text-align: center;">  <p style="margin-left: 20px;">Video: 40 msec Audio: 240 msec</p> </div> <hr style="border: 1px solid black;"/> <p>With offset greater than selected hard resync threshold, resync is immediately applied.</p> <div style="text-align: center;">  <p style="margin-left: 20px;">Video: 40 msec Audio: 440 msec</p> </div>	<p>Sets threshold at which hard resync is applied if audio-video offset exceeds threshold (see below). Hard resync provides fastest snyc-up suitable for off-air manipulation. Conversely, a threshold setting high enough to accommodate normal on-air offsets allows on-air resync that is glitch-free.</p> <p>(Range is 1.5 to 13.0 frames in 0.1 frame increments)</p> <p>In this example, initial offset of 200 msec (appr. 6 frames) is below 9 frame threshold and results in soft resync being progressively applied.</p> <hr style="border: 1px solid black;"/> <p>In this example, initial offset of 400 msec (appr. 12 frames) is above 9 frame threshold and results in immediate hard resync.</p>
<p>• Audio Offset Control</p> <div style="border: 1px solid #ccc; padding: 5px; margin-bottom: 10px;"> <p>Audio Offset from Video (ms) -575.0</p>  </div>	<p>Adds or reduces (offsets) audio delay from the matching video delay (audio delay offset setting adds or removes delay in addition to any delay included by other actions). This control is useful for correcting lip sync problems when video and audio paths in the chain experience differing overall delays.</p> <p>(-575.0 msec to 575.0 msec range; null = 0.0 msec)</p> <p>Note: Delay offset values of less than approximately 1 frame are progressively applied by the card to provide a seamless, glitch-free retiming. However, delay offset values exceeding 1-1/2 frames may result in a slight audio discontinuity at the moment when the offset is applied using this control if the Audio Hard Resync Threshold control is not at a setting greater than the delay offset.</p> <p>To prevent this condition during an on-air manipulation, it is recommended that the Audio Hard Resync Threshold control be set high enough such that expected delay offsets exceeding 1-1/2 frames are progressively applied.</p> <p>Note: If using Audio Offset control to perform off-air corrections, it is recommended to temporarily set the Audio Hard Resync Threshold control to its minimum setting, thereby allowing the offset to be assessed and corrected as fast as possible.</p>

Table 3-2 9062 Function Submenu List — continued

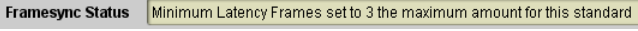

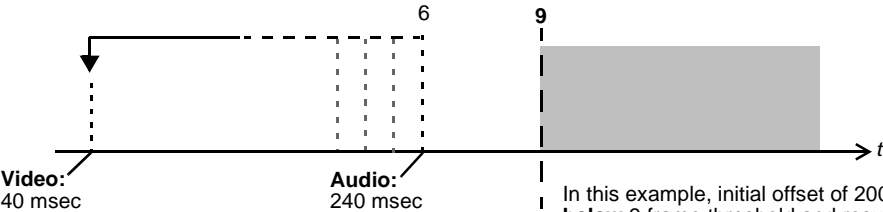
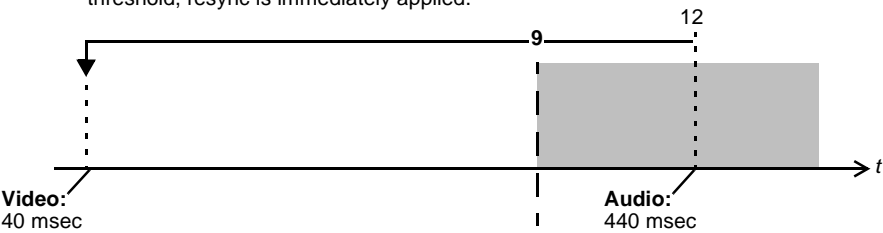

	(continued)
<ul style="list-style-type: none"> • Current Audio Delay Display 	<p>Displays the current input-to-output audio delay (in msec units) as well as in terms of Frames/fractional frame (in number of lines).</p>
<ul style="list-style-type: none"> • Video Delay Display 	<p>Displays the current input-to-output video delay (in msec units) as well as in terms of Frames/fractional frame (in number of lines).</p>
<ul style="list-style-type: none"> • Framesync Status Display 	<p>Displays the current framesync status as follows:</p>  <ul style="list-style-type: none"> • Framesync status OK.  <ul style="list-style-type: none"> • Framesync Enable set to Off.  <ul style="list-style-type: none"> • Improper or missing framesync reference.  <ul style="list-style-type: none"> • Latency frames selection exceeds limits. <p>Note: See Minimum Latency Frames Control (p. 3-27) for more information about this message.</p>
<ul style="list-style-type: none"> • Loss of Input Signal Selection 	<p>In the event of input video Loss of Signal (LOS), determines action to be taken as follows:</p> <ul style="list-style-type: none"> • Disable Outputs: Disable all outputs. • Freeze Last Frame: Freeze image to last good frame (last frame having valid SAV and EAV codes). • Freeze to Color: Freeze image to a color raster (as selected using Framesync LOS Freeze Color control). <p>Note: Freeze Last Frame and Freeze to Color choices are functional only when frame sync is set to lock to valid reference.</p>
<ul style="list-style-type: none"> • Framesync LOS Freeze Color 	<p>In the event of LOS with Freeze to Color enabled above, sets the image raster color from choices shown to the left.</p>

Table 3-2 9062 Function Submenu List — continued



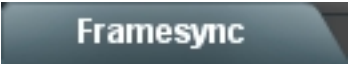
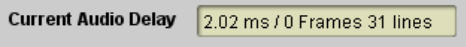
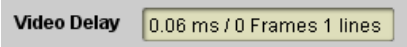

	(continued)
<ul style="list-style-type: none"> • Custom Color Hue 	<p>Adjusts raster hue (phase angle) for custom LOS color. (-360° to 360° range in 0.1° steps; null = 0°)</p>
<ul style="list-style-type: none"> • Custom Color Saturation 	<p>Adjusts raster saturation level for custom LOS color. (0% to 100% range in 0.1% steps)</p>
<ul style="list-style-type: none"> • Custom Color Y Level 	<p>Adjusts raster luma level for custom LOS color. (64 to 940 range)</p>
<ul style="list-style-type: none"> • Reset/Resync Framesync 	<p>Reset Framesync resets the frame sync, clearing any buffered audio and video.</p> <p>Resync Video and Reference resets the input processing paths for video and reference.</p> <p>When Confirm is clicked, a Confirm? pop-up appears, requesting confirmation.</p> <ul style="list-style-type: none"> • Click Yes to reset the frame sync. • Click No to reject reset. <p>Note: These controls are not normally used or required when the card is receiving a stable, continuous frame sync reference.</p>

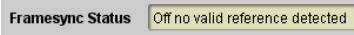
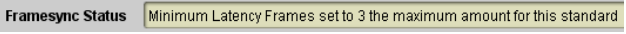
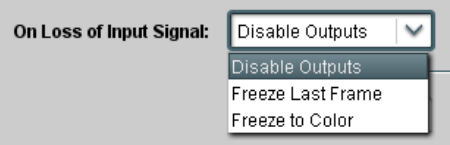
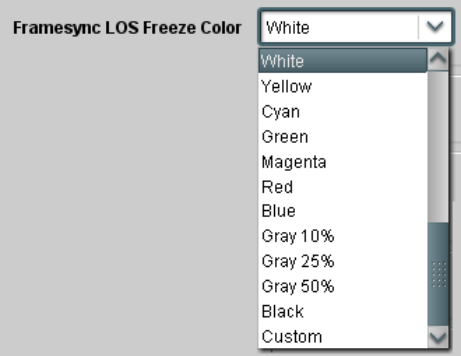
Table 3-2 9062 Function Submenu List — continued

<p>Embedded Audio Group 1/2</p>	<p>Selects the audio source for each embedded audio channel 1 thru 8 (Embedded Audio Groups 1 and 2). Also provides Gain, Phase Invert, and Muting controls for each channel.</p>
<p>The example above shows various Source selections and individual audio control settings for audio sources fed to the Destination channels Embedded Ch 1 thru Embedded Ch 8 in Embedded Audio Groups 1 and 2, with the resulting setup (right).</p> <p>The source-to-destination correlation shown here is only an example; any of the sources on the left can connect to any of the destinations on the right, or to Embedded Audio Groups 3 and 4 (not shown here). Additional sources not shown here are also available. These are described on the following pages.</p> <p>The controls shown here are described in detail on the following pages.</p>	

Table 3-2 9062 Function Submenu List — continued



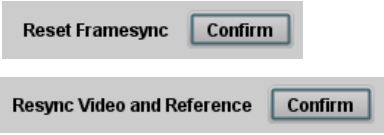

<p>Embedded Audio Group 1/2</p>	<p>(continued)</p>
<p>• SD Audio Depth</p> 	<p>Allows option of using 24-bit audio data structure per SMPTE 272M, §3.10 (default is 20-bit per SMPTE 272M, §3.5).</p> <p>Note:</p> <ul style="list-style-type: none"> • If 24-bit depth is desired, make certain downstream equipment is compatible with 24-bit SD audio data. • Depth control setting applied here affects both Embedded Audio Group 1/2 and 3/4.
<p>• Group Enable</p> 	<p>When enabled (On), enables the embedding of the corresponding embedded audio group (Embedded Audio Group 1 or Embedded Audio Group 2).</p> <ul style="list-style-type: none"> • Embedded Audio Group 1 consists of embedded channels 1 thru 4. • Embedded Audio Group 2 consists of embedded channels 5 thru 8. <p>Two Group Enable buttons correspondingly enable or disable Embedded Audio Group 1 and Embedded Audio Group 2.</p> <p>Disabling a group removes the entire group of embedded audio channels while preserving the settings of the channels belonging to the group.</p>
<p>Note:</p> <ul style="list-style-type: none"> • Embedded Ch 2 thru Embedded Ch 8 have controls identical to the Source, Gain, Mute, and Phase controls described here for Embedded Ch 1. Therefore, only the Embedded Ch 1 controls are shown here. • For each channel, its source and destination should be considered and appropriately set. Unused destination channels should be set to the Silence selection. 	
<p>• Embedded Channel Source</p> 	<p>Using the Source drop-down list, selects the audio input source to be embedded in the corresponding embedded channel from the choices described below.</p>
<p>• Embedded Ch 1 thru Ch 16 as Source</p> 	<p>Embed Ch 1 thru Embed Ch 16 range in Source drop-down list enables an embedded channel (Ch 1 thru Ch 16) to be the source for the selected destination Embedded Audio Group channel.</p> <p>(In this example, Embed Ch 1 (embedded Ch 1) is the source for destination Embedded Ch 1)</p>
<p>• Down Mix Left or Right as Source</p> 	<p>Down Mix Left and Down Mix Right selections in Source drop-down list allow either downmixer left or right channel to be the source for the selected destination Embedded Audio Group channel.</p> <p>(In this example, the Down Mix Left channel is the source for destination Embedded Ch 1)</p> <p>Note: Down Mix Left and Down Mix Right channels are a stereo pair derived from the L, C, R, Ls, and Rs channel inputs selected using the Audio Mixing function. The stereo pair consists of basic L/R PCM signals with no additional encoded information.</p> <p>Refer to Audio Mixing function description on page 3-42 for more information.</p>

Table 3-2 9062 Function Submenu List — continued



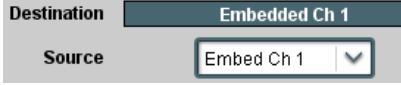
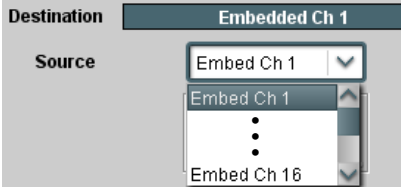

<div style="background-color: #444; color: white; padding: 5px; text-align: center; font-weight: bold;">Embedded Audio Group 1/2</div>	(continued)
<p>• Mono Mix as Source</p> 	<p>Mono selection in Source drop-down list allows mono mix content to be the source for the selected destination Embedded Audio Group channel. (In this example, the mono content is the source for destination Embedded Ch 1)</p> <p>Note: Mono mix content is set up using Mono Mixer Selection in the Audio Mixing function). Refer to Audio Mixing function description on page 3-42 for more information.</p>
<p>• Tone Generator 1 thru 4 as Source</p> 	<p>Tone Generator 1 thru Tone Generator 4 range in Source drop-down list enables one of four tone generators (Tone 1 thru Tone 4) to be the source for the selected destination Embedded Audio Group channel. (In this example, Tone 1 (tone generator 1) is the source for destination Embedded Ch 1)</p> <p>Note: Tone generator frequencies can be independently set for the four tone generator sources.</p> <p>Refer to Tone Generator function description on page 3-42 for more information.</p>
<p>• Silence (Mute) as Source</p> 	<p>Silence selection in Source drop-down list mutes the selected destination Embedded Audio Group channel. Use this setting for unused destination channels.</p> <p>(In this example, silence (muting) is applied to Embedded Ch 1)</p>
<p>• Gain (dB) Control</p> 	<p>Adjusts and displays relative gain (in dB) applied to the corresponding destination Embedded Audio Group channel.</p> <p>(-80 to +40 dB range in 0.1 dB steps; unity = 0.0 dB)</p>
<p>• Mute Control</p> 	<p>Allows pushbutton On/Off channel muting while saving all other settings.</p>
<p>• Phase Control</p> 	<p>Selects between Normal and Invert phase (relative to source original phase) for the destination Embedded Audio Group channel.</p>

Table 3-2 9062 Function Submenu List — continued

Embedded Audio Group 3/4	<p>Selects the audio source for each embedded audio channel 9 thru 16 (Embedded Audio Groups 3 and 4). Also provides Gain, Phase Invert, and Muting controls for each channel.</p>
<p>The example above shows various Source selections and individual audio control settings for various audio sources fed to the Destination channels Embedded Ch 9 thru Embedded Ch 16 in Embedded Audio Groups 3 and 4, with the resulting setup (right).</p> <p>The source-to-destination correlation shown here is only an example; any of the sources on the left can connect to any of the destinations on the right, or to Embedded Audio Groups 1 and 2 (not shown here). Additional sources not shown here are also available.</p>	

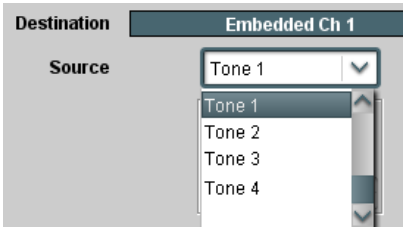
Table 3-2 9062 Function Submenu List — continued

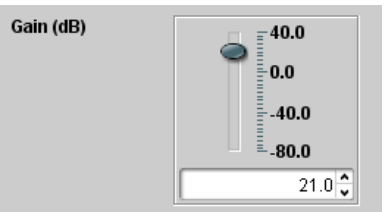

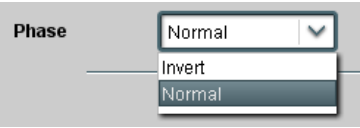



	<p>(continued)</p>
<p>• SD Audio Depth</p> 	<p>Allows option of using 24-bit audio data structure per SMPTE 272M, §3.10 (default is 20-bit per SMPTE 272M, §3.5).</p> <p>Note:</p> <ul style="list-style-type: none"> • If 24-bit depth is desired, make certain downstream equipment is compatible with 24-bit SD audio data. • Depth control setting applied here affects both Embedded Audio Group 1/2 and 3/4.
<p>• Group Enable</p> 	<p>When enabled (On), enables the embedding of the corresponding embedded audio group (Embedded Audio Group 3 or Embedded Audio Group 4).</p> <ul style="list-style-type: none"> • Embedded Audio Group 3 consists of embedded channels 9 thru 12. • Embedded Audio Group 4 consists of embedded channels 13 thru 16. <p>Two Group Enable buttons correspondingly enable or disable Embedded Audio Group 3 and Embedded Audio Group 4.</p> <p>Disabling a group removes the entire group of embedded audio channels while preserving the settings of the channels belonging to the group.</p>
<p>Note:</p> <ul style="list-style-type: none"> • Embedded Ch 9 thru Embedded Ch 16 have controls that are identical to the Source, Gain, Mute, and Phase controls described for Embedded Ch 1. Refer to Embedded Audio Group 1/2 on page 3-31 for descriptions of these controls. • For each channel, its source and destination should be considered and appropriately set. Unused destination channels should be set to the Silence selection. 	
	<p>Extracts and preserves Dolby® metadata from the input SDI, and allows the metadata to be re-inserted in the output SDI. This allows scaling and/or format conversions without losing Dolby® metadata.</p>
<p>• VBI Metadata Removal</p> 	<p>VBI Metadata Removal (On/Off) allows metadata to be removed (On) even if the Scaler is not enabled. (This control is default set to Off, with metadata being passed when Scaler is disabled)</p> <p>Note: When the Scaler is enabled, Dolby metadata is automatically removed. Set the Metadata Embedding control to On to re-insert metadata as described above.</p>
<p>• Metadata Embedding</p> 	<p>Metadata Embedding (On/Off) controls SMPTE 2020-1 metadata embedding in the SDI video output.</p> <ul style="list-style-type: none"> • When set to On, metadata is extracted from the SDI input video, buffered, and re-directed to the output SDI video. • When set to Off, metadata is not embedded in the output SDI video.
<p>• Metadata Output Line</p> 	<p>Allows selection of SMPTE 2020-1 metadata line location within the VANC space for re-inserted Dolby® metadata. (Range is 9 thru 41; default is line #13.)</p> <p>Note:</p> <ul style="list-style-type: none"> • Although the output line drop-down will allow any choice within the 9 thru 41 range, the actual range is automatically clamped (limited to) certain ranges to prevent inadvertent conflict with active picture area depending on video format. See Ancillary Data Line Number Locations and Ranges (p. 3-8) for more information. • The card does not check for conflicts on a given line number. Make certain the selected line is available and carrying no other data unless existing metadata is to be intentionally overwritten.

Table 3-2 9062 Function Submenu List — continued

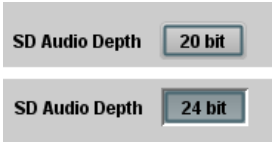

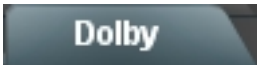
	Provides support for closed captioning setup.
<p>Note: When receiving HD-SDI, both CEA 608 and CEA 708 are supported, with CEA 608 and CEA 708 (containing CEA 608 packets) converted to line 21 closed captioning on outputs down-converted to SD (on up-convert of SD, only CEA 608 closed captioning is generated).</p>	
<p>• Closed Captioning On/Off</p> 	<p>Turns on or turns off the Closed Captioning on the output.</p> <p>Note:</p> <ul style="list-style-type: none"> • When set to On, closed captioning is set to standard default line number. See Ancillary Data Line Number Locations and Ranges (p. 3-8). • The card does not check for conflicts on a given line number. Make certain selected line is available and carrying no other data. • Closed captioning line may contain active unintended data even if closed captioning is set to Off. If closed captioning is not to be used, it is recommended to use the Top Line Suppression control to eliminate the possibility of this unintended data from appearing in the active video area. (See Scaler tab Top line suppression control for more details.) • Closed captioning On/Off will not remove existing packets unless the Scaler is enabled. To remove packets without changing output format, set Scaler to Enabled and HD:Convert to: to Same as Input. (See Scaler tab Top line suppression control for more details.)

Table 3-2 9062 Function Submenu List — continued

<div style="background-color: #333; color: white; padding: 5px; text-align: center; font-weight: bold;">Closed Captioning</div>	(continued)								
<p>• Closed Captioning Input Status</p> <div style="border: 1px solid #ccc; padding: 5px; margin-top: 10px;"> Input Status CDP Packet on Line 16 </div>	<p>Displays incoming Closed Captioning status as follows:</p> <ul style="list-style-type: none"> • If closed captioning is present, a message similar to the example shown left is displayed. Also displayed is the VANC line number of the incoming closed captioning packet (or SD waveform-based VANC line number). • If no closed captioning is present in the video signal, Not Present or Disabled is displayed. <p>Note: • Packet closed captioning status Captioning Rejected Due To message can appear due to the items described below. The closed captioning function assesses <i>cdp_identifier</i>, <i>cdp_frame_rate</i>, <i>ccdata_present</i>, and <i>caption_service_active</i> items contained in the packet header to make the determinations listed below. Refer to CEA-708-B for more information.</p> <table border="1" style="width: 100%; border-collapse: collapse;"> <thead> <tr> <th style="text-align: left;">Message</th> <th style="text-align: left;">Description</th> </tr> </thead> <tbody> <tr> <td>Unsupported Frame Rate</td> <td>Film rate closed-captioning (either as pass-through or up/down conversion) is not supported by the card.</td> </tr> <tr> <td>Data Not Present</td> <td>Packet is marked from closed captioning source external to the card that no data is present.</td> </tr> <tr> <td>No Data ID</td> <td>Packet from closed captioning source external to the card is not properly identified with 0x9669 as the first word of the header (unidentified packet).</td> </tr> </tbody> </table> <ul style="list-style-type: none"> • caption service is marked as inactive display indicates bit in packet from upstream source may inadvertently be set as inactive. In this case, closed captioning data (if present) is still processed and passed by the card as normal. • The closed captioning function does not support PAL closed captioning standards. 	Message	Description	Unsupported Frame Rate	Film rate closed-captioning (either as pass-through or up/down conversion) is not supported by the card.	Data Not Present	Packet is marked from closed captioning source external to the card that no data is present.	No Data ID	Packet from closed captioning source external to the card is not properly identified with 0x9669 as the first word of the header (unidentified packet).
Message	Description								
Unsupported Frame Rate	Film rate closed-captioning (either as pass-through or up/down conversion) is not supported by the card.								
Data Not Present	Packet is marked from closed captioning source external to the card that no data is present.								
No Data ID	Packet from closed captioning source external to the card is not properly identified with 0x9669 as the first word of the header (unidentified packet).								
<p>• Closed Captioning HD Output Line</p> <div style="border: 1px solid #ccc; padding: 5px; margin-top: 10px;"> HD Output Line 10 </div>	<p>Selects the VANC line number (9 thru 41) for the closed caption data when the output is HD.</p> <p>Note: • Although the output line drop-down will allow any choice within the 9 thru 41 range, the actual range is automatically clamped (limited to) certain ranges to prevent inadvertent conflict with active picture area depending on video format. See Ancillary Data Line Number Locations and Ranges (p. 3-8) for more information.</p> <ul style="list-style-type: none"> • The card does not check for conflicts on a given line number. Make certain the selected line is available and carrying no other data unless existing metadata is to be intentionally overwritten. 								

Table 3-2 9062 Function Submenu List — continued

<div style="background-color: #333; color: white; padding: 5px; display: inline-block; border-radius: 5px;">Timecode</div>	<p>Provides timecode data extraction from various sources, and provides formatting and re-insertion controls for inserting the timecode into the output video.</p>														
<p>Shown below is an example in which received 720p 5994 SDI video containing an SDI ATC_VITC timecode is to be outputted instead with both ATC_VITC and ATC_LTC timecodes using this function. Each Timecode control is fully described on the pages that follow.</p>															
<div style="border: 1px solid black; padding: 5px; display: inline-block;"> <p>720p 5994 w/ ATC_VITC → 9062 → 720p 5994 w/ ATC_VITC w/ ATC_LTC</p> </div>	<table border="1" style="width: 100%; border-collapse: collapse;"> <tr> <td style="padding: 2px;">SDI VITC Waveform Status</td> <td style="padding: 2px;">Unlocked</td> </tr> <tr> <td style="padding: 2px;">SDI ATC VITC Status</td> <td style="padding: 2px;">00:10:46:02.0, Field 1 Line 9, Field 2 Line 571</td> </tr> <tr> <td style="padding: 2px;">SDI ATC LTC Status</td> <td style="padding: 2px;">Unlocked</td> </tr> </table> <table border="1" style="width: 100%; border-collapse: collapse;"> <tr> <td style="padding: 2px;">Source Priority 1</td> <td style="padding: 2px;">ATC VITC</td> </tr> <tr> <td style="padding: 2px;">Source Priority 2</td> <td style="padding: 2px;">None</td> </tr> <tr> <td style="padding: 2px;">Source Priority 3</td> <td style="padding: 2px;">None</td> </tr> <tr> <td style="padding: 2px;">Source Priority 4</td> <td style="padding: 2px;">None</td> </tr> </table>	SDI VITC Waveform Status	Unlocked	SDI ATC VITC Status	00:10:46:02.0, Field 1 Line 9, Field 2 Line 571	SDI ATC LTC Status	Unlocked	Source Priority 1	ATC VITC	Source Priority 2	None	Source Priority 3	None	Source Priority 4	None
SDI VITC Waveform Status	Unlocked														
SDI ATC VITC Status	00:10:46:02.0, Field 1 Line 9, Field 2 Line 571														
SDI ATC LTC Status	Unlocked														
Source Priority 1	ATC VITC														
Source Priority 2	None														
Source Priority 3	None														
Source Priority 4	None														
<p>A Noting that the incoming video contains SDI ATC_VITC timecode data (as shown in the status display), set the Source Priority drop-down lists to include SDI ATC_VITC timecode data as a choice. This extracts SDI ATC_VITC timecode data from the incoming video.</p>	<table border="1" style="width: 100%; border-collapse: collapse;"> <tr> <td style="padding: 2px;">HD ATC VITC Insertion</td> <td style="padding: 2px;">Enabled</td> </tr> <tr> <td style="padding: 2px;">HD ATC VITC Insertion Line Field 1</td> <td style="padding: 2px;">9 - SMPTE 12M-2-2008 Recommended</td> </tr> <tr> <td style="padding: 2px;">HD ATC VITC Insertion Line Field 2</td> <td style="padding: 2px;">8 (571) - SMPTE 12M-2-2008 Recommended</td> </tr> </table> <table border="1" style="width: 100%; border-collapse: collapse;"> <tr> <td style="padding: 2px;">HD ATC LTC Insertion</td> <td style="padding: 2px;">Enabled</td> </tr> <tr> <td style="padding: 2px;">HD ATC LTC Insertion Line</td> <td style="padding: 2px;">10 - SMPTE 12M-2-2008 Recommended</td> </tr> </table>	HD ATC VITC Insertion	Enabled	HD ATC VITC Insertion Line Field 1	9 - SMPTE 12M-2-2008 Recommended	HD ATC VITC Insertion Line Field 2	8 (571) - SMPTE 12M-2-2008 Recommended	HD ATC LTC Insertion	Enabled	HD ATC LTC Insertion Line	10 - SMPTE 12M-2-2008 Recommended				
HD ATC VITC Insertion	Enabled														
HD ATC VITC Insertion Line Field 1	9 - SMPTE 12M-2-2008 Recommended														
HD ATC VITC Insertion Line Field 2	8 (571) - SMPTE 12M-2-2008 Recommended														
HD ATC LTC Insertion	Enabled														
HD ATC LTC Insertion Line	10 - SMPTE 12M-2-2008 Recommended														
<p>B In this example, it is desired to provide both SDI ATC_VITC and ATC_LTC timecode data in the HD output video. As such, set both HD ATC VITC Insertion and HD ATC LTC Insertion to Enabled.</p> <p>In the example here, the line numbers are set to the default SMPTE 12M-2-2008 recommended values.</p>	<p style="text-align: right;"> Insert Control ATC_VITC Insertion = Enabled ATC_LTC Insertion = Enabled Line Number Control ATC_VITC1 = Line 9 (default SMPTE 12M-2) ATC_VITC2 = Line 8 (571) (default SMPTE 12M-2) ATC_LTC = Line 10 (default SMPTE 12M-2) </p>														

Table 3-2 9062 Function Submenu List — continued

Timecode	(continued)
<p>Option Audio LTC and RS-485 LTC controls described below only appear on cards with +LTC licensed optional feature. This feature allows bidirectional conversion between VBI-based timecode and LTC timecode on audio and RS-485 interfaces.</p>	
<p>• Timecode Source Status Displays</p> <div style="border: 1px solid #ccc; padding: 5px; background-color: #f9f9f9;"> <p>SDI VITC Waveform Status 05:20:19:27.0</p> <p>SDI ATC_LTC Status Unlocked</p> <p>SDI ATC_VITC Status Unlocked</p> <hr/> <p>Audio LTC Status 21:02:40:02.1</p> <p>Audio LTC Source Embedded Input Ch 9 ▾</p> </div>	<p>Displays the current status and contents of the supported timecode formats shown to the left.</p> <ul style="list-style-type: none"> If a format is receiving timecode data, the current content (timecode running count and line number) is displayed. If a format is not receiving timecode data, Unlocked is displayed. <hr/> <ul style="list-style-type: none"> If Audio LTC is being received, the timecode running count is displayed. Audio LTC Source selects audio source to be used by card audio LTC function from Emb Ch 1 thru Ch 16. <p>Note: Audio LTC Source must be appropriately set for card to receive and process audio LTC.</p>
<p>• RS-485 Port LTC Control</p> <div style="border: 1px solid #ccc; padding: 5px; background-color: #f9f9f9;"> <p>RS-485 Port Function LTC In (Overrides Audio LTC Source) ▾</p> <p style="margin-left: 20px;">Dolby Metadata</p> <p style="margin-left: 20px;">LTC In (Overrides Audio LTC Source)</p> <p style="margin-left: 20px;">LTC Output</p> </div>	<p>Allows RS-485 port to be used to receive LTC, or send LTC over RS-485 port as follows:</p> <ul style="list-style-type: none"> If RS-485 LTC is to be received via the shared RS-485 port, set the RS-485 Port Function control to LTC In. If RS-485 LTC is to be outputted via the shared RS-485 port, set the RS-485 Port Function control to LTC Output. The timecode string carried on the LTC output is that selected using the Source Priority controls described on the next page.
<p>• Incoming ATC Packet Removal Control</p> <div style="border: 1px solid #ccc; padding: 5px; background-color: #f9f9f9;"> <p>Incoming ATC Packet Removal Disabled</p> </div>	<p>Enables or disables removal of existing input video ATC timecode packets from the output. This allows removal of undesired existing timecodes from the output, resulting in a “clean slate” where only desired timecodes are then re-inserted into the output. (For example, if both SDI ATC_VITC and ATC_LTC are present on the input video, and only ATC_LTC is desired, using the Removal control will remove both timecodes from the output. The ATC_LTC timecode by itself can then be re-inserted on the output using the other controls discussed here.)</p> <p>Note: When the Scaler is enabled, ATC packets are automatically removed. The Timecode function must be used to re-insert the timecode data into the output video.</p>

Table 3-2 9062 Function Submenu List — continued



	(continued)
<p>• Source Priority</p> 	<p>As described here, selects the priority assigned to each of the three supported formats (or none) in the event the preferred source is unavailable.</p> <p>Each of the four Source Priority selection lists allows assignment of source priority from the following choices:</p>  <p>Source Priority 1 thru Source Priority 4 select the preferred format to be used in descending order (i.e., Source Priority 2 selects the second-most preferred format, and so on).</p>
<p>• Output Status Display</p> 	<p>Displays the current content and source being used for the timecode data as follows:</p>  <ul style="list-style-type: none"> • Output status OK (in this example, SDI VITC timecode received and outputted).  <ul style="list-style-type: none"> • Timecode Insertion button set to Disabled; output insertion disabled. <p>Note:</p> <ul style="list-style-type: none"> • If timecode is not available from Source Priority selections performed, timecode on output reverts to Free Run (internal count) mode. • Because the 1's digit of the display Frames counter goes from 0 to 29, the fractional digit (along with the 1's digit) indicates frame count as follows: <ul style="list-style-type: none"> 0.0 Frame 0 0.1 Frame 1 1.0 Frame 2 1.1 Frame 3 • • • 29.1 Frame 59
<p>• Offset Controls</p> 	<p>Allows the current timecode count to be advanced or delayed on the output video.</p> <ul style="list-style-type: none"> • Offset Advance or Delay selects offset advance or delay. • Offset Field delays or advances or delays timecode by one field. • Offset Frame delays or advances or delays timecode by up to 5 frames. <p>Note: Default settings are null, with both controls set at zero as shown.</p>

Table 3-2 9062 Function Submenu List — continued

Timecode	(continued)
<p>Note:</p> <ul style="list-style-type: none"> Although the output line drop-down on the controls described below will allow a particular range of choices, the actual range is automatically clamped (limited) to certain ranges to prevent inadvertent conflict with active picture area depending on video format. See Ancillary Data Line Number Locations and Ranges (p. 3-8) for more information. The card does not check for conflicts on a given line number. Make certain the selected line is available and carrying no other data. Insertion controls described below enable or disable insertion on output video only when the Scaler is enabled. Existing waveform or packet-based data on an unscaled stream are not affected by these controls and are passed on the SDI output. 	
<p>• SD VITC Waveform Insertion Controls</p> <div style="border: 1px solid #ccc; padding: 5px; background-color: #f9f9f9;"> <p>VITC Waveform Output 1 Line Number <input style="width: 80px;" type="text" value="14"/></p> <p>VITC Waveform Output 2 Line Number <input style="width: 80px;" type="text" value="16"/></p> <p style="text-align: right;">SD VITC Waveform Insertion <input type="checkbox"/> Enabled</p> </div>	<p>For SD output, enables or disables SD VITC waveform timecode insertion into the output video, and selects the VITC1 and VITC2 line numbers (6 thru 22) where the VITC waveform is inserted.</p> <p>Note:</p> <ul style="list-style-type: none"> If only one output line is to be used, set both controls for the same line number. SD VITC Waveform Insertion control only affects VITC waveforms inserted (or copied to a new line number) by this function.
<p>• SD ATC Insertion Control</p> <div style="border: 1px solid #ccc; padding: 5px; background-color: #f9f9f9;"> <p>SD ATC_VITC Insertion <input type="checkbox"/> Enabled</p> <p>SD ATC Insertion Line <input style="width: 150px;" type="text" value="13 - SMPTE 12M-2-2008 Recommended"/></p> </div>	<p>For SD output, enables or disables SD ATC_VITC timecode insertion into the output video, and selects the line number for ATC_VITC.</p>
<p>• HD ATC_LTC Insertion Control</p> <div style="border: 1px solid #ccc; padding: 5px; background-color: #f9f9f9;"> <p>HD ATC_LTC Insertion <input type="checkbox"/> Enabled</p> <p>HD ATC_LTC Insertion Line <input style="width: 150px;" type="text" value="10 - SMPTE 12M-2-2008 Recommended"/></p> </div>	<p>For HD output, enables or disables ATC_LTC timecode insertion into the output video, and selects the line number for ATC_LTC timecode data.</p>
<p>• HD ATC_VITC Insertion Control</p> <div style="border: 1px solid #ccc; padding: 5px; background-color: #f9f9f9;"> <p>HD ATC_VITC Insertion <input type="checkbox"/> Enabled</p> <p>HD ATC_VITC Insertion Line Field 1 <input style="width: 150px;" type="text" value="9 - SMPTE 12M-2-2008 Recommended"/></p> <p>HD ATC_VITC Insertion Line Field 2 <input style="width: 150px;" type="text" value="8 (571) - SMPTE 12M-2-2008 Recommended"/></p> </div>	<p>For HD output, enables or disables ATC_VITC timecode insertion into the output video, and selects the line number for ATC_VITC1 and ATC_VITC2.</p> <p>Note: If only one output line is to be used, set both controls for the same line number.</p>
<p>• ATC_VITC Legacy Support Control</p> <div style="border: 1px solid #ccc; padding: 5px; background-color: #f9f9f9;"> <p>ATC VITC Legacy Support <input type="checkbox"/> Disabled</p> </div>	<p>When enabled, accommodates equipment requiring ATC_VITC packet in both fields as a "field 1" packet (non-toggling).</p> <p>Note: Non-toggling VITC1 and VITC2 packets do not conform to SMPTE 12M-2-2008 preferences. As such, ATC_VITC Legacy Support should be enabled only if required by downstream equipment.</p>

Table 3-2 9062 Function Submenu List — continued

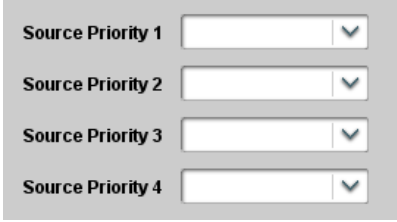

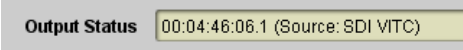
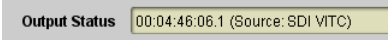
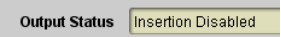
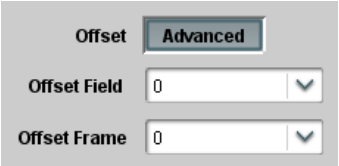
	<p>Sets the test tone frequency for each of four tone generators (Tone Generator 1 thru 4).</p>
<p>• Frequency Selection Lists</p> <p>Tone Generator 1 Frequency 1 KHz ▼</p> <p>⋮</p> <p>Tone Generator 4 Frequency 1 KHz ▼</p>	<p>Selects the frequency for each of the four tone generators. 18 discrete sine wave frequencies are available, ranging from 50 Hz to 16 kHz (default frequency is 1.0 kHz).</p> <p>Note: Unity-gain signal level is equivalent to -20 dBu.</p>
	<p>Provides down-mix audio routing selections that multiplexes any five embedded audio channel sources into a stereo pair (Down Mix Left and Down Mix Right), or selection of any two audio sources to be mono-mixed to serve as a monaural source.</p> <p>With an optional upmixer licensable feature activated, any normal PCM stereo pair can be fed to the upmixer to generate 5.1 surround sound audio which in turn can be applied to six user-selectable channels.</p>
<p>• Down Mixer Selection</p> 	<p>Separate drop-down lists for Left, Right, Center, Left Surround (Ls), and Right Surround (Rs) inputs allow embedded channel (or silence) audio source selection for each of the five inputs as shown below.</p>  <p>The example below shows selection from various sources and the resulting stereo pair DM-L and DM-R. The two signals comprising the pair can be routed and processed the same as any other audio input source.</p>  <p>Note: The stereo pair are basic L/R PCM signals with no additional encoded information.</p>

Table 3-2 9062 Function Submenu List — continued



	(continued)
<p>• Center Mix Ratio Control</p> 	<p>Adjusts the attenuation ratio of center-channel content from 5-channel source that is re-applied as Lt and Rt content to the DM-L and DM-R stereo mix.</p> <ul style="list-style-type: none"> • Minimum attenuation setting (-0.0 dB) applies no ratiometric reduction. Center channel content is restored as in-phase center-channel content with no attenuation, making center-channel content more predominate in the overall mix. • Maximum attenuation setting (-10.0 dB) applies a -10 dB ratiometric reduction of center-channel content. Center-channel content is restored as in-phase center-channel content at a -10 dB ratio relative to overall level, making center-channel content less predominate in the overall mix. <p>(0.0 dB to -10.0 dB range in 0.1 dB steps; default = -3 dB)</p> <p>Note: Default setting of -3.0 dB is recommended to maintain center-channel predominance in downmix representative to that of the original source 5-channel mix.</p>
<p>• Surround Mix Ratio Control</p> 	<p>Adjusts the attenuation ratio of surround-channel content from 5-channel source that is re-applied as Lo and Ro content to the DM-L and DM-R stereo mix.</p> <ul style="list-style-type: none"> • Minimum attenuation setting (-0.0 dB) applies no ratiometric reduction. Surround-channel content is restored with no attenuation, making Lo and Ro content more predominate in the overall mix. • Maximum attenuation setting (-10.0 dB) applies a -10 dB ratiometric reduction of surround-channel content. Surround-channel content is restored at a -10 dB ratio relative to overall level, making surround-channel content less predominate in the overall mix. <p>(0.0 dB to -10.0 dB range in 0.1 dB steps; default = -3 dB)</p> <p>Note: Default setting of -3.0 dB is recommended to maintain surround-channel predominance in downmix representative to that of the original source 5-channel mix.</p>
<p>• Mono Mixer Selection</p> 	<p>Separate drop-down lists for Left and Right inputs allow selected embedded input channels to provide an additional mono-mixed channel. The resulting mono mix (Mono) is available as an audio source for any of the destination embedded output channels as shown below.</p>  <p>Note: Selection of any two channels for mono mixing in no way affects the source channels themselves.</p>

Table 3-2 9062 Function Submenu List — continued

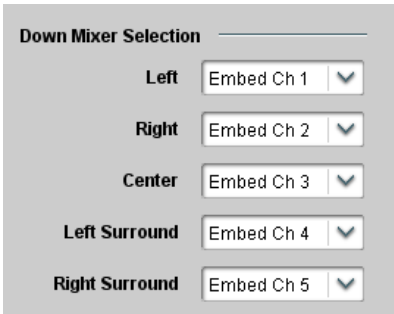
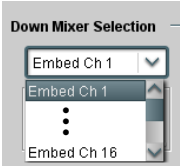
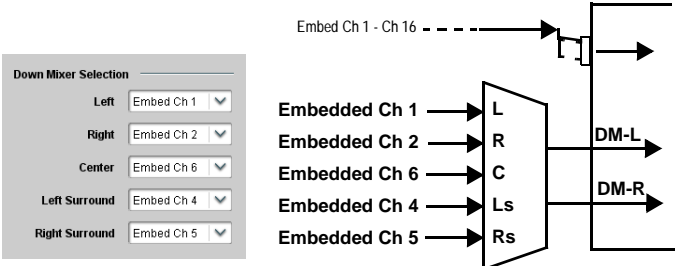
<p>Audio Mixing</p>	<p>(continued)</p>
<p>Option </p> <p>Note:</p> <ul style="list-style-type: none"> • 2.0-to-5.1 upmixer function is an optional licensable feature. This function and its controls appear only when a license key is entered and activated. Refer to Licensable Features function description on page 3-47 for more information. • Channel sources used by the upmixer are post-processed signals received from the Audio Routing/Gain Control function. When active, the channel selections made using this function are directly embedded in the output SDI. Refer to 2.0-to-5.1 Upmix Function (p. 1-13) in Chapter 1, "Introduction" for detailed functional description and signal flow. • For any six channels selected for this function, the Left and Right channel selections always serve as the stereo input pair. 	
<p>• 2.0-to-5.1 Up Mixer Selection</p> <div style="border: 1px solid #ccc; padding: 5px; background-color: #f0f0f0;"> <p>Up Mixer Selection</p> <p>Left <input type="text" value="Embed Ch 1"/> ▼</p> <p>Right <input type="text" value="Embed Ch 2"/> ▼</p> <p>Center <input type="text" value="Embed Ch 3"/> ▼</p> <p>LFE <input type="text" value="Embed Ch 4"/> ▼</p> <p>Left Surround <input type="text" value="Embed Ch 5"/> ▼</p> <p>Right Surround <input type="text" value="Embed Ch 6"/> ▼</p> </div>	<p>Separate drop-down lists for Left, Right, Center, LFE, Left Surround, and Right Surround allow embedded audio source selection, and embedded channel assignments for the six generated 5.1 channels.</p> <div style="border: 1px solid #ccc; padding: 5px; background-color: #f0f0f0; margin-bottom: 10px;"> <p>Up Mixer Selection</p> <p><input type="text" value="Embed Ch 1"/> ▼</p> <p>⋮</p> <p><input type="text" value="Embed Ch 16"/> ▼</p> <p><input type="text" value="Silence"/> ▼</p> </div> <p>The example below shows selection of embedded channels 1 and 2 as the received stereo source (Embed Ch1 and Ch 2 for Left and Right drop-down list selections in the Up Mixer Selection tool).</p> <p>Using the setup shown in the example, when upmix is active the embedded channel 1/2 stereo pair is overwritten with the new stereo pair L/R on channels 1/2. As selected in the example, the additional 5.1 channels C, LFE, Left Surround (Ls), and Right Surround (Rs) overwrite Emb Ch 3 – Ch 6, respectively.</p> <div style="display: flex; align-items: center;"> <div style="border: 1px solid #ccc; padding: 5px; background-color: #f0f0f0; margin-right: 20px;"> <p>Up Mixer Selection</p> <p>Left <input type="text" value="Embed Ch 1"/> ▼</p> <p>Right <input type="text" value="Embed Ch 2"/> ▼</p> <p>Center <input type="text" value="Embed Ch 3"/> ▼</p> <p>LFE <input type="text" value="Embed Ch 4"/> ▼</p> <p>Left Surround <input type="text" value="Embed Ch 5"/> ▼</p> <p>Right Surround <input type="text" value="Embed Ch 6"/> ▼</p> </div> </div>

Table 3-2 9062 Function Submenu List — continued

<div style="background-color: #333; color: white; padding: 5px; text-align: center; font-weight: bold;">Audio Mixing</div>	(continued)
<p>• Up Mixer Mode Control</p> 	<p>Enables or bypasses upmixer as follows:</p> <ul style="list-style-type: none"> • Auto: Automatic enable/bypass of 5.1 upmix function as follows: <ul style="list-style-type: none"> • If detected signal level on all four of the selected channels designated as Center, LFE, Left Surround, and Right Surround are below the level threshold set using the 5.1 Detection Threshold control, upmixer overwrites all six selected channels with the new 5.1 content generated by the upmixer. • If detected signal level on any of the four of the selected channels designated as Center, LFE, Left Surround, and Right Surround is above the level threshold set using the 5.1 Detection Threshold control, upmixer is bypassed and the original channels pass unaffected. • Always Upmix: Manual enable turns on upmixer and overwrites content on all six selected channels with new 5.1 content generated by the upmixer regardless of original signal level or content. • Bypass: Manual disable bypasses the upmixer. When bypassed, the six embedded audio channels pass unaffected.
<p>• Up Mixer Status Display</p> 	<p>Shows activity status of upmixer processing as follows:</p> <ul style="list-style-type: none"> • Auto Mode - Currently Upmixing: With upmixer enable set to Auto, indicates selected channels designated as Center, LFE, Left Surround, and Right Surround are clear for use (as described above); upmixer is currently up-mixing received stereo pair and overwriting the six selected channels with new 5.1 upmix. • Auto Mode - Currently Bypassed: With upmixer enable set to Auto, indicates selected channels designated as Center, LFE, Left Surround, and Right Surround have content (such as existing original 5.1 or other content); upmixer is bypassed (disabled) and allows normal passage of six selected channels. • Upmixing: Indicates upmixer is manually enabled (set to Always Upmix) and is currently up-mixing received stereo pair and overwriting the six selected channels with new 5.1 upmix. • Bypassed: Indicates upmixer is manually disabled (set to Bypass) and is currently passing all selected channels unaffected.
<p>• Auto Crossfade Speed Controls</p> 	<p>Individual controls select the relative crossfade transition speed between Upmix to Bypass (going to inactive; from 5.1 to 2.0) and Bypass to Upmix (going to active; from 2.0 to 5.1) when upmixer enable is set to Auto and the active threshold (as set by the 5.1 Detection Threshold control) is crossed in either direction.</p> <p>To suit program material and production aesthetic preferences, several choices are available as shown to the left. Slower settings allow for a more gradual transition between modes, however with a longer interval before levels stabilize. Faster settings conversely allow for a smaller interval before levels stabilize, however with greater perceived abruptness.</p>

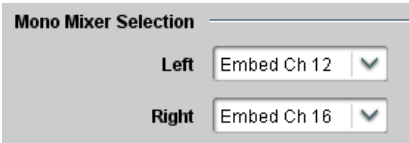
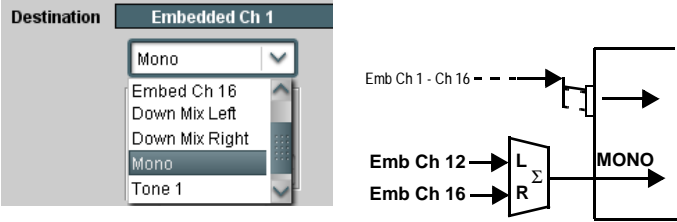
Table 3-2 9062 Function Submenu List — continued



<div style="background-color: #333; color: white; padding: 5px; text-align: center; font-weight: bold;">Audio Mixing</div>	(continued)
<p>• 5.1 Detection Threshold Control</p> 	<p>Adjusts the threshold at which selected channels designated as C, LFE, Ls, and Rs are considered to have viable content, or at which signal levels can be considered insignificant when upmixer enable is set to Auto. Setting affects automatic enable/bypass of 5.1 upmix function as follows:</p> <ul style="list-style-type: none"> • If detected signal level on all four of the selected channels designated as Center, LFE, Left Surround, and Right Surround are below the level threshold set using the 5.1 Detection Threshold control, upmixer allows overwrite of all six selected channels with the new 5.1 signal complement. • If detected signal level on any of the four of the selected channels designated as Center, LFE, Left Surround, and Right Surround is above the level threshold set using the 5.1 Detection Threshold control, upmixer is bypassed, thereby releasing the selected six channels and allowing the original channels to pass unaffected. <p>(Range is -150 dB to 0 dB in 0.1dB steps; 0 dB equivalent to +24 dBu=> 0 dBFS)</p> <hr/> <p>Typically, the 5.1 Detection Threshold control should be set to provide a usable threshold that maintains a threshold at which valid levels large enough over the threshold disable the auto upmix (A, left), while nuisance levels considerably below the threshold (B, left) are rejected, allowing the upmixer to stay locked in the enabled mode and overwrite these signals with the new signals.</p>  <p>Optimum setting is dependent on program material general overall levels. A -60 dB setting is recommended for material closely adhering to the SMPTE -20 dBFS Alignment level for normal material such as dialog.</p>
<p>• Center Width Control</p> 	<p>Adjusts center channel content (in terms of percentage) applied to L and R channels.</p> <ul style="list-style-type: none"> • Minimum setting keeps all L+R (mono) content confined to center (C) channel, with any center channel content removed from L and R channels. • Higher settings progressively blend respective L and R mono content back into L and R channels, with 100% setting resulting in center channel level going to zero and L/R channels becoming normal L/R channels containing some mono content. <p>(0% to 100% range in 0.1% steps; default = 0%)</p>
<p>• Surround Depth Control</p> 	<p>Adjusts surround channel content (in terms of percentage) applied to Ls and Rs channels.</p> <ul style="list-style-type: none"> • Maximum setting results in greatest surround channel levels. • Lower settings progressively diminish surround channel levels, with 0% setting resulting in no Ls or Rs level, with Ls and Rs content progressively folded back into L and R, respectively. <p>(0% to 100% range in 0.1% steps; default = 100%)</p>

Table 3-2 9062 Function Submenu List — continued

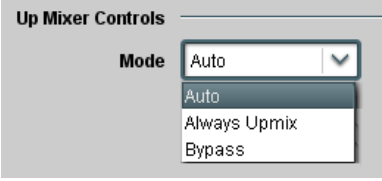
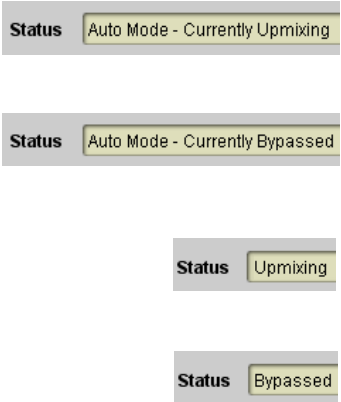
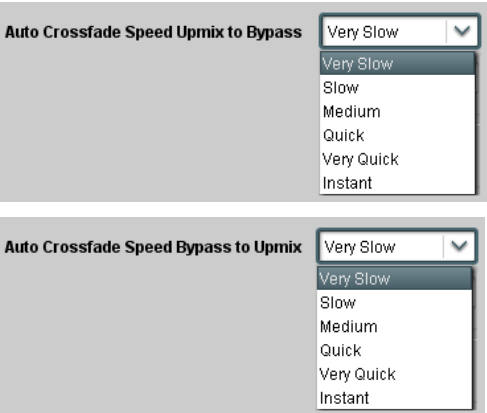

	<p>Allows activation of optional licensed features.</p>
<p>Note: For card pre-ordered with licensed feature(s), the activation steps described below are not required; the feature will already be installed activated. To order features and obtain a license key, contact Cobalt[®] sales at sales@cobaltdigital.com or at the contact information in Contact Cobalt Digital Inc. in Chapter 1, "Introduction". Please provide the "SSN" number of your card (displayed in the Card Info pane) when contacting us for your key.</p>	
<p>• License Feature and Key Entry window</p> 	<p>Activate licensable feature as described below.</p> <ol style="list-style-type: none"> 1. Enter the feature key string in the Feature Key box. Press return or click outside of the box to acknowledge entry. <p>Note: Entry string is case sensitive. Do not enter any spaces.</p> 2. In the DashBoard™ Card Info pane, wait for the feature identification to be shown for the card product number (for example, "-UM" appearing after the card part number) and Valid Key Entered to be displayed. This indicates the key was correctly entered and recognized by the card. <p>Note: If DashBoard™ card function submenu/control pane does not re-appear, close the card and re-open it.</p> 3. Click and confirm Reboot. When the card function submenu/control pane appears again, the licensable feature will be available. <p>Note: Applying the licensable feature and its reboot has no effect on prior settings. All control settings and drop-down selections are retained.</p>
	<p>Allows up to 16 card user settings configuration presets to be saved in a Preset and then recalled (loaded) as desired. All current settings (including list selections and scalar (numeric) control settings such as Gain, etc.) are saved when a Preset Save is invoked.</p>
	<p>The Preset Name field and Preset Save button allow custom user setting configurations to be labeled and saved to a Preset for future use.</p> <p>The Preset Load button and the Selected Preset drop-down list allow saved presets to be selected and loaded as desired. When a preset is loaded, it immediately becomes active with all user settings now automatically set as directed by the preset.</p> <p>Saved presets can be uploaded to a computer for use with other same-model COMPASS™ cards.</p> <p>Each of the items to the left are described in detail on the following pages.</p>
<p>• Selected Preset</p> 	<p>Selected Preset 1 thru Selected Preset 16 range in drop-down list selects one of 16 stored presets as ready for Save (being written to) or for Load (being applied to the card).</p> <p>Note: The preset names shown to the left are the default (unnamed) preset names. All 16 presets in this case are loaded identically with the factory default settings.</p>

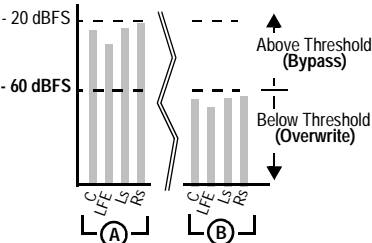
Table 3-2 9062 Function Submenu List — continued



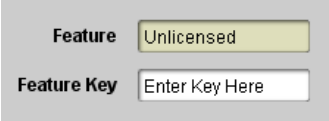

	(continued)
<p>• Preset Save and Load</p> <p>Preset Save <input type="button" value="Confirm"/></p> <p>Preset Load <input type="button" value="Confirm"/></p>	<ul style="list-style-type: none"> • Preset Save stores all current card control settings to the currently selected preset. (For example, if Preset 1 is selected in the Selected Preset drop-down list, clicking and confirming Preset Save will then save all current card control settings to Preset 1) • Preset Load loads (applies) all card control settings defined by whatever preset (Preset 1 thru Preset 16) is currently selected in the Selected Preset drop-down list. (For example, if Preset 3 is selected in the Selected Preset drop-down list, clicking and confirming Preset Load will then apply all card control settings defined in Preset 3).
<p>• Card Name</p> <p>Card Name <input type="text" value="RCVR 21 Input Processing"/></p>	<p>Text entry field provides for optional entry of card name, function, etc. (as shown in this example).</p> <p>Note: Card name can be 31 ASCII characters maximum.</p>
<p>• Preset Name</p> <p>Preset Name <input type="text" value="FactPre"/></p>	<p>With one of 16 presets selected, provides for entry of custom name for the preset (as shown in example below).</p> <div style="display: flex; align-items: center;"> <div style="margin-right: 20px;"> <p>Selected Preset <input type="text" value="2.RCVR21"/></p> <p>Preset Name <input type="text" value="RCVR21"/></p> </div> <div> <p>Entering text in Preset Name field (in this example, "RCVR21") applies custom name to selected Preset (in this example, Preset 2)</p> </div> </div> <p>Note: Preset name can be seven ASCII characters maximum.</p>

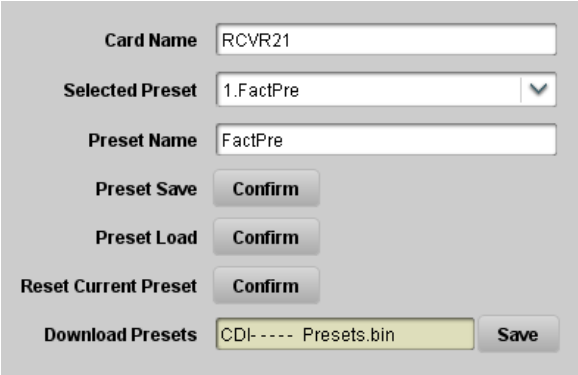
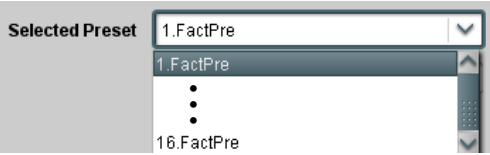
Table 3-2 9062 Function Submenu List — continued

	<p>(continued)</p>
<p>• Download Presets</p> 	<p>Download Presets allows all 16 presets to be stored to a specified location on a network computer for use with other same-model COMPASS™ cards.</p>
<p>• Reset Current Preset</p> 	<p>• Reset Current Preset resets all parameters (including preset custom name entered) of the currently selected Preset (as displayed in the Selected Preset field) to factory default settings.</p> <p>The above button has a Confirm? pop-up that appears, requesting confirmation.</p>

Download a presets file to a computer on the card's DashBoard network to save presets. Preset files stored on a computer can then be uploaded back to the card.

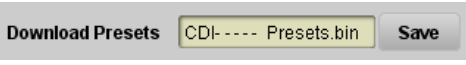
Note also that a presets file can **also be uploaded to other same-model COMPASS® cards**. In this manner, presets built up using a single card can be easily applied to other same-model cards without repeating the setup work on the other cards.

Download (save) card presets to a network computer by clicking **Download Presets – Save** at the bottom of the Presets page.

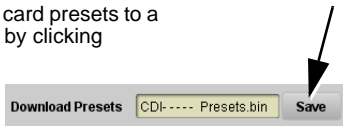

Browse to a desired save location (in this example, *My Documents\Cobalt Presets*).

The file can then be renamed if desired (*RCVR21 Presets* in this example) before saving.

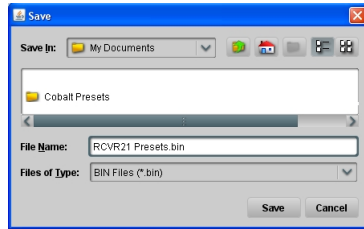

Upload (open) card presets from a network computer by clicking **Upload** at the bottom of DashBoard.



Browse to the location where the file was saved on the computer or drive (in this example, *My Documents\Cobalt Presets*).

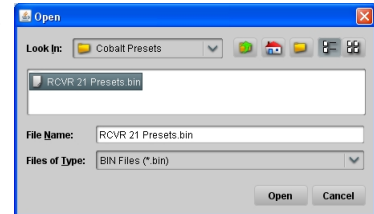

Select the desired file and click **Open** to load the file to the card.

To upload presets saved from one card to another same-model card, simply click **Upload** on the other same-model card's DashBoard page and repeat the same steps here.

- Note:**
- Preset transfer between card download and file upload is on a **group** basis (i.e., individual presets cannot be downloaded or uploaded separately).
 - After uploading a presets file, engagement of a desired preset is only assured by pressing the Preset Load button for a desired preset.

Troubleshooting

This section provides general troubleshooting information and specific symptom/corrective action for the 9062 card and its remote control interface. The 9062 card requires no periodic maintenance in its normal operation; if any error indication (as described in this section) occurs, use this section to correct the condition.

Error and Failure Indicator Overview

The 9062 card itself and its remote control systems all (to varying degrees) provide error and failure indications. Depending on how the 9062 card is being used (i.e, standalone or network controlled through DashBoard™ or a Remote Control Panel), check all available indications in the event of an error or failure condition.

The various 9062 card and remote control error and failure indicators are individually described below.

Note: The descriptions below provide general information for the various status and error indicators. For specific failures, also use the appropriate subsection listed below.

- Basic Troubleshooting Checks (p. 3-54)
- 9062 Processing Error Troubleshooting (p. 3-55)
- Troubleshooting Network/Remote Control Errors (p. 3-57)

9062 Card Edge Status/Error Indicators and Display

Figure 3-6 shows and describes the 9062 card edge status indicators and display. These indicators and the display show status and error conditions relating to the card itself and remote (network) communications (where applicable). Because these indicators are part of the card itself and require no external interface, the indicators are particularly useful in the event of communications problems with external devices such as network remote control devices.

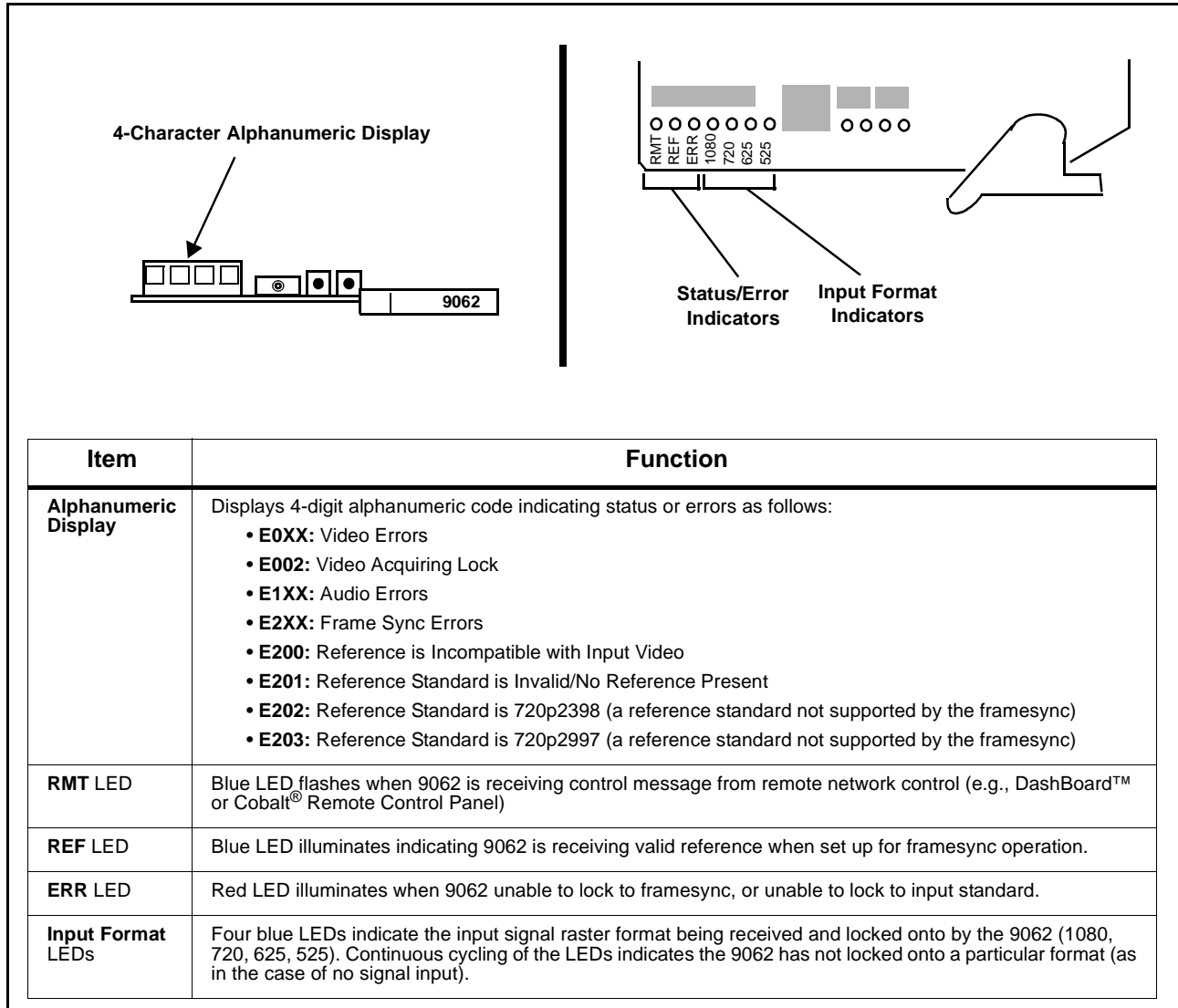

Figure 3-6 9062 Card Edge Status Indicators and Display

DashBoard™ Status/Error Indicators and Displays

Figure 3-7 shows and describes the DashBoard™ status indicators and displays. These indicator icons and displays show status and error conditions relating to the 9062 card itself and remote (network) communications.

Indicator Icon or Display	Error Description
	<p>Red indicator icon in Card Access/Navigation Tree pane shows card with Error condition (in this example, the Card Access/Navigation Tree pane shows a general error issued by the 9062 card in slot 6).</p> <p>Specific errors are displayed in the Card Info pane (in this example “No connection to device” indicating 9062 card is not connecting to frame/LAN).</p> <p>If the 9062 card is not connecting to the frame or LAN, all controls are grayed-out (as shown in the example here).</p>
	<p>Gray indicator icon in Card Access/Navigation Tree pane shows card(s) are not being seen by DashBoard™ due to lack of connection to frame LAN (in this example, both a 9062 card in slot 6 and the MFC-8320-N Network Controller Card for its frame in slot 0 are not being seen).</p>
	<p>Yellow indicator icon in Card Access/Navigation Tree pane shows card with Alert condition (in this example, the Card Access/Navigation Tree pane shows a general alert issued by the MFC-8320-N Network Controller Card).</p> <p>Clicking the card slot position in the Card Access/Navigation Tree (in this example Network Controller Card “Slot 0: MFC-8320-N”) opens the Card Info pane for the selected card. In this example, a “Fan Door Open” specific error is displayed.</p>
	<p>Yellow indicator icon in 9062 Card Info pane shows error alert, along with cause for alert (in this example, the 9062 is receiving no video input, or a video input that is invalid for the card and/or its current settings).</p>
	<p>Where available, error messages within a function submenu pane show highly specific information relating to detected errors (in this example, message shows an invalid or missing Framesync Enable reference selection).</p>

Figure 3-7 DashBoard™ Status Indicator Icons and Displays

Access Card Info panes for specific cards by clicking the card slot position in the Card Access/Navigation Tree pane (as shown in the example in Figure 3-8).

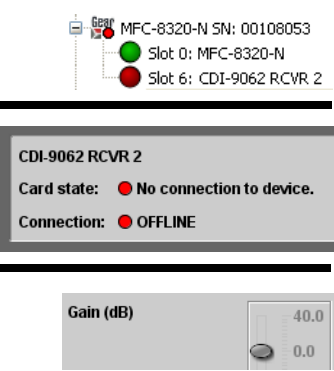
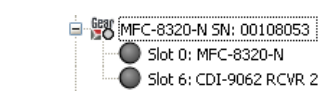
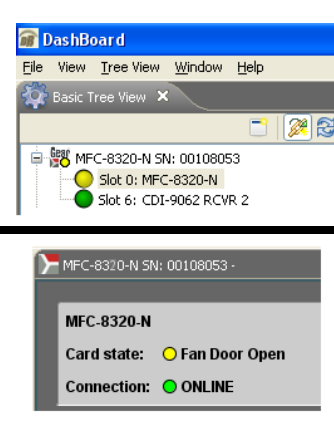
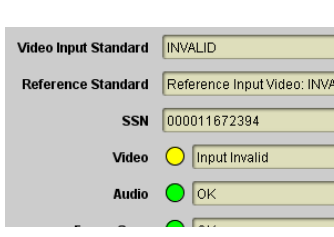
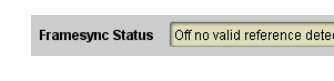
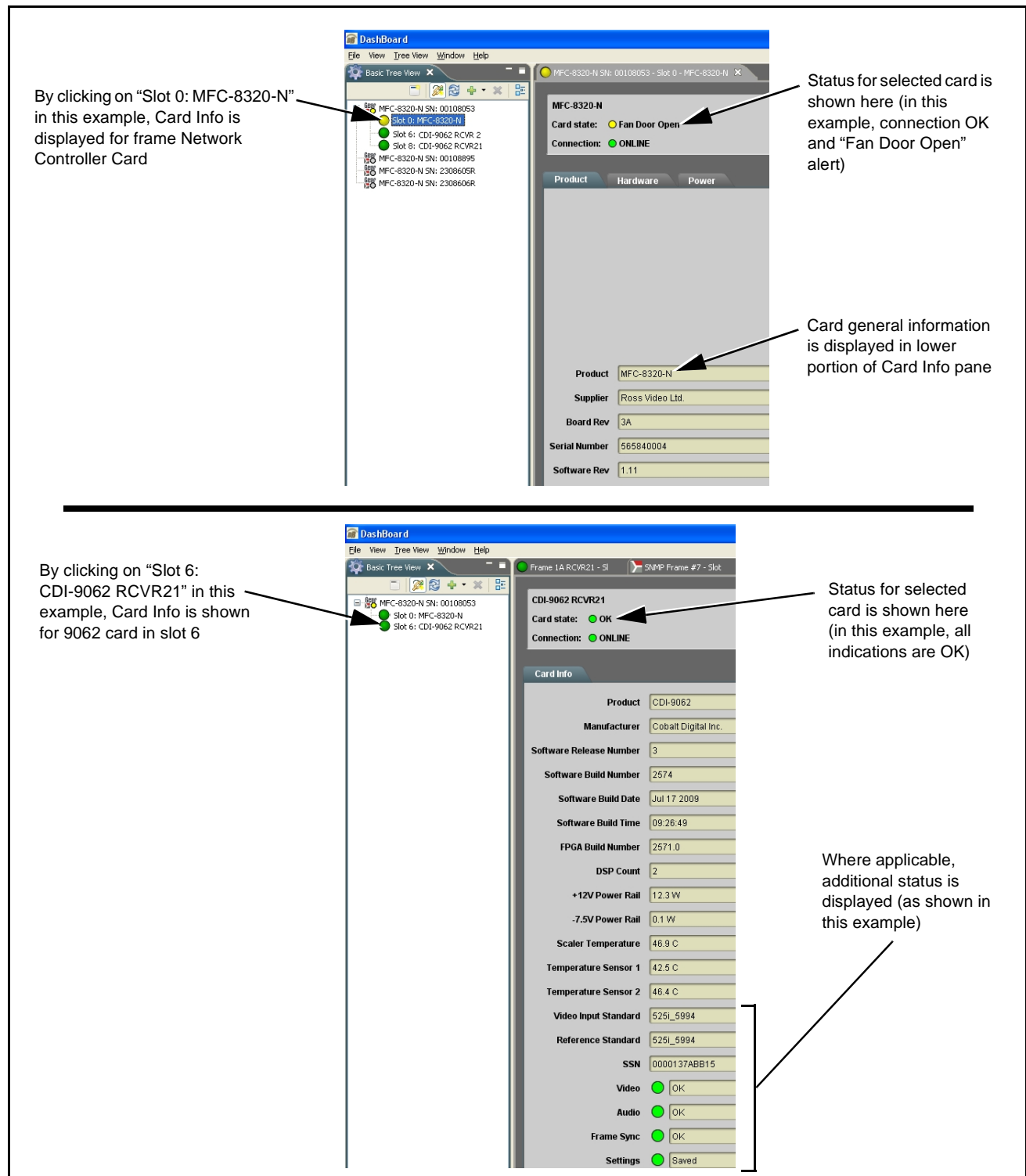

Figure 3-8 Selecting Specific Cards for Card Info Status Display

Basic Troubleshooting Checks

Failures of a general nature (affecting many cards and/or functions simultaneously), or gross inoperability errors are best addressed first by performing basic checks before proceeding further. Table 3-3 provides basic system checks that typically locate the source of most general problems. If required and applicable, perform further troubleshooting in accordance with the other troubleshooting tables in this section.

Table 3-3 Basic Troubleshooting Checks

Item	Checks
Verify power presence and characteristics	<ul style="list-style-type: none"> • On both the frame Network Controller Card and the 9062, in all cases when power is being properly supplied there is always at least one indicator illuminated. Any card showing no illuminated indicators should be cause for concern. • Check the Power Consumed indications for both the +12 V and -7.5 V supply rails for the 9062 card. This can be observed using the DashBoard™ Card Info pane, or using the card edge controls and indicators as shown in Figure 3-4 on page 3-7. <ul style="list-style-type: none"> • If either of the rail supplies show no power being consumed, either the frame power supply, connections, or the 9062 card itself is defective. • If either of the rail supplies show excessive power being consumed (see Technical Specifications (p. 1-19) in Chapter 1, “Introduction”), the 9062 card may be defective.
Check Cable connection secureness and connecting points	Make certain all cable connections are fully secure (including coaxial cable attachment to cable ferrules on BNC connectors). Also, make certain all connecting points are as intended. Make certain the selected connecting points correlate to the intended card inputs and/or outputs. Cabling mistakes are especially easy to make when working with large I/O modules.
Card seating within slots	Make certain all cards are properly seated within its frame slot. (It is best to assure proper seating by ejecting the card and reseating it again.)
Check status indicators and displays	On both DashBoard™ and the 9062 card edge indicators, red indications signify an error condition. If a status indicator signifies an error, proceed to the following tables in this section for further action.
Troubleshoot by substitution	All cards within the frame can be hot-swapped, replacing a suspect card or module with a known-good item.

9062 Processing Error Troubleshooting

Table 3-4 provides 9062 processing troubleshooting information. If the 9062 card exhibits any of the symptoms listed in Table 3-4, follow the troubleshooting instructions provided.

In the majority of cases, most errors are caused by simple errors where the 9062 is not appropriately set for the type of signal being received by the card.

Note: The error indications shown below are typical for the corresponding error conditions listed. Other error indications not specified here may also be displayed on DashBoard™ and/or the 9062 card edge status indicators.

Note: Where errors are displayed on both the 9062 card and network remote controls, the respective indicators and displays are individually described in this section.

Table 3-4 Troubleshooting Processing Errors by Symptom



Symptom	Error/Condition	Corrective Action
<ul style="list-style-type: none"> DashBoard™ shows Video yellow icon and Input Invalid message in 9062 Card Info pane.  <ul style="list-style-type: none"> Card edge Input Format LEDs show continuous cycling. 	No video input present	Make certain intended video source is connected to appropriate 9062 card video input. Make certain BNC cable connections between frame Rear I/O Module for the card and signal source are OK.
<ul style="list-style-type: none"> DashBoard™ shows Frame Sync red icon and Reference Invalid message in 9062 Card Info pane.  <ul style="list-style-type: none"> Card edge red ERR indicator illuminated. 	Frame sync reference not properly selected or not being received	<ul style="list-style-type: none"> If external frame sync reference is not intended to be used, make certain the Framesync Enable selection list is set to Off or Input Video as desired. If external frame sync reference is intended to be used, make certain selected external frame sync reference is active on frame bus. (External reference signals Reference 1 and Reference 2 are distributed to the 9062 and other cards via a frame bus.) <p>Refer to Framesync function submenu tab on page 3-26 for more information.</p>

Table 3-4 Troubleshooting Processing Errors by Symptom — continued

Symptom	Error/Condition	Corrective Action
<p>DashBoard™ shows Framesync Status error message in 9062 Framesync function submenu screen.</p> 	Specified Minimum Latency Frames setting exceeds 9062 card buffer space for the selected output video format	<p>Reduce the Minimum Latency Frames setting as specified in the error message to correct the error.</p> <p>Note: Due to card memory limits, the maximum available Minimum Latency Frames is related to the output video format selected.</p> <p>For example, with a 1080i 5994 output, the maximum setting is 5. For a 1080i film (2398) output, the maximum setting is 3 (due to the increased buffer space needed for the slower frame rate). Conversely, greater maximum settings are allowed for SD formats such as 525i 5994, where the practical maximum limit is 13.</p>
<p>DashBoard™ shows Output Status error message in 9062 Timecode function submenu screen.</p> 	Timecode not available due to lack of appropriate input timecode data	<p>Timecode output requires that source and priority are appropriately selected. Also, video input must contain appropriate timecode data and framesync reference.</p> <p>Refer to Timecode function submenu tab on page 3-38 for more information.</p>
Video/audio synchronization or delay noted.	Source synchronization condition	<p>Use the Audio Offset from Video control to compensate for video/audio delay.</p> <p>Refer to Framesync function submenu tab on page 3-26 for more information.</p>
Unsmooth, “jerky” motion observed on video output with Framesync set to lock to input video.	Incompatible negative H/V delay value user setting of Vertical Delay or Horizontal Delay controls	Negative vertical or horizontal delay values (using the controls below) should not be used when using Input Video mode. To add an offset in this case, instead apply a positive value that results in the desired net offset.
Ancillary data (closed captioning, timecode, Dolby® metadata, AFD) not transferred through 9062.	<ul style="list-style-type: none"> Control(s) not enabled 	<ul style="list-style-type: none"> Make certain respective control is set to On or Enabled (as appropriate).
	<ul style="list-style-type: none"> VANC line number conflict between two or more ancillary data items 	<ul style="list-style-type: none"> Make certain each ancillary data item to be passed is assigned a unique line number (see Ancillary Data Line Number Locations and Ranges on page 3-8).
<p>Audio signal(s) do not route as expected.</p> <p>Parameter control not available as expected.</p>	Embedded audio contains Dolby® E or Dolby Digital encoded signal	<p>When a valid Dolby® E or Dolby Digital signal (in accordance with SMPTE 337M) is detected on an embedded audio signal, gain and polarity controls are bypassed (even though controls may appear to be functional). Gain and polarity controls are not available for this signal type.</p> <p>Refer to Status displays in Audio Input Controls function submenu tab on page 3-10 for more information.</p>

Table 3-4 Troubleshooting Processing Errors by Symptom — continued

Symptom	Error/Condition	Corrective Action
Audio not processed or passed through card.	<ul style="list-style-type: none"> Input audio of type that cannot be locked by 9062 card 	<ul style="list-style-type: none"> Embedded audio must be nominal 48 kHz input. <p>Note: Although the Status Displays in Audio Input Controls function submenu tab will show audio formats other than “Present, Professional” as being locked (such as “Present, Consumer”), in any case the audio must be at nominal 48 kHz rate for lock and processing to occur.</p>
Audio not processed or passed through card (cont.)	<ul style="list-style-type: none"> Enable control not turned on 	<ul style="list-style-type: none"> Group Enable button for Embedded Audio Group 1/2 or Embedded Audio Group 3/4 function submenu must be turned on for sources to be embedded into respective embedded channels.
	<ul style="list-style-type: none"> Upmixer inadvertently enabled (Upmixer Licensed Feature Only) 	<ul style="list-style-type: none"> Make certain upmixer is set to Bypass if not intended for use. <p>Note: When manually enabled or set for automatic enable with appropriate signal levels, upmixer overwrites selected embedded channels with new data; same-channel embedded output will no longer represent same-channel embedded inputs for selected channels.</p>
	<ul style="list-style-type: none"> Dolby-encoded pair not recognized by downstream devices/systems 	<ul style="list-style-type: none"> If framesync is enabled and using Input Video as source, Audio SRC must be set to Off to maintain integrity of Dolby pair for downstream devices.

Troubleshooting Network/Remote Control Errors

Refer to Cobalt® reference guide “Remote Control User Guide” (PN 9000RCS-RM) for network/remote control troubleshooting information.

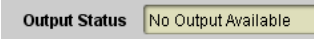
In Case of Problems

Should any problem arise with this product that was not solved by the information in this section, please contact the Cobalt Digital Inc. Technical Support Department.

If required, a Return Material Authorization number (RMA) will be issued to you, as well as specific shipping instructions. If required, a temporary replacement item will be made available at a nominal charge. Any shipping costs incurred are the customer’s responsibility. All products shipped to you from Cobalt Digital Inc. will be shipped collect.

The Cobalt Digital Inc. Technical Support Department will continue to provide advice on any product manufactured by Cobalt Digital Inc., beyond the warranty period without charge, for the life of the product.

See Contact Cobalt Digital Inc. (p. 1-22) in Chapter 1, “Introduction“ for contact information.

This page intentionally blank



Cobalt Digital Inc.

2406 E. University Ave.
Urbana, IL 61802
Voice 217.344.1243 • Fax 217.344.1245
www.cobaltdigital.com