



BMW Motorrad



Rider's Manual (US Model)

**R 1200 GS**

## Motorcycle/Retailer Data

### Motorcycle Data

---

Model

---

Vehicle identification number

---

Color number

---

Initial registration

---

License plate

### Retailer Data

---

Contact in Service

---

Ms./Mr.

---

Phone number

---

Retailer's address/phone number (company stamp)

## Welcome to BMW

Congratulations on choosing a motorcycle from BMW Motorrad and welcome to the community of BMW motorcycle owners and riders. Familiarize yourself with your new motorcycle so that you can ride it safely and confidently in all highway traffic situations.

### About this Rider's Manual

Please read this Rider's Manual carefully before starting to use your new BMW. It contains important information on how to operate the controls and how to get the most benefit from your BMW's advanced technical features.

In addition, it contains information on maintenance and care to help you maintain your motorcycle's reliability and safety, as well as its value.

Documentation confirming performance of scheduled maintenance is a precondition for generous handling of out-of-warranty claims and goodwill warranty treatment.

Should you want to sell your BMW one day, please also remember to turn over the Ride's Manual to the new owner. It is an important part of your motorcycle.

### Suggestions and complaints

If you have any questions concerning your motorcycle, your authorized BMW Motorrad retailer is always happy to provide advice and assistance.

We wish you many miles of safe and enjoyable riding on your BMW

BMW Motorrad.

01 40 8 406 507



# Table of Contents

<b>1 General instructions ....</b>	<b>5</b>	<b>3 Displays .....</b>	<b>19</b>	Dynamic Traction Control (DTC) .....	66
Overview .....	6	Indicator and warning lights .....	20	Electronic chassis and suspension adjustment (D-ESA) .....	68
Abbreviations and symbols .....	6	TFT display in Pure Ride view .....	21	Riding mode .....	71
Equipment .....	7	TFT display in menu view .....	23	PRO riding mode .....	73
Technical data .....	7	Warning lights .....	24	Cruise control .....	75
Notice concerning current status .....	7	<b>4 Operation.....</b>	<b>53</b>	Hill Start Control .....	77
<b>2 Overviews .....</b>	<b>9</b>	Steering and ignition lock .....	54	Anti-theft alarm (DWA) .....	79
Overall view, left side.....	11	Ignition with Keyless Ride .....	56	Tire Pressure Monitor (TPM) .....	81
Overall view, right side .....	13	Emergency on/off switch (kill switch) .....	60	Heated grips .....	82
Underneath seat .....	14	Lights .....	60	Onboard computer .....	82
Multifunction switch, left ....	15	Hazard warning lights system .....	62	Rider and passenger seats .....	83
Multifunction switch, right .....	17	Turn indicators .....	63	<b>5 TFT display .....</b>	<b>87</b>
Instrument panel .....	18	Antilock Brake System (ABS).....	63	General notes .....	88
		Automatic Stability Control (ASC) .....	65	Principle.....	89
				Pure Ride view .....	95
				General settings.....	97
				Bluetooth.....	98
				My Vehicle .....	102
				Navigation.....	105

Media .....	107	Off-road riding .....	125	<b>9 Maintenance .....</b>	<b>151</b>
Phone .....	107	Shifting gears .....	126	General instructions .....	152
Switching GPS synchro- nization on or off .....	108	Brakes .....	127	Tool kit .....	152
Displaying the software ver- sion .....	108	Parking your motorcy- cle.....	129	Service tool kit .....	152
Displaying license informa- tion.....	108	Refueling .....	130	Front wheel stand.....	153
<b>6 Setting.....</b>	<b>109</b>	Securing motorcycle for transport .....	134	Engine oil .....	154
Mirrors .....	110	<b>8 Technology in de- tail.....</b>	<b>137</b>	Brake system .....	155
Headlight.....	110	General notes .....	138	Clutch.....	159
Wind shield .....	111	Antilock Brake System (ABS).....	138	Coolant.....	159
Clutch.....	112	Automatic Stability Control (ASC) .....	141	Tires .....	161
Brakes .....	112	Dynamic Traction Control (DTC) .....	142	Rims and tires.....	162
Handlebars .....	113	Dynamic ESA .....	143	Wheels .....	163
Spring preload .....	113	Riding mode .....	144	Air filter.....	169
Damping .....	114	Tire pressure control (RDC) .....	146	Light sources .....	171
<b>7 Riding.....</b>	<b>117</b>	Shift assistant .....	148	Jump-starting .....	175
Safety information.....	118	Hill Start Control .....	149	Battery .....	177
Observe checklist .....	120			Fuses .....	181
Always before riding off ...	120			Data link connector .....	182
At every third refueling stop .....	121			<b>10 Accessories .....</b>	<b>185</b>
Starting.....	121			General notes .....	186
Running in .....	124			Onboard power sockets.....	186
				Case .....	187
				Topcase.....	190
				Navigation system.....	196

<b>11 Care</b> .....	<b>201</b>	Electrical system .....	220	Certificate for TFT instru-	
Care products .....	202	Alarm system .....	222	ment cluster.....	257
Washing your motorcy-		Dimensions .....	222	<b>15 Index</b> .....	<b>260</b>
cle.....	202	Weights .....	225		
Cleaning sensitive motorcy-		Performance data .....	226		
cle parts.....	203	<b>13 Service</b> .....	<b>227</b>		
Paint care .....	204	Reporting safety			
Protective wax coating ....	204	defects .....	228		
Store motorcycle .....	204	BMW Motorrad Service ...	229		
Return motorcycle to		BMW Motorrad Mobility			
use .....	204	Services.....	229		
<b>12 Technical data</b> .....	<b>205</b>	Maintenance proce-			
Troubleshooting chart .....	206	dures .....	229		
Screw connections .....	209	BMW Service .....	230		
Fuel .....	211	Maintenance schedule ....	233		
Engine oil .....	212	Maintenance confirma-			
Engine .....	212	tions.....	234		
Clutch .....	213	Service confirmations ....	248		
Transmission .....	214	<b>14 Appendix</b> .....	<b>251</b>		
Rear-wheel drive .....	215	Certificate for Electronic			
Frame .....	215	Immobilizer .....	252		
Chassis and		Certificate for Key-			
suspension .....	216	less Ride .....	254		
Brakes .....	218	Certificate for Tire Pressure			
Wheels and tires .....	219	Control .....	256		

## General instructions

Overview .....	6
Abbreviations and symbols .....	6
Equipment .....	7
Technical data .....	7
Notice concerning current status ....	7

## Overview

This Rider's Manual has been designed to provide quick and efficient orientation. The quickest way for you to find information on specific topics is to consult the comprehensive index at the back of the manual. If you would like to start with a quick overview of your motorcycle, this information has been provided in chapter 2. All maintenance and repair work carried out on your motorcycle will be documented in Chapter 12. Documentation confirming performance of scheduled maintenance is a precondition for generous handling of out-of-warranty claims and goodwill warranty treatment.

When the time comes to sell your BMW, remember to hand over this Rider's Manual; it is an important part of the motorcycle.

## Abbreviations and symbols



**CAUTION** Hazard with low risk. Failure to avoid this hazard can result in minor or moderate injury.



**WARNING** Hazard with moderate risk. Failure to avoid this hazard can result in death or serious injury.



**DANGER** Hazard with high risk. Failure to avoid this hazard results in death or serious injury.



**ATTENTION** Special instructions and precautionary measures. Non-compliance can cause damage to the vehicle or accessories and warranty claims may be denied as a result.



**NOTICE** Special information on operating and inspecting your motorcycle as well

as maintenance and adjustment procedures.



Indicates the end of an item of information.



Instruction.



Result of an activity.



Reference to a page with more detailed information.



Indicates the end of accessory or equipment-dependent information.



Tightening torque.



Technical data.

NV

National-market version.



OE	Optional extra. BMW Motorrad optional extras are already completely installed during motorcycle production.
OA	Optional accessory. BMW Motorrad optional accessories can be purchased and installed at your authorized BMW Motorrad retailer.
ABS	Anti-Lock Brake System.
ASC	Automatic Stability Control.
D-ESA	Electronic chassis and suspension adjustment.
DTC	Dynamic Traction Control (optional equipment only in combination with Pro riding modes).

DWA	Anti-theft alarm.
EWS	Electronic immobilizer.
TPC	Tire Pressure Control (TPC).

## Equipment

When you ordered your BMW motorcycle, you chose various items of custom equipment. This Rider's Manual describes optional equipment (OE) offered by BMW and selected optional accessories (OA). This explains why the manual may also contain descriptions of equipment which you have not ordered. Please note, too, that your motorcycle might not be exactly as illustrated in this manual on account of country-specific differences.

If your motorcycle comes with equipment not described here, you can find the descriptions in a separate manual.

## Technical data

All dimensions, weights and outputs in the Rider's Manual relate to the German DIN standards and comply with their tolerance specifications. Versions for individual countries may differ.

## Notice concerning current status

The outstanding levels of safety and quality furnished by every BMW motorcycle are the result of ongoing advanced development focusing on continuous improvement in design and engineering as well as equipment and accessories. For this reason, some aspects of your motorcycle may vary from the descriptions in this Rider's Manual. In addition, BMW Motorrad cannot guarantee the total absence of errors. For this reason BMW is unable to recognize any claims stemming



from the information, illustrations and descriptions in this manual.

## Overviews

Overall view, left side .....	11
Overall view, right side .....	13
Underneath seat .....	14
Multifunction switch, left .....	15
Multifunction switch, right.....	17
Instrument panel .....	18



## Overall view, left side

- 1 Fuel filler opening  
( 131)
- 2 Seat lock ( 83)
- 3 Adjuster for rear damping (at the bottom on the spring strut) ( 114)

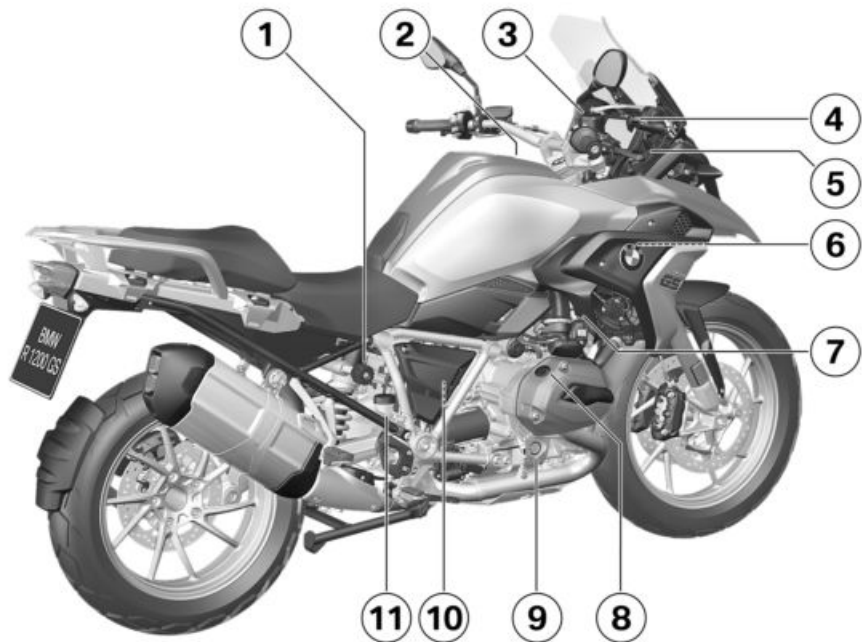

## Overall view, right side

- 1** Adjuster for spring preload, rear (➡ 113)
- 2** Air cleaner (under center fairing panel) (➡ 169)
- 3** Brake fluid reservoir, front (➡ 157)
- 4** Height adjuster for windshield (➡ 111)
- 5** Power socket (➡ 186)
- 6** Vehicle Identification Number (at fork bearing)  
Type plate (on the steering-head bearing)
- 7** Coolant level indicator (➡ 159)  
Coolant tank (➡ 160)
- 8** Oil filler opening (➡ 155)
- 9** Engine oil indicator (➡ 154)
- 10** Behind the side panel:  
Battery (➡ 177)  
Positive battery connection point (➡ 175)  
Data link connector (➡ 182)
- 11** Brake-fluid reservoir, rear (➡ 158)

## Underneath seat

- 1 Standard tool kit (►► 152)
- 2 Rider's Manual (US Model)
- 3 Tire inflation pressure table
- 4 Load capacity table
- 5 Adjuster for the rider's seat height (►► 84)
- 6 Fuses (►► 181)

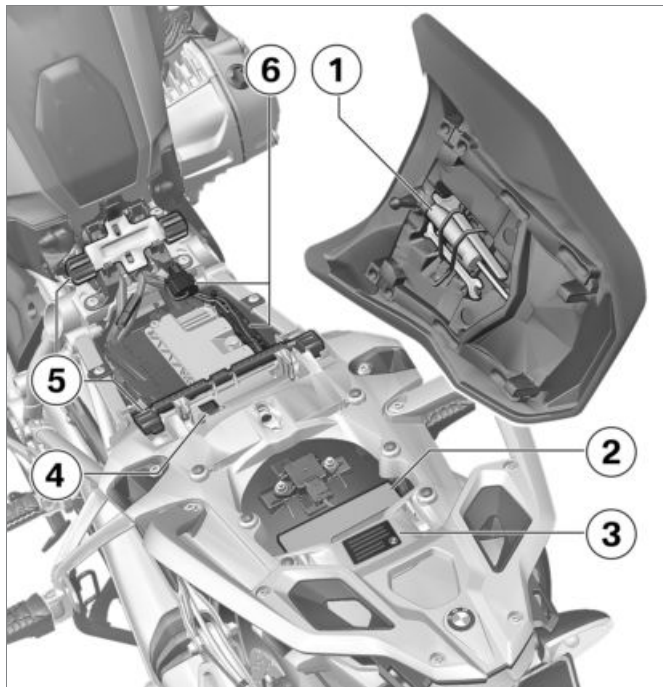



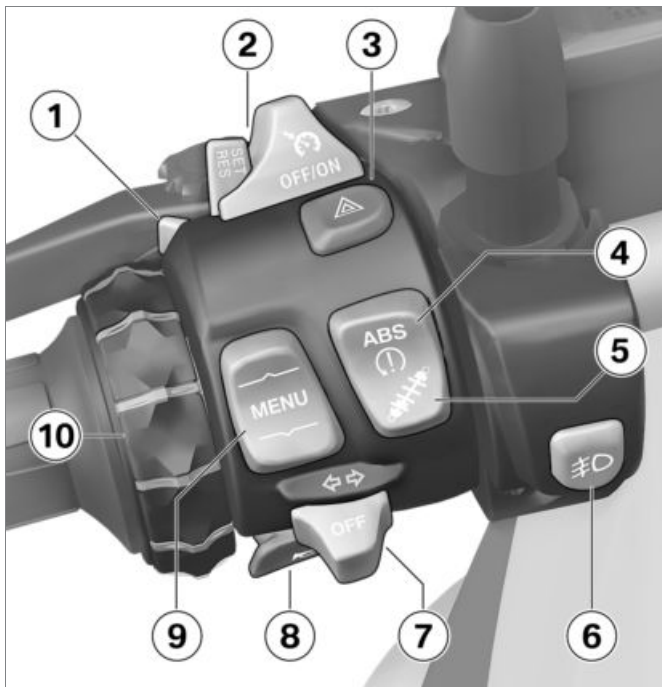

## Multifunction switch, left

- 1 High beam and headlight flasher (➡ 61)
- 2 – with cruise control<sup>OE</sup>  
Cruise control (➡ 75).
- 3 Hazard warning lights system (➡ 62)
- 4 ABS (➡ 63)  
ASC (➡ 65)  
– with riding modes Pro<sup>OE</sup>  
DTC (➡ 66)
- 5 – with Dynamic ESA<sup>OE</sup>  
Dynamic ESA adjustment options (➡ 68)
- 6 – with LED auxiliary headlight<sup>OA</sup>  
Additional headlight (➡ 62).
- 7 Turn indicators (➡ 63)
- 8 Horn
- 9 Rocker button MENU (➡ 89)

- 10** Multi-Controller  
Operating elements  
( 89)

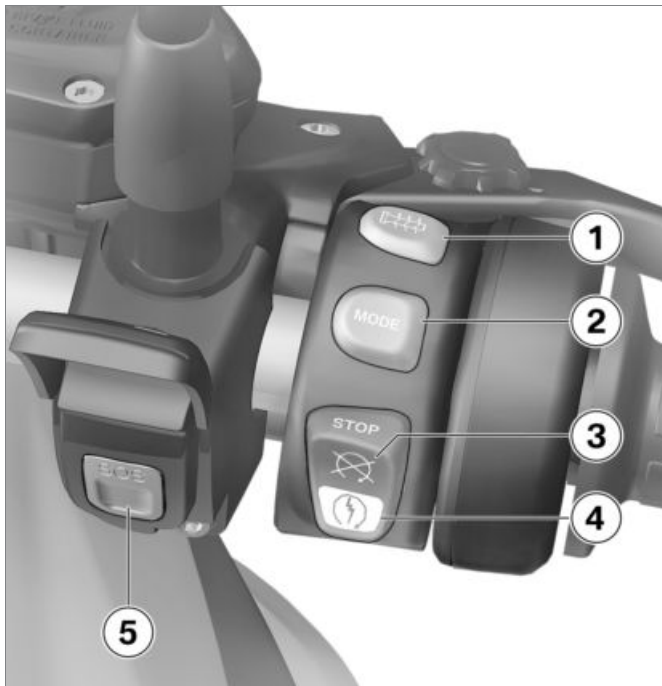

## Multifunction switch, right

- 1 – with heated grips<sup>OE</sup>  
Heated grips (➔ 82).
- 2 Riding mode (➔ 71)
- 3 Emergency on/off switch  
(kill switch) (➔ 60)
- 4 Starter button  
Starting engine (➔ 121).
- 5 SOS button

## Instrument panel

- 1 Indicator and warning lights (➡ 20)
- 2 TFT display (➡ 21)  
(➡ 23)
- 3 Alarm system LED  
– with anti-theft alarm system (DWA)<sup>OE</sup>  
Alarm signal (➡ 80)  
– with Keyless Ride<sup>OE</sup>  
Indicator light for radio-operated key  
Ignition with Keyless Ride (➡ 57).
- 4 Photosensor (for adjusting brightness of instrument lighting)

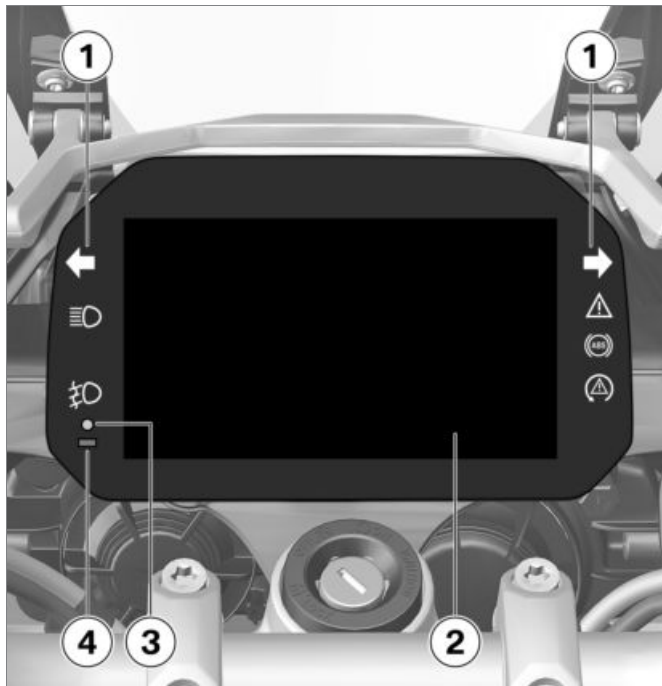

## Displays

Indicator and warning lights .....	20
TFT display in Pure Ride view .....	21
TFT display in menu view .....	23
Warning lights .....	24

## Indicator and warning lights

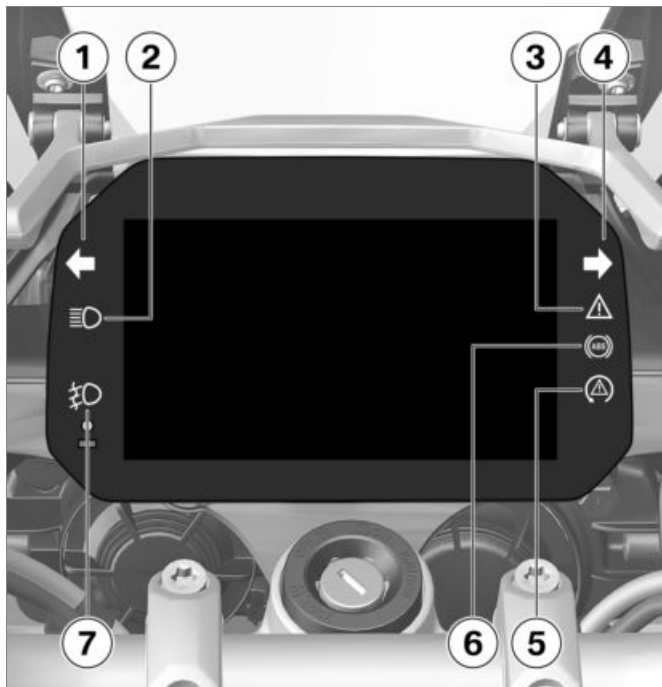

- 1 Turn indicator, left  
Operating turn signals (►► 63).
- 2 High beam (►► 61)
- 3 General warning light (►► 24)
- 4 Turn indicator, right
- 5 ASC (►► 47)  
– with riding modes Pro<sup>OE</sup>
- 6 DTC (►► 48)  
ABS (►► 63)
- 7 – with LED auxiliary headlight<sup>OA</sup>  
Additional headlight (►► 62).

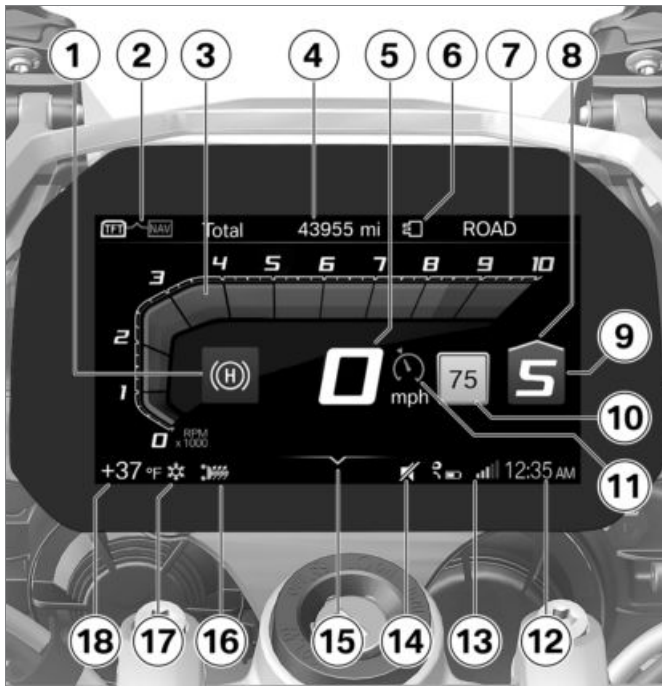



## TFT display in Pure Ride view

- 1 Hill Start Control (➡ 50)
- 2 Operating focus change (➡ 93)
- 3 Tachometer (➡ 95)
- 4 Rider info status line (➡ 94)
- 5 Speedometer
- 6 Coding plug (➡ 74)
- 7 Riding mode (➡ 71)
- 8 Upshift recommendation (➡ 96)
- 9 Gear indicator, "N" is shown in neutral position (idle).
- 10 Road sign detection (➡ 95)
- 11 – with cruise control<sup>OE</sup>  
Cruise control (➡ 75).
- 12 Time (➡ 97)
- 13 Connection status (➡ 99)
- 14 Muting (➡ 97)
- 15 User help

- 16** Heated grip settings  
( 82)
- 17** Outside temperature warning ( 35)
- 18** Ambient temperature



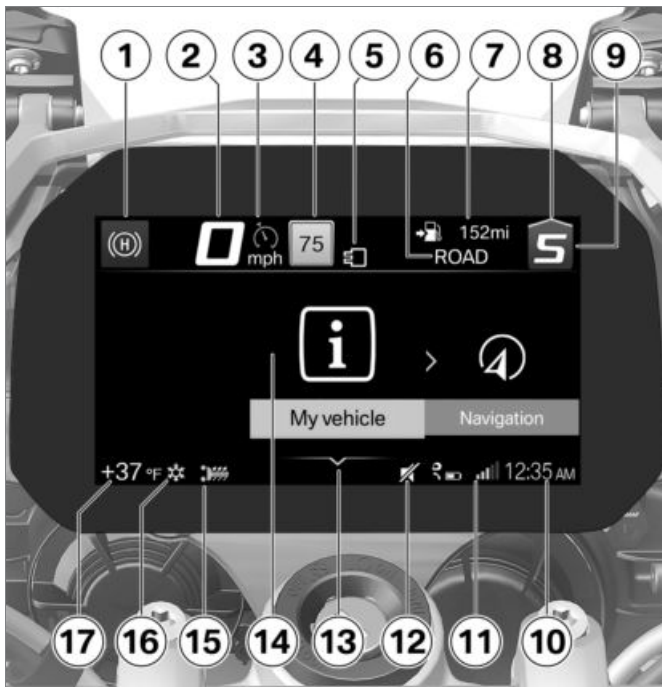

## TFT display in menu view

- 1 Hill Start Control (➡ 50)
- 2 Speedometer
- 3 – with cruise control<sup>OE</sup>  
Cruise control (➡ 75).
- 4 Road sign detection (➡ 95)
- 5 Coding plug (➡ 74)
- 6 Riding mode (➡ 71)
- 7 Rider info status line (➡ 94)
- 8 Upshift recommendation (➡ 96)
- 9 Gear indicator, "N" is shown in neutral position (idle).
- 10 Time
- 11 Connection status
- 12 Muting (➡ 97)
- 13 User help
- 14 Menu panel
- 15 Heated grip settings (➡ 82)

- 16 Outside temperature warning (☀️➡️ 35)
- 17 Ambient temperature

## Warning lights

### Displays

Warnings are displayed with appropriate warning lights. Warnings are indicated by the general warning light in conjunction with a dialog in the TFT display. The universal warning light lights up in either yellow or red depending on the urgency of the warning.



The universal warning light lights up for the most urgent warning.

You will find an overview of the potential warnings on the following pages.



### Check Control display

The messages in the display are shown differently in the display. Different colors and characters are used depending on the priority:

- Green CHECK OK **1**: no message, values optimal.
- White circle with small "i" **2**: information.
- Yellow warning triangle **3**: warning message, value not optimal.
- Red warning triangle **3**: warning message, value critical

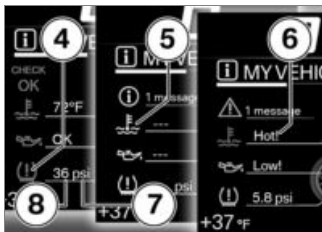

### Value display

The symbols **4** differ in their display. Different colors are used depending on the assessment of value. Instead of numerical values **8** with units **7**, texts **6** are also displayed:

### Color of the symbol

- Green: (OK) current value is optimal.
- Blue: (Cold!) current temperature is too low.
- Yellow: (Low! /High!) current value is too low or too high.
- Red: (Hot! /High!) current temperature or value is too high.

- White: (---) there is no valid value. Instead of the value, dashes **5** are displayed.

### NOTICE

The evaluation of the individual values is possible in part only after a certain riding duration or speed. If a measured value cannot yet be displayed due to unfulfilled measurement conditions, dashes are displayed instead as placeholders. As long as no valid measured value is available, no evaluation is carried out in the form of a colored symbol.◀













### Check Control dialog

Messages are output as Check Control dialog **1**.

- If several Check Control messages of the same priority are present, the messages change in the order in which they occur, until they are acknowledged.
- If the symbol **2** is active, this can be acknowledged by tilting the Multi-Controller to the left.
- Check Control messages are dynamically attached as additional tabs to the pages in the Vehicle menu (► 91). The

message can be called up as long as the error persists.











## Overview of warning indicators

Indicator and warning lights	Display text	Meaning
	 Ice crystal symbol is displayed.	Outside temperature warning (►►► 35)
 General warning light lights up yellow.	 Remote key not in range.	Radio-operated key outside reception range (►►► 35)
 General warning light lights up yellow.	 Remote key battery at 50%.	Replacing the battery of the key fob transmitter (►►► 36)
	 Remote key battery low.	
 General warning light lights up yellow.	 is displayed in yellow.	Vehicle voltage too low (►►► 36)
	 Vehicle voltage low.	
 General warning light shows red.	 is displayed in red.	Vehicle voltage critical (►►► 36)

## Indicator and warning lights

### Display text











### Meaning

		Vehicle voltage critical!	Vehicle voltage critical (➡ 36)	
	General warning light lights up yellow.		The faulty light source is displayed.	Light source defect (➡ 37)
		Anti-theft alarm batt. capacity low.	Anti-theft alarm battery low charge (➡ 38)	
	General warning light lights up yellow.		Anti-theft alarm battery discharged.	Anti-theft alarm system battery discharged (➡ 38)
		Oil level too low! Check oil level.	Low engine oil level (➡ 39)	
	General warning light shows red.		Coolant temperature too high!	Coolant temperature too high (➡ 39)
	General warning light lights up yellow.		No communication with engine control.	Engine control failure (➡ 40)

## Indicator and warning lights

## Display text











## Meaning

 General warning light lights up yellow.	 Fault in the engine control.	Engine in emergency-operation mode (▶▶▶▶ 40)
 General warning light flashes yellow.	 Serious fault in the engine control.	Serious fault in the engine control (▶▶▶▶ 40)
 General warning light lights up yellow.	 is displayed in yellow.	Tire pressure at the limits of the permissible tolerance. (▶▶▶▶ 42)
	 Tire pressure not at setpoint.	
 General warning light flashes red.	 is displayed in red.	Tire pressure is outside the approved tolerance range (▶▶▶▶ 43)
	 Tire pressure not at setpoint.	
	 Tire Press. Monitor. Loss of pressure.	











## Indicator and warning lights

### Display text

### Meaning

		"---"	Transmission fault (►► 44)
 General warning light lights up yellow.		"---"	Sensor faulty or system fault (►► 44)
 General warning light lights up yellow.		TPM sensors battery low..	Battery of the tire pressure sensor weak (►► 45)
		Fall sensor faulty.	Fall sensor defective (►► 45)
		Side stand monitoring faulty	Side stand monitoring faulty (►► 45)
 ABS indicator light flashes.			ABS self-diagnosis not completed (►► 45)
 ABS indicator light lights up.		Off!	ABS deactivated (►► 46)
		ABS deactivated.	













Indicator and warning lights	Display text	Meaning
 ABS indicator light lights up.	 Limited ABS availability!	ABS fault (→ 46)
 ABS indicator light lights up.	 ABS failure!	ABS failure (→ 46)
 ABS indicator light lights up.	 ABS Pro failure!	ABS Pro failure (→ 46)
 ASC indicator and warning light flashes rapidly.		ASC intervention (→ 47)
 ASC indicator and warning light flashes slowly.		ASC self-diagnosis not completed (→ 47)
 ASC indicator and warning light lights up.	 Off!	ASC switched off (→ 47)
	 Traction control deactivated.	

## Indicator and warning lights

## Display text

## Meaning

	ASC indicator and warning light lights up.	 Traction control failure!	ASC fault (→ 48)
	DTC indicator and warning light flashes rapidly.		DTC intervention (→ 48)
	DTC indicator and warning light flashes slowly.		DTC self-diagnosis not completed (→ 48)
	DTC indicator and warning light lights up.	 Off!	DTC switched off (→ 49)
		 Traction control deactivated.	
	DTC indicator and warning light lights up.	 Traction control failure!	DTC error (→ 49)
	General warning light lights up yellow.	 Spring strut adjustment faulty!	D-ESA fault (→ 49)

## Indicator and warning lights

## Display text

## Meaning



Fuel reserve is being used up. Drive to the nearest filling station.

Fuel down to reserve (▬▬▬➔ 50)



Stop symbol is displayed.

Hill Start Control active (▬▬▬➔ 50)



General warning light flashes yellow.



Stop symbol flashes briefly.

Hill Start Control deactivated automatically (▬▬▬➔ 50)



General warning light flashes yellow.



Stop symbol flashes briefly.

Hill Start Control can not be activated (▬▬▬➔ 50)



Gear indicator flashes.

Gear not programmed (▬▬▬➔ 51)



Left turn signal indicator light flashes green.

Hazard warning lights system switched on (▬▬▬➔ 51)



Right turn signal indicator light flashes green.

**Indicator and warning lights****Display text****Meaning**

is displayed in white.

Service due (▬▶ 52)

Service due!



General warning light lights up yellow.



is displayed in yellow.

Service date missed (▬▶ 52)

Service overdue!

## Ambient temperature

The outside temperature is shown in the status line of the TFT display.

Engine heat can lead to spurious readings of ambient temperature when the motorcycle is stationary. When the effects of engine heat on the monitored temperature become excessive, dashes instead of the value are displayed.



If the outside temperature drops below the following limit value, there is a risk of black ice forming.



Limit value for outside temperature

Approx. 37 °F (Approx. 3 °C)

The first time the temperature drops below this value, the outside temperature display and ice

crystal symbol will flash in the status line of the TFT display.

## Outside temperature warning



Ice crystal symbol is displayed.

Possible cause:



The outside temperature measured on the motorcycle is less than:

Approx. 37 °F (Approx. 3 °C)



### WARNING

#### Risk of black ice, even above 37 °F (3 °C)

Accident hazard

- At a low outside temperature, icy conditions must be expected on bridges and in shady road areas. ◀
- Think well ahead when driving.

## Radio-operated key outside reception range

– with Keyless Ride<sup>OE</sup>



General warning light lights up yellow.



Remote key not in range. Do not stop engine. No engine restart possible.

Possible cause:

Communication between the key fob transmitter and the engine electronics is disrupted.

- Check the battery in the key fob transmitter.
- with Keyless Ride<sup>OE</sup>
- Replacing the battery of the key fob transmitter (▶▶▶ 59).
- Use reserve key for further driving.
- with Keyless Ride<sup>OE</sup>
- Battery of the key fob transmitter is empty or the key fob transmitter is lost (▶▶▶ 58).

- Should the Check Control dialog appear while riding, keep calm. You can continue driving; the engine will not turn off.
- Have the defective key fob transmitter replaced by an authorized BMW Motorrad retailer.

## Replacing the battery of the key fob transmitter

 General warning light lights up yellow.

 Remote key battery at 50%. No functional limitation.

 Remote key battery low. Limited central locking function. Change battery.

Possible cause:

- The battery for the key fob transmitter is no longer charged to full capacity. Operation of the key fob

transmitter is only ensured for a limited time.

- with Keyless Ride<sup>OE</sup>
- Replacing the battery of the key fob transmitter (▶▶▶ 59).

## Vehicle voltage too low

 General warning light lights up yellow.

 is displayed in yellow.

 Vehicle voltage low. Switch off unneeded consumers.

## WARNING

### Discharged battery causes various motorcycle systems to fail, such as the lighting, engine or ABS

Accident hazard

- Do not continue riding.◀

The battery is not being charged. If the journey is continued, the

vehicle electronics will discharge the battery.

## NOTICE

If the 12 V battery is installed incorrectly, or if the terminals are swapped (e.g. when jump-starting), the fuse for the alternator regulator may blow.◀

Possible cause:

Alternator or alternator drive faulty, battery faulty or fuse for alternator regulator blown.

- Have the malfunction corrected as soon as possible at an authorized service facility, preferably an authorized BMW Motorrad Retailer.

## Vehicle voltage critical

 General warning light shows red.

 is displayed in red.

 Vehicle voltage critical! Consumers were switched off Check battery condition.

### **WARNING**

**Discharged battery causes various motorcycle systems to fail, such as the lighting, engine or ABS**

Accident hazard

• Do not continue riding.◀

The battery is not being charged. If the journey is continued, the vehicle electronics will discharge the battery.

### **NOTICE**

If the 12 V battery is installed incorrectly, or if the terminals are swapped (e.g. when jump-start-

ing), the fuse for the alternator regulator may blow.◀

Possible cause:

Alternator or alternator drive faulty, battery faulty or fuse for alternator regulator blown.

- Have the malfunction corrected as soon as possible at an authorized service facility, preferably an authorized BMW Motorrad Retailer.

### **Light source defect**

 General warning light lights up yellow.

 The faulty light source is displayed:

 High beam faulty!

 Turn indicator front left faulty! Or Turn indicator front right faulty!

 Low beam faulty!

 Front parking lamp faulty!

 Daytime running light faulty!

– with LED auxiliary headlight<sup>OA</sup>

 Left auxiliary headlight faulty! or Right auxiliary headlight faulty!◀

 Tail light faulty!

 Brake light faulty!

 Rear left turn signal faulty! Or Rear right turn signal faulty!

 License plate light faulty!

– Have checked by a specialist workshop.

## WARNING

### Overlooking the vehicle in traffic due to a defective light source on the vehicle

Safety risk

- Replace defective bulbs as soon as possible; it is best always to carry a complete set of spare bulbs on the motorcycle. ◀

Possible cause:

One or more bulbs are defective.

- Determine defective bulbs via visual inspection.
- Replacing low and high-beam light sources in headlight (▮▮▮▮▶ 171).
- Replacing light source for parking light (▮▮▮▶ 172).
  - with LED headlight<sup>OE</sup>
- Have LED headlamp replaced (▮▮▮▶ 175).

- Replacing front and rear turn indicator light sources (▮▮▮▶ 174).
- Have rear LED light replaced (▮▮▮▶ 175).

### Anti-theft alarm battery low charge

– with anti-theft alarm system (DWA)<sup>OE</sup>

 Anti-theft alarm batt. capacity low. No limitations. Arrange an appointment at a specialist workshop.

## NOTICE

This fault message is only shown for a short time immediately following the Pre-Ride-Check. ◀

Possible cause:

The anti-theft alarm battery no longer has its full capacity. The operation of the anti-theft alarm system is only ensured for a lim-

ited time with the motorcycle battery disconnected.

- Contact an authorized service facility, preferably an authorized BMW Motorrad retailer.

### Anti-theft alarm system battery discharged

– with anti-theft alarm system (DWA)<sup>OE</sup>

 General warning light lights up yellow.

 Anti-theft alarm battery discharged. No independent alarm. Arrange an appointment at a specialist workshop.

## NOTICE

This fault message is only shown for a short time immediately following the Pre-Ride-Check. ◀



Possible cause:

The anti-theft alarm system battery is completely discharged. Operation of the anti-theft alarm system is no longer ensured when the motorcycle's battery is disconnected.

- Contact an authorized service facility, preferably an authorized BMW Motorrad retailer.

## Electronic oil level check

 The electronic oil level check evaluates the oil level in the engine with OK or Low!

The conditions required for using the electronic oil level check are as follows:

- Engine at normal operating temperature.
- Engine idling for at least ten seconds.
- Side stand retracted.

- Motorcycle standing vertically on level surface.

If the stated conditions are not met, no oil level measurement is possible. Dashes are displayed instead of the information.

## Low engine oil level

 Oil level too low! Check oil level.

Possible cause:

The electronic oil level sensor has detected that the engine's oil level is too low. At next refueling stop:

- Check engine oil level (▢▢▢▢ 154).
- If oil level is too low:
- Topping up engine oil (▢▢▢▢ 155).
- If the oil level is correct:
- Contact an authorized workshop, preferably an authorized BMW Motorrad retailer.

## Coolant temperature too high

 General warning light shows red.

 Coolant temperature too high! Check coolant level. Carry on at moderate pace to cool.

## ATTENTION

### Riding with overheated engine

Engine damage

- Be sure to observe the measures listed below. ◀

Possible cause:

Coolant level is too low.

- Checking coolant level (▢▢▢▢ 159).

If coolant level is too low:

- Allow the engine to cool down.
- Topping up coolant (▢▢▢▢ 160).
- Have the coolant system checked at a specialist

workshop, preferably by an authorized BMW Motorrad retailer.

Possible cause:

The coolant temperature is too high.

- If possible, continue driving in the part-load range to cool down the engine.

If the coolant temperature is frequently too high:

- Have the fault corrected as soon as possible by a specialist workshop, preferably an authorized BMW Motorrad retailer.

### Engine control failure

 General warning light lights up yellow.

 No communication with engine control. Multiple sys. affected. Ride carefully to the next specialist workshop

### Engine in emergency-operation mode

 General warning light lights up yellow.

 Fault in the engine control. Onward journey possible. Ride carefully to next specialist workshop.

### WARNING

#### Unusual handling when engine is in emergency operation mode

Accident hazard

- Adapt riding style: avoid rapid acceleration and passing maneuvers. ◀

Possible cause:

The engine control unit has diagnosed a fault which impairs the engine performance or throttle response. The engine is running in the emergency-operation

mode. In exceptional cases, the engine stops and can no longer be started.

- Have the malfunction corrected as soon as possible at an authorized service facility, preferably an authorized BMW Motorrad Retailer.
- » It is possible to continue riding, however the engine performance and engine speed range may be impaired and not function as normal.

### Serious fault in the engine control

 General warning light flashes yellow.

 Serious fault in the engine control. Onward journey possible. Engine damage possible. Have checked by workshop.

## WARNING

### Damage to the engine when it is in the emergency operating mode

#### Accident hazard

- Adapt riding style: ride slowly, avoid rapid acceleration and passing maneuvers.
- If possible, have the motorcycle picked up and the malfunction source eliminated by a specialized service facility, preferably an authorized BMW Motorrad Retailer. ◀

#### Possible cause:

The engine control unit has diagnosed a fault, which can lead to a severe secondary fault. The engine is in the emergency-operation mode.

- Continued driving is possible, however it is not recommended.

- Avoid high load and engine speed ranges if possible.
- Have the malfunction corrected as soon as possible at an authorized service facility, preferably an authorized BMW Motorrad Retailer.

### Tire pressure

- with Tire Pressure Monitor (TPM)<sup>OE</sup>

In addition to the menu screen **MY VEHICLE** and the Check Control messages, there is also the screen **TIRE PRESSURE** for displaying the tire pressures:



The left values refer to the front wheel, the right values to the rear wheel.

The pressure difference is displayed via actual and target tire pressure.

Immediately after switching on the ignition, only dashes are displayed. The transmission of the tire pressure values begins only after the first time the minimum speed has been exceeded:



TPC/RDC sensor is not active

min 19 mph (min 30 km/h)  
(The TPC/RDC sensor does not transmit a signal to the motorcycle until this minimum speed has been exceeded.)



The tire pressures are shown in the TFT display with temperature compensation and are always based on the following tire air temperature:

68 °F (20 °C)



If the tire symbol is also displayed in yellow or red, it is a warning. The pressure difference is emphasized with an exclamation point in the same color.



If the level concerned is borderline in terms of the permissible tolerance, the general warning light also lights up yellow.



If the monitored tire inflation pressure is outside the specified range the general warning light will flash red.

Further information about the BMW Motorrad TPM can be found in the "Technology in detail" chapter from page (▶▶▶ 146).

### Tire pressure at the limits of the permissible tolerance.

– with Tire Pressure Monitor (TPM)<sup>OE</sup>



General warning light lights up yellow.



is displayed in yellow.



Tire pressure not at setpoint. Check tire pressure.

Possible cause:

The measured tire inflation pressure is in the limit area of the permissible tolerance.

- Correct tire pressure.
- Before adjusting the tire pressure, please observe the information about temperature compensation and adjusting the tire pressure in the "Technology in detail" chapter:
  - » Temperature compensation (▶▶▶ 147)
  - » Tire pressure adjustment (▶▶▶ 147)
  - » The target tire pressures can be found in the following locations:
    - Back cover of the operating instructions

- Instrument cluster in the **TIRE PRESSURE** view
- Sign under the seat bench

## Tire pressure is outside the approved tolerance range

- with Tire Pressure Monitor (TPM)<sup>OE</sup>



General warning light flashes red.



is displayed in red.



Tire pressure not at setpoint. Stop immediately! Check tire pressure.



Tire Press. Monitor. Loss of pressure. Stop immediately! Check tire pressure.



## WARNING

### Tire inflation pressure is outside approved range.

Poorer handling characteristic of the motorcycle.

- Adapt your style of riding accordingly. ◀

Possible cause:

The measured tire inflation pressure is outside the approved tolerance range.

- Check tire for damage and suitability for continued use. If it is still possible to drive with tire:
- Correct tire inflation pressure at the next opportunity.
- Before adjusting the tire pressure, please observe the information about temperature compensation and adjusting the tire pressure in the "Technology in detail" chapter:

- » Temperature compensation (▶▶▶ 147)
- » Tire pressure adjustment (▶▶▶ 147)
- » The target tire pressures can be found in the following locations:
  - Back cover of the operating instructions
  - Instrument cluster in the **TIRE PRESSURE** view
  - Sign under the seat bench
- Have the tire checked for damage at an authorized service facility, preferably an authorized BMW Motorrad retailer.



## NOTICE

The TPC/RDC warning message can be deactivated in the off-road mode. ◀

If you are unsure about the tire's suitability for continued riding:

- Do not continue riding.
- Contact roadside service.

## Transmission fault

- with Tire Pressure Monitor (TPM)<sup>OE</sup>



"----"

Possible cause:

The vehicle has not reached the minimum speed (► 146).



TPC/RDC sensor is not active

min 19 mph (min 30 km/h)  
(The TPC/RDC sensor does not transmit a signal to the motorcycle until this minimum speed has been exceeded.)

- Observe the TPM display at higher speed.



Only when the general warning light also lights up is this a permanent fault.

In this case:

- Have fault eliminated at a specialist service facility, preferably

an authorized BMW Motorrad retailer.

Possible cause:

The radio link to the TPM sensors is disrupted. There are radio systems in the surrounding area that are causing interference to the connection between the TPM control unit and the sensors.

- Observe the TPM display in different surroundings.



Only when the general warning light also lights up is this a permanent fault.

In this case:

- Have fault eliminated at a specialist service facility, preferably an authorized BMW Motorrad retailer.

## Sensor faulty or system fault

- with Tire Pressure Monitor (TPM)<sup>OE</sup>



General warning light lights up yellow.



"----"

Possible cause:

Wheels without installed TPC/RDC sensors are mounted.

- Retrofit wheel set with TPC/RDC sensors.

Possible cause:

1 or 2 TPC/RDC sensors have failed or a system error has occurred.

- Have fault eliminated at a specialist service facility, preferably an authorized BMW Motorrad retailer.

## Battery of the tire pressure sensor weak

– with Tire Pressure Monitor (TPM)<sup>OE</sup>



General warning light lights up yellow.



TPM sensors battery low. Function limited. Have checked by a specialist workshop.



### NOTICE

This fault message is only shown for a short time immediately following the Pre-Ride-Check. ◀

Possible cause:

The battery of the tire inflation pressure sensor no longer has its full capacity. The operation of the tire inflation pressure control is only ensured for a limited time.

- Contact an authorized workshop, preferably an authorized BMW Motorrad retailer.

## Fall sensor defective



Fall sensor faulty. Have checked by a specialist workshop.

Possible cause:

The fall sensor is not functioning.

- Contact an authorized service facility, preferably an authorized BMW Motorrad retailer.

## Side stand monitoring faulty



Side stand monitoring faulty To avoid breakdown do not stop engine. Have checked by spec. workshp.

Possible cause:

The side-stand switch or its wiring is damaged.

- Contact an authorized service facility, preferably an authorized BMW Motorrad retailer.

## ABS self-diagnosis not completed



ABS indicator light flashes.

Possible cause:



ABS self-diagnosis routine not completed

ABS is not available, as the self-diagnosis routine was not completed. (The motorcycle must reach a specified minimum speed before the system can check operation of the wheel speed sensors: 3 mph (5 km/h))

- Ride off slowly. It must be noted that the ABS function

is not available until the self-diagnosis has been completed.

### ABS deactivated



ABS indicator light lights up.



Off!



ABS deactivated.

Possible cause:

The ABS system was deactivated by the rider.

- Switch on ABS function (▣▣▣ 64).

### ABS fault



ABS indicator light lights up.



Limited ABS availability! Onward journey possible. Ride carefully to next specialist workshop.

Possible cause:

The ABS control unit has detected an error. The partially integral brake has failed. The ABS function is limited.

- It remains possible to continue riding. Observe additional information on special situations which can lead to ABS fault messages (▣▣▣ 139).
- Have the malfunction corrected as soon as possible at an authorized service facility, preferably an authorized BMW Motorrad Retailer.

### ABS failure



ABS indicator light lights up.



ABS failure! Onward journey possible. Ride carefully to next specialist workshop.

Possible cause:

The ABS control unit has detected an error. The ABS function is not available.

- It remains possible to continue riding. Observe additional information on special conditions that can lead to an ABS error message (▣▣▣ 139).
- Have the malfunction corrected as soon as possible at an authorized workshop, preferably an authorized BMW Motorrad retailer.

### ABS Pro failure

– with riding modes Pro<sup>OE</sup>



ABS indicator light lights up.



ABS Pro failure! Onward journey possible. Ride carefully to next specialist workshop.



Possible cause:

The ABS Pro control unit has detected a fault. The ABS Pro function is not available. The ABS function remains available. ABS only supports braking in straight-ahead riding.

- It remains possible to continue riding. Observe additional information on special situations which can lead to an ABS Pro fault message (139).
- Have the malfunction corrected as soon as possible at an authorized service facility, preferably an authorized BMW Motorrad Retailer.

### ASC intervention

– without riding modes Pro<sup>OE</sup>



ASC indicator and warning light flashes rapidly.

ASC has detected instability at the rear wheel and responded by reducing the torque. The in-

dicator and warning light flashes longer than the ASC intervention lasts. This feature continues to furnish the rider with visual feedback confirming that the system has initiated active closed-loop intervention even after the critical situation has passed.

### ASC self-diagnosis not completed

– without riding modes Pro<sup>OE</sup>



ASC indicator and warning light flashes slowly.

Possible cause:



ASC self-diagnosis routine not completed

ASC is not available because the self-diagnosis routine was not completed. (The motorcycle must reach a specified minimum speed before the system can check operation of the wheel sensors: min 3 mph (min 5 km/h))

- Ride off slowly. The ASC indicator and warning light must go out after several meters. If the ASC indicator and warning light continues to flash:
- Contact an authorized workshop, preferably an authorized BMW Motorrad retailer.

### ASC switched off



ASC indicator and warning light lights up.



Off!



Traction control deactivated.

Possible cause:

The rider has switched off the ASC system.

– without riding modes Pro<sup>OE</sup>

- Activating ASC function (→ 65).

### ASC fault



ASC indicator and warning light lights up.



Traction control failure! Onward

journey possible. Ride carefully to the next specialist workshop.

Possible cause:

The ASC control unit has detected a fault. The ASC function is not available.

- It remains possible to continue riding. Please be aware that ASC functionality is no longer available. Observe the additional information on situations that can lead to an ASC fault (→ 142).
- Have the malfunction corrected as soon as possible at an authorized service facility, preferably an authorized BMW Motorrad Retailer.

### DTC intervention

– with riding modes Pro<sup>OE</sup>



DTC indicator and warning light flashes rapidly.

DTC has detected instability at the rear wheel and responded by reducing the torque. The indicator and warning light flashes longer than the DTC intervention lasts. This feature continues to furnish the rider with visual feedback confirming that the system has initiated active closed-loop

intervention even after the critical situation has passed.

### DTC self-diagnosis not completed

– with riding modes Pro<sup>OE</sup>



DTC indicator and warning light flashes slowly.

Possible cause:



DTC self-diagnosis not completed

The DTC function is not available, as the self-diagnosis function has not been completed. (To check wheel speed sensors, motorcycle must reach a minimum speed with engine running: min 3 mph (min 5 km/h))

- Ride off slowly. It must be noted that the DTC function is not available until the self-diagnosis has been completed.

## DTC switched off

– with riding modes Pro<sup>OE</sup>



DTC indicator and warning light lights up.



Off!



Traction control deactivated.

Possible cause:

The DTC system was deactivated by the rider.

- Switching on DTC (▶▶▶ 67).

## DTC error

– with riding modes Pro<sup>OE</sup>



DTC indicator and warning light lights up.



Traction control failure! Onward journey possible. Ride carefully to the next specialist workshop.

Possible cause:

The DTC control unit has detected an error.



## ATTENTION

### Damage to components

Damage to sensors, for example, with the resultant malfunctions

- Do not carry along any objects under the rider's or passenger's seat.
- Secure vehicle tools.◀
- Do not damage the rotational speed sensor.
- It must be noted that the DTC function is not available at all or is restricted.
- It remains possible to continue riding. You should also observe the additional information on situations that can lead to a DTC fault (▶▶▶ 142).
- Have the malfunction corrected as soon as possible at an authorized service facility,

preferably an authorized BMW Motorrad Retailer.

## D-ESA fault



General warning light lights up yellow.



Spring strut adjustment faulty! Onward journey possible. Ride carefully to next specialist workshop.

Possible cause:

The D-ESA control unit has detected a fault. Damping action and/or the spring adjustment may be the cause. In the Auto loading mode, the cause may be a fault in the function of the riding position compensation. In this state, the motorcycle is probably heavily damped and is uncomfortable to drive, particularly on poor roads. Alternatively, the spring preload may be set incorrectly.

- Have the malfunction corrected as soon as possible at an authorized service facility, preferably an authorized BMW Motorrad Retailer.

## Fuel down to reserve

 Fuel reserve is being used up. Drive to the nearest filling station.

### WARNING

#### Rough engine running or switching off of the engine due to a fuel shortage

Accident hazard, damage to catalytic converter

- Do not drive to the extent that the fuel tank is completely empty. ◀

Possible cause:

At the most, the fuel tank still contains the reserve fuel quantity.



Reserve fuel quantity

Approx. 1.1 gal (Approx. 4 l)

- Refueling procedure (▶▶▶ 131).

## Hill Start Control active

– with riding modes Pro<sup>OE</sup>



Stop symbol is displayed.

Possible cause:

The Hill Start Control (▶▶▶ 149) was activated by the rider.

- Switch off Hill Start Control.
- Using Hill Start Control (▶▶▶ 78).

## Hill Start Control deactivated automatically

– with riding modes Pro<sup>OE</sup>



General warning light flashes yellow.



Stop symbol flashes briefly.

Possible cause:

The Hill Start Control was deactivated automatically.

- Side stand was folded out.
  - » Hill Start Control is deactivated if the side stand is folded out.
- Engine was stopped.
  - » Hill Start Control is deactivated if the engine is stopped.
- The rider has driven off with Hill Start Control activated.
- Using Hill Start Control (▶▶▶ 78).

## Hill Start Control can not be activated

– with riding modes Pro<sup>OE</sup>



General warning light flashes yellow.



Stop symbol flashes briefly.

Possible cause:

The Hill Start Control can not be activated.

- Fold in side stand.
- » Hill Start Control only functions when the side stand is folded in.
- Start engine.
- » Hill Start Control only functions with the engine running.

### Gear not programmed

– with gearshift assistant Pro<sup>OE</sup>

**N** The gear indicator flashes.  
The gearshift assistant Pro has no function.

Possible cause:

- with gearshift assistant Pro<sup>OE</sup>  
The transmission sensor has not been programmed completely.
- Shift to idle **N** and let engine run at least 10 seconds while the motorcycle is stationary so that idle can be programmed in.

- Use clutch control to shift to all gears and drive at least 10 seconds in each gear.
  - » The gear indicator stops flashing when the transmission sensor has been programmed successfully.
- If the transmission sensor has been programmed completely, the Pro gearshift assistant will operate as described (►► 148).
- If the programming procedure is unsuccessful, have the fault eliminated at a specialist workshop, preferably an authorized BMW Motorrad retailer.

### Hazard warning lights system switched on



Left turn signal indicator light flashes green.



Right turn signal indicator light flashes green.

Possible cause:

The hazard warning lights system was switched on by the rider.

- Operating hazard warning flashers (►► 62).

### Service display



When a service date elapses without service, the general warning light lights up in yellow, appearing together with the date and mileage (kilometer reading) display.

If the service time is exceeded, a yellow Check Control message is displayed. In addition, the displays for service, a service appointment and the remaining distance are highlighted with exclamation points in the menu screens MY VEHICLE and SERVICE REQUIREMENTS.

 **NOTICE**

If the service display appears more than a month before the service date, the current day's date must be reset in the instrument cluster. This situation can occur if the battery was disconnected.◀

### Service due



is displayed in white.

Service due! Have BMW Motorrad Retailer perform service.

Possible cause:

Service is due because of the driving performance or the date.

- Have service performed regularly by a specialist workshop, preferably an authorized BMW Motorrad retailer.

- » The operating and road safety of the vehicle remains unchanged.
- » The best-possible value retention of the vehicle is ensured.

### Service date missed



General warning light lights up yellow.



is displayed in yellow.

Service overdue! Have BMW Motorrad Retailer perform service.

Possible cause:

Service is overdue because of the riding performance or the date.

- Have service performed regularly by a specialist workshop, preferably an authorized BMW Motorrad retailer.
- » The operating and road safety of the vehicle remains unchanged.

- » The best-possible value retention of the vehicle is ensured.

## Operation

Steering and ignition lock .....	54	Hill Start Control .....	77
Ignition with Keyless Ride .....	56	Anti-theft alarm (DWA) .....	79
Emergency on/off switch (kill switch) .....	60	Tire Pressure Monitor (TPM) .....	81
Lights .....	60	Heated grips .....	82
Hazard warning lights system .....	62	Onboard computer .....	82
Turn indicators .....	63	Rider and passenger seats .....	83
Antilock Brake System (ABS) .....	63		
Automatic Stability Control (ASC) .....	65		
Dynamic Traction Control (DTC) ....	66		
Electronic chassis and suspension adjustment (D-ESA) .....	68		
Riding mode .....	71		
PRO riding mode .....	73		
Cruise control .....	75		

## Steering and ignition lock

### Vehicle keys

You are provided with 2 ignition keys.

Should you lose your keys, refer to the information regarding the electronic immobilizer (EWS) (► 55).

A single key fits the steering and ignition lock, the fuel filler cap and the seat lock.

The cases and the topcase can also be ordered with locks for the same key on request. Please contact an authorized workshop for this purpose, preferably an authorized BMW Motorrad retailer.

### Locking handlebars

- Turn handlebars to left.

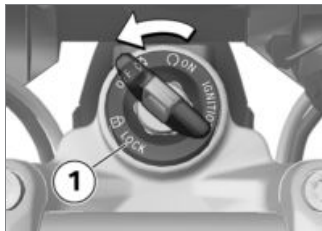

- Turn key to position **1** while moving handlebars slightly.
  - » Ignition, lights and all electrical circuits switched off.
  - » Handlebars are locked.
  - » Key can now be removed.

## Switching on ignition

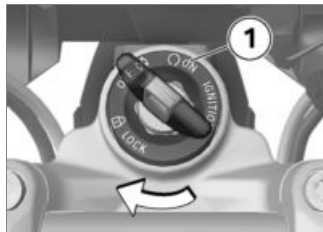

- Insert key into the steering and ignition lock. Turn key to position **1**.
  - » Parking lights and all function circuits are switched on.
  - » Pre-Ride-Check is carried out. (► 122)
  - » ABS self-diagnosis is performed. (► 122)
    - without riding modes Pro<sup>OE</sup>
  - » ASC self-diagnosis in progress. (► 123)◁
  - with riding modes Pro<sup>OE</sup>
    - » DTC self-diagnosis is performed. (► 124)◁



## Welcome light

- Switch on the ignition.
  - » The parking lamp briefly lights up.
  - with LED auxiliary headlight<sup>OA</sup>
  - » The supplementary LED headlights briefly light up.<

## Switch off ignition

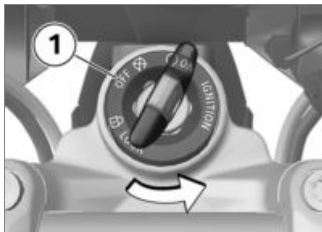

- Turn key to position **1**.
  - » After the ignition is switched off, the instrument cluster remains switched on for a short period of time and indicates possibly present fault codes.
  - » Handlebars not locked.

- » Electrically powered accessories remain operational for a limited period of time.
- » Battery can be recharged via onboard socket.
- » Key can now be removed.
- with LED auxiliary headlight<sup>OA</sup>
- The supplementary LED headlights switch off shortly after the ignition is switched off.<

## EWS Electronic immobilizer

The motorcycle's electronic circuitry monitors the data stored in the ignition key through a ring antenna incorporated in the steering and ignition lock. The engine management system does not enable engine starting until this key has been recognized as "authorized" for your motorcycle.

## NOTICE

A further key attached to the same ring as the ignition key used to start the engine could "irritate" the electronics, in which case the enabling signal for starting is not issued. Always store further vehicle keys separately from the ignition key.◀

If you lose one of your motorcycle keys, you can have it disabled by your authorized BMW motorcycle retailer.

When having a key disabled you should also bring all of the motorcycle's remaining keys with you. The engine can no longer be started using a disabled key; however, a disabled key can be enabled again.

Emergency and spare keys are only available through an authorized BMW Motorrad retailer. The keys are part of an inte-

grated security system, so the retailer is under an obligation to check the legitimacy of all applications for replacement/extra keys.

## Ignition with Keyless Ride

– with Keyless Ride<sup>OE</sup>

### Vehicle keys

#### NOTICE

The indicator light for the radio-operated key flashes as long as the radio-operated key is being searched for.

If the radio-operated key or the emergency key is detected, it goes out.

If the radio-operated key or the emergency key is not detected, it lights up briefly. ◀

You are provided with one radio-operated key and one emergency

key. Should you lose your keys, refer to the information regarding the electronic immobilizer (EWS) (▶▶ 55).

The ignition, tank filler cap and anti-theft alarm system are controlled with the radio-operated key. The seat lock, topcase and case can be operated manually.

#### NOTICE

When the range of the radio key is exceeded (e.g. in case or Topcase), the motorcycle cannot be started.

If the radio-operated key continues to be missing, the ignition is switched off after approx. 1.5 minutes to protect the battery charge.

It is advisable to carry the radio-operated key directly on your person (e.g. in a jacket pocket) and to also carry the emergency key as an alternative. ◀



Range of Keyless Ride radio-operated key

– with Keyless Ride<sup>OE</sup>

Approx. 3.3 ft (Approx. 1 m) ◀

## Locking handlebars Requirement

Handlebars are turned to the left. Radio-operated key is within reception range.



- Press and hold button **1**.
- » Steering lock audibly locks.
- » Ignition, lights and all electrical circuits switched off.

- To unlock the steering lock, briefly press button **1**.

## Switching on ignition Requirement

Radio-operated key is within reception range.

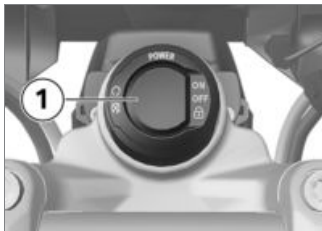

- The ignition can be activated in **two** ways.

### Version 1:

- Briefly press button **1**.
- » Parking light and all function circuits are switched on.

- with LED auxiliary headlight<sup>OA</sup>
  - » LED additional headlights are switched on.<
  - » Pre-Ride-Check is carried out. (➡ 122)
  - » ABS self-diagnosis is performed. (➡ 122)
- without riding modes Pro<sup>OE</sup>
  - » ASC self-diagnosis in progress. (➡ 123)<

### Version 2:

- Steering lock is locked, press and hold button **1**.
- » Steering lock is unlocked.
- » Parking lights and all function circuits switched on.
- » Pre-Ride-Check is carried out. (➡ 122)
- » ABS self-diagnosis is performed. (➡ 122)
- without riding modes Pro<sup>OE</sup>
  - » ASC self-diagnosis in progress. (➡ 123)<

## Switch off ignition

### Requirement

Radio-operated key is within reception range.

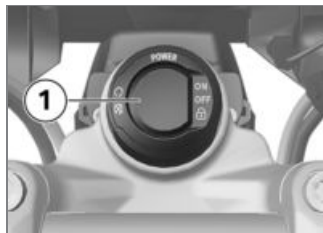

- The ignition can be deactivated in **two** ways.

### Version 1:

- Briefly press button **1**.
- » Light is switched off.
- » Handlebars are not locked.

### Version 2:

- Turn handlebars to left.
- Press and hold button **1**.
- » Light is switched off.
- » Steering lock is locked.

## EWS Electronic immobilizer

The motorcycle's electronic circuitry monitors the data stored in the radio-operated key through a ring antenna in the radio-operated lock. The engine management system does not enable engine starting until the radio-operated key has been recognized as "authorized" for your motorcycle.



### NOTICE

An additional key attached to the same ring as the radio-operated key used to start the engine could "irritate" the electronics, in which case the enabling signal for starting is not issued.

Always store further vehicle keys separately from the radio-operated key. ◀

If you lose a radio-operated key, you can have it disabled by your authorized BMW Motorrad retailer. When having a key disabled you should also bring all of the motorcycle's remaining keys with you.

The engine can no longer be started using a disabled radio-operated key; however, a disabled radio-operated key can be enabled again.

Emergency and spare keys are only available through an authorized BMW Motorrad retailer. As the radio-operated keys are part of an integrated security system, the retailer is under an obligation to check your legitimacy.

## Battery of the key fob transmitter is empty or the key fob transmitter is lost

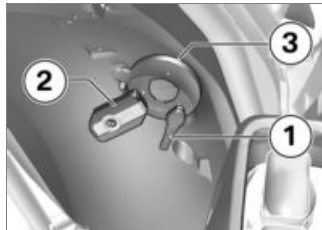

- Should you lose your keys, refer to the information regarding the electronic immobilizer (**EWS**).
- Should you lose the radio-operated key while driving, the motorcycle can be started by using the emergency key.
- If the battery of the key fob transmitter is empty, the vehicle can be started by touching

the rear wheel cover with the key fob transmitter.

- Hold the emergency key **1** or the empty key fob transmitter **2** against the rear wheel cover at the height of the antenna **3**.

## NOTICE

The emergency key or the drained radio-operated key must **contact** the rear wheel cover. ◀

 Period in which the engine must be started. Then unlocking must be repeated.

30 s

- » Pre-Ride-Check is carried out.
- Key has been detected.
- Engine can be started.
- Starting engine (➡ 121).

## Replacing the battery of the key fob transmitter

If the key fob transmitter fails to react when the button is pressed briefly or is pressed and held:

- The battery of the key fob transmitter no longer has its full charging capacity.



Remote key battery low. Limited central locking function. Change battery.

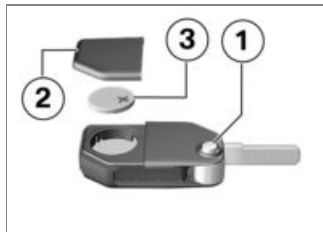

- Press button **1**.
- » Key bit folds open.
- Press battery cover **2** upward.

- Remove battery **3**.
- Dispose of the old battery in accordance with legal regulations. Do not dispose of the battery in the household waste.



## ATTENTION

### Unsuitable or improperly inserted batteries

Component damage

- Use a battery compliant with the manufacturer's specifications.
- When inserting the battery, make sure that the polarity is correct. ◀
- Insert the new battery with the positive terminal up.



Battery type

for Keyless Ride radio-operated key

CR 2032

- Install battery cover **2**.
- » Red LED in instrument panel flashes.
- » The key fob transmitter is working again.

## Emergency on/off switch (kill switch)



- 1** Emergency on/off switch (kill switch)



### WARNING

#### Operation of the emergency ON/OFF switch when riding

Danger of falling due to blocking of rear wheel

- Do not operate the emergency ON/OFF switch when riding. ◀

The engine can be switched off easily and quickly using the emergency on/off switch.

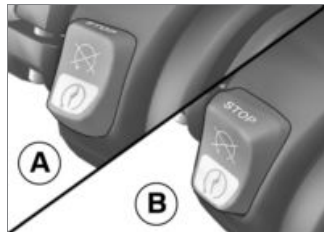

- A** Engine switched off  
**B** Operating position

## Lights

### Low-beam headlight and parking lights

The parking lights come on automatically when the ignition is switched on.

## NOTICE

The parking lights are a strain on the battery. Do not leave the ignition switched on longer than absolutely necessary. ◀

The low-beam headlight switches on automatically when the engine is started.

## High beam and headlight flasher

- Switching on ignition (▶▶▶ 54).



- Press switch **1** toward front to switch on high beam.

- Pull switch **1** toward rear to actuate headlight flasher.

## Headlight courtesy delay feature

- Turn off ignition.



- Immediately after turning off the ignition, pull switch **1** back and hold until the headlight courtesy delay feature turns on.
  - » The vehicle lights light up for one minute and then turn off automatically.
- This can be used after parking the vehicle in order to illu-

minate the path to the house door, for instance.

## Parking lights

- Switch off ignition (▶▶▶ 55).



- Immediately after switching off the ignition, push button **1** to left and hold it until the parking lamps come on.
- Switch ignition on and then off again to switch off parking light.

## Additional headlight

– with LED auxiliary headlight<sup>OA</sup>

### Requirement

The auxiliary headlights are only active if the low-beam headlight is active.

#### NOTICE

The auxiliary headlights are approved for use as fog lights and may only be used in poor weather conditions. Comply with the country-specific road traffic regulations. ◀

- Starting engine (▶▶▶ 121).



- Press button **1** to turn on the additional headlight.



The indicator light for the additional headlight lights up.

- Press button **1** again to turn off the additional headlight.

## Hazard warning lights system

### Operating hazard warning flashers

- Switching on ignition (▶▶▶ 54).

#### NOTICE

The hazard warning flashers place a strain on the battery. Do not use the hazard warning flashers for longer than absolutely necessary. ◀



- Press button **1** to switch on the hazard warning lights system.
- » Ignition can be switched off.
- To switch off the hazard warning lights system, switch on the ignition, as required, and press button **1** once again.



## Turn indicators

### Operating turn signals

- Switching on ignition (☞ 54).



- Press button **1** to left to switch on left-side turn signals.
- Press button **1** to right to switch on right-side turn signals.
- Move button **1** to center position to switch off turn signals.



Turn indicator cancellation

The turn indicators automatically switch off when the defined riding time and distance have been reached.

## Antilock Brake System (ABS)

### Deactivating ABS function

- Switching on ignition (☞ 54).



#### NOTICE

The ABS function can also be deactivated while driving.◀



- Press and hold button **1** until the ABS indicator and warning light changes its display behavior.

Once the button **1** has been pressed, the current ASC/DTC system status and ABS system status ON are displayed.

» First, the ASC indicator and warning light changes its behavior. Press and hold button **1** until the ABS indicator and warning light reacts. In this case, the ASC/DTC setting does not change.

 ABS indicator light lights up.

Possible ABS system status **OFF!** is displayed.



- Release button **1** after changeover of the ABS system status.

ASC/DTC system status remains unchanged and a new ABS system status **OFF!** is displayed briefly.

 ABS indicator light continues to be lit up.

- » The ABS function is switched off.
- » The integral function remains active.
  - with riding modes Pro<sup>OE</sup>
- » The function of the Hill Start Control remains active.<
- More detailed information on BMW Motorrad Integral ABS brake systems can be found

in the "Technology in detail" chapter:

- » Partially integral brake (  138)
  - with riding modes Pro<sup>OE</sup>
- » Function of the Hill Start Control (  149) <

### Switch on ABS function



- Press and hold button **1** until the ABS indicator and warning light changes its display behavior.

Once the button **1** has been pressed, the current ASC/DTC system status and ABS system status **OFF!** are displayed.

 ABS indicator light goes out, and starts to flash if self-diagnosis has not been completed.

Possible ABS system status **ON** is displayed.

- Release button **1** after changeover of the ABS system status.

 ABS indicator light remains off or continues to flash.

ASC/DTC system status remains unchanged and a new ABS system status **ON** is displayed briefly.

- » The ABS function is switched on.
- As an alternative, the ignition can also be turned off and then on again.



If the ABS indicator and warning light lights up after switching the ignition off and on and then continuing driving above the minimum speed, an ABS fault has occurred.

min 6 mph (min 10 km/h)

- with riding modes Pro<sup>OE</sup>
- If the coding plug is not installed, the ignition can also be turned off and then on again as an alternative.◀

## Automatic Stability Control (ASC)

### Deactivating ASC function

- without riding modes Pro<sup>OE</sup>
- Switching on ignition (▮▶ 54).



### NOTICE

The ASC function can also be deactivated while driving.◀◀



- Press and hold button **1** until the ASC indicator and warning light changes its display behavior.

Once the button **1** has been pressed, the ASC system status ON and current ABS system status are displayed.



ASC indicator and warning light lights up.

Possible ABS system status OFF! is displayed.

- Release button **1** after changeover of the ASC system status.

The new ASC system status OFF! is displayed briefly. The ABS system status remains unchanged.



ASC indicator and warning light continues to be lit up.

- » The ASC function is switched off.

### Activating ASC function

- without riding modes Pro<sup>OE</sup>



- Press and hold button **1** until the ASC indicator and warning

light changes its display behavior.

Once the button **1** has been pressed, the ASC system status OFF! and current ABS system status are displayed.



ASC indicator and warning light is no longer lit; if self-diagnosis is incomplete, it begins flashing.

Possible ABS system status ON is displayed.

- Release button **1** after changeover of the status.



ASC indicator and warning light remains off or continues flashing.

The new ASC system status ON is displayed briefly. The ABS system status remains unchanged.

- » The ASC function is switched on.
- If the coding plug is not installed, the ignition can also be switched off and then on again as an alternative.



## NOTICE

More detailed information on the BMW Motorrad Automatic Stability Control (ASC) system can be found in the section "Technology in detail".◀



If the ASC indicator and warning light lights up after switching the ignition off and on and then continuing driving with the following minimum speed, a ASC fault has occurred.

min 3 mph (min 5 km/h)

- More detailed information on the Automatic Stability Control

can be found in the "Technology in detail" chapter:

- » How does ASC work? (▶▶▶ 141)

## Dynamic Traction Control (DTC)

– with riding modes Pro<sup>OE</sup>

### Deactivating DTC

- Switch on the ignition.



## NOTICE

The DTC function can also be deactivated while driving.◀



ABS system status remains unchanged.

 DTC indicator and warning light remains on.

» The DTC function is switched off.

### Switching on DTC



• Press and hold button **1** until the DTC indicator light changes its behavior.

Once the button **1** has been pressed, the DTC system status **OFF!** and current ABS system status are displayed.

 DTC indicator and warning light goes out; if self-diagnosis has not been completed, it begins to flash.

Possible DTC system status **ON** is displayed.

• Release button **1** after changeover of the status.

 DTC indicator light remains off or continues to flash.

The new DTC system status **ON** is displayed briefly. The ABS system status remains unchanged.

» The DTC function is switched on.

• If the coding plug is not installed, the ignition can also be switched off and then on again as an alternative.

- Press and hold button **1** until the DTC indicator light changes its behavior.

Once the button **1** has been pressed, the DTC system status **ON** and current ABS system status are displayed.

 DTC indicator and warning light lights up.

Possible DTC system status **OFF!** is displayed.

- Release button **1** after changeover of the status. The new DTC system status **OFF!** is displayed briefly. The

 If the DTC indicator light lights up after switching the ignition off and on and then continuing to ride at the following minimum speed, a DTC fault has occurred.

min 3 mph (min 5 km/h)

- More detailed information on the Dynamic Traction Control can be found in the "Technology in detail" chapter:
- » How does Traction Control function? (➡ 142)

## Electronic chassis and suspension adjustment (D-ESA)

– with Dynamic ESA<sup>OE</sup>

### Dynamic ESA adjustment options

The electronic chassis and suspension adjustment Dynamic ESA can automatically adapt your motorcycle to the load. If the spring preload is set to **Auto**, the rider does not need to worry about the load setting. More detailed information on Dynamic ESA can be found in the "Technology in detail" (➡ 143) chapter.

### Available damping modes

- For roads: Road and Dyna.
- For off-road: Enduro

### Available load settings

- Fixed, minimum spring preload: Min
- Active riding position compensation with automatic adjustment of the spring preload: Auto

- Fixed, maximum spring preload: Max

### Display suspension setting

- Switching on ignition (➡ 54).



- Press button **1** briefly to display current setting.

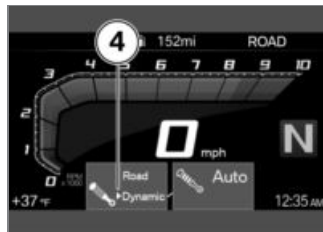
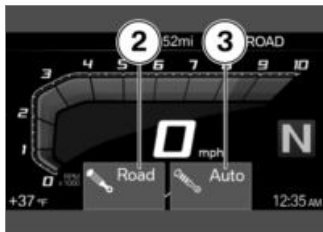

Once the button **1** has been pressed, the chassis and suspension adjustment for damping **2** and spring preload **3** are displayed.

» The display automatically disappears again after a short time.

## Setting suspension compliance

- Switching on ignition (➡ 54).

- Press button **1** briefly to display current setting.
- To set the damping rate:
- Repeatedly press button **1** briefly until the desired setting is displayed.

### NOTICE

The damping cannot be adjusted while the motorcycle is being ridden.◀

The selection arrow **4** is displayed.

» The selection arrow **4** goes away after the changeover of the status.

The following settings are available:

- **Road**: damping for comfortable riding on roads
- **Dyna.**: damping for dynamic riding on roads
- **Enduro**: damping for off-road riding. Only available in the **ENDURO** or **ENDURO PRO** riding

modes and cannot be adjusted further in these riding modes.

The following message is displayed if no setting is possible in the selected riding mode. Example: In **ENDURO** riding mode damping not adjusted.



To set the spring preload:

- Starting engine (121).
- Repeatedly press and hold button **1** until the desired setting is displayed.



## NOTICE

BMW Motorrad recommends using the **Max** setting for off-road operation and the **Min** setting for a better seat-to-ground height.◀



## NOTICE

The settings **Min**, **Auto** and **Max** can only be selected while stationary.◀

The following message is displayed if no setting is possible: **Loading adjust. only avail. when halted.**

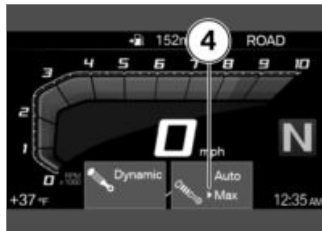

The selection arrow **4** is displayed.

» The selection arrow **4** goes away after the changeover of the status.

The following settings are available:

- **Min**: minimum spring preload
- **Auto**: automatic adjustment of the spring preload
- **Max**: maximum spring preload

» If the button **1** is not pressed for an extended period, the damping action and the spring



preload will be adjusted to the displayed settings.

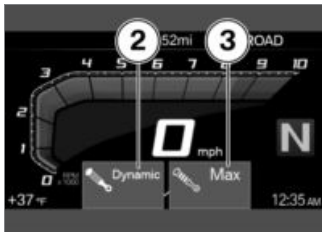

The new chassis and suspension adjustments for damping **2** and spring preload **3** are displayed briefly.

- At very low temperatures, unload the motorcycles before increasing the spring preload, and have the passenger dismount if necessary.
- » The chassis and suspension adjustment display goes away once the adjustment procedure has been completed.

» In the loading mode `Auto`, the spring preload is only adjusted after riding off.

## Riding mode

### Use of the riding modes

BMW Motorrad has developed riding scenarios for your motorcycle from which you can select the one matching your situation:

#### Series

- RAIN: riding on wet roads.
- ROAD: riding on dry roads.

– with riding modes Pro<sup>OE</sup>

#### With riding mode Pro

- DYNAMIC: dynamic riding on dry roads.
- ENDURO: off-road riding with road tires.

#### With riding mode Pro and installed coding plug

- DYNAMIC PRO: Dynamic riding on dry roads taking into

account settings made by the rider.

- ENDURO PRO: Off-road riding with knobby off-road tires taking into account settings made by the rider.

With the coding plug installed, the riding modes `DYNAMIC PRO` and `ENDURO PRO` replace the riding modes `DYNAMIC` and `ENDURO`.

For each of these scenarios, the optimum interaction between throttle response, ABS control and ASC/DTC control is provided.

– with Dynamic ESA<sup>OE</sup>

The chassis and suspension adjustments can also be adapted in the selected scenario.

More detailed information about the riding modes can be found in the "Technology in detail" (➡ 144) chapter.

## Select riding mode

- Switching on ignition (➡ 54).



- Press button **1**.



The active riding mode **2** moves into the background and the first selectable riding mode **3** is dis-

played. The guide **4** shows how many riding modes are available.



## ATTENTION

### Turning on off-road mode (Enduro and Enduro Pro) when in road mode

Risk of falling due to unstable riding conditions when braking or accelerating in the ABS or ASC/DTC control range

- Switch off-road mode (Enduro and Enduro Pro) during off-road riding on only.◀

- Press button **1** repeatedly until desired riding mode is shown.

## NOTICE

When selecting the **ENDURO PRO** mode: keep in mind that the ABS control for the rear wheel is deactivated.◀

The following riding modes can be selected:

- **RAIN**: for riding on wet roads.
- **ROAD**: for riding on dry roads.

– with riding modes **Pro<sup>OE</sup>**

The following riding modes can also be selected:

- **DYNAMIC**: for dynamic riding on dry roads.
- **ENDURO**: for riding off-road with road tires.<

– with riding modes **Pro<sup>OE</sup>**

With the coding plug installed, the riding modes **ENDURO PRO** and **DYNAMIC PRO** replace

the riding modes **ENDURO** and **DYNAMIC**.

- **DYNAMIC PRO**: For dynamic riding on dry roadways while taking into account the settings made by the rider.
- **ENDURO PRO**: For riding off road with off-road tires with large tread blocks while taking into account the settings made by the rider.<

- » When the motorcycle is stationary, the selected riding mode is activated after approx. 2 seconds.
- » The new riding mode is activated during operation under the following conditions:
  - Throttle grip is in idle position.
  - Brake is not engaged.
- » The riding mode selected and its associated engine-characteristic, ABS, ASC / DTC and Dynamic ESA settings are re-

tained even after the ignition has been switched off.

## PRO riding mode

– with riding modes Pro<sup>OE</sup>

### Adjustment option

The PRO riding modes can be set individually.

### Setting up PRO riding mode

- Install coding plug (➡ 74).
- Switching on ignition (➡ 54).
- Call up the **Settings, Vehicle settings** menu.
  - » The following PRO riding modes can be adapted:
    - **ENDURO PRO** riding mode
    - **DYNAMIC PRO** riding mode
- Select and confirm riding mode.

## Setting up Enduro Pro

- with riding modes Pro<sup>OE</sup>
- Setting up PRO riding mode (➡ 73).



The **Engine** system has been selected. The current setting is displayed as a diagram **1** with explanatory texts relating to the system **2**.

- Select system and confirm.



The possible settings **3** and the relevant explanations **4** can be browsed.

- Setting up system.
  - » The Engine, DTC and ABS systems can be set up in the same way.
- The settings can be reset to the factory settings:
- Resetting riding mode settings (▣▣▣▣ 74).

### Setting up Dynamic Pro

- Setting up PRO riding mode (▣▣▣▣ 73).
- Setting up systems as for ENDURO PRO riding mode.



### NOTICE

ABS can only be set in the Enduro PRO riding mode.◀

### Resetting riding mode settings

- Setting up PRO riding mode (▣▣▣▣ 73).
- Select *Reset* and confirm.
  - » The following factory settings apply for ENDURO PRO RIDING MODE:
    - DTC: Enduro Pro
    - ABS: Enduro Pro
    - ENGINE: Road
  - » The following factory settings apply for DYNAMIC PRO RIDING MODE:
    - DTC: Dynamic
    - ENGINE: Dynamic

### Install coding plug

- Switch off ignition (▣▣▣▣ 55).

- Remove rider's seat (▣▣▣▣ 84).



### ATTENTION

#### Penetration of dirt and moisture in the open connector

Malfunctions

- After removing the encoding plug, refit the cover cap.◀
- Remove protective cap **1** of the plug connection .



- To do so, press locking mechanism **1** and pull cap off.
- Install coding plug.
- Switch on the ignition.



The symbol for the coding plug **1** is displayed. The riding modes **ENDURO PRO** and

**DYNAMIC PRO** can be selected and replace the riding modes **ENDURO** and **DYNAMIC**.

- Installing rider's seat (➔ 85).

## Cruise control

– with cruise control<sup>OE</sup>

### Display while adjusting (road sign detection not active)

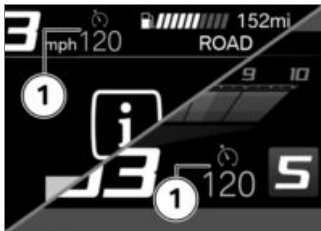

The symbol **1** for the cruise control is displayed in the Pure Ride view and in the upper status line.

### Display while adjusting (road sign detection active)



The symbol **1** for the cruise control is displayed in the Pure Ride view and in the upper status line.

### Turning cruise control on Requirement

The cruise control is only available after switching from the **Enduro** or **Enduro Pro** riding modes.

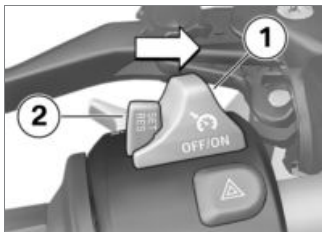

- Move switch **1** to the right.
- » Button **2** is operable.

### Store speed

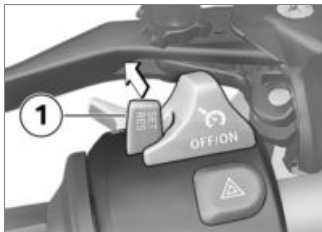

- Briefly press button **1** forward.

	Adjustment range of the cruise control (gear-dependent)
	12...130 mph (20...210 km/h)

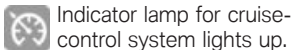

Indicator lamp for cruise-control system lights up.

- » The motorcycle maintains your current cruising speed and the setting is saved.

### Accelerating

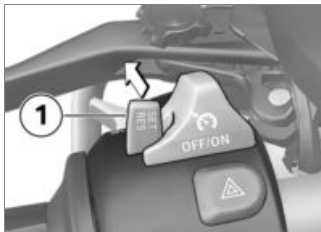

- Briefly press button **1** forward.

- » Speed is increased by 1.2 mph (2 km/h) each time the button is pressed.

- Press button **1** forward and hold.
- » The motorcycle accelerates steplessly.
- » If button **1** is no longer pressed, the speed reached is maintained and saved.

### Decreasing speed

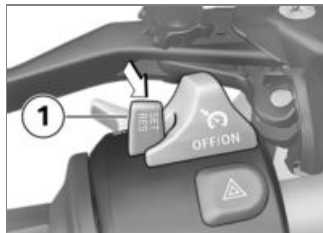

- Briefly press button **1** backward.
- » Speed is reduced by 1.2 mph (2 km/h) each time the button is pressed.

- Press button **1** back and hold.
  - » The motorcycle decelerates steplessly.
  - » If the button **1** is no longer pressed, the speed achieved is maintained and saved.

## Deactivate cruise control

- Actuate brakes, clutch or throttle grip (take back throttle beyond back position) to deactivate cruise-control system.
  - » Cruise control indicator lamp goes out.

## Resume former cruising speed

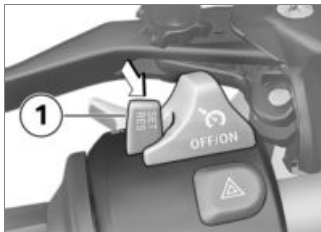

- Briefly push button **1** back to return to the speed saved beforehand.



### NOTICE

Opening the throttle does not deactivate the cruise-control system. If you release the throttle grip, the motorcycle will decelerate only to the cruising speed saved in memory, even though you might have intended slowing to a lower speed.◀



Indicator lamp for cruise-control system lights up.

## Switch off cruise-control system

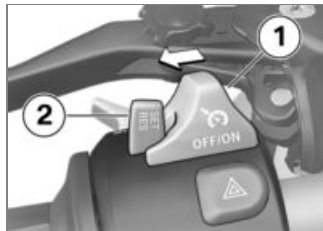

- Push switch **1** to left.
  - » The system is deactivated.
  - » Button **2** is locked.

## Hill Start Control

– with riding modes Pro<sup>OE</sup>

## Display

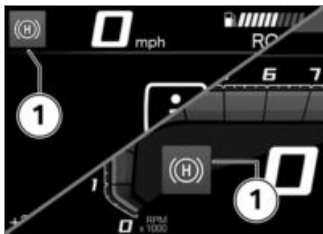

The symbol **1** for the drive-off assistant is displayed in the Pure Ride view and in the upper status line.

### Using Hill Start Control Requirement

The motorcycle is stopped.



#### ATTENTION

**Switching off the engine or ignition, folding out the side stand, timeout (approx. 20**

### minutes) or in the event of a fault

Hill Start Control brake failure

- It is imperative to secure the motorcycle by manual braking.◀



#### NOTICE

Hill Start Control is only a convenience system for easier hill-starting and should, therefore, not be confused with a parking brake.◀

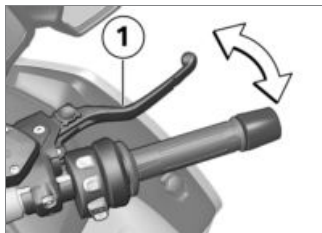

- Apply brake lever **1** firmly and then quickly release again.



Stop symbol is displayed.

- » Hill Start Control is activated.
- To switch off the Hill Start Control, actuate the parking brake lever **1** again.



Stop symbol disappears.

- Alternatively, drive off in 1st or 2nd gear.



#### NOTICE

Hill Start Control is automatically deactivated when driving off.◀



General warning light flashes yellow.



Stop symbol flashes briefly.



The stop symbol disappears after the brakes have been released completely.



- » Hill Start Control is turned off.
- More detailed information on Hill Start Control can be found in the "Technology in detail" chapter:
- » Function of the Hill Start Control (➡ 149)

## Anti-theft alarm (DWA)

### Activation

– with anti-theft alarm system (DWA)<sup>OE</sup>

- Switching on ignition (➡ 54).
- Anti-theft alarm system settings (➡ 81).
- Turn off ignition.
- » If DWA is activated, DWA is automatically activated after the ignition is switched off.
- » Activation takes approximately 30 seconds to complete.
- » Turn indicators are illuminated twice.

- » Confirmation tone sounds twice (if programmed).
- » The anti-theft alarm system is active.
- with Keyless Ride<sup>OE</sup>

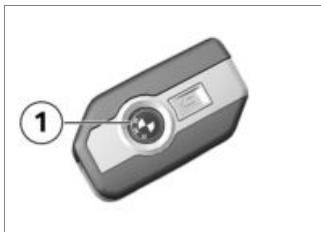

- Turn off ignition.
- Press button **1** on the radio-operated key twice.
- » Activation takes approximately 30 seconds to complete.
- » Turn indicators are illuminated twice.
- » Confirmation tone sounds twice (if programmed).

- » The anti-theft alarm system is active.

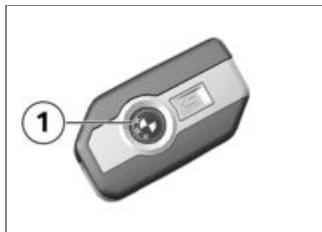

- To deactivate the movement sensor (for example if you are about to transport the motorcycle on a train and the swaying movement of the moving train could trip the alarm), press button **1** on the radio-operated key during the activation phase.
- » Turn signals are illuminated three times.
- » Confirmation tone sounds three times (if programmed).
- » Movement sensor is deactivated.

## Alarm signal

- with anti-theft alarm system (DWA)<sup>OE</sup>

The DWA alarm can be set off by:

- Motion sensor
- Switch-on attempt with an unauthorized ignition key.
- Disconnecting the DWA from the motorcycle battery (DWA battery takes over the power supply – alarm sound only, hazard warning lights do not flash)

If the DWA battery is discharged all functions remain operational; the only difference is that the alarm cannot be set off if the system is disconnected from the motorcycle battery.

The duration of the alarm is approx. 26 seconds. During the alarm, an alarm tone sounds and the turn indicators flash. The type of alarm sound can be set

by an authorized BMW Motorrad retailer.

- with Keyless Ride<sup>OE</sup>

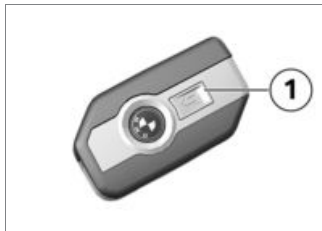

A triggered alarm can be canceled at any time by pressing the button **1** on the radio-operated key without deactivating the DWA.

If an alarm was triggered while the motorcycle was unattended, the rider is notified accordingly by an alarm tone sounding once when the ignition is switched on. The DWA LED then signals

the reason for the alarm for one minute.

### Light signals on DWA LED:

- 1 flash: motion sensor 1
- 2 flashes: motion sensor 2
- 3 flashes: ignition turned on with unauthorized ignition key
- 4 flashes: alarm system disconnected from vehicle battery
- 5 flashes: motion sensor 3

### Deactivation

- with anti-theft alarm system (DWA)<sup>OE</sup>
  - Emergency on/off switch (kill switch) in normal operating position.
  - Switch on the ignition.
    - » Turn indicators light up once.
    - » Confirmation tone sounds once (if programmed).
    - » DWA is switched off.

– with Keyless Ride<sup>OE</sup>

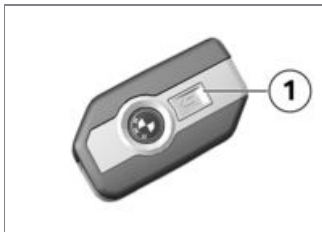

- Press button **1** on the radio-operated key once.

#### **NOTICE**

If the alarm function is deactivated by means of the remote control and the ignition then not switched on, the alarm function is automatically reactivated after 30 seconds if "Activation after ignition off" has been programmed.◀

- » Turn indicators light up once.
- » Confirmation tone sounds once (if programmed).

» DWA is switched off.

### **Anti-theft alarm system settings**

- Switching on ignition (▮▮▮ 54).
- Call up menu **Settings, Vehicle settings, Alarm system**.
  - » The following settings are available:
    - Adapt warning signal
    - Switch **Tilt sensor** on and off
    - Switch **Arming tone** on and off
    - Switch **Arm automatically** on and off
    - » Adjustment options (▮▮▮ 81)

### **Adjustment options**

**Warning signal:** set the alarm tone to be rising and falling, or intermittent.

**Tilt sensor:** activate the tilt sensor to monitor the inclination of the vehicle. The anti-theft

alarm system reacts, for example, in the event of attempted wheel theft or towing away.

#### **NOTICE**

When transporting the vehicle, deactivate the tilt sensor to prevent the anti-theft alarm system from activating.◀

**Arming tone:** confirmation alarm tone after activation/deactivation of the DWA in addition to the turn signals lighting up.  
**Arm automatically:** automatic activation of the alarm function when the ignition is switched off.

### **Tire Pressure Monitor (TPM)**

– with riding modes Pro<sup>OE</sup>

## Switching the minimum pressure warning on or off

- The minimum pressure of the tires can be freely selected. When the minimum pressure is reached, a minimum pressure warning can be displayed.
- Call up menu *Settings, Vehicle settings, RDC*.
- Switch *Min. pressure warning* on or off.

## Heated grips

– with heated grips<sup>OE</sup>

## Operating heated grips

### NOTICE

The heated grips option can only be activated when the engine is running. ◀

### NOTICE

The increase in power consumption caused by the heated grips can drain the battery if you are riding at low engine speeds. If the battery is inadequately charged, the heated grips are switched off to ensure starting capability. ◀

- Starting engine (▶▶▶ 121).

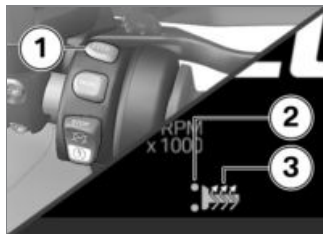

- Press the button **1** repeatedly until the desired heating level **2** is shown in front of the heated grip symbol **3**.

The handlebar grips can be heated at two different levels.



50 % heating output



100 % heating output

- » The 2nd heating level is used for fast heat-up of the grips; then the switch should be switched back to the 1st level.
- » If no further changes are made the selected heating level is adopted as the setting.
- To switch off the heated grips, press the button **1** repeatedly until the heated grip symbol **3** goes out.

## Onboard computer

### Calling up the onboard computer

- Call up menu *My vehicle*.

- Scroll to the right until the ONBOARD COMPUTER menu screen is displayed.

## Resetting the onboard computer

- Calling up the onboard computer (▣▣▣ 82).
- Press MENU rocker button down.
- Select `Reset all values` or `Reset individual values` and confirm.

The following values can be individually reset:

- Break
- Journey
- Current
- ∅ Speed
- ∅ Consump.

## Calling up the travel onboard computer

- Calling up the onboard computer (▣▣▣ 82).

- Scroll to the right until the TRIP COMPUTER menu screen is displayed.

## Resetting the travel onboard computer

- Calling up the travel onboard computer (▣▣▣ 83).
- Press MENU rocker button down.
- Select `Automatic reset` or `Reset everything` and confirm.

## Rider and passenger seats

### Remove passenger seat

- Park motorcycle, ensuring that support surface is firm and level.



- Turn seat lock **1** to the right with ignition key and hold while pressing passenger seat downward in rear area **2** to support unlocking.
- Lift passenger seat at front and release key.
- Take off passenger seat and place on a clean surface with upholstered side facing downward.

### Install passenger seat



**ATTENTION**

**Damage to components**

Damage to sensors, for example, with the resultant malfunctions

- Do not carry along any objects under the rider's or passenger's seat.
- Secure vehicle tools. ◀

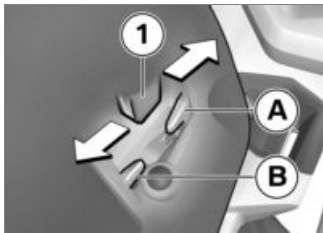

- Take adjustment direction of passenger seat into account depending on position of rider's seat.
- Passenger seat can be adjusted to 2 different seat positions.
- Insert passenger seat in mount with both lugs **1** centered.

- Rear seat position: push passenger seat toward rear **A**.
- Front seat position: push passenger seat toward front **B**.
- » Lugs **1** of passenger seat are correctly fixed in place.



- Firmly press down passenger seat **1** at front.
- » Passenger seat clicks audibly into place.

### Remove rider's seat

- Remove passenger seat (▮▮▮ 83).

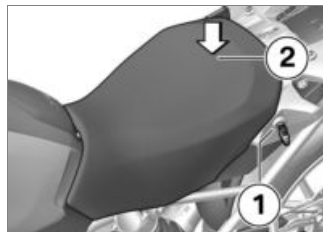

- Turn seat lock **1** to the left with ignition key and hold while pushing rider's seat downward in rear area **2** to support unlocking.
- Lift the rider's seat and release the key.
- Take off the rider's seat and place on a clean surface with the upholstered side facing down.

### Adjusting the rider's seat height and inclination

- Remove rider's seat (▮▮▮ 84).

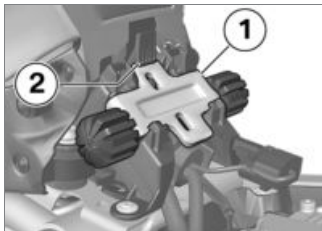

- In order to remove the front height adjustment **1**, push locking mechanism **2** forwards to remove the height adjustment upwards.

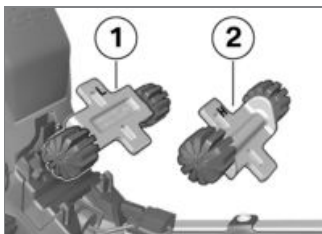

- In order to adjust the low seat position, install the front height

adjustment in orientation **1** (identification L).

- In order to adjust the high seat position, install the front height adjustment in orientation **2** (identification H).

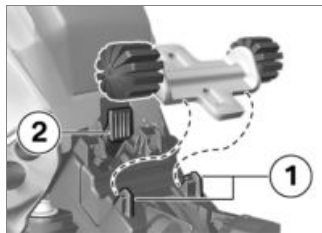

- First, slide the front height adjustment under mounts **1**. Then press locking mechanism **2**, until it engages.

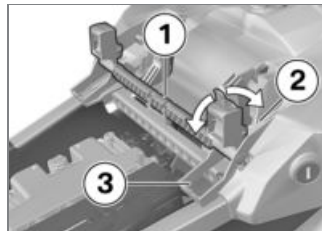

- In order to adjust the low seat position, swivel rear height adjustment **1** into position **3** (identification L).
- In order to adjust the high seat position, swivel rear height adjustment **1** into position **2** (identification H).

If seat tilt should be changed:

- Position the front and rear height adjustment differently.

### Installing rider's seat

- Remove passenger seat (➡ 83).

- Adjusting the rider's seat height and inclination (▮▮▮ 84).

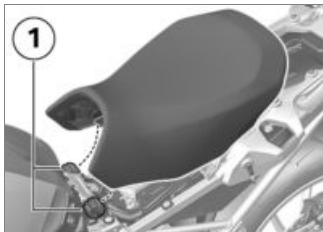

- Insert the rider's seat into the fixtures **1** on the left and right and place loosely on the motorcycle.
- Press rider's seat forward slightly in the rear area and then press down firmly until the locking mechanism engages.



## **TFT display**

General notes.....	88
Principle .....	89
Pure Ride view.....	95
General settings .....	97
Bluetooth .....	98
My Vehicle.....	102
Navigation .....	105
Media.....	107
Phone .....	107
Switching GPS synchronization on or off.....	108
Displaying the software version ....	108
Displaying license information.....	108

## General notes

### Warnings



#### WARNING

#### Operation of a smartphone while riding or with the engine running

Accident hazard

- Observe the relevant road traffic regulations.
- Do not use while riding (except for applications without operation such as telephony via the hands-free system).◀



#### WARNING

#### Distraction from traffic conditions and loss of control

Risk of accident through the use of integrated information systems and communication devices during the journey

- Operate these systems or devices only if the traffic situation allows.
- If necessary, stop and operate the system or devices at a standstill.◀

### Connectivity functions

Connectivity functions include media, telephony and navigation. Connectivity functions can be used if the TFT display is connected with a mobile end device and a helmet (►► 99). You can find more information about the Connectivity functions at: [bmw-motorrad.com/connectivity](http://bmw-motorrad.com/connectivity)



#### NOTICE

If the fuel tank is between the mobile end device and the TFT display, the Bluetooth connection may be restricted. BMW Motorrad recommends

storing the mobile end device above the fuel tank (e.g. in the jacket pocket).◀



#### NOTICE

Depending on the mobile end device, the scope of the Connectivity functions may be limited.◀

### BMW Motorrad Connected App

With the BMW Motorrad Connected App, you can call up information about the vehicle and usage. To use some features such as navigation, the app must be installed on the mobile end device and be connected to the TFT display. The app starts the route guidance and adapts the navigation.



## NOTICE

On some mobile devices, e.g. with operating system iOS, the BMW Motorrad Connected App must be called up before using. ◀

### Notice concerning current status

After the editorial deadline, there may be updates to the TFT display. For this reason, some aspects of your motorcycle may vary from the descriptions in this Rider's Manual. Updated information at: [bmw-motorrad.com](http://bmw-motorrad.com)

## Principle Operating elements

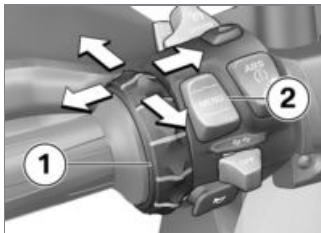

All contents of the display are controlled by the Multi-Controller **1** and the rocker button MENU **2**.

The following functions are possible depending on the context.

### Functions of the Multi-Controller

#### Turn the Multi-Controller up:

- Move cursor up in lists.
- Make settings.
- Increase volume.

#### Turn the Multi-Controller down:

- Move cursor down in lists.
- Make settings.
- Reduce volume.

#### Tilt Multi-Controller to the left:

- Activate the function according to the operating feedback.
- Activate function to the left or back.
- After settings, return to menu view.
- In the menu view: move up one hierarchy level.
- In the My Vehicle menu: leaf to the next menu sheet.

#### Tilt Multi-Controller to the right:

- Activate the function according to the operating feedback.
- Confirm selection.
- Confirm settings.
- Leaf to the next menu step.

- Scroll to right in lists.
- In the My Vehicle menu: leaf to the next menu sheet.

## Rocker button MENU functions

### NOTICE

Instructions given by the navigation system are displayed as a dialog if the **Navigation** menu is not called up. The operation of the rocker button MENU is temporarily restricted.◀

### Briefly press the MENU up:

- In the menu view: move up one hierarchy level.
- In the Pure Ride view: change display for rider info status line.

### MENU long press up:

- In the menu view: open Pure Ride view.

- In the Pure Ride view: change the operating focus to the navigator.

### MENU short press down:

- Change a hierarchy level down.
- No function when lowest hierarchy level is reached.

### MENU long press down:

- Return to the last menu, after a menu change has been previously carried out by long press of the rocker button MENU at the top.

## Operating instructions in the main menu

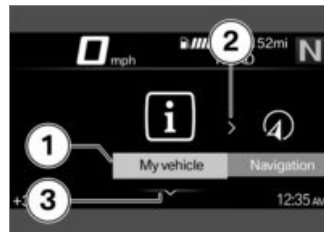

The operating instructions indicate whether and which interactions are possible.

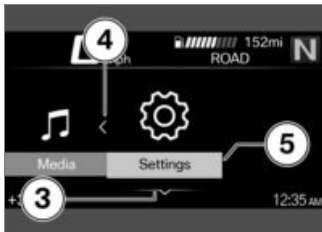

## Operating instructions in submenus

In addition to the operating instructions in the main menu, there are additional operating instructions in submenus.

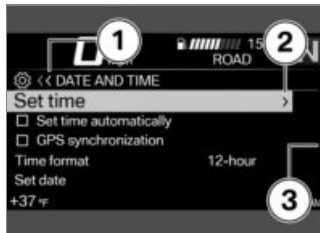

## Meaning of the operating instructions:

- Operating instruction **1**: the left end has been reached.
- Operating instruction **2**: you can leaf to the right.
- Operating instruction **3**: you can leaf down.

## Meaning of the operating instructions:

- Operating instruction **1**: the left end has been reached.
- Operating instruction **2**: you can leaf to the right.
- Operating instruction **3**: you can leaf down.
- Operating instruction **4**: you can leaf to the left.
- Operating instruction **5**: the right end has been reached.

whether it is possible to return to the top.

- Operating instruction **2**: another submenu level can be called up.
- Operating instruction **3**: there are more entries than can be displayed.

## Show Pure Ride view

- Rocker button MENU long press up.

## Switching functions on and off



Some items are preceded by a box. The box indicates whether the function is switched on or off. Action symbols after the menu items illustrate what is switched by briefly tilting the Multi-Controller to the right.

### Examples for switching on and off:

- Symbol **1** indicates that the function is switched on.
- Symbol **2** indicates that the function is switched off.

- Symbol **3** indicates that the function can be switched off.
- Symbol **4** indicates that the function can be switched on.

## Calling up the menu

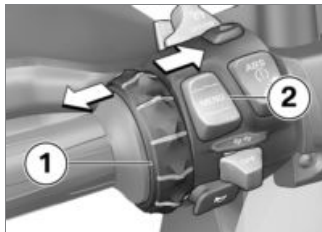

- Show Pure Ride view (▬▬▬▬ 91).
- Briefly press button **2** downward.

The following menus can be called up:

- My vehicle
- Navigation
- Media
- Telephone
- Settings

- Press Multi-Controller **1** repeatedly briefly to the right until the desired menu item is marked.
- Briefly press button **2** downward.



### NOTICE

The Settings menu can only be called up while stationary. ◀

## Moving the cursor in lists

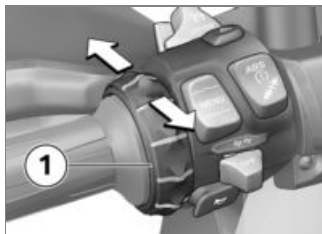

- Calling up the menu (▬▬▬▬ 92).
- To move the cursor down in lists, turn the Multi-Controller **1**

down until the desired entry is marked.

- To move the cursor up in lists, turn the Multi-Controller **1** up until the desired entry is marked.

## Confirming the selection

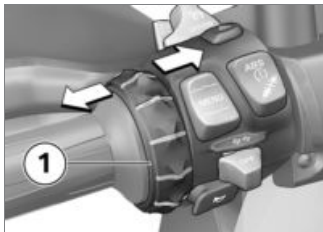

- Select desired entry.
- Multi-Controller **1** short press to right.

## Calling up the last menu used

- In the Pure Ride view: rocker button MENU long press down.

- » The last used menu is called up. The last marked entry is selected.

## Operating focus change

- with preparation for navigation system<sup>OE</sup>

When the Navigator is connected, you can switch between the operation of the Navigator and the TFT display.

## Changing the operating focus

- with preparation for navigation system<sup>OE</sup>

- Securely fasten navigation device (►► 196).
- Show Pure Ride view (►► 91).
- Rocker button MENU long press up.
  - » Operating focus changes to the Navigator or the TFT display. The respectively active device is marked on the left in the up-

per status line. Operator actions apply to the respectively active device until the operating focus is changed again.

- » Operating the navigation system (►► 197)

## System status displays

The system status is displayed in the lower menu area when a function has been switched on or off.

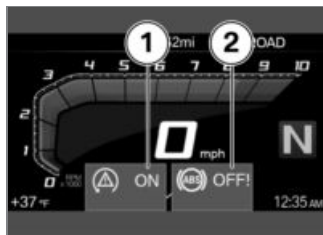

## Examples of the meaning of the system statuses:

- System status **1**: ASC/DTC function is switched on.

- System status **2**: ABS function is switched off.

## Changing the display for rider info status line

### Requirement

The motorcycle is stopped. The Pure Ride view is displayed.

- Switching on ignition (➡ 54).
  - » In the TFT display, all information necessary for operation on public roads is provided by the onboard computer. The information can be displayed in the upper status line.
- with Tire Pressure Monitor (TPM)<sup>OE</sup>
  - » In addition, information from the Tire Pressure Monitor can be displayed.<
- Selecting the content of the rider info status line (➡ 95).



- Long press button **1** to display the Pure Ride view.
- Press button **1** briefly to select the value in the upper status line **2**.

The following values can be indicated:

- Odometer *Total*
- Trip distance 1 *Current*
- Trip distance 2 *Current*
- Current fuel consumption *Consumption*



Average fuel consumption 1



Average fuel consumption 2



Riding time 1



Riding time 2



Inactive period 1



Inactive period 2



Average speed 1



Average speed 2



Tire pressure



Fuel gage.



Range



## Selecting the content of the rider info status line

- Call up menu **Settings**, **Display**, **Status line content**.
- Turn on desired displays.
  - » You can switch between the selected displays in the rider info status line. If there are no displays selected, then only the range is displayed.

## Making settings

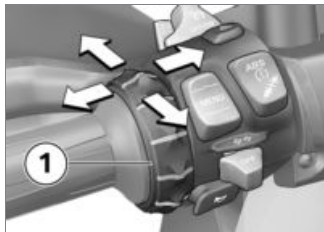

- Select desired settings menu and confirm.

- Turn Multi-Controller **1** down until the desired setting is marked.
- If an operating instruction is present, tilt Multi-Controller **1** to the right.
- If no operating instruction is present, tilt Multi-Controller **1** to the left.
  - » The setting is saved.

## Switching road sign detection on or off Requirement

The vehicle is connected to the Navigator or a compatible mobile end device. The BMW Motorrad Connected App is installed on the mobile end device.

- **Speed Limit Info** displays the currently permitted maximum speed.
- Call up menu **Settings**, **Display**.

- Switch **Speed Limit Info** on or off.

## Pure Ride view

### Tachometer

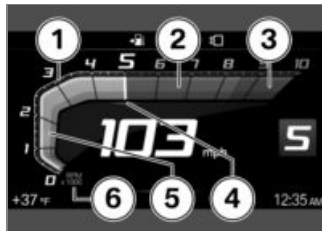

- 1 Scale
- 2 Low engine speed range
- 3 High/red engine speed range
- 4 Needle
- 5 Trailing indicator
- 6 Unit for tachometer: 1000 revolutions per minute



## NOTICE

Depending on the oil temperature, the red engine speed range changes:

The colder the engine, the lower the speed at which the red engine speed range begins.

The warmer the engine, the higher the speed at which the red engine speed range begins. When the operating temperature is reached, the display of the red engine speed range no longer changes.

If the engine speed is too high, the entire scale flashes.

The upshift recommendation is also dynamically adapted.◀

## Range



The range **1** indicates the distance that can still be driven with the remaining fuel. This distance is calculated based on fuel quantity and average consumption.

- If the motorcycle is standing on its side stand, the motorcycle's inclined position will prevent the fuel level from being registered accurately. For this reason the range is only recalculated with the side stand retracted.

- The range is output together with a warning after the fuel reserve level is reached.
- After refueling, the range is recalculated provided the fuel quantity is greater than the fuel reserve.
- The determined range is an approximate reading.

## Upshift recommendation



Upshift recommendation **1** signals the economically best point in time for upshifting.

## General settings

### Adjusting the volume

- Connecting rider's and passenger's helmets (☰➔ 100).
- Increase volume: turn Multi-Controller up.
- Reduce volume: turn Multi-Controller down.
- Mute: turn Multi-Controller all the way down.

### Setting the date

- Switching on ignition (☰➔ 54).
- Call up menu **Settings, System settings, Date and time, Set date.**
- Set **Day, Month and Year.**
- Confirm setting.

### Setting the date format

- Call up menu **Settings, System settings, Date and time, Date format.**
- Select desired setting.
- Confirm setting.

### Set clock

- Switching on ignition (☰➔ 54).



### Adjusting the clock while riding

Accident hazard

- Adjust the clock only when the motorcycle is stationary.◀
- Call up menu **Settings, System settings, Date and time, Set time.**
- Set **Hour and Minute.**

### Switching the automatic time setting on or off



Depending on the equipment, the time of day is updated automatically.◀



### Adjusting the clock while riding

Accident hazard

- Adjust the clock only when the motorcycle is stationary.◀
- Call up menu **Settings, System settings, Date and time.**
- Switch **Set time** automatically on or off.

### Setting the time format



### Adjusting the clock while riding

Accident hazard

- Adjust the clock only when the motorcycle is stationary.◀
- Call up menu **Settings, System settings, Date and time, Time format.**

- Select desired setting.
- Confirm setting.

## Setting the unit of measurement

- Call up menu `Settings, System settings, Units`.

The following units of measurement can be set:

- Distance covered
- Pressure
- Temperature
- Consumption

## Setting the language

- Call up menu `Settings, System settings, Language`.

The following languages can be set:

- Chinese
- German
- English
- Spanish
- French
- Italian

- Dutch
- Portuguese
- Russian
- Ukrainian

## Adjusting brightness

- Call up menu `Settings, Display, Brightness`.
- Adjust brightness.

## Resetting all settings

- All settings in menu `Settings` can be reset to factory settings.
- Call up menu `Settings`.
- Select `Reset all` and confirm.

The settings of the following menus are reset:

- `Vehicle settings`
- `System settings`
- `Connections`
- `Display`
- `Information`

- » Existing Bluetooth connections are not deleted.

## Bluetooth

### Short-range radio technology

The Bluetooth function may not be offered depending on the country of use.

Bluetooth is a short-range radio technology. Bluetooth devices are short-range devices (transmitting with a limited range) on the license-free ISM band (Industrial, Scientific, Medical) between 2.402 GHz and 2.480 GHz. They can be operated anywhere in the world without requiring a license. Although Bluetooth is designed to establish robust links over a short distance, disturbances are possible, as they are with any wireless technology. Links may be disturbed, interrupted briefly or lost entirely. Especially when several devices are operated in one Bluetooth network, there is



- Select PAIR NEW MOBILE DEVICE and confirm.

Mobile end devices are searched for.



During the pairing, the Bluetooth symbol flashes in the lower status line.

Visible mobile end devices are displayed.

- Select mobile end device and confirm.
- Follow the instructions on the mobile end device.
- Confirm that the codes match.
- » The connection is established and the connection status is updated.
- » If the connection cannot be established, the troubleshooting chart in the "Technical data" chapter may provide assistance. (►►► 207)
- » Telephone data will be transferred to the vehicle automati-

cally depending on the mobile end device.

- » Telephone data (►►► 108)
- » If the phone book is not displayed, the troubleshooting chart in the "Technical data" chapter may provide assistance. (►►► 208)
- » If the Bluetooth connection does not work as expected, the troubleshooting chart in the "Technical data" chapter may provide assistance. (►►► 207)

### Connecting rider's and passenger's helmets

- Pairing (►►► 99).
- Select Rider's helmet or Passenger helm. and confirm.
- Make communication system of the helmet visible.
- Select PAIR NEW RIDER'S HELMET or PAIR NEW PASSENGER HELMET and confirm.

Helmets are searched for.



During the pairing, the Bluetooth symbol flashes in the lower status line.

Visible helmets are displayed.

- Select helmet and confirm.
- » The connection is established and the connection status is updated.
- » If the connection cannot be established, the troubleshooting chart in the "Technical data" chapter may provide assistance. (►►► 207)
- » If the Bluetooth connection does not work as expected, the troubleshooting chart in the "Technical data" chapter may provide assistance. (►►► 207)

### Deleting connections

- Call up menu Settings, Connections.
- Select Delete connections.

- To delete an individual connection, select the connection and confirm.
- To delete all connections, select `Delete all connections` and confirm.

## My Vehicle

### Start screen

- 1 Check Control display Displays (➡ 24)
- 2 Coolant temperature (➡ 39)
- 3 Range (➡ 96)
- 4 Total distance covered
- 5 Service display (➡ 51)
- 6 Tire pressure, rear (➡ 41)
- 7 Vehicle voltage (➡ 177)
- 8 Engine oil level (➡ 39)
- 9 Tire pressure, front (➡ 41)





## Operating instructions

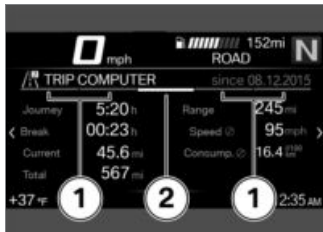

- Operating instruction **1**: tab that shows how far to the left or right you can leaf.
- Operating instruction **2**: tab that shows the position of the current menu screen.

## Leafing through menu sheets

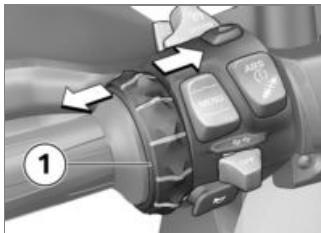

- Call up menu *My vehicle*.
- Short press Multi-Controller **1** to the right to leaf to the right.
- Short press Multi-Controller **1** to the left to leaf to the left.

The following screens are included in the *My Vehicle* menu:

- MY VEHICLE
- Check Control messages (if present)
- ONBOARD COMPUTER
- TRIP COMPUTER

- with Tire Pressure Monitor (TPM)<sup>OE</sup>
- TIRE PRESSURE ◀
- SERVICE REQUIREMENTS
- For more information on tire pressure and Check Control messages, please refer to the "Displays" chapter.



### NOTICE

Check Control messages are dynamically added as additional tabs to the menu screens in the *My Vehicle* menu. ◀

## Onboard computer and travel onboard computer

The menu screens *ONBOARD COMPUTER* and *TRIP COMPUTER* show data about the vehicle and the journey, such as average values.

## Service display

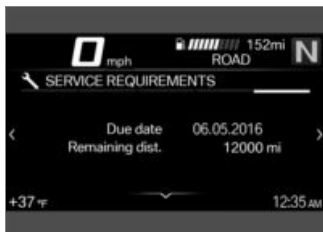

If the remaining time until the next service is less than a month, or the next service is due in less than 700 mi (1000 km), a white Check Control message is displayed.

## Navigation

### Warnings

#### WARNING

#### **Operation of a smartphone while riding or with the engine running**

Accident hazard

- Observe the relevant road traffic regulations.
- Do not use while riding (except for applications without operation such as telephony via the hands-free system).◀

#### WARNING

#### **Distraction from traffic conditions and loss of control**

Risk of accident through the use of integrated information systems and communication devices during the journey

- Operate these systems or devices only if the traffic situation allows.
- If necessary, stop and operate the system or devices at a standstill.◀

#### **Prerequisite**

The vehicle is connected to a compatible mobile end device.

#### **Prerequisite**

The BMW Motorrad Connected App is installed on the mobile end device.

#### NOTICE

On some mobile devices, e.g. with operating system iOS, the BMW Motorrad Connected App must be called up before using.◀

### Entering destination address

- Connecting a mobile end device (▶▶▶▶▶ 99).
- Call up the BMW Motorrad Connected App and start the route guidance.
- In the TFT display, call up menu *Navigation*.
  - » Active route guidance is displayed.
  - » If the active route guidance is not displayed, the troubleshooting chart in the "Technical data" chapter may provide assistance. (▶▶▶▶▶ 208)

### Selecting a destination from previous destinations

- Call up menu *Navigation*, *Recent destinations*.
- Select destination and confirm.
- Select *Start route guidance*.

## Selecting a destination from favorites

- The FAVORITES menu shows all destinations that have been saved as favorites in the BMW Motorrad Connected App. No new favorites can be created on the TFT display.
- Call up menu Navigation, Favorites.
- Select destination and confirm.
- Select Start guidance.

## Entering special destinations

- Special destinations such as places of interest can be shown on the map.
- Call up menu Navigation, POIs.

The following places can be selected:

- At current location
- At destination

- Along the route
- Select in which location you want to search for special destinations.

For example, the following special destination can be selected:

- Filling station
- Select special destination and confirm.
- Select Start route guidance and confirm.

## Specifying route criteria

- Call up menu Navigation, Route criteria.

The following criteria can be selected:

- Route type
- Avoid
- Select desired Route type.
- Switch desired Avoid on or off.

The number of switched on avoidances is displayed in parentheses.

## Ending route guidance

- Call up menu Navigation, Active route guidance.
- Select End route guidance and confirm.

## Switching spoken instructions on or off

- Connecting rider's and passenger's helmets (👤➔ 100).
- The navigation can be read aloud by a computer voice. The Spoken instructions must be switched on for this.
- Call up menu Navigation, Active route guidance.
- Switch Spoken instructions on or off.

## Repeating the last spoken instruction

- Call up menu Navigation, Active route guidance.
- Select Current instruction and confirm.

## Media

### Prerequisite

The vehicle is connected to a compatible mobile end device and a compatible helmet.

### Controlling music playback

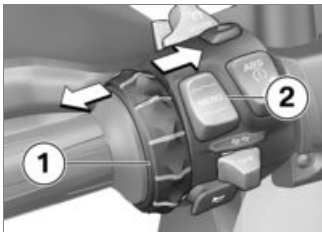

- Call up menu **Media**.

#### NOTICE

BMW Motorrad recommends that the volume in the mobile end device is set to maximum before riding. ◀

- Adjusting the volume (▬▬▬▶ 97).
- Next title: briefly tilt Multi-Controller **1** to the right.
- Last title or beginning of the current title: briefly tilt Multi-Controller **1** to the left.
- Fast forward: Multi-Controller **1** long tilt to the right.
- Fast backward: Multi-Controller **1** long tilt to the left.
- Call up the context menu: press bottom part of button **2**.

#### NOTICE

Depending on the mobile end device, the scope of the Connectivity functions may be limited. ◀

- » The following functions can be used in the context menu:
  - Start playback OR Pause playback.
  - Select the **Now playing**, **All artists**, **All albums** OR **All tracks** categories for search and playback.

- Select **Playlists**.

You can make the following adjustments in the **Audio options** submenu:

- Switch **Shuffle** on or off.
- Select **Repeat: Off**, **One** (current song) or **All**.

## Phone

### Prerequisite

The vehicle is connected to a compatible mobile end device and a compatible helmet.

## Making a phone call



- Call up menu **Telephone**.
- Accept call: tilt Multi-Controller **1** to the right.
- Reject call: tilt Multi-Controller **1** to the left.
- End call: tilt Multi-Controller **1** to the left.

## Muting

The microphone in the helmet can be muted during active conversations.

## Phone calls with several participants

During a phone call, you can accept a second call. The first call is put on hold. The number of active calls is displayed in the **Telephone** menu. You can switch between two calls.

## Telephone data

Depending on the mobile end device, telephone data will be automatically transferred to the vehicle after the pairing (➔ 99).  
**Phone book:** List of the contacts stored in the mobile end device

**Call list:** List of the calls with the mobile end device

**Favorites:** List of the favorites stored in the mobile end device

## Switching GPS synchronization on or off

- Call up menu **Settings, System settings, Date and time**.
- Switch **GPS synchronization** on or off.

## Displaying the software version

- Call up menu **Settings, Information, Software version**.

## Displaying license information

- Call up menu **Settings, Information, Licenses**.

## Setting

Mirrors .....	110
Headlight .....	110
Wind shield .....	111
Clutch .....	112
Brakes .....	112
Handlebars .....	113
Spring preload .....	113
Damping .....	114

## Mirrors

### Adjusting mirrors



- Move mirror into desired position by twisting.

### Adjusting mirror arm

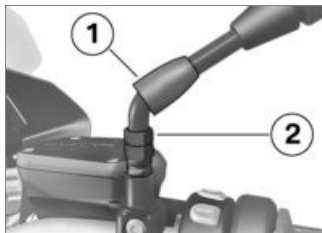

- Slide protective cap **1** up over screw connection on mirror arm.
- Loosen the nut **2**.
- Turn mirror arm into desired position.
- Tighten nut to specified torque while holding mirror arm in place.



Mirror (locknut) on adapter

16 lb/ft (22 Nm) (Left-hand thread)

- Slide protective cap **1** over screw fitting.

## Headlight

### Headlamp range and spring preload

The headlamp range generally remains constant due to the adjustment of the spring preload to the loading state.

Spring preload adjustment may only be insufficient when the motorcycle is very heavily loaded. In this case, the headlamp range must be adjusted to the weight.



### NOTICE

If there are doubts as to the correct headlight range, have the adjustment checked by a specialized workshop, preferably by an authorized BMW Motorrad retailer. ◀



## Headlight range adjustment



In the case of high payload, if the spring preload adjustment is not sufficient anymore to avoid blinding the oncoming traffic:

- Turn adjustment wheel **1** counterclockwise to lower the headlight beam.

If the motorcycle is ridden again with lower payload:

- Have the headlight default setting readjusted by an authorized workshop, preferably an authorized BMW Motorrad retailer.

– with LED headlight<sup>OE</sup>

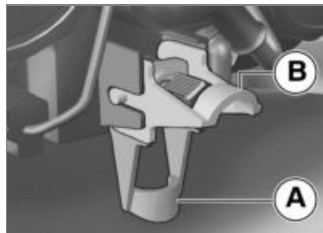

- A swiveling lever is used for the headlight range adjustment.
- **A** Neutral position
- **B** Position with heavy payload◀

## Wind shield Adjusting windshield

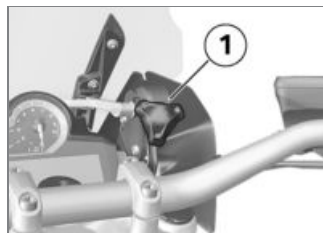

**! WARNING**

### Adjusting the windshield while driving

Accident hazard

- Only adjust the windshield when the motorcycle is stationary.◀
- Turn adjustment wheel **1** clockwise to lower the windshield.

- Turn adjustment wheel **1** counterclockwise to raise the windshield.

## Clutch

### Adjusting clutch lever



**WARNING**

#### Adjusting the clutch lever while driving

Accident hazard

- Only adjust the clutch lever when the motorcycle is stationary.◀

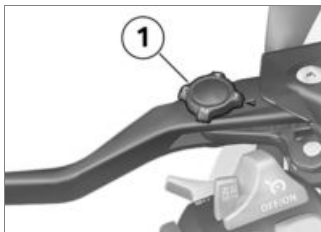

- Turn adjusting wheel **1** into desired position.



**NOTICE**

The adjustment wheel can be turned more easily if you press the clutch lever forward when doing so.◀

- » Four settings are available:
  - Position 1: smallest distance between handlebar grip and clutch lever
  - Position 4: largest distance between handlebar grip and clutch lever

## Brakes

### Adjusting handbrake lever



**WARNING**

#### Adjusting the brake lever while driving

Accident hazard

- Only adjust the brake lever when the motorcycle is stationary.◀

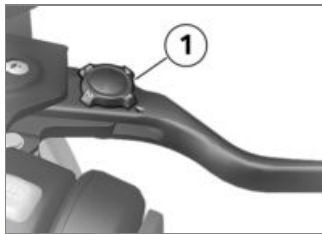

- Turn adjusting wheel **1** into desired position.



## NOTICE

The adjustment wheel can be turned more easily if you press the handbrake lever forward when doing so.◀

- » Four settings are available:
- Position 1: smallest distance between handlebar grip and brake lever
- Position 4: largest distance between handlebar grip and brake lever

## Handlebars

### Adjustable handlebars

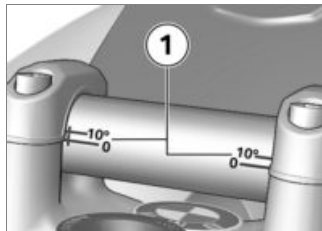

The handlebars inclination can be adjusted in the areas of the mark **1**.

Have the handlebars adjusted by a specialist workshop, preferably an authorized BMW Motorrad retailer.

### Spring preload

- without Dynamic ESA<sup>OE</sup>

## Setting

It is essential to set the spring preload to suit the load carried by the motorcycle. Increase spring preload when the vehicle is heavily loaded and reduce spring preload accordingly when the vehicle is lightly loaded.

### Adjusting spring preload at rear wheel



## WARNING

### Adjusting the spring preload while riding.

Accident hazard

- Adjust the spring preload only when the motorcycle is stationary.◀
- Park motorcycle, ensuring that support surface is firm and level.



## WARNING

### Uncoordinated settings of spring preload and spring strut damping.

Poorer handling.

- Adjust damping characteristic to changed spring preload. ◀
- To increase spring load, turn the adjustment wheel **1** in direction of arrow HIGH.
- To decrease spring load, turn the adjustment wheel **1** in direction of arrow LOW.



Basic setting of spring preload, rear

Turn adjustment wheel as far as possible into LOW direction. (One-up without load)

Turn adjuster wheel as far as possible in LOW direction, then rotate 15 turns in HIGH direction. (One-up with load)

Turn adjuster wheel as far as possible in LOW direction, then rotate 30 turns in HIGH direction. (Two-up and load)

## Damping

– without Dynamic ESA<sup>OE</sup>

## Setting

The damping must be adjusted to the road conditions and the spring preload.

- A rough road surface requires softer damping than a smooth road surface.
- An increase in spring preload requires firmer damping, a reduction in spring preload requires softer damping.

## Adjusting damping on rear wheel

- Park motorcycle, ensuring that support surface is firm and level.
- Adjust damping from the left side of the vehicle.



- To increase damping, turn adjusting screw **1** in clockwise direction.
- To reduce damping, turn adjusting screw **1** in counterclockwise direction.

 Basic setting of rear wheel rear-wheel damping

Turn adjuster wheel as far as possible clockwise, then 8 clicks counterclockwise (One-up without load)

 Basic setting of rear wheel rear-wheel damping

Turn adjuster wheel as far as possible clockwise, then 2 clicks counterclockwise (One-up with load)

Turn adjuster wheel as far as possible clockwise, then 2 clicks counterclockwise (Two-up with load)



## **Riding**

Safety information .....	118
Observe checklist.....	120
Always before riding off .....	120
At every third refueling stop.....	121
Starting .....	121
Running in .....	124
Off-road riding .....	125
Shifting gears .....	126
Brakes .....	127
Parking your motorcycle .....	129
Refueling .....	130
Securing motorcycle for transport .....	134

## Safety information

### Rider's Equipment

Do not ride without the correct clothing. Always wear:

- Helmet
- Rider's suit
- Gloves
- Boots

This applies even to short journeys, and to every season of the year. Your authorized BMW Motorrad Dealer will be happy to advise you and has the correct clothing for every purpose.

### Reduced clearance in inclined position

- with low-slung<sup>OE</sup>

Motorcycles with lowered running gear have less ground clearance in all positions than motorcycles with standard running gear.



### WARNING

#### When cornering with lowered motorcycles, motorcycle parts can contact the road surface sooner than normal.

Accident hazard

- Carefully test the clearance of the motorcycle in an inclined position and adjust your riding style accordingly. ◀

Test the clearance of your motorcycle at an angle in safe situations. Remember to take the limited ground clearance of your motorcycle into account when driving over curbs and similar obstacles.

The lowering of the motorcycle shortens the spring travel (see the chapter "Technical Data"). A possible reduction in the accustomed driving comfort may result. Especially when riding with

a passenger, the spring preload should be adjusted accordingly.

### Load



### WARNING

#### Reduced riding stability caused by overloading and uneven loading

Accident hazard

- Do not exceed the gross weight limit and observe the loading information. ◀
- Adjust spring preload and damping rate for the current gross vehicle weight.
  - with case<sup>OA</sup>
- Ensure that case volumes on left and right are equal.
- Make sure that weight is uniformly distributed between right and left.
- Pack heavy pieces of luggage and cargo as low and as close



to the center of the motorcycle as possible.

- Observe the maximum payload and maximum speed as indicated on the label in the case (see also the chapter "Accessories").◀
- with topcase<sup>OA</sup>
- Observe the maximum payload and maximum speed as indicated on the label in the topcase (see also the chapter "Accessories").◀
- with tank bag<sup>OA</sup>
- Observe maximum payload of tank rucksack.



Payload of tank rucksack

max 11 lbs (max 5 kg)◀

## Speed

If you ride at high speed, always bear in mind that various boundary conditions can adversely affect the handling of your motorcycle:

- Settings of spring-strut and shock absorber system
- Unevenly distributed load
- Loose clothing
- Insufficient tire inflation pressure
- Tire tread in poor condition
- Etc.

## Maximum speed with studded or winter tyres



**DANGER**

**Maximum speed of the motorcycle is higher than the permissible maximum rated speed of the tires.**

Risk of accident due to tire damage at high speed.

- Observe the maximum permissible speed for the tyres.◀

With studded or winter tyres, the maximum permissible speed for the tyres must be observed. Attach a label specifying the maximum permissible speed in the field of view of the instrument cluster.

## Risk of poisoning

Exhaust fumes contain carbon monoxide, which is colorless and odorless but highly toxic.



**WARNING**

## Harmful exhaust gas

Danger of suffocation

- Do not inhale exhaust fumes.
- Do not run the engine in closed rooms.◀

## Burn hazard



### CAUTION

#### Intense heating up of engine and exhaust system while riding

Burn hazard

- After parking the motorcycle, make sure that no persons or objects come into contact with the engine and exhaust system.◀

#### Catalytic converter

If misfire causes unburned fuel to enter the catalytic converter, there is a danger of overheating and damage.

The following must be observed:

- Do not run the fuel tank dry.
- Do not run the engine with the spark-plug cap removed.
- Stop the engine immediately if it misfires.
- Use unleaded fuel only.

- Comply with all specified maintenance intervals.



### ATTENTION

#### Unburned fuel in the catalytic converter

Damage to catalytic converter

- Note the points listed for protection of the catalytic converter.◀

#### Danger of overheating



### ATTENTION

#### Engine idling for a lengthy period while at a standstill

Overheating due to insufficient cooling; in extreme cases vehicle fire

- Do not allow the engine to idle unnecessarily.
- After starting, ride off immediately.◀

## Modifications



### ATTENTION

#### Modifications to the motorcycle (e.g. engine control unit, throttle valves, clutch)

Damage to the affected parts, failure of safety-relevant functions, expiration of warranty

- Do not make any modifications.◀

#### Observe checklist

- Use the following checklist to check your motorcycle at regular intervals.

#### Always before riding off

- Check operation of the brake system.
- Check operation of the lighting and signal system.
- Checking clutch function (▶▶ 159).

- Check tire tread depth (▣▣▣ 162).
- Checking tire pressure (▣▣▣ 161).
- Check secure hold of cases and luggage.

## At every third refueling stop

- without Dynamic ESA<sup>OE</sup>
- Adjuster for spring preload, rear (▣▣▣ 113).
- Adjusting damping on rear wheel (▣▣▣ 114).◀
- with Dynamic ESA<sup>OE</sup>
- Setting suspension compliance (▣▣▣ 69).◀
- Check engine oil level (▣▣▣ 154).
- Check front brake pad thickness (▣▣▣ 156).
- Check rear brake pad thickness (▣▣▣ 156).

- Checking front brake fluid level (▣▣▣ 157).
- Checking rear brake fluid level (▣▣▣ 158).
- Checking coolant level (▣▣▣ 159).

## Starting

### Starting engine

- Switch on the ignition.
  - » Pre-Ride-Check is carried out. (▣▣▣ 122)
  - » ABS self-diagnosis is performed. (▣▣▣ 122)
- without riding modes Pro<sup>OE</sup>
  - » ASC self-diagnosis in progress. (▣▣▣ 123)◀
- with riding modes Pro<sup>OE</sup>
  - » DTC self-diagnosis is performed. (▣▣▣ 124)◀
- Engage neutral, or pull back clutch lever if a gear is engaged.

## NOTICE

You cannot start the motorcycle with the side stand extended and a gear engaged. The engine will switch itself off if it is started with the transmission in neutral and then a gear is engaged before retracting the side stand.◀

- In the case of cold start or under cold temperatures: Pull back clutch lever.



- Press starter button **1**.
- » Engine starts.

» If the engine fails to start, the troubleshooting table in the chapter "Technical Data" may provide assistance (➡ 206)  
Recharge the battery before you attempt to start the engine again, or use jumper cables:

- Charging connected battery (➡ 177).
- Jump-starting (➡ 175).

### NOTICE

The starting attempt is automatically interrupted if battery voltage is too low.◀

## Pre-Ride-Check

When the ignition is switched on, the instrument cluster performs a test routine on the indicator and warning lights - this is the "Pre-Ride-Check." Starting the engine before the test routine is completed will cancel the remainder of the routine.

### Phase 1

All indicator and warning lights are switched on.  
After a longer standstill of the vehicle, an animation is displayed during the system start.

### Phase 2

The universal warning light changes from red to yellow.

### Phase 3

The previously activated indicator and warning lights are now switched off consecutively in reverse order.

If one of the indicator or warning lights did not turn on:

- Have the malfunction corrected as soon as possible at an authorized service facility, preferably an authorized BMW Motorrad Retailer.

## ABS self-diagnosis

The self-diagnosis routine checks whether the BMW Motorrad Integral ABS is ready for operation. The self-diagnosis routine launches automatically when you switch on the ignition.

### Phase 1

- » Check on system components monitored by diagnostic system while motorcycle is parked.
-  ABS indicator light flashes.

### Phase 2

- » Check wheel sensors while starting off.
-  ABS indicator light flashes.

## ABS self-diagnosis completed

- » The ABS indicator and warning light goes out.



ABS self-diagnosis routine not completed

ABS is not available, as the self-diagnosis routine was not completed. (The motorcycle must reach a specified minimum speed before the system can check operation of the wheel speed sensors: 3 mph (5 km/h))

If an ABS error is displayed after the ABS self-diagnosis is completed:

- It remains possible to continue riding. Bear in mind that neither the ABS function nor the integral function is available.
- Have the malfunction corrected as soon as possible at an authorized service facility, preferably an authorized BMW Motorrad Retailer.

## ASC self-diagnosis

– without riding modes Pro<sup>OE</sup>

The self-diagnosis routine checks whether the BMW Motorrad ASC is ready for operation. The self-diagnosis routine runs automatically when you switch on the ignition.

### Phase 1

» Check on system components monitored by the diagnostic system while motorcycle is parked.



ASC indicator and warning light flashes slowly.

### Phase 2

» Checking the diagnosable system components while the motorcycle is moving.



ASC indicator and warning light flashes slowly.

## ASC self-diagnosis completed

» The ASC indicator and warning light goes out.

- Check the display of all indicator and warning lights.



ASC self-diagnosis routine not completed

ASC is not available because the self-diagnosis routine was not completed. (The motorcycle must reach a specified minimum speed before the system can check operation of the wheel sensors: min 3 mph (min 5 km/h))

If an ASC error is displayed after the ASC self-diagnosis is completed:

- It remains possible to continue riding. It must be noted that the ASC function is not available.

- Have the malfunction corrected as soon as possible at an authorized service facility, preferably an authorized BMW Motorrad Retailer.

## DTC self-diagnosis

– with riding modes Pro<sup>OE</sup>

The self-diagnosis routine is determining whether BMW Motorrad DTC is ready for operation. The self-diagnosis routine runs automatically when you switch on the ignition.

### Phase 1

- » Check on system components monitored by diagnostic system while motorcycle is parked.



DTC indicator and warning light flashes slowly.

### Phase 2

- » Checks diagnosis-capable system components when motorcycle starts to move.



DTC indicator and warning light flashes slowly.

## DTC self-diagnosis completed

- » The DTC symbol is no longer displayed.
- Check the display of all indicator and warning lights.



DTC self-diagnosis not completed

The DTC function is not available, as the self-diagnosis function has not been completed. (To check wheel speed sensors, motorcycle must reach a minimum speed with engine running: min 3 mph (min 5 km/h))

If an DTC error is displayed after the DTC self-diagnosis is completed:

- It remains possible to continue riding. It must be noted

that the availability of the DTC function is restricted or it is not available at all.

- Have the malfunction corrected as soon as possible at an authorized service facility, preferably an authorized BMW Motorrad Retailer.

## Running in

### Engine

- While running in the motorcycle, vary the throttle opening and engine-speed range frequently; avoid driving for long periods at a constant speed.
- Choose curvy, slightly hilly sections of road if possible.
- Observe the engine run-in speeds.



Engine break-in speeds

<5000 min<sup>-1</sup> (Odometer reading 0...621 miles (0...1000 km))



Engine break-in speeds

no full throttle (Odometer reading 0...621 miles (0...1000 km))

- Observe mileage, after which the running-in check should be performed.



Mileage until running-in check

311...746 miles (500...1200 km)

## Brake pads

New brake pads must be run in before they achieve their optimum friction force. This initial reduction in braking efficiency can be compensated for by exerting greater pressure on the brake levers.



## WARNING

### New brake pads

Extension of the braking distance, accident hazard

- Brake early.◀

## Tires

New tires have a smooth surface. This must be roughened by riding in a restrained manner at various heel angles until the tires are run in. This running in procedure is essential if the tires are to achieve maximum grip.



## WARNING

### Loss of adhesion of new tires on wet roads and at extreme angles

Accident hazard

- Always think well ahead and avoid extreme angles.◀

## Off-road riding

### For off-road riding

#### Rims



## ATTENTION

### Heavier off-road use than riding on unpaved roads

Damage to the standard cast aluminum rims

- For heavier offroad use, use the cross-spoke wheels available as optional equipment.◀

### After riding off-road

BMW Motorrad recommends the following after riding off-road:

## Tire pressure

### WARNING

#### When driving off-road, lower tire pressure than riding on paved roads

Risk of accident due to poorer handling characteristics.

- Ensure proper tire inflation pressure. ◀

## Brakes

### WARNING

#### Riding on unpaved or dirty roads

Delayed braking effect due to dirty brake discs and brake pads

- Brake early until the brakes are clean again. ◀

### ATTENTION

#### Riding on unpaved or dirty roads

Increased brake pad wear

- Check the brake pad thickness more often and replace the brake pads sooner. ◀

## Spring preload and damping

### WARNING

#### Modified values for spring preload and spring strut damping when riding off-road

Poorer handling characteristics on paved roads

- Set correct spring preload and correct spring strut damping before leaving off-road terrain. ◀

## Rims

BMW Motorrad recommends checking the rims for possible damage after riding off-road.

## Air cleaner element

### ATTENTION

#### Dirty air filter element

Engine damage

- When driving in dusty terrain, check air filter insert for soiling at short intervals and clean or replace if necessary. ◀

Use under very dusty conditions (deserts, savannas, etc.) requires the use air cleaner elements specially developed for these kinds of applications.

## Shifting gears

– with gearshift assistant Pro<sup>OE</sup>

## Pro shift assistant

### NOTICE

When changing gear using the Pro Gear-shift Assistance function, the cruise-control system



is automatically deactivated for safety reasons. ◀

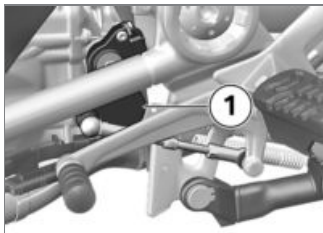

- Gears are engaged at the foot gearshift lever using the standard procedure.
- » The gearshift assistant provides help with upward and downward gear shifts without the clutch or the accelerator having to be operated.
- This is not an automatic transmission.
- The rider is an essential part of the system and makes the decision as to when to change gear.

- The sensor **1** on the gear-lever shaft detects the intention to change gear and initiates gearshift assistance.
- » When driving at constant speed in low gears at high revs, changing gear without using the clutch can result in major load change reactions.
- BMW Motorrad recommends only changing gear using the clutch in such situations.
- The Pro gearshift assistant should not be used in the range of the of the rev limiter.
- » No shifting support is provided in the following situations:
  - With the clutch operated.
  - If the gear lever is not in the zero position
  - When upshifting with the throttle closed (coasting overrun mode) or when decelerating.
- To be able to make another gear change using the gearshift assistant Pro, the gearshift

- lever must be fully released after the first gear change.
- » More detailed information on the gearshift assistant Pro can be found in the "Technology in detail" chapter:
  - with riding modes Pro<sup>OE</sup>
  - » Pro gearshift assistant (▶▶ 148)◀

## Brakes

### How do you achieve the shortest stopping distances?

The dynamic load distribution between the front and rear wheel changes during braking. The heavier you brake, the greater the weight transfer to the front wheel. Increases in the load at an individual wheel are accompanied by a rise in the effective braking force that the wheel can provide.

To achieve the shortest possible braking distance, the front brake must be applied quickly and with increasing force. This procedure provides ideal exploitation of the extra weight transfer to the front wheel. The clutch should also be disengaged at the same time.

With the "forced braking" often practiced in which the brake pressure is generated as quickly as possible and with great force, the dynamic load distribution cannot follow the increased deceleration and the braking force cannot be completely transferred to the road surface.

Locking up of the front wheel is prevented by the BMW Motorrad Integral ABS.

## Descending mountain passes



### WARNING

#### Braking only with the rear-wheel brake when descending mountain passes

Reduced or braking action, destruction of the brakes caused by overheating

- Use both front and rear brakes, and make use of the engine's braking effect as well. ◀

#### Wet, soiled brakes

Moisture and dirt on the brake rotors and the brake pads result in a decrease in the braking action.

Delayed or poorer braking action must be expected in the following situations:

- When driving in the rain and through puddles.
- After washing the vehicle.
- When driving on roads spread with salt.
- After working on the brakes due to oil or grease residues.
- When driving on soiled roads or offroad.



### WARNING

#### Poorer braking action due to moisture and dirt

Accident hazard

- Brake until brakes are dry or clean; clean if necessary.
- Brake early until the full braking action is available again. ◀

#### ABS Pro

- with riding modes Pro<sup>OE</sup>

## Physical riding limits

### **WARNING**

#### **Braking in curves**

Danger of falling despite ABS Pro

- The rider is always responsible for adapting his/her driving style.
- Do not reduce the system's extra safety margin with careless riding or unnecessary risks.◀

ABS Pro is available in all riding modes except for Enduro PRO.

#### **Falling cannot be excluded**

Although ABS Pro represents valuable support and an enormous safety advantage for the rider when braking in the inclined position, it by no means redefines the physical riding limits. It is still possible to exceed those limits through misjudgments or riding errors. In extreme cases this may result in a fall.

## Use on public roads

ABS Pro helps make riding your motorcycle on public roads even safer. When braking due to unexpected hazards in curves, locking-up and slipping of the wheels is prevented within the scope of the physical riding limits.

### **NOTICE**

ABS Pro was not developed to increase the individual braking performance in the inclined position in the limit range.◀

## Parking your motorcycle

### **Side stand**

- Switch off engine.

### **ATTENTION**

### **Poor ground conditions in area of stand**

Component damage caused by tipping over

- Always check that the ground under the stand is level and firm.◀

### **ATTENTION**

### **Loading of the side stand with additional weight**

Component damage caused by tipping over

- Do not sit on the motorcycle when it is parked on the side stands.◀
- Fold out side stand and park motorcycle.
- Turn handlebars to the left.
- On slopes point the motorcycle uphill and engage 1st gear.

### **Center stand**

- Switch off engine.

 **ATTENTION**
**Poor ground conditions in area of stand**

Component damage cause by tipping over

- Always check that the ground under the stand is level and firm. ◀

 **ATTENTION**
**Center stand folds if subject to sharp movements.**

Component damage cause by tipping over

- Do not sit on the motorcycle while it is resting on the center stand. ◀
- Fold out center stand and jack up motorcycle.
- On a grade, the motorcycle should always face uphill; select 1st gear.

## Refueling

### Fuel specifications Requirement

For optimal fuel economy, the gasoline should be sulfur-free or very low in sulfur content.

 **ATTENTION**
**Refueling with leaded fuel**

Damage to catalytic converter

- Do not refuel with leaded gasoline or gasoline with metallic additives, e.g. manganese or iron. ◀

 **ATTENTION**
**Use of Ethanol E85 as fuel**

Damage to the engine and fuel supply

- Do not refuel with E85, i.e. fuel with an ethanol content of 85 %, or with Flex Fuel. ◀

- Fuels with a maximum ethanol content of 10 %, meaning "E10," may be used for refueling. Ethanol should satisfy the quality standards for the US (ASTM 4806-xx) and Canada (CGSB-3.511-xx). "xx" - comply with the current standard in each case.



Recommended fuel quality

Normal unleaded  
87 AKI (91 ROZ/RON)



Alternative fuel quality

Regular unleaded (restrictions with regard to power and consumption.) (max. 10 % ethanol, E10)  
87 AKI (91 ROZ/RON)  
87 AKI

» If the quality is lower, a conversion is necessary. Have your

motorcycle programmed accordingly beforehand by your authorized BMW Motorrad retailer.

## Refueling procedure

### WARNING

#### Fuel is highly flammable

Fire and explosion hazard

- Do not smoke. Never bring a naked flame near the fuel tank. ◀

### ATTENTION

#### Component damage

Component damage due to over-filled fuel tank

- If the fuel tank is overfilled, the excess fuel will flow into the carbon canister and lead to component damage there.
- Only fill the fuel tank to the lower edge of the fuel filler neck. ◀

### ATTENTION

#### Contact of fuel and plastic surfaces

Damage to surfaces (become unattractive or cloudy)

- Immediately clean plastic surfaces after contact with fuel. ◀
- Place motorcycle on center stand, ensuring that it is resting on a firm and level support surface.

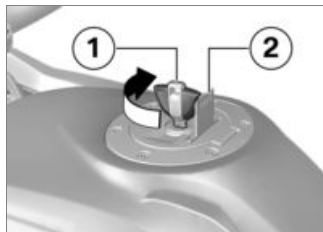

- Open protective cap 2. ◀

- Unlock fuel-tank cap 1 with ignition key by turning clockwise, then swivel it up. ◀



- Do not fill the tank past the bottom edge of the filler neck. ◀

### NOTICE

When refueling after running on fuel reserve, the resulting total fuel quantity must be greater than the fuel reserve, so that the new filling level is detected and the fuel warning light is switched off. ◀

 **NOTICE**

The "usable fuel quantity" specified in the technical data is the fuel quantity, which can be refueled if the fuel tank was completely emptied, i.e., if the engine dies off due to lack of fuel. ◀



Usable fuel quantity

Approx. 5.3 gal (Approx. 20 l)



Reserve fuel quantity

Approx. 1.1 gal (Approx. 4 l)

- Press fuel tank cap down firmly to close.
- Remove vehicle key and close protective cap.

## Refueling procedure

– with Keyless Ride<sup>OE</sup>

### Requirement

Steering lock is unlocked.



### WARNING

#### Fuel is highly flammable

Fire and explosion hazard

- Do not smoke. Never bring a naked flame near the fuel tank. ◀



### WARNING

#### Escaping of fuel due to expansion under exposure to heat with overfilled fuel tank

Accident hazard

- Do not overfill the fuel tank. ◀



### ATTENTION

#### Contact of fuel and plastic surfaces

Damage to surfaces (become unattractive or cloudy)

- Immediately clean plastic surfaces after contact with fuel. ◀
  - Place motorcycle on center stand, ensuring that it is resting on a firm and level support surface.
- with Keyless Ride<sup>OE</sup>
- Switch off ignition (▶▶▶ 57).



### NOTICE

After the ignition is switched off, the fuel filler cap can be opened within the specified run-on time even without the radio-operated key being within the reception area. ◀



After-running period for opening the fuel filler cap

2 min

» There are **2 ways** to open the fuel filler cap:

- Within the run-on time.
- After the run-on time expires.

## Version 1

- with Keyless Ride<sup>OE</sup>

### Requirement

Within the run-on time



- Slowly pull lug **1** of fuel filler cap upward.
- » Fuel filler cap unlocked.
- Open fuel filler cap completely.

## Version 2

- with Keyless Ride<sup>OE</sup>

### Requirement

After run-on time expires

- Bring radio-operated key into reception range.
- Slowly pull up lug **1**.
  - » The indicator light for the radio-operated key flashes as long as the radio-operated key is being searched for.
- Slowly pull lug **1** of fuel filler cap upward again.
  - » Fuel filler cap unlocked.
- Open fuel filler cap completely.



- Refuel with a fuel meeting the specifications above, continuing until fuel is no higher than lower edge of filler neck.



### NOTICE

When refueling after running on fuel reserve, the resulting total fuel quantity must be greater than the fuel reserve, so that the new filling level is detected and the fuel warning light is switched off. ◀

 **NOTICE**

The "usable fuel quantity" specified in the technical data is the fuel quantity, which can be refueled if the fuel tank was completely emptied, i.e., if the engine dies off due to lack of fuel.◀



Usable fuel quantity

Approx. 5.3 gal (Approx. 20 l)



Reserve fuel quantity

Approx. 1.1 gal (Approx. 4 l)

- Press fuel filler cap of fuel tank down firmly.
- » Fuel filler cap audibly engages.
- » Fuel filler cap automatically locks after run-on time expires.
- » The engaged fuel filler cap locks immediately when the

steering lock is locked or during starting.

## Securing motorcycle for transport

- Protect all component surfaces against which straps are routed against scratching. For example, use adhesive tape or soft cloths.

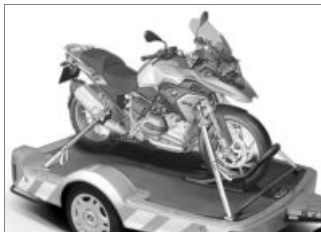

### ATTENTION

**Motorcycle tips to the side when raising**

Component damage cause by tipping over

- Secure the motorcycle against tipping to the side, preferably with the assistance of a second person.◀
- Push motorcycle onto transport surface, and do not place on side stand or center stand.

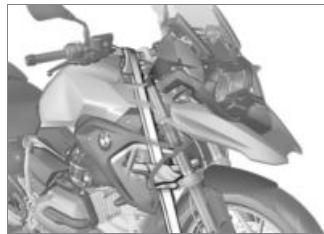

### ATTENTION

**Pinching of components**

Component damage



- Do not pinch components, e.g. brake lines or wiring harnesses.◀
- Fasten front straps to both sides of the handlebars.
- Guide straps through leading link and then tension.

the suspension compressed as much as possible.



- Secure and tighten the luggage straps at the rear on the brackets for the passenger footrests on both sides.
- Tension all straps evenly; the motorcycle should be pulled down against its springs with



## Technology in detail

General notes.....	138
Antilock Brake System (ABS) .....	138
Automatic Stability Control (ASC) .....	141
Dynamic Traction Control (DTC) .....	142
Dynamic ESA.....	143
Riding mode .....	144
Tire pressure control (RDC).....	146
Shift assistant.....	148
Hill Start Control .....	149

## General notes

More information on the topic of technology is available at:

**[bmw-motorrad.com/technology](http://bmw-motorrad.com/technology)**

## Antilock Brake System (ABS)

### Partially integral brake

Your motorcycle is equipped with a partially integral brake configuration. Both front and rear brakes are applied simultaneously when you pull the handbrake lever.

The footbrake lever acts only on the rear brake.

The BMW Motorrad Integral ABS adapts the braking force distribution between the front and rear wheel brake to the loading of the motorcycle during braking with ABS control.



## ATTENTION

### Attempt at a burn-out despite integral function

Damage to rear-wheel brake and clutch

- Do not perform burn-out. ◀

### How does ABS work?

The maximum braking force that can be transferred to the road surface is partially dependent on the friction coefficient of the road surface. Gravel, ice, snow and wet roads offer a considerably lower friction coefficient than a dry, clean asphalt surface. The poorer the friction coefficient of the road surface is, the longer the braking distance will be.

If the maximum transferable braking force is exceeded when the rider increases the brake pressure, the wheels begin to lock and driving stability is lost, and a fall can result. Before this sit-

uation occurs, ABS is activated and the brake pressure is adjusted to the maximum transferable braking force. This enables the wheels to continue to turn and maintains driving stability regardless of the road surface condition.

### What happens when rough roads are encountered?

Bumpy or rough roads can briefly lead to a loss of contact between the tires and the road surface, until the transferable braking force is reduced to zero. If the brakes are applied in this situation, the ABS must reduce the brake pressure to ensure driving stability when contact to the road is restored. At this point, the BMW Motorrad Integral ABS must assume extremely low friction coefficients (gravel, ice, snow) so that the road wheels

turn in every imaginable case and the driving stability is ensured. After detecting the actual conditions, the system adjusts the optimum brake pressure.

## How is the BMW Motorrad Integral ABS noticeable to the rider?

If the ABS system must reduce the braking forces due to the conditions described above, then vibrations can be felt at the handbrake lever.

If the handbrake lever is pulled, then braking pressure is built up at the rear wheel with the integral function. If the footbrake lever is first actuated after this, the brake pressure already built up can be felt earlier than the counter-pressure, than when the footbrake lever is actuated before or together with the handbrake lever.

## Lifting off rear wheel

However, during extremely heavy and rapid deceleration it is possible that the BMW Motorrad Integral ABS will not prevent the rear wheel from lifting off the ground. In these cases, the motorcycle can also flip end over end.



### Lifting off of the rear wheel due to heavy braking

Accident hazard

- When braking heavily, bear in mind that the ABS control cannot always be relied on to prevent the rear wheel from lifting off the ground. ◀

## What are the design characteristics of the BMW Motorrad Integral ABS?

The BMW Motorrad Integral ABS ensures driving stability on any surface within the limits of driving physics. The system is not optimized for special requirements resulting under extreme weather conditions offroad or on the racetrack. Handling should be adopted to driving skills and road conditions.

### Special situations

To detect the tendency of the wheels to lock up, the speeds of the front and rear wheel are compared. If implausible values are detected over a longer period of time, the ABS function is deactivated for safety reasons and an ABS error is indicated. A self-diagnosis routine must be com-

pleted before the error will be displayed.

Apart from problems with the BMW Motorrad ABS, unusual riding conditions can also cause a fault message to be generated:

- Warm-up on the center or auxiliary stand at idle or with gear engaged.
- Rear wheel locked-up for a longer period of time by engine brake, e.g. when riding downhill on slippery surfaces.

Should a fault code occur due to an unusual driving condition, the ABS function can be reactivated by switching the ignition off and then on again.

## How important is regular maintenance?



### WARNING

#### Failure to have maintenance performed on the brake system regularly.

Accident hazard

- To ensure that the ABS is in a properly maintained condition, it is vital that the specified service intervals be observed.◀

#### Reserves for safety

But remember: the potentially shorter braking distances which BMW Motorrad Integral ABS permits must not be used as an excuse for careless riding. ABS is primarily a means of ensuring a safety margin in genuine emergencies.



### WARNING

#### Braking in curves

Risk of accident despite ABS

- The rider is always responsible for adapting his/her driving style.
- Do not reduce the additional safety function with careless riding or unnecessary risks.◀

#### Further development of ABS to ABS Pro

- with riding modes Pro<sup>OE</sup>

In the past, the BMW Motorrad ABS system provided for a very high level of safety while braking during straight-ahead riding. Now ABS Pro also offers increased safety even when braking in curves. ABS Pro prevents locking-up of the wheels even in case of rapid brake actuation. ABS Pro reduces abrupt changes in steering forces, especially during panic braking, and therefore decreases the risk of unwanted wheelies occurring.

## ABS control

From a technical standpoint, ABS Pro adjusts the ABS control to the angle of inclination of the motorcycle in dependence on the respective riding situation. Signals for the roll and yaw rate and the lateral acceleration are used to determine the inclination of the motorcycle.

With an increasing inclination, the braking pressure gradient is increasingly limited at the start of braking. This results in a slower pressure buildup. In addition, the pressure modulation in the range of the ABS control is more uniform.

## Advantages for the rider

The advantages of ABS Pro for the rider are sensitive response and high braking and riding stability with the best possible deceleration, even in curves.

## Automatic Stability Control (ASC)

### How does ASC work?

BMW Motorrad ASC compares the wheel speeds of the front and rear wheels. From the speed difference the slip, and with it the stability reserves on the rear wheel are determined. When a slip limit is exceeded, the engine torque is adapted by the engine management system.

### What are the design characteristics of the BMW Motorrad ASC?

BMW Motorrad ASC is designed as an assistance system for the rider and for riding on public roads. The extent to which the rider affects ASC control can be considerable (weight shifts when cornering, loose luggage on the motorcycle), especially when ap-

proaching the limits imposed by the laws of physics.

The Enduro riding mode should be activated for off-road riding. In this mode the controlling intervention by the ASC is carried out later, enabling controlled drifting. The system is not optimized for the special conditions encountered under extreme weather during off-road and race-track use. BMW Motorrad ASC can be switched off under these conditions.



### Risky riding style

Accident hazard despite ASC

- The rider is always responsible for adapting his/her driving style.
- Do not reduce the system's extra safety margin with careless riding or unnecessary risks. ◀

## Dynamic Traction Control (DTC)

### How does Traction Control function?

Traction Control is available in two versions

- **Without** taking the angle into account: Automatic Stability Control ASC
- ASC is a rudimentary function intended to prevent falls.
- **With** taking the angle into account: Dynamic Traction Control DTC
- The additional inclined position and acceleration information enables the DTC to make more precise and comfortable adjustments.

Traction Control compares the wheel circumferential speeds of the front and rear wheels. The slip, and with it the stability reserves at the rear wheel, are de-

termined from the speed difference. The engine management system adapts the engine torque when the slip limit is exceeded.



### WARNING

#### Risky riding style

Risk of accident despite DTC

- The rider is always responsible for adapting his/her driving style.
- Do not reduce the system's extra safety margin with careless riding or unnecessary risks. ◀

#### Special situations

As lean angles increase, acceleration potential is also progressively restricted by the laws of physics. This can result in reduced acceleration when coming out of very tight curves.

To detect spinning or slipping away of the rear wheel, among other things the speeds of the front and rear wheel are compared and the angle with DTC compared to ASC is taken into account.

- with riding modes Pro<sup>OE</sup>

If the value for the angle are detected to be implausible for a long period, a replacement value is used for the angle or the DTC function is deactivated. In these cases, a DTC error is displayed. A self-diagnosis routine must be completed before the error will be displayed.

Under the following unusual riding conditions, BMW Motorrad Traction Control may be deactivated automatically.

#### Unusual riding conditions:

- Driving on the rear wheel (wheelie) for a longer period.



- Rear wheel spinning in place with front brake engaged (burn out).
- Heating up on an auxiliary stand at idle speed or with gear engaged.

If the coding plug is not in use, turning the ignition off and on again and then riding the motorcycle at a minimum speed reactivates the DTC after a fault.



Minimum speed for DTC activation

min 3 mph (min 5 km/h)

If the front wheel loses contact with the ground under extreme acceleration, the ASC or DTC function reduces the engine torque in the **RAIN** and **ROAD** riding modes until the front wheel makes contact with the ground again.

The riding modes **ENDURO** and **ENDURO PRO** are designed for off-road riding and are not suitable for road operation.

In the riding modes **DYNAMIC**, **DYNAMIC PRO** and **ENDURO**, the front wheel lift-off detection permits brief wheelies.

The front wheel lift-off detection is switched off in riding mode **ENDURO PRO**.

BMW Motorrad recommends that you respond to the front wheel lifting off by twisting back the throttle grip somewhat to return to a stable driving condition as quickly as possible.

On a slippery surface, the throttle grip should never be suddenly twisted back completely unless the clutch is disengaged at the same time. The engine braking torque can cause the rear wheel to slip, resulting in an unstable driving state. This case cannot

be controlled by BMW Motorrad DTC.

## Dynamic ESA

– with Dynamic ESA<sup>OE</sup>

### Riding position compensation

The electronic chassis and suspension adjustment Dynamic ESA can automatically adapt your motorcycle to the load. If the spring preload is set to **Auto**, the rider does not need to worry about the load setting. When driving off and while driving, the system monitors the compression at the rear wheel and corrects the spring preload so that the correct riding position is adjusted. The damping is also adapted automatically to the load. Using leveling sensors, Dynamic ESA detects movements of the chassis and suspension and responds to

them by adapting the EDC valves. As a result, the chassis and suspension is adjusted to the conditions of the surface.

Dynamic ESA calibrates itself at regular intervals to ensure that the system functions properly.

## Adjustment options

### Damping modes

- Road: damping for comfortable riding on roads
- Dyna.: damping for dynamic riding on roads
- Enduro: damping for off-road riding

### Load settings

- Auto: active riding position compensation with automatic adjustment of the spring preload and damping action
- Min: minimum spring preload
- Max: maximum spring preload (for off-road use)

- The rider can select the spring preload settings Min and Max but they can not be modified. The riding position compensation function is inactive in the settings Min and Max.

## Riding mode

### Selection

To adapt the motorcycle to the road condition and the desired riding experience, the following riding modes can be selected:

- RAIN
- ROAD (standard mode)
- with riding modes Pro<sup>OE</sup>
- DYNAMIC
- ENDURO

With the coding plug installed, the riding modes **DYNAMIC PRO** and **ENDURO PRO** replace the riding modes **DYNAMIC** and **ENDURO**.

For each of these riding modes, adapted settings for the ABS, ASC/DTC systems and for the throttle response are available.

- with Dynamic ESA<sup>OE</sup>

The Dynamic ESA alignment depends on the selected riding mode as well.

ABS and/or ASC/DTC can be switched off in each riding mode. The following explanations always refer to the riding safety systems that are switched on.

### Throttle response

- In the RAIN and ENDURO riding modes: restrained
- In the ROAD and ENDURO PRO riding modes: direct
- In the DYNAMIC and DYNAMIC PRO riding modes: dynamic
- Throttle response can be set differently in the DYNAMIC

PRO and ENDURO PRO riding modes using SETUP (▣➡ 71).

## **ABS**

- The rear wheel lift-off detection is active in all driving modes.
- In the RAIN, ROAD, DYNAMIC and DYNAMIC PRO riding modes, the ABS is matched to road operation.
- In the ENDURO riding mode, ABS is matched to off-road operation using road tires.
- with riding modes Pro<sup>OE</sup>
- In the ENDURO PRO riding mode, ABS control is not applied to the rear wheel if the footbrake lever is actuated. ABS is aligned to off-road operation using massive-bar tires.
- ABS can be set differently in the ENDURO PRO riding mode using SETUP (▣➡ 71).
- In the RAIN, ROAD, DYNAMIC and DYNAMIC PRO riding

modes, ABS Pro is fully available. The inclination the motorcycle has when braking in curves is reduced to a minimum.

- In the ENDURO riding mode, ABS Pro is only available when there is good road friction. Compared to the ROAD riding mode, there is reduced support; instead, this mode is designed to achieve the highest braking effect.
- In the ENDURO PRO riding mode, ABS Pro is not available.
- without riding modes Pro<sup>OE</sup>

## **ASC**

- The front wheel lift-off detection is active in all driving modes.
- ASC is matched to road operation.
- In ROAD riding mode, ASC offers high driving stability and

maximum driving stability in RAIN riding mode.

- with riding modes Pro<sup>OE</sup>

## **DTC**

### **Tires**

- In the RAIN, ROAD, DYNAMIC and DYNAMIC PRO riding modes, DTC is matched to road operation using road tires.
- In the ENDURO riding mode, DTC is matched to off-road operation using road tires.
- In the ENDURO PRO riding mode, DTC is matched to off-road operation using knobby tires.

### **Driving stability**

- Intervention of the DTC in the RAIN riding mode occurs at an early enough stage to achieve maximum riding stability.
- In the ROAD riding mode, the intervention of the DTC occurs later than in the RAIN

- riding mode. Slipping of the rear wheel is avoided whenever possible.
- In the RAIN and ROAD driving modes, the front wheel is prevented from lifting off the ground.
- In the DYNAMIC and DYNAMIC PRO riding modes, the DTC intervenes later than in the ROAD riding mode so that minor drifts at the end of curves and brief wheelies are possible.
- DTC can be set differently in the DYNAMIC PRO riding mode using SETUP (➡ 71).
- In ENDURO riding mode, DTC intervenes even later and is matched to off-road operation so that even longer drifts and brief wheelies at the end of curves are also possible.
- In the ENDURO PRO riding mode, DTC control assumes that knobby tires are being

- used in off-road conditions. Longer wheelies and wheelies in lower inclined positions are permitted. The front wheel lift-off detection is turned off, whereby in extreme cases flipping over backwards is possible!
- DTC can be set differently in the ENDURO PRO riding mode using SETUP (➡ 71).

### Changing setting

Riding modes can be changed when the vehicle is at a standstill with the ignition switched on. A changeover while riding is possible under the following conditions:

- No drive torque at rear wheel.
- No brake pressure in the braking system.

For a changeover while riding, the following steps must be carried out:

- Turn back throttle grip.
- Do not actuate brake lever.

First the desired riding mode is preselected. The new selection is not activated until the specified conditions are present in all affected systems.

The selection menu does not disappear in the display until the riding mode has been switched over.

### Tire pressure control (RDC)

- with Tire Pressure Monitor (TPM)<sup>OE</sup>

### Operation

A sensor located in each tire monitors the air temperature and the inflation pressure inside the tire and transmits this information to the control unit.

The sensors are equipped with a centrifugal controller, which does

not enable the transmission of the measured values until the minimum speed is exceeded for the first time.



Minimum speed for the transmission of the TPC/RDC measured values:

min 19 mph (min 30 km/h)

Before initial reception of the tire pressure, -- is shown in the display for each tire. The sensors continue to transmit the measured readings for some time after the vehicle comes to a stop.



Transmission time of the measured values after vehicle standstill:

min 15 min

If an TPC/RDC control unit is installed but the wheels have no sensors, a fault message is generated.

## Tire inflation pressure ranges

The TPC/RDC control unit distinguishes between three inflation pressure ranges matched to the motorcycle:

- Inflation pressure within the permissible tolerance.
- Inflation pressure at the limits of the permissible tolerance.
- Inflation pressure outside the permissible tolerance.

## Temperature compensation

The tire inflation pressure is temperature dependent, i.e. it increases or decreases together with the tire air temperature. The tire temperature is dependent on the outside temperature, the riding style and the length of the journey.



The tire pressures are shown in the TFT display with temperature compensation and are always based on the following tire air temperature:

68 °F (20 °C)

Tire pressure gages at gas stations do not make any adjustment for the air temperature, the tire pressure indicated depends on the temperature of the air in the tire. As a result, in most cases the values displayed there do not match the values shown in the TFT display.

## Tire pressure adjustment

Compare the TPC/RDC value in the TFT display with the value on the back cover of the operating instructions. The difference between the two values must be compensated with the tire infla-

tion pressure tester at the filling station.



Example

According to the rider's manual, the tire pressure should have the following value:

36.3 psi (2.5 bar)

The following value is displayed in the TFT display:

33.4 psi (2.3 bar)

Missing is thus:

2.9 psi (0.2 bar)

The tester at the filling station shows:

34.8 psi (2.4 bar)

To produce the correct tire pressure, this must be increased to the following value:

37.7 psi (2.6 bar)

## Shift assistant

- with riding modes Pro<sup>OE</sup>

### Pro gearshift assistant

Your motorcycle is equipped with a Pro gearshift assistant originally developed for racing but now specially adapted for touring use. It allows you upshift and downshift under almost any load conditions and in virtually all engine-speed ranges without operating the clutch or accelerator.

#### Benefits

- 70-80 % of all gear changes can be performed without using the clutch.
- Less movement between pilot and pillion due to shorter gear-change intervals.
- Throttle does not have to be closed when changing gear under acceleration.

- During deceleration and downshifts (throttle plate closed) the system blips the throttle to obtain the correct engine speed.
- Shifting times are faster than when the clutch is used to change gears.

For the system to detect the rider's intention to change gear, the gearshift lever previously not operated must be moved against the force of the spring by a certain amount of "overtravel" in the desired direction with a normal to brisk action and held in that position until the gear change is completed. A further increase of the force applied to the gearshift lever during the gear-shift operation is not necessary. After the gear change is completed, the gear lever must be fully released before the Pro gearshift assistant can execute a new gear change. The load factor (throt-

tle grip position) should remain constant both prior to and during execution of shifts using the Pro gearshift assistant. Changing the accelerator twist-grip position during the gear-shift operation may cause the function to abort and/or the gear change to fail. The Pro gearshift assistant does not provide support when gear changes are made using the clutch.

### Downshifts

- Downshifts are assisted up to the speed at which the engine reaches maximum rpm in the gear to be engaged. Over-revving is thus prevented.

 Maximum engine speed
max 9000 min <sup>-1</sup>

### Upshifts

- Upshifting is supported until the idling speed is reached in the target gear.
- This prevents the idling speed from being dropped below.

 Idle speed
1150 min <sup>-1</sup> (Engine at operating temperature)

### Hill Start Control

- with riding modes Pro<sup>OE</sup>

### Function of the Hill Start Control

The Hill Start Control prevents an uncontrolled rolling back on slopes by means of targeted intervention in the partial integral ABS brake system, without the rider having to continuously operate the brake lever. When the

Hill Start Control is activated, the pressure in the rear brake system is built up so that the motorcycle remains in position on an incline.

### Effects of the holding pressure on the behavior when driving off

- If a low brake pressure is used for holding, only a small amount of holding pressure is built up. The brakes release quickly when driving off. Driving off more softly is therefore possible. Additional turning of the throttle grip is hardly required.
- If a higher brake pressure is used for holding, a higher amount of holding pressure is built up. The brakes release a bit more slowly when driving off. Since more torque is required for driving off in this case, an additional turning of the throttle grip is necessary.

### **Behavior when the vehicle is rolling or slipping**

- If the vehicle rolls with the Hill Start Control active, the holding pressure is increased.
- If the rear wheel slips, the brake will be released again after approx. 1 m. This prevents the vehicle from rolling with the rear wheel blocked.

### **Releasing the brake when stopping the engine**

The Hill Start Control is deactivated if the engine is stopped using the emergency off switch or if the side stand is folded out. In addition to the indicator and warning lights, the rider is to be made aware about the deactivation of the Hill Start Control by the following behavior:

### **Brake warning jerk**

- The brake is released briefly and immediately activated again.
- This causes a jerk that the rider can feel.
- The brake is released slowly.
- The vehicle is unbraked.
- The rider must brake the vehicle manually.



### **NOTICE**

When the ignition is switched off, the holding pressure is built up immediately and without brake warning jerk.◀



## Maintenance

General instructions.....	152
Tool kit .....	152
Service tool kit.....	152
Front wheel stand .....	153
Engine oil .....	154
Brake system .....	155
Clutch .....	159
Coolant .....	159
Tires.....	161
Rims and tires .....	162
Wheels .....	163
Air filter .....	169
Light sources .....	171
Jump-starting.....	175
Battery.....	177

Fuses .....	181
Data link connector .....	182

## General instructions

The "Maintenance" chapter describes work involving the checking and replacement of wear parts that can be performed with a minimum of effort.

If special tightening torques are to be taken into account for assembly, these are listed. An overview of all required tightening torques is contained in the chapter "Technical Data".

Further information about maintenance and repair work can be obtained on DVD through your authorized BMW Motorrad retailer.

Special tools and thorough specialized knowledge are required to carry out some of the work. If you are in doubt, consult an authorized workshop, preferably your authorized BMW Motorrad retailer.

## Tool kit



- 1** Screwdriver handle
  - Use with screwdriver insert
  - Topping up engine oil (➡ 155).
- 2** Reversible screwdriver insert
  - Phillips PH1 and Torx T25
  - Remove light sources in front and rear turn indicators (➡ 174).
  - Remove battery cover (➡ 178).
- 3** Open-ended wrench
  - Wrench size: 8/10 mm

- 3** – Removing battery (➡ 178).
- 4** Open-ended wrench
  - Wrench size: 14
  - Adjusting mirror arm (➡ 110).

## Service tool kit

– with service tool set<sup>OA</sup>

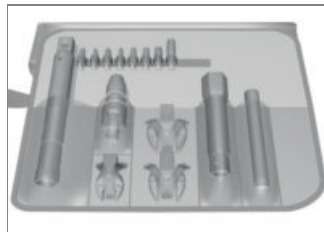

For more extensive service operations (such as wheel removal and installation), BMW Motorrad has put together a service tool kit matched to your motorcycle. You can purchase this tool kit from

your authorized BMW Motorrad retailer.

## Front wheel stand

### Mount front wheel stand

#### ATTENTION

#### Use of the BMW Motorrad front wheel stand without an additional center or auxiliary stand

Component damage cause by tipping over

- Place the motorcycle on the center stand or an auxiliary stand before lifting it with the BMW Motorrad front wheel stand.◀
- Place motorcycle on center stand, ensuring that it is resting on a firm and level support surface.
- Use basic stand with front wheel mount. The base stand and its accessories are avail-

able through your authorized BMW Motorrad retailer.

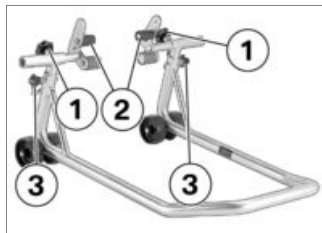

- Loosen screws **1**.
- Push two mounts **2** outward, continuing until front suspension fits between them.
- Use locating pins **3** to set front wheel stand to desired height.
- Center front wheel stand relative to front wheel and push it against front axle.

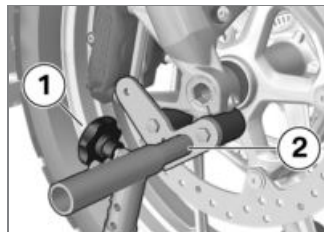

- Align two mounts **2** so that front suspension rests securely on them.
- Tighten screws **1**.

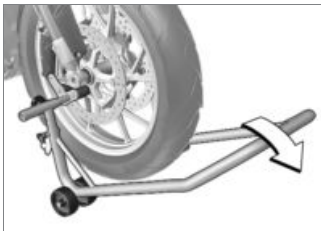

### ATTENTION

#### Center stand retracts if motorcycle is lifted too high.

Component damage cause by tipping over

- When raising the motorcycle, make sure that the center stand remains on the ground.◀
- Apply uniform pressure to push front wheel stand down and raise motorcycle.

## Engine oil

### Check engine oil level

#### ATTENTION

**Misinterpretation of the oil filling quantity, as the oil level is temperature-dependent (the higher the temperature, the higher the oil level)**

Engine damage

- Only check the oil level after a longer journey or when the engine is warm.◀
- Switch off engine at operating temperature.
- Place motorcycle on center stand, ensuring that it is resting on a firm and level support surface.
- Wait five minutes to allow oil to drain to the oil pan.

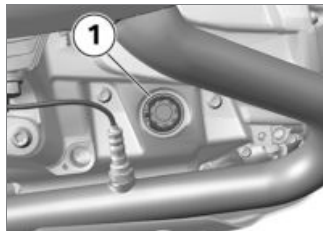

- Read oil level in display **1**.



 Specified level of engine oil

between MIN- and MAX mark

If oil level is below MIN mark:

- Topping up engine oil (▣▶ 155).

If oil level is above MAX mark:

- Have oil level corrected at an authorized service facility, preferably an authorized BMW Motorrad retailer.

## Topping up engine oil

- Park motorcycle, ensuring that support surface is firm and level.

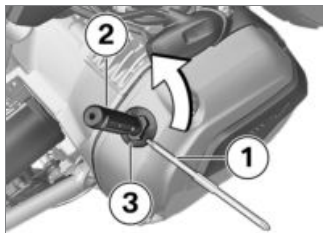

- Wipe area around oil fill location to clean it.

- To be able to apply force more easily, insert the interchangeable screwdriver bit **1**, Torx end first, into the screwdriver handle **2** (from motorcycle toolkit).
- Locate specified tool from vehicle toolkit on oil fill location **3** and turn counterclockwise.
- Check engine oil level (▣▶ 154).



### ATTENTION

#### Use of too little or too much engine oil

Engine damage

- Always make sure that the oil level is correct.◀
- Add engine oil up to specified level.



Engine oil, quantity for topping up

max 1 quarts (max 0.95 l) (Difference between MIN and MAX)

- Check engine oil level (▣▶ 154).
- Install the oil filler cover **3**.

## Brake system

### Check brake operation

- Actuate the handbrake lever.  
» Pressure point must be clearly perceptible.
- Actuate the footbrake lever.  
» Pressure point must be clearly perceptible.

If no clear pressure points are perceptible:



### ATTENTION

#### Improper working on the brake system

Endangering of the operating safety of the brake system

- Have all work on the brake system carried out by experts.◀
- Have the brakes checked at an authorized workshop, preferably

an authorized BMW Motorrad retailer.

## Check front brake pad thickness

- Park motorcycle, ensuring that support surface is firm and level.



- Visually inspect left and right brake pads to determine their thickness. Viewing direction: between wheel and front suspension toward brake pads **1**.



Front brake-pad wear limit

0.04 in (1.0 mm) (Only friction material without carrier plate. Wear markings (grooves) must be clearly visible.)

If the wear indicators are no longer clearly visible:



### WARNING

#### Dropping below the minimum pad thickness

Reduced braking action, damage to the brake

- In order to ensure the operating reliability of the brake system, make sure that the brake pads are not worn beyond their minimum thickness. ◀
- Have brake pads replaced at an authorized service facility, preferably an authorized BMW Motorrad retailer.

## Check rear brake pad thickness

- Park motorcycle, ensuring that support surface is firm and level.



- Conduct a visual inspection of the brake pad thickness. Viewing direction: between splash guard and rear wheel toward brake pads **1**.



 Rear brake-pad wear limit

0.04 in (1.0 mm) (Only friction material without carrier plate.)

If wear limit is reached:

### **WARNING**

#### **Dropping below the minimum pad thickness**

Reduced braking action, damage to the brake

- In order to ensure the operating reliability of the brake system, make sure that the brake

pads are not worn beyond their minimum thickness. ◀

- Have brake pads replaced at an authorized service facility, preferably an authorized BMW Motorrad retailer.

### **Checking front brake fluid level**

#### **WARNING**

#### **Insufficient brake fluid in the brake-fluid reservoir**

Considerably reduced braking performance caused by air in the brake system

- Adjust the riding mode immediately until the fault is rectified.
- Check brake fluid level regularly. ◀
- Make sure ground is level and firm and place motorcycle on its center stand.

- Move handlebars into straight-ahead position.



- Check brake fluid level in front brake-fluid reservoir **1**.

#### NOTICE

The brake fluid level in the brake-fluid reservoir drops due to brake pad wear. ◀



Front brake fluid level

Brake fluid, DOT4

The brake fluid level must not fall below the MIN mark. (Brake-fluid reservoir horizontal, motorcycle standing upright)

If brake fluid level falls below the approved level:

- Have defect corrected as soon as possible by an authorized workshop, preferably an authorized BMW Motorrad retailer.

## Checking rear brake fluid level

### WARNING

#### Insufficient brake fluid in the brake-fluid reservoir

Considerably reduced braking performance caused by air in the brake system

- Adjust the riding mode immediately until the fault is rectified.
- Check brake fluid level regularly. ◀
- Make sure ground is level and firm and place motorcycle on its center stand.





- Read brake fluid level at rear brake-fluid reservoir **1**.



## NOTICE

The brake fluid level in the brake-fluid reservoir drops due to brake pad wear. ◀



Rear brake fluid level

Brake fluid, DOT4

The brake fluid level must not fall below the MIN mark. (Brake-fluid reservoir horizontal, motorcycle standing upright)

If brake fluid level falls below the approved level:

- Have defect corrected as soon as possible by an authorized workshop, preferably an authorized BMW Motorrad retailer.

## Clutch

### Checking clutch function

- Pull back the clutch lever.
  - » Pressure point must be clearly perceptible.

If no clear pressure point can be felt:

- Have the clutch checked by an authorized workshop, preferably an authorized BMW Motorrad retailer.

## Coolant

### Checking coolant level

- Park motorcycle, ensuring that support surface is firm and level.



### ⚠ CAUTION

#### Hot engine

Burn hazard

- Maintain a safe distance from the hot engine.
- Do not touch the hot engine. ◀
- Read off coolant level on expansion tank **1**.



Required coolant level

Between **MIN** and **MAX** marks on the expansion tank (Engine cold)

If coolant level drops below approved level:

- Top up coolant (➡ 160).

## Topping up coolant

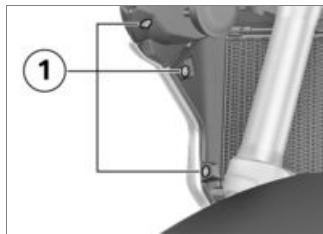

- Remove screws **1**.



- Remove screws **1**.
- Pull side trim panel **2** from the clamp **3** and remove.

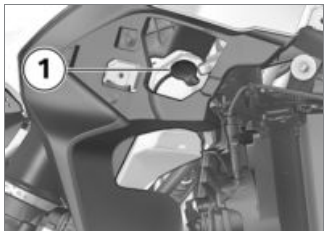

- Open cap **1**.
- Add coolant up to specified level.
- Checking coolant level (►► 159).
- Close cap of expansion tank.



- Insert side trim panel **2** into the slot **4**.
- Engage clamp **3**.



- Install screws **1**.

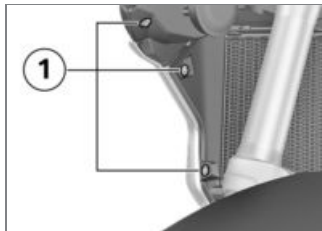

- Install screws **1**.

## Tires

### Checking tire pressure



**WARNING**

#### Incorrect tire inflation pressure

Poorer handling characteristic of motorcycle, reduction of tire service life

- Ensure proper tire inflation pressure. ◀

**WARNING****Automatic opening of vertically installed valve inserts at high speeds**

Sudden loss of tire inflation pressure

- Use valve caps with rubber sealing ring and screw on firmly. ◀
- Park motorcycle, ensuring that support surface is firm and level.
- Check tire pressures against data below.



Tire pressure, front

36.3 psi (2.5 bar) (with tire cold)



Tire pressure, rear

42.1 psi (2.9 bar) (with tire cold)

If tire pressure is too low:

- Correct tire pressure.

**Rims and tires****Checking rims**

- Park motorcycle, ensuring that support surface is firm and level.
- Subject wheel rims to visual inspection for defects.
- Have damaged rims checked and, if necessary, replaced by a specialist service facility, preferably an authorized BMW Motorrad retailer.

**Check tire tread depth****WARNING****Riding with heavily worn tyres**

Risk of accident due to poorer rideability

- If necessary, replace the tyres before the legally specified minimum tread depth is reached. ◀
- Park motorcycle, ensuring that support surface is firm and level.
- Check tire tread depth in main tread grooves with wear indicators.

**NOTICE**

Tread wear marks are integrated into the main grooves on every tire. If the tire tread has worn down to the level of the marks, the tire is completely worn. The locations of the marks are indi-

cated on the edge of the tire, e.g. by the letters TI, TWI or by an arrow. ◀

When the minimum tread depth is reached:

- Replace the worn tires.

## Checking spokes

– with cross spoke wheels<sup>OE</sup>

- Park motorcycle, ensuring that support surface is firm and level.
- Using the handle of a screwdriver or similar object, run it over the spokes and listen to the sound pattern.

If the sound pattern is uneven:

- Have spokes checked by a specialist workshop, preferably by an authorized BMW Motorrad Retailer.

## Wheels

### Affect of wheel sizes on suspension control systems

The wheel sizes play a major role for the ABS and ASC suspension control systems. The diameter and width of the wheels stored in the control unit have particular significance as the basis for all necessary calculations. A change in these sizes resulting from conversion to wheels not installed as standard equipment can seriously affect the control efficiency of these systems.

The sensor rings required for wheel speed detection must also match the installed control systems and may not be replaced. If you want to equip your motorcycle with different wheels, please contact a specialist service facility, preferably a BMW Motorrad retailer. In some

cases the data stored in the control units can be adapted for the new wheel sizes.

### TPC/RDC sticker

- with Tire Pressure Monitor (TPM)<sup>OE</sup>

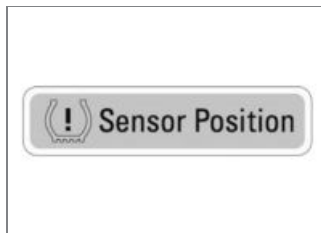

### ATTENTION

#### Improper tire removal

Damage to the TPC/RDC sensors

- Inform a specialist service facility or an authorized BMW Motorrad retailer on the

fact that the wheel is equipped with a TPC/RDC sensor. ◀

On motorcycles equipped with TPC/RDC, a corresponding sticker is located on the wheel rim at the position of the TPC/RDC sensor. During a tire change it must be ensured that the TPC/RDC sensor is not damaged. Inform the BMW Motorrad retailer or the authorized workshop of the TPC/RDC sensor.

### Removing front wheel

- Make sure ground is level and firm and place motorcycle on its center stand.

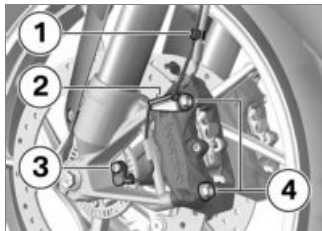

- Detach wheel speed sensor lead from retaining clips **1** and **2**.
- Remove screw **3** and take wheel speed sensor out of bore.
- Mask off areas of wheel rim that could be scratched in the process of removing the brake calipers.



### ATTENTION

#### Unintentional pressing together of brake pads

Component damage when mounting the brake caliper or

when pressing the brake pads apart

- Do not actuate the brakes with the brake caliper removed. ◀
- Remove securing screws **4** of left and right brake calipers.

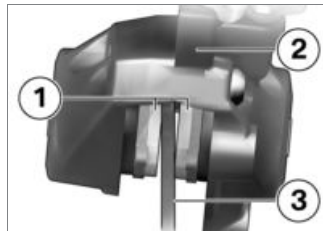

- Push brake pads **1** slightly apart by turning the brake caliper **2** back and forth against the brake rotor **3**.
- Carefully pull brake calipers back and outward to remove them from brake rotors.

- Raise front of motorcycle, preferably using a BMW Motorrad front wheel stand, continuing until the wheel rotates freely.
- Mount front wheel stand (➡ 153).

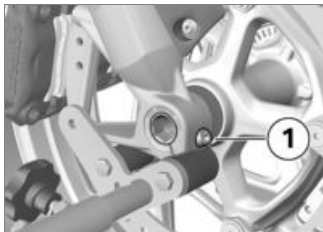

- Remove right-hand axle clamping screw **1**.

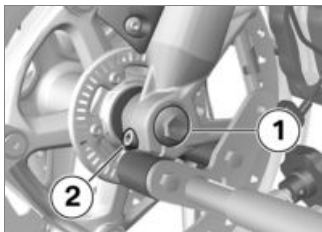

- Remove the screw **1**.
- Remove left axle clamping screw **2**.
- Slightly press the quick-release axle inward for a better grip on the right side.

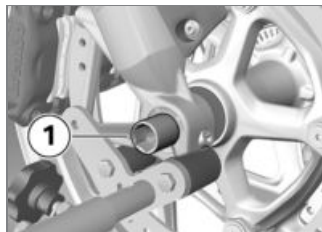

- Pull quick-release axle **1** out while supporting the front wheel.
- Place front wheel down and roll it forward out of the front suspension.

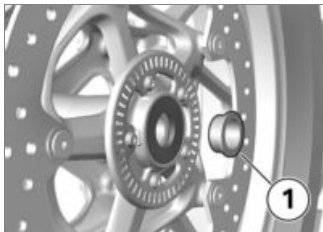

- Remove spacer bushing **1** from the wheel hub.

### Installing front wheel

#### WARNING

#### Use of a wheel which does not comply with series specifications

Malfunctions during control interventions by ABS and ASC

- Please see the information on the effect of wheel sizes on the ABS and ASC chassis control systems at the beginning of this chapter. ◀

#### ATTENTION

#### Tightening of screwed connections with incorrect tightening torque

Damage or loosening of screwed connections

- Always have the tightening torques checked by a specialized workshop, preferably an authorized BMW Motorrad retailer. ◀

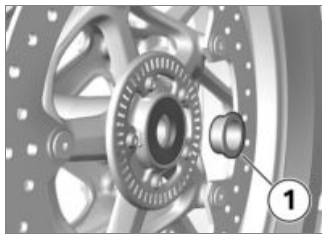

- Mount spacing bushing **1** on left side in wheel hub.

#### ATTENTION

#### Front wheel installation opposite the running direction

Accident hazard

- Observe running direction arrows on tire or rim. ◀
- Roll front wheel into front suspension.

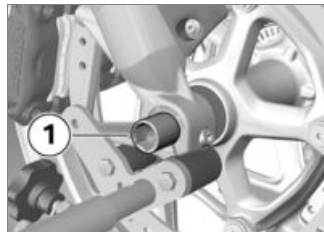

- Lift front wheel and install quick-release axle **1**.
- Remove front wheel stand and firmly compress front forks. Do not actuate handbrake lever at the same time.



- Mount front wheel stand (1111153).

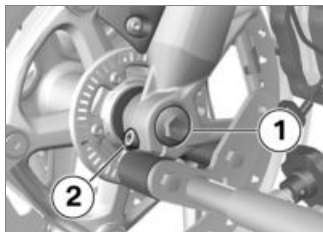

- Install screw **1** with specified torque. Brace quick-release axle on the right side at the same time.

 Quick-release axle in telescopic fork

22 lb/ft (30 Nm)

- Tighten left axle clamping screw **2** with appropriate torque.

 Clamping screw for quick-release axle in telescopic fork

14 lb/ft (19 Nm)



- Tighten the right-hand axle clamping screw **1** with the specified torque.

 Clamping screw for quick-release axle in telescopic fork

14 lb/ft (19 Nm)

- Remove front wheel stand.

- Slide the brake calipers on the left-hand and right-hand side onto the brake rotors.

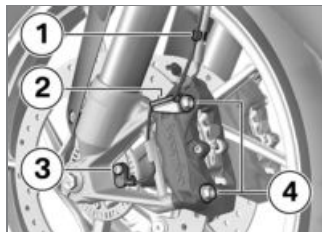

- Install securing screws **4** on left and right with specified torque.

 Brake caliper on telescopic forks

28 lb/ft (38 Nm)

- Remove adhesive tape from wheel rim.

## WARNING

### Brake pads do not contact the brake disc

Risk of accident due to delayed braking effect.

- Before driving off, check that the braking effect kicks in without any delay. ◀
- Engage the brakes repeatedly, continuing until the brake pads seat against the rotors.
- Locate wheel speed sensor lead in the retaining clips **1** and **2**.
- Insert wheel speed sensor in bore and install screw **3**.



Wheel speed sensor on fork

Joint compound: Micro-encapsulated

6 lb/ft (8 Nm)

## Removing rear wheel

- Make sure ground is level and firm and place motorcycle on its center stand.
- Shift into first gear.

## CAUTION

### Hot exhaust system

Burn hazard

- Do not touch hot exhaust system. ◀
- Let rear muffler cool down.



- Remove bolts **1** of rear wheel, holding wheel as you do so.

- Roll rear wheel out toward rear.

## Install rear wheel

## WARNING

### Use of a wheel which does not comply with series specifications

Malfunctions during control interventions by ABS and ASC

- Please see the information on the effect of wheel sizes on the ABS and ASC chassis control systems at the beginning of this chapter. ◀



## ATTENTION

### Tightening of screwed connections with incorrect tightening torque

Damage or loosening of screwed connections

- Always have the tightening torques checked by a specialized workshop, preferably

an authorized BMW Motorrad retailer. ◀

- Place rear wheel on rear wheel support.



- Install wheel studs **1** with specified torque.

 Tighten rear wheel on wheel flange

Tightening sequence: Tighten crosswise

44 lb/ft (60 Nm)

## Air filter

### Replacing air cleaner insert



- Remove rider's seat (► 84).
- Remove screws **1** and **2**.
- Remove center fairing panel.

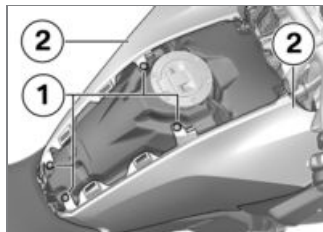

- Remove screws **1**.
- Loosen cover panel **2** on both sides.

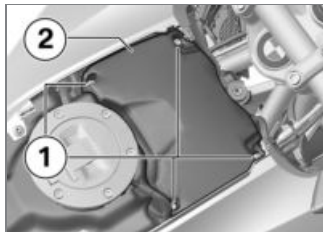

- Remove screws **1**.
- Remove air filter cover **2**.

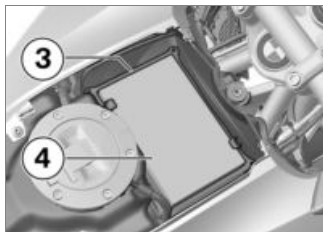

- Remove frame **3**.
- Remove air filter element **4**.

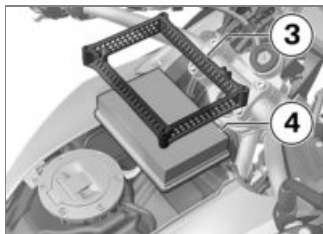

- Clean air filter element **4** or replace, if necessary.
- Replace air filter element **4** and frame **3**.

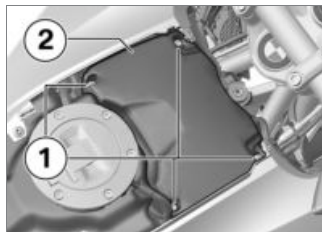

- Put on air filter cover **2**.
- Install the screws **1**.

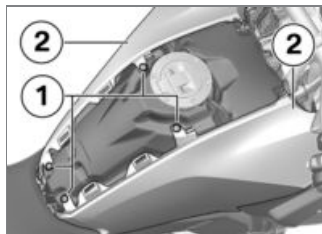

- Position cover panel **2** on both sides.
- Install screws **1**.

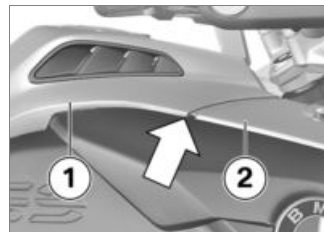

- Place tank cover **1** in position, taking care that the guide (**arrow**) is underneath the upper front wheel cover **2**.

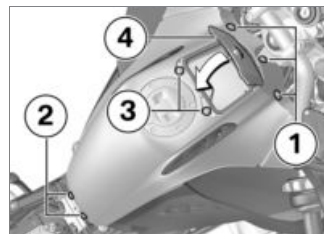

- Install screws **1**, **2** and **3**.

- Close lid **4** of storage compartment.
- Installing rider's seat (➡ 85).

## Light sources

### Replacing low and high-beam light sources in headlight

– without LED headlight<sup>OE</sup>

#### NOTICE

The alignment of connector, spring wire strap and bulb may differ from that shown in the following illustrations. ◀

- Park motorcycle, ensuring that support surface is firm and level.
- Turn off ignition.

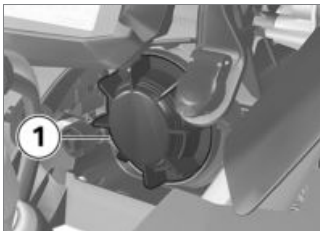

- Remove cover panel **1** by turning counter-clockwise in order to replace the low-beam headlight.



- Remove cover panel **1** by turning counter-clockwise in order

to replace the light source for the high beams.



- Disconnect plug **1**.



- Release wire spring **1** from the detent and fold to side.
- Remove light source **2**.

- Replace defective light source.

 Bulbs for low-beam headlight

H7 / 12 V / 55 W

– with LED headlight<sup>OE</sup>

LED<

 Bulb for high-beam headlight

H7 / 12 V / 55 W

– with LED headlight<sup>OE</sup>

LED<

- To protect the glass against soiling, only grasp the light source by the base.



- Insert the light source **2**, taking care to ensure that the lug **3** is positioned correctly.



#### NOTICE

The alignment of the bulb may differ from the illustration.◀

- Insert wire spring **1** into the detent.

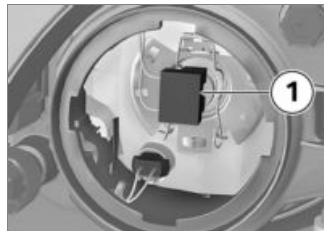

- Connect connector **1**.
- Position cover panel and install it by turning clockwise.

#### Replacing light source for parking light

– without LED headlight<sup>OE</sup>

- Park motorcycle, ensuring that support surface is firm and level.
- Turn off ignition.

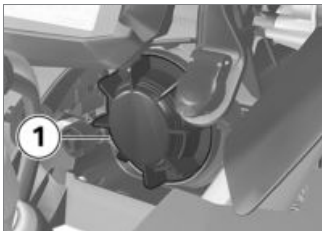

- Remove cover panel **1** by turning counter-clockwise.



- Remove light source **1** from the socket.
- Replace defective light source.

 Bulb for parking light
W5W / 12 V / 5 W
– with LED headlight <sup>OE</sup>
LED<

- To prevent contaminants from being deposited on the glass surface, always use a clean, dry cloth to hold the light source.



- Insert bulb **1** in bulb socket.



- Remove bulb holder **1** from the headlight housing.



- Install bulb socket **1** into the headlight housing.
- Position cover panel and install it by turning clockwise.

## Replacing front and rear turn indicator light sources

- Park motorcycle, ensuring that support surface is firm and level.
- Turn off ignition.



- Remove screw **1**.



- Pull glass on screw connection side out of mirror housing.

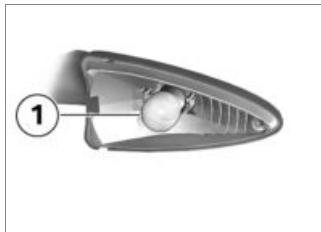

- Remove light source **1** from the mirror housing by turning it counterclockwise.

- Replace defective light source.



Bulbs for flashing turn indicators, front

RY10W / 12 V / 10 W



Bulbs for flashing turn indicators, rear

RY10W / 12 V / 10 W

- To prevent contaminants from being deposited on the glass surface, always use a clean, dry cloth to hold the light source.

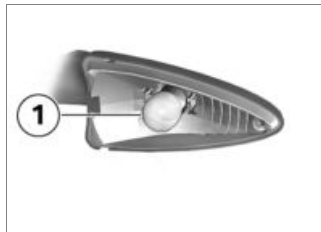

- Install light source **1** by turning clockwise in light housing.





- Insert inside end of lens into light housing and close it.



- Fit the screw **1**.

## Replacing LED tail light

The LED tail light can only be completely replaced.

- For details please contact a specialist service facility, preferably an authorized BMW Motorrad Retailer.

## Replace LED headlamp

– with LED headlight<sup>OE</sup>

- LED headlamps can only be replaced as a complete unit. For details please contact a specialist service facility, preferably an authorized BMW Motorrad Retailer.

## Replace additional LED headlight

– with LED auxiliary headlight<sup>OA</sup>

The LED additional headlights can only be completely replaced; it is not possible to replace individual LEDs.

Please contact a specialized workshop, preferably an authorized BMW Motorrad retailer.

## Jump-starting



**CAUTION**

### Touching live parts of the ignition system when the engine is running

Electrocution

- Do not touch parts of the ignition system when the engine is running.◀



**ATTENTION**

### Current too high when jump-starting the motorcycle

Cable fire or damage to the motorcycle electronics

- Do not jump-start the motorcycle using the power socket, only via the battery terminal.◀

**ATTENTION****Contact between crocodile clips of jump leads and motorcycle**

Danger of short circuit

- Use jump leads fitted with fully insulated crocodile clips at both ends.◀

**ATTENTION****Jump-starting with a voltage higher than 12 V**

Damage to the motorcycle's electronics

- The battery of the donor motorcycle must have a voltage of 12 V.◀
- Park motorcycle, ensuring that support surface is firm and level.
- Remove battery cover (▣▶ 178).
- Do not disconnect the battery from the onboard electrical sys-

tem when jump-starting the engine.

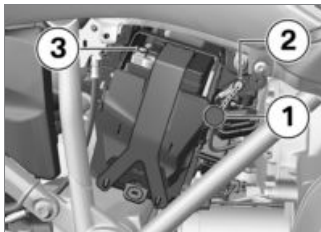

- Remove protective cap **1**.
- Begin by connecting the red jump lead to the positive battery connection point **2** on the drained battery and the other end to the positive terminal of the donor battery.
- Then clamp one end of the black jump lead to the donor battery's negative terminal **3** while connecting the other end to the drained battery's negative terminal.

- Allow engine on support motorcycle to run while jump-starting.
- Start engine of motorcycle with discharged battery in usual way; if engine does not start, wait a few minutes before repeating attempt in order to protect starter motor and donor battery.
- Allow both engines to idle for a few minutes before disconnecting jumper cables.
- Disconnect jumper cable from negative terminals first, then disconnect second cable from positive terminals.

**NOTICE**

To start the engine, do not use start sprays or similar items.◀

- Install the protective cap.
- Installing battery cover (▣▶ 180).

## Battery

### Maintenance instructions

Correct battery maintenance combined with proper charging and storage procedures extends the battery's service life, and is also required for warranty claims. Compliance with the points below is important in order to maximize battery life:

- Keep the surface of the battery clean and dry.
- Do not open the battery.
- Do not top up with water.
- Be sure to read and comply with the instructions for charging the battery on the following pages.
- Do not turn the battery upside down.



#### ATTENTION

#### Discharging of the connected battery by the vehicle electronics (e.g. clock)

Total discharge of battery leading to a rejection of warranty claims

- During riding breaks of more than 4 weeks, connect a trickle-charger to the battery. ◀



#### NOTICE

BMW Motorrad has developed a trickle-charger specially designed for compatibility with the electronics of your motorcycle. Using this charger, you can keep the battery charged during long periods when the motorcycle is not being used without having to disconnect the battery from the motorcycle's onboard systems. Additional information is available at your authorized BMW Motorrad retailer. ◀

### Charging connected battery



#### ATTENTION

#### Charging the battery connected to the vehicle using the battery terminals

Damage to the motorcycle's electronics

- Disconnect the battery before charging on the battery terminals. ◀



#### ATTENTION

#### Charging a fully discharged battery via the power socket or additional onboard socket

Damage to the motorcycle's electronics

- Always charge a fully discharged battery (battery voltage below 9 V; with the ignition switched on, the indicator lights and the multifunction display remain

off) directly at the poles of the **disconnected** battery.◀



## ATTENTION

### Unsuitable chargers connected to the power socket

Damage to charger and vehicle electronics

- Use suitable BMW chargers. The correct charger is available through your authorized BMW Motorrad retailer.◀
- Charge disconnected battery via onboard socket.



## NOTICE

The motorcycle's onboard electronics know when the battery is fully charged. The onboard socket is switched off when this happens.◀

- Comply with operating instructions of charger.



## NOTICE

If you are unable to charge the battery via the onboard socket, you may be using a charger that is not compatible with your motorcycle's electronics. In this case, charge the battery directly from the terminals of the battery disconnected from the vehicle.◀

### Charging disconnected battery

- Charge battery using a suitable charger.
- Comply with operating instructions of charger.
- Once battery is fully charged, disconnect charger's terminal clips from battery terminals.



## NOTICE

In the case of longer periods when the motorcycle is not being used, the battery must be

recharged regularly. See the instructions for caring for your battery. Always fully recharge the battery before returning it to use.◀

### Removing battery

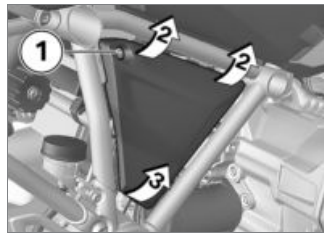

- Turn off ignition.
- Remove the screw **1**.
- Pull battery cover at top slightly forward at the positions **2**.
- In order not to damage the battery cover and the mount, remove the battery cover upward at position **3**.

- with anti-theft alarm system (DWA)<sup>OE</sup>
- Switch off anti-theft alarm system if necessary.◀



- Remove negative battery cable **1** and rubber strap **2**.



- Pull mounting plate on position **1** outward and remove it upward.
- Slightly lift and remove battery from holder until positive terminal becomes accessible.



- Remove positive battery cable **1** and pull out battery.

## Install battery

### NOTICE

If the 12 V battery is installed incorrectly, or if the terminals are swapped (e.g. when jump-starting), the fuse for the alternator regulator may blow.◀

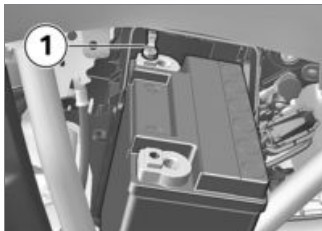

- Fasten positive battery cable **1**.
- Slide battery into holder.



- Fasten negative battery cable **1**.
- Fasten battery with rubber strap **2**.



- Fit the screw **1**.
- Set clock (☰→ 97).
- Setting the date (☰→ 97).

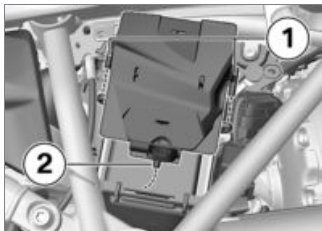

- First, insert mounting plate into supports **1**. Next, press it under the battery at position **2**.

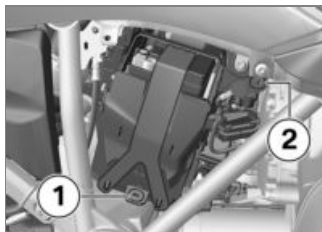

- Insert battery cover into mount **1** and press it into mount **2**.

## Fuses

### Replace fuses

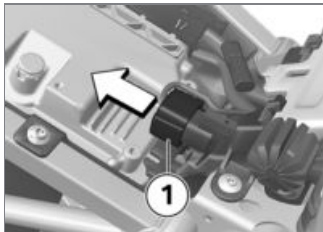

- Turn off ignition.
- Remove rider's seat (➡ 84).
- Disconnect plug **1**.

### ATTENTION

#### Bypassing defective fuses

Risk of short circuit and fire

- Do not bypass defective fuses.
- Replace defective fuses with new fuses.◀
- Consult the fuse assignment diagram and replace the defective fuse.

### NOTICE

If the fuses blow frequently, have the electrical system checked by an authorized specialized workshop, preferably an authorized BMW Motorrad retailer.◀

- Install connector **1**.
- Installing rider's seat (➡ 85).

## Fuse assignment

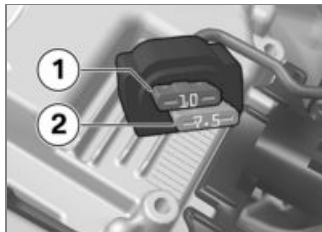

- |          |   |
|----------|---|
| <b>1</b> | 10 A<br>Instrument cluster<br>Anti-theft alarm system (DWA)<br>Ignition switch<br>Diagnostic socket |
| <b>2</b> | 7.5 A<br>Multifunction switch, left<br>Tire Pressure Control (TCP/RDC)                              |

## Fuse for alternator regulator

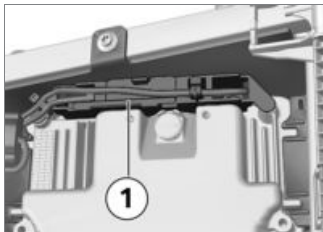

- 1** 50 A  
Alternator regulator

## Data link connector Removing the diagnostic connector



### CAUTION

**Incorrect procedure followed when disconnecting the data link connector for the On-Board Diagnostics.**

Motorcycle experiences malfunctions

- Only have the data link connector disconnected by a specialist workshop or other authorized persons during your next BMW Service appointment.
- Have the work performed by appropriately trained staff.
- Refer to the vehicle manufacturer specifications. ◀
- Remove battery cover (➡ 178).

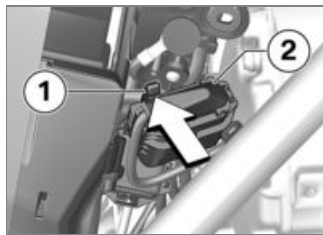

- Press the hook **1** and lift out the data link connector **2**.

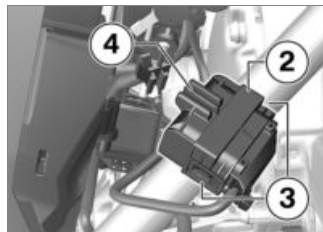

- Press the locking mechanisms **3** on both sides.
- Remove the data link connector **2** from the bracket **4**.
- » The diagnosis and information system interface can be connected at the diagnostic connector **2**.

## Secure the data link connector

- Disconnect the diagnosis and information system interface.



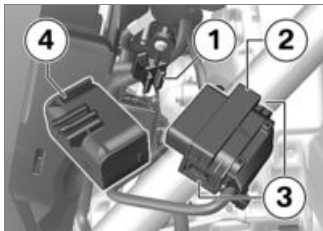

- Plug the seat data link connector **2** into the bracket **4**.
  - » The locking mechanisms **3** engage on both sides.
- Connect the bracket **4** to the mount **1**.



- Make sure that the hook **5** has engaged.
- Installing battery cover (→ 180).



## **Accessories**

General notes.....	186
Onboard power sockets .....	186
Case.....	187
Topcase .....	190
Navigation system .....	196

## General notes

### CAUTION

#### Use of products from other manufacturers

##### Safety risk

- BMW Motorrad cannot examine or test each product of outside origin to ensure that it can be used on or in connection with BMW motorcycles without constituting a safety hazard. Nor is this guarantee provided when the official approval of a specific country has been granted. Tests conducted by these instances cannot make provision for all operating conditions experienced by BMW motorcycles and, consequently, they are not sufficient in some circumstances.
- Use only parts and accessories approved by BMW for your motorcycle. ◀

The safety, operation and suitability of the parts and accessory products have been checked extensively by BMW. Therefore, BMW assumes responsibility for these products. BMW shall not be liable for unapproved parts and accessory products of any kind.

Whenever you are planning modifications, comply with all the legal requirements. The motorcycle must not violate the regulations governing motorcycle approval for highway use applicable in your own country.

Your authorized BMW Motorrad retailer offers you qualified advice in choosing genuine BMW parts, accessories and other products. More information on the topic of accessories is available at:

**[bmw-motorrad.com/accessories](http://bmw-motorrad.com/accessories)**

## Onboard power sockets

### Connection of electrical devices

- The ignition must be switched on before electrical devices connected to the power sockets can be operated.

### Cable routing

- The cables from the onboard sockets to the auxiliary devices must be routed in such a way that they do not impede the rider.
- Cable routing must not restrict the steering angle and the handling characteristics.
- Cables must not be trapped.

### Automatic deactivation

- The onboard sockets are automatically switched off during starting.
- These sockets are switched off approx. 15 minutes after

switching off the ignition to reduce the strain on the onboard electrical system. Additional devices with low power consumption are possibly not detected by the vehicle electronics. In these cases, onboard sockets are already switched off shortly after the ignition is switched off.

- In case of insufficient battery voltage, the onboard sockets are switched off to maintain the ability to start the motorcycle.
- If the maximum loadability specified in the technical data is exceeded, the onboard sockets are switched off.

## Case

### Opening case

– with case<sup>OA</sup>

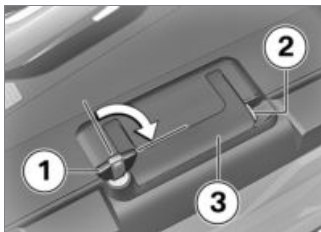

- Turn key **1** clockwise.
- Hold down yellow locking device **2** and fold out carrying handle **3**.



- Press yellow button **1** downward while opening case lid.

### Adjusting case volume

– with case<sup>OA</sup>

- Open and empty case.



- Engage pivot lever **1** in upper end position to obtain smaller volume.
- Engage pivot lever **1** in lower end position to set larger volume.
- Close case.

## Closing case

– with case<sup>OA</sup>

- Turn key in case lock perpendicular to direction of travel.
- Close case lid.
- » The lid clicks audibly into place.

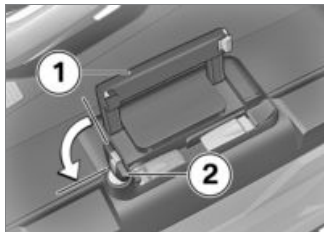

### ATTENTION

#### Folding down the carrying handle when the case is locked

Damage to the locking tab

- Before folding down the carrying handle, make sure that the slot of the case lock is per-

pendicular to the direction of travel. ◀

- Fold carrying handle **1** down.
- Turn key **2** counterclockwise and remove.

## Removing case

– with case<sup>OA</sup>

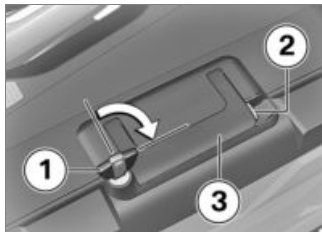

- Turn key **1** clockwise.
- Hold down yellow locking device **2** and fold out carrying handle **3**.



- Pull up red release lever **1**.
- » Locking flap **2** pops up.
- Fold locking flap all the way open.
- Remove case from mount by its handle.

## Mounting case

– with case<sup>OA</sup>



- Pull up red release lever **1**.
- » Locking flap **2** pops up.
- Fold locking flap all the way open.

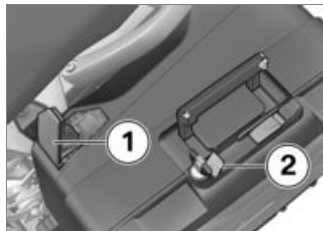

- Press locking flap **1** down until resistance can be felt.
- Next, press locking flap and red release lever **2** down at the same time.
- » Locking flap clicks into place.

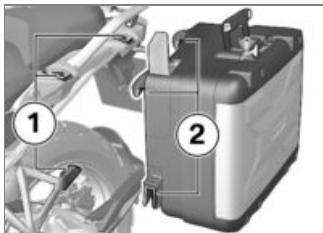

- Insert case from the top into mounts **1** and **2**.

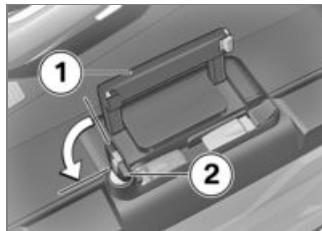

### **ATTENTION**

#### **Folding down the carrying handle when the case is locked**

Damage to the locking tab

- Before folding down the carrying handle, make sure that the slot of the case lock is perpendicular to the direction of travel. ◀
- Fold carrying handle **1** down.
- Turn key **2** counterclockwise and remove.

## Maximum payload and maximum speed

Observe maximum payload and maximum speed as indicated on label in case.

If you cannot find your combination of motorcycle and case on the label, contact your BMW Motorrad Retailer.

The following values apply to the combination described here:



Maximum speed for riding with Vario case

max 112 mph (max 180 km/h)



Payload per Vario case

max 22 lbs (max 10 kg)

## Topcase

### Opening topcase

– with topcase<sup>OA</sup>

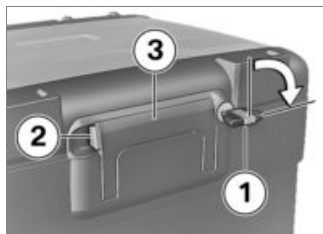

- Turn key **1** clockwise.
- Hold down yellow locking device **2** and fold out carrying handle **3**.



- Press yellow button **1** forward while opening the topcase lid.

### Adjusting topcase volume

– with topcase<sup>OA</sup>

- Open and empty topcase.





- Engage pivot lever **1** in front end position to set larger volume.
- Engage pivot lever **1** in rear end position to set smaller volume.
- Close topcase.

### Closing topcase

– with topcase<sup>OA</sup>

- Close topcase lid with firm pressure.

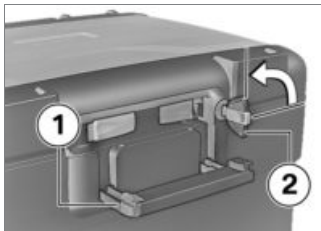

### ATTENTION

#### Folding down the carrying handle when the case is locked

Damage to the locking tab

- Before folding down the carrying handle, make sure that the slot of the topcase lock is vertical. ◀
- Fold carrying handle **1** down.
  - » Carrying handle audibly engages.
- Turn key **2** counterclockwise and remove.

### Removing topcase

– with topcase<sup>OA</sup>

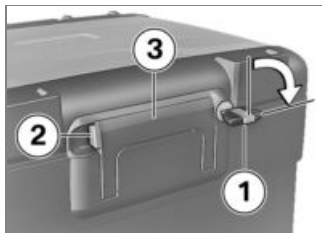

- Turn key **1** clockwise.
- Hold down yellow locking device **2** and fold out carrying handle **3**.

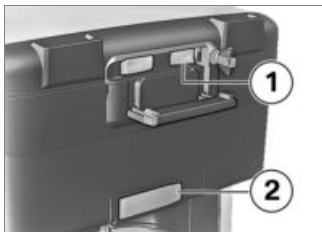

- Pull red lever **1** toward rear.  
» Locking flap **2** pops up.
- Fold locking flap all the way open.
- Remove topcase from mounting by its handle.

## Mounting topcase

– with topcase<sup>OA</sup>

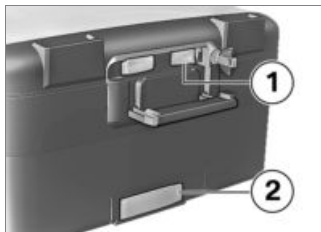

- Pull red lever **1** toward rear.  
» Locking flap **2** pops up.
- Fold locking flap all the way open.

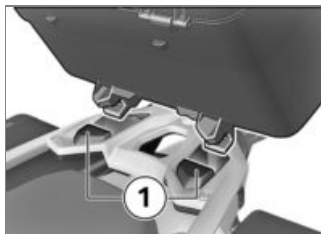

- Hook topcase into front holders **1** of topcase retaining plate.

- Press topcase onto topcase retaining plate at rear.



- Press locking flap **1** forward until resistance can be felt.
- Next, press locking flap and red release lever **2** forward at the same time.  
» Locking flap clicks into place.

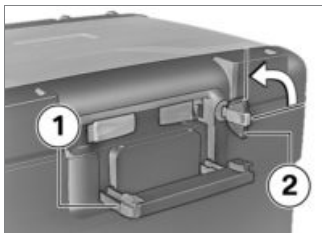

### ATTENTION

#### Folding down the carrying handle when the case is locked

Damage to the locking tab



- Before folding down the carrying handle, make sure that the slot of the topcase lock is vertical. ◀
- Fold carrying handle **1** down.
  - » Carrying handle audibly engages.
- Turn key **2** counterclockwise and remove.

#### Maximum payload and maximum speed

Observe maximum payload and top speed as indicated on label in Topcase.

If you cannot find your combination of motorcycle and topcase on the sign, contact your authorized BMW Motorrad retailer.

The following values apply to the combination described here:

	Maximum speed when riding with loaded Vario topcase
	max 112 mph (max 180 km/h)
	Payload of Vario topcase
	max 11 lbs (max 5 kg)

#### Mount topcase

– with topcase 2 large, 49 l<sup>OA</sup>

### ! WARNING

#### Topcase not properly secured

Driving safety is impaired

- Topcase must not shake and must be fastened clearance-free. ◀



- Pull handle **1** up as far as it will go.

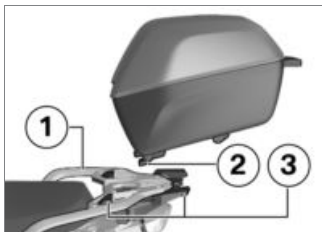

- Hook the topcase into the luggage rack **1**. Make sure that the hooks **2** fit securely into the mountings **3**.
- Press handle down until it engages.



- Turn key in topcase lock into Position **1** and remove.



Maximum speed  
when driving with  
Topcase 2 large, 49 l

max 112 mph (max 180 km/h)



Payload of Top-  
case 2 large, 49 l

max 11 lbs (max 5 kg)

- Do not exceed values for maximum speed and payload.

## Open topcase

– with topcase 2 large, 49 l<sup>OA</sup>



- Turn key in topcase lock into Position **1**.



- Press lock barrel **1** forward.

- » Release lever **2** pops up.
- Pull release lever all the way up.
- » Topcase lid opens.

## Close topcase

– with topcase 2 large, 49 l<sup>OA</sup>

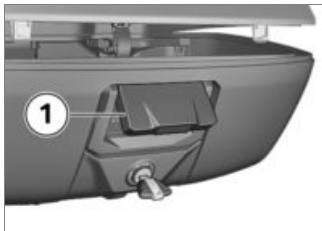

- Pull release lever **1** all the way up.
- Close topcase lid and hold it down. Ensure that no items are trapped between cover and case.

## NOTICE

The topcase can also be locked if the lock is in the LOCK position. Under such circumstances, ensure that the ignition key is not in the topcase. ◀

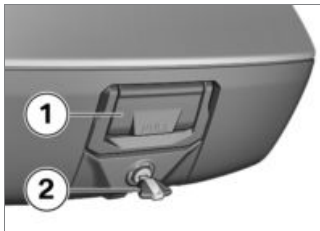

- Press release lever **1** down until it engages.
- Turn key **2** in topcase lock to the **LOCK** position and remove.

## Remove topcase

– with topcase 2 large, 49 l<sup>OA</sup>



- Turn key in topcase lock into Position **1**.
- » Handle pops out.



- Fold handle **1** all the way up.
- Raise the rear of the topcase and pull it off luggage rack.

## Navigation system

– with preparation for navigation system<sup>OE</sup>

## Securely fasten navigation device

### NOTICE

The navigation preparation is suitable for the BMW Motorrad Navigator IV and the BMW Motorrad Navigator V.◀

### NOTICE

The locking system of the Mount Cradle offers no protection against theft. Remove the navigation system and store in a safe place after every drive.◀

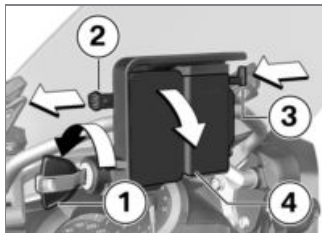

- Turn ignition key **1** counter-clockwise.
- Pull shut-off lock **2** to **left**.
- Press in locking device **3**.
- » Mount Cradle is unlocked and cover **4** can be removed with

a rotating movement toward front.

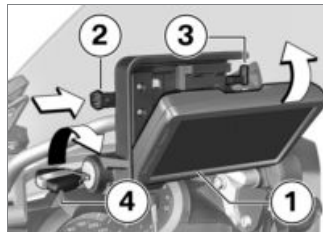

- Mount navigation device **1** in lower area and swing toward rear with a rotating movement.
- » Navigation device audibly engages.
- Slide shut-off lock **2** completely to **right**.
- » Locking device **3** is locked.
- Turn ignition key **4** clockwise.
- » Navigation device is locked and ignition key can be removed.

## Removing the navigation device and installing the cover panel

### ATTENTION

#### Dust and dirt on the contacts of the Mount Cradle

Damage to the contacts

- Reinstall the cover after end of each drive.◀

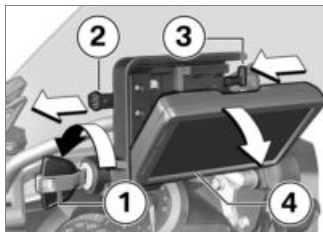

- Turn ignition key **1** counter-clockwise.
- Pull shut-off lock **2** completely to **left**.
- » Locking device **3** is unlocked.

- Slide locking device **3** completely to **left**.
- » Navigation device **4** is unlocked.
- Remove navigation device **4** downward with a tilting movement.

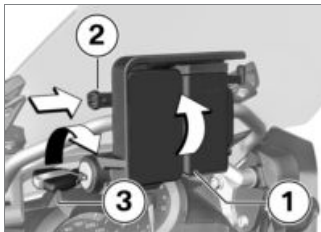

- Mount cover **1** in lower area and swing upward with a rotating movement.
- » Cover audibly engages.
- Slide shut-off lock **2** to **right**.
- Turn ignition key **3** clockwise.
- » Cover **1** is secured.

## Operating the navigation system

### NOTICE

The following description refers to the Navigator V. The Navigator IV does not offer all options described.◀

### NOTICE

Only the latest version of the BMW Motorrad communication system is supported. A software update may be required for the BMW Motorrad communication system. In this case, please contact your authorized BMW Motorrad retailer.◀

If the BMW Motorrad Navigator is installed and the operating focus is switched to the Navigator (➡ 93), several of its functions can be operated directly from the handlebars.

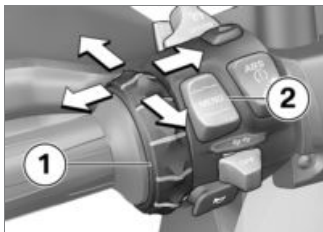

The navigation system can be operated using the Multi-Controller **1** and the rocker button MENU **2**.

### Turn Multi-Controller 1 up and down

In the compass and Mediaplayer page: increase or decrease the volume of Bluetooth-connected BMW Motorrad communication system.

In the BMW special menu: select menu items.

### Briefly tilt Multi-Controller 1 to the left and right

Switch between the main pages of the Navigator:

- Map view
- Compass
- Mediaplayer
- BMW special menu
- My motorcycle page

### Long tilt the Multi-Controller 1 to the left and right

Activate specific functions on the Navigator display. These functions are indicated with an arrow to the right or the left above the corresponding touch field.

 The function is triggered by long actuation to the right.

 The function is triggered by long actuation to the left.

### Press rocker button MENU 2 down

Change operating focus to Pure Ride view.

In detail, the following functions can be operated:

#### Map view

- Turning upward: increase size of map section (Zoom in).
- Turn downward: reduce size of map section (Zoom out).

#### Compass page

- Turning increases or reduces volume of a BMW Motorrad communication system connected via Bluetooth.

#### BMW special menu

- Speak: Repeat last navigation announcement.
- Way point: Save current way point as favorite.
- Navigate home: Starts navigation to the home address (is



grayed-out if no home address is set).

- Mute: Switch automatic navigation announcements (off: the top line in the display shows a crossed-out lip icon). Navigation announcements can still be output via "Speak". All other sound outputs remain switched on.
- Switching off display: Switch off display.
- Dial home number: Dials the home phone number saved in the Navigator (not shown unless a communication system and a telephone are connected).
- Detour: Activates the detour function (only displayed if a route is active).
- Skip: Skips the next way point (only displayed if route is provided with way points).

## My Motorcycle

- Turn: Changes the number of data displayed.
- By tapping on a data field on the display, a menu opens where data can be selected.
- The values available for selection are dependent on the optional extras installed.

## Mediaplayer

- Long actuation to left: play previous title.
- Long actuation to right: play next title.
- Turning increases or reduces volume of a BMW Motorrad communication system connected via Bluetooth.

### NOTICE

The Mediaplayer function is only available when using a Bluetooth device with A2DP standard, such

as a BMW Motorrad communication system.◀

## Warning and status messages



Warning and status messages of the motorcycle are indicated with a corresponding symbol **1** at the upper left on the map view.

### NOTICE

If a BMW Motorrad communication system is connected, an acoustic signal is also sounds in case of a warning.◀

If several warning messages are active, the number of messages is indicated below the warning triangle.

A list of all warning messages is opened by pressing on the warning triangle with more than one message.

Additional information is displayed when a message is selected.



## NOTICE

Detailed information cannot be displayed for all warnings. ◀

## Special functions

Due to integration of the BMW Motorrad Navigator, there are a number of differences from the descriptions in the instruction manual for the Navigator.

### Reserve fuel level warning

The settings for the fuel gauge are not available, as the reserve warning is being transferred from

the vehicle to the Navigator. If the message is active, the nearest filling stations are displayed when the message is pressed.

### Time and Date

The Navigator sends the time and date to the motorcycle. Transfer of this data into the instrument cluster must be activated in the **SETUP** menu of the instrument cluster.

### Security settings

The BMW Motorrad Navigator V can be secured against unauthorized use with a four-digit PIN (Garmin Lock). When this function is activated, once the Navigator GPS receiver is cradled on the motorcycle and the ignition is switched on you will receive a prompt asking whether the motorcycle should be added to the list of secure vehicles. If you answer "Yes" to this question,

the Navigator saves the vehicle identification number (VIN) of this motorcycle in its internal memory.

A maximum of five VINs can be saved in this way.

When the Navigator is subsequently switched on by switching on the ignition on one of those motorcycles, entry of the PIN is no longer necessary.

If the Navigator is removed from the motorcycle while switched on, a security prompt asking for the PIN to be entered is issued.

### Screen brightness

Screen brightness is adjusted by the motorcycle while the unit is cradled. No manual input is necessary.

The automatic setting can be switched off in the display settings in the Navigator if desired.

## Care

Care products .....	202
Washing your motorcycle .....	202
Cleaning sensitive motorcycle parts .....	203
Paint care .....	204
Protective wax coating .....	204
Store motorcycle .....	204
Return motorcycle to use .....	204

## Care products

BMW Motorrad recommends that you use cleaning and care products available at your authorized BMW Motorrad retailer. BMW Care Products have been materials tested, laboratory tested, and field tested and provide optimum care and protection for the materials used in your vehicle.



### ATTENTION

#### Use of unsuitable cleaning and care agents

Damage to motorcycle parts

- Do not use any solvents such as nitro thinners, cold cleaners, fuel or similar, and do not use cleaning agents that contain alcohol. ◀

## Washing your motorcycle

BMW Motorrad recommends that you use BMW Insect Remover to soften and wash off insects and stubborn dirt from painted parts before washing the motorcycle.

To prevent stains, do not wash the motorcycle immediately after it has been exposed to bright sunlight and do not wash it in the sun.

Make sure that the motorcycle is washed frequently, especially during the winter months.

To remove road salt, clean the motorcycle with cold water immediately after completion of every trip.



### WARNING

**Damp brake disks and brake pads after washing the mo-**

## torcycle, after riding through water or in the rain

Poorer braking action, accident hazard

- Brake early until the brake rotors and brake pads are dry. ◀



### ATTENTION

#### Increased effect of salt caused by warm water

Corrosion

- Only use cold water to remove road salt. ◀



### ATTENTION

#### Damage caused by high water pressure from high-pressure cleaners or steam-jet devices

Corrosion or short circuit, damage to labels, to seals, to hydraulic brake system, to the electrical system and the seat

- Exercise caution when using high-pressure or steam-jet devices. ◀

## Cleaning sensitive motorcycle parts

### Plastics



#### ATTENTION

#### Use of unsuitable cleaning agents

Damage to plastic surfaces

- Do not use abrasive cleaners or cleaners containing alcohol or solvents.
- Do not use insect sponges or sponges with a hard surface. ◀

#### Fairings and panels

Clean fairings and panels with water and BMW plastic cleaner.

### Windshields and lenses are manufactured in plastic

Clean off dirt and insects with a soft sponge and plenty of water.



#### NOTICE

Soften stubborn dirt and dead insects by covering the affected areas with a wet cloth. ◀



Clean with water and sponge only.



Do not use chemical cleansers.

### Chrome

Especially in the case of road salt, carefully clean chrome parts with plenty of water and BMW auto shampoo. Use chrome polish for additional treatment.

### Radiator

Clean the radiator regularly to prevent overheating of the engine due to inadequate cooling. For example, use a garden hose with low water pressure.



#### ATTENTION

#### Bending of radiator fins

Damage to radiator fins

- When cleaning, ensure that the cooler fins are not bent. ◀

### Rubber parts

Treat rubber components with water or BMW rubber protection coating agent.



#### ATTENTION

#### Use of silicone sprays for care of rubber seals

Damage to rubber seals

- Do not use silicone sprays or care products that contain silicone. ◀

## Paint care

Washing the vehicle on a regular basis will help prevent long-term damage from harmful substances, and is especially important when your vehicle is used in areas with high levels of air pollution or where natural contaminants such as tree resin and pollen are present.

At the same time, you should remove particularly aggressive materials immediately; otherwise changes in the paint and discoloration can occur. These include spilled fuel, oil, grease and brake fluid as well as bird droppings. It is advisable to use BMW Car Polish or BMW Paint Cleaner in this case.

Contamination on the paint finish is particularly easy to see after the motorcycle has been washed. Remove this type of soiling with cleaning naphtha or spirit on a clean cloth or cotton

ball. BMW Motorrad recommends using BMW tar remover for removing tar spots. Then add a protective wax coating to the paint at these locations.

## Protective wax coating

Paint must be protected, if water no longer pearls up on it.

To preserve the finish of your vehicle, BMW Motorrad recommends BMW Car Wax or agents that contain carnauba or synthetic waxes.

## Store motorcycle

- Clean motorcycle.
- Completely fill the motorcycle's fuel tank.
- Removing battery (▣▣▣ 178).
- Spray the brake and clutch lever, and the center and side stand pivots with a suitable lubricant.

- Preserve bare metal and chrome-plated parts with an acid-free grease (Vaseline).
- Park motorcycle in a dry room, raising it to remove weight from both wheels (preferably using the front wheel and rear-wheel stand offered by BMW Motorrad).

## Return motorcycle to use

- Remove the protective wax coating.
- Clean motorcycle.
- Install battery (▣▣▣ 179).
- Observe checklist (▣▣▣ 120).

## Technical data

Troubleshooting chart .....	206
Screw connections .....	209
Fuel.....	211
Engine oil .....	212
Engine .....	212
Clutch .....	213
Transmission .....	214
Rear-wheel drive.....	215
Frame .....	215
Chassis and suspension .....	216
Brakes .....	218
Wheels and tires .....	219
Electrical system.....	220
Alarm system .....	222
Dimensions .....	222

Weights.....	225
Performance data.....	226

## Troubleshooting chart

Engine does not start.

Possible cause	Remedy
Side stand extended and gear engaged	Retract side stand.
Gear engaged and clutch not disengaged	Place transmission in neutral or disengage clutch.
No fuel in tank	Refueling procedure (▮▮▮▮▶ 131).
Battery drained	Charging connected battery (▮▮▮▮▶ 177).
Overheating protection for starter motor has activated. Starter motor can only be actuated for a limited period.	Leave the starter motor to cool down for around 1 minute until it becomes available again.



Bluetooth connection is not established.

### **Possible cause**

### **Remedy**

Necessary pairing steps were not performed.

Refer to the operating instructions of the communication system for the necessary steps for pairing.

The communication system is not connected automatically despite successful pairing.

Switch off the communication system of the helmet and connect again after one to two minutes.

Too many Bluetooth devices are stored in the helmet.

Delete all pairing entries in the helmet (see the operating instructions of the communication system).

There are additional vehicles with Bluetooth-capable devices nearby.

Avoid simultaneous pairing with multiple vehicles.

Bluetooth connection is disrupted.

### **Possible cause**

### **Remedy**

Bluetooth connection to the mobile end device is interrupted.

Switch off energy saving mode.

Bluetooth connection to the helmet is interrupted.

Switch off the communication system of the helmet and connect again after one to two minutes.

Volume in the helmet cannot be adjusted.

Switch off the communication system of the helmet and connect again after one to two minutes.

Phone book is not displayed in the TFT display.

**Possible cause**

Phone book was has not yet been transferred to the vehicle.

**Remedy**

During pairing to the mobile end device, confirm the transfer of the telephone data (►► 108).

Active route guidance is not displayed in the TFT display.

**Possible cause**

Navigation from the BMW Motorrad Connected App was not transferred.

Route guidance cannot be started.

**Remedy**

Call up the BMW Motorrad Connected App on the connected mobile end device before riding.

Ensure that there is a data connection to the mobile end device and check the map data on the mobile end device.

## Screw connections

Front wheel	Value	Valid
<b>Quick-release axle in telescopic fork</b>		
M12 x 20	22 lb/ft (30 Nm)	
<b>Clamping screw for quick-release axle in telescopic fork</b>		
M8 x 35	14 lb/ft (19 Nm)	
<b>Brake caliper on telescopic forks</b>		
M10 x 65	28 lb/ft (38 Nm)	
<b>Wheel speed sensor on fork</b>		
M6 x 16 Micro-encapsulated	6 lb/ft (8 Nm)	
Rear wheel	Value	Valid
<b>Tighten rear wheel on wheel flange</b>		
M10 x 1.25 x 40	<b>Tightening sequence: Tighten cross-wise</b>	
	44 lb/ft (60 Nm)	

Mirrors	Value	Valid
<b>Mirror (locknut) on adapter</b>		
M10 x 1.25	Left-hand thread, 16 lb/ft (22 Nm)	
<b>Adapter on clamping block</b>		
M10 x 14 - 4.8	18 lb/ft (25 Nm)	
Handlebars	Value	Valid
<b>Clamping block (handlebar clamp) on fork bridge</b>		
M8 x 35	<b>Tightening sequence: Tighten on block in front (in the direction of travel)</b>	
	14 lb/ft (19 Nm)	

## Fuel

Recommended fuel quality	Normal unleaded 87 AKI (91 ROZ/RON)
Alternative fuel quality	Regular unleaded (restrictions with regard to power and consumption.) (max. 10 % ethanol, E10) 87 AKI (91 ROZ/RON) 87 AKI
Usable fuel quantity	Approx. 5.3 gal (Approx. 20 l)
Reserve fuel quantity	Approx. 1.1 gal (Approx. 4 l)
Emission standard	Euro 4

## Engine oil

Engine oil, capacity	max 1.1 gal (max 4 l), with filter replacement
Specification	SAE 5W-40, API SL/JASO MA2, Additives (for instance, molybdenum-based substances) are prohibited, because they would attack the coatings on engine components, BMW Motorrad recommends BMW Motorrad ADVANTEC Ultimate oil.
Engine oil, quantity for topping up	max 1 quarts (max 0.95 l), Difference between MIN and MAX

**BMW recommends** **ADVANTEC**  
ORIGINAL BMW ENGINE OIL

## Engine

Engine number location	Lower right of engine block beneath the starter
Engine type	122EN
Engine design	Air-/liquid-cooled two cylinder four-stroke opposed-twin engine with double overhead camshaft and a counterbalance shaft
Displacement	1170 cc (1170 cm <sup>3</sup> )
Cylinder bore	4 in (101 mm)
Piston stroke	2.9 in (73 mm)

Compression ratio	12.5:1
Rated output	125 hp (92 kW), at engine speed: 7750 min <sup>-1</sup>
– with reduction of power <sup>OE</sup>	107 hp (79 kW), at engine speed: 7750 min <sup>-1</sup>
Torque	92 lb/ft (125 Nm), at engine speed: 6500 min <sup>-1</sup>
– with reduction of power <sup>OE</sup>	90 lb/ft (122 Nm), at engine speed: 5250 min <sup>-1</sup>
Maximum engine speed	max 9000 min <sup>-1</sup>
Idle speed	1150 min <sup>-1</sup> , Engine at operating temperature

## Clutch

Clutch design	Multi-disk oil-bath clutch, slipper clutch
---------------	--

## Transmission

Transmission design	6-speed transmission with helical cut dog ring gears
Transmission gear ratios	1.000 (60:60 teeth), Primary gear ratio 1.650 (33:20 teeth), Transmission input ratio 2.438 (39:16 teeth), 1st gear 1.714 (36:21 teeth), 2nd gear 1.296 (35:27 teeth), 3rd gear 1.059 (36:34 teeth), 4th gear 0.943 (33:35 teeth), 5th gear 0.848 (28:33 teeth), 6th gear 1.061 (35:33 teeth), Transmission output ratio



## Rear-wheel drive

Type of final drive	Shaft drive with bevel gears
Type of rear suspension	Cast-aluminum single swing arm with BMW Motorrad Paralever
Gear ratio of final drive	2.91 (32:11 teeth)

## Frame

Frame design	Steel-tube frame with partially self-supporting drive unit, steel-tube rear frame
Location of type plate	Frame at front left on steering head
Location of the vehicle identification number	Frame at front right on steering head

## Chassis and suspension

### Front wheel

Type of front suspension	BMW Telelever, upper fork bridge tilt decoupled, leading link mounted in engine and on telescopic fork, centrally positioned spring strut supported on leading link and frame
Design of the front-wheel suspension	Central spring strut with coil spring
– with Dynamic ESA <sup>OE</sup>	Central spring strut with coil spring and expansion tank, electrically adjustable rebound-stage and compression damping
Spring travel, front	7.5 in (190 mm), on wheel
– with Style 1 <sup>OE</sup>	8.3 in (210 mm), on wheel
– with sport suspension <sup>OE</sup>	
– with low-slung <sup>OE</sup>	6.2 in (158 mm), on wheel

<b>Rear wheel</b>	
Type of rear suspension	Cast-aluminum single swing arm with BMW Motorrad Paralever
Type of rear suspension	Central spring strut with coil spring, adjustable rebound-stage damping and spring preload
– with Dynamic ESA <sup>OE</sup>	Central spring strut with coil spring and expansion tank, electrically adjustable rebound-stage and compression damping, electrically adjustable spring preload
Spring travel at rear wheel	7.9 in (200 mm)
– with Style 1 <sup>OE</sup>	8.7 in (220 mm)
– with sport suspension <sup>OE</sup>	
– with low-slung <sup>OE</sup>	6.7 in (170 mm)

## Brakes

### Front wheel

Type of front brake	Hydraulically operated double disc brakes with 4-piston radial monobloc calipers and floating brake discs
Front brake pad material	Sintered metal
Free travel of brake actuation (Front wheel brake)	Approx. 0.07 in (Approx. 1.85 mm), at piston

### Rear wheel

Type of rear brake	Hydraulically operated disk brake with 2-piston floating caliper and fixed brake disk
Rear brake pad material	Sintered metal
Blow-by clearance of footbrake lever	0.04...0.06 in (1...1.5 mm), Between frame and footbrake lever

## Wheels and tires

Recommended tire combinations	An overview of the current tire approvals is available from your authorized BMW Motorrad retailer or on the Internet at <a href="http://bmw-motorrad.com">bmw-motorrad.com</a> .
Speed category of front/rear tires	V, minimum requirement: 149 mph (240 km/h)

### Front wheel

Front wheel design	Aluminum cast wheel
– with cross spoke wheels <sup>OE</sup>	Cross spoke wheel
Front-wheel rim size	3.00" x 19"
Front tire designation	120/70 R 19
Load index for front tire	At least 60
Permissible front-wheel imbalance	max 0.2 oz (max 5 g)

### Rear wheel

Rear wheel design	Aluminum cast wheel
– with cross spoke wheels <sup>OE</sup>	Cross spoke wheel
Rear-wheel rim size	4.50" x 17"
Rear tire designation	170/60 R 17
Load index for rear tire	At least 72
Permissible rear-wheel imbalance	max 1.6 oz (max 45 g)

**Tire inflation pressures**

Tire pressure, front	36.3 psi (2.5 bar), with tire cold
Tire pressure, rear	42.1 psi (2.9 bar), with tire cold

**Electrical system**

Electrical rating of onboard sockets	max 5 A, all onboard sockets together
Fuse carrier 1	10 A, Slot 1: instrument cluster, anti-theft alarm system (DWA), ignition lock, diagnostic socket 7.5 A, Slot 2: left multifunction switch, Tire Pressure Control (TCP/RDC)
Fuse carrier	50 A, Fuse 1: Voltage regulator

**Battery**

Battery design	AGM (Absorptive Glass Mat) battery.
Battery voltage	12 V
Battery capacity	12 Ah

**Spark plugs**

Spark plugs, manufacturer and designation	NGK LMAR8D-J
Electrode gap of spark plug	0.03±0.01 in (0.8±0.1 mm), New 0.04 in (1.0 mm), Wear limit

<b>Bulbs</b>	
Bulb for high-beam headlight	H7 / 12 V / 55 W
– with LED headlight <sup>OE</sup>	LED
Bulbs for low-beam headlight	H7 / 12 V / 55 W
– with LED headlight <sup>OE</sup>	LED
Bulb for parking light	W5W / 12 V / 5 W
– with LED headlight <sup>OE</sup>	LED
Bulb for taillight/brake light	LED
Bulbs for flashing turn indicators, front	RY10W / 12 V / 10 W
Bulbs for flashing turn indicators, rear	RY10W / 12 V / 10 W

## Alarm system

Activation time	Approx. 30 s
Alarm duration	Approx. 26 s
Battery type	CR 123 A

## Dimensions

Motorcycle length	86.9 in (2207 mm), over splash guard
Motorcycle height	56.3...58.7 in (1430...1490 mm), over windshield, at DIN unladen weight
– with Style 1 <sup>OE</sup>	51.7...54 in (1312...1372 mm), over windshield, at DIN unladen weight
– with Style 1 <sup>OE</sup> – with sport suspension <sup>OE</sup>	52.4...54.8 in (1332...1392 mm), over windshield, at DIN unladen weight
– with Style 1 <sup>OE</sup> – with sport suspension <sup>OE</sup> – with passenger package <sup>OE</sup>	57.1...59.4 in (1450...1510 mm), over windshield, at DIN unladen weight
– with low-slung <sup>OE</sup>	55.3...57.7 in (1405...1465 mm), over windshield, lower position, at DIN unladen weight
Motorcycle width	37.5 in (952 mm), with mirrors



Rider's seat height	33.5...34.3 in (850...870 mm), without rider at unladen weight
– with comfort seat <sup>OE</sup>	32.5...33.3 in (825...845 mm), without rider at unladen weight
– with comfort seat high <sup>OE</sup>	33.5...34.3 in (850...870 mm), without rider at unladen weight
– with low rider's seat <sup>OE</sup>	32.3...33.1 in (820...840 mm), without rider at unladen weight
– with Style 1 <sup>OE</sup>	33.9 in (860 mm), without rider at unladen weight
– with Style 1 <sup>OE</sup> – with seat extra high <sup>OE</sup>	34.6 in (880 mm), without rider at unladen weight
– with Style 1 <sup>OE</sup> – with passenger package <sup>OE</sup>	33.5...34.3 in (850...870 mm), without rider at unladen weight
– with Style 1 <sup>OE</sup> – with sport suspension <sup>OE</sup>	34.6 in (880 mm), without rider at unladen weight
– with Style 1 <sup>OE</sup> – with sport suspension <sup>OE</sup> – with seat extra high <sup>OE</sup>	35.4 in (900 mm), without rider at unladen weight
– with Style 1 <sup>OE</sup> – with sport suspension <sup>OE</sup> – with passenger package <sup>OE</sup>	34.3...35 in (870...890 mm), without rider at unladen weight

– with low-slung <sup>OE</sup>	31.5...32.3 in (800...820 mm), without rider at unladen weight
Rider's inside-leg arc, heel to heel	73.6...75.2 in (1870...1910 mm), without rider at unladen weight
– with comfort seat <sup>OE</sup>	74...74.8 in (1880...1900 mm), without rider at unladen weight
– with comfort seat high <sup>OE</sup>	75.6...76.4 in (1920...1940 mm), without rider at unladen weight
– with low rider's seat <sup>OE</sup>	71.7...73.2 in (1820...1860 mm), without rider at unladen weight
– with Style 1 <sup>OE</sup>	74 in (1880 mm), without rider at unladen weight
– with Style 1 <sup>OE</sup> – with seat extra high <sup>OE</sup>	75.6 in (1920 mm), without rider at unladen weight
– with Style 1 <sup>OE</sup> – with passenger package <sup>OE</sup>	73.6...75.2 in (1870...1910 mm), without rider at unladen weight
– with Style 1 <sup>OE</sup> – with sport suspension <sup>OE</sup>	75.6 in (1920 mm), without rider at unladen weight
– with Style 1 <sup>OE</sup> – with sport suspension <sup>OE</sup> – with seat extra high <sup>OE</sup>	77.2 in (1960 mm), without rider at unladen weight

<ul style="list-style-type: none"> <li>– with Style 1<sup>OE</sup></li> <li>– with sport suspension<sup>OE</sup></li> <li>– with passenger package<sup>OE</sup></li> </ul>	75.2...76.8 in (1910...1950 mm), without rider at unladen weight
<ul style="list-style-type: none"> <li>– with low-slung<sup>OE</sup></li> </ul>	70.5...72 in (1790...1830 mm), without rider at unladen weight

## Weights

Vehicle curb weight	538 lbs (244 kg), DIN unladen weight, ready for road, fuel tank 90 % full, without OE
Permissible gross weight	1014 lbs (460 kg)
Maximum payload	476 lbs (216 kg)

## Performance data

Top speed	>124 mph (>200 km/h)
-----------	----------------------

## **Service**

Reporting safety defects .....	228
BMW Motorrad Service .....	229
BMW Motorrad Mobility Services .....	229
Maintenance procedures .....	229
BMW Service .....	230
Maintenance schedule .....	233
Maintenance confirmations .....	234
Service confirmations .....	248

## Reporting safety defects

If you think that your motorcycle has a fault which may cause an accident, injury or death, you must inform the NHTSA (National Highway Traffic Safety Administration) immediately and BMW of North America, LLC.

If the NHTSA receives other similar complaints, it may open an investigation. If it finds that a safety defect exists in a group of vehicles, the NHTSA may order the manufacturer to perform a recall and remedy campaign. However, the NHTSA cannot become involved in individual problems between you, your authorized BMW Motorrad retailer, or BMW of North America, LLC.

You can contact the NHTSA by calling the Vehicle Safety Hotline on 1-888-327-4236 (Teletypewriter TTY for the hearing impaired: 1-800-424-9153) for free, by visiting the website at <http://www.safercar.gov> or by writing to Administrator, NHTSA, 400 Seventh Street, SW., Washington, DC 20590. Further information on vehicle safety is available at <http://www.safercar.gov>.

## BMW Motorrad Service

With its worldwide retailer network, BMW Motorrad can attend to you and your motorcycle in over 100 countries around the globe. Authorized BMW Motorrad retailers have the technical information and expertise needed to conduct reliable service and repairs covering every aspect of your BMW.

You will find the nearest authorized BMW Motorrad retailer to you at our website:

**[bmw-motorrad.com](http://bmw-motorrad.com)**

### **WARNING**

#### **Improperly performed maintenance and repair work**

Accident hazard caused by subsequent damage

- BMW Motorrad recommends having corresponding work on the motorcycle carried out

by a specialized workshop, preferably by an authorized BMW Motorrad retailer. ◀

To ensure that your BMW consistently remains in optimal condition BMW Motorrad urges you to observe the recommended service intervals.

Have all maintenance and repair work confirmed in the "Service" chapter in this manual. Documentation confirming regular maintenance is essential for generous treatment of claims submitted after the warranty period has expired (goodwill).

You can obtain information on the contents of the BMW Services from your BMW Motorrad retailer.

## BMW Motorrad Mobility Services

The BMW Motorrad Mobility Services furnish you and your new BMW motorcycle with extra security by offering a wide array of assistance services in the event of a breakdown (BMW Roadside Assistance, breakdown assistance, vehicle recovery and retrieval, etc.).

Contact your authorized BMW Motorrad retailer for additional information on available mobility-maintenance services.

### **Maintenance procedures**

#### **BMW Pre-Delivery Check**

The BMW pre-delivery check is carried out by your authorized BMW Motorrad retailer before it turns over the vehicle to you.

## BMW Running-in Check

The BMW running-in check must be carried out between 300 mls (500 km) and 750 mls (1200 km).

## BMW Service

BMW Service is carried out once a year. The scope of the services performed may be dependent on the motorcycle owner and the mileage driven. Your BMW Motorrad retailer confirms that the service has been performed and enters the date for the next service.

For riders who drive long distances annually, it may be necessary to come in for service before the entered date. In this case a corresponding maximum odometer reading will also be entered in the confirmation of service. If this odometer reading is reached be-

fore the next service date, service must be performed sooner.

The service interval indicator in the display reminds you of the next service date approx. one month or 620 miles (1000 km) before the entered values.

More information on the topic of service is available at:

**[bmw-motorrad.com/service](http://bmw-motorrad.com/service)**

The required scope of maintenance work for your motorcycle can be found in the following maintenance plan:







## Maintenance schedule

- 1** BMW Running-in check (including oil change)
- 2** BMW Service Standard Scope
- 3** Engine oil change with filter
- 4** Oil change in the rear bevel gears
- 5** Check valve clearance
- 6** Replace all spark plugs
- 7** Replace air cleaner insert
- 8** Check or replace the air filter element
- 9** Change brake fluid in entire system
  - a** annually or every 6000 miles (10000 km) (whichever comes first)
  - b** annually or every 12000 miles (20000 km) (whichever comes first)
  - c** when used off-road, annually or every 6000 miles (10000 km) (whichever comes first)
  - d** for the first time after one year, then every two years

## Maintenance confirmations

### BMW Service standard scope

The repair procedures belonging to the BMW Service standard package are listed below. The actual maintenance work applicable for your vehicle may differ.

- Performing the brief test using the BMW Motorrad diagnosis system
- Visual inspection of hydraulic clutch system
- Visual check of brake lines, brake hoses and connections
- Checking front brake pads and brake disks for wear
- Checking brake fluid level of front brake
- Checking rear brake pads and brake disk for wear
- Checking brake fluid level for rear brake
- Checking coolant level
- Checking side stand for ease of movement
- Checking the center stand for ease of movement
- Check the tire tread depth and tire pressure
- Check the tension of the spokes and tighten as needed
- Checking the lighting and signal system
- Functional check for engine starting suppression
- Final inspection and check for road safety
- Set the service due date and remaining distance before next service
- Checking charging state of battery
- Confirm the BMW service in the vehicle literature

## BMW pre-delivery check

performed

on \_\_\_\_\_

\_\_\_\_\_  
Stamp, signature

## BMW Running-in Check

performed

on \_\_\_\_\_

at km \_\_\_\_\_

Next service

latest

on \_\_\_\_\_

or, if reached earlier

at km \_\_\_\_\_

\_\_\_\_\_  
Stamp, signature

**BMW Service**

performed

on \_\_\_\_\_

at km \_\_\_\_\_

Next service

latest

on \_\_\_\_\_

or, if reached earlier

at km \_\_\_\_\_

Work performed

BMW Service

Engine oil change with filter

Oil change in rear bevel gears

Checking valve clearance

Replacing all spark plugs

Replacing air cleaner element

Checking or replacing air cleaner element (maintenance)

Changing brake fluid in entire system

Yes

No

Information

-----

-----

-----

-----

-----

-----

-----

-----

\_\_\_\_\_

Stamp, signature

**BMW Service**

performed

on \_\_\_\_\_

at km \_\_\_\_\_

Next service

latest

on \_\_\_\_\_

or, if reached earlier

at km \_\_\_\_\_

Work performed

BMW Service

Engine oil change with filter

Oil change in rear bevel gears

Checking valve clearance

Replacing all spark plugs

Replacing air cleaner element

Checking or replacing air cleaner ele-

ment (maintenance)

Changing brake fluid in entire system

Yes

No

Information

-----  
-----  
-----  
-----  
-----  
-----  
-----  
-----

\_\_\_\_\_  
Stamp, signature

**BMW Service**

performed

on \_\_\_\_\_

at km \_\_\_\_\_

Next service

latest

on \_\_\_\_\_

or, if reached earlier

at km \_\_\_\_\_

Work performed

BMW Service

Engine oil change with filter

Oil change in rear bevel gears

Checking valve clearance

Replacing all spark plugs

Replacing air cleaner element

Checking or replacing air cleaner element (maintenance)

Changing brake fluid in entire system

Yes

No

Information

-----

-----

-----

-----

-----

-----

-----

-----

\_\_\_\_\_

Stamp, signature



**BMW Service**

performed

on \_\_\_\_\_

at km \_\_\_\_\_

Next service

latest

on \_\_\_\_\_

or, if reached earlier

at km \_\_\_\_\_

Work performed

BMW Service

Engine oil change with filter

Oil change in rear bevel gears

Checking valve clearance

Replacing all spark plugs

Replacing air cleaner element

Checking or replacing air cleaner ele-

ment (maintenance)

Changing brake fluid in entire system

Yes No

Information

-----  
-----  
-----  
-----  
-----  
-----  
-----  
-----

\_\_\_\_\_  
Stamp, signature

**BMW Service**

performed

on \_\_\_\_\_

at km \_\_\_\_\_

Next service

latest

on \_\_\_\_\_

or, if reached earlier

at km \_\_\_\_\_

Work performed

BMW Service

Engine oil change with filter

Oil change in rear bevel gears

Checking valve clearance

Replacing all spark plugs

Replacing air cleaner element

Checking or replacing air cleaner element (maintenance)

Changing brake fluid in entire system

Yes

No

Information

-----

-----

-----

-----

-----

-----

-----

-----

\_\_\_\_\_

Stamp, signature

**BMW Service**

performed

on \_\_\_\_\_

at km \_\_\_\_\_

Next service

latest

on \_\_\_\_\_

or, if reached earlier

at km \_\_\_\_\_

Work performed

BMW Service

Engine oil change with filter

Oil change in rear bevel gears

Checking valve clearance

Replacing all spark plugs

Replacing air cleaner element

Checking or replacing air cleaner element (maintenance)

Changing brake fluid in entire system

Yes

No

Information

-----  
-----  
-----  
-----  
-----  
-----  
-----  
-----

\_\_\_\_\_  
Stamp, signature

**BMW Service**

performed

on \_\_\_\_\_

at km \_\_\_\_\_

Next service

latest

on \_\_\_\_\_

or, if reached earlier

at km \_\_\_\_\_

Work performed

BMW Service

Engine oil change with filter

Oil change in rear bevel gears

Checking valve clearance

Replacing all spark plugs

Replacing air cleaner element

Checking or replacing air cleaner element (maintenance)

Changing brake fluid in entire system

Yes

No

Information

-----

-----

-----

-----

-----

-----

-----

-----

\_\_\_\_\_

Stamp, signature

**BMW Service**

performed

on \_\_\_\_\_

at km \_\_\_\_\_

Next service

latest

on \_\_\_\_\_

or, if reached earlier

at km \_\_\_\_\_

Work performed

BMW Service

Engine oil change with filter

Oil change in rear bevel gears

Checking valve clearance

Replacing all spark plugs

Replacing air cleaner element

Checking or replacing air cleaner element (maintenance)

Changing brake fluid in entire system

Yes

No

Information

-----  
-----  
-----  
-----  
-----  
-----  
-----  
-----

\_\_\_\_\_  
Stamp, signature

**BMW Service**

performed

on \_\_\_\_\_

at km \_\_\_\_\_

Next service

latest

on \_\_\_\_\_

or, if reached earlier

at km \_\_\_\_\_

Work performed

BMW Service

Engine oil change with filter

Oil change in rear bevel gears

Checking valve clearance

Replacing all spark plugs

Replacing air cleaner element

Checking or replacing air cleaner element (maintenance)

Changing brake fluid in entire system

Yes

No

Information

-----

-----

-----

-----

-----

-----

-----

-----

\_\_\_\_\_

Stamp, signature

**BMW Service**

performed

on \_\_\_\_\_

at km \_\_\_\_\_

Next service

latest

on \_\_\_\_\_

or, if reached earlier

at km \_\_\_\_\_

Work performed

BMW Service

Engine oil change with filter

Oil change in rear bevel gears

Checking valve clearance

Replacing all spark plugs

Replacing air cleaner element

Checking or replacing air cleaner element (maintenance)

Changing brake fluid in entire system

Yes No

Information

-----  
-----  
-----  
-----  
-----  
-----  
-----  
-----

\_\_\_\_\_  
Stamp, signature

**BMW Service**

performed

on \_\_\_\_\_

at km \_\_\_\_\_

Next service

latest

on \_\_\_\_\_

or, if reached earlier

at km \_\_\_\_\_

Work performed

BMW Service

Engine oil change with filter

Oil change in rear bevel gears

Checking valve clearance

Replacing all spark plugs

Replacing air cleaner element

Checking or replacing air cleaner element (maintenance)

Changing brake fluid in entire system

Yes

No

Information

-----

-----

-----

-----

-----

-----

-----

-----

\_\_\_\_\_

Stamp, signature



**BMW Service**

performed

on \_\_\_\_\_

at km \_\_\_\_\_

Next service

latest

on \_\_\_\_\_

or, if reached earlier

at km \_\_\_\_\_

Work performed

BMW Service

Engine oil change with filter

Oil change in rear bevel gears

Checking valve clearance

Replacing all spark plugs

Replacing air cleaner element

Checking or replacing air cleaner element (maintenance)

Changing brake fluid in entire system

Yes No

Information

-----  
-----  
-----  
-----  
-----  
-----  
-----  
-----

\_\_\_\_\_  
Stamp, signature

## Service confirmations

The table serves to provide evidence of maintenance and repair work, as well as installed optional accessories and special campaigns performed.

Work performed	at km	Date

<b>Work performed</b>	<b>at km</b>	<b>Date</b>



## Appendix

Certificate for Electronic Immobilizer .....	252
Certificate for Keyless Ride .....	254
Certificate for Tire Pressure Control .....	256
Certificate for TFT instrument cluster .....	257

## FCC Approval

### Ring aerial in the ignition switch



To verify the authorization of the ignition key, the electronic immobilizer exchanges information with the ignition key via the ring aerial.

This device complies with Part 15 of the FCC rules. Operation is subject to the following two conditions:

- (1) This device may not cause harmful interference, and
- (2) this device must accept any interference received, including interference that may cause undesired operation.



Any changes or modifications not expressly approved by the party responsible for compliance could void the user's authority to operate the equipment. ◀

## Approbation de la FCC

### Antenne annulaire présente dans le commutateur d'allumage



Pour vérifier l'autorisation de la clé de contact, le système d'immobilisation électronique échange des

informations avec la clé de contact via l'antenne annulaire.

Le présent dispositif est conforme à la partie 15 des règles de la FCC. Son utilisation est soumise aux deux conditions suivantes :

- (1) Le dispositif ne doit pas produire d'interférences nuisibles, et
- (2) le dispositif doit pouvoir accepter toutes les interférences extérieures, y compris celles qui pourraient provoquer une activation inopportune.



Toute modification qui n'aurait pas été approuvée expressément par l'organisme responsable de l'homologation peut annuler l'autorisation accordée à l'utilisateur pour utiliser le dispositif. ◀

## Certifications

---

### BMW Keyless Ride ID Device



#### USA, Canada

Product name: BMW Keyless Ride ID Device  
FCC ID: YGOHUF5750  
IC: 4008C-HUF5750

#### Canada:

Operation is subject to the following two conditions:

- (1) This device may not cause harmful interference, and
- (2) this device must accept any interference received, including interference that may cause undesired operation.

#### USA:

This device complies with Part 15 of the FCC rules. Operation is subject to the following two conditions:

- (1) This device may not cause harmful interference, and
- (2) this device must accept any interference received, including interference that may cause undesired operation.



Any changes or modifications not expressly approved by the party responsible for compliance could void the user's authority to operate the equipment.



# Declaration Of Conformity

---

We declare under our responsibility that the product

## **BMW Keyless Ride ID Device (Model: HUF5750)**

complies with the appropriate essential requirements of the article 3 of the R&TIE and the other relevant provisions, when used for its intended purpose. Applied Standards:

1. Health and safety requirements contained in article 3 (1) a)
  - EN 60950-1:2006+A11:2009+A1:2010+A12:2011; Information technology equipment- Safety
2. Protection requirements with respect to electromagnetic compatibility article 3 (1) b)
  - EN 301 489-1 (V1 .9.2, 09/2011 ), Electromagnetic compatibility and radio spectrum matters (ERM); Electromagnetic compatibility (EMC) standard for radio equipment and services; Part 1: Common technical requirements
  - EN 301 489-3 (V1.4.1, 08/2002) Electromagnetic compatibility and radio spectrum matters (ERM); Electromagnetic compatibility (EMC) standard for radio equipment and services; Part 3: Specific conditions for short range devices (SRD) operating on frequencies between 9 kHz and 40 GHz
3. Means of the efficient use of the radio frequency spectrum article 3 (2)
  - EN 300 220-1 & -2 (V2.4.1, 05/2012), electromagnetic compatibility and radio spectrum matters (ERM); Short range devices (SRD); Radio equipment to be used in the 25 MHz to 1000 MHz frequency range with power levels ranging up to 500 mW;  
Part 1: Technical characteristics and test methods.  
Part 2: Harmonized EN covering essential requirements under article 3.2 of the R&TIE directive

The product is labeled with the CE marking: **CE**

Velbert, October 15<sup>th</sup>, 2013

---

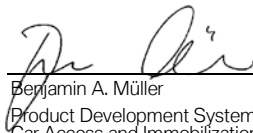

---

Benjamin A. Müller  
Product Development Systems  
Car Access and Immobilization – Electronics  
Huf Hüsbeck & Fürst GmbH & Co. KG  
Steeger Straße 17, D-42551 Velbert

## Certification Tire Pressure Control (TPC)

---

FCC ID: MRXBC54MA4  
IC: 2546A-BC54MA4

FCC ID: MRXBC5A4  
IC: 2546A-BC5A4

This device complies with Part 15 of the FCC Rules and with Industry Canada license-exempt RSS standard(s).

Operation is subject to the following two conditions:

- (1) This device may not cause harmful interference, and
- (2) This device must accept any interference received, including interference that may cause undesired operation.

Le présent appareil est conforme aux CNR d'Industrie Canada applicables aux appareils radio exempts de licence. L'exploitation est autorisée aux deux conditions suivantes:

- (1) l'appareil ne doit pas produire de brouillage, et
- (2) l'utilisateur de l'appareil doit accepter tout brouillage radioélectrique subi, même si le brouillage est susceptible d'en compromettre le fonctionnement.

**WARNING:** Changes or modifications not expressly approved by the party responsible for compliance could void the user's authority to operate the equipment. The term "IC:" before the radio certification number only signifies that Industry Canada technical specifications were met.

# Declaration of Conformity

## Radio equipment TFT instrument cluster

For all Countries without EU

### Technical information

BT operating frq. Range: 2402 – 2480 MHz

BT version: 4.2 (no BTLE)

BT output power: < 4 dBm

WLAN operating frq. Range: 2412 – 2462 MHz

WLAN standards: IEEE 802.11 b/g/n

WLAN output power: < 20 dBm

### Manufacturer and Address

Manufacturer:

Robert Bosch Car Multimedia GmbH

Adress: Robert Bosch Str. 200,

31139 Hildesheim, GERMANY

### Turkey

Robert Bosch Car Multimedia GmbH, ICC6.5in tipi telsiz sisteminin 2014/53/EU nolu yönetmeliğe uygun olduğunu beyan eder. AB Uygunluk Beyanı'nın tam metni, aşağıdaki internet adresinden görülebilir: <http://cert.bosch-carmultimedia.net>

### Brazil

Este equipamento opera em caráter secundário, isto é, não tem direito a proteção contra interferência prejudicial, mesmo de estações do mesmo tipo, e não pode causar interferência a sistemas operando em caráter primário.

## **Canada**

This device complies with Industry Canada's licence-exempt RSSs and part 15 of the FCC Rules. Operation is subject to the following two conditions:

(1) this device may not cause interference, and  
(2) this device must accept any interference, including interference that may cause undesired operation of the device.

Changes or modifications not expressly approved by the party responsible for compliance could void the user's authority to operate the equipment.

Le présent appareil est conforme aux CNR d'Industrie Canada applicables aux appareils radio exempts de licence. L'exploitation est autorisée aux deux conditions suivantes : (1) l'appareil ne doit pas produire de brouillage, et (2) l'appareil doit accepter tout brouillage radioélectrique subi, même si le brouillage est susceptible d'en compromettre le fonctionnement.

## **Mexico**

La operación de este equipo está sujeta a las siguientes dos condiciones:

(1) es posible que este equipo o dispositivo no cause interferencia perjudicial y  
(2) este equipo o dispositivo debe aceptar cualquier interferencia, incluyendo la que pueda causar su operación no deseada.

## **Taiwan, Republic of**

根據 NCC 低功率電波輻射性電機管理辦法 規定：  
第十二條

經型式認證合格之低功率射頻電機，非經許可，公司、商號或使用者均不得擅自變更頻率、加大功率或變更原設計之特性及功能。

### 第十四條

低功率射頻電機之使用不得影響飛航安全及干擾合法通信；經發現有干擾現象時，應立即停用，並改善至無干擾時方得繼續使用。

前項合法通信，

指依電信法規定作業之無線電通信。

低功率射頻電機須忍受合法通信或工業、科學及醫療用電波輻射性電機設備之干擾。

## **Thailand**

เครื่องโทรคมนาคมและอุปกรณ์นี้

มีความสอดคล้องตามข้อกำหนดของ กทท.

(This telecommunication equipments is in compliance with NTC requirements)

## **United States (USA)**

This device complies with Industry Canada's licence-exempt RSSs and part 15 of the FCC Rules. Operation is subject to the following two conditions:

(1) this device may not cause interference, and  
(2) this device must accept any interference, including interference that may cause undesired operation of the device.

Changes or modifications not expressly approved by the party responsible for compliance could void the user's authority to operate the equipment.

Le présent appareil est conforme aux CNR d'Industrie Canada applicables aux appareils radio exempts de licence. L'exploitation est autorisée aux deux conditions suivantes : (1) l'appareil ne doit pas produire de brouillage, et (2) l'appareil doit accepter tout brouillage radioélectrique subi, même si le brouillage est susceptible d'en compromettre le fonctionnement.

-  
-Coding plug  
Installing, 74

**A**

Abbreviations and symbols, 6

**ABS**

Control, 15  
Displays, 45  
Operating, 63  
Self-diagnosis, 122  
Technology in detail, 138

**Accessories**

General instructions, 186

**Air filter**

Position in motorcycle, 13  
Replacing the insert, 169

**Ambient temperature**

Outside temperature  
warning, 35

**Anti-theft alarm system**

Indicator light, 18  
Operating, 79  
Technical data, 222  
Warning indicator, 38

**ASC**

Control, 15  
Display, 47  
Operating, 65  
Self-diagnosis, 123  
Technology in detail, 142

**B****Battery**

Charging connected  
battery, 177  
Charging disconnected  
battery, 178  
Indicator light for vehicle  
voltage, 36  
Installing, 179  
Maintenance instructions, 177  
Removing, 178  
Technical data, 220

**Bluetooth, 98**

Pairing, 99

**Brake fluid**

Check fluid level at rear, 158  
Check front fluid level, 157  
Front fluid tank, 13  
Rear fluid tank, 13

**Brake pads**

Check front, 156  
Check rear, 156  
Running in, 125

**Brakes**

ABS Pro in detail, 140  
ABS Pro dependent on riding  
mode, 128  
Adjusting handlebar lever, 112  
Checking operation, 155  
Safety information, 127  
Technical data, 218

**Breaking in, 124****Bulbs**

High-beam headlamp, 171  
Low-beam headlight, 171  
Parking lights, 172  
Replace additional LED  
headlight, 175  
Replace LED headlamp, 175

Replacing LED tail light, 175  
Technical data, 221  
Turn indicators, 174  
Warning indicator for defective bulb, 37

## C

Case, 187  
Check Control  
  Dialog, 24  
  Display, 24  
Checklist, 120  
Clock  
  Adjusting, 97  
Clutch  
  Adjusting handlebar lever, 112  
  Checking operation, 159  
  Technical data, 213  
Coolant  
  Check fill level, 159  
  Indicator light for excess temperature, 39  
  Topping up, 160  
Cruise-control system  
  Operating, 75

## D

Damping  
  Rear adjuster, 11  
Diagnostic connector  
  fasten, 182  
  Loosen, 182  
Dimensions  
  Technical data, 222  
DTC  
  Indicator and warning light , 48  
  Operating, 66  
  Self-diagnosis, 124  
  Switching off, 66  
  Switching on, 67  
  Technology in detail, 142

## E

Electrical system  
  Technical data, 220  
Emergency on/off switch (kill switch), 17  
  Operating, 60

## Engine

  Indicator light for engine control, 40  
  Starting, 121  
  Technical data, 212  
  Warning light for electronic engine management, 40

## Engine oil

  Check fill level, 154  
  Electronic oil level check, 39  
  Filling level indicator, 13  
  Filling location, 13  
  Indicator light for engine oil level, 39  
  Technical data, 212  
  Topping up, 155

## Equipment, 7

## ESA

  Control, 15  
  Operating, 68

## F

## Frame

  Technical data, 215  
Front wheel stand  
  Mounting, 153

- Fuel
  - Filling location, 11
  - Refueling, 131
  - refueling with Keyless Ride, 132, 133
  - Technical data, 211
- Fuel reserve
  - Range, 96
  - Warning indicator, 50
- Fuses
  - Replacing, 181
- G**
  - Gearshift assistant
    - Gear not programmed, 51
    - Riding, 126
    - Technology in detail, 148
- H**
  - Handlebars
    - Adjusting, 113
  - Hazard warning flashers
    - Control, 15, 17
    - Operating, 62
- Headlight
  - Headlamp range, 110
  - Headlight range adjustment, 11
- Headlight courtesy delay
  - feature, 54, 61
- Heated handlebar grips
  - Control, 17
  - Operating, 82
- Hill Start Control, 77, 149
  - can not be activated, 50
  - Indicator and warning lights, 50
  - Operating, 78
  - Technology in detail, 149
- Horn, 15
- I**
  - Ignition
    - Switching off, 55
    - Switching on, 54
  - Immobilizer
    - Emergency key, 58
    - Spare key, 55
  - Indicator lights, 18
    - Overview, 20
- Instrument cluster
  - Ambient light photosensor, 18
  - Overview, 18
- J**
  - Jump-start, 175
- K**
  - Keyless Ride
    - Battery of the key fob transmitter is empty or the key fob transmitter is lost, 58
    - EWS Electronic immobilizer, 58
    - Locking handlebars, 56
    - Switch off ignition, 57
    - Switching on ignition, 57
    - Unlocking fuel filler cap, 132, 133
    - Warning indicator, 35, 36
  - Keys, 54, 56
- L**
  - Lights
    - Control, 15
    - Headlight courtesy delay feature, 61



- Low beams, 60
- Operating headlight flasher, 61
- Operating high-beam headlight, 61
- Operating the auxiliary headlight, 62
- Parking lights, 60, 61

Lowered suspension

- Limitations, 118

Luggage

- Loading information, 118

## **M**

Maintenance

- General instructions, 152
- Maintenance schedule, 233

Maintenance confirmations, 234

Maintenance intervals, 229

Media

- Operating, 107

Menu

- Calling up, 92

Mirrors

- Adjusting, 110

Mobility Services, 229

Motorcycle

- Care, 201
- Cleaning, 201
- Parking, 129
- Returning to use, 204
- Storage, 204
- Tying down, 134

Multifunction switch

- Overall view, left, 15
- Overall view, right, 17

## **N**

Navigation

- Operating, 105

Notice concerning current status, 7

## **O**

Offroad riding, 125

Onboard computer, 82

Onboard power socket

- Information on use, 186
- Position on vehicle, 13

Onboard tool kit

- Position on motorcycle, 14

Operating focus

- change, 93

Outside temperature

- Display, 35

Overview of warning indicators, 27

Overviews

- Indicator and warning lights, 20
- Instrument panel, 18
- Left side of motorcycle, 11
- Left-side multifunction switch, 15
- My Vehicle, 102
- Right side of motorcycle, 13
- Right-hand multifunction switch, 17
- TFT display, 21, 23
- Underneath seat, 14

## **P**

Pairing, 99

Parking light, 61

Performance data

- Technical data, 226

Phone  
  Operating, 107

Pre-Ride-Check, 122

Pure Ride  
  Overview, 21

**R**

RDC  
  Rim sticker, 163  
  Technology in detail, 146  
  Warning lights, 42

Rear-wheel drive  
  Technical data, 215

Refueling, 131  
  with Keyless Ride, 132, 133

Remote control  
  Replacing the battery, 59

Rider info status line  
  Adjusting, 94, 95

Rider's Manual (US Model)  
  Position on motorcycle, 14

Riding mode  
  Adjusting, 71  
  Control, 17  
  Set riding mode PRO, 73  
  Technology in detail, 144

Road sign detection  
  Switching on/off, 95

**S**

Safety instructions  
  On braking, 127  
  On riding, 118

Seat  
  Height adjustment position, 14

Seats  
  Adjust seat height, 84  
  Locking mechanism, 11  
  Removing and installing, 83

Service, 229  
  Reporting safety defects, 228

Service display, 51

Shifting gears  
  Upshift recommendation, 96

Spark plugs  
  technical data, 220

Speedometer, 18

Spring preload  
  Adjusting, 113  
  Rear adjuster, 13

Starting, 121  
  Control, 17

Steering lock  
  Locking, 54

Suspension  
  Technical data, 216

Switching off, 129

**T**

Tachometer, 18  
  Tachometer, 95

Technical data  
  Alarm system, 222  
  Battery, 220  
  Brakes, 218  
  Bulbs, 221  
  Chassis and suspension, 216  
  Clutch, 213  
  Dimensions, 222  
  Electrical system, 220  
  Engine, 212  
  Engine oil, 212  
  Frame, 215  
  Fuel, 211  
  Performance data, 226

- Rear-wheel drive, 215
- Spark plugs, 220
- Standards, 7
- Transmission, 214
- Weights, 225
- Wheels and tires, 219
- TFT display, 18
  - Control, 15
  - Operating, 92, 93, 94
  - Overview, 21, 23
  - Select display readings, 89
- Threaded fasteners, 209
- Tire Pressure Control TPC/RDC
  - Display, 41
- Tires
  - Checking tire pressures, 161
  - Checking tire tread depth, 162
  - Inflation pressure table, 14
  - Inflation pressures, 220
  - Maximum speed, 119
  - Running in, 125
  - Technical data, 219
- Topcase
  - Operating, 190
- Torques, 209
- Traction Control
  - ASC, 141, 142
  - DTC, 142
- Transmission
  - Technical data, 214
- Troubleshooting chart, 206
- Turn indicators
  - Control, 15
  - Control, right, 17
  - Operating, 63
- Type plate
  - Position on vehicle, 13
- V**
- Values
  - Display, 24
- Vehicle identification number
  - Position on vehicle, 13
- Vehicle voltage
  - Warning indicator, 36
- W**
- Warning lamps, 18
  - ABS, 45
  - Alarm system, 38
  - ASC, 47
- Coolant temperature, 39
- Displays, 24
- DTC, 48
- Electronic engine management, 40
- Engine management system, 40
- Engine oil level, 39
- Fuel reserve, 50
- Gear not programmed, 51
- Hill Start Control, 50
- Light source defect, 37
- My Vehicle, 102
- Outside temperature warning, 35
- Overview, 20
- TPM Tire Pressure Monitor, 42
- Vehicle voltage, 36
- Weights
  - Load capacity table, 14
  - Technical data, 225
- Wheels
  - Checking rims, 162
  - Checking spokes, 163
  - Install rear wheel, 168

- Installing front wheel, 166
  - Removing front wheel, 164
  - Size change, 163
  - Technical data, 219
- Windshield
- Adjusting, 111
  - Adjustment element, 13



The descriptions and illustrations in this manual may vary from your own motorcycle's actual equipment, depending upon its equipment level and accessories as well as your specific national version. No claims stemming from these differences can be recognized.

Dimensions, weights, fuel consumption and performance data are quoted to the customary tolerances.

The right to modify designs, equipment and accessories is reserved.

Errors and omissions excepted.

© 2017 Bayerische Motoren Werke Aktiengesellschaft  
80788 Munich, Germany  
Reprints and duplication of this work, in whole or part, are prohibited without the express written approval of BMW Motorrad, Aftersales.

Original Rider's Manual, printed in Germany.

Important data for refueling:

<b>Fuel</b>	
Recommended fuel quality	Normal unleaded 87 AKI (91 ROZ/RON)
Alternative fuel quality	Regular unleaded (restrictions with regard to power and consumption.) (max. 10 % ethanol, E10) 87 AKI (91 ROZ/RON) 87 AKI
Usable fuel quantity	Approx. 5.3 gal (Approx. 20 l)
Reserve fuel quantity	Approx. 1.1 gal (Approx. 4 l)
<b>Tire inflation pressures</b>	
Tire pressure, front	36.3 psi (2.5 bar), with tire cold
Tire pressure, rear	42.1 psi (2.9 bar), with tire cold

You can find further information on all aspects of your vehicle at:  
[bmw-motorrad.com](http://bmw-motorrad.com)

**BMW recommends** **ADVANTEC**  
ORIGINAL BMW ENGINE OIL

Order No.: 01 40 8 406 507  
11.2017, 3rd edition, 07

