

SHARP[®]

Carousel[®]

OVER THE RANGE MODELS

R-1405, R-1406

microwave
cooking
and installation instructions
guide



FOR CUSTOMER ASSISTANCE

To aid in reporting this microwave oven in case of loss or theft, please record below the model number and serial number located on the unit. We also suggest you record all the information listed and retain for future reference.

MODEL NUMBER _____	SERIAL NUMBER _____
DATE OF PURCHASE _____	
DEALER _____	TELEPHONE _____
SERVICER _____	TELEPHONE _____

TO PHONE:

DIAL 1-800-BE-SHARP (237-4277) for :

SERVICE (for your nearest Sharp Authorized Servicer)
PARTS (for your authorized parts distributor)
ADDITIONAL CUSTOMER INFORMATION
ACCESSORIES and COOKBOOK

TO WRITE:

Sharp Electronics Corporation
Customer Assistance Center
1300 Naperville Drive
Romeoville, IL 60446-1091

TO ACCESS INTERNET: www.sharppusa.com

Please provide the following information when you write or call: model number, serial number, date of purchase, your complete mailing address (including zip code), your daytime telephone number (including area code) and description of the problem.

PRECAUTIONS TO AVOID POSSIBLE EXPOSURE TO EXCESSIVE MICROWAVE ENERGY

- (a) Do not attempt to operate this oven with the door open since open-door operation can result in harmful exposure to microwave energy. It is important not to defeat or tamper with the safety interlocks.
- (b) Do not place any object between the oven front face and the door or allow soil or cleaner residue to accumulate on sealing surfaces.
- (c) Do not operate the oven if it is damaged. It is particularly important that the oven door close properly and that there is no damage to the: (1) door (bent), (2) hinges and latches (broken or loosened), (3) door seals and sealing surfaces.
- (d) The oven should not be adjusted or repaired by anyone except properly qualified service personnel.

CONTENTS

For Customer Assistance	2	Special Features	22-25
Precautions to Avoid Possible		Popcorn	22
Exposure to Excessive		Reheat	22-23
Microwave Energy	2	Cook	24
Contents	3	Defrost	25
Consumer Limited Warranty.....	4	Other Convenient Features	26-27
Product Information Card	4	Multiple Sequence Cooking.....	26
Important Safety Instructions.....	5	Timer	26
Unpacking & Installation Instructions	6-13	More or Less Time Adjustment.....	26
Electrical Grounding Instructions	7	Minute Plus.....	26
Optional Accessories	14	Child Lock.....	26
Information You Need to Know	15-17	Audible Signal Elimination.....	27
About Your Oven	15	Demonstration Mode.....	27
About Food.....	15	Light	27
About Utensils and Coverings.....	16	Fan	27
About Children and the Microwave.....	16	Replacing Parts	27
About Microwave Cooking.....	17	Cleaning and Care	28
About Safety	17	Service Call Check	29
Part Names.....	18-19	Cookbook Information	29
Before Operating	20	Specifications	30
To Set the Clock	20	Cookbook Order Form	30
Stop/Clear	20	Guia Auto-Touch.....	31
Manual Operation	21	Auto-Touch Guide	Back Cover
Time Cooking	21		
To Set Power Level	21		
Manual Defrost.....	21		

CONSUMER LIMITED WARRANTY

SHARP ELECTRONICS CORPORATION warrants to the first consumer purchaser that this Sharp brand product (the "Product"), when shipped in its original container, will be free from defective workmanship and materials, and agrees that it will, at its option, either repair the defect or replace the defective Product or part thereof with a new or remanufactured equivalent at no charge to the purchaser for parts or labor for the period(s) set forth below.

This warranty does not apply to any appearance items of the Product nor to the additional excluded item(s) set forth below nor to any Product the exterior of which has been damaged or defaced, which has been subjected to misuse, abnormal service or handling, or which has been altered or modified in design or construction.

In order to enforce the rights under this limited warranty, the purchaser should follow the steps set forth below and provide proof of purchase to the servicer.

The limited warranty described herein is in addition to whatever implied warranties may be granted to purchasers by law. ALL IMPLIED WARRANTIES INCLUDING THE WARRANTIES OF MERCHANTABILITY AND FITNESS FOR USE ARE LIMITED TO THE PERIOD(S) FROM THE DATE OF PURCHASE SET FORTH BELOW. Some states do not allow limitations on how long an implied warranty lasts, so the above limitation may not apply to you.

Neither the sales personnel of the seller nor any other person is authorized to make any warranties other than those described herein, or to extend the duration of any warranties beyond the time period described above on behalf of Sharp.

The warranties described herein shall be the sole and exclusive warranties granted by Sharp and shall be the sole and exclusive remedy available to the purchaser. Correction of defects, in the manner and for the period of time described herein, shall constitute complete fulfillment of all liabilities and responsibilities of Sharp to the purchaser with respect to the Product, and shall constitute full satisfaction of all claims, whether based on contract, negligence, strict liability or otherwise. In no event shall Sharp be liable, or in any way responsible, for any damages or defects in the Product which were caused by repairs or attempted repairs performed by anyone other than an authorized servicer. Nor shall Sharp be liable or in any way responsible for any incidental or consequential economic or property damage. Some states do not allow the exclusion of incidental or consequential damages, so the above exclusion may not apply to you.

THIS WARRANTY GIVES YOU SPECIFIC LEGAL RIGHTS. YOU MAY ALSO HAVE OTHER RIGHTS WHICH VARY FROM STATE TO STATE.

Your Product Model Number & Description:

R-1405 or R-1406 Home Use Carousel™ Microwave Oven. (Be sure to have this information available when you need service for your Product.)

Warranty Period for this Product:

One (1) year parts and labor in-home service. The warranty period continues for an additional six (6) years, for a total of seven (7) years, with respect to the magnetron tube in the Product for parts only. Labor and the servicer trip charge are not provided free of charge for this additional period.

Additional Item(s) Excluded from Warranty Coverage (if any):

Non-functional accessories, turntable and light bulbs.

Where to Obtain Service:

From a Sharp Authorized Servicer located In the United States. Be sure to have **Proof of Purchase** available. For in-home service, the servicer will come to the unit's location. If it is necessary to remove the unit for repair, the servicer will reinstall the unit at no extra charge, provided it was installed according to Sharp's Installation Instructions. To find the location of the nearest Sharp Authorized Servicer, call Sharp toll free at 1-800-BE-SHARP (1-800-237-4277).

TO OBTAIN SUPPLY, ACCESSORY OR PRODUCT INFORMATION, CALL 1-800-BE-SHARP OR VISIT www.sharppusa.com. SAVE THE PROOF OF PURCHASE AS IT IS NEEDED SHOULD YOUR OVEN EVER REQUIRE WARRANTY SERVICE.

PRODUCT INFORMATION CARD

The product information card should be completed within ten days of purchase and returned. It is necessary to write the model and serial numbers, found on the nameplate in the oven cavity, on the product information card. We will keep it on file and help you access the information in case of loss, damage or theft. This will also enable us to contact you in the unlikely event that any adjustments or modifications are ever required for your oven.

IMPORTANT SAFETY INSTRUCTIONS

When using electrical appliances basic safety precautions should be followed, including the following:

WARNING - To reduce the risk of burns, electric shock, fire, injury to persons or exposure to excessive microwave energy:

1. **READ ALL INSTRUCTIONS BEFORE USING THE APPLIANCE.**
2. Read and follow the specific “**PRECAUTIONS TO AVOID POSSIBLE EXPOSURE TO EXCESSIVE MICROWAVE ENERGY**” on inside front cover.
3. This appliance must be grounded. Connect only to properly grounded outlet. See “**GROUNDING INSTRUCTIONS**” on page 7.
4. Install or locate this appliance only in accordance with the provided installation instructions.
5. Some products such as whole eggs and sealed containers—for example, closed glass jars—are able to explode and should not be heated in this oven.
6. Use this appliance only for its intended use as described in this manual. Do not use corrosive chemicals or vapors in this appliance. This type of oven is specifically designed to heat, cook or dry food. It is not designed for industrial or laboratory use.
7. As with any appliance, close supervision is necessary when used by children.
8. Do not operate this appliance if it has a damaged cord or plug, if it is not working properly or if it has been damaged or dropped.
9. This appliance should be serviced only by qualified service personnel. Contact nearest Sharp Authorized Servicer for examination, repair or adjustment.
10. Do not cover or block any openings on the appliance.
11. Do not store or use this appliance outdoors. Do not use this product near water—for example, near a kitchen sink, in a wet basement, near a swimming pool, or similar locations.
12. Do not immerse cord or plug in water.
13. Keep cord away from heated surfaces.
14. Do not let cord hang over edge of table or counter.
15. See door surface cleaning instructions on page 28.
16. To reduce the risk of fire in the oven cavity:
 - a. Do not overcook food. Carefully attend to appliance when paper, plastic or other combustible materials are placed inside the oven to facilitate cooking.
17. Liquids, such as water, coffee or tea are able to be overheated beyond the boiling point without appearing to be boiling. Visible bubbling or boiling when the container is removed from the microwave oven is not always present. **THIS COULD RESULT IN VERY HOT LIQUIDS SUDDENLY BOILING OVER WHEN A SPOON OR OTHER UTENSIL IS INSERTED INTO THE LIQUID.**
 - b. Remove wire twist-ties from paper or plastic bags before placing bag in oven.
 - c. **If materials inside the oven ignite, keep oven door closed, turn oven off and disconnect the power cord or shut off power at the fuse or circuit breaker panel.**
 - d. Do not use the cavity for storage purposes. Do not leave paper products, cooking utensils or food in the cavity when not in use.
18. Clean ventilation openings and grease filters frequently—Grease should not be allowed to accumulate on ventilation openings, louver or grease filters.
19. Use care when cleaning the louver and the grease filters. Corrosive cleaning agents, such as lye-based oven cleaners, may damage the louver and the grease filters.
20. When flaming food under the hood, turn the fan on.
21. This appliance is suitable for use above both gas and electric cooking equipment 36” wide or less.

To reduce the risk of injury to persons:

- a. Do not overheat the liquid.
- b. Stir the liquid both before and halfway through heating it.
- c. Do not use straight-sided containers with narrow necks. Use a wide-mouthed container.
- d. After heating, allow the container to stand in the microwave oven at least for 20 seconds before removing the container.
- e. Use extreme care when inserting a spoon or other utensil into the container.

SAVE THESE INSTRUCTIONS

UNPACKING AND INSTALLATION INSTRUCTIONS

UNPACKING AND EXAMINING YOUR OVEN

Open the bottom of the carton, bend the carton flaps back and tilt the oven over to rest on plastic foam pad. Lift carton off oven and remove all packing materials, WALL and TOP CABINET TEMPLATE, Turntable, and Turntable Support. **SAVE THE CARTON AS IT MAY MAKE INSTALLATION EASIER.**

1. Remove the feature sticker from the outside of the door, if there is one.
2. **DO NOT REMOVE THE WAVEGUIDE COVER**, which is located on the right side wall of the oven cavity. Check to see that there is a WALL TEMPLATE and TOP CABINET TEMPLATE. Read enclosures and **SAVE** the Operation Manual.

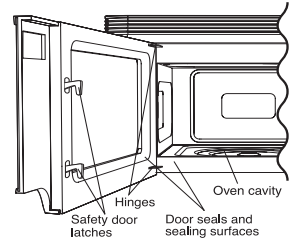

Check the oven for any damage, such as misaligned or bent door, damaged door seals and sealing surfaces, broken or loose door hinges and latches and dents inside the cavity or on the door. If there is any damage, do not operate the oven and contact your dealer or SHARP AUTHORIZED SERVICER. See Installation Instructions for more details.

INSTALLATION INSTRUCTION

Please read all instructions thoroughly before installing the Over the Range Microwave Oven/Hood System. Two people are recommended to install this product.

If a new electrical outlet is required, its installation should be completed by a qualified electrician before the Microwave Oven/Hood is installed. See 3 ELECTRICAL GROUNDING INSTRUCTIONS on page 7.

1 MOUNTING SPACE

This Microwave Oven/Hood requires a mounting space on a wall as shown in Figure 1. It is designed to be used with standard 12-inch wall cabinets.

If the space between the wall cabinets is 36 or 42 inches, a Filler Panel Kit can be used to fill the gap. The metal filler panels come in 3-inch wide pairs. One set is needed for a 36-inch opening and 2 sets for a 42-inch opening. See page 14 for ordering information. The Filler Panel Kit should be installed before the Microwave Oven/Hood is installed.

2 WALL CONSTRUCTION

This Microwave Oven/Hood should be mounted against and supported by a flat vertical wall. The wall must be flat for proper installation. If the wall is not flat, use spacers to fill in the gaps. Wall construction should be a minimum of 2" x 4" wood studing and 3/8" or more thick dry wall or plaster/lath. The mounting surfaces must be capable of supporting weight of 110 pounds—the oven and contents—AND the weight of all items which would normally be stored in the top cabinet above the unit.

The unit should be attached to a minimum of one 2" x 4" wall stud.

To find the location of the studs, one of the following methods may be used:

- A. Use a stud finder, a magnetic device which locates the nails in the stud.
- B. Use a hammer to tap lightly across the mounting surface to find a solid sound. This will indicate stud location.

The center of the stud can be located by probing the wall with a small nail to find the edges of the stud and then placing a mark halfway between the edges. The center of any adjacent studs will normally be 16" or 24" to either side of this mark.

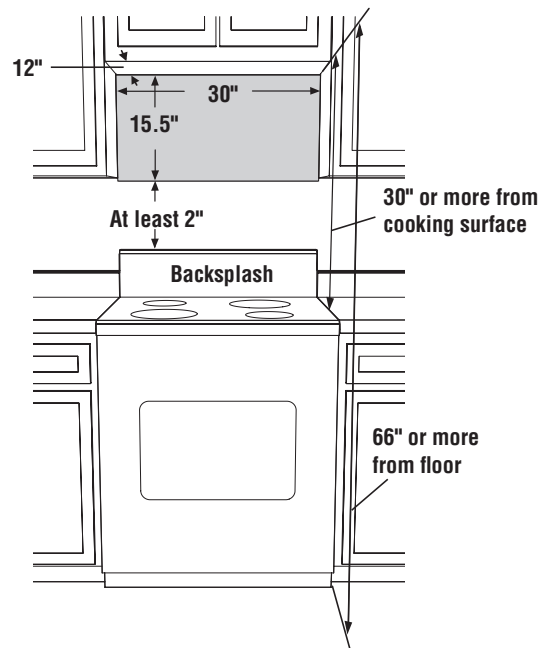

Figure 1

UNPACKING AND INSTALLATION INSTRUCTIONS

3 ELECTRICAL GROUNDING INSTRUCTIONS

This appliance must be grounded. This oven is equipped with a cord having a grounding wire with a grounding plug. It must be plugged into a wall receptacle that is properly installed and grounded in accordance with the National Electrical Code and local codes and ordinances. In the event of an electrical short circuit, grounding reduces risk of electric shock by providing an escape wire for the electric current.

WARNING - Improper use of the grounding plug can result in a risk of electric shock.

Electrical Requirements

The oven is equipped with a 3-prong grounding plug. **DO NOT UNDER ANY CIRCUMSTANCES CUT OR REMOVE THE GROUNDING PIN FROM THE PLUG. DO NOT USE AN EXTENSION CORD.**

The Power Supply Cord and plug must be connected to a separate 120 Volt AC, 60 Hz, 15 Amp, or more branch circuit, single grounded receptacle. The receptacle should be located inside the cabinet directly above the Microwave Oven mounting location as shown in Figure 2.

NOTE:

1. If you have any questions about the grounding or electrical instructions, consult a qualified electrician or serviceperson.
2. Neither Sharp nor the dealer can accept any liability for damage to the oven or personal injury resulting from failure to observe the correct electrical connection procedures.

Radio or TV Interference

Should there be any interference caused by the microwave oven to your radio or TV, check that the microwave oven is on a different electrical circuit, relocate the radio or TV as far away from the oven as feasible or check position and signal of receiving antenna.

4 HOOD EXHAUST DUCT

When the hood is vented to the outside, a hood exhaust duct is required. All ductwork must be metal; absolutely do not use plastic duct. Check that all connections are made securely. Please read the following carefully:

Exhaust connection: The hood exhaust has been designed to connect to a standard 3-1/4" x 10" rectangular duct. If round duct is required, a rectangular-to-round adaptor must be used.

Rear exhaust: If a rear or horizontal exhaust is to be used, care should be taken to align the exhaust with the space between the studs, or wall should be prepared at the time it is constructed by leaving enough space between wall studs to accommodate exhaust.

Maximum duct length: For satisfactory air movement, the total duct length of 3-1/4" x 10" rectangular or 6" diameter round duct should not exceed 140 feet.

Elbows, adapters, wall caps, roof caps, etc. present additional resistance to air flow and are equivalent to a section of straight duct which is longer than their actual physical size. When calculating the total length, add the equivalent lengths of all transitions and adapters plus the length of all straight duct sections. Figure 3 shows the approximate feet of equivalent length of some typical ductwork parts. Use the values in parentheses for calculating air flow resistance equivalent, which should total less than 140 feet.

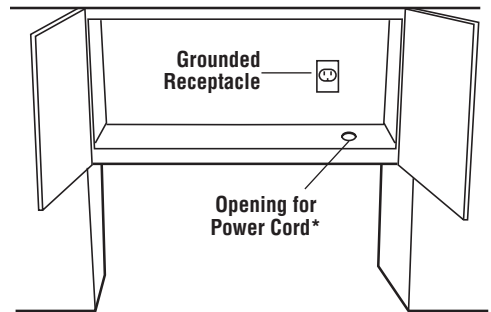
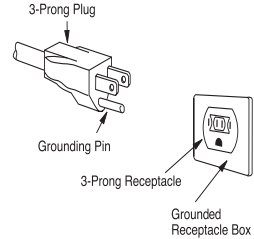
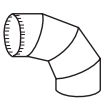

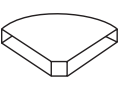

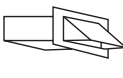



Figure 2

IMPORTANT: * Power cord opening for metal cabinets: Deburr opening to remove rough edges.

Figure 3

 90° ELBOW (10 FT.)	 45° ELBOW (5 FT.)	 ADAPTOR (5 FT.)	 10" WIDE ELBOW (10 FT.)
 90° ELBOW (25 FT.)	 45° ELBOW (5 FT.)	 WALL CAP (40 FT.)	 ROOF CAP (24 FT.)

UNPACKING AND INSTALLATION INSTRUCTIONS

5 TOOLS RECOMMENDED FOR INSTALLATION

- Phillips Screwdriver
- Electric Drill
- 1/2", 5/8" and 3/32" Drill Bits
- 1-1/2" Wood Bit or Metal Hole Cutter (if metal cabinet is used)
- Saw to cut exhaust opening (if needed)
- Protective Drop Cloth for product and range - you may also use carton for protection
- Scissors
- Pencil
- Measure
- Tape

6 INSTALLATION HARDWARE

The INSTALLATION HARDWARE items ① - ⑤ are in a small bag. Items ⑥ - ⑨ are packed separately. All items are in a small carton packed below the oven.

ITEM	NAME	QUANTITY	PART CODE
①	Wood Screw 5 X 30 mm	4	XTSS750P35000
②	Toggle Bolt with nuts #10 - 24 x 50 mm	4	LX-BZ0195WRE0
③	Top Cabinet Screw 5 X 85 mm	2	XBPS750P85000
④	Tapping Screw 4 x 12 mm	1	XOTS740P12000
⑤	Flat Washer 30 mm diameter	2	XWH750-16300
⑥	Rear Cushion	1	PCUSUB059MRP0
⑦	Exhaust Damper Assembly	1	FFTA-B005MRK0
⑧	Scale Plate	2	LANG-B002MRP0
⑨	Grease Filter	2	PFIL-B002MRE0

Figure 4

Parts shown not to common scale.

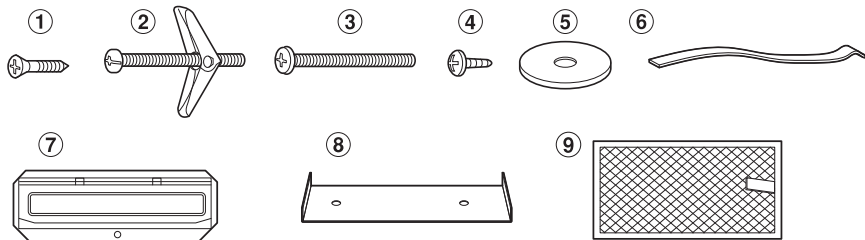

7 PREPARATION OF THE OVEN

Separate mounting plate from oven by removing two screws. See illustration below. Save these screws for use in section 11 MOUNTING OVEN TO WALL, step 5.

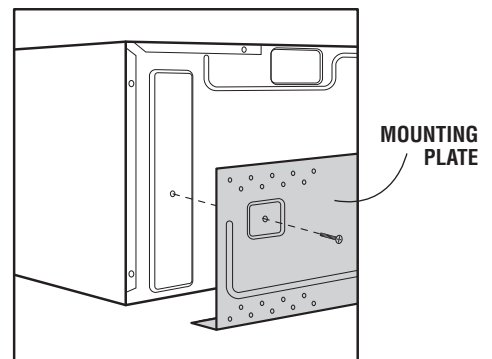

BACK OF MICROWAVE

UNPACKING AND INSTALLATION INSTRUCTIONS

8 VENTILATION SYSTEM (PREPARING OVEN FOR INSTALLATION)

This Microwave Oven/Hood is designed for adaptation to three types of hood ventilation systems. Select the type required for your installation.

Recirculating — non-vented, ductless. Follow installation procedure (A). Recirculating requires the use of the Charcoal Filter, which has already been installed in the oven.

Horizontal Exhaust — outside ventilation. Follow installation procedure (B).

Vertical Exhaust — outside ventilation. Follow installation procedure (C).

(A) RECIRCULATING: NON-VENTED, DUCTLESS OPERATION

The unit is shipped assembled for recirculating.

- NOTE:
1. The Exhaust Damper Assembly ⑦ is not required for recirculating operation.
 2. The Charcoal Filter should be replaced every 6 to 12 months, depending on use.
 3. The Charcoal Filter RK-250 is also sold as an accessory. See page 14 for ordering information.
 4. Continue on section 9. **OVEN INSTALLATION** (page 11).

(B) HORIZONTAL EXHAUST: OUTSIDE VENTILATION

1. Remove 2 screws from back edge and 3 screws from the top center of Fan Cover Bracket. Save 2 screws to be used later and discard remaining 3. Remove Fan Cover Bracket by sliding it in the opposite direction of the arrow on the Fan Cover Bracket, as shown in Figure 5.
2. Lift Hood Fan Unit carefully and slip wires out of cavity. See Figure 6.
- CAUTION: Do not pull or stretch hood fan wiring.**
3. Rotate the Hood Fan Unit 180° so that the fan blade openings are facing the back of the oven. See Figure 7 (A). Replace Hood Fan Unit into the oven. Be careful not to pinch the wire and the Hood Fan Unit. See Figure 7 (B).
4. Put the wire back into the cavity. See Figure 9 .
5. Continue on section 9. **OVEN INSTALLATION** (page 11).

Figure 5

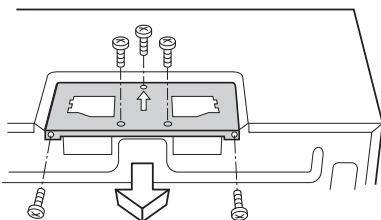

Figure 6

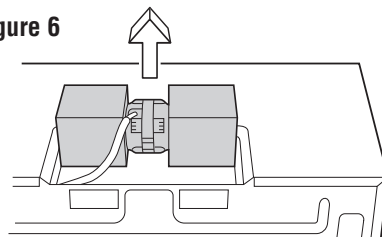

Figure 7

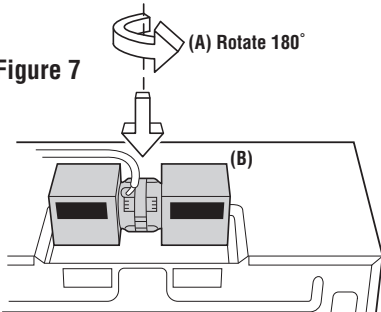
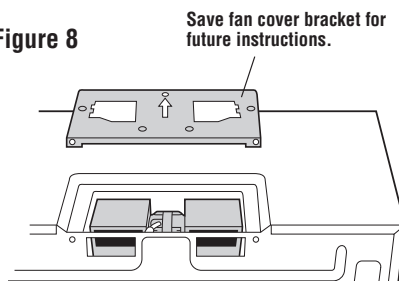

Figure 8



UNPACKING AND INSTALLATION INSTRUCTIONS

(C) VERTICAL EXHAUST: OUTSIDE VENTILATION

1. Remove and save 2 screws from back edge and 3 screws from the top center of the Fan Cover Bracket. Remove Fan Cover Bracket by sliding it in the opposite direction of the arrow on the Fan Cover Bracket as shown in Figure 9.

2. Lift Hood Fan Unit carefully and slip wires out of cavity. See Figure 10.

CAUTION: Do not pull or stretch hood fan wiring.

3. Rotate the Hood Fan Unit 90° so that the fan blade openings are facing the top of the oven. See Figure 11 (A). Replace Hood Fan Unit into the oven. Be careful not to pinch the lead wire between the inner bracket and the Hood Fan Unit. Put the lead wire into Wire Box. See Figure 11 (B).

4. Replace the Fan Cover Bracket by sliding it into the slits in the same direction as the arrow on the Fan Cover Bracket. Make sure the fan blades are visible through the top openings in the oven before proceeding.

5. Attach the Fan Cover Bracket to unit with the 2 screws from back edge and 3 screws from the top center of the Fan Cover Bracket, which were removed in Step 1 above. See Figure 12. The Hood Fan Unit is now rotated for vertical exhaust operation.

6. Attach the Exhaust Damper Assembly (7) to the fan cover on the top of the outercase cabinet by sliding it into the slits in the same direction as the arrow. Use 1 Tapping Screw 4 X12 mm (4) from the INSTALLATION HARDWARE and tighten into place See Figure 13.

7. Continue on section 9. OVEN INSTALLATION (page 6).

Figure 9

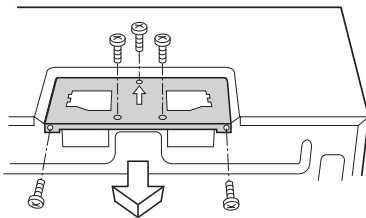

Figure 10

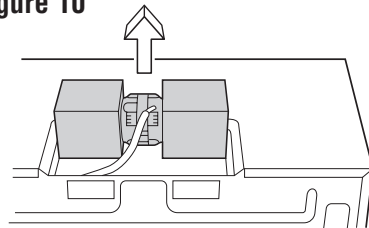

Figure 11

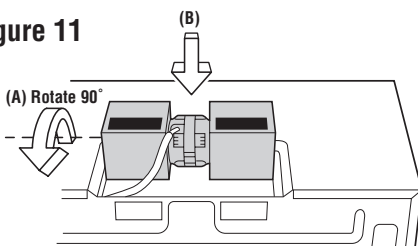

Figure 12

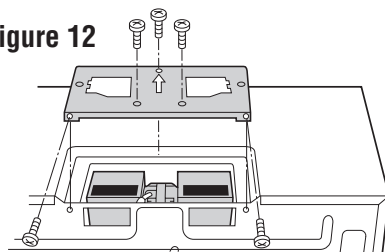
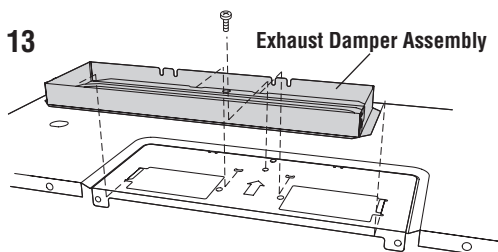

Figure 13



UNPACKING AND INSTALLATION INSTRUCTIONS

9 OVEN INSTALLATION

THIS OVEN CANNOT BE PROPERLY INSTALLED WITHOUT REFERRING TO THE MOUNTING INSTRUCTIONS FOUND ON WALL AND TOP CABINET TEMPLATES.

THE NEXT STEP IS TO READ AND FOLLOW MOUNTING INFORMATION ON WALL AND TOP CABINET TEMPLATES. **THIS OVEN MUST BE ATTACHED TO AT LEAST ONE WALL STUD. SEE WALL CONSTRUCTION ON PAGE 6.**

WHEN DONE WITH TEMPLATES, PROCEED TO MOUNTING SCALE PLATE SECTION.

MOUNTING SCALE PLATE

Attach 2 Scale Plates ⑧ with tape (not included). See Figure 14 and WALL TEMPLATE for locations.

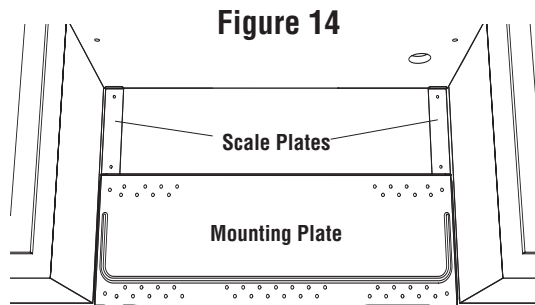

MOUNTING PLATE

1. Separate 4 Toggle Bolts ②, packed in the INSTALLATION HARDWARE, from the Toggle Nuts.
2. Match 5/8" holes (not in studs), drilled through WALL TEMPLATE into wall to corresponding holes on Mounting Plate.
3. Insert Toggle Bolts into matched openings on Mounting Plate. Put Toggle Nuts on Toggle Bolts. See Figure 15.
4. Position the Mounting Plate with the Toggle Bolts attached at the wall location and insert Toggle Nuts and Bolts through the holes in the wall with the Toggle Nuts closed. Figure 16. Use Wood Screws ① to attach the Mounting Plate to studs.

NOTE: Before insertion, be sure you leave a space more than the thickness of the wall between the Mounting Plate and the end of each of the Toggle Nuts (in the closed position). If you do not leave enough space, the Toggle Nut will not be able to open on the other side of the wall. **Also, once a Toggle Nut opens, it cannot be withdrawn from the hole; therefore make sure all of the Toggles are in the correct position before insertion.**

5. Align the Mounting Plate carefully and hold in position while tightening Toggle Bolts. Pull Toggle Bolt toward you and turn clockwise to tighten. Figure 17.

Figure 15

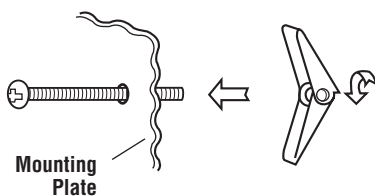

Figure 16

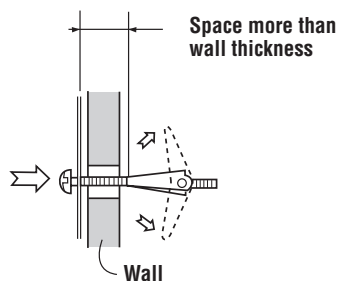
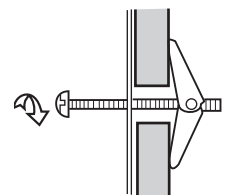

Figure 17



UNPACKING AND INSTALLATION INSTRUCTIONS

10 PREPARATION AND USE OF THE CARTON TO ASSIST IN THE INSTALLATION OF THE MICROWAVE OVEN

Utilization of the carton may make installation easier.

1. Place carton upside down. See Figure 18.
2. Using cutting line around the carton, cut into two pieces (A) and (B). See Figure 19.
3. Position oven to assist in mounting to the wall. See Figure 20.

Figure 18

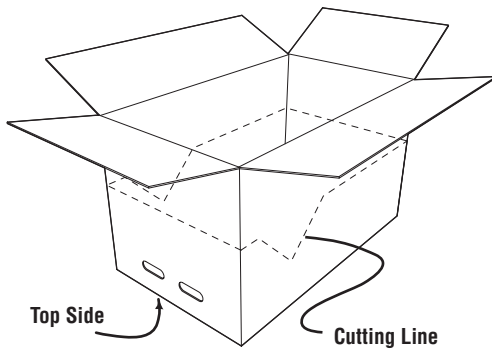

Figure 19

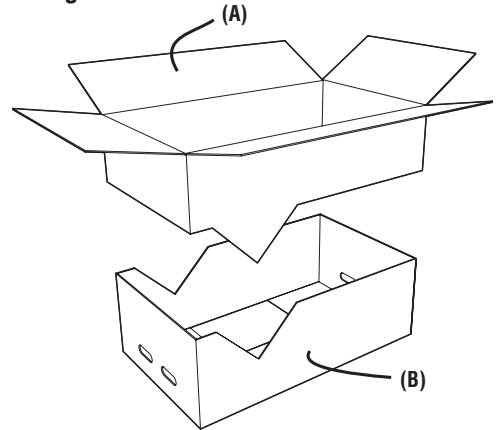
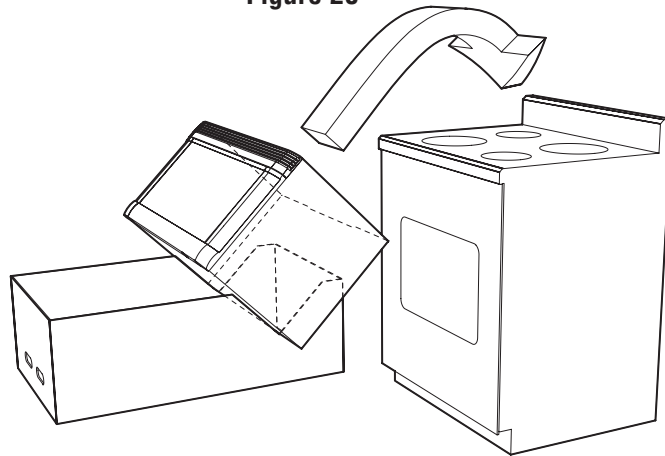

Figure 20



UNPACKING AND INSTALLATION INSTRUCTIONS

11 MOUNTING OVEN TO THE WALL

Two people are recommended to attach the Microwave Oven/Hood to the Mounting Plate.

1. Thread the Power Supply Cord through the hole made in the bottom of the top cabinet.
2. Lift and tilt the oven forward. Hook the back bottom of the oven to the bottom of the Mounting Plate. See Figure 21.
3. Lift the front of the oven up to the bottom of the cabinet. Keep the Power Supply Cord tight to avoid interference with mounting the oven flush with the bottom of the cabinet.
4. Use the two Top Cabinet Screws ③ and two Flat Washers ⑤, supplied in the INSTALLATION HARDWARE, to attach the unit to the top cabinet. Tighten until the top of the oven is tight against the bottom of the cabinet. See Figure 22.
5. Attach the two Bottom Plate Screws saved from section 7 PREPARATION OF THE OVEN. See Figure 23.
6. Install the two Grease Filters ⑨. See Figure 23.

Figure 21

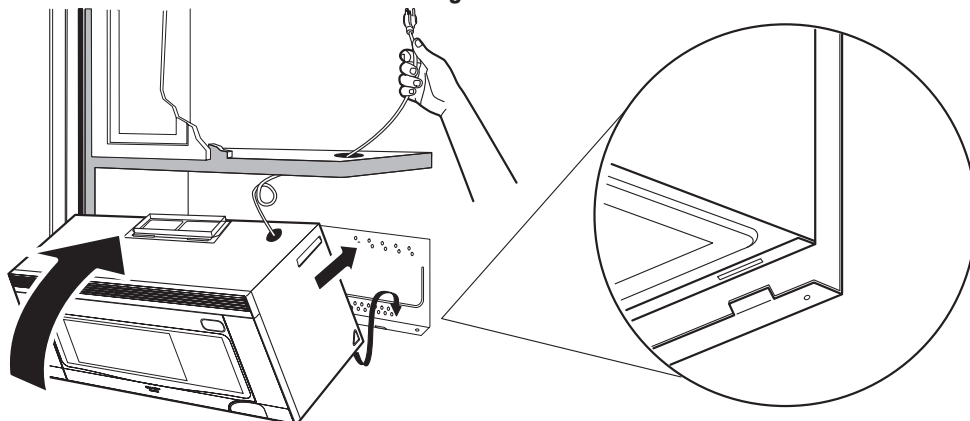

Figure 22

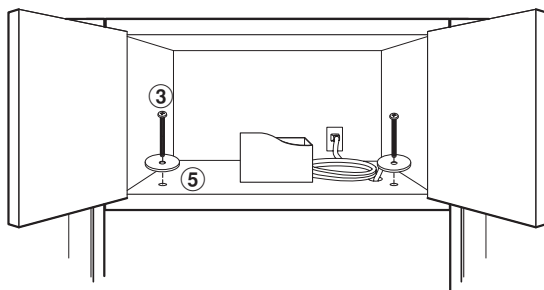
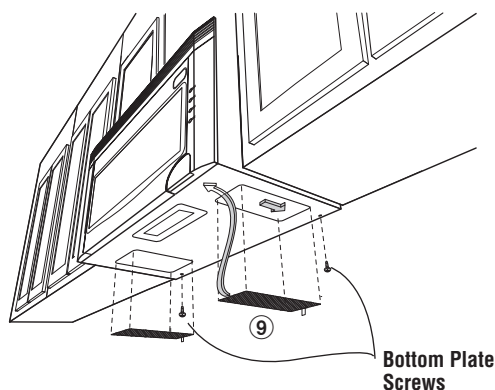

Figure 23



CHECKLIST FOR INSTALLATION

1. Make sure the unit has been installed according to all of the Installation Instructions and the Wall and Top Cabinet Templates.
2. Plug in the power cord.
3. Keep the Operation Manual and Installation Instructions.

OPTIONAL ACCESSORIES

Two optional accessories are available for this oven.

1. Charcoal Filter (RK-250). This is required when hood exhaust is recirculated. See Charcoal Filter on page 27. If dealer does not stock this item, it can be ordered by calling 1-800-237-4277.
2. Filler Panel Kit. For use when the oven is installed in a 36-inch or 42-inch wide opening. The metal filler panels come in 3-inch wide pairs for 36-inch and 6-inch wide pairs for 42-inch wide opening. White, black, biscuit and stainless steel are available.

To purchase contact: Imperial Cal Products, Inc.
425 Apollo Street
Brea, CA 92821
Phone: (800) 851-4192 or (714) 990-9100
Fax: (714) 990-3350
www.imperialhoods.com

INFORMATION YOU NEED TO KNOW

ABOUT YOUR OVEN

This Operation Manual is valuable: read it carefully and always save it for reference.

A good microwave cookbook is a valuable asset. Check it for microwave cooking principles, techniques, hints and recipes. See pages 29 and 30 for ordering the Sharp Carousel Microwave Cookbook.

NEVER use the oven without the turntable and support nor turn the turntable over so that a large dish could be placed in the oven. The turntable will turn both clockwise and counterclockwise.

ALWAYS have food in the oven when it is on to absorb the microwave energy.

When using the oven at power levels below 100%, you may hear the magnetron cycling on and off. It is normal

for the exterior of the oven to be warm to the touch when cooking or reheating.

Condensation is a normal part of microwave cooking. Room humidity and the moisture in food will influence the amount of moisture that condenses in the oven. Generally, covered foods will not cause as much condensation as uncovered ones. Ventilation openings must not be blocked.

The oven is for food preparation only. It should not be used to dry clothes or newspapers.

All ovens are rated 950 watts by using the IEC Test Procedure. In using recipes or package directions, check food a minute or two before the minimum time and add time accordingly.

ABOUT FOOD

FOOD	DO	DON'T
Eggs, sausages, nuts, seeds, fruits & vegetables	<ul style="list-style-type: none"> • Puncture egg yolks before cooking to prevent "explosion". • Pierce skins of potatoes, apples, squash, hot dogs and sausages so that steam escapes. 	<ul style="list-style-type: none"> • Cook eggs in shells. • Reheat whole eggs. • Dry nuts or seeds in shells.
Popcorn	<ul style="list-style-type: none"> • Use specially bagged popcorn for the microwave oven. • Listen while popping corn for the popping to slow to 1 or 2 seconds or use special POPCORN pad. 	<ul style="list-style-type: none"> • Pop popcorn in regular brown bags or glass bowls. • Exceed maximum time on popcorn package.
Baby food	<ul style="list-style-type: none"> • Transfer baby food to small dish and heat carefully, stirring often. Check temperature before serving. • Put nipples on bottles after heating and shake thoroughly. "Wrist" test before feeding. 	<ul style="list-style-type: none"> • Heat disposable bottles. • Heat bottles with nipples on. • Heat baby food in original jars.
General	<ul style="list-style-type: none"> • Cut baked goods with filling after heating to release steam and avoid burns. • Stir liquids briskly before and after heating to avoid "eruption". • Use deep bowl, when cooking liquids or cereals, to prevent boilovers. 	<ul style="list-style-type: none"> • Heat or cook in closed glass jars or air tight containers. • Can in the microwave as harmful bacteria may not be destroyed. • Deep fat fry. • Dry wood, gourds, herbs or wet papers.

ABOUT UTENSILS AND COVERINGS

It is not necessary to buy all new cookware. Many pieces already in your kitchen can be used successfully in your new microwave oven. Make sure the utensil does not touch the interior walls during cooking.

Use these utensils for safe microwave cooking and reheating:

- glass ceramic (Pyroceram®), such as Corningware®.
- heat-resistant glass (Pyrex®)
- microwave-safe plastics
- paper plates
- microwave-safe pottery, stoneware and porcelain
- browning dish (Do not exceed recommended preheating time. Follow manufacturer's directions.)

These items can be used for short time reheating of foods that have little fat or sugar in them:

- wood, straw, wicker

DO NOT USE

- metal pans and bakeware
- dishes with metallic trim
- non-heat-resistant glass
- non-microwave-safe plastics (margarine tubs)
- recycled paper products
- brown paper bags
- food storage bags
- metal twist-ties

Should you wish to check if a dish is safe for microwaving, place the empty dish in the oven and microwave on HIGH for 30 seconds. A dish which becomes very hot should not be used.

ABOUT CHILDREN AND THE MICROWAVE

Children below the age of 7 should use the microwave oven with a supervising person very near to them. Between the ages of 7 and 12, the supervising person should be in the same room.

The child must be able to reach the oven comfortably; if not, he/she should stand on a sturdy stool.

At no time should anyone be allowed to lean or swing on the oven door.

The following coverings are ideal:

- Paper towels are good for covering foods for reheating and absorbing fat while cooking bacon.
- Wax paper can be used for cooking and reheating.
- Plastic wrap that is specially marked for microwave use can be used for cooking and reheating. DO NOT allow plastic wrap to touch food. Vent so steam can escape.
- Lids that are microwave-safe are a good choice because heat is kept near the food to hasten cooking.
- Oven cooking bags are good for large meats or foods that need tenderizing. DO NOT use metal twist ties. Remember to slit bag so steam can escape.

How to use aluminum foil in your microwave oven:

- Small flat pieces of aluminum foil placed smoothly on the food can be used to shield areas that are either defrosting or cooking too quickly.
- Foil should not come closer than one inch to any surface of the oven.

Should you have questions about utensils or coverings, check a good microwave cookbook or follow recipe suggestions.

ACCESSORIES There are many microwave accessories available for purchase. Evaluate carefully before you purchase so that they meet your needs. A microwave-safe thermometer will assist you in determining correct doneness and assure you that foods have been cooked to safe temperatures. Sharp is not responsible for any damage to the oven when accessories are used.

Children should be taught all safety precautions: use potholders, remove coverings carefully, pay special attention to packages that crisp food because they may be extra hot.

Don't assume that because a child has mastered one cooking skill he/she can cook everything.

Children need to learn that the microwave oven is not a toy. See page 26 for Child Lock feature.

ABOUT MICROWAVE COOKING

- Arrange food carefully. Place thickest areas towards outside of dish.
- Watch cooking time. Cook for the shortest amount of time indicated and add more as needed. Food severely overcooked can smoke or ignite.
- Cover foods while cooking. Check recipe or cook-book for suggestions: paper towels, wax paper, microwave plastic wrap or a lid. Covers prevent spattering and help foods to cook evenly.
- Shield with small flat pieces of aluminum foil any thin areas of meat or poultry to prevent overcooking before dense, thick areas are cooked thoroughly.
- Stir foods from outside to center of dish once or twice during cooking, if possible.
- Turn foods over once during microwaving to speed cooking of such foods as chicken and hamburgers. Large items like roasts must be turned over at least once.
- Rearrange foods such as meatballs halfway through cooking both from top to bottom and from the center of the dish to the outside.
- Add standing time. Remove food from oven and stir, if possible. Cover for standing time which allows the food to finish cooking without overcooking.
- Check for doneness. Look for signs indicating that cooking temperatures have been reached.
 - Doneness signs include:**
 - Food steams throughout, not just at edge.
 - Center bottom of dish is very hot to the touch.
 - Poultry thigh joints move easily.
 - Meat and poultry show no pinkness.
 - Fish is opaque and flakes easily with a fork.

ABOUT SAFETY

- Check foods to see that they are cooked to the United States Department of Agriculture's recommended temperatures.
- ALWAYS use potholders to prevent burns when handling utensils that are in contact with hot food. Enough heat from the food can transfer through utensils to cause skin burns.
- Avoid steam burns by directing steam away from the face and hands. Slowly lift the farthest edge of a dish's covering and carefully open popcorn and oven cooking bags away from the face.
- Stay near the oven while it's in use and check cooking progress frequently so that there is no chance of overcooking food.
- NEVER use the cavity for storing cookbooks or other items.
- Select, store and handle food carefully to preserve its high quality and minimize the spread of foodborne bacteria.
- Keep waveguide cover clean. Food residue can cause arcing and/or fires.
- Use care when removing items from the oven so that the utensil, your clothes or accessories do not touch the safety door latches.

TEMP	FOOD
160°F	... for fresh pork, ground meat, boneless white poultry, fish, seafood, egg dishes and frozen prepared food.
165°F	... for leftover, ready-to-reheat refrigerated, and deli and carry-out "fresh" food.
170°F	... white meat of poultry.
180°F	... dark meat of poultry.

To test for doneness, insert a meat thermometer in a thick or dense area away from fat or bone. NEVER leave the thermometer in the food during cooking, unless it is approved for microwave oven use.

PART NAMES

FRONT VIEW

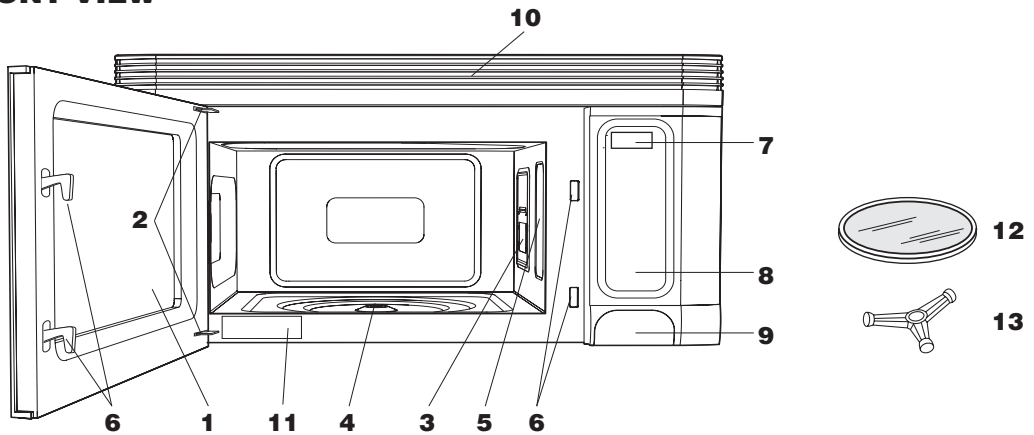

BOTTOM VIEW

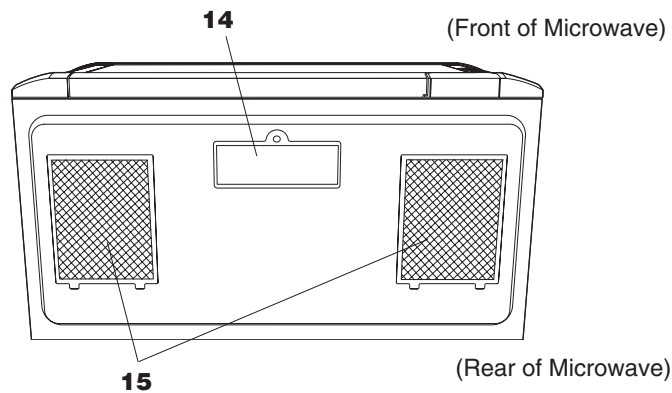

- | | |
|--|--|
| <p>1 Oven door with see-through window
Be careful with the edge of the oven door as it is glass and could chip or break.</p> <p>2 Door hinges</p> <p>3 Waveguide cover: DO NOT REMOVE.</p> <p>4 Turntable motor shaft</p> <p>5 Oven light
It will light when oven is operating or door is open.</p> <p>6 Safety door latches
The oven will not operate unless the door is securely closed.</p> <p>7 Time display: Digital display, 99 minutes, 99 seconds</p> <p>8 Auto-Touch control panel</p> | <p>9 One touch DOOR OPEN button.
Push to open door.</p> <p>10 Louver</p> <p>11 Nameplate</p> <p>12 Removable turntable
The turntable will rotate clockwise or counter-clockwise. Only remove for cleaning.</p> <p>13 Removable turntable support
First, carefully place the turntable support in the motor shaft in the center of the oven floor. Then, place the turntable on the turntable support securely.</p> <p>14 Light cover</p> <p>15 Grease filters</p> |
|--|--|

CONTROL PANEL

Words in the lower portion of the display will light to indicate what function is in progress.

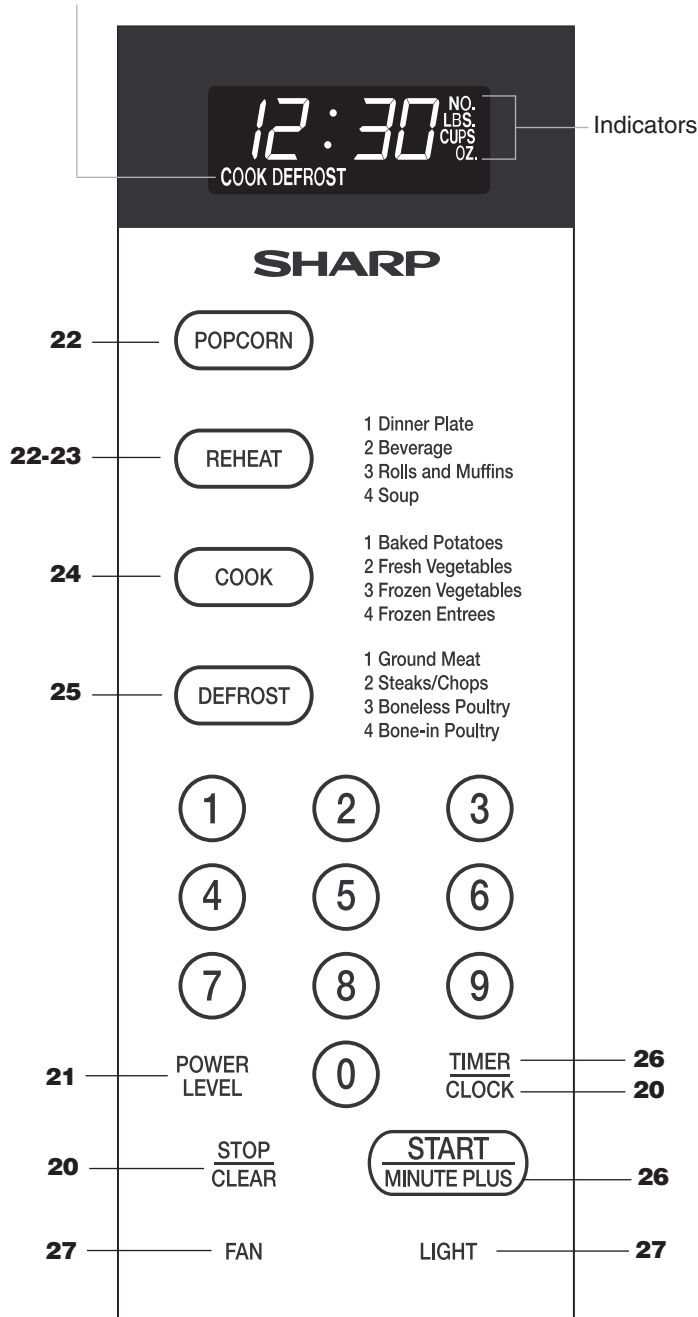

Number next to the control panel illustration indicates pages on which there are feature descriptions and usage information.









BEFORE OPERATING

- Before operating your new microwave oven make sure you read and understand this operation manual completely.
- Before the oven can be used, follow these procedures:

1. Plug in the oven. Close the door. The oven display will then begin flashing **88:88**.
2. Touch the **STOP/CLEAR** pad. **00:00** will appear.
3. Set clock.

TO SET THE CLOCK

- Suppose you want to enter the correct time of day 12:30 (A.M. or P.M.).

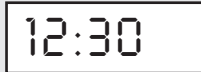
PROCEDURE	DISPLAY
1  Touch CLOCK pad.	
2     Enter the correct time of day by touching the numbers in sequence.	
3  Touch CLOCK pad again.	

This is a 12 hour clock. If you attempt to enter an incorrect clock time, **ERROR** will appear in the display. Touch the **STOP/CLEAR** pad and re-enter the time.

- If the electrical power supply to your microwave oven should be interrupted, the display will intermittently show **88:88** after the power is reinstated. If this occurs during cooking, the program will be erased. The time of day will also be erased. Simply touch **STOP/CLEAR** pad and reset the clock for the correct time of day.

STOP/CLEAR

Touch the **STOP/CLEAR** pad to:

1. Erase if you make a mistake during programming.
2. Cancel timer.
3. Stop the oven temporarily during cooking.
4. Return the time of day to the display.
5. Cancel a program during cooking, touch twice.

MANUAL OPERATION

TIME COOKING

Your oven can be programmed for 99 minutes 99 seconds (99.99). Always enter the seconds after the minutes, even if they are both zeros.

- Suppose you want to cook for 5 minutes at 100%.

PROCEDURE	DISPLAY
1 [5] [0] [0] Enter cooking time.	5.00
2 [START MINUTE PLUS] Touch START pad.	5.00 COOK

TO SET POWER LEVEL

There are eleven preset power levels.

Using lower power levels increases the cooking time which is recommended for foods such as cheese, milk and long slow cooking of meats. Consult cookbook or recipes for specific recommendations.

TOUCH POWER LEVEL PAD NUMBER OF TIMES FOR DESIRED POWER	APPROXIMATE PERCENTAGE OF POWER	COMMON WORDS FOR POWER LEVELS
POWER LEVEL x 1	100%	High
POWER LEVEL x 2	90%	
POWER LEVEL x 3	80%	
POWER LEVEL x 4	70%	Medium High
POWER LEVEL x 5	60%	
POWER LEVEL x 6	50%	Medium
POWER LEVEL x 7	40%	
POWER LEVEL x 8	30%	Med Low/Defrost
POWER LEVEL x 9	20%	
POWER LEVEL x 10	10%	Low
POWER LEVEL x 11	0%	

- Suppose you want to defrost for 5 minutes at 30%.

PROCEDURE	DISPLAY
1 [5] [0] [0] Enter defrosting time.	5.00
2 [POWER LEVEL] x 8 Touch POWER LEVEL pad eight times or hold down until the desired power level appears.	P-30
3 [START MINUTE PLUS] Touch START pad.	5.00 COOK
4 When the defrost time is complete, a long tone will sound and [END] will appear in the display.	

MANUAL DEFROST

If the food that you wish to defrost is not listed on the DEFROST CHART or is above or below the limits in the "Amount" column on the DEFROST CHART (see page 25), you need to defrost manually.

You can defrost any frozen food, either raw or previously cooked, by using Power Level for 30%. Follow the exact 4-step procedure found under To Set Power Level. Estimate defrosting time and press **POWER LEVEL** pad eight times for 30% power.

For either raw or previously cooked frozen food the rule of thumb is approximately 4 minutes per pound. For example, defrost 4 minutes for 1 pound of frozen spaghetti sauce.

Always stop the oven periodically to remove or separate the portions that are defrosted. If food is not defrosted at the end of the estimated defrosting time, program the oven in 1 minute increments on Power Level 30% until totally defrosted.



When using plastic containers from the freezer, defrost only long enough to remove from the plastic in order to place in a microwave-safe dish.

SPECIAL FEATURES

POPCORN

The POPCORN setting automatically provides the correct cooking time for most brands of microwave popcorn. You may wish to try several and choose your favorite. Pop only one bag at a time. Unfold bag and place in oven according to directions.

- Suppose you want to pop a 3.5 oz bag (regular) of popcorn.

PROCEDURE	DISPLAY
	
Touch POPCORN once. The oven starts automatically.	

- Touch **POPCORN** once for 3.5 oz bag (regular).
- Touch **POPCORN** twice within 2 seconds for 2.85 - 3.5 oz bag (light regular).
- Touch **POPCORN** three times within 2 seconds for 1.5 or 1.75 oz bag (snack).







NOTE:





To use **POPCORN** pad, touch within 3 minutes after cooking, opening and closing the door or touching the **STOP/CLEAR** pad.

REHEAT

REHEAT automatically computes the correct warming time and microwave power level for foods shown in the chart on page 23.

- Suppose you want to reheat 3 cups of soup.

PROCEDURE	DISPLAY
1 	
Touch REHEAT once.	
2  Select desired Reheat setting. (Ex: touch number pad  to select 1 cup of soup.	 

3 	
Repeat touching same number pad  to increase quantity to 3 cups. (Ex: touch  two more times for 3 cups or hold down until the desired quantity appears.)	
4 	Touch START pad.

NOTE:

1. To reheat different foods or foods above or below the quantity allowed on the REHEAT CHART, use manual operation.
2. Reheat can be programmed with More or Less Time Adjustment. See page 26.

SPECIAL FEATURES

REHEAT CHART

FOOD	AMOUNT	PROCEDURE
1. Dinner Plate	1 plate	Use this setting to reheat precooked foods from the refrigerator. Place meaty portions and bulky vegetables to outside of plate. Cut large items like baked potatoes in smaller pieces. Flatten foods such as mashed potatoes and other dense foods. Cover with wax paper or plastic wrap. ONE PLATE ONLY. After cooking, check that food is very hot throughout and that the bottom center of the plate is very hot. If not, continue heating using time and power level. Allow to stand, covered, 1 to 2 minutes.
	1 Regular	Touch REHEAT and then the number pad 1 once for a regular amount of food: approximately 4 oz sliced meat or poultry, 1/2 cup potato or rice and 1/2 cup of vegetables or equivalent. REG will appear in the display.
	1 Large	Touch REHEAT and then the number pad 1 twice within 2 seconds for a larger amount of food on a dinner plate. LARGE will appear in the display.
	1 Small	Touch REHEAT and then the number pad 1 three times within 3 seconds for a smaller amount of food on a dinner plate. SMALL will appear in the display.
2. Beverage	.5-2.0 cups	This setting is good for restoring cooled beverages to a better drinking temperature. Touch REHEAT and then the number 2 pad for a 0.5 cup increase per touch. Stir liquid briskly before heating and stir carefully at end of cycle to avoid "eruption."
3. Rolls/ Muffins	1-8	Use this setting to warm rolls, muffins, biscuits, bagels etc. Large items should be considered as 2 or 3 regular size. Arrange on plate; cover with paper towel. For refrigerated rolls or muffins, it may be necessary to double the entered amount to ensure the proper serving temperature. For example, enter quantity of 2 for 1 refrigerated muffin.
4. Soup	1-6 cups	Place in a bowl or casserole. Cover with lid or plastic wrap. At end, stir, re-cover and let stand 1 to 3 minutes.

SPECIAL FEATURES

COOK

COOK automatically computes the correct cooking time and microwave power level for foods shown in the chart below.

- Suppose you want to cook 3 medium baked potatoes.

PROCEDURE	DISPLAY
1 COOK Touch COOK once.	FOOD
2 1 Select desired Cook setting. (Ex: touch number pad 1 to select Baked Potatoes.	1 1 <small>NO.</small>
3 1 Repeat touching same number pad 1 to increase quantity to 3 potatoes. (Ex: touch two more times for 3 potatoes or hold down until the desired quantity appears.)	3 <small>NO.</small>

4

START
MINUTE PLUS

Touch **START** pad.

TIPS: Foods can be covered with wax paper or vented plastic wrap. Temperatures of foods covered with plastic wrap tend to be slightly higher than those covered with wax paper.

NOTE:

1. More or less food than the quantity listed in the chart should be cooked following the guidelines in any microwave cookbook.
2. COOK can be programmed with More or Less Time Adjustment. See page 26.
3. The final cooking result will vary according to the food condition (e.g. initial temperature, shape, quality). Check food for temperature after cooking. If additional time is needed, continue to cook manually.

COOK CHART











FOOD	AMOUNT	PROCEDURE
1. Baked Potatoes	1-6 medium	Pierce with fork in several places; place on paper towel on turntable. At end of cooking time, remove from oven, wrap in foil and let stand 5 to 10 minutes.
2. Fresh Vegetables	1-6 cups	For beans, carrots, corn and peas, add 1 tablespoon of water per cup. For broccoli, Brussels sprouts, cabbage and cauliflower, cook immediately after washing with no additional water. If you like tender crisp vegetables, double or triple measured quantity per setting. After cooking, remove from oven, stir, cover and let stand 3 to 5 minutes before serving.
3. Frozen Vegetables	1-6 cups	Add no water. Cover with lid or plastic wrap. After cooking, stir and let stand, covered, for 3 minutes.
4. Frozen Entrees	6-17 oz	Use this setting for frozen, convenience foods. It will give satisfactory results for most brands. You may wish to try several and choose your favorite. Remove package from outer wrapping and follow package directions for covering. After cooking, let stand, covered, for 1 to 3 minutes.
	6-8 oz	Touch COOK and number pad 4 once for package weight of 6-8 oz. 6-8 will appear in the display.
	9-11 oz	Touch COOK and number pad 4 twice for package weight of 9-11 oz. 9-11 will appear in the display.
	12-14 oz	Touch COOK and number pad 4 three times for package weight of 12-14 oz. 12-14 will appear in the display.
	15-17 oz	Touch COOK and number pad 4 four times for package weight of 15-17 oz. 15-17 will appear in the display.

SPECIAL FEATURES

DEFROST

DEFROST automatically defrosts all the foods shown in the DEFROST CHART below. Round the weight to the nearest tenth of a pound. To enter weight, touch **DEFROST** and number pad for desired food then number pads for weight.

- Suppose you want to defrost a 3.0 pound steak .

PROCEDURE	DISPLAY
1  <p>Touch DEFROST once.</p>	
2  <p>Touch number  for Steaks/Chops</p>	
3   <p>Touch number pads for desired weight. (Ex: touch   for 3.0 lb.)</p>	
4  <p>Touch START pad.</p>	
<p>The oven will stop and directions will be displayed.</p>	

- 5** After the 1st stage, open the door, turn steak over and shield any warm portions. Close the door.



Touch **START** pad.

- 6** After the 2nd stage, open the door and shield any warm portions. Close the door.



Touch **START** pad.

After defrost cycle ends, cover and let stand as indicated in chart below.

NOTE:

1. DEFROST can be programmed with More or Less Time Adjustment. Touch the **POWER LEVEL** pad once or twice after selecting the amount. See page 26.
2. To defrost other foods or foods above or below the weights allowed on the DEFROST CHART, use time and 30% power. See MANUAL DEFROST on page 21.
3. If you attempt to enter more or less than the allowed amount as indicated in the chart below,  will appear in the display.

DEFROST CHART

FOOD	AMOUNT	PROCEDURE
1. Ground Meat	.5 - 2.0 lb	Pull apart and remove any thawed pieces after each stage. Let stand, covered, for 5 to 10 minutes.
2. Steaks/ Chops	.5 - 3.0 lb	After each stage, rearrange and if there are warm or thawed portions, shield with small flat pieces of aluminum foil. Remove any meat or fish that is nearly defrosted. Let stand, covered, for 10 to 20 minutes.
3. Boneless Poultry	.5 - 2.0 lb	After each stage, if there are warm or thawed portions, rearrange or remove. Let stand, covered, for 10 to 20 minutes.
4. Bone-in Poultry	.5 - 3.0 lb	After each stage, if there are warm or thawed portions, rearrange or remove. Let stand, covered, for 10 to 20 minutes.

NOTE: Check foods when oven signals. After final stage, small sections may still be icy. Let stand to continue thawing. Do not defrost until all ice crystals are thawed.

Shielding prevents cooking from occurring before the center of the food is defrosted. Use small smooth strips of aluminum foil to cover edges and thinner sections of the food.

OTHER CONVENIENT FEATURES

MULTIPLE SEQUENCE COOKING

Your oven can be programmed for up to 3 automatic cooking sequences, switching from one power level setting to another automatically.

Sometimes cooking directions tell you to start on one power level and then change to a different power level. Your oven can do this automatically.

- Suppose you want to cook roast beef for 5 minutes at 100% and then continue to cook for 30 minutes at 50%.

PROCEDURE

- 1 First enter cooking time. Then touch **POWER LEVEL** once for 100% power.

5	0	0
---	---	---

POWER LEVEL

 x 1
- 2 Then enter second cooking time. Touch **POWER LEVEL** pad 6 times for 50% power.

3	0	0	0
---	---	---	---

POWER LEVEL

 x 6
- 3 Touch **START** pad.

START
MINUTE PLUS

NOTE:

1. If **POWER LEVEL** pad is touched,

P-HI

 will be displayed.
2. If 100% is selected as the final sequence, it is not necessary to touch the **POWER LEVEL** pad.

TIMER

- Suppose you want to time a 3-minute long distance phone call.

PROCEDURE

- 1 Enter time.

3	0	0
---	---	---
- 2 Touch **TIMER** pad.

TIMER
CLOCK
- 3 To cancel the timer, touch the **STOP/CLEAR** pad once.

STOP
CLEAR

MORE OR LESS TIME ADJUSTMENT

Should you discover that you like any of the Cook, Defrost, Reheat or Popcorn settings slightly **more** done, touch the **POWER LEVEL** pad **once** after touching your choice of pads or before touching **START** pad. The display will show

MORE

.

Should you discover that you like any of the Cook, Defrost, Reheat or Popcorn settings slightly **less** done, touch the **POWER LEVEL** pad **twice** after touching your choice of pads or before touching **START** pad. The display will show

LESS

.

MINUTE PLUS

Minute Plus allows you to cook for a minute at 100% by simply touching the **MINUTE PLUS** pad. You can also extend cooking time in multiples of 1 minute by repeatedly touching the **MINUTE PLUS** pad during manual cooking.

- Suppose you want to heat a cup of soup for one minute.

PROCEDURE

- Touch **MINUTE PLUS** pad.
- | |
|-------------|
| START |
| MINUTE PLUS |

NOTE:

1. To use Minute Plus, touch pad within 3 minutes after cooking, closing the door, touching the **STOP/CLEAR** pad or during cooking.
2. Minute Plus cannot be used with special features.

CHILD LOCK

The Child Lock prevents unwanted oven operation such as by small children.

The oven can be set so that the control panel is deactivated or locked. To set, touch **TIMER/CLOCK** pad, the number

1

 and then touch the **START** pad and hold for three seconds. Should a pad be touched,

LOCK

 will appear in the display.

To cancel, touch **TIMER/CLOCK**, the number

1

 and **STOP/CLEAR** pads.

OTHER CONVENIENT FEATURES

AUDIBLE SIGNAL ELIMINATION

If you wish to have the oven operate with no audible signals, touch **TIMER/CLOCK**, the number [5] and then touch **START** pad and hold for three seconds.

To cancel and restore the audible signal, touch **TIMER/CLOCK**, the number [5] and **STOP/CLEAR** pads.

FAN

The fan will automatically start when heat rises from range surface units or burners. This protects the microwave oven from excessive temperature rise. The fan will stay on until the temperature decreases. It cannot be turned off manually during this time.

Press **FAN** pad one time to turn it on and once again to turn it off.

DEMONSTRATION MODE

To demonstrate, touch **TIMER/CLOCK**, the number [0] and then touch the **START** pad and hold for three seconds. [DEMO] will appear in the display. Cooking operations and specific special features can now be demonstrated with no power in the oven. For example, touch **MINUTE PLUS** pad and the display will show [1:00] and count down quickly to [END].

To cancel, touch **TIMER/CLOCK**, the number [0] and **STOP/CLEAR** pads. If easier, unplug the oven from the electrical outlet and replug.

LIGHT

Press the **LIGHT** pad one time to turn it on and once again to turn it off.

REPLACING PARTS

CHARCOAL FILTER

Charcoal Filter, Sharp part number RK-250 is used for nonvented, recirculated installation. The filter should be changed every 6 to 12 months depending on use. See page 14 for ordering information.

1. Disconnect power to the oven at the circuit breaker panel or by unplugging.
2. Remove the three louver mounting screws and push down carefully on the tab at each end of the louver to disengage it. (See illustration.)
3. Pull the louver away from the unit.
4. Change the charcoal filter.
5. Carefully push the louver back into place (engaging both the bottom and top tabs) and replace the screws removed in step 2.

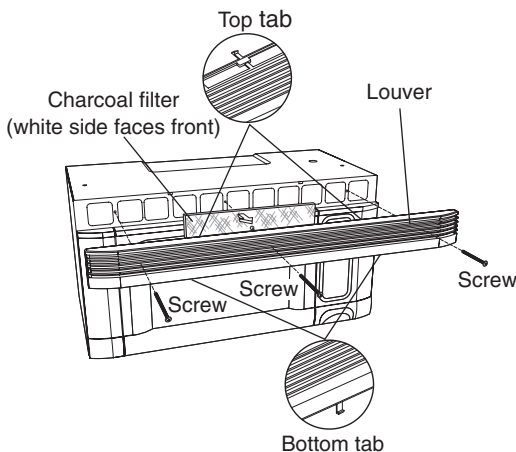

LIGHT

1. To replace light bulbs, first disconnect power to the oven at the circuit breaker panel or by unplugging.
2. To release cover, remove the screw on the light cover. (See illustration.)
3. Replace light bulbs with equivalent watt bulb available from your Sharp Authorized Servicer or parts distributor. Bulbs are also available at most hardware stores or lighting centers. **DO NOT USE A BULB LARGER THAN 30 WATTS.**
4. Close light cover and secure with screw removed in step 2.

CAUTION: Light cover may become very hot. Do not touch glass when light is on.

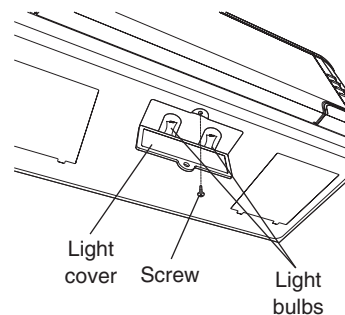

CLEANING AND CARE

Disconnect the power cord before cleaning or leave the door open to inactivate the oven during cleaning.

Exterior

The outside surface is precoated steel and plastic. Clean the outside with mild soap and water; rinse and dry with a soft cloth. Do not use any type of household or abrasive cleaner.

Door

Be careful with the edge of the oven door as it is glass and could chip or break. Wipe the window on both sides with a damp cloth to remove any spills or splatters. Metal parts will be easier to maintain if wiped frequently with a damp cloth. Avoid the use of spray and other harsh cleaners as they may stain, streak or dull the door surface.

Touch Control Panel

Wipe the panel with a cloth dampened slightly with water only. Dry with a soft cloth. Do not scrub or use any sort of chemical cleaners. Close door and touch **STOP/CLEAR**.

Interior

Cleaning is easy because little heat is generated to the interior surfaces; therefore, there is no baking and setting of spills or spattering. To clean the interior surfaces, wipe with a soft cloth and warm water. **DO NOT USE ABRASIVE OR HARSH CLEANERS OR SCOURING PADS.** For heavier soil, use baking soda or a mild soap; rinse thoroughly with hot water. The rack can be cleaned with hot soapy water, rinsed and dried.

Odor Removal

Occasionally, a cooking odor may remain in the oven. To remove, combine 1 cup water, grated peel and juice of 1 lemon and several whole cloves in a 2-cup glass measuring cup. Boil for several minutes using 100% power. Allow to set in oven until cool. Wipe interior with a soft cloth.

Turntable/Turntable Support

The turntable and turntable support can be removed for easy cleaning. Wash them in mild, sudsy water; for stubborn stains use a mild cleanser and non-abrasive scouring sponge. They are also dishwasher-proof. Use upper rack of dishwasher. The turntable motor shaft is not sealed, so excess water or spills should be wiped up immediately.

Waveguide Cover

The waveguide cover is located on the right side wall of the oven cavity. It is made from mica so requires special care. Keep the waveguide cover clean to assure good oven performance. Carefully wipe with a damp cloth any food splatters from the surface of the cover immediately after they occur. Built-up splashes may overheat and cause smoke or possibly catch fire. **DO NOT REMOVE THE WAVEGUIDE COVER.**

Grease Filters

Filters should be cleaned at least once a month. Never operate the fan or oven without the filters in place.

1. Pull down slightly on the tab toward the front of the oven and remove the filter. Repeat for the other filter.
2. Soak the filters in a sink or dish pan filled with hot water and detergent. **DO NOT** use ammonia or other alkali; they will react with the filter material and darken it.
3. Agitate and scrub with a brush to remove embedded dirt.
4. Rinse thoroughly and shake dry.
5. Replace by fitting the filter back into the opening.

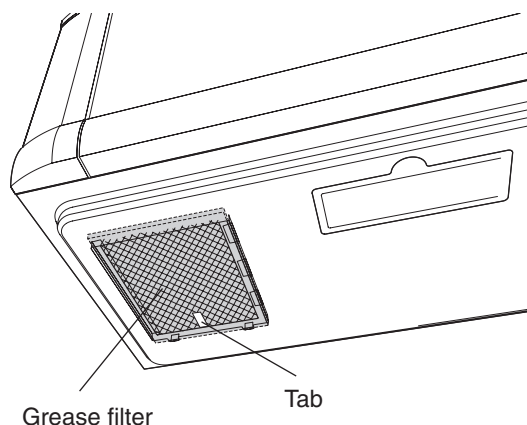

SERVICE CALL CHECK

Please check the following before calling for service:

Place one cup of water in a glass measuring cup in the oven and close the door securely.
Operate the oven for one minute at HIGH 100%.

- A** Does the oven light come on? YES _____ NO _____
- B** Does the cooling fan work?
(Put your hand over the left side of louver.) YES _____ NO _____
- C** Does the turntable rotate?
(It is normal for the turntable to turn in either direction.) YES _____ NO _____
- D** Is the water in the oven warm? YES _____ NO _____

If "NO" is the answer to any of the above questions, please check electrical outlet, fuse and/or circuit breaker. If they are functioning properly, CONTACT YOUR NEAREST SHARP AUTHORIZED SERVICER. A microwave oven should never be serviced by a "do-it-yourself" repair person.

NOTE:

- If time appearing in the display is counting down very rapidly, check Demonstration Mode on page 27 and cancel.
- If the oven is set for more than 30 minutes at 80, 90 or 100 percent power level, after the first 30 minutes the power level will automatically adjust itself to 70 percent power to avoid overcooking.

COOKBOOK INFORMATION

125 GREAT RECIPES

- All about your microwave
- Color photos
- Step-by-step instructions
- Durable wipe-clean soft cover with 192 7" x 10" pages
- Helpful tips and special techniques

SHARP[®] MICROWAVE OVEN COOKBOOK

TO ORDER

Simply call this toll-free number: **1-800-237-4277**. Please have your credit card ready.

If you prefer to order by mail, complete and return the order form on page 30. Please include check or money order (payable to Sharp Electronics Corporation) for \$14.00 plus \$4.50 shipping & handling and tax, if applicable, per book.

SATISFACTION GUARANTEED

You must be completely satisfied with the Sharp Microwave Oven Cookbook. If, within 14 days, you are dissatisfied for any reason, simply return the book and we'll gladly refund your \$14.00 plus tax.

(SOLAMENTE ESCRITO EN INGLES!)

SPECIFICATIONS

R-1405, R-1406

AC Line Voltage:	Single phase 120V, 60Hz, AC only
AC Power Required:	1640 watts, 14.0 amps.
Output Power:*	950 watts
Frequency:	2450 MHz
Outside Dimensions:	29 15/16"(W) x 16 1/4"(H) x 15 9/16"(D)
Cavity Dimensions:	17 1/2"(W) x 9 7/8"(H) x 14 15/16"(D)
Oven Capacity:**	1.4 Cu. Ft.
Cooking Uniformity:	Turntable, diameter 14 1/8" & Stirrer Fan
Weight:	Approx. 55 lb

* The International Electrotechnical Commission's standardized method for measuring output wattage. This test method is widely recognized.

** Internal capacity is calculated by measuring maximum width, depth and height. Actual capacity for holding food is less.

In compliance with standards set by:

FCC – Federal Communications Commission Authorized.

DHHS – Complies with Department of Health and Human Services (DHHS) rule, CFR, Title 21, Chapter I, Subchapter J.



– This symbol on the nameplate means the product is listed by Underwriters Laboratories, Inc.

----- - Cut along this line. -----

COOKBOOK ORDER FORM

Please send me _____ cookbooks at \$18.50 each \$ _____

Illinois sales tax, (if applicable) per book \$.91 no. of books _____ \$ _____

TOTAL ORDER AMOUNT \$ _____

I have enclosed a check made payable to Sharp Electronics Corporation.

Please bill my VISA MASTERCARD AMERICAN EXPRESS

Acct. No _____ Expiration date _____ / _____

Signature _____

(All credit card orders must be signed.)

Name _____

Address _____

City _____ State _____ Zip _____

Daytime Phone No. (_____) _____

Mail to: Sharp Electronics Corporation
Attention: Customer Assistance Center
1300 Naperville Drive
Romeoville, IL 60446-1091

Price is subject to change without notice.

GUIA AUTO-TOUCH

Para mayor información y precauciones de seguridad, consulte el Manual de Operaciones.

PONER LA HORA

Si aparece **88:88** en la pantalla, primero oprima "STOP/CLEAR".

1 Oprima **TIMER/CLOCK**.



2 Ponga la hora correcta del día oprimiendo los números en secuencia (Ej: 12:30).



3 Oprima **TIMER/CLOCK** otra vez.



OPERACION MANUAL

Cocimiento con Alta Energia

1 Marque el tiempo de cocimiento al oprimir los números. (Ej: 1 min. 30 sec.)

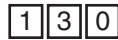

2 Oprima el **START**.



Energia de Cocimiento Variable

1 Después de realizar el primer paso (Num. 1 arriba), oprima el **POWER LEVEL** ocho veces para 30%.



2 Oprima el **START**.



POPCORN

Oprima **POPCORN** una vez para el tamaño normal de palomitas.
2 veces para el tamaño normal "light".
3 veces para el tamaños botana.



REHEAT

1 Pulse el botón **REHEAT**.



2 Seleccione el programa deseado en el configuración de **REHEAT** (Ex: Pulse 4 para recalentar 1 taza de sopa.)



3 Pulse dos veces el botón 4 para 3 tazas.



4 Pulse el botón **START**.



RECALENTAR TABLA

TIPO DE COMIDA	CANTIDAD
1. Dinner Plate	1 plato: Normal, Grande o Chico
2. Beverage	0,5 a 2,0 tazas
3. Rolls/Muffins	1 a 8 piezas
4. Soup	1 a 6 tazas

COOK

1 Pulse el botón **COOK**.



2 Seleccione el programa deseado en el configuración de **COOK** (Ex: Pulse 2 para cocinar 1 taza de verdura fresca.)



3 Pulse dos veces el botón 2 para 3 tazas.



4 Pulse el botón **START**.



COOK TABLA

TIPO DE COMIDA	CANTIDAD
1. Baked Potatoes	1 a 6 tam.
2. Fresh Vegetables	1 a 6 tazas
3. Frozen Vegetables	1 a 6 tazas
4. Frozen Entrees	6 a 17 onzas

DEFROST

1 Pulse el botón **DEFROST**.



2 Seleccione el programa deseado en el configuración de **DEFROST** (Ex: Pulse 2 para filetes.)



3 Pulse el botón 3 y 0 para 3,0 libras.



4 Pulse el botón **START**.



DEFROST TABLA

TIPO DE COMIDA	CANTIDAD
1. Ground Meat	,5 a 2,0 libras
2. Steaks/Chops	,5 a 3,0 libras
3. Boneless Poultry	,5 a 2,0 libras
4. Bone-in Poultry	,5 a 3,0 libras

MINUTO EXTRA

Oprima **MINUTE PLUS** para obtener un minuto al 100% de energia o para agregar otro minuto durante el cocimiento manual. Vuelva a oprimirlo para obtener minutos adicionales.



AUTO-TOUCH GUIDE

For more complete information and safety precautions, refer to your Operation Manual.

SET CLOCK

If **88:88** is in the display, first touch **STOP/CLEAR**.

- 1 Touch **TIMER/CLOCK** pad.
- 2 Enter correct time of the day by touching numbers in sequence. (Ex: 12:30)
- 3 Touch **TIMER/CLOCK** pad again.

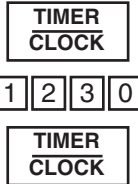

MANUAL OPERATION

High Power Cooking

- 1 Enter cooking time by touching number pads. (Ex: 1 min. 30 sec.)
- 2 Touch **START** pad.



Variable Power Cooking

- 1 After Step 1 above, touch **POWER LEVEL** pad eight times for 30%.
- 2 Touch **START** pad.

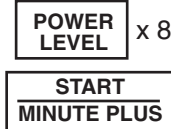

POPCORN

Touch **POPCORN** pad once for regular size, twice for light regular size or three times for snack size.



REHEAT

- 1 Touch **REHEAT** pad.
- 2 Select desired Reheat setting. (Ex: touch **4** to reheat 1 cup of soup.)
- 3 Touch number **4** two more times for 3 cups.
- 4 Touch **START** pad.

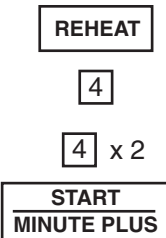

REHEAT CHART

FOOD	AMOUNT
1. Dinner Plate	1 plate: Regular, Large or Small
2. Beverage	.5 - 2.0 cups
3. Rolls/Muffins	1 - 8 pieces
4. Soup	1 - 6 cups

COOK

- 1 Touch **COOK** pad.
- 2 Select desired Cook setting. (Ex: touch **2** to cook 1 cup of fresh vegetables.)
- 3 Touch number **2** two more times for 3 cups.
- 4 Touch **START** pad.

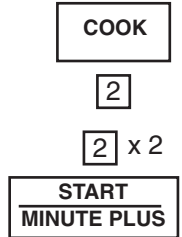

COOK CHART

FOOD	AMOUNT
1. Baked Potatoes	1 - 6 medium
2. Fresh Vegetables	1 - 6 cups
3. Frozen Vegetables	1 - 6 cups
4. Frozen Entrees	6 - 17 oz.

DEFROST

- 1 Touch **DEFROST** pad.
- 2 Select desired Defrost setting. (Ex: touch **2** to defrost steak.)
- 3 Touch number **3** and **0** for 3.0 lb.
- 4 Touch **START** pad.

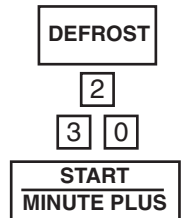

DEFROST CHART

FOOD	AMOUNT
1. Ground Meat	.5 - 2.0 lb
2. Steaks/Chops	.5 - 3.0 lb
3. Boneless Poultry	.5 - 2.0 lb
4. Bone-in Poultry	.5 - 3.0 lb

MINUTE PLUS

Touch **MINUTE PLUS** for one minute at 100% power or to add a minute during manual cooking. Continue to touch for additional minutes.



Carousel® is a registered trademark of Sharp Corporation.

SHARP®

SHARP ELECTRONICS CORPORATION
Sharp Plaza, Mahwah, New Jersey 07430-2135

TINSEB318MRK3

