

DESCRIPTION

Demonstration circuit 562A-B is an isolated synchronous forward converter featuring the LT1725 and LTC1693. The design provides an isolated 5V at 20A from 48V (36V to 72V) input. Isolation voltage is 1500VDC. The circuit features low input capacitance, feedback without an opto-isolator, input undervoltage lockout and short circuit cycling protection to minimize thermal stress.

Design files for this circuit board are available. Call the LTC factory.

Table 1. Performance Summary ($T_A = 25^\circ\text{C}$) $V_{IN} = 48\text{V}$, full load, unless otherwise specified.

PARAMETER	CONDITION	VALUE
Minimum Input Voltage		36V
Maximum Input Voltage		72V
Output Voltage (V_{OUT})	$V_{IN} = 36\text{V to } 72\text{V}$, $I_{OUT} = 0\text{A to } 20\text{A}$	$5.0\text{V} \pm 2.5\%$
Maximum Input Current	$V_{IN} = 36\text{V}$, $I_{OUT} = 20\text{A}$	3.10A
Inrush Transient	$V_{IN} = 72\text{V}$	$0.5 \text{ A}^2\text{s}$
Maximum Output Current		20A
Nominal Switching Frequency		200kHz
Output Short Circuit Period	Cycling, Auto-restart	300ms
Dynamic Response	Peak Deviation	250mV
	Load Step 50% to 100%	
	Settling Time (to within 10mV of set point)	200 μs
Efficiency	$V_{IN} = 48\text{V}$, $I_{OUT} = 20\text{A}$	91.5% Typical
Output Ripple	$V_{IN} = 48\text{V}$, $I_{OUT} = 20\text{A}$ (20MHz BW)	100mV _{P-P}
Isolation Voltage		1500 VDC
Isolation Resistance		10 M Ω
Isolation Capacitance		2200 pF

OPERATING PRINCIPLES

CIRCUIT OVERVIEW

This single transistor forward converter operates at a nominal switching frequency of 200 kHz. Pulse width modulation control is done by U1, the LT1725 controller. Galvanic isolation is met with transformer T1,

T2 and L1. C7 is used as a local bypass to reduce common mode currents.

The primary side power path is comprised of T1, C6, C24, C25 and Q1 the primary switch. Power is transferred during the on time of Q1. MOSFETs Q3-Q6 are the secondary synchronous rectifiers. L1, C1 and C2

QUICK START GUIDE FOR DEMONSTRATION CIRCUIT 562A-B 36-72VIN TO 5V@20A, ISOLATED SINGLE TRANSISTOR FORWARD CONVERTER

form the secondary output filter. L2, C6, C24 and C25 form the primary input filter. C5 bypasses the input terminals. For large values of input inductance, an external 22 μ F aluminum electrolytic capacitor will damp the input filter and provide adequate stability. This will however, increase inrush transient current from 0.5A²s to about 3.5 A²s. See Linear Technology Application Note AN19 for a discussion on input filter stability analysis.

An auxiliary winding on L1 performs two functions; it provides output feedback information and supplies bias voltage to the LT1725. U2, the LTC1693, synchronizes with the LT1725 via T2, a small pulse transformer, to provide gate drive to secondary switching MOSFETs.

During an output short circuit, the primary bias supply collapses. This results in the converter harmlessly cycling on and off, reducing power dissipation to a minimum. The cycling rate is nominally 3.3Hz with 48V input. When the short is removed, the converter returns to normal operation.

DC562A-B relies on the pcb area (2.5"x3") and 200 linear feet per minute of airflow to provide full load operation to 50°C ambient without the use of a heat sink. The area might be reduced further (depending on airflow and ambient temperature) when used as part of a larger pcb. The maximum output power is primarily limited by component temperature rise. For example, for continued reliability, temperature should be kept below 105°C and the magnetics temperature rise should be limited to 50°C. Assuming 50°C ambient, this corresponds to 55°C surface mount component temperature rise. Figures 6 through 16 detail the temperature rise for the hottest components in the design with and without airflow. Based on these measurements and assuming a 50°C ambient, it is recommended that the output load current be limited to 15A without airflow and 20A with 200 linear feet per minute of airflow.

When input voltage is applied, R8 provides trickle charge current to C10, resulting in a turn on delay of approximately 1000ms at 36Vin.

Figure 5 shows efficiency. Figures 6 through 16 show hot spot temperature rise.

FORWARD CONVERTER DESIGN EQUATIONS

The single-transistor forward converter is a good choice for 48V telecom applications. This topology is used quite extensively in many modular designs. Unlike the flyback, energy is not intentionally stored in the power transformer. This allows for a much smaller transformer design.

The forward converter has pulsating current in the input capacitor and continuous current in the output capacitor. Worst case ripple current for the input capacitor occurs at 60% duty cycle. Four 0.82 μ F ceramic capacitors (C5, C6, C24 and C25) are used for the input filter. The basic single-transistor synchronous forward converter diagram is shown in Figure 3. The idealized equations for duty cycle relationships are shown below.

Basic Duty Cycle Equation:

$$V_{OUT} = V_{IN} \cdot DC \cdot \frac{N_s}{N_p}$$

Input Capacitor RMS Current:

$$I_{RMS} = I_{OUT} \cdot \frac{N_s}{N_p} \cdot \sqrt{DC - DC^2}$$

Output Capacitor RMS Current:

$$I_{RMS} = \frac{I_L(pk-pk)}{\sqrt{12}}$$

Inductor Ripple Current:

$$I_L(pk-pk) = \frac{(V_{OUT} + V_D) \cdot (1-DC) \cdot f_{sw}}{L}$$

Primary RMS Current:

$$I_{RMS} = I_{OUT} \cdot \frac{N_s}{N_p} \cdot \sqrt{DC}$$

Secondary RMS Current:

$$I_{RMS} = I_{OUT} \cdot \sqrt{DC}$$

QUICK START GUIDE FOR DEMONSTRATION CIRCUIT 562A-B 36-72VIN TO 5V@20A, ISOLATED SINGLE TRANSISTOR FORWARD CONVERTER

SAFETY AND ISOLATION

The demo board is designed to meet the requirements of UL 60950, 3rd edition for basic insulation in secondary circuits. The input is considered to be a TNV-2 circuit, and the output is SELV. The bridging capacitor C7 has an agency file number. A 5A fast blow type fuse must be placed in series with the ungrounded (hot) input line. The transformer is designed to meet the basic insulation requirement with an isolation voltage of 1500VDC. The core is considered part of the secondary circuit.

CONDUCTED EMI

Tests for conducted emissions were performed for the demo board. An external PI filter using a 68 μ F aluminum electrolytic capacitor, 37 μ H inductor and

10 μ F film capacitor is required for the CISPR 22 class B limit. No tests for radiated RFI were performed. Proper grounding and layout technique must be observed to minimize radiation. See Figure 4 for EMI test setup. For EMI graphs see Figures 17 and 18.

RELIABILITY

Reliability prediction for the circuit has been calculated using the Telcordia (formerly Bellcore) SR-332. The black box technique was used. The calculation was made assuming a grounded, fixed, controlled environment and quality level II. A 50% electrical stress at 40°C yields an MTBF (mean time between failures) of 1.5 million hours.

QUICK START PROCEDURE

Demonstration circuit 562A-B is easy to set up to evaluate the performance of the LT1725 and LTC1693. Refer to Figure 1 for proper measurement equipment setup and follow the procedure below:

NOTE: When measuring the input or output voltage ripple, care must be taken to avoid a long ground lead on the oscilloscope probe. Measure the input or output voltage ripple by touching the probe tip directly across the Vin or Vout and GND terminals. See Figure 2 for proper scope probe technique.

1. For normal operation, a minimum of 36V must be applied at the input. Input voltages lower than 36V

will keep the converter from turning on due to the undervoltage lockout feature in the LT1725.

2. Connect a 36-72V power supply, a 22 μ F 100V capacitor and meters to the Vin pins, as shown in Figure 1. Observe proper polarity.
3. Connect a 0-20A load and meters to the Vout pins, as shown in Figure 1.
4. After all connections are made, turn on the input power and verify the output voltage, regulation, ripple voltage, efficiency and other parameters.

NOTE: If there is no output, temporarily disconnect the load to make sure that the load is not set too high.

QUICK START GUIDE FOR DEMONSTRATION CIRCUIT 562A-B 36-72VIN TO 5V@20A, ISOLATED SINGLE TRANSISTOR FORWARD CONVERTER

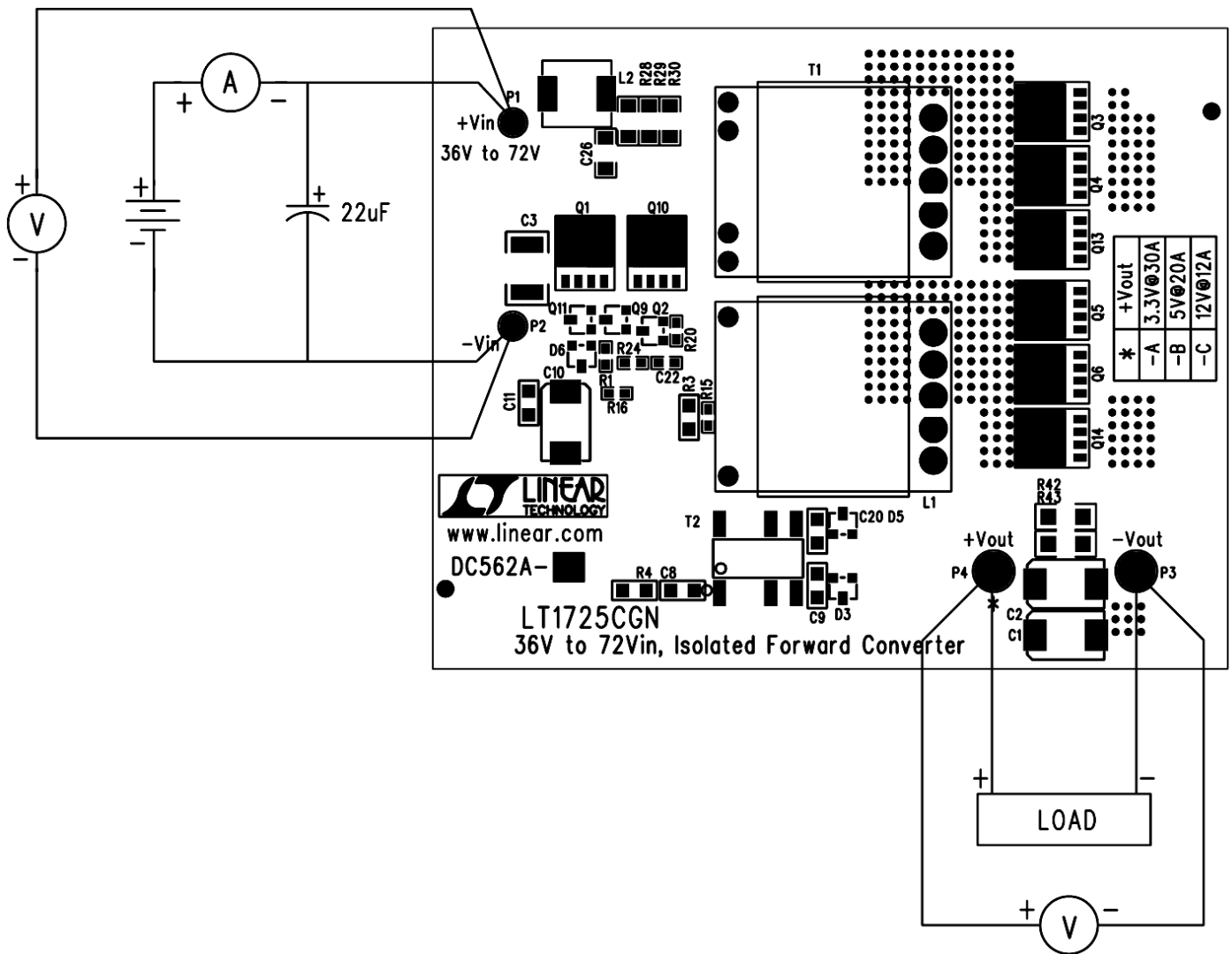

Figure 1. Proper Measurement Equipment Setup

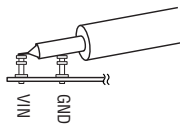

Figure 2. Measuring Input or Output Ripple

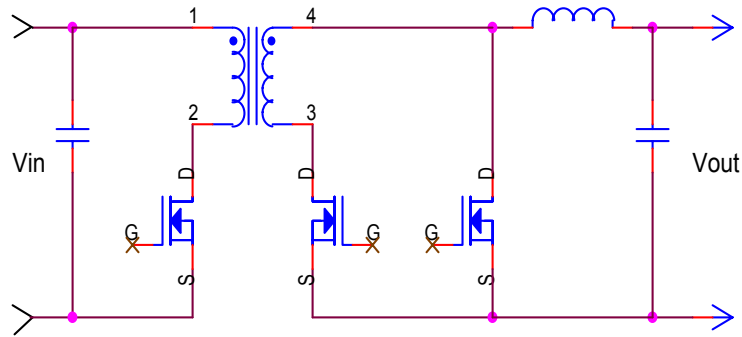

Figure 3. Basic single transistor synchronous forward converter

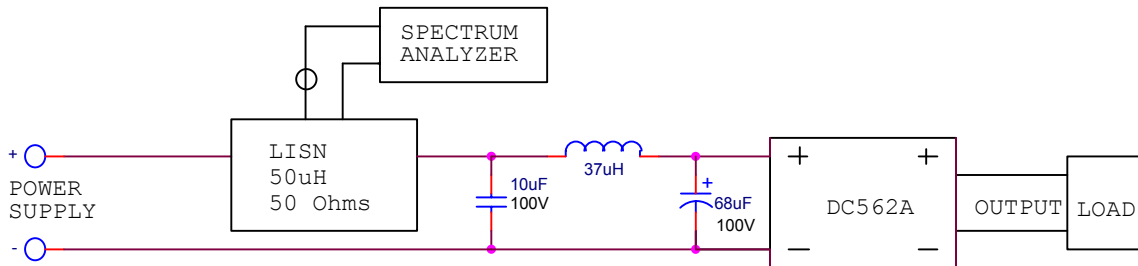

Figure 4. EMI Setup

QUICK START GUIDE FOR DEMONSTRATION CIRCUIT 562A-B

36-72VIN TO 5V@20A, ISOLATED SINGLE TRANSISTOR FORWARD CONVERTER

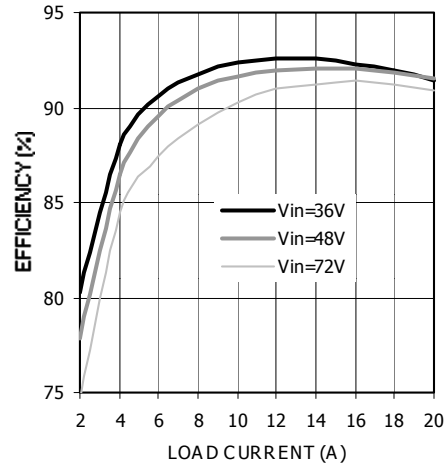

Figure 5. Typical Efficiency

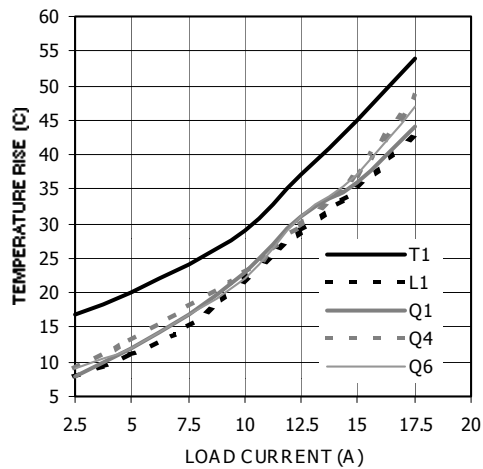

Figure 6. T1 and L1 Core and Q1, Q4, and Q6 Case Temperature Rise at 36Vin, No Airflow

QUICK START GUIDE FOR DEMONSTRATION CIRCUIT 562A-B

36-72VIN TO 5V@20A, ISOLATED SINGLE TRANSISTOR FORWARD CONVERTER

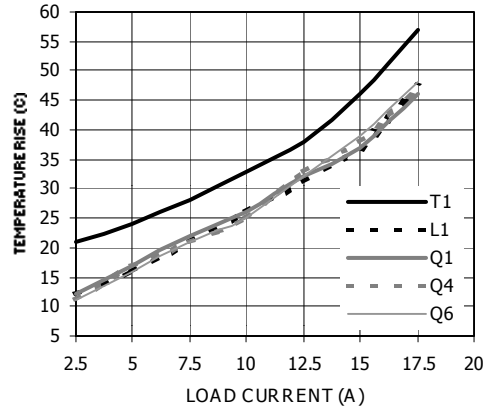

Figure 7. T1 and L1 Core and Q1, Q4, and Q6 Case Temperature Rise at 48Vin, No Airflow

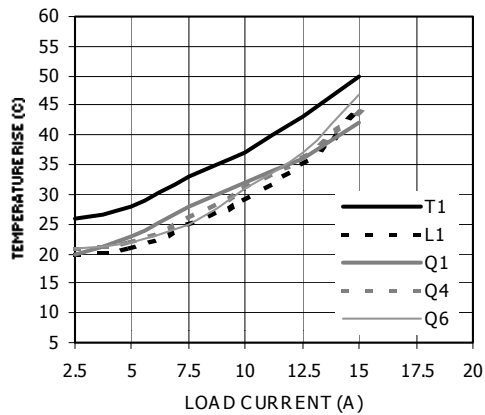

Figure 8. T1 and L1 Core and Q1, Q4, and Q6 Case Temperature Rise at 72Vin, No Airflow

QUICK START GUIDE FOR DEMONSTRATION CIRCUIT 562A-B 36-72VIN TO 5V@20A, ISOLATED SINGLE TRANSISTOR FORWARD CONVERTER

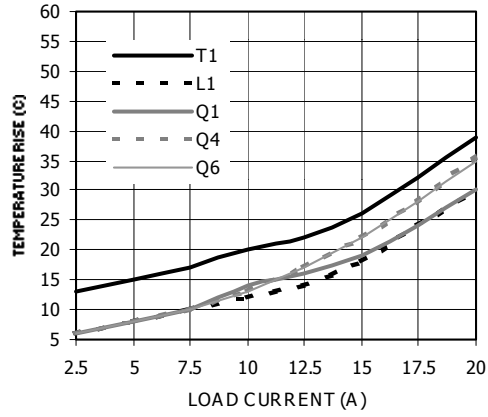

Figure 9. T1 and L1 Core and Q1, Q4, and Q6 Case Temperature Rise at 36Vin with 200LFM of Airflow

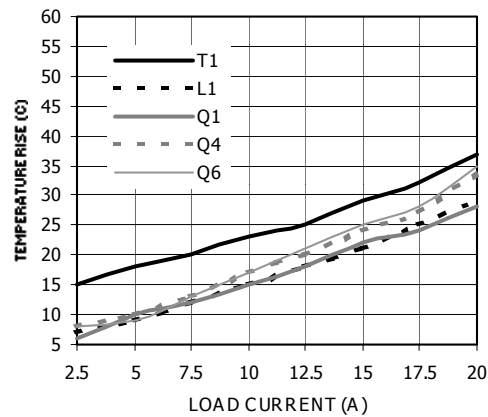

Figure 10. T1 and L1 Core and Q1, Q4, and Q6 Case Temperature Rise at 48Vin with 200LFM of Airflow

QUICK START GUIDE FOR DEMONSTRATION CIRCUIT 562A-B 36-72VIN TO 5V@20A, ISOLATED SINGLE TRANSISTOR FORWARD CONVERTER

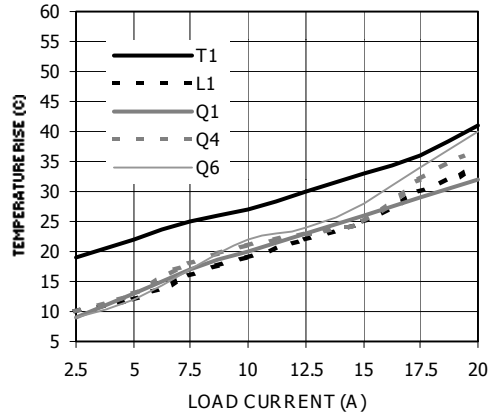

Figure 11. T1 and L1 Core and Q1, Q4, and Q6 Case Temperature Rise at 72Vin with 200LFM of Airflow

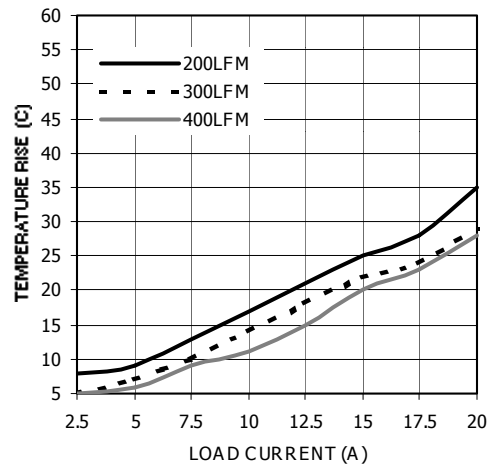

Figure 12. Q6 Case (Hottest component on board) Temperature Rise at 48Vin with 200LFM, 300LFM and 400LFM of Airflow

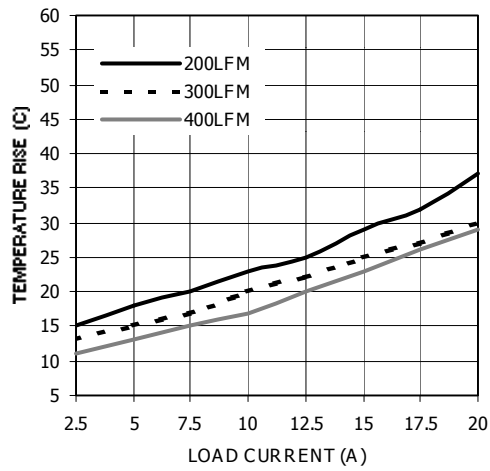

Figure 13. T1 Core Temperature Rise at 48Vin with 200LFM, 300LFM and 400LFM of Airflow

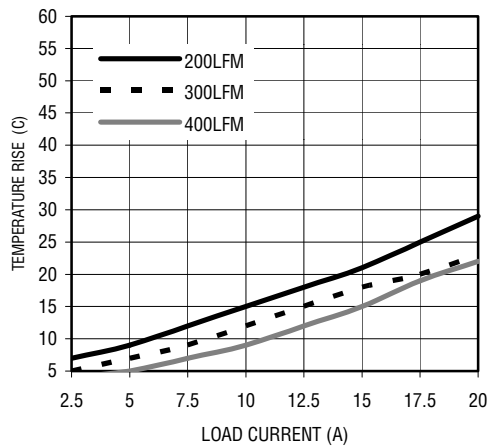

Figure 14. L1 Core Temperature Rise at 48Vin with 200LFM, 300LFM and 400LFM of Airflow

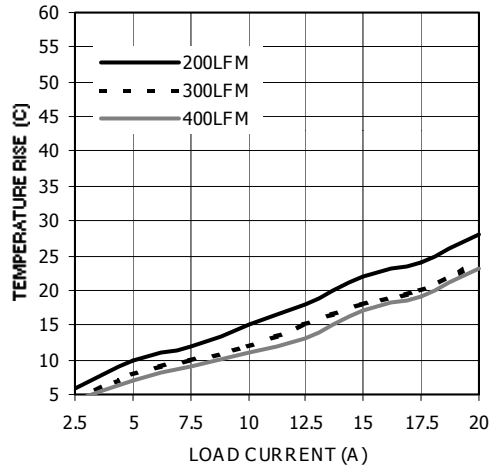

Figure 15. Q1 Case Temperature Rise at 48Vin with 200LFM, 300LFM and 400LFM of Airflow

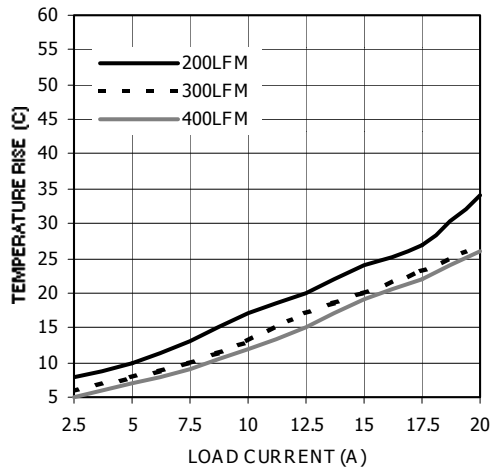

Figure 16. Q4 Case Temperature Rise at 48Vin with 200LFM, 300LFM and 400LFM of Airflow

QUICK START GUIDE FOR DEMONSTRATION CIRCUIT 562A-B 36-72VIN TO 5V@20A, ISOLATED SINGLE TRANSISTOR FORWARD CONVERTER

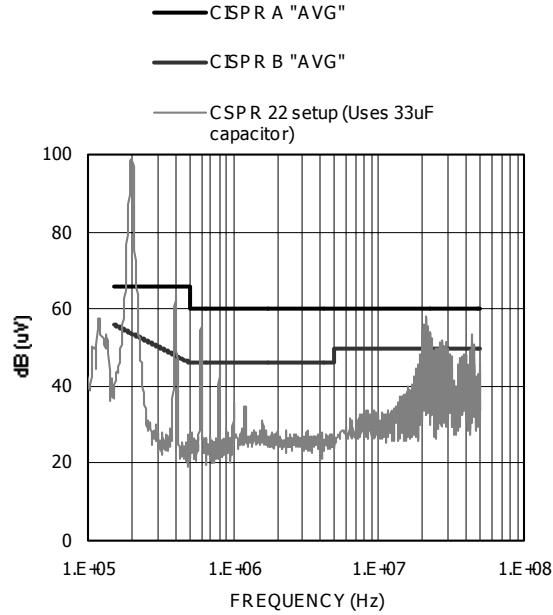

Figure 17. Conducted Emissions at $V_{IN} = 48V$, 20A load, without input PI Filter

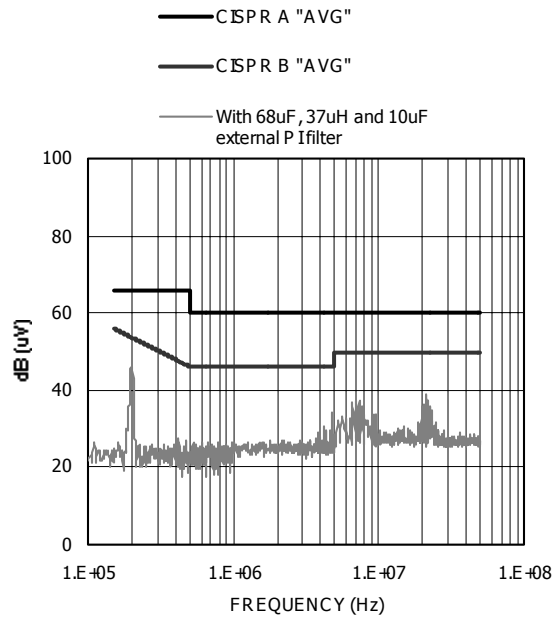
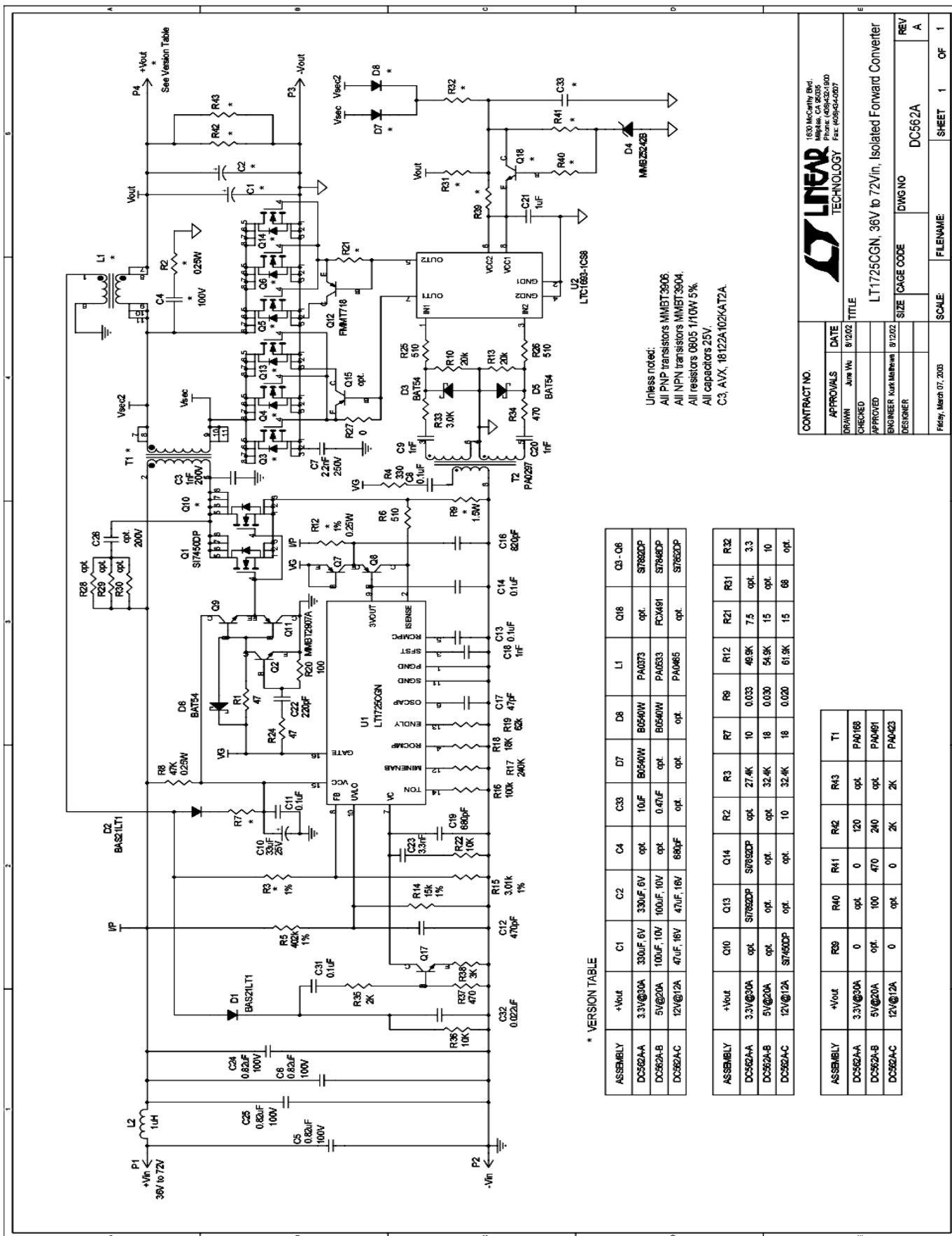

Figure 18. Conducted Emissions at $V_{IN} = 48V$ with External PI Filter, 20A load, with input PI Filter

QUICK START GUIDE FOR DEMONSTRATION CIRCUIT 562A-B 36-72VIN TO 5V@20A, ISOLATED SINGLE TRANSISTOR FORWARD CONVERTER



Unless noted:
 All PNP transistors MMBT3906.
 All NPN transistors MMBT3904.
 All resistors 0605 1/10W 5%.
 All capacitors 25V.
 C3, AVX, 18122A-102KAT2A.

* VERSION TABLE

ASSEMBLY	+Vout	C1	C2	C3	C4	C10	Q10	Q13	Q14	R2	R3	R7	R8	R9	R12	R21	R31	R32	Q3-06
DC562A-A	3.3V@30A	330uF, 6V	330uF, 6V	10uF	opt.	opt.	opt.	opt.	opt.	opt.	27.4K	10	0.033	48.9K	7.5	opt.	opt.	3.3	ST7852DP
DC562A-B	5V@20A	100uF, 10V	100uF, 10V	opt.	0.47uF	opt.	opt.	opt.	opt.	opt.	32.4K	18	0.030	54.9K	15	opt.	opt.	10	ST7848DP
DC562A-C	12V@12A	47uF, 16V	47uF, 16V	880uF	opt.	opt.	opt.	opt.	opt.	opt.	32.4K	18	0.020	61.9K	15	opt.	opt.	opt.	ST7852DP

ASSEMBLY	+Vout	R39	R40	R41	R42	R43	T1
DC562A-A	3.3V@30A	0	opt.	0	120	opt.	PA0168
DC562A-B	5V@20A	opt.	100	470	240	opt.	PA0491
DC562A-C	12V@12A	0	opt.	0	2K	2K	PA0423

LINEAR TECHNOLOGY
 1330 McCarty Blvd.
 Milpitas, CA 95035
 Phone: (408)432-8000
 Fax: (408)432-0007

CONTRACT NO. _____ DATE 9/12/02
 DRAWN _____ TITLE LT1725CGN, 36V to 72Vin, Isolated Forward Converter
 CHECKED _____
 APPROVED _____
 ENGINEER Kurt Helms 9/12/02
 DESIGNER _____

SIZE _____ CAGE CODE _____ DWG NO DC562A
 SCALE _____ FILENAME _____ SHEET 1 OF 1

File#, March 07, 2003