



HarmonicGuard® Series
Drive Applied Harmonic Filter Kit
Installation, Operation, and Maintenance Manual



TCI, LLC
W132 N10611 Grant Drive
Germantown, Wisconsin 53022

Phone: 414-357-4480
Fax: 414-357-4484
Helpline: 800-TCI-8282

Web Site: <http://www.transcoil.com>
© 2019 TCI, LLC All rights reserved

Product No: 29289 Effective: 01/06/2020 Version: N

No part of this publication may be reproduced, stored in a retrieval system, or transmitted in any form or by any means, mechanical, electronic, photocopying, recording, or otherwise, without the prior written permission of TCI, LLC. The information in this manual is subject to change without notice. Every precaution has been taken in the preparation of this manual. TCI, LLC assumes no responsibility for errors or omissions. Neither is any liability assumed for damages resulting from the use of the information contained in this publication.

Revision	Description	Date
A	Release	
B	Added 600 V Option	10/22/14
C	Updated Kit Numbering system	02/03/15
D	Updated Kit Usages Instructions	09/13/16
E	Updated 480 V 60 Hz HGP Fuse Tables	06/26/17
F	Updated 480 V 60 Hz HGP Fuse Tables	10/19/17
G	Updated Fuse Requirements Table	12/01/17
H	Updated Filter Schematics	04/23/18
J	Update to include compliance	11/15/18
K	Update to include PQconnect	08/22/19
L	Update to include Bluetooth capability with PQconnect	09/25/19
M	Fixes to PQconnect section	11/11/19
N	Updates to PQconnect section	01/06/20

No part of this publication may be reproduced, stored in a retrieval system, or transmitted in any form or by any means, mechanical, electronic, photocopying, recording, or otherwise, without the prior written permission of TCI, LLC. The information in this manual is subject to change without notice. Every precaution has been

taken in the preparation of this manual. TCI, LLC assumes no responsibility for errors or omissions. Neither is any liability assumed for damages resulting from the use of the information contained in this publication.

Performance Guarantee

Select and install the appropriate HarmonicGuard® Passive Harmonic Filter Kit in a variable torque, variable frequency AC drive application, within our published technical specifications and we guarantee that the input current distortion will be less than or equal to 5% THID for standard HGP Series filters at full load, and less than 8% at 30% load. If a properly sized and installed filter fails to meet its specified THID level, TCI will provide material for necessary modifications or replacement filter at no charge.

HG filters can also provide similar performance in other drive applications such as constant torque, DC drives and other phase controlled rectifiers, but actual THID levels can vary by load and/or speed and therefore cannot be guaranteed.

Consult factory for assistance when applying HGP filters on these types of equipment.

MINIMUM SYSTEM REQUIREMENTS:

The guaranteed performance levels of this filter will be achieved when the following system conditions are met:

Frequency: 60Hz \pm 0.75Hz

System Voltage: Nominal System Voltage (line to line) \pm 10%

Balanced Line Voltage: Within 0.5%

Background Voltage Distortion: < 0.5% THVD

The input VFD current waveform shall be consistent with that of a VFD with 3% AC line reactance at full load.

NOTE: The presence of background voltage distortion will cause motors and other linear loads to draw harmonic currents.

Additional harmonic currents may flow into the HGP filter if there is harmonic voltage distortion already on the system.

If higher levels of harmonic voltage distortion (2%-5%) are present, please use the high voltage distortion wiring of the HGP filter kit.

***For PQconnect:** To run PQvision software, minimum system requirements are Windows 7 and 1280 x 720 resolution.

Table of Contents

1.0 Safety	2
Safety Instructions Overview	2
Warnings and Cautions	2
General Safety Instructions	3
2.0 General Information	4
Intended Audience	4
Receiving Inspection.....	4
Storage Instructions.....	4
TCI Limited Warranty Policy	4
3.0 Pre-Installation Planning	6
Verify the Application	6
Recommendations Kit Usage	6
HGP Kit Part Numbering System	6
Technical Specifications	7
Select a Suitable Location	8
4.0 Installation	7
Installation Guidelines.....	7
Mounting the Filter Kit.....	8
Power Wiring	8
SCCR Ratings	9
Filter Wire Sizing.....	11
KDR Line Reactor Installation Instructions	14
Tuning Reactor	17
Tuned Circuit Capacitors	17
Capacitor Brackets	19
Contactor (Optional Customer Supplied).....	19
5.0 PQconnect	20
Product Description	20
Installation.....	21
Mounting	21
Wiring.....	23
PQconnect PCB Calibration	26
PQvision Software	30
Modbus RTU.....	38
RS485 to USB Serial Converter	51
6.0 Troubleshooting	54

1.0 Safety

The information presented in this manual covers the HGP filter kits only. For the full HGP manual please visit:

<https://transcoil.com/Products/HGP-Passive-Harmonic-Filter.htm>

Safety Instructions Overview

This section provides the safety instructions which must be followed when installing, operating, and servicing the HGP Filter kit. If neglected, physical injury or death may follow, or damage may occur to the filter or equipment connected to the filter. The material in this chapter must be read and understood before attempting any work on or with the product.

The HGP filter is intended to be connected to the input terminals of one or more VFDs. Three-phase power is connected to the input terminals of the filter and power is supplied to the VFD or VFDs through the filter. The instructions, and particularly the safety instructions, for the VFDs, motors, and any other related equipment must be read, understood, and followed when working on any of the equipment.



Warnings and Cautions

This manual provides two types of safety instructions. Warnings are used to call attention to instructions that describe steps that must be taken to avoid conditions that can lead to a serious fault condition, physical injury, or death.

Cautions are used to call attention to instructions that describe steps that must be taken to avoid conditions that can lead to a malfunction and possible equipment damage.

Warnings

Readers are informed of situations that can result in serious physical injury and/or serious damage to equipment with warning statements highlighted by the following symbols:

<p>Warning</p> 	<p>Dangerous Voltage Warning: warns of situations where high voltage can cause physical injury and/or damage equipment. The text next to this symbol describes ways to avoid the danger.</p>
<p>Warning</p> 	<p>General Warning: warns of situations that can cause physical injury and/or damage equipment by means other than electrical. The text next to this symbol describes ways to avoid the danger.</p>
<p>Warning</p> 	<p>Electrostatic Discharge Warning: warns of situations in which an electrostatic discharge can damage equipment. The text next to this symbol describes ways to avoid the danger.</p>







Cautions

Readers are informed of situations that can lead to a malfunction and possible equipment damage with caution statements:

<p>Caution</p> 	<p>General Caution: identifies situations that can lead to a malfunction and possible equipment damage. The text describes ways to avoid the situation.</p>
---	---

General Safety Instructions

These safety instructions are intended for all work on the HGP filter. Additional safety instructions are provided at appropriate points on other sections of this manual.

<p>Warning</p> 	<p>Be sure to read, understand, and follow all safety instructions.</p>
<p>Warning</p> 	<p>Only qualified electricians should carry out all electrical installation and maintenance work on the HGP filter.</p>
<p>Warning</p> 	<p>All wiring must be in accordance with the National Electrical Code (NEC) and/or any other codes that apply to the installation site.</p>
<p>Warning</p> 	<p>Disconnect all power before working on the equipment. Do not attempt any work on a powered HGP filter.</p>
<p>Warning</p> 	<p>The HGP filter, drive, motor, and other connected equipment must be properly grounded.</p>
<p>Warning</p> 	<p>After switching off the power, always allow 5 minutes for the capacitors in the HGP filter and in the drive to discharge before working on the HGP, the drive, the motor, or the connecting wiring. It is a good idea to check with a voltmeter to make sure that all sources of power have been disconnected and that all capacitors have discharged before beginning work.</p>

2.0 General Information

Thank you for selecting the HGP filter kit. TCI has produced this filter for use in many variable frequency drive (VFD) applications that require input power line harmonic current reduction. This manual gives an overview of how to install, operate and maintain the HGP PQconnect Filter kit. Please contact TCI Technical Support or visit transcoil.com/Support.htm for additional information.

Intended Audience

This manual is intended for use by all personnel responsible for the assembly, wiring installation, operation and maintenance of the HGP filters and kits. Such personnel are expected to have knowledge of electrical wiring practices, electronic components and electrical schematic symbols. Panel design using a TCI HGP Filter Kit should be performed with appropriate engineering supervision so the design meets the requirements based on materials utilized in the construction of the panel, wiring practices followed by your shop, and the actual ambient conditions of the components for each application.

Receiving Inspection

The HGP filter kit has been thoroughly inspected at the factory and carefully packaged for shipment. When you receive the unit, you should immediately inspect the shipping container and report any damage to the carrier that delivered the unit. Verify that the part number of the components you received is the same as the part numbers listed on the engineering drawings for the kit.

Storage Instructions

If the HGP Kit filter is to be stored before use, be sure that it is stored in a location that conforms to published storage humidity and temperature specifications on the applicable technical drawings available at: <https://transcoil.com/products/kits-page/hgp-kits/>. Store the unit in its original packaging.

TCI Limited Warranty Policy

TCI, LLC (“TCI”) warrants to the original purchaser only that its products will be free from defects in materials and workmanship under normal use and service for a period originating on the date of shipment from TCI and expiring at the end of the period described below:

Product Family	Warranty Period
KLR, KDR	For the life of the drive with which they are installed.
HGA, KLC, KLCUL, KMG, MSD, V1k	One (1) year of useful service, not to exceed 18 months from the date of shipment.
PF Guard, HGP, HGL, HG7, HSD, KRF	Three (3) years from the date of shipment.
KCAP, KTR,	Five (5) years from the date of shipment.
All Other Products	One (1) year of useful service, not to exceed 18 months from the date of shipment.

The foregoing limited warranty is TCI’s sole warranty with respect to its products and TCI makes no other warranty, representation, or promise as to the quality or performance of TCI’s products. THIS EXPRESS LIMITED WARRANTY IS GIVEN IN LIEU OF AND EXCLUDES ANY AND ALL EXPRESS OR IMPLIED WARRANTIES INCLUDING, WITHOUT LIMITATION, ANY IMPLIED WARRANTY OF MERCHANTABILITY OR FITNESS FOR A PARTICULAR PURPOSE.

This warranty shall not apply if the product was:

- a) Altered or repaired by anyone other than TCI;
- b) Applied or used for situations other than those originally specified; or
- c) Subjected to negligence, accident, or damage by circumstances beyond TCI’s control, including but not limited to, improper storage, installation, operation, or maintenance.

If, within the warranty period, any product shall be found in TCI's reasonable judgment to be defective, TCI's liability and the Buyer's exclusive remedy under this warranty is expressly limited, at TCI's option, to (i) repair or replacement of that product, or (ii) return of the product and refund of the purchase price. Such remedy shall be Buyer's sole and exclusive remedy. TCI SHALL NOT, IN ANY EVENT, BE LIABLE FOR INCIDENTAL DAMAGES OR FOR CONSEQUENTIAL DAMAGES INCLUDING, BUT NOT LIMITED TO, LOSS OF INCOME, LOSS OF TIME, LOST SALES, INJURY TO PERSONAL PROPERTY, LIABILITY BUYER INCURS WITH RESPECT TO ANY OTHER PERSON, LOSS OF USE OF THE PRODUCT OR FOR ANY OTHER TYPE OR FORM OF CONSEQUENTIAL DAMAGE OR ECONOMIC LOSS.

The foregoing warranties do not cover reimbursement for removal, transportation, reinstallation, or any other expenses that may be incurred in connection with the repair or replacement of the TCI product.

The employees and sales agents of TCI are not authorized to make additional warranties about TCI's products. TCI's employees and sales agent's oral statements do not constitute warranties; these shall not be relied upon by the Buyer, and are not part of any contract for sale. All warranties of TCI embodied in this writing and no other warranties are given beyond those set forth herein.

TCI will not accept the return of any product without its prior written approval. Please consult TCI Customer Service for instructions on the Return Authorization Procedure.

3.0 Pre-Installation Planning

Verify the Application

The HGP is a drive-applied harmonic filter designed and developed by TCI to reduce the harmonic currents drawn from the power source by VFDs. The published HGP voltage, Power (HP or kW) and current ratings apply to matching power (HP or kW) rated standard VFDs with six-pulse diode bridge rectifiers. The HGP may also be sized to filter other loads such as SCR six-step drives, SCR Direct Current (DC) motor drives, thyristor furnaces, battery chargers, electroplating supplies or other types of nonlinear loads. In many cases, the filter power rating (HP or kW) will differ from load power rating (HP or kW). Please contact TCI Technical Support for additional information and support on sizing HGP harmonic filters for your non six-pulse diode front end VFD applications.

The HGP is a passive filter connected in series with the input terminals of a VFD or several VFDs that operate as a group. It is designed to provide a low impedance path for the major harmonic currents demanded by the drive.

Recommendations Kit Usage

Panel design using a TCI HGP Filter Kit should be performed with appropriate engineering supervision so the design meets the requirements based on materials utilized in the construction of the panel, wiring practices followed by your shop, and the actual ambient conditions of the components for each application.

HGP Kit Part Numbering System

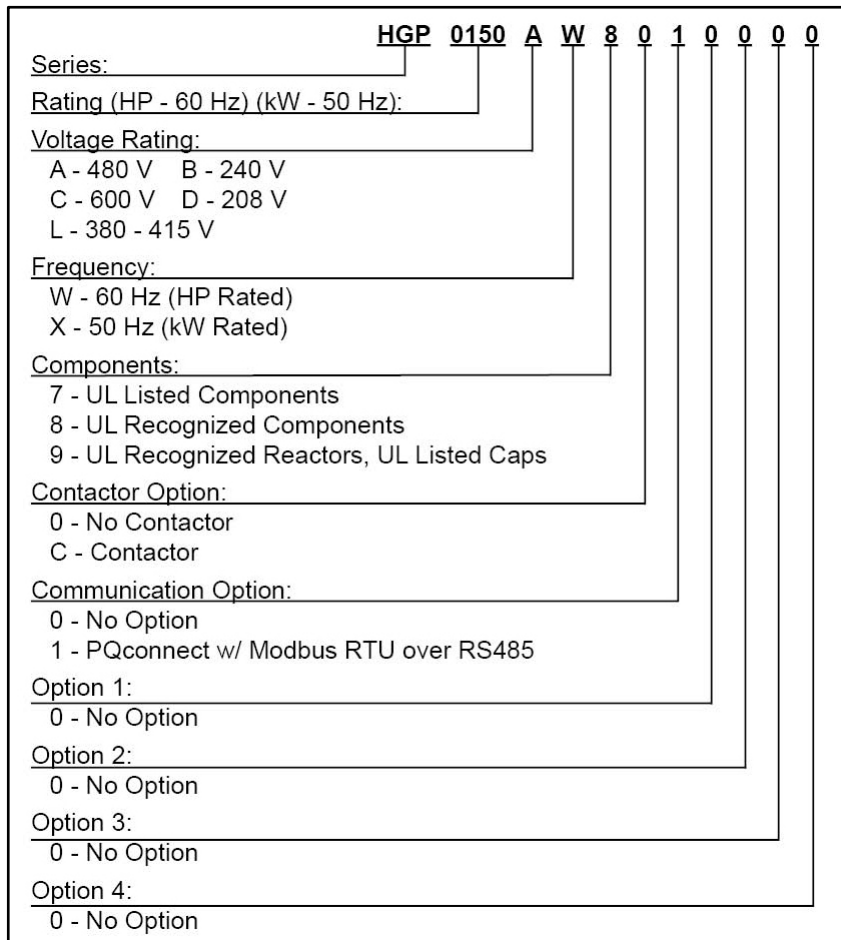





Figure 1: HGP Kit Part Numbering System

Make sure that the HGP kit is correct for the application. The voltage ratings of the filter kit must match the input voltage rating of the connected drive. The horsepower and current ratings of the filter kit must be appropriate for the connected load.

Technical Specifications

Table 1 - HarmonicGuard® Passive Filter Technical Specifications

Electrical Characteristics	
Voltage Rating	208, 240, 380-415, 440, 480 or 600 VAC
Phase	3
Compliance	IEEE-519 2014
Operating Frequency	50 or 60 Hz
Motor drive input power rating range	1.5 – 1250 HP for 480V units. Power range varies depending on system voltage.
Immunity from Voltage Distortion	Less than 5% THID at full load with THVD as high as 5%*
Overload Capability	200% of current rating for 3 minutes
Environmental Conditions	
Operating Temperature	Kit component ambient: 50°C (122°F)
Storage Temperature	60°C (140°F)
Elevation	Up to 2,000 m without derating
Humidity	95% non-condensing
Agency approvals or certifications	
Capacitor Assemblies	 UL and cUL Listed
Capacitors	 UR and cUR Recognized
Reactors	 UR and cUR Recognized
Reactors	 UL and cUL Listed
Performance Guarantee	
To meet the requirements for the Performance Guarantee the minimum system conditions must conform to the following: <ul style="list-style-type: none"> • No more than 1.5% Source inductance • The input VFD current waveform shall be consistent with that of a VFD with 3% AC line reactance at full load 	

Please consult TCI regarding optimum filter performance when applied to DC drives.

4.0 Installation

Installation Guidelines

Installation Checklist

The following are the key points to be followed for a successful installation.

- Make sure that the installation location will not be exposed to direct sunlight, corrosive or combustible airborne contaminants, excessive dirt or liquids.
- Select a mounting area that will allow adequate cooling air and maintenance access.

- Make sure that all wiring conforms to the requirements of the National Electrical Code (NEC) and/or other applicable electrical codes.
- Ground the filter components using properly sized grounding conductor.
- Connect three-phase power to the input terminals of the HGP, L1, L2, and L3.
- Connect the output power terminals of the HGP line reactor, T1, T2, and T3, to the input power terminals of the VFD.

Select a Suitable Location

Environment

Locating the HGP filter kit in a suitable environment will help ensure proper performance and a normal operating life. Refer to the environmental specifications listed on Table 1 - HarmonicGuard® Passive Filter Technical Specifications.

<p>Warning</p> 	<p>Unless specifically labeled as approved for such use, this equipment is not suitable for use in an explosive atmosphere or in a "Hazardous (Classified) Location" as defined in article 500 of the National Electrical Code (NEC).</p>
---	---

The unit must be installed in an area where it will not be exposed to:

- Direct sunlight
- Rain or dripping liquids (unless the filter kit is installed in a Type 3R enclosure)
- Corrosive liquids or gasses
- Explosive or combustible gases or dust
- Excessive airborne dirt and dust
- Excessive vibration

Working Space

Provide sufficient access and working space around the unit to permit ready and safe installation, operation and maintenance. Make sure that the installation conforms to all working space and clearance requirements of the National Electrical Code (NEC) and/or any other applicable codes. Provide sufficient unobstructed space to allow cooling air to flow through the unit.

Mounting the Filter Kit

When mounting the filter kit in your own enclosure, you must provide an enclosure that is adequately sized and ventilated sufficiently to prevent overheating. Refer to the applicable kit drawings for rating and dimensions. The maximum temperature of the air around the HGP filter capacitors, line reactor, tuning reactor, and optional PQconnect PCB should not exceed 50°C (122°F). Consult the table of filter power dissipation below when planning enclosure ventilation.

Power Wiring

When selecting a mounting location for the HGP filter kit, plan for the routing of the power wiring. Make sure all wiring conforms to the requirements of the NEC electrical codes and can handle the max current required according to your filter in Table 3 – 208 V, 60Hz, HGP through Table 7 – 600 V, 60Hz, HGP.

NOTE: If your filter kit includes the PQconnect PCB please also read Section 5.0 for proper mounting and wiring installation.

Filter Schematic

The schematics shown below are illustrations of typical HGP filter wiring.

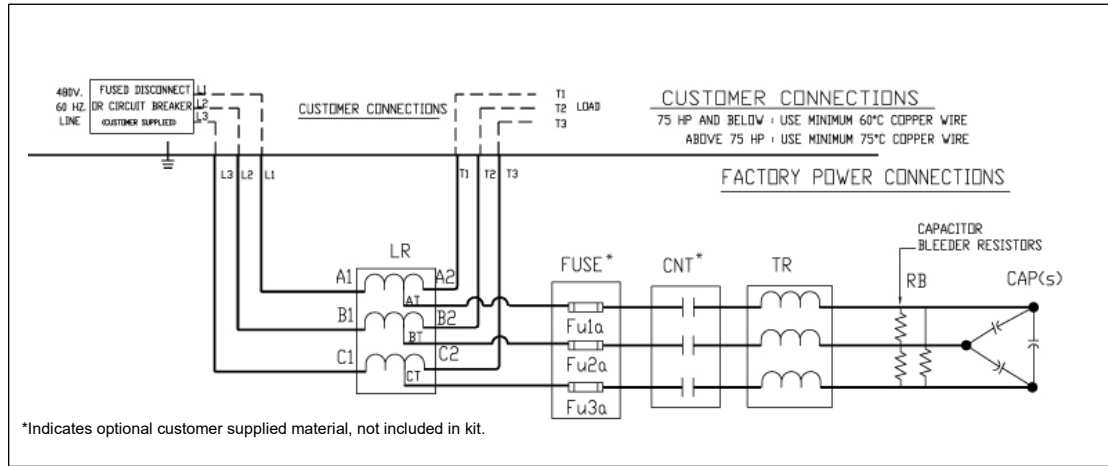

Figure 1 : Typical HGP Filter Wiring for up to 480 V/800 HP

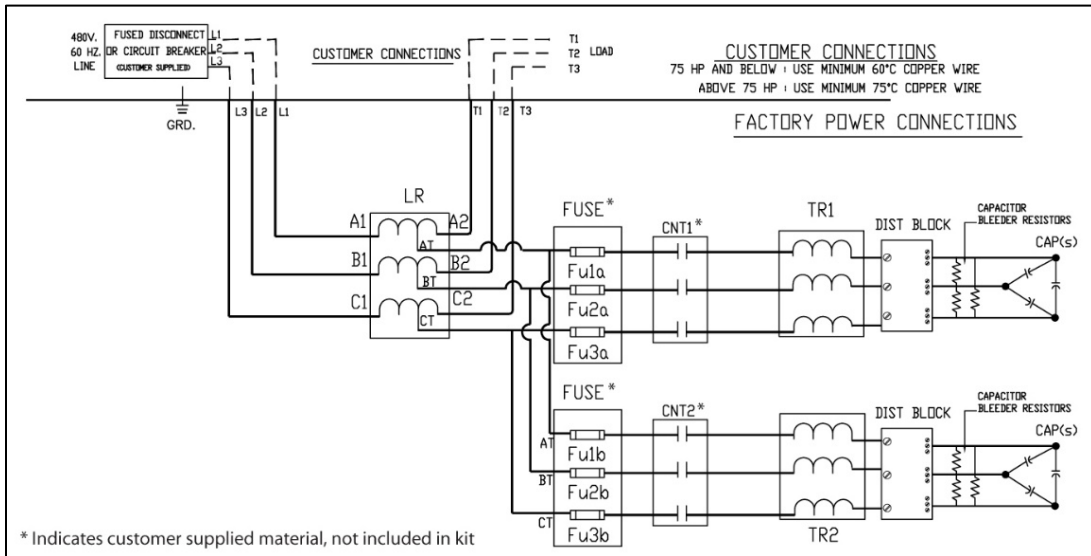

Figure 2 : HGP Filter Wiring for 480 V/900 HP and Larger Rating

SCCR Ratings

If you need an SCCR greater than the default values of components, for example, 10 kA for terminal blocks or 5 kA for contactors, pay attention to component selection and circuit fusing. Contactors need to be protected by line or branch tuned circuit fusing based on their published SCCR.

TCI HGP Kit include reactors that are not required to have a short circuit current rating per UL 508A SB4.2.1 Exception 1.

See Table 2 for line fuse requirements to complete 100 kA SCCR. Larger kits include dry-type capacitors that are not required to have a short circuit current rating per UL 508A SB4.2.1 Exception 1. Small horsepower HGP kits (see Table 2) have a line fuse requirement in order to reduce incoming 100 kA short circuit current to 10 kA on the panel suitable for the oil filled capacitors used on these small horsepower ratings.

Table 2 – Customer Installed Line Fuse Requirements to Comply with 100kA SCCR

Voltage/ Frequency	Size (HP)	Customer installed line fuse requirement for 100kA SCCR
600/60	≤ 25	Use appropriately rated Class J, T, or L fuse less than or equal to 60 A
600/60	> 25	No requirement for SCCR
480/60	≤ 25	Use appropriately rated Class J, T, or L fuse less than or equal to 60 A
480/60	> 25	No requirement for SCCR
440/60	≤ 20	Use appropriately rated Class J, T, or L fuse less than or equal to 60 A
440/60	> 20	No requirement for SCCR
440/50	≤ 15 kW	Use appropriately rated Class J, T, or L fuse less than or equal to 60 A
440/50	> 15 kW	No requirement for SCCR
415/60	≤ 20	Use appropriately rated Class J, T, or L fuse less than or equal to 60 A
415/60	> 20	No requirement for SCCR
415/50	≤ 15 kW	Use appropriately rated Class J, T, or L fuse less than or equal to 60 A
415/50	> 15	No requirement for SCCR
240/60	≤ 7.5	Use appropriately rated Class J, T, or L fuse less than or equal to 60 A
240/60	> 7.5	No requirement for SCCR
208/60	≤ 7.5	Use appropriately rated Class J, T, or L fuse less than or equal to 60 A
208/60	> 7.5	No requirement for SCCR

**Please review UL 508A SB4.1 in context of the final filter design (any deviation from the TCI HGP filter of similar rating) and Table 2 – Customer Installed Line Fuse Requirements to Comply with 100kA SCCR to confirm applicable SCCR.*

KP capacitor kit KPCUL assemblies are listed UL 508 assemblies, and therefore do not carry an SCCR.

Customer or installer shall provide UL required overcurrent protection upstream of filter.

Filter Wire Sizing

Wire Sizing

Wires need to be sized based on current to be carried, wire insulation temperature rating, panel temperature rating, bundling of wires, and appropriate codes and standards. Wire size between the power source and the filter line reactor, as well as the line reactor and the drive input, are based on rated filter line current. Wire size in the branch circuit is based on rated tuned circuit current. If the capacitor wiring is split into separate capacitor branches, the current each branch carries is proportional to the value of capacitance in each branch.

Table 3 – 208 V, 60Hz, HGP

HGP Rating (HP)	Tuned Circuit Current (A)	Line Current (A)
5	10.3	16.7
7.5	17.1	24.2
10	25.7	30.8
15	34.4	46.2
20	42.9	59.4
25	51.5	74.8
30	68.6	88
40	103	114
60	129	169
75	154	211
100	205	273
150	310	396
200	412	528
250	515	660
300	641	792

Table 4 – 240 V, 60Hz, HGP

HGP Rating (HP)	Tuned Circuit Current (A)	Line Current (A)
5	10.3	15.2
7.5	13.7	22
10	17.1	28
15	25.7	42
20	34.4	54
25	42.9	68
30	51.5	80
40	68.6	104
50	77.0	130
60	103	154
75	129	192
100	154	248
125	205	318
150	257	360
200	308	480
250	410	604
300	513	722
400	641	954

Table 5 – 480 V, 60Hz, HGP

HGP Rating (HP)	Watts Loss	Tuned Circuit Current (A)	Line Current (A)
1.5	80	0.9	3
3	85	1.5	4.8
5	85	2.2	7.6
7.5	115	5.1	11
10	135	5.1	14
15	190	8.6	21
20	230	10.3	27
25	285	13.7	34
30	240	17.1	40
40	435	25.7	52
50	455	25.7	65
60	600	34.2	77
75	750	42.8	96
100	700	51.3	124
125	815	68.4	156
150	1075	77.0	180
200	1325	103	240
250	1475	128	302
300	1875	154	361
350	1725	180	414
400	1775	205	477
450	2000	231	515
500	2300	257	590
600	1975	308	720
700	1975	359	840
800	2025	410	960
900	2250	230/230 (Parallel Branches)	1080
1000	2500	257/257 (Parallel Branches)	1200

Note: Addition of PQconnect option increases Watts Loss by 10.

Table 6 – 380-415 V, 50Hz, HGP

HGP Rating (HP)	Tuned Circuit Current (A)	Line Current (A)
2	1.5	4.3
3	2.2	6.1
7.5	5.1	14
10	8.6	18
15	10.3	27
20	13.7	34
25	25.7	43
30	25.7	51
40	25.7	66
50	42.8	83
60	51.3	103
75	68.4	128
100	77.0	165
125	103	208
150	103	240
175	128	275
200	154	320
250	180	403
300	257	482
350	257	560
400	308	636
450	308	711
500	359	786
600	410	960
700	513	1120
750	513	1200
800	650	1280
900	650	1440
950	650	1520

Table 7 – 600 V, 60Hz, HGP

HGP Rating (HP)	Tuned Circuit Current (A)	Line Current (A)
5	1.8	6.1
7.5	4.1	9
10	4.1	11
15	6.8	17
20	8.2	22
25	10.9	27
30	13.7	32
40	20.5	41
50	20.5	52
60	27.4	62
75	34.2	77
100	41.0	99
125	54.7	125
150	61.6	144
200	82.1	192
250	103	242
300	123	289
350	144	336
400	164	382
450	185	412
500	205	472
600	246	576
700	287	672
800	328	780
900	369	864
1000	410	960

KDR Line Reactor Installation Instructions

Recommendations and Considerations

When installing the KDR Line Reactors on the INPUT side of the VFD, please use the following guidelines when wiring the unit:

The KDR Line Reactor is a 3-phase device and should be wired in series and positioned on the input side of the VFD.

All Terminal Block connectors will be marked. A1, B1, and C1 are the input terminals where the 3 phases of incoming power are to be wired. The tap for the filter connection will be marked AT, BT, and CT. Output terminals will be marked A2, B2, and C2. Do not swap input and output terminals. Units with copper bus or ring lug terminals are not marked. Wiring from the output terminals should connect to the input of the VFD.

Refer to NEC (National Electrical Code) wiring practices for appropriate wire sizes for your application.

TCI recommends that these reactors be wired and located as close to the front end of the VFD as possible to have the greatest success in both protecting the VFD as well as mitigating line harmonics. We recommend this be 10 feet of cable or less.

Reactors generate a lot of heat in normal operations and their surfaces get very hot. In standard 40°C ambient or less installations, a clearance of 3 inches on all sides of the reactors and its enclosure is recommended for assisting in heat dissipation. This is a general guideline for typical applications. If the reactor is being installed next to a heat sensitive instrument or control device, we recommend

reviewing specific requirements on heat limitations. Line reactor heat loss information is available on the web at <https://transcoil.com/products/kits-page/hgp-kits>.

These reactors are designed to be floor-mounted or wall-mounted. Large open-style devices should be panel mounted by incorporating a bracket that would act as a shelf to support the reactor and/or enclosure. When installing an open style device in an existing control cabinet, drive cabinet, motor control center, or other large enclosure, the reactor should be mounted in the lower half of the cabinet to prevent hot spots or pockets of heat. Locating the reactor in the lower half of the cabinet typically allows better thermal dissipation and heat convection. Reactors with ducts should be mounted vertically for proper cooling.

NOTE: If the PQconnect PCB board is included in your kit please read through mounting and wiring practices found in section 5.0.

Line Reactor Wiring

In the higher performance HGP design, tapped line reactor wiring is more critical than standard line reactor designs. Before tapped line reactors, it did not matter if you connected the A1, B1, C1 to the line side or the drive side, however, on the HGP, the terminals cannot be swapped. Incorrect wiring of the line reactor will result in poor harmonic mitigation and could damage the reactor. Consult the reactor drawing for your line reactor to verify proper filter wiring. All line reactor drawings are available on the parts web page:

<https://transcoil.com/products/kits-page/hgp-kits>

The incoming line must be wired to the winding start noted as A1, B1, and C1 in the reactor drawing. The tuned circuit is typically connected to the winding tap noted as AT, BT, and CT in the reactor drawing, or it may be connected to the winding end noted as A2, B2, and C2 in the reactor drawing.

- In small line reactors with nine position terminal blocks, the terminal block is wired A1, AT, A2, B1, BT, B2, C1, CT, and C2 from left to right.

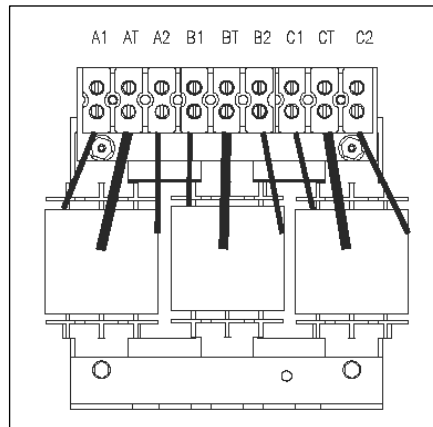

Figure 3 – Nine Position Terminal Block

- In small line reactors with six position terminal blocks, the terminal block is wired A1, A2, B1, B2, C1, and C2 from left to right. The tap lugs AT, BT, and CT extend out from the front face of the coil.

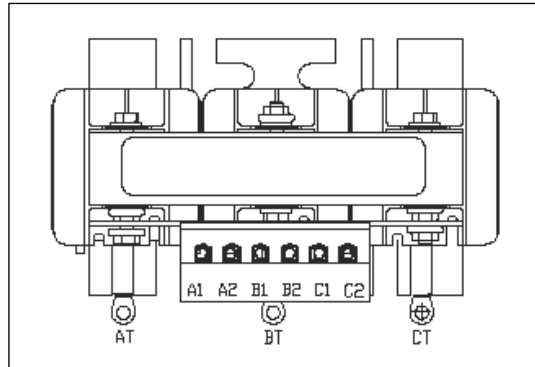

Figure 4 – Six Position Terminal Block

- In line reactors where current exceeds terminal block capability, ring lugs are used for all three terminations. Note from the drawing below, the tap connection is at the lower right side of the coil.

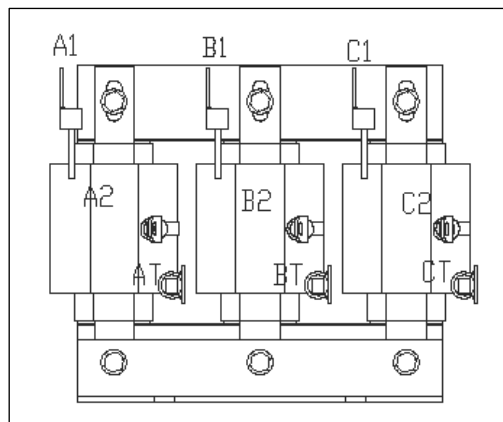

Figure 5 – Ring Lug Terminations

- In larger line reactors, all three terminals extend from the front of the reactor, and are constructed from copper bus bar terminals. Unless you are an expert on start and finish windings, consult the reactor drawing to be sure which terminal is which. In the example below, the tap winding is on the bottom of the coil.

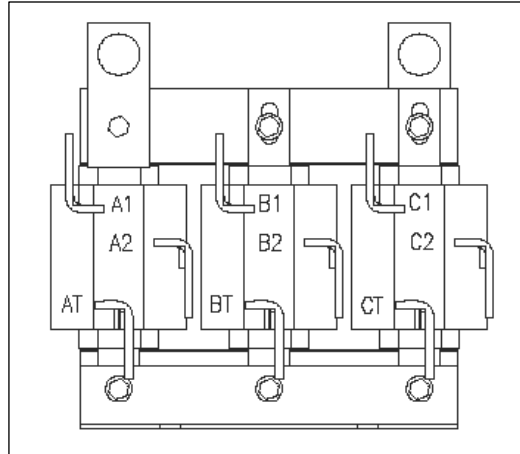

Figure 6 – Copper Flag Terminations

- In the largest line reactors, the tap connection is off a winding that projects out from the front of the reactor.

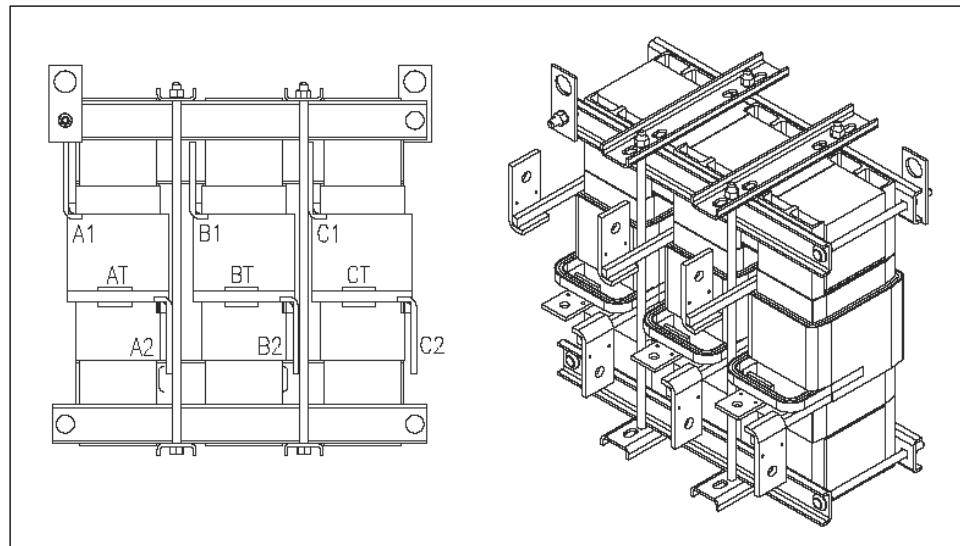

Figure 7 – In-Line Tap Termination

Tuning Reactor

The standard schematics above illustrate the normal configuration where the tuned circuit is connected to the line reactor tap. If high background voltage distortion is present, typically when the background voltage distortion exceeds 3% THD, the tuned circuit is connected to A2, B2, and C2 of the line reactor to improve harmonic performance under high background distortion conditions.

The tuning reactor supplied with the HGP kit has six terminals A1, A2, B1, B2, C1, and C2. As long as a consistent three terminals are used, the A1, B1, and C1 tuned reactor terminals or A2, B2, and C2 tuned reactor terminals can be connected to the line reactor tap at AT, BT, and CT.

Tuned Circuit Capacitors

The capacitors supplied in the HGP kit are intended to be connected in parallel with each other. Typically these are three terminal three-phase capacitors with the internal capacitive elements connected in delta. Each capacitor has a bleeder resistor connected across the three input terminals to ensure voltage discharges in the time required by UL. Do not connect capacitors to

power unless the bleeder resistors are connected, hazardous voltages will remain across the capacitors after the power has been disconnected.

As a check, the total kVAR of capacitors connected to the tuned reactor should match the part number of the reactor. For example, the kit for a 480 V/100 HP HGP contains two 15 kVAR capacitors for a total of 30 kVAR. These are wired in parallel to the tuning reactor, KTR30A65HG.

For the largest 480V HGP kits, there are two tuned circuits connected in parallel with each other. For example, the 480 V/900 HP HGP kit contains 270 kVAR of capacitors. One tuned reactor KTR135A65HG is wired to 135 kVAR of capacitors; the second tuned reactor KTR135A65HG is wired to the remaining 135 kVAR of capacitors.

Please note that the labeled capacitor kVAR is rated at 480V or 600 V. So, in cases where the voltage of the “kit” is different, such as 400 V, the kVAR of the capacitors will be different than what the label states. Frequency is also a consideration in the kVAR rating. This means that the kVAR of the KTR tuning reactor will be different from the total capacitance of all capacitors included in the kit. This is normal.

The small horsepower kits, 480 V/1.5 HP through 480 V/10 HP and 600V/5 HP through 600 V/10 HP are supplied with single-phase capacitors for each filter.

These capacitors are connected in wye, and the bleeder resistors are connected across the terminals of each capacitor.

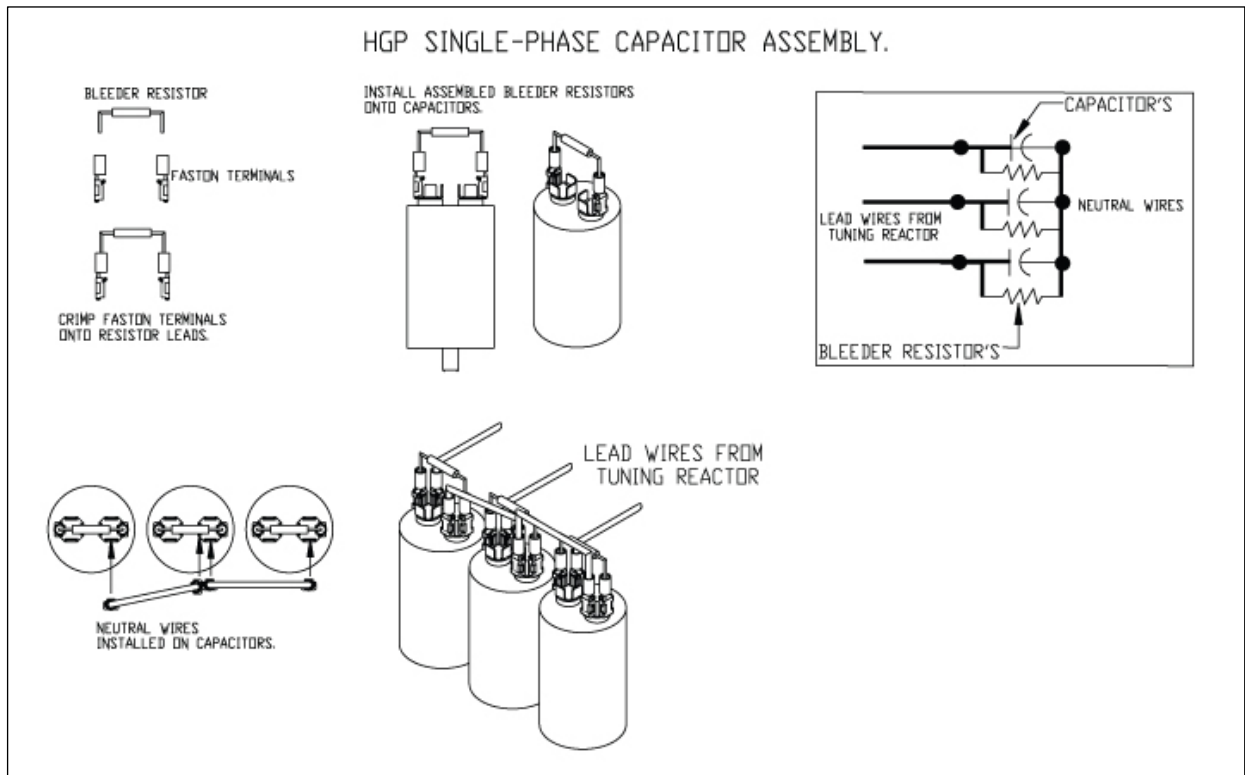

Figure 8 –Bleeder Resistor Installation and Wiring for Single-Phase

Capacitor Brackets

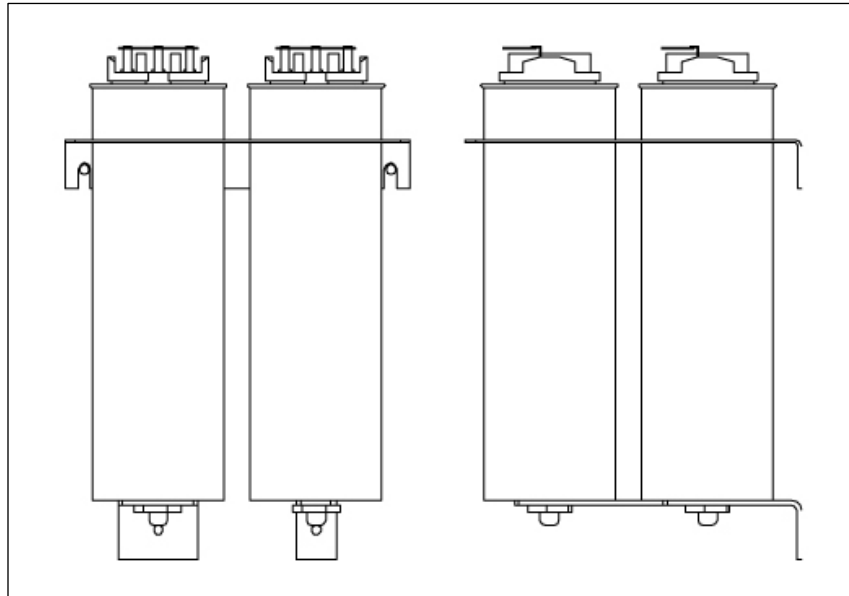

Figure 9 – Capacitors and Brackets

Capacitor brackets supplied with the HGP CP kits mount the capacitors from a right angle bracket using the studs on the bottom of the capacitors. The bracket surrounding the capacitors is mounted near the top of the capacitor can. Rubber grommet material is placed around the large diameter holes to prevent the edges of the bracket damaging the capacitor cans. This hole does not firmly clamp the capacitors, and is not intended to do so: such a design would prevent the internal capacitor pressure disconnection means from operating. This bracket prevents gross motion of the capacitors during shipping vibration which could fracture the mounting bracket or allow the capacitors to hit other components.

Contactors (Customer Supplied)

Your panels may include contactors to remove the tuned circuit from the filter under no load or light load conditions. Select contactor size based on the contactor UL general purpose current rating to handle 110% of the tuned circuit current from the tables above. The impedance of the line and tuning reactors removes the need for special capacitor rated contactors in this application.

5.0 PQconnect

Product Description

The PQconnect is an integrated controls option for TCI’s industry leading passive harmonic filter used for filtering the input of variable frequency motor drives (VFDs). In the passive harmonic filter, the PQconnect provides basic tuned circuit contactor control and provides unit status detection, metering, waveforms and power quality data. The PQconnect data is made available via basic Modbus RTU over RS485 serial connection. The PQconnect is UL listed and intended for commercial and industrial applications. By default, the PQconnect is manufactured to close the contactor at 30% load.

*Please verify you have the latest manual version for your PQconnect software by visiting <https://transcoil.com/products/kits-page/hgp-kits/>

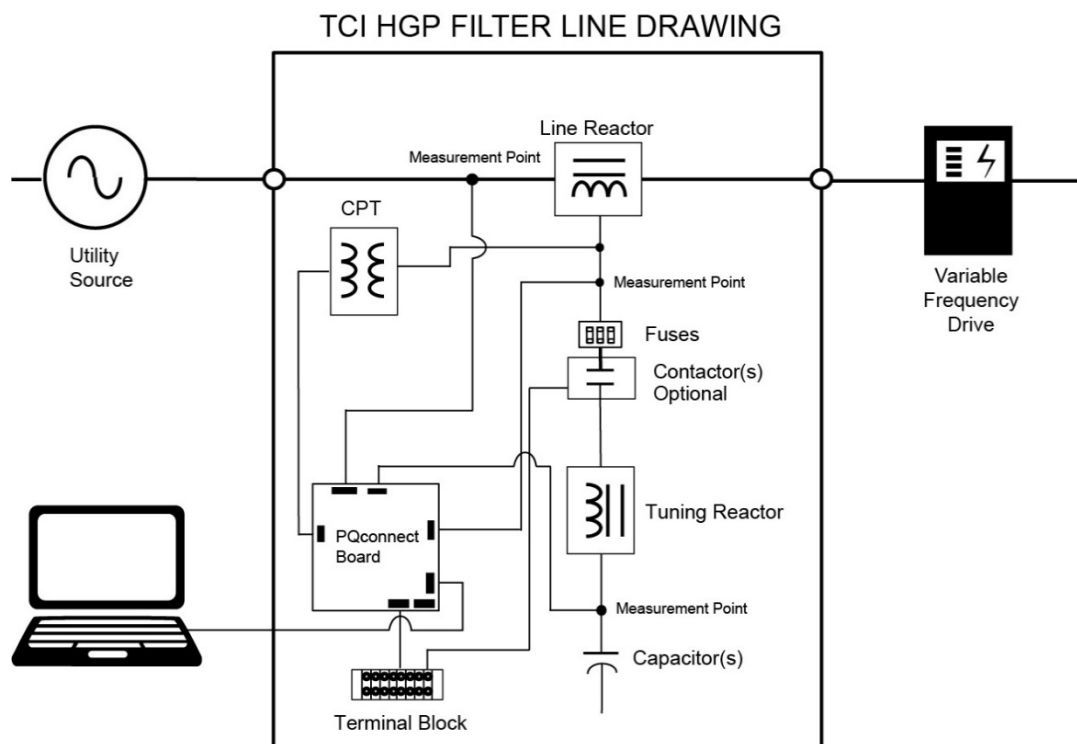

Figure 10 : HGP Filter with PQconnect Typical Connection Diagram

Installation

Installation Checklist

The following are the key points to be followed for a successful installation of the PQconnect board.

- Make sure that the installation location will not be exposed to direct sunlight, corrosive or combustible airborne contaminants, excessive dirt or liquids.
- Select a mounting area that will allow adequate cooling air and maintenance access.
- Make sure that all wiring conforms to the requirements of the National Electrical Code (NEC) and/or other applicable electrical codes.
- Connect the HGP equipment-grounding lug to the system ground of the premises wiring system. Use a properly sized grounding conductor.
- Connect three-phase power from the KDR Line reactor to the input terminals of the PQconnect board, J1, J2, and J3.
- Connect 120VAC Power (customer supplied) to the input power supply header J12 on the PCB
- Connect RS 485 to USB serial converter to the Modbus RTU header J5.
- Use PQvision software from TCI website to calibrate PQconnect PCB.
- Ensure all component connections are torqued before energizing filter.

NOTE: PQvision software is required to calibrate the PQconnect PCB

Mounting

Selecting a Suitable Location

When mounting the PQconnect board, provide an adequately ventilated location to prevent overheating. Refer to the applicable kit drawings for PCB dimensions. The maximum temperature of the air around the HGP filter components should not exceed 50°C (122°F). Consult the watts loss columns above in Filter Wire Sizing for Watts Loss when planning enclosure ventilation. When selecting a mounting location for the PQconnect PCB, plan for the routing of the power wiring. Figure 11 Shows a representative schematic of power wiring. Note that there are direct connections from the KDR line reactor to the PQconnect PCB.

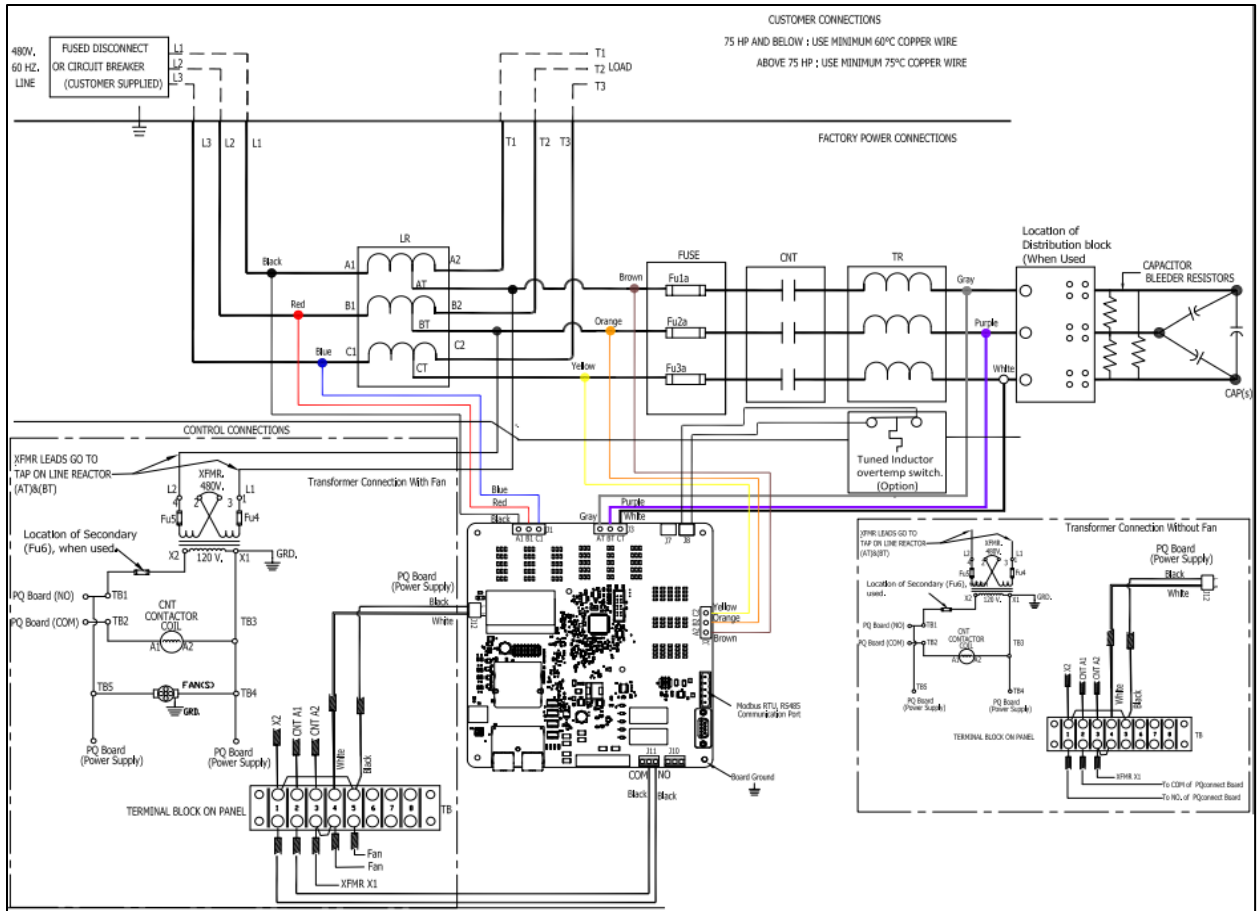

Figure 11 : Typical HGP Filter Wiring with PQconnect PCB

Mounting Hardware

Figure 13 below shows the standoffs and screws provided with the kits to mount the board on the bracket.

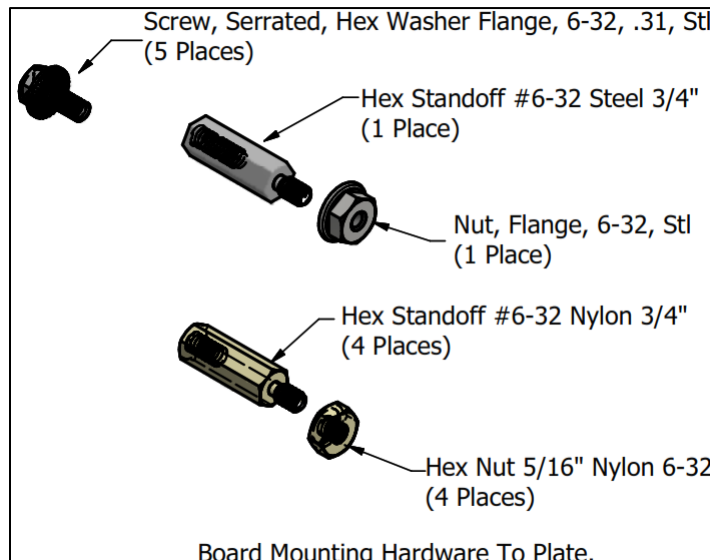

Figure 12 : Typical HGP Filter Wiring with PQconnect PCB

Reference Drawing **PKPQ5** for complete board mounting with the bracket.

When mounting the bracket into the enclosure there are three guidelines to follow.

1. Determine best location where there is adequate ventilation, depth for components, and cables; away from any heat source.
2. The inside surface of the enclosure must be free of protrusions or obstructions in the area where the PQconnect board will rest.
3. Drill holes as needed per dimension provided.

To ensure the board has a solid ground connection. The metal stud and nut provided with the kit will need to be installed onto the grounding pad of the board. *Figure 14* below indicates the location of the ground connection.

Wiring

When selecting a mounting location for the PQconnect PCB, plan for the routing of the power wiring. Make sure all wiring conforms to the requirements of the NEC electrical codes and can handle the max current required.

PCB Connections

Most connections to PQconnect will be made on the PCB. Refer to connection diagrams in Figure 13. The details of the power and communications terminals are shown in Table 8: Power & Communications Terminals. Form C relays are available on the PCB, these connections are shown in Table 10: Form C Relay Contacts. Two relay outputs are available on the PCB.

The relay contactor control command output connection on J11 of the PCB allows the user to open/close the contactor of the HGP filter. The second relay (output connections on J12) is optional and could be used for a second contactor for dual tuned circuit filters or as a secondary status detection.

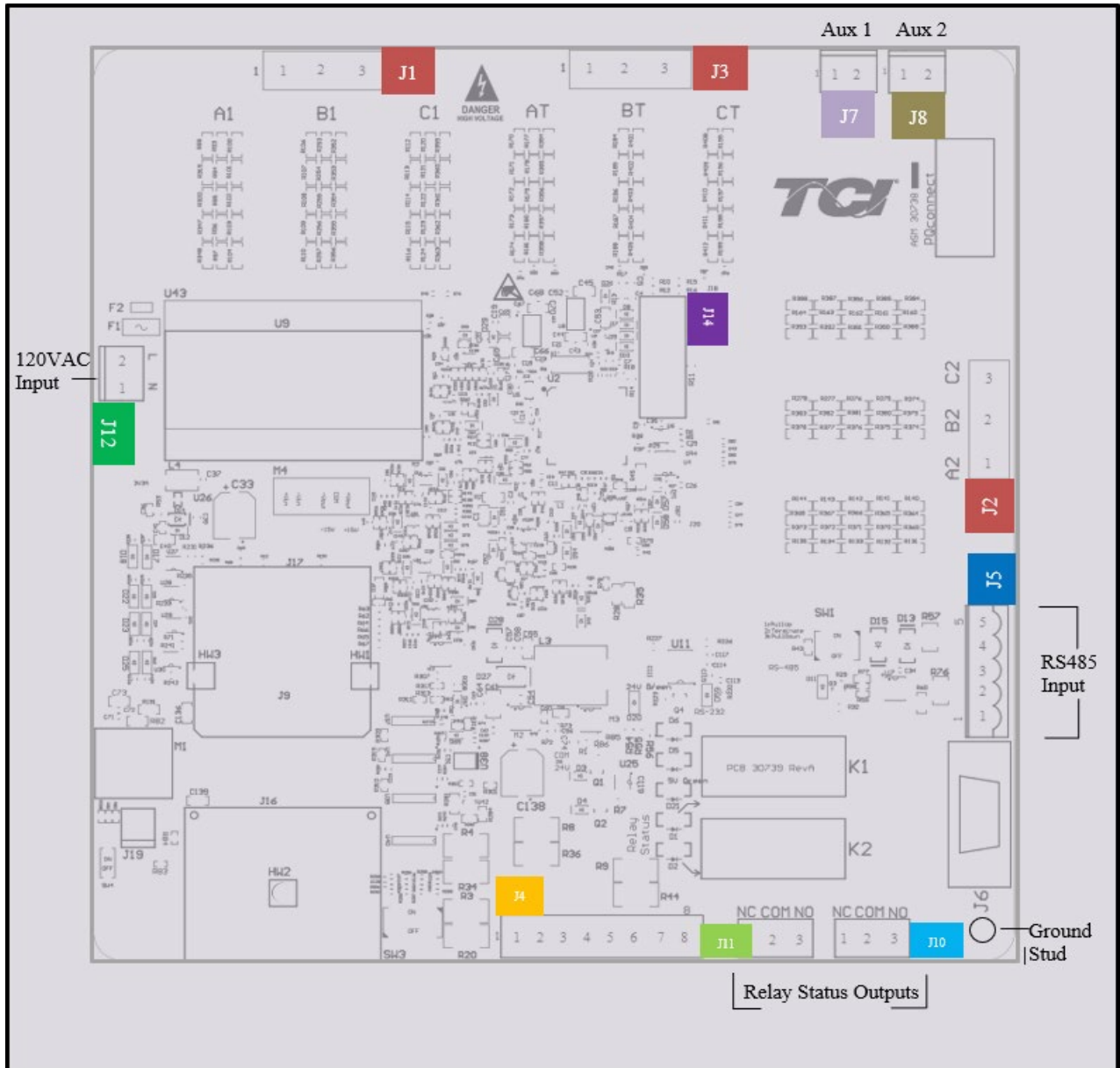

Figure 13: PQconnect Connection Terminals

Table 8: Power & Communications Terminals

Terminal	PCB Pin Connections	Reactor Connections	Description	Label	Rating
J1	A1	A1 (KDR)	Voltage Sense leads leading from J1 to the Line Reactor Input	Phase A	600 VAC
	B1	B1 (KDR)		Phase B	
	C1	C1 (KDR)		Phase C	
J2	A2	AT (KDR)	Voltage Sense leads leading from J2 to the Line Reactor Tap	Phase A	
	B2	BT (KDR)		Phase B	
	C2	CT (KDR)		Phase C	
J3	A3	KTR Output A	Voltage Sense leads leading from J3 to the Tuning Reactor Output	Phase A	
	B3	KTR Output B		Phase B	
	C3	KTR Output C		Phase C	
J4	1,2,3,4	N/A	Not Connected		N/A
	5,6,7,8		Current transformer connections	Only used for filters with dual tuned circuits	N/A
J5	1		RS485	Not Connected	N/A
	2			A (D-)	
	3			Ground	
	4			B (D+)	
	5			Not connected	
J12	1		Input Power from control power transformer	Neutral	120 VAC
	2			Line	
J14	1-14		Micro Programming	For factory use	N/A

Note: The power terminals on the PQconnect accepts 28 to 14 AWG stranded wire, with a tightening torque of 4.4 in-lb (0.5 Nm). **For further detail of connections, view HGP schematic 29597-PQ2.**

Depending on the size of the line reactor, you have the option of different terminations based on the reactor. Table 9: Voltage sense wire termination, provides examples of the terminations used for the voltage sense wires from the PQconnect to the line reactor. All recommendations are used with 18 AWG stranded wire.

Table 9: Voltage sense wire termination

Connector Termination	Manufacturer Part Number	Manufacturer	Description	KDR Line Reactor Size
Metal tab	43178-4002	Molex, LLC	Blade Contact 18-20 AWG Crimp Male Blade	Small line reactors with six or nine position terminal blocks. Reference Figures 4 and 5
3/8" Ring Lug	2-320573-4	TE Connectivity Amp Connectors	Ring Terminal Connector	Large line reactors with copper bus bar terminals Reference Figures 6, 7 and 8
1/4" Ring Lug	2-31894-2	TE Connectivity Amp Connectors		
1/2" Ring Lug	61863-2	Tyco Electronics		

Note: Voltage sense wire terminals J1, J2 & J3 accept wire gauges of 16-28 AWG with a tightening torque of 4.4 in-lb (0.5 Nm). Alternate/Equivalent tabs and ring lugs may be used for terminations. Please consult with TCI Tech-support if there are any questions for alternate parts or for reactor termination.

Table 10: Form C Relay Contacts/ Customer Inputs/Outputs

Terminal	Pin	Description	Label	Tightening Torque	Wire Range
J7	1, 2	Multi-functional digital Input 1	Customer contact, normally open	3.5 lb-in (0.4 Nm)	28-12 AWG
J8	1, 2	Multi-functional digital Input 1	Customer contact, normally open	3.5 lb-in (0.4 Nm)	28-12 AWG
J11	1	Digital output form C Contact 1	Normally Closed (NC)	4.4 lb-in (0.5 Nm)	28-14 AWG
	2		Common (COM)		
	3		Normally Open (NO)		
J10	1	Digital output form C Contact 2	Normally Closed (NC)	4.4 lb-in (0.5 Nm)	28-14 AWG
	2		Common (COM)		
	3		Normally Open (NO)		

Note: Form-C relay contacts are gold plated with a load rating of 5.0A @ 120VAC

The filter is set to control the contactor pickup/drop-out at 30% of load current by factory default. This setting can be changed in the tech access page from the settings menu.

Multi-functional digital inputs have the following functions:

- DEFAULT: 0 = Disabled
- 1 = Tuning Reactor Thermal Switch Input
- 2 = Line Reactor Thermal Switch Input
- 3 = Reset Command
- 4 = External Control Input

Digital Output form C Contact

- J11 reserved for contactor control
- J10 used for status detection

PQconnect PCB Calibration

Once the PQconnect connections are made the PCB must be calibrated to the HGP filter components to ensure proper accuracy and operation of the completed filter. The following steps will allow for units to be properly calibrated.

Note: *Instillation of the PQvision desktop interface is required for calibration. Please see next section “PQvision Software” before proceeding with PCB calibration.*

Equipment: *Calibrated current clamp meter, laptop, RS485 to USB converter*

Step 1: After assembling HGP with PQconnect, ground the filter and install **only the line side connections** to the appropriate phases first. **Do not install the load side connections for calibration process.**

Ensure communication connections and voltage sense wires are made, follow Table 8: Power & Communications Terminals for further detail.

Step 2: Energize filter

Step 3: Open PQvision interface and connect to a communication port

- A “CONNECTED” message will appear verifying that the RS485 converter is connected to the board.
- If there are any difficulties communicating to the desktop interface, a “NO COM” message will appear. Refer to the Trouble Shooting section for possible solutions.

If desktop interface does not show the com port, disengage power from filter and check wiring to the RS485 converter.

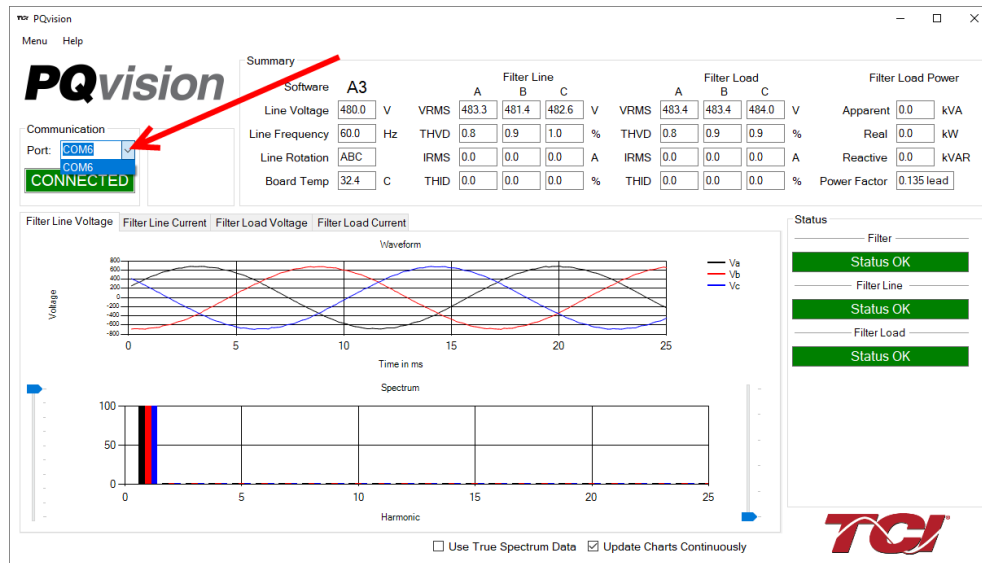

Figure 14: Communication Port (COM port)

Step 4: Select Menu and Settings (Tech level access is required) as shown in Figure 15: Settings

- Password **08252014**

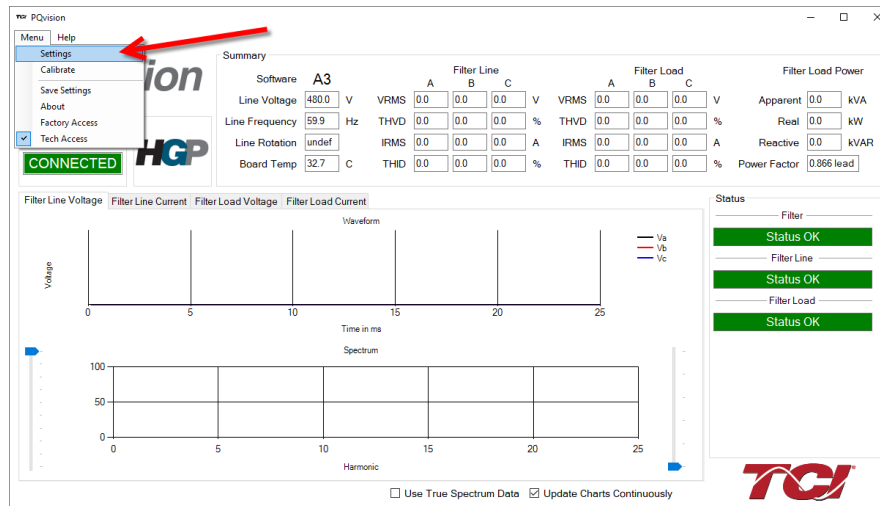

Figure 15: Settings

Step 5: Ensure that Force Closed is selected as shown below.

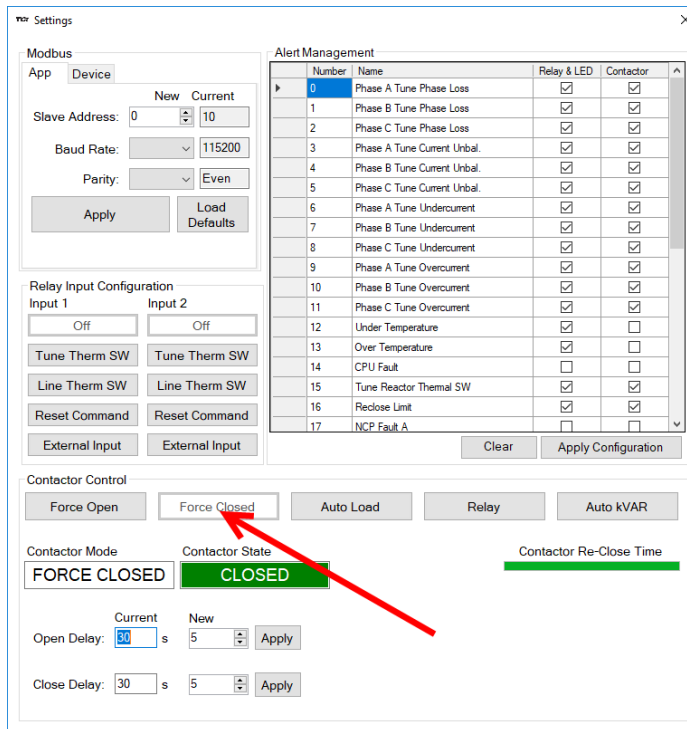

Figure 16: Settings Menu

Step 6: Select Menu and Calibrate

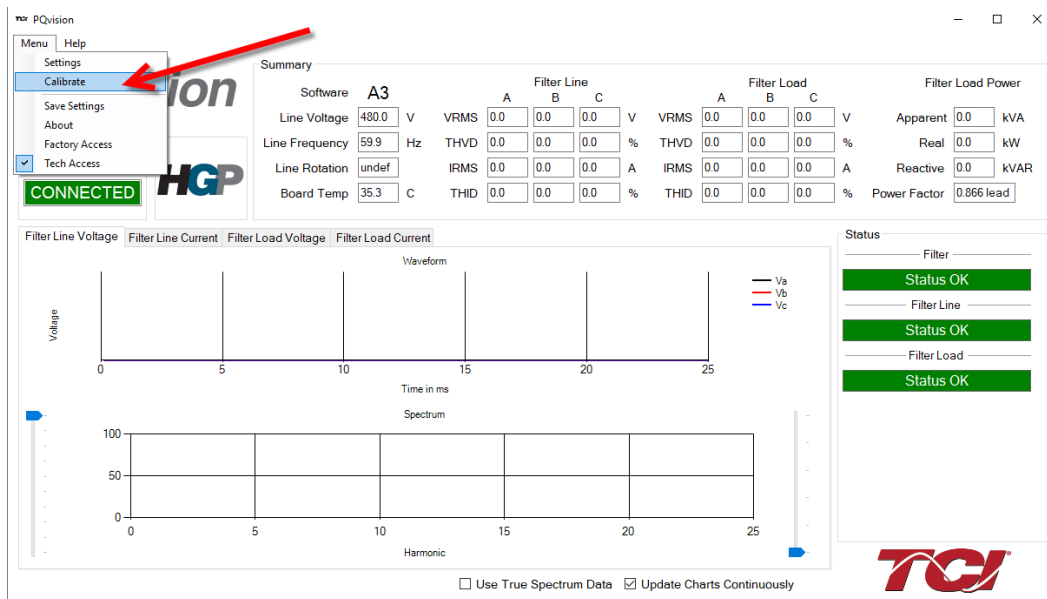

Figure 17: Calibration

Step 7: Follow through the calibration screen shown in Figure 19

Figure 18: Calibration Mode

- Enter Calibration Mode
 - Note: If there is a problem with the board it will not enter calibration mode
 - Contact Tech-Support if board does not enter the calibration state.
- Enter or scroll for Model Number of the HGP Unit (Select Next)
 - **Note:** Only the first 9 characters of the model number need to be entered
 - For example: 250HP 480V 60Hz HGP; unit model number **HGP0250AW** would be acceptable.
- Verify your model number.
 - Filter information (Voltage, frequency, Horsepower, Type) will show after the model number has been selected.

Figure 19: Filter Information

- Select Next

Step 6: Enter Current measurements

- With the current clamp meter measure each individual phase from input of the filter and
 - Calibration will not continue unless fields are entered
- Select Apply
 - Calibration may take up to 1-2 minutes

Step 7: Finalization

- For units with contactor control, select the enable contactor control
 - Select auto reset check box for auto contactor reset
- For units without a contactor, de-select enable contactor control and auto reset
- Save and Exit

Step 8: Final connections

- Disengage power from the filter after the calibration steps are complete, proceed with connecting the load side connections of the filter.
 - If a PLC is being used make sure to make these connections to the Modbus header of the PCB
- Re-energize filter

PQvision Software

PQvision PC application Screen Elements

This section focuses on the operation of the PQvision application. The PC application contains several screens that allow the user to monitor the status of the HarmonicGuard® Passive filter. Additionally, the PQvision application can be used for contactor control and basic setup of the HarmonicGuard® Passive filter.

Please ensure the latest version of PQvision is downloaded to your PC by accessing the software at <https://transcoil.com/products/hgp-5-passive-harmonic-filter/pqvision-software/>

A RS485 to USB converter was included with your HGP with PQconnect purchase. To run the PQvision software the converter will need to be connected to terminal J5 on the PQconnect PCB with pin orientation as described in Table 8, the USB connector will need to be run to laptop or PC.

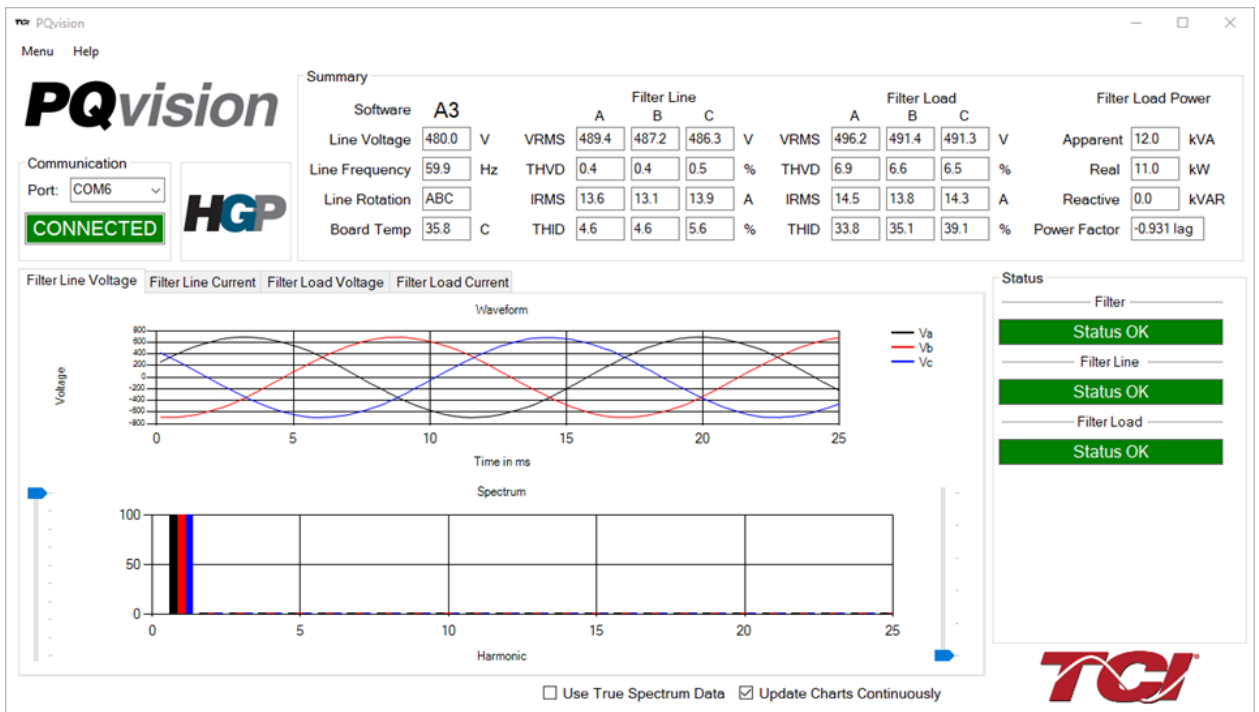

Figure 20: PQvision Desktop Application

Table 11: PQvision PC Navigation

Options	Description
<p style="text-align: center;">Toolbar</p>	<p>Communication Status and Communication Port</p> <p>To determine the COM port, go to Device Manager Ports (COM & LPT) and find "USB Serial Port"</p> <p><i>Note: If Modbus settings differ from the default values above; Set and save desired Modbus settings, then cycle power of the HarmonicGuard® Passive filter.</i></p>
	<p>DSP Rev: Latest software revision will be displayed</p> <p>To update the software, select "Software Update" under the menu "Tech access is required to perform the update"</p>
	<p>Menu: Save settings, about screen, software update, tech access</p> <p>Settings – Modbus, contactor control, kVAR settings, alert management view Figure 21 - Figure 23</p>
	<p>Help – Direct links to the TCI Home page and tech-support contact information.</p>
<p style="text-align: center;">Summary Data</p>	<p>(THVD) Displays the Total Harmonic Distortion of the utility Line/Load voltage as a percentage</p>
	<p>(THID) Displays the Total Harmonic Distortion of the utility Line/Load current as a percentage</p>
	<p>Displays three-phase real power (P) of the filter input/output in kW</p>
	<p>Displays three-phase reactive power (Q) of the filter input/output in kVAR</p>
	<p>Displays three-phase apparent power (S) of the filter input/output in kVA</p>
	<p>Displays filters output power factor. 1.00 indicates unity power factor. A negative power factor indicates lagging power factor</p>
	<p>Displays the current utility line frequency in Hz</p>
	<p>Displays the supply voltage into the HarmonicGuard® Passive filter</p>
	<p>Displays the filters input/output phase current in Amps RMS</p>
	<p>Displays Line rotation</p>
<p style="text-align: center;">Waveforms</p>	<p>The PQconnect PC application supports capture and display of real time system voltage and current data. Three phase waveform data can be viewed for Filter Line/Load Voltage, and Filter Line/Load Current.</p> <p>Phase A – Black Phase B – Red Phase C – Blue</p>
	<p>Harmonic Spectrum (Left toggle to zoom in on the spectrum and right to increase the spectrum to the 50th harmonic) the value of the fundamental is 100.</p>
<p style="text-align: center;">Status Detections</p>	<p>Status alerts for the input, output and of the filter will display according to severity of the alerts</p> <p>Hovering over status alert will give a brief description of what the problem may be.</p>

To access the settings page as seen in , under the Menu toolbar select Tech Access and Enter password **08252014** to enable. In the PQvision settings a user can set their desired Modbus settings, however this will require the PQconnect reset command. As well as controlling the contactor and enabling/ disabling alerts. Table 13 below describes the settings menu.

PQconnect Reset command: if changing the Modbus settings, the user will be required to reset the PCB after saving settings. This can be easily done through the menu by clicking menu and Reset PQconnect. The reset command will only work if the PCB is communicating to the desktop application or Modbus network. Note: resetting the board will open the contactor if contactor state is closed.

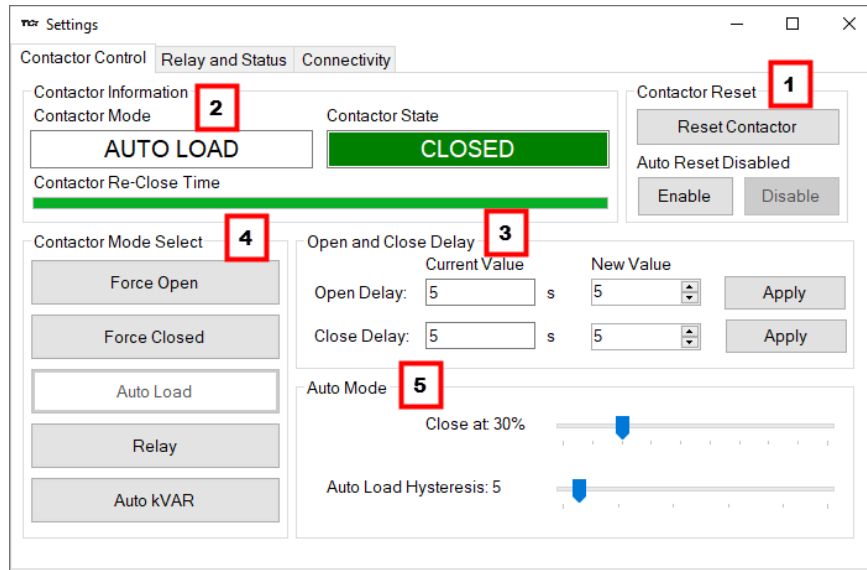

Figure 21: Contactor Control Settings Menu

Table 12: Contactor Control Settings Menu

Designators	Name	Description
1.	Contactor Reset	Allows the user to reset the state of the contactor. By default, the contactor is set to Auto reset the contactor
2.	Contactor information	Explains the contactor control mode and state.
3.	Open and Close Delay	Contactor delays in seconds. After selecting desired new value apply and save settings.
4.	Contactor Mode Select	There are multiple ways to control the contactor. Force Open will leave the contactor in an open state. Force Closed will leave the contactor in a closed state. Auto Load will close the contactor based on the load percentage selected Relay will open/close the contactor depending on relay input configuration. By default, these are disabled. Auto kVAR: Based on the size of the filter the user can adjust their target kVAR settings to open/close the contactor When changing the contactor control state, save settings to make the change final. Saving settings will open the contactor.
5.	Auto Mode	Auto Mode allows the user to adjust the conditions how the contactor closes. Example in figure 7 above the user can close the contactor between 10-100% load.

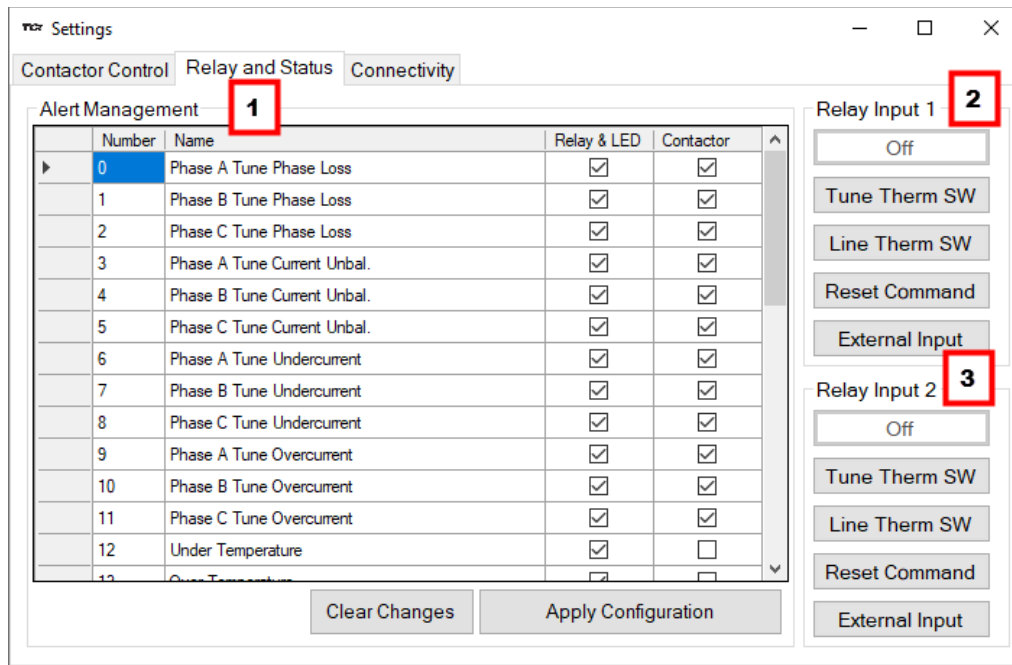

Figure 22: Relay and Status Settings Menu

Table 13: Relay and Status Settings Menu

Designators	Name	Description
1.	Alert Management	<p>Enable and Disable status detections. Depending on which status conditions the user would like to view</p> <p>The column labeled Relay & LED will show the LED pattern of the status detection and send a warning.</p> <p>The column labeled Contactor will open the contactor if the selected status is checked and send the warning.</p> <p>After selecting desired status conditions, the user will need to select apply configuration and save settings to make the change final.</p>
2.	Relay Input 1	<p>Relay Inputs are based on how the board is connected to digital inputs. There is the option of having a thermal switch on the line reactor or tuning reactor. There is also an external control input option.</p> <ul style="list-style-type: none"> J7 of the PCB is configured as Relay input 1 Select desired relay action if applicable and save settings
3.	Relay Input 2	<p>Relay Inputs are based on how the board is connected to digital inputs. There is the option of having a thermal switch on the line reactor or tuning reactor. There is also an external control input option.</p> <ul style="list-style-type: none"> J8 of the PCB is configured as Relay input 1 Select desired relay action if applicable and save settings

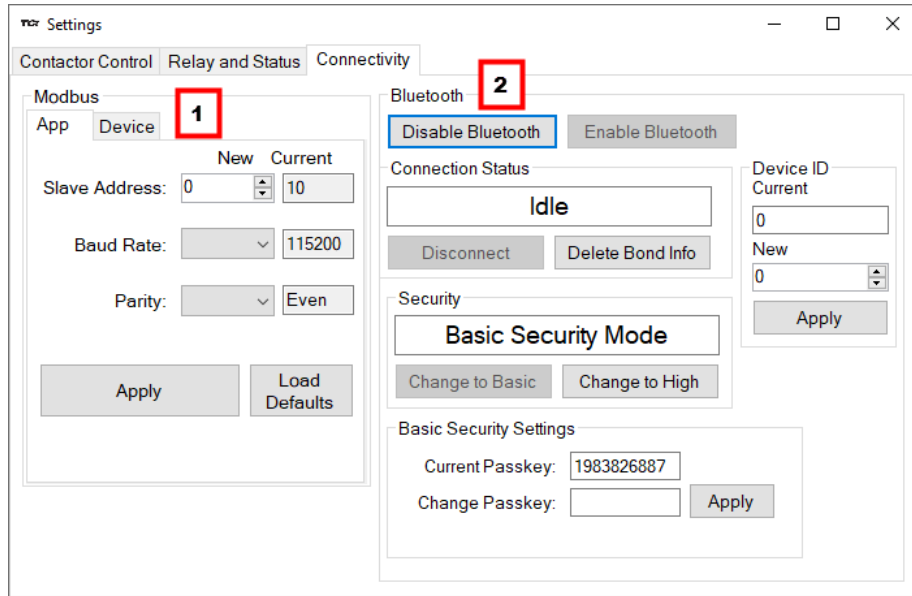
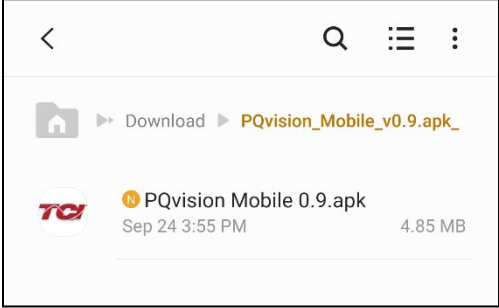
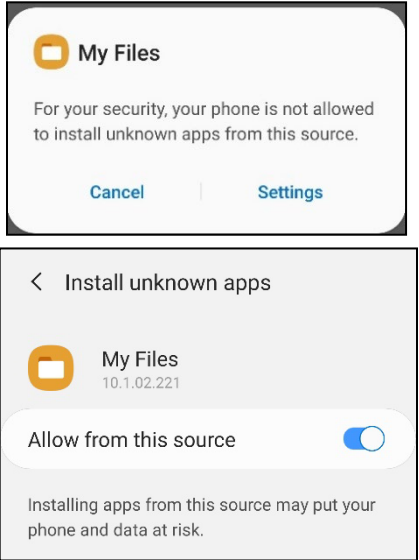
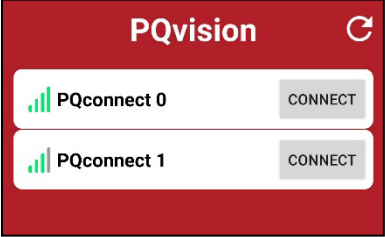

Figure 23: Connectivity Settings Menu

Table 14: Connectivity Settings Menu

Designators	Name	Description
1.	Modbus	Allows the user to change Modbus settings of the App and device . When changing Modbus settings of the device the user will select apply and save settings. Afterwards the user will need to de-energize power to the filter and re-energize the filter.
2.	Bluetooth	<p>By default, Bluetooth will be enabled.</p> <p>Connection status will determine if the device is paired with another device.</p> <p>There are two security modes the user can select.</p> <ul style="list-style-type: none"> High security Mode: has the option of accepting and denying new connections to the device. Basic security Mode: has the option of changing the passkey if the user would like to change from the default values. <p>Save settings after making all selections</p>

PQconnect Bluetooth® App Setup

System Requirements:	Android OS 5.0 or higher Bluetooth 4.2
Installation Instructions	
<ol style="list-style-type: none"> Download the app using your mobile device. Extract the contents of the downloaded zip folder. Tap on the APK file to install. Note: The Android system may require permission to install apps from sources other than the Play Store. 	
<ol style="list-style-type: none"> A warning may appear. Click on settings and click slider for “allow from this source.” 	
Pairing Instructions	
<ol style="list-style-type: none"> Once installed, open the PQvision mobile app. (You must allow PQconnect to use Bluetooth.) Any Bluetooth capable PQconnect devices in range will be automatically displayed on the connection screen. Tap CONNECT next to your target PQconnect device. Each PQconnect device in the app will be identified by their Device ID. A prompt to enter the Bluetooth pairing passkey will pop up automatically. The password is 111111. 	

- Once the passkey is successfully entered, all filter data will be presented.

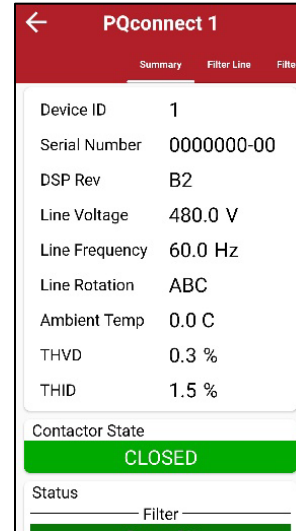

Changing Settings

- Once connected to a PQconnect device, scroll to the bottom of the Summary page, and tap Settings to open the Settings screen
- Change any setting or tap the unlock button to unlock parameter access.

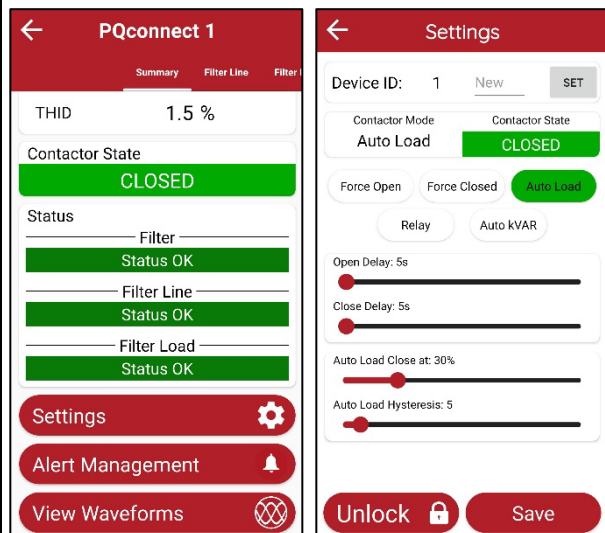

3. If prompted, enter the tech password – **08252014** – to unlock parameter access.

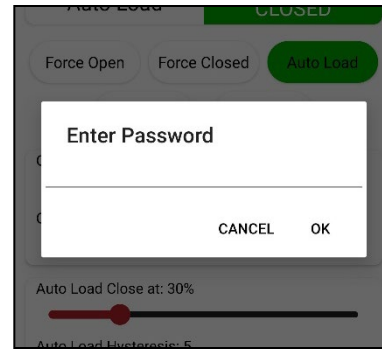

Troubleshooting

1. Ensure Bluetooth is enabled on the Android device.
2. If no PQconnect devices are displayed on the connect screen:
 - Move closer to the unit to ensure the device is in range.
 - Verify that the PQconnect is powered on and that the CPU LED is blinking.
 - Restart the app.
3. If the pairing prompt does not appear automatically:
 - Wait up to 15 seconds for the prompt to appear.
 - Close the app completely and reopen it.

Please report any issues to TCI: tech-support@transcoil.com

Modbus RTU

Introduction

The PQconnect Modbus RTU network communication interface transmits and receives command and status data from the PQconnect Modbus master over a RS-485 serial link. Modbus RTU is a simple serial communications protocol originally developed by Modicon for use with Programmable Logic Controllers (PLCs) in control of industrial devices. Modbus RTU is commonly supported by most PLCs and is an open, royalty-free communications standard.

Wiring and Configuration

The PQconnect implements a Modbus RTU Master/Slave device, which supports two-wire RS-485 signal levels. The PQconnect communication port used for the Modbus RTU interface is connected directly to the PCB. The communication port is located on the side of the PQconnect board.

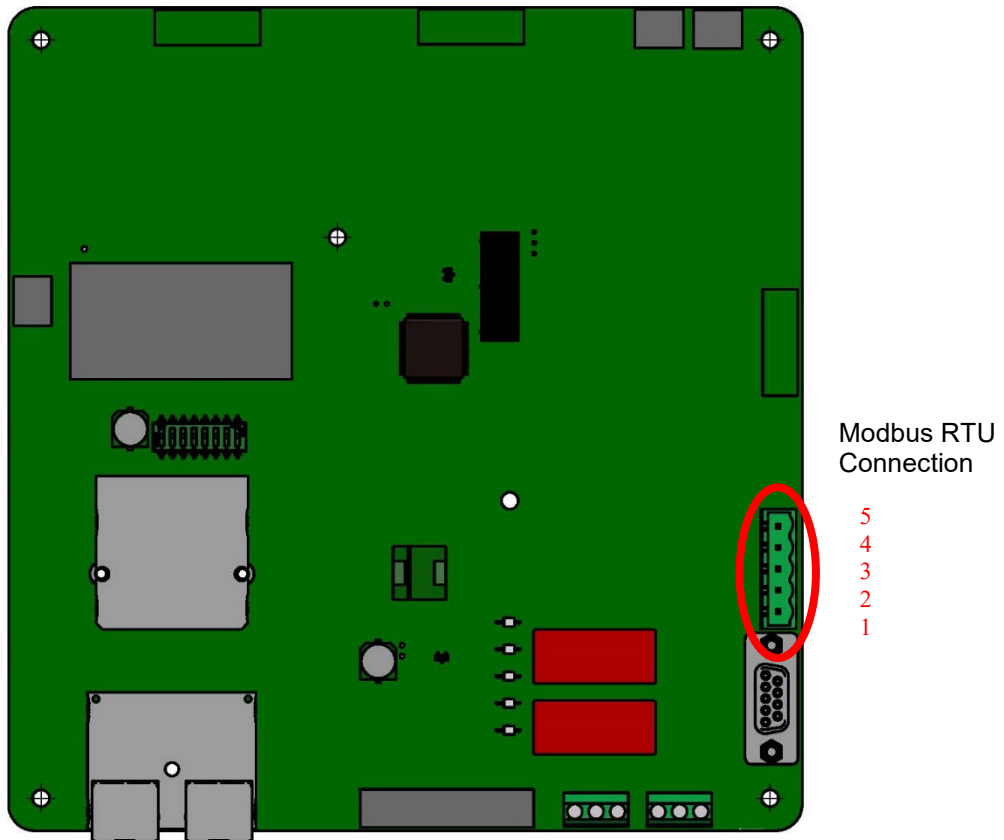

Figure 24 : PQconnect Modbus RTU Connection

Modbus RTU Display Connections

The hardware pinout for the J5 communication header and default settings is shown below.

Table 15: Modbus Connector Pin Definitions

J5 Header Pinout	Signal Name	Signal Type
1	No connect	-
2	D+	RS-485 B (non-inverting)
3	GND	RS-485 SC/G
4	D-	RS-485 A (inverting)
5	No connect	-

The default protocol settings for the RS-485 Modbus RTU interface are shown below.

Table 16: Modbus RTU Protocol Settings

Parameter	Default Value	Units
Baud Rate	115200	Bd
Data Bits	8	Bits
Stop Bits	1	Bits
Parity	Even	-
Slave ID	10	-

The default settings can be modified via the PQconnect system menu. A Tech level access password is required to change these parameters. Ensure the board communicates to the desktop app and then First go to Menu → Settings → Device settings → Change to desired Modbus parameters → Apply → Menu → Save Settings. Finally, go to Menu → Reset PQconnect, this will reboot the PQconnect with the desired Modbus parameters. Note: if the contactor state is closed it will open when clicking the reset command.

The network interface on the PQconnect allows the user to control the contactor and show internal status data of the HarmonicGuard® Passive filter. The PQconnect PC application, PQvision, acts as a ModbusRTU master device for the network interface.

Table 17: Configuration Switches

SW1	Configure Modbus Connection on J5 Header	1 – Enable 560Ω bias resistor on D-.
		2 – Enable 120Ω termination resistor.
		3 - Enable 560Ω pull-up on D+.
J20	Remove jumper to use default Modbus settings on next reboot.	

The input and output registers from the HarmonicGuard® Passive filter are mapped to the Modbus Analog Output Holding Registers starting at address 40000. See Table 18: Network Interface INPUT/Setpoint Register Map through Table 21 for definitions of the input register maps, and Table 25: Network Interface OUTPUT/Feedback Register Map through Table 30: Network Interface OUTPUT/Feedback Register Map for definitions of the output register maps. All input and output registers are two bytes in size and formatted as 16-bit signed integers.

Note: All parameters with an asterisk (*) in the description will require the Tech level access codes parameter key A: 0x007D (125) and parameter key B: 0xEA6E (60014).

Register Map

Write Parameters:

Table 18: Network Interface INPUT/Setpoint Register Map

Parameter Name	I/O Reg Address Offset	Signal Direction to Filter	Data Values and Examples	Description
PARAM_USER_CMD_REQ	500	Input	9 = Save Current Values to Flash 21 = Set User Access 25 = Set Access to Tech Access (access key needs to be set to 0825 for key A and 2014 for key B) 150 = Load Values from Flash 200 = Restore Defaults to Flash	
TRACE_GO_DONE	501	Input	0 = Capture Done 1 = Start Capture	Trace Data points for waveforms
SYS_RESET	502	Input	0 = No Command 1 = Reset Contactor Closed	Reset contactor
PARAM_KEY_A	503	Input	Enter Key A	Read/write parameters under Tech Access
PARAM_KEY_B	504	Input	Enter Key B	
CT_RATIO	505	Input	XXXX:5 where XXXX is the primary turns count of the CT 1000 = 1000:5 Range 5 to 10000	Dual Tuned Circuit Current Transformer (CT) ratios* Note: Only required for units with dual tuned circuits
SYS_CONTROL_MODE	510	Input	0 = Always Open 1 = Always Closed DEFAULT: 2= Auto load 3 = Auto kVAR 4 = External Control Input 5 = No contactor	Contactor control; keep contactor always open/closed, auto turn on/off based on desired load or kVAR, external relay input. *
SYS_AUTO_CONTACTOR_CLOSED	511	Input	DEFAULT: 0 = Disable 1 = Enable	Contactor auto reclose, this will attempt to reclose the contactor after it has been open through a status condition.* Enable through calibration steps if the unit has a contactor.
RATED_CURRENT	520	Input	1000 = 100 A Range: 3 to 1500 A	Filter rated current*
RATED_VOLTAGE	521	Input	4800 = 480Vrms Range: 120 to 690 Vrms	Filter rated voltage*
RATED_FREQUENCY	522	Input	50 = 50 Hz 60 = 60 Hz	Filter rated frequency*

Write Parameters:

Table 19: Network Interface INPUT/Setpoint Register Map

Parameter Name	I/O Reg Address Offset	Signal Direction to Filter	Data Values and Examples	Description
STATUS_FILTER_A_RELAY_ACTION	540	Input	0 = Disabled DEFAULT: 9 Range: 0 to 65535	To Enable desired status detections, enter bit mask from table by converting to decimal
STATUS_FILTER_B_RELAY_ACTION	541	Input	0 = Disabled DEFAULT: 49151 Range: 0 to 65535	If a status is active and the bit corresponding to that status in this mask is set, the relay will be activated. Reference Table 22: Filter Status References*
STATUS_LINE_RELAY_ACTION	542	Input	0 = Disabled DEFAULT: 71 Range: 0 to 65535	To Enable desired status detections, enter bit mask from table by converting to decimal If a status is active and the bit corresponding to that status in this mask is set, the relay will be activated Reference Table 23: Filter Line Status References*
STATUS_FILTER_LOAD_RELAY_ACTION	543	Input	0 = Disabled DEFAULT: 63 Range: 0 to 65535	To Enable desired status detections, enter bit mask from table by converting to decimal If a status is active and the bit corresponding to that status in this mask is set, the relay will be activated. Reference Table 24: Filter Load Status References*
CNT_CLOSE_LOAD_THERSHOLD	570	Input	DEFAULT: 30 = 30% Range: 10 to 100 %	Contactore close threshold in percent rated current*
CNT_CLOSE_LOAD_HYSTERESIS	571	Input	DEFAULT: 5 = 5% Range: 2 to 50 %	Contactore will open when it reaches the hysteresis *
CNT_CLOSE_KVAR_THERSHOLD	572	Input	DEFAULT: 50 = 50 kVAR Range: 0 to 1000 kVAR	Contactore close threshold for kVAR control*
CNT_CLOSE_KVAR_HYSTERESIS	573	Input	DEFAULT: 10 = 10% Range: 5 to 100 %	Contactore will open when it reaches the hysteresis *
CNT_CLOSE_DELAY	574	Input	DEFAULT: 5 = 5 seconds Range: 1 to 3600 seconds	Contactore Close Delay*
CNT_OPEN_DELAY	575	Input	DEFAULT: 5 = 5 seconds Range: 1 to 3600 seconds	Contactore Open Delay*

Write Parameters:

Table 20: Network Interface INPUT/Setpoint Register Map

Parameter Name	I/O Reg Address Offset	Signal Direction to Filter	Data Values and Examples	Description
SYS_PF_STEP_1_KVAR	576	Input	DEFAULT: 5 = 5 kVAR Steps Range: 1 to 200 kVAR	Desired filter kVAR for contactor to enable*
SYS_PF_STEP_2_KVAR	577	Input	DEFAULT: 5 = 5 kVAR Steps Range: 1 to 200 kVAR	Filter Second Tuned Circuit kVAR (Only used for filters with dual tuned circuits) *
CNT_AUTO_RECLOSE_DELAY	580	Input	DEFAULT: 10 = 10 seconds Range: 10 to 3600 seconds	Contactor auto re-close delay time*
CNT_POWER_ON_DELAY	581	Input	DEFAULT: 1 = 1 second Range: 0 to 3600 seconds	System Power on Delay*
CNT_AUTO_RECLOSE_ATTEMPTS	582	Input	DEFAULT: 5 = 5 attempts Range: 1 to 15	Maximum number of contactors auto re-close attempts allowed*
CNT_AUTO_RECLOSE_TIMESPAN	583	Input	DEFAULT: 600 = 600 seconds Range: 300 to 3600 seconds	Maximum number of contactors auto re-close attempts time span*
MB_SLAVE_ADDRESS	600	Input	DEFAULT: = 10 Range: 0 to 255	Modbus RTU Device Slave Address*
MB_BAUD_RATE	601	Input	DEFAULT: 11520 = 115200 baud rate 3840 = 38400 baud rate 960 = 9600 baud rate	Modbus RTU Device Baud Rate*
MB_PARITY	602	Input	0 = None 1 = Odd DEFAULT: 2 = Even	Modbus RTU Device Parity*
SYS_INPUT_1_CONFIG	610	Input	DEFAULT: 0 = Disabled 1 = Tuning Reactor Thermal Switch Input 2 = Line Reactor Thermal Switch Input 3 = Reset Command 4 = External Control Input	Customer external control input*
SYS_INPUT_2_CONFIG	611	Input	DEFAULT: 0 = Disabled 1 = Tuning Reactor Thermal Switch Input 2 = Line Reactor Thermal Switch Input 3 = Reset Command 4 = External Control Input	Customer external control inputs*
PHASE_ROTATION	693	Input	DEFAULT: 1 = ABC Rotation Expected 2 = ACB Rotation Expected	Filter expected input phase orientation*
SYS_MAG_CAL_ENABLE	700	Input	0 = Disable 1 = Enable	System magnitude Calibration
SYS_I_LINE_CAL_A	710	Input	1000 = 100A Range: 3 to 1500	Input current measured on A phase of the filter* Note: For calibration setup

Write Parameters:

Table 21: Network Interface INPUT/Setpoint Register Map

Parameter Name	I/O Reg Address Offset	Signal Direction to Filter	Data Values and Examples	Description
SYS_I_LINE_CAL_B	711	Input	1000 = 100 A Range: 3 to 1500 A	Input current measured on B phase of the filter* Note: For calibration setup
SYS_I_LINE_CAL_C	712	Input		Input current measured on C phase of the filter* Note: For calibration setup
SYS_I_TUNE_CAL_A	713	Input		Tune circuit current measured on A phase of the filter* Note: For calibration setup
SYS_I_TUNE_CAL_B	714	Input		Tune circuit current measured on B phase of the filter* Note: For calibration setup
SYS_I_TUNE_CAL_C	715	Input		Tune circuit current measured on C phase of the filter* Note: For calibration setup
SYS_MAG_CAL_TOL	716	Input	0 = Calibration Command not active 1 = Enter calibration state	System mag calibration state
MODEL_NUM	902	Input	Set to 203	Filter Model number

Table 22: Filter Status References

16-bit values	
Register B	
Bit	Status Detection
0	TUNE_PHASE_LOSS_A
1	TUNE_PHASE_LOSS_B
2	TUNE_PHASE_LOSS_C
3	TUNE_BALANCE_LOSS_A
4	TUNE_BALANCE_LOSS_B
5	TUNE_BALANCE_LOSS_C
6	TUNE_UNDERCURRENT_A
7	TUNE_UNDERCURRENT_B
8	TUNE_UNDERCURRENT_C
9	TUNE_OVERCURRENT_A
10	TUNE_OVERCURRENT_B
11	TUNE_OVERCURRENT_C
12	UNDER_TEMP
13	OVER_TEMP
14	CPU_ERROR
15	TUNE_REACTOR_THERMAL_SW
Register A	
0	RECLOSE_LIMIT
1	NCP_FAULT_A
2	NCP_FAULT_B
3	LINE_REACTOR_THERMAL_SW

Table 23: Filter Line Status References

16-bit values	
Bit	Status Detection
0	PHASE_LOSS_A
1	PHASE_LOSS_B
2	PHASE_LOSS_C
3	OVERVOLTAGE_A
4	OVERVOLTAGE_B
5	OVERVOLTAGE_C
6	FILTER_FREQ_MISMATCH
7	HIGH_VOLTAGE_THD
8	LINE_PHASE_ROTATION

Table 24: Filter Load Status References

16-bit values	
Bit	Status Detection
0	BALANCE_A
1	BALANCE_B
2	BALANCE_C
3	OVERCURRENT_A
4	OVERCURRENT_B
5	OVERCURRENT_C

Read Parameters:

Table 25: Network Interface OUTPUT/Feedback Register Map

Parameter Name	I/O Reg Address Offset	Signal Direction from Filter	Data Values and Examples	Description
DSP_SW_VER	12	Output	Two 8bit ASCII Characters 0x0141 = ASCII for "A1"	Software revision code for processor.
DSP_MODEL_NUM_RO	13	Output	203 = HGP Kit	System Model Number
LINE_VOLTAGE	20	Output	4800 = 480 Vrms Range: 120 to 690 Vrms	Filter input voltage
LINE_FREQ	21	Output	60 = 60 Hz 50 = 50 Hz	Filter input frequency
LINE_ROT	22	Output	1 = ABC Rotation Expected 2 = ACB Rotation Expected	Filter input phase orientation
V_LINE_AB_RMS	30	Output	Volts RMS 4800 = 480 Vrms Range: 0 to 1000 Vrms	Source Utility Line Phase to Phase Voltage (A-B)
V_LINE_BC_RMS	31	Output		Source Utility Line Phase to Phase Voltage (B-C)
V_LINE_CA_RMS	32	Output		Source Utility Line Phase to Phase Voltage (C-A)
V_LOAD_AB_RMS	50	Output		Filter Output Phase to Phase Voltage (A-B)
V_LOAD_BC_RMS	51	Output		Filter Output Phase to Phase Voltage (B-C)
V_LOAD_CA_RMS	52	Output		Filter Output Phase to Phase Voltage (C-A)
V_TUNE_A_RMS	70	Output		Filter Tuned Circuit Phase A Voltage
V_TUNE_B_RMS	71	Output		Filter Tuned Circuit Phase B Voltage
V_TUNE_C_RMS	72	Output		Filter Tuned Circuit Phase C Voltage)
I_LINE_A_RMS	36	Output		Filter Input Current Phase A
I_LINE_B_RMS	37	Output		Filter Input Current Phase B
I_LINE_C_RMS	38	Output		Filter Input Current Phase C
I_LOAD_A_RMS	56	Output		Filter Output Current Phase A
I_LOAD_B_RMS	57	Output		Filter Output Current Phase B
I_LOAD_C_RMS	58	Output		Filter Output Current Phase C
I_TUNE_A_RMS	76	Output		Filter Tuned Circuit Current Phase A
I_TUNE_B_RMS	77	Output		Filter Tuned Circuit Current Phase B
I_TUNE_C_RMS	78	Output		Filter Tuned Circuit Current Phase C
I_LINE_A_THD	39	Output		% THID 50 = 5.0% THID
I_LINE_B_THD	40	Output	Phase B THID for line current feedback	
I_LINE_C_THD	41	Output	Phase C THID for line current feedback	
I_LOAD_A_THD	59	Output	Phase A THID for load current feedback	
I_LOAD_B_THD	60	Output	Phase B THID for load current feedback	
I_LOAD_C_THD	61	Output	Phase C THID for load current feedback	

Read Parameters:

Table 26: Network Interface OUTPUT/Feedback Register Map

Parameter Name	I/O Reg Address Offset	Signal Direction from Filter	Data Values and Examples	Description
I_TUNE_A_THD	79	Output	% THID 50 = 5.0% THID	Phase A THID for tuned circuit current feedback
I_TUNE_B_THD	80	Output		Phase B THID for tuned circuit current feedback
I_TUNE_C_THD	81	Output		Phase C THID for tuned circuit current feedback
V_LINE_AB_THD	33	Output	% THVD 50 = 5.0% THVD	A-B Phase to Phase THVD
V_LINE_BC_THD	34	Output		B-C Phase to Phase THVD
V_LINE_CA_THD	35	Output		C-A Phase to Phase THVD
V_LOAD_AB_THD	53	Output		A-B Phase to Phase THVD
V_LOAD_BC_THD	54	Output		B-C Phase to Phase THVD
V_LOAD_CA_THD	55	Output		C-A Phase to Phase THVD
V_TUNE_A_THD	73	Output		Tuning circuit A Phase THVD
V_TUNE_B_THD	74	Output		Tuning circuit B Phase THVD
V_TUNE_C_THD	75	Output		Tuning circuit C Phase THVD
I_LINE_A_TDD	42	Output	% iTDD 50 = 5.0% iTDD	Filter input total Demand Distortion Phase A iTDD
I_LINE_B_TDD	43	Output		Filter input total Demand Distortion Phase B iTDD
I_LINE_C_TDD	44	Output		Filter input total Demand Distortion Phase C iTDD
SYS_POWER_ON	201	Output	0 = Power Off 1 = Power On	Indicates if the filter has input power available
SYS_STATUS_OK	202	Output	0 = Filter is operating 1 = Filter has indicated status warning	Indicates filters status
SYS_AT_CAPACITY	203	Output	0 = Nominal 1 = At Capacity	Indicates if the filter is running at its maximum current capacity
T_AMBIENT	204	Output	250 = 25.0 C°	Filter internal ambient temperature
SYS_STATE	256	Output	0,1 = Initialization 2 = Power on Delay 3 = Unit Self State Inhibit 4 = Reset 5 = Force Open Contactor 6 = Force Close Contactor 7 = Auto Load Open 8 = Auto Load Close 9 = Auto kVAR Close 10 = Auto kVAR Open 11 = External Open 12 = External Close 13 = No Contactor 14 = Contactor Closed Inhibited 15 = Calibrate offsets 16 = Calibrate Magnitude 17 = No Communication 18 = Communication configuration 19 = Calibrate Check	Indicates the present state of the system state machine.

Read Parameters:

Table 27: Network Interface OUTPUT/Feedback Register Map

Parameter Name	I/O Reg Address Offset	Signal Direction from Filter	Data Values and Examples	Description
P_LOAD_APPARENT_TOTAL	120	Output	100 = 100 kVA Range: 0 to 1000 kVA	Total Filter output apparent power
P_LOAD_REAL_TOTAL	121	Output	100 = 100kW Range: 0 to 1000 kW	Total Filter output real power
P_LOAD_REACTIVE_TOTAL	122	Output	100 = 100 kVAR Range: 0 to 1000 kVAR	Total Filter output reactive power; Negative number indicates inductive power. Positive number indicates capacitive power
P_LOAD_POWER_FACTOR	123	Output	1,000 = 1.00 Unity PF -95 = 0.95 Lagging PF 95 = 0.95 Leading PF Range: -99 to 1000	Filter output Displacement Power Factor - Negative values indicate lagging power factor
I_LINE_A_HARM_1	140	Output	Fundamental = 1000 = 100% Range: 0 to 100 %	Filter input phase A spectrum data. Data points from the fundamental to the 25 th harmonic. If the user would like the full spectrum data points up to the 50 th harmonic; the user will have to run the full data capture command.
I_LINE_A_HARM_3	141	Output		
I_LINE_A_HARM_5	142	Output		
I_LINE_A_HARM_7	143	Output		
I_LINE_A_HARM_11	144	Output		
I_LINE_A_HARM_13	145	Output		
I_LINE_A_HARM_17	146	Output		
I_LINE_A_HARM_19	147	Output		
I_LINE_A_HARM_23	148	Output		
I_LINE_A_HARM_25	149	Output		
I_LINE_B_HARM_1	160	Output	Fundamental = 1000 = 100% Range: 0 to 100 %	Filter input phase B spectrum data. Data points from the fundamental to the 25 th harmonic. If the user would like the full spectrum data points up to the 50 th harmonic; the user will have to run the full data capture command.
I_LINE_B_HARM_3	161	Output		
I_LINE_B_HARM_5	162	Output		
I_LINE_B_HARM_7	163	Output		
I_LINE_B_HARM_11	164	Output		
I_LINE_B_HARM_13	165	Output		
I_LINE_B_HARM_17	166	Output		
I_LINE_B_HARM_19	167	Output		
I_LINE_B_HARM_23	168	Output		
I_LINE_B_HARM_25	169	Output		
I_LINE_C_HARM_1	180	Output	Fundamental = 1000 = 100% Range: 0 to 100 %	Filter input phase C spectrum data. Data points from the fundamental to the 25 th harmonic. If the user would like the full spectrum data points up to the 50 th harmonic; the user will have to run the full data capture command.
I_LINE_C_HARM_3	181	Output		
I_LINE_C_HARM_5	182	Output		
I_LINE_C_HARM_7	183	Output		
I_LINE_C_HARM_11	184	Output		
I_LINE_C_HARM_13	185	Output		
I_LINE_C_HARM_17	186	Output		
I_LINE_C_HARM_19	187	Output		
I_LINE_C_HARM_23	188	Output		

I_LINE_C_HARM_25	189	Output		
------------------	-----	--------	--	--

Read Parameters:

Table 28: Network Interface OUTPUT/Feedback Register Map

Parameter Name	I/O Reg Address Offset	Signal Direction from Filter	Data Values and Examples	Description	
BOARD_TEMP	204	Output	Range -40C to 75C	Board will give a status condition of overtemp if it exceeds 75C or undertemp if the temperature descends past -40C	
CNT_CLOSED	200	Output	0 = Contactor Closed 1 = Contactor Open	Indicates the status of the Filters tuned circuit contactor.	
STATUS_FILTER_A	210	Output	0 = Disabled To Enable desired status detections, enter bit mask from table by converting to decimal Range: 0 to 65535	Reference Table 22: Filter Status References.	
STATUS_FILTER_B	211	Output			
STATUS_FILTER_A_RELAY_ACTION_RO	230	Output			
STATUS_FILTER_B_RELAY_ACTION_RO	231	Output			
STATUS_FILTER_A_CNT_ACTION_RO	240	Output			
STATUS_FILTER_B_CNT_ACTION_RO	241	Output			
STATUS_LINE	212	Output		Reference Table 23: Filter Line Status References.	
STATUS_LINE_RELAY_ACTION_RO	232	Output			
STATUS_LINE_CNT_ACTION_RO	242	Output			
STATUS_FILTER_LOAD	213	Output			Reference Table 24: Filter Load Status References.
STATUS_FILTER_LOAD_RELAY_ACTION_RO	233	Output			
STATUS_FILTER_LOAD_CNT_ACTION_RO	243	Output			
SYS_CONTROL_MODE_RO	250	Output	0 = Always Open 1 = Always Closed 2 = Auto load 3 = Auto kVAR 4 = External Control Input 5 = No contactor	Contactor control; keep contactor always off/on, auto turn on/off based on desired load percentage or kVAR, external relay input.	
TRACE_GO_DONE_RO	251	Output	0 = Capture Done 1 = Start Capture	Indicates waveform data	
SYS_AUTO_FAULT_RESET_RO	252	Output	0 = Disabled 1 = Enabled	Displays auto contactor reset	
CT_RATIO_RO	253	Output	XXXX:5 where XXXX is the primary turns count of the CT 1000 = 1000:5 Range 5 to 10000	Dual Turned Circuit Current Transformer (CT) ratios Note: Only required for units with two tuned circuits	
PARAM_ACCESS_LEVEL_RO	254	Output	0 = Base access 1 = Tech access	Level of parameter access to read and/or change parameter inputs	

Read Parameters:

Table 29: Network Interface OUTPUT/Feedback Register Map

Parameter Name	I/O Reg Address Offset	Signal Direction from Filter	Data Values and Examples	Description
CNT_STATUS	257	Output	0 = Contactor Closed 1 = Contactor Open	Contactor command status
RATED_VOLTAGE_RO	260	Output	4800 = 480Vrms Range: 120 to 690 Vrms	Filter rated voltage
RATED_CURRENT_RO	261	Output	1000 = 100 A Range: 3 to 1500 Arms	Filter rated current
RATED_FREQUENCY	262	Output	50 = 50 Hz 60 = 60 Hz	Filter rated frequency
CNT_CLOSE_LOAD_THRESHOLD_RO	270	Output	DEFAULT: 30 = 30% Range: 10 to 100 %	Contactor close threshold based on the load *
CNT_CLOSE_LOAD_HYSTERESIS_RO	271	Output	DEFAULT: 5 = 5% Range: 2 to 50 %	Contactor will open when it reaches the hysteresis percentage
CNT_CLOSE_KVAR_THRESHOLD_RO	272	Output	100 = 100 kVAR Range: 0 to 1000 kVAR	Contactor close threshold for kVAR control*
CNT_CLOSE_KVAR_HYSTERESIS_RO	273	Output	DEFAULT: 10 = 10% Range: 5 to 100 %	Contactor will open when it reaches the hysteresis percentage
CNT_CLOSE_DELAY_RO	274	Output	DEFAULT: 5 = 5 seconds Range: 1 to 3600 seconds	Displays set value of contactor closed delay time
CNT_OPEN_DELAY_RO	275	Output	DEFAULT: 5 = 5 seconds Range: 1 to 3600 seconds	Displays set value of contactor open delay time
CNT_AUTO_RECLOSE_DELAY_RO	280	Output	DEFAULT: 300 = 300 seconds Range: 120 to 3600 seconds	Indicates contactor auto reclose delay time
CNT_POWER_ON_DELAY_RO	281	Output	DEFAULT: 0 = 0 seconds Range: 0 to 3600 seconds	Indicates contactors power on delay time
CNT_AUTO_RECLOSE_ATTEMPS_RO	282	Output	DEFAULT: 5 = 5 attempts Range 1 to 15	Indicates set value of attempts
CNT_AUTO_RECLOSE_TIMESPAN_RO	283	Output	DEFAULT: 1800 = 1800 seconds Range: 300 to 3600 seconds	Displays timespan of contactor to reclose
CNT_AUTO_RECLOSE_TIMER_RO	284	Output		Displays count down time for contactor to reclose
SYS_CNT_MIN_OFF_TIME_RO	285	Output	DEFAULT: 60 = 60 seconds Range: 30 to 300 seconds	Minimum time off for contactor re-closures
SYS_CNT_MIN_OFF_TIMER	286	Output		Displays count down time for contactor re-closures
MB_SLAVE_ADDRESS_RO	300	Output	DEFAULT: = 10 Range: 0 to 255	Modbus slave address
MB_BAUD_RATE_RO	301	Output	960 = 9600 moderate 3840 = 38400 baud rate DEFAULT: 11520 = 115200 baud rate	Modbus baud rate

Read Parameters:

Table 30: Network Interface OUTPUT/Feedback Register Map

Parameter Name	I/O Reg Address Offset	Signal Direction from Filter	Data Values and Examples	Description
MB_PARITY_RO	302	Output	0 = None 1 = Odd DEFAULT: 2 = Even	Modbus Parity
RELAY_INPUT_STATUS	320	Output	0 = Enabled DEFAULT: 1 = Disabled	Digital relay status
RELAY_INPUT_1_CONFIG_RO	321	Output	DEFAULT: 0 = Disabled 1 = Tuning Reactor Thermal Switch Input 2 = Line Reactor Thermal Switch Input 3 = Reset Command 4 = External Control Input	Customer external control inputs
RELAY_INPUT_2_CONFIG_RO	322	Output	DEFAULT: 0 = Disabled 1 = Tuning Reactor Thermal Switch Input 2 = Line Reactor Thermal Switch Input 3 = Reset Command 4 = External Control Input	Customer external control inputs
SYS_SERIAL_NUM_2_RO	350	Output	Parameter contains UUUU in the UUUULLLL-NN serial number format.	Unit serial number section - upper 16 bits of 32-bit unit job number
SYS_SERIAL_NUM_1_RO	351	Output	Parameter contains LLLL in the UUUULLLL-NN serial number format.	Unit serial number section - lower 16 bits of 32-bit unit job number
SYS_SERIAL_NUM_0_RO	352	Output	Parameter contains NN in the UUUULLLL- NN serial number format.	Unit serial number section - two-digit unit number
SYS_NULL_STAT	400	Output	0 = Not calibrated 1 = Unit is calibrated	System auto null status *
SYS_NULL_TMR	401	Output	0 = Unit is not calibrating 1 = Unit is Calibrating	System null timer; indicates whether the unit is calibrating*
SYS_INT_HB	402	Output	Range: 0 to 65535	Processor internal heartbeat. Internal counter that counts up and rolls over to zero used to verify processor clock operation. *
SYS_BG_HB	403	Output	Range: 0 to 65535	Processor background heartbeat. Internal counter that counts up and rolls over to zero used to verify processor clock operation *

RS485 to USB Serial Converter

Example Application Using “Simply Modbus Master 8.1.0”

The Modbus RTU network interface port is configured for RS-485 signal levels. The following example uses an RS-485 to USB converter to connect the PQconnect to a laptop PC running the Modbus RTU master application. The picture below shows an example “B&B SmartWorx, Inc Model: USPTL4” model RS-422/485 converter. As another alternative RS-485 converter there is WINGONEER USB 2.0 to RS485 Serial Converter Adapter CP2104.



Figure 25: B&B SmartWorx, Inc Model: USPTL4 model RS-422/485 converter

With the example above shown in Figure 24, the user can make proper connections from the RS485 converter to the PQconnect J5 communication header. Table 31 below indicates the positions where the RS485 connections lead to. Please ensure the correct dip switch settings are applied before installing.

Table 31: USPTL4 to J5 Header Connections

USPTL4 Pin Out	J5 Header Pinout	Wire Harness (TCI PN: 31617)
-	No connect	-
TDA (-)	A (Pin 4)	Red
GND	GND (Pin 3)	Black
TDB(+)	B (Pin 4)	White
-	No connect	-

USPTL4 RS485 Converter Dip Switch settings

All four switches of the B&B converter from the factory should be set to the ON position and should look like the following.

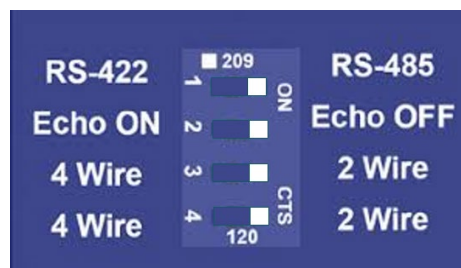

Figure 26: Dip Switch settings

Example Setup Instructions to Read Data from the PQconnect Unit:

- Connect the cable to the communication header “J5”
- Connect USB end to the computer
 - Determine the assigned COM port number for the RS-485 to USB converter using the computer device manager control panel.
 - The converter used in this example typically enumerates between the range of COM5 to COM20 on a standard laptop computer running the Microsoft windows operating system
- Open the Simply Modbus Master software
 - Can be downloaded from the link below:
 - <http://www.simplymodbus.ca/manual.htm>
 - The trial version of the software is free and fully functional for this task hence no License key is necessary
- Next, configure the fields in Figure 27 shown below. These are again the default settings of the PQconnect COM port.
 - Note: The “notes” section of the display data registers are filled in manually

Example Setup Instructions to Write Data to the PQconnect Unit:

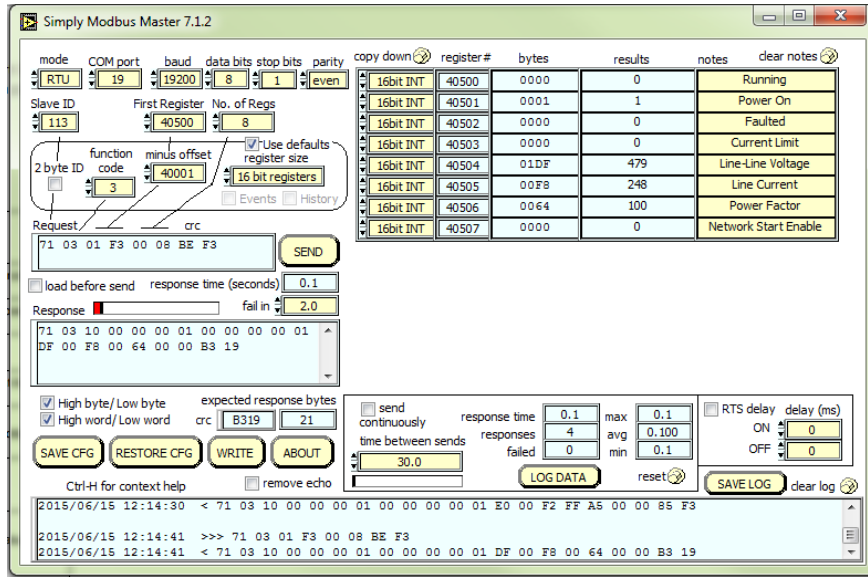

Figure 27: Example Setup Instructions

- In order to control the contactor in the unit, first the user will need tech access by writing the parameter keys
 - Navigate to the settings menu and then select force open or force close button.
 - The contactor state box will indicate if the contactor is open or closed.
- Next, select the “WRITE” button on the screen shown above.
 - The screen below will be shown. Configure the fields as shown in Figure 28.

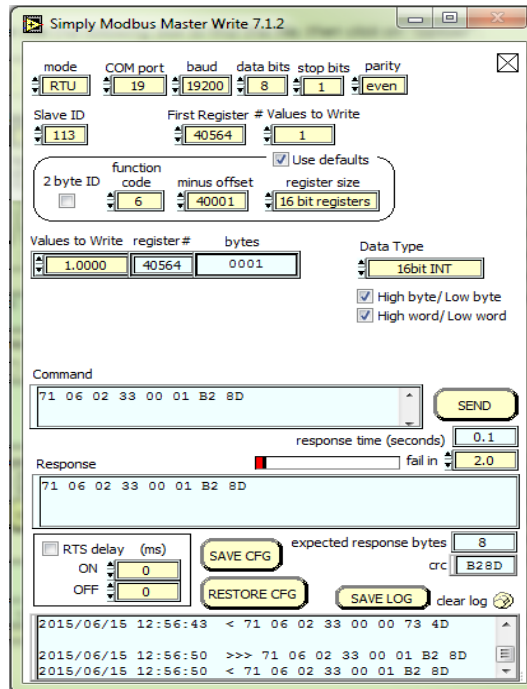



Figure 28: WRITE Configure Fields

- Select “0” in the field “Values to Write” to close the contactor or “1” to open the contactor.

6.0 Troubleshooting

HarmonicGuard® Passive Filter Status Warning

If the desktop interface indicates a status warning, hover over the status detection for a brief description. Depending on the condition there are multiple ways to try and clear the status warnings.

<p>Warning</p> 	<p>Only qualified electricians should carry out all electrical installation & maintenance work on the HGP.</p> <p>Disconnect all sources of power to the and connected equipment before working on the equipment. Do not attempt any work on a powered HGP.</p> <p>This HGP unit contains high voltages and capacitors. Wait at least five minutes after disconnecting power from the filter before attempting to service the conditioner. Check for zero voltage between all terminals on the capacitors. Also, check for zero voltage between all phases of the input and output lines. All maintenance and troubleshooting must be done by a qualified electrician. Failure to follow standard safety procedures may result in death or serious injury.</p> <p>Unless an external disconnect means has been provided everything ahead of the filter circuit breaker, including the reactors, will still be energized.</p>
---	---

Receiving Inspection

The connectivity board has been thoroughly inspected and functionally tested at the factory and carefully packaged for shipment. After receiving the unit, immediately inspect the shipping container and report any damage to the carrier that delivered the unit. Verify that the part number of the unit received is the same as the part number listed on the purchase order.

Connectivity Board Problem

The HGP is comprised of five major components; the PQconnect connectivity board, the line reactor, the tuning reactor, the contactor and the capacitors. The PQconnect PCB contains diagnostic LEDs. The locations of the LEDs are shown in Figure 29 and their functions are listed in Table 32: LED Functions.

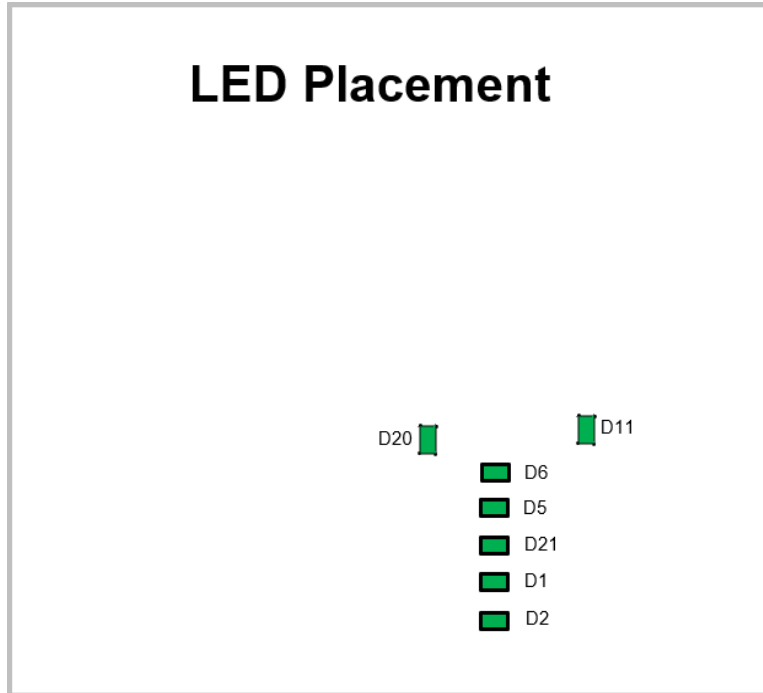

Figure 29: PQconnect LED Placements

Table 32: LED Functions

LED	LED Color	Description
D1	Green	Tuned circuit contactor control 1
D2	Green	Optional 2 nd Status LED/ tuned circuit contactor control 2
D5	Green	Status LED
D6	Green	Microprocessor Status LED
D11	Green	RS485 Communication is active
D20	Green	24V LED
D21	Green	5V LED

Note: Status LED's will blink according to the filter status. The microprocessor status LED will blink 1hz if the filter is okay, however if there has been an alert the LED will blink according to the status detection. . It will initially start with a slow blink (2 = filter lower, 3 = filter upper, 4 = filter input, 5 = filter load) then blink fast depending on the status code.

The table below shows the specified blinks for each status condition.

Table 33: Specified Blinks for Each Status Condition

Status Condition	Group (Slow blinks)	LED Specifier (Fast Blinks)
Tune Phase A Loss	2	1
Tune Phase B Loss		2
Tune Phase C Loss		3
Tune Balance Loss Phase A		4
Tune Balance Loss Phase B		5
Tune Balance Loss Phase C		6
Tune Undercurrent Phase A		7
Tune Undercurrent Phase B		7
Tune Undercurrent Phase C		9
Tune Overcurrent Phase A		10
Tune Overcurrent Phase B		11
Tune Overcurrent Phase C		12
Under Temperature		13
Over Temperature		14
CPU Error		15
Tune Reactor Thermal		16
Reclose Limit	3	1
Line Reactor Thermal		4
Filter Line Phase A Loss	4	1
Filter Line Phase B Loss		2
Filter Line Phase C Loss		3
Filter Line Overvoltage Phase A		4
Filter Line Overvoltage Phase B		5
Filter Line Overvoltage Phase C		6
Filter Line Frequency Mismatch		7
Filter Line High THVD		8
Filter Line Phase Rotation	9	
Filter Load Phase A imbalance	5	1
Filter Load Phase B imbalance		2
Filter Load Phase C imbalance		3
Filter Load Phase A Overcurrent		4
Filter Load Phase B Overcurrent		5
Filter Load Phase C Overcurrent		6

Communication Problems

- J5 Communication Header
 - With the power de-energized from the filter, check wiring leading to J5 header
 - If the user is using a different RS485 converter than the example above please follow the datasheet for the A & B signals and ground for proper setup
- Ensure the drivers of the RS485 to USB converter is installed to the computer. Simple way of checking while the RS485 converter connected is to go to the device manager and scroll down to ports. There will be a device connected to the ports. If your device is not listed, the user will need to install the correct drivers of the RS485 converter.

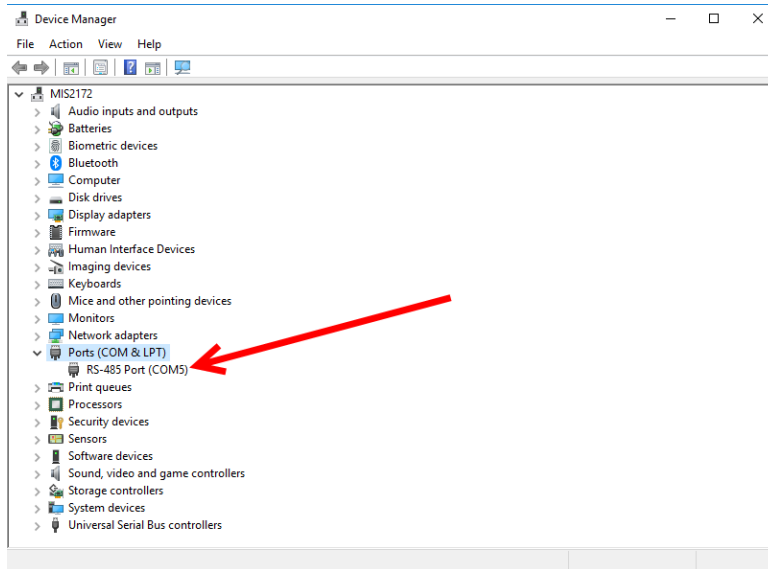

- PQvision App Load Defaults
 - With the RS485 Converter connected to the circuit board
 - Energize Filter
 - Open PQvision desktop interface
 - Go to **Settings**

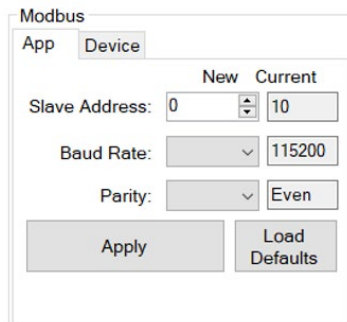

- Select Load Defaults
- Select Apply

- Default Modbus settings should be applied. Try connecting to the COM port
 - If this doesn't work de-energize power to the filter and try flipping the A and B signal wires leading to the J5 header of the circuit board.
- Hard Reset Modbus settings (Worst Case)
 - To perform a hard reset of Modbus settings the user will need to remove jumper J20 with the power de-energized from the filter. Once the jumper is removed connect the RS485 converter to J5 header and energize filter.
 - Open PQvision
 - Confirm there is a COM port under Communication and try to connect
 - Note if connecting to the COM port does not work, try flipping the A and B signal wires leading to the J5 header of the circuit board
 - Load defaults and apply
 - Save settings and de-energize filter
 - Connect jumper to J20
 - Energize filter
 - Try connecting to PCB
 - All modbus settings should be set to default settings at this point
 - If the board doesn't connect after trying hard reset contact TCI Tech-Support

Debug Status Conditions

Based on the status condition there are various ways a status can appear. Some status conditions are not critical are used as warnings. Before investigating the filter internally, disengage supply voltage to the filter. If problems persist after initial checks, please contact TCI Tech-Support.

Table 34: Status Conditions

Status Condition	Description	Debug/ Resolution
Filter Tune Phase Loss A, B, or C	Phase loss in one of the phases of the filter tune circuit	Check fuses of the tune circuit Check power connections of the tune circuit Check voltage sense wires leading to the board and reactor, make sure they are properly connected
Filter Tune balance Loss Phase A, B, or C	Filter tune imbalance on one of the phases.	Check power connections of the tune circuit Check voltage sense wires leading to the board and reactor, make sure they are properly connected
Filter Tune Undercurrent Phase A, B, or C	Filter tune current is seeing less current than expected	Make sure you have the right size filter selected for the application. Based on the model number the filter will expect a certain amount of current in the tune circuit. Check voltage sense wires leading to the board and reactor, make sure they are properly connected
Filter Tune Overcurrent Phase A, B, or C	Filter tune current is seeing more current than expected	Make sure you have the right size filter selected for the application. Based on the model number the filter will expect a certain amount of current in the tune circuit. Check voltage sense wires leading to the board and reactor, make sure they are properly connected
Under Temperature	Filter ambient temperature is operating below threshold (-40C)	Check fuses of control power transformers leading to the heater.
Over Temperature	Filter ambient temperature is operating above threshold (+75C)	Check fuses of control power transformers leading to fans. Make sure fans are operating
CPU Error	Processor Malfunction	Power cycle unit and if issue persists upgrade firmware and/or contact tech support
Reactor Thermal Switch	Reactor Thermal Switch is open	Check thermal switch connections to PCB and check if thermal switch is damaged
Reclose Limit	Contactors Reclose is at its limit	The contactor will close for many reasons if you are experiencing any issues with the contactor view Table 35: Contactor Codes for further details.
Filter Line Phase Loss A, B, or C	Filter line phase loss	Check fused disconnect or circuit breaker upstream of the filter. Check input power connections to the filter
Filter Line Overvoltage Phase A, B, or C	Filter overvoltage on one of the phases.	Check input power connections to filter Check voltage setpoint, based on the filter model number entered the filter is expecting a certain input voltage.
Filter Frequency Mismatch	Line Frequency does not match program setpoint	During the user calibration the filter frequency is set based on the model number entered. Verify the frequency
Filter Line High THVD	High voltage Total Harmonic Distortion	Check fuses leading to filter capacitors If fuses are not blown, measure Capacitance of the capacitors Check power connections of the unit
Filter Line Rotation	Filter phase rotation	Phase rotation differs from default setting. Status condition can be turned off or switched to ACB
Filter Load Phase Imbalance A, B, or C	Phase imbalance between the phases	Check power connections of the line side of the filter Check voltage sense wires leading to the board and reactor, make sure they are properly connected
Filter load Overcurrent Phase A, B, or C	Filter output current is more than expected	Make sure you have the right size filter selected for the application. Based on the model number the filter will expect a certain amount of current in the tune circuit. Check voltage sense wires leading to the board and reactor, make sure they are properly connected

Contactor Problem

Parameter 257 Contactor Status can be used to determine why the PQconnect board is not closing the tuned circuit contactor. The following tables define what a specific contactor status code value means and list potential resolutions to allow the contactor to close.

Note that some setpoint parameters require tech level parameter access to be viewable over the serial connection or via the PQvision software. The tech level parameter access key is available above.

Table 35: Contactor Codes

Code	Description	Resolution
1	Contactors is already commanded closed.	The PQconnect is presently commanding the tuned circuit contactor to be closed. If the contactor is not closing check the wiring from the PCB J11 control relay header to the tuned circuit contactor and 120VAC control power transformer.
2	Contactors is open due to a Force Open control mode.	The present contactor control mode (feedback parameter 250) is set to Force Open. This control mode will keep the contactor open at all times. To change the control mode see setpoint parameter 510.
3	Contactors is open due to an automatic load control mode and insufficient load Amps to close the contactor.	The present contactor control mode (feedback parameter 250) is set to Automatic Load Control and the measured filter load Amps are below the configured close threshold (feedback parameter 270). The contactor will be closed when the filter load Amps exceed the close threshold. The contactor close filter load current threshold can be adjusted via setpoint parameter 570. The contactor close threshold parameter is scaled in units of percent rated nameplate filter current.
4	Contactors is open due to an automatic kVAR control mode.	The present contactor control mode (feedback parameter 250) is set to Automatic kVAR Control and closing the contactor would exceed the max allowable kVAR flowing to the source to be exceeded (feedback parameter 272). The contactor will be closed when the inductive load kVAR minus the capacitive tuned circuit kVAR of the passive filter is below the max kVAR setpoint parameter. The max kVAR setpoint parameter can be adjusted via setpoint 572.
5	Contactors is open due to an external contactor open command.	<p>The present contactor control mode (feedback parameter 250) is set to External Control and the external command is set to open the contactor. The external contactor control command is wired to the PQconnect PCB header J7 where shorting pins 1 and 2 of that header equal a close command.</p> <p>The internal state of the external control command can be audited via feedback parameter 320 in bit position 0. If an external contactor close command is correctly being input to the PQconnect board then confirm the J7 header input is configured as the external control command by verifying feedback parameter 321 is set to a value of 2=external command input. If the input configuration parameter 321 is not set to 2=external command input the input configuration can be changed via setpoint parameter 610.</p>
6	Contactors is open because the PQconnect has been configured without a contactor.	The present contactor control mode (feedback parameter 250) is set to No Contactor Mode. No Contactor mode is typically reserved for HGP units that do not include a tuned circuit control contactor. If your HGP unit does include a tuned circuit contactor but the PQconnect is configured to not support a contactor please call TCI technical support.
7	Contactors is open due status detection.	<p>The contactor is open due to a filter, filter line, or filter load status detection being detected that is configured to open the tuned circuit contactor when detected. The PQconnect continuously monitors the internal conditions of the HGP passive filter and the external conditions of the filter line and load currents and voltages. Some status conditions, such as tuned circuit overcurrent, are configured to open the tuned circuit contactor when detected as a self-protection feature.</p> <p>The presently configured contactor open actions can be audited using feedback parameters 240-Filter A, 241-Filter B 242-Filter Line and 243 Filter Load. The set or clear status of these contactor open status detections can be viewed via feedback parameters 210-Filter A, 211-Filter B 212-Filter Line and 213 Filter Load. Also, the present value of all status detections and whether they are configured to open the tune circuit contactor when detected can be viewed via the PQvision software settings menu screen.</p> <p>To reset all status conditions and attempt to re-close the contactor the unit can be power cycled, a serial command can be sent over the network interface via setpoint parameter 502, or an external wired reset command can be input to the PQconnect PCB at header J8 where shorting pins 1 and 2 of that header equal a close command. The internal state of the external wired reset command can be audited via feedback parameter 320 in bit position 1. If an external reset command is correctly being input to the PQconnect board then confirm the J8 header input is configured as the external reset command by verifying feedback parameter 322 is set to a value of 1=external reset command input. If the input configuration parameter 322 is not set to 1=external reset command input the input configuration can be changed via setpoint parameter 611.</p>
8	Contactors is open due to a parameter inhibit condition.	The contactor is open because the PQconnect is still loading stored parameters in flash memory. This condition should clear shortly after the unit is powered up. If this contactor status condition persists power cycle the unit and call TCI technical support if the condition does not clear.
9	Contactors is open due to a unit power on delay.	The contactor is open because the PQconnect is waiting for the configured power on delay time to expire. The power on delay time in units of seconds can be viewed via feedback parameter 281. The power on delay time can be adjusted via setpoint parameter 581.
10	Contactors is open due to a calibration inhibit.	The contactor is open because the unit is presently undergoing an internal calibration procedure, or no calibration data has been stored to the unit's flash memory. If this contactor status condition persists power cycle the unit and call TCI technical support if the condition does not clear.
11	Contactors is being held open due to the minimum reclose timer.	An internal contactor close event is pending but the contactor is being held open because it was recently closed, and the minimum reclose time has not been yet achieved. The minimum contactor re-close time in units of seconds is viewable via feedback parameter 285. This time out period allows

		<p>any residual stored charge in the tune circuit capacitors to be dissipated by bleeder resistors before the tune circuit is re-energized.</p> <p>If a minimum time is not enforced between repeated contactor close events the contactor may re-close and apply line voltage out of phase with the residual voltage on the tuned circuit capacitors. This could cause high currents to flow through the tuned circuit contactor and potentially blow the contactor protective fuses. The remaining time on the minimum contactor re-close timer can be viewed on feedback parameter 286.</p>
12	Contactor is being held open due to close delay timer.	<p>An internal contactor close event is pending but the contactor is being held open because the configured contactor close delay time out period has not yet been achieved. The automatic contactor control modes (load current control and line kVAR control) are configured with contactor close and open delay timers to avoid changing the contactor state due to short transient conditions. The presently configured contactor close delay time in units of seconds is viewable via feedback parameter 274. The contactor close delay time can be adjusted via setpoint parameter 574</p>
13	Contactor is being held open due to the auto reclose delay	<p>An internal contactor automatic reclose event is pending but the contactor is being held open because the configured automatic re-close time has not been achieved yet.</p> <p>The PQconnect continuously monitors the internal conditions of the HGP passive filter and the external conditions of the filter line and load currents and voltages. Some status conditions are configured to open the tuned circuit contactor when detected as a self-protection feature. An optional feature can be enabled (feedback parameter 252) to attempt to re-close the tuned circuit contactor after a status condition has been detected. The auto reclose enable setpoint parameter is parameter 511 and the auto reclose delay time setpoint parameter is parameter 580.</p>
14	Contactor is being held open due to auto reclose limit being reached.	<p>An internal contactor automatic reclose event is pending but the contactor is being held open because the number of re-close attempts in a set time period has been exceeded.</p> <p>The PQconnect continuously monitors the internal conditions of the HGP passive filter and the external conditions of the filter line and load currents and voltages. Some status conditions are configured to open the tuned circuit contactor when detected as a self-protection feature. An optional feature can be enabled (feedback parameter 252) to attempt to re-close the tuned circuit contactor after a status condition has been detected. However, if too many re-close attempts (parameter 282) are made within a set time period (parameter 283) the unit will stop attempting to auto reclose.</p> <p>To debug which status conditions caused the contactor open event the presently configured contactor open actions can be audited using feedback parameters 240-Filter A, 241-Filter B 242-Filter Line and 243 Filter Load. The set or clear status of these contactor open status detections can be viewed via feedback parameters 210-Filter A, 211-Filter B 212-Filter Line and 213 Filter Load. Also, the present value of all status detections and whether they are configured to open the tune circuit contactor when detected can be viewed via the PQvision software settings menu screen.</p> <p>When the auto re-close limit has been reached a power cycle of the passive filter unit is required to clear the condition and allow the contactor to re-close.</p>

<p>Warning</p> 	<p>Many electronic components located within the filter are sensitive to static electricity. Voltages imperceptible to human touch can reduce the life, affect performance and/or destroy sensitive electronic devices. Use proper electrostatic discharge (ESD) procedures when servicing the filter and its circuit boards.</p>
---	---



TCI, LLC
W132 N10611 Grant Drive
Germantown, Wisconsin 53022

Phone: 414-357-4480
Fax: 414-357-4484
Helpline: 800-TCI-8282
Web Site: <http://www.transcoil.com>
© 2019 TCI, LLC All rights reserved

Part No: 29289

Effective: 01/06/2020 Version: N
