

SH20-5526-0

Interactive Productivity Facility: VSE Feature User's Guide

Program Product

Release 4.0

Program Number 5748-MS1

The Interactive Productivity Facility is a tool designed to assist in the management and use of computer systems. This manual provides the information necessary to use this product in a VSE or VM/VSE environment. The facilities of the product are described in detail. This includes hints and tips, a tutorial for new users, a menu and dialog cross reference, and sample service dialogs.



First Edition (September 1981)

This edition applies to Release 4, Modification Level 0, of the program product Interactive Productivity Facility (5748-MS1) and to all subsequent versions, releases and modifications until otherwise indicated in new editions or Technical Newsletters.

Changes are continually made to the information herein. Therefore, before using this publication, consult your System/370 Bibliography (GC20-0370) for the editions that are applicable and current.

References in this publication to IBM products, programs, or services do not imply that IBM intends to make these available in all countries in which IBM operates.

Publications are not stocked at the address given below; requests for copies of IBM publications should be made to your IBM representative or to the IBM branch office serving your locality.

A form for readers' comments has been provided at the back of this publication. If this form has been removed, address comments to: IBM Corporation, Technical Publications, Dept. 824, 1133 Westchester Avenue, White Plains, New York 10604. IBM may use or distribute whatever information you supply in any way it believes appropriate without incurring any obligation to you.

SUMMARY OF AMENDMENTS

Edition SH20-5526-0 documents:

Addition of full product installation and service support for the following:

- VSE/VSAM Space Management for SAM Feature
- VSE/VSAM Backup/Restore Feature
- VSE/POWER Shared Spooling Feature
- VSE/OCCF

Deletion of product support for the following:

- DOS/VS COBOL
- DOS/VS RPG II
- DOS PL/I
- ELIAS-I
- DMS/CICS/VS
- DMS/CICS/VS IAG

Support for maintenance and creation of printer form control buffers (FCBs)

Support for VSE/ICCF Release 3.0

- Support for additional printed output disposition entry in CRJE parameter in tailoring VSE/ICCF dialog
- Addition of a new program, DTSNTFY, to reassemble/catalog modified VSE/ICCF source members

Support for VSE/Advanced Functions Release 3.0

- Support for BUFSIZE parameter of SYS command in ASI tailoring dialog

- Deletion of ERRQ, XECB, BUFSIZE, JIB, NRES, and TP parameters and change of DOC=NO specification to DOC=3277 in supervisor tailoring dialog

Support for installation of products that are not supported by the VSE System IPO/E

Support for service and install enhancements

- Deletion of the punching of I.books and the invocation of DTSUTIL in a VM/VSE environment without VSE/ICCF
- Addition of steps in the installation and service of ACF/VTAM and ACF/VTAME, to copy \$\$RA transients into IJSYSRS from the appropriate production library
- Modification of steps to PUT dialogs, to copy the system history file to a work history file and back at each checkpoint

Support for requesting the conversion of a combination of shipped ASI procedures and procedures existing from a prior release

Support for user definition of menus to the Interactive Productivity Facility menu hierarchy

Documentation describing the migration of tables

Enhancement to librarian dialogs to perform the creation of new or backup/restore of existing production and user libraries

Addition of a VSE/ICCF procedure to compress Interactive Productivity Facility members

Support for VM/VSE as a feature of VSE System IPO/E

- Availability of VSE Interactive Productivity Facility dialogs to work with the VM/System Product System IPO/E
- Console interface routines for VM/VSE environment
- Query for the presence of VSE/ICCF in the system while running the first time use dialog

Addition of the following new sections to Chapter 1

- VSE Fast Path Menu Panels
- Dialog Flow Examples
- Hints and Tips

Movement of the following sections to the new Interactive Productivity Facility VSE Feature Reference Manual

- Debugging Information
- Dialog Descriptions

Removal of non-Interactive Productivity Facility product information, much of which has been included in VSE System IPO/E documentation

Edition SH20-4083-0 documents:

Uplevelled releases:

- CICS/VS Release 1.5
- DL/I Release 1.5 ICR2
- **Note:** DL/I DOS/VS Release 1.5 ICR2 is required for DL/I DOS/VS High Level Program Interface (HLPI) support.
- ACF/NCP/VS Release 2.1
- Interactive Productivity Facility - VSE Environment Release 3.0

Dropped products

- VSE/PT 5796-PLQ
- CICS/VS PA II 5798-CFP
- VSE RJE Workstation 5746-RC9
- VSAPL 5748-AP1
- IIS (CICS) 5748-XX6
- DPCX HSS/SSS
 - DOS/VS 3790 HSS SCP 5747-BQ1
 - DOS/VS SSS 5747-CC6

Added documentation support for features

- VSE/POWER Shared Spooling Feature
- VSE/VSAM Space Management for SAM Feature
- VSE/VSAM Backup/Restore Feature

SAMPLIB additions

- VSE/PT
- CICS/VS PA II
- DOS/VSE RJE Workstation
- VSE/POWER Shared Spooling Feature
- VSE/VSAM Space Management for SAM Feature
- VSE/VSAM Backup/Restore Feature

Library set changes

- Some products moved from one library set to another

Service dialog flowcharting

Enhanced service support for CICS/VS and DL/I source statement libraries

CICS/VS changes

- The VSE System IPO/E DFHJCT books were modified to allow support of the monitor control facility of CICS/VS Release 1.5.
- The pregenerated PCTs and PPTs for CICS/VS were updated to include additional system entries required for Release 1.5.
- With CICS/VS 1.5, the separate Facility Error Recognition System, (FERS), file is no longer required as FERS uses the intra-partition data set. All pregenerated DFHSIT tables were updated to allow FERS VSAM support.
- A new DFHMCT table is generated in the VSE System IPO/E for the monitor control facility of CICS/VS 1.5.
- The support for VSAPL, IIS, and CICS/VS PA II in the pregenerated DFHFCT, DFHPCT, DFHPPT, DFHDCT, and DFHTCT tables was removed since those products are no longer features of the VSE System IPO/E.
- The program DFHXMOLS, which is a CICS/VS 1.5 sample transaction for monitor control facility, is pregenerated in the VSE System IPO/E.

- Via ASI tailoring, the SVA-eligible CICS/VS 1.5 phases can be selectively loaded into the SVA.

Support of ICCF options

TTF startup tailoring

DTSSG macro support

Support for foreground partition standard labels

Additional parameter support in ASI tailoring

NRES parameter in supervisor increased

IODEV parameter in supervisor increased

Utility aids

The following aids have been added to the administration environment:

- Panel printout facility
- VSE SYSIN tape retrieval

Improved use of DASD space

PREFACE

This publication describes the Interactive Productivity Facility and the facilities available through its use. It includes both introductory and reference information.

It discusses primarily the VSE implementation of the Interactive Productivity Facility. However, it also includes information about the differences between the VSE implementation and the VM/VSE implementation. Information for users of the VM/VSE Feature is highlighted as follows:

[VM/VSE FEATURE NOTE]

For more information on the VM/VSE Feature, refer to the VM/VSE Feature Program Directory, the VSE System IPO/E Planning Guide, and to the VM/SP System IPO/E documents listed below.

CONTENT

This publication includes six major chapters:

Chapter 1 - Interactive Productivity Facility Overview introduces the Interactive Productivity Facility and specifically discusses what the Interactive Productivity Facility is and how to use it, and provides a chart specifying the location of information for each dialog.

Chapter 2 - System Management Guide Checklist is designed to be used while running the online activities of the System Management Guide. Additional information is provided for each step of the System Management Guide.

Chapter 3 - System Management discusses the activities that keep a computer system operational.

Chapter 4 - System Use discusses program development and those activities involved in the creation of a work product by an end user.

Chapter 5 - Environment Definition discusses the creation and maintenance of environment definitions.

Chapter 6 - First Use Tutorial describes the topics to be investigated if this is the first time you have used Interactive Productivity Facility.

The publication contains four appendixes:

- Appendix A - Display Terminal Considerations
- Appendix B - Menu and Dialog Cross Reference
- Appendix C - Panels and Dialog Manager
- Appendix D - Sample Service Dialogs

PREREQUISITE KNOWLEDGE

If you are using VSE/ICCF, you should have a basic understanding of VSE/ICCF since the Interactive Productivity Facility operates under the control of VSE/ICCF. If you are running Interactive Productivity Facility under VM/CMS, you should have a basic understanding of VM/CMS. Refer to the VM/SP documents listed below. Also, if you are not familiar with the operation of your terminal, review the section 'Display Terminal Considerations,' page 168, before reading Chapter 1.

RELATED READING

Listed below are the form numbers and titles of publications to which you can refer for detailed information.

Interactive Productivity Facility (5748-MS1)

GH20-2492 VSE Feature General Information Manual
GH20-5527 Programming Specifications
GX20-2383 VSE Feature Reference Summary
GX20-2387 VM Feature Reference Summary
SH20-2486 VSE Feature Reference Manual
SX20-2346 Program Function Key Template for 3277
SX20-2355 Program Function Key Template for 3276/3278
 none VM Feature User's Guide

VSE System IPO/E (5750-AAA, 5750-AAB, 5750-AAC)

GC20-1936 Planning Guide
GC20-1935 General Information Manual
GC20-1933 User's Guide
 none VM/VSE Feature Guide
 none Program Directory
 none Reference Guide
 none Communications Guide

VSE/ICCF (5746-TS1)

GC33-6065 Specifications
GC33-6066 General Information
GX33-9006 Reference Summary Card
SC33-6067 Installation and Operations Reference
SC33-6068 Terminal User's Guide
SC33-6069 Messages

VM/SP System IPO/E (5750-AAK)

GC20-1890 General Information Manual
GC20-1874 Planning Guide
 none Program Directory

CONTENTS

Chapter 1 - Interactive Productivity Facility Overview	1
Log On VSE/ICCF	1
Steps in Logging On	1
Invoking the Interactive Productivity Facility	2
Leaving the Interactive Productivity Facility Environment	3
Job Submission Routine: IPFSUB	4
Submit to VSE	4
Decompress Routine: IPFDCMP	5
Compress Routine: IPFRCMP	6
Log Off VSE/ICCF	7
Light-Pen Use	7
Program Function (PF) Key Use	8
VSE Fast Path Menu Panels	8
VSE Menu Panels by Panel ID	8
VSE Menu Panels by Panel Title	9
Interactive Productivity Facility User Options Files	10
Interactive Productivity Facility Naming Conventions	12
VSE/ICCF Library Use	13
Interactive Productivity Facility Libraries	14
Interactive Productivity Facility Operation	16
Response Time Considerations	18
Terminal Communication	19
Initialization	20
VSE/VMCF CMS Communication Interface Routines	20
VSE/VMCF Virtual Console Interface	20
Command Formats	22
VSE/VMCF CP Command Interface	24
VSE/VMCF VSE Requirements	25
Dialog Components	26
Menu Hierarchy Overview	26
Menu Hierarchy Detail	30
Dialog Flow Examples	34
First Use Tutorial	34
Change Automatic System Initialization (ASI) Parameter	42
Hints and Tips	66
Install	66
Service	66
Migration	70
Chapter 2 - System Management Guide Checklist	74
VSE System Management Guide Flow	74
VSE System Management Guide Panel Sequence	78
Create System Profile	79
Hardware Table Update	81
Supervisor Assembly	82
ASI Tailoring	84
VSE/POWER Assembly	85

Library Update	86
Standard Labels	88
ASI Tailoring with Standard Labels	89
Dialog Customization	90
Backup VSE/ICCF File	91
Install Products	93
Backup Libraries	96
Verification	97
Verify VSE/VSAM	98
Verify Batch Products	99
Verify Online Products	100
Verify CICS/VS	102
Online Verifies with CICS/VS	103
VSE/VSAM Verify Delete	105
System Management Guide Completion	106
Additional Tailoring Activities	107
Move Page Data Set Steps	108
Move VSE/POWER File Steps	109
Move VSE/ICCF File Steps	110
Chapter 3 - System Management	111
System Management Guide	111
Administration	112
System Administration	112
Data Base Administration	122
Communication Administration	123
Installing Optional Components	127
Introduction	127
Service Libraries	127
Data Set Considerations	129
Installation Job Stream	130
Installation Guide	133
Introduction	133
Update Product Table (Non-System IPO/E Products)	134
Create Copy Files	135
Update Product Table (System IPO/E Products)	138
Prepare Libraries	139
ASI Tailoring	140
Installation	141
Environment Definition - Adding to the Menu Hierarchy	141
Verifying Optional Components	142
DASD Requirements	142
VSE/VSAM Considerations	143
Controlling Execution Sequence of Verification Job Streams	143
Verification of CICS/VS-Dependent Components	143
Product Considerations	144
Dump Analysis	144
Service	145
Service Dialogs	146
Program Update Tapes	147
Program Temporary Fixes	147
DASD File Requirements	149
Apply PUT	150

Restart PUT	154
Applying Selective PUT Libraries	155
Apply PTF	155
Applying APAR/LOCAL Corrective Service	157
Archiving Changes	159
History Function	159
JCL Comments	160
Operations	161
JCL Creation	161
Utilities	161
Chapter 4 - System Use for VSE/ICCF Users	163
Program Development	163
Chapter 5 - Environment Definition	165
Chapter 6 - First Use Tutorial	166
Appendix A. Display Terminal Considerations	168
Introduction	168
3277/3278 Terminal Diagrams	168
Initial Steps	173
Appendix B. Menu and Dialog Cross Reference	175
Cross Reference by Menu	175
Cross Reference by Description	180
Appendix C. Panels and Dialog Manager	185
Appendix D. Sample Service Dialogs	188
Sample PUT Dialog	188
Sample Corrective Service Dialog	202
Index	241

FIGURES

1.	Program function key use by panel type	8
2.	All prefixes used in the Interactive Productivity Facility	12
3.	Interactive Productivity Facility Prefixes in the core image library	13
4.	Sample VSE/ICCF partition layout	17
5.	Sample VSE/ICCF interactive partition running the Interactive Productivity Facility	18
6.	Supported CP commands	24
7.	Interactive Productivity Facility main menu for VSE	27
8.	System management hierarchy	28
9.	System use hierarchy for VSE only	29
10.	Environment definition hierarchy	29
11.	Sample initial panel	35
12.	Sample first use tutorial panel	37
13.	Fast path tutorial	39
14.	Fast path tutorial (continued)	41
15.	Initial menu panel	43
16.	System management menu panel	45
17.	Administration menu panel	47
18.	System administration menu panel	49
19.	Administration menu explain panel	51
20.	System administration menu panel	53
21.	Tailoring system components menu panel	55
22.	ASI data entry panel	57
23.	ASI data entry panel (continued)	59
24.	ASI tailoring menu panel	61
25.	ASI define label area data entry panel	63
26.	ASI tailoring menu panel	65
27.	Service library A	128
28.	Service library B	128
29.	Service library C	128
30.	Service library D	129
31.	Service library E	129
32.	Service library F	129
33.	Service process work areas	149
34.	3277 terminal screen and keyboard	169
35.	3277 keyboard	170
36.	3278 screen	171
37.	3278 keyboard	172

CHAPTER 1 - INTERACTIVE PRODUCTIVITY FACILITY OVERVIEW

The Interactive Productivity Facility is a tool designed to assist in the management and use of computer systems. This IBM licensed program operates either under the control of the Interactive Computing and Control Facility (VSE/ICCF) on a VSE system or under the VM/SP Conversational Monitor System (VM/CMS). This manual discusses primarily the VSE implementation of the Interactive Productivity Facility; however, differences between the VSE and VM/VSE implementations are noted.

Since the Interactive Productivity Facility operates under the control of VSE/ICCF, you must first perform a VSE/ICCF logon. This identifies you as an authorized user of the system.

| **[VM/VSE FEATURE NOTE]** If you are a user of the VM/VSE Feature running under VM/CMS, refer to the appropriate section of the Interactive Productivity Facility VM Feature User's Guide instead of the following sections from log on through log off.

LOG ON VSE/ICCF

In order to log on to VSE/ICCF, you must have a preassigned:

1. USERID

| A one to four character unique ID. The supplied system administrator ID is AAAA.

2. PASSWORD

A one to six character password associated with the USERID. The supplied password for AAAA is ICCF.

STEPS IN LOGGING ON

1. Turn on the terminal.

2. Adjust the brightness.

3. Clear the screen.

| 4. Enter in upper case: **ICCF**.

5. Press the ENTER key.

A VSE/ICCF screen will be displayed, asking you to log on.

6. Enter: **/logon userid**.

(where **userid** is your unique ID).

7. Press the ENTER key.

The words ***ENTER 6 CHAR PASSWORD** will appear on the screen if your ID is in the user directory. If it is not, contact your system administrator.

8. Enter **password**.

This is the unique password assigned for your ID. The password will not display on your screen.

9. Press the ENTER key.

Unless you are logging on as the system administrator (AAAA), at this point, your screen will display the VSE/ICCF logo, indicating you have successfully logged on. If you get a message **PASSWORD INCORRECT**, repeat the above two steps. If you still get **PASSWORD INCORRECT**, contact your system administrator.

INVOKING THE INTERACTIVE PRODUCTIVITY FACILITY

Once you have logged on to VSE/ICCF, the next step is to invoke the Interactive Productivity Facility.

1. Enter: **@IPF** (at sign IPF)

2. Press the ENTER key.

| **Note:** Message K867I may be displayed during Interactive Productivity
| Facility initialization followed by ***PARTIAL END PRINT**. This is an
| information-only message from VSE/ICCF. You should respond by
| pressing the ENTER key.

An Interactive Productivity Facility menu panel will be displayed. If this is the first time you have used the Interactive Productivity Facility, it will be the menu panel, **DTR\$**. You should select **FIRST USE TUTORIAL**. Otherwise, it will be the menu panel displayed the last time you exited the Interactive Productivity Facility, and you are ready to proceed with your work.

| **Caution:** If you modify IPPPROC by changing **/SET LINESIZE 80**, error
| code SC10 may occur. **/SET LINESIZE 80** must not be changed. A terminal

| malfunction may also cause this error. If this should happen, try
| another terminal.

LEAVING THE INTERACTIVE PRODUCTIVITY FACILITY ENVIRONMENT

To leave the Interactive Productivity Facility environment, you must have concluded an activity and have a menu panel displayed on your terminal. That is a panel which is requesting you to select a new activity, not a data entry panel, which is prompting you for input. If the panel you are looking at does not have the word ICCF at the bottom, you are in the middle of an activity, and must conclude it. You may either complete your current activity, or leave it immediately by doing any of the following:

- Probing the word **CANCEL** at the bottom of the screen with a light-pen
- Typing the word **CANCEL** on the input line at the bottom of the screen, and pressing the ENTER key
- Pressing the PF3 key

If you do any of these, a menu panel will be displayed with **ICCF** as one of the selections on the service line at the bottom of the screen.

You may now leave the Interactive Productivity Facility environment by doing one of the following:

- Probing the **ICCF** selection at the bottom of the screen with a light-pen
- Typing the word **ICCF** on the input line at the bottom of the screen, and pressing the ENTER key
- Pressing the PF4 key

| When the Interactive Productivity Facility terminates, a check will be
| made to determine if an error was logged during the session. If an
| error was logged, you will be given the chance to enter a debugging
| procedure. The process will lead you to editing files using the
| VSE/ICCF editor. Information on the error may then be reviewed. See
| the Interactive Productivity Facility VSE Feature Reference Manual,
| SH20-2486 for more information.

JOB SUBMISSION ROUTINE: IPFSUB

The output of most dialogs is one or more VSE job streams in the form of VSE/POWER jobs. A default VSE/POWER job name is provided during the execution of the dialog. This is also the name under which the job stream is filed as a member of your VSE/ICCF library. You may change the name if you wish. In some cases, you may also change the provided VSE/POWER job class, priority, disposition, and accounting fields.

After the job is filed in your library, select the ICCF option from the service line at the bottom of the panel. View the job with the VSE/ICCF editor, if you wish, and make any desired changes. Then submit the job to VSE, using the supplied VSE/ICCF procedure IPFSUB with the job name.

The IPFSUB procedure submits job streams directly to the VSE/POWER queue without overriding any JCL statements.

After the job has been submitted, use the VSE/ICCF command /STATUSP to determine if the job is awaiting execution, executing, or completed. If you specified the RETURN option on your IPFSUB command, you may look at the output from the job with the /LISTP command. Refer to the VSE/ICCF Terminal User's Guide (SC33-6068) for details on the use of these commands.

[VM/VSE FEATURE NOTE] The following sections apply to users of the VM/VSE Feature only. If you are not using this feature, continue with 'Decompress Routine: IPFDCMP' on page 5.

SUBMIT TO VSE

All jobs should be submitted to a VSE virtual machine by using the SUBVSE EXEC. A detailed explanation of how this EXEC works is obtained by typing "SUBVSE ?."

The SUBVSE EXEC can be invoked in CMS or from the command line of any Interactive Productivity Facility menu panel. This function is also invoked internally by all Interactive Productivity Facility functions that submit jobs to the VSE virtual machine.

The job stream punched to the VSE machine is modified by this function to provide standard interfaces to the ROUTER facility and the VSE/VMCF communication facility. Access to the 19E Y disk and the 301 V disk is required for submitting jobs to VSE.

SUBVSE modifies the POWER jobname. If the POWER name of the job that you submit is LISTIOBG, then SUBVSE will change this to XXXLISTI, where XXX is your prefix in the SUB\$VSET table. The output of the job

will be returned to your virtual reader. See the 'Section 5 - SUBVSE Requirements' in the Interactive Productivity Facility VSE Feature Reference Manual for further information on table SUB\$VSET.

SUBVSE also modifies each DOS job card. The specification of VSE/VMCF options is done on the DOS job card. There is more information on this topic in 'SUBVSE Requirements' in the Interactive Productivity Facility VSE Feature Reference Manual.

Note: SUBVSE cannot route the output back to you if there is no POWER JECL. In this case, the POWER jobname would become the same as the VSE jobname. The output would be sent to the system printer.

DECOMPRESS ROUTINE: IPFDCMP

All the Interactive Productivity Facility members in the VSE/ICCF libraries 51 through 67 are shipped in a compressed format. Therefore, if any changes have to be made to these Interactive Productivity Facility members, the following steps must be performed:

1. From your VSE/ICCF terminal enter :

IPFDCMP member-name

When the member is found, the following message will appear :

```
THE MEMBER nnnnnnnn HAS BEEN FOUND IN LIBRARY xx
PRESS ENTER TO CONTINUE.
```

nnnnnnnn is the member name, and xx is the number of the library in which it was located. Note this library number, you will need it later.

When this VSE/ICCF procedure is complete, the member in decompressed format will be in your primary library as defined in your profile record.

2. Update the member.
3. Test this update while the member is in your own library.
4. The new member may be compressed by using the procedure IPFRCMP.
5. **/SWitch xx** where xx is the number of the library in which the member was originally found during step 1.
6. **/PURge member-name**
7. **/CONNect y** where y is your primary library.

8. Execute the copyfile macro to place the updated member in the VSE/ICCF library.

@COPYFILE member-name member-name

9. **/Switch RESET**

10. **/PURge member-name**

If the member is not in a compressed format, IPFDCMP will copy it into your library without decompressing.

If the member is found in your own library (as defined in your profile record), the following warning message will appear:

THE FILE xxxxxxxx IS IN YOUR PRIMARY LIBRARY. IF THIS PROCEDURE IS EXECUTED, IT WILL BE REPLACED BY A FILE IN A NONCOMPRESSED FORMAT. ENTER: **EXIT** TO TERMINATE OR **REPLACE** TO REPLACE IT.

If **REPLACE** is entered, a copy of the target member will be saved.

COMPRESS ROUTINE: IPFRCMP

An Interactive Productivity Facility member that has been decompressed can be compressed by using the IPFRCMP procedure.

Enter: **IPFRCMP member-name**

If the member is already compressed, no compression will occur.

If the member is not in your own library, as defined in your profile record, the following message will appear:

MEMBER member-name NOT IN PRIMARY LIBRARY

Compressing Interactive Productivity Facility members may improve performance and disk usage by reducing the number of VSE/ICCF library blocks and physical I/Os needed to read these members from the VSE/ICCF DTSFILE. The dialog manager decompresses a table when it updates it. Therefore, we suggest that you compress only the members used in input (panels, skeletons, message files) or tables that are updated very little, such as ADM\$SHIP.

If an abnormal shutdown occurs while a member is being compressed, follow this procedure:

- Bring VSE/ICCF back up
- Logon with your ID

- **/LIST member-name**

If your member is not in the library, it was saved. Issue the command:

- **/RENAME SAVP@@@@ member-name**

Now you are ready to rerun the compress procedure.

LOG OFF VSE/ICCF

Use the following steps to logoff VSE/ICCF:

1. Enter: **/LOGOFF.**
2. Press the ENTER key.

A screen will be displayed, saying that you are now logged off.

LIGHT-PEN USE

The light-pen, if available, can be used to select choices on menu panels and to select options shown on the service line of all panels.

You can see which fields are light-pen detectable by pressing the tip of the light-pen with your finger when a panel is displayed. A bright horizontal line will appear in the fields that are detectable.

PROGRAM FUNCTION (PF) KEY USE

When you are working with Interactive Productivity Facility panels, the following PF keys can be used to select the service shown:

MENU	DATA ENTRY	EXPLAIN	INFORMATION MENU
PF1 = EXPLAIN	PF1 = EXPLAIN	PF1 = OVERVIEW	PF1 = OVERVIEW
PF3 = RETURN	PF3 = CANCEL	PF3 = END	PF3 = END
PF4 = ICCF/CMS	PF5 = RETRY	PF7 = BACK	PF6 = INITIAL
PF6 = INITIAL		PF8 = FORWARD	

Figure 1. Program function key use by panel type: Guidance for PF key use is also given on the Program Function Key Templates (SX20-2346 for 3277 and SX20-2355 for 3276/3278.)

VSE FAST PATH MENU PANELS

This section lists the Interactive Productivity Facility menu panels that can be accessed by the fast path method by entering **=panel-id** on any menu panel (for example, =ADM\$). The panels appear in alphabetic sequence, first by panel ID, and then by panel title.

Note: The panels accessible by the fast path are also listed for quick reference on the Interactive Productivity Facility VSE Feature Reference Summary.

[VM/VSE FEATURE NOTE] The System Use panel (SYU\$) is replaced by the version supplied with the VM/VSE Feature.

VSE MENU PANELS BY PANEL ID

ADM\$	System Administration
ADM\$1	System Profile
ADM\$15	Library Information
ADM\$153	Library Information: PUT/PTF
ADM\$2	Logons/Passwords
ADM\$4	Tailor System Components
AMS\$	Access Method Services

CAT\$	Catalog Management
DSF\$	Data Set Management
DTR\$	Initial
ENV\$	Environment Definition
LIB\$	VSE Librarian
OPN\$	Operations
SPC\$	Space Management
SRV\$	Service
SRV\$2	Apply Cumulative PTF
SRV\$3	Archive PTF/APAR Fix
SRV\$4	MSHP
SRV\$5	Apply APAR/Local Function Selection
SRV\$52	Apply APAR/Local Library Selection
SRV\$523	Apply APAR/Local: Post Options
SRV\$8	JCL Comments
SYI\$	First Use Tutorial (VSE Only)
SYM\$	System Management
SYM\$1	Administration
SYM\$2	Data Base Administration
SYM\$33	Communication Administration
SYU\$	System Use (VSE Only)
TCI\$	CICS/VS
TCI\$1	Maintain Processing Program Table
TCI\$2	Maintain Program Control Table
TCI\$3	Maintain Terminal Control Table
TCI\$4	Maintain File Control Table
UTA\$	Utility Aids
UTL\$	VSE Utilities
UTL\$1	BACKUP RESTORE
UTL\$2	Fast Copy
VER\$	Verification
VMT\$	First Use Tutorial (VM/VSE)

VSE MENU PANELS BY PANEL TITLE

Access Method Services	AMS\$
Administration	SYM\$1
Apply APAR/Local Function Selection	SRV\$5
Apply APAR/Local Library Selection	SRV\$52
Apply APAR/Local: Post Options	SRV\$523
Apply Cumulative PTF	SRV\$2
Archive PTF/APAR Fix	SRV\$3
BACKUP RESTORE	UTL\$1
Catalog Management	CAT\$
CICS/VS	TCI\$
Communication Administration	SYM\$33
Data Base Administration	SYM\$2
Data Set Management	DSF\$
Environment Definition	ENV\$
Fast Copy	UTL\$2

First Use Tutorial (VSE Only)	SYI\$
First Use Tutorial (VM/VSE)	VMT\$
Initial	DTR\$
JCL Comments	SRV\$8
Library Information	ADM\$15
Library Information: PUT/PTF	ADM\$153
Logons/Passwords	ADM\$2
Maintain File Control Table	TCI\$4
Maintain Processing Program Table	TCI\$1
Maintain Program Control Table	TCI\$2
Maintain Terminal Control Table	TCI\$3
MSHP	SRV\$4
Operations	OPN\$
Service	SRV\$
Space Management	SPC\$
System Administration	ADM\$
System Management	SYM\$
System Profile	ADM\$1
System Use (VSE Only)	SYU\$
Tailor System Components	ADM\$4
Utility Aids	UTA\$
Verification	VER\$
VSE Librarian	LIB\$
VSE Utilities	UTL\$

INTERACTIVE PRODUCTIVITY FACILITY USER OPTIONS FILES

| **[VM/VSE FEATURE NOTE]** If you are using the VM/VSE Feature running under VM/CMS, refer to the section 'Tailoring Interactive Productivity Facility' in the Interactive Productivity Facility VM Feature User's Guide.

The dialog manager, when initiated, searches for a user options file (DTR\$OPT) that controls six Interactive Productivity Facility parameters. This file is optional and if none is found, defaults are taken that are assembled within the dialog manager. The user options file controls a number of system defaults, including the name of the display table. The display table in turn, controls a number of items that appear on the Interactive Productivity Facility panels. The display table is mandatory if invoked by the user options file and must be in a VSE/ICCF library to which the user has read/write access.

The most significant reason for changing the options is to change the language of the panels and the corresponding responses.

USER OPTIONS FILE ITEMS

The items that can be specified in the user options file are:

- Whether displayed messages should have the message number and environment identity. Default is NO.
- Name of the default initial panel. Default is DTR\$.
- Case in which to display panels (either mixed or upper case). Mixed case can only be displayed if the terminal has the hardware feature. The default is MIXED case.
- Name of the display table containing the tables to be used by the display service function of the dialog manager. Default is NO. If NO is specified, constants defined within the dialog manager are used.
- There are two other parameters in this file - TRACE and TEST. These are for IBM use only and should always be NO. If they are modified, the results are unpredictable.

DISPLAY TABLE

The display table controls the following Interactive Productivity Facility items:

- The content of the direction lines for all the panels
- The content of the selection lines for all the panels
- A synonym table of up to 70 synonyms for Interactive Productivity Facility responses
- Program function key settings for Interactive Productivity Facility responses for all panels
- A connect table that relates Interactive Productivity Facility member prefixes to the VSE/ICCF sublibrary in which they reside. (The dialog manager uses the connect table to connect to a particular library to retrieve an item.)

Sample user options and display tables are shipped in VSE/ICCF library 58. The name of the supplied options file is DTR\$OPT. The name of the supplied display table is DTR\$DTBL. Both tables can be altered and activated to change any of the above items.

Notes:

1. Refer to the section 'User Options Files' in the Interactive Productivity Facility VSE Feature Reference Manual for more information about these tables and listings of the tables.
2. If you have migrated from a prior release of Interactive Productivity Facility, you must erase the prior release version of DTR\$OPT and DTR\$DTBL from your primary library before you use Interactive Productivity Facility for the first time.

INTERACTIVE PRODUCTIVITY FACILITY NAMING CONVENTIONS

Interactive Productivity Facility member names are prefixed according to environments. Every member also has the symbol \$ in the fourth position of the name. An example is INS\$CORM which is in the installation environment.

[VM/VSE FEATURE NOTE] These naming conventions are used for the file names of VM/CMS files.

The following list shows all the prefixes in the Interactive Productivity Facility. This list includes both core image and relocatable library members and VSE/ICCF members, such as panels, messages, skeletons, and tables.

ADM	AMS	CAT	CUS	DBL
DEL	DFH	DSF	DTR	ENV
ERR	INS	IPF	LIB	OPN
PDV	RPT	SPC	SRV	SUB
SYI	SYM	SYU	TAS	TCI
TEP	TPW	TRJ	TSA	UTA
UTL	VER			

Figure 2. All prefixes used in the Interactive Productivity Facility

If you create a program that has the same name as one used by the Interactive Productivity Facility, the first one encountered in a concatenated library search is the one that is executed. VSE System IPO/E concatenates the Interactive Productivity Facility functions last in the search sequence. When creating new programs, if you do not put a \$ in the fourth position of the name, you will not conflict with Interactive Productivity Facility functions.

Listed below are the three character prefixes for the Interactive Productivity Facility functions that are in the core image library:

ADM	CAT	CUS	DBL	DSF
DTR	ENV	INS	IPF	LIB
OPN	PDV	RPT	SPC	SRV
SUB	SYI	SYM	SYU	TAS
TCI	TEP	TPW	TRJ	TSA
UTA	UTL	VER		

Figure 3. Interactive Productivity Facility Prefixes in the core image library

VSE/ICCF LIBRARY USE

Some of the data you enter using dialogs is saved in tables. You can recognize tables created by the dialogs by the '\$' in the fourth position of the member name. Do not try to save tables in the VSE/ICCF common library. The Interactive Productivity Facility will not access the common library. When job streams are created, your responses are internally converted from table format to JCL or macro format by the dialog. If you subsequently make changes to the generated output, they will not be reflected in the tables and will be lost the next time the dialog is invoked.

You can use the dialogs to create job streams for educational or other purposes. JCL created by a dialog can be used as a model for creating similar job streams of your own. The advantage of this is that error-free JCL requiring few changes is produced. These job streams can also help you understand how to use various VSE programs, such as VSE/VSAM Access Method Services, or MSHP.

In many cases, you can save job streams and tables under names you supply to the dialogs. These members are saved on your user library. The dialog will check for the existence of a member with the same name and, if found, give you the choice of replacing the old member with the new one or supplying a new name. You can query the contents of your library by using the VSE/ICCF /LIBRARY command. Be sure to avoid using names that contain a '\$' in the fourth position.

You should estimate your VSE/ICCF library space requirements and enlarge the library, if necessary. The base install process provides a procedure for expanding the library if needed. If you run out of space while running a dialog, you must increase your free library space and rerun the dialog. Job streams that are no longer required should be purged, or the library file can be expanded.

You should frequently back up the VSE/ICCF library using the VSE/ICCF utility DTSUTIL. This will reduce the recovery effort needed to reflect changes made since the last backup in the event your library is destroyed. Although there are no dialogs to backup and restore your VSE/ICCF file, the required job streams are supplied in SAMPLIB. To ensure the integrity of the VSE/ICCF libraries, you should run the DTS analysis recovery utility before running the backup job. Regular reorganization of these libraries will also improve VSE/ICCF library access time. If you make extensive use of VSE/ICCF, you should reorganize the libraries daily. We recommend that you use the DTSUTIL utility of VSE/ICCF to do this.

INTERACTIVE PRODUCTIVITY FACILITY LIBRARIES

The following is a list of the libraries used by the Interactive Productivity Facility, and the types of dialog members that reside in them:

LIBRARY 50

- Reserved

LIBRARY 51

- Administration environment messages, skeletons, and tables

LIBRARY 52

- Installation environment
- Verification environment
- Files that create job streams to delete verification files

LIBRARY 53

- CICS/VS tailoring

LIBRARY 54

- First use tutorial

LIBRARY 55

- Service environment messages, skeletons, and tables

LIBRARY 56

- Automatic system initiation (ASI) procedure tailoring

- VSE/POWER tailoring
- VSE/POWER RJE tailoring

LIBRARY 57

- Environment definition
- VSE supervisor tailoring
- Utility aids
- EP/VS tailoring

LIBRARY 58

- Interactive Productivity Facility files and system tables
- Miscellaneous items not explicitly defined in other libraries

LIBRARY 59

- Sample job streams (SAMPLIB)

LIBRARY 60

- System utilities use
- Librarian use

LIBRARY 61

- Reserved for optional product use

LIBRARY 62

- Reserved for optional product use

LIBRARY 63

- DL/I Interactive Macro Facility

LIBRARY 64

- Reserved

LIBRARY 65

- Access Method Services use

LIBRARY 66

- Administration environment panels

LIBRARY 67

- Service environment panels

LIBRARY 68 - 80

- Reserved

Members have also been added to the VSE/ICCF common library (Library 2). These members begin with the three characters 'IPF'.

Caution: Since USERID AZZZ is associated with Interactive Productivity Facility members, you should not delete it from your VSE/ICCF definition. If it is deleted, you may not be able to complete maintenance for Interactive Productivity Facility members residing in VSE/ICCF libraries.

INTERACTIVE PRODUCTIVITY FACILITY OPERATION

The Interactive Productivity Facility requires an interactive subsystem and a terminal control monitor under which to operate. The interactive subsystem under VSE is the VSE Interactive Computing and Control Facility (VSE/ICCF). Terminal control is provided by TTF, a terminal monitor that is part of VSE/ICCF (System IPO/E B/I base), or by CICS/VS (DC and DB/DC bases). A VSE partition running VSE/ICCF is organized as indicated in Figure 4 on page 17.

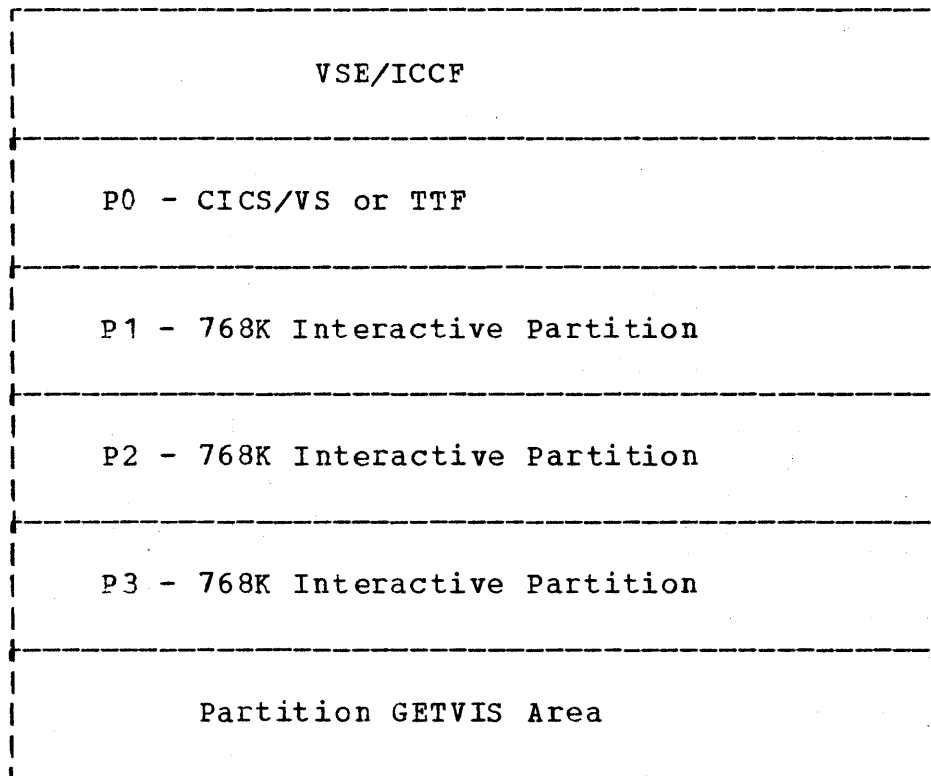

Figure 4. Sample VSE/ICCF partition layout

The Interactive Productivity Facility runs in any VSE/ICCF Interactive Partition of 768K or more. A VSE/ICCF Interactive Partition, in which an Interactive Productivity Facility dialog is running, is organized as indicated in Figure 5 on page 18.

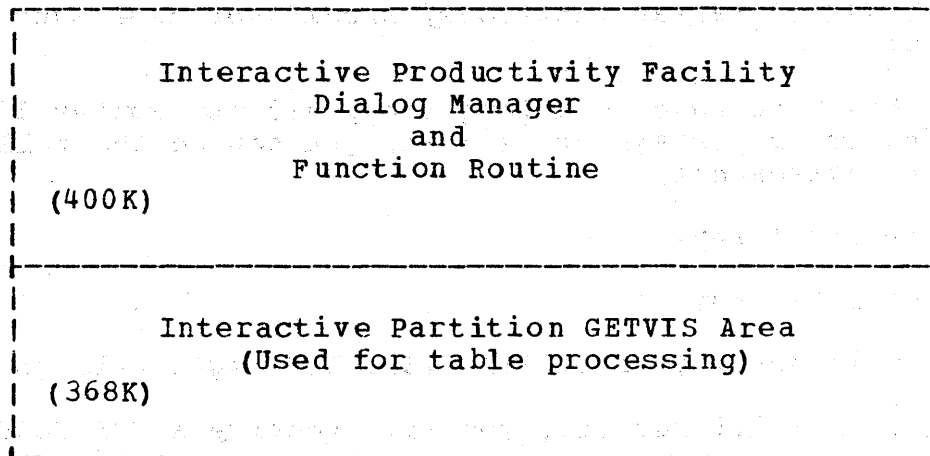

Figure 5. Sample VSE/ICCF interactive partition running the Interactive Productivity Facility

RESPONSE TIME CONSIDERATIONS

Some Interactive Productivity Facility dialogs contain extremely complex processing logic, perform a considerable number of I/O operations, and create large job streams. While actual response time is a function of all the work being done on your system, a response time of one or two minutes on a lightly loaded system would not be unusual.

These longer running dialogs are generally the ones you run seldom, or only once. They include:

- Dialogs which update your system profile, such as:
 - First time installation
 - Installation of optional System IPO/E components
 - Standard label tailoring
 - ASI procedure tailoring
- Verification of large components, such as CICS/VS or DL/I DOS/VS
- Service dialogs

The dialogs you run more frequently, such as CICS/VS table updates, VSE/VSAM, or VSE librarian functions, should not have such long response times.

| If a dialog has been running a long time, and you wonder if it is
| still running or if the system is down, you can do the following in
| the VSE/ICCF environment:

1. Press the RESET key.
2. Press the ENTER key.

If the system is down, your SYSTEM AVAILABLE light will go off.

If the dialog is still running, you will receive a VSE/ICCF message:

*BG IN PROGRESS, INPUT IGNORED, UNITS=XXXX,XXXX,XXXX

At this time, you can enter the asynchronous mode by entering the VSE/ICCF command **/ASYNC**. You can then do other online work while Interactive Productivity Facility continues processing. You can check dialog status by entering **/SHOW EXEC**. If the Interactive Productivity Facility is ready to display another panel, a message will indicate that you should enter **/SYNC** to synchronize your terminal back to the Interactive Productivity Facility; then press ENTER, and the panel will be displayed. You must not access any Interactive Productivity Facility members for update while in asynchronous mode. If you do and the dialog attempts to update the same member, the dialog will fail.

When the dialog completes, another Interactive Productivity Facility panel will be displayed. The above process applies only to local terminals.

TERMINAL COMMUNICATION

The following characteristics apply to user interaction with the Interactive Productivity Facility:

- Display terminals are the only means of communication with the user.
- Responses to menus can be initiated by light-pen selection or keyboard data entry.
- Program function keys, light-pen, or keyboard input can be used for the selections available on the service line of the panel.

A uniform definition for the use of program function keys within Interactive Productivity Facility environments is supplied with that

component. Other software components distributed with System IPO/E may also provide their own program function key definitions.

INITIALIZATION

| **[VM/VSE FEATURE NOTE]** If you are using the VM/VSE Feature running
| under VM/CMS, refer to the VM/VSE Feature Guide, section 'Post
| Installation Tasks'.

The Interactive Productivity Facility is initialized by invoking a VSE/ICCF macro supplied by the Interactive Productivity Facility. This is accomplished by entering '@IPF' after logging on to VSE/ICCF.

VSE/VMCF CMS COMMUNICATION INTERFACE ROUTINES

| **[VM/VSE FEATURE NOTE]** This section describes console interface
| routines that are only relevant to the VM/VSE user. If you are not
| using the VM/VSE Feature, skip this section and continue with 'Dialog
| Components' on page 26.

VSE/VMCF VIRTUAL CONSOLE INTERFACE

| VSE/VMCF virtual console interface routines allow the efficient use of
| a common VSE system by a number of CMS users.

| The VSE/VMCF Virtual Console Interface programs and functions enable
| the CMS terminal user to obtain information from VSE, and to interact
| with the VSE system at the CMS user terminal without using the VSE
| console. In fact, the VSE console can be disconnected when running in
| 1050 mode.

| Facilities provided include:

| **ECHO** Provides the ability to have VSE console messages
| copied (echoed) on the CMS terminal. To enable this
| function, every VSE job card must contain
| (userid,ECHO=YES) or (userid,ECHO=REPLY). ECHO=YES
| causes every message generated by the job to be
| copied. ECHO=REPLY causes those messages requiring
| a reply to be copied along with the two preceding
| messages for that job.

Note: See the topic 'Modification Done by SUBVSE EXEC' in the Interactive Productivity Facility VSE Feature Reference Manual for further information.

REPLY

Provides the ability to reply to VSE console messages from the CMS terminal. You may reply only to messages issued by jobs and subtasks running in a partition owned by you. Ownership of a partition is established by placing the owner's CMS USERID in parentheses into the VSE job card. You may own a partition without specifying that messages are to be echoed. However, if messages requiring replies are expected, ECHO=REPLY should be specified to ensure that the partition is not blocked for other users. (Module VSEREP)

REDISPLAY

Provides the ability to redisplay the last three VSE console messages and the last outstanding console message requiring a reply for one or all partitions. Alternatively, the last twenty console messages and input from any source can be displayed. On this display, the CMS USERID of the originator of any input is shown. Input originating from the VSE console is indicated by a blank CMS USERID. (Module VSEMSG)

ISSUE VSE COMMANDS

Provides the ability to issue VSE commands. Normal VSE commands may be issued (for example, MAP, PRTY, and VSE/POWER commands). Not all users should be authorized to use this module. (Module VSECMD).

ISSUE CP COMMANDS

Provides the ability to issue CP commands through the VSE virtual machine. Authorized users may issue commands such as LINK, SPOOL, and RESET. Not all users should be authorized to use this module. (Module VSECP).

Each function is implemented using a different module in the CMS virtual machine. Any of these modules may be invoked from the command line of an Interactive Productivity Facility menu panel.

Not all users should have access to all the modules. In particular, the use of VSECMD and VSECP should be carefully controlled. These two modules can be moved to a separate CMS minidisk with access controlled through a LINK password.

Note: The VSE console interface routines are incompatible with VSE/OCCF. The VSECMD, VSECP, and CPCMD routines will still function properly. The VSEREP and VSEMSG routines will not function when VSE/OCCF is active. VSECMD may not be used to emulate VSEREP by entering a command such as **O RETRY** to reply to a message on the VSE virtual machine. Any attempt to reply to a VSE message via VSEREP or

VSECMD will result in rejection of the reply by the VSE console interface routines with a warning that no reply is outstanding or MSGOD11I INVALID REPLY ID from VSE. Any attempt to enter a CP command on a VSE DOC console via the * CP command facility will result in MSG1R98I * INVALID VSE/POWER COMMAND. In addition the ECHO and REPLY options of SUBVSE will not function when OCCF is active.

COMMAND FORMATS

VSEMSG

VSEMSG	?
	dosid (pn) (LAST) (ALL)

where:

? causes an explanation of the command format to be displayed at your terminal.

dosid the userid of the VSE virtual machine.

pn is the id of the partition for which a display is requested.

LAST displays the last 20 messages and input on the VSE system console.

ALL displays the last three messages and the last outstanding message requiring a reply issued by all active partitions and subtasks.

ALL is the default. Attention routine and supervisor messages are displayed if a partition id is specified.

VSEREP

VSEREP	?
	dosid

where:

? causes an explanation of the command format to be displayed at your terminal.

dosid is the userid of the VSE virtual machine.

You will be prompted for the text of this reply, which must follow the rules of VSE Asynchronous Operator Communication (in other words, the command must be a one to three digit reply-id in the range 0 - 255 followed by the reply text).

Note: If more than one task in a partition has a reply outstanding, only the last reply-id will be accepted by these routines. VSECMD may be used for other replies.

VSECMD

VSECMD	?
	dosid

where:

? causes an explanation of the command format to be displayed at the your terminal.

dosid is the userid of the VSE virtual machine.

You will be prompted for the text of this command. If the command is a reply to a partition not owned by you, it must follow the rules of VSE Asynchronous Operator Communication (in other words, it must be a one to three digit reply-id in the range 0 to 255 followed by the reply text). CP commands can not be issued using this module; VSECP must be used.

VSECP

VSECP	?
	vseid

where:

? causes an explanation of the command format to be displayed at the your terminal.

vseid is the userid of the VSE virtual machine.

You will be prompted for the CP command, which must be specified as described in the VM/SP manuals.

VSE/VMCF CP COMMAND INTERFACE

It is frequently desirable to be able to manipulate the VSE virtual machine's virtual I/O environment by issuing CP commands.

Facilities provided include:

1. The ability to enter CP commands from a VSE system console without entering the CP READ state. CP commands can be entered as AR commands preceded by "* CP." This facility is especially useful to users of a "DOC" VSE system console which cannot enter CP READ state.
2. The ability to issue CP commands from a VSE job stream. A limited set of commands is allowed to provide user control of virtual I/O devices during job execution (phases \$\$BCPCMD and CPCMD).

A summary of the commands issued with the CP return code for each will be printed on SYSLST.

CPCMD

```
// EXEC CPCMD  
cpcmd parameter-list  
cpcmd parameter-list  
/*
```

where:

cpcmd is a valid CP command from the following list which must be specified as described in the VM/SP manuals. Abbreviations are not supported.

CHANGE	CLOSE	DEFINE	DETACH
LINK	MESSAGE	ORDER	PURGE
RESET	REWIND	SPOOL	TAG
TRANSFER			

Figure 6. Supported CP commands

VSE/VMCF VSE REQUIREMENTS

VSE Supervisor Requirements

This release of the VSE/VMCF CMS Communication Interface routines requires VSE Advanced Functions Release 3.

The VSE supervisor must specify;

VM=YES in the SUPVR macro
ASYNOC=YES in the FOPT macro

and must have the SGVMCF macro specified after the IOTAB macro. The SGVMCF macro is supplied with the VM/VSE feature of the Interactive Productivity Facility and is specified with no parameters. The SGVMCF macro is automatically included by the Interactive Productivity Facility whenever you tailor your supervisors.

Note: The \$\$A\$SUPD supervisor supplied with the VSE System IPO/E meets the above requirements.

VSE Storage Requirements

The \$VMCF supervisor extension routine requires 16K of system GETVIS storage. This may be reserved in the \$IPL... procedure by specifying "SVA GETVIS=16K." The System IPO/E supplied IPL procedures do this automatically.

Job Control requires the user exit \$JOBEXIT to be loaded into the SVA. This is automatically done by the VSE SVA list \$SVACSC.

IPL and Job Control User Exits

The VSE/VMCF Communications Interface Routines make use of both the IPL User Exit (\$SYSOPEN) and the Job Control User Exit (\$JOBEXIT). The VSE default exit routines which the System IPO/E replaced are renamed and supplied as OSYSOPEN and OJOBEXIT. Existing user exit routines may be linked to the VSE/VMCF user exit routines without modification.

To create a combined IPL user exit, use MAINT to catalog the user exit to user relocatable library 1 (USRRL1) as USYSOPEN. You must restore service relocatable library A (SRVRLA) to disk in order to have access

to the System IPO/E IPL exit. You may do this by using the preservice dialog for component 5745-SC-IOX. This dialog may be selected from menu SRV\$5. Then release the job VMCFKUS from the reader queue. This job will link the user exit with the System IPO/E exit. The resulting phase must not exceed 4K. After this link job you must also run the rename job VMCFRENM. You should not run VMCFRENM until after you have done any link edit you may require of the job exit routine.

To create a combined job control user exit, use MAINT to CATALR your user exit to USRRL1 with a name of UJOBEXIT. You must restore service relocatable library A (SRVRLA) to disk in order to have access to the System IPO/E JCL exit. You may do this by using the preservice dialog for component 5745-SC-IOX. This dialog may be selected from menu SRV\$5. Then release the job VMCFKIJ from the reader queue. This job will link the user exit with the System IPO/E exit. After this link job you must also run the rename job VMCFRENM. You should not run VMCFRENM until after you have done any link edit you may require of the IPL exit routine.

Note: You must run the rename job. The IPL and job exit phases catalog as VMCFOPEN and VMCFEXIT respectively, not as \$SYSOPEN and \$JOBEXIT. This is so that you can verify that the link edit jobs have run properly for these critical system phases before the phases go into production. The VMCFRENM job renames these phases to \$SYSOPEN and \$JOBEXIT.

DIALOG COMPONENTS

Interactive Productivity Facility dialogs communicate via several different screen formats, called panels. These panels are distributed as members of various VSE/ICCF libraries. They are displayed on 3270-type terminals, using the full screen display capability, and are generated for a 24 X 80 matrix of characters. A description of the panels and the dialog manager may be found in Appendix C.

[VM/VSE FEATURE NOTE] If you are using the VM/VSE Feature running under VM/CMS, refer to the section 'Dialog Components' in the Interactive Productivity Facility VM Feature User's Guide.

MENU HIERARCHY OVERVIEW

The Interactive Productivity Facility provides the control for presenting a hierarchy of menu panels through which a specific

activity can be selected and performed. This control is performed by the menu manager, which displays menu panels and analyzes your responses.

If your response corresponds to a lower level menu panel, the selected menu panel is displayed. If your response corresponds to a dialog, the dialog is invoked. When it completes, the menu manager redisplay the menu panel which was used to invoke the dialog.

If your response is ICCF or CMS, the menu manager saves the name of the menu panel from which the ICCF or CMS exit is invoked. This panel is displayed by default when you re-enter the Interactive Productivity Facility. You are then returned to VSE/ICCF or VM/CMS.

Figure 7 shows the information on the main menu panel. Figure 8 on page 28 summarizes the system management hierarchy. Figure 9 on page 29 shows the system use menu hierarchy and Figure 10 on page 29 gives an overview of the environment definition hierarchy.

[VM/VSE FEATURE NOTE] In the VM/VSE environment, the information on the main menu panel differs from Figure 7, and the system use menu hierarchy of Figure 9 on page 29 is replaced by the version supplied with the VM/VSE Feature. Refer to the appendix of the VM/VSE Feature Guide for the menu panels in the VM/VSE environment.

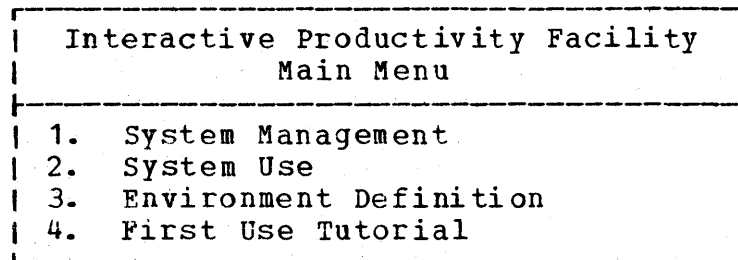

Figure 7. Interactive Productivity Facility main menu for VSE

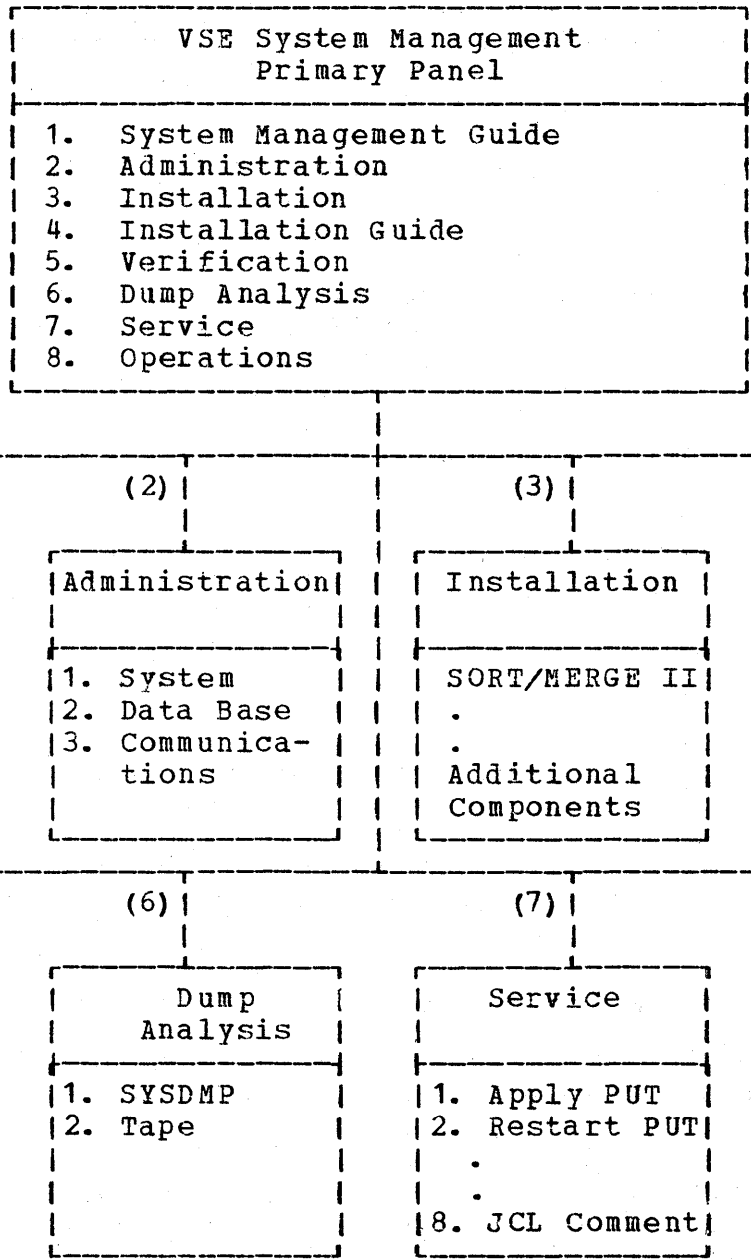

Figure 8. System management hierarchy

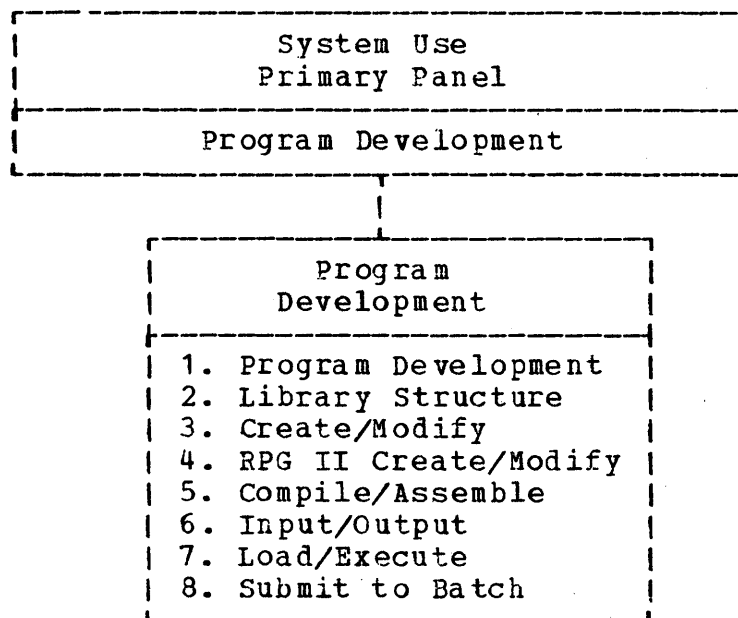

Figure 9. System use hierarchy for VSE only

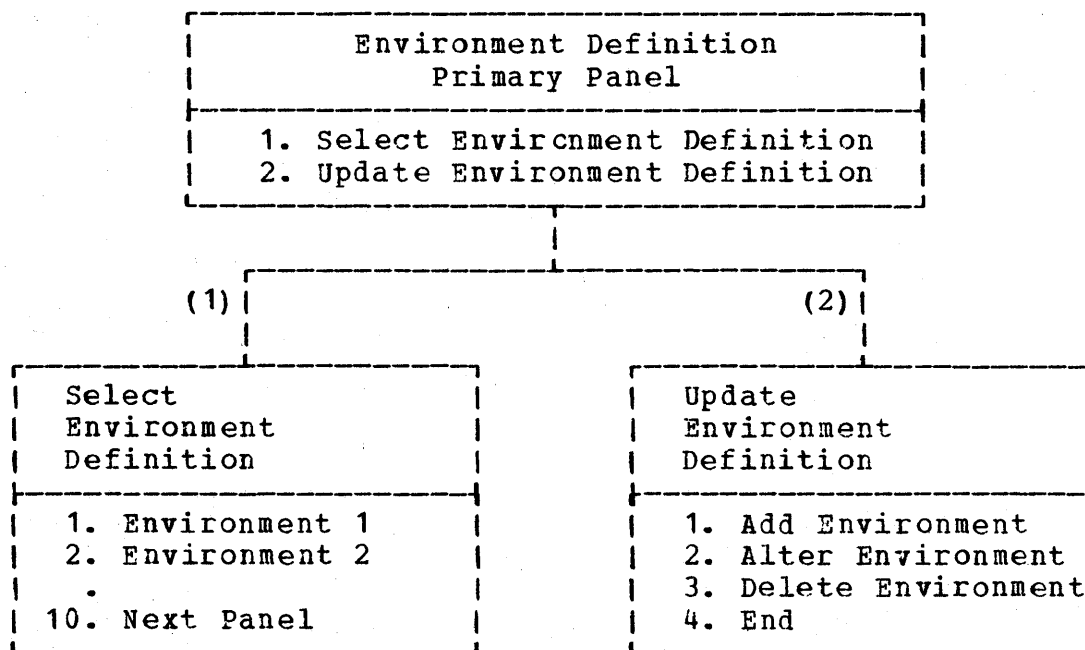

Figure 10. Environment definition hierarchy

MENU HIERARCHY DETAIL

This chart will assist you in locating information about the dialog you wish to run. For an overview of the dialog, refer to the page under the Overview column. For detailed information on the function for a dialog, refer to the Interactive Productivity Facility Reference Manual.

Menu Hierarchy Information	Overview
System Use (VSE Only)	page 163
Program Development	page 163
System Management	page 111
System Management Guide	page 111
Administration	page 112
System Administration	page 112
System Profile	page 112
First Time Use	page 112
I/O Configuration	page 113
Software Products	page 114
Add Software Products	page 114
Create Copy Files	page 114
Library Information	page 115
Label Information	page 115
Logons/Passwords	page 116
Add VSE/ICCF User	page 116
Delete VSE/ICCF User	page 116
Change VSE/ICCF User	page 116
Add CICS/VS User	page 116
Delete CICS/VS User	page 116
Change CICS/VS User	page 116
Assemble/Catalog SNT	page 116
Librarian	page 116
Display Library Members	page 116
Delete Library Members	page 116
Rename Library Members	page 116
Catalog Library Members	page 116
Create Libraries	page 116
Copy/Merge Libraries	page 116
Backup Library Sets	page 116

Menu Hierarchy Information	Overview
Restore Library Sets	page 118
System Tailoring	page 118
Supervisor Tailoring	page 118
ASI Procedure Tailoring	page 118
VSE/POWER Tailoring	page 118
VSE/ICCF Tailoring	page 118
	page 160
TTF Tailoring	page 118
Modify VSE/ICCF Tables	page 118
Modify Security Table	page 118
Run Security Reports	page 120
Dialog Customization	page 121
Utility Aids	page 121
* Retrieve Job From SYSIN	page 121
* Print Panels	page 121
FCB Maintenance	page 122
Data Base Administration	page 122
VSE/VSAM	page 123
Catalog Management	page 123
Define Catalog	page 123
Delete Catalog	page 123
Copy Out Catalog	page 123
Copy In Catalog	page 123
Transport Catalog	page 123
List Catalog	page 123
Space Management	page 123
Define Space	page 123
Delete Space	page 123
Data Set Management	page 123
Define Cluster	page 123
Delete Cluster	page 123
Alter Cluster	page 123
Copy File	page 123
Export File	page 123
Import File	page 123
Print File	page 123
Verify File	page 123
Display File	page 123

* VSE/ICCF users only.

Menu Hierarchy Information	Overview
Communication Administration	page 123
CICS/VS Tables	page 123
CICS Programs	page 123
Add Program	page 123
Delete Program	page 123
Change Program	page 123
Assemble/Catalog PPT	page 123
CICS Transactions	page 123
Add Transactions	page 123
Delete Transactions	page 123
Change Transactions	page 123
Assemble/Catalog PCT	page 123
CICS Terminals, Lines	page 123
Add Terminal	page 123
Delete Terminal	page 123
Change Terminal	page 123
Assemble/Catalog TCT	page 123
CICS Data Sets, Data Bases	page 123
Add Data Set	page 123
Delete Data Set	page 123
Change Data Set	page 123
Assemble/Catalog FCT	page 123
VSE/POWER RJE	page 125
EP/VS	page 126
Installation	page 127
Installation Guide	page 133
Verification	page 142
Dump Analysis	page 144
Service	page 145
Apply PUT	page 150
Restart PUT	page 154
Apply Selective PUT	page 155
Apply PTF	page 155
Print Cover Letters	page 155
Apply PTF	page 155
Apply Cumulative PTF	page 156
Apply Backout PTF	page 156
Apply APAR/Local	page 157
Preservice	page 158
Corrective Service	page 158

Menu Hierarchy Information

Overview

Alter Core Image	page 158
Alter Relocatable	page 158
Alter Source	page 158
Undo Core Image	page 158
Undo Relocatable	page 158
Post Service	page 159
Archive Fix	page 159
History Function	page 159
Retrace History	page 159
Remove History Record	page 159
Condense History	page 159
Backup History File	page 159
Restore History	page 159
JCL Comments	page 160
Operations	page 161
JCL Creation	page 161
VSE Utilities	page 161
Backup Restore Utilities	page 161
Fast Copy Utilities	page 161
Copy Diskette Utilities	page 161
Display VTOC Utilities	page 162
Environment Definition	page 165
Select Environment Definition	page 141
Update Environment Definition	page 165
First Use Tutorial	page 166
Introduction	page 166
Adjusting Screen	page 166
Exiting	page 166
Cursor Movement	page 166
Indicators	page 166
Management/Use	page 166
Menu Panel	page 166
Data Entry Panel	page 166
Explain Panel	page 166
Insert/Delete and Erase	page 166
Other Keys	page 166
Light-pen	page 166
Fast Path	page 166

DIALOG FLOW EXAMPLES

The following two examples show samples of panel sequences that you might see when using the Interactive Productivity Facility to execute the indicated tasks. These panels are assumed to be at the point where the required data has been entered but before the ENTER key has been pressed. The entered data appears highlighted.

FIRST USE TUTORIAL

Assume you want to learn how to use the fast path capability. When you log on to the Interactive Productivity Facility, you are presented with the main menu panel similar to Figure 11 on page 35. You would select FIRST USE TUTORIAL by using the light-pen or by selecting choice 4 by entering a 4 in the input area as shown in the figure and pressing ENTER.

[VM/VSE FEATURE NOTE] In the VM/VSE environment, you will have a different main menu panel from Figure 11 on page 35. However, you may select the VM FIRST USE TUTORIAL from that panel. The prefix of the First Use Tutorial panels in the VM/VSE environment is VMT\$. For more information on VMT\$, refer to the section 'Menu Hierarchy and First Use Tutorial' in the Interactive Productivity Facility VM Feature User's Guide.

Select the activity you wish to perform.

Welcome to the Interactive Productivity Facility. This product is designed to operate with the System IPO/E, and to simplify the USE and MANAGEMENT of your computer system. If you are using the system for the first time, we recommend you select the FIRST USE TUTORIAL.

- 1 SYSTEM MANAGEMENT
- 2 SYSTEM USE
- 3 ENVIRONMENT DEFINITION
- 4 FIRST USE TUTORIAL

5748-MS1 COPYRIGHT, IBM CORP., 1979, 1981
LICENSED MATERIAL - PROGRAM PROPERTY OF IBM

=> 4

PF1=EXPL

3=RETURN

4=ICCF

6=INIT

Figure 11. Sample initial panel

| The first use tutorial menu panel, Figure 12 on page 37, now replaces
| the initial menu panel on the previous page. It shows the activities
| available in the first use tutorial plus a brief definition of each
| function. As you see in the figure, FAST PATH is selection 13.
| Light-pen select that choice, or enter 13 in the input area as shown
| and press ENTER.

FIRST USE TUTORIAL

SYIS\$

Select the activity you wish to perform.

TOPICS IN THIS TUTORIAL

If you want help on how to proceed, enter or select EXPLAIN (PF1)

- | | | |
|----|---------------------------|---|
| 1 | INTRODUCTION | Describes this tutorial. |
| 2 | ADJUSTING SCREEN | How to adjust intensity and contrast. |
| 3 | EXITING | How to leave the dialog. |
| 4 | CURSOR MOVEMENT | How to use the tab and "arrow" keys. |
| 5 | INDICATORS | Describes Input Inhibited and System Available functions for the 3277 and 3278. |
| 6 | MANAGEMENT / USE | Describes the types of environments. |
| 7 | MENU PANEL | How to use. |
| 8 | DATA ENTRY PANEL | How to use. |
| 9 | EXPLAIN PANEL | How to use. |
| 10 | INSERT / DELETE AND ERASE | How to use. |
| 11 | OTHER KEYS | How to use the CLEAR, PF, and APL keys. |
| 12 | LIGHTPEN | How to use. |
| 13 | FAST PATH | How to use. |

=> 13

PF1=EXPL

3=RETURN

4=ICCF

6=INIT

Figure 12. Sample first use tutorial panel

| At this point, you have completed the menu selection and displayed the
| first fast path panel, (Figure 13 on page 39). This panel introduces
| the fast path capability and tells you to press ENTER to continue.

Enter the required data and press enter.

You can go directly to a given primary menu from any other primary menu, or the initial menu, by entering the following command:

=panelname

Where panelname is the name that appears in the upper right corner of the screen when a primary or initial menu panel is displayed.

You cannot go to or exit from a

data entry, explain, or information menu panel with this command. You will get an error message if you try.

It is only operative for primary and initial menu panels. You will be given an opportunity to try this on the next panel.

Press ENTER to continue.

=>

PF1=EXPL

3=CANCEL

5=RETRY

Figure 13. Fast path tutorial

| You receive instructions to execute fast path commands. The
| instructions tell you what to do, what will happen, when you can use
| this function, and that this ends the topic 'Fast Path.' (Figure 14 on
| page 41)

| If you press ENTER (or enter CANCEL), you will return to the first use
| tutorial menu panel, (Figure 12 on page 37). From that panel you can
| return to the main menu panel or leave the Interactive Productivity
| Facility and return to VSE/ICCF (or CMS).

Enter the required data and press enter.

You will be executing the following commands on another panel, so copy them onto a piece of paper.

1. Select CANCEL (or press ENTER.
2. Enter: =dtr\$
This takes you to the initial menu.
3. Enter: =syi\$
This returns you to the primary menu for this tutorial.

By using '=panelname' on any primary or initial menu, you can go directly to the desired menu panel.

Perform these steps now for practice in using this command.

This concludes the topic 'FAST PATH.'

=>

PF1=EXPL

3=CANCEL

5=RETRY

Figure 14. Fast path tutorial (continued)

| CHANGE AUTOMATIC SYSTEM INITIALIZATION (ASI) PARAMETER

| This is the second example. This time let's assume you want to change
| the ASI specifications used for your VSE system initialization. For
| example, assume you want to define an optional label information area
| by including the DLA command. Again you start with the main menu
| panel, but this time you want to perform a system management function.
| To do this, light-pen select SYSTEM MANAGEMENT on the menu panel or
| enter 1 in the input area as shown in Figure 15 on page 43.

INTERACTIVE PRODUCTIVITY FACILITY: INITIAL MENU DTR\$

Select the activity you wish to perform.

Welcome to the Interactive Productivity Facility. This product is designed to operate with the System IPO/E, and to simplify the USE and MANAGEMENT of your computer system. If you are using the system for the first time, we recommend you select the FIRST USE TUTORIAL.

- 1 SYSTEM MANAGEMENT
- 2 SYSTEM USE
- 2 ENVIRONMENT DEFINITION
- 3 FIRST USE TUTORIAL

5748-MS1 COPYRIGHT, IBM CORP., 1979, 1981
LICENSED MATERIAL - PROGRAM PROPERTY OF IBM

=> 1

PF1=EXPL 3=RETURN 4=ICCF 6=INIT

Figure 15. Initial menu panel

| The system management menu panel now replaces the main menu panel.
| Since you want to do an administrative function, select 2 either by
| light-pen or by entering 2 and pressing ENTER as shown in Figure 16 on
| page 45.

Select the activity you wish to perform.

- | | | |
|---|-------------------------|---|
| 1 | SYSTEM MANAGEMENT GUIDE | Perform Initial Path Activities |
| 2 | ADMINISTRATION | Perform Administrator Functions |
| 3 | INSTALLATION | Install VSE Optional Components |
| 4 | INSTALLATION GUIDE | Install Components not Selected During
First Time Use and Components Outside
System IPO/E Product Set |
| 5 | VERIFICATION | Verify Installation of VSE Components |
| 6 | DUMP ANALYSIS | Analyze VSE/IPCS Dump |
| 7 | SERVICE | Apply Service to the VSE System |
| 8 | OPERATIONS | Select an Operations Utility |

=> 2

PF1=EXPL

3=RETURN

4=ICCF

6=INIT

Figure 16. System management menu panel

| Because there are several administrative functions available, you are
| now presented with another menu panel describing the three types of
| administrative functions as shown in Figure 17 on page 47. Because
| you want to change a system specification, you select choice 1 on the
| administration menu panel. Again you can use the light-pen or enter a
| 1 in the input area and press ENTER.

SYSTEM MANAGEMENT: ADMINISTRATION MENU SYM\$1

Select the activity you wish to perform.

- | | | |
|---|------------------------------|--|
| 1 | SYSTEM ADMINISTRATION | Perform System Administration for Profiles, Passwords, Librarian, and Tailoring of Supervisor, ASI and VSE/POWER |
| 2 | DATA BASE ADMINISTRATION | Perform Data Base Administration for VSE/VSAM and DL/I |
| 3 | COMMUNICATION ADMINISTRATION | Perform Communication Administration for CICS/VS, RJE, and EP/VS |

=> 1

PF1=EXPL

3=RETURN

4=ICCF

6=INIT

Figure 17. Administration menu panel

| The system administration menu shown in Figure 18 on page 49 now
| replaces the main administration menu. Let's assume you are not sure
| which choice to make. As you see in the figure, EXPL (explain) is
| indicated for PF1. Press PF1.

Select the activity you wish to perform.

- | | | |
|---|------------------------|---|
| 1 | SYSTEM PROFILE | Create/maintain your system profile table. This should be the first activity you perform when you install the System IPO/E. |
| 2 | LOGONS/PASSWORDS | Maintain VSE/ICCF and CICS/VS logon ID's |
| 3 | LIBRARIAN | Perform VSE Librarian function |
| 4 | SYSTEM TAILORING | Tailor VSE system components |
| 5 | MODIFY VSE/ICCF TABLES | Modify VSE/ICCF tables |
| 6 | MODIFY SECURITY TABLE | Modify Access Control security table |
| 7 | RUN SECURITY REPORTS | Run Access Control security reports |
| 8 | DIALOG CUSTOMIZATION | Delete Interactive Productivity Facility dialogs not required |
| 9 | UTILITY AIDS | Select one of the dialog aids |

=>

PF1=EXPL

3=RETURN

4=ICCF

6=INIT

Figure 18. System administration menu panel

| An explain panel now replaces the system administration menu panel.
| Scroll through the three pages of the explain and find on page two,
| Figure 19 on page 51, that system tailoring includes modifying ASI
| specifications. Since you no longer need the explain, press PF3 to
| END and the system administration menu is redisplayed.

END leaves explanation, FORWARD continues explanation.

LOGONS/PASSWORDS: Select this option to control access to VSE/ICCF and CICS/VS. This activity helps you define users of VSE/ICCF and CICS/VS, how they identify themselves to the system and what resources (such as VSE/ICCF libraries and CICS/VS programs) they may access.

LIBRARIAN: Select this option to display a menu of VSE library activities.

SYSTEM TAILORING: Select this option to get a menu of system tailoring activities. This includes supervisor, ASI procedure, and VSE/POWER tailoring.

DIALOG CUSTOMIZATION: Select this option to delete the Interactive Productivity Facility dialogs that you will not use. For example, batch interactive users may elect to delete the CICS/VS tailoring dialogs to save library

=>

PF1=OVER

2=ASSIST

3=END

7=BACK

8=FORW

Figure 19. Administration menu explain panel

| Select 4, System Tailoring, shown again in Figure 20 on page 53, since
| the explain panel told you that this function includes modifying ASI
| specifications. After entering a 4, press ENTER.

Select the activity you wish to perform.

- | | | |
|---|------------------------|--|
| 1 | SYSTEM PROFILE | Create/maintain your system profile table. This should be the first activity you perform when you install the System IPO/E |
| 2 | LOGONS/PASSWORDS | Maintain VSE/ICCF and CICS/VS logon ID's |
| 3 | LIBRARIAN | Perform VSE Librarian function |
| 4 | SYSTEM TAILORING | Tailor VSE system components |
| 5 | MODIFY VSE/ICCF TABLES | Modify VSE/ICCF tables |
| 6 | MODIFY SECURITY TABLE | Modify Access Control security table |
| 7 | RUN SECURITY REPORTS | Run Access Control security reports |
| 8 | DIALOG CUSTOMIZATION | Delete Interactive Productivity Facility dialogs not required |
| 9 | UTILITY AIDS | Select one of the dialog aids |

=> 4

PF1=EXPL

3=RETURN

4=ICCF

6=INIT

Figure 20. System administration menu panel

| Figure 21 on page 55 shows the menu for the functions available to
| tailor system components. By following this one path through system
| management, you can see the many functions available to you. As you
| see on the tailor system component menu, you want choice 2. Use the
| light-pen to select ASI PROCEDURE TAILORING or you enter a 2 in the
| input area and press ENTER.

Select the activity you wish to perform.

- | | | |
|---|-------------------------|---|
| 1 | SUPERVISOR TAILORING | Generate VSE Supervisor Assembly |
| 2 | ASI PROCEDURE TAILORING | Modify Automatic System
Initialization |
| 3 | VSE/POWER TAILORING | Generate VSE/POWER Assembly |
| 4 | VSE/ICCF TAILORING | Tailor VSE/ICCF |
| 5 | TTF TAILORING | Tailor VSE/ICCF TTF |

=> 2

PF1=EXPL

3=RETURN

4=ICCF

6=INIT

Figure 21. Tailoring system components menu panel

| The first ASI data entry panel is now displayed. The dialog will help
| you create a new set of specifications and save it by name or, update
| a set saved previously, or omit a save name and use the default name
| presented and update the default specifications. For our example,
| update the default specifications, \$IPL006. To do this, just press
| ENTER.

TAILORING: AUTOMATIC SYSTEM INITIALIZATION (ASI) TASSMAS1

Enter the required data and press enter.

Enter the name of the ASI specification to be changed, or to be used as default values for addition of new specifications. Also enter the name under which you wish to save new specifications. If a save name is not entered, you will update the default specifications. DELETE in ACTION field will delete the default name specification.

SAVE NAME	DEFAULT NAME	ACTION
==> _____	==> \$IPL006	==> _____

Names of specifications you have access to are:
\$IPL006

=>

PF1=EXPL 3=CANCEL 5=RETRY

Figure 22. ASI data entry panel

| This panel presented now, ASI PROCS: IPL SPECIFICATIONS, shows some
| of the default values in \$IPL006. The optional label information area
| that we want to specify is not available on this panel. Press ENTER to
| reach the next panel.

Enter the required data and press enter.

You may select your supervisor and some other IPL options with this panel. The response YES to the IPL log option is normally a good practice.

IPL CONSOLE	==> 01F	The console you wish to use during IPL.
SUPERVISOR PAGING	==> YES	Do you wish the pageable part of the supervisor to page or not (YES or NO)
IPL LOG OPTION	==> YES	Do you wish IPL commands to LOG on the IPL console (YES or NO)
VIRTUAL STORAGE	==> _____	The VSIZE you desire if mode = 370 (Number of kilobytes. Specify five digits up to 16384.)
SUPERVISOR	==> \$\$A\$SUPD	The supervisor you wish to IPL.

=>

PF1=EXPL

3=CANCEL

5=RETRY

Figure 23. ASI data entry panel (continued)

| The panel presented now includes DLA -- Modify Optional Label Area
| (DLA) Definition. Therefore, select 3.

Enter the required data and press enter.

- | | | |
|---|---------------------|---|
| 1 | SYSTEM DEFINES | Modify Miscellaneous System Definition |
| 2 | SVA | Modify Shared Virtual Area (SVA) Definition |
| 3 | DLA | Modify Optional Label Area (DLA) Definition |
| 4 | DPD | Modify Page Data Set Definition |
| 5 | DLF | Modify Optional Define Lock File Definition |
| 6 | SYSTEM COMMANDS | Modify system commands ALLOC, ALLOCR, priority and system standard options |
| 7 | VSE/POWER STARTUP | Modify VSE/POWER startup and BG and foreground partitions' device assignments |
| 8 | GENERATE JOB STREAM | Update Tables and Generate JCL Streams |

=> 3

PF1=EXPL 3=CANCEL 5=RETRY

Figure 24. ASI tailoring menu panel

| You are now presented with the data entry panel on which you can
| define your label area. Enter your data and press ENTER. The data is
| now stored in a table. Another function is available that can produce
| JCL statements from the stored data.

Enter the required data and press enter.

DLA NAME	==> LABAREA__	Name of Optional Label Area (blank field will delete entry)
DLA DISK ADDRESS	==> 160_	Address of Disk Volume where label area is to reside
START ADDRESS	==> 200__	Starting cylinder or Block Address
LABEL AREA SIZE	==> _____	Cylinder or Blocks for Label Area (leave blank for VSE defaults)
SECURED DATA SET?	==> YES_	YES will secure the DLA data set, NO or blank will bypass security

=>

PF1=EXPL 3=CANCEL 5=RETRY

Figure 25. ASI define label area data entry panel

| The ASI menu panel is now redisplayed, (Figure 26 on page 65). To
| produce the JCL statements to define your label area using the
| information that you stored in the table, select 8 **GENERATE JOB**
| **STREAM**. Then use the ASI Tailoring Menu to select other tasks, return
| to other Interactive Productivity Facility menus to select tasks, or
| submit the newly created JCL to VSE to define your label area.

TAILORING: AUTOMATIC SYSTEM INITIALIZATION (ASI) MENU TASMAS2

Enter the required data and press enter.

- | | | |
|---|---------------------|---|
| 1 | SYSTEM DEFINES | Modify Miscellaneous System Definition |
| 2 | SVA | Modify Shared Virtual Area (SVA) Definition |
| 3 | DLA | Modify Optional Label Area (DLA) Definition |
| 4 | DPD | Modify Page Data Set Definition |
| 5 | DLF | Modify Optional Define Lock File Definition |
| 6 | SYSTEM COMMANDS | Modify system commands ALIOC, ALLOCR, priority and system standard options |
| 7 | VSE/POWER STARTUP | Modify VSE/POWER startup and BG and foreground partitions' device assignments |
| 8 | GENERATE JOB STREAM | Update Tables and Generate JCL Streams |

=> 8

PF1=EXPL

3=CANCEL

5=RETRY

Figure 26. ASI tailoring menu panel

HINTS AND TIPS

INSTALL

This section explains potential problem situations in installation and ways to bypass the problems if needed.

- Additional members required in production libraries

Situation

You can install products on your system that are outside the VSE System IPO/E product set. They may require members from a System IPO/E supported product that do not reside in the relocatable or source statement production library to be online on a day to day basis.

Bypass

Modify an existing copy file for the product whose member you want placed in the production library. The dialog, create copy files, accessed off of the system profile menu, ADM\$1, may be used for this purpose. Once the copy file has been modified, run the pre and post service dialogs in the corrective service environment to recreate the production libraries using the updated copy files. For example, several products require the source statement book E.MRMOD of VSE Advanced Functions. This book is not contained within the copy file INS\$VSES. Execute the create copy file dialog, updating INS\$VSES to contain E.MRMOD. Next, execute the pre and post service dialogs for a product that has an entry of INS\$VSES in the ADM\$SHIP table. 5745-SC-IOX is one. These jobs will recreate the relocatable and source statement production A libraries. Source statement production library A would then contain E.MRMOD.

SERVICE

This section explains potential problem situations in service application and ways to bypass the problems if needed.

- Service libraries overlapped

Situation

During a PUT application, the default area used for the service libraries on the system work packs is also used as a PUT work

area. Therefore, if you have a service library resident in the default location, it will be overlaid.

Bypass

Backup service libraries residing in the default location before releasing the job to apply a PUT.

- Resident service libraries require spindles beyond the minimum specified operating environment.

Situation

If you make a service library resident on a removable pack, during a PUT application you will need more spindles, or drives, than the System IPO/E installation requires. This is because the PUT application job stream requires two work packs. For example, during PUT application on 3330's the PUT relocatable library is created on SYSWK3. The PUT relocatable library is then moved to SYSWK2 for the MSHP upgrade to the individual service libraries. Thus, SYSWK2 and SYSWK3 are the two PUT work packs. Normally, the service libraries are restored to SYSWK2 with the PUT relocatable library. However, if a service library is resident on another volume, say SYSWK7, then three spindles would be needed. SYSWK2, SYSWK3, and SYSWK7 would be required at the same time.

Bypass

If you make any service libraries permanently resident on a removable pack, you must have one spindle beyond the minimum requirement available during the application of a PUT. For example, a B/I System IPO/E user using 3310s, 3330s or 3340s must have 4 spindles, or drives, to install the System IPO/E. If a service library is permanently resident on a removable pack, this user must have 5 spindles, or drives, available during application of a PUT.

- Mixed 3330/3340 DASD users get incorrect JCL.

Situation

Users with a mix of 3330s and 3340s for SYSWK2 and SYSWK3 will create incorrect JCL when running the preservice dialog of the corrective service environment trying to restore two service libraries to the default locations. The job to restore one of the service libraries to SYSWK3 will use extent and library allocation information corresponding to DASD of the type of SYSWK2. This is a permanent restriction.

Bypass

Modify the JCL in the following manner:

Locate the job that restores one of the service libraries to SYSWK3. Keep the starting address of the first service library (in most cases there will be a relocatable and a source statement library). Convert the number of tracks to the number required for the DASD type of SYSWK3. This information can be found in the Minimum DASD Layout Section of the VSE System IPO/E Reference Manual. Relocate the starting address of the second library (if it exists) to the end of the first library. Modify the number of tracks as above. The library directory allocation sizes must also be converted to agree with the DASD type of SYSWK3.

- Editing of PUT job streams

Situation

If the PUT job stream is edited, care must be taken not to add sequence numbers to the job stream. The addition of sequence numbers will cause various errors, such as supervisor assembly errors, because the MSHP preprocessor shifts the job stream one character to the left during its processing. This could put a sequence number into column 72 thus creating a continuation character.

Bypass

Do not add sequence numbers to the job stream.

- Improper RESOLVES statement causes MSHP abend

Situation

When an APAR or local fix is applied, care must be taken when entering the RESOLVES statement. If there is no leading and following single quote, MSHP will abend and may partially apply a fix.

Bypass

A leading and following single quote must be added as noted on the RESOLVES statement panel SRV\$FIX4.

- Overlapping service libraries

Situation

All service libraries occupy the same default area on the system work packs. Therefore, it is possible to cause service libraries to overlap.

Bypass

Before restoring a service library to the default area, ensure you have backed up service libraries that currently reside there. If

you are installing products or applying service to products that reside in more than a single service library using the default locations, you must backup one service library before proceeding to the next.

- Backout PTFs cannot include VSE/ICCF updates

Situation

Unable to completely backout PTFs which include updates to VSE/ICCF, Interactive Productivity Facility, or related products with ICCF members included.

Bypass

This situation is caused by the distribution of VSE/ICCF members as I.books on PTFs. For example, let us assume that a PTF to the Interactive Productivity Facility updated a JCL skeleton, TAS\$JCL3, with I.TAS\$JCL3. The I.book would be punched to a tape, used as input to DTSUTIL, and deleted. However, there would be no I.TAS\$JCL3 in the service source library for MSHP to use to create a backout PTF. That member only exists on the ICCF libraries. The only way to ensure backout of ICCF library members is to retain a backup of your ICCF libraries from which you can extract the needed member.

- MSGM211I because the service libraries are full

Situation

MSGM211I and MSGM212I may occur during the application of PUT tapes or large amounts of corrective service to the service libraries. These messages occur during the application of service because the service libraries do not have enough room for the serviced members. This may occur because the service adds more or larger members to the service library. Also, the service you are applying may add many members to the service library temporarily.

Bypass

You may bypass this problem in two ways. The first is to make the service libraries larger by splitting them on different packs. The second is to temporarily decrease the service library contents by deleting some members during service application. See the appendix, 'Service Library Full Problems', in the Interactive Productivity Facility VSE Feature Reference Manual for an explicit example of how to bypass this problem.

- Apply PUT will not execute with VSE/Access Control Logging and Reporting support

Situation

If you are running under a supervisor which includes support for VSE/Access Control Logging and Reporting, you can not execute the Apply PUT job stream.

Bypass

IPL a supervisor which does not contain support for VSE/Access Control Logging and Reporting and then run the Apply PUT job stream.

MIGRATION

All users migrating from a prior Interactive Productivity Facility release to Release 4.0 should read the following information. Users who are not migrating can also gain valuable information about the structure of the Interactive Productivity Facility by reading this information.

The conversion necessary to migrate from prior releases to Release 4.0 is done via the first time use dialog.

- User options and save file changes

If you have migrated from a prior release of Interactive Productivity Facility, you must erase the prior release version of DTR\$OPT, DTR\$DTBL, and DTR\$SAVE from your primary library before you use Interactive Productivity Facility for the first time. These members have changed in format.

- Interactive Productivity Facility table format change

Some Interactive Productivity Facility tables have a changed format. When necessary, the Interactive Productivity Facility tables are converted from the prior release to the current release format during first time use. The system profile table convert process may delete or change items in your current system profile tables. The following is a summary of the Interactive Productivity Facility table changes which you need to be aware of during migration.

- System profile tables (labels and libraries)

The disk label profile (ADM\$DTAB) and library profile (ADM\$LTAB) tables are recreated using the new format and DASD allocations. Any labels which you already have in tables

ADM\$DTAB and ADM\$LTAB will be added to the new ADM\$DTAB and ADM\$LTAB. This is only done if the old label is unique, in other words does not already exist in the new ADM\$DTAB and ADM\$LTAB shipped with this release of Interactive Productivity Facility.

Your partition standard labels for BG, F2, and F3 (ADM\$PAR0, ADM\$PAR2, and ADM\$PAR3) are replaced by the shipped partition standard labels.

Entries for user library set USRx11, where x is the library type, are replaced by the shipped version in table ADM\$ULIB. All other existing entries are retained.

- System profile tables (products)

Existing product tables, ADM\$SHIP and ADM\$PROD, are recreated during first time use. No migration is performed on these tables. Products previously installed but not supported by the current release of the VSE System IPO/E will no longer be recorded. If the product was in the production libraries on the packs used by the System IPO/E, the product must be reinstalled. If the product was installed in another library set, outside of the System IPO/E DASD layouts, you must update the system profile to reflect the product ID and location.

- System Profile Tables (hardware)

An existing I/O configuration table is converted and retained if you indicate you do not want the table recreated. The volume serial numbers for the various disk addresses are added to ADM\$HDWT. If the dummy VSE/ICCF device addresses do not exist in the old hardware table, they are added. These addresses are 02A, 02C, 02D, and 02E.

• Migration of supervisor tailoring tables

The supervisor tailoring tables are also converted from prior release format to the Release 4.0 format. The Release 1.0 user should be aware of the defaults for the following:

- DASD sharing Default = NO
- Library concatenation Default = 15
- NTASK Default = 208

Your current supervisor BUFSIZE parameter will be added to the appropriate ASI specification SYS command during ASI conversion.

When the supervisor tailoring tables are converted, the supervisors which are shipped with the System IPO/E Release 3.0 are added to your supervisor tailoring tables. This is only done

for System IPO/E supervisors which do not already exist in your supervisor tailoring tables. You may wish to save any supervisors you have with the name \$\$\$SUPA, B, C, and D under different names and then delete those supervisors before you install this release of the Interactive Productivity Facility. For example, you could save your current supervisor named \$\$\$SUPD as \$\$\$SUPO. Then delete your current \$\$\$SUPD. When you run first time use, your \$\$\$SUPO will be converted and the new \$\$\$SUPD will be added to your supervisor tailoring tables.

- Migration of ASI tailoring tables

Your old ASI tables are converted to the current format during first time use. You are given a choice of converting some or all of the ASI procedures in your primary library to the Release 4.0 format. If you do not want to convert the old ASI tables in the primary library to the new format, you must erase the old ASI tables. These tables begin with the letters TAS\$. They reside in your primary ICCF library. If you erase all members which begin with TAS\$ from your primary ICCF library, you may then choose to process some or all of the ASI tables shipped with Interactive Productivity Facility Release 4.0. The EXPLAIN for panel TAS\$CNV1, which can be selected during the ASI conversion process, contains more information.

You may also convert your prior release ASI tables and select some of the shipped Interactive Productivity Facility Release 4.0 ASI tables. After you convert your prior release ASI tables, you are given the choice of adding some of the shipped ASI table entries to the entries you converted. You may wish to do this in order to have available both your prior release ASI specifications and the ASI specification with which you IPLed. If any of your current ASI specifications begin with \$IPL, you should save them under a different name and delete them, or not select them for ASI conversion. You may not have both a converted prior release ASI specification and a shipped ASI specification of the same name. For example, if you currently have an ASI specification named \$IPL006 and you use \$IPL006 during base install, you should save your current \$IPL006 as OLD006 before you attempt to install this release of Interactive Productivity Facility. Then you may delete \$IPL006 from your tables and include \$IPL006 from the shipped ASI tables.

- ASI parameter requirements

The implication of converting the ASI procedures from an earlier release is that you are responsible for verifying that your ASI procedures are compatible with the System IPO/E. In particular, you must verify that the following parameters are compatible with the VSE System IPO/E which you are installing. The ASI procedures shipped with the VSE System IPO/E are documented in the VSE System IPO/E Reference Guide.

-- ALLOC and ALLOCR

ALLOC and ALLOCR must be sufficient for the new level of the products which you are installing. These values are selected in the background procedures section of ASI tailoring.

-- System and partition device assignments

The addresses of SYSCAT, SYSREC, and SYSDMP must match the shipped System IPO/E values, or you must review the standard labels and make any necessary changes. See the EXPLAIN panel TAS\$DEF1 for system defines in ASI tailoring for more information.

The SYSLNK assignment for BG must be DOSPES or you must change the shipped standard labels to reflect your SYSLNK. SYS001, SYS002, SYS003, and SYS004 assignments for BG must be the same as the system IPO/E value, or you must make the appropriate standard label changes.

Programmer and system logical unit assignments for all partitions should be checked to verify that they do not conflict with the System IPO/E standards. In particular all assignments for BG, F2, and F3 must be checked because those partition standard labels have been replaced during first time use. Any files which reside on DOSRES, SYSWK1, SYSWK2, SYSWK3, or SYSWK4 should be checked. The System IPO/E standard labels for each DASD type are documented in the VSE System IPO/E Reference Manual. You must know which IPL and JCL procedures you used to IPL your system to select the correct labels. You may also use the system profile label dialog information to check your standard labels.

• The device addresses for VSE/POWER may not be as the ASI procedure assumes them to be. For example, the system punch may be expected to be at address 00D but, 00D may be a diskette reader. This could cause errors during VSE/POWER initialization. You should make sure that both the hardware profile and the VSE/POWER ASI parameters are accurate and agree. The FOREGROUND PROC section of ASI tailoring, panels TAS\$F1P1 and TAS\$F1P3, contain device specifications for VSE/POWER.

CHAPTER 2 - SYSTEM MANAGEMENT GUIDE CHECKLIST

This checklist is designed to help you complete the activities associated with the System Management Guide of the Interactive Productivity Facility. Use it while running the online dialogs.

VSE SYSTEM MANAGEMENT GUIDE FLOW

The following flow describes the building of the VSE system that is supported by the Interactive Productivity Facility. The System Management Guide Checklist assists you in completing these activities. When documents other than this one should be reviewed, they are listed to the right of the activity.

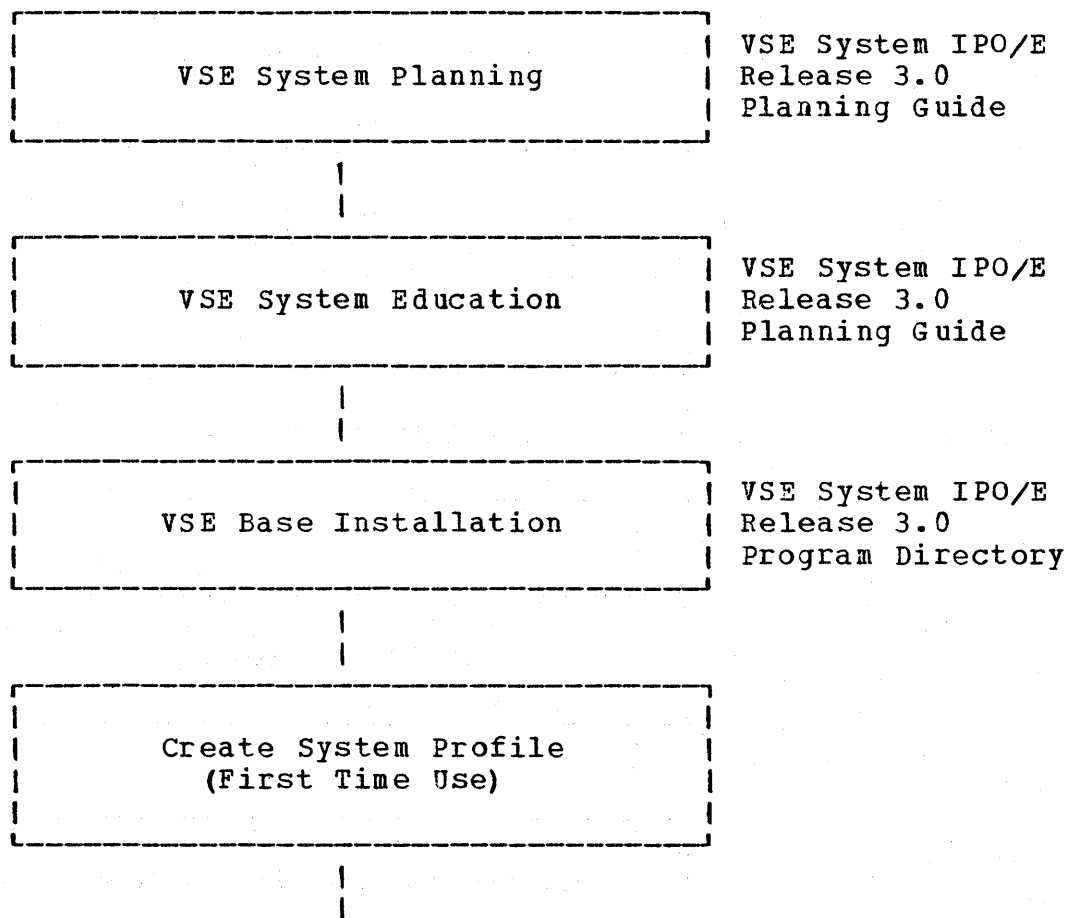

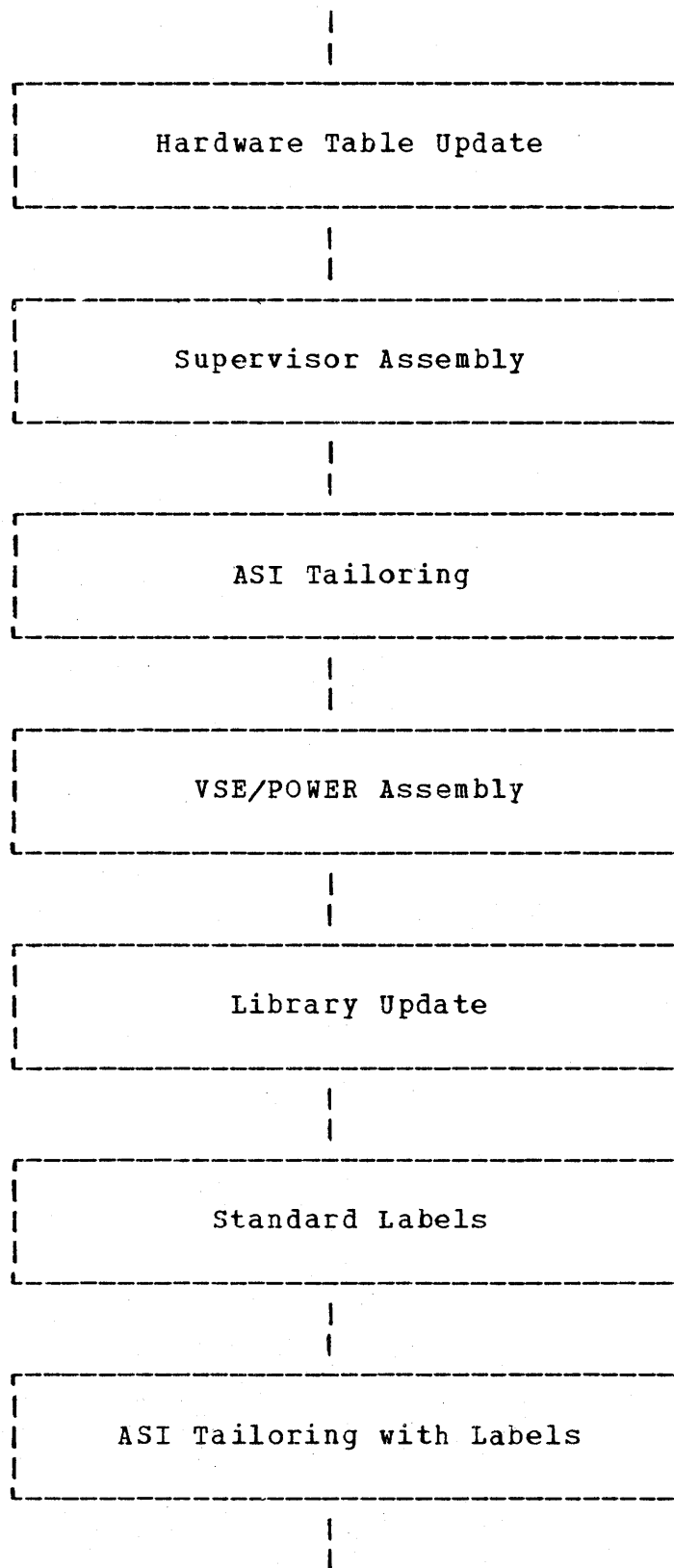

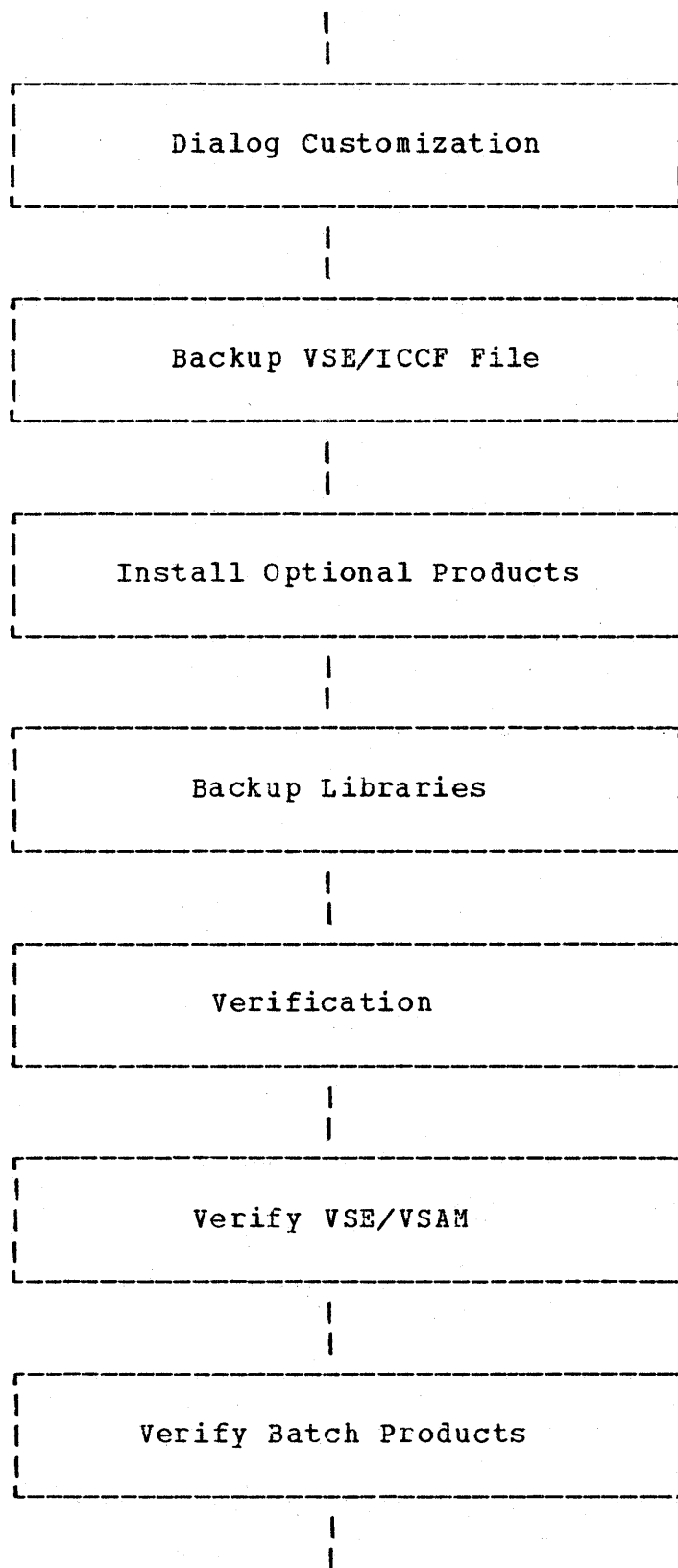

VSE System IPO/E
Release 3.0
User's Guide

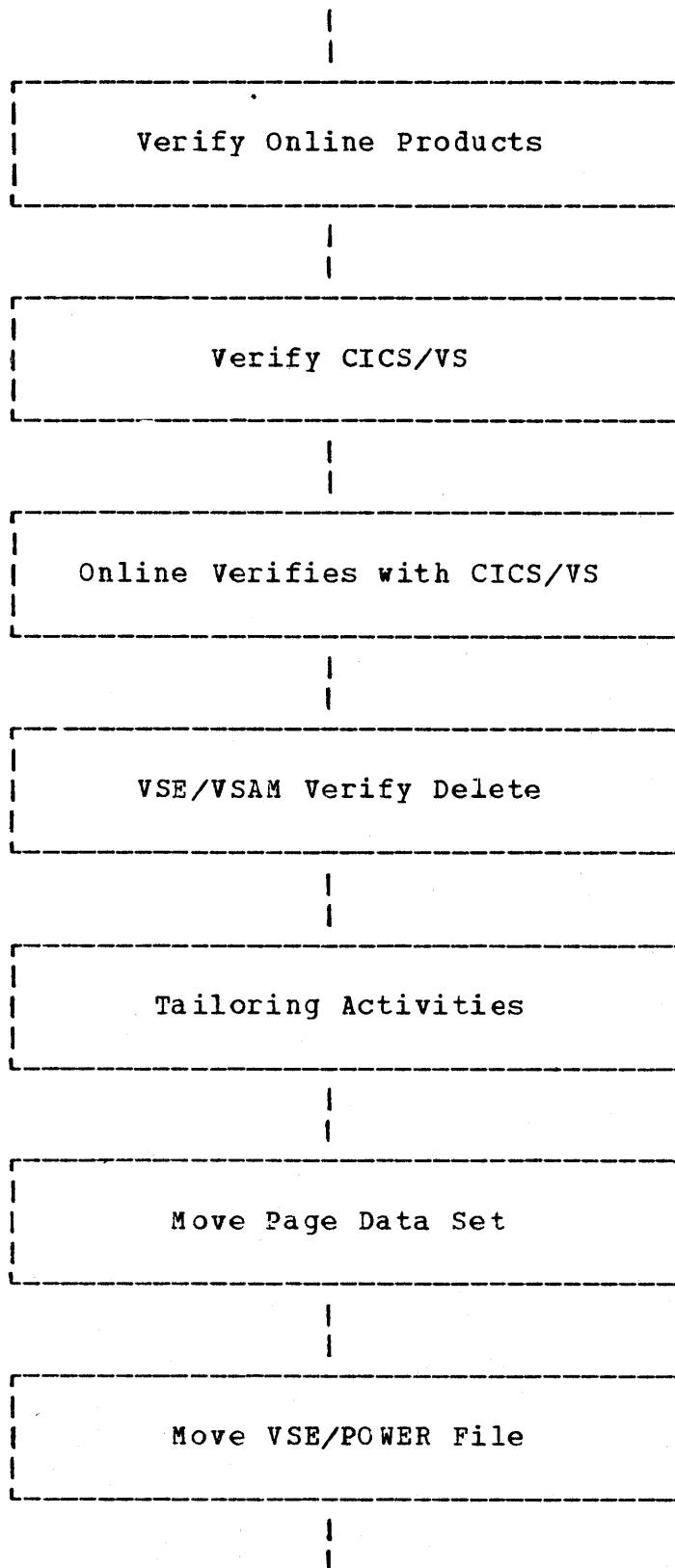

|
|
|-----|
Move VSE/ICCF File

|
|
|-----|
User Application Migration

VSE System IPO/E
Release 3.0
Planning Guide

VSE SYSTEM MANAGEMENT GUIDE PANEL SEQUENCE

| **[VM/VSE FEATURE NOTE]** If you are using the VM/VSE Feature running
| under VM/CMS, refer first to the section 'Post Installation Tasks' in
| the VM/VSE Feature Guide. Also refer to the section 'SUBVSE
| Requirements' in the Interactive Productivity Facility VSE Feature
| Reference Manual and to the section 'Submit to VSE' in this manual for
| information on submitting the created JCL to VSE in the VM/VSE
| environment. You may use SUBVSE instead of IPFSUB in the following
| descriptions in the VM/VSE environment.

| To start the System Management Guide in the VSE environment, log on to
| VSE/ICCF using the system administrator ID, AAAA. Enter @IPF to enter
| the Interactive Productivity Facility. Enter =sym\$ on the first panel
| displayed and press enter. Select 1, System Management Guide. This
| will display the first panel of the System Management Guide.

Notes:

- | 1. As you continue through the System Management Guide, some
| activities require you to leave the Guide in order to complete the
| activity, and you will not be returned to a Guide panel. Follow
| the instructions above, or those associated with the specific
| activity below, to return to the Guide.

- | 2. If you use the fast path facility, =panel-id, while in the System
| Management Guide, your sequential progress through the Guide may
| be different than expected. If you use fast path to go to another
| part of the Guide and then select NEXT DIALOG or PRIOR DIALOG, you
| will be presented with the Guide panel after or prior to the one
| from which you entered fast path. You will not be presented with
| the one after or prior to the one presented as a result of fast
| path.

CREATE SYSTEM PROFILE

SYSTEM MANAGEMENT GUIDE: CREATE SYSTEM PROFILE SYM\$G1

The first time use dialog creates your system profile. You will be prompted to provide information concerning your hardware and software configuration. You will need to know what ASI procedure you used to IPL the system during the base installation process, what DASD types and addresses you will be using, and what System IPO/E products you plan on installing. Be sure to specify all products that will be installed on your system now, or in the future. A job stream will be created and filed under the default name of FIRSTUSE. This job stream will create production libraries based on the products you plan to install.

After completing the dialog, submit the JCL produced to VSE. Review the printed output of the job execution before continuing.

- | | | |
|---|----------------|------------------------------|
| 1 | FIRST TIME USE | Create System Profile Tables |
| 2 | NEXT DIALOG | Continue to Next Dialog |

This dialog sets up your system profile. The existence of the system profile is essential for the execution of many other dialogs. For this reason, you cannot proceed beyond the initial panel of the System Management Guide until this dialog has been run to completion.

If you rerun this dialog for any reason, a panel will display indicating which items may be lost. If you proceed beyond this panel, you must allow the dialog to finish, or your profile will be incomplete.

1. Select 1 to enter the dialog.
2. Refer to the Interactive Productivity Facility VSE Feature Reference Manual for dialog information.
3. Make sure you select all products that will be installed on your system now, or in the future, so that enough DASD space will be allocated. The dialog allocates IBM production library space based on the sizes of the products you select. If you later decide to add products and do not reserve space now, you may have to backup, recreate, and restore several libraries in order to obtain enough space to install them.
4. When the dialog completes, return to VSE/ICCF (or VM/CMS).
5. Enter **IPFSUB FIRSTUSE** to submit the created JCL to VSE (or **SUBVSE FIRSTUSE** in the VM/VSE environment).

6. If the job has a disposition of H or L, release it from the reader queue by entering **R RDR,FIRSTUSE** on the VSE console.
7. Review the printed output to ensure proper execution.
8. Re-enter the Interactive Productivity Facility (**@IPF**). Enter **=sym\$g1** if panel SYM\$G1 is not displayed.
9. Select 2 to continue to the next dialog.

HARDWARE TABLE UPDATE

SYSTEM MANAGEMENT GUIDE: HARDWARE TABLE UPDATE SYM\$G2

The I/O table dialog updates the I/O configuration table created by the first time use dialog. The initial table contains entries based on the hardware contained in the IPL procedure you specified. You will need to have information concerning the hardware attached to your system locally (that is, all hardware to be included in your ASI procedure) in order to update your table.

After entering the dialog, we recommend you first browse the existing entries and note what changes and additions must be made. You can then edit the entire table, or update a single entry. Note that certain pseudo devices are needed for VSE/ICCF. If you have VSE/ICCF installed you should not delete these entries. They may, however, be modified if you have real devices at those addresses. No JCL is created by this dialog.

1	I / O TABLE	Update Hardware I/O Table
2	NEXT DIALOG	Continue to Next Dialog
3	PRIOR DIALOG	Return to Previous Dialog

1. Select 1 to enter the dialog.
2. Refer to the Interactive Productivity Facility VSE Feature Reference Manual for dialog information.
3. Select BROWSE and note changes required to existing entries.
4. Select UPDATE to make changes to existing devices, add new devices, or delete devices.
5. After completing all updates, select BROWSE to verify the table accurately reflects your configuration.
6. When control returns from the dialog, select 2 to continue with the next dialog.

SUPERVISOR ASSEMBLY

SYSTEM MANAGEMENT GUIDE: SUPERVISOR ASSEMBLY SYM\$G3

The System IPO/E ships four pre-assembled supervisors. Most users will find they can use one of these. If you require a customized supervisor, the supervisor dialog will help you create one. The dialog also enables you to delete unwanted supervisors. We recommend you do this, because all supervisors defined in the system will be re-assembled during the application of a PUT tape. You should delete neither the supervisor you are currently using, nor the one in your default ASI procedure. To see what parameters were used in the shipped supervisors, use the display facility provided in this dialog. If you generate a new supervisor, a service library will be required. You will be asked to give information required to restore this library. The dialog will create JCL with the default name of SUPVRGEN which you must then submit to VSE.

1 SUPERVISOR	Create/Delete/Display Supervisors
2 NEXT DIALOG	Continue to Next Dialog
3 PRIOR DIALOG	Return to Previous Dialog
4 INITIAL DIALOG	Return to Initial Dialog

1. Select 1 to enter the dialog.
2. Refer to the Interactive Productivity Facility VSE Feature Reference Manual for dialog information.
3. Delete all supervisors you will not need. This is accomplished by selecting the supervisor to be deleted, and specifying **YES** on the DELETE line. If you wish to delete three supervisors, you must run the dialog three times and create three separate job streams.
4. Display the parameters of the supervisor you are using, noting any changes you want to make.
5. You will be asked if you want to backup work packs during the running of the dialog to create a new supervisor. Since you do not have the VSE/Fast Copy program product installed (and it is also not necessary at this point to backup the libraries), respond **NO**.
6. Make any required changes in the parameters.
7. When the dialog completes, return to VSE/ICCF (or VM/CMS).
8. Enter **IPFSUB filename** (or **SUBVSE filename**) to submit the created JCL to VSE, where filename is the name of a job stream created by the dialog. If you created four job streams, issue **IPFSUB** (or **SUBVSE**) for each filename.

9. The created job will save the old supervisor under the name `$$$SAVx` (where x is A, B, C, or D) in the system core image library.
10. If the job has a disposition of H or L, release it from the reader queue by entering `R RDR,filename` on the VSE console. The JCL will catalog your new supervisor to an IBM library.
11. Review the printed output to ensure proper execution.
12. If you assembled a new supervisor, it will be effective the next time you IPL.
13. Re-enter the Interactive Productivity Facility by entering `IPF`. Enter `=sym$g3` if panel SYM\$G3 is not displayed.
14. Select 2 to continue to the next dialog.

ASI TAILORING

SYSTEM MANAGEMENT GUIDE: ASI TAILORING SYM\$G4

The ASI tailoring dialog creates a 'standard' ASI procedure that can be used to IPL your system without operator intervention. The dialog is based on the hardware profile table you created in the previous dialog, and additional information the dialog will request. Through the dialog you can specify changes to IPL commands, VSE/POWER startup parameters, and partition standard assignments. The dialog also enables you to include system standard labels in the created JCL. We recommend you include standard labels so that the labels will be reset each time the system is IPL'ed. Note: You have the capability of creating multiple ASI procedures for IPLing different environments by specifying a unique save name when requested by the dialog. The dialog creates a job stream with the default name of ASIPROC which you must submit to VSE.

1	ASI TAILORING	Create Tailored ASI Procedure
2	NEXT DIALOG	Continue to Next Dialog
3	PRIOR DIALOG	Return to Previous Dialog
4	INITIAL DIALOG	Return to Initial Dialog

1. Select 1 to enter the dialog.
2. Refer to the Interactive Productivity Facility VSE Feature Reference Manual for dialog information.
3. The default name on the first panel saves user response information, not the output JCL.
4. When the dialog completes, return to VSE/ICCF (or VM/CMS).
5. Enter **IPFSUB ASIPROC** (or **SUBVSE ASIPROC**) to submit the created JCL to VSE.
6. If the JCL has a disposition of H or L, release the job from the reader queue by entering **R RDR,ASIPROC** on the VSE console.
7. The job will save the old ASI procedure under the name \$IPLSAV, and the old JCL procedures under the name \$xJCLSAV (where x is the partition ID) in the system procedure library.
8. Review the printed output to ensure proper execution.
9. You do not have to re-IPL at this time. However, the next time you IPL, your new ASI procedure will be used.
10. Re-enter the Interactive Productivity Facility by entering **@IPF**. If panel SYM\$G4 is not displayed, enter **=sym\$g4**.

VSE/POWER ASSEMBLY

SYSTEM MANAGEMENT GUIDE: VSE/POWER ASSEMBLY SYM\$G5

The System IPO/E ships a pre-assembled VSE/POWER phase, DTRPOWER, that most users can use. If you require a customized VSE/POWER system, the VSE/POWER dialog will help you create one. If you assemble a new phase, use the name you specified in the ASI procedure for VSE/POWER (the default is DTRPOWER). You will be asked if you want to tailor POWER/RJE. Since you have not installed POWER/RJE at this point, respond NO. If you assemble a new phase, a service library will be required. You will be asked to give information required to restore this library. The dialog creates JCL with the default name of DTRPOWER. We recommend you change this to the name of the phase specified in your ASI procedure. Then, submit the job to VSE.

1	VSE / POWER	Assemble VSE/POWER
2	NEXT DIALOG	Continue to Next Dialog
3	PRIOR DIALOG	Return to Previous Dialog
4	INITIAL DIALOG	Return to Initial Dialog

1. Select 1 to enter the dialog.
2. Refer to the Interactive Productivity Facility VSE Feature Reference Manual for dialog information.
3. You will be asked if you want to backup work packs during the running of the dialog to create a new VSE/POWER phase. Since you do not have the VSE/Fast Copy product installed (and it is also not necessary at this point to backup the libraries), respond **NO**.
4. When the dialog completes, return to VSE/ICCF (or VM/CMS).
5. Submit the created JCL to VSE by entering **IPFSUB filename** (or **SUBVSE filename** under VM/VSE) where filename is the name under which you filed the job stream.
6. If the JCL has a disposition of H or L, release the job from the reader queue by entering **R RDR,filename** on the VSE console.
7. Review the printed output to ensure proper execution.
8. The new VSE/POWER phase will be effective the next time you initiate VSE/POWER.
9. Re-enter the Interactive Productivity Facility by entering **@IPF**. If panel SYM\$G5 is not displayed, enter **=sym\$g5**.

LIBRARY UPDATE

SYSTEM MANAGEMENT GUIDE: LIBRARY UPDATE

SYM\$G6

The library update dialog helps you maintain libraries on your system. Information on libraries you have created thus far, is contained in your profile. There are several types of libraries controlled by this dialog. IBM production and service libraries contain System IPO/E supported program products installed on your system. Production libraries are kept online and are subsets of the service libraries which are normally kept on tape. User libraries contain your own programs. Initially, one user library is defined for use by the dialogs. PUT/PTF libraries are temporary libraries used during the installation of optional products, and the application of service.

Numerous other dialogs use this library information when creating JCL, so it is crucial to keep the table current. IBM and user libraries controlled by the dialog will be concatenated through the creation of LIBDEF chains.

Press ENTER to continue with the library update dialog.

SYSTEM MANAGEMENT GUIDE: LIBRARY UPDATE

SYM\$G6A

We recommend you enter the dialog and browse the current entries. If you wish to keep your service libraries on disk, make the appropriate changes to the volume serial number and starting location. Make sure you don't overlap an IPO/E required area. Refer to the System IPO/E Reference Manual for the System IPO/E defined DASD layouts.

The dialog may create a job stream with the default name of NEWLIB which you must submit to VSE. At the completion of the dialog, to re-enter the Guide, select RETURN, or enter '=sym\$', and select 1, System Management Guide.

- | | | |
|---|----------------|----------------------------|
| 1 | LIBRARY UPDATE | Update Library Information |
| 2 | NEXT DIALOG | Continue to Next Dialog |
| 3 | PRIOR DIALOG | Return to Previous Dialog |
| 4 | INITIAL DIALOG | Return to Initial Dialog |

1. Select 1 to enter the dialog.
2. Refer to the Interactive Productivity Facility VSE Feature Reference Manual for dialog information.
3. Browse the current entries.
4. If you make any changes in allocations for libraries that currently reside on disk, JCL will be created to relocate the libraries to reside on the correct volume serial, at the correct starting address.
5. When the dialog completes, return to VSE/ICCF (or VM/CMS).
6. Submit the created JCL to VSE by entering **IPFSUB filename** (or **SUBVSE filename** under VM/VSE) where filename is the name under which you filed the job stream.
7. If the JCL has a disposition of H or L, release the job from the reader queue by entering **R RDR,filename** on the VSE console.
8. Review the printed output to ensure proper execution.
9. Re-enter the Interactive Productivity Facility by entering **@IPF**. If panel SYM\$G6A is not displayed, enter **=sym\$g6a**.
10. Select 2 to continue with the next dialog.

STANDARD LABELS

SYSTEM MANAGEMENT GUIDE: STANDARD LABELS

SYM\$G7

The label processing dialog helps you establish your own standard labels. All of the labels for the System IPO/E defined files are included in your profile. This dialog allows you to update, add, or delete entries. When you first begin the dialog, we recommend you select standard labels, and browse through the existing entries. Note: You may not change labels for libraries with this dialog. All changes to libraries must be made using the previous dialog (Library Update). Labels for the libraries are included in JCL generated from the tables. Labels should be added for all user data sets you want kept in the standard labels. This dialog will generate JCL with the default name of STDLABEL which you must then submit to VSE.

1	LABEL PROCESSING	Add Additional Standard Labels
2	NEXT DIALOG	Continue to Next Dialog
3	PRIOR DIALOG	Return to Previous Dialog
4	INITIAL DIALOG	Return to Initial Dialog

1. Select 1 to enter the dialog.
2. Refer to the Interactive Productivity Facility VSE Feature Reference Manual for dialog information.
3. First browse the current entries. All System IPO/E system labels reflect the shipped values. User labels migrated from prior releases will also be shown.
4. Enter any additional labels you want in your standard labels.
5. If you have defined a second extent for your ICCF library (DTSFILE), remember to add that extent information to your standard labels.
6. You may wish to file this job stream with a disposition of K or L, so it will remain in the reader queue after execution.
7. When the dialog completes, select ICCF (or CMS).
8. Submit the created JCL to VSE by entering **IPFSUB STDLABEL** (or **SUBVSE STDLABEL** under VM/VSE) for standard labels or **IPFSUB PARLABEL** (or **SUBVSE PARLABEL** under VM/VSE) for partition labels.
9. If the JCL has a disposition of H or L, release the job from the reader queue by entering **R RDR,filename** on the VSE console.

10. Review the printed output to ensure proper execution.
11. Re-enter the Interactive Productivity Facility. Enter =sym\$g7 if panel SYM\$G7 is not displayed.

ASI TAILORING WITH STANDARD LABELS

SYSTEM MANAGEMENT GUIDE: ASI TAILORING

SYM\$G8

We recommend at this point that you rerun the ASI tailoring dialog in order to include the changes you made to your libraries, and your new standard labels. Note: When you run the dialog, all your entries from the previous run are retained. You should not have to make any changes to the dialog entries. Review the generated job stream, then submit it to VSE. This job will update the procedure library. If your new ASI procedure will not IPL for any reason, the old ASI procedures are named \$IPLSAV and \$xJCLSAV (where x is the partition ID).

1	ASI TAILORING	Add Additional Standard Labels to ASI
2	NEXT DIALOG	Continue to Next Dialog
3	PRIOR DIALOG	Return to Previous Dialog
4	INITIAL DIALOG	Return to Initial Dialog

1. Select 1 to enter the dialog.
2. Refer to the Interactive Productivity Facility VSE Feature Reference Manual for dialog information.
3. When the dialog completes, select ICCF (or CMS).
4. Enter **IPFSUB ASIPROC** (or **SUBVSE ASIPROC** under VM/VSE) to submit the created JCL to VSE.
5. If the JCL has a disposition of H or L, release the job from the reader queue by entering **R RDR,ASIPROC** on the VSE console.
6. Review the printed output to ensure proper execution.
7. You do not have to re-IPL at this time. However, the next time you IPL, your new ASI procedure will be used.
8. Re-enter the Interactive Productivity Facility. Enter =sym\$g8 if panel SYM\$G8 is not displayed.

9. Select 2 to continue with the next dialog.

DIALOG CUSTOMIZATION

SYSTEM MANAGEMENT GUIDE: DIALOG CUSTOMIZATION SYM\$G9

The dialog customization dialog helps you delete members from the VSE/ICCF DTSFILE, or CMS file, that you do not need. The reason for doing this, is to free DASD space for your own use. You will be asked to select items you wish to delete. For example, if you are a Batch/Interactive user, you may not want to run dialogs that create CICS/VS tables. VSE/ICCF or CMS members that are used in CICS/VS tailoring may then be deleted. If you attempt to run a dialog for which you have deleted members, you will receive an error message stating that some item could not be found. This dialog should be used with care. If you delete items you need, you will have to reload those members from the original VSE/ICCF DTSFILE tape that came with the System IPO/E.

- | | | |
|---|----------------------|---------------------------|
| 1 | DIALOG CUSTOMIZATION | Delete Members |
| 2 | NEXT DIALOG | Continue to Next Dialog |
| 3 | PRIOR DIALOG | Return to Previous Dialog |
| 4 | INITIAL DIALOG | Return to Initial Dialog |

[VM/VSE FEATURE NOTE] In the VM/VSE environment, this dialog should be restricted to use by userid MAINT to maintain system integrity.

1. Select 1 to enter the dialog.
2. Refer to the Interactive Productivity Facility VSE Feature Reference Manual for dialog information.
3. Make sure you select only those items you wish to delete from your system.
4. When the dialog completes, select ICCF (or CMS).
5. Enter **IPPSUB CUSVJOB** to submit the created JCL to VSE. (Under VM/VSE, no JCL is created.)
6. If the JCL has a disposition of H or L, release the job from the reader queue by entering **R RDR,CUSVJOB** on the VSE console.
7. Review the printed output to ensure proper execution.

8. Delete the VSE/ICCF members by entering **CUS\$PROC** on the VSE/ICCF terminal. This procedure will switch to the proper sublibraries and delete the requested members.

[VM/VSE FEATURE NOTE] You may delete the dialogs from VM/CMS by entering **CUS\$EXEC** in the VM/VSE environment.

9. Re-enter the Interactive Productivity Facility. Enter **=sym\$g9** if panel **SYM\$G9** is not displayed.

10. Select 2 to continue to the next dialog.

BACKUP VSE/ICCF FILE

SYSTEM MANAGEMENT GUIDE: BACKUP VSE/ICCF FILE SYM\$G10

If you are a VSE/ICCF user, you should make a practice of backing up and restoring the VSE/ICCF file on a regular basis. As members are added and deleted, you will notice that it takes longer to process the file. Restoring the file will reset the disk pointers. If you deleted members in the last dialog, you should backup and restore your file now. There are no dialogs to do this. However, we have supplied the required job streams in **SAMPLIB**. Connect to sublibrary 59 and submit the following three jobs:

- A. **ICCFBACK** backs up the file to tape.
- B. **ICCFMAT** formats the disk file area.
- C. **ICCFREST** restores the file to disk.

Send these jobs to VSE with a disposition of **HOLD**, terminate the VSE/ICCF partition, then release the jobs to execute in sequence. These jobs will not execute properly while VSE/ICCF is active.

- | | | |
|---|----------------|----------------------------------|
| 1 | RETURN TO MENU | Return to System Management Menu |
| 2 | NEXT DIALOG | Continue to Next Dialog |
| 3 | PRIOR DIALOG | Return to Previous Dialog |

[VM/VSE FEATURE NOTE VSE/ICCF USERS] In the VM/VSE environment, the job streams **ICCFBACK**, **ICCFMAT**, and **ICCFREST** are distributed on the tape **VM/VSE.SAMPLIB**. They can be submitted by entering **SUBVSE filename** after they are loaded into VM/CMS from the tape.

1. Enter **ICCF** to return to VSE/ICCF.

2. Enter **/CONNECT 59**.

3. Review sample job streams ICCFBACK, ICCFFMAT, and ICCFREST. If you have relocated the VSE/ICCF DTSFILE to a volume other than DOSRES, the statement: // ASSGN SYS010,DISK,TEMP,VOL=DOSRES,SHR must be modified to reflect that change. If you have added another extent, add its ASSGN statement also.
4. Enter **IPFSUB ICCFBACK.**
5. Enter **IPFSUB ICCFFMAT.**
6. Enter **IPFSUB ICCFREST.**
7. Enter **/CONNECT OFF.**
8. Terminate the VSE/ICCF partition.
9. On the VSE console, enter **R RDR,ICCFBACK.**
10. Review the printed output to ensure proper execution.
11. On the VSE console, enter **R RDR,ICCFMAT.**
12. Review the printed output to ensure proper execution.
13. On the VSE console, enter **R RDR,ICCFREST.**
14. Review the printed output to ensure proper execution.
15. Startup the VSE/ICCF partition.
16. Re-enter the Interactive Productivity Facility. Enter **=sym\$g10** if panel SYM\$G10 is not displayed.
17. Select 2 to continue with the next dialog.

INSTALL PRODUCTS

SYSTEM MANAGEMENT GUIDE: INSTALL PRODUCTS SYM\$G11

The optional product install dialog: You are now ready to install System IPO/E supported optional products into your IBM production and service libraries. All the IBM production libraries you will need were created when you ran the job stream produced by the first time use dialog. Your service A library exists on tape. If you ordered CICS/VS with your System IPO/E, you also have service libraries B (CICS/VS primary and secondary libraries) and E (CICS/VS tertiary and macro libraries) on tape. If you require service libraries C, D, or F, they will be created. If you want to keep your service libraries online (and changed the label information through the library update dialog), the JCL created will use the areas you specified. Note: The default allocations of the service libraries overlay the same area. If you are using the default allocations, and are installing products into more than one library, you must backup all but the last service library processed to tape.

The install dialog creates JCL to install any number of products at one time. The dialog groups the products to be installed together by library.

Press ENTER to continue with the install dialog.

SYSTEM MANAGEMENT GUIDE: INSTALL PRODUCTS SYM\$G11A

All products going to library A will be installed first, then B, and so on. The dialog will request information supplied on the external tape label of the optional tapes you received. We recommend you do the following. Take all the tapes that contain optional products (including DL/I, BTAM-ES, VTAM, and VTAME). Write a volume number on each tape starting with 1. The dialog will request the volume number and file number for each product. A panel will be displayed for each product that requires entries in CICS/VS tables requesting whether the product should be included in the CICS/VS tailoring procedures. If you reply YES, required entries will be included each time you assemble CICS/VS tables using the CICS/VS tailoring dialogs. This dialog will create JCL with the default names of INSTALL, which you must submit to VSE.

- | | | |
|---|----------------|---------------------------|
| 1 | INSTALL | Install Optional Products |
| 2 | NEXT DIALOG | Continue to Next Dialog |
| 3 | PRIOR DIALOG | Return to Previous Dialog |
| 4 | INITIAL DIALOG | Return to Initial Dialog |

Note: If you want to install products outside the product set of the VSE System IPO/E or products supported by the VSE System IPO/E but not selected during first time use, use the Installation Guide. You can access the Installation Guide by selecting 7 on the system management menu, SYM\$. (enter =sym\$ to get to menu SYM\$.)

1. Select 1 to enter the dialog.
2. Refer to the Interactive Productivity Facility VSE Feature Reference Manual for dialog information.
3. Select the products you wish to install at this time. This dialog creates JCL to install all products for which you enter file and volume numbers. The FILE number refers to the number of the first file on the tape containing that product. The file number appears on the external label on the tape as you received it.

Notes:

- a. The VOLUME on the product selection panel refers to the physical tape volume. Each physical tape volume that contains optional products, DL/I, BTAM-ES, ACF/VTAM, or ACF/VTAME must have a different volume number which you assign. If the physical tape volume contains only one product, use a file number of 1. It is extremely important to enter information correctly, since the dialog generates JCL to mount and dismount tape volumes, as well as tape forward space commands based on this information.
 - b. BTAM-ES, ACF/VTAM, and ACF/VTAME must be installed by this dialog in order to install the product into the production libraries. You must also run the appropriate TP access method starter system delete job after installation. This is necessary even if you installed the starter system of one of these products during the Base Installation process.
4. We recommend that you break this activity into several steps, one step per library set. If you decide to do this, be sure to execute the JCL in the sequence in which the Interactive Productivity Facility creates it. This is essential to the proper creation of your production libraries.
 5. When the dialog completes, select ICCF (or CMS).
 6. Enter **IPFSUB INSTALL** (or **SUBVSE INSTALL** under VM/VSE) to submit the created JCL to VSE.

Note: If the execution of the install job stream fails for any reason, **PFLUSH BG** rather than **CANCEL**ing it. This will prevent the remainder of the job stream from executing.

7. All LIBDEFS are dropped at the beginning of the install job stream, and reestablished at the end. If the job does not run to completion, perform the following steps to reestablish the system LIBDEFS:
 - a. Release the job PAUSEBG from the system reader - **R RDR,PAUSEBG**
 - b. Issue - **0 ASSGN SYSCLB,UA**
 - c. Issue - **0 // EXEC PROC=LIBDEF**
 - d. End the job by responding - **0**
- | 8. If the job fails and you have not merged any products to the
| production core image or service libraries, you may restart the job
| stream.
- | 9. If the job fails and you have merged product(s) to the production
| core image or service libraries, you should delete those members
| that were merged and condense the library before restarting the
| install job stream. This procedure will keep you from running out
| of library space.
10. If the JCL has a disposition of H or L, release the job from the
reader queue by entering **R RDR,INSTALL** on the VSE console.
11. Review the printed output to ensure proper execution.
12. Re-enter the Interactive Productivity Facility. Enter **=sym\$g11a** if
panel SYM\$G11A is not displayed.
13. Select 2 to continue with the next dialog.

BACKUP LIBRARIES

SYSTEM MANAGEMENT GUIDE: BACKUP LIBRARIES

SYM\$G12

Now that you have installed your optional products, we recommend you backup your production libraries. You should backup your libraries on a regular basis. The backup library sets dialog helps you do this.

This dialog creates JCL under the default name of BACKUP which you must submit to VSE.

1	BACKUP LIBRARIES	Backup Production Libraries
2	NEXT DIALOG	Continue to Next Dialog
3	PRIOR DIALOG	Return to Previous Dialog
4	INITIAL DIALOG	Return to Initial Dialog

1. Select 1 to enter the dialog.
2. Refer to the Interactive Productivity Facility VSE Feature Reference Manual for dialog information.
3. Create the job stream to backup your production libraries by specifying **ALL** on panel ADM\$BKR1.
4. When the dialog completes, select ICCF (or CMS).
5. Enter **IPFSUB BACKUP** (or **SUBVSE BACKUP** under VM/VSE) to submit the created JCL to VSE.
6. If the JCL has a disposition of H or L, release the job from the reader queue by entering **R RDR, BACKUP** on the VSE console.
7. Review the printed output to ensure proper execution.
8. Re-enter the Interactive Productivity Facility. Enter **=sym\$g12** if panel SYM\$G12 is not displayed.
9. Select 2 to continue with the next dialog.

VERIFICATION

SYSTEM MANAGEMENT GUIDE: VERIFICATION

SYM\$G13

Verification: The next few menus of the System Management Guide will lead you through the verification of the products you have just installed. Each time you elect to verify a product from a menu within the Guide (with the exception of VSE/VSAM), you will be returned to the verification menu, VER\$, at the completion of the dialog. To re-enter the Guide, select RETURN, or enter '=sym\$', and select 1, System Management Guide.

The purpose of the verification programs is to ensure that products have been installed to the proper libraries, not to exercise all of the functions of the individual products. We recommend very strongly that you use a separate DASD spindle for the VERIFY spindle, if one is available. It does not matter what device type is used for the verify spindle.

Press ENTER to continue with the verification dialogs.

VERIFY VSE/VSAM

SYSTEM MANAGEMENT GUIDE: VERIFY VSE/VSAM SYM\$G13A

VSAM is required by many of the product verifies. For this reason, you should run the VSAM verify first. A user VSAM catalog is created on the verify spindle to control all verify VSAM data sets. An entry is made in your master catalog as well. If you scratch the verify spindle, you should remove the master catalog entry for the user catalog.

This dialog creates JCL with the default name VERVSAM which you must submit to VSE. Once the VSAM data space is defined, return to the Guide and proceed through the other verifies.

1	VERIFY VSAM	Define VSAM User Catalog and Data Space
2	NEXT DIALOG	Continue to Next Dialog
3	PRIOR DIALOG	Return to Previous Dialog
4	INITIAL DIALOG	Return to Initial Dialog

1. Select 1 to enter the dialog.
2. Refer to the VSE System IPO/E User's Guide for additional verification information.
3. Refer to the Interactive Productivity Facility VSE Feature Reference Manual for dialog information.
4. When the dialog completes, select ICCF (or CMS).
5. Enter **IPFSUB VERVSAM** (or **SUBVSE VERVSAM** under VM/VSE) to submit the created JCL to VSE.
6. If the JCL has a disposition of H or L, release the job from the reader queue by entering **R RDR,VERVSAM** on the VSE console.
7. Review the printed output to ensure proper execution.
8. If you need to remove the user catalog entry from the master catalog, run the delete option for the VSE/VSAM verify.
9. Re-enter the Interactive Productivity Facility. Enter **=sym\$g13a** if panel SYM\$G13A is not displayed.
10. Select 2 to continue the verify process.

VERIFY BATCH PRODUCTS

SYSTEM MANAGEMENT GUIDE: VERIFY BATCH PRODUCTS SYM\$G14

Now that you have the VSAM space created, you should run the verifies for each of the following products that you have installed. The default job stream name is listed for each. You must submit each of these job streams to VSE.

EP/VS	(VEREPVS)	SORT/MERGE II	(VĒRSORT)
VSE/DITTO	(VERDITTO)	ACCESS CONTROL	(VERLOG)
POWER/RJE	(VERPOWER)		

1	VERIFY	Verify Batch Products
2	NEXT DIALOG	Continue to Next Dialog
3	PRIOR DIALOG	Return to Previous Dialog
4	INITIAL DIALOG	Return to Initial Dialog

1. Select 1 to display the verification menu, VER\$, which lists products for which you can run verifies.
2. Refer to the Interactive Productivity Facility VSE Feature Reference Manual for dialog information.
3. For each product you wish to verify:
 - a. Select the product from the verification menu, VER\$.
 - b. When the dialog completes, select ICCF (or CMS).
 - c. Enter **IPFSUB filename** (or **SUBVSE filename** under VM/VSE) to submit the created JCL to VSE, where filename is either the appropriate product verify default job name or the job name you entered on the job submission panel.
 - d. If the JCL has a disposition of H or L, release the job from the reader queue by entering **R RDR,filename** on the VSE console.
 - e. Review the printed output to ensure proper execution.
 - f. Re-enter the Interactive Productivity Facility. Enter =ver\$ if panel VER\$ is not displayed.
4. After verifying all installed batch products, re-enter the System Management Guide by entering =sym\$g14, and select 2 to continue with the verify process.

VERIFY ONLINE PRODUCTS

SYSTEM MANAGEMENT GUIDE: VERIFY ONLINE PRODUCTS SYM\$G15

You should now run the batch jobs for the products you plan to verify with CICS/VS. Run the verify dialog for each of the following products you have installed. The default job stream name is listed for each. You must submit each of these job streams to VSE. These jobs build data sets used during the online verification jobs.

DL/I (VERDLI)
DATA DICTIONARY (VERDICT)

1	VERIFY	Verify Online Products
2	NEXT DIALOG	Continue to Next Dialog
3	PRIOR DIALOG	Return to Previous Dialog
4	INITIAL DIALOG	Return to Initial Dialog

1. Select 1 to display the verification menu, VER\$.
2. Refer to the Interactive Productivity Facility VSE Feature Reference Manual for dialog information.

Note: The DL/I and Data Dictionary verify JCL create two VSE/POWER jobs. Both must be released from the reader queue. The first job moves data into the USRSL1 source statement library to be accessed via the source statement library inclusion (SLI) function of VSE/POWER. The VSE/POWER source statement library is set up by executing the output of the ASI tailoring dialog, and initializing VSE/POWER. Initializing VSE/POWER opens the source statement library for SLI.

3. For each product to be verified:
 - a. Select the product from the verification menu, VER\$.
 - b. When the dialog completes, select ICCF (or CMS).
 - c. Enter **IPFSUB filename** (or **SUBVSE filename** under VM/VSE) to submit the created JCL to VSE, where filename is the product verify default job name or the job name you entered on the dialog job submission panel.
 - d. If the JCL has a disposition of H or L, release the job from the reader queue by entering **R RDR,filename** on the VSE console.
 - e. Review the printed output to ensure proper execution.

- f. Re-enter the Interactive Productivity Facility. Enter **=ver\$** if panel VER\$ is not displayed.
4. After verifying all online products, return to the System Management Guide by entering **=sym\$g15**, and select 2 to continue the verify process.

VERIFY CICS/VS

SYSTEM MANAGEMENT GUIDE: CICS/VS VERIFY

SYM\$G16

The CICS/VS standalone verify can now be executed. Run the verify dialog and select CICS/VS. When asked which products you wish to verify with CICS/VS, leave all entries NO. A job stream will be created with the default name of VERCICS. This job will run in the BG partition. After submitting the job, log off ICCF, and release the job. Data sets will be created which you may use in future verifies.

1	VERIFY	Verify CICS/VS
2	NEXT DIALOG	Continue to Next Dialog
3	PRIOR DIALOG	Return to Previous Dialog
4	INITIAL DIALOG	Return to Initial Dialog

1. Select 1 to display the verification menu, VER\$.
2. Refer to the section 'CICS/VS Verification Considerations' in the VSE System IPO/E User's Guide for CICS/VS verification information.
3. Refer to the Interactive Productivity Facility VSE Feature Reference Manual for dialog information.
4. Select CICS/VS for verification.
5. When the dialog completes, select ICCF (or CMS).
6. Enter **IPFSUB VERCICS** (or **SUBVSE VERCICS** under VM/VSE) to submit the created JCL to VSE.
7. Logoff VSE/ICCF (or CMS)
8. If the JCL has a disposition of H or L, release the job from the reader queue by entering **R RDR,filename** on the VSE console.
9. The job stream starts CICS/VS in the BG partition.
10. Enter the CICS/VS transaction **CRTE SYSID=MROB** to route the verify transactions to the BG partition.
11. After completing the online test, terminate the CICS/VS test partition. Additional jobs in the verify JCL will print CICS/VS data sets. The pauses are included here to allow you to cancel those jobs not applicable to you.
12. Log on VSE/ICCF in F2 or CMS.

- a. Re-enter the Interactive Productivity Facility. Enter =syn\$g16.

13. Select 2 to continue the verify process.

ONLINE VERIFIES WITH CICS/VS

SYSTEM MANAGEMENT GUIDE: ONLINE VERIFIES SYM\$G17

You are now ready to verify products under CICS/VS. Select each product individually with CICS/VS.

Run the verify dialog, selecting CICS/VS, for each product you wish to verify. Refer to the VSE System IPO/E User's Guide to determine partition size requirements and for online transactions that can be run. Be sure to specify the local terminal you wish to use for the verify procedures if you are not using the Multi Region Operation facility.

- | | | |
|---|----------------|---------------------------|
| 1 | VERIFY | Verify Online Products |
| 2 | NEXT DIALOG | Continue to Next Dialog |
| 3 | PRIOR DIALOG | Return to Previous Dialog |
| 4 | INITIAL DIALOG | Return to Initial Dialog |

1. Select 1 to display the verification menu, VER\$.
2. Refer to the section 'CICS/VS Verification Considerations' in the VSE System IPO/E User's Guide for CICS/VS verification information.
3. Refer to the Interactive Productivity Facility VSE Feature Reference Manual for dialog information.
4. For each product to be verified with CICS/VS:
 - a. Select CICS for verification.
 - b. A screen will be displayed asking which product you wish to verify with CICS/VS. Select the product to be verified.
 - c. When the dialog completes, select ICCF (or CMS).
 - d. Enter **IPFSUB filename** (or **SUBVSE filename** under VM/VSE) to submit the created JCL to VSE.
 - e. Logoff VSE/ICCF or CMS.

- f. If the JCL has a disposition of H or L, release the job from the reader queue by entering **R RDR,filename** on the VSE console.
 - g. The job stream will start CICS/VS in the BG partition.
 - h. Enter the CICS/VS transaction **CRTE SYSID=MROB** to route the verify transactions to the BG partition.
 - i. After completing the online test, terminate the CICS/VS partition and complete the verification job stream.
 - j. Log on VSE/ICCF in F2 or CMS.
 - k. Re-enter the Interactive Productivity Facility. Enter **=syn\$g16**.
5. Select 2 to continue the verify process.

VSE/VSAM VERIFY DELETE

SYSTEM MANAGEMENT GUIDE: VSAM VERIFY DELETE SYM\$G18

Now that you have completed the verification of your products, you should run the verify dialog and select VSAM with the DELETE option. The job created will remove all verify VSAM data sets, VSAM space, and the user catalog entry from the master catalog. The JCL will have the default name of DELVSAM which you should then submit to VSE. You may choose to delete the VSAM data sets for one product at a time, if you wish.

1	VERIFY	Delete VSAM Catalog and Space
2	NEXT DIALOG	Continue to Next Dialog
3	PRIOR DIALOG	Return to Previous Dialog
4	INITIAL DIALOG	Return to Initial Dialog

1. Select 1 to enter the dialog.
2. Refer to the Interactive Productivity Facility VSE Feature Reference Manual for dialog information.
3. Select the delete option for VSE/VSAM. This will remove the VSE/VSAM space and catalog from the VERIFY spindle.
4. When the dialog completes, select ICCF (or CMS).
5. Enter **IPFSUB DELVSAM** (or **SUBVSE DELVSAM** under VM/VSE) to submit the created JCL to VSE.
6. If the JCL has a disposition of H or L, release the job from the reader queue by entering **R RDR,DELVSAM** on the VSE console.
7. Review the printed output to ensure proper execution.
8. Re-enter the Interactive Productivity Facility. Enter **=sym\$g18**.
9. Select 2 to continue to the next dialog.

SYSTEM MANAGEMENT GUIDE COMPLETION

SYSTEM MANAGEMENT GUIDE: COMPLETION

SYM\$G19

You have now completed the installation and verification of all your products, and are ready to begin modifying your environment for production. There are a number of dialogs available to assist you in performing additional tailoring. We recommend you review the Interactive Productivity Facility VSE Feature Reference Manual for further information, or browse through the menu hierarchy. On the next panel are typical activities you may wish to execute depending on the products you have installed.

- | | | |
|---|-----------------------|----------------------------------|
| 1 | SYSTEM MANAGEMENT | Return to System Management Menu |
| 2 | ADDITIONAL ACTIVITIES | Additional Tailoring Activities |
| 3 | PRIOR DIALOG | Return to Previous Dialog |
| 4 | INITIAL DIALOG | Return to Initial Dialog |

Select 2 to obtain information on additional tailoring activities.

ADDITIONAL TAILORING ACTIVITIES

SYSTEM MANAGEMENT GUIDE: ADDITIONAL ACTIVITIES SYM\$G20

You may wish to review the following activities:

- | | |
|----------------------------|------------------------------|
| A. System Tailoring | accessed from panel ADM\$4. |
| B. Data Base Tailoring | accessed from panel SYM\$2. |
| C. TP Tailoring | accessed from panel SYM\$33. |
| D. User Library Definition | accessed from panel ADM\$15. |
| E. User Library Creation | accessed from panel LIB\$. |

The following informational panels can be viewed without leaving the Guide.

- | | |
|--------------------------|-----------------------------------|
| 1 MOVE PAGE DATA SET | Tips for Moving Page Data Set |
| 2 MOVE VSE / POWER FILES | Tips for Moving VSE/POWER Files |
| 3 MOVE VSE / ICCF FILE | Tips for Moving VSE/ICCF File |
| 4 RETURN TO GUIDE | Return to System Management Guide |

To access the activities listed above, use the fast path facility to reach the appropriate menu panel. For example, enter =adm\$4 to obtain the system tailoring menu panel.

MOVE PAGE DATA SET STEPS

SYSTEM MANAGEMENT GUIDE: MOVE PAGE DATA SET SYM\$PDS

If you wish to move the page data set for performance reasons, or change its size, execute the following steps:

- A. Execute the ASI tailoring dialog, and specify the new area, or areas, to be used in your IPL procedure. You may want to place the page data set under fixed head areas on multiple spindles. This is now possible because the page data set may occupy up to 15 extents.
- B. Submit the JCL created to catalog the new procedure.
- C. The next time you IPL the system, the new area will be used.

1 RETURN

Return to Additional Activities
menu

Select 1 to return to the System Management Guide.

MOVE VSE/POWER FILE STEPS

SYSTEM MANAGEMENT GUIDE: MOVE VSE/POWER FILES SYM\$PWR

If you wish to move the VSE/POWER files for performance reasons, or to change their size, execute the following steps:

- A. Modify the standard labels for the files using the label processing dialog, specifying the new area to be used.
- B. Execute the ASI tailoring dialog to include any new VSE/POWER labels and device assignments. Specify OP to allow the operator to format the files.
- C. Submit both jobs with a disposition of HOLD.
- D. Terminate the VSE/ICCF partition.
- E. Execute both jobs.

1 CONTINUE VSE/POWER

Continue Move VSE/POWER Files
Instructions

SYSTEM MANAGEMENT GUIDE: MOVE VSE/POWER FILES SYM\$PWRA

- F. PSTOP all VSE/POWER controlled partitions.
- G. POFFLOAD SAVE the VSE/POWER data files (punch, list and reader queues). To empty the account file, use the PACCOUNT command.
- H. Terminate VSE/POWER.
- I. IPL the system to use the new labels.
- J. During VSE/POWER startup, format the new file areas.
- K. POFFLOAD LOAD the VSE/POWER reader, printer, and punch queues.
- L. Reexecute the ASI tailoring dialog to remove the OP entry added in step B.

1 RETURN

Return to Additional Activities
menu

Select 1 to return to the System Management Guide.

MOVE VSE/ICCF FILE STEPS

SYSTEM MANAGEMENT GUIDE: MOVE VSE/ICCF FILE SYM\$ICF

If you have VSE/ICCF installed, and wish to move the VSE/ICCF file for performance reasons, or to change its size, execute the following steps:

- A. Modify standard labels for the files using the label processing dialog specifying the new area to be used.
- B. Execute the ASI tailoring dialog to pick up the new labels.
- C. Submit both jobs with a disposition of HOLD.
- D. Modify jobs ICCFFMAT, and ICCFREST in sublibrary 59 with the proper assignments for DTSFILE. Do not modify ICCFBACK at this time.
- E. Submit from sublibrary 59, the jobs ICCFBACK, ICCFFMAT, and ICCFREST with a disposition of KEEP.

1 CONTINUE VSE/POWER Continue move VSE/POWER files instructions

SYSTEM MANAGEMENT GUIDE: MOVE VSE/ICCF FILE SYM\$ICFA

- F. Terminate the VSE/ICCF partition.
- G. Execute ICCFBACK to back up the file.
- H. Execute the standard label and ASI jobs.
- I. Re-IPL the system, or execute procedure STDLABEL.
- J. Execute ICCFFMAT to format the new area.
- K. Execute job ICCFREST to restore the file from tape to the new area.
- L. Start up the VSE/ICCF partition.
- M. Modify ICCFBACK in sublibrary 59 with the proper assignments for DTSFILE.

1 RETURN Return to Additional Activities menu

CHAPTER 3 - SYSTEM MANAGEMENT

System management consists of activities that keep a computer system operational. The following categories of system management activities have been defined:

System Management Guide	Perform Initial System Activities
Administration	Perform Administrator Functions
Installation	Install Optional Features
Installation Guide 	Install Components not Selected During First Time Use and Components Outside System IPO/E Product Set
Verification	Verify Optional Feature Install
Dump Analysis	Analyze VSE/IPCS Dump
Service 	Apply Service to your system or product set via MSHP
Operation	Select an Operations Utility

SYSTEM MANAGEMENT GUIDE

The System Management Guide is online documentation that guides you through the dialogs generally required when installing your system. The panels that compose the guide are actually menu panels that call a system management dialog or menu. In most cases, the System Management Guide calls a function directly. When the function completes, control is returned to the calling menu within the System Management Guide. However, in a few instances it displays the system management menu panel. After selecting from the menu panel, you must return to the guide. This may easily be done by typing **=sym\$** and then entering **1**. Processing returns to where you left off.

The section, 'System Management Guide Checklist,' shows the panels that are displayed and gives additional information. Although it is possible to install the system by going directly to the menu panels for the functions, we strongly recommend using the System Management Guide to ensure proper sequence and no accidental omissions. The functions executed within the System Management Guide are the same as those accessed from the regular menu structure. The System Management Guide simply provides an alternate, more structured path to those functions.

ADMINISTRATION

The Interactive Productivity Facility generates JCL. To have this JCL match the configuration of your system, information is contained in internal tables. The administration environment builds and updates these tables in addition to creating JCL. There are three subdivisions of administration: system administration, data base administration, and communication administration.

SYSTEM ADMINISTRATION

These dialogs create and maintain tables and produce JCL for:

- System Profile
- Logons and Passwords
- Using the Librarian Programs
- System Tailoring Functions
- VSE/ICCF Tables
- Dialog Customization
- Utility Aids

Each item is explained below.

System Profile

The system profile tables define:

- The software components installed on your system
- The hardware installed on your system
- The locations and names of your libraries
- The locations and names of various system and user files

The first time use dialog initializes your profiles based on the VSE System IPO/E supplied IPL procedure used (if any), your DASD type and addresses, and the VSE System IPO/E optional products you select for installation on your system.

Note: It is very important to select all products you plan to install now or in the future. Library sizes are allocated based on the sizes of the products you select. An omission at this point can cause extra work later.

These profiles are used when performing many system management functions. Dialogs are provided to help you maintain these profiles. They are also updated by other dialogs, where appropriate. If you change your software, hardware, libraries, or file labels, you must update your profiles with the new information. If your profiles do not accurately reflect your environment, dialogs that use this information will not execute properly.

The profile tables are created on your primary library. They should not be removed. Activities that affect these profiles must be performed under the VSE/ICCF system administrator user ID, AAAA. If multiple users execute dialogs that create or modify profiles, multiple profiles will be created that may not accurately reflect the status of your system.

The following sections describe the various profiles, and the information they contain.

I/O CONFIGURATION PROFILE: The I/O configuration profile table, ADM\$HDWT, is created during the first time use dialog based on the pregenerated IPL procedure you used. If you did not use a VSE System IPO/E supplied IPL procedure, a default table will be created containing only the VSE/ICCF required dummy devices and the DASD you describe for DOSRES, SYSWK1, etc. You must enter the remaining entries yourself.

If you have already created an ADM\$HDWT table using Release 1, 2, or 3 of Interactive Productivity Facility, or during a previous execution of the first time use dialog, a panel will display asking whether or not you want to recreate your hardware table based on the IPL procedure you select. If you choose to save your existing table, the entries will be converted to the VSE System IPO/E Release 3.0 format and saved. This profile is used when applying service to determine the DASD type on which libraries reside. It is also used to tailor your automated system initialization (ASI) procedures.

The I/O configuration profile table contains the following information:

- Device address (in 'Cuu' format)
- Device type
- Device mode
- DASD switching
- DASD sharing

- DASD volume serial number

Note: When you add a new device to the I/O configuration profile table, you must rerun the ASI tailoring dialog. The new device will have an IPL ADD command automatically generated. However, the new device may affect some other ASI IPL commands. For example, a new disk may be used in the DPD command. You will have to evaluate the impact of adding the new device on your ASI procedure.

SOFTWARE PRODUCT PROFILE: Initially, the software product profile tables show as installed only those components that comprise the System IPO/E base. As you install various optional components using the dialogs provided in the installation environment, the software product profile tables are updated to reflect this. It is possible to add entries to the software product profile tables for products outside the System IPO/E product set. Once this is done, you can use Interactive Productivity Facility dialogs to install and service those products. A dialog is provided to create the copy files associated with those products. Copy files used during product installation and servicing, recreate production libraries by copying members from the service libraries.

The software profile tables contain the following information for each software component you have installed:

- Product number
- Component number
- Product name
- Release, version, and modification level
- Component level code
- The library set where the product resides
- Whether this component requires entries in CICS/VS management tables
- Names of copy files, if any
- Other information required for installation process

This information is used by the service environment in order to apply service to the correct libraries.

When updating these tables, CICS/VS support can be added or deleted. The next time CICS/VS tables are assembled, support for the component will be appropriately added or deleted from the table being assembled. For example, if CICS/VS support is added for DL/I DOS/VS, and the CICS/VS processing program table (PPT) is reassembled, all programs

required to run DL/I DOS/VS under CICS/VS will be added to the PPT. (You must reassemble and catalog your CICS/VS tables to activate the new support.)

The names of the tables created are ADM\$PROD and ADM\$\$SHIP. ADM\$\$SHIP is the master table shipped with the System IPO/E and contains information about all products within the System IPO/E product set. ADM\$PROD contains entries for products known to be installed on your system plus a subset of the information contained in ADM\$\$SHIP.

LIBRARY PROFILE: The library profile table, ADM\$LTAB, describes all libraries distributed with the System IPO/E, including production and service libraries. It is used in the service environment to establish library sizes and allocations for the application of PUT tapes.

The library profile table contains the following information:

- Library label
- Library size, including directories
- Library location

DISK LABEL PROFILE: The disk label profile table, ADM\$DTAB, contains information about your VSE standard labels. It initially contains label information for all files distributed with VSE System IPO/E with the exception of partition standard labels, which are in the tables ADM\$PARx, where x corresponds to 0, 1, ..., A, B depending upon which partitions have standard labels defined. Dialogs are provided to help you update this profile with label information for your own files. The disk label profile is used during PUT tape application, and also to create system standard label and partition standard label job streams.

The disk label profile table contains the following information:

- Library and file labels for VSE standard labels
- Library and file labels for the service process

Note: System work files (SYSLNK, SYS001, SYS002, SYS003, SYS004) are provided only for the background partition, in the BG partition labels created using the default disk label profile. If you need system work areas in other partitions, create similar work labels (in a different area), and define your work areas in foreground partition standard labels, using the disk label profile update dialog.

If you have already created an ADM\$DTAB table using an earlier release of Interactive Productivity Facility, any user entries that have been added to the table will be copied into the Release 4.0 table during the execution of the first time use dialog. However, the partition standard labels for BG, F2, and F3 are deleted during first time use.

Logons/Passwords

Dialogs are provided to help you add, change, or delete entries in VSE/ICCF user profile records and the CICS/VS sign-on table. These profile records identify authorized users of the VSE/ICCF system. Based on your responses, a job stream is created to update the user profile records or the appropriate table with your changes.

Note: This job stream must be run when VSE/ICCF is down, since the user profile records cannot be updated while VSE/ICCF is operational.

Librarian

Dialogs are provided to help you create job streams to manage system and private libraries. Using these dialogs, you can create, copy, or merge libraries. You can also display, delete, rename, or catalog library members.

The create libraries dialog generates job streams to create a private library.

The copy/merge library dialog generates a job stream to copy or merge members between libraries.

The display library dialogs generate job streams to display library directories, display library members, or de-edit and display the E sublibrary of a source library.

The delete library members dialog generates a job stream to delete library members from any library.

The rename library members dialog generates a job stream to rename library members in any library.

The catalog library members dialog generates a job stream to catalog to one of the four library types.

BACKUP LIBRARY SETS: This dialog produces the JCL needed to back up all your production and user library sets or any combination that you desire. The panel that controls the backup identifies the library sets as PRDXLa for production libraries, and USRXLn for user libraries (where a has a range of A-G, and n has a range of 1-8). The XL shows that the entire set of core image, relocatable, and source statement libraries is used.

If you reply **ALL** in the PRDXLA field, all libraries defined in your system profile tables will be backed up.

Library backup is controlled by a comparing the entries in the system profile table with the entries on the panel. Therefore, if you make an entry for a library that does not exist, no JCL will be produced for that library.

When you back up your system, you should include the POWER SLI library as part of that backup. The VSE System IPO/E POWER SLI library is USRSL1, which is part of the USRXL1 library set on panel ADM\$BKR1. In order to restore your full system, you will have to use two steps. In step one, using the standalone RESTORE, restore SYSRES. In step two, use the online version of RESTORE from SYSRES of step one to restore all your private libraries. You must use the online version to restore the private libraries because the standalone version of RESTORE will not restore private libraries which have been backed up with the new assign method used for multiple private library backup. For details on how to use the online restore process with an UPSI of 1 for operator prompting, see the VSE/Advanced Functions System Utilities Manual, (SC33-6100).

An example a panel appears below:

```

LIBRARIAN: BACKUP/RESTORE LIBRARY SETS      ADM$BKR1

Enter a nonblank character for the library sets you wish to
BACKUP. If you wish to BACKUP all library sets, enter ALL in
the first field.

==>  PRDXLA      ==>  PRDXLB      ==>  PRDXLC      ==>  PRDXLD      ==>  PRDXLE
==>           ==>      X           ==>           ==>      X           ==>

==>  PRDXLF      ==>  PRDXLG      ==>  USRXL1      ==>  USRXL2      ==>  USRXL3
==>      X       ==>           ==>           ==>      X           ==>

==>  USRXL4      ==>  USRXL5      ==>  USRXL6      ==>  USRXL7      ==>  USRXL8

Here we show backing up the libraries for B, D, F, and 2.
For library F, only the core image library will be backed
up. This is because there is no production relocatable or
source statement library defined for that library set.

```

RESTORE LIBRARY SET: This function is the exact reverse of the backup described above. It uses the same dialog and panel. The only change on the panel is that the word BACKUP is replaced by RESTORE.

The libraries will be restored to the location described in the system profile table, ADM\$DTAB, and will use the library and directory sets defined in table ADM\$LTAB.

| If you want to reallocate your libraries, use the LIBRARY INFORMATION
| dialog accessed off the system profile menu. This dialog will back up
| the affected libraries, reallocate them according to your updates, and
| restore them to disk.

Caution: Should you accidentally change the allocations in the system profile tables prior to creating the JCL for the backup, you may have a problem. Since we do not include the extent information for the backup, it is only a problem if you actually move the library to another disk volume.

System Tailoring

| These dialogs generate and update tables containing the parameters
| needed for assembling your supervisor, ASI procedures, and POWER startup
| table. Also provided are dialogs which will alter the standard defaults
| of the VSE/ICCF system and regenerate the TTF system.

We strongly recommend that you delete any default supervisors you will not use. During the application of service, all supervisors found in the tables will be reassembled. Naturally, reassembling supervisors you do not use is time-consuming and unnecessary.

VSE/ICCF and VSE/Access Control Security Tables

VSE/ICCF SECURITY: VSE/ICCF provides facilities which protect libraries, library members, files, and core image phases against unauthorized access from interactive partitions. This security takes several forms.

- User identification code
- Logon password
- Shared versus owned libraries
- Primary and connected libraries
- Public versus private data

- Normal versus alternate security
- Common data
- Member passwords
- Protection for user files and programs

Refer to the VSE/ICCF Installation and Operations Reference Manual (SC33-6067) for information about the types of security.

VSE/ICCF provides tables in which restricted files and programs may be defined and to which only authorized users have access.

Via the system program table and the load protection table, core image library phases are protected against unauthorized usage. User files are protected via the system file table. To modify the security tables, select MODIFY VSE/ICCF TABLES from the ADM\$ panel. Function ADM\$IST will assist you with modifying the security tables.

VSE/ICCF can also use the access control facility of VSE/Advanced Functions. This function is made available by the SEC parameter in the supervisor macro FOPT.

The VSE/ICCF access control tables are books in the VSE source statement library. They become valid for your VSE/ICCF system when you assemble the modules DTSSUBMT and DTSCJENT with your version of the tables.

The difference between access control in VSE/ICCF and in VSE/Advanced Functions is the time when access control takes place. For files, the access violation is detected under VSE/ICCF only when referencing the file via a /FILE card. With VSE/Advanced Functions access control, the violation is detected when the file is opened. Programs listed in the system program table are rejected when the /LOAD statement is encountered under VSE/ICCF; whereas phases listed in the program load table are rejected when the corresponding FETCH/LOAD is executed under VSE/ICCF.

Note: With VSE/ICCF access control, it is not possible to detect access violations when a file is accessed without a /FILE card; that is, the label information for that file has been provided at VSE/ICCF startup time, or it is in the standard label area.

The system program and system file tables also contain information that is not security related.

VSE/ACCESS CONTROL SECURITY TABLES: Protection for core image phases and files used in jobs submitted to a VSE/POWER controlled partition can

also be provided if the VSE/Access Control function is made available at VSE/ICCF initialization time.

VSE/Access Control Logging and Reporting further extends these facilities. Refer to Data Security Under the VSE System (GC33-6077) and VSE/Access Control Logging and Reporting General Information Manual (GH12-5130).

The function ADM\$SEC will help with the security table and will build a job to assemble a new table, if you modify the current table. To use this function, select from the ADM\$ panel MODIFY SECURITY TABLE. You can then ADD, CHANGE, DELETE, and DISPLAY information about the table.

The access control table, DTSECTAB, contains all the information necessary for the system to perform access authorization checking. This information is stored in two types of entries: user profile and resource profile entries.

Information in a user profile entry includes the user identifier and the password for identification and validity checking plus the access control class(es) and update indication for authorization checking.

A resource profile entry includes the resource name, the access control class(es) for authorization checking, and the logging option(s) for recording either all accesses to this resource or only the violations. Normally it is the security administrator who personally defines and updates the access control table of his system. This table gives him a centralized view of access control within the entire system.

Note: VSE/ICCF uses its own table, called user profile (located in the VSE/ICCF library), for the identification and authentication check during the VSE/ICCF logon procedure. A VSE/ICCF user submitting jobs for processing in a batch partition of the system must also be defined in the access control table DTSECTAB.

VSE/ACCESS CONTROL LOGGING AND REPORTING: VSE/Access Control Logging and Reporting consists of two parts:

- The Logger
- The Reporting Module

The logger records security events. The reporting module has five activities. It is used to initialize, dump, restore, selectively print, and reset the log data set.

To use the VSE/Access Control Logging and Reporting activities select from ADM\$ panel RUN SECURITY REPORTS.

Dialog Customization

The Interactive Productivity Facility dialog customization activity removes unwanted dialogs from the system to save DASD space and improve performance.

| **[VM/VSE FEATURE NOTE]** In the VM/VSE environment, this activity should
| be restricted to use by userid MAINT to maintain system integrity.

In the VSE environment, dialog customization creates a VSE job that removes core image library members of the Interactive Productivity Facility dialogs. This job must be submitted to VSE to accomplish the deletions. A VSE/ICCF procedure is also created that purges the Interactive Productivity Facility VSE/ICCF members for the dialogs selected to be deleted. This procedure must be executed for the deletions to occur.

Dialogs should be deleted if you do not plan to use them. For example, the batch interactive user probably does not require either CICS/VS tailoring dialogs or verification jobs for CICS/VS related products.

Furthermore, the first use tutorial should be eliminated if it has been taken, and there is no desire to refer to it again. The first use tutorial contains about 100 panels so substantial DASD space will be saved if it is removed.

Utility Aids

The Utility Aids provide the following capabilities:

- | • Selective job retrieval from a VSE SYSIN tape (valid only under
| VSE/ICCF)

This dialog creates a VSE job stream which will read the SYSIN tape, select the job or jobs you specify, and punch them into the VSE/POWER punch queue. When the execution is complete, you can then read them from the VSE/POWER punch queue with VSE/ICCF. By running the VSE/ICCF macro named @UTA\$JOB, you can copy the job or jobs from the punch queue into a VSE/ICCF member. If several VSE jobs with the same job name are present on the tape, all of them will be placed in the same VSE/ICCF member, imbedded between * \$\$ JOB and * \$\$ EOJ VSE/POWER JECL control statements.

- | • Printing of Interactive Productivity Facility panels (valid only
| under VSE/ICCF)

This dialog provides the ability to print any Interactive Productivity Facility panel. The panel can be printed in upper or lower case characters, but may vary depending on the character set

of the printer used. In addition to printing any menu, entry, or dmenu panel, you can also request printing of the related explain panels. The dialog creates a job stream which, when submitted to a VSE partition, will print the panel or panels specified on SYSLST. During dialog execution you must enter the name, or generic name, of each panel of which a printed copy is desired. The generic name should consist of at least the first three characters of the panel set name preceded by an asterisk; for example, *ADM, *ADM\$, or *ADM\$LAB.

- Forms control buffer (FCB) maintenance

This dialog provides the ability to define or update forms control buffers for buffered printers such as the 3203, 3211, 3262, 3289, or 5203. These forms control buffers can also be cataloged into the VSE core image library. The phases are then eligible to be loaded via the LFCB attention routine command, via the VSE/POWER * \$\$ LST JECL control statement, or via the SYSBUFLD program.

Some standard FCBs are already defined in the FCB table (UTA\$FCBT). You may alter these predefined entries, or you may define your own.

After you define your FCBs, you can create a job stream to catalog selected FCBs in a specific VSE core image library.

DATA BASE ADMINISTRATION

Interactive Productivity Facility data base administration dialogs will assist you in administering your data bases. The first dialog provides access method services management. This includes the management of catalogs, spaces, and data sets.

The DL/I user has available the Interactive Macro Facility (IMF), which provides DL/I control block definition and generation. For further information on IMF, consult the DL/I DOS/VS IMF User's Guide (SH24-5007).

The following DL/I capabilities are available:

- DBD definition and change
- DBD generations
- PSB definition and change
- PSB generations and block builds
- ACT definition and change
- ACT generation

VSE/VSAM

Dialogs are provided to help you create VSE/VSAM access method services job streams. These job streams can be used on catalogs, space, and data sets to perform many of the VSE/VSAM functions.

CATALOG MANAGEMENT: The catalog management dialogs will help you DEFINE, DELETE, PACKUP, RESTORE, TRANSPORT, and LIST the VSE/VSAM catalog.

SPACE MANAGEMENT: The space management dialogs will help you DEFINE and DELETE VSE/VSAM space in the catalog.

DATA SET MANAGEMENT: The data set management dialogs will help you DEFINE, DELETE, ALTER, COPY, EXPORT, IMPORT, PRINT, VERIFY, and DISPLAY data set information.

You can also use these dialogs to COPY and PRINT sequential files.

COMMUNICATION ADMINISTRATION

These dialogs are used for creating and updating tables for CICS/VS, VSE/POWER RJE and EP/VS.

For CICS/VS, four tables are maintained: processing program table (DFHPPT), program control table (DFHPCT), terminal control table (DFHTCT), and file control table (DFHFCT).

CICS/VS Tables

Dialogs are provided to help you maintain the following CICS/VS tables:

- Processing program table (PPT)
- Program control table (PCT)
- Terminal control table (TCT)
- File control table (FCT)
- Sign-on table (SNT)

All of these tables are updated within the communication administration environment, except the SNT, which is updated within the system administration environment.

Note: The dialogs make certain restrictions on which table parameters may be specified, and that not all CICS/VS tables are supported.

The dialogs provide the following activities for each table:

- Add entries
- Delete entries
- Change entries
- Assemble/catalog the selected table

You are prompted for the input required to perform the above activities. Each parameter is explained, examples are provided, and recommendations are made regarding appropriate parameter values. You should refer to the explain panels when using these dialogs for the first time.

After modifying a table, you have the following options:

- Cancel all changes made during the current session.
- Update the table without assembling the new version.
- Update the table and assemble the new version.

Note: CICS/VS table information is maintained within internal tables maintained by the dialogs. For your changes to take effect, you must assemble the new table version.

The System IPO/E ships a number of preassembled CICS/VS tables in the core image library that are used for the ICCF/CICS/VS startup or the CICS/VS verify startups. Interactive Productivity Facility does not ship any pregenerated internal tables for tailoring CICS/VS tables. It is therefore necessary to do an add to a CICS/VS table before trying to delete, change, or assemble. The source for the preassembled CICS/VS tables has been cataloged in the service library B source statement library as G.macros. You must use a suffix that does not contain a dollar sign (\$) or a pound sign (#) when adding a CICS/VS table because CICS/VS Release 1.5 will reject these characters and give you an unsuffixed table. Please note that table suffix T1 is reserved for the use of the Interactive Productivity Facility.

Notes for Existing CICS/VS Users: If you have existing CICS/VS tables, with entries you wish to use, you have two options:

1. Add all the entries from your old tables via the dialogs.
2. Create a VSE/ICCF file with a unique name that contains only user table entries (that is, no JCL, IBM entries, TYPE=INITIAL, or TYPE=FINAL). If you want to include this file in your CICS/VS table assembly, you will be asked in the dialogs for the name of this file. The job stream created will then include your table entries

before the DFHxxx TYPE=FINAL macro where xxx is FCT, PCT, PPT, or TCT.

If you use this method, be sure to remove any entries for CICS/VS and any other component you installed using Interactive Productivity Facility installation dialogs. Support for these components is automatically included by the dialogs.

The second method is faster but has some disadvantages. Entries included in this manner are included in the table as is. They are not checked by the table preparation dialogs for validity. Since the individual entries in this file cannot be examined, the dialogs cannot check that any further entry you make via the dialog is not in conflict with an entry defined in the data you included. Also, the entry delete and modify dialogs cannot update entries in your included file. You will get the full benefit of the table preparation dialogs only if you use the dialogs exclusively to add entries to your table.

Note: Be sure to read the section on 'CICS/VS Migration' in the System IPO/E Planning Guide (GC20-1936).

HINTS AND TIPS

- The PPT dialog automatically creates an application load table (ALT) assembly job stream. If you have an ALT of your own, modify the dialog-created job stream to delete this job.
- You do not have the option of ordering your tables. Your user entries always come together, in the order they were entered via the dialog. Any entries required by CICS/VS and any optional components installed via the installation dialogs are also included in the tables.
- The TCT dialog provides BTAM support only for 3270-class devices, and the system console. You will have to add support for other devices yourself.
- The FCT dialog supports only VSE/VSAM and DL/I. If you have BDAM or ISAM files, you will have to add entries for them yourself.

VSE/POWER RJE

The VSE/POWER RJE dialogs help you generate a remote job entry system suitable for your operating environment. Each VSE/POWER RJE parameter is explained and appropriate parameter values are recommended. Interdependent parameter definitions are indicated, and acceptable values suggested.

The system-supplied VSE/POWER RJE and user-defined specifications can be displayed for use in creating new specifications, should you need multiple RJE systems. VSE/POWER/RJE tailoring requires that you tailor VSE/POWER first and reply RJE=YES to that dialog.

To help update a VSE/POWER RJE system, the following subsets of parameters are provided:

- BSC line definitions
- SNA terminal definitions
- BSC terminal definitions
- 3780 definition
- 2770, 2780 definition

| **Note:** If you are going to significantly change your SNA terminal
| definitions, you should tailor VSE/POWER RJE through the VSE/POWER
| tailoring dialog. This will allow you to update the SNA parameter of
| the POWER macro. You should respond **YES** when the VSE/POWER tailoring
| dialog asks if you wish to tailor RJE.

EP/VS

A tailoring dialog for EP/VS (TEP\$ASM) is located in the communication administration environment. Using the dialog, you can create an EP/VS specifically tailored to your environment. Three job streams are created by the dialog. The first job stream will catalog source macros to a user source statement library. The second will submit those macros to the first stage of a two-stage generation procedure. The third job stream will complete the two-stage generation procedure. You will be able to edit the job streams after they have been created by the tailoring dialog. This will allow you to change the job streams to suit your environment.

INSTALLING OPTIONAL COMPONENTS

INTRODUCTION

An Interactive Productivity Facility dialog is provided to help you install optional software components. You can create the JCL to install all or any subset of products during a single execution of the install dialog. The products you select will be installed by library. If you do not have your service libraries disk resident, selecting all the products to be installed in a single library set at a time can save you backup/restore time. Installing those products and performing any tailoring and assemblies required before installing products in a different library will eliminate having to restore the service library at a later time.

When you select a component for installation, you are prompted for information about its location on the distribution tape and the tape volume number on which it resides. The external label of the distribution tape lists each component and a corresponding file number. You must know this number to respond to the installation dialog.

SERVICE LIBRARIES

The installation dialog obtains information from the system profile tables. These tables identify the labels and volume serial numbers of the service libraries to be used when a component is installed. Listed below are the components and the service libraries into which they are installed.

VSE	5745-030
VSE/Advanced Functions	5746-XE8
VSE/IPCS	5746-SA1
VSE/ICCF	5746-TS1
VSE/POWER	5746-XE3
VSE/VSAM	5746-AM2
Interactive Productivity Facility	5748-MS1
VSE/POWER/RJE	5746-XE3
VSE/OCCF	5746-XC5
VSE/VSAM Space Management Feature	5746-AM2
VSE/VSAM Backup/Restore Feature	5746-AM2
VSE/POWER Shared Spooling Feature	5746-XE3

Figure 27. Service library A

CICS/DOS/VS	5746-XX3
-------------	----------

Figure 28. Service library B

BTAM SCP	5746-CG1
BTAM-ES	5746-RC5
VSE/Fast Copy	5746-AM4
VSE/DITTO	5746-UT3
VTAM SCP for ACF/VTAME	5747-CG2
ACF/VTAME for DOS/VSE	5746-RC7
VTAM SCP for ACF/VTAM	5747-CF1
ACF/VTAM for DOS/VSE	5746-RC3
Sort/Merge II	5746-SM2
EP/VS - DOS/VS	5747-AG1
VSE/Access Control Logging and Reporting	5746-XE7

Figure 29. Service library C

DB/DC Data Dictionary	5746-XXC
DL/I DOS/VS	5746-XX1

Figure 30. Service library D

CICS/VS Tertiary and Macro Library	5746-XX3
------------------------------------	----------

Figure 31. Service library E

ACF/NCP/VS	5735-XX1
SSP for ACF/NCP/VS	5735-XX3
NCP/SSP SCP	5747-CH1
NCP/SSP SCP with PEP	5747-CH1

Figure 32. Service library F

The default system profile tables define which components go into which service libraries, as shown above.

You may change the location of the service libraries by modifying your disk label and library profiles. If you have enough DASD to make the service libraries disk-resident, you will save a substantial amount of backup/restore activity during installation and service.

DATA SET CONSIDERATIONS

If you have backed up one or more disks to tape in order to do the installation, do not run jobs that require files that have been backed up. Not only will the jobs not run, but in the case of VSAM data sets, catalog pointers could become mismatched.

If you choose not to back up the contents of your disks to tape, but choose to restore the service libraries to their default locations, you will overlay the dump data set area. Before using these dump areas, you

must recreate and reformat them. Follow the instructions provided in the VSE System IPO/E Program Directory describing how to format the VSE system dump files.

INSTALLATION JOB STREAM

The optional install dialog creates a job stream containing the steps described below. Mixed architecture does not imply the overall configuration has DASD of mixed architectures, but rather that the libraries currently being used are on a split of FBA and CKD devices. Job sequence numbers are provided for each VSE job. They are found on a comment statement following each VSE // JOB statement. This feature provides you with a means of cross-referencing your original job stream with the console listings produced during the execution of those jobs.

1. If mixed architecture exists, a private core image library is created.
2. If the job to create the appropriate service libraries has previously been generated, you are given the option of recreating this job, or including a job to restore the already created libraries. If a job to create these libraries has never been generated, one is included.

Note: If you have not relocated your service libraries and now choose to restore one, it may well be restored to an area that is currently occupied by a different service library. In order to allow this to occur, you must previously have backed up the service library that is about to be overlaid, and respond **0 delete** to messages that tell you an unexpired file is about to be overlaid, or that there is an equal file ID in the VTOC.

3. A job is included that uses MSHP to restore the component distribution libraries and associated history file from the distribution tape to temporary restore areas. The same restore areas are used for the installation of multiple products.
4. A job is included to perform a DSERV that displays the contents of the restored distribution libraries for the component. Save the output for reference purposes.
5. If the product currently being installed has VSE/ICCF members that must be restored to the DTSFILE, the jobs required to perform this task are included here. The VSE/ICCF members are supplied as I.books in the distribution source statement library. They are punched into the internal reader along with a DTSUTIL job to merge them into the DTSFILE. They are then deleted from the restored component source statement library. VSE/ICCF must be terminated

before the DTSUTIL job can be executed. The job is generated with a job class of 2, the same partition in which VSE/ICCF is executed.

6. A job is included that uses MSHP to install the restored component libraries to the system. This single job performs the following functions:
 - a. Merges all the component's core image library phases to the appropriate production core image library if mixed architecture does not exist, and into the private core image library created in the first step above if mixed architecture does exist.
 - b. Merges all the component's relocatable and source members to the appropriate service libraries.
 - c. Updates the system history file with information contained in the component history file.
7. A job is included to modify the retention period of the MSHP temporary restore areas created above to make them expired files. This eliminates the need to respond 0 **delete** to messages that tell you there is an overlap on an unexpired file or an equal file in the VTOC for files MSHP.RESTORE.SYSCLB.FILE, MSHP.RESTORE.SYSRLB.FILE, MSHP.RESTORE.SYSSLB.FILE, and DOS.AUXILIARY.HISTORY.FILE.
8. A job is included to retrace the MSHP system history information for the component. If the component is classified as a feature by MSHP, such as POWER/RJE, a retrace is made of all the features installed.
9. The steps above are repeated for each product selected to be installed that resides in the current service library.
10. If mixed architecture exists, the distribution tape is removed, a scratch tape mounted, and the private core image library created in the first step above is backed up to tape. If the service libraries were just created, the tape is restored overlaying the production core image library. Otherwise, the tape is restored to a newly created private core image library residing on DASD of different architecture than the one created in the first step above, and merged into the production core image library.
11. If mixed architecture exists, a private relocatable library is created, and the relocatable production members are merged in. The library is backed up to tape and restored into the production relocatable library. This step is repeated for the source statement library.
12. If mixed architecture does not exist, all members in the production relocatable library are deleted. A subset of the relocatable modules is then copied from the relocatable service library to the relocatable production library. This step is repeated for the source statement library.

13. You are now given the option of backing up the service library to tape. This job should be run if you do not wish to keep the service libraries disk-resident.
14. The default location for all service libraries is the same. Thus, if you are installing products in more than one library and have not modified the library default allocations, you must back up the service libraries of one library set before proceeding to the next. If you fail to do this, the service libraries corresponding to the next library set having products installed will be created or restored over the service libraries of the library set currently being processed.
15. The steps outlined above are repeated for each service library that has products to be installed.
16. The last job to be executed is one that reestablishes the system LIBDEFs. If, for some reason, the install job stream does not run to completion, and this job is not executed, you must perform the following steps to reestablish the system LIBDEFs. Release the job PAUSEBG from the system reader queue. Respond `0 ASSGN SYSCLB,UA` and `0 // EXEC PROC=LIBDEF`. Enter 0 to end the job. This procedure can be executed in any partition any time the system LIBDEFs are lost. Simply release the appropriate PAUSE job and, in place of 0, supply the corresponding partition number.
17. If you are installing ACF/VTAM or ACF/VTAME, a job will be included to copy the RAS transients from production core image library C to production core image library A.

Additional jobs may be required to completely install some components. In some cases, there will be further instructions in the installation JCL itself. For example, you may have to use tailoring or verification dialogs to finish installing certain components.

It is important to run the install job stream from beginning to end. Products are not completely installed until their associated libraries have been processed to completion. There is no restart facility supported in the optional product install environment.

It is also required that you execute the install job streams in the exact sequence in which you create them. If this requirement is not followed, your production libraries may not contain all of the modules or source books of products which you believe to be installed.

Note: You may include optional products in the SDL list at ASI tailoring time. When you install those optional products, you may get message 3M99I, 'MSHP active - phases not loaded into SVA'. This message can be ignored. The phases will be loaded at next IPL.

INSTALLATION GUIDE

The Installation Guide is similar to the System Management Guide. It is a menu structure used to guide you through the steps required to install components not selected during the first time use dialog, and those outside the System IPO/E product set.

Steps include updating the software products system profile tables, creating copy files, creating new libraries or enlarging existing ones, and actually installing the product. Once these steps have been followed for a particular product, that product can then be serviced as well as installed using Interactive Productivity Facility dialogs.

The following sections display copies of the panels that comprise the Installation Guide along with some additional information on each panel.

INTRODUCTION

INSTALLATION GUIDE: INTRODUCTION

SYM\$11

The following series of panels will guide you through the steps required to install a non-System IPO/E supported product, or a System IPO/E supported product not selected during the first time use dialog. These steps may include updating the software products system profile tables, creating copy files, creating new libraries or enlarging existing ones, and actually installing the product.

Indicate below whether or not the product you want to install is supported by the System IPO/E.

- | | |
|-----------------------------------|---|
| 1 NON-SYSTEM IPO/E PRODUCT | Non-System IPO/E Supported Product. |
| 2 SYSTEM IPO/E PRODUCT | System IPO/E Supported Product not Selected During the First Time Use Dialog. |

Select the appropriate response to continue.

UPDATE PRODUCT TABLE (NON-SYSTEM IPO/E PRODUCTS)

INSTALLATION GUIDE: UPDATE PRODUCT TABLE

SYM\$12

The installation of products using the System IPO/E install dialog is driven off of product information contained in the software product system profile tables, ADM\$SHIP and ADM\$PROD. Entries containing this information are supplied for products supported by the System IPO/E. In order to install products outside the System IPO/E product set, you must add this information to the software product system profile tables using the dialog below.

1 ADD SOFTWARE PRODUCT

Add Product Information to the Software Products System Profile Table.

2 CONTINUE

Continue with the Installation Guide.

This dialog will prompt you for the product component numbers, component level codes, product number, library set into which the product will be installed, release number, whether the product has VSE/ICCF members, number of files on the product distribution tape, if copy files exist, and product library sizes. This information is stored in the software products system profile tables and used by the optional product install and service dialogs, among others.

Refer to the product documentation for this information. Much of it may be found in the product program directory. Refer also to the VSE System IPO/E User's Guide.

CREATE COPY FILES

INSTALLATION GUIDE: CREATE COPY FILES

SYM\$13

Non-System IPO/E supported products that have relocatable modules or source statement books that are to reside in IBM relocatable or source statement **production** libraries must have copy files. JCL created by the install and service dialogs contain jobs that perform a DELETx ALL (where x is R or S) on production libraries. The production libraries are then rebuilt using the copy files corresponding to the products known to be installed in that library. If copy files do not exist for a product, not only will the members not be placed in the production libraries at install time, but if they are placed there without dialog assistance, they will be lost the first time a product is installed or serviced in that library using dialog generated jobs.

- | | |
|----------------------------|---------------------------------------|
| 1 CREATE COPY FILES | Create Product Copy Files. |
| 2 CONTINUE | Continue with the Installation Guide. |

A copy file is one that contains statements used as input by install and service dialogs. These dialogs produce as output COPYR and COPYS statements. These statements contain names of product members that are to reside in the relocatable and source statement production libraries.

The Interactive Productivity Facility optional product install dialog restores product libraries from a distribution tape to temporary restore areas. It merges the core image phases into the production core image library, and the relocatable and source statement members into the corresponding service libraries. The relocatable and source statement production libraries are then built using the copy files. The software products profile table shows which products are installed and the names of their copy files. The modules and source books listed in the copy files are copied from the service library to the production library.

Members contained in copy files should be only those members required online for every day, production activities. A product may have one, two, or no copy files.

Much of the information needed to determine which members should reside in the production libraries may be obtained from the product documentation. You may have to return to this dialog later to add members as needed.

The following two panels are used to input member names into copy file INS\$xxx where xxx is a unique product associated character string.

SYSTEM PROFILE: CREATE COPY FILES

ADM\$CPY3

Enter the relocatable modules you want to place in the copy file INS\$xxx below. This panel will be redisplayed until you enter **NO** in the **CONTINUE** field.

FIRST THREE CHARS **===>** ___

Optionally specify first three characters of modules to be entered.

CONTINUE **===>** ___

Should panel be redisplayed?

===> ___ **===>** ___ **===>** ___ **===>** ___ **===>** ___

===> ___ **===>** ___ **===>** ___ **===>** ___ **===>** ___

===> ___ **===>** ___ **===>** ___ **===>** ___ **===>** ___

===> ___ **===>** ___ **===>** ___ **===>** ___ **===>** ___

SYSTEM PROFILE: CREATE COPY FILES

ADM\$CPY4

Enter the source statement books you want to place in the copy file INS\$xxx below. This panel will be redisplayed until you respond **NO** to **CONTINUE**.

SUBLIBRARY ===> _

What sublibrary should be used for source statement books entered below?

CONTINUE ===> ___

Should panel be redisplayed?

===> _____ ===> _____ ===> _____ ===> _____ ===> _____

===> _____ ===> _____ ===> _____ ===> _____ ===> _____

===> _____ ===> _____ ===> _____ ===> _____ ===> _____

===> _____ ===> _____ ===> _____ ===> _____ ===> _____

UPDATE PRODUCT TABLE (SYSTEM IPO/E PRODUCTS)

INSTALLATION GUIDE: UPDATE PRODUCT TABLE

SYM\$14

System IPO/E optional products selected during the first time use dialog are flagged as products that will be installed. JCL is produced to create the libraries into which those products will be installed. Several libraries have their sizes calculated dynamically, based on the sum of the selected products sizes. For this reason, only products selected during first time use are displayed for possible installation by the optional product install dialog. When installing a product not selected during first time use, you may wish to modify the default library into which the product will be installed. You must update the software products profile table to flag the product as one which is to be installed. These activities can be accomplished using the dialog below.

- | | |
|----------------------------------|---|
| 1 UPDATE SOFTWARE PRODUCT | Update Product Entry in the Software Products System Profile Table. |
| 2 CONTINUE | Continue with the Installation Guide. |

If you have used your DASD space so that increasing the size of an existing library would require significant reorganization of your DASD layouts, you may want to modify the default library into which a System IPO/E supported product is to be installed. Once this product has been flagged for installation, it will be displayed on the optional product install dialog panels. It may then be installed and serviced using Interactive Productivity Facility dialogs.

PREPARE LIBRARIES

INSTALLATION GUIDE: PREPARE LIBRARIES

SYM\$15

It is your responsibility to create the production and service libraries into which these products will be installed. It may be necessary to create a new library set, or enlarge an existing one. The dialogs below allow you to modify your current library and file configuration. They may also create JCL to create, back up, or restore libraries, and perform checking to ensure you are not causing libraries and files to overlap.

- | | | |
|---|---------------------------------|---|
| 1 | USER LIBRARIES | Modify User Library Size and Locations |
| 2 | IBM PRODUCTION LIBRARIES | Modify IBM Production and Service Libraries |
| 3 | PUT/PTF LIBRARIES | Modify PUT/PTF Libraries and Files |
| 4 | LABEL INFORMATION | Modify System Labels |
| 5 | CONTINUE | Continue with the Installation Guide |

The sizes of several production library sets were calculated dynamically during the first time use dialog based on the products you indicated would be installed on your system. If you now plan to install a product you did not select at that time, or a product outside the System IPO/E product set, you must ensure sufficient library space exists to contain that product.

When determining how large to make or how much to increase the size of a library set, keep in mind that servicing a product may make the product larger. Thus, it is a good idea to allow an additional ten percent for production libraries, and twenty percent for service libraries.

Also remember, if you install a product twice, the production relocatable and source statement libraries are recreated, but the production core image, and service relocatable and source statement libraries are not. Thus, to reinstall, you must do one of the following:

- Delete the old version and condense or backup/restore the libraries

- Recreate the production core image, service relocatable, and source statement libraries and reload these libraries as they were before you installed the product
- Restore from an old backup that does not contain the product you wish to reinstall

ASI TAILORING

INSTALLATION GUIDE: ASI TAILORING

SYM\$16

You may want to rerun the ASI tailoring dialog in order to include changes made to your library and file configuration. Note: When you run the dialog, all entries from the previous run are retained. You should not have to make any changes to the dialog entries. Review the generated job stream, then submit it to VSE. If your new ASI procedure will not IPL for any reason, the old ASI procedures are named \$IPLSAV and \$xJCLSAV (where x is the partition ID).

- | | |
|-----------------|---------------------------------------|
| 1 ASI TAILORING | Create Tailored ASI Procedure. |
| 2 CONTINUE | Continue with the Installation Guide. |

If, during the preparation of libraries to receive the additional products you plan to install, you have created new libraries, or moved existing ones to a new volume, you must rerun the ASI tailoring dialog to establish updated system LIBDEFS.

INSTALLATION

INSTALLATION GUIDE: INSTALLATION

SYM\$17

You are now ready to install the products. The required information is stored in the software products profile tables, the products are flagged as ones to be installed, required copy files have been created, and the libraries have been created or enlarged to accommodate the products. The dialog below can also be accessed off the system management menu, SYM\$. It is placed here for your convenience. This panel concludes the Installation Guide.

- | | | |
|----------|---------------------|---------------------------------------|
| 1 | INSTALLATION | Install Products. |
| 2 | END | Return to the System Management Menu. |

This is the last panel within the Installation Guide. Selecting number 2, END, will return you to the system management menu, SYM\$. Now that you have performed all the required steps within the Installation Guide, installation and servicing of the added products proceeds just as it does for a System IPO/E supported product selected during the first time use dialog.

ENVIRONMENT DEFINITION - ADDING TO THE MENU HIERARCHY

Some non-System IPO/E products include Interactive Productivity Facility dialogs. If you install such a product, you may add these dialogs to the Interactive Productivity Facility hierarchy by using the environment definition dialog. This dialog is accessed by entering =env\$ or selecting ENVIRONMENT DEFINITION on panel DTR\$. Selection of UPDATE ENVIRONMENT DEFINITION, 2, will allow you to add, alter, or delete an environment. Selection of SELECT ENVIRONMENT DEFINITION, 1, will allow you to enter a previously defined environment.

An environment is a collection of menus and functions required to perform a given task. System management is an environment included in the Interactive Productivity Facility.

When you add a non-System IPO/E product dialog to the Interactive Productivity Facility menu hierarchy, you must also add the VSE/ICCF libraries in which the dialogs reside to the Interactive Productivity Facility connect table.

| **Note:** See the section 'User Options Files' in the Interactive
| Productivity Facility VSE Feature Reference Manual and the section
| 'Interactive Productivity Facility User Options Files' earlier in this
| manual for more information on the format and contents of DTR\$DTBL and
| the connect table it contains.

VERIFYING OPTIONAL COMPONENTS

The purpose of the verification programs is to ensure that products have been installed in the proper libraries, not to exercise all of the functions of the individual products (verify option). They are also used to delete the data sets used during verification (delete option). You are prompted for the verify or delete option and for the DASD type and volume serial number of the disk to be used for verification.

Many of the verifies require that USRSL1 be defined in the LIBDEF for F1 so that VSE/POWER SLI capability is active. This can be accomplished by running the ASI tailoring dialog, executing the job stream created, and IPLing the system.

| **Caution:** Although you may select VERIFICATION on panel SYM\$, you should
| use the System Management Guide version of the verify dialogs. The
| panels in the System Management Guide are intended for first time
| install activities. The verify dialogs accessed directly from menu
| panel SYM\$ are intended for someone familiar with the verify process.

DASD REQUIREMENTS

We recommend very strongly that, if possible, you use a separate DASD volume for the verify files. It does not matter what device type is used for the verify volume. If you do not have an additional volume available, you may run the verify job streams using one of the System IPC/E-provided minimum required volumes. However, be aware that these job streams will overlay any files present on the volume. Therefore, the files must be recreated or restored after the job streams complete.

| If your DASD type is 3350 or 3370, a third volume is required to run
| the verify jobs.

| If you do not have a scratch volume and your DASD type is 3310, 3330,
| or 3340, we recommend that you use SYSWK3 for the verify volume.

No data-secured files may exist on the verify volume. If the volume you select for verification contains any such files (for example, VSE/VSAM catalogs), you must initialize the volume or remove the files before running any verification job streams.

Some verification job streams create VSE/VSAM catalogs and clusters. When you have verified all your components, you must remove the data-secured files from the verify volume before attempting to use it for other purposes. This may be accomplished by selecting VSE/VSAM on the verification menu and selecting the delete option on the next data entry panel.

VSE/VSAM CONSIDERATIONS

Most of the verify job streams require VSE/VSAM. Therefore, the verify for VSE/VSAM should be the first one you run. This will define a user catalog on the verify disk and allocate data space for the verification of other components. This user catalog will contain entries only from the verify job streams, not from any other Interactive Productivity Facility dialogs. The verification job streams assume that the verify volume is completely available for use. The files created on this volume have been mapped out in order not to overlay one another regardless of which components you are verifying.

The VSE/VSAM verify job stream is created with a default VSE/POWER disposition of H, which means it will not execute until you release it from the VSE/POWER reader queue.

Note: Make sure that this job stream has run successfully before submitting other verify job streams.

CONTROLLING EXECUTION SEQUENCE OF VERIFICATION JOB STREAMS

In the VSE/ICCF environment, verify job streams for all components have a default VSE/POWER disposition of H, which means they will not execute until you release them from the VSE/POWER reader queue. You may change the disposition on the job disposition panel before filing the job stream, or edit the job stream in your VSE/ICCF library (or VM/CMS file).

Note: Review the output of each verify job stream to ensure proper execution.

VERIFICATION OF CICS/VS-DEPENDENT COMPONENTS

Batch verification of optional components that depend upon CICS/VS should be done before verifying CICS/VS itself, because these job

streams load data files needed to verify such components with CICS/VS.

An example of the verify sequence to be followed for a DB/DC user who has installed SORT and Data Dictionary would be:

- VSE/VSAM verify batch
- SORT verify batch
- DL/I DOS/VS verify batch
- CICS/VS online
- CICS/VS-DL/I DOS/VS online

The following components require the verify for CICS/VS to ensure correct installation:

- DL/I DOS/VS online
- Data Dictionary

PRODUCT CONSIDERATIONS

For detailed information on product verification or other product specific information, refer to the System IPO/E publications listed in the preface of this manual.

DUMP ANALYSIS

The analyze dump dialogs provide an interface to the VSE/Interactive Problem Control System (VSE/IPCS) that allows you to:

- Process a dump from either disk or tape
- Optionally print an APAR report and save the dump on tape
- Print a formatted or unformatted dump
- Select options for formatted printing

Each parameter is explained, and valid input indicated, along with recommendations to assist you.

We recommend that new users initially accept the system-provided defaults to gain quick access to VSE/IPCS.

Note: The creation of various dump files is necessary before VSE/IPCS dump processing is possible.

SERVICE

The following section contains information on applying service to the program products contained in the VSE System IPO/E.

| Appendix D of this manual contains a sample hypothetical put
| application and a sample of the corrective service activities.

Basically, there are two types of service:

- Corrective service - Applying some type of fix to your libraries to resolve a problem you have experienced
- Preventive service - Applying fixes to your system before experiencing a problem

Preventive service can be broken down further to voluntary and involuntary service.

- Voluntary preventive service: taking an overt action to uplevel your system on the current release. The application of a program update tape (PUT) is the normal means for accomplishing this.
- Involuntary preventive service: upgrading your system as a result of another action. When you installed the VSE System IPO/E, you received a system that we upgraded before sending it to you. Your intentions may have been to go from Release 2 of Advanced Functions to Release 3. However, you also received preventive service.

Let us now look at some of the aspects of preventive service. These are presented in a question and answer format. Some of the questions are actual ones received during earlier releases; others are purely fictional and used for instructional purposes.

- **Question:** My system is working fine, why should I spend the time and effort to apply a PUT tape?
 - **Answer:** Good question! Ideally, if you were never to write a new program, change a JCL statement, or have a hardware error, there would not be any need for applying a program update tape. However, any changes can open up paths to previously undiscovered errors. Some errors can have severe effects, especially when dealing with any type of file or data base structure.
- **Question:** The last time I applied a PUT tape there was an error in one of the PTFs. Doesn't IBM ever test anything?

- **Answer:** The tapes are tested. Not only do we test the tapes internally, we also test them in customer accounts before making them available for general use. Sometimes problems still slip through. This is why you should always call the IBM Support Center before the application of the PUT tape for a list of any known problems.

• **Question:** I had a problem with a tape I/O module and called the IBM Support Center. They told me the problem was fixed on the PUT tape that I received last month. I had already applied the tape, what happened?

- **Answer:** This is difficult to answer without additional information. A couple of things could have caused the problem.

The most logical reason is that the fix affected either the DTFMT macro or the MMOD I/O module. If the fix was to the DTFMT macro, or the I/O module is assembled in your source program, it would be necessary to reassemble your program to include the fix. Otherwise, you would have to re-link-edit your program to include the I/O module.

Another possibility is that the PTF was not applied because of an APAR fix on your system that is not picked up by the PTF, or that the PTF was rejected due to a missing prerequisite. If you check the printed output from the PUT application, you should see if the PTF was actually applied or not.

SERVICE DIALOGS

The service dialogs provide a means for applying service to your system. This service may be in the form of program update tapes (PUTs), program temporary fixes (PTFs), or authorized program analysis report (APAR) fixes.

The service dialogs support only those components with service information distributed in MSHP format. The service dialogs generate VSE, JCL, and MSHP control statements to perform each of the service functions. Before applying service to your system, you must ensure that the system profile tables accurately reflect your system. The tables must describe the names and actual DASD locations of your libraries, as well as the work libraries required for the service process. See the section "System Profile" for more detailed information.

Some of these dialogs contain extremely complex processing logic, perform many I/O operations, and create large job streams. While actual response time is a function of all the work being done on your system, a response time of one or two minutes on a lightly loaded system would not be unusual.

PROGRAM UPDATE TAPES

A program update tape (PUT) has a standard format for applying service to the system control program (SCP) and most IBM licensed program products that have Field Engineering local service.

The PUT is produced by IBM Field Engineering and tested on a system that has all components installed. It is then tested in various user locations before being made available for general use. Consult the IBM Support Center before applying a PUT for any problems that may be outstanding. The service dialogs allow rejection of any PTF on the PUT should the need arise.

Refer to the directions sent with the PUT for information on printing the PUT documentation. Be sure to follow any special instructions in the PUT document for the PUT level that you are applying. This could include reassemblies, link-edits, etc.

PROGRAM TEMPORARY FIXES

Program temporary fixes (PTFs) are created to provide immediate relief to certain programming errors. Errors of a less severe nature will not have PTFs created, but will be fixed in the next release of the product.

Basically, the distribution of PTFs can be made in four ways:

1. Included in the preventive service files on a PUT tape
2. As part of the corrective service files on a PUT tape
3. A single PTF on tape, card, or diskette
4. Two or more PTFs as a cumulative PTF file on tape

The second item listed, corrective service files on a PUT, is actually the same as the fourth item, a cumulative PTF file. A nice feature is that even though there are multiple corrective service files, the MSHP preprocessor knows where the PTFs are and will forward space the tape to the correct file.

The service dialogs support all of the above with one exception; they do not permit applying a PTF from cards or diskette. However, it is a very simple matter to copy the PTF from cards or diskette to a tape blocked 3440. You may then use the apply cumulative PTF dialog to apply the PTF. (By definition, a cumulative PTF file contains two or more PTFs, but neither the dialog nor MSHP knows that you only have one PTF, so it works!).

To copy the single PTF file to tape you may use the program product VSE/DITTO, or the OBJMAINT program. Since everyone has the OBJMAINT program, this is a sample of what the JCL would look like:

```

* $$ JOB JNM=PTFTOTAP,CLASS=3,DISP=K
// JOB PTFTOTAP COPY A SINGLE PTF TO TAPE
* THIS JOB WILL COPY FROM A DISKETTE TO TAPE
// DLBL UIN,'PTFINPUT.FILE.1',07/021,DU
// EXTENT SYS004
// ASSGN SYS004,3540
* IF INPUT IS FROM CARD SUBSTITUTE
* THE ABOVE 3 STATEMENTS WITH
* // ASSGN SYS004,SYSIPT
// ASSGN SYS005,TAPE
// EXEC OBJMAINT
./ ACTION JOBTYP=DOS,DATA=SYS004
./ BLOCK BLKSIZE=3440
* THE FOLLOWING STATEMENT SHOULD BE
* USED FOR PTFS IN CARD FORMAT AND
* A CARD WITH $$ IN COLUMNS 1 AND 2
* SHOULD BE PLACED AFTER THE DECK.
./ CARD DELIM=$$
./ COPY
* IF THE PTF IS ON CARDS IT FOLLOWS THIS STATEMENT
.
.
.
.
.
$$
/*
/ε
* $$ EOJ

```

Backout PTFs

Backout PTFs may be created by replying YES to the SRV\$UPG1 or SRV\$UPG6 panel. The backout PTFs will be punched to tape as cumulative PTF files. Only PTFs that affect the relocatable and source statement libraries will produce good backout PTFs. PTFs that affect the core image library will not have backout phases punched, and you will receive error messages on SYSLST.

Backout PTFs have the same format as regular PTFs except they contain your original modules and books. They are produced as a cumulative PTF file, and may be applied using the apply PTF dialog for cumulative PTF files. These backout PTFs then can be used to remove a PTF that is later found to be in error.

Since the backout PTFs may not be complete, and it takes additional processing time to create them, we do not recommend that you use this

option. Instead, keep a backup of your system before the application of the service.

DASD FILE REQUIREMENTS

System files used by the Interactive Productivity Facility generally have an internal name which is used to locate them in the system profile tables. These names are referred to as generic names (for lack of a better term). A list of the names for the files used in the service process is provided below.

The service process requires the following work areas:

PUTCL1	- Composite PUT core image library
PUTRL1	- Composite PUT relocatable library
PUTSL1	- Composite PUT source statement library
PTHST1	- Composite PUT history file
SYSNRS	- New SYSRES containing the applied service
PUTCL2	- Intermediate PUT core image library
PUTRL2	- Intermediate PUT relocatable library
PUTSL2	- Intermediate PUT source statement library
PTHST2	- Intermediate PUT history file
PUTNRS	- Intermediate staging area for core image library
WORKHST	- Intermediate systems history file
SAVEHST	- Intermediate work systems history file

Figure 33. Service process work areas

In addition to the work areas, the service process requires a volume for the service libraries. These libraries may be retained on disk and the requested volume mounted, or they may reside on tape. The service dialogs ask if the service libraries are on tape or disk. They will generate a restore job, if on tape, or a mount message if on disk.

It is assumed that the service volumes are on tape and that the disk that will contain the service libraries contains user data. Therefore, job streams can be produced to copy those disks to tape, using the VSE/Fast Copy utility. After a disk is copied, it will be initialized, with the VTOC in the SYSRES location on the pack.

The allocations for the above work areas have been predefined in the system profile tables. The allocations will only have to be changed if there have been changes to the library sizes.

Some of the service functions will require the use of quite a few tapes. For example, the application of a PUT tape will generally require two tapes for the backup of your system, a new tape for each service library, a tape for the new SYSRES that is created, a scratch tape for servicing VSE/ICCF members, and a tape for each service library if you create backout PTFs. If you have a mixed architecture or mixed DASD environment, you will require a few more scratch tapes.

APPLY PUT

CAUTION

During execution of the job streams, you will receive messages - "M069A SYSCLB is assigned, do you intend to upgrade a private core image library? If so, press END/ENTER. Otherwise, enter CANCEL." This is normal, and you should press END/ENTER.

Also during execution you will receive messages - "M094A Existing History file is going to be overwritten. Enter DELETE if you agree. Otherwise, enter CANCEL." This is normal, and you should enter DELETE.

If you indicate to the service dialogs that you want your user volumes backed up to tape, job streams will be generated to back up your volumes and then to initialize them. If you use a scratch volume which you do not copy to tape, you should initialize it with the VTOC in the SYSRES position before running the service process. If the VTOC is already in the SYSRES position, and there are no data secured files on the disk, you may omit the initialize disk step.

When servicing library A, all of the supervisors contained in the system profile tables will be reassembled. If there are supervisors that you don't need, remove them from the tables. Do not try to bypass the assembly of the supervisors. The only way that the supervisors get into the new SYSRES is from the assembly. Ensure that the supervisors have assembled and link-edited correctly doing an IPL of the new SYSRES tape.

It is difficult to predict exactly how large a partition and GETVIS area are required. Based on early tests, it is wise to allocate at least 1 megabyte to the background partition.

The job stream execution is a multi-stage operation. All of the jobs prior to the first execution of the MSHP preprocessor are the first stage. The MSHP preprocessor, a program supplied with the PUT tape, will produce JCL that must run before the remainder of the Interactive Productivity Facility JCL. This is accomplished by executing the preprocessor to read the Interactive Productivity Facility JCL and create the stage two Interactive Productivity Facility JCL following its own. If CICS/VS is to be serviced along with other products, the stage 2 JCL will include a second execution of the preprocessor in order to service CICS/VS. Due to the size of CICS/VS, this product can not be serviced in the same pass as the other products. Thus, CICS/VS is excluded during the first pass of the preprocessor in order to service all other products. This second execution of the preprocessor will produce a third stage JCL job stream which will execute the preprocessor a third time to handle the CICS/VS MACLIB library. This is necessary due to the limited space available for the PUT libraries.

A large amount of JCL is produced. This is primarily due to the need for multiple service libraries. You should not attempt to acquire an in depth knowledge of the JCL that is produced. If you experience any difficulties with its execution, please call your IBM Support Center.

One of the jobs in the JCL produced by the service dialogs cannot execute while VSE/ICCF is running, because it catalogs data into the VSE/ICCF library. The job contains comment statements that will instruct the operator at the appropriate time.

| After the job stream has completed, if you applied service to
| components residing in library A, a new standalone SYSRES tape will be
| produced. You must IPL from this tape and restore the libraries to
| your DOSRES volume. You must standalone restore the new SYSRES before
| system backup. The new SYSRES is not a system backup. It does not
| contain a properly updated history file.

Checkpoints

Throughout the JCL there are checkpoint messages that appear on the console. If you should have a problem, and the job has to be canceled, it is possible to restart from the last successful checkpoint. You should not attempt to restart from a point other than one of the checkpoints.

The restart dialog will create the necessary JCL to restart from a checkpoint number that you specify. It assumes that all of the history files and work areas have been left intact from the aborted PUT run.

Dialog Flowchart Diagrams

It is possible to obtain a dynamic flow diagram based on your system configuration and the responses you give during the execution of the PUT (and PTF) dialogs. The flow diagram will be saved as a file with the name SRV\$FLOW in your user library. If a file by this name already exists, it will be overwritten. This diagram will be most useful when printed in hard-copy form. This file details the creation and handling of files and data. It will help give you a better idea of what steps are actually taking place within the JCL which the dialog has produced.

Supervisor Assemblies

The table created and/or modified by the tailoring dialogs is used as input to the service dialogs to determine what supervisors need to be reassembled. Therefore, to save needless reassemblies, use the tailoring dialogs to delete any supervisors that you do not need for your system.

You will be given the option of whether or not you want a listing and cross reference for the supervisor assemblies. Although a listing uses a lot of paper, if there are any problems with the system, listings are very valuable for trouble shooting.

Questions and Answers on PUT

Note: Appendix D contains a sample hypothetical put application.

- **Question:** If PUT stands for program update tape, why do you say PUT tape? Aren't you actually saying program update tape tape?
 - **Answer:** Yes, it is redundant, but much easier to say. Therefore, you will find PUT tape used in most cases in this document.
- **Question:** After running the dialog to produce the PUT JCL, I edited it and saw that there were Vs at the start of the JCL. What's wrong?
 - **Answer:** Nothing is wrong. Here is a brief explanation of how the PUT JCL works.

The first part of the JCL does not contain a V. It runs normally until we invoke the MSHP preprocessor from the PUT tape. At that point, the output JCL from the preprocessor must run before the remainder of the JCL we created. Therefore, the

preprocessor first punches its JCL and then starts reading from the reader. As it reads the statements, it shifts them one position to the left. It does this until it reaches a /*.

Effectively, the preprocessor's JCL gets inserted right in the middle of our JCL, and we have achieved a stage one, stage two operation without you being aware of it. You may find it interesting that with this release you will have VVs in front of some of the JCL if you are servicing CICS/VS, and VVVs in front of other JCL if you are servicing CICS/VS in addition to other products. Now we have made it a possible stage one, stage two, stage three, and stage four operation.

- **Question:** When applying the PUT tape, I received several messages M119I REVOKE PTF IS INCOMPLETE DUE A FAILING SERV. What causes this?
 - **Answer:** As you were running the dialog you replied YES to panel SRV\$UPG1 to produce backout PTFs. (backout and revoke are synonymous.) Due to the way that we update the core image library, you do not get backout PTFs for that library. Therefore, you receive the message. We strongly recommend that you keep a backup of your system libraries should the need for removing a PTF arise.
- **Question:** When applying the PUT JCL, the target library is always an empty private core image library. Why don't you just upgrade the normal core image library and save some steps?
 - **Answer:** You are certainly right that we would save some steps in doing so, but let me explain the process first and why we do it that way.

The target library is an empty core image library.

After the upgrade is complete, this library contains all of the service that was applied from the PUT tape.

The CORGZ program is used with a COPYC NEW statement that copies everything from your old library into the private work library.

Everything in your old library is then deleted which resets all internal pointers.

The work library is then copied to your old library.

Now to answer your question concerning the steps we go through.

When MSHP does the upgrade, it will check to see if there is enough available room in the core image, relocatable, and source statement libraries. If there is insufficient

room in either the relocatable or source statement libraries, it can do a delete of the modules (or macros) that will be replaced, and then condense the library. It can not do this for the core image library. Therefore, all that it does is give you a warning message and cancel the job. It is then up to you to determine what can be deleted from the core image library, delete it, condense the library, and restart the job. By the steps that we go through, we eliminate that possibility. There should always be enough room for the upgrade.

- **Question:** I understand the need for getting the serviced modules into the production libraries, but why don't you just merge them in instead of moving the libraries all around?

- **Answer:** This is similar to the above question. We move the libraries around to eliminate the need for doing a condense, or just not having enough room to do the merge. The current process is less complicated than it was for Release 1. In Release 2 we specify that your user modules, macros, etc. should be in your own libraries. We then do a two-step process:
 - Delete all of the members in the production library.
 - Merge all of the production members from the service library into the production library.

- **Question:** When applying a PUT tape, it tried to punch all of the I. members from the service library. There weren't any there so why did it try to punch them?

- **Answer:** Members that are in the I. library are fixed to VSE/ICCF DTSFILE members. Generally these are PTFs for the Interactive Productivity Facility itself. The dialog does not know if there are any PTFs, so it goes through the steps anyway.

RESTART PUT

During the execution of the JCL produced by the apply PUT dialog there may be reasons for aborting the run, such as an unrecoverable I/O error on tape, power failures, or programming failures. Whatever the reason, this dialog will produce the JCL necessary for a restart from the last good checkpoint.

During the execution of the JCL, checkpoint messages containing a sequence number will appear on the console. To restart, you supply the dialog with the last number you successfully passed. The dialog will pick up from there and repeat the panels. Naturally, the dialog assumes that files created during the execution of previous steps still exist.

If for some reason they do not, you will have to use the apply PUT dialog.

This dialog depends on the successful completion of the apply PUT dialog. The dialog saves a table, SRV\$LIB, which contains a list of the libraries to be serviced. The restart PUT facility does not function properly for the selective PUT dialog. It functions properly only for the apply PUT dialog.

You should not execute any other dialogs between apply PUT and restart PUT. For example, if you ran apply PUT, and got as far as checkpoint 2, flushed the job, and ran apply PTF. When the PTF application finished, files needed for the restart PUT would no longer exist.

APPLYING SELECTIVE PUT LIBRARIES

The PUT tape consists of stacked libraries in restore format. Each optional component is in a separate library on the tape. It is possible to apply one or more components by using the apply selective dialog. Components are identified by a three character identifier that is given in the PUT tape documentation.

You may find this dialog useful for applying preventive service in a corrective mode. If you are having problems with a product, a fix exists on the PUT, and time does not permit the installation of the entire PUT at this time, you may use this dialog.

APPLY PTF

PTF application requires the use of the PUT areas as described above. PTFs may be in multiple files, but may be applied to only one service library at a time. Therefore, applying (multiple) PTFs to two service libraries will require that you run the PTF dialogs twice.

The PTF process will update your production libraries as well as the service libraries. However, it will not automatically assemble your supervisors. If you apply PTFs to any supervisor macros, you must reassemble the supervisors affected.

Print Cover Letters

The cover letters, that describe the contents and purpose of the PTFs are machine readable and supplied on a separate file. Refer to the PUT

document for the location of this file on your tape. You may need cover letter information to properly enable (or activate) a PTF, or you may print the cover letters for your own information. This dialog is available from the apply cumulative PTFs menu.

Apply PTF (from PUT)

This dialog is used to apply a PTF from the corrective service files on the PUT tape. The PTFs contained in these files are documented in the machine readable cross reference on the PUT tape. A dialog is available from the APPLY PUT selection off the service menu to print the cross reference list.

Note especially any information in the PUT document concerning prerequisite PTFs that should be applied prior to applying the PUT tape. You may use this dialog for applying those PTFs. Generally, these will be PTFs to system products, such as MSHP or the CORGZ program.

Apply PTF (from cumulative PTF tape)

If you emergency order any PTFs, you will generally receive them on tape. This dialog is used to apply them from that tape. It is similar to the apply PTF above with the exception of the input tape. It will be your responsibility to properly position the tape to the file that contains the PTFs.

Apply Backout PTF

During the application of a PUT tape or a PTF, you may have created backout PTFs. This dialog creates the necessary JCL to apply the backout PTF to your system. This effectively removes the PTF that was on your system and returns your libraries to their original state.

Note: This will not work for PTFs that affect only the core image library. VSE/POWER is an example of this type of PTF. PTFs that are contained in the relocatable library and link-edited into the core image library will work correctly.

APPLYING APAR/LOCAL CORRECTIVE SERVICE

MSHP supports the application of corrective service to the core image, relocatable, and source statement libraries, for APAR and local fixes. It also provides a means for removing the fixes, if they were applied as revokable.

All changes using the APAR/LOCAL fix dialogs are recorded in the system history file. Core image and relocatable fixes that were applied as revokable have the information for removing the fix recorded in the history file. For the source statement library, the revokable option will cause a "backout" deck to be punched on SYSPCH. This deck may be used later should it be necessary to remove a fix.

APAR/LOCAL fix changes to the core image library may be done without a service library online. For the relocatable and source statement libraries, the service library must be mounted.

Two dialogs are provided for restoring the service libraries, merging into the production relocatable and source libraries, and backing up the service libraries. These dialogs, preservice and postservice, should be run before and after applying or removing any corrective service.

After applying corrective service to the service libraries, you may want to perform additional steps, such as assembling a program, before backing up the library to tape. Any such steps must be performed prior to running the output from the postservice dialog.

You may find the preservice and postservice dialogs handy for your own activities that need the service libraries. There are only two requirements for using them: you must give the 11 character component ID for a product in the libraries; and, you must run the preservice dialog prior to running the postservice dialog.

Hints:

1. There are some examples on the explain panels for many of the panels. If you have any doubts about what to enter, refer to the explain panels first, and then the VSE/Advanced Function MSHP User's Guide.
2. Currently the MSHP manual does not mention it, but you may only expand a core image phase that is self relocating, in other words link-edited to zero. These are generally transients (phases starting with \$\$). It is possible to expand a phase that is not self relocating by using absolute rather than relative addresses. However, once you do so, you will not be able to remove the fix.

Preservice

This dialog should be run before applying any corrective service (other than PTFs) to either the relocatable or source library. It will restore the service library you require and build a LIBDEF chain.

You may find this dialog useful in generating JCL for a random library. You may then change the JCL to point to a non-Interactive Productivity Facility supported library.

| If you have a mix of 3330's and 3340's for SYSWK2 and SYSWK3, you will
| need to correct the JCL after running the preservice dialog of the
| Corrective Service Environment trying to restore two service libraries.
| Locate the job that restores one of the service libraries to SYSWK3.
| Keep the starting address of the first service library (in most cases
| there will be a relocatable and a source statement library.) Convert
| the number of tracks to the number required for the DASD Layout Section
| in the VSE System IPO/E Reference Manual. Relocate the starting address
| of the second library (if it exists) to the end of the first library.
| Modify the number of tracks as above. The library directory allocation
| sizes must be converted to agree with the DASD type of SYSWK3. This
| DASD configuration of 3330s and 3340s for SYSWK2 and SYSWK3 is not
| supported by the Interactive Productivity Facility.

Corrective Service

This dialog applies an APAR/LOCAL fix to the core image, relocatable, or source statement libraries.

We recommend you specify that the fix is revokable. In the case of the core image and relocatable library fixes, the original data is contained in the history file and may be removed by the undo function. For the source statement library, the revokable option causes the original source book to be punched on SYSPCH as a backout book. Unfortunately, we have no way of inserting any of the necessary LIBDEF statements for cataloging it back into the proper source statement library. Therefore, if you need to remove a fix, you will have to modify the deck to add the necessary LIBDEF statements.

Caution: When making entries that require the data in certain columns, be sure to use the space bar rather than the cursor positioning keys.

Hint: Save the JCL that was produced by this dialog and use the LIBDEF and JCL statements to insert into the backout book.

Post Service

When finished with the corrective service dialog, you should run this dialog, if you ran the preservice dialog.

This dialog will recreate the appropriate production relocatable and source statement libraries, if you serviced a component that has modules or macros in the production libraries. It will also back up your service libraries to tape, fast copy user data from tape, and reestablish your normal production LIBDEF search chain.

ARCHIVING CHANGES

Service dialogs allow you to archive PTFs or APAR fixes into the MSHP history file. You will be prompted to supply all necessary information for PTFs that are not in MSHP format. The information required should be found in the cover letter supplied with the PTF.

All APAR fixes or local fixes applied to your system must be recorded in the history file. This is to ensure integrity of your system when applying PUTs or PTFs.

A local fix is recorded by using a prefix of ##, followed by a unique five-digit number; for example, ##05013, which could be the month and day that you applied the fix.

HISTORY FUNCTION

MSHP records all changes made to the system in a unique file, the system history file. It uses this file to ensure that the service being applied does not destroy any service already on the system.

The service dialogs allow easy access to the system history file for the purposes of:

- Retrieving information
- Updating the file
- Backing up the file to tape
- Restoring the file from tape

Normally the system history file is updated automatically by MSHP. However, if you are applying an APAR fix or a PTF which is not in MSHP format, you should record fix application with these dialogs. The

dialogs prompt you for the required information and then produce a job stream for updating the history file.

When there is service for VSE/ICCF, the pregenerated system is included with the service. This means trouble if you have tailored your VSE/ICCF system. Basically you have two options:

- You may enter =SRV\$523 after running preservice to restore the service library and set up the LIBDEFS. Then, on panel SRV\$523 select the DTSSG assembly. You may then enter the options that you altered when originally tailoring the VSE/ICCF system, and the dialog will reassemble and catalog the necessary phases. To aid you in remembering what options you changed, display the member ADM\$OPT. It contains a history of everything that you have ever changed from the default values.
- You may rerun the VSE/ICCF tailoring dialog after first purging the tables that it uses. The tables are named ADM\$ICFT and ADM\$ICFU. When you rerun the dialog, the original default tables will be used, and your changes will then cause reassembly of the affected phases.

Caution: If you do not perform one of the above steps, you may find that you may not be able to start up VSE/ICCF. Since the Interactive Productivity Facility program requires VSE/ICCF, you will not be able to run it either. As an example, the default system allows you to have up to five extents for the DTSSFILE. You feel that you need more, so you alter it to seven. After applying service from the PUT tape, the pregenerated system is in the core image library of the IPL tape. You IPL the tape which comes down over your existing SYSRES, and then try to bring up VSE/ICCF. There will be problems handling your seven extents when it is pregenerated for five.

Here is a suggestion. After creating the JCL to apply the PUT tape, perform the necessary steps listed above to do your reassemblies. Submit the JCL created to VSE/POWER with a disposition of L. This will leave it in the reader queue. After you IPL the tape, and before trying to bring up VSE/ICCF, release the jobs from the queue. If this fails, you can fall back to your system backup that we recommended earlier.

JCL COMMENTS

Some of the service dialogs generate a substantial amount of JCL. For example, the application of a PUT to an IPO/E System with all optional products, mixed architecture, and service on the tape for all products, would produce around 3500 JCL statements. Assuming an error rate of 1/20 of 1% would mean two statements would be incorrect. How will you find them? Perhaps more important, how will you ever figure out what the JCL is doing? The answer is to select JCL comments on the SRV\$ menu and turn on the JCL comments feature. Then, rerun the service dialog.

| It will take longer to run the dialog, and it will produce more JCL. In
| addition, some processes such as apply PUT and apply PTF allow the
| creation of an optional flow diagram. The flow diagram provides a
flowchart of the PUT and PTF job streams. Using the printed output from
the failure, the flow diagram, and the JCL comments, you should be able
to determine the problem. If not, call the IBM Support Center for
assistance.

Note: The flow diagram assumes that the source and relocatable service
libraries both restore to the same pack. If you split them across
packs, you must do the necessary interpolation.

OPERATIONS

This section describes the facilities provided by the Interactive
Productivity Facility to aid you in the operation of your system after
it has been installed. The facilities discussed here are directed
toward the VSE system itself. They include JCL creation and VSE
utilities.

JCL CREATION

This dialog helps you create the job control statements required to run
jobs under VSE or in a VSE/ICCF interactive partition. Job streams are
produced to execute compilers, utilities, or application programs.

The output from jobs that execute in a VSE/ICCF interactive partition
is directed to disk files or the terminal. Input comes from disk files,
the terminal, or the job stream itself. The output for jobs that
execute in a VSE batch partition is directed to the system printer (or
to the terminal if you submit it with the return option). Other I/O
devices supported include disk, tape, or diskette.

UTILITIES

Dialogs are provided to help you create job streams and to back up and
restore libraries, fast copy files and volumes, copy diskettes, and
display volume table of contents. These utilities are a conversion of
the Release 1 ICCF prompts (@AID) and do not interface with the System
IPO/E profile tables. The concatenation method is recommended since it
is compatible with the library structure while the assign method may
conflict with library definitions (LIBDEF) in the System IPO/E.

Backup and Restore Utilities

Note: For restore of any system or user library, you should use the library information dialog to add or change information and use the restore system libraries dialog to restore your libraries.

The backup dialog generates a job stream to back up libraries by the assign or concatenation method.

The restore dialog generates a job stream to restore libraries by the assign or concatenation method.

Fast Copy Utility

The fast copy dialog generates a job stream to copy files or volumes from disk to tape, tape to disk, or disk to disk.

The copy diskette dialog generates a job stream to copy diskettes.

Display VTOC

The display volume table of contents (VTOC) displays information concerning all files in the VTOC.

CHAPTER 4 - SYSTEM USE FOR VSE/ICCF USERS

System use consists of activities that interface directly with an end user to help create a work product.

[VM/VSE FEATURE NOTE] In the VM/VSE environment these activities are replaced by those supplied with the VM Feature.

The following category of system use activity has been defined in the VSE environment:

Program Development - Develop programs under VSE/ICCF and review VSE/ICCF usage

PROGRAM DEVELOPMENT

The program development environment provides information required to create, modify, compile, and execute programs under VSE/ICCF. It consists of a series of explain panels accessed through an information menu. This structure allows you to examine the information relating to a specific topic of interest. Information is available on the topics described below.

Program Development - Purpose and scope of program development under VSE/ICCF. The VSE/ICCF command language is also described.

Library Structure - Use and structure of libraries under VSE/ICCF. This topic includes a description of the library file and types of user libraries.

Create/Modify - Creation and modification of program source statements. Included are sections on temporary work/storage areas, invoking the VSE/ICCF full screen editor, and full screen editor commands. In addition, a VSE/ICCF common library member, IPF\$EXP, containing full screen editor command and general use information, is provided to make this information more readily available when needed.

RPG II Create/Modify - Creation and modification of RPG II source programs. Describes how to invoke the RPG II source entry facility (RSEF).

Compile/Assemble - Compilation and assembly of source programs. This topic describes the ASSEMBLE, COBOL, PL/I,

and RPG II procedures, the LINKNGO program, and the /DATA job entry statement.

Input/Output - Definition of program input and output files. This topic describes how to specify normal VSE files and VSE/ICCF member files. The /FILE and /OPTION job entry statements are also described.

Load/Execute - Loading and execution of a program. Foreground vs. Background tasks, the /LOAD job entry statement, and the /EXEC and /RUN Commands are included under this topic.

Submit to Batch - Submission of jobs for batch execution. Described are jobs eligible for submission and the method of submission.

Further information about program development under VSE/ICCF, and VSE/ICCF in general may be found in the VSE/Interactive Computing and Control Facility Terminal User's Guide (SC33-6068).

CHAPTER 5 - ENVIRONMENT DEFINITION

An environment is the collection of menus and functions required to perform a given task. System management is an environment included with the Interactive Productivity Facility. You may need to define environments that are not included with the Interactive Productivity Facility. For example, the product ELIAS-I ships Interactive Productivity Facility dialogs which are not part of the Interactive Productivity Facility program product. Environment definition is the way you can integrate such dialogs into the Interactive Productivity Facility menu hierarchy.

Environment definition has two main functions:

1. Select Environment Definition

You can enter an environment, such as ELIAS-I, from this choice. When you choose an environment, the appropriate menu is displayed for that environment.

2. Update Environment Definition

You can add, alter, or delete an environment from this choice. You are allowed to enter an environment name, the menu associated with the name, and some comments.

The table ENV\$DEFT contains all the information required for environment definitions. If you wish to have the environment definitions someone else has, you may simply replace your copy of ENV\$DEFT with their copy. This table must be in your primary library to be effective.

Note: You should add the VSE/ICCF libraries which you use for the environment to the Interactive Productivity Facility connect table. See the section 'User Options Files' in the Interactive Productivity Facility VSE Feature Reference Manual and the section 'Interactive Productivity Facility User Options Files' earlier in this manual for further information.

CHAPTER 6 - FIRST USE TUTORIAL

This tutorial covers the following topics:

Introduction	Brief overview of both the first use tutorial and the Interactive Productivity Facility.
Adjusting Screen	How to adjust the brightness and contrast
Exiting	How to exit from the Interactive Productivity Facility and return to VSE/ICCF
Cursor Movement	How to use the arrow and tab keys to position the cursor to a desired location on the screen
Indicators	Describes the meaning and use of the input inhibited, system available, and insert mode indicators for the 3277 terminal, and similar functions for the 3278
Management/Use	Describes these two basic areas of system activity and shows examples
Menu Panel	Describes the use of menu panels in dialogs and what their service line options will do if selected
Data Entry Panel	Describes the use of data entry panels in dialogs and what their service line options will do if selected
Explain Panel	Describes the use of explain panels in dialogs and what their service line options will do when selected. The OVERVIEW option is also explained, and examples shown.
Insert/Delete/Eraser	How to use the INS MODE, DEL, and ERASE keys
Other Keys	How to use the CLEAR, RESET, program function (PF), program attention (PA), test request, and APL keys
Light-Pen	How to use the light-pen when responding to panels that contain pen-detectable fields
Fast Path	How to use the fast path to go directly from one menu to another.

After completing these topics, you should be able to:

- Briefly describe the System IPO/E
- Briefly describe the Interactive Productivity Facility
- Adjust the screen of the display terminal
- Move the cursor to any position on the screen
- Correct keying errors
- Use the CLEAR, RESET, PF, PA, and APL keys
- Describe the services provided on the bottom line of panels
- Move quickly through the menu structure to locate a desired panel
- Locate additional explanatory material for a given panel

APPENDIX A. DISPLAY TERMINAL CONSIDERATIONS

INTRODUCTION

This section should be read by people who have never used a 3270-type terminal before. It includes basic information about how to use such terminals, and how these terminals are used to access the Interactive Productivity Facility.

3277/3278 TERMINAL DIAGRAMS

The following diagrams show where the various keys and indicators are located on the 3277 and 3278 screens and keyboards. The numbers in the diagrams correspond to the numbered items that follow.

3277 SCREEN

INTERACTIVE PRODUCTIVITY FACILITY: INITIAL MENU DTR\$

Welcome to the Interactive Productivity Facility.
This product is designed to operate with the VSE
System IPO/E, and to simplify the USE and
MANAGEMENT of your computer system. If you are
using the system for the first time, we recom-
mend you select the FIRST USE TUTORIAL.

- 1 SYSTEM MANAGEMENT
- 2 SYSTEM USE
- 3 ENVIRONMENT DEFINITION
- 4 FIRST USE TUTORIAL

5748-MS1 COPYRIGHT, IBM CORP., 1979, 1981

1 PF1=EXPL 3=RETURN 4=ICCF 6=INIT

Figure 34. 3277 terminal screen and keyboard

The following numbered items correspond to the numbers appearing in Figure 34 on page 169 and Figure 35.

1. OFF-PUSH Switch
2. System Available, Insert Mode, and Input Inhibited indicators

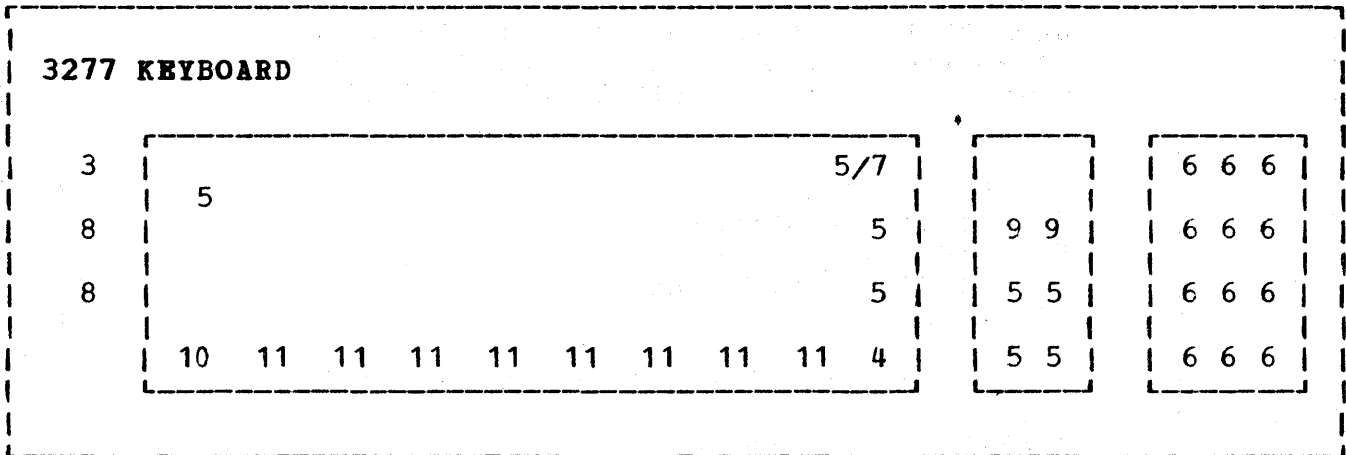

Figure 35. 3277 keyboard

- | | |
|-------------------------|--------------------------------|
| 3. CLEAR key | 8. Erase Input, Erase EOF keys |
| 4. ENTER key | 9. Insert Mode/Delete keys |
| 5. Cursor moving keys | 10. Reset key. |
| 6. PF keys | 11. Space bar |
| 7. APL key (if present) | |

3278 SCREEN

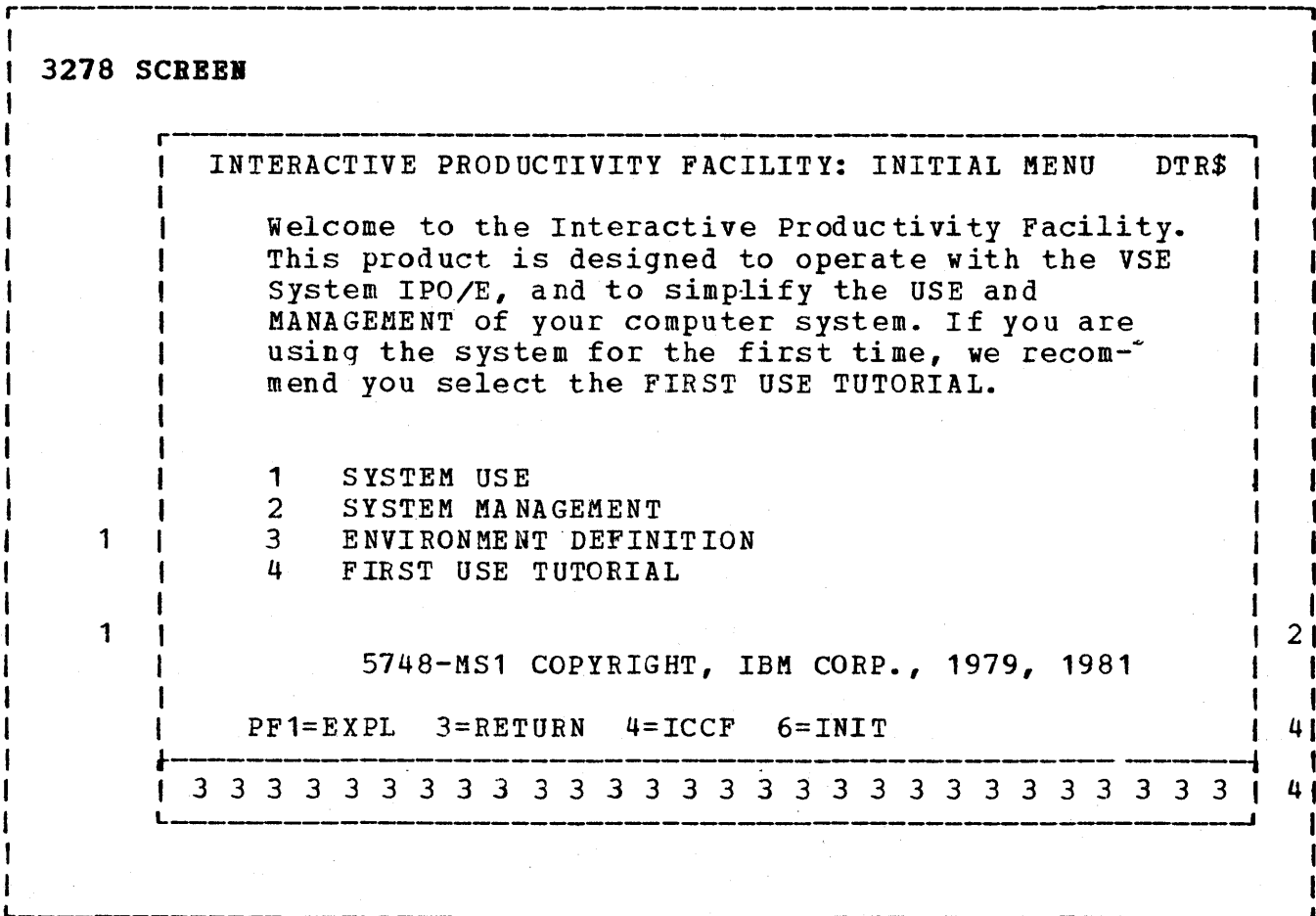

Figure 36. 3278 screen

The following numbered items correspond to the numbers appearing in Figure 36 and Figure 37 on page 172.

- 1. ON-OFF (I/O)
- 2. Normal/Test
- 3. Operator communication line
- 4. Contrast/brightness control

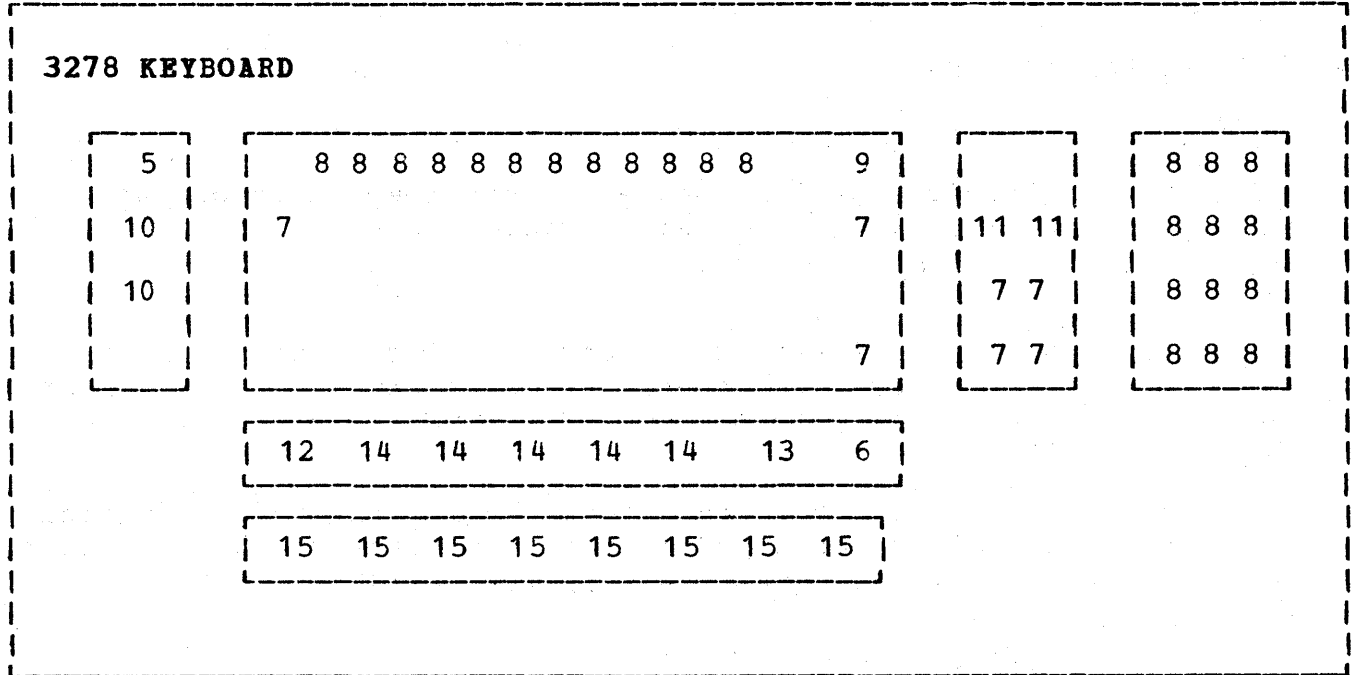

Figure 37. 3278 keyboard

- | | |
|---------------------------------|------------------------|
| 5. CLEAR key | 11. Insert/Delete keys |
| 6. ENTER key | 12. Reset key |
| 7. Cursor moving keys | 13. ALT key |
| 8. PF keys | 14. Space bar |
| 9. APL key | 15. Reference pocket |
| 10. Erase Input, Erase EOF keys | |

INITIAL STEPS

1. Turn on the terminal.

3277:

Pull out the OFF-PUSH switch located at the lower left of the display screen. It is a circular, serrated knob.

3278:

Press the upper part of the orange On/Off switch (marked I/O) located to the left of the screen. To the right of the screen are two blue switches. The one marked Normal/Test should be in the Normal position.

Once the terminal warms up, the screen should display information indicating that it is connected to a running system. This requires a minute or so. If this does not happen, try adjusting the brightness.

2. Adjust the brightness:

3277:

Turn the OFF-PUSH switch serrated knob clockwise.

3278:

Turn the knob at the lower right of the screen clockwise. It has a picture on it resembling the sun.

3. Clear the screen.

3277:

Press the CLEAR key at the upper left of the keyboard.

3278:

Press the CLEAR key while holding down the ALT key. The CLEAR key is labeled on the forward face of the top left side of the keyboard and the ALT key is located to the right of the long space bar at the bottom of the keyboard.

The information currently on the screen should be cleared. If it does not clear, try pressing the RESET key (lower left of main keyboard) and then the CLEAR key (3277), or the ALT and CLEAR keys (3278).

At this point, refer to the section, 'How to Get Started,' page 1, for information on how to log on to VSE/ICCF and the Interactive Productivity Facility.

APPENDIX B. MENU AND DIALOG CROSS REFERENCE

These two cross references will help you quickly locate a desired menu or dialog. The first is arranged in order by menu, and the second by description of the dialog or menu item.

Each entry shows the menu panel where the description is found. It will also show either the next menu or the dialog that will be called for each selection on the menu panel.

CROSS REFERENCE BY MENU

MENU	SEL	NEXT MENU	DIALOG	DESCRIPTION
ADM\$	1	ADM\$1		SYSTEM PROFILE
ADM\$	2	ADM\$2		LOGONS/PASSWORDS
ADM\$	3	LIB\$		LIBRARIAN
ADM\$	4	ADM\$4		SYSTEM TAILORING
ADM\$	5		ADM\$IST	MODIFY VSE/ICCF TABLES
ADM\$	6		ADM\$SEC	MODIFY SECURITY TABLE
ADM\$	7		ADM\$REP	RUN SECURITY REPORTS
ADM\$	8		CUSS\$DIA	DIALOG CUSTOMIZATION
ADM\$	9	UTA\$		UTILITY AIDS
ADM\$1	1		ADM\$FST	FIRST TIME USE
ADM\$1	2		ADM\$HDW	I/O CONFIGURATION
ADM\$1	3		ADM\$SFT	SOFTWARE PRODUCTS
ADM\$1	4		ADM\$SFN	ADD SOFTWARE PRODUCTS
ADM\$1	5		ADM\$CPY	CREATE COPY FILES
ADM\$1	6	ADM\$15		LIBRARY INFORMATION
ADM\$1	7		ADM\$LAB	LABEL INFORMATION
ADM\$15	1		ADM\$LBR	USER LIBRARIES
ADM\$15	2		ADM\$LBR	PRODUCTION/SERVICE LIBRARIES
ADM\$15	3		ADM\$LBR	PUT/PTF LIBRARIES
ADM\$153	1		ADM\$BRW	BROWSE LIBRARIES
ADM\$153	2		ADM\$PUT	UPDATE LIBRARY
ADM\$2	1		ADM\$USR	ADD VSE/ICCF USER
ADM\$2	2		ADM\$DSR	DELETE VSE/ICCF USER

MENU	SEL	NEXT MENU	DIALOG	DESCRIPTION
ADM\$2	3		ADM\$CSR	CHANGE VSE/ICCF USER
ADM\$2	4		ADM\$ASN	ADD CICS/VS USER
ADM\$2	5		ADM\$DSN	DELETE CICS/VS USER
ADM\$2	6		ADM\$CSN	CHANGE CICS/VS USER
ADM\$2	7		ADM\$MSN	ASSEMBLE/CATALOG SNT
ADM\$4	1		TSA\$MAS	SUPERVISOR TAILORING
ADM\$4	2		TAS\$MAS	ASI PROCEDURE TAILORING
ADM\$4	3		TPW\$ASM	VSE/POWER TAILORING
ADM\$4	4		ADM\$ICF	VSE/ICCF TAILORING
ADM\$4	5		ADM\$MTC	TTF TAILORING
AMS\$	1	CAT\$		CATALOG /MANAGEMENT
AMS\$	2	SPC\$		SPACE MANAGEMENT
AMS\$	3	DSF\$		DATA SET MANAGEMENT
CAT\$	1		CAT\$DEF	DEFINE CATALOG
CAT\$	2		CAT\$DEL	DELETE CATALOG
CAT\$	3		CAT\$BAC	COPY OUT CATALOG
CAT\$	4		CAT\$RES	COPY IN CATALOG
CAT\$	5		CAT\$TPT	TRANSPORT CATALOG
CAT\$	6		CAT\$LST	LIST CATALOG
DSF\$	1		DSF\$DEF	DEFINE CLUSTER
DSF\$	2		DSF\$DEL	DELETE CLUSTER
DSF\$	3		DSF\$ALT	ALTER CLUSTER
DSF\$	4		DSF\$COP	COPY FILE
DSF\$	5		DSF\$EXP	EXPORT FILE
DSF\$	6		DSF\$IMP	IMPORT FILE
DSF\$	7		DSF\$PRT	PRINT FILE
DSF\$	8		DSF\$VER	VERIFY FILE
DSF\$	9		DSF\$DSP	DISPLAY FILE
DTR\$	1	SYM\$		SYSTEM MANAGEMENT
DTR\$	2	SYU\$		SYSTEM USE
DTR\$	3	ENV\$		ENVIRONMENT DEFINITION
DTR\$	4	SYI\$		FIRST USE TUTORIAL
ENV\$	1		ENV\$DEF	SELECT ENVIRONMENT
ENV\$	2		ENV\$DEF	UPDATE ENVIRONMENT
LIB\$	1		LIB\$DSP	DISPLAY LIBRARY MEMBERS
LIB\$	2		LIB\$DEL	DELETE LIBRARY MEMBERS
LIB\$	3		LIB\$REN	RENAME LIBRARY MEMBERS
LIB\$	4		LIB\$CAT	CATALOG LIBRARY MEMBERS
LIB\$	5		LIB\$CRT	CREATE LIBRARIES
LIB\$	6		LIB\$COP	COPY/MERGE LIBRARIES
LIB\$	7		ADM\$BKR	BACKUP LIBRARY SETS
LIB\$	8		ADM\$BKR	RESTORE LIBRARY SETS

MENU	SEL	NEXT MENU	DIALOG	DESCRIPTION
OPN\$	1		OPN\$JCL	JCL CREATION
OPN\$	2	UTL\$		VSE UTILITIES
SPC\$	1		SPC\$DEF	DEFINE SPACE
SPC\$	2		SPC\$DEL	DELETE SPACE
SRV\$	1		SRV\$PUT	APPLY PUT
SRV\$	2		SRV\$PUT	RESTART PUT
SRV\$	3		SRV\$PUT	APPLY SELECTIVE PUT
SRV\$	4	SRV\$2		APPLY PTF
SRV\$	5	SRV\$5		APPLY APAR/LOCAL
SRV\$	6	SRV\$3		ARCHIVE FIX
SRV\$	7	SRV\$4		HISTORY FUNCTION
SRV\$	8	SRV\$8		JCL COMMENTS
SRV\$2	1		SRV\$CVL	PRINT COVER LETTERS
SRV\$2	2		SRV\$PTF	APPLY PTF
SRV\$2	3		SRV\$PTF	APPLY CUMULATIVE PTF
SRV\$2	4		SRV\$PTF	APPLY BACKOUT PTF
SRV\$3	1		SRV\$AAP	ARCHIVE APAR FIX
SRV\$3	2		SRV\$APT	ARCHIVE PTF
SRV\$4	1		SRV\$RET	RETRACE HISTORY
SRV\$4	2		SRV\$REM	REMOVE HISTORY RECORD
SRV\$4	3		SRV\$CON	CONDENSE HISTORY
SRV\$4	4		SRV\$BAC	BACKUP HISTORY FILE
SRV\$4	5		SRV\$RHS	RESTORE HISTORY
SRV\$5	1		SRV\$PRE	PRE SERVICE
SRV\$5	2	SRV\$52		CORRECTIVE SERVICE
SRV\$5	3		SRV\$POS	POST SERVICE
SRV\$52	1		SRV\$FIX	ALTER CORF IMAGE
SRV\$52	2		SRV\$FIX	ALTER RELOCATABLE
SRV\$52	3		SRV\$FIX	ALTER SOURCE
SRV\$52	4		SRV\$UND	UNDO CORE IMAGE
SRV\$52	5		SRV\$UND	UNDO RELOCATABLE
SRV\$523	1	SRV\$52		CONTINUE SERVICE
SRV\$523	2		SRV\$GEN	CREATE DFHGEN JCL
SRV\$523	3		SRV\$GEN	CREATE E.BOOK
SRV\$523	4		SRV\$GEN	CREATE DTSSG JCL
SRV\$523	5		SRV\$POS	POST SERVICE
SRV\$8	1		SRV\$CMN	TURN COMMENTS ON
SRV\$8	2		SRV\$CMN	TURN COMMENTS OFF
SYI\$	1		SYI\$1	INTRODUCTION
SYI\$	2		SYI\$2	ADJUST SCREEN
SYI\$	3		SYI\$3	EXITING
SYI\$	4		SYI\$4	CURSOR MOVEMENT

MENU	SEL	NEXT MENU	DIALOG	DESCRIPTION
SYI\$	5		SYI\$5	INDICATORS
SYI\$	6		SYI\$6	MANAGEMENT / USE
SYI\$	7		SYI\$7	MENU PANEL
SYI\$	8		SYI\$8	DATA ENTRY PANEL
SYI\$	9		SYI\$9	EXPLAIN PANEL
SYI\$	10		SYI\$10	INSERT / DELETE AND ERASE
SYI\$	11		SYI\$11	OTHER KEYS
SYI\$	12		SYI\$12	LIGHT-PEN
SYI\$	13		SYI\$13	FAST PATH
SYM\$	1		SYM\$GUI	SYSTEM MANAGEMENT GUIDE
SYM\$	2	SYM\$1		ADMINISTRATION
SYM\$	3		INS\$CAR	INSTALLATION
SYM\$	4	SYM\$I1		INSTALLATION GUIDE
SYM\$	5	VER\$		VERIFICATION
SYM\$	6		RPT\$DMP	DUMP ANALYSIS
SYM\$	7	SRV\$		SERVICE
SYM\$	8	OPN\$		OPERATIONS
SYM\$I1	1	SYM\$I2		NON-SYSTEM IPO/E PRODUCT
SYM\$I1	2	SYM\$I4		SYSTEM IPC/E PRODUCT
SYM\$I2	1		ADM\$SFN	ADD SOFTWARE PRODUCT
SYM\$I2	2	SYM\$I3		CONTINUE (INSTALLATION GUIDE)
SYM\$I3	1		ADM\$CPY	CREATE COPY FILES
SYM\$I3	2	SYM\$I5		CONTINUE (INSTALLATION GUIDE)
SYM\$I4	1		ADM\$SFT	UPDATE SOFTWARE PRODUCT
SYM\$I4	2	SYM\$I5		CONTINUE (INSTALLATION GUIDE)
SYM\$I5	1		ADM\$LBR	USER LIBRARIES
SYM\$I5	2		ADM\$LBR	IBM PRODUCTION LIBRARIES
SYM\$I5	3		ADM\$LBR	PUT/PTF LIBRARIES
SYM\$I5	4		ADM\$LAB	LABEL INFORMATION
SYM\$I5	5	SYM\$I6		CONTINUE (INSTALLATION GUIDE)
SYM\$I6	1		TAS\$MAS	ASI TAILORING
SYM\$I6	2	SYM\$I7		CONTINUE (INSTALLATION GUIDE)
SYM\$I7	1		INS\$CAR	INSTALLATION
SYM\$I7	2	SYM\$		END (INSTALLATION GUIDE)
SYM\$1	1	ADM\$		SYSTEM ADMINISTRATION
SYM\$1	2	SYM\$2		DATA BASE ADMINISTRATION
SYM\$1	3	SYM\$33		COMMUNICATION ADMINISTRATION
SYM\$2	1	DLZ\$		INTERACTIVE MACRO FACILITY
SYM\$2	2	AMS\$		VSE/VSAM
SYM\$33	1	TCI\$		CICS/VS TABLES
SYM\$33	2		TRJ\$ASM	VSE/POWER RJE
SYM\$33	3		TEP\$ASM	EP/VS

MENU	SEL	NEXT MENU	DIALOG	DESCRIPTION
SYU\$	1		PDV\$EXP	PROGRAM DEVELOPMENT (VSE)
TCI\$	1	TCI\$1		CICS PROGRAMS
TCI\$	2	TCI\$2		CICS TRANSACTIONS
TCI\$	3	TCI\$3		CICS TERMINALS, LINES
TCI\$	4	TCI\$4		CICS DATA SETS, DATA BASES
TCI\$1	1		TCI\$APP	ADD PROGRAM
TCI\$1	2		TCI\$DPP	DELETE PROGRAM
TCI\$1	3		TCI\$CPP	CHANGE PROGRAM
TCI\$1	4		TCI\$MPP	ASSEMBLE/CATALOG PPT
TCI\$2	1		TCI\$APC	ADD TRANSACTION
TCI\$2	2		TCI\$DPC	DELETE TRANSACTION
TCI\$2	3		TCI\$CPC	CHANGE TRANSACTION
TCI\$2	4		TCI\$MPC	ASSEMBLE/CATALOG PCT
TCI\$3	1		TCI\$ATC	ADD TERMINAL
TCI\$3	2		TCI\$DTC	DELETE TERMINAL
TCI\$3	3		TCI\$CTC	CHANGE TERMINAL
TCI\$3	4		TCI\$MTC	ASSEMBLE/CATALOG TCT
TCI\$4	1		TCI\$AFC	ADD DATA SET
TCI\$4	2		TCI\$DFC	DELETE DATA SET
TCI\$4	3		TCI\$CFC	CHANGE DATA SET
TCI\$4	4		TCI\$MFC	ASSEMBLE/CATALOG FCT
UTA\$	1		UTA\$SEL	RETRIEVE SYSIN JOB (ICCF ONLY)
UTA\$	2		UTA\$PPN	PRINT PANELS (ICCF ONLY)
UTA\$	3		UTA\$FCB	FCB MAINTENANCE
UTL\$	1	UTL\$1		BACKUP RESTORE UTILITIES
UTL\$	2	UTL\$2		FAST COPY UTILITIES
UTL\$	3		UTL\$COP	COPY DISKETTE UTILITIES
UTL\$	4		UTL\$DSP	DISPLAY VTOC UTILITIES
UTL\$1	1		UTL\$CRE	LIBRARY BACKUP
UTL\$1	2		UTL\$RES	LIBRARY RESTORE
UTL\$2	1		UTL\$FCY	COPY DISK TO DISK
UTL\$2	2		UTL\$DMP	DUMP DISK TO TAPE
UTL\$2	3		UTL\$RST	RESTORE TAPE TO DISK
VER\$	1		VER\$IFY	VSE/VSAM
VER\$	2		VER\$IFY	SORT/MERGE II
VER\$	3		VER\$IFY	CICS/VS
VER\$	4		VER\$IFY	VSE/DITTO
VER\$	5		VER\$IFY	VSE/POWER/RJE
VER\$	6		VER\$IFY	EP/VS (3705)
VER\$	7		VER\$IFY	DL/I
VER\$	8		VER\$IFY	DATA DICTIONARY
VER\$	9		VER\$IFY	VSE/ACCESS CONTROL

CROSS REFERENCE BY DESCRIPTION

DESCRIPTION	MENU	SEL	DIALOG	NEXT MENU
ADD CICS/VS USER	ADM\$2	4	ADM\$ASN	
ADD DATA SET	TCI\$4	1	TCI\$AFC	
ADD PROGRAM	TCI\$1	1	TCI\$APP	
ADD SOFTWARE PRODUCT	SYM\$I2	1	ADM\$SFN	
ADD SOFTWARE PRODUCTS	ADM\$1	4	ADM\$SFN	
ADD TERMINAL	TCI\$3	1	TCI\$ATC	
ADD TRANSACTION	TCI\$2	1	TCI\$APC	
ADD VSE/ICCF USER	ADM\$2	1	ADM\$USR	
ADJUST SCREEN	SYI\$	1	SYI\$2	
ADMINISTRATION	SYM\$	2		SYM\$1
ALTER CLUSTER	DSF\$	3	DSF\$ALT	
ALTER CORE IMAGE	SRV\$52	1	SRV\$FIX	
ALTER RELOCATABLE	SRV\$52	2	SRV\$FIX	
ALTER SOURCE	SRV\$52	3	SRV\$FIX	
APPLY APAR/LOCAL	SRV\$	5		SRV\$5
APPLY BACKOUT PTF	SRV\$2	4	SRV\$PTF	
APPLY CUMULATIVE PTF	SRV\$2	3	SRV\$PTF	
APPLY PTF	SRV\$	4		SRV\$2
APPLY PTF	SRV\$2	2	SRV\$PTF	
APPLY PUT	SRV\$	1	SRV\$PUT	
APPLY SELECTIVE PUT	SRV\$	3	SRV\$PUT	
ARCHIVE APAR FIX	SRV\$3	1	SRV\$AAP	
ARCHIVE FIX	SRV\$	6		SRV\$3
ARCHIVE PTF	SRV\$3	2	SRV\$APT	
ASI PROCEDURE TAILORING	ADM\$4	2	TAS\$MAS	
ASI TAILORING	SYM\$I6	1		TAS\$MAS
ASSEMBLE/CATALOG SNT	ADM\$2	7	ADM\$MSN	
ASSEMBLE/CATALOG PPT	TCI\$1	4	TCI\$MPP	
ASSEMBLE/CATALOG PCT	TCI\$2	4	TCI\$MPC	
ASSEMBLE/CATALOG TCT	TCI\$3	4	TCI\$MTC	
ASSEMBLE/CATALOG FCT	TCI\$4	4	TCI\$MFC	
BACKUP HISTORY FILE	SRV\$4	4	SRV\$BAC	
BACKUP LIBRARY SETS	LIB\$	7	ADM\$BKR	
BACKUP RESTORE UTILITIES	UTL\$	1		UTL\$1
BROWSE LIBRARIES	ADM\$153	1	ADM\$BRW	
CATALOG LIBRARY MEMBERS	LIB\$	4	LIB\$CAT	
CATALOG MANAGEMENT	AMS\$	1		CAT\$
CHANGE CICS/VS USER	ADM\$2	6	ADM\$CSN	
CHANGE DATA SET	TCI\$4	3	TCI\$CFC	
CHANGE PROGRAM	TCI\$1	3	TCI\$CPP	

DESCRIPTION	MENU	SEL	DIALOG	NEXT MENU
CHANGE TERMINAL	TCI\$3	3	TCI\$CTC	
CHANGE TRANSACTION	TCI\$2	3	TCI\$CPC	
CHANGE VSE/ICCF USER	ADM\$2	3	ADM\$CSR	
CICS DATA SETS, DATA BASE	TCI\$	4		TCI\$4
CICS PROGRAMS	TCI\$	1		TCI\$1
CICS TERMINALS, LINES	TCI\$	3		TCI\$3
CICS TRANSACTIONS	TCI\$	2		TCI\$2
CICS/VS	VER\$	3	VER\$IFY	
CICS/VS TABLES	SYM\$33	1		TCI\$
COMMUNICATION ADMIN.	SYM\$1	3		SYM\$33
CONDENSE HISTORY	SRV\$4	3	SRV\$CON	
CONTINUE SERVICE	SRV\$523	1		SRV\$52
CONTINUE (INSTALL GUIDE)	SYM\$I2	2		SYM\$I3
CONTINUE (INSTALL GUIDE)	SYM\$I3	2		SYM\$I5
CONTINUE (INSTALL GUIDE)	SYM\$I4	2		SYM\$I5
CONTINUE (INSTALL GUIDE)	SYM\$I5	5		SYM\$I6
CONTINUE (INSTALL GUIDE)	SYM\$I6	2		SYM\$I7
COPY DISK TO DISK	UTL\$2	1	UTL\$FCY	
COPY DISKETTE UTILITIES	UTL\$	3	UTL\$COP	
COPY FILE	DSF\$	4	DSF\$COP	
COPY IN CATALOG	CAT\$	4	CAT\$RES	
COPY OUT CATALOG	CAT\$	3	CAT\$BAC	
COPY/MERGE LIBRARIES	LIB\$	6	LIB\$COP	
CORRECTIVE SERVICE	SRV\$5	2		SRV\$52
CREATE COPY FILES	ADM\$1	5	ADM\$CPY	
CREATE COPY FILES	SYM\$I3	1	ADM\$CPY	
CREATE DFHGEN JCL	SRV\$523	2	SRV\$GEN	
CREATE DTSSG JCL	SRV\$523	4	SRV\$GEN	
CREATE E.BOOK	SRV\$523	3	SRV\$GEN	
CREATE LIBRARIES	LIB\$	5	LIB\$CRT	
CURSOR MOVEMENT	SYI\$	4	SYI\$4	
DATA BASE ADMINISTRATION	SYM\$1	2		SYM\$2
DATA DICTIONARY	VER\$	8	VER\$IFY	
DATA ENTRY PANEL	SYI\$	8	SYI\$8	
DATA SET MANAGEMENT	AMS\$	3		DSF\$
DEFINE CATALOG	CAT\$	1	CAT\$DEF	
DEFINE CLUSTER	DSF\$	1	DSF\$DEF	
DEFINE SPACE	SPC\$	1	SPC\$DEF	
DELETE CATALOG	CAT\$	2	CAT\$DEL	
DELETE CICS/VS USER	ADM\$2	5	ADM\$DSN	
DELETE CLUSTER	DSF\$	2	DSF\$DEL	
DELETE DATA SET	TCI\$4	2	TCI\$DFC	

DESCRIPTION	MENU	SEL	DIALOG	NEXT MENU
DELETE LIBRARY MEMBERS	LIB\$	2	LIB\$DEL	
DELETE PROGRAM	TCI\$1	2	TCI\$DPP	
DELETE SPACE	SPC\$	2	SPC\$DEL	
DELETE TERMINAL	TCI\$3	2	TCI\$DTC	
DELETE TRANSACTION	TCI\$2	2	TCI\$DPC	
DELETE VSE/ICCF USER	ADM\$2	2	ADM\$DSR	
DIALOG CUSTOMIZATION	ADM\$	8	CUS\$DIA	
DISPLAY FILE	DSF\$	9	DSF\$DSP	
DISPLAY LIBRARY MEMBERS	LIB\$	1	LIB\$DSP	
DISPLAY VTOC UTILITIES	UTL\$	4	UTL\$DSP	
DL/I	VER\$	7	VER\$IFY	
DUMP ANALYSIS	SYM\$	6	RPT\$DMP	
DUMP DISK TO TAPE	UTL\$2	2	UTL\$DMP	
END (INSTALLATION GUIDE)	SYM\$I7	2		SYM\$
ENVIRONMENT DEFINITION	DTR\$	3		ENV\$
EP/VS	SYM\$33	3	TEP\$ASM	
EP/VS (3705)	VER\$	6	VER\$IFY	
EXITING	SYI\$	3	SYI\$3	
EXPLAIN PANEL	SYI\$	9	SYI\$9	
EXPORT FILE	DSF\$	5	DSF\$EXP	
FAST COPY UTILITIES	UTL\$	2		UTL\$2
FAST PATH	SYI\$	13	SYI\$13	
FCB MAINTENANCE	UTA\$	3	UTA\$FCB	
FIRST TIME USE	ADM\$1	1	ADM\$FST	
FIRST USE TUTORIAL	DTR\$	4		SYI\$
HISTORY FUNCTION	SRV\$	7		SRV\$4
IBM PRODUCTION LIBRARIES	SYM\$I5	2	ADM\$LBR	
I/O CONFIGURATION	ADM\$1	2	ADM\$HDW	
IMPORT FILE	DSF\$	6	DSF\$IMP	
INDICATORS	SYI\$	5	SYI\$5	
INSERT / DELETE / ERASE	SYI\$	10	SYI\$10	
INSTALLATION	SYM\$	3	INS\$CAR	
INSTALLATION	SYM\$I7	1	INS\$CAR	
INSTALLATION GUIDE	SYM\$	4		SYM\$I1
INTERACTIVE MACRO FACILITY	SYM\$2	1		DLZ\$
INTRODUCTION	SYI\$	1	SYI\$1	
JCL COMMENTS	SRV\$	8		SRV\$8
JCL CREATION	OPN\$	1	OPN\$JCL	
LABEL INFORMATION	ADM\$1	7	ADM\$LAB	
LABEL INFORMATION	SYM\$I5	4	ADM\$LAB	
LIBRARIAN	ADM\$	3		LIB\$
LIBRARY BACKUP	UTL\$1	1	UTL\$CRE	

DESCRIPTION	MENU	SEL	DIALOG	NEXT MENU
LIBRARY INFORMATION	ADM\$1	6		ADM\$15
LIBRARY RESTORE	UTL\$1	2	UTL\$RES	
LIGHT-PEN	SYI\$	12	SYI\$12	
LIST CATALOG	CAT\$	6	CAT\$LST	
LOGONS/PASSWORDS MANAGEMENT / USE	ADM\$	2		ADM\$2
MENU PANEL	SYI\$	6	SYI\$6	
MODIFY SECURITY TABLE	SYI\$	7	SYI\$7	
MODIFY VSE/ICCF TABLES	ADM\$	6	ADM\$SEC	
NON-SYSTEM IPO/E PRODUCT OPERATIONS	ADM\$	5	ADM\$IST	
OTHER KEYS	SYM\$I 1	1		SYM\$I2
POST SERVICE	SYM\$	8		OPN\$
POST SERVICE	SYI\$	11	SYI\$11	
PRE SERVICE	SRV\$5	3	SRV\$POS	
PRINT COVER LETTERS	SRV\$523	5	SRV\$POS	
PRINT FILE	SRV\$5	1	SRV\$PRE	
PRINT PANELS (ICCF)	SRV\$2	1	SRV\$CVL	
PRODUCTION/SERVICE LIBR	DSF\$	7	DSF\$PRT	
PROGRAM DEVELOPMENT (ICCF)	UTA\$	2	UTA\$PPN	
PUT/PTF LIBRARIES	ADM\$15	2	ADM\$LBR	
PUT/PTF LIBRARIES	SYU\$	1	PDV\$EXP	
REMOVE HISTORY RECORD	ADM\$15	3	ADM\$LBR	
RENAME LIBRARY MEMBERS	SYM\$I5	3	ADM\$LBR	
RESTART PUT	SRV\$4	2	SRV\$REM	
RESTORE HISTORY	LIB\$	3	LIB\$REN	
RESTORE LIBRARY SETS	SRV\$	2	SRV\$PUT	
RESTORE TAPE TO DISK	SRV\$4	5	SRV\$RHS	
RETRACE HISTORY	LIB\$	8	ADM\$BKR	
RETRIEVE SYSIN JOB (ICCF)	UTL\$2	3	UTL\$RST	
RUN SECURITY REPORTS	SRV\$4	1	SRV\$RET	
SELECT ENVIRONMENT	UTA\$	1	UTA\$SEL	
SERVICE	ADM\$	7	ADM\$REP	
SOFTWARE PRODUCTS	ENV\$	1	ENV\$DEF	
SORT/MERGE II	SYM\$	7		SRV\$
SPACE MANAGEMENT	ADM\$1	3	ADM\$SFT	
SUPERVISOR TAILORING	VER\$	2	VER\$IFY	
SYSTEM ADMINISTRATION	AMS\$	2		SPC\$
SYSTEM IPO/E PRODUCT	ADM\$4	1	TSA\$MAS	
SYSTEM MANAGEMENT	ADM\$	1		ADM\$
SYSTEM MANAGEMENT GUIDE	SYM\$1	1		SYM\$I4
SYSTEM PROFILE	SYM\$I2	2		SYM\$
	DTR\$	1		
	SYM\$	1	SYM\$GUI	
	ADM\$	1		ADM\$1

DESCRIPTION	MENU	SEL	DIALOG	NEXT MENU
SYSTEM TAILORING	ADM\$	4		ADM\$4
SYSTEM USE	DTR\$	2		SYU\$
TRANSPORT CATALOG	CAT\$	5	CAT\$TPT	
TTF TAILORING	ADM\$4	5	ADM\$MTC	
TURN COMMENTS ON	SRV\$8	1	SRV\$CMN	
TURN COMMENTS OFF	SRV\$8	2	SRV\$CMN	
UNDO CORE IMAGE	SRV\$52	4	SRV\$UND	
UNDO RELOCATABLE	SRV\$52	5	SRV\$UND	
UPDATE ENVIRONMENTS	ENV\$	2	ENV\$DEF	
UPDATE LIBRARY	ADM\$153	2	ADM\$PUT	
UPDATE SOFTWARE PRODUCT	SYM\$I4	1	ADM\$\$SFT	
USER LIBRARIES	ADM\$15	1	ADM\$LBR	
USER LIBRARIES	SYM\$15	1	ADM\$LBR	
UTILITY AIDS	ADM\$	9		UTA\$
VERIFICATION	SYM\$	5		VER\$
VERIFY FILE	DSF\$	8	DSF\$VER	
VSE UTILITIES	OPN\$	2		UTL\$
VSE/ACCESS CONTROL	VER\$	9	VER\$IFY	
VSE/DITTO	VER\$	4	VER\$IFY	
VSE/ICCF TAILORING	ADM\$4	4	ADM\$ICF	
VSE/POWER TAILORING	ADM\$4	3	TPW\$ASM	
VSE/POWER/RJE	SYM\$33	2	TRJ\$ASM	
VSE/POWER/RJE	VER\$	5	VER\$IFY	
VSE/VSAM	SYM\$2	2		AMS\$
VSE/VSAM	VER\$	1	VER\$IFY	

APPENDIX C. PANELS AND DIALOG MANAGER

The following types of panels may be displayed:

- **Menu panels**

Present lists of selectable activities. When you select a menu item, another panel is displayed, continuing the activity you selected. For example, the first menu panel you see when you invoke the Interactive Productivity Facility lists the first use tutorial as a selectable item. This tutorial covers the features provided with the System IPO/E. If you select this item, the first panel in the first use tutorial will be displayed.

- **Data entry panels**

Prompt you for keyed input necessary for a given function to be performed. For example, if you want to apply a program update (PUT) tape to your system, you are prompted for the device address on which the PUT tape will be mounted.

- **Explain panels**

Provide additional information about a menu or data entry panel, and the activity you are performing.

- **Information menu panels**

Present lists of topics on which explanatory material is available. When you select a topic number, one or more explain panels, or additional information menu panels are displayed, giving you further information. Such panels may be used to provide an overview of a major activity, or to explain data entry panels that contain many items to be keyed.

Other components of the Interactive Productivity Facility are:

- **Tables**

These are files that reside in VSE/ICCF libraries. They are used to hold information about your system or to save responses entered via dialogs.

- **Skeletons**

These are files that reside in VSE/ICCF libraries. They are used to create job streams. They are not job streams themselves, but contain rules for creating job streams. Data entered from panels is merged with data in the skeleton to produce a completed job stream.

- **Function routines**

These are modules that reside in the system core image library, and contain the logic to perform a given activity.

The dialogs do not modify the components to which they interface. You can exit from the Interactive Productivity Facility and communicate with the system in traditional ways.

The program that controls these dialogs is called the dialog manager. It is composed of the following subfunctions:

- **Menu manager**

- Analyzes user responses to menu panels
- Determines the sequence of panels and the path of users through the system
- Saves the name of the last user menu panel for redisplay when you re-enter after exiting the Interactive Productivity Facility

- **Display service**

- Substitutes variables supplied by the calling routine
- Writes panel to display device
- Reads response from display device
- Handles selection line requests such as EXPLAIN

- **Explain service**

- Displays one or more panels that further explain the items on a menu or data entry panel. In some situations, this service will display a menu panel that lists the categories of general information
- Lets you review the information and then return to the point in the dialog where EXPLAIN was requested

- **Additional services**

- Full-screen display
- Restart capability
- Set messages to be displayed on the next screen
- Save and restore variables between terminal sessions
- Create tailored JCL for execution in a batch environment

APPENDIX D. SAMPLE SERVICE DIALOGS

SAMPLE PUT DIALOG

The following pages show an example of a hypothetical application of a PUT. The sample panels shown are reformatted for this document, and may not contain the exact wording of the actual panels. Additional information for most of the panels shown below is available via the online explain panels.

The box at the bottom of each sample panel describes the activity taking place.

This example is for a 4331 using five spindles.

SYSTEM MANAGEMENT: SERVICE MENU		SRV\$
1	APPLY PUT	Apply Program Update Tape
2	RESTART PUT	Restart Aborted PUT Run
3	APPLY SELECTIVE PUT	Apply Selected PUT Features
4	APPLY PTF	Apply Program Temporary Fix Tape
5	APPLY APAR/LOCAL	Apply/Remove Corrective Fix
6	ARCHIVE FIX	Archive a PTF or an APAR Fix
7	HISTORY FUNCTION	Select System History File Function
8	JCL COMMENTS	Turn JCL comments ON or OFF

For this example we select the APPLY PUT function, indicating that we want to create the JCL for applying a program update tape (PUT) to the system.

APPLY PUT: PRINT PUT DOCUMENT

SRV\$PUT2

If you have not previously printed the PUT documentation, a reply of YES below will print the document or PTF cross reference.

If you want to print the PTF cover letters, use the apply PTF panel. A reply of YES below will cause the exit from this dialog to the apply PTF panel.

After you have referenced the document, reenter the Apply PUT dialog and reply NO to the entries on this panel.

PRINT PUT DOCUMENT ===> NO Enter YES to print the document.

PRINT XREF ===> NO Enter YES to print the cross reference.

Enter NO in both fields to continue with APPLY PUT dialog.

JOB DISPOSITION

SUB\$PRO5

JOB NAME	===> PUT	Enter the name under which the job will be submitted or saved.
POWER PRIORITY	===> 3	Priority 1-9 for this job.
POWER CLASS	===> A	If an asterisk is shown, no change can be made.
POWER DISPOSITION	===> D	Enter disposition as D,H,K, or L.
POWER ACCOUNTING	===> 07154479	===> 112979

This is the standard job submission panel that describes the disposition of this job. The information submitted will be entered into the VSE/POWER job statement and into the VSE Job statement. The POWER ACCOUNTING field consists of two 8-byte fields, which will appear as one contiguous 16-byte field.

CREATE DIALOG FLOW DIAGRAM

SRV\$FLO1

A diagram depicting the flow of the JCL produced by this dialog can be created. The flow diagram will be saved as a file with the name SRV\$FLOW. If you elect to have a flow diagram created, and a file with the name SRV\$FLOW already exists, it will be overwritten.

CREATE FLOW DIAGRAM	===> YES	Enter YES to create a flow diagram describing the JCL produced by this dialog.
---------------------	----------	--

To obtain a flow diagram describing the job stream produced by this dialog, enter YES. This flow diagram is tailored to your particular installation, and to the responses you provide within the dialog.

APPLY PUT: SERVICED COMPONENTS

SRV\$DET1

5746

XE8

G98

VSE ADVANCED FUNCTIONS

ANY SERVICE ?

==> YES

Enter NO if you do not
have any service on the
PUT tape for any of the
above components for
service library A.

From the documentation sent with the PUT tape, we know what
components will be serviced. Since there is service for the
component on this panel, we reply YES.

APPLY PUT: SERVICED COMPONENTS

SRV\$DET1

5746 XX 300

N33

CICS/VS

ANY SERVICE ?

==> NO

Enter NO if you do not
have any service on the
PUT tape for any of the
above components for
service library B.

Since there is no service for CICS/VS on this PUT, we reply
NO.

APPLY PUT: SERVICED COMPONENTS

SRV\$DET1

5746 SM 200	G40	SORT/MERGE II
5745 UT 300	G92	VSE/DITTO

ANY SERVICE ?

==> YES

Enter NO if you do not have any service on the PUT tape for any of the above components for service library C.

Since there is service for SORT/MERGE II on this PUT, we reply YES.

BACKUP SYSRES

SRV\$PPT1

If you do not have a current backup of the system, this activity will create one. Enter NO for the tape unit address if you do not want a backup.

TAPE UNIT ADDRESS

==> 300

Enter address as cuu, or NO.

Note: The tape unit address supplied above will be used for the remainder of this PUT/PTF process.

We want to take a backup of the system first, so we entered the address of the tape drive that we will be using. This is defined in our I/O configuration profile table, ADM\$HDWT, as an 8809 tape drive.

FAST COPY DISK TO TAPE

SRV\$FCD1

This activity will create the necessary JCL to fast copy your SYSWK3 disk volume to tape, and reinitialize the volume. In the case of nonremovable DASD, this step may be necessary to provide the work areas needed for this activity.

FAST COPY VOLUME

==> YES

Enter NO to omit the copy step, or YES to perform the copy.

Our disk label profile table, ADM\$DTAB, indicates that the data on this volume will be replaced during the service process. Therefore, we press ENTER to create the JCL to fast copy the volume to tape and initialize the VTOC. The VTOC will be cleared and moved to the SYSRES position on the volume.

FAST COPY DISK TO TAPE

SRV\$FCD1

This activity will create the necessary JCL to fast copy your SYSWK4 disk volume to tape, and reinitialize the volume. In the case of nonremovable DASD, this step may be necessary to provide the work areas needed for this activity.

FAST COPY VOLUME

==> YES

Enter NO to omit the copy step, or YES to perform the copy.

Same as above.

APPLY PUT: FEATURE EXCLUDE

SRV\$MPR1

Enter below the numbers of any features that you wish to exclude from this PUT application.

FEATURE CODE ===> Enter CLC number
(EXAMPLE: G13).

FEATURE CODE ===> Enter CLC number
(EXAMPLE: G13).

FEATURE CODE ===> Enter CLC number
(EXAMPLE: G13).

FEATURE CODE ===> Enter CLC number
(EXAMPLE: G13).

This panel will be repeated as long as you continue to make entries. A blank entry in the list will terminate the list.

This panel allows exclusion of service for a component or feature that is on the PUT tape. Exclusion is accomplished by the 3-character code that describes the product. Making an entry on this panel will omit the product when the libraries are restored from the PUT tape.

RESTORE SERVICE LIBRARIES

SRV\$RST1

This panel creates the JCL to restore your "A" service library from tape to disk.

You may omit this step if the library is already on disk.

RESTORE LIBRARY A ===> YES Enter NO to bypass
restoring service library
A.

We do not keep the service libraries on disk, so we must restore them from tape. After updating them with the PTFs from the PUT, we will back them up to tape for later use.

APPLY PUT: UPGRADE OPTIONS

SRV\$UPG1

Your "A" service libraries will be updated by MSHP. If you wish to reject an individual PTF, or all the PTFs for a component, or create backout PTFs, reply YES below in the appropriate field.

EXCLUDE COMPONENTS	===> YES	Enter YES to exclude components.
REJECT PTFs	===> YES	Enter YES to reject PTFs.
REVOKABLE	===> NO	Enter YES to create backout PTFs.

If you replied YES to exclude components or reject PTFs, a detail panel requesting the component ID and the PTF number will be presented next.

Just to show you what the panels look like, we have entered YES to both the EXCLUDE COMPONENTS and REJECT PTFs entries. Normally, we would not reject any PTFs or exclude any components unless directed to do so by the IBM Support Center.

APPLY PUT: UPGRADE OPTIONS

SRV\$UPG2

Enter below the IDs of the components that you wish to exclude.

Example:

5745 SC JCL

==> 5745 ==> sc ==> sup

This panel will be repeated as long as you continue to make entries.

Here we show that we do not want to apply any service for the supervisor component. This would be an exceptional incident. Normally, you would want to apply service for all components, because the total service has been tested together as a package.

PTFs that will be rejected must be identified by component. Enter below the component for the PTFs that you wish to reject for the "A" service library.

Example:

5745 SC JCL

==> 5745 ==> sc ==> vsm

Next we identify a component for which we will reject PTFs. It is important that we name the correct component. If we gave the wrong component, MSHP would reject the statement and the PTF would be applied.

APPLY PUT: UPGRADE OPTIONS

SRV\$UPG4

Enter below the numbers of the PTFs for component 5745-SC-VSM which you do not want applied to your system.

PTF NUMBER	===> UD16445	Enter PTF number (EXAMPLE: UD12345).
PTF NUMBER	===> UD16488	Enter PTF number (EXAMPLE: UD12345).
PTF NUMBER	===>	Enter PTF number (EXAMPLE: UD12345).
PTF NUMBER	===>	Enter PTF number (EXAMPLE: UD12345).
PTF NUMBER	===>	Enter PTF number (EXAMPLE: UD12345).

This panel will be repeated as long as you continue to make entries. A blank as the last entry in the list will terminate the list.

Now we enter the PTF numbers for VSAM that we will be rejecting. This would happen when there were known problems with the PTFs, and we did not want to apply them to our system.

APPLY PUT: UPGRADE OPTIONS

SRV\$UPG5

You may reject PTFs for components other than 5745-SC-VSM. However, the rejected PTFs must be for the "A" service libraries.

- | | | |
|---|-----------------------|---|
| 1 | ADDITIONAL COMPONENTS | Select this item if you have more PTFs to reject. |
| 2 | CONTINUE | Select this item to continue with the upgrade. |

If there were PTFs for other components we would select number 1. Because we do not have any others to reject, we selected CONTINUE.

VSE SUPERVISOR: GENERATION OPTIONS

TSA\$GEN1

The VSE/Advanced Functions supervisor assembly will generate a job stream with OPTION NOXREF and PRINT NOGEN. OPTION XREF causes the assembler to print the symbolic cross reference. The PRINT GEN instruction will print all statements generated by the processing of a macro instruction. OPTION NOXREF suppresses the printing of the symbolic cross reference. PRINT NOGEN suppresses printing of the statements generated by the processing of macro instructions. If you want a full listing (OPTION XREF and PRINT GEN), enter YES.

FULL LISTING	===> NO	Generate full listing for supervisor assembly. Enter YES or NO.
--------------	---------	--

Note: A full listing produces a large amount of paper. It is normally used for debugging.

BACKUP SERVICE LIBRARIES

SRV\$BKP1

This panel creates the JCL to back up your "A" service library from disk to tape.

You may omit this step if you are going to keep the library on disk.

BACKUP LIBRARY A ===> YES Enter NO to omit backing up service library A.

We have now produced all of the JCL and MSHP control statements necessary to apply service to the service A libraries. We will now create the JCL to back up the libraries to tape. Just to be on the safe side, it is best to use a physical tape other than the one that previously contained the libraries. That way, if anything goes wrong you will still have the old tape available.

RESTORE SERVICE LIBRARIES

SRV\$RST1

This panel creates the JCL to restore your "C" service library from tape to disk.

You may omit this step if the library is already on disk.

RESTORE LIBRARY C ===> YES Enter NO to bypass restoring service library C.

This panel shows that we are now going to restore the service library for C.

APPLY PUT: UPGRADE OPTIONS

SRV\$UPG1

Your "C" service libraries will be updated by MSHP. If you wish to reject an individual PTF, or all the PTFs for a component, or create backout PTFs, reply YES below in the appropriate field.

EXCLUDE COMPONENTS	===> NO	Enter YES to exclude components.
REJECT PTFs	===> NO	Enter YES to reject PTFs.
REVOKABLE	===> NO	Enter YES to create backout PTFs.

If you replied YES to exclude components or reject PTFs, a detail panel requesting the component ID and the PTF number will be presented next.

This is a normal case and we do not want to exclude any components or reject any PTFs.

BACKUP SERVICE LIBRARIES

SRV\$BKP1

This panel creates the JCL to back up your "C" service library from disk to tape.

You may omit this step if you are going to keep the library on disk.

BACKUP LIBRARY C	===> YES	Enter NO to omit backing up service library C.
------------------	----------	--

As before with the service libraries A, we now back up the service libraries C.

FAST COPY TAPE TO DISK

SRV\$FCT1

Because you copied disk volume SYSWK2 to tape, this panel will create the necessary JCL to recreate your disk volume from tape.

FAST COPY TAPE

==> YES

Enter YES to copy the tape to disk, or NO to bypass this step.

This panel will be repeated for the number of volumes that you've previously copied.

We previously fast-copied this volume to tape so we will now create the JCL to restore it from tape.

FAST COPY TAPE TO DISK

SRV\$FCT1

Because you copied disk volume SYSWK3 to tape, this panel will create the necessary JCL to recreate your disk volume from tape.

FAST COPY TAPE

==> YES

Enter YES to copy the tape to disk, or NO to bypass this step.

This panel will be repeated for the number of volumes that you've previously copied.

Same as above.

SAMPLE CORRECTIVE SERVICE DIALOG

The following is a sample of the corrective service activities. Answers to questions that involve the backup and restore of the service libraries depend on the system being used, and whether the service libraries remain online. Answers to questions that ask whether you want to backup and restore volumes depend on what information you have stored on those volumes.

Job submission panels are not shown. They require no additional input except to rename some job names to produce job streams with unique names.

Note: Differences between the field names used in Interactive Productivity Facility and MSHP are explained on the corrective service explain panels. Refer to these explain panels for details on what MSHP control statements are created from the user input entered on the following panels.

SYSTEM MANAGEMENT: SERVICE MENU		SRV\$
1	APPLY PUT	Apply Program Update Tape
2	RESTART PUT	Restart Aborted PUT Run
3	APPLY SELECTIVE PUT	Apply Selected PUT Features
4	APPLY PTF	Apply Program Temporary Fix Tape
5	APPLY APAR/LOCAL	Apply/Remove Corrective Fix
6	ARCHIVE FIX	Archive a PTF or an APAR Fix
7	HISTORY FUNCTION	Select System History File Function
8	JCL COMMENTS	Turn JCL comments ON or OFF

The selection of number 5 will take us to the APAR/LOCAL service menu.

SERVICE: APPLY APAR/LOCAL FUNCTION SELECTION

SRV\$5

If you are going to apply a corrective APAR/LOCAL fix to the relocatable or source libraries, it will be necessary to first select the PRE SERVICE function. After it has completed, you may then select the CORRECTIVE SERVICE function. When you have finished with the corrective service function, select POST SERVICE to restore your system to normal.

- | | | |
|---|--------------------|---|
| 1 | PRE SERVICE | Create JCL to prepare the system for applying corrective service. |
| 2 | CORRECTIVE SERVICE | Go to the menu panel for affected library selection. |
| 3 | POST SERVICE | Create JCL to merge libraries and restore system to production. |

Select number 1. The following panels will generate the JCL to perform the preprocessing required for corrective service. It will produce a job stream named PRESRV.

BACKUP SYSRES

SRV\$PPT1

If you do not have a current backup of the system, this activity will create one. Enter NO for the tape unit address if you do not want a backup.

TAPE UNIT ADDRESS ==> 300 Enter address as cuu, or NO.

Note: The tape unit address supplied above will be used for the remainder of this activity.

Enter the address of the actual tape drive that you will use. The tape drive must be defined in the ADM\$HDWT hardware table.

TAPE UNIT ADDRESS

SRV\$FCD2

This activity may require the use of a tape drive. Enter the address of a tape unit that may be used.

TAPE UNIT ADDRESS ===> 300 Enter as cuu.

This panel is displayed only if you do not want a backup of your system.

FAST COPY DISK TO TAPE

SRV\$FCD1

This activity will create the necessary JCL to fast copy your SYSWK2 disk volume to tape, and reinitialize the volume. In the case of nonremovable DASD, this step may be necessary to provide the work areas needed for this activity.

FAST COPY VOLUME ===> YES Enter NO to omit the copy step, or YES to perform the copy.

This panel is only displayed for DASD device types of 3310, 3330, or 3340. It may be repeated for SYSWK3.

COMPONENT ID

SRV\$PTF2

Enter the component identifier for the component to receive the fixes.

Example:

5745

SC

JCL

==> 5745

==> SC

==> SUP

Here we enter the component identifier. For this example we show a change in the supervisor.

APPLY APAR/LOCAL: ADDITIONAL LIBRARY SRV\$APR2

You are going to restore library A for component 5745-SC-SUP. If you require another service library, select the library from the list below.

- | | | |
|---|-----------------------|---|
| 1 | NO ADDITIONAL LIBRARY | Select to continue with only library A. |
| 2 | SERVICE LIBRARY | B |
| 3 | SERVICE LIBRARY | C |
| 4 | SERVICE LIBRARY | E |
| 5 | | |
| 6 | | |
| 7 | | |

A unique feature of this function is the ability to restore an additional service library. A dynamic panel is built based on the component ID you supply and the number of service libraries that exist on your system. Selection number 3 as shown above would restore service library C as well as A. However, when the libraries are backed up to tape, only service library A may be backed up.

In this instance only service library A is needed, but we selected service library C just as an example.

RESTORE SERVICE LIBRARIES

SRV\$RST1

This panel creates the JCL to restore your "A" service library from tape to disk.

You may omit this step if the library is already on disk.

RESTORE LIBRARY A ===> YES Enter NO to bypass
restoring service library
A.

This panel is presented because service library A is where
5745-SC-SUP resides.

RESTORE SERVICE LIBRARIES

SRV\$RST1

This panel creates the JCL to restore your "C" service library from tape to disk.

You may omit this step if the library is already on disk.

RESTORE LIBRARY C ===> YES Enter NO to bypass
restoring service library
C.

This panel is presented because we selected 3 back on panel
SRV\$APR2.

SERVICE: APPLY APAR/LOCAL FUNCTION SELECTION

SRV\$5

If you are going to apply a corrective APAR/LOCAL fix to the relocatable or source libraries, it will be necessary to first select the PRE SERVICE function. After it has completed, you may then select the CORRECTIVE SERVICE function. When you have finished with the corrective service function, select POST SERVICE to restore your system to normal.

- | | | |
|---|---------------------------|---|
| 1 | PRE SERVICE | Create JCL to prepare the system for applying corrective service. |
| 2 | CORRECTIVE SERVICE | Go to the menu panel for affected library selection. |
| 3 | POST SERVICE | Create JCL to merge libraries and restore system to production. |

Select number 2. Preservice has now completed, and we select the corrective service function to actually apply the service.

MSHP will apply or remove corrective APAR/LOCAL fixes to one type of library at a time. Select from the list below the lowest level library you want a fix applied to.

- | | | |
|---|-------------------|--|
| 1 | ALTER CORE IMAGE | Core image library corrective fix |
| 2 | ALTER RELOCATABLE | Relocatable library corrective fix |
| 3 | ALTER SOURCE | Source statement library corrective fix |
| 4 | UNDO CORE IMAGE | Remove core image library corrective fix. |
| 5 | UNDO RELOCATABLE | Remove relocatable library corrective fix. |

First we will show the application of a change to a member in the core image library. Actually, we did not need to previously run preservice for this step. However, the output from preservice will be used in a later step.

APPLY APAR/LOCAL: CORRECT MSHP STATEMENT SRV\$FIX1

The information requested below will identify the component that the corrective fix is for, and the APAR/LOCAL fix number assigned to the fix.

APAR/LOCAL NUMBER	==> ##07021	Enter a two character prefix followed by a five digit number.
REVOKABLE	==> YES	Do you want to be able to remove the fix ?
SYSPCH ASSIGNMENT	==> 00D	For a fix you must have SYSPCH assigned (enter CUU) For nonsource fixes this field is ignored.

Enter the affected component. Example:

5745 SC JCL

==> 5745 ==> SC ==> AIT

Here we indicate the LOCAL fix number and that we wish to have the fix revokable. By having it revokable we will be able to remove it via the undo dialog. We also indicate that we will service the attention, initiator, terminator component.

APPLY APAR/LOCAL: AFFECTS MSHP STATEMENT SRV\$FIXD

The information requested below will identify the PHASE that the corrective fix is for. In the case of a macro, enter the sublibrary prefix.

AFFECTED MEMBER ===> \$\$BATTNB Enter the PHASE that will be affected by this corrective fix.

SUBLIBRARY PREFIX ===> For macros, enter the sublibrary prefix.

The member that we are going to change in the core image library is named \$\$BATTNB. We leave the second field blank as it pertains only to macros.

APPLY APAR/LOCAL: CSECT AND EXPAND SRV\$FIX2

Fixes to the relocatable library require the CSECT information. The CSECT ID is always "1" for the core image library.

CSECT ID ===> 1 Enter a one to three digit number

Corrective fixes to the relocatable library and to self relocatable phases in the core image library, may be expanded to provide a patch area at the end.

EXPAND LENGTH ===> Enter a one to six digit decimal number for the number of additional bytes, if any.

Since \$\$BATTNB is a transient and it resides in the core image library, its CSECT ID is one. We do not need to expand the size of the phase, so the second field is left blank.

This panel will be repeated until you reply /END in the address field.

RELATIVE ADDRESS	==> D6	Enter a one to six digit hex number where the new text will replace the old text.
VERIFY OLD TEXT	==> C1C7C54B	Enter the hex data that is currently at the relative address entered above.
REPLACEMENT NEW TEXT	==> E24B4040	Enter the new hex data that is to replace the old text.

The relative address is the displacement from the start of the phase to where the data is located. In the case of transients, which are always link-edited to zero, this is easy as it is also the absolute address. We show the address as 0000D6. Left zeros are not required. The old data to be found at that address is given first and then the replacement data.

APPLY APAR/LOCAL: MSHP ALTER STATEMENT SRV\$FIX3

This panel will be repeated until you reply /END in the address field.

RELATIVE ADDRESS	===> /END	Enter a one to six digit hex number where the new text will replace the old text.
VERIFY OLD TEXT	===>	Enter the hex data which is currently at the relative address entered above.
REPLACEMENT NEW TEXT	===>	Enter the new hex data which is to replace the old text.

When the panel displayed, it had DA in the relative address field. The address is automatically incremented based on the number of bytes entered in the previous panel. In this case, we have no more data so we enter /END.

APPLY APAR/LOCAL: ADDITIONAL PHASES/MODULES SRV\$FIXF

You may change additional PHASES for ##07021. If this fix is for the relocatable library, all additional modules must be link edited by the same link book.

ADDITIONAL PHASE	===> NO	Enter YES if you have additional PHASES.
------------------	---------	--

If we had additional phases to change, we would reply YES in the field shown. Since we do not, we take the default of NO.

The MSHP resolves statement will put a comment in the history file pertaining to the change you are making.

Its use is option, you may press enter without making any entries.

Enter your comment below within single quotes. Only 37 bytes are permitted.

Example:

'This is a corrective fix to ijbjc2'

	1	2	3	3
1	0	0	0	7

'This is a local fix to \$\$BATNB'

The information entered will be placed into the history file and shown when executing an MSHP LOOKUP command. Be sure to enter the single quotes around the comment. There is no way that the Interactive Productivity Facility can check to see if the quotes are missing. However, MSHP will check, and the job will fail if they are missing.

Note: There is no dialog support for the MSHP LOOKUP command. Its use is documented in the VSE Advanced/Functions MSHP User's Guide (SC33-6101). It is basically an interactive command and prints the output on SYSLOG.

MSHP will apply or remove corrective APAR/LOCAL fixes to one type of library at a time. Select from the list below the lowest level library you want a fix applied to.

- | | | |
|---|--------------------------|--|
| 1 | ALTER CORE IMAGE | Core image library corrective fix |
| 2 | ALTER RELOCATABLE | Relocatable library corrective fix |
| 3 | ALTER SOURCE | Source statement library corrective fix |
| 4 | UNDO CORE IMAGE | Remove core image library corrective fix. |
| 5 | UNDO RELOCATABLE | Remove relocatable library corrective fix. |

Now we will show an example of applying a local fix to the relocatable library.

APPLY APAR/LOCAL: CORRECT MSHP STATEMENT

SRV\$FIX1

The information requested below will identify the component that the corrective fix is for, and the APAR/LOCAL fix number assigned to the fix.

APAR/LOCAL NUMBER	===> ##09001	Enter a two character prefix followed by a five digit number.
REVOKABLE	===> YES	Do you want to be able to remove the fix ?
SYSPCH ASSIGNMENT	===> 00D	For a fix you must have SYSPCH assigned (enter CUU) For nonsource fixes this field is ignored.

Enter the affected component. Example:

5745 SC JCL

==> 5745 ==> SC ==> JCL

We enter the local fix number (all local fixes start with ##), and again say that the fix is revokable.

Note: Generally, you will always want to have the fixes revokable so in case things do not go well, you can back them off. However, you should also have a standalone backup of the system.

APPLY APAR/LOCAL: AFFECTS MSHP STATEMENT SRV\$FIXD

The information requested below will identify the MODULE that the corrective fix is for. In the case of a macro, enter the sublibrary prefix.

AFFECTED MEMBER ===> IJBJC3 Enter the MODULE that will be affected by this corrective fix.

SUBLIBRARY PREFIX ===> For macros, enter the sublibrary prefix.

Here we identify the member in the relocatable library as IJBJC3.

APPLY APAR/LOCAL: CSECT AND EXPAND SRV\$FIX2

Fixes to the relocatable library require the CSECT information. The CSECT ID is always "1" for the core image library.

CSECT ID ===> 2 Enter a one to three digit number

Corrective fixes to the relocatable library and to self relocatable phases in the core image library, may be expanded to provide a patch area at the end.

EXPAND LENGTH ===> Enter a one to six digit decimal number for the number of additional bytes, if any.

In this case, the CSECT ID for the change is two. Most APAR changes will contain this information. If you are installing a local fix, you can RSERV the module to get the information.

EX10707

APPLY APAR/LOCAL: MSHP ALTER STATEMENT

SRV\$FIX3

This panel will be repeated until you reply /END in the address field.

RELATIVE ADDRESS ==> 65E

Enter a one to six digit hex number where the new text will replace the old text.

VERIFY OLD TEXT ==> 40D9C5C1

Enter the hex data that is currently at the relative address entered above.

REPLACEMENT NEW TEXT ==> 40C1E5C1

Enter the new hex data that is to replace the old text.

This is the same panel as used for the example above.

This panel will be repeated until you reply /END in the address field.

RELATIVE ADDRESS ===> 662

Enter a one to six digit hex number where the new text will replace the old text.

VERIFY OLD TEXT ===> C4E8

Enter the hex data that is currently at the relative address entered above.

REPLACEMENT NEW TEXT ===> C9D3

Enter the new hex data that is to replace the old text.

We have additional data, so we enter it. Since it is contiguous with the previous data, the location is updated automatically and we do not have to change it.

APPLY APAR/LOCAL: MSHP ALTER STATEMENT

SRV\$FIX3

This panel will be repeated until you reply /END in the address field.

RELATIVE ADDRESS ==> /END

Enter a one to six digit hex number where the new text will replace the old text.

VERIFY OLD TEXT ==>

Enter the hex data that is currently at the relative address entered above.

REPLACEMENT NEW TEXT ==>

Enter the new hex data that is to replace the old text.

The address was updated to 664 since we entered only 2 bytes of data in the previous panel. We have completed the changes so we enter /END.

APPLY APAR/LOCAL: ADDITIONAL PHASES/MODULES

SRV\$FIXF

You may change additional MODULES for #09001. If this fix is for the relocatable library, all additional modules must be link edited by the same link book.

ADDITIONAL MODULE ==> NO

Enter YES if you have additional MODULES.

APPLY APAR/LOCAL: INVOLVES MSHP STATEMENT SRV\$FIXE

The information requested below will identify the link-edit book required to link-edit the corrective fix into the core image library.

INCLUDE LINK BOOK ==> IJBJC

Enter the name of the link book that will link-edit this fix or press enter if there is no link-edit required.

The module we changed must be link-edited into the core image library to become effective. IJBJC is the name of the link book that includes all of the necessary link-edit statements.

The MSHP resolves statement will put a comment in the history file pertaining to the change you are making.

Its use is optional, you may press enter without making any entries.

Enter your comment below within single quotes. Only 37 bytes are permitted.

Example:

'This is a corrective fix to ijbjc2'

	1	2	3	3
1	0	0	0	7

'This is a corrective fix to IJBjc3'

The information entered will be placed into the history file and shown when executing an MSHP LOOKUP command. Be sure to enter the single quotes around the comment. There is no way that the Interactive Productivity Facility can check to see if the quotes are missing. However, MSHP will check, and the job will fail if they are missing.

Note: There is no dialog support for the MSHP LOOKUP command. Its use is documented in the VSE Advanced/Functions MSHP User's Guide (SC33-6101). It is basically an interactive command and prints the output on SYSLOG.

MSHP will apply or remove corrective APAR/LOCAL fixes to one type of library at a time. Select from the list below the lowest level library you want a fix applied to.

- | | | |
|---|---------------------|--|
| 1 | ALTER CORE IMAGE | Core image library corrective fix |
| 2 | ALTER RELOCATABLE | Relocatable library corrective fix |
| 3 | ALTER SOURCE | Source statement library corrective fix |
| 4 | UNDO CORE IMAGE | Remove core image library corrective fix. |
| 5 | UNDO RELOCATABLE | Remove relocatable library corrective fix. |

Next we will show an example of updating books in the source statement library.

APPLY APAR/LOCAL: CORRECT MSHP STATEMENT SRV\$FIX1

The information requested below will identify the component that the corrective fix is for, and the APAR/LOCAL fix number assigned to the fix.

APAR/LOCAL NUMBER	===> ##08022	Enter a two character prefix followed by a five digit number.
REVOKABLE	===> YES	Do you want to be able to remove the fix ?
SYSPCH ASSIGNMENT	===> 00D	For a fix you must have SYSPCH assigned (enter CUU) For nonsource fixes this field is ignored.

Enter the affected component. Example:

5745 SC JCL

==> 5745 ==> SC ==> SUP

APPLY APAR/LOCAL: AFFECTS MSHP STATEMENT SRV\$FIXD

The information requested below will identify the MACRO that the corrective fix is for. In the case of a macro, enter the sublibrary prefix.

AFFECTED MEMBER	===> CCB	Enter the MACRO that will be affected by this corrective fix.
SUBLIBRARY PREFIX	===> E	For macros, enter the sublibrary prefix.

Here we indicate that we are going to update the E.CCB macro.

Select from the list below the next statement that you want for inclusion in your corrective fix to the source statement library.

- | | | |
|---|---------------|---------------------------------|
| 1 | VERIFY | Verify existing data. |
| 2 | INSERT | Insert new data. |
| 3 | REPLACE | Replace existing data with new. |
| 4 | DELETE | Delete existing data. |
| 5 | NEW MACRO | Change an additional macro. |
| 6 | CONTINUE | Finish processing. |

First we will verify a location within the macro to make sure that we will be updating the correct information.

In updating E.macros in the source statement library, you may verify the location of a statement. This would insure that the macro is at the level that you expect. Enter the sequence number for the statement that you wish to verify. You may specify a base number, and then in the VERIFY INCREMENT field, give a relative increment to the base number. The sequence numbers are in cols 73 to 78.

VERIFY LOCATION ==> 260000 Enter a one to six digit number.

VERIFY INCREMENT ==> Enter a one to two digit number, or leave blank.

Note: There are examples of the use of verify on the explain panel.

260000 is the sequence number in the macro in columns 73-78.

Enter the statement that you expect to find at location
260000 + 0.

The statement you enter must correspond to the original, column
by column.

You need not enter the entire statement, truncation occurs to
the right.

Example:

CLEAR SR R0,R0

	1	1	2	3	4	5	6
1	0	6	0	0	0	0	0

CAUTION: Input field is nulls. Use space bar for positioning.

Here we enter the statement that we expect to find at
location 260000. The columns are critical. If we entered
the 255 in column 17 instead of 16, the verify would fail.

Select from the list below the next statement that you want for inclusion in your corrective fix to the source statement library.

- | | | |
|---|-----------|---------------------------------|
| 1 | VERIFY | Verify existing data. |
| 2 | INSERT | Insert new data. |
| 3 | REPLACE | Replace existing data with new. |
| 4 | DELETE | Delete existing data. |
| 5 | NEW MACRO | Change an additional macro. |
| 6 | CONTINUE | Finish processing. |

Now that we have verified the correct level of the macro, we will now add a new statement.

APPLY APAR/LOCAL: INSERT LOCATION

SRV\$FIX8

This panel identifies the location in the macro where you wish to add additional lines, and the number of lines to add. The statements will be added after the sequence number you supply in the field INSERT LOCATION. For E.macros you may supply an offset, as an increment to the INSERT LOCATION, in the field INSERT INCREMENT. The sequence numbers are in cols 73-78.

INSERT LOCATION	==> 420000	Enter a one to six digit number.
INSERT INCREMENT	==>	Enter a one to two digit number, or leave blank.
NUMBER ADDITIONAL	==> 1	Enter the number of additional lines that you wish to add after the location identified above.

We are going to add one statement directly after the existing statement numbered 420000. Actually, what we are doing is poor practice. We should have verified statement 420000 rather than 260000 since there could have been statements added between 260000 and 420000, and then our update would be incorrect.

APPLY APAR/LOCAL: INSERT DATA

SRV\$FIX9

Enter a statement that you wish to add.

Example:

INCR1	LA	R1,255(R1)	INCREMENT	R1	BY	255		
1	0	1 2	3	4	5	6		
		6 0	0	0	0	0		

MNOTE 3,'THE THIRD OPERAND IS INVALID'

The MNOTE is the statement that we are adding.

Select from the list below the next statement that you want for inclusion in your corrective fix to the source statement library.

- | | | |
|---|----------------|--|
| 1 | VERIFY | Verify existing data. |
| 2 | INSERT | Insert new data. |
| 3 | REPLACE | Replace existing data with new. |
| 4 | DELETE | Delete existing data. |
| 5 | NEW MACRO | Change an additional macro. |
| 6 | CONTINUE | Finish processing. |

Next we will replace an existing statement with a new one.

This panel identifies the location in the macro of lines you wish to replace. If it is a single line, enter it in the REPLACE TO field. For E.macros you may supply an offset, as an increment to the FROM or TO locations, in the field FROM/TO OFFSET. The sequence numbers are in cols 73 - 78.

REPLACE FROM	==>	Enter a one to six digit number.
REPLACE FROM OFFSET	==>	Enter a one to two digit number increment, or leave blank. blank.
REPLACE TO	==> 340000	Enter a one to six digit number.
REPLACE TO OFFSET	==>	Enter a one to two digit number increment, or leave blank.
NUMBER REPLACEMENT	==> 1	Enter the number of replacement lines that you wish to input as replacement for the lines identified above.

We are going to replace line number 340000. This panel provides a lot of flexibility. It allows you to replace a range of statements with one or more statements, and replace a single statement with one or more statements.

Note: For more information on the fields above, refer to the VSE Advanced/Functions MSHP User's Guide (SC33-6101).

APPLY APAR/LOCAL: REPLACEMENT DATA

SRV\$FIX8

Enter a statement that you wish to use as a replacement.

Example:

```

REPL1  SR      R1,R1          CLEAR REGISTER 1
      1      1  2          3      4      5      6
1      0      6  0          0      0      0      0
      MNOTE 0,'THERE IS A POSSIBLE ERROR'
    
```

Here we replace the existing statement with the one shown above.

APPLY APAR/LOCAL: SOURCE SELECTION

SRV\$FIX5

Select from the list below the next statement that you want for inclusion in your corrective fix to the source statement library.

- | | | |
|---|---------------|---------------------------------|
| 1 | VERIFY | Verify existing data. |
| 2 | INSERT | Insert new data. |
| 3 | REPLACE | Replace existing data with new. |
| 4 | DELETE | Delete existing data. |
| 5 | NEW MACRO | Change an additional macro. |
| 6 | CONTINUE | Finish processing. |

Next we will delete a statement.

APPLY APAR/LOCAL: DELETE LOCATION

SRV\$FIXC

This panel identifies the location in the macro of lines you wish to delete. If it is a single line, enter it in the DELETE TO field. For E.macros you may supply an offset, as an increment to the FROM or TO locations, in the field FROM/TO OFFSET. The sequence numbers are in cols 73 to 78.

DELETE FROM	===>	Enter a one to six digit number.
DELETE FROM OFFSET	===>	Enter a one to two digit number increment, or leave blank. blank.
DELETE TO	===> 430000	Enter a one to six digit number.
DELETE TO OFFSET	===>	Enter a one to two digit number increment, or leave blank.

Above, we added a statement after statement 420000. Now we delete statement 430000. We could have used the replace function and specified 430000. It would have accomplished the same thing.

Note: For more information on the fields above, refer to the VSE Advanced/Functions MSHP User's Guide (SC33-6101).

APPLY APAR/LOCAL: MSHP RESOLVES STATEMENT

SRV\$FIX4

The MSHP resolves statement will put a comment in the history file pertaining to the change you are making.

Its use is option, you may press enter without making any entries.

Enter your comment below within single quotes. Only 37 bytes are permitted.

Example:

'This is a corrective fix to ijbjc2'

	1	2	3	3
1	0	0	0	7

'This is a corrective fix to E.CCB'

APPLY APAR/LOCAL: SOURCE SELECTION

SRV\$FIX5

Select from the list below the next statement that you want for inclusion in your corrective fix to the source statement library.

- | | | |
|---|-----------|---------------------------------|
| 1 | VERIFY | Verify existing data. |
| 2 | INSERT | Insert new data. |
| 3 | REPLACE | Replace existing data with new. |
| 4 | DELETE | Delete existing data. |
| 5 | NEW MACRO | Change an additional macro. |
| 6 | CONTINUE | Finish processing. |

We have finished with E.CCB. If we had another macro to change for this APAR/LOCAL fix, we would select 5. We do not, so we select 6 to continue processing.

SERVICE: APPLY APAR/LOCAL LIBRARY SELECTION

SRV\$52

MSHP will apply or remove corrective APAR/LOCAL fixes to one type of library at a time. Select from the list below the lowest level library you want a fix applied to.

- | | | |
|---|------------------------|--|
| 1 | ALTER CORE IMAGE | Core image library corrective fix |
| 2 | ALTER RELOCATABLE | Relocatable library corrective fix |
| 3 | ALTER SOURCE | Source statement library corrective fix |
| 4 | UNDO CORE IMAGE | Remove core image library corrective fix. |
| 5 | UNDO RELOCATABLE | Remove relocatable library corrective fix. |

We now select number 4 to generate a job stream to remove a core image library corrective fix.

APPLY APAR/LCCAL: UNDO MSHP STATEMENT

SRV\$UND1

The information requested below will identify the component APAR/LOCAL fix number assigned to the fix that you wish to remove from your system.

APAR/LOCAL NUMBER ==> ##07021 Enter a two character prefix followed by a five digit number.

Enter the affected component. Example:

5745 SC JCL

==> 5745 ==> SC ==> AIT

Since we applied local fix ##07021 as a revokable fix, we can now remove it. We do not have to supply the original data, as MSHP has kept it in the system history file for us (that's what revokable does).

SERVICE: APPLY APAR/LOCAL LIBRARY SELECTION

SRV\$52

MSHP will apply or remove corrective APAR/LOCAL fixes to one type of library at a time. Select from the list below the lowest level library you want a fix applied to.

- | | | |
|---|-------------------|--|
| 1 | ALTER CORE IMAGE | Core image library corrective fix |
| 2 | ALTER RELOCATABLE | Relocatable library corrective fix |
| 3 | ALTER SOURCE | Source statement library corrective fix |
| 4 | UNDO CORE IMAGE | Remove core image library corrective fix. |
| 5 | UNDO RELOCATABLE | Remove relocatable library corrective fix. |

Next we will remove a fix from the relocatable library.

APPLY APAR/LOCAL: UNDO MSHP STATEMENT

SRV\$UND1

The information requested below will identify the component APAR/LOCAL fix number assigned to the fix that you wish to remove from your system.

APAR/LOCAL NUMBER ==> ##09001 Enter a two character prefix followed by a five digit number.

Enter the affected component. Example:

5745 SC JCL

==> 5745 ==> SC ==> JCL

This will remove the fix from the relocatable library. It then relink-edits the module into the core image library.

SERVICE: APPLY APAR/LOCAL LIBRARY SELECTION

SRV\$52

MSHP will apply or remove corrective APAR/LOCAL fixes to one type of library at a time. Select from the list below the lowest level library you want a fix applied to.

- | | | |
|---|-------------------|---|
| 1 | ALTER CORE IMAGE | Core image library corrective fix |
| 2 | ALTER RELOCATABLE | Relocatable library corrective fix |
| 3 | ALTER SOURCE | Source statement library
corrective fix |
| 4 | UNDO CORE IMAGE | Remove core image library
corrective fix. |
| 5 | UNDO RELOCATABLE | Remove relocatable library
corrective fix. |

Enter RETURN to return to the initial corrective service menu.

SERVICE: APPLY APAR/LOCAL FUNCTION SELECTION

SRV\$5

If you are going to apply a corrective APAR/LOCAL fix to the relocatable or source libraries, it will be necessary to first select the PRE SERVICE function. After it has completed, you may then select the CORRECTIVE SERVICE function. When you have finished with the corrective service function, select POST SERVICE to restore your system to normal.

- 1 PRE SERVICE Create JCL to prepare the system for applying corrective service.
- 2 CORRECTIVE SERVICE Go to the menu panel for affected library selection.
- 3 POST SERVICE **Create JCL to merge libraries and restore system to production.**

Next we do postservice. This dialog will ask which libraries you wish to back up, if any, and which volumes you wish to Fast-Copy back. It will produce a job stream to perform any backups you requested, and reestablish your system LIBDEFS. It is filed under the name POSSRV.

BACKUP SERVICE LIBRARIES

SRV\$BKP1

This panel creates the JCL to back up your "A" service library from disk to tape.

You may omit this step if you are going to keep the library on disk.

BACKUP LIBRARY A

==> YES

Enter NO to omit backing up service library A.

FAST COPY TAPE TO DISK

SRV\$FCT1

Because you copied disk volume SYSWK2 to tape, this panel will create the necessary JCL to recreate your disk volume from tape.

FAST COPY TAPE

===> YES

Enter YES to copy the tape to disk, or NO to bypass this step.

This panel will be repeated for the number of volumes that you've previously copied.

This panel may be repeated for SYSWK3.

INDEX

A

adding to the menu hierarchy 141
additional tailoring
 activities 107
administering the DB
 environment 122
administering the DC
 environment 123
administration 112
administration environment 112
APAR 144, 159
apply PTF 155
apply PUT 150, 154
applying APAR/LOCAL corrective
 service 157
applying selective PUT
 libraries 155
archive 159
archiving changes 159
ASI tailoring 84, 89, 140
assemblies 118, 127, 152
assembly 163
asynchronous mode 19

B

backout PTFs 148
backup and restore utilities 162
backup libraries 96
backup library sets 116
backup VSE/ICCF file 91
batch execution 164

C

checkpoint 151
checkpoint/restart 154
CICS/VS dependent components 142
CICS/VS tables 123

CICS/VS users 124
command interface 23
 CPCMD 24
communication administration 123
compressing library members 6
concatenated libraries 12
console interface 20
conversion to Release 4.0 70
core image library 12, 131
corrective service 158
cover letter 155
create copy files 135
create system profile 79
customization of dialogs 121

D

DASD requirements for
 service 149
DASD requirements for
 verification 142
data entry panel 185
data security 120
data set considerations 129
DB administration 122
DC administration 123
decompressing library members 5
dialog components 26
dialog cross reference 175
dialog customization 90, 121
dialog flow 34
dialog flowchart diagrams 152
dialog manager 10, 185
dialogs, examples 34
disk label profile 115
display service 11, 186
display table 11
display terminal
 considerations 168
DL/I 122
documentation xi
DTR\$OPT 10
DTSFILE 6, 130, 154
dump analysis 144

E

ECHO 20
environment definition 141, 165
environment definition
 hierarchy 29
EP/VS 126
EXPLAIN 51
explain panels 185
explain service 186

F

fast copy utility 162
fast path 8, 107, 166
FCB maintenance 122
first time installation 18
first time use 112
first use tutorial 14, 34, 121,
 166
full-screen 187
function routines 186
functions 12

H

hardware table update 81
hierarchy, menu 26, 30
history function 159

I

I/O configuration profile 113
install products 93
install tips 66
install, potential problems 66
installation 133, 141
 of optional components 127
installation environment 114
Installation Guide 94, 133
installation job stream 130
Interactive Macro Facility 15

introduction 133
IPFDCMP 5
IPFPROC 2
I?FRCMP 6
IPFSUB 4

J

JCL comments 160
JCL creation 161
job retrieval 121
job streams 4, 130
job submission 4

L

librarian 116
library
 concatenated 12
 core image 12, 131
 relocatable 12, 131
 service 127
library profile 115
library structure 163
library update 86
light-pen 7, 19, 166
loading a program 164
local fix 159
logoff 7
logon 1, 116

M

Maintain System History Program
 (MSHP) 130, 131, 146, 147, 151,
 152, 153, 157, 159
menu cross reference 175
menu hierarchy 26, 30
menu manager 27, 186
menu panel 2, 8, 185
migration tips 70
mixed architecture 130
move page data set 108
move VSE/ICCF file 110

move VSE/POWER file 109

N

naming conventions 12

O

online verifies 103
operations 161
operations utilities 161
optional components 127, 142
options 10

P

panel printing 121
panel types 185
password 1, 2, 116
post service 159
prefixes 12
prepare libraries 139
preservice 158
preventive service 145
profile
 disk label 115
 I/O configuration 113
 library 115
 software product 114
 system 112
profile update 115
program development 30, 163
program function key 8, 166,
 170, 172
program loading 164
program temporary fixes 146,
 147, 155
program update tapes 146, 147,
 152
PUT libraries 155

R

recommended service
 libraries 127
REDISPLAY 21
 VSECMD 23
 VSECP 23
 VSEMSG 22
 VSEREP 22
reference material xi
relocatable library 12, 131
REPLY 21
response time 18
restart 32, 151
restart PUT 154
restore 31
restore library set 118

S

sample PUT dialog 188
security 118
select environment
 definition 165
selectable activities 185
selective job retrieval 121
service 145
 service dialogs 146
 service files 149
 service libraries 127, 157
 service process 149
 service process work area 149
 service tips 66
 service, potential problems 66
SGVMCF macro 25
skeletons 185
software product profile 111
standard labels 88
submit to batch 164
SUBVSE EXEC 4
 SUBVSE 4
supervisor assemblies 152
supervisor assembly 82
system administration 112
system files
 13 149
system history file 159
system management 74, 111

System Management Guide 74, 111
system management guide
 completion 106
system management hierarchy 28
system profile tables 112, 127,
 129
system tailoring 118
system use 30, 163
system use hierarchy 29

[T]

tables 185
tailoring 30, 118
tape volume number 127
terminal diagrams 168
terminal use 168, 173
TTF 16

[U]

update environment
 definition 165
update product table 134, 138
user options file 10
userid 1
utilities 161
utility aids 121

[V]

verification 97, 142, 143
verification job streams 142
verify batch products 99

verify CICS/VS 102
verify online products 100
verify VSE/VSAM 98
verifying optional
 components 142
VM/VSE Feature iv, ix, x, xi, 1,
 4, 8, 10, 12, 20, 26, 27, 34,
 78, 79, 82, 84, 85, 87, 88, 89,
 90, 91, 94, 96, 98, 99, 100,
 102, 103, 105, 121, 163
VSE/Access Control security
 tables 119
VSE/DITTO 148
VSE/ICCF 13, 16
 library 14
VSE/ICCF partition 16
VSE/ICCF security 118
VSE/POWER assembly 85
VSE/POWER RJE 125
VSE/VSAM 123, 143
VSE/VSAM considerations 142
VSE/VSAM verify delete 105

[W]

work area 149

[3]

3277 168, 170, 173
3278 168, 171, 173

You may use this form to communicate your comments about this publication, its organization, or subject matter, with the understanding that IBM may use or distribute whatever information you supply in any way it believes appropriate without incurring any obligation to you.

Your comments will be sent to the author's department for whatever review and action, if any, is deemed appropriate. Comments may be written in your own language; use of English is not required.

Note: Copies of IBM publications are not stocked at the location to which this form is addressed. Please direct any requests for copies of publications, or for assistance in using your IBM system, to your IBM representative or to the IBM branch office serving your locality.

Possible topics for comment are:

Clarity Accuracy Completeness Organization Coding Retrieval Legibility

If you wish a reply, give your name, company, mailing address, and date:

Note: Staples can cause problems with automated mail sorting equipment.
Please use pressure sensitive or other gummed tape to seal this form.

What is your occupation? _____

Number of latest Newsletter associated with this publication: _____

Thank you for your cooperation. No postage stamp necessary if mailed in the U.S.A. (Elsewhere, an IBM office or representative will be happy to forward your comments or you may mail directly to the address in the Edition Notice on the back of the title page.)

Reader's Comment Form

Fold and tape

Please Do Not Staple

Fold and tape

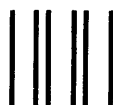

NO POSTAGE
NECESSARY
IF MAILED
IN THE
UNITED STATES

BUSINESS REPLY MAIL
FIRST CLASS PERMIT NO. 40 ARMONK, N.Y.

POSTAGE WILL BE PAID BY ADDRESSEE:

International Business Machines Corporation
Department 824
1133 Westchester Avenue
White Plains, New York 10604

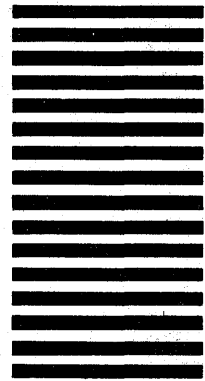

Fold and tape

Please Do Not Staple

Fold and tape



International Business Machines Corporation
Data Processing Division
1133 Westchester Avenue, White Plains, N.Y. 10604

IBM World Trade Americas/Far East Corporation
Town of Mount Pleasant, Route 9, North Tarrytown, N.Y., U.S.A. 10591

IBM World Trade Europe/Middle East/Africa Corporation
360 Hamilton Avenue, White Plains, N.Y., U.S.A. 10601

----- Cut or Fold Along Line -----

Interactive Productivity Facility VSE Feature User's Guide Printed in U.S.A. SH20-5526-0



International Business Machines Corporation
Data Processing Division
1133 Westchester Avenue, White Plains, N.Y. 10604

IBM World Trade Americas/Far East Corporation
Town of Mount Pleasant, Route 9, North Tarrytown, N.Y., U.S.A. 10591

IBM World Trade Europe/Middle East/Africa Corporation
360 Hamilton Avenue, White Plains, N.Y., U.S.A. 10601