

# > PG707X/PG707W

## Projector User Guide

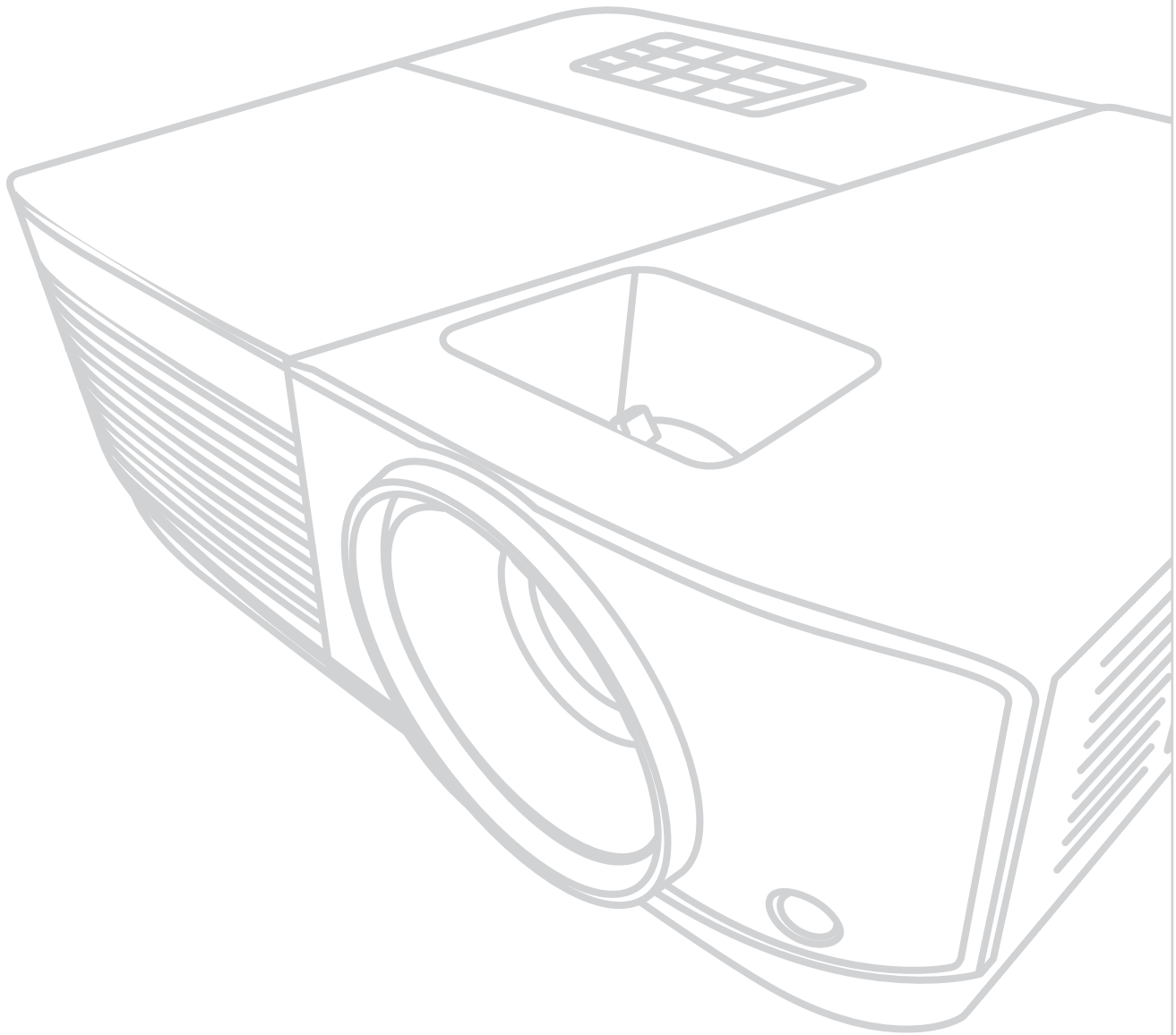

**IMPORTANT:** Please read this User Guide to obtain important information on installing and using your product in a safe manner, as well as registering your product for future service. Warranty information contained in this User Guide will describe your limited coverage from ViewSonic Corporation, which is also found on our web site at <http://www.viewsonic.com> in English, or in specific languages using the Regional selection box in the upper right corner of our website. "Antes de operar su equipo lea cuidadosamente las instrucciones en este manual"

Model No. VS18090/VS18089  
Model Name: PG707X/PG707W

## **Thank you for choosing ViewSonic®**

As a world-leading provider of visual solutions, ViewSonic® is dedicated to exceeding the world's expectations for technological evolution, innovation, and simplicity. At ViewSonic®, we believe that our products have the potential to make a positive impact in the world, and we are confident that the ViewSonic® product you have chosen will serve you well.

Once again, thank you for choosing ViewSonic®!

## > Safety Precautions - General

Please read the following **Safety Precautions** before you start using the projector.

- Keep this user guide in a safe place for later reference.
- Read all warnings and follow all instructions.
- Allow at least 20" (50 cm) clearance around the projector to ensure proper ventilation.
- Place the projector in a well-ventilated area. Do not place anything on the projector that prevents heat dissipation.
- Do not place the projector on an uneven or unstable surface. The projector may fall over, causing personal injury or projector malfunction.
- Do not use if the projector is tilted at an angle of more than 10° degrees left or right, nor at an angle of more than 15° degrees forwards or backwards.
- Do not look straight at the projector lens during operation. The intense light beam may damage your eyes.
- Always open the lens shutter or remove the lens cap when the projector lamp is on.
- Do not block the projection lens with any objects when the projector is under operation as this could cause objects to become heated and deformed or even cause a fire.
- The lamp becomes extremely hot during operation. Allow the projector to cool for approximately 45 minutes prior to removing the lamp assembly for replacement.
- Do not use lamps beyond the rated lamp life. Excessive use of lamps beyond the rated life could cause them to break on rare occasions.
- Never replace the lamp assembly or any electronic component unless the projector is unplugged.
- Do not attempt to disassemble the projector. There are dangerous high voltages inside which may cause death if you should come into contact with live parts.
- When moving the projector, be careful not to drop or bump the projector on anything.
- Do not place any heavy objects on the projector or connection cables.
- Do not stand the projector on end vertically. Doing so may cause the projector to fall over, causing personal injury or projector malfunction.
- Avoid exposing the projector to direct sunlight or other sources of sustained heat. Do not install near any heat sources such as radiators, heat registers, stoves, or other devices (including amplifiers) that may increase the temperature of the projector to dangerous levels.

- Do not place liquids near or on the projector. Liquids spilled into the projector may cause it to fail. If the projector does become wet, disconnect it from the power supply and call your local service center to have the projector serviced.
- When the projector is under operation, you may sense some heated air and odor from its ventilation grill. It is a normal operation and not a defect.
- Do not attempt to circumvent the safety provisions of the polarized or grounding-type plug. A polarized plug has two blades with one wider than the other. A grounding-type plug has two blades and a third grounding prong. The wide and third blade are provided for your safety. If the plug does not fit into your outlet, obtain an adapter and do not attempt to force the plug into the outlet.
- When connecting to a power outlet, DO NOT remove the grounding prong. Please ensure grounding prongs are NEVER REMOVED.
- Protect the power cord from being treaded upon or pinched, particularly at the plug, and at the point where it emerges from the projector.
- In some countries, the voltage is NOT stable. This projector is designed to operate safely within a voltage between 100 to 240 volts AC, but could fail if power cuts or surges of  $\pm 10$  volts occur. In areas where voltage may fluctuate or cut out, it is recommended that you connect your projector through a power stabilizer, surge protector, or uninterruptable power supply (UPS).
- If smoke, an abnormal noise, or a strange odor is present, immediately switch the projector off and call your dealer or ViewSonic®. It is dangerous to continue using the projector.
- Use only attachments/accessories specified by the manufacturer.
- Disconnect the power cord from the AC outlet if the projector is not being used for a long period of time.
- Refer all servicing to qualified service personnel.



**CAUTION:** Possibly hazardous optical radiation is emitted from this product. As with any bright light source, do not stare into the beam,  
RG2 IEC 62471-5:2015.

## > Safety Precautions - Ceiling Mounting

Please read the following **Safety Precautions** before you start using the projector.

If you intend to mount the projector on the ceiling, we strongly recommend that you use a proper fitting projector ceiling mount kit and that you ensure it is securely and safely installed.

If you use an inappropriate projector ceiling mount kit, there is a safety risk that the projector may fall from the ceiling due to an improper attachment through the use of the wrong gauge or length screws.

You can purchase a projector ceiling mount kit from the place you purchased your projector. We recommend that you also purchase a separate security cable and attach it securely to both the anti-theft lock slot on the projector and the base of the ceiling mount bracket. This will perform the secondary role of restraining the projector should its attachment to the mounting bracket become loose.

# > Contents

<b>Safety Precautions - General .....</b>	<b>3</b>
Features.....	10
Package Contents .....	10
Product Overview.....	11
Projector.....	11
Controls and Functions .....	11
Connection Ports.....	12
Remote Control .....	13
Controls and Functions .....	13
Remote Control Effective Range .....	14
Replacing the Remote Control Batteries.....	14
<b>Initial Setup.....</b>	<b>15</b>
Choosing a Location.....	15
Projection Dimensions.....	16
PG707X.....	16
4:3 Image on a 4:3 Screen.....	16
4:3 Image on a 16:10 Screen.....	17
PG707W .....	18
16:10 Image on a 16:10 Screen.....	18
16:10 Image on a 4:3 Screen.....	19
Mounting the Projector .....	20
Preventing Unauthorized Use.....	21
Using the Security Slot .....	21
Using the Password Function .....	22
Setting a Password.....	22
Changing the Password.....	23
Disabling the Password Function .....	23
Forgetting the Password .....	24
Password Recall Procedure .....	24
Locking the Control Keys.....	25

<b>Making Connections .....</b>	<b>26</b>
Connecting to Power .....	26
Connecting to Video Sources.....	27
HDMI Connection .....	27
Composite Video Connection.....	28
Connecting to Computer Sources.....	29
VGA Connection .....	29
VGA Out Connection .....	29
Connecting to Audio .....	30
<b>Operation.....</b>	<b>31</b>
Turning the Projector On/Off .....	31
Starting Up the Projector .....	31
First Time Activation .....	31
Shutting Down the Projector.....	32
Selecting an Input Source .....	33
Adjusting the Projected Image .....	34
Adjusting the Projector's Height and Projection Angle.....	34
Auto-Adjusting the Image .....	34
Fine-Tuning the Image Size and Clarity .....	34
Correcting Keystone .....	35
Adjusting 4 corners .....	36
Hiding the Image .....	36
Controlling the Projector through a LAN Environment .....	37
Configuring the LAN Control Settings.....	37
Controlling the Projector through a Web Browser .....	39
About Crestron e-Control® .....	43
PJLink™, SNMP, AMX and Xpanel Formats Supported .....	46

<b>Menu Functions .....</b>	<b>47</b>
General On-Screen Display (OSD) Menu Operation .....	47
On-Screen Display (OSD) Menu Tree.....	48
DISPLAY Menu .....	54
IMAGE Menu .....	57
POWER MANAGEMENT Menu .....	61
BASIC Menu .....	64
ADVANCED Menu .....	67
SYSTEM Menu.....	72
INFORMATION Menu .....	75
<b>Appendix.....</b>	<b>76</b>
Specifications.....	76
Projector Dimensions .....	77
Timing Chart .....	77
Analog RGB.....	77
HDMI (PC).....	79
HDMI (Video).....	80
Video .....	80
IR Control Table .....	81
Address Code .....	82
RS-232 Command Table .....	83
Pin Assignment.....	83
Interface.....	83
Command Table .....	83
Glossary .....	90
Troubleshooting .....	93
Common Problems.....	93
LED Indicators.....	94
Maintenance.....	95
General Precautions .....	95
Cleaning the Lens .....	95
Cleaning the Case .....	95
Storing the Projector .....	95
Disclaimer.....	95



Light Source Information .....	96
Light Source Hour .....	96
Extending Light Source Life .....	96
Light Source Replacement Timing .....	97
Replacing the Light Source .....	97
<b>Regulatory and Service Information .....</b>	<b>98</b>
Compliance Information .....	98
FCC Compliance Statement .....	98
Industry Canada Statement .....	98
CE Conformity for European Countries .....	98
Declaration of RoHS2 Compliance .....	99
Indian Restriction of Hazardous Substances .....	100
Product Disposal at End of Product Life .....	100
Copyright Information .....	101
Customer Service .....	102
Limited Warranty .....	103
Mexico Limited Warranty .....	106

# > Introduction

The ViewSonic PG707X/PG707W, which features 4000 ANSI lumens and a 22000:1 contrast ratio, is a high brightness and contrast ratio projector that produces the finest of details regardless of the amount of ambient light in the environment. It is suitable for any small-to-medium sized space, such as meeting rooms or classrooms and is equipped with several connection options.

## Features

- Amazing 20,000 hours lamp life.
- Power saving function that decreases the lamp power consumption by up to 60% when no input signal is detected for a set time period.
- USB Type A port for streaming with an HDMI wireless dongle, supplying power, and updating Firmware.
- 7 color modes for different projection purposes.
- Presentation timer for better time management during presentations.
- LAN Settings allowing management of projector status from a remote computer.
- 3D display supported.
- Less than 0.5W power consumption when power saving mode is turned on.
- Quick Auto Search, thus speeding up the signal detecting process.
- One-key auto-adjustment for displaying the best picture quality (only for analog signal).
- Digital keystone correction and/or 4 corner adjustment to correct distorted images.
- Ability to display 1.07 billion colors.
- Multi-language On-Screen Display (OSD) menus.
- HDMI CEC (Consumer Electronics Control) function allowing synchronized power ON/OFF operation between the projector and a CEC-compatible DVD player device connected to the HDMI input of the projector.

## Package Contents

- Projector
- Power Cord
- Video Cable
- Remote Control & Batteries
- Quick Start Guide

**NOTE:** The power cord and video cables included in your package may vary depending on your country. Please contact your local reseller for more information.

# Product Overview

## Projector

### Controls and Functions

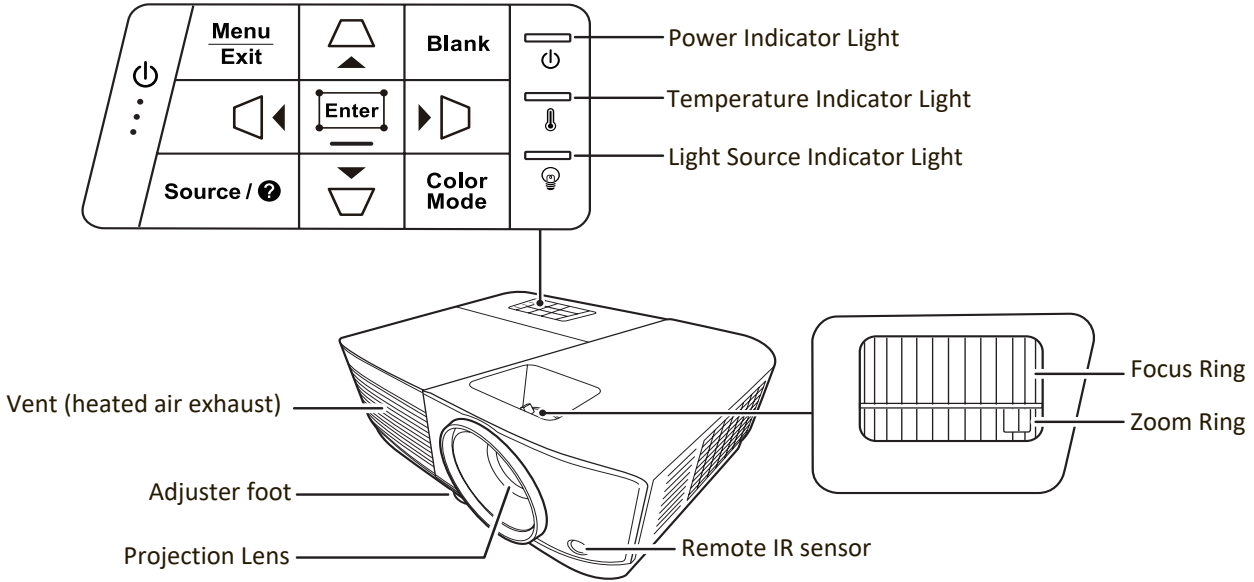

Key	Description
[Power]	Toggles the projector between standby mode and Power On.
[Keystone Keys]	Manually corrects distorted images resulting from an angled projection.
[Left/Right/Up/Down]	Selects the desired menu items and makes adjustments when the On-Screen Display (OSD) Menu is activated.
Menu/Exit	Turns on or off the On-Screen Display (OSD) Menu.
Source	Displays the input source selection bar.
[Help]	Displays the HELP menu with a long press for 3 seconds.
Blank	Hides the screen picture.
Enter	Enacts the selected On-Screen Display (OSD) Menu item when the OSD Menu is activated.
[Corner Adj. Key]	Displays the <b>Corner Adj.</b> menu.
Color Mode	Displays the color mode selection bar.

# Connection Ports

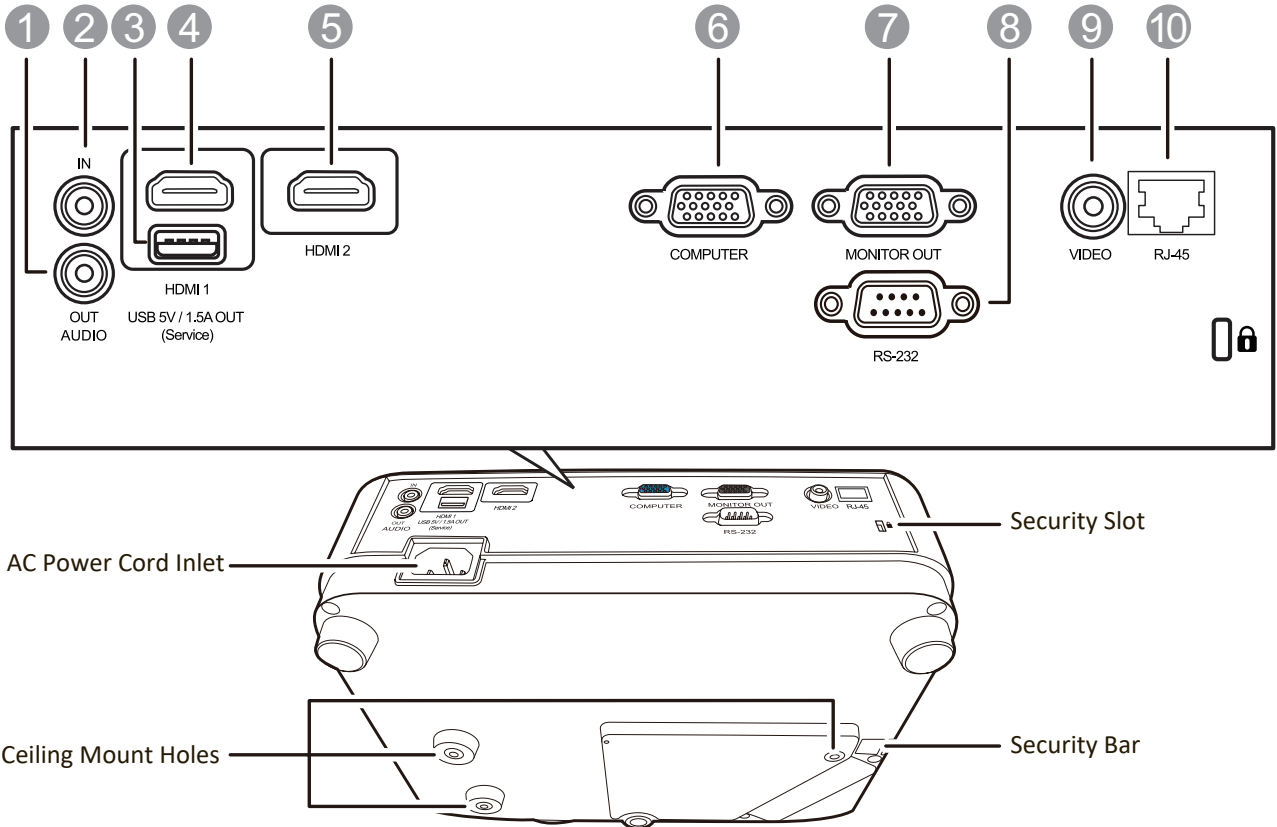

Port	Description
[1] AUDIO OUT	Audio signal output socket.
[2] AUDIO IN	Audio signal input socket.
[3] USB 5V/1.5A OUT	USB Type A port.
[4] HDMI 1	HDMI port.
[5] HDMI 2	HDMI port.
[6] COMPUTER	RGB (PC) signal input socket.
[7] MONITOR OUT	RGB (PC) signal output socket.
[8] RS-232	RS-232 control port.
[9] VIDEO	Composite video port.
[10] RJ-45	LAN port.

# Remote Control

## Controls and Functions

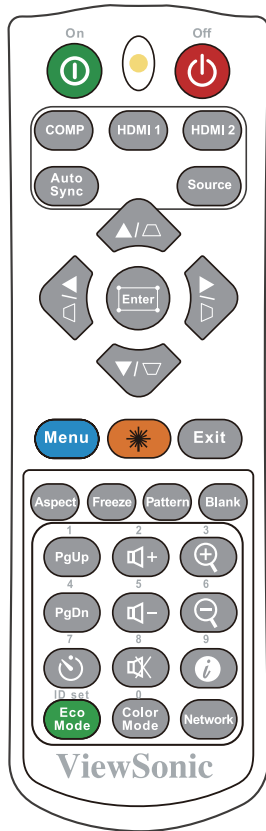

Button	Description
⏻ On/⏻ Off	Toggles between standby mode and Power On.
COMP	Selects the source from the <b>COMPUTER IN</b> port for display.
HDMI 1	Selects the source from the <b>HDMI 1</b> port for display.
HDMI 2	Selects the source from the <b>HDMI 2</b> port for display.
Auto Sync	Automatically determines the best picture timings for the displayed image.
Source	Displays the source selection bar.
[⏏/⏏/⏏/⏏] Keystone Keys	Manually corrects distorted images resulting from an angled projection.
Enter	Enacts the selected OSD Menu item.
⏏ (Corner adjustment)	Displays the <b>Corner Adj.</b> menu.

Button	Description
◀ Left/ ▶ Right ▲ Up/ ▼ Down	Selects the desired menu items and makes adjustments.
Menu	Turns on/off the On-Screen Display (OSD) Menu or goes back to previous OSD Menu.
★ (Laser)	Emits visible laser pointer light for presentation purposes.
Exit	Exits and saves menu settings.
Aspect	Displays the aspect ratio selection bar.
Freeze	Freezes the projected image.
Pattern	Displays embedded test pattern.
Blank	Hides the screen picture.
PgUp (Page Up)/ PgDn (Page Down)	Operates your display software program (on a connected PC) which responds to page up/down commands (like Microsoft PowerPoint). <b>NOTE:</b> Only available when a PC input signal is selected.
⌚ (Presentation Timer)	Displays the <b>Presentation Timer</b> menu.
Eco Mode	Selects the <b>Eco</b> mode.
🔊+ (Volume Up)	Increases the volume level.
🔊- (Volume Down)	Decreases the volume level.
🔇 (Mute)	Toggles audio between on and off.
Color Mode	Displays the color mode selection bar.
🔍+	Magnifies the projected picture size.
🔍-	Reduces the projected picture size.
ⓘ (INFORMATION)	Displays the <b>INFORMATION</b> menu.
Network	Displays the <b>LAN Control Settings</b> menu.

## Remote Control Effective Range

To ensure proper function of the remote control follow the steps below:

1. The remote control must be held at an angle within 30° perpendicular to the projector's IR remote control sensor(s).
2. The distance between the remote control and the sensor(s) should not exceed 8 m (26 ft.)

**NOTE:** Refer to the illustration for the location of the infrared (IR) remote control sensor(s).

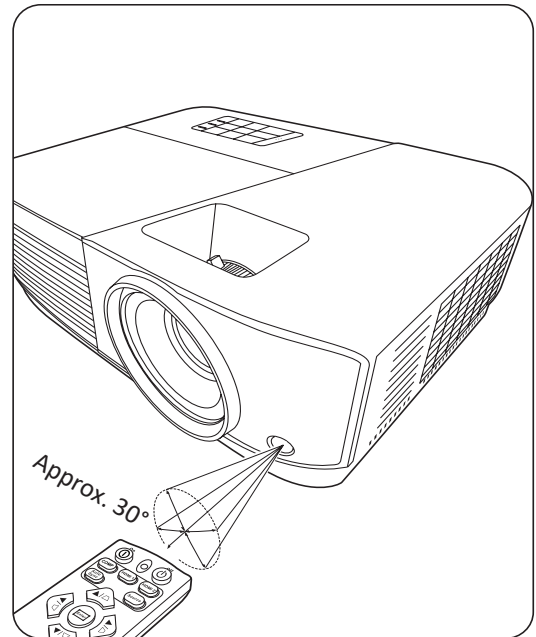

## Replacing the Remote Control Batteries

1. Remove the battery cover from the rear of the remote control by pressing the finger grip and sliding it down.
2. Remove any existing batteries (if necessary) and install two AAA batteries.

**NOTE:** Observe the battery's polarities as indicated.

3. Replace the battery cover by aligning it with the base and pushing it back into position.

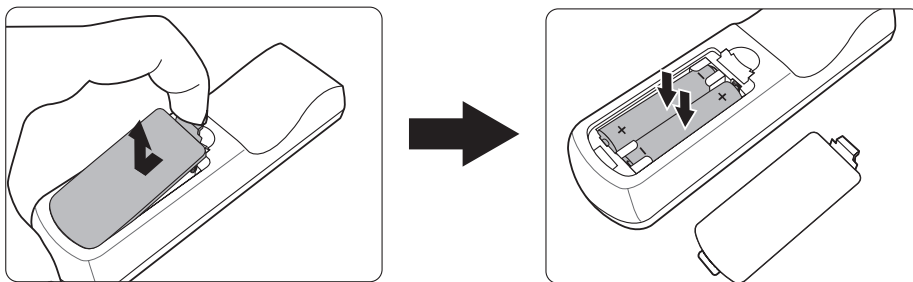

### NOTE:

- Avoid leaving the remote control and batteries in excessive heat or a humid environment.
- Replace only with the same or equivalent type recommended by the battery manufacturer.
- Dispose of the used batteries according to the manufacturer's instructions and local environment regulations for your region.
- If the batteries are drained or if you will not be using the remote control for an extended period of time, remove the batteries to avoid damage to the remote control.

# > Initial Setup

This section provides detailed instructions for setting up your projector.

## Choosing a Location

Personal preference and room layout will decide the installation location. Consider the following:

- Size and Position of your screen.
- Location of a suitable power outlet.
- Location and Distance between the projector and other equipment.

The projector is designed to be installed in one of the following locations:

### 1. Front

The projector is placed near the floor in front of the screen.

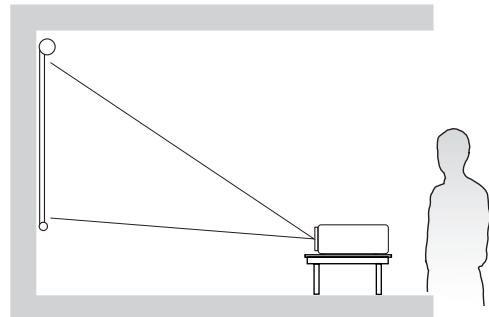

### 2. Front Ceiling

The projector is suspended upside-down from the ceiling in front of the screen.

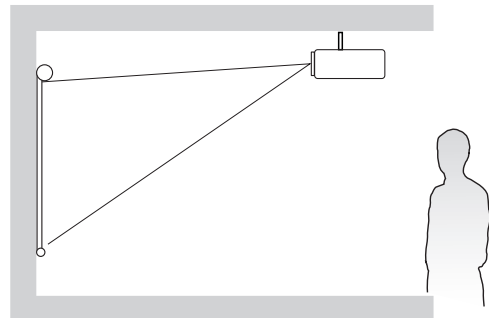

### 3. Rear Ceiling

The projector is suspended upside-down from the ceiling behind the screen.

**NOTE:** A special rear projection screen is required.

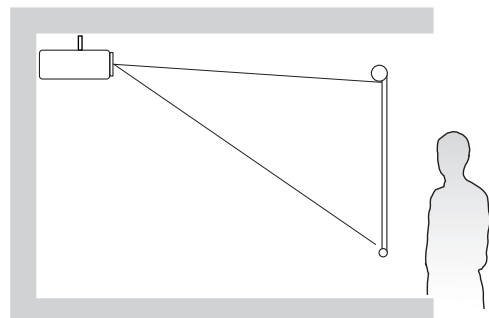

### 4. Rear

The projector is placed near the floor behind the screen.

**NOTE:** A special rear projection screen is required.

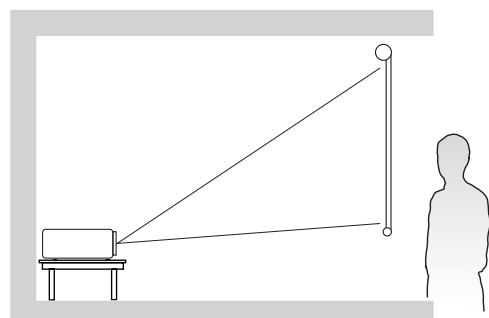

# Projection Dimensions

**NOTE:** See “Specifications” on page 76 for the native display resolution of this projector.

## PG707X

- **4:3 Image on a 4:3 Screen**

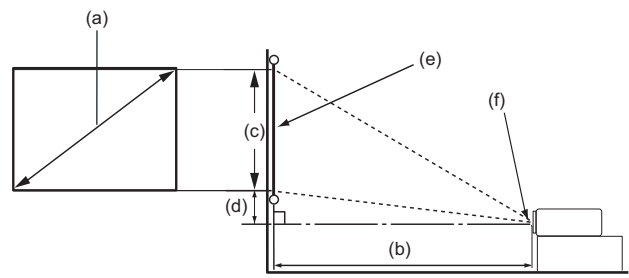
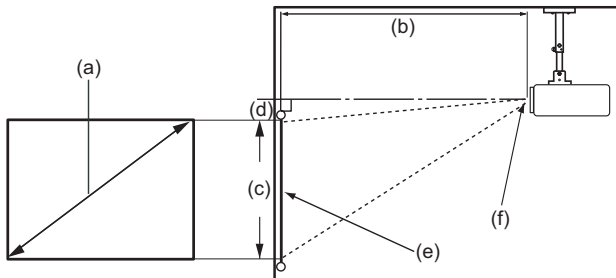

- **4:3 Image on a 16:10 Screen**

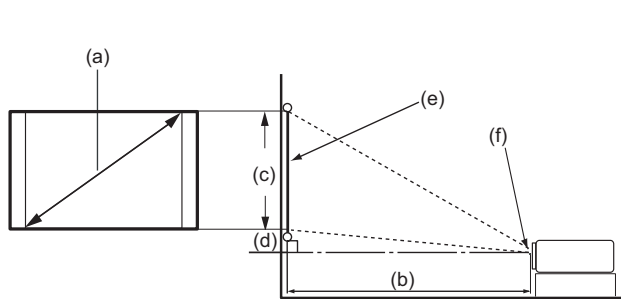
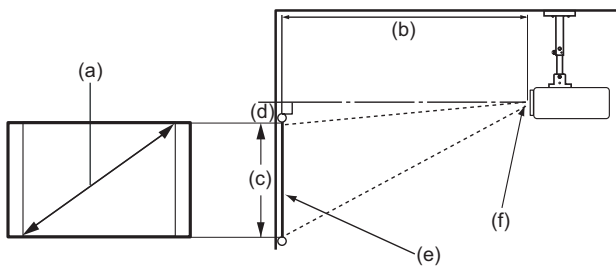

**NOTE:** (e) = Screen / (f) = Center of Lens

### 4:3 Image on a 4:3 Screen

(a) Screen Size		(b) Projection Distance				(c) Image Height		(d) Vertical Offset			
		minimum		maximum				minimum		maximum	
in.	mm	in.	mm	in.	mm	in.	mm	in.	mm	in.	mm
30	762	36	923	47	1200	18	457	1.4	34.3	1.4	34
40	1016	48	1231	63	1600	24	610	1.8	45.7	1.8	46
50	1270	61	1538	79	2000	30	762	2.3	57.2	2.3	57
60	1524	73	1846	94	2400	36	914	2.7	68.6	2.7	69
70	1778	85	2154	110	2800	42	1067	3.2	80.0	3.2	80
80	2032	97	2462	126	3200	48	1219	3.6	91.4	3.6	91
90	2286	109	2769	142	3600	54	1372	4.1	102.9	4.1	103
100	2540	121	3077	157	4000	60	1524	4.5	114.3	4.5	114
110	2794	133	3385	173	4400	66	1676	5.0	125.7	5.0	126
120	3048	145	3692	189	4800	72	1829	5.4	137.2	5.4	137
130	3302	157	4000	205	5200	78	1981	5.9	148.6	5.9	149
140	3556	170	4308	220	5600	84	2134	6.3	160.0	6.3	160
150	3810	182	4615	236	6000	90	2286	6.8	171.5	6.8	171
160	4064	194	4923	252	6400	96	2438	7.2	182.9	7.2	183
170	4318	206	5231	268	6800	102	2591	7.7	194.3	7.7	194



(a) Screen Size		(b) Projection Distance				(c) Image Height		(d) Vertical Offset			
		minimum		maximum				minimum		maximum	
in.	mm	in.	mm	in.	mm	in.	mm	in.	mm	in.	mm
180	4572	218	5538	283	7200	108	2743	8.1	205.7	8.1	206
190	4826	230	5846	299	7600	114	2896	8.6	217.2	8.6	217
200	5080	242	6154	315	8000	120	3048	9.0	228.6	9.0	229
250	6350	303	7692	394	10000	150	3810	11.3	285.8	11.3	286
300	7620	363	9231	472	12000	180	4572	13.5	342.9	13.5	343

### 4:3 Image on a 16:10 Screen

(a) Screen Size		(b) Projection Distance				(c) Image Height		(d) Vertical Offset			
		minimum		maximum				minimum		maximum	
in.	mm	in.	mm	in.	mm	in.	mm	in.	mm	in.	mm
30	762	32	815	42	1060	16	404	1.2	30	1.2	30
40	1016	43	1087	56	1413	21	538	1.6	40	1.6	40
50	1270	54	1359	70	1767	26	673	2.0	50	2.0	50
60	1524	64	1631	83	2120	32	808	2.4	61	2.4	61
70	1778	75	1903	97	2473	37	942	2.8	71	2.8	71
80	2032	86	2174	111	2827	42	1077	3.2	81	3.2	81
90	2286	96	2446	125	3180	48	1212	3.6	91	3.6	91
100	2540	107	2718	139	3533	53	1346	4.0	101	4.0	101
110	2794	118	2990	153	3887	58	1481	4.4	111	4.4	111
120	3048	128	3262	167	4240	64	1615	4.8	121	4.8	121
130	3302	139	3533	181	4593	69	1750	5.2	131	5.2	131
140	3556	150	3805	195	4947	74	1885	5.6	141	5.6	141
150	3810	161	4077	209	5300	79	2019	6.0	151	6.0	151
160	4064	171	4349	223	5653	85	2154	6.4	162	6.4	162
170	4318	182	4621	236	6007	90	2289	6.8	172	6.8	172
180	4572	193	4892	250	6360	95	2423	7.2	182	7.2	182
190	4826	203	5164	264	6713	101	2558	7.6	192	7.6	192
200	5080	214	5436	278	7067	106	2692	7.9	202	7.9	202
250	6350	268	6795	348	8833	132	3365	9.9	252	9.9	252
300	7620	321	8154	417	10600	159	4039	11.9	303	11.9	303

**NOTE:** There is a 3% tolerance among these numbers due to optical component variations. It is recommended to physically test the projection size and distance before permanently installing the projector.

**PG707W**

• **16:10 Image on a 16:10 Screen**

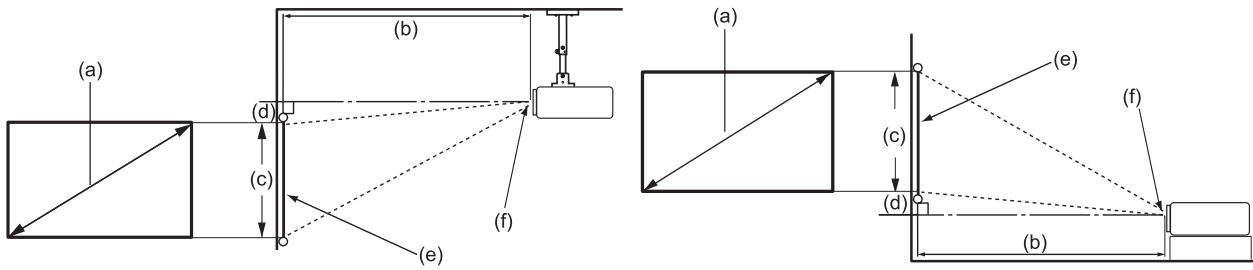

• **16:10 Image on a 4:3 Screen**

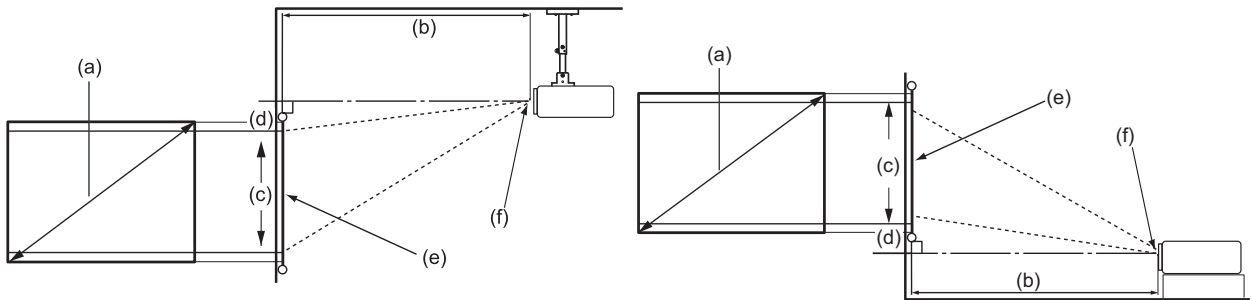

**NOTE:** (e) = Screen / (f) = Center of Lens

**16:10 Image on a 16:10 Screen**

(a) Screen Size		(b) Projection Distance				(c) Image Height		(d) Vertical Offset			
		minimum		maximum				minimum		maximum	
in.	mm	in.	mm	in.	mm	in.	mm	in.	mm	in.	mm
30	762	31	779	40	1013	16	404	1.6	40.4	1.6	40
40	1016	41	1039	53	1351	21	538	2.1	53.8	2.1	54
50	1270	51	1299	66	1689	26	673	2.6	67.3	2.6	67
60	1524	61	1559	80	2026	32	808	3.2	80.8	3.2	81
70	1778	72	1818	93	2364	37	942	3.7	94.2	3.7	94
80	2032	82	2078	106	2702	42	1077	4.2	107.7	4.2	108
90	2286	92	2338	120	3039	48	1212	4.8	121.2	4.8	121
100	2540	102	2598	133	3377	53	1346	5.3	134.6	5.3	135
110	2794	112	2857	146	3715	58	1481	5.8	148.1	5.8	148
120	3048	123	3117	160	4052	64	1615	6.4	161.5	6.4	162
130	3302	133	3377	173	4390	69	1750	6.9	175.0	6.9	175
140	3556	143	3637	186	4728	74	1885	7.4	188.5	7.4	188
150	3810	153	3897	199	5066	79	2019	7.9	201.9	7.9	202
160	4064	164	4156	213	5403	85	2154	8.5	215.4	8.5	215
170	4318	174	4416	226	5741	90	2289	9.0	228.9	9.0	229
180	4572	184	4676	239	6079	95	2423	9.5	242.3	9.5	242
190	4826	194	4936	253	6416	101	2558	10.1	255.8	10.1	256
200	5080	205	5195	266	6754	106	2692	10.6	269.2	10.6	269
250	6350	256	6494	332	8443	132	3365	13.2	336.5	13.2	337
300	7620	307	7793	399	10131	159	4039	15.9	403.9	15.9	404

## 16:10 Image on a 4:3 Screen

(a) Screen Size		(b) Projection Distance				(c) Image Height		(d) Vertical Offset			
		minimum		maximum				minimum		maximum	
in.	mm	in.	mm	in.	mm	in.	mm	in.	mm	in.	mm
30	762	29	735	38	956	15	381	1.5	38	1.5	38
40	1016	39	980	50	1274	20	508	2.0	51	2.0	51
50	1270	48	1225	63	1593	25	635	2.5	64	2.5	64
60	1524	58	1470	75	1912	30	762	3.0	76	3.0	76
70	1778	68	1715	88	2230	35	889	3.5	89	3.5	89
80	2032	77	1961	100	2549	40	1016	4.0	102	4.0	102
90	2286	87	2206	113	2867	45	1143	4.5	114	4.5	114
100	2540	96	2451	125	3186	50	1270	5.0	127	5.0	127
110	2794	106	2696	138	3504	55	1397	5.5	140	5.5	140
120	3048	116	2941	151	3823	60	1524	6.0	152	6.0	152
130	3302	125	3186	163	4142	65	1651	6.5	165	6.5	165
140	3556	135	3431	176	4460	70	1778	7.0	178	7.0	178
150	3810	145	3676	188	4779	75	1905	7.5	191	7.5	191
160	4064	154	3921	201	5097	80	2032	8.0	203	8.0	203
170	4318	164	4166	213	5416	85	2159	8.5	216	8.5	216
180	4572	174	4411	226	5735	90	2286	9.0	229	9.0	229
190	4826	183	4656	238	6053	95	2413	9.5	241	9.5	241
200	5080	193	4901	251	6372	100	2540	10.0	254	10.0	254
250	6350	241	6127	314	7965	125	3175	12.5	318	12.5	318
300	7620	289	7352	376	9558	150	3810	15.0	381	15.0	381

**NOTE:** There is a 3% tolerance among these numbers due to optical component variations. It is recommended to physically test the projection size and distance before permanently installing the projector.

## Mounting the Projector

**NOTE:** If you buy a third-party mount, please use the correct screw size. Screw size can vary depending on the thickness of the mounting plate.

1. To ensure the most secure installation, please use a ViewSonic® wall or ceiling mount.
2. Ensure the screws used to attach a mount to the projector meet the following specifications:
  - Screw type: M4 x 8 mm
  - Maximum Screw length: 8 mm

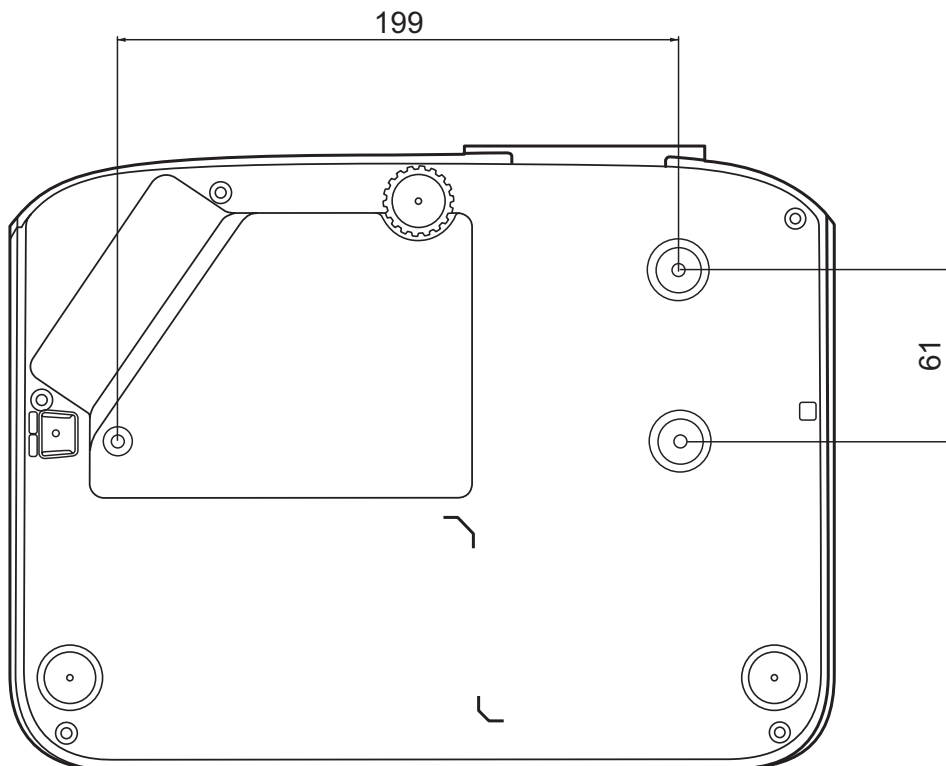

**NOTE:**

- Avoid installing the projector near a heat source.
- Keep at least a 10 cm gap between the ceiling and the bottom of the projector.

## Preventing Unauthorized Use

The projector has several built-in security features to prevent theft, access, or accidental setting changes.

### Using the Security Slot

To help prevent the projector from being stolen, use a security slot locking device to secure the projector to a fixed object.

Below is an example of setting up a security slot locking device:

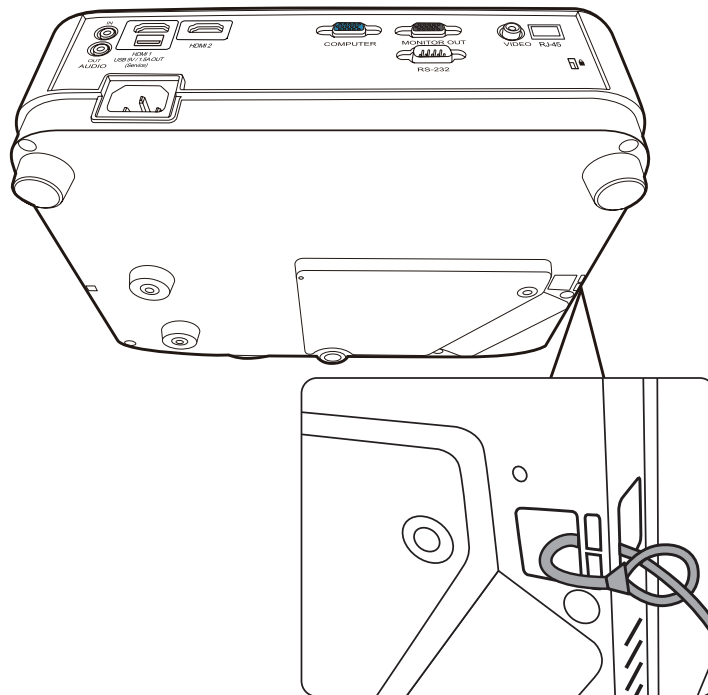

**NOTE:** The security slot can also be used as a safety anchor if the projector is mounted to the ceiling.

## Using the Password Function

To help prevent unauthorized access or use, the projector offers a password security option. The password can be set through the On-Screen Display (OSD) Menu.

**NOTE:** Make note of your password, and keep it in a safe place.

### Setting a Password

1. Press **Menu** to open the OSD Menu and go to: **SYSTEM > Security Settings** and press **Enter**.
2. Highlight **Power On Lock** and select **On** by pressing **◀/▶**.
3. As pictured to the right, the four arrow keys (**▲**, **▶**, **▼**, **◀**) represent 4 digits (1, 2, 3, 4). Press the arrow keys to enter a six digit password.



5. Confirm the new password by re-entering the new password. Once the password is set, the OSD Menu will return to the **Security Settings** page.
6. Press **Exit** to leave the OSD Menu.

**NOTE:** Once set, the correct password must be entered every time the projector is started.

## Changing the Password

1. Press **Menu** to open the OSD Menu and go to: **SYSTEM > Security Settings > Change Password**.
2. Press **Enter**, the message, 'INPUT CURRENT PASSWORD' will appear.
3. Enter the old password.
  - » If the password is correct, the message, 'INPUT NEW PASSWORD' will appear.
  - » If the password is incorrect, a password error message will appear for 5 seconds followed by the message, 'INPUT CURRENT PASSWORD'. You can try again or press **Exit** to cancel.
4. Enter a new password.
5. Confirm the new password by re-entering the new password.
6. To leave the OSD Menu, press **Exit**.

**NOTE:** The digits being input will display as asterisks (\*).

## Disabling the Password Function

1. Press **Menu** to open the OSD Menu and go to: **SYSTEM > Security Settings > Power On Lock**.
2. Press ◀/▶ to select **Off**.
3. The message, "Input Password" will appear. Enter the current password.
  - » If the password is correct, the OSD Menu returns to the Password page with "**Off**" shown in the row of **Power On Lock**.
  - » If the password is incorrect, a password error message will appear for 5 seconds followed by the message, 'INPUT CURRENT PASSWORD'. You can try again or press **Exit** to cancel.

**NOTE:** Please keep the old password, as you will need it to reactivate the password function.

## Forgetting the Password

If the password function is activated, you will be asked to enter the six-digit password every time you turn on the projector. If you enter the wrong password, the password error message, as pictured to the right, will appear for 5 seconds, and the message 'INPUT PASSWORD' follows.

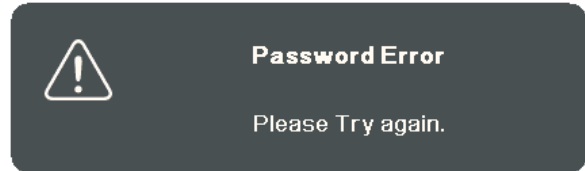

You can retry or if you do not remember, you can use the "Password Recall Procedure".

**NOTE:** If you enter an incorrect password 5 times in succession, the projector will automatically shut down for a short time.

## Password Recall Procedure

1. When the message 'INPUT CURRENT PASSWORD' appears, press and hold **Auto Sync** for 3 seconds. The projector will display a coded number on the screen.
2. Write down the number and turn off your projector.
3. Seek help from the local service center to decode the number. You may be required to provide proof of purchase documentation to verify that you are an authorized user of the projector.

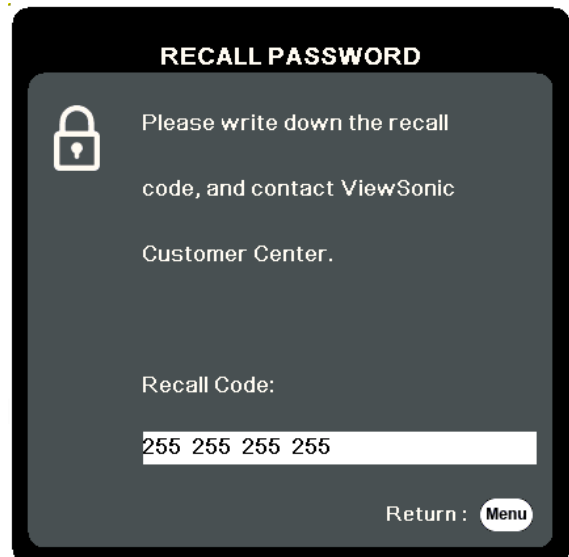



## Locking the Control Keys

With the control keys on the projector locked, you can prevent your settings from being changed accidentally (by children, for example).

**NOTE:** When the **Panel Key Lock** is On, no control keys on the projector will operate except **Power**.

1. Press **Menu** to open the OSD Menu and go to: **SYSTEM > Panel Key Lock**.
2. Press **▲/▼** to select **On**.
3. Select **Yes** and press **Enter** to confirm.
4. To release panel key lock, press and hold **▶** on the projector for 3 seconds.

**NOTE:** You can also use the remote control to enter the **SYSTEM > Panel Key Lock** menu and select **Off**.

## > Making Connections

This section guides you on how to connect the projector with other equipment.

### Connecting to Power

1. Connect the power cord to the AC IN jack at the rear of the projector.
2. Plug the power cord into a power outlet.

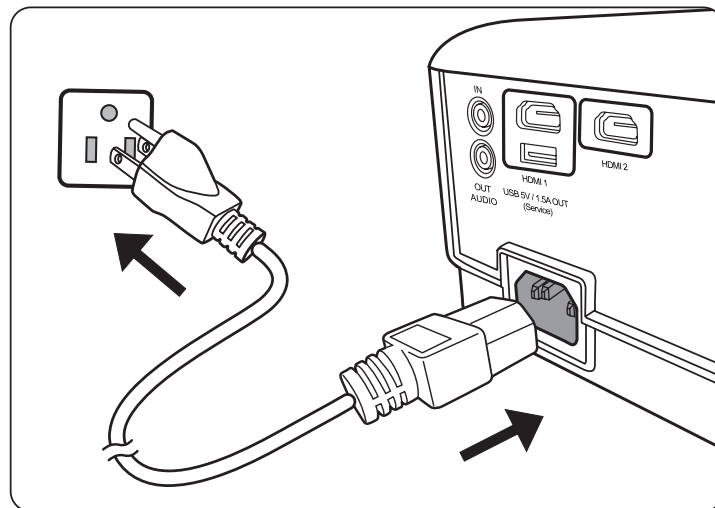

**NOTE:** When installing the projector, incorporate a readily accessible disconnect device in the fixed wiring, or connect the power plug to an easily accessible outlet near the unit. If a fault should occur during operation of the projector, use the disconnect device to switch off the power supply, or disconnect the power plug.

# Connecting to Video Sources

## HDMI Connection

Connect one end of an HDMI cable to the HDMI port of your video device. Then connect the other end of the cable to the **HDMI 1** or **HDMI 2** port of your projector.

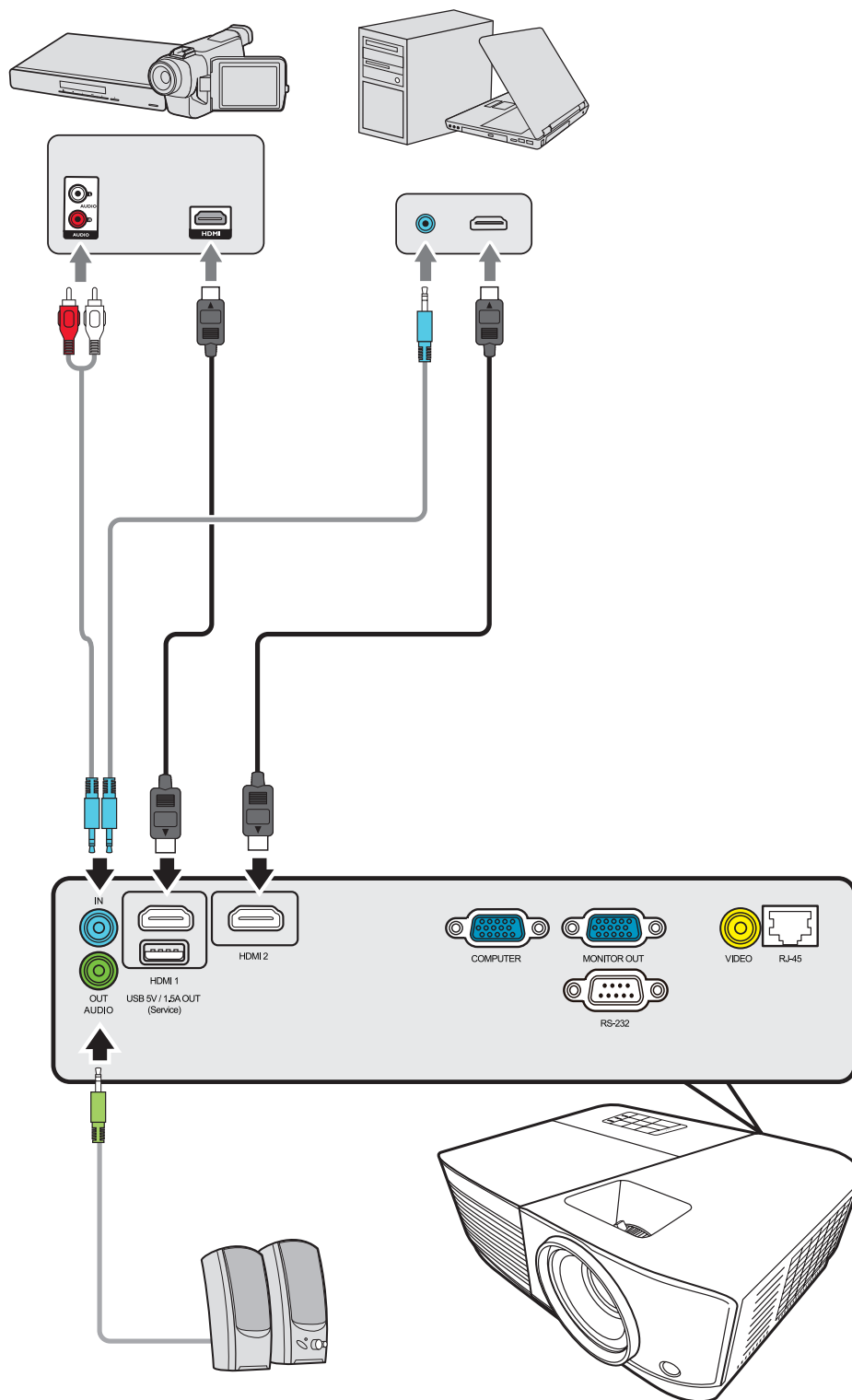

## Composite Video Connection

Connect one end of a Video cable to the Video port of your video device. Then connect the other end of the cable to the **VIDEO** port of your projector.

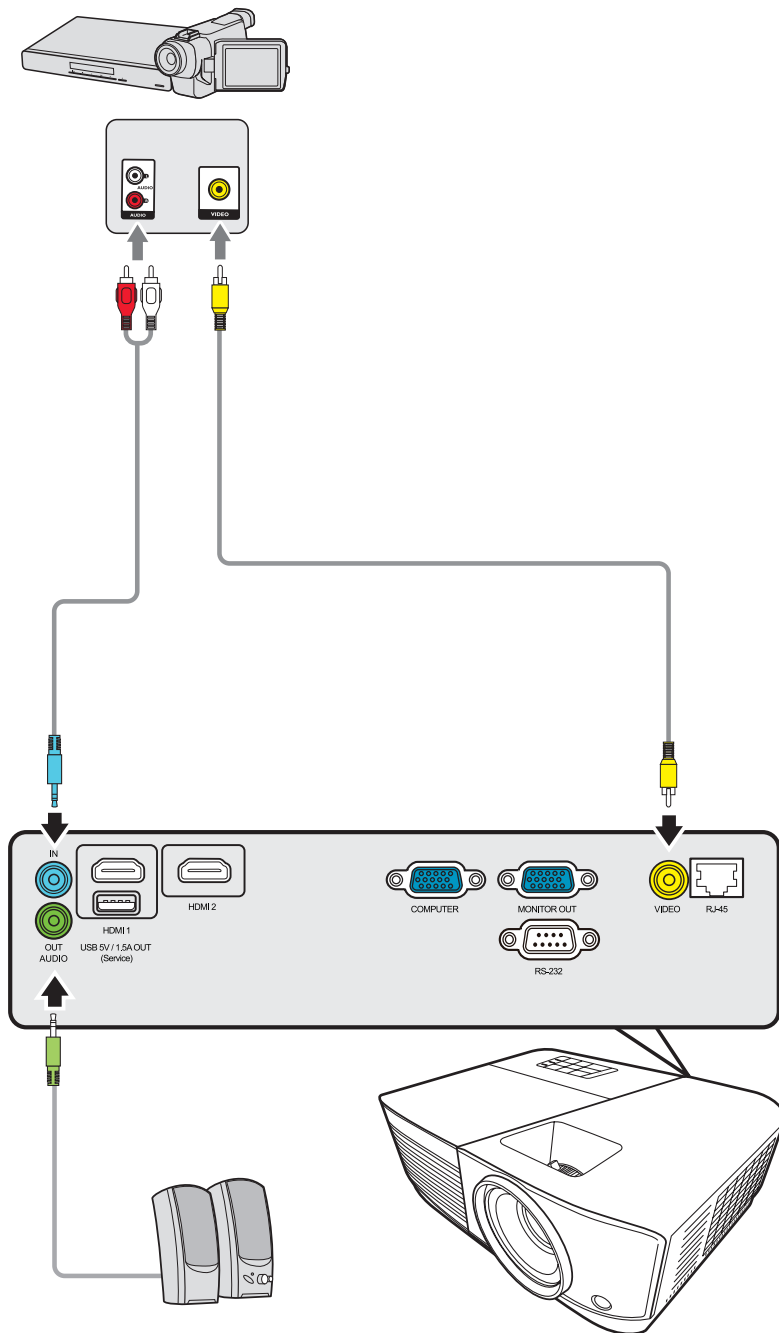

# Connecting to Computer Sources

## VGA Connection

Connect one end of a VGA cable to the VGA port of your computer. Then connect the other end of the cable to the **COMPUTER IN** port of your projector.

**NOTE:** Some notebooks do not turn on their external displays automatically when connected to a projector. You may have to adjust your notebook's projection settings.

## VGA Out Connection

After establishing the VGA Connection, connect one end of a VGA cable to the VGA port of your monitor. Then connect the other end of the cable to the **MONITOR OUT** port of your projector.

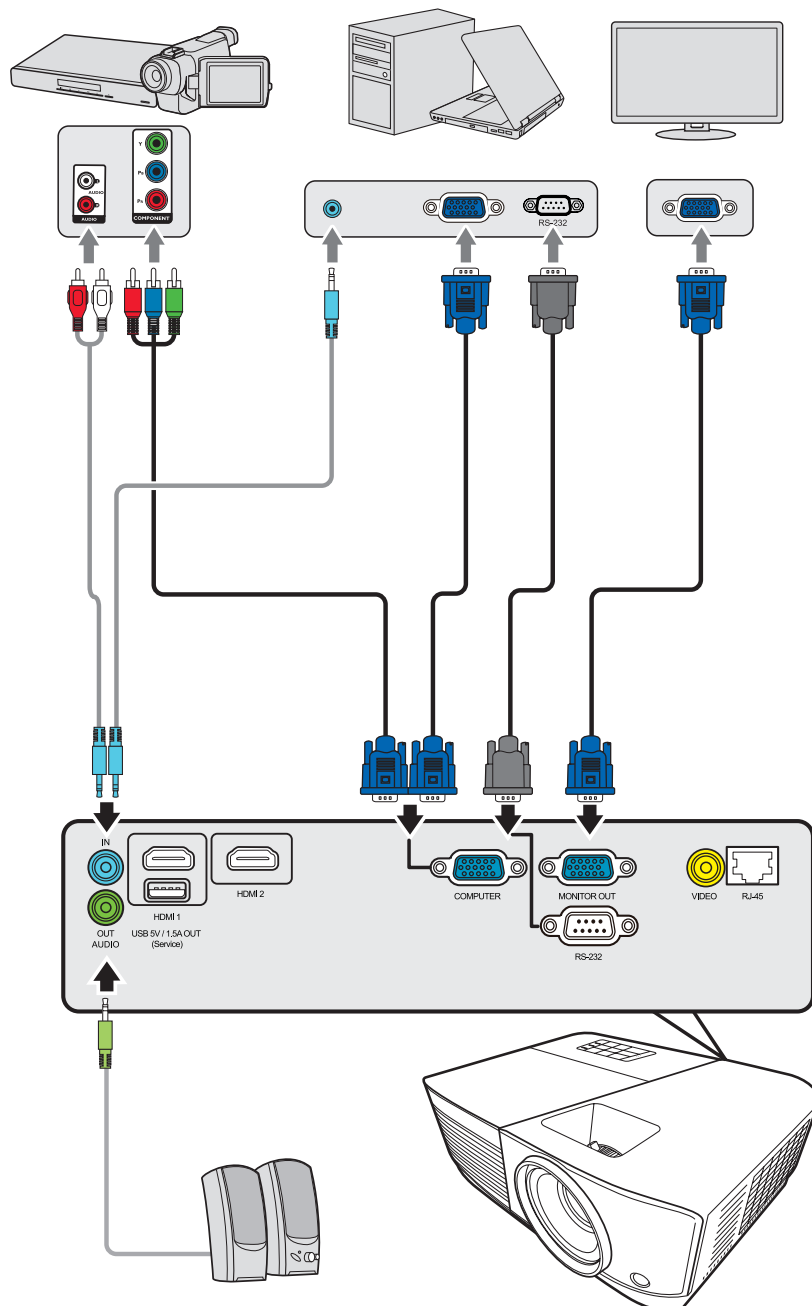

## Connecting to Audio

The projector is equipped with speakers, however, you can also connect external speakers to the **AUDIO OUT** port of the projector.

**NOTE:** The audio output is controlled by the projector's **Volume** and **Mute** settings.

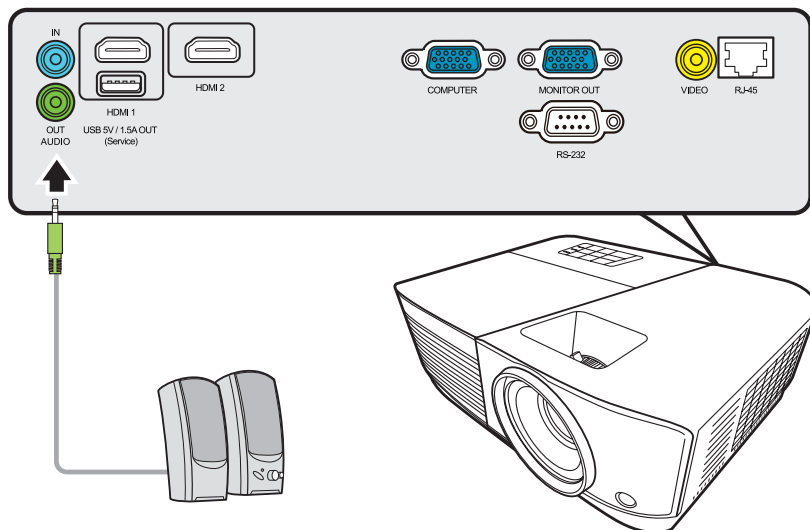

# > Operation

## Turning the Projector On/Off

### Starting Up the Projector

1. Press the **Power** button to turn on the projector.
2. The lamp will light up, and a “**Power On/Off Ring Tone**” will play.
3. The Power Indicator Light stays Green when the projector is On.

#### NOTE:

- If the projector is still hot from previous use, it will run the cooling fan for 90 seconds before activating the lamp.
  - To maintain lamp life, once you turn the projector On, wait at least five (5) minutes before turning it off.
4. Turn on all of the connected equipment, i.e. notebook, and the projector will start to search for an input source.

**NOTE:** If the projector detects an input source, the Source Selection Bar will appear. If an input source is not detected, the message, ‘No Signal’ will appear.

### First Time Activation

If the projector is activated for the first time, select your OSD language following the on-screen instructions.



## Shutting Down the Projector

1. Press the **Power** or **Off** button and a confirmation message will appear to prompt you to press the **Power** or **Off** button a second time. Additionally you can press any other button to cancel.

**NOTE:** If you do not respond in a few seconds after the first press, the message will disappear.

2. Once the cooling process finishes, a **“Power On/Off Ring Tone”** will play.
3. Disconnect the power cord from the power outlet if the projector will not be used for an extended period of time.

### **NOTE:**

- To protect the lamp, the projector will not respond to commands during the cooling process.
- Do not unplug the power cord before the projector completely shuts down.



## Selecting an Input Source

The projector can be connected to multiple devices at the same time. However, it can only display one full screen at a time.

If you want the projector to automatically search for the input source, ensure the **Quick Auto Search** function in the **SYSTEM** menu is **On**.

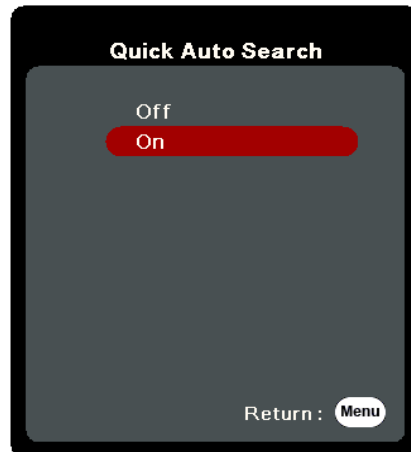

The **Input Source** can also be manually selected by pressing one of the source selection buttons on the remote control, or by cycling through the available input sources.

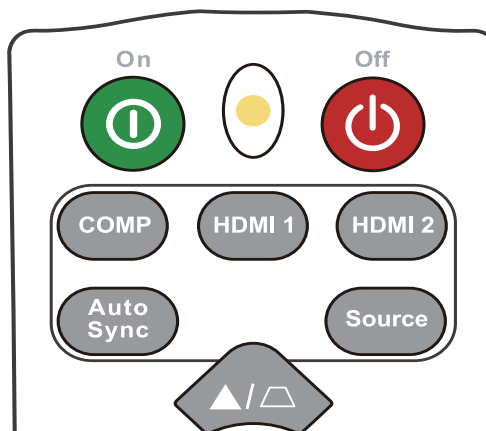

To manually select the input source do the following:

1. Press **Source**, and a source selection menu will appear.
2. Press **▲/▼** until your desired signal is selected and press **Enter**.
3. Once detected, the selected source information will be displayed on the screen for a few seconds.

**NOTE:** If there are multiple devices connected to the projector, repeat steps 1-2 to search for another source.

# Adjusting the Projected Image

## Adjusting the Projector's Height and Projection Angle

The projector is equipped with one (1) adjuster foot. Adjusting the foot will change the projector's height and the vertical projection angle. Carefully adjust the feet to fine tune the projected image's position.

## Auto-Adjusting the Image

Sometimes, you may need to improve the picture quality. To do this, press **Auto Sync** on the remote control. Within five (5) seconds, the built-in Intelligent Auto Adjustment function will re-adjust the Frequency and Clock values to provide the best picture quality.

Upon completion, the current source information will appear in the upper left corner for three (3) seconds.

**NOTE:** This function is only available when the PC D-Sub input source (analog RGB/ COMPUTER IN) is selected.

## Fine-Tuning the Image Size and Clarity

To adjust the projected image to the size that you need, rotate the Zoom Ring.

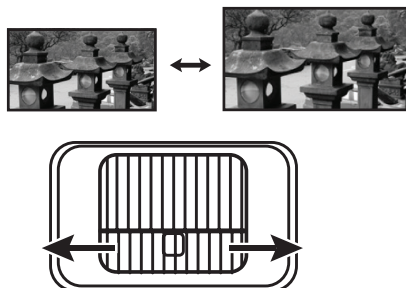



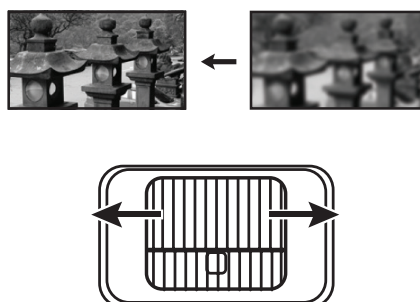

To improve the clarity of the image, rotate the Focus Ring.



## Correcting Keystone

Keystoning refers to the situation where the projected image becomes a trapezoid due to angled projection.

To correct this, besides adjusting the height of the projector, you may also:

1. Use the keystone keys on the projector or remote control to display the keystone page.
2. After the keystone page is displayed, press  to correct keystone at the top of the image. Press  to correct keystone at the bottom of the image. Press  to correct keystone at the right side of the image. Press  to correct keystone at the left side of the image.

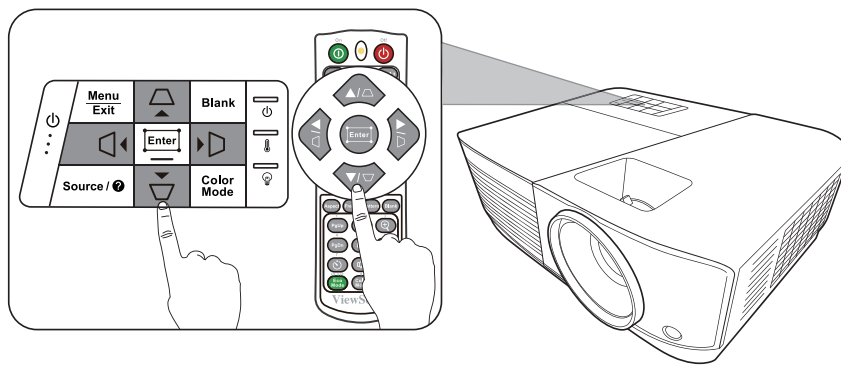
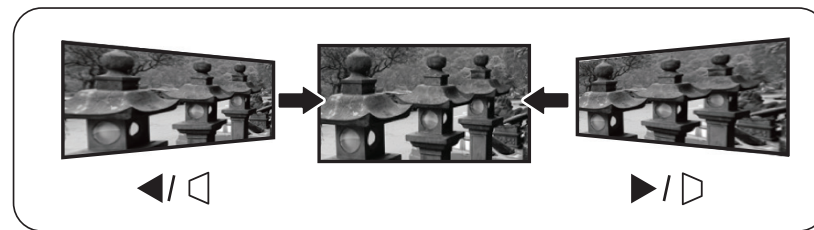
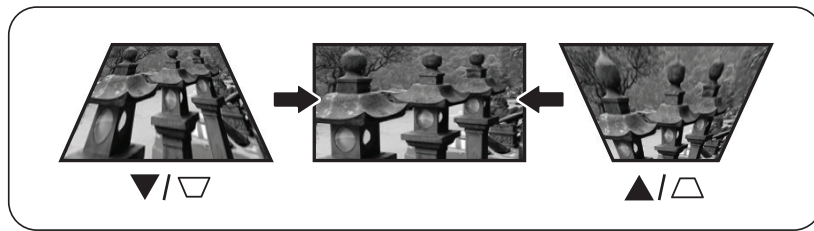

## Adjusting 4 corners

You can manually adjust the shape and size of an image that is unevenly rectangular on all sides.

1. To display the Corner Adj. page, you can do one of the followings:
  - Press **Enter**.
  - Open the OSD menu and go to the **DISPLAY > Corner Adj.** menu and press **Enter**.
2. Use ▲/▼/◀/▶ to select the corner you wish to adjust and press **Enter**.
3. Use ◀/▶ to select an adjustment method that suits your need and press **Enter**.
4. As indicated on the screen (▲/▼ for a 45-degree angle adjustment and ▲/▼/◀/▶ for a 90-degree angle adjustment), press ▲/▼/◀/▶ to adjust its shape and size. You can press **Menu** or **Exit** to go back to a previous step. A long press for 2 seconds on **Enter** will reset the settings on the corner that you chose.

### NOTE:

- Adjusting keystone will reset the **Corner Adj.** settings.
- After the **Corner Adj.** settings have been modified, some aspect ratios or timings are not available. When that happens, reset the settings on all 4 corners.

## Hiding the Image

In order to draw the audience's full attention to the presenter, you can press **Blank** on the projector or remote control to hide the screen image. Press any key on the projector or remote control to restore the image.

**CAUTION:** Do not block the projection lens as this could cause the blocking object to become heated and deformed or even cause a fire.

# Controlling the Projector through a LAN Environment

The projector supports Crestron® software. With correct settings for the LAN Control Settings menu, you can manage the projector from a computer using a web browser when the computer and the projector are properly connected to the same local area network.

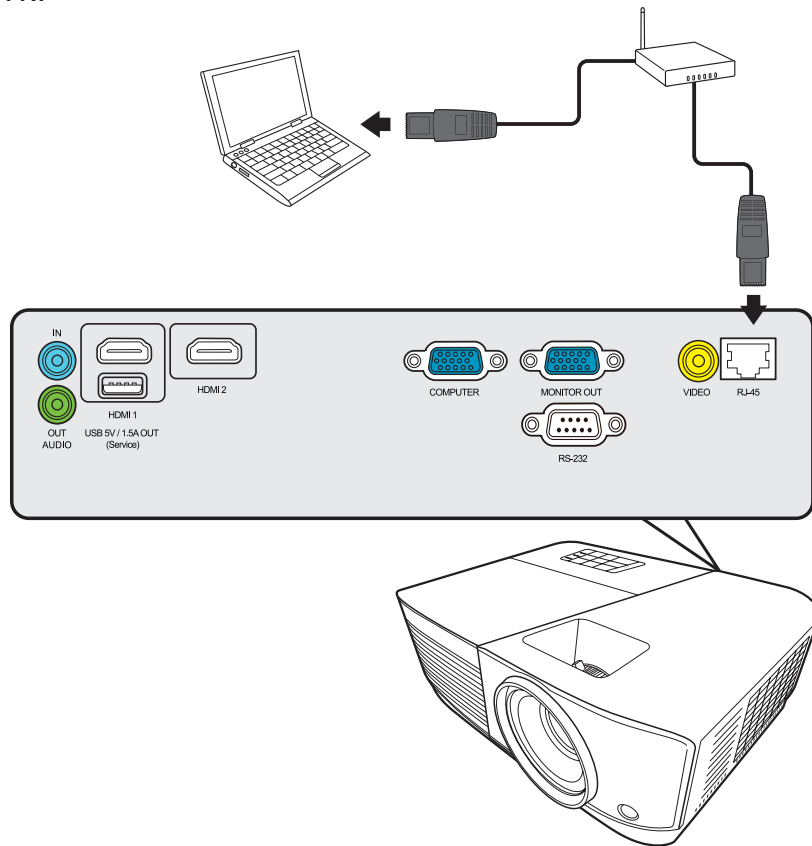

## Configuring the LAN Control Settings

- If you are in a DHCP environment:
  1. Take a RJ45 cable and connect one end to the RJ45 LAN input jack of the projector and the other end to the RJ45 port.
  2. Open the OSD menu and go to the **ADVANCED > LAN Control Settings** menu. Press **Enter** to display the **LAN Control Settings** page. Or you can press **Network** to open the **LAN Control Settings** menu directly.
  3. Highlight **LAN Settings** and press ◀ / ▶ to select **DHCP ON**.
  4. Press ▼ to highlight **Apply** and press **Enter**.
  5. Please wait for 15 - 20 seconds, and then re-enter the **LAN Settings** page. The **Projector IP Address, Subnet Mask, Default Gateway, DNS Server** settings will be displayed. Make note of the IP address displayed in the **Projector IP Address** row.

**NOTE:**

- If the **Projector IP Address** still does not appear, contact your network administrator.
  - If the RJ45 cables are not properly connected, the **Projector IP Address, Subnet Mask, Default Gateway** and **DNS Server** settings will display 0.0.0.0. Make sure the cables are properly connected and perform the procedures above again.
  - If you need to connect to the projector in its standby mode, set **Standby LAN Control** to **On** in the **ADVANCED > LAN Control Settings** menu.
- If you are in a non-DHCP environment:
    1. Repeat steps 1-2 above.
    2. Highlight **LAN Settings** and press ◀/▶ to select **Static IP**.
    3. Contact your ITS administrator for information on the **Projector IP Address, Subnet Mask, Default Gateway, DNS Server** settings.
    4. Press ▲/▼ to select the item you want to modify and press **Enter**.
    5. Press ◀/▶ to move the cursor and the press ▲/▼ to enter the value.
    6. To save the settings, press **Enter**. If you do not want to save the settings, press **Exit**.
    7. Press ▼ to highlight **Apply** and press **Enter**.

**NOTE:**

- If the RJ45 cables are not properly connected, the **Projector IP Address, Subnet Mask, Default Gateway, DNS Server** settings will display 0.0.0.0. Make sure the cables are properly connected and perform the procedures above again.
- If you wish to connect to the projector in its standby mode, be sure you have selected **Static IP** and obtained the **Projector IP Address, Subnet Mask, Default Gateway** and **DNS Server** information when the projector is on.

## Controlling the Projector through a Web Browser

Once you have the correct IP address for the projector and the projector is on or in standby mode, you can use any computer that is on the same local area network to control the projector.

**NOTE:**

- If you are using Microsoft Internet Explorer, make sure it is version 7.0 or higher.
- The screen shots in this manual are for reference only, and may differ from the actual design.
- Please pay attention to the limitation of input length (including space and other punctuation keys) in the list below:

Category Item		Input Length	Maximum Number of Characters
Network Settings	Network	DHCP/Manual	(N/A)
		IP Address	XXX.XXX.XXX.XXX
		Subnet Mask	XXX.XXX.XXX.XXX
		Gateway	XXX.XXX.XXX.XXX
		DNS Server	XXX.XXX.XXX.XXX
		AMX device discover	(N/A)
	Password	Administrator	(N/A)
		New Password	8
		Confirm Password	8
	SNMP	SysLocation	22
		SysName	22
		SysContact	22
Email Alert	Email Setting	To	40
		Cc	40
		Subject	40
		From	40
	SMTP Setting	Server	30
		User Name	21
		Password	14
	Alert Condition	Fan Error	(N/A)
		Lamp Error	(N/A)
		Over Temperature	(N/A)
		Submit	(N/A)
Issue Test Mail		(N/A)	

**NOTE:** / > < \$ % + \ ' " " ' are prohibited.

1. Enter the address of the projector in the address bar of your browser and press **Enter**.

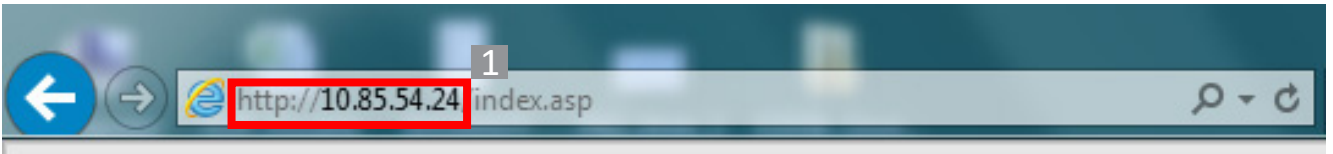

The main page of the Network Control will appear.

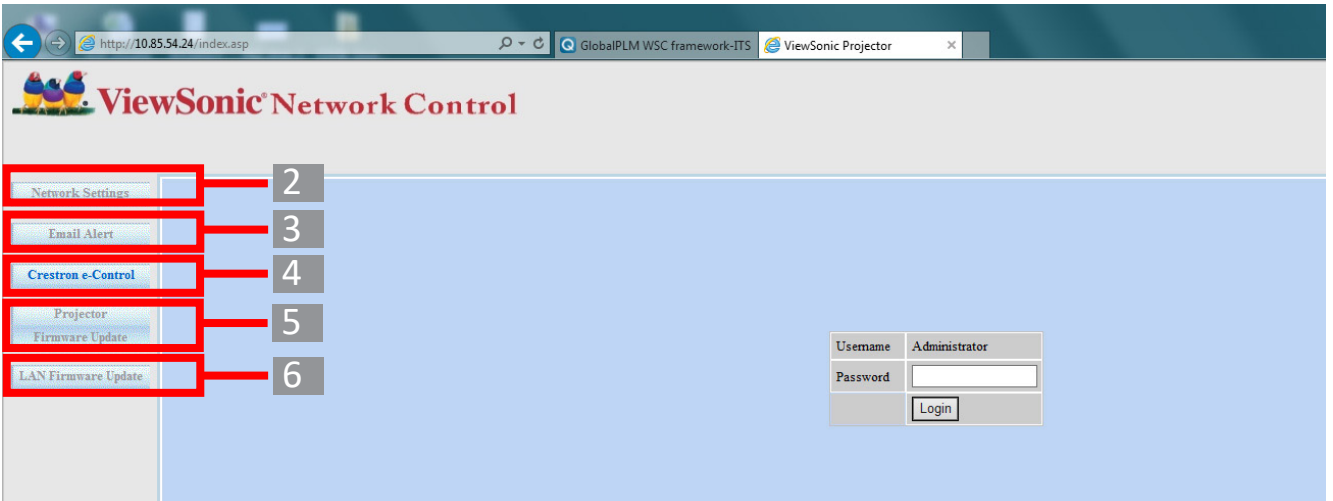

**NOTE:** Accessing the Network Settings, Email Alert page, or Projector/LAN Firmware Update page requires the Administrator's password. The default password is "0000".

2. This page allows you to make adjustments to the AMX and SNMP settings. In the **AMX device discover** row, when **ON** is selected, the projector can be detected by controllers of AMX connected to the same network. For the details of **AMX Device Discovery**, visit the AMX web site at <http://www.amx.com/>.





3. If your projector is connected to a network which supports Simple Mail Transfer Protocol (SMTP), you can configure it to alert you via email on significant events.

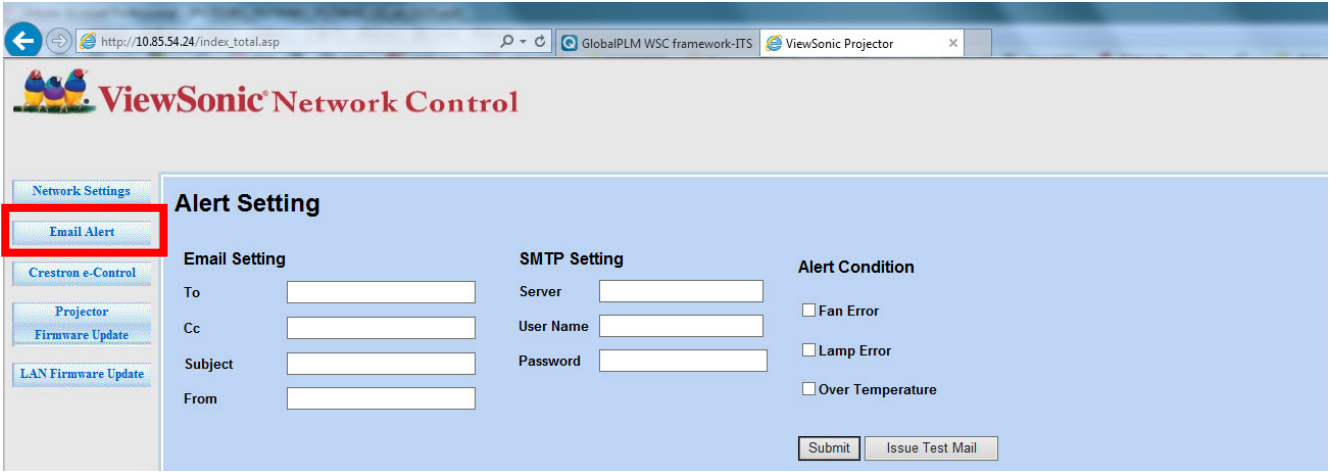

4. The **Crestron (e-Control)**® page displays the Crestron e-Control user interface.

5. Projector Firmware Update

i. Visit ViewSonic’s website to download the Projector Software Update Firmware by LAN: <https://www.viewsonic.com>.

ii. Upload the Projector Firmware file to the Network Control website.

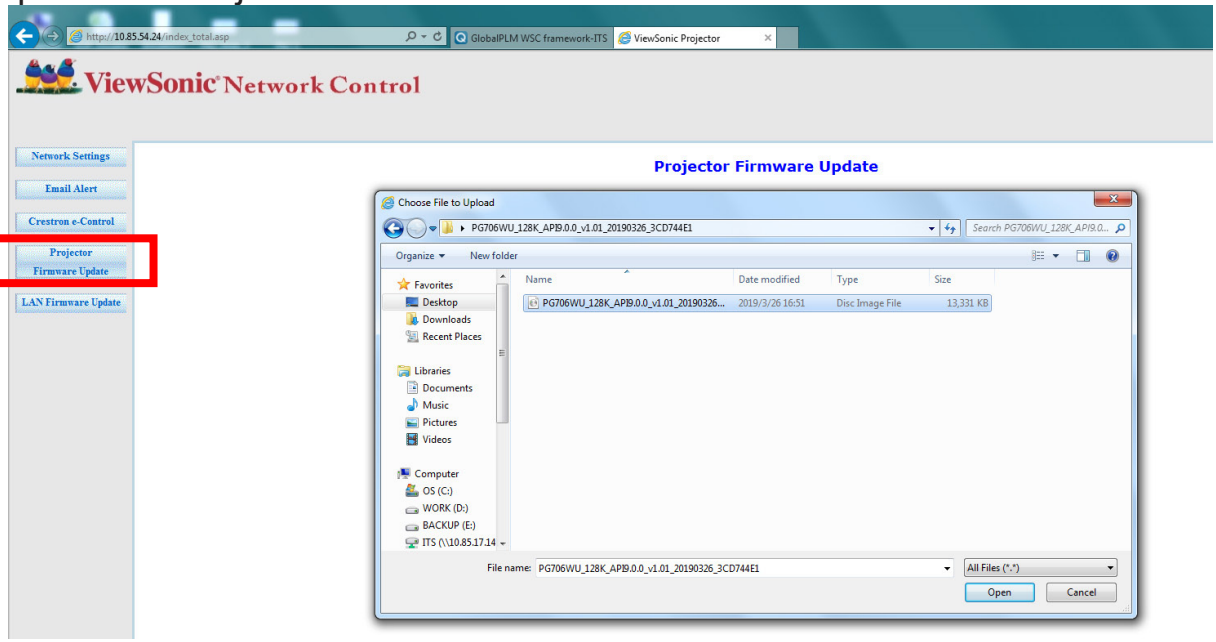

iii. Please read the Warning message and press the “OK” button to confirm the update.

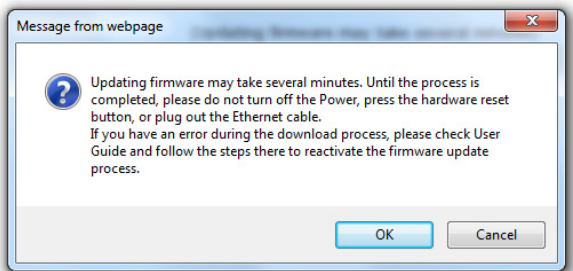

**NOTE:** If the download process fails, please refer to the “Projector Software Update Firmware by USB” below.

**A.** Visit ViewSonic’s website to download the Projector Software Update Firmware : **<https://www.viewsonic.com>**.

**B.** Connect the USB A cable to the projector and computer.

**C.** Continuously press the projector’s **Power** Key and **Menu** Key while connected to a power outlet.

**D.** The LED will begin to flash, and downloading will restart.

**v.** The software program will start automatically. Please wait for a few minutes until it is completed.

**vi.** Click “Exit” once the update has finished.

**CAUTION:** Do not turn off the projector or computer while updating.

## 6. LAN Firmware Update

**i.** Visit ViewSonic’s website to download the LAN Firmware: **<https://www.viewsonic.com>**.

**ii.** Upload the LAN Firmware file to the Network Control website.

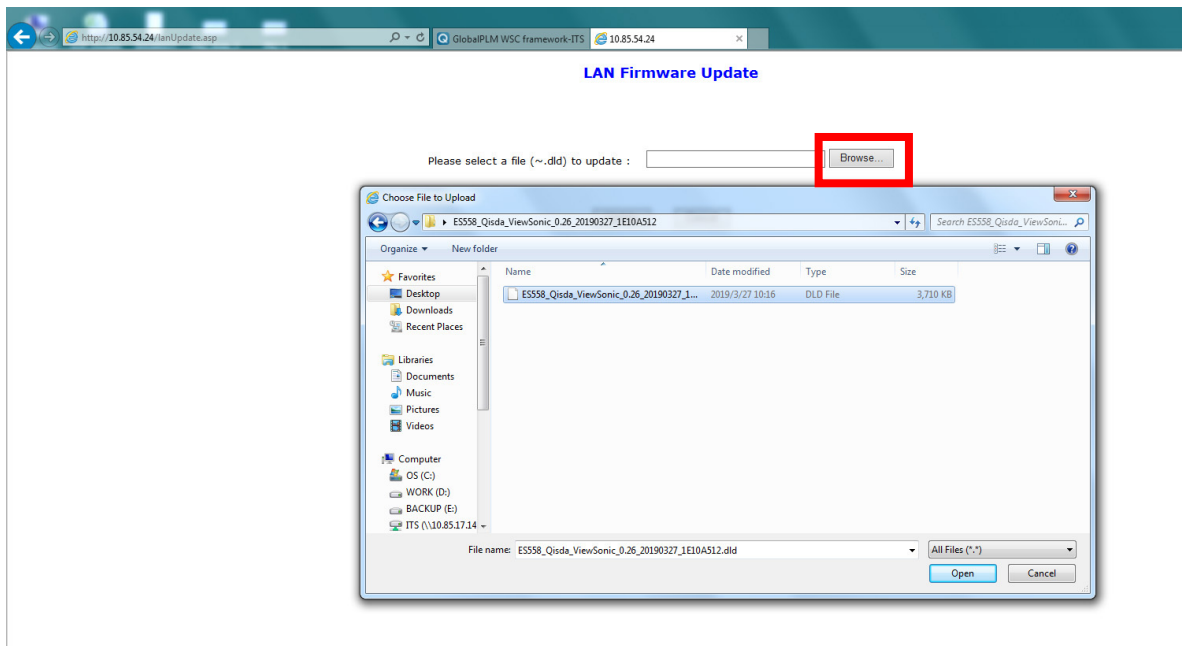

**iii.** After finishing the LAN Firmware update, please go to **Crestron e-Control®** page and click the “info” button to check the LAN Firmware version.

## About Crestron e-Control®

1. The Crestron e-Control® page provides a variety of virtual keys to control the projector or adjust the projected pictures.

You can press ◀/▶ to reveal more buttons.



- i. These buttons function the same as the ones on the OSD menus or remote control.
- ii. To switch between input signals, click on your desired signal.

### NOTE:

- The source list varies according to the connections available on the projector.
- When you use the projector control panel or remote control to change the OSD menu settings, it may take a while for the web browser to synchronize these changes with the projector.

2. The **Tools** page allows you to manage the projector, configure the LAN control settings and secure access to remote network operations on this projector.

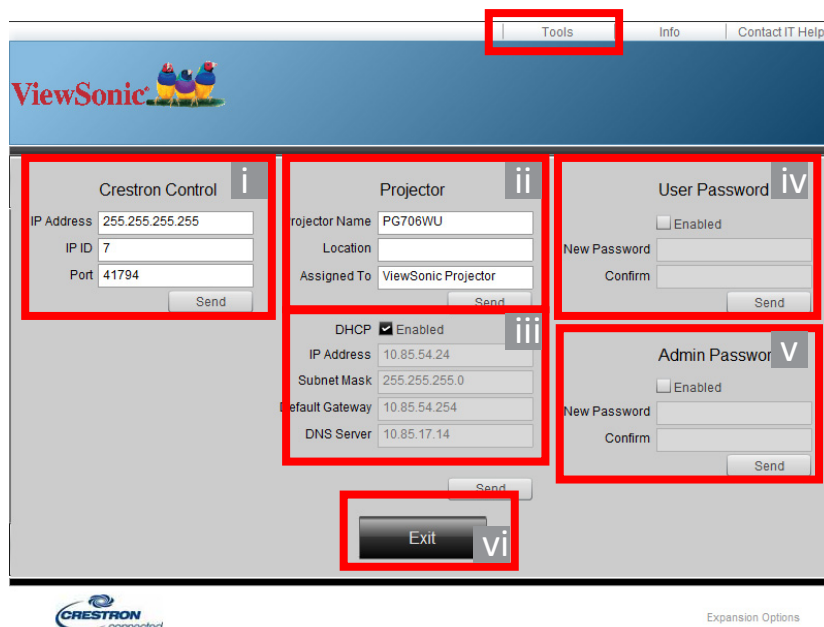

- i. This section is only used with the Crestron Control System. Please contact Creston or refer to its user manual for setup information.
- ii. You can name the projector, keep track of its location and the person in charge of it.
- iii. You can adjust the **LAN Control Settings**.
- iv. Once set, access to the remote network operation on this projector will be password-protected.
- v. Once set, access to the tools page will be password-protected.

**NOTE:**

- To prevent errors, only input the English alphabet and digits on the **Tools** page.
- After making the adjustments, press the “Send” button and the data will be saved for the projector.

- vi. Press “Exit” to go back to the Remote Network Operation page.

Please pay attention to the limitation of input length (including space and other punctuation keys) in the list blow:

Category Item	Input Length	Maximum Number of Characters
Crestron Control	IP Address	16
	IP ID	4
	Port	5
Projector	Projector Name	22
	Location	22
	Assigned To	22
Network Configuration	DHCP (Enabled)	(N/A)
	IP Address	15
	Subnet Mask	15
	Default Gateway	15
	DNS Server	15
User Password	Enabled	(N/A)
	New Password	15
	Confirm	15
Admin Password	Enabled	(N/A)
	New Password	15
	Confirm	15

3. The **Info** page displays the information and status of the projector.

Press “Exit” to go back to the Remote Network Operation page.

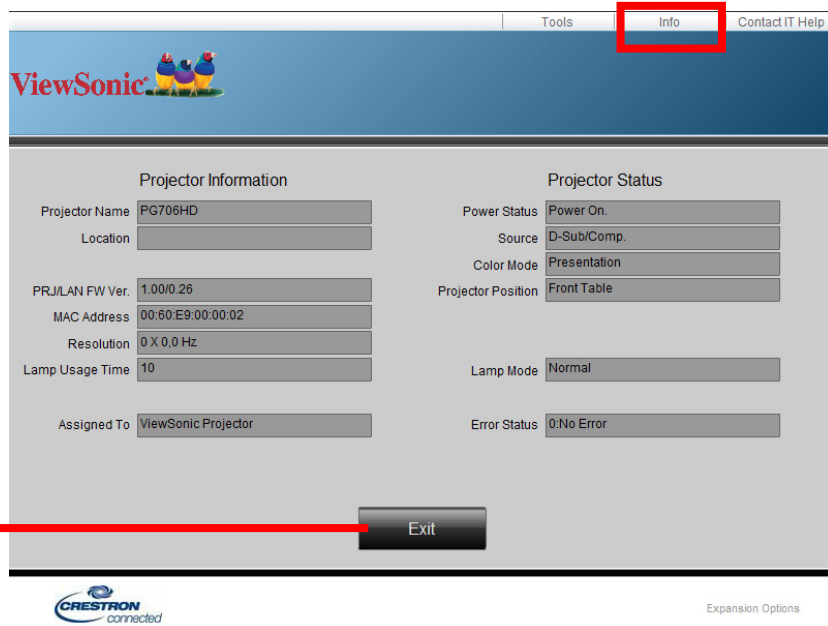

4. After selecting the “**Contact IT Help**”, the HELP DESK window will appear in the upper right corner of the screen. You will be able to deliver messages to RoomView™ software administrators/users who are connected to the same local area network.

For more information, visit <http://www.crestron.com> & [www.crestron.com/getroomview](http://www.crestron.com/getroomview).

## Crestron RoomView

On the “Edit Room” page, enter the IP Address (or hostname) as shown on the projector’s on-screen display (OSD) menu, and “02” for IPID, “41794” for the reserved Crestron control port.

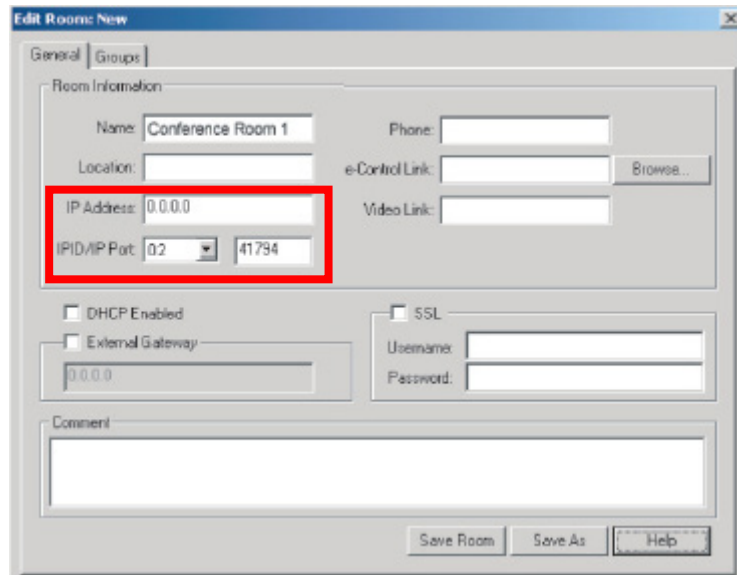

The screenshot shows the 'Edit Rooms: New' dialog box with the following fields and values:

- Name: Conference Room 1
- Phone: [Empty]
- Location: [Empty]
- e-Control Link: [Empty] (with a 'Browse...' button)
- Video Link: [Empty]
- IP Address: 0.0.0.0
- IPID/IP Port: 02 (dropdown) | 41794
- DHCP Enabled:
- External Gateway: 0.0.0.0
- SSL:
- Username: [Empty]
- Password: [Empty]
- Comment: [Empty text area]
- Buttons: Save Room, Save As, Help

Please go to the below website to get the RoomView™ User Guide and more information:

[http://www.crestron.com/products/roomview\\_connected\\_embedded\\_projectors\\_devices/resources.asp](http://www.crestron.com/products/roomview_connected_embedded_projectors_devices/resources.asp)

## PJLink™, SNMP, AMX and Xpanel Formats Supported

This projector is PJLink™, SNMP V.1, AMX or Xpanel V1.10 compliant. For details, please follow its user guide or website respectively to control and manage projectors.

# > Menu Functions

This section will introduce the On-Screen Display (OSD) Menu and its options.

## General On-Screen Display (OSD) Menu Operation

**NOTE:** The OSD screenshots in this manual are for reference only and may differ from the actual design. Some of the following OSD settings may not be available. Please refer to the actual OSD of your projector.

The projector is equipped with an On-Screen Display (OSD) Menu for making various adjustments. It can be accessed by pressing **Menu** on the projector or remote control.

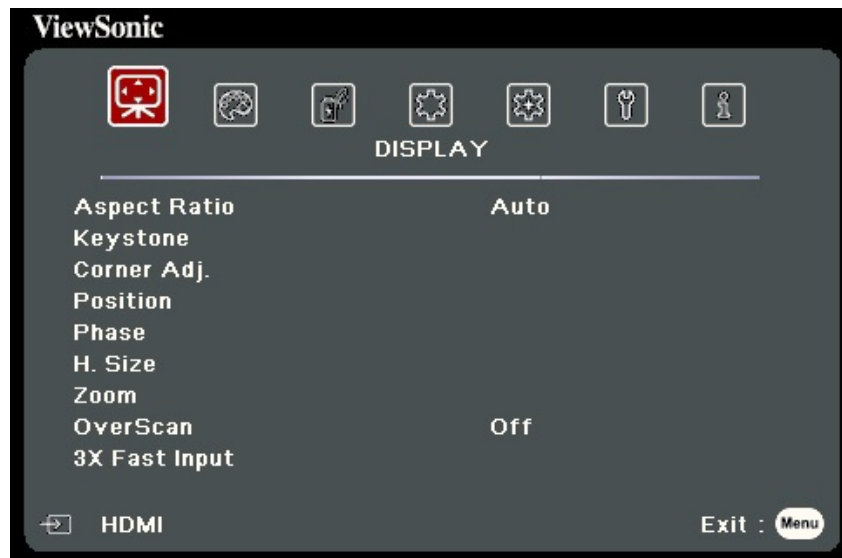

1. Press ◀/▶ to select a main menu. Then press **Enter** or use ▲/▼ to access the sub-menu list.
2. Press ▲/▼ to select the menu option. Then press **Enter** to display its sub-menu, or press ◀/▶ to adjust/select the setting.

**NOTE:** Some sub-menu options may have another sub-menu. To enter the respective sub-menu, press **Enter**. Use ▲/▼ or ◀/▶ to adjust/select the setting.

## On-Screen Display (OSD) Menu Tree

Main Menu	Sub-menu	Menu Option	
DISPLAY	Aspect Ratio	Auto	
		4:3	
		16:9	
		16:10	
		Native	
	Keystone	Vertical	-40~40
		Horizontal	-40~40
	Corner Adj.	Top-Right	45°/90°
		Top-Left	45°/90°
		Bottom-Right	45°/90°
		Bottom-Left	45°/90°
	Position	X: -5 ~ 5, Y: - 5 ~ 5	
	Phase	0~31	
	H. Size	-15~15	
	Zoom	0.8X ~2.0X	
	OverScan	Off/1/2/3/4/5	
	3X Fast Input	Inactive	
Active			



Main Menu	Sub-menu	Menu Option		
IMAGE	Color Mode	Brightest		
		Presentation		
		Standard		
		Photo		
		Movie		
		User 1		
		User 2		
	Brightness	0~100		
	Contrast	-50~50		
	Color Temp.	8000K/6500K/5500K		
		Red Gain	0~100	
		Green Gain	0~100	
		Blue Gain	0~100	
		Red Offset	-50~+50	
		Green Offset	-50~+50	
		Blue Offset	-50~+50	
	Advanced	Color	-50~50	
		Tint	-50~50	
		Sharpness	0~31	
		Gamma	1.8/2.0/2.2/2.35/ 2.5/Cubic/sRGB	
		Brilliantcolor	Off/1/2/3/4/ 5/6/7/8/9/10	
		Noise Reduction	0~31	
		Color Management	Primary Color	
			Hue	
			Saturation	
			Gain	
	Reset Color Settings	Reset		
Cancel				

Main Menu	Sub-menu	Menu Option		
<b>POWER MANAGEMENT</b>	Auto Power On	Signal	Disable/VGA/HDMI/All	
		CEC	Disable/Enable	
		Direct Power On	Disable/Enable	
	Smart Energy	Auto Power Off	Disable/10 min/20 min/30 min	
		Sleep Timer	Disable/30 min/1 hr/2hr/3 hr/4 hr/ 8 hr/12 hr	
		Power Saving	Disable/Enable	
	Standby Settings	VGA Loop Through	Off/On	
		Audio Pass Through	Off/On	
	Quick Power Off	Disable		
		Enable		
	USB A Power	On		
		Off		
	<b>BASIC</b>	Audio Settings	Mute	Off/On
Audio Volume			0~20	
Power On/Off Ring Tone			Off/On	
Presentation Timer		Timer Period	1~240 m	
		Timer Display	Always/1 min/2 min/3 min/Never	
		Timer Position	Top-Left/Bottom-Left/Top-Right/Bottom-Right	
		Timer Counting Direction	Count Down/Count Up	
		Sound Reminder	Off/On	
		Start Counting/Off		
		Pattern		
Blank Timer		Off		
		Test Card		
Blank Timer		Disable/5 min/10 min/15 min/20 min/25 min/30 min		

Main Menu	Sub-menu	Menu Option	
<b>BASIC</b>	Message	Off	
		On	
	Splash Screen	Black	
		Blue	
		ViewSonic	
	<b>ADVANCED</b>	3D Settings	
Off			
Frame Sequential			
Frame Packing			
Top-Bottom			
Side-by-Side			
3D Sync Invert			Disable/Invert
Save 3D Settings			Yes/No
HDMI Settings		HDMI Format	Auto/RGB/YUV
		HDMI Range	Auto/Enhanced/Normal
LAN Control Settings		LAN Settings	DHCP ON/Static IP
		Projector IP Address	
		Subnet Mask	
		Default Gateway	
		DNS Server	
		Standby LAN Control	Off/On
		Apply	

Main Menu	Sub-menu	Menu Option		
<b>ADVANCED</b>	Light Source Settings	Light Source Mode	Normal/Eco/ Dynamic Eco/ SuperEco+	
		Reset Light Source Hours	Reset/Cancel	
		Light Source Hours Information	Light Source Usage Time	Normal
			Eco	
			Dynamic Eco	
			SuperEco+	
			Equivalent Light Source Hour	
	Closed Caption	Closed Caption Enable	Off/On	
		Caption Version	CC1/CC2/CC3/CC4	
	Reset Settings	Reset		
		Cancel		
<b>SYSTEM</b>	Language	Multi-Language OSD Selection		
	Projector Position	Front Table		
		Rear Table		
		Rear Ceiling		
		Front Ceiling		
	Menu Settings	Menu Display Time	5 sec/10 sec/15 sec/20 sec/25 sec/30 sec	
		Menu Position	Center/Top-Left/ Top-Right/ Bottom-Left/ Bottom-Right	
	High Altitude Mode	Off		
		On		
	Quick Auto Search	Off		
		On		
Security Settings	Change Password			
	Power On Lock	Off/On		

Main Menu	Sub-menu	Menu Option	
<b>SYSTEM</b>	Panel Key Lock	Off	
		On	
	Remote Control Code	1/2/3/4/5/6/7/8	
	Control Method	RS-232	
		USB	
Baud Rate	2400/4800/9600/14400/19200/38400/57600/115200		
<b>INFORMATION</b>	Source		
	Color Mode		
	Resolution		
	Color System		
	IP address		
	MAC address		
	Firmware Version		
	3X Fast Input		
	S/N		

## DISPLAY Menu

1. Press the **Menu** button to display the On-Screen Display (OSD) Menu.
2. Press ◀/▶ to select the **DISPLAY** menu. Then press **Enter** or use ▲/▼ to access the **DISPLAY** menu.

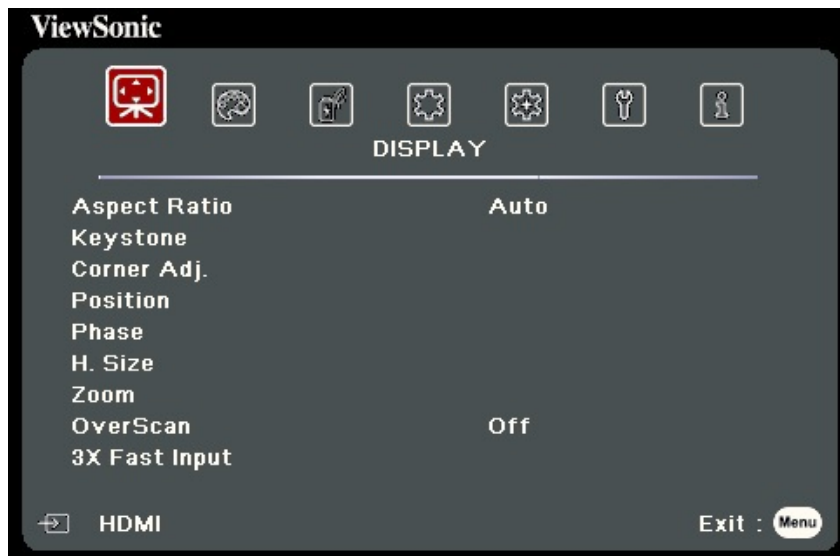

3. Press ▲/▼ to select the menu option. Then press **Enter** to display its sub-menu, or press ◀/▶ to adjust/select the setting.

**NOTE:** Some sub-menu options may have another sub-menu. To enter the respective sub-menu, press **Enter**. Use ▲/▼ or ◀/▶ to adjust/select the setting.

Menu Option	Description
Aspect Ratio	<p><u>Auto</u> Scales an image proportionally to fit the projector's native resolution in its horizontal width. This is suitable for the incoming image which is neither in 4:3 nor 16:9 and you want to make most use of the screen without altering the image's aspect ratio.</p> <p><u>4:3</u> Scales an image so that it is displayed in the center of the screen with a 4:3 aspect ratio. This is most suitable for 4:3 images like computer monitors, standard definition TV, and 4:3 aspect DVD movies, as it displays them without aspect alteration.</p> <p><u>16:9</u> Scales an image so that it is displayed in the center of the screen with a 16:9 aspect ratio. This is most suitable for images which are already in a 16:9 aspect, like high definition TV, as it displays them without aspect alteration.</p> <p><u>16:10</u> Scales an image so that it is displayed in the center of the screen with a 16:10 aspect ratio. This is most suitable for images which are already in a 16:10 aspect, as it displays them without aspect alteration.</p> <p><u>Native</u> Projects an image as its original resolution and resizes it to fit within the display area. For input signals with lower resolutions, the projected image will be displayed in its original size.</p>
Keystone	Adjusts the keystone situation where the projected image becomes a trapezoid due to angled projection.
Corner Adj.	Adjusts the shape and size of an image that is unevenly rectangular on all sides.
Position	<p>Adjust the position of the projected image.</p> <p><b>NOTE:</b></p> <ul style="list-style-type: none"> <li>• This function is only available when a PC input signal is selected.</li> <li>• The adjustment range may vary under different timings.</li> </ul>
Phase	<p>Adjusts the clock phase to reduce image distortion.</p> <p><b>NOTE:</b> This function is only available when a PC input signal is selected.</p>

Menu Option	Description
H. Size	Adjusts the horizontal width of the image. <b>NOTE:</b> This function is only available when a PC input signal is selected.
Zoom	Magnifies the projected image and allows you to navigate the image.
OverScan	Adjusts the overscan rate from 0% to 5%. <b>NOTE:</b> This function is only available when a Composite Video or HDMI input signal is selected.
3X Fast Input	This function is favorable to frame rate reducing. Quick response time in native timing can be achieved. When enabled, the following settings will return to factory preset values: Aspect Ratio, Keystone, Corner Adj., Position, Zoom, OverScan. <b>NOTE:</b> This function is only available when a native timing input signal is selected.







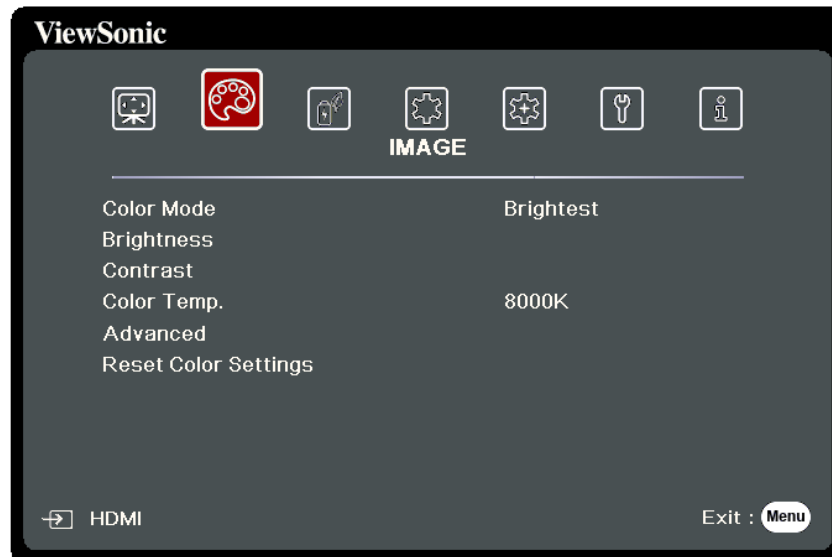







## IMAGE Menu

1. Press the **Menu** button to display the On-Screen Display (OSD) Menu.
2. Press ◀/▶ to select the **IMAGE** menu. Then press **Enter** or use ▲/▼ to access the **IMAGE** menu.



3. Press ▲/▼ to select the menu option. Then press **Enter** to display its sub-menu, or press ◀/▶ to adjust/select the setting.

**NOTE:** Some sub-menu options may have another sub-menu. To enter the respective sub-menu, press **Enter**. Use ▲/▼ or ◀/▶ to adjust/select the setting.

Menu Option	Description
Color Mode	<p><u>Brightest</u> Maximizes the brightness of the projected image. This mode is suitable for environments where extra-high brightness is required, such as using the projector in well lit rooms.</p> <p><u>Presentation</u> Designed for presentations under daylight environment to match PC and notebook coloring.</p> <p><u>Standard</u> Designed for normal circumstances in a daylight environment.</p> <p><u>Photo</u> Designed for photo viewing.</p> <p><u>Movie</u> For playing colorful movies, video clips from digital cameras or DVs through the PC input for best viewing in a blackened (little light) environment.</p> <p><u>User 1/User 2</u> Recalls the customized settings. After User 1/User 2 is selected, some of the sub-menus under the <b>IMAGE</b> menu can be adjusted, according to your selected input source.</p>
Brightness	<p>The higher the value, the brighter the image. Adjust this option so the black areas of the image appear just as black and details in the dark area are more visible.</p> <div style="display: flex; justify-content: space-around; align-items: flex-end;">    </div> <div style="display: flex; justify-content: space-around; align-items: center; margin-top: 5px;"> <div style="text-align: center;">  -30         </div> <div style="text-align: center;">  50         </div> <div style="text-align: center;">  +80         </div> </div>
Contrast	<p>Use this to set the peak white level after you have previously adjusted the <b>Brightness</b> setting.</p> <div style="display: flex; justify-content: space-around; align-items: flex-end;">    </div> <div style="display: flex; justify-content: space-around; align-items: center; margin-top: 5px;"> <div style="text-align: center;">  -30         </div> <div style="text-align: center;">  0         </div> <div style="text-align: center;">  +40         </div> </div>

Menu Option	Description
Color Temp.	<p><u>8000K</u> Images appear bluish white.</p> <p><u>6500K</u> Images maintain a normal white appearance.</p> <p><u>5500K</u> Images appear reddish white.</p> <p>To set a custom color temperature, you can further adjust the following items:</p> <p><u>Red Gain/Green Gain/Blue Gain</u> Adjusts the Contrast levels of Red, Green, and Blue.</p> <p><u>Red Offset/Green Offset/Blue Offset</u> Adjusts the Brightness levels of Red, Green, and Blue.</p>
Advanced	<p><u>Color</u> A lower setting produces less saturated colors. If the setting is too high, colors will be overpowering and may appear unrealistic.</p> <p><u>Tint</u> A higher value will make the picture more greenish while a lower value will make the picture more reddish.</p> <p><u>Sharpness</u> A higher value will sharpen the image, while a lower value will soften the image.</p> <p><u>Gamma</u> Gamma refers to the brightness level of the projector's grayscale levels.</p> <p><u>Brilliantcolor</u> This feature utilizes a new color-processing algorithm and system level enhancements to enable higher brightness while providing truer, more vibrant colors in the projected picture. It enables a greater than 50% brightness increase in mid-tone images, which are common in video and natural scenes, so the projector reproduces images in realistic and true colors. If you prefer images with that quality, select a level that suits your need.</p>

Menu Option	Description
Advanced	<p><u>Noise Reduction</u>  This function reduces electrical image noise caused by different media players. The higher the setting, the less the noise. (Not available when input signal is HDMI.)</p> <p><u>Color Management</u>  Only in permanent installations with controlled lighting levels such as boardrooms, lecture theaters, or home theaters, should color management be considered. Color management provides fine color control adjustment to allow for more accurate color reproduction. Select Primary Color first and adjust its range/values in Hue, Saturation and Gain.</p>
Reset Color Settings	Returns current image settings to the factory preset values.

# POWER MANAGEMENT Menu

1. Press the **Menu** button to display the On-Screen Display (OSD) Menu.
2. Press ◀/▶ to select the **POWER MANAGEMENT** menu. Then press **Enter** or use ▲/▼ to access the **POWER MANAGEMENT** menu.

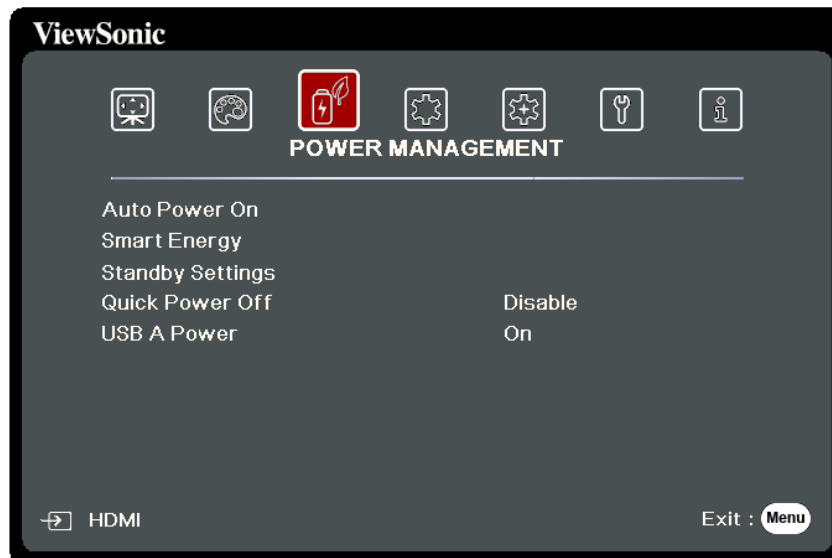

3. Press ▲/▼ to select the menu option. Then press **Enter** to display its sub-menu, or press ◀/▶ to adjust/select the setting.

**NOTE:** Some sub-menu options may have another sub-menu. To enter the respective sub-menu, press **Enter**. Use ▲/▼ or ◀/▶ to adjust/select the setting.

Menu Option	Description
Auto Power On	<p><u>Signal</u> Selecting VGA/HDMI allows the projector to turn on automatically once the VGA/HDMI signal is fed through the VGA/HDMI cable. You can also select All and the projector will turn on automatically upon receiving either a VGA or HDMI signal.</p> <p><u>CEC</u> This projector supports CEC (Consumer Electronics Control) function for synchronized power on/off operation via HDMI connection. That is, if a device that also supports CEC function is connected to the HDMI input of the projector, when the projector's power is turned off, the power of the connected device will also be turned off automatically. When the power of the connected device is turned on, the projector's power will be turned on automatically.</p> <p><b>NOTE:</b></p> <ul style="list-style-type: none"> <li>• In order for the CEC function to work properly, make sure that the device is correctly connected to the HDMI input of the projector via an HDMI cable, and its CEC function is turned on.</li> <li>• Depending on the connected device, the CEC function may not work.</li> </ul> <p><u>Direct Power On</u> Allows the projector to turn on automatically once power is fed through the power cord.</p>
Smart Energy	<p><u>Auto Power Off</u> Allows the projector to turn off automatically after a set period of time once no input source is detected to prevent unnecessary waste of lamp life.</p> <p><u>Sleep Timer</u> Allows the projector to turn off automatically after a set period of time to prevent unnecessary waste of lamp life.</p> <p><u>Power Saving</u> Lowers power consumption if no input source is detected. When Enable is selected, the projector lamp mode will change to SuperEco+ mode after no signal is detected for five (5) minutes. This will also help prevent any unnecessary waste of lamp life.</p>

Menu Option	Description
Standby Settings	<p>The functions below are available in standby mode (plugged in, but not turned on).</p> <p><u>VGA Loop Through</u> When selecting On, the projector outputs the signal received only from COMPUTER IN.</p> <p><u>Audio Pass Through</u> When selecting On, the projector outputs an audio signal when the Audio In and Audio Out sockets are correctly connected to a proper device.</p>
Quick Power Off	<p><u>Enable</u> The projector will not enter the cooling process after being shut down.</p> <p><u>Disable</u> The projector will enter the normal cooling process after being shut down.</p> <p><b>NOTE:</b> If you attempt to restart the projector right after it's been turned off, it may not be turned on successfully and will rerun its cooling procedure.</p>
USB A Power	<p>When On, the USB Type A port can supply power, and the Control Method will automatically switch to RS-232.</p>

## BASIC Menu

1. Press the **Menu** button to display the On-Screen Display (OSD) Menu.
2. Press ◀/▶ to select the **BASIC** menu. Then press **Enter** or use ▲/▼ to access the **BASIC** menu.

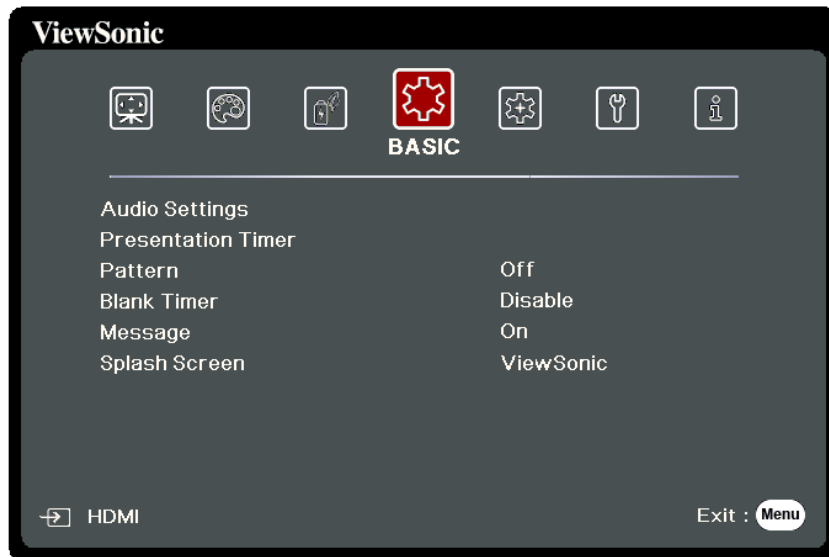

3. Press ▲/▼ to select the menu option. Then press **Enter** to display its sub-menu, or press ◀/▶ to adjust/select the setting.

**NOTE:** Some sub-menu options may have another sub-menu. To enter the respective sub-menu, press **Enter**. Use ▲/▼ or ◀/▶ to adjust/select the setting.



Menu Option	Description
Audio Settings	<p><u>Mute</u> Select On to temporarily turn off the projector's internal speaker or the volume being output from the audio output jack.</p> <p><u>Audio Volume</u> Adjusts the volume level of the projector's internal speaker or the volume being output from the audio output jack.</p> <p><u>Power On/Off Ring Tone</u> Turns on/off the ring tone during the starting up and shutting down process.</p>
Presentation Timer	<p>Presentation timer can indicate the presentation time on the screen to help you achieve better time management when giving presentations.</p> <p><u>Timer Period</u> Sets the time period. If the timer is already on, the timer will restart whenever the Timer Period is reset.</p> <p><u>Timer Display</u> Allows you to decide if you want the timer to show up on the screen for one of the following time periods:</p> <ul style="list-style-type: none"> <li>» Always: Displays the timer on screen throughout the presentation time.</li> <li>» 1 min/2 min/3 min: Displays the timer on screen in the last 1/2/3 minute(s).</li> <li>» Never: Hides the timer throughout the presentation time.</li> </ul> <p><u>Timer Position</u> Sets the timer position.</p> <p><u>Timer Counting Direction</u> Sets your desired counting direction between:</p> <ul style="list-style-type: none"> <li>» Count Down: Decreases from the preset time to 0.</li> <li>» Count Up: Increases from 0 to the preset time.</li> </ul> <p><u>Sound Reminder</u> Allows you to decide if you want to activate a sound reminder. Once enabled, a double beep sound will be heard at the last 30 seconds of counting down/up, and a triple beep sound will be produced when the timer is up.</p> <p><u>Start Counting/Off</u> Select Start Counting to activate the timer. Select Off to cancel it.</p>

Menu Option	Description
Pattern	Helps adjust the image size and focus, and checks for distortion in the projected image.
Blank Timer	<p>Allows the projector to return the image automatically after a period of time when there is no action taken on the blank screen. To display the blank screen, press <b>Blank</b> on the projector or remote control.</p> <p><b>NOTE:</b> Do not block the projection lens as this could cause the blocking object to become heated and deformed or even cause a fire.</p>
Message	Sets reminder messages, i.e. “Blank” message, On or Off.
Splash Screen	Selects which logo screen will appear during projector start-up.

## ADVANCED Menu

1. Press the **Menu** button to display the On-Screen Display (OSD) Menu.
2. Press ◀/▶ to select the **ADVANCED** menu. Then press **Enter** or use ▲/▼ to access the **ADVANCED** menu.

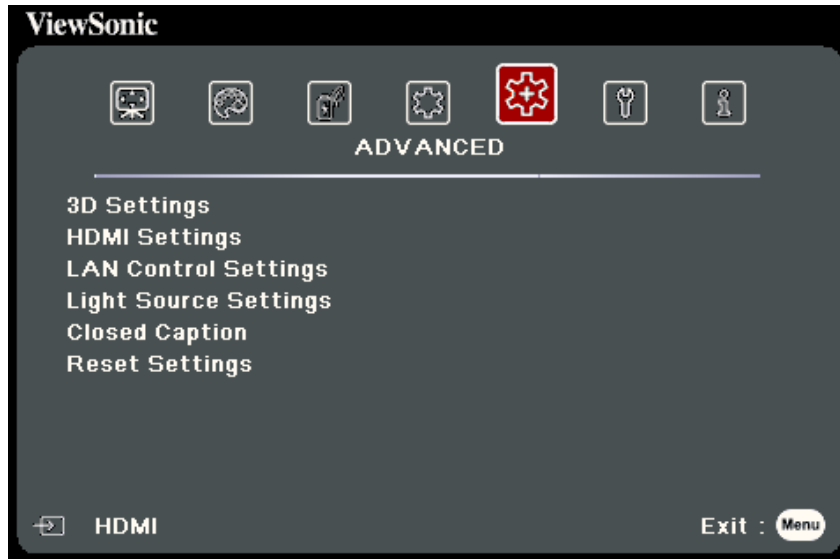

3. Press ▲/▼ to select the menu option. Then press **Enter** to display its sub-menu, or press ◀/▶ to adjust/select the setting.

**NOTE:** Some sub-menu options may have another sub-menu. To enter the respective sub-menu, press **Enter**. Use ▲/▼ or ◀/▶ to adjust/select the setting.

Menu Option	Description
3D Settings	<p>This projector features a 3D function which enables you to enjoy 3D movies, videos, and sporting events in a more realistic way by presenting the depth of the images. You need to wear a pair of 3D glasses to view 3D images.</p> <p><u>3D Sync</u> The default setting is Auto and the projector automatically chooses an appropriate 3D format when detecting 3D content. If the projector cannot recognize the 3D format, choose a 3D mode.</p> <p><u>3D Sync Invert</u> When you discover the inversion of the image depth, enable this function to correct the problem.</p> <p><u>Save 3D Settings</u> Saves current 3D settings. 3D settings will automatically be applied if the same resolution and input source are selected.</p> <p><b>NOTE:</b> When the 3D Sync function is on:</p> <ul style="list-style-type: none"> <li>• The brightness level of the projected image will decrease.</li> <li>• The Color Mode, Light Source Mode, Zoom, and OverScan cannot be adjusted.</li> </ul>
HDMI Settings	<p><u>HDMI Format</u> Select a suitable color space according to the color space setting of the output device connected.</p> <ul style="list-style-type: none"> <li>» Auto: Sets the projector to detect the color space setting of the input signal automatically.</li> <li>» RGB: Sets the color space as RGB.</li> <li>» YUV: Sets the color space as YUV.</li> </ul> <p><u>HDMI Range</u> Select a suitable HDMI color range according to the color range setting of the output device connected.</p> <ul style="list-style-type: none"> <li>» Auto: Sets the projector to detect the HDMI range of the input signal automatically.</li> <li>» Enhanced: Sets the HDMI color range as 0 - 255.</li> <li>» Normal: Sets the HDMI color range as 16 - 235.</li> </ul>

Menu Option	Description					
LAN Control Settings	<p data-bbox="502 190 699 226"><u>LAN Settings</u></p> <ul style="list-style-type: none"> <li data-bbox="549 235 1465 360">» DHCP ON: Select this if you are in a DHCP environment and Projector IP Address, Subnet Mask, Default Gateway, DNS Server settings will be automatically retrieved.</li> <li data-bbox="549 376 1469 456">» Static IP: Select this if you are in a non-DHCP environment and make adjustments to below settings.</li> </ul> <table border="1" data-bbox="502 472 1469 685"> <tr> <td data-bbox="502 472 849 517"><u>Projector IP Address</u></td> <td data-bbox="849 472 1469 685" rowspan="4">Only available when <u>LAN Settings</u> is set to Static IP. Use /to select a column and use / to adjust the value.</td> </tr> <tr> <td data-bbox="502 517 849 562"><u>Subnet Mask</u></td> </tr> <tr> <td data-bbox="502 562 849 607"><u>Default Gateway</u></td> </tr> <tr> <td data-bbox="502 607 849 651"><u>DNS Server</u></td> </tr> </table> <p data-bbox="502 714 820 750"><u>Standby LAN Control</u></p> <p data-bbox="502 766 1347 846">Allows the projector to provide the network function in standby mode.</p> <p data-bbox="502 864 592 900"><u>Apply</u></p> <p data-bbox="502 916 799 952">Enacts the settings.</p>	<u>Projector IP Address</u>	Only available when <u>LAN Settings</u> is set to Static IP. Use /to select a column and use / to adjust the value.	<u>Subnet Mask</u>	<u>Default Gateway</u>	<u>DNS Server</u>
<u>Projector IP Address</u>	Only available when <u>LAN Settings</u> is set to Static IP. Use /to select a column and use / to adjust the value.					
<u>Subnet Mask</u>						
<u>Default Gateway</u>						
<u>DNS Server</u>						

Menu Option	Description
Light Source Settings	<p><u>Light Source Mode</u></p> <ul style="list-style-type: none"> <li>» Normal: Provides full lamp brightness.</li> <li>» Eco: Reduces lamp power consumption by 21% and lowers brightness to extend the lamp life and decreases the fan noise.</li> <li>» Dynamic Eco: Reduces lamp power consumption by up to 35% depending on the content brightness level.</li> <li>» SuperEco+: Reduces lamp power consumption by 63% and lowers brightness to extend the lamp life and decreases the fan noise.</li> </ul> <p><b>NOTE:</b> To control the lamp temperature, Eco Mode will be switched on for 10 minutes in every 4 hours when the Light Source Mode is set as SuperEco+.</p> <p><u>Reset Light Source Hours</u> Resets the lamp timer after a new lamp is installed. For changing the lamp, please contact qualified service personnel.</p> <p><u>Light Source Hours Information</u></p> <ul style="list-style-type: none"> <li>» Light Source Usage Time: Displays the number of hours the lamp has been used.</li> <li>» Equivalent Light Source Hour: Displays the overall lamp life. The method of calculating the equivalent light source hour is as follows: Total (equivalent) Light Source Hour = 3.33 x (hours used in Normal mode) + 2 x (hours used in Eco mode) + 1.33 x (hours used in Dynamic Eco mode) + 1 x (hours used in SuperEco+ mode)</li> </ul>
Closed Caption	<p><u>Closed Caption Enable</u> Activates the function when the selected input signal carries closed captions.</p> <p><b>NOTE:</b></p> <ul style="list-style-type: none"> <li>• Captions: An on-screen display of the dialogue, narration, and sound effects of TV programs and videos that are closed captioned (usually marked as “CC” in TV listings).</li> <li>• This function is only available when a Composite video input signal is selected and its system format is NTSC.</li> </ul> <p><u>Caption Version</u> To view captions, select CC1, CC2, CC3, or CC4 (CC1 displays captions in the primary language in your area).</p>

<b>Menu Option</b>	<b>Description</b>
Reset Settings	Returns all settings to the factory preset values. When using Reset Settings, the following settings will still remain: Keystone, Corner Adj., Zoom, USB A Power, Language, Projector Position, LAN Settings, High Altitude Mode, Security Settings, Remote Control Code, Control Method, and Baud Rate.

## SYSTEM Menu

1. Press the **Menu** button to display the On-Screen Display (OSD) Menu.
2. Press ◀/▶ to select the **SYSTEM** menu. Then press **Enter** or use ▲/▼ to access the **SYSTEM** menu.

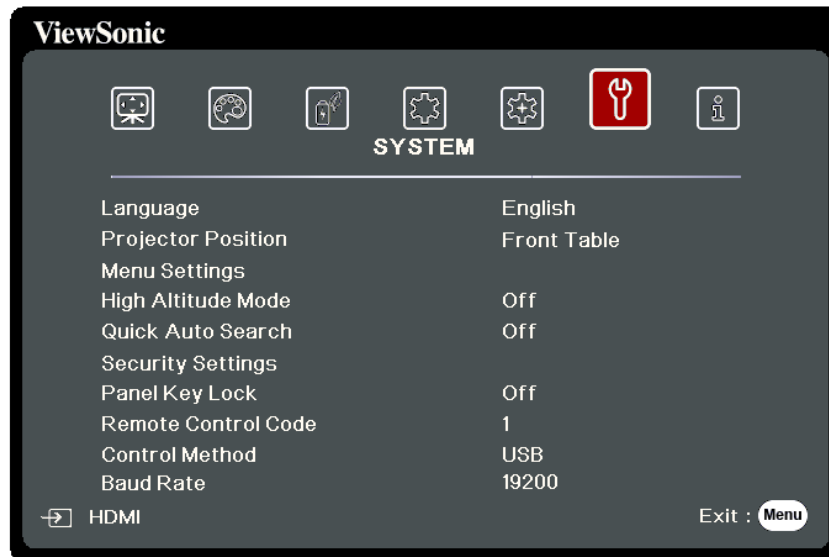

3. Press ▲/▼ to select the menu option. Then press **Enter** to display its sub-menu, or press ◀/▶ to adjust/select the setting.

**NOTE:** Some sub-menu options may have another sub-menu. To enter the respective sub-menu, press **Enter**. Use ▲/▼ or ◀/▶ to adjust/select the setting.



Menu Option	Description
Language	Sets the language for the On-Screen Display (OSD) Menu.
Projector Position	Selects a proper position for the projector.
Menu Settings	<p><u>Menu Display Time</u> Sets the length of time the OSD Menu will remain active after your last interaction.</p> <p><u>Menu Position</u> Sets the OSD Menu's position.</p>
High Altitude Mode	<p>We recommend you use the High Altitude Mode when your environment is between 1,500 m to 3,000 m above sea level, and ambient temperature is between 5°C–25°C.</p> <p><b>NOTE:</b></p> <ul style="list-style-type: none"> <li>• Do not use High Altitude Mode if your environment is between 0 to 1,499 m, and the temperature is between 5°C to 35°C. If used, the projector will become over cooled.</li> <li>• Using “High Altitude Mode” may cause more operating noise, as the fan speed will be increased to improve cooling and performance.</li> </ul>
Quick Auto Search	Allows the projector to automatically search for the signals.
Security Settings	See “Using the Password Function” on page 22.
Panel Key Lock	Locks the control keys on the projector.
Remote Control Code	<p>Sets the remote control code for this projector (between 1~8). When multiple adjacent projectors are in operation at the same time, switching the codes can prevent interference from other remote controls. After the remote control code is set, switch to the same ID for the remote control to control this projector. To switch the code for the remote control, press <b>ID set</b> and the number button corresponding to the remote control code together for 5 seconds or more. The initial code is set to 1. When the code is switched to 8, the remote control can control every projector.</p> <p><b>NOTE:</b> If different codes are set on the projector and remote control, there will be no response from the remote control. When that happens, a message will display to remind you to switch the code for the remote control.</p>
Control Method	Allows you to select a preferred control port: through the RS-232 port or the USB port. When selecting USB, USB A Power will be switched to Off automatically.

<b>Menu Option</b>	<b>Description</b>
Baud Rate	Selects a baud rate that is identical with your computer's so that you can connect the projector using a suitable RS-232 cable and control the projector with RS-232 commands.

# INFORMATION Menu

1. Press the **Menu** button to display the On-Screen Display (OSD) Menu.
2. Press ◀/▶ to select the **INFORMATION** menu and display its contents.

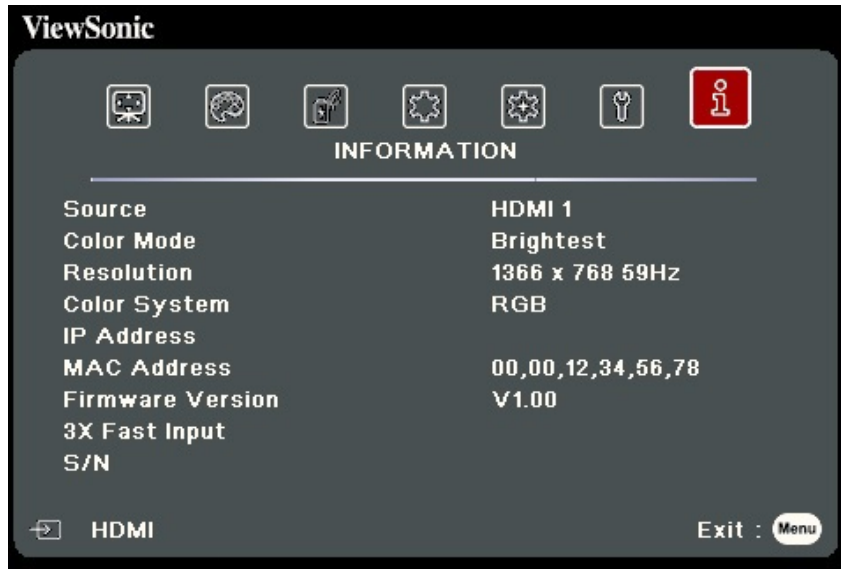

Menu Option	Description
Source	Shows the current input source.
Color Mode	Shows the selected mode in the IMAGE menu.
Resolution	Shows the native resolution of the input source.
Color System	Shows input system format.
IP address	Shows the IP address of your projector.
MAC address	Shows the MAC Address of your projector.
Firmware Version	Shows the current firmware version.
3X Fast Input	Shows whether the function is activated or not.
S/N	Shows the serial number for this projector.

# > Appendix

## Specifications

Item	Category	PG707X	PG707W
Projector	Type	DLP Lamp	
	Display Size	30" ~ 300"	
	Brightness (Lumens)	4,000 ANSI	
	Throw Ratio	1.51~1.97 (78"±3%@2.4m)	1.21~1.57 (87"±3%@2.26m)
	Lens	1.3x±2% Optical Zoom	
	Lamp Type	UHP 203W E20.7i	
	Display System	1-CHIP DMD	
Input Signal	VGA	$f_h$ : 15K~102KHz, $f_v$ :48~120Hz, Pixel rate: 170MHz	
	HDMI	$f_h$ : 15K~102KHz, $f_v$ :23~120Hz, Pixel rate: 170MHz	
Resolution	Native	1024 x 768	1280 x 800
Power Adapter <sup>1</sup>	Input Voltage	AC 100-240V, 50/60 Hz (auto switch)	
Operating conditions	Temperature	0°C to 40°C (32°F to 104°F)	
	Humidity	0% to 90% (non-condensing)	
	Altitude	0 to 1,499 m at 5°C to 35°C 1,500 to 3,000 m at 5°C to 25°C	
Storage conditions	Temperature	-20°C to 60°C (non-condensing)	
	Humidity	0% to 90% (non-condensing)	
	Altitude	0 to 1,219 m at -20°C to 30°C	
Dimensions	Physical (W x H x D)	294 x 110 x 218 mm (11.6" x 4.3" x 8.6")	
Weight	Physical	2.3 kg (5.1 lbs)	
Power Saving Modes	On <sup>2</sup>	255W (Typical)	
	Off	< 0.5W (Standby)	

<sup>1</sup> Please use the power adapter from ViewSonic® or an authorized source only.

<sup>2</sup> The test condition follows EEI standards.

## Projector Dimensions

294 mm (W) x 110 mm (H) x 218 mm (D)

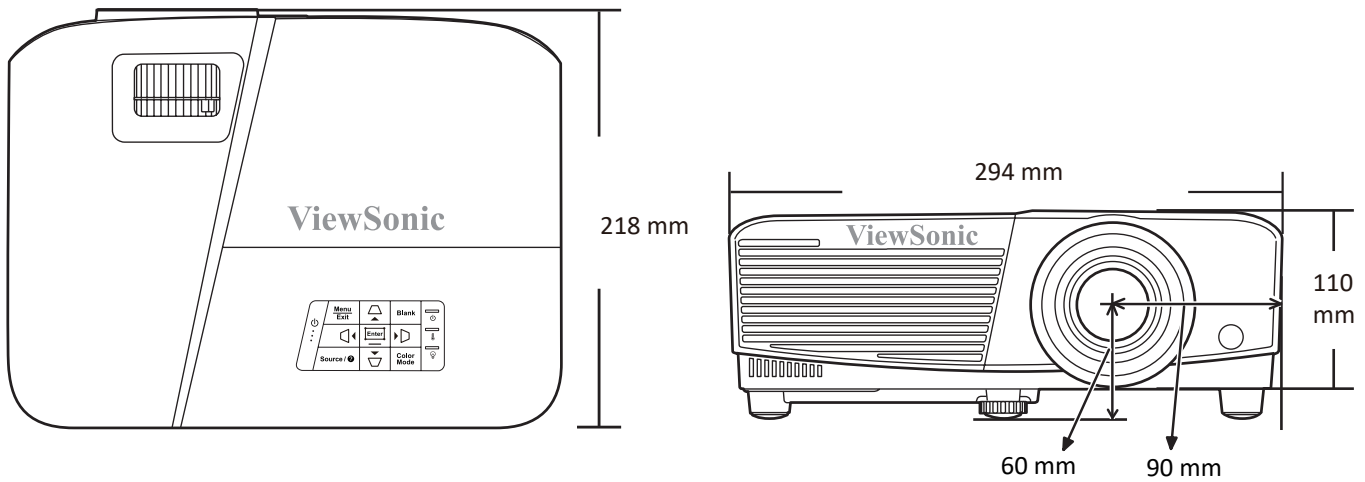

## Timing Chart

### Analog RGB

Resolution	Mode	Refresh rate (Hz)	H-frequency (kHz)	Clock (MHz)	3D Sync		
					Frame Sequential	Top-Bottom	Side-by-Side
720 x 400	720 x 400_70	70.087	31.469	28.3221			
640 x 480	VGA_60	59.94	31.469	25.175	Supported	Supported	Supported
	VGA_72	72.809	37.861	31.5			
	VGA_75	75	37.5	31.5			
	VGA_85	85.008	43.269	36			
800 x 600	SVGA_60	60.317	37.879	40	Supported	Supported	Supported
	SVGA_72	72.188	48.077	50			
	SVGA_75	75	46.875	49.5			
	SVGA_85	85.061	53.674	56.25			
	SVGA_120 (Reduce Blanking)	119.854	77.425	83	Supported		
1024 x 768	XGA_60	60.004	48.363	65	Supported	Supported	Supported
	XGA_70	70.069	56.476	75			
	XGA_75	75.029	60.023	78.75			
	XGA_85	84.997	68.667	94.5			
	XGA_120 (Reduce Blanking)	119.989	97.551	115.5	Supported		
1152 x 864	1152 x 864_75	75	67.5	108			
1024 x 576	NB Timing	60	35.82	46.966			
1024 x 600	NB Timing	64.995	41.467	51.419			
1280 x 720	1280 x 720_60	60	45	74.25	Supported	Supported	Supported

Resolution	Mode	Refresh rate (Hz)	H-frequency (kHz)	Clock (MHz)	3D Sync		
					Frame Sequential	Top-Bottom	Side-by-Side
1280 x 768	1280 x 768_60	59.87	47.776	79.5	Supported	Supported	Supported
1280 x 800	WXGA_60	59.81	49.702	83.5	Supported	Supported	Supported
	WXGA_75	74.934	62.795	106.5			
	WXGA_85	84.88	71.554	122.5			
	WXGA_120 (Reduce Blanking)	119.909	101.563	146.25	Supported		
1280 x 1024	SXGA_60	60.02	63.981	108		Supported	Supported
	SXGA_75	75.025	79.976	135			
	SXGA_85	85.024	91.146	157.5			
1280 x 960	1280 x 960_60	60	60	108		Supported	Supported
	1280 x 960_85	85.002	85.938	148.5			
1360 x 768	1360 x 768_60	60.015	47.712	85.5		Supported	Supported
1440 x 900	WXGA+_60	59.887	55.935	106.5		Supported	Supported
1400 x 1050	SXGA+_60	59.978	65.317	121.75		Supported	Supported
1600 x 1200	UXGA	60	75	162		Supported	Supported
1680 x 1050	1680x1050_60	59.954	65.29	146.25		Supported	Supported
640 x 480@67Hz	MAC13	66.667	35	30.24			
832 x 624@75Hz	MAC16	74.546	49.722	57.28			
1024 x 768@75Hz	MAC19	74.93	60.241	80			
1152 x 870@75Hz	MAC21	75.06	68.68	100			
1920 x 1080 (VESA)	1920 x 1080_60	60	67.5	148.5			

## HDMI (PC)

Resolution	Mode	Refresh rate (Hz)	H-frequency (kHz)	Clock (MHz)	3D Sync		
					Frame Sequential	Top-Bottom	Side-by-Side
640 x 480	VGA_60	59.94	31.469	25.175	Supported	Supported	Supported
	VGA_72	72.809	37.861	31.5			
	VGA_75	75	37.5	31.5			
	VGA_85	85.008	43.269	36			
720 x 400	720 x 400_70	70.087	31.469	28.3221			
800 x 600	SVGA_60	60.317	37.879	40	Supported	Supported	Supported
	SVGA_72	72.188	48.077	50			
	SVGA_75	75	46.875	49.5			
	SVGA_85	85.061	53.674	56.25			
	SVGA_120 (Reduce Blanking)	119.854	77.425	83	Supported		
1024 x 768	XGA_60	60.004	48.363	65	Supported	Supported	Supported
	XGA_70	70.069	56.476	75			
	XGA_75	75.029	60.023	78.75			
	XGA_85	84.997	68.667	94.5			
	XGA_120 (Reduce Blanking)	119.989	97.551	115.5	Supported		
1152 x 864	1152 x 864_75	75	67.5	108			
1024 x 576	NB Timing	60	35.82	46.966			
1024 x 600	NB Timing	64.995	41.467	51.419			
1280 x 720	1280 x 720_60	60	45	74.25	Supported	Supported	Supported
1280 x 768	1280 x 768_60	59.87	47.776	79.5	Supported	Supported	Supported
1280 x 800	WXGA_60	59.81	49.702	83.5	Supported	Supported	Supported
	WXGA_75	74.934	62.795	106.5			
	WXGA_85	84.88	71.554	122.5			
	WXGA_120 (Reduce Blanking)	119.909	101.563	146.25	Supported		
1280 x 1024	SXGA_60	60.02	63.981	108		Supported	Supported
	SXGA_75	75.025	79.976	135			
	SXGA_85	85.024	91.146	157.5			
1280 x 960	1280 x 960_60	60	60	108		Supported	Supported
	1280 x 960_85	85.002	85.938	148.5			
1360 x 768	1360 x 768_60	60.015	47.712	85.5		Supported	Supported
1440 x 900	WXGA+_60	59.887	55.935	106.5		Supported	Supported
1400 x 1050	SXGA+_60	59.978	65.317	121.75		Supported	Supported
1600 x 1200	UXGA	60	75	162		Supported	Supported

Resolution	Mode	Refresh rate (Hz)	H-frequency (kHz)	Clock (MHz)	3D Sync		
					Frame Sequential	Top-Bottom	Side-by-Side
1680 x 1050	1680x1050_60	59.954	65.29	146.25		Supported	Supported
640 x 480@67Hz	MAC13	66.667	35	30.24			
832 x 624@75Hz	MAC16	74.546	49.722	57.28			
1024 x 768@75Hz	MAC19	74.93	60.241	80			
1152 x 870@75Hz	MAC21	75.06	68.68	100			
1920 x 1080 (VESA)	1920 x 1080_60	60	67.5	148.5			

## HDMI (Video)



















Video mode	Resolution	Horizontal frequency (KHz)	Vertical frequency (Hz)	Dot Clock frequency (MHz)	3D Sync			
					Frame Sequential	Frame Packing	Top-Bottom	Side-by-Side
480i	720(1440) x 480	15.73	59.94	27	Supported			
480p	720 x 480	31.47	59.94	27	Supported		Supported	Supported
576i	720(1440) x 576	15.63	50	27	Supported			
576p	720 x 576	31.25	50	27	Supported		Supported	Supported
720/50p	1280 x 720	37.5	50	74.25		Supported	Supported	
720/60p	1280 x 720	45	60	74.25		Supported	Supported	
1080/50i	1920 x 1080	28.13	50	74.25				Supported
1080/60i	1920 x 1080	33.75	60	74.25				Supported
1080/24P	1920 x 1080	27	24	74.25		Supported	Supported	
1080/50P	1920 x 1080	56.25	50	148.5			Supported	Supported
1080/60P	1920 x 1080	67.5	60	148.5			Supported	Supported

## Video

Video mode	Horizontal frequency (KHz)	Vertical frequency (Hz)	Sub-carrier Frequency (MHz)	3D Sync
				Frame Sequential
NTSC	15.73	60	3.58	Supported
PAL	15.63	50	4.43	Supported
SECAM	15.63	50	4.25 or 4.41	Supported
PAL-M	15.73	60	3.58	Supported
PAL-N	15.63	50	3.58	Supported
PAL-60	15.73	60	4.43	Supported
NTSC4.43	15.73	60	4.43	Supported



# IR Control Table

Key	Format	Byte 1	Byte 2	Byte 3	Byte 4
 On	NEC-F2	83	F4	4F	B0
 Off	NEC-F2	83	F4	4E	B1
COMP	NEC-F2	83	F4	41	BE
HDMI/HDMI 1	NEC-F2	83	F4	58	A7
HDMI 2	NEC-F2	83	F4	59	A6
Auto Sync	NEC-F2	83	F4	8	F7
Source	NEC-F2	83	F4	40	BF
 Up/ 	NEC-F2	83	F4	0B	F4
 Left/ 	NEC-F2	83	F4	0E	F1
Enter/ 	NEC-F2	83	F4	15	EA
 Right/ 	NEC-F2	83	F4	0F	F0
 Down/ 	NEC-F2	83	F4	0C	F3
Menu	NEC-F2	83	F4	30	CF
 (INFORMATION)	NEC-F2	83	F4	97	68
Exit	NEC-F2	83	F4	28	D7
Aspect	NEC-F2	83	F4	13	EC
Freeze	NEC-F2	83	F4	03	FC
Pattern	NEC-F2	83	F4	55	AA
Blank	NEC-F2	83	F4	7	F8
PgUp	NEC-F2	83	F4	06	F9
PgDn	NEC-F2	83	F4	05	FA
 (Mute)	NEC-F2	83	F4	14	EB
 -(Volume Down)	NEC-F2	83	F4	83	7C
 +(Volume Up)	NEC-F2	83	F4	82	7D
 (Zoom in)	NEC-F2	83	F4	67	98
 (Zoom out)	NEC-F2	83	F4	68	97
Eco Mode	NEC-F2	83	F4	2B	D4
Color Mode	NEC-F2	83	F4	10	EF
Network	NEC	X3	F4	69	96
 (Presentation Timer)	NEC	X3	F4	27	D8

## Address Code

Code 1	83F4
Code 2	93F4
Code 3	A3F4
Code 4	B3F4
Code 5	C3F4
Code 6	D3F4
Code 7	E3F4
Code 8	F3F4

# RS-232 Command Table

## Pin Assignment

Pin	Description	Pin	Description
1	NC	2	RX
3	TX	4	NC
5	GND	6	NC
7	RTSZ	8	CTSZ
9	NC		

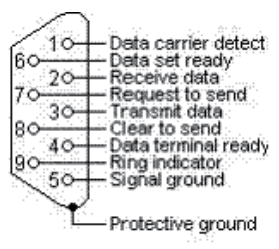

## Interface

RS-232 Protocol	
Baud Rate	115200 bps (default)
Data Length	8 bit
Parity Check	None
Stop Bit	1 bit
Flow Control	None

## Command Table

Function	Type	Action	Command
Power	Write	ON	0x06 0x14 0x00 0x04 0x00 0x34 0x11 0x00 0x00 0x5D
Power	Write	OFF	0x06 0x14 0x00 0x04 0x00 0x34 0x11 0x01 0x00 0x5E
Power	Write	ON/OFF	0x06 0x14 0x00 0x04 0x00 0x34 0x11 0x34 0x00 0x91
Power	Read	Status	0x07 0x14 0x00 0x05 0x00 0x34 0x00 0x00 0x11 0x00 0x5E
Reset Settings	Write	Reset Settings	0x06 0x14 0x00 0x04 0x00 0x34 0x11 0x02 0x00 0x5F
Reset Color Settings	Write	Reset Color Settings	0x06 0x14 0x00 0x04 0x00 0x34 0x11 0x2A 0x00 0x87
Splash Screen	Write	Black	0x06 0x14 0x00 0x04 0x00 0x34 0x11 0x0A 0x00 0x67
Splash Screen	Write	Blue	0x06 0x14 0x00 0x04 0x00 0x34 0x11 0x0A 0x01 0x68
Splash Screen	Write	ViewSonic	0x06 0x14 0x00 0x04 0x00 0x34 0x11 0x0A 0x02 0x69
Splash Screen	Read	Status	0x07 0x14 0x00 0x05 0x00 0x34 0x00 0x00 0x11 0x0A 0x68
Quick Power Off	Write	OFF	0x06 0x14 0x00 0x04 0x00 0x34 0x11 0x0B 0x00 0x68
Quick Power Off	Write	ON	0x06 0x14 0x00 0x04 0x00 0x34 0x11 0x0B 0x01 0x69
Quick Power Off	Read	Status	0x07 0x14 0x00 0x05 0x00 0x34 0x00 0x00 0x11 0x0B 0x69
High Altitude Mode	Write	OFF	0x06 0x14 0x00 0x04 0x00 0x34 0x11 0x0C 0x00 0x69
High Altitude Mode	Write	ON	0x06 0x14 0x00 0x04 0x00 0x34 0x11 0x0C 0x01 0x6A
High Altitude Mode	Read	Status	0x07 0x14 0x00 0x05 0x00 0x34 0x00 0x00 0x11 0x0C 0x6A
Light Source Mode	Write	Normal	0x06 0x14 0x00 0x04 0x00 0x34 0x11 0x10 0x00 0x6D
Light Source Mode	Write	Eco	0x06 0x14 0x00 0x04 0x00 0x34 0x11 0x10 0x01 0x6E
Light Source Mode	Write	Dynamic Eco	0x06 0x14 0x00 0x04 0x00 0x34 0x11 0x10 0x02 0x6F

Function	Type	Action	Command
Light Source Mode	Write	SuperEco+	0x06 0x14 0x00 0x04 0x00 0x34 0x11 0x10 0x03 0x70
Light Source Mode	Read	Status	0x07 0x14 0x00 0x05 0x00 0x34 0x00 0x00 0x11 0x10 0x6E
Message	Write	OFF	0x06 0x14 0x00 0x04 0x00 0x34 0x11 0x27 0x00 0x84
Message	Write	ON	0x06 0x14 0x00 0x04 0x00 0x34 0x11 0x27 0x01 0x85
Message	Read	Status	0x07 0x14 0x00 0x05 0x00 0x34 0x00 0x00 0x11 0x27 0x85
Projector Position	Write	Front Table	0x06 0x14 0x00 0x04 0x00 0x34 0x12 0x00 0x00 0x5E
Projector Position	Write	Rear Table	0x06 0x14 0x00 0x04 0x00 0x34 0x12 0x00 0x01 0x5F
Projector Position	Write	Rear Ceiling	0x06 0x14 0x00 0x04 0x00 0x34 0x12 0x00 0x02 0x60
Projector Position	Write	Front Ceiling	0x06 0x14 0x00 0x04 0x00 0x34 0x12 0x00 0x03 0x61
Projector Position	Read	Status	0x07 0x14 0x00 0x05 0x00 0x34 0x00 0x00 0x12 0x00 0x5F
3D Sync	Write	OFF	0x06 0x14 0x00 0x04 0x00 0x34 0x12 0x20 0x00 0x7E
3D Sync	Write	Auto	0x06 0x14 0x00 0x04 0x00 0x34 0x12 0x20 0x01 0x7F
3D Sync	Write	Frame Sequential	0x06 0x14 0x00 0x04 0x00 0x34 0x12 0x20 0x02 0x80
3D Sync	Write	Frame Packing	0x06 0x14 0x00 0x04 0x00 0x34 0x12 0x20 0x03 0x81
3D Sync	Write	Top Bottom	0x06 0x14 0x00 0x04 0x00 0x34 0x12 0x20 0x04 0x82
3D Sync	Write	Side by Side	0x06 0x14 0x00 0x04 0x00 0x34 0x12 0x20 0x05 0x83
3D Sync	Read	Status	0x07 0x14 0x00 0x05 0x00 0x34 0x00 0x00 0x12 0x20 0x7F
3D Sync Invert	Write	OFF	0x06 0x14 0x00 0x04 0x00 0x34 0x12 0x21 0x00 0x7F
3D Sync Invert	Write	ON	0x06 0x14 0x00 0x04 0x00 0x34 0x12 0x21 0x01 0x80
3D Sync Invert	Read	Status	0x07 0x14 0x00 0x05 0x00 0x34 0x00 0x00 0x12 0x21 0x80
Contrast	Write	Decrease	0x06 0x14 0x00 0x04 0x00 0x34 0x12 0x02 0x00 0x60
Contrast	Write	Increase	0x06 0x14 0x00 0x04 0x00 0x34 0x12 0x02 0x01 0x61
Contrast	Read	Get Value	0x07 0x14 0x00 0x05 0x00 0x34 0x00 0x00 0x12 0x02 0x61
Brightness	Write	Decrease	0x06 0x14 0x00 0x04 0x00 0x34 0x12 0x03 0x00 0x61
Brightness	Write	Increase	0x06 0x14 0x00 0x04 0x00 0x34 0x12 0x03 0x01 0x62
Brightness	Read	Get Value	0x07 0x14 0x00 0x05 0x00 0x34 0x00 0x00 0x12 0x03 0x62
Aspect ratio	Write	Auto	0x06 0x14 0x00 0x04 0x00 0x34 0x12 0x04 0x00 0x62
Aspect ratio	Write	4:3	0x06 0x14 0x00 0x04 0x00 0x34 0x12 0x04 0x02 0x64
Aspect ratio	Write	16:9	0x06 0x14 0x00 0x04 0x00 0x34 0x12 0x04 0x03 0x65
Aspect ratio	Write	16:10	0x06 0x14 0x00 0x04 0x00 0x34 0x12 0x04 0x04 0x66
Aspect ratio	Write	Native	0x06 0x14 0x00 0x04 0x00 0x34 0x12 0x04 0x09 0x6B
Aspect ratio	Write	Cycle	0x06 0x14 0x00 0x04 0x00 0x34 0x13 0x31 0x00 0x90
Aspect ratio	Read	Get Value	0x07 0x14 0x00 0x05 0x00 0x34 0x00 0x00 0x12 0x04 0x63
Auto Adjust	Write	Execute	0x06 0x14 0x00 0x04 0x00 0x34 0x12 0x05 0x00 0x63
Horizontal position	Write	Shift Right	0x06 0x14 0x00 0x04 0x00 0x34 0x12 0x06 0x01 0x65
Horizontal position	Write	Shift Left	0x06 0x14 0x00 0x04 0x00 0x34 0x12 0x06 0x00 0x64
Horizontal position	Read	Get Value	0x07 0x14 0x00 0x05 0x00 0x34 0x00 0x00 0x12 0x06 0x65
Vertical position	Write	Shift Up	0x06 0x14 0x00 0x04 0x00 0x34 0x12 0x07 0x00 0x65

Function	Type	Action	Command
Vertical position	Write	Shift Down	0x06 0x14 0x00 0x04 0x00 0x34 0x12 0x07 0x01 0x66
Vertical position	Read	Get Value	0x07 0x14 0x00 0x05 0x00 0x34 0x00 0x00 0x12 0x07 0x66
Color temperature	Write	5500K	0x06 0x14 0x00 0x04 0x00 0x34 0x12 0x08 0x00 0x66
Color temperature	Write	6500K	0x06 0x14 0x00 0x04 0x00 0x34 0x12 0x08 0x01 0x67
Color temperature	Write	8000K	0x06 0x14 0x00 0x04 0x00 0x34 0x12 0x08 0x03 0x69
Color temperature	Read	Get Value	0x07 0x14 0x00 0x05 0x00 0x34 0x00 0x00 0x12 0x08 0x67
Color temperature-Red gain	Write	Decrease	0x06 0x14 0x00 0x05 0x00 0x34 0x12 0x3A 0x00 0x00 0x99
Color temperature-Red gain	Write	Increase	0x06 0x14 0x00 0x05 0x00 0x34 0x12 0x3A 0x00 0x01 0x9A
Color temperature-Red gain	Read	Get value	0x07 0x14 0x00 0x05 0x00 0x34 0x00 0x00 0x12 0x3B 0x9A
Color temperature-Green gain	Write	Decrease	0x06 0x14 0x00 0x05 0x00 0x34 0x12 0x3A 0x01 0x00 0x9A
Color temperature-Green gain	Write	Increase	0x06 0x14 0x00 0x05 0x00 0x34 0x12 0x3A 0x01 0x01 0x9B
Color temperature-Green gain	Read	Get value	0x07 0x14 0x00 0x05 0x00 0x34 0x00 0x00 0x12 0x3C 0x9B
Color temperature-Blue gain	Write	Decrease	0x06 0x14 0x00 0x05 0x00 0x34 0x12 0x3A 0x02 0x00 0x9B
Color temperature-Blue gain	Write	Increase	0x06 0x14 0x00 0x05 0x00 0x34 0x12 0x3A 0x02 0x01 0x9C
Color temperature-Blue gain	Read	Get value	0x07 0x14 0x00 0x05 0x00 0x34 0x00 0x00 0x12 0x3D 0x9C
Color temperature-Red offset	Write	Decrease	0x06 0x14 0x00 0x05 0x00 0x34 0x12 0x3E 0x00 0x00 0x9D
Color temperature-Red offset	Write	Increase	0x06 0x14 0x00 0x05 0x00 0x34 0x12 0x3E 0x00 0x01 0x9E
Color temperature-Red offset	Read	Get value	0x07 0x14 0x00 0x05 0x00 0x34 0x00 0x00 0x12 0x3F 0x9E
Color temperature-Green offset	Write	Decrease	0x06 0x14 0x00 0x05 0x00 0x34 0x12 0x3E 0x01 0x00 0x9E
Color temperature-Green gain	Write	Increase	0x06 0x14 0x00 0x05 0x00 0x34 0x12 0x3E 0x01 0x01 0x9F
Color temperature-Green offset	Read	Get value	0x07 0x14 0x00 0x05 0x00 0x34 0x00 0x00 0x12 0x40 0x9F
Color temperature-Blue offset	Write	Decrease	0x06 0x14 0x00 0x05 0x00 0x34 0x12 0x3E 0x02 0x00 0x9F
Color temperature-Blue offset	Write	Increase	0x06 0x14 0x00 0x05 0x00 0x34 0x12 0x3E 0x02 0x01 0xA0
Color temperature-Blue offset	Read	Get value	0x07 0x14 0x00 0x05 0x00 0x34 0x00 0x00 0x12 0x41 0xA0

Function	Type	Action	Command
Blank	Write	ON	0x06 0x14 0x00 0x04 0x00 0x34 0x12 0x09 0x01 0x68
Blank	Write	OFF	0x06 0x14 0x00 0x04 0x00 0x34 0x12 0x09 0x00 0x67
Blank	Read	Status	0x07 0x14 0x00 0x05 0x00 0x34 0x00 0x00 0x12 0x09 0x68
Keystone-Vertical	Write	Decrease	0x06 0x14 0x00 0x04 0x00 0x34 0x12 0x0A 0x00 0x68
Keystone-Vertical	Write	Increase	0x06 0x14 0x00 0x04 0x00 0x34 0x12 0x0A 0x01 0x69
Keystone-Vertical	Read	Get value	0x07 0x14 0x00 0x05 0x00 0x34 0x00 0x00 0x12 0x0A 0x69
Color mode	Write	Brightest	0x06 0x14 0x00 0x04 0x00 0x34 0x12 0x0B 0x00 0x69
Color mode	Write	Movie	0x06 0x14 0x00 0x04 0x00 0x34 0x12 0x0B 0x01 0x6A
Color mode	Write	Standard	0x06 0x14 0x00 0x04 0x00 0x34 0x12 0x0B 0x04 0x6D
Color mode	Write	Photo	0x06 0x14 0x00 0x04 0x00 0x34 0x12 0x0B 0x13 0x7C
Color mode	Write	Presentation	0x06 0x14 0x00 0x04 0x00 0x34 0x12 0x0B 0x14 0x7D
Color mode	Write	Cycle	0x06 0x14 0x00 0x04 0x00 0x34 0x13 0x33 0x00 0x92
Color mode	Write	User1	0x06 0x14 0x00 0x04 0x00 0x34 0x12 0x0B 0x18 0x81
Color mode	Write	User2	0x06 0x14 0x00 0x04 0x00 0x34 0x12 0x0B 0x19 0x82
Color mode	Read	Status	0x07 0x14 0x00 0x05 0x00 0x34 0x00 0x00 0x12 0x0B 0x6A
Reset current color settings	Write	Reset	0x06 0x14 0x00 0x04 0x00 0x34 0x11 0x2A 0x00 0x87
Primary Color	Write	R	0x06 0x14 0x00 0x04 0x00 0x34 0x12 0x10 0x00 0x6E
Primary Color	Write	G	0x06 0x14 0x00 0x04 0x00 0x34 0x12 0x10 0x01 0x6F
Primary Color	Write	B	0x06 0x14 0x00 0x04 0x00 0x34 0x12 0x10 0x02 0x70
Primary Color	Write	C	0x06 0x14 0x00 0x04 0x00 0x34 0x12 0x10 0x03 0x71
Primary Color	Write	M	0x06 0x14 0x00 0x04 0x00 0x34 0x12 0x10 0x04 0x72
Primary Color	Write	Y	0x06 0x14 0x00 0x04 0x00 0x34 0x12 0x10 0x05 0x73
Primary Color	Read	Status	0x07 0x14 0x00 0x05 0x00 0x34 0x00 0x00 0x12 0x10 0x6F
Hue / Tint	Write	Decrease	0x06 0x14 0x00 0x04 0x00 0x34 0x12 0x11 0x00 0x6F
Hue / Tint	Write	Increase	0x06 0x14 0x00 0x04 0x00 0x34 0x12 0x11 0x01 0x70
Hue / Tint	Read	Get value	0x07 0x14 0x00 0x05 0x00 0x34 0x00 0x00 0x12 0x11 0x70
Saturation	Write	Decrease	0x06 0x14 0x00 0x04 0x00 0x34 0x12 0x12 0x00 0x70
Saturation	Write	Increase	0x06 0x14 0x00 0x04 0x00 0x34 0x12 0x12 0x01 0x71
Saturation	Read	Get value	0x07 0x14 0x00 0x05 0x00 0x34 0x00 0x00 0x12 0x12 0x71
Gain	Write	Decrease	0x06 0x14 0x00 0x04 0x00 0x34 0x12 0x13 0x00 0x71
Gain	Write	Increase	0x06 0x14 0x00 0x04 0x00 0x34 0x12 0x13 0x01 0x72
Gain	Read	Get value	0x07 0x14 0x00 0x05 0x00 0x34 0x00 0x00 0x12 0x13 0x72
Sharpness	Write	Decrease	0x06 0x14 0x00 0x04 0x00 0x34 0x12 0x0E 0x00 0x6C
Sharpness	Write	Increase	0x06 0x14 0x00 0x04 0x00 0x34 0x12 0x0E 0x01 0x6D
Sharpness	Read	Get value	0x07 0x14 0x00 0x05 0x00 0x34 0x00 0x00 0x12 0x0E 0x6D
Freeze	Write	ON	0x06 0x14 0x00 0x04 0x00 0x34 0x13 0x00 0x01 0x60
Freeze	Write	OFF	0x06 0x14 0x00 0x04 0x00 0x34 0x13 0x00 0x00 0x5F
Freeze	Read	Status	0x07 0x14 0x00 0x05 0x00 0x34 0x00 0x00 0x13 0x00 0x60

Function	Type	Action	Command
Source input	Write	D-Sub/Comp. 1	0x06 0x14 0x00 0x04 0x00 0x34 0x13 0x01 0x00 0x60
Source input	Write	D-Sub/Comp. 2	0x06 0x14 0x00 0x04 0x00 0x34 0x13 0x01 0x08 0x68
Source input	Write	HDMI 1	0x06 0x14 0x00 0x04 0x00 0x34 0x13 0x01 0x03 0x63
Source input	Write	HDMI 2	0x06 0x14 0x00 0x04 0x00 0x34 0x13 0x01 0x07 0x67
Source input	Write	Composite Video	0x06 0x14 0x00 0x04 0x00 0x34 0x13 0x01 0x05 0x65
Source input	Read	Status	0x07 0x14 0x00 0x05 0x00 0x34 0x00 0x00 0x13 0x01 0x61
Quick Auto Search	Write	ON	0x06 0x14 0x00 0x04 0x00 0x34 0x13 0x02 0x01 0x62
Quick Auto Search	Write	OFF	0x06 0x14 0x00 0x04 0x00 0x34 0x13 0x02 0x00 0x61
Quick Auto Search	Read	Status	0x07 0x14 0x00 0x05 0x00 0x34 0x00 0x00 0x13 0x02 0x62
Mute	Write	ON	0x06 0x14 0x00 0x04 0x00 0x34 0x14 0x00 0x01 0x61
Mute	Write	OFF	0x06 0x14 0x00 0x04 0x00 0x34 0x14 0x00 0x00 0x60
Mute	Read	Status	0x07 0x14 0x00 0x05 0x00 0x34 0x00 0x00 0x14 0x00 0x61
Volume	Write	Increase	0x06 0x14 0x00 0x04 0x00 0x34 0x14 0x01 0x00 0x61
Volume	Write	Decrease	0x06 0x14 0x00 0x04 0x00 0x34 0x14 0x02 0x00 0x62
Volume	Write	Write Value	0x06 0x14 0x00 0x04 0x00 0x34 0x13 0x2A 0x11 0x9A
Volume	Read	Get Value	0x07 0x14 0x00 0x05 0x00 0x34 0x00 0x00 0x14 0x03 0x64
Language	Write	English	0x06 0x14 0x00 0x04 0x00 0x34 0x15 0x00 0x00 0x61
Language	Write	Français	0x06 0x14 0x00 0x04 0x00 0x34 0x15 0x00 0x01 0x62
Language	Write	Deutsch	0x06 0x14 0x00 0x04 0x00 0x34 0x15 0x00 0x02 0x63
Language	Write	Italiano	0x06 0x14 0x00 0x04 0x00 0x34 0x15 0x00 0x03 0x64
Language	Write	Español	0x06 0x14 0x00 0x04 0x00 0x34 0x15 0x00 0x04 0x65
Language	Write	РУССКИЙ	0x06 0x14 0x00 0x04 0x00 0x34 0x15 0x00 0x05 0x66
Language	Write	繁體中文	0x06 0x14 0x00 0x04 0x00 0x34 0x15 0x00 0x06 0x67
Language	Write	简体中文	0x06 0x14 0x00 0x04 0x00 0x34 0x15 0x00 0x07 0x68
Language	Write	日本語	0x06 0x14 0x00 0x04 0x00 0x34 0x15 0x00 0x08 0x69
Language	Write	한국어	0x06 0x14 0x00 0x04 0x00 0x34 0x15 0x00 0x09 0x6A
Language	Write	Swedish	0x06 0x14 0x00 0x04 0x00 0x34 0x15 0x00 0x0a 0x6B
Language	Write	Dutch	0x06 0x14 0x00 0x04 0x00 0x34 0x15 0x00 0x0b 0x6C
Language	Write	Turkish	0x06 0x14 0x00 0x04 0x00 0x34 0x15 0x00 0x0c 0x6D
Language	Write	Czech	0x06 0x14 0x00 0x04 0x00 0x34 0x15 0x00 0x0d 0x6E
Language	Write	Portuguese	0x06 0x14 0x00 0x04 0x00 0x34 0x15 0x00 0x0e 0x6F
Language	Write	Thai	0x06 0x14 0x00 0x04 0x00 0x34 0x15 0x00 0x0f 0x70
Language	Write	Polish	0x06 0x14 0x00 0x04 0x00 0x34 0x15 0x00 0x10 0x71
Language	Write	Finnish	0x06 0x14 0x00 0x04 0x00 0x34 0x15 0x00 0x11 0x72
Language	Write	Arabic	0x06 0x14 0x00 0x04 0x00 0x34 0x15 0x00 0x12 0x73
Language	Write	Indonesia	0x06 0x14 0x00 0x04 0x00 0x34 0x15 0x00 0x13 0x74
Language	Write	Hindi	0x06 0x14 0x00 0x04 0x00 0x34 0x15 0x00 0x14 0x75
Language	Write	Vie	0x06 0x14 0x00 0x04 0x00 0x34 0x15 0x00 0x15 0x76



Function	Type	Action	Command
Language	Write	Greek	0x06 0x14 0x00 0x04 0x00 0x34 0x15 0x00 0x16 0x77
Language	Read	Status	0x07 0x14 0x00 0x05 0x00 0x34 0x00 0x00 0x15 0x00 0x62
Light Source Usage Time	Write	Reset to ZERO	0x06 0x14 0x00 0x04 0x00 0x34 0x15 0x01 0x00 0x62
Light Source Usage Time	Read	Get Usage Time	0x07 0x14 0x00 0x05 0x00 0x34 0x00 0x00 0x15 0x01 0x63
HDMI Format	Write	RGB	0x06 0x14 0x00 0x04 0x00 0x34 0x11 0x28 0x00 0x85
HDMI Format	Write	YUV	0x06 0x14 0x00 0x04 0x00 0x34 0x11 0x28 0x01 0x86
HDMI Format	Write	Auto	0x06 0x14 0x00 0x04 0x00 0x34 0x11 0x28 0x02 0x87
HDMI Format	Read	Status	0x07 0x14 0x00 0x05 0x00 0x34 0x00 0x00 0x11 0x28 0x86
HDMI Range	Write	Enhanced	0x06 0x14 0x00 0x04 0x00 0x34 0x11 0x29 0x00 0x86
HDMI Range	Write	Normal	0x06 0x14 0x00 0x04 0x00 0x34 0x11 0x29 0x01 0x87
HDMI Range	Write	Auto	0x06 0x14 0x00 0x04 0x00 0x34 0x11 0x29 0x02 0x88
HDMI Range	Read	Status	0x07 0x14 0x00 0x05 0x00 0x34 0x00 0x00 0x11 0x29 0x87
CEC	Write	OFF	0x06 0x14 0x00 0x04 0x00 0x34 0x11 0x2B 0x00 0x88
CEC	Write	ON	0x06 0x14 0x00 0x04 0x00 0x34 0x11 0x2B 0x01 0x89
CEC	Read	Status	0x07 0x14 0x00 0x05 0x00 0x34 0x00 0x00 0x11 0x2B 0x89
Error status	Read	Status	0x07 0x14 0x00 0x05 0x00 0x34 0x00 0x00 0x0C 0x0D 0x66
Brilliant Color	Write	OFF	0x06 0x14 0x00 0x04 0x00 0x34 0x12 0x0F 0x00 0x6D
Brilliant Color	Write	Color 1	0x06 0x14 0x00 0x04 0x00 0x34 0x12 0x0F 0x01 0x6E
Brilliant Color	Write	Color 2	0x06 0x14 0x00 0x04 0x00 0x34 0x12 0x0F 0x02 0x6F
Brilliant Color	Write	Color 3	0x06 0x14 0x00 0x04 0x00 0x34 0x12 0x0F 0x03 0x70
Brilliant Color	Write	Color 4	0x06 0x14 0x00 0x04 0x00 0x34 0x12 0x0F 0x04 0x71
Brilliant Color	Write	Color 5	0x06 0x14 0x00 0x04 0x00 0x34 0x12 0x0F 0x05 0x72
Brilliant Color	Write	Color 6	0x06 0x14 0x00 0x04 0x00 0x34 0x12 0x0F 0x06 0x73
Brilliant Color	Write	Color 7	0x06 0x14 0x00 0x04 0x00 0x34 0x12 0x0F 0x07 0x74
Brilliant Color	Write	Color 8	0x06 0x14 0x00 0x04 0x00 0x34 0x12 0x0F 0x08 0x75
Brilliant Color	Write	Color 9	0x06 0x14 0x00 0x04 0x00 0x34 0x12 0x0F 0x09 0x76
Brilliant Color	Write	Color 10	0x06 0x14 0x00 0x04 0x00 0x34 0x12 0x0F 0x0A 0x77
Brilliant Color	Read	Status	0x07 0x14 0x00 0x05 0x00 0x34 0x00 0x00 0x12 0x0F 0x6E
Remote Control Code	Write	code 1	0x06 0x14 0x00 0x04 0x00 0x34 0x0C 0x48 0x00 0xA0
Remote Control Code	Write	code 2	0x06 0x14 0x00 0x04 0x00 0x34 0x0C 0x48 0x01 0xA1
Remote Control Code	Write	code 3	0x06 0x14 0x00 0x04 0x00 0x34 0x0C 0x48 0x02 0xA2
Remote Control Code	Write	code 4	0x06 0x14 0x00 0x04 0x00 0x34 0x0C 0x48 0x03 0xA3
Remote Control Code	Write	code 5	0x06 0x14 0x00 0x04 0x00 0x34 0x0C 0x48 0x04 0xA4



Function	Type	Action	Command
Remote Control Code	Write	code 6	0x06 0x14 0x00 0x04 0x00 0x34 0x0C 0x48 0x05 0xA5
Remote Control Code	Write	code 7	0x06 0x14 0x00 0x04 0x00 0x34 0x0C 0x48 0x06 0xA6
Remote Control Code	Write	code 8	0x06 0x14 0x00 0x04 0x00 0x34 0x0C 0x48 0x07 0xA7
Remote Control Code	Read	Status	0x07 0x14 0x00 0x05 0x00 0x34 0x00 0x00 0x0C 0x48 0xA1
Over Scan	Write	OFF	0x06 0x14 0x00 0x04 0x00 0x34 0x11 0x33 0x00 0x90
Over Scan	Write	Value 1	0x06 0x14 0x00 0x04 0x00 0x34 0x11 0x33 0x01 0x91
Over Scan	Write	Value 2	0x06 0x14 0x00 0x04 0x00 0x34 0x11 0x33 0x02 0x92
Over Scan	Write	Value 3	0x06 0x14 0x00 0x04 0x00 0x34 0x11 0x33 0x03 0x93
Over Scan	Write	Value 4	0x06 0x14 0x00 0x04 0x00 0x34 0x11 0x33 0x04 0x94
Over Scan	Write	Value 5	0x06 0x14 0x00 0x04 0x00 0x34 0x11 0x33 0x05 0x95
Over Scan	Read	Get Value	0x07 0x14 0x00 0x05 0x00 0x34 0x00 0x00 0x11 0x33 0x91
Remote Key	Write	Menu	0x02 0x14 0x00 0x04 0x00 0x34 0x02 0x04 0x0F 0x61
Remote Key	Write	Exit	0x02 0x14 0x00 0x04 0x00 0x34 0x02 0x04 0x13 0x65
Remote Key	Write	Top	0x02 0x14 0x00 0x04 0x00 0x34 0x02 0x04 0x0B 0x5D
Remote Key	Write	Bottom	0x02 0x14 0x00 0x04 0x00 0x34 0x02 0x04 0x0C 0x5E
Remote Key	Write	Left	0x02 0x14 0x00 0x04 0x00 0x34 0x02 0x04 0x0D 0x5F
Remote Key	Write	Right	0x02 0x14 0x00 0x04 0x00 0x34 0x02 0x04 0x0E 0x60
Remote Key	Write	Source	0x02 0x14 0x00 0x04 0x00 0x34 0x02 0x04 0x04 0x56
Remote Key	Write	Enter	0x02 0x14 0x00 0x04 0x00 0x34 0x02 0x04 0x15 0x67
Remote Key	Write	Auto	0x02 0x14 0x00 0x04 0x00 0x34 0x02 0x04 0x08 0x5A
AMX	Write	AMX response	AMX
Operating temperature	Read	Get Value	0x07 0x14 0x00 0x05 0x00 0x34 0x00 0x00 0x15 0x03 0x65
Light Source mode cycle	Write	Light Source mode cycle	0x06 0x14 0x00 0x04 0x00 0x34 0x13 0x36 0x00 0x95

# Glossary

This section describes the standard glossary of terms used in projector models. All terms are listed in alphabetical order.

**NOTE:** Some terms may not be applicable to your projector.

## **A** **Aspect Ratio**

Refers to the ratio of the image width to the image height.

## **Auto Sync**

Built-in intelligent auto adjustment function that will re-adjust the frequency and clock values to provide the best picture quality.

## **B** **Blank**

Temporarily hide the screen image to maintain audience focus when necessary.

## **Brightest Mode**

Maximizes the brightness of the projected image. This mode is ideal for environments where extra-high brightness is required, such as using the projector in well lit rooms.

## **Brightness**

Adjusts brightness levels of the screen image.

## **C** **CEC (Consumer Electronics Control)**

Synchronizes power on/off operation via HDMI connection. That is, if a device that also supports CEC function is connected to the HDMI input of the projector, when the projector's power is turned off, the power of the connected device will also be turned off automatically. When the power of the connected device is turned on, the projector's power will be turned on automatically.

## **Color**

Adjusts the color saturation.

## **Color Mode**

The projector is preset with several predefined color modes to suit operating, environmental, and input source needs.

- C Color Temp.**  
Allows users to select specific color temperature settings to further customize their viewing experience.

Projector Default	Projector Original Status
8000K	Images appear bluish white.
6500K	Default color temperature. Images maintain a normal white appearance. Recommended for general use.
5500K	Images appear reddish white.

**Contrast**

Adjusts the difference between the image background (black level) and the foreground (white level).

- F Focus Ring**  
Manually improve the clarity of the projected image.

- G Gamma**  
Allows the user to manually select the greyscale curve of the projector.

- H HDMI Range**  
Allows the user to select HDMI greyscale range between 0~255 (Enhanced Range) , 16~235 (Normal Range) or Auto by the signal type detected.

**High Altitude Mode**

Optional mode for users who live in an environment between 1,500 m and 3,000 m above sea level, and the temperature is between 5° C and 25° C. Activating it will improve projector cooling and performance.

- I INFORMATION**  
Displays the timing mode (video signal input), the projector model number, the serial number, and the ViewSonic® website URL.

**Input Select**

Toggles between the various input options that are available for the projector.

**K Keystone**  
The distortion of an image caused by projecting it onto an angled surface. It can be adjusted vertically via the  **Keystone Keys**.

**L Light Source Settings**  
The projector's light source information and settings can be viewed and adjusted by viewing the "Light Source Hours Information" or adjusting the "Light Source Mode".

**M Movie Mode**  
A Color Mode appropriate for playing colorful movies, video clips from digital cameras, or DVs through the PC input. Best for a low light environment.

**O OverScan**  
Refers to a cropped image on your monitor's screen. A setting on your monitor zooms in on movie content, so that you cannot see the outermost edges of the film.

**P Pattern**  
Projects a grid to be used for image adjustment and fine-tuning.

**Projector Position**

The projected image can be adjusted based on the installation location of the projector, i.e. ceiling or rear projection installation.

**R RS-232**  
A standard code for serial communication transmission of data, used for connection to other devices or controller via serial port or LAN port.

**S Sharpness**  
Adjusts the picture quality.

**Standard Mode**

A Color Mode that is designed for normal viewing circumstances in a daylight environment.

**Z Zoom Ring**  
Manually adjust the size of the projected image.



# Troubleshooting

## Common Problems

This section describes some common problems that you may experience when using the projector.

Problem	Possible Solutions
The projector does not turn on	<ul style="list-style-type: none"><li>• Ensure the power cord is properly attached to the projector and to the power outlet.</li><li>• If the cooling process has not completed, please wait until it has finished then try to turn on the projector again.</li><li>• If the above does not work, try another power outlet or another electrical device with the same power outlet.</li></ul>
There is no picture	<ul style="list-style-type: none"><li>• Ensure the video source cable is connected properly, and that the video source is turned on.</li><li>• If the input source is not selected automatically, select the correct source with the <b>Source</b> key on either the projector or the remote control.</li></ul>
The image is blurred	<ul style="list-style-type: none"><li>• Adjusting the <b>Focus Ring</b> will help correctly focus the projection lens.</li><li>• Ensure the projector and screen are aligned properly. If necessary, adjust the height of the projector as well as the projection angle and direction.</li></ul>
The remote control does not work	<ul style="list-style-type: none"><li>• Ensure there are no obstacles between the remote control and projector; and that they are within 8 m (26 ft) of each other.</li><li>• The batteries may be out of power, please check and replace if necessary.</li></ul>

## LED Indicators

Light			Status and Description
			
Power			
Green Flashing	Off	Off	Stand-by mode
Green	Off	Off	Powering up
Green	Off	Off	Normal operation
Green Flashing	Off	Off	Normal power-down cooling
Red	Off	Off	Downloading
Green	Green	Green	Burn in off
Lamp			
Green Flashing	Off	Red	First light source-lit error cooling
Off	Off	Red	Light source error in normal operation
Green	Off	Red	Color wheel start has failed
Heating/Cooling			
Off	Red	Off	Fan 1 error (actual fan speed is outside the desired speed).
Off	Red	Red	Fan 2 error (actual fan speed is outside the desired speed).
Off	Red	Green	Fan 3 error (actual fan speed is outside the desired speed).
Off	Red	Orange	Fan 4 error (actual fan speed is outside the desired speed).
Red Flashing	Red	Off	Fan 5 error (actual fan speed is outside the desired speed).
Red Flashing	Red Flashing	Off	Fan 6 error (actual fan speed is outside the desired speed).
Red	Red	Red	Thermal sensor 1 open error (the remote diode has an open-circuit condition).
Red	Red	Green	Thermal sensor 2 open error (the remote diode has an open-circuit condition).
Green	Red	Red	Thermal sensor 1 short error (the remote diode has an open-circuit condition).
Off	Red	Green	Thermal sensor 2 short error (the remote diode has an open-circuit condition).
Orange	Red	Red	Temperature 1 error (over limited temperature).
Orange	Red	Green	Temperature 2 error (over limited temperature).
Off	Green	Red	Fan IC #1 I2C connection error.

# Maintenance

## General Precautions

- Make sure the Projector is turned off and the power cable is unplugged from the power outlet.
- Never remove any parts from the Projector. Contact ViewSonic® or a reseller when any part of the Projector needs replacing.
- Never spray or pour any liquid directly onto the case.
- Handle the Projector with care, as a darker-colored projector, if scuffed, may show marks more clearly than a lighter-colored projector.

## Cleaning the Lens

- Use a canister of compressed air to remove dust.
- If the lens is still not clean, use lens-cleaning paper or moisten a soft cloth with lens cleaner and gently wipe the surface.

**CAUTION:** Never rub the lens with abrasive materials.

## Cleaning the Case

- Use a soft, lint-free, dry cloth to remove dirt or dust.
- If the case is still not clean, apply a small amount of non-ammonia, non-alcohol based, mild non-abrasive detergent onto a clean, soft, lint-free cloth, then wipe the surface.

**CAUTION:** Never use wax, alcohol, benzene, thinner, or other chemical detergents.

## Storing the Projector

If you intend to store the Projector for an extended period of time:

- Ensure the temperature and humidity of the storage area are within the recommend range.
- Retract the adjuster foot completely.
- Remove the batteries from the Remote Control.
- Pack the Projector in its original packaging or equivalent.

## Disclaimer

- ViewSonic® does not recommend the use of any ammonia or alcohol-based cleaners on the lens or case. Some chemical cleaners have been reported to damage the lens and/or case of the projector.
- ViewSonic® will not be liable for damage resulting from use of any ammonia or alcohol-based cleaners.

## Light Source Information

This section will provide a better understanding of your projector's light source.

### Light Source Hour

When the projector is being used, the duration (in hours) of light source usage is automatically calculated by the built-in timer.

To obtain the light source hour information:

1. Press **Menu** to open the OSD Menu and go to: **Advanced > Light Source Settings > Light Source Hours Information**.
2. Press **Enter** and the **Light Source Hours Information** page will appear:
3. Press **Exit** to leave the menu.

### Extending Light Source Life

To prolong light source life, you can adjust the following settings in the OSD Menu.

### Setting Light Source Mode

Setting the projector in **Eco**, **Dynamic Eco**, or **SuperEco+** mode reduces system noise, power consumption, and extends the light sources operational life.

Light Source Mode	Description
Normal	Provides full lamp brightness.
Eco	Reduces lamp power consumption by 21% and lowers brightness, and decreases fan noise.
Dynamic Eco	Reduces lamp power consumption by up to 35% depending on the content's brightness level.
SuperEco+	Reduces lamp power consumption by 63% and lowers brightness to extend the lamp life and decreases the fan noise.

To set the Light Source Mode, open the OSD Menu and go to: **Advanced > Light Source Settings > Light Source Mode** and press ◀/▶ to select and press **Enter**.

### Setting Auto Power Off

This allows the projector to turn off automatically after a set period of time once no input source is detected.

Open the OSD Menu and go to: **POWER MANAGEMENT > Smart Energy > Auto Power Off** and press ◀/▶ to disable or adjust the time.



## **Light Source Replacement Timing**

When the **Light Source Indicator Light** lights up, please install a new lamp or consult your dealer.

**CAUTION:** An old lamp may cause a malfunction in the projector and in some instances the lamp may explode.

## **Replacing the Light Source**

It is recommended to turn the power off and disconnect the projector from the power outlet, and contact a qualified service personnel for lamp replacement.

# > Regulatory and Service Information

## Compliance Information

This section addresses all connected requirements and statements regarding regulations. Confirmed corresponding applications shall refer to nameplate labels and relevant markings on the unit.

### FCC Compliance Statement

This device complies with part 15 of FCC Rules. Operation is subject to the following two conditions: (1) this device may not cause harmful interference, and (2) this device must accept any interference received, including interference that may cause undesired operation. This equipment has been tested and found to comply with the limits for a Class B digital device, pursuant to part 15 of the FCC Rules.

These limits are designed to provide reasonable protection against harmful interference in a residential installation. This equipment generates, uses, and can radiate radio frequency energy, and if not installed and used in accordance with the instructions, may cause harmful interference to radio communications. However, there is no guarantee that interference will not occur in a particular installation. If this equipment does cause harmful interference to radio or television reception, which can be determined by turning the equipment off and on, the user is encouraged to try to correct the interference by one or more of the following measures:

- Reorient or relocate the receiving antenna.
- Increase the separation between the equipment and receiver.
- Connect the equipment into an outlet on a circuit different from that to which the receiver is connected.
- Consult the dealer or an experienced radio/TV technician for help.

**WARNING:** You are cautioned that changes or modifications not expressly approved by the party responsible for compliance could void your authority to operate the equipment.

### Industry Canada Statement

CAN ICES-3 (B)/NMB-3(B)

### CE Conformity for European Countries

 The device complies with the EMC Directive 2014/30/EU and Low Voltage Directive 2014/35/EU.

**The following information is only for EU-member states:**

The mark shown to the right is in compliance with the Waste Electrical and Electronic Equipment Directive 2012/19/EU (WEEE). The mark indicates the requirement NOT to dispose of the equipment as unsorted municipal waste, but use the return and collection systems according to local law.

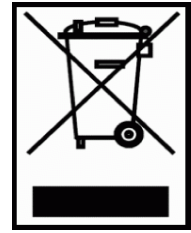

**Declaration of RoHS2 Compliance**

This product has been designed and manufactured in compliance with Directive 2011/65/EU of the European Parliament and the Council on restriction of the use of certain hazardous substances in electrical and electronic equipment (RoHS2 Directive) and is deemed to comply with the maximum concentration values issued by the European Technical Adaptation Committee (TAC) as shown below:

Substance	Proposed Maximum Concentration	Actual Concentration
Cadmium (Cd)	0.01%	< 0.01%
Lead (Pb)	0.1%	< 0.1%
Mercury (Hg)	0.1%	< 0.1%
Hexavalent Chromium (Cr6+)	0.1%	< 0.1%
Polybrominated biphenyls (PBB)	0.1%	< 0.1%
Polybrominated diphenyl esthers (PBDE)	0.1%	< 0.1%
Bis(2-Ethylhexyl) phthalate (DEHP)	0.1%	< 0.1%
Benzyl butyl phthalate (BBP)	0.1%	< 0.1%
Dibutyl phthalate (DBP)	0.1%	< 0.1%
Diisobutyl phthalate (DIBP)	0.1%	< 0.1%

**Certain components of products as stated above are exempted under the Annex III of the RoHS2 Directives as noted below:**

- Mercury in cold cathode fluorescent lamps and external electrode fluorescent lamps (CCFL and EEFL) for special purposes not exceeding (per lamp):
  - » Short length (500 mm): maximum 3.5 mg per lamp.
  - » Medium length (> 500 mm and 1,500 mm): maximum 5 mg per lamp.
  - » Long length (> 1,500 mm): maximum 13 mg per lamp.
- Lead in glass of cathode ray tubes.
- Lead in glass of fluorescent tubes not exceeding 0.2% by weight.
- Lead as an alloying element in aluminum containing up to 0.4% lead by weight.
- Copper alloy containing up to 4% lead by weight.
- Lead in high melting temperature type solders (i.e. lead-based alloys containing 85% by weight or more lead).
- Electrical and electronic components containing lead in a glass or ceramic other than dielectric ceramic in capacitors, e.g. piezoelectronic devices, or in a glass or ceramic matrix compound.

### **Indian Restriction of Hazardous Substances**

Restriction on Hazardous Substances statement (India). This product complies with the “India E-waste Rule 2011” and prohibits use of lead, mercury, hexavalent chromium, polybrominated biphenyls or polybrominated diphenyl ethers in concentrations exceeding 0.1 weight % and 0.01 weight % for cadmium, except for the exemptions set in Schedule 2 of the Rule.

### **Product Disposal at End of Product Life**

ViewSonic® respects the environment and is committed to working and living green. Thank you for being part of Smarter, Greener Computing. Please visit the ViewSonic® website to learn more.

#### **USA & Canada:**

<http://www.viewsonic.com/company/green/recycle-program/>

#### **Europe:**

<http://www.viewsoniceurope.com/uk/support/recycling-information/>

## Copyright Information

Copyright© ViewSonic® Corporation, 2020. All rights reserved.

Microsoft, Windows, and the Windows logo are registered trademarks of Microsoft Corporation in the United States and other countries.

ViewSonic® and the three birds logo are registered trademarks of ViewSonic® Corporation.

VESA is a registered trademark of the Video Electronics Standards Association. DPMS and DDC are trademarks of VESA.

**Disclaimer:** ViewSonic® Corporation shall not be liable for technical or editorial errors or omissions contained herein; nor for incidental or consequential damages resulting from furnishing this material, or the performance or use of this product.

In the interest of continuing product improvement, ViewSonic® Corporation reserves the right to change product specifications without notice. Information in this document may change without notice.

No part of this document may be copied, reproduced, or transmitted by any means, for any purpose without prior written permission from ViewSonic® Corporation.

## Customer Service

For technical support or product service, see the table below or contact your reseller.

**NOTE:** You will need the product's serial number.

Country/ Region	Website	Country/ Region	Website
<b>Asia Pacific &amp; Africa</b>			
Australia	<a href="http://www.viewsonic.com/au/">www.viewsonic.com/au/</a>	Bangladesh	<a href="http://www.viewsonic.com/bd/">www.viewsonic.com/bd/</a>
中国 (China)	<a href="http://www.viewsonic.com.cn">www.viewsonic.com.cn</a>	香港 (繁體中文)	<a href="http://www.viewsonic.com/hk/">www.viewsonic.com/hk/</a>
Hong Kong (English)	<a href="http://www.viewsonic.com/hk-en/">www.viewsonic.com/hk-en/</a>	India	<a href="http://www.viewsonic.com/in/">www.viewsonic.com/in/</a>
Indonesia	<a href="http://www.viewsonic.com/id/">www.viewsonic.com/id/</a>	Israel	<a href="http://www.viewsonic.com/il/">www.viewsonic.com/il/</a>
日本 (Japan)	<a href="http://www.viewsonic.com/jp/">www.viewsonic.com/jp/</a>	Korea	<a href="http://www.viewsonic.com/kr/">www.viewsonic.com/kr/</a>
Malaysia	<a href="http://www.viewsonic.com/my/">www.viewsonic.com/my/</a>	Middle East	<a href="http://www.viewsonic.com/me/">www.viewsonic.com/me/</a>
Myanmar	<a href="http://www.viewsonic.com/mm/">www.viewsonic.com/mm/</a>	Nepal	<a href="http://www.viewsonic.com/np/">www.viewsonic.com/np/</a>
New Zealand	<a href="http://www.viewsonic.com/nz/">www.viewsonic.com/nz/</a>	Pakistan	<a href="http://www.viewsonic.com/pk/">www.viewsonic.com/pk/</a>
Philippines	<a href="http://www.viewsonic.com/ph/">www.viewsonic.com/ph/</a>	Singapore	<a href="http://www.viewsonic.com/sg/">www.viewsonic.com/sg/</a>
臺灣 (Taiwan)	<a href="http://www.viewsonic.com/tw/">www.viewsonic.com/tw/</a>	ประเทศไทย	<a href="http://www.viewsonic.com/th/">www.viewsonic.com/th/</a>
Việt Nam	<a href="http://www.viewsonic.com/vn/">www.viewsonic.com/vn/</a>	South Africa & Mauritius	<a href="http://www.viewsonic.com/za/">www.viewsonic.com/za/</a>
<b>Americas</b>			
United States	<a href="http://www.viewsonic.com/us">www.viewsonic.com/us</a>	Canada	<a href="http://www.viewsonic.com/us">www.viewsonic.com/us</a>
Latin America	<a href="http://www.viewsonic.com/la">www.viewsonic.com/la</a>		
<b>Europe</b>			
Europe	<a href="http://www.viewsonic.com/eu/">www.viewsonic.com/eu/</a>	France	<a href="http://www.viewsonic.com/fr/">www.viewsonic.com/fr/</a>
Deutschland	<a href="http://www.viewsonic.com/de/">www.viewsonic.com/de/</a>	Қазақстан	<a href="http://www.viewsonic.com/kz/">www.viewsonic.com/kz/</a>
Россия	<a href="http://www.viewsonic.com/ru/">www.viewsonic.com/ru/</a>	España	<a href="http://www.viewsonic.com/es/">www.viewsonic.com/es/</a>
Türkiye	<a href="http://www.viewsonic.com/tr/">www.viewsonic.com/tr/</a>	Україна	<a href="http://www.viewsonic.com/ua/">www.viewsonic.com/ua/</a>
United Kingdom	<a href="http://www.viewsonic.com/uk/">www.viewsonic.com/uk/</a>		

## **Limited Warranty**

### ViewSonic® Projector

#### **What the warranty covers:**

ViewSonic warrants its products to be free from defects in material and workmanship, under normal use, during the warranty period. If a product proves to be defective in material or workmanship during the warranty period, ViewSonic will, at its sole option, repair or replace the product with a like product. Replacement product or parts may include remanufactured or refurbished parts or components.

#### **Limited Three (3) year General Warranty**

Subject to the more limited one (1) year warranty set out below, North and South America: Three (3) years warranty for all parts excluding the lamp, three (3) years for labor, and one (1) year for the original lamp from the date of the first consumer purchase.

Other regions or countries: Please check with your local dealer or local ViewSonic office for the warranty information.

#### **Limited One (1) year Heavy Usage Warranty:**

Under heavy usage settings, where a projector's use includes more than fourteen (14) hours average daily usage, North and South America: One (1) year warranty for all parts excluding the lamp, one (1) year for labor, and ninety (90) days for the original lamp from the date of the first consumer purchase; Europe: One (1) year warranty for all parts excluding the lamp, one (1) year for labor, and ninety (90) days for the original lamp from the date of the first consumer purchase.

Other regions or countries: Please check with your local dealer or local ViewSonic office for the warranty information.

Lamp warranty subject to terms and conditions, verification and approval. Applies to manufacturer's installed lamp only. All accessory lamps purchased separately are warranted for 90 days.

#### **Who the warranty protects:**

This warranty is valid only for the first consumer purchaser.

**What the warranty does not cover:**

1. Any product on which the serial number has been defaced, modified or removed.
2. Damage, deterioration, failure, or malfunction resulting from:
  - a. Accident, abuse, misuse, neglect, fire, water, lightning, or other acts of nature, improper maintenance, unauthorized product modification, or failure to follow instructions supplied with the product.
  - b. Operation outside of product specifications.
  - c. Operation of the product for other than the normal intended use or not under normal conditions.
  - d. Repair or attempted repair by anyone not authorized by ViewSonic.
  - e. Any damage of the product due to shipment.
  - f. Removal or installation of the product.
  - g. Causes external to the product, such as electric power fluctuations or failure.
  - h. Use of supplies or parts not meeting ViewSonic's specifications.
  - i. Normal wear and tear.
  - j. Any other cause which does not relate to a product defect.
3. Removal, installation, and set-up service charges.

**How to get service:**

1. For information about receiving service under warranty, contact ViewSonic Customer Support (please refer to "Customer Support" page). You will need to provide your product's serial number.
2. To obtain warranted service, you will be required to provide (a) the original dated sales slip, (b) your name, (c) your address, (d) a description of the problem, and (e) the serial number of the product.
3. Take or ship the product freight prepaid in the original container to an authorized ViewSonic service center or ViewSonic.
4. For additional information or the name of the nearest ViewSonic service center, contact ViewSonic.

**Limitation of implied warranties:**

There are no warranties, express or implied, which extend beyond the description contained herein including the implied warranty of merchantability and fitness for a particular purpose.



**Exclusion of damages:**

ViewSonic's liability is limited to the cost of repair or replacement of the product.

ViewSonic shall not be liable for:

1. Damage to other property caused by any defects in the product, damages based upon inconvenience, loss of use of the product, loss of time, loss of profits, loss of business opportunity, loss of goodwill, interference with business relationships, or other commercial loss, even if advised of the possibility of such damages.
2. Any other damages, whether incidental, consequential or otherwise.
3. Any claim against the customer by any other party.

**Effect of local law:**

This warranty gives you specific legal rights, and you may also have other rights which vary from local authority. Some local governances do not allow limitations on implied warranties and/or do not allow the exclusion of incidental or consequential damages, so the above limitations and exclusions may not apply to you.

**Sales outside the U.S.A. and Canada:**

For warranty information and service on ViewSonic products sold outside of the U.S.A. and Canada, contact ViewSonic or your local ViewSonic dealer.

The warranty period for this product in mainland China (Hong Kong, Macao and Taiwan Excluded) is subject to the terms and conditions of the Maintenance Guarantee Card.

For users in Europe and Russia, full details of warranty provided can be found in [www.viewsoniceurope.com](http://www.viewsoniceurope.com) under Support/Warranty Information.

## **Mexico Limited Warranty**

### **ViewSonic® Projector**

#### **What the warranty covers:**

ViewSonic warrants its products to be free from defects in material and workmanship, under normal use, during the warranty period. If a product proves to be defective in material or workmanship during the warranty period, ViewSonic will, at its sole option, repair or replace the product with a like product. Replacement product or parts may include remanufactured or refurbished parts or components & accessories.

#### **How long the warranty is effective:**

3 years for all parts excluding the lamp, 3 years for labor, 1 year for the original lamp from the date of the first consumer purchase.

Lamp warranty subject to terms and conditions, verification and approval. Applies to manufacturer's installed lamp only.

All accessory lamps purchased separately are warranted for 90 days.

#### **Who the warranty protects:**

This warranty is valid only for the first consumer purchaser.

#### **What the warranty does not cover:**

1. Any product on which the serial number has been defaced, modified or removed.
2. Damage, deterioration or malfunction resulting from:
  - a. Accident, misuse, neglect, fire, water, lightning, or other acts of nature, unauthorized product modification, unauthorized attempted repair, or failure to follow instructions supplied with the product.
  - b. Any damage of the product due to shipment.
  - c. Causes external to the product, such as electrical power fluctuations or failure.
  - d. Use of supplies or parts not meeting ViewSonic's specifications.
  - e. Normal wear and tear.
  - f. Any other cause which does not relate to a product defect.
3. Any product exhibiting a condition commonly known as "image burn-in" which results when a static image is displayed on the product for an extended period of time.
4. Removal, installation, insurance, and set-up service charges.

**How to get service:**

For information about receiving service under warranty, contact ViewSonic Customer Support (Please refer to the attached Customer Support page). You will need to provide your product's serial number, so please record the product information in the space provided below on your purchase for your future use. Please retain your receipt of proof of purchase to support your warranty claim.

**For Your Records**

Product Name: \_\_\_\_\_

Model Number: \_\_\_\_\_

Document Number: \_\_\_\_\_

Serial Number: \_\_\_\_\_

Purchase Date: \_\_\_\_\_

Extended Warranty Purchase? \_\_\_\_\_(Y/N)

If so, what date does warranty expire? \_\_\_\_\_

1. To obtain warranty service, you will be required to provide (a) the original dated sales slip, (b) your name, (c) your address, (d) a description of the problem, and (e) the serial number of the product.
2. Take or ship the product in the original container packaging to an authorized ViewSonic service center.
3. Round trip transportation costs for in-warranty products will be paid by ViewSonic.

**Limitation of implied warranties:**

There are no warranties, express or implied, which extend beyond the description contained herein including the implied warranty of merchantability and fitness for a particular purpose.

**Exclusion of damages:**

ViewSonic's liability is limited to the cost of repair or replacement of the product. ViewSonic shall not be liable for:

1. Damage to other property caused by any defects in the product, damages based upon inconvenience, loss of use of the product, loss of time, loss of profits, loss of business opportunity, loss of goodwill, interference with business relationships, or other commercial loss, even if advised of the possibility of such damages.
2. Any other damages, whether incidental, consequential or otherwise.
3. Any claim against the customer by any other party.
4. Repair or attempted repair by anyone not authorized by ViewSonic.

Contact Information for Sales & Authorized Service (Centro Autorizado de Servicio) within Mexico:

**Name, address, of manufacturer and importers:**

México, Av. de la Palma #8 Piso 2 Despacho 203, Corporativo Interpalmas,  
Col. San Fernando Huixquilucan, Estado de México  
Tel: (55) 3605-1099 <http://www.viewsonic.com/la/soporte/index.htm>

NÚMERO GRATIS DE ASISTENCIA TÉCNICA PARA TODO MÉXICO: 001.866.823.2004

**Hermosillo:**

Distribuciones y Servicios Computacionales SA de CV.  
Calle Juarez 284 local 2  
Col. Bugambilias C.P: 83140  
Tel: 01-66-22-14-9005  
E-Mail: [disc2@hmo.megared.net.mx](mailto:disc2@hmo.megared.net.mx)

**Villahermosa:**

Compumantenimientos Garantizados, S.A. de C.V.  
AV. GREGORIO MENDEZ #1504  
COL, FLORIDA C.P. 86040  
Tel: 01 (993) 3 52 00 47 / 3522074 / 3 52 20 09  
E-Mail: [compumantenimientos@prodigy.net.mx](mailto:compumantenimientos@prodigy.net.mx)

**Puebla, Pue. (Matriz):**

RENTA Y DATOS, S.A. DE C.V. Domicilio:  
29 SUR 721 COL. LA PAZ  
72160 PUEBLA, PUE.  
Tel: 01(52).222.891.55.77 CON 10 LINEAS  
E-Mail: [datos@puebla.megared.net.mx](mailto:datos@puebla.megared.net.mx)

**Veracruz, Ver.:**

CONEXION Y DESARROLLO, S.A DE C.V. Av. Americas # 419  
ENTRE PINZÓN Y ALVARADO  
Fracc. Reforma C.P. 91919  
Tel: 01-22-91-00-31-67  
E-Mail: [gacosta@qplus.com.mx](mailto:gacosta@qplus.com.mx)

**Chihuahua**

Soluciones Globales en Computación  
C. Magisterio # 3321 Col. Magisterial  
Chihuahua, Chih.  
Tel: 4136954  
E-Mail: [Cefeo@soluglobales.com](mailto:Cefeo@soluglobales.com)

**Cuernavaca**

Compusupport de Cuernavaca SA de CV  
Francisco Leyva # 178 Col. Miguel Hidalgo  
C.P. 62040, Cuernavaca Morelos  
Tel: 01 777 3180579 / 01 777 3124014  
E-Mail: [aquevedo@compusupportcva.com](mailto:aquevedo@compusupportcva.com)

**Distrito Federal:**

QPLUS, S.A. de C.V.  
Av. Coyoacán 931  
Col. Del Valle 03100, México, D.F.  
Tel: 01(52)55-50-00-27-35  
E-Mail : [gacosta@qplus.com.mx](mailto:gacosta@qplus.com.mx)

**Guadalajara, Jal.:**

SERVICRECE, S.A. de C.V.  
Av. Niños Héroes # 2281  
Col. Arcos Sur, Sector Juárez  
44170, Guadalajara, Jalisco  
Tel: 01(52)33-36-15-15-43  
E-Mail: [mmiranda@servicrece.com](mailto:mmiranda@servicrece.com)

**Guerrero Acapulco**

GS Computación (Grupo Sesicomp)  
Progreso #6-A, Colo Centro  
39300 Acapulco, Guerrero  
Tel: 744-48-32627

**Monterrey:**

Global Product Services  
Mar Caribe # 1987, Esquina con Golfo Pérsico  
Fracc. Bernardo Reyes, CP 64280  
Monterrey N.L. México  
Tel: 8129-5103  
E-Mail: [aydeem@gps1.com.mx](mailto:aydeem@gps1.com.mx)

**MERIDA:**

ELECTROSER  
Av Reforma No. 403Gx39 y 41  
Mérida, Yucatán, México CP97000  
Tel: (52) 999-925-1916  
E-Mail: [rrrb@sureste.com](mailto:rrrb@sureste.com)

**Oaxaca, Oax.:**

CENTRO DE DISTRIBUCION Y  
SERVICIO, S.A. de C.V.  
Murguía # 708 P.A., Col. Centro, 68000, Oaxaca  
Tel: 01(52)95-15-15-22-22  
Fax: 01(52)95-15-13-67-00  
E-Mail: [gpotai2001@hotmail.com](mailto:gpotai2001@hotmail.com)

**Tijuana:**

STD  
Av Ferrocarril Sonora #3780 L-C  
Col 20 de Noviembre  
Tijuana, Mexico

**FOR USA SUPPORT:**

ViewSonic Corporation  
14035 Pipeline Ave. Chino, CA 91710, USA  
Tel: 800-688-6688  
E-Mail: <http://www.viewsonic.com>

Projector Mexico Warranty Term Template In UG  
VSC\_TEMP\_2006

