



## Operator Manual



2400 Trade Centre Avenue  
Longmont, CO 80503 USA

# CONTENTS

<b>1.0</b>	<b>Specification .....</b>	<b>4</b>
1.1	General Specifications .....	4
1.2	Physical Specifications.....	5
<b>2.0</b>	<b>General Information.....</b>	<b>5</b>
2.1	Product Safety Information.....	5
2.2	Laser Safety Information .....	5
<b>3.0</b>	<b>Introduction.....</b>	<b>7</b>
<b>4.0</b>	<b>Unpacking the Instrument.....</b>	<b>7</b>
<b>5.0</b>	<b>WIBS-NEO Quick-Start.....</b>	<b>8</b>
5.1	Set Up .....	8
5.2	Instrument Operation and Data Collection.....	10
<b>6.0</b>	<b>Logging onto the Remote WIBS-NEO network.....</b>	<b>11</b>
6.1	Remote NEO network (Windows 7) .....	11
6.2	Logging onto the RemoteNEO network from a MAC OS: .....	13
<b>7.0</b>	<b>WIBS-NEO Software .....</b>	<b>14</b>
7.1	NEO Main Window .....	15
7.2	Histograms Window .....	16
7.3	Single Particle Window.....	18
7.4	Data Storage Window .....	19
7.5	System Settings .....	20
7.6	Status.....	21
<b>8.0</b>	<b>Maintenance.....</b>	<b>21</b>
8.1	Zero-Count Check.....	22
8.2	Running WIBS-NEO in Forced Trigger Mode .....	22
<b>Appendix A: Theory of Operation .....</b>		<b>23</b>
Design.....		23
Aerosol Sampling System .....		23
Particle Size .....		28
Particle Shape.....		28
Appendix H: Logging onto the Remote NEO Network (Windows 10) using Ethernet .....		37
File Transfer.....		37

# FIGURES

Figure 1: Shipped System Components.....	7
Figure 2: Power Cord and Rear Panel .....	8
Figure 3: Connecting the Peripherals.....	9
Figure 4: Find the Instrument (wireless) .....	11
Figure 5: Wireless Network Password .....	12
Figure 6: Search Windows for Remote Desktop .....	12
Figure 7: WIN 7 Remote Desktop Window.....	12
Figure 8: Connect to the Instrument on the network .....	13
Figure 9: Mac Remote desktop connection window .....	14
Figure 11: WIBS-NEO Main User Interface .....	16
Figure 12: WIBS-NEO Histograms Tab.....	17
Figure 13: Frequency plots .....	17
Figure 14: WIBS-NEO Single Particle Tab .....	18
Figure 15: WIBS-NEO Data Storage Tab .....	19
Figure 16: WIBS-NEO System Settings Tab .....	20
Figure 17: WIBS-NEO Status Tab.....	21
Figure 18: The WIBS-NEO Measurement Cycle .....	24
Figure 19: WIBS-NEO Flow System Diagram .....	25
Figure 20: Visualization of Scattering Volume and its Surrounding Clean Sheath Flow....	26
Figure 21: Derivation of particle Asphericity Factor, AF, measuring azimuthal variation in forward scattering of the particle.....	28

# 1.0 Specification

## 1.1 General Specifications

Measured Parameters	<ul style="list-style-type: none"> <li>• Single-Particle Light Scattering</li> <li>• Single-Particle Fluorescence (Three Emission Wavebands)</li> <li>• Particle Size</li> <li>• Particle Asymmetry Factor (AF)</li> </ul>
Derived Parameters	Particle Concentration
Particle Size Range	0.5 µm to 30 µm
Maximum Concentration	466 particles/cm <sup>3</sup> for fluorescent particle counting (10% coincidence) 9,500 particles/cm <sup>3</sup> for sizing and counting (10% coincidence)
Fluorescence excitation	Dual Wavelength, 280 nm and 370 nm
Fluorescence detection	Dual Waveband, 310-400 nm and 420-650 nm
Flow Rate	<ul style="list-style-type: none"> <li>• Sample Flow: 0.3 L/min</li> <li>• Sheath Flow: 2.1 L/min</li> </ul>
Front Panel Features	<ul style="list-style-type: none"> <li>• ON/OFF LED (Blue)</li> <li>• Pump Status LED (Green)</li> <li>• Particle Detection LED (Yellow)</li> <li>• 2 x USB Connector</li> <li>• Ethernet Port</li> <li>• VGA</li> </ul>
Rear Panel Features	<ul style="list-style-type: none"> <li>• Power Connection</li> <li>• Sample Flow Exhaust Port (Unfiltered)</li> </ul>
Laser	Class I Laser Product Contains internally a Class3B 635 nm diode laser, 15 mW
Pump	Diaphragm Pump
Power Requirements	100 - 240V ~ 3A 50-60Hz
Embedded Computer	Intel Core i7 6600U Dual Core 2.6Ghz 8.0G Ram Windows E7 64bit
Use Conditions	<ul style="list-style-type: none"> <li>• Class I Equipment – Grounding required for safety</li> <li>• Mains supply voltage fluctuations may not exceed +/-10% of the rated supply voltage range</li> <li>• Over-voltage category II – Transient over-voltages</li> </ul>
Maximum RH%	5% to 90%, non-condensing
Electrical Rating	100-240V~50/60Hz 10A
Pollution Rating	Degree 3 Harsh Environment
Ingress Protection Rating	Ordinary Protection Only - (Not Protected against ingress of moisture or fluids)
Operating Temperature Range	5°C to 40°C (40°F to 104°F)
Storage Temperature Range	-40°C to 70°C (-40°F to 158°F)
Maximum Aerosol Sampling Altitude	12192m (40,000 ft) – Instrument contained in pressurized aircraft
Maximum Operating Altitude	0 to 2000m (6562 ft) Contact DMT for guidance to operate at altitudes >2000m

Fuses	(2) 250V 5 A T
-------	----------------

## 1.2 Physical Specifications

Weight	28 lbs (12.7 kg)
Dimensions	17.825" W x 14.825" L x 11.5" H (with inlet) 13" H (with zero filter) 45.3 cm W x 37.7 cm L x 29.2 cm H (with inlet) 33 cm H (with zero filter)

## 2.0 General Information

In no event will Droplet Measurement Technologies, LLC (DMT) be liable for direct, indirect, special, incidental or consequential damages resulting from any defect or omissions in this manual.

DMT reserves the right to make changes to this manual and the products it describes at any time, without notice or obligation. Revised editions can be found on the manufacturer's website.

All DMT product names and the Droplet Measurement Technologies Logo are trademarks of Droplet Measurement Technologies, LLC.

All other brand and product names are trademarks, or registered trademarks, of their respective owners.

### 2.1 Product Safety Information

DMT is not responsible for any damages due to misapplication or misuse of this product including, without limitation, direct, incidental and consequential damages, and disclaims such damages to the full extent permitted under applicable law. The user is solely responsible to identify critical application risks and install appropriate mechanisms to protect processes during a possible equipment malfunction.

Please read this entire manual before unpacking, setting up or operating this equipment. Pay special attention to all danger and caution statements. Failure to do so could result in serious injury to the operator or damage to the equipment.

Make sure that the protection provided by this equipment is not impaired. Do not use or install this equipment in any manner other than that specified in this manual.

### 2.2 Laser Safety Information

The WIBS-NEO is distributed as a Class 1 Laser Product and is intended to be serviced only by factory trained personnel. Never remove, modify, or defeat safety controls. Contact DMT for instrument service or applications assistance.

The WIBS-NEO product contains a fully enclosed path 635nm, 15mW Class 3B laser.

**CAUTION** – *Class 3B lasers are hazardous for eye exposure. They can heat skin and materials but are not considered a burn hazard. For visible-light lasers, Class 3B laser output power is between 5 and 499 milliwatts. Class 3B is the same as the Roman numeral "Class IIIb" visible on some product safety labels.*

**CAUTION** – Strict observance of the following Warning labels is advised:



Back panel of the WIBS-NEO

Exterior of the laser frame:



Model: **WIBS-NEO**  
S/N: **1404-0011**  
Manufacture Date: **April 2014**  
**[www.dropletmeasurement.com](http://www.dropletmeasurement.com)**  
**Longmont, CO, Patent 7,436,515**

Back panel of the WIBS-NEO

## 3.0 Introduction

The Wideband Integrated Bioaerosol Sensor-New Electronics Option (WIBS-NEO) is designed to provide highly sensitive measurements of bioaerosols. The instrument uses two UV filtered flashlamp sources to excite fluorescence in individual particles. Detection wavebands have been selected to optimize detection of common bioaerosol components such as tryptophan and nicotinamide adenine di-nucleotide (NADH).

The original WIBS detector was developed by the University of Hertfordshire and is licensed to and manufactured by Droplet Measurement Technologies, LLC (DMT).

## 4.0 Unpacking the Instrument

Each shipped system contains the following items (Figure 1):

- Pelican Case, Power Cord, Combo Keyboard/Mouse, International Plug Adapters, and a Zero Count (HEPA) filter.
- USB storage device containing the WIBS-NEO Toolkit and supporting documentation.
- USB Wireless Adapter
- Operator Manual, WIBS-NEO Toolkit Software manual, and NEO Calibration/Data sheet.

The Pelican case should be saved and used to return the analyzer to DMT if service or calibration is needed. Check shipped items for damage immediately upon receipt. Notify both the carrier and DMT if any damage is noted.



Figure 1: Shipped System Components

## 5.0 WIBS-NEO Quick-Start

### 5.1 Set Up

The WIBS-NEO power entry port is located on the rear panel (Figure 2) of the WIBS-NEO instrument. Be sure to use the appropriate region power cord adapter (supplied) to connect the cord to an outlet.



*Figure 2: Power Cord and Rear Panel*



**Warning:** This equipment must be grounded. Never defeat the ground conductor or operate the equipment in the absence of a suitably installed ground connector. Contact the appropriate electrical inspection authority or an electrician if you are uncertain suitable grounding is available.



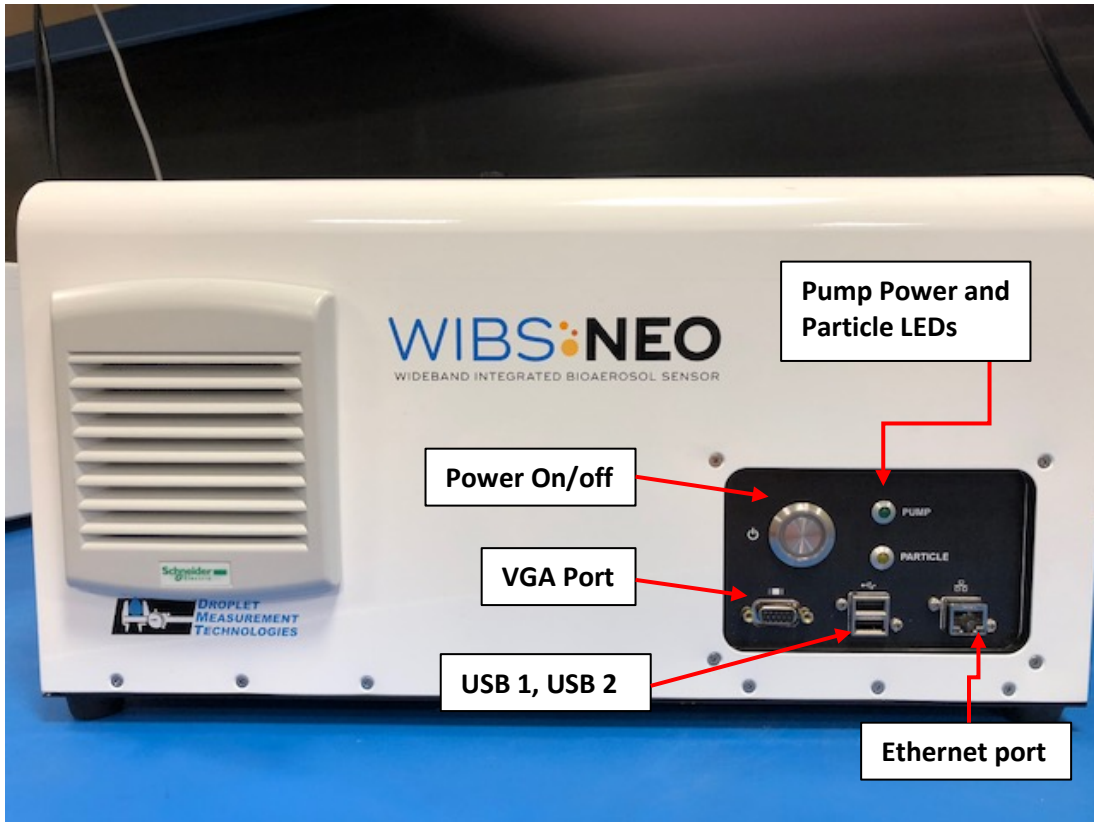



Figure 3: Connecting the Peripherals

1. Connect the Monitor to the VGA port.
2. Connect the NETIS USB wireless network adapter and the supplied combination USB keyboard/mouse to the 2 USB ports in front of the instrument (Figure 3).  
\* For Automated Remote Desktop access, the Netis Wireless Adapter must be inserted before the power to the unit is engaged so that the on-board computer can automatically generate the RemoteNEO network.
3. System access passwords are available for Administrative use, please see caution below:

WIBS-NEO Admin Password: Yogi

**CAUTION:** The **Administrative** password allows access to default and calibration settings that when either accidentally or intentionally changed may produce invalid data and affect the accurate performance of this unit. It is recommended that only certain default settings are changed, which are highlighted in this manual. Pay close attention to the written **Cautions and/or Warnings** contained in the following sections before changing any settings. Change settings only with the guidance of an experienced user of this unit.

## 5.2 Instrument Operation and Data Collection

- Once the WIBS-NEO is connected to power and peripherals, depress the main Power button,  (Figure 3) found on the front of the unit, this action will start the computer.
- Click on the NEO shortcut icon found on the windows desktop to start the program or, it can be also be found in the **Start Menu > All Programs > NEO** list. 
- The NEO software starts up automatically in data acquisition mode. The system will start the instrument pump and begin displaying data within a few seconds. A heart symbol located at the upper right-hand corner of the display will alternately flash red to green to indicate that the software is operating normally.

**NOTE:** The embedded computer is intended to run the software for the WIBS-NEO instrument. Installing and running additional programs on the computer including Anti-Virus software, may compromise the performance of the system.

**NOTE:** If the pump is not set to “ON” at startup, a window will automatically pop up indicating that the pump is set to “OFF” and display a “button” that must be checked to keep the pump in the off position. The software will pause for 30 seconds to allow the operator time to override the pump start command. If the “button” is not clicked, the software will close the window and start the pump automatically.

Once the program and pump are running you can choose to perform several actions including: Record and save data; acquire Forced Trigger data; manually record Forced Trigger data; automate Forced Trigger data.

**NOTE:** Refer to section 7.0 WIBS-NEO Software for details.

- Record** and save data by clicking the tab on the Main Interface as shown below:



(Red=off) (Green=Recording)

- Acquiring and saving a Forced Trigger data set is recommended before each experiment.** The Forced Trigger (see section 8.2) background file can be subtracted from the standard data set to account for background noise in the cavity. Forced trigger data may be collected manually or automatically according to the user’s preference.
- To **Manually** acquire a Forced Trigger data set, toggle the “Forced Trigger” switch on the **System Settings** Tab to the ON position. The pump will automatically turn off during this operation and will automatically turn back on when the “Forced Trigger” switch is toggled back to the OFF position.
- To **Automate** a Forced Trigger data file during data saving ONLY, **Enable the Forced Trigger Scheduler** via the check box found in Data Storage window Section. Forced Trigger Data will be recorded at pre-set intervals (See Section 7.4 for more information). If the buttons below are flashing between yellow and red, Forced Trigger data is being recorded.



## 6.0 Logging onto the Remote WIBS-NEO network

The remote NEO wireless network (Host) can be utilized by a remote computer workstation to access and control the WIBS-NEO instrument without a direct interface. The network is set-up as an access point in order to simplify the connection. When using the Windows Remote Desktop to remotely connect to the instrument, the user has full access to the embedded computer and can start the sampling process, load experiments, and acquire data as if they were directly connected to the system.

The data can then be transferred, copied, or shared so that the embedded computer hard drive has as little stored data as possible at any given time. There is access to the disk drives on the local computer during a Remote Desktop session. One can redirect the local disk drives, including the hard disk drives, CD-ROM disk drives, and mapped network disk drives so that files may be transferred between the local host and the remote computer in the same way that files can be copied from a network share by using the following procedure:

Start Microsoft Windows Explorer to view the disk drives and files for each redirected disk drive. Alternatively, there is access to view the files for each redirected disk drive in My Computer.

The drives are displayed as "drive\_letter on terminal\_server\_client\_name" in both Windows Explorer and in My Computer.

To view the disk drives and files for the redirected disk drive:

Click Start, point to All Programs (or Programs), point to Accessories, point to Communications, and then click Remote Desktop Connection.

Click Options, and then click the Local Resources tab.

Click Disk Drives, and then click Connect.

The data can now be transferred.

### 6.1 Remote NEO network (Windows 7)

See Appendix H to log onto the remote NEO network if you are using (Windows 10)

1. Click on the wireless connections icon,  on the lower right of your desktop. On the Pop-up screen, select the NEOXXXX (where XXXX represents the last 4 digits of the serial number of the instrument) (Figure 4) you want to connect to, and click on the "Connect" button.

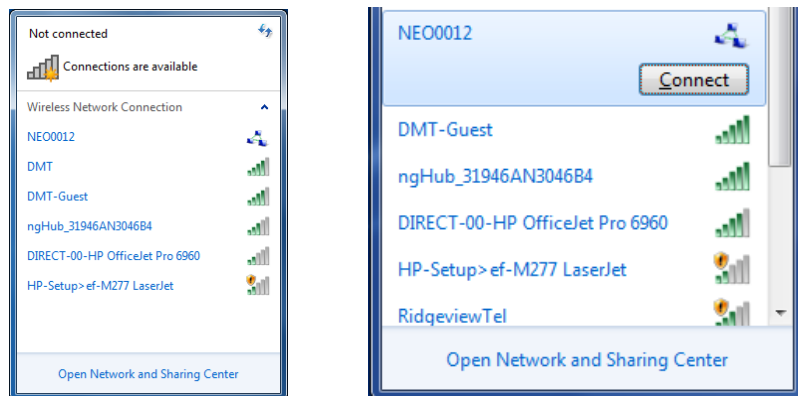

Figure 4: Find the Instrument (wireless)

- The “**Connect to a Network**” window will pop up.



Figure 5: Wireless Network Password

- Enter “**12345678**” as the security key (password) (Figure 5) for the network and click “**OK**”, it may take several seconds for the connection to become active.
- To start the remote desktop application, click on the Windows Start Button, and enter “**mstsc**” (Microsoft Terminal Server Client) into the search window (Figure 6) then choose “**run**” or hit the enter key. The Remote Desktop Connection utility may also be accessed directly from the Windows Start Menu.

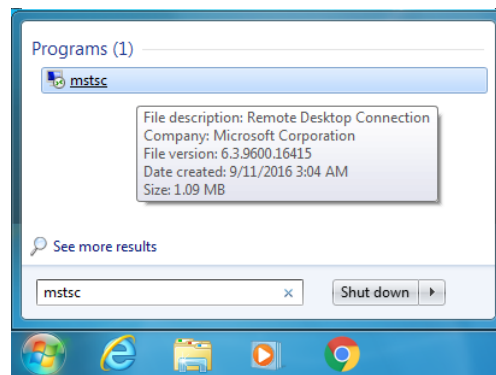

Figure 6: Search Windows for Remote Desktop

- The Remote Desktop Connection window will pop up (Figure 7).
- In the Remote Desktop Connection window, enter “**NEO**” into the Computer field, and “**NEO\user**” into the user name field.

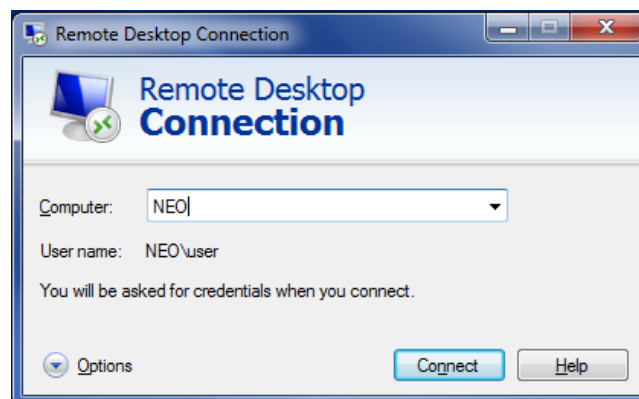

Figure 7: WIN 7 Remote Desktop Window

7. Click on **“Connect”** and a **“Windows Security”** popup window will appear.

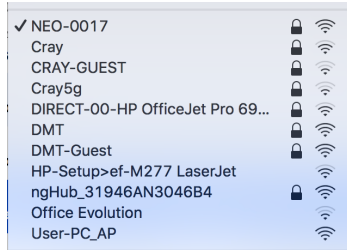

Figure 8:Connect to the Instrument on the network

8. Enter **“neo”** for the password then check **“Remember my credentials”**.
9. Click on the **“OK”** button and the connection to the NEO desktop will be established for remote access.
10. To return to normal operation and exit the remote desktop application, select the **“X”** near the upper right corner of the screen and the connection will be terminated. The NEO instrument will continue to remain active in the background.

## 6.2 Logging onto the RemoteNEO network from a MAC OS:

1. Connect to the WIBS-NEO wireless network.



2. Startup the Microsoft Remote Desktop application on the MAC

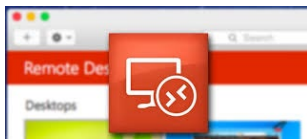

3. Select **+** to add a connection.

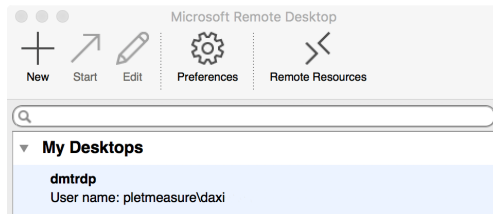

- An “**Edit Remote Desktop**” window will pop up (Figure 9). In the connection field enter “**NEO**”
4. In the PC name field enter: 192.168.159.1. This is a static IP address range required to complete the connection. Enter: “**user**” into the user name field.
  5. Enter: “**neo**” into the password field.

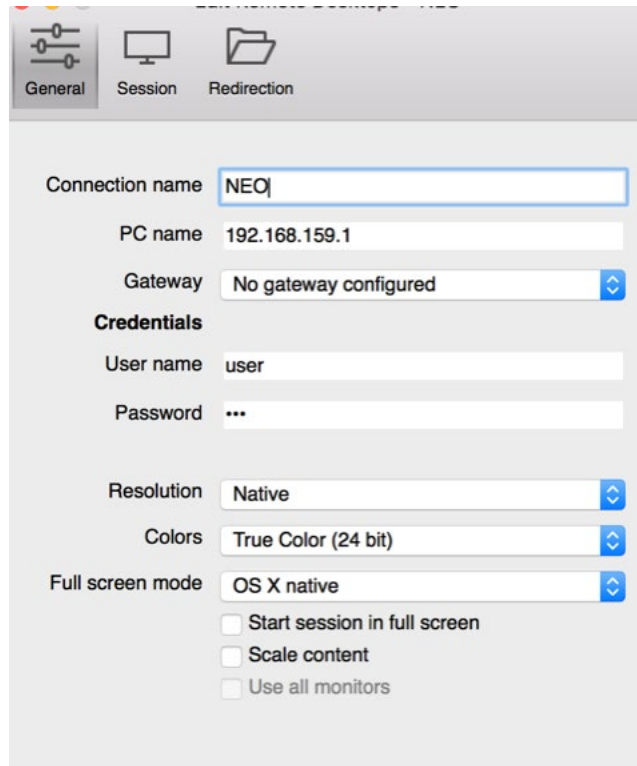

Figure 9: Mac Remote desktop connection window

6. There are no other configurations required. Gateway will be left blank.
7. Save the connection.

## 7.0 WIBS-NEO Software

The following software programs are provided with the unit:

- NEO.exe - Data acquisition and data playback.
- WIBS-NEO toolkit - reads HDF5 files for analysis of collected data in Igor.

NEO.exe is pre-loaded on the C: drive of the WIBS-NEO unit. The toolkit as well as a copy of NEO.exe will be located on the USB storage device that ships with the unit. Instructions for loading the toolkit program, Igor, and establishing the Igor license are included in the WIBS-NEO Toolkit Manual Doc-0433.

The particle data files collected during normal operation are stored directly as HDF5 to allow faster playback of the data and more efficient data storage compression. HDF5 compressed files are roughly 10% of the size of the file if it were written in CSV. The WIBS-NEO toolkit reads HDF5 files directly and can be used for quick data analysis. To avoid data loss, be aware of the remaining storage on your hard drive and be careful not to exceed that file size. The NEO software will warn the user when the hard drive is nearing capacity and will stop saving data when the storage location drive has less than 1 MB of storage remaining. In addition, we recommend that data is stored to or transferred to an external dedicated drive, instead of the WIBS on board computer to avoid running out of the disk space. The WIBS-NEO data storage partition (D:) contains ~90GB of data storage space.

The WIBS-NEO instrument uses several programs for different aspects of the data handling. The user interface is written using LabVIEW and provided as an executable. The data analysis or WIBS-NEO toolkit program is written in IGOR. An IGOR license and serial number is provided with each WIBS-NEO instrument.

Each day the NEO.exe is loaded, a new directory labeled YYYYMMDD will be created in the target directory for data saving. Individual data directories are created each time the **Save Data** command is clicked on the NEO.exe program. If the user is only interested in analyzing particles that were excited by the flashlamp, the option to **Save Unexcited Particles (HDF5 Only)** should be selected.

The configuration of the NEO.exe program is found in the "NEOconfiguration.ini" file. This file is read each time the NEO.exe program loads and contains all of the operational parameters for the software and calibration. These parameters include flow rates, flashlamp settings, data display and storage options.

## **HELPFUL SOFTWARE TIPS**

When the NEO.exe program is opened the main WIBS-NEO screen will appear with a frequency histogram plot detailing measured particles on the left and time series plots for (selectable) recorded housekeeping parameters on the right. Each of the tabs will bring up a new screen allowing for instrument control or display of selected WIBS-NEO parameters. The parameter that is displayed can be chosen by scrolling through the up and down arrows to the left of the displayed parameters or by clicking in the white box. This will cause a drop-down menu to appear and the parameter can be chosen from the list. The user can adjust minimum and maximum values of the graph by clicking inside the graph and entering the desired value.



The **Save Data** switch controls writing data to file. With this switch in the down position (shown in red) data is not written to file, only displayed on the screen. If you click the Save Data box, the switch will move to the up position and the switch display will change to green. Data will now be written to file. The data file name will be displayed in the **Data Folder** ('B' in Figure 10) box on the upper left of the main WIBS-NEO screen.

The grey **Save Config** box in the upper right-hand corner of any of the graphic display screens,

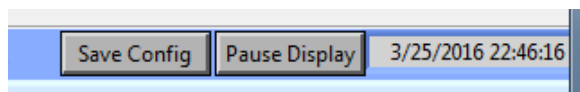

allows the user to save any configuration or display changes made during the **software session**.

If the **Pause Display** button is selected, the graphic display of data is paused, allowing for screen captures.

Under the **File** tab located at the upper left hand of the window, you can perform a screen capture which will save the current screen as a .jpg. There is also an option to **Exit** the WIBS-NEO software program under this tab.

## **7.1 NEO Main Window**

(Figure 10) shows the WIBS-NEO main tab. The **Particles Saved** window (A) records particle data for the number of fluorescent, non-fluorescent and cumulative mass data for those particles, written to file. The **Data Folder** box (B) will show the current data file name and storage path. The time series plots on the right allow any housekeeping parameter which is written to file to be displayed in real time. The window (C) at the top of the graphs allows for the following parameters to be chosen:

**Time(sec), Timestamp, Elapsed time, Error Code, TEC\_T, Bias V, Board\_1, Sys\_V, HK1- HK12, XE1 Power, XE2 Power, Concentration (Excited), Concentration (All), Sheath flow (L/Min), and Sample flow (L/Min).**

The scatter plot on the left of the screen (**D**) details the measured particles. The user can choose to display Xe1 (280 nm) excited particles or Xe2 (370 nm) excited particles by clicking inside of the **Channel Hist** box (**E**) at the top of the graph. The data points on the histogram are colored to indicate the emission wavelength band. To display a Frequency or PbP (particle by particle) plot use the switch (**F**) at the bottom of the graph. To choose the time duration of data to be displayed on the plot, select the time period using drop down box (**G**).

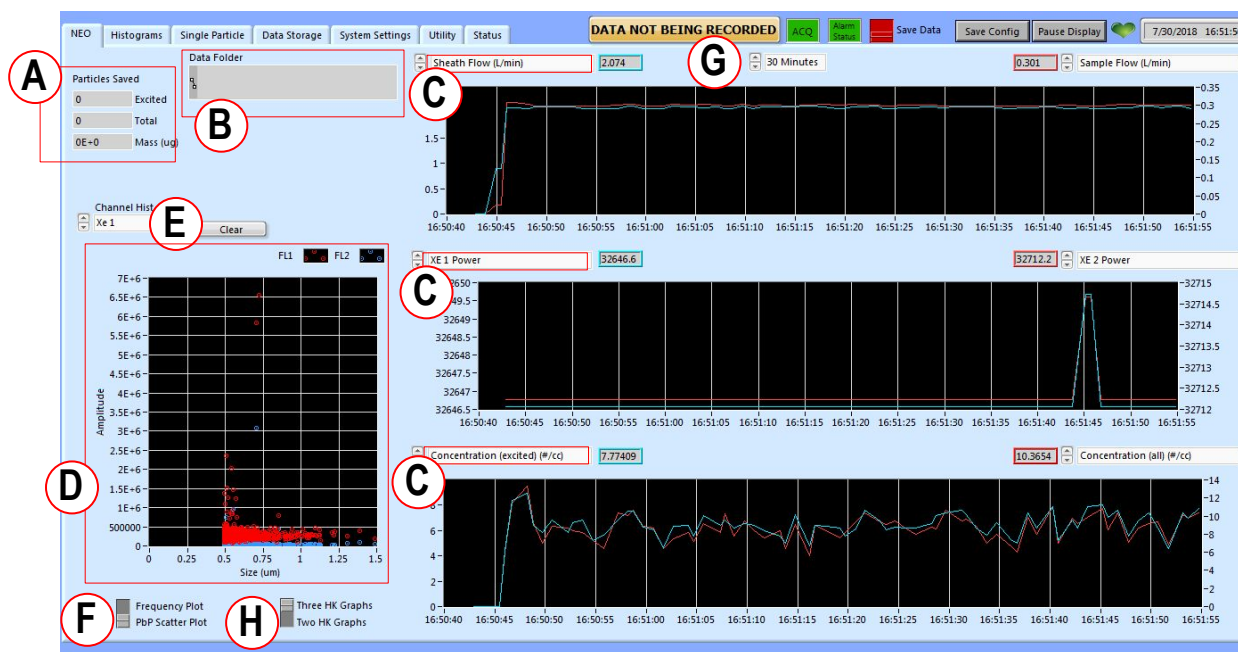

Figure 10: WIBS-NEO Main User Interface

The user controls whether two or three graphs are displayed by selecting the switch (**H**) under the histogram plot.

## 7.2 Histograms Window

(Figure 11) shows the Histograms Tab where detailed information is displayed for particles being measured in real time. The top three time series graphs allow the user to view the particle peak response for:

1. FL1\_280nm Peak: 310-400 nm fluorescence emission detected by FL1 in response to the Xe1 280 nm excitation.
2. FL2\_280nm Peak: 420-650 nm fluorescence emission detected by FL2 in response to the Xe1 280 nm excitation.
3. FL2\_370nm Peak: 420-650 nm fluorescence emission detected by FL2 in response to the Xe2 370 nm excitation.
4. Asphericity of particle (see Appendix B), or time of flight for particle.
5. Size of particle in um
6. Excited particle concentration in  $\#/cm^3$

The Histogram types and corresponding fields (1-6) are called out in (Figure 12). These displays are 3D time series plots, with the color of the data symbol showing the number of particles as indicated by



the color scale on the lower left. Display panels on the right are normally hidden, but when the “Show Freq vs. Size Plots” tab is clicked the plots are displayed and display one second cross sections of the data and the average, maximum, and minimum values for each measured parameter as shown in Figure 13.

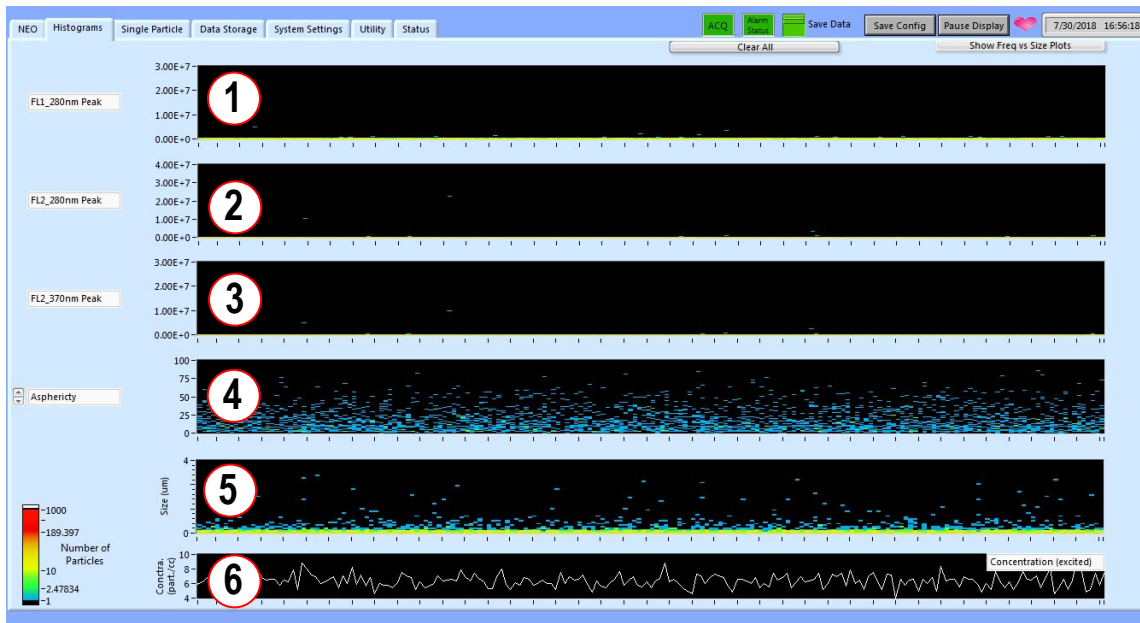

Figure 11:WIBS-NEO Histograms Tab

Clicking anywhere within the graph will trigger the software to open up a window enabling the user to edit the display parameters for the histograms.

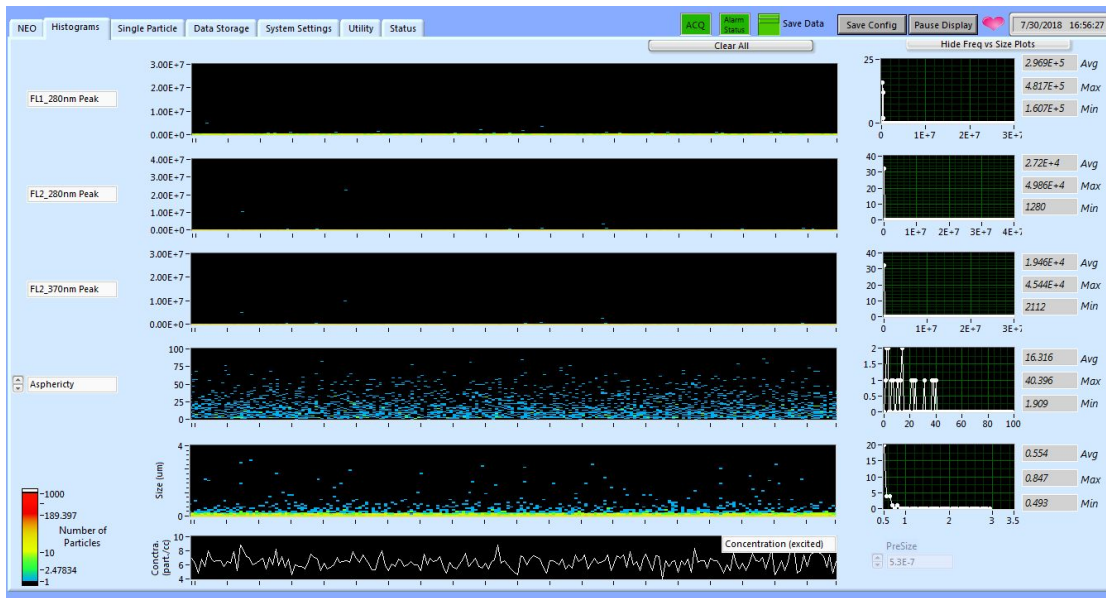

Figure 12:Frequency plots

The **Clear All** button on the top right of the page allows the user to clear all displayed data and restart the time series.

## 7.3 Single Particle Window

The **Single Particle** tab, shown in (Figure 13), shows an oscilloscope type view of the particle response. The axis scale can be changed by right-clicking on the axis, unchecking autoscale, and then updating the values. Two traces are displayed, one showing the FL2 signal which contains both the particle size trace and FL2 fluorescence emission trace and the other showing the fluorescence emission data for the FL1 channel.

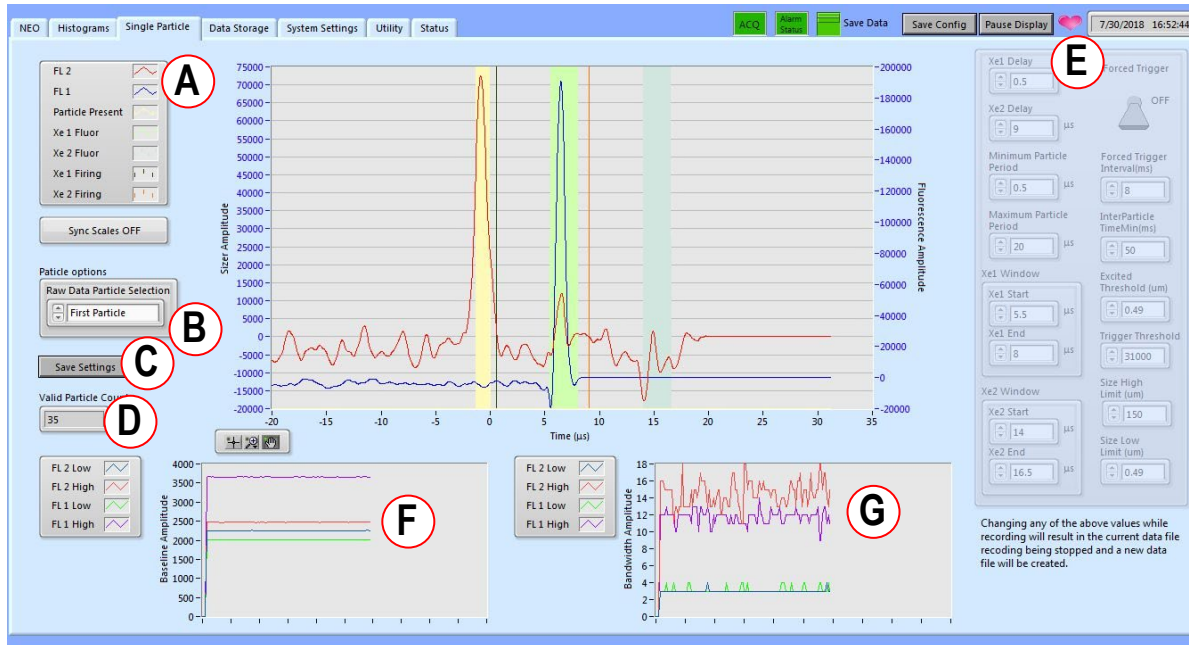

Figure 13: WIBS-NEO Single Particle Tab

**FL1, FL2:** (A) Identifies the detector channel chosen for display.

**Particle options:** (B) This selection box allows the user to display the **first, last, smallest, largest, fastest or slowest** particle in the last second of data.

**Save Settings:** (C) If any settings are changed, they can be saved to your data file.

**Valid particle count:** (D) Measure of the number of particles processed in that one second data period.

**Trigger Settings:** (E) Each of these normally greyed out parameters are set at the factory as part of calibration and should only be changed after consulting Droplet Measurement Technologies. These fields are **Administrator** password protected.

**Baseline Amplitude:** (F) This plot tracks and stores the baselines for the high and low gain detector channels for each detector in the system.

**Bandwidth Amplitude:** (G) This plot tracks and stores the detector bandwidth for the high gain and low gain detector channels in the system.

## 7.4 Data Storage Window

The **Data Storage** tab, (Figure 14) allows the user to configure the data to be saved and to add notes to the data files.

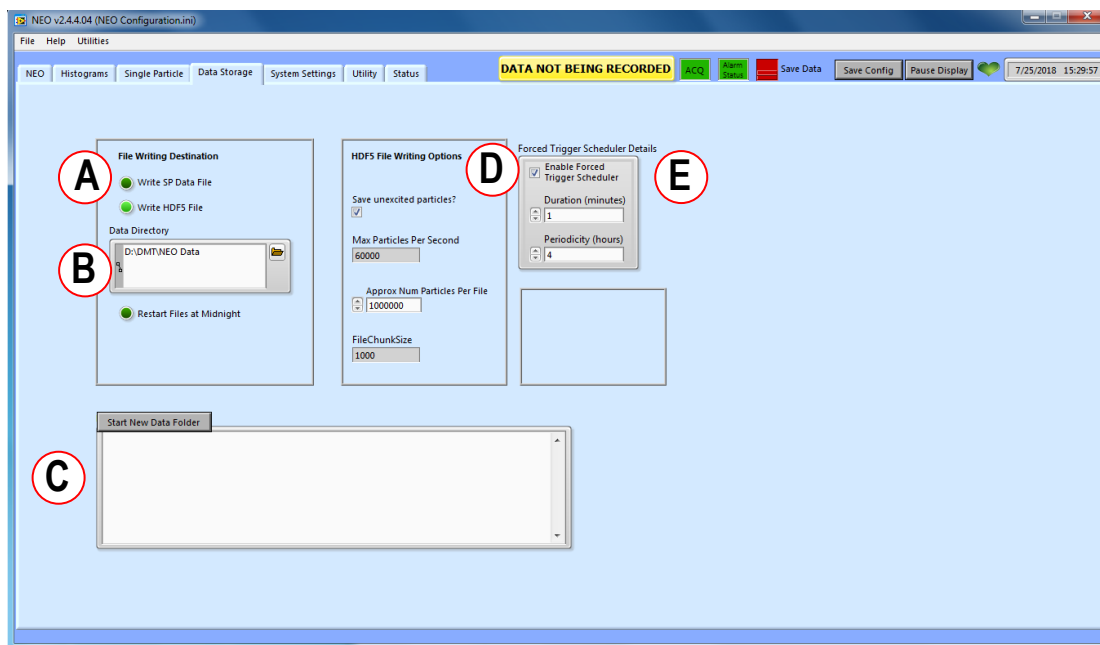

Figure 14: WIBS-NEO Data Storage Tab

The check boxes on the left of (Figure 15) detail the format in which particle data is stored.

- **Write SP Data File**- Single particle traces shown in ‘single particle tab’ (need SP data reader)
- **Write HDF5 File**- Particle data (HDF5) files that import directly into the WIBS-NEO toolkit.
- **Restart Files at Midnight** – When selected will create a new data file folder subheading for each new date.

The **Write HDF5** file box (A) should always be checked unless special experiments are underway.

The **Data directory** box, (B) allows the user to select where on the computer or network the data file is to be written. Each data set is named with the date and time. Data may not be written to the “C:” drive partition which is write protected to preserve the operating system settings.

The **Data File Notes** box, (C) allows the user to enter specific notes about the experiment which will be attached to the data file when writing to the file is stopped. The notes can be entered before writing to file or during the file writing process.

In the **HDF5 File Writing Options** box, (D) the user can choose to save either all particles or only those particles that are excited by the flashlamp and may also specify how many particles are written to a file before a new file is written. The “Max Particles Per Second” field is factory set to save disk space and flag particle data during periods when single particle data integrity is lost due to particle coincidence at high concentrations. Data will be written for particles up to the Max Particles field value, a data flag will be set indicating coincidence, and the remaining data for that second will be truncated.

**Forced Trigger Scheduler Details:** (E) Set duration and frequency of automatic Forced Trigger background data collection during data saving.

## 7.5 System Settings

The **System Settings** tab (Figure 15), allows the user to manually engage a **Forced Trigger** background. This setting may be manually triggered during data collection and will be written into a file that can be subtracted from the full data file for a focused data set the same as it would be written by the forced trigger scheduler program. The setting may also be manually engaged without data saving to view trigger background levels in real time on the Histograms software tab. More information regarding the use of **Forced Trigger** background files can be found in Section 8.3.

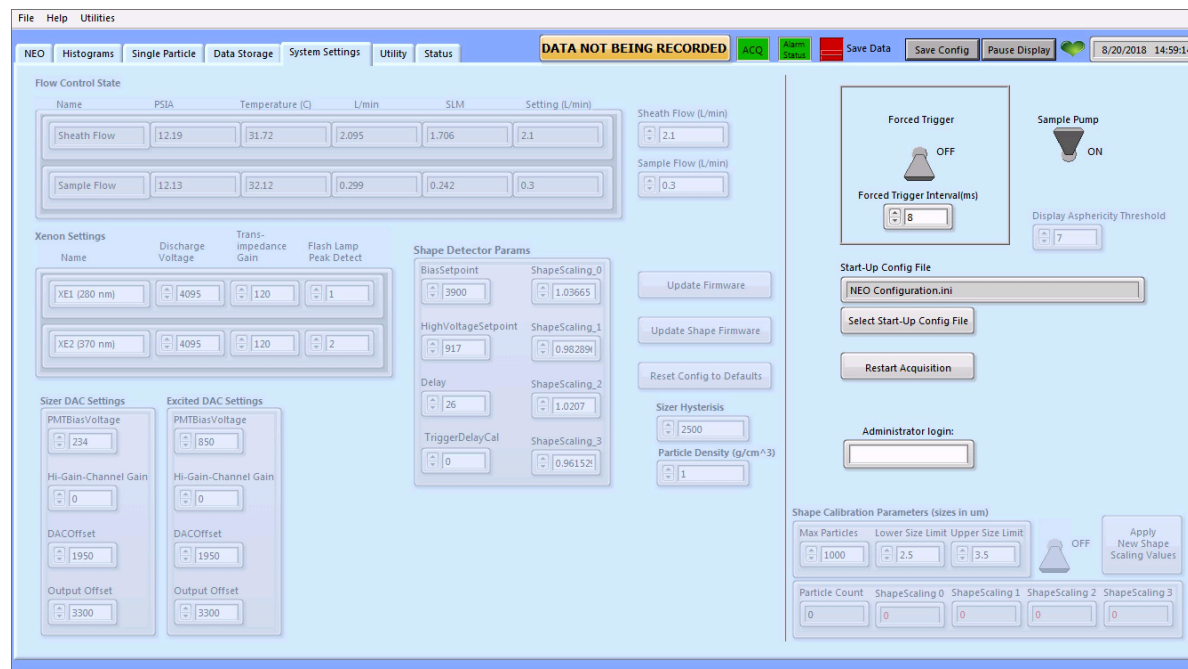

Figure 15: WIBS-NEO System Settings Tab

The Greyed-out areas on the Settings Tab above describe defaults, calibration factors, and Administrator functions.

- **Flow Control PSIA, Temperature, L/min (liters per minute), SLM (standard liters per minute).** Allows you to monitor the sheath and sample flow controllers in real time.
- **Sheath Flow/Sample Flow:** Can be changed from defaults (2.1/0.3 L/min) based on customer needs. Please consult factory prior to changing from default values.
- **Update Firmware** – Critical WIBS-NEO firmware releases will occasionally be sent out to customers and can be installed in the field through this feature.
- **Xenon settings-** Flashlamp settings based on calibration not typically changed.
- **Shape detector-** Quadrant PMT settings not typically changed.
- **Sizer DAC Settings-** Default settings for particle sizes not typically changed.
- **Excited DAC Settings-** Settings for data Acquisition not typically changed.
- **Shape Calibration** – Shape calibration dialogue is used as part of the factory setup and should not be changed by the end user.

## 7.6 Status

The **Status Tab**, (Figure 16) shows important alarm, program, and data folder information.

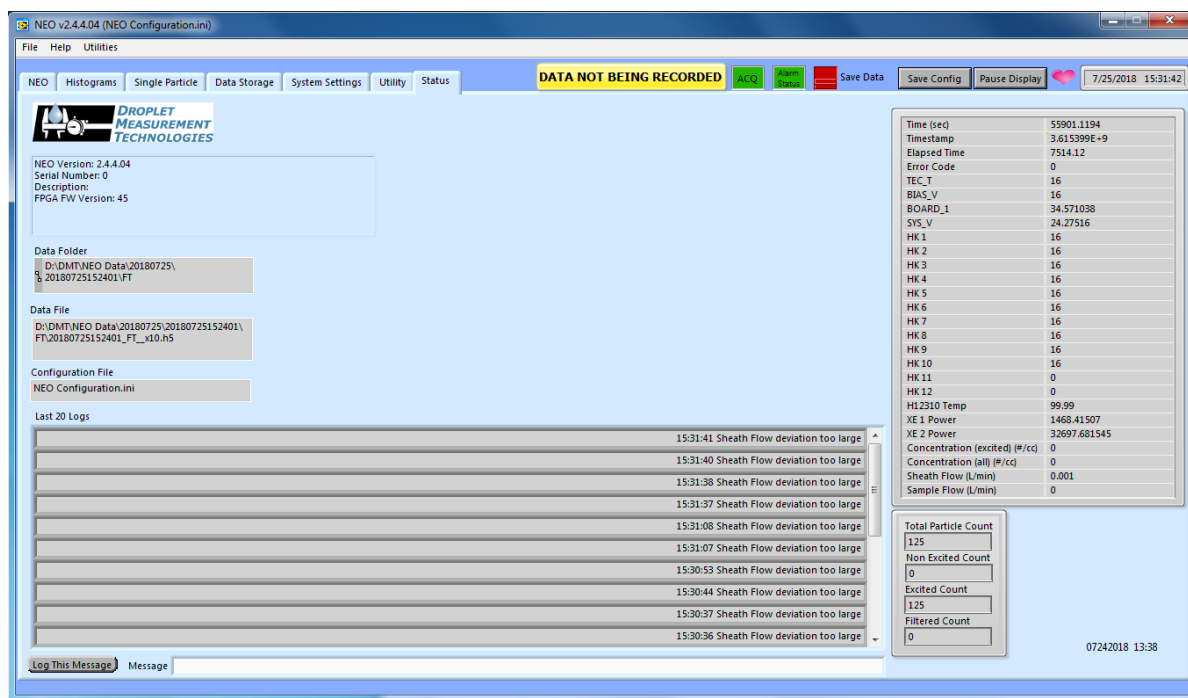

Figure 16: WIBS-NEO Status Tab

Below are descriptions of items on the status tab.

- Alarm status – Green when everything is running normally. Red when there is a critical alarm
- Data folder – records the location where data is being written
- Configuration file – Shows the current configuration file. If this is changed you will have to restart the program to use the new configuration.
- Last 20 log – records details for the last 20 actions.
- Total Particle Count - All qualified particles measured in the previous one second period.
- Non-Excited Count - The number of particles that were qualified that were measured but not UV excited due to flashlamp duty cycle or interparticle timing constraints in the previous one second period.
- Excited Count - The number of particles records containing full data for size, shape, and fluorescence for the previous one second period.
- Filtered Count - The number of particle events that did not meet qualification criteria and were discarded based on transit time, over/undersize, coincidence, or other particle qualification criteria.

## 8.0 Maintenance

The WIBS-NEO instrument contains no user serviceable components. All units are recommended to be returned to DMT for service on a yearly basis for inspection, update, and calibration. Any and all inquiries for service, repair, or replacement should be directed to the sales representative or may be submitted to DMT in writing by emailing [info@dropletmeasurement.com](mailto:info@dropletmeasurement.com).

## 8.1 Zero-Count Check

A zero-count check should be conducted weekly or if issues are suspected. To perform the check, place the (HEPA) filter that was supplied with your unit, on the inlet. Operate the instrument in sampling mode with the pump on for a minimum of five minutes. Particle counts should be less than 1 every thirty seconds after five minutes of operation with the filter in place. Remove the filter assembly to resume normal operation.

Users should also check the flow on a monthly basis. To check the flow, place a flow meter on the inlet. Run the WIBS-NEO in sampling mode with the pump on. The flow reading should be approximately 0.3 L/min.

## 8.2 Running WIBS-NEO in Forced Trigger Mode

The optical filters in the WIBS-NEO are designed to prevent the flashlamp light from reaching the photomultiplier detectors. Regardless, some light will reach this assembly due to the limitations of the optical filters and the buildup of contamination in the chamber. These factors will combine with some electronic noise from the instrument to result in a cavity background signal. In order to adjust the instrument data to account for background noise, the WIBS-NEO should be run in a **Forced Trigger** mode periodically. There is also an option to automate the Forced Trigger data using the Forced Trigger scheduler in the Data Storage window.

To manually create a file for the **Forced Trigger** background:

- Set the Forced Trigger interval to 8 ms or higher.
- Activate the Forced Trigger switch. The software will automatically turn off the sample pump and turn the pump back on when the Forced Trigger switch is turned OFF.
- A one-minute Forced Trigger will collect adequate data to define the background .
- Turn on the Save Data switch to write the file data.
- The data system will automatically write the file as a forced trigger file (FT) anytime data collection is turned on and the Forced Trigger is engaged manually.

The **Forced Trigger** mode provides a good check of basic instrument operation. Should the **Forced Trigger** levels change significantly, or if there is a significant drift noticed that deviates from normal averages, it can mean a change in the optical performance of the WIBS-NEO.

The **Forced Trigger** background should be run at least once a week, and if the WIBS-NEO is operated in a monitoring mode, it is recommended to utilize the forced trigger scheduler to automatically conduct a **Forced Trigger** measurement at least once a day. In order to obtain the most accurate fluorescence data, the **Forced Trigger** readings should be subtracted on a channel-by-channel basis from the sample data. This can be performed automatically when using the WIBS-NEO data analysis Tool Kit for data analysis.

To automate the **Forced Trigger** background file:

- Locate the software Data Storage Tab / Forced Trigger Scheduler details and select the "Enable Forced Trigger scheduler" button.
- The automated Forced Trigger Scheduler will write Forced Trigger data into separate data files for later review.
- Choose the period and duration for your Forced Trigger data and locate save location.
- A one-minute Forced Trigger will provide adequate data to define the background noise.

## Appendix A: Theory of Operation

### Design

The single-particle fluorescence sensor, WIBS-NEO, employs a central optical chamber around which are arranged the following components:

1. A continuous-wave, 635nm diode laser used as a light scattering source for particle sizing and shape detection
2. A quadrant photomultiplier tube (PMT) used to determine particle shape from forward scattered light.
3. Two pulsed Xenon sources emitting at different UV wavelengths.
4. Two detector channels:
  - FL1 – (Channel 1) Detects particle fluorescence emission.
  - FL2 – (Channel 2) Detects particle fluorescence emission, particle count, and particle size.

### Aerosol Sampling System

In operation, aerosol is drawn from the ambient atmosphere via a laminar-flow delivery system. The system has been designed to maintain the particle flow velocity for altitudes up to 40,000 feet in a pressurized cabin. Recalibration is not necessary over a wide range of pressure differentials, which is a significant advantage of the NEO design. The NEO flow system renders suspended particles in a single file stream as they pass through the focused laser beam and will also tend to align fibrous particles lengthwise in the direction of flow. The total flow is approximately 2.4 SLPM, of which 2.1 SLPM is filtered before being re-introduced to form a sheath flow. The sample and sheath flow are adjustable through the software interface. The sheath flow serves to confine the sample flow (0.3 L/min) to maintain particle alignment with the 635nm CW laser gaussian peak. A small bleed flow is used to continuously purge the optical chamber of any remaining particles. The intersection of this aerosol sample flow and laser beam defines the scattering volume, a cylindrical area approximately 0.7 mm in diameter and 60  $\mu\text{m}$  deep (Figure 17). Particle velocity is maintained in the 28 m/s range through the sample chamber. Each particle entering the scattering volume (position 1 in Figure 17) scatters light in all directions. The side-scattered light is collected by two high numerical-aperture chamber mirrors. The collected light passes through an aperture in one of the mirrors and onto a dichroic beam-splitter before being detected by the FL2 channel PMT. The light is converted to an electrical pulse as shown on the Single Particle tab, which is used to size the particle and trigger the flashlamps to fire in succession. The detector system is precisely timed to detect the 280nm emission response followed by the 370nm emission response following each respective excitation.

The FL1 detector is filtered to detect fluorescence emission only in the 310 to 400nm range and the FL2 detector is filtered to detect fluorescence emission only in the 420-650nm range as well as to serve as the optical particle counter in response to the 635nm CW laser used in the instrument. The system “dead time” is defined as the period between the moment a particle enters the laser and the 370nm emission response of the particle is recorded and represents the period of time where a new particle entering the laser cannot be detected by the system. Through the use of high speed electronics, system “dead time” is reduced to less than 15 $\mu\text{s}$  for each particle fluorescence event recorded.

**NOTE:** Light scattered in the forward direction as a result of the particle interacting with the 635nm CW laser as part of the trigger sequence falls onto a separate Quadrant PMT and is also recorded and used to assess particle shape; see Appendix B.

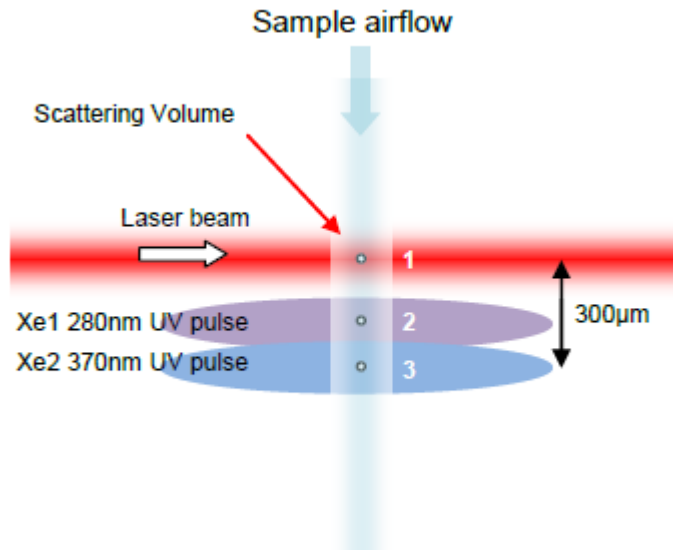

Figure 17: The WIBS-NEO Measurement Cycle



### Flow System Diagram:

(Figure 18) shows a section view of the aerosol flow through the WIBS-NEO

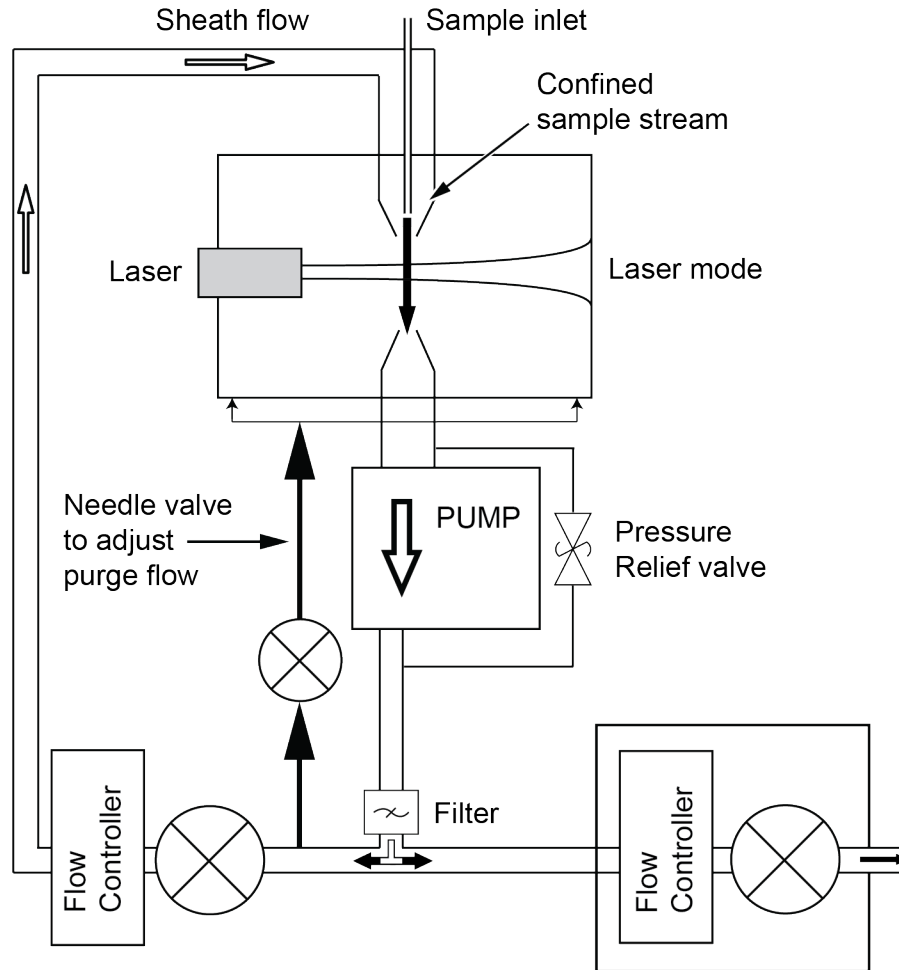
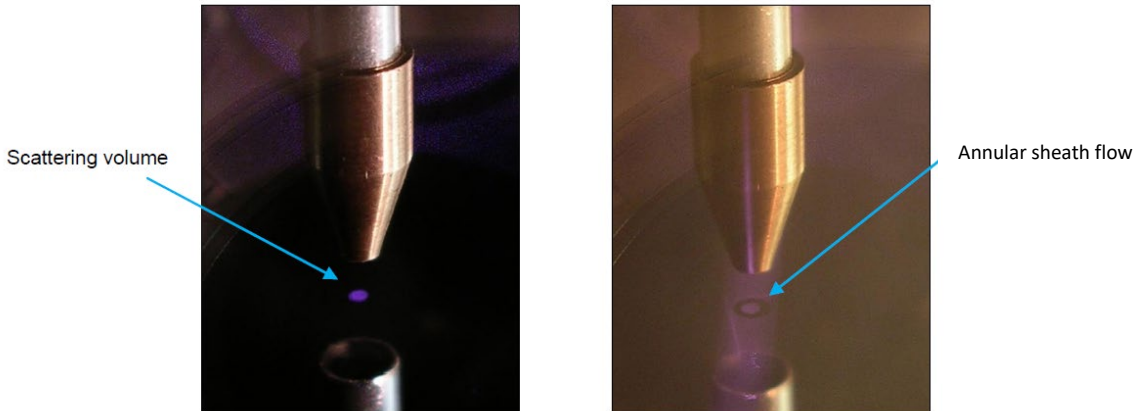

Figure 18: WIBS-NEO Flow System Diagram

### ***Additional Notes on Aerosol Flow:***

Once the aerosol has entered the Inlet assembly, the majority of the flow (approx. 90%) is directed through a HEPA filter and then returned as both a sheath flow (to surround the sample flow with particle-free air) and a small bleed flow of clean air into the chamber. The sheath flow has the effect of constraining the sample flow as the two flows pass through the tapered delivery nozzle, as illustrated in (Figure 19) below.



*Figure 19: Visualization of Scattering Volume and its Surrounding Clean Sheath Flow*

The full aerosol flow (sample + sheath + bleed) is drawn out of the chamber by the WIBS-NEO sampling pump and recycled through a HEPA filter. The outflow of the pump is delivered to an exhaust port adjacent to the power entry port on the WIBS-NEO rear connector panel.

## **Appendix B: Warranty and Contact Information**

The seller warrants that the equipment supplied will be free from defects in material and workmanship for a period of one (1) year from the confirmed date of purchase of the original buyer.

The equipment owner will pay for shipping to DMT, while DMT will pay for the return shipping expense.

Consumable components such as tubing, filters, pump diaphragms, and Nafion humidifiers and dehumidifiers are not covered by this warranty.

Service procedures and repairs are warranted for 90 days.

Droplet Measurement Technologies, LLC can be contacted at the following address:

Droplet Measurement Technologies, LLC  
2400 Trade Centre Avenue  
Longmont, Colorado USA 80503  
Telephone: +1 (303) 440-5576  
Fax: +1 (303) 440-1965  
[www.dropletmeasurement.com](http://www.dropletmeasurement.com)

## Appendix C: Particle Size / Shape Determinations

### Particle Size

Like most optical particle counters (OPCs), WIBS-NEO uses a particle size calibration based on the calculated MIE theory curve determined by the cavity and laser design. The size of each particle is calculated in real time to provide a true single particle sizing measurement. MIE theory assumes that particles are spherical, uniformly illuminated, and of a specified refractive index. In the case of the WIBS-NEO, the calibration curve is referenced to aerosols of standard monodisperse polystyrene latex (PSL) microspheres. PSL was chosen as the calibration standard for convenience since they can easily and safely be used in the lab and field using a simple nebulizer because the refractive index of PSL is close to that of many common ambient aerosol species. The refractive index of the NIST traceable PSL sizing standards used by DMT for calibration is 1.58.

Since this calibration curve is based on PSL spheres, the reported size should be taken only as an estimate when measuring spherical particles of different refractive index (e.g., water droplets) or non-spherical solid particles. The asphericity factor (AF) is also a good reference for sizing accuracy since irregular particle shapes will directly influence light scattering and reduce the accuracy of MIE calculations.

### Particle Shape

WIBS-NEO incorporates an analysis of the forward scattered light captured by the Quadrant PMT to determine an estimate of particle shape, or more correctly, scattering asymmetry. This approach is used by a number of aerosol analysis instruments (e.g., references 8-12). The process used in WIBS-NEO is illustrated in (Figure 20) below.

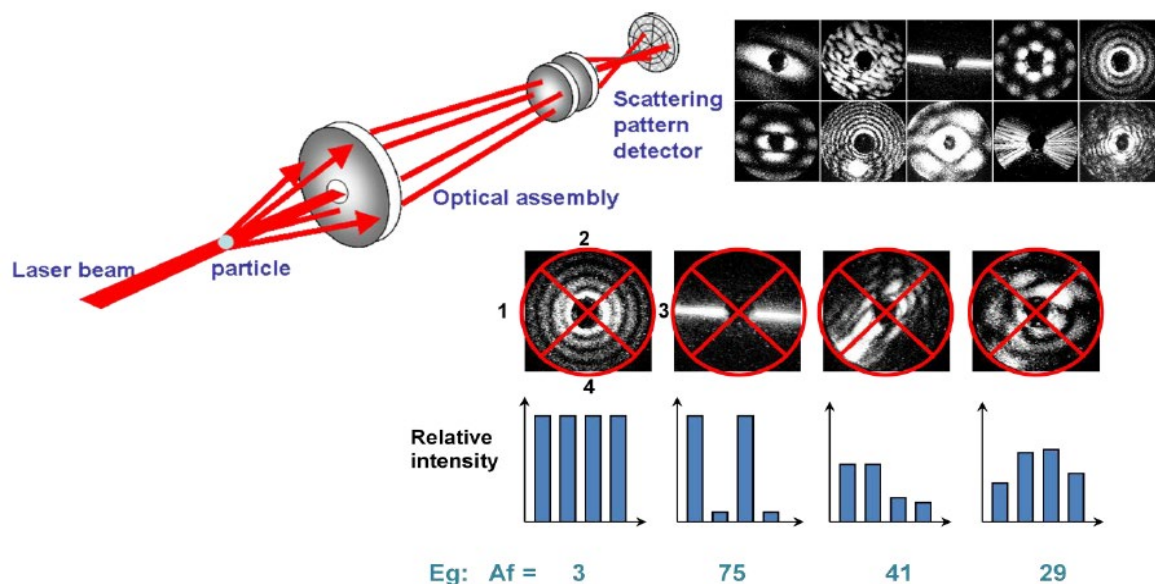

Figure 20: Derivation of particle Asphericity Factor, AF, measuring azimuthal variation in forward scattering of the particle

In (Figure 20), examples of typical forward scattering patterns produced by particles of differing shape are shown in the top-right. These images were recorded using a high-resolution intensified CCD camera. In WIBS-NEO, a much simpler detector configuration is used, based on the quadrant PMT. This is for reasons of both cost and speed of response. The figure illustrates how the quadrant PMT would respond to particles of different shape – from left to right a droplet (spherical), fiber, flake, and irregular cubic particle. WIBS-NEO records the scatter intensity values received by each quadrant and determines the root-mean-square variation around the mean value to yield an Asphericity Factor, AF, such that a perfect sphere would correspond to  $AF = 0$ , and a high aspect ratio fiber to an AF approaching 100. In reality, the combined influence of electronic and optical noise in the scattering signal acquisition results in spherical particles having measured AF values less than 10, rather than zero.

Calculated AF data for each particle is provided in real-time to the user and the four individual quadrant peak values are recorded independently in the data file for later analysis by other methods if preferred.

## Appendix D: Data Files and description

### HDF5 Particle by Particle Data file description

The WIBS NEO instrument includes place holders for additional channels and new instrument capabilities that may not be currently available or installed on all instruments. Some of the channel outputs within the data stream output will contain either floating data lines, NAN (Not A Number), or no data at all. As Always, we welcome you to contact DMT for support, to share ideas for new capabilities, suggestions for software improvements, or requests for customization for your specific needs.

The following list contains the relevant data channel names and descriptions for the WIBS-NEO data stream:

Board\_1: Temperature of the 408 Board

Conc\_Excited\_cm3: Excited particle count/sample flow rate concentration of total particles (#/cm<sup>3</sup>)

Conc\_Total\_cm3: Total particle count/sample flow rate Concentration of total particles (#/cm<sup>3</sup>)

H12310\_Temperature: Not currently implemented

Max\_Transit\_Time\_Counts: # of all particles in data stream that exceed max particle period time as set in the NEO software configuration settings

Min\_Transit\_Time\_Counts: # particles in data stream that fall below min particle period time as set in the NEO software configuration settings

Num\_Discarded\_Particles: Total # of particles that either exceed the coincidence threshold set in the configurations settings as max particles per second value, exceed Min or Max particle period, or exceed the SIZE HIGH LIMIT as set in the NEO software configuration (Default =100000 counts)

Num\_oversize\_Rejects: Total # of particle events that saturate the A/D converter

RH: Not currently implemented

SYS\_V: System Power measured at the control board reference

Sample\_MassFlow: Sample mass flow rate read from MFC

Sample\_PSIA: Sample pressure read from MFC

Sample\_SetPoint: Flow rate set point read from MFC

Sample\_Temperature: Sample temp read from MFC

Sample\_VolumetricFlowRate: Sample flow rate read from MFC

Seconds: Seconds since 1/1/1904, EPOCH timestamp. Will match computer timestamp

**Sheath\_MassFlow:** Sample mass flow rate read from MFC

**Sheath\_PSIA:** Sample pressure read from MFC

**Sheath\_SetPoint:** Flow rate set point read from MFC

**Sheath\_Temperature:** Sample temp read from MFC

**Sheath\_VolumetricFlowRate:** Sample flow rate read from

**Temperature:** Not currently implemented

**Total\_Particle\_Count:** Total number of particles displayed and written to file that are not rejected by any criteria and used as # particles for concentration calculations

**Valid\_Particle\_Count:** Total number of particles displayed and written to file that are not rejected by any criteria and have been excited by the flashlamps - used as # particles for excited concentration calculations the excited particle count duty cycle Max is 125/s based on maximum flashlamp duty cycle

**Xe1\_Power:** Flashlamp intensity monitor

**Xe2\_Power:** Flashlamp intensity monitor

**Asphericity:** AF value calculated using the scaled voltage response of the four shape quadrants

**Density\_g\_cm3:** User defined constant in the NEO configuration file used to estimate the total mass of sampled particles during data saving only. Default is 1g/cm3

**EP\_Overflow\_Flag:** Excited Particle Overflow Flag - Diagnostic value for troubleshooting data in the excited particle stream – No end user utility

**Flag\_Excited:** Particle excited by flashlamps = 1, Not excited = 0

**Mass\_ug:** Mass of the particle calculated from particle size and **Density\_g\_cm3** variable as set in configuration file settings

**NF\_Shape\_0-3:** ADC value recorded from each individual quadrant of the 4 channel PMT corresponding to a valid particle trigger

**NF\_Sizer\_Relative\_Peak:** Height of peak in ADC value relative to ADC baseline value used for particle sizing

**NF\_Sizer\_Transit\_Time\_nsec:** Transit time of particle through 635 nm laser beam reported as the number 25 ns clock cycles and is based on the system clock 40 MHz sampling rate

**Size\_um:** Calculated size of particle (um) based on ADC value of Peak Detector

**Xe1\_FluoroPeak:** Fluorescence peak intensity ADC value based on Xe1 excitation

**Xe2\_FluoroPeak:** Fluorescence peak intensity ADC value based on Xe2 excitation

## Appendix E: DMT Software License

DMT Licenses the WIBS-NEO software only upon the condition that you accept all of the terms contained in this license agreement.

This software is provided by DMT “as is” and any express or implied warranties, including, but not limited to, the implied warranties of merchantability and fitness for a particular purpose are disclaimed. Under no circumstances and under no legal theory, whether in tort, contract, or otherwise, shall DMT or its developers be liable for any direct, indirect, incidental, special, exemplary, or consequential damages (including damages for work stoppage; computer failure or malfunction; loss of goodwill; loss of use, data or profits; or for any and all other damages and losses). Some states do not allow the limitation or exclusion of implied warranties and you may be entitled to additional rights in those states.

## Appendix F: Third Party Software Licenses

### Hierarchical Data Format 5 (HDF5):

h5labview, <http://h5labview.sf.net>

Copyright (c) 2013, Martijn Jasperse

All rights reserved. Redistribution and use in source and binary forms, with or without modification, are permitted provided that the following conditions are met:

Redistributions of source code must retain the above copyright notice, this list of conditions and the following disclaimer. Redistributions in binary form must reproduce the above copyright notice, this list of conditions and the following disclaimer in the documentation and/or other materials provided with the distribution.

THIS SOFTWARE IS PROVIDED BY THE COPYRIGHT HOLDERS AND CONTRIBUTORS "AS IS" AND ANY EXPRESS OR IMPLIED WARRANTIES, INCLUDING, BUT NOT LIMITED TO, THE IMPLIED WARRANTIES OF MERCHANTABILITY AND FITNESS FOR A PARTICULAR PURPOSE ARE DISCLAIMED. IN NO EVENT SHALL THE COPYRIGHT HOLDER OR CONTRIBUTORS BE LIABLE FOR ANY DIRECT, INDIRECT, INCIDENTAL, SPECIAL, EXEMPLARY, OR CONSEQUENTIAL DAMAGES (INCLUDING, BUT NOT LIMITED TO, PROCUREMENT OF SUBSTITUTE GOODS OR SERVICES; LOSS OF USE, DATA, OR PROFITS; OR BUSINESS INTERRUPTION) HOWEVER CAUSED AND ON ANY THEORY OF LIABILITY, WHETHER IN CONTRACT, STRICT LIABILITY, OR TORT (INCLUDING NEGLIGENCE OR OTHERWISE) ARISING IN ANY WAY OUT OF THE USE OF THIS SOFTWARE, EVEN IF ADVISED OF THE POSSIBILITY OF SUCH DAMAGE.

Copyright Notice and License Terms for  
HDF5 (Hierarchical Data Format 5) Software Library and Utilities

-----  
HDF5 (Hierarchical Data Format 5) Software Library and Utilities

Copyright 2006-2012 by The HDF Group.

NCSA HDF5 (Hierarchical Data Format 5) Software Library and Utilities

Copyright 1998-2006 by the Board of Trustees of the University of Illinois.

All rights reserved.

This work was partially produced at the University of California, Lawrence Livermore National Laboratory (UC LLNL) under contract no. W-7405-ENG-48 (Contract 48) between the U.S. Department of Energy (DOE) and The Regents of the University of California (University) for the operation of UC LLNL.

**DISCLAIMER:**

This work was prepared as an account of work sponsored by an agency of the United States Government. Neither the United States Government nor the University of California nor any of their employees, makes any warranty, express or implied, or assumes any liability or responsibility for the accuracy, completeness, or usefulness of any information, apparatus, product, or process disclosed, or represents that its use would not infringe privately- owned rights. Reference herein to any specific commercial products, process, or service by trade name, trademark, manufacturer, or otherwise, does not necessarily constitute or imply its endorsement, recommendation, or favoring by the United States Government or the University of California. The views and opinions of authors expressed herein do not necessarily state or reflect those of the United States Government or the University of California, and shall not be used for advertising or product endorsement purposes.

Copyright Notice and License Terms for  
HDF5 (Hierarchical Data Format 5) Software Library and Utilities

-----  
HDF5 (Hierarchical Data Format 5) Software Library and Utilities  
Copyright 2006-2015 by The HDF Group.

NCSA HDF5 (Hierarchical Data Format 5) Software Library and Utilities  
Copyright 1998-2006 by the Board of Trustees of the University of Illinois.  
All rights reserved.

-----  
Redistribution and use in source and binary forms, with or without modification, are permitted for any purpose (including commercial purposes) provided that the following conditions are met:

1. Redistributions of source code must retain the above copyright notice, this list of conditions, and the following disclaimer.
2. Redistributions in binary form must reproduce the above copyright notice, this list of conditions, and the following disclaimer in the documentation and/or materials provided with the distribution.
3. In addition, redistributions of modified forms of the source or binary code must carry prominent notices stating that the original code was changed and the date of the change.
4. All publications or advertising materials mentioning features or use of this software are asked, but not required, to acknowledge that it was developed by The HDF Group and by the National Center for Supercomputing Applications at the University of Illinois at Urbana-Champaign and credit the contributors.
5. Neither the name of The HDF Group, the name of the University, nor the name of any contributor may be used to endorse or promote products derived from this software without specific prior written permission from The HDF Group, the University, or the Contributor, respectively.



Contributors: National Center for Supercomputing Applications (NCSA) at the University of Illinois, Fortner Software, Unidata Program Center (netCDF), The Independent JPEG Group (JPEG), Jean-loup Gailly and Mark Adler (gzip), and Digital Equipment Corporation (DEC).

Portions of HDF5 were developed with support from the Lawrence Berkeley National Laboratory (LBNL) and the United States Department of Energy under Prime Contract No. DE-AC02-05CH11231.

The following statement applies to those portions of the product and must be retained in any redistribution of source code, binaries, documentation, and/or accompanying materials

## **Future Technology Devised International (FTDI):**

**IMPORTANT NOTICE: PLEASE READ CAREFULLY BEFORE INSTALLING THE RELEVANT SOFTWARE:** This license agreement ("License") is a legal agreement between you ("Licensee" or "you") and Future Technology Devices International Limited of 2 Seaward Place, Centurion Business Park, Glasgow, Scotland, G41 1HH (UK Company Number SC136640) ("Licensor" or "we) for use of driver software provided by the Licensor ("Software").

BY INSTALLING OR USING THIS SOFTWARE YOU AGREE TO THE TERMS OF THIS LICENSE WHICH WILL BIND YOU. IF YOU DO NOT AGREE TO THE TERMS OF THIS LICENSE, WE ARE UNWILLING TO LICENSE THE SOFTWARE TO YOU AND YOU MUST DISCONTINUE USE OR INSTALLATION.

1. Grant and scope of license
  - 1.1 In consideration of you agreeing to abide by the terms of this License, the Licensor hereby grants to you a non-exclusive, non-transferable, royalty free license to use the Software on the terms of this License.
  - 1.2 In this License a "Genuine FTDI Component" means an item of hardware that was manufactured for, and sold by, the Licensor or a member of the Licensor's group of companies. It does not include any counterfeit or fake products.
  - 1.3 If you are a manufacturer of a device that includes a Genuine FTDI Component (each "Device") then you may install the Software onto that device. If you are a seller or distributor of a Device then You may distribute the Software with the Device. If you are a user of a Device then you may install the Software on the Device, or onto a computer system in order to use the Device.
  - 1.4 In each of those cases you may:
    - 1.4.1 Install and use the Software for your purposes only; and
    - 1.4.2 Only use the Software in conjunction with products based on and/or incorporating a Genuine FTDI Component.
2. The Software will not function properly on or with a component that is not a Genuine FTDI Component. Use of the Software as a driver for, or installation of the Software onto, a component that is not a Genuine FTDI Component, including limitation counterfeit components, MAY IRRETRIEVABLY DAMAGE THAT COMPONENT. It is the licensee's responsibility to make sure that all chips it installs the Software on, or uses the Software as a driver for, are Genuine FTDI Components. If in doubt, contact the Licensor.
3. If a custom vendor ID and/or product ID or description string are used, it is the responsibility of the product manufacturer to maintain any changes and subsequent WHQL re-certification as a result of making these changes.
  - 3.1 Except as expressly set out in this License or as permitted by any local law, you undertake:

- 3.1.1 Not to copy the Software, except where such copying is incidental to normal use of the 3.1.2 Software or where it is necessary for the purpose of back-up or operational security; not to rent, lease, sub-license, loan, translate, merge, adapt, vary or modify the Software or any part of it;
  - 3.1.2 Not to make alterations to, or modifications of, the whole or any part of the Software nor permit the Software or any part of it to be combined with, or become incorporated in, any other programs;
  - 3.1.3 Not to disassemble, de-compile, reverse engineer or create derivative works based on the whole or any part of the Software;
  - 3.1.4 To keep all copies of the Software secure;
  - 3.1.5 To include the copyright notice of the Licensor on all entire and partial copies of the Software in any form; and
  - 3.1.6 Not to provide, or otherwise make available, the Software in any form, in whole or in part (including, but not limited to, program listings, object and source program listings, object code and source code) to any person.
4. Intellectual property rights
  - 4.1 You acknowledge that all intellectual property rights in the Software throughout the world belong to the Licensor, that rights in the Software are licensed (not sold) to you, and that you have no rights in, or to, the Software other than the right to use them in accordance with the terms of this License.
5. Warranty
  - 5.1 To the maximum extent permitted by applicable law, the software is provided "as is".
  - 5.2 All implied warranties, implied conditions and/or implied licenses are excluded from this License, including but not limited to implied warranties of quality and/or fitness for purpose (in all cases) to the fullest extent permitted by law.
  - 5.3 You acknowledge that the Software has not been developed to meet your individual requirements and that the Software may not be uninterrupted or free of bugs or errors.
6. Licensor's liability
  - 6.1 To the maximum extent permitted by applicable law, in no event shall the Licensor be liable for any:
    - 6.1.1 special loss or damage;
    - 6.1.2 incidental loss or damage;
    - 6.1.3 indirect or consequential loss or damage;
    - 6.1.4 loss of income;
    - 6.1.5 loss of business;
    - 6.1.6 loss of profits;
    - 6.1.7 loss of revenue;
    - 6.1.8 loss of contracts;
    - 6.1.9 business interruption;
    - 6.1.10 loss of the use of money or anticipated savings;
    - 6.1.11 loss of information;
    - 6.1.12 loss of opportunity;
    - 6.1.13 loss of goodwill or reputation; and/or
    - 6.1.14 loss of, damage to or corruption of data; (in each case) of any kind howsoever arising and whether caused by delict (including negligence), breach of contract or otherwise.
  - 6.2 FTDI's total liability to you in relation to the Software shall not exceed 500 US Dollars.
  - 6.3 Nothing in this License limits or excludes liability for death or personal injury or for fraud.
7. Termination
  - 7.1 The Licensor may terminate this License immediately if:
    - 7.1.1 you fail to comply with any of the terms and conditions of the License; or
    - 7.1.2 you commence or participate in any legal proceedings against the Licensor.
  - 7.2 Upon termination:
    - 7.2.1 all rights granted to you under this License shall cease;

- 7.2.2 you must cease all activities authorized by this License; and
  - 7.2.3 you must immediately delete or remove the Software from all computer equipment in your possession and immediately destroy all copies of the Software then in your possession, custody or control.
- 8. Transfer of rights and obligations
  - 8.1 You may not transfer, assign, charge or otherwise dispose of this License, or any of our rights or obligations arising under it.
  - 8.2 The Licensor may transfer, assign, charge, sub-contract or otherwise dispose of this License, or any of his rights or obligations arising under it, at any time during the term of the License.
- 9. Waiver
  - 9.1 If the Licensor fails, at any time during the term of this License, to insist on strict performance of any of your obligations under this License, or if the Licensor fails to exercise any of the rights or remedies to which he is entitled under this License, this shall not constitute a waiver of such rights or remedies and shall not relieve you from compliance with such obligations.
  - 9.2 A waiver by the Licensor of any default shall not constitute a waiver of any subsequent default.
  - 9.3 No waiver by the Licensor of any of these terms and conditions shall be effective unless it is expressly stated to be a waiver and is communicated to you in writing.
- 10. Severability

If any of the terms of this License are determined by any competent authority to be invalid, unlawful or unenforceable to any extent, such term, condition or provision will to that extent be severed from the remaining terms, conditions and provisions which will continue to be valid to the fullest extent permitted by law.
- 11. Entire agreement
  - 11.1 This License constitutes the whole agreement between us and supersedes any previous arrangement, understanding or agreement between us, relating to the licensing of the Software.
  - 11.2 Each party acknowledges that in entering into this License it does not rely on any statement, representation, warranty or understanding other than those expressly set out in this License. Each party agrees that it will have no remedy in respect of any statement, representation, warranty or understanding that is not expressly set out in this License. Each party agrees that its only remedy in respect of those representations, statements, assurances and warranties that are set out in this License will be for breach of contract in accordance with the terms of this License.
  - 11.3 The parties agree that nothing in this License will limit or exclude any liability they may have for fraud.
- 12. Miscellaneous
  - 12.1 This License does not create a partnership or joint venture between the parties to it, nor authorize a party to act as agent for the other.
  - 12.2 This License does not create any legal rights enforceable by any third party.
  - 12.3 This License may only be varied by express written legal agreement between the parties.
- 13. Law and jurisdiction

This License, its subject matter or its formation (including non-contractual disputes or claims) shall be governed by and construed in accordance with Scots law and submitted to the non-exclusive jurisdiction of the Scottish courts.

## Appendix G: References

- [1] A single-particle multichannel bioaerosol fluorescence sensor, Kaye P.H., Stanley W.R., and Hirst E. *Optics Express* 13, 10, 3583-3593 (2005).
- [2] A dual-wavelength single particle aerosol fluorescence monitor. Kaye P H., Stanley W R., Foot V E., Baxter K., and Barrington S J., *Proc. SPIE Conference on Optically Based Biological and Chemical Sensing, Bruges Sept. 2005*, eds. Carrano J C. and Zukauskas A., vol 5990, pp. 59900N-1 to 59900N-12, (2005).
- [3] Fluorescent particle counter for detecting airborne bacteria and other biological particles, Pinnick, R.G., S.C. Hill, S.C., Nachman, P., Pendleton, J.D., Fernandez, G.L., Mayo M.W., and Bruno, J.G., *Aerosol Sci.Tech.* 23, 4, 653-664 (1995).
- [4] Design of an instrument for real-time detection of bioaerosols using simultaneous measurement of particle aerodynamic size and intrinsic fluorescence, Hairston, P.P., Ho, J. and Quant, F.R. *J. Aerosol Sci.* 28, 3,471-480 (1997).
- [5] Size and fluorescence measurements for field detection of biological aerosols, Seaver, M., Eversole, J. D., Hardgrove, J. J., Cary, W. K. Jr., and Roselle, D. C. *Aerosol Sci. Technol.* 30, 174–185 (1999).
- [6] Particle fluorescence spectrometer for real-time single particle measurements of atmospheric organic carbon and biological aerosol, Pan, Y-L., Pinnick, R.G., Hill, S., and Chang R.K., *Environmental Science and Technology*. In press. (2008).
- [7] Simultaneous light scattering and intrinsic fluorescence measurement for the classification of airborne particles, Kaye P.H., Barton J.E., Hirst E., and Clark, J.M. *Appl. Opt.* 39, 21, 3738-3745 (2000).
- [8] A Real-time Monitoring System for Airborne Particle Shape and Size Analysis, Kaye, P.H., Alexander-Buckley, K, Hirst, E, and Saunders S. *Journal of Geophysical Research (Atmospheres)*, 101, D14, 19215-19221 (1996).
- [9] A Neural Network based Spatial Light Scattering Instrument for Hazardous Airborne Fiber Detection. Hirst, E., Kaye P.H., and Wang-Thomas Z. *Applied Optics* 36, 24, 6149-6156 (1997).
- [10] Spatial Light Scattering as a Means of Characterising and Classifying Non-spherical Particles. Kaye, P.H. *Measurement Science and Technology*. 9, 2, 141-149 (1998).
- [11] Discrimination of micrometre-sized ice and super-cooled droplets in mixed-phase cloud. Hirst E., Kaye P H., Greenaway R S., Field P., and Johnson D W. *Atmospheric Environment* 35, 1, 33-47 (2001).
- [12] Classification of small ice crystal shapes using Fourier analysis of azimuthal scattering patterns. Z. Ulanowski, C. Stopford, E. Hesse, P.H. Kaye, E. Hirst & M. Schnaiter. *Faraday Discussions 137: Spectroscopy and Dynamics of Microparticles, Bristol, 2-4 July (2007)*.

## Appendix H: Logging onto the Remote NEO Network (Windows 10) using Ethernet

The WIBS-NEO instrument can be connected to the intranet or a single computer using an ethernet cable and the instrument's Ethernet port, which is located with the other interface connections. Remote Desktop is one example of a remote program that can be run on a host machine to connect to the WIBS-NEO instrument over the Internet.

To connect to the remote WIBS-NEO computer, that computer must be turned on, and it must have a network connection. Remote Desktop must be enabled on the WIBS-NEO computer, and you must have permission to connect. For permission to connect, you must know the list of users.

The WIBS-NEO wireless network is named NEO0XXX; where XXX is the serial number of NEO.

Wireless Connection:

Wireless Network ID: NEO0XXX  
Password: 12345678

If your user account doesn't require a password to sign in, you'll need to add a password before you are allowed to start a connection with a remote computer.

Remote Desktop: Static IP 192.168.159.1  
User: neo\user  
Password: neo

### File Transfer

Files can be transferred from the WIBS-NEO onboard computer to the host machine using the **right click copy** and **paste** features. To transfer files, navigate to the WIBS-NEO data folder. Select the files to transfer, and copy them by right-clicking and selecting **Copy**. Then minimize the remote desktop function, navigate to the desired file location, and paste the files using the right-click function. After right-clicking to paste the files, it may take up to a minute for the program to respond.

Another option for copying files is to put them on a shared folder. You can share a folder on the remote machine by double-clicking on it and then selecting **Share This Folder** under the **File and Folder tasks**. This will bring up a window where you can select **Share This Folder** using a radio button. After clicking **OK**, navigate back to the host machine desktop. Bring up Windows Explorer and in the path field type "\\ " followed by the IP address of the remote desktop computer. The shared folder should now be visible, and you can copy its files to any other location.