

Safety Limit Switches Selection Guide



| Series | HLM Series | HLM-SS Series | LSPS Series |
|--------------------------------------|--|--|--|
| Prices start at | \$64.00 | \$129.00 | \$21.50 |
| Description | Die-cast metal body safety limit switch | Stainless steel body safety limit switch | Plastic body safety limit switch |
| Material of Construction | Die-cast zinc aluminum casing | Stainless steel 316 casing | Plastic casing |
| Degree of Protection (IEC529) | IEC IP67 | IEC IP67/IP69 | IEC IP67 |
| Maximum Switching Frequency | 6,000 operations/day | 6,000 operations/day | 6,000 operations/day |
| Mechanical Service Life | 2,500,000 cycles | 2,500,000 cycles | 2,500,000 cycles |
| Contact Configuration | Each model available with: 2 N.C. / 2 N.O. slow action break before make contacts, or 1 N.O. / 1 N.C. snap action contacts | Each model available with: 2 N.C. / 2 N.O. slow action break before make contacts, or 1 N.O. / 1 N.C. snap action contacts | Each model available with: 2 N.C. / 2 N.O. slow action break before make contacts, or 1 N.O. / 1 N.C. snap action contacts |
| Conduit Opening | One cable hole | One cable hole | One cable hole |
| Connection | 1/2 inch female NPT conduit | 1/2 inch female NPT conduit | 1/2 inch female NPT conduit |
| Agency Approvals | CE, UL (file E258676) | CE, UL (file E258676) | CE, UL (file E258676) |



| Series | LSMM Series | LSPM Series | AP2 Series |
|--------------------------------------|--|--|---|
| Prices start at | \$40.50 | \$30.50 | \$14.50 |
| Description | Panel mount die-cast metal body safety limit switch | Panel mount plastic body safety limit switch | 30 mm limit switches with pull button reset |
| Material of Construction | Die-cast zinc aluminum casing | Plastic casing | Plastic casing, double insulated |
| Degree of Protection (IEC529) | IEC IP67 | IEC IP67 | IEC IP65 |
| Maximum Switching Frequency | 6,000 operations/day | 6,000 operations/day | Contact blocks: 1 cycle per second (all) |
| Mechanical Service Life | 2,500,000 cycles | 2,500,000 cycles | 1,000,000 operations interlock and limit switches |
| Contact Configuration | Each model available with: 2 N.C. / 1 N.O. slow action break before make contacts, or 1 N.O. / 1 N.C. snap action contacts | Each model available with: 2 N.C. / 1 N.O. slow action break before make contacts, or 1 N.O. / 1 N.C. snap action contacts | X11 - Slow action break before make, positive opening, 1 N.O. + 1 N.C. W02 - Simultaneous, slow action, positive opening, 2 N.C. |
| Conduit Opening | One cable hole | One cable hole | One cable hole, 1/2" NPT adapter |
| Connection | Pigtail; 2m / 6.5 ft cable length | Pigtail; 2m / 6.5 ft cable length | 2x2.5mm2 (AWG14) to 2x0.5mm2 (AWG 18) |
| Agency Approvals | CE, UL (file E258676) | CE, UL (file E258676) | CE, UL file E189258, CSA 176294, RoHS |

IDEM Type LSPS (Plastic Body) Safety Limit Switches

IDEM limit switches are designed to be mounted for position sensing applications, such as guard doors, conveyors, machine beds, elevators, etc.

They are available with a range of actuator heads and either slow or snap action contacts.

Features

- Standard duty plastic bodies (red color)
- Enclosure protection to IP67 (suitable for washdown)
- Direct opening NC safety contact(s) to EN60947-5-1 
- High mechanical life: Over 10 million cycles
- Head position adjustment to any of 4 positions



| IDEM Type LSPS (Plastic Body) Safety Limit Switches | | | | | | |
|---|---------|---|--|-------------------------------|-----------|-----------------------------|
| Part Number | Price | Type | Contacts | Action | Bar Chart | Connection |
| LSPS-171002 | \$21.50 | Polyester plunger | 2 N.C. safety contacts / 1 N.O. monitoring contact | Slow action break before make | A | 1/2 inch female NPT conduit |
| LSPS-171008 | \$21.50 | | 1 N.C. safety contact / 1 N.O. monitoring contact | Snap action | B | |
| LSPS-171011 | \$21.50 | Plunger with polyester roller | 2 N.C. safety contacts / 1 N.O. monitoring contact | Slow action break before make | A | |
| LSPS-171017 | \$21.50 | | 1 N.C. safety contact / 1 N.O. monitoring contact | Snap action | B | |
| LSPS-171020 | \$22.50 | Hinge lever with polyester roller | 2 N.C. safety contacts / 1 N.O. monitoring contact | Slow action break before make | C | |
| LSPS-171026 | \$22.50 | | 1 N.C. safety contact / 1 N.O. monitoring contact | Snap action | D | |
| LSPS-171047 | \$26.50 | Side rotary adjustable lever with large rubber roller | 2 N.C. safety contacts / 1 N.O. monitoring contact | Slow action break before make | E | |
| LSPS-171053 | \$26.50 | | 1 N.C. safety contact / 1 N.O. monitoring contact | Snap action | F | |
| LSPS-171056 | \$27.50 | Side rotary adjustable lever with polyester roller | 2 N.C. safety contacts / 1 N.O. monitoring contact | Slow action break before make | E | |
| LSPS-171062 | \$27.50 | | 1 N.C. safety contact / 1 N.O. monitoring contact | Snap action | F | |
| LSPS-171065 | \$23.50 | Side rotary adjustable brass rod | 2 N.C. safety contacts / 1 N.O. monitoring contact | Slow action break before make | E | |
| LSPS-171071 | \$23.50 | | 1 N.C. safety contact / 1 N.O. monitoring contact | Snap action | F | |

Bar Charts

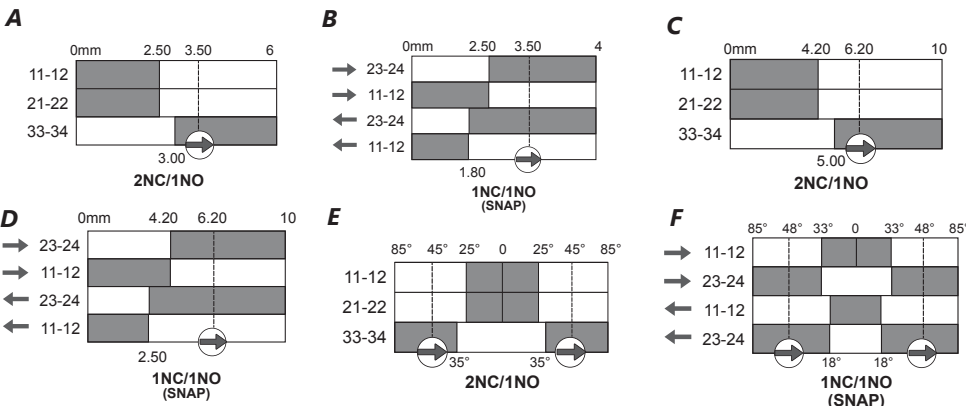

Contacts Configuration Charts

Slow Action 2NC 1NO

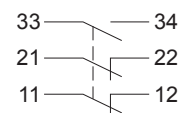

Snap Action 1NC 1NO

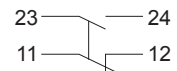

IDEM Type LSPS (Plastic Body) Safety Limit Switches

Dimensions

mm [in]

LSPS-171002
LSPS-171008

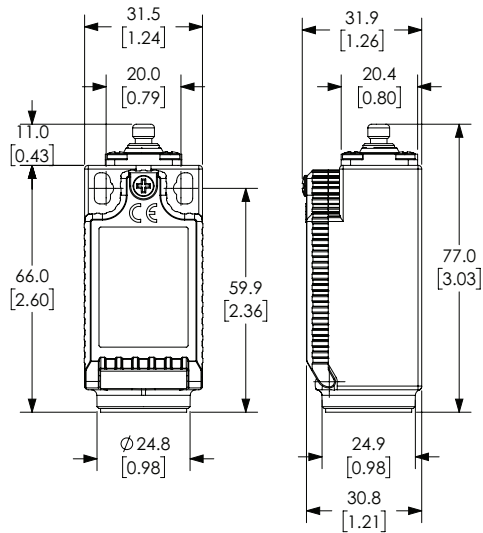

LSPS-171011
LSPS-171017

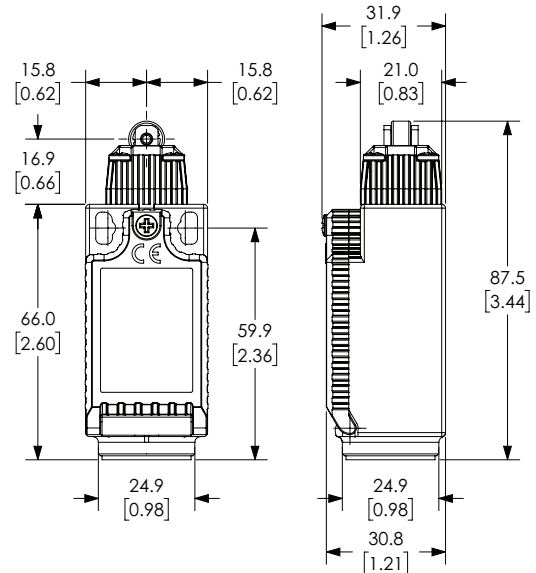

LSPS-171065
LSPS-171071

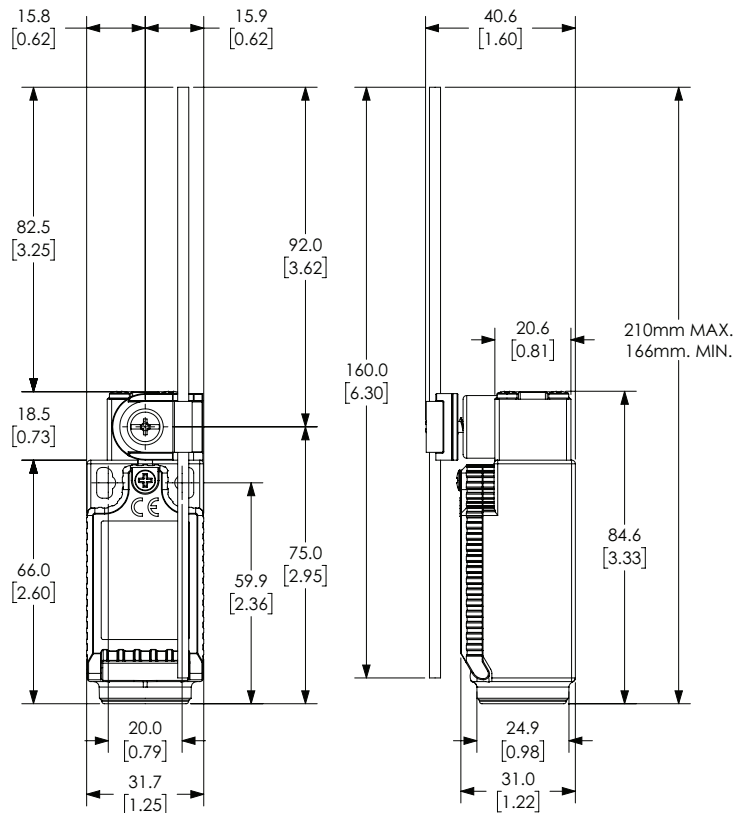

LSPS-171020
LSPS-171026

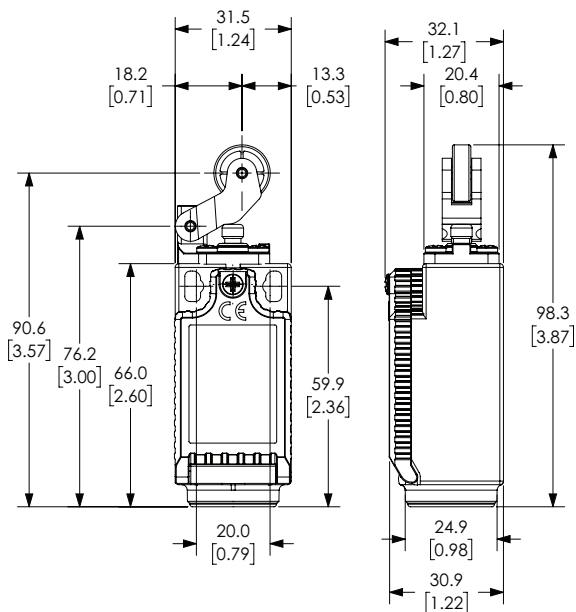

IDEM Type LSPS (Plastic Body) Safety Limit Switches

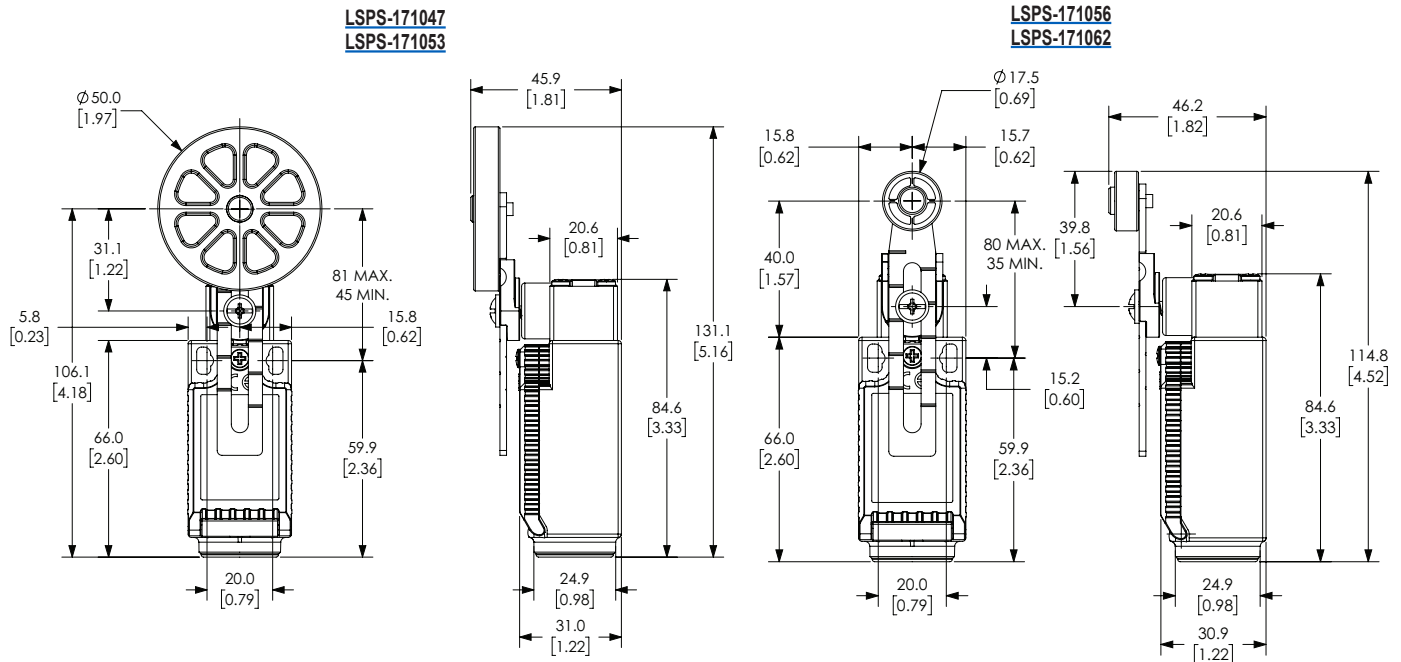

| IDEM Type LSPS (Plastic Body) Safety Limit Switches Specifications | |
|--|--|
| Safety Characteristic Data | |
| Performance level | Up to PLe depending on the system architecture |
| Category | Up to Cat 4 depending on the system architecture |
| Safety Integrity Level | Up to SIL3 depending on the system architecture |
| B10d | 2.5 x 10 ⁶ operations |
| Safety Data - Annual Usage | 8 cycles per hour / 24 hours per day / 365 days |
| MTTFd | 356 years |
| PFHd (1/h) | 3.44 x 10 ⁻⁸ |
| Proof Test Interval T1 | 35 years |
| Electrical and General Specifications | |
| Utilization Category | AC15 A300 240V, 3A |
| Minimum Switched Current | 5mA, 5VDC |
| Thermal Current | 10A |
| Rated Insulation Voltage | 300VAC |
| Max. Switching Speed | 250 mm/sec |
| Max. Switching Frequency | 6,000 operations/day |
| Case Material | Plastic |
| Operating Temperature | -25° to +80°C [-13° to +176°F] |
| Mechanical Life Expectancy | 2,500,000 cycles |
| Enclosure Protection | IP67 |
| Vibration | IEC 68-2-6 |
| Conductor Size | 1.5 mm ² |
| Head Screws/Torque | 1Nm |
| Lid Screws/Torque | 1Nm |
| Recommended Mounting Bolt Torque | 2Nm |
| Recommended Mounting Screws | M4 |
| Agency Approvals | CE, UL (file E258676) |

Note: When the product is used differently from the assumptions shown (different load, operating frequency, etc.) the values must be adjusted accordingly.

IDEM Safety Limit Switches - Operation, Installation and Maintenance



Note: These guidelines apply to all IDEM Safety Limit Switches

Operation:

Operation of the switches is achieved when a moving object causes deflection of the switch plungers or levers.

For safety applications it is important that the moving object does not pass completely over the switch actuators so as to cause the actuator to return to its original position.

Installation Guide:

Correct mounting of limit switches is critical to obtain optimum performance and ensure safety reliability.

Installation of all switches must be in accordance with a risk assessment for the individual application.

Installation must only be carried out by competent personnel and in accordance with these instructions.

1. Never use the switch as a mechanical stop. Ensure that the actuator is protected from mechanical shock.
2. For switches with linear actuators the actuating direction and force from the moving object should be applied in line with the axis of the plunger.
3. For switches with rotary actuators or rollers the operating cam from the moving object should be designed such that the switch is never operated beyond its over travel position. Always use a 30 degree tapered actuating cam.

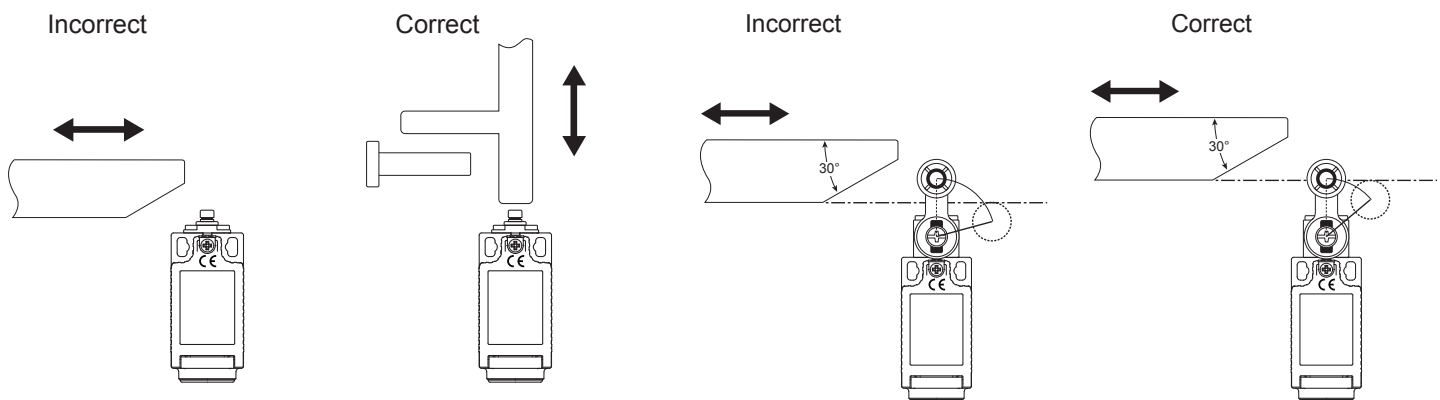

4. Always ensure that when running electrical conductors that they are routed correctly and no damage can occur to the cable insulation.
5. Always use correct mounting bolts (M4 or M5 depending on the switch model) and ensure 2Nm tightening torque for secure fitting.
6. Ensure 1Nm tightening torque for conduit plugs and cable glands to achieve IP rating.
7. The safety functions and mechanics must be tested regularly. For applications where infrequent guard access is foreseeable, the system must have a manual function test to detect a possible accumulation of faults. Do this at least once per month for PLe Cat3/4 or once per year for PLd Cat3 (ISO13849-1). Where possible, it is recommended that the control system of the machine demands and monitors these tests, and stops or prevents the machine from starting if the test is not done. (See ISO14119).

Maintenance:

Every Month: Check switch actuator and body for signs of mechanical damage and wear. Replace any switch showing damage.

Every 6 Months: Isolate power and remove cover. Check screw terminal tightness and check for signs of moisture ingress. Never attempt to repair any switch.

Safety Products



Warning: Safety products sold by AutomationDirect are Safety components only. The purchaser/installer is solely responsible for the application of these components and ensuring all necessary steps have been taken to assure each application and use meets all performance and applicable safety requirements and/or local, national and/or international safety codes as required by the application. AutomationDirect cannot certify that our products, used solely or in conjunction with other AutomationDirect or other vendors' products, will assure safety for any application. Any person using or applying any products sold by AutomationDirect is responsible for learning the safety requirements for their individual application and applying them, and therefore assumes all risks, and accepts full and complete responsibility, for the selection and suitability of the product for their respective application.

AutomationDirect does not provide design or consulting services, and cannot advise whether any specific application or use of our products would ensure compliance with the safety requirements for any application.