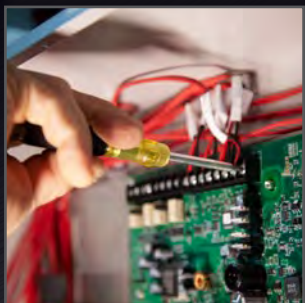




Proper use and care of

# Hand Tools





# EXPERIENCE The Klein Difference

Not all hand tools are the same. With Klein tools, there really is a difference – a difference you can see and feel every time you use them.

What sets Klein apart from other manufacturers are the extra steps we take to make our tools special.

Things like induction hardening...hot riveting...and using the highest-quality U.S. materials. These are the reasons why professional tool users have preferred the Klein brand for over 155 years.

Klein Tools® was founded in 1857 by Mathias Klein, a skilled toolmaker who built a reputation for manufacturing the highest quality tools. Today, Klein Tools is still owned and managed by the Klein family. The company is dedicated to making the best hand tools in the industry.



The result – the Klein brand is the #1 preferred hand tool in the electrical industry, as well as one of the leading brands used in the maintenance, construction and industrial trades. Loyalty to Klein Tools is so strong because Klein has made a commitment to these professionals while providing the extras that make our tools that much better.

# Why Pros Choose Klein

**Custom, US-made tool steel.**

**Unique handle tempering** helps absorb the “snap” when cutting wire.

**Hot-riveted joint** ensures smooth action and no handle wobble.

**Induction hardened cutting knives** for long life.

**High leverage design** for 46% greater cutting power.

**Sure-gripping** cross-hatched knurled jaws.

Heavy-Duty cutting pliers available. Cuts ACSR, screws, nails, and most hardened wire.



## Side-Cutting Pliers

# Why Pros Choose Klein

**Cushion-Grip** handle allows for greater torque and comfort.

**Integral flanges** inside handle provide solid, twist-resistant blade anchor.

**Special heat-treated shafts.**

**Precision-machined** tip for exact fit.

**Patented Tip-Ident®** quickly identifies the type of screwdriver and screwdriver tip orientation.

**Premium chrome plated** for smooth feel and corrosion resistance.

**Meets or exceeds** applicable ANSI and MIL specifications.



## Screwdrivers

# Why Pros Choose Klein



Textured handles

**Color-coded handles:**  
red indicates stranded wire;  
yellow indicates solid wire.

Spring-loaded action for self-opening.

**Precision-ground stripping holes** for easy removal of insulation.

**Black-oxide finish** resists corrosion.

Wire looping and bending holes

Easy-to-read wire gauge markings



## Wire Strippers/Cutters

# FOR

- PROFESSIONAL TRADESMEN
  - INDUSTRY SAFETY PROGRAMS
    - CLASSROOM INSTRUCTION
      - DO-IT-YOURSELF USERS

## FOREWORD

This booklet describes various hand tools, including wrenches, pliers, striking and struck tools, screwdrivers, vises, clamps, snips, and tool boxes. This booklet defines the intended use of these tools, cautions against misuse and abuse and indicates when a tool should be repaired or retired from service and replaced with a new one for the sake of efficiency and safety.

The procedures and practices suggested in this booklet represent the consensus of opinion of the leading hand tool manufacturers of America and constitute a safety code endorsed by the Hand Tools Institute (HTI). If any conflict exists between the employer's safety rules and those stated herein, it is suggested that the more stringent rules take precedent. This caution applies particularly to the wearing of eye protection during in-plant operations.

The booklet is divided into twelve sections for easier reading and reference. Section five provides redressing instructions for those tools requiring redressing in normal use. Two caricatures are used to illustrate the Rights and Wrongs that apply to hand tool use. This booklet is one of several items produced by HTI to promote the safe use of hand tools. Please visit [www.hti.org](http://www.hti.org) for more information.

Ergonomic considerations are not discussed in this booklet. It is the recommendation of HTI that users be familiar with the degree of awkwardness and repetition in their selection and use of hand tools and to plan accordingly. More information is available through the National Institute for Occupational Safety and Health (NIOSH) at [www.cdc.gov/niosh](http://www.cdc.gov/niosh), and through the Human Factors Ergonomics Society (HFES) at [www.hfes.org](http://www.hfes.org).

## HAND TOOLS INSTITUTE

**25 North Broadway • Tarrytown, New York 10591 • U.S.A.**

**[www.hti.org](http://www.hti.org) • [hti@hti.org](mailto:hti@hti.org)**

**Member of  
American National Standards Institute  
National Safety Council**

## IMPORTANT

This book is not a substitute for manufacturers' instructions or warnings. Because tools may differ, always consult manufacturers' instructions or warnings if provided. It is not the intent of this book to cover all types of hand tools or special applications.



# CONTENTS

	Page
Section I. WRENCHES	
Box Wrenches	1-4
Open-End Wrenches	1-4
Combination Wrenches	1-5
Sockets, Handles, and Attachments	1-5
Impact Sockets	1-8
Nutdrivers	1-8
Adjustable Wrenches	1-10
Spanner Wrenches	1-10
Hex Key Wrenches	1-11
Torque Wrenches	1-11
Section II. PLIERS	
Linemen's Side Cutting Pliers	2-2
Ironworker's Pliers	2-2
Long Nose Pliers	2-3
Diagonal Cutting Pliers	2-3
Flat-Nose Pliers	2-4
End-Cutting Pliers	2-5
Slip Joint Pliers	2-5
Multiple Position Pliers	2-5
Locking Pliers	2-6
Retaining Ring Pliers	2-7
Section III. STRIKING TOOLS	
Nail Hammers	3-2
Ball Peen Hammers	3-3
Riveting and Setting Hammers	3-3
Scaling and Chipping Hammers	3-3
Bricklayers' Hammers	3-4
Prospecting Picks	3-4
Soft Face and Non-Ferrous Hammers and Mallets	3-4
Dead Blow Hammers	3-5
Tack Hammers	3-5
Engineers' Hammers and Sledges, Double Face	3-5
Blacksmiths' Hand Hammers and Sledges, Straight and Cross Peen	3-6
Stone Sledges and Spalling Hammers	3-6
Hand Drilling Hammers	3-7
Woodchoppers' Mauls	3-7
Axes and Hatchets	3-7

## Section IV. STRUCK OR HAMMERED TOOLS

Cold Chisels	4-1
Hot Chisels	4-2
All-Steel Wood and Ripping Chisels	4-2
Handled Wood Chisels	4-2
Hand Punches	4-2
Blacksmiths' Round Punches	4-3
Blacksmiths' Backing Out Punches	4-3
Drift Pins	4-3
Star Drills	4-4
Brick Chisels and Brick Sets	4-4
Wood Splitting Wedges	4-5
Nail Puller Bars	4-5
Nail Sets	4-5

## Section V. REDRESSING INSTRUCTIONS 5-1

## Section VI. SCREWDRIVERS

Basic Safety Rules	6-1
Driving the Screw	6-2
Clearance Holes	6-4
Ratchet Screwdrivers	6-6
Screwdrivers for Recessed Openings	6-7
Specialty Screwdrivers	6-9
Magnetic Tip Screwdrivers	6-10

## Section VII. VISES

Machinist's Vise	7-1
Utility Vise	7-1
Woodworker's Vise	7-2
Clamp-on Vises	7-2
Pipe Vises	7-3
Drill Press Vise	7-4
Milling Machine Vise	7-5
Automotive Vise	7-5
Specialty Vises	7-5

## Section VIII. CLAMPS

C-Clamps	8-1
Deep Throat C-Clamps	8-1
Machinist's Clamps	8-1
Welder's C-Clamps	8-1
Bar Clamps	8-2
Pipe Clamps	8-2
Well Driller's Clamp	8-2
Handscrews	8-3



Section VIII. CLAMPS (continued)

Spring Clamps	8-3
Miter Clamps	8-3
Corner Clamps	8-3
Three-way Clamps	8-4

Section IX. METAL CUTTING SNIPS & CUTTERS

Tinner Snips	9-1
Compound Leverage (Aviation) Snips	9-2
Cutters	9-5

Section X. TOOL BOXES, CHESTS, AND CABINETS

Tool Boxes	10-1
Tool Chests	10-1
Tool Cabinets	10-1

Section XI. AUTOMOTIVE TOOLS

Brake Service Tools	11-1
Engine Tools	11-2
Battery Service Tools	11-4
Ignition and Electrical Tools	11-4
Miscellaneous Tools	11-5
Muffler and Tail-Pipe Tools	11-6
Body and Fender Hammers	11-6
Body Repair Dollies and Spoons	11-7
Mechanic Gear Pullers	11-8

Section XII. PIPE TOOLS

Pipe Wrenches	12-1
Pipe Cutters	12-2
C Frame Cutter	12-2
Hinged Cutter	12-2
Rotary Cutter	12-2
Pipe Reamers	12-3
Pipe Threaders and Dies	12-4
Flaring Tools	12-6
Tube Cutters	12-7

# SECTION I. WRENCHES

## INTRODUCTION

Wrenches are designed for holding and turning nuts, bolts, cap screws, plugs and various threaded parts. Quality wrenches, regardless of their type, are designed to keep leverage and intended load in safe balance. Standard wrench types are available with both American Standard Inch and Metric openings. Special wrenches are also available for servicing and overhaul of certain widely used equipment.

Different types of wrenches are of different strengths and are designed for different purposes such as for wrenching high strength fasteners. Box end and socket type wrenches, because they surround the fastener head, are the strongest types of wrenches and have less chance of slipping off the fastener. Open end, flare nut, and adjustable wrenches are not as strong as the corresponding sizes of box or socket wrenches, because they do not surround the fastener head, and are not intended for heavy loads, such as breaking loose frozen fasteners.

### Proper Use and Care of Wrenches

1. Select a wrench whose opening exactly fits the nut. If the wrench is not exactly the correct size for the fastener, it may damage the corners of the fastener, slip, or break. Care should be exercised in selecting only inch wrenches for inch fasteners and only metric sizes for metric fasteners

High strength fasteners - grades 5 and 8, 12 Pt. nuts and bolts, and

many other aerospace fasteners require unusually high torque for their size and, therefore, require special care in the selection and use of wrenches (see Table 1-1 for fastener markings).

2. Always pull on a wrench handle and adjust your stance to prevent a fall if sudden release occurs.

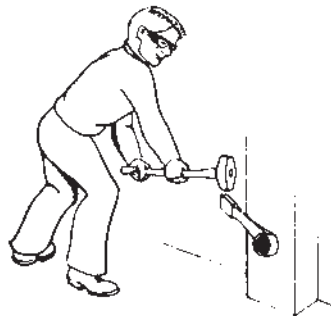


ADJUST YOUR STANCE AND PULL WHEN APPLYING HIGH TORQUE.

## RIGHT

Figure 1-2

3. To free a "frozen" nut or bolt, use a striking-face box wrench or a heavy-duty box or socket wrench. Application of penetrating oil to the fastener threads beforehand is recommended.






WEAR SAFETY GOGGLES AND USE A HEAVY SLEDGE TYPE HAMMER ON A STRIKING FACE.

## RIGHT

Figure 1-3

Table 1-1 Fastener Markings

<b>Head Marking</b>	<b>Fastener Grade</b>
 <p data-bbox="226 626 352 654"><b>NO MARK</b></p>	<p data-bbox="695 508 823 553"><b>1 or 2</b></p>
	<p data-bbox="742 773 772 818"><b>5</b></p>
	<p data-bbox="742 1040 772 1086"><b>8</b></p>

Notes:

1. Metric bolts may be labeled with the class value, such as 8.8 or 10.9.
2. Many other fastener markings exist. ASME, ANSI, ISO, and other authorities provide reference information.

## Avoiding Abuse/Misuse

1. **Never** use a pipe extension or other form of "cheater" to increase the leverage of any wrench.

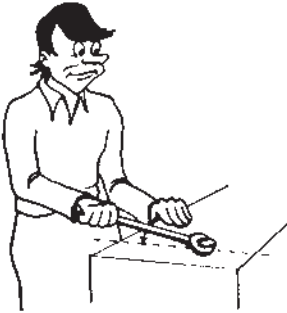


**NEVER USE A LEVERAGE EXTENSION ON A WRENCH HANDLE.**

# WRONG

Figure 1-4

2. **Never** cock an open-end wrench. Be sure the nut or bolt head is fully engaged.



**NEVER COCK OR TILT AN OPEN-END WRENCH. THE NUT MUST BE FULLY SEATED.**

# WRONG

Figure 1-5

3. Avoid over- or under torquing. A Torque Wrench will permit tightening to the exact torque required.

4. **Never** expose any wrench to excessive heat that may change the hardness and metal structure and ruin the tool. See section V.

5. **Never** grind a wrench, even as a means of identification.

6. **Never** use a wrench that has been damaged by being bent, cracked, or severely worn.

## 7. ELECTRICAL WARNING.

**Always** disconnect the power before working on electrical equipment or devices. **Never** depend on an insulated tool to protect you from electricity. Ordinary plastic coated handles are designed for comfort and provide no electrical insulation. Other tools, such as insulated and insulating, that have high dielectric insulation are so identified. The high dielectric insulation is intended only as secondary protection and for use by trained personnel.

## BOX WRENCHES

### Description

Box wrenches are made in long and short designs with double offset and 15° angle offsets. Twelve-point, hex and square openings are available in regular and heavy-duty designs. Double head types have different openings in each head. The Ratcheting type has both hex and 12-point openings. The Striking Face wrench is made in both straight and offset designs with 6 and 12-point openings.

Box wrenches in the regular design are designed for general service. The Heavy-Duty and Striking Face designs are designed for the service indicated.



## BOX WRENCHES

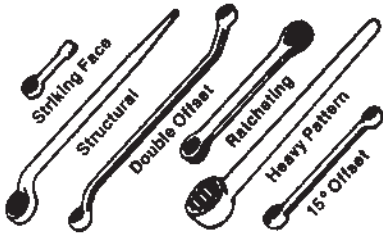


Figure 1-6

### Proper Use and Care

1. Use only a sledge type hammer on a Striking Face wrench.
2. Always wear safety goggles to protect your eyes.

### Avoiding Abuse/Misuse

1. Split box and Flare Nut wrenches are for tubing fitting and should not be used for general nut and bolt applications.
2. Ratcheting Box wrenches are for light duty and should not be used in heavy-duty applications.
3. Never use an extension on the wrench handle.

### When to Repair or Replace

Attempts to repair Box wrenches are not recommended. Discard any wrench with broken, worn, or

## OPEN-END WRENCHES

### Description

Open-End wrenches are designed for limited-torque, run-up/down, and adjustment work. Special designs are intended for the type of service that their name implies; e.g., Tappet, Ignition, Structural, etc.

The most widely used Open-End wrenches are made with openings at a 15° angle, which permits complete rotation of hex nuts with a 30° swing by flipping the wrench.

They are available in both single and double head designs; double head designs have different openings in each head, except Hydraulic wrenches, which have the same opening on each end but different offsets.

Ignition wrenches are small, thin wrenches having openings at 15° and 60°. Tappet wrenches, both single and double head, have openings at 15° angles, and are longer and thinner. Construction wrenches are made with a variety of openings and have a drift handle for aligning bolt holes. Structural wrenches are similar to the Construction design except they have straight openings and an offset handle. Many other types are available.

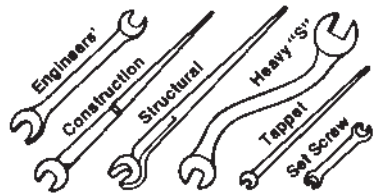


Fig 1-7 Open End Wrenches

### Avoiding Abuse/Misuse

1. Do not use an Open-End wrench to free a "frozen" nut. Use a box wrench because it is stronger.
2. **Never** use a hammer on this type of wrench.





**DON'T HAMMER ON THIS WRENCH.**

## **WRONG**

**Figure 1-8**

**3. Never** use an extension on the handle.

### **When to Repair or Replace**

Do not attempt to repair Open-End wrenches. Discard any wrench with cracks or spread, nicked, or battered jaws, or bent handle.

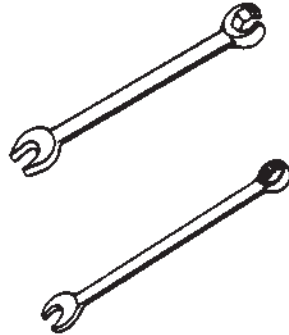
## **COMBINATION WRENCHES**

### **Description**

The most widely used designs are made in long and short types having a 15° angle open end and a 12-point box opening of the same size opposite. The box opening is offset at a 15° angle to the handle for clearance. The Split Box or Flare Nut design is for use on tube fittings. This type has a 6- or 12-point opening offset 15° from the plane of the handle with a tube opening slot at an angle to the axis of the handle. This design is also available with openings of different size at each end.

Combination wrenches are designed for a wide variety of work. The box opening adds to their versatility and strength. The Flare Nut design with its hex box

opening is especially useful in air conditioning and refrigeration work where tubing terminates on flare nuts.



**Figure 1-9 Combination  
Wrenches**

### **Proper Use**

The Split Box or Flare Nut design is for use on tube fittings and should not be used for high torque applications.

### **Avoiding Abuse/Misuse**

- 1.** Do not use the open end of these wrenches to free a "frozen" nut or to final tighten a hex nut. Use the box opening.
- 2. Never** use an extension on the wrench handle.

### **When to Repair or Replace**

Attempts to repair combination wrenches are not recommended. Discard any wrench with spread, nicked or battered jaws on the open end or rounded or damaged points on the box end. Discard wrenches with bent handles.

## **SOCKETS, HANDLES, AND ATTACHMENTS**

### **Description**

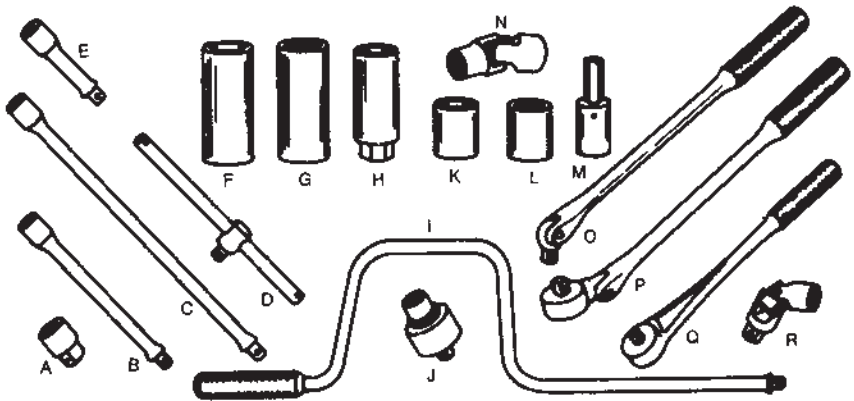
There are two common types of sockets - hand and impact - different in design and hardness. Hand sockets usually have a bright

finish but may have a black finish. Impact sockets have a black finish and usually have thicker walls.



Figure 1-10 Sockets

Sockets are made in regular length and deep length. Openings may be 12, 8, 6 point or square. Spark plug sockets have rubber inserts or other devices to hold the plug. Universal joint sockets are also available.



- |       |                      |   |                           |
|-------|----------------------|---|---------------------------|
| A     | ADAPTER              | K | REGULAR 6-POINT SOCKET    |
| B,C,E | EXTENSION BARS       | L | REGULAR 12-POINT SOCKET   |
| D     | SLIDING T HANDLE     | M | HEX SOCKET SCREW SOCKET   |
| F     | DEEP 6-POINT SOCKET  | N | UNIVERSAL 12-POINT SOCKET |
| G     | DEEP 12-POINT SOCKET | O | FLEX HANDLE               |
| H     | SPARK PLUG SOCKET    | P | FLEX HEAD RATCHET         |
| I     | SPEEDER HANDLE       | Q | REVERSIBLE RATCHET        |
| J     | RATCHET ADAPTER      | R | UNIVERSAL JOINT           |

Figure 1-11 Sockets, Handles, and Attachments

Hand Socket wrenches are made in a wide range of sizes and capacities. All have square drives ranging from 1/4" to 3 1/2" drive size. Each drive size represents an increase in strength. The popular sizes of sockets are made in three drive sizes. For high-strength fasteners, only the largest drive size should be used. It is always preferable to use the largest available drive size but where it is not available and the bolting is not high-strength, then the medium size socket can be used. The smallest

size should be reserved for where there is insufficient space for a larger socket or handle. The larger drives have longer and stronger handles which is also a guide as to how much force should be applied to a socket. Hand sockets should never be used on impact wrenches.

Handle types include Reversible Ratchet, Sliding Tee, Speeder, Breaker Bar, and Flex Head. Attachments include extension bars, adapters, flexible joints, universal joints, and various socket



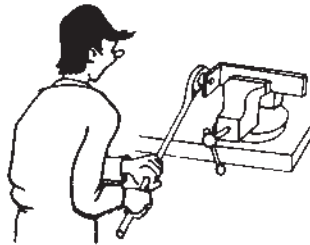
bits such as hex, slotted, Phillips screw, etc.

### Proper Use and Care

1. Select size and type of socket to fit nut (inch/metric).
2. Select the largest possible drive size – many sockets are available with smaller drive sizes than should be used at high load. They may be used for run-up (pre-tightening) or other low-load applications. See Table 1-2 for recommendations for drive sizes.
3. Select appropriate handle
4. Select extension and joint
5. **CAUTION:** The possibility exists for a lower torque rated accessory or socket or a combination of accessories and socket to be used in conjunction with a higher rated ratchet or drive tool.
6. Care should be exercised so as not to overload the lowest rated component.
7. **CAUTION:** Adapters and attachments reduce the load capacity of the tool, and should not be used under heavy load.
8. Periodic cleaning and inspection of handles, sockets and attachments is very important. Many manufacturers supply parts, repair kits and instructions for servicing their ratchet wrenches and handles. Repairs to the handles or ratcheting mechanism should be made with the manufacturer's own parts.

### Avoiding Abuse/Misuse

1. **Never** increase the leverage of a wrench handle by use of a pipe or other form of cheater on the wrench handle.
2. **Never** use hand sockets on power drive or impact wrenches.
3. When using adapters, remember that when adapting "down" (big handle, small socket) you build up tremendous torque potential and risk breaking the socket.
4. When adapting "up" (small handle, big socket) there is a risk of applying too much force to the handle and it may break.



**THIS HANDLE IS TOO BIG  
FOR THE SMALL SOCKET.**

## WRONG

Figure 1-12

### When to Repair or Replace

Do not attempt to repair sockets. Discard sockets or attachments with any sign of cracking. Discard any socket with rounded or damaged wrench openings, or with worn or deformed drive ends.



Table 1-2 Drive Size and Hex Size Loading Recommendations

Hex Size	¼" Drive	3/8" Drive	½" Drive	¾" Drive	1" Drive
1/8 to 7/32	OK				
¼ to 11/32	OK	OK			
3/8 to 9/16	OK	OK	OK		
19/32 to 11/16		OK	OK		
¾ to 1			OK	OK	
1 1/16 to 1 ¼			OK	OK	OK
1 ½				OK	OK
1 9/16 to 3½					OK

## IMPACT SOCKETS

### Proper Use

1. Wear safety goggles.
2. Put the socket on the fastener before starting the impact gun.
3. Use adapters only for special applications-not for general use.
4. Mind the joints between the gun and fasteners for less loss of torque and less wear.

### Avoiding Abuse/Misuse

1. **Never** use a nail or homemade pin for holding a socket in place.
2. **Never** exceed a gun pressure rating of 90 psi.
3. **Never** dwell on a socket after it has stopped turning. This can damage both the socket and the fastener.
4. Do not hold impact sockets, universal joints, or extensions while impact tool is running. Serious hand and wrist injury can occur.
5. If an impact gun will not remove a socket, try using penetrating oil, a slugging wrench, or a larger impact gun.

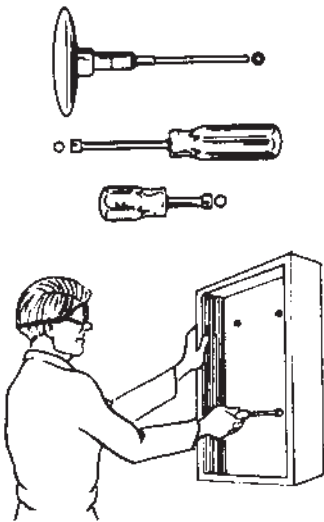
## NUTDRIVERS

Nutdrivers are screwdriver-type tools, which in their simplest form, have a one-piece shank and socket secured in a fixed handle. Socket heads have openings for hex nuts, bolts and screws up to 3/4 " nut size. Color coded nutdrivers typically use the coding in Table 1-3. Shafts may be solid, drilled part way, full hollow-plain, or magnetic for holding small fasteners.



**Table 1-3 Nutdriver Color Coding**

Opening Size (inch)	Color	Opening Size (mm)
5/64	Yellow	2
3/32	Blue	3
7/64	Brown	3.2
1/8	Red	4
5/32	Yellow	4.5
3/16	Black	5
7/32	Brown	5.5
1/4	Red	6
9/32	Orange	7
5/16	Yellow	8
11/32	Green	9
3/8	Blue	10
7/16	Brown	11
1/2	Red	12
9/16 and larger	Optional	13 and larger



**NUT DRIVERS ARE EXCELLENT  
CLOSE-QUARTERS TOOLS.**

**RIGHT**

**Figure 1-13 Nutdrivers**

Handles, both regular and reversible ratcheting, are available to accommodate interchangeable shanks for recessed head screws such as Phillips®, Frearson®, Hex, Spline and Scrulox® and for slotted screws as well as for standard 1/4" drive sockets.

### **Non-Detachable Socket Wrenches**

These wrenches have fixed openings, both hex and square, and are available in tee and offset handle types.



**Figure 1-14 Non-detachable  
Socket Wrenches**

## ADJUSTABLE WRENCHES

Adjustable wrenches are available in lengths from 4 to 24 inches. They are designed to provide a wide range of capacity in a single tool and are a convenient service wrench for repairmen, linemen, etc. Adjustable wrenches are not intended to replace fixed opening wrenches for production or general service work. Although they have limited strength, they are convenient when you can only take a few tools with you or when you encounter an unusual size of fastener.

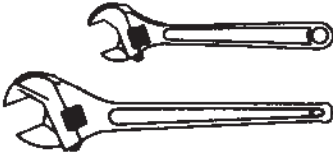
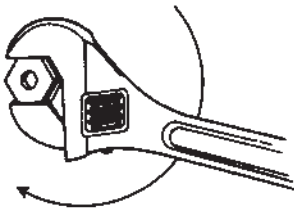


Figure 1-15 Adjustable Wrenches

### Proper Use and Care

1. Adjustable wrenches should be tightly adjusted to the nut and pulled so that force is on the side of the fixed jaw.
2. Periodic inspections should be made to detect damaged jaws, knurls, pins and springs.
3. Damaged parts should be replaced.



**RIGHT**

Figure 1-16 Force applied to Fixed Jaw

### Avoiding Abuse/Misuse

1. Do not use an Adjustable wrench to free a "frozen" nut or to final tighten a nut.
2. **Never** pull on a wrench adjusted to a loose fit with a fastener.
3. **Never** use a hammer or extension on this wrench.

### When to Repair or Replace

Discard any wrench with cracks, or spread or damaged fixed jaw or bent handle.

## SPANNER WRENCHES

Spanner wrenches are made in a variety of designs as illustrated in Figure 1-17. Spanner wrenches are primarily used in machine shops. They are used on machine tools for adjusting collars, lock nuts, rings, spindle bearings, face plate draw nuts, etc.



Figure 1-17 Spanner Wrenches

### Avoiding Abuse/Misuse

1. **Never** hammer on a wrench handle.
2. **Never** use a pipe or other cheater bar on the handle.

### When to Repair or Replace.

Do not attempt to repair Spanner wrenches. If pins, hooks or forging are bent, deformed, or cracked, discard the tool.

## HEX KEY WRENCHES

Hex Key wrenches are made in several configurations. The most basic is the L-shaped individual wrench; another is a set of various sizes integrated into a common handle.



Figure 1-18 Hex Key Wrenches

Screwdriver and tee handle configurations are also available. The wrenching end can be standard hex or star and may be specially shaped for improved access to and retention of the fastener.

### Avoiding Abuse/Misuse

1. **Never** hammer on a hex key wrench.
2. **Never** use a pipe or other cheater bar on the handle or key end.

### When to Repair or Replace

Do not attempt to repair hex key wrenches. If they are bent, deformed, or cracked, discard the tool.

## TORQUE WRENCHES

Torque wrenches, also called torque instruments, are used in

various operations where proper torquing of nuts, bolts and other fasteners is critical. Such operations include assembly and inspection of gear trains and bearings, setting of clutches and brakes, maintenance repair, overhaul and experimental work.

Torque instruments measure torque in inch-pounds (lbf-in) and foot-pounds (lbf-ft), as well as Newton-meters (N m) and centimeter-kilograms (cm kg). Many torque wrenches are available with dual scales for conventional and metric measurements.

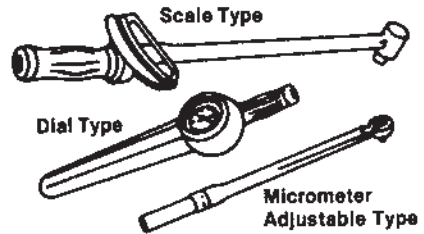


Figure 1-19 Torque Instruments

Two basic hand torque wrenches are audible signal and visual display. One type signals applied torque by momentarily releasing the wrench for a few degrees of free travel. The release is usually (but not always) accompanied by a click sound thus giving the wrench its popular names: Click Torque Wrenches or simply Clickers. Torque value is set using a micrometer scale on the wrench or preset by an adjusting screw in the handle cavity (which precludes accidental resetting).

A second type indicates, rather than signals, torque. Applied torque is indicated on a dial or electronic digital display. Some models have memory pointers that remain at the maximum reading attained until manually reset.

For low torque applications, torque screwdrivers are usually used. They are available in either the release (free wheeling) type, or in the indicating type.

The most widely used torque wrenches have square drives to utilize standard detachable sockets. Both ratcheting and non-ratcheting types are available.

Drive Size	Max. Torque
1/4"	250 lbf-in
3/8"	100 lbf-ft
1/2"	250 lbf-ft
3/4"	700 lbf-ft
1"	2000 lbf-ft
1 1/2"	6000 lbf-ft

### Torque Multipliers.

Torque multipliers are multi-gearred tools generally used with ratchets or ratcheting torque wrenches as the drive component. Input is multiplied through the gearing four or more times depending on the model used. A reaction bar, which locks into the head of the torque multiplier, must rest securely against an object sturdy enough to withstand the force that will be generated. When driving a torque multiplier with a torque wrench, a torque loss factor at the fastener, caused by frictional losses through the gear train, must be taken into consideration in determining the desired torque at the output side of the torque multiplier. Torque loss factors are available from most torque tool manufacturers. Torque wrenches are available which can be used between the output side of the torque multiplier and the fastener. When used in this manner, the actual torque on the fastener

may be read without the need to compensate for frictional loss.



Figure 1-20 Torque Multiplier



Figure 1-21 Flexible Head



Figure 1-22 Interchangeable Head



Figure 1-23 Electronic

### Proper Use and Care

1. Read instructions / literature completely and understand proper use of torque instrument prior to usage and store instructions / literature for future use.
2. Select the proper type, capacity and accuracy of torque instrument for the application.
3. Inspect torque instruments and all accessories for damage, wear, and cracking prior to use. Have these instruments replaced or repaired by qualified service technicians using only genuine replacement parts and then have them recalibrated. Most manufacturers provide repair and calibration service. The

manufacturer will advise if the tool can be repaired or should be replaced.

**4.** Periodic recalibration is required to maintain accuracy of a torque instrument. The time interval between calibrations depends upon the frequency of use. Calibration should be verified at least once a year or every 5,000 torque applications, whichever occurs first. If the instrument is to be used in extreme temperature and/or humidity conditions it should be calibrated at those conditions to ensure the accuracy of the torque instrument. If the instrument is subjected to overload or shock it should be recalibrated regardless of the time since the last calibration.

**5.** Always pull a torque instrument slowly and steadily, have good footing, and be prepared to release force the instant the instrument signals proper torque level to avoid overtightening. Adjust your stance to prevent a fall if something should give suddenly.

**6.** For torque instruments with ratchet heads: observe manufacturer's recommendations for inspecting, cleaning, lubricating and repairing ratchet heads. Ratchet mechanism may slip or break if dirty, if mismatched or worn parts are used, or if direction lever is not fully engaged. Ratchets that slip or break may cause injury.

**7.** The use of an adapter, extension, or universal may require an adjustment to dial/set torque to get proper fastener torque. Refer to instructions for determining the adjustment factor and related calculations. Only use accessories with a torque instrument that have

adequate strength/torque capacity for the application. A flexible head wrench in a flexed position will produce a different torque than in the unflexed (straight) position.

**8.** Always know the proper units of torque specified for an application. Always obtain torque values from the equipment manufacturer. Know the allowable torque range for fasteners to be torqued. Use a torque instrument with matching units or convert values using torque conversion tables.

**9.** Many torque instruments require a preloading procedure prior to use: see manufacturer's instructions.

**10.** Many torque instruments must be stored at their lowest setting. See manufacturer's instructions for specific requirements.

**11.** Always work with clean threads that are free of corrosion. It is important to follow the product manufacturer's instructions for specific torque loadings – particularly when recommendations are for dry, oiled or plated threads.

**12.** When not in use, the adjustable type wrench should be set to the lowest torque.

**13.** Read torque values on indicating torque wrenches by looking at the dial at 90° to its surface (from straight above). If this is difficult to do, compensate by observing how much the apparent scale readings change when viewing from different angles.

**14.** Observe markings on interchangeable heads, or manufacturer's instructions, to ensure that the capacity of the head is appropriate for the handle.



## Avoiding Abuse/Misuse

1. Do not over-tighten a nut or bolt with a conventional wrench before applying a torque wrench.
2. Do not exceed rated torque for the torque instrument, sensors, adapters, extensions, and other accessories. Exceeding rated torque may cause the instrument to break. Broken or slipping instruments can cause injury.
3. **Never** use torque instrument to break fasteners loose.
4. Do not use a torque instrument to support yourself.
5. Do not use cheater bars on torque instruments.
6. A Torque wrench is a precision instrument and should not be roughly handled. **Never** use it as a hammer, a pry, or as a conventional wrench - use it only as a torque tool.
7. When using adjustable type wrenches do not over torque by applying torque past the release point. At the low torque setting, the

"click" signal might be very soft or missing altogether. Learn the feel of the release, rather than relying on the sound.

8. Cheater bars should **never** be used unless specifically permitted (or supplied) by the wrench's manufacturer. Most torque wrenches operate accurately only when they are held by their designated grips.

### When to Repair or Replace

Do not use torque instruments with sockets or fasteners showing wear or cracks.

Do not use torque instruments that have been abused, submerged in fluid (unless designed for such use), appear damaged, or have excessive wear.

If a torque wrench has been dropped it should be checked on a torque tester for accuracy.



## NOTES

---

---

---

---

---

---

---

---

---

---

## SECTION II. PLIERS

### INTRODUCTION

Pliers of various types are used by practically every tool user, both amateur and professional. There are many types and sizes; each designed for specific uses, although their versatility makes some pliers adaptable for many jobs. Choose the right pliers for the job.

#### Basic Safety Rules Which Apply to the Use of Pliers

1. Pliers should not be used for cutting hardened wire unless specifically manufactured for this purpose.
2. **Never** expose pliers to excessive heat. This may change the material properties and ruin the tool.
3. Always cut at right angles. **Never** rock from side to side or bend the wire back and forth against the cutting edges.
4. Don't bend stiff wire with light pliers. Using the tips to bend too large a wire can damage long nose pliers. Use a sturdier tool.
5. **Never** use pliers as a hammer nor hammer on the handles. They may crack or break, or edges may be nicked by such abuse.



**NEVER EXPOSE PLIERS  
TO EXCESSIVE HEAT.**

## **WRONG**

Figure 2-1



**ALWAYS CUT AT RIGHT ANGLES—DON'T  
ROCK SIDE TO SIDE WHEN CUTTING WIRE.**

## **RIGHT**

Figure 2-2

6. **Never** extend the length of handles to secure greater leverage. Use a larger pair of pliers.
7. Pliers should not be used on nuts or bolts. A wrench will do the job better and with less risk of damage to the fastener.
8. Oil pliers occasionally. A drop of oil at the joint will lengthen tool life and assure easy operation.
9. Safety glasses or goggles should be worn when cutting wire, etc. to protect eyes.
10. **Never** attempt to cut "HOT" wire.



**PLIERS ARE NOT MADE FOR HAMMERING.**

## **WRONG**

Figure 2-3

**WARNING.** COMFORT GRIPS ON HANDLES ARE NOT INTENDED TO GIVE ANY DEGREE OF PROTECTION AGAINST ELECTRIC SHOCK AND SHALL NOT BE USED ON OR NEAR LIVE ELECTRIC CIRCUITS.

## LINEMEN'S SIDE CUTTING PLIERS

### LINEMEN'S SIDE CUTTING PLIERS

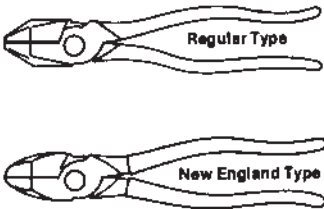


Figure 2-4

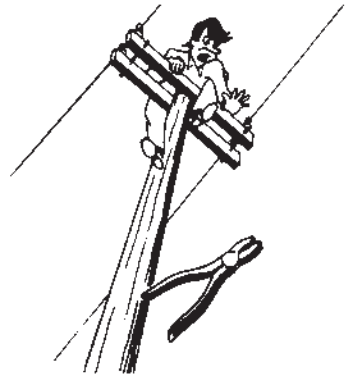
Two head designs are available: Standard, also known as bevel nose, and New England, also known as round nose, which is more streamlined. The bevel nose may be used for de-burring conduit. Handles may have plain or comfort grips. High leverage designs are also available, as are pliers incorporating sleeve twisters and threaded bolt-holding openings. Sizes range from 6¼ to 9¼ inches in length. These are heavy-duty tools designed for the professional engaged in electrical, communications, and construction work.

#### Proper Use

Always cut at right angles.

#### Avoiding Abuse/Misuse

1. **Never** expose pliers to excessive heat.
2. Don't rock pliers from side to side when cutting wire.
3. **Never** use pliers as a hammer, or drop on hard or paved surfaces.
4. **Never** attempt to cut "HOT" wire.



**DON'T DROP PLIERS ON HARD OR PAVED SURFACES.**

## WRONG

Figure 2-5

## IRONWORKERS' PLIERS

### IRONWORKERS' PLIERS



Figure 2-6

These pliers are very similar to Linemen's pliers except that they have a hook bend on one handle and may have a coil spring to hold the jaws open. Available in standard and high leverage designs. These wire-cutting pliers are designed for cutting soft tie wire used in tying concrete reinforcing bars and form work involving pulling, twisting, and cutting wire.

#### Proper Use

Always cut at right angles.

#### Avoiding Abuse/Misuse

1. **Never** expose pliers to excessive heat.
2. Don't rock pliers from side to side when cutting wire.
3. **Never** use pliers as a hammer or drop on hard or paved surfaces.

## LONG NOSE PLIERS

## LONG NOSE PLIERS

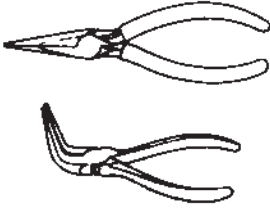


Figure 2-7

This type of pliers includes various nose configurations. They may be available with wire cutters or notches for stripping insulated wire. Small and miniature sizes are designed for electronic work. Handles may have plain or comfort grips. Certain designs are made in both straight and curved nose design. Typical sizes range from 4 to 12 inches in length. Most Long Nose Pliers are designed for electrical, telephone and electronic work involving smaller wire gauges. They will reach into awkward places and perform work difficult with any other tool. Their usefulness, however, is not limited to wire work.

### Proper Use and Care

1. Cut at right angle to the wire.
2. Serrations on the gripping surface may be cleared of foreign materials by brushing with a file card or stiff wire brush.

### Avoiding Abuse/Misuse

1. **Never** expose these pliers to excessive heat.
2. Don't bend stiff wire with the tip of the pliers.
3. **Never** rock the pliers side to side when cutting.
4. **Never** pry with the nose of the pliers.
5. **Never** attempt to cut "HOT" wire.



**WRONG**

Figure 2-8

**When to Repair or Replace.** Attempts to repair Linemen's side cutting, Long Nose, and Ironworker's pliers are not recommended. Discard any pliers that are cracked, broken, sprung, or have deformed cutting edges.

## DIAGONAL CUTTING PLIERS

## DIAGONAL CUTTING PLIERS

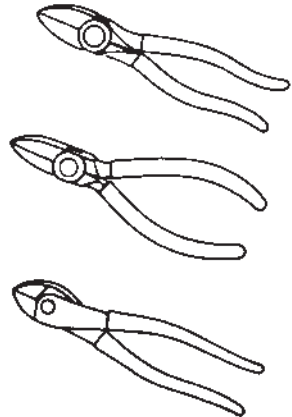


Figure 2-9

Diagonal Cutters are made in several designs ranging from the high leverage, heavy-duty design down to the mini design for electronic work. There are

designs for flush cutting, semi-flush cutting, and standard cutting. Some have wire-skinning holes- some have coil springs to open the jaws. Handles may have plain or comfort grips. Typical sizes range from 4 to 12 inches in length. Diagonal Cutting pliers are designed for electrical, electronic, telephone, general and automotive work.



HEAVY DIAGONALS ARE FINE FOR CUTTING THE SPREAD ENDS OF COTTER PINS.

## RIGHT

Figure 2-10

### Proper Use and Care

1. Flush cutting and semi-flush cutting pliers should be used only for cutting small soft wires used in electronic wiring applications.
2. It is recommended that the standard cutting edge pliers be used for all general cutting requirements except hard wire.
3. Always cut at right angles.
4. Dull cutting edges may be touched up with a small, medium grade honing stone.

### Avoiding Abuse/Misuse

1. **Never** expose pliers to excessive heat.
2. Don't rock pliers from side to side when cutting wire.
3. **Never** use pliers as a hammer, or drop on hard or paved surfaces.

**When to Repair or Replace.** Attempts to repair these pliers are not recommended. Discard any pliers that are cracked, broken, sprung, or have deformed cutting edges.

## FLAT NOSE PLIERS

Often referred to as "Duck Bill," these pliers have a flat nose in various widths, and are available with plain or comfort grip handles. Typical sizes range from 4 to 12 inches in length. Flat Nose pliers have diverse uses in the electrical, telephone, electronic and other fields. They are extensively used in repair and assembly work and in textile weaving and knitting operations.



Figure 2-11 Flat Nose or "Duck Bill" Pliers

### Avoiding Abuse/Misuse

1. **Never** expose these pliers to excessive heat.
2. Do not use as a hammer or as a prying tool.
3. **Never** use Flat Nose Pliers to pry or twist.



DON'T USE FLAT NOSE PLIERS TO PRY OR TWIST.

## WRONG

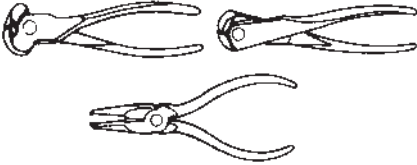
Figure 2-12

**When to Repair or Replace.** Attempts to repair these pliers are not

recommended. Discard any pliers that are cracked, broken or sprung.

### END CUTTING PLIERS

End cutting pliers, also known as nippers, range from heavy-duty, high leverage designs down to traverse end cutters designed for precision electronic work. They are available with plain or comfort grip handles. Typical sizes range from 4 to 12 inches in length.



**Figure 2-13 End Cutting Pliers**  
**Proper Use**

End Cutting pliers are designed for cutting soft wire, nails, rivets, etc. close to the work surface.



**END CUTTERS ARE IDEAL FOR CUTTING TIE WIRES CLOSE TO THE CONCRETE WALL.**

## RIGHT

**Figure 2-14**

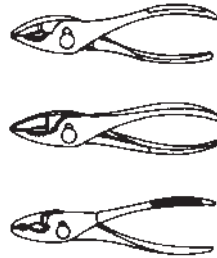
### Avoiding Abuse/Misuse

1. **Never** expose these pliers to excessive heat.
2. **Never** use as a hammer, nail puller, or prying tool.
3. **Never** attempt to cut "HOT" wire.

**When to Repair or Replace.** Attempts to repair these pliers are not recommended. Discard any pliers that are cracked, broken, sprung' or have deformed cutting edges.

### SLIP JOINT PLIERS

These pliers are available in several designs; standard, thin nose, bent nose and heavy-duty. Their slip joint capability increases the capacity range. They are available with or without wire cutters in sizes from 4 to 10 inches in length. Handles are available with plain or comfort grips.



**Figure 2-15 Slip Joint Pliers**

These versatile tools are designed for a wide range of service involving gripping, turning and bending.

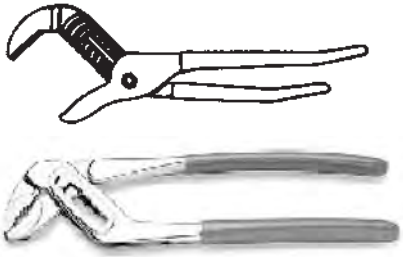
### Avoiding Abuse/Misuse

1. **Never** expose these pliers to excessive heat.
2. **Never** use as a hammer.

**When to Repair or Replace.** Attempts to repair these pliers are not recommended. Discard any pliers that are cracked, broken or sprung.

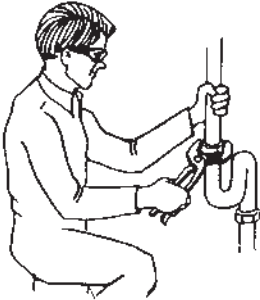
### MULTIPLE POSITION PLIERS

These wide-range capacity pliers are made with tongue and groove or other multiple position joint adjustment designs. Jaw capacities up to 5<sup>3</sup>/<sub>8</sub> inches are available. Jaws may be smooth or serrated and curved or straight.. Sizes range from 4 to 20<sup>1</sup>/<sub>4</sub> inches in length.



**Figure 2-16 Multiple Position Pliers**

These pliers are widely used by plumbers, electricians, auto mechanics and professionals in the construction and industrial fields. They will grip a variety of shapes.



**PLUMBERS, ELECTRICIANS AND MAINTENANCE WORKERS HAVE MANY JOBS WHERE TONGUE AND GROVE PLIERS ARE INVALUABLE.**

**RIGHT**  
Figure 2-17

**Avoiding Abuse/Misuse**

1. **Never** expose these pliers to excessive heat.
2. **Never** use as a hammer.

**When to Repair or Replace.** Attempts to repair these pliers are not recommended. Discard any pliers that are cracked, broken, or sprung.

**LOCKING PLIERS**

Locking pliers are available in a variety of sizes with straight or curved jaws. Compound leverage systems lock jaws and hold various shapes and sizes of work.

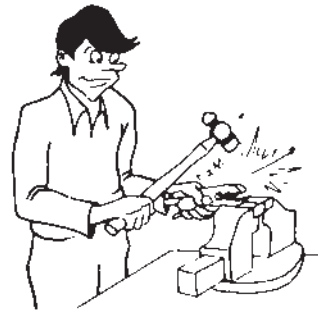


**Figure 2-18 Locking Pliers**

Locking pliers are combination tools which function as pliers, wrenches, or clamps. They are not intended to replace open-end or box wrenches because of possible damage to fitting or fastener.

**Avoiding Abuse/Misuse**

Do not hammer to tighten jaws or to cut wire or bolts.



**DON'T HAMMER ON PLIERS TO CUT WIRE OR BOLTS.**

**WRONG**

Do not expose locking pliers to heat from welding torches or contact with welding electrodes. When subjected to severe vibration such as encountered during riveting, locking pliers holding the work pieces should be wired or taped closed to prevent accidental opening. Do not use pipe, other extensions, or hammering to increase torque applied to these tools. They should **never** be used as steps or ladders to support personnel.

**When to Repair or Replace.** Avoid excessive wear on working parts by frequent lubrication. Attempts to repair these tools are not recommended. Discard any damaged tool.





### RETAINING RING PLIERS

These pliers are used to install or remove retaining rings, also known as circlips, grip rings, or snap rings, used on brakes, transmissions, shafts, and machine tools. Piston rings are a type of grip ring.

#### Proper Use and Care

1. First loosen retaining ring with punch or similar tool to remove bond from rust and accumulated dirt in groove.
2. Use largest tips that fit in the holes in the retaining ring, or the largest tips applicable to the grip ring.
3. Push tips of pliers as far as possible into retaining ring holes before squeezing handles.
4. Use minimal pressure needed to remove or install ring.

#### Avoiding Abuse/Misuse

1. Never use your pliers for anything other than installing and removing retaining rings or grip rings.

2. Caution: Take care that retaining rings do not get dislodged from tips of pliers -always protect your eyes with safety goggles.

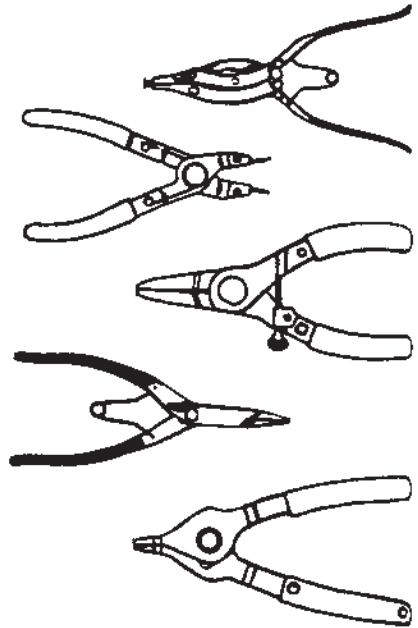


Figure 2-19 Retaining Ring Pliers

#### NOTES

---



---



---



---



---



---



---

## SECTION III. STRIKING TOOLS

**(Users and bystanders - always wear safety goggles when using striking tools)**

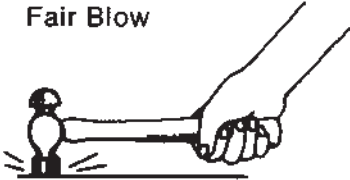
### INTRODUCTION

Hammers and other striking tools are perhaps the most widely used, and probably the most often abused of all hand tools. They are made in various types, sizes and configurations for specific purposes. They should be selected for their intended use and used only for those purposes for which they are designed. Misuse can cause the striking face to chip, possibly resulting in eye or other serious injury.

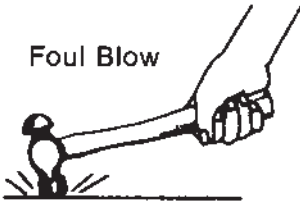
#### **Basic Safety Rules that Apply to the use of Hammers**

A hammer blow should always be struck squarely with the hammer striking face parallel with the surface being struck. Always avoid glancing blows and over and under strikes.

**Fair Blow**



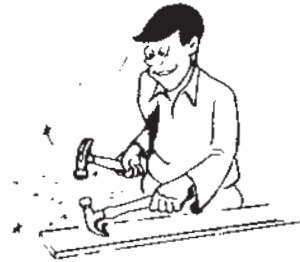
**Foul Blow**



### RIGHT

When striking another tool (chisel, punch, wedge, etc.), the striking face of the proper hammer should have a diameter at least 3/8" larger than the face of the struck tool.

Always use a hammer of suitable size and weight for the job. Don't use a tack hammer to drive a spike, nor a sledge to drive a tack.



### WRONG

Never use one hammer to strike another hammer, a hatchet, or other hardened objects.





Discard any striking tool if it shows dents, cracks, chips, mushrooming, or excessive wear.

Never regrind, weld or reheat-treat a hammer.

Always follow safety precautions shown on striking tools.

Users and bystanders always wear safety goggles.



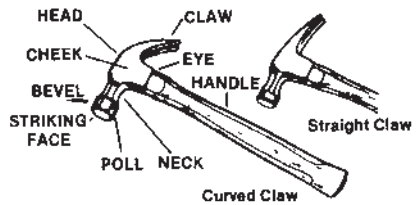
Never use a striking tool with a loose or damaged handle.



## NAIL HAMMERS

Nail hammers are made in two designs; curved claw and straight or ripping claw. The face is slightly crowned with the edges beveled, although certain heavy-duty designs may have checkered faces designed to reduce glancing blows and flying nails. Handles may be wood, steel, or fiberglass. Steel and fiberglass handles are generally furnished with rubber-type grips that are occasionally used on wood handles.

### NAIL HAMMERS



### Proper Use

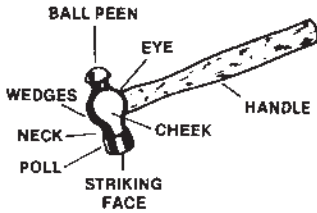
Nail hammers are designed for driving unhardened nails only, using the center of the hammer face. The claws are for pulling unhardened nails and ripping woodwork and should not be struck against metal.



**WARNING:** Hardened steel-cut, pole barn, and masonry nails should **never** be driven with a nail hammer. These nails may shatter or may cause a hammer face to chip with an indirect or glancing blow, and should **never** be driven, even when using the proper tool, unless safety goggles are worn. When not driven through a piece of wood, a hole should be started with a small star drill or masonry bit. A hand drilling hammer or sledge is the proper tool to use.

## BALL PEEN HAMMERS

### BALL PEEN HAMMERS



Ball peen (or ball pein) hammers have a rounded, slightly crowned striking face with beveled edges and a round, ball shaped peen. Handles may be wood, steel, or fiberglass. The steel and fiberglass handles are commonly furnished with rubber-type grips, which are occasionally used on wood handles.

#### Proper Use

Ball peen hammers of the proper size are designed for striking chisels and punches, and for riveting, shaping, and straightening unhardened metal.

When striking a struck tool (chisel or punch), the striking face of the hammer should have a diameter at least  $3/8$ " larger than the face of the struck tool.

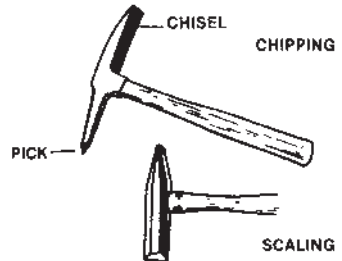
## RIVETING AND SETTING HAMMERS

These hammers are strictly specialized tools intended only for driving and spreading unhardened rivets, inserting glazier points and forming sheet metal. Handles are usually wood. The **Machinists' Riveting** hammer has a round poll with a slightly beveled, flat striking face and rounded cross peen. The **Tinners' Riveting** hammer has an octagon poll with a flat striking face with slightly beveled edges. The cross peen is slightly rounded. The **Tinners' Setting** hammer's face has sharp corners and no bevels. The cross peen has a sharp beveled edge.

## Proper Use

The Riveting hammer is designed for driving and spreading rivets on sheet metal work. The Setting hammer is designed for forming sharp corners, closing and peening seams and lock edges, and for use by glaziers for inserting glazier points. **Never** use these hammers for general purpose work - they are strictly specialized tools intended only for driving and spreading unhardened rivets, inserting glazier points and forming sheet metal.

## SCALING AND CHIPPING HAMMERS



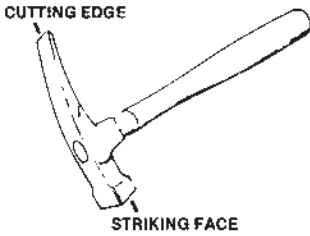
Scaling and chipping hammers are special-purpose tools and are made in varying configurations by different manufacturers. The two designs illustrated are typical.

#### Proper Use

These hammers are popular in iron foundries and welding shops. They are designed for chipping welds, scale, rust and paint from unhardened metal.



## BRICKLAYERS' HAMMERS



Bricklayers' hammers are special-purpose tools. The striking face is flat with beveled edges. The blade has a sharp, hardened cutting edge. Handles may be wood, steel, or fiberglass and may be furnished with rubber-type grips.

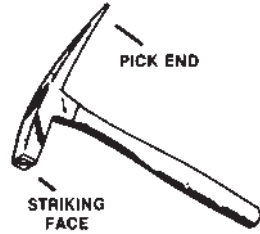
### Proper Use

Bricklayers' hammers are designed for setting and cutting (splitting) bricks, masonry tile, and concrete blocks, and for chipping mortar from bricks.



**WRONG**

## PROSPECT PICKS



These are special purpose tools used by geologists and prospectors. The striking face is flat with beveled edges. The long pick is pointed and may be either round or square. Handles may be wood, solid steel or fiberglass, and may be furnished with rubber grips. Picks are **NEVER** to be used as an aid in climbing.

### Proper Use

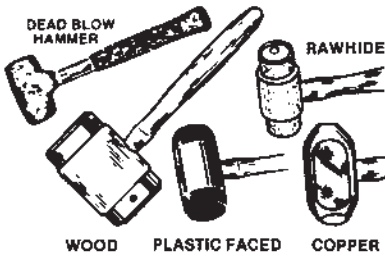
Prospecting picks are designed for splitting rock and for digging and prying out rock with the pick.



## SOFT FACE AND NON FERROUS HAMMERS AND MALLETs

The faces of soft face hammers and mallets are made of various non-ferrous materials (wood, rawhide, rubber, plastic, copper, brass, lead, etc.). Heads are typically cylindrically shaped with two flat striking faces. Handles are usually wood or fiberglass. Rubber and plastic hammers are used for setting stone and alignment applications. Plastic hammers may have replaceable tips available in varying degrees of hardness.





### Proper Use

Soft face hammers are intended for striking blows where steel hammers would mar or damage the surface of the work. Wooden mallets are properly used for striking wood and plastic handled chisels, gouges, wood pins and small stakes, and to form or shape sheet metal. They should never be used to drive nails or screws, or to strike sharp metal objects.

### DEAD BLOW HAMMERS

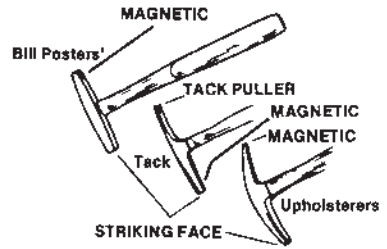
Dead blow hammers are designed to reduce or eliminate rebound of the hammer after striking and object.

#### Proper Use

Dead blow hammers are intended for use when vibration or rebound needs to be minimized.

### TACK HAMMERS

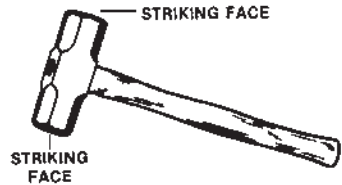
Tack hammers are usually made in the designs illustrated. One end of the head is magnetized to hold tacks. Handles are usually wood. The tack hammer has a long thin claw for pulling tacks in corners and along walls; also used for removing light moldings. The heads of the other two designs are designed for starting and driving tacks only.



### Proper Use

Primary use of these light-duty hammers is holding and driving tacks and upholstery nails. The magnetic end is used for starting the tack; the opposite end, for driving.

### ENGINEERS' HAMMERS AND SLEDGES, DOUBLE FACE



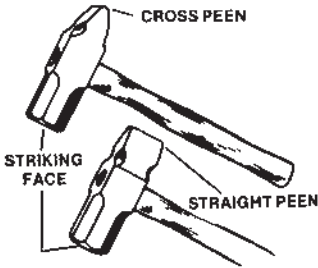
These types of hammers, generally referred to as sledges, are made in various different head configurations. All designs have crowned striking faces with beveled edges.

#### Proper Use

Sledges are designed for general sledging operations in striking wood, metal, concrete, or stone. Common uses are drifting heavy timbers and striking spikes, cold chisels, star drills and hardened nails.



## BLACKSMITHS' HAND HAMMERS AND SLEDGES, STRAIGHT AND CROSS PEEN



These- heavy-duty hammers are designed for blacksmiths' use in striking unhardened metal. The striking face is crowned with a beveled edge.

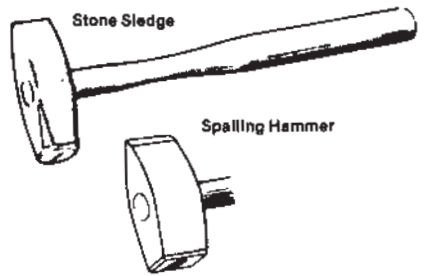
### Proper Use

The striking face is used for striking unhardened metal. The peens are used for shaping (fullering) and bending unhardened metal.



**RIGHT**

## STONE SLEDGES AND SPALLING HAMMERS



Stone sledges are designed for breaking up stone and concrete. Spalling hammers are designed for cutting and shaping stone and concrete. The sledge usually has a crowned, oval striking face with a napping face opposite. The spalling hammer may have a beveled or straight edged face.

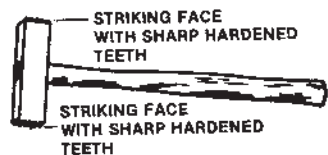
### Proper Use

These sledges and hammers are designed for striking stone and concrete. They should not be used for striking metal.



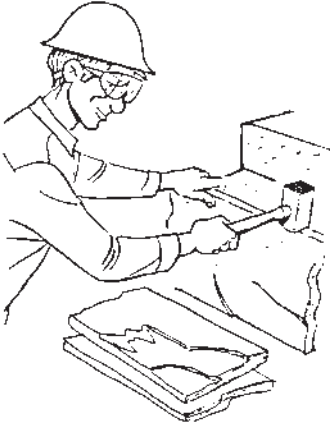
**RIGHT**

## BUSH HAMMERS





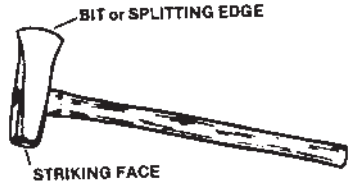
This is a striking tool of compact, rectangular design having striking faces with sharp, hardened teeth.



**RIGHT**  
Proper Use

Bush hammers are designed for roughing and chipping concrete.

**WOODCHOPPERS' MAULS**



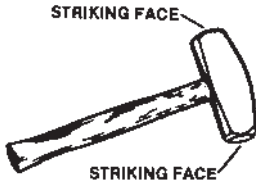
Woodchoppers' mauls have a round, bevel-edged striking face with a bit or splitting edge opposite. These tools are designed for splitting wood.

**Proper Use**

They are designed for use in conjunction with wood splitting wedges by first making a notch with the splitting edge and then driving the wedge with the maul's striking face.



**HAND DRILLING HAMMERS**



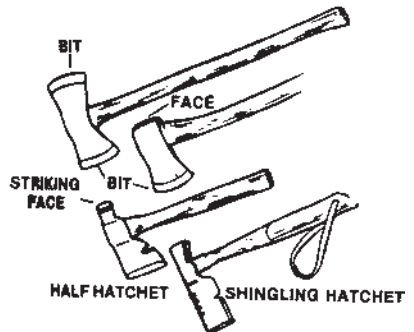
These heavy short handled hammers have double-faced heads that have crowned and beveled striking faces. Their design permits heavy blows with limited swing-especially advantageous in restricted working areas.

**Proper Use**

These hammers are designed for uses with chisels, punches, star drills and hardened nails.



**WRONG**  
**AXES AND HATCHETS**



Axes and hatchets are made in various designs and head configurations. The more widely used types are illustrated. An axe is generally used with both hands while a hatchet is generally used with one hand.

Handles may be wood, steel, or fiberglass. Steel and fiberglass handles are generally furnished with rubber-type grips that are occasionally used on wood handles.

### Proper Use

The double bit axe is usually used to fell, trim, or prune trees and to split and cut wood. It is also used for notching and shaping logs and timbers. The single bit axe, in addition to the above uses, is used to drive wood stakes with the face.

Hatchets are used for cutting, splitting, trimming and hewing, and driving unhardened nails and stakes with the striking face. The cutting edges of axes and hatchets are designed for cutting wood and equally soft materials. The striking faces of hatchets are properly hardened for driving common nails but should **never** be used to strike chisels, punches, star drills or other hardened metal tools, or for striking stone or concrete.

### Avoiding Abuse/Misuse

**Never** use a striking tool for anything other than the uses described above.

**Never** strike one hammer with or against another hammer or a hatchet.

**Never** strike concrete, steel chisels or similarly hard objects with a nail hammer as the hammer face or object being struck may chip, possibly resulting in eye or other serious bodily injury.

**Never** use a striking tool with a loose or damaged handle.

**Never** strike with the side or cheek of a hammer.

**Never** use a sledge to strike a hammer, another sledge, hatchet, axe, or maul.

Avoid glancing blows against other hardened surfaces.

Avoid glancing blows to minimize chipping of the hammer.

**Never** use an axe or a hatchet as a wedge or a maul.

### When to Repair or Replace

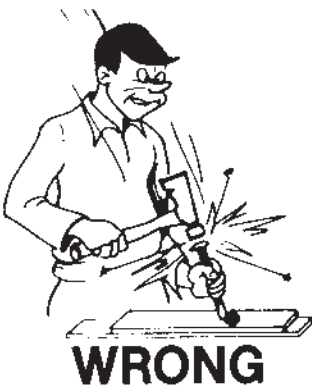
Do not use any hammer if the striking face or its bevel show dents, chips, mushrooming or is excessively worn, or if the claws show indentations or nicks inside the nail slot, or if the claw is broken.

If only the handle is damaged, replace it with an equivalent new handle.

Cutting edges on mauls, hatchets, and axes may be redressed. See instructions in section V.

Tips on certain designs of soft faced and nonferrous hammers and mallets can be replaced should they become damaged.

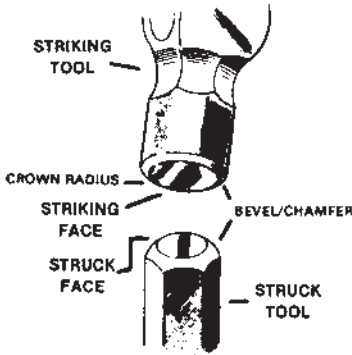
Do not use bush hammers if teeth are dull and/or flattened.



## SECTION IV. STRUCK OR HAMMERED TOOLS

(Users and bystanders - always wear safety goggles when using striking or struck tools.)

### INTRODUCTION



This section deals with tools that are struck with the tools described in Section III.

The striking and struck faces of tools are designed to direct the force of blows toward the center or body of the tool. Blows struck off center are not directed toward the body of the tool where they can be absorbed, but rather travel directly along the sides of the tool where there is insufficient back-up material. The angle and thickness of the cutting edges of tools are designed to give maximum effectiveness and durability.

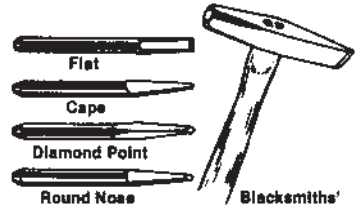
### When to Repair or Replace

Never use a struck tool if it is bent or shows dents, cracks, chips, mushrooming, or excessive wear.

If only the handle is damaged, replace it with an equivalent new handle.

If the cutting edge, point end, or bit is dull it may be redressed as instructed in Section V.

## COLD CHISELS



Cold chisels may be made from round, square, hexagon or octagon steel stock. The blacksmiths' cold chisel is fitted with a handle. Cold chisels have a cutting edge or bit at one end and a struck face on the opposite end.

### Proper Use

Cold chisels are designed for cutting, shaping and removing metal softer than the cutting edge itself such as cast iron, wrought iron, steel, bronze, copper, etc.

### Avoiding Abuse/Misuse

**Never** use cold chisels for cutting or splitting stone or concrete.

**Never** use a dull chisel or one with a mushroomed head.

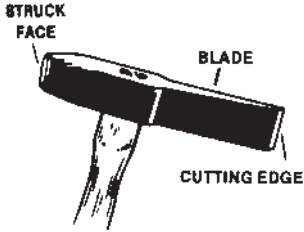
**Never** use a chisel with a loose or damaged handle.



**WRONG**



## HOT CHISELS



Hot chisels or hot cutters have handles and are similar to blacksmiths' cold chisels except that the cutting edge or bit is wider and the blade is thinner.

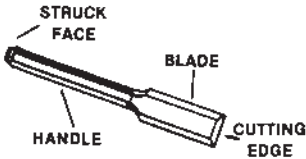
### Proper Use

Hot chisels are designed for cutting hot steel.

### Avoiding Abuse/Misuse

**Never** use hot chisels for cutting cold metal, stone or concrete

## ALL-STEEL WOOD AND RIPPING CHISELS



This type of wood chisel is comprised of a blade, handle, cutting edge, and struck face made from a single piece of steel

### Proper Use

These are heavy-duty wood-cutting tools designed for rough work.

### Avoiding Abuse/Misuse

**Never** use a wood chisel on metal, concrete, stone, or other hardened objects.

## HANDLED WOOD CHISELS

This type of wood chisel is comprised of a blade, handle, cutting edge, and struck face with the handles being made of plastic or wood

### Proper Use

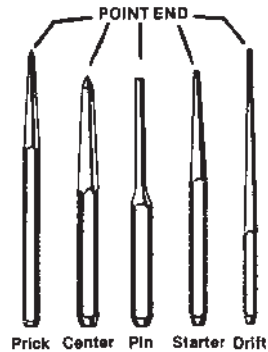
These tools are designed for general purpose carpentry work.

### Avoiding Abuse/Misuse

**Never** use a wood chisel on metal, concrete, stone, or other hardened objects.

## HAND PUNCHES

Hand punches are made in the various designs illustrated from square, round, hexagon or octagon steel stock. Tip designs exist for a variety of applications. Prick punches have a relatively sharp point. Center punches have a more blunt angle than that of the prick punch. Pin punches have a flat end and no taper. Starter punches are similar to the pin punch but has a tapered shank. Drift punches are similar to starter punches only with a longer tapered section.



### Proper Use

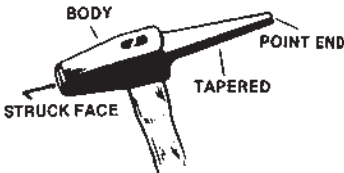
Prick and Center punches are designed to mark metal and other materials softer than the point end, starter and pin punches are designed to drive and

remove pins and rivets, respectively, and drift punches are designed to align holes in different sections of material.

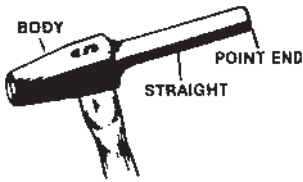


**RIGHT**

### BLACKSMITHS' ROUND PUNCHES



### BLACKSMITHS' BACKING OUT PUNCHES



Blacksmiths' round and backing out punches are made from a solid piece of steel. The punch end of the round punch is tapered from point to body, whereas the punch end of the backing out punch is the same diameter from point to

body. Both types are fitted with handles.

### Proper Use

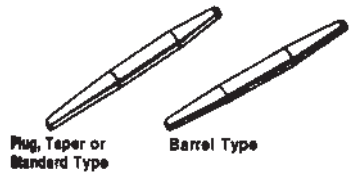
Blacksmiths' round punches are designed for drifting holes, aligning and driving pins. Blacksmiths' backing out punches are designed for backing out bolts, rivets and pins.

### Avoiding Abuse/Misuse

**Never** use a punch with a mushroomed struck face or with a dull, chipped or deformed point.

**Never** use a punch with a loose or damaged handle.

### DRIFT PINS



Drift pins are made from round steel stock. The Plug or Standard type has an abrupt taper at one end and a longer taper at the other end. The Barrel type has equal tapers at both ends.

### Proper Use

Drift pins are designed for aligning holes in metal.

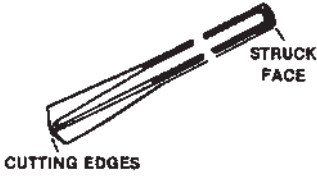
### Avoiding Abuse/Misuse

**Never** use a drift pin as a punch.

**Never** strike a drift pin if either end is chipped or mushroomed.



## STAR DRILLS



The cutting end of a star drill resembles four chisels joined at their cutting edges to form a cross.

### Proper Use

Star drills are designed for drilling holes in masonry (stone, concrete, brick, etc.). They should be struck squarely with a hand drilling hammer or sledge, and the drill should be rotated after each blow.

### Avoiding Abuse/Misuse

**Never** use a star drill on anything but masonry.

**Never** use a star drill with a dull cutting edge or with a chipped, battered or mushroomed struck face.

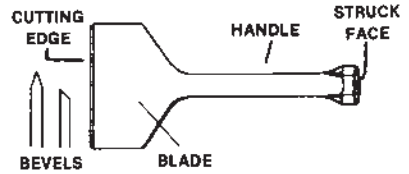


**RIGHT**



**ALWAYS WEAR SAFETY GOGGLES  
TO PROTECT YOUR EYES**

## BRICK CHISELS AND BRICK SETS



These types of chisels and sets are comprised of a blade, handle and struck face made from a single piece of steel. Brick chisels have a double bevel to form the cutting edge; Brick sets have a single bevel.

### Proper Use

These chisels and sets are designed for scoring and cutting, adjusting and trimming bricks or blocks. They should be struck with a hand drilling hammer or sledge.-not a bricklayers' hammer or a nail hammer.

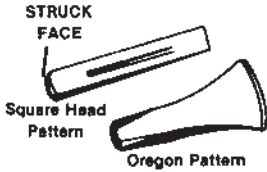
### Avoiding Abuse/Misuse

**Never** use brick chisels and sets on metal - they are strictly masonry tools.



**WRONG**

## WOOD SPLITTING WEDGES

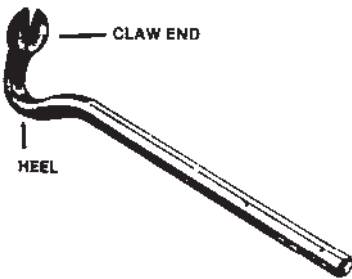


Wood splitting wedges are usually made from a single piece of steel. They are made in various designs; the ones illustrated being the most commonly used.

### Proper Use

Wood splitting wedges are designed for splitting logs, firewood, staves and other wood products. Always use a woodchoppers' maul or an axe to make a starting notch. Wedges should be struck with a sledge or woodchoppers' maul having a larger striking face than the struck face of the wedge. If the wedge becomes jammed in the wood, use a second wedge in an adjacent location to free it.

## NAIL PULLER BARS



Nail puller bars are made from bar steel stock. The claw ends are formed at an angle to pull nails.

### Proper Use

Nail puller bars are designed for extracting deeply imbedded nails. The

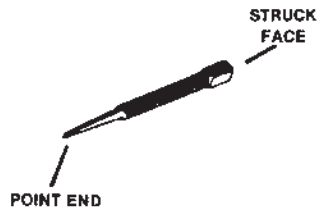
claw is driven into the wood under the nail head by striking the heel of the claw with a heavy hammer such as a hand drilling hammer or sledge. The nail is then extracted at an angle by pulling the bar in the direction of the user. Care should be taken while pulling on the bar to keep ones balance and avoid injury.

### Avoiding Abuse/Misuse

**Never** use a nail hammer to strike a nail puller bar. The striking face is too small and may chip.



## NAIL SETS



Nail sets are made from bar steel stock and have a cupped point end opposite the struck face.

### Proper Use

Nail sets are used to drive finishing nail heads below a wood surface.

### Avoiding Abuse/Misuse

**Never** use a nail set for punching holes in metal, marking metal, aligning holes or driving pins or rivets.

## SECTION V. REDRESSING INSTRUCTIONS

The redressing and reshaping of tools having chipped, battered, or mushroomed striking or struck surfaces is not recommended. When a tool has reached this stage through normal use or abuse, it should be replaced.

Tools should never be exposed to excessive heat. Color change in a tool, from straw to dark blue, is a good indication that it has been exposed to excessive heat and should be replaced.

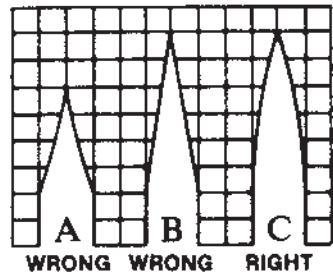
There are three basic rules that apply to the redressing of dull cutting edges:

1. Rigidly support the tool being redressed.
2. Use a hand file or whetstone only, never a grinding wheel. File or stone away from the cutting edge.
3. The original contour of the cutting edge should be restored.



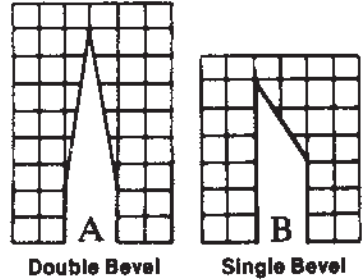
### Axes.

Use a hand file for redressing. Start 2 or 3 inches back from the cutting edge and file to about 1/2 inch from the edge. Work for a fan shape, leaving reinforcement at corners for strength. File the remaining 1/2 inch, blending into previously filed area preserving the original contour of the cutting edge. Remove all scratches with a whetstone or hone 1/2" back from the cutting edge. See cross section C illustration below for the "right" way to shape the edge in redressing axes. Other illustrations show "wrong" ways to re-dress axes.



### Hatchets.

Hatchets with double bevels should be redressed as illustrated in A below. Hatchets with single bevels should be redressed as illustrated in B below. Use a hand file for redressing removing scratches with a whetstone.



### Cold Chisels (Flat).

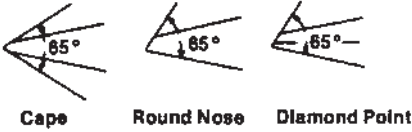
Cold chisels are hardened on the cutting edge. Re-dressing may be done with a hand file or whetstone restoring to original shape or to an included angle of approximately 70 degrees (see illustration below).





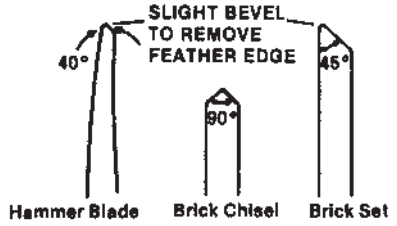
**Other Machinists' Chisels.**

Other commonly used metal-working chisels are Round Nose, Diamond Point and Cape. Redressing instructions are the same as for flat cold chisels except that bevel angles are approximately as illustrated.



**Bricklayers' Tools.**

Bricklayers' tools should be redressed to approximately the angles illustrated.



**Hot Chisels.**

These are handled tools used for cutting hot metal. Re-dressing instructions are the same as for cold chisels.

**Punches.**

The working end of pin and rivet punches and blacksmiths' punches should be redressed flat and square with the axis of the tool. The point of center punches should be redressed flat and square with the axis of the tool. The point of center punches should be redressed to an included angle of approximately 60 degrees; prick punches, to an included angle of approximately 30 degrees.

**Woodchoppers' Mauls and Wood Splitting Wedges.**

The instructions for redressing axes apply also to these tools although they have heavier heads and thicker sections in the bit. Hand file the splitting edge to an included angle of approximately 70 degrees. See cold chisel illustration for 70 degree included angle.

**Star Drills.**

Hand file all cutting edges to an included angle of approximately 70 degrees. See cold chisel illustration for included angle of 70 degrees.

**Prospecting Picks.**

Redress with a hand file to restore original contour of the pick end.

**NOTES**

---



---



---



---



---



---



---



---



---

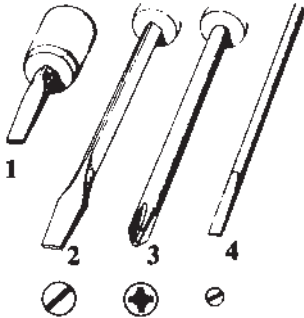


---

## SECTION VI. SCREWDRIVERS INTRODUCTION

Screwdrivers are available in a wide variety of shapes, sizes, and materials; and are all designed for one use: driving and withdrawing threaded fasteners such as wood screws, machine screws, and self-tapping screws. The most common abuse is using a screwdriver that doesn't match or fit the screw.

A screwdriver should **never** be used as a pry bar.



**Fig. 6-1 Typical screwdrivers**

1. Stubby screwdriver for working in close quarters.
2. Screwdriver with a square shank to which a wrench can be applied to remove stubborn screws.
3. Screwdriver for Phillips screws.

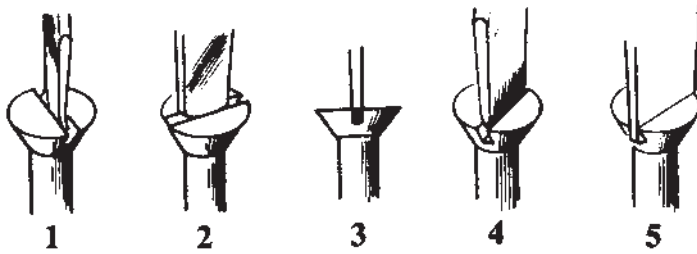
4. Cabinet screwdriver has a thin shank to reach and drive screws in deep, counterbored holes.

Be careful not to confuse a Phillips screwdriver with other "cross point" screwdrivers. They are not interchangeable. See Page 6-7 for how they differ.

### BASIC SAFETY RULES THAT APPLY TO THE USE OF A SCREWDRIVER

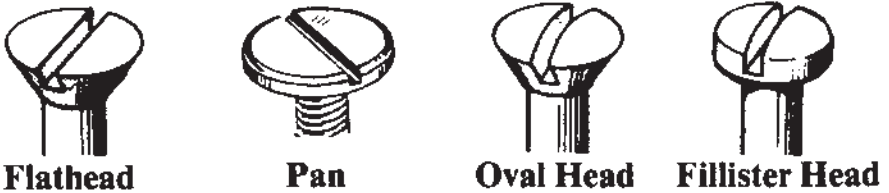


1. Always match the size of the screwdriver to the *job*. Make sure that the tip fits the slot of the screw and always match the type of screwdriver to the *head* of the screw.
2. **Never** use a screwdriver as a cold chisel or punch.
3. **Never** use a screwdriver (or any other tool, for that matter) near live (hot) electrical wires. Always disconnect power before working near or on electrical components.
4. **Never** expose a screwdriver to excessive heat.
5. Do not use a screwdriver that has a worn or broken handle.
6. **Never** use a screwdriver as a pry bar.



1. This tip is too narrow for the screw slot; it may bend or break under pressure.
2. A rounded or worn tip. Such a tip may ride out of the slot as pressure is applied.
3. This tip is too thick. It is likely to chew up the slot of the screw.
4. This tip fits, but it is too wide and will damage the material as the screw is driven home. See fig. 6-8
5. The right tip. This tip is a snug fit in the slot and does not project beyond the screw head.

**Fig 6-2 Slotted Head Screwdrivers**



**Fig. 6-3 Common Slotted Head Screws**

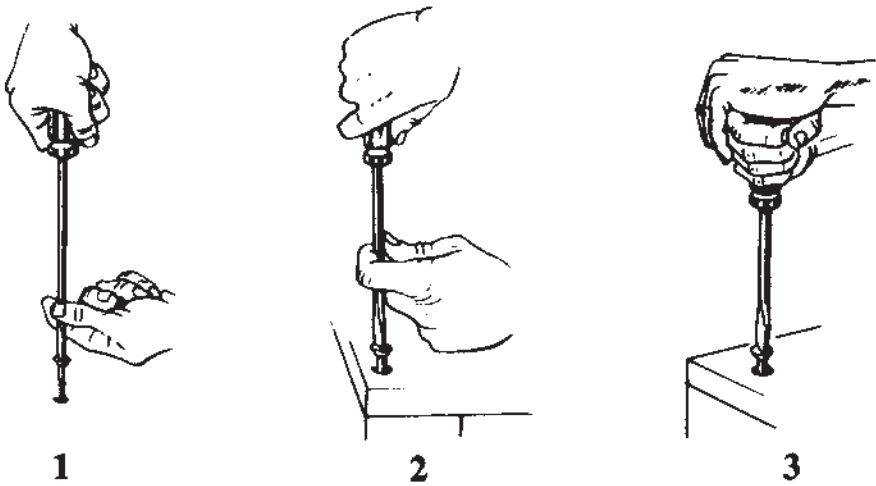
## DRIVING THE SCREW

A pilot hole may be required before driving a screw. This is especially important when driving a screw into dense material or when the screw is near the edge of a surface. Pilot holes can be made in soft materials with an awl if the screws to be used are small. However, if you are driving No. 6 and larger screws it is best to *drill* a pilot hole or use a threaded screw hole starter. Pilot holes should always be

made if the screws are to be driven into dense material.

If the screw is a flathead, the pilot hole should also be countersunk so the head of the screw will be flush with the work when it is driven home. The proper size pilot hole depends on the type of screw and the material(s) being fastened.

Refer to the Machinists Handbook for recommendations.



**Fig. 6-4 the Right Way to Drive a Screw**

1. Insert the tip of the screw in the pilot hole. Insert the screwdriver tip in the slot of the screw. Hold the tip steady with one hand and make sure the shank of the screwdriver is perpendicular to the head of the screw and in line with the shank of the screw.
2. Use the left hand (if you are right-handed) to keep the blade steady as you turn the handle of the screwdriver.
3. After the screw is almost in, it is safe to use both hands as shown for extra turning power to seat the screw. Note the position of the left hand (if you are right-handed). Using both hands will allow additional downward pressure to be applied; thus making certain that the driver tip is firmly seated in the screw slot. If the screw is a flathead, make sure that the pilot hole has a countersunk recess at top and screwdriver tip is narrow enough to avoid touching the material.

The job of driving the screw can be eased considerably if the threads are

given an application of wax - this is preferable to soap, as soap has a tendency to rust the screw threads making future withdrawal difficult.

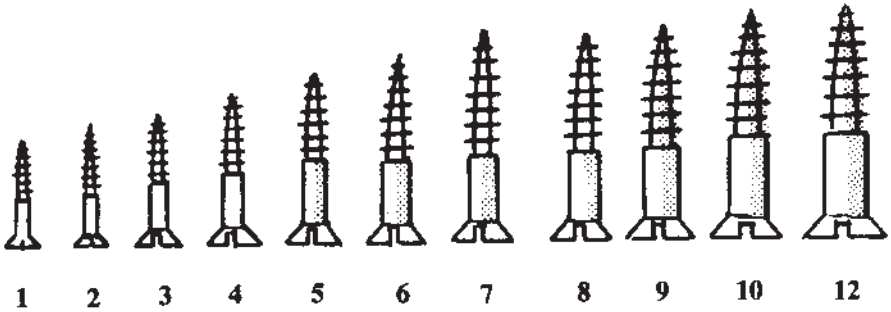
Unless you have drilled or made some sort of a pilot hole, a screw will tend to follow the grain when used on wood. So, having drilled or made a pilot hole, hold the screw as indicated in Fig. 6-4 with the screwdriver tip firmly engaged in the slot. Turn the screwdriver gently to engage the first one or two threads of the screw and make sure that the screw is being driven straight. After the screw has been started, and you know it will be driven straight, remove your fingers from the screw and apply your efforts to the screwdriver. The screw should be perpendicular to the surface of the work (unless the screw is to be driven at an angle) with the screwdriver held in line with the screw.

It is much easier to drive a screw straight if the handle of the screwdriver is large enough to maintain the necessary torque for the size of the screw to be used.

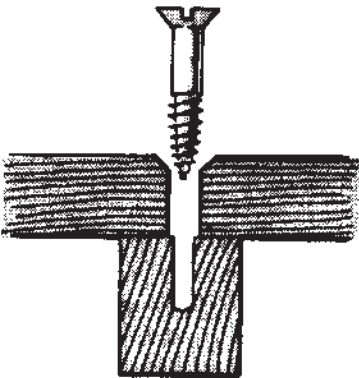
## CLEARANCE HOLES

Sometimes, when fastening a metal bracket to wood or when screwing two pieces of wood together, a clearance hole equal to the diameter of the screw body or shank is necessary in addition to a pilot hole. Without the clearance hole, the body or the threads of the screw will hang up on the leading piece,

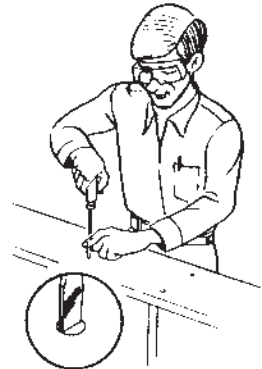
preventing the workpieces from being drawn together tightly. See Fig. 6. The proper size clearance hole depends on the type of screw and the material(s) being fastened. Refer to the *Machinists Handbook* for recommendations.



**Fig. 6-5.** Screws are available in many lengths. However, the number by which a screw is designated, such as a No. 10, always refers to its shank diameter. Fig. 6-5 shows actual size screws and their corresponding number.



**Fig. 6-6.** A clearance hole is necessary when fastening two items together with a screw.



**RIGHT**

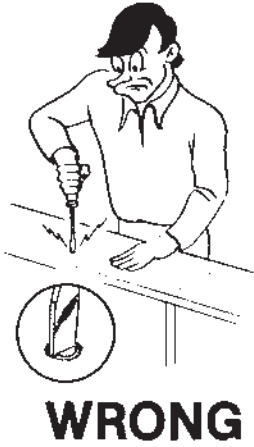
**Fig. 6-7.** The blade of the screwdriver is a snug fit in the slot of the screw and does not quite project to the edge.



## SCREWDRIVERS FOR SLOTTED STYLE SCREWS

The flat tip screwdriver is used for screws with slotted heads. These screwdrivers are usually classified

according to tip width and blade length. Generally, the longer the length, the wider the tip-but not always, as some rather long screwdrivers may have a narrow tip. Cabinet style screwdrivers, which have long shanks and narrow tips, are useful for driving screws into recessed and counterbored openings in furniture and cabinets. There are also short, stubby screwdrivers with wide tips for driving screws in confined quarters.



**Fig. 6-8.** Don't use a screwdriver whose tip extends beyond the length of the slot in the screw. A tip that is too wide may damage the material as the screw is being driven flush with the material.

Most screwdriver tips are tapered. The tip thickness determines the size of the screw that the screwdriver will drive without damaging the screw slot. The taper permits the screwdriver to drive more than one size of screw.



**Fig. 6-9.** Drill pilot and clearance holes when driving screws that are near the edge. In some applications, wax on the threads will reduce the effort required.

Some screwdrivers are available with hexagonal or square shanks or bolsters so that a wrench can be used on the shank for extra turning power. **Never** use pliers on a screwdriver, to prevent damaging the screwdriver or injuring the user. Use the largest possible screwdriver that will fit the slot of the screw. As a rule, the bigger the screwdriver, the larger the diameter of the handle, and the larger the diameter of the handle, the greater the torque, or turning power.



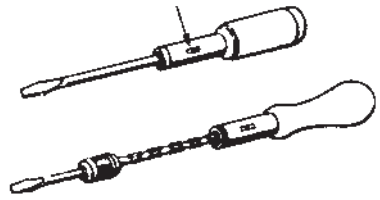


## WRONG

**Fig. 6-10.** The wood will always split if you drive a screw too close to the end of the work without first drilling a pilot and clearance hole.

## RATCHET SCREWDRIVERS

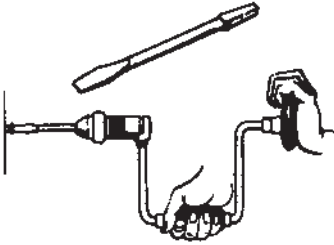
One type of rapid-action screwdriver is the spiral ratchet screwdriver. This screwdriver has a spring-loaded mechanism in the handle. Pushing down on the handle causes the bit of the screwdriver to turn rapidly, thus driving the screw in a shorter time than could be accomplished with the use of a conventional screwdriver. Letting up on the handle allows the operator to continue the action. These screwdrivers come in several styles. Some have the mechanism as part of the handle; others have it as part of the shank. In either case, a small lever is set so that even though the operator moves the handle back and forth - or up and down - the bit of the screwdriver moves in only one direction, to drive the screw. The lever can also be set so that the ratchet action removes the screw. It also can be set so that the screwdriver can be used as a conventional screwdriver, with no ratchet action.



**Fig. 6-11.** Two types of ratchet screwdrivers. The one at the top has the ratchet mechanism in the handle. The lower screwdriver has the ratchet in the handle and operates with a spiral action. *When using any spiral ratchet screwdriver, it is best to push down firmly and slowly-until the screw is properly started- otherwise you may find that the bit has slipped out of the slot. These screwdrivers should be stored only in the extended position to prevent the possibility of a sudden, unexpected release.*

**Large screws** in tough wood can be more easily driven by using special bits that fit into a carpenter's brace. Because tremendous turning power is generated by the brace, make sure you have a proper pilot hole, as it is quite easy to shear off the head or even to twist the screw in half if too much pressure is applied to a screw. It is always best to drill a pilot hole when driving large screws with a carpenter's brace.





**Fig. 6-12.** Special screwdriver bit that can be chucked into a carpenter's brace.



**WRONG**

**Fig. 6-14.** Never use a screwdriver as a chisel.



**WRONG**

**Fig. 6-13.** Don't use pliers on the shank of a screwdriver to remove a stubborn screw.

### SCREWDRIVERS FOR SCREWS WITH RECESSED OPENINGS

The most common screw with a recessed "slot" is the Phillips screw. These screws have what appear to be two slots at right angles to each other. A conventional screwdriver should never be used to drive a Phillips screw - or any other type of a screw with a specialized opening. Such screws are shown in Fig. 16. *Always* use the screwdriver especially designed to drive these fasteners.





## RECESSED SCREWS AND SCREWDRIVERS



**Phillips**



**Reed & Prince**



**Pozidriv**



**Bristo**



**Torque Set**



**Torx**



**Slab**



**Hex Socket**



**Scrulox  
(Robertson)**



**Clutch Head  
(new style, type A)**



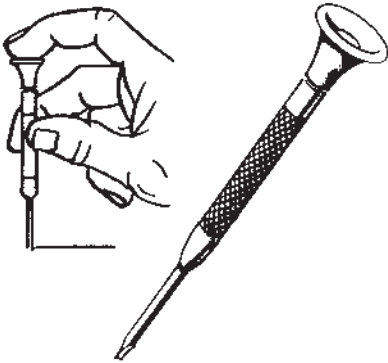
**Clutch Head  
(old style, type G)**

**Fig. 6-16**

## SPECIALITY SCREWDRIVERS

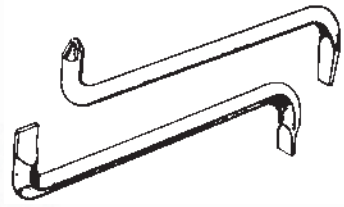
In addition to the types of screws and screwdrivers described so far, there are many screwdrivers whose use is quite specialized.

**Jeweler's Screwdrivers.** These are distinguished by a rotating head which is held by the forefinger to steady the screwdriver while the thumb and middle finger turn the screwdriver to remove or install the small screws used by jewelers, model railroad fans, and persons who work with tiny parts and screws.

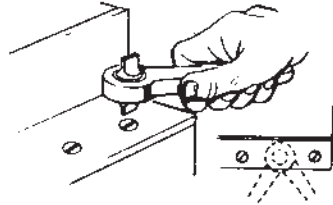


**Fig. 6-17.** Jeweler's screwdrivers, used with tiny screws, are steadied by placing forefinger on the free-turning knob.

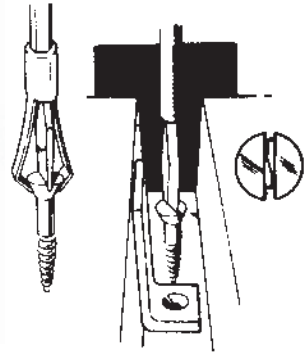
**Offset Screwdrivers.** These screwdrivers are designed for removing and inserting screws in places where it is impossible to use a straight shank screwdriver. They are available in many combinations: narrow tip on one side and a wide tip on the other side; Phillips tip on one side and a conventional tip on the other side; with two Phillips tips (one large and one small); with same size tips at each end, but one tip is at right angles to the handle while the other tip is parallel to the handle (this arrangement makes the screw-driver extremely handy when turning area is limited).



**Fig. 6-19.** Offset screwdrivers for driving screws in awkward places.



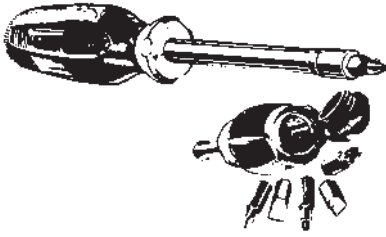
**Fig. 6-20.** A ratchet-type offset screwdriver for working in tight spots; it is reversible.



**Fig. 6-21.** The screw-holding screwdriver is a must for working in close quarters as shown. The type shown at the left uses clips to hold the screw. The one at the right has a sliding collar that spreads the split blade of the screwdriver to hold the screw. After the screw has been firmly started, further driving can be done with a conventional screwdriver.

 **ALWAYS WEAR SAFETY GOGGLES TO PROTECT YOUR EYES**

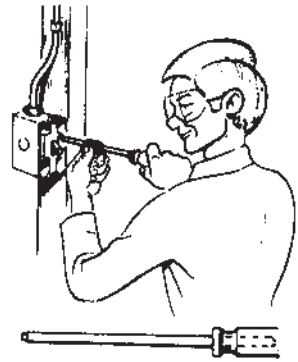
## MAGNETIC TIP SCREWDRIVER



**Interchangeable Magnetic Tip Screwdrivers.** These screwdrivers have a magnet in the shaft so that they not only hold the bit but can also hold the screw. In addition, the variety of bits for this type of screwdriver is limitless and the unused bits can be stored in the handy compartmented handle.

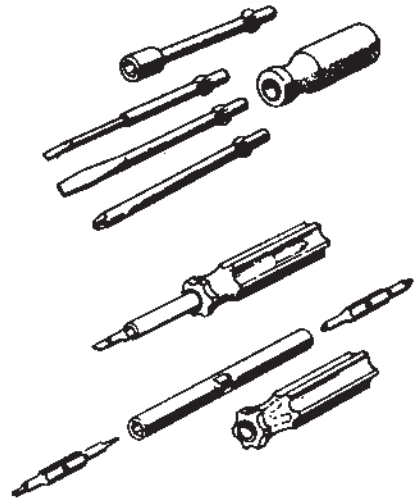
**Interchangeable Blade Screwdrivers.** The hollow handle of this type of screwdriver will accept a number of different type blades. Sometimes the blades are double-ended with a narrow tip on one end and a wider tip on the other end. Combinations of Phillips, conventional, Clutch Head, Scrulox, and hex head are available.

**Insulated Screwdrivers.** These are used by electricians and maintenance workers. As their name implies, the shank as well as the handle are completely insulated with a dielectric material intended only as a secondary protection. Information about insulated screwdrivers can be found in ASTM F 1505 and IEC 60900. **Never** depend on an insulated screwdriver handle, shank cover, or blade to insulate you from electricity. Insulated blades are intended only as a protective measure against shorting out components.



## RIGHT

**Fig. 6-22.** Handle and shank are covered with an insulated material that is intended only for secondary protection. Turn off current when doing this kind of work.



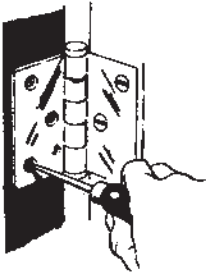
**Fig. 6-23.** Two types of screwdrivers that use interchangeable bits. The one at the left has a hollow handle that will accept any one of the four bits shown. The screwdriver at the right has two double-ended bits held in each end of a tube. The tube is reversible in the handle and the bits are reversible in the tube.



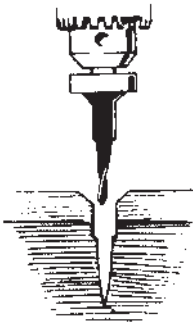
**Non-sparking Screwdriver.** Found chiefly on yachts and boats, these screwdrivers are made out of an alloy, usually beryllium copper, which will not emit a spark if accidentally struck against metal. They minimize the risk of explosion when used under hazardous conditions, such as when working in the hold of a ship that may be filled with gasoline fumes.

**The Awl.** A handy accessory to a screwdriver set is an awl. With it, you can make a starting hole in soft wood for a screw.

Force the awl into the wood with a twisting motion. The hole need not be as deep as the length of the screw. With large screws, and especially when working with hard wood, it is always advisable to first drill a pilot hole before attempting to drive the screw.



**Fig. 6-24.** An awl can be used to make a starting hole for small screws in soft wood.



**Fig. 6-25.** This device drills a pilot hole, a clearance hole, and counter-sunk

recess for flathead screws all in one operation.



## Proper Use

- **Do** use a screw-holding screwdriver to get screws started in awkward, hard-to-reach area.
- **Do** use an offset screwdriver in close quarters where a conventional screwdriver cannot be used.
- **Do** use a ratchet-type screwdriver for speed and comfort when a great number of screws are to be driven.
- Screwdrivers used in the shop are best stored in a rack. This way, the proper selection of the right screwdriver can be quickly made.
- Keep the screwdriver handle clean; a greasy handle is apt to cause an accident.

## Avoiding Abuse/Misuse

- **Never** hold the work in one hand while using the screwdriver with the other. If the screwdriver slips out of the slot (we told you to use the right size screwdriver!) you will be most likely to receive a gash on your hand.
- **Never** use a screwdriver with rounded edges or tips; it will slip and cause damage to the work or you.
- **Never** use a screwdriver near a live wire or for electrical testing.
- **Never** use a screwdriver to check a storage battery or to determine if an electrical circuit is live.



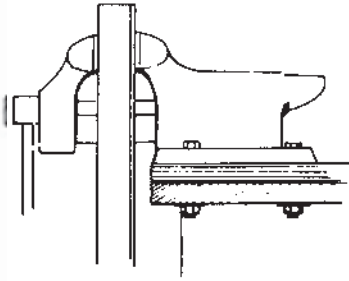
## SECTION VII. VISES

### INTRODUCTION

Vises are usually mounted on a workbench or a similar firm support, to hold the material to be worked on. While most of these vises can be used for a wide variety of work, it is important to select the vise most suitable for the prime application and strong enough for any work required.

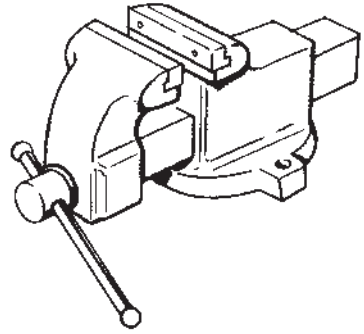
Models are made with stationary bases, swivel bases, pipe jaws (combination vises), with replaceable jaw inserts, and even with jaws that swivel.

Special purpose vises include **the sheet metal worker's vise** (thin, tapered jaws that allow close work) and **hydraulic** models with a rapid movement of the sliding jaw. Smooth jaw models and copper jaw caps are available to prevent possible marring of the work.



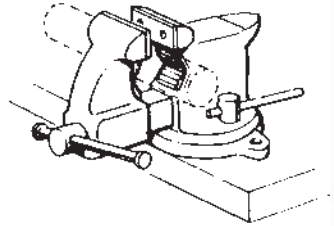
It is important to mount any vise with the stationary jaw projecting slightly beyond the edge of the workbench so that long work can then be clamped in the vise without interference from the edge of the workbench.

## MACHINIST'S VISE



Designed to withstand the great strains in industrial work and similar applications, these vises are available in jaw widths of three to eight inches. The Machinist's Vise should always be bolted, never screwed, to the workbench.

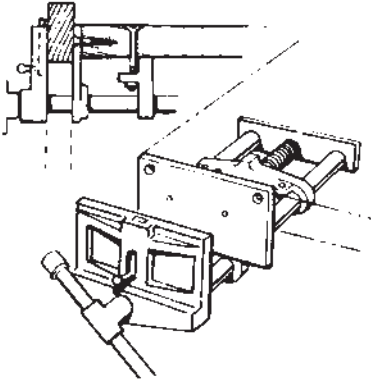
## UTILITY VISE



The Utility Vise, like the machinist's vise, should also be bolted to the workbench top, never screwed in place. The utility, or workshop vise, is a lighter duty version of the machinist's vise. It usually has pipe jaws located below the flat jaw facings and comes in jaw widths from three to five inches. The Acme thread, or the screw that draws the jaws together, may or may not be exposed. Most models are made with swivel bases and replaceable jaw inserts.



## WOODWORKER'S VISE

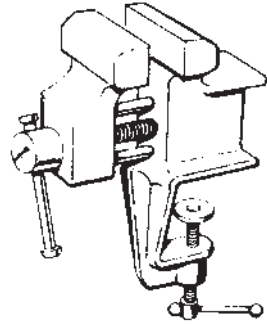


The Woodworker's Vise is bolted to the underside of the work-bench. Mount it so the top of the vise jaw is flush with the surface of the bench and flush with the corner of the bench.

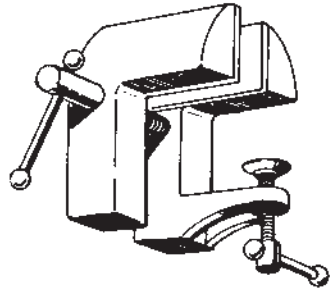
The woodworker's vise is used when working with wood. To protect the work, and to get a good grip on large pieces of wood, the jaws on these vises are much larger than the jaws on other vises, generally being four by seven inches and even larger four by ten inches. This type of vise is available with a rapid-action nut that allows the movable jaw to be moved in and out quickly with the final tightening by turning the handle a half-turn or so.

Woodworkers' vises usually have drilled and tapped holes so that liners of wood can be mounted in the jaws to prevent marring the work.

## CLAMP-ON VISES



The Clamp-on Vise can be quickly mounted at the edge of any convenient work surface.



Clamp-On Vise designed for woodworkers is portable and holds work horizontally or vertically.

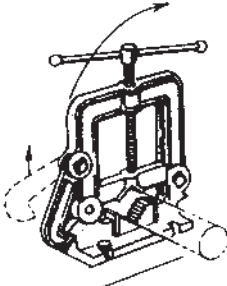
These are generally used for light duty work. Instead of being bolted to the workbench, they are clamped with a C-clamp arrangement. One of their benefits is their portability as they can be quickly moved from place to place. Smaller vises for working with wood also have a C-clamp arrangement for mounting. These are known as sawhorse vises, or carpenter's vises. These vises usually have pre-drilled holes for attaching wood faces. This vise is "L" shaped which makes it ideal for holding work in either a vertical or horizontal position.



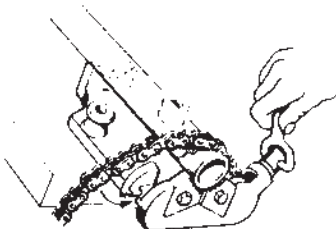
## PIPE VISES

Pipe vises are especially designed to hold pipe or round stock. They are available with capacities to hold pipe up to 12 inches in diameter. The two main types are the yoke vise and the chain vise, with the latter specially designed to hold irregular work. Both types are available with tripods and are called **tripod vises**. A **clamp kit vise** can be mounted without drilling holes for temporary attachment where light-duty work is to be performed.

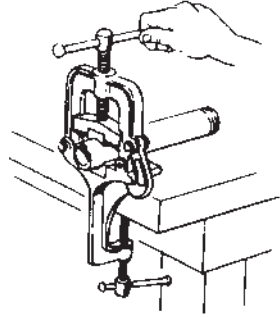
Pipe vises are made in a number of different forms, including vises with bolt holes for permanent mounting and portable vises with clamp attachments for temporary mounting on benches, studs, posts, etc. Yoke pipe vises should not be used for holding or pulling vertical pipe.



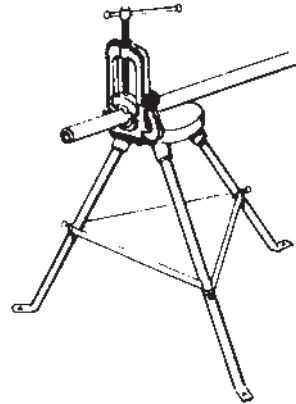
Yoke Type Pipe Vise is bolted to the workbench. Note the hinge at one end and the hook at the other so that the pipe need not be "threaded" through the vise jaws to be worked on. Yoke vises have jaws on the top and bottom which are optimum for holding pipe to be threaded.



The Chain Vise is designed to hold pipe as well as irregular work. Work is released from the vise by loosening the nut and then re-moving the pipe--from the vise. This allows the pipe to be installed or removed without having to slide its entire length through the vise.



The Clamp Kit Vise can be temporarily mounted without drilling holes, sometimes on the nearest 2x4, for light-duty work.



The Yoke Type Vise and the Chain Vise are available in portable workbench models with a tripod stand. Tripod vises (also known as Tristand vises) can be used chain style for 1/8" - 6" pipe or yoke style for 1/8" - 21/2" pipe.

### Proper Use of Pipe Vises

1. Use the correct size vise for the job.



2. Grip the pipe as close to the end of the pipe as possible.
3. Use pipe supports if pipe extends beyond base in order to prevent vise from tipping or falling.
4. Maintain proper footing and balance at all times.
5. Keep work area free of obstacles, debris, etc. that may cause hazard or distraction.
6. Wear safety glasses.
7. Lightly oil all moving parts.
8. Use jaw liners with a vise if there is any possibility of marring the work.
9. Keep exposed threads free of chips and dirt.

### Avoiding Abuse/Misuse

1. Keep non-painted parts well lubricated and free from rust.
2. Keep handles free from grease and oil.
3. Do not extend the chain on chain vises to allow larger pipe to be held.
4. Do not use excessive force which could damage tools and work pieces.
5. Do not hammer on the handle.
6. Do not use flame near vise, which could weaken the chain or cause chipping or flattening of teeth.
7. Adjust leg stiffness if trisand vises begin to wobble.
8. Inspect chain for separation of the links or other damage.
9. **Never** repair by brazing or welding. See Section V.

### When to Repair or Replace

Replace a bent handle.

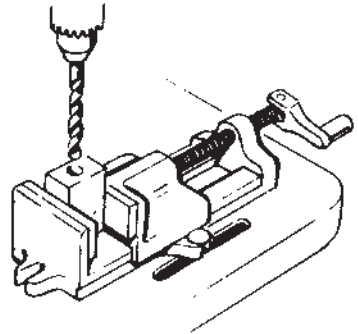
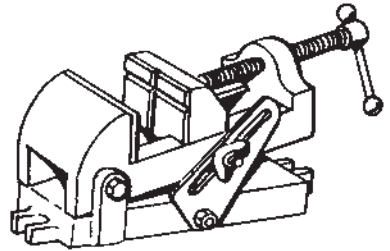
Replace worn jaw inserts.

When excessive play develops in the handle adjust the nut and screw or replace them.

Discard any vise that exhibits the slightest hairline fracture.

## DRILL PRESS VISE

This vise is used in conjunction with a drill press. The jaws are made so that it will accept round, square, or oddly shaped work and hold it firmly in place. Some have a quick release feature. The movable jaw can be quickly moved up to the work, or away from the work, without turning the handle. The handle is then used for the final half-turn or so to loosen or tighten the jaws.

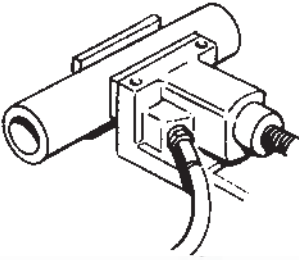
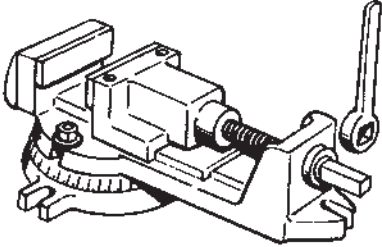


The Drill Press Vise should be securely bolted to the drill press table through the lugs provided in the base of the vise. Some drill press vises, as shown in upper drawing, are adjustable for drilling holes at an angle.



## MILLING MACHINE VISE

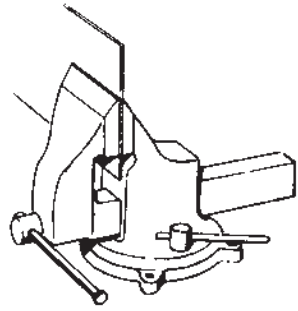
These vises, used with milling machines, have a swivel base graduated in the degrees of a circle; also available with an air-hydraulic operating system.



Milling machine vises, used in machine shops, are made with graduated swivel and stationary bases. They are also available for power operation using an air-hydraulic system. Caution: Make sure the base is securely bolted to the bed of the machine.

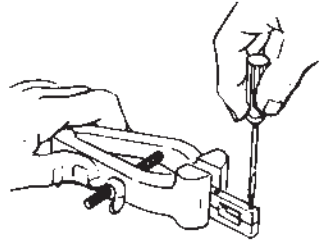
## AUTOMOTIVE VISE

The automotive vise is specifically designed for the automobile after-market such as service stations, garages, and automobile and truck agencies. This vise has the combined features of the machinist's and workshop vises. It has the pipe jaws and economy of the workshop vise with a machined bench plate having a 360° swivel and the positive lock feature of the machinist's vise.

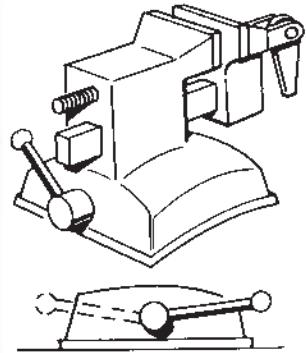


The Sheet Metal Vise has a deep throat and thin, tapered jaws to allow for close work. The jaws on this type of vise are smooth.

## SPECIALTY VISES

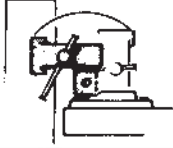


**Model Maker's Vise.** (Also known as the Hand Vise) A light duty vise with 2-inch jaws, hand held for use with small work. The jaws are tightened by means of a thumbnut.

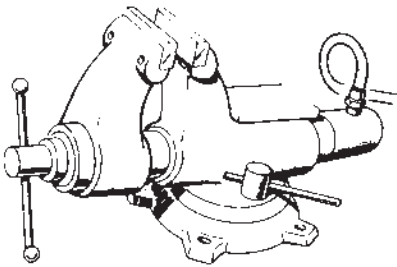


**Vacuum Base Vises.** These vises even require less work to mount than the clamp-on vises. Their base consists of a rubber pad that is arched into a concave

shape by means of a lever. When the vise is placed on a smooth surface and the lever is turned, a vacuum is created that firmly holds the vise in place. These vises are designed for light duty work.



This type of vise is designed so that it can be flipped to hold the work in a vertical position as shown in the small illustration. After flipping, an auxiliary handle is used to keep the jaws in their new position.



**Hydraulic Vise.** Two types are available. One kind has a built-in hydraulic booster-reservoir to multiply the power of your hand as the handle is turned. The other type, used in production work, operates by means of an air-hydraulic system controlled with a foot pedal. The big advantage with such a vise is the amount of time saved in installing and removing the work and

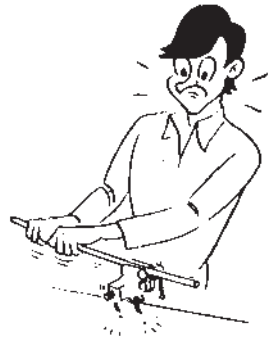
the extra tightness with which it holds the work.

The air-hydraulic vise opens and closes by means of a foot control. It locks on to the work with a force of more than 2,000 pounds. Made with stationary and swivel bases in jaw widths up to six inches.



## RIGHT

Use a vise large enough to hold the work without strain. Base of vise should be bolted to a smooth even surface to prevent unnecessary stresses to base when vise is in use. Note that the vise is bolted to the bench.



## WRONG

Don't try to bend a heavy rod in a light vise.

## Proper Use

10. Use bolts in all the holes in the base of the vise.
11. Use lock washers under the nuts.
12. When work is held in the vise for sawing, saw as close to the jaws as possible (to prevent vibration). Be careful not to cut into the jaws.
13. When clamping extra long work, support the far end of work rather than putting extra pressure on the vise.
14. Lightly oil all moving parts.
15. Use jaw liners with a vise if there is any possibility of marring the work.
16. Keep exposed threads free of chips and dirt.

## Avoiding Abuse/Misuse

Do not use the jaws of the vise as an anvil.  
Avoid clamping work with heavy pressure at the corner of the vise jaws as they may break off a corner of a jaw.  
Never use an extension handle for extra clamping pressure.  
Never pound on the handle to tighten beyond hand pressure.

### When to Repair or Replace

Replace a bent handle.  
Replace worn jaw inserts.  
When excessive play develops in the handle adjust the nut and screw or replace them.  
Discard any vise that exhibits the slightest hairline fracture.

## NOTES

## SECTION VIII. CLAMPS

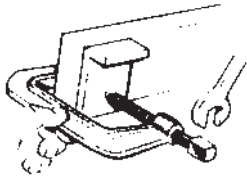
### INTRODUCTION

Clamps are tools that are used for temporarily holding work securely in place. In selecting the proper clamp style and size match the work-holding requirements of the application with the following clamp features:

- strength and weight
- opening length of reach
- throat depth - depth of reach
- ease of adjustment
- clamping surface - material used and size

### C-CLAMPS

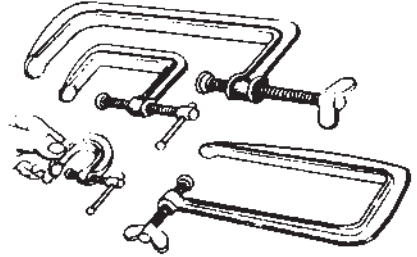
C-clamps come in a variety of sizes and strengths. C-clamps generally have four parts: the frame, the screw, the handle and the swivel pad. The frame is usually made from stampings, castings or drop forged steel. Drop forged steel generally provides the most strength. Most clamps have a sliding crosspin handle or a wing nut for tightening the clamp. Certain heavy-duty clamps have screws that end in a square head and the tightening is done with a wrench. The swivel pad at the end of the screw allows the clamp to position itself on non-parallel work and prevents work from being marred. Certain C-clamps designed for heavy-duty applications are designed without swivel pads.



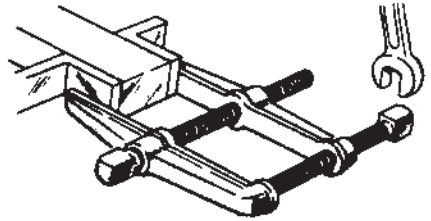
This type of extra heavy-duty forged steel clamp uses a wrench for tightening.

### DEEP THROAT C-CLAMPS

Deep throat C-clamps are designed with a larger throat capacity. See the illustration in the bottom right portion of the figure below.

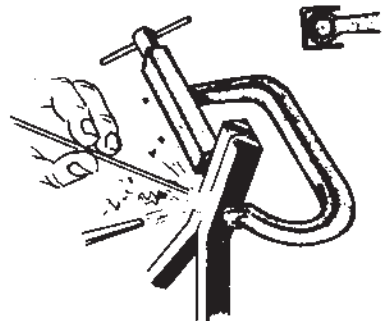


### MACHINIST'S CLAMPS



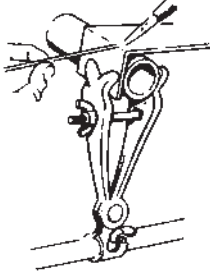
Machinist's Clamps resemble C-clamps but are made entirely of drop-forged steel. Their jaws are parallel to each other; they cannot be set to non-parallel positions. Two screws, one in the center and one at the end are used to tighten the clamp against the work.

### WELDER'S C-CLAMPS



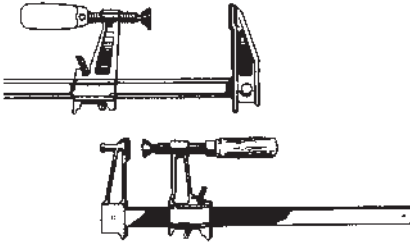
**Welder's C-Clamps** are specially protected to prevent welding spatter

from adhering to and eventually ruining the clamp. Its parts may be coated with a spatter-resistant plating (copper or cadmium). In addition, welder's C-clamps are made with shields to protect the screw against damage.

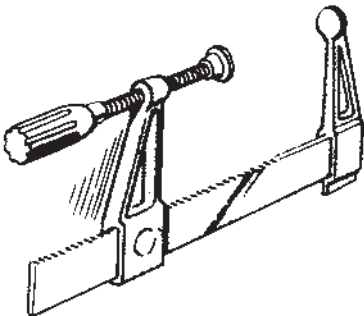


Welder's clamp for holding odd-shape work.

### BAR CLAMPS



A **bar clamp** consists of a steel bar with a fixed jaw at one end and a sliding or adjustable part that has a screw with a handle and swivel. In use, the sliding part that has the screw is pushed up to the work and then the handle is turned to tighten the clamp.

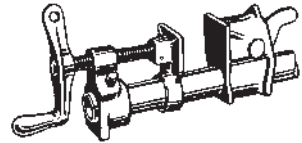


Serrated bar clamp

Many bar clamps have disc clutches in the sliding jaw to engage the clamp at any place on the bar. These clutches provide rapid adjustment in addition to secure hold. A screw or similar device is used for applying the final pressure.

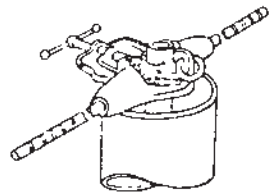


### PIPE CLAMPS



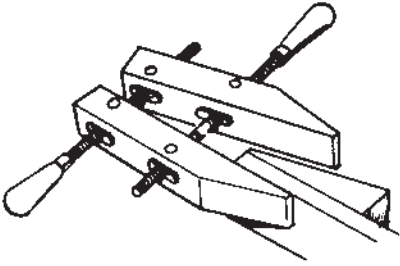
A **pipe clamp** is used with pipe. The pipe is attached to a fixed jaw and a movable adjustable jaw is installed on the other end of the pipe. In use, the adjustable jaw is pushed up to the work and the handle or crank of the clamp is turned to secure the work. The capacity of the pipe clamp is only limited to the length of the pipe available.

### WELL DRILLER'S CLAMPS



Well driller's clamps are specially designed for holding and lifting pipe vertically. Pipe jaws are corrugated perpendicular to pipe. Do not exceed manufacturers recommended limits for holding or lifting pipe.

## HANDSCREWS

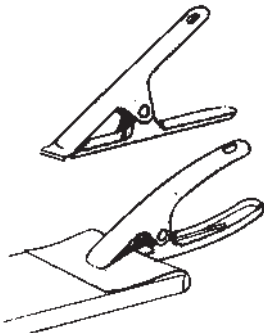


### Handscrew Clamp

The **handscrew**, also called a **cabinet makers clamp**, can be used to clamp work whose sides are not parallel to each other. This clamp has two screws, one with a left-hand thread and the other with a right-hand thread. The openings through which the screws pass are slightly elongated so that the jaws can assume a non-parallel position-if necessary-to match the surfaces of the work. The jaws move in opposite directions due to the action of the right- and left-hand threads as the handles are turned.

Keep the threaded rods of these clamps lightly oiled. But, make certain that there is no oil on the jaws; and keep the jaws smooth to protect the work.

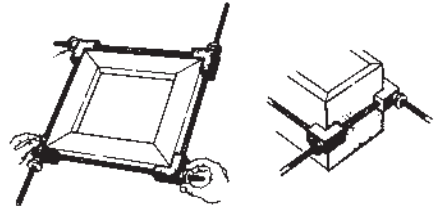
## SPRING CLAMPS



Spring clamps range in capacity from one to four inches and are available with padded jaws to protect the work.

Use them only where moderate pressure is required.

## MITER CLAMPS

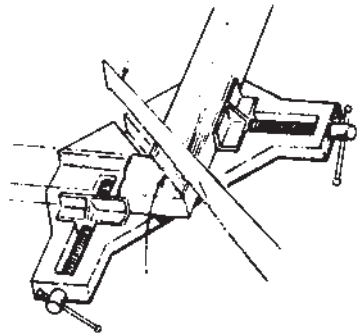


### Miter Clamps

The Miter Clamp is used to apply pressure to all four joints of a square or rectangular frame simultaneously.

**Caution:** Test for squareness at *each* corner before applying final pressure.

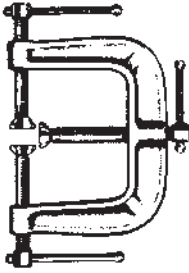
## CORNER CLAMPS



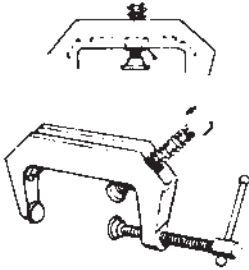
Corner clamps are similar to miter clamps but are used for a single mitered corner.



## THREE-WAY CLAMPS



The three-way Clamp.



### Adjustable three-way clamp

Three-way clamps allow pressure to be applied in two directions.

### Proper Use and Care

1. Use clamps of the proper capacity.
2. Make sure swivel at end of the screw is turning freely before using.
3. Use pads with clamps to avoid marring the work.
4. Keep all moving parts lightly oiled and clean, and make sure there is

no dirt or oil on any part that will come in contact with the work.

5. Always remove clamps as soon as the required job is finished. Clamps serve only as temporary devices for holding work securely in place.
6. Store C-clamps by clamping them in a rack, not in a drawer.

### Avoiding Abuse/Misuse

1. Do not use a wrench, pipe, hammer, or pliers, to gain extra tightening; a wrench should be used only on those clamps especially designed for tightening with a wrench.
2. Never use a C-clamp for hoisting work. Special lifting clamps are made for this purpose.
3. Never use a C-clamp for hoisting or for supporting a scaffold or platform that may be used to carry people. Vibration may cause the clamps to loosen and the load to break loose.

### When to Repair or Replace

1. Do not attempt to repair clamps.
2. Discard any clamp that has a bent frame or a bent spindle.

### NOTES



# SECTION IX. METAL CUTTING SNIPS & CUTTERS

## METAL CUTTING SNIPS INTRODUCTION

Metal Cutting Snips are designed to shear or cut primarily sheet metal and other sheet materials including vinyl, plastic, cloth, canvas, cardboard, etc. They are generally not designed to cut round materials such as wire, cable, nails, or rods as these non-sheet materials are apt to damage the cutting edge or the shearing action of the snip.

There are two basic types of Metal Cutting Snips. The oldest type Metal Cutting Snip is a heavy duty scissor type snip called a **Tinner Snip**. The more modern type Metal Cutting Snip uses a series of pivots to multiply handle force into increased cutting force at the blades and is called a **Compound Leverage Snip** or **Aviation Snip**.

### TINNER SNIPS

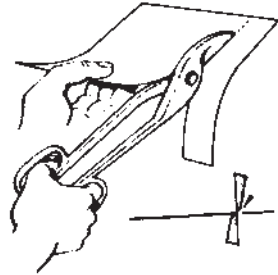
There are two basic styles of Tinner Snips. **Stationary Blade** styles are designed with a bow for fingers or thumb at one end of the handle and a cutting edge ground into the opposite end of the handle. **Replaceable Blade** styles feature blades that can be replaced from the handles when worn.

There are three basic blade patterns of Stationary Blade Tinner Snips; *Straight Blade Pattern* is the traditional blade pattern, *Duckbill Blade Pattern* is designed to cut tight curves, and *Bulldog Blade Pattern* is designed to cut thicker materials than other blade patterns and is generally 16-inches in overall length. Both Straight Blade Pattern and Duckbill Blade Pattern Tinner Snips are of various overall lengths generally from 7-inches to 12-

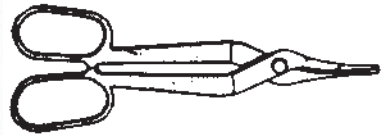
inches. Cutting capacity increases as overall snip length increases.

There are two different designs of Replaceable Blade Tinner Snips. *Regular* models are most versatile and cut straight as well as wide curves. *Offset* models cut tighter curves and flow material away from the blades making long cuts easier. Offset models also raise the user's hand above the material being cut.

### Stationary Blade Tinner Snips



*Straight Blade Pattern* Stationary Blade Tinner Snips are generally used for making straight line cuts or cutting wide curves. Cut a straight line by firmly butting the cut edge of the material against the inside ground surface of the the blade while guiding the snip straight by sliding it along the surface's cut edge.



*Duckbill Blade Pattern* Stationary Blade Tinner Snips cut tighter curves than Straight Blade Pattern Tinner Snips, however, require slightly more hand pressure. They can also be used for straight cuts.



*Bulldog Blade Pattern Stationary Blade Tinner Snips* are generally 16 inches in overall length and are designed to power cut thick materials.

### Replaceable Blade Tinner Snips



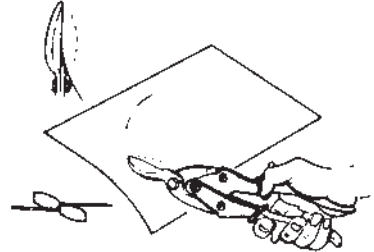
*Regular* models are used similarly to Straight Blade Pattern Stationary Blade Tinner Snips. Cut a straight line by firmly butting the cut edge of the material against the inside flat surface of the blade while guiding the snip and sliding it along the surface's cut edge.



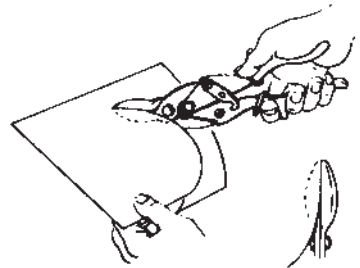
*Offset* model Replaceable Blade Tinner Snips cut tighter curves, flow material away from blades making long straight cuts easier, and position the user's hand safely above the material being cut. There are two blade designs. Use Left Cut Design models to cut straight or left curves. Use Right Cut Design models (as shown above) to cut straight or right curves.

## COMPOUND LEVERAGE SNIPS (AVIATION SNIPS)

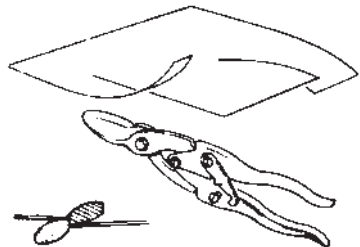
Compound Leverage Snips are more commonly called Aviation Snips. Aviation Snips generally require less effort to cut sheet metal than Tinner Snips. There are six basic styles of Aviation Snips.



**Right cut snips typically have green handles**

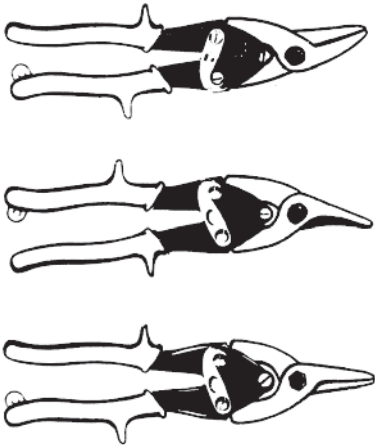


**Left cut snips typically have red handles.**

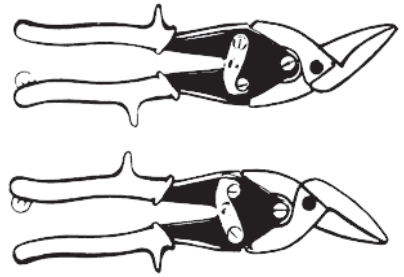


**Straight cut snips typically have yellow handles.**

Some styles of Aviation Snips are available in as many as three different blade patterns. Right Cut and Left Cut blade patterns cut straight and respective curves. Straight Cut blade patterns cut straight and wider curves to both the left and right. It is easier to cut curves across your body than away from your body, therefore a Left Cut blade pattern is easiest to use in your right hand and a Right Cut blade pattern is easiest to use in your left hand. The Straight Cut blade pattern is the most versatile because it can be used in either hand and will cut wide curves in either direction.



Regular Style models are in three blade patterns; *Left Cut*, *Right Cut*, and *Straight Cut*. This style is strong and versatile. This style is best used to trim or cut almost any type sheet material and will cut up to 18 gauge cold-rolled sheet steel.



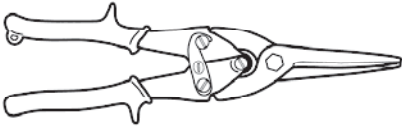
Offset Style models are in three blade patterns; *Left Cut*, *Right Cut*, and *Straight Cut*. This style flows material away from the blades allowing the user to make long cuts through large sheets of material easier. Left Cut and Right Cut Offset Models cut tightest curves respective to their blade pattern. All blade patterns of Offset Style Aviation Snips position the user's hand safely above the material being cut.



Upright Style models are in two blade patterns; *Left Cut* (shown above) and *Right Cut*.

This style features handles that are 90 degrees to the cutting plain for a more ergonomic wrist motion. This style is easily maneuvered in tight spaces and can be used with blades up or down in a push or pull motion. Upright Style models position the user's hand safely above the material being cut.

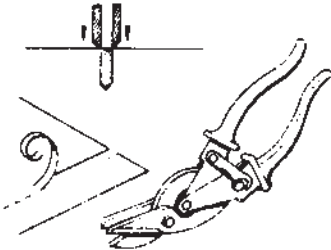
## Proper Use and Care of Metal Cutting Snips



Long Cut Style models are in *Straight Cut* blade pattern only. This style is used for maximum cut length per cutting stroke where a long straight cut without re-gripping of material is most desired. This style is often used to make long straight cuts through thin materials such as vinyl and aluminum siding.



Bulldog Cut Style models are in *Straight Cut* blade pattern. This style is used for making straight cuts through thick materials and for cutting sheet metal up to 16 gauge cold-rolled. It can be used to cut through rolled edges, seams, and multiple layers of sheet metal up to 0.062 inch total thickness.



Pipe & Duct (Double Cut) Style model is in *Straight Cut* blade pattern. This style aviation snip cuts a narrow section equal to the width of the center blade as it cuts. The material on either side of the cut tends to stay flat as only the narrow section takes a curl as it is cut. This style can be used in stovepipe and downspout work where distortion on either side of the cut is not desirable.

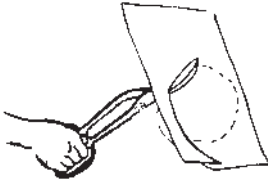
1. It is advisable not to cut exactly on the layout line (to avoid extra finishing work). It is good practice to leave about 1/32-inch of metal beyond the layout line for final dressing and finishing.

2. As the cut is being made, try not to make the cut the full length of the blades if points of blades severely overlap. If the points of the blades severely overlap and a cut is made through the points, the material being cut will have a tendency to tear sideways as the cut is completed. If points severely overlap, stop the cut about 1/4-inch before reaching the points of the blades and then take a fresh bite.

3. When trimming a large sheet of metal, it is best to cut at the left side of the sheet if you are right handed and at the right side of the sheet if you are left handed. This way the waste will be curling up and out of the way while the rest of the sheet will remain flat.

4. When making a straight cut, place the work over the workbench so that the layout line is slightly beyond the edge of the bench. Hold the snips so that the blades are at an exact right angle to the material being cut. The edges of the material may be bent or burred if the blades are not at right angles to the work.

5. To cut a large circle or hole in sheet metal or other sheet materials, start by drilling or punching a small entry hole in the center of the circle and proceed to make a spiral cut leading out to the desired circumference. Keep cutting away until all unwanted material is removed.



6. To cut a large circle or disc from sheet metal or other sheet materials, start from the outside of the material and make a cut tangent to the layout line but slightly beyond it to allow for dressing and finishing. This way you will always be able to see the layout line and still have material left over for final dressing and finishing.
7. Keep the blade pivot bolt and nut properly adjusted at all times.
8. Occasionally oil the pivot bolt.
9. Snips should be carefully put away after use. Wipe the cutting edges with a lightly oiled cloth.

## **WORK SAFETY WITH METAL CUTTING SNIPS. ALWAYS WEAR SAFETY GOGGLES.**

### **Avoiding Abuse/Misuse**

1. Follow the manufacturer's instructions for use, capacity, and proper care of the snip.
2. Be careful of the sharp edges on the cutting blades. Keep blades closed when snip is not in use. Use safety latch to keep blades closed on Aviation Snip models.
3. Be careful of the sharp edges of the material being cut as you use the tool. Always wear gloves when working with snips.
4. Never use a snip to cut sheet metal thicker than 0.062 inches.

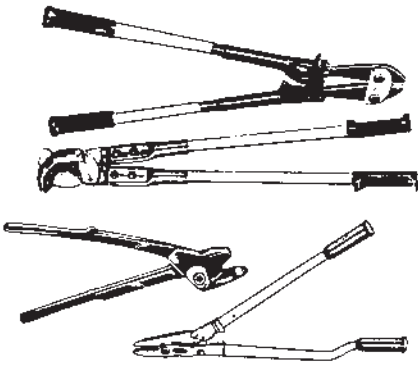


## **WRONG**

5. Never use snips to cut heavy wire, cable, nails, rod, etc., as these materials may damage the cutting edge or the shearing action of the snip.
6. Use the right size and style of snip for the job at hand. Don't try to cut tight curves with a straight pattern snip. Use offset models for long cuts through large sheets of material.
7. Avoid springing the blades. This is the result of trying to cut material that is too thick.
8. Use only hand pressure for cutting. Never hammer, or use your foot, to get extra pressure on the cutting blades. Do not use "cheater bars" on handles.
9. Do not attempt to re-sharpen a snip blade in a sharpening device designed for knives, scissors, or garden tools.

## **CUTTERS INTRODUCTION**

There are many types and sizes of cutters used to cut selected-ferrous and non-ferrous metals described below. Each cutter is designed for a specific type and size of material to be cut.



## TYPES OF CUTTERS

### Description

There are different head styles and tool configurations ranging in length from 6" to 42" for cutting different materials. Models that have blades that pass each other normally cut only non-ferrous cable. Cutters are used to cut ferrous materials such as steel wire and cable, rod wire rope, aircraft cable, guy strand, fencing, bolts and steel strapping. Other cutters are used for cutting non-ferrous material such as copper and aluminum. Cutters are used in plant maintenance, construction, electrical construction and maintenance, and other operations.

### Proper Use and Care

1. Be certain to select the proper cutter for the job.
2. Follow manufacturers' instructions or obtain professional advice.
3. Cutters should be adjusted and lubricated daily when in use. Jaws may be sharpened according to instructions shipped with the cutter.
4. To prevent injury from flying metal, wrap a burlap bag, wiping cloth or rag around the cutting jaws so metal pieces cannot fly.
5. Keep cutting tools in good repair; lubricate moving parts only. Keep the

handles clean and free from oil and grease.

6. Remember that metal flies when cut. The harder the metal, the farther it will fly. One way to prevent injury from flying metal is to wrap a burlap bag, wiping cloth, or rag around the cutting jaws so metal pieces cannot fly.

7. When using a cutter, warn those in the area to take precautionary measures to avoid possible injury from possible flying metal pieces.

8. Remember that the hardness of the stock being cut is as important as its size.

### Avoiding Abuse/Misuse

1. Wear protective gloves and safety goggles when using cutters.
2. Wear safety shoes.
3. **Never** use a pipe extension or other form of "cheater" to increase the leverage of any handle.
4. **Never** expose jaws to excessive heat that may change the hardness and metal structure and ruin the cutting ability. See section V.
5. Do not hammer on the handles of cutters.
6. Don't cut diagonally. Keep material being cut at right angles to the cutting edges of jaws. Improper cutting may contribute to personal injury or damage to tool.
7. Don't attempt to use a cutting tool until its proper and safe uses are fully understood.
8. Don't exceed rated capacity of tool.
9. Don't pry or twist with tool when cutting.

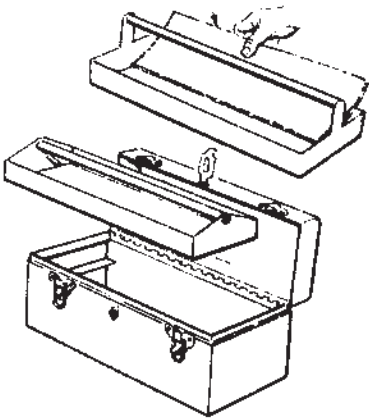
**When to Replace.** Attempts to repair cutters are not recommended. Discard any cutter that is cracked, broken or shows signs of looseness or play due to wear in the compound leverage toggle.

# SECTION X. TOOL BOXES, CHESTS AND CABINETS

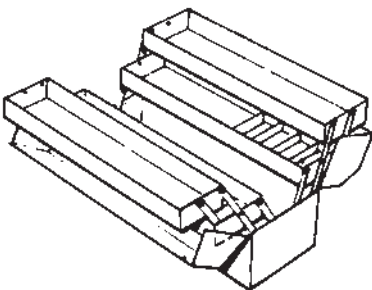
## INTRODUCTION

Tool boxes can be divided into three classes: **hand boxes**, **chests**, and **cabinets**. Cabinets (commonly referred to as “roll cabs”) are mounted on casters while the smaller tool boxes (some with drawers and some without) are designed to be hand carried.

### TOOL BOXES



Tool box with lift-out tray

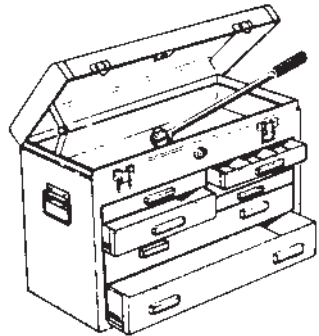


Tool box with lever-operated  
trays

Portable types may have up to five drawers, a lift-out tray, or a cantilevered tray that automatically opens out when the cover is lifted. In addition to the

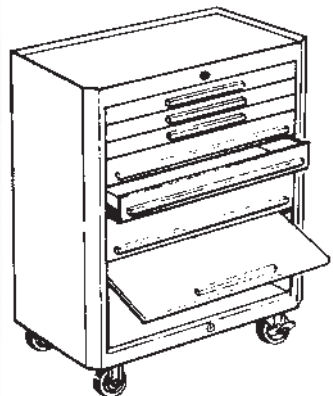
handle on the top of the tool box cover, some tool boxes have handles at each end designed to hold an extra heavy load of tools. Some tool boxes will have a catch or a hasp at each end and may be able to be locked with either a padlock or its own built-in lock.

### TOOL CHESTS



**Tool Chests** are usually heavier, stronger, and of course have a much greater capacity than tool boxes. The drawers on some models can be secured with their own built-in locks. Some have a tote tray that can be removed for carrying only those tools needed for a particular job. Most tool chests are designed to be placed on top of tool cabinets.

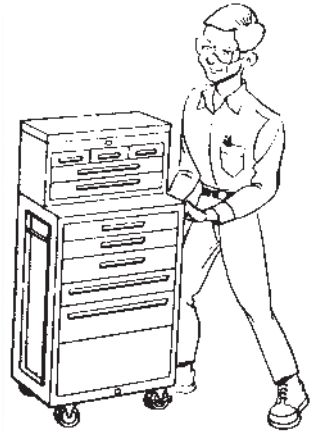
### TOOL CABINETS



**Tool Cabinets** are larger than tool chests and are always mounted on casters. They typically have a locking arrangement that will lock all drawers automatically. Casters on some models may be locked by means of a brake to prevent rolling.

### Proper Use and Care

1. Lightly oil all moving parts such as drawers, trays, and hinges at regular intervals.
2. Use graphite, not oil, on locks and padlocks.
3. Touch up all rusted spots, pay particular attention to the bottom of tool boxes.
4. Ensure that handles are firmly attached to the tool box.
5. Drawers and trays that hold sharp-edged tools such as chisels, screwdrivers, etc. should be lined with cork, felt, or scrap carpeting.
6. Set the brakes on the locking casters after you have rolled the cabinet to your work area.
7. Make sure that the wheels on tool cabinets are turning freely.
8. Keep your tool box or chest locked when not in use.
9. Sand, or file down, any sharp edges that may cause damage to clothes or fingers. Such sharp edges are usually caused by dropping the tool box to the floor instead of placing it on the floor.
10. Wipe away all grease and moisture from tools before storing them in the tool box, chest, or cabinet.

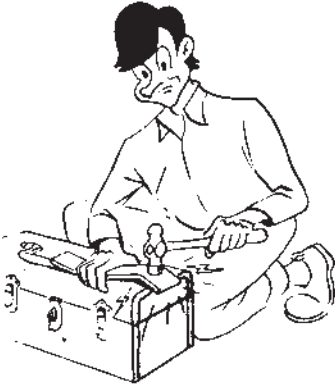


**RIGHT**

11. Tool cabinets should be pushed and not pulled.
12. Close all drawers before moving tool cabinet.
13. Push the tool cabinet not the chest.
14. Secure the tool chest to the cabinet, if possible.
15. Open only one drawer at a time.
16. **READ AND FOLLOW ALL SAFETY MESSAGES** that are affixed to, or that accompany, tool boxes.



## Avoiding Abuse/Misuse

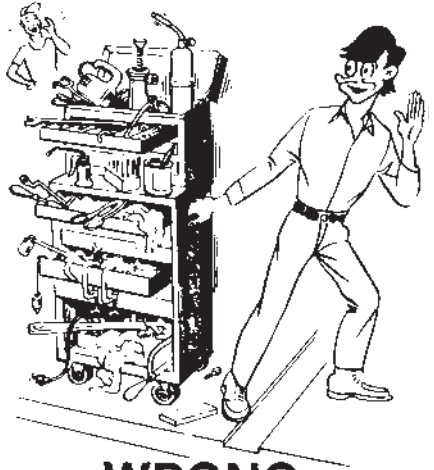


**WRONG**



**WRONG**

1. Never use a tool box for an anvil, workbench, ladder, or similar purpose.
2. Do not overload a tool cabinet with too many extra chests or tool trays; it may tip over.
3. Do not open more than one drawer at a time.
4. Do not move a tool cabinet before locking all drawers.
5. Don't use a tool cabinet for a workbench.



**WRONG**

6. Do not roll a tool cabinet with loose tools or parts on top of the cabinet, or with a tool chest that is not properly fastened.

NOTES

---

---

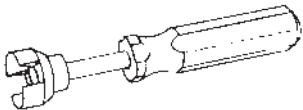
---

# SECTION XI. AUTOMOTIVE TOOLS INTRODUCTION

There are well over 300 different non-power hand tools available on the market specifically intended for servicing cars, each with a special configuration of its own to service parts of the car, such as the carburetor, cylinders, drive train, valves, shock absorbers, windshield wipers, etc. Some of the tools are shaped to reach into difficult to get into places and remove special fit-tings while other tools, such as the slide hammer puller, will make the removal of a rear axle from a car a relatively easy job.

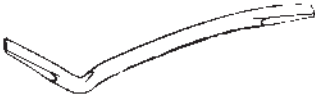
Before you service a car, be certain you are qualified to do the job correctly, using the proper tool safely. Whenever using any tool, always wear safety goggles to prevent possible eye injury.

## BRAKE SERVICE TOOLS



### BRAKE SHOE RETAINING SPRING TOOL

To remove and replace dish type washer. Knurled cup securely grips washer on both small and standard cars.



### BRAKE ADJUSTMENT TOOL

Use to adjust drum brakes. Shape fits drum opening; angle provides leverage for easy adjustment.



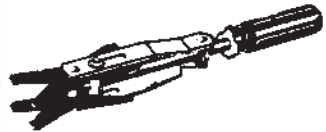
### BRAKE CYLINDER HONE

Hones all cylinders with straight bore or blind end.



### BRAKE BLEEDER WRENCH

Hex ends fit on bleeder valves to bleed brake cylinders.



### DISC BRAKE PAD SPREADER

Spreads pads and holds them in position when assembling caliper over rotor.



### TIRE TREAD AND BRAKE LINING GAUGE

Measures the amount of lining remaining on drum and disc brake pads. Measures tire tread depth. Works on disc brakes without removing caliper.



### DISC ROTOR/BALL JOINT GAUGE

Checks ball joint wear and disc rotor run-out. Includes roller contact for checking wheel runout and a contact for checking tire runout. Can also be used

as general purpose gauge for checking gear backlash, valve guide wear, and camshaft wear.



### **BRAKE RESETTING GAUGE**

Determines proper clearance between brake lining and drum. Inside calipers measure drum diameter. Outside calipers transfer measurement to brake shoes. Knurled knob locks measurement.



### **BRAKE SPRING TOOL**

Use special socket for removing return-spring and the other end for replacing spring.

## **ENGINE TOOLS**



### **FLYWHEEL TURNER**

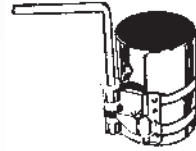
Use when working on clutches, transmissions, installing rings or other jobs that require the crankshaft to be in a specific position.



### **THROTTLE ADJUSTING TOOL**

Adjusts RPM without disturbing original carburetor setting. Handy for tune-ups, timing, or air-conditioning

service. Compact size. Can be used without removing air-cleaner.



### **PISTON RING COMPRESSOR**

Designed for use on all passenger cars. 2 1/8" to 5" capacity. Two-band ratchet type with enlarged crimped edge to prevent compressor from entering cylinder.



### **VALVE SPRING COMPRESSOR**

For use on overhead valves. Longer jaws enables use on high performance engines. Offset jaws designed to grip valve spring in parallel compression. There's no need to remove the cylinder head. Hex head on center screw allows use of ratchet wrench for faster use. The sliding "T" handle is designed for use in tight places. For use on cars and light trucks.



### **HYDRAULIC TAPPET REMOVER**

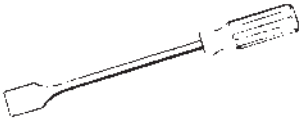
Removes sticking hydraulic valve tappets. Jaws spread apart to clamp recessed area of tappet. Sliding hammer bangs them out.



### **AIR HOLD FITTING**

Used to apply air pressure to keep valves closed while servicing single valves. Engine may rotate slightly when

air applied. Use caution, avoid pinch points.



### **GASKET SCRAPER**

Scrapes mating surfaces clean before installing new gaskets on water pumps, thermostat housings, cylinder heads, etc.



### **CARBURETOR AND DISTRIBUTOR ADJUSTING TOOL**

Allows fine adjustment and easy access. No need to remove the air filter. Unique 90 degree and 30 degree angles get into the most cramped areas. Includes screw-driver attachment for carburetor.



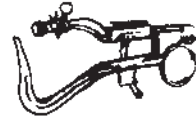
### **REVERSIBLE FAN WRENCH**

Removes and installs fan bolts and clutch fans on most air conditioned cars. Handle is offset to prevent skinned knuckles on honeycomb radiator structure. Also provides easy access to nuts under car seats.



### **PISTON RING FILER**

File piston rings with this portable rotary filer. Use to accurately size any make, type, or diameter ring. Place opening of piston ring over cutter. Turn handle until proper ring clearance is obtained. Includes extra hard carbide coated cutter file.



### **PISTON RING GROOVE CLEANER**

Holder secures piston in position during cleaning. Spring release for quick removal of piston.

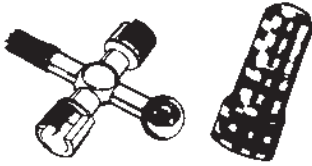


### **CYLINDER HEAD RETHREADER TAP**

Repairs damaged spark plug threads with thread inserts.



## BATTERY SERVICE TOOLS



### CLAMP AND POST CLEANER

**Proper Use.** Turn brush clockwise and counterclockwise on post and inside clamp to remove corrosion.

**Avoiding Abuse/Misuse.** Never reinstall a clamp without removing all corrosion from post and clamp, thereby insuring a good electrical connection.



### BATTERY PLIERS

**Proper Use.** Grasp battery clamp nut firmly. Turn one quarter turn at a time. Do not hit battery case.

**Avoiding Abuse/Misuse.** Never use standard pliers. It will round corners off battery nut and may break battery case.



### BATTERY TERMINAL CLAMP SPREADER

**Proper Use.** Insert head inside clamp, spread, and ream inside of clamp.

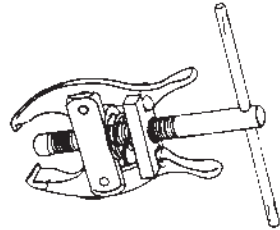
**Avoiding Abuse/Misuse.** Never use a hammer to pound clamp or post. This will break post or battery case.



### BATTERY CARRIER

**Proper Use.** Adjust so all three grips fit tightly on battery, before lifting.

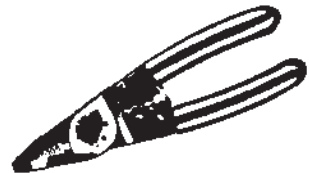
**Avoiding Abuse/Misuse.** Do not pick up battery without a carrier. It can drop and cause injury or breakage.



### BATTERY TERMINAL PULLER

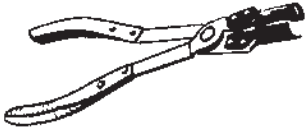
**Proper Use.** Removes corroded clamps, including spring types. The sharp jaws engage either below or on sides of cable terminals and lift tightest terminals without damaging battery cases or posts. Center screw swivel makes it an effective puller for generator bearings and magneto gears.

## IGNITION AND ELECTRICAL TOOLS



### WIRE STRIPPER AND CRIMPER

An all-around tool for crimping solderless terminals, splicing, cutting and stripping.



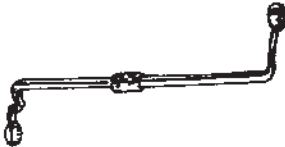
### **BULB BASE REMOVER PLIER**

Removes corroded base when bulb is broken. Serrated lip on jaws gives firm hold for tight, positive grip without crushing bulb base.



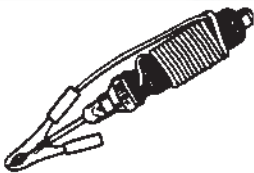
### **SPARK PLUG OPENING THREAD CHASER**

Cleans threads of carbon corrosion and metal.



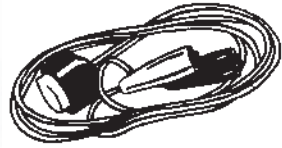
### **DISTRIBUTOR CLAMP WRENCH**

A necessity for any shop doing distributor work. Gets to the nut locking the distributor and enables the mechanic to loosen nut, adjust timing, and lock distributor.



### **HIGH-LOW VOLTAGE TESTER**

Tests for voltage, spark and continuity in 6, 12 and 24 volt systems. Ground clip and touch probe to point being tested. Tester bulb will light if voltage present. Screw probe into opposite end of handle to check for spark.



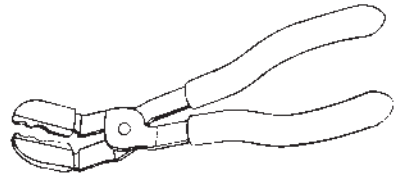
### **REMOTE CONTROL STARTER SWITCH**

Use to bypass ignition switch on any engine with a solenoid starter switch. Lets you crank engine while working in engine compartment.



### **SPARK PLUG GAP GAUGE**

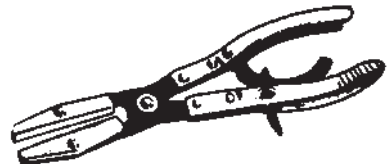
Measures spark plug electrode gap. Includes two electrode adjusting tools.



### **INSULATED SPARK PLUG TERMINAL PLIERS**

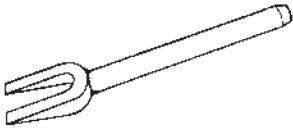
No more shocks with this special tool designed to remove cable terminals from spark plugs quickly and easily.

## **MISCELLANEOUS TOOLS**



### **RADIATOR HOSE "PINCH- OFF" PLIERS**

Eliminates necessity of draining cooling system when installing thermostats and water pumps on all pressurized cooling systems. Also works on heater hose.



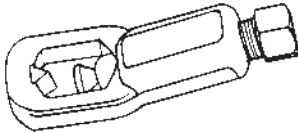
### **BALL JOINT SEPARATOR**

When placed between the ball joint and steering knuckle, and given a few sharp blows with a hammer, this tool separates these stubborn parts with ease.



### **SHOCK ABSORBER WRENCH**

This tool is a must for the easy removal and installation of shock absorbers.



### **UNIVERSAL NUT CRACKER**

Splits most stubborn nuts 5/16" through 3/4" in diameter. Works in channels not accessible to other tools. Parallel action of pusher cracks nuts without damaging bolt threads.

### **MUFFLER & TAIL PIPE TOOLS**



### **EXHAUST AND TAIL PIPE CUTTER**

Adjustable for cutting various diameters of exhaust and tail pipes. Oil cutter wheel before use.



### **EXHAUST & TAIL PIPE EXPANDER**

Flares and shapes the pipe end.



### **MUFFLER AND TAIL PIPE CHISEL**

## **BODY & FENDER HAMMERS**

Body Repair Hammers are special-purpose tools designed and intended only for use in straightening, shaping, shrinking, picking and finishing damaged sheet metal panels normally found on bodies and fenders of motor vehicles. They are intended to be used separately or together with Dolly Blocks and Spoons for these repairs.



### **DINGING HAMMER**

Designed to rough out metal work in preparation for finishing.



### **LIGHT FINISHING HAMMER**

Light weight and perfectly balanced for final finishing work.



### **SHRINKING HAMMER**

Has large faces, serrated for shrinking and smooth-for finishing.



### **HEAVY FINISHING HAMMER**

A well balanced hammer for all-around finishing work.



### **LONG FINISHING HAMMER**

Designed for finishing metal work in areas where long reach is required.



### **FINISHING HAMMER**

A light weight, well-balanced finishing hammer with a wedge-shaped cross pein for use on fender



### **PECKING HAMMER**

Forged steel head combines long pointed end for pecking out small dents and round slightly crowned face for finishing.

### **Proper Uses and Care**

1. Body repair hammers should only be used to strike sheet metal panels.

### **Avoiding Abuse/Misuse**

1. The cheeks or necks of body repair hammers and the handles should not be used for striking or pounding.
2. To avoid possible injury from flying objects, safety goggles or equivalent

eye protection should be worn by the user and by all persons in the immediate area in which any striking tool is being used.

3. No area section or portion of the body repair hammerhead should be ground, welded, treated by reheating, or otherwise altered from the original condition as furnished by the manufacturer.

### **When to Repair or Replace.**

1. Body repair hammerheads should be inspected prior to each use and replaced at first sign of chipping, mushrooming, or cracking of any portion.
2. Handles should be inspected prior to each use to verify they are free of splinters or cracks and are held tight in the tool. Handles that are damaged should be replaced.

## **BODY REPAIR DOLLIES AND SPOONS**

Body Repair Dollies and spoons are special-purpose tools designed and intended only for use in straightening, shaping, shrinking and finishing damaged sheet metal panels normally found on bodies and fenders of motor vehicles. They are intended to be used separately or together with Body Hammers for these repairs.



### **LOW CROWN DOLLY**

Useful, popular shape with many different curves and angles.



### **UNIVERSAL OR "RAILROAD" DOLLY**

Ideal for bumping out dents.





### **TOE DOLLY**

Has many radii with flat bottom and side. Ends are high crowned. Ideal for both flat and curved surfaces.



### **WEDGE OR "COMMA" DOLLY**

A popular dolly designed for fender beads and flanges. Flat side works well on long curves while thin edge is ideal for corners and beading.



### **HEAVY WEDGE DOLLY**

Unique shape and low crown are ideal for shrinking body metal and for raising beads and molding.



### **HEEL DOLLY**

Semi-elliptical shape has two flat and two crowned working surfaces. Useful in restricted spaces. May be used for shrinking body metal.



### **"CHEESE GRATER" BODY FILE**

Files look like a cheese grater, are used to shape plastic body filler before the patch is fully hardened.

## **Proper Uses and Care**

1. Dolly Blocks and Spoons should only be used to strike sheet metal panels.

### **Avoiding Abuse/Misuse**

1. Dolly Blocks should not be struck directly by any type of hammer or other striking tool.

2. To avoid possible injury from flying objects, safety goggles or equivalent eye protection should be worn by the user and by all persons in the immediate area in which any striking tool is being used.

4. Dolly Blocks and spoon should not be ground, welded, treated by reheating, or otherwise altered from their original condition, except for Dolly Blocks where mushrooming of the working surface from tool usage should be promptly redressed to the original contour by the use of a whetstone or file (see Section V).

### **When to Repair or Replace.**

Dolly Blocks and Spoons should be inspected prior to each use and replaced at the first sign of chipping or cracking.

## **MECHANIC GEAR PULLERS INTRODUCTION**

Mechanical Gear Pullers are used for the removal of gears, pulleys, bearings, flanges and fly wheels from shafts and/or housings for the repair or replacement of any of these components.

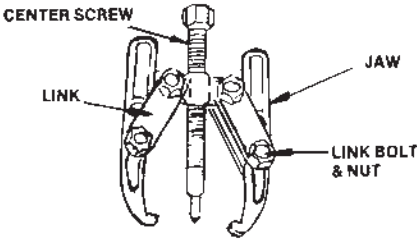
There are two general types of pullers:

1. Jaw type - consisting of two or more jaws, a center screw, a yoke, several links, and a quantity of bolts and nuts for attachment of the jaws to the yoke.

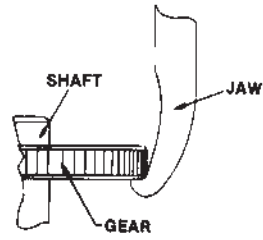
a) Adjustable: allows the user to increase reach.

- b) Reversible: allows internal and external pulling.
2. Bolt type: consisting of a cross arm, a center screw, and several side screws in various sizes for the attachment of the tool to the gear or pulley to be removed.

**JAW TYPE PULLERS**



**CAUTION:** It is impossible to predict the exact force required for every pulling job. Set-up requirements and the size, shape and condition of the part being pulled vary a great deal. In addition, the puller, its attachments and accessories are versatile. Therefore, it is possible that components in a pulling set-up may have different strength. The lowest "capacity" component then determines the capacity of the set-up. These tools should be used only by trained personnel. Use only after the operating instructions have been read and fully understood. If you are at all unsure of which tool or attachment to select or the proper use of the selective tool, contact the tool manufacturer. Reach and spread dimensions of the job must first be determined. A typical example of the reach and spread dimension is shown below. Notice that the length of the protruding shaft and the thickness of the component determine the reach needed. The width of the component determines the spread required.

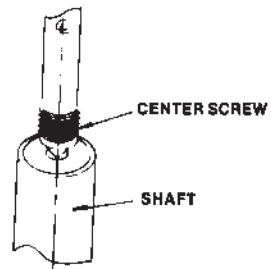


**A**

**PROPER ALIGNMENT FOR GEAR REMOVAL**

Before attaching the puller, lubricate the center screw with machine oil. Attach the "jaws" to the pulley or gear so that the "jaw gripping" surface is in direct contact to the gear or pulley with as much area as possible. Position the center screw in the center of the shaft with the point of the center screw in this indentation.

Next, hand tighten the center screw until the puller is snug on the part, making sure that the "jaw gripping surfaces" are still in the correct position. Attach a box-end wrench or socket and ratchet to the center screw hex head.

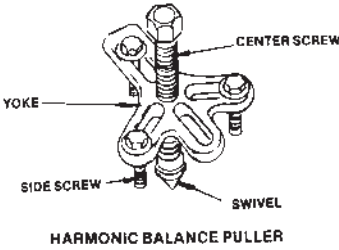
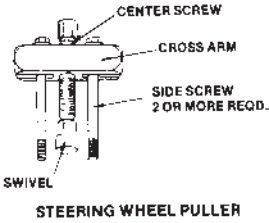


**B**

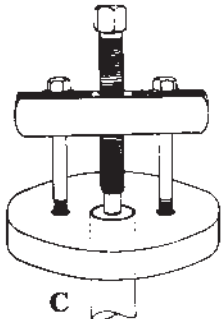
**CENTER SCREW ON CENTER OF SHAFT**

Turn the center screw clockwise until the gear or pulley is removed. If the gear or pulley can not be loosened, use a larger capacity puller.

## BOLT TYPE PULLER



If the bolt type puller is to be used, first lubricate the center screw as previously described. Choose the correct side screws considering thread size, length and number of screws needed. Next, place the yoke and center screw assembly on the shaft. While holding the assembly with one hand, place the side screws through the slots provided in the yoke and into the threaded holes in the pulleys or gears or gear, turning them evenly so that when the center screw is tightened, the yoke will remain properly aligned with the shaft.

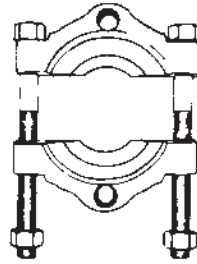


Attach the appropriate wrench or socket and ratchet to the center screw hex head and turn the center screw clockwise until the gear or pulley is removed.

## BEARING PULLING ATTACHMENTS

These attachments may not withstand the full capacity of the pullers in which they are used. The shape and condition of the part being pulled affects the capacity at which the puller blocks and/or studs may bend or break. Always select the largest attachments that will fit the part to be pulled.

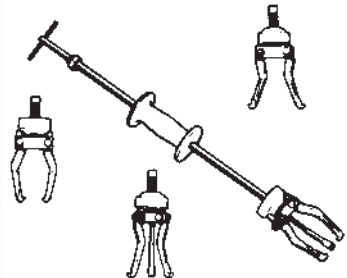
### PULLING ATTACHMENTS



Pulling attachments are used in conjunction with jaw and bolt type pullers to get behind the parts being pulled.

When the housing lacks sufficient surface for the puller legs to bear against, a pulling attachment may be used to provide support.

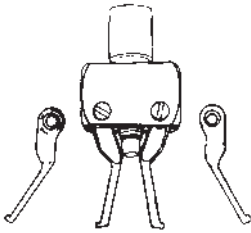
### SLIDE HAMMER PULLING WITH ATTACHMENTS



Slide hammer pullers, when used in conjunction with puller jaws or other attachments, can be used to pull various size pilot bearings, oil seals, bushings,

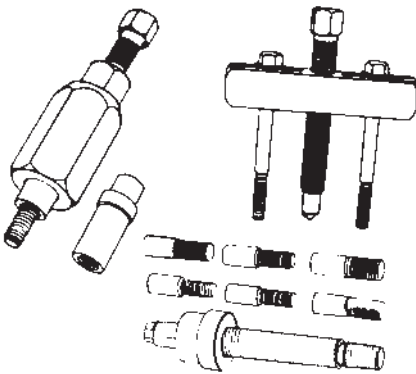
timing gears, harmonic balancers, axle shafts and other tightly fitted parts. A slide hammer puller is combined with an internal pulling attachment. It is ideal for removing parts from blind holes, especially when there is no housing to brace the puller legs against; and when no center shaft is present to rest the center screw of the puller against.

### INTERNAL PULLERS



Internal pulling attachments are used to get a straight pull, thus avoiding damage to a housing or other parts. Used in combination with a bolt puller or a slide hammer puller, this attachment enables one to easily reach into a blind hole and remove a bearing race, threader or oil seal. Jaws of the attachment are readily adjustable to fit various diameters.

### SPECIAL PULLERS



Special pullers are designed for such unique pulling jobs as removing harmonic type balancers, timing gears

for pulleys, alternator and power steering pump pulleys, and for removing bearings, bushings, sleeves and other parts from blind holes.

### Proper Uses and Care

1. Always select the proper puller for each pulling job. Always use a puller equal to required capacity or larger than required.
2. Before use, the center screw should be lubricated with machine oil.
3. Always use hand tools on gear pullers, not power tools.
4. Always make sure that the puller is aligned with the shaft, assuring a straight pull during its operation.
5. Always clean the puller after use and store in a clean dry place.
6. Cover work with canvas to stop potential flying objects

### Avoiding Abuse/Misuse

1. Never use power tools on gear pullers.
2. Never strike a puller with a hammer or other striking tool.
3. Discard or replace any functioning parts showing excessive wear, dents, chipping, or cracks; or if center screw threads or attaching fasteners show signs of galling or seizing.
4. If attaching fasteners are replaced they should be replaced only with a manufacturer's replacement part or with its equivalent.

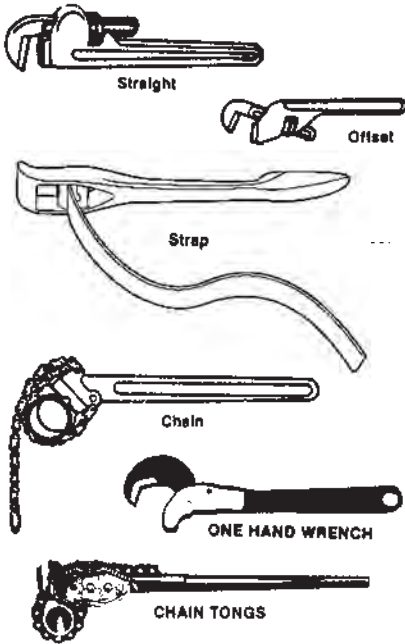
## SECTION XII. PIPE TOOLS

### INTRODUCTION

This section deals with those hand tools used to wrench, cut, thread, flare, or ream pipe or tubing.

#### PIPE WRENCHES

Pipe wrenches are manufactured in a variety of types. Each type has a special purpose and some types offer choices of material for jaws and handles.



The most common type of pipe wrench is the straight handle design. The straight pipe wrench is offered with a high tensile strength handle and forged jaws, in both ferrous and non-ferrous materials. For hazardous applications, some aluminum wrenches can be supplied with beryllium copper jaws, springs, and pins to comply with safety requirements.

Offset Wrenches are similar to the straight wrench, but the opening of the

jaws is angled at 23° or parallel to the long axis of the handle instead of 90° as with the straight wrench.

Strap Wrenches provide gripping power without scratching or deforming plastic or polished metal pipe. A specially woven nylon strap is extra strong and treated for slip resistance.

The One Hand Wrench is adjustable to different sizes without finger adjustment, and is useful for working in very confined, hard to reach areas.

The Chain Wrench is for similar service to the straight pipe wrench, but is designed to ratchet in either direction, and is also useful in gripping odd shapes.

Chain Tongs are used for larger, extra heavy duty jobs. They employ longer, forged steel handles and pre-tested chains.

Compound Leverage Wrenches provide additional mechanical advantage for a given handle length.

#### Proper Use and Care

1. The jaw and chain type wrenches are designed for turning and holding pipes and fittings in service where tooth marks are not objectionable. Use a Strap Wrench to avoid tooth marks.
2. When using a straight or offset pipe wrench, always maintain a gap between the back of the hook jaw and the pipe. This position concentrates pressure on the jaws, producing the maximum gripping action and rotating force. The offset handle design is ideal for close quarters where the normal entry of a straight handle is limited.
3. Always PULL rather than push on the wrench handle.
4. Inspect Pipe Wrenches periodically for worn or unsafe parts and replace them.

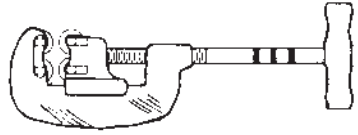
## Avoiding Abuse/Misuse

1. **Never** use a pipe extension or other form of "cheater" to increase leverage. The wrench can break resulting in serious injury.
2. Periodic cleaning and inspections should be made to detect worn or broken teeth on jaws that should be replaced.
3. Replacement pins and chains are available for chain wrenches and replacement straps for strap wrenches.
4. Do not use pipe wrench on square stock (such as pipe tap or extractor). High loads on serrations from corners of square can result in chipped jaws and danger to operator.
5. Never use a Pipe Wrench as a hammer, nor strike a Pipe Wrench with a hammer.
6. Pipe Wrenches are designed to turn or hold pipe; never use a Pipe Wrench to bend, raise or lift a pipe.
7. Discard any wrench with bent handle or broken housing.

## PIPE CUTTERS

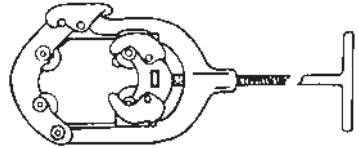
Pipe Cutters are made in the popular "C" shaped frame type, hinged type and rotary type. Pipe cutters are made for cutting most piping materials, and typically have one cutter wheel and two rollers, or three or four cutter wheels and no rollers. Advantages of three and four wheel cutters are that the pipe can be cut in close quarters by moving the cutter back and forth with-out rotating the cutter completely around the pipe. Standard steel pipe cutters usually cut 1/2 to 2 inch pipe with some made for 3, 4 and 6 inch pipe.

## "C" FRAME CUTTER



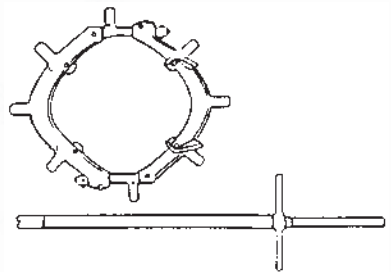
The "C" shaped frame cutter is made with a feed screw that causes the moveable housing to slide forward making contact with the pipe. Another variation of the "C" frame cutter is made with spring tension guide bars that help provide square alignment on corroded pipe surfaces.

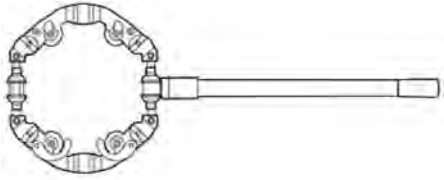
## HINGED CUTTER



The unique feature of this cutter is that the frame hinges are open and locked solidly around a pipe, thereby saving time when performing large diameter pipe repair. Designed for tight places in cutting steel, cast and ductile iron with four cutter wheels, these cutters do not have to be rotated around the pipe. They cut pipe diameters from 4" to 12". Guides insure square cut off.

## ROTARY CUTTER





Rotary Cutters are designed for cutting pipe diameters from 6 to 36 inches, are of closed frame design, use 4 cutter wheels, and feature an auxiliary extension handle. Guides insure a square cut.

### Proper Use and Care

1. Mount cutters perpendicular to the pipe.
2. Lightly tighten cutter and rotate the cutter 360° to insure proper tracking of C frame cutters. For hinged and rotary cutters, use a 90° – 110° swing to test wheel tracking. Ensure proper tracking before continuing.
3. Firmly tighten the cutter every revolution while cutting.
4. Oil working parts to reduce friction.
5. If there is not enough space to swing the single wheel pipe cutter completely around pipe, then a three or four-wheel cutter should be used.
6. Be certain the cutting wheel is suitable to cut type of pipe material. A thin wheel is suitable for cutting ordinary steel pipe; stout wheels are made to cut cast iron and ductile iron. Other wheels are available for stainless steel, plastic and other materials.

### Avoiding Abuse/Misuse

1. Never use a pipe cutter as a C clamp.

2. Never use the cutter as a lever to break off a partially cut piece of pipe.
3. Never use wheels designed for steel in cutting ductile or cast iron.
4. Never apply excessive pressure. Especially when used in conjunction with a power drive, reduce the feed rate, as an unreasonable amount of pressure could fracture the cutter wheel causing injury.
5. Pipe cutter wheels, rollers, pins and screws that are nicked, worn, or otherwise damaged should be replaced.

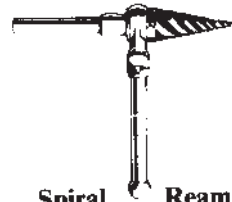
### PIPE REAMERS

While a pipe is being cut, a burr forms on its inside diameter. This burr could act as a trap to snag sediment or mineral deposits that might flow through the pipe. Therefore, it is necessary to cleanly remove the burr. There are two basic models of hand-held reamers: the straight fluted reamer, and the spiral reamer.



**Straight Flute Reamer**

The straight fluted reamer is most frequently used when the pipe is being rotated by a power drive.



**Spiral Reamer**

The spiral ratchet reamer has self-feeding design especially useful for

easy, fast, manual reaming. This type of reamer is also commonly used to enlarge holes in conduit box outlets or other sheet metal applications.

### Proper Use and Care

1. The operator should use only enough force to remove burr; it is not necessary to bevel the inside of the pipe.
2. If the pipe is being held stationary in a vise, then slight end pressure coupled with a ratcheting action will easily remove the burr.

### Avoiding Abuse/Misuse

Do not use a spiral reamer on a rotating pipe. The spiral is self-feeding and its sharp edges could dig into the wall of the pipe and get hung up. The ratchet handle could then rotate out of control causing injury to the operator.

## PIPE THREADERS AND DIES

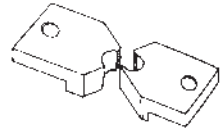
Pipe threaders are made for the purpose of threading pipe, conduit or bolt stock. Special dies, which have a different rake angle, are made for threading PVC plastic pipe. Types of pipe dies include solid, adjustable, split, and segment dies. Solid die chasers are a non-adjustable part of the die and cut a standard gage thread. Adjustable dies, which are made as a matched set, are used in maintenance or other work where adjustments for thread size are required because of variance from standard OD. Segment type chasers are used in drop head ratchet threaders. Dies are manufactured to exacting tolerances in several different universally recognized standards. The most common standard in the United States is the American Standard Taper Pipe Thread that is simply referred to by the letters "NPT." There are also straight pipe thread dies known as

National Pipe Straight Mechanical Dies, "NPSM."

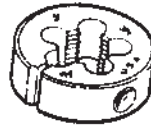
**Pipe Dies** used in drop head or standard threaders are full width dies and the correct pipe taper is built into the die itself.



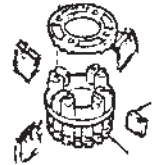
BLOCK DIE



ADJUSTABLE SPLIT DIE



SPLIT BUTTON DIE



SEGMENT DIES  
(NON ADJUSTABLE)

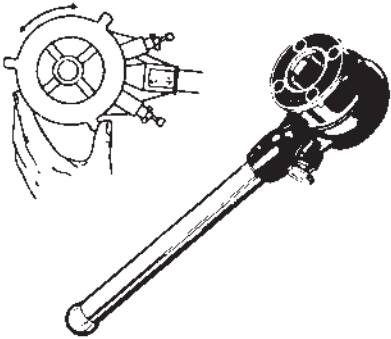
**Bolt Dies (Round Button Dies)** which have straight threads rather than tapered threads, are primarily manufactured to two U.S. standards; Unified National Coarse and Unified National Fine, denoting the number of pitches or threads per inch. All dies have a throat or flared opening for starting the die on the pipe.

### Proper Use and Care

To thread pipe the operator simply puts the throat of the die against the pipe end and starts to ratchet, while applying end pressure against the stock to start the threading. A good cutting oil should be used during thread operation. When the end of the pipe is flush with the end of the die a "Full Width Thread" has been achieved and the die head is reversed to remove it from the threaded pipe.

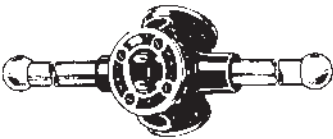


## DROP HEAD RATCHET THREADER



The Drop Head Ratchet Threader (Pipe) is found in virtually every plumber's tool box. It's ideal for low volume threading and can be used with or without a power drive. These threaders feature replace-able cutting dies which are frequently referred to as die segments or dies. The drop head threader features an integral guide, and the entire head is exchanged when changing sizes. Another style of threader features an integral adjustable guide similar to a lathe chuck, and only the die is ex-changed to change size.

## THREE WAY THREADER



Both plumbers and electricians use the three way threader because they feature the three die sizes most commonly used. This type of threader uses the same type dies as the drop head threader but does not have a ratcheting feature, but rather has two handles.



## 3-Way Bolt Threader

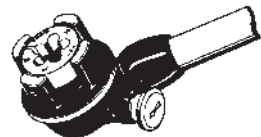
These threaders use the round button dies to cut bolt threads (UNC or UNF) from 1/4 inch through 1 inch. They can be used by hand or with a power drive.

## RECEDING THREADER



## Receding Threader

In this type of threader, the dies, which are narrower than a "Full Width" die, automatically follow an angled path or taper, and hence recede. Most commonly made in 1-2 inch range or larger, the feed of dies is controlled by a lead screw arrangement that is secured on the pipe by a quick operating chuck. Because the threader uses half width dies, it requires less pulling effort by the operator.



## Ratchet Bolt Threader

## Proper Use and Care

1. In tapping, be certain to use the correct tap size in the hole. It is

recommended that the hole be of such size that the thread cut by the tap will be about 75 percent as deep as the thread on the tap.

2. Cast iron can be tapped dry but lubricant should be used with other metals.
3. Always thread the pipe flush with the outer end of the die to give a full nipple.
4. Always use a quality cutting oil while threading for proper cooling and longer life of the die. It promotes clean threads and prevents chips from being welded to the die and tearing threads.

### Avoiding Abuse/Misuse

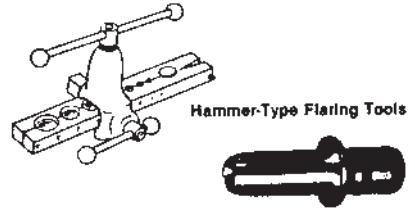
1. Insufficient oiling causes poor threads that could result in leaky installations, and reduced die life. Do not permit chips to clog flutes, as this will prevent tap from turning.
2. Do not attempt to thread hardened steel as this will probably result in a chipped or otherwise damaged die.
3. Do not thread any rod or other cylindrical object that is larger in diameter than the major diameter of the die thread.
4. When removing, rapid spinning of the threading stock is not recommended as this may damage the tool.
5. Replace dies when teeth break, produce torn threads or when dies do not produce standard size threads.

## FLARING TOOLS

One method of joining light metal and plastic tubing to fittings is by flaring. Fittings and flares are categorized by degree, commonly 45° or 37°. There are two types of flaring tools, hammer

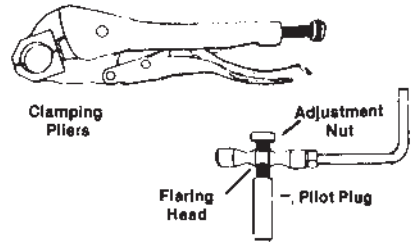
and screw type. Different types of flaring tools are used for plastic and for metal tubing as illustrated below.

### Metal Tubing



Eight sizes for all 3/8" through 2" water tube.

### Plastic Flaring Tools



### Proper Use and Care

#### Screw Type-

1. Select a tool that forms the correct flare to match the angle of the fitting.
2. Tubing to be flared should be cut with a tubing cutter to assure a straighter cut.
3. Ream the inside diameter of the tube to remove burrs for a smoother flare.
4. Position and clamp tubing in flaring bars with end of the tube flush with top of bar and center cone over tubing.
5. Screw the cone down until flare is made.

**Hammer Flare-**Used for soft copper water tube.

1. Insert tool in tube.
2. Strike with hammer to produce flare. (See Section IV-Struck or Hammered Tools.)



**ALWAYS WEAR SAFETY GOGGLES  
TO PROTECT YOUR EYES**

### **Avoiding Abuse/Misuse**

1. Do not flare hard copper or tubing not designed for flared joints.
2. Do not use flaring tool clamp for holding rod or pipe.
3. Replace or repair flaring tool when clamp no longer holds tube without slipping or when flare becomes misaligned.

### **PLASTIC FLARING TOOLS**

Plastic pipe inside diameters vary with pipe materials and uses.

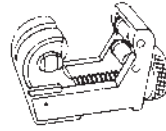
#### **Proper Use**

1. The pilot plug of the flaring tool must match the inside diameter of the tubing.
2. Tubing needs to be cut square and be free of burrs.
3. Back off flaring head to nut stop, insert pilot plug in tubing and clamp firmly.
4. Screw down the flaring head all the way to form full flare, reverse to nut stop and unclamp.
5. Lightly oil threads on plug for easier operation.

#### **Avoiding Abuse/Misuse**

1. Do not use clamp as pliers for holding other objects.
2. Never use tool as a hammer, and protect flaring plug threads from damage.
3. Do not attempt to use on sizes or classes of pipes not stamped on the tool.

### **TUBING CUTTERS**



**Mini Cutter**



**Quick Acting  
Tubing Cutter**

**Tubing Cutters** usually contain one cutter wheel and, with a quick change of the cutter wheel, are used for cutting metal or plastic. They are used to make quick, square cuts leaving a minimum burr. Sizes range from 1/8" to 10".

#### **Proper Use and Care**

1. Select the proper cutter wheel type for cutting metal or plastic.
2. Use light feed pressure on the first revolution to make sure cutter tracks.
3. Firmly tighten the screw every revolution.
4. Keep rotating parts clean and lightly oiled.

#### **Avoiding Abuse/Misuse**

1. To maintain cutter alignment, be careful not to drop or throw cutter.
2. Do not use to cut glass tubing or steel pipe.
3. Never use a copper cutting wheel for plastic, or vice versa.
4. Inspect cutter wheels for worn or broken edges and replace when needed.
5. Inspect and repair cutter when it does not track or cut square.

# The Klein Tools Connection

## GET CONNECTED!

Klein Tools believes keeping you informed means keeping you involved. That's why we are providing you with the informational tools that will keep you up-to-date and connected with everything Klein. From innovative new product lines to the classics that never grow old, it's all here for you.

Visit us at [www.kleintools.com](http://www.kleintools.com) to:

- View our product index – complete with product photos and descriptions
- Locate your nearest Klein distributor
- Learn of new products firsthand
- Obtain contact information at Klein
- Learn the history of Klein Tools
- Use interactive product demonstrations
- Get connected to industry links
- Check out our line of Klein apparel
- And much more...



## No access to the internet?

Give us a call at  
**1-800-553-4676**

or write us at:

Klein Tools, Inc.  
450 Bond Street  
PO Box 1418  
Lincolnshire, IL 60069-1418

**For Professionals... Since 1857™**



## **HAND TOOLS INSTITUTE**

**25 North Broadway • Tarrytown, New York 10591 • U.S.A.**

**[www.hti.org](http://www.hti.org) • [hti@hti.org](mailto:hti@hti.org)**

**Member of  
American National Standards Institute  
National Safety Council**

### **IMPORTANT**

This book is not a substitute for manufacturers' instructions or warnings. Because tools may differ, always consult manufacturers' instructions or warnings if provided. It is not the intent of this book to cover all types of hand tools or special applications.

Fourth Edition  
Copyright ©2007 Hand Tools Institute

All rights reserved. This book or any part thereof may not be reproduced in any form without written permission of the publisher. Unauthorized copies subject to statutory penalties of \$750 to \$30,000 plus additional penalties.  
Printed in the United States of America.

**[www.kleintools.com](http://www.kleintools.com)**

# Tool Sets

Some projects are more complex than others and require a variety of tools. Klein has tool kits to assist professionals with these demanding projects.

## 41-Piece Tool Set

Cat. No.	Description	Cat. No.	Description
BLK12	L Style Ball End Hex Key Caddy Set 12-Piece	630-3/16	3/16" Nut Driver with 3" Hollow Shaft
J203-6	Long Nose Side Cutting Pliers, 6-3/4"	630-1/4	1/4" Nut Driver 3" Shaft Cushion Grip
J203-8N	Journeyman™ Long Nose Pliers Side Cutting, 8"	630-5/16	5/16" Nut Driver Cushion-Grip 3" Shaft
J502-10	Journeyman™ Pump Pliers, 10"	630-11/32	11/32" Nut Driver 3" Hollow Shaft
D507-8	Adjustable Wrench, Extra Capacity 8"	630-3/8	3/8" Nut Driver with 3" Hollow Shaft
D507-12	Adjustable Wrench Extra Capacity, 12"	630-7/16	7/16" Hollow Nut Driver, 3", Cushion-Grip
600-1	5/16" Cabinet Tip Screwdriver 1-1/2"	630-1/2	1/2" Nut Driver, 3" Shaft, Cushion-Grip
600-4	1/4" Screwdriver Heavy Duty Square Shank	650	Cushion-Grip Scratch Awl
601-3	3/16" Cabinet Tip Screwdriver 3"	662	#2 Square Screwdriver with 4" Round Shank
601-6	3/16" Cabinet Tip Screwdriver 6"	670-6	Screwdriver, 3/16" Cabinet, Rapi-Driv®, 6"
602-6	5/16" Keystone Tip Screwdriver, 6" Length	86225	Double Hook Magnetic Tape Measure, 25-Foot
603-1	Stubby Screwdriver, #2 Phillips, 1-1/2" Shank	935R	Aluminum Torpedo Level Rare Earth Magnet
603-3	#1 Phillips Screwdriver, 3" Round Shank	J1005	Journeyman™ Crimping/Cutting Tool
603-4B	#2 Wire Bending Phillips Screwdriver	K1412	Klein-Kurve® Dual NM Cable Stripper/Cutter
605-6	1/4" Cabinet Tip Screwdriver, Heavy Duty, 6"	J2000-9NETP	9" Journeyman™ Wire Pulling Pliers Heavy Duty Side Cutting



Cat. No. 80141

Cat. No.	Description	Cat. No.	Description
J2000-48	8" Diagonal HD Cutting Pliers Angled Head	56003	1/8" Wide Steel Fish Tape 125 ft
5003-18	Tool Bag, Canvas with Leather Bottom, 18"	58889	Padded Adjustable Shoulder Strap
5139	Canvas Zipper Bag	60053	Protective Eyewear, Black Frame, Clear Lens
11055	Solid and Stranded Copper Wire Stripper and Cutter	J63050	Journeyman™ High Leverage Cable Cutter
44133	Klein-Kurve® Retractable Utility Knife	85191	Conduit-Fitting and Reaming Screwdriver
46037	Cable Splicer's Kit		

## 28-Piece Tool Set

Cat. No.	Description	Cat. No.	Description
D203-8	8" Long Nose Pliers Side-Cutting	630-1/4	1/4" Nut Driver 3" Shaft Cushion Grip
D213-9NETP	Side Cutting and Tape Pulling Pliers, 9"	630-5/16	5/16" Nut Driver Cushion-Grip 3" Shaft
85191	Conduit-Fitting and Reaming Screwdriver	630-11/32	11/32" Nut Driver 3" Hollow Shaft
D248-8	8" Diagonal Cutting Pliers High Leverage	630-3/8	3/8" Nut Driver with 3" Hollow Shaft
D502-10	Pump Pliers, 10"	630-7/16	7/16" Hollow Nut Driver, 3", Cushion-Grip
506-10	10" Adjustable Wrench Standard Capacity	630-1/2	1/2" Nut Driver, 3" Shaft, Cushion-Grip
600-4	1/4" Screwdriver Heavy Duty Square Shank	662	#2 Square Screwdriver with 4" Round Shank
601-6	3/16" Cabinet Tip Screwdriver 6"	670-6	Screwdriver, 3/16" Cabinet, Rapi-Driv®, 6"
602-6	5/16" Keystone Tip Screwdriver, 6" Length	86125	25-Foot Non-Magnetic Tape Measure
603-4B	#2 Wire Bending Phillips Screwdriver	935	Torpedo Level
605-6	1/4" Cabinet Tip Screwdriver, Heavy Duty, 6"	1005	Crimping and Cutting Tool for Connectors
630-3/16	3/16" Nut Driver with 3" Hollow Shaft	5102-16	16" Canvas Tool Bag
		5139	Canvas Zipper Bag



Cat. No. 80028

Cat. No.	Description	Cat. No.	Description
11045	Wire Stripper/Cutter (10-18 AWG Solid)	60053	Protective Eyewear, Black Frame, Clear Lens
44100	Utility Knife with Retractable Blade		

# 18-Piece Tool Set

Cat. No.	Description	Cat. No.	Description
J203-8N	Journeyman™ Long Nose Pliers Side Cutting, 8"	662	#2 Square Screwdriver with 4" Round Shank
J502-10	Journeyman™ Pump Pliers, 10"	670-6	Screwdriver, 3/16" Cabinet, Rapi-Drive®, 6"
D507-10	Adjustable Wrench Extra Capacity, 10"	86225	Double Hook Magnetic Tape Measure, 25-Foot
603-3	#1 Phillips Screwdriver, 3" Round Shank	J2000-9NETP	9" Journeyman™ Wire Pulling Pliers Heavy Duty Side Cutting
603-4B	#2 Wire Bending Phillips Screwdriver	J2000-48	8" Diagonal HD Cutting Pliers Angled Head
605-4	1/4" Cabinet Tip Screwdriver 4" Shank	5165	10 Pocket Tool Pouch Knife Snap
605-6	1/4" Cabinet Tip Screwdriver, Heavy Duty, 6"	5705	PowerLine™ Web Work Belt
630-1/4	1/4" Nut Driver 3" Shaft Cushion Grip	11055	Solid and Stranded Copper Wire Stripper and Cutter
630-5/16	5/16" Nut Driver Cushion-Grip 3" Shaft	60053	Protective Eyewear, Black Frame, Clear Lens



Cat. No. 80118

# 14-Piece Tool Set

Cat. No.	Description	Cat. No.	Description
D203-8	8" Long Nose Pliers Side-Cutting	605-6	1/4" Cabinet Tip Screwdriver, Heavy Duty, 6"
D213-9NETP	Side Cutting and Tape Pulling Pliers, 9"	670-6	Screwdriver, 3/16" Cabinet, Rapi-Drive®, 6"
D248-8	8" Diagonal Cutting Pliers High Leverage	86125	25-Foot Non-Magnetic Tape Measure
D502-10	Pump Pliers, 10"	5164	8-Pocket Tool Pouch Slotted
603-3	#1 Phillips Screwdriver, 3" Round Shank	5225	Adjustable PolyWeb Tool Belt
603-4B	#2 Wire Bending Phillips Screwdriver	11045	Wire Stripper/Cutter (10-18 AWG Solid)
605-4	1/4" Cabinet Tip Screwdriver 4" Shank	60056	Protective Frameless Eyewear Clear Lens



Cat. No. 80014

# 12-Piece Tool Set

Cat. No.	Description	Cat. No.	Description
5166	7-Pocket Tool Pouch	11045	Wire Stripper/Cutter (10-18 AWG Solid)
5225	Adjustable PolyWeb Tool Belt	D248-8	8" Diagonal Cutting Pliers High Leverage
603-3	#1 Phillips Screwdriver, 3" Round Shank	D203-8	8" Long Nose Pliers Side-Cutting
603-4	#2 Phillips Screwdriver 4" Round Shank	D213-9NETP	Side Cutting and Tape Pulling Pliers, 9"
605-4	1/4" Cabinet Tip Screwdriver 4" Shank	D502-10	Pump Pliers, 10"
605-6	1/4" Cabinet Tip Screwdriver, Heavy Duty, 6"	928-25HV	Tape Measure, High Visibility Case, 25-Foot



Cat. No. 5300

# 12-Piece Tool Set

Cat. No.	Description	Cat. No.	Description
D213-9NETP	Side Cutting and Tape Pulling Pliers, 9"	603-4	#2 Phillips Screwdriver 4" Round Shank
D248-8	8" Diagonal Cutting Pliers High Leverage	605-4	1/4" Cabinet Tip Screwdriver 4" Shank
D203-8	8" Long Nose Pliers Side-Cutting	661	Screwdriver, #1 Square Recess Tip, 4" Shank
D502-10	Pump Pliers, 10"	662	#2 Square Screwdriver with 4" Round Shank
11045	Wire Stripper/Cutter (10-18 AWG Solid)	5719	PowerLine™ Series 18 Pocket Electrician Tool Pouch
86375	7.5 M Double Hook Magnetic Tape Measure	5705	PowerLine™ Web Work Belt



Cat. No. 92003

# 6-Piece Tool Set

Cat. No.	Description
603-4	#2 Phillips Screwdriver 4" Round Shank
605-4	1/4" Cabinet Tip Screwdriver 4" Shank
11055	Solid and Stranded Copper Wire Stripper and Cutter
D2000-9NE	9" Pliers Heavy Duty Side-Cutting
5204	Lightweight Utility Belt Blue
5119	4 Pocket Tool Pouch 6-1/2" x 8-1/2"



Cat. No. 80006







# TRADESMAN CLUB

- Receive the Tradesman Club eNewsletter
- Be one of the first to know about Klein Tools' newest products, innovations and special deals
- Advance your knowledge by learning what works for other tradesmen
- Get the chance to win great prizes
- Participate in contests and promotions only available to Klein Tradesman Club members
- View past eNewsletter issues
- Redeem your Loyalty Rewards points for cool Klein gear

With Klein Tools Loyalty Rewards Program you earn and redeem rewards points for a variety of activities. There are now more ways than ever before to earn Loyalty Rewards points so sign up today!

## NEW PRODUCTS

Earn Loyalty Rewards Points each time you click on one of our new product links (up to 10 times per month).

## TRAINING

Earn Loyalty Rewards Points by attending a local Klein training event.

## SURVEYS

Opt-in to receive surveys, most of our surveys reward participation by giving Loyalty Rewards Points.

## NEWSLETTERS

Each newsletter, there will be a hidden link that will award Loyalty Rewards Points once clicked.

## TEST YOUR KNOWLEDGE

Watch a quick video and correctly answer the questions to earn Loyalty Rewards Points

## WHEEL OF KLEIN!

Keep an eye on your Klein Tradesman Club Active Offers, to earn spins on our new Wheel of Klein. Sign up now to get your FREE Spin!

## TRADE SHOWS/EVENTS

Visit our booth at trade shows and other events. Ask our team members about winning Loyalty Rewards Points.

Membership has its privileges!

# JOIN TODAY!

[www.kleintradesmanclub.com](http://www.kleintradesmanclub.com)