



**FORD PERFORMANCE
PARTS**

UNLEASH MORE POWER!

SUPERCHARGERS / INTAKES / PERFORMANCE EXHAUST

ENHANCED
AGILITY
HANDLING PACKS FOR
THE STREET & TRACK

PROJECT PARTS

Build the Project of Your Dreams
First-Ever Automatic Transmission
Power Modules



IT'S ALL HERE

Ford Performance Parts for Your
**MUSTANG, FOCUS, FIESTA,
F-150 and RAPTOR**

DOWNLOAD MORE PERFORMANCE

Mustang Power Packs
Put More Calibrated Gallop
in Your Stallion

GET ALUMINATED... A52XS ENGINE

580-HP A52XS Latest Member
of Aluminator Crate Engine Family



Do it well, or not at all.

AGREED.



For more than 35 years Ford Performance Parts has been producing and developing performance parts with enthusiasts in mind. Whether you are building from the ground up or working to get that extra tenth of a second, Ford Performance delivers the products you need. We're proud to offer crate engines and performance components that are designed and engineered to rigorous Ford Performance standards. They have earned their right to wear the Ford Oval.



**FORD PERFORMANCE
PARTS**

PERFORMANCEPARTS.FORD.COM



2018 PARTS CATALOG FEATURES



14 SUPERCHARGER

Superchargers from Ford Performance Parts not only deliver a significant boost in horsepower, but are Ford Performance validated, street-legal and emissions-certified as well.



15 POWER PACKS

Emissions-legal performance calibrations for Mustang GT (North America only) are offered with various levels of hardware, providing customers with more options and price points.



31 HANDLING PACKS

Assembled Handling Packs make for the perfect suspension system for drivers who demand the most from their car on the street or the track.

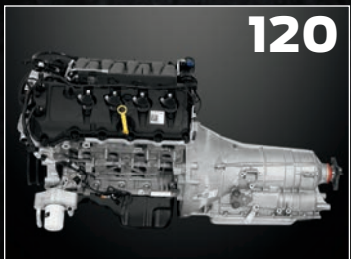

120 POWER MODULES

Power Modules are the complete powertrain solution for any Ford – in both manual and automatic transmission configurations.



126 A52XS ENGINE

Capable of producing 580 horsepower, the 5.2L Aluminator XS engine offers a high-performance aftermarket option for Mustang enthusiasts in search of enhanced powertrain options.



ON THE COVER

Ford Performance's Shelby FP350S, a turn-key race car developed to compete in Trans Am and SCCA racing classes to continue the long tradition of winning Mustangs.

TABLE OF CONTENTS

| | |
|--|--------------|
| PERFORMANCE PARTS DESIGNATION..... | 12 |
| 2015-2018 FORD MUSTANG | 13-38 |
| SUPERCHARGER KIT 670 HP..... | 14 |
| POWER UPGRADES..... | 15-16 |
| RADIATOR..... | 17 |
| OIL-AIR SEPARATORS..... | 17 |
| EXHAUST SYSTEMS..... | 18-24 |
| SHIFTER AND SHIFT KNOB..... | 25 |
| CLUTCH FLUID LINE UPGRADE..... | 26 |
| KNUCKLE KIT WITH TOE BEARING..... | 26 |
| REAR TOE LINK AND BEARING ASSEMBLY..... | 27 |
| RING GEARS AND PINIONS..... | 27 |
| RING AND PINION INSTALLATION KIT AND BOLTS..... | 27-28 |
| SEALS AND BUSHINGS..... | 28 |
| DIFFERENTIALS..... | 28 |
| AXLE HALF SHAFTS..... | 29 |
| SHOCKS AND STRUTS..... | 29 |
| SPRINGS..... | 30 |
| SWAY BAR KITS..... | 30 |
| HANDLING PACKS..... | 31-32 |
| DRIVESHAFT LOOP..... | 33 |
| STRUT TOWER BRACE..... | 33 |
| BRAKE KITS..... | 34 |
| ACCESSORIES..... | 35-37 |
| WHEELS, LUG NUTS AND CENTER CAPS..... | 37-38 |
| FORD MUSTANG | 39-73 |
| POWER UPGRADE PACKAGES..... | 39 |
| COLD AIR KITS..... | 39-40 |
| AIR FILTERS..... | 42 |
| TECH TIP – DYNAMOMETER TESTING AND CALIBRATIONS..... | 43-48 |
| TRACKEY AND TRACK CAL..... | 49-50 |
| SUPERCHARGERS..... | 50 |
| EXHAUST SYSTEMS..... | 51-53 |
| RADIATORS..... | 54 |
| WHEELS, LUG NUTS AND CENTER CAPS..... | 55-59 |
| HANDLING PACKS..... | 60-61 |
| STRUTS AND SHOCKS..... | 62 |
| SPRING KITS..... | 63-64 |
| SWAY BAR KITS..... | 65 |
| STRUT TOWER BRACES..... | 66 |
| CONTROL ARMS AND BUSHING KITS..... | 66-68 |
| BRAKE KITS..... | 69-70 |
| ACCESSORIES..... | 71-73 |
| FORD FOCUS | 74-96 |
| MP275 PERFORMANCE UPGRADE..... | 75 |
| INTERCOOLER UPGRADE..... | 76 |
| LOW RESTRICTION INTAKE KIT..... | 76 |
| HIGH-FLOW INDUCTION HOSE..... | 77 |
| CHARGE PIPE UPGRADE KIT..... | 77 |
| LOWER INTERCOOLER PIPE UPGRADE..... | 78 |
| SPARK PLUGS..... | 78 |
| COLD AIR KITS..... | 78-80 |
| FR1 POWER UPGRADE PACK..... | 79 |
| CALIBRATION WITH SPARK PLUGS..... | 79 |
| BOOST HOSE KIT..... | 80 |
| COOLANT HOSE KITS..... | 80-81 |
| AIR FILTER AND AIR FILTER END CAP..... | 81 |
| UPRATED AIR RECIRCULATION VALVE..... | 82 |
| OIL CONTROL SYSTEM..... | 82 |
| SOUND SYMPOSER DELETE KIT..... | 82 |
| 2.0L I4 ENGINES..... | 83 |
| CONTROL PACKS..... | 83 |
| FUEL INJECTOR UPGRADE SET..... | 84 |
| ROLL RESTRICTOR/REAR MOTOR MOUNT..... | 85 |
| RADIATOR UPGRADE..... | 84 |
| SHIFTERS, SHIFT KNOBS AND SHIFT BOOT..... | 85-86 |
| DIFFERENTIAL AND INSTALLATION KIT..... | 86 |
| STRUT TOWER BRACE..... | 87 |
| BRAKE KITS, BRAKE HOSES AND COOLING DEFLECTOR..... | 87 |
| SUSPENSION KITS, SHOCKS AND STRUTS..... | 88 |
| SPRING KITS..... | 89 |
| EXHAUST SYSTEMS..... | 89-90 |
| ACCESSORIES..... | 90-91 |
| WHEELS AND CENTER CAP..... | 91-92 |
| FOCUS RS HIGH-FLOW INDUCTION KIT AND HOSE..... | 93 |
| FOCUS RS CHARGE PIPE UPGRADE KIT..... | 93 |
| FOCUS RS AIR RECIRCULATION VALVE..... | 94 |
| FOCUS RS SOUND SUPPRESSION CHAMBER..... | 94 |
| FOCUS RS SHORT THROW SHIFTER..... | 94 |
| FOCUS RS DIFFERENTIAL..... | 95 |
| FOCUS RS PTU BRACE UPGRADE..... | 95 |
| FOCUS RS BRAKE HOSE SET..... | 95 |
| FOCUS RS SPORT SPRING SET..... | 95 |
| FOCUS RS EXHAUST SYSTEM..... | 96 |
| FOCUS RS SPOILER KIT..... | 96 |
| FOCUS RS WHEEL, LUG NUTS AND CENTER CAP..... | 96 |

| | |
|--|----------------|
| FORD FIESTA | 97-106 |
| MP215 PERFORMANCE UPGRADE..... | 98 |
| INTERCOOLER UPGRADE..... | 98 |
| SOUND SYMPOSER DELETE KIT..... | 98 |
| CHARGE PIPE UPGRADES..... | 99 |
| INDUCTION UPGRADE KITS..... | 100 |
| AIR FILTERS..... | 101 |
| COOLANT HOSE KIT..... | 101 |
| BOOST HOSE KIT..... | 101 |
| ROLL RESTRICTOR/REAR MOTOR MOUNT..... | 101 |
| EXHAUST SYSTEMS..... | 102 |
| SHIFTERS..... | 103 |
| DIFFERENTIAL AND INSTALLATION KIT..... | 104 |
| HANDLING PACK..... | 105 |
| SPORT SPRING SET..... | 105 |
| STRUT TOWER BRACE..... | 105 |
| LOWER CHASSIS BRACE..... | 105 |
| BRAKE LINE KIT AND BRAKE HOSES..... | 106 |
| LOWER FRONT SPLITTER..... | 106 |
| WHEEL CENTER CAP..... | 106 |
| FORD TRUCKS | 107-118 |
| 6.7L TURBO KIT..... | 108 |
| 6.7L INJECTOR NOZZLE AND PUMP KIT..... | 108 |
| 3.5L TWIN TURBO UPGRADE KIT..... | 108 |
| LIGHTNING MASS AIR METER..... | 108 |
| LOWERING KITS..... | 108 |
| WHEELS, LUG NUTS AND BEAD LOCK RING KITS..... | 109 |
| RAPTOR FRONT SKID PLATE..... | 110 |
| STEERING WHEEL KITS..... | 110 |
| EXHAUST SYSTEMS..... | 111-117 |
| AUXILIARY LIGHT BARS..... | 118 |
| TAURUS SHO EXHAUST SYSTEM..... | 118 |
| FORD PERFORMANCE ENGINES | 119-209 |
| CRATE ENGINES – COYOTE MODULAR AND COMPONENTS | 120-144 |
| 5.0L COYOTE POWER MODULES..... | 120-121 |
| COYOTE MODULAR CRATE ENGINES..... | 122-126 |
| 5.0L COYOTE CONTROL PACKS AND WIRING HARNESSSES..... | 127-128 |
| COYOTE ENGINE BLOCKS..... | 129-133 |
| COYOTE BLOCK HARDWARE..... | 134 |
| COYOTE MOTOR MOUNTS..... | 134 |
| COYOTE FORGED CRANKSHAFTS..... | 134 |
| COYOTE GEROTOR OIL PUMP..... | 134 |
| COYOTE OIL PUMP INSTALLATION KIT..... | 135 |
| COYOTE RACE OIL PAN..... | 135 |
| COYOTE OIL LINE AND OIL FILTER ADAPTORS..... | 135 |
| OIL COOLER..... | 135 |
| CAMSHAFT SETS AND CAMSHAFT DRIVE KITS..... | 136 |
| COYOTE CYLINDER HEADS..... | 137 |
| CYLINDER HEAD CHANGING KITS..... | 138 |
| COYOTE ROLLER FINGER FOLLOWER KITS..... | 139 |
| COYOTE LASH ADJUSTER KIT..... | 139 |
| VALVES AND VALVE SPRING KIT..... | 139 |
| COYOTE TIMING CHAIN TENSIONERS..... | 140 |
| INTAKE MANIFOLDS AND INSTALLATION KIT..... | 140 |
| COYOTE COLD SPARK PLUG SET..... | 141 |
| COYOTE COIL COVERS..... | 141-142 |
| COYOTE FRONT AND CAM COVERS..... | 141 |
| COYOTE ENGINE COVER KITS..... | 142 |
| ENGINE COMPARTMENT CAP COVER KIT..... | 142 |
| ENGINE DRESS-UP KIT..... | 142 |
| CAM COVER BALL STUD KIT..... | 142 |
| COYOTE ENGINE IGNITION COIL SET..... | 143 |
| AUTO TRANS FLEXPLATE AND BOLTS..... | 143 |
| ALTERNATOR KIT..... | 143 |
| HIGH TORQUE MINI-STARTER..... | 143 |
| COYOTE HIGH-RPM COMPETITION PULSE RING..... | 143 |
| PERFORMANCE COOLING FAN..... | 144 |
| POWER STEERING PUMP BRACKET..... | 144 |
| WATER PUMPS..... | 144 |
| INTERCOOLER PUMP KIT..... | 144 |
| COYOTE AIR CONDITIONING KIT..... | 144 |
| CRATE ENGINES – MODULAR AND COMPONENTS | 145-160 |
| MODULAR SHORT BLOCKS AND BLOCKS..... | 145-146 |
| ENGINE MOUNT BRACKETS..... | 146 |
| PLUG AND DOWEL KITS..... | 147 |
| MAIN CAP BOLT KIT..... | 147 |
| HIGH-VOLUME OIL PUMPS AND PICKUP TUBES..... | 147-148 |
| COBRA JET CRANKSHAFT..... | 147 |
| CRANKSHAFT DAMPER..... | 147 |
| CAMSHAFT DRIVE KITS..... | 148 |
| HEAD CHANGING KITS..... | 149 |
| CAMSHAFT SETS AND CAMSHAFT BOLTS..... | 150 |
| ROCKER ARM SET AND LASH ADJUSTERS..... | 150 |
| TIMING CHAIN TENSIONER KIT..... | 150 |
| INTAKE MANIFOLDS..... | 151 |
| EXHAUST MANIFOLD GASKETS..... | 151 |
| A/C ELIMINATOR KIT..... | 151 |

TABLE OF CONTENTS

| | | | |
|--|----------------|--|----------------|
| SPARK PLUG WIRES..... | 152 | TIMING COVER..... | 200 |
| 3-VALVE COLD SPARK PLUG SETS..... | 153 | SPARK PLUG WIRES..... | 200 |
| IGNITION COIL SETS..... | 153 | CRATE ENGINES – PUSH ROD I4 | 201-209 |
| COIL COVERS..... | 154 | 1.6L 4-CYLINDER BLOCK..... | 201 |
| CAM COVERS..... | 154 | 4-CYLINDER VALVE COVER..... | 201 |
| INTAKE SHROUD..... | 154 | NASCAR ENGINE PARTS..... | 202-203 |
| 2.0L I4 ENGINE KIT..... | 155 | ENGINE AND BLOCK SPECS AND DIMENSIONS..... | 205-209 |
| 2.0L ECOBOOST CONTROL PACK..... | 155 | ENGINE ELECTRONICS/FUEL INJECTION | 210-226 |
| 2.0L ECOBOOST ENGINE ORIENTATION KIT..... | 156 | CONTROL PACKS AND WIRING HARNESSES..... | 211-215 |
| 2.0L ECOBOOST CYLINDER HEAD..... | 156 | TECH TIP – SELECTING EFI COMPONENTS/SYSTEM TIPS..... | 216-222 |
| 2.0L ECOBOOST COLD SPARK PLUG SET..... | 156 | FUEL INJECTORS..... | 223 |
| 2.3L MUSTANG ECOBOOST CRATE ENGINE..... | 157 | THROTTLE BODIES..... | 224-225 |
| 2.3L ECOBOOST CONTROL PACK..... | 157 | MAF HOUSING AND TUNER KIT..... | 226 |
| 2.3L MUSTANG ECOBOOST CYLINDER BLOCK..... | 158 | FUEL PUMPS..... | 226 |
| 2.3L ECOBOOST CYLINDER HEAD..... | 158 | GT500 RESONATOR ELIMINATOR KIT..... | 226 |
| 2.3L ECOBOOST CRANKSHAFT..... | 159 | F-150 LIGHTNING MASS AIR METER..... | 226 |
| 2.3L ECOBOOST HIGH-PERFORMANCE CAMSHAFTS..... | 159 | DRIVELINE COMPONENTS | 227-245 |
| 2.3L BALANCE SHAFT BLOCK-OFF PLUG..... | 159 | TRANSMISSIONS..... | 228-230 |
| 3.5L V6 ECOBOOST ENGINE KIT..... | 160 | TECH TIP – TRANSMISSION/CLUTCH INSTALLATION..... | 228 |
| 3.5L ECOBOOST CONTROL PACK..... | 160 | TRANSMISSION COOLER AIR SCOOP..... | 230 |
| PUSH ROD CRATE ENGINES AND COMPONENTS | 161-194 | TRANSMISSION MOUNT..... | 230 |
| PUSH ROD CRATE ENGINES, SMALL BLOCK..... | 162-167 | BEARING RETAINER, T-5..... | 230 |
| SEALED RACING CRATE ENGINES..... | 168-169 | TRANSMISSION REBUILD KIT, T-5..... | 230 |
| SHORT BLOCK ASSEMBLIES..... | 170-172 | TRANSMISSION DIPSTICKS AND TUBES..... | 231 |
| ENGINE BLOCKS..... | 173-175 | SHIFTERS AND SHIFT KNOBS..... | 231 |
| CYLINDER SLEEVES..... | 173 | BELLHOUSINGS AND INSTALLATION KIT..... | 232 |
| PLUG AND DOWEL KITS..... | 176 | STARTER INDEX PLATES..... | 233 |
| CAMSHAFT BEARINGS..... | 176 | RING GEAR BOLT SETS..... | 233 |
| CYLINDER HEAD STUD AND BOLT KITS..... | 177 | FLYWHEEL BOLT SET..... | 233 |
| CAMSHAFT RETAINER PLATES..... | 177 | PRESSURE PLATE BOLT AND DOWEL KITS..... | 233 |
| CRANKSHAFT..... | 178 | FLYWHEELS..... | 234-235 |
| CRANKSHAFT DAMPERS AND SPACERS..... | 178 | CLUTCH KITS..... | 236 |
| OIL PUMPS..... | 179 | THROWOUT BEARING..... | 236 |
| OIL PUMP DRIVESHAFTS..... | 179 | ROLLER PILOT BEARINGS..... | 236 |
| OIL PANS..... | 179-180 | CLUTCH LINKAGE KITS..... | 237 |
| OIL PICKUP TUBES..... | 179-180 | CLUTCH ADJUSTERS..... | 237 |
| OIL PAN REINFORCEMENT RAILS..... | 181 | CLUTCH FLUID LINE UPGRADE..... | 237 |
| OIL FILTERS..... | 181 | AXLE GIRDLE COVERS..... | 239 |
| OIL FILTER ADAPTER..... | 181 | AXLE INSTALLATION KIT..... | 239 |
| OIL DIPSTICK AND TUBE..... | 181 | KIT CAR IRS HUB, BEARING AND KNUCKLE SET..... | 239 |
| CYLINDER HEADS..... | 182, 184 | PINION NUT, UNIVERSAL..... | 239 |
| INTAKE AND EXHAUST VALVES..... | 183-184 | RING GEAR AND PINION SETS..... | 240 |
| VALVE GUIDE KIT..... | 183 | PINION FLANGES..... | 240 |
| VALVE STEM SEALS..... | 183 | RING AND PINION INSTALLATION KITS..... | 240-241 |
| VALVE PUSH ROD GUIDE PLATES..... | 184-185 | AXLE BEARING AND SEAL KITS..... | 241 |
| ROCKER ARM STUDS..... | 185 | DIFFERENTIAL REBUILD KITS, TRACTION-LOK..... | 241 |
| VALVE SPRINGS AND VALVE SPRING RETAINERS..... | 185 | DIFFERENTIALS..... | 242, 244 |
| CAMSHAFTS..... | 186 | DIFFERENTIAL FRICTION MODIFIER..... | 242 |
| ROLLER CAMSHAFT CONVERSION KIT..... | 187 | 9.75" DIFFERENTIAL COVER..... | 242 |
| ROLLER CAM LIFTERS..... | 187 | PINION SEAL..... | 242 |
| LIFTER PUSH ROD CUP..... | 187 | SPEEDOMETER ADJUSTER..... | 243 |
| TIMING CHAIN AND SPROCKET SETS..... | 187-188 | PINION BEARING RETAINER..... | 244 |
| ROCKER ARM PEDESTAL SHIM KIT..... | 188 | RING GEAR TO DIFFERENTIAL CASE BOLT..... | 244 |
| ROCKER CHANNEL KIT..... | 188 | DIFFERENTIAL BEARING ADJUSTER LOCK AND BOLT KIT..... | 244 |
| VALVE PUSH RODS..... | 188 | 5-LUG REAR DISC BRAKE KIT..... | 244 |
| ENGINE GASKETS AND SEALS..... | 188-190 | DRIVESHAFTS..... | 245 |
| INTAKE MANIFOLDS..... | 191 | DRIVESHAFT SLIP YOKES..... | 245 |
| INTAKE MANIFOLD GASKETS..... | 190-191 | DRIVESHAFT LOOP, COBRA JET..... | 245 |
| EFI HEAT SPACERS..... | 191 | U-JOINT KIT..... | 245 |
| WATER PUMPS..... | 192 | APPEARANCE AND DRESS-UP | 246-262 |
| THERMOSTAT HOUSING..... | 192 | GAUGES..... | 247-248 |
| TIMING CHAIN COVER..... | 192 | VALVE COVERS..... | 249-252 |
| PULLEY SETS..... | 193 | AIR CLEANERS..... | 253 |
| CRANKSHAFT PULLEY SPACERS..... | 193 | BREATHER CAPS AND GROMMETS..... | 253 |
| IDLER BRACKET..... | 193 | OIL FILL CAP COVER..... | 253 |
| A/C ELIMINATOR KITS..... | 193-194 | INTAKE PLAQUES, COBRA..... | 253 |
| ACCESSORY DRIVE KITS..... | 194 | MUSTANG HOOD LIFT KIT..... | 259 |
| SPARK PLUG WIRE SETS..... | 194 | HOOD LATCH AND PIN KITS..... | 259 |
| STARTERS..... | 194 | WIRE LOOMS..... | 259 |
| CRATE ENGINES – PUSH ROD BIG BLOCK AND COMPONENTS | 195-200 | IGNITION COIL BRACKET..... | 259 |
| CYLINDER BLOCK, BIG BLOCK..... | 195 | DISTRIBUTOR HOLD-DOWN CLAMP..... | 259 |
| PLUG AND DOWEL KIT..... | 195 | FENDER COVERS..... | 260 |
| ENGINE MOUNTS..... | 195 | TRACK MAT..... | 260 |
| CYLINDER HEADS..... | 196 | EMBLEMS FOR DECK LIDS, FENDERS AND GRILLES..... | 260-261 |
| INTAKE AND EXHAUST VALVES..... | 197 | LICENSE PLATES AND LICENSE PLATE FRAME..... | 261 |
| VALVE PUSH ROD GUIDE PLATE..... | 197 | TIRE SHADE, "FORD PERFORMANCE"..... | 261 |
| ENGINE GASKETS..... | 197 | BANNERS AND PENNANTS..... | 262 |
| 460 INTAKE MANIFOLD..... | 197 | DECALS..... | 262 |
| CAMSHAFT BEARINGS..... | 198 | TENT, "FORD PERFORMANCE"..... | 262 |
| TIMING CHAIN AND SPROCKET SETS..... | 198 | ACCESSORIES AND APPAREL | 263-290 |
| CRANKSHAFT DAMPER AND DAMPER SPACER..... | 198 | FORD CUSTOM ACCESSORIES..... | 264-282 |
| HIGH-VOLUME OIL PUMP..... | 198 | ACCESSORIES AND APPAREL, FORD MERCHANDISE..... | 284-289 |
| OIL PUMP DRIVESHAFT..... | 198 | FORD PERFORMANCE DEALER LIST | 291-294 |
| OIL PAN KITS..... | 199-200 | FORD PERFORMANCE LIMITED WARRANTY | 295-302 |
| OIL PICKUP TUBES..... | 199 | SUGGESTED RETAIL PRICE LIST | 303-309 |
| OIL PAN GASKET..... | 200 | PARTS INDEX | 310-316 |
| REAR MAIN OIL SEAL..... | 200 | | |
| WATER PUMP BACKING PLATE..... | 200 | | |

OUR PILLARS OF PERFORMANCE

We've been involved in racing for more than a century, so, when it comes to performance, there's a lot of know-how baked into our DNA. In 1901, when Henry Ford entered his car, "Sweepstakes," in a high-profile race, he was up against a formidable rival – Alexander Winton, one of the best-known and most successful racers and car builders of the time. To perhaps give his underpowered car an advantage, Ford came up with ceramic spark insulation to prevent fouling. His victory set him on a course to establish Ford Motor Company two years later, and established our mindset about innovation through performance that endures today.

We love to win – always have; that's what competition is all about. And, we especially love it when you win, whether that means winning a race or owning a Ford vehicle that exceeds your aspirations and satisfies your passion for performance.

Our philosophy for success is built on four pillars that encompass every aspect of performance, including every conceivable type of performance vehicle, to the parts needed to build or modify them and the engineering that goes into them, to the most important part, you, the performance enthusiasts who love your Ford vehicles.

1. PERFORMANCE CARS

Ford has a long history of creating performance variants of its vehicles. In the early days, it was primarily aftermarket companies that offered parts for "hopping up" cars like the Model T, and later the Ford V8s of the 1930s, '40s and early '50s. In the Total Performance decade of the 1960s, however, actual production performance variants began appearing in dealer showrooms. These cars are the lifeblood of enthusiast communities around the world who enjoy performance cars, and driving them.

Ford GT

The Ford GT supercar, launched in 2016, is today's pinnacle product of Ford Performance. From the beginning, the car was developed with racing in mind, specifically, the world of GT racing and its premiere event, the 24 Hours of Le Mans, in which Ford scored its first victory in 1966 with the GT40 Mk II. At the forefront in the Ford GT's engineering innovations were advanced aerodynamics for outstanding downforce with minimal drag, advanced lightweight materials for a very



Ford GT



From left: Focus ST, Focus RS, Ford GT, F-150 Raptor, GT350, Fiesta ST

rigid but also very lightweight chassis, and advancements in the power and efficiency of EcoBoost® engine technology. Innovations in these areas provide benefits for both the Ford GT race car and the production car, and ultimately for every vehicle in the Ford lineup.

The Ford GT features a mid-mounted engine with rear-wheel drive and an aerodynamic, two-door coupe body shell. It has the most powerful EcoBoost® production engine ever – a next-generation twin-turbocharged EcoBoost® V6 producing more than 600 horsepower. The Ford GT makes extensive use of lightweight materials, including carbon fiber and aluminum, which helps enable outstanding acceleration and handling.

Mustang Performance Variants

Two of the best known of the 1960s performance variants are the original Shelby GT350 Mustang and the BOSS 302 Mustang, and there have been many, many since.

Of course, advances can never stop or let up. Today's Shelby GT350 Mustang is a 21st century creation of the original, with the same performance goals achieved with the most advanced technologies. The 2017 GT350 ranks as the most track-capable production Mustang ever (also the primary goal of the 1965 original), and its 526 hp, 5.2-liter V8 with 429 lb.-ft. of torque is the most powerful naturally aspirated Ford production V8 ever. The current GT350's R model takes performance one step further, being equipped for extra-serious racetrack use.

Focus ST

The Focus ST, launched in 2012, was created by Ford Team RS, the European arm of Ford's Global Performance Vehicle group. Their goal was to produce a performance hatchback with superb driving dynamics, and indeed to improve the entire driving experience.

Modifications for accomplishing that goal included specially tuned springs and shock absorbers that deliver

sharper dynamic performance – with a 2.0-liter EcoBoost® engine with 252 hp and 270 lb.-ft. of torque – and interior and exterior designs with a performance look, feel and function. The Focus ST was immediately acclaimed as a fun-to-drive car that brought the best of European compact-car driving dynamics to North America.

Fiesta ST

Like its larger Focus sibling, the Ford Fiesta ST delivers everything enthusiasts could want in compact car performance. The 1.6-liter EcoBoost® engine produces a potent 197 hp and 202 lb.-ft. of torque, and delivers the performance feel of a much larger engine. With the ST's lower center of gravity and ride height versus standard Fiesta, along with its precision sport-tuned suspension and braking system and three-mode electronic stability control, the Fiesta ST packs more than its share of fun-to-drive character. Ford Performance provides even more for all these small car variants, in the form of parts and accessories to personalize your car and tweak its tuning to suit your desires. These include power upgrade packs, handling packs, exhaust systems, brake kits, and much, much more.

Focus RS

Ford's "RS" performance nameplate is well-known in Europe, with its long, distinguished heritage that began with the all-conquering Ford Escort RS series in the 1970s and '80s that won eight consecutive British Rally Championships from 1971 through 1978, and World Rally Championships in 1979 and 1981.

The new Focus RS marks the first North American appearance of the badge. Its unique, 2.3-liter EcoBoost® engine produces a remarkable 350 horsepower and 350 lb.-ft. of torque, and its new Ford Performance all-wheel-drive system provides an exceptional level of handling capability.



F-150 Raptor

F-150 Performance Variants

For much of the past century, the idea of a “performance truck” was laughable. Trucks were for load hauling, for work. All that has changed during the past couple of decades, after Ford brought the performance-truck idea to life in 1993 with the first SVT F-150 Lightning.

The longest-running performance arena for trucks, however, is off-road racing, which gained prominence in the 1960s when the Baja 1000 caught the world’s imagination. Over the years there have been plenty of production 4-wheel-drive vehicles on the market, with varying degrees of off-road capability, but never a true off-road performance production vehicle until the 2010 SVT F-150 Raptor. It was designed not just to handle the rough stuff, but to do it at speed – a true, race-proven desert pre-runner.

The 2017 F-150 Raptor is the latest iteration of that concept, with its extensive use of lightweight, military-grade aluminum that reduces weight by some 500 pounds, and the most advanced powertrain, transfer case and suspension ever found in an F-150.

2. PERFORMANCE PARTS AND RACE CARS

More than 115 years have passed since Henry Ford’s innovative ceramic spark insulation helped him win that pivotal race in 1901. The world has changed, but in the car business, performance still is a vital ingredient, and always will be. Today’s Ford Performance Parts operations had modest beginnings when Ford Special Vehicle Operations (SVO) was launched in 1981. Over time, the range of parts offerings widened and grew, as did advances in engineering methods, materials and technologies. The performance enthusiast’s “must-have” equipment list changed and grew. Items like MAF sensors and control packs began appearing in the performance parts catalogs.

Today, you can “personalize” almost any aspect of your Ford vehicle with our wide-ranging lineup. There is everything from nuts, bolts and gaskets to superchargers, calibration tools, crate engines and turn-key race cars.

Only a major OEM can apply the engineering knowledge and resources that go into making these performance parts. Also, Ford Performance engineers are enthusiasts, gear-heads and racers. They know what it takes to produce a winning combination, and have the experience, skills and assets to do it right.

Another big advantage is Ford Performance’s collaboration with the mainstream vehicle engineering teams. The engineers tap into all that data and knowledge then they apply development and testing processes on the high-performance parts and vehicles. The result: Products developed, tested and engineered to rigorous Ford Performance standards, which gives you the performance, reliability and durability that adds up to tremendous value.



Mustang Shelby FP350S



Cobra Jet



Mustang GT4

Purpose-Built Race Cars

Ford Performance's purpose-built, production-based race cars are ready for the track, and offer turn-key solutions for people who want to go racing. They are a natural extension of the Ford Performance parts program – the ultimate parts cars.

Ford Performance began engineering and producing turn-key race cars in 2003-2004, developing the Mustang FR500C that made its debut in the 2005 season of the Grand Am Cup's GS class. The result was a sweep of the GS driver, manufacturer and team championships.

Mustang Shelby FP350S

In December 2016, Ford Performance introduced its new Shelby FP350S at the Performance Racing Industry trade show in Indianapolis. The car is designed for road racing in Trans Am, NASA and SCCA club racing. This car, too, is based on the championship-winning Shelby GT350R-C, and is delivered ready to race.

This vehicle is the successor to the BOSS 302S that won 3 Pirelli World Challenge Manufacturer's Championships in addition to several SCCA Touring Championships.

Mustang GT4

The new Mustang GT4 was unveiled in November 2016 at the SEMA show in Las Vegas. It is based on the Shelby GT350R-C, which won the GS class championship in the 2016 IMSA Continental Tire SportsCar Challenge – its first full season of competition. The GT4 features a 5.2-liter V8 and 6-speed Holinger paddle-shift transmission, and is ready for any GT4 series in the world.

2016 Cobra Jet

The modern Cobra Jet program started with 50 cars for the 2008 model year, and continued with 50-unit builds in 2010, 2012, 2013 and 2014. Like its predecessors, the 2016 Cobra Jet is legal for National Hot Rod Association Stock and Super Stock drag racing, as well as in several other drag racing organizations.

The Cobra Jet's engine is made up of 75 percent production Mustang GT components, topped by a front-inlet Whipple™ supercharger. Ford Performance believes it is important to use production hardware wherever possible, because it ensures that parts are readily available and reasonably priced for racers, and the production parts also are highly durable because they passed rigorous dyno and drag strip testing.

3. PROFESSIONAL RACING

Ford's diversity of product lines appeal to equally diverse groups of people. And, since many of our product lines have nameplates involved in racing, it only makes sense to appeal to as many of their fans as we can – fans of stock car racing, drag racing, road racing, rally, action sports and off-road racing – and give them a Ford flag to rally around.

There's also our racing heritage spanning more than 115 years that infuses our thinking and our work ethic. It's a global heritage, with success stories going back to the 1930s, when a Ford V8 won the Monte Carlo Rally ... the four consecutive GT40 wins at Le Mans in the 1960s ... the all-conquering DFV Formula 1 engine from the late 1960s to the early 1980s ... the hugely successful European Escort RS rally cars of the same period ... up to today's Focus and Fiesta RS competitors. Add in more than 600 wins in

NASCAR® and more than 200 wins in NHRA®, it all makes Ford the only manufacturer that has had as much impact and success in motorsports around the globe.



2017 Daytona 500 win



1966 Ford GT win at Le Mans

Technology Transfer – Both Ways

It is also vital that, where appropriate, our current production technology has a racing connection. That's why EcoBoost® is in racing. The technology benefits everyday motorists and racers alike: great combination of power and fuel efficiency.

It started with Formula Ford racing in Europe, and is spreading around the world in that venerable open-wheel class. EcoBoost® definitely elevates Formula Ford into the 21st century, with newly minted F-150 Raptor and Focus RS owners joining club events across the country.

Victory at Le Mans

EcoBoost® also was front and center on (and in) the racing version of the Ford GT – an FIA GT-class car that, in 2016, began racing in the FIA World Endurance Championship and IMSA's WeatherTech SportsCar Championship. Two, two-car Ford GT teams were both fielded by Chip Ganassi Racing with Felix Sabates, with one two-car team running each series.

The biggest race of the year was the 24 Hours of Le Mans, round three of the World Endurance Championship.

All four cars from both teams ran at Le Mans, and finished first, third, fourth and ninth in the LMGTE Pro class. It was a historic victory, on the 50th anniversary of Ford's first Le Mans victory in 1966.



Ken Block Focus RS WRX

4. GRASS-ROOTS RACING AND THE PERFORMANCE COMMUNITY

Professional racing is our most visible involvement, but supporting the grass-roots levels of racing is no less important, because they involve very large numbers of competitors who carry the Ford banner and are opinion influencers. We support them with contingency awards for performance in their series, with technical information and advice, and with the availability of performance parts that help to make their race vehicles more competitive.

Performance Driver Training

Great racing and performance vehicles are at their best with a skilled driver behind the wheel, so Ford Performance supports a variety of racing and performance-driving schools. They amount to a multifaceted "performance university" for people who want to elevate their skills and experience to a higher level.

For rally drivers, or anyone who wants to experience the excitement of doing it in the dirt, there's Team O'Neil's Fiesta Rally Experience. At the Utah Motorsports Campus there are several programs: The Ford Performance Driving School is for anyone who wants to improve vehicle control or road racing skills, while the Raptor Assault Experience is for off-road and desert performance driving. Also at the UMC are the GT350 Track Attack, exclusively for Shelby GT350 owners, the ST Octane Academy with programs for owners of the Fiesta ST and Focus ST, and the RS Adrenaline Academy for owners of the awesome Focus RS. Finally, the Roy Hill Drag Racing School develops the skills of controlling enormous straight-line power.

These are opportunities for drivers to learn and explore the limits of their own vehicles, and to learn the skills and techniques required to drive those vehicles safely and well.

Performance Community

Grass-roots racing is just one part of a very large community of performance enthusiasts. It encompasses people involved with show cars and show events, vintage street cars and race cars, street-rods, plus car owner clubs and car collectors. They all are part of it. And there's nothing quite as satisfying as talking with and/or learning from a person who shares your passion for performance. Since your loyalty as a Ford enthusiast is very, very important to us, we have ongoing initiatives to help nurture these communities of performance-minded people, and strengthen our relationship with the Ford enthusiast clubs.

One initiative is our toll-free 1-800-FORD-788 Ford Performance Info Center and Techline, where you can get vehicle, product, club and event information – and even expert technical advice on Ford Performance engines and hardware.

In the Enthusiasts section of FordPerformance.com there's a listing of independent clubs whose members can now enjoy a variety of benefits beyond having an online information clearinghouse. Thanks to all those years of working with enthusiasts at the grass-roots level, Ford Performance is able to offer these clubs what they had said they wanted the most: a sustainable connection with the company.



2017 Woodward Dream Cruise



GT350 Track Attack

At Ford Performance, we're focused on more than just winning and innovating (for us and for you). In 1901, Henry Ford came up with ceramic spark insulation, which certainly helped him win, and it also turned out to be an enduring contribution to automotive technology. But from all accounts he did it because that was just the way his mind worked – see a problem, find the right solution. For him, it was the natural thing to do. That's an enduring legacy, especially here at Ford Performance. It's just the way we do things.



Ford Performance Parts staff



FORD PERFORMANCE

Instructions

Ford Performance Parts Digital Resources

- Instructions can also be downloaded from the Ford Performance Parts website:

performanceparts.ford.com/instruction-sheets/

- Other engine and installation Tech Tips can be downloaded from the Ford Performance Parts website at:

performanceparts.ford.com/engine-building-tips/

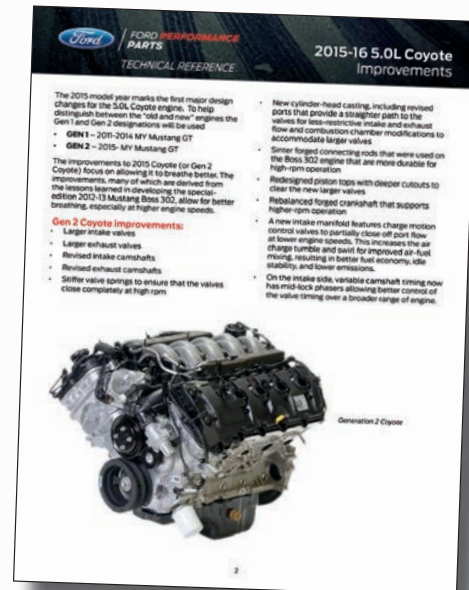

Ford Performance Techline

800-FORD788

(800-367-3788)

International Calls Dial 313-621-0771

8:30 am to 5:00 pm EST Monday-Friday



FORD PERFORMANCE

Techline

800-367-3788



International Calls Dial 313-621-0771
8:30 am to 5:00 pm EST Monday-Friday

Ford Performance Techline experts have the answers and information needed to get your Ford Performance components installed and running.

- Access to a large database of specifications
- Staffed by hands-on enthusiasts and racers
- Over 80 years of collective experience with Ford Performance Parts



FORD PERFORMANCE

PERFORMANCE PARTS DESIGNATIONS



As a leading manufacturer of performance parts, Ford Motor Company recognizes a special responsibility regarding environmental concerns. Ford Performance is committed to a program of performance parts development that allows motorsport enthusiasts to modify their vehicles and meet emission requirements.

Using guidelines established by the State of California for aftermarket parts used in vehicles driven on public highways, this catalog identifies parts that are acceptable for use on emission-controlled motor vehicles using the "50-States Street Legal" logo pictured below. Parts without the logo are intended for off-road and competition purposes only.

PARTS WITH



"Street Legal" by Executive Order

These add-on or modified parts are considered "Street Legal" because they have an Executive Order from the State of California. Ford Performance has demonstrated through emission testing that the use of these parts does not adversely affect vehicle emissions of production vehicles with certified emission control systems.

PARTS WITHOUT



These parts do not have an Executive Order from the State of California and are not considered "Street Legal."

IMPORTANT NOTICE

This catalog primarily lists special performance parts, many of which are designed for off-highway use only. U.S. and Canadian laws and regulations prohibit removal of or tampering with components installed on production vehicles to meet emission requirements or to comply with motor vehicle safety regulations applicable to vehicles manufactured for use on public roads. Customers are advised that vehicles equipped with parts designated for "off-highway use" should not be operated on public roads. Ford offers such parts only for track or off-highway or competitive performance use. Such parts have a special "warning" label (see insert at right). All parts in this catalog without the "50-States Street Legal" logo pictured above are included in this designation.

FUTURE DEVELOPMENTS

While many Ford Performance parts have no application for cars driven on public highways, Ford Performance continues to develop, analyze and test additional engine and powertrain parts with the goal of making them "Street Legal." Ford's vision is to provide products meeting all of our various customers' needs while remaining environmentally responsible.

For more information, call the Ford Performance Techline at (800)367-3788.

WARNING:

This part has been designed and is intended for off-highway application only. Installation of this part on a vehicle that is driven on public roads may violate U.S. and Canadian laws and regulations relating to emission requirements and motor vehicle safety standards. In addition, installation of this part may adversely affect the warranty coverage on your vehicle.

FORD MUSTANG



2015-2018 MUSTANG

2015-2017 MUSTANG GT SUPERCHARGER KIT 670 HP



M-6066-M8627*

- Fits 2015-2017 Mustang GT with manual or automatic transmission
- 670 hp at approximately 9 psi of boost with 93 octane fuel
- All customers who purchased the kit at 627 hp please contact the Ford Performance Techline at 800-367-3788 if you have NOT received your calibration upgrade to 670 hp
- Kit comes complete with all hardware for install
- Exclusive calibration 50-state emissions legal
- Developed with ROUSH® Performance
- Calibration does not support adaptive cruise

Kit includes:

- 2.3L Twin Vortices Series (TVS) Supercharger Assembly. The R2300 Supercharger features new TVS technology. The new TVS features new four-lobe rotors and high-flow inlet and outlet ports that greatly enhance thermal efficiency, enabling greater volumetric capacity at higher revolutions per minute (rpm)

- Lower intake manifold
- Dual 60 mm electronic throttle body
- Air inlet system
- Fuel rails
- Complete air-to-liquid intercooler system includes pump, heat exchanger and reservoir
- Drive belt: FEAD 6-rib system
- 47 lb/hr, 6-hole, high-impedance fuel injectors
- Ford Performance ProCal tool (requires laptop and internet access) with performance calibration for significantly improved throttle response and performance feel

NOTE: Powertrain calibrations are developed and supported for U.S. and Canadian vehicles only. Federal and state laws prohibit any person from installing aftermarket add-on or modified parts prior to the sale of a new motor vehicle.



2015-2017 MUSTANG GT SUPERCHARGER RIGHT HAND DRIVE CLOSE OUT PANEL KIT

M-9066-M8RHD

The Ford Performance Right Hand Drive (RHD) modification kit for the M-6066-M8627 Supercharger Kit allows owners of RHD 2015-2017 Mustang GT with 5.0L V8 engines the ability to infuse their Mustang with up to 670 horsepower. This kit is only needed for RHD 2015-2017 Mustang, and only contains the additional parts needed to install the 670 hp kit on factory built RHD Mustang.

Kit includes:

- RHD closeout foam seal
- 27 mm constant tension clamp – black
- 19 mm x 19 mm connector (3/4" x 3/4")
- Battery closeout foam seal

- RHD brake aspirator extension
- Grille to fascia fasteners
- 5.6 mm (7/32") bypass hose
- Installation instructions

Applications:

- 2015-2017 Mustang GT 5.0L V8 Coupe RHD models – manual & automatic
- 2015-2017 Mustang GT 5.0L V8 convertible RHD models – manual & automatic



*This component is eligible for the Ford Performance Parts Limited Warranty. See the Ford Performance Parts Limited Warranty on pages 295-302 for details.

2015-2017 MUSTANG GT PERFORMANCE CALIBRATION POWER PACKS



- Fits 2015-2017 Mustang GT
- Features exclusive no-lift shift strategy and enhanced throttle response
- Ford Performance calibrations feature exclusive Ford proprietary software and engineering
- Ford Performance calibrations are 50-state legal with CARB EO (D-598-19)
- Calibrations available for manual and automatic transmission
- Allows gear ratio changes up to 4.09:1
- Automatic calibrations feature optimized performance shift schedule
- Premium fuel, 91 octane or higher, is required

Calibration Notes:

- Ford Performance ProCal tool, included with all calibrations, requires laptop and internet access for calibration install
- At this time power packs are sold separately and cannot be upgraded without the purchase of an entire kit
- Powertrain calibrations are developed and supported for U.S. and Canadian vehicles
- Federal and state laws prohibit any person from installing aftermarket add-on or modified parts prior to the sale of a new motor vehicle

Calibrations are available with three levels of hardware and performance.

MUSTANG POWER PACK

M-9603-M8 – Power Pack 1

- Includes high-flow K&N air filter
- 13 hp and 16 lb-ft peak gains over stock
- 40 lb-ft gain at 1500 rpm
- Laptop required, not included



M-9603-M8A – Power Pack 2

- Includes GT350 cold air intake with 87 mm throttle body and exclusive intake adapter (hardware available separately without calibration as Part No. M-9603-M50)
- 21 hp and 24 lb-ft peak gains over stock
- 40 lb-ft gain at 1500 rpm
- Industry exclusive open air filter with CARB EO

Laptop required, not included

NOTE: Does not fit properly with Ford Performance M-6766-A50 Oil-Air Separator due to throttle body stack up/alignment.



M-9452-M8 – Power Pack 3

- Includes GT350 cold air intake with 87 mm throttle body and GT350 Intake Manifold M-9424-M52
- 37 hp and 5 lb-ft peak gains over stock
- 60 hp gain at 7500 rpm
- Industry's only 50-state legal calibration with performance intake manifold
- Laptop required, not included



2015-2018 MUSTANG

2015-2017 MUSTANG 5.0L COLD AIR INTAKE (NO CAL)

M-9603-M50

- Fits 2015-2017 Mustang GT
- Includes GT350 open element air-box w/inlet tube and M-9926-M52 Throttle Body
- Proprietary throttle body adapter allows installation with no changes to Mustang GT intake manifold
- Cold air inlet allows better breathing for increased horsepower
- Throttle body is larger than Mustang GT (87 mm vs. 80 mm)
- Kit is available with exclusive CARB legal Ford Performance calibration, Part No. M-9603-M8A for a gain of 21 peak horsepower
- Includes production GT350 air filter, high-flow K&N replacement filter available as Part No. M-9601-G
- Calibration is necessary to prevent engine damage! Calibration not included!



2015-2017 MUSTANG 2.3L ECOBOOST® PERFORMANCE CALIBRATION KIT

M-9603-M4

- M-9603-M23 Cold Air Intake Kit
- ProCal 3 calibration interface
- Calibration voucher
- Laptop required, not included

Calibration features:

- Peak gains of 25 hp at 5500 rpm and 70 lb-ft torque at 2200 rpm
- 40 hp and 60 lb-ft torque average gain from 2500-5000 rpm
- 75 hp and 64 lb-ft average gain from 5500-6800 rpm
- 100 hp maximum gain at 6000 rpm
- Horsepower and torque gains throughout the powerband
- Exclusive Ford Performance warranty when dealer installed
- Ford Performance calibrations are 50-state legal with CARB EO (D-598-18)
- Allows gear ratio changes up to 4.09:1
- Automatic calibrations feature optimized performance shift schedule
- **Horsepower and torque gains will not be optimized until fuel octane is learned**



2015-2017 MUSTANG 2.3L COLD AIR INTAKE (NO CAL)

M-9603-M23

- Fits 2015-2017 Mustang with 2.3L engine
- Includes GT350 open element air-box with proprietary inlet housing
- Uses production air hose from inlet to turbocharger, making for a quick and easy installation
- Kit is available with exclusive CARB legal Ford Performance calibration see Part No. M-9603-M4
- Calibration not included!



2016 MUSTANG COBRA JET AIR INLET

M-9600-SCJ16

- As used on 2016 Cobra Jet with supercharged engine M-6007-SCJ16
- Includes air inlet tube with molded boot for throttle body attachment and M-9601-D Conical Air Filter
- Can be used with Whipple™ 2.9L 2015-2017 supercharger kits for off-road use
- Approximate 140 mm diameter at MAF sensor location
- MAF sensor sold separately
- Does not include serialized build plaque – plaque is exclusive to turn-key Cobra Jet race cars
- Air filter mounts in fender well
- Calibration is necessary to prevent engine damage! Calibration not included!



2015-2018 MUSTANG SHELBY GT350 AIR FILTER

M-9601-G

- Fits 2015-2018 Shelby GT350
- Also fits 2010-2014 Mustang Shelby GT500 5.4 and 5.8L supercharged engines
- AIRAID® premium filter is hand-built using the finest materials available today
- Filter element is blue
- This high-flow filter uses multiple cotton gauze layer construction that's washable and reusable
- Delivers significant improvements in airflow while providing outstanding filtration
- The oil-free maintenance makes them one of the easiest filters to service on the market
- Servicing these filters is simple – just wash with a mild household detergent, rinse, allow to dry and reinstall



2015-2017 MUSTANG GT, I4 AND V6 HIGH-FLOW K&N/ FORD PERFORMANCE AIR FILTER

M-9601-M

K&N 4-ply panel washable air filter.

- Fits stock 2015-2017 Mustang GT, I4 and V6 air-box
- For GT350 see Part No. M-9601-G
- Flows approximately 22% more than stock filter at 1.5" H2O delta pressure
- Does not require PCM recalibration



5.0L/5.2L COYOTE OIL-AIR SEPARATOR RH

M-6766-A50

- Fits 2011-2017 5.0L Mustang GT, 2012-2013 5.0L BOSS 302, 2011-2014 5.0L F-150 and 2015-2017 5.2L GT350 engines
- This oil-air separator is a must-have for any track enthusiast!
- Precision molded canister with unique filter media separates oil vapor from the air in the PCV system
- Designed and engineered specifically for installation on the Ford Coyote family engines
- All OEM quality hoses and fittings are used for a high quality installation and function
- **Canister is located on the right front (passenger side) of the engine**
- This is a highly engineered system, not a universal "fits-all" kit, developed by the experts who know your Coyote engine best
- Canister is easy to drain by removing PCV lines off canister, removing canister and draining oil
- Engineered and manufactured in the USA
- A top seller for Ford Performance Parts



5.2L GT350 OIL-AIR SEPARATOR LH

M-6766-A50S

- Fits 2015-2017 Mustang GT350 5.2L Coyote engine
- This oil-air separator is a must-have for any track enthusiast!
- Precision molded canister with unique filter media separates oil vapor from the air in the PCV system
- Designed and engineered specifically for installation on the GT350 5.2L Coyote engine
- All OEM quality hoses and fittings are used for a high quality installation and function
- **Canister is located on the left front (driver side) of the engine**
- This is a highly engineered system, not a universal "fits-all" kit, developed by the people who know your engine best
- Canister is easy to drain by removing PCV lines off canister, removing canister and draining oil
- Engineered and manufactured in the USA
- A top seller for Ford Performance Parts



2015-2018 MUSTANG GT 5.0L PERFORMANCE GT350 RADIATOR

M-8005-M8

- Fits: 2015-2018 Mustang GT 5.0L with manual and automatic transmission
- Fits: 2015-2018 Mustang GT350
- Original equipment on 2015-2017 Mustang GT350 and Mustang GT equipped with the Performance Pack option
- Radiator is less restrictive and provides more volume than standard radiator
- Improved cooling over stock non-Performance Pack Mustang radiator



2015-2017 MUSTANG FORD PERFORMANCE RADIATOR COVER

M-8291-FP

- Fits 2015-2017 Mustang except GT350
- As used on 2016 Cobra Jet
- OEM radiator cover with "FORD PERFORMANCE" machined into surface
- Due to material properties some machine marks in logo may be present



2015-2018 MUSTANG

2015-2018 MUSTANG GT350 ACTIVE CAT-BACK SPORT EXHAUST SYSTEM



M-5200-MSS

This cat-back active exhaust system with integral X-pipe bolts directly to the stock factory catalytic converters, making your Mustang 100% emission compliant while providing an aggressive muscle car sound. The tuned stainless steel mufflers retain the factory active exhaust functionality and not only sound great but look great too.

- Fits 2015-2018 Mustang GT350 5.2L
- Uniquely designed and tuned to provide optimum performance, aggressive sound, durability and pure driving excitement
- Manufactured in the USA from high-quality 304 stainless steel
- Features ultra-smooth mandrel bends, warp-free flanges and superior craftsmanship
- Integral X-pipe with 2.5" stainless steel mandrel bent cat-back tubing
- Bolts to stock catalytic converters
- Maintains factory active exhaust functionality
- Uses stock hangers and mounts

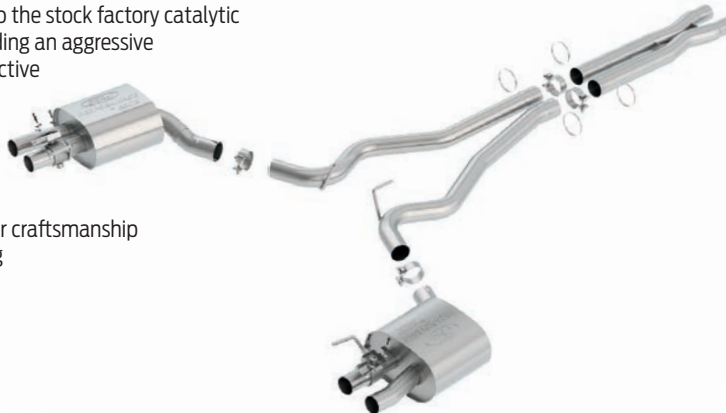

2015-2017 MUSTANG GT 5.0L CAT-BACK ACTIVE EXHAUST SYSTEM KIT WITH GT350 EXHAUST TIPS AND LOWER VALANCE



M-5200-M8

- Fits 2015-2017 Mustang GT 5.0L Coupe and Convertible with premium rear bumper
- Uniquely designed and tuned to provide optimum performance, aggressive sound, durability and pure driving excitement
- Adds GT350 active exhaust functionality with two 2.5" NPP valves to be able to change the exhaust sound
- Features 2.5" ultra-smooth mandrel bends, warp-free flanges and superior craftsmanship
- Manufactured in the USA from high-quality 304 stainless steel
- Bolts to stock catalytic converters
- Integral X-pipe

System includes:

- Rear lower GT350 valance with quad exhaust tips
- Control module and all needed wiring
- Detailed installation instructions



2016-2018 MUSTANG GT 5.0L EC-TYPE CAT-BACK EXHAUST SYSTEM

M-5200-M8GB 4" Black Tips

M-5200-M8GC 4" Chrome Tips

M-5200-M8GBA 2018 Dual Quad Black Tips

M-5200-M8GCA 2018 Dual Quad Chrome Tips

M-5200-M8GFA 2018 Dual Quad Carbon Fiber Tips

This cat-back exhaust system bolts directly to the stock factory catalytic converters, making your Mustang 100% emission compliant while providing an aggressive muscle car sound. The tuned stainless steel mufflers with stainless steel tips not only sound great but look great too.

NOTE: EUROPEAN SPEC EXHAUST SYSTEM

- EC-Type-Approval Number: e1*70/157*2007/34*12412*00
- Fits 2016-2018 Mustang GT 5.0L Coupe and Convertible
- Bolts to stock catalytic converters
- 2.5" stainless steel mandrel bent cat-back tubing
- Uses stock hangers and mounts



M-5200-M8GC shown

2016-2017 MUSTANG GT 5.0L CAT-BACK EC-TYPE EXHAUST SYSTEM WITH GT350 EXHAUST TIPS AND LOWER VALANCE

M-5200-M8GBV

NOTE: EUROPEAN SPEC EXHAUST SYSTEM

- EC-Type-Approval Number: e1*70/157*2007/34*12412*00
- Fits 2016-2017 Mustang GT 5.0L Coupe and Convertible with premium rear bumper
- Bolts to stock catalytic converters
- 2.5" stainless steel mandrel bent cat-back tubing
- GT350 quad exhaust tips
- Uses stock hangers and mounts
- Includes rear lower GT350 valance



2015-2018 MUSTANG GT 5.0L CAT-BACK TOURING EXHAUST SYSTEM

M-5200-M8TB* 2015-2017 4" Black Tips

M-5200-M8TC* 2015-2017 4" Chrome Tips

M-5200-M8TBA* 2018 Dual Quad Black Tips **NEW**

M-5200-M8TCA* 2018 Dual Quad Chrome Tips **NEW**

M-5200-M8TFA* 2018 Dual Quad Carbon Fiber Tips **NEW**

- Fits 2015-2018 Mustang GT 5.0L Coupe and Convertible
- Uniquely designed and tuned to provide optimum performance, aggressive sound, durability and pure driving excitement
- Meets 95 decibel drive-by noise standard for aftermarket exhaust systems when installed on stock applications
- Manufactured in the USA from high-quality 304 stainless steel
- Features ultra-smooth mandrel bends, warp-free flanges and superior craftsmanship
- Integral X-pipe with 2.5" stainless steel mandrel bent cat-back tubing
- Bolts to stock catalytic converters
- Approximately 30 lbs lighter than the factory cat-back system
- Uses stock hangers and mounts



M-5200-M8TC shown

2015-2018 MUSTANG GT 5.0L CAT-BACK SPORT EXHAUST SYSTEM

M-5200-M8SB* 2015-2017 4" Black Tips

M-5200-M8SC* 2015-2017 4" Chrome Tips

M-5200-M8SBA* 2018 Dual Quad Black Tips **NEW**

M-5200-M8SCA* 2018 Dual Quad Chrome Tips **NEW**

M-5200-M8SFA* 2018 Dual Quad Carbon Fiber Tips **NEW**

- Fits 2015-2018 Mustang GT 5.0L Coupe and Convertible
- Uniquely designed and tuned to provide optimum performance, aggressive sound, durability and pure driving excitement
- Manufactured in the USA from high-quality 304 stainless steel
- Features ultra-smooth mandrel bends, warp-free flanges and superior craftsmanship
- Integral X-pipe with 2.5" stainless steel mandrel bent cat-back tubing
- Bolts to stock catalytic converters
- Approximately 30 lbs lighter than the factory cat-back system
- Uses stock hangers and mounts

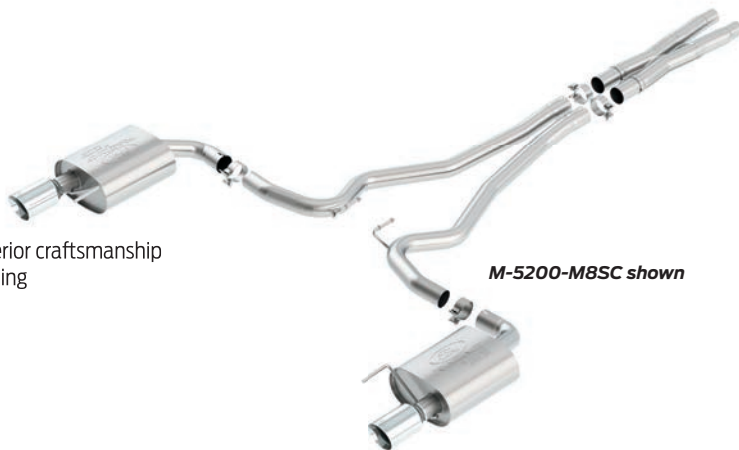

M-5200-M8SC shown

*This component is eligible for the Ford Performance Parts Limited Warranty. See the Ford Performance Parts Limited Warranty on pages 295-302 for details.

2015-2018 MUSTANG

2015-2017 MUSTANG 5.0L CAT-BACK TOURING EXHAUST SYSTEM WITH GT350 EXHAUST TIPS AND LOWER VALANCE



M-5200-M8TBV*

- Fits 2015-2017 Mustang GT 5.0L Coupe and Convertible with premium rear bumper
- Uniquely designed and tuned to provide optimum performance, aggressive sound, durability and pure driving excitement
- Meets 95 decibel drive-by noise standard for aftermarket exhaust systems when installed on stock applications
- Manufactured in the USA from high-quality 304 stainless steel
- Features ultra-smooth mandrel bends, warp-free flanges and superior craftsmanship
- Integral X-pipe with 2.25" stainless steel cat-back tubing
- Bolts to stock catalytic converters
- Approximately 30 lbs lighter than the factory cat-back system
- GT350 quad exhaust tips
- Uses stock hangers and mounts
- Includes rear lower GT350 valance



2015-2017 MUSTANG GT 5.0L CAT-BACK SPORT EXHAUST SYSTEM WITH GT350 EXHAUST TIPS AND LOWER VALANCE



M-5200-M8SBV*

- Fits 2015-2017 Mustang GT 5.0L Coupe and Convertible with premium rear bumper
- Uniquely designed and tuned to provide optimum performance, aggressive sound, durability and pure driving excitement
- Manufactured in the USA from high-quality 304 stainless steel
- Features ultra-smooth mandrel bends, warp-free flanges and superior craftsmanship
- Integral X-pipe with 2.5" stainless steel cat-back tubing
- Bolts to stock catalytic converters
- Approximately 30 lbs lighter than the factory cat-back system
- GT350 quad exhaust tips
- Uses stock hangers and mounts
- Includes rear lower GT350 valance



2015-2017 MUSTANG GT 5.0L TOURING MUFFLER KIT WITH GT350 EXHAUST TIPS AND LOWER VALANCE



M-5230-M8TBV*

- Fits 2015-2017 Mustang GT 5.0L Coupe and Convertible with premium rear bumper
- Uniquely designed and tuned to provide optimum performance, aggressive sound, durability and pure driving excitement
- Meets 95 decibel drive-by noise standard for aftermarket exhaust systems when installed on stock applications
- Made from high-quality 304 stainless steel
- Features ultra-smooth mandrel bends, warp-free flanges and superior craftsmanship
- 2.5" stainless steel mandrel bent tubing
- Uses stock hangers and mounts
- GT350 quad exhaust tips
- Includes rear lower GT350 valance



2015-2017 MUSTANG GT 5.0L SPORT MUFFLER KIT WITH GT350 EXHAUST TIPS AND LOWER VALANCE



M-5230-M8SBV*

- Fits 2015-2017 Mustang GT 5.0L Coupe and Convertible with premium rear bumper
- Uniquely designed and tuned to provide optimum performance, aggressive sound, durability and pure driving excitement
- Made from high-quality 304 stainless steel
- Features ultra-smooth mandrel bends, warp-free flanges and superior craftsmanship
- 2.5" stainless steel mandrel bent tubing
- Uses stock hangers and mounts
- GT350 quad exhaust tips
- Includes rear lower GT350 valance



*This component is eligible for the Ford Performance Parts Limited Warranty. See the Ford Performance Parts Limited Warranty on pages 295-302 for details.

2015-2018 MUSTANG GT 5.0L TOURING MUFLER KIT

M-5230-M8TC* 2015-2017 4" Chrome Tips

M-5230-M8TCA* 2018 Dual Quad Chrome Tips **NEW**

M-5230-M8TBA* 2018 Dual Quad Black Tips **NEW**

- Fits 2015-2018 Mustang GT 5.0 Coupe and Convertible
- 2.5" stainless steel mandrel bent tubing
- Aggressive sound is 50-state drive-by noise legal
- Uses stock hangers and mounts
- Factory exhaust pipe must be cut to install clamp on Ford Performance axle-back mufflers



M-5230-M8TC shown

2015-2018 MUSTANG GT 5.0L SPORT MUFLER KIT

M-5230-M8SC* 2015-2017 4" Chrome Tips

M-5230-M8SCA* 2018 Dual Quad Chrome Tips **NEW**

M-5230-M8SBA* 2018 Dual Quad Black Tips **NEW**

- Fits 2015-2018 Mustang GT 5.0L Coupe and Convertible
- Uniquely designed and tuned to provide optimum performance, aggressive sound, durability and pure driving excitement
- Made from high-quality 304 stainless steel
- Features ultra-smooth mandrel bends, warp-free flanges and superior craftsmanship
- 2.5" stainless steel mandrel bent tubing
- Uses stock hangers and mounts
- Factory exhaust pipe must be cut to install clamp on Ford Performance axle-back mufflers



2015-2018 MUSTANG GT X-PIPE

M-5251-M8*

- Fits 2015-2018 Mustang GT 5.0L Coupe and Convertible
- 409 stainless steel X-pipe
- Converts your factory H-pipe to a more efficient X-pipe
- Cutting of factory exhaust required for installation
- Clamp-on installation – does not require welding! Installs using existing front factory clamps and supplied rear clamps



2015-2018 MUSTANG GT 5.0L SIDE EXIT EXHAUST SYSTEM

M-5220-M8*

- Fits 2015-2018 Mustang GT 5.0L Coupe
- Production-quality quad exhaust styled from the 2012-2013 Mustang BOSS 302
- Kit includes left- and right-side exhaust pipes with polished 304 stainless steel tips, 409 stainless steel X-pipe and mounting hardware
- Converts your factory H-pipe to a more efficient X-pipe
- Cutting of factory exhaust required for installation
- Clamp-on installation – does not require welding!
- Installs using existing front factory clamps and supplied rear clamps



*This component is eligible for the Ford Performance Parts Limited Warranty. See the Ford Performance Parts Limited Warranty on pages 295-302 for details.

2015-2018 MUSTANG

2016-2018 MUSTANG 2.3L ECOBOOST® EC-TYPE CAT-BACK EXHAUST SYSTEM

- M-5200-M4GB** 2015-2017 4" Black Tips
- M-5200-M4GC** 2015-2017 4" Chrome Tips
- M-5200-M4GBA** 2018 4" Black Tips **NEW**
- M-5200-M4GCA** 2018 4" Chrome Tips **NEW**
- M-5200-M4GFA** 2018 4" Carbon Fiber Tips **NEW**

This cat-back exhaust system bolts directly to the stock factory catalytic converters, making your Mustang 100% emission compliant while providing an aggressive muscle car sound. The tuned stainless steel mufflers with 4" chrome-plated stainless steel tips not only sound great but look great too.

NOTE: EUROPEAN SPEC EXHAUST SYSTEM

- EC-Type-Approval Number: e1*70/157/*2007/34*12410*00
- Fits 2016-2018 Mustang 2.3L EcoBoost® Coupe and Convertible
- Bolts to stock catalytic converter
- 2.25" stainless steel mandrel bent cat-back tubing
- Uses stock hangers and mounts



M-5200-M4GB shown

2016-2017 MUSTANG 2.3L CAT-BACK EC-TYPE EXHAUST SYSTEM WITH GT350 EXHAUST TIPS AND LOWER VALANCE

M-5200-M4GBV

NOTE: EUROPEAN SPEC EXHAUST SYSTEM

- EC-Type-Approval Number: e1*70/157/*2007/34*12410*00
- Fits 2016-2017 Mustang 2.3L EcoBoost® Coupe and Convertible with premium rear bumper
- Bolts to stock catalytic converters
- 2.25" stainless steel mandrel bent cat-back tubing
- GT350 quad exhaust tips
- Uses stock hangers and mounts
- Includes rear lower GT350 valance



2015-2018 MUSTANG 2.3L ECOBOOST® CAT-BACK TOURING EXHAUST SYSTEM

- M-5200-M4TB*** 2015-2017 4" Black Tips
- M-5200-M4TC*** 2015-2017 4" Chrome Tips
- M-5200-M4TBA*** 2018 4" Black Tips **NEW**
- M-5200-M4TCA*** 2018 4" Chrome Tips **NEW**
- M-5200-M4TFA*** 2018 4" Carbon Fiber Tips **NEW**

This cat-back exhaust system with integral Y-pipe bolts directly to the stock factory catalytic converter, making your Mustang 100% emission compliant while providing an aggressive muscle car sound. The tuned stainless steel mufflers with 4" chrome-plated stainless steel tips not only sound great but look great too.

- Fits 2015-2018 Mustang 2.3L EcoBoost® Coupe and Convertible
- Uniquely designed and tuned to provide optimum performance, aggressive sound, durability and pure driving excitement
- Meets 95 decibel drive-by noise standard for aftermarket exhaust systems when installed on stock applications
- Manufactured in the USA from high-quality 304 stainless steel
- Features ultra-smooth mandrel bends, warp-free flanges and superior craftsmanship
- Integral Y-pipe with 2.25" stainless steel cat-back tubing
- Bolts to stock catalytic converter
- Approximately 20 lbs lighter than the factory cat-back system
- Uses stock hangers and mounts



M-5200-M4TC shown



*This component is eligible for the Ford Performance Parts Limited Warranty. See the Ford Performance Parts Limited Warranty on pages 295-302 for details.



2015-2018 MUSTANG 2.3L ECOBOOST® CAT-BACK SPORT EXHAUST SYSTEM

- M-5200-M4SB*** 2015-2017 4" Black Tips
- M-5200-M4SC*** 2015-2017 4" Black Tips
- M-5200-M4SBA*** 2018 4" Black Tips **NEW**
- M-5200-M4SCA*** 2018 4" Chrome Tips **NEW**
- M-5200-M4SFA*** 2018 4" Carbon Fiber Tips **NEW**

This cat-back exhaust system with integral Y-pipe bolts directly to the stock factory catalytic converter, making your Mustang 100% emission compliant while providing an aggressive muscle car sound. The tuned stainless steel mufflers with 4" chrome-plated stainless steel tips not only sound great but look great too.

- Fits 2015-2018 Mustang 2.3L EcoBoost® Coupe and Convertible
- Uniquely designed and tuned to provide optimum performance, aggressive sound, durability and pure driving excitement
- Manufactured in the USA from high-quality 304 stainless steel
- Features ultra-smooth mandrel bends, warp-free flanges and superior craftsmanship
- Integral Y-pipe with 2.25" stainless steel cat-back tubing
- Bolts to stock catalytic converter
- Approximately 20 lbs lighter than the factory cat-back system
- Uses stock hangers and mounts



M-5200-M4SB shown

2015-2018 MUSTANG 2.3L ECOBOOST® TOURING MUFFLER KIT



- M-5230-M4TC*** 2015-2017 4" Chrome Tips
- M-5230-M4TCA*** 2018 4" Chrome Tips **NEW**
- M-5230-M4TBA*** 2018 4" Black Tips **NEW**

- Fits 2015-2018 Mustang 2.3L EcoBoost® Coupe and Convertible
- Uniquely designed and tuned to provide optimum performance, aggressive sound, durability and pure driving excitement
- Meets 95 decibel drive-by noise standard for aftermarket exhaust systems when installed on stock applications
- Made from high-quality 304 stainless steel
- Features ultra-smooth mandrel bends, warp-free flanges and superior craftsmanship
- 2.25" stainless steel mandrel bent tubing
- Uses stock hangers and mounts
- Factory exhaust pipe must be cut to install clamp on Ford Performance axle-back mufflers



2015-2018 MUSTANG 2.3L ECOBOOST® SPORT MUFFLER KIT



- M-5230-M4SC*** 2015-2017 4" Chrome Tips
- M-5230-M4SCA*** 2018 4" Chrome Tips **NEW**
- M-5230-M4SBA*** 2018 4" Black Tips **NEW**

- Fits 2015-2018 Mustang 2.3L EcoBoost® Coupe and Convertible
- Uniquely designed and tuned to provide optimum performance, aggressive sound, durability and pure driving excitement
- Manufactured in the USA from high-quality 304 stainless steel
- Features ultra-smooth mandrel bends, warp-free flanges and superior craftsmanship
- 2.25" stainless steel tubing
- Uses stock hangers and mounts
- Factory exhaust pipe must be cut to install clamp on Ford Performance axle-back mufflers



*This component is eligible for the Ford Performance Parts Limited Warranty. See the Ford Performance Parts Limited Warranty on pages 295-302 for details.

2015-2018 MUSTANG

2015-2017 MUSTANG 2.3L CAT-BACK TOURING EXHAUST SYSTEM WITH GT350 EXHAUST TIPS AND LOWER VALANCE

M-5200-M4TBV*

- Fits 2015-2017 Mustang 2.3L EcoBoost® Coupe and Convertible with premium rear bumper
- Uniquely designed and tuned to provide optimum performance, aggressive sound, durability and pure driving excitement
- Meets 95 decibel drive-by noise standard for aftermarket exhaust systems when installed on stock applications
- Manufactured in the USA from high-quality 304 stainless steel
- Features ultra-smooth mandrel bends, warp-free flanges and superior craftsmanship
- Integral Y-pipe with 2.25" stainless steel cat-back tubing
- Bolts to stock catalytic converter
- Approximately 20 lbs lighter than the factory cat-back system
- GT350 quad exhaust tips
- Uses stock hangers and mounts
- Includes rear lower GT350 valance

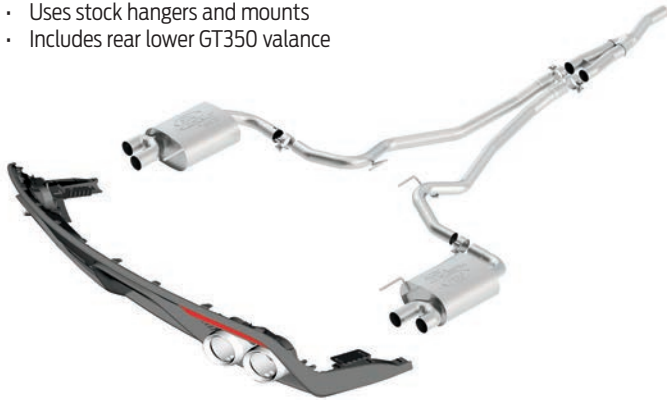

2015-2017 MUSTANG 2.3L ECOBOOST® TOURING MUFFLER KIT WITH GT350 EXHAUST TIPS AND LOWER VALANCE

M-5230-M4TBV*

- Fits 2015-2017 Mustang 2.3L EcoBoost® Coupe and Convertible with premium rear bumper
- Uniquely designed and tuned to provide optimum performance, aggressive sound, durability and pure driving excitement
- Meets 95 decibel drive-by noise standard for aftermarket exhaust systems when installed on stock applications
- Manufactured in the USA from high-quality 304 stainless steel
- Features ultra-smooth mandrel bends, warp-free flanges and superior craftsmanship
- 2.25" stainless steel tubing
- GT350 quad exhaust tips
- Uses stock hangers and mounts
- Includes rear lower GT350 valance



2015-2017 MUSTANG 2.3L CAT-BACK SPORT EXHAUST SYSTEM WITH GT350 EXHAUST TIPS AND LOWER VALANCE

M-5200-M4SBV*

- Fits 2015-2017 Mustang 2.3L EcoBoost® Coupe and Convertible with premium rear bumper
- Uniquely designed and tuned to provide optimum performance, aggressive sound, durability and pure driving excitement
- Manufactured in the USA from high-quality 304 stainless steel
- Features ultra-smooth mandrel bends, warp-free flanges and superior craftsmanship
- Integral Y-pipe with 2.25" stainless steel cat-back tubing
- Bolts to stock catalytic converter
- GT350 quad exhaust tips
- Uses stock hangers and mounts
- Includes rear lower GT350 valance



2015-2017 MUSTANG 2.3L ECOBOOST® SPORT MUFFLER KIT WITH GT350 EXHAUST TIPS AND LOWER VALANCE

M-5230-M4SBV*

- Fits 2015-2017 Mustang 2.3L EcoBoost® Coupe and Convertible with premium rear bumper
- Uniquely designed and tuned to provide optimum performance, aggressive sound, durability and pure driving excitement
- Manufactured in the USA from high-quality 304 stainless steel
- Features ultra-smooth mandrel bends, warp-free flanges and superior craftsmanship
- 2.25" stainless steel tubing
- GT350 quad exhaust tips
- Uses stock hangers and mounts
- Includes rear lower GT350 valance



*This component is eligible for the Ford Performance Parts Limited Warranty. See the Ford Performance Parts Limited Warranty on pages 295-302 for details.

2015-2018 MUSTANG SHORT THROW SHIFTER KIT

M-7210-M8*

- Approximately 19% reduction in throw
- Increased driver feel and feedback
- Kit includes all necessary hardware and instructions to install in 2015-2018 Mustang with manual transmission (GT, 2.3L, 3.7L)
- Comes with exclusive Ford Racing 6-speed shift knob
- Requires some assembly
- Retains stock M12 x 1.25 thread for shift knob

Kit includes:

- Reduced throw shifter lever with pin
- Reverse lockout sleeve
- M-7213-M8 6-Speed Shift Knob
- Increased durometer bushing kit
- Shifter body gasket
- Shift knob jam nut
- Thread locking compound
- Grease
- Installation instructions



2015-2018 MUSTANG GT350 SHIFTER KIT – WITHOUT KNOB

M-7210-M8A

- Approximately 16% reduction in throw
- Increased driver feel and feedback
- Slight increase in NVH over production shifter
- Kit includes all necessary hardware and instructions to install in 2015-2018 Mustang GT350
- DOES NOT include shift knob. Use stock shift knob or optional Ford Performance knobs. See performanceparts.ford.com for details
- Retains stock M10 x 1.25 thread for shift knob
- Requires some assembly

Kit includes:

- Reduced throw shifter lever
- Reverse lockout sleeve
- Shift knob jam nut
- Thread locking compound
- Grease
- Installation instructions



2015-2018 MUSTANG SHIFTER KIT – WITHOUT KNOB

M-7210-MA

- Approximately 19% reduction in throw
- Increased driver feel and feedback
- Kit includes all necessary hardware and instructions to install in 2015-2018 Mustang with manual transmission (GT, 2.3L, 3.7L)
- DOES NOT include shift knob. Use stock shift knob or M-7213-M8 Ford Racing Knob or M-7213-M8A Ford Performance Knob
- Retains stock M12 x 1.25 thread for shift knob
- Requires some assembly

Kit includes:

- Reduced throw shifter lever with pin
- Reverse lockout sleeve
- Increased durometer bushing kit
- Shifter body gasket
- Shift knob jam nut
- Thread locking compound
- Grease
- Installation instructions



FORD PERFORMANCE SHIFT KNOB 6-SPEED

M-7213-M8A

- Fits stock 2015-2018 Mustang shifter, M-7210-M8 and M-7210-MA Ford Racing short throw shifters
- 6-speed black shift knob with "Ford Performance" logo
- Retains stock M12 x 1.25 thread for shift knob



FORD RACING SHIFT KNOB 6-SPEED

M-7213-M8

- Fits stock 2015-2018 Mustang shifter, M-7210-M8 and M-7210-MA Ford Racing short throw shifters
- Included in M-7210-M8 Shifter Kit
- 6-speed black shift knob with "Ford Racing" logo
- Retains stock M12 x 1.25 thread for shift knob



2015-2018 MUSTANG CARBON FIBER SHIFT KNOB

M-7213-MCF

- Fits stock 2015-2018 Mustang shifter, M-7210-M8 and M-7210-MA Ford Performance short throw shifters
- 6-speed carbon fiber shift knob with genuine carbon fiber weave
- Retains stock M12 x 1.25 thread for shift knob
- Easy do-it-yourself installation



FORD PERFORMANCE GT350 SHIFT KNOB 6-SPEED

M-7213-M8SB Black

M-7213-M8SR Red

M-7213-M8SW White

- Fits stock 2015-2018 Mustang GT350 shifter and M-7210-M8A Ford Performance Short Throw Shifter
- 2" diameter knob for enhanced feel
- 6-speed shift knob with recessed "GT350" logo
- Gloss finish
- Retains stock GT350 M10 x 1.25 thread for shift knob



M-7213-M8SR shown

*This component is eligible for the Ford Performance Parts Limited Warranty. See the Ford Performance Parts Limited Warranty on pages 295-302 for details.

2015-2018 MUSTANG

2015-2017 MUSTANG HIGH-PERFORMANCE CLUTCH FLUID LINE UPGRADE

M-7512-B

- Fits 2015-2017 Mustang GT with manual transmission
- Upgraded clutch fluid line for high temperature, high performance applications
- Strongly recommended for vehicles equipped with headers!
- Replaces factory plastic line
- Stainless steel hard line with braided stainless steel flex hose reduces line expansion
- Includes No. 10 O-rings



2015-2018 MUSTANG REAR WHEEL HUB KIT WITH ARP® STUDS

M-1104-B

- Fits 2015-2018 Mustang GT, 2.3L EcoBoost® and V6
- Rear hubs equipped with ARP® wheel studs

Kit includes:

- One pair of upgraded rear hubs with 3" ARP® wheel studs
- Hub attachment bolts
- Open end wheel lug nuts M-1012-N
- Axle retaining nuts

3" ARP® stud specifications:

- Wheel stud style: Press-in
- Thread size: M14 x 1.5 RH in.
- Knurl diameter: 0.625"
- Under head length: 3.4"



2015-2018 MUSTANG EXTENDED ARP® WHEEL STUD KIT

M-1107-C

- Service replacement for Ford Performance M-1104-AB and M-1104-B front and rear wheel hub kits, with extended ARP® studs
- Sold as 1 package of 10 studs
- Requires M-1012-N Open End Lug Nuts or equivalent

3" ARP® stud specifications:

- Wheel stud style: Press-in
- Thread size: M14 x 1.5 RH in.
- Knurl diameter: 0.625"
- Under head length: 3.4"



2015-2018 MUSTANG FRONT WHEEL HUB KIT WITH ARP® STUDS

M-1104-AB

- Fits 2015-2018 Mustang GT, 2.3L EcoBoost® and V6
- Front hubs equipped with ARP® wheel studs

Kit includes:

- One pair of upgraded front hubs with 3" ARP® studs
- M-1012-N Open End Wheel Lug Nuts
- Hub retaining nuts
- Hub retaining nut covers

3" ARP® stud specifications:

- Wheel stud style: Press-in
- Thread size: M14 x 1.5 RH in.
- Knurl diameter: 0.625"
- Under head length: 3.4"



2015-2017 MUSTANG AUTOMATIC IRS PINION FLANGE

M-4851-M8A

Original equipment on 2015-2017 Mustang GT Super 8.8" IRS with automatic transmission. For use on M-4001-88373T and M-4001-88355, which come equipped with manual transmission pinion flange.



2015-2018 MUSTANG MANUAL TRANS COOLER AIR SCOOP

M-5025-M8

- Fits 2015-2018 Mustang with manual transmission
- Transmission cooler scoop for off-road performance driving
- Requires removal for engine oil change



2015-2018 MUSTANG IRS KNUCKLE KIT WITH TOE BEARING



M-5970-M

- 2015-2018 Mustang IRS knuckles and hubs
- Limits down time for FR3 suspension kit install. M-5A460-M Toe Link Bearing Kit has been pressed in for easy bolt-in installation in the chassis
- Can be used in kit car custom builds
- For kit car or custom vehicle construction, M-2300-MR Rear Brake Kit is recommended



2015-2018 MUSTANG KNUCKLE TO TOE LINK BEARING ASSEMBLY

M-5A460-M

- Fits 2015-2018 Mustang GT and 2.3L EcoBoost®
- Integral component of the M-FR3A-M8A Track Handling Pack
- Replaces the rubber toe link bushing in the rear knuckle with a Delrin®-lined spherical bearing
- Removes suspension compliance with minimal impact to ride quality
- Improves handling, especially in power down situations
- Includes 2 bearings



2015-2018 MUSTANG PERFORMANCE PACK REAR TOE LINK KIT

M-5972-M

- Fits 2015-2018 Mustang
- Original equipment on Performance Pack equipped Mustang
- Delrin®-lined spherical bearings prevent deflection compared to base toe link
- Toe links are included in the M-FR3A-M8A and M-FR3A-MAA handling packs
- Kit includes two rear toe links and two toe link cam bolts



RING AND PINION INSTALLATION KIT SUPER 8.8" IRS



M-4210-B3

- Fits all Super 8.8" IRS axles in 2015-2018 Mustang

Bill of material:

- OEM pinion bearings and races
- OEM differential bearings and races
- Pinion and differential shims
- Crush sleeve
- Pinion nut
- Pinion seal
- Ring gear bolts
- Gear-marking compound

NOTE: Does not fit earlier 1986-2014 8.8" axles.



MUSTANG SUPER 8.8" IRS RING GEAR AND PINION SET



| PART NUMBER | AXLE | RING & PINION |
|----------------------|------|---------------|
| M-4209-88355A | 8.8" | 3.55 |
| M-4209-88373A | 8.8" | 3.73 |
| M-4209-88409A | 8.8" | 4.09 |

- Fits 2015-2018 Mustang Super 8.8" IRS center section
- Includes OEM crush sleeve and pinion nut
- Requires M-4210-B3 Mustang 8.8" ring-gear and pinion install kit
- Made in United States in the Ford Sterling Axle Plant
- OEM quality – our superior surface finish, hardening and manufacturing consistency provides the strongest and quietest gears in the market
- **Requires aftermarket calibration if vehicle is not originally equipped with this gear ratio**

NOTE: 3.15 ratio differential not compatible with 3.31, 3.55 and 3.73 ratio gears. Use differential M-4204-MT or M-4204-M.

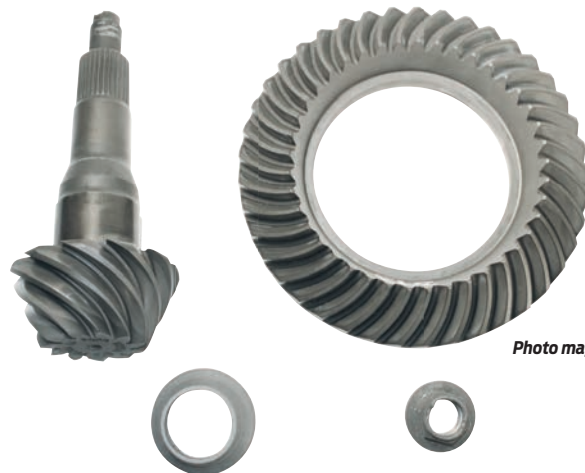

Photo may vary

2015-2018 MUSTANG

SUPER 8.8" RING GEAR BOLT KIT (10 PIECES)



M-4216-C

- Fits 2015-2016 Mustang IRS
- M12 x 1.25 x 26 mm
- Grade 10.9
- One-time-use bolts
- Set of 10 bolts
- Recommended for use with Super 8.8" M-4209-88373A and M-4209-88355A ring and pinion sets



2015-2017 MUSTANG SUPER 8.8" IRS BEARING AND SEAL KIT



M-4413-B

- Fits 2015-2017 Mustang Super 8.8" IRS axle
- Kit includes:
- Two inner stub shaft bearings
 - Two inner stub shaft bearing housing seals
 - Recommended for use with M-4210-B3 Gear Install Kit



GT350 DIFFERENTIAL COOLER KIT

M-4000-M8S



- Fits 2015-2018 Mustang Shelby GT350
- Kit includes components from the production GT350 Track/R model rear differential cooler system and a unique stand-alone wiring harness with mechanical and thermal switches
- Complete wiring harness with switching, relay and fuse included
- Differential cooler
- Cooler pump
- Cooler lines
- Mounting hardware
- Differential cover
- Detailed instructions



2015-2017 MUSTANG 8.8" TRACTION-LOK DIFFERENTIAL



M-4204-M

- Fits 2015-2017 Mustang GT, V6 and I4 with 3.31, 3.55, 3.73 and 4.09 ratio gears only
- Traction-Lok 8.8" differential
- Fits 34-spline axles
- Requires 4 oz of CM-19546-A1 Friction Modifier with initial fill
- For use with M-4209-88355A and M-4209-88373A Super 8.8" gear sets
- Use M-4210-B3 Differential Install Kit



2015-2016 MUSTANG GT TORSEN® DIFFERENTIAL



M-4204-MT

- Fits 2015-2016 Mustang GT, V6 and I4 with 3.31, 3.55, 3.73 and 4.09 ratio gears only
- Standard on 2015-2016 Mustang GT performance pack
- Fits 34-spline axles
- Torsen® T-2R-type differential
- Features full-time torque sensing, torque biasing



2015-2017 MUSTANG SUPER 8.8" IRS LOADED DIFFERENTIAL HOUSING 3.55



M-4001-88355

- Loaded differential housing for 2015-2017 Mustang IRS
- Fits Mustang GT and V6 with manual transmission
- Iron housing with aluminum cover
- Includes 3.55:1 ratio gear set M-4209-88355A and M-4204-M Traction-Lok Differential
- Original equipment on 2015-2017 Mustang GT
- Custom calibration required for speedometer and shift corrections
- Automatic transmission requires M-4851-M8A Pinion Flange

2015-2017 MUSTANG IRS LOADED DIFFERENTIAL HOUSING 3.73 TORSEN®



M-4001-88373T

- Loaded differential housing for 2015-2017 Mustang IRS
- Fits Mustang GT and V6 with manual transmission
- Iron housing with aluminum cover
- Includes 3.73:1 ratio M-4209-88373A Gear Set and M-4204-MT Torsen® Differential
- Original equipment on 2015 Mustang GT Performance Pack
- Custom calibration required for speedometer and shift corrections
- Automatic transmission requires M-4851-M8A Pinion Flange



M-4001-88373T shown

2015-2018 MUSTANG HALF SHAFT UPGRADE KIT



- M-4130-MA** Half Shaft Kit
- M-4138-MA** Right Half Shaft
- M-4139-MA** Left Half Shaft

- Fits all 2015-2018 Mustang – GT, V6, I4 and GT350
- Fits in place of production half shafts with no other vehicle modifications
- Severe duty serviceable CV joints with CNC billet centers support up to 1500 hp
- CNC-machined from aerospace high-alloy materials
- Billet one-piece 34-spline inner and 32-spline outer stub ends
- Axle shafts feature anti-wheel-hop technology
- Shafts feature blue powder coating for corrosion resistance
- Built by G-Force Engineering, available only through Ford Performance
- Off-road use only
- Manufacturer's limited lifetime warranty on axle bars and stubs, 2-year warranty on wear components



2015-2018 MUSTANG TRACK STRUT AND SHOCK KIT

M-18000-F

- Fits 2015-2018 Mustang GT and 2.3L EcoBoost® Coupes
- Designed specifically as part of the M-FR3A-M8A Track Handling Pack
- Designed for use with M-5300-Y Track Lowering Springs
- Track tuned by Ford Performance engineers

Kit includes:

- M-FR3A-M8A Track Front Dampers
- M-FR3A-M8A Track Rear Shocks
- Front strut top mounts
- Front strut spring retainer
- Front damper anti-squeek pads
- Strut rod nuts
- Threadlock



NOTE: When using Ford Performance M-5300-Y Track Lowering Springs or any other aftermarket lowering springs, it is recommended to use Ford Performance Mustang M-5570-B Jounce Bumper Kit.

NOTE: Please reference a Ford service manual for installation information and correct torque specifications. May require alignment after installation.

2015-2018 MUSTANG FRONT STRUT MOUNT (PAIR)

M-18183-M

- Original equipment on 2016-2018 Mustang
- Original equipment on 2015 Mustang GT equipped with the Performance Pack
- Increased bushing durometer compared to base 2015 Mustang
- Used in assembled FR3 handling kits M-FR3A-M8A & M-FR3A-MAA
- Perfect for DIY strut assembly replacement



2015-2018 MUSTANG GT350 HALF SHAFT KIT



M-4130-M8S

- Fits 2015-2018 Mustang GT, 2.3L EcoBoost® and V6
- Original equipment on 2015-2017 Mustang GT350
- Increased diameter left side half shaft vs. Mustang GT
- Value priced upgrade for mild drivetrain modifications and naturally aspirated engines
- Kit includes both right and left half shafts



2015-2018 MUSTANG JOUNCE BUMPER & HARDWARE KIT

M-5570-B

- Fits 2015-2018 Mustang GT and 2.3L EcoBoost®
- Modified production jounce bumpers for lowered vehicles
- Includes installation hardware
- Included in the M-5300-X and M-5300-Y spring kits as well as M-FR3A-M8A and M-FR3A-MAA assembled handling packs



2015-2018 MUSTANG FR3 TRACK SUSPENSION SINGLE FRONT SERVICE STRUT



M-18001-AG

Individual front service strut for 2015-2018 Mustang FR3 track suspension kits

Shock used in the following Ford Performance kits:

- 2015-2018 Mustang M-FR3A-M8A Track Handling Pack
- 2015-2018 Mustang M-18000-F Track Strut and Shock Kit



2015-2018 MUSTANG FR3 TRACK SUSPENSION SINGLE REAR SERVICE SHOCK



M-18001-AS

Individual rear service shock for 2015-2018 Mustang FR3 track suspension kits.

Shock used in the following Ford Performance kits:

- 2015-2018 Mustang M-FR3A-M8A Track Handling Pack
- 2015-2018 Mustang M-18000-F Track Strut and Shock Kit



2015-2018 MUSTANG

2015-2018 MUSTANG GT350 LOWERING SPRINGS

M-5300-W

- Fits 2015-2018 Mustang GT350 and GT350R
- Gives a more aggressive-looking stance as well as increased handling dynamics, yet maintains excellent ride quality
- Lowers car approximately 20 mm front and rear
- Works with both standard and MagneRide™ suspension systems
- Designed to work with production struts, shocks and sway bars
- May cause slightly harsher ride when compared to stock springs



2015-2018 MUSTANG TRACK LOWERING SPRINGS

M-5300-Y

- Fits 2015-2018 Mustang GT and 2.3L EcoBoost® Coupe
- Component of the M-FR3A-M8A Track Handling Pack
- Lowers car approximately 1"
- Gives a more aggressive-looking stance with a focus on handling and on track performance
- High quality manufacturing – produced by OEM spring supplier
- Includes M-5570-B Jounce Bumpers
- Will cause slightly harsher ride compared to stock springs
- Designed to work with the M-18000-F Track Strut and Shock Kit and M-5490-E Track Sway Bar Kit
- For 1" lowering springs designed for stock struts, shocks and sway bars see M-5300-X

NOTE: Please reference a Ford service manual for installation information and correct torque specifications. May require alignment after installation.



2015-2018 MUSTANG STREET LOWERING SPRINGS

M-5300-X

- Fits 2015-2018 Mustang GT and 2.3L EcoBoost® Coupe
- Designed to work with production struts, shocks and sway bars
- Lowers car approximately 1"
- Gives a more aggressive-looking stance as well as increased handling dynamics, yet maintains excellent ride quality
- Highest quality manufacturing – produced by OEM spring supplier
- Includes M-5570-B Jounce Bumpers
- May cause slightly harsher ride compared to stock springs



2015-2018 MUSTANG STREET SWAY BAR AND SPRING KIT

M-5700-MA

- Fits 2015-2018 Mustang GT and 2.3L EcoBoost® Coupe
- Kit includes: M-5490-E Mustang Track Sway Bar Kit and M-5300-X Mustang Street Lowering Springs
- Lowers car approximately 1"
- May cause a slightly harsher ride compared to stock springs
- Gives a more aggressive-looking stance as well as increased handling dynamics, yet maintains excellent ride quality
- Highest quality manufacturing – produced by OEM spring supplier
- Includes M-5570-B Jounce Bumpers and all sway bar mounting hardware and bushings
- For replacement sway bar bushings, use M-5490-BKD Track Sway Bar Bushing Kit

NOTE: Please reference a Ford service manual for installation information and correct torque specifications. May require alignment after installation.



2015-2018 MUSTANG TRACK SWAY BAR KIT

M-5490-EA

- Fits 2015-2018 Mustang GT and 2.3L EcoBoost® Coupe
- Sway bar kit designed for increased handling and performance
- Best when used with the M-18000-F Track Strut and Shock Kit and M-5300-Y Springs
- Includes all mounting hardware and bushings
- Included in the M-FR3A-M8A Track Handling Pack
- Used in Justin Pawlak's Formula Drift Mustang
- For replacement sway bar bushings use M-5490-BKD Track Sway Bar Bushing Kit

NOTE: Please reference a Ford service manual for installation information and correct torque specifications. May require alignment after installation.





2015-2018 MUSTANG TRACK HANDLING PACK M-FR3A-M8A*

The Ford Performance Parts assembled Track Handling Pack is the perfect suspension system for the driver who demands the most from their car on the track or on the street. Kit includes pre-assembled struts, which do NOT require a spring compressor, and are ready to bolt in! Put a little "road race" into your Mustang with Ford Performance Track Handling Pack. The Track Handling Pack is one of the most popular Ford Performance Parts upgrades for 2015-2018 Mustang. It is used on the 2016 Hertz Shelby GT-H Mustang, 2015-2017 Shelby Super Snake and on the Ford Performance Racing School Mustang GT.

- Fits 2015-2017 Mustang GT and 2.3L EcoBoost® Coupe
- Fits 2018 Mustang GT and 2.3L EcoBoost® Coupe without MagneRide™
- All components are designed to work together as a package
- Lowers car approximately 1"
- Gives a more aggressive-looking stance with a focus on handling and on track performance
- Will cause slightly harsher ride compared to stock springs

Track Handling Pack includes:

- Assembled Front Struts and Rear Shocks M-18000-F
- Track Lowering Springs M-5300-Y
- Performance Pack Upper Front Strut Mounts M-18183-M
- Jounce Bumper Kit M-5570-B
- Sway Bar Kit M-5490-E
- Performance Pack Rear Toe Links M-5972-M
- Toe Link to Knuckle Bearings M-5A460-M
- For replacement sway bar bushings, use Track Sway Bar Bushing Kit M-5490-BKD

NOTE: Please reference a Ford service manual for installation information and correct torque specifications. May require alignment after installation.

*This component is eligible for the Ford Performance Parts Limited Warranty. See the Ford Performance Parts Limited Warranty on pages 295-302 for details.

2015-2018 MUSTANG

2015-2018 MUSTANG STREET HANDLING PACK

M-FR3A-MAA

The Ford Performance Parts assembled Street Handling Pack is the perfect suspension system for the driver who wants improved handling and a lower stance but doesn't want or need all of the benefits of the Track Handling Pack. The Street Handling Pack includes pre-assembled struts, which do NOT require a spring compressor, and are ready to bolt in! Give your Mustang the look and performance you want with the Street Handling Pack!

- Fits 2015-2017 Mustang GT and 2.3L EcoBoost® Coupe
- Fits 2018 Mustang GT and 2.3L EcoBoost® Coupe without MagneRide™
- All components work together as a package
- Lowers car approximately 1"
- Gives a more aggressive-looking stance with a focus on handling and street performance

Street Handling Pack includes:

- Assembled front Performance Pack struts
- Performance Pack rear shocks
- M-5300-X Street Lowering Springs
- Performance Pack upper strut mounts
- M-5570-B Jounce Bumpers & Hardware Kit (jounce bumpers are installed on the assembled front Performance Pack struts)
- Performance Pack front and rear sway bars
- Performance Pack rear toe links

NOTE: A Mustang that originally came equipped with the Performance Pack option only needs the M-5300-X Street Lowering Springs to achieve the lowered ride height or upgrade to the M-FR3A-M8A Track Handling Pack.

NOTE: Please reference a Ford service manual for installation information and correct torque specifications. May require alignment after installation.



2015-2018 MUSTANG HANDLING PACK FASTENER KIT

M-FR3-FASTENA

- Fits: 2015-2018 Mustang GT and 2.3L EcoBoost® Coupe
- Includes all hardware that is associated with Ford Performance M-FR3A-M8A Track Handling Pack and M-FR3A-MAA Street Handling Pack

Includes hardware for the following applications:

- Front damper assembly and mounting hardware
- Front sway bar mounting hardware
- Rear toe link mounting hardware including the rear outer alignment cam
- Rear lower control arm mounting hardware
- Rear upper control arm mounting hardware
- Rear knuckle mounting hardware
- Rear sway bar mounting hardware
- Rear shock assembly and mounting hardware



2015-2018 MUSTANG PERFORMANCE PACK FRONT CONTROL ARM KIT

M-3075-F

- Fits 2015-2018 Mustang GT and 2.3L EcoBoost®
- Original equipment on 2015-2017 Mustang GT Performance Package
- The rearward Performance Pack front control arms are forged steel and contain a spherical bearing mount versus the tubular weldment and rubber bushing found on base Mustang
- The forward Performance Pack front control arms are forged steel and contain an air deflector to aid in brake cooling
- Includes right and left forward and rearward front Performance Pack control arms and all installation hardware



2015-2018 MUSTANG GT350R STRUT TOWER BRACE KIT

M-20201-GT350

- Fits 2015-2018 Left Hand Drive (LHD) Mustang GT, 2.3L EcoBoost® and GT350
- Original equipment on 2015-2017 GT350R and GT350 Track Package equipped Mustang
- Fabricated high-strength tubular aluminum
- 2.5 lbs lighter than the base GT350 stamped steel brace
- Improves handling and limits suspension flex
- Kit includes GT350R strut tower brace, cowl C-brace and mounting hardware
 - Cowl C-brace only needed when car was not originally equipped with the brace

NOTE: Does not fit 2015-2017 Mustang GT with Ford Performance supercharger or 3.7L V6.

NOTE: For Right Hand Drive (RHD) Mustang, use Part No. M-20201-M350RHD.



2015-2018 MUSTANG GT350R RIGHT HAND DRIVE STRUT TOWER BRACE KIT

M-20201-M350RHD

- Fits 2015-2018 Right Hand Drive (RHD) Mustang GT 5.0L and 2.3L EcoBoost®
- Original equipment on 2015-2017 GT350R and GT350 Track Package equipped Mustang
- Fabricated high-strength tubular aluminum
- 2.5 lbs lighter than the base GT350 stamped steel brace
- Improves handling and limits suspension flex
- Kit includes GT350R strut tower brace, cowl C-brace and mounting hardware
 - Cowl C-brace only needed when car was not originally equipped with the brace

NOTE: Does not fit 2015-2017 Mustang GT with Ford Performance supercharger or 3.7L V6.

NOTE: This part is for use on Right Hand Drive (RHD) Mustang only. For Left Hand Drive (LHD) Mustang, use Part No. M-20201-GT350.



2015-2018 MUSTANG RIGHT HAND DRIVE STRUT TOWER BRACE

M-20201-MARHD

- Fits 2015-2018 Right Hand Drive (RHD) Mustang GT 5.0L and 2.3L EcoBoost®
- Stamped steel beam design
- Kit includes rear cowl brace and mounting hardware
- Black powdercoated brace with stainless steel "Ford Performance" emblem

NOTE: Does not fit 2015-2017 Mustang GT with Ford Performance supercharger or 3.7L V6.

NOTE: This part is for Right Hand Drive (RHD) Mustang only. For Left Hand Drive (LHD) Mustang, use Part No. M-20201-M.



2015-2018 MUSTANG FORD PERFORMANCE STRUT TOWER BRACE

M-20201-MA

- Fits 2015-2018 Mustang GT 5.0L and 2.3L EcoBoost®
- Stamped steel beam design
- Kit includes rear cowl brace and mounting hardware
- Black powdercoated brace with stainless steel "Ford Performance" emblem

NOTE: Does not fit 2015-2016 Mustang GT with Ford Performance supercharger or 3.7L V6.



2015-2018 MUSTANG DRIVESHAFT LOOP

M-5478-6M

- Fits 2015-2018 Mustang with one-piece driveshaft only
- Similar to M-5478-CJ Cobra Jet Driveshaft Loop
- Meets most drag racing sanctioning body requirements
- Contains driveshaft in the event of front U-joint breakage



2015-2018 MUSTANG

2015-2018 MUSTANG REAR BRAKE KIT

M-2300-MR

- Fits 2015-2018 Mustang GT and 2.3L EcoBoost®
- Production rear brake components used on the 2015-2017 Mustang GT
- Kit is designed for use with M-5970-M Mustang IRS Knuckle Kit used in custom vehicle construction

Kit includes:

- Right and left brake calipers
- Caliper brackets
- Brake rotors
- Right and left brake splash shields
- Brake splash shield mounting hardware
- Brake pads
- Caliper slide pin kit
- Caliper bracket bolts

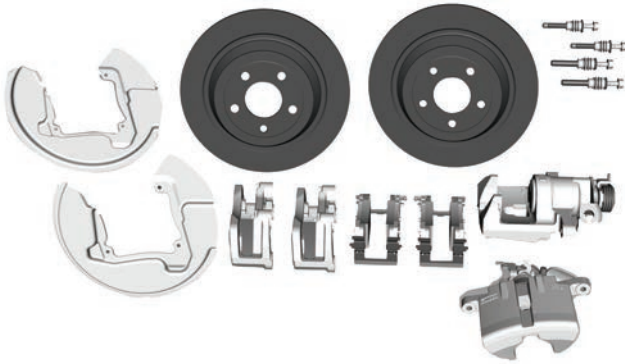

2015-2018 MUSTANG PERFORMANCE GT350R BRAKE KIT



M-2300-Y

- Fits 2015-2018 Mustang GT 5.0L and 2.3L EcoBoost®
- Fits both Right Hand Drive (RHD) and Left Hand Drive (LHD) Mustang
- Original equipment on 2015-2018 GT350R
- Brembo® 6-piston gloss red aluminum fixed front calipers
- Brembo® 4-piston gloss red aluminum rear calipers
- Front rotors are 15.5" cross-drilled with directional vanes
- Rear rotors are 14.9" cross-drilled

Kit includes:

- GT350R front calipers
- GT350R front rotors
- GT350R front brake pads
- Front caliper adapters
- GT350R rear calipers
- GT350R rear rotors
- GT350R rear brake pads
- GT350R parking brake assemblies
- Rear GT350R knuckle
- GT350R axle assemblies
- All needed hardware
- Detailed instructions



NOTE: Stock 2015-2017 Mustang, Mustang EcoBoost® and Mustang GT 17", 18", 19" (including non and Performance Pack) and 20" wheels will not clear the GT350R brake calipers.

2015-2018 GT350 BRAKE UPGRADE KIT

M-2300-AA



- Fits 2015-2018 Mustang GT350
- Upgrades the stock GT350 matte black brake calipers to the desirable gloss red calipers
- Original equipment on 2015-2018 GT350R
- Brembo® 6-piston gloss red aluminum fixed front calipers
- Brembo® 4-piston gloss red aluminum rear calipers
- Front rotors are 15.5" cross-drilled with directional vanes
- Rear rotors are 14.9" cross-drilled

Kit includes:

- GT350R front calipers
- GT350R front rotors
- GT350R front brake pads
- GT350R rear calipers
- GT350R rear rotors
- GT350R rear brake pads
- All needed hardware



2015-2018 MUSTANG PERFORMANCE PACK 6-PISTON FRONT BRAKE KIT

M-2300-V

- Fits 2015-2018 Mustang GT and 2.3L EcoBoost®
- Original equipment on 2015-2017 Mustang GT Performance Package
- Brembo® 6-piston satin black aluminum calipers
- 15" vented brake rotors
- Includes production brake pads, rotors, dust shields and installation hardware
- Requires Ford Performance wheels M-1007-M199B, M-1007-M199S, M-1007-M199SA, M-1007-M199DS or equivalent for caliper clearance

NOTE: Kit includes front brake hoses to install 6-piston calipers on 2.3L EcoBoost® models. Brake hoses are not used when installing this kit on Mustang GT 5.0L models.



2005-2018 MUSTANG "FORD PERFORMANCE" WINDSHIELD BANNER

M-1820-MB

- Fits 2005-2018 Mustang
- Die-cut white lettering that will adhere to a properly prepared windshield
- 48" long banner with 2" tall, white "FORD PERFORMANCE" script



2005-2018 MUSTANG "FORD PERFORMANCE" WINDSHIELD BANNER – WHITE AND RED

M-1820-MR

- Fits 2005-2018 Mustang
- Die-cut lettering that will adhere to a properly prepared windshield
- 48" long banner with 2" tall "FORD PERFORMANCE" script
- **Banner includes white color "FORD" and red color "PERFORMANCE" lettering**
- Same banner as used in Ford Performance FP350S road race car, Ford Performance marketing vehicles, Monster Energy NASCAR® cup series, etc.

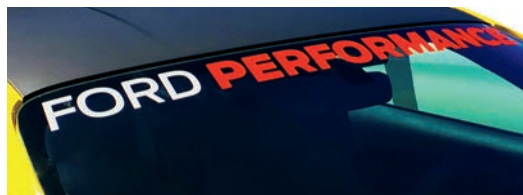

2018 MUSTANG "FORD PERFORMANCE" LOGO RECARO® SEAT SET

M-63660005-MF

- Fits 2018 Mustang GT and EcoBoost® I4 except convertibles
- Similar to the optional RECARO® sport seat found in the 2018 Mustang GT
- This seat is equipped with an integrated headrest, seat belt pass-through openings and enhanced shoulder, back and thigh area bolsters
- Features an embroidered "Ford Performance" logo on front of seat back
- Black leather 4-way manual adjustment (driver); 2-way manual adjustment (passenger)
- Includes original equipment air bags and OCS sensor
- Manufactured for Ford Performance by RECARO®
- Sold as a pair

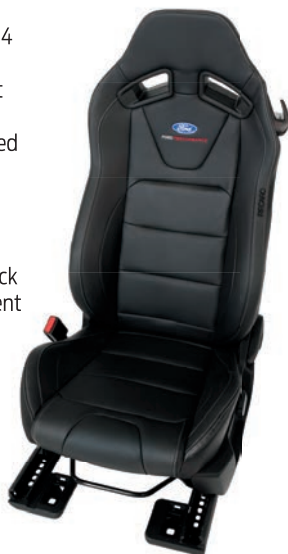

2015-2017 MUSTANG "FORD PERFORMANCE" LOGO RECARO® SEAT SET

M-63660005-ME

- Fits 2015-2017 Mustang GT, V6 and EcoBoost® I4 except convertibles
- Similar to the optional RECARO® sport seat found in the 2015-2016 Mustang GT
- This seat is equipped with an integrated headrest, seat belt pass-through openings and enhanced shoulder, back and thigh area bolsters
- Features an embroidered "Ford Performance" logo on front of seat back
- Black leather 4-way manual adjustment (driver); 2-way manual adjustment (passenger)
- Includes original equipment air bags and OCS sensor
- Manufactured for Ford Performance by RECARO®
- Sold as a pair



2015-2018 MUSTANG GT350R REAR SEAT INSTALLATION KIT

M-63840-MS

- Fits 2015-2018 Mustang GT350R
- Kit includes all components necessary to add a rear seat to a GT350R
- Kit adds all original GT350 occupant restraint systems
- Unique rear seat upholstery matches the front seats, including the signature GT350R red stitching



2015-2018 MUSTANG REAR SEAT DELETE KIT

M-6346612-M

- Fits 2015-2018 Mustang GT Coupe, 2.3L EcoBoost® Coupe and GT350
- Original equipment on 2015-2017 Mustang GT350R
- Kit includes all needed rear seat delete trim panels and installation hardware



2015-2018 MUSTANG

2015-2017 MUSTANG RED STARTER BUTTON INSTALLATION KIT

M-10B776-MR

The Ford Performance Parts red starter button kit is designed to replace the stock silver starter button cap found on GT and 2.3L Mustang with the popular red GT350/GT350R starter button cap, giving your car a distinctive appearance.

- Fits 2015-2017 Mustang GT 5.0L and 2.3L EcoBoost®
- Kit includes a GT350 red starter button cap and replacement trim clips to use as needed
- Thorough installation instructions and available installation video



2015-2018 MUSTANG DECK LID TRIM PANEL

M-16600-MA

- Fits all 2015-2018 Mustang models
- Customize the appearance of the rear of your 2015-2018 Mustang with the Ford Performance deck lid trim panel. This is the production trim panel from the 2018 Mustang that is pulled from the production mold before the mounting holes for the "Running Horse" or "GT" badges are placed in the part. The part is finished in gloss black. This is the perfect "blank canvas" to create a special custom look for any 2015-2018 Mustang. The provision for the rear mounted camera is retained.
- Includes complete deck lid trim panel



2015-2018 MUSTANG TIE-DOWN KIT

M-1700-M

- Includes hooks for front and rear tie-down of Mustang for transport
- Rear hooks mount just in front of rear tires on frame rail
- Front hooks attach to frame rail next to k-member
- Includes installation instructions
- As used on 2016 Cobra Jet
- Coupe/fastback only – does not fit convertible vehicles



2015-2018 MUSTANG HOOD LIFT KIT W/LASER ENGRAVED "FORD PERFORMANCE" LOGO

M-16826-MA

Simply start to lift your hood and let the hood lift system take over. Your hood will lift and hold firmly at the raised position – no wind or bumping will knock your hood down on your head. These gas struts are rated at 90 lbs to hold up OEM and specialty hoods. Due to the leverage when open, a 90 lbs rated strut will keep the hood open securely.

- Fits 2015-2018 Mustang. Does not fit GT350
- Ford Performance hood lift kit w/laser engraved "Ford Performance" logo
- 90 lbs rating
- Designed for all OEM base Mustang, Mustang GT and many aftermarket hoods
- These hood lifts utilize two gas struts that lift and hold the hood without the need for a prop rod
- Made from lightweight steel and aluminum, they feature a durable black powdercoated finish to give your engine bay a much cleaner appearance
- Includes the necessary mounting brackets
- If your aftermarket hood is lighter than the factory hood, use caution when opening the hood due to the power of the strut



2015-2017 MUSTANG PERFORMANCE PACK BOOST GAUGE KIT

M-10849-A

- Fits 2015-2017 Mustang GT 5.0L Performance Pack equipped Mustang
- Original equipment on 2015-2017 Performance Pack 2.3L EcoBoost® Mustang
- Kit provides an easy way to read boost levels on a Mustang that has installed a forced induction setup, while maintaining the OEM look and functionality
- Features oil pressure and vacuum/boost gauge
- Easy plug-and-play installation
- Compatible with MyColor interior lighting
- Installation is plug-and-play and does not require any cutting or splicing

Kit includes:

- Oil pressure/boost gauge
- Trim clips
- Detailed instructions

NOTE: Boost gauge has been validated with Ford Performance, Roush® and Whipple® supercharger kits. Other supercharger kits and aftermarket performance calibrations can prevent boost gauge from functioning.



2015-2018 MUSTANG REAR TOW HOOK ASSEMBLY

M-17954-RB

- Fits 2015-2018 Shelby GT350 & GT350R
- Fits 2015-2017 Mustang GT front and rear locations
- Original equipment on Shelby FP350S
- Bright red powdercoat finish
- Bolts in place – no welding required
- Requires the removal of center mount reverse light



2015-2018 GT350 FRONT TOW HOOK ASSEMBLY

M-17954-FA

- Fits 2015-2018 Shelby GT350 & GT350R
- Original equipment on Shelby FP350S
- Bright red powdercoat finish
- Bolts in place – no welding required
- Front upper grill requires modification to install



2015-2017 MUSTANG FENDER COVERS (PAIR)

M-1822-M

- Protect your 2015-2017 Mustang GT, V6 or I4 from scratches with these molded plastic front fender covers
- **Sourced right from the Ford Flat Rock Assembly Plant, home of the Mustang, where they are used in production**
- A unique, one-time opportunity part for the serious Mustang enthusiast
- Quantities are very limited and it is unlikely these will be available in the future
- Includes both right- and left-side fender covers
- Does not fit Mustang GT350



2015-2018 MUSTANG LUG NUT KIT

M-1012-M

- Fits 2015-2018 Mustang
- Fits new M14 x 1.5 wheel stud
- Kit contains 5 lug nuts



2015-2018 MUSTANG OPEN BACK LUG NUT KIT

M-1012-N

- Fits all 2015-2018 Mustang
- Kit contains 5 lug nuts
- Fits new M14 x 1.5 wheel stud
- Included with Ford Performance Parts M-1104-AB Front Wheel Hub Kit with Extended ARP® Studs
- Included with Ford Performance Parts M-1104-B Rear Wheel Hub Kit with Extended ARP® Studs
- Can be used with Ford Performance Parts M-1107-C Wheel Stud Kit



2015-2018 MUSTANG BLACK LUG NUT KIT (5 PCS)

M-1012-MB

- Fits 2015-2018 Mustang, Mustang GT, GT350 and GT350R
- Fits 2017-2018 GT
- Original equipment on the 2018 Ford GT
- Ford Performance Parts black lug nuts use physical vapor deposition technology (PVD), which provides a scratch- and wear-resistant finish that ensures a perfect look for an extended period of time under intense use and provides surface wear resistance that cannot be provided by electroplating, anodizing or lacquer
- Fits M14 x 1.5 wheel stud
- Kit contains 5 lug nuts

NOTE: Hand installation and removal with non-marring lug nut sockets is strongly recommended to prevent surface damage to the black lug nuts.



FORD PERFORMANCE WHEEL CENTER CAP

M-1096-FP3

- Fits 2015-2018 Mustang
- Fits 2016-2018 Focus RS
- "Ford Performance" logo on a gloss black background



2015-2018 MUSTANG WHEEL CENTER CAP

M-1096-O

- Fits 2015-2018 Mustang with 19" wheels
- Chrome "Running Horse" on a black background



FORD PERFORMANCE 2015-2018 MUSTANG WHEELS

2015-2018 MUSTANG GT 19" X 9" & 19" X 9.5" PERFORMANCE PACK WHEEL SET WITH TPMS KIT

M-1007K-M19XB Matte Black

M-1007K-M19XGB Gloss Black

- Fits 2015-2018 Mustang
- Clears Performance Pack brakes
- Paint finish clearcoated to OEM standards
- Includes 19" x 9" front wheels and 19" x 9.5" rear wheels
- Matte black wheels include the Ford Performance M-1096-FP3 Center Caps; gloss black wheels include the Mustang M-1096-O Center Caps
- Includes M-1180-B TPMS Sensor and Activation Tool Kit
- 5-lug, 114 mm (4.5") bolt circle
- 52.5 mm offset on 19" x 9.5" wheel and 45 mm offset on 19" x 9" wheel
- 186 mm backspacing on 19" x 9.5" wheel and 172 mm backspacing on 19" x 9" wheel



M-1007K-M19XB
Matte Black shown

2015-2018 MUSTANG GT PERFORMANCE PACK REAR WHEEL 19" X 9.5"

M-1007-M1995B Matte Black

M-1007-M1995GB Gloss Black

- Fits 2015-2018 Mustang
- Gloss black wheel is original equipment on the 2015-2018 Mustang GT Performance Pack, and the matte black wheels offer the same wheel style with a unique Ford Performance paint finish
- Paint finish clearcoated to OEM standards
- Matte black wheels include the Ford Performance M-1096-FP3 Center Caps; gloss black wheels include the Mustang M-1096-O Center Cap
- Clears Performance Pack brakes
- Use with M-1180-B TPMS Sensor and Activation Tool Kit
- Valve stem TPMS compatible
- 19" x 9" wide
- 5-lug, 114 mm (4.5") bolt circle
- 52.5 mm offset
- 186 mm backspacing



M-1007-M1995B
Matte Black shown

2015-2018 MUSTANG GT PERFORMANCE PACK FRONT WHEEL 19" X 9"

M-1007-M199B Matte Black

M-1007-M199GB Gloss Black

- Fits 2015-2018 Mustang
- Gloss black wheel is original equipment on the 2015-2018 Mustang GT Performance Pack, and the matte black wheels offer the same wheel style with a unique Ford Performance paint finish
- Paint finish clearcoated to OEM standards
- Matte black wheels include the Ford Performance M-1096-FP3 Center Caps; gloss black wheels include the Mustang M-1096-O Center Cap
- Clears Performance Pack brakes
- Use with M-1180-B TPMS Sensor and Activation Tool Kit
- Valve stem TPMS compatible
- 19" x 9" wide
- 5-lug, 114 mm (4.5") bolt circle
- 45 mm offset
- 172 mm backspacing



M-1007-M199B shown

2015-2018 MUSTANG ECOBOOST® PERFORMANCE PACK WHEEL 19" X 9"

M-1007-M199DS Dark Stainless

M-1007-M199SA Sparkle Silver

- Fits 2015-2018 Mustang
- Same styling as 2015-2017 Mustang EcoBoost® I4 Performance Pack wheel with a unique Ford Performance paint finish
- Paint finish clearcoated to OEM standards
- Includes Ford Performance M-1096-FP3 Center Cap
- Clears Performance Pack 6-piston brakes
- Works with M-1180-B TPMS Sensor and Activation Tool Kit
- Valve stem TPMS compatible
- 19" x 9" wide
- 5-lug, 114 mm (4.5") bolt circle
- 45 mm offset
- 172 mm backspacing



M-1007-M199SA
Sparkle Silver shown

2015-2018 MUSTANG ECOBOOST® 19" X 9" PERFORMANCE PACK WHEEL SET WITH TPMS KIT

M-1007K-M199DS Dark Stainless

M-1007K-M199S Sparkle Silver

- Fits 2015-2018 Mustang
- Clears Performance Pack brakes
- Same styling as 2015-2017 Mustang EcoBoost® I4 Performance Pack wheels with a unique Ford Performance paint finish
- Paint finish clearcoated to OEM standards
- Includes Ford Performance M-1096-FP3 Center Cap
- Includes M-1180-B TPMS Sensor and Activation Tool Kit
- 19" x 9" wide
- 5-lug, 114 mm (4.5") bolt circle
- 45 mm offset
- 172 mm backspacing



M-1007K-M199DS
Dark Stainless shown

MUSTANG AND F-150 TPMS SENSOR AND ACTIVATION TOOL KIT

M-1180-B

- Fits 2015-2018 Mustang
- Fits 2015-2018 F-150
- Fits 2017-2018 F-150 Raptor
- Kit contains 4 valve-mounted snap-in tire pressure monitor sensors (valve stem TPMS) and tire pressure monitor activation tool
- Mustang and F-150 require that tire pressure monitor sensors are installed and properly activated
- Failure to install and activate sensors will cause tire pressure monitor light to remain on
- Activation tool can be used to retrain sensors after tire rotation
- Warning: Requires wheels specifically designed for valve-mounted snap-in tire pressure monitor sensors



NOTE: Will NOT work on 2007-2014 Mustang V6, GT or GT500.

NOTE: For use on North American LHD Mustang only.

NOTE: Valve stems are not designed for speeds over 155 mph.

2005-2014 MUSTANG

2011-2014 MUSTANG GT POWER UPGRADE PACKAGE M-FR1-MGTB*



- Fits 2011-2014 Mustang GT
- For 2005-2009 Mustang GT, see M-FR1-MGTI. For 2010 Mustang GT, see M-FR1-MGTA
- Approximate peak increase of 16 hp and 7 lb-ft on 93 octane fuel
- Up to 60 lb-ft increase at 1500 rpm!
- Skip-shift disable (2011-2012 only, not necessary on 2013-2014 models)

Kit includes:

- Ford Performance ProCal tool with performance calibration
- 2011-2014 Mustang GT M-9601-MGT High-Flow K&N/Ford Performance Air Filter
- 2011-2014 Mustang M-5230-MGTCA1 GT Muffler Kit (50 State)
- CM-6731-FL820 High Performance Oil Filter
- Premium (91 octane or higher) fuel only

- **Due to multiple powertrain calibrations, online registration is required to receive ProCal calibration delivery tool after purchase**
- **Ford Performance does not ship ProCal tools directly overseas. Customers must make special arrangements with their Ford Performance Distributor**

- Powertrain calibrations are developed and supported for U.S. and Canadian vehicles only
- Unlike many of our competitors, this Ford Performance Power Upgrade Package is 50-state emissions legal and eligible for limited warranty when installed by a Ford or Lincoln dealer
- Federal and state laws prohibit any person from installing aftermarket add-on or modified parts prior to the sale of a new motor vehicle



2005-2009 MUSTANG V6 POWER UPGRADE PACKAGE M-2007-FR1V6*



- Fits 2005-2009 Mustang V6 with manual or automatic transmission. For 2010 Mustang V6, see M-FR1-MV6
- Approximate increase of 15 peak hp and up to 17 lb-ft over stock

Kit includes:

- Ford Performance ProCal tool with performance calibration for significantly improved throttle response and performance feel
- M-9603-V605 2005-2009 Mustang V6 Cold Air Kit With Performance Calibration
- M-5230-V6 2005-2009 Mustang V6 Touring Dual Exhaust Kit (50 State)
- CM-6731-FL820 High Performance Oil Filter

- Utilizes production quality components which mount in the stock location. The high-flow molded plastic bucket features a painted "Ford Racing" logo with unique clean-air tube which provides an enhanced intake sound
- Premium (91 octane or higher) fuel only

- **Due to multiple powertrain calibrations, online registration is required to receive procal calibration delivery tool after purchase**
- **Ford Performance does not ship ProCal tools directly overseas. Customers must make special arrangements with their Ford Performance Distributor**

- Powertrain calibrations are developed and supported for U.S. and Canadian vehicles only
- Unlike many of our competitors, this Ford Performance Power Upgrade Package is 50-state emissions legal
- Federal and state laws prohibit any person from installing aftermarket add-on or modified parts prior to the sale of a new motor vehicle



*This component is eligible for the Ford Performance Parts Limited Warranty. See the Ford Performance Parts Limited Warranty on pages 295-302 for details.

2005-2014 MUSTANG



2011-2014 MUSTANG GT FORD PERFORMANCE CALIBRATION WITH HIGH-FLOW K&N AIR FILTER

M-9603-MGTB*

- Fits 2011-2014 Mustang GT
- For 2005-2009 Mustang GT, see M-9603-GTB
- Approximate peak increase of 16 hp and 7 lb-ft on 93 octane fuel
- Up to 60 lb-ft increase at 1500 rpm!
- Eliminates skip shift on 2011-2012 manual transmission applications

Kit includes:

- Ford Performance ProCal tool with performance calibration
- 2010-2014 Mustang GT M-9601-MGT High-Flow K&N/Ford Performance Air Filter
- Premium (91 octane or higher) fuel only
- **Due to multiple powertrain calibrations, online registration is required to receive ProCal calibration delivery tool after purchase**
- **Ford Performance does not ship ProCal tools directly overseas. Customers must make special arrangements with their Ford Performance Distributor**
- Powertrain calibrations are developed and supported for U.S. and Canadian vehicles only
- Unlike many of our competitors, this Ford Performance Power Upgrade Package is 50-state emissions legal and eligible for limited warranty when installed by a Ford or Lincoln dealer
- Federal and state laws prohibit any person from installing aftermarket add-on or modified parts prior to the sale of a new motor vehicle



2007-2009 MUSTANG SVT 5.4L 4V COLD AIR TUNER KIT (CALIBRATION REQUIRED)

M-9603-M54SC



- Fits 2007-2009 Mustang SVT
- Designed for those who want the Ford Racing intake for aftermarket performance tuning/calibration
- Kit comes with hardware only! Calibration not included! Kit intended for aftermarket calibrators
- Ford Racing cold air kits utilize production quality components which mount in the stock location (reuse of mass air meter sensor required)
- Kit includes 113 mm mass air meter and **no** calibration
- For replacement air filter element see M-9601-D
- **A performance calibration is necessary to prevent engine damage. Calibration not included!**



2007-2009 MUSTANG SVT 113 MM COLD AIR KIT

M-9603-SVT07



- Fits 2007-2009 Mustang SVT
- Approximate increase of 40 hp/30 lb-ft over stock

Kit includes:

- Ford Performance ProCal tool with performance calibration for significantly improved throttle response and performance feel. A certified pre-owned ProCal tool may be provided
- 113 mm mass air sensor housing
- M-9601-D Disposable Air Filter Element
- Premium (91 octane or higher) fuel only
- **Due to multiple calibrations, online registration is required to receive ProCal tool after purchase**
- **Ford Performance does not ship ProCal tools directly overseas. Customers must make special arrangements with their Ford Performance Distributor**
- Engine calibrations are developed and supported for U.S. and Canadian vehicles only
- Unlike many of our competitors, this Ford Performance Power Upgrade Package is 50-state emissions legal
- Federal and state laws prohibit any person from installing aftermarket add-on or modified parts prior to the sale of a new motor vehicle



5.0L COBRA JET COLD AIR KIT

M-9603-M50CJ

- Fits 2011-2014 Mustang GT and 2012-2013 BOSS 302 with Cobra Jet 5.0L M-9424-M50CJ Intake Manifold
- Intake manifold requires throttle body M-9926-MSVT, M-9926-CJ65 or M-9926-SCJ
- High-flow filter, high-flow molded plastic air filter bucket and unique clean-air inlet tube with "Ford Racing" logo
- 102 mm air inlet diameter
- Design based on 5.0L NA Cobra Jet race car
- 2013-2014 Mustang GT heat extractor may allow drainage of water onto air filter. Modify as necessary
- **Calibration is necessary to prevent engine damage! Calibration not included!**

NOTE: CJ inlet tube does not have provisions for aspirator tube hook up common to automatic transmission equipped 2011-2014 Mustang GT.



*This component is eligible for the Ford Performance Parts Limited Warranty. See the Ford Performance Parts Limited Warranty on pages 295-302 for details.

2014 COBRA JET HEAT SHIELD FOR AIR INLET

M-9605-CJ14

- As used on 2014 Cobra Jet with 2.9L supercharger
- Excellent upgrade for 2013 Cobra Jet
- Reduces air inlet temperature
- Saw as much as 30 hp gain in testing, depending on conditions
- Could be modified for custom applications



2005-2009 MUSTANG V6 4.0L COLD AIR TUNER KIT (CALIBRATION REQUIRED)

M-9603-M40

- Fits 2005-2009 Mustang V6 with manual or automatic transmission
- Designed for those who want the Ford Performance cold air intake for aftermarket performance tuning/calibration
- Kit comes with hardware only! Calibration not included! Kit intended for aftermarket calibrators
- Ford Performance cold air kit utilizes production quality components which mount in the stock location. The higher flowing molded plastic bucket features a painted "Ford Racing" logo with unique air tube providing an enhanced intake sound and 85 mm mass air meter housing (reuse of mass air meter sensor required)
- For replacement air filter element, see M-9601-B
- **Calibration is necessary to prevent engine damage! Calibration not included!**



2005-2009 MUSTANG V6 COLD AIR KIT WITH PERFORMANCE CALIBRATION

M-9603-V605

- Fits 2005-2009 Mustang V6 with manual or automatic transmission
- Approximate increase of 12 peak hp – up to 13 lb-ft over stock

Kit includes:

- Ford Performance ProCal tool with performance calibration for significantly improved throttle response and performance feel. A certified pre-owned ProCal tool may be provided
- Disposable M-9601-B Air Filter Element
- Utilizes production quality components which mount in the stock location. The high-flow molded plastic bucket features a painted "Ford Racing" logo with unique clean-air tube which provides an enhanced intake sound
- Premium (91 octane or higher) fuel only
- **Due to multiple powertrain calibrations, online registration is required to receive ProCal calibration delivery tool after purchase**
- **Ford Performance does not ship ProCal tools directly overseas. Customers must make special arrangements with their Ford Performance Distributor**
- Powertrain calibrations are developed and supported for U.S. and Canadian vehicles only
- Unlike many of our competitors, this Ford Performance Power Upgrade Package is 50-state emissions legal
- Federal and state laws prohibit any person from installing aftermarket add-on or modified parts prior to the sale of a new motor vehicle



*This component is eligible for the Ford Performance Parts Limited Warranty. See the Ford Performance Parts Limited Warranty on pages 295-302 for details.

2005-2014 MUSTANG

REPLACEMENT FILTERS

2007-2009 MUSTANG SVT COLD AIR AND SUPERCHARGER UPGRADE KIT REPLACEMENT AIR FILTER

M-9601-D

- Replacement air filter for the 2007-2009 Mustang SVT 113 mm M-9603-SVT07 Cold Air Kit and M-6066-SGT Supercharger Upgrade Kit



2005-2009 MUSTANG GT/V6 COLD AIR KIT DISPOSABLE HIGH-FLOW AIR FILTER REPLACEMENT

M-9601-B

- Replacement disposable air filter for Ford Performance 2005-2009 Mustang GT M-9603-GTB Cold Air Kit, 2005-2009 Mustang V6 M-9603-V605 Cold Air Kit, 2005-2009 Mustang V6 4.0L M-9603-M40 Cold Air Kit and 2005-2009 Mustang V6 M-9603-V605 Cold Air Kit
- Original equipment replacement air filter for 2008-2009 Mustang Bullitt. Not for use with stock 2005-2010 Mustang GT or V6 air-box



2010-2014 MUSTANG GT & 2011-2014 V6 HIGH-FLOW K&N/FORD PERFORMANCE AIR FILTER

M-9601-MGT

K&N 4 ply panel washable air filter

- K&N 4 ply panel washable air filter
- Fits stock 2010-2014 Mustang GT air-box. **Will NOT fit 2005-2009**
- Fits stock 2011-2014 Mustang V6 air-box. **Will NOT fit 2005-2010**
- Fits stock 2012-2013 Mustang BOSS 302
- Flows approximately 22% more than stock filter at 1.5" H2O delta pressure
- Co-engineered by K&N and Ford Performance
- Does not require PCM recalibration



AIR FILTER ELEMENT

M-9601-C

- Service replacement air filter for M-9603-GT06 Cold Air Kit



ProCal

PERFORMANCE CALIBRATIONS



ProCal is included in select Cold Air Kits, Power Upgrade Packages, and Supercharger Kits.

Ford Performance Calibrations are engineered to generate optimal horsepower and torque, while delivering:

- *Engine Durability*
- *Exceptional Drivability*
- *50-State Emissions Compliancy*

ProCal Tool – New and Improved!

- Enhanced features: now accepts input for axle ratio and tire size
- Easy-to-read display
- Step-by-step calibration loading instructions
- OBD II diagnostic code display capability

Trust Ford Performance ProCal to unlock your vehicle's potential without putting your powertrain at risk.



FORD PERFORMANCE

performance.ford.com



DYNAMOMETER TESTING AND FORD PERFORMANCE CALIBRATIONS

A question we at Ford Performance Parts are often asked is “Why do certain companies claim to make more power with their power upgrade kits than you do with your kits?” To address that question properly, it is necessary to understand some of the intricacies of chassis dynamometer testing, as well as some of the compromises that must be made in order to simultaneously meet our standards for performance, emissions, durability and safety.

CHASSIS DYNAMOMETER TESTING

There are two main types of chassis dynamometers (dynos) in widespread use today.

- An inertia dyno uses a large spinning drum that is accelerated by the drive wheels of the test vehicle. Power is then computed by knowing the inertia of the drum and how quickly it was accelerated. Torque can then be calculated by knowing the speed of the drum.
- An eddy-current dyno absorbs and measures power by rotating a metallic disc through a magnetic field.



Without getting into which dyno is more “correct” under what conditions, and why, we will simply say that these two types of dynos typically do not always give the same result even with all else being equal. It is generally not possible to accurately compare numbers from one type of dyno with those from the other type of dyno. Each type of dyno has its own advantages and disadvantages, but as long as all the tuning work is done on the same type of dyno, it doesn’t really matter which one is used.

With any dyno testing there is a need for correction factors that are applied to the raw numbers the dyno actually measures. These correction factors are an attempt to correct for varying atmospheric conditions such as humidity, barometric pressure and air temperature. The two most common standards are SAE J1349 and SAE J607 (sometimes known as “STD” on some dynos). How correction factors are calculated is given in the “Crate Engine” section of this catalog. For this article, understand that these correction factors will give results that are different from each other, with SAE J1349 typically about 4% lower than SAE J607. OEMs will almost always quote J1349 corrected numbers when advertising horsepower and torque. Some “tuning” shops will report STD numbers because they are always higher than SAE. Be sure to ask which correction factor is being used when comparing dyno numbers!

Whenever comparing dyno results, always be sure that the numbers are corrected to the same standard. Despite these correction factors, atmospheric conditions can play an additional role in terms of ignition timing. The correction factors account only for the change in the density of the air due to atmospheric conditions and cannot account for things like engine borderline spark sensitivity. As inlet air temperature increases, the PCM will generally retard spark to prevent detonation using the particular octane of fuel for which it was calibrated. Correction factors cannot account for this because different engine designs can have different spark sensitivity and different

sensitivity of torque relative to ignition timing. Basically this means that the closer the actual conditions are to the SAE J1349 standard (77° F inlet air, 29.31 inHg barometric pressure), the more comparable the results are to those quoted by the manufacturer. Unless otherwise explicitly stated, **all horsepower numbers in the Ford Performance catalog have been determined by using the SAE J1349 standard.**

When testing a particular calibration or performance-enhancing part by performing back-to-back dyno runs, it is critical to keep test conditions as similar as possible between the runs. This sounds obvious but is very commonly overlooked by many aftermarket companies who frequently publish dyno charts depicting large gains, but fail to give all the necessary data to show the tests were run under similar conditions. In order to be certain that the test conditions are as similar as possible, the following data is mandatory and needs to be collected for each run:

- Ambient air temperature
- Barometric pressure
- Inlet air temperature (on a forced-induction car, this is usually downstream of the power adder)
- Air/fuel (A/F) ratio (preferably upstream of any catalyst)

Truly meaningful power numbers cannot be collected without this data!

It is also a good idea to make sure the A/F ratio sensor (often called a “wideband” sensor) in use on the dyno has not been exposed to leaded fuel and has not been in service for an excessive period of time (greater than six months, depending on frequency of use). A/F ratio is the single most important parameter to measure accurately when doing any sort of dyno tuning, so it is critical the sensor is providing accurate information. When doing any PCM calibration on a dyno, **the resulting calibration will only be as good as the A/F sensor.**

These additional inputs should be used for ideal dyno testing and calibration:

- Air/fuel ratio and spark advance commanded by the PCM
- Fuel injector pulse width
- Fuel pump duty cycle (in the case of ERFS)
- MAF sensor voltage
- Fuel pressure
- Engine oil temperature
- Differential oil temperature



DYNAMOMETER TESTING AND FORD PERFORMANCE CALIBRATIONS (continued...)

How drivetrain affects wheel horsepower:

Most chassis dyno tests are performed using the “roll-on” method, where the vehicle’s drive wheels are accelerated in a particular gear from a low speed to a high speed (generally to the rev limit of the engine) in one continuous sweep. Because of this constant acceleration, engine and transmission inertia, drive wheel inertia, tire characteristics, gear ratio and axle ratio can all affect the final measured horsepower. Generally a heavier wheel will take more torque to accelerate at the same rate as a lighter wheel, so heavier wheels will tend to reduce the measured wheel horsepower. Gear ratio comes into play because as the gear ratio strays from a 1:1, the efficiency drops and therefore the measured horsepower at the wheels also drops. This is why most dyno runs are run in the 1:1 gear (i.e., 4th gear in a 5-speed overdrive transmission) whenever possible. The same logic applies to axle ratio as well, which means that **changing nothing but axle ratio can have an effect on measured wheel horsepower**. Remember, this does NOT change brake (flywheel) horsepower, only the delivered wheel horsepower due to the change in drivetrain efficiency. When comparing dyno numbers, be sure the wheels, tires, gear ratio and gear, as well as all the other parameters previously mentioned, are the same from run to run!

How calibration can cause misleading dyno results:

Production calibrations have an inferred catalyst temperature protection model which constantly calculates the temperature in the hottest part of the hottest catalyst. This calculated temperature is based on many PCM parameters, such as engine speed, load, ingested air mass, time, inlet air temperature, EGR flow rate and many others.

When the catalyst model calculates that the catalyst temperature is about to exceed a level that is safe for the catalyst (generally around 1650° F), the PCM will richen the A/F mixture as necessary to lower the exhaust gas temperature and cool the catalyst. This richened A/F ratio will decrease power output, but is absolutely necessary to keep the catalyst from being permanently damaged. Unless A/F ratio is monitored during a dyno pull, the dyno operator will have no idea when catalyst temperature protection has been invoked and can make erroneous conclusions with regard to power output.

As a trivial example of how this can affect dyno testing, consider a supercharged production vehicle with production calibration performing back-to-back runs under identical conditions except as noted. The car is driven to a dyno facility and immediately put on the dyno and a run is performed, yielding a result of 420 hp. In this example, A/F ratio is not monitored. A part is swapped for another “high-performance” part and another dyno run is performed, resulting in 430 hp. The dyno operator concludes the “high-performance” part is worth 10 hp. This is not accurate because when the car was first dyno tested, its catalysts were sufficiently hot that catalyst temperature protection was invoked during the dyno pull, which reduced power output by richening the A/F ratio. While the car was having the parts swapped, the catalysts cooled down enough that during the next dyno pull catalyst temperature protection was not invoked. The engine made more power on the second pull because it was running a leaner A/F ratio closer to optimal and not necessarily because of the “high-performance” part. If the dyno operator was monitoring A/F ratio, this would have been readily apparent.

If the operator was monitoring the A/F ratio commanded by the PCM, the activation of catalyst temperature protection would become self-evident. In this example, the erroneous conclusion that was reached suggested the “high-performance” part was worth 10 hp when it really wasn’t, but the opposite can also occur quite easily. Without covering every possible scenario, it will suffice to say that dyno numbers are ONLY meaningful when supporting data such as A/F ratio, inlet air temperature and the others listed above are also provided.

There is also a model for oxygen sensor protection and exhaust valve protection that when not taken into account can cause misleading dyno data. In general, exhaust temperatures greater than about 1650° F can damage exhaust valves, and extreme care is taken in production calibrations to ensure that sustained engine operation beyond that temperature does not occur. This is rarely an instantaneous failure but rather one that over time “tulips” the exhaust valves and ultimately will fail the engine.

Aftermarket cold air kit manufacturers that claim to work without the need of a PCM recalibration are a common source of misleading dyno power claims. Some of the manufacturers of these kits claim enormous power gains using nothing but their kit and a production calibration. Most of these claims are not supported with A/F, inlet temperature or spark advance traces during the dyno pulls that are shown in their advertising. In some cases, the apparent increase in power is due to differing dyno test conditions as mentioned previously, while in other cases they can be due to the fact that the MAF sensor transfer function in the PCM is left stock. If the cold air kit flows more air and the MAF transfer function in the PCM is stock, it will not “know” about the extra air that’s entering the engine. This will result in the engine running an A/F ratio that is leaner than it should be for engine durability. While this has the potential to produce more power, it can also be potentially damaging to catalysts, exhaust valves, piston rings and other engine components. The commanded spark advance can also be incorrect and result in detonation or pre-ignition with potentially catastrophic results. One should be very suspect if a particular cold air kit claims a huge power increase over stock at low engine rpm and without a calibration. Air inlet restrictions generally only become significant at higher airflows, so if a claim is made that a cold air kit increases torque at 2000 rpm without the aid of a calibration, you can be sure that varying dyno test conditions or a significant change in A/F ratio are the cause. **Ask for more supporting data!**

Similar misleading results can be caused by a failure to keep inlet air temperature constant between runs. The PCM will retard spark timing to prevent detonation as inlet air temperature increases, lowering power output. On a forced-induction car, the inlet air temperature is generally measured after the power adder (and after the intercooler, if applicable) and can be MUCH greater than ambient temperature. Careful monitoring of A/F ratio and inlet air temperature are critical to making accurate conclusions regarding the effectiveness of various high-performance parts.

Secondary factors that also affect measured wheel horsepower are engine oil temperature, differential oil temperature, humidity, etc. **It simply cannot be overstated that all conditions need to be as similar as possible between dyno runs in order to have a meaningful scientific conclusion, which requires the supporting data previously discussed.**

FORD PERFORMANCE CALIBRATIONS

The calibrations that Ford Performance provides for our cold air and supercharger kits are done by Ford engineers who, in many cases, worked on the actual production vehicles. No one is more familiar with Ford engines and Ford control systems than Ford engineers. Extreme care is taken to provide as much power and torque as can be safely delivered, but also to deliver extremely high durability and exceptional drivability. Most of our kits are also 50-state emissions legal and many are now even offered with a warranty when dealer installed.



Most aftermarket tuners other than Ford Performance do a few “tricks” that we do NOT recommend, such as:

- **Turning off the inferred catalyst, oxygen sensor and exhaust valve temperature protection logic** discussed in the previous section. This prevents the PCM from richening the A/F ratio to protect these components, which can result in more power under certain conditions. The downside is **drastically** decreased durability of these expensive components, which can result in the “check engine light” coming on, as well as increased exhaust emissions due to failed catalytic converters. Ford Performance does not compromise durability or emissions by turning off this calibration logic.
- They often advance spark timing to potentially unsafe levels. We test our calibrations in a wind tunnel and in hot, dry weather to verify that potentially damaging spark knock or catastrophic pre-ignition does not occur. We also do cold weather and altitude testing as well as extensive emissions and durability testing on several vehicles before we release a calibration to the customer. Most other companies do not have the time or the resources to do the same type of testing that we do. Some companies do not realize that they need to perform this type of testing in the first place!

DYNAMOMETER TESTING AND FORD PERFORMANCE CALIBRATIONS (continued...)

Automatic transmission calibration is an area where Ford Performance sets itself apart from other “tuners.” We generally make extensive calibration changes to not only improve shift quality and give the transmission a more performance-oriented feel, but take great care to ensure that durability is not compromised to levels we feel would be unacceptable to a customer. In development, we monitor things like clutch slip times, slip energies, band temperatures and other variables to make calibration changes as appropriate so that the customer can be sure of a quality product that will continue to deliver improved performance in the long term. As mentioned before, these changes are performed, in many cases, by the same engineers who designed and developed the vehicles in the first place, and who are more familiar than anyone with their performance and durability envelopes.

Many of our competitors develop their calibrations exclusively on a chassis dyno and go straight from there to the end customer. While dyno work is a critical part of the development process, it is only one piece of a very complex puzzle. Calibrating for wide open throttle (WOT) is generally simple, but the bulk of the calibration effort is getting the part (and closed) throttle drivability correct. Our calibrations are developed not only on the dyno, but also on the street for production (or better) quality drivability, and across many vehicles to allow for manufacturing tolerances. Varied driving conditions, constant data monitoring and long-term testing ensure consistent drivability and exceptional durability.

In recent years, cars and trucks have shifted toward electronic throttle control (ETC) or “drive-by-wire” systems for packaging, cost and enhanced calibration functions. Ford Performance calibrations for ETC vehicles take advantage of some of the increased functionality offered by these systems by changing the relationship between the pedal and the throttle for improved “performance feel.” This allows us to provide substantial improvements in “performance feel” even on the kits where the peak horsepower increase might be considered modest by some. The peak power numbers do not always tell the whole story.

Why some companies claim to make more power:

Some claims are due to poor and misleading dynamometer test practices, as well as a fundamental lack of understanding of the way Ford PCMs work. Others are genuine but at the expense of engine, catalyst or drivetrain durability and emissions.

Hopefully, this article gives you the tools necessary to determine what is real dyno horsepower, manipulated false horsepower and temporary horsepower waiting to cause a failure. We are confident that as a potential customer, you will agree that no one knows your car or truck better than the Ford engineers who designed it in the first place. Our kits offer the best blend of performance, durability and drivability that exists on the market today.



2005-2014 FORD MUSTANG

2013-2014 MUSTANG GT CALIBRATION TRACK CAL

M-14204-MGTTC* Track Cal 2013-2014 Mustang GT

M-14204-MGTTCU* Track Cal Update 2013-2014 Mustang GT **NEW**

TrackKey and Track Cal are Ford Performance exclusive calibrations that provide added functionality to 2013-2014 Mustang GT with manual transmission. TrackKey is also available for 2012-2013 BOSS 302.

Both calibrations include these exclusive features:

- Driver adjustable Launch Control, or “2-step engine speed limiting”
- Driver adjustable Pit Lane Speed Control
- “Lopey” idle
- Improved engine performance – up to 60 lb-ft at 1500 rpm & peak increases of 16 hp and 7 lb-ft on 93 octane fuel

TrackKey or Track Cal – Which is right for me?

TrackKey provides the customer a unique key that activates the calibration once it has been installed. TrackKey is sold and installed exclusively through U.S. and Canadian Ford and Lincoln dealers. Special equipment and training is required to install TrackKey. TrackKey is available for some 2014 Mustang GT with manual transmission (build date after 7/1/2013).



Track Cal is supplied via the exclusive ProCal flash tool. It is always active, but “lopey” idle can be turned off. Available for all 2013-2014 Mustang GT with manual transmission.

How do TrackKey and Track Cal work?

TrackKey and Track Cal both contain exclusive calibration features designed for track use and derived from the same software algorithms and features employed in Ford Performance turn-key race cars such as the BOSS 302R, BOSS 302S and Cobra Jet.

Engine performance is similar to the calibration available in the Ford Performance M-FR1-MGTB Kit and modifies several PCM parameters, including:

- Twin Independent Variable Cam Timing (Ti-VCT)
- Engine braking
- Ignition timing
- Wide-open throttle fueling
- Accelerator pedal map
- Idle speed
- Throttle response



TrackKey and Track Cal for Mustang GT

- Alter several thousand lines of code and several hundred calibration parameters
- Are the only calibrations of their type that have gone through the rigorous Ford Performance test procedures
- Are a 50-state legal aftermarket engine performance software upgrade for the 2013-2014 Mustang GT with manual transmission (TrackKey only available on 2014 MY build date after 7/1/2013)

NOTE: Federal and state laws prohibit any person from installing aftermarket add-on or modified parts prior to the sale of a new motor vehicle.

*This component is eligible for the Ford Performance Parts Limited Warranty. See the Ford Performance Parts Limited Warranty on pages 295-302 for details.

2005-2014 FORD MUSTANG

REAL POWER. REAL PERFORMANCE. REAL SUBSTANCE. TRACKKEY. INDUSTRY-FIRST TECHNOLOGY.

2012-2013 MUSTANG BOSS 302 TRACKKEY

M-9603-MBTKA

The highly sought after BOSS TrackKey calibration is BACK and with more features than ever before. Recently, an update to Ford software provided the inability to download TrackKey at Ford dealerships. This kit comes with a ProCal 2 calibration tool with the exclusive TrackKey calibration and a performance air filter. Additionally, this tool offers the ability to modify tire size and gear ratio settings in the calibration.

TrackKey is a 50-state legal aftermarket engine performance software upgrade for the 2012-2013 BOSS 302 and BOSS 302 Laguna Seca. It is not compatible with any other vehicle.

TrackKey is an exclusive Ford Performance calibration that provides added functionality for 2012-2013 BOSS 302 owners. This calibration includes these exclusive features:

- Driver adjustable Launch Control, or "2-step engine speed limiting"
- Driver adjustable Pit Lane Speed Control
- "Lopey" idle

TrackKey provides the customer a unique key that activates the calibration once it has been installed. TrackKey is sold through Ford Performance retailers. The calibration is downloaded via the exclusive ProCal 2 flash tool that's included.

How does TrackKey work?

TrackKey contains exclusive calibration features designed for track use and derived from the same software algorithms and features employed in Ford Performance turn-key race cars such as the BOSS 302R, BOSS 302S and Cobra Jet.

Engine performance is similar to the calibration available in the Ford Performance M-FRI-MGTB kit and modifies several PCM parameters, including:



- Twin Independent Variable Cam Timing (Ti-VCT)
- Engine braking
- Ignition timing
- Wide-open throttle fueling
- Accelerator pedal map
- Idle speed
- Throttle response
- Skip-shift disable (available for 2012 BOSS 302, not necessary on 2013 model)

NOTE: Requires the use of 91-octane or higher ("premium") fuels at all times. Federal and state laws prohibit any person from installing aftermarket add-on or modified parts prior to the sale of a new motor vehicle. Please see instructions. The customer's vehicle will still have to have the key recognized as a TrackKey at any Ford dealer. For technical assistance, please contact the Ford Performance Techline at (800)367-3788.



2007-2012 GT500 2.3L TVS SUPERCHARGER TUNER KIT W/SCJ THROTTLE BODY

M-6066-MSVT23

M-6066-MSVT2365

- Fits 2011-2012 Mustang Shelby GT500. Requires custom calibration!
- Fits 2007-2010 Mustang Shelby GT500. Requires custom length belt and additional parts, not included. Requires custom calibration!
- TVS supercharger unit from 2013 Mustang Shelby GT500 program
- Supercharger rotors feature four lobes with a 160° twist
- Does not include sensors

Kit includes:

- 2.3L Twin Vortices Series (TVS) supercharger features 4-lobe rotors and 68 mm pulley
- M-9926-SCJ Super Cobra Jet Oval Throttle Body allows maximum performance, M-6066-MSVT2365 available with Cobra Jet dual 65 mm throttle body for improved idle
- Supercharger to throttle body elbow
- 2013 GT500 supercharger belt
- Fuel rail with crossover, Part No. DR3Z-9F792-B, provides adequate clearance to supercharger
- Fuel injector retainer clips

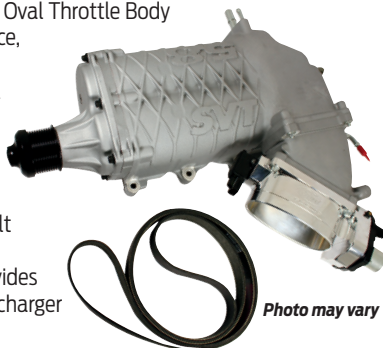

Photo may vary

2007-2010 MUSTANG SVT UPGRADED HEAT EXCHANGER

M-8229-MSVT

- Original equipment on 2011-2012 Mustang SVT
- Fits 2007-2010 Mustang SVT
- Increased efficiency over production 2007-2010 Mustang SVT heat exchanger
- Reduced air charge temperatures
- Requires no modifications to install
- Includes brackets and mounts



5.4L 4V PERFORMANCE INTERCOOLER

M-6775-MSVT

- Fits 2007-2014 Mustang Shelby GT500 5.4L and 5.8L 4V engine
- Excellent upgrade for prior model GT500 and 5.4L Cobra Jet Mustang
- Less restriction and more efficient heat extraction than earlier model intercooler
- Aluminum construction
- Standard equipment on 2013-2014 Mustang Shelby GT500
- Includes gasket to supercharger, charge cooler gasket and inlet/outlet O-rings



FORD PERFORMANCE MUSTANG SVT EXHAUST SYSTEMS

2013-2014 MUSTANG SHELBY GT500 SPORT MUFFLER KIT (49 STATE)

M-5230-MSVTLB

- Fits 2013-2014 Mustang Shelby GT500
- 304 stainless steel muffler body construction
- 304 stainless steel chrome-plated 4" tips
- Louder, throatier exhaust note
- 49-state drive-by noise legal (not legal in CA)



2011-2012 MUSTANG SHELBY GT500 SPORT MUFFLER KIT (49 STATE)

M-5230-MSVTLA*

- Fits 2011-2012 Mustang Shelby GT500
- 304 stainless steel muffler body construction
- 304 stainless steel chrome-plated "Ford Racing" embossed 4" tips
- Louder, throatier exhaust note
- Requires factory muffler clamps
- 49-state drive-by noise legal (not legal in CA)



2011-2014 MUSTANG GT500 SIDE EXHAUST

M-5220-MSVT

- Fits 2011-2014 Mustang Shelby GT500 Coupe
- 2012-2013 BOSS 302 style side exhaust
- Can be used on convertible with appropriate spacer and longer bolt (not included) for side pipe to clear convertible brace
- Kit includes left and right side exhaust pipes with polished 304 stainless steel tips, 409 stainless steel H-pipe and hardware
- Requires cutting of factory exhaust for installation



2005-2009 MUSTANG GT/2007-2009 MUSTANG SHELBY GT500 "S" MUFFLER KIT

M-5230-S

- Fits 2005-2009 Mustang GT
- Fits 2007-2009 Mustang Shelby GT500
- Meets 95 decibel drive-by noise standard for aftermarket exhaust systems when installed on stock applications
- Throatier exhaust note
- 409 aluminized stainless steel corrosion-resistant muffler body construction
- Polished 304 stainless steel 3.5" diameter tips
- For 2010 Mustang GT and Shelby GT500 see M-5230-SA

NOTE: 409 stainless exhaust material is titanium stabilized ferritic stainless steel. 409 stainless is used in applications where appearance is a secondary consideration to mechanical properties and corrosion resistance and where some weldability is required. An example of 409 stainless usage is catalytic converter assemblies. 409 stainless has excellent forming characteristics and is rust-through resistant. A surface rust will form in most instances. This rust retards further corrosion.



*This component is eligible for the Ford Performance Parts Limited Warranty. See the Ford Performance Parts Limited Warranty on pages 295-302 for details.

2005-2014 FORD MUSTANG

FORD PERFORMANCE MUSTANG GT EXHAUST SYSTEMS

2005-2009 MUSTANG GT SPECIAL EDITION MUSTANG MUFFLER KIT



M-5230-GTB

- Fits 2005-2009 Mustang GT
- Meets 95 decibel drive-by noise standard for aftermarket exhaust systems when installed on stock applications
- Muffler used as standard equipment on the 2008 Mustang Bullitt
- Throatier exhaust note
- 409 aluminized stainless steel corrosion-resistant muffler body construction with polished 304 stainless steel 3.5" diameter tips



2013-2014 MUSTANG GT AXLE-BACK QUAD TIP MUFFLERS WITH REAR LOWER VALENCE

M-5230-MSVTC

- Fits 2013-2014 Mustang GT
- 409 aluminized stainless steel corrosion-resistant muffler body construction with twin polished 304 stainless steel 4" diameter tips
- Mufflers are original equipment on 2013-2014 Mustang Shelby GT500
- Throatier exhaust note
- Clamp-on installation
- Shelby GT500 rear lower valence includes installation hardware
- Cutting of original lower fascia required for installation of GT500 valence
- 50-state drive-by noise legal



2011-2014 MUSTANG GT MUFFLER KIT (50 STATE)

M-5230-MGTCA1*

- Fits 2011-2014 Mustang GT
- 409 aluminized stainless steel corrosion-resistant muffler body construction with polished 304 stainless steel 4" diameter tips
- Mufflers were standard on 2011-2012 Mustang Shelby GT500
- Throatier exhaust note
- 50 state drive-by noise legal

NOTE: 409 stainless exhaust material is titanium stabilized ferritic stainless steel. 409 stainless is used in applications where appearance is a secondary consideration to mechanical properties and corrosion resistance and where some weldability is required. An example of 409 stainless usage is catalytic converter assemblies. 409 stainless has excellent forming characteristics and is rust-through resistant. A surface rust will form in most instances. This rust retards further corrosion.



2011-2014 MUSTANG GT & 2011-2012 GT500 3" EXHAUST SYSTEM

M-5230-MGTCA30

- Fits 2011-2014 Mustang GT and 2011-2012 GT500
- **Cat-back exhaust system**
- 3" exhaust system delivers an aggressive exhaust sound
- Includes X-pipe for improved flow
- Polished 4.5" exhaust tips feature embossed "Ford Racing" logo
- 49-state legal mufflers



2011-2014 MUSTANG GT/BOSS SPORT MUFFLER KIT (49 STATE)



M-5230-MGTLA*

- Fits 2011-2014 Mustang GT
- Fits 2012-2013 Mustang BOSS
- 304 stainless steel muffler body construction with 304 stainless steel chrome-plated "Ford Racing" embossed 4" exhaust tips
- Louder, throatier exhaust note
- Designed to eliminate exhaust drone at sustained rpms
- Requires factory muffler clamps
- 49-state drive-by noise legal (not legal in CA)



MUSTANG GT X-PIPE

M-5251-R

2005-2010 Mustang GT

M-5251-MGTA*

2011-2014 Mustang GT built after 5/10/10



- 409 stainless steel X-pipe
- Converts your factory H-pipe to a more efficient X-pipe
- M-5251-R requires cutting of factory exhaust for installation
- Clamp-on installation – does not require welding!
- M-5251-R kit includes 2 clamps
- M-5251-MGTA installs using existing factory clamps



*This component is eligible for the Ford Performance Parts Limited Warranty. See the Ford Performance Parts Limited Warranty on pages 295-302 for details.

FORD PERFORMANCE MUSTANG V6 EXHAUST SYSTEMS

2011-2014 MUSTANG V6 TOURING MUFFLERS (50 STATE)

M-5230-MV6CA*

- Fits 2011-2014 Mustang V6
- 304 stainless steel construction
- Louder, throatier exhaust note
- Includes mufflers with "Ford Racing" embossed 3.5" exhaust tips
- 50-state drive-by noise legal



2011-2014 MUSTANG V6 SPORT MUFFLERS (49-STATE LEGAL)

M-5230-MV6LA*

- Fits 2011-2014 Mustang V6
- 304 stainless-steel muffler body construction with 304 stainless steel chrome-plated 3.5" tips
- Louder, throatier exhaust note
- Requires factory muffler clamps
- 49-state drive-by noise legal (not legal in CA)



2005-2009 MUSTANG V6 TOURING DUAL EXHAUST KIT

M-5230-V6

- Fits 2005-2009 Mustang V6
- Louder, throatier exhaust note
- Meets 95 decibel drive-by noise standard for aftermarket exhaust systems when installed on stock applications
- Includes M-5230-GTB Mufflers used as standard equipment on the 2008 special edition Mustang
- 409 aluminized stainless steel muffler body construction with polished 304 stainless steel 3.5" diameter tips
- Includes 409 stainless steel X-pipe
- Requires minor modification of rear bumper cover (template included in kit)

NOTE: 409 stainless exhaust material is titanium stabilized ferritic stainless steel. 409 stainless is used in applications where appearance is a secondary consideration to mechanical properties and corrosion resistance and where some weldability is required. An example of 409 stainless usage is catalytic converter assemblies. 409 stainless has excellent forming characteristics and is rust-through resistant. A surface rust will form in most instances. This rust retards further corrosion.



2011-2014 MUSTANG V6 X-PIPE

M-5251-MV6A*

- Fits 2011-2014 Mustang V6
- 409 stainless steel X-pipe
- Converts your factory H-pipe to a more efficient X-pipe
- Requires cutting of factory exhaust for installation
- Clamp on installation – does not require welding!



*This component is eligible for the Ford Performance Parts Limited Warranty. See the Ford Performance Parts Limited Warranty on pages 295-302 for details.

FORD MUSTANG

“STAGE 8” LOCKING HEADER BOLT SYSTEMS

These kits fit most V8 and many other engines. Includes 16 bolts and locking hardware.



| PART NUMBER | SIZE | FITS |
|-------------------|----------------|---|
| M-9432-A50 | 3/8"-16 x .75" | Most headers on push rod engines |
| M-9432-A51 | 3/8"-16 x 1" | Ford Performance “Shorty” headers on push rod engines |

- 100% reliable, zero failures in more than 17,000,000 applications. Header fasteners will not back out. Eliminates need to monitor and tighten bolts regularly
- Grade 8 aircraft quality bolts made in U.S.A. Duplex nickel plated
- Manufacturer’s Lifetime Warranty



2005-2014 MUSTANG GT ALUMINUM RADIATOR

M-8005-MGT

- Fits 2005-2014 Mustang GT and 2012-2013 BOSS 302
- Service replacement part for the FR500S and BOSS 302S race car
- Uses OEM fan and mounting points for bolt-in installation
- All aluminum construction
- Increased cooling over production radiator
- Excellent upgrade for open track or road race S197 Mustang



2011-2014 MUSTANG GT BOSS 302 RADIATOR

M-8005-MBR

- Fits 2011-2014 Mustang GT with manual transmission
- Original equipment on 2012-2013 Mustang BOSS 302
- Improved cooling over stock Mustang GT 5.0L 4V Ti-VCT radiator

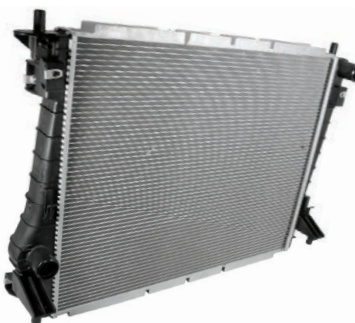

2005-2010 MUSTANG GT DE-GAS BOTTLE

M-8080-A

- Fits 2005-2010 Mustang GT
- Coolant expansion/fill tank features a billet radiator style neck
- Comes with the M-8100-A “Ford Racing” 16 lb Pressure Cap
- Same part as used on the Mustang FR500S race car



RADIATOR CAP WITH “FORD RACING” LOGO

M-8100-A

- Fits most radiators
- Service replacement for the Mustang FR500S race car
- 16 lb cap
- Does not fit production de-gas bottles



“PUT A FORD ON YOUR FORD”



Ford Performance Parts uses the Society of Automotive Engineers (SAE) and American Society for Testing and Materials (ASTM) standards: SAE J175 and J328 for impact and fatigue testing and ASTM B368 for chrome testing. These standards define a series of tests that ensure the safety and finish of a wheel.

THESE TESTS ARE THE MINIMUM STANDARD USED TO DEFINE THE ENDURANCE OF FPP WHEELS.

IMPACT TESTING

This test simulates a curb impact on the side of a tire/wheel assembly. During testing, a tire/wheel assembly is mounted at a 13-degree angle to a test fixture by the hub. A weight is dropped from 9 inches onto the assembly at the tire/wheel intersection. The mass of the weight is determined by a formula, using the vehicle weight.

DYNAMIC CORNERING FATIGUE TESTING

This test simulates lateral loads applied to a wheel by the vehicle. During testing, a wheel is clamped to a fixture by the front face and a constant bending moment is applied through the hub. A wheel of new design will run a minimum of 1,000,000 cycles before approved. The load applied is determined by a formula, using the vehicle weight.

DYNAMIC RADIAL FATIGUE TESTING

This test simulates axial loads applied to a wheel by the vehicle. During testing, a tire/wheel assembly is mounted to an axle by the hub. A large drum drives the assembly while a load is applied perpendicular to the tire patch. A wheel of new design will run a minimum of 5,000,000 cycles. The load applied is determined by a formula, using the vehicle weight.

CHROME QUALITY TESTING

Copper-accelerated acetic acid-salt spray, commonly known as CASS testing, is the standard method used to test the corrosive performance of copper/nickel/chromium-plated wheels. The test is performed in a sealed chamber with a highly acetic spray directed onto the wheel for a predetermined amount of time, usually 66 hours.

FORD PERFORMANCE MUSTANG WHEEL SETS WITH TPMS

MUSTANG BOSS 302S 19" X 9" WHEEL SET WITH TPMS SENSOR KIT – GLOSS BLACK WITH MACHINED FACE

M-1007KIT-DC199LGB 19" x 9"

M-1007KIT-DC19910LGB 19" x 9" Front, 19" x 10" Rear

- Wheels fit 2005-2014 Mustang GT, 2007-2012 Shelby GT500 and 2005-2014 Mustang V6
- Kit does not fit 2013-2014 Shelby GT500
- Kit includes four wheels and 2010-2014 Mustang M-1180-A TPMS Sensors and Activation Tool
- For wheel specs, see M-1007-DC199LGB or M-1007-DC19910LGB. For TPMS specs, see M-1180-A



MUSTANG SHELBY GT500 19" X 9.5" WHEEL SET WITH TPMS KIT – MATTE BLACK

M-1007KIT-SA1995

- Fits 2005-2014 Mustang V6 and Mustang GT
- Fits 2007-2012 Shelby GT500
- Matte black paint finish, clearcoated to OEM standards
- Forged aluminum
- Original equipment front wheel on 2014 Shelby GT500
- Clears OEM Brembo® brakes and M-2300-S and M-2300-T Ford Performance Brake Kits
- Valve stem TPMS compatible
- 19" x 9.5" wide
- 5-lug, 114 mm (4.5") bolt circle
- 44 mm offset
- 179 mm backspacing

Kit includes:

- Four M-1007-SA1995MB Wheels
- Ford Racing M-1096-FR Center Caps
- M-1180-A TPMS Sensor and Activation Tool Kit

NOTE: Kit does not fit 2013-2014 Shelby GT500. 2013-2014 Mustang Shelby GT500 require a high-speed bolt-on TPMS sensor.



MUSTANG SHELBY GT500 19" X 9" WHEEL SET WITH TPMS KIT – DARK STAINLESS

M-1007KIT-SA199

- Fits 2005-2014 Mustang V6 and Mustang GT
- Fits 2007-2012 Shelby GT500
- Dark stainless finish with mid-gloss clearcoat
- Forged aluminum
- Same look as the 2011-2012 Mustang Shelby GT500 Performance Package front wheel with a unique width
- 19" x 9.5" width
- 5-lug, 114 mm (4.5") bolt circle
- 44 mm offset
- 179 mm backspacing
- For wheel specs see M-1007-SA199 on page 58. For TPMS sensor specs see M-1180-A on page 57

Kit includes:

- Four M-1007-SA199 Wheels
- M-1096-FR "Ford Racing" Center Caps
- M-1180-A TPMS Sensors and Activation Tool Kit

NOTE: Kit does not fit 2013-2014 Shelby GT500. 2013-2014 Mustang Shelby GT500 require a high-speed bolt-on TPMS sensor.



MUSTANG AND FOCUS TPMS SENSOR AND ACTIVATION TOOL KIT

M-1180-A

- Fits 2010-2014 Mustang V6 and Mustang GT
- Fits 2010-2012 Shelby GT500
- Fits 2013-2018 Focus ST
- Fits 2010-2018 Focus
- Kit contains 4 valve-mounted snap-in tire pressure monitor sensors (valve stem TPMS) and tire pressure monitor activation tool
- Mustang and Focus require that tire pressure monitor sensors are installed and properly activated. Failure to install and activate sensors will cause tire pressure monitor light to remain on
- Activation tool can be used to retrain sensors after tire rotation
- Warning: Requires wheels specifically designed for valve-mounted snap-in tire pressure monitor sensors

NOTE: Will NOT work on 2007-2009 Mustang V6, GT or GT500. Valve stems are not designed for speeds over 155 mph.



MUSTANG BOSS 302S FRONT WHEEL 19" X 9" – GLOSS BLACK WITH MACHINED FACE

M-1007-DC199LGB*

- Fits 2005-2014 Mustang V6 and Mustang GT
- Fits 2007-2014 Shelby GT500
- Standard equipment on Ford Performance BOSS 302S factory-built race car M-FR500-B302S
- Machined face with gloss black accents, clearcoated to OEM standards
- Includes Mustang M-1096-A "Bar and Pony" Center Cap
- For 19" x 10" rear wheel see M-1007-DC1910LGB
- Clears OEM Brembo® brakes and Ford Performance brake kits M-2300-S and M-2300-T
- Valve stem TPMS compatible
- 19" x 9" wide
- 5-lug, 4.5" bolt circle
- 42 mm offset
- 6.7" backspacing



Photo may vary

MUSTANG 18" X 8" MESH SPOKE WHEEL – MATTE BLACK

M-1007-P188MB*

- Fits 2005-2014 Mustang V6 and Mustang GT
- Matte black paint finish, clearcoated to OEM standards
- Includes "Ford Racing" M-1096-FR1 Center Cap
- Band and valve stem TPMS compatible
- 18" x 8" wide
- 5-lug, 114 mm (4.5") bolt circle
- 44 mm offset
- 160 mm backspacing

NOTE: Will not work with OEM Mustang Brembo® brakes.



MUSTANG BOSS 302S REAR WHEEL 19" X 10" – GLOSS BLACK WITH MACHINED FACE

M-1007-DC1910LGB*

- Fits 2005-2014 Mustang V6 and Mustang GT
- Fits 2007-2014 Shelby GT500
- Original equipment on Ford Performance Mustang BOSS 302S factory-built race car M-FR500-B302S
- Machined face with gloss black accents, clearcoated to OEM standards
- Includes Mustang "Bar and Pony" center cap M-1096-A
- For 19" x 9" BOSS 302S front wheel see M-1007-DC199LGB
- Clears OEM Brembo® brakes and M-2300-S and M-2300-T Ford Performance brake kits
- Valve stem TPMS compatible
- 19" x 10" wide
- 5-lug, 114 mm (4.5") bolt circle
- 47.5 mm offset
- 187 mm backspacing



Photo may vary

*For 2005-2010 vehicles with 16" wheels from the factory: Installing 17" x 8" wheels, use 4R3Z-3932-BA Steering Stop. Installing 18" x 8.5" or 18" x 9.5" wheels, use 6R3Z-3932-CA Steering Stop. For vehicles with 17" wheels from the factory: Installing 18" x 8.5" or 18" x 9.5" wheels, use 6R3Z-3932-CA Steering Stop. 2011-2014 Mustang may require steering stops. Call the Ford Performance Techline at (800)367-3788 for more information.

FORD MUSTANG

MUSTANG SHELBY GT500 19" X 9" WHEEL – DARK STAINLESS

M-1007-SA199*

- Fits 2005-2014 Mustang V6 and Mustang GT
- Fits 2007-2014 Shelby GT500
- Dark stainless finish with mid-gloss clearcoat
- Forged aluminum
- Same look as the 2011-2012 Mustang Shelby GT500 Performance Package front wheel with a unique width
- Includes M-1096-FR "Ford Racing" Center Cap
- Clears OEM Brembo® brakes and M-2300-S and M-2300-T Ford Performance brake kits
- Valve stem TPMS compatible
- 19" x 9" wide
- 5-lug, 114 mm (4.5") bolt circle
- 40 mm offset
- 167 mm backspacing



MUSTANG SHELBY GT500 19" X 9.5" 5-SPOKE WHEEL – MATTE BLACK

M-1007-SA1995MB

- Fits 2005-2014 Mustang V6 and Mustang GT
- 2007-2014 Shelby GT500
- Matte black paint finish, clearcoated to OEM standards
- Forged aluminum
- Original equipment front wheel on 2014 Shelby GT 500
- Includes M-1096-FR "Ford Racing" Center Cap
- Clears OEM Brembo® brakes and M-2300-S and M-2300-T Ford Performance brake kits
- Valve stem TPMS compatible
- 19" x 9.5" wide
- 5-lug, 114 mm (4.5") bolt circle
- 44 mm offset
- 179 mm offset



MUSTANG SHELBY GT500 WHEEL

M-1007-S1895*

- Fits 2005-2014 Mustang GT
- Fits 2011-2014 Mustang V6
- Fits 2007-2012 Shelby GT500
- Bright machined face with medium argent painted pockets
- Original equipment on the 2007-2009 Mustang GT500
- Includes M-1096-N SVT Center Cap
- Band TPMS compatible
- Fits 2005-2010 Mustang V6 equipped with M-2300-D Brake Kit
- Fits M-2300-S Brembo® Brake Kit
- 18" x 9.5" wide
- 5-lug, 114 mm (4.5") bolt circle
- 45 mm offset
- 180 mm backspacing

NOTE: Manufactured in batches; color may not match factory wheels.

NOTE: Wheel is not compatible with valve stem mount TPMS.



EXTERIOR CHROME CLEANING PROCEDURES

- Wash the vehicle first, using cool or lukewarm water and a neutral pH shampoo, such as Motorcraft® Detail Wash (ZC-3-A).
- Use Custom Brite Metal Cleaner (ZC-15), available from your authorized dealer. Apply the product as you would a wax to clean bumpers and other chrome parts; allow the cleaner to dry for a few minutes and then wipe off the haze with a clean, dry rag.

ALUMINUM WHEELS AND WHEEL COVERS CLEANING PROCEDURES

Aluminum wheels and wheel covers are coated with a clearcoat paint finish. To maintain their shine:

- Clean weekly with Motorcraft® Wheel and Tire Cleaner (ZC-37-A) available from your authorized dealer. Heavy dirt and brake dust accumulation may require agitation with a sponge. Rinse thoroughly with a strong stream of water.
- Never apply any cleaning chemical to hot or warm wheel rims or covers.
- Some automatic car washes may cause damage to the finish on your wheel rims or covers. Chemical-strength cleaners, or cleaning chemicals, in combination with brush agitation to remove brake dust and dirt, could wear away the clearcoat finish over time.
- Do not use hydrofluoric acid-based or high caustic-based wheel cleaners, steel wool, fuels or strong household detergent.
- To remove tar and grease, use Motorcraft® Bug and Tar Remover (ZC-42), available from your authorized dealer.

*For 2005-2010 vehicles with 16" wheels from the factory: Installing 17" x 8" wheels, use 4R3Z-3932-BA Steering Stop. Installing 18" x 8.5" or 18" x 9.5" wheels, use 6R3Z-3932-CA Steering Stop. For vehicles with 17" wheels from the factory: Installing 18" x 8.5" or 18" x 9.5" wheels, use 6R3Z-3932-CA Steering Stop. 2011-2014 Mustang may require steering stops. Call the Ford Performance Techline at (800)367-3788 for more information.

FORD RACING LUG NUTS AND CENTER CAPS

| WHEEL PART NUMBER | VEHICLE APPLICATION | STATUS | CENTER CAPS | | | | | | | | | LUG NUTS | |
|-------------------|---------------------|-----------|-------------|------------|-----------|-----------|-----------|------------|----------|----------|----------|----------|------------|
| | | | M-1096-A | M-1096-FP3 | M-1096-RS | M-1096-FA | M-1096-FR | M-1096-FRI | M-1096-K | M-1096-N | M-1096-Q | | M-1096-O |
| M-1007-DC1785 | F-150 | ACTIVE | | | | | | | | | X | | NA |
| M-1007-W1785B | F-150 | ACTIVE | | | | | | | | | | | M-1012-FA |
| M-1007-P2085MB | F-150 | ACTIVE | | | | | | | | | | | M-1012-FA |
| M-1007-R198GB | FOCUS | ACTIVE | | O | X | | | | | | | | NA |
| M-1007-P198MB | FOCUS | ACTIVE | | | | | | | | | X | | NA |
| M-1007-M188GB | FOCUS | ACTIVE | | | | | | | | | X | | NA |
| M-1007-PF188MB | FOCUS | ACTIVE | | | | | | | | | X | | NA |
| M-1007-R1985 | FOCUS | CANCELLED | | | | | | | | | X | | M-1012-RSA |
| M-1007-R1985B | FOCUS | CANCELLED | | | | | | | | | X | | M-1012-RSA |
| M-1007-R1985W | FOCUS | CANCELLED | | | | | | | | | X | | M-1012-RSA |
| M-1007-S177 | FOCUS | ACTIVE | | | | | | | | X | | | NA |
| M-1007-S177B | FOCUS | ACTIVE | | | | | X | | | | | | NA |
| M-1007-FA | FOCUS/FIESTA | ACTIVE | | | | O | | | | | | | NA |
| M-1007-M199GB | MUSTANG | ACTIVE | | O | | | | | | | | X | M-1012-M |
| M-1007-M1995GB | MUSTANG | ACTIVE | | O | | | | | | | | X | M-1012-M |
| M-1007-DC199LGB | MUSTANG | ACTIVE | X | | | | | O | | | | | M-1012-A |
| M-1007-DC1910LGB | MUSTANG | ACTIVE | X | | | | | X | | | | | M-1012-A |
| M-1007-P188MB | MUSTANG | ACTIVE | O | | | | | X | | | | | M-1012-A |
| M-1007-SA199 | MUSTANG | ACTIVE | O | | | | X | | | | | | M-1012-A |
| M-1007-SA1995MB | MUSTANG | ACTIVE | | | | | X | | | O | | | M-1012-A |
| M-1007-S1895 | MUSTANG | ACTIVE | | | | | O | | O | X | | | M-1012-A |
| M-1007-M199B | MUSTANG | ACTIVE | | X | | | | | | | | O | M-1012-M |
| M-1007-M1995B | MUSTANG | ACTIVE | | X | | | | | | | | O | M-1012-M |
| M-1007-M199DS | MUSTANG | ACTIVE | | X | | | | | | | | O | M-1012-M |
| M-1007-M199SA | MUSTANG | ACTIVE | | X | | | | | | | | O | M-1012-M |
| AS DELIVERED | | X | | | | | | | | | | | |
| OPTIONS | | O | | | | | | | | | | | |

M-1096-FA



M-1096-FR



M-1096-FRI



M-1096-N



M-1096-K



M-1096-A



M-1096-Q



M-1096-O



M-1012-A



M-1096-FP3



M-1096-RS



ASSEMBLED MUSTANG HANDLING PACKS



M-FR3A-MGTAA shown

2005-2014 MUSTANG GT COUPE ASSEMBLED HANDLING PACK

M-FR3A-MGTA*

The Ford Performance assembled handling pack includes pre-assembled struts. No spring compressor required, strut/spring assembly is ready to bolt in! Put a little "road race" into your Mustang GT with the Ford Performance handling pack. It's tuned to deliver improved handling without sacrificing ride quality.

- Fits 2005-2014 Mustang GT Coupe
- All components are designed to work together as a package
- Lowers car approximately 1"

Handling Pack includes:

- M-18000-A Assembled Front Struts with rear shocks, M-5300-P Lowering Springs, M-18183-C Upgraded Strut Mount and M-5570-A Jounce Stops
- M-5490-A Sway Bar Kit
- M-4264-A Adjustable Rear Panhard Bar
- Includes all factory required one-time use fasteners

NOTE: Some factory fasteners are one-time use. Please reference service manual for reuse information and correct torque specifications. Requires alignment after installation.

2005-2014 MUSTANG GT COUPE ASSEMBLED HANDLING PACK ADJUSTABLE

M-FR3A-MGTAA*

The Ford Performance assembled handling pack includes pre-assembled struts and springs. No spring compressor required, strut/spring assembly is ready to bolt in! Make your Mustang GT a corner-carving machine with the added performance of an adjustable FR3 Handling Pack. The adjustable struts/shocks allow you to tune your suspension to street or track conditions. One click using the supplied tool adjusts for both compression and rebound.

- Fits 2005-2014 Mustang GT Coupe
- All components are designed to work together as a package
- Lowers car approximately 1"

Handling Pack includes:

- Assembled adjustable M-18000-C Front Struts with adjustable rear shocks, M-5300-P Lowering Springs, M-18183-C Upgraded Strut Mount and M-5570-A Jounce Stops
- M-5490-A Sway Bar Kit
- M-4264-A Adjustable Rear Panhard Bar
- Includes all factory required one-time use fasteners

NOTE: Some factory fasteners are one-time use. Please reference service manual for reuse information and correct torque specifications. Requires alignment after installation.

*This component is eligible for the Ford Performance Parts Limited Warranty. See the Ford Performance Parts Limited Warranty on pages 295-302 for details.

MUSTANG HANDLING PACKS

2007-2014 MUSTANG SVT COUPE HANDLING PACK

M-FR3-MSVTA* Unassembled

M-FR3A-MSVTA* Assembled

Make your 2007-2014 Shelby GT500 a corner-carving machine with the added performance of the Ford Performance FR3 Handling Pack. The pack is uniquely tuned to fit the 2007-2014 Shelby GT500 Coupe (does not fit 2013-2014 Track Pack).

- Lowers 2007-2012 approximately 1.25". All components are designed to work together as a package
- Lowers 2013-2014 approximately .400" front, 1.000" rear
- M-20201-C Strut Tower Brace recommended for 2007-2009 Shelby GT500
- M-20201-MSVTC recommended for 2010 Shelby GT500
- Struts/Shocks are adjustable and manufactured by Dynamic® Suspensions (the same company that makes struts/shocks for the Ford Performance Mustang road race car)

Handling Pack includes:

- M-18000-C Adjustable Struts/Shocks
- M-5300-L Lowering Springs
- M-5490-B Sway Bar Kit
- M-18183-C Upper Strut Mounts
- M-5570-A Jounce Bumpers

NOTE: Some factory fasteners are one-time use. Please reference a Ford service manual for reuse information and correct torque specifications. May require alignment after installation.

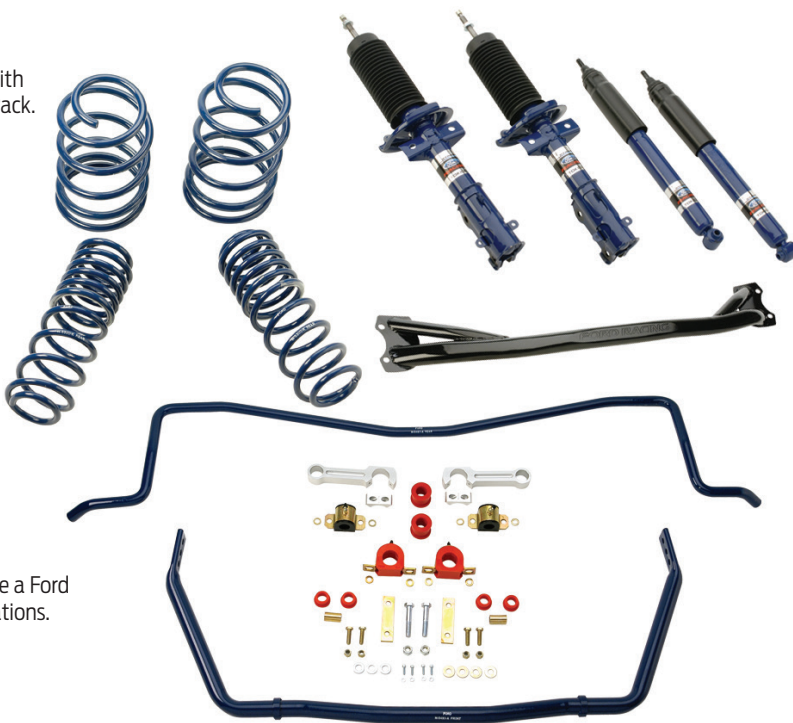

M-FR3-MSVTA shown

2005-2014 MUSTANG HANDLING PACK FASTENER KIT



M-FR3-FASTENERS*

- Fits 2005-2014 Mustang GT
- Includes all hardware that is associated with Ford Performance M-FR3A-MGTA Handling Pack and M-FR3A-MGTAA Handling Pack

Includes hardware for the following applications:

- Brake line retaining bolt (front)
- Sway bar bracket nut (front & rear)
- Rear jounce bumper bolt
- Strut top mount nut
- Rear lower shock bolt
- Rear lower shock nut
- Panhard rod nut
- Panhard rod bolt
- Front end chassis brace nut
- Front sway bar end-link nut
- Strut to knuckle bolt
- Strut to knuckle nut
- Front end chassis brace bolt



*This component is eligible for the Ford Performance Parts Limited Warranty. See the Ford Performance Parts Limited Warranty on pages 295-302 for details.

FORD MUSTANG

2005-2014 MUSTANG GT/2007-2014 MUSTANG SVT ADJUSTABLE STRUT/SHOCK KIT

M-18000-C

- Fits 2007-2014 Shelby GT500 (except 2013-2014 Track Pack) and 2005-2010 Mustang GT
- Will fit 2011-2014 Mustang GT. Requires use of Ford Performance springs and M-18183-C Upper Strut Mounts
- Engineered specifically for improved handling on both stock ride height and lowered 2007-2012 Mustang SVT and 2005-2014 Mustang GT
- Single adjustment with two-way response
- Recommended for Mustang SVT use with M-5300-L Spring Kit, M-5490-B Sway Bar Kit and M-20201-C Strut Tower Brace (2007-2009 Mustang SVT only)
- Recommended for Mustang GT use with M-5300-P Spring Kit (1" drop), M-5300-K Spring Kit (1.5" drop), M-5490-A Sway Bar Kit and M-20201-S197 Strut Tower Brace
- Will not fit 2013-2014 GT500 Track Pack

NOTE: Some factory fasteners are one-time use. Please reference a Ford service manual for reuse information and correct torque specifications. May require alignment after installation.



2005-2014 MUSTANG COUPE DYNAMIC STRUT/SHOCK KIT

M-18000-A

- Fits 2005-2010 Mustang GT and Mustang V6
- Will fit 2011-2014 Mustang GT and Mustang V6. Requires Ford Performance springs and M-18183-C Upper Strut Mounts
- Dynamic® Suspension strut/shock, same manufacturer as Mustang road race car
- M-18001-AF Single Service Front Strut for M-18000-A
- M-18001-AR1 Single Service Rear Shock for M-18000-A
- Unique Ford Performance tune
- Designed specifically for lowered vehicles
- Mustang GT Coupe owners: Use with M-5300-K or M-5300-P Springs and M-5490-A Sway Bar Kit for optimum performance
- Mustang V6 Coupe owners: Use with M-5300-N Springs and M-5490-C Sway Bar Kit for optimum performance

NOTE: Some factory fasteners are one-time use. Please reference a Ford service manual for reuse information and correct torque specifications. Requires checking alignment after installation.



2005-2014 MUSTANG JOUNCE BUMPER KIT

M-5570-A

- Fits 2005-2014 Mustang V6, GT and 2007-2011 Shelby GT500
- GT500 jounce bumpers designed for improved stability/ride comfort when used in conjunction with Ford Performance Parts lowering springs
- Original equipment on 2012-2014 Shelby GT500
- Recommended for lowered vehicles
- Includes front and rear jounce bumpers



1979-2004 MUSTANG FRONT/REAR SPRING KITS



- Fits 1979-2004 Mustang
- Lower your Mustang and improve handling
- The height on some cars will vary

| PART NUMBER | MODEL YEAR | AMOUNT LOWERED (V8) | | SPRING RATES (LB/IN) | |
|--------------------|-------------|---------------------|-------|----------------------|---------|
| | | FRONT | REAR | FRONT | REAR |
| M-5300-B ⑤ | 1979-2004 ④ | .875" ① | .5" ② | 425/530 | 200/300 |
| M-5300-C ⑤ | 1979-2004 ④ | .875" ① | .5" ② | 650 | 200/300 |
| M-5300-G ③⑤ | 1979-2004 ④ | 1.2" | 1.2" | 500/570 | 170/310 |



Photo may vary

NOTES:

Expect some deterioration in ride quality.

- ① 1994-2004 models – 1-1/8"
- ② 1994-2004 models – 3/4"
- ③ Convertible only
- ④ Will not fit 1999-2004 Cobra
- ⑤ Due to vehicle assembly tolerances, these specifications may vary

2005-2014 MUSTANG FRONT STRUT MOUNT UPGRADE (PAIR)

M-18183-C

- Fits 2005-2010 Mustang V6/GT and 2007-2014 Shelby GT500
- Will fit 2011-2014 Mustang V6 when used with Ford Performance M-18000-A or M-18000-C Dampers and M-5300-N Springs
- Will fit 2011-2014 Mustang GT when used with Ford Performance M-18000-A or M-18000-C Dampers and M-5300-K or M-5300-P Springs
- Original equipment on the 2011-2014 Shelby GT500 Coupe
- Increased durometer over base strut mount



MUSTANG REAR UPPER SHOCK MOUNT

M-18197-A

- Service replacement for the Ford Performance Mustang road race cars, FR500S, BOSS 302R and BOSS 302S
- Used to install eyelet-style coilover dampers on the rear of a 2005-2012 Mustang
- Bolt-in design/weld-in optional
- Sold in pairs

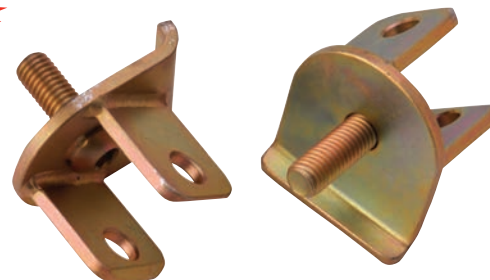

SPRING KITS

2007-2014 MUSTANG SHELBY GT500 SPRINGS



M-5300-L

- Fits 2007-2014 Mustang Shelby GT500 Coupe
- Gives a more aggressive-looking stance, as well as increased handling dynamics
- Validated for use with electronically controlled Track Pack option (2013-2014 model year)
- Lowers 2007-2012 approximately 1.25"
- Lowers 2013-2014 approximately .4" front, 1" rear
- May cause slightly harsher ride compared to stock springs
- Recommended for use with M-18000-C Damper Kit and M-5490-B Sway Bar Kit (except 2013-2014 Track Pack)
- M-5570-A Mustang Jounce Bumper Kit recommended with installation of springs (original equipment on 2012-2014, recommended for 2007-2011)
- M-18183-C Strut Mounts recommended (original equipment on 2012-2014, recommended for 2007-2011)

NOTE: Some factory fasteners are one-time use. Please reference a Ford service manual for reuse information and correct torque specifications. May require alignment after installation.

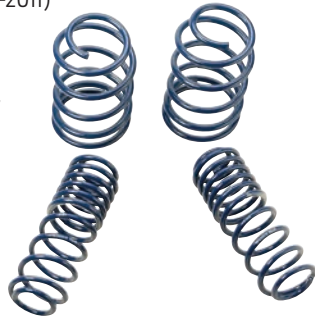

2005-2014 MUSTANG GT COUPE STREET LOWERING SPRINGS



M-5300-KA



- Fits 2005-2010 Mustang GT Coupe
- Fits 2011-2014 Mustang GT Coupe when used with GT500 M-18183-C Strut Mount Upgrade Kit
- Gives a more aggressive looking stance as well as increased handling dynamics
- Lowers car approximately 1.5"
- Progressive spring, designed for increased handling and performance
- Use with M-18000-A, M-18000-C and M-5490-A for optimum performance
- GT500 M-5570-A Mustang Jounce Bumper Kit recommended with installation of springs
- May cause slightly harsher ride compared to stock springs
- GT500 M-18183-C Strut Mount Upgrade Kit recommended for 2005-2010 Mustang GT

NOTE: Some factory fasteners are one-time use. Please reference a Ford service manual for reuse information and correct torque specifications. May require alignment after installation.

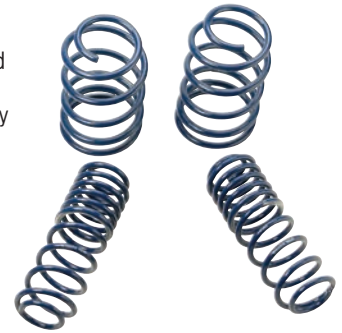

2005-2014 MUSTANG GT TRACK LOWERING SPRINGS



M-5300-PA



- Fits 2005-2010 Mustang GT Coupe
- Fits 2011-2014 Mustang GT Coupe when used with M-18183-C Upper Strut Mounts and M-18000-A Shocks/Struts or M-18000-C Adjustable Shocks/Struts
- Gives a more aggressive looking stance as well as increased handling dynamics
- Lowers car approximately 1"
- Progressive spring, designed for increased handling and performance
- Use with M-18000-A, M-18000-C and M-5490-A for optimum performance
- M-5570-A Mustang Jounce Bumper Kit recommended with installation of springs
- May cause slightly harsher ride compared to stock springs
- M-18183-C Strut Mounts recommended for 2005-2010 Mustang GT

NOTE: Some factory fasteners are one-time use. Please reference a Ford service manual for reuse information and correct torque specifications. May require alignment after installation.

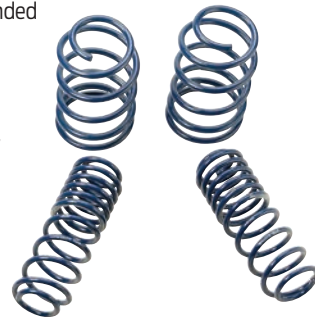

2013 COBRA JET SPRING KIT



M-5300-RA

- Improved performance and stance compared to prior offerings
- Allows full range of adjustment with M-5649-CJ Stock Cobra Jet Rear Suspension
- Excellent upgrade for 2008-2012 Cobra Jet or any 2005-2013 Mustang set up for drag racing
- As used on the 2013 Mustang Cobra Jet program

Photo may vary



2012-2013 BOSS 302 LOWERING SPRINGS

M-5300-T

- Fits 2012-2013 Mustang BOSS 302 and BOSS 302 Laguna Seca edition
- Gives a more aggressive looking stance as well as increased handling dynamics
- Lowers car approximately 15 mm (0.6") front and 35 mm (1.375") rear
- Includes M-5570-A Mustang Jounce Bumper Kit
- May cause slightly harsher ride compared to stock springs

NOTE: Some factory fasteners are one-time use. Please reference a Ford service manual for reuse information and correct torque specifications. May require alignment after installation.





2005-2014 MUSTANG GT COUPE SWAY BAR KIT

M-5490-A*

- Sway bar kit designed for increased handling and performance on 2005-2014 Mustang GT Coupe
- Best when used with M-18000-A or M-18000-C Struts/Shocks and M-5300-K Springs (1.5" drop), or M-5300-P Springs (1" drop)
- Includes all mounting hardware
- For replacement bushings use M-5490-BKA Bushing Kit

2007-2012 MUSTANG SVT SWAY BAR KIT

M-5490-B*

- Sway bar kit designed for increased handling and performance on 2007-2012 Shelby GT500 Coupe
- Front bar: 35 mm, tubular; Rear bar: 24 mm, solid
- Designed to be used with M-18000-C Dampers, M-5300-L Springs and M-20201-C Brace (2007-2009 only)
- Includes all mounting hardware



2005-2014 MUSTANG GT CONVERTIBLE SWAY BAR KIT

M-5490-D*

- Sway bar kit designed for increased handling and performance on 2005-2014 Mustang GT Convertible
- Best when used with M-18000-A Strut/Shock Kit or M-18000-C Adjustable Strut/Shock Kit
- Includes all mounting hardware

***NOTE:** Some factory fasteners are one-time use. Please reference a Ford service manual for reuse information and correct torque specifications.

BUSHING KITS

M-5490-BKA

- Includes all the bushings to rebuild the M-5490-A Sway Bar Kit
- Urethane bushings should be checked every 12 months of use

M-5490-BKB

- Includes all the bushings to rebuild the M-5490-B Sway Bar Kit
- Urethane bushings should be checked every 12 months

M-5490-BKC

- Includes all the bushings to rebuild the M-5490-C or M-5490-D Sway Bar Kit
- Urethane bushings should be checked every 12 months

M-5490-BKD ^{NEW}

Includes all the bushings needed to rebuild the front and rear 2015-2017 Mustang track sway bar used in the following kits:

- 2015-2018 Mustang M-FR3A-M8 Track Handling Pack
- 2015-2018 Mustang M-5700-M Street Sway Bar and Spring Kit
- 2015-2018 Mustang M-5490-E Track Sway Bar Kit

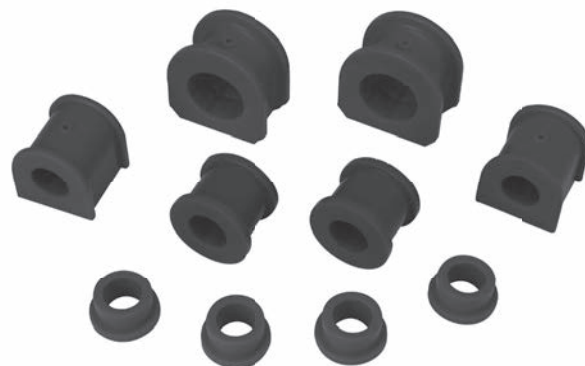

COMPLETE HARDWARE KITS

M-5490-HWA

- Includes all the hardware and bushings to rebuild the M-5490-A Sway Bar Kit
- Sway bars not included

M-5490-HWB

- Includes all the hardware and bushings to rebuild the M-5490-B Sway Bar Kit
- Sway bars not included

M-5490-HWC

- Includes all the hardware and bushings to rebuild the M-5490-C and M-5490-D Sway Bar Kit
- Sway bars not included



REPLACEMENT SWAY BAR LINK

M-5490-LINKA

- Includes one sway bar link with bushings
- Fits M-5490-A Sway Bar Kit

M-5490-LINKB

- Includes one sway bar link with bushings
- Fits M-5490-B Sway Bar Kit

M-5490-LINKC

- Includes one sway bar link with bushings
- Fits M-5490-C and M-5490-D sway bar kits



FORD MUSTANG

BOSS 302R ELECTRIC STEERING RACK

M-3200-EPAS

- Service replacement for 2012-2014 Mustang BOSS 302R race car
- Electric assist steering rack with performance calibration
- Designed for road racing with racing tires
- Off-road use only!



2005-2009 MUSTANG GT COUPE FRONT LOWER A-ARM BRACE UPGRADE KIT



M-5025-A

- Fits 2005-2009 Mustang GT Coupe
- Original equipment on convertible and 2007-2009 Shelby GT500
- Increases chassis stiffness



2005-2014 MUSTANG V6 STRUT TOWER BRACE

M-20201-F

- Fits 2005-2014 Mustang V6
- Silver powdercoated with etched "Ford Racing" logo
- Parallel beam design for added rigidity

NOTE: Some factory fasteners are one-time use. Please reference a Ford service manual for reuse information and correct torque specifications.



2005-2010 MUSTANG GT FRONT LOWER CONTROL ARM UPGRADE KIT

M-3075-E

- Fits 2005-2010 Mustang GT built on or before 8/3/09 with 18 mm ball joint shaft
- Original equipment on 2007-2009 Shelby GT500
- Increased strength ball joints
- Kit contains 1 RH and 1 LH lower control arm assembly

NOTE: Some factory fasteners are one-time use. Please reference a Ford service manual for reuse information and correct torque specifications.



2005-2014 MUSTANG CASTER AND CAMBER ALIGNMENT ECCENTRIC BOLT KIT



M-3B236-A

The caster and camber eccentric kit contains everything you need to adjust the caster and camber on your 2005-2014 Mustang

- Fits 2005-2014 Mustang

Kit contains:

- Both front camber eccentric bolts
- Both front caster eccentric bolts
- All needed hardware



2005-2014 MUSTANG GT STRUT TOWER BRACE



M-20201-S197

- Fits 2005-2010 Mustang GT without engine dress-up cover
- Fits 2011-2014 Mustang GT with engine dress-up cover
- Parallel beam design for added rigidity
- Black powdercoated
- Stainless steel "Ford Racing" emblem
- Does not fit V6, supercharged Mustang GT, or 2005-2010 Mustang GT with intake shroud
- Does not fit with M-9424-463V Intake Manifold

NOTE: Some factory fasteners are one-time use. Please reference a Ford service manual for reuse information and correct torque specifications.



2011-2014 MUSTANG FRONT CONTROL ARM KIT W/EXTENDED BALL JOINT

M-3075-RA

- Fits 2011-2014 Mustang
- Service replacement for 2013 Mustang BOSS 302S race car
- Ball joint is 19.2 mm longer than stock; offers improved geometry for track use
- Threaded ball joint for easy replacement
- M-5638-C Front Control Arm Bushing Kit and M-3130-R4 Bump Steer Kit recommended
- Off-road use only



1979-1993 MUSTANG/CAPRI FRONT LOWER CONTROL ARM KIT



M-3075-A

- Fits 1979-1993 Mustang/Capri
- Kit includes LH and RH lower control arm assemblies (produced on original Ford production tooling), greaseable ball joint, ball joint boot, grease fittings, nut and cotter pin
- Dramatically improves impact harshness qualities of vehicle on early Fox bodies (1979-1984)
- Recommended when heavy-duty suspension components are added
- Fits other Fox bodies:
 - 1978-1982 Fairmont/Zephyr
 - 1980-1982 Thunderbird/Cougar
 - 1981-1982 Granada/Monarch
 - 1983-1985 LTD/Marquis
- Made in the USA!



MUSTANG ROAD RACE REAR LOWER CONTROL ARM BUSHINGS

M-5638-A

- Service replacement part for Mustang FR500C and BOSS 302R race car
- Replacement bushings for rear lower control arms
- Includes 8 bushings and 4 sleeves



2005-2014 MUSTANG COMPETITION FRONT BUSHING KIT

M-5638-C

- Fits Mustang BOSS 302R, FR500C, FR500S, 2005-2014 Mustang GT, V6, Shelby GT500 and 2012-2013 Mustang BOSS 302
- Front lower control arm bushing kit for 2005-2014 Mustang
- Original equipment on 2013 Mustang Cobra Jet and Mustang BOSS 302S
- Rear bushings are smaller and lighter than production – ideal for header access
- Low drag Delrin® – aluminum forward bushings removes the bushing as a damping force
- Increased stiffness for minimal suspension deflection and increased steering response
- Off-road use only!



WHEEL NUTS (5-PACK)

M-1012-G



- Fits 2005-2014 Mustang and most other 1/2"-20 applications
- Service replacement for the Mustang FR500S and BOSS 302S race car
- 1/2"-20 thread plated steel cone seat lug nuts
- Open-ended for use with long wheel studs
- 13/16" hex



2005-2014 MUSTANG V6/BOSS/GT/ SHELBY GT500 HUB KIT WITH ARP® STUDS

M-1104-A

- Fits 2005-2014 Mustang V6, BOSS, GT, Shelby GT500
- Service replacement part for the Mustang FR500S and BOSS 302S race car
- Equipped with M-1107-A ARP® Front Wheel Studs
- 3" ARP® stud specifications: wheel stud style – press-in; thread size – 1/2"-20 RH; knurl diameter – .549"; under head length – 3.315"

Kit includes:

- One pair of upgrade hubs with 3" ARP® studs
- New hub nut

NOTE: For replacement open end wheel lug nuts see M-1012-G.



2005-2014 MUSTANG BUMP STEER KIT

M-3130-R4

- Fits 2005-2014 Mustang
- Service replacement for 2013 Mustang BOSS 302S race car
- Allows adjustment of bump steer after making changes to control arm geometry, control arm position or if you have significantly increased caster
- Kit includes pair of spherical rod ends, tapered stud, assortment of spacers and hardware
- Toe adjustments are easily made without tire removal
- Off-road use only!



FORD MUSTANG

2005-2014 MUSTANG REAR LOWER CONTROL ARM UPGRADE KIT

M-5538-A

- Fits 2005-2011 Mustang GT, 2005-2014 Mustang GT with auto transmission, and 2005-2014 Mustang V6
- Standard equipment on 2007-2014 Shelby GT500, 2013-2014 Mustang GT with Track Pack, and 2011-2014 Mustang GT with manual transmission
- Increased bushing durometer and stiffness for high-performance applications
- For race applications see M-5649-S or M-5649-R1 tubular control arm kits

NOTE: Some factory fasteners are one-time use. Please reference service manual for reuse information and correct torque specifications.

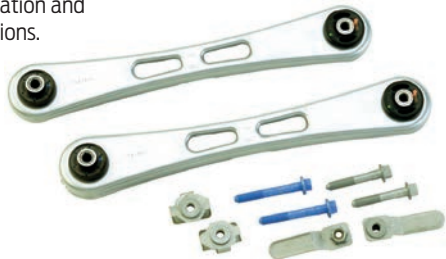

2005-2014 MUSTANG LOWER CONTROL ARM RELOCATION BRACKET

M-5650-A

- Fits 2005-2014 Mustang GT and 2007-2014 Shelby GT500. Requires aftermarket lower control arms
- Service replacement for 2012 Mustang BOSS 302S race car
- Bracket allows adjustment of rear lower control arm mounting point at axle housing
- Allows adjustment of instant center for optimum traction
- NOT compatible with production lower control arms
- Off-road use only



2005-2014 MUSTANG ADJUSTABLE PANHARD BAR

M-4264-A

- Fits 2005-2014 Mustang
- Service replacement part for the FR500S and BOSS 302 R1 race car
- Also for use on NASA AI and AIX class S197 Mustang
- Allows adjustment to the rear suspension vs. the factory non-adjustable bar
- 1.125" OD x .095" wall thickness 4130 chrome moly bar
- Low deflection urethane rod ends and steel sleeves
- Offset mounts allows bar to clear rear differential cover
- For replacement bushings use 2005-2014 Mustang M-4266-A Adjustable Panhard Bar Bushing Kit



2005-2014 MUSTANG TUBULAR REAR LOWER CONTROL ARM KIT – SPHERICAL BEARING

M-5649-S

- Fits 2005-2014 Mustang GT and 2007-2014 Shelby GT500
- Service replacement part for 2012 Mustang BOSS 302S race car
- Made from steel tube with high-strength spherical rod ends
- Increased stiffness for minimal suspension deflection
- Non-adjustable
- Off-road use only
- Great for use with M-5650-A Rear Control Arm Relocation Bracket
- For street applications see M-5538-A Control Arm Kit
- For tubular control arms with urethane bushings see M-5649-R1 Control Arm Kit



2005-2014 MUSTANG TUBULAR REAR LOWER CONTROL ARM KIT – URETHANE BUSHINGS

M-5649-R1

- Fits all 2005-2014 Mustang V6, GT, Shelby GT500 and 2012-2013 BOSS 302
- Service replacement for the Mustang FR500C and BOSS 302R race car
- Features low deflection urethane bushings and tubular steel construction
- Increased stiffness for minimal suspension deflection
- The kit comes complete with bushings and sleeves and can be installed with basic shop tools
- Great for use with M-5650-A Rear Control Arm Relocation Bracket
- Replacement M-5638-A Urethane Bushing/Sleeve Kit available
- For street applications, see M-5538-A Control Arm Kit
- For tubular control arms with spherical bearing ends, see M-5649-S Control Arm Kit



2005-2014 MUSTANG ADJUSTABLE PANHARD BAR BUSHING KIT

M-4266-A

- Service replacement bushing kit for Ford Performance 2005-2014 M-4264-A Adjustable Panhard Bar

Kit includes:

- Steel bushing sleeves
- Urethane bushings



2005-2010 MUSTANG V6 FRONT BRAKE UPGRADE KIT

M-2300-D

- Fits 2005-2010 Mustang V6
- Upgrades Mustang V6 11.5" front rotors to the larger Mustang GT 12.4" rotors for increased stopping power
- Uses existing calipers and brake pads
- Easy to install, no brake bleeding required
- For caliper clearance requires 17" or larger 2005-2014 Mustang GT wheels such as M-1007-T178B, M-1007-T178S, M-1007-S1885B and M-1007-DC1895



1994-2004 MUSTANG GT REAR BRAKE BRACKET UPGRADE KIT

M-2300-M

- Used to install Mustang Cobra, Mach 1, or Special Edition rear calipers on 1994-2004 Mustang GT
- Kit includes production 11.65" rotors, caliper mounting brackets, moan braces, dust shields and dust shield bolts



2005-2014 MUSTANG GT 14" SVT BRAKE UPGRADE KIT W/2-PIECE ROTORS

M-2300-SA

- Fits 2005-2014 Mustang GT (ABS only)
- Kit will upgrade the front brakes to Ford Performance 2-piece 14" brake rotors and 4-piston Brembo® calipers
- Includes Shelby GT500 rear pads for use in stock Mustang GT rear calipers
- Includes Goodridge® DOT four-piece stainless steel hose kit and attaching parts
- Requires 18" M-1007-DC1895, M-1007-S1895, M-1007-S1895B1 or 19" M-1007-DC199B, M-1007-SA199 or M-1007-DC199LGB Ford Performance wheel or equivalent for caliper clearance
- Kit also clears track use only M-1007-R1895 and M-1007-R1895S 18" Mustang race wheels



2005-2014 MUSTANG GT 14" SVT BRAKE UPGRADE KIT

M-2300-S

- Fits 2005-2014 Mustang GT (ABS only)
- Kit will upgrade the front brakes to 2007-2012 Shelby GT500 14" rotors and 4-piston Brembo® calipers
- Includes Shelby GT500 rear pads for use in stock Mustang GT rear calipers
- Includes Goodridge® DOT four-piece stainless steel hose kit and attaching parts
- Requires 18" M-1007-DC1895, M-1007-S1895, M-1007-S1895B1 or 19" M-1007-DC199B, M-1007-SA199 or M-1007-DC199LGB Ford Performance wheel or equivalent for caliper clearance
- Kit also clears track use only M-1007-R1895 and M-1007-R1895S 18" Mustang race wheels



2005-2014 MUSTANG 6-PISTON 15" BRAKE UPGRADE KIT

M-2300-T

- Fits 2005-2014 Mustang GT Coupe
- Fits 2012-2013 BOSS 302
- Original equipment on 2013-2014 Shelby GT500
- Front features: Brembo® 6-piston gloss black aluminum calipers and 15" vented brake rotors
- Rear features: Single-piston calipers, rear axle caliper brackets and 13.8" vented brake rotors
- Includes production front brake hoses, front and rear brake pads, front tie rod heat shields and installation hardware
- Requires Ford Performance M-1007-SA199, M-1007-SA1910, M-1007-DC199LGB, M-1007-SA1995MB wheels or M-1007KIT-DC19910LGB, M-1007KIT-DC199CH, M-1007KIT-DC199LGB, M-1007KIT-SA199, M-1007KIT-SA19910 wheel kits or equivalent for caliper clearance
- Kit also clears track use only wheels, M-1007-R1895, M-1007-R1810 and M-1007-R1895S 18" Mustang Ford Performance/BBS race wheels



1994-2004 MUSTANG COBRA R FRONT BRAKE UPGRADE KIT

M-2300-X

Front Brake Kit

M-2300-XP

Front Brake Pads



M-2300-XR

Front Brake Rotors



- Fits 1994-2004 Mustang GT and 1994-2004 Cobra
- Original equipment on 2000 Mustang Cobra R
- Brembo® 4-piston gloss black aluminum calipers
- 13" vented and slotted brake rotors
- Includes braided stainless brake lines and installation hardware
- May require larger wheels

NOTE: 1994-1995 Mustang GT requires 1994 Cobra master cylinder.



FORD MUSTANG

2013-2014 MUSTANG BOSS 302S BRAKE DUCT

M-2004-MR

- Fits 2013-2014 Mustang BOSS 302S and 302R race car
- Rivets behind 2013 BOSS Mustang front fascia
- Thermoformed ABS black plastic



MUSTANG FR500C, BOSS 302R/S BRAKE BOOSTER

M-2005-R

- Service replacement for FR500C, BOSS 302R/R1 and BOSS 302S race cars
- Specific race valving for lightweight vehicles with race tires
- Provides enhanced feedback at high speeds
- Reduced assist by 30% compared to production Mustang GT brake booster
- Revised pedal modulation for more gradual braking and less initial "bite" at initial travel
- Engineered and available exclusively through Ford Performance



2005-2014 MUSTANG BRAKE LINE UPGRADE KIT

M-2078-MB

- Fits 2005-2014 Mustang GT
- Fits 2005-2014 Mustang GT with Brembo® package
- Fits 2007-2012 Shelby GT500
- Fits 2011-2014 Mustang V6
- Brake line kit used on 2012-2013 Mustang BOSS 302
- Low expansion rubber lines for improved brake response
- Front and rear lines included



ADJUSTABLE PARKING BRAKE CABLE

M-2810-A

- Front parking brake cable for M-2300-F and M-2300-K brake kits



2005-2014 MUSTANG HIGH-PERFORMANCE BRAKE COOLING SHIELDS

M-20045-MSVT

- Fits 2005-2014 Mustang GT, Mustang V6 and 2007-2012 Shelby GT500
- Protects tie rod end from heat while improving heat dissipation from front brakes
- Perfect for high-performance track use
- Replaces factory dust shield
- Original equipment on 2013-2014 Mustang Shelby GT500



9" DRUM BRAKE BACKING PLATE KIT

M-2209-B

- Used with M-1126-B Brake Drum
- 11" x 2.25" brakes for late model 9" axle housing
- 1" diameter wheel cylinder
- 3.150" center pilot hole
- .381" attaching bolt holes
- 3.56" x 2" attaching bolt pattern
- Service parts, 1985 F150
- Kit includes 2 new assembled backing plates with brake shoes, wheel cylinder, self-adjuster, parking brake and springs
- Sold in pairs



11" X 2.25" BRAKE DRUM

M-1126-B

- Brake drum for 9" axle M-2209-B Backing Plate Kit
- 5-lug, 4.5" bolt circle
- Axle center pilot hole 2.780"
- Sold individually
- Wall thickness at hub .125"
- Backspacing from outer edge to hub area 3.575"



BRAKE PROPORTIONING VALVE

M-2328-C

- Compact, lightweight (.5 lb) aluminum brake proportioning valve
- "Kneepoint" is adjustable from 100 to 1000 psi
- Inlet and outlet ports have 1/8"-27 NPT threads for maximum installation flexibility



2013-2014 BOSS LAGUNA SECA FRONT SPLITTER KIT

M-16601-MBA

- Fits 2013-2014 Mustang GT California Special and 2013 BOSS 302 with M-17A626-MB Splitter Kit Bracket
- Fits 2013-2014 Mustang GT and V6 with M-16601-MBKIT Install Kit
- Original equipment on 2013 BOSS 302 Laguna Seca and BOSS 302S
- Service replacement for 2013 BOSS 302 Laguna Seca and BOSS 302S
- Increases front downforce for road racing and open track applications
- Splitter made from durable ABS material
- Brackets are black powdercoated
- Includes splitter and installation hardware
- Off-road use only



2010-2012 MUSTANG GT FRONT SPLITTER KIT

M-16601-MB

- Fits 2010-2012 Mustang GT with GT/CS or BOSS lower fascia insert Part No. BR3Z-17626-AB
- Increases front downforce for road racing and open track applications
- Splitter made from durable ABS material
- Brackets are black powdercoated
- Includes M-16601P-MB Splitter and M-17A626-MB Bracket and installation hardware
- Off-road use only



BOSS 302S FRONT SPLITTER HARDWARE KIT

M-16601H-S

- Service hardware kit for BOSS 302S race car front splitter
- Hardware kit includes fasteners and support rods for M-16601-S Splitter
- Does not include fasteners for M-17A626-MB Bracket



2010-2012 MUSTANG GT LAGUNA SECA SPLITTER KIT

M-16601-MBKITA

- Includes all parts to transform the front lower fascia of your 2010-2012 GT (non-California Special) into a 2012 BOSS Laguna Seca lower front fascia with splitter
- For 2010-2012 Mustang GT California Special, only M-16601-MB is required to add Laguna splitter
- Original equipment on 2012 Mustang BOSS Laguna Seca
- Includes 2012 BOSS 302 lower grille insert, 2012 BOSS 302 Laguna Seca lower deflector, 2012 BOSS 302 Laguna Seca upper splitter and fasteners, and M-17A626-MB Laguna Splitter Bracket
- Increases front downforce for road racing and open track events
- Splitter made from durable ABS material
- Brackets are black powdercoated



2010-2012 SPLITTER HARDWARE KIT

M-16601H-MB

- Service hardware for BOSS 302 front splitter as used on BOSS 302 Laguna Seca and M-16601-MB 2010-2012 Splitter Kit



2005-2009 MUSTANG SVT REAR SPOILER

M-16600-SVTC

- Fits 2005-2009 Mustang GT
- Original equipment on 2007-2009 Mustang SVT
- Fits into existing Mustang GT spoiler bolt holes
- No drilling required when installed on Mustang GT with factory spoiler
- Must be painted to match color of car



2005-2014 MUSTANG HOOD LIFT KIT W/LASER-ENGRAVED "FORD PERFORMANCE" LOGO



M-16826-M

Simply start to lift your hood and let the hood lift system take over. Your hood will lift and hold firmly at the raised position – no wind or bumping will knock your hood down on your head. These gas struts are rated at 90 lbs to hold up OEM and specialty hoods.

- Fits 2005-2014 Mustang
- 90 lbs rating
- Designed for all OEM base, Mustang GT, GT500 and many aftermarket hoods
- These hood lifts utilize two gas struts that lift and hold the hood without the need for a prop rod
- Made from lightweight steel and aluminum, they feature a durable black powdercoated finish to give your engine bay a much cleaner appearance
- Includes the necessary mounting brackets
- No drilling required. The stamped steel brackets included in this kit are designed to bolt into the existing mounting holes in the hood so there is no drilling required for installation
- If your aftermarket hood is lighter than the factory hood, use caution when opening the hood due to the power of the strut



2005-2014 MUSTANG LIGHTWEIGHT TUBULAR FRONT BUMPER



M-17757-MB

- Fits 2005-2014 Mustang
- For off-road competition use only!
- Service replacement part for 2013 BOSS 302S
- Powdercoated black
- Requires modifications to the front Mustang fascia to accommodate tow hook
- 8.6 lbs – 30% lighter than stock
- Includes bracket for M-17954-A Front Tow Hook
- Includes attachments for Ford Performance M-16601P-MB or M-16601-MBA splitter kits



2010 COBRA JET MIRROR BLOCKOFF PLATE

M-17728-CJ10

- Service replacement part for the 2010 Mustang Cobra Jet race car
- Designed to fill void left when removing side mirrors for race car application
- Fits 2010 Mustang
- For off-road use only!



MODIFIED 2013 BOSS 302S GRILLE

M-8200-MBRA

- Fits 2013 Mustang BOSS 302
- Production front grille on 2013 Ford Performance Mustang BOSS 302S race car
- Modified grille insert increases airflow to the radiator
- Fog light openings cut out and filled with heavy-duty wire mesh
- Flat black finish

2012 MUSTANG BOSS 302S FRONT GRILLE

M-8200-MBR

- Fits 2010-2012 Mustang GT and 2012 Mustang BOSS 302
- Production front grille on Ford Performance Mustang BOSS 302S race car
- Modified grille insert increases airflow to the radiator
- Fog light openings cut out and filled with heavy-duty wire mesh
- Accepts stock BOSS 302 Mustang grille emblem
- Flat black finish



TOW HOOK LOOP KIT

M-17954-A

- Service part for Ford Performance Fiesta Spec-B and FR500S Mustang Challenge race car
- Does not include bumper beam attaching hardware



MUSTANG FRONT TOW RING KIT

M-17954-F

- Fits 2013 Mustang GT and 2013 Mustang BOSS 302 front fascia
- Bright red tow ring pivots for ease of use
- Includes weld-on bumper beam bracket
- Front fascia requires cutting to mount tow ring kit



MUSTANG REAR TOW RING KIT

M-17954-RA

- Fits 2013 Mustang GT and 2013 Mustang BOSS 302 rear fascia
- Bright red tow ring pivots for ease of use
- Includes weld-on bumper beam bracket
- Rear fascia requires cutting to mount ring kit



2006-2014 MUSTANG FLOOR MATS



| | |
|-------------------|----------------------------------|
| M-13086-MP | 2013-2014 Gray "GT500" |
| M-13086-MN | 2013-2014 Black with Silver Pony |
| M-13086-MM | 2013-2014 Black "BOSS 302" |
| M-13086-MJ | 2012 Black "BOSS 302" |
| M-13086-MH | 2012 Black with Silver Pony |
| M-13086-MG | 2010 Gray "GT500" |
| M-13086-MF | 2010 Black with Silver Pony |
| M-13086-ME | 2006-2009 Black "Mustang" |
| M-13086-MD | 2006-2009 Gray "Mustang" |

- Premium-grade carpeting is custom fit to the exact contour of Mustang
- Dual retention on driver- and passenger-side mats



FORD PERFORMANCE STEERING WHEEL – OFF-ROAD



M-3600-RA

- Fits 2005-2018 Mustang race cars
- Same steering wheel as used on 2013-2015 Mustang Cobra Jet and 2012-2014 Mustang BOSS 302S, BOSS 302R, FR500C and FR500S but with "Ford Performance" logo
- Requires custom wiring to retain any factory steering wheel buttons

NOTE: This steering wheel is for off-road use only.



STEERING WHEEL HUB ADAPTER



M-3602-R

- Same as used on FR500S, 2013-2014 BOSS 302S, 2013 and 2016 Cobra Jet Mustang



FORD CUSTOM SILL PLATES

Customize your sill plates with your name, a message or any of our official Mustang logos.

- Works with 2005 and newer model year Mustang
- Compatible with ambient lighting-equipped Mustang
- Add your own name or statement, up to 22 characters
- Choose from many logos
- Quick, DIY installation
- Contains fully assembled driver- and passenger-side sill plates
- Resistant to scratching and scuffing
- Protected from UV fading
- Tested to OEM engineering standards
- Direct OEM replacement part
- Available in black



Available at
www.FordShowParts.com
 or (800)367-3788

ALUMINUM AND URETHANE SPECIAL EDITION MUSTANG PEDAL COVER



- M-2301-A** Accelerator pedal cover
- M-2301-B** Brake or clutch pedal cover (1 per package)
- M-2301-C** Left-foot dead pedal cover

- Fits 1994-2004 Mustang
- Direct replacement for stock pedal
- Easy to install, no drilling required
- Brushed aluminum finish with urethane knobs for better grip
- Custom styling for the muscle car enthusiast



FORD FOCUS





2013-2017 FOCUS ST MOUNTUNE® MP275 PERFORMANCE UPGRADE WITH HANDSET/CAL

- 2363-280-BB*** 2015-2017 Black
- 2363-280-BA*** 2013-2014 Black

The mountune® MP275 Focus ST performance upgrade consists of engineered components designed to optimize the performance of the vehicle without sacrificing reliability. Tested and validated on the notorious British B roads, Los Angeles freeways and countless laps of the famed Nurburgring Nordschleife, the mountune® MP275 Focus ST upgrade delivers maximum reliable performance. The mountune® Focus ST MP275 performance upgrade is endorsed by Ford and features factory-level integration while exploiting the potential of the Focus ST. The MP275 performance upgrade includes mountune® high-quality, engineered components to ensure long life and a perfect fit. Backing up the mountune® components is our world-class, performance ECU calibration engineered to add maximum reliable performance. Developed in-house by our team of experienced engineers, the MP275 ECU calibration has been validated through a wide range of performance tests and durability cycles resulting in a complete performance upgrade system that is legal for street use in the United States.

2363-AF-CAP mountune® air filter end cap can be added to the mountune® high-flow air filter to control sound and provide air filter protection in harsh weather conditions.

Included with the MP275 performance upgrade:

- mountune® induction kit
- mountune® high-flow intercooler
- mountune® mTune handset
- All installation hardware
- “mountune®” performance badge

NOTE: Premium fuel required. Performance gains were measured with 93 octane fuel (USA). Your results may vary depending on fuel quality, vehicle condition and geographical location.

Stock Focus:

Power 252 hp
Torque 270 lb-ft

mountune® Focus ST with mountune® MP275 performance upgrade:

Power 275 hp
Torque 296 lb-ft



2363-280-BA shown

*This component is eligible for the Ford Performance Parts Limited Warranty. See the Ford Performance Parts Limited Warranty on pages 295-302 for details.

2013-2017 FOCUS ST MOUNTUNE® INTERCOOLER UPGRADE



2363-IC-BA2* 2015-2017 Black

2363-IC-BA* 2013-2014 Black

The mountune® Focus ST high-performance intercooler upgrade includes everything you need to optimize performance and is the foundation for further power upgrades. Using a 14-row extruded lightweight tube and fin alloy core with cast alloy end tanks for improved flow characteristics provides substantial reduction in Air Charge Temperature (ACT) with minimal pressure drop, ensuring optimum charge air temperature and therefore power. The larger than stock intercooler is essential for sustained high speed or track use and is not as prone to heat soak as smaller intercooler cores. The mountune® Focus ST intercooler upgrade has reduced outlet air temperatures by over 39%.

mountune® developed a considerably larger and more efficient tube and fin type core that retains the OE mounting locations and includes ram air guides to direct airflow through the core and not around it. Lightweight cast alloy end tanks ensure improved intake airflow and include robust mounting points that do not require drilling for installation. Using a tailored intercooler core allowed the use of the OE intercooler hoses and piping. Excellent turbocharger response is maintained by retaining the OE intercooler track. Each intercooler is powdercoated in black or silver to ensure years of corrosion-free service.

- Superior tube and fine construction
- No drilling is required for installation
- Core size: 29.5" x 11.7" x 2.0"
- High-quality brackets and hardware included

NOTE: The removal of the vehicle Active Grille Shutter (AGS) is required for the installation of this product.

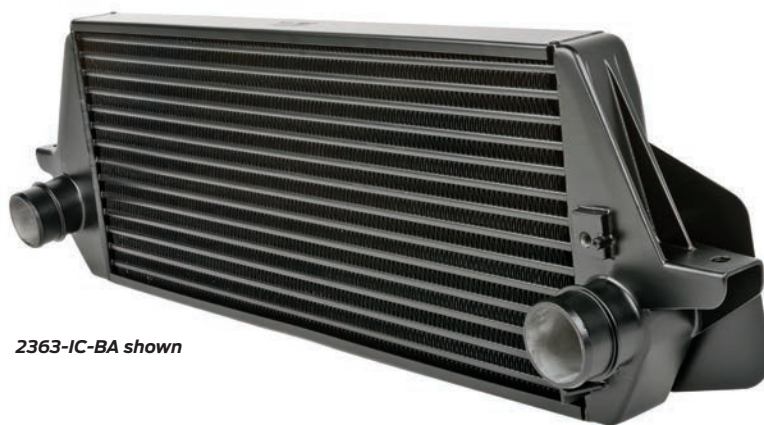

2363-IC-BA shown

2013-2018 FOCUS ST MOUNTUNE® LOW RESTRICTION INTAKE KIT – BLACK



2363-CAIS-BA*

The mountune® high-performance induction includes everything you need to optimize the intake tract to improve airflow characteristics and remove internal obstructions to improve intake airflow directly to the turbocharger. The kit consists of a cast aluminum low restriction crossover duct in a black finish with a detailed mountune® logo, high-flow air filter, silicone coupling hose and coupling attachment clamps.

- Fits 2013-2018 Focus ST
- Cast aluminum construction
- Installation is simple and only requires simple hand tools

mountune® 2363-AF-CAP Air Filter End Cap can be added to the mountune® high-flow air filter to control sound and provide air filter protection in harsh weather conditions.



*This component is eligible for the Ford Performance Parts Limited Warranty. See the Ford Performance Parts Limited Warranty on pages 295-302 for details.



2013-2018 FOCUS ST MOUNTUNE® ULTRA HIGH-PERFORMANCE HIGH-FLOW INDUCTION HOSE

- 2363-IH-BLK** Black
- 2363-IH-BLU** Blue
- 2363-IH-YEL** Yellow

The mountune® high-flow induction hose for the Focus ST replaces the original flexible coupling hose between the air-box and intake pipe. Designed with a smooth flow interior, the mountune® high-flow induction hose enhances airflow to the engine and improves response.

- Fits 2013-2018 Focus ST
- Works with mountune® low-restriction intake or with original intake system
- Increased airflow and response
- High-quality silicone construction
- Stainless steel wire reinforced
- Includes upgraded hose clamp set



2013-2016 FOCUS ST MOUNTUNE® CHARGE PIPE UPGRADE KIT

- 2363-CPK-BLK** Black
- 2363-CPK-BLU** Blue
- 2363-CPK-RED** Red

The mountune® complete intercooler charge pipe upgrade kit features a massive 39% improvement in airflow. The mountune® engineers optimized the charge air ducting and lower hot side charge pipe to reduce the pressure drop from a power robbing 8.4 kPa to an impressive 6 kPa. The mountune® complete intercooler charge pipe upgrade kit is easy to install and complements the performance of the mountune® intercooler upgrade for the Focus ST. This kit is also compatible with the original intercooler and systems that use the original intercooler charge pipes.

- Fits 2013-2016 Focus ST
- High-flow stainless steel lower intercooler pipe
- Easy installation (no drilling)
- Stainless steel wire reinforced silicone boost hoses
- Nomex®-lined silicone hoses



- Red**
- Blue**
- Yellow**
- Black/Yellow**

2013-2016 FOCUS ST MOUNTUNE® LOWER INTERCOOLER PIPE UPGRADE

2363-HP-AA

The mountune® lower intercooler pipe upgrade directly replaces the factory lower intercooler pipe, featuring a 39% increase in airflow. Easy to install, it is compatible with the mountune® ultra high-performance silicone boost hose kit or the original intercooler coupling hoses.

- Fits 2013-2016 Focus ST
- Smooth-flow, mandrel-bent stainless steel construction
- OE-style mounting brackets
- 39% increase in airflow
- Improves turbocharger response and performance



2013-2018 FOCUS ST/RS/MUSTANG ECOBOOST® COLD SPARK PLUG SET

M-12405-20T

- Fits 2013-2018 Focus ST 2.0L 4-cylinder EcoBoost® engine
- Fits 2016-2018 Focus RS 2.3L 4-cylinder EcoBoost® engine
- Fits 2015-2018 Mustang 4-cylinder EcoBoost® engine
- For use in engines with higher than stock cylinder combustion pressures
- Two heat ranges colder than the stock 2.0L/2.3L EcoBoost® engine spark plug
- Same spark plugs that are included with M-9603A-FST Performance Calibration Kit
- Sold in engine sets of 4
- Spark plugs gapped to 0.028" (0.71 mm)



2013-2018 FOCUS ST COLD AIR INTAKE KIT

M-9603-FST

- Fits 2013-2018 Ford Focus ST with 2.0L EcoBoost® I4 engine
- Kit includes new drop-in high-flow air filter and Ford Performance air inlet
- Complete with everything you need for installation
- CAD designed
- Lowers air inlet temperatures, which reduces turbo outlet temperatures, in turn increasing torque output



2013-2017 FOCUS ST FRI POWER UPGRADE PACK

M-FRI-FSTA

- Fits 2013-2017 Focus ST with 2.0L EcoBoost® I4 engine
- Maximum of 90 lb-ft torque increase at 2800 rpm on 93 octane fuel
- Significant torque increase up to 4200 rpm
- Revised sound symposer software and calibration for more natural engine sound
- Premium (91 octane or higher) fuel only
- All Ford Performance power upgrade packages are 50-state emissions legal and eligible for limited warranty when installed by a Ford or Lincoln dealer or ASE certified technician. See the Ford Performance Warranty section for more information

Kit includes:

- Ford Performance Focus ST calibration with ProCal3 (requires laptop and internet access, not included) and M-14204-FSTA Spark Plug Kit
- 2013-2017 Focus ST M-9603A-FSTA Cold Air Intake with high-flow K&N/Ford Performance air filter
- Focus ST M-5200-FST Cat-back Exhaust System

NOTE: Powertrain calibrations are developed and supported for U.S. and Canadian vehicles only. Federal and state laws prohibit any person from installing aftermarket add-on or modified parts prior to the sale of a new motor vehicle. Spark plugs gapped to 0.028" (0.71 mm).



NEW

2013-2017 FOCUS ST CALIBRATION, SPARK PLUGS AND COLD AIR INTAKE

M-9603A-FSTA

- Fits 2013-2017 Focus ST with 2.0L EcoBoost® I4 engine
- Maximum of 90 lb-ft torque increase at 2800 rpm on 93 octane fuel
- Significant torque increase up to 4200 rpm
- Revised sound symposer software and calibration for more natural engine sound
- Premium (91 octane or higher) fuel only
- All Ford Performance power upgrade packages are 50-state emissions legal and eligible for limited warranty when installed by a Ford or Lincoln dealer or ASE certified technician. See the Ford Performance Warranty section for more information

Kit includes:

- Ford Performance Focus ST calibration with ProCal3 (requires laptop and internet access, not included) and M-14204-FSTA Spark Plug Kit
- 2013-2016 Focus ST M-9603-FST Cold Air Intake with high-flow K&N/Ford Performance air filter

NOTE: Powertrain calibrations are developed and supported for U.S. and Canadian vehicles only. Federal and state laws prohibit any person from installing aftermarket add-on or modified parts prior to the sale of a new motor vehicle. Spark plugs gapped to 0.028" (0.71 mm).



NEW

2013-2017 FOCUS ST CALIBRATION WITH SPARK PLUGS

M-14204-FSTA

- Fits 2013-2017 Focus ST with 2.0L EcoBoost® I4 engine
- Maximum of 90 lb-ft torque increase at 2800 rpm on 93 octane fuel
- Significant torque increase up to 4200 rpm
- Revised sound symposer software and calibration for more natural engine sound
- Premium (91 octane or higher) fuel only

Kit includes:

- Ford Performance Focus ST calibration with ProCal3 (requires laptop and internet access, not included)
- Ford Performance M-14205-20T Cold Spark Plug Set for 2.0L EcoBoost® (required with calibration)

NOTE: Powertrain calibrations are developed and supported for U.S. and Canadian vehicles only. Unlike many of our competitors, this Ford Performance calibration is 50-state emissions legal and eligible for limited warranty when installed by a Ford or Lincoln dealer or ASE certified technician. See the Ford Performance Warranty section for more information. Federal and state laws prohibit any person from installing aftermarket add-on or modified parts prior to the sale of a new motor vehicle. Spark plugs gapped to 0.028" (0.71 mm).



NEW

FORD FOCUS

2013-2017 FOCUS ST PERFORMANCE RS COLD AIR INTAKE BOX

M-9603-FSTA

- Fits 2013-2017 Focus ST
- Fits 2016-2018 Focus RS
- Includes Focus RS open element air-box with a K&N high-flow air filter
- Cold air inlet allows better breathing for increased horsepower
- Easy installation



2013-2017 FOCUS ST MOUNTUNE® ULTRA HIGH-PERFORMANCE SILICONE BOOST HOSE KIT

- 2363-BHK-BLK** Black
- 2363-BHK-BLU** Blue
- 2363-BHK-RED** Red
- 2363-BHK-YEL** Yellow

The mountune® boost hose upgrade kit for the Focus ST consists of three stainless steel wire reinforced hoses manufactured with 3-ply Nomex® fabric to ensure flawless performance in extreme conditions. This kit is compatible with the mountune® intercooler upgrade or the original Focus intercooler and is an exact replacement for the original parts.

- Fits 2013-2017 Focus ST
- Nomex® construction resists heat up to 250° C
- Easy installation



2363-BHK-BLK shown

2013-2017 FOCUS ST MOUNTUNE® ULTRA HIGH-PERFORMANCE SILICONE COOLANT KIT

- 2363-CHK-BLK** Black
- 2363-CHK-BLU** Blue
- 2363-CHK-RED** Red
- 2363-CHK-YEL** Yellow

The mountune® ultra high-performance silicone coolant hose kit caters to owners who demand the best high performance silicone hose upgrade available. The mountune® coolant hose upgrade kit for the Focus ST consists of two ultra high-performance silicone hoses manufactured with 3-ply Nomex® fabric to ensure flawless performance in extreme conditions. This kit is an exact replacement for the original upper and lower radiator hoses.

- Fits 2013-2017 Focus ST
- Nomex® construction resists heat up to 250° C
- Easy installation



2363-CHK-BLK shown



2013-2017 FOCUS ST MOUNTUNE® ULTRA HIGH-PERFORMANCE SILICONE ANCILLARY COOLANT KIT

- 2363-AHK-BLK** Black
- 2363-AHK-BLU** Blue
- 2363-AHK-RED** Red
- 2363-AHK-YEL** Yellow

The mountune® high performance silicone hose range caters to owners who demand the best high-performance silicone hose upgrade available. The mountune® ancillary coolant hose upgrade kit for the Focus ST consists of two high-performance silicone hoses manufactured to the highest standards to ensure flawless performance in extreme conditions. This kit is an exact replacement for the original bypass coolant hoses.

- Fits 2013-2017 Focus ST
- Easy installation



2363-AHK-BLK shown

FOCUS RS AND ST MOUNTUNE® HIGH-FLOW AIR FILTER

2363-AF-AA

The mountune® high-flow air filter has been designed for maximum airflow and efficiency while maintaining superior filtration. Engineered with proprietary double layer cotton gauze with deep pleats that creates a 10-15% increase in filtration surface area compared to other filters on the market. The oiled filter media is encapsulated in steel mesh that helps to maintain the perfect shape under the most extreme conditions. Each mountune® filter is manufactured using a four-step process resulting in a precision fit and virtually no seepage of rubber frame material into the filter media, producing the maximum available filter area. Additionally, the mountune® high-flow air filter features a factory-style locating outer flange that helps lock the filter in place to ensure correct pressure on the inlet flange.

- Fits 2016-2018 Focus RS
- Fits 2012-2018 Focus
- Fits 2013-2018 Focus ST
- Fits 2012-2018 Escape
- Factory-like fit
- Pre-oiled
- Increased performance
- Lifetime warranty

2363-AF-CAP mountune® Air Filter End Cap can be added to the mountune® high-flow air filter to control sound and provide air filter protection in harsh weather conditions.



RS AND ST MOUNTUNE® HIGH-FLOW AIR FILTER END CAP

2363-AF-CAP

The mountune® high-flow air filter end cap can be used to control sound or provide air filter protection in harsh weather conditions. For use with mountune® 2363-AF-AA high-flow air filter.

- Fits the following vehicles equipped with a mountune® high-flow air filter:
 - 2016-2018 Focus RS
 - 2013-2018 Focus ST
 - 2012-2018 Focus
 - 2012-2018 Escape
- Designed for easy installation and removal

NOTE: Air filter is not included.



2013-2018 FOCUS ST MOUNTUNE® UPRATED AIR RECIRCULATION VALVE

2226-TRV-AA

The mountune® uprated air recirculation valve is a direct replacement for the OE component. Machined from solid aluminum with an improved metal piston and rubber sealing system, the mountune® valve is suitable for vehicles in advanced state of tune. The original valve features a rubber diaphragm that does not function effectively when the pressure differential across the turbocharger compressor housing is increased above the original operating conditions. This can cause the valve to open prematurely, leading to possible turbocharger damage due to increased turbo shaft speed.

- Fits 2013-2018 Focus ST
- Fits 2013-2015 Fusion 2.0L EcoBoost®
- Mounts directly on turbocharger
- Easy installation
- Suitable for vehicles running higher than stock boost pressure
- Superior piston-type design
- Valve is serviceable



2013-2018 FOCUS ST 2.0L ECOBOOST® OIL CONTROL SYSTEM

2363-OC-AA

The mountune® 2.0L EcoBoost® oil control system has been designed to maintain oil supply around the oil pump pickup during high G load corners and extreme driving when the crankshaft balance shaft assembly has been removed from the engine. Installation of a balance shaft delete alone can lead to engine damage in certain conditions due to inadequate engine oil pressure. Validated under extreme conditions, the mountune® oil control system is perfect for track use or other hard driving conditions.

- Fits 2013-2018 Focus ST
- Includes CNC aluminum balance shaft delete assembly, high-temp NBR one-way valves, CNC laser-cut aluminum plate
- Can be installed with engine in car

NOTE: Oil pan/sump is not included.

NOTE: Removal of the engine balance shaft will increase noise, vibration and harshness.



2013-2018 FOCUS ST MOUNTUNE® SYMPOSER DELETE KIT

2363-SD-AA

The mountune® sound symposer delete kit provides an easy way to remove the sound symposer assembly, allowing a more natural engine sound. The sound symposer delete kit installs easily with the original hardware and includes high quality fittings that provide an easily accessible source of boost pressure for additional modifications or engine monitoring.

- Fits 2013-2018 Focus ST
- Includes CNC aluminum delete plate with machined mountune® motorsport "M" logo and high-quality fittings
- Durable black anodized finish



2.0L I4 ECOBOOST® CRATE ENGINE KIT

M-6007-20T*

- Engine from Ford Focus ST
- Production rating of 252 hp @ 5500 rpm
- Production rating of 270 lb-ft of torque @ 3000 rpm
- When used with M-6017-20T Engine Control Pack and 93 octane unleaded fuel, torque is increased 90 lb-ft at 2800 rpm – with a significant increase up to 4200 rpm. See the power curve for Part No. M-6017-20T
- All-aluminum construction – about 55 pounds lighter than a comparable naturally aspirated V6 engine
- 9.3:1 compression ratio – premium fuel recommended
- Ti-VCT strategy employs twin independent variable camshaft timing for optimized fuel economy, performance and emissions
- Borg-Warner® turbocharger with low-inertia rotor spins at speeds up to 195,000 rpm, producing up to 16 psi of boost
 - Optimized design ensures that maximum torque is achieved at very low engine revs
 - Peak torque available from 2000 to 4500 rpm
- Direct-injection high-pressure fuel system
 - Seven jets on each injector spray fuel directly into the combustion chamber
- Engine design has been optimized for maximum operating efficiency, with a focus on minimizing friction and other parasitic losses
 - Low-friction coatings on the piston rings and highly polished surfaces on the tappets
- M-6017-20T Control Pack available for custom vehicle builds
- The weight of the engine only is approximately 300 lbs

Engine kit includes:

- Starter
- Alternator
- Front accessory drive and belt
- Intercooler and air intake ducting
- Air cleaner assembly
- Manual transmission flexplate/flywheel



CONTROL PACK – FOCUS ST 2.0L ECOBOOST® MANUAL TRANSMISSION

M-6017-20T

Looking to add 2.0L EcoBoost® power from the Focus ST to your custom built vehicle? Take the complexity and mystery out of wiring an M-6007-20T 2.0L EcoBoost® engine!

- Designed to run the M-6007-20T Focus ST crate engine with a manual transmission
- Unique control pack harness replaces stock body harness and is designed for custom built vehicle. Harness includes OBD-II diagnostic port to assist in vehicle calibration upload and problem diagnosis
- Includes PCM with Ford Performance high-performance calibration
- Includes electronic throttle control accelerator pedal, eliminating throttle cable routing problems
- Includes power distribution module and oxygen sensor
- Includes M-12405-20T Cold Spark Plug Set required for performance calibration
- 2.0L EcoBoost® crate engine includes intercooler, air intake ducting and air cleaner assembly required to complete controls kit installation
- PCM with Ford Performance calibration requires return-type fuel system; will not work with returnless fuel system

NOTE: Installation of this PCM in a Focus ST will result in a no-start condition.

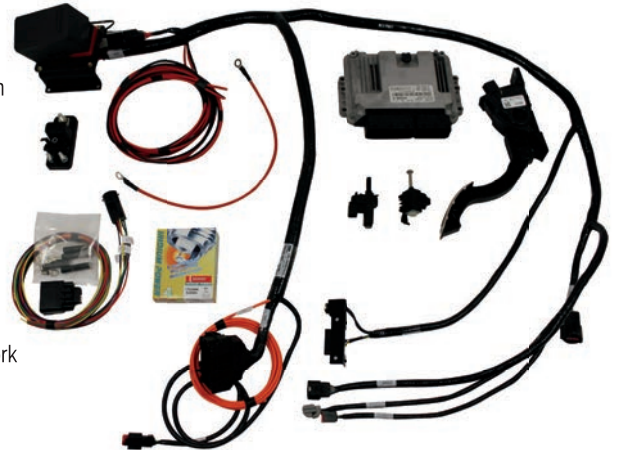

*This component is eligible for the Ford Performance Parts Limited Warranty. See the Ford Performance Parts Limited Warranty on pages 295-302 for details.

2013-2016 FOCUS ST MOUNTUNE® TRIPLE-PASS RADIATOR UPGRADE

MP2546-12020-AA1

mountune® has teamed up with global cooling experts CSF to offer the ultimate cooling solution for the Focus ST. This new high-performance, all-aluminum, triple-pass radiator has been tested and validated over thousands of miles in high-powered EcoBoost® applications, as well as proven on the track in the most demanding conditions. The new mountune® Focus ST radiator features CSF's exclusive B-Tube technology as well as an ultra-efficient multilouvered fin configuration for maximum surface area contact and heat dissipation. Additionally, the triple-pass flow structure allows the coolant to flow across the core of the radiator 3 times before exiting the radiator, for the lowest outlet temperatures possible.

The collaboration between mountune® and CSF has resulted in an industry leading radiator that has been designed and engineered to be a complete drop-in fit. All original mounting brackets have been CNC machined for the purpose of allowing the original fan assembly to bolt on without hassle, and the new core to easily drop in place without any modifications required during install.

Once the OEM radiator's performance is maxed out and coolant temperatures rise, the vehicle's protection system activates "limp mode," reducing engine performance and power. This situation is a typical occurrence during track days and sustained high-speed use. The mountune® high-performance triple-pass radiator upgrade maintains and stabilizes outlet temperatures for constant and consistent performance throughout a wide range of demanding driving conditions, significantly reducing the risk of power loss while protecting your engine when it's needed most.

- Fits 2013-2016 Focus ST
- Superior performance
- Easy installation, bolt-on performance
- Triple-pass and B-Tube technology
- Track tested
- Engineered to perform on stock and modified cars



2013-2017 FOCUS ST MOUNTUNE® HIGH-FLOW DI FUEL INJECTOR UPGRADE SET

E048-07-121

The original fuel injectors found on the 2.0L EcoBoost® engine begin to reach their maximum flow limit in the low 300BHP power range. One of the primary requirements for producing higher power figures is upgrading the original fuel injectors with components that have increased flow capacity. The mountune® high-flow di fuel injector upgrade has been proven in applications that exceed 360 bhp. Engineered and developed for our motorsport programs, these are of the highest quality and are direct replacements for the original components.

- Fits 2013-2017 Focus ST
- Matched set of four
- High quality, motorsport grade
- Flow rate: 1250 cc/mm

NOTE: Revised engine calibration is required for use with this product.





FOCUS RS AND ST MOUNTUNE® QUICK SHIFT

2363-BSA-AA*

The mountune® Focus ST quick-shift reduces the shift throw by 25%, allowing quick and more precise gear changes, which enhances the driving experience. Machined from solid aluminum upper bridge. Plated steel counterweights ensure positive shift engagement and smooth operation. All components are plated or anodized for years of durability.

- Fits 2016-2018 Focus RS
- Fits 2013-2018 Focus ST
- Easy installation
- Direct replacement for factory part
- Hard anodized finish to ensure against corrosion
- Drift tool included



FOCUS RS AND ST MOUNTUNE® ROLL RESTRICTOR/ REAR MOTOR MOUNT

2363-RR-AA

The mountune® roll restrictor/rear motor mount reduces the amount of engine roll/movement during hard acceleration and gear changing. The mountune® roll restrictor is machined from high-quality aluminum, and features a unique size and shore hardness polyurethane bushing engineered to control with horizontal plane NVH. The bonus of using polyurethane is that not only has it been engineered to give increased stiffness without causing excessive vibrations, it also doesn't deteriorate like rubber does, so the service life of the component is greatly increased.

- Fits 2016-2018 Focus RS
- Fits 2013-2018 Focus ST
- High-quality anodized billet aluminum body
- Polyurethane bushing
- Reduction in engine movement
- Minimal effect on NVH



2012-2014 FOCUS 5-SPEED SHORT THROW SHIFTER

M-7210-FS

- Fits 2012-2014 Ford Focus with 5-speed manual transmission
- 30% shorter shift throws than OEM shifter
- Nickel-plated shift handle prevents corrosion



2013-2018 FOCUS ST SHORT THROW SHIFTER

M-7210-FST*

- Fits 2013-2018 Focus ST
- Reduces shifter throw by 18% over factory shifter

NOTE: 2015-2017 Focus ST requires the original shift boot to be installed onto the short throw shifter assembly.



*This component is eligible for the Ford Performance Parts Limited Warranty. See the Ford Performance Parts Limited Warranty on pages 295-302 for details.

FOCUS RS, ST AND FIESTA ST MOUNTUNE® SHIFT KNOB

2364-GK-AA Yellow/Black

2364-GK-AB Black/Black

The mountune® billet aluminum and acetel resin gear knob has been carefully designed to further enhance the driving experience of your car in both aesthetics and ergonomics. Robust feel and weight (114g) ensures smooth shifts. The aluminum base features a hard wearing anodized coating with precision laser etching and is designed as a direct replacement for the factory knob, fully incorporating the reverse gear shift interlock mechanism. The acetel resin top, a material chosen for its temperature stable nature, ensures that the usual hot/cold heat transfer associated with replacement gear knobs is not experienced with the mountune® upgrade.

- Fits 2016-2018 Focus RS
- Fits 2013-2018 Focus ST
- Fits 2013-2018 Fiesta ST
- High-quality anodized aluminum base
- Laser-etched "mountune®" logo
- Temperature-stable acetel resin top
- Direct replacement for factory part



FOCUS ST SHIFT KNOB – CARBON FIBER, BLACK, FOR 6 SPEED

M-7213-FSTCF

Accent the interior of your Focus ST with arresting 6-speed action. Add some exotic high-performance-inspired radiance: This glossy spherical shift knob features the bright "ST" logo and authentic carbon fiber – an exceptionally strong material with an extremely attractive crystalline structure – that's weave patterned. It's a precise fit and the perfect complement to the matching carbon-fiber emergency brake handle, instrument cluster bezel trim and front door spears available from Ford Accessories.

- Easy do-it-yourself installation



2013-2018 FOCUS ST QUAIFE TORQUE BIASING DIFFERENTIAL

2363-ATB-AA

Maximize traction and performance with the Quaife ATB helical limited slip differential for the Focus ST MMT6 gearbox. A direct replacement for the standard open differential, the Quaife ATB differential transforms your car's performance and improves cornering. Unlike a conventional plate-style limited slip differential, the Quaife differential relies on gears rather than clutch plates for its operation. That means it is much smoother in operation and never locks harshly with a set pre-load of wheel slip across the driven axle. Instead, the Quaife differential automatically biases the torque away from the spinning wheel, across the axle to a constantly varying degree

- Fits 2013-2018 Focus ST
- Maintenance-free design that retains the standard lubrication
- Reduces torque steer and snatching
- Produced from certified steel billets and CNC machined before being inspected to 9001 standards
- Proven in circuit, drag and rally racing as well as daily road use

NOTE: M-4026-FST Focus ST Quaife Torque Biasing Differential Installation Kit is needed to install this part.



2013-2018 FOCUS ST QUAIFE TORQUE BIASING DIFFERENTIAL INSTALLATION KIT

M-4026-FST

Installation kit needed to install the 2363-ATB-AA Focus ST Quaife Torque Biasing Differential

- Fits 2013-2018 Focus ST with Quaife torque biasing differential

Kit includes:

- Differential bearings – Qty 2
- Ring gear bolts – Qty 10
- Axle seals – Qty 2
- Gasket maker – Qty 2
- Threadlock and sealer – Qty 2 (1 red, 1 blue)
- Installation instructions





2012-2018 FOCUS FRONT STRUT TOWER BRACE

7063-FSB-AA

The mountune® front strut tower brace improves rigidity and adds sharpness to the response of the vehicle. Engineered from 1.5" x .5" (38 mm x 12 mm) highly polished extruded contoured aluminum tubing with steel endplates for a precise fit and added strength. Installation is straightforward and requires no drilling or other modifications to the vehicle.

- Fits 2013-2018 Focus ST
- Fits 2012-2018 Focus 2.0L
- Fits 2012-2018 Focus 1.6L
- High luster, gold powdercoated steel endplates
- Polished aluminum cross brace with laser-etched mountune® motorsport "M" logo
- Compatible with the original intake and aftermarket intakes
- Easy installation



2013-2018 FOCUS ST PERFORMANCE FRONT RS BRAKE UPGRADE KIT



M-2300-W

- Fits 2013-2018 Focus ST
- Original equipment on the 2016 Focus RS
- Brembo® 4-piston calipers finished in RS blue
- 13.7" (347 mm) vented RS brake rotors
- M-2300-WR Focus RS Rear Brake Kit available

Kit includes:

- RS Brembo® calipers
- Production RS brake rotors
- Production RS brake pads
- RS brake hoses
- M-2004-FRS RS Brake Air Deflector Kit
- All needed installation hardware

NOTE: Requires Ford Performance 2016 mk3 Focus RS M-1007-R198GB wheel or equivalent for caliper clearance.



2013-2018 FOCUS ST PERFORMANCE REAR RS BRAKE UPGRADE KIT



M-2300-WR

- Fits 2013-2018 Focus ST
- Original equipment on the 2016 Focus RS
- Rear calipers are finished in RS blue
- Complements the M-2300-W Focus RS Front Brake Kit

Kit includes:

- RS rear calipers
- Production ST brake rotors
- Production RS brake pads
- Brake hoses
- All needed installation hardware



2013-2018 FOCUS ST MOUNTUNE® BRAKE HOSE SET



7063-BH-C346

mountune® high-performance brake hoses virtually eliminate brake hose expansion, delivering more consistent braking and a firmer brake pedal which improves braking performance for competition or everyday driving. Manufactured from stainless steel braided hose with reinforced ends and zinc-plated fittings to ensure easy bolt on, direct replacement installation without the need for clumsy adapters or additional fittings. This product meets the guidelines of the U.S. Dept. of Transportation FMVSS-571.106 requirements and is DOT compliant.

- Fits 2013-2018 Focus ST
- Improved brake pedal feel
- Easy installation

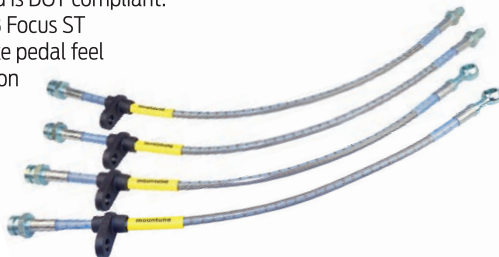

2013-2018 FOCUS ST FRONT BRAKE COOLING DEFLECTOR KIT



M-2004-FRS

- Fits 2013-2018 Focus ST
- Fits 2016-2018 Focus RS
- Original equipment on the 2016 Focus RS
- Used in the M-2300-W Focus ST Performance Front Brake Kit
- Brake air deflectors direct airflow to the front brakes to aid in brake cooling

Kit includes:

- Right front brake air cooling deflector
- Left front brake air cooling deflector
- Installation hardware
- Installation instructions



FORD FOCUS

2000-2005 FOCUS SUSPENSION KIT

M-3000-ZX3

- Fits 2000-2005 ZX3, ZX4 and ZX5 Focus
- Original equipment on Focus SVT
- Upgrades your stock Focus suspension to Focus SVT suspension
- Improved handling characteristics without ride degradation
- Reduced ride height approximately .5"

NOTE: Some factory fasteners are one-time use. Please reference service manual for reuse information and correct torque specifications. Requires alignment after installation.



2000-2005 FOCUS SVT STRUT/SHOCK KIT

M-18000-ZX3

- Fits 2000-2005 Focus models except wagon
- Focus SVT strut/shock kit improves handling over OEM Focus strut/shock
- Includes front struts with strut mount, spring seats and rear shocks

NOTE: Some factory fasteners are one-time use. Please reference service manual for reuse information and correct torque specifications. May require alignment after installation.



2000-2005 FOCUS ASSEMBLED SUSPENSION KIT

M-3000-ZX3A

- Fits 2000-2005 ZX3, ZX4 and ZX5 Focus
- Pre-assembled front struts
- Original equipment on Focus SVT suspension
- Upgrades your stock Focus suspension to Focus SVT
- Improved handling characteristics without ride degradation
- Reduced ride height approximately .5"
- Front struts come assembled with upper strut mounts and springs installed
- Kit does not include front or rear sway bars

NOTE: Some factory fasteners are one-time use. Please reference service manual for reuse information and correct torque specifications. Requires alignment after installation.



2006-2007 FOCUS PERFORMANCE SHOCK/STRUT KIT

M-18000-ZX3B

- Fits 2006-2007 Focus except wagon
- Improves handling over OEM Focus struts/shocks
- Includes front struts with mounts, spring seats and rear shocks

NOTE: Some factory fasteners are one-time use. Please reference service manual for reuse information and correct torque specifications. May require alignment after installation.





2014-2018 FOCUS ST MOUNTUNE® SPORT SPRING SET 2363-MSK-AB

mountune® engineers developed a spring set that would enhance and optimize the handling of the Focus ST while providing advanced ride quality, enhanced performance, and an aggressive level stance that is only offered by a true progressive rate spring. The outcome of countless validation miles on numerous British "B" roads, the Bruntingthorpe Proving Ground and the famous Nordschleife is the ultimate spring upgrade set for the 2014-2015 Focus ST.

- Fits 2014-2018 Focus ST
- Front ride height reduction of approximately 1"
- Rear ride height reduction of approximately 1.4"



2363-MSK-AA shown

2012-2018 FOCUS LOWERING SPRINGS

M-5300-V 2014-2018 Focus ST

M-5300-U 2013 Focus ST

M-5300-S 2012-2013 Focus – Does not fit Focus ST

- Improves handling and stance
- Lowers vehicle approximately .3"-.6"
- Includes attachment hardware
- M-5300-S includes front and rear jounce bumpers
- May cause slightly harsher ride compared to stock springs

NOTE: Some factory fasteners are one-time use. Please reference a Ford service manual for reuse information and correct torque specifications. May require alignment after install.



M-5300-S shown

2013-2018 FOCUS ST MOUNTUNE® HIGH-FLOW EXHAUST 2363-CBE-AA*

The mountune® Focus ST (C346 ST) high-flow exhaust system is manufactured from 2.5", AISI 304 stainless steel mandrel bent tubing with laser-cut flanges. All muffler assemblies are robotically TIG welded AISI 304 stainless steel for long life under extreme performance and feature consistent internal diameter throughout the entire length of the assembly. To ensure improved performance while controlling sound, each muffler includes a three-layer hybrid synthetic sound absorption packing that eliminates droning, booming and other undesirable tones. Tubing diameter also has a major impact on sound quality and careful consideration was given to size and performance. Slip fit connections have been used at various strategic points to allow for easy installation and adjustment.

- Fits 2013-2018 Focus ST
- Large 4" rolled edge, polished stainless steel tips with "mountune®" logo
- Full width rear hanger ensures stable tip location
- Heavy-duty BOSS-type clamps
- Meets 95 decibel drive-by noise standard for aftermarket exhaust systems when installed on stock applications
- Does not affect Ford vehicle warranty

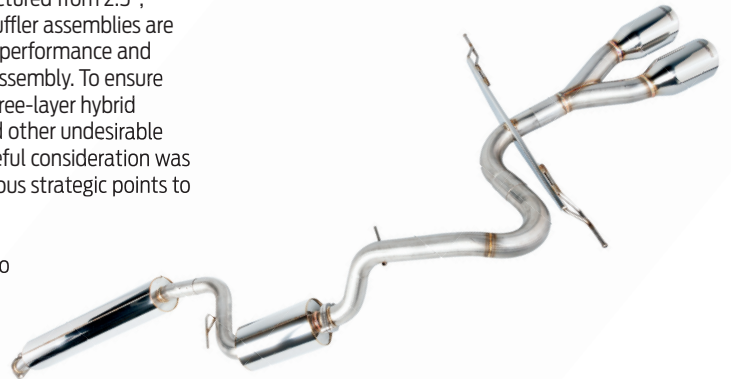

2013-2018 FOCUS ST CAT-BACK SPORT EXHAUST SYSTEM

M-5200-FST*

- Fits 2013-2018 Focus ST
- Cat-back performance exhaust system
- Uniquely designed and tuned to provide optimum performance, a deep and throaty sound, durability and pure driving excitement
- Meets 95 decibel drive-by noise standard for aftermarket exhaust systems when installed on stock applications
- Manufactured in the USA from high-quality 304 stainless steel
- Features ultra-smooth mandrel bends, warp-free flanges and superior craftsmanship



*This component is eligible for the Ford Performance Parts Limited Warranty. See the Ford Performance Parts Limited Warranty on pages 295-302 for details.

FORD FOCUS

2012-2014 FOCUS ST HATCHBACK EXHAUST SYSTEM WITH REAR FASCIA

M-5230-FSHA

- Fits 2012-2014 base Focus Hatchback
- Meets 95 decibel drive-by noise standard for aftermarket exhaust systems when installed on stock applications
- Original equipment on 2013 Focus ST
- Includes unpainted 2013 Focus ST rear lower fascia, brackets, reflectors, inserts and installation hardware
- Factory exhaust pipe requires cutting to install clamp-on Ford Performance exhaust
- 409 aluminized stainless steel corrosion-resistant muffler body construction with a polished 304 stainless steel tip



2012-2018 FOCUS HATCHBACK AXLE-BACK EXHAUST SYSTEM

M-5230-FSH*

- Fits 2012-2018 Focus Hatchback manual and automatic transmission with PZEV evaporative emission
- 304 stainless steel muffler body construction with polished tips
- Deeper, throatier exhaust note
- 50-state drive-by noise legal
- Factory exhaust pipe requires cutting to install clamp-on Ford Performance exhaust



2013-2018 FOCUS ST MOUNTUNE® DYNAMIC SIDE SPLASH



- 2363-SS-BLK** Satin Black
- 2363-SS-RG** Metallic Radio Gray
- 2363-SS-WHT** Gloss White

High-quality dynamic side splash allows the discerning Focus ST owner to add a touch of mountune® to their car.

- Fits 2013-2018 Focus ST
- Precision cut 3M® automotive-grade vinyl
- Includes fitting instructions and applicator tool



2013-2014 FOCUS ST MOUNTUNE® LOWER SPORT SPOILER



2363-CS-AA

The mountune® sport spoiler adds style and road presence and is easy to install with simple hand tools. Crafted in the USA from automotive-grade polyurethane, the mountune® sport spoiler comes finished in a satin Euro black that complements the existing lower grille trim. The mountune® motorsport "M" badge is incorporated into the leading edge for added style. Installs with simple hand tools using two non-intrusive fasteners and 3M® tape.

- Mildly aggressive style
- Produced from OE automotive-grade material
- Easy installation



*This component is eligible for the Ford Performance Parts Limited Warranty. See the Ford Performance Parts Limited Warranty on pages 295-302 for details.

2015-2018 FOCUS ST PERFORMANCE RS STEERING WHEEL KIT

M-3600-FRS

- Fits 2015-2018 Focus ST
- Fits 2016-2018 Focus RS
- Steering wheel includes unique Focus RS branding and blue stitching
- Kit contains a heated 2016 Focus RS steering wheel and all needed installation hardware
- Steering wheel works with factory heated and non-heated steering wheel equipped cars

NOTE: Heated steering wheel will not function when installed onto cars that are not equipped with the heated steering wheel option.



FOCUS "FORD PERFORMANCE" WINDSHIELD BANNER

M-1820-FFP

- Fits 2012-2017 Focus
- Die-cut white lettering that will adhere to a properly prepared windshield
- 2" tall "FORD PERFORMANCE"



2012-2018 FOCUS ST 18" X 8" WHEEL SET WITH TPMS KIT – GLOSS BLACK

M-1007K-M188GB

- Fits 2013-2018 Focus ST
- Fits 2012-2018 Focus
- Focus ST cast aluminum wheel with gloss black finish, clearcoated to OEM standards
- Includes M-1180-A TPMS Sensor and Activation Tool Kit
- Includes M-1096-Q Ford "Blue Oval" Center Cap
- 18" x 8" wide
- 5-lug, 108 mm bolt circle
- 55 mm offset
- 169.5 mm backspacing



2013-2018 FOCUS ST 19" X 8" WHEEL SET WITH TPMS KIT – MATTE BLACK

M-1007K-P198MB

- Fits 2013-2018 Focus ST
- Fits 2013-2018 Escape
- Matte black paint finished to OEM standards
- Includes M-1180-A TPMS Sensor and Activation Tool Kit
- Includes M-1096-Q Ford "Blue Oval" Center Cap
- 19" x 8" wide
- 5-lug, 108 mm bolt circle
- 52.5 mm offset
- 168.49 mm backspacing



FOCUS WHEEL CENTER CAP

M-1096-Q

- Fits 2012-2018 Ford Performance Parts Focus 18" and 19" wheels
- Chrome "Ford" logo on a blue background
- Comes standard on Ford Performance Parts 2012-2015 18" and 19" Focus wheels M-1007-M188GB, M-1007-PF188MB, M-1007-R1985, M-1007-R1985B, and M-1007-R1985W



FORD FOCUS

2012-2018 FOCUS ST WHEEL 18" X 8" – GLOSS BLACK

M-1007-MI88GB

- Fits 2013-2018 Focus ST
- Fits 2012-2018 Focus
- Focus ST cast aluminum wheel with gloss black finish, clearcoated to OEM standards
- Includes M-1096-Q Ford "Blue Oval" Center Cap
- Valve stem TPMS compatible
- 18" x 8" wide
- 5-lug, 108 mm bolt circle
- 55 mm offset
- 169.5 mm backspacing



2013-2018 FOCUS ST 19" X 8" WHEEL – MATTE BLACK



M-1007-PI98MB

- Fits 2013-2018 Focus ST
- Fits 2013-2018 Escape
- Matte black paint finished to OEM standards
- Includes M-1096-Q Ford "Blue Oval" Center Cap
- Valve stem is TPMS compatible
- 19" x 8" wide
- 5-lug, 108 mm bolt circle
- 52.5 mm offset
- 168.49 mm backspacing



FOCUS ST 5-SPOKE 18" X 8" WHEEL SET WITH TPMS KIT – MATTE BLACK



M-1007K-PF188MB

- Fits 2013-2018 Focus ST
 - Fits 2012-2018 Focus
 - Matte black finish, clear coated to OEM standards
 - 18" x 8" wide
 - 5-lug, 108 mm bolt circle
 - 55 mm offset
 - 171 mm backspacing
- Wheel kit includes:
- Four M-1007-PF188MB Wheels
 - TPMS M-1180-A Sensor and Activation Tool Kit
 - M-1096-Q Ford "Blue Oval" Center Cap



2000-2011 FOCUS "FORD RACING" RALLY WHEEL

M-1007-S177B

- Fits 2000-2011 Focus
- Fits 2000-2004 Focus SVT
- Black paint finished to OEM standards
- Clears Focus SVT front (300 mm) brakes
- Includes CM-1096-FR "Ford Racing" Center Cap
- Same as M-1007-S177E Wheel except with a black finish
- 17" x 7" wide
- 4-lug, 108 mm bolt circle
- 49 mm offset
- 5.94" backspacing

NOTE: Wheel is not valve stem TPMS compatible.



FOCUS SVT 17" X 7" WHEEL – SILVER

M-1007-S177

- Fits 2000-2011 Focus
- Original equipment on the Focus SVT
- Includes "SVT" center cap
- 17" x 7" wide
- 4-lug, 108 mm bolt circle
- 49 mm offset
- 5.94" backspacing

NOTE: Wheel is not TPMS compatible.



FOCUS ST 5-SPOKE 18" X 8" WHEEL – MATTE BLACK

M-1007-PF188MB

- Fits 2013-2018 Focus ST
- Fits 2012-2018 Focus
- Matte black finish, clear coated to OEM standards
- Includes M-1096-Q Ford "Blue Oval" Center Cap
- Valve stem TPMS compatible
- 18" x 8" wide
- 5-lug, 108 mm bolt circle
- 55 mm offset
- 171 mm backspacing



2016-2018 FOCUS RS MOUNTUNE® HIGH-FLOW INDUCTION KIT

2536-CAIS-BLK Black
2536-CAIS-LBLU Blue

The mountune® mk3 Focus RS induction kit consists of a high-flow, low-loss cast aluminum crossover duct that maximizes the package space available and improves intake airflow directly into the turbocharger. When coupled with the high-flow mountune® induction hose and uniquely designed air filter with dual inlet, the mountune® induction kit will provide increased airflow, improved engine response and increased power.

- Fits 2016-2018 Focus RS
- Low-loss cast aluminum crossover duct
- Silicone high-flow induction hose with clamps
- Silicone coupling hose with clamps
- mountune® high-flow dual-entry air filter
- Easy installation requiring only simple hand tools



2016-2018 FOCUS RS MOUNTUNE® HIGH-FLOW INDUCTION HOSE

2536-IH-BLK Black
2536-IH-LBLU Blue

The mountune® high-flow induction hose for the Focus RS replaces the original flexible coupling hose between the air-box and intake pipe. Designed with a smooth-flow interior, the mountune® high-flow induction hose enhances airflow to the engine and improves response. The mountune® high-flow induction hose features stainless steel wire reinforced sections to prevent deformation under high engine load. The compound curve design ensures perfect fit and is compatible with the mountune® low-restriction intake as well as the original intake system.

- Fits 2016-2018 Focus RS
- Increased airflow and response
- High-quality silicone construction
- Stainless steel wire reinforced
- Easy installation
- Includes upgraded hose clamp set

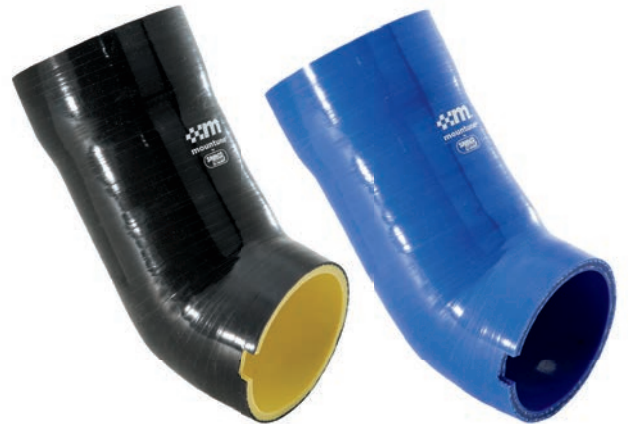

2016-2018 FOCUS RS MOUNTUNE® CHARGE PIPE UPGRADE KIT

2536-CPK-BLK Black
2536-CPK-LBLU Blue

The mountune® charge pipe upgrade kit for the Focus RS boasts an improvement in pressure drop, is easy to install and comes with two different hose color options. The mountune® engineers have optimized the charge air ducting and lower hot side charge pipe to reduce the pressure drop to yield an impressive 2.4 kPa improvement. This kit is also compatible with the OE intercooler and systems that use the original intercooler charge pipes.

- Fits 2016-2018 Focus RS
- Includes high-flow mandrel-bent stainless steel lower intercooler hard pipe
- Easy installation (no drilling)
- Stainless steel wire reinforced, Nomex®-lined silicone boost hoses



2016-2018 FOCUS RS MOUNTUNE® UPDATED AIR RECIRCULATION VALVE

2536-TRV-AA

The mountune® updated turbo recirculating valve (TRV) is a direct replacement for the OE component. Machined from solid aluminum with a piston-type design (compared to the OE diaphragm), the more robust design and material are suitable for vehicles in advanced state of tune. A diaphragm-design recirculation valve could function less effectively when the pressure differential across the turbocharger compressor housing is increased above the original operating conditions. This can cause the valve to open prematurely, leading to possible turbocharger damage due to increased turbo shaft speed. During development, with increased boost pressure, compressor-out temperatures were seen to exceed the safe operating limit of the OE valve. The mountune® mk3 Focus RS TRV is engineered to withstand much greater temperatures while maintaining performance, making it an essential upgrade for cars running increased boost pressure.

- Fits 2016-2018 Focus RS
- Mounts directly on OE turbocharger
- Easy installation
- Suitable for vehicles running increased boost pressure
- Higher safe operating temperature
- Superior piston-type design
- Hard anodized for durability



2016-2018 FOCUS RS MOUNTUNE® SOUND SUPPRESSION CHAMBER

2536-SSC-AA

The mk3 Focus RS produces some fantastic noises, but some cars also exhibit a “whistle” either on idle or during light throttle openings. As airflow and power output is increased, this noise becomes exacerbated, so cars that seemingly didn’t whistle, appear to, incorrectly being associated with the part that’s increasing the airflow. This noise is actually the byproduct of the air passing through the compressor housing on the turbocharger – it’s the same principle as the noise heard when blowing across the top of a bottle. The mountune® Sound Suppression Chamber (SSC) replaces the OE resonator found on the OE turbocharger and can be installed in minutes (with appropriate access to the turbocharger). Despite its simple appearance, the SSC’s dimensions, materials used and internal configuration all play a crucial part in cancelling out this unwanted NVH (Noise Vibration Harshness) “whistle.” If you experience this noise after installing any upgraded air filter, induction kit or when using a calibration that increases power output, the mountune® SSC is for you.

- Fits 2016-2018 Focus RS
- Cancels out “whistle”/unwanted NVH apparent on some vehicles
- Easy to install
- Hard anodized



2016-2018 FOCUS RS SHORT THROW SHIFTER

M-7210-FRS

- Fits 2016-2018 Focus RS
- Reduces shifter throw by 10% over factory shifter



2016-2018 FOCUS RS QUAIFE TORQUE BIASING DIFFERENTIAL

2536-ATB-AA

Maximize traction and performance with the Quaife ATB helical limited slip differential for the Focus RS. A direct replacement for the standard open differential, the Quaife ATB differential transforms your car's performance and improves cornering. Unlike a conventional plate-style limited slip differential, the Quaife differential relies on gears rather than clutch plates for its operation. That means it is much smoother in operation and never locks harshly with a set pre-load of wheel slip across the driven axle. Instead, the Quaife differential automatically biases the torque away from the spinning wheel, across the axle to a constantly varying degree.

- Fits 2016-2018 Focus RS
- Maintenance-free design that retains the standard lubrication
- Reduces torque steer and snatching
- Produced from certified steel billets and CNC machined before being inspected to 9001 standards
- Proven in circuit, drag and rally racing as well as daily road use



2363-ATB-AA shown

2016-2018 FOCUS RS MOUNTUNE® PTU BRACE UPGRADE

2536-PBKT-AA

Engineered and manufactured from high-strength 7075 aluminum alloy, the mountune® PTU brace upgrade provides improved rigidity through robust CAD design and features an additional mounting point compared to the standard stamped steel part. As torque and power are increased over standard levels, the Focus RS PTU casting can fail due to torsional load and strain caused from hard launches and aggressive driving. Supplied with all required mounting hardware, the mountune® PTU brace can be installed without removing the driveshaft.

- Fits 2016-2018 Focus RS
- Reduces chance of PTU case failure
- Machined from high-strength 7075 aluminum alloy
- Long lasting anodized finish
- Easy installation



2016-2018 FOCUS RS MOUNTUNE® BRAKE HOSE SET

2536-BLK-AA

The mountune® mk3 Focus RS braided brake line kit is manufactured from the highest quality materials. This hose kit features a PTFE inner, complete with a stainless steel outer braid which eliminates the spongy feel often experienced under arduous conditions, giving improved pedal feel while also offering superior resistance to abrasion and corrosion. This kit not only provides the performance, reliability and safety demanded, but also offers aesthetic enhancements that improve the appearance of any installation.

- Fits 2016-2018 Focus RS
- Set of four lines (front and rear)
- Supplied with all required mounting hardware
- Improved pedal feel
- TUV approved/DOT compliant
- Manufactured by Goodridge®



2016-2018 FOCUS RS MOUNTUNE® SPORT SPRING SET

2536-MSK-RS1

The mountune® spring upgrade set is the ultimate spring upgrade set for the mk3 Focus RS, offering enhanced performance with a slightly lower and mature stance. Engineered to be compatible with the original shock absorbers for the perfect combination of performance and looks.

- Fits 2016-2018 Focus RS
- Optimized spring rate
- Ride height reduction front: 15 mm
- Ride height reduction rear: 15 mm
- Durable high-gloss finish



FORD FOCUS

2016-2018 FOCUS RS ACTIVE CAT-BACK SPORT EXHAUST SYSTEM

M-5200-FRS

- Fits 2016-2018 Focus RS
- Uniquely designed and tuned to provide optimum performance, aggressive sound, durability and pure driving excitement
- Retains the factory active exhaust control with a 2.5" NPP valve
- Manufactured in the USA from high-quality 304 stainless steel
- Features 3" exhaust pipe with ultra-smooth mandrel bends, warp-free flanges and superior craftsmanship
- Dual rear exit with 4" chrome-plated stainless steel exhaust tips with embossed "Ford" logo



NEW

2016-2018 FOCUS RS REAR SPOILER KIT

M-5844210-RS

Install one of the most anticipated Focus RS parts on your Focus with the Ford Performance Parts Focus RS rear spoiler kit.

- Fits 2013-2018 Focus ST
- Fits 2016-2018 Focus RS
- Fits 2012-2018 Focus Hatch
- Distinct RS look
- Easy installation

Kit includes:

- 2016 Focus RS shadow black rear spoiler
- High-mounted stop-lamp assembly
- All needed attachment hardware
- Installation instructions



NEW

MK2 FOCUS RS WHEEL LUG NUT KIT

M-1012-RSA

WARNING!

Only use the Ford Performance mk2 Focus RS lug nuts with Ford Performance mk2 RS wheels. The mk2 RS wheel is NOT compatible with the standard North American lug nuts that came on your Focus. Use of other lug nuts may result in the wheel coming loose from the hub and loss of vehicle control resulting in potential injury or death. You must retain the original equipment lug nuts for use with original wheels and/or spare tire where applicable.

- Fits 2012-2016 Focus with Ford Performance mk2 RS wheels M-1007-R1985, M-1007-R1985B and M-1007-R1985W only!
- Sold in pack of 5



MK3 FOCUS RS WHEEL 19" X 8" – GLOSS BLACK

M-1007-R198GB

- Fits 2013-2018 Focus ST
- Fits 2016-2018 mk3 Focus RS
- Fits 2012-2017 Focus Hatchback
- 19" x 8" wide
- Gloss black paint finished to OEM standards
- Valve stem is TPMS compatible
- 5-lug, 108 mm bolt circle
- 50 mm offset
- 160 mm backspacing
- Includes M-1096-RS Ford Performance "RS" Center Cap



NEW

2016-2018 FOCUS "RS" CENTER CAP

M-1096-RS

- Fits 2016-2018 Focus RS
- Set yourself apart from other RS owners with this subtle change
- Replaces the stock "Ford" logo center caps found on Focus RS
- Included with Ford Performance M-1007-R198GB mk3 Focus RS Wheel



NEW

FORD FIESTA



FORD FIESTA

2013-2016 FIESTA ST MOUNTUNE® MP215 PERFORMANCE UPGRADE

2364-215-AA*

The mountune® MP215 Fiesta ST performance upgrade consists of engineered components designed to optimize the performance of the vehicle without sacrificing reliability. Tested and validated on the notorious British B roads, Los Angeles freeways and countless laps of the famed Nurburgring Nordschleife, the mountune® MP215 Fiesta ST upgrade delivers maximum reliable performance.

The mountune® MP215 performance upgrade is ideal for those who want engineered performance gains backed by reliability.

The mountune® MP215 performance upgrade features factory level integration while exploiting the potential of the Fiesta ST. The MP215 performance upgrade includes mountune® high-quality, engineered components to ensure performance and reliability. Backing up the mountune® components is our world-class, performance ECU calibration engineered to add maximum consistent performance. Developed in-house by our team of experienced calibrations engineers, the MP215 ECU calibration has been validated through a wide range of performance tests and durability cycles and is stable under all conditions.

Typical performance gains (see **NOTE**)

| | | |
|--------------------------------|-----------------------------------|--|
| Standard Fiesta ST: | mountune® Fiesta ST 215PS: | NOTE: Premium fuel required. Performance gains were measured with 93 octane fuel (USA). Your results may vary depending on fuel quality, vehicle condition and geographical location. |
| 0-62 mph: 6.9 secs | 0-60 mph: 6.4 secs | |
| 31-62 mph (4th gear): 6.4 secs | 31-62 mph (4th gear): 5.7 secs | |

Included with the MP215 performance upgrade:

mountune® high-flow induction kit
mountune® mTune handset



2014-2017 FIESTA ST MOUNTUNE® INTERCOOLER UPGRADE – BLACK

2364-IC-BA*

The mountune® high-performance intercooler upgrade for the Fiesta ST includes everything you need to optimize the performance and is the foundation for further power upgrades. Using a 7-row extruded tube and fin core, the mountune® intercooler gives a marked improvement in both Air Charge Temperature (ACT) and pressure drops, ensuring optimum charge air temperature and therefore power. Our intercooler upgrade also maximizes the available package space while retaining the essential air management ducting for the engine's cooling system.

The packaging for the intercooler and radiator on the Fiesta ST is very compact, leaving little space to effectively and safely install an upgraded intercooler. The mountune® intercooler upgrade was engineered to retain the original Ford cooling pack and air ducting system. This helps maintain engine cooling temperatures, thereby avoiding "over-heat" conditions that reduce engine power.



- Fits 2014-2017 Fiesta ST
- Superior tube and fin construction
- No drilling required
- High quality mounting hardware
- Larger than stock surface area

2013-2017 MOUNTUNE® FIESTA ST SYMPOSER DELETE KIT

2364-SD-AA

The mountune® sound symposer delete kit provides an easy way to remove the sound symposer assembly, allowing a more natural engine sound. The sound symposer delete kit installs easily with the original hardware and includes high-quality fittings that provide an easily accessible source of boost pressure for additional modifications or engine monitoring.

- Fits 2013-2017 Fiesta ST
- CNC aluminum
- Machined mountune® motorsport "M" logo
- High-quality fittings included
- Durable black anodized finish
- Easy installation



*This component is eligible for the Ford Performance Parts Limited Warranty. See the Ford Performance Parts Limited Warranty on pages 295-302 for details.



2014-2017 FIESTA ST MOUNTUNE® CHARGE PIPE UPGRADE

- 2364-CPK-BLK** Black
- 2364-CPK-RED** Red
- 2364-CPK-BLU** Blue
- 2364-CPK-YEL** Yellow

The mountune® charge pipe upgrade kit for Fiesta ST features a substantial improvement in airflow. The mountune® engineers optimized the charge air ducting and lower hot side charge pipe to reduce the pressure drop by an impressive 2.4 kPa. The mountune® charge pipe upgrade kit is easy to install and complements the performance of the mountune® alloy intercooler upgrade for the mk7 Fiesta ST. This kit is also compatible with the original intercooler and systems that use the original intercooler charge pipes.

- Fits 2014-2017 Fiesta ST
- High-flow stainless steel lower rear intercooler pipe Nomex®-lined high-flow
- Samco® Sport silicone boost hoses (6-piece kit)
- Easy installation (no drilling) optimized performance – everything you need, nothing you don't



2364-CPK-BLK shown



- Red**
- Blue**
- Yellow**
- Black/Yellow**

mountune® hose colors available

2014-2017 FIESTA ST MOUNTUNE® HIGH-FLOW LOWER INTERCOOLER CHARGE PIPE

2364-HP-AA

The mountune® high-flow lower intercooler charge pipe upgrade features a substantial improvement in airflow. This upgrade is compatible with the original intercooler and hoses as well as with aftermarket systems that use the original intercooler charge pipe. The mountune® intercooler charge pipe is easy to install and complements the performance of the mountune® intercooler upgrade for the Fiesta ST.

- Fits 2014-2017 Fiesta ST
- High-flow stainless steel lower intercooler pipe
- Easy installation
- For maximum performance, use with our 2364-IC-AA mountune® Intercooler Upgrade – Silver or 2364-IC-BA – Black and our 2364-BHK-BLK mountune® Ultra High-Performance Silicone Boost Hose Kit



FORD FIESTA

2014-2015 FIESTA ST MOUNTUNE® FULL INDUCTION UPGRADE KIT



2364-INT-BLK Black

2364-INT-RED Red

2364-INT-BLU Blue

2364-INT-YEL Yellow

The mountune® Fiesta ST full induction upgrade includes a uniquely constructed aluminum air-box that has been engineered with features that reduce the delta pressure drop by 2 kPa that, when coupled with the included mountune® high-flow air filter, provides a 21% increase in airflow. The mountune® full induction upgrade also includes the mountune® high-flow induction hose that replaces the restrictive OE inlet hose, providing a further increase in airflow. This kit provides the foundation for further performance upgrades with an engineered approach that retains the OE appearance and reliability while providing a rich, deep induction note that reflects performance.

- Fits 2014-2015 Fiesta ST
- Powdercoated aluminum air-box base
- Retains original air-box cover
- Easy installation



2364-INT-BLK shown

2013-2015 FIESTA ST MOUNTUNE® INDUCTION HOSE



2364-IH-BLK Black

2364-IH-RED Red

2364-IH-BLU Blue

2364-IH-YEL Yellow

The mountune® high-flow induction hose for the Fiesta ST was engineered to increase airflow to the turbocharger and replaces the restrictive factory hose between the air-box and the turbocharger inlet pipe. Produced exclusively by Samco® Sport, the mountune® high-flow induction hose features stainless steel wire reinforced sections to prevent deformation under engine load. Back-to-back comparisons with the OE hose on the mountune® in-house flow bench revealed an impressive improvement in airflow of over 35%.

- Fits 2013-2015 Fiesta ST
- High-quality silicone construction
- Stainless steel wire reinforced
- Easy installation



2364-IH-BLK shown

*This component is eligible for the Ford Performance Parts Limited Warranty. See the Ford Performance Parts Limited Warranty on pages 295-302 for details.

FIESTA MOUNTUNE® HIGH-FLOW AIR FILTER



2364-AF-AA

The mountune® high-flow air filter has been designed for maximum airflow and efficiency while maintaining superior filtration. Engineered exclusively for mountune® by Green Filter USA, the mountune® high-flow air filter features proprietary double-layer cotton gauze with deep pleats that creates a 10-15% increase in filtration surface area compared to other filters on the market. The oiled filter media is encapsulated in steel mesh that helps to maintain the perfect shape under the most extreme conditions. Each mountune® filter is manufactured using a four-step process resulting in a precision fit and virtually no seepage of rubber frame material into the filter media, producing the maximum available filter area.

- Fits 2013-2016 Fiesta ST
- Fits 2012-2016 1.6L Fiesta
- Fits 2015-2016 1.0L Fiesta
- Increased engine performance and efficiency
- Engineered fit for drop-in installation
- Lifetime warranty
- Exact replacement for the factory filter
- Pre-oiled

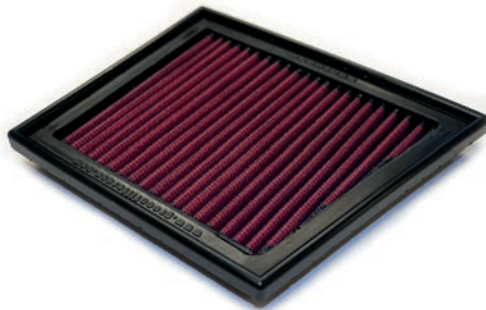

2014-2016 FIESTA ST MOUNTUNE® ULTRA HIGH-PERFORMANCE SILICONE BOOST HOSE KIT



2364-BHK-BLK Black

2364-BHK-BLU Blue

2364-BHK-RED Red

2364-BHK-YEL Yellow

The mountune® boost hose upgrade kit for the Fiesta ST consists of three stainless steel wire reinforced hoses manufactured with 3-ply Nomex® fabric to ensure flawless performance in extreme conditions. This kit is compatible with the mountune® intercooler upgrade or the original Fiesta intercooler and is an exact replacement for the original parts.

- Fits 2014-2016 Fiesta ST
- Nomex® construction resists heat up to 250° C
- Compatible with mountune® or original intercooler
- Easy installation



2364-BHK-BLK shown

2012-2016 FIESTA HIGH-FLOW K&N AIR FILTER

M-9601-FSB

- Fits all 2012-2016 Ford Fiesta 1.6L L4 F/I
- K&N washable high-flow air filter
- Does not require PCM recalibration



2014-2015 FIESTA ST MOUNTUNE® ULTRA HIGH-PERFORMANCE SILICONE COOLANT KIT



2364-CHK-BLK Black

2364-CHK-BLU Blue

2364-CHK-RED Red

2364-CHK-YEL Yellow

The mountune® ultra high-performance silicone coolant hose kit caters to owners who demand simply the best high performance silicone hose upgrade available. The mountune® coolant hose upgrade kit for the Fiesta ST consists of two high-performance silicone hoses manufactured with 3-ply Nomex® fabric to ensure flawless performance in extreme conditions. This kit is an exact replacement for the original upper and lower radiator hoses.

- Fits 2014-2015 Fiesta ST
- Nomex® construction resists heat up to 250° C
- Easy installation



2364-CHK-BLK shown

2013-2017 FIESTA ST ROLL RESTRICTOR/ REAR MOTOR MOUNT



2364-RR-AA

The mountune® roll-restrictor/rear motor mount reduces the amount of engine roll/movement during hard acceleration and gear changing. Machined from high-quality aluminum with polyurethane bushings, the mountune® roll restrictor/rear motor mount reduces engine movement with minimal effect to NVH (Noise Vibration Harshness)

- Fits 2013-2017 Fiesta ST
- High-quality anodized billet aluminum body
- Polyurethane bushings
- Reduces engine movement
- Minimal effect on NVH



FORD FIESTA

2014-2017 FIESTA ST HIGH-FLOW CAT-BACK EXHAUST SYSTEM

2364-CBE-AB

The mountune® Fiesta ST (C346 ST) high-flow exhaust system is manufactured from 2.5" AISI 304 stainless steel mandrel-bent tubing with laser-cut flanges. All muffler assemblies are robotically TIG welded AISI 304 stainless steel for long life under extreme performance and feature consistent internal diameter throughout the entire length of the assembly. To ensure improved performance while controlling sound, each muffler includes a three-layer hybrid synthetic sound absorption packing that eliminates droning, booming and other undesirable tones. Tubing diameter also has a major impact on sound quality, and careful consideration was given to size and performance. Slip fit connections have been used at various strategic points to allow for easy installation and adjustment.

- Fits 2014-2017 Fiesta ST
- Large 3.25" rolled edge, polished stainless steel tips with "mountune®" logo
- Full width rear hanger ensures stable tip location
- Heavy duty BOSS-type clamps
- Meets 95 decibel drive-by noise standard for aftermarket exhaust systems when installed on stock applications
- Does not affect Ford vehicle warranty
- Limited lifetime warranty



2011-2017 FIESTA CAT-BACK EXHAUST SYSTEM

M-5230-FAC*

- Fits 2011-2017 Fiesta Hatchback
- Meets 95 decibel drive-by noise standard for aftermarket exhaust systems when installed on stock applications
- 304 stainless steel muffler body construction with chrome tips
- Legal for B-spec race series
- Deeper, throatier exhaust note



2011-2017 FIESTA AXLE-BACK MUFFLER

M-5230-FAB*

- Fits 2011-2017 Ford Fiesta
- Meets 95 decibel drive-by noise standard for aftermarket exhaust systems when installed on stock applications
- 304 stainless steel muffler body construction with polished tips
- Deeper, throatier exhaust note over factory muffler
- Factory exhaust pipe requires cutting to install clamp-on Ford Performance exhaust



*This component is eligible for the Ford Performance Parts Limited Warranty. See the Ford Performance Parts Limited Warranty on pages 295-302 for details.



2013-2016 FIESTA 5-SPEED MOUNTUNE® QUICK SHIFT

2130-BSA-AA*

The mountune® quick-shift for Fiesta 5-speeds replaces the factory shift arm located at the gearbox. Throw is reduced by 20% allowing quick and more precise gear changes.

- Fits 2013-2016 Fiesta 5-speed
- Reduces shifter throw by 20%
- Plated finish for durability
- Can be used in conjunction with mountune® Fiesta 5-speed short throw shifter 2130-STS-AA to give an ultra short (32%) reduction in shift throw

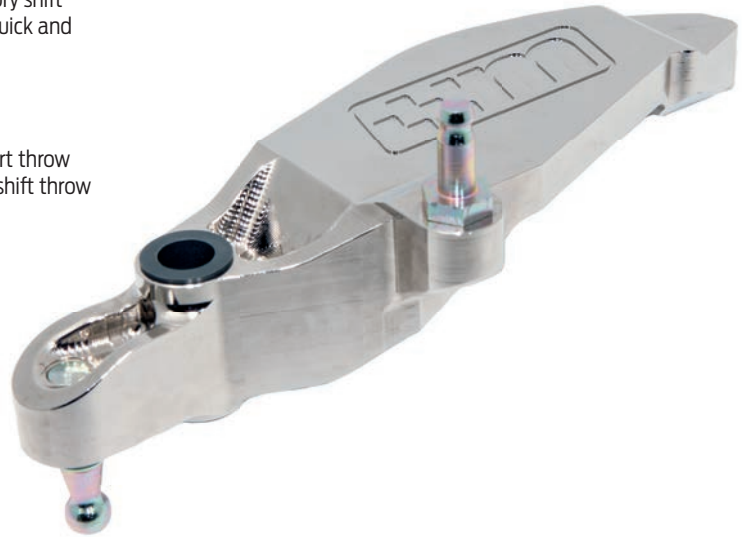

2014-2017 FIESTA ST MOUNTUNE® QUICK SHIFT

2238-BQS-AA*

The mountune® Fiesta ST quick shift reduces the shift throw by 30% allowing quick and more precise gear changes, which enhances the driving experience. Machined from billet aluminum, the mountune® quick shift is easily installed.

- Fits 2014-2017 Fiesta ST
- Reduces shift throw by 30%
- Nickel-plated finish to ensure against corrosion
- Installation tool included



*This component is eligible for the Ford Performance Parts Limited Warranty. See the Ford Performance Parts Limited Warranty on pages 295-302 for details.

2014-2017 FIESTA ST QUAIFE TORQUE BIASING DIFFERENTIAL

2364-ATB-AA

Maximize traction and performance with the Quaife ATB helical limited slip differential for the Fiesta ST B6 gearbox. A direct replacement for the standard open differential, the Quaife ATB differential transforms your car's performance and improves cornering. Unlike a conventional plate-style limited slip differential, the Quaife differential relies on gears rather than clutch plates for its operation. That means it is much smoother in operation and never locks harshly with a set pre-load of wheel slip across the driven axle. Instead, the Quaife differential automatically biases the torque away from the spinning wheel, across the axle to a constantly varying degree.

- Fits 2014-2017 Fiesta ST
- Maintenance-free design that retains the standard lubrication
- Reduces torque steer and snatching
- Produced from certified steel billets and CNC machined before being inspected to 9001 standards
- Proven in circuit, drag and rally racing as well as daily road use

NOTE: Fiesta ST M-4026-FA Quaife Torque Biasing Differential Installation Kit is needed to install this part.



2014-2017 FIESTA ST QUAIFE TORQUE BIASING DIFFERENTIAL INSTALLATION KIT

M-4026-FA

Installation kit needed to install the 2364-ATB-AA Fiesta ST Quaife Torque Biasing Differential

- Fits 2014-2017 Fiesta ST with Quaife torque biasing differential
- Kit includes:

- Differential bearings – Qty 2
- Ring gear bolts – Qty 10
- Axle seals – Qty 2
- Gasket maker – Qty 2
- Threadlock and sealer – Qty 2 (1 red, 1 blue)
- Installation instructions



2011-2017 FIESTA HANDLING PACK

M-FR3-FA*

- Fits 2011-2017 Fiesta Sedan and Hatchback
- Delivers improved handling characteristics without ride degradation
- Reduced ride height 12 mm-15 mm lower front
- Reduced ride height 22 mm-28 mm lower rear
- Includes front struts, front springs, rear shocks and rear springs

NOTE: Some factory fasteners are one-time use. Please reference service manual for reuse information and correct torque specifications. May require alignment after installation.



2014-2017 FIESTA ST MOUNTUNE® SPORT SPRING SET

2364-MSK-BA

mountune® engineers developed a spring set that would enhance and optimize the handling of the Fiesta ST while providing advanced ride quality, enhanced performance and an aggressive level stance. The outcome of countless validation miles on numerous British B roads, the Bruntingthorpe Proving Ground, and the famous Nordschleife is the ultimate spring upgrade set for the Fiesta ST.

- Fits 2014-2017 Fiesta ST
- Front ride height reduction of approximately 1"
- Rear ride height reduction of approximately .8"

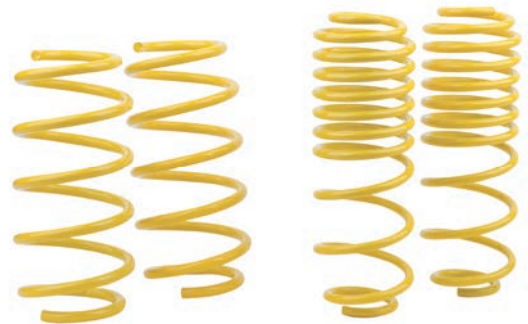

2013-2017 FIESTA ST FRONT STRUT TOWER BRACE

7064-FSB-AA

The mountune® front strut tower brace improves rigidity and adds sharpness to the response of the vehicle. Engineered from 1.5" x .5" (38 mm x 12 mm) highly polished extruded contoured aluminum tubing with steel end plates for a precise fit and added strength. Installation is straightforward and requires no drilling or other modifications to the vehicle.

- Fits 2013-2017 Fiesta ST
- High-luster, gold powdercoated steel end plates
- Polished extruded aluminum cross brace with laser etched mountune® motorsport "M" logo
- Compatible with the original intake and many aftermarket intakes
- Easy installation



2013-2017 FIESTA ST MOUNTUNE® LOWER CHASSIS BRACE

7064-LCB-AA

The lower chassis brace improves rigidity and adds sharpness to the response of your Fiesta ST. Engineered steel construction easily installs using existing hardware with no drilling required. Further strengthens front subframe and compliments the mountune® 7064-FSB-AA Front Strut Brace.

- Fits 2013-2017 Fiesta ST
- High-luster, gold powdercoated steel
- Mounts with existing hardware
- Easy installation



*This component is eligible for the Ford Performance Parts Limited Warranty. See the Ford Performance Parts Limited Warranty on pages 295-302 for details.

FORD FIESTA

MOUNTUNE® 6-PIECE STICKER SET 5000-STK-SET



The mountune® sticker set contains 6 high-quality vinyl stickers printed in the USA using durable and vivid ink for long lasting performance. The self adhesive backing ensures secure placement on most surfaces. mountune®... since 1980.

- Large stickers are 8" x 1.35"
- Small stickers are 4" x 1.5"



FIESTA "FORD RACING" CENTER CAP M-1096-FA

- Fits M-1007-FA Ford Racing 15-spoke Fiesta Wheel
- Gray background with blue "Ford Oval" and red "Racing" script



2011-2014 FIESTA STAINLESS STEEL BRAKE LINE KIT M-2078-FA

- Fits 2011-2014 Fiesta
- Stainless steel braided brake line kit for Fiesta B-spec build
- Includes new brake line bracket C-clips and front banjo bolts with copper washers
- FMVSS 106 and DOT compliant

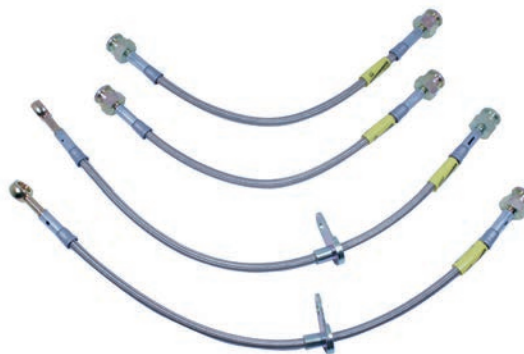

2013-2016 FIESTA ST MOUNTUNE® BRAKE HOSE SET 7064-BH-B299



mountune® high-performance brake hoses virtually eliminate brake hose expansion, delivering more consistent braking and a firmer brake pedal which improves braking performance for competition or everyday driving. Manufactured in the USA from stainless steel braided hose with reinforced ends and zinc-plated fittings to ensure easy bolt on, direct replacement installation without the need for clumsy adapters or additional fittings. This product meets the guidelines of the U.S. Dept. of Transportation FMVSS-571.106 requirements and is DOT compliant.

- Fits 2013-2016 Fiesta ST
- Includes new sealing washers
- Improved brake pedal feel
- Easy installation

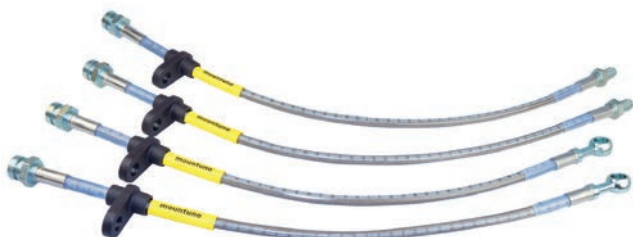

2014-2017 FIESTA ST MOUNTUNE® LOWER FRONT SPLITTER 2364-FS-AA



The mountune® Fiesta ST front splitter has been designed for the North American market 5-door Fiesta ST with its region-specific front bumper profile, ensuring correct fitment. Styled to match the contour of the front bumper, a prominent center riser has also been incorporated that doubles as a robust center support for added stability. Produced from durable multilayer reinforced FRP with double thick, satin black gel coat to provide a stable surface for paint or other suitable finish. Can also be left unpainted; however, the untreated surface may discolor over time.

- Fits 2014-2017 Fiesta ST
- Made in the USA
- Easy installation
- Hardware included
- Satin black finish



FORD TRUCKS



6.7L DIESEL TURBO KIT

M-TURBO-67

Replacement 2015-2016 turbo and hardware for 6.7L diesel. Higher performance capability than pre-2015 turbos.

Kit includes:

- Turbocharger assembly
- Lower intake manifold
- Exhaust heatshield
- EGR inlet tube
- Turbo outlet clamps
- Exhaust outlet tubes (RH & LH)
- Intake shields
- Turbo oil line
- All gaskets, including EGR
- All fasteners, spacers and studs

NOTE: Use on model years other than 2015-2016

not validated by Ford Performance. Calibration not included.



6.7L DIESEL INJECTOR NOZZLE AND PUMP KIT

M-9546-67

Original equipment on 2015-2016 6.7L diesel engine. Higher flow than prior model injectors.

Kit includes:

- FC3Z-9A543-A Injection Pump
- FC3Z-9H529-A Left Bank Nozzles and Feed Lines
- FC3Z-9H529-B Right Bank Nozzles and Feed Lines

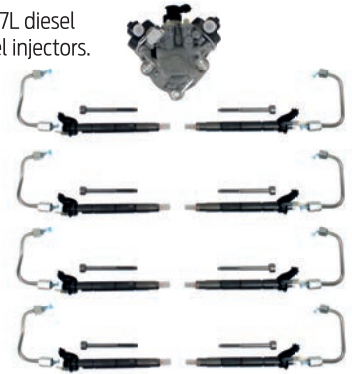

F-150 TWIN TURBO UPGRADE KIT 3.5L GEN 2

M-9438-35TA

- Fits 2013-2015 F-150 3.5L EcoBoost® engine
- Complete replacement turbochargers that fit in the stock location and deliver added power and torque
- Requires custom calibration to take full advantage of the improved power
- For off-road use only

Kit includes:

- New, larger Borg Warner® left and right turbochargers
- Turbocharger heat shields
- Exhaust adapters
- O-rings, gaskets and fasteners



2004-2014 F-150 REAR LOWERING KIT

M-3000-G

- Fits 2004-2014 F-150
- Designed to lower the rear of your truck without sacrificing the factory ride quality
- Reduces rear ride height approximately 2.0" on a 2WD or 1.5" on a 4WD, giving you more of that leveled, sport truck stance you want
- Kit includes lowering shackles, pinion shims and installation hardware



2001-2004 F-150 LIGHTNING MASS AIR METER

M-12579-L54

- Fits 2001-2004 F-150 Lightning
- Stock replacement 90 mm Lightning mass air meter
- Requires recalibration for use on other vehicles



2015-2017 F-150 REAR LOWERING KIT

M-3000-H

- Fits 2015-2017 F-150 4WD Regular Cab, Super Cab and Super Crew
- Reduces rear ride height approximately 1.5", giving you more of that leveled, sport truck stance you want
- Kit includes laser cut steel lowering shackles with urethane bushings



2015-2017 F-150 COMPLETE LOWERING KIT

M-3000-H4

- Fits 2015-2017 F-150 4WD Super Cab and Super Crew
- Reduces front ride height approximately 1.5" and rear ride height approximately 2.5", giving you more of that leveled, sport truck stance you want
- Kit includes precision tuned front coils, laser-cut steel lowering shackles with urethane bushings and laser cut strut spacer for front height adjustability



2017-2018 F-150 RAPTOR BEAD-LOCK WHEEL KIT



M-1007-W1785B

- Fits 2017-2018 F-150 Raptor
- The bead-lock wheel kit includes everything needed to upgrade your base Raptor wheels to have performance off-road bead-locking capability
- Off-road proven in all of the 2016 Best in the Desert series racing events and in the 2016 Baja 1000
- Wheel is finished in a matte black paint finish, clearcoated to OEM standards, and the trim ring is finished in a magnetic gray paint finish, clearcoated to OEM standards
- 17" x 8.5" wide
- 6-lug, 135 mm bolt circle
- 34 mm offset
- 150 mm backspacing
- Use with M-1180-B TPMS Sensor and Tool Kit

Kit includes:

- 17" forged aluminum bead-lock capable wheel
- Factory forged aluminum trim ring
- "Ford" center cap
- Ford Performance M-1021-F15RB Bead-Lock Ring Kit

NOTE: Bead-lock configuration is for off-road use only.



2010-2014 F-150 SVT RAPTOR BEAD-LOCK WHEEL

M-1007-DC1785

- Fits 2010-2014 F-150 Raptor
- 17" x 8.5" wide
- 6-lug, 135 mm bolt circle
- 34 mm offset
- 156.6 mm backspacing
- Satin black painted center with clearcoat aluminum bead-lock ring
- Includes bead-lock wheel, center cap, bead-lock ring, OE beauty ring, 24 fasteners and mounting instructions
- Bead-lock configuration is for off-road use only
- Off-road proven at the 2013 Baja 1000



2015-2018 F-150 20" X 8.5" 6-SPOKE WHEEL SET WITH TPMS KIT – MATTE BLACK



M-1007K-P20XB

- Fits 2015-2018 F-150
- Matte black paint finish, clearcoated to OEM standards
- Includes blue "Ford Oval" center caps
- Includes M-1180-B Sensor and Activation Tool Kit
- 6-lug, 135 mm bolt circle
- 44 mm offset
- 160 mm backspacing



2017-2018 RAPTOR BEAD LOCK WHEEL TRIM RING SET



- M-1021-F15BL** Blue (set of 4)
- M-1021-F15BL1** Blue (1 ring)
- M-1021-F15OR** Orange (set of 4)
- M-1021-F15OR1** Orange (1 ring)
- M-1021-F15RD** Red (set of 4)
- M-1021-F15RD1** Red (1 ring)

- Fits 2017-2018 Raptor with the factory bead-lock wheel option or Ford Performance Parts M-1007-W1785B Bead-Lock Wheel Kit
- Raptor bead-lock trim rings provide an easy way to customize your Raptor and give your bead-lock wheels a unique and awesome look!
- Forged aluminum and CNC machined
- Durable powdercoat finish
- Set includes four blue powdercoated trim rings
- Easy installation



F-150 RAPTOR BEAD LOCK RING KIT

- M-1021-F15RB** 2017-2018
- M-1021-F15RA** 2013-2014

- Fits F-150 Raptor with factory bead-lock wheel option
- Includes forged aluminum bead-lock ring, 24 fasteners and mounting instructions
- Bead-lock configuration is for off-road use only



2015-2018 F-150 20" X 8.5" 6-SPOKE WHEEL – MATTE BLACK



M-1007-P2085MB

- Fits 2015-2018 F-150
- Matte black paint finish, clearcoated to OEM standards
- Includes blue "Ford Oval" center cap
- Valve stem TPMS compatible
- Use with M-1180-B TPMS Sensor and Activation Tool Kit
- Also available as a four wheel set M-1007K-P20XB with a TPMS kit
- 20" x 8.5" wide
- 6-lug, 135 mm bolt circle
- 44 mm offset
- 160 mm backspacing



2015-2018 F-150 LUG NUT KIT

M-1012-FA

- Fits 2015-2018 F-150
 - Fits 2017-2018 Raptor
 - Fits M14 x 1.5 wheel stud
 - Kit contains 6 lug nuts
- NOTE:** For use on alloy wheels only.



2017-2018 F-150 RAPTOR SKID PLATE KIT

M-5018-F15RB

Get the undercarriage protection you need for your new Raptor with the same skid plates that were used on the 2017 Ford Raptor race truck. The Ford Performance skid plate kit protects the transmission and transfer case from undercarriage rock damage. Made from powdercoated 3/16" thick aluminum and designed to bolt on and fit the truck perfectly.

- Fits 2017-2018 F-150 Raptor
- Protects the transmission and transfer case from rock damage
- Made from 3/16" thick powdercoated aluminum plate
- Laser-cut "Ford Performance" logos on the main cover
- Easy bolt-on installation
- Same skid plates that were used on the 2017 Raptor Best in The Desert race truck that competed in the Baja 1000 and the Mint 400

Kit includes:

- Front cover that protects the front differential and steering area
- Main cover that protects the transmission and transmission cross member
- Rear cover that protects rear exposed section of transfer case
- All needed brackets, cross members and hardware



2015-2017 F-150 RAPTOR PERFORMANCE STEERING WHEEL KIT – ORANGE SIGHTLINE

M-3600-F15ROR

- Fits 2015-2017 F-150
- Fits 2017-2018 Raptor
- Original equipment on 2017-2018 Raptor with the Interior Color Accent Package (60R)
- Black leather construction with orange stitching and an orange leather sightline
- The Raptor steering wheel has a more aggressive look and defined feel than F-150 steering wheels
- Easy installation
- Steering wheel comes equipped with wire harness, trim bezel and Raptor steering wheel controls. Installation into a non-Raptor F-150 and Raptor equipped with the Technology Package (68R) requires the steering wheel controls to be swapped from the original steering wheel
- Steering wheel is a great addition to a 2017 Raptor that did not come with the Interior Color Accent Package (60R)
- Kit includes a 2017 Raptor orange sightline heated steering wheel and all needed installation hardware

NOTE: Heated steering wheel will not function when installed onto vehicles that are not equipped with the heated steering wheel option.

NOTE: Paddle shifters will not function when installed onto F-150 trucks that were not originally equipped with paddle shifters from the factory.



2015-2017 F-150 RAPTOR PERFORMANCE STEERING WHEEL KIT – RED SIGHTLINE

M-3600-F15RRD

- Fits 2015-2017 F-150
- Fits 2017-2018 Raptor
- Original equipment on 2017-2018 Raptor without the Interior Color Accent Package (60R)
- Black leather construction with perforated sides, gray stitching and a red leather sightline
- The Raptor steering wheel has a more aggressive look and defined feel than F-150 steering wheels
- Easy installation
- Steering wheel comes equipped with a wire harness, trim bezel and Raptor steering wheel controls. Installation into a non-Raptor F-150 and Raptor equipped with the Technology Package (68R) requires the steering wheel controls to be swapped from the original steering wheel
- Kit includes a 2017 Raptor red sightline heated steering wheel and all needed installation hardware

NOTE: Heated steering wheel will not function when installed onto vehicles that are not equipped with the heated steering wheel option.

NOTE: Paddle shifters will not function when installed onto F-150 trucks that were not originally equipped with paddle shifters from the factory.



MUSTANG AND F-150 TPMS SENSOR AND ACTIVATION TOOL KIT

M-1180-B

- Fits 2015-2017 Mustang
- Fits 2015-2018 F-150
- Fits 2017-2018 F-150 Raptor
- Kit contains 4 valve-mounted snap-in tire pressure monitor sensors (valve stem TPMS) and tire pressure monitor activation tool
- Mustang and F-150 requires that tire pressure monitor sensors are installed and properly activated
- Failure to install and activate sensors will cause tire pressure monitor light to remain on
- Activation tool can be used to retrain sensors after tire rotation
- Warning: Requires wheels specifically designed for valve-mounted snap-in tire pressure monitor sensors

NOTE: Will NOT work on 2007-2014 Mustang V6, GT or GT500.

NOTE: For use on North American LHD Mustang only.

NOTE: Valve stems are not designed for speeds over 155 mph.



FORD PERFORMANCE F-150 CAT-BACK EXHAUST SYSTEMS

Ford Performance has partnered with industry-leader Borla® Exhaust to offer the first in a series of Ford Performance by Borla® exhaust systems. Constructed from ultra-smooth mandrel bent 300-series stainless steel tubing, these cat-back systems are designed to Ford Performance specs and give your truck an aggressive sound. These cat-back exhaust systems bolt directly to the stock factory catalytic converters, making your F-150 100% emission compliant. These tuned stainless steel mufflers with chrome-plated stainless steel tips not only sound great but look great too.



2015-2017 F-150 5.0L CAT-BACK EXHAUST SYSTEMS

M-5200-F1550DSB*

- F-150 Sport cat-back rear-exit exhaust system with black chrome tips for 5.0L engine. 49-state drive-by noise legal

M-5200-F1550DTB*

- F-150 Touring cat-back rear-exit exhaust system with black chrome tips for 5.0L engine. 50-state drive-by noise legal

M-5200-F1550RSB*

- F-150 Sport cat-back side-exit exhaust system with black chrome tips for 5.0L engine. 49-state drive-by noise legal

M-5200-F1550RTB*

- F-150 Touring cat-back side-exit exhaust system with black chrome tips for 5.0L engine. 50-state drive-by noise legal

M-5200-F1550DSC*

- F-150 Sport cat-back rear-exit exhaust system with chrome tips for 5.0L engine. 49-state drive-by noise legal

M-5200-F1550DTC*

- F-150 Touring cat-back rear-exit exhaust system with chrome tips for 5.0L engine. 50-state drive-by noise legal

M-5200-F1550RSC*

- F-150 Sport cat-back side-exit exhaust system with chrome tips for 5.0L engine. 49-state drive-by noise legal

M-5200-F1550RTC*

- F-150 Touring cat-back side-exit exhaust system with chrome tips for 5.0L engine. 50-state drive-by noise legal

- Uniquely designed and tuned to provide optimum performance, aggressive sound, durability and pure driving excitement
- Made from high-quality 304 stainless steel
- Choice of dual rear-exit or side-exit with chrome- or black chrome-plated 4" exhaust tips embossed with "Ford Racing" logo
- Features ultra-smooth mandrel bends, warp-free flanges and superior craftsmanship
- Alternative wheelbases: 157" requires M-5248-F15157* Mid-Pipe; 163" requires M-5248-F15163* Mid-Pipe

NOTE: Also fits 122" and 141" wheelbases. Requires shortening the mid-pipe. Please refer to install instructions.



*This component is eligible for the Ford Performance Parts Limited Warranty. See the Ford Performance Parts Limited Warranty on pages 295-302 for details.

FORD PERFORMANCE F-150 CAT-BACK EXHAUST SYSTEMS



2015-2017 F-150 3.5L CAT-BACK EXHAUST SYSTEMS

M-5200-F1535DSB*

- F-150 Sport cat-back rear-exit exhaust system with black chrome tips for 3.5L engine. 49-state drive-by noise legal

M-5200-F1535DTB*

- F-150 Touring cat-back rear-exit exhaust system with black chrome tips for 3.5L engine. 50-state drive-by noise legal

M-5200-F1535RSB*

- F-150 Sport cat-back side-exit exhaust system with black chrome tips for 3.5L engine. 49-state drive-by noise legal

M-5200-F1535RTB*

- F-150 Touring cat-back side-exit exhaust system with black chrome tips for 3.5L engine. 50-state drive-by noise legal

M-5200-F1535DSC*

- F-150 Sport cat-back rear-exit exhaust system with chrome tips for 3.5L engine. 49-state drive-by noise legal

M-5200-F1535DTC*

- F-150 Touring cat-back rear-exit exhaust system with chrome tips for 3.5L engine. 50-state drive-by noise legal

M-5200-F1535RSC*

- F-150 Sport cat-back side-exit exhaust system with chrome tips for 3.5L engine. 49-state drive-by noise legal

M-5200-F1535RTC*

- F-150 Touring cat-back side-exit exhaust system with chrome tips for 3.5L engine. 50-state drive-by noise legal

2015-2017 F-150 2.7L CAT-BACK EXHAUST SYSTEMS

M-5200-F1527DSB*

- F-150 Sport cat-back rear-exit exhaust system with black chrome tips for 2.7L engine. 49-state drive-by noise legal

M-5200-F1527DTB*

- F-150 Touring cat-back rear-exit exhaust system with black chrome tips for 2.7L engine. 50-state drive-by noise legal

M-5200-F1527RSB*

- F-150 Sport cat-back side-exit exhaust system with black chrome tips for 2.7L engine. 49-state drive-by noise legal

M-5200-F1527RTB*

- F-150 Touring cat-back side-exit exhaust system with black chrome tips for 2.7L engine. 50-state drive-by noise legal

M-5200-F1527DSC*

- F-150 Sport cat-back rear-exit exhaust system with chrome tips for 2.7L engine. 49-state drive-by noise legal

M-5200-F1527DTC*

- F-150 Touring cat-back rear-exit exhaust system with chrome tips for 2.7L engine. 50-state drive-by noise legal

M-5200-F1527RSC*

- F-150 Sport cat-back side-exit exhaust system with chrome tips for 2.7L engine. 49-state drive-by noise legal

M-5200-F1527RTC*

- F-150 Touring cat-back side-exit exhaust system with chrome tips for 2.7L engine. 50-state drive-by noise legal

- Uniquely designed and tuned to provide optimum performance, aggressive sound, durability and pure driving excitement
- Made from high-quality 304 stainless steel
- Choice of dual rear-exit or side-exit with chrome- or black chrome-plated 4" exhaust tips embossed with "Ford Racing" logo
- Features ultra-smooth mandrel bends, warp-free flanges and superior craftsmanship
- Alternative wheelbases: 157" requires M-5248-F15157* Mid-pipe; 163" requires M-5248-F15163* Mid-pipe

NOTE: Also fits 122" and 141" wheelbases. Requires shortening the mid-pipe. Please refer to install instructions.



*This component is eligible for the Ford Performance Parts Limited Warranty. See the Ford Performance Parts Limited Warranty on pages 295-302 for details.

FORD PERFORMANCE 2011-2014 F-150 5.0L CAT-BACK EXHAUST SYSTEMS

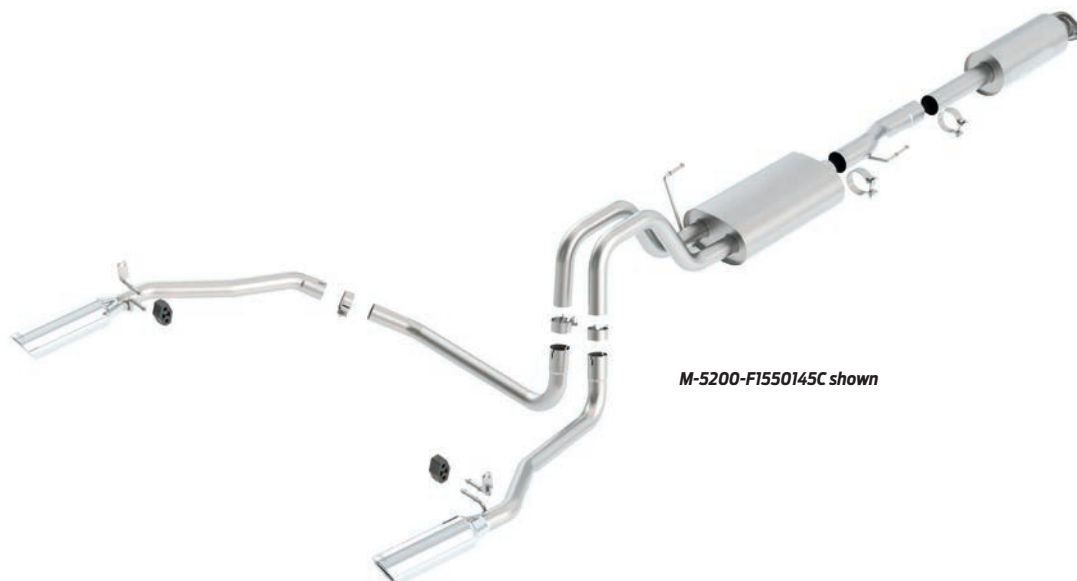

M-5200-F1550145C shown

FORD F-150 5.0L COYOTE CAT-BACK TOURING EXHAUST SYSTEM 145" WB

M-5200-F1550145C*

- Fits 2011-2014 F-150 5.0L Coyote engine with 145" wheelbase
- 50-state legal for drive-by noise
- Uniquely designed and tuned to provide optimum performance, aggressive sound, durability and pure driving excitement
- Made from high-quality 304 stainless steel
- Dual rear exit with 304 stainless steel chrome-plated "Ford Racing" embossed 4" exhaust tips
- Features ultra-smooth mandrel bends, warp-free flanges and superior craftsmanship
- Does not require removal of spare tire

FORD F-150 5.0L COYOTE CAT-BACK SPORT EXHAUST SYSTEM 145" WB

M-5200-F1550145L*

- Fits 2011-2014 F-150 5.0L Coyote engine with 145" wheelbase
- 49-state legal for drive-by noise. Louder than touring exhaust system
- Uniquely designed and tuned to provide optimum performance, aggressive sound, durability and pure driving excitement
- Made from high-quality 304 stainless steel
- Dual rear exit with 304 stainless steel chrome-plated "Ford Racing" embossed 4" exhaust tips
- Features ultra-smooth mandrel bends, warp-free flanges and superior craftsmanship
- Does not require removal of spare tire

F-150 5.0L COYOTE CAT-BACK TOURING EXHAUST MID-PIPES

Mid-pipe converts M-5200-F1550145C 145" WB F-150 5.0L Ti-VCT Cat-Back Touring Exhaust System to fit 126" wheelbase 2011-2014 Ford F-150 pickup.

126" wheelbase requires **M-5248-F15126C*** Mid-Pipe

133" wheelbase requires **M-5248-F15133C*** Mid-Pipe

157" wheelbase requires **M-5248-F15157C*** Mid-Pipe

163" wheelbase requires **M-5248-F15163C*** Mid-Pipe

F-150 3.5L ECOBOOST® AND 5.0L COYOTE CAT-BACK SPORT EXHAUST MID-PIPES

Mid-pipes convert 145" WB sport exhaust systems to fit specific wheelbase 2011-2014 Ford F-150 pickups.

126" wheelbase requires **M-5248-F15126L*** Mid-Pipe

133" wheelbase requires **M-5248-F15133L*** Mid-Pipe

157" wheelbase requires **M-5248-F15157L*** Mid-Pipe

163" wheelbase requires **M-5248-F15163L*** Mid-Pipe

*This component is eligible for the Ford Performance Parts Limited Warranty. See the Ford Performance Parts Limited Warranty on pages 295-302 for details.

FORD PERFORMANCE 2011-2014 F-150 3.5L CAT-BACK EXHAUST SYSTEMS

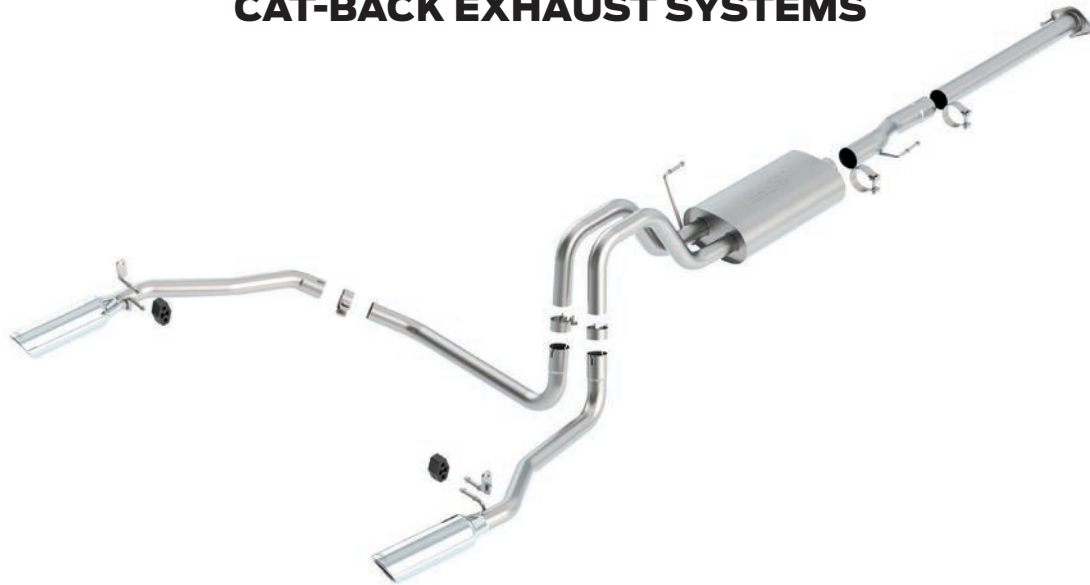

FORD F-150 3.5L ECOBOOST® CAT-BACK SPORT EXHAUST SYSTEM 145" WB

M-5200-F1535145L*

- Fits 2011-2014 F-150 3.5L EcoBoost® engine with 145" wheelbase
- 49-state legal for drive-by noise
- Uniquely designed and tuned to provide optimum performance, aggressive sound, durability and pure driving excitement
- Made from high-quality 304 stainless steel
- Dual rear exit with 304 stainless steel chrome-plated "Ford Racing" embossed 4" exhaust tips
- Features ultra-smooth mandrel bends, warp-free flanges and superior craftsmanship
- Does not require removal of spare tire

F-150 3.5L ECOBOOST® AND 5.0L COYOTE CAT-BACK SPORT EXHAUST MID-PIPES

Mid-pipes convert 145" WB sport exhaust systems to fit specific wheelbase 2011-2014 Ford F-150 pickups.

126" wheelbase requires **M-5248-F15126L*** Mid-Pipe

133" wheelbase requires **M-5248-F15133L*** Mid-Pipe

157" wheelbase requires **M-5248-F15157L*** Mid-Pipe

163" wheelbase requires **M-5248-F15163L*** Mid-Pipe

*This component is eligible for the Ford Performance Parts Limited Warranty. See the Ford Performance Parts Limited Warranty on pages 295-302 for details.



FORD PERFORMANCE 2017-2018 F-150 SVT RAPTOR 3.5L CAT-BACK EXHAUST SYSTEMS



M-5200-F15RSB shown

Exhaust tips with "Ford" logo

2017-2018 F-150 RAPTOR 3.5L CAT-BACK TOURING EXHAUST SYSTEM



- M-5200-F15RTB*** Black Tips
- M-5200-F15RTC*** Chrome Tips
- M-5200-F15RTCF*** Carbon Tips

This Raptor exhaust system has been designed by Ford Performance engineers working with Borla® Industries. It includes unique Ford Performance technology that is not used in other aftermarket systems. This design provides optimum performance and premium durability while eliminating the low-end (1100-1900 rpm) cabin drone that is inherent in some other aftermarket systems.

- Fits 2017-2018 F-150 Raptor with a 145" wheelbase. 133" wheelbase trucks require an additional mid-pipe listed below
- Uniquely designed and tuned with two 3" passive exhaust valves to provide optimum performance, a deep and throaty sound, durability and pure driving excitement
- Meets 95 decibel drive-by noise standard for aftermarket exhaust systems when installed on stock applications
- Manufactured in the USA from high-quality 304 stainless steel
- Features 2.75" exhaust pipe with ultra-smooth mandrel bends, warp-free flanges and superior craftsmanship
- Dual rear exit with 4.5" exhaust tips with embossed "Ford" logo
- Does not require removal of spare tire

NOTE: 133" wheelbase Raptor requires M-5248-F15R133 Mid-Pipe.

2017-2018 F-150 RAPTOR 3.5L ECOBOOST® 133" WHEELBASE EXHAUST SYSTEM MID-PIPE



M-5248-F15R133*

- Fits 2017-2018 F-150 Raptor 3.5L EcoBoost® with a 133" wheelbase
- Mid-pipe converts the following 2017-2018 Raptor Ford Performance exhaust systems to work on 133" wheelbase trucks: M-5200-F15RSB, M-5200-F15RSC, M-5200-F15RSCF, M-5200-F15RTB, M-5200-F15RTC, M-5200-F15RTCF

2017 F-150 RAPTOR 3.5L CAT-BACK SPORT EXHAUST SYSTEM



- M-5200-F15RSB*** Black Tips
- M-5200-F15RSC*** Chrome Tips
- M-5200-F15RSCF*** Carbon Tips

This 2017 Raptor exhaust system has been designed by Ford Performance engineers working with Borla® Industries. It includes unique Ford Performance technology that is not used in other aftermarket systems. This design provides optimum performance and premium durability while eliminating the low-end (1100-1900 rpm) cabin drone that is inherent in some other aftermarket systems.

- Fits 2017 F-150 Raptor with a 145" wheelbase. 133" wheelbase trucks require an additional mid-pipe listed below.
- Uniquely designed and tuned with one 3" passive exhaust valve to provide optimum performance, aggressive sound, durability and pure driving excitement
- Manufactured in the USA from high-quality 304 stainless steel
- Features 2.75" exhaust pipe with ultra-smooth mandrel bends, warp-free flanges and superior craftsmanship
- Dual rear exit with 4.5" exhaust tips with embossed "Ford" logo
- Does not require removal of spare tire

NOTE: 133" wheelbase Raptor requires M-5248-F15R133 Mid-Pipe.

2017-2018 F-150 RAPTOR 3.5L ECOBOOST® 133" WHEELBASE EXHAUST SYSTEM MID-PIPE



M-5248-F15R133*

- Fits 2017-2018 F-150 Raptor 3.5L EcoBoost® with a 133" wheelbase
- Mid-pipe converts the following 2017-2018 Raptor Ford Performance exhaust systems to work on 133" wheelbase trucks: M-5200-F15RSB, M-5200-F15RSC, M-5200-F15RSCF, M-5200-F15RTB, M-5200-F15RTC, M-5200-F15RTCF

*This component is eligible for the Ford Performance Parts Limited Warranty. See the Ford Performance Parts Limited Warranty on pages 295-302 for details.

FORD PERFORMANCE 2011-2014 F-150 SVT RAPTOR 6.2L CAT-BACK EXHAUST SYSTEMS

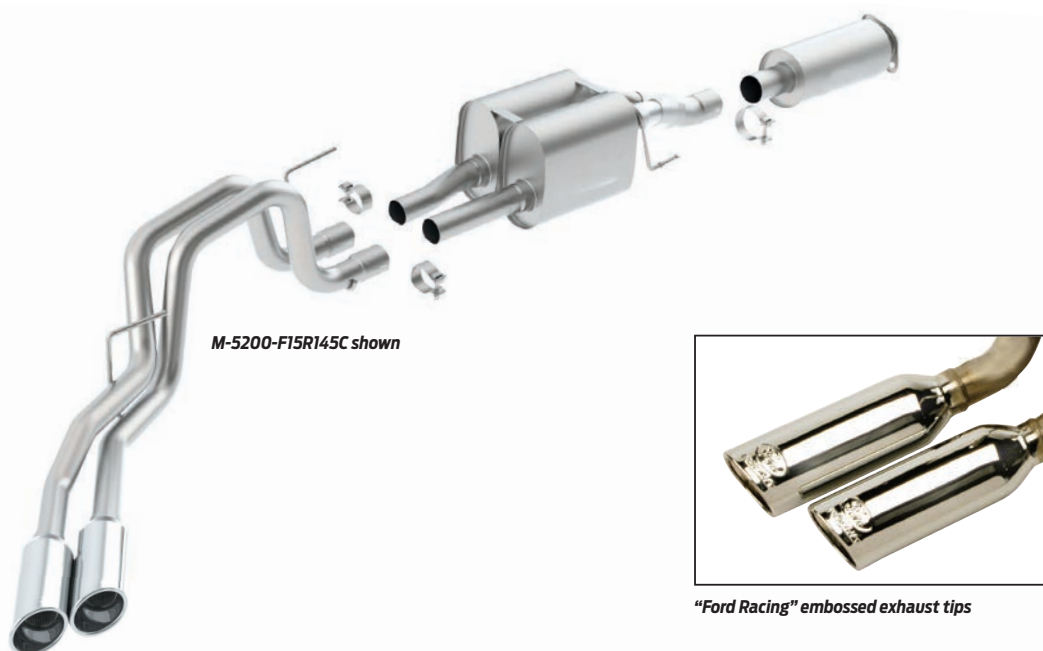

2011-2014 F-150 SVT RAPTOR 6.2L CAT-BACK TOURING EXHAUST SYSTEM 145" WB

M-5200-F15R145C*

- Fits 2011-2014 F-150 Raptor 6.2L with 145" wheelbase
 - 133" wheelbase trucks require an additional mid-pipe listed below
- Ford Performance touring exhaust systems provide a sound that is deep and throaty but still remains within the 95 decibel drive-by noise standard
- Meets 95 decibel drive-by noise standard for aftermarket exhaust systems when installed on stock applications
- Manufactured in the USA from high-quality 304 stainless steel
- Features ultra-smooth mandrel bends, warp-free flanges and superior craftsmanship
- Side exit with chrome-plated stainless steel exhaust tips
- Does not require removal of spare tire
- **133" wheelbase Raptor** requires M-5248-F15R133C Mid-Pipe

2011-2014 F-150 SVT RAPTOR 6.2L 133" WB CAT-BACK TOURING EXHAUST MID-PIPE

M-5248-F15R133C*

- Fits 2011-2014 F-150 SVT Raptor 6.2L with a 133" wheelbase
- Mid-pipe converts M-5200-F15R145C F-150 SVT Raptor 6.2L 145" Touring Exhaust System to fit 133" wheelbase

2011-2014 F-150 SVT RAPTOR 6.2L CAT-BACK SPORT EXHAUST SYSTEM 145" WB

M-5200-F15R145L*

- Fits 2011-2014 F-150 Raptor 6.2L with 145" wheelbase
 - 157" and 163" wheelbase trucks require an additional mid-pipe
- Ford Performance sport exhaust systems are uniquely designed and tuned to provide an aggressive and throaty high performance sound that is sure to enhance your driving experience
- Manufactured in the USA from high-quality 304 stainless steel
- Features ultra-smooth mandrel bends, warp-free flanges and superior craftsmanship
- Side exit with chrome-plated stainless steel exhaust tips
- Does not require removal of spare tire
- **133" wheelbase Raptor** requires M-5248-F15R133L Mid-Pipe

2011-2014 F-150 SVT RAPTOR 6.2L 133" WB CAT-BACK SPORT EXHAUST MID-PIPE

M-5248-F15R133L*

- Fits 2011-2014 F-150 SVT Raptor 6.2L with a 133" wheelbase
- Mid-pipe converts M-5200-F15R145L F-150 SVT Raptor 6.2L 145" Sport Exhaust System to fit 133" wheelbase

*This component is eligible for the Ford Performance Parts Limited Warranty. See the Ford Performance Parts Limited Warranty on pages 295-302 for details.

2014 F-150 TREMOR 3.5L CAT-BACK SPORT EXHAUST SYSTEM – SIDE EXIT, BLACK CHROME TIPS

M-5200-F1535126L*

- Fits 2014 F-150 Tremor Sport Truck with 3.5L EcoBoost® engine and 126" wheel base
- Ford Performance sport exhaust systems are uniquely designed and tuned to provide an aggressive and throaty high performance sound that is sure to enhance your driving experience
- Manufactured in the USA from high-quality 304 stainless steel
- Features ultra-smooth mandrel bends, warp-free flanges and superior craftsmanship
- Side exit with stainless steel black chrome plated exhaust tips



FORD RACING 2010-2014 F-150 RAPTOR CHROME EXHAUST TIPS

M-5255-F15R

- Fits 2010-2014 F-150 Raptor and 2009-2013 F-150 Harley truck with twin-pipe exhaust
- Chromed stainless steel tips etched with "Ford Racing" logo
- 3.5" outside diameter
- Angle-cut design
- Easy to install clamp-on design
- Includes one pair of tips and clamps



2010-2014 F-150 SVT RAPTOR ENHANCED FRONT SKID PLATE

M-5018-F15R

- Fits 2010-2014 F-150 SVT Raptor
- Replaces production front skid plate
- Added side and center reinforcements
- Complete with mounting brackets and hardware
- Powdercoated "foundry finish" gray
- "Ford Racing" logo, right and left sides

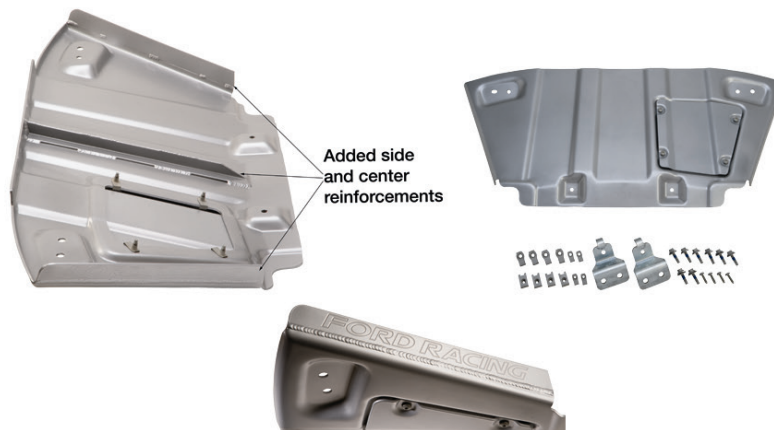

*This component is eligible for the Ford Performance Parts Limited Warranty. See the Ford Performance Parts Limited Warranty on pages 295-302 for details.

2010-2017 TAURUS SHO CAT-BACK TOURING EXHAUST SYSTEM

M-5200-SHOTC

This cat-back exhaust system bolts directly to the stock factory catalytic converters, making your Taurus SHO 100% emission compliant while providing an aggressive muscle car sound. The tuned stainless steel mufflers with 4" chrome-plated stainless steel tips not only sound great but look great too.

- Fits 2010-2017 Taurus SHO
- Uniquely designed and tuned to provide optimum performance, aggressive sound, durability and pure driving excitement
- Meets 95 decibel drive-by noise standard for aftermarket exhaust systems when installed on stock applications
- Manufactured in the USA from high-quality 304 stainless steel
- Features ultra-smooth mandrel bends, warp-free flanges and superior craftsmanship
- Bolts to stock catalytic converter
- 2.25" stainless steel cat-back tubing
- 4" chrome-plated stainless steel tip
- Uses stock hangers and mounts





FORD PERFORMANCE ENGINES



FORD PERFORMANCE ENGINES

5.0L COYOTE POWER MODULE WITH 6R80 6-SPEED AUTOMATIC TRANSMISSION

M-9000-PMCA*

Complete modern powertrain solution for any Ford.

- 2017 Mustang GT 5.0L 435 hp Coyote engine
- 6R80 6-speed automatic transmission
- Complete engine controller and wiring harness

The crew at Ford Performance has spec'd out a complete kit to simplify the swap of modern 5.0L Coyote power into just about any Ford vehicle. The Coyote power module teams the Mustang GT 435 hp 5.0L Coyote V8 with a state-of-the-art 6R80 6-speed transmission – and all the electronics and hardware to finish the installation. Coyote power module simplifies both the shopping and build experience by kitting up the right parts that are matched to deliver potent performance with civilized driveability. The engine control pack and wiring harness is truly plug-and-play and simplifies the conversion to modern electronically fuel injected V8 high-performance engine.

- 2017 Mustang GT M-6007-M50AAUTO 5.0L Coyote Engine
- 435 hp/400+ lb-ft of torque
- 11.0:1 compression ratio
- Aluminum block
- 6R80 6-speed transmission (as found in 2017 Mustang GT) with flex plate, torque converter, transmission lines and wiring
- Gear shifter assembly
- BOSS 302 M-8600-M50BALT Alternator Kit
- Starter and starter index plate
- Control pack PCM and installation kit is tunable for power upgrades – M-6017-M50A
- Runs on pump gas
- Installation hardware
- Mustang GT 409 stainless steel tubular exhaust manifold on the RIGHT SIDE ONLY

NEW



*This component is eligible for the Ford Performance Parts Limited Warranty. See the Ford Performance Parts Limited Warranty on pages 295-302 for details.

NEW

2/24
 FORD PERFORMANCE
 3-YEAR/36,000 MILE WARRANTY

5.0L COYOTE POWER MODULE WITH 6-SPEED MANUAL TRANSMISSION

M-9000-PMCM*

Complete modern powertrain solution for any Ford.

- 2017 Mustang GT 5.0L 435 hp Coyote engine
- Tremec® 6-speed manual transmission
- Complete engine controller and wiring harness

The crew at Ford Performance has spec'd out a complete kit to simplify the swap of modern 5.0L Coyote power into just about any Ford vehicle. The Coyote power module teams the Mustang GT 435 hp 5.0L Coyote V8 with a state-of-the-art Tremec® 6-speed transmission – and all the electronics and hardware to finish the installation. Coyote power module simplifies both the shopping and build experience by kitting up the right parts that are matched to deliver potent performance with civilized driveability. The engine control pack and wiring harness is truly plug-and-play and simplifies the conversion to modern electronically fuel injected V8 high-performance engine.

- 2017 Mustang GT M-6007-M50A 5.0L Coyote Engine
- 435 hp/400+ lb-ft of torque
- 11.0:1 compression ratio
- Aluminum block
- BOSS 302 M-8600-M50BALT Alternator Kit
- Starter and starter index plate
- Control pack PCM and installation kit is tunable for power upgrades – M-6017-504V
- Runs on pump gas
- Steel quicktime bellhousing
- M-7600-B Roller Pilot Bearing
- M-7003-M6266 Tremec® 6-Speed Transmission (2.66 1st gear/26 spline)
- Clutch fork/throw-out bearing
- M-7560-T46 Clutch Kit
- Installation hardware
- Mustang GT 409 stainless steel tubular exhaust manifold on the RIGHT SIDE ONLY

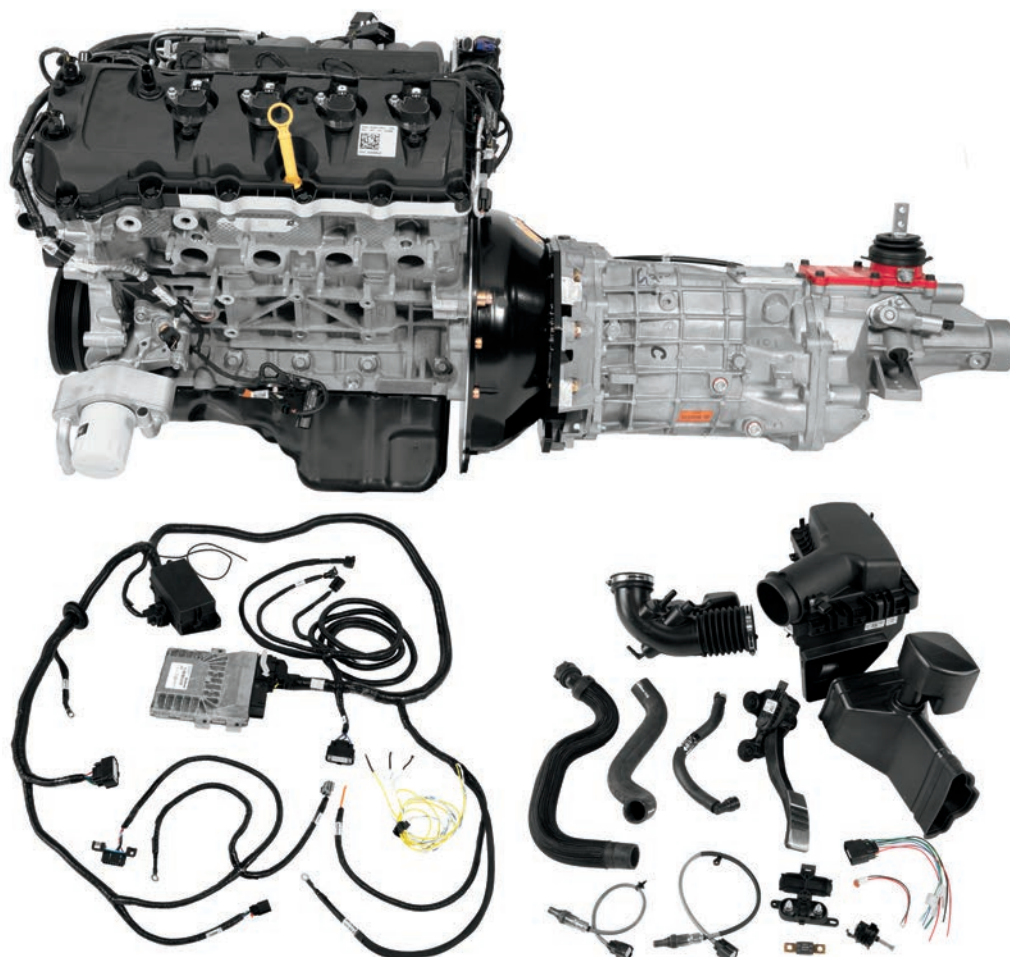

*This component is eligible for the Ford Performance Parts Limited Warranty. See the Ford Performance Parts Limited Warranty on pages 295-302 for details.

FORD PERFORMANCE ENGINES

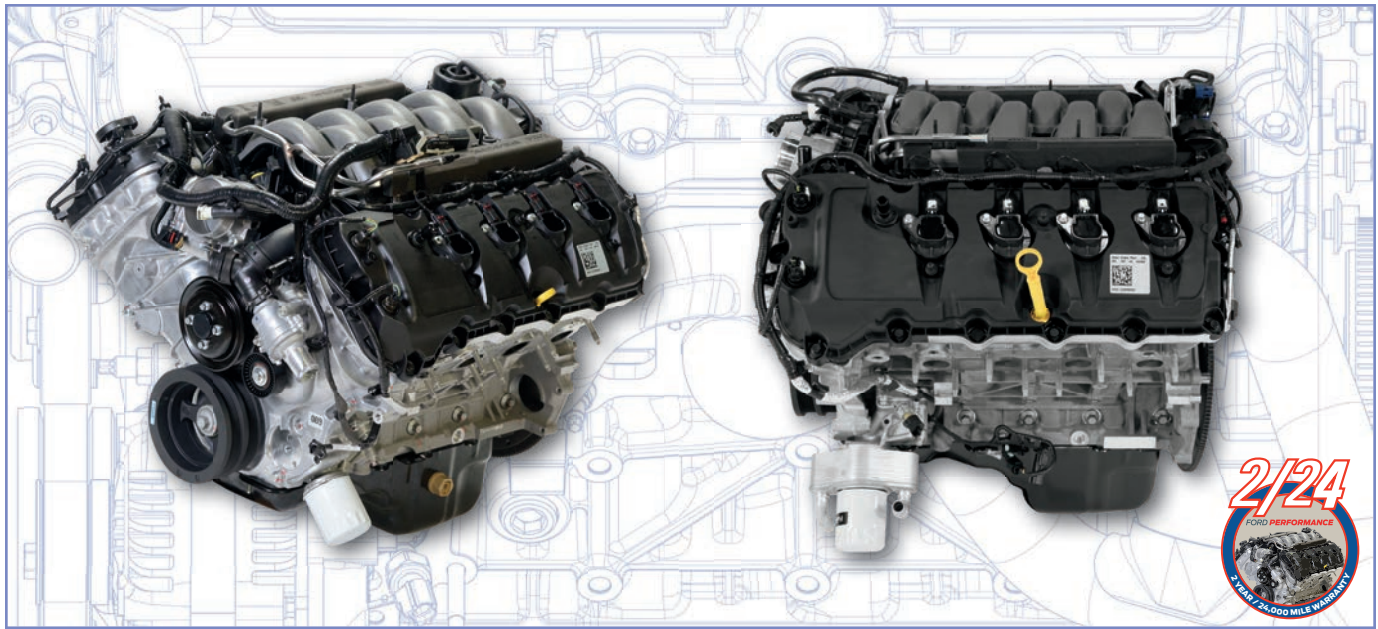

5.0L COYOTE 435 HP MUSTANG CRATE ENGINE

M-6007-M50A*

Manual Transmission

M-6007-M50AAUTO*

Automatic Transmission



The Ford Performance all-aluminum 2017 5.0L Coyote crate engine is a modern 5.0L 32-valve DOHC V8 that uses advanced features like Twin Independent Variable Camshaft Timing (Ti-VCT) to deliver 435 hp @ 6500 rpm and 400+ lb-ft of torque @ 4250 rpm (with premium fuel). The lightweight aluminum cylinder block features cross-bolted main bearing caps and thick main bearing bulkheads for bottom-end strength, optimized oil drainback and windage control to improve high-rpm performance.

- 435 hp/400+ lb-ft of torque
- 11.0:1 compression ratio
- Hypereutectic aluminum pistons
- Forged steel connecting rods
- Forged steel crankshaft
- Aluminum block
- 8 qt capacity oil pan
- Tuned composite intake manifold provides efficient air delivery and weight savings
- 80 mm single bore "drive by wire" throttle body with variable runner control

- Aluminum cylinder heads, DOHC, four valves per cylinder, variable intake and exhaust camshaft timing
- Mustang GT 409 stainless steel tubular exhaust manifold on the RIGHT SIDE ONLY
- Includes engine harness and flywheel flexplate
- Engine mount bosses and bellhousing mount pattern common to 4.6L modular engines
- Vehicle harness and PCM not included
- For M-6007-M50A, use Ford Performance wiring, M-6017-504A PCM and Installation Kit designed for project car installation
- For M-6007-M50AAUTO, use Ford Performance NEW wiring, M-6017-M50A PCM and Installation Kit designed for project car installation
- Does not include alternator; for alternator kit see M-8600-M50BALT
- 5.0L Coyote air conditioning kit available, see M-8600-M50AC
- 5.0L Mustang motor mount kit available, see M-6038-M50
- 5.0L Mustang engine cover kit available, see M-9680-M50A
- Photo and specs may vary
- Engine weight: 445 lbs

NOTE: In order for low oil sensor to function in 2015-2016 Mustang, reuse existing oil pan or replace with BR3Z-6675-A Pan, available at any Ford dealer.

2015-2017 5.0L COYOTE STREET ROD CAST IRON EXHAUST MANIFOLDS

M-9430-SR50A

- Fits 2015-2017 5.0L Coyote engine
- From 2015-2017 Ford F-150 5.0L Coyote truck program
- Great for street rod builds or other Coyote swap projects where cast iron exhaust manifolds are desired



*This component is eligible for the Ford Performance Parts Limited Warranty. See the Ford Performance Parts Limited Warranty on pages 295-302 for details.

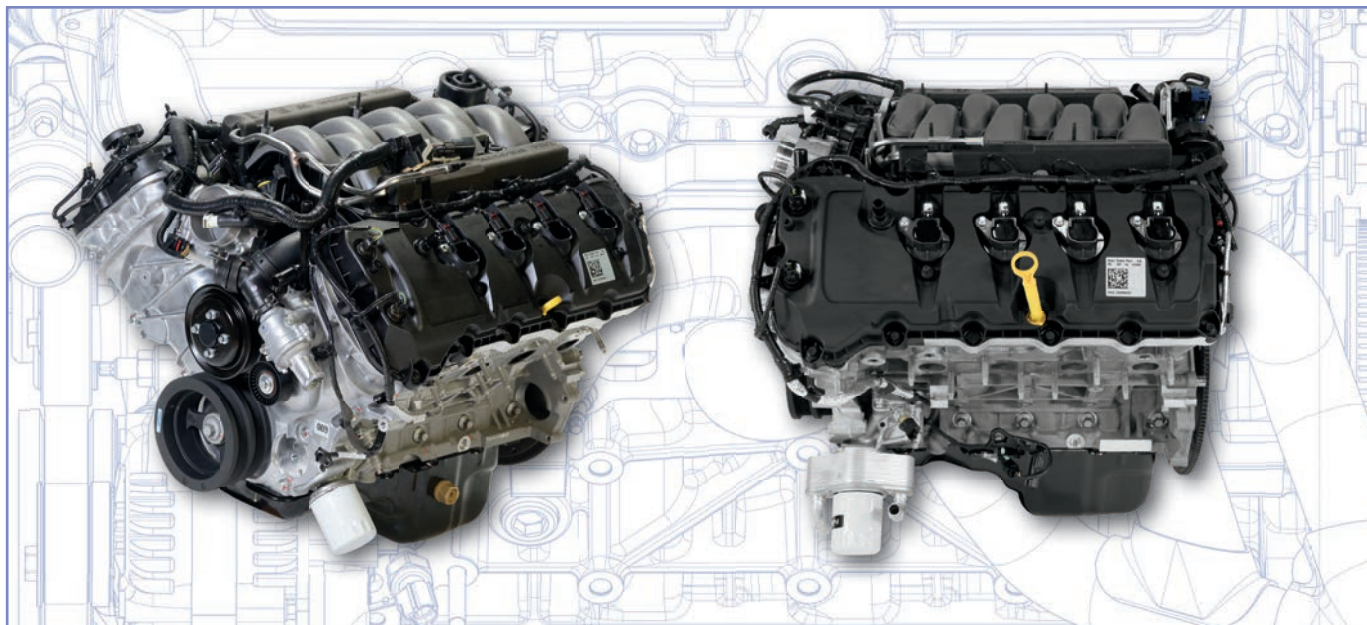

5.0L 2017 “GEN 2” NMRA COYOTE STOCK SEALED RACING ENGINE

M-6007-M50SA



“Sealed” Gen 2, 2017 Coyote crate engine for use in NMRA-Coyote sanctioned racing, the Ford Performance all-aluminum 2017 5.0L Coyote crate engine is a modern 5.0L 32-valve DOHC V8 that uses advanced features like Twin Independent Variable Camshaft Timing (Ti-VCT) to deliver 435 hp @ 6500 rpm and 400+ lb-ft of torque @ 4250 rpm (with premium fuel). The lightweight aluminum cylinder block features cross-bolted main bearing caps and thick main bearing bulkheads for bottom-end strength, optimized oil drainback and windage control to improve high-rpm performance.

- 435 hp/400+ lb-ft of torque
- 11.0:1 compression ratio
- Hypereutectic aluminum pistons
- Forged steel connecting rods
- Forged steel crankshaft
- Aluminum block
- 8 qt capacity oil pan
- Tuned composite intake manifold provides efficient air delivery and weight savings

- 80 mm single bore “drive by wire” throttle body with variable runner control
- Aluminum cylinder heads, DOHC, four valves per cylinder, variable intake and exhaust camshaft timing
- Mustang GT 409 stainless steel tubular exhaust manifold on the RIGHT SIDE ONLY
- Includes manual transmission engine harness and flywheel
- Vehicle harness and PCM not included
- Use Ford Performance wiring, M-6017-504V PCM and Installation Kit designed for street rod/project car installation
- Does not include alternator, for alternator kit see M-8600-M50BALT
- Engine mount bosses and bellhousing mount pattern common to 4.6L modular engines
- 5.0L Mustang engine cover kit available, see M-9680-M50A
- Photo and specs may vary
- Engine weight: 444 lbs

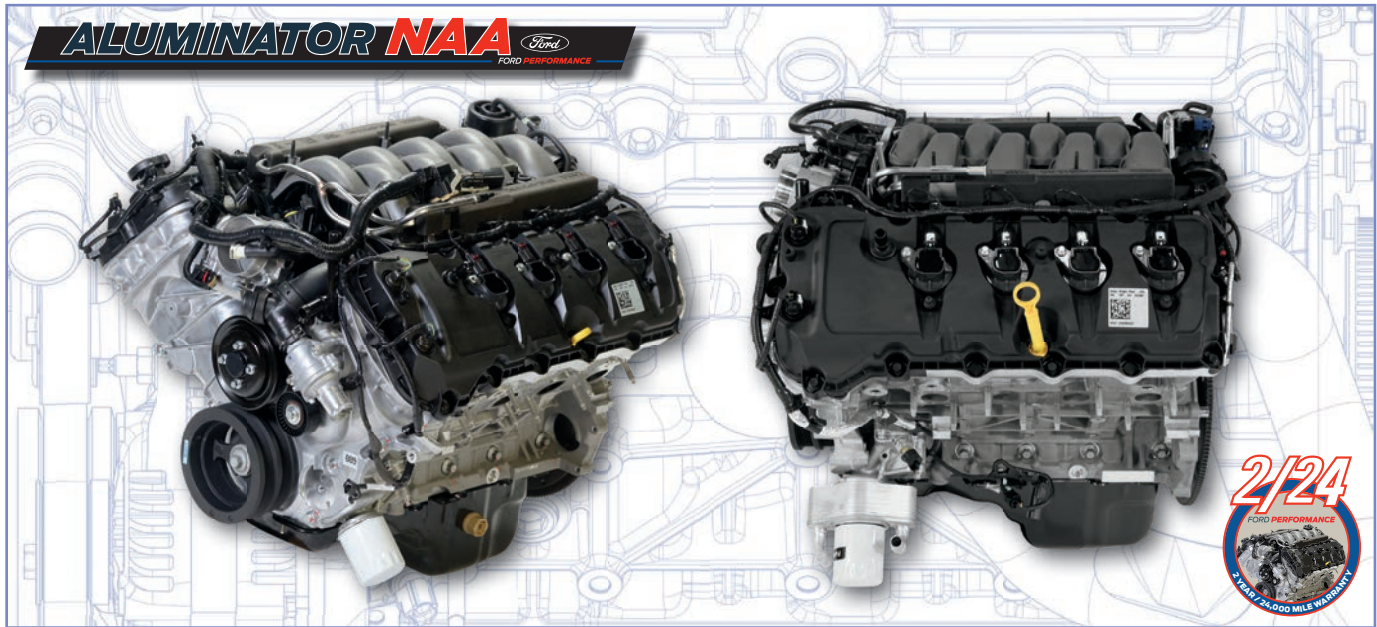

5.0L COYOTE ALUMINATOR NA CRATE ENGINE

M-6007-A50NAA*

Ford Performance has taken the Mustang GT 5.0L Coyote engine and created another in its series of Aluminator crate engines built to deliver higher performance. The 5.0 Aluminator NA is built with connecting rods and pistons designed specifically for high-performance applications. Mahle® 11.0:1 compression ratio forged pistons are hard anodized and feature Grafal® low-friction coating. The connecting rods are premium Manley® H-beam with ARP® 2000 bolts and fitted with BOSS 302 high-performance bearings. The 5.0L Aluminator NA is a direct bolt-in for 2015-2017 Mustang GT. It can be used in street rod or resto-mod builds using the Ford Performance M-6017-504V 5.0L Engine Control Pack.

- Fits 2015-2017 Mustang GT
- 5.0L (302 cubic inches)
- 11.0:1 compression ratio (nominal)
- Mahle® hard anodized forged pistons with Grafal® low-friction coating
- Manley® H-beam connecting rods with ARP® 2000 bolts
- BOSS 302 connecting rod bearings
- Forged steel crankshaft
- Uses production 2017 Mustang GT aluminum block
- Large rear sump oil pan with 8 qt capacity features optimized oil drainback and windage tray to control oil and improve high-rpm performance
- Tuned composite Mustang GT intake manifold with production "drive by wire" 80 mm throttle body variable runner control

- Four-valve-per-cylinder aluminum heads with roller-finger followers reduce friction
- M-6513-M50BR BOSS 302 Valve Springs
- Mustang GT production camshafts
 - Intake: 13 mm lift/260° duration
 - Exhaust: 13 mm lift/263° duration
- Includes Ford Performance M-9680-M50A Engine Cover Kit (not pictured)
- Includes Ford Performance colder, heat range zero (0) M-12405-M50 Spark Plugs
- Includes Ford Performance M-6731-FL820 Oil Filter
- Includes M-6600-50CJ Billet Steel Gerotor Oil Pump
- Vehicle harness and PCM not included. Use Ford Performance wiring, M-6017-504V PCM and Installation Kit designed for manual transmission street rod/project car installation. Can also be equipped with automatic engine harness and then used in conjunction with automatic transmission control pack – see M-6017-M50A for more information
- Engine does not include engine harness or flywheel/flexplate
- Does not include alternator; for alternator kit, see M-8600-M50BALT
- Engine mount bosses and bellhousing mount pattern common to 4.6L modular engines
- Does not include exhaust manifolds

NOTE: In order for low oil sensor to function in 2015-2016 Mustang, reuse existing oil pan or replace with BR3Z-6675-A pan, available at any Ford dealer.

*This component is eligible for the Ford Performance Parts Limited Warranty. See the Ford Performance Parts Limited Warranty on pages 295-302 for details.

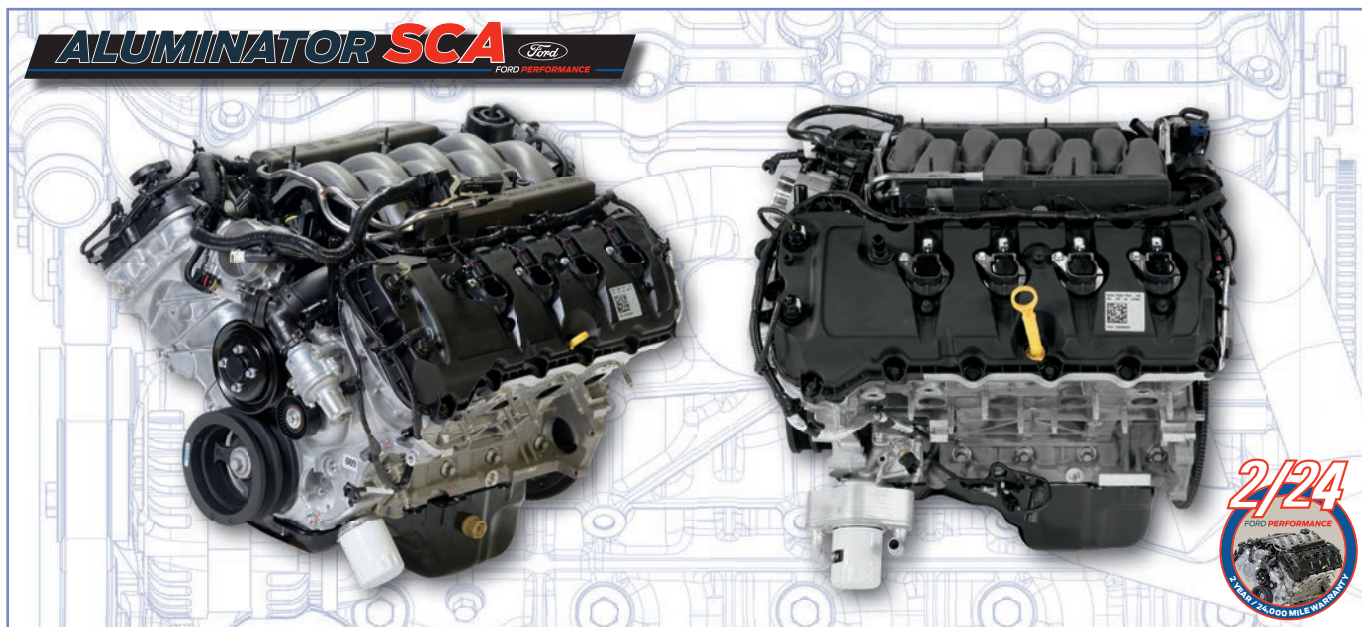

5.0L COYOTE ALUMINATOR SC CRATE ENGINE

M-6007-A50SCA*

The Ford Performance 5.0L Coyote Aluminator crate engine is a modern 5.0L 32-valve DOHC V8 that uses advanced features like Twin Independent Variable Camshaft Timing (Ti-VCT) to deliver big power. Unlike the factory 5.0L engine, the Aluminator is built with low compression forged pistons and H-beam connecting rods to meet the demands of forced induction.

This crate engine is used (and abused) in Justin Pawlak's Formula Drift Mustang!

- Fits 2015-2017 Mustang GT
- 5.0L (302 cubic inches)
- 9.5:1 compression ratio for supercharged applications (nominal)
- Mahle® hard anodized forged pistons with Graphal® low-friction coating
- Manley® H-beam connecting rods with ARP® 2000 bolts
- Mustang GT forged steel crankshaft
- Uses production Mustang GT aluminum cylinder block
- Large rear sump oil pan with 8 qt capacity features optimized oil drainback and windage tray to control oil and improve high-rpm performance
- Tuned composite Mustang GT intake manifold with production "drive by wire" 80 mm throttle body
- Four-valve-per-cylinder aluminum heads with roller-finger followers reduce friction

- Mustang GT production camshafts
 - Intake: 13 mm lift/260° duration
 - Exhaust: 13 mm lift/263° duration
- Heads feature M-6513-M50BR BOSS 302 Valve Springs
- Includes Ford Performance colder, heat range zero (0) spark plugs for supercharging, Part No. M-12405-M50
- Includes Ford Performance M-6731-FL820 Oil Filter
- Includes M-6600-50CJ Billet Steel Gerotor Oil Pump
- Vehicle harness and PCM not included. Use Ford Performance wiring, M-6017-504V PCM and Installation Kit designed for street rod/project car installation. Can also be equipped with automatic engine harness and then used in conjunction with automatic transmission controls pack – see M-6017-M50A for more information
- Engine does not include engine harness or flywheel/flexplate
- Does not include alternator; for alternator kit, see M-8600-M50BALT
- Engine mount bosses and bellhousing mount pattern common to 4.6L modular engines.

NOTE: Due to 9.5:1 compression ratio, custom tuning is required for optimum performance

- Includes Ford Performance M-9680-M50A 5.0L Mustang Engine Cover Kit (not pictured)
- Does not include exhaust manifolds

NOTE: In order for low oil sensor to function in 2015-2016 Mustang, reuse existing oil pan or replace with BR3Z-6675-A Pan, available at any Ford dealer.

*This component is eligible for the Ford Performance Parts Limited Warranty. See the Ford Performance Parts Limited Warranty on pages 295-302 for details.

FORD PERFORMANCE ENGINES



5.2L ALUMINATOR 5.2 XS CRATE ENGINE

M-6007-A52XS*

NEW

Ford Performance has taken the technology and hardware developed for the Shelby GT350 Mustang and has created the ultimate naturally aspirated, 5.2L cross-plane crankshaft crate engine. With a rating of 580 hp, the new Aluminator 5.2 XS is the **most powerful naturally aspirated modular crate engine ever built by Ford Performance**. This is the worthy successor of our previous rendition – the “A50XS.” Every Aluminator is hand-assembled by the same technicians who build the Mustang Cobra Jet drag racing engines. Premium aftermarket components are used to ensure durability, like unique Manley® connecting rods with ARP® rod bolts and Mahle® forged pistons. Unique components developed specifically for the Cobra Jet racing program are used, including Cobra Jet short runner – high-rpm intake manifold, 1517 CFM dual 65 mm CJ throttle body and competition high-rpm pulse ring. Ford Performance engineers developed a balanced combination of high-end, 580 hp and strong mid-range torque with the Cobra Jet intake manifold, unique camshafts and fully CNC-ported GT350 cylinder heads.

- Designed to work with 2015-2017 Mustang GT electronics – custom calibration required!
- 580 hp
- 445 lb-ft torque
- 5.2L (317 cubic inches)
- 12:1 compression ratio
- Mahle® hard-anodized forged pistons with Graphal® low-friction coating
- Unique Manley® H-beam connecting rods with ARP® 2000 bolts
- Unique Ford Performance M-6303-M52 Forged Steel Cross-Plane Crankshaft
- Uses Ford Performance M-6010-M52 Shelby GT350 Cylinder Block
- Ford Performance M-6675-M52 Shelby GT350 Oil Pan which features integrated windage and slosh baffles as well as an integrated oil pickup
- Ford Performance M-9424-M50CJ Cobra Jet Tuned Intake (will not clear production 2015-2017 hood without modification). Please contact Techline for more information

- Ford Performance M-9926-CJ65 Dual 65 mm Bore Throttle Body
- Four-valve-per-cylinder Shelby GT350 fully CNC-ported aluminum heads with roller-finger camshaft followers
- Unique Ford Performance M-6550-M52 Camshafts
- Camshaft specifications:
 - Intake camshaft – 14 mm lift/270° duration
 - Exhaust camshaft – 14 mm lift/270° duration
- Low leak-rate Variable Cam Timing (VCT) phasers
- Robust primary timing chains as used on Shelby GT350R
- Ford Performance M-9593-LU47 47 lb Fuel Injectors
- Ford Performance M-12A227-CJ13 High RPM Pulse Ring
- Unique Ford Performance blue coil covers with added unique badging. This coil cover is not available anywhere other than the Aluminator 5.2 XS!
- Ford Performance M-12405-M50A Zero (0) Heat Range Spark Plugs
- Ford Performance M-6731-FL820 Oil Filter
- 200 amp alternator and Front Engine Accessory Drive (FEAD) kit as used on the Cobra Jet race car
- Vehicle harness and PCM not included. Use Ford Performance M-6017-504V Control Pack which contains wiring, PCM and installation kit – designed for street rod/project car installation with a manual transmission. For automatic transmission version, please see M-6017-M50A Control Pack. Custom calibration required with either control pack!
- Engine does not include engine harness or flywheel/flexplate
- Engine mount bosses and bellhousing mount pattern common to 4.6L modular engines
- Headers not included
- Assembly plant lift brackets not included
- Premium unleaded fuel only!

NOTE: Custom PCM calibration required when installing crate engine in all vehicles, including 2015-2017 Mustang.

*This component is eligible for the Ford Performance Parts Limited Warranty. See the Ford Performance Parts Limited Warranty on pages 295-302 for details.

CONTROL PACK – 2015-2017 COYOTE 5.0L WITH AUTOMATIC TRANSMISSION

M-6017-M50A

- Take the complexity and mystery out of wiring a late model 5.0L Coyote engine!
- Designed to run 2015-2017 5.0L 4V Ti-VCT Coyote auto transmission engines, with 6R80 Mustang GT 6-speed auto transmission. Manual transmission engines require GU5Z-12A581-EF Engine Harness available from your local Ford dealer
- Includes PCM with Ford Performance calibration
- Includes electronic throttle control accelerator pedal, which eliminates throttle cable routing problems
- Unique control pack harness replaces stock body harness and is designed for custom vehicle builds
- Features OBD-II diagnostic port to assist in vehicle calibration upload and problem diagnosis
- Includes power distribution module, air-box, air inlet tube, MAF sensor, upper and lower radiator hoses and HEGO sensors
- PCM with Ford Performance calibration requires return-type fuel system; will not work with returnless fuel system

NOTE: Installation of this PCM in a 2015-2017 Mustang GT will result in a no-start condition.

NOTE: Not for use with a 2015-2017 F150 engine.

NEW



CONTROL PACK – 2015-2017 COYOTE 5.0L WITH MANUAL TRANSMISSION

M-6017-504V

- Take the complexity and mystery out of wiring a late model 5.0L Coyote engine!
- Designed to run 2015-2017 5.0L 4V Mustang Coyote engines, M-6007-M50A and M-6007-A50NAA 5.0L 4V Ti-VCT crate engines with manual transmission

NOTE: Not for use with 2015-2017 F-150 engines

- Includes PCM with Ford Performance calibration
- Includes electronic throttle control accelerator pedal, which eliminates throttle cable routing problems
- Unique control pack harness replaces stock body harness and is designed for custom vehicle builds
- Features OBD-II diagnostic port to assist in vehicle calibration upload and problem diagnosis
- Includes power distribution module, air-box, air inlet tube, MAF sensor, upper and lower radiator hoses and HEGO sensors
- PCM with Ford Performance calibration requires return-type fuel system; will not work with returnless fuel system
- For 2011-2014 engines use M-6017-A504VA Control Pack
- For 2015-2017 automatic transmission version controls pack that works in conjunction with 6R80 transmission, use M-6017-M50A

NOTE: Supercharged versions and M-6007-A50SCA (lower compression ratio) require custom calibration.

NOTE: Installation of this PCM in a 2015-2017 Mustang GT will result in a no-start condition.

NOTE: Remanufactured PCM.



FORD PERFORMANCE ENGINES

CONTROL PACK – 2011-2014 COYOTE 5.0L 4V MANUAL TRANSMISSION WITH SPEED DIAL

M-6017-A504VA

Take the complexity and mystery out of wiring a late model 5.0L 4V Ti-VCT engine!

- Replaces M-6017-A504V Control Pack; adds wiring for M-4209ADPT-AC Speed Dial to pick up transmission output speed
- Designed to run 2011-2014 5.0L 4V Coyote engines, M-6007-M50 and M-6007-A50NA 5.0L 4V Coyote crate engines with manual transmission. M-6007-A50SC, M-6007-A50XS, BOSS 302 and truck engines require modifications. Call Ford Performance Techline @ 800-FORD788 for more information
- Includes PCM with Ford Performance calibration, supercharged. M-6007-A50SC, M-6007-A50XS, BOSS 302 and truck engines require custom calibration
- Includes electronic throttle control accelerator pedal, which eliminates throttle cable routing problems
- Unique control pack harness replaces stock body harness and is designed for custom vehicle builds
- Features OBD-II diagnostic port to assist in vehicle calibration upload and problem diagnosis
- Includes power distribution module, air-box, air inlet tube, MAF sensor, upper and lower radiator hoses, PCV hoses and HEGO sensors
- PCM with Ford Performance calibration requires return-type fuel system; will not work with returnless fuel system

NOTE: Installation of this PCM in a 2011-2014 Mustang GT will result in a no-start condition.



5.0L COYOTE ENGINE HARNESS

M-12508-M50

- Fits 2011-2014 Coyote 5.0L engine with BOSS 302 or CJ intake manifold
- 2/27/12 and newer VCT solenoids BR3Z-6M280-D required
- Compatible with Ford Performance Racing Parts M-6017-A504V Control Pack
- Can be used as a core for stand-alone EFI installations
- Used on M-6007-A50XS crate engine



5.0L COYOTE AUTO TRANSMISSION ENGINE HARNESS

M-12508-M50A

- Fits late, Gen 2 (2016-2017 MY) 5.0L Coyote engines
- This engine harness is used with automatic transmission vehicles
- Allows the engine to be used in conjunction with an automatic transmission
- Harness connector is compatible with Ford 6R80 automatic transmission

NOTE: Fits late-style coil on plugs – Ford Performance M-12029-M50E





2017 MUSTANG 5.0L COYOTE LONG BLOCK

M-6006-M50A

The Ford Performance all-aluminum 2017 5.0L Coyote crate engine is a modern 5.0L 32-valve DOHC V8 that uses advanced features like Twin Independent Variable Camshaft Timing (Ti-VCT) to deliver 435 hp @ 6500 rpm and 400+ lb-ft of torque @ 4250 rpm (with premium fuel). The lightweight aluminum cylinder block features cross-bolted main bearing caps and thick main bearing bulkheads for bottom-end strength, optimized oil drainback and windage control to improve high-rpm performance. This long block is an alternative to the M-6007-M50A Complete Engine for those who don't need a fully dressed and ready to run engine.

- Fits 2015-2017 Mustang GT
- Does NOT include the following:
 - Intake manifold and throttle body
 - Fuel rails and fuel injectors
 - Engine wiring harness
 - Water pump pulley
 - Ignition coils
 - Exhaust manifolds



The M-6006-M50A Long Block shares these features and components with the M-6007-M50A Coyote Engine

- 11.0:1 compression ratio
- Hypereutectic aluminum pistons
- Forged connecting rods
- Forged steel crankshaft
- Aluminum block
- 8 qt capacity oil pan
- Aluminum cylinder heads, DOHC, four valves per cylinder, variable intake and exhaust camshaft timing
- Vehicle harness and PCM not included
- Does not include alternator; for alternator kit, see M-8600-M50BALT
- Engine mount bosses and bellhousing mount pattern common to 4.6L modular engines
- Ford Performance 5.0L Mustang engine cover kit available; see M-9680-M50A
- Photo and specs may vary
- Engine weight: 444 lbs

NOTE: In order for low oil sensor to function in 2015-2016 Mustang, reuse existing oil pan or replace with BR3Z-6675-A Pan, available at any Ford dealer.

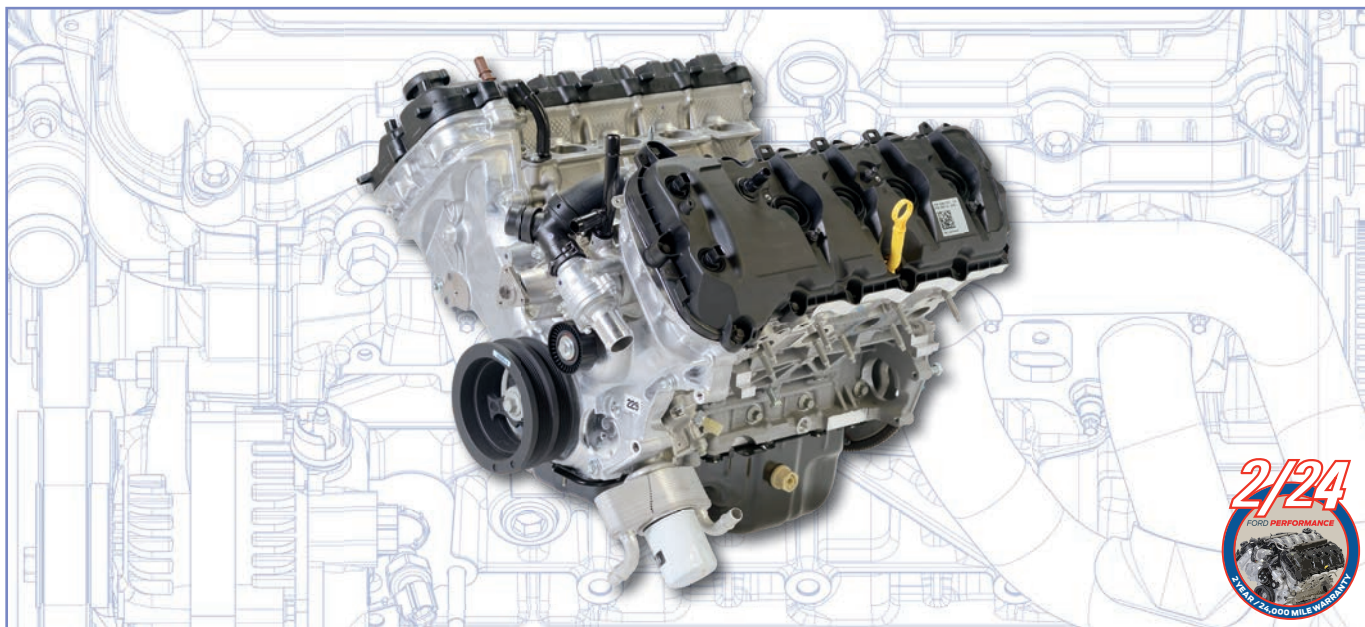

5.0L COYOTE LONG BLOCK GEN 1

M-6006-M50A1



The Ford Performance 5.0L Coyote crate engine is a modern 4-valve DOHC V8 that delivers 435 hp, pulls to 7000 rpm, and is happy cruising along at highway speed. The 2015 model year marks the first major design changes for the 5.0L Coyote engine.

To help distinguish between the “old and new” engines, the Gen 1 and Gen 2 designations will be used.

- GEN 1 - 2011-2014 Mustang GT
- GEN 2 - 2015-2017 Mustang GT

The M-6006-M50A1 Long Block has been developed for the customer who needs a Coyote that will run in a 2011-2014 Mustang or run with a Gen 1 engine control system. Custom tune required, not included.

This long block does not include the following:

- Intake manifold and throttle body
- Fuel rails and fuel injectors
- Engine wiring harness
- Water pump pulley
- Ignition coils
- Exhaust manifolds

The M-6006-M50A1 Long Block shares these features and components with the M-6007-M50A Coyote engine.

The improvements to 2015-2017 Coyote (Gen 2) focus on allowing it to breathe better. The improvements, many of which are derived from the lessons learned in developing the special edition 2012-2013 Mustang BOSS 302, allow for better breathing, especially at higher engine speeds.

Gen 2 Coyote improvements:

- Larger intake valves
- Larger exhaust valves
- Revised intake camshafts
- Revised exhaust camshafts

- Stiffer valve springs to ensure that the valves close completely at high rpm
- New cylinder-head casting, including revised ports that provide a straighter path to the valves for less-restrictive intake and exhaust flow and combustion chamber modifications to accommodate larger valves
- Redesigned piston tops with deeper cutouts to clear the new larger valves
- Rebalanced forged crankshaft that supports higher-rpm operation
 - 11.0:1 compression ratio
 - Hypereutectic aluminum pistons
 - Forged connecting rods
 - Forged steel crankshaft
 - Aluminum block
 - 8 qt capacity oil pan
- Aluminum cylinder heads, DOHC, four valves per cylinder, variable intake and exhaust camshaft timing
- Mustang GT automatic transmission flexplate
- Vehicle harness and PCM not included
- Long block is compatible with engine harness VCT harnesses after 2/27/2012. See M-12508-M50 if your engine is currently equipped with early VCT solenoids and engine harness
- Does not include alternator; for alternator kit see M-8600-M50BALT
- Engine mount bosses and bellhousing mount pattern common to 4.6L modular engines
- Photo and specs may vary
- Engine weight: 444 lbs

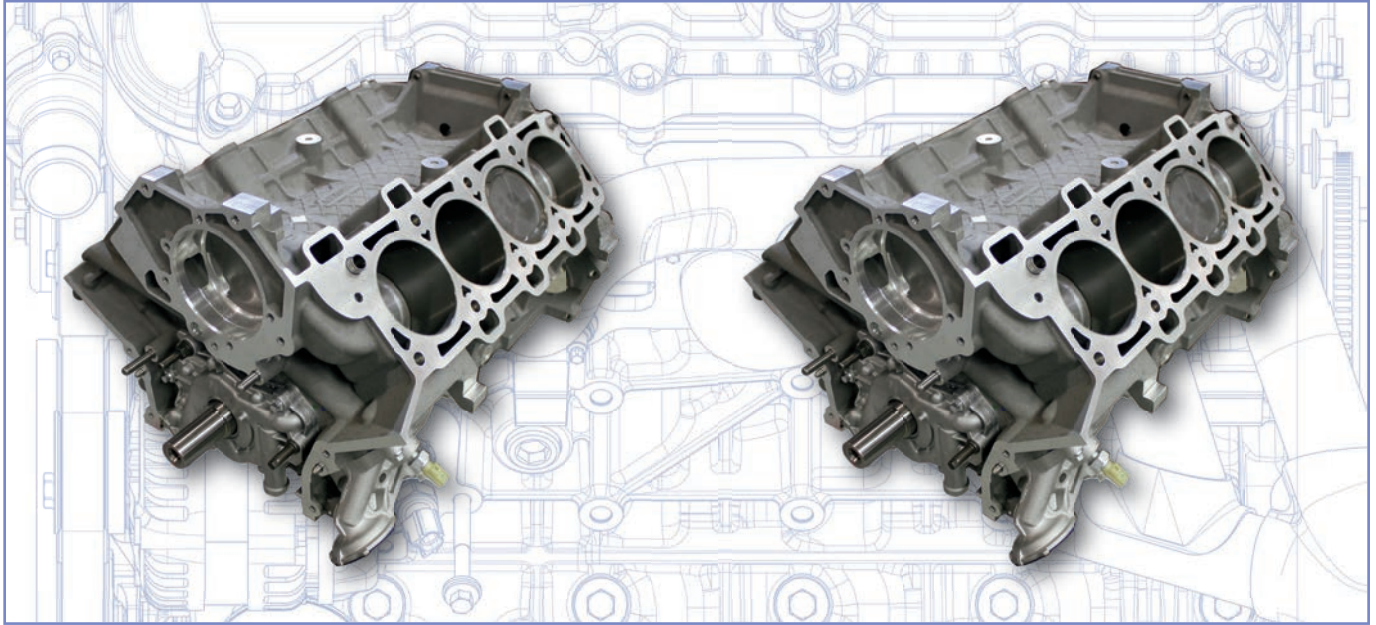

5.0L COYOTE ALUMINATOR SHORT BLOCK

M-6009-A50NAA NA Short Block 11.0:1 ratio

M-6009-A50SCA SC Short Block 9.5:1 ratio

Just like the fully built-up engines, Aluminator short blocks are hand assembled and use Manley® connecting rods with ARP® rod bolts and Mahle® forged pistons. Two versions are available – 9.5:1 and 11.0:1 compression ratio.

These Aluminator short blocks serve as a strong foundation for the enthusiast who wants to spec and finish a Coyote build to his or her particular application and needs.

Ford Performance engineers have taken care of the toughest part of building a new engine by designing a strong and durable short block that offers a wide range of power possibilities. And every Ford Performance Aluminator short block is precision internal balanced and hand-assembled in the U.S. with performance clearances.

Ford Performance offers a number of components to finish the build, including the simple-to-install control pack to get it up and running in just about any vehicle – from early model Mustang to resto-rods to classic muscle cars to street rods.

Specs: M-6009-A50NAA Aluminator Short Block

- 5.0L 302 cubic inches
- 11.0:1 compression ratio (nominal)
- For 9.5:1 compression ratio version, see-M-6009-A50SCA
- Mahle® hard anodized forged pistons with Graphal® low-friction coating
- Manley® H-beam connecting rods with ARP® 2000 bolts
- 2015-2017 (Gen 2) production aluminum cylinder block features cross-bolted main bearing caps and thick main bearing bulkheads for bottom-end strength
- Ford Performance M-6600-50CJ High-Performance Billet Steel Gerotor Oil Pump and Pickup Tube
- This short block includes the Gen 2 oil filter adapter
- Assembled and ready for your 5.0L heads, cams and timing set
- Modified heads and cams larger than the M-6550-M50BINT/ M-6550-M50BEXH require checking piston-to-valve clearance

NOTE: Installation of 5.2L heads require piston modification for proper piston-to-valve clearance

- Photo and specs may vary

Specs: M-6009-A50SCA Aluminator Short Block

- 5.0L 302 cubic inches
- 9.5:1 compression ratio (nominal)
- For 11.0:1 compression ratio version, see-M-6009-A50NAA
- Mahle® hard anodized forged pistons with Graphal® low-friction coating
- Manley® H-beam connecting rods with ARP® 2000 bolts
- 2015-2017 (Gen 2) production aluminum cylinder block features cross-bolted main bearing caps and thick main bearing bulkheads for bottom-end strength
- Ford Performance M-6600-50CJ High-Performance Billet Steel Gerotor Oil Pump and Pickup Tube
- Photo and specs may vary

FORD PERFORMANCE ENGINES

2011-2014 5.0L COYOTE PRODUCTION CYLINDER BLOCK

M-6010-M504V

- Mustang GT 5.0L 4V Coyote production aluminum block
- Fits 2011-2014 Mustang; will not fit 2015
- Low-pressure cast 319 aluminum
- Pressed-in thin-wall iron liners
- 92.2 mm bore size
- Cross-bolted nodular iron main bearing caps
- Block features 11 mm cylinder head bolts (2011-2012 engine builds using this block will require 11 mm head bolts)
- Block has provisions for engine oil squirters
- Includes dowels and plugs



2015-2017 5.0L COYOTE PRODUCTION CYLINDER BLOCK

M-6010-M504VB

- 2015-2017 Mustang GT 5.0L Coyote production aluminum block
- Low pressure cast 319 aluminum
- Pressed-in thin-wall iron liners
- 92.2 mm bore size
- Block uses 11 mm head bolts
- Cross-bolted nodular iron main bearing caps
- Block has provisions for piston oil squirters, use M-6026-A50A – not included
- Includes dowels and plugs

NOTE: The 2015-2017 block has a unique oil filter adapter pad that is not compatible with 2011-2014 blocks.



5.0L COYOTE ALUMINUM PERFORMANCE BLOCK

M-6010-M50R

- Special casting of the 5.0L Coyote block with improvements to support higher horsepower engine builds
- Water jacket below cylinder bore has been updated to add more material for strength
- The intake side of the bore at the deck surface includes a cast-in brace to improve strength of the cylinder wall and head gasket sealing
- 1/4" drain plug provision on right side of block for coolant draining
- Low-pressure cast 319 aluminum
- Pressed-in thin-wall iron liners
- 92.2 mm bore size
- Cross-bolted nodular iron main bearing caps
- Uses 11 mm cylinder head bolts
- This block is compatible with Gen 1 (2011-2014) and Gen 2 (2015-2017) cylinder heads
- Note that the head gasket must match the cylinder head
- Must use Gen 1 oil filter adapter
- Block has provisions for piston oil squirters
- Includes plugs and dowels

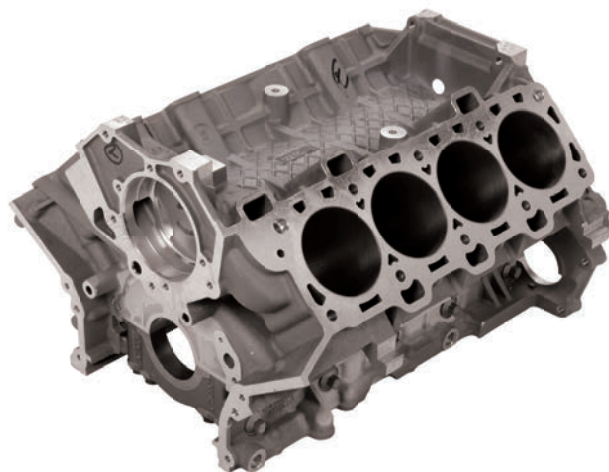



5.2L COYOTE ALUMINUM CYLINDER BLOCK

M-6010-M52

- Original equipment for the 2015-2017 Mustang GT350
- 94.0 mm bore
- Special high-performance casting of the Coyote block with improvements to support higher horsepower engine builds
- Water jacket below cylinder bore has been updated to add more material for strength
- The intake side of the bore at the deck surface includes a cast-in brace to improve strength of the cylinder wall and head gasket sealing
- Block features plasma transferred wire arc spray weld liner coating
- Liner coating provides improved durability and heat transfer, reduced friction and a weight savings compared to the Mustang GT aluminum block
- Cylinder bores are finish-honed and ready to assemble
- All block features are finish-machined, including head deck and crank bore
- Cylinder liner coating does not require unique piston rings or piston material
- Cross-bolted nodular iron main bearing caps
- Uses 12 mm cylinder head bolts
- Block has provisions for piston oil squirters
- Includes plugs and dowels

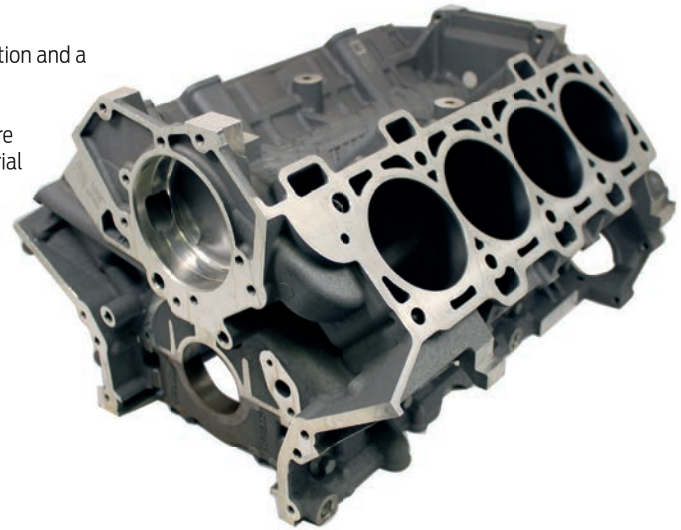

MODULAR & COYOTE ENGINE SHIPPING AND STORAGE CRADLE

M-6038-M

- Fits all modular 4.6L-5.8L and all Coyote 5.0L engines
- Does not fit M-6010-BOSS50 Block
- Fabricated metal shipping and storage rack
- Cradle base has four 1/2" holes to bolt the cradle to a pallet or for coasters
- Black powdercoat
- Includes bolts
- This is the same shipping cradle used by Ford Performance on select Aluminator engines
- Made in the USA



FORD PERFORMANCE ENGINES

5.0L COYOTE BLOCK HARDWARE KIT 2011-2017

M-6026-A50A

Hardware kit for use in 2011-2017 5.0L Coyote engine builds.

Kit includes:

- Main cap bolts
- Piston cooling nozzles
- .75" cup plug
- 13.84 mm cup plug
- 14 mm cup plug
- Transmission dowels
- Front/rear cover dowels
- Cylinder head dowels
- Timing chain guide dowels



5.2L COYOTE MAIN BOLT KIT

M-6345-M52



- Fits 2011-2017 5.2L GT350 and 5.0L Coyote blocks
- Complete set of production main cap and side bolts
- These are one-time use torque-to-yield bolts



5.0L Ti-VCT BILLET STEEL GEROTOR OIL PUMP

M-6600-50CJ

- Fits all 5.0L Ti-VCT engine applications
- Oil pump assembly with billet steel gerotor set
- Produced by OEM manufacturer to minimum allowable tolerances
- Pump assembly is pressure and flow tested with OEM procedure
- Recommended for race and power adder applications
- Used on 2013-2014 Cobra Jet engines and Ford Performance Aluminator crate engines

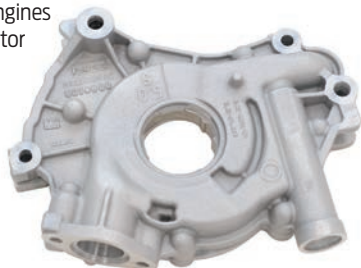

5.0L COYOTE MOTOR MOUNT KIT

M-6038-M50

- Fits 2011-2017 5.0L Mustang GT engines
- Coyote engine mount kit for engine swaps
- Includes cast aluminum engine brackets, engine mounts and hardware



COYOTE CRANKSHAFT RAW FORGING

M-6303-M50RF

- Raw crankshaft forging for the 5.0L Coyote engine
- This crankshaft has no machining
- Will accommodate strokes of 92.7 mm to 95.7 mm with a standard journal size, or larger with a smaller rod journal size



5.0L COYOTE MUSTANG BOSS 302 FORGED CRANK

M-6303-M50B

- Finish machined-forged steel crankshaft as used in the production 2012-2013 Mustang BOSS 302 engine
- 92.7 mm stroke
- Balance is compatible with the BOSS 302 connecting rod and piston assembly
- Requires balancing if used with another rod and piston assembly



COYOTE 5.2L FORGED CRANKSHAFT

M-6303-M52

- Finish machined cross plane forged steel crankshaft for use with the M-6010-M52 Coyote Block
- 93 mm stroke
- Standard main and rod journal sizes
- Will require balancing



5.0L COYOTE OIL PUMP INSTALLATION KIT M-6600-A50PKIT

- Fits 2011-2017 5.0L Coyote Mustang GT and F-150 engines
- This kit is intended to be used when installing an oil pump on a 5.0L Coyote engine

Kit includes:

- Timing cover gaskets and seals
- Oil pan gaskets
- Damper bolt
- Damper seal

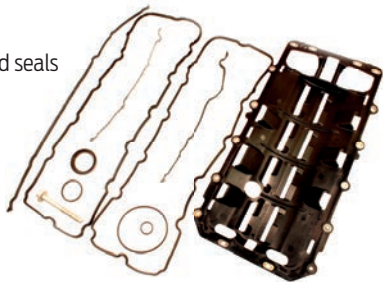

5.2L COYOTE GT350 OIL PAN AND PUMP KIT

M-6675-M52

- Fits all 5.2L, and Gen 1 and Gen 2 5.0L Coyote engines
- Includes the production GT350 high-output oil pump, oil pan, high-pressure oil pressure sending unit and hardware
- This unique composite oil pan includes integrated windage and slosh baffles and the oil pickup integrated into the floor of the pan
- Used on Ford Performance M-6007-A52XS Engine



MUSTANG BOSS 302 ENGINE OIL COOLER M-6642-MB

- Original equipment on 2012-2013 Mustang BOSS 302. Fits 2011-2014 Mustang GT with 5.0L 4V Ti-VCT engine
- Engine-mounted oil cooler
- Water-to-oil type cooler
- Kit includes BOSS 302 radiator hose with integral oil cooler fitting
- Uses M-6731-FL820 Ford Performance High-Performance Oil Filter



COYOTE GEN 2 OIL FILTER ADAPTER KIT

M-6880-M501

- Oil filter adapter for use on the 2015-2017 5.0L Coyote M-6010-M504VB Block
- Includes "Ford Racing" CM-6731-FL820 Oil Filter and adapter fasteners



2011-2017 5.0L COYOTE 4V Ti-VCT RACE OIL PAN

M-6675-M50BR

- Fits 2011-2017 Mustang 5.0L Coyote Ti-VCT engine
- Used on Mustang BOSS 302R, BOSS 302S and 2013 Cobra Jet Mustang engine
- Internal baffle system designed for road race applications
- 12 qt capacity
- Includes oil pickup tube
- Black powdercoated
- Pipe plug fitting for oil temperature gauge



2011-2014 5.0L 4V Ti-VCT OIL LINE ADAPTER

M-6881-M50

- Fits 2011-2014 5.0L Coyote engines
- Blue anodized billet aluminum oil line adapter replaces oil filter adapter
- Allows installation of remote mounted oil filter and oil cooler
- Designed for -10 AN lines with O-ring port fittings
- Includes adapter-to-engine block O-rings and mounting bolts
- Can be used with M-6007-M50, M-6007-A50NA, M-6007-A50SC, M-6007-A50XS crate engines when stock oil filter requires relocation
- Recommended for street car applications

WARNING: Your selection of fittings and filter adapter may restrict oil flow, causing engine damage.



2015-2017 5.0L COYOTE OIL LINE ADAPTER

M-6881-M50A

- Fits 2015-2017 5.0L Coyote engines
- Blue anodized billet aluminum oil line adapter replaces oil filter adapter
- Allows installation of remote mounted oil filter and oil cooler
- Includes two -12 AN (male) fittings & O-rings
- Includes adapter-to-engine block O-ring and mounting bolts

WARNING: Your selection of fittings and filter adapter may restrict oil flow, causing engine damage.



FORD PERFORMANCE ENGINES

COYOTE 5.2L HIGH-PERFORMANCE CAMS – GEN 1



M-6550-M52A

- Intake and exhaust camshaft set for use in the 2015-2017 5.2L cylinder heads with 2011-2014 (Gen 1) 5.0L cam phasers, timing chains and engine control system
- 14 mm lift/270° duration – intake and exhaust
- Must use the 5.0L Gen 1 cam phasers, timing chains and crank sprocket
- Phasers must be limited to 20° advance maximum via calibration or mechanical limiters
- Must use the 5.2L M-6564-M52 Roller Finger Followers
- These cams are to be used with the standard 5.0L Coyote firing order
- Custom calibration required



COYOTE 5.2L HIGH-PERFORMANCE CAMS – GEN 2



M-6550-M52

- Intake and exhaust camshaft set for use in the 2015-2017 5.2L cylinder heads with 2015-2017 (Gen 2) 5.0L cam phasers, timing chains and engine control system
- 14 mm lift/270° duration – intake and exhaust
- Must use the 5.0L Gen 2 cam phasers and chains and crank sprocket
- These cams are to be used with the standard 5.0L Coyote firing order
- Custom calibration required



2012-2013 BOSS 302 EXHAUST CAM SET FOR COYOTE 5.0L

M-6550-M50BEXH

- Higher lift and longer duration for increased engine performance
- 13 mm lift/290° duration (stock 11 mm lift/263° duration)
- Compatible with M-6049-M50BR and M-6050-M50BR Mustang BOSS 302 cylinder head
- Will work with Mustang GT 5.0L 4V Ti-VCT cylinder head with modification for rocker arm clearance
- Requires use of BOSS 302 M-6513-M50BR Valve Spring Kit
- The cams are used on the 2013 Cobra Jet naturally aspirated engine
- Use with long tube headers for optimum performance gains
- Custom calibration required
- Sold as a pair of camshafts

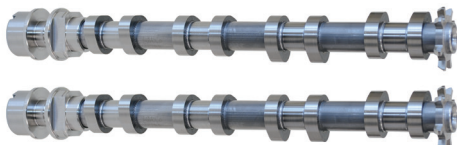

2012-2013 BOSS 302 INTAKE CAM SET FOR COYOTE 5.0L

M-6550-M50BINT

- Higher lift and longer duration for increased engine performance
- 13 mm lift/263° duration vs. 12 mm lift/260° duration on Mustang GT 5.0L engine
- Compatible with M-6049-M50BR and M-6050-M50BR Mustang BOSS 302 Cylinder Head
- Check cam follower roller to cylinder head clearance with base 2011-2014 Mustang GT 5.0L 4V Ti-VCT cylinder head
- Recommend use of BOSS 302 M-6513-M50BR Valve Spring Kit
- The cams are used on the 2013 Cobra Jet naturally aspirated engine
- Custom calibration required
- Sold as a pair of camshafts

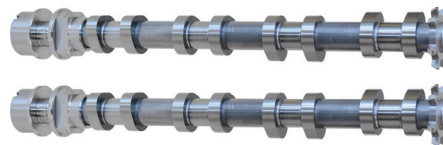

2015-2017 5.0L 4V Ti-VCT MUSTANG COYOTE CAMSHAFT DRIVE KIT

M-6004-A5015

Camshaft drive kit for the 5.0L Coyote engine with an aluminum block.

- Fits 2015 5.0L 4V Ti-VCT Mustang Coyote engine (For 2011-2014, see M-6004-A504)

Kit includes new production:

- Tensioner arms
- Chain guides
- Primary and secondary timing chains
- Primary and secondary timing chain tensioners
- Camshaft VCT phasers and bolts
- Crankshaft sprocket
- Includes dowel pin and fasteners



Photos may vary

2011-2014 5.0L 4V Ti-VCT MUSTANG COYOTE CAMSHAFT DRIVE KIT

M-6004-A504

Camshaft drive kit for the 5.0L 4V Ti-VCT Mustang Coyote engine with an aluminum block.

- Fits: 2011-2014 5.0L 4V Ti-VCT Mustang Coyote engine (for 2015, see M-6004-A5015)

Kit includes new production:

- Tensioner arms
- Chain guides
- Primary and secondary timing chains
- BOSS primary timing chain tensioners
- Secondary timing chain tensioners
- Camshaft VCT phasers and bolts
- Crankshaft sprocket
- Includes dowel pin and fasteners



MUSTANG GT 5.0L COYOTE CYLINDER HEAD

M-6049-M50 RH

M-6050-M50 LH

- Production Mustang GT 5.0L Gen 1 Coyote aluminum cylinder head
- Fits 2011-2014 Mustang GT
- Finished machined cylinder head ready to install
- 193 cc intake port volume
- 31 mm exhaust valve
- 37 mm intake valve
- Includes intake and exhaust valves, springs and retainers
- Does not include cams or rocker arms
- Use M-6067-M50BR Head Changing Kit

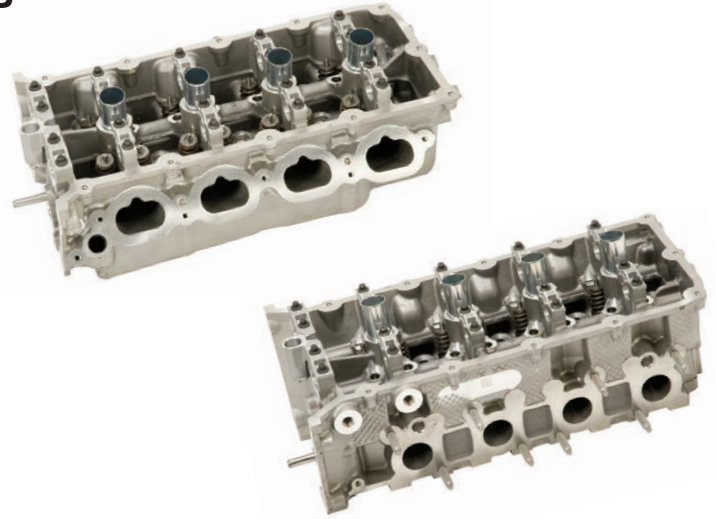

2015-2017 MUSTANG GT 5.0L COYOTE CYLINDER HEAD

M-6049-M50A RH

M-6050-M50A LH

- Production 2015-2017 Mustang GT 5.0L Gen 2 Coyote aluminum cylinder head
- Improved flow compared to the 2011-2014 5.0L cylinder head
- Will fit 2011-2014 Coyote engines with minor intake manifold modification and the use of 2015-2017 head gaskets. Use M-6067-M50 Head Changing Kit for 2013-2014 blocks with 11 mm head bolts
- Finished machined cylinder head ready to install
- 193 cc intake port volume
- 31.8 mm exhaust valve
- 37.3 mm intake valve
- Includes intake and exhaust valves, springs and retainers
- Does not include cams, M-6564-M50 Rocker Arms or M-6500-M50 Lash Adjusters

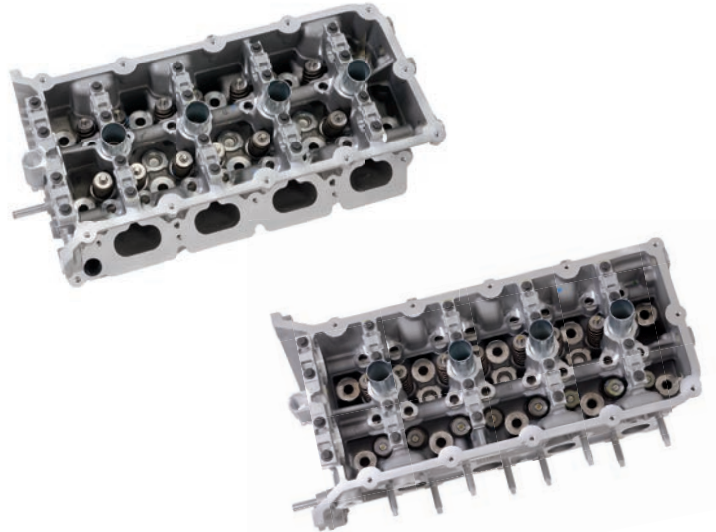

COYOTE GT350 CYLINDER HEAD

M-6049-M52 RH

M-6050-M52 LH

- Production cylinder head for the 5.2L GT350
- Fully CNC-ported intake ports, exhaust ports and combustion chamber
- Larger port sizing than the 2015-2017 5.0L Coyote cylinder heads
- 38.3 mm intake valve and 32.5 mm exhaust valve
 - 2015-2017 5.0L Coyote valve sizes are 37.3 mm intake, 31.8 mm exhaust
- New valvetrain geometry allows for higher valve lift
- Lightweight hollow-stem intake valves and sodium-filled exhaust valves
- Loaded head assembly minus camshafts, rocker arms and lash adjusters
- To use on 5.0L Coyote requires unique camshaft due to valvetrain geometry (M-6550-M52 or M-6550-M52A)
- Installation of 5.2L heads on 5.0L engine requires piston modification for proper piston-to-valve clearance
- Requires 5.2L M-6564-M52 Rocker Arms and lash adjusters



FORD PERFORMANCE ENGINES

2015-2017 5.0L COYOTE HEAD CHANGING KIT – 11 MM HEAD BOLTS

M-6067-M50

- Fits 2015-2017 Mustang 5.0L Coyote cylinder head
- Note that 2015 Coyote head gasket is unique and will not interchange with 2011-2014 engines
- Kit includes multilayer steel head gaskets and high-strength torque-to-yield 11 mm head bolts



BOSS 302R HEAD CHANGING KIT – 12 MM

M-6067-M50BR

- Fits 2012 5.0L BOSS 302R Ti-VCT cylinder head and base 2011-2012 5.0L Ti-VCT cylinder head
- Improved sealing for high cylinder pressure
- Kit includes multilayer steel head gaskets and high-strength 12 mm torque-to-yield head bolts

BOSS 302R HEAD CHANGING KIT – 11 MM HEAD BOLTS

M-6067-M50BR11

- Fits 2013 5.0L BOSS 302R Ti-VCT cylinder head and 2013-2014 base 5.0L Ti-VCT cylinder head
- Improved sealing for high cylinder pressure
- Kit includes multilayer steel head gaskets and high-strength torque-to-yield 11 mm head bolts



5.2L COYOTE HEAD CHANGING KIT

M-6067-M52



- Fits 5.2L Coyote cylinder head on a 5.2L block
- Kit includes multilayer steel head gaskets and high-strength torque-to-yield 12 mm head bolts



5.0L COYOTE HEAD CHANGING KIT – 5.2L HEAD ON 5.0L BLOCK

M-6067-M5052



- This head gasket is to be used to install the 5.2L GT350 Coyote cylinder head on a standard 2015-2017 5.0L Coyote block
- Note that 2015-2017 Coyote head gasket is unique and will not interchange with 2013-2014 engines
- Kit includes multilayer steel head gaskets and high-strength torque-to-yield 11 mm head bolts

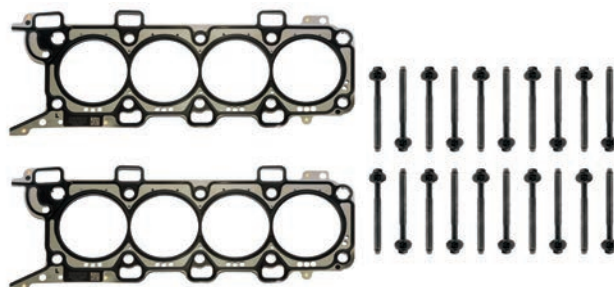

5.0L COYOTE ROLLER FINGER FOLLOWER KIT

M-6564-M50

- Fits 2011-2015 5.0L Coyote engines
- Full engine set of 32 camshaft roller finger followers



5.2L COYOTE ROLLER FINGER FOLLOWER KIT

M-6564-M52

- Fits 2015-2017 5.2L Coyote engines
- Full engine set of 32 camshaft roller finger followers



5.0L COYOTE LASH ADJUSTER ASSEMBLY KIT

M-6500-M50

- Fits 2011-2017 5.0L Coyote engines
- Full engine set of 32 camshaft lash adjusters
- Use with M-6564-M50 Follower Kit for 5.0L heads, and M-6564-M52 Follower Kit for 5.2L heads



BOSS 302R VALVE SPRING KIT

M-6513-M50BR

- Valve spring used on 2012-2013 Mustang BOSS 302 engine
- Higher seat pressure than base valve spring
- 300 N closed 700 N open BOSS 302
- 265 N closed 650 N open Mustang GT
- Installed height 40 mm, same as Mustang GT
- 8000 rpm compatible
- Use with cams up to 13 mm lift
- Can be used on base 5.0L Ti-VCT head
- Sold in sets of 16



5.2L COYOTE VALVE SPRING KIT

M-6513-M52

- Fits 5.2L Coyote cylinder heads
- This is the production 5.2L valve spring and hardware
- Will fit not 5.0L Coyote cylinder heads

Kit includes the following:

- 9L8E-6514-AA Valve Spring Retainer – Qty 32
- F53E-6518-AB Valve Spring Retainer Key – Qty 64
- GR3E-6513-AA Intake Valve Spring (Blue) – Qty 16
- GR3E-6513-BA Exhaust Valve Spring (Orange) – Qty 16
- GR3E-6A517-AA Valve Stem Seal – Qty 32



EXHAUST VALVE LIGHTWEIGHT 5.2L COYOTE – QTY 8

M-6505-M52

- Fits 5.2L Coyote cylinder heads
- Production lightweight exhaust valves
- 32.5 mm diameter
- For reference Gen 2 Coyote is 31.8 mm



INTAKE VALVE LIGHTWEIGHT 5.2L COYOTE – QTY 8

M-6507-M52

- Fits 5.2L Coyote cylinder heads
- Production lightweight intake valves
- 38.3 mm diameter
- For reference Gen 2 Coyote is 37.3 mm



FORD PERFORMANCE ENGINES

5.0L COYOTE BOSS 302 TIMING CHAIN TENSIONERS

M-6266-M50B

- Fits 2011-2017 5.0L Coyote engines
- Designed for improved timing chain durability in high rpm applications
- Used on 2013 Mustang Cobra Jet engine program
- Includes a pair of primary chain tensioners and bolts



BOSS 302 INTAKE MANIFOLD

M-9424-M50BR

- Fits 2011-2014 Mustang GT with manual transmission
- Original equipment on Mustang BOSS 302, 302S and 302R race cars
- Made from lightweight composite material
- Short runners for optimum flow at high rpm
- Includes unique "Ford Racing" intake badging
- O-ring intake gaskets included
- M-9444-M50B BOSS 302 Intake Manifold Install Kit is recommended and includes the necessary production components to complete the installation. Minor wiring harness modifications required
- **Calibration is necessary to prevent engine damage! Calibration not included!**

NOTE: BOSS inlet tube does not have provisions for aspirator tube hook up common to automatic equipped 2011-2014 Mustang GT.



BOSS 302 INTAKE MANIFOLD INSTALL KIT

M-9444-M50B

- This kit includes the necessary production Mustang BOSS 302 hardware to complete the installation of M-9424-M50BR Intake Manifold on a 2011-2014 Mustang GT 5.0L 4V Ti-VCT engine

Kit Includes:

- Fuel vapor hose
- Fuel vapor fuse bracket and fasteners
- Fuel line
- Air inlet tube assembly – throttle body to air-box

NOTE: Boss inlet tube does not have provisions for aspirator tube hook up common to automatic transmission equipped 2011-2014 Mustang GT.



GT350 5.2L COYOTE INTAKE MANIFOLD

M-9424-M52



- GT350 intake manifold assembly with Charge Motion Control Valves – CMCV
- Requires GT350 87 mm M-9926-M52 Throttle Body
- Intake is tuned for 7500 rpm peak power
- Will fit 2015-2017 5.0L Coyote engines. Requires custom calibration. Calibration not included



COBRA JET 5.0L 4V INTAKE MANIFOLD

M-9424-M50CJ

- Fits 2011-2014 Mustang GT with manual transmission and 2012-2013 Boss 302
- Based on intake manifold used on naturally aspirated version of 2013 Mustang Cobra Jet race car
- Significant power increase above the M-9424-M50BR Ford Racing BOSS 302 Intake Manifold with no loss of torque
- Runners tuned for 7750 rpm peak power
- Made from lightweight composite material
- Total intake volume 635 cubic inches
- Designed and tested to 20+ psi
- O-ring intake gaskets included
- Requires M-9926-MSVT, M-9926-CJ65, or M-9926-SCJ Throttle Body
- Requires Cobra Jet 5.0L M-9603-M50CJ Cold Air Kit to mate to oval throttle body
- Mustang GT requires M-9444-M50B Installation Kit or equivalent (inlet hose in kit not used)
- Compatible with production 5.0L Ti-VCT fuel rail
- Not compatible with strut tower brace
- Nitrous oxide not recommended for use with this manifold
- **Calibration is necessary to prevent engine damage! Calibration not included!**

NOTE: CJ inlet tube does not have provisions for aspirator tube hookup common to automatic equipped 2011-2014 Mustang GT.



PERFORMANCE 5.0L COYOTE COLD SPARK PLUG SET

M-12405-M50A

- Recommended for use with 2011-2014 Mustang GT 5.0L Coyote M-6066-MGT525D and M-6066-MGT624D Supercharger Kit
- Recommended for use with 2011-2017 Mustang GT vehicles running aftermarket superchargers
- One heat range colder than the stock 2011-2017 Mustang GT 5.0L 4V Ti-VCT engine spark plugs
- As used on the 2016 Cobra Jet engine
- Similar performance to M-12405-M50, but with more robust construction for race applications
- 0.035 plug gap for supercharged applications recommended
- Sold in set of 8



5.0L COYOTE FRONT & CAM COVER KIT

M-6580-M50

This kit provides the front and top end sealing components for 2011-2015 5.0L 4V Ti-VCT Coyote engine build projects.

Kit includes these parts:

- Oil fill cap – Qty 1
- LH crankcase vent fitting – Qty 1
- RH crankcase vent fitting – Qty 1
- Idler pulley – Qty 1
- Idler pulley bolt – Qty 1
- Damper bolt – Qty 1
- Damper washer – Qty 1
- Dipstick and tube – Qty 1
- Cam cover RH – Qty 1
- Cam cover LH – Qty 1
- Front cover – Qty 1
- Front cover bolt & washer – Qty 5
- Front cover stud – Qty 2
- Front main seal – Qty 1
- Water pump and front cover bolt – Qty 8
- M6 x 22 mm oil pan bolt – Qty 4



5.0L COYOTE COIL COVER "BOSS 302"

M-6067-50B302

- Fits 2011-2017 Mustang 5.0L 4V Ti-VCT Coyote engine
- Fits 2011-2017 F-150 5.0L 4V Ti-VCT Coyote engine with use of M-6067B-F150
- Fits 2015-2017 Shelby GT350 5.2L
- Premium die-cast aluminum
- Blue powdercoat finish with laser-etched "BOSS 302" logo
- Made in the USA



MUSTANG 5.0L COYOTE COIL COVER – "FORD PERFORMANCE"

M-6067-50FP

- Fits 2011-2017 Mustang 5.0L 4V Ti-VCT Coyote engine
- Fits 2011-2017 F-150 5.0L 4V Ti-VCT Coyote engine with use of M-6067B-F150
- Fits 2015-2017 Shelby GT350 5.2L
- Premium die-cast aluminum
- Blue powdercoat finish with laser-etched "Ford Performance" logo
- Made in the USA



5.0L COYOTE FRONT COVER FOR SUPERCHARGED APPLICATIONS

M-6059-M50SC

- Fits 2011-2017 5.0L Coyote engines
- Front cover modified for use with a Ford Performance supercharger

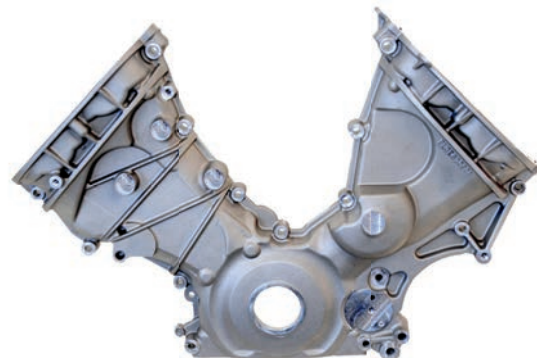

FORD PERFORMANCE ENGINES

5.0L COYOTE "POWERED BY FORD" COIL COVERS

M-6P067-M50B Blue

M-6P067-M50BL Black

- Fits 2011-2017 5.0L Coyote Mustang GT
- Fits 2011-2017 5.0L F-150 4V 5.0L Ti-VCT Coyote engine with use of M-6067B-F150
- Fits 2015-2017 Shelby GT350 5.2L
- "POWERED BY FORD" script
- Made from composite material



M-6P067-M50B shown

MUSTANG 5.0L COYOTE COIL COVERS

M-6067-50BK Black Powdercoat

M-6067-50C Chrome

- Fits 2011-2017 Mustang 4V 5.0L Ti-VCT Coyote engine
- Fits 2011-2017 F-150 4V 5.0L Ti-VCT Coyote engine with use of M-6067B-F150
- Fits 2015-2017 Shelby GT350 5.2L
- Premium die-cast aluminum
- Laser-etched "Ford Racing" logo
- Made in the USA



M-6067-50BK shown

5.0L COYOTE CAM COVER BALL STUD KIT

M-6067B-F150

- Fits 2011-2017 Coyote engines w/o factory ball studs
- Allows for coil cover attachment on all 2011-2017 5.0 4V F-150 Coyote engines
- OEM quality, steel ball studs
- Kit of 6 ball studs (1 kit required per engine)



BOSS INTAKE MANIFOLD/COYOTE ENGINE DRESS-UP KIT

M-9680-BOSS

Directly from the 2012-2013 Mustang BOSS 302, this kit is designed to finish off the look of any Coyote-powered vehicle equipped with a BOSS 302 intake manifold.

- Fits 2011-2017 Coyote 5.0L Ti-VCT engines
- Cleans up engine bay by covering fuel rail, injectors and wiring
- Foam isolators help to block out injector noise while dressing up engine bay
- OEM parts off of 2012-2013 BOSS 302 Mustang

Kit includes:

- Driver-side isolator
- Passenger-side isolator
- Purge canister (PCV) bracket
- Hardware



5.0L COYOTE ENGINE COVER KIT

M-9680-M50

- Original equipment on manual transmission 2011-2014 Mustang GT 5.0L Ti-VCT Coyote engine
- Intake cover includes "5.0" emblem and "32V TiVCT" script
- Coil covers include "POWERED BY FORD" script
- Perfect add-on for 2011-2014 5.0L Ti-VCT Coyote crate engine install



2015-2017 MUSTANG BILLET ALUMINUM ENGINE COMPARTMENT CAP COVER SET W/LASER-ENGRAVED "FORD PERFORMANCE"



M-6766-M50

Billet aluminum CNC-machined cap covers with the "Ford Performance" logo laser-engraved in the top. Each cap cover is designed to push into place over the existing engine cap and held in place with double-sided tape. The cap covers are clear anodized to protect the finish and maintain long-lasting beauty.

- Fits 2015-2017 Mustang GT 5.0L, GT350 and GT350R 5.2L

Set includes:

- Engine oil cap
- Brake reservoir cap
- Radiator overflow tank cap
- Windshield washer reservoir cap
- Supercharger intercooler reservoir cap



NOTE: The supercharger intercooler reservoir cap works with Ford Performance M-6066-M8627 Supercharger Kit and is not used on non-supercharged applications.

2015 MUSTANG GT COYOTE ENGINE COVER KIT

M-9680-M50A

- Original equipment on manual transmission 2015-2017 Mustang GT 5.0L 4V Ti-VCT Coyote engine
- Intake cover includes "5.0" emblem
- Coil covers include "POWERED BY FORD" script
- Both covers are molded in silver/gray
- Perfect add-on for all Mustang and other cars powered by the 5.0L 4V Ti-VCT Coyote M-6007-M50A Crate Engine

NOTE: Does not include strut tower brace shown in part image.



5.0L COYOTE ENGINE IGNITION COIL SET (8)

M-12029-M50C

- Fits all 2011-2/23/16 Mustang GT and F-150 5.0L 4V Ti-VCT Coyote engines
- This is a set of 8 OEM production ignition coils and bolts for a 5.0L Coyote engine

NOTE: Does not fit engines built after 2/23/16 due to electrical connector change, including crate engines



LATE 5.0L COYOTE ENGINE IGNITION COIL SET (8)

M-12029-M50E

- Fits all 2/24/16 and later-built Mustang GT and F-150 5.0L 4V Ti-VCT Coyote engines. For vehicles and harnesses built prior to 2/24/16, see Part No. M-12029-M50C
- This is a set of 8 OEM production ignition coils and bolts for a 5.0L Coyote engine

NOTE: Does not fit engines built 2/23/16 and prior due to electrical connector change, including crate engines. These coils only work with the latest level wiring harness (GR3T prefix).



MUSTANG BOSS 302 ALTERNATOR KIT

M-8600-M50BALT

This kit includes special high-performance components as used on the production 2012-2013 Mustang BOSS 302 and is designed to operate at higher rpm.

This kit fits Mustang 5.0L Coyote engine and features:

- High-performance BOSS Alternator with 1-way clutch to prevent belt hop-off during upshifts
- Higher tension belt tensioner
- Larger pulley to slow the armature speed, reduce drag and reduce parasitic hp loss
- Also fits M-6007-M50A, M-6007-M50AAUTO, M-6007-A50NAA, M-6007-A50SCA and M-6007-A50XS Ford Performance crate engines
- Kit includes OEM Mustang BOSS 302 alternator, tensioner, idler pulley, belt and mounting hardware



5.0L COYOTE AUTOMATIC TRANSMISSION FLEXPLATE BOLTS

M-6379-M50A

- Set of 8 one-time use torque-to-yield production flexplate bolts



5.0L COYOTE AUTOMATIC TRANSMISSION FLEXPLATE AND BOLTS

M-6375-A50C

- Production automatic transmission flexplate for the Mustang 5.0L Coyote with 6R80 transmission
- Includes 8 one-time use torque-to-yield flexplate to crankshaft bolts



HIGH-TORQUE MINI STARTER – COYOTE & MODULAR ENGINES

M-11000-C50

- Fits 5.0L Coyote, 4.6L, 5.4L and 5.8L modular RWD with automatic and manual transmissions
- Compact construction, great for header clearance
- Weighs approximately 6 lbs
- Comes with starter cables
- Must use diode protected fenderwell solenoid when used in non-production applications. Call the Ford Performance Techline at (800)367-3788 for more details



5.0L COYOTE HIGH RPM COMPETITION PULSE RING

M-12A227-CJ13

- Fits 2011-2017 5.0L Coyote engines
- Ignition pulse ring modified to support higher rpm engine builds
- Extends rpm range from 7700 to 8100 rpm
- Developed for the 2013 Cobra Jet program



FORD PERFORMANCE ENGINES

ELECTRIC WATER PUMP KIT FOR COYOTE 5.0L

M-8501-M50CJ16

- As used on 2016 Cobra Jet race car

Kit includes:

- Electric water pump
- Wiring pigtail for pump
- Block side outlet plate
- Requires custom hoses and mounting bracket for installation
- For off-road use only

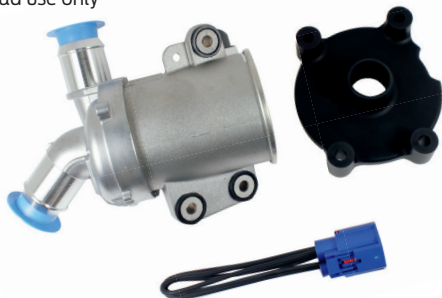

HIGH PERFORMANCE INTERCOOLER PUMP KIT – COBRA JET – GT500



M-8501-M58

- Ideal for high-performance supercharged applications using air-to-liquid intercooler
- Original equipment on 2016 Cobra Jet race car and 2013-2014 GT500
- Kit includes pump, wiring pigtail, mounting bracket and fasteners



2005-2014 MUSTANG PERFORMANCE COOLING FAN

M-8C607-MSVT

- Fits 2005-2014 Mustang GT and 2007-2014 Mustang Shelby GT500
- Original equipment cooling fan on 2013-2014 Mustang Shelby GT500
- Added cooling capacity for performance applications



BOSS 302R 5.0L POWER STEERING PUMP BRACKET

M-8511-M50BR

- Bracket allows power steering pump to be mounted to 2011-2017 5.0L Coyote engine
- Allows power steering pump from 2005-2010 Mustang GT to be used
- Power steering pump mounts in position of factory A/C compressor



MUSTANG SHELBY GT500 ELECTRIC WATER PUMP

M-8501-MSVT

- Production 2007-2012 Mustang Shelby GT500 intercooler coolant circulation pump
- Used to circulate water through supercharger intercooler and heat exchanger
- Inlet and outlet hose connection diameter is 19 mm/3/4"
- Can be used in many coolant pumping applications
- Includes rubber isolated mounting bracket



5.0L COYOTE AIR CONDITIONING KIT

M-8600-M50AC

This kit includes 2015 Mustang GT AC compressor, lines and drive belt for custom engine installations.

- Fits 2011-2017 5.0L 4V Ti-VCT Coyote engines and 2015-2017 Mustang GT
- Kit includes:
- A/C compressor
 - A/C compressor clutch/pulley
 - 5.0L FEAD belt
 - A/C high-pressure line
 - A/C low-pressure line
 - Fasteners



5.3L MODULAR STROKER SHORT BLOCK

M-6009-B53

Build BIG modular power. The Ford Performance 5.3L Modular Stroker short block is a great way to build modular power – from mild to wild – naturally aspirated or supercharged – 2-valve, 3-valve or 4-valve. Ford Performance engineers have taken care of the toughest part of building a new engine by designing a strong and durable short block that offers a wide range of power possibilities. Ford Performance uses only the best parts, starting with the BOSS modular block, and adding forged Eagle® steel crankshaft, forged Eagle® H-beam connecting rods with floating piston pins, and forged Mahle® pistons. Bored and stroked to 5.3 liters, this short block is precision internal balanced and ready to be finished to your specific application.

- Engine type: 4.6L based modular short block
- Displacement: 5.3L/323 cubic inches
- Bore x stroke: 3.701" bore x 3.750" stroke
- Block: Ford Performance M-6010-BOSS50 Cast Iron Performance Block
- Crankshaft: Eagle® 3.750" stroke forged steel crankshaft with 8-bolt flywheel pattern
- Connecting rods: Eagle® 5.850" forged steel H-beam rods with ARP® 2000 bolts
- Pistons: Mahle® forged aluminum pistons with a dish that is compatible with 2-, 3- or 4-valve heads
- New high-pressure oil pump
- Neutral balance rotating assembly
- Designed for 2-, 3- or 4-valve cylinder head combinations (piston-to-valve check required depending on camshaft)
- Assembled and ready for your heads, cam and timing set

NOTE: 2005-2010 Mustang 3V applications will need motor mount adapter Part No. M-6031-BOSS50.

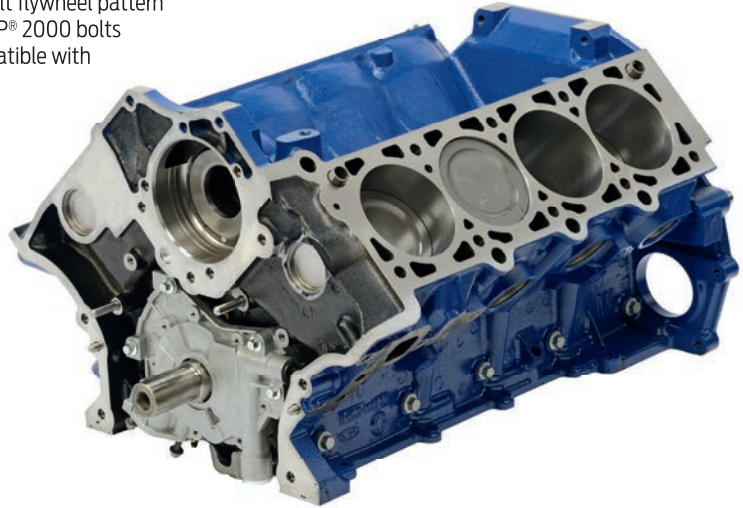

5.4L 4V FORGED IRON SHORT BLOCK SUPERCHARGED

M-6009-C54SC4

- Fits 2007-2010 Mustang Shelby GT500 and 1999-2004 F-150 Lightning
- 5.4L cast iron block
- Forged steel 8-bolt crankshaft
- Forged steel H-beam connecting rods
- Forged aluminum 16 cc dish pistons
- Approximately 8.1:1 compression ratio when used with Mustang SVT 4V 5.4L 52.7 cc heads
- Built with all NEW PARTS
- Includes oil pump
- Will accept 2V and 4V cylinder heads
- Will not work with 3-valve cylinder heads
- Block configured for use with 2007-2010 Mustang Shelby GT500 water pump

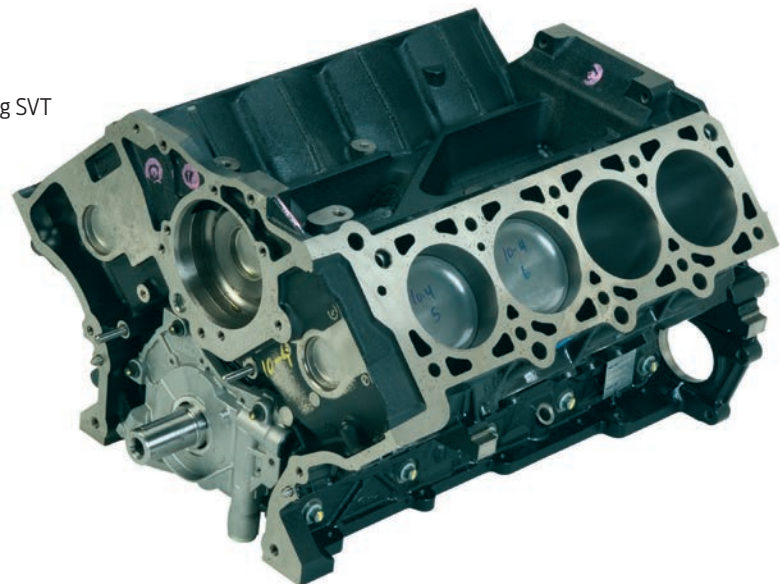

FORD PERFORMANCE ENGINES

5.4L PRODUCTION CAST IRON CYLINDER BLOCK

M-6010-M54

- Production 5.4L block
- Windsor-style main cap locators
- 90.2 mm bore size
- Newer casting design features lower-end improvements to minimize noise, vibration and harshness
- Fully machined, ready to assemble

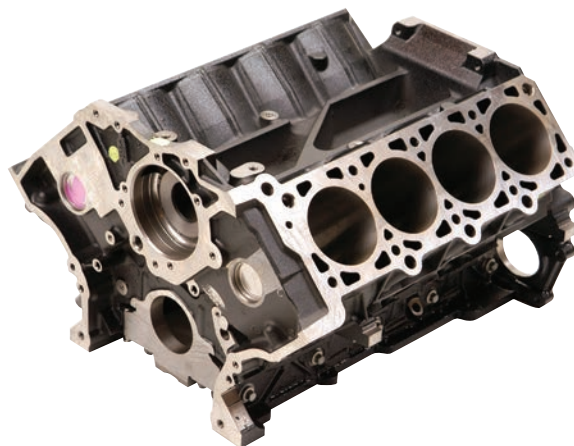

5.0L CAST IRON MODULAR BOSS CYLINDER BLOCK

M-6010-BOSS50

The BOSS 5.0 block is a 4.6L deck height, 94 mm cylinder bore cast iron block. The block uses a proprietary iron mix to yield the strongest possible casting strength with the least porosity and greatest consistency.

NOTE: The BOSS 5.0L modular block does not have a finish milled head deck surface and the cylinder bores are rough honed.

- Siamese 94 mm bore
- 17 mm main web minimal thickness
- 4-bolt main with interference fit nodular iron-machined caps
- Increased main web window size for improved crankcase breathing
- Head gaskets for 3V applications use M-6067-3V50; for all others, contact Cometic® Gasket
- For installation in 2005-2010 Mustang, use M-6031-BOSS50 Engine Mount Brackets
- Weighs approximately 165 lbs

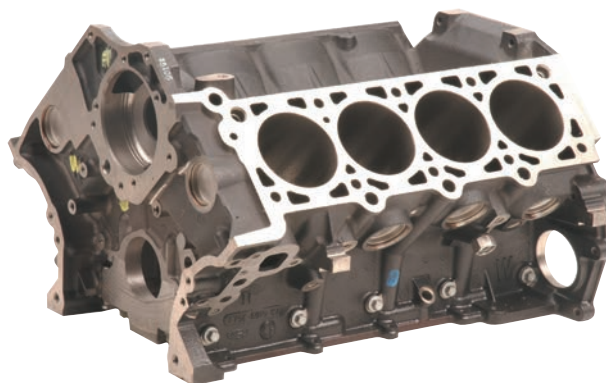

ENGINE MOUNT BRACKETS

M-6031-BOSS50

- Designed to install the M-6010-BOSS50 Block in a 2005-2010 Mustang

Kit includes:

- Aluminum engine mounting brackets
- Adapter plates
- Hardware



4.6 LITER ALUMINUM BLOCK PLUG AND DOWEL KIT

M-6026-A46

- Kit includes all necessary dowels, drain plugs and cup plugs for rebuilding production 4.6L aluminum block

Kit includes:

- 376099-S Plug Cup .075" – Qty 4
- 391186-S101 Threaded Drain Plug – Qty 2
- F75E-18B402-AA Water Heater Tube – Qty 1
- N806435-S Cup Plug – Qty 1
- N807198-SMOD Shortened Dowel N807198-S – Qty 2
- N808315-S Cup Plug (38.3 DIA) – Qty 1
- W701228-S Front/Rear Cover Dowels – Qty 4
- W704594-S300 Cylinder Head Dowels – Qty 4



4.6L 3V ALUMINUM BLOCK MAIN CAP BOLT KIT

M-6345-A46

- Fits 2005-2010 4.6L 3V aluminum cylinder blocks and M-6010-A46NA Ford Performance block

• Kit contains all main bolts for one block

Kit includes:

- M9 x 32 mm cross bolts – Qty 10
- M10 x 102.5 mm main cap inner w/stud bolts – Qty 10
- M8 x 80 mm main cap outer bolts – Qty 10
- M10 x 91 mm main cap inner bolts – Qty 6
- Bolts are torque-to-yield and must be replaced after each use



5.4L COBRA JET CRANKSHAFT

M-6303-C54SC4

- Service replacement part for the 2008 and 2010 Mustang Cobra Jet race car
- Original equipment for 2007-2012 Shelby GT500
- Fits most 5.4L blocks
- Forged steel
- 106 mm stroke
- Standard journal diameters
- 8-bolt flywheel
- Damper bolt hole counter bored to strengthen crank snout for supercharged applications
- Use Ford Part No. 4G7Z-6A340-AA Damper Bolt (3.400" long), Ford Part No. 7R3Z-6332-A Damper Bolt Washer and Ford Part No. 7R3Z-6378-A Diamond Coated Lock Washer between the damper and the timing gear



4.6L HIGH VOLUME OIL PUMP AND PICKUP TUBE

M-6600-D46

- Fits 1996-2004 Mustang 4.6L 2V
- Stock replacement oil pump and pickup tube for 1996-2004 Mustang SVT 4.6L 4V
- Increases flow on 4.6L 2V engines

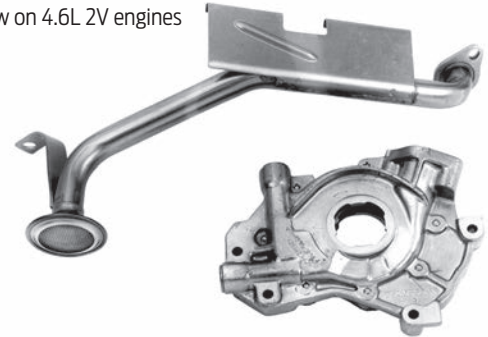

2008 MUSTANG SVT CRANKSHAFT DAMPER

M-6312-SVT

- New factory replacement damper from the 2008 Mustang SVT GT500 5.4L 4V V8 engine
- 10 lbs lighter than the 2007 factory SVT crankshaft damper
- Recommended on the 2007 Mustang SVT when using Ford Performance M-6066-SGT Supercharger



PLUG AND DOWEL KIT

M-6026-CI46

- Kit includes all necessary dowels, drain plugs and cup plugs for rebuilding M-6010-BOSS50 and M-6010-D46 Block
- 391186-S101 Threaded Drain Plug – Qty 2
- F75E-18B402-AA Water Heater Tube – Qty 1
- N806040-S Solid Dowels – Qty 2
- N806435-S Cup Plug – Qty 2
- N807198-SMOD Shortened Dowel N807198-S – Qty 2
- N807198-S Transmission Dowel – Qty 1
- N808315-S Cup Plug (38.3 DIA) – Qty 10
- W701228-S Front/Rear Cover Dowels – Qty 4
- W704594-S300 Cylinder Head Dowels – Qty 4



FORD PERFORMANCE ENGINES

4.6L/5.4L/5.8L HIGH-VOLUME OIL PUMP W/PICKUP

M-6600-F46

- Fits 2005-2010 4.6L 3V Mustang, 2007-2012 5.4L 4V Shelby GT500, 2013-2014 5.8L 4V Shelby GT500
- Stock replacement for 2013-2014 5.8L 4V Shelby GT500
- Recommended for applications requiring higher volume and pressure
- Includes a steel backing plate:
 - Reduce internal leakage
 - Reduce cavitation erosion
- Includes pickup tube

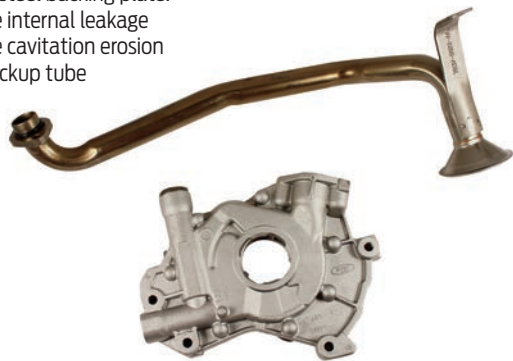

4.6L 3V CAMSHAFT DRIVE KIT

M-6004-463V

Camshaft drive kit for the 4.6L 3V aluminum and iron block.

- Fits 2005-2010 engines
- Kit includes new production:
- Tensioner arms
 - Chain guides
 - Cover gaskets and front seal
 - Primary timing chains
 - Primary chain tensioners
 - Camshaft sprockets, spacers, bolts and washers
 - Crankshaft sprocket
 - Crank position trigger wheel
 - Includes fasteners



4.6L 4V CAMSHAFT DRIVE KIT

M-6004-A464

Camshaft drive kit for the 4.6L 4-valve aluminum block.

- Fits 1996-2004 4.6L 4V engines
- Will not fit 1993-1998 camshafts

- Kit includes new production:
- Tensioner arms
 - Chain guides
 - Front cover gaskets and front main seal
 - Primary and secondary timing chains
 - Primary and secondary timing chain tensioners
 - Camshaft sprockets, spacers, bolts and washers
 - Crankshaft sprocket
 - Crank position trigger wheel
 - Includes fasteners



4.6L 2V CAMSHAFT DRIVE KIT

M-6004-462V

Camshaft drive kit for the 4.6L 2-valve aluminum or cast iron block.

- Fits 2001 and newer 4.6L 2V engines
- Will fit earlier 2V engines (1991-2000), requires RH chain guide dowel pin hole to be drilled and tapped for a reducing thread insert with 6M x 1.00 internal threads

Kit includes new production:

- Tensioner arms
- Chain guides
- Cover gaskets and front seal
- Primary timing chains
- Chain tensioners
- Camshaft sprockets, spacers, bolts and washers
- Crankshaft sprocket
- Crank position trigger wheel
- Includes fasteners



5.4L 4V MUSTANG SVT CAMSHAFT DRIVE KIT

M-6004-54SVT

Camshaft drive kit for the Mustang SVT 5.4L 4-valve engine with an aluminum or cast iron block.

- Fits: 2007-2013 5.4L 4V Shelby GT500
- Includes reduced diameter camshaft sprockets used on Shelby GT500

Kit includes new production:

- Tensioner arms
- Chain guides
- Front cover gaskets and front main seal
- Primary and secondary timing chains
- Primary and secondary timing chain tensioners
- Camshaft sprockets, spacers, bolts and washers
- Crankshaft sprocket and diamond-coated washer
- Crank position trigger wheel
- Includes fasteners



5.4L 4V CAMSHAFT DRIVE KIT

M-6004-A544

Camshaft drive kit for the 5.4L 4V. Standard equipment on Ford GT 5.4L 4V engine. Recommended for high horsepower and/or high rpm applications.

- Fits both 5.4L 4V aluminum and cast iron block engines
- Larger diameter cam gears not compatible with Shelby GT500 cam covers

Kit includes new production:

- Tensioner arms
- Chain guides
- Primary and secondary timing chains
- Primary and secondary composite timing chain tensioners
- Camshaft sprockets, spacers, bolts and washers
- Crankshaft sprocket and diamond-coated washer
- Crank position trigger wheel
- Includes fasteners



4.6L 2V SOHC HEAD CHANGING KIT

M-6067-D46

- Contains all components necessary for changing cylinder heads on 1996-2004 Mustang 4.6L 2V SOHC engine (may fit other make and model years 4.6L 2V SOHC engines)
- Kit includes multilayer steel head gaskets, exhaust manifold gaskets and high-strength torque-to-yield head bolts
- Includes spacers that make this task significantly easier to remove and replace heads while on the car
- Highly recommended when installing M-6049-P46 and M-6050-P46 cylinder heads



4.6L 4V HEAD CHANGING KIT

M-6067-T46

- Contains all components necessary for changing cylinder heads on 1996-2004 4.6L 4V Mustang naturally aspirated engines (not supercharged)
- Kit includes multilayer steel head gaskets and high-strength torque-to-yield head bolts
- Includes spacers that make this task significantly easier to remove and replace heads while on the car
- Highly recommended when installing heads on 4.6L 4V



5.4L 4V S/C HEAD CHANGING KIT

M-6067-MSVT

- Fits 5.4L DOHC engines
- Original equipment on 2007-2011 Mustang SVT and 2008 Mustang FR500CJ race car
- Improved sealing for high cylinder pressure applications
- Kit includes multilayer steel head gaskets and high-strength torque-to-yield head bolts

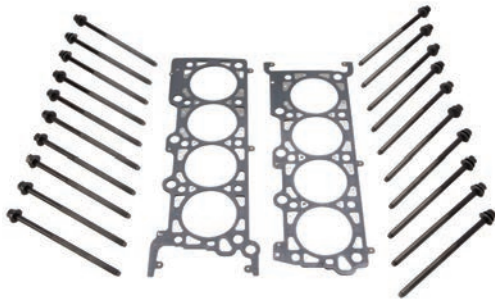

5.0L 3V HEAD CHANGING KIT

M-6067-3V50

- Fits M-6010-BOSS50 5.0L modular engine block with 94 mm bore and 3V cylinder heads
- Kit includes multilayer steel head gaskets and high-strength torque-to-yield head bolts



4.6L 3V HEAD CHANGING KIT

M-6067-3V46

- Fits 4.6L 3V modular engine with standard 90.2 mm bore
- Highly recommended when installing M-6049-N3VPA and M-6050-N3VPA CNC ported cylinder heads and M-6049-N3V and M-6050-N3V production cylinder heads
- Kit includes multilayer steel head gaskets and high-strength torque-to-yield cylinder head bolts



5.8L 4V S/C HEAD CHANGING KIT

M-6067-M58

- Fits 2013 Mustang Shelby GT500 5.8L 4V engine
- Kit includes multilayer steel head gasket and torque-to-yield head bolts
- Improved sealing for high cylinder pressure applications

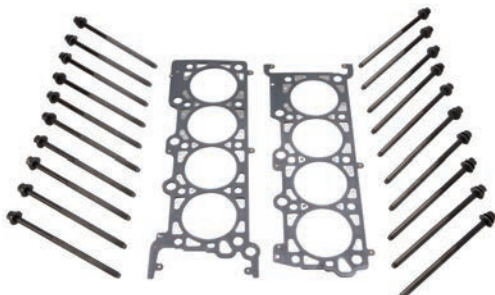

FORD PERFORMANCE ENGINES

2005-2010 MUSTANG GT HIGH LIFT HOT ROD CAM SET

M-6550-3V

- Give any 3-valve 4.6L or 5.4L a "loppy" idle reminiscent of 1960s muscle cars!
- Engineered for naturally aspirated and supercharged applications
- Excellent upgrade for the 2005-2010 Mustang GT 4.6L 3V engine
- Increases lift from the stock 11 mm/0.433" to 12 mm/0.472"
- Intake/exhaust duration of 221°/240° (@ 0.050" lift), lobe separation of 110°
- Compatible with production valve springs, followers and lash adjusters up to 6800 rpm
- Must be used with long tube headers to achieve a significant power gain
- M-9424-463V 4.6L High-flow Intake and M-9926-3V Throttle Body recommended
- Works well with Ford Performance M-9926-3V 62 mm Throttle Body, M-9424-463V 4.6L High-flow Intake and ported cylinder heads
- Approximately 50 hp gain with the stock intake manifold and Ford Performance M-6049-N3VOA/M-6050-N3VPA CNC heads at 6500 rpm. These cylinder heads are for reference only, and no longer produced by Ford Performance
- **Custom Calibration required! Calibration not included!** Recommended WOT cam timing values included in instructions



FORD GT AND MUSTANG SVT 5.4L LASH ADJUSTERS

M-6500-GT

- Unique lash adjusters fit Ford GT and Mustang SVT 5.4L DOHC cylinder heads
- Includes 16 intake and 16 exhaust lash adjusters



4.6L 3V CAMSHAFT BOLT

M-6279-463V

- Fits 2005-2010 4.6L 3V engines
- Kit includes two (2) bolts
- Torque-to-yield design
- Torque information: Stage 1: Tighten to 40 Nm (30 lb-ft). Stage 2: Tighten an additional 90°



5.4L 4V STEEL TIMING CHAIN TENSIONER KIT

M-6266-54ST



- Fits 5.4L 4V engines
- Production steel primary right and left timing chain tensioners
- Includes Part No. F6AZ-6L266-DA and F6AZ-6L266-CA (1 of each Part No.)
- 1 kit required per engine



MUSTANG SVT 5.4L MODULAR ROCKER ARM SET

M-6529-MSVT

- Original equipment on Ford GT 5.4L engine
- Recommended upgrade for all years 4.6L/5.4L, 4V and 2V engines
- 4 grams lighter, stiffer, and better engagement on lash adjuster over 4.6L DOHC rocker arms
- Lightest and strongest modular finger follower available for modular 4.6L/5.4L, 4V and 2V engines
- Sold in a set of 16



MODULAR 3V ROCKER ARM AND LASH ADJUSTER KIT

M-6529-3V

- Fits 4.6L 3V cylinder heads
- Original production part as used on 2005-2010 Mustang GT
- Sold in engine sets (24 rocker arms and 24 lash adjusters)



4.6L 3V PERFORMANCE INTAKE MANIFOLD

M-9424-463V

- Fits 2005-2010 4.6L 3V Mustang engines
- Works well with Ford Performance M-6550-3V Hot Rod Camshafts, M-6049-N3VPA High-Performance CNC-Ported 3V Cylinder Heads and Ford Performance M-9926-3V 62 mm Throttle Body
- Lightweight composite construction (same material as OE intake manifold)
- Manifold works well with forced induction
- Designed and tested to 20+ psi
- Less heat soak than aluminum intakes
- High-flow runners and open plenum design, fits under factory Mustang hood
- MAP sensor mounting boss for speed-density applications
- Includes intake manifold gaskets
- **Calibration required! Calibration not included!**
- Does not fit with Ford Performance strut tower braces

NOTE: Throttle body not included.



4.6L PERFORMANCE IMPROVEMENT (PI) INTAKE MANIFOLD

M-9424-P46

- Production composite intake manifold used on 2001-2004 4.6L SOHC 2V Mustang GT
- Manifold fits 1999-2004 performance improvement (PI) head ports
- For off-road use only; can be used on 1996-1998 engines with performance improvement (PI) heads, custom calibration required
- Additional modifications and parts required
- Requires 4C3Z-9439-CA Intake Gasket Set available from your local Ford dealer



1996-2010 MUSTANG A/C ELIMINATOR KIT

M-19216-D46

- Fits 1996-2010 Mustang with 4.6L engine SOHC/DOHC
- Cast aluminum idler pulley bracket replaces the air conditioning compressor
- Removes weight from the front of car for better weight distribution for racing
- Bolts included
- Uses stock belt
- For 1994-1995 Mustang and 1991-1993 Thunderbird with 5.0L engine, see M-19216-A50

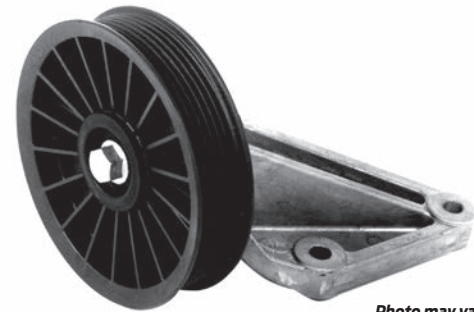
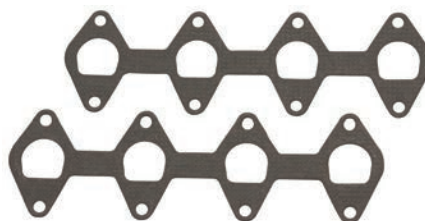
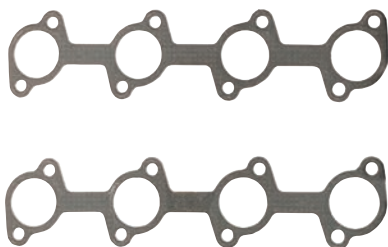

Photo may vary

EXHAUST MANIFOLD GASKETS RACE QUALITY (SOLD IN PAIRS)

| PART NUMBER | CYLINDER HEAD APPLICATION |
|---------------------|---------------------------|
| M-9448-A462 | 4.6L SOHC |
| M-9448-A463V | 4.6L/5.4L 3V |
| M-9448-A464 | 4.6L DOHC |



FORD PERFORMANCE ENGINES

9 MM SPARK PLUG WIRE SETS – “FORD RACING”

Wire-wound custom ignition wire sets feature low resistance for minimum spark loss. Silicone insulation and boots withstand high temperatures and voltage loss for minimum cross-fire and are highly resistant to fuels, oils and solvents. Long-life, tough stainless steel terminals for post-type distributor caps. Includes coil wire for socket-type coil and “Ford Racing” identification. Cylinder number appears on each wire.

Spark plug wires feature high-quality 9 mm wire available in two colors: blue and red.

| PART NUMBER | APPLICATION | WIRE COLOR | END CONFIG. |
|---------------------|---------------------|------------|---------------|
| M-12259-C462 | 4.6L 2V Mustang | Blue | 45° Long Boot |
| M-12259-C464 | 4.6L 4V Mustang | Blue | 45° Long Boot |
| M-12259-R462 | 4.6L 2V Mustang | Red | 45° Long Boot |
| M-12259-R464 | 4.6L 4V Mustang | Red | 45° Long Boot |
| M-12259-T462 | 4.6L 2V F-150 Truck | Blue | 45° Long Boot |



M-12259-C462/Mustang 4.6L SOHC 9 mm Wire Set



M-12259-R462/Mustang 4.6L SOHC 9 mm Wire Set



2007-2014 MUSTANG SVT 4V IGNITION COIL SET

M-12029-4V

- Fits 2007-2012 Shelby GT500 5.4L DOHC and 2013-2014 Shelby GT500 5.8L DOHC
- One engine set of stock replacement coils



FPP 3V COLD SPARK PLUG SET (12 MM THREAD)

M-12405-3V12MM

- Fits 2008 and newer 3V heads requiring the 12 mm thread
- For use in engines with higher than stock cylinder combustion pressures or sustained high rpm
- One heat range colder than the stock Mustang GT and 5.4L truck engine spark plugs
- Sold in engine sets of 8
- Use M-12405-3V0 Spark Plugs for early-style 2005-2008 3V heads

NOTES:

- 2008 engines with late-style 12 mm spark plugs can be identified by coil engineering number 8L3E.
- 2005-2008 engines with early-style 16 mm "High Thread" design spark plugs can be identified by coil engineering number 3L3E.
- All 2009-2010 engines use 12 mm spark plugs.



4.6L/5.4L 3V IGNITION COIL SET

M-12029-3V

- Fits Mustang 4.6L and 5.4L 3V engines with 12 mm spark plugs. Does not fit 3V heads with "High Thread" design spark plugs
- Direct replacement for 4.6L and 5.4L 3V engines equipped with 8L3E coils
- Required when installing Ford Performance heads M-6049-463VP3, M-6049-N3V, M-6049-N3VPA and M-6050-463VP3, M-6050-N3V, M-6050-N3VPA on 2005-2007 and early 2008 Mustang GT originally equipped with "High Thread" design heads
- Engines with late-style 12 mm spark plugs can be identified by coil engineering number 8L3E. Engines with early-style 16 mm "High Thread" design spark plugs can be identified by coil engineering number 3L3E.
- One engine set of stock replacement coils.



FPP 3V COLD SPARK PLUG (16 MM THREAD)

M-12405-3V0

- Fits 2005-2008 3V heads requiring the 16 mm thread
- For use in engines with higher than stock cylinder combustion pressures or sustained high rpm
- Unique design is proprietary to Ford 3-valve engines
- One heat range colder than the stock Mustang GT plug
- Two heat ranges colder than the stock 5.4L 3V truck engine plug
- Sold in engine sets of 8
- Use M-12405-3V12MM spark plugs for 2008 and newer 3V heads

NOTES:

- 2008 engines with late-style 12 mm spark plugs can be identified by coil engineering number 8L3E.
- 2005-2008 engines with early-style 16 mm "High Thread" design spark plugs can be identified by coil engineering number 3L3E.
- All 2009-2010 engines use 12 mm spark plugs.



FORD PERFORMANCE ENGINES

4.6L/5.4L 4V "FORD RACING" CAST COIL COVERS

M-6067-D

- Fits most 4.6L/5.4L DOHC engines with coil-on-plug ignition
- Polished die-cast aluminum
- Features two-color "Ford Racing" logo



2007-2014 MUSTANG SVT COIL COVERS

M-6067-C

- Original equipment on the 2007-2014 Mustang SVT
- Fits most 4.6L/5.4L/5.8L DOHC engines with coil-on-plug ignition

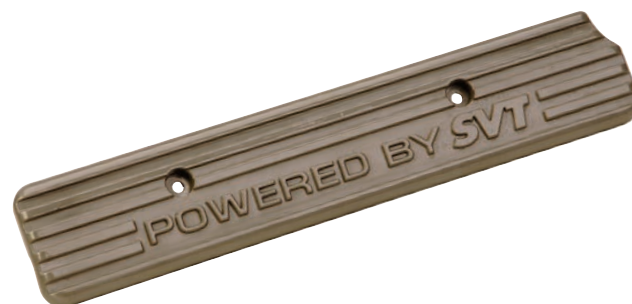

"FORD RACING" COATED 3-VALVE CAM COVERS

M-6582-FR3VBL Blue Powdercoated Finish

M-6582-FR3VBLK Black Powdercoated Finish

- Fits 2005-2010 3-valve 4.6L/5.4L engines
- Die-cast
- Powdercoat finish
- Laser-etched "Ford Racing" logo
- Includes cam cover gaskets, VCT solenoid grommet and fasteners
- 50-state street legal when installed with appropriate closed PCV hardware



2005-2010 MUSTANG GT INTAKE SHROUD

M-6949-3V

- Original equipment on 2007-2010 Mustang GT
- Fits 2005-2010 Mustang GT
- May require 2007 Mustang throttle body studs (W712289 S437) and nuts (W520411 S437) from Ford dealer
- Will not fit with Ford Performance M-20201-S197 Strut Tower Brace or with Ford Performance superchargers





2.0L I-4 ECOBOOST® CRATE ENGINE KIT

M-6007-20T*

- Engine from 2013-2014 Ford Focus ST
- Production rating of 252 hp @ 5500 rpm
- Production rating of 270 lb-ft of torque @ 3000 rpm
- When used with M-6017-20T Engine Control Pack and 93 octane unleaded fuel, torque is increased 90 lb-ft at 2800 rpm – with a significant increase up to 4200 rpm. See the power curve for M-6017-20T
- All-aluminum construction – about 55 pounds lighter than a comparable naturally aspirated V6 engine
- 9.3:1 compression ratio – Premium fuel recommended
- Ti-VCT strategy employs twin independent variable camshaft timing for optimized fuel economy, performance and emissions
- Borg-Warner® turbocharger with low-inertia rotor spins at speeds up to 195,000 rpm, producing up to 16 psi of boost
 - Optimized design ensures that maximum torque is achieved at very low engine revs
 - Peak torque available from 2000 to 4500 rpm
- Direct-injection high-pressure fuel system
 - Seven jets on each injector spray fuel directly into the combustion chamber
- Engine design has been optimized for maximum operating efficiency, with a focus on minimizing friction and other parasitic losses
 - Low-friction coatings on the piston rings and highly polished surfaces on the tappets
- M-6017-20T Control Pack available for custom vehicle builds
- The weight of the engine only is approximately 300 lbs

Kit includes:

- Starter
- Alternator
- Front accessory drive and belt
- Intercooler and air intake ducting
- Air cleaner assembly
- Manual transmission flexplate/flywheel



CONTROL PACK – FOCUS ST 2.0L ECOBOOST® MANUAL TRANSMISSION

M-6017-20T

Looking to add 2.0L EcoBoost® power from the Focus ST to your custom built vehicle? Take the complexity and mystery out of wiring a M-6007-20T 2.0L EcoBoost® Engine!

- Designed to run the M-6007-20T Focus ST crate engine with a manual transmission
- Unique control pack harness replaces stock body harness and is designed for custom built vehicle. Harness includes OBD-II diagnostic port to assist in vehicle calibration upload and problem diagnosis
- Includes PCM with Ford Performance high-performance calibration
- Includes electronic throttle control accelerator pedal, eliminating throttle cable routing problems
- Includes power distribution module and oxygen sensor
- Includes M-12405-20T Cold Spark Plug Set required for performance calibration
- 2.0L EcoBoost® crate engine includes intercooler, air intake ducting and air cleaner assembly required to complete control kit installation
- PCM with Ford Performance calibration requires return-type fuel system; will not work with returnless fuel system

NOTE: Installation of this PCM in a Focus ST will result in a no-start condition.

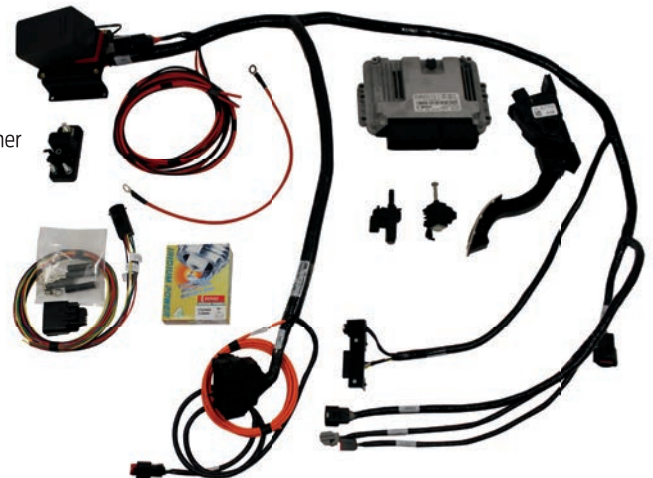

*This component is eligible for the Ford Performance Parts Limited Warranty. See the Ford Performance Parts Limited Warranty on pages 295-302 for details.

FORD PERFORMANCE ENGINES

2.0L FOCUS ST ECOBOOST® ENGINE ORIENTATION KIT

M-6006-20

- 2.0L Focus ST engine orientation change kit
- Includes all the necessary components to mount the 2.0L Focus ST engine in a north/south or longitudinal orientation
- High-flow intake manifold, water outlet components and seals, oil pan and oil pickup tube, PCV components, all necessary unique fasteners
- Intake manifold requires small modification to mount 2.0L Focus ST throttle body

Kit includes:

- 3M4G-6625-AA Oil Pickup Tube O-ring
- BR2E-6K258-BA Main Bearing Cap Stud Bolt
- FR3E-6622-CA Oil Pickup Tube
- FR3E-6675-AF Oil Pan
- FR3E-6750-BA Oil Dipstick
- FR3E-6A785-BB Oil Separator
- FR3E-6K817-BA PCV Tube
- FR3E-8255-AA Water Outlet Gasket
- FR3E-8594-CD Coolant Connector
- FR3E-8K556-BA Water Outlet
- FR3E-9424-JA Intake Manifold
- W500014-S437 Oil Pickup Tube Fastener
- W701219-S437 Oil Pickup Tube Fastener
- W702757-S437 Oil Pickup Tube Fastener
- W715723-S437 Coolant Connector Fastener



2.0L ECOBOOST® HEAD INDIVIDUAL PORT

M-6049-20EBIP

- Cylinder head for the 2.0L EcoBoost® engine as used in the European market
- Features individual exhaust ports
- Intended for higher horsepower custom engine builds
- Head comes assembled with valves and springs
- Intake valve size: 32.5 mm
- Exhaust valve size: 28 mm (2.3L = 30 mm)
- Combustion chamber size: 42.2 cc nominal
- No camshaft or roller followers included
- Production intake from all 2.0L and 2.3L engines will fit
- Requires custom exhaust manifold
- Designed with direct injection fuel system features
- Uses 2.0L EU AG9Z-6051-A Head Gasket
- Oil drainback passage modifications are necessary to use this head on the 2.3L Mustang EcoBoost® block. Contact Ford Performance Techline for instructions



2013-2018 FOCUS ST/RS/MUSTANG ECOBOOST® COLD SPARK PLUG SET

M-12405-20T

- Fits 2013-2018 Focus ST 2.0L 4 cylinder EcoBoost® engine
- Fits 2016-2018 Focus RS 2.3 4 cylinder EcoBoost® engine
- Fits 2015-2018 Mustang 4 cylinder EcoBoost® engine
- For use in engines with higher than stock cylinder combustion pressures
- Two heat ranges colder than the stock 2.0L/2.3L EcoBoost® engine spark plug
- Same spark plugs that are included with M-9603A-FST Performance Calibration Kit
- Sold in engine sets of 4
- Spark plugs gapped to 0.028" (0.71 mm)



2.3L MUSTANG ECOBOOST® CRATE ENGINE KIT M-6007-23T

Ford Performance Parts offers the high tech Mustang 2.3L EcoBoost® turbocharged engine as a crate engine kit. The swap possibilities are endless – from early street rods, kit cars and most generations of Mustang to just about any other vehicle build. The Ford Performance M-6017-23T Control Pack helps make for an easy plug-and-play installation.

- 2.3L EcoBoost® engine as used in the 2015-2017 Mustang
- 310 hp/320 lb-ft torque (with 93 octane fuel)
- Designed for traditional rear drive installations
- Includes production turbocharger and engine wiring harness

Kit includes:

- Starter and mounting hardware
- Alternator and mounting hardware
- Uses M-6017-23T Control Pack



2.3L ECOBOOST® ENGINE CONTROL PACK M-6017-23T

- Includes bodyside harness, PCM and sensors necessary to run a 2.3L EcoBoost® engine in most applications
- Recommended for use with M-6007-23T Crate Engine
- Requires return-style fuel system
- Retains factory technology, such as electronic throttle, variable cam timing and turbo boost control

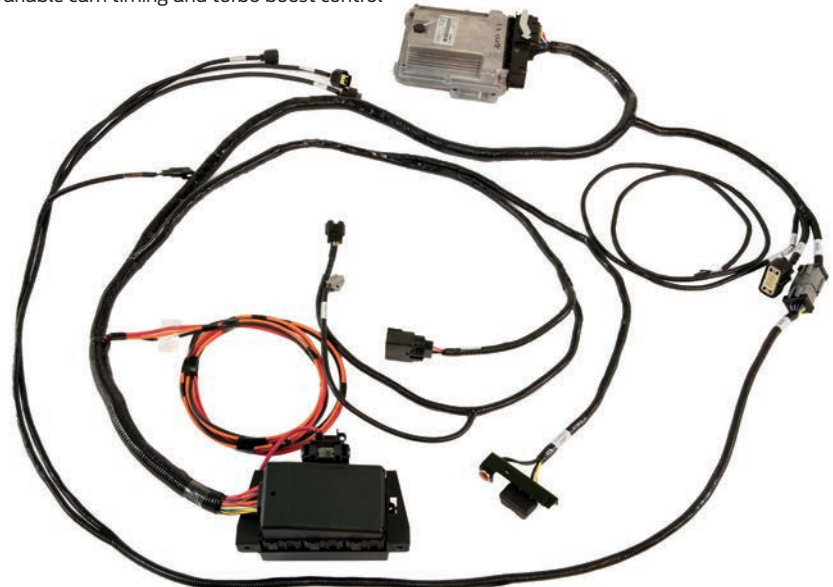

FORD PERFORMANCE ENGINES

2.3L ECOBOOST® MUSTANG CYLINDER BLOCK

M-6010-23T

- Production Mustang 2.3L EcoBoost® cylinder block
- Includes plugs, dowels and other production hardware for buildup
- Also available for an EcoBoost® engine build are:
 - M-6303-23EB 2.3L EcoBoost® Crankshaft
 - M-6049-M23 2.3L Mustang EcoBoost® Cylinder Head



2015-2017 MUSTANG 2.3L ECOBOOST® CYLINDER HEAD

M-6049-M23

- Fits 2015-2017 Mustang EcoBoost® engines
- This is the production IEP (integrated exhaust port) cylinder head
- Includes water jacket plugs and valve seals
- Does not include valves, valve springs, retainers, lifters or followers

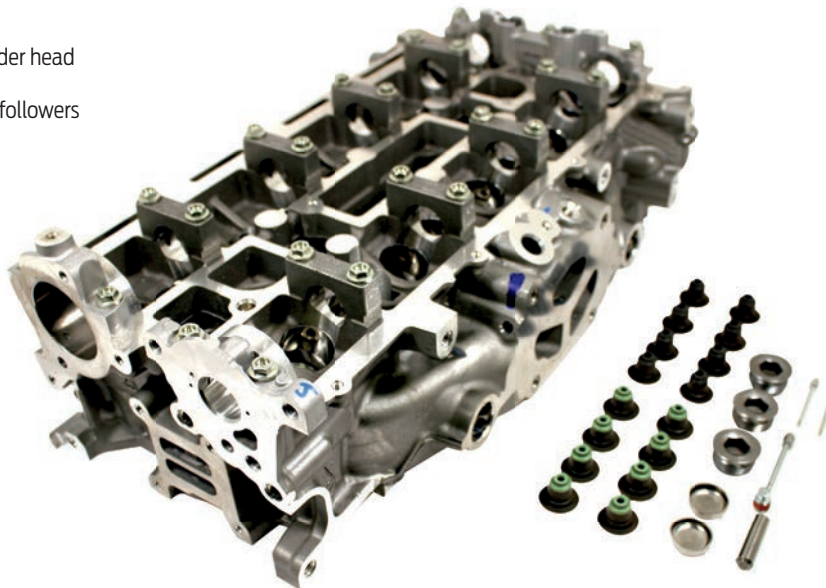

2.3L ECOBOOST® CRANKSHAFT

M-6303-23EB

- Production crankshaft as used in the 2.3L EcoBoost® Mustang
- Forged steel construction ready for installation
- Also available for an EcoBoost® engine build are:
 - M-6010-23EB 2.3L EcoBoost® Cylinder Block
 - M-6049-M23 2.3L Mustang EcoBoost® Cylinder Head



2.3L ECOBOOST® HIGH-PERFORMANCE CAMS

M-6250-23EBH

- Fits 2015 Mustang 2.3L EcoBoost® engines
- These cams provide more lift and duration
- Intake cam lift increased from 7.9 mm to 9.0 mm and duration increased 4° to 240° (total degrees)
- Exhaust cam lift increased from 7.4 mm to 7.8 mm and duration increased 16° to 240° (total degrees)
- Cams will work with stock pistons
- No valve spring change is required



2.3L ECOBOOST® BALANCE SHAFT BLOCK-OFF PLUG

M-6026-23BSBP

- Fits 2.0L and 2.3L EcoBoost® engines
- Allows for removal of the balance shaft
- 20 lb decrease in rotating mass in the engine
- Increases oil volume to the upper end of the engine



NEW

FORD PERFORMANCE ENGINES

3.5L V6 ECOBOOST® CRATE ENGINE KIT

M-6007-35T*

- 365 hp @ 5000 rpm
- 420 lb-ft of torque @ 2500 rpm
- All-aluminum construction
- 10.0:1 compression ratio
- Dual overhead camshafts with variable camshaft timing
- High-pressure direct fuel injection
- Regular unleaded fuel recommended
- Lightweight die-cast aluminum block with six-bolt press-fit main bearing caps with piston-cooling jets
- Fully counterweighted forged steel crankshaft
- High-strength forged powder metal connecting rods with floating pins
- Lightweight aluminum high-strength pistons with low-friction skirt coating
- Tuned composite upper and lower intake manifold
- 6 qt die-cast aluminum deep sump oil pan
- Engine weight is 417 lbs (without accessory drive)
- Use Ford Performance M-6017-35CNTRL Control Pack, which includes PCM and installation kit designed for street rod/project car installation

Kit includes:

- Starter
- Alternator
- Front accessory drive and belt
- Air cleaner assembly and ducting
- Flexplate/flywheel



CONTROL PACK – 2013-2016 3.5L ECOBOOST® MANUAL TRANSMISSION

M-6017-35CNTRL

Wiring and engine controller for 3.5L EcoBoost® with manual transmission.

- Designed to run the M-6007-35T Crate Engine
- Includes PCM with Ford Performance calibration
- Includes Electronic Throttle Control accelerator pedal, which eliminates throttle cable routing problems
- Unique control pack harness replaces stock body harness and is designed for custom vehicle builds
- Features OBD-II diagnostic port to assist in vehicle calibration upload and problem diagnosis
- Includes power distribution module, air-box, inlet tube, and HEGO sensors
- PCM with Ford Performance calibration requires return-type fuel system, will not work with returnless fuel system
- Visit performance.ford.com for detailed installation instructions and bill of materials

NOTE: Installation of this PCM in any originally equipped 3.5L EcoBoost® vehicle will result in a no-start condition.

NOTE: This will work on 2013-2016 F150 3.5L engines.

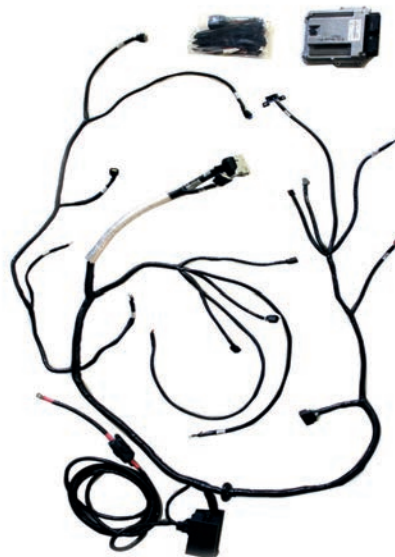

*This component is eligible for the Ford Performance Parts Limited Warranty. See the Ford Performance Parts Limited Warranty on pages 295-302 for details.

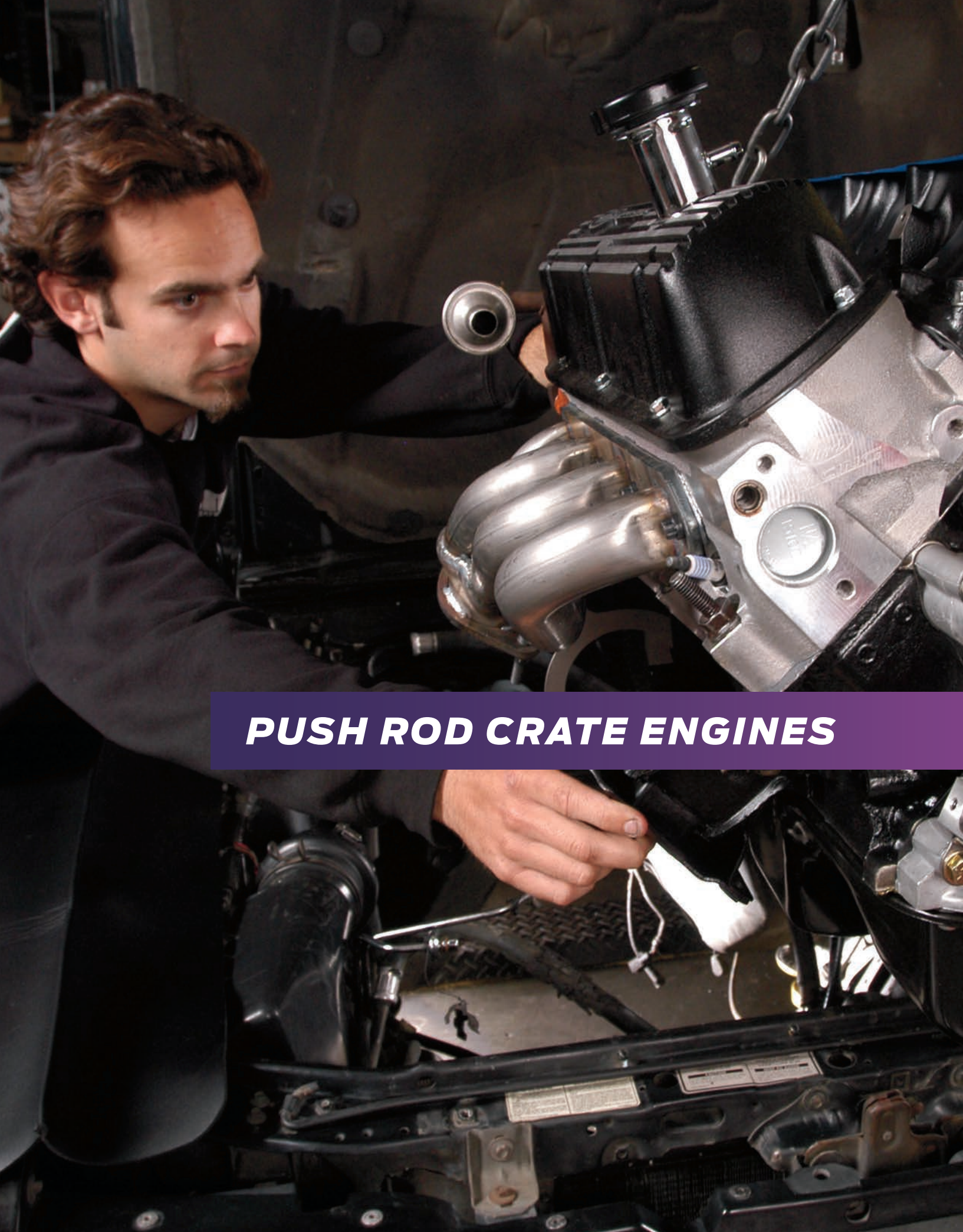

PUSH ROD CRATE ENGINES

FORD PERFORMANCE ENGINES

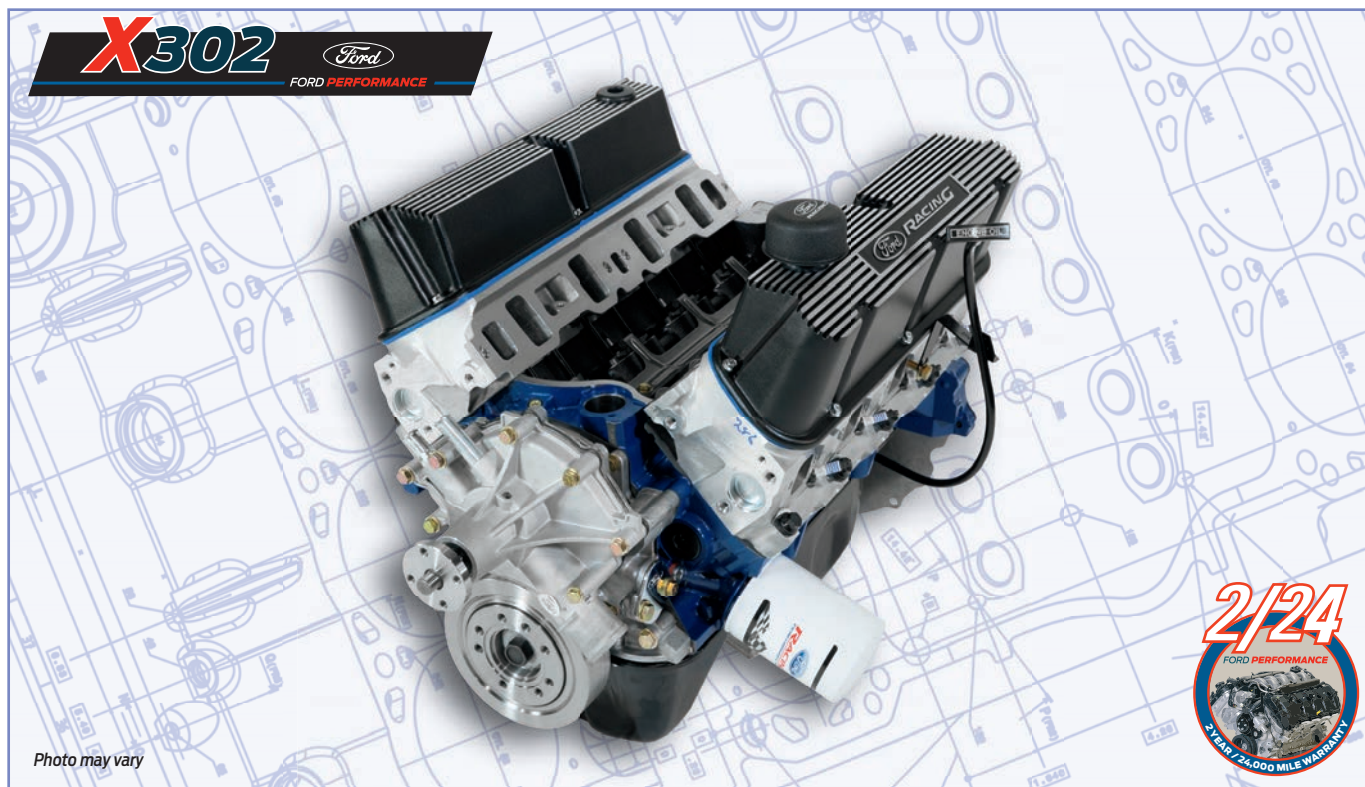

Photo may vary

302 CUBIC INCH BOSS CRATE ENGINE

M-6007-X302B* 345 hp – B303 Camshaft – Manual Transmission

M-6007-X302E* 340 hp – E303 Camshaft – Auto or Manual Transmission

- New BOSS 302 crate engines feature race quality components at competitive pricing
- Utilizing all forged internals, the X302B and X302E crate engines are an excellent value and a solid foundation for any performance combination, including forced induction
- 302 cubic inches
- 345 hp
- 9.0:1 compression ratio (nominal)
- Forged pistons
- Forged steel connecting rods
- BOSS M-6010-BOSS302 4-Bolt Main Block
- M-6268-A302 Double Roller Timing Chain Set
- Forged steel crankshaft
- Rear sump pan fits most Fox body cars
- Ford Performance aluminum GT-40 M-6049-X306 Cylinder Heads with 1.94" intake valves and 1.54" exhaust valves
- M-6564-B351 Roller Rocker Arms – 1.60:1 ratio
- Includes M-6375-D302B Steel Flywheel
- Does not include intake manifold or distributor (MSD Part No. 8598 recommended)
- Built with all NEW parts
- Can be used in kit cars, street rods, Mustang, Fox-bodied cars, and trucks

INSTALLATION NOTES: Some or all of the following items may need to be changed from your original engine or modified for proper installation:

- Depending on your application, a different timing cover, water pump, oil pan and pickup may be required.
- Engine has a rear sump oil pan and pickup, standard rotation timing cover, reverse rotation water pump and non-EFI valve covers.
- Timing cover will work with most standard rotation water pumps.
- M-6287-B302 Fuel Pump Eccentric installed, allows use of mechanical fuel pump.
- A reverse rotation water pump is installed. Other applications may require different water pump and timing chain cover.
- M-6582-W351PR Valve Covers should fit most non-EFI applications. Optional valve covers sold separately.
- M-6316-D302 Damper may require a spacer for pulley alignment.
- M-6375-D302B Flywheel included; will work for most 157-tooth manual transmission applications. For other transmissions use the proper neutral balance.
- Intake manifold not included.
- Includes M-9439-A50 Intake Gaskets as well as pilot bearing.
- Firing order 1-3-7-2-6-5-4-8 (5.0L HO and 351W firing order).
- Steel distributor gear required.
- Shipping weight approximately 525 lbs.
- Built with current available parts. Photo and specs may vary.
- Engine installation tuning tips at performanceparts.ford.com.

See Also...

- Crate Engine Warranty – Pages 295-297

*This component is eligible for the Ford Performance Parts Limited Warranty. See the Ford Performance Parts Limited Warranty on pages 295-302 for details.

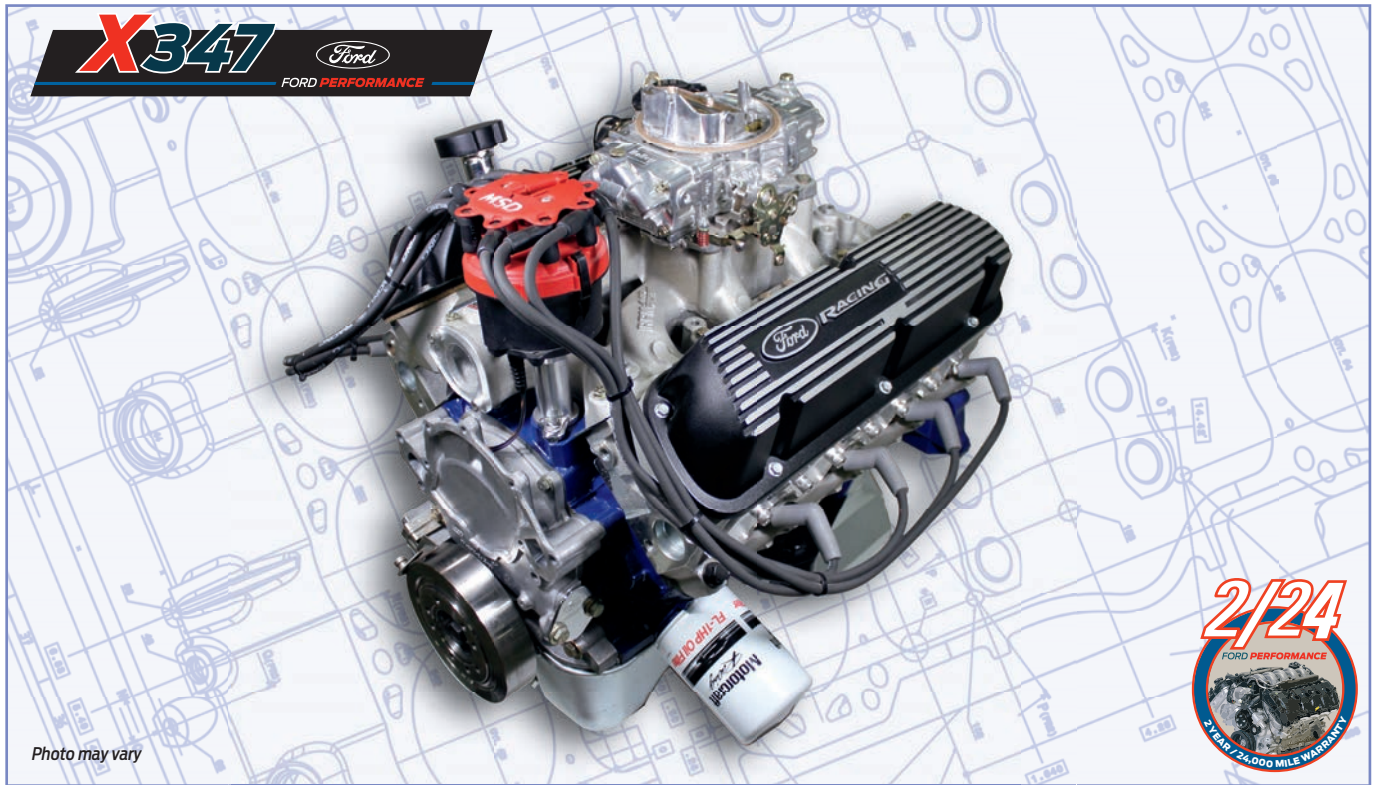

Photo may vary

X347D STREET CRUISER-DRESSED CRATE ENGINE

M-6007-X347DF* Front Sump

M-6007-X347DR* Rear Sump

The most popular crate engine size just got better and easier thanks to the engineers at Ford Performance. The proven 347 stroker combination has been optimized for street cruising with a perfectly matched cam/cylinder head/intake manifold/carb combination that runs on pump gas. It takes the guesswork and installation issues out of the way with a complete intake and distributor package that has been developed and tested by Ford Performance engineers. To dress out the X347D, the Ford Performance engineers spec'd parts from the best in the aftermarket, like Holley®, Edelbrock® and MSD®.

The X347D is hand assembled with all new parts, including Ford Performance "X" heads and internals from some of the best aftermarket performance parts manufacturers. The BOSS 302 block is bored .030" oversize and fitted with Mahle® forged pistons. The rotating assembly is all SCAT® forged steel with I-beam rods fitted with ARP® rod bolts and full floating pins.

The camshaft is what really makes the X347D the perfect street cruiser – the intake and exhaust lobes have fast opening ramps to keep port velocity high. The engine idles happily at 800 rpm and pulls 19 inches of vacuum. That translates into snappy acceleration at low engine speeds – and power that pulls strong to 6000 rpm. Ford Performance aluminum "X" heads with high swirl combustion chambers top off the engine. Completing the street tuned package is an Edelbrock Performer RPM® Air-Gap intake and Holley Street Avenger® carb. An MSD® billet distributor and "Ford Racing" spark plug wires finish the package.

The X347D is the perfect carbureted replacement engine for a vintage muscle car, late model project, truck or street rod. And unlike the imitators, no other crate engine has the Blue Oval heritage and Ford Performance engineering and technical support.

360 hp

400 lb-ft of Torque

- Engine type: 302-based small block Ford
- Displacement: 347 cu in
- Bore x stroke: 4.030" bore x 3.400" stroke
- Block: BOSS 302 8.2" deck – M-6010-BOSS302
- Crankshaft: SCAT® forged steel
- Connecting rods: SCAT® forged steel I-beam connecting rods
- Pistons: Forged Mahle® w/floating wrist pins
- Cylinder heads: Ford Performance aluminum, 64 cc chamber – M-6049-X306
- Valve size: 1.94" intake, 1.54" exhaust
- Compression ratio: 9.6:1
- Edelbrock Performer RPM® Air-Gap manifold (Part No. 7521)
- Holley Street Avenger® 570 CFM carburetor with vacuum secondaries, 4-corner idle and electric choke (Part No. 83570)
- Rocker arms: Roller rockers 1.6:1 ratio
- M-6582-A301R Valve Covers: "Ford Racing" aluminum
- MSD® billet distributor (MSD® Part No. 8598)
- M-12259-M301 Black Spark Plug Wires "Ford Racing" 9 mm
- Recommended fuel: Unleaded premium
- Maximum recommended rpm: 6000 rpm
- Camshaft type: Hydraulic roller. COMP Cams®
- Camshaft lift: .533"/.533"
- Camshaft duration – intake/exhaust (@.050"): 206°/206°
- M-6268-A302 Double Roller Timing Chain Set
- Vibration damper: Ford Performance SFI approved
- Oil pan: high performance, 7 qt capacity and windage tray/scrapper
- Balanced: Internal. Use neutral balance flywheel

*This component is eligible for the Ford Performance Parts Limited Warranty. See the Ford Performance Parts Limited Warranty on pages 295-302 for details.

FORD PERFORMANCE ENGINES

Z2363

Ford
FORD PERFORMANCE



M-6007-Z2363FT shown



363 CUBIC INCH 500 HP BOSS CRATE ENGINE – “Z2” HEADS

M-6007-Z2363FT* Front Sump

M-6007-Z2363RT* Rear Sump

New Z2 cylinder heads with “Velocity Vane.”

- 507 hp on pump gas – in a 302-sized package
- Built with the best all-new parts
- Uses standard SBF headers and accessory mounts
- From the guys who know Ford Performance Best – Ford Performance engineers

507 hp @ 6500 rpm

450 lb-ft torque @ 5100 rpm

- Engine type: 302-based small block Ford
- Displacement: 363 cu in
- Bore x stroke: 4.125" bore x 3.400" stroke
- Block: BOSS 302 8.2 deck M-6010-BOSS302
- Crankshaft: SCAT® forged steel
- Connecting rods: SCAT® forged steel I-beam connecting rods and ARP® bolts
- Pistons: Forged Mahle® w/floating wrist pins
- Camshaft type: Hydraulic roller
- Camshaft lift: .580"/.602"
- Camshaft duration (@.050 in): 232°/240°
- Cylinder heads: Ford Performance M-6049-Z2 Aluminum “Z2” Cylinder Heads



- Valve size: 2.05" intake, 1.60" exhaust
- Valve springs: PAC® 1219X Ovate Beehive™
- Compression ratio: 10.2:1 (nominal)
- Rocker arms: Roller rockers – 1.65:1 ratio
- Vibration damper: Ford Performance SFI approved
- Valve covers: “Ford Racing” cast aluminum 302-139
- Oil pan: high performance, 7 qt capacity and windage tray/scrapper
- Water pump: Edelbrock® high performance
- Includes Ford Performance M-9439-A50 intake manifold gaskets
- Does not include distributor, intake and flywheel
- Required fuel: Premium unleaded
- Built with current available parts. Photo and specs may vary.
- Engine installation tuning tips at performanceparts.ford.com

*This component is eligible for the Ford Performance Parts Limited Warranty. See the Ford Performance Parts Limited Warranty on pages 295-302 for details.

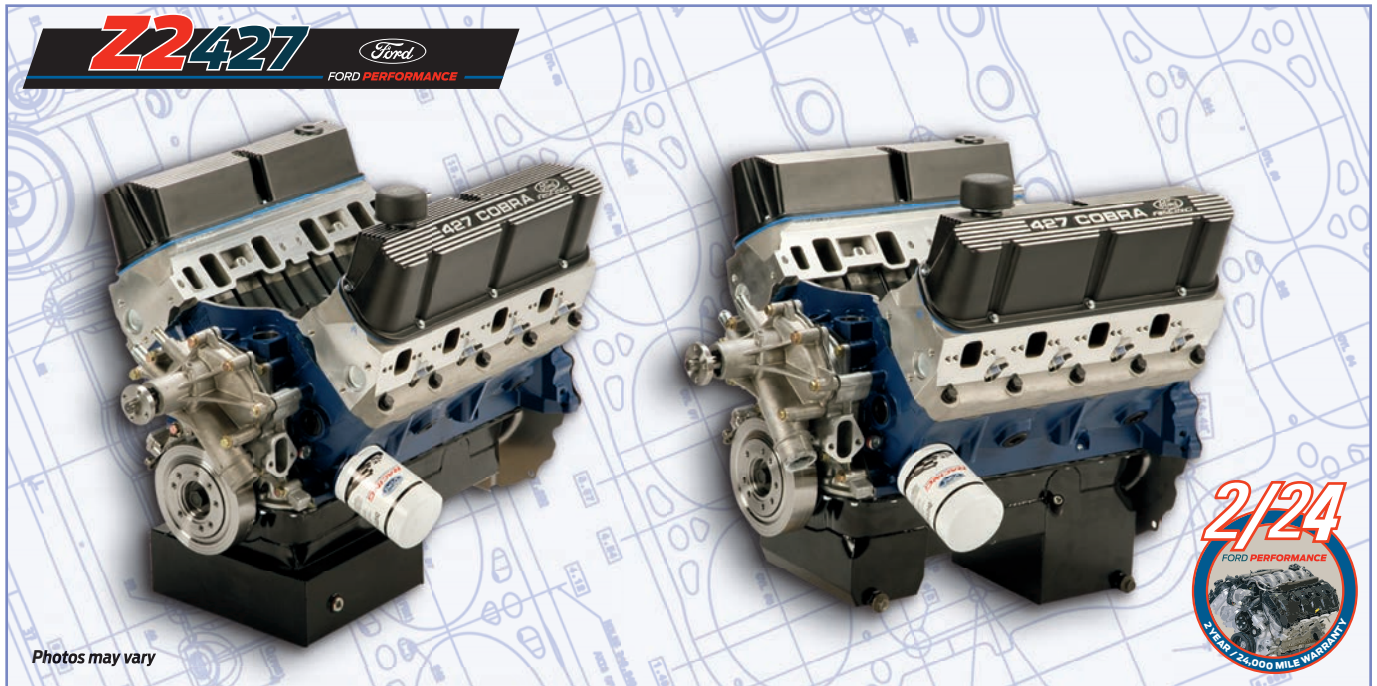

Photos may vary



427 CUBIC INCH 535 HP CRATE ENGINE – “Z2” HEADS



M-6007-Z2427FFT* Front Sump

M-6007-Z2427FRT* Rear Sump

The company that created the famous 427 FE engine offers a modern version of the legendary motor. Built on the Ford Performance BOSS 351 block, the 427 crate engine is engineered and built for driveability and durability while delivering big power. Ideal for Ford projects requiring 500+ horsepower in a reliable small block package.

Now equipped with Ford Performance “Z2” cylinder heads – these heads promote improved power throughout the rpm range while retaining OEM exhaust and accessory mounting locations when compared to other aftermarket cylinder heads.

535 hp @ 5600 rpm

545 lb-ft torque @ 4500 rpm

- Engine type: 351-based small block Ford
- Displacement: 427 cu in
- Bore x stroke: 4.125" bore x 4.00" stroke
- Block: BOSS 351 9.5 deck
- Crankshaft: SCAT® forged steel
- Connecting rods: SCAT® forged steel H-beam connecting rods and ARP® bolts
- Pistons: Forged Mahle® w/floating wrist pin
- Camshaft type: Hydraulic roller
- Camshaft lift: .594"/.618"
- Camshaft duration – intake/exhaust (@.050"): 242°/248°
- Cylinder heads: Ford Performance M-6049-Z2 Aluminum “Z2” Cylinder Heads
- Valve size: 2.02" intake, 1.60" exhaust
- Valve springs: PAC® 1219X Ovate Beehive™
- Compression ratio: 10.5:1 (nominal)
- Rocker arms : Roller rockers
- Rocker arm ratio: 1.65:1
- M-6316-D302 Vibration Damper – Ford Performance SFI approved
- Valve covers: Satin black, aluminum with “Ford Racing” script – 302-135

- Oil pan: Steel with deep sump pan with windage tray/scrapper
- Water pump: included long type – standard rotation
- Distributor: not included. MSD® distributor – Part No. 85840 recommended (distributor modifications for intake clearance necessary)
- Recommended fuel: Premium unleaded
- Ignition timing: 32° at 4000 rpm
- Maximum recommended rpm: 5600 rpm
- Balanced: Internally balanced – use neutral balance flywheel (not included)
- Recommended intake: Edelbrock® Part No. 2924 Super Victor® (not included)
- Front sump pan fits most kits cars without Mustang II suspension
- New block, oil and water pumps, performance oil pan and high-performance harmonic balancer
- Can be used in kit cars, street rods, Mustang, cars and trucks
- Water pump included – standard rotation
- Depending on your application, a different timing cover, water pump, performance oil pan and pickup may be required
- Engine has a performance deep sump oil pan and pickup, standard rotation timing cover, standard rotation water pump and non-EFI valve covers
- Timing cover will work with most standard rotation water pumps
- M-6287-B302 Fuel Pump Eccentric installed, allows use of mechanical fuel pump
- Valve covers should fit most non-EFI applications. Optional valve covers sold separately
- M-6316-D302 Damper may require a spacer for pulley alignment
- Intake manifold not included
- Includes intake gaskets and pilot bearing
- Firing order 1-3-7-2-6-5-4-8 (5.0L HO and 351W firing order)
- Steel distributor gear required
- Shipping weight approximately 570 lbs
- Built with current available parts. Photo and specs may vary
- Engine installation tuning tips at performanceparts.ford.com

See Also...

- Crate Engine Warranty – Pages 295-297

*This component is eligible for the Ford Performance Parts Limited Warranty. See the Ford Performance Parts Limited Warranty on pages 295-302 for details.

FORD PERFORMANCE ENGINES

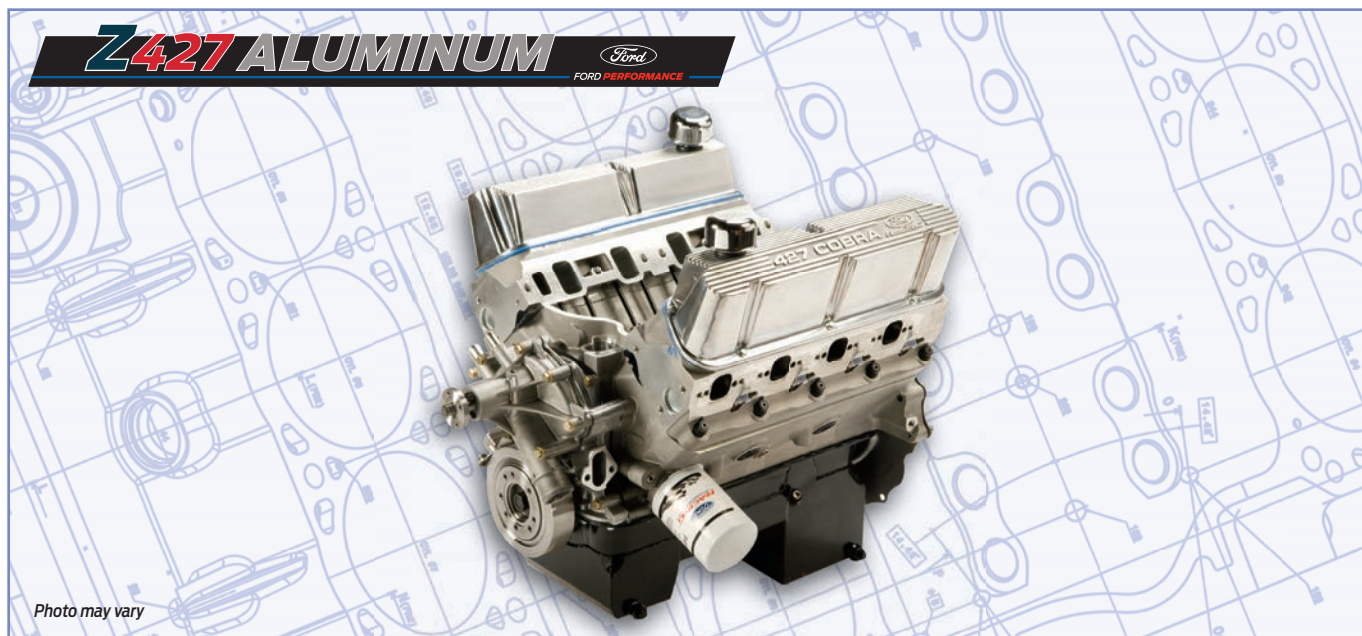

427 CUBIC INCH 600 HP ALUMINUM CRATE ENGINE

M-6007-Z427AFT Front Sump

M-6007-Z427ART Rear Sump

The company that created the famous 427 FE engine announces a modern version of the legendary motor. Built on the Ford Performance aluminum Z351 block, the 427 crate engine is engineered and hand assembled for driveability and durability while still offering a throaty growl. The Z427 is built with real high-performance parts from premier aftermarket companies, like Mahle®, SCAT®, Clevite®, COMP®, PAC®, Fel-Pro® and more. This engine is ideal for street rods, kit cars and all Ford projects requiring big power in a reliable, lightweight package.

600 hp @ 6500 rpm

558 lb-ft torque @ 5000 rpm

- Engine type: 351-based small block Ford
- Displacement: 427 cu in
- Bore x stroke: 4.125" bore x 4.00" stroke
- Block: Ford Performance M-6010-Z351 Aluminum 4-Bolt Main Block
- Crankshaft: SCAT® forged steel
- Connecting rods: SCAT® forged steel H-beam connecting rods and ARP® bolts
- Pistons: Forged Mahle® w/floating wrist pin
- Camshaft type: Solid steel billet roller
- Camshaft lift – intake/exhaust: .644"/.653"
- Camshaft duration – intake/exhaust (@.050 in): 258°/260°
- Timing chain: M-6268-B302 Double Roller Timing Chain
- Cylinder heads: CNC-ported Ford Performance M-6049-Z304P Aluminum "Z" Cylinder Heads
- Valve size: 2.08" intake valves and 1.60" exhaust valves
- Valve springs: PAC® 1243
- Compression ratio: 11.1:1 (nominal)
- Rocker arms: Roller rockers
- Rocker arm ratio: 1.65:1
- M-6316-D302 Vibration Damper – Ford Performance SFI approved
- M-6582-W427B Valve Covers: Ford Performance cast aluminum black wrinkle finish, "427 Cobra" script



- Oil pan: Steel with deep sump pan with windage tray/scrapper – 9 qt capacity
- Water pump: included long-type – standard rotation
- Distributor: not included. MSD® distributor Part No. 85840 recommended (distributor modifications for intake clearance necessary)
- **Mechanical cam engine – No Warranty**
- Recommended fuel: Leaded 110 octane

INSTALLATION NOTES: Some or all of the following items may need to be changed from your original engine or modified for proper installation:

- Depending on your application, a different timing cover, water pump, performance oil pan and pickup may be required.
- Engine has a performance deep sump oil pan and pickup, standard rotation timing cover, standard rotation water pump and non-EFI valve covers.
- Timing cover will work with most standard rotation water pumps.
- M-6287-B302 Fuel Pump Eccentric installed, allows use of mechanical fuel pump
- M-6582-W427B Valve Covers should fit most non-EFI applications. Optional valve covers sold separately.
- M-6316-D302 Damper may require a spacer for pulley alignment.
- Flywheel not included; use proper neutral balance flywheel.
- Intake manifold not included.
- Includes intake gaskets and pilot bearing.
- Firing order 1-3-7-2-6-5-4-8 (5.0L HO and 351W firing order).
- Bronze distributor gear required.
- Exhaust port raised 5/8" may require custom headers.
- Shipping weight approximately 460 lbs.
- Built with current available parts. Photo and specs may vary.
- Engine installation tuning tips at performanceparts.ford.com.

See Also...

- Crate Engine Warranty – Pages 295-297

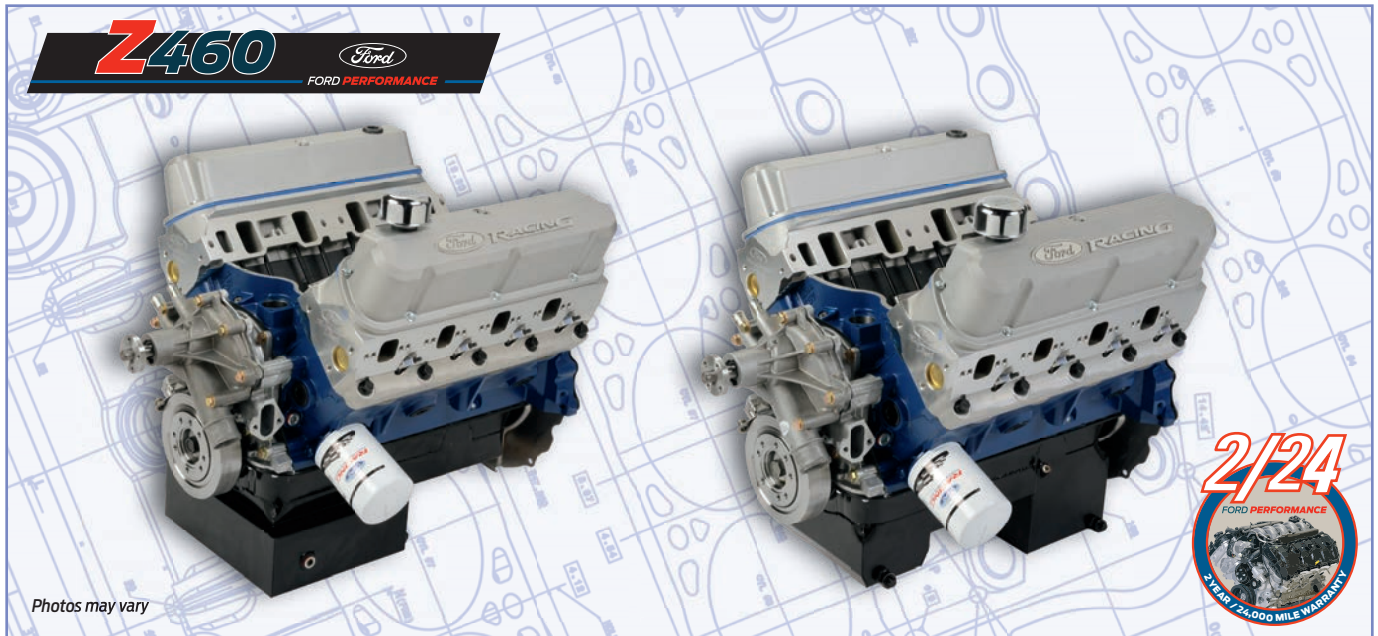

Photos may vary

460 CUBIC INCH 575 HP BOSS CRATE ENGINE

M-6007-Z460FFT* Front Sump

M-6007-Z460FRT* Rear Sump

Ford Performance has taken its BOSS block to the max with the biggest small block Windsor crate engine ever – the Z460. With 575 horsepower and 575 lb-ft of torque, Z460 packs a pump-gas-fueled punch that works well on the street and on the track.

The foundation of Z460 is the legendary Ford Performance BOSS block topped off with high-port/high-flow “Z” heads. Premium components from the best aftermarket companies are used throughout the engine, like a SCAT® forged steel crankshaft, SCAT® forged H-beam connecting rods, forged Mahle® pistons and Clevite® bearings. And every Ford Performance Z460 engine is hand assembled in the U.S. with performance clearances.

575 hp @ 5500 rpm

575 lb-ft torque @ 4700 rpm

- Engine type: 351-based small block Ford
- Displacement: 460 cu in
- Bore x stroke: 4.150" bore x 4.250" stroke
- Block: BOSS 351 9.5" deck
- Crankshaft: SCAT® forged steel
- Connecting rods: SCAT® forged steel H-beam 6.125" length connecting rods
- Pistons: Forged Mahle® w/floating wrist pin
- Camshaft type: Hydraulic roller
- Camshaft lift: .594"/.618"
- Camshaft duration (@.050 in): 242°/248°
- Cylinder heads: Ford Performance M-6049-Z304DA Aluminum “Z” Cylinder Heads
- Valve size: 2.02" intake, 1.60" exhaust
- Compression ratio: 10.0:1 (nominal)
- Rocker arm ratio: 1.65:1
- M-6316-D302 Vibration Damper: Ford Performance – SFI approved
- Valve covers: Ford Performance 302-137 cast aluminum gray crinkle, “Ford Racing” logo
- Oil pan: Steel with deep front (9 qt) or rear sump (7 qt) pan with louvered windage tray and crankshaft scraper – 9 qt capacity
- Ford Performance M-8501-G351 Water Pump: included, long-type – standard rotation

- Includes Ford Performance M-9439-A50 Intake Manifold Gaskets
- Distributor: not included. Steel distributor gear required
- Required fuel: Premium unleaded
- Ignition timing: 32° at 4000 rpm
- Maximum recommended rpm: 5600 rpm
- Balanced: Internal. Use neutral balance flywheel
- Recommended intake: Edelbrock® Part No. 2924 Super Victor® (not included)
- New block, oil pump, water pump, performance oil pan and high-performance harmonic balancer
- Engine power ratings achieved with Edelbrock® Super Victor® intake, Holley® 850 CFM carburetor, long tube headers

INSTALLATION NOTES: Some or all of the following items may need to be changed from your original engine or modified for proper installation:

- Depending on your application, a different timing cover, water pump, performance oil pan and pickup may be required.
- Engine has a performance sump oil pan and pickup, standard rotation timing cover, standard rotation water pump and non-EFI valve covers.
- Timing cover will work with most standard rotation water pumps.
- M-6287-B302 Fuel Pump Eccentric installed, allows use of mechanical fuel pump.
- Valve covers should fit most non-EFI applications. Optional valve covers sold separately.
- M-6316-D302 Damper may require a spacer for pulley alignment.
- Flywheel not included, use proper neutral balance flywheel
- Intake manifold not included.
- Includes intake gaskets and pilot bearing.
- Firing order 1-3-7-2-6-5-4-8 (5.0L HO and 351W firing order).
- Steel distributor gear required.
- Exhaust port raised 5/8" may require custom headers.
- Shipping weight approximately 570 lbs.
- Built with current available parts. Photo and specs may vary.
- Engine installation tuning tips at performanceparts.ford.com.

*This component is eligible for the Ford Performance Parts Limited Warranty. See the Ford Performance Parts Limited Warranty on pages 295-302 for details.

FORD PERFORMANCE ENGINES

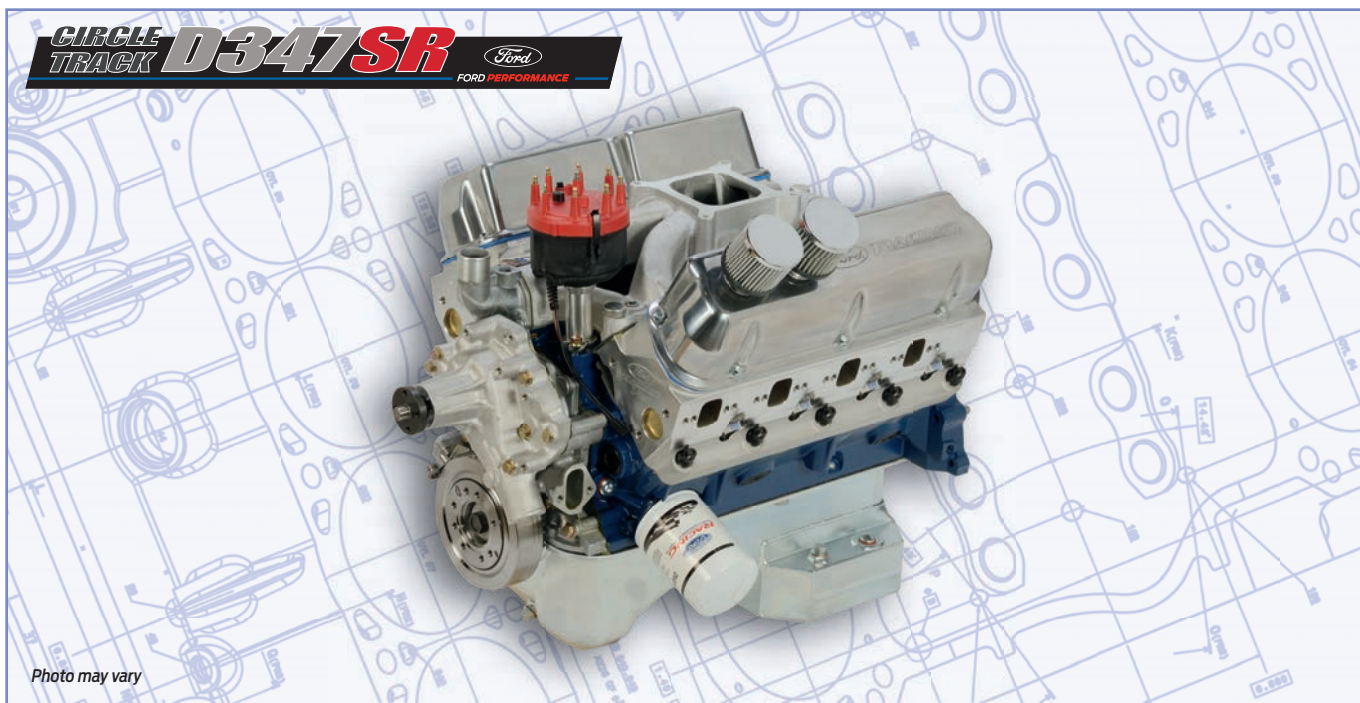

Photo may vary

347 CUBIC INCH 415 HP SEALED RACING ENGINE

M-6007-D347SR
M-6007-D347SR7



Ford sealed racing engines are built to professional racing series standards and deliver reliable lasting performance. These aren't built from repackaged production parts, but real racing parts, like forged crank, rods and pistons with full floating piston pins. Each engine is assembled by hand with racing clearances. Built with the Ford Performance BOSS 302 block, these engines deliver reliable and consistent performance lap after lap.

- Built for asphalt and dirt circle track racing series that require a sealed racing engine
- 347 cubic inches – 4.030" bore x 3.400" stroke
- BOSS 302 race block
- 415 hp @ 6000 rpm, 400 lb-ft @ 4900 rpm (with headers and a 650 CFM Holley® carburetor, not included)
- 10:1 compression ratio (nominal)
- SCAT® forged crankshaft
- SCAT® forged steel cap screw connecting rods
- Mahle® forged pistons with floating pins
- M-6250-F303 Hydraulic Roller Camshaft, .528" lift intake and exhaust, duration at .050" is 226° intake and exhaust
- M-6268-A302 Double Roller Timing Chain Set
- High-performance 7 qt rear sump circle track oil pan
- Ford Racing aluminum "Z" M-6049-Z304DA Cylinder Heads with 2.02" intake valves and 1.60" exhaust valves
- PAC® 1218 Ovate Beehive™ valve springs
- 1.65:1 ratio roller rocker arms
- Edelbrock® Victor Jr.® M-9424-D302 Intake Manifold
- Edelbrock® water pump
- SFI-approved vibration damper
- MSD® billet distributor
- ARP® head studs
- Ford Racing polished aluminum M-6582-CT2 Circle Track Valve Covers

- High-volume oil pump
- Engine is sealed for circle track competition where rules allow
- Engine weight as equipped is 431 lbs (includes 7 qt of oil)
- Additional technical information can be found at performanceparts.ford.com/circle-track/
- Competes directly with the GMPP "604" crate engine
- Engine is internally balanced, "0" balance flywheel required
- Flywheel is not included

INSTALLATION NOTES: See engine installation and tuning tips. Some or all of the following items may need to be changed from your original engine or modified for proper installation:

- This engine has a rear sump performance oil pan and pickup, regular rotation timing cover and regular rotation water pump, and non-EFI valve covers. Depending on your application, a different timing cover, water pump, performance oil pan and pickup may be required. See installation notes.
- M-6287-B302 Fuel Pump Eccentric installed, allows use of mechanical fuel pump.
- A standard rotation water pump is installed on the engine. Other applications may require a different water pump and timing chain cover.
- M-6316-D302 Damper may require a spacer for pulley alignment.
- M-6375-D302B Flywheel not included but will work for most 157-tooth manual transmission applications.
- Firing order 1-3-7-2-6-5-4-8 (5.0L HO and 351W order).
- Built with current available parts.
- Photo and specs may vary.
- Shipping weight approximately 475 lbs.

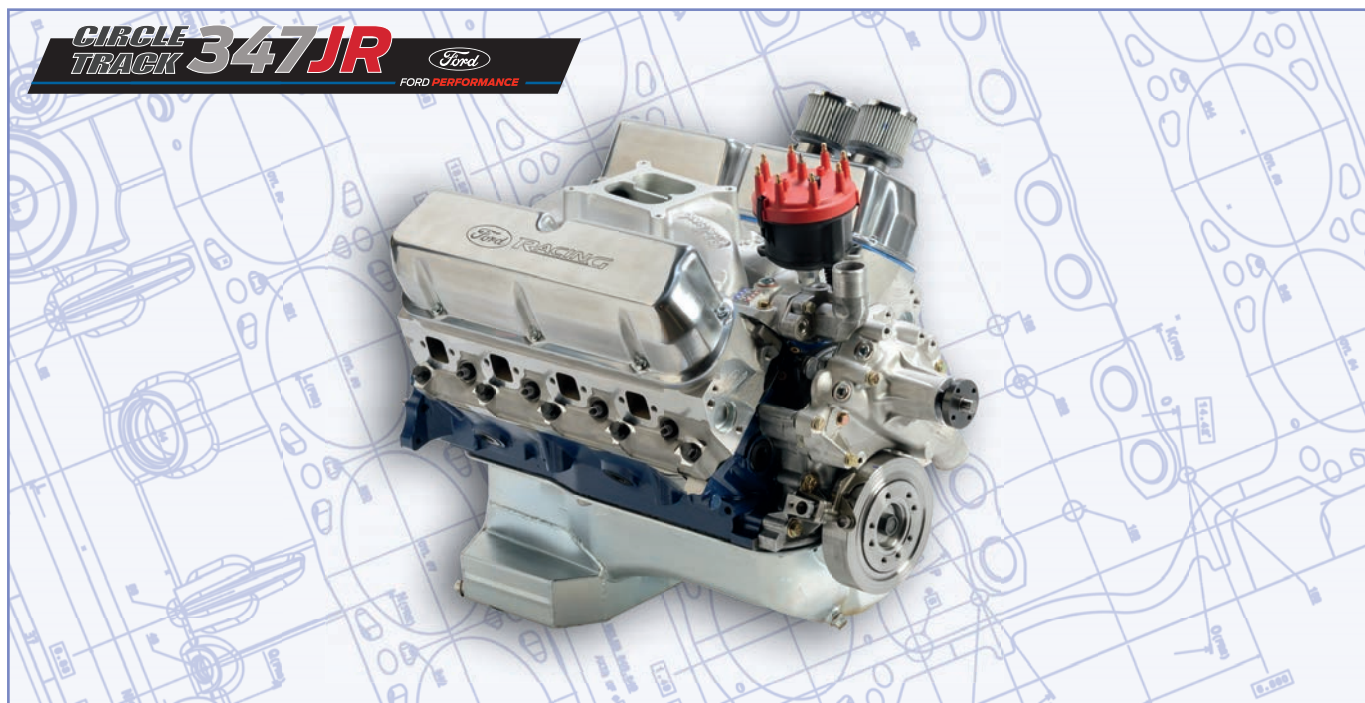

347 CUBIC INCH 350 HP SEALED CRATE ENGINE M-6007-S347JR



Ford sealed racing engines are built to professional racing series standards and deliver reliable lasting performance. These aren't built from repackaged production parts, but real racing parts like forged crank, rods and pistons with full floating piston pins. Based on the Ford Racing BOSS 302 block, these engines deliver reliable and consistent performance lap after lap. S347JR has been approved for use in the American Canadian Tour (ACT) Late Model series.

- Built for asphalt and circle track racing series that require a sealed or "crate" racing engine
- 347 cubic inches – 4.030" bore x 3.400" stroke
- BOSS 302 M-6010-BOSS302 Race Block
- 350 hp @ 5500 rpm, 400 lb-ft of torque @ 4000 rpm (with headers and 2V 500 CFM Holley® carburetor, not included)
- 10.5:1 compression ratio (nominal)
- SCAT® forged crankshaft
- SCAT® forged steel cap screw connecting rods
- Forged Mahle® pistons with floating pin
- COMP Cams® 35-410-8 hydraulic roller camshaft, .533" lift intake and exhaust, duration at .050" is 206° intake and exhaust
- M-6268-A302 Double Roller Timing Chain Set
- High-performance 7qt rear sump circle track oil pan
- MSD® billet distributor
- ARP® head studs
- Ford Racing aluminum "X" M-6049-X307 Cylinder Heads with 1.94" intake valves and 1.54" exhaust valves
- PAC 1218 Ovate Beehive™ valve springs
- 1.60:1 ratio M-6564-B351 Roller Rocker Arms
- Edelbrock® Performer RPM Air-Gap dual plane aluminum intake manifold
- Edelbrock® water pump
- MSD® billet distributor
- High volume M-6600-D2 Oil Pump
- "Ford Racing" M-6582-CT2 Polished Aluminum Valve Covers

- High-performance SFI-approved M-6316-D302 Vibration Damper
- Engine weight as equipped is 414 lbs (includes 7 qt of oil)
- Engine is sealed for circle track competition where rules allow
- Competes against GMPP "603" crate engine
- Additional technical information can be found at performanceparts.ford.com/circle-track/
- Engine is internally balanced, "0" balance flywheel required
- Flywheel not included

INSTALLATION NOTES: See engine installation and tuning tips. Some or all of the following items may need to be changed from your original engine or modified for proper installation:

- This engine has a rear sump performance oil pan and pickup, regular rotation timing cover and regular rotation water pump, and non-EFI valve covers.
- The timing chain cover will work with most regular rotation water pumps.
- M-6287-B302 Fuel Pump Eccentric installed, allows use of mechanical fuel pump.
- A standard rotation water pump is installed on the engine. Other applications may require a different water pump and timing chain cover.
- The M-6316-D302 Damper may require a spacer for pulley alignment.
- M-6375-D302B Flywheel not included but will work for most 157-tooth manual transmission applications. For other transmission applications use the proper "0" balance flywheel.
- Firing order 1-3-7-2-6-5-4-8 (5.0L HO and 351W order).
- Built with current available parts. Photo and specs may vary.
- Shipping weight approximately 475 lbs.

FORD PERFORMANCE ENGINES

347 CUBIC INCH BOSS SHORT BLOCK M-6009-347



The Ford Performance 347 short block lets you build it your way by adding your choice of heads, cam, intake and oil pan. It's the perfect foundation to build a powerful 8.2" deck engine for your vintage muscle car, street rod, Fox body or late model Mustang. This is the same short block used in the 347 sealed racing crate engines, M-6007-D347SR and M-6007-S347JR. Nothing but the best parts are used inside, including: forged crankshaft, forged I-beam connecting rods with floating piston pins and the BOSS 302 block.

- Engine type: 302 based small block Ford
- Displacement: 347 cu in
- Bore x stroke: 4.030" bore x 3.400" stroke
- Block: M-6010-BOSS302 BOSS 4-Bolt Main Block 8.2" deck height
- Piston-to-deck height: .010" below deck (nominal)
- Crankshaft: SCAT® forged steel: 3.400" stroke
- Connecting rods: SCAT® forged steel I-beam connecting rods with floating pin and ARP® bolts
- Pistons: Mahle® forged aluminum, 1.5 mm, 1.5 mm, 3.00 mm rings, valve reliefs for X306, X307, Z304DA, Z304P, N351, and other inline valve Windsor cylinder heads. 6 cc valve pockets. Check piston-to-valve clearance
- Hydraulic roller camshaft compatible
- Internally balanced. Requires "0" balance flywheel and damper
- Recommended cylinder head fasteners M-6065-BOSS Head Bolts or M-6014-BOSS Studs depending on application
- Most aftermarket performance cylinder heads are compatible with this short block. Ford Performance short blocks are built with pistons designed for 20 degree valve angle heads and will fit stock or most spread valve guide center lines

- Designed for M-6049-X306/X307/Z304DA/Z304P and N351 cylinder heads. Not designed for production 302/351W or M-6049-Y302/Y303/X302/X303/X304/X305 cylinder heads
- Assembled and ready for your heads, cam and timing chain set
- Requires M-6051-CP331 or M-6051-S331 head gaskets
- High-performance M-6316-D302 Harmonic Balancer is recommended
- High-volume M-6600-D2 Oil Pump recommended
- 302 bolt pattern, oil pan and timing cover
- Built with all NEW PARTS
- Photo and specs may vary



363 CUBIC INCH BOSS SHORT BLOCK M-6009-363



The Ford Performance Z363 short block lets you build it your way by adding your choice of heads, cam, intake and oil pan. It's the perfect foundation to build a powerful 8.2" deck engine for your vintage muscle car, street rod, Fox body or late model Mustang. This is the same short block used in the 500 hp M-6007-Z2363FT Crate Engine. By taking the bore out to 4.125", the displacement of the popular 347 stroker has been increased to 363 cubic inches. Nothing but the best parts are used inside, including: forged crankshaft, forged I-beam connecting rods with floating piston pins and the BOSS 302 block. The Z363 short block fits many of the vehicles originally built with a 289 or 302 8.2" deck height block.

- Engine type: 302 based small block Ford
- Displacement: 363 cu in
- Bore x stroke: 4.125" bore x 3.400" stroke
- Block: BOSS M-6010-BOSS302 4-Bolt Main Block 8.2" deck height
- Piston-to-deck height: .010" below deck (nominal)
- Crankshaft: SCAT® forged steel: 3.400" stroke
- Connecting rods: SCAT® forged steel I-beam connecting rods with floating pin and ARP® bolts
- Pistons: Mahle® forged aluminum, 1.5 mm, 1.5 mm, 3.00 mm rings, valve reliefs for X306, X307, Z304DA, Z304P, N351, and other inline valve Windsor cylinder heads. 6 cc valve pockets. Check piston-to-valve clearance
- Hydraulic roller camshaft compatible
- Internally balanced. Requires "0" balance flywheel and damper
- Recommended cylinder head fasteners M-6065-BOSS Head Bolts or M-6014-BOSS Studs depending on application
- Most aftermarket performance cylinder heads are compatible with this short block. Ford Performance short blocks are built with pistons

- designed for 20° valve angle heads and will fit stock or most spread valve guide center lines
- Designed for M-6049-X306/X307/Z304DA/Z304P and N351 cylinder heads. Not designed for production 302/351W or M-6049-Y302/Y303/X302/X303/X304/X305 cylinder heads
- Assembled and ready for your heads, cam and timing chain set
- Requires M-6051-R351 Head Gaskets
- High-performance M-6316-D302 Harmonic Balancer is recommended
- High-volume M-6600-D2 Oil Pump recommended
- 302 bolt pattern, oil pan and timing cover
- Built with all NEW PARTS
- Photo and specs may vary





427 CUBIC INCH BOSS SHORT BLOCK M-6009-427F

The Ford Performance 427 short block lets you build it your way by adding your choice of heads, cam, intake and oil pan. It's the perfect foundation to build a powerful 9.5" deck engine for your vintage muscle car, street rod, Fox body or late model Mustang. This is the same short block used in the 575 hp Z427 crate engine. Nothing but the best parts are used inside, including: forged crankshaft, forged I-beam connecting rods with floating piston pins and the BOSS 351 block. This short block is hand assembled with performance clearances in the U.S. The 427 short block fits many of the vehicles originally built with Windsor and Cleveland small blocks.

- Engine type: 351 based small block Ford
- Displacement: 427 cu in
- Bore x stroke: 4.125" bore x 4.00" stroke
- Block: BOSS M-6010-BOSS35195 4-Bolt Main Block 9.5" deck height
- Piston-to-deck height: .005" below piston-to-deck height (nominal)
- Crankshaft: SCAT® forged steel: 4.000" stroke
- Connecting rods: SCAT® forged steel H-beam connecting rods with floating pin and ARP® bolts
- Pistons: Mahle® forged aluminum, with reliefs for Z304D, Z304P, N351, and other inline valve Windsor cylinder heads. 17 cc piston dish. Check piston-to-valve clearance
- Hydraulic roller camshaft compatible
- Internally balanced
- Recommended cylinder head fasteners M-6065-BOSS Head Bolts or M-6014-BOSS Studs depending on application
- Most aftermarket performance cylinder heads are compatible with this short block. Ford Performance short blocks are built with pistons designed for 20° valve angle heads and will fit stock or spread valve guide center lines
- Designed for M-6049-X306/X307/Z304DA cylinder heads. Not designed for production 302/351W or M-6049-Y302/Y303/X302/X303/X304/X305 cylinder heads
- Assembled and ready for your heads, cam and timing chain set
- Requires M-6051-R351 Head Gaskets
- 351W bolt pattern, oil pan and timing cover
- High-performance M-6316-D302 Harmonic Balancer is recommended
- Built with all NEW PARTS
- Photo and specs may vary



427 ALUMINUM SHORT BLOCK M-6009-427A

Build it your way with Ford Performance short blocks. Want to build a powerful Ford engine for your vintage muscle car, street rod, Fox body or late model Mustang? A Ford Performance short block is the perfect foundation. Ford Performance engineers have taken care of the toughest part of building a new engine by designing a strong, durable short block that offers a wide range of power possibilities. We use only the best parts for our short blocks, like a forged steel crankshaft, forged H-beam connecting rods with floating piston pins, forged Mahle® pistons, and the Ford Performance aluminum block. And every Ford Performance short block is hand assembled in the U.S. with performance clearances; these aren't assembly line truck engines made by machines!

- Engine type: 351 based small block Ford
- Displacement: 427 cu in
- Bore x stroke: 4.125" bore x 4.00" stroke
- Block: Ford Performance M-6010-Z351 Aluminum 4-Bolt Main Block 9.5" deck height
- Piston-to-deck height: .005" below piston-to-deck height (nominal)
- Crankshaft: SCAT® forged steel: 4.000" stroke
- Connecting rods: SCAT® forged steel H-beam connecting rods with floating pin and ARP® bolts
- Pistons: Mahle® 4.125" bore forged, with reliefs for Z304D, Z304P, N351, and other inline valve Windsor cylinder heads. 17 cc piston dish. Check piston-to-valve clearance
- Hydraulic roller camshaft compatible. Requires aftermarket tie bar hydraulic lifters
- 0.060" oil galley restrictors included for solid roller cam applications
- Internally balanced
- Uses standard Windsor M-6059-D351 Timing Cover
- Standard Windsor oil pan flange
- Recommended cylinder head fasteners M-6065-BOSS Head Bolts or M-6014-BOSS Studs depending on application
- Most aftermarket performance cylinder heads are compatible with this short block. Ford Performance short blocks are built with pistons designed for 20° valve angle heads and will fit stock or spread valve guide center lines
- Not designed for production 302/351W or M-6049-Y302/Y303/X302/X303/X304/X305 cylinder heads
- Assembled and ready for your heads, cam and timing chain set
- Requires M-6051-R351 Head Gaskets
- Oil pan and timing cover are a 351W bolt pattern
- High-performance M-6316-D302 Harmonic Balancer is recommended
- Built with all NEW PARTS
- Photo and specs may vary



FORD PERFORMANCE ENGINES

460 CUBIC INCH BOSS SHORT BLOCK – WINDSOR SB BASED

M-6009-460

Build it your way with Ford Performance short blocks. Want to build a powerful Ford engine for your vintage muscle car, street rod, Fox body or late model Mustang? A Ford Performance short block is the perfect foundation. Ford Performance engineers have taken care of the toughest part of building a new engine by designing a strong, durable short block that offers a wide range of power possibilities. We use only the best parts for our short blocks, like a forged steel crankshaft, forged H-beam connecting rods with floating piston pins, forged Mahle® pistons, and the Ford Performance BOSS block. And every Ford Performance short block is hand assembled in the U.S. with performance clearances – these aren't assembly line truck engines made by machines!

- Engine type: 351 based small block Ford
- Displacement: 460 cu in
- Bore x stroke: 4.150" bore x 4.25" stroke
- Block: BOSS M-6010-BOSS35195 4-Bolt Main Block 9.5" deck height
- Piston-to-deck height: .005" below piston-to-deck height (nominal)
- Crankshaft: SCAT® forged steel: 4.250" stroke
- Connecting rods: SCAT® forged steel H-beam 6.125" length connecting rods with floating pin and ARP® bolts
- Pistons: Mahle® 4.150" bore forged, with reliefs for Z304D, Z304P, N351, and other inline valve Windsor cylinder heads. 30 cc piston dish. Check piston-to-valve clearance
- Hydraulic roller camshaft compatible
- Internally balanced
- Recommended cylinder head fasteners M-6065-BOSS Head Bolts or M-6014-BOSS Studs depending on application
- Most aftermarket performance cylinder heads are compatible with this short block. Ford Performance short blocks are built with pistons designed for 20° valve angle heads and will fit stock or spread valve guide center lines
- Designed for M-6049-X306/X307/Z304DA cylinder heads. Not

designed for production 302/351W or M-6049-Y302/Y303/X302/X303/X304/X305 cylinder heads

- Assembled and ready for your heads, cam and timing chain set
- Requires M-6051-R351 Head Gaskets
- 351W bolt pattern, oil pan and timing cover
- High-performance M-6316-D302 Harmonic Balancer is recommended
- Built with all NEW PARTS
- Photo and specs may vary



351 ALUMINUM BLOCK 9.2" DECK

M-6010-Z35192

Ford Performance has added a 9.2" deck height version of its Z351 aluminum Windsor block to its product line. This 9.2" deck height block is great for smaller displacement builds without the penalty of a taller deck. Like the 9.5" deck height version, the block is cast from high-strength 356-T6 grade aluminum and uses splayed 4-bolt main caps on #2-3-4 mains. The block is "user friendly" and designed to use conventional Windsor components, like cam, timing chain, timing chain cover, oil pan and oil pump. With a weight of 106 pounds, it's nearly 90 pounds lighter than an iron Ford Performance Race Parts BOSS 351 block.

- High-strength aluminum block, 356-T6 grade aluminum
- Splayed 4-bolt, steel billet main caps on 2, 3 and 4
- 2-bolt main caps on 1 and 5
- ARP® studs on all inner mains; ARP® bolts on 2-3-4 splayed outer positions
- Uses standard Windsor timing chain, timing chain cover, oil pan and oil pump
- 4.110"-4.115" bore as delivered, cast iron sleeves – finish at 4.125"
- 9.2" deck height, 2.75" crankshaft (351C) main journal diameter. 2.9415"-2.9425" diameter finished main bearing bore
- Lifter bores finished .8753"-.8768"
- 2.2032"-2.2052" diameter cam bearing bores. Uses M-6261-J351 or M-6261-R351 cam bearing
- Maximum stroke 4.000"
- Wet sump oiling system
- Weight 106 lbs



351 ALUMINUM BLOCK 9.5" DECK

M-6010-Z351

- High-strength aluminum block, 356-T6 grade aluminum
- Splayed 4-bolt, steel billet main caps on 2, 3 and 4
- 2-bolt main caps on 1 and 5
- 4.110"-4.115" bore as delivered, cast iron sleeves – finish at 4.125"
- 9.5" deck height, accepts small block timing chain, timing chain cover and oil pump
- 2.75" crankshaft (351C) main journal diameter. 2.9415"-2.9425" diameter finished main bearing bore
- Lifter bores finished .8753"-.8768"
- 2.2032"-2.2052" diameter cam bearing bores. Uses M-6261-J351 or M-6261-R351 cam bearings
- Maximum stroke 4.250"
- Wet sump oiling system
- Weight 118 lbs



CYLINDER SLEEVES FOR M-6010-Z35192 ALUMINUM BLOCK

M-6012-C35192

- Replacement sleeves for the M-6010-Z35192 Block
- Standard 4.280" O.D. and 4.075" I.D.
- Sold in set of 8



CYLINDER SLEEVES SET OF 8

M-6012-C351

- Replacement sleeves for the M-6010-Z351 Block
- Standard 4.280" O.D. and 4.075" I.D.
- Sold in set of 8



FORD PERFORMANCE ENGINES

FORD PERFORMANCE BOSS CYLINDER BLOCKS

Ford Performance engineers have designed the replacement for the legendary BOSS 302 and 351 blocks using the latest technology and manufacturing techniques from both the production and racing worlds. The BOSS block capability has been proven around the world – both on the track and on the street. By preserving many of the dimensions and features from the original 289-351 blocks, the BOSS blocks are compatible as replacements for use in just about any vehicle that used a Windsor-style engine. Cast from diesel-grade iron and designed with added material in key areas, BOSS block strength is far superior to any Ford OE block ever produced.

- Nodular iron main caps – splayed 4-bolt pattern on 2, 3, 4 mains. 2-bolt main on first and fifth main caps
- Finished lifter bores – uses stock size 302/351 lifters
- Machined to accept factory hydraulic roller lifter guides and lifter guide retainer
- NASCAR®-inspired revised oiling and cooling system
- Siamese bore with drilled coolant crossover holes to aid cooling – except on big bore versions

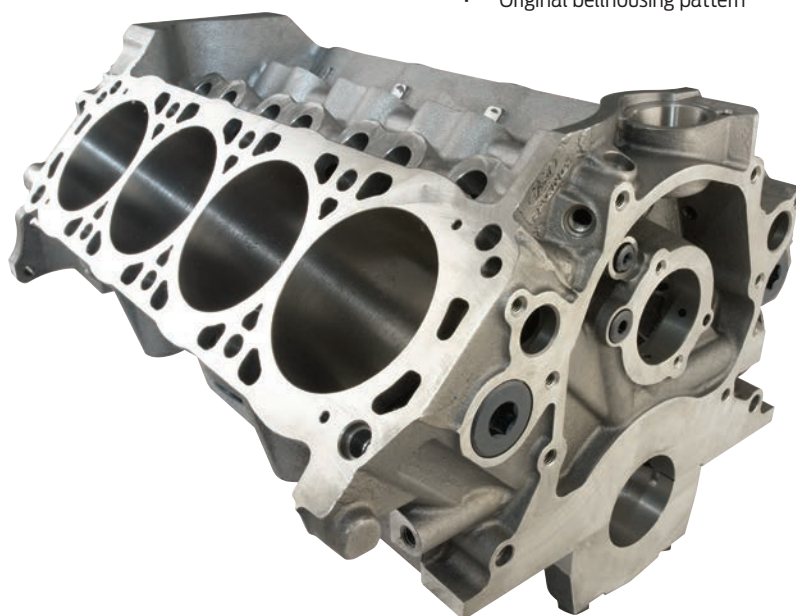

- Increased bulkhead material and deck thickness (.500"-.560")
- Threaded core and galley plugs (straight thread port plugs with O-ring)
- Head bolt thread engagement is moved lower in the block to minimize bore distortion and thus requires special length 1/2" head bolts
- Designed for Ford Performance M-6049-X306/X307/C3/D3/Z304DA or Yates®-style cylinder heads. Not designed for production 302/351W or M-6049-Y302/Y303/X302/X303/X304/X305 cylinder heads
- Uses common O.D. cam bearings
- Unique M-6026-S351 Cam Plug included
- Designed to be compatible with the original 302 and 351W blocks and includes the following features:
 - Designed to use stock-type timing cover. M-6059-D351 Timing Cover recommended (includes fuel pump provision)
 - Fits factory Mustang oil pan with M-6622-BOSS302 Custom Oil Pickup Tube
 - Retains clutch cross shaft pivot hole
 - Original-style oil filter location – M-6731-FL1A recommended
 - Original motor mount BOSS locations
 - Original bellhousing pattern

| Block | M-6010-BOSS302 | M-6010-B302BB | M-6010-BOSS35192 | M-6010-B35192BB | M-6010-BOSS35195 | M-6010-BOSS351BB |
|----------------------------|---|------------------------------------|---|---|---|---|
| Bore Size as delivered | 3.990"-3.995" | 4.115"-4.120" | 3.990"-3.995" | 4.115"-4.120" | 3.990"-3.995" | 4.115"-4.120" |
| Siamese Bore | Yes | Yes | Yes | Yes | Yes | Yes |
| Cross Drilled | Yes | No | Yes | No | Yes | No |
| Maximum Bore Size | 4.125" | Sonic test for greater than 4.125" | 4.125" | Sonic test for greater than 4.125" | | Sonic test for greater than 4.125" |
| Maximum Stroke Recommended | 3.400" | 3.400" | 4.000" | 4.000" | 4.250" | 4.250" |
| Main Bearings | Main bearing bore same as stock 302 | Main bearing same as stock 302 | Main bearing bore same as stock 351 Cleveland | Main bearing bore same as stock 351 Cleveland | Main bearing bore same as stock 351 Cleveland | Main bearing bore same as stock 351 Cleveland |
| Deck Thickness | .500"-.560" | .500"-.560" | .500"-.560" | .500"-.560" | .500"-.560" | .500"-.560" |
| Head Bolt Size | 1/2-13 UNC | | | | | |
| Lifter Bore Size | .8753"-.8768" | .8753"-.8768" | .8753"-.8768" | .8753"-.8768" | .8753"-.8768" | .8753"-.8768" |
| Rear Seal Type | M-6701-B302 1-Piece Rear Seal | M-6701-B302 1-Piece Rear Seal | M-6701-B351 1-Piece Rear Seal | M-6701-B351 1-Piece Rear Seal | M-6701-B351 1-Piece Rear Seal | M-6701-B351 1-Piece Rear Seal |
| Weight | 175 | 175 | 195 | 195 | 205 | 205 |
| Maximum Displacement | 363 cubic inches | 363 cubic inches | 427 cubic inches | 427 cubic inches | 454 cubic inches | 468 cubic inches |
| Recommended Parts | | | | | | |
| Head Gaskets | M-6051-S331 M-6051-CP331 M-6051-R351 M-6051-B341 | M-6051-R351 | M-6051-S331 M-6051-CP331 M-6051-R351 M-6051-B341 | M-6051-R351 | M-6051-S331 M-6051-CP331 M-6051-R351 M-6051-B341 | M-6051-R351 |
| Cam Bearings | M-6261-J351 or M-6261-R351 | | | | | |
| Head Stud Kit | M-6014-Z304, M-6014-BOSS Head Stud Kit | | | | | |
| Head Bolt Kit | M-6014-BOSS Head Bolt Kit | | | | | |
| Rear Main Seal | M-6701-B302 | M-6701-B302 | M-6701-B351 | M-6701-B351 | M-6701-B351 | M-6701-B351 |



BOSS BLOCKS

- ▶ 302 to 468 Cubic Inches
- ▶ 8.2" – 9.2" – 9.5" Deck
- ▶ CNC-machined for exacting tolerances of +/- 0.001"
- ▶ The foundation for building power and race-winning performance

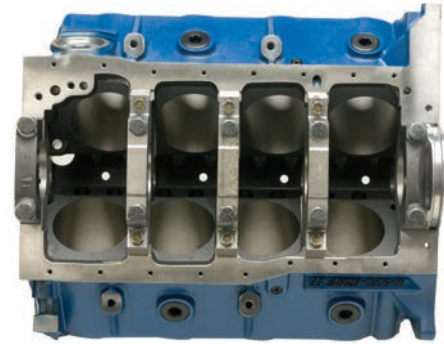

"Using a BOSS 351 block as a foundation became a no-brainer. The block provides about the best bang for the buck anywhere and hardly costs any more than a stock Windsor block that has been fully machined and blueprinted. But the BOSS block still has some advantages over that, namely, it's cast using diesel-grade iron, which exhibits a much greater tensile strength than a stock casting. Plus, there is extra meat in all the critical stress areas.

"When you put it all together, you get a block that shrugs off 500-plus horsepower blasts and asks for more."

– Jeff Huneycutt
Project Big-Inch BOSS, 5.0 Magazine

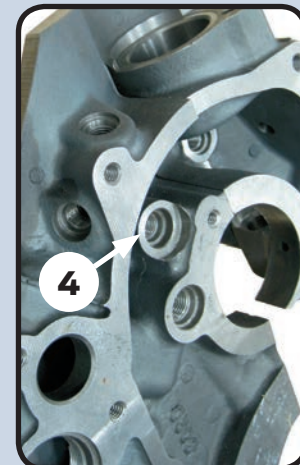
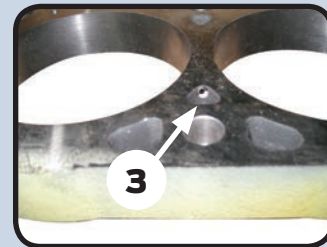
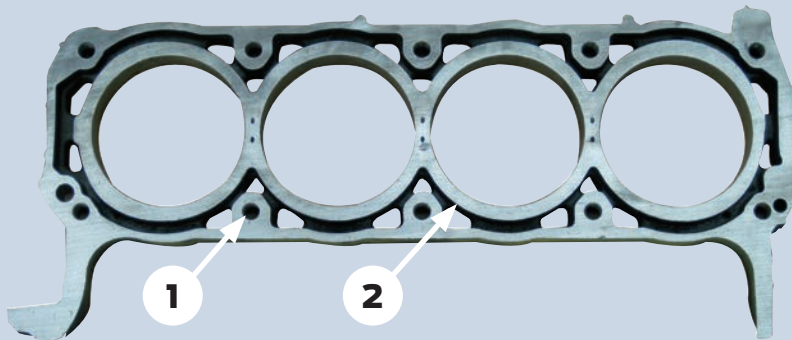

- 1** 1/2" head bolt columns moved lower in the block to minimize bore distortion and improve clamping force
- 2** Siamese bore with thick cylinder walls and exterior walls
- 3** Drilled coolant crossover holes to aid cooling
- 4** NASCAR®-inspired front feed to both lifter oil galleries

FORD PERFORMANCE ENGINES

PLUG AND DOWEL KIT

M-6026-A

Service replacement plug and dowel kit for M-6010-BOSS302/BOSS35192/BOSS35195/BOSS351BB and 351 race blocks with O-ring threaded plugs. Black anodized aluminum plugs with Buna® O-rings for the oil galleys, water drains and core holes. Dowels for front cover, clutch housing and cylinder heads.



ENGINE BLOCK THREADED CORE PLUGS

M-6026-B302

- Fits 289/302/351C/351W/429/460
- Includes 6 threaded 1.25" NPT cast iron plugs
- Block tapped 1.25" NPT to accept plugs
- Ford Performance M-6010-A460 Block

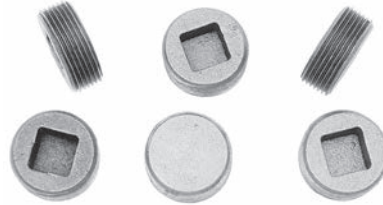

CAMSHAFT BEARINGS

M-6261-J351

- Fits 302/351 Ford Performance blocks
- Common outer and inner diameter replacement cam bearings for use in M-6010-R302/S302/R351/R352/S351/V351/W351/R451/R452/R453/B302BB/BOSS302/BOSS35192/BOSS35195/BOSS351BB cast iron blocks
- Use with custom ground common O.D. camshaft



FORD PERFORMANCE CYLINDER BLOCK CAMSHAFT PLUG

M-6026-S351

- Service camshaft plugs for Ford Performance M-6010-R302/S302/R351/R352/R353/R354/R355/S351/V351/W351/BOSS302/BOSS351 cylinder blocks
- Package of 10



PRODUCTION BLOCK PLUG AND DOWEL KIT

M-6026-A302

- Fits 289/302/351W production blocks
- Includes all necessary dowels, cup plugs and pipe plugs for rebuilding production V8 blocks
 - Timing cover dowels – Qty 2
 - Head dowels – Qty 4
 - Transmission dowels – Qty 2
 - Core plug cups – Qty 15
 - Camshaft core plug cup – Qty 1



CAMSHAFT BEARINGS – ROLLER (SOLD IN ENGINE SETS)

These low-friction, roller camshaft bearings only require oil "splash" lubrication. Oil feed holes can be totally blocked off to reduce oil aeration and windage losses. Engine block must be machined to accept bearing size shown in chart. NOTE: The 351 cam journals are NOT production dimensions. These roller bearings require an SAE 8620 steel camshaft.

| PART NUMBER | APPLICATION | O.D. DESCRIPTION | I.D. DESCRIPTION | LENGTH |
|--------------------|-------------|------------------|------------------|--------|
| M-6261-D351 | 351 Ford | (1-4) 2.48" | (1-4) 2.165" | .787" |
| | | (5) 2.28" | (5) 1.969" | |

NOTE: Requires camshaft retainer plate modifications.



BOSS BLOCK CYLINDER HEAD STUD KIT

M-6014-BOSS

- 1/2" cylinder head studs required for installation of the Ford Performance M-6049-X306/X307/Z304DA heads onto the M-6010-BOSS302, M-6010-B302BB, M-6010-BOSS35195, M-6010-BOSS35192, M-6010-B35192BB blocks
- Includes 12-point nuts and hardened washers
- Sold in engine sets

NOTE: Check header-to-head stud and nut for clearance.



CYLINDER HEAD STUD KIT

M-6014-Z304

- 1/2" cylinder head studs required when installing M-6049-Z304/Z304A/Z304D/Z304DA heads on a 351W block (except BOSS 351 block)
- 1/2" diameter studs with 12-point nuts and hardened washers
- Sold in engine sets



BOSS BLOCK HEAD BOLT SET

M-6065-BOSS

- 1/2" ARP® cylinder head bolts required for installation of the Ford Performance M-6049-X306/X307/Z304DA heads onto the M-6010-BOSS302, M-6010-B302BB, M-6010-BOSS35195, M-6010-BOSS35192, M-6010-BOSS351BB blocks
- Includes hardened washers
- Sold in engine sets



HEAD BOLT KIT

M-6065-D289

- Use when installing stock 351W, Ford Performance cast iron M-6049-L302/L303 or Ford Performance aluminum M-6049-Y302/Y303/X302/X303/X304/X305/X306/X307 head on 289/302 blocks
- Kit features 20 ARP® cylinder head bolts with 7/16" diameter thread
- Includes 20 special stepped washers
- Sold in engine sets



302-351W CAMSHAFT RETAINER PLATE

| PART NUMBER | APPLICATION | DESCRIPTION |
|--------------------|-----------------------------|---|
| M-6269-A302 | 302/351W | <ul style="list-style-type: none"> • Production replacement for 302 and 351W engines • For use with flat tappet and hydraulic roller camshafts • Designed for timing chain sets requiring .250" thick retainer plate • Not for use with steel cam gears |
| M-6269-A351 | 302/351 Ford Performance | <ul style="list-style-type: none"> • Steel replacement for production cast iron thrust plate for severe service • Use with steel timing chain sprocket • Required when using M-6268-B302 Timing Chain Set |



M-6269-A351

FORD PERFORMANCE ENGINES

HIGH STRENGTH FORGED STEEL 3.40" STROKER CRANKSHAFT

M-6303-C340

Fits 302 production and Ford Performance cylinder blocks. Stock 2.1232" rod journal diameters. Use with M-6200-D50 "Sportsman" rods (5.40" long) and 1.090" CD pistons in standard 302 block for 347 cu in.

Features:

- Lightening holes
- Rounded CW leading edge, tapered trailing edge
- Rod and main journals are nitrided and polished
- Requires custom pistons, rods and balancing



5.0L CRANKSHAFT DAMPER KIT

M-6316-M50

- New stock replacement crankshaft damper for most 1981-1995 5.0L/302 engines
- 50 oz-in balance factor
- Crankshaft damper overall length is 3.950"
- 4-bolt pulley pattern
- Kit includes E4TZ-A Crankshaft Damper and FITZ-A Timing Pointer



CRANKSHAFT DAMPERS

- Ford Performance crankshaft dampers are used on most Ford Performance push rod crate engines
- Billet steel construction, meets SFI 18-1 requirements
- Elastomer-style harmonic vibration damper
- Laser-etched timing marks and "Ford Racing" logo
- 3- and 4-bolt pulley mounting holes
- Clear powdercoat finish

| PART NUMBER | ENGINE | BALANCE | NOTES | MASS (LBS) |
|--------------------|-----------------|------------|---------------------|------------|
| M-6316-A50 | 302 (1981-1993) | 50 oz-in | Meets SFI 18-1 ①②③⑤ | 12.1 |
| M-6316-C351 | 302/351W | 28.2 oz-in | Meets SFI 18-1 ①②③⑥ | 11.5 |
| M-6316-D302 | 302/351W | Neutral | Meets SFI 18-1 ③⑥ | 10.6 |

- NOTES:**
- ① Damper has removable weight that allows use as a neutral balance unit for internally balanced crankshafts. 1994-2001 Mustang and Explorer requires modification
 - ② Does not clear early timing chain cover with rear installed seal
 - ③ 3.000" overall length
 - ④ Tuned for use on 521 crate engine
 - ⑤ Passenger side 11 o'clock timing marks only
 - ⑥ Passenger side 11 o'clock timing marks and driver side 2 o'clock timing marks



M-6316-A50



M-6316-A50/M-6316-C351

CRANKSHAFT PULLEY SPACERS

Use these crank pulley spacers with Ford Performance M-6316-C351/A50/D302 crank dampers to achieve proper belt alignment on late model 302 and 351 Windsor engines.

| PART NUMBER | ENGINE | CRANK PULLEY BOLT PATTERN | SPACER THICKNESS |
|--------------------|----------|---------------------------|------------------|
| M-8510-A351 | 302/351W | 4 | .350" |
| M-8510-B351 | 302/351W | 4 | .950" |
| M-8510-C351 | 302/351W | 4 | .875" |
| M-8510-D351 | 302/351W | 4 | .909" |

INSTALLATION NOTES

Early 3-bolt crank pulleys generally bolt directly to the damper with flanged pulley pilot (damper is drilled for 3- and 4-bolt patterns).

Pulley alignment should be checked and any misalignment corrected with the proper thickness spacer.



Photo may vary

351W HIGH-VOLUME OIL PUMP M-6600-B3



- Fits 1969-1997 351W
- High volume – standard pressure
- Use with Ford Performance BOSS 351 blocks
- Requires bolt-on pickup (not included)
- Due to the higher pumping capacity of this pump, it is not recommended for use with a stock capacity oil pan
- This pump will not fit stock rear sump oil pans because of its larger size
- Recommended with M-6675-DRS351 and M-6675-FT351 oil pans



289/302 HIGH-VOLUME OIL PUMP M-6600-D2



- Fits 1963-2000 289/302
- High volume – standard pressure
- Use with Ford Performance BOSS 302 block
- Used in Ford Performance 347 and 363 crate engines
- Requires bolt-on pickup (not included)
- Due to the higher pumping capacity of this pump, it is not recommended for use with a stock capacity oil pan
- This pump will not fit stock rear sump oil pans because of its larger size
- Recommended with M-6675-DRS302 and M-6675-FT302 oil pans

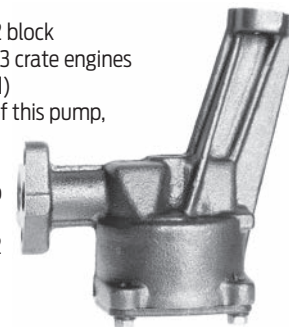

351 DEEP REAR SUMP OIL PICKUP TUBE FOR Z351 ALUMINUM BLOCK M-6622-DRS351A

- Fits M-6675-DRS351 Deep Rear Sump Oil Pan when used with the M-6010-Z351 Aluminum Block
- High-flow funnel-style pickup same as used on Mustang Cobra 4.6L 4V engines
- Thin wire screen delivers more than twice the flow area compared to many aftermarket pickup screens
- Thin wall 3/4" diameter tubing reduces vibration fatigue
- Quality built-in precision fixtures for a consistent OEM-level fit



BOSS 302 OIL PICKUP TUBE M-6622-BOSS302



- For use with M-6010-BOSS302 block
- Clears 4-bolt main caps
- Fits stock Fox body Mustang pans
- Fits FISE pans used on 1991-1995 Mustang



OIL PUMP DRIVE SHAFT



- M-6605-B302** Fits 289-302 EFI- and non-EFI & Ford Performance BOSS 302 blocks
- M-6605-A341** Fits 351W & all Ford Performance BOSS 351 blocks
- Heavy duty
- Chrome moly steel
- Centerless ground



ENGINE SWAP OIL PAN KITS

| PART NUMBER | SUMP | CAPACITY | FINISH | APPLICATION/DESCRIPTION |
|-------------------|------|----------|---------|---|
| M-6675-A50 | Rear | 5 qt | Painted | 5.0L oil pan kit. Includes rear sump oil pan, dipstick, dipstick tube, pickup and main cap stud. Ideal for engine swaps. Fits 1979-1995 Mustang and Fox chassis vehicles. Fits 1983-2001 production blocks. NOTE: Does not have provision for low oil sender. Fasteners not included. |
| M-6675-A58 | Rear | 5 qt | Painted | 351W/5.8L oil pan kit. Includes rear sump oil pan, dipstick, dipstick tube, pickup and main cap stud. Ideal for engine swaps. Fits 1979-1995 Mustang and Fox chassis vehicles. Fits 1969-1997 production blocks. Fasteners not included. |



HIGH-CAPACITY PERFORMANCE OIL PANS

Designed by Ford Performance for use on its crate engines, these oil pans are constructed to deliver power and durability.

Features include:

- Full-length scraper to direct oil away from the crankshaft
- Full-length bolt in louvered windage tray to control oil
- Baffling and trap doors in the sump to keep the pickup submerged
- during performance driving
- Semi-gloss black powdercoat finish
- Laser-cut and TIG welded in precision fixtures for consistent OEM-level fit

REAR SUMP

302 DEEP REAR SUMP OIL PAN

M-6675-DRS302

- 7 qt capacity
- Rear sump depth is 9.1" – rear sump width is 8.7" – front sump depth is 6.7"
- Includes 3/8" NPT bung to mount an oil temperature sending unit
- Includes 3/8" NPT access hole to adjust oil pump spring pressure
- Fits standard 302 Windsor block oil pan bolt pattern
- Designed to clear 4-bolt main cap Ford Performance BOSS 302 blocks
- Used on Ford Performance M-6007-Z363RT Crate Engine
- Use M-6622-DRS302 Pickup

351 DEEP REAR SUMP OIL PAN

M-6675-DRS351

- 7 qt capacity
- Rear sump depth is 9.1" – rear sump width is 8.7" – front sump depth is 6.7"
- Fits standard 351 Windsor block oil pan bolt pattern
- Includes 3/8" NPT bung to mount an oil temperature sending unit
- Includes 3/8" NPT access hole to adjust oil pump spring pressure
- Used on Ford Performance M-6007-Z427FRT and M-6007-Z427ART crate engines
- Use M-6622-DRS351 Pickup



M-6675-DRS351 shown

DEEP REAR SUMP OIL PICKUP TUBE

M-6622-DRS302 Fits Pan M-6675-DRS302

M-6622-DRS351 Fits Pan M-6675-DRS351

- High-flow funnel-style pickup same as used on Mustang Cobra 4.6L 4V engines
- Thin wire screen delivers more than twice the flow area compared to many aftermarket pickup screens
- Thin wall 3/4" diameter tubing reduces vibration fatigue
- Quality built-in precision fixtures for a consistent OEM level fit



M-6622-DRS351 shown

FRONT SUMP

302 FRONT T-SUMP RACING OIL PAN

M-6675-FT302

- 7 qt capacity
- Sump depth is 7.5" – T-sump width is 12.1" – T-sump length from the front of the pan is 10.6"
- Includes 3/8" NPT bung to mount an oil temperature sending unit
- Includes 3/8" NPT access hole to adjust oil pump spring pressure
- Fits standard 302 Windsor block oil pan bolt pattern
- Designed to clear 4-bolt main cap Ford Performance BOSS 302 blocks
- Used on Ford Performance M-6007-Z2363FT Crate Engine
- Use M-6622-FT302 Pickup

351 FRONT T-SUMP RACING OIL PAN

M-6675-FT351

- 9 qt capacity
- Sump depth is 8.1" – T-sump width is 12.15" – T-sump length from the front of the pan is 10.4"
- Fits standard 351 Windsor block oil pan bolt pattern
- Includes 3/8" NPT bung to mount an oil temperature sending unit
- Includes 3/8" NPT access hole to adjust oil pump spring pressure
- Designed to clear 4-bolt main cap Ford Performance BOSS 351 blocks
- Used on Ford Performance M-6007-Z427FFT Crate Engine
- Use M-6622-FT351 Pickup

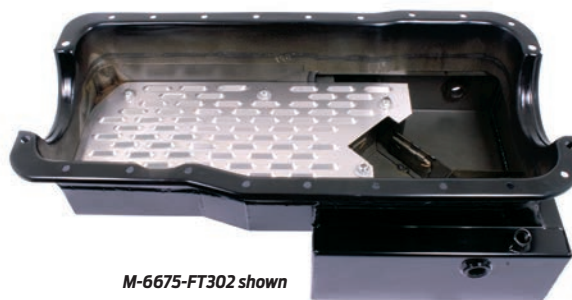

M-6675-FT302 shown

FRONT SUMP OIL PICKUP TUBE

M-6622-FT302 Fits Pan M-6675-FT302

M-6622-FT351 Fits Pan M-6675-FT351

- For use with production block
- Fits front sump oil pans
- High-flow funnel-style pickup same as used on Mustang Cobra 4.6L 4V engines
- Thin wire screen delivers more than twice the flow area compared to many aftermarket pickup screens
- Thin wall 3/4" diameter tubing reduces vibration fatigue
- Quality built-in precision fixtures for a consistent OEM level fit



M-6622-FT302 shown



CASE OF FORD RACING HIGH-PERFORMANCE OIL FILTERS SOLD AS CASE OF 12

- Synthetic – polymer/cellulose – fiber blend media
- Heavy-gauge base and canister for higher burst strength and impulse fatigue resistance
- High-quality silicone antidrains back valve
- Nonstick sealing gasket for ease of installation and removal
- Long life with standard and synthetic motor oils
- Up to 50% more filtering capacity than standard filters
- Improved filtering efficiency
- This technology is only available through Ford Performance Parts



| Motorcraft® PART NUMBER | PERFORMANCE FILTER | PART NUMBER |
|-------------------------|------------------------|----------------------------------|
| FL1A | CM-6731-FL1A (Single) | M-6731-FL1A (Case of 12) |
| FL820S | CM-6731-FL820 (Single) | M-6731-FL820 (Case of 12) |

NOTE: Check Ford Performance Distributors for single filter part numbers.

NOTE: FL820 can be used in many FL500 applications.

289-302 SB OIL PAN REINFORCEMENT RAILS

M-6674-302

Precision laser-cut steel rails help minimize the chance of oil pan leaks on 289-302 based small block Ford engines. These reinforcement rails are designed to be used with flat flange oil pans and M-6710-A50 One-Piece Silicone Rubber Oil Pan Gasket. These reinforcement rails are used on all Ford Performance 302/347/363 crate engines.

- Includes left and right 3/16" steel precision laser-cut reinforcement rails
- Fits original oil pan flange
- M-6710-A50 Oil Pan Gasket recommended
- Longer oil pan bolts are recommended



351W OIL PAN REINFORCEMENT RAILS

M-6674-351

Precision laser-cut steel rails help minimize the chance of oil pan leaks on 351W based small block Ford engines. These reinforcement rails are designed to be used with flat flange oil pans and M-6710-A351 One-Piece Silicone Rubber Oil Pan Gasket. These reinforcement rails are used on all Ford Performance 427-460 CID 351W-based small block crate engines.

- Includes left and right 3/16" steel precision stamped laser-cut reinforcement rails
- Fits original oil pan flange
- M-6710-A351 Oil Pan Gasket recommended
- Longer oil pan bolts are recommended

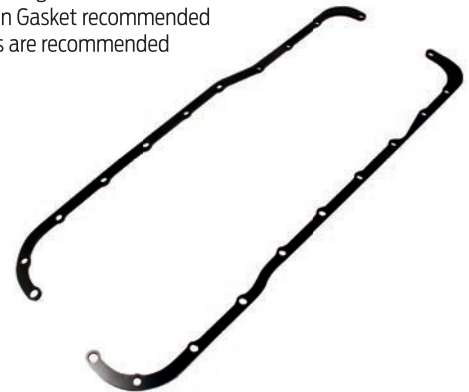

PUSH ROD V8 90 DEGREE OIL FILTER ADAPTER

M-6880-A50

- Adapter screws into original oil filter location and rotates filter toward front of engine to provide clearance for engine swaps and chassis modifications
- Fits most Ford small and big block push rod engines that use Ford Racing CM-6731-FL1A or Motorcraft® FL-1A Oil Filter (filter sold separately)
- Replacement O-rings, Fel-Pro® Part Nos. FP3330537 (small) and 72494 (large)



ENGINE OIL DIPSTICK/TUBE

M-6750-C303

- Fits 1983-1993 5.0L Mustang
- Chrome-plated tube with bracket



FORD PERFORMANCE ENGINES

302/351W "X" HEAD ALUMINUM ASSEMBLED

M-6049-X306

Assembled Head (64 cc chamber)

M-6049-X307

Assembled Head (58 cc chamber)



NEW AND IMPROVED, NOW ASSEMBLED WITH BEEHIVE™ SPRINGS AND HARDWARE. FAST, EASY WAY TO BOLT ON 65 HORSEPOWER! TRUE BOLT-ON PERFORMANCE.

- For use on 289/302/351 Windsor-style engines
 - Intake flows approximately 240 cfm at .550" lift (at 28" of H2O)
 - Exhaust flows approximately 170 cfm at .500" lift (at 28" of H2O)
 - Machined for 1.94" intake and 1.54" exhaust valve diameters
 - Ford Performance "X" heads use either GT-40 or aftermarket performance intake manifolds. Check your intake manifold for port match; not all intakes are compatible due to the tall high-flow ports. Does not fit Ford Performance M-9424-Z51 or M-9424-Z51P intake manifolds
 - Combustion chamber volume 64 cc
 - Intake port volume 178 cc, exhaust port volume 62 cc
 - High temperature exhaust valve seats. Bronze guides
 - Designed for bolt-on rocker arms, machined for gasket seat spark plug. Compatible with some Ford Performance intakes, headers, and valve train components
 - High-quality original equipment style 356-T6 aluminum castings, machining and components
 - Each aluminum head weighs approximately 22 lbs – approximately 25 lbs lighter than each production cast iron head
- These GT-40 style heads use AGSP-32C spark plugs
 - Each head is leak tested prior to assembly
 - Assembled with M-6507-J302 Intake Valves, M-6505-G302 Exhaust Valves, PAC 1219X Ovate Beehive™ valve springs. Closed spring pressure is 145 lbs @1.800", 358 lbs @1.175". Compatible with all Ford Performance roller camshafts and aftermarket hydraulic roller camshafts up to .600" lift
 - Feature 10° locks, steel valve spring retainers and stock valve seals
 - Designed to be used on Ford Performance M-6010-BOSS302, M-6010-B302BB, M-6010-BOSS35195, M-6010-BOSS35192 and M-6010-BOSS351BB BOSS blocks. M-6065-BOSS Head Bolts or M-6014-BOSS Head Stud Kit and M-6051-CP331/S331 Head Gasket, or Big Bore application M-6051-R351 recommended
 - Must use M-6065-D289 Head Bolt Kit to install cylinder heads on 289/302 production blocks or head bolt and M-6051-A50 Head Gasket Kit
 - Designed for M-6564-B351 Bolt-Down Rocker Arms for a 1.6 ratio. Use M-6564-A50 for a 1.7 ratio. Check rocker arm clearance to valve springs with production rocker arms
 - Uses Fel-Pro® exhaust gasket part number 1415

NOTE: Will not fit 1986 5.0L with flat-top pistons unless pistons are notched for valve relief.

Z2 289/302/351W ALUMINUM HEAD WITH "VELOCITY VANE"

M-6049-Z2

This aluminum small block Ford cylinder head features an advanced "Velocity Vane" intake port design that delivers outstanding street/strip power. Developed with the aid of advanced computer aided engineering simulation tools, the unique "Velocity Vane" intake port design improves power throughout the rpm range. This high-performance aluminum cylinder head is a direct bolt-on for Ford 289/302/351W engines and retains OEM exhaust, intake and accessory mounting locations.

- Fits 289/302/351 Windsor engines
- Cast from prime 356-T6 aluminum
- Heads retain Ford OEM intake and exhaust port location and flange
- Intake ports feature a unique "Velocity Vane" in port floor to direct airflow around the valve stem – that leads to more horsepower and torque throughout the full power range
- 20° inline valve angle
- Premium stainless steel valves – 2.05" intake, 1.60" exhaust valves
- PAC 1219X conical-style valve springs with machined retainers and 10° machined valve locks. Most hydraulic cams can be used with these springs
- Valve spring closed pressure – 145 lbs @1.800"
- Valve spring open pressure – 358 lbs @ 1.175"
- Coil bind @1.100", 0.650" max lift
- Includes laser-cut guide plates for use with 5/16" push rods and 7/16" rocker studs
- Steel alloy intake and exhaust valve seats
- Manganese-bronze valve guides
- 63 cc combustion chamber
- Uses gasket style 14 mm spark plugs
- Uses standard roller rocker – M-6564-K351 recommended
- Check piston-to-valve clearance, including radial valve clearance, before installing these cylinder heads on your engine
- Uses M-9439-A50 Intake Gasket and Fel-Pro® exhaust gasket Part No. 1415



INTAKE VALVE — SINGLE GROOVE (SOLD INDIVIDUALLY)

| PART NUMBER | APPLICATION | HEAD DIAMETER | TIP LENGTH | TOTAL LENGTH | STEM DIAMETER | GROOVE TYPE | VALVE WEIGHT | DESCRIPTION |
|--------------------|---|---------------|------------|--------------|---------------|-------------|--------------|---|
| M-6507-J302 | GT-40 Aluminum Head M-6049-Y302/Y303/X302/ X303/X304/X305/X306/X307 | 1.940" | .383" | 5.078" | 11/32" | Square cut | 113.2 grams | Premium stainless steel, swirl polished, under-cut stem |

EXHAUST VALVE — SINGLE GROOVE (SOLD INDIVIDUALLY)

| PART NUMBER | APPLICATION | HEAD DIAMETER | TIP LENGTH | TOTAL LENGTH | STEM DIAMETER | GROOVE TYPE | VALVE WEIGHT | DESCRIPTION |
|--------------------|--|---------------|------------|--------------|---------------|-------------|--------------|---|
| M-6505-G302 | GT-40 Iron Head M-6049-L302/303 Ford Performance Aluminum Head M-6049-X306/X307 | 1.540" | .383" | 5.078" | 11/32" | Square cut | 120 grams | Premium stainless steel, swirl polished, under-cut stem |

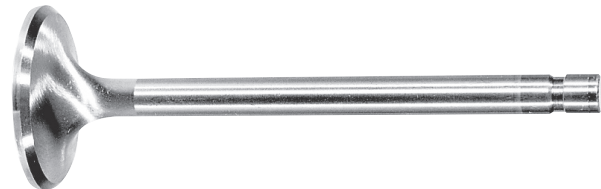
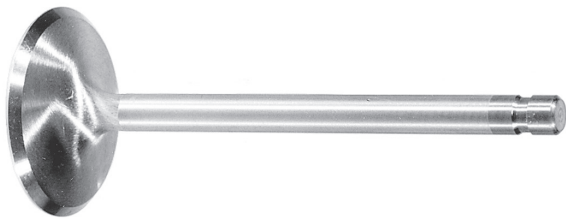

BRONZE VALVE GUIDE KIT

M-6510-XRBVG

- Sold in sets of 4
- Replacement bronze valve guides for the M-6049-Y302/Y303/X302/X303/X304/X305/X306/X307 heads
- .557" outside diameter
- Inside diameter designed for 11/32" valves, HONING REQUIRED



VALVE STEM SEALS POSITIVE-TYPE, GUIDE-MOUNTED SEAL

| PART NUMBER | TYPE | APPLICATION NOTES | PACKAGING |
|-------------------|---------------------|--|---|
| M-6571-A50 | Rubber ^① | GT-40 cylinder heads. No machining required | Pkg. of 8 intake and 8 exhaust seals |

NOTES: ^① Fits most production .550"-.570" diameter guides.



FORD PERFORMANCE ENGINES

302/351W "Z" HEAD ALUMINUM – ASSEMBLED 63CC



- M-6049-Z304DA** Assembled Head
- M-6049-Z304D** Bare Head
- M-6049-Z304DA7** Assembled Head w/7 mm Valves
- M-6049-Z304D7** Bare Head w/7 mm Valves
- M-6049-Z304P** CNC-ported Head

- Fits 302/351 Windsor engines
- Cast from prime A356 T6 aluminum
- Heads are cast with high-flow ports
- 20° inline valves
- Premium stainless steel 2.02" M-6507-A304 Intake and 1.60" M-6505-B304 Exhaust Valves
- Uses PAC 1219X conical-style valve springs with machined retainers and machined valve locks. Most hydraulic cams can be used with these springs.
 - Valve spring closed pressure – 145 lbs @1.800"
 - Valve spring open pressure – 358 lbs @ 1.175"

- Includes laser-cut M-6566-Z304D Guide Plates for use with 5/16" push rods and 7/16" rocker studs (ARP® DRP154 rocker stud)
- Steel alloy intake and exhaust valve seats
- Manganese-bronze valve guides
- 63 cc CNC'd combustion chamber
- Intake port volume as cast: 204 cc
- Exhaust port volume as cast: 85 cc
- Accepts both tapered seat and gasket style 14 mm spark plugs (Motorcraft® AGSP-32-PP, Autolite® 3924, 3925)
- Requires M-6564-F351 1.65:1 or M-6564-G351C 1.5:1 ratio roller rocker arms with .150" offset intake push rod cup (not included)
- Raised exhaust port exit, custom headers may be required
- Ford Performance M-9439-A50 Intake Manifold Gasket recommended
- Uses Fel-Pro® exhaust gasket Part No. 1487
- Fel-Pro® VS13264T valve cover gasket recommended
- Check piston-to-valve clearance, including radial valve clearance, before installing these cylinder heads on your engine



VALVE PUSH ROD GUIDE PLATE (SOLD IN PKG. OF 8)

Use with mechanical cams, threaded stud, adjustable (non-rail) rocker arms and hardened push rods. May require modification for use with roller rocker arms.

| PART NUMBER | CYLINDER HEAD | PUSH ROD DIAMETER |
|---------------------|---------------------|-------------------|
| M-6566-Z304D | M-6049-Z304D/Z304DA | .3125" |



INTAKE VALVES – SINGLE GROOVE (SOLD INDIVIDUALLY)

| PART NUMBER | APPLICATION | HEAD DIAMETER | TIP LENGTH | TOTAL LENGTH | STEM DIAMETER | GROOVE TYPE | VALVE WEIGHT | DESCRIPTION |
|---------------------|------------------------------|---------------|------------|--------------|---------------|-------------|--------------|--|
| M-6507-A304 | M-6049-Z304/ Z304D/Z304DA | 2.020" | .290" | 5.340" | 11/32" | Square cut | 122 grams | Premium stainless steel and swirl polished |
| M-6507-D3047 | M-6049-Z304/ Z304DA7 | 2.020" | .325" | 5.340" | 7 mm | Bead lock | 103 grams | Premium stainless steel and swirl polished |



EXHAUST VALVES – SINGLE GROOVE (SOLD INDIVIDUALLY)

| PART NUMBER | APPLICATION | HEAD DIAMETER | TIP LENGTH | TOTAL LENGTH | STEM DIAMETER | GROOVE TYPE | VALVE WEIGHT | DESCRIPTION |
|---------------------|-------------------------|---------------|------------|--------------|---------------|-------------|--------------|--|
| M-6505-B304 | M-6049-Z304D/ Z304DA | 1.600" | .290" | 5.365" | 11/32" | Square cut | 120 grams | Premium stainless steel and swirl polished |
| M-6505-D3047 | M-6049-Z304DA7 | 1.600" | .340" | 5.365" | 7 mm | Bead lock | 95.4 grams | Premium stainless steel and swirl polished |





PAC 1219X BEEHIVE™ VALVE SPRING

M-6513-1219X

PAC 1219X valve spring as used on M-6049-Z304DA Cylinder Heads.

- O.D. large end – 1.207"
- I.D. small end – 0.650"
- Installed height (valve closed) – 145 lbs @ 1.800"
- Open valve (valve open) – 358 lbs @ 1.175"
- Spring rate 340
- Max coil bind – 1.100"



N-351 PUSH ROD GUIDE PLATE

M-6566-N351

Specifically designed by Ford Performance for the N351 Sportsman Short Track cast iron cylinder head, these guide plates are for use with a 3/8" push rod.

- Made from hardened laser-cut steel – 0.125" thick
- For use with 3/8" push rods
- Rocker stud center line is 1.850"
- Push rod center line is 1.980"
- Designed for use with roller rocker – intake rocker is 0.150" offset
- Black oxide finish



VALVE ROCKER ARM STUDS

(SOLD IN PKG. OF 16)

Requires head to be tapped for threaded rocker arm stud.

| PART NUMBER | APPLICATION | DESCRIPTION |
|--------------------|--------------------------------------|---|
| M-6527-C311 | 302 BOSS/351C BOSS, 429/460 Wedge | 7/16" dia. shoulder with 7/16" threads. Mounting length is 1.850". For use with stud girdles. |



VALVE SPRING RETAINERS (SOLD IN PKG. OF 16)

| PART NUMBER | APPLICATION VALVE | SPRING | DESCRIPTION | SPRING O.D. | RETAINER O.D. | STEP DIMENSIONS | |
|-------------------|---|--|-------------------|-------------|---------------|-----------------|----------|
| | | | | | | 1ST STEP | 2ND STEP |
| M-6514-A50 | Single lock groove. 11/32" dia. stem | M-6513-A50 M-6513-B351 M-6049-N351 and all GT-40 ①② | 7° machined steel | 1.500" | 1.375" | 1.060" | .675" |



NOTES: ① Use of M-6514-B50 Retainers on 1979-1995 production valves of 5.0L (302) HO and production GT-40 engines eliminates exhaust rotators and will result in 1.800" intake and exhaust spring "installed height." ② With Ford Performance stainless steel valves.

FORD PERFORMANCE ENGINES

FORD PERFORMANCE CAMSHAFTS

The Ford Performance Camshaft Specification chart below describes individual cams currently available from Ford Performance.

SMALL BLOCK V8 HYDRAULIC ROLLER TAPPET CAMSHAFTS

| PART NUMBER | ENGINE | ROCKER RATIO | INTAKE EVENTS (.050") | | EXHAUST EVENTS (.050") | | DURATION (SAE) | | LIFT (INCHES) | | LOBE CENTER | |
|-----------------------------------|-------------------------------|--------------|-----------------------|---------|------------------------|--------|----------------|------|---------------|--------|-------------|------|
| | | | OPEN | CLOSE | OPEN | CLOSE | INT. | EXH. | LOBE | VALVE | INT. | EXH. |
| M-6250-B303 ① ② ③ ⑥ | 1985 and later 302 roller cam | 1.60 | 5° BTC | 39° ABC | 49° BBC | 5° BTC | 284° | 284° | .300 I | .480 I | 107° | 117° |
| | | | | | | | 224° | 224° | .300 E | .480 E | | |
| M-6250-E303 ① ② ③ ⑥ | 1985 and later 302 roller cam | 1.60 | 0° BTC | 40° ABC | 40° BBC | 0° BTC | 282° | 282° | .311 I | .498 I | 110° | 110° |
| | | | | | | | 220° | 220° | .311 E | .498 E | | |
| M-6250-F303 ① ② ③ ④ ⑥ ⑦ | 1985 and later 302 roller cam | 1.60 | 4° BTC | 42° ABC | 52° BBC | 6° BTC | 288° | 288° | .320 I | .512 I | 109° | 119° |
| | | | | | | | 226° | 226° | .320 E | .512 E | | |
| M-6250-X303 ① ② ③ ④ ⑥ ⑧ | 1985 and later 302 roller cam | 1.60 | 5° BTC | 39° ABC | 49° BBC | 5° BTC | 286° | 286° | .339 I | .542 I | 107° | 117° |
| | | | | | | | 224° | 224° | .339 E | .542 E | | |



The legendary B303 cam developed by Ford Performance for the 5.0L Fox body Mustang. This cam provides a noticeable power improvement and lumpy idle while maintaining good driveability with a manual transmission. Works well with carburetors or mass air fuel injection.

- Fits 1985 and later 302 roller cam blocks
- Will also fit 1963-1984 non-roller cam 289-302 blocks when used with M-6500-T58 Hydraulic Roller Lifters
- Will also fit 1994-1997 351W blocks with factory roller cam
- Will also fit 1969-1993 non-roller cam 351W blocks when used with M-6500-T58 Hydraulic Roller Lifters
- Requires upgraded valve springs. For stock cylinder head applications use M-6513-A50 Valve Springs installed at 1.820". For aftermarket cylinder heads, M-6513-BH recommended
- Valve spring requirements: 120 lbs valve seat pressure minimum, 295 lbs open
- On EFI engines, performance camshafts work only with mass air induction systems. Will not work with Explorer EEC-V EFI or speed density EFI systems
- Also fits 1994-1997 351W with factory roller cam when used with mass air EFI
- Stock 5.0L HO cam advertised specs are 266°/266° duration, 0.444"/0.444" lift
- Higher stall torque converter recommended for automatic transmissions

NOTE: Camshaft intake and exhaust valve events are measured at 0.050" tappet lift. The duration figures in the shaded area are taken at 0.050" tappet lift. This is useful to check the cam with a degree wheel during installation. The solid color is advertised duration. For comparison purposes, add intake and exhaust lobe centers and divide by 2 to calculate "camshaft center line" specification for Ford Racing camshafts.

NOTES:

- ① On EFI engines, performance camshafts work only with mass air induction systems. Will not work with Explorer EEC-V EFI.
- ② Also fits 1994-1997 351W with factory roller cam when used with mass air EFI.
- ③ Stock 5.0L HO cam advertised specs are 266°/266° duration, 0.444"/0.444" lift.
- ④ May require piston modification for piston-to-valve clearance. Valve clearance should be checked.
- ⑤ May require longer pushrods.
- ⑥ High-stall torque converter recommended for automatic transmissions.
- ⑦ Great for superchargers. Manual transmission recommended.
- ⑧ Good torque and power up to 6200 rpm. Manual transmission recommended.

BILLET STEEL HYDRAULIC ROLLER CAMSHAFT

M-6250-C580T

The C580T cam was developed by Ford Performance. It's a dual pattern cam with a strong lumpy idle that makes good power from 3000 through 6500 rpm. This is a true street-strip cam and works best with a manual transmission or higher stall speed torque converter and high numerical rear end gears. Works well with carburetors or mass air fuel injection.

- Billet steel hydraulic roller camshaft
- Camshaft lift (in): .580"/.602" with 1.65:1 rocker ratio - .563"/.584" with 1.6:1 rocker ratio
- Camshaft duration (@.050 in): 232°/240°

- 112° lobe separation and 107° intake valve center line
- Ford Performance M-6500-R302H High-Performance Hydraulic Roller Lifters are recommended in factory roller cam blocks
- Manual transmission or higher stall torque converter (3000 rpm) recommended for automatic transmissions
- Fits 1985-2000 302, 1994-1997 351W roller cam blocks, Ford Performance BOSS 302 and BOSS 351 race blocks
- Will also fit non-roller cam 289, 302 and 351W blocks when used with tie-bar aftermarket hydraulic roller lifters
- Requires upgraded valve springs
- Check valve-to-piston clearance

HYDRAULIC ROLLER CAM LIFTERS M-6500-R302

- Direct replacement for 302/351W production small block hydraulic roller lifter applications
- Use M-6500-R302H High-Performance Roller Cam Lifters for higher rpm and severe duty applications
- Uses production dog-bone type tie bars and retainer plate components included in M-6253-A50 Roller Cam Conversion Kit
- Sold in a set of 16 lifters

M-6500-R302 Hydraulic Roller Lifter shown



- This unique lifter construction for a drop-in hydraulic roller lifter is an exclusive from Ford Performance and fits any small block Ford roller cam application. While the R302H was developed specifically for racing conditions, it's the right choice when assembling a high-performance small block that uses a hydraulic roller camshaft.
- High-performance hydraulic roller tappet recommended for performance and racing applications
- Modified OEM lifter features ceramic check ball and higher rate piddle valve spring to improve performance at higher rpms and higher oil temperatures
- Ford Performance dyno tests have shown 300 to 400 rpm increase in rpm range over stock OEM-type hydraulic roller lifter in Ford Performance sealed crate engines
- Direct replacement for the OEM small block hydraulic roller lifter applications
- Uses OEM dog-bone type tie bars and retainer plate components included in M-6253-A50 Roller Cam Conversion Kit
- Sold in a set of 16 lifters

HIGH-PERFORMANCE HYDRAULIC ROLLER CAM LIFTERS M-6500-R302H

It's not often that little changes can deliver big results – but in the case of the Ford Performance R302H Lifter, that's exactly the case.

Before getting into the technical details of the lifter, here's the background on why and how this special lifter was developed by the engineers at Ford Performance. Circle track racers who use the production hydraulic roller lifter in 347 crate engines reported that their engine seemed to lose power during long green flag runs. Dyno testing by Ford Performance engineers confirmed that – and showed a dramatic performance fall off over 6000 rpm with hot oil temperatures. The problem was traced to the piddle valve check ball, which would become unseated at high rpm when the oil got hot. The fix was a lighter-weight ceramic piddle valve check ball combined with a higher-rate piddle valve spring to keep it seated. The results of these two small changes were impressive – and noticeable by the racers. The power range was extended 300-400 rpm in hot operating conditions – and more importantly, the performance fall off on those long runs was gone.

| PART NUMBER | APPLICATION | TYPE/DESCRIPTION |
|---------------------|------------------------|--|
| M-6500-R302 | All Roller Small Block | Hydraulic roller tappet OEM replacement |
| M-6500-R302H | All Roller Small Block | High-performance hydraulic roller tappet recommended for performance and racing applications. Direct OEM lifter size replacement |

HIGH-PERFORMANCE TOOL STEEL LIFTER PUSH ROD CUP

M-6500-R302HLC

- Tool steel push rod cup for the M-6500-R302 or M-6500-R302H hydraulic roller lifter
- Intended for high rpm and competition use
- Set of 16 cups



ROLLER CAM CONVERSION KIT M-6253-A50



- Fits 1985-2001 302, 1994-1997 351W
- Fits Ford Performance BOSS 302 and BOSS 351 blocks
- This kit is designed to help engine builders assemble Ford Performance BOSS blocks into complete engines
- Kit includes 8 hydraulic roller lifter powdered metal tie bars, 1 retainer plate and 2 bolts
- Not for use in production non-roller cam blocks



DOUBLE ROLLER TIMING CHAIN SET

The crank sprocket has 2-degree increments for timing adjustment of up to 8 degrees retarded, 8 degrees advanced or straight-up (no advance or retard). Chain is rugged, double-row type with oversized .250" rollers that deliver long life and reliability.



Full Roller Timing Chain and Sprocket Set

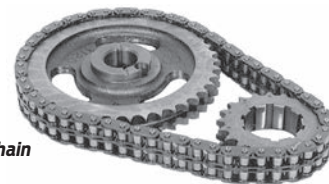

| PART NUMBER | APPLICATION | DESCRIPTION |
|--------------------|---------------|---|
| M-6268-A302 | 289/302/351W | Full roller chain with 9-position multi-index crank sprocket. Includes M-6269-A302 Thrust Plate and 1" camshaft dowel pin. Cam sprocket is made from cast iron. Crank sprocket is made from induction-hardened, billet steel. Compatible with one-piece M-6287-B302 Fuel Pump Eccentric. Depending on camshaft manufacturer and application, other dowel pin length may be required. Not compatible with two-piece fuel pump eccentric. |
| M-6268-B302 | 289/302/351W | Same as M-6268-A302, except cam sprocket is made from steel for maximum competition engines. Use with M-6269-A351 Hardened Thrust Plate. |
| M-6268-A351 | 351C/351M/400 | Full roller chain with 9-position multi-index crank sprocket. |
| M-6287-B302 | 289/302/351W | Eccentric for M-6268-B302 and A302 Kits – mechanical fuel pump drive, with 3/8" bolt. |
| M-6287-C302 | 289/302/351W | Eccentric for M-6268-B302 and A302 Kits – mechanical fuel pump drive, with 7/16" bolt. |

FORD PERFORMANCE ENGINES

HY-VO® TIMING CHAIN AND GEAR SET

M-6268-F302



- Developed with combined efforts from Roush® Industries, Borg-Warner® Automotive and Morse Tec®
- This new generation timing chain set is twice as strong as a standard roller chain and three times as strong as a timing belt
- Improved tolerances for reduced backlash
- It gained 2 horsepower at 7000 rpm
- Multi-indexing crank sprocket
- Use with M-6269-A351 Hardened Thrust Plate
- Replacement Hy-Vo® timing chain M-6268-G302

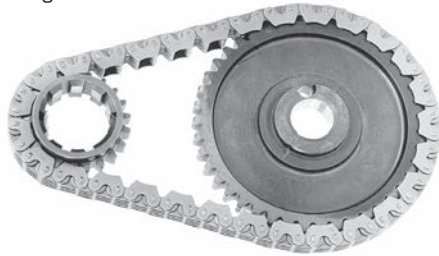

ROCKER CHANNEL KIT

M-6588-A50



- Fits 5.0L/5.8L production heads and GT-40 heads
- For production stamped steel and Ford Performance bolt-on roller rockers
- Ties two rocker arms together for proper alignment



VALVE PUSH RODS (PACKAGE OF 16)



| PART NUMBER | YEAR | ENGINE | DESCRIPTION | DIAMETER | GAUGE LENGTH | TYPE |
|--------------------|-------------|--------|---|----------|--------------|---------------|
| M-6565-L302 | 1985.5-1996 | 5.0L | Hydraulic roller tappet stamped steel and most roller rockers ① | .312" | 6.272" | Ball and Ball |

NOTE: ① Production style not for use with guide plate.

HI-PERFORMANCE ENGINE GASKET SET

M-6003-A50



- Fits 289/302/351W (1963-2001)
- Manufactured to Ford specs by Fel-Pro®
- Kit includes production-style graphite head gaskets and Print-O-Seal® intake gasket
- Includes four-piece oil pan gasket and valve cover gaskets
- Also includes front and rear oil seals plus most gaskets for a complete rebuild

NOTE: Does not include one-piece rear main for 351W, use M-6701-B351. Head gaskets not for use with Ford Performance BOSS blocks. Intake gaskets fit base production heads only.

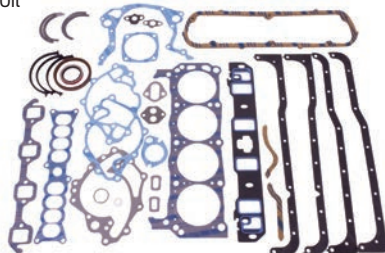

302/351W ONE-PIECE REAR MAIN OIL SEAL

M-6701-B302



- Direct replacement one-piece crankshaft rear main seal for 1983-2001 5.0L/302 blocks
- Also fits Ford Performance M-6010-BOSS302 and M-6010-B302BB block

M-6701-B351

- 351W one-piece rear main oil seal
- High temperature resistant material
- Direct replacement one-piece crankshaft rear main seal for 351W from 7/11/83-1997
- Use on Ford Performance 351W blocks manufactured after 6/1/93
- Also fits Ford Performance M-6010-BOSS35192, M-6010-B35192BB, M-6010-BOSS35195 and M-6010-BOSS351BB block



ROCKER ARM PEDESTAL SHIM KIT

M-6529-B302



- Fits 302 and 351 pedestal-style cylinder heads, like Ford Performance M-6049-X306 and M-6049-X307
- Use with bolt-on M-6564-A50 and M-6564-B351 roller rocker arms to obtain correct lifter pre-load
- Shim kit is used to reduce lifter pre-load and includes 16 each of the following thickness shims: .010", .020", .030" and .040"



VALVE ROCKER ARM PEDESTAL SHIM KIT

M-6529-A302



- Fits 302 and 351 pedestal-style cylinder heads, like Ford Performance M-6049-X306 and M-6049-X307
- Use with bolt-on M-6564-A50, M-6564-B351 and M-6564-C351 roller rocker arms to obtain correct lifter pre-load
- Shim kit includes 16 thin and 16 thick shims, which can be used to reduce lifter pre-load by 0.030" (thin shim), 0.060" (thick shim), or 0.090" (thin plus thick shim)





CYLINDER HEAD GASKETS (SOLD IN PAIRS)

| PART NUMBER | CYLINDER BORE APPLICATION | BORE DIAMETER | GASKET DIAMETER | COMPRESSED THICKNESS | COMPRESSED VOLUME | DESCRIPTION |
|--------------------------|--|---------------|-----------------|----------------------|-------------------|--|
| M-6051-C51 ① | 302/351 | 4.00" | 4.100" | .047" | 10.169 cc | Fits push rod 302 and 351 Ford high-performance engines. |
| M-6051-D50 ① | 302 | 4.100" | 4.100" | .045" | 9.7 cc | Includes 9 short head bolts, 10 long head bolts, 1 short head bolt with stud. Recommended for high-performance applications when using a stock block. |
| M-6051-A302 ① | 289/302/351W Production-type Cast Iron and Aluminum Heads | 4.00" | 4.100" | .042" | 9.1 cc | 4.00" standard bore "competition" gasket for cast iron or aluminum cylinder heads on 302 and 351W production blocks. Features solid metallic core with wire encased combustion chamber seal for applications. Surfaces are Teflon® coated. |
| M-6051-S331 ① | 302/351 | 4.00" | 4.100" | .040" | 8.8 cc | Pre-flattened steel wire combustion ring. Exhaust side is straight to accommodate FPP block water passages. |
| M-6051-CP331 ① | 302/351 | 4.00" | 4.100" | .040" | 8.8 cc | Pre-flattened copper wire combustion ring. Exhaust side is straight to accommodate FPP block water passages. |
| M-6051-B341 ① | Big Bore 351 Ford Performance Blocks | 4.125" | 4.160" | .040" | 9.1 cc | 4.125" overbore "competition" gasket. Same as M-6051-D331 Gasket except designed for Ford Performance blocks with larger 4.125" overbore. Bore flange valve pockets have been added to unshroud intake and exhaust valves. Set includes unique right- and left-hand gaskets! |
| M-6051-R351 ① | 302/351 Ford Performance | Up to 4.125" | 4.160" | .040" | 9.0 cc | For use on M-6010-R351/R352/R451/R452/BOSS302/B302BB/BOSS35195/BOSS35192/BOSS351BB. |

NOTES:

- ① Several different water hole patterns have been used on 302 and 351W Ford Performance cylinder blocks and heads since their introduction. Engine assemblers should lay the head gasket on the block and the cylinder head (with front of gasket toward the front of the engine) to make sure there is a path for coolant flow from the block into the head. In some cases, holes may have to be drilled in the block or head, or punched in the gasket.

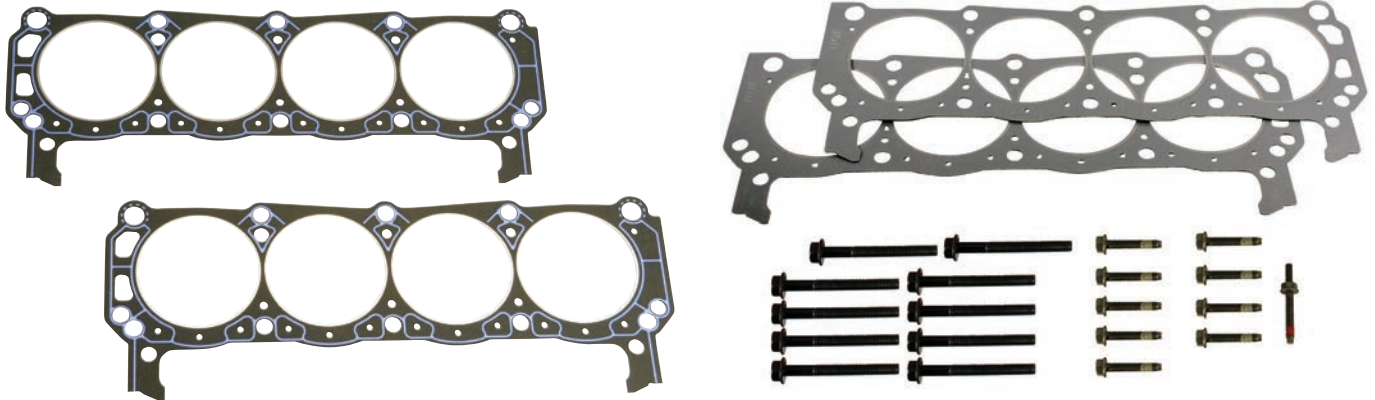

FORD PERFORMANCE ENGINES

ONE-PIECE RUBBER OIL PAN GASKET

M-6710-A50

- Fits 1963-2001 289/302
- Designed for use with smooth rail oil pans. Recommended for M-6675-DRS302, M-6675-FT302 and M-6675-A50 oil pans
- One-piece design, rubber bonded on steel reinforcement



M-6710-A351

- Fits 1969-1997 351W/5.8L
- Designed for use with smooth rail oil pans. Recommended for M-6675-DRS351, M-6675-FT351 and M-6675-A58
- One-piece design, rubber bonded on steel reinforcement



GRAPHITE INTAKE GASKET FOR STD PORT 302/351W

M-9439-G50

- Graphite intake gasket for standard 302 and 351W intake port openings
- Fits all production heads with rectangle water openings and GT-40 cast iron heads



302/351W INTAKE MANIFOLD GASKET

M-9439-A50

- Fits Ford Performance small block "X" and "Z" aluminum cylinder heads except M-6049-Z304P. For intake gaskets for M-6049-Z304P, see M-9439-ZP
- Fits Ford Performance small block "N" cast iron cylinder heads
- Sold in engine set
- Synthetic rubber Print-O-Seal® (Fel-Pro® Inc.) bead around ports provides improved sealing
- Designed for improved port location and allows mild porting
- Non-stick coating, steel reinforced
- Gasket thickness 0.065"

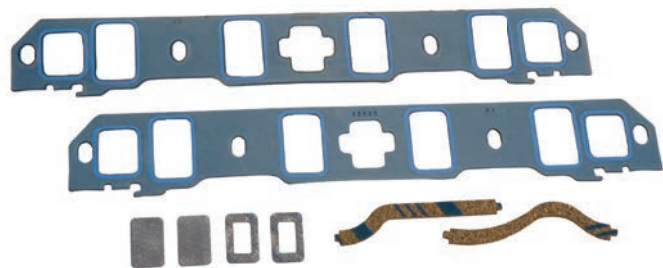

PORTED "Z" CYLINDER HEAD INTAKE MANIFOLD GASKET

M-9439-ZP

- Intake gasket is designed to fit Ford Performance ported 302-351 W high-flow "Z" M-6049-Z304P Cylinder Heads
- Fits most single plane intake manifolds, but needs to be checked for port alignment and for adequate sealing surface



EXHAUST MANIFOLD GASKET RACE QUALITY (SOLD IN PAIRS)

PART NUMBER

CYLINDER HEAD APPLICATION

M-9448-B302

Production 289/302/351W

NOTE: Header flanges available from Hedman® headers. Contact local distributor.

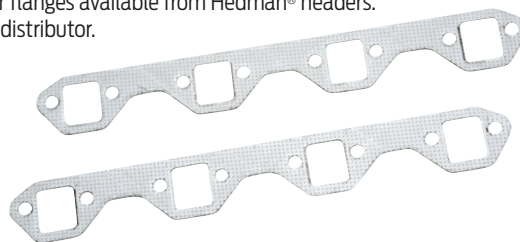

VALVE ROCKER ARM COVER GASKET (SOLD IN PAIRS)

PART NUMBER

APPLICATION

DESCRIPTION/NOTES

M-6584-A50

289/302/351W
M-6049-X306/X307

Production-type design featuring metal gasket with bonded O-ring. Part of high-performance 5.0L M-6051-D50 Gasket Kit. Designed for valve covers without a gasket lip. (Does not fit M-6049-Z304DA Cylinder Heads and M-6582-BOSS/BOSSP/BOSS302/W427B/W427P valve covers. For these applications, Fel-Pro® VS 13264T recommended.)



289/302 DUAL PLANE INTAKE MANIFOLD

M-9424-F302



- For use with 8.206" deck height block and inline valve heads
- 4.375" at the front of the carburetor pad, 5.250" at the rear
- Dual plane intake
- 1500-6000 rpm range
- For use with any mid-rpm small block application, great for street cars and mild race engines
- Excellent fuel distribution
- Does not fit "Z", "Z2" or the GT-40 "X" heads

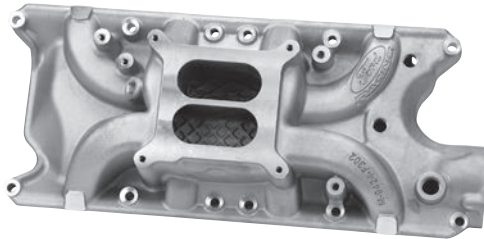

289/302 SINGLE PLANE VICTOR JR.® INTAKE MANIFOLD

M-9424-D302



- For use with 8.206" deck height block and inline valve heads
- 5.35" at the front of the carburetor pad, 5.42" at the rear
- Single plane Victor Jr.-style intake 3500-8000 rpm range
- For use with any high-rpm small block application

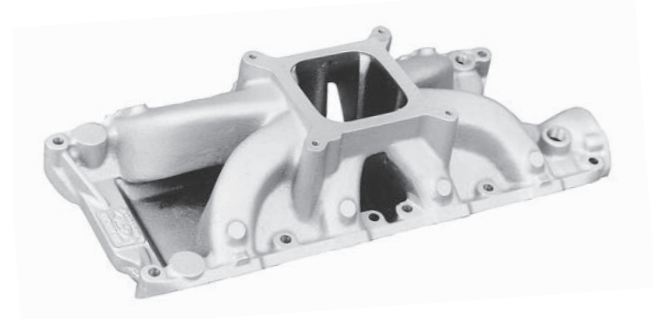

EFI HEAT SPACERS

- Made in the USA
- CNC-machined from Westinghouse® Type C phenolic material. Fits between the upper and lower manifolds to help dissipate heat and significantly increase performance



M-9486-A51 .5" Stock 5.0L Intake

Includes 4 each of a 2" long 5/16 x 18 bolt and flat washer, and 2 each of a 6-5/16" long 5/16 x 18 bolt and flat washer, for 1986-1993 5.0L intake.

M-9486-A52 .5" Cobra Intake

Includes 2 each, 1-3/16" long 5/16 x 18 bolts, 5-7/16" long 5/16 x 18 bolts and 6" long 5/16 x 18 bolts, for Ford Performance Cobra intake manifold. New and improved quality.

M-9486-A53 1" Cobra Intake

Includes longer bolts for Ford Performance Cobra intake manifold. 4 each, 7-1/4" long 5/16 x 18 bolts, and 2 each, 2-3/4" long 5/16 x 18 bolts, with flat washers. New and improved quality.



EDELBROCK® 2929 SUPER VICTOR® INTAKE MANIFOLD

M-9424-E2929



- Edelbrock® Super Victor® single plane aluminum intake manifold
- Fits 9.2" deck height only. 351W style engines only



EFI UPPER-TO-LOWER INTAKE MANIFOLD GASKET

M-9486-A50



- Production-style GT-40 upper-to-lower intake gasket
- Sold in package of five



FORD PERFORMANCE ENGINES

302/351W MAXIMUM FLOW ALUMINUM WATER PUMP

M-8501-F351

- Standard rotation water pump for 1970-1978 5.0L and 1970-1987 351W engines
- Features premium quality aluminum casting, HD 3/4" ball/roller bearing, CNC-machined curved vane impeller and billet steel hub
- Driver-side water inlet
- Provides maximum flow, maximum pressure and equal distribution to both sides of the block



289/302/351W SHORT SERPENTINE BELT WATER PUMP KIT

M-8501-A50

- Fits 289/302/351W small block Ford engines
- Approximately 1.75" shorter than old-style pumps
- Serpentine belt, reverse rotation water pump
- Engine overall length from front of water pump to back of block is 27"
- Kit includes special timing chain cover with short water pump and gaskets. Driver-side radiator hose inlet
- Meets OEM specifications for water flow
- Original equipment on 1994-1995 Mustang GT
- No fuel pump mounting boss or provision for dipstick assembly, must use electric fuel pump

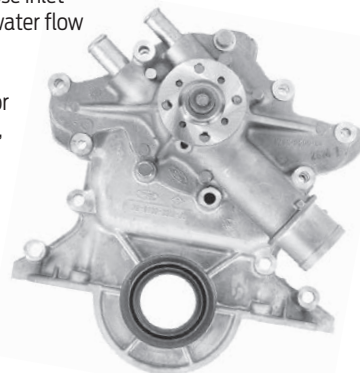

SHORT SERPENTINE BELT WATER PUMP

M-8501-D50

- Same water pump used in M-8501-A50 Short Serpentine Belt Water Pump Kit
- Direct replacement for 1994-1995 Mustang 5.0L/302
- Can be used with the Explorer timing chain cover



90-DEGREE THERMOSTAT HOUSING

M-8592-M90

- Fits 302/351W engines
- Die-cast aluminum 90° thermostat housing
- Radiator hose is 1-1/2" and bypass hose is 3/4"
- Used in Fox body Mustang 1979-1995
- Same as discontinued Ford Service Part No. FOZZ-8592-B



302-351W STREET ROD SHORT V-BELT WATER PUMP

M-8501-E351S

- Fits 302/351W engines
- Provides approx. 1.5" of space at the front of the engine, allowing for more radiator-to-water pump clearance without a recessed fire wall
- Driver-side (left hand) radiator hose inlet
- Must use with long style (3.950") 4-bolt crankshaft damper. Can be used with M-6316-M50 (50 oz-in) Crankshaft Damper or M-6316-A50 (50 oz-in), M-6316-C351 (28 oz-in) and M-6316-D351 (0 oz-in) crankshaft dampers with appropriate spacer
- .750" pulley pilot shaft
- Can be used with M-6059-D351 Timing Chain Cover or most stock standard rotation timing chain covers
- Requires custom pulleys (not included). Call the Ford Performance Techline for more information at (800)367-3788

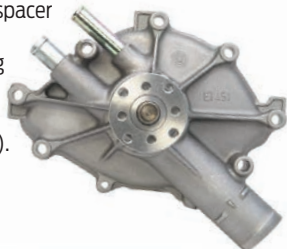

289/302/351W FRONT TIMING CHAIN COVER

M-6059-D351

- High quality die-cast aluminum production timing chain cover
- Fits 289/302/351W blocks, including Ford Performance BOSS 302 and Ford Performance BOSS 351
- For standard rotation water pump, including M-8501-G351 or reverse rotation water pump M-8501-C50
- Includes dipstick tube hole for front sump oil pan and fuel pump mounting boss

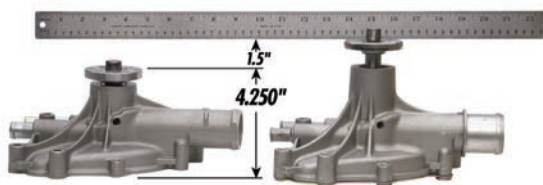
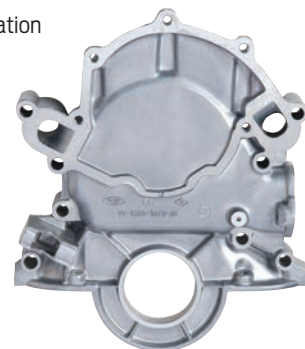

FORD PERFORMANCE ENGINES

1965-1969 MUSTANG BILLET SINGLE GROOVE PULLEY SET



M-8509-CM

- Fits 1965-1969 Mustang with 289/302/351W
- 3-bolt crank pulley
- Single-groove crank pulley
- Single-groove water pump pulley



1970-1978 MUSTANG BILLET SINGLE GROOVE PULLEY SET



M-8509-DM

- Fits 1970-1978 Mustang with 302/351W/351C
- 4-bolt crank pulley
- Single-groove crank pulley
- Single-groove water pump pulley



1970-1978 MUSTANG BILLET DUAL GROOVE PULLEY SET



M-8509-EM

- Fits 1970-1978 Mustang with 289/302/351W/351C
- 4-bolt crank pulley
- Dual-groove crank pulley
- Single-groove water pump pulley



CRANKSHAFT PULLEY SPACERS

Use these crank pulley spacers with Ford Performance M-6316-C351/A50/D302 crank dampers to achieve proper belt alignment on late model 302 and 351 Windsor engines.



| PART NUMBER | ENGINE | CRANK PULLEY BOLT PATTERN | SPACER THICKNESS |
|--------------------|----------|---------------------------|------------------|
| M-8510-A351 | 302/351W | 4 | .350" |
| M-8510-B351 | 302/351W | 4 | .950" |
| M-8510-C351 | 302/351W | 4 | .875" |
| M-8510-D351 | 302/351W | 4 | .909" |



Crankshaft Pulley Spacer
M-8510-A351 shown

INSTALLATION NOTES

Early 3-bolt crank pulleys generally bolt directly to the damper with flanged pulley pilot (damper is drilled for 3- and 4-bolt patterns).

Pulley alignment should be checked and any misalignment corrected with the proper thickness spacer.

1979-1993 MUSTANG OFF-ROAD IDLER BRACKET



M-8604-A50

- Fits 1979-1993 302/351 Mustang applications when catalytic converters are not used
- Competition air pump idler bracket for off-road use only, where air pump is not necessary
- This idler is a direct bolt-on replacement for stock air pumps and uses a standard serpentine belt
- Uses stock belt

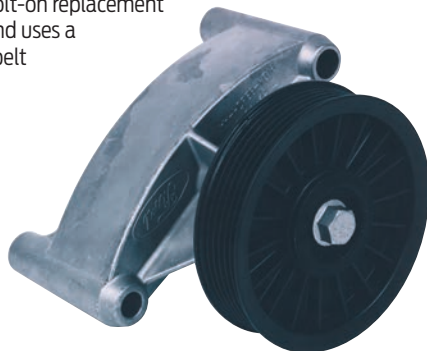

1994-1995 MUSTANG GT A/C ELIMINATOR KIT



M-19216-A50

- Fits 1994-1995 Mustang GT and 1991-1993 Thunderbird with 5.0L engine
- Cast aluminum idler pulley bracket replaces the air conditioning compressor
- Removes weight from the front of the car
- Bolts included
- Uses stock belt

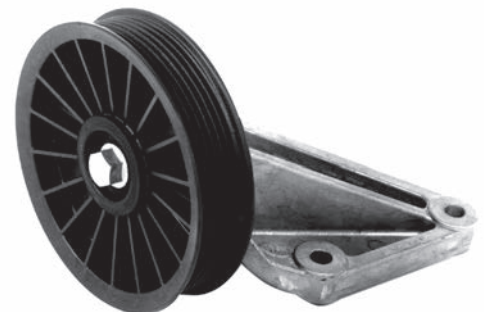

FORD PERFORMANCE ENGINES

1985-1993 MUSTANG 351W ENGINE SWAP ACCESSORY DRIVE KITS

- M-8511-A351** Power Steering Only
- M-8511-B351** Power Steering and A/C

- Fits 1985-1993 Mustang 351W
- These brackets allow use of your 5.0L front-end accessory drive components when swapping to a 351W (5.8L) engine. Simply replace production bracket with the new bracket using all existing bolts and hardware. Serpentine belt selection will vary, depending on whether or not you choose to use optional underdrive pulleys



M-8511-B351



M-8511-A351

1985-1993 MUSTANG A/C ELIMINATOR KIT M-8511-A50

- Fits 1985-1993 Mustang
- Bracket conversion kit to remove air conditioning compressor for racing applications
- Two-piece bracket kit moves the power steering pump up to where the A/C compressor was
- Hardware included
- Requires new belt (not included)

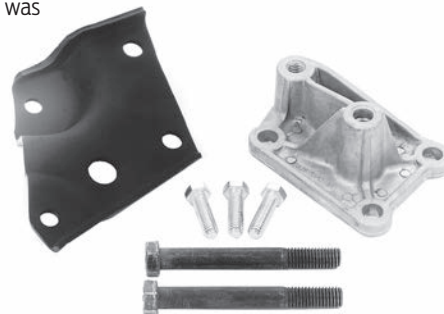

9 MM SPARK PLUG WIRE SETS – “FORD RACING”

Wire-wound custom ignition wire sets feature low resistance for minimum spark loss. Silicone insulation and boots withstand high temperatures and voltage loss for minimum cross-fire and are highly resistant to fuels, oils and solvents. Long-life, tough stainless steel terminals for post-type distributor caps. Includes coil wire for socket-type coil and “Ford Racing” identification. Cylinder number appears on each wire.

NEW AND IMPROVED. Spark plug wires feature high quality 9 mm wire available in 4 colors: blue, black, yellow and red.

| PART NUMBER | APPLICATION | WIRE COLOR | END CONFIG. |
|---------------------|---------------------|------------|-------------|
| M-12259-C301 | 5.0L/5.8L V8 Engine | Blue | 45° Boot |
| M-12259-R301 | 5.0L/5.8L V8 Engine | Red | 45° Boot |
| M-12259-M301 | 5.0L/5.8L V8 Engine | Black | 45° Boot |
| M-12259-Y301 | 5.0L/5.8L V8 Engine | Yellow | 45° Boot |
| M-12259-C302 | V6 and V8 Universal | Blue | 45° Boot |
| M-12259-M302 | V6 and V8 Universal | Black | 45° Boot |

NOTES:

- Universal sets can be cut to length with a crimping tool. Includes terminals for post- and socket-type coils, plus easy-to-follow instructions.
- M-12259-C301/R301/M301/Y301/C302/M302 wire sets do not fit distributorless ignition system (DIS) 5.0L/302 Explorer engines. The universal wire sets do not fit distributorless ignition system (DIS).



HIGH TORQUE MINI STARTER – SMALL BLOCK

M-11000-MT164

- Fits most 289/302/351W/351C engines **with 164-tooth manual transmission flywheel**; for 157-tooth applications, see M-11000-B51
- Small diameter mini starter great for additional header clearance
- Weighs approximately 5 lbs less than pre-1989 production starters, yet provides more cranking power
- Comes with special battery cables and instructions. Must use diode protected fenderwell solenoid



HIGH TORQUE MINI STARTER – SMALL BLOCK

M-11000-B51

- Fits most 289/302/351W/351C engines **except 164-tooth manual transmission**; for 164-tooth flywheel, see M-11000-MT164
- Small diameter mini starter great for additional header clearance
- Weighs approximately 5 lbs less than pre-1989 production starters, yet provides more cranking power
- Comes with special battery cables and instructions. Must use diode protected fenderwell solenoid

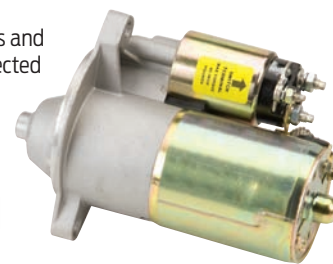



460 SIAMESE BORE CYLINDER BLOCK

M-6010-A460 Bore Range 4.360"-4.600"

M-6010-A460BB Bore Range 4.490"-4.600"

- High-strength block for professional competition
- 10.322" deck height +/- .005"
- Cast iron block with 4-bolt main caps on journals 2, 3 and 4
- Nodular iron main caps
- 3.000" main journal diameter
- Siamese cylinder bore design
- Can be bored/stroked to produce 598 cu in
- Wet sump oiling design
- Priority main oiling system design
- Weighs approximately 275 lbs

NOTE: Siamese blocks are solid casting between the cylinder bores. There are no water passages between them. This is done to increase the strength of the block. 4-bolt main cap requires stock oil pan modifications.



PLUG AND DOWEL KIT

M-6026-A460

Use with M-6010-A460 Cylinder Block. Kit includes cam plug, oil gallery plugs, transmission dowels and head dowels.



1979-1995 460 FOX ENGINE SWAP MOUNTS

M-6038-A460

- Use in 1979-1995 Mustang and other Fox chassis cars to mount 429/460 engines
- Rubber insulated mount kit is designed to work with M-6675-A460 Rear Sump Oil Pan Kit and custom headers
- Does not fit I6 cylinder front crossmember

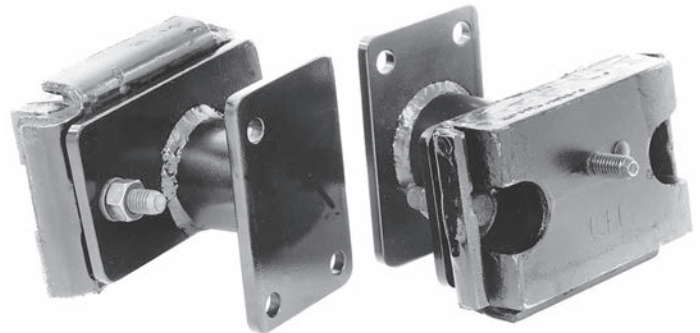

FORD PERFORMANCE ENGINES

SUPER COBRA JET CYLINDER HEADS



M-6049-SCJ Bare Head

M-6049-SCJA Assembled With Dual Springs

M-6049-SCJB Assembled With Dual Springs w/Damper

- Fits 429 and 460 cu in engines (except BOSS 429)
- Valve angles and locations designed to reduce cylinder wall shrouding and improve flow
- Combustion chambers to accommodate the more centrally located valves
- Production 429 Cobra Jet intake and exhaust manifolds bolt on
- Production Ford 429/460 valve cover bolt pattern
- M-6582-C460 Ford Performance Valve Covers recommended
- 2.200" intake valve, 1.76" exhaust valve
- Flows approximately 330 cfm intake and 225 cfm exhaust
- 72 cc combustion chambers
- 290 cc intake runner, 148 cc exhaust runner
- Uses M-6564-A460 Rocker Arm
- Uses Motorcraft AGSP series spark plugs

NOTE: If replacing Ford Performance or production 429 Cobra Jet heads, new intake valve notches are required.

NOTE: Uses Fel-Pro® exhaust gasket Part No. 1420 and Fel-Pro® intake gasket Part No. 1231.

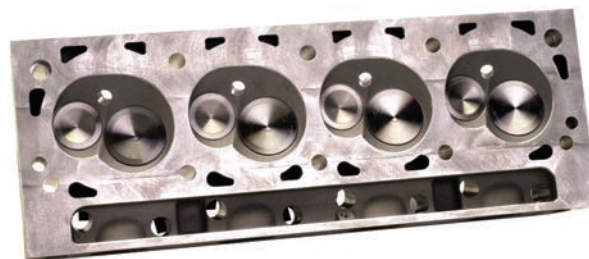

FORD PERFORMANCE 460 "SPORTSMAN" WEDGE-STYLE CYLINDER HEADS



M-6049-C460

- For use with Ford Performance M-6010-A460 Cylinder Block
- Used for professional competition and serious "Sportsman" racers
- Made from 356-T6 aluminum with bronze valve guides and a premium valve seat insert material compatible with titanium valves
- Valve angles are 7.5° intake, 8.0° exhaust with no side cant
- Raised intake and exhaust ports
- 65 cc wedge-style combustion chamber
- 4.600" recommended bore size (4.500" minimum)
- 2.450" intake, 1.900" exhaust recommended diameters
- Port and combustion chamber design based on Ford Performance 351 Yates® cylinder head

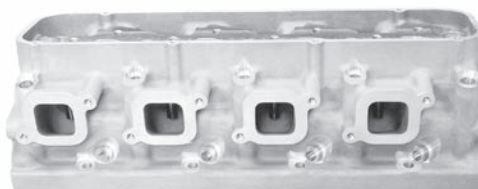
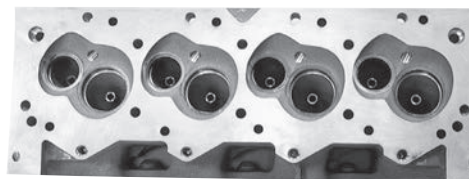

FORD PERFORMANCE ENGINES

EXHAUST VALVE – SINGLE GROOVE (SOLD INDIVIDUALLY)

| PART NUMBER | APPLICATION | HEAD DIAMETER | TIP LENGTH | TOTAL LENGTH | STEM DIAMETER | GROOVE TYPE | VALVE WEIGHT | DESCRIPTION |
|--------------------|---|---------------|------------|--------------|---------------|-------------|--------------|-------------------------|
| M-6505-A429 | CJ/SCJ Aluminum M-6049-A429/B429/C429, M-6049-SCJ/SCJA/SCJB | 1.760" | 0.250" | 5.050" | 11/32" | Square Cut | 122.1 grams | Premium stainless steel |

INTAKE VALVE – SINGLE GROOVE (SOLD INDIVIDUALLY)

| PART NUMBER | APPLICATION | HEAD DIAMETER | TIP LENGTH | TOTAL LENGTH | STEM DIAMETER | GROOVE TYPE | VALVE WEIGHT | DESCRIPTION |
|--------------------|--|---------------|------------|--------------|---------------|-------------|--------------|-------------------------|
| M-6507-B429 | 429/460 Wedge SCJ Aluminum M-6049-SCJ/ SCJA/SCJB | 2.200" | 0.250" | 5.265" | 11/32" | Square Cut | 143.7 grams | Premium stainless steel |



VALVE PUSH ROD GUIDE PLATE (SOLD IN PKG. OF 8)



Use with mechanical cams, threaded stud, adjustable (non-rail) rocker arms and hardened push rods. May require modification for use with roller rocker arms.

| PART NUMBER | CYLINDER HEAD | PUSH ROD DIAMETER |
|-------------------|--------------------------|-------------------|
| M-6566-SCJ | M-6049-SCJ/ SCJA/SCJB | .375" |



HIGH-PERFORMANCE ENGINE GASKET SET



M-6003-A429

- Manufactured to Ford specs by Fel-Pro®
- The kit includes race-quality head gaskets and Print-O-Seal® intakes, oil pan and valve cover gaskets
- Includes front and rear oil seals plus all gaskets for a complete rebuild
- This high-performance gasket set is a must when rebuilding your Big Block Ford

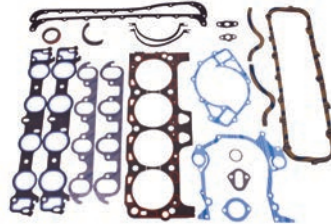

460/460 FORD PERFORMANCE SINGLE PLANE INTAKE MANIFOLD



M-9424-C460

- For use with 10.322" deck height block and M-6049-C460 "wedge" race heads
- 8.64" carburetor pad height
- High-rpm power
- For use on drag race engines

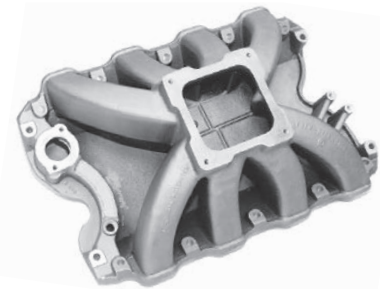

CYLINDER HEAD GASKETS (SOLD IN PAIRS)



| PART NUMBER | CYLINDER BORE APPLICATION | BORE DIAMETER | GASKET DIAMETER | COMPRESSED THICKNESS | COMPRESSED VOLUME | NOTES |
|--------------------|---------------------------|---------------|-----------------|----------------------|-------------------|---|
| M-6051-A441 | 429/460 Wedge | 4.360" Std. | 4.500" | 0.0425" | 11.2 cc | Race-quality competition gasket. Features solid metal core and wire-encased combustion chamber seal |
| M-6051-B460 | 429/460 Wedge | Up to 4.625" | 4.670" | 0.038" | 10.7 cc | Competition gasket with round water openings to match M-6010-A460 Engine Blocks |



FORD PERFORMANCE ENGINES

CAMSHAFT BEARINGS – ROLLER (SOLD IN ENGINE SETS)

These low-friction, roller camshaft bearings only require oil “splash” lubrication. Oil feed holes can be totally blocked off to reduce oil aeration and windage losses. Engine block must be machined to accept bearing size shown in chart.

| PART NUMBER | APPLICATION | O.D. DESCRIPTION | I.D. DESCRIPTION | LENGTH |
|--------------------|---------------|------------------|------------------|--------|
| M-6261-A460 | 429/460 Wedge | 2.500" | 2.125" | .625" |

NOTE: The 429-460 dimensions are production. These roller bearings require an SAE 8620 steel camshaft.



DOUBLE ROLLER TIMING CHAIN SETS

- Full roller chain with 9-position multi-index crank sprocket. The crank sprocket has 2° increments for timing adjustment of up to 8° retarded, 8° advanced, or straight-up (no advance or retard)
- Chain is rugged, double-row type with oversized .250" rollers that deliver long life and reliability
- Crank sprocket is made from induction-hardened, billet steel

| PART NUMBER | APPLICATION | DESCRIPTION |
|--------------------|------------------------|--|
| M-6268-A390 | 390/427/428 FE Engines | Cam sprocket is made from cast iron |
| M-6268-B429 | 429/460 | Cam sprocket is made from cast iron. Compatible with single-piece fuel pump eccentric. Not for use with two-piece fuel pump eccentric |
| M-6268-A460 | 429/BOSS 429/460 | Recommended for competition engine builds. Requires steel thrust plate. M-6269-A460 Roller Bearing Thrust Plate recommended. Cam sprocket is made from steel. Compatible with single-piece fuel pump eccentric. Not for use with two-piece fuel pump eccentric |

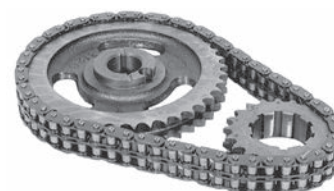

Full Roller Timing Chain and Sprocket Set

CRANKSHAFT DAMPER

- Ford Performance crankshaft dampers are used on most Ford Performance push rod crate engines
- Billet steel construction, meets SFI 18-1 requirements
- Elastomer-style harmonic vibration damper
- Laser-etched timing marks and “Ford Racing” logo
- 3- and 4-bolt pulley mounting holes
- Clear powdercoat finish

| PART NUMBER | ENGINE | BALANCE | NOTES | MASS (LBS) |
|--------------------|---------|---------|-----------------|------------|
| M-6316-A460 | 429/460 | Neutral | Meets SFI 18-1 | 10.1 |
| M-6316-A521 | 514/521 | Neutral | Meets SFI 18-1Ⓢ | 10.1 |

NOTE: Ⓢ Tuned for use on 521 crate engine.



460/514 CRANKSHAFT DAMPER SPACER M-6359-D460



- Spacer with counterweight for 1979-1997 external balanced 460 engines
- Same as discontinued production service part D9TZ-6359-A



429/460 HIGH-VOLUME OIL PUMP M-6600-A460



- Fits 1968-1996 429/460
- High volume – standard pressure
- Requires bolt-on style pickup (not included)
- Does not fit 429 Cobra Jet oil pump pickup tube
- Recommended with M-6675-DRS460 and M-6675-FT460 oil pans
- Due to the higher pumping capacity of this pump, it is not recommended for use with a stock capacity oil pan



429/460 OIL PUMP DRIVESHAFT M-6605-A429



- Fits 429/460/BOSS 429 & Ford Performance A460 blocks
- Heavy duty
- Heat treated chrome moly steel
- Centerless ground

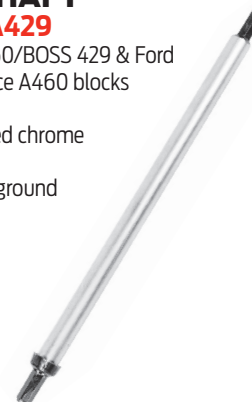

HIGH-CAPACITY PERFORMANCE OIL PANS

REAR SUMP

460 DEEP REAR SUMP OIL PAN

M-6675-DRS460

Designed by Ford Performance, the M-6675-DRS460 Oil Pan is constructed to deliver power and durability.

- Fits 429/460 and Ford Performance M-6007-A460 blocks
- 7 qt capacity
- Full-length scraper to direct oil away from the crankshaft
- Full-length bolt-in louvered windage tray to control oil
- Baffling and trap doors in the sump to keep the pickup submerged during performance driving
- Semigloss black powdercoat finish
- Laser-cut and TIG welded-in precision fixtures for consistent OEM-level fit
- Use M-6622-DRS460 Pickup. Requires rear sump truck oil pump
- Accepts STD and HV oil pumps



460 DEEP REAR SUMP OIL PICKUP TUBE

M-6622-DRS460

- Use with M-6675-DRS460 460 Deep Rear Sump Oil Pan
- Quality built-in precision fixtures for a consistent OEM-level fit
- High-flow funnel-style pickup same as used on Mustang Cobra 4.6L 4V engines
- Thin wire screen delivers more than twice the flow area compared to many aftermarket pickup screens
- Thin wall 3/4" diameter tubing reduces vibration fatigue



FRONT SUMP

460 FRONT SUMP OIL PAN

M-6675-FT460

Designed by Ford Racing, the M-6675-FT460 Oil Pan is constructed to deliver power and durability.

- Fits 429/460 and Ford Racing M-6007-A460 blocks
- 7 qt capacity
- Full-length scraper to direct oil away from the crankshaft
- Full-length bolt-in louvered windage tray to control oil
- Baffling and trap doors in the sump to keep the pickup submerged during performance driving
- Semigloss black powdercoat finish
- Laser-cut and TIG welded-in precision fixtures for consistent OEM-level fit
- Use M-6622-FT460 Pickup
- Accepts STD and HV oil pumps



460 FRONT SUMP OIL PAN PICKUP TUBE

M-6622-FT460

- Use with M-6675-FT460 Front Sump Oil Pan
- Quality built-in precision fixtures for a consistent OEM-level fit
- High-flow funnel-style pickup same as used on Mustang Cobra 4.6L 4V engines
- Thin wire screen delivers more than twice the flow area compared to many aftermarket pickup screens
- Thin wall 3/4" diameter tubing reduces vibration fatigue



FORD PERFORMANCE ENGINES

ENGINE SWAP OIL PAN KIT

| PART NUMBER | SUMP | CAPACITY | FINISH | APPLICATION/DESCRIPTION |
|--------------------|------|----------|---------|---|
| M-6675-A460 | Rear | 6 qt | Painted | 429/460/7.5L oil pan kit. Includes rear sump oil pan, dipstick, dipstick tube, pickup and main cap stud. Ideal for engine swaps. Fits 1979-1995 Mustang and Fox chassis vehicles. Fits 1968-1997 production blocks. Rear sump oil pump required, not included. Fasteners not included. NOTE: Some block/timing cover applications may require 5/16" to 1/4" conversion studs. Not recommended for M-6010-A460 Race Block. |



429/460 CRANKSHAFT REAR MAIN OIL SEAL

M-6701-A460

- Fits M-6010-A460 and M-6010-A460BB. Two-piece, split design
- High-temperature rubber material



460 BIG BLOCK WATER PUMP BACKING PLATE

M-8501-460BP

- Great replacement backing plate for hard-to-find OEM plate
- Made from steel material
- Fits M-8501-C460 Water Pump and production water pumps

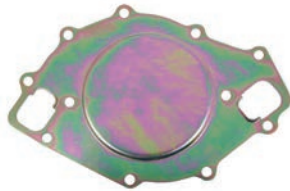

429/460 ONE-PIECE RUBBER OIL PAN GASKET

M-6710-A460

- Fits 1968-1997 429/460
- Designed for use with smooth rail oil pans. Recommended for M-6675-DRS460, M-6675-FT460 and M-6675-A460
- One-piece design, rubber bonded on steel reinforcement

NOTE: Some block/timing cover applications may require 5/16" to 1/4" conversion studs.



460 BIG BLOCK TIMING COVER

M-6059-460

- Fits 460 and 514 Ford Performance big blocks
- Cast aluminum construction with black finish
- Does not have provisions for dipstick in timing cover or mechanical fuel pump
- Oil pan to timing cover bolt holes 1/4-20
- Includes M-8501-460BP Big Block Water Pump Backing Plate



9 MM SPARK PLUG WIRE SETS – “FORD RACING”

Wire-wound custom ignition wire sets feature low resistance for minimum spark loss. Silicone insulation and boots withstand high temperatures and voltage loss for minimum crossfire and are highly resistant to fuels, oils and solvents. Long-life, tough stainless steel terminals for “post” type distributor caps. Includes coil wire for socket-type coil and “Ford Racing” identification. Cylinder number appears on each wire.

Spark plug wires feature high-quality 9 mm wire.

| PART NUMBER | APPLICATION | WIRE COLOR | END CONFIG. |
|---------------------|---------------------|------------|-------------|
| M-12259-C460 | 7.0L/7.5L V8 Engine | Blue | 45° Boot |
| M-12259-R460 | 7.0L/7.5L V8 Engine | Red | 45° Boot |





M-6010-16K shown

1.6 LITER 4-CYLINDER KENT BLOCK

M-6010-16K

The legendary Formula Ford Kent block is reborn with an all-new iron casting that is stronger than the original! The block was designed to replace production 1.6L Kent blocks for SCCA® Formula Ford competition.

- Standard 8.200" deck height with extra material for decking
- Cylinder bores semifinished to 3.185"-3.187" diameter to allow the engine to be built to desired clearances
- Max bore size is 3.226" (81.94 mm)
- Lifter bore diameter: .5155"-.5145"
- Block cast from 40,000 psi gray iron
- Lower clutch housing bolt bosses reinforced
- Select areas around main bearing webs strengthened
- Center main will accept upper and lower crankshaft thrust bearing inserts
- Includes cam bearings (installed)



1.6 LITER 4-CYLINDER LOTUS BLOCK

M-6010-16L

The Lotus block features an all-new gray iron casting that is stronger than the original and accepts the Lotus cylinder head.

- Standard 7.800" deck height with extra material for decking
- Machined and delivered with cylinder bores semifinished at 3.228"-3.226" (81.99 mm-81.94 mm) diameters
- Block is designed for standard bore engine builds
- Lifter bore diameter: .5155"-.5145"
- Block cast from 40,000 psi gray iron
- Lower clutch housing bolt bosses reinforced
- Select areas around main bearing webs strengthened
- Center main will accept upper and lower crankshaft thrust bearing inserts
- Includes cam bearings (installed)



4-CYLINDER KENT VALVE COVER

M-6582-16K

- Fits 1.6L Kent cylinder head
- Cast aluminum construction



NASCAR® ENGINE PARTS

FR9 NASCAR® CYLINDER BLOCK

M-6010-R500

Features:

- Lightweight compacted graphite iron casting
- Cross-flow cooling
- Cast-in camshaft tunnel
- Inner and outer piston squirter provisions
- Front engine plate mounting (no side mounts)
- Dry sump only design
- 4-bolt steel main caps
- Internal oil passages to the cylinder heads

Specifications:

- Deck height: 9.000"
- Bore spacing: 4.500"
- Camshaft height: 6.150"
- Bore size range: 4.000"-4.185"
- Main journal diameter: 2.250"
- Cam bearing diameter: 60 mm roller

Required Components:

- M-6049-E1 Cylinder Head
- M-8C368-FR9 Water Manifold
- M-8051-FR9 Water Pump Assembly

Recommended Use:

- Approved for the NASCAR® Cup Series
- Circle track competition

Builder Notes:

- Semifinished cylinder bores, main bearing bores and lifter bores – must be honed to final size
- The FR9 engine is unique and does not share any components with previous 351 Windsor- or Cleveland-based engines
- For FR9 engine-related components not offered by Ford Performance, contact Roush Yates® Performance Parts at (704)662-6982



FR9 NASCAR® CYLINDER HEAD

M-6049-E1 Fits M-6010-R500 NASCAR® Cylinder Block

Features:

- Lightweight A356-T6 aluminum casting
- Cross-flow cooling
- Internal oil passages for valvetrain lubrication
- Splayed and canted intake valves
- 5-bolt head bolt pattern

Specifications:

- Intake valve angle: 11.0° x 4.0°
- Exhaust valve angle: 7.5° x 0°
- Valve spacing: 1.94"
- Intake flange angle: 90°
- Exhaust flange angle: 60°

Required Components:

- M-6010-R500 Cylinder Block
- M-8C368-FR9 Water Manifold

Recommended Use:

- Approved for the NASCAR® Cup and Nationwide Series
- Circle track competition

Builder Notes:

- Heads are semifinished, requiring porting and combustion chamber machining
- Valve guides and seats are not included
- M-8C368-FR9 Water Manifold mounts directly to the cylinder heads
- The FR9 engine is unique and does not share any components with previous 351 Windsor- or Cleveland-based engines
- For FR9 engine-related components, contact Roush Yates® Performance Parts at (704)662-6982



FR9 WATER OUTLET MANIFOLD

M-8C368-FR9

Features:

- Lightweight aluminum casting
- Straight outlet to accommodate LH or RH radiator water inlet
- Provision for water temperature sensor
- For use with M-6049-E1 Heads

Recommended Use:

- Circle track competition

Builder Notes:

- O-ring sealing provisions are machined into M-6049-E1 Cylinder Head
- The FR9 engine is unique and does not share any components with previous 351 Windsor- or Cleveland-based engines
- For FR9 engine-related components, contact Roush Yates® Performance Parts at (704)662-6982

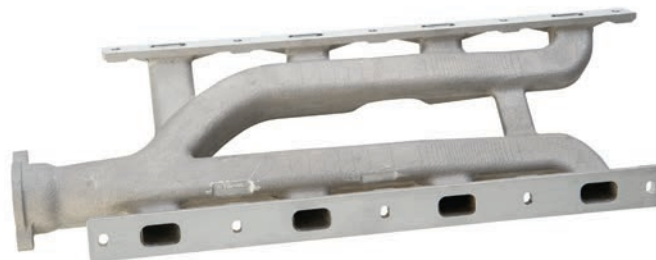

FR9 WATER PUMP ASSEMBLY

M-8051-FR9

Features:

- Includes water pump and housing
- Lightweight aluminum castings
- EMP Stewart Components® race-proven pump cartridge
- Designed to mount to front engine plate

Recommended Use:

- Circle track competition

Builder Notes:

- The FR9 engine is unique and does not share any components with previous 351 Windsor- or Cleveland-based engines

NASCAR® ENGINE PARTS

NASCAR® INTAKE MANIFOLDS

Features:

- For use with M-6049-E1 Heads
- A356-T6 aluminum casting
- Plenum and runner interiors are as-cast
- Intended operating range is 6000 rpm-9500 rpm
- Approved for NASCAR® restrictor plate and open Sprint Cup events

Required Components:

- M-6049-E1 Cylinder Head

Builder Notes:

- Intake manifold plenum and runners require porting before use
- The FR9 engine is unique and does not share any components with previous 351 Windsor- or Cleveland-based engines

FR9 INTAKE MANIFOLD – FUEL INJECTION

M-9424-E554

- For use with NASCAR® mandated fuel-injection system
- Casting features bosses to accommodate fuel injector and fuel rail machining
- Approved for NASCAR® Sprint Cup Series

FR9 INTAKE MANIFOLD

M-9424-E651

- For use with a carburetor
- Approved for NASCAR® Xfinity® and Truck Series





Actions speak louder than words.

AGREED.

For more than 35 years Ford Performance Parts has been producing and developing performance parts with enthusiasts in mind. Whether you are building from the ground up or working to get that extra tenth of a second, Ford Performance delivers the products you need. We're proud to offer crate engines and performance components that are designed and engineered to rigorous Ford Performance standards. They have earned their right to wear the Ford Oval.



PERFORMANCEPARTS.FORD.COM

FORD PERFORMANCE ENGINES

CYLINDER BLOCKS

| ENGINE GROUP PART NUMBER | 302 FORD M-6010- BOSS302 | 302 FORD M-6010- B302BB | 351 FORD M-6010- BOSS35192 | 351 FORD M-6010- BOSS35192BB | 351 FORD M-6010- BOSS35195 | 351 FORD M-6010- BOSS351BB |
|-----------------------------|---|--|---|---|---|---|
| Description/Intended Usage | Professional Competition | Professional Competition | Professional Competition | Professional Competition | Professional Competition | Professional Competition |
| Block Material | Cast Iron | Cast Iron | Cast Iron | Cast Iron | Cast Iron | Cast Iron |
| Nominal Deck Height | 8.206" | 8.206" | 9.200" | 9.200" | 9.500" | 9.500" |
| CID Capacity | 363 | 363 | 427 | 427 | 454 | 468 |
| Cylinder Design | Siamese | Siamese | Siamese | Siamese | Siamese | Siamese |
| Cylinder Bore Range | 4.000"-4.125" | 4.000"-4.125" | 4.000"-4.125" | 4.000"-4.125" | 4.000"-4.125" | 4.000"-4.185" |
| Oil Sump Design | Wet | Wet | Wet | Wet | Wet | Wet |
| Crankshaft Journal Diameter | 2.248" | 2.248" | 2.750" | 2.750" | 2.750" | 2.750" |
| Main Cap Bolts | Four on 2,3,4 | Four on 2,3,4 | Four on 2,3,4 | Four on 2,3,4 | Four on 2,3,4 | Four on 2,3,4 |
| Bearing Cap Material | Nodular Iron | Nodular Iron | Nodular Iron | Nodular Iron | Nodular Iron | Nodular Iron |
| Recommended Max. Stroke | 3.400" | 3.400" | 4.000" | 4.000" | 4.250" | 4.250" |
| Rear Crankshaft Seal Type | 1-Piece | 1-Piece | 1-Piece | 1-Piece | 1-Piece | 1-Piece |
| Cam Bearing Design | M-6261-J351 Standard Cam | M-6261-J351 Standard Cam | M-6261-J351 Standard Cam | M-6261-J351 Standard Cam | M-6261-J351 Standard Cam | M-6261-J351 Standard Cam |
| Oil Filter Mount | Block | Block | Block | Block | Block | Block |
| Hyd. Roller Cam. Compatible | Yes | Yes | Yes | Yes | Yes | Yes |
| Cam Plug | M-6026-S351 | M-6026-S351 | M-6026-S351 | M-6026-S351 | M-6026-S351 | M-6026-S351 |

| ENGINE GROUP PART NUMBER | 351 FORD M-6010-Z351 | 351 FORD M-6010-Z35192 | 460 FORD M-6010-A460 | 460 FORD M-6010-A460BB | NASCAR® FORD M-6010-R500 |
|-----------------------------|---------------------------------|-----------------------------------|---------------------------------|-----------------------------------|-------------------------------------|
| Description/Intended Usage | Professional Competition | Professional Competition | Professional Competition | Professional Competition | Professional Competition |
| Block Material | Aluminum | Aluminum | Cast Iron | Cast Iron | Compacted Graphite Iron |
| Nominal Deck Height | 9.500" | 9.200" | 10.322" | 10.322" | 9.000" |
| CID Capacity | 434 | 427 | 598 | 598 | - |
| Cylinder Design | Siamese | Siamese | Siamese | Siamese | Non-Siamese |
| Cylinder Bore Range | 4.000"-4.125" | 4.000"-4.125" | 4.360"-4.600" | 4.500"-4.600" | 4.000"-4.185" |
| Oil Sump Design | Wet | Wet | Wet | Wet | Dry |
| Crankshaft Journal Diameter | 2.750" | 2.750" | 3.000" | 3.000" | 2.000"-2.250" |
| Main Cap Bolts | Four | Four | Four on 2,3,4,5 | Four on 2,3,4,5 | Four |
| Bearing Cap Material | Steel | Steel | Nodular Iron | Nodular Iron | Steel |
| Recommended Max. Stroke | 4.250" | 4.250" | 4.500" | 4.500" | - |
| Rear Crankshaft Seal Type | 1-Piece | 1-Piece | 2-Piece | 2-Piece | 1-Piece |
| Cam Bearing Design | M-6261-J351 Standard Cam | M-6261-J351 Standard Cam | Std. | Std. | Roller |
| Oil Filter Mount | Block | Block | Block | Block | Remote |
| Hyd. Roller Cam Compatible | - | - | - | - | - |
| Cam Plug | M-6026-S351 | - | - | - | - |

FORD PERFORMANCE ENGINES

PUSH ROD CRATE ENGINES AND SHORT BLOCKS

| PART NUMBER | M-6007-X302B | M-6007-X302E | M-6007-X347DF/X347DR | M-6009-347 | M-6009-363 |
|---|-----------------------|-----------------------|---|---|---|
| Displacement (cu in) | 302 | 302 | 347 | 347 | 363 |
| Horsepower (hp) Racer Correction (SAE J607) | 345 | 340 | N/A | N/A | N/A |
| Torque (lb-ft) Racer Correction (SAE J607) | 350 | 350 | N/A | N/A | N/A |
| Compression Ratio | 9.0:1 | 9.0:1 | 9.6:1 | N/A | N/A |
| Cylinder Heads | M-6049-X306 | M-6049-X306 | M-6049-X306 | N/A | N/A |
| Camshaft | B303 hydraulic roller | E303 hydraulic roller | Hydraulic roller | N/A | N/A |
| Crankshaft | 3.000" cast | 3.000" cast | 3.400" forged | 3.400" forged | 3.400" forged |
| Piston | 4.030" forged | 4.030" forged | 4.030" Mahle® forged Grafal® coated skirt | 4.030" Mahle® forged Grafal® coated skirt | 4.125" Mahle® forged Grafal® coated skirt |
| Connecting Rod | Forged I-beam 5.090" | Forged I-beam 5.090" | Forged I-beam 5.400" | Forged I-beam 5.400" | Forged I-beam 5.400" |
| Valve Cover | M-6582-W351PR | M-6582-W351PR | M-6582-A301R Ford Racing Aluminum | N/A | N/A |
| Oil Pan | Rear sump | Rear sump | 7 qt front sump/7 qt rear sump | N/A | N/A |
| Water Pump | N/A | N/A | None | N/A | N/A |
| Block | M-6010-BOSS302 | M-6010-BOSS302 | M-6010-BOSS302 | M-6010-BOSS302 | M-6010-BOSS302 |

| PART NUMBER | M-6007-Z2363FT/Z2363RT | M-6007-S347JR | M-6007-D347SR | M-6007-D347SR7 | M-6009-427F |
|---|---|---|---|---|---|
| Displacement (cu in) | 363 | 347 | 347 | 347 | 427 |
| Horsepower (hp) Racer Correction (SAE J607) | 500 | 350 | 415 | 415 | N/A |
| Torque (lb-ft) Racer Correction (SAE J607) | 450 | 400 | 400 | 400 | N/A |
| Compression Ratio | 10.2:1 | 10.5:1 | 10.0:1 | 10:1 | N/A |
| Cylinder Heads | M-6049-Z2 | M-6049-X307 | M-6049-Z304DA | M-6049-Z304DA7 | N/A |
| Camshaft | Hydraulic roller | Hydraulic roller | F303 hydraulic roller | F303 hydraulic roller | N/A |
| Crankshaft | 3.400" forged | 3.400" forged | 3.400" forged | 3.400" forged | 4.000" forged |
| Piston | 4.125" Mahle® forged Grafal® coated skirt | 4.030" Mahle® forged Grafal® coated skirt | 4.030" Mahle® forged Grafal® coated skirt | 4.030" Mahle® forged Grafal® coated skirt | 4.125" Mahle® forged Grafal® coated skirt |
| Connecting Rod | Forged I-beam 5.400" | Forged I-beam 5.400" | Forged I-beam 5.400" | Forged I-beam 5.400" | Forged H-beam 6.250" |
| Intake | N/A | RPM Air-Gap 302 | Victor Jr.® | Victor Jr.® | N/A |
| Distributor | N/A | MSD® Billet Distributor | MSD® Billet Distributor | MSD® Billet Distributor | N/A |
| Valve Cover | Ford Racing 302-139 | M-6582-CT2 | M-6582-CT2 | M-6582-CT2 | N/A |
| Oil Pan | 7 qt front sump/7 qt rear sump | 7 qt rear sump | 7 qt rear sump | 7 qt rear sump | N/A |
| Water Pump | V-belt | V-belt | V-belt | V-belt | N/A |
| Block | M-6010-BOSS302 | M-6010-BOSS302 | M-6010-BOSS302 | M-6010-BOSS302 | M-6010-BOSS35195 |

| PART NUMBER | M-6007-Z2427FFT/Z2427FRT | M-6007-Z427AFT/Z427ART | M-6007-Z460FFT/Z460FRT |
|---|---|---|---|
| Displacement (cu in) | 427 | 427 | 460 |
| Horsepower (hp) Racer Correction (SAE J607) | 535 | 600 | 580 |
| Torque (lb-ft) Racer Correction (SAE J607) | 545 | 550 | 580 |
| Compression Ratio | 10.5:1 | 11.1:1 | 10.0:1 |
| Cylinder Heads | M-6049-Z2 | M-6049-Z304P | M-6049-Z304DA |
| Camshaft | Hydraulic roller | Solid roller | Hydraulic roller |
| Crankshaft | 4.000" forge | 4.000" forged | 4.150" forged |
| Piston | 4.125" Mahle® forged Grafal® coated skirt | 4.125" Mahle® forged Grafal® coated skirt | 4.250" Mahle® forged Grafal® coated skirt |
| Connection Rod | Forged H-beam 6.250" | Forged H-beam 6.250" | Forged H-beam 6.125" |
| Valve Cover | Ford Racing 302-135 | M-6582-W427P | Ford Racing 302-137 |
| Oil Pan | 9 qt front sump/7 qt rear sump | 9 qt front sump/7 qt rear sump | 9 qt front sump/7 qt rear sump |
| Water Pump | V-belt | V-belt | V-belt |
| Block | M-6010-BOSS35195 | M-6010-Z351 | M-6010-BOSS35195 |

FORD PERFORMANCE ENGINES

MODULAR CRATE ENGINES AND SHORT BLOCKS

| PART NUMBER | M-6007-M50A | M-6007-A50NAA | M-6007-A50SCA | M-6007-A52XS |
|--------------------------------|---|---|---|---|
| Displacement | 5.0L | 5.0L | 5.0L | 5.2L |
| Horsepower (hp) | 435 | 435 | N/A | 580 |
| Torque (lb-ft) | 400 | 400 | N/A | N/A |
| Compression Ratio | 11.0:1 | 11.0:1 | 9.5:1 | 12.0:1 |
| Combustion Chamber Volume (cc) | 56 | 56 | 56 | 55.6 |
| Cylinder Heads | Production | Production | Production | GT350 CNC-ported |
| Camshafts | Production | Production | Production | M-6550-M52 |
| Crankshaft | Forged steel | Forged steel | Forged steel | Forged steel |
| Connecting Rod | Forged steel | Manley® H-beam | Manley® H-beam | Manley® H-beam |
| Piston | Cast, hard-anodized ring grooves Grafal® coated skirts | Mahle® forged hard-anodized ring grooves Grafal® coated skirts | Mahle® forged hard-anodized ring grooves Grafal® coated skirts | Mahle® forged hard-anodized ring grooves Grafal® coated skirts |
| Intake Manifold | 2015-2017 Mustang | 2015-2017 Mustang | 2015-2017 Mustang | M-9424-M50CJ Cobra Jet tuned intake |
| Ignition | Coil on plug | Coil on plug | Coil on plug | Coil on plug |
| Valve Covers | Production | Production | Production | Exclusive |
| Oil Pan | Production | Production | Production | M-6675-M52 |
| Water Pump | Production | Production | Production | Production |
| Block | Production Mustang GT 5.0L | Production Mustang GT 5.0L | Production Mustang GT 5.0L | M-6010-M52 |

| PART NUMBER | M-6009-A50NAA | M-6009-A50SCA | M-6009-B53 |
|--------------------------------|---|---|--|
| Displacement | 5.0L | 5.0L | 5.3L |
| Horsepower (hp) | N/A | N/A | N/A |
| Torque (lb-ft) | N/A | N/A | N/A |
| Compression Ratio | N/A | N/A | 11.56:1 (44 cc chamber) (2VPI) 10.50:1 (51 cc chamber) (3V) 10.23:1 (53 cc chamber) (4V) |
| Combustion Chamber Volume (cc) | N/A | N/A | N/A |
| Cylinder Heads | N/A | N/A | N/A |
| Camshafts | N/A | N/A | N/A |
| Crankshaft | Forged steel | Forged steel | Forged Eagle® 8-bolt steel |
| Connecting Rod | Manley® H-beam | Manley® H-beam | Eagle® forged H-beam |
| Piston | Mahle® forged hard-anodized ring grooves Grafal® coated skirts | Mahle® forged hard-anodized ring grooves Grafal® coated skirts | Mahle® forged hard-anodized ring grooves Grafal® coated skirts |
| Intake Manifold | N/A | N/A | N/A |
| Ignition | N/A | N/A | N/A |
| Valve Covers | N/A | N/A | N/A |
| Oil Pan | N/A | N/A | N/A |
| Water Pump | N/A | N/A | N/A |
| Block | Production Mustang GT 5.0 | Production Mustang GT 5.0 | Production 4.6L Mustang aluminum |

FORD PERFORMANCE ENGINES

BASIC ENGINE DIMENSIONS (INCHES) Gasoline Engines

| DISPLACEMENT | YEARS | BORE | STROKE | BORE SPACING | MAIN JOURNAL DIA. | ROD JOURNAL DIA. | CON ROD LENGTH (MEAN) | DECK HEIGHT | PISTON COMP HT |
|-------------------------|----------|-------|--------|--------------|-------------------|------------------|-----------------------|-------------|----------------|
| 1.6L Kent | 1971-73 | 3.188 | 3.056 | 3.780 | 2.1253 | 1.9372 | 4.928 | 8.2272 | — |
| 1.6L CVH | 1981-85 | 3.150 | 3.130 | 3.614 | 2.383 | 1.886 | 5.195 | 8.212 | 1.451 |
| 1.9L CVH | 1985-87 | 3.230 | 3.465 | 3.614 | 2.383 | 1.886 | 5.195 | 8.378 | 1.451 |
| 1.9L CVH | 1988-96 | 3.230 | 3.465 | 3.614 | 2.383 | 1.728 | 5.195 | 8.378 | 1.451 |
| 1.8L ZETEC® DOHC | 1991-96 | 3.270 | 3.350 | 3.583 | 1.966 | 1.771 | 5.230 | 8.130 | 1.108 |
| 2.0L I4 Duratec® | 2005-TBD | 3.445 | 3.272 | 3.780 | 2.047 | 1.850 | 5.758 | 8.540 | 1.122 |
| 2.0L CVH | 1997-98 | 3.339 | 3.465 | 3.614 | 2.383 | 1.728 | 5.195 | 8.378 | 1.451 |
| 2.0L OHC ① | 1971-74 | 3.575 | 3.029 | 4.016 | 2.244 | 2.047 | 4.982 | 8.146 | 1.595 ⑤ |
| 2.0L OHC ② | 1983-87 | 3.520 | 3.126 | 4.173 | 2.399 | 2.047 | 5.205 | 8.368 | 1.583 |
| 2.0L ZETEC® | 1995-04 | 3.339 | 3.465 | 3.614 | 2.283 | 1.847 | 5.3618 ⑥ | 8.378 | 1.3012 ⑦ |
| 2.0L V6 | 2001-04 | 3.215 | 2.631 | 4.016 | 2.479 | 1.967 | 5.686 | 8.189 | 1.181 |
| 2.2L Probe | 1988-92 | 3.390 | 3.700 | 3.810 | 2.360 | 2.006 | 6.200 | 9.500 | 1.450 |
| 2.3L I4 Duratec® | 2001-07 | 3.445 | 3.701 | 3.780 | 2.047 | 1.968 | 6.094 | 9.094 | 1.122 |
| 2.3L OHC | 1974-97 | 3.780 | 3.126 | 4.173 | 2.399 | 2.047 | 5.205 | 8.368 | 1.583 |
| 2.5L OHC | 1998 | 3.780 | 3.401 | 4.173 | 2.399 | 2.047 | 5.457 | 8.368 | 1.211 |
| 2.3L HSC | 1984-94 | 3.680 | 3.300 | 4.080 | 2.249 | 2.124 | 5.457 | 8.700 | 1.520 |
| 2.5L HSC | 1986-91 | 3.680 | 3.583 | 4.080 | 2.249 | 2.124 | 5.990 | 9.400 | 1.579 |
| 2.5L V6 Duratec® | 1995-99 | 3.245 | 3.130 | 4.016 | 2.480 | 1.968 | 5.437 | 8.189 | 1.181 |
| 2.5L V6 Duratec® | 1999-07 | 3.215 | 3.130 | 4.016 | 2.480 | 1.968 | 5.437 | 8.189 | 1.181 |
| 2.6L V6 | 1972-73 | 3.545 | 2.630 | 4.760 | 2.244 | 2.127 | — | 8.084 | 1.546 |
| 2.8L V6 | 1974-80 | 3.650 | 2.700 | 4.760 | 2.244 | 2.127 | 5.140 | 8.084 | 1.539 |
| 2.9L V6 | 1986-92 | 3.661 | 2.835 | 4.760 | 2.244 | 2.126 | 5.140 | 8.858 | 1.461 |
| 3.0L V6 | 1986-07 | 3.504 | 3.150 | 4.330 | 2.519 | 2.126 | 5.532 | 8.661 | 1.535 |
| 3.0L V6 Duratec® | 1997-07 | 3.504 | 3.130 | 4.016 | 2.480 | 1.968 | 5.437 | 8.189 | 1.181 |
| 3.5L V6 Duratec® | 2006-07 | 3.642 | 3.413 | 4.173 | 2.658 | 2.205 | 6.011 | 8.970 | 1.240 |
| 3.0L V6 SHO | 1989-95 | 3.500 | 3.150 | 4.330 | 2.516 | 2.047 | 5.780 | 8.660 | 1.307 |
| 3.2L V6 SHO | 1993-95 | 3.620 | 3.150 | 4.330 | 2.516 | 2.047 | 5.780 | 8.660 | 1.307 |
| 3.4L V8 SHO | 1996 | 3.245 | 3.130 | 4.016 | 2.480 | 1.968 | 5.437 | 8.189 | 1.181 |
| 3.8L V6 | 1982-95 | 3.810 | 3.390 | 4.193 | 2.5194 ④ | 2.311 | 5.914 | 9.232 | 1.602 |
| 3.8L V6 | 1997-03 | 3.810 | 3.390 | 4.193 | 2.519 | 2.311 | 6.091 | 9.232 | 1.450 |
| 3.9L V6 | 2004-07 | 3.810 | 3.465 | 4.193 | 2.519 | 2.311 | 6.091 | 9.232 | 1.411 |
| 3.9L V8 ⑧ | 2000-02 | 3.386 | 3.346 | 3.858 | 2.441 | 2.205 | 6.115 | 8.880 | 1.211 |
| 3.9L V8 ⑧ | 2002-07 | 3.386 | 3.346 | 3.858 | 2.441 | 2.087 | 6.115 | 8.880 | 1.211 |
| 4.0L V6 | 1990-00 | 3.950 | 3.320 | 4.760 | 2.244 | 2.126 | 5.748 | 8.858 | 1.442 |
| 4.0L V6 | 1997-07 | 3.950 | 3.320 | 4.760 | 2.244 | 2.126 | 5.748 | 8.858 | 1.440 |
| 4.2L V6 | 1997-07 | 3.810 | 3.740 | 4.193 | 2.519 | 2.311 | 6.091 | 9.232 | 1.273 |
| 4.5L Ford Performance ③ | | 4.080 | 3.500 | 4.469 | 2.749 | 2.100 | 6.088 | 9.232 | ③ |
| 4.6L V8 | 1991-07 | 3.552 | 3.543 | 3.937 | 2.657 | 2.086 | 5.933 | 8.937 | 1.221 |
| 5.0L V8 ⑨ | | 3.700 | 3.543 | 3.937 | 2.657 | 2.086 | 5.933 | 8.937 | 1.221 |
| 5.0L V8 | 2011-12 | 3.629 | 3.647 | 3.937 | 2.652 | 2.082 | 5.933 | 8.937 | 1.220 |
| 5.4L V8 | 1997-07 | 3.552 | 4.165 | 3.937 | 2.657 | 2.086 | 6.658 | 10.079 | 1.167 |
| 5.8L V8 | 2013 | 3.681 | 4.230 | 3.937 | 2.6567-2.6577 | 2.0867-2.0859 | 6.6575 | 10.0673 | 1.2185-1.2224 |
| 6.8L V10 | 1997-07 | 3.552 | 4.165 | 3.937 | 2.657 | 2.086 | 6.657 | 10.079 | 1.221 |
| 6.0L V12 | 1999-07 | 3.504 | 3.130 | 4.016 | 2.657 | 1.968 | 5.437 | 8.189 | 1.181 |
| 200 I6 | 1963-83 | 3.680 | 3.126 | 4.080 | 2.249 | 2.124 | 4.715 | 7.808 | 1.511 |
| 250 I6 | 1969-80 | 3.680 | 3.910 | 4.080 | 2.399 | 2.124 | 5.880 | 7.808 | — |
| 240 I6 | 1965-72 | 4.000 | 3.180 | 4.480 | 2.399 | 2.123 | 6.795 | 10.000 | 1.605 |
| 300 I6 | 1965-96 | 4.000 | 3.980 | 4.480 | 2.399 | 2.123 | 6.210 | 10.000 | 1.757 |
| 221 V8 | 1962-63 | 3.500 | 2.870 | 4.380 | 2.249 | 2.123 | 5.155 | 8.206 | 1.595 |
| 255 V8 | 1979-82 | 3.680 | 3.000 | 4.380 | 2.249 | 2.123 | 5.155 | 8.206 | 1.600 |
| 260 V8 | 1962-64 | 3.800 | 2.870 | 4.380 | 2.249 | 2.123 | 5.155 | 8.206 | 1.600 |
| 289 | 1963-68 | 4.000 | 2.870 | 4.380 | 2.249 | 2.123 | 5.155 | 8.206 | 1.605 |
| 302 | 1968-96 | 4.000 | 3.000 | 4.380 | 2.249 | 2.123 | 5.090 | 8.206 | 1.605 |
| 302 BOSS | 1969-70 | 4.000 | 3.000 | 4.380 | 2.249 | 2.123 | 5.150 | 8.201-8.210 | 1.530 |
| 302 Ford Performance ③ | | 4.000 | 3.000 | 4.380 | 2.249 | 2.123 | 5.150 | 8.201-8.210 | ③ |
| 351W | 1969-70 | 4.000 | 3.500 | 4.380 | 3.000 | 2.311 | 5.956 | 9.480 | 1.769 |
| 351W | 1971-96 | 4.000 | 3.500 | 4.380 | 3.000 | 2.311 | 5.956 | 9.503 | 1.769 |
| 351 Ford Performance ③ | | 4.000 | 3.500 | 4.380 | 2.749 | 2.311 | 5.956 | 9.503 | ③ |
| 351 Ford Performance ③ | | 4.000 | 3.500 | 4.380 | 2.249 | 2.311 | 5.780 | 9.206 | ③ |
| 351C * BOSS | 1970-74 | 4.000 | 3.500 | 4.380 | 2.749 | 2.311 | 5.780 | 9.206 | 1.647 |
| 351M | 1975-85 | 4.000 | 3.500 | 4.380 | 3.000 | 2.311 | 6.580 | 10.297 | 1.947 |

- ① Car (EAO)
- ② Ranger/Bronco II
- ③ Non-production blocks. Dimensions for reference
- ④ 3.8L SC #1-2-3 - 2.5190", #4 - 2.5096"
- ⑤ Sport 2000 - 1.6395"
- ⑥ 1997 - 5.482"
- ⑦ 1997 - 1.181"
- ⑧ 3.9L V8 used in the Thunderbird and Lincoln LS is based on the Jaguar® V8 design
- ⑨ Aftermarket from Ford Performance

NOTES:

- All 4-cylinder (except 1.6L Kent) and all V6 engines are metric. Dimensions shown in inches.
- 3.9L V8 used in the Thunderbird and Lincoln LS is based on the Jaguar® V8 design.
- 6.0L V8, 6.4L V8 and 7.3L V8 - ITEC® Powerstroke.

FORD PERFORMANCE ENGINES

BASIC ENGINE DIMENSIONS (INCHES) CONTINUED Gasoline Engines

| DISPLACEMENT | YEARS | BORE | STROKE | BORE SPACING | MAIN JOURNAL DIA. | ROD JOURNAL DIA. | CON ROD LENGTH (MEAN) | DECK HEIGHT | PISTON COMP HT |
|--------------------------|---------|-------|--------|--------------|-------------------|------------------|-----------------------|----------------------|----------------|
| 400 | 1971-81 | 4.000 | 4.000 | 4.380 | 3.000 | 2.311 | 6.580 | 10.292-10.302 | 1.647 |
| 352 | 1960-66 | 4.000 | 3.500 | 4.630 | 2.749 | 2.438 | 6.540 | 10.170 | 1.825 |
| 390 | 1961-71 | 4.050 | 3.780 | 4.630 | 2.749 | 2.438 | 6.489 | 10.170 | 1.775 |
| 406 | 1962-63 | 4.130 | 3.780 | 4.630 | 2.749 | 2.438 | 6.489 | 10.170 | 1.745 |
| 410 | 1966-67 | 4.050 | 3.980 | 4.630 | 2.749 | 2.438 | 6.489 | 10.170 | 1.674 |
| 427 | 1963-68 | 4.230 | 3.780 | 4.630 | 2.749 | 2.438 | 6.489 | 10.170 | 1.752 |
| 428 | 1966-70 | 4.130 | 3.980 | 4.630 | 2.749 | 2.438 | 6.489 | 10.170 | 1.674 |
| 429 STD | 1968-73 | 4.360 | 3.590 | 4.900 | 3.000 | 2.500 | 6.605 | 10.300 (1968-70) | 1.890 |
| 429 STD | 1968-73 | 4.360 | 3.590 | 4.900 | 3.000 | 2.500 | 6.605 | 10.310 (1970 1/2-71) | 1.890 |
| 429 CJ/SCJ | 1969-70 | 4.360 | 3.590 | 4.900 | 3.000 | 2.500 | 6.605 | 10.322 (1972-73) | 1.890 |
| 429 BOSS (S) | 1969 | 4.360 | 3.590 | 4.900 | 3.000 | 2.500 | 6.549 | 10.300 | 1.926 |
| 429 BOSS (T) | 1969-70 | 4.360 | 3.590 | 4.900 | 3.000 | 2.500 | 6.605 | 10.300 | 1.870 |
| 460/460 Ford Performance | 1969-96 | 4.360 | 3.850 | 4.900 | 3.000 | 2.500 | 6.605 | 10.322 (1972-96) | 1.756 |

ENGINE SWAP SIZE CHART

5.0L 4V TI-VCT ENGINE

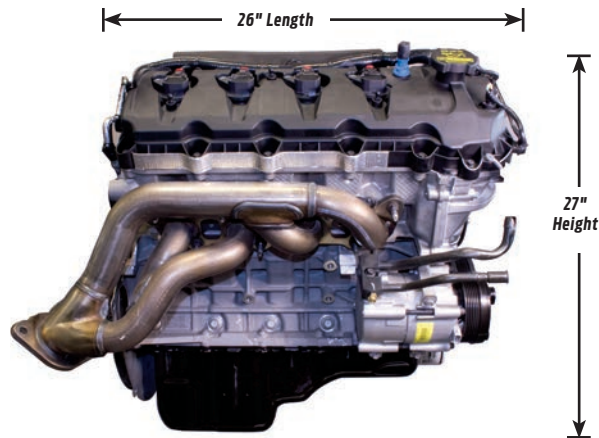

NOTE: 28" Width

4.6L MODULAR ENGINE

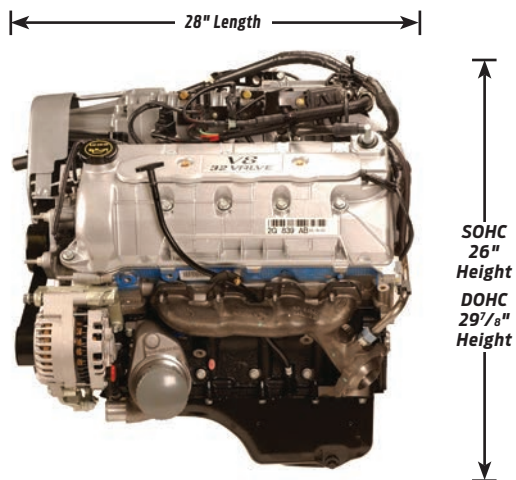

302/351W/460 ENGINE

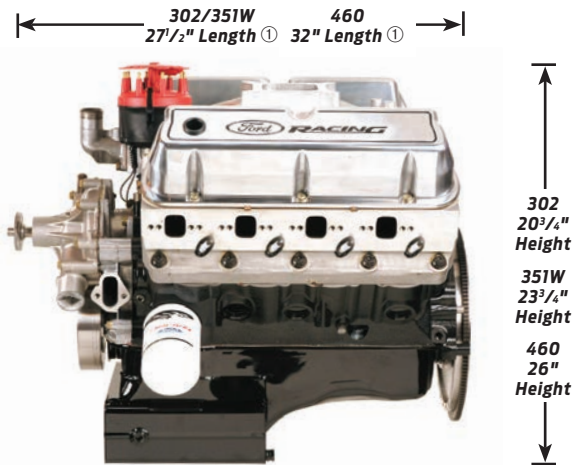

**ENGINE ELECTRONICS/
FUEL INJECTION**

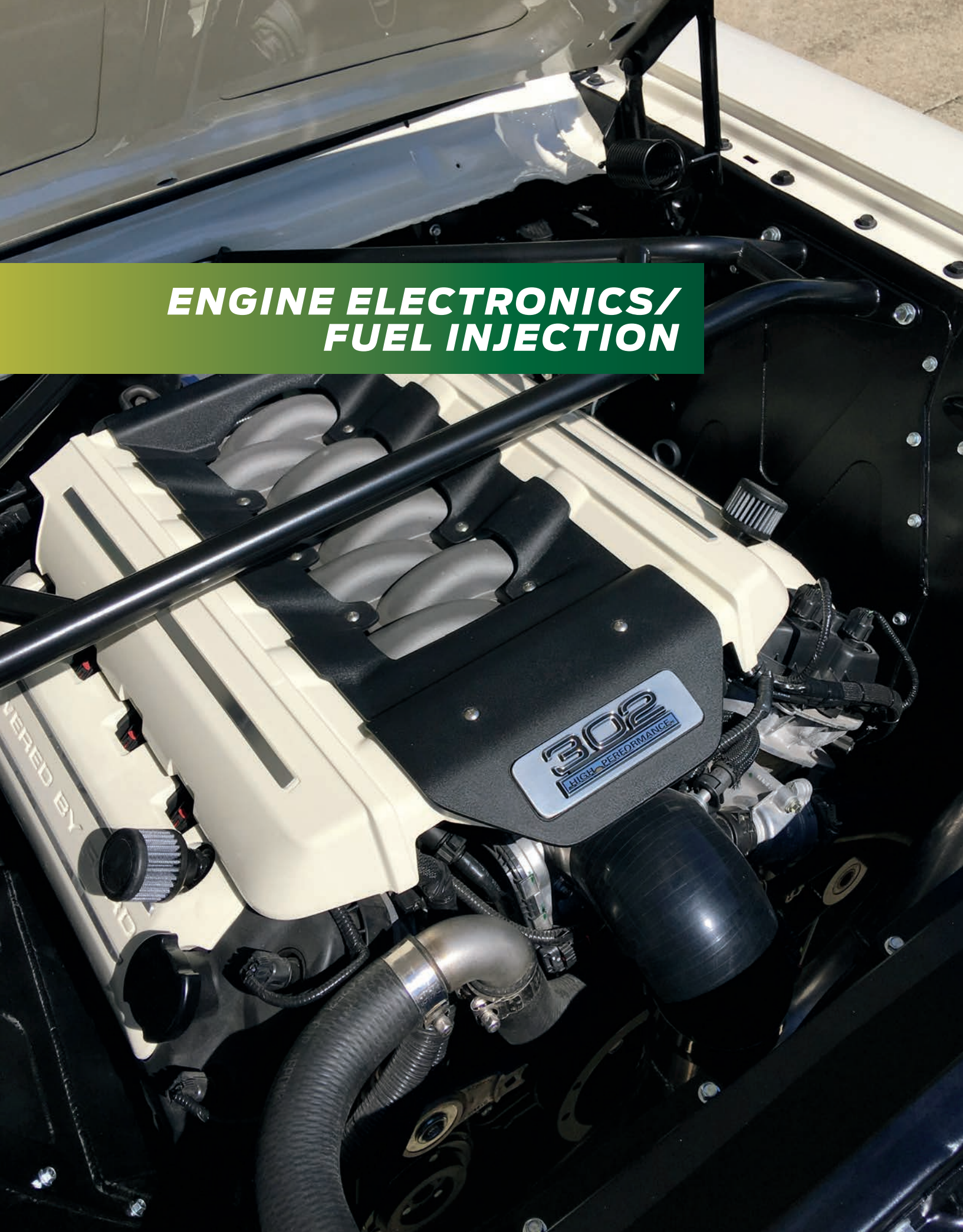

CONTROL PACK – FOCUS ST 2.0L ECOBOOST® WITH MANUAL TRANSMISSION

M-6017-20T

Looking to add 2.0L EcoBoost® power from the Focus ST to your custom built vehicle? Take the complexity and mystery out of wiring an M-6007-20T 2.0L EcoBoost® Engine!

- Designed to run the M-6007-20T Focus ST Crate Engine with a manual transmission
- Unique control pack harness replaces stock body harness and is designed for custom built vehicle. Harness includes OBD-II diagnostic port to assist in vehicle calibration upload and problem diagnosis
- Includes PCM with Ford Performance high-performance calibration
- Includes electronic throttle control accelerator pedal, eliminating throttle cable routing problems
- Includes power distribution module and oxygen sensor
- Includes M-12405-20T Cold Spark Plug Set required for performance calibration
- 2.0L EcoBoost® crate engine includes intercooler, air intake ducting and air cleaner assembly required to complete control kit installation
- PCM with Ford Performance calibration requires return-type fuel system; will not work with returnless fuel system

NOTE: Installation of this PCM in a Focus ST will result in a no-start condition.

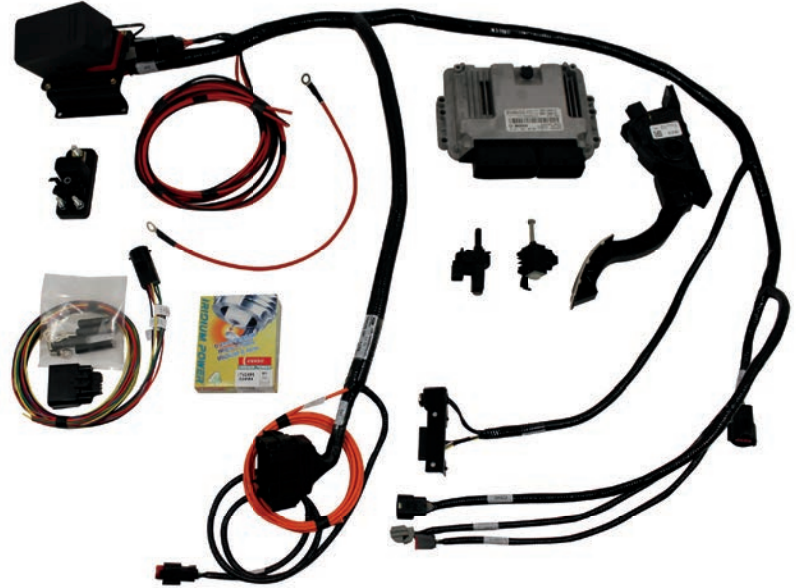

ENGINE ELECTRONICS/FUEL INJECTION

2.3L ECOBOOST® ENGINE CONTROL PACK

M-6017-23T

- Includes bodyside harness, PCM and sensors necessary to run a 2.3L EcoBoost® engine in most applications
- Recommended for use with M-6007-23T Crate Engine
- Requires return-style fuel system
- Retains factory technology, such as electronic throttle, variable cam timing, and turbo boost control
- See instructions for full bill of materials



CONTROL PACK – 2013-2016 3.5L ECOBOOST® WITH MANUAL TRANSMISSION

M-6017-35CNTRL

Wiring and engine controller for 3.5L EcoBoost® with manual transmission

- Designed to run the M-6007-35T Crate Engine
- Includes PCM with Ford Performance calibration
- Includes electronic throttle control accelerator pedal – eliminates throttle cable routing problems
- Unique control pack harness replaces stock body harness and is designed for custom vehicle builds
- Features OBD-II diagnostic port to assist in vehicle calibration upload and problem diagnosis
- Includes power distribution module, air-box, inlet tube and HEGO sensors
- PCM with Ford Performance calibration requires return-type fuel system; will not work with returnless fuel system
- Visit performance.ford.com for detailed installation instructions and bill of materials

NOTE: Installation of this PCM in any originally equipped 3.5L EcoBoost® vehicle will result in a no-start condition.

NOTE: This will work on 2013-2016 F150 3.5L engines.

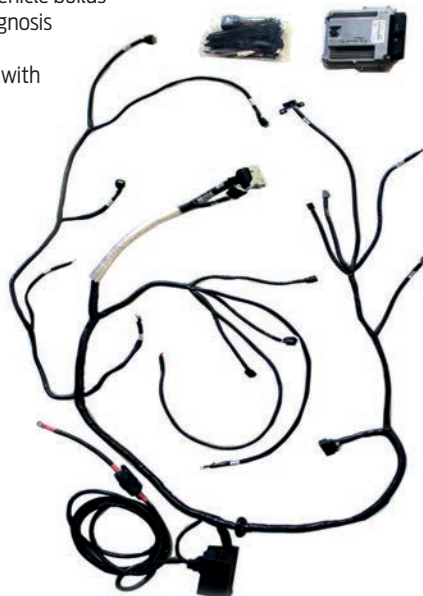

CONTROL PACK – 2015-2017 COYOTE 5.0L WITH AUTOMATIC TRANSMISSION

M-6017-M50A

- Take the complexity and mystery out of wiring a late model 5.0L Coyote engine!
- Designed to run 2015-2017 5.0L 4V Ti-VCT Coyote auto transmission engines, with 6R80 Mustang GT 6-speed auto transmission. Manual transmission engines require GU5Z-12A581-EF Engine Harness available from your local Ford dealer
- Includes PCM with Ford Performance calibration
- Includes electronic throttle control accelerator pedal, which eliminates throttle cable routing problems
- Unique control pack harness replaces stock body harness and is designed for custom vehicle builds
- Features OBD-II diagnostic port to assist in vehicle calibration upload and problem diagnosis
- Includes power distribution module, air-box, air inlet tube, MAF sensor, upper and lower radiator hoses and HEGO sensors
- PCM with Ford Performance calibration requires return-type fuel system; will not work with returnless fuel system

NOTE: Installation of this PCM in a 2015-2017 Mustang GT will result in a no-start condition.

NOTE: Not for use with a 2015-2017 F150 engine.



CONTROL PACK – 2011-2014 COYOTE 5.0L 4V WITH MANUAL TRANSMISSION AND SPEED DIAL

M-6017-A504VA

- Take the complexity and mystery out of wiring a late model 5.0L 4V Ti-VCT engine!
- Replaces M-6017-A504V Control Pack – adds wiring for M-4209ADPT-AC Speed Dial to pick up transmission output speed
- Designed to run 2011-2014 5.0L 4V Coyote engines, M-6007-M50 and M-6007-A50NA 5.0L 4V Coyote crate engines with manual transmission. M-6007-A50SC, M-6007-A50XS, BOSS 302 and truck engines require modifications – call Ford Performance Techline @ (800)367-3788 for more information
- Includes PCM with Ford Performance calibration. Supercharged M-6007-A50SC, M-6007-A50XS, BOSS 302 and truck engines require custom calibration
- Includes electronic throttle control accelerator pedal, which eliminates throttle cable routing problems
- Unique control pack harness replaces stock body harness and is designed for custom vehicle builds
- Features OBD-II diagnostic port to assist in vehicle calibration upload and problem diagnosis
- Includes power distribution module, air-box, air inlet tube, MAF sensor, upper and lower radiator hoses, PCV hoses and HEGO sensors
- PCM with Ford Performance calibration requires return-type fuel system; will not work with returnless fuel system

NOTE: Installation of this PCM in a 2011-2014 Mustang GT will result in a no-start condition.



ENGINE ELECTRONICS/FUEL INJECTION

CONTROL PACK – 2015-2017 COYOTE 5.0L WITH MANUAL TRANSMISSION

M-6017-504V

- Take the complexity and mystery out of wiring a late model 5.0L Coyote engine!
- Designed to run 2015-2017 5.0L 4V Mustang Coyote engines, M-6007-M50A and M-6007-A50NAA 5.0L 4V Ti-VCT crate engines with manual transmission

NOTE: Not for use with 2015-2017 F-150 engines.

- Includes PCM with Ford Performance calibration
- Includes electronic throttle control accelerator pedal, which eliminates throttle cable routing problems
- Unique control pack harness replaces stock body harness and is designed for custom vehicle builds
- Features OBD-II diagnostic port to assist in vehicle calibration upload and problem diagnosis
- Includes power distribution module, air-box, air inlet tube, MAF sensor, upper and lower radiator hoses and HEGO sensors
- PCM with Ford Performance calibration requires return-type fuel system; will not work with returnless fuel system
- For 2011-2014 engines, use M-6017-A504VA Control Pack
- For 2015-2017 automatic transmission version control pack that works in conjunction with 6R80 transmission, use M-6017-M50A

NOTE: Supercharged versions and M-6007-A50SCA (lower compression ratio) require custom calibration.

NOTE: Installation of this PCM in a 2015-2017 Mustang GT will result in a no-start condition.

NOTE: Remanufactured PCM.



5.0L COYOTE ENGINE HARNESS

M-12508-M50

- Fits 2011-2014 Coyote 5.0L engine with BOSS 302 or CJ intake manifold
- 2/27/12 and newer VCT solenoids BR3Z-6M280-D required
- Compatible with Ford Performance Parts M-6017-A504V Control Pack
- Can be used as a core for stand-alone EFI installations
- Used on M-6007-A50XS Crate Engine



5.0L COYOTE AUTO TRANS ENGINE HARNESS

M-12508-M50A

- Fits late, Gen 2 (2016-2017 MY) 5.0L Coyote engines
- This engine harness is used with automatic transmission vehicles
- Allows the engine to be used in conjunction with an automatic transmission
- Harness connector is compatible with Ford 6R80 automatic transmissions

NOTE: Fits late-style Ford Performance M-12029-M50E Coil on Plugs.



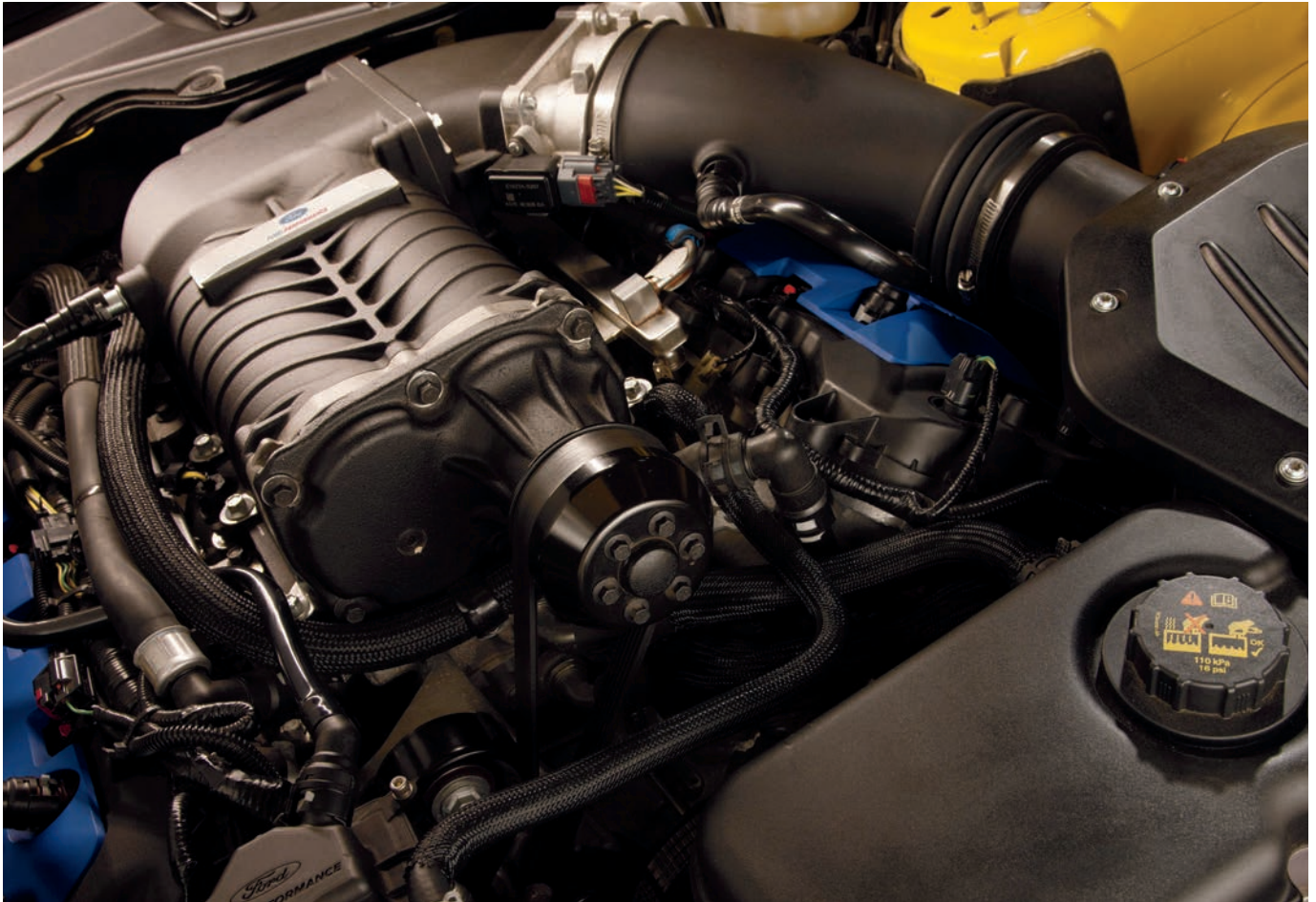

302/351W MULTIPOINT EFI WIRING HARNESS

M-12071-A50

- Direct fit on 1986-1993 H.O. engine
- Can be easily adapted to many other Ford V8 push rod engines
- Easy installation: Uses a single connector for all required connections
- Kit consists of a single harness with integral connections for injectors and O2 sensors
- Fully loomed, from PCM to all sensors and injectors, to save time on installation
- Typical installation takes less than 1 hour
- Requires PCM (not included) from 1989-1993 Mustang 5.0L H.O.
- Compatible with engines using both H.O. and non-H.O. firing orders
- Provisions for electric fan control output
- Kit includes compact fuse and relay box, "Check Engine" light, and all necessary grommets

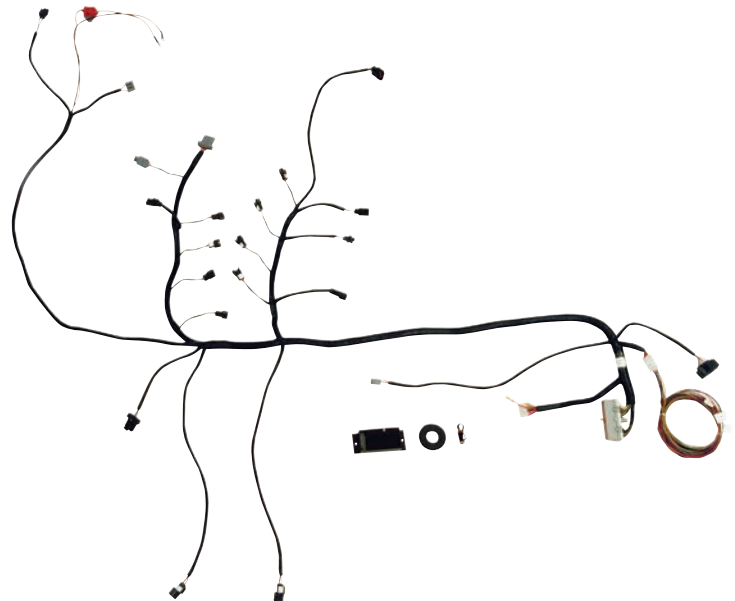

PROPERLY SELECTING ELECTRONIC FUEL INJECTION COMPONENTS

One of the more commonly misunderstood aspects of Electronic Fuel Injection (EFI) is how to select the correct size fuel injectors, fuel pump and Mass Airflow (MAF) sensor for a particular engine horsepower output. The following information is intended to offer a very brief tutorial on properly selecting the most common EFI components.

FUEL INJECTORS

First and foremost, adding larger fuel injectors alone will NOT create extra horsepower! The purchase of larger fuel injectors should only be considered when your engine has exceeded the horsepower capacity of the existing fuel injectors, at which point larger injectors are then required to SUPPORT the additional horsepower. If you add larger-than-stock injectors to an otherwise stock engine, you should not expect any horsepower increase whatsoever. In fact, you will most likely create many drivability issues that were not present before the swap to larger injectors.



The nominal injection pressure for many Ford EFI systems is 39.15 psi (270 kPa) “across the injector.” The term “across the injector” takes manifold pressure and fuel rail pressure into account, and is usually referred to as “delta pressure.” (See “Measuring Fuel Pressure” on pages 218-219 for more details.) Ford Performance’s fuel injectors are always rated at 39.15 psi delta, so the fuel injector sizing discussions found below will assume a fuel pressure of at least 39.15 psi delta.

There are some exceptions to the above-mentioned nominal injection pressure. In relatively recent years, emissions regulations have become so stringent that the government is now regulating the emissions output that gasoline vehicles are allowed to produce even when the engine is not running! This is referred to as “evaporative emissions” and results from unburned hydrocarbons (raw fuel) emitting into the atmosphere from the fuel tank, fuel lines, injector leakage, intake manifold, etc., when the engine is shut off. This is the fundamental purpose of the charcoal canister (and hydrocarbon trap in the air-box on many vehicles) and is also the reason that Ford and other manufacturers switched to the Returnless Fuel Systems (RFS) found in production vehicles today. These systems have only a fuel supply line from the tank to the engine, with no return line. The primary reason for these systems is that evaporative emissions increase as the temperature of the fuel in the tank increases. On a conventional return system, the fuel is sent to the engine through the supply line, and the excess is returned (via the mechanical fuel pressure regulator) to the tank through the return line. Since the engine is hot, this process heats up the fuel and thus increases evaporative emissions. To combat this, the returnless fuel systems were invented. Currently, Ford uses two primary types of RFS, which are called Electronic Returnless Fuel System (ERFS) and Mechanical Returnless Fuel System (MRFS). The latter is the simpler of the two systems and controls the fuel rail to a constant pressure via a (non-vacuum referenced) regulator in the tank, which is typically set to 55 psi. The Powertrain Control Module (PCM) then calculates the pressure across the injector, either by inferring or measuring manifold pressure and subtracting from the calibrated rail pressure set-point. This is referred to as a Constant Rail Pressure (CRP) system. ERFS, on the other hand, has no mechanical regulator at all, but instead has a Fuel Rail Pressure Transducer (FRPT) mounted on the fuel rail that measures fuel rail pressure relative to manifold pressure and feeds that information back to the PCM. The PCM then controls the Fuel Pump Driver Module (FPDM), which in turn varies the voltage to the fuel pump (or pumps) in the tank to supply the correct pressure and flow rate to the injectors. Most of the time this pressure is maintained at 39.15 psi delta, but when the fuel temperature rises, this pressure can be boosted in order to delay the onset of boiling the fuel. Some vehicles also boost the pressure under some conditions in order to get away with using smaller flow-rate fuel injectors for various reasons beyond the scope of this tutorial. This is referred to as a Constant Injection Pressure (CIP) system. Both V6 and V8 Mustang used ERFS between 1999 and 2010 and MRFS from 2011 forward.

If you are trying to compare injector flow rates and you have flow data at one delta pressure, you can easily calculate the flow rate at a different delta pressure as follows:

Flow rate at new delta pressure = (flow rate at old pressure) x $\sqrt{\text{new pressure/old pressure}}$

Example: What is the flow rate for an injector at 43.5 psi if it is rated at 60 lb/hr at 39.15 psi?

Flow rate at 43.5 psi delta = $60 \times \sqrt{43.5/39.15} = 63.2 \text{ lb/hr}$

You can use the following information to properly determine what size injectors are needed for various applications. For this example, we will use a naturally aspirated 5.0L V8 engine making 300 hp. Keep in mind that this is FLYWHEEL (also known as brake) horsepower, NOT wheel horsepower.

Engines require a certain fuel flow rate that is generally measured in lb/hr (pounds per hour) and can be calculated via knowledge of its Brake Specific Fuel Consumption (BSFC). By definition, BSFC represents how much fuel (in lb) is required per hour per each brake horsepower the engine produces. Most naturally aspirated production gasoline engines generally operate on a 0.42 to 0.52 lb/hp-hr BSFC at wide open throttle (WOT). High-performance gasoline and race engines (12.5:1 compression ratio and higher), which tend to be extremely efficient, can sometimes have a BSFC as low as 0.38 to 0.42. More clearly stated, this means that if you have a gasoline engine that makes 300 brake horsepower, its total maximum fuel requirement in lb/hr can be calculated as follows:

Fuel flow requirement = (brake horsepower) x (BSFC)

Example: A 300 hp naturally aspirated gasoline-powered V8 requires what size fuel injector?

First, assume a BSFC of 0.50 lb/hr and injection pressure of 39.15 psi across the injector.

$300 \text{ hp} \times 0.50 \text{ lb/hp-hr} = 150 \text{ lb/hr}$ maximum total fuel flow requirement

Since this is the total fuel flow requirement to the engine, we must now divide this by the number of injectors being used to determine the flow rate necessary for each injector so that you can select the correct size injector from this catalog. In this example, we have an 8-cylinder engine using 1 injector per cylinder, which gives: **150 lb/hr/8 injectors = 18.8 lb/hr per cylinder.**

PROPERLY SELECTING ELECTRONIC FUEL INJECTION COMPONENTS (continued...)

So, technically, the engine only needs a 19 lb/hr fuel injector to support 300 hp, but this will require that the injector is at nearly a 100% duty cycle in order to achieve this horsepower level. Duty cycle refers to how long the injector needs to be open (flowing fuel) in order to supply the required amount of fuel. If the injector needs a 100% duty cycle at a particular engine speed and load to inject enough fuel, that means it is open all the time. Under most conditions, fuel is injected when the intake valves are closed, which helps with fuel atomization and efficiency. If the injectors need to be on 100% of the time to supply enough fuel, this means that some fuel is being injected while the intake valves are open. Depending on the overlap of the cam in the engine, some of this unburned fuel can be blown right past the exhaust valve, or be poorly atomized, which makes for a less-efficient combustion process. Perhaps more importantly, operating a fuel injector between roughly 85% and 99% duty cycle does not give the injector sufficient time to close before it is commanded to open again. This can cause extreme variability in the amount of fuel actually injected, which can sometimes result in a rich condition. Similar issues exist at the low end of the flow region at extremely low duty cycles, but this is highly dependent on the type and flow rate of each model of injector. In this case, the injector does not have enough time to fully open before it is commanded to close again, which causes extreme variability that can result in a lean condition. For these reasons, we generally recommended selecting an injector with a flow rate sufficiently high that it will not be required to exceed an 85% duty cycle. So, to figure out what size fuel injector will result in an 85% duty cycle, divide the original result by 0.85: **18.75 lb/hr/0.85 = 22.1 lb/hr requirement**.

Since the next popular injector size available is 24 lb/hr, this is the correct size injector that you should choose for this particular application. Keep in mind that this discussion assumes your fuel pump, lines, regulator, etc., are sufficient to be able to maintain at least 39.15 psi across the injector at all engine speeds and loads (even under boost, if applicable). Now that you have selected an injector, the calibration (or "tune") in the PCM must either be changed or a different MAF must be used (see "Mass Airflow Sensors" on page 220 for more details).

This calculation can also be reversed to give the maximum safe hp a set of injectors can support, which gives:

$$\text{Max safe hp} = [(\text{injector size}) \times (\text{total \# of injectors}) \times (\text{max duty cycle})] / \text{BSFC}$$

Example: The following guide is a general rule of thumb for sizing fuel injectors on an 8-cylinder engine using a BSFC of 0.50. Forced-induction engines typically range from a BSFC of 0.55 to 0.65, with the latter value arising from the fuel enrichment necessary to keep exhaust temperatures below 1650 deg F and catalyst temperatures below 1750 deg F.

Naturally Aspirated: $(19 \text{ lb} \times 8 \times .85) / .50 = 258.4$ or approx 258 hp @ 85% duty cycle
 Forced-Induction @ 0.55: $(19 \text{ lb} \times 8 \times .85) / .55 = 234.9$ or approx 235 hp @ 85% duty cycle
 Forced-Induction @ 0.65: $(19 \text{ lb} \times 8 \times .85) / .65 = 198.8$ or approx 199 hp @ 85% duty cycle

Inj Flow Rate (@ 40 psid)

24 lb/hr
 30 lb/hr
 32 lb/hr
 39 lb/hr
 47 lb/hr
 60 lb/hr
 80 lb/hr

Naturally Aspirated hp (@ 0.50)

326 hp @ 85% Duty Cycle
 408 hp @ 85% Duty Cycle
 435 hp @ 85% Duty Cycle
 530 hp @ 85% Duty Cycle
 639 hp @ 85% Duty Cycle
 816 hp @ 85% Duty Cycle
 1088 hp @ 85% Duty Cycle

Forced-Induction hp (@ 0.65)

251 hp @ 85% Duty Cycle
 314 hp @ 85% Duty Cycle
 335 hp @ 85% Duty Cycle
 408 hp @ 85% Duty Cycle
 492 hp @ 85% Duty Cycle
 628 hp @ 85% Duty Cycle
 837 hp @ 85% Duty Cycle

Remember, the above calculations assume a fuel pressure of 39.15 psid. If you can raise fuel pressure and still be sure that your fuel pump can supply the desired flow rate, then these maximum horsepower numbers will increase.

FUEL PUMPS

Most EFI fuel pumps are rated for flow at 12 volts @ 40 psi. Most vehicle charging systems operate anywhere from 13.2V to 14.4V. Within limits, the more voltage you feed a pump (for a given current), the faster it spins, resulting in a higher output of fuel from the same fuel pump. Rating a fuel pump at 12V should offer a fairly conservative fuel flow rating allowing you to safely determine the pump's ability to supply an adequate amount of fuel for a particular application, assuming the gauge of wire feeding power to the pump is sufficient to carry the current required.

As previously mentioned, engines actually require a certain **mass** of fuel, NOT a certain **volume** of fuel per hour per horsepower. This can offer a bit of confusion since most fuel pumps are rated by volume, and not by mass. To determine the proper fuel pump required, a few mathematical conversions will need to be performed using the following information. There are 3.785 liters in 1 U.S. gallon, and 1 gallon of gasoline (0.72 specific gravity @ 65° F) weighs 6.009 lb.

An additional fact to consider regarding the BSFC is that the specific gravity of the fuel that you are using is very important. The fuel that you put in your car should only be obtained from a source which supplies fuel intended for an automobile. Some people make the mistake of using aviation fuel (sometimes referred to as "Av Gas"), thinking that the higher octane of this fuel may offer a performance gain. The problem is that TRUE aviation fuel has a much lower specific gravity (commonly as low as 0.62 to 0.65) than automotive grade fuel (0.72 to 0.76). As previously stated, an engine requires a certain **mass** of fuel per hour per horsepower, and 1 gallon of aviation gasoline has a lower mass than 1 gallon of automotive gasoline. Since the specific gravity of aviation gasoline is only about 90% that of automotive gasoline, all other things being equal, your engine will run approximately 10% lean by using aviation gasoline. Be sure to take the specific gravity and stoichiometric ratio of your desired fuel into consideration when sizing the fuel pump and injectors. Note that the stoichiometric ratio is highly fuel-dependent and should be obtained from the fuel supplier prior to performing any PCM calibration.

It is always a good idea to apply a safety factor to account for things such as pump-to-pump variability, voltage loss between the pump and the battery, etc., so we recommend you multiply the final output of the fuel pump by 0.90 to determine the capacity of the fuel pump at 90% output to be on the safe side.



ENGINE ELECTRONICS/FUEL INJECTION

PROPERLY SELECTING ELECTRONIC FUEL INJECTION COMPONENTS (continued...)

To determine the overall capacity of a fuel pump rated in liters per hour (L/hr), use the following additional conversions:

| Do: | To Get: |
|-----------------------------------|------------------------------------|
| (L/hr)/3.785 | → U.S. gallons/hr |
| Multiply above by 6.009 lb/gallon | → lb/hr |
| Multiply above by 0.9 | → Capacity in lb/hr at 90% |
| Divide above by BSFC | → "Horsepower capacity" (flywheel) |

So, for a fuel pump rated at 110L/hr for example, supplying a naturally aspirated engine:

| | |
|---------------|---|
| 110/3.785 | = 29.06 U.S. gallons/hr |
| 29.06 x 6.009 | = 174.62 lb/hr |
| 174.62 x 0.90 | = 157 lb/hr @ 90% capacity |
| 157/0.50 | = 314 hp safe naturally aspirated "horsepower capacity" |

Safe "horsepower capacity" @ 40 psi with 12V assuming 0.5 lb/hp-hr BSFC

| |
|---|
| 60L/hr pump = 95 lb/hr x 0.90 = 86 lb/hr, safe for up to 170 naturally aspirated flywheel hp |
| 88L/hr pump = 140 lb/hr x 0.90 = 126 lb/hr, safe for up to 250 naturally aspirated flywheel hp |
| 110L/hr pump = 175 lb/hr x 0.90 = 157 lb/hr, safe for up to 310 naturally aspirated flywheel hp |
| 155L/hr pump = 246 lb/hr x 0.90 = 221 lb/hr, safe for up to 440 naturally aspirated flywheel hp |
| 190L/hr pump = 302 lb/hr x 0.90 = 271 lb/hr, safe for up to 540 naturally aspirated flywheel hp |
| 255L/hr pump = 405 lb/hr x 0.90 = 364 lb/hr, safe for up to 720 naturally aspirated flywheel hp |

Very Important Note: For any type of forced-induction engine, the above maximum power levels will be reduced because as the boost pressure increases, the fuel pressure required from the pump also increases, creating an additional load to the fuel pump, which results in a decreased fuel flow rate at the higher pressure. In order to do proper fuel pump sizing for these applications, a fuel pump map is required, which shows flow rate versus delivery pressure for a given voltage. For example, a 255L/hr pump at 40 psi may only supply 200L/hr at 58 psi (40 psi plus 18 lbs of boost). Additionally, if you use a fuel supply line that is not large enough, this can result in decreased fuel flow due to the pressure drop. For example, 255L/hr at the pump may only result in 220L/hr at the fuel rail because as the required pressure increases (due to the pressure loss from the supply line restriction), the maximum flow rate of the pump decreases. Figure 1 shows an example fuel pump map for a pump assembly at a supply voltage of 13V.

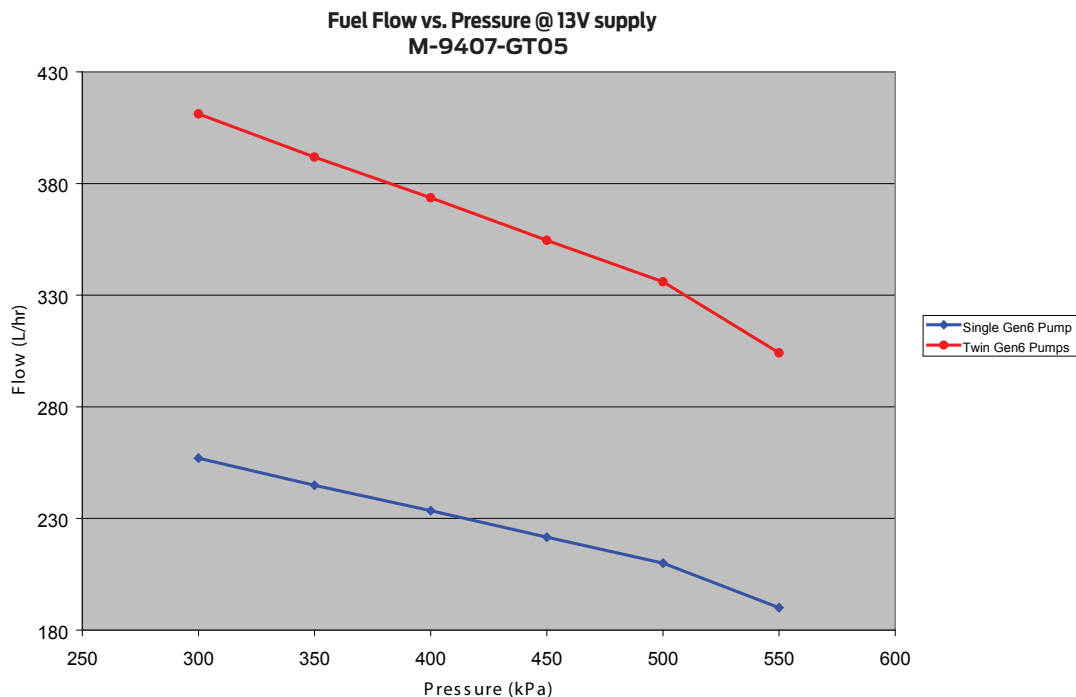

Figure 1

MEASURING FUEL PRESSURE

The above fuel pump sizing information should be regarded as a **guideline** in selecting the size of pump you need. Once installed in the car, you still need to **verify** that adequate fuel pressure (at least 39.15 psi across the injector) is maintained at all engine speeds and loads. Do not skip this fuel pressure verification step, as failure to maintain adequate fuel pressure can cause issues ranging from calibration difficulty to engine failure due to running lean.

PROPERLY SELECTING ELECTRONIC FUEL INJECTION COMPONENTS (continued...)



As mentioned earlier, all injector flow rates published in this catalog have been determined at a pressure of 39.15 psi (270 kPa) across the injector, but to what does the phrase “across the injector” refer? To understand this fully, we first need to discuss three different methods of measuring pressure.

The first is called **absolute** pressure. This is defined as the pressure relative to a complete vacuum, such as would be found in outer space. For instance, atmospheric pressure (the air we breathe) is typically around 14.7 psi absolute (29.93 inHg) at sea level, depending on temperature and weather conditions. An engine that has a vacuum signal of 12 “inches” simply means that the absolute pressure in the intake manifold is 12 inHg less than the atmospheric pressure. When you subtract the 12 inHg from the atmospheric pressure of 29.93 inHg, you are left with a positive pressure of 17.93 inHg, or roughly 9 psi absolute as compared to a complete vacuum. Sometimes you will see absolute pressure in psi written as “psia.”

The second is called **gauge** pressure, which is pressure relative to atmospheric pressure. In general, everyone is most familiar with gauge pressure, because it is what you measure when you check the air in your tires or when you connect a fuel pressure gauge to the fuel rail. An engine which makes 6 psi of boost at sea level is actually equivalent to 20.7 psi absolute ($14.7 + 6 = 20.7$). Sometimes you will see gauge pressure in psi written as “psig.”

The third is called **delta** pressure and is very much like gauge pressure, but instead of being relative to atmospheric, it can be relative to any other pressure, such as the pressure in the intake manifold. Sometimes you will see delta pressure in psi written as “psid.”

When we quote pressure “across the injector,” what we really mean is the delta pressure (or difference) between the fuel rail and the intake manifold. On CRP systems, the rail gauge pressure is constant while the delta pressure varies depending on manifold pressure. This means if a fuel pressure gauge is connected to the rail, the reading it gives will be constant. On CIP systems, the system controls the delta pressure, either by use of a mechanical regulator referenced to the intake manifold (in a traditional or “return” system), or by the use of the FRPT and the PCM (with ERFS). This means that if you connect a fuel pressure gauge to the fuel rail on one of these systems, you will see fuel pressure vary depending on intake manifold pressure. This is because the gauge is measuring gauge pressure, which is relative to atmospheric, but the EFI system is controlling the fuel rail pressure relative to intake manifold pressure which is changing depending on engine load (your right foot) among other things. On a naturally aspirated engine, the manifold pressure at idle is typically around 10 psia, and the manifold pressure at WOT will be atmospheric, so typically at the fuel rail you will see approximately 30 psig at idle and at least 39.15 psig at WOT, depending on whether or not you have ERFS and whether or not it is boosting pressure for one of the reasons mentioned in the previous section. On a forced-induction engine, the highest manifold pressure that the engine can reach will be atmospheric plus the maximum boost your configuration can obtain. This means that to keep 39.15 psid across the injector, the gauge pressure will have to increase by the same amount as the maximum boost. A couple of examples should make these concepts more clear. First, consider a naturally aspirated conventional return fuel (non-ERFS, non-MRFS) EFI system with a mechanical vacuum referenced regulator set at the stock pressure setting. The system will try to keep the pressure across the injector at 39.15 psid regardless of engine load, so if you have a fuel pressure gauge attached to the fuel rail, you will see a maximum pressure of 39.15 psig at WOT if the system is doing its job properly. Now consider a forced-induction engine making a maximum of 10 psig boost, also with a conventional EFI system and mechanical regulator set to the stock pressure setting. The system will still try to keep the pressure across the injector at 39.15 psi, so this time your fuel pressure gauge attached to the rail should read a maximum of $39.15 + 10 = 49.15$ psig. If it never gets to 49.15 psig at WOT, your fuel system is inadequate for your engine. You will need to either increase the capacity of the pump, minimize the voltage loss between the pump and the battery or decrease the pressure loss between the pump and the engine through the use of larger lines, etc., and re-test. Do NOT try to “tune around” this type of fuel delivery problem. It will bite you in the long run, and can result in hard-to-diagnose problems at best all the way to engine failure at worst. Note that during a WOT event, the fuel pump in the forced-induction engine must supply fuel at a higher pressure than in the naturally aspirated engine. As mentioned in the previous section, this means that the fuel pump supplying the forced-induction engine will have a lower maximum flow rate capability than the fuel pump supplying the naturally aspirated engine. This is a critical concept to grasp because it means that in general, **for engines with equal brake horsepower, the fuel pump supplying the forced-induction engine will need to have more capacity than the fuel pump supplying the naturally aspirated engine!**

PROPERLY SELECTING ELECTRONIC FUEL INJECTION COMPONENTS (continued...)

MASS AIRFLOW SENSORS

On EFI systems that use an MAF sensor, this is the single most important sensor on the engine for determining a proper air/fuel (A/F) ratio. Unfortunately, it is also one of the most misunderstood sensors on the engine, as well. The engine's air/fuel ratio and spark advance are determined by the PCM primarily from the input received from the MAF sensor. This is also why it is of critical importance that there are no air leaks (defined as air entering the intake stream between the MAF and the combustion chamber) in an MAF-based system. Air leaks can cause a "Check Engine" light, rough idling, stalling, spark knock, electronic throttle control failure mitigation modes, drivability issues, and in extreme cases, complete engine failure, depending on their magnitude.



As with fuel injectors, changing the MAF alone will not result in more horsepower on an otherwise stock engine. A different MAF sensor should only be considered after engine modification which either causes the stock sensor to become a flow restriction **or** when the stock MAF sensor electronics are insufficient to measure the airflow that the modified engine is capable of ingesting. This latter point is critical in understanding when an MAF needs to be replaced. It is possible to have two MAF sensors that are equal in size, but capable of different maximum power levels. This is because the electronics in each MAF are different and are capable of measuring different maximum airflow, despite the fact that the size of the MAF housing is the same. For example, you can have two different 90 mm MAF sensors but one will be capable of measuring 60 lb/min of air, while the other can measure, say, 100 lb/min of air. They both present the same airflow restriction (which is dictated primarily by their physical size) but they are definitely NOT interchangeable. So how do you know how much air your MAF needs to be capable of measuring? If you have an approximation of the engine's BSFC at WOT, as well as a target air/fuel ratio in mind, the amount of air that your MAF sensor needs to be capable of measuring (in lb/hr) can be calculated as follows. Note that this formula includes a safety factor of 10%.

Max airflow = 1.10 x (power x BSFC x A/F ratio)

Example: What is the max airflow a naturally aspirated 300 hp gasoline engine will ingest?

First, assume a BSFC of 0.50 lb/hp-hr and A/F ratio of 12:1.

Max airflow = 1.1 x (300 x 0.50 x 12) = **1980 lb/hr**

Now that we know the minimum size fuel injector and MAF that we need, we have to consider what the PCM will do with this new hardware. The two main methods of dealing with the installation of a new MAF and injectors are to either "trick" the PCM by careful selection of injectors and a "matched" MAF, or by changing the calibration in the PCM to match the MAF and injectors that you selected.

The first method requires an MAF sensor that has been "curved" to a certain flow rate of injector. For instance, let's say your engine originally came with 19 lb/hr injectors and you replaced them with 39 lb/hr injectors. To use this method, you will need an MAF with electronics that have been modified such that it will output a signal proportional to an airflow that is 19/39 times as great as the stock MAF would measure. This will result in the PCM delivering the correct amount of fuel despite the fact that the injector size has been increased from 19 lb/hr to 39 lb/hr. The downside of this method is that many other variables, such as spark advance, are determined from the MAF sensor through a parameter called "load." For a given engine rpm, as load increases, required spark advance decreases. Since, by using this method, the MAF outputs a signal that is lower than the stock MAF, the calculated load will also be lower. This means that commanded spark advance will be higher than it should be, which can potentially result in spark knock and other concerns. While this method works quite well on less-sophisticated electronics, such as the EEC-IV found in a Fox body Mustang, it is not recommended for newer vehicles which have a much higher dependency on the calculated value of load.

The second and much preferred method requires the ability to alter the calibration inside the PCM. When using this method, the actual flow data for the injector (available on our website for all FPP injectors), as well as the "transfer function" for the MAF, are entered into the calibration in the PCM. Generally, it is recommended to test the new calibration on a dynamometer to ensure that the engine receives the correct A/F ratio at all speeds and loads. Provided this is performed by a competent and experienced operator using proper equipment, this is by far the best method and will result in the best part-throttle drivability and idle, and the least amount of trouble with "Check Engine" lights, returnless fuel, electronic throttle monitors, transmission shifting, etc. Ford Performance upgrade kits and their associated calibrations are designed to work together seamlessly, taking much of the hard work out of upgrading the performance of your vehicle.

Prior to tuning on a dyno, you should be absolutely certain that the ground circuits for the EFI system are in pristine condition. Doing so will help to ensure that the calibration you and your tuner develop on the dyno will also work when you leave the shop. It can't be overstated that prior to the vehicle being tuned in any way, all vacuum leaks, electrical issues, etc., need to be resolved. Fixing them before you go to the dyno will always be cheaper than paying for dyno time while you're wrenching on your car.

If you have any questions not addressed in this tutorial, please contact the Ford Performance Techline at (800)367-3788 and we will be happy to assist you.

EFI SYSTEM TIPS

Always remember to disconnect the battery before doing any wiring on your vehicle!

ELECTRICAL GROUNDS

The single leading cause of most electrical problems is poor grounds.

Ideally, the ground for the fuel injection system should connect directly to the battery at the negative post. Using the steel chassis or engine block as a ground can create excessive resistance, causing the Powertrain Control Module (PCM) to function improperly.

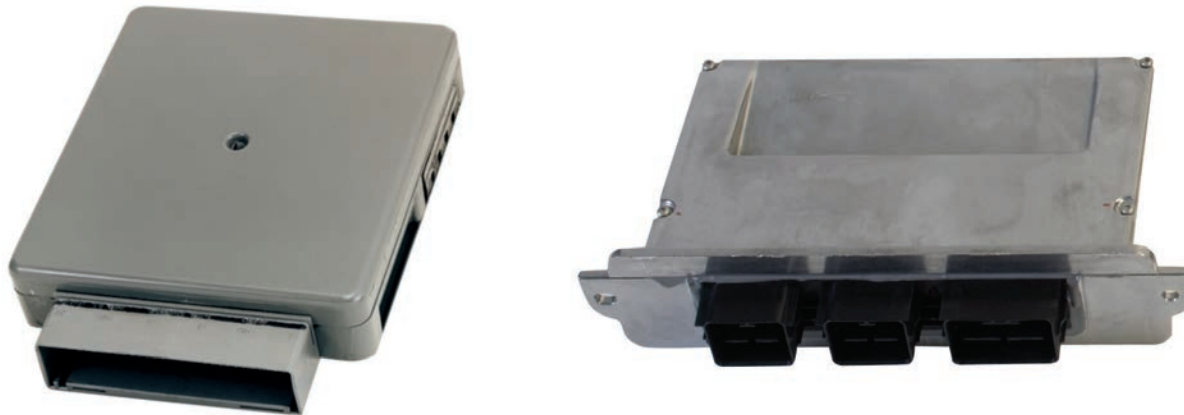

An example of how a high ground or connection resistance can have very serious effects is as follows. This particular case applies to a 2005 Mustang GT, but can easily be extended to any electronically controlled Ford vehicle: consider the case where a PCM is reading an MAF sensor signal of 4.1V (due to a high ground or connection resistance) when it should really be reading 4.3V. This equates to a difference in measured air mass of 13%. That is, the MAF will be telling the PCM that there is 13% less air entering the engine than there really is. Let's say this happens at WOT, where air/fuel ratio is critical not only to performance, but also to engine durability. The result is that the actual air/fuel ratio can go from a safe 12.5:1 to a potentially damaging 14.1:1, just from a 0.2V change in the MAF return signal!

All PCM sensors, not just the MAF, are affected in a similar fashion, so it is absolutely critical that all electrical connections are solid and that the grounds are reliable. The potential penalty for a bad ground can range from strange drivability issues that are difficult to diagnose all the way to a damaged engine, as in the above example.

All resistance tests should be done with the ignition key in the off position. Having voltage going through the system can return a false reading of excessive resistance. Additionally, it is possible to have a ground that tests OK when the engine is cold, but not when the engine is hot. Heat increases resistance, so these tests should be performed on a warm engine when possible.

To test for an adequate ground circuit in the EFI system for a 1986 to 1993 5.0L Mustang, use a volt-ohm meter to check the resistance of the following circuits:

- **To verify a proper ground to the PCM**, check the resistance from pin 40 and pin 60 DIRECTLY to the negative side of the battery. Resistance should be no greater than 0.2 ohms.
- **To verify a proper ground to the main PCM harness**, check the resistance from the MAF sensor at pin "B" DIRECTLY to the negative side of the battery. Resistance should be no greater than 0.2 ohms.
- **To verify a proper ground to the engine harness**, check the resistance from the black wire at the Throttle Position Sensor (TPS) DIRECTLY to the negative side of the battery. Resistance should be no greater than 0.3 ohms.

Note that while 0.2 ohms or less is desirable, a resistance as high as 0.5 ohms is considered acceptable. Greater than 0.5 ohms is excessive and could result in drivability concerns.

A weak ground connection can also cause the PCM's internal reference voltage regulator to function incorrectly. This can be checked at the TPS by checking voltage between the black ground wire and the orange reference voltage wire. With the key on, this voltage signal should be somewhere between 4.7V and 5.3V.

GENERAL TIPS

- Whenever possible, the PCM should be mounted inside the vehicle to protect it from water damage. The PCM should also be mounted with the electrical connectors at the bottom to avoid trapping water. Some PCMs on newer model cars are mounted under the hood, but they are sealed against moisture and designed to operate in such an environment. When in doubt, mount the PCM inside the vehicle.

EFI SYSTEM TIPS (continued...)

- When setting the voltage at the TPS, you should check the voltage between the black and green wires (1986-1993 5.0L Mustang). This voltage should be somewhere between 0.96V and 0.98V. If the key is on while the engine is off, set the voltage at 0.96V. If the engine is running, set it at 0.98V. The TPS can be set by loosening the mounting screws and slightly rotating the sensor. If you are unable to achieve the proper setting, you may need to elongate the TPS mounting holes.
- If you ever need to lengthen any harness leads for your specific application, it is strongly advised that you lengthen only one wire at a time, which will help to avoid making mistakes.
- If you are using long tube headers and need to lengthen the leads of the harness to reach the Heated Exhaust Gas Oxygen (HEGO, also known as O₂ or oxygen) sensors, NEVER lengthen the wires of the O₂ sensor itself. These wires are made up of a unique material and you will disrupt the signal coming from the O₂ sensor **even if they are soldered correctly!** If you must increase the length of the leads to the O₂ sensor, always lengthen the wires on the wiring harness side of the O₂ sensor. Many aftermarket companies offer HEGO sensor extensions that work quite well and are a quick and easy solution to this problem.
- When soldering two or more wires together, you should “tin” the bare ends to be soldered. This will prevent cold solder joints and make the process easier. “Crimp” style or “solder-less” connectors are not recommended. Over time, these have a tendency to loosen and permit corrosion. Additionally, these connectors can commonly allow short circuits to develop within the connection. Many of these problems within the harness can be difficult to locate. Always use weather-tight heat shrink over all soldered joints.
- If the factory coolant tubes are not used, the Engine Coolant Temperature (ECT) sensor should be installed directly into the threaded boss in the intake manifold near the thermostat, if applicable. This is a coolant passage.
- The ACT sensor should generally not be moved from the stock location. Some aftermarket companies offer ACT relocation kits while making false claims of increased horsepower by reading cooler air. While it is true that a cooler air can result in more power, this “trick” is not cooling the incoming air, but instead is merely reading the temperature from a different location. This can have a negative effect on overall engine performance and drivability because the PCM was calibrated under the assumption that the ACT sensor was in the stock design location. On a forced-induction engine, it is generally preferable to have the ACT sensor located after the power adder and after the intercooler, if applicable, which will simplify the calibration (“tuning”) process. Some of our FPP supercharger kits leave the ACT sensor in the stock location upstream of the supercharger, but this was accounted for in the calibration and should not be changed.
- Protect the air filter element from turbulence created by the engine cooling fan. This is commonly referred to as “fan wash.” If you are using an open element air filter on the end of the MAF sensor, it is strongly advised that you use a shield to reduce the effects of the turbulence.
- It's best if the air filter gets cold air from in front of the radiator. If the filter is located in the engine compartment, as in many street rod applications, the inlet air temperature can be up to 60 degrees hotter than ambient, which can result in a 5% torque loss from the air density decrease. The PCM will also retard ignition timing for the hotter air, which can result in an additional 5-10% torque loss. Colder air is always better.
- An improperly functioning charging system can cause engine running problems. Under-drive pulleys spin the accessories slower, meaning that they consume less power from the engine. This results in a greater net horsepower available at the flywheel, but at a cost. Normally this is not a problem, but some systems may not perform properly if you under-drive the alternator excessively, especially if you've increased the electrical load on the system through the use of bigger cooling fans, high-capacity fuel pump, stereo system, etc. If the alternator does not generate enough voltage to keep the system adequately charged, it can have an adverse effect on the EFI system and result in a variety of drivability issues.
- The inside diameter of the fuel return line should be at least 75% of the size of the inside diameter of the fuel supply line.

FUEL PUMP LOCATION

A common and often overlooked problem is the location of the fuel pump or pumps. Optimally, the fuel pump should be mounted IN THE TANK to reduce the possibility of pump cavitation. Cavitation is essentially localized boiling caused by a reduction in pressure, generally occurring on the inlet side of a pump. This localized boiling results in fuel vapor bubbles which will reduce the volume of fuel the pump is capable of delivering to the engine. Any reduction in pressure or increase in temperature at the inlet side of the pump increases the chances that cavitation will occur. For this reason, it is always best to either have the pump inside the tank immersed in fuel or (in the case of an external pump) gravity fed, which will increase the pressure on the inlet side of the pump. If the fuel pump has to “pull” the fuel, this will result in a reduction in pressure at the fuel pump inlet, potentially allowing cavitation and, thus, vapor bubbles to develop. These vapor bubbles are then drawn into the fuel pump and exit the high-pressure side of the fuel pump as compressed vapor. They travel the entire length of the fuel system and are expelled through the fuel injector. This can cause issues ranging from stumbles and hesitations to engine damage due to insufficient fuel delivery and lean A/F ratios. Sometimes this problem can characterize itself by only appearing when the weather gets warmer, which can confound the diagnosis of the issue. In certain cases, it may seem to only develop when driving on certain surfaces, because pavement reflects more heat than an off-road 4x4 trail. Remember, more heat and lower pressure on the inlet side of the pump means a greater chance of cavitation, which is to be avoided whenever possible.

If you are using an external-mounted fuel pump, you should run a very coarse (typically around 100 micron) filter on the inlet side of the fuel pump, and a finer (typically around 10 micron) filter on the outlet side of the pump. A paper filter is NOT recommended on the inlet of the fuel pump because it can cause a restriction in fuel flow which, as mentioned previously, can lead to cavitation.



ENGINE ELECTRONICS/FUEL INJECTION

NOT ALL INJECTORS ARE ALIKE.

All Ford Performance injectors are held to the same original equipment specifications that are used in millions of Ford vehicles currently on the road. With mandatory emissions requirements for 100,000 miles, our injectors have to be durable and consistent. Some of our competitors' injectors are not built to original equipment standards and are often held to no specific build tolerance.

Don't trust your performance vehicle to just any injector, trust the brand with millions of vehicles on the road and over 100 years of racing experience, Ford Performance!

"After working with the Ford Performance 80 lb/hr injectors in several projects, I'm thoroughly convinced that they are the best all-around fuel injectors for most of today's Mustang performance applications – naturally aspirated and/or with power adders."
– KJ Jones, 5.0 Mustang & Super Fords

| PART NUMBER (SETS OF 8) | FLOW RATE | IMPEDANCE | LENGTH | CONNECTOR | ADAPTER | COLOR |
|--|-----------|------------|--------|-----------|------------|-----------------------|
| M-9593-LU24A | 24 lb/hr | 11-18 ohms | L | USCAR® | M-14464-A8 | Black |
| M-9593-M39 | 39 lb/hr | 11-18 ohms | L | USCAR® | M-14464-A8 | Dark Blue |
| M-9593-G302 | 47 lb/hr | 11-18 ohms | M | USCAR® | M-14464-A8 | Black w/Yellow Stripe |
| M-9593-LU47 | 47 lb/hr | 11-18 ohms | L | USCAR® | M-14464-A8 | Black w/Silver Tip |
| M-9593-MU52 | 52 lb/hr | 11-18 ohms | M | USCAR® | M-14464-A8 | Black |
| M-9593-LU60  | 60 lb/hr | 11-12 ohms | L | USCAR® | M-14464-A8 | Black |
| M-9593-LU80  | 80 lb/hr | 11-12 ohms | L | USCAR® | M-14464-A8 | Black w/Blue Tip |

All injector flow rates are quoted at a delta pressure of 39.15 psi. To convert to a delta pressure of 43.5 psi, multiply flow rate by 1.054.

FUEL INJECTOR ADAPTER KIT (USCAR® TO JETRONIC®)

M-14464-U2J

- Adapts USCAR®-style harness to Jetronic®/Minitimer®-style injector
- Single-piece design for improved reliability and aesthetics over our competitors' adapters
- Packaged in sets of (8)
- M-14464-A8 kit adapts Jetronic®/Minitimer®-style harness to USCAR®-style fuel injectors



BODY STYLE



EV1



EV6



EV14

CONNECTORS



Jetronic®/
Minitimer®



USCAR®

LENGTH

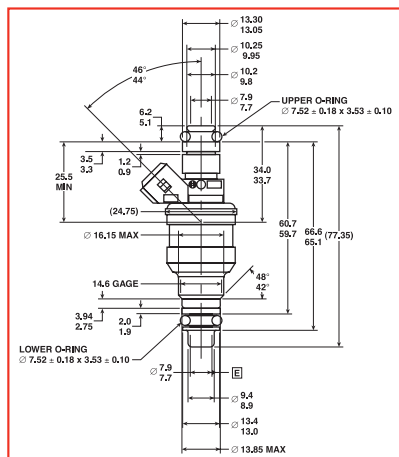

Long

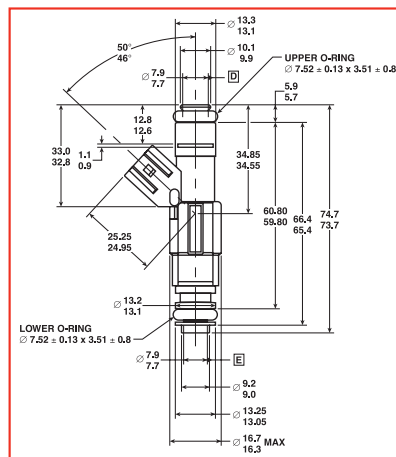

Long

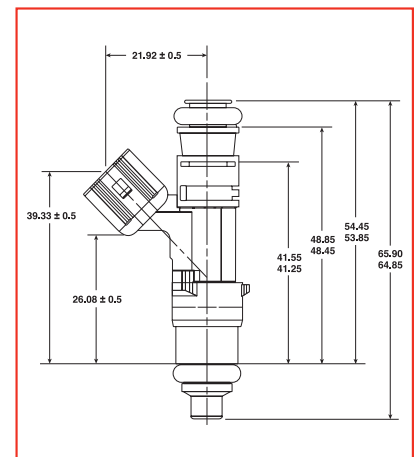

Medium





ENGINE ELECTRONICS/FUEL INJECTION

PERFORMANCE THROTTLE BODIES FOR VEHICLES EQUIPPED WITH ELECTRONIC THROTTLE CONTROL (ETC)

Electronic throttle control was introduced on the Mustang in 2005. Its introduction has made attention to detail and setup of replacement throttle bodies even more critical than in the past. Ford Performance throttle bodies are tested and engineered to give the customer trouble-free operation and are set up from the factory ready to bolt on. **Custom ECU calibration is required.**

All Ford Performance ETC throttle bodies feature:

- All factory sensors installed — no need to try to take apart your original throttle body
- Calibrated for idle airflow using the same procedure as production throttle bodies
- Precision billet construction with tapered inlet for consistent high flow
- Polished aluminum for great looks
- Throttle bodies feature CNC'd "Ford Racing" logo
- Validation through hundreds of hours of dyno, racing and street performance driving

| PART NUMBER | ENGINE | FITS | SIZE | REQUIRES | NOTES | |
|---|--------------------|--|---|---|--|--|
| M-9926-M5090 | 5.0L DOHC Coyote | 2011-2014 Mustang GT/ 2012-2013 BOSS 302 (stock 80 mm) (NOT compatible with 2015 Mustang GT) | 90 mm | M-9474-M50 Adapter for OEM Mustang GT 5.0L 4V Coyote intake M-9474-M50B Adapter for Ford Performance M-9424-M50BR BOSS Intake Requires use of 4" I.D. silicone hose adapter or reducer 4" air inlet tube is recommended for maximum horsepower Calibration required | M-9474-M50 Adapter rotates throttle body approximately 15° counterclockwise M-9680-M50 Engine Cover covers throttle body on 5.0L 4V Coyote intake 4" diameter leading edge larger-than-stock throttle body When using factory 3.5" diameter air inlet tube, the molded rubber throttle body hose must be removed Includes jumper harness M-9424-M50BR BOSS Intake can be port matched to accept throttle body without adapter, requires custom gasket/RTV CFM rating: 1132 cfm; with adapter: 1101 cfm (stock 80 mm throttle body: 913 cfm)* | |
|  | M-9474-M50B | BOSS 302 | 2011-2014 Mustang GT/ 2012-2013 BOSS 302 | 90 mm | M-9424-M50BR Intake and M-9926-M5090 Throttle Body | Spacer used to adapt M-9926-M5090 90 mm Billet Aluminum Throttle Body to M-9424-M50BR 2012-2013 BOSS 302 Intake |
|  | M-9474-M50 | 5.0L 4V Coyote | 2011-2014 Mustang GT | 90 mm | M-9926-M5090 Throttle Body and 5.0L Mustang GT Ti-VCT Intake Manifold | Spacer rotates throttle body approximately 15° counterclockwise to clear intake cover |
|  | M-9926-3V | 4.6L | 2005-2010 Mustang GT (stock dual 55 mm) | Dual bore 62 mm | Calibration required | CFM rating: 1306 cfm (stock dual 55 mm throttle body: 953 cfm)* Works well with Ford Performance M-6550-3V Hot Rod Camshafts, M-6049-N3VPA High-Performance CNC-Ported 3V Cylinder Heads and M-9424-463V Performance Intake Manifold |
|  | M-9926-CJ65 | 5.4L SC | 2007-2014 Shelby GT500 (stock dual 60 mm) | Dual bore 65 mm | Calibration required | Fits 2011-2014 Mustang GT with M-6066-MGT624D Ford Performance Supercharger Kit Fits M-9424-M50CJ 5.0L Cobra Jet Intake Manifold CFM rating: 1517 cfm* |
|  | | | | | | |



*All cfm ratings are calibrated at 28" of water, measured on SuperFlow® SF-1020 Flow Bench.

ENGINE ELECTRONICS/FUEL INJECTION

| PART NUMBER | ENGINE | FITS | SIZE | REQUIRES | NOTES |
|--|----------------|-------------------------|-------|----------|--|
| M-9926-MSVT | 5.4L SC | 2007-2014 Shelby GT500 | 60 mm | | New stock replacement |
|  | | | | | |
| M-9926-MGT | 4.6L 3V | 2005-2010 Mustang GT | 55 mm | | New stock replacement |
|  | | | | | |
| M-9926-M52 <small>NEW</small> | 5.2L | 2015-2017 Mustang GT350 | 87 mm | | New stock replacement Can be used with M-9424-M52 Intake Manifold Includes fasteners |
|  | | | | | |
| M-9926-M2370 <small>NEW</small> | 2.3L EcoBoost® | 2015-2017 Mustang | 70 mm | | Replaces production 60 mm throttle body Billet aluminum construction with polished exterior Complete bolt-on replacement fully compatible with the production air intake system Includes new mounting bolts |
|  | | | | | |

MECHANICAL REPLACEMENT THROTTLE BODIES FOR AFTERMARKET ENGINE CONTROL SYSTEMS

For those enthusiasts who want to run a late model engine with an aftermarket ECU that requires a mechanical linkage, Ford Performance offers throttle bodies to make the conversion easy. All mechanical linkage throttle bodies feature a 2003-2004 Cobra-style linkage and throttle cable connection. Throttle cable and cable stop plate are not included and must be custom fabricated. Our mechanical throttle bodies are legal for NHRA® competition on the Mustang Cobra Jet. Check www.NHRA.com for a full list of throttle bodies for the 2008-2014 Cobra Jet.

| PART NUMBER | ENGINE | FITS | SIZE | REQUIRES |
|---|---------|----------------------|-----------------|--|
| M-9926-CJ65M | 5.4L | 2010 Cobra Jet | Dual bore 65 mm | Requires aftermarket engine control system |
|  | | | | |
| M-9926-SCJM | 5.4L SC | 2010 Super Cobra Jet | Mono-blade | Requires aftermarket engine control system |
|  | | | | |

ENGINE ELECTRONICS/FUEL INJECTION

COBRA JET 123 MM BILLET MAF HOUSING

M-9600-CJ



- 123 mm mass airflow sensor housing
- Add to your underhood "bling" factor with this massive mass airflow sensor housing that looks as good as it performs!
- Cobra Jet mass air meter housing – recommended for highly modified 2007-2012 Mustang SVT
- Proven to support over 800 hp in 2007-2011 Shelby GT500 applications
- Fits production air tube
- Precision CNC'd billet aluminum
- Polished finish
- This kit includes the housing and mounting tab
- Perfect upgrade to existing Ford Racing Mustang SVT power upgrade, cold air and supercharger kits!
- Recommend M-9601-D Air Filter
- Does not include calibration, COMPUTER CALIBRATION REQUIRED, sold for tuner use



SUPER COBRA JET 140 MM MAF TUNER KIT

M-9600-SCJ



- 140 mm mass airflow sensor housing
- 2010 Super Cobra Jet mass air meter housing – recommended for highly modified 2007-2011 Shelby GT500
- Proven to support over 1100 hp in 2007-2011 Shelby GT500 applications
- Precision CNC'd billet aluminum
- Polished finish
- Perfect upgrade to existing Ford Racing Mustang SVT power upgrade, cold air and supercharger kits!
- Does not include calibration, COMPUTER CALIBRATION REQUIRED, sold for tuner use
- Recommend M-9601-D Air Filter
- 140 mm MAF housing requires a custom air tube and may have interference issues with the factory hood when using production engine mounts



2010-2014 MUSTANG SHELBY GT500 RESONATOR ELIMINATOR KIT

M-9B659-MSVT



- Fits 2010-2014 Shelby GT500
- Designed for improved airflow



2001-2004 F-150 LIGHTNING MASS AIR METER

M-12579-L54



- Fits 2001-2004 F-150 Lightning
- Stock replacement 90 mm Lightning mass air meter
- Requires recalibration for use on other vehicles



MUSTANG GT DUAL FUEL PUMP KIT

M-9407-MSVTA 2010

M-9407-GT05 2005-2009



- Includes harness, dual fuel pumps, drop-in housing and fuel pump driver module
- Includes all installation hardware
- Highly recommended for any application making over 400 hp
- Does not include calibration, COMPUTER CALIBRATION REQUIRED, sold for tuner use

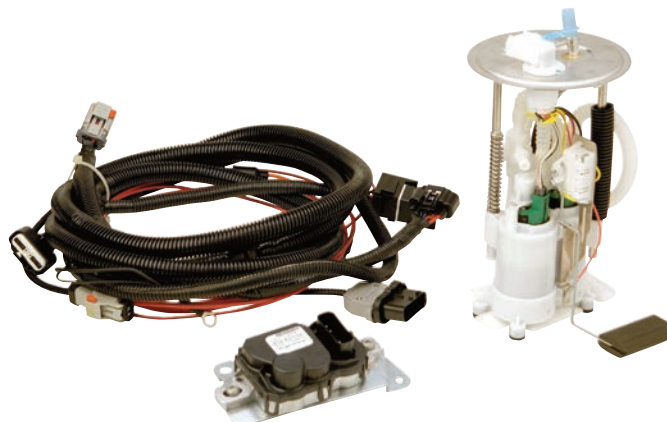

FORD 216064



DRIVELINE

USA

TECH TIPS

CLUTCH/TRANSMISSION INSTALLATION TIPS 1986 and newer V8 Mustang

The flywheel-to-crankshaft bolts must be hand-torqued to 75-85 lb-ft (302/351W) and 54-64 lb-ft (4.6L).

The 10.5" pressure plate bolts must be torqued to 12-24 lb-ft and 11" pressure plate bolts to 33 lb-ft + 1/4 turn.

Be sure to use the alignment dowels in the flywheels.

Pressure plate bolts and alignment dowels for the 10.5" clutch can be purchased using Part No. M-6397-A302. N808969-S100 Pressure Plate Bolts and DIFZ-6397-B Alignment Dowels are for the 11" pressure plate.

Evenly tighten bolts in a circular direction one turn at a time.

Bellhousing alignment is crucial for proper clutch and transmission function.

Due to production tolerances of engine blocks and bellhousings, it is possible for the transmission center line and crankshaft center line to be misaligned. Misalignment can cause transmission gear wear, transmission jumping out of gear, driveline vibration, clutch pedal vibration, pilot bearing noise, release bearing noise or excessive clutch spin time. It may also damage the pilot bearing, transmission mainshaft bearing and clutch hub. It will also cause harsh shifting.

Before installing the bellhousing, check the block mounting surface and bellhousing surfaces for nicks, dents, paint debris, etc. These are some things that could affect the accuracy of your measurements.

HOW TO CHECK BELLHOUSING ALIGNMENT

The first step is to check bellhousing face runout. You are checking for parallelism of the back of the bellhousing to the back of the block. Install the dial indicator (as shown in Fig. 1). Rotate the crankshaft and mark down the reading. Be sure to push the crankshaft against the thrust bearing for an accurate reading. Maximum runout is .010. The next step is checking bellhousing bore runout. You are checking to see if the bellhousing bore center line is aligned with crankshaft center line. Reposition the dial indicator in the bellhousing bore (as shown in Fig. 2). Rotate the crankshaft and mark down the readings. Maximum out of concentricity is .015. If the bore runout is out of spec, install appropriate offset dowels.

Offset alignment dowels can be purchased from Lakewood®.

.007 PN 15950

.014 PN 15960

.021 PN 15970

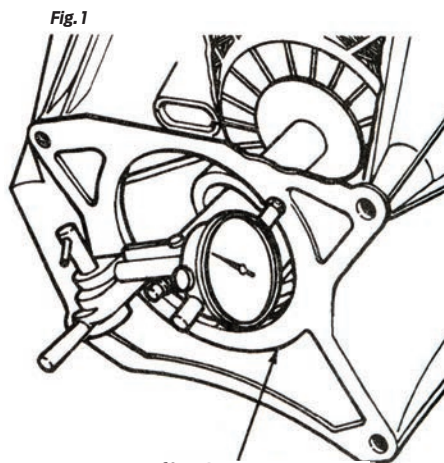

Fig. 1

Face of housing
(Must be clean and free of nicks,
burrs or foreign material.)

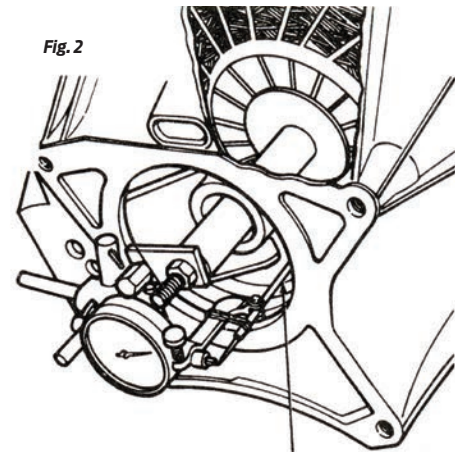

Fig. 2

Level tip rides on bore surface.
This surface must be clean
and free of nicks, burrs
or foreign material.

TREMEC® 6-SPEED TRANSMISSIONS

Magnum T-56 technology from Tremec® provides more torque capacity and smoother shifting than 6-speeds of the past. Requires aftermarket bellhousing available through Quicktime® Bellhousings. For small block Ford 302/351, use Quicktime® Part No. 8031. For modular 4.6L/5.0L/5.4L, use Quicktime® Part No. 8080.

- Fits SBF, 4.6L SOHC/DOHC and 5.0L Ti-VCT engines
- Can be used in 1999-2004 Mustang and Cobra
- May require shorter driveshaft, modified crossmember/trans mount and other minor modifications
- 700 lb-ft torque capacity
- Input shaft is 26 spline; output shaft is 31 spline
- Provision for both mechanical and electronic speedometer
- Mechanical speedo drive gear has 7 teeth
- Electronic speedo rotor has 12 positions

M-7003-M6266 2.66 1st Gear/26 Spline

- Gear ratios: 1st 2.66; 2nd 1.78; 3rd 1.30; 4th 1.00; 5th 0.80; 6th 0.63

M-7003-M6295 2.97 1st Gear/26 Spline

- Gear ratios: 1st 2.97; 2nd 2.10; 3rd 1.46; 4th 1.00; 5th 0.74; 6th 0.50

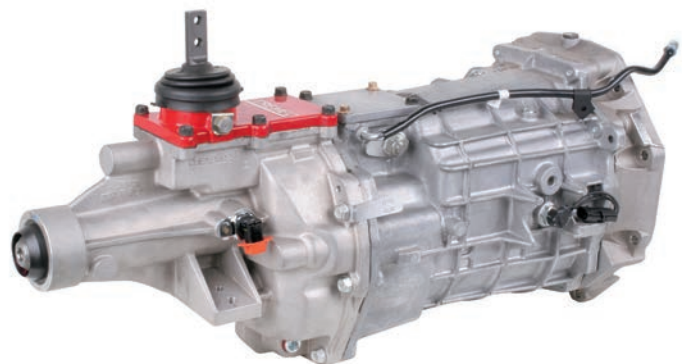

M-7003-M6295 shown

TREMEC® TRANSMISSION KIT MAGNUM XL M-7003-M6XL

- Fits 2005-2014 Mustang GT
- 2.97 gear ratio
- Trans mount isolated shifter and shift ball
- 700 lb-ft torque capacity
- New extended length tail section designed to eliminate the semiremote shifter
- SFI-approved steel bellhousing
- Reuses the OEM hydraulic clutch release system
- Includes swap-specific steel crossmember and OE-quality rubber transmission mount

NOTES:

- Users will need to convert to a 26-spline clutch disc and 1-piece slip yoke-style prop shaft (not included).
- Magnum XL transmissions are designed to accept the factory hydraulic release bearing from a 2005-current Mustang GT.
- GT500 bearings may also be used but will require a custom adaptor to maintain proper stack up (not included).

- 2005-2010 Mustang applications are a direct plug-and-play with regards to the speedometer.
- 2011-up models will require speedometer recalibration via ECU tuning or a separate plug-in signal converter from sine to hall-effect signal, such as the Abbott Enterprises ERA or Dakota Digital SGI-1 (not included)
- 2015 model installation kits are not currently available



TREMEC® 5-SPEED EXTRA HD TRANSMISSION (CLOSE RATIO)

M-7003-R58C

- 600 lb-ft torque capacity
- Gear ratios: 1st 2.87; 2nd 1.90; 3rd 1.34; 4th 1.00; 5th 0.82
- Features improved shift forks, one-piece counter-shaft, gears made of 4615 steel, which increases the torque capacity over that of the M-7003-R58 model
- Input shaft is 26 spline and output shaft is 31 spline
- Requires a unique M-6392-R58 Bellhousing to install in a 1979-1995 Mustang
- To fit in a 1979-1993 Mustang, use M-5059-A Crossmember
- To fit in a 1994-1995 Mustang, modify vehicle crossmember, lengthen driveshaft .625" and use E6ZZ-7515-A Clutch Fork
- 31-spline driveshaft yoke required
- Requires unique M-7550-T302 Clutch Disc (10.5") designed for use with 26-spline input
- Can be used in 4.6L applications with M-6392-M46 Bellhousing and M-7560-T46 Clutch Kit (11")
- Tremec® recommends Synchronesh® fluid

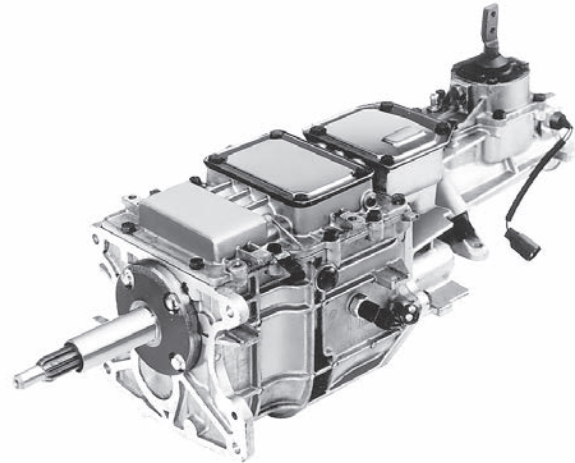

TREMEC® 5-SPEED EXTRA HD TRANSMISSION (CLOSE RATIO 26 SPLINE)

M-7003-R58H

- Close ratio 1st through 4th
- 600 lb-ft torque capacity
- Gear ratios: 1st 2.87; 2nd 1.90; 3rd 1.34; 4th 1.00; 5th 0.68
- Features improved shift forks, one-piece counter-shaft, gears made of 4615 steel, which increases the torque capacity over that of the M-7003-R58 model
- Input shaft is 26 spline; output shaft is 31 spline
- Requires M-6392-R58 Bellhousing to install in a 1979-1995 Mustang
- For 1979-1993 Mustang applications, use M-5059-A Crossmember (1979-1981 will require modification)
- For 1994-1995 Mustang applications, modify vehicle crossmember, lengthen driveshaft .625" and use E6ZZ-7515-A Clutch Fork
- 31-spline driveshaft yoke required
- Requires unique M-7550-T302 Clutch Disc (10.5") designed for use with 26-spline input
- Can be used in 4.6L applications with M-6392-M46 Bellhousing and M-7560-T46 Clutch Kit (11")
- Tremec® recommends Synchronesh® fluid

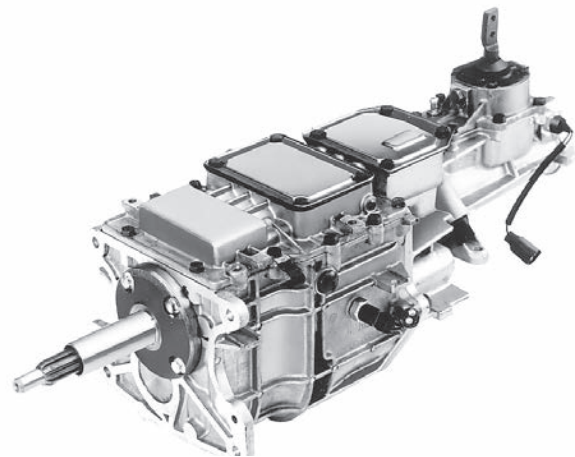

TREMEC® UPGRADED SUPER-DUTY T-5 TRANSMISSION

M-7003-Z

- 1979-1993 Mustang V8 only
- Heavy-duty "World Class" T-5 5-speed manual transmission with short throw shifter
- 300 lb-ft torque capacity
- Gear ratios: 1st 2.95; 2nd 1.94; 3rd 1.34; 4th 1.00; 5th 0.63
- Double moly 2nd speed, 3rd speed and countershaft cluster gears
- Carbon fiber 3-4 blocker rings
- Improved synchronizers and bearings
- 1-1/16" diameter 10-spline input shaft
- 28-spline output shaft

- 7-tooth speedometer drive gear
- Cobra-style pocket bearing
- Steel input bearing retainer
- Transmission uses Mercon® fluid or Dexron® III



ADJUSTABLE #3 CROSSMEMBER TRANSMISSION MOUNT

M-5059-A

This crossmember is a double hump design that simplifies installation of dual exhaust systems on Fox-bodied vehicles. The outer tubes are not welded to the center support, and thus can be adjusted to fit most engine/transmission combinations. It directly fits all Fox-bodied vehicles with a 4.5" dimension between the crossmember mounting brackets. It can be used on Fox vehicles with a 2.75" mounting dimension by relocating the brackets. It does not fit 1982 and later Continental or 1984 and later Mark VII, because they have a unique crossmember.

4.5" MOUNTING DIMENSION

| YEAR | FOX VEHICLE |
|----------------|-----------------|
| 1980-1988 | T-Bird/Cougar |
| 1982-1993 | Mustang/Capri |
| 1982 | Fairmont/Zephyr |
| 1983 and later | LTD/Marquis |

2.75" MOUNTING DIMENSION

| YEAR | FOX VEHICLE |
|-----------|-----------------|
| 1978-1981 | Fairmont/Zephyr |
| 1979-1981 | Mustang/Capri |
| 1981-1982 | Granada/Monarch |



MUSTANG BOSS 302 MANUAL TRANS COOLER AIR SCOOP

M-5025-MBR

- Transmission cooler scoop original equipment on 2012-2013 Mustang BOSS 302 Laguna Seca
- Fits 2011-2014 Mustang GT with manual transmission and 2012-2013 Mustang BOSS
- Replaces OEM pencil brace



T-5 BEARING RETAINER

M-7050-A Fits 1983-1993 V8 applications

M-7050-B Fits 1994-1995 V8 applications

- Replacement T-5 bearing retainer with steel throw-out bearing sleeve
- Fits production and Ford Performance T-5 transmissions
- Length from trans face to end of sleeve is 4.480" for M-7050-A and 5.160" for M-7050-B



T-5 REBUILD KIT

M-7000-A

This 94-piece world class T-5 transmission rebuild kit can be used on all of the following T-5 applications:

- M-7003-Z Transmission
- M-7003-A Transmission
- M-7003-X Transmission
- 1985-1995 5.0L Mustang
- 1985-1993Ⓢ 2.3L Mustang
- 1985-1986 2.3L Mustang SVO
- 1985-1988Ⓢ 2.3L Thunderbird Turbo Coupe
- 1994-current 3.8L V6 Mustang with T-5 transmission

NOTE: Ⓢ 1987-1993 models will require additional input bearing and race. See your Ford and Lincoln dealer.



AUTOMATIC TRANSMISSION DIPSTICK/TUBES

M-6750-D303 Fits case fill C-4 transmissions

M-6750-E303 Fits C-6 transmissions

- Chrome dipstick, tube assembly and bracket



2007-2009 MUSTANG SVT SHORT THROW SHIFTER

M-7210-B*

- Fits 2007-2009 Mustang SVT
- Urethane body vibration isolators
- 25% reduction in throw
- Bolts in stock location
- Requires reuse of production stick and knob or the Ford Racing exclusive M-7213-J Black Knob and Stick or M-7213-K White Knob and Stainless Steel Stick



M-7210-B



M-7213-J

M-7213-K



2011-2014 MUSTANG V6/GT 6-SPEED SHIFTER

M-7210-MGTB*

- Fits 2011-2014 Mustang GT, V6 and BOSS 302 with 6-speed manual transmission
- Shorter shift throws than OEM shifter
- Blue anodized shifter handle and bracket
- Includes white "Ford Racing" logo shifter ball. Ford Racing shifter ball and adapter only fits cars originally equipped with leather shift knob. Will not fit vehicles originally equipped with aluminum shift knob
- Vehicles originally equipped with aluminum shift knob require reuse of factory shift knob or installation of BR3Z-7277-A Shifter Boot
- Retains reverse lock-out



1979-2004 MUSTANG HURST® T-5/T-45 SHIFTER

M-7210-M

- Fits T-5 and T-45 transmission. Does not fit Tremec® 3650 transmission, 2001 and newer Mustang Cobra, Mustang Bullitt and Mustang GT (3650 transmission has the drain plug in the bottom of the case)
- Fits 1979-1995 V8 Mustang with T-5 transmission
- Fits 1994-2004 V6 Mustang with T-5 transmission
- Fits 1996-2001 V8 Mustang with T-45 transmission
- One-piece 6061-T6 aluminum CNC-machined base
- Positive stops to prevent over-travel
- Super short throw
- Chrome stick and white knob



2005-2009 MUSTANG GT SHORT THROW SHIFTER

M-7210-MGT

- Designed by Ford Racing and Hurst®
- Fits 2005-2009 Mustang GT
- Chrome stick with "Ford Racing" white shift knob
- High-lubricity polymer-bearing with unique shifter rod and OE main stamping
- Includes jam nut
- Urethane body vibration isolators
- Reduced throw



*This component is eligible for the Ford Performance Parts Limited Warranty. See the Ford Performance Parts Limited Warranty on pages 295-302 for details.

MODULAR BELLHOUSING INSTALLATION KIT

M-7771-A

- Modular bellhousing installation kit
- Kit includes:
 - 1 clutch ball stud
 - 7 bellhousing-to-block bolts
 - 2 starter index plate-to-bellhousing bolts
- Fits M-6392-M46 Bellhousing. See M-7007-A for starter index plate



302/351 T-5 BELLHOUSING

M-6392-E

- 1979-1993 5.0L Mustang T-5 bellhousing. Will also fit 289/302/351C/351W
- Can be used as a replacement part or for building a kit car or street rod
- Cast aluminum
- Requires diaphragm-type clutch. With 10-spline input shaft use M-7560-A302N Clutch Kit
- Can be used with M-7007-B Starter Index Plate
- Can be used with M-7553-A302 Clutch Linkage Upgrade Kit



302/351 BELLHOUSING FOR TREMEC® 5-SPEED

M-6392-R58

- Unique bellhousing required for M-7003-R58C and M-7003-R58H Tremec® 5-speed transmission
- Fits 289/302/351C/351W engines with 157-tooth flywheel
- Designed for 1979-1993 Mustang V8 clutch fork
- Requires diaphragm-type clutch. With 10-spline input shaft use M-7560-A302N Clutch Kit
- Can be used with M-7007-B Starter Index Plate
- Can be used with M-7553-A302 Clutch Linkage Upgrade Kit

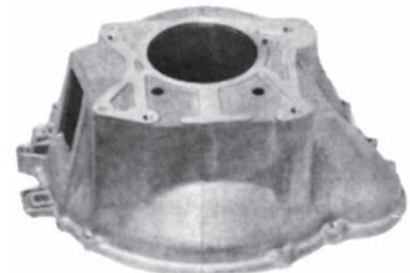

4.6L/5.0L/5.4L MODULAR BELLHOUSING

M-6392-M46

- 4.6L/5.4L Tremec® 3550 Cobra R bellhousing
- Use to mate the Tremec® 3550 transmission to the 4.6L/5.0L 4V Ti-VCT/5.4L modular engines
- Minor modification is required for transmission clearance and mounting in some applications
- Cast aluminum production-style bellhousing
- Also works with 5.0L Ti-VCT engine
- Can also be used with M-7007-A Starter Index Plate
- Can also be used with M-7515-A Clutch Release Lever
- Can also be used with M-7771-A Bellhousing Installation Kit

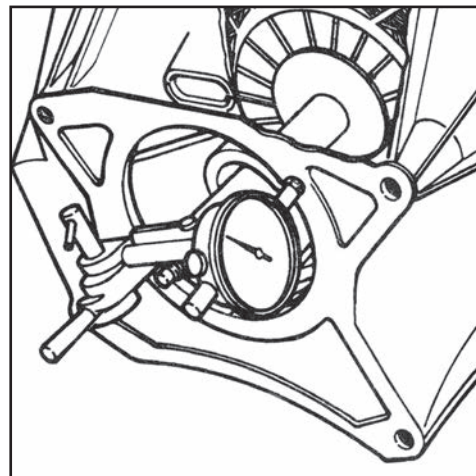

See Bellhousing Alignment Tech Tip on page 228.

MANUAL TRANSMISSION FLYWHEEL-TO-CRANKSHAFT BOLT



- M-4216-A200** Package of 100
M-4216-A210 Package of 10
- 7/16"-20 x .9375" bolt
 - Push rod V8 engines

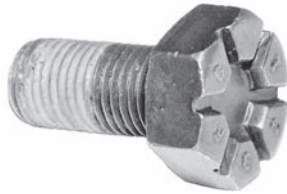

8.8" RING GEAR BOLT SET



- M-4216-A300** Package of 10
- 7/16"-20 x .875" bolts
 - Set of 10 bolts
 - Can also be used for automatic transmission flywheels



4.6L MANUAL FLYWHEEL BOLTS

M-6379-B

- Fits 4.6L modular engines with manual transmission flywheels
- M10 x 1 x 26.5 bolt
- Package of 8



STARTER INDEX PLATE – MODULAR BLOCK MANUAL TRANSMISSION

M-7007-A

- Fits 4.6L/5.4L and 5.0 Coyote modular engine with manual transmission except Ford GT
- Fits M-6392-M46 Bellhousing
- Metal plate that goes between the block and the transmission bellhousing
- The starter index plate positions the starter to ensure proper starter drive-to-flywheel ring gear alignment



STARTER INDEX PLATE – SMALL BLOCK MANUAL TRANSMISSION

M-7007-B

- Fits 1979-1995 Mustang V8 with manual transmission and production bellhousing
- Fits bellhousing M-6392-E and M-6392-R58
- Metal plate that goes between the block and the transmission bellhousing
- The starter index plate positions the starter to ensure proper starter drive-to-flywheel ring gear alignment



STARTER INDEX PLATE – MODULAR BLOCK AUTOMATIC TRANSMISSION

M-6373-A

- Fits 4.6/5.4L modular engine with production automatic transmissions 4R70, 4R75, 4R100
- Metal plate that goes between the block and the transmission bellhousing
- The starter index plate positions the starter to ensure proper starter drive-to-flywheel ring gear alignment



5.0L COYOTE FLYWHEEL BOLT KIT

M-6379-C



- Production manual transmission flywheel bolts for the 5.0L Coyote engine
- Includes 8 bolts



PRESSURE PLATE BOLT AND DOWEL KIT

M-6397-B46

For use with Ford Performance and production flywheels on 4.6L and 5.0L Coyote engines to align and attach the 11" 6 or 9 bolt diaphragm-style pressure plate to the flywheel.

- Increased clamp load over stock bolts on 1999-2010 applications (see instructions for proper torque specs)
- Dowels are necessary to align and stiffen the pressure plate shell. If the dowels are not used, the clutch may chatter and the engine vibrate

Kit includes:

- Six dowel pins total, three for early applications, three for later applications
- Nine 10 mm X 1.5 pressure plate bolts for use with 11" modular flywheel



10.5" PRESSURE PLATE BOLT AND DOWEL KIT

M-6397-A302











- Use with Ford Performance flywheels to align and attach the 10.5" diaphragm-style clutch pressure plate to the flywheel. For 11" clutch application, see M-6397-A46
- This kit includes three dowel pins that are necessary to align and stiffen the pressure plate shell. NOTE: If these dowels are not used, the clutch may chatter
- This kit includes six 8 mm bolts with integral lock washers

NOTE: Ford Performance and production flywheels have metric bolt holes for diaphragm-style clutches. Ford Performance billet steel flywheels have metric bolt holes for diaphragm-style clutches and 5/16"-18 SAE bolt holes for "long"-style clutches.



MANUAL TRANSMISSION FLYWHEELS FOR PUSH ROD ENGINES

| PART NUMBER | MATERIAL/ CLUTCH DAMPER WEIGHT | CLUTCH DAMPER ASSEMBLY COUNTER BORE | RING GEAR | CRANK BOLTS | UNBALANCED | APPLICATION |
|---------------------------|--|-------------------------------------|-----------|-------------|------------|---|
| M-6375-A302B ① |  Billet Steel 23 lbs | 6.00" | 157-tooth | 6 bolts | 28.2 oz-in | Pre-1981 302 engines and 351 engines using 157T flywheels with 10.5" diaphragm clutch. Meets SFI 1.1 |
| M-6375-A302AB ① |  Aluminum 12 lbs | 6.00" | 157-tooth | 6 bolts | 28.2 oz-in | Pre-1981 302 engines and 351 engines using 157T flywheels with 10.5" diaphragm clutch. Reduced rotating mass. Meets SFI 1.1 |
| M-6375-B302 ① |  Cast Iron | | 157-tooth | 6 bolts | 50.0 oz-in | 1981 and later 302 engines. Direct replacement for 1986-1995 5.0 Mustang |
| M-6375-C302B ① |  Billet Steel 23 lbs | 6.00" | 157-tooth | 6 bolts | 50.0 oz-in | 1981 and later 302 engines using 157T flywheels with 10.5" clutch. Meets SFI 1.1 |
| M-6375-D302B ① |  Billet Steel 23 lbs | 6.00" | 157-tooth | 6 bolts | 0 oz-in | All small blocks using 157T flywheel, 10.5" diaphragm clutch with 0-unbalance rotating assemblies. Meets SFI 1.1 |
| M-6375-D302AB ① |  Aluminum 12 lbs | 6.00" | 157-tooth | 6 bolts | 0 oz-in | All small blocks using 157T flywheel, 10.5" diaphragm clutch with 0-unbalance rotating assemblies. Reduced rotating mass. Meets SFI 1.1 |
| M-6375-K302 |  Billet Steel 30 lbs | 6.00" | 164-tooth | 6 bolts | 28.2 oz-in | Pre-1981 302 engines and 351 engines using 164T flywheels. 10.5" long, 11" long and diaphragm clutches. Meets SFI 1.1 |
| M-6375-M302 |  Billet Steel 30 lbs | 6.00" | 164-tooth | 6 bolts | 0 oz-in | All small blocks using 164T flywheels with 0-unbalance rotating assemblies. 10.5" long, 11" long and diaphragm. Meets SFI 1.1 |
| M-6375-N427 |  Billet Steel 29 lbs | 6.00" | 184-tooth | 6 bolts | 0 oz-in | Fits 1965 and newer 360, 390, 427 FE engines. 11" long and diaphragm, 11.5" and 12" long clutches. Meets SFI 1.1 |

NOTES:

- ① Diaphragm clutch uses metric bolts and dowel pins. Requires metric N602549-S51M Pressure Plate Bolts and D1FZ-6397-B Alignment Dowel Pins or M-6397-A302 Ford Performance Kit.







M-6375-D302B shown



M-6375-A302B shown

MANUAL TRANSMISSION FLYWHEELS FOR MODULAR ENGINES

| PART NUMBER | MATERIAL/ WEIGHT | CLUTCH DAMPER ASSEMBLY COUNTER BORE | RING GEAR | CRANK BOLTS | UNBALANCED | APPLICATION |
|---------------------------|--|---|-----------|----------------|------------|---|
| M-6375-D46 ①② |  Nodular Iron 21 lbs | 6.320" | 164-tooth | 6 bolts | 0 oz-in | 4.6L SOHC Mustang with 10.5" clutch. Has increased rpm capacity over stock cast iron flywheel |
| M-6375-F46A ①②③ |  Billet Steel 29 lbs | 6.00" | 164-tooth | 6 bolts | 0 oz-in | Fits 6-bolt 4.6L Mustang with 10.5" clutch and some 11" clutch applications. Does not fit 2005-2010 Mustang production clutch disc. Meets SFI 1.1 |
| M-6375-G46A ①②③ |  Billet Steel 29 lbs | 6.00" | 164-tooth | 8 bolts | 0 oz-in | Fits 8-bolt 4.6L Mustang with 10.5" clutch and some 11" clutch applications. Does not fit 2005-2010 Mustang production clutch disc. Meets SFI 1.1 |
| M-6375-M50 ①②③ | Billet Steel 20 lbs | 7.050" | 164-tooth | 8 bolts | 0 oz-in | Fits 8-bolt crank 4.6L and 5.0L Coyote engines with 11" clutch applications. Does not fit 2005-2015 Mustang production clutch disc. Drilled for 6- or 9-bolt pressure plate. Replaces M-6375-G46A. Saves 9 lbs. Meets SFI 1.1 |
| M-6375-R00A ①②③ |  Aluminum 12 lbs | 6.200" | 164-tooth | 8 bolts | 0 oz-in | Fits 8-bolt 4.6L Mustang with 10.5" clutch and some 11" clutch applications with 6-bolt pressure plate. Does not fit 2005-2013 Mustang production clutch disc. Reduced rotating mass. Meets SFI 1.1 |

NOTES:

- ① Diaphragm clutch uses metric bolts and dowel pins. Requires metric N602549-S51M Pressure Plate Bolts and DIFZ-6397-B Alignment Dowel Pins or M-6397-A302 Ford Performance Kit.
- ② 4.6L engines may have 6 or 8 bolts to attach to the crankshaft. Check the engine code before ordering. Romeo-built engines have 6 bolts and Windsor-built engines have 8 bolts. All Cobra engines have 8 bolts. The 8th character in the VIN is (X) for Windsor engine plant or (W) for Romeo engine plant.
- ③ Requires M-6397-A46 Bolt and Dowel Kit for 11" clutch applications.



M-6375-D46 shown



M-6375-R00A shown

Did you know...

1968-1980 302 engines were built with a 28 oz imbalance factor.





1981-2001 302 engines were built with a 50 oz imbalance factor.

1969-1997 351W engines were built with a 28 oz imbalance factor.

1970-1974 351C engines were built with a 28 oz imbalance factor.

NOTE: Severe engine damage will result if you use the wrong flywheel or damper on your engine.

CLUTCHES

| PART NUMBER | DESCRIPTION | ENGINE | DIAMETER | SPLINE | TECHNICAL INFORMATION |
|---|----------------|-----------|----------|---------------------|--|
| M-7560-A302N ①②③④ | HD Clutch Kit | SBF V8 | 10.5" | 1-1/16" x 10 spline | Consists of M-7550-A302N Disc, M-7563-A302N Pressure Plate and D9ZZ-7548-A Throwout Bearing |
| M-7560-T46  ① | 11" Clutch Kit | 4.6L DOHC | 11" | 1-1/8" x 26 spline | Kit contains 11" clutch disc with 26-spline hub and pressure plate. Clutch disc with carbon/copper lining on flywheel side and carbon lining on pressure plate side. Centrifugal assist design pressure plate with 25% more torque capacity than production Cobra. Used when installing M-7003-R58C and M-7003-R58H transmissions into 1996-2004 4.6L Mustang with production 11" flywheel or Ford Performance flywheels M-6375-F46A, M-6375-G46A or M-6375-R00A |
| M-7550-X302  ①②③ | Disc | SBF V8 | 10.5" | 1-1/16" x 10 spline | HD disc with carbon/copper lining on flywheel side and carbon lining on pressure plate side |
| M-7550-T302  ①③ | Disc | SBF V8 | 10.5" | 1-1/8" x 26 spline | HD disc with carbon/copper lining on flywheel side and carbon lining on pressure plate side. Designed for 26-spline shaft on M-7003-R58C and M-7003-R58H transmissions. Will work with M-7563-A302N/B302/C302N/D302 pressure plates |
| M-7563-B302  ①③④ | Pressure Plate | SBF V8 | 10.5" | 1-1/16" x 10 spline | HD diaphragm-type with centrifugal assist. Has approx. 25% more capacity than stock Mustang unit. Cast iron plate |

- NOTES:** ① Clutches have NO warranty!
 ② All clutch discs have 1.0625"-10 spline hub.
 ③ Fits all 1986-2001 Mustang GT, 1993-1998 Cobra with T-5 or T-45 transmissions. 2001-2004 Mustang GT with 3650 transmission and 1999-2003 Cobra use an 11" clutch. OK to mix and match Ford Racing clutch discs and pressure plates but do NOT install a FPP pressure plate with a stock disc or vice versa as disengagement problems may occur. Installation of 10.5" clutch assemblies on 1979-1985 vehicles equipped with 10" clutch requires new flywheel (see page 234). Metric fasteners and dowel pins must be used with 10.5" clutches.
 ④ Requires metric N602549-S51M Pressure Plate Bolts and D1FZ-6397-B Alignment Dowel Pins. M-6397-A302 Ford Performance Kit (see page 233).

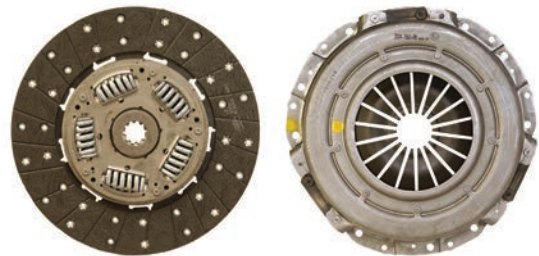

1979-2004 MUSTANG V8 HD THROWOUT BEARING

M-7548-A

- Fits 1979-2004 Mustang with manual transmission and V8 engine
- Self-centering bearing design
- Heavy-duty design lasts longer than most aftermarket bearings



ROLLER PILOT BEARING FOR 289/302/351C AND 351W

M-7600-A

- Production roller pilot bearing fits 289, 302, 351C and 351W crankshafts
 - Designed for .669 diameter input shaft
- NOTE:** Pre-greased – do not add extra grease. Clutch and bearing damage may occur.



ROLLER PILOT BEARING 4.6L/5.4L AND 5.0L 4V Ti-VCT MODULAR ENGINES

M-7600-B

- Production roller pilot bearing fits 4.6L/5.4L and 5.0L 4V Ti-VCT modular engines
- NOTE:** Pre-greased – do not add extra grease. Clutch and bearing damage may occur.



ROLLER PILOT BEARING – HIGH LOAD – 4.6L/5.4L/5.0L4

M-7600-C

- Production roller pilot bearing fits 4.6L/5.4L and 5.0L 4V Ti-VCT modular engines
- Similar to M-7600-B but for higher load applications
- Pre-greased – do not add extra grease. Clutch and bearing damage may occur.



1979-1993 V8 MUSTANG CLUTCH LINKAGE UPGRADE KIT

M-7553-A302

- Fits 1979-1993 Mustang with factory self-adjusting clutch quadrant
- This kit consists of a beefed-up clutch release fork and heavy-duty self adjusting high-lubricity polymer-lined clutch cable
- Can be used with M-7548-A HD Throwout Bearing
- Can be used with M-7554-A Topside Clutch Adjuster and M-7583-A Double Hook Clutch Quadrant

NOTES:

- 1984 and later cars have heavy-duty cable as original equipment.
- 1986 and later cars have beefed-up clutch release fork as original equipment.
- To install this kit in 1979-1981 vehicles with manual adjustment clutch mechanisms, the 1982 and later self-adjusting quadrant mechanism must be purchased from Ford and Lincoln dealers.



V8 MUSTANG ADJUSTABLE CLUTCH LINKAGE KIT

M-7553-B302 Cable and quadrant 1982-1995

M-7553-C302 Adjustable clutch service cable 1982-1995

M-7553-D302 Cable and quadrant 1996-2004

M-7553-E302 Adjustable clutch service cable 1996-2004

- Includes all parts required to convert stock non-adjustable clutch cable to fully-adjustable type
- Now you can adjust clutch pedal travel to your driving habits



2005-2017 MUSTANG HIGH PERFORMANCE CLUTCH FLUID LINE UPGRADES

M-7512-A Fits 2005-2014 Mustang V6, GT, BOSS 302 and Shelby GT500 Mustang with manual transmission (Service replacement for Mustang race cars FR500CJ, FR500C, FR500S, BOSS 302R and BOSS 302S)

M-7512-B Fits 2015-2017 Mustang GT with manual transmission

- Upgraded clutch fluid line for high temperature, high performance applications
- Replaces factory plastic line
- Stainless steel hard line with braided stainless steel flex hose reduces line expansion
- Includes No. 10 O-rings



1979-2004 V6 AND V8 MUSTANG TOPSIDE CLUTCH ADJUSTER

M-7554-A

- Fits 1979-2004 V6 and V8 Mustang
- Allows you to adjust clutch engagement without going under the car
- Eliminates the rubber bushing at the engine compartment bulkhead for more precise clutch action



1982-2004 V8 MUSTANG DOUBLE-HOOK CLUTCH QUADRANT

M-7583-A

- Fits 1982-2004 V8 Mustang
- Double-Hook design lets you use an adjustable clutch cable or topside clutch adjuster and stock cable
- CNC-machined from billet aluminum



1996-2004 MUSTANG CLUTCH RELEASE LEVER

M-7515-A

- Fits 1996-2004 V8 Mustang
- Stock replacement clutch release lever
- Can be used with M-6392-M46 Bellhousing
- Can be used with M-7548-A HD Throwout Bearing





FORD PERFORMANCE

Ring Gear Sets

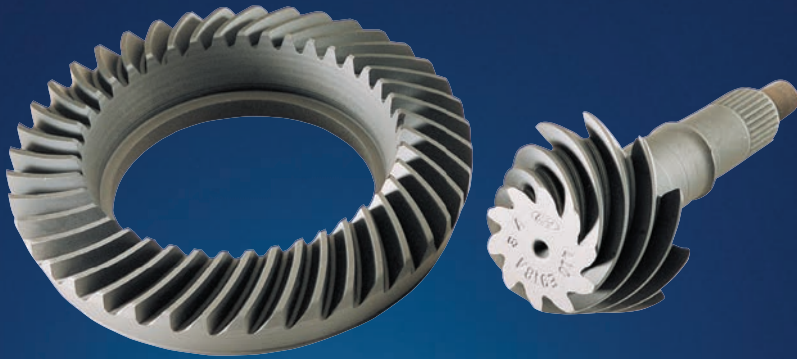

- OEM Quality – Our superior surface finish, hardening and manufacturing consistency provide the strongest and quietest 8.8" gears on the market!
- 8.8" gears available in 3.08, 3.15, 3.27, 3.31, 3.55, 3.73, 4.10 and 4.56 ratios. 7.5" gears available in 3.73 and 4.10 ratios.
- Now available 8.8" gears for 2015-2018 Mustang in 3.55, 3.73 and 4.09 ratios.
- Made in the USA at the Ford Sterling Axle Plant.
- Race Proven – Ford Performance 8.8" gears are the choice of championship road racing and drag racing teams.



Go Further

8.8" ALUMINUM AXLE COVER WITH DIFFERENTIAL COOLER PORTS

M-4033-KA

- Original equipment on 2013-2014 Mustang Shelby GT500 with Track Pack option
- Fits 8.8" Ford rear end, except IRS
- Recommended for road racing or extended high-speed/high-temperature applications to reduce gear oil break down, increase gear and bearing life
- Cooling fins help reduce gear oil temperature
- Cover machined for differential cooler pickup and return fittings. 1/2 -14 NPSF dryseal straight pipe threads
- Pipe plugs installed, must be removed to install differential cooler fittings
- Includes 10 hex-head bolts with anaerobic yellow thread locking compound
- Includes 7/16-20 UNF vent plug when used in applications with alternative vent provisions
- Cover machined for temp sensor with M10 X 1.6-6h threads
- Will not fit IRS differential or with differential mounted anti-lock brake exciter ring



8.8" AXLE GIRDLE COVER KIT

M-4033-G2

- Fits 8.8" axle
- Fits 1986-2004 Mustang GT
- Low profile design also fits 2005-2014 Mustang GT and 2007-2014 Shelby GT500 Mustang except 2013-2014 Track Pack option
- Lightweight 356-T6 aluminum casting replaces rear cover on 8.8"
- Load bolts provide additional support for differential bearing caps
- Increase ring and pinion gear life
- Will not fit IRS; see Part No. M-4033-G33



NOTES:

- Check exterior clearance to chassis/suspension.
- Optional differential cooler on 2013-2014 Shelby GT500 requires modifications.

1999-2004 COBRA IRS AXLE GIRDLE COVER

M-4033-G3

- Fits 1999-2004 Mustang Cobra
- Load bolts provide additional support for differential bearing caps
- Increased ring and pinion gear life
- Fits IRS only



KIT CAR IRS HUB

M-1109-A

- 5 x 4.5" bolt circle, 2.775" wheel pilot hub for popular Mustang size wheels
- Should be used with M-5970-A IRS Knuckle Kit
- Original equipment on 1999-2004 Mustang Cobra

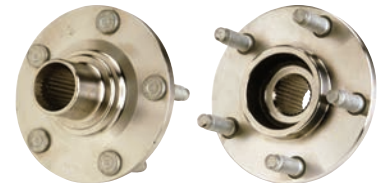

1979-2004 MUSTANG 8.8" AXLE INSTALLATION KIT

M-4050-B

- Fits 1979-2004 non-IRS Mustang axle
- Contains two bushings, two C-locks and one 4-ounce bottle of M-19546-A12 Friction Modifier



KIT CAR IRS KNUCKLE SET

M-5970-A

- Knuckles for use in kit car IRS systems
- Original equipment on 1989-1997 Thunderbird and 1993-1998 Mark VIII
- Includes M-1215-A
- Use with M-1109-A, sold separately
- Hub not included



KIT CAR IRS BEARING

M-1215-A

- For use with M-1109-A Kit Car IRS Hub
- Original equipment on 1993-1998 Mark VIII, 1989-1997 Thunderbird and 1999-2004 Cobra



UNIVERSAL PINION NUT

M-4213-A

- Universal-design 3/4-20 hex flange pinion lock nut
- Fits 6.75", 7.5", 8.8" and 9" axle assemblies
- Flange diameter 1.610"
- 100 per pack



8.8" RING GEAR AND PINION SETS



| PART NUMBER | AXLE | RING & PINION |
|-----------------------------|------|---------------|
| MUSTANG/RANGER/F-150 | | |
| M-4209-88308 | 8.8" | 3.08 |
| M-4209-88315 | 8.8" | 3.15 |
| M-4209-88327 | 8.8" | 3.27 |
| M-4209-88331 | 8.8" | 3.31 |
| M-4209-88355 | 8.8" | 3.55 |
| M-4209-88373 | 8.8" | 3.73 |
| M-4209-88410 | 8.8" | 4.10 |
| M-4209-88456 | 8.8" | 4.56 |

No one does 8.8" gears better than Ford Performance – stronger and quieter.

The 8.8" rear end has been the standard in performance since its introduction in the Mustang in 1986, and Ford Performance is the manufacturer of choice when it's time to hop-up your axle. Ford Performance recommends our installation kits for all 8.8" ring & pinion gear sets. These installation kits use the highest quality components and are often upgrades to what the vehicle came with.

- **Made in the United States** at the Ford Sterling Axle Plant (competitors in our price range are primarily produced in China)
- **OEM quality** – Our superior surface finish, hardening and manufacturing consistency provide the strongest and quietest 8.8" gears in the market! Higher quality gears means more satisfied customers!
- **Race proven** – Ford Performance 8.8" gears are the choice of championship road racing and drag racing teams, including Multimatic Motorsports

When you're purchasing a new 8.8" gear set, make sure your bearings and shims are up to the task with a Ford Performance High-Performance Installation Kit!



8.8" RING & PINION INSTALLATION KIT



M-4210-A

- Fits all 8.8" axles 1986-2014 including IRS
- Perfect for new gear installation in vehicles when new bearings are not required

Kit includes:

- Pinion and carrier shims
- Crush sleeve
- Pinion nut
- Pinion seal
- Ring gear bolts



MUSTANG SUPER 8.8" IRS RING GEAR AND PINION SET



| PART NUMBER | AXLE | RING & PINION |
|----------------------|------|---------------|
| M-4209-88355A | 8.8" | 3.55 |
| M-4209-88373A | 8.8" | 3.73 |
| M-4209-88409A | 8.8" | 4.09 |

- Fits 2015-2018 Mustang Super 8.8" IRS center section
- Includes OEM crush sleeve and pinion nut
- Requires M-4210-B3 Mustang 8.8" ring-gear and pinion install kit
- Made in United States in the Ford Sterling Axle Plant
- OEM quality – our superior surface finish, hardening and manufacturing consistency provides the strongest and quietest gears in the market
- **Requires aftermarket calibration if vehicle is not originally equipped with this gear ratio**

NOTE: 3.15 ratio differential not compatible with 3.31, 3.55, 3.73 and 4.09 ratio gears. Use differential M-4204-MT or M-4204-M

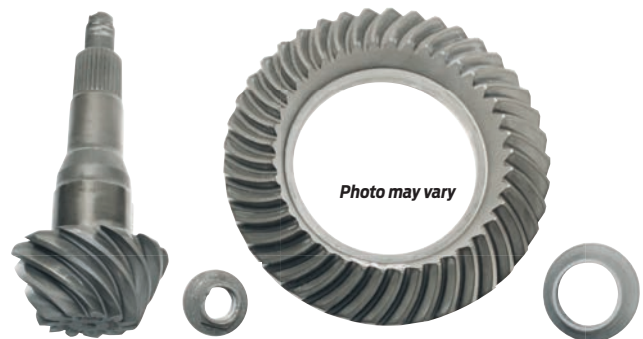

2003-2004 COBRA PINION FLANGE



M-4851-B

- Fits 8.8" axles, original equipment on 2003-2004 Mustang Cobra and F-150
- <4.250" U-joint flange bolt circle (3.500" U-joint flange bolt circle, use M-4851-C)
- Replaces E9TZ-4851-A



PINION FLANGE 8.8" AXLE

M-4851-C

- Fits 8.8" axles except 2003-2004 Mustang Cobra IRS, F-150 and 2005-up Mustang
- 3.500" U-joint flange bolt circle (4.250" U-joint flange bolt circle, use M-4851-B)
- Replaces E9SZ-4851-A



8.8" RING GEAR AND PINION INSTALLATION KIT

M-4210-B2

- Fits all 8.8" axles 1986-2014, including IRS except 2013 BOSS and 2013-2014 GT500
- Excellent upgrade for all 8.8" rear ends
- High-torque bearing adds durability for modified vehicles
- Contains all components from M-4210-A plus all differential bearings

NOTE: Does not fit 2013 BOSS or 2013-2014 GT500 with axle codes S-215-D and S-219-D.

Kit includes:

- 2012 Shelby GT500 high-torque rear pinion bearings
- Pinion and carrier shims
- Heavy-duty carrier bearings
- Gear-marking compound
- Crush sleeve
- Pinion nut
- Pinion seal
- Ring gear bolts
- Cover gasket



8.8" RING AND PINION INSTALLATION KIT

M-4210-C3

- Fits all 1986-2004 8.8" axle assemblies except IRS differential
- Contains all components from M-4210-B2 plus M-1225-B 8.8" Axle Bearing and Seal Kit

Kit includes:

- 2012 Shelby GT500 high-torque pinion bearing
- Pinion and carrier shims
- Crush sleeve
- Pinion nut
- Pinion seal
- Ring gear bolts
- Mustang GT carrier bearings
- Gear-marking compound
- Cover gasket



8.8" AXLE BEARING AND SEAL KITS

M-1225-B

- Fits 1986-2004 Mustang
- 8.8" outer axle shaft bearing and seal kit for non-IRS axles
- Kit contains two outer axle shaft bearings and seals
- 2.256" O.D. bearing

M-1225-B1

- Fits 2005-2014 Mustang GT and Mustang GT500
- 8.8" outer axle shaft bearing and seal kit
- Kit contains two outer axle shaft bearings and seals
 - 2.5308"/2.5315" bearing O.D.
 - 1.6189"/1.6194" bearing I.D.



M-1225-B shown



M-4413-A shown

M-4413-A

- For use in rebuild 8.8" IRS differentials prior to 2015-2016 Mustang. Will not fit 2015-2018 Mustang
- Kit includes two inner stub shaft pilot bearings and two inner stub shaft pilot bearing housing seals

7.5" RING GEAR AND PINION INSTALLATION KIT

M-4210-B75

- Fits all 7.5" axles
- Excellent upgrade for all 7.5" rear ends
- High-torque bearing adds durability for modified vehicles

Kit includes:

- 2012 Shelby GT500 high-torque pinion bearing
- Pinion and carrier shims
- Crush sleeve
- Pinion nut
- Pinion seal
- Ring gear bolts
- Heavy-duty carrier bearings
- Gear-marking compound



8.8" TRACTION-LOK REBUILD KIT

M-4700-B

- Fits 8.8" Traction-Lok differentials prior to 2015-2016 Mustang. Will not fit 2015-2018 Mustang Super 8.8"

Kit includes:

- Clutch pack
- Shims
- Differential pin lock bolt with thread lock
- Friction modifier CM-19546-A1



8.8" TRACTION-LOK REBUILD KIT WITH CARBON DISCS

M-4700-C

- Fits all 8.8" Traction-Lok differentials
- Carbon fiber discs designed for higher torque usage
- Used in 2003-2004 Cobra and Mustang GT500

Kit includes:

- Carbon fiber clutch pack
- Shims
- 31-spline S-spring. 28-spline applications require use of 28-spline S-spring (not included)
- Differential pin lock bolt with thread lock
- Instruction sheet



FRICTION MODIFIER FOR CLUTCH-TYPE LIMITED-SLIP DIFFERENTIALS

M-19546-A12

- Case of 12. (Single bottles Part No. CM-19546-A1)
- Specially formulated additive to provide smooth operation of clutch-type limited-slip differentials



8.8" T-2 TORSEN® DIFFERENTIALS

M-4204-T31

- 8.8" differential
- Fits 31-spline axles
- Torsen® T-2-type differential
- Features full-time torque-sensing, torque-biasing
- Fits solid axle and 2000-2004 Cobra IRS with 31 spline
- M-4204-T28 fits solid axle and 1999 Cobra/Thunderbird/Mark VII with IRS (2000-2004 Cobra has 31 spline)



2012-2013 MUSTANG BOSS 302 TORSEN® DIFFERENTIAL

M-4204-MB

- Fits 2005-2014 Mustang GT and 2007-2014 Shelby GT500 with 8.8" axle and 31 spline
- Fits 8.8" axle with 31 spline
- 8.8" Torsen® differential
- 2.7 drive bias ratio
- 31 spline
- Features full-time torque-sensing, torque-biasing differential
- Standard on 2012-2013 BOSS 302 Mustang Laguna Seca package
- Will accept anti-lock exciter ring
- Does not fit IRS applications



MUSTANG FR500S DIFFERENTIAL

M-4204-T31H

- 8.8" differential
- Fits 31-spline axles
- Torsen® T-2R (Race) type differential with high bias 4.0 ratio
- To achieve the higher bias ratio, the assembly is more complex and designed for race durability
- Service part for the Mustang FR500S race car
- Can be used for performance street or road race applications
- Not for use in drag race applications
- Does not fit IRS applications



8.8" TRACTION-LOK LIMITED SLIP DIFFERENTIAL

M-4204-F318C

- 8.8" differential
- Fits 31-spline axles
- Fits solid or independent rear suspension
- Carbon fiber clutch plates for increased durability
- Will accept anti-lock exciter ring
- Requires 4 oz of CM-19546-A1 Friction Modifier with initial fill
- Original equipment in 2003-2004 Mustang Cobra



9.75" DIFFERENTIAL COVER

M-4033-F975

- Ford Performance branded differential cover
- Fits all F-150 with 9.75" differential
- Rugged powdercoat finish



9" "BENDA" AXLE PINION SEAL

M-4676-A111

- This premium 9" pinion oil seal was developed for high-speed, high-temperature applications
- Developed by Dave Benda, Materials Control Supervisor, Ford Sterling Plant



SPEED-DIAL SPEEDOMETER ADJUSTER M-4209ADPT-AC



- Used to correct speedometer because of tire size or gear ratio changes
- Fits 1994-2004 Mustang manual and automatic transmission
- Fits 2005-2010 Mustang with manual transmission. Will correct speedometer. It has no limit on magnitude of gear ratio change for manual transmission vehicles
- Fits 2005-2010 Mustang automatic transmission. Will correct speedometer to equivalent of 10% gear ratio change, higher or lower

NOTE: To maintain cruise control function on 2005-2010 Mustang automatic and manual transmissions, gear change is limited to equivalent of 5% higher or lower ratio (< +/-5% change). For example, a gear change from 3.55 to 3.73 results in a gear ratio reduction of 4.8%, so cruise control will continue to operate normally. A gear ratio change from 3.55 to 4.11 results in a gear ratio reduction of 13.6%, so cruise control operation is lost.

- The Speed-Dial scales a frequency-based vehicle speed signal up/down to maintain accurate vehicle speed indication to the instrument cluster and PCM
- Easy 4-wire installation
- No reprogramming of PCM necessary

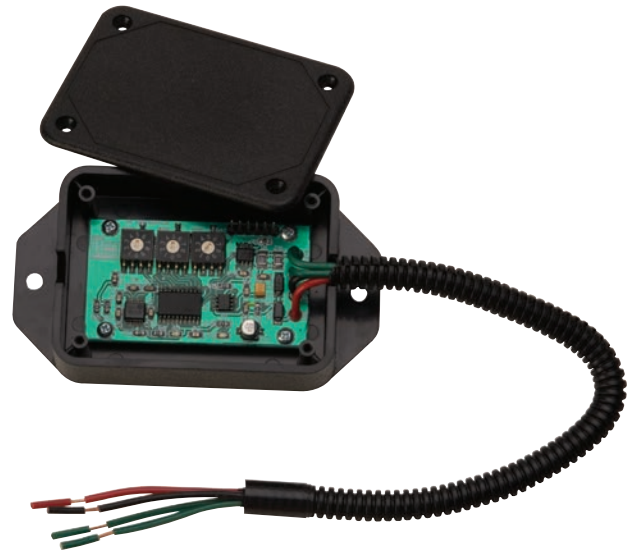

SPEEDOMETER GEAR USAGE CHART – 7.5" AND 8.8" AXLE

The chart specifies the driven gear recommended to obtain approximately correct mph readings when the listed Ford Performance ring and pinion gears are used in conjunction with the indicated speedometer drive gear and Mustang original equipment 15"/16"/17" tires (800-815 revolutions/mile). A dash in the chart indicates that particular combination cannot be obtained. If you are using oversize/undersize tires, obtain the revolutions/mile information from the tire manufacturer and plug it into the formula below. The part numbers of the various speedometer drive and driven gears are shown in the charts. The gears can be obtained from any Ford and Lincoln dealer. They are not available from Ford Performance. The drive gears on T-5/T-45/SROD/Tremec® manual transmissions can be changed. The drive gear on Ford rear-wheel automatic transmissions is machined into the output shaft. Changing the drive gear is impractical since it requires a new output shaft and transmission teardown. Most have 7 or 8 teeth.

| SPEEDOMETER DRIVEN GEAR TEETH | | | |
|-------------------------------|------------------|------|------|
| AXLE RATIO | DRIVE GEAR TEETH | | |
| | 6T | 7T ① | 8T ② |
| 3.08 | – | 18 | 20 |
| 3.27 | 16 | 19 | 21 |
| 3.45/3.55 | 17 | 20 | – |
| 3.73 | 18 | 21 | – |
| 4.10 | 20 | – | – |
| 4.30 | 21 | – | – |

- NOTES:** ① Used in most vehicles with V8 and T-5 transmissions from 1983-1989 and 1996-1998 Cobra with T-45 transmissions.
 ② Used on 1990-1995 Mustang V8 with T-5 transmissions and 1996-1998 Mustang GT with T-45 transmissions.
 ③ Discontinued.

| T-5 MANUAL TRANS. DRIVE GEARS (17285) | | | MANUAL TRANS. DRIVEN GEARS (17271) | | | AUTO TRANS. DRIVEN GEARS (17271) | | |
|--|--------|---------------------|------------------------------------|--------|---------------------|----------------------------------|--------|---------------------|
| NUMBER OF TEETH | COLOR | SERVICE PART NUMBER | NUMBER OF TEETH | COLOR | SERVICE PART NUMBER | NUMBER OF TEETH | COLOR | SERVICE PART NUMBER |
| 6 | Black | E3ZZ-B | 16 | Wine | CODZ-A | 16 | Blue | D0AZ-A ③ |
| 7 | Yellow | E3ZZ-A | 17 | White | C3DZ-C | 17 | Green | C7SZ-A |
| 8 | Green | F0ZZ-A | 18 | Yellow | CODD-B | 18 | Gray | C7SZ-B ③ |
| T-45 MANUAL TRANS. DRIVE GEARS (17285) | | | 19 | Pink | CODZ-B | 19 | Tan | C7VY-A |
| | | | 20 | Black | C1DZ-A | 20 | Orange | C8SZ-B |
| 7 | | F6ZZ-AA | 21 | Red | C4OZ-A | 21 | Purple | D0OZ-B |
| 8 | | F6ZZ-BA | | | | | | |

SPECIAL APPLICATIONS DRIVEN GEAR CALCULATION EXAMPLE

STEP 1

If your axle/tire combination is not in the above charts, you can calculate the number of teeth required on the driven gear by using this formula:

$$\text{Driven Gear Teeth} = \frac{\text{Drive Gear Teeth} \times \text{Axle Ratio} \times \text{Tire Rev. Per Mile}}{1000} = \frac{7 \times 3.73 \times 815}{1000} = 21.3 \text{ (driven gear teeth)}$$

STEP 2

- T-5 Trans.
- Drive Gear Teeth = 7
- Axle Ratio = 3.73
- Tire Rev. Per Mile = 815 (225/60 VR15)

STEP 3

You would select driven gear with closest whole number of teeth, which would be the 21-tooth C40Z-17271-A part.

9" STEEL DIFFERENTIAL CARRIER

M-4141-HS

- Fits 9" Ford rear-end housing
- Developed using finite element analysis (FEA) to withstand the demands of NASCAR® racing
- Steel casting has nearly double the tensile and yield strength and elongation vs. cast iron
- Case investment cast from 8620 steel
- Bearings caps machined from 4130 steel
- ARP® bolts
- 3.250" differential bearing diameter
- Approximate weight: 21 lbs



9" TRAC-LOK LIMITED SLIP DIFFERENTIAL

M-4204-F28A 28 spline

M-4204-F31A 31 spline

- 9" differential
- 4-spring aggressive torque bias
- Street/strip application
- 1536 steel billet case caps
- Cast high-strength nodular iron case
- OEM profile gears made of high-manganese, high-chromium alloy steel
- Rebuildable



BOLT – RING GEAR TO DIFFERENTIAL CASE

M-4216-A200 Sold in pkg. of 100

M-4216-A210 Sold in pkg. of 10

- 7/16"-20 x .9375" bolt
- The most popular 9" ring gear bolt, for use on open differentials, Detroit Lockers and spools

NOTE: Will NOT fit Traction-Lok differentials. Same as flywheel bolts, see page 233.



9" DIFFERENTIAL BEARING ADJUSTER LOCK AND BOLT KIT

M-4144-B

- Includes 2 locks and 2 bolts to secure differential bearing adjusting nuts on 9" nodular carriers produced after November 1989



9" "DAYTONA" PINION BEARING RETAINER

M-4614-B

- Nodular iron
- Pinion bearing retainer is a direct fit and functional replacement for the C3AZ-4614-B unit, which is no longer serviced by Ford Customer Service Division
- Comes complete with TBAA-4616-A (HM89410) Large Rear Cup and B7A-4614-A (M88010) Small Front Cup

NOTE: Use TBAA-4621-A (HM-89443) Large Rear Bearing and B7A-4621-A (M-88048) Small Front Bearing with these retainers.



5-LUG REAR DISC BRAKE KIT – LATE MODEL FORD 9" TRUCK AXLE HOUSING

M-2300-G2

Looking to add some stopping power to the rear of your classic Ford? Tired of searching through junk yards or settling for mismatched rear disc brake parts? This Ford Performance rear disc brake kit includes OE quality calipers, rotors and mounting components.

- Kit includes 11.8" vented rotors, single piston calipers with integral parking brake, custom mounting brackets and attaching hardware
- Rotors feature the common 5-hole, 4.5" diameter passenger car bolt pattern with 2.780" center hub
- Mounting brackets fit the popular 9" late model Ford axle housings with 2" x 3.56" pattern and big 3.15" diameter bearing
- This kit is designed for vehicle installations with a 2.5" brake gap (housing flange-to-axle-shaft flange)
- Includes E-coated caliper mounting brackets, moan braces and dust shields
- Due to large 11.8" diameter rotor and floating caliper design, most production and aftermarket 15" wheels will not fit

NOTE: Wheel spacers not recommended for use with brake kit.

NOTE: Does not fit Mustang 8.8" axle.

NOTE: Hoses, tubes, parking brake cables and wheels are NOT included in this kit. Additional parts and machining may be required. For more information, call the Techline at (800)367-3788.





HD ALUMINUM DRIVESHAFT ASSEMBLY



M-4602-G 28 Spline

M-4602-J 31 Spline

- M-4602-G fits 1979-1995 Mustang/Capri 5.0L vehicles with T-5/SROD/C-4/AOD, 1979-1993 with Tremec® transmissions and 7.5" or 8.8" axles
- M-4602-J fits 1996-2004 Mustang and 1996-1998 Cobra 4.6L with manual transmission
- High strength, 3.5" diameter 0.114" wall thickness 6061-RT62 aluminum seamless drawn tube
- 1330 U-joints 45.5" long (CL to CL of U-joints)
- Will not fit 1999-2004 Cobra



BOSS 302R DRIVESHAFT

M-4602-S

- Service replacement part for Mustang BOSS 302R race car
- 31-spline yoke
- 1330 U-joints with 4-bolt SN95 flange
- 42" length from centerline of U-joints
- Made from 6061-T6 aluminum, 3.5" diameter x 0.125" wall thickness
- Does not fit production Mustang



COBRA JET DRIVESHAFT LOOP

M-5478-CJ



- Service replacement for the Mustang FR500CJ race car
- Meets most drag racing sanctioning body requirements
- Contains driveshaft in the event of front U-joint breakage
- Fits 2005-2009 Mustang with TR6060 transmission
- For use with one-piece driveshafts only



31-SPLINE DRIVESHAFT YOKE

M-4841-A

- Fits 31-spline output shafts
- The splines have an undercut .530" long, with a 1.425" I.D.
- Uses 1330 U-joints
- Use with production T-45, C-6, 3550 and 3650 transmissions
- U-joint cap diameter 1.062"
- U-joint width 3.500"
- Yoke O.D. is 1.685". Machined area length, 6.068"
- Center of U-joint to front of yoke, 7.750" (approx.)

28-SPLINE DRIVESHAFT SLIP YOKE

M-4841-B

- For replacement use or custom driveshaft construction
- Fits 28-spline output shafts
- No undercut on splines
- Uses 1330 U-joint
- Fits C-4, AOD and T-5 transmissions
- U-joint cap diameter 1.062"
- U-joint width 3.500"
- Yoke O.D. 1.500". Machined area length, 4.680"
- Center of U-joint to front of yoke, 6.760" (approx.)



M-4841-A shown

SPECIAL U-JOINT KIT

M-4635-A



- Kit consists of a hybrid 1310/1330 series cross, plus (4) 1.0625" OD and (2) 1.125" OD caps and locking clips
- Allows small and large Ford drivetrain components to be interchanged



ONE-PIECE MUSTANG GT DRIVESHAFT

M-4602-MGTA 1336 mm in length; fits 2005-2010 Mustang GT w/manual transmission

M-4602-MGTM 1430 mm in length; fits 2011-2014 Mustang GT w/auto or manual transmission

M-4602-MSVT 1312 mm in length; fits 2007-2012 Mustang Shelby GT

- Direct bolt-in right out of the box
- Designed for increased horsepower applications to deliver peak endurance and optimum strength
- 3.5" diameter 6061-T6 aluminum tubing with .125" wall thickness provides exceptional strength and reliability
- 1350 SERIES Dana Spicer 5-1350X solid body universal joints...much stronger than the 1330 series versions available for Mustang
- Reduced overall weight and rotating mass delivers improved driving performance and provides quicker acceleration
- Comes with 1350 series flange yoke to bolt to transmission
- Comes with 1350 series flange yoke to bolt to OE Mustang rear end flange...NO adapter required
- Spline and slip design to allow for installation and suspension movement
- Hard plastic boot to keep grease in and water out protects spline and slip from contaminants
- Eliminates the need for a center support bearing
- Fully assembled and balanced
- Off-road use only



M-4602-MSVT shown

APPEARANCE/DRESS-UP

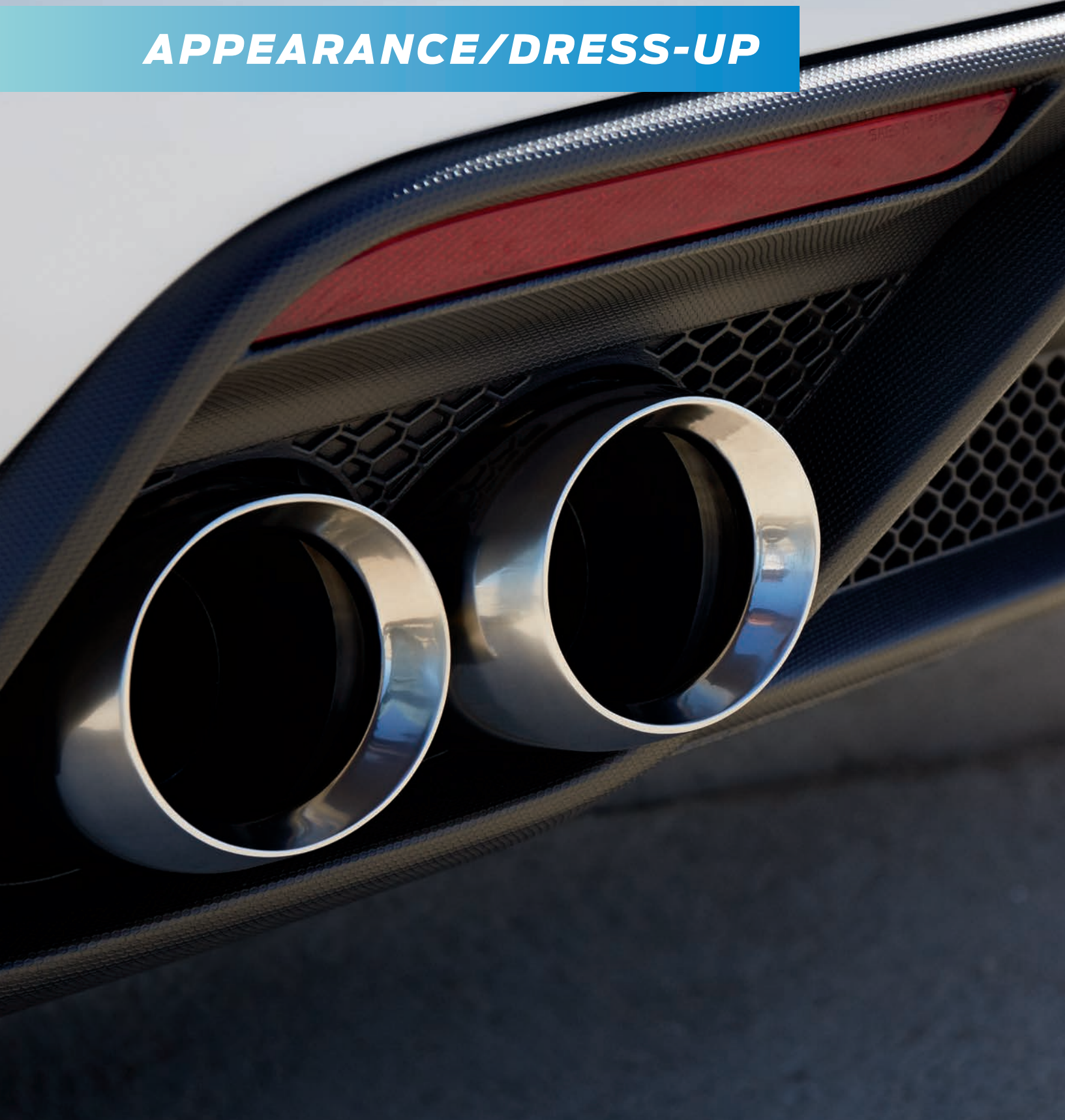



FORD PERFORMANCE GAUGE COLLECTION

CHROME BEZEL SERIES KIT

M-19017-B961

- Bezel embossed with "Ford" emblem
- Luxurious chrome design with white background, gray sweep zone, black graphics and needle-style pointer
- Includes all components necessary to install
- All gauges are electric operation. Case diameter is 3-1/8" (speedometer) and 2-1/16" (water, oil, fuel & battery)
- Fuel-level sender compatibility is 240 OHM empty, 33 OHM full – 12 volt
- Fuel-level sender is adjustable from 6" to 23"
- Speedometer, oil pressure gauge and sender, water temperature gauge and sender, fuel level gauge and sender, and battery voltage gauge

NOTE: 5-gauge kit includes: speedometer, oil pressure gauge and sender, water temperature gauge and sender, fuel level gauge and sender, and battery voltage gauge. Needles do not zero.



For the complete line of Ford Performance Competition Gauges, see AutoMeter.com

FORD RACING MUSTANG GAUGE PACK M-6304GPACK-MA

- Original equipment on 2012 Mustang BOSS 302 Laguna Seca
- Designed for use in 2010-2014 Mustang GT, 2012-2013 Mustang BOSS 302
- Includes dash-mounted gauge pod and three 2-1/16" gauges
- Oil pressure gauge
- Vehicle performance gauge
- Water temperature gauge
- Includes unique "Ford Racing" adapter plate for easy installation
- Easy installation with included wiring harness and detailed instructions
- Perfect for street and open track use



FORD RACING MUSTANG DASH GAUGE POD M-6304GPOD-A

- Fits 2005-2014 Mustang GT, Shelby GT500 and Mustang V6
- Gauge pod accepts 3 standard 2-1/16" gauges
- Includes dash mounting bracket



APPEARANCE/DRESS-UP

"FORD RACING" COMPETITION GAUGES

Ford Performance through-the-dial LED competition-style gauges.

These high-quality, full-sweep gauges, available in 2-1/16" diameter along with our 3-3/8" tachometer with shift light, all sport the red and blue "Ford Racing" logo on a black background with white numerals.



M-9275-BFSE

2-1/16" Electric
Fuel Pressure Gauge
0-100 psi



M-9278-BFSE

2-1/16" Electric
Oil Pressure Gauge
0-100 psi



M-10883-BFSE

2-1/16" Electric
Water Temperature Gauge
100° F-260° F



M-10885-BFSE

2-1/16" Electric
Pyrometer measures
from 0-1600° F.
Includes K-type
thermocouple



M-11622-BFSE

2-1/16" Electric
Vacuum/Boost
Pressure Gauge
30 inHg/30 psi



M-17360-B

3-3/8" Electric Pedestal Mount
Shift Light Tachometer
10,000 rpm



2015-2017 MUSTANG PERFORMANCE PACK BOOST GAUGE KIT

M-10849-A

- Fits 2015-2017 Mustang GT 5.0L Performance Pack equipped Mustang
- Original equipment on 2015-2017 Performance Pack 2.3L EcoBoost® Mustang
- Kit provides an easy way to read boost levels on Mustang with installed forced induction setup, while maintaining the OEM look and functionality
- Features oil pressure and vacuum/boost gauge
- Easy plug-and-play installation
- Compatible with MyColor interior lighting
- Installation is plug-and-play and does not require any cutting or splicing

Kit includes:

- Oil pressure/boost gauge
- Trim clips
- Detailed instructions

NOTE: Boost gauge has been validated with Ford Performance, Roush® and Whipple® supercharger kits. Other supercharger kits and aftermarket performance calibrations can prevent boost gauge from functioning.



For the complete line of Ford Performance Competition Gauges, see AutoMeter.com

FORD PERFORMANCE VALVE COVERS

Die-cast aluminum with baffle.

CHROME ALUMINUM

M-6582-LE302C

- Fits 289/302/351W
- Chrome finish
- "Ford Racing" logo
- Will clear stud girdle and roller rocker arms (3.75" tall)
- Includes oil fill cap and grommets
- 50-state street legal when installed with appropriate closed PCV hardware



289/302/351W CIRCLE TRACK

M-6582-CT2

Circle track valve covers as used on the Ford Racing 347 and 374 sealed racing engines. The breather stacks have been moved to the front of the valve cover for air-box clearance and are welded to the valve cover to ensure against oil leaks. Inside, the breather stack oil control baffle is also welded in place for durability.

- Fits 289/302/351W
- Two 1-3/8" x 3-1/4" breather stacks in the left side valve cover – welded in place
- Includes 2 clamp-on breathers
- Laser-etched "Ford Racing" logo
- Will clear stud girdle and roller rocker arms (3.880" tall)



BLACK SATIN

M-6582-LE302SBK

- Fits 289/302/351W
- Black satin finish
- Laser-etched "Cobra" snake logo
- Will clear stud girdle and roller rocker arms (3.75" tall)
- Includes oil fill cap and grommets
- 50-state street legal when installed with appropriate closed PCV hardware



BLACK SATIN

M-6582-LE302BK

- Fits 289/302/351W
- Black satin finish
- "Ford Racing" logo
- Will clear stud girdle and roller rocker arms (3.75" tall)
- Includes oil fill cap and grommets
- 50-state street legal when installed with appropriate closed PCV hardware



BLACK SATIN

M-6582-A

- Fits 289/302/351W (except EFI)
- Black satin finish
- "Cobra Powered by Ford" logo
- May require modifications for roller rockers
- Includes oil fill cap and grommets
- 50-state street legal when installed with appropriate closed PCV hardware



POLISHED ALUMINUM

M-6582-A302R

- Fits 289/302/351W (except EFI)
- Polished finish
- "Ford Racing" logo
- May require modifications for roller rockers
- Includes oil fill cap and grommets
- Has 1.200" round oil fill/PCV holes
- 50-state street legal when installed with appropriate closed PCV hardware



BLUE SATIN

M-6582-LE302BL

- Fits 289/302/351W
- Blue satin finish
- "Ford Racing" logo
- Will clear stud girdle and roller rocker arms (3.75" tall)
- Includes oil fill cap and grommets
- 50-state street legal when installed with appropriate closed PCV hardware



BLACK SATIN

M-6582-F302

- Fits 289/302/351W (except EFI)
- Black satin finish
- "Cobra" logo (original open letter Cobra)
- May require modifications for roller rockers
- Includes oil fill cap and grommets
- 50-state street legal when installed with appropriate closed PCV hardware



BLACK SATIN

M-6582-A301R

- Fits 289/302/351W (except EFI)
- Black satin finish
- "Ford Racing" logo
- May require modifications for roller rockers
- Includes oil fill cap and grommets
- Has 1.200" round oil fill/PCV holes
- 50-state street legal when installed with appropriate closed PCV hardware



APPEARANCE/DRESS-UP

FORD PERFORMANCE VALVE COVERS

- Die-cast aluminum with baffle
- Includes oil fill cap and grommets
- 50-state street legal when installed with appropriate closed PCV hardware

POLISHED ALUMINUM

M-6582-F301

- Fits 289/302/351W (except EFI)
- Polished finish
- "Mustang Powered By Ford" logo
- May require modifications for roller rockers
- Has 1.200" round oil fill/PCV holes



BLACK SATIN

M-6582-B301

- Fits 289/302/351W (except EFI)
- Black satin finish
- "Mustang Powered By Ford" logo
- May require modifications for roller rockers
- Has 1.200" round oil fill/PCV holes



FORD RACING 289-351 SLANT EDGE BLACK STEALTH

302-135B

- Fits 289/302/351W
- Satin, all-black "Stealth" finish
- Raised "Ford Racing" logo
- Not designed for use on factory 5.0L EFI intake manifold
- Will clear stud girdle and roller rocker arms (3.35" tall)
- Includes long bolts for center upper bolt hole (1 per valve cover)



BLACK SATIN SMALL BLOCK 427

M-6582-W427B

- Fits 289/302/351W (except EFI)
- Pentroof 427 style, used on Ford Racing SB 427 crate engines
- Black satin finish
- "427 Cobra" logo
- May require modifications for roller rockers
- Valve covers are not compatible with M-6584-A50 Gasket, Fel-Pro® VS 13264T recommended



FORD RACING 289-351 SLANT EDGE BLACK

302-135

- Fits 289/302/351W
- Satin black finish
- Raised "Ford Racing" logo
- Not designed for use on factory 5.0L EFI intake manifold
- Will clear stud girdle and roller rocker arms (3.35" tall)
- Includes long bolts for center upper bolt hole (1 per valve cover)



FORD RACING 289-351 SLANT EDGE POLISHED

302-138

- Fits 289/302/351W
- Polished aluminum finish
- Recessed "Ford Racing" logo
- Not designed for use on factory 5.0L EFI intake manifold
- Will clear stud girdle and roller rocker arms (3.35" tall)
- Includes long bolts for center upper bolt hole (1 per valve cover)



FORD RACING 289-351 SLANT EDGE BLUE

302-136

- Fits 289/302/351W
- Ford blue finish
- Raised "Ford Racing" logo
- Not designed for use on factory 5.0L EFI intake manifold
- Will clear stud girdle and roller rocker arms (3.35" tall)
- Includes long bolts for center upper bolt hole (1 per valve cover)



FORD RACING 289-351 SLANT EDGE GRAY

302-137

- Fits 289/302/351W
- Gray crinkle finish
- Raised "Ford Racing" logo
- Not designed for use on factory 5.0L EFI intake manifold
- Will clear stud girdle and roller rocker arms (3.35" tall)
- Includes long bolts for center upper bolt hole (1 per valve cover)



FORD RACING 289-351 SLANT EDGE CHROME

302-139

- Fits 289/302/351W
- Chrome finish
- Recessed "Ford Racing" logo
- Not designed for use on factory 5.0L EFI intake manifold
- Will clear stud girdle and roller rocker arms (3.35" tall)
- Includes long bolts for center upper bolt hole (1 per valve cover)



FORD PERFORMANCE VALVE COVERS

- Die-cast aluminum with baffle
- Includes oil fill cap

BLACK SATIN M-6000-C302



- Fits 1986-1993 EFI Mustang
- Black satin finish
- "Cobra" logo (original open letter Cobra)
- May require modifications for roller rockers
- 50-state street legal



POLISHED ALUMINUM M-6000-D302



- Fits 1986-1993 EFI Mustang
- Polished finish "Cobra" logo (original open letter Cobra)
- May require modifications for roller rockers
- 50-state street legal



BLACK SATIN M-6000-E302



- Fits 1986-1993 EFI Mustang
- Black satin finish
- "Mustang Powered By Ford" logo
- May require modifications for roller rockers
- 50-state street legal



POLISHED ALUMINUM M-6000-F302



- Fits 1986-1993 EFI Mustang
- Polished finish
- "Mustang" logo
- May require modifications for roller rockers
- 50-state street legal



BLACK SATIN M-6000-J302R



- Fits 1986-1993 EFI Mustang
- Black satin finish
- "Ford Racing" logo
- May require modifications for roller rockers
- 50-state street legal



BLACK SATIN TRUCK M-6582-A351R



- Fits 302 and 351W EFI trucks
- Black satin finish
- "Ford Racing" logo
- May require modifications for roller rockers
- 50-state street legal



POLISHED ALUMINUM M-6582-Z351

- Fits 1969-1970 BOSS 302/351C/351M/400
- Polished finish
- "Ford Racing" logo
- Will clear stud girdle and roller rocker arms (4" tall)
- Includes grommets



CLEVELAND BLACK ALUMINUM M-6582-Z351B

- Fits 1969-1970 BOSS 302/351C/351M/400
- Satin finish
- "Ford Racing" logo accent in red
- Will clear stud girdle and roller rocker arms (4" tall)
- Includes grommets



APPEARANCE/DRESS-UP

FORD PERFORMANCE VALVE COVERS

- Die-cast aluminum with baffle
- Includes oil fill cap and grommets
- 50-state street legal when installed with appropriate closed PCV hardware

POLISHED ALUMINUM

M-6582-A342R

- Fits 1969-1970 BOSS 302/351C/351M/400
- Polished finish
- "Ford Racing" logo
- May require modifications for roller rockers



BLACK SATIN

M-6582-C351BK

- Fits 1969-1970 BOSS 302/351C/351M/400
- Black satin finish
- "351 CLEVELAND" logo
- May require modifications for roller rockers



POLISHED ALUMINUM

M-6582-C460

- Fits 429/460
- Polished finish
- "Ford Racing" logo
- Will clear stud girdle and roller rocker arms (4.5" tall)



BLACK SATIN

M-6582-A341R

- Fits 302 BOSS/351C/351M/400
- Black satin finish
- "Ford Racing" logo
- May require modifications for roller rockers



POLISHED ALUMINUM

M-6582-C351PD

- Fits 1969-1970 BOSS 302/351C/351M/400
- Polished finish
- "351 CLEVELAND" logo
- May require modifications for roller rockers



BLACK SATIN

M-6582-B

- Fits 352/360/390/427/428
- Black satin finish
- "Cobra Le Mans" logo
- May require modifications for roller rockers
- Has 1.200" round oil fill/PCV holes



289-302-351W SB FORD RACING BLACK RIBBED ALUMINUM

M-6582-W351PR

- Fits 289/302/351W (except EFI)
- Pentroof 427 style 4.500" tall
- Used on Ford Racing SB X302E/B, Z363FT/RT and Z427AFT/RT crate engines
- Black satin finish
- "Ford Racing" logo
- May require modifications for roller rockers
- Valve covers are not compatible with M-6584-A50 Gasket; Fel-Pro® VS 13264T recommended



460 ALUMINUM SATIN BLACK

M-6582-B460

- Fits 429/460
- Satin black finish
- "Ford Performance" logo
- Will clear stud girdle and roller rocker arms (5.75" tall)



POLISHED ALUMINUM

M-6582-A427

- Fits 352/360/390/427/428
- Polished finish
- "Cobra Le Mans" logo
- May require modifications for roller rockers
- Has 1.200" round oil fill/PCV holes



BREATHER CAP W/"FORD RACING" LOGO

M-6766-FRNVBK Black Powdercoated
M-6766-FRNVBL Blue Powdercoated
M-6766-FRNVCH Chrome

- Fits most 289/302/351W Ford Racing valve covers
- Laser-etched "Ford Racing" logo
- Push-in type
- Open crank design



M-6766-FRNVBL shown

BREATHER CAP W/"FORD RACING" LOGO

M-6766-FRVBK Black Powdercoated
M-6766-FRVBL Blue Powdercoated
M-6766-FRVCH Chrome

- Fits most 289/302/351W Ford Racing valve covers
- Laser-etched "Ford Racing" logo
- Push-in type
- Closed crankcase design



M-6766-FRVBK shown

UNIVERSAL VALVE COVER BREATHER CAP GROMMETS

M-6892-F

- Kit includes one grommet for push-in breather cap and one for a PCV valve
- Grommets fit all Ford Performance valve covers for push rod engines
- Grommets designed for 1.200" hole
- Also converts twist-in breather valve cover to push-in style breather



SLANT EDGE "FORD RACING" AIR CLEANER

302-999



- Cast gray crinkle finish matches the Ford Performance Parts 302-137 Valve Cover
- Uses genuine 3" Motorcraft® air filter elements (Part No. FA612R) for maximum airflow
- The air cleaner lid attaches to a short stud that is screwed into the center of the carburetor. Lid has a threaded boss on the underside, and is simply spun into place by the installer
- Each kit is supplied with necessary mounting hardware



CHROMED ALUMINUM OIL FILL CAP COVER FOR 4.6L/5.4L/6.8L

M-6766-MP46A



- Fits all years of modular engine
- Installs over factory plastic oil fill cap (not included)
- Features "Ford Racing" logo painted in blue and red
- Clearcoated



COBRA INTAKE PLAQUE

M-1447-D46 1996-1998 – 4" tall x 2.25" wide

M-1447-F46 1999-2001 – 3.4" tall x 2.25" wide

- Cobra intake plaque from Cobra upper intake manifold
- Designed in the shape of the Cobra snake
- High-quality embossed Cobra snake
- Blue inlay on brushed aluminum background
- Two-way tape for easy installation



OVAL AIR CLEANER ASSEMBLIES

M-9600-C302 "Cobra" Logo

M-9600-K302 "Mustang" Logo

- For single 4V carburetors
- Die-cast aluminum lid with stamped steel base
- Black satin finish
- Assembly height is 2.5"
- Includes mounting hardware





Ford 289-302-351W Slant-Edge Valve Covers

Turn heads with this new aggressive and modern look for your engine. As a result of innovative mold design, these die-cast valve covers offer more internal clearance for large valvetrain applications. With **11** choices available, they will provide a totally personalized look. Tall, with a removable baffle. Grommets and bolts included. Sold in pairs. U.S. Pat. D670,360.

Note: Not for use on engines with EFI manifolds.

Ford RACING

- Black Crinkle, Raised emblems 302-135
- Ford® Blue, Raised emblems 302-136
- Cast Gray Crinkle, Raised emblems 302-137
- Polished, Recessed black emblems 302-138
- Chrome, Recessed black emblems 302-139

Ford MUSTANG

- Black Crinkle, Raised emblems 302-140

Ford RACING Collector's Series

- Green, Raised emblems..... 302-141
- White, Raised emblems..... 302-142
- Red, Raised emblems..... 302-143
- Yellow, Raised emblems 302-144
- Powdercoat-Ready, Raised emblems..... 302-146

Ford 289-302-351W Stamped Steel Valve Covers

These affordable, high-quality stamped steel valve covers are offered in a deep chrome plated look, black crinkle and the new carbon-style look. In addition to the classic raised "Ford RACING" emblem, you may choose from a new selection of recessed styles featuring the striking "COBRA," "MUSTANG," and "RACING" emblems. All valve covers include baffles and grommets. Sold in pairs.

Note: Not for use on engines with EFI manifolds.



Ford RACING

| | |
|----------------------------------|---------|
| Chrome, Embossed emblems | 302-070 |
| Black Crinkle, Red emblems | 302-072 |
| Chrome, Black emblems..... | 302-071 |
| Carbon-Style, Red emblems..... | 302-008 |

Ford MUSTANG

| | |
|----------------------------------|---------|
| Black Crinkle, Red emblems | 302-101 |
| Chrome, Black emblems | 302-100 |

Ford COBRA

| | |
|----------------------------------|---------|
| Black Crinkle, Red emblems | 302-117 |
| Chrome, Black emblems..... | 302-116 |



Ford 289-302-351W Die-Cast Aluminum Valve Covers

"Ford COBRA" and "Ford MUSTANG" styles join the venerable "Ford RACING" style. These premium valve covers are "Tall," and designed to clear roller rockers and polylock nuts. They have recessed emblems with inlaid paint. All valve covers include baffles and grommets. Sold in pairs.

Note: Not for use on engines with EFI manifolds.

Ford RACING

| | |
|---|---------|
| Polished, Black emblems (was M-6582-E302P)..... | 302-001 |
| Chrome, Black emblems (was M-6582-R302) | 302-002 |
| Black Crinkle, Red emblems (was M-6582-L302) | 302-003 |

Ford COBRA

| | |
|----------------------------------|---------|
| Polished, Black emblems | 302-055 |
| Black Crinkle, Red emblems | 302-056 |

Ford MUSTANG

| | |
|----------------------------------|---------|
| Polished, Black emblems | 302-030 |
| Black Crinkle, Red emblems | 302-031 |



Official
Licensed
Product

*Except those in categories with asterisks, these products are not legal for sale or use on pollution controlled vehicles.



NEW! Slant-Edge Air Cleaner Kits

Complete your engine look with a Slant-Edge Air Cleaner to match your valve covers. Whether you have Slant-Edge valve covers or a set from a different series, these air cleaners will bring your engine look together in head-turning fashion. The air cleaner lid does not use a traditional center nut, because it attaches to the carburetor with a threaded boss on the underside and is simply spun down into place. They are supplied with genuine Motorcraft® 2-5/8" high filter element (Part No. FA-612R) for maximum airflow. Each kit is supplied with necessary mounting hardware.

Technical Note: After installing a new air cleaner, always lower the hood slowly to confirm sufficient clearance visually. Minimum clearance of 3-3/4" is required from the top of the carburetor gasket area to the underside of the hood.

The air cleaner bases are recessed for a low profile appearance, maximum performance and hood clearance. Patent Pending.

Ford RACING

- Black Crinkle, Raised emblems **NEW!** 302-380
- Ford® Blue, Raised emblems **NEW!** 302-381
- Cast Gray Crinkle, Raised emblems **NEW!** 302-382
- Polished, Recessed black emblems **NEW!** 302-383
- Chrome, Recessed black emblems **NEW!** 302-384
- Black Crinkle, Recessed red emblems **NEW!** 302-385

Air Cleaners

The air cleaner is one of the most visible parts on a car's engine, so now is the time to add a premium "Ford RACING," "MUSTANG" or "COBRA" emblem to your ride for the perfect customized look! These 13" diameter air cleaners fit 2V and 4V carburetors, and are supplied with a genuine Motorcraft® 2-5/8" high filter element (Part No. FA-612R). The tops and bases have matching finishes (excluding Carbon-Style), and each kit is supplied with necessary mounting hardware. Classic air cleaner kits are supplied with special die-cast Ford Oval center nuts (also offered separately).

Technical Note: After installing a new air cleaner kit, always lower the hood slowly to confirm sufficient clearance visually. Minimum clearance of 4" is required from the top of the carburetor gasket area to the underside of the hood.



Air Cleaner Center Nuts*

Add some extra flair to your custom air cleaner by topping it with a distinctive Ford or Mustang center nut available in chrome or black finishes. Fits 1/4-20 carburetor studs.

Ford Oval

| | |
|---------------------------------|---------|
| Chrome (was M-9697-A)..... | 302-333 |
| Black Crinkle | 302-334 |
| Black Crinkle, Red emblem | 302-339 |

Mustang Pony

| | |
|----------------------------|---------|
| Chrome (was M-9697-C)..... | 302-337 |
| Black Crinkle..... | 302-338 |

Classic Stamped Steel Air Cleaner Kits

Ford RACING

| | |
|--|---------|
| Black Crinkle, Red emblem | 302-352 |
| Chrome, Embossed emblems (was M-9600-A302R)..... | 302-350 |
| Chrome, Black emblem | 302-351 |
| Carbon-Style, Red emblem | 302-354 |

Ford COBRA

| | |
|---------------------------------|---------|
| Black Crinkle, Red emblem | 302-372 |
| Chrome, Black emblem | 302-371 |

Ford MUSTANG

| | |
|---------------------------------|---------|
| Chrome, Black emblem | 302-361 |
| Black Crinkle, Red emblem | 302-362 |



Updated Mustang Pony Emblem!



Official
Licensed
Product

*Except those in categories with asterisks, these products are not legal for sale or use on pollution controlled vehicles.



Mini Nuts*

- Chrome (was M-6680-A)302-315
- Black Crinkle302-316

Wing Nuts*

- Chrome (was M-6680-A302).....302-325
- Black Crinkle 302-326

Air Breather Caps

Ford RACING

- Chrome (twist type, not shown)
(was M-6766-A302)302-200
- Chrome
(was M-6766-B302).....302-215
- Black Crinkle302-216
- Chrome, filter, with hood
(was M-6766-K302).....302-235
- Chrome, filter, without hood
(was M-6766-H302).....302-236

- Black Crinkle, filter, with hood**NEW!** 302-233
- Black Crinkle, filter, without hood**NEW!** 302-234

Ford MUSTANG

- Chrome302-220
- Black Crinkle302-221

Ford COBRA

- Chrome302-225
- Black Crinkle302-226

Wire Looms and Dividers*

Ford RACING Wire Looms

- Chrome with Blue
(was M-12297-B14).....302-636
- Chrome with Black.....302-640

Ford Oval Wire Dividers

- Blue: 2, 3, 4-wire, 2 each
(was M-12297-B02/B03/B04).....302-637
- Black: 2, 3, 4-wire, 2 each.....302-641

Engine Oil Dipsticks*

- Chrome w/Blue anodized aluminum handle
(was M-6750-B302).....302-400
- Chrome (was M-6750-A302).....302-401





MUSTANG HOOD LIFT KIT W/LASER-ENGRAVED "FORD PERFORMANCE" LOGO

Simply start to lift your hood and let the hood lift system take over. Your hood will lift and hold firmly at the raised position – no wind or bumping will knock your hood down on your head. These gas struts are rated at 90 lbs to hold up OEM and specialty hoods. Due to the leverage when open, a 90 lbs rated strut will keep the hood open securely.

- Ford Performance hood lift kit w/laser-engraved "Ford Performance" logo
- 90 lbs rating
- These hood lifts utilize two gas struts that lift and hold the hood without the need for a prop-rod
- Made from lightweight steel and aluminum, they feature a durable black powdercoated finish to give your engine bay a much cleaner appearance
- If your aftermarket hood is lighter than the factory hood, use caution when opening the hood due to the power of the strut
- Includes the necessary mounting brackets

M-16826-MA

- Fits 2015-2018 Mustang – does not fit GT350
- Designed for all OEM base Mustang, Mustang GT and many aftermarket hoods

M-16826-M

- Fits 2005-2014 Mustang
- Designed for all OEM base, Mustang GT, GT500 and many aftermarket hoods
- No drilling required. The stamped steel brackets included in this kit are designed to bolt into the existing mounting holes so there is no drilling required for installation



M-16826-MA shown

HOOD LATCH AND PIN KIT

M-16700-A

- That competition look you've always wanted
- This is similar to the original hood pin kit used on early Mustang and Fairlane
- Can be used with most original and aftermarket hoods
- This part is not designed to fit the 2005 and newer Mustang



COBRA JET AND FR500S HOOD PIN KIT

M-16700-S

- Service replacement part for the 2010 Cobra Jet and FR500S Mustang race cars
- Includes one pair of plated hood pins with two-piece clasps



CUSTOM BILLET WIRE LOOMS

M-12297-L900

- Ford Oval billet aluminum spark plug wire looms with ball milled logos
- Fits 8 mm and 9 mm wire
- Keeps all wires neat and away from headers
- Adjustable brackets fit all big and small block engines except FE V8
- Use with universal spark plug wires



DISTRIBUTOR HOLD-DOWN CLAMP

M-12270-A302

- 2.3L HSC, V6 and V8 except FE



CHROME IGNITION COIL BRACKET

M-12044-A2

- Universal fit for canister style ignition coil
- Chrome plated steel



APPEARANCE/DRESS-UP

“FORD PERFORMANCE” FENDER COVER

M-1822-A7

- Protect that beautiful paint job from scratches, chemicals and oil with this strong, sturdy and slip-resistant “Ford Performance” fender cover
- Measures 27" x 36" and is acid/grease resistant
- Features handy “ridged” area in which to place small tools and parts



“FORD PERFORMANCE” TRACK MAT

M-1822-A8

- 2' x 4' folding mat
- Includes “Ford Performance” logo
- 100% polypropylene fibers
- 3/4" closed cell foam
- Impact absorbing cushion
- Water and stain resistant



SVT DECKLID EMBLEM

M-1447-SVT

- Original equipment on Mustang SVT Cobra and Contour SVT
- Similar to SVT emblem used on Focus SVT
- Two-way tape for easy installation
- Injection molded plastic
- Chrome finish



CHROME V8 BADGE

M-7843-V8

- Vintage style V8 logo
- Two-way tape for easy installation
- 2.5" tall x 1.5" wide
- Injection molded plastic
- Chrome finish



MUSTANG SVT “COBRA” SNAKE FENDER EMBLEMS

M-1447-C 4.25" tall x 2.50" wide

Original equipment on 2007-2009 Shelby Mustang GT500.

M-1447-SR 2.875" tall x 1.700" wide

Original equipment on 1994-2004 Mustang SVT Cobra.

- Includes right- and left-side emblems
- Two-way tape for easy installation
- Injection molded plastic
- Chrome finish



M-1447-C shown



2007-2009 MUSTANG SVT “COBRA” SNAKE FENDER EMBLEMS – RED

M-1447-R

- Fits 2007-2009 GT500 (can be modified to fit many different applications by removing locating posts on the back of emblem)
- Original equipment on 2009 GT500 equipped with limited edition “Red Stripe Appearance Package”
- Includes right- and left-side emblems
- Two-way tape for easy installation
- 4.25" tall by 2.50" wide
- Injection molded plastic
- Red/silver finish



COBRA JET GRILLE EMBLEM

M-16098-CJG

- Inspired by the Ford Performance FR500CJ Cobra Jet Mustang
- Laser-cut metal snake with flames, painted red, white and blue
- Complete with two studs for mounting
- Can be affixed to grille or kept as a keepsake
- Approximately 3" tall x 4.5" wide



2015-2017 MUSTANG 5.0L FENDER EMBLEM

M-1447-M50A Chrome

M-1447-M50AB Black

- Original equipment on 2015-2017 Mustang GT
- Includes right- and left-side emblems
- Two-way tape for easy installation
- Injection molded plastic



M-1447-M50AB shown



2011-2014 MUSTANG 5.0L FENDER EMBLEM

M-1447-M50

- Original equipment on 2011-2014 Mustang GT
- Includes right- and left-side emblems
- Two-way tape for easy installation
- Injection molded plastic
- Chrome finish



BLACK AND SILVER ECOBOOST® EMBLEM

M-1447-EBBLK



- Black and silver EcoBoost® emblem/badge
- 3-1/2" long x 9/16" wide – Qty 2
- Complement any EcoBoost®-powered hot rod, street rod or vehicle
- Can be attached on engine covers, doors, fenders, hatches, hoods, etc.
- Automotive-grade double-sided tape included on back of emblem



BLACK AND CHROME ECOBOOST® EMBLEM – LARGE SIZE

M-1447-EBBLKLG



- Black and chrome EcoBoost® emblem/badge
- Large size – 5-11/16" long x 13/16" wide – Qty 2
- Complement any EcoBoost®-powered hot rod, street rod or vehicle
- Can be attached on engine covers, doors, fenders, hatches, hoods, etc.
- Automotive-grade double-sided tape included on back of emblem



SILVER ECOBOOST® EMBLEM

M-1447-EB



- Silver with blue/green EcoBoost® logo
- 4-11/16" long x 11/16" wide x 5/16" deep – Qty 2
- Complement any EcoBoost®-powered hot rod, street rod or vehicle
- Can be attached on engine covers, doors, fenders, hatches, hoods, etc.
- Automotive-grade double-sided tape included on back of emblem



SILVER ECOBOOST® EMBLEM – MEDIUM SIZE

M-1447-EBMED



- Silver with blue/green EcoBoost® logo
- 5-5/8" long x 13/16" wide – Qty 2
- Complement any EcoBoost®-powered hot rod, street rod or vehicle
- Can be attached on engine covers, doors, fenders, hatches, hoods, etc.
- Automotive-grade double-sided tape included on back of emblem



ECOBOOST® EMBLEM SILVER – LARGE SIZE

M-1447-EBLG



- Silver with blue/green EcoBoost® logo
- Large size – 7-3/8" long x 1" wide – Qty 2
- Complement any EcoBoost®-powered hot rod, street rod or vehicle
- Can be attached on engine covers, doors, fenders, hatches, hoods, etc.
- Automotive-grade double-sided tape included on back of emblem



"POWERED BY FORD PERFORMANCE" BADGE

M-16098-PBFP

- "Powered by Ford Performance" classic fender badge
- Chrome-plated 3-dimensional nameplate with red, black and blue accents
- 5-5/8" long x 1-5/8" high – Qty 2
- Self-adhesive backing designed for application on flat surfaces



STAINLESS STEEL "FORD PERFORMANCE" LICENSE PLATE FRAME

M-1828-SS304C



- Dress up your vehicle with this high-quality license plate frame
- Brushed 304 stainless steel with black laser-etched "Ford Performance" logo



"FORD PERFORMANCE" LICENSE PLATE – SINGLE

M-1828-FPONE



- This license plate has a "Ford Performance" logo on white background
- Sold individually



"FORD PERFORMANCE" TIRE SHADE

M-1822-A9



Ford Performance tire shade blocks the sun's hot rays from your rear tires and keeps them cool for more consistent pressures at the track.

- 42" x 36"
- Safely attaches to body panels via five heavy-duty suction cups
- Made of durable white vinyl with screen printed "Ford Performance" logo
- Fits over most wheel opening sizes



APPEARANCE/DRESS-UP

E-Z UP® INSTANT SHELTERS

"Ford Performance" E-Z UP® Instant Shelter®

Includes: top, frame and cover bag;
blue with white logo.

| PART NUMBER | SIZE |
|--------------------|-----------|
| M-1827-T10A | 10' x 10' |
| M-1827-T20A | 10' x 20' |

ACCESSORIES

"Ford Performance" E-Z UP® Instant Shelter® sidewall

With large "Ford Performance" logo; blue with white logo.

| PART NUMBER | SIZE |
|--------------------|---------------|
| M-1827-W10A | 10' Sidewall* |

*Two 10' sidewalls are required to cover a 20' section.

- E-Z Up® portable shelters are available in 2 sizes
- White "Ford Performance" logo over blue top
- White, powdercoated, rust-resistant steel frame with blue commercial grade 500 denier polyester top
- Patented, elevated center design for increased headroom
- Reinforced trusses with aircraft strength fasteners
- Improved Auto-Peak® and Auto-Slider® offer smoother setup
- Telescoping legs lock into place using the new toggle lock and release system
- Cover bag included
- Sent directly from the manufacturer, please allow 2-3 weeks for delivery



ORDER THESE PRODUCTS FROM ANY FORD PERFORMANCE DEALER. NO RETURN ON SPECIAL ORDERS.

"FORD RACING" DECAL (25 PKG)

M-1820-A1

Pkg. of 25 "Ford Racing" decals with adhesive backing that easily peels off for fast application. 4" x 2-1/2".

"FORD RACING" MINI-DECALS

M-1820-B1

Pkg. of 25 single sheet "peel-off" vinyl decals. Each sheet includes (4) small, (1) medium and (1) large decal. Overall size of group – approximately 6" x 1-3/4". White with blue "Ford" and red "Racing."



"FORD RACING" 50' PENNANT STRING

M-1827-P1 Ford Racing

M-1827-P2 Ford Performance



- Pennant string
- 50' long
- String of rectangular and pennant flags
- Great for any race track, car show, or gearhead's garage



Proudly Made
in the
USA

"FORD PERFORMANCE" BANNER

M-1827-FP

- 5' wide x 3' high
- Multipurpose banners ideal for races, car shows, car clubs, promotions, garage or man cave
- White background with blue and red lettering on heavy gauge plastic
- Includes grommets at attachment points



"FORD PERFORMANCE" DECAL – 10 PACK



M-1820-FP

- 10" x 4"
- "Ford Performance" decals with white background, adhesive backing
- Pkg. of 10



"FORD RACING" VINYL DIE-CUT 15" DECAL

M-1820-FR2 2 Pack

M-1820-FR15 10 Pack

- 15" "Ford Racing" logo decal, red and blue
- Die-cut decals are cut around the letters and logos within the decal to make it appear to be printed directly onto surface after it is applied



"FORD RACING" GENUINE MUSCLE PARTS BANNER

M-1827-A60

- A modern version of the classic "Ford Racing" Genuine Muscle Parts graphic
- Banner is 68" wide x 27" high
- Includes grommets



"FORD RACING" MUSCLE PARTS DECAL

M-1820-A60

- A modern version of the classic "Ford Racing" Genuine Muscle Parts graphic
- Decal is 9.5" wide x 4.5" high
- Great for toolboxes or anywhere in the garage
- Packaged 10 decals per pack



**ACCESSORIES
AND APPAREL**





A



B



C



D



E



F



G

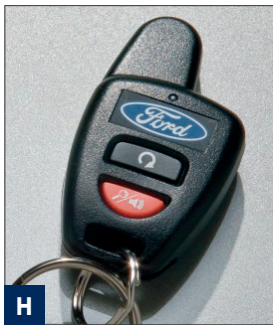

H

ELECTRONICS

Audio Upgrade by KICKER®

Space-saving system with 10" subwoofer and 200-watt RMS digital amp for Livin' Loud® bass.

- A.** CE8Z-18808-A Subwoofer Only, For Sedan Models

Fits Model Years 2011-2018

Bullfrog® Hop by KICKER®

Take-anywhere speaker with signature bass (1.65" drivers, 1.4" x 2.8" subwoofers), 100' streaming, 360° soundfield, AUX jack and 12-hour battery; water-resist/dust-tight IP67 rating.

- + B.** VHL3Z-18808-A Portable Bluetooth® Speaker

Fits Model Years 2013-2018

Bullfrog® Jump by KICKER®

Take-anywhere speaker with signature bass (3" drivers, 3" x 4" subwoofers), 100' streaming, 360° soundfield, FM tuner, AUX jack and 20-hour battery; water-resist/dust-tight IP66 rating.

- + C.** VHL3Z-18808-B Portable Bluetooth® Speaker

Fits Model Years 2013-2018

Bumper-Mounted Warning Sensors by Rosen®

In Reverse, this system scans up to 7' behind your vehicle to help alert you to objects. Requires installation Tool Kit VAS4Z-15A866-C.

- D.** VAS4Z-15A866-B Reverse Sensor

Fits Model Years 2011-2018

Keyless Entry Keypad

Programmable, backlit keypad unlocks or locks your vehicle; no wiring or drilling necessary.

- E.** ES7Z-14A626-A Not Available For Vehicles With Push-Button Start (PEPS)⁴

Fits Model Years 2011-2018

Rear Seat Entertainment – NextBase® Duo Cinema by VOXXHirschmann™

Two adjustable LED 10.1" screens – with a DVD player, plus HDMI and USB inputs, on the master unit – mount on 2-post head restraints; you can show the same thing on both screens.

- + F.** VGJ5Z-10E947-A Dual Portable DVD Players
- + F.** VHJ5Z-10E947-A Single Portable DVD Player

Fits Model Years 2013-2018

Remote Start System

Warm or cool your vehicle interior from afar at the push of a button; range is up to 1,000'⁵
 100 Series: Vehicle parking lights turn on to indicate engine is running.

Bi-Directional: No need to see vehicle – fob flashes/beeps when engine starts; with car find.

- G.** EE8Z-19G364-A Series 100. For Vehicles Equipped Without Push-Button Start.
- G.** EE8Z-19G364-C Series 100. For Vehicles Equipped With Push-Button Start.
- H.** EE8Z-19G364-B Bi-Directional. For Vehicles Equipped Without Push-Button Start.
- H.** EE8Z-19G364-D Bi-Directional. For Vehicles Equipped With Push-Button Start.

Fits Model Years 2014-2018

Vehicle Security System – Ford Perimeter Plus

Has components not available from the factory – if glass or a body panel is impacted, 2-stage shock sensor interprets severity. Alarm also sounds if hood/trunk/hatch/doors forced open.

- I. EE8Z-19A361-A For Vehicles Equipped With Factory Remote Keyless. Uses Factory Key Fob.

Fits Model Years 2014-2018

EXTERIOR

Bumper Protector, Rear

Scuff-resistant appliqué helps safeguard the paint when loading or unloading cargo.

- J. EE8Z-17B807-A Clear, With FIESTA Script

Fits Model Years 2014-2018

Deflector, Aeroskin™ Hood Protector by Lund®

Sleek profile adds appeal and hugs the contours, shielding against bugs, stones and debris.

- K. VAE8Z-16C900-A Smoke-Color

Fits Model Years 2014-2018

Deflectors, Side Window by EGR®

On the go or when parked, let fresh air in and keep rain out; also helps keep sun out of eyes.

- + L. VGE8Z-18246-A Smoke-Color, Front and Rear, 4-Piece Set, For Sedan
- + M. VGE8Z-18246-B Smoke-Color, Front and Rear, 4-Piece Set, For Hatchback

Fits Model Years 2011-2018

Fog Lamp Bezels

A touch more blackout treatment – switch out the bezels surrounding your fog lamps.

- N. EE8Z-17E811-AA Ebony

Fits Model Years 2014-2018

Fuel Plug, Locking

Help ward away tampering with this precision-fit plug; easy on/off at the twist of a key.

- O. 8U5Z-9C268-B

Fits Model Years 2011-2018

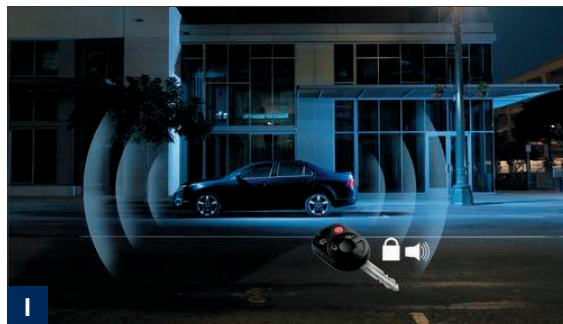

WHEN YOU'RE READY TO PERSONALIZE:

Visit accessories.ford.com

—or—

See your Ford dealer

+ New content added to this issue. | *Ford Licensed Accessory. | ²Vehicle application and restrictions apply. Additional components are required. See dealer for details. | ³Consult your Owner's Manual for specific weight ratings. | ⁴PEPS (Passive Entry/Passive Start) is the Push-Button Start System. | ⁵Distance may vary depending on vehicle location and environment. | ⁶Consult Owner's Manual for details on roof-rack load limits.

FORD FIESTA



A



B

Full Vehicle Cover

Exclusive high-performance fabric with patented encapsulation process: Custom-patterned protection is breathable, foldable and soft-on-paint; outdoor/indoor use.

- A.** EE8Z-19A412-A Weathershield® Style, With ST Logo, For Fiesta ST

Fits Model Years 2014-2018



C



D

Full Vehicle Covers by Covercraft®

Bonded 4-layer composite utilizes bi-component, side-by-side technology: Custom-patterned protection is breathable, foldable and soft-on-paint; outdoor/indoor use.

- A.** VBA6Z-19A412-A Noah® Style, For Hatchback

- A.** VBA6Z-19A412-B Noah® Style, For Sedan

Fits Model Years 2011-2018

Graphics Kit by VISCO®

Mix and match from a sensational selection of eye-grabbing stripes; precision-fit. For Fiesta Hatchback.

- B.** VGA6Z-6320000-A Matte Black, Lower Blade Side Stripe

- C.** VGA6Z-6320000-B Matte Black, Upper Side Stripe

- D.** VGA6Z-6320000-C Matte Black, Dual Over-The-Top Stripes

- E.** VGA6Z-6320000-D Matte Black, Offset Over-The-Top Stripes

- F.** VGA6Z-6320000-E Matte Black, Lower Side Stripes With Fiesta

Fits Model Years 2014-2018



E



F

Graphics Kit, Checkered Flag

Sweet, sweeping design nods to the rally racing roots inherent to every Fiesta; precision-fit.

- G.** EE8Z-5420000-AA Ebony

- H.** EE8Z-5420000-AB Silver

Fits Model Years 2011-2018



G



H

Graphics Kit, FIESTA Lower Door Stripe

Enhance those lower bodyside lines with these make-a-statement stripes; precision-fit.

- I.** DE8Z-5420000-AA Ebony

- J.** DE8Z-5420000-AB Silver

Fits Model Years 2011-2018



I



J

Graphics Kit, FIESTA Tattoo

Guaranteed to turn heads, this striking tribal tattoo spells out Fiesta; precision-fit.

- K.** BE8Z-5420000-AA Black

- L.** BE8Z-5420000-AB Silver

Fits Model Years 2011-2018



K



L

Racks and Carriers by THULE^{®1} **Bike Carrier, Roof-Mounted, Upright⁶**

For loading and unloading, a convenient lever operates the self-adjusting clamps; lockable. *Requires Roof Rack and Crossbar System* by THULE.[®] *Crossbars can accommodate a second roof-mounted bike carrier.*

M. VAT4Z-7855100-K Carries 1 Bike
Fits Model Years 2011-2018



Racks and Carriers by THULE^{®1} **Cargo Box, Roof-Mounted⁶**

Heavy-duty design helps keep out the elements; lockable passenger-side opening is handy. *Requires Roof Rack and Crossbar System* by THULE.[®]

N. VAT4Z-7855100-F 55" x 25" x 12"
Fits Model Years 2011-2018



Racks and Carriers by THULE^{®1} **Paddleboard Carrier, Roof-Mounted⁶**

Telescoping design for a custom fit; locking cam and steel-reinforced webbing add security. *Requires Roof Rack and Crossbar System* by THULE.[®]

O. VFT4Z-7855100-B Stand-up
Fits Model Years 2011-2018



Racks and Carriers by THULE^{®1} **Removable Roof Rack and Crossbar System⁶**

Versatile system helps transport cargo conveniently on top; with bars, feet, fit kit and locks.

P. VDA6Z-7855100-A
Fits Model Years 2011-2018

Racks and Carriers by THULE^{®1} **Ski/Snowboard Carrier, Roof-Mounted, Flat Top⁶**

Locking carrier slides to side of vehicle for easy access; with SpeedLink mounting hardware. *Requires Roof Rack and Crossbar System* by THULE.[®]

Q. VDT4Z-7855100-D Carries 6 Pairs of Skis or 4 Snowboards
Fits Model Years 2011-2018



Splash Guards, Flat

The classic way to help minimize road spray, protecting your paintwork from chips.

R. F6AZ-16A550-AA Mid-Gray, Front Only, 2-Piece Set, With "Ford Oval" Logo
Fits Model Years 2011-2018

Splash Guards, Molded

Uniquely contoured to stylishly help reduce road spray, protecting your finish from chips.

S. 8A6Z-16A550-A Mid-Gray, Rear Only, 2-Piece Set, For Hatchback, Without Logo
S. BE8Z-16A550-AC Mid-Gray, Front Only, 2-Piece Set, Without Logo
Fits Model Years 2011-2018



Spoiler, Rear Roof

This racing-inspired, aero-designed accent enhances looks and helps keep the window clean.

T. 8A6Z-5844210-AB Primed, For Hatchback Only
Fits Model Years 2014-2018

WHEN YOU'RE READY TO PERSONALIZE:

Visit accessories.ford.com

—or—

See your Ford dealer

+ New content added to this issue. | ¹Ford Licensed Accessory. | ²Vehicle application and restrictions apply. Additional components are required. See dealer for details. | ³Consult your Owner's Manual for specific weight ratings. | ⁴PEPS (Passive Entry/Passive Start) is the Push-Button Start System. | ⁵Distance may vary depending on vehicle location and environment. | ⁶Consult Owner's Manual for details on roof-rack load limits.



A



B

Spoiler, Rear Winglet

Unique racing-inspired, aero-designed accent looks sharp and helps keep the window clean.
Not available for Fiesta ST.

- A.** FE8Z-5844210-A Primed, For Hatchback Only.
Attaches to Existing Factory Spoiler.

Fits Model Years 2015-2018

INTERIOR

Armrest by Polytec FOHA¹

Add this cushioned support – complete with covered storage space – to the center console.

- B.** VBA6Z-54644A22-AA Black

Fits Model Years 2011-2018



C



D

Ash Cup/Coin Holder

Keep ashes or change tidily in place; sized just right to slot into a center-console cupholder.

- C.** 5L8Z-7804810-AAA Without Lighter Element
- D.** CM5Z-5404788-AA With Lighter Element

Fits Model Years 2014-2018



E



F

Cargo Area Protector

Preserve flooring with this grooved, raised-lip tray that's shaped to your vehicle's contours.

- E.** EE8Z-6111600-AA Black, For Fiesta ST
- F.** EE8Z-6111600-BA Black, For Titanium Hatchback

Fits Model Years 2014-2018

- G.** BE8Z-6111600-AA Black, For Sedan
- H.** EE8Z-6111600-CA Black, For S and SE Hatchback

Fits Model Years 2011-2018



G



H

Cargo Net

Stretchable, soft braided cording helps keep assorted items in back secure and under control.

- I.** VAA6Z-54550A66-A Envelope Style

Fits Model Years 2011-2018



I



J

Cargo Organizer, Soft

These smart mix-and-match ways to contain groceries and personal belongings can minimize topples or preserve freshness; bag is collapsible, and both organizers store flat.
Cooler Bag: Insulated, lightweight carryall helps keep food and drink cool or warm; zippered.
Large Organizer: 4 mildew-resistant compartments and hookable straps; just over 3' long.
Standard Organizer: 3 mildew-resistant compartments and built-in handles; just over 2' long.

- J.** AE5Z-19H484-A Cooler Bag With Adjustable Carrying Strap
- K.** EE5Z-78115A00-A Large, Folding
- L.** EE5Z-78115A00-B Standard, Folding

Fits Model Years 2011-2018



K



L

**WHEN YOU'RE READY
TO PERSONALIZE:**

Visit accessories.ford.com

–or–

See your Ford dealer

Door Sill Plates

Non-Illuminated: Polished front plates add more dynamism whenever getting in and out.
Illuminated: Simply open either front door to activate the LED glow on the associated plate.

- M.** DE8Z-54132A08-A Stainless Steel, Non-Illuminated, 2-Piece Set, Front
- N.** DE8Z-54132A08-B Stainless Steel, Illuminated, 2-Piece Set, Front
- O.** DE8Z-54132A08-C Stainless Steel, Non-Illuminated, 2-Piece Set, Front, With "ST" Logo
- P.** DE8Z-54132A08-D Stainless Steel, Illuminated, 2-Piece Set, Front, With "ST" Logo

Fits Model Years 2014-2018

First Aid Kit by DC Safety™

Compact case houses emergency essentials – from bandages to sponges – for care on-the-go.

- Q.** VFL3Z-19F515-C

Fits Model Years 2011-2018

Roadside Assistance Kit by DC Safety™

From the reflective vest and bungee tie-down, to jumper cables and a multi-tool, be prepared.

- R.** VFL3Z-19F515-A

Fits Model Years 2011-2018

Floor Mats, All-Weather

Deep grooves and a raised-surround edge help keep mud and slush contained; spray clean. *Dual retention on driver-side mat.*

- S.** EE8Z-5413300-AA Black, 4-Piece Set, With "ST" Script

Fits Model Years 2014-2018

- T.** BE8Z-5413300-AB Black, 4-Piece Set

Fits Model Years 2011-2018

Floor Mats, Carpeted

Premium-grade carpeting complements the interior and protects flooring from wear and tear. *Dual retention on driver-side mat.*

- U.** CA6Z-5413300-AB Charcoal Black, 4-Piece Set

Fits Model Years 2012-2018

Gear Indicator Shift Knob by Gaslock®

Black soft-touch surface complemented with satin-chrome aluminum and a red LCD display.

- V.** VAR3Z-7213-B Illuminated, For Manual Transmission

Fits Model Years 2011-2018

Gear Shift Knob

Exotic high-performance-inspired radiance capped in authentic, weave-patterned carbon fiber.

Not available on Fiesta ST.

- W.** FM5Z-7213-A Black, Carbon Fiber, For 5-Speed Manual Transmission

Fits Model Years 2014-2018

Gear Shift Knob

Exotic high-performance-inspired radiance capped in authentic, weave-patterned carbon fiber.

For Fiesta ST.

- X.** FM5Z-7213-C Black, Carbon Fiber, For 6-Speed Manual Transmission

Fits Model Years 2014-2018

Interior Light Kit

Change up your LED coloration for the center cupholder and front footwells; mix of 7 hues.

- Y.** CL8Z-13E700-AA

Fits Model Years 2011-2018



M



N



O



P



Q



R



S



T



U



V



W



X



Y

+ New content added to this issue. | *Ford Licensed Accessory. | ²Vehicle application and restrictions apply. Additional components are required. See dealer for details. | ³Consult your Owner's Manual for specific weight ratings. | ⁴PEPS (Passive Entry/Passive Start) is the Push-Button Start System. | ⁵Distance may vary depending on vehicle location and environment. | ⁶Consult Owner's Manual for details on roof-rack load limits.

FORD FIESTA



A



B



C



D



E



F

**WHEN YOU'RE READY
TO PERSONALIZE:**

Visit accessories.ford.com

—or—

See your Ford dealer

Tablet Cradle by LumenSM

Securely holds an iPad[®] for backseat viewing; rotates to portrait or landscape mode, and tilts.

A. VEL3Z-19A464-A Mounts to Headrest Supports

Fits Model Years 2011-2018

WHEELS

16" x 6.5" 8-Spoke Sparkle Silver²

Turn heads when you turn corners in these alloy wheels; engineered and tested to rigorous Ford requirements, including extensive evaluation for corrosion resistance.

B. EE8Z-1K007-A Sold Individually

Fits Model Years 2014-2018

16" x 6.5" Black-Painted, Machined²

Turn heads when you turn corners in these alloy wheels; engineered and tested to rigorous Ford requirements, including extensive evaluation for corrosion resistance.

C. FE8Z-1K007-A Sold Individually

Fits Model Years 2014-2018

16" x 6.5" Polished²

Turn heads when you turn corners in these alloy wheels; engineered and tested to rigorous Ford requirements, including extensive evaluation for corrosion resistance.

D. CE8Z-1K007-A Sold Individually

Fits Model Years 2011-2018

17" x 7" Black-Painted²

Turn heads when you turn corners in these alloy wheels; engineered and tested to rigorous Ford requirements, including extensive evaluation for corrosion resistance.

For Fiesta ST.

E. GE8Z-1K007-A Sold Individually

Fits Model Years 2016-2018

Wheel Lock Kit

Help prevent wheel/tire theft; 1 locking lug nut replaces 1 original lug nut on each wheel.

Includes: 4 locking lugs and 1 key.

F. DM5Z-1A043-A Chrome-Plated For Exposed Lugs

Fits Model Years 2014-2018

ELECTRONICS

Bullfrog® Hop by KICKER®¹

Take-anywhere speaker with signature bass (1.65" drivers, 1.4" x 2.8" subwoofers), 100' streaming, 360° soundfield, AUX jack and 12-hour battery; water-resist/dust-tight IP67 rating.

+ G. VHL3Z-18808-A Portable Bluetooth® Speaker

Fits Model Years 2013-2018



Bullfrog® Jump by KICKER®¹

Take-anywhere speaker with signature bass (3" drivers, 3" x 4" subwoofers), 100' streaming, 360° soundfield, FM tuner, AUX jack and 20-hour battery; water-resist/dust-tight IP66 rating.

+ H. VHL3Z-18808-B Portable Bluetooth® Speaker

Fits Model Years 2013-2018

Bumper-Mounted Warning Sensors by Rosen®¹

In Reverse, this system scans up to 7' behind your vehicle to help alert you to objects. Requires installation Tool Kit VAS4Z-15A866-C.

I. VAS4Z-15A866-B Reverse Sensor (Not available on Focus Electric)

Fits Model Years 2007-2018



Keyless Entry Keypad

Programmable, backlit keypad unlocks or locks your vehicle; no wiring or drilling necessary. Not available on Focus Electric.

J. ES7Z-14A626-A Not Available For Vehicles With Push-Button Start (PEPS)⁴

Fits Model Years 2006-2018



Rear Seat Entertainment – NextBase® Duo Cinema by VOXXHirschmannSM

Two adjustable LED 10.1" screens – with a DVD player, plus HDMI and USB inputs, on the master unit – mount on 2-post head restraints; you can show the same thing on both screens.

+ K. VGJ5Z-10E947-A Dual Portable DVD Players

+ K. VHJ5Z-10E947-A Single Portable DVD Player

Fits Model Years 2013-2018



VEHICLE SECURITY SYSTEM – FORD PERIMETER PLUS AND REMOTE START SYSTEMS

Vehicle Security System – Ford Perimeter Plus

Has components not available from the factory – if glass or a body panel is impacted, 2-stage shock sensor interprets severity. Alarm also sounds if hood/trunk/hatch/doors forced open.

Requires dealer installation. Basic remote start (up to 300' range) is available for factory fobs when activated by dealer. Vehicle must be equipped with factory power door locks.

+ L. JJ5Z-19A361-A Plug 'n Play Module With Harness

Fits Model Year 2018

Remote Start System – Long-Range

From up to 1,000'⁵ away, heat up or cool down your vehicle with the 1-button remotes that come with this system; parking lights turn on to indicate the engine is running.

Requires dealer installation. (May require additional equipment.) Includes Ford Perimeter Plus Vehicle Security System. Security system functions and basic remote start (up to 300' range) are available for factory fobs when activated by dealer.

+ L. JJ5Z-19A361-A Plug 'n Play Module With Harness

+ M. JS7Z-15K601-C Long-Range Remote Start Kit

Fits Model Year 2018



⁺ New content added to this issue. | ¹Ford Licensed Accessory. | ²Vehicle application and restrictions apply. Additional components are required. See dealer for details. | ³Consult your Owner's Manual for specific weight ratings. | ⁴PEPS (Passive Entry/Passive Start) is the Push-Button Start System. | ⁵Distance may vary depending on vehicle location and environment. | ⁶Consult Owner's Manual for details on roof-rack load limits.

FORD FOCUS + ELECTRIC



Remote Start System – Long-Range With Confirmation

At up to 1,000',⁵ there's no need to see your vehicle to know it's heating up or cooling down: The system's 2-button remote flashes/beeps to indicate engine idling; with long-range car find.

Requires dealer installation. (May require additional equipment.) Includes Ford Perimeter Plus Vehicle Security System. Security system functions and basic remote start (up to 300' range) are available for factory fobs when activated by dealer. Not available on Focus ST or Focus Electric.

- + A. JJ5Z-19A361-A Plug 'n Play Module With Harness
- + B. JS7Z-15K601-B Long-Range With Confirmation Remote Start Kit

Fits Model Year 2018



Remote Start System – Optional Ultra-Long-Range Extender

More than double your remote-start reach: Maximize it up to a full 2,500'.⁵

Requires dealer installation. For Long-Range Remote Start System and Long-Range Remote Start System With Confirmation.

- + C. JS7Z-15603-A Ultra-Long-Range Extender Antenna Kit

Fits Model Year 2018



Vehicle Security System – Ford Perimeter Plus – Optional LED Kit

A handy visual cue and break-in deterrent; LED indicator turns on when security is active. *Requires Vehicle Security System – Ford Perimeter Plus Module.*

- D. DM5Z-19D596-A LED Kit

Fits Model Years 2016-2018

EXTERIOR

Bumper Protector, Rear

Scuff-resistant appliqué helps safeguard the paint when loading or unloading cargo.

- E. F1EZ-17B807-AA Clear, With FOCUS Script

Fits Model Years 2015-2018



Deflector, Aeroskin™ Hood Protector by Lund®

Sleek profile adds appeal and hugs the contours, shielding against bugs, stones and debris.

- F. VV6Z-16C900-A Smoke-Color

Fits Model Years 2015-2018

Deflectors, Side Window by Lund®

On the go or when parked, let fresh air in and keep rain out; also helps keep sun out of eyes.

- + G. VGM5Z-18246-A Smoke-Color, Front and Rear, 4-Piece Set

Fits Model Years 2012-2018



Fuel Plug, Locking

Help ward away tampering with this precision-fit plug; easy on/off at the twist of a key. *Not available on Focus Electric.*

- H. 8U5Z-9C268-B

Fits Model Years 2012-2018



Full Vehicle Covers

Exclusive high-performance fabric with patented encapsulation process: Custom-patterned protection is breathable, foldable and soft-on-paint; outdoor/indoor use.

- I. CM5Z-19A412-A Weathershield® Style, For Focus Electric
- J. DM5Z-19A412-A Weathershield® Style, For Focus ST, With ST Logo

Fits Model Years 2013-2018

Full Vehicle Covers by Covercraft®

Custom-patterned protection is breathable, foldable and soft-on-paint; outdoor/indoor use. **WeatherShield® Style:** Exclusive high-performance fabric with patented encapsulation process. **Noah® Style:** Bonded 4-layer composite utilizes bi-component, side-by-side technology.

K. VG1EZ-19A412-A Weathershield® Style, For Focus RS
Fits Model Years 2016-2018

L. VCS4Z-19A412-A Noah® Style, For 4-Door Vehicles
M. VFM5Z-19A412-A Noah® Style, For 5-Door Vehicles, With Antenna Pocket
Fits Model Years 2012-2018

Graphics – Bodyside

Enhance those lower bodyside lines with this make-a-statement stripe; precision-fit.

N. CM5Z-5420000-AA Silver
Fits Model Years 2012-2018

Graphics – Over-the-Top Stripe

Add even more sizzle to your ST with these in-your-face special effects; precision-fit.

O. F1EZ-5420000-AA Red, For Focus ST
P. F1EZ-5420000-AB Black, For Focus ST
Fits Model Years 2015-2018

Graphics Kit by visco®

Mix and match from a sensational selection of eye-grabbing stripes; precision-fit. *For Focus Hatchback.*

Q. VGM5Z-6320000-A Matte Black, Lower Side Stripe
R. VGM5Z-6320000-B Matte Black, Upper Side Stripe
S. VGM5Z-6320000-C Matte Black, Dual Over-the-Top Stripe
T. VGM5Z-6320000-D Matte Black, Off-Set Over-the-Top-Stripe
Fits Model Years 2012-2018

Racks and Carriers by THULE®¹ Bike Carrier, Roof-Mounted, Upright⁶

For loading and unloading, a convenient lever operates the self-adjusting clamps; lockable. *Requires Roof Rack and Crossbars System by THULE®. Crossbars can accommodate a second roof-mounted bike carrier.*

U. VAT4Z-7855100-K Carries 1 Bike
Fits Model Years 2008-2018

Racks and Carriers by THULE®¹ Cargo Box, Roof-Mounted⁶

Heavy-duty design helps keep out the elements; lockable passenger-side opening is handy. *Requires Roof Rack and Crossbars System by THULE®.*

V. VAT4Z-7855100-F 55" x 25" x 12"
Fits Model Years 2008-2018

Racks and Carriers by THULE®¹ Kayak Carrier, Roof-Mounted⁶

Transport your kayak stably and securely, all with quick and easy loading and unloading. **Flat:** Flexible cushioned pads conform to hull; with center load straps and end tie-downs. **Folding:** Popular J-style steel cradles have adjustable padding; fold down when not in use. *Requires Roof Rack and Crossbars System by THULE®.*

W. VAT4Z-7855100-G Flat
X. VAT4Z-7855100-H Folding
Fits Model Years 2008-2018



K



L



M



N



O



P



Q



R



S



T



U



V



W



X

+ New content added to this issue. | ¹Ford Licensed Accessory. | ²Vehicle application and restrictions apply. Additional components are required. See dealer for details. | ³Consult your Owner's Manual for specific weight ratings. | ⁴PEPS (Passive Entry/Passive Start) is the Push-Button Start System. | ⁵Distance may vary depending on vehicle location and environment. | ⁶Consult Owner's Manual for details on roof-rack load limits.

FORD FOCUS + ELECTRIC



A



B



C



D



E



F



G



H

Racks and Carriers by THULE®^{®1} Paddleboard Carrier, Roof-Mounted⁶

Telescoping design for a custom fit; locking cam and steel-reinforced webbing add security. Requires Roof Rack and Crossbars System by THULE®.

A. VFT4Z-7855100-B Stand-up

Fits Model Years 2012-2018

Racks and Carriers by THULE®^{®1} Removable Roof Rack and Crossbar System⁶

Versatile system transports cargo conveniently and securely; with bars, feet, fit kit and locks.

B. VDS4Z-7855100-A

Fits Model Years 2012-2018

Racks and Carriers by THULE®^{®1} Ski/Snowboard Carrier, Roof-Mounted, Flat Top⁶

Locking carrier slides to side of vehicle for easy access; with SpeedLink mounting hardware. Requires Roof Rack and Crossbars System by THULE®.

C. VDT4Z-7855100-D Carries 6 Pairs of Skis or 4 Snowboards

Fits Model Years 2008-2018

Splash Guards, Flat

The classic way to help minimize road spray, protecting your paintwork from chips. Not available on Focus Electric, Focus ST or Focus RS.

D. F6AZ-16A550-AA Black, Front or Rear, 2-Piece Set, With "Ford Oval" Logo (Front Only For 2011-2014)

Fits Model Years 2008-2018

Splash Guards, Molded

Uniquely contoured to stylishly help reduce road spray, protecting your finish from chips. Not for use on Focus ST or Focus RS.

E. BM5Z-16A550-A Black, Rear Only, 2-Piece Set, For Hatchback, Without Logo

E. BM5Z-16A550-C Black, Front Only, 2-Piece Set, For Sedan or Hatchback, Without Logo

Fits Model Years 2012-2018

Splash Guards, Molded

Uniquely contoured to stylishly help reduce road spray, protecting your finish from chips.

E. BM5Z-16A550-B Black, Rear Only, 2-Piece Set, For Sedan, Without Logo

Fits Model Years 2012-2018

Spoiler, Rear

Decklid: Add this racing-inspired, aero-designed accent for sportier standout looks.

Roof: Racing-inspired, aero-designed accent enhances looks and helps keep the window clean.

F. GM5Z-5444210-AA Primed, For 4-Door Vehicles, Decklid

Fits Model Years 2015-2018

G. BM5Z-5844210-AB Primed, For 5-Door Vehicles, Roof

Fits Model Years 2012-2018

Spoiler, Rear Winglets

Wing it: Match your vehicle's exterior or mix things up with contrasting colors; aero-designed. Not for use on Focus ST.

H. FM5Z-5844210-A Primed, For Hatchback Only.

Attaches to Existing Factory Spoiler.

Fits Model Years 2015-2018

WHEN YOU'RE READY
TO PERSONALIZE:

Visit accessories.ford.com

—or—

See your Ford dealer

INTERIOR

Ash Cup/Coin Holder

Keep ashes or change tidily in place; sized just right to slot into a center-console cupholder. *Not available on Focus Electric.*

- I. CM5Z-5404788-AA With Lighter Element

Fits Model Years 2012-2018

Cargo Area Protector

Preserve flooring with this grooved, raised-lip tray that's shaped to your vehicle's contours. *Not available with full-size spare.*

- J. CM5Z-6111600-EA Black, Sedan Without Subwoofer
- K. CM5Z-6111600-FA Black, Sedan With Subwoofer
- L. CM5Z-6111600-GA Black, Hatchback Without Subwoofer
(Not Available on Focus Electric)
- M. CM5Z-6111600-HA Black, Hatchback With Subwoofer
(Not Available on Focus Electric)

Fits Model Years 2012-2018

Cargo Mat, Carpeted

Luxurious, contoured mat adds a layer of stain-resistant protection against dirt and debris.

- N. CV6Z-5411600-CA Black, Sedan Without Subwoofer
- O. CV6Z-5811600-DA Black, Hatchback Without Subwoofer
(Not Available on Focus Electric)

Fits Model Years 2012-2018

Cargo Net

Stretchable, soft braided cording helps keep assorted items in back secure and under control.

- P. VAA6Z-54550A66-A Envelope Style, Hatchback

Fits Model Years 2017-2018

Cargo Organizer

Removable, adjustable divider system handily separates items; raised sides aid containment.

- Q. H1EZ-78115A00-AA Behind 2nd Row Seat, For Focus Electric

Fits Model Years 2017-2018

Cargo Organizer, Soft

Insulated, lightweight carryall helps keep food and drink cool or warm; zippered.

- R. AE5Z-19H484-A Cooler Bag With Adjustable Carrying Strap

Fits Model Years 2005-2018

Cargo Organizer, Soft

Smart ways to contain groceries and personal belongings, minimizing topples; both organizers store flat.

Large Organizer: 4 mildew-resistant compartments and hookable straps; just over 3' long.
Standard Organizer: 3 mildew-resistant compartments and built-in handles; just over 2' long.
Not for use with Focus Electric.

- S. EE5Z-78115A00-A Large, Folding
- T. EE5Z-78115A00-B Standard, Folding

Fits Model Years 2005-2018

Charge Cord Bag by THULE®

Neatly protect and store your cord within the semi-hardshell case; zippered open/close.

- U. VCV6Z-10C744-A For Focus Electric

Fits Model Years 2013-2018



+ New content added to this issue. | *Ford Licensed Accessory. | ²Vehicle application and restrictions apply. Additional components are required. See dealer for details. | ³Consult your Owner's Manual for specific weight ratings. | ⁴PEPS (Passive Entry/Passive Start) is the Push-Button Start System. | ⁵Distance may vary depending on vehicle location and environment. | ⁶Consult Owner's Manual for details on roof-rack load limits.

FORD FOCUS + ELECTRIC



A



B

First Aid Kit by DC Safety™

Compact case houses emergency essentials – from bandages to sponges – for care on-the-go.

A. VFL3Z-19F515-C

Fits Model Years 2010-2018

Roadside Assistance Kit by DC Safety™

From the reflective vest and bungee tie-down, to jumper cables and a multi-tool, be prepared.

B. VFL3Z-19F515-A

Fits Model Years 2010-2018



C

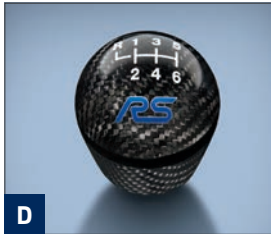

D

Floor Mats, Carpeted

Premium-grade carpeting complements the interior and protects flooring from wear and tear. *Dual retention on driver-side mat.*

C. CM5Z-5413300-BA Black, 4-Piece Set

Fits Model Years 2012-2018

Gear Shift Knob

Exotic high-performance-inspired radiance capped in authentic, weave-patterned carbon fiber.

+ D. H1EZ-7213-A Black, Carbon Fiber, For 6-Speed Manual Transmission, For RS

Fits Model Years 2016-2018

E. FM5Z-7213-B Black, Carbon Fiber, Without Logo, For 6-Speed Manual Transmission

F. FM5Z-7213-C Black, Carbon Fiber, For 6-Speed Manual Transmission, For ST

Fits Model Years 2013-2018



E

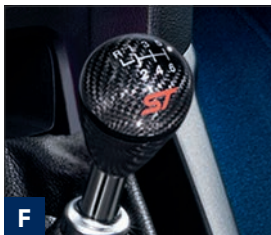

F

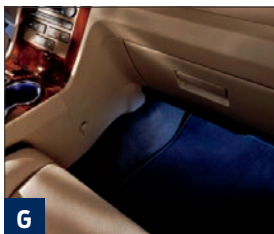

G



H

Interior Light Kit

Change up your LED coloration for the center cupholder and front footwells; mix of 7 hues. *Not available on Focus ST or Focus Electric.*

G. CL8Z-13E700-AA

Fits Model Years 2008-2018

Interior Trim, Door Spears

Exotic high-performance-inspired radiance wrapped in authentic, weave-patterned carbon fiber.

H. G1EZ-58310A00-AA Carbon Fiber

Fits Model Years 2013-2018

Interior Trim, Emergency Brake Handle

Exotic high-performance-inspired radiance wrapped in authentic, weave-patterned carbon fiber. *For manual transmission.*

I. G1EZ-2780-A Carbon Fiber

Fits Model Years 2013-2018

Interior Trim, Instrument Cluster Bezel

Exotic high-performance-inspired radiance wrapped in authentic, weave-patterned carbon fiber.

J. G1EZ-10N848-AA Carbon Fiber, For Focus ST

Fits Model Years 2013-2018



I



J

**WHEN YOU'RE READY
TO PERSONALIZE:**

Visit accessories.ford.com

—or—

See your Ford dealer

Sport Pedals

The genuine aluminum alloy covers make for a more engaging, performance-oriented drive. *Not available on Focus ST.*

K. FM5Z-9G757-A For Manual Transmission

Fits Model Years 2015-2018

Tablet Cradle by Lumen^{®1}

Securely holds an iPad[®] for backseat viewing; rotates to portrait or landscape mode, and tilts.

L. VEL3Z-19A464-A Mounts to Headrest Supports

Fits Model Years 2012-2018

WHEELS

Wheel Center Cap

Switch out your stock "Ford Blue Oval" center caps with these sweet "RS" blue logo versions.

M. GM5Z-1130-A Focus RS Kit, Set of 4

Fits Model Years 2016-2018

Wheel Lock Kit

Help prevent wheel/tire theft; 1 locking lug nut replaces 1 original lug nut on each wheel. *Includes: 4 locking lugs and 1 key.*

N. F6SZ-1A043-AA Chrome-Plated For Exposed Lugs

Fits Model Years 2004-2018

Winter Wheel and Tire Package

When seasons change, get a grip with this unique wheel and tire setup; engineered and tested to rigorous Ford requirements, including extensive analysis in extreme cold and snow.

O. GM5Z-1K007-A For Focus RS

Fits Model Years 2016-2018



+ New content added to this issue. | ¹Ford Licensed Accessory. | ²Vehicle application and restrictions apply. Additional components are required. See dealer for details. | ³Consult your Owner's Manual for specific weight ratings. | ⁴PEPS (Passive Entry/Passive Start) is the Push-Button Start System. | ⁵Distance may vary depending on vehicle location and environment. | ⁶Consult Owner's Manual for details on roof-rack load limits.

FORD MUSTANG



A



B



C



D



E



F

ELECTRONICS

Bullfrog® Hop by KICKER®¹

Take-anywhere speaker with signature bass (1.65" drivers, 1.4" x 2.8" subwoofers), 100' streaming, 360° soundfield, AUX jack and 12-hour battery; water-resist/dust-tight IP67 rating.

+ A. VHL3Z-18808-A Portable Bluetooth® Speaker

Fits Model Years 2011-2018

Bullfrog® Jump by KICKER®¹

Take-anywhere speaker with signature bass (3" drivers, 3" x 4" subwoofers), 100' streaming, 360° soundfield, FM tuner, AUX jack and 20-hour battery; water-resist/dust-tight IP66 rating.

+ B. VHL3Z-18808-B Portable Bluetooth® Speaker

Fits Model Years 2011-2018

Rear Seat Entertainment – NextBase® Duo Cinema by VOXXHirschmann™

Two adjustable LED 10.1" screens – with a DVD player, plus HDMI and USB inputs, on the master unit – mount on 2-post head restraints; you can show the same thing on both screens.

+ C. VGJ5Z-10E947-A Dual Portable DVD Players

+ C. VJH5Z-10E947-A Single Portable DVD Player

Fits Model Years 2011-2018

VEHICLE SECURITY SYSTEM – FORD PERIMETER PLUS AND REMOTE START SYSTEMS

Vehicle Security System – Ford Perimeter Plus

Has components not available from the factory – if glass or a body panel is impacted, 2-stage shock sensor interprets severity. Alarm also sounds if a door, liftgate or hood is forced open. *Requires dealer installation. Basic remote start (up to 300' range) is available for factory fobs when activated by dealer. Vehicle must be equipped with factory power door locks.*

+ D. JS7Z-19A361-A Plug 'n Play Module With Harness

Fits Model Year 2018

Remote Start System – Long-Range

From up to 1,000'¹⁵ away, heat up or cool down your vehicle with the 1-button remotes that come with this system; parking lights turn on to indicate the engine is running.

Requires dealer installation. (May require additional equipment.) Includes Ford Perimeter Plus Vehicle Security System. Security system functions and basic remote start (up to 300' range) are available for factory fobs when activated by dealer.

+ D. JS7Z-19A361-A Plug 'n Play Module With Harness

+ E. JS7Z-15K601-C Long-Range Remote Start Kit

Fits Model Year 2018

Remote Start System – Long-Range With Confirmation

At up to 1,000'¹⁵ there's no need to see your vehicle to know it's heating up or cooling down: The system's 2-button remote flashes/beeps to indicate engine idling; with long-range car find.

Requires dealer installation. (May require additional equipment.) Includes Ford Perimeter Plus Vehicle Security System. Security system functions and basic remote start (up to 300' range) are available for factory fobs when activated by dealer.

+ D. JS7Z-19A361-A Plug 'n Play Module With Harness

+ F. JS7Z-15K601-B Long-Range With Confirmation Remote Start Kit

Fits Model Year 2018

**WHEN YOU'RE READY
TO PERSONALIZE:**

Visit accessories.ford.com

–or–

See your Ford dealer

Remote Start System – Optional Ultra-Long-Range Extender

More than double your remote-start reach: Maximize it up to a full 2,500!⁵
 Requires dealer installation. For Long-Range Remote Start System and Long-Range Remote Start System With Confirmation.

- + G.** JS7Z-15603-A Ultra-Long-Range Extender Antenna Kit
 Fits Model Year 2018

Vehicle Security System – Ford Perimeter Plus – Optional LED Kit

A handy visual cue and break-in deterrent; LED indicator turns on when security is active. Requires Vehicle Security System – Ford Perimeter Plus Module.

- H.** DM5Z-19D596-A LED Kit
 Fits Model Years 2015-2018

EXTERIOR

Front Trim by Dakkota Lighting Technologies¹

Running Pony lights up at night when headlamps activate; has chrome-like finish in daytime. Not for use with Shelby GT350, Shelby GT350R, California Special or Pony Package vehicles.

- I.** VFR3Z-8A224-A Lighted, Mustang “Pony” Emblem
 Fits Model Years 2015-2018

Full Vehicle Covers

Custom-patterned protection is breathable, foldable and soft-on-paint; outdoor/indoor use. **WeatherShield® Style:** Exclusive high-performance fabric with patented encapsulation process. **Noah® Style:** Bonded 4-layer composite utilizes bi-component, side-by-side technology.

- J.** FR3Z-19A412-E Weathershield® Style, For Shelby GT350 With “Cobra” Logo
- K.** FR3Z-19A412-F Weathershield® Style, For Shelby GT350R With Raised Spoiler and “Cobra” Logo
- L.** GR3Z-19A412-A Weathershield® Style, For Coupe, California Special
- M.** GR3Z-19A412-B Weathershield® Style, For Convertible, California Special

Fits Model Years 2016-2018

- N.** FR3Z-19A412-A Weathershield® Style, For Coupe, With Logo
- O.** FR3Z-19A412-B Noah® Style, For Coupe, With Logo
- P.** FR3Z-19A412-C Weathershield Style, For Convertible, With Logo
- Q.** FR3Z-19A412-D Noah® Style, For Convertible, With Logo

Fits Model Years 2015-2018

Graphics Kit by visco² **Over-The-Top Stripes**

Evoke that pulse-pounding competition image wherever the road takes you: Extra-breathhtaking, extra-wide split stripes run the full length of the car; precision-fit. For Mustang Base and GT Coupe models. See dealer for additional details.

- R.** VGR3Z-6320000-B 10" Wide, Matte Black, Dual Stripes
- S.** VGR3Z-6320000-C 10" Wide, Gloss White, Dual Stripes
- T.** VGR3Z-6320000-D 10" Wide, Intense Blue, Dual Stripes
- U.** VGR3Z-6320000-F 10" Wide, Hot Rod Red, Dual Stripes

Fits Model Years 2015-2018



+ New content added to this issue. | ¹Ford Licensed Accessory. | ²Vehicle application and restrictions apply. Additional components are required. See dealer for details. | ³Consult your Owner's Manual for specific weight ratings. | ⁴PEPS (Passive Entry/Passive Start) is the Push-Button Start System. | ⁵Distance may vary depending on vehicle location and environment. | ⁶Consult Owner's Manual for details on roof-rack load limits.

FORD MUSTANG

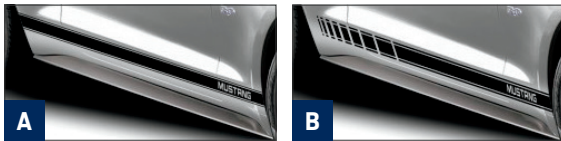

Graphics Kit by VISCO® Side Stripe Kit

Evoke that pulse-pounding competition image wherever the road takes you: Your choice of stellar stripe excitement running along the car's lower bodyside; precision-fit. See dealer for additional details.

- A.** VFR3Z-6320000-A Matte Black, Tri-Bar
VFR3Z-6320000-B Gloss White, Tri-Bar
- B.** VFR3Z-6320000-C Matte Black, Speed Stripe
VFR3Z-6320000-D Gloss White, Speed Stripe

Fits Model Years 2015-2018



Scoops, Quarter Windows by Air Design®

Trick-out your Pony with these old-school-cool scoops, featuring faux honeycomb grilles. Not for use with convertible models.

- + C.** VJR3Z-63280B10-AA Burgundy Velvet
- + D.** VJR3Z-63280B10-AB Orange Fury
- + E.** VJR3Z-63280B10-AC Kona Blue

Fits Model Year 2018



- F.** VHR3Z-63280B10-AA Ingot Silver
- G.** VHR3Z-63280B10-AB Race Red
- H.** VHR3Z-63280B10-AC Ruby Red
- I.** VHR3Z-63280B10-AD Triple Yellow
- J.** VHR3Z-63280B10-AE Magnetic
- K.** VHR3Z-63280B10-AF Absolute Black
- L.** VHR3Z-63280B10-AG Lightning Blue
- M.** VHR3Z-63280B10-AH Oxford White

Fits Model Years 2015-2018



- N.** VHR3Z-63280B10-AJ Grabber Blue
- O.** VHR3Z-63280B10-AK White Platinum
- P.** VGR3Z-63280B10-A Matte Black

Fits Model Years 2015-2017



Scoops, Side by Air Design®

Trick-out your Pony with these old-school-cool scoops, featuring faux honeycomb grilles.

- + Q.** VJR3Z-63279D36-AA Burgundy Velvet
- + R.** VJR3Z-63279D36-AB Orange Fury
- + S.** VJR3Z-63279D36-AC Kona Blue

Fits Model Year 2018

- T.** VHR3Z-63279D36-AA Ingot Silver
- U.** VHR3Z-63279D36-AB Race Red
- V.** VHR3Z-63279D36-AC Ruby Red
- W.** VHR3Z-63279D36-AD Triple Yellow
- X.** VHR3Z-63279D36-AE Magnetic
- Y.** VHR3Z-63279D36-AF Absolute Black
- Z.** VHR3Z-63279D36-AG Lightning Blue
- AI.** VHR3Z-63279D36-AH Oxford White

Fits Model Years 2015-2018

- BI.** VGR3Z-63279D36-A Matte Black
- CI.** VHR3Z-63279D36-AJ Grabber Blue
- DI.** VHR3Z-63279D36-AK White Platinum

Fits Model Years 2015-2017

**WHEN YOU'RE READY
TO PERSONALIZE:**

Visit accessories.ford.com

—or—

See your Ford dealer

Spoiler, Rear

Add one of these racing-inspired, aero-designed accents to the tail for souped-up sizzle.

- EI.** GR3Z-6344210-BC Shelby Track Package Spoiler, Absolute Black (Paint to Match)

Fits Model Years 2016-2018

- FI.** FR3Z-6344210-AC For Coupe, Primed, Blade-Style, Decklid
- GI.** FR3Z-6344210-BC For Coupe, Primed, Raised Blade-Style, Decklid
- HI.** FR3Z-7644210-AB For Convertible, Primed, Blade-Style, Decklid

Fits Model Years 2015-2018

INTERIOR

Cargo Organizer, Soft

These smart mix-and-match ways to contain groceries and personal belongings can minimize topples or preserve freshness; bag is collapsible, and both organizers store flat. **Cooler Bag:** Insulated, lightweight carryall helps keep food and drink cool or warm; zippered. **Large Organizer:** 4 mildew-resistant compartments and hookable straps; just over 3' long. **Standard Organizer:** 3 mildew-resistant compartments and built-in handles; just over 2' long.

- II.** AE5Z-19H484-A Cooler Bag With Adjustable Carrying Strap
- JI.** EE5Z-78115A00-A Large, Folding
- KI.** EE5Z-78115A00-B Standard, Folding

Fits Model Years 2004-2018

First Aid Kit by DC Safety™¹

Compact case houses emergency essentials – from bandages to sponges – for care on-the-go.

- LI.** VFL3Z-19F515-C

Fits Model Years 2010-2018

Roadside Assistance Kit by DC Safety™¹

From the reflective vest and bungee tie-down, to jumper cables and a multi-tool, be prepared.

- MI.** VFL3Z-19F515-A

Fits Model Years 2010-2018

Floor Liners

High-and-wide protection made to original Ford specs: Extra-tall walls and deep-set grooves contain what's tracked in or spilled within; firm-yet-flexible construction with nibbed backing.

Dual retention on driver-side liner.

- + NI.** HR3Z-6313300-AA Black, 4-Piece Set, With "Pony" Logo

Fits Model Years 2015-2018

Floor Mats, Carpeted

Premium-grade carpeting complements the interior and protects flooring from wear and tear. *Dual retention on driver- and passenger-side mats.*

- + OI.** JR3Z-6313300-BA Black, 2-Piece Set, With Black "Pony" Logo

Fits Model Year 2018

- PI.** FR3Z-6313086-AA Black, 2-Piece Set, With Silver "Pony" Logo

Fits Model Years 2015-2018



⁺ New content added to this issue. | ¹Ford Licensed Accessory. | ²Vehicle application and restrictions apply. Additional components are required. See dealer for details. | ³Consult your Owner's Manual for specific weight ratings. | ⁴PEPS (Passive Entry/Passive Start) is the Push-Button Start System. | ⁵Distance may vary depending on vehicle location and environment. | ⁶Consult Owner's Manual for details on roof-rack load limits.

FORD MUSTANG



A



B



C



D

Gear Shift Knob

Exotic high-performance-inspired radiance capped in authentic, weave-patterned carbon fiber.

- A.** FR3Z-7213-D Black, Carbon Fiber, Without Logo, For 6-Speed Manual Transmission

Fits Model Years 2016-2018

Interior Light Kit

Change up your LED coloration for the center cupholder and front footwells; mix of 7 hues.

- B.** CL8Z-13E700-AA

Fits Model Years 2010-2018

Sport Pedals

The genuine aluminum alloy covers make for a more engaging, performance-oriented drive.

- C.** BR3Z-9G757-A Brushed Aluminum, For Automatic Transmission
D. BR3Z-9G757-B Brushed Aluminum, For Manual Transmission

Fits Model Years 2010-2018



E

Sunscreen UVS100® Custom by Covercraft®¹

To help deflect damaging, heat-building UV rays, this sure-fit, accordion-fold screen has a reflective silver outer surface triple laminated over an insulating foam-core center; felt inner side.

- + E.** VJR3Z-78519A02-A

Fits Model Years 2015-2018

Tablet Cradle by Lumen®²

Securely holds an iPad® for backseat viewing; rotates to portrait or landscape mode, and tilts.

- F.** VEL3Z-19A464-A Mounts to Headrest Supports

Fits Model Years 2010-2018

WHEELS



F



G

V6 Mini Spare Tire

Sized just right for stay-put storage in the covered trunk well; kit consists of an 18" x 5" aluminum wheel (plus tire and valve stem), a scissor jack, wrench and retainer bracket. *Not available for vehicles originally equipped with summer tires or 20" wheels/tires.*

- G.** FR3Z-1K007-C

Fits Model Years 2015-2018

Wheel Center Caps

Change out to the wild west-running Pony that's been a tradition since the first Mustang.

- H.** FR3Z-1130-C 4-Piece Set, With "Pony" Logo

Fits Model Years 2015-2018



H



I

Wheel Lock Kit

Help prevent wheel/tire theft; 1 locking lug nut replaces 1 original lug nut on each wheel. *Includes: 4 locking lugs and 1 key.*

- I.** GR3Z-1A043-A Chrome-Plated For Exposed Lugs

Fits Model Years 2015-2018

LIMITED WARRANTY INFORMATION FOR FORD ORIGINAL ACCESSORIES, ALONG WITH FORD LICENSED ACCESSORIES. Ford Original Accessories will be warranted for whichever provides you the greatest benefit: 24 months/unlimited mileage, or the remainder of your Bumper-to-Bumper 3-year/36,000-mile New Vehicle Limited Warranty. Ford Licensed Accessories (FLA) are warranted by the accessory manufacturer's warranty. FLA are designed and developed by the accessory manufacturer and have not been designed or tested to Ford Motor Company engineering requirements. Contact your Ford dealer for details and/or a copy of all limited warranties.

FORD PROTECT™ EXTENDED SERVICE PLANS. Whether you purchase or lease your Ford vehicle, insist on genuine Ford Protect extended service plans. Ford Protect has a variety of plans to give you peace-of-mind protection whether you want vehicle component or maintenance coverage. Plus, they are fully backed by Ford and honored at all Ford dealerships in the U.S., Canada and Mexico. When you visit your dealer, insist on genuine Ford Protect extended service plans.

FORD CREDIT. Get the ride you want. Whether you plan to lease or finance, you'll find the choices that are right for you at Ford Credit. Ask your Ford dealer for details or check us out at fordcredit.com.

⁺ New content added to this issue. | ¹Ford Licensed Accessory. | ²Vehicle application and restrictions apply. Additional components are required. See dealer for details. | ³Consult your Owner's Manual for specific weight ratings. | ⁴PEPS (Passive Entry/Passive Start) is the Push-Button Start System. | ⁵Distance may vary depending on vehicle location and environment. | ⁶Consult Owner's Manual for details on roof-rack load limits.

MAKE IT OFFICIAL!

WITH **CERTIFICATES OF AUTHENTICITY**

MUSTANG BULLITT
The Ford Performance Group certifies that Vehicle Identification Number 1ZVHT82H485177555 is a limited-edition, 2008 Ford Mustang Bullitt assembled at Auto Alliance International on 02/18/2008. This vehicle is #2065 of a build of 6,624 which includes all pre-production units for 2008/09 and is one of 4377 manufactured in Dark Highland Green for your model year.

FORD SHELBY GT500
The Ford Performance Group and Ford Special Vehicle Team certify that Vehicle Identification Number 1ZVBP8J270522253 is a limited-edition, 2013 Ford Shelby GT500 assembled at Flat Rock Assembly on 05/03/2012. This vehicle is #52 of a build of 4877 coupes and is #7 of 461 manufactured in Performance White.

MUSTANG
2013
Mustang
VIN: 1F3P30A684D343349
MSRP: \$23,750
Destination Charge: \$750
Total MSRP: \$24,500

FORD SHELBY GT500
2013
Ford Shelby GT500
VIN: 1ZVBP8J270522253
MSRP: \$52,750
Destination Charge: \$750
Total MSRP: \$53,500

Order your official Certificate of Authenticity today!

- AVAILABLE FOR:**
- Taurus SHO
 - Mustang Bullitt
 - Mustang GT/CS
 - 2005-2006 Ford GT
 - 2007-up Shelby GT500
 - F-150 SVT Raptor
 - 1984-1986 Mustang SVO
 - 2003-2004 Mustang Mach 1
 - 2003-2004 Mercury Marauder
 - 1993-2004 SVT-powered vehicles
 - MCA Edition Mustang
 - 2012-2013 BOSS 302
 - 2012-2017 Focus ST
 - 2015-2017 GT 350

AND MORE!

Also available from Ford Show Parts

Window Stickers for 2007-2017 Ford Vehicles

WWW.FORDSHOWPARTS.COM
800-367-3788



FORD PERFORMANCE

ACCESSORIES AND APPAREL

RS FLEECE JACKET

Storm placket with chin guard, contrast center front with reverse coil zipper, cuffs with thumb holes, chest pocket, 2 lower pockets, audio port access, adjustable shockcord, embroidered logo, polyester fabric bonded with polyester microfleece. Platinum/Blue.

A. 1500436

RS PRATER POLO

The look and feel of a modern and sporty polo. Moisture-wicking, UV protection, snag-resistant, 3-button placket, 2-piece self-fabric collar, 3D patch, micro polyester. Steel Gray/Black.

B. 1500437

RS GRAPHIC T-SHIRT

Combed ringspun cotton, fitted crew styling, prelaundered to reduce shrinkage. White.

C. 1427761

FORD ST GRAPHIC T-SHIRT

Combed ringspun cotton, fitted crew styling, prelaundered to reduce shrinkage. Black.

D. 1427762

RS H2GO HYDRA BOTTLE

Single-wall stainless steel, flip-up straw, includes gift box. 24 oz. Hand wash recommended. Do not microwave. Blue.

E. 1500434

RS PERFORMANCE CAP

Structured, pro mid crown, stitching on visor and eyelets, polyester moisture wicking fabric, adjustable hook-and-loop closure. Graphite.

F. 1500433

RS COLORBLOCK CAP

Structured, 6-panel, low crown, cotton twill, adjustable hook-and-loop closure. Charcoal/Black.

G. 1500432

RS OGIO® APEX RUCKSACK

Polyester fabric, double buckle front flap, front flap zipper pocket, laptop compartment fits up to size 17", interior mesh organizer pockets, 2 side pockets, embroidered logo. 18.5" x 12.25" x 6.5". Heather Gray.

H. 1500435



A.



B.



C.



D.



E.



F.



G.



H.

ACCESSORIES AND APPAREL



A.

FORD PERFORMANCE SUNBURST POLARIZED SUNGLASSES

Scratch-resistant, polarized gray lenses block 99.9% UVA/UVB rays. Microfiber storage pouch. Screened Ford Performance logo. Black.

A. 1431790



B.



C.

FORD PERFORMANCE OGIO® SOFT SHELL JACKET

100% poly stretch shell that is wind and water resistant. Waterproof center front zipper, articulated shaping for ease of movement, zip-through collar, set-in sleeves with shaped cuffs and slight drop tail hem. Black.

B. 1429238 Men's

C. 1429237 Ladies'



E.



F.



D.

FORD PERFORMANCE OGIO® X-OVER CAP

Unstructured low-profile peak, moisture-wicking polyester, branded OGIO® details/visor trim, adjustable antique pewter buckle closure. Black/Red.

D. 1416610

FORD PERFORMANCE LADIES' NIKE POLO

Dri-FIT fabric provides moisture management technology. Comfortable micro pique polo has exceptionally soft hand. Tailored for a feminine fit and features a Johnny collar and open hem sleeves. The Swoosh trademark is embroidered on the left sleeve. Made of 4.4-ounce, 100% polyester.

E. 1429235 White 1429528 Black

FORD PERFORMANCE NIKE POLO

Dri-FIT fabric provides moisture management technology. Comfortable micro pique polo has exceptionally soft hand. Features a flat knit collar, three-button placket, open hem sleeves. The Swoosh trademark is embroidered on the left sleeve. Made of 4.4-ounce, 100% polyester.

F. 1429529 White 1429236 Black

FORD PERFORMANCE IGLOO® DIESEL COOLER

Denier polyester; antimicrobial, antileak liner; 45-can capacity; zip front pocket; metal bottle opener; aluminum pull handle; side/top grab handles; shoulder strap. 23" x 17" x 13". Screened "Ford Performance" logo. Gray.

G. 1431789



G.



H.

FORD PERFORMANCE OUTLANDER CAMP CHAIR

Folding polyester chair with steel frame, cup holder, removable 9-can cooler, headrest pocket, carry bag. 400 lb. capacity. Screened "Ford Performance" logo. Black.

H. 1431788

ACCESSORIES AND APPAREL

FORD PERFORMANCE VACUUM BOTTLE

Double-wall, vacuum-insulated stainless steel body with threaded lid. 26 oz. Hand-wash only. Do not microwave. Matte Black.

A. 1416622

FORD PERFORMANCE KEY CHAIN

Solid metal fob offers a color-filled decoration and everyday performance. Standard split key ring. Measures 2.5" wide. Silver.

B. 1416621

FORD PERFORMANCE OGIO® TRAX POLO

Double-mesh performance polyester; contrast insets at sides, shoulders, sleeves, and 3-button hidden placket; open hem sleeves; red and white "Ford Performance" logo. Black/Gray.

C. 1428746

FORD PERFORMANCE OGIO® ENDURANCE FITTED CAP

Structured peak; wicking, breathable polyester; reflective OGIO® and "Ford Oval" logos; decorative side panels. Stretch sweatband fits most. Gray.

D. 1416624

FORD PERFORMANCE COUNTER STOOL

Retro 50s styling with single foot ring; padded, 360° swiveling seat; nylon floor glides; steel frame. 30" height. Digital "Ford Performance" logo. Black.

E. 1429547

F. 1500248 Replacement seat for 1429547

FORD PERFORMANCE OGIO® BOOM DUFFEL

Polyester fabric, U-shaped main bay, ventilated shoe tunnel, front/side zip pockets, molded grab handle, detachable shoulder strap. 13" x 24" x 12". Blue.

G. 1416630

FORD PERFORMANCE OGIO® CARBON BACKPACK

Polyester fabric, 2 zippered bays, organizer panel in front pocket, padded straps, audio pocket with line port, 2 mesh holsters. 18" x 11" x 8". Black.

H. 1416613



A.



B.



C.



D.



F.



E.



G.



H.

ACCESSORIES AND APPAREL

A.

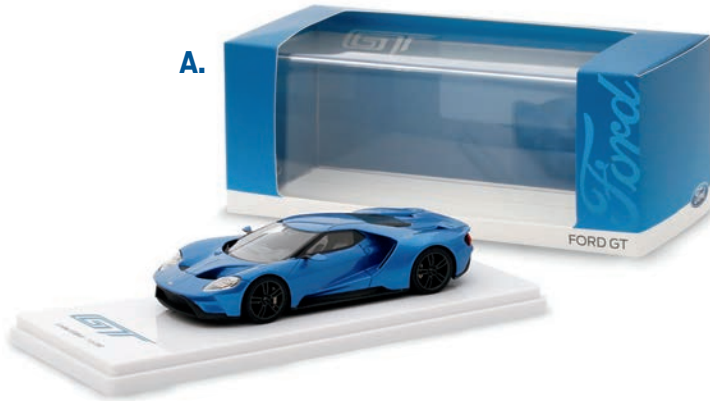

1:43 2017 FORD GT RESIN MODEL

Limited edition 1:43 scale replica of the newly redesigned Ford GT. Debuting at the 2015 Detroit Auto Show, this redesign looks to make a dent in the exotic supercar market. Blue. Quantities limited.

WARNING: CHOKING HAZARD – Small parts. Not for children under 3 years.

A. 1424611

FORD GT ROUND WALL CLOCK

Brushed aluminum frame, glass lens, 3-hand quartz movement. AA battery included. 10" x 1.88". Custom Ford GT art.

B. 1430033

2017 FORD GT REVELL SNAPTITE® SCALE-MODEL KIT

1:24 scale-model GT with 28 SnapTite® pieces for ages 8+. 7.63" x 3.25" assembled. Blue. **WARNING:** CHOKING HAZARD – Small parts. Not for children under 3 years.

C. 1429205

FORD GT CALLAWAY INDUSTRY POLO

Moisture-wicking, stretch-fit polyester; contrast stitching; 3-button placket; Callaway-embossed buttons; side vents. Black.

D. 1427754

FORD GT T-SHIRT

Combed ringspun cotton, unisex sizing, fitted biceps, shoulder tape, side seams. Royal.

E. 1427756

FORD GT COUNTER STOOL

Retro 50s styling with single foot ring; padded, 360° swiveling seat; nylon floor glides; steel frame. 30" height. Digital Ford "GT" logo. Black.

F. 1429548

G. 1500249 Replacement seat for 1429548

FORD GT CAP

Structured, moisture-wicking poly-mesh body; mid-profile peak; UV screen; adjustable Velcro® closure. Black.

H. 1427757

B.



C.



D.



E.



G.



F.



H.



ACCESSORIES AND APPAREL

2017 FORD GT SPECIAL EDITION 1:18 DIECAST

Diecast model features metal body with plastic parts. Includes opening door, hood and trunk, fully functional steering, four-wheel suspension, and detailed chassis with separated exhaust system. Mounted on plastic stand.

A. 1500544 Silver

B. 1500543 Blue

SHELBY GT350 T-SHIRT

Combed ringspun cotton, fitted crew styling, paint splatter artwork may vary between shirts, prelaundered to reduce shrinkage. Black.

C. 1427759

COBRA FOAM CLOCK

3D foam clock. Requires AA battery (not included). 15.25" x 16.75". Multicolor. Made in USA.

D. 1430038

FORD SHELBY GT350 CAP

Structured cotton twill body and adjustable Velcro® closure. "Ford Performance" on side panel. White/Red/Gray/Black.

E. 1427763

FORD SHELBY GT350 CAP

Structured chino twill, cut-and-sew visor, adjustable clip buckle. Embroidered GT350 art and "Ford Performance" logo. Black.

F. 1430036

FORD GT RECTANGULAR METAL SIGN

Indoor tin sign with coated front. 16" x 12.5". Printed GT stacked cars art with "GT" and "Ford Performance" logos. Multicolor.

G. 1430032



A.



B.



C.



D.



E.



F.



G.

ACCESSORIES AND APPAREL



2017 RAPTOR OFF-ROAD KINGS DIECAST

Collect the 2017 Raptor model that is authentic right down to the tiny details. Made of die-cast metal with plastic details, oversized off-road tires, raised suspension with shocks, simulated LED light bars, and opening doors and tailgate. 1:24 scale. Black.

A. 1501310



F-150 2017 RAPTOR DIECAST SCALE MODEL

Collect a model of a pickup that is authentic right down to the tiny details. Made of die-cast metal with plastic details, it has an authentic paint color, treaded tires and realistic emblems. Opening panels reveal even more detail inside. 2017 Raptor in 1:24 scale. Blue.

B. 1430039



F-150 RAPTOR OFF-ROAD T-SHIRT

Preshrunk cotton, double-needle stitching, taped shoulders. Screened Raptor art and "Ford Performance" logo. Gray.

C. 1430040



F-150 RAPTOR SIDEWINDER T-SHIRT

Preshrunk cotton, double-needle stitching, taped shoulders. Screened "Raptor" and "Ford Performance" logos. Royal.

D. 1430041



F-150 RAPTOR MESH CAP

Unstructured washed twill front, mesh back, adjustable clip buckle closure. Embroidered "F-150 Raptor" logo on woven label. Black.

E. 1430042



FORD F-150 SHEEN ALUMINUM BOTTLE

Easy-clean, food-grade aluminum and flip-top, spill-resistant lid with carabiner hook. BPA free. 20 oz. Silver.

F. 1427765

LIGHT IT UP

WITH **PERSONALIZED MUSTANG SCUFF PLATES**

NOW AVAILABLE

Ford Mustang illuminated personalized scuff plates, using LED lighting to illuminate your own personal logo on an aluminum-finish appliqué. Your name or logo is laser-etched into the appliqué and is illuminated with multicolor lighting.

- 2005-2017 Mustang
- Direct OEM replacement part
- Quick, DIY installation
- Add personal style to your Mustang
- Add your own custom, laser-etched logo that illuminates
- Available for 2005-2017 Mustang in red, green, blue or white
- Fully compatible with ambient lighting-equipped 2010-2017 Mustang
- Contains fully assembled driver- and passenger-side scuff plates, with custom content on both
- Resistant to scratching and scuffing
- Protected from UV fading
- Tested to OEM engineering standards
- Full range of Mustang special-edition logos available for imprinting



WWW.FORDSHOWPARTS.COM
800-367-3788



FORD PERFORMANCE

CODES:

- LS = LOCAL SALES**
- MO = MAIL ORDER**
- EB = ENGINE BUILDER**
- IN = INSTALLATION**
- WH = WHOLESALE**

ALABAMA

THE PARTS HOUSE
DOTHAN, AL 36301
334-836-9800
IN, WH

ARKANSAS

CRAFT PERFORMANCE ENGINES
ARKADELPHIA, AR 71923
870-246-7460
MO, EB

ARIZONA

AMP PERFORMANCE
PHOENIX, AZ 85034
602-437-2727
LS, MO, EB, IN, WH

JIM CLICK FORD-LINCOLN
TUCSON, AZ 85711
800-362-7002
LS, MO, IN, WH

SANDERSON FORD/SPECIALTY PARTS
GLENDALE, AZ 85301
888-364-3673
LS, MO, WH

CALIFORNIA

AUTOCARS/SPEEDSHOP DIRECT
ATASCADERO, CA 93422
877-773-3329
LS, MO, WH

CAL-STATE AUTO PARTS, INC.
SAN DIEGO, CA 92123
858-292-1622
WH

DENBESTE MOTORSPORTS
WINDSOR, CA 95492
707-836-1534
LS, MO, EB

ESSLINGER ENGINEERING
SOUTH EL MONTE, CA 91733
626-444-4919
LS, EB, IN

FAIRVIEW FORD SALES, INC.
SAN BERNARDINO, CA 92412
909-386-0220
LS, IN, WH

GALPIN AUTO SPORTS
VAN NUYS, CA 91406
818-922-3800
LS, MO, EB, IN, WH

HAWAII RACING
SIMI VALLEY, CA 93065
805-583-8880
LS, MO, EB, WH

HILLBANK MOTOR SPORTS
IRVINE, CA 92618
888-445-5226
LS, MO, IN, WH

MODULAR MOTORSPORTS
CAMARILLO, CA 93012
805-383-4130
EB, WH

MOTOR WAREHOUSE
SACRAMENTO, CA 95815
916-920-2221
WH

MOUNTUNE
CARSON, CA 90745
714-424-9400

MUSCLE MOTORS DISTRIBUTION
ESCONDIDO, CA 92029
844-466-7347
LS, MO, EB, IN, WH

MUSTANGS PLUS
STOCKTON, CA 95205
800-999-4289
LS, MO

NPW – SPEED WAREHOUSE
HAYWARD, CA 94541
510-786-3555
WH

NPW – SPEED WAREHOUSE
SAN JOSE, CA 33764
408-453-2171
WH

NPW – SPEED WAREHOUSE
TUSTIN, CA 92780
714-832-9521
WH

SERRAMONTE FORD
COLMA, CA 94014
650-755-7007

SPEED WAREHOUSE INC./CMA WAREHOUSE
GARDENA, CA 90248
323-318-7070
WH

TEAM C, INC.
BELLFLOWER, CA 90706
562-866-3887

TURNKEY ENGINE SUPPLY
OCEANSIDE, CA 92056
760-966-2663
LS, EB

WEST COAST DIFFERENTIALS
RANCHO CORDOVA, CA 95742
800-642-0950
WH

COLORADO

COLORADO MUSTANG SPECIALISTS
AURORA, CO 80010
303-343-7024
LS, MO, IN, WH

CONNECTICUT

MUSTANGS UNLIMITED
MANCHESTER, CT 06042
888-398-9898
LS, MO, WH

FLORIDA

BRANDON FORD
TAMPA, FL 33619
813-621-7759
LS, IN, WH

BRANDON FORD PARTS CENTER
TAMPA, FL 33619
813-371-7925
LS, IN, WH

BROTHERS PERFORMANCE WAREHOUSE
DELAND, FL 32724
800-486-2681
LS, MO, IN, WH

DELRAY MOTORS, INC.
DELRAY BEACH, FL 33483
800-433-0018
LS, WH

GARY YEOMANS FORD
DAYTONA BEACH, FL 32124
800-231-6172
LS, MO, IN, WH

ICONIC PARTS
BOYNTON BEACH, FL 33426
561-752-3693
LS, MO, IN, WH

LETHAL PERFORMANCE INC.
WELLINGTON, FL 33414
561-753-8105
LS, MO, WH

NATIONAL AUTO PARTS WAREHOUSE
MIAMI, FL 33155
305-263-8220
WH

NATIONAL AUTO PARTS WAREHOUSE
POMPANO BEACH, FL 33069
954-968-5200
WH

NATIONAL PERFORMANCE WAREHOUSE
CLEARWATER, FL 33764
727-531-8497
WH

NATIONAL PERFORMANCE WAREHOUSE
MIAMI, FL 33014
800-344-0368
WH

POWERED BY FORD
ORLANDO, FL 32805
407-843-3673
LS, MO, EB, IN, WH

STEEDA AUTOSPORTS
POMPANO BEACH, FL 33069
954-960-0774
LS, MO, IN, WH

THE PARTS HOUSE
JACKSONVILLE, FL 32256
866-874-2229
IN, WH

THE PARTS HOUSE
MIAMI, FL 33169
866-874-2229
IN, WH

THE PARTS HOUSE
ORLANDO, FL 32804
866-874-2229
IN, WH

THE PARTS HOUSE
PINELLAS PARK, FL 33773
866-874-2229
IN, WH

THE PARTS HOUSE
TALLAHASSEE, FL 32304
850-575-2000
IN, WH

GEORGIA

ATHENS FORD
ATHENS, GA 30606
706-354-1130

AUTONATION FORD LINCOLN
UNION CITY, GA 30291
770-964-8604
LS, MO, IN, WH

BARNETT PERFORMANCE
ATLANTA, GA 30312
800-533-1320
LS, MO, WH

GWINNETT PLACE FORD
DULUTH, GA 30096
866-665-9318
LS, MO, WH

JON KAASE RACING, INC.
WINDER, GA 30680
770-307-0241

DEALER LIST

MUSTANGS UNLIMITED, INC.

LAWRENCEVILLE, GA 30043
770-446-1965

LS, MO, WH

STEEDA AUTOSPORTS

VALDOSTA GA, 31601
229-249-8151

LS, MO, IN, WH

SUMMIT RACING EQUIPMENT

MCDONOUGH, GA 30253
800-230-3030

LS, MO, WH

ILLINOIS

CHICAGO PARTS AND SOUND

ELK GROVE VILLAGE, IL 60007
630-350-1500

LS, IN, WH

D.S.S. COMPETITION ENGINES

ST. CHARLES, IL 60174
630-587-1169

LS, MO, EB, WH

ROD BAKER FORD SALES

PLAINFIELD, IL 60586
815-439-3400

LS, IN, WH

WEIR FORD

RED BUD, IL 62278
866-712-2388

LS, MO, EB, IN, WH

WEIR WHOLESALE PARTS

RED BUD, IL 62278
866-712-2388

LS, MO, EB, IN, WH

INDIANA

BRENSPEED

PIERCETON, IN 46562
574-594-9559

LS, MO, EB, IN, WH

RAY SKILLMAN PERFORMANCE FORD

GREENWOOD, IN 46143
317-881-2706

LS, IN, WH

THE TIRE RACK

SOUTH BEND, IN 46628-8422
888-541-1777

MO

KANSAS

GFORCE ENGINEERING

WICHITA, KS 67214
316-260-8433

MEL HAMBELTON FORD, INC.

WICHITA, KS 67209
316-462-3673

KENTUCKY

B F EVANS FORD

LIVERMORE, KY 42352
270-278-2376

LS, MO, EB, WH

CORNETT RACING ENGINES

SOMERSET, KY 42501
606-678-2226

LS, MO, EB

MASSACHUSETTS

FORTE PARTS CONNECTION

FRAMINGHAM, MA 01702
508-875-0016

LS, MO, EB, IN, WH

IMPERIALCARS.COM

MENDON, MA 01756
508-473-2800

LS, MO, IN, WH

MARYLAND

RAMSEY FORD

RISING SUN, MD 21911
888-862-1266

SPEED UNLIMITED PERFORMANCE CENTER

MORNINGSIDE, MD 20746
301-420-2727

LS, MO, WH

MAINE

BUTLER MACMASTER

HALLOWELL, ME 04347
207-623-8895

LS, MO, EB

MICHIGAN

CLASSIC DESIGN CONCEPTS

WIXOM, MI 48393
866-624-7997

LS, MO, IN, WH

CPS MICHIGAN

TROY, MI 48084
248-269-9106

LS, IN, WH

DIVERSIFIED PRODUCTS MARKETING, INC.

PLYMOUTH, MI 48170
734-459-0130

MO, WH

DTS/DRIVE TRAIN SPECIALISTS

WARREN, MI 48089
800-521-0628

LS, MO, IN

HOLBROOK RACING ENGINES

LIVONIA, MI 48150
734-762-4315

LS, EB, IN

KINETIC RACING ENGINES

WESTLAND, MI 48185
734-595-7593

EB

KOHR MOTORSPORTS

WESTLAND, MI 48185
734-306-6032

LAFONTAINE PERFORMANCE CENTER

HIGHLAND, MI 48357
248-714-1519

LS, MO, EB, IN, WH

LASCO FORD

FENTON, MI 48430
810-629-2255

LS, MO, IN, WH

LEO CAPALDI RACING, INC.

CHESTERFIELD, MI 48047
586-949-RACE

LS, MO, IN, WH

LIVEROIS MOTORSPORTS

DEARBORN, MI 48125
313-561-5500

LS, MO, EB, IN, WH

MOTOR STATE DISTRIBUTING

WATERVLIT, MI 49098
269-463-4113

WH

ROUSH PERFORMANCE

LIVONIA, MI 48150
800-59-ROUSH

SUBURBAN FORD OF STERLING HEIGHTS

STERLING HEIGHTS, MI 48313
586-268-7500

LS, MO, IN, WH

TOTAL PERFORMANCE

CLINTON TOWNSHIP, MI 48036
586-468-3673

LS, MO, EB, IN, WH

VARSITY FORD INC.

ANN ARBOR, MI 48106
734-996-2300

LS, MO, IN, WH

VILLAGE FORD

DEARBORN, MI 48124
313-565-6799

LS, MO, WH

WATSON RACING

BROWNSTOWN TWP., MI 48193
734-759-0555

LS, MO, IN, WH

MINNESOTA

APPLE VALLEY FORD LINCOLN

APPLE VALLEY, MN 55124
952-431-5900

LS, MO, EB, IN, WH

AUTONATION FORD OF WHITE BEAR LAKE

WHITE BEAR LAKE, MN 55110
800-328-9552

LS, MO, EB, IN, WH

MADELIA FORD

MADELIA, MN 56062
507-642-3268

LS, MO, IN, WH

MISSOURI

ARONSON MOTORSPORTS

CHILLICOTHE, MO 64601
660-646-4553

LS, EB, WH

GATEWAY CLASSIC MUSTANG

BOURBON, MO 65441
573-732-3541

LS, MO, IN

LYNDON'S AUTOMOTIVE

BLOOMFIELD, MO 63825
573-568-2089

LS, MO, EB, WH

SUNSET AUTO COMPANY

ST. LOUIS, MO 63127
314-843-4431

LS, MO, IN, WH

NORTH CAROLINA

CAPITAL FORD OF ROCKY MOUNT

ROCKY MOUNT, NC 27804
252-977-1234

LS, MO, EB, IN, WH

G-FORCE TRANSMISSION

ASHBORO, NC 27205
336-625-3844

HILBISH MOTOR CO.

KANNAPOLIS, NC 28083
800-849-0233

LS, MO, EB, IN, WH

ROUGH YATES PERFORMANCE PARTS

MOORESVILLE, NC 28117
704-662-6982

LS, MO, EB

NEBRASKA

SPEEDWAY MOTORS

LINCOLN, NE 68528
402-323-3210

NEW JERSEY

DOWNS FORD, INC.

TOMS RIVER, NJ 08753
732-349-2240 EXT 958

LS, MO, EB, IN, WH

JDM ENGINEERING INC.

FREEHOLD, NJ 07728
732-780-0770

LS, MO, EB, IN

JOE HECK RACING

OCEAN, NJ 07712
732-330-2329

LS, MO, WH

PAUL MACHENRY & COMPANY

MOORESTOWN, NJ 08057
800-969-3673

LS, MO, IN, WH

NEVADA

CJ PONY PARTS, INC.
LAS VEGAS, NV 89115
800-888-6473
LS, MO, IN, WH

SUMMIT RACING EQUIPMENT

SPARKS, NV 89431
800-230-3030
LS, MO, WH

TURN 14 DISTRIBUTION

RENO, NV 89506
267-468-0350
WH

NEW YORK

LEVITTOWN FORD
HICKSVILLE, NY 11801
877-460-9497
LS, MO, IN, WH

NORTHCOAST PERFORMANCE
ONTARIO, NY 14519
585-216-1210
LS, MO, WH

S-K SPEED RACING EQUIPMENT

LINDENHURST, NY 11757
631-957-9525
LS, MO, EB, WH

OHIO

DON WOOD FORD LINCOLN INC.
ATHENS, OH 45701
740-589-3638
LS, MO, EB, IN, WH

GEORGE'S SPEED SHOP
DAYTON, OH 45404
937-233-0353
LS, EB, WH

JEGS HIGH PERFORMANCE
COLUMBUS, OH 43211
614-294-5151
LS, MO, WH

JEGS HIGH PERFORMANCE
DELAWARE, OH 43015
800-345-4545
LS, MO, WH

PAUL'S AUTOMOTIVE ENGINEERING
CINCINNATI, OH 45242
513-791-1087
LS, MO, EB, IN

RICART FORD (RABID CUSTOMS)
CANAL WINCHESTER, OH 43110
614-836-6567
LS

SUMMIT RACING EQUIPMENT
TALLMADGE, OH 44278
800-230-3030
LS, MO, WH

OKLAHOMA

CLASSIC RECREATIONS
YUKON, OK 73099
405-577-6464
LS, EB, IN

OREGON

IVEY ENGINES
PORTLAND, OR 97230
503-255-1123
EB

PENNSYLVANIA

AMERICANMUSCLE.COM
MALVERN, PA 19355
1-866-727-1266
LS, MO, WH

BESHORE & KOLLER FORD, INC.
MANCHESTER, PA 17345
717-266-3651
LS, MO, IN, WH

CJ PONY PARTS, INC.
HARRISBURG, PA 17112
800-888-6473
LS, MO, IN, WH

FRED BEANS FORD OF BOYERTOWN
BOYERTOWN, PA 19512
610-367-6981
LS, MO, EB, WH

G-FORCE TRANSMISSION
CLEONA, PA 17042
717-202-8360

KEYSTONE AUTOMOTIVE OPERATIONS, INC.
EXETER, PA 18643
570-655-4514

MCNEW'S AUTOMOTIVE
DILLSBURG, PA 17019
717-432-9503
LS, MO, EB, IN, WH

PHOENIX PERFORMANCE LLC
PHOENIXVILLE, PA 19460
610-482-0141

SPRINGFIELD FORD, INC.
SPRINGFIELD, PA 19064
610-544-3778
LS, MO, EB, IN, WH

TURN 14 DISTRIBUTION
HATFIELD, PA 19440
267-468-0350
WH

RHODE ISLAND

TASCA AUTOMOTIVE GROUP
CRANSTON, RI 02920
401-681-1300

TEXAS

AER MFG., INCORPORATED
CARROLLTON, TX 75006
972-418-6499

DALLAS MUSTANG PARTS

DALLAS, TX 75238
800-MUSTANG
LS, MO, EB, IN, WH

LATEMODEL RESTORATION SUPPLY INC.
HEWITT, TX 76643
254-296-6500
LS, MO, WH

MAC HAIK FORD LINCOLN
GEORGETOWN, TX 78626
800-804-4423
LS, MO, IN, WH

SCOGGIN-DICKEY PARTS CENTER
LUBBOCK, TX 79424
800-456-0211
LS, MO, EB, WH

SOUTHWEST FORD, INC.
WEATHERFORD, TX 76086
800-256-7933
LS, MO, WH

SUMMIT RACING EQUIPMENT
ARLINGTON, TX 76018
800-230-3030
LS, MO, WH

TOMMIE VAUGHN MOTORS
HOUSTON, TX 77008
713-869-4755
LS, MO, EB, IN, WH

UTAH

FORD PERFORMANCE RACING SCHOOL
GRANTSVILLE, UT 84074
724-992-2460
LS

VIRGINIA

BRYANT MOTORSPORTS
SALEM, VA 24153
540-387-3854
LS, MO, EB, WH

PURVIS FORD, INC.
FREDERICKSBURG, VA 22401
540-710-1450
LS, WH

TED BRITT FORD SALES
FAIRFAX, VA 22030
703-591-8484
LS, MO, IN, WH

VERMONT

RPM RACING ENGINES
GEORGIA, VT 05478
802-524-7406
LS, MO, EB, WH

WASHINGTON

ALDRIDGE MOTORSPORTS
VANCOUVER, WA 98682
503-284-8484
LS, MO, EB, IN, WH

BICKFORD FORD
SNOHOMISH, WA 98290
800-527-1101
LS, IN, WH

FORD POWERTRAIN APPLICATIONS
PUYALLUP, WA 98371
253-848-9503
LS, MO, EB

WISCONSIN

GORDIE BOUCHER FORD
MENOMONEE FALLS, WI 53051
262-250-9838
LS, MO, EB, IN, WH

PEGASUS AUTO RACING SUPPLIES
NEW BERLIN, WI 53146
800-688-6946
LS, MO, WH

PUERTO RICO

FAJARDO FORD
ROAD #3 KM 41.8, FAJARDO
00738-7005
PUERTO RICO
787-355-5555
LS, IN

CANADA

Central Region

CAMPBELL FORD SALES, LTD.
OTTAWA, ON K1Z 0A3
613-725-3611
LS, MO, IN, WH

DIXIE FORD SALES
MISSISSAUGA, ON L4W 1E6
905-629-0003
LS, IN, WH

KARBELT SPEED & CUSTOM
AJAX, ON L1S 4N8
905-619-6660
WH

R.C.O. ENTERPRISES INC.
AYLMER, ON N5H 2S1
800-297-0874
MO, WH

SEAN HYLAND MOTORSPORT
WOODSTOCK, ON N4V 1B7
519-421-2291
LS, MO, EB, IN

SMYL'S HIGHLAND FORD
SAULT STE MARIE, ON P6B 4Y5
705-759-5050

Eastern Region

FORMULE FORD INC.
GRANBY, QC J2J 0M2
450-777-1777
LS, MO, IN, WH

DEALER LIST

Pacific Region

WEST COAST FORD LINCOLN

MAPLE RIDGE, BC V2X 2P8
604-465-5481

LS, IN, WH

BROWN BROS FORD SALES

VANCOUVER, BC V5X 2S6
604-324-7504

LS, IN, WH

Western Region

DENNY ANDREWS FORD SALES, INC.

EDMONTON AB T5S 1A7
780-489-9999

FREEDOM FORD SALES

EDMONTON AB T6C 4H8
780-462-7575

AUSTRALIA

METRO FORD PARTS DISTRIBUTION CENTRE

BRISBANE, QLD 4009
61-7-3000-7166

LS, MO, WH

EAGLE AUTO PARTS

DANDENONG, VICT 3175
011-613-8710-3000

LS, MO, WH

HERROD MOTORSPORT

THOMASTOWN
MELBOURNE 3074

+61 3 9464 5100

LS, EB, IN, WH

PRA GARAGE

CAMPBELLFIELD, VICTORIA 3061
+61 3 9300 7300

NEW ZEALAND

STA PARTS (SEGEDIN TRUCK & AUTO PARTS LTD)

AIRPORT OAKS, AUCK
011-649-256-1120

LS, MO, WH

CTB PERFORMANCE AND ACCESSORIES

AUCKLAND 2104
+64 9 278 3185

EB, IN, WH

EUROPEAN COUNTRIES

REAL STEEL

COWLEY, MIDDLESEX UB8 2JP
GREAT BRITAIN
44-1895-440505

LS, MO, EB, WH

GRAND GARAGE PAUL WENGLER

ETTELBRUCK, LUXEMBOURG 9353
+35281215735

LS, MO, IN, WH

HANSEN RACING AB

SPANGA 163 54
SWEDEN
46 (0) 8 474 50 50

POWER TORQUE ENGINEERING LTD

BINLEY, COVENTRY CV3 2RQ
UNITED KINGDOM
0046 02476 635757

LS, MO, WH

TEAMFLORAL

8800 ROESELARE
BELGIUM
+32 51 465648

LS, MO, EB, IN, WH

US-PARTS/FINN-AM OY

00880 HELSINKI
FINLAND
358-9-251-31999

SOUTH AFRICA

LAZ PERFORMANCE

CENTURION 0157
+2712 649 4200



PERFORMANCE CRATE ENGINE LIMITED WARRANTY

Rev. May 31, 2017

Ford Performance warrants for 24 months or 24,000 miles / 40,000 kilometres, whichever occurs first subsequent to the original retail purchase, that it will repair or replace, at its option, any Ford Performance engine part that, after inspection, is found to have failed due to a defect in factory supplied material or workmanship. Ford Performance may use new or remanufactured parts for replacement. This limited warranty is valid for the original retail purchaser and is transferable to subsequent owners.

Refer to the Ford Performance Crate Engine Warranty Reference Chart on pages 296-297 for specific coverage by Part Number.

Covered engine parts include the engine block and cylinder heads, all internally lubricated parts of the engine, including pistons, piston rings, piston pins, crankshaft and main bearings, connecting rods and rod bearings, camshaft and camshaft bearings, timing chain, timing chain gears, intake and exhaust valves, valve springs, oil pump, push rods, rocker arms, valve lash adjusters, hydraulic lifters and valve stem seals, to the extent that the original engine contains the referenced warranted part. Parts that require normal manufacturer's recommended replacement intervals are not covered under this warranty.

In the Province of Quebec, none of the limitations and exclusions below will exclude or restrict the warranty provided for in Sections 37 and 38 of the Quebec Consumer Protection Act. This warranty does not preclude the operation of any other provincial statute, which in certain circumstances may not allow some of the limitations and exclusions described in this warranty.

To the extent allowed by law, loss of time, inconvenience, loss of the use of the vehicle, commercial loss and incidental and consequential damages are not covered. There is no other express or implied warranty on these Ford Performance engines including, but not limited to, any implied warranty of merchantability or fitness for a particular purpose.

This engine warranty does not cover:

- Sealed racing engines and other high-performance engines with mechanical lifter camshafts.
 - Parts which are replaced as part of normal maintenance.
 - Engine installation or removal costs.
 - Damage due to improper engine installation, negligence, alteration or accident, including use related to competition racing, marine or motorcycle applications or for other non-vehicle usage.
 - Damage due to addition of power adders such as superchargers, turbochargers or nitrous oxide.
 - Engines where the vehicle odometer has been disconnected or the mileage has been altered.
 - Damage caused by lack of proper maintenance, failure to follow maintenance schedule intervals or failure to use or maintain proper type and levels of fluids, fuel, oil and lubricants, including accelerated wear from contaminated oil or fuel wash.
 - Damage due to engine overheating or oil starvation.
 - Damage resulting from improper engine tuning including, piston skirt scuffing, damage indicated by head gaskets exhibiting burned or crushed fire ring(s), or damage caused by improper combustion, detonation or pre-ignition, as indicated by melted, broken or eroded pistons.
 - Damage resulting from improper transmission installation, including crankshaft thrust bearing damage on transmission side only.
 - Damage caused by foreign objects dropped or drawn into cylinders or the crankcase.
 - Towing, shipping, rental vehicles, loss of time, inconvenience, loss of use or other economic loss to the extent allowed by law, except in the Province of Quebec where reasonable costs of towing and shipping are covered.
 - Ford Performance engines installed in vehicles registered and/or normally operated outside the United States or Canada.
- Proof of proper maintenance is the owner's responsibility. Keep all maintenance receipts and be prepared to make them available.

To obtain warranty repair or replacement, please contact the Ford Performance Call Center at (800) 367-3788, International 01 (313) 621-0771, fwrnty@ford.com, or PO Box 490, Dearborn, MI 48121.



PERFORMANCE CRATE ENGINE LIMITED WARRANTY

Late Model Engine Reference Chart

Rev. May 31, 2017

| Part Number | Description | Warranty* |
|------------------------|---|-----------|
| M-6000-35TK | 3.5L ECOBOOST ENGINE & CONTROL PACK KIT | YES |
| M-6006-M50A | 2015-2017 MUSTANG 5.0L COYOTE LONG BLOCK | YES |
| M-6006-M50A1 | 5.0L COYOTE LONG BLOCK GEN 1 | YES |
| M-6006-M50BOSSS | BOSS 302S SERVICE LONG BLOCK | YES |
| M-6007-20T | 2.0L ECOBOOST ENGINE KIT | YES |
| M-6007-23T | 2.3L MUSTANG ECOBOOST CRATE ENGINE | YES |
| M-6007-23TK | 2.3L MUSTANG ECOBOOST ENGINE AND CONTROL PACK KIT | YES |
| M-6007-35T | 3.5L GTDI ECOBOOST V6 ENGINE KIT | YES |
| M-6007-A50NAA | CRATE ENGINE COYOTE ALUMINATOR N/A | YES |
| M-6007-A50SCA | CRATE ENGINE ALUMINATOR S/C | YES |
| M-6007-A50XS | 5.0L ALUMINATOR XS CRATE ENGINE 500HP | YES |
| M-6007-A52XS | 5.2L COYOTE ALUMINATOR XS | YES |
| M-6007-M50A | 2017 MUSTANG 5.0L COYOTE CRATE ENGINE | YES |
| M-6007-M50AAUTO | 5.0L COYOTE 435HP MUSTANG CRATE ENGINE AUTOMATIC | YES |
| M-6007-M50AK | 5.0L COYOTE CRATE ENGINE AND CONTROL PACK | YES |
| M-6007-M50S | CRATE ENGINE SEALED RACING 5.0L 4V | — |
| M-6007-M50SA | SEALED COYOTE STOCK ENGINE GEN2 | — |
| M-6007-SCJ16 | COBRA JET ENGINE 2016 | — |
| M-6009-A50NAA | 5.0L COYOTE ALUMINATOR NA SHORT BLOCK | — |
| M-6009-A50SCA | 5.0L COYOTE ALUMINATOR SC SHORT BLOCK | — |
| M-6009-B53 | 5.3L MODULAR BOSS STROKER SHORT BLOCK | — |
| M-6009-C54SC4 | 5.4 4V S/C IRON SHORT BLOCK | — |
| M-9000-20TIVCT | 20Ti-VCT ENGINE AND CONTROL KIT | YES |
| M-9000-20TK | 2.0L ECOBOOST ENGINE AND CONTROL PACK KIT | YES |
| M-9000-PMCA | 5.0L COYOTE POWER MODULE 6 SPEED AUTOMATIC | YES |
| M-9000-PMCM | 5.0L COYOTE POWER MODULE 6 SPEED MANUAL | YES |

*Limited Engine Warranty of 2 yr. or 24,000 mi. or 40,000 km.



PERFORMANCE CRATE ENGINE LIMITED WARRANTY

Push Rod Engine Reference Chart

Rev. May 31, 2017

| Part Number | Description | Warranty* |
|------------------------|---|-----------|
| M-6007-D347SR | CRATE ENGINE SEALED CIRCLE TRACK | — |
| M-6007-D347SR7 | CRATE ENGINE 347 SEALED RACING 7 MM VALVES | — |
| M-6007-S347JR | CRATE ENGINE SEALED RACING | — |
| M-6007-X302B | CRATE ENGINE BOSS302 PUSH ROD | YES |
| M-6007-X302E | CRATE ENGINE BOSS302 PUSH ROD | YES |
| M-6007-X347DF | FRONT SUMP 347 STREET ENGINE DRESSED | YES |
| M-6007-X347DR | REAR SUMP 347 STREET ENGINE | YES |
| M-6007-X427FFT | CRATE ENGINE 427 X-HEAD IRON BLOCK - FRONT SUMP | YES |
| M-6007-X427FRT | CRATE ENGINE 427 X-HEAD IRON BLOCK - REAR SUMP | YES |
| M-6007-Z2363FT | 363 CUBIC INCH 500 HP BOSS CRATE ENGINE | YES |
| M-6007-Z2363RT | 363 CUBIC INCH 500 HP BOSS CRATE ENGINE | YES |
| M-6007-Z2427FFT | CRATE ENGINE 427 IRON BLOCK - FRONT SUMP | YES |
| M-6007-Z2427FRT | CRATE ENGINE 427 IRON BLOCK - REAR SUMP | YES |
| M-6007-Z427AFT | CRATE ENGINE 427 ALUMINUM BLOCK - FRONT SUMP | — |
| M-6007-Z427ART | CRATE ENGINE 427 ALUMINUM BLOCK - REAR SUMP | — |
| M-6007-Z460FFT | CRATE ENGINE 460 IRON BLOCK - FRONT SUMP | YES |
| M-6007-Z460FRT | CRATE ENGINE 460 IRON BLOCK - REAR SUMP | YES |
| M-6009-347 | SHORT BLOCK 347 NEUTRAL BALANCE | — |
| M-6009-363 | SHORT BLOCK BOSS 363 CU IN | — |
| M-6009-427A | 427 CUBIC INCH ALUMINUM SHORT BLOCK | — |
| M-6009-427F | 427 CUBIC INCH BOSS SHORT BLOCK | — |
| M-6009-460 | 460 CUBIC INCH BOSS SHORT BLOCK | — |

*Limited Engine Warranty of 2 yr. or 24,000 mi. or 40,000 km.



**SELECT FORD PERFORMANCE PARTS
AND
mountune® PERFORMANCE PARTS LIMITED WARRANTY
Rev. August 1, 2017**

Ford Motor Company, The American Road, Dearborn, MI 48025, provides a Limited Warranty on select Ford Performance Parts and mountune® Performance Parts as described herein when installed on late model Ford vehicles. This warranty works in conjunction with – and does not void – the Manufacturer’s New Vehicle Limited Warranty. It is valid for the original retail purchaser of the vehicle and is transferable to subsequent vehicle owners.

Performance Packs and Component Parts

Performance Packs and Components are warranted for factory-supplied material or workmanship when correctly and completely installed on a late model Ford vehicle by an authorized Ford or Lincoln Dealer, Shelby American, Inc., mountune LLC or an automotive service technician certified by the Institute for Automotive Service Excellence (ASE) or endorsed by the Red Seal Program (RSE). This Performance Packs and Components Limited Warranty begins upon installation and registration of the part(s) with Ford Performance and remains in effect for the balance of 36 months or 36,000 miles / 60,000 kilometres, whichever occurs first, *calculated from the start date of the manufacturer’s New Vehicle Limited Warranty.*

Installation of these select Ford Performance and mountune warranted performance packs and components by an authorized installer will NOT void your New Vehicle Limited Warranty. Engine, driveline and suspension concerns not caused by the use of Ford Performance or mountune parts remain eligible for warranty coverage according to the terms of the New Vehicle Limited Warranty.

Ford Performance and mountune parts are aftermarket parts. The use of Ford Performance and mountune parts may impact the performance characteristics of other systems of the vehicle. Even when operating properly, Ford Performance and mountune parts, such as these, have the potential to adversely impact other systems of the vehicle. If an adverse impact is caused by a warranted Ford Performance or mountune performance pack or component, the period and coverage of this Ford Performance Limited Warranty applies to the repairs.

Premium Fuel Requirement: Customers who purchase power upgrade packs, cold air kits with calibration, engine calibrations, or superchargers are required to use 91-octane or higher (“premium”) fuels at all times. Any failures associated with the non-use of premium fuel will be ineligible for warranty repair.

Performance Handling Pack FR3/FR3A Note: Performance handling packs are designed for “Track Day” ride and handling. Such performance standards suggest the vehicle ride will be more indicative of race performance vehicles. Certain vehicle conditions including, but not limited to, squeaks, rattles and harsh ride related to use of a Performance Handling Pack or components will not be covered under this Limited Warranty. The performance handling pack requires the use of original equipment size wheels only. It is strongly recommended after installation that the alignment be checked to ensure measurements are within factory specifications. Premature tire degradation will not be covered under this Limited Warranty. Contact the **Ford Performance Call Center at (800) 367-3788 or fwrnty@ford.com** for front end alignment information.

Warranty Registration: This Limited Warranty requires that parts must be purchased from an authorized Ford Performance Distributor and installed by an authorized Ford or Lincoln Dealer, Shelby American, Inc., mountune LLC or an automotive service technician certified by the Institute for Automotive Service Excellence (ASE) or endorsed by the Red Seal Program (RSE). Proof of purchase is required for submission of warranty claims. Registration for this warranty must be submitted through the **Ford Performance Call Center at (800) 367-3788 or fwrnty@ford.com** with the vehicle identification number (VIN), part installation repair order and date, Ford Performance part number, and owner contact information.



FORD PERFORMANCE

WARRANTED PERFORMANCE PACKS AND COMPONENT PARTS

The Ford Performance Parts Limited Warranty covers the following select Mustang, Fiesta, Focus, F-150 and Taurus performance pack and component part numbers:

Mustang GT

Power Upgrade Packs: M-9452-M8, (2015-2017)

Cold Air Kits/High-Flow Filters w/ Calibration: M-9603-M8 (2015-2017), M-9603-M8A (2015-2017)

Shifters: M-7210-M8 (2015-2017), M-7210-MA (2015-2017)

Handling Packs: M-FR3A-M8A (2015-2017), M-FR3A-MAA (2015-2017)

Exhaust/X-Pipe: M-5230-M8* (2015-2017), M-5200-M8* (2015-2017), M-5220-M8 (2015-2017), M-5251-M8 (2015-2017)

Mustang EcoBoost®

Cold Air Kits/High-Flow Filters w/ Calibration: M-9603-M4 (2015-2017)

Shifters: M-7210-M8 (2015-2017), M-7210-MA (2015-2017)

Handling Packs: M-FR3A-MAA, M-FR3A-M8A (2015-2017)

Exhaust: M-5230-M4* (2015-2017), M-5200-M4* (2015-2017)

Mustang GT350

Shifters: M-7210-M8A (2015-2017)

Exhaust: M-5200-MSS (2015-2017)

Fiesta/Fiesta ST

Calibration/Cold Air Kits w/ Calibration: mountune 2364-215-AA (2014-2015), mountune 2364-CAIS-AA (2014-2015), mountune 2364-IC-AA (2014-2015), mountune 2364-IC-BA (2014-2015)

Shifters: mountune 2238-BQS-AA (2014-2015), mountune 2130-BSA-AA (2012-2015)

Exhaust: M-5230-FAC (2011-2017), M-5230-FAB (2011-2017), M-5200-FAST (2014-2017)

Focus/Focus ST/Focus RS

Power Upgrade Packs: M-FR1-FSTA (2014-2017)

Calibration/Cold Air Kits w/ Calibration: M-14204-FSTA (2014-2017), M-9603A-FSTA (2014-2017), M-9603-FRS (2016-2017), mountune 2363-280-BB (2015-2017), mountune 2363-CAIS-BA (2014-2017), mountune 2363-IC-BA2 (2015-2017)

Shifters: M-7210-FST (2014-2017), mountune 2363-BSA-AA (2014-2017)

Exhaust: M-5230-FSH (2014-2017), M-5200-FSH (2014-2016), M-5200-FST (2014-2017), M-5200-FRS (2016-2017), mountune 2363-CBE-AA (2014-2017)

F-150/F-150 Raptor

Exhaust F-150: M-5200-F15* (2015-2017)

Exhaust Raptor 3.5L: M-5248-F15R* (2017)

TAURUS SHO

Exhaust: M-5200-SHOTC (2010-2017)

*All exhaust system part numbers that begin with M-5230-M8, M-5200-M8, M-5230-M4, M-5200-M4, M-5200-F15 or M-5248-F15R are covered under the Ford Performance Parts Limited Warranty. See www.performanceparts.ford.com for part-specific product warranties.



**SELECT FORD PERFORMANCE PARTS
LIMITED WARRANTY
Rev. August 1, 2017**

Superchargers MY 2015-2017

Select superchargers are warranted for factory-supplied material or workmanship when correctly and completely installed by an authorized Ford or Lincoln Dealer, Shelby American, Inc. or an automotive service technician certified by the Institute for Automotive Service Excellence (ASE) or endorsed by the Red Seal Program (RSE).

Installation of these select Ford Performance warranted superchargers by an authorized installer will NOT void your New Vehicle Limited Warranty. Engine, driveline and suspension concerns not caused by an installed Ford Performance supercharger remain eligible for warranty coverage according to the terms of the New Vehicle Limited Warranty.

Ford Performance superchargers are aftermarket parts. The use of Ford Performance superchargers may impact the performance characteristics of other systems of the vehicle. Even when operating properly, Ford Performance superchargers, such as these, have the potential to adversely impact other systems of the vehicle. Engine, driveline and suspension concerns caused by an installed Ford Performance supercharger are not eligible for warranty coverage according to the terms of the New Vehicle Limited Warranty or this Ford Performance Supercharger Limited Warranty.

Supercharger Application: Superchargers are covered by this Limited Warranty only when installed by an authorized installer on a 5.0L engine in the vehicle for which they were designed, i.e. the Mustang GT MY 2015-2017 and the Shelby GT MY 2015-2017.

Ford Performance Parts Limited Warranty supercharger coverage: Part Number: **M-6066-M8627** is warranted for factory-supplied material or workmanship for 36 months or 36,000 miles / 60,000 kilometres from the vehicle's original in-service date as determined by Ford OASIS (Online Automotive Service Information System). Contact **(800) 597-6874** for warranty concerns or warranty claim prior approval.

Premium Fuel Requirement: Customers who purchase power upgrade packs, cold air kits with calibration, TracKey/Track Cal engine calibrations, or superchargers are required to use 91-octane or higher ("premium") fuels at all times. Any failures associated with the non-use of premium fuel will be ineligible for warranty repair.

Warranty Registration: This limited warranty requires that parts must be purchased from an authorized Ford Performance Parts Distributor Dealer and installed by an authorized Ford or Lincoln Dealer, Shelby American, Inc., mountune® LLC or an automotive service technician certified by the Institute for Automotive Service Excellence (ASE) or endorsed by the Red Seal Program (RSE). Proof of purchase is required for submission of warranty claims. Registration for this warranty must be submitted through the **Ford Performance Call Center at (800) 367-3788** or **fwrnty@ford.com** with the vehicle identification number (VIN), part installation repair order and date, Ford Performance Parts part number, and owner contact information.

Optional Limited Powertrain Warranty: Optional powertrain warranty is available for purchase within thirty (30) days of the service order installation date identified on your installation receipt. Contact **ROUSH Performance Customer Service at (800) 597-6874** or **rppcustomerservice@roush.com**.



**SELECT FORD PERFORMANCE PARTS
WARRANTY LIMITATIONS
Rev. August 1, 2017**

The following limitations apply to the products covered by this Ford Performance Parts Limited Warranty:

- The purchase invoice(s) is required for submission of warranty claims.
- Where a warranted Ford Performance part is replaced under this Limited Warranty, the replacement Ford Performance part is warranted only for the time remaining in the original Limited Warranty.
- **This warranty does not cover parts with:**
 - Damage as a result of misuse of a vehicle, such as competitive racing, overloading, driving over curbs or using the vehicle as a stationary power source.
 - Damage or corrosion due to accidents, misuse, negligence, lack of proper maintenance or failure to follow maintenance schedule intervals. Proof of proper maintenance is the owner's responsibility. Keep all receipts and be prepared to make them available.
 - Damage or surface corrosion from the environment such as acid rain, airborne fallout (chemicals, tree sap), stones, salt, road hazards, wind storm, lightning, floods and other natural disasters.
 - Normal wear, tear or deterioration such as discoloration, fading, or blurring.
 - Damage due to improper installation, alteration, including calibration, use related to racing or competition, marine or motorcycle applications, or other non-vehicle usage.
- **This warranty does not cover:**
 - Non-Ford Performance parts or Genuine Ford replacement parts or accessories which Ford Dealers may sell or install on your Ford vehicle.
 - Parts replaced or labor charges incurred as part of normal vehicle maintenance.
 - Engine damage associated with use of fuels less than 91-octane.
 - Replacement parts or accessories installed on a Ford vehicle in which the odometer has been altered, or on which the actual mileage cannot be readily determined.
 - Replacement parts or accessories used in applications for which they are not designed.
 - Towing, shipping, rental vehicles, loss of time, inconvenience, loss of use or other economic loss to the extent allowed by law, except in the Province of Quebec where reasonable costs of towing and shipping are covered.
 - Parts installed in vehicles registered and/or operated outside the United States or Canada.
- Should Ford Performance modify any currently released parts which apply to this warranty program, Ford Performance is not obligated to update any previously manufactured parts.
- In the Province of Quebec, none of the limitations and exclusions above exclude or restrict the warranty provided for in sections 37 and 38 of the Quebec Consumer Protection Act.

NOTE: Federal and many state and provincial laws prohibit the removal, modification or rendering inoperative of any part that affects emissions or safety on motor vehicles used on public streets or highways. Ford Performance customers are responsible for complying with applicable federal, state, provincial and local environmental laws, including but not limited to, with respect to vehicle emissions. It is the responsibility of the customer to determine if their modified vehicle complies with applicable laws.

THIS LIMITED WARRANTY GIVES YOU SPECIFIC LEGAL RIGHTS. YOU MAY HAVE OTHER RIGHTS THAT VARY FROM STATE TO STATE AND PROVINCE TO PROVINCE. THIS LIMITED WARRANTY IS THE ONLY EXPRESS WARRANTY APPLICABLE TO THESE PARTS. FORD PERFORMANCE AND FORD MOTOR COMPANY ARE NOT RESPONSIBLE FOR ANY TIME FOR WHICH YOU MAY LOSE THE USE OF YOUR VEHICLE, ANY INCONVENIENCE YOU MIGHT BE CAUSED, THE LOSS OF YOUR TRANSPORTATION OR ANY PART THEREOF, OR ANY OTHER INCIDENTAL OR CONSEQUENTIAL DAMAGES YOU MAY HAVE. YOU MAY HAVE SOME IMPLIED WARRANTIES UNDER STATE OR PROVINCIAL LAW, FOR EXAMPLE, THE IMPLIED WARRANTY OF MERCHANTABILITY OR THE IMPLIED WARRANTY OF FITNESS FOR A PARTICULAR PURPOSE.

Questions or concerns relating to this warranty policy may be answered by contacting the **Ford Performance Call Center at (800) 367-3788, International 01 (313) 621-0771, or fwrnty@ford.com.**



CONSUMER DISCLAIMER NOTICE

All Ford Performance parts are aftermarket parts. Ford Performance parts are not Genuine Ford Parts. Therefore, they may not be used in any application that requires the use of Genuine Ford Parts. The use of Ford Performance parts and components may impact the performance characteristics of other systems of the vehicle. When operating properly, Ford Performance crate engines, performance parts and components have the potential to adversely impact other systems of the vehicle. Except as set forth herein, such damage is the sole responsibility of the consumer and is not covered by this Limited Warranty.

Consumers are solely and completely responsible for evaluating their vehicle to ensure that the vehicle, and each part of that vehicle, is appropriate for this Ford Performance engine, part or component. It is the consumer's sole responsibility to have the performance enhancement parts properly installed on their vehicle along with any modifications necessary for the proper performance of the vehicle. Vehicle damage caused by a consumer's failure to modify the vehicle properly for use of one or more Ford Performance parts and components is not covered by this Limited Warranty and is the sole responsibility of the consumer. This Limited Warranty and/or the New Vehicle Limited Warranty on your vehicle may be voided, either in whole or in part, where the vehicle has been damaged due to a consumer's failure to modify the vehicle properly as necessary for use of Ford Performance parts and components.

Most Ford Performance parts are not sold with a warranty. Ford Performance parts are sold "as is", "with all faults", "as they stand" and without any express warranty whatsoever, unless otherwise expressly designated herein. To the fullest extent allowed by the state and federal law, Ford Motor Company expressly disclaims the implied warranties of merchantability and of fitness for a particular purpose, even if a particular purpose is mentioned herein. Ford also expressly disclaims all liability for direct, indirect, special, incidental or consequential damages, including but not limited to, damage or loss of property or equipment, loss of profits or

revenue, cost of purchase or replacement of goods, or claims of customers of the purchaser that result from the use of any and all parts or vehicles contained in this catalog. In no event shall the liability of Ford Motor Company, whether in tort, contract or otherwise, exceed the cost of the part or vehicle. However, you may have legal rights which vary from state to state.

Should any parts contained within this catalog prove defective following their purchase, the buyer and not the manufacturer, distributor or retailer, shall assume the entire cost of all necessary servicing and/or repair. The entire risk as to the performance of such parts or vehicles is with the buyer.

No vehicle in this catalog or offering is street legal or certified under federal motor vehicle safety standards and regulations. Vehicles that are not street legal or certified under federal motor vehicle safety standards and regulations are neither intended nor certified for use on public roads. Many of the parts in this catalog are not designed or tested for crashworthiness or to meet the safety needs of the motoring public. Instead, these parts are designed and intended for race vehicles on race tracks with engineers supervising the installation and use of the race parts to ensure that the safety needs of the race driver are met. The racing parts could conceivably be combined in an infinite combination, and the use of some parts on some vehicles could adversely affect the performance of the vehicle or other race parts.

To the extent that a part contained within this catalog comes with a warranty from the original manufacturer, not Ford Performance or Ford Motor Company, the buyer should contact the original manufacturer for any and all warranty repair or replacement. To determine which parts come with a warranty from the original manufacturer, not Ford Performance, please contact the **Ford Performance Call Center at (800) 367-3788, fwrnty@ford.com or:**

**FORD PERFORMANCE PARTS
P.O. BOX 490
DEARBORN, MI 48121**

SUGGESTED RETAIL PRICE LIST

FOR THE MOST UP-TO-DATE PRICING AND TECH INFO VISIT performance.ford.com

| Part Number | Description | Pg. No. | Sugg. Retail | Part Number | Description | Pg. No. | Sugg. Retail |
|----------------|--|---------|--------------|----------------------|--|---------|--------------|
| 2130-BSA-AA | MOUNTUNE QUICK-SHIFT FIESTA 5 SPD | 103 | \$239.00 | 2536-IH-BLK | 2016 FOCUS RS HIGH-FLOW INDUCTION HOSE - BLACK | 93 | \$69.00 |
| 2226-TRV-AA | MOUNTUNE UPATED AIR RE-CIRCULATION VALVE | 82 | \$159.00 | 2536-IH-LBLU | 2016 FOCUS RS HIGH-FLOW INDUCTION HOSE - BLUE | 93 | \$69.00 |
| 2238-BQS-AA | MOUNTUNE BILLET QUICK-SHIFT FIESTA ST | 103 | \$159.00 | 2536-MSK-RS1 | FOCUS RS MOUNTUNE SPORT SPRING SET | 95 | \$259.00 |
| 2363-280-BA | MP275 UPGRADE BLACK W/HANDSET/CAL - FOCUS ST | 75 | \$2,149.00 | 2536-PBKT-AA | FOCUS RS MOUNTUNE PTU BRACE | 95 | \$169.00 |
| 2363-280-BB | PERFORMANCE UPGRADE MP275 FOCUS ST 2015-2016 | 75 | \$1,999.00 | 2536-SSC-AA | FOCUS RS MOUNTUNE SOUND SUPPRESSION CHAMBER | 94 | \$59.00 |
| 2363-AF-AA | MOUNTUNE HIGH-FLOW AIR FILTER - FOCUS ST | 81 | \$59.00 | 2536-TRV-AA | MOUNTUNE UPATED AIR RECIRCULATION VALVE | 94 | \$169.00 |
| 2363-AF-CAP | MOUNTUNE AIR FILTER END CAP | 81 | \$15.00 | 302-135 | VALVE COVER FORD SB SLANT EDGE BLACK | 250 | \$316.00 |
| 2363-AHK-BLK | MOUNTUNE SILICONE ANCILLARY HOSE KIT BLK - FOCUS ST | 81 | \$145.00 | 302-135B | FORD RACING 289-351 SLANT EDGE VALVE COVER STEALTH | 250 | \$316.00 |
| 2363-AHK-BLU | MOUNTUNE SILICONE ANCILLARY HOSE KIT BLUE - FOCUS ST | 81 | \$145.00 | 302-136 | VALVE COVER FORD SB SLANT EDGE FORD BLUE | 250 | \$316.00 |
| 2363-AHK-RED | MOUNTUNE SILICONE ANCILLARY HOSE KIT RED - FOCUS ST | 81 | \$145.00 | 302-137 | VALVE COVER FORD SB SLANT EDGE GRAY CRINKLE | 250 | \$316.00 |
| 2363-AHK-YEL | MOUNTUNE SILICONE ANCILLARY HOSE KIT Y/B - FOCUS ST | 81 | \$145.00 | 302-138 | VALVE COVER FORD SB SLANT EDGE POLISHED | 250 | \$295.00 |
| 2363-ATB-AA | QUAIFE TORQUE BIASING DIFF. FOCUS ST 2013-2017 | 86 | \$999.00 | 302-139 | VALVE COVER FORD SB SLANT EDGE CHROME | 250 | \$423.00 |
| 2363-BHK-BLK | MOUNTUNE SILICONE BOOST HOSE KIT BLACK - FOCUS ST | 80 | \$315.00 | 302-999 | SLANT EDGE AIR CLEANER | 253 | \$145.00 |
| 2363-BHK-BLU | MOUNTUNE SILICONE BOOST HOSE KIT BLUE - FOCUS ST | 80 | \$315.00 | 5000-STK-SET | MOUNTUNE 6 PIECE STICKER SET | 106 | \$10.00 |
| 2363-BHK-RED | MOUNTUNE SILICONE BOOST HOSE KIT RED - FOCUS ST | 80 | \$315.00 | 7063-BH-C346 | 2013-2016 FOCUS ST MOUNTUNE SS BRAKE HOSE SET | 87 | \$129.00 |
| 2363-BHK-YEL | MOUNTUNE SILICONE BOOST HOSE KIT Y/B - FOCUS ST | 80 | \$315.00 | 7063-FSB-AA | FRONT STRUT TOWER BRACE FOCUS ST 2013-2017 | 87 | \$215.00 |
| 2363-BSA-AA | MOUNTUNE QUICK-SHIFT - FOCUS ST | 85 | \$199.00 | 7064-BH-B299 | 2013-2016 FIESTA ST MOUNTUNE SS BRAKE HOSE SET | 106 | \$129.00 |
| 2363-CAIS-BA | MOUNTUNE INDUCTION KIT BLACK - FOCUS ST | 76 | \$379.00 | 7064-FSB-AA | 2013-2016 FIESTA ST STRUT TOWER BRACE | 105 | \$215.00 |
| 2363-CBE-AA | MOUNTUNE HIGH-FLOW EXHAUST - FOCUS ST | 89 | \$799.00 | 7064-LCB-AA | 2013-2016 FIESTA ST LOWER CHASSIS BRACE | 105 | \$215.00 |
| 2363-CHK-BLK | MOUNTUNE SILICONE COOLANT HOSE KIT BLK - FOCUS ST | 80 | \$135.00 | CM-19546-A1 | FRICTION MODIFIER (SINGLE BOTTLE) | 242 | \$14.95 |
| 2363-CHK-BLU | MOUNTUNE SILICONE COOLANT HOSE KIT BLUE - FOCUS ST | 80 | \$135.00 | CM-6731-FL1A | FL1A HI PERF OIL FILTER | 181 | \$16.95 |
| 2363-CHK-RED | MOUNTUNE SILICONE COOLANT HOSE KIT RED - FOCUS ST | 80 | \$135.00 | CM-6731-FL820 | FL820 HI PERF OIL FILTER | 181 | \$16.95 |
| 2363-CHK-YEL | MOUNTUNE SILICONE COOLANT HOSE KIT YLW - FOCUS ST | 80 | \$135.00 | E048-07-121 | MT UPATED FUEL INJECTOR SET OF 4 - FOCUS ST | 84 | \$599.99 |
| 2363-CPK-BLK | MOUNTUNE INTERCOOLER CHARGE PIPE BLK - FOCUS ST | 77 | \$449.00 | M-1007-DC1785 | WHEEL FORGED BEAD LOCK RAPTOR 2013-2014 | 109 | \$570.00 |
| 2363-CPK-BLU | MOUNTUNE INTERCOOLER CHARGE PIPE BLUE - FOCUS ST | 77 | \$449.00 | M-1007-DC1910LGB | WHEEL GLOSS BLACK 2005-2014 MUSTANG 10" REAR | 57 | \$279.00 |
| 2363-CPK-RED | MOUNTUNE INTERCOOLER CHARGE PIPE RED - FOCUS ST | 77 | \$449.00 | M-1007-DC199LGB | WHEEL GLOSS BLACK 2005-2014 MUSTANG 9" FRONT | 57 | \$279.00 |
| 2363-CPK-YEL | MOUNTUNE INTERCOOLER CHARGE PIPE YEL - FOCUS ST | 77 | \$449.00 | M-1007-M188GB | WHEEL 18"X8" GLOSS BLACK FOCUS | 92 | \$239.00 |
| 2363-CS-AA | MOUNTUNE LOWER SPORT SPOILER - FOCUS ST 2013-2014 | 90 | \$249.00 | M-1007-M1995B | 2015-2017 MUSTANG PP 19"X9.5" WHEEL - MATTE BLACK | 38 | \$328.00 |
| 2363-HP-AA | MOUNTUNE LOWER INTERCOOLER CHARGE PIPE - FOCUS ST | 78 | \$149.00 | M-1007-M199B | WHEEL 19"X9" PERF PACK BLK MUSTANG 2015 | 38 | \$328.00 |
| 2363-IC-BA | MOUNTUNE INTERCOOLER BLK - 2013-2014 FOCUS ST | 76 | \$999.00 | M-1007-M199DS | WHEEL 19"X9" PERF PACK DARK 14 MUSTANG 2015 | 38 | \$187.00 |
| 2363-IC-BA2 | INTERCOOLER - BLACK FOCUS ST 2015-2016 | 76 | \$999.00 | M-1007-M199S | WHEEL 19"X9" SILVER MUSTANG 2015 | 38 | \$205.00 |
| 2363-IH-BLK | INDUCTION HOSE HIGH-FLOW FOCUS ST - BLACK | 77 | \$69.00 | M-1007-M199SA | WHEEL PERFORMANCE PACK SPARKLE SILVER MUSTANG 2015 | 38 | \$96.00 |
| 2363-IH-BLU | INDUCTION HOSE HIGH-FLOW FOCUS ST - BLUE | 77 | \$69.00 | M-1007-P188MB | WHEEL 18"X8" MATTE PONY | 57 | \$165.00 |
| 2363-IH-YEL | INDUCTION HOSE HIGH-FLOW FOCUS ST - YELLOW | 77 | \$69.00 | M-1007-P198MB | 2012-2016 FOCUS ST 19"X8" WHEEL - MATTE BLACK | 92 | \$150.00 |
| 2363-MSK-AB | 2014-2017 FOCUS ST SPRING KIT | 89 | \$259.00 | M-1007-P2085MB | 2015-2018 F-150 20"X8.5" 6-SPOKE WHEEL - MATTE BLACK | 109 | \$310.00 |
| 2363-OC-AA | OIL PAN BAFFLE W/BAL SHAFT DEL FOCUS ST 2013-2015 | 82 | \$199.00 | M-1007-PF188MB | 2012-2017 FOCUS ST WHEEL 18"X8" - MATTE BLACK | 92 | \$173.00 |
| 2363-RR-AA | 2013-2016 FOCUS ST ROLL RESTRICTOR | 85 | \$159.00 | M-1007-R198GB | 2016 FOCUS RS 19" WHEEL - GLOSS BLACK | 96 | \$258.00 |
| 2363-SD-AA | SYMPOSER DELETE KIT FOCUS ST 2013-2017 | 82 | \$39.00 | M-1007-S177 | SVT FOCUS WHEEL | 92 | \$175.00 |
| 2363-SS-BLK | FOCUS ST MOUNTUNE DYNAMIC SIDE SPLASH - BLACK | 90 | \$119.00 | M-1007-S177B | FOCUS RALLY WHEEL BLACK | 92 | \$172.00 |
| 2363-SS-GR | FOCUS ST MOUNTUNE DYNAMIC SIDE SPLASH - GRAY | 90 | \$119.00 | M-1007-S1895 | WHEEL MSVT 2007 | 58 | \$232.00 |
| 2363-SS-WHT | FOCUS ST MOUNTUNE DYNAMIC SIDE SPLASH - WHITE | 90 | \$119.00 | M-1007-SA199 | WHEEL FRONT MSVT 2005-2012 | 58 | \$430.00 |
| 2364-215-AA | MOUNTUNE MP215 PERFORMANCE UPGRADE - FIESTA ST | 98 | \$999.00 | M-1007-SA1995MB | WHEEL SPLIT 5-SPOKE SATIN BLACK MSVT 2013 | 58 | \$420.00 |
| 2364-AF-AA | MOUNTUNE HIGH-FLOW AIR FILTER - FIESTA ST | 101 | \$45.00 | M-1007-W1785B | F-150 RAPTOR BEAD-LOCK WHEEL KIT | 109 | \$699.00 |
| 2364-ATB-AA | QUAIFE TORQUE BIASING DIFF FIESTA ST 2014-2016 | 104 | \$1,049.00 | M-1007K-M188GB | FOCUS ST 18"X8" WHEEL SET WITH TPMS - GLOSS BLACK | 91 | \$1,081.00 |
| 2364-BHK-BLK | INTERCOOLER HOSE KIT BLK - FIESTA ST | 101 | \$299.00 | M-1007K-M199DS | WHEEL KIT PERF PACK 19"X9" DARK MUSTANG 2015 | 38 | \$790.00 |
| 2364-BHK-BLU | MOUNTUNE CHARGE PIPE UPGRADE KIT BLU - FIESTA ST | 101 | \$299.00 | M-1007K-M199S | WHEEL KIT PERF PACK SILVER 19"X9" MUSTANG 2015 | 38 | \$483.00 |
| 2364-BHK-RED | MOUNTUNE INTERCOOLER HOSE KIT RED - FIESTA ST | 101 | \$299.00 | M-1007K-M199XB | 2015-2017 MUSTANG PP WHEEL KIT 19"X9" 9.5" - MATTE BLACK | 38 | \$1,325.00 |
| 2364-BHK-YEL | MOUNTUNE INTERCOOLER HOSE KIT YLW - FIESTA ST | 101 | \$299.00 | M-1007K-M199GB | 2015-2017 MUSTANG PP WHEEL KIT 19"X9" 9.5" - GLOSS BLACK | 38 | \$930.00 |
| 2364-CBE-AB | CAT-BACK SYS. STAINLESS STEEL FIESTA ST (N AMER) | 102 | \$739.00 | M-1007K-P198MB | 2013-2017 FOCUS ST 19"X8" WHEEL SET WITH TPMS KIT | 91 | \$865.00 |
| 2364-CHK-BLK | MOUNTUNE PERFORM. SILICONE COOLANT KIT - FIESTA ST | 101 | \$129.00 | M-1007K-P20XB | 2015-2018 F-150 6-SPOKE 20"X8.5" WHEEL KIT - MB | 109 | \$1,449.00 |
| 2364-CHK-BLU | MOUNTUNE PERFORM. SILICONE COOLANT KIT FIESTA S | 101 | \$129.00 | M-1007K-PF188MB | FOCUS 18"X8" 5-SPOKE WHEEL SET WITH TPMS KIT - M | 92 | \$945.00 |
| 2364-CHK-RED | MOUNTUNE PERFORM. SILICONE COOLANT KIT FIESTA ST | 101 | \$129.00 | M-1007KIT-DC19910LGB | WHEEL KIT MUSTANG GLS BLK 19"X9" (2) 19"X10" (2) TPMS | 56 | \$1,200.00 |
| 2364-CHK-YEL | MOUNTUNE PERFORM. SILICONE COOLANT KIT FIESTA ST | 101 | \$129.00 | M-1007KIT-DC19910LGB | WHEEL KIT GLOSS BLK 19"X9" (4) WITH TPMS | 56 | \$1,000.00 |
| 2364-CPK-BLK | MOUNTUNE CHARGE PIPE UPGRADE BLK FIESTA ST 2014-2016 | 99 | \$399.00 | M-1007KIT-SA199 | MUSTANG SVT 2012 19"X9" (4) WITH TPMS | 56 | \$1,790.00 |
| 2364-CPK-BLU | MOUNTUNE CHARGE PIPE UPGRADE BLU FIESTA ST 2014-2016 | 99 | \$399.00 | M-1007KIT-SA1995 | WHEEL SET 19"X9.5" (4) WITH TPMS MSVT 2014 | 56 | \$1,695.00 |
| 2364-CPK-RED | MOUNTUNE CHARGE PIPE UPGRADE RED FIESTA ST 2014-2016 | 99 | \$399.00 | M-1012-A | WHEEL NUT (5 PACK) | 59 | \$12.00 |
| 2364-CPK-YEL | MOUNTUNE CHARGE PIPE UPGRADE YEL FIESTA ST 2014-2016 | 99 | \$399.00 | M-1012-FA | F-150 LUG NUT KIT | 109 | \$25.00 |
| 2364-FS-AA | 2014-2016 FIESTA ST MOUNTUNE LOWER FRONT SPLITTER | 106 | \$299.00 | M-1012-G | WHEEL NUT (5 PACK) | 67 | \$12.00 |
| 2364-GK-AA | GEARKNOB - BLACK W/ YELLOW FOCUS ST / FIESTA ST | 86 | \$69.00 | M-1012-M | 2015-2017 MUSTANG LUG NUT KIT | 37 | \$12.00 |
| 2364-GK-AB | GEARKNOB - BLACK W/ BLACK FOCUS ST / FIESTA ST | 86 | \$69.00 | M-1012-MB | BLACK LUG NUT KIT (5 PCS) | 37 | \$54.00 |
| 2364-HP-AA | MOUNTUNE LWR INTERC HARD PIPE STAINLESS STL FIESTA ST | 99 | \$119.00 | M-1012-N | 2015-2018 MUSTANG OPEN BACK LUG NUT KIT | 37 | \$12.00 |
| 2364-IC-BA | MOUNTUNE INTERCOOLER BLACK - FIESTA ST | 98 | \$799.00 | M-1012-RSA | MK2 FOCUS RS LUG NUT (5 PACK) | 96 | \$15.00 |
| 2364-IH-BLK | MOUNTUNE INDUCTION HOSE B/Y - FIESTA ST | 100 | \$159.00 | M-1021-F15BL | RAPTOR BEAD-LOCK WHEEL TRIM RING KIT - BLUE | 109 | \$464.00 |
| 2364-IH-BLU | MOUNTUNE INDUCTION HOSE BLUE - FIESTA ST | 100 | \$159.00 | M-1021-F15BL1 | 2017 RAPTOR BEAD-LOCK WHEEL TRIM RING - BLUE | 109 | \$119.00 |
| 2364-IH-RED | MOUNTUNE INDUCTION HOSE RED - FIESTA ST | 100 | \$159.00 | M-1021-F15OR | RAPTOR BEAD-LOCK WHEEL TRIM RING KIT - ORANGE | 109 | \$464.00 |
| 2364-IH-YEL | MOUNTUNE INDUCTION HOSE YELLOW - FIESTA ST | 100 | \$159.00 | M-1021-F15ORI | 2017 RAPTOR BEAD-LOCK WHEEL TRIM RING - ORANGE | 109 | \$119.00 |
| 2364-INT-BLK | MOUNTUNE INDUCTION UPGRADE KIT BLK FIESTA ST 2014 | 100 | \$450.00 | M-1021-F15RA | 2013-2014 RAPTOR BEAD-LOCK RING KIT | 109 | \$199.00 |
| 2364-INT-BLU | MOUNTUNE INDUCTION UPGRADE KIT BLU FIESTA ST 2014 | 100 | \$450.00 | M-1021-F15RB | RAPTOR BEAD-LOCK RING WITH FASTENERS | 109 | \$199.00 |
| 2364-INT-RED | MOUNTUNE INDUCTION UPGRADE KIT RED FIESTA ST 2014-2015 | 100 | \$450.00 | M-1021-F15RD | RAPTOR BEAD-LOCK WHEEL TRIM RING KIT - RED | 109 | \$464.00 |
| 2364-INT-YEL | MOUNTUNE INDUCTION UPGRADE KIT YEL FIESTA ST 2014-2015 | 100 | \$450.00 | M-1021-F15RD1 | 2017 RAPTOR BEAD-LOCK WHEEL TRIM RING - RED | 109 | \$119.00 |
| 2364-MSK-BA | SPRING FIESTA ST 5-DOOR (USA) | 105 | \$269.00 | M-10849-A | PERFORMANCE PACK BOOST CLUSTER KIT | 248 | \$295.00 |
| 2364-RR-AA | ROLL RESTRICTOR MOTOR MT FIESTA ST 2013-2016 | 101 | \$149.00 | M-10883-BFSE | ORDER DIRECTLY FROM AUTOMETER | 248 | \$176.00 |
| 2364-SD-AA | 2013-2016 FIESTA ST 1.6L SOUND SYMPOSER DELETE | 98 | \$39.00 | M-10885-BFSE | ORDER DIRECTLY FROM AUTOMETER | 248 | \$278.18 |
| 2536-ATB-AA | FOCUS RS QUAIFFE TORQUE BIASING DIFFERENTIAL | 95 | \$1,199.00 | M-1096-A | WHEEL CAP MUSTANG BAR & PONY 2005 | 59 | \$30.00 |
| 2536-BLK-AA | RS MOUNTUNE BRAKE HOSE SET | 95 | \$169.00 | M-1096-FA | FORD RACING CENTER CAP - FIESTA M-1007-FA | 59 | \$40.00 |
| 2536-CAIS-BLK | FOCUS RS MOUNTUNE INTAKE DUCT KIT - BLACK | 93 | \$499.00 | M-1096-FP3 | FORD PERF. CENTER CAP 2015 MUSTANG - BLACK | 37 | \$48.00 |
| 2536-CAIS-LBLU | FOCUS RS MOUNTUNE INTAKE DUCT KIT - BLUE | 93 | \$499.00 | M-1096-FR | CENTER CAP | 59 | \$60.00 |
| 2536-CPK-BLK | MOUNTUNE CHARGE PIPE UPGRADE KIT - BLACK | 93 | \$549.00 | M-1096-FRI | CENTER CAP FORD RACING 2005-2014 | 59 | \$61.00 |
| 2536-CPK-LBLU | MOUNTUNE CHARGE PIPE UPGRADE KIT - BLUE | 93 | \$549.00 | M-1096-K | CENTER CAP MUSTANG TRI-BAR | 59 | \$60.00 |

For important information about the proper usage of performance parts, please see page 12. See pages 295-302 for important safety, emissions and warranty information.

SUGGESTED RETAIL PRICE LIST

FOR THE MOST UP-TO-DATE PRICING AND TECH INFO VISIT performance.ford.com

| Part Number | Description | Pg. No. | Sugg. Retail |
|-----------------|--|---------|--------------|
| M-1096-N | CENTER CAP | 59 | \$27.00 |
| M-1096-O | MUSTANG WHEEL CENTER CAP | 37 | \$20.00 |
| M-1096-Q | FOCUS WHEEL CENTER CAP | 91 | \$15.63 |
| M-1096-RS | 2016 FOCUS RS WHEEL CENTER CAP | 96 | \$45.00 |
| M-10B776-MR | MUSTANG GT350 RED START BUTTON | 36 | \$50.00 |
| M-11000-B51 | MINI-STARTER - SBF | 194 | \$323.00 |
| M-11000-C50 | STARTER KIT MODULAR ENGINES | 143 | \$329.00 |
| M-11000-MT164 | HIGH TORQUE MINI STARTER - SBF | 194 | \$339.00 |
| M-1104-A | WHEEL HUB FRONT W/STUDS FR500S | 67 | \$290.00 |
| M-1104-AB | 2015-2017 MUSTANG FRONT WHEEL HUB KIT WITH ARP STUDS | 26 | \$360.00 |
| M-1104-B | 2015-2017 MUSTANG REAR WHEEL HUB KIT WITH ARP STUDS | 26 | \$385.00 |
| M-1104-B | 2015-2017 MUSTANG REAR WHEEL HUB KIT WITH ARP STUDS | 26 | \$385.00 |
| M-1107-C | MUSTANG EXTENDED ARP WHEEL STUDS | 26 | \$164.00 |
| M-1109-A | COBRA IRS HUB (1 EACH) | 239 | \$215.00 |
| M-1126-B | 11"X2.25" BRAKE DRUM | 70 | \$68.95 |
| M-11622-BF5E | ORDER DIRECTLY FROM AUTOMETER | 248 | \$345.27 |
| M-1180-A | TPMS ACTIVATION TOOL AND SENSORS 2010-2014 | 57 | \$349.00 |
| M-1180-B | TPMS SENSOR AND TOOL KIT - 2015-2016 MUSTANG, F-150 | 38 | \$215.00 |
| M-12029-3V | 4.6L 3V IGNITION COIL SET | 153 | \$315.00 |
| M-12029-4V | IGNITION COIL SET 4V | 153 | \$315.00 |
| M-12029-M50C | IGNITION COIL SET 5.0L 4V | 143 | \$435.00 |
| M-12029-M50E | 5.0L COYOTE IGNITION COIL SET (8) | 143 | \$135.00 |
| M-12044-A2 | CHROME COIL BRACKET | 259 | \$11.25 |
| M-12071-A50 | MULTIPOINT EFI WIRING HARNESS 302/351W | 215 | \$775.00 |
| M-1215-A | KIT CAR IRS BEARING | 239 | \$79.00 |
| M-1225-B | 8.8" AXLE BEARING AND SEAL KIT (PAIR) | 241 | \$42.00 |
| M-1225-B1 | AXLE BEARING KIT 8.8" MUSTANG 2005-2014 | 241 | \$54.95 |
| M-12259-C301 | IGNITION WIRE SET BLUE 9 MM | 194 | \$57.95 |
| M-12259-C302 | 9 MM IGNITION WIRE SET BLUE | 194 | \$57.95 |
| M-12259-C460 | IGNITION WIRE SET BLUE 9 MM | 200 | \$57.95 |
| M-12259-C462 | IGNITION WIRE SET BLUE 4.6L 2V | 152 | \$98.50 |
| M-12259-C464 | IGNITION WIRE SET 4.6L 4V BLUE | 152 | \$122.95 |
| M-12259-M301 | IGNITION WIRE SET BLACK 9 MM | 194 | \$57.95 |
| M-12259-M302 | 9 MM IGNITION WIRE SET BLACK | 194 | \$57.95 |
| M-12259-R301 | 9 MM IGNITION WIRE SET RED | 194 | \$57.95 |
| M-12259-R460 | 9 MM IGNITION WIRE SET RED | 200 | \$57.95 |
| M-12259-R462 | 4.6L 2V IGNITION WIRE SET RED | 152 | \$98.50 |
| M-12259-R464 | IGNITION WIRE SET RED 4.6L 4V | 152 | \$122.95 |
| M-12259-T462 | 4.6L 2V F150 WIRE SET BLUE | 152 | \$98.50 |
| M-12259-Y301 | IGNITION WIRE SET 9 MM YELLOW | 194 | \$57.95 |
| M-12270-A302 | DISTRIBUTOR HOLDDOWN CLAMP | 259 | \$8.95 |
| M-12297-L900 | LOOM SET FORD STREET ROD | 259 | \$119.00 |
| M-12405-20T | SPARK PLUG SET COLD 2.0T (4 PLUGS) | 78 | \$91.00 |
| M-12405-3V0 | SPARK PLUG SET 3V COLD 16 MM (8 PACK) | 153 | \$119.00 |
| M-12405-3V12MM | SPARK PLUG 3V 12 MM THREAD | 153 | \$100.00 |
| M-12405-M50A | SPARK PLUG SET 5.0L 4V HEAT RANGE 0 | 141 | \$70.00 |
| M-12508-M50 | ENGINE HARNESS 5.0L TIVCT | 214 | \$395.00 |
| M-12508-M50A | ENGINE HARNESS 5.0L TIVCT AUTOMATIC 2015 | 214 | \$325.00 |
| M-12579-L54 | 90 MM LIGHTNING AIR METER | 226 | \$269.00 |
| M-12A227-CJ13 | PULSE RING 5.0L HIGH RPM COMPETITION | 143 | \$115.00 |
| M-13086-MD | 2006-2009 MUSTANG GRAY FLOOR MATS "MUSTANG" TAG | 73 | \$87.00 |
| M-13086-ME | 2006-2009 MUSTANG BLACK FLOOR MATS "MUSTANG" TAG | 73 | \$87.00 |
| M-13086-MF | 2010 MUSTANG BLACK FLOOR MAT "SILVER PONY" | 73 | \$87.00 |
| M-13086-MG | 2010 MUSTANG GT500 GRAY FLOOR MATS | 73 | \$87.00 |
| M-13086-MH | 2012 MUSTANG BLACK FLOOR MATS "SILVER PONY" | 73 | \$87.00 |
| M-13086-MJ | 2012 MUSTANG BLACK FLOOR MATS "BOSS 302" | 73 | \$87.00 |
| M-13086-MM | 2013-2014 MUSTANG BLACK FLOOR MATS "BOSS 302" | 73 | \$104.00 |
| M-13086-MN | 2013-2014 MUSTANG BLACK FLOOR MAT "SILVER PONY" | 73 | \$104.00 |
| M-13086-MP | 2013-2014 MUSTANG GRAY FLOOR MATS "GT500" | 73 | \$104.00 |
| M-14204-FSTA | CAL WITH SPARK PLUGS FOCUS ST 2013-2016 | 79 | \$620.00 |
| M-14204-MGTTTC | TRACK CAL MGT 2013-2014 | 49 | \$609.00 |
| M-14204-MGTTTCU | TRACK CAL UPGRADE MUST GT 2013-2014 | 49 | \$369.00 |
| M-14464-UJ2 | FUEL INJECTOR ADAPTERS UJ2 (8 PACK) | 223 | \$95.00 |
| M-1447-C | FENDER EMBLEMS COBRA SVT 2007 | 260 | \$88.00 |
| M-1447-D46 | 1996-1998 COBRA INTAKE PLAQUE | 253 | \$95.50 |
| M-1447-EB | ECOBOOST EMBLEM SILVER | 261 | \$39.00 |
| M-1447-EBBLK | ECOBOOST EMBLEM BLACK | 261 | \$24.95 |
| M-1447-EBBLKLG | ECOBOOST EMBLEM BLACK/CHROME - LARGE SIZE | 261 | \$49.00 |
| M-1447-EBLG | ECOBOOST EMBLEM SILVER - LARGE SIZE | 261 | \$24.95 |
| M-1447-EBMED | ECOBOOST EMBLEM SILVER - MED. SIZE | 261 | \$45.00 |
| M-1447-F46 | 1999-2001 COBRA INTAKE PLAQUE | 253 | \$145.00 |
| M-1447-M50 | MUSTANG 2011 5.0L FENDER EMBLEM SET | 260 | \$34.95 |
| M-1447-M50A | 2015-2017 MUSTANG 5.0L FENDER EMBLEM - CHROME | 260 | \$24.95 |
| M-1447-M50AB | 2015-2017 MUSTANG 5.0L FENDER EMBLEM - BLACK | 260 | \$35.00 |
| M-1447-R | 2007-2009 MUSTANG SVT RED COBRA "SNAKE" FENDER EMB. | 260 | \$109.00 |
| M-1447-SR | FENDER EMBLEMS COBRA "SNAKE" (PAIR) | 260 | \$18.00 |
| M-1447-SVT | EMBLEM DECKLID SVT | 260 | \$14.50 |
| M-16098-CJG | GRILLE EMBLEM COBRA JET 2008 | 260 | \$75.00 |
| M-16098-PBFP | "POWERED BY FORD PERFORMANCE" BADGE | 261 | \$99.00 |

| Part Number | Description | Pg. No. | Sugg. Retail |
|-----------------|--|---------|--------------|
| M-16600-MA | 2018 MUSTANG DECK LID TRIM PANEL | 36 | \$179.00 |
| M-16600-SVTC | SVT MUSTANG REAR WING 2005-2009 | 71 | \$265.00 |
| M-16601-MB | SPLITTER KIT LAGUNA MUSTANG 2010-2012 | 71 | \$829.95 |
| M-16601-MBA | SPLITTER KIT FRONT MUSTANG LAGUNA 2013-2014 | 71 | \$904.00 |
| M-16601-MBKITA | 2010-2012 MUST GT LAGUNA SPLITTER KIT | 71 | \$1,199.00 |
| M-16601H-MB | 2010-2012 SPLITTER HARDWARE KIT | 71 | \$294.00 |
| M-16601H-S | HARDWARE KIT - SPLITTER BOSS 302S | 71 | \$379.00 |
| M-16700-A | HOOD LATCH KIT | 259 | \$41.00 |
| M-16700-S | HOOD PIN KIT FOR FR500S & CJ | 259 | \$70.00 |
| M-16826-M | 2005-2014 MUSTANG FORD PERFORMANCE HOOD STRUTS | 72 | \$99.00 |
| M-16826-MA | HOOD STRUTS 2015-2017 MUSTANG GT | 36 | \$99.00 |
| M-1700-M | MUSTANG TIE DOWN KIT | 36 | \$104.00 |
| M-17360-B | ORDER DIRECTLY FROM AUTOMETER | 248 | \$343.73 |
| M-17728-CJ10 | MIRROR BLOCK OFF PLATE CJ 2010 | 72 | \$165.00 |
| M-17757-MB | TUBULAR BUMPER FT LIGHTWEIGHT MUSTANG 2005-2014 | 72 | \$335.58 |
| M-17954-A | TOW HOOK LOOP KIT | 72 | \$60.00 |
| M-17954-F | TOW RING KIT FRONT | 72 | \$77.00 |
| M-17954-FA | GT350 FRONT TOW HOOK | 37 | \$88.00 |
| M-17954-RA | TOW RING KIT REAR | 72 | \$77.00 |
| M-17954-RB | 2015-2017 MUSTANG REAR TOW HOOK ASSEMBLY | 37 | \$110.00 |
| M-18000-A | DAMPER KIT MUST GT 2005-2014 | 62 | \$764.00 |
| M-18000-C | DAMPER KIT ADJ MGT 2005-2014 / MSVT 2007-2014 | 62 | \$915.00 |
| M-18000-F | STRUT AND SHOCK KIT MGT 2015-2017 | 29 | \$698.00 |
| M-18000-ZX3 | FOCUS SVT DAMPER KIT | 88 | \$242.00 |
| M-18000-ZX3B | DAMPER KIT 2006 FOCUS | 88 | \$267.00 |
| M-18001-AF | SINGLE SERVICE FRONT STRUT M-18000-A | 62 | \$200.00 |
| M-18001-AG | SINGLE SERVICE FRONT STRUT | 29 | \$197.00 |
| M-18001-ARI | SINGLE SERVICE REAR SHOCK M-18000-A | 62 | \$184.00 |
| M-18001-AS | SINGLE SERVICE REAR SHOCK | 29 | \$199.00 |
| M-18183-C | STRUT MOUNT UPGRADE MGT 2005-2014 | 63 | \$159.00 |
| M-18183-M | STRUT MOUNT UPGRADE MUSTANG 2015 | 29 | \$164.00 |
| M-18197-A | REAR SHOCK MOUNT KIT | 63 | \$86.00 |
| M-1820-A1 | "FORD RACING" DECAL (25 PKG) 4"X1-1/2" | 262 | \$18.00 |
| M-1820-A60 | DECAL "FORD RACING MUSCLE PARTS" (10 PK) | 262 | \$25.00 |
| M-1820-B1 | "FORD RACING" COMBO MINI DECAL (25 PKG) 6"X1-3/4" | 262 | \$9.95 |
| M-1820-FFP | FOCUS "FORD PERFORMANCE" WINDSHIELD BANNER | 91 | \$50.00 |
| M-1820-FP | "FORD PERFORMANCE" DECAL - TEN PACK | 262 | \$16.00 |
| M-1820-FR15 | "FORD RACING" DIE-CUT DECALS 15" (10 PK) | 262 | \$85.00 |
| M-1820-FR2 | "FORD RACING" DIE-CUT DECALS 15" (2 PK) | 262 | \$22.00 |
| M-1820-MB | WINDSHIELD BANNER "FORD PERFORMANCE" MUSTANG 2015 | 35 | \$50.00 |
| M-1820-MR | 2015-2017 "FORD PERFORMANCE" WINDSHIELD BANNER - RED | 35 | \$65.00 |
| M-1822-A7 | FORD PERFORMANCE FENDER COVER | 260 | \$19.95 |
| M-1822-A8 | TRACK MAT FORD PERFORMANCE | 260 | \$49.95 |
| M-1822-A9 | FORD PERFORMANCE DRAG RACING TIRE SHADE | 261 | \$50.00 |
| M-1822-M | FENDER COVER 2015 MUSTANG (PAIR) | 37 | \$325.00 |
| M-1827-A60 | BANNER "FORD RACING MUSCLE PARTS" | 262 | \$8.50 |
| M-1827-FP | BANNER "FORD PERFORMANCE" 3'X5' | 262 | \$35.00 |
| M-1827-P1 | RACING PENNANT STRING 50' | 262 | \$30.00 |
| M-1827-P2 | "FORD PERFORMANCE" 50' PENNANT STRING | 262 | \$75.00 |
| M-1827-T10A | TENT FORD PERFORMANCE 10' X 10' | 262 | \$780.00 |
| M-1827-T20A | TENT FORD PERFORMANCE 10' X 20' | 262 | \$1,270.00 |
| M-1827-W10A | TENT WALL FORD PERFORMANCE 10' | 262 | \$195.00 |
| M-1828-FPONE | FORD PERFORMANCE LICENSE PLATE - SINGLE | 261 | \$13.50 |
| M-1828-SS304C | FORD PERFORMANCE LICENSE PLATE FRAME BRUSHED | 261 | \$33.50 |
| M-19017-B961 | ORDER DIRECTLY FROM AUTOMETER | 247 | \$610.47 |
| M-19216-A50 | A/C DELETE KIT 5.0L 1994-1995 MUSTANG | 193 | \$72.00 |
| M-19216-D46 | A/C DELETE KIT 4.6L 1996-2010 | 151 | \$65.00 |
| M-19546-A12 | FRICITION MODIFIER (CASE OF 12) | 247 | \$129.00 |
| M-2004-FRS | FOCUS ST FRONT BRAKE AIR DEFLECTOR KIT | 87 | \$125.00 |
| M-2004-MR | BRAKE DUCT INLET KIT MGT 2013-2014 | 70 | \$190.00 |
| M-20045-MSVT | BRAKE SHIELDS 2005-2014 | 70 | \$66.00 |
| M-2005-R | BRAKE BOOSTER BOSS 302R/302S | 70 | \$2,900.00 |
| M-2007-FR1V6 | POWER UPGRADE PACK MV6 2005-2009 | 39 | \$1,430.00 |
| M-20201-F | STRUT TOWER BRACE MV6 2005-2014 | 66 | \$251.00 |
| M-20201-GT350 | 2015-2016 MUSTANG GT350 STRUT TOWER BRACE KIT | 33 | \$346.00 |
| M-20201-M350RHD | MUSTANG GT350 STRUT TOWER BRACE KIT - RHD | 33 | \$425.00 |
| M-20201-MA | S550 FORD PERFORMANCE STRUT TOWER BRACE | 33 | \$239.00 |
| M-20201-MARHD | FORD PERF RHD MUSTANG STRUT TOWER BRACE KIT | 33 | \$325.00 |
| M-20201-S197 | STRUT TOWER BRACE MGT 2005-2014 | 66 | \$212.00 |
| M-2078-FA | FIESTA BRAKE LINE KIT STAINLESS | 106 | \$115.00 |
| M-2078-MB | BRAKE LINE UPGRADE KIT MUSTANG 2005-2014 | 70 | \$103.00 |
| M-2209-B | 9" DRUM BRAKE BACK PLATE KIT | 70 | \$337.00 |
| M-2300-AA | GT350 BRAKE UPGRADE KIT | 34 | \$2,950.00 |
| M-2300-D | FRONT BRAKE UPGRADE KIT MV6 2005-2010 | 69 | \$199.00 |
| M-2300-G2 | DISC BRAKE KIT 9" AXLE | 244 | \$450.00 |
| M-2300-M | REAR BRAKE BRACKET KIT MGT 1994-2004 | 69 | \$435.00 |
| M-2300-MR | 2015 MUSTANG REAR BRAKE KIT | 34 | \$575.00 |

SUGGESTED RETAIL PRICE LIST

FOR THE MOST UP-TO-DATE PRICING AND TECH INFO VISIT performance.ford.com

| Part Number | Description | Pg. No. | Sugg. Retail | Part Number | Description | Pg. No. | Sugg. Retail |
|---------------|--|---------|--------------|------------------|---|---------|--------------|
| M-2300-S | BRAKE UPGRADE KIT MGT 2005-2014 | 69 | \$1,550.00 | M-4266-A | 2005-2014 MUSTANG ADJUSTABLE PANHARD BAR BUSHING KIT | 68 | \$35.00 |
| M-2300-SA | ROTOR KIT 2-PC 4-PISTON MGT 2005-2014 | 69 | \$2,250.00 | M-4413-A | SEAL KIT 8.8" IRS BEARING | 241 | \$44.00 |
| M-2300-T | BRAKE KIT 6-PISTON 15" MUSTANG 2005-2014 | 69 | \$2,850.00 | M-4413-B | SEAL KIT SUPER 8.8" IRS | 28 | \$36.00 |
| M-2300-V | BRAKE UPGRADE KIT 6-PISTON MUSTANG 2015-2017 | 34 | \$1,759.00 | M-4602-G | DRIVESHAFT ASSY ALUM | 245 | \$555.00 |
| M-2300-W | FOCUS ST PERFORMANCE RS FRONT BRAKE KIT | 87 | \$1,125.00 | M-4602-J | ALUM. D/S ASSY 1996-2004 MUSTANG 4.6 M/T | 245 | \$499.00 |
| M-2300-WR | FOCUS ST PERFORMANCE RS REAR BRAKE KIT | 87 | \$410.00 | M-4602-MGTA | 2005-2010 MUSTANG GT ONE-PIECE DRIVESHAFT M/T | 245 | \$799.00 |
| M-2300-X | BRAKE KIT FRONT COBRA R | 69 | \$1,586.00 | M-4602-MGTM | 2011-2014 MUSTANG ONE-PIECE DRIVESHAFT | 245 | \$829.00 |
| M-2300-XP | 1994-2004 MUSTANG COBRA R FRONT BRAKE PAD KIT | 69 | \$156.00 | M-4602-MSVT | 2007-2012 GT500 ONE-PIECE DRIVESHAFT | 245 | \$849.00 |
| M-2300-XR | 1994-2004 MUSTANG COBRA R FRONT BRAKE ROTOR KIT | 69 | \$485.00 | M-4602-S | DRIVESHAFT, BOSSRI | 245 | \$639.00 |
| M-2300-Y | MUSTANG GT350R BRAKE KIT | 34 | \$4,850.00 | M-4614-B | PINION BEARING RETAINER 9" | 244 | \$119.00 |
| M-2301-A | ACCELERATOR PEDAL PAD | 73 | \$26.00 | M-4635-A | U-JOINT KIT | 245 | \$49.00 |
| M-2301-B | PEDAL PAD (SINGLE) - BRAKE OR CLUTCH | 73 | \$23.95 | M-4676-A111 | PINION OIL SEAL | 242 | \$19.95 |
| M-2301-C | DEAD PEDAL PAD | 73 | \$21.00 | M-4700-B | TRACTION-LOK KIT 8.8" | 241 | \$105.00 |
| M-2328-C | ALUM PROPORTIONING VALVE | 70 | \$56.50 | M-4700-C | TRACTION-LOK REBUILD KIT CARBON 8.8" | 241 | \$165.00 |
| M-2810-A | PARK BRAKE CABLE (FRONT) | 70 | \$37.00 | M-4841-A | SLIP YOKE 31 SPLINE | 245 | \$109.00 |
| M-3000-G | LOWERING KIT REAR F-150 2004-2013 | 108 | \$119.00 | M-4841-B | SLIP YOKE 28 SPLINE | 245 | \$85.00 |
| M-3000-H | 2015-2017 F-150 REAR LOWERING KIT | 108 | \$128.00 | M-4851-B | PINION FLANGE COBRA 2003-2004 | 240 | \$64.00 |
| M-3000-H4 | 2015-2017 F-150 LOWERING KIT - LESS JOUNCE BUMPERS | 108 | \$475.00 | M-4851-C | PINION FLANGE 8.8" AXLE | 240 | \$51.95 |
| M-3000-ZX3 | SUSPENSION KIT FOCUS SVT | 88 | \$364.00 | M-4851-MBA | SUPER 8.8" IRS MUSTANG AUTOMATIC PINION FLANGE | 26 | \$79.00 |
| M-3000-ZX3A | SUSPENSION KIT FOCUS SVT | 88 | \$444.00 | M-5018-F15R | F150 RAPTOR FRONT SKID PLATE | 117 | \$515.00 |
| M-3075-A | LOWER CONTROL ARMS PAIR | 67 | \$354.00 | M-5018-F15RB | RAPTOR SKID PLATE KIT | 110 | \$947.00 |
| M-3075-E | FRONT LOWER ARM UPGRADE MGT 2005-2010 | 66 | \$430.00 | M-5025-A | A-ARM BRACE FRONT LOWER MGT 2005-2009 | 66 | \$63.75 |
| M-3075-F | MUSTANG PP FRONT LOWER CONTROL ARM KIT | 32 | \$355.00 | M-5025-M8 | TRANS COOLER SCOOP MGT 2015 | 26 | \$259.00 |
| M-3075-RA | CONTROL ARM KIT EXT BALL JOINT MUSTANG 2011-2014 | 66 | \$706.00 | M-5025-MBR | TRANS COOLER AIR SCOOP | 230 | \$149.00 |
| M-3130-R4 | 2005-2014 MUSTANG BUMP STEER KIT | 67 | \$239.00 | M-5059-A | TRANS CROSS MEMBER | 230 | \$78.50 |
| M-3200-EPAS | STEERING RACK ELECTRIC RACING SPECIAL | 66 | \$1,175.00 | M-5200-F1527DSB | 2015-2017 F-150 2.7 SPORT EXH SYS - REAR EXIT - BLK TIP | 112 | \$1,395.00 |
| M-3600-F15ROR | 2015-2017 F-150 RAPTOR STEERING WHEEL KIT - ORANGE | 110 | \$535.00 | M-5200-F1527DSC | 2015-2017 F-150 2.7 SPORT EXH SYS - REAR EXIT - CHR TIP | 112 | \$1,345.00 |
| M-3600-F15RRD | 2015-2017 F-150 RAPTOR STEERING WHEEL KIT - RED | 110 | \$499.00 | M-5200-F1527DTB | 2015-2017 F-150 2.7 TOUR EXH SYS - REAR EXIT - BLK TIP | 112 | \$1,395.00 |
| M-3600-FRS | FOCUS RS STEERING WHEEL | 91 | \$248.00 | M-5200-F1527DTC | 2015-2017 F-150 2.7 TOUR EXH SYS - REAR EXIT - CHR TIP | 112 | \$1,345.00 |
| M-3600-RA | FORD PERFORMANCE STEERING WHEEL OFF-ROAD | 73 | \$308.00 | M-5200-F1527RSB | 2015-2017 F-150 2.7 SPORT EXH SYS - SIDE EXIT - BLK TIP | 112 | \$1,395.00 |
| M-3602-R | STEERING WHEEL ADAPTER | 73 | \$119.00 | M-5200-F1527RSC | 2015-2017 F-150 2.7 SPORT EXH SYS - SIDE EXIT - CHR TIP | 112 | \$1,345.00 |
| M-3B236-A | SI97 FRONT SUSPENSION ECCENTRIC PACK | 66 | \$90.00 | M-5200-F1527RTB | 2015-2017 F-150 2.7 TOUR EXH SYS - SIDE EXIT - BLK TIP | 112 | \$1,395.00 |
| M-4000-MBS | GT350 DIFFERENTIAL COOLER KIT | 28 | \$2,495.00 | M-5200-F1527RTC | 2015-2017 F-150 2.7 TOUR EXH SYS - SIDE EXIT - CHR TIP | 112 | \$1,345.00 |
| M-4001-88355 | 2015-2017 MUSTANG IRS LOADED DIFF HOUSING 3.55 | 28 | \$1,099.00 | M-5200-F1535126L | 2014 F-150 TREMOR 3.5 SPORT EXH SYS - BLK TIP | 117 | \$1,249.00 |
| M-4001-88373T | DIFF HOUSING TORSEN LOADED MUSTANG 2015-2016 | 28 | \$2,199.00 | M-5200-F1535145L | EXHAUST SPORT CAT-BACK 3.5L 145" WB F-150 2011-2014 | 114 | \$1,195.00 |
| M-4026-FA | FIESTA ST QUAIPE DIFFERENTIAL INSTALLATION KIT | 104 | \$221.00 | M-5200-F1535D5B | 2015-2017 F-150 3.5 SPORT EXH SYS - REAR EXIT - BLK TIP | 112 | \$1,395.00 |
| M-4026-FST | FOCUS ST QUAIPE DIFFERENTIAL INSTALLATION KIT | 86 | \$157.00 | M-5200-F1535DSC | 2015-2017 F-150 3.5 SPORT EXH SYS - REAR EXIT - CHR TIP | 112 | \$1,345.00 |
| M-4033-F975 | 9.75" AXLE DIFFERENTIAL COVER | 242 | \$250.00 | M-5200-F1535DTB | 2015-2017 F-150 3.5 TOUR EXH SYS - REAR EXIT - BLK TIP | 112 | \$1,395.00 |
| M-4033-G2 | AXLE GIRDLER COVER 8.8" MGT | 239 | \$259.00 | M-5200-F1535DTC | 2015-2017 F-150 3.5 TOUR EXH SYS - REAR EXIT - CHR TIP | 112 | \$1,345.00 |
| M-4033-G3 | AXLE GIRDLER COVER COBRA IRS 1999-2004 | 239 | \$319.00 | M-5200-F1535RSB | 2015-2017 F-150 3.5 SPORT EXH SYS - SIDE EXIT - BLK TIP | 112 | \$1,395.00 |
| M-4033-KA | DIFF COVER 8.8" ALUM FINNED WITH TAPPED HOLES | 239 | \$255.00 | M-5200-F1535RSC | 2015-2017 F-150 3.5 SPORT EXH SYS - SIDE EXIT - CHR TIP | 112 | \$1,345.00 |
| M-4050-B | 8.8" AXLE INSTALL KIT | 239 | \$45.00 | M-5200-F1535RTB | 2015-2017 F-150 3.5 TOUR EXH SYS - SIDE EXIT - BLK TIP | 112 | \$1,395.00 |
| M-4130-MBS | MUSTANG GT350 HALF SHAFT KIT | 29 | \$465.00 | M-5200-F1535RTC | 2015-2017 F-150 3.5 TOUR EXH SYS - SIDE EXIT - CHR TIP | 112 | \$1,345.00 |
| M-4130-MA | 2015-2017 MUSTANG HALF SHAFT UPGRADE KIT | 29 | \$1,910.00 | M-5200-F1550145C | EXHAUST TOURING CAT-BACK 5.0L 145" WB F-150 2011-2014 | 113 | \$1,195.00 |
| M-4138-MA | 2015-2016 MUSTANG HALF SHAFT ASSEMBLY (RIGHT SIDE) | 29 | \$1,025.00 | M-5200-F1550145L | EXHAUST SPORT CAT-BACK 5.0L 145" WB F-150 2011-2014 | 113 | \$1,195.00 |
| M-4139-MA | 2015-2016 MUSTANG HALF SHAFT ASSEMBLY (LEFT SIDE) | 29 | \$1,025.00 | M-5200-F1550D5B | 2015-2017 F-150 5.0 SPORT EXH SYS - REAR EXIT - BLK TIP | 111 | \$1,395.00 |
| M-4141-HS | STEEL 9" CARRIER | 244 | \$895.00 | M-5200-F1550DSC | 2015-2017 F-150 5.0 SPORT EXH SYS - REAR EXIT - CHR TIP | 111 | \$1,345.00 |
| M-4144-B | NUT LOCK & BOLT KIT | 244 | \$6.50 | M-5200-F1550DTB | 2015-2017 F-150 5.0 TOUR EXH SYS - REAR EXIT - BLK TIP | 111 | \$1,395.00 |
| M-4204-F28A | TRAC-LOC 9" 28T AG | 244 | \$565.00 | M-5200-F1550DTC | 2015-2017 F-150 5.0 TOUR EXH SYS - REAR EXIT - CHR TIP | 111 | \$1,345.00 |
| M-4204-F318C | COBRA DIFF 8.8" 3IT | 242 | \$389.00 | M-5200-F1550RSB | 2015-2017 F-150 5.0 SPORT EXH SYS - SIDE EXIT - BLK TIP | 111 | \$1,395.00 |
| M-4204-F31A | TRAC-LOC 9" 31T AG | 244 | \$565.00 | M-5200-F1550RSC | 2015-2017 F-150 5.0 SPORT EXH SYS - SIDE EXIT - CHR TIP | 111 | \$1,345.00 |
| M-4204-M | DIFFERENTIAL MUSTANG 2015 | 28 | \$199.00 | M-5200-F1550RTB | 2015-2017 F-150 5.0 TOUR EXH SYS - SIDE EXIT - BLK TIP | 111 | \$1,395.00 |
| M-4204-MB | DIFFERENTIAL TORSEN MUSTANG B302 | 242 | \$1,079.00 | M-5200-F1550RTC | 2015-2017 F-150 5.0 TOUR EXH SYS - SIDE EXIT - CHR TIP | 111 | \$1,345.00 |
| M-4204-MT | TORSEN DIFFERENTIAL MUSTANG 2015 | 28 | \$895.00 | M-5200-F15R145C | 2011-2014 F-150 RAPTOR 6.2 TOUR EXH SYS - CHR TIP | 116 | \$1,449.00 |
| M-4204-T31 | TORSEN DIFF 8.8" 3IT | 242 | \$739.00 | M-5200-F15R145L | 2011-2014 F-150 RAPTOR 6.2 SPORT EXH SYS - CHR TIP | 116 | \$1,449.00 |
| M-4204-T31H | FR500/BOSS R/S DIFFERENTIAL (T2R) | 242 | \$1,020.00 | M-5200-F15R5B | 2017 F-150 RAPTOR 3.5 SPORT EXH SYS - BLK TIPS | 115 | \$1,925.00 |
| M-4209-88308 | RING & PINION 8.8" 3.08 | 240 | \$285.00 | M-5200-F15RSC | 2017 F-150 RAPTOR 3.5 SPORT EXH SYS - CHR TIPS | 115 | \$1,845.00 |
| M-4209-88315 | 8.8" 3.15 RING & PINION | 240 | \$259.00 | M-5200-F15RSCF | 2017 F-150 RAPTOR 3.5 SPORT EXH SYS - CF TIPS | 115 | \$2,250.00 |
| M-4209-88327 | RING & PINION 8.8" 3.27 | 240 | \$259.00 | M-5200-F15RTB | 2017 F-150 RAPTOR 3.5 TOUR EXH SYS - BLK TIPS | 115 | \$1,925.00 |
| M-4209-88331 | RING & PINION 8.8" 3.31 | 240 | \$259.00 | M-5200-F15RTC | 2017 F-150 RAPTOR 3.5 TOUR EXH SYS - CHR TIPS | 115 | \$1,845.00 |
| M-4209-88355 | RING & PINION 8.8" 3.55 | 240 | \$259.00 | M-5200-F15RTCF | 2017 F-150 RAPTOR 3.5 TOUR EXH SYS - CF TIPS | 115 | \$2,250.00 |
| M-4209-88355A | RING & PINION 8.8" 3.55 IRS | 240 | \$249.00 | M-5200-FRS | 2016-2017 FOCUS RS 2.3 SPORT ACTIVE EXHAUST SYSTEM | 96 | \$1,825.00 |
| M-4209-88373 | RING & PINION 8.8" 3.73 | 240 | \$259.00 | M-5200-FST | 2013-2017 FOCUS ST 2.0 SPORT EXHAUST SYSTEM | 89 | \$995.00 |
| M-4209-88373A | RING & PINION 8.8" 3.73 IRS | 240 | \$249.00 | M-5200-M46B | 2016-2017 MUSTANG 2.3 EC-TYPE EXH SYSTEM - BLACK TIP | 22 | \$1,689.00 |
| M-4209-88409A | RING & PINION 8.8" 4.09 IRS | 240 | \$349.00 | M-5200-M46BV | 2016-2017 MUSTANG 2.3 EC-TYPE EXH SYS - 350 TIP - VALANCE | 22 | \$2,995.00 |
| M-4209-88410 | RING & PINION 8.8" 4.10 | 240 | \$259.00 | M-5200-M46C | 2016-2017 MUSTANG 2.3 EC-TYPE EXH SYSTEM - CHROME TIP | 22 | \$1,689.00 |
| M-4209-88456 | RING & PINION 8.8" 4.56 | 240 | \$329.00 | M-5200-M45B | 2015-2017 MUSTANG 2.3 SPORT EXH SYSTEM - BLACK TIP | 23 | \$1,549.00 |
| M-4209ADPT-AC | SPEED-DIAL SPEEDOMETER ADJUSTER | 243 | \$249.00 | M-5200-M45BV | 2015-2017 MUSTANG 2.3 SPORT EXH SYS - 350 TIP - VALANCE | 24 | \$2,240.00 |
| M-4210-A | RING & PINION INSTALL KIT 8.8" | 240 | \$49.00 | M-5200-M45C | 2015-2017 MUSTANG 2.3 SPORT EXH SYSTEM - CHROME TIP | 23 | \$1,489.00 |
| M-4210-B2 | RING & PINION INSTALL KIT 8.8" | 241 | \$159.00 | M-5200-M4TB | 2015-2017 MUSTANG 2.3 TOURING EXH SYSTEM - BLACK TIP | 22 | \$1,549.00 |
| M-4210-B3 | RING & PINION INSTALL KIT IRS 2015 | 27 | \$169.00 | M-5200-M4TBV | 2015-2017 MUSTANG 2.3 TOUR EXH SYS - 350 TIP - VALANCE | 24 | \$2,240.00 |
| M-4210-B75 | RING & PINION INSTALL KIT 75" | 241 | \$129.00 | M-5200-M4TDC | 2015-2017 MUSTANG 2.3 TOURING EXH SYSTEM - CHROME TIP | 22 | \$1,489.00 |
| M-4210-C3 | DIFF INSTALL KIT INC BEARINGS AND SEAL 8.8" | 241 | \$149.00 | M-5200-M8 | 2015-2017 MUSTANG 5.0 CAT BACK ACTIVE EXH SYSTEM KIT | 18 | \$3,169.00 |
| M-4213-A | PINION NUTS (100 PACK) | 239 | \$145.00 | M-5200-M8GB | 2016-2017 MUSTANG 5.0 EC-TYPE EXH SYSTEM - BLACK TIP | 18 | \$1,889.00 |
| M-4216-A200 | RING GEAR BOLTS (100 PACK) | 244 | \$165.00 | M-5200-M8GBV | 2016-2017 MUSTANG 5.0 EC-TYPE EXH SYS-350 TIP - VALANCE | 19 | \$2,995.00 |
| M-4216-A210 | MANUAL FLYWHEEL BOLT (10 PACK) | 244 | \$19.35 | M-5200-M8GC | 2016-2017 MUSTANG 5.0 EC-TYPE EXH SYSTEM - CHROME TIP | 18 | \$1,889.00 |
| M-4216-A300 | 8.8" RING GEAR BOLT SET OF TEN | 232 | \$11.50 | M-5200-M8SB | 2015-2017 MUSTANG 5.0 SPORT EXH SYSTEM - BLACK TIP | 19 | \$1,549.00 |
| M-4216-C | RING GEAR BOLT KIT SUPER 8.8" (10 PIECES) | 28 | \$13.95 | M-5200-M8SBV | 2015-2017 MUSTANG 5.0 SPORT EXH SYS- 350 TIP - VALANCE | 20 | \$2,460.00 |
| M-4264-A | PANHARD BAR MUSTANG 2005-2014 | 68 | \$282.00 | M-5200-M8SC | 2015-2017 MUSTANG 5.0 SPORT EXH SYSTEM - CHROME TIP | 19 | \$1,489.00 |

For important information about the proper usage of performance parts, please see page 12. See pages 295-302 for important safety, emissions and warranty information.

SUGGESTED RETAIL PRICE LIST

FOR THE MOST UP-TO-DATE PRICING AND TECH INFO VISIT performance.ford.com

| Part Number | Description | Pg. No. | Sugg. Retail | Part Number | Description | Pg. No. | Sugg. Retail |
|-----------------|--|---------|--------------|------------------|---|---------|--------------|
| M-5200-M8TB | 2015-2017 MUSTANG 5.0 TOURING EXH SYSTEM - BLACK TIP | 19 | \$1,549.00 | M-5638-C | BUSHING KIT BOSS 302S FRONT REPLACEMENT | 67 | \$595.00 |
| M-5200-M8TBV | 2015-2017 MUSTANG 5.0 TOUR EXH SYS - 350 TIP - VALANCE | 20 | \$2,460.00 | M-5649-RI | CONTROL ARM REAR LOWER KIT FR500C | 68 | \$214.00 |
| M-5200-M8TC | 2015-2017 MUSTANG 5.0 TOURING EXH SYSTEM - CHROME TIP | 19 | \$1,489.00 | M-5649-S | BOSS S CONTROL ARM KIT, REAR LOWER MUSTANG | 68 | \$449.95 |
| M-5200-MSS | 2015-2017 GT350 5.2 SPORT ACTIVE EXHAUST SYSTEM | 18 | \$2,395.00 | M-5650-A | BOSS S MUSTANG REAR LWR CTRL ARM RELOC BKT | 68 | \$178.00 |
| M-5200-SHOTC | 2010-2017 TAURUS SHO TOURING EXHAUST - CHROME TIP | 118 | \$1,425.00 | M-5700-M | 2015 MUSTANG GT SPRING AND SWAY BAR PACKAGE | 30 | \$782.00 |
| M-5220-M8 | SIDE EXHAUST KIT 2015-2017 MGT | 21 | \$1,219.00 | M-5844210-RS | FOCUS RS REAR SPOILER KIT | 96 | \$788.00 |
| M-5220-MSVT | EXHAUST KIT QUAD SIDE MSVT 2011-2014 | 51 | \$1,199.00 | M-5970-A | KIT CAR KNUCKLE | 239 | \$499.00 |
| M-5230-FAB | MUFFLER KIT AXLE-BACK FIESTA 2011-2015 | 102 | \$529.00 | M-5970-M | KNUCKLE KIT IRS W/TOE BRG MUSTANG 2015-2017 | 27 | \$540.00 |
| M-5230-FAC | MUFFLER KIT TOURING CAT-BACK FIESTA HATCH 2011-2014 | 102 | \$739.00 | M-5972-M | REAR TOE LINK MUSTANG 2015 (PACK OF 2) | 27 | \$79.00 |
| M-5230-FSH | EXHAUST AXLE-BACK FOCUS HATCH 2012-2016 | 90 | \$407.00 | M-5A460-M | MUSTANG GT KNUCKLE TO TOE LINK BEARING ASSEMB | 27 | \$85.00 |
| M-5230-FSHA | EXHAUST KIT FOCUS HATCH 2012-2014 | 90 | \$476.00 | M-6000-C302 | VALVE COVER - COBRA KIT | 251 | \$199.95 |
| M-5230-GTB | MUFFLER KIT SPECIAL EDITION MGT 2005-2009 | 52 | \$529.00 | M-6000-D302 | VALVE COVER - COBRA EFI | 251 | \$229.95 |
| M-5230-M45BV | 2015-2017 MUSTANG 2.3 SPORT EXH AXLE - 350 TIP - VALANCE | 24 | \$1,900.00 | M-6000-E302 | VALVE COVER - MUSTANG EFI | 251 | \$199.95 |
| M-5230-M4SC | 2015-2017 MUSTANG 2.3 SPORT EXH AXLE - CHROME TIP | 23 | \$895.00 | M-6000-F302 | VALVE COVER | 251 | \$229.95 |
| M-5230-M4TBV | 2015-2017 MUSTANG 2.3 TOUR EXH AXLE - 350 TIP - VALANCE | 24 | \$1,900.00 | M-6000-J302R | VALVE COVERS - BLACK RACING EFI | 251 | \$199.95 |
| M-5230-M4TC | 2015-2017 MUSTANG 2.3 TOURING EXH AXLE - CHROME TIPS | 23 | \$895.00 | M-6003-A429 | ENGINE GASKET SET | 197 | \$142.00 |
| M-5230-M8SBV | 2015-2017 MUSTANG 5.0 SPORT EXH AXLE - 350 TIP - VALANCE | 20 | \$2,090.00 | M-6003-A50 | ENGINE GASKET SET | 188 | \$137.00 |
| M-5230-M8TBV | 2015-2017 MUSTANG 5.0 TOUR EXH AXLE - 350 TIP - VALANCE | 20 | \$2,090.00 | M-6004-462V | CAMSHAFT DRIVE KIT 4.6L 2V | 148 | \$510.00 |
| M-5230-M8TC | 2015-2017 MUSTANG 5.0 SPORT EXH AXLE - CHROME TIPS | 21 | \$895.00 | M-6004-463V | TIMING CHAIN KIT MODULAR 4.6L 3V | 148 | \$640.00 |
| M-5230-MGTC1 | MUFFLER KIT MGT/MSVT 2011-2014 | 52 | \$559.99 | M-6004-54SVT | CAM DRIVE KIT SVT 5.4L 4V | 148 | \$575.00 |
| M-5230-MGTC3A0 | 2011-2014 MUSTANG GT 3" EXH | 52 | \$1,549.00 | M-6004-A464 | CAMSHAFT DRIVE KIT 4.6L 4V | 148 | \$615.00 |
| M-5230-MGLTA | MUFFLER KIT SPORT MGT 2011-2014 | 52 | \$774.95 | M-6004-A5015 | CAM DRIVE KIT MGT 2015-2017 | 136 | \$620.00 |
| M-5230-MSVTC | EXHAUST KIT QUAD TIP MGT 2013-2014 | 52 | \$999.00 | M-6004-A504 | CAM DRIVE KIT MGT 2011-2014 | 136 | \$670.00 |
| M-5230-MSVT1A | MUFFLER KIT SPORT MSVT 2011-2012 | 51 | \$799.95 | M-6004-A544 | CAMSHAFT DRIVE KIT 5.4L 4V | 148 | \$430.00 |
| M-5230-MSVT1B | MUFFLER KIT SPORT MSVT 2013-2014 | 51 | \$1,349.00 | M-6006-20 | ENGINE ORIENTATION COMPONENT KIT 2.0L | 154 | \$299.00 |
| M-5230-MV6CA | MUFFLER KIT TOURING MV6 2011-2014 | 53 | \$795.00 | M-6006-M50A | 2015-2017 MUSTANG 5.0L COYOTE LONG BLOCK | 129 | \$6,395.00 |
| M-5230-MV6LA | MUFFLER KIT SPORT MV6 2011-2014 | 53 | \$799.95 | M-6006-M50A1 | 5.0L COYOTE LONG BLOCK GEN 1 | 131 | \$7,875.00 |
| M-5230-S | MUFFLER KIT FR500S MGT/MSVT 2005-2009 | 51 | \$639.00 | M-6007-20T | 2.0L ECOBOOST ENGINE KIT | 155 | \$8,000.00 |
| M-5230-V6 | EXHAUST KIT DUAL MV6 2005-2009 | 53 | \$817.00 | M-6007-23T | 2.3L MUSTANG ECOBOOST CRATE ENGINE | 157 | \$7,795.00 |
| M-5248-F15126C | 5.0L TOURING 126" WB MID-PIPE 2011-2014 | 113 | \$79.95 | M-6007-35T | 3.5L GTDI ECOBOOST V6 ENGINE KIT | 160 | \$9,400.00 |
| M-5248-F15126L | 3.5L/5.0L SPORT 126" WB MID-PIPE 2011-2014 | 113 | \$79.95 | M-6007-A50NAA | CRATE ENGINE COYOTE ALUMINATOR N/A | 124 | \$10,995.00 |
| M-5248-F15133C | 5.0L TOURING 133" WB MID-PIPE 2011-2014 | 113 | \$79.95 | M-6007-A50SCA | CRATE ENGINE ALUMINATOR S/C | 125 | \$10,995.00 |
| M-5248-F15133L | 3.5L/5.0L SPORT 133" WB MID-PIPE 2011-2014 | 114 | \$79.95 | M-6007-A52XS | 5.2L COYOTE ALUMINATOR XS | 126 | \$19,995.00 |
| M-5248-F15157C | 5.0L TOURING 157" WB MID-PIPE 2011-2014 | 113 | \$79.95 | M-6007-D347SR | CRATE ENGINE SEALED CIRCLE TRACK | 168 | \$9,300.00 |
| M-5248-F15157L | 3.5L/5.0L SPORT 157" WB MID-PIPE 2011-2014 | 113 | \$79.95 | M-6007-D347SR7 | CRATE ENGINE 347 SEALED RACING 7 MM VALVES | 168 | \$10,450.00 |
| M-5248-F15163C | 5.0L TOURING 163" WB MID-PIPE 2011-2014 | 113 | \$79.95 | M-6007-M50A | 2017 MUSTANG 5.0L COYOTE CRATE ENGINE | 122 | \$7,975.00 |
| M-5248-F15163L | 3.5L/5.0L SPORT 163" WB MID-PIPE 2011-2014 | 113 | \$79.95 | M-6007-M50AAUTO | 5.0L COYOTE 435 HP MUSTANG CRATE ENGINE AUTOMATIC | 122 | \$7,875.00 |
| M-5248-F15R133 | RAPTOR 133" WHEELBASE EXHAUST MID PIPE | 115 | \$200.00 | M-6007-M50SA | SEALED COYOTE STOCK ENGINE GEN2 | 123 | \$8,500.00 |
| M-5248-F15R133C | 6.2L TOURING 133" WB MID-PIPE | 116 | \$79.95 | M-6007-5347JR | CRATE ENGINE SEALED RACING | 169 | \$8,199.00 |
| M-5248-F15R133L | 6.2L SPORT 133" WB MID-PIPE | 116 | \$79.95 | M-6007-X302B | CRATE ENGINE BOSS302 PUSH ROD | 162 | \$8,150.00 |
| M-5251-M8 | X-PIPE MGT 2015-2017 | 21 | \$274.00 | M-6007-X302E | CRATE ENGINE BOSS302 PUSH ROD | 162 | \$8,150.00 |
| M-5251-MGTA | X-PIPE KIT MGT 2011-2014 | 52 | \$259.95 | M-6007-X347DF | FRONT SUMP 347 STREET ENGINE DRESSED | 163 | \$10,795.00 |
| M-5251-MV6A | V6 X-PIPE MUSTANG 2011-2014 | 53 | \$205.00 | M-6007-X347DR | REAR SUMP 347 STREET ENGINE | 163 | \$10,295.00 |
| M-5251-R | X-PIPE KIT MUSTANG 2005-2010 | 52 | \$182.00 | M-6007-Z2363FT | 363 CUBIC INCH 500 HP BOSS CRATE ENGINE | 164 | \$10,650.00 |
| M-5255-F15R | EXHAUST TIPS FORD RACING LOGO (PAIR) | 117 | \$269.00 | M-6007-Z2363RT | 363 CUBIC INCH 500 HP BOSS CRATE ENGINE | 164 | \$10,650.00 |
| M-5300-B | SPRING KIT FRONT/REAR MUSTANG 1979-2004 | 63 | \$269.00 | M-6007-Z2427FFT | 427 CUBIC INCH 535 HP BOSS CRATE ENGINE | 165 | \$11,000.00 |
| M-5300-C | SPRING KIT FRONT/REAR MUSTANG 1979-2004 | 63 | \$224.00 | M-6007-Z2427FRT | 427 CUBIC INCH 535 HP BOSS CRATE ENGINE | 165 | \$11,000.00 |
| M-5300-G | SPRING KIT 1979-2004 MUSTANG | 63 | \$270.00 | M-6007-Z427AFT | CRATE ENGINE 427 ALUMINUM BLOCK - FRONT SUMP | 166 | \$15,995.00 |
| M-5300-KA | 2005-2014 MUSTANG SPRING KIT 1.5" DROP | 64 | \$221.00 | M-6007-Z427ART | CRATE ENGINE 427 ALUMINUM BLOCK - REAR SUMP | 166 | \$15,995.00 |
| M-5300-L | LOWERING SPRINGS (1.25") MSVT 2007-2014 | 64 | \$260.00 | M-6007-Z460FFT | CRATE ENGINE 460 IRON BLOCK - FRONT SUMP | 167 | \$10,900.00 |
| M-5300-PA | LOWERING KIT 1" MGT 2005-2014 | 64 | \$221.00 | M-6007-Z460FRT | CRATE ENGINE 460 IRON BLOCK - REAR SUMP | 167 | \$10,900.00 |
| M-5300-RA | SPRING KIT COBRA JET MUSTANG 2005-2013 | 64 | \$310.00 | M-6009-347 | SHORT BLOCK 347 NEUTRAL BALANCE | 170 | \$5,049.00 |
| M-5300-S | 2012-2013 FOCUS SPRING KIT | 89 | \$247.00 | M-6009-363 | SHORT BLOCK BOSS 363 CU IN | 170 | \$5,199.00 |
| M-5300-T | LOWERING KIT MGT/BOSS/LAGUNA 2012-2013 | 64 | \$359.00 | M-6009-427A | 427 CUBIC INCH ALUMINUM SHORT BLOCK | 171 | \$8,500.00 |
| M-5300-U | LOWERING KIT 2013 FOCUS ST | 89 | \$135.00 | M-6009-427F | 427 CUBIC INCH BOSS SHORT BLOCK | 171 | \$5,449.00 |
| M-5300-V | LOWERING SPRINGS FOCUS ST 2014-2016 | 89 | \$299.95 | M-6009-460 | 460 CUBIC INCH BOSS SHORT BLOCK | 172 | \$6,495.00 |
| M-5300-W | MUSTANG GT350 SPRINGS | 30 | \$359.00 | M-6009-A50NAA | 5.0L COYOTE ALUMINATOR NA SHORT BLOCK | 131 | \$6,695.00 |
| M-5300-X | LOWERING SPRINGS STREET MGT 2015 | 30 | \$356.00 | M-6009-A50SCA | 5.0L COYOTE ALUMINATOR SC SHORT BLOCK | 131 | \$6,695.00 |
| M-5300-Y | LOWERING SPRINGS TRACK MGT 2015 | 30 | \$356.00 | M-6009-B53 | 5.3L MODULAR BOSS STROKER SHORT BLOCK | 145 | \$6,800.00 |
| M-5478-6M | 2015 MUSTANG DRIVESHAFT LOOP | 33 | \$149.00 | M-6009-C54SC4 | 5.4 V/C IRON SHORT BLOCK | 145 | \$5,495.00 |
| M-5478-CJ | CJ DRIVESHAFT LOOP | 245 | \$159.00 | M-6010-16K | CYLINDER BLOCK KENT 1.6L HIGH DECK (8.200) | 201 | \$1,450.00 |
| M-5490-A | SWAY BARS MGT 2005-2014 | 65 | \$477.00 | M-6010-16L | CYLINDER BLOCK LOTUS 1.6L SHORT DECK (7.780) | 201 | \$1,775.00 |
| M-5490-B | SWAY BAR KIT MSVT 2007-12 | 65 | \$505.00 | M-6010-23T | 2.3L ECOBOOST MUSTANG CYLINDER BLOCK | 158 | \$995.00 |
| M-5490-BKA | SWAY BAR REPLACEMENT BUSHING KIT | 65 | \$44.00 | M-6010-A460 | CYLINDER BLOCK A460 | 195 | \$2,795.00 |
| M-5490-BKB | SWAY BAR REPLACEMENT BUSHING KIT | 65 | \$42.00 | M-6010-A460BB | CYLINDER BLOCK 460 SIAMESE BIG BORE | 195 | \$2,949.00 |
| M-5490-BKC | SWAY BAR REPLACEMENT BUSHING KIT | 65 | \$42.00 | M-6010-B302BB | BOSS 302 4.115" BIG BORE ENGINE BLOCK | 174 | \$2,350.00 |
| M-5490-BKD | TRACK SWAY BAR BUSHING KIT | 65 | \$87.00 | M-6010-B35192BB | BLOCK 9.2 DECK BIG BORE | 174 | \$2,650.00 |
| M-5490-D | SWAY BAR KIT CONV MGT 2005-2014 | 65 | \$469.00 | M-6010-BOSS302 | CYLINDER BLOCK BOSS 302 | 174 | \$2,195.00 |
| M-5490-EA | 2015-2018 MUSTANG TRACK SWAY BAR KIT | 30 | \$520.00 | M-6010-BOSS35192 | BOSS 351W BLOCK 9.2 DECK | 174 | \$2,550.00 |
| M-5490-HWA | SWAY BAR COMPLETE HARDWARE KIT | 65 | \$175.00 | M-6010-BOSS35195 | BOSS 351W BLOCK 9.5 DECK | 174 | \$2,550.00 |
| M-5490-HWB | SWAY BAR COMPLETE HARDWARE KIT | 65 | \$175.00 | M-6010-BOSS35198 | BOSS 351W BLOCK 9.5 DECK 4.120 BIG BORE | 174 | \$2,650.00 |
| M-5490-HWC | SWAY BAR COMPLETE HARDWARE KIT | 65 | \$175.00 | M-6010-BOSS50 | MODULAR 5.0L IRON BLOCK | 146 | \$2,050.00 |
| M-5490-LINKA | SWAY BAR SINGLE REPLACEMENT END LINK | 65 | \$91.00 | M-6010-M504V | 5.0L COYOTE ALUMINUM BLOCK | 132 | \$1,749.00 |
| M-5490-LINKB | SWAY BAR SINGLE REPLACEMENT END LINK | 65 | \$91.00 | M-6010-M504VB | CYLINDER BLOCK 5.0L 4V 2015 | 132 | \$1,749.00 |
| M-5490-LINKC | SWAY BAR SINGLE REPLACEMENT END LINK | 65 | \$91.00 | M-6010-M50R | CYLINDER BLOCK 5.0L ALUMINUM RACE SPECIAL | 132 | \$3,250.00 |
| M-5538-A | CONTROL ARM REAR LOWER MGT 2005-2014 | 68 | \$154.00 | M-6010-M52 | 5.2L COYOTE ALUMINUM CYLINDER BLOCK | 133 | \$3,059.00 |
| M-5570-A | JOUNCE BUMPER KIT MUSTANG 2005-2014 | 63 | \$39.00 | M-6010-M54 | CYLINDER BLOCK IRON 5.4L | 146 | \$1,299.00 |
| M-5570-B | JOUNCE BUMPER & HARDWARE PACK MUSTANG 2015 | 29 | \$80.00 | M-6010-R500 | FR9 CYLINDER BLOCK | 202 | \$13,150.00 |
| M-5638-A | BUSHING KIT, REAR LOWER FR500C | 67 | \$52.00 | M-6010-Z351 | CYLINDER BLOCK ALUM 9.5 DECK | 173 | \$5,600.00 |

SUGGESTED RETAIL PRICE LIST

FOR THE MOST UP-TO-DATE PRICING AND TECH INFO VISIT performance.ford.com

| Part Number | Description | Pg. No. | Sugg. Retail | Part Number | Description | Pg. No. | Sugg. Retail |
|-----------------|--|---------|--------------|----------------|--|---------|--------------|
| M-6010-Z35192 | 351 ALUMINUM BLOCK 9.2" DECK | 173 | \$5,600.00 | M-6067B-F150 | COIL COVER BALL STUD | 142 | \$24.95 |
| M-6012-C351 | CYLINDER SLEEVES SET OF 8 Z351 BLOCK | 173 | \$535.00 | M-6250-23EBH | CAM SET HIPO 2.3L ECOBOOST | 159 | \$200.00 |
| M-6012-C35192 | CYLINDER SLEEVES Z35192 BLOCK (8 PACK) | 173 | \$535.00 | M-6250-B303 | HYD ROLLER CAMSHAFT | 186 | \$295.00 |
| M-6014-BOSS | CYLINDER HEAD STUD KIT | 177 | \$249.00 | M-6250-C580T | HYDRAULIC ROLLER CAM SB BILLET | 186 | \$399.00 |
| M-6014-Z304 | CYLINDER HEAD STUD KIT | 177 | \$220.00 | M-6250-E303 | CAMSHAFT - HYDRAULIC ROLLER | 186 | \$295.00 |
| M-6017-20T | CONTROL PACK 2.0L ECOBOOST | 211 | \$1,980.00 | M-6250-F303 | HYDRAULIC ROLLER CAMSHAFT | 186 | \$295.00 |
| M-6017-23T | CONTROL PACK 2.3L ECOBOOST | 213 | \$1,995.00 | M-6250-X303 | HYDRAULIC ROLLER CAMSHAFT | 186 | \$295.00 |
| M-6017-35CENTRL | CONTROL PACK 3.5L GTDI MT | 213 | \$2,299.00 | M-6253-A50 | ROLLER CAM CONV. KIT | 187 | \$75.00 |
| M-6017-504V | CONTROL PACK 5.0L 4V 2015-2017 MT | 214 | \$1,999.00 | M-6261-A460 | CAMSHAFT BEARINGS | 198 | \$59.00 |
| M-6017-A504VA | CONTROL PACK 5.0L 4V 2011-2014 W/SPEED DIAL WIRING | 213 | \$1,999.00 | M-6261-D351 | ROLLER CAM BEARINGS | 176 | \$89.00 |
| M-6017-M50A | 2015-2017 COYOTE CONTROL PACK WITH AUTOMATIC TRANS | 213 | \$2,149.00 | M-6261-J351 | CAMSHAFT BEARINGS STD CAM COMMON OD | 176 | \$99.00 |
| M-6026-23BSBP | 2.3L ECOBOOST BALANCE SHAFT BLOCK-OFF PLUG | 159 | \$40.00 | M-6266-54ST | 5.4L 4V STEEL TIMING CHAIN TENSIONER KIT | 150 | \$175.00 |
| M-6026-A | ALUMINUM PLUG & DOWEL KIT | 176 | \$210.00 | M-6266-M50B | 5.0L BOSS TIMING CHAIN TENSIONER | 140 | \$152.00 |
| M-6026-A302 | PLUG & DOWEL KIT | 176 | \$27.00 | M-6268-A302 | CHAIN & SPROCKET SET | 187 | \$159.00 |
| M-6026-A46 | BLOCK KIT AL 4.6L | 147 | \$24.95 | M-6268-A351 | CHAIN & SPROCKET SET | 187 | \$199.00 |
| M-6026-A460 | PLUG & DOWEL KIT | 195 | \$23.00 | M-6268-A390 | CHAIN & SPROCKET SET | 198 | \$140.00 |
| M-6026-A50A | COYOTE BLOCK HARDWARE KIT 2011-17 | 134 | \$65.00 | M-6268-A460 | CHAIN & SPROCKET SET | 198 | \$180.00 |
| M-6026-B302 | THREAD-IN CORE PLUG KIT | 176 | \$26.50 | M-6268-B302 | CHAIN & SPROCKET SET | 187 | \$129.00 |
| M-6026-C146 | PLUG & DOWEL KIT | 147 | \$44.00 | M-6268-B429 | CHAIN & SPROCKET SET | 198 | \$129.00 |
| M-6026-S351 | CAM PLUGS FOR RACE BLOCK (10 PK) | 176 | \$9.00 | M-6268-F302 | CHAIN & SPROCKET SET | 188 | \$539.00 |
| M-6031-BOSS50 | ENGINE MOUNT BRACKET - IRON MOD BLOCK | 146 | \$295.00 | M-6269-A302 | THRUST PLATE 302-351W | 177 | \$55.00 |
| M-6038-A460 | FOX 460 ENGINE MOUNTS | 195 | \$250.00 | M-6269-A351 | CAMSHAFT THRUST PLATE | 177 | \$52.00 |
| M-6038-M | ENGINE SHIPPING CRADLE - MODULAR & COYOTE | 133 | \$140.00 | M-6279-463V | CAMSHAFT BOLT KIT 4.6L 3V | 150 | \$35.95 |
| M-6038-M50 | MOTOR MOUNT KIT COYOTE 5.0L | 134 | \$169.00 | M-6287-B302 | ECCENTRIC | 187 | \$79.00 |
| M-6049-20EBIP | 2.0L ECOBOOST HEAD INDIVIDUAL PORT | 156 | \$950.00 | M-6287-C302 | ECCENTRIC | 187 | \$79.00 |
| M-6049-C460 | CYLINDER HEAD | 196 | \$1,300.00 | M-6303-23EB | CRANKSHAFT 2.3L ECOBOOST | 159 | \$499.00 |
| M-6049-E1 | CYLINDER HEAD | 202 | \$1,885.00 | M-6303-C340 | FINISHED CRANKSHAFT FORGED | 178 | \$750.00 |
| M-6049-M23 | 2015-2016 MUSTANG 2.3L ECOBOOST CYL HEAD | 158 | \$699.00 | M-6303-C54SC4 | CRANKSHAFT COBRA JET MUSTANG | 147 | \$495.00 |
| M-6049-M50 | MUSTANG 5.0L COYOTE RH HEAD ASSEMBLY | 137 | \$1,099.00 | M-6303-M50B | CRANKSHAFT FORGED BOSS 5.0L COYOTE | 134 | \$449.00 |
| M-6049-M50A | 2015-2017 MUSTANG GT 5.0L COYOTE CYL HEAD RH | 137 | \$1,150.00 | M-6303-M50RF | COYOTE CRANKSHAFT RAW FORGING | 134 | \$325.00 |
| M-6049-M52 | GT350 CYLINDER HEAD RH | 137 | \$2,495.00 | M-6303-M52 | COYOTE 5.2L FORGED CRANKSHAFT | 134 | \$1,250.00 |
| M-6049-SCJ | CYLINDER HEAD | 196 | \$869.00 | M-6304GPACK-MA | GAUGE PACK LAGUNA MUSTANG GT 2010-2014 | 247 | \$1,449.00 |
| M-6049-SCJA | CYLINDER HEAD 72 CC | 196 | \$1,145.00 | M-6304GPDD-A | GAUGE POD MUSTANG 2005-2014 | 247 | \$146.00 |
| M-6049-SCJB | CYLINDER HEAD | 196 | \$1,210.00 | M-6312-SVT | 2008 SVT COBRA CRANKSHAFT DAMPER | 147 | \$299.00 |
| M-6049-X306 | CYLINDER HEAD 64 CC | 182 | \$775.00 | M-6316-A460 | CRANKSHAFT DAMPER | 198 | \$390.00 |
| M-6049-X307 | X CYLINDER HEAD 58 CC CHAMBER | 182 | \$775.00 | M-6316-A50 | CRANKSHAFT DAMPER | 178 | \$440.00 |
| M-6049-Z2 | CYLINDER HEAD AL Z2 302/351W | 182 | \$1,475.00 | M-6316-A521 | CRANKSHAFT DAMPER | 198 | \$445.00 |
| M-6049-Z304D | ALUM CYLINDER HEAD | 184 | \$1,050.00 | M-6316-C351 | CRANKSHAFT DAMPER | 178 | \$369.00 |
| M-6049-Z304D7 | Z-304D HEAD - 7 MM BARE SEMIFINISHED | 184 | \$800.00 | M-6316-D302 | CRANKSHAFT DAMPER SB 0 BALANCE | 178 | \$370.00 |
| M-6049-Z304DA | CYLINDER HEAD ASSEMBLY | 184 | \$1,600.00 | M-6316-M50 | 5.0L DAMPER KIT | 178 | \$100.00 |
| M-6049-Z304DA7 | CYLINDER HEAD W/7 MM VALVES | 184 | \$1,499.00 | M-6345-A46 | MAIN CAP BOLT KIT 4.6L ALUM BLOCK | 147 | \$50.00 |
| M-6049-Z304P | CNC PORTED "Z" CYL HEAD | 184 | \$1,149.00 | M-6345-M52 | 5.2L COYOTE MAIN BOLT KIT | 134 | \$40.00 |
| M-6050-M50 | MUSTANG 5.0L COYOTE LH HEAD ASSEMBLY | 137 | \$1,099.00 | M-6346612-M | 2015-17 MUSTANG REAR SEAT DELETE KIT | 35 | \$903.00 |
| M-6050-M50A | 2015-2017 MUSTANG GT 5.0L COYOTE CYL HEAD LH | 137 | \$1,150.00 | M-6359-D460 | CRANK SPACER | 198 | \$67.00 |
| M-6050-M52 | GT350 CYLINDER HEAD LH | 137 | \$2,495.00 | M-63660005-ME | 2015-2017 MUSTANG FORD PERFORMANCE RECARO SEATS | 35 | \$3,282.00 |
| M-6051-A302 | HEAD GASKET | 189 | \$86.00 | M-63660005-MF | 2018 MUSTANG FORD PERFORMANCE RECARO SEATS | 35 | \$3,365.00 |
| M-6051-A441 | 460-521 HEAD GASKET SET | 197 | \$98.00 | M-6373-A | STARTER INDEX PLATE MODULAR BLOCK AUTO TRANS | 233 | \$55.00 |
| M-6051-B341 | HEAD GASKET SET | 189 | \$95.00 | M-6375-A302AB | FLYWHEEL ALUM 157T 28.2 | 234 | \$429.00 |
| M-6051-B460 | HEAD GASKET SET | 197 | \$70.00 | M-6375-A302B | FLYWHEEL STEEL 157T 28.2 | 234 | \$297.00 |
| M-6051-C51 | HEAD GASKET SET PUSH ROD V8 5.0L/5.8L | 189 | \$32.25 | M-6375-A50C | 5.0L COYOTE AUTO TRANS FLEXPLATE AND BOLTS | 143 | \$80.00 |
| M-6051-CP331 | HEAD GASKET SET | 189 | \$89.00 | M-6375-B302 | FLYWHEEL M/T 157T 50 | 234 | \$219.00 |
| M-6051-D50 | HEAD GASKET AND BOLT KIT 5.0L PUSH ROD | 189 | \$85.50 | M-6375-C302B | FLYWHEEL STEEL 157T 50 | 234 | \$299.00 |
| M-6051-R351 | HEAD GASKET SET | 189 | \$98.00 | M-6375-D302AB | FLYWHEEL ALUMINUM 157T 0 BALANCE | 234 | \$469.00 |
| M-6051-S331 | HEAD GASKET SET | 189 | \$88.00 | M-6375-D302B | FLYWHEEL STEEL 157T 0 | 234 | \$295.00 |
| M-6059-460 | 460/BIG BLOCK TIMING COVER | 200 | \$195.00 | M-6375-D46 | FLYWHEEL M/T 4.6L 6 BOLT NI | 235 | \$152.00 |
| M-6059-D351 | TIMING CHAIN COVER 302-351 | 192 | \$157.95 | M-6375-F46A | FLYWHEEL BILLET 6 BOLT | 235 | \$350.00 |
| M-6059-M50SC | 5.0L COYOTE FRONT COVER FOR SC APPLICATIONS | 141 | \$164.00 | M-6375-G46A | FLYWHEEL BILLET 8 BOLT | 235 | \$369.00 |
| M-6065-BOSS | BOSS BLOCK HEAD BOLT SET X HEAD | 177 | \$139.00 | M-6375-K302 | FLYWHEEL 164 T 28.2 OZ IN | 234 | \$369.00 |
| M-6065-D289 | HEAD BOLT KIT | 177 | \$139.00 | M-6375-M302 | FLYWHEEL 164T 0 OZ IN | 234 | \$369.00 |
| M-6066-M8627 | SUPERCHARGER KIT 670 HP MGT 2015-2017 | 14 | \$7,100.99 | M-6375-M50 | FLYWHEEL LIGHTWEIGHT BILLET 8 BOLT | 235 | \$369.00 |
| M-6066-MSVT23 | SUPERCHARGER TUNER KIT 2.3L TVS MSVT 2007-2012 | 50 | \$3,799.00 | M-6375-N427 | FLYWHEEL 184T 0 OZ IN | 234 | \$369.00 |
| M-6066-MSVT2365 | TUNER KIT TVS 2.3L W/65 MM TB MSVT 2007-2012 | 50 | \$3,869.00 | M-6375-R00A | FLYWHEEL ALUMINUM 4.6/5.4L 8 BOLT | 235 | \$489.00 |
| M-6067-3V46 | HEAD CHANGING KIT 4.6L 3V | 149 | \$105.00 | M-6379-B | FLYWHEEL BOLTS 4.6L MANUAL (8 PACK) | 233 | \$14.95 |
| M-6067-3V50 | 5.0L 3V HEAD GASKET KIT | 149 | \$439.00 | M-6379-C | 5.0L COYOTE FLYWHEEL BOLT | 233 | \$16.50 |
| M-6067-50B302 | MUSTANG 5.0L COYOTE COIL COVER BOSS 302 | 141 | \$300.00 | M-6379-M50A | 5.0L COYOTE AUTOMATIC TRANSMISSION FLEXPLATE BOLTS | 143 | \$32.00 |
| M-6067-50BK | COIL COVER 5.0L 4V BLACK | 142 | \$294.00 | M-63840-MS | 2015-2017 GT350R REAR SEAT INSTALLATION KIT | 35 | \$999.00 |
| M-6067-50C | COIL COVER 5.0L 4V CHROME | 142 | \$399.00 | M-6392-E | BELLHOUSING 5.0L T-5 | 232 | \$359.00 |
| M-6067-50FP | MUSTANG 5.0L COYOTE COIL COVER FORD PERFORMANCE | 141 | \$300.00 | M-6392-M46 | 4.6 3550 BELLHOUSING | 232 | \$625.00 |
| M-6067-C | COIL COVERS MSVT 2007-2014 | 154 | \$108.95 | M-6392-R58 | CLUTCH HOUSING TREMEC ALUM | 232 | \$345.00 |
| M-6067-D | COIL COVERS DIE-CAST 5.4L 4V / 4.6L 4V | 154 | \$239.00 | M-6397-A302 | PRESSURE PLATE BOLT AND DOWEL KIT 10.5" | 233 | \$18.95 |
| M-6067-D46 | HEAD CHANGING KIT 2V | 149 | \$160.00 | M-6397-B46 | PRESSURE PLATE BOLT AND DOWEL KIT 11" | 233 | \$19.95 |
| M-6067-M50 | CYL HEAD CHANGING KIT - 11 MM 2015 COYOTE | 138 | \$160.00 | M-6500-GT | FORD GT AND SVT 5.4L LASH ADJUSTERS | 150 | \$310.00 |
| M-6067-M50S2 | 5.0L COYOTE HEAD CHANGING KIT - 5.2L HEAD ON 5.0L | 138 | \$160.00 | M-6500-M50 | LASH ADJUSTER ASSEMBLY COYOTE | 139 | \$345.00 |
| M-6067-M50BR | CYLINDER HEAD CHANGING KIT BOSS302R | 138 | \$160.00 | M-6500-R302 | TAPPET SET HYDRAULIC ROLLER (16) | 187 | \$141.95 |
| M-6067-M50BR11 | CYLINDER HEAD CHANGING KIT 11 MM BOSS 302R | 138 | \$160.00 | M-6500-R302H | HYDRAULIC TAPPET OEM TYPE HI PERFORMANCE | 187 | \$220.00 |
| M-6067-M52 | 5.2L COYOTE HEAD CHANGING KIT | 138 | \$200.00 | M-6500-R302HLC | HARDENED STEEL LIFTER CUP FOR M-6500-R302H | 187 | \$230.00 |
| M-6067-M58 | GT500 5.8L CYLINDER HEAD CHANGING KIT | 149 | \$180.00 | M-6505-A429 | EXHAUST VALVE | 197 | \$19.00 |
| M-6067-MSVT | HEAD CHANGING KIT 4V S/C | 149 | \$165.00 | M-6505-B304 | EXHAUST VALVE | 184 | \$19.00 |
| M-6067-T46 | HEAD CHANGING KIT 4V | 149 | \$160.00 | M-6505-D3047 | EXHAUST VALVE 7 MM | 184 | \$18.50 |

For important information about the proper usage of performance parts, please see page 12. See pages 295-302 for important safety, emissions and warranty information.

SUGGESTED RETAIL PRICE LIST

FOR THE MOST UP-TO-DATE PRICING AND TECH INFO VISIT performance.ford.com

| Part Number | Description | Pg. No. | Sugg. Retail |
|-----------------|---|---------|--------------|
| M-6505-G302 | EXHAUST VALVE | 183 | \$14.25 |
| M-6505-M52 | EXHAUST VALVE 5.2L COYOTE - QTY 8 | 139 | \$130.00 |
| M-6507-A304 | INTAKE VALVE | 184 | \$19.00 |
| M-6507-B429 | INTAKE VALVE | 197 | \$19.00 |
| M-6507-D3047 | INTAKE VALVE 7 MM | 184 | \$18.50 |
| M-6507-J302 | INTAKE VALVE X-HEAD (SINGLE) | 183 | \$17.50 |
| M-6507-M52 | INTAKE VALVE LIGHTWEIGHT 5.2L COYOTE (8 PACK) | 139 | \$240.00 |
| M-6510-XRBVG | GUIDE-BRONZE VALVE 4 PK | 183 | \$32.00 |
| M-6513-1219X | PAC 1219X BEEHIVE VALVE SPRING | 185 | \$195.00 |
| M-6513-M50BR | VALVE SPRING KIT BOSS 302R | 139 | \$66.00 |
| M-6513-M52 | 5.2L COYOTE VALVE SPRING KIT | 139 | \$275.00 |
| M-6514-A50 | VALVE SPRING RETAINERS (16) | 185 | \$54.00 |
| M-6527-C311 | ROCKER ARM STUDS (16) | 185 | \$72.00 |
| M-6529-3V | ROCKER ARM AND LASH ADJ KIT 3V MODULAR | 150 | \$385.00 |
| M-6529-A302 | ROCKER ARM SHIM KIT | 188 | \$11.00 |
| M-6529-B302 | ROCKER ARM PEDESTAL SHIM KIT | 188 | \$15.95 |
| M-6529-MSVT | ROCKER ARM SET 5.4L (SET OF 16) | 150 | \$309.00 |
| M-6550-3V | CAMSHAFTS 4.6L 3V MGT 2005-2010 | 150 | \$959.00 |
| M-6550-M50BEXH | BOSS EXHAUST CAMSHAFT - 13 MM LIFT / 290 DURATION | 136 | \$950.00 |
| M-6550-M50BINT | BOSS INTAKE CAMSHAFT - 13 MM LIFT / 263 DURATION | 136 | \$969.00 |
| M-6550-M52 | COYOTE 5.2L HIGH-PERFORMANCE CAMS GEN 2 | 136 | \$1,800.00 |
| M-6550-M52A | COYOTE 5.2L HIGH-PERFORMANCE CAMS GEN1 | 136 | \$1,800.00 |
| M-6564-M50 | ROLLER FINGER FOLLOWER KIT COYOTE | 139 | \$199.00 |
| M-6564-M52 | ROLLER FINGER FOLLOWER KIT 5.2L COYOTE | 139 | \$595.00 |
| M-6565-L302 | PUSH RODS (16 PACK) | 188 | \$45.00 |
| M-6566-N351 | N-351 PUSH ROD GUIDE PLATE | 185 | \$85.00 |
| M-6566-SCJ | GUIDE PLATE (8 PACK) | 197 | \$69.00 |
| M-6566-Z304D | PUSH ROD GUIDE PLATES 8 PACK | 184 | \$58.00 |
| M-6571-A50 | VALVE STEM SEAL (SET OF 16) | 183 | \$36.50 |
| M-6580-M50 | TIMING AND CAM COVER KIT 5.0L TVTCT | 141 | \$499.00 |
| M-6582-16K | KENT ROCKER COVER - CAST | 201 | \$159.95 |
| M-6582-A | VALVE COVER COBRA SET | 249 | \$199.95 |
| M-6582-A301R | VALVE COVER SET | 249 | \$199.95 |
| M-6582-A302R | VALVE COVER SET | 249 | \$237.00 |
| M-6582-A341R | BLACK SATIN VALVE COVER | 252 | \$239.95 |
| M-6582-A342R | VALVE COVER SET | 252 | \$249.95 |
| M-6582-A351R | EFI TRUCK VALVE COVER SET | 251 | \$199.95 |
| M-6582-A427 | VALVE COVER POLISHED COBRA (PAIR) | 252 | \$249.95 |
| M-6582-B | VALVE COVER BLK COBRA SET | 252 | \$239.95 |
| M-6582-B301 | VALVE COVER BLK MUSTANG (PAIR) | 250 | \$199.95 |
| M-6582-B460 | 460 ALUMINUM VALVE COVER SATIN BLACK | 252 | \$299.00 |
| M-6582-C351BK | 351 CLEVELAND VALVE COVER | 252 | \$239.95 |
| M-6582-C351PD | POLISHED VALVE COVER | 252 | \$249.95 |
| M-6582-C460 | VALVE COVER SET POLISHED | 252 | \$249.00 |
| M-6582-CT2 | VALVE COVERS SMALL BLOCK CIRCLE TRACK | 249 | \$249.00 |
| M-6582-F301 | VALVE COVER POLISHED MSTG SET | 250 | \$229.95 |
| M-6582-F302 | VALVE COVER SET BLK COBRA | 249 | \$199.95 |
| M-6582-FR3VBL | COVER - VALVE 3V BLUE | 154 | \$415.00 |
| M-6582-FR3VBLK | COVER - VALVE 3V BLK | 154 | \$415.00 |
| M-6582-LE302BK | VALVE COVER BLACK | 249 | \$199.95 |
| M-6582-LE302BL | COVER - VALVE | 249 | \$199.95 |
| M-6582-LE302C | COVER - VALVE | 249 | \$319.95 |
| M-6582-LE302SBK | COVER - VALVE SMALL BLOCK | 249 | \$199.95 |
| M-6582-W351PR | VALVE COVER FORD RACING SB PENT ROOF BLACK | 252 | \$229.00 |
| M-6582-W427B | VALVE COVER SET | 250 | \$189.95 |
| M-6582-Z351 | POLISHED VALVE COVER SET | 251 | \$249.00 |
| M-6582-Z351B | VALVE COVER AL BLACK 351C | 251 | \$249.00 |
| M-6584-A50 | VALVE COVER GASKET SET 5.0L (PAIR) | 190 | \$40.95 |
| M-6588-A50 | ROCKER CHANNEL KIT (8 PACK) | 188 | \$27.75 |
| M-6600-50CJ | GEROTOR OIL PUMP STEEL 5.0L CJ | 134 | \$805.00 |
| M-6600-A460 | HIGH VOLUME OIL PUMP | 198 | \$99.00 |
| M-6600-A50PKIT | OIL PUMP INSTALL KIT 5.0L COYOTE | 135 | \$80.00 |
| M-6600-B3 | HIGH VOLUME OIL PUMP | 179 | \$75.00 |
| M-6600-D2 | HIGH VOLUME OIL PUMP | 179 | \$62.00 |
| M-6600-D46 | OIL PUMP HIGH VOLUME WITH PICKUP TUBE | 147 | \$99.00 |
| M-6600-F46 | OIL PUMP AND PICKUP HIGH VOL 4.6L / 5.4L | 148 | \$135.00 |
| M-6605-A341 | OIL PUMP SHAFT HD | 179 | \$38.00 |
| M-6605-A429 | OIL PUMP SHAFT HD | 198 | \$38.00 |
| M-6605-B302 | OIL PUMP SHAFT HD | 179 | \$38.00 |
| M-6622-BOSS302 | PICKUP TUBE BOSS 302 BLOCK | 179 | \$120.00 |
| M-6622-DRS302 | PICKUP TUBE | 180 | \$96.00 |
| M-6622-DRS351 | PICKUP TUBE | 180 | \$96.00 |
| M-6622-DRS351A | OIL PUMP PICKUP TUBE FOR ALUMINUM BLOCK | 179 | \$140.00 |
| M-6622-DRS460 | 460 REAR SHIM PICKUP TUBE | 199 | \$37.00 |
| M-6622-FT302 | PICKUP TUBE 302 FRONT SUMP | 180 | \$154.95 |
| M-6622-FT351 | 351 FRONT SUMP PICKUP TUBE | 180 | \$150.00 |
| M-6622-FT460 | PICKUP TUBE FRONT T-SUMP 460 | 199 | \$37.00 |
| M-6642-MB | OIL COOLER 5.0L MUSTANG | 135 | \$180.00 |
| M-6674-302 | REINFORCEMENT 302 OIL PAN | 181 | \$89.00 |

| Part Number | Description | Pg. No. | Sugg. Retail |
|---------------|---|---------|--------------|
| M-6674-351 | REINFORCEMENT OIL PAN FLANGE | 181 | \$89.00 |
| M-6675-A460 | OIL PAN KIT 460 FOX | 200 | \$219.00 |
| M-6675-A50 | OIL PAN KIT 5.0L | 179 | \$215.00 |
| M-6675-A58 | OIL PAN KIT 351 FOX BODY | 179 | \$175.00 |
| M-6675-DRS302 | 302 DEEP REAR SUMP OIL PAN | 180 | \$560.00 |
| M-6675-DRS351 | 351W DEEP REAR SUMP OIL PAN | 180 | \$555.00 |
| M-6675-DRS460 | 460 DEEP REAR SUMP OIL PAN | 199 | \$775.00 |
| M-6675-FT302 | OIL PAN 302 FRONT T-SUMP | 180 | \$585.00 |
| M-6675-FT351 | OIL PAN 351W FRONT T-SUMP | 180 | \$599.00 |
| M-6675-FT460 | 460 FRONT T-SUMP OIL PAN | 199 | \$939.00 |
| M-6675-M50BR | OIL PAN 5.0L B302R | 135 | \$1,399.00 |
| M-6675-M52 | GT350 OIL PAN & PUMP KIT | 135 | \$625.00 |
| M-6701-A460 | REAR MAIN SEAL | 200 | \$23.00 |
| M-6701-B302 | REAR MAIN SEAL | 188 | \$13.50 |
| M-6701-B351 | REAR MAIN SEAL | 188 | \$13.50 |
| M-6710-A351 | OIL PAN GASKET (1 PIECE) | 190 | \$32.00 |
| M-6710-A460 | OIL PAN GASKET 7.5L (1 PIECE) | 200 | \$28.95 |
| M-6710-A50 | OIL PAN GASKET 5.0L | 190 | \$24.50 |
| M-6731-FL1A | CASE OF 12 CM-6731-FL1A | 181 | \$195.00 |
| M-6731-FL820 | OIL FILTER HI-PERF (CASE OF 12) | 181 | \$198.00 |
| M-6750-C303 | ENGINE OIL DIPSTICK/TUBE | 181 | \$33.00 |
| M-6750-D303 | TRANS DIPSTICK & TUBE | 231 | \$33.00 |
| M-6750-E303 | TRANS DIPSTICK & TUBE | 230 | \$33.00 |
| M-6766-A50 | 5.0L/5.2L COYOTE OIL-AIR SEPARATOR RH | 17 | \$199.00 |
| M-6766-A50S | 5.2L GT350 OIL-AIR SEPARATOR LH | 17 | \$199.00 |
| M-6766-FRNVBK | BREATHER CAP WITH FR LOGO | 253 | \$18.00 |
| M-6766-FRNVBL | BREATHER CAP NO VENT HOSE | 253 | \$16.00 |
| M-6766-FRNVCH | BREATHER CAP WITH LOGO NO VENT TUBE | 253 | \$17.00 |
| M-6766-FRVBK | BREATHER BLACK WITH LOGO | 253 | \$17.00 |
| M-6766-FRVBL | BREATHER WITH FR LOGO | 253 | \$17.00 |
| M-6766-FRVCH | BREATHER WITH LOGO | 253 | \$17.00 |
| M-6766-M50 | 5.0L COYOTE FORD PERFORMANCE ALUMINUM CAP KIT | 142 | \$170.00 |
| M-6766-MP46A | OIL FILL CAP FR LOGO ALUM CHROMED | 253 | \$59.00 |
| M-6775-MSVT | PERFORMANCE INTERCOOLER 5.4L 4V | 50 | \$1,099.00 |
| M-6880-A50 | OIL FILTER ADAPTOR 90 DEGREE | 181 | \$113.00 |
| M-6880-M501 | COYOTE GEN 2 OIL FILTER ADAPTER KIT | 135 | \$74.00 |
| M-6881-M50 | 2011-2014 5.0L COYOTE OIL LINE ADAPTER | 134 | \$200.00 |
| M-6881-M50A | 2015-2017 5.0L COYOTE OIL LINE ADAPTER | 135 | \$240.00 |
| M-6892-F | BREATHER AND PCV GROMMETS | 253 | \$7.99 |
| M-6949-3V | INTAKE SHROUD MGT | 154 | \$126.00 |
| M-6P067-M50B | COIL COVERS 5.0L COYOTE POWERED BY FORD BLUE | 142 | \$99.95 |
| M-6P067-M50BL | COIL COVERS BLACK 5.0L COYOTE | 142 | \$115.00 |
| M-7000-A | TRANSMISSION REBUILD KIT T5 | 230 | \$479.00 |
| M-7003-M6266 | TRANSMISSION 6-SPEED 2.66 1ST GEAR | 228 | \$3,695.00 |
| M-7003-M6295 | TRANSMISSION 6-SPEED 2.97 1ST GEAR | 228 | \$3,695.00 |
| M-7003-M6XL | TRANSMISSION KIT MAGNUM XL MGT 2005-2014 | 229 | \$4,260.00 |
| M-7003-R5BC | TRANSMISSION TREMEC TKO-600 5-SPD EXTRA HD | 229 | \$2,940.00 |
| M-7003-R5BH | TREMEC TKO-600 5-SPD HDO TRANS | 229 | \$2,940.00 |
| M-7003-Z | SHD T-5 TRANSMISSION | 230 | \$2,200.00 |
| M-7007-A | STARTER INDEX PLATE - MODULAR | 233 | \$49.00 |
| M-7007-B | STARTER INDEX PLATE - SMALL BLOCK | 233 | \$69.00 |
| M-7050-A | BEARING RETAINER | 230 | \$75.00 |
| M-7050-B | BEARING RETAINER | 230 | \$75.00 |
| M-7210-B | SHORT THROW SHIFTER MSVT 2007-2009 | 231 | \$229.00 |
| M-7210-FRS | FOCUS RS SHORT THROW SHIFTER | 94 | \$488.00 |
| M-7210-FS | SHORT THROW SHIFTER 2012-2014 FOCUS | 85 | \$275.00 |
| M-7210-FST | SHORT THROW SHIFTER FOCUS ST | 85 | \$469.00 |
| M-7210-M | SHIFTER HURST T5/T45 | 231 | \$325.00 |
| M-7210-M8 | SHORT THROW SHIFTER KIT 2015-2017 MUSTANG | 25 | \$329.00 |
| M-7210-M8A | SHORT THROW SHIFTER KIT GT350 2015-2017 | 25 | \$379.00 |
| M-7210-MA | 2015-2017 MUSTANG SHIFTER KIT - WITHOUT KNOB | 25 | \$269.00 |
| M-7210-MGT | SHIFTER MGT 2005-2009 | 231 | \$315.00 |
| M-7210-MGTB | SHIFTER 6-SPD MGT 2011-2014 | 231 | \$539.00 |
| M-7213-FSTCF | FOCUS ST CARBON FIBER SHIFT KNOB | 86 | \$95.00 |
| M-7213-M8 | FORD RACING S550 SHIFT KNOB 6-SPEED | 25 | \$84.00 |
| M-7213-M8A | FORD PERFORMANCE 2015-2017 SHIFT KNOB 6-SPEED | 25 | \$84.00 |
| M-7213-M8SB | SHIFT KNOB FP GT350R BLACK | 25 | \$79.00 |
| M-7213-M8SR | SHIFT KNOB FP GT350R RED | 25 | \$79.00 |
| M-7213-M8SW | SHIFT KNOB FP GT350R WHITE | 25 | \$79.00 |
| M-7213-MCF | 2015-2017 MUSTANG CARBON FIBER SHIFT KNOB | 25 | \$95.00 |
| M-7512-A | HOSE, HYD CLUTCH 2005-2014 MUSTANG | 237 | \$359.00 |
| M-7512-B | CLUTCH LINE UPGRADE MUSTANG 2015 | 26 | \$369.00 |
| M-7515-A | CLUTCH LEVER SN95 | 237 | \$85.00 |
| M-7548-A | CLUTCH RELEASE BEARING | 236 | \$69.95 |
| M-7550-T302 | CLUTCH DISC 26-10.5 | 236 | \$149.00 |
| M-7550-X302 | CLUTCH DISC | 236 | \$159.00 |
| M-7553-A302 | LINKAGE KIT | 237 | \$64.00 |
| M-7553-B302 | ADJ CLUTCH CABLE KIT | 237 | \$119.00 |
| M-7553-C302 | SERVICE CABLE | 237 | \$60.00 |

SUGGESTED RETAIL PRICE LIST

FOR THE MOST UP-TO-DATE PRICING AND TECH INFO VISIT performance.ford.com

| Part Number | Description | Pg. No. | Sugg. Retail | Part Number | Description | Pg. No. | Sugg. Retail |
|----------------|--|---------|--------------|------------------|--|---------|--------------|
| M-7553-D302 | CABLE AND QUADRANT KIT | 237 | \$118.00 | M-9474-M50B | BOSS 302 THROTTLE BODY SPACER FOR M-9926-M5090 | 224 | \$68.00 |
| M-7553-E302 | SERVICE CABLE 1996-2004 | 237 | \$59.00 | M-9486-A50 | GASKET UPPER TO LOWER (5 PACK) | 191 | \$26.00 |
| M-7554-A | BULKHEAD ADJUSTER | 237 | \$79.00 | M-9486-A51 | INTAKE SPACER | 191 | \$79.00 |
| M-7560-A302N | CLUTCH KIT HD 10.5" | 236 | \$315.00 | M-9486-A52 | INTAKE SPACER | 191 | \$88.95 |
| M-7560-T46 | CLUTCH ASSEMBLY 26-11.0 | 236 | \$575.00 | M-9486-A53 | INTAKE SPACER | 191 | \$96.95 |
| M-7563-B302 | 10.5" CENT CLUTCH | 236 | \$399.00 | M-9546-67 | 6.7L DIESEL INJECTOR NOZZLE KIT | 108 | \$3,195.00 |
| M-7583-A | DOUBLE HOOK QUADRANT | 237 | \$59.00 | M-9593-G302 | FUEL INJECTOR 47# (8 PACK) | 223 | \$369.00 |
| M-7600-A | ROLLER PILOT BEARING. 669 | 236 | \$14.95 | M-9593-LU24A | FUEL INJECTOR 24# (8 PACK) | 223 | \$339.00 |
| M-7600-B | ROLLER PILOT BEARING 4.6L/5.4L/5.0L4V | 236 | \$14.95 | M-9593-LU47 | FUEL INJECTOR 47# (8 PACK) | 223 | \$457.00 |
| M-7600-C | ROLLER PILOT BEARING - HIGH LOAD - 4.6L/5.4L/5.0L4 | 236 | \$29.00 | M-9593-LU60 | FUEL INJECTOR 60# (8 PACK) | 223 | \$579.00 |
| M-771-A | HARDWARE KIT MODULAR TRANSMISSION | 232 | \$49.00 | M-9593-LU80 | FUEL INJECTOR 80# (8 PACK) | 223 | \$579.00 |
| M-7843-V8 | BADGE STICK-ON CHROME V8 | 260 | \$14.25 | M-9593-M39 | FUEL INJECTOR 39# (8 PACK) | 223 | \$489.00 |
| M-8005-M8 | PERFORMANCE RADIATOR MGT 2015 | 17 | \$620.00 | M-9593-MU52 | FUEL INJECTOR 52# (SET OF 8) | 223 | \$415.00 |
| M-8005-MBR | RADIATOR MUSTANG 2011-2014 | 54 | \$785.00 | M-9600-C302 | OVAL AIR CLEANER | 253 | \$127.00 |
| M-8005-MGT | RADIATOR MGT 2005-2014 | 54 | \$772.00 | M-9600-CJ | COBRA JET 123 MM MAF (CAL REQUIRED) | 226 | \$550.00 |
| M-8080-A | DE-GAS BOTTLE | 54 | \$201.00 | M-9600-K302 | OVAL AIR CLEANER | 253 | \$127.00 |
| M-8100-A | RADIATOR CAP "FORD RACING" LOGO | 54 | \$13.75 | M-9600-SCJ | MAF 140 MM SCJ 2010 | 226 | \$669.00 |
| M-8200-MBR | MODIFIED 2012 BOSS 302S GRILLE | 72 | \$382.00 | M-9600-SCJ16 | 2016 MUSTANG COBRA JET AIR INLET TUBE | 16 | \$329.00 |
| M-8200-MBRA | MODIFIED 2013 BOSS 302S GRILLE | 72 | \$403.00 | M-9601-B | COLD AIR KIT FILTER ELEMENT MGT/MV6 2005-2009 | 42 | \$33.95 |
| M-8229-MSVT | INTERCOOLER HEAT EXCHANGER MSVT | 50 | \$469.00 | M-9601-C | REPLACEMENT FILTER ELEMENT FOR SS CAK | 42 | \$89.00 |
| M-8291-FP | 2015-2017 MUSTANG RAD COVER FORD PERF BRAND | 17 | \$105.00 | M-9601-D | CAK FILTER ELEMENT MSVT 2007-2009 | 42 | \$77.00 |
| M-8501-460BP | WATER PUMP BACKING PLATE BIG BLOCK 460 | 200 | \$32.25 | M-9601-FSB | 2012-2016 FIESTA HIGH-FLOW K&N AIR FILTER | 101 | \$48.00 |
| M-8501-A50 | WATER PUMP KIT | 192 | \$239.00 | M-9601-G | GT350 PERFORMANCE AIR FILTER | 17 | \$92.00 |
| M-8501-D50 | SHORT SERPENTINE WATER PUMP | 192 | \$72.00 | M-9601-M | 2015-2016 MUST AIR FILTER - 5.0L, 2.3L, 3.7L | 17 | \$72.00 |
| M-8501-E351S | WATER PUMP | 192 | \$180.00 | M-9601-MGT | AIR FILTER MGT 2010-2014 / MV6 2011-2014 | 42 | \$74.00 |
| M-8501-F351 | WATER PUMP | 192 | \$236.00 | M-9603-FST | COLD AIR INTAKE KIT 2.0L FOCUS ST | 78 | \$308.00 |
| M-8501-FR9 | WATER PUMP | 202 | \$900.00 | M-9603-FSTA | FOCUS ST PERFORMANCE RS COLD AIR INTAKE KIT | 80 | \$146.00 |
| M-8501-M50CJ16 | ELECTRIC WATER PUMP KIT COYOTE 5.0L | 144 | \$399.00 | M-9603-M23 | 2015-2017 MUSTANG 2.3L COLD AIR INTAKE (NO CAL) | 16 | \$419.00 |
| M-8501-M58 | INTERCOOLER PUMP KIT MSVT 2014 | 144 | \$425.00 | M-9603-M4 | 2015-2017 MUSTANG 2.3L CAK WITH CAL | 16 | \$725.00 |
| M-8501-MSVT | ELECTRIC WATER PUMP MSVT | 144 | \$199.00 | M-9603-M40 | MUSTANG V6 4.0L TUNER KIT (CAL REQUIRED) | 41 | \$279.00 |
| M-8509-CM | BILLET V-PULLEYS, 1 GROOVE | 193 | \$270.00 | M-9603-M50 | 2015-2017 MUSTANG 5.0L COLD AIR INTAKE (NO CAL) | 16 | \$549.00 |
| M-8509-DM | BILLET V-PULLEYS, 1 GROOVE | 193 | \$270.00 | M-9603-M50CJ | COLD AIR INTAKE 5.0L COBRA JET | 40 | \$449.00 |
| M-8509-EM | BILLET V-PULLEYS, 2 GROOVE | 193 | \$270.00 | M-9603-M54SC | MUSTANG SVT 5.4L TUNER KIT (CAL REQUIRED) | 40 | \$450.00 |
| M-8510-A351 | CRANK PULLEY SPACER | 178 | \$42.00 | M-9603-M8 | 2015-2017 MUSTANG 5.0L PERF. CAL | 15 | \$599.00 |
| M-8510-B351 | CRANK PULLEY SPACER | 178 | \$42.00 | M-9603-M8A | 2015-2017 MUST 5.0L CAL WITH CAK AND THROTTLE BODY | 15 | \$969.00 |
| M-8510-C351 | SPACER CRANKSHAFT PULLEY | 178 | \$42.00 | M-9603-MBTKA | BOSS 302 TRACKEY CALIBRATION WITH PROCAL TOOL | 50 | \$689.00 |
| M-8510-D351 | SPACER CRANKSHAFT PULLEY | 178 | \$38.00 | M-9603-MVTB | AIR FILTER AND CALIBRATION MGT 2011-2014 | 40 | \$489.00 |
| M-8511-A351 | ACCESSORY DRIVE KIT P.S. | 194 | \$84.00 | M-9603-SVT07 | COLD AIR KIT MSVT 2007-2009 | 40 | \$969.00 |
| M-8511-A50 | A/C ELIMINATOR KIT | 194 | \$99.00 | M-9603-V605 | COLD AIR KIT MV6 2005-2009 | 41 | \$629.00 |
| M-8511-B351 | ACCESSORY DRIVE KIT - A/C | 194 | \$120.00 | M-9603A-FSTA | 2013-2017 FOCUS ST CALIBRATION, SPARK PLUGS, CAI | 79 | \$795.00 |
| M-8511-M50BR | BOSS 302R POWER STEERING PUMP BRKT | 144 | \$294.00 | M-9605-CJ14 | 2014 MUSTANG COBRA JET AIR INLET HEAT SHIELD | 41 | \$65.00 |
| M-8592-M90 | T-STAT HOUSING 90 DEGREE | 192 | \$75.00 | M-9680-BOSS | MUSTANG ENGINE DRESS UP & ISOLATOR KIT | 142 | \$149.00 |
| M-8600-M50AC | A/C ADD KIT 5.0L COYOTE | 144 | \$999.00 | M-9680-M50 | ENGINE COVER KIT 5.0L COYOTE | 142 | \$159.00 |
| M-8600-M50BALT | ALTERNATOR KIT BOSS 5.0L COYOTE | 143 | \$330.00 | M-9680-M50A | ENGINE COVER MGT 2015 | 142 | \$159.00 |
| M-8604-A50 | COMP. A/P IDLER | 193 | \$102.00 | M-9926-3V | 3V MUSTANG THROTTLE BODY (62 MM) | 224 | \$729.00 |
| M-8C368-FR9 | WATER MANIFOLD | 202 | \$664.95 | M-9926-CJ65 | DUAL 65 MM THROTTLE BODY | 224 | \$759.00 |
| M-8C607-MSVT | COOLING FAN MGT 2005-2014 / MSVT 2005-2012 | 144 | \$335.00 | M-9926-CJ65M | MECHANICAL DBTB 65 MM | 225 | \$739.00 |
| M-9000-PMCA | 5.0L COYOTE POWER MODULE 6-SPEED AUTOMATIC | 120 | \$15,950.00 | M-9926-M2370 | MUSTANG 2.3L ECOBOOST 70 MM THROTTLE BODY | 225 | \$695.00 |
| M-9000-PMCM | 5.0L COYOTE POWER MODULE 6-SPEED MANUAL | 121 | \$15,950.00 | M-9926-M5090 | THROTTLE BODY 5.0L 4V 90 MM | 224 | \$729.00 |
| M-9066-M8RHD | 2015-2017 MUST GT SUPERCHARGER RHD CLOSE OUT PANEL | 146 | \$139.99 | M-9926-M52 | GT350 5.2L COYOTE THROTTLE BODY 87 MM | 225 | \$249.00 |
| M-9275-BFSE | ORDER DIRECTLY FROM AUTOMETER | 248 | \$345.95 | M-9926-MGT | THROTTLE BODY 55 MM 4.6L 3V 2005-2010 | 225 | \$289.00 |
| M-9278-BFSE | ORDER DIRECTLY FROM AUTOMETER | 248 | \$346.01 | M-9926-MSVT | THROTTLE BODY DUAL BORE SVT 60 MM | 225 | \$229.00 |
| M-9407-GT05 | FUEL PUMP KIT COBRA DUAL | 226 | \$869.00 | M-9926-SCJM | THROTTLE BODY SCJ MECH OVAL MONOBLADE | 225 | \$739.00 |
| M-9407-MSVTA | DUAL FUEL PUMP KIT MGT 2010 | 226 | \$899.00 | M-9B659-MSVT | AIR INLET TUBE MSVT 2010-2014 | 226 | \$104.00 |
| M-9424-463V | MANIFOLD EFI 4.6L 3V | 151 | \$775.00 | M-FP500-FP350S | 2017 FP ROAD RACE MUSTANG | - | \$114,990.00 |
| M-9424-C460 | INTAKE MANIFOLD | 197 | \$725.00 | M-FR1-FSTA | POWER UPGRADE PACK FOCUS ST 2013-2016 | 79 | \$1,728.00 |
| M-9424-D302 | INTAKE MANIFOLD | 191 | \$325.00 | M-FR1-MGTB | POWER UPGRADE PKG MGT 2011-2014 | 39 | \$995.00 |
| M-9424-E2929 | EDELBROCK SUPER VICTOR INTAKE MANIFOLD 9.2 | 191 | \$349.00 | M-FR3-FA | HANDLING PACK FIESTA 2011-2013 | 105 | \$299.95 |
| M-9424-E554 | INTAKE MANIFOLD - FR9 EFI | 203 | \$600.00 | M-FR3-FASTENA | 2015-2016 MUSTANG HANDLING PACK FASTENER KIT | 32 | \$152.00 |
| M-9424-E651 | NASCAR - INTAKE MANIFOLD | 203 | \$625.00 | M-FR3-FASTENERS | 2005-2014 MUSTANG HANDLING PACK FASTENER KIT | 61 | \$89.00 |
| M-9424-F302 | INTAKE MANIFOLD | 191 | \$235.00 | M-FR3-MSVTA | HANDLING PACK (1.25" DROP) MSVT 2007-2014 | 61 | \$2,080.00 |
| M-9424-M50BR | INTAKE MANIFOLD BOSS302R | 140 | \$839.00 | M-FR3A-M8 | 2015-2017 MUSTANG TRACK HANDLING PACK | 31 | \$1,520.00 |
| M-9424-M50CJ | INTAKE MANIFOLD 5.0L 4V COBRA JET | 140 | \$1,225.00 | M-FR3A-MA | 2015-2017 MUSTANG STREET HANDLING PACK | 32 | \$1,119.00 |
| M-9424-M52 | GT350 5.2L COYOTE INTAKE MANIFOLD | 140 | \$1,495.00 | M-FR3A-MGTA | HANDLING PACK ASSY (1" DROP) MGT 2005-2014 | 60 | \$1,895.00 |
| M-9424-P46 | INTAKE MANIFOLD 4.6L PI | 151 | \$354.00 | M-FR3A-MGTAA | HANDLING PACK ADJ ASSY MGT 2005-2014 | 60 | \$2,275.00 |
| M-9430-SR50A | COYOTE CAST IRON EXHAUST MANIFOLD KIT | 122 | \$229.00 | M-FR3A-MSVTA | HANDLING PACK ASSEMBLED MSVT 2007-2014 | 61 | \$2,107.00 |
| M-9432-A50 | LOC HEADER BOLT 3/4" SET | 54 | \$73.00 | M-FR500-CJ16B | 2016 COBRA JET BLUE | - | \$99,900.00 |
| M-9432-A51 | LOC HEADER BOLT 1" SET | 54 | \$80.00 | M-TURBO-67 | 6.7L TURBO UPGRADE | 108 | \$2,895.00 |
| M-9438-35TA | F-150 TWIN TURBO UPGRADE KIT 3.5L GEN 2 | 108 | \$2,895.00 | MP2546-12020-AA1 | FOCUS ST MOUNTUNE TRIPLE PASS RADIATOR | 85 | \$599.00 |
| M-9439-A50 | INTAKE MANIFOLD GASKET | 190 | \$67.00 | | | | |
| M-9439-G50 | INTAKE GASKET GRAPHITE STD PORT 5.0L | 190 | \$13.50 | | | | |
| M-9439-ZP | PORTED Z HEAD INTAKE MANIFOLD GASKET | 190 | \$44.00 | | | | |
| M-9444-M50B | INSTALLATION KIT - BOSS 302 INTAKE MANIFOLD | 140 | \$240.00 | | | | |
| M-9448-A462 | REPLACEMENT HEADER GASKETS 4.6L 2V (PAIR) | 151 | \$37.00 | | | | |
| M-9448-A463V | REPLACEMENT HEADER GASKETS 4.6L 3V (PAIR) | 151 | \$37.00 | | | | |
| M-9448-A464 | HEADER GASKETS 4.6L 4V (PAIR) | 151 | \$27.00 | | | | |
| M-9448-B302 | HEADER GASKETS 5.0L (PAIR) | 190 | \$11.95 | | | | |
| M-9452-M8 | 2015-2017 MUSTANG GT PERFORMANCE INTAKE KIT | 15 | \$2,469.00 | | | | |
| M-9474-M50 | 5.0 COYOTE THROTTLE BODY SPACER FOR M-9926-M5090 | 224 | \$68.00 | | | | |

For important information about the proper usage of performance parts, please see page 12. See pages 295-302 for important safety, emissions and warranty information.

PARTS INDEX

| Description | Part Number | Page |
|--|----------------|------|
| A/C ADD KIT 5.0L COYOTE | M-8600-M50AC | 144 |
| A/C DELETE KIT 4.6L 1996-2010 | M-19216-D46 | 151 |
| A/C DELETE KIT 5.0L 1994-1995 MUSTANG | M-19216-A50 | 193 |
| A/C ELIMINATOR KIT | M-8511-A50 | 194 |
| A-ARM BRACE FRONT LOWER MGT 2005-2009 | M-5025-A | 66 |
| ACCESSORY DRIVE KIT - A/C | M-8511-B351 | 194 |
| ACCESSORY DRIVE KIT - P.S. | M-8511-A351 | 194 |
| AIR CLEANER OVAL | M-9600-C302 | 253 |
| AIR CLEANER OVAL | M-9600-K302 | 253 |
| AIR CLEANER SLANT EDGE | 302-999 | 253 |
| AIR FILTER - 5.0L, 2.3L, 3.7L 2015-2016 MUST | M-9601-M | 17 |
| AIR FILTER 2012-2016 FIESTA HIGH-FLOW K&N | M-9601-FSB | 101 |
| AIR FILTER AND CALIBRATION MGT 2011-2014 | M-9603-MGTB | 40 |
| AIR FILTER END CAP MOUNTUNE | 2363-AF-CAP | 81 |
| AIR FILTER GT350 PERFORMANCE | M-9601-G | 17 |
| AIR FILTER HIGH-FLOW - FIESTA ST MOUNTUNE | 2364-AF-AA | 101 |
| AIR FILTER HIGH-FLOW - FOCUS ST MOUNTUNE | 2363-AF-AA | 81 |
| AIR FILTER MGT 2010-2014 / MV6 2011-2014 | M-9601-MGT | 42 |
| AIR INLET HEAT SHIELD 2014 MUSTANG COBRA JET | M-9605-CJ14 | 41 |
| AIR INLET TUBE 2016 MUSTANG COBRA JET | M-9600-SCJ16 | 16 |
| AIR INLET TUBE MSVT 2010-2014 | M-98659-MSVT | 226 |
| AIR METER 90 MM LIGHTNING | M-12579-L54 | 226 |
| AIR RECIRCULATION VALVE UPATED MOUNTUNE | 2226-TRV-AA | 82 |
| AIR RECIRCULATION VALVE UPATED - FOCUS RS MOUNTUNE | 2536-TRV-AA | 94 |
| ALTERNATOR KIT BOSS 5.0L COYOTE | M-8600-M50BALT | 143 |
| ANCILLARY HOSE KIT SILICONE BLK - FOCUS ST MOUNTUNE | 2363-AHK-BLK | 81 |
| ANCILLARY HOSE KIT SILICONE BLUE - FOCUS ST MOUNTUNE | 2363-AHK-BLU | 81 |
| ANCILLARY HOSE KIT SILICONE RED - FOCUS ST MOUNTUNE | 2363-AHK-RED | 81 |
| ANCILLARY HOSE KIT SILICONE Y/B - FOCUS ST MOUNTUNE | 2363-AHK-YEL | 81 |
| AUTO TRANS FLEXPLATE AND BOLTS 5.0L COYOTE | M-6375-A50C | 143 |
| AUTOMATIC TRANSMISSION FLEXPLATE BOLTS 5.0L COYOTE | M-6379-M50A | 143 |
| AXLE BEARING AND SEAL KIT (PAIR) 8.8" | M-1225-B | 241 |
| AXLE BEARING KIT 8.8" MUSTANG 2005-2014 | M-1225-B1 | 241 |
| AXLE GIRDLE COVER 8.8" MGT | M-4033-G2 | 239 |
| AXLE GIRDLE COVER COBRA IRS 1999-2004 | M-4033-G3 | 239 |
| AXLE INSTALL KIT 8.8" | M-4050-B | 239 |
| BADGE "POWERED BY FORD PERFORMANCE" | M-16098-PBFP | 261 |
| BADGE STICK-ON CHROME V8 | M-7843-V8 | 260 |
| BALANCE SHAFT BLOCK-OFF PLUG 2.3L ECOBOOST | M-6026-23BSBP | 159 |
| BANNER "FORD PERFORMANCE" 3' X 5' | M-1827-FP | 262 |
| BANNER FORD RACING MUSCLE PARTS | M-1827-A60 | 262 |
| BEARING KIT CAR IRS | M-1215-A | 239 |
| BEARING RETAINER | M-7050-A | 230 |
| BEARING RETAINER | M-7050-B | 230 |
| BELLHOUSING 5.0L T-5 | M-6392-E | 232 |
| BELLHOUSING 4.6 3550 | M-6392-M46 | 232 |
| BLOCK HARDWARE KIT 2011-2017 COYOTE | M-6026-A50A | 134 |
| BLOCK HEAD BOLT SET X HEAD BOSS | M-6065-BOSS | 177 |
| BLOCK KIT AL 4.6L | M-6026-A46 | 147 |
| BOOST HOSE KIT SILICONE BLUE - FOCUS ST MOUNTUNE | 2363-BHK-BLU | 80 |
| BOOST HOSE KIT SILICONE RED - FOCUS ST MOUNTUNE | 2363-BHK-RED | 80 |
| BOOST HOSE KIT SILICONE Y/B - FOCUS ST MOUNTUNE | 2363-BHK-YEL | 80 |
| BOOST HOSE SILICONE BLACK - FOCUS ST MOUNTUNE | 2363-BHK-BLK | 80 |
| BRAKE AIR DEFLECTOR KIT FRONT FOCUS ST | M-2004-FRS | 87 |
| BRAKE BACK PLATE KIT 9" DRUM | M-2209-B | 70 |
| BRAKE BOOSTER BOSS 302R/302S | M-2005-R | 70 |
| BRAKE BRACKET KIT REAR MGT 1994-2004 | M-2300-M | 69 |
| BRAKE DRUM 11" X 2.25" | M-1126-B | 70 |
| BRAKE DUCT INLET KIT MGT 2013-2014 | M-2004-MR | 70 |
| BRAKE HOSE SET - FOCUS RS 2016-2017 | 2536-BLK-AA | 95 |
| BRAKE HOSE SET SS - FIESTA ST 2013-2016 MT | 7064-BH-B299 | 106 |
| BRAKE HOSE SET SS - FOCUS ST 2013-2016 | 7063-BH-C346 | 87 |
| BRAKE KIT 6 PISTON 15" MUSTANG 2005-2014 | M-2300-T | 69 |
| BRAKE KIT DISC 9" AXLE | M-2300-G2 | 244 |
| BRAKE KIT FRONT COBRA R | M-2300-X | 69 |
| BRAKE KIT MUSTANG GT350R | M-2300-Y | 34 |
| BRAKE KIT PERFORMANCE RS FRONT FOCUS ST | M-2300-W | 87 |
| BRAKE KIT PERFORMANCE RS REAR FOCUS ST | M-2300-WR | 87 |
| BRAKE KIT REAR 2015 MUSTANG | M-2300-MR | 34 |
| BRAKE LINE KIT STAINLESS FIESTA | M-2078-FA | 106 |
| BRAKE LINE UPGRADE KIT MUSTANG 2005-2014 | M-2078-MB | 70 |
| BRAKE PAD KIT FRONT 1994-2004 MUSTANG COBRA R | M-2300-XP | 69 |
| BRAKE PROPORTIONING VALVE ALUM | M-2328-C | 70 |
| BRAKE ROTOR KIT FRONT 1994-2004 MUSTANG COBRA R | M-2300-XR | 69 |
| BRAKE SHIELDS 2005-2014 | M-20045-MSVT | 70 |
| BRAKE UPGRADE KIT 6-PISTON MUSTANG 2015-2017 | M-2300-V | 34 |
| BRAKE UPGRADE KIT FRONT MV6 2005-2010 | M-2300-D | 69 |
| BRAKE UPGRADE KIT GT350 | M-2300-AA | 34 |
| BRAKE UPGRADE KIT MGT 2005-2014 | M-2300-S | 69 |

| Description | Part Number | Page |
|--|----------------|------|
| BREATHING AND PCV GROMMETS | M-6892-F | 253 |
| BREATHING BLACK WITH LOGO | M-6766-FRVBK | 253 |
| BREATHING CAP NO VENT HOSE | M-6766-FRNVBL | 253 |
| BREATHING CAP WITH "FR" LOGO | M-6766-FRNVBK | 253 |
| BREATHING CAP WITH LOGO NO VENT TUBE | M-6766-FRNVCH | 253 |
| BREATHING WITH "FR" LOGO | M-6766-FRVBL | 253 |
| BREATHING WITH LOGO | M-6766-FRVCH | 253 |
| BUMP STEER KIT 2005-2014 MUSTANG | M-3130-R4 | 67 |
| BUMPER TUBULAR FT LT WT MUSTANG 2005-2014 | M-17757-MB | 72 |
| BUSHING KIT BOSS 302S FRONT REPLACEMENT | M-5638-C | 67 |
| BUSHING KIT, REAR LOWER FR500C | M-5638-A | 67 |
| CALIBRATION WITH PROCAL TOOL BOSS 302 TRACKEY | M-9603-MBTKA | 50 |
| CAM BEARINGS ROLLER | M-6261-D351 | 176 |
| CAM CONV. KIT ROLLER | M-6253-A50 | 187 |
| CAM PLUGS FOR RACE BLOCK (10 PK) | M-6026-S351 | 176 |
| CAM SB BILLET HYDRAULIC ROLLER | M-6250-C580T | 186 |
| CAM SET HIPO 2.3L ECOBOOST | M-6250-23EBH | 159 |
| CAMS GEN 2 COYOTE 5.2L HIGH PERFORMANCE | M-6550-M52 | 136 |
| CAMS GEN1 COYOTE 5.2L HIGH PERFORMANCE | M-6550-M52A | 136 |
| CAMSHAFT - HYDRAULIC ROLLER | M-6250-E303 | 186 |
| CAMSHAFT BEARINGS | M-6261-A460 | 198 |
| CAMSHAFT BEARINGS STD CAM COMMON OD | M-6261-J351 | 176 |
| CAMSHAFT BOLT KIT 4.6L 3V | M-6279-463V | 150 |
| CAMSHAFT BOSS EXHAUST - 13 MM LIFT / 290 DURATION | M-6550-M50BEXH | 136 |
| CAMSHAFT BOSS INTAKE - 13 MM LIFT / 263 DURATION | M-6550-M50BINT | 136 |
| CAMSHAFT DRIVE KIT 4.6L 2V | M-6004-462V | 148 |
| CAMSHAFT DRIVE KIT 4.6L 4V | M-6004-A464 | 148 |
| CAMSHAFT DRIVE KIT 5.4L 4V | M-6004-A544 | 148 |
| CAMSHAFT DRIVE KIT MGT 2011-2014 | M-6004-A504 | 136 |
| CAMSHAFT DRIVE KIT MGT 2015-2017 | M-6004-A5015 | 136 |
| CAMSHAFT DRIVE KIT SVT 5.4L 4V | M-6004-54SVT | 148 |
| CAMSHAFT HYD ROLLER | M-6250-B303 | 186 |
| CAMSHAFT HYD ROLLER | M-6250-F303 | 186 |
| CAMSHAFT HYD ROLLER | M-6250-X303 | 186 |
| CAMSHAFT THRUST PLATE | M-6269-A351 | 177 |
| CAMSHAFT THRUST PLATE 302-351W | M-6269-A302 | 177 |
| CAMSHAFTS 4.6L 3V MGT 2005-2010 | M-6550-3V | 150 |
| CHAIN & SPROCKET SET | M-6268-A302 | 187 |
| CHAIN & SPROCKET SET | M-6268-A351 | 187 |
| CHAIN & SPROCKET SET | M-6268-A390 | 198 |
| CHAIN & SPROCKET SET | M-6268-A460 | 198 |
| CHAIN & SPROCKET SET | M-6268-B302 | 187 |
| CHAIN & SPROCKET SET | M-6268-B429 | 198 |
| CHAIN & SPROCKET SET | M-6268-F302 | 188 |
| CHARGE PIPE UPGRADE BLK FIESTA ST 2014-2016 MOUNTUNE | 2364-CPK-BLK | 99 |
| CHARGE PIPE UPGRADE BLU FIESTA ST 2014-2016 MOUNTUNE | 2364-CPK-BLU | 99 |
| CHARGE PIPE UPGRADE KIT BLACK - FOCUS RS MOUNTUNE | 2536-CPK-BLK | 93 |
| CHARGE PIPE UPGRADE KIT BLUE - FIESTA ST MOUNTUNE | 2364-BHK-BLU | 101 |
| CHARGE PIPE UPGRADE KIT BLUE - FOCUS RS MOUNTUNE | 2536-CPK-LBLU | 93 |
| CHARGE PIPE UPGRADE RED FIESTA ST 2014-2016 MOUNTUNE | 2364-CPK-RED | 99 |
| CHARGE PIPE UPGRADE YEL FIESTA ST 2014-2016 MOUNTUNE | 2364-CPK-YEL | 99 |
| CHASSIS BRACE LOWER - FIESTA ST 2013-2016 | 7064-LCB-AA | 105 |
| CLUTCH 10.5" CENT | M-7563-B302 | 236 |
| CLUTCH ASSEMBLY 26-11.0 | M-7560-T46 | 236 |
| CLUTCH BULKHEAD ADJUSTER | M-7554-A | 237 |
| CLUTCH CABLE AND QUADRANT KIT | M-7553-D302 | 237 |
| CLUTCH CABLE KIT ADJ | M-7553-B302 | 237 |
| CLUTCH DISC 26-10.5 | M-7550-T302 | 236 |
| CLUTCH DISC | M-7550-X302 | 236 |
| CLUTCH HOSE, HYD 2005-2014 MUSTANG | M-7512-A | 237 |
| CLUTCH HOUSING TREMEC ALUM | M-6392-R58 | 232 |
| CLUTCH KIT HD 10.5" | M-7560-A302N | 236 |
| CLUTCH LEVER SN95 | M-7515-A | 237 |
| CLUTCH LINE UPGRADE MUSTANG 2015 | M-7512-B | 26 |
| CLUTCH LINKAGE KIT | M-7553-A302 | 237 |
| CLUTCH QUADRANT DOUBLE HOOK | M-7583-A | 237 |
| CLUTCH RELEASE BEARING | M-7548-A | 236 |
| CLUTCH SERVICE CABLE | M-7553-C302 | 237 |
| CLUTCH SERVICE CABLE 1996-2004 | M-7553-E302 | 237 |
| COIL BRACKET CHROME | M-12044-A2 | 259 |
| COIL COVER 5.0L - 4V CHROME | M-6067-50C | 142 |
| COIL COVER 5.0L - 4V BLACK | M-6067-50BK | 142 |
| COIL COVER BALL STUD | M-6067B-F150 | 142 |
| COIL COVER BOSS 302 MUSTANG 5.0L COYOTE | M-6067-50B302 | 141 |
| COIL COVER FORD PERFORMANCE MUSTANG 5.0L COYOTE | M-6067-50FP | 141 |
| COIL COVERS 5.0L COYOTE POWERED BY FORD BLUE | M-6P067-M50B | 142 |
| COIL COVERS BLACK 5.0L COYOTE | M-6P067-M50BL | 142 |

PARTS INDEX

| Description | Part Number | Page |
|---|-----------------|------|
| COIL COVERS DIE-CAST 5.4L 4V / 4.6L 4V | M-6067-D | 154 |
| COIL COVERS MSVT 2007-2014 | M-6067-C | 154 |
| COLD AIR INTAKE (NO CAL) 2015-2017 MUSTANG 2.3L | M-9603-M23 | 16 |
| COLD AIR INTAKE 2015-2017 MUSTANG 5.0L (NO CAL) | M-9603-M50 | 16 |
| COLD AIR INTAKE 5.0L COBRA JET | M-9603-M50CJ | 40 |
| COLD AIR INTAKE CALIBRATION, SPARK PLUGS 2013-2017 FOCUS ST | M-9603A-FSTA | 79 |
| COLD AIR INTAKE KIT 2.0L FOCUS ST | M-9603-FST | 78 |
| COLD AIR INTAKE KIT FOCUS ST PERFORMANCE RS | M-9603-FSTA | 80 |
| COLD AIR KIT FILTER ELEMENT MGT/MV6 2005-2009 | M-9601-B | 42 |
| COLD AIR KIT FILTER ELEMENT MSVT 2007-2009 | M-9601-D | 42 |
| COLD AIR KIT FILTER ELEMENT REPLACEMENT FOR SS | M-9601-C | 42 |
| COLD AIR KIT MSVT 2007-2009 | M-9603-SVT07 | 40 |
| COLD AIR KIT MV6 2005-2009 | M-9603-V605 | 41 |
| COLD AIR KIT W/CAL AND THROTTLE BODY 2015-2017 MUST 5.0L | M-9603-M8A | 15 |
| COLD AIR KIT WITH CAL 2015-2017 MUSTANG 2.3L | M-9603-M4 | 16 |
| COLD AIR TUNER KIT MUSTANG SVT 5.4L (CAL REQUIRED) | M-9603-M54SC | 40 |
| COLD AIR TUNER KIT MUSTANG V6 4.0L (CAL REQUIRED) | M-9603-M40 | 41 |
| COMP. A/P IDLER | M-8604-A50 | 193 |
| CONTROL ARM KIT EXT BALL JOINT MUSTANG 2011-2014 | M-3075-RA | 66 |
| CONTROL ARM KIT, REAR LOWER MUSTANG BOSS S | M-5649-S | 68 |
| CONTROL ARM REAR LOWER KIT FR500C | M-5649-RI | 68 |
| CONTROL ARM REAR LOWER MGT 2005-2014 | M-5538-A | 68 |
| CONTROL ARM RELOC BKT REAR LOWER BOSS S MUSTANG | M-5650-A | 68 |
| CONTROL ARM UPGRADE FRONT LOWER MGT 2005-2010 | M-3075-E | 66 |
| CONTROL ARMS LOWER PAIR | M-3075-A | 67 |
| CONTROL PACK 2.0L ECOBOOST | M-6017-20T | 211 |
| CONTROL PACK 2.3L ECOBOOST | M-6017-23T | 213 |
| CONTROL PACK 3.5L GTDI MT | M-6017-35CNTRL | 213 |
| CONTROL PACK 5.0L 4V 2011-2014 W/SPEED DIAL WIRING | M-6017-A504VA | 213 |
| CONTROL PACK 5.0L 4V 2015-2017 M/T | M-6017-504V | 214 |
| CONTROL PACK WITH AUTOMATIC TRANS 2015-2017 COYOTE | M-6017-M50A | 213 |
| COOLANT HOSE KIT SILICONE BLK - FOCUS ST MOUNTUNE | 2363-CHK-BLK | 80 |
| COOLANT HOSE KIT SILICONE RED - FOCUS ST MOUNTUNE | 2363-CHK-RED | 80 |
| COOLANT HOSE KIT SILICONE YLW - FOCUS ST MOUNTUNE | 2363-CHK-YEL | 80 |
| COOLANT HOSE KIT SILICONE BLU - FOCUS ST MOUNTUNE | 2363-CHK-BLU | 80 |
| COOLANT KIT PERF. SILICONE BLU - FIESTA ST MOUNTUNE | 2364-CHK-BLU | 101 |
| COOLANT KIT PERF. SILICONE BLK - FIESTA ST MOUNTUNE | 2364-CHK-BLK | 101 |
| COOLANT KIT PERF. SILICONE RED - FIESTA ST MOUNTUNE | 2364-CHK-RED | 101 |
| COOLANT KIT PERF. SILICONE YEL - FIESTA ST MOUNTUNE | 2364-CHK-YEL | 101 |
| COOLING FAN MGT 2005-2014 / MSVT 2005-2012 | M-8C607-MSVT | 144 |
| CRANK PULLEY SPACER | M-8510-A351 | 178 |
| CRANK PULLEY SPACER | M-8510-B351 | 178 |
| CRANK SPACER | M-6359-D460 | 198 |
| CRANKSHAFT 2.3L ECOBOOST | M-6303-23EB | 159 |
| CRANKSHAFT COBRA JET MUSTANG | M-6303-C54SC4 | 147 |
| CRANKSHAFT COYOTE 5.2L FORGED | M-6303-M52 | 134 |
| CRANKSHAFT DAMPER | M-6316-A460 | 198 |
| CRANKSHAFT DAMPER | M-6316-A50 | 178 |
| CRANKSHAFT DAMPER | M-6316-A521 | 198 |
| CRANKSHAFT DAMPER | M-6316-C351 | 178 |
| CRANKSHAFT DAMPER 2008 SVT COBRA | M-6312-SVT | 147 |
| CRANKSHAFT DAMPER KIT 5.0L | M-6316-M50 | 178 |
| CRANKSHAFT DAMPER SB 0 BALANCE | M-6316-D302 | 178 |
| CRANKSHAFT FORGED BOSS 5.0L COYOTE | M-6303-M50B | 134 |
| CRANKSHAFT FORGED FINISHED | M-6303-C340 | 178 |
| CRANKSHAFT PULLEY SPACER | M-8510-C351 | 178 |
| CRANKSHAFT PULLEY SPACER | M-8510-D351 | 178 |
| CRANKSHAFT RAW FORGING COYOTE | M-6303-M50RF | 134 |
| CRATE ENGINE 2.3L MUSTANG ECOBOOST | M-6007-23T | 157 |
| CRATE ENGINE 347 SEALED RACING 7 MM VALVES | M-6007-D347SR7 | 168 |
| CRATE ENGINE 363 CUBIC INCH 500 HP BOSS | M-6007-Z2363FT | 164 |
| CRATE ENGINE 363 CUBIC INCH 500 HP BOSS | M-6007-Z2363RT | 164 |
| CRATE ENGINE 427 ALUMINUM BLOCK - FRONT SUMP | M-6007-Z427AFT | 166 |
| CRATE ENGINE 427 ALUMINUM BLOCK - REAR SUMP | M-6007-Z427ART | 166 |
| CRATE ENGINE 427 CUBIC INCH 535 HP BOSS | M-6007-Z427FFT | 165 |
| CRATE ENGINE 427 CUBIC INCH 535 HP BOSS | M-6007-Z427FRT | 165 |
| CRATE ENGINE 460 IRON BLOCK - FRONT SUMP | M-6007-Z460FFT | 167 |
| CRATE ENGINE 460 IRON BLOCK - REAR SUMP | M-6007-Z460FRT | 167 |
| CRATE ENGINE 5.0L COYOTE 2017 MUSTANG | M-6007-M50A | 122 |
| CRATE ENGINE 5.2L COYOTE ALUMINATOR XS | M-6007-A52XS | 126 |
| CRATE ENGINE ALUMINATOR S/C | M-6007-A50SCA | 125 |
| CRATE ENGINE AUTOMATIC 5.0L COYOTE 435 HP MUSTANG | M-6007-M50AAUTO | 122 |
| CRATE ENGINE BOSS302 PUSH ROD | M-6007-X302B | 162 |
| CRATE ENGINE BOSS302 PUSH ROD | M-6007-X302E | 162 |
| CRATE ENGINE COYOTE ALUMINATOR N/A | M-6007-A50NAA | 124 |
| CRATE ENGINE DRESSED FRONT SUMP 347 STREET | M-6007-X347DF | 163 |
| CRATE ENGINE GEN2 SEALED COYOTE STOCK | M-6007-M50SA | 123 |
| CRATE ENGINE REAR SUMP 347 STREET | M-6007-X347DR | 163 |
| CRATE ENGINE SEALED CIRCLE TRACK | M-6007-D347SR | 168 |

| Description | Part Number | Page |
|--|------------------|------|
| CRATE ENGINE SEALED RACING | M-6007-S347JR | 169 |
| CYLINDER BLOCK 2.3L ECOBOOST MUSTANG | M-6010-23T | 158 |
| CYLINDER BLOCK 460 SIAMESE BIG BORE | M-6010-A460BB | 195 |
| CYLINDER BLOCK 5.0L ALUMINUM RACE SPECIAL | M-6010-M50R | 132 |
| CYLINDER BLOCK 5.0L COYOTE ALUMINUM | M-6010-M504V | 132 |
| CYLINDER BLOCK 5.0L 4V 2015 | M-6010-M504VB | 132 |
| CYLINDER BLOCK 5.2L COYOTE ALUMINUM | M-6010-M52 | 133 |
| CYLINDER BLOCK 9.2" DECK BIG BORE | M-6010-B35192BB | 174 |
| CYLINDER BLOCK 9.2" DECK BOSS 351W | M-6010-BOSS35192 | 174 |
| CYLINDER BLOCK 9.2" DECK 351 ALUMINUM | M-6010-Z35192 | 173 |
| CYLINDER BLOCK 9.5" DECK 4.120 BIG BORE BOSS 351W | M-6010-BOSS351BB | 174 |
| CYLINDER BLOCK 9.5" DECK BOSS 351W | M-6010-BOSS35195 | 174 |
| CYLINDER BLOCK A460 | M-6010-A460 | 195 |
| CYLINDER BLOCK ALUM 9.5" DECK | M-6010-Z351 | 173 |
| CYLINDER BLOCK BOSS 302 | M-6010-BOSS302 | 174 |
| CYLINDER BLOCK BOSS 302 4.115" BIG BORE ENGINE | M-6010-B302BB | 174 |
| CYLINDER BLOCK FR9 | M-6010-R500 | 202 |
| CYLINDER BLOCK IRON 5.4L | M-6010-M54 | 146 |
| CYLINDER BLOCK KENT 1.6L HIGH DECK (8.200) | M-6010-16K | 201 |
| CYLINDER BLOCK LOTUS 1.6L SHORT DECK (7.780) | M-6010-16L | 201 |
| CYLINDER BLOCK MODULAR 5.0L IRON | M-6010-BOSS550 | 146 |
| CYLINDER HEAD | M-6049-C460 | 196 |
| CYLINDER HEAD | M-6049-E1 | 202 |
| CYLINDER HEAD | M-6049-SCJ | 196 |
| CYLINDER HEAD | M-6049-SCJB | 196 |
| CYLINDER HEAD "X" 58 CC CHAMBER | M-6049-X307 | 182 |
| CYLINDER HEAD 2.3L ECOBOOST 2015-2016 MUSTANG | M-6049-M23 | 158 |
| CYLINDER HEAD 64 CC | M-6049-X306 | 182 |
| CYLINDER HEAD 72 CC | M-6049-SCJA | 196 |
| CYLINDER HEAD AL Z2 302/351W | M-6049-Z2 | 182 |
| CYLINDER HEAD ALUM | M-6049-Z304D | 184 |
| CYLINDER HEAD ASSEMBLY | M-6049-Z304DA | 184 |
| CYLINDER HEAD ASSEMBLY LH 5.0L COYOTE MUSTANG | M-6050-M50 | 137 |
| CYLINDER HEAD ASSEMBLY RH 5.0L COYOTE MUSTANG | M-6049-M50 | 137 |
| CYLINDER HEAD CHANGING KIT - 11 MM 2015 COYOTE | M-6067-M50 | 138 |
| CYLINDER HEAD CHANGING KIT 11 MM BOSS 302R | M-6067-M50BR11 | 138 |
| CYLINDER HEAD CHANGING KIT 2V | M-6067-D46 | 149 |
| CYLINDER HEAD CHANGING KIT 4V | M-6067-T46 | 149 |
| CYLINDER HEAD CHANGING KIT 4V S/C | M-6067-MSVT | 149 |
| CYLINDER HEAD CHANGING KIT 5.0L COYOTE - 5.2L HEAD ON 5.0L | M-6067-M5052 | 138 |
| CYLINDER HEAD CHANGING KIT 5.2L COYOTE | M-6067-M52 | 138 |
| CYLINDER HEAD CHANGING KIT BOSS302R | M-6067-M50BR | 138 |
| CYLINDER HEAD CHANGING KIT GT500 5.8L | M-6067-M58 | 149 |
| CYLINDER HEAD CNC-PORTED "Z" | M-6049-Z304P | 184 |
| CYLINDER HEAD INDIVIDUAL PORT 2.0L ECOBOOST | M-6049-20EBIP | 156 |
| CYLINDER HEAD LH 5.0L COYOTE 2015-2017 MUSTANG GT | M-6050-M50A | 137 |
| CYLINDER HEAD LH GT350 | M-6050-M52 | 137 |
| CYLINDER HEAD RH 5.0L COYOTE 2015-2017 MUSTANG GT | M-6049-M50A | 137 |
| CYLINDER HEAD RH GT350 | M-6049-M52 | 137 |
| CYLINDER HEAD STUD KIT | M-6014-BOSS | 177 |
| CYLINDER HEAD STUD KIT | M-6014-Z304 | 177 |
| CYLINDER HEAD W/7 MM VALVES | M-6049-Z304DA7 | 184 |
| CYLINDER HEAD Z-304D - 7 MM BARE SEMIFINISHED | M-6049-Z304D7 | 184 |
| CYLINDER SLEEVES SET OF 8 Z351 BLOCK | M-6012-C351 | 173 |
| CYLINDER SLEEVES Z35192 BLOCK (8 PACK) | M-6012-C35192 | 173 |
| DAMPER KIT 2006 FOCUS | M-18000-ZX3B | 88 |
| DAMPER KIT ADJ MGT 2005-2014 / MSVT 2007-2014 | M-18000-C | 62 |
| DAMPER KIT FOCUS SVT | M-18000-ZX3 | 88 |
| DAMPER KIT MUST GT 2005-2014 | M-18000-A | 62 |
| DECAL "FORD PERFORMANCE" (10 PACK) | M-1820-FP | 262 |
| DECAL "FORD RACING" (25 PKG) 4" X 2-1/2" | M-1820-A1 | 262 |
| DECAL "FORD RACING" MUSCLE PARTS (10 PK) | M-1820-A60 | 262 |
| DECAL MINI "FORD RACING" COMBO (25 PKG) 6" X 1 3/4" | M-1820-B1 | 262 |
| DECALS "FORD RACING" DIE-CUT 15" (10 PK) | M-1820-FR15 | 262 |
| DECALS "FORD RACING" DIE-CUT 15" (2 PK) | M-1820-FR2 | 262 |
| DE-GAS BOTTLE | M-8080-A | 54 |
| DIFF HOUSING TORSEN LOADED MUSTANG 2015-2016 | M-4001-88373T | 28 |
| DIFFERENTIAL (T2R) FR500/BOSS R/S | M-4204-T31H | 242 |
| DIFFERENTIAL 8.8" 3IT COBRA | M-4204-F318C | 242 |
| DIFFERENTIAL BEARING ADJ NUT LOCK & BOLT KIT | M-4144-B | 244 |
| DIFFERENTIAL CARRIER STEEL 9" | M-4141-HS | 244 |
| DIFFERENTIAL COOLER KIT GT350 | M-4000-M8S | 28 |
| DIFFERENTIAL COVER 8.8" ALUM FINNED WITH TAPPED HOLES | M-4033-KA | 239 |
| DIFFERENTIAL COVER 9.75" AXLE | M-4033-F975 | 242 |
| DIFFERENTIAL HOUSING IRS LOADED 3.55 2015-2017 MUSTANG | M-4001-88355 | 28 |
| DIFFERENTIAL INSTALL KIT INC BRNGS AND SEAL 8.8" | M-4210-C3 | 241 |
| DIFFERENTIAL INSTALLATION KIT QUAIFE FIESTA ST | M-4026-FA | 104 |
| DIFFERENTIAL MUSTANG 2015 | M-4204-M | 28 |
| DIFFERENTIAL QUAIFE TORQUE BIASING - FOCUS RS | 2536-ATB-AA | 95 |

PARTS INDEX

| Description | Part Number | Page |
|--|------------------|------|
| DIFFERENTIAL QUAIFE TORQUE BIASING FIESTA ST 2014-2016 | 2364-ATB-AA | 104 |
| DIFFERENTIAL QUAIFE TORQUE BIASING FOCUS ST 2013-2017 | 2363-ATB-AA | 86 |
| DIFFERENTIAL TORSEN 8.8" 31T | M-4204-T31 | 242 |
| DIFFERENTIAL TORSEN MUSTANG 2015 | M-4204-MT | 28 |
| DIFFERENTIAL TORSEN MUSTANG B302 | M-4204-MB | 242 |
| DIFFERENTIAL TRAC-LOC 9" 28T AG | M-4204-F28A | 244 |
| DIFFERENTIAL TRAC-LOC 9" 31T AG | M-4204-F31A | 244 |
| DIFFERENTIAL TRACTION LOK REBUILD KIT 8.8" | M-4700-B | 241 |
| DIFFERENTIAL TRACTION-LOK REBUILD KIT CARBON 8.8" | M-4700-C | 241 |
| DIFFERENTIAL INSTALLATION KIT QUAIFE FOCUS ST | M-4026-FST | 86 |
| DISTRIBUTOR HOLDDOWN CLAMP | M-12270-A302 | 259 |
| DRIVESHAFT ASSY 1996-2004 MUSTANG 4.6 M/T | M-4602-J | 245 |
| DRIVESHAFT ASSY ALUM | M-4602-G | 245 |
| DRIVESHAFT LOOP 2015 MUSTANG | M-5478-6M | 33 |
| DRIVESHAFT LOOP CJ | M-5478-CJ | 245 |
| DRIVESHAFT ONE-PIECE M/T 2005-2010 MUSTANG GT | M-4602-MGTA | 245 |
| DRIVESHAFT ONE-PIECE 2007-2012 GT500 | M-4602-MSVT | 245 |
| DRIVESHAFT ONE-PIECE 2011-2014 MUSTANG | M-4602-MGMT | 245 |
| DRIVESHAFT, BOSSRI | M-4602-S | 245 |
| DYNAMIC SIDE SPLASH BLACK - FOCUS ST MOUNTUNE | 2363-SS-BLK | 90 |
| DYNAMIC SIDE SPLASH GRAY - FOCUS ST MOUNTUNE | 2363-SS-RG | 90 |
| DYNAMIC SIDE SPLASH WHITE - FOCUS ST MOUNTUNE | 2363-SS-WHT | 90 |
| ECCENTRIC | M-6287-B302 | 187 |
| ECCENTRIC | M-6287-C302 | 187 |
| EMBLEM "5.0L" FENDER BLACK 2015-2017 MUSTANG | M-1447-M50AB | 260 |
| EMBLEM "5.0L" FENDER CHROME 2015-2017 MUSTANG | M-1447-M50A | 260 |
| EMBLEM "ECOBOOST" BLACK | M-1447-EBBLK | 261 |
| EMBLEM "ECOBOOST" BLACK/CHROME - LARGE | M-1447-EBBLKLG | 261 |
| EMBLEM "ECOBOOST" SILVER | M-1447-EB | 261 |
| EMBLEM "ECOBOOST" SILVER - LARGE SIZE | M-1447-EBLG | 261 |
| EMBLEM "ECOBOOST" SILVER - MEDIUM SIZE | M-1447-EBMED | 261 |
| EMBLEM DECKLID "SVT" | M-1447-SVT | 260 |
| EMBLEM GRILLE COBRA JET 2008 | M-16098-CJG | 260 |
| EMBLEM RED "COBRA" SNAKE FENDER 2007-2009 MUSTANG SVT | M-1447-R | 260 |
| EMBLEM SET "5.0L" FENDER MUSTANG 2011 | M-1447-M50 | 260 |
| EMBLEMS "COBRA" SNAKE (PAIR) FENDER | M-1447-SR | 260 |
| EMBLEMS FENDER "COYOTE" SVT 2007 | M-1447-C | 260 |
| ENGINE CAP KIT 5.0L COYOTE FORD PERFORMANCE ALUMINUM | M-6766-M50 | 142 |
| ENGINE COVER KIT 5.0L COYOTE | M-9680-M50 | 142 |
| ENGINE COVER MGT 2015 | M-9680-M50A | 142 |
| ENGINE DRESS UP & ISOLATOR KIT MUSTANG | M-9680-BOSS | 142 |
| ENGINE GASKET SET | M-6003-A429 | 197 |
| ENGINE GASKET SET | M-6003-A50 | 188 |
| ENGINE HARNESS 5.0L TI-VCT | M-12508-M50 | 214 |
| ENGINE HARNESS 5.0L TI-VCT AUTOMATIC 2015 | M-12508-M50A | 214 |
| ENGINE KIT 2.0L ECOBOOST | M-6007-20T | 155 |
| ENGINE KIT 3.5L GTDI ECOBOOST V6 | M-6007-35T | 160 |
| ENGINE MOUNT BRACKET - IRON MOD BLOCK | M-6031-BOSS50 | 146 |
| ENGINE MOUNT KIT COYOTE 5.0L | M-6038-M50 | 134 |
| ENGINE MOUNTS FOX 460 | M-6038-A460 | 195 |
| ENGINE OIL DIPSTICK/TUBE | M-6750-C303 | 181 |
| ENGINE ORIENTATION COMPONENT KIT 2.0L | M-6006-20 | 154 |
| ENGINE SHIPPING CRADLE - MODULAR & COYOTE | M-6038-M | 133 |
| EXH 3.0" 2011-2014 MUST GT | M-5230-MGTCA30 | 52 |
| EXH AXLE 2.3 SPORT - 350 TIP - VALANCE 2015-2017 MUSTANG | M-5230-M4SBV | 24 |
| EXH AXLE 2.3 TOURING - CHROME TIPS 2015-2017 MUSTANG | M-5230-M4TC | 23 |
| EXH AXLE 2.3 TOURING - 350 TIP - VALANCE 2015-2017 MUSTANG | M-5230-M4TBV | 24 |
| EXH AXLE 5.0 SPORT - CHROME TIPS 2015-2017 MUSTANG | M-5230-M8TC | 21 |
| EXH AXLE 5.0 SPORT - 350 TIP - VALANCE 2015-2017 MUSTANG | M-5230-M8SBV | 20 |
| EXH AXLE 5.0 TOURING - 350 TIP - VALANCE 2015-2017 MUSTANG | M-5230-M8TBV | 20 |
| EXH AXLE 2.3 SPORT - CHROME TIP 2015-2017 MUSTANG | M-5230-M4SC | 23 |
| EXH SYS 2.3 EC-TYPE - 350 TIP - VALANCE 2016-2017 MUSTANG | M-5200-M4GBV | 22 |
| EXH SYS 2.3 SPORT - 350 TIP - VALANCE 2015-2017 MUSTANG | M-5200-M4SBV | 24 |
| EXH SYS 2.3 TOURING - CHROME TIP 2015-2017 MUSTANG | M-5200-M4TC | 22 |
| EXH SYS 2.3 TOURING - 350 TIP - VALANCE 2015-2017 MUSTANG | M-5200-M4TBV | 24 |
| EXH SYS 2.7 SPORT - REAR EXIT - CHR TIP 2015-2017 F-150 | M-5200-F1527DSC | 112 |
| EXH SYS 2.7 SPORT - REAR EXIT - BLK TIP 2015-2017 F-150 | M-5200-F1527DSB | 112 |
| EXH SYS 2.7 SPORT - SIDE EXIT - BLK TIP 2015-2017 F-150 | M-5200-F1527RSB | 112 |
| EXH SYS 2.7 SPORT - SIDE EXIT - CHR TIP 2015-2017 F-150 | M-5200-F1527RSC | 112 |
| EXH SYS 2.7 TOURING - REAR EXIT - BLK TIP 2015-2017 F-150 | M-5200-F1527DTB | 112 |
| EXH SYS 2.7 TOURING - REAR EXIT - CHR TIP 2015-2017 F-150 | M-5200-F1527DTC | 112 |
| EXH SYS 2.7 TOURING - SIDE EXIT - BLK TIP 2015-2017 F-150 | M-5200-F1527RTB | 112 |
| EXH SYS 2.7 TOURING - SIDE EXIT - CHR TIP 2015-2017 F-150 | M-5200-F1527RTC | 112 |
| EXH SYS 3.5 SPORT - BLK TIP 2014 F-150 TREMOR | M-5200-F1535I26L | 117 |
| EXH SYS 3.5 SPORT - BLK TIPS 2017 F-150 RAPTOR | M-5200-F15RSB | 115 |
| EXH SYS 3.5 SPORT - CF TIPS 2017 F-150 RAPTOR | M-5200-F15RSCF | 115 |
| EXH SYS 3.5 SPORT - CHR TIPS 2017 F-150 RAPTOR | M-5200-F15RSC | 115 |
| EXH SYS 3.5 SPORT - REAR EXIT - BLK TIP 2015-2017 F-150 | M-5200-F1535DSB | 112 |
| EXH SYS 3.5 SPORT - REAR EXIT - CHR TIP 2015-2017 F-150 | M-5200-F1535DSC | 112 |

| Description | Part Number | Page |
|---|------------------|------|
| EXH SYS 3.5 SPORT - SIDE EXIT - BLK TIP 2015-2017 F-150 | M-5200-F1535RSB | 112 |
| EXH SYS 3.5 SPORT - SIDE EXIT - CHR TIP 2015-2017 F-150 | M-5200-F1535RSC | 112 |
| EXH SYS 3.5 TOURING - BLK TIPS 2017 F-150 RAPTOR | M-5200-F15RTB | 115 |
| EXH SYS 3.5 TOURING - CF TIPS 2017 F-150 RAPTOR | M-5200-F15RTCF | 115 |
| EXH SYS 3.5 TOURING - CHR TIPS 2017 F-150 RAPTOR | M-5200-F15RTC | 115 |
| EXH SYS 3.5 TOURING - REAR EXIT - BLK TIP 2015-2017 F-150 | M-5200-F1535DTB | 112 |
| EXH SYS 3.5 TOURING - REAR EXIT - CHR TIP 2015-2017 F-150 | M-5200-F1535DTC | 112 |
| EXH SYS 3.5 TOURING - SIDE EXIT - BLK TIP 2015-2017 F-150 | M-5200-F1535RTB | 112 |
| EXH SYS 3.5 TOURING - SIDE EXIT - CHR TIP 2015-2017 F-150 | M-5200-F1535RTC | 112 |
| EXH SYS 3.5L/5.0L SPORT 126" WB MID-PIPE 2011-2014 | M-5248-F15126L | 113 |
| EXH SYS 3.5L/5.0L SPORT 133" WB MID-PIPE 2011-2014 | M-5248-F15133L | 114 |
| EXH SYS 3.5L/5.0L SPORT 157" WB MID-PIPE 2011-2014 | M-5248-F15157L | 113 |
| EXH SYS 3.5L/5.0L SPORT 163" WB MID-PIPE 2011-2014 | M-5248-F15163L | 113 |
| EXH SYS 5.0 EC-TYPE - BLACK TIP 2016-2017 MUSTANG | M-5200-M8GB | 18 |
| EXH SYS 5.0 EC-TYPE - CHROME TIP 2016-2017 MUSTANG | M-5200-M8GC | 18 |
| EXH SYS 5.0 EC-TYPE - 350 TIP - VALANCE 2016-2017 MUSTANG | M-5200-M8GBV | 19 |
| EXH SYS 5.0 SPORT - 350 TIP - VALANCE 2015-2017 MUSTANG | M-5200-M8SBV | 20 |
| EXH SYS 5.0 SPORT - BLACK TIP 2015-2017 MUSTANG | M-5200-M8SB | 19 |
| EXH SYS 5.0 SPORT - REAR EXIT - BLK TIP 2015-2017 F-150 | M-5200-F1550DSB | 111 |
| EXH SYS 5.0 SPORT - REAR EXIT - CHR TIP 2015-2017 F-150 | M-5200-F1550DSC | 111 |
| EXH SYS 5.0 SPORT - SIDE EXIT - BLK TIP 2015-2017 F-150 | M-5200-F1550RSB | 111 |
| EXH SYS 5.0 SPORT - SIDE EXIT - CHR TIP 2015-2017 F-150 | M-5200-F1550RSC | 111 |
| EXH SYS 5.0 TOURING - CHROME TIP 2015-2017 MUSTANG | M-5200-M8TC | 19 |
| EXH SYS 5.0 TOURING - REAR EXIT - BLK TIP 2015-2017 F-150 | M-5200-F1550DTB | 111 |
| EXH SYS 5.0 TOURING - REAR EXIT - CHR TIP 2015-2017 F-150 | M-5200-F1550DTC | 111 |
| EXH SYS 5.0 TOURING - SIDE EXIT - BLK TIP 2015-2017 F-150 | M-5200-F1550RTB | 111 |
| EXH SYS 5.0 TOURING - SIDE EXIT - CHR TIP 2015-2017 F-150 | M-5200-F1550RTC | 111 |
| EXH SYS 5.0 TOURING - 350 TIP - VALANCE 2015-2017 MUSTANG | M-5200-M8TBV | 20 |
| EXH SYS 5.0L TOURING 126" WB MID-PIPE 2011-2014 | M-5248-F15126C | 113 |
| EXH SYS 5.0L TOURING 133" WB MID-PIPE 2011-2014 | M-5248-F15133C | 113 |
| EXH SYS 5.0L TOURING 157" WB MID-PIPE 2011-2014 | M-5248-F15157C | 113 |
| EXH SYS 5.0L TOURING 163" WB MID-PIPE 2011-2014 | M-5248-F15163C | 113 |
| EXH SYS 5.2 SPORT ACTIVE 2015-2017 GT350 | M-5200-MSS | 18 |
| EXH SYS 6.2 SPORT - CHR TIP 2011-2014 F-150 RAPTOR | M-5200-F15R145L | 116 |
| EXH SYS 6.2 TOURING - CHR TIP 2011-2014 F-150 RAPTOR | M-5200-F15R145C | 116 |
| EXH SYS KIT 5.0 CAT-BACK ACTIVE 2015-2017 MUSTANG | M-5200-M8 | 18 |
| EXH SYSTEM 2.3 EC-TYPE - BLACK TIP 2016-2017 MUSTANG | M-5200-M4GB | 22 |
| EXH SYSTEM 2.3 EC-TYPE - CHROME TIP 2016-2017 MUSTANG | M-5200-M4GC | 22 |
| EXH SYSTEM 2.3 SPORT - BLACK TIP 2015-2017 MUSTANG | M-5200-M4SB | 23 |
| EXH SYSTEM 2.3 SPORT - CHROME TIP 2015-2017 MUSTANG | M-5200-M4SC | 23 |
| EXH SYSTEM 2.3 TOURING - BLACK TIP 2015-2017 MUSTANG | M-5200-M4TB | 22 |
| EXH SYSTEM 5.0 SPORT - CHROME TIP 2015-2017 MUSTANG | M-5200-M8SC | 19 |
| EXH SYSTEM 5.0 TOURING - BLACK TIP 2015-2017 MUSTANG | M-5200-M8TB | 19 |
| EXHAUST AXLE-BACK FOCUS HATCH 2012-2016 | M-5230-FSH | 90 |
| EXHAUST HIGH-FLOW - FOCUS ST MOUNTUNE | 2363-CBE-AA | 89 |
| EXHAUST KIT DUAL MV6 2005-2009 | M-5230-V6 | 53 |
| EXHAUST KIT FOCUS HATCH 2012-2014 | M-5230-FSHA | 90 |
| EXHAUST KIT QUAD SIDE MSVT 2011-2014 | M-5220-MSVT | 51 |
| EXHAUST KIT QUAD TIP MGT 2013-2014 | M-5230-MSVTC | 52 |
| EXHAUST KIT SIDE EXIT 2015-2017 MGT | M-5220-M8 | 21 |
| EXHAUST MANIFOLD KIT COYOTE CAST IRON | M-9430-SR50A | 122 |
| EXHAUST MID-PIPE 133" WHEELBASE RAPTOR | M-5248-F15R133 | 115 |
| EXHAUST MID-PIPE 6.2L SPORT 133" WB | M-5248-F15R133L | 116 |
| EXHAUST MID-PIPE 6.2L TOURING 133" WB | M-5248-F15R133C | 116 |
| EXHAUST SPORT CAT-BACK 3.5L 145" WB F150 2011-2014 | M-5200-F1535145L | 114 |
| EXHAUST SPORT CAT-BACK 5.0L 145" WB F-150 2011-2014 | M-5200-F1550145L | 113 |
| EXHAUST SYS. CAT-BACK STAINLESS STEEL FIESTA ST (N AMER) | 2364-CBE-AB | 102 |
| EXHAUST SYSTEM 2.0 SPORT 2013-2017 FOCUS ST | M-5200-FST | 89 |
| EXHAUST SYSTEM 2.3 SPORT ACTIVE 2016-2017 FOCUS RS | M-5200-FRS | 96 |
| EXHAUST TIPS "FORD RACING" LOGO (PAIR) | M-5255-F15R | 117 |
| EXHAUST TOURING CAT-BACK 5.0L 145" WB F1-50 2011-2014 | M-5200-F1550145C | 113 |
| EXHAUST TOURING - CHROME TIP 2010-2017 TAURUS SHO TOURING | M-5200-SHOTC | 118 |
| EXHAUST VALVE | M-6505-A429 | 197 |
| EXHAUST VALVE | M-6505-B304 | 184 |
| EXHAUST VALVE | M-6505-G302 | 183 |
| EXHAUST VALVE 5.2L COYOTE - QTY 8 | M-6505-M52 | 139 |
| EXHAUST VALVE 7 MM | M-6505-D3047 | 184 |
| EXHAUST X-PIPE KIT MGT 2011-2014 | M-5251-MGTA | 52 |
| EXHAUST X-PIPE KIT MUSTANG 2005-2010 | M-5251-R | 52 |
| EXHAUST X-PIPE MGT 2015-2017 | M-5251-M8 | 21 |
| EXHAUST X-PIPE V6 MUSTANG 2011-2014 | M-5251-MV6A | 53 |
| FENDER COVER "FORD PERFORMANCE" | M-1822-A7 | 260 |
| FENDER COVER 2015 MUSTANG (PAIR) | M-1822-M | 37 |
| FLOOR MAT BLACK "SILVER PONY" 2010 MUSTANG | M-13086-MF | 73 |
| FLOOR MAT BLACK "SILVER PONY" 2013-2014 MUSTANG | M-13086-MN | 73 |
| FLOOR MATS BLACK "BOSS 302" 2012 MUSTANG | M-13086-MJ | 73 |
| FLOOR MATS BLACK "BOSS 302" 2013-2014 MUSTANG | M-13086-MM | 73 |
| FLOOR MATS BLACK "MUSTANG" TAG 2006-2009 MUSTANG | M-13086-ME | 73 |
| FLOOR MATS BLACK "SILVER PONY" 2012 MUSTANG | M-13086-MH | 73 |

PARTS INDEX

| Description | Part Number | Page |
|--|-----------------|------|
| FLOOR MATS GRAY "GT500" 2010 MUSTANG | M-13086-MG | 73 |
| FLOOR MATS GRAY "GT500" 2013-2014 MUSTANG | M-13086-MP | 73 |
| FLOOR MATS GRAY "MUSTANG" TAG 2006-2009 MUSTANG | M-13086-MD | 73 |
| FLYWHEEL 164T 28.2 OZ IN | M-6375-K302 | 234 |
| FLYWHEEL 164T 0 OZ IN | M-6375-M302 | 234 |
| FLYWHEEL 184T 0 OZ IN | M-6375-N427 | 234 |
| FLYWHEEL ALUMINUM 157T 28.2 | M-6375-A302AB | 234 |
| FLYWHEEL ALUMINUM 157T 0 BALANCE | M-6375-D302AB | 234 |
| FLYWHEEL ALUMINUM 4.6/5.4L 8 BOLT | M-6375-R00A | 235 |
| FLYWHEEL BILLET 6 BOLT | M-6375-F46A | 235 |
| FLYWHEEL BILLET 8 BOLT | M-6375-G46A | 235 |
| FLYWHEEL BOLT 5.0L COYOTE | M-6379-C | 233 |
| FLYWHEEL BOLT MANUAL (10 PACK) | M-4216-A210 | 244 |
| FLYWHEEL BOLTS 4.6L MANUAL (8 PACK) | M-6379-B | 233 |
| FLYWHEEL LIGHTWEIGHT BILLET 8 BOLT | M-6375-M50 | 235 |
| FLYWHEEL M/T 157T 50 | M-6375-B302 | 234 |
| FLYWHEEL M/T 4.6L 6 BOLT NI | M-6375-D46 | 235 |
| FLYWHEEL STEEL 157T 0 | M-6375-D302B | 234 |
| FLYWHEEL STEEL 157T 28.2 | M-6375-A302B | 234 |
| FLYWHEEL STEEL 157T 50 | M-6375-C302B | 234 |
| FRICITION MODIFIER (CASE OF 12) | M-19546-A12 | 242 |
| FRICITION MODIFIER (SINGLE BOTTLE) | CM-19546-A1 | 242 |
| FRONT COVER FOR SC APPLICATIONS 5.0L COYOTE | M-6059-M50SC | 141 |
| FUEL INJECTOR 24# (8 PACK) | M-9593-LU24A | 223 |
| FUEL INJECTOR 39# (8 PACK) | M-9593-M39 | 223 |
| FUEL INJECTOR 47# (8 PACK) | M-9593-G302 | 223 |
| FUEL INJECTOR 47# (8 PACK) | M-9593-LU47 | 223 |
| FUEL INJECTOR 52# (SET OF 8) | M-9593-MU52 | 223 |
| FUEL INJECTOR 60# (8 PACK) | M-9593-LU60 | 223 |
| FUEL INJECTOR 80# (8 PACK) | M-9593-LU80 | 223 |
| FUEL INJECTOR ADAPTERS U2J (8 PACK) | M-14464-U2J | 223 |
| FUEL INJECTOR NOZZLE KIT 6.7L DIESEL | M-9546-67 | 108 |
| FUEL INJECTOR UPGRATED SET OF 4 - FOCUS ST MT | E048-07-121 | 84 |
| FUEL PUMP KIT COBRA DUAL | M-9407-GT05 | 226 |
| FUEL PUMP KIT MGT 2010 DUAL | M-9407-MSVTA | 226 |
| GASKET UPPER TO LOWER (5 PACK) | M-9486-A50 | 191 |
| GAUGE - ORDER DIRECTLY FROM AUTOMETER | M-10883-BFSE | 248 |
| GAUGE - ORDER DIRECTLY FROM AUTOMETER | M-10885-BFSE | 248 |
| GAUGE - ORDER DIRECTLY FROM AUTOMETER | M-11622-BFSE | 248 |
| GAUGE - ORDER DIRECTLY FROM AUTOMETER | M-17360-B | 248 |
| GAUGE - ORDER DIRECTLY FROM AUTOMETER | M-19017-B961 | 247 |
| GAUGE - ORDER DIRECTLY FROM AUTOMETER | M-9275-BFSE | 248 |
| GAUGE - ORDER DIRECTLY FROM AUTOMETER | M-9278-BFSE | 248 |
| GAUGE PACK LAGUNA MUSTANG GT 2010-2014 | M-6304GPACK-MA | 247 |
| GAUGE PERFORMANCE PACK BOOST CLUSTER KIT | M-10849-A | 248 |
| GAUGE POD MUSTANG 2005-2014 | M-6304GPOD-A | 247 |
| GEARKNOB - BLACK W/ BLACK FOCUS ST / FIESTA ST | 2364-GK-AB | 86 |
| GEARKNOB - BLACK W/ YELLOW FOCUS ST / FIESTA ST | 2364-GK-AA | 86 |
| GRILLE MODIFIED 2012 BOSS 302S | M-8200-MBR | 72 |
| GRILLE MODIFIED 2013 BOSS 302S | M-8200-MBRA | 72 |
| GUIDE PLATE (8 PACK) | M-6566-SCJ | 197 |
| GUIDE PLATES 8 PACK PUSH ROD | M-6566-Z304D | 184 |
| HALF SHAFT ASSEMBLY (LEFT SIDE) 2015-2016 MUSTANG | M-4139-MA | 29 |
| HALF SHAFT ASSEMBLY (RIGHT SIDE) 2015-2016 MUSTANG | M-4138-MA | 29 |
| HALF SHAFT KIT MUSTANG GT350 | M-4130-MBS | 29 |
| HALF SHAFT UPGRADE KIT 2015-2017 MUSTANG | M-4130-MA | 29 |
| HANDLING PACK 1.25" MSVT 2007-2014 | M-FR3-MSVTA | 61 |
| HANDLING PACK 2015-2017 MUSTANG STREET | M-FR3A-MAA | 32 |
| HANDLING PACK 2015-2017 MUSTANG TRACK | M-FR3A-MBA | 31 |
| HANDLING PACK ADJ ASSY MGT 2005-2014 | M-FR3A-MGTAA | 60 |
| HANDLING PACK ASSEMBLED MSVT 2007-2014 | M-FR3A-MSVTA | 61 |
| HANDLING PACK ASSY (1" DROP) MGT 2005-2014 | M-FR3A-MGTA | 60 |
| HANDLING PACK FASTENER KIT 2005-2014 MUSTANG | M-FR3-FASTENERS | 61 |
| HANDLING PACK FASTENER KIT 2015-2016 MUSTANG | M-FR3-FASTENA | 32 |
| HANDLING PACK FIESTA 2011-2013 | M-FR3-FA | 105 |
| HEAD BOLT KIT | M-6065-D289 | 177 |
| HEAD CHANGING KIT 4.6L 3V | M-6067-3V46 | 149 |
| HEAD GASKET | M-6051-A302 | 189 |
| HEAD GASKET AND BOLT KIT 5.0L PUSH ROD | M-6051-D50 | 189 |
| HEAD GASKET KIT 5.0L 3V | M-6051-CP350 | 149 |
| HEAD GASKET SET | M-6051-B341 | 189 |
| HEAD GASKET SET | M-6051-B460 | 197 |
| HEAD GASKET SET | M-6051-CP331 | 189 |
| HEAD GASKET SET | M-6051-R351 | 189 |
| HEAD GASKET SET | M-6051-S331 | 189 |
| HEAD GASKET SET 460-521 | M-6051-A441 | 197 |
| HEAD GASKET SET PUSH ROD V8 5.0L/5.8L | M-6051-C51 | 189 |
| HEADER BOLT 1" SET LOC | M-9432-A51 | 54 |
| HEADER BOLT 3/4" SET LOC | M-9432-A50 | 54 |

| Description | Part Number | Page |
|--|----------------|------|
| HEADER GASKET REPLACEMENT 4.6L 3V (PAIR) | M-9448-A463V | 151 |
| HEADER GASKETS 4.6L 4V (PAIR) | M-9448-A464 | 151 |
| HEADER GASKETS 5.0L (PAIR) | M-9448-B302 | 190 |
| HEADER GASKETS REPLACEMENT 4.6L 2V (PAIR) | M-9448-A462 | 151 |
| HOOD LATCH KIT | M-16700-A | 259 |
| HOOD PIN KIT FOR FR500S & CJ | M-16700-S | 259 |
| HOOD STRUTS 2015-2017 MUSTANG GT | M-16826-MA | 36 |
| HOOD STRUTS FORD PERFORMANCE 2005-2014 MUSTANG | M-16826-M | 72 |
| IGNITION COIL SET (8) 5.0L COYOTE | M-12029-M50E | 143 |
| IGNITION COIL SET 4.6L 3V | M-12029-3V | 153 |
| IGNITION COIL SET 4V | M-12029-4V | 153 |
| IGNITION COIL SET 5.0L 4V | M-12029-M50C | 143 |
| IGNITION WIRE SET 4.6L 4V BLUE | M-12259-C464 | 152 |
| IGNITION WIRE SET 9 MM YELLOW | M-12259-Y301 | 194 |
| IGNITION WIRE SET BLACK 9 MM | M-12259-M301 | 194 |
| IGNITION WIRE SET BLACK 9 MM | M-12259-M302 | 194 |
| IGNITION WIRE SET BLUE 4.6L 2V | M-12259-C462 | 152 |
| IGNITION WIRE SET BLUE 4.6L 2V F150 | M-12259-T462 | 152 |
| IGNITION WIRE SET BLUE 9 MM | M-12259-C301 | 194 |
| IGNITION WIRE SET BLUE 9 MM | M-12259-C302 | 194 |
| IGNITION WIRE SET BLUE 9 MM | M-12259-C460 | 200 |
| IGNITION WIRE SET RED 4.6L 2V | M-12259-R462 | 152 |
| IGNITION WIRE SET RED 4.6L 4V | M-12259-R464 | 152 |
| IGNITION WIRE SET RED 9 MM | M-12259-R301 | 194 |
| IGNITION WIRE SET RED 9 MM | M-12259-R460 | 200 |
| INDUCT. UPGRADE KIT BLK - FIESTA ST 2014 MOUNTUNE | 2364-INT-BLK | 100 |
| INDUCT. UPGRADE KIT BLU - FIESTA ST 2014 MOUNTUNE | 2364-INT-BLU | 100 |
| INDUCT. UPGRADE KIT RED - FIESTA ST 2014-2015 MOUNTUNE | 2364-INT-RED | 100 |
| INDUCT. UPGRADE KIT YEL - FIESTA ST 2014-2015 MOUNTUNE | 2364-INT-YEL | 100 |
| INDUCTION HOSE B/Y - FIESTA ST MOUNTUNE | 2364-IH-BLK | 100 |
| INDUCTION HOSE BLUE - FIESTA ST MOUNTUNE | 2364-IH-BLU | 100 |
| INDUCTION HOSE HIGH-FLOW BLACK - FOCUS ST | 2363-IH-BLK | 77 |
| INDUCTION HOSE HIGH-FLOW BLUE - FOCUS ST | 2363-IH-BLU | 77 |
| INDUCTION HOSE HIGH-FLOW YELLOW - FOCUS ST | 2363-IH-YEL | 77 |
| INDUCTION HOSE HIGH-FLOW BLACK - 2016 FOCUS RS | 2536-IH-BLK | 93 |
| INDUCTION HOSE HIGH-FLOW BLUE - 2016 FOCUS RS | 2536-IH-BLU | 93 |
| INDUCTION HOSE RED - FIESTA ST MOUNTUNE | 2364-IH-RED | 100 |
| INDUCTION HOSE YELLOW - FIESTA ST MOUNTUNE | 2364-IH-YEL | 100 |
| INDUCTION KIT BLACK - FOCUS ST MOUNTUNE | 2363-CAIS-BA | 76 |
| INTAKE DUCT KIT BLACK - FOCUS RS MOUNTUNE | 2536-CAIS-BLK | 93 |
| INTAKE DUCT KIT BLUE - FOCUS RS MOUNTUNE | 2536-CAIS-LBLU | 93 |
| INTAKE GASKET GRAPHITE STD PORT 5.0L | M-9439-G50 | 190 |
| INTAKE KIT PERFORMANCE 2015-2017 MUSTANG GT | M-9452-M8 | 15 |
| INTAKE MANIFOLD | M-9424-C460 | 197 |
| INTAKE MANIFOLD | M-9424-D302 | 191 |
| INTAKE MANIFOLD | M-9424-F302 | 191 |
| INTAKE MANIFOLD - FR9 EFI | M-9424-E554 | 203 |
| INTAKE MANIFOLD 4.6L PI | M-9424-P46 | 151 |
| INTAKE MANIFOLD 5.0L 4V COBRA JET | M-9424-M50CJ | 140 |
| INTAKE MANIFOLD BOSS302R | M-9424-M50BR | 140 |
| INTAKE MANIFOLD EDSELBROCK SUPER VICTOR 9.2 | M-9424-E2929 | 191 |
| INTAKE MANIFOLD EFI 4.6L 3V | M-9424-463V | 151 |
| INTAKE MANIFOLD GASKET | M-9439-A50 | 190 |
| INTAKE MANIFOLD GASKET PORTED Z HEAD | M-9439-ZP | 190 |
| INTAKE MANIFOLD GT350 5.2L COYOTE | M-9424-M52 | 140 |
| INTAKE MANIFOLD INSTALLATION KIT - BOSS 302 | M-9444-M50B | 140 |
| INTAKE MANIFOLD NASCAR | M-9424-E651 | 203 |
| INTAKE PLAQUE 1996-1998 COBRA | M-1447-D46 | 253 |
| INTAKE PLAQUE 1999-2001 COBRA | M-1447-F46 | 253 |
| INTAKE SHROUD MGT | M-6949-3V | 154 |
| INTAKE SPACER | M-9486-A51 | 191 |
| INTAKE SPACER | M-9486-A52 | 191 |
| INTAKE SPACER | M-9486-A53 | 191 |
| INTAKE VALVE | M-6507-A304 | 184 |
| INTAKE VALVE | M-6507-B429 | 197 |
| INTAKE VALVE 7 MM | M-6507-D3047 | 184 |
| INTAKE VALVE LIGHTWEIGHT 5.2L COYOTE (8 PACK) | M-6507-M52 | 139 |
| INTAKE VALVE X-HEAD (SINGLE) | M-6507-J302 | 183 |
| INTERCOOLER HARD PIPE LOWER STAINLESS STL FIESTA ST MOUNTUNE | 2364-HP-AA | 93 |
| INTERCOOLER - BLACK FOCUS ST 2015-2016 MOUNTUNE | 2363-IC-BA2 | 76 |
| INTERCOOLER BLACK - FIESTA ST MOUNTUNE | 2364-IC-BA | 98 |
| INTERCOOLER BLK - 2013-2014 FOCUS ST MOUNTUNE | 2363-IC-BA | 76 |
| INTERCOOLER CHARGE PIPE BLK - FOCUS ST MOUNTUNE | 2363-CPK-BLK | 77 |
| INTERCOOLER CHARGE PIPE BLUE - FOCUS ST MOUNTUNE | 2363-CPK-BLU | 77 |
| INTERCOOLER CHARGE PIPE LOWER - FOCUS ST MOUNTUNE | 2363-HP-AA | 77 |
| INTERCOOLER CHARGE PIPE RED - FOCUS ST MOUNTUNE | 2363-CPK-RED | 78 |
| INTERCOOLER HEAT EXCHANGER MSVT | M-8229-MSVT | 50 |
| INTERCOOLER HOSE KIT BLK - FIESTA ST MOUNTUNE | 2364-BHK-BLK | 101 |
| INTERCOOLER HOSE KIT RED - FIESTA ST MOUNTUNE | 2364-BHK-RED | 101 |

For important information about the proper usage of performance parts, please see page 12.
See pages 295-302 for important safety, emissions and warranty information.

PARTS INDEX

| Description | Part Number | Page |
|---|----------------|------|
| INTERCOOLER HOSE KIT YLW - FIESTA ST MOUNTUNE | 2364-BHK-YEL | 101 |
| INTERCOOLER PERFORMANCE 5.4L 4V | M-6775-MSVT | 50 |
| INTERCOOLER PUMP KIT MSVT 2014 | M-8501-M58 | 144 |
| JOUNCE BUMPER & HARDWARE PACK MUSTANG 2015 | M-5570-B | 29 |
| JOUNCE BUMPER KIT MUSTANG 2005-2014 | M-5570-A | 63 |
| KNUCKLE KIT CAR | M-5970-A | 239 |
| KNUCKLE KIT IRS W/TOE BEARING MUSTANG 2015-2017 | M-5970-M | 27 |
| KNUCKLE TO TOE LINK BEARING ASSEMBLY MUSTANG GT | M-5A460-M | 27 |
| LASH ADJUSTER ASSEMBLY COYOTE | M-6500-M50 | 139 |
| LASH ADJUSTERS FORD GT AND SVT 5.4L | M-6500-GT | 150 |
| LICENSE PLATE "FORD PERFORMANCE" - SINGLE | M-1828-FPONE | 261 |
| LICENSE PLATE FRAME BRUSHED "FORD PERFORMANCE" | M-1828-SS304C | 261 |
| LIFTER CUP HARDENED STEEL FOR M-6500-R302HLC | M-6500-R302HLC | 187 |
| LONG BLOCK 5.0L COYOTE 2015-2017 MUSTANG | M-6006-M50A | 129 |
| LONG BLOCK GEN 1 5.0L COYOTE | M-6006-M50A1 | 131 |
| LOOM SET FORD STREET ROD | M-12297-L900 | 259 |
| LOWER CONTROL ARM KIT FRONT PERF. PACK MUSTANG | M-3075-F | 32 |
| LOWERING KIT 1" MGT 2005-2014 | M-5300-PA | 64 |
| LOWERING KIT 2013 FOCUS ST | M-5300-U | 89 |
| LOWERING KIT - LESS JOUNCE BUMPERS 2015-2017 F-150 | M-3000-H4 | 108 |
| LOWERING KIT MGT/BOSS/LAGUNA 2012-2013 | M-5300-T | 64 |
| LOWERING KIT REAR 2015-2017 F-150 | M-3000-H | 108 |
| LOWERING KIT REAR F-150 2004-2013 | M-3000-G | 108 |
| LOWERING SPRINGS (1.25") MSVT 2007-2014 | M-5300-L | 64 |
| LOWERING SPRINGS FOCUS ST 2014-2016 | M-5300-V | 89 |
| LOWERING SPRINGS STREET MGT 2015 | M-5300-X | 30 |
| LOWERING SPRINGS TRACK MGT 2015 | M-5300-Y | 30 |
| MAF 140 MM SCJ 2010 | M-9600-SCJ | 226 |
| MAF COBRA JET 123 MM (CAL REQUIRED) | M-9600-CJ | 226 |
| MAIN BOLT KIT 5.2L COYOTE | M-6345-M52 | 134 |
| MAIN CAP BOLT KIT 4.6L ALUM BLOCK | M-6345-A46 | 147 |
| MAIN SEAL REAR | M-6701-A460 | 200 |
| MAIN SEAL REAR | M-6701-B302 | 188 |
| MAIN SEAL REAR | M-6701-B351 | 188 |
| MIRROR BLOCK OFF PLATE CJ 2010 | M-17728-CJ10 | 72 |
| MP215 PERFORMANCE UPGRADE - FIESTA ST MOUNTUNE | 2364-215-AA | 98 |
| MP275 PERFORMANCE UPGRADE FOCUS ST 2015-2016 MOUNTUNE | 2363-280-BB | 75 |
| MP275 UPGRADE BLACK W/HANDSET/CAL - FOCUS ST MOUNTUNE | 2363-280-BA | 75 |
| MUFFLER KIT AXLE-BACK FIESTA 2011-2015 | M-5230-FAB | 102 |
| MUFFLER KIT FR500S MGT/MSVT 2005-2009 | M-5230-S | 51 |
| MUFFLER KIT MGT/MSVT 2011-2014 | M-5230-MGTCA1 | 52 |
| MUFFLER KIT SPECIAL EDITION MGT 2005-2009 | M-5230-GTB | 52 |
| MUFFLER KIT SPORT MGT 2011-2014 | M-5230-MGTLA | 52 |
| MUFFLER KIT SPORT MSVT 2011-2012 | M-5230-MSVTLA | 51 |
| MUFFLER KIT SPORT MSVT 2013-2014 | M-5230-MSVTLB | 51 |
| MUFFLER KIT SPORT MV6 2011-2014 | M-5230-MV6LA | 53 |
| MUFFLER KIT TOURING CAT-BACK FIESTA HATCH 2011-2014 | M-5230-FAC | 102 |
| MUFFLER KIT TOURING MV6 2011-2014 | M-5230-MV6CA | 53 |
| MUSTANG 2016 COBRA JET BLUE | M-FR500-CJ16B | - |
| MUSTANG ROAD RACE 2017 FORD PERFORMANCE | M-FP500-FP350S | - |
| OIL COOLER 5.0L MUSTANG | M-6642-MB | 135 |
| OIL FILL CAP FR LOGO ALUM CHROMED | M-6766-MP46A | 253 |
| OIL FILTER ADAPTER KIT COYOTE GEN 2 | M-6880-M501 | 135 |
| OIL FILTER ADAPTOR 90 DEGREE | M-6880-A50 | 181 |
| OIL FILTER CASE OF 12 CM-6731-FL1A | M-6731-FL1A | 181 |
| OIL FILTER FL1A HI PERF | CM-6731-FL1A | 181 |
| OIL FILTER FL820 HI PERF | CM-6731-FL820 | 181 |
| OIL FILTER HI PERF. (CASE OF 12) | M-6731-FL820 | 181 |
| OIL LINE ADAPTER 2011-2014 5.0L COYOTE | M-6881-M50 | 134 |
| OIL LINE ADAPTER 2015-2017 5.0L COYOTE | M-6881-M50A | 135 |
| OIL PAN & PUMP KIT GT350 | M-6675-M52 | 135 |
| OIL PAN 302 DEEP REAR SUMP | M-6675-DRS302 | 180 |
| OIL PAN 302 FRONT T-SUMP | M-6675-FT302 | 180 |
| OIL PAN 351W DEEP REAR SUMP | M-6675-DRS351 | 180 |
| OIL PAN 351W FRONT T-SUMP | M-6675-FT351 | 180 |
| OIL PAN 460 DEEP REAR SUMP | M-6675-DRS460 | 199 |
| OIL PAN 460 FRONT T-SUMP | M-6675-FT460 | 199 |
| OIL PAN 5.0L B302R | M-6675-M50BR | 135 |
| OIL PAN BAFFLE W/BAL SHAFT DEL FOCUS ST 2013-2015 | 2363-OC-AA | 82 |
| OIL PAN FLANGE REINFORCEMENT | M-6674-351 | 181 |
| OIL PAN GASKET 5.0L | M-6710-A50 | 190 |
| OIL PAN GASKET 7.5L (1 PIECE) | M-6710-A460 | 200 |
| OIL PAN GASKET (1 PIECE) | M-6710-A351 | 190 |
| OIL PAN KIT 351 FOX BODY | M-6675-A58 | 179 |
| OIL PAN KIT 460 FOX | M-6675-A460 | 200 |
| OIL PAN KIT 5.0L | M-6675-A50 | 179 |
| OIL PAN REINFORCEMENT 302 | M-6674-302 | 181 |
| OIL PICKUP TUBE | M-6622-DRS302 | 180 |
| OIL PICKUP TUBE | M-6622-DRS351 | 180 |

| Description | Part Number | Page |
|--|------------------|------|
| OIL PICKUP TUBE 302 FRONT SUMP | M-6622-FT302 | 180 |
| OIL PICKUP TUBE 351 FRONT SUMP | M-6622-FT351 | 180 |
| OIL PICKUP TUBE 460 REAR SUMP | M-6622-DRS460 | 199 |
| OIL PICKUP TUBE BOSS 302 BLOCK | M-6622-BOSS302 | 179 |
| OIL PICKUP TUBE FRONT T-SUMP 460 | M-6622-FT460 | 199 |
| OIL PUMP AND PICKUP HIGH VOL 4.6L / 5.4L | M-6600-F46 | 148 |
| OIL PUMP GEROTOR STEEL 5.0L CJ | M-6600-50CJ | 134 |
| OIL PUMP HIGH VOLUME | M-6600-A460 | 198 |
| OIL PUMP HIGH VOLUME | M-6600-B3 | 179 |
| OIL PUMP HIGH VOLUME | M-6600-D2 | 179 |
| OIL PUMP HIGH VOLUME WITH PICKUP TUBE | M-6600-D46 | 147 |
| OIL PUMP INSTALL KIT 5.0L COYOTE | M-6600-A50PKIT | 135 |
| OIL PUMP PICKUP TUBE FOR ALUMINUM BLOCK | M-6622-DRS351A | 179 |
| OIL PUMP SHAFT HD | M-6605-A341 | 179 |
| OIL PUMP SHAFT HD | M-6605-A429 | 198 |
| OIL PUMP SHAFT HD | M-6605-B302 | 179 |
| OIL-AIR SEPARATOR LH 5.2L GT350 | M-6766-A50S | 17 |
| OIL-AIR SEPARATOR RH 5.0L/5.2L COYOTE | M-6766-A50 | 17 |
| PANHARD BAR BUSHING KIT ADJUSTABLE 2005-2014 MUSTANG | M-4266-A | 68 |
| PANHARD BAR MUSTANG 2005-2014 | M-4264-A | 68 |
| PARK BRAKE CABLE (FRONT) | M-2810-A | 70 |
| PEDAL PAD (SINGLE) - BRAKE OR CLUTCH | M-2301-B | 73 |
| PEDAL PAD ACCELERATOR | M-2301-A | 73 |
| PEDAL PAD DEAD PEDAL | M-2301-C | 73 |
| PENNANT STRING "FORD PERFORMANCE" 50' | M-1827-P2 | 262 |
| PENNANT STRING 50' RACING | M-1827-P1 | 262 |
| PERF. CAL 2015-2017 MUSTANG 5.0L | M-9603-M8 | 15 |
| PERFORMANCE CAL WITH SPARK PLUGS FOCUS ST 2013-2016 | M-14204-FSTA | 79 |
| PINION BEARING RETAINER 9" | M-4614-B | 244 |
| PINION FLANGE 8.8" AXLE | M-4851-C | 240 |
| PINION FLANGE COBRA 2003-2004 | M-4851-B | 240 |
| PINION FLANGE SUPER 8.8" IRS MUSTANG AUTOMATIC | M-4851-M8A | 26 |
| PINION NUTS UNIVERSAL (100 PACK) | M-4213-A | 239 |
| PINION OIL SEAL | M-4676-A111 | 242 |
| PLUG & DOWEL KIT | M-6026-A302 | 176 |
| PLUG & DOWEL KIT | M-6026-A460 | 195 |
| PLUG & DOWEL KIT | M-6026-C146 | 147 |
| PLUG & DOWEL KIT ALUMINUM | M-6026-A | 176 |
| PLUG KIT THREAD-IN CORE | M-6026-B302 | 176 |
| POWER MODULE 6-SPEED AUTOMATIC 5.0L COYOTE | M-9000-PMCA | 120 |
| POWER MODULE 6-SPEED MANUAL 5.0L COYOTE | M-9000-PMCM | 121 |
| POWER STEERING PUMP BRKT BOSS 302R | M-8511-M50BR | 144 |
| POWER UPGRADE PACK FOCUS ST 2013-2016 | M-FR1-FSTA | 79 |
| POWER UPGRADE PACK MV6 2005-2009 | M-2007-FR1V6 | 39 |
| POWER UPGRADE PKG MGT 2011-2014 | M-FR1-MGTB | 39 |
| PRESSURE PLATE BOLT AND DOWEL KIT 10.5" | M-6397-A302 | 233 |
| PRESSURE PLATE BOLT AND DOWEL KIT 11" | M-6397-B46 | 233 |
| PTU BRACE - FOCUS RS MOUNTUNE | 2536-PBKT-AA | 95 |
| PULLEYS V BILLET, 1 GROOVE | M-8509-CM | 193 |
| PULLEYS V BILLET, 1 GROOVE | M-8509-DM | 193 |
| PULLEYS V BILLET, 2 GROOVE | M-8509-EM | 193 |
| PULSE RING 5.0L HIGH RPM COMPETITION | M-12A227-CJ13 | 143 |
| PUSH ROD GUIDE PLATE N-351 | M-6566-N351 | 185 |
| PUSH RODS (16 PACK) | M-6565-L302 | 188 |
| QUICK-SHIFT - FOCUS ST MOUNTUNE | 2363-BSA-AA | 85 |
| QUICK-SHIFT BILLET FIESTA ST MOUNTUNE | 2238-BQS-AA | 103 |
| QUICK-SHIFT FIESTA 5-SPD MOUNTUNE | 2130-BSA-AA | 103 |
| RADIATOR CAP "FORD RACING" LOGO | M-8100-A | 54 |
| RADIATOR COVER FORD PERF BRAND 2015-2017 MUSTANG | M-8291-FP | 17 |
| RADIATOR MGT 2005-2014 | M-8005-MGT | 54 |
| RADIATOR MUSTANG 2011-2014 | M-8005-MBR | 54 |
| RADIATOR PERFORMANCE MGT 2015 | M-8005-M8 | 17 |
| RADIATOR TRIPLE PASS FOCUS ST MOUNTUNE | MP2546-12020-AA1 | 85 |
| REAR SEAT DELETE KIT 2015-2017 MUSTANG | M-6346612-M | 35 |
| REAR SEAT INSTALLATION KIT 2015-2017 GT350R | M-63840-MS | 35 |
| REAR WING 2005-2009 SVT MUSTANG | M-16600-SVTC | 71 |
| RING & PINION 8.8" 3.08 | M-4209-88308 | 240 |
| RING & PINION 8.8" 3.15 | M-4209-88315 | 240 |
| RING & PINION 8.8" 3.27 | M-4209-88327 | 240 |
| RING & PINION 8.8" 3.31 | M-4209-88331 | 240 |
| RING & PINION 8.8" 3.55 | M-4209-88355 | 240 |
| RING & PINION 8.8" 3.73 | M-4209-88373 | 240 |
| RING & PINION 8.8" 4.10 | M-4209-88410 | 240 |
| RING & PINION 8.8" 4.56 | M-4209-88456 | 240 |
| RING & PINION 8.8" 3.55 IRS | M-4209-88355A | 240 |
| RING & PINION 8.8" 3.73 IRS | M-4209-88373A | 240 |
| RING & PINION 8.8" 4.09 IRS | M-4209-88409A | 240 |
| RING & PINION INSTALL KIT 8.8" | M-4210-A | 240 |
| RING & PINION INSTALL KIT IRS 2015 | M-4210-B3 | 27 |

PARTS INDEX

| Description | Part Number | Page |
|--|----------------|------|
| RING & PINION INSTALLATION KIT 7.5" | M-4210-B75 | 241 |
| RING & PINION INSTALLATION KIT 8.8" | M-4210-B2 | 241 |
| RING GEAR BOLT 8.8" (SET OF TEN) | M-4216-A300 | 232 |
| RING GEAR BOLT KIT SUPER 8.8 (10 PIECES) | M-4216-C | 28 |
| RING GEAR BOLTS (100 PACK) | M-4216-A200 | 244 |
| ROCKER ARM AND LASH ADJ KIT 3V MODULAR | M-6529-3V | 150 |
| ROCKER ARM PEDESTAL SHIM KIT | M-6529-B302 | 188 |
| ROCKER ARM SET 5.4L (SET OF 16) | M-6529-MSVT | 150 |
| ROCKER ARM SHIM KIT | M-6529-A302 | 188 |
| ROCKER CHANNEL KIT (8 PACK) | M-6588-A50 | 188 |
| ROCKER COVER KENT - CAST | M-6582-16K | 201 |
| ROCKER ARM STUDS (16) | M-6527-C311 | 185 |
| ROLL RESTRICTOR 2013-2016 FOCUS ST | 2363-RR-AA | 85 |
| ROLL RESTRICTOR MOTOR MOUNT FIESTA ST 2013-2016 MOUNTUNE | 2364-RR-AA | 101 |
| ROLLER FINGER FOLLOWER KIT 5.2L COYOTE | M-6564-M52 | 139 |
| ROLLER FINGER FOLLOWER KIT COYOTE | M-6564-M50 | 139 |
| ROLLER PILOT BEARING - HIGH LOAD - 4.6L/5.4L/5.0 L4 | M-7600-C | 236 |
| ROLLER PILOT BEARING .669 | M-7600-A | 236 |
| ROLLER PILOT BEARING 4.6L/5.4L/5.0L 4V | M-7600-B | 236 |
| ROTOR KIT 2-PC 4-PISTON MGT 2005-2014 | M-2300-SA | 69 |
| SEAL KIT 8.8" IRS BEARING | M-4413-A | 241 |
| SEAL KIT SUPER 8.8" IRS | M-4413-B | 28 |
| SEATS RECARO FORD PERFORMANCE 2015-2017 MUSTANG | M-63660005-ME | 35 |
| SEATS RECARO FORD PERFORMANCE 2018 MUSTANG | M-63660005-MF | 35 |
| SHIFT KNOB 2015-2017 MUSTANG CARBON FIBER | M-7213-MCF | 25 |
| SHIFT KNOB 6-SPEED FORD PERFORMANCE 2015-2017 | M-7213-M8A | 25 |
| SHIFT KNOB 6-SPEED FORD RACING S550 | M-7213-M8 | 25 |
| SHIFT KNOB FOCUS ST CARBON FIBER | M-7213-FSTCF | 86 |
| SHIFT KNOB FP GT350R BLACK | M-7213-M8SB | 25 |
| SHIFT KNOB FP GT350R RED | M-7213-M8SR | 25 |
| SHIFT KNOB FP GT350R WHITE | M-7213-M8SW | 25 |
| SHIFTER 6-SPD MGT 2011-2014 | M-7210-MGTB | 231 |
| SHIFTER HURST T5/T45 | M-7210-M | 231 |
| SHIFTER KIT 2015-2017 MUSTANG - WITHOUT KNOB | M-7210-MA | 25 |
| SHIFTER KIT SHORT THROW 2015-2017 MUST | M-7210-M8 | 25 |
| SHIFTER KIT SHORT THROW GT350 2015-2017 | M-7210-M8A | 25 |
| SHIFTER MGT 2005-2009 | M-7210-MGT | 231 |
| SHIFTER SHORT THROW FOCUS 2012-2014 | M-7210-FS | 85 |
| SHIFTER SHORT THROW FOCUS RS | M-7210-FRS | 94 |
| SHIFTER SHORT THROW FOCUS ST | M-7210-FST | 85 |
| SHIFTER SHORT THROW MSVT 2007-2009 | M-7210-B | 231 |
| SHOCK MOUNT KIT REAR | M-18197-A | 63 |
| SHOCK SINGLE SERVICE REAR | M-18001-AS | 29 |
| SHOCK SINGLE SERVICE REAR M-18000-A | M-18001-ARI | 62 |
| SHORT BLOCK 347 NEUTRAL BALANCE | M-6009-347 | 170 |
| SHORT BLOCK 427 CUBIC INCH ALUMINUM | M-6009-427A | 171 |
| SHORT BLOCK 427 CUBIC INCH BOSS | M-6009-427F | 171 |
| SHORT BLOCK 460 CUBIC INCH BOSS | M-6009-460 | 172 |
| SHORT BLOCK 5.0L COYOTE ALUMINATOR NA | M-6009-A50NAA | 131 |
| SHORT BLOCK 5.0L COYOTE ALUMINATOR SC | M-6009-A50SCA | 131 |
| SHORT BLOCK 5.3L MODULAR BOSS STROKER | M-6009-B53 | 145 |
| SHORT BLOCK 5.4 4V S/C IRON | M-6009-C54SC4 | 145 |
| SHORT BLOCK BOSS 363 CUBIC INCH | M-6009-363 | 170 |
| SKID PLATE FRONT F150 RAPTOR | M-5018-F15R | 117 |
| SKID PLATE KIT RAPTOR | M-5018-F15RB | 110 |
| SLIP YOKE 28 SPLINE | M-4841-B | 245 |
| SLIP YOKE 31 SPLINE | M-4841-A | 245 |
| SOUND SUPPRESSION CHAMBER - FOCUS RS MOUNTUNE | 2536-SSC-AA | 94 |
| SOUND SYMPOSER DELETE 1.6L 2013-2016 FIESTA ST | 2364-SD-AA | 98 |
| SPARK PLUG 3V 12 MM THREAD | M-12405-3V12MM | 153 |
| SPARK PLUG SET 3V COLD 16 MM (8 PACK) | M-12405-3V0 | 153 |
| SPARK PLUG SET 5.0L 4V HEAT RANGE 0 | M-12405-M50A | 141 |
| SPARK PLUG SET COLD 2.0T (4 PLUGS) | M-12405-20T | 78 |
| SPEED-DIAL SPEEDOMETER ADJUSTER | M-4209ADPT-AC | 243 |
| SPLITTER HARDWARE KIT 2010-2012 | M-16601H-MB | 71 |
| SPLITTER HARDWARE KIT BOSS 302S | M-16601H-S | 71 |
| SPLITTER KIT 2010-2012 MUSTANG GT LAGUNA | M-16601-MBKITA | 71 |
| SPLITTER KIT FRONT 2013-2014 MUSTANG LAGUNA | M-16601-MBA | 71 |
| SPLITTER KIT 2010-2012 MUSTANG LAGUNA | M-16601-MB | 71 |
| SPLITTER LOWER FRONT - 2014-2016 FIESTA ST MOUNTUNE | 2364-FS-AA | 106 |
| SPOILER KIT REAR FOCUS RS | M-5844210-RS | 96 |
| SPOILER LOWER SPORT - 2013-2014 FOCUS ST MOUNTUNE | 2363-CS-AA | 90 |
| SPRING - FIESTA ST 5-DOOR (USA) | 2364-MSK-BA | 105 |
| SPRING AND SWAY BAR PACKAGE 2015 MUSTANG GT | M-5700-M | 30 |
| SPRING KIT 1.5" DROP 2005-2014 MUSTANG | M-5300-KA | 64 |
| SPRING KIT 1979-2004 MUSTANG | M-5300-G | 63 |
| SPRING KIT 2012-2013 FOCUS | M-5300-S | 89 |
| SPRING KIT 2014-2017 FOCUS ST | 2363-MSK-AB | 89 |
| SPRING KIT COBRA JET 2005-2013 MUSTANG | M-5300-RA | 64 |

| Description | Part Number | Page |
|---|-----------------|------|
| SPRING KIT FRONT/REAR 1979-2004 MUSTANG | M-5300-B | 63 |
| SPRING KIT 1979-2004 MUSTANG | M-5300-C | 63 |
| SPRING SET SPORT - FOCUS RS MOUNTUNE | 2536-MSK-RS1 | 95 |
| SPRINGS MUSTANG GT350 | M-5300-W | 30 |
| START BUTTON RED MUSTANG GT350 | M-10B776-MR | 36 |
| STARTER INDEX PLATE - MODULAR | M-7007-A | 233 |
| STARTER INDEX PLATE MODULAR BLOCK AUTO TRANS | M-6373-A | 233 |
| STARTER INDEX PLATE SMALL BLOCK | M-7007-B | 233 |
| STARTER KIT MODULAR ENGINES | M-11000-C50 | 143 |
| STARTER - MINI - SBF | M-11000-B51 | 194 |
| STARTER - MINI HIGH TORQUE - SBF | M-11000-MT164 | 194 |
| STEERING RACK ELECTRIC RACING SPECIAL | M-3200-EPAS | 66 |
| STEERING WHEEL ADAPTER | M-3602-R | 73 |
| STEERING WHEEL FOCUS RS | M-3600-FRS | 91 |
| STEERING WHEEL FORD PERFORMANCE OFF-ROAD | M-3600-RA | 73 |
| STEERING WHEEL KIT - ORANGE 2015-2017 F-150 RAPTOR | M-3600-F15ROR | 110 |
| STEERING WHEEL KIT - RED 2015-2017 F-150 RAPTOR | M-3600-F15RRD | 110 |
| STICKER SET MOUNTUNE 6 PIECE | 5000-STK-SET | 106 |
| STRUT AND SHOCK KIT MGT 2015-2017 | M-18000-F | 29 |
| STRUT MOUNT UPGRADE MGT 2005-2014 | M-18183-C | 63 |
| STRUT MOUNT UPGRADE 2015 MUSTANG | M-18183-M | 29 |
| STRUT SINGLE SERVICE FRONT | M-18001-AG | 29 |
| STRUT SINGLE SERVICE FRONT M-18000-A | M-18001-AF | 62 |
| STRUT TOWER BRACE - 2013-2016 FIESTA ST | 7064-FSB-AA | 105 |
| STRUT TOWER BRACE FRONT - 2013-2017 FOCUS ST | 7063-FSB-AA | 87 |
| STRUT TOWER BRACE KIT - RHD MUSTANG GT350 | M-20201-M350RHD | 33 |
| STRUT TOWER BRACE KIT 2015-2016 MUSTANG GT350 | M-20201-GT350 | 33 |
| STRUT TOWER BRACE KIT FORD PERF RHD MUSTANG | M-20201-MARHD | 33 |
| STRUT TOWER BRACE MGT 2005-2014 | M-20201-S197 | 66 |
| STRUT TOWER BRACE MV6 2005-2014 | M-20201-F | 66 |
| STRUT TOWER BRACE S550 FORD PERFORMANCE | M-20201-MA | 33 |
| SUPERCHARGER KIT 670 HP MGT 2015-2017 | M-6066-M8627 | 14 |
| SUPERCHARGER RHD CLOSE OUT PANEL 2015-2017 MUST GT | M-9066-M8RHD | 14 |
| SUPERCHARGER TUNER KIT 2.3L TVS MSVT 2007-2012 | M-6066-MSVT23 | 50 |
| SUPERCHARGER TUNER KIT 2.3L TVS W/65 MM TB MSVT 2007-2012 | M-6066-MSVT2365 | 50 |
| SUSPENSION ECCENTRIC PACK S197 FRONT | M-3B236-A | 66 |
| SUSPENSION KIT FOCUS SVT | M-3000-ZX3A | 88 |
| SUSPENSION KIT FOCUS SVT | M-3000-ZX3 | 88 |
| SWAY BAR COMPLETE HARDWARE KIT | M-5490-HWA | 65 |
| SWAY BAR COMPLETE HARDWARE KIT | M-5490-HWB | 65 |
| SWAY BAR COMPLETE HARDWARE KIT | M-5490-HWC | 65 |
| SWAY BAR KIT MSVT 2007-2012 | M-5490-B | 65 |
| SWAY BAR REPLACEMENT BUSHING KIT | M-5490-BKA | 65 |
| SWAY BAR REPLACEMENT BUSHING KIT | M-5490-BKB | 65 |
| SWAY BAR REPLACEMENT BUSHING KIT | M-5490-BKC | 65 |
| SWAY BAR SINGLE REPLACEMENT END LINK | M-5490-LINKA | 65 |
| SWAY BAR SINGLE REPLACEMENT END LINK | M-5490-LINKB | 65 |
| SWAY BAR SINGLE REPLACEMENT END LINK | M-5490-LINKC | 65 |
| SWAY BARS MGT 2005-2014 | M-5490-A | 65 |
| SWAY BAR KIT CONV MGT 2005-2014 | M-5490-D | 65 |
| SWAY BAR BUSHING KIT TRACK | M-5490-BKD | 65 |
| SWAY BAR KIT TRACK 2015-2018 MUSTANG | M-5490-EA | 30 |
| SYMPOSER DELETE KIT 2013-2017 FOCUS ST | 2363-SD-AA | 82 |
| TAPPET HYDRAULIC OEM TYPE HI PERFORMANCE | M-6500-R302H | 187 |
| TAPPET SET HYD ROLLER (16) | M-6500-R302 | 187 |
| TENT "FORD PERFORMANCE" 10' X 10' | M-1827-T10A | 262 |
| TENT "FORD PERFORMANCE" 10' X 20' | M-1827-T20A | 262 |
| TENT WALL "FORD PERFORMANCE" 10' | M-1827-W10A | 262 |
| THROTTLE BODY 5.0L 4V 90 MM | M-9926-M5090 | 224 |
| THROTTLE BODY 55 MM 4.6L3V 2005-2010 | M-9926-MGT | 225 |
| THROTTLE BODY 87 MM GT350 5.2L COYOTE | M-9926-M52 | 225 |
| THROTTLE BODY DUAL BORE MECHANICAL 65 MM | M-9926-CJ65M | 225 |
| THROTTLE BODY DUAL BORE 65 MM | M-9926-CJ65 | 224 |
| THROTTLE BODY DUAL BORE SVT 60 MM | M-9926-MSVT | 225 |
| THROTTLE BODY MUSTANG 2.3L ECOBOOST 70 MM | M-9926-M2370 | 225 |
| THROTTLE BODY SCJ MECH OVAL MONOBLADE | M-9926-SCJM | 225 |
| THROTTLE BODY SPACER FOR M-9926-M5090 5.0 COYOTE | M-9474-M50 | 224 |
| THROTTLE BODY SPACER FOR M-9926-M5090 BOSS 302 | M-9474-M50B | 224 |
| THROTTLE BODY (62 MM) 3V MUSTANG | M-9926-3V | 224 |
| TIE DOWN KIT MUSTANG | M-1700-M | 36 |
| TIMING AND CAM COVER KIT 5.0L TI-VCT | M-6580-M50 | 141 |
| TIMING CHAIN COVER 302-351 | M-6059-D351 | 192 |
| TIMING CHAIN KIT MODULAR 4.6L 3V | M-6004-463V | 148 |
| TIMING CHAIN TENSIONER 5.0L BOSS | M-6266-M50B | 140 |
| TIMING CHAIN TENSIONER KIT 5.4L 4V STEEL | M-6266-54ST | 150 |
| TIMING COVER 460/BIG BLOCK | M-6059-460 | 200 |
| TIRE SHADE "FORD PERFORMANCE" DRAG RACING | M-1822-A9 | 261 |
| TOE LINK REAR MUSTANG 2015 (PACK OF 2) | M-5972-M | 27 |
| TOW HOOK ASSEMBLY REAR 2015-2017 MUSTANG | M-17954-RB | 37 |

For important information about the proper usage of performance parts, please see page 12.
See pages 295-302 for important safety, emissions and warranty information.

PARTS INDEX

| Description | Part Number | Page |
|--|-----------------|------|
| TOW HOOK FRONT GT350 | M-17954-FA | 37 |
| TOW HOOK LOOP KIT | M-17954-A | 72 |
| TOW RING KIT FRONT | M-17954-F | 72 |
| TOW RING KIT REAR | M-17954-RA | 72 |
| TPMS ACTIVATION TOOL AND SENSORS 2010-2014 | M-1180-A | 57 |
| TPMS SENSOR AND TOOL KIT - 2015-2016 MUSTANG, F-150 | M-1180-B | 38 |
| TRACK CAL MGT 2013-2014 | M-14204-MGTTC | 49 |
| TRACK CAL UPGRADE 2013-2014 MUSTANG GT | M-14204-MGTTCU | 49 |
| TRACK MAT "FORD PERFORMANCE" | M-1822-A8 | 260 |
| TRANS COOLER AIR SCOOP | M-5025-MBR | 230 |
| TRANS COOLER SCOOP MGT 2015 | M-5025-M8 | 26 |
| TRANS CROSS MEMBER | M-5059-A | 230 |
| TRANS DIPSTICK & TUBE | M-6750-D303 | 231 |
| TRANS DIPSTICK & TUBE | M-6750-E303 | 230 |
| TRANSMISSION 6-SPEED 2.66 1ST GEAR | M-7003-M6266 | 228 |
| TRANSMISSION 6-SPEED 2.97 1ST GEAR | M-7003-M6295 | 228 |
| TRANSMISSION HARDWARE KIT MODULAR | M-7771-A | 232 |
| TRANSMISSION KIT MAGNUM XL MGT 2005-2014 | M-7003-M6XL | 229 |
| TRANSMISSION REBUILD KIT T-5 | M-7000-A | 230 |
| TRANSMISSION SHD T-5 | M-7003-Z | 230 |
| TRANSMISSION TREMEC TKO-600 5-SPD EXTRA HD | M-7003-R58C | 229 |
| TRANSMISSION TREMEC TKO-600 5-SPD HDO | M-7003-R58H | 229 |
| TRIM PANEL DECK LID 2018 MUSTANG | M-16600-MA | 36 |
| T-STAT HOUSING 90 DEGREE | M-8592-M90 | 192 |
| TURBO UPGRADE 6.7L | M-TURBO-67 | 108 |
| TWIN TURBO UPGRADE KIT 3.5L GEN 2 F-150 | M-9438-35TA | 108 |
| U-JOINT KIT | M-4635-A | 245 |
| VALVE COVER | M-6582-LE302BL | 249 |
| VALVE COVER | M-6582-LE302C | 249 |
| VALVE COVER - COBRA KIT | M-6000-C302 | 251 |
| VALVE COVER 351 CLEVELAND | M-6582-C351BK | 252 |
| VALVE COVER - 3V BLK | M-6582-FR3VBLK | 154 |
| VALVE COVER AL BLACK 351C | M-6582-Z351B | 251 |
| VALVE COVER BLACK | M-6582-LE302BK | 249 |
| VALVE COVER BLACK SATIN | M-6582-A341R | 252 |
| VALVE COVER BLK COBRA SET | M-6582-B | 252 |
| VALVE COVER BLK MUSTANG (PAIR) | M-6582-B301 | 250 |
| VALVE COVER COBRA SET | M-6582-A | 249 |
| VALVE COVER FORD RACING SB PENT ROOF BLACK | M-6582-W351PR | 252 |
| VALVE COVER FORD SB SLANT EDGE BLACK | 302-135 | 250 |
| VALVE COVER FORD SB SLANT EDGE CHROME | 302-139 | 250 |
| VALVE COVER FORD SB SLANT EDGE FORD BLUE | 302-136 | 250 |
| VALVE COVER FORD SB SLANT EDGE GRAY CRINKLE | 302-137 | 250 |
| VALVE COVER FORD SB SLANT EDGE POLISHED | 302-138 | 250 |
| VALVE COVER GASKET SET 5.0L (PAIR) | M-6584-A50 | 190 |
| VALVE COVER POLISHED COBRA (PAIR) | M-6582-A427 | 252 |
| VALVE COVER POLISHED MSTG SET | M-6582-F301 | 250 |
| VALVE COVER POLISHED | M-6582-C351PD | 252 |
| VALVE COVER SATIN BLACK 460 ALUMINUM | M-6582-B460 | 252 |
| VALVE COVER SET | M-6582-A301R | 249 |
| VALVE COVER SET | M-6582-A302R | 249 |
| VALVE COVER SET | M-6582-A342R | 252 |
| VALVE COVER SET | M-6582-W427B | 250 |
| VALVE COVER SET BLK COBRA | M-6582-F302 | 249 |
| VALVE COVER SET EFI TRUCK | M-6582-A351R | 251 |
| VALVE COVER SET POLISHED | M-6582-C460 | 252 |
| VALVE COVER SET POLISHED | M-6582-Z351 | 251 |
| VALVE COVER SLANT EDGE FORD RACING 289-351 BLACK STEALTH | 302-135B | 250 |
| VALVE COVER COBRA EFI | M-6000-D302 | 251 |
| VALVE COVER 3V BLUE | M-6582-FR3VBL | 154 |
| VALVE COVERS BLACK RACING EFI | M-6000-J302R | 251 |
| VALVE COVERS SMALL BLOCK CIRCLE TRACK | M-6582-CT2 | 249 |
| VALVE COVER SMALL BLOCK | M-6582-LE302SBK | 249 |
| VALVE COVER | M-6000-F302 | 251 |
| VALVE COVER MUSTANG EFI | M-6000-E302 | 251 |
| VALVE GUIDE - BRONZE 4 PK | M-6510-XRBVG | 183 |
| VALVE SPRING KIT 5.2L COYOTE | M-6513-M52 | 139 |
| VALVE SPRING KIT BOSS 302R | M-6513-M50BR | 139 |
| VALVE SPRING PAC 1219X BEEHIVE | M-6513-1219X | 185 |
| VALVE SPRING RETAINERS (16) | M-6514-A50 | 185 |
| VALVE STEM SEAL (SET OF 16) | M-6571-A50 | 183 |
| WATER MANIFOLD | M-8C368-FR9 | 202 |
| WATER PUMP | M-8501-E351S | 192 |
| WATER PUMP | M-8501-F351 | 192 |
| WATER PUMP | M-8501-FR9 | 202 |
| WATER PUMP BACKING PLATE BIG BLOCK 460 | M-8501-460BP | 200 |
| WATER PUMP ELECTRIC MSVT | M-8501-MSVT | 144 |
| WATER PUMP KIT | M-8501-A50 | 192 |
| WATER PUMP KIT ELECTRIC COYOTE 5.0L | M-8501-M50CJ6 | 144 |

| Description | Part Number | Page |
|--|----------------------|------|
| WATER PUMP SHORT SERPENTINE | M-8501-D50 | 192 |
| WHEEL BEAD-LOCK RING KIT RAPTOR 2013-2014 | M-1021-F15RA | 109 |
| WHEEL BEAD-LOCK RING WITH FASTENERS RAPTOR | M-1021-F15RB | 109 |
| WHEEL BEAD-LOCK TRIM RING BLUE RAPTOR 2017 | M-1021-F15BL1 | 109 |
| WHEEL BEAD-LOCK TRIM RING KIT BLUE RAPTOR | M-1021-F15BL | 109 |
| WHEEL BEAD-LOCK TRIM RING KIT ORANGE RAPTOR | M-1021-F15OR | 109 |
| WHEEL BEAD-LOCK TRIM RING KIT RED RAPTOR | M-1021-F15RD | 109 |
| WHEEL BEAD-LOCK TRIM RING ORANGE RAPTOR 2016 | M-1021-F15OR1 | 109 |
| WHEEL BEAD-LOCK TRIM RING RED RAPTOR 2017 | M-1021-F15RD1 | 109 |
| WHEEL BLACK FOCUS RALLY | M-1007-S177B | 92 |
| WHEEL CAP MUSTANG BAR & PONY 2005 | M-1096-A | 59 |
| WHEEL CENTER CAP | M-1096-FR | 59 |
| WHEEL CENTER CAP | M-1096-N | 59 |
| WHEEL CENTER CAP 2016 FOCUS RS | M-1096-RS | 96 |
| WHEEL CENTER CAP FOCUS | M-1096-Q | 91 |
| WHEEL CENTER CAP FORD PERF. BLACK 2015 MUSTANG | M-1096-FP3 | 37 |
| WHEEL CENTER CAP FORD RACING - FIESTA M-1007-FA | M-1096-FA | 59 |
| WHEEL CENTER CAP FORD RACING 2005-2014 | M-1096-FR1 | 59 |
| WHEEL CENTER CAP MUSTANG TRI-BAR | M-1096-K | 59 |
| WHEEL CENTER CAP MUSTANG TRI-BAR | M-1096-O | 37 |
| WHEEL FORGED BEAD-LOCK 2013-2014 RAPTOR | M-1007-DC1785 | 109 |
| WHEEL FRONT MSVT 2005-2012 | M-1007-SA199 | 58 |
| WHEEL GLOSS BLACK 10" REAR 2012 MUSTANG | M-1007-DC1910LGB | 57 |
| WHEEL GLOSS BLACK 18"X8" FOCUS | M-1007-M188GB | 92 |
| WHEEL GLOSS BLACK 19" 2016 FOCUS RS | M-1007-R198GB | 96 |
| WHEEL GLOSS BLACK 9" FRONT 2012 MUSTANG | M-1007-DC199LGB | 57 |
| WHEEL HUB FRONT W/STUDS FR500S | M-1104-A | 67 |
| WHEEL HUB IRS COBRA (1 EACH) | M-1109-A | 239 |
| WHEEL HUB KIT WITH ARP STUDS FRONT 2015-2017 MUSTANG | M-1104-AB | 26 |
| WHEEL HUB KIT WITH ARP STUDS REAR 2015-2017 MUSTANG | M-1104-B | 26 |
| WHEEL HUB KIT WITH ARP STUDS REAR 2015-2017 MUSTANG | M-1104-B | 26 |
| WHEEL KIT 6-SPOKE MATTE BLACK 20"X8.5" 2015-2018 F-150 | M-1007K-P20XB | 109 |
| WHEEL KIT BEAD-LOCK F-150 RAPTOR | M-1007-W1785B | 109 |
| WHEEL KIT GLOSS BLK 19"X9" (4) WITH TPMS | M-1007KIT-DC199LGB | 56 |
| WHEEL KIT MUSTANG GLS BLK 19"X9" (2) 19"X10" (2) TPMS | M-1007KIT-DC19910LGB | 56 |
| WHEEL KIT PERF. PACK 19"X9" DARK 2015 MUSTANG | M-1007K-M199DS | 38 |
| WHEEL KIT PERF. PACK GLOSS BLACK 19"X9"/9.5" 2015-2017 MUSTANG | M-1007K-M19XGB | 38 |
| WHEEL KIT PERF. PACK MATTE BLACK 19"X9"/9.5" 2015-2017 MUSTANG | M-1007K-M19XB | 38 |
| WHEEL KIT PERF. PACK SILVER 19"X9" 2015 MUSTANG | M-1007K-M199S | 38 |
| WHEEL LUG NUT (5 PACK) | M-1012-A | 59 |
| WHEEL LUG NUT KIT BLACK (5 PCS) | M-1012-MB | 37 |
| WHEEL LUG NUT KIT 2015-2018 F-150 | M-1012-FA | 109 |
| WHEEL LUG NUT KIT MK2 (5 PACK) FOCUS RS | M-1012-RSA | 96 |
| WHEEL LUG NUT KIT 2015-2017 MUSTANG | M-1012-M | 37 |
| WHEEL LUG NUT KIT OPEN BACK 2015-2018 MUSTANG | M-1012-N | 37 |
| WHEEL MATTE BLACK 18"X8" 2012-2017 FOCUS ST | M-1007-PF188MB | 92 |
| WHEEL MATTE BLACK 18"X8" MUSTANG | M-1007-P188MB | 57 |
| WHEEL MATTE BLACK 19"X8" 2012-2016 FOCUS ST | M-1007-P198MB | 92 |
| WHEEL MSVT 2007 | M-1007-S189S | 58 |
| WHEEL NUT (5 PACK) | M-1012-G | 67 |
| WHEEL PERF. PACK DARK STAINLESS 19"X9" I4 2015-2017 MUSTANG | M-1007-M199DS | 38 |
| WHEEL PERF. PACK MATTE BLK FRONT 19"X9" 2015-2017 MUSTANG | M-1007-M199B | 38 |
| WHEEL PERF. PACK MATTE BLK REAR 19"X9.5" 2015-2017 MUSTANG | M-1007-M1995B | 38 |
| WHEEL PERF. PACK SILVER 19"X9" I4 2015-2017 MUSTANG | M-1007-M199SA | 38 |
| WHEEL PERF. PACK SILVER 19"X9" 2015-2017 MUSTANG GT | M-1007-M199S | 38 |
| WHEEL SET 19"X9.5" (4) WITH TPMS MSVT 2014 | M-1007KIT-SA199S | 56 |
| WHEEL SET MUSTANG SVT 2012 19"X9" (4) WITH TPMS | M-1007KIT-SA199 | 56 |
| WHEEL SET WITH TPMS GLOSS BLACK 18"X8" FOCUS ST | M-1007K-M188GB | 91 |
| WHEEL SET WITH TPMS KIT 5-SPOKE MATTE BLACK 18"X8" FOCUS ST | M-1007K-PF188MB | 92 |
| WHEEL SET WITH TPMS KIT MATTE BLACK 19"X8" 2013-2017 FOCUS ST | M-1007K-P198MB | 91 |
| WHEEL SILVER 17"X7" FOCUS SVT | M-1007-S177 | 92 |
| WHEEL 6-SPOKE MATTE BLACK 20"X8.5" 2015-2018 F-150 | M-1007-P2085MB | 109 |
| WHEEL SPLIT 5-SPOKE SATIN BLACK MSVT 2013 | M-1007-SA1995MB | 58 |
| WHEEL STUDS EXTENDED ARP MUSTANG | M-1107-C | 26 |
| WINDSHIELD BANNER "FORD PERFORMANCE" FOCUS | M-1820-FFP | 91 |
| WINDSHIELD BANNER "FORD PERFORMANCE" WHITE & RED 2015-2017 | M-1820-MR | 35 |
| WINDSHIELD BANNER "FORD PERFORMANCE" 2015 MUSTANG | M-1820-MB | 35 |
| WIRING HARNESS MULTIPOINT EFI 302/351W | M-12071-A50 | 215 |



FORD PERFORMANCE

GENERAL INFORMATION AND TECHNICAL ASSISTANCE

Ford Performance Parts are available through Ford and Lincoln dealers and selected independent automotive specialty/performance outlets.

Ford Motor Company reserves the right to change, without notice or obligation, its products, prices, specifications and materials.

**GENERAL INQUIRIES
AND TECHNICAL QUESTIONS
ON PRODUCTS SHOULD BE
ADDRESSED TO:**

Ford Performance Parts
P.O. Box 490
Dearborn, MI 48121

**For official
Ford Motor Company
shop manuals
and wiring
diagrams, call
Helm Publications
at 1-800-782-4356.**

TECHNICAL ASSISTANCE TECHLINE

Telephone (800)367-3788

International (313)621-0771

(FOR FORD PERFORMANCE PARTS ONLY)

When you need fast, reliable, up-to-date information about Ford Performance Parts equipment, call the Ford Performance Techline. You'll reach staff with a huge database of specifications and automotive know-how. The staff includes long-time racers and performance experts with many years of hands-on Ford experience, and the database includes everything from the Ford Performance Parts parts catalog to an extensive library of high-performance reference materials.

You can call the Techline with questions about Ford Performance Parts at (800)367-3788, international (313)621-0771. If you need more in-depth information, write to Ford Performance Parts.

For correct assistance, be sure to include the following information:

- Name and address
- Day and evening phone number
- Year/make/model of vehicle
- Original factory engine CID, transmission type and axle ratio
- Proposed modification changes

If you cannot find Ford Performance Parts parts locally, call the Techline for purchase assistance.

**See our website at
performanceparts.ford.com**

**NEW for 2018
Product information, dealer list and more!**



© Ford Motor Company
Thirty-Fifth Edition – 2018

All rights reserved. This book or any part may not be reproduced in any form without written permission from Ford Motor Company.

Share pictures of your Ford Performance equipped vehicle
on Facebook and Instagram and use **#fordperformance**



1960 FORD F-100
Built by: Legens Hot Rods Owner: Jeff Perkins
Gen 2 Coyote Crate Engine



2013 FORD MUSTANG BOSS 302 LAGUNA SECA
Built by: Ron Valine Owner: Ron Valine
Ford Performance TrackKey Calibration



1964 FORD FAIRLANE 500
Built by: CHE Performance Owner: M. Lance Tavana
Gen 2 Coyote Crate Engine



GEN 3 TYPE 65 COUPE-R
Built by: Factory Five Racing Owner: Snap-On Tools
Aluminator 5.2XS Crate Engine



1941 FORD WAGON
Built by: TEN/Street Rodder Owner: Tim Foss
Coyote Power Module – Automatic



2016 A/C COBRA REPLICA
Built by: Scott Spencer Owner: Scott Spencer
Gen 2 Coyote Crate Engine



1972 FORD MAVERICK
Built by: The SEMA Garage Owner: The SEMA Garage
EcoBoost 2.3T Engine Kit



2014 FORD FOCUS ST
Built by: Wes Duenkel Owner: Wes Duenkel
Ford Performance Focus ST Calibration



1967 FORD MUSTANG
Built by: TEN/Street Rodder Owner: Street Rodder
Z2363FT 363 CI 500HP Crate Engine



1972 FORD MAVERICK
Built by: Craig Johnson Owner: Craig Johnson
EcoBoost 3.5T Engine Kit



1963 FORD THUNDERBIRD
Built by: Manns Restoration Owner: Gary Surdyke
Gen 2 Coyote Crate Engine



1963 FORD FALCON SPRINT
Built by: Roger Gaynor Owner: Roger Gaynor
Gen 2 Coyote Crate Engine



FORDPERFORMANCE.COM