

Method Development Guide for Hypercarb Columns



Hypercarb™ has unique properties as a packing for HPLC, which differ from those of silica-based stationary phases. It has exceptional ability to retain very polar compounds and to separate closely related compounds. The hydrophobic and electrostatic retention mechanisms that explain this behavior also require a different approach to develop a method on this stationary phase. In this guide we have reviewed a successful approach to method development on Hypercarb columns.

Method Development Guide for Hypercarb Columns

1. Introduction	4	6. Use of high temperature in LC and LC/MS	8	8. Wash procedures	28
1.1. Properties of Porous Graphitic Carbon	4	6.1. Advantages	8	8.1. Removal of TFA and DEA	28
1.2. Mechanisms of inter	4	6.2. Column and oven requirements	9	8.2. Acid/base wash	28
2. Organic modifier strength	5	7. Method development	10	8.3. Strong organic wash	28
3. Mobile phase additives	6	7.1. Generic conditions	10	8.4. Normal phase wash	28
4. Column geometry selection	7	7.2. Very Polar Analytes	12	9. Applications	29
5. Hypercarb columns for very polar analytes and in LC/MS	7	7.3. Acidic analytes	15	10. References	34
		7.4. Non-acidic analytes	17		
		7.5. High temperature and temperature programming	22		
		7.5.1. High temperature to reduce run time	22		
		7.5.2. Selectivity changes with temperature	22		
		7.5.3. Temperature programming	25		
		7.5.4. "Green" LC	25		

1. Introduction

1.1. Properties of Porous Graphitic Carbon –

Hypercarb media is 100% porous graphitic carbon (PGC). The particles are spherical and fully porous. On a microscope scale, the surface of PGC is composed of flat sheets of hexagonally arranged carbon atoms as in a very large polynuclear aromatic molecule. The surface is crystalline and highly reproducible, with no micro pores or chemically bonded phase.

The properties of Hypercarb as a stationary phase in HPLC have been utilized to provide solutions to a wide range of what might normally be considered problematic separations in HPLC. Hypercarb provides unique retention and separation of very polar compounds. The surface of Hypercarb is stereo-selective with the capability to separate geometric isomers and other closely related compounds. Hypercarb is stable throughout the entire pH range 1-14, and is not affected by aggressive mobile phases. Its compatibility with all solvent systems enables separation of a wide range of polarities within a single chromatographic run.

1.2. Mechanisms of interaction – The flat, highly crystalline Hypercarb surface leads to retention mechanisms which are different from those observed on silica-based bonded phases. The overall retention on Hypercarb is a combination of two mechanisms:

- 1) dispersive interactions between analyte – mobile phase and analyte – graphite surface, by which retention increases as the hydrophobicity of the molecule increases
- 2) charge induced interactions of a polar analyte with the polarizable surface of graphite.

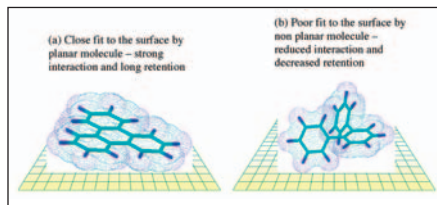

Figure 1: Schematic showing analyte alignment at the surface of PGC – A close fit to the surface of PGC allow for intense dispersive/charge induced interactions to take place and thus strong retention.

Thus, the strength of analyte interactions with Hypercarb is largely dependent on the molecular area in contact with the graphite surface (Figure 1), and also on the type and positioning of the functional groups in relation to the graphite surface, at the points of contact.

Ross discussed the polarizability of the surface of graphite as the key to understanding the mechanism by which polar compounds are retained (Figure 2).¹ Ross and Knox calculated values pertaining to the polar retention effect on graphite, by comparing retention behavior of test polar solutes with those of equivalent hydrocarbons.^{2,3}

The unique retention mechanisms on Hypercarb columns requires a specific approach to method development.

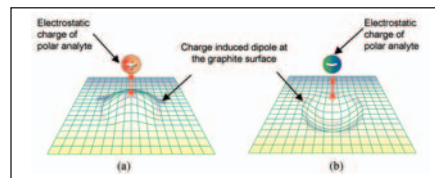
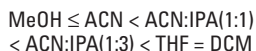

Figure 2: Schematic representation of polar analyte retention – In which a) positive and b) negative charges, approach the graphite surface, resulting in a charge-induced dipole at the graphite surface.

2. Organic modifier strength

The elutropic solvent series associated with silica bonded phases does not always apply to Hypercarb. The strength of organic solvents is solute-dependent and an important tool to adjust retention and selectivity. In general, methanol (MeOH) and acetonitrile (ACN) are similar in strength but weaker than 2-propanol (IPA) which in turn is weaker than either tetrahydrofuran (THF) or dichloromethane (DCM). The pressure difficulties associated with the use of IPA may be overcome by mixing it with ACN in a proportion of 1:1 or 3:1. This approach increases the relative elution strength of ACN whilst avoiding excessive backpressure. For the purpose of method development it can be assumed that the organic solvent elution strength increases as follows:



Although MeOH and ACN have similar strength for most analyte types, in some cases they may provide different selectivity. An example is the reversal of the elution order of 1) Phenol, 2) Resorcinol, 3) Phloroglucinol; if a mobile phase of H₂O/MeOH is used the elution order is 1), 2), 3), i.e., the higher the analyte polarity, the more retained - this is the inverse of reversed-phase (RP-LC) systems; however, if ACN is used instead of MeOH the elution order becomes 3), 2), 1) as would be expected in conventional RP-LC. (Figure 3). This can be attributed to the higher dipole moment of acetonitrile, with the resulting stronger analyte-mobile phase dispersive interaction. Another solvent which often provides different selectivity to ACN is dioxane, although both have in general similar elution strength. In non-aqueous analysis of hydrophobic solutes (i.e., compounds with high hydrocarbon content) which are retained mainly by dispersive interactions, it has been shown by Gaudin *et al.*⁴ that chloroform and toluene are the strongest solvents, followed by DCM and THF.

Figure 3: Separation of phenols on Hypercarb column

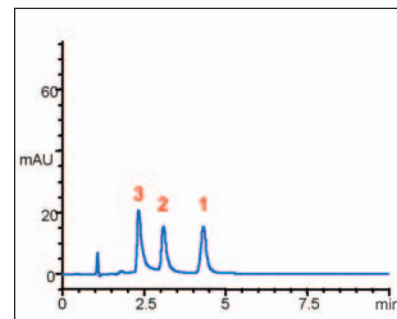

Column:	Hypercarb 5 μm, 50 x 4.6 mm
Part Number:	35005-054630
Mobile Phase:	H ₂ O/ACN (80:20)
Flow Rate:	0.7 mL/min
Detection:	UV at 254 nm
Temperature:	25 °C

1. Phenol
2. Resorcinol
3. Phloroglucinol

3. Mobile phase additives

Retention of polar compounds and ions on Hypercarb is due to specific interactions between solutes and delocalized electrons on the graphite surface, which behaves both as an electron donor and electron acceptor. The type and concentration of electronic modifiers in the mobile phase can have a noticeable effect on the retention, selectivity and also on the peak symmetry of solutes separated on Hypercarb columns.

The most commonly used electronic modifier, trifluoroacetic acid (TFA), can act as a competitive modifier which reduces polar retention. When separating ionizable acidic solutes, very often it is essential to use TFA in order to obtain elution in a reasonable run time. TFA competes with the acidic solutes for the graphite surface, preventing very strong retention of these. When analyzing ionizable basic solutes TFA behaves as an ion pairing agent which improves peak shape at the same time as it increases retention; it is believed that in this case, TFA forms an ion pair with the analyte increasing retention moderately but also improving resolution and peak shape via electronic interactions with the graphite surface.

Elfakir and Dreux compared the effect on solute retention of various acidic electronic modifiers and salts.⁵ They found that

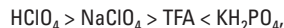

and that the resolution values were also dependent on the concentration of the electronic modifier.

Diethylamine (DEA) also behaves as an electronic modifier and is very useful when strong retention on the graphite surface results in broad, asymmetrical peaks or very late eluting peaks, for basic or acidic analytes. In the separation of basic analytes DEA can produce sharp symmetrical peaks, even for compounds such as procainamides which are known for producing poor peak shapes. It is thought that DEA competes with the basic analytes for the surface of the graphite, and thus reduces retention. For acidic analytes, this modifiers's electronic interaction with the graphite surface will improve resolution and peak shape.

1-Methylpiperidine is another alternative electronic modifier for basic compounds, which improves peak symmetry.

4. Column geometry selection

Hypercarb provides increased dispersive interactions relative to alkyl chain bonded supports. Thus, a Hypercarb column will show much stronger retention than a silica based C18 phase, for a given column length; a relatively short Hypercarb column should be used to

achieve comparable resolution. In most cases, a 100 mm length column is enough for any separation. The internal diameter will depend on various factors such as detection technique, amount of sample available, etc.

5. Hypercarb columns for very polar analytes and in LC/MS

As discussed in section 1.2 polar molecules show affinity towards the graphite surface, and thus it is possible to obtain good retention and elution of polar species on Hypercarb. The key to the analysis of polar species is to obtain sufficient retention to enable qualitative and quantitative analysis. In general, C18-silicas exhibit low capacity factors for polar analytes, even when fully aqueous mobile phases are utilized. The analysis of very polar compounds under reversed phase LC/MS is challenging because typical hydrophobic stationary phases do not provide enough retention to resolve and

quantify these types of compound, using the mobile phases permitted with mass spectrometric detection. Hypercarb is the ideal stationary phase for the RP-LC/MS of polar analytes for several reasons:

- Hypercarb provides unique retention and separation of very polar compounds with “MS friendly” mobile phases such as 0.1% formic or acetic acid and low concentrations of volatile buffers such as ammonium acetate or ammonium formate;
- Polar compounds are well retained on Hypercarb, therefore high concentrations of organic modifiers can be employed, which improves nebulization in atmospheric pressure ionization techniques, and thus improves sensitivity of the analysis;
- It allows shorter column lengths and smaller diameters to be used without compromising peak capacity, often with increased sensitivity;
- There is no modification of the porous graphitic carbon surface on Hypercarb, thus it is stable with any mobile phase and there are no issues of phase bleed.

6. Use of high temperature in LC and LC/MS

6.1. Advantages – The use of high temperatures and temperature programming in reversed-phase liquid chromatography (RP-LC) is becoming increasingly popular in laboratories where high throughput is important. Mobile phase viscosity is reduced as separation temperature increases and therefore higher flow rates can be utilized to achieve fast separations, without exceeding the standard operational pressure limits of the HPLC system. The optimum linear velocity increases proportionally to T/η (temperature/eluent viscosity), and therefore the flow rate for optimum efficiency is shifted to a higher value at higher temperatures.⁶ As a consequence, the analysis speed can be improved by as much as 5- to 15-fold, when temperature is increased from ambient to 200 °C. Reduced back-pressure at high temperature also allows longer columns packed with small particles to be used to facilitate the resolution of complex samples.

An additional benefit of using high temperature is that the lower mobile phase viscosity enhances the mass-transfer of the solute between the mobile and stationary phase, resulting in higher column efficiency and improved peak asymmetry. There are two major benefits to obtaining more efficient and symmetrical peaks: increased resolution and peak height, which in turn improves signal-to-noise ratios and the sensitivity of the analysis.

Another interesting aspect of high-temperature liquid chromatography (HT-LC) is the possibility of using high temperature water as the mobile phase.^{7,8} At room temperature water is too weak as a solvent to elute all except the most polar analytes but as the temperature of the water is increased, particularly above its boiling point, its dielectric constant (which is a measure of polarity) decreases, thereby increasing its elution strength in RP-LC.⁹ The advantages of using high-temperature water are the reduction or elimination of hazardous organic solvents, thereby providing a more environmentally friendly and cheaper LC solution, and also the possibility of coupling with flame ionization detection (FID), which is a very sensitive, universal detection technique.¹⁰

Temperature can also be used as a method development parameter to change the selectivity of the separation, especially for polar and ionizable compounds since the ionization equilibrium in solution is temperature dependent. This is detailed in section 7.5 of this guide.

HT-LC shows advantages when coupled with mass spectrometry. When HT-LC is used in combination with ESI and APCI, the mobile phase reaches the ion source at elevated temperature, which aids the vaporization and desolvation processes, thus increasing the ionization efficiency and consequently the sensitivity of the analysis.¹¹

6.2. Column and oven requirements –

Routine HT-LC requires a thermally stable column. However, columns packed with alkyl-modified silicas, most generally used in RP-LC, should not be used above 60–70 °C, a limit that is dependent upon the silica, ligand, and mobile phase composition (water content, pH). At these temperatures hydrolysis of the organosilane bond or dissolution of the silica may occur leading to column failure. Hypercarb is 100% carbon with no bonded ligands, and is therefore chemically very stable. It has been demonstrated that Hypercarb can be used routinely up to 200 °C under isothermal or temperature gradient conditions, without any loss in performance.^{11,12} Moreover, because Hypercarb has no bonded phase, column bleed does not occur, which means that this column packing can be used in HT-LC with detection techniques such as mass spectrometry, evaporative light scattering detection and FID, which are sensitive to column bleed. The one consideration for the use of Hypercarb columns at high temperatures is that the column hardware must not contain PEEK components. Hardware with full stainless steel construction is available for this purpose.

Ovens and column heaters specifically designed for HT-LC are now commercially available. These include temperature programming, mobile phase preheating, and mobile phase pre-detector cooling. Mobile phase preheating is an important requirement at column temperatures above 80 °C to prevent band dispersion caused by thermal mismatch across the diameter of the column.¹³ When using UV detection it is also necessary to cool the mobile phase to prevent damage of the flow cell; the mobile phase pre-detector cooler is bypassed when FID or MS detection are used. Another system requirement in HT-LC is that a backpressure regulator is used to maintain the mobile phase in the liquid state, especially if the temperature is close to or above the boiling point.

7. Method development

Knowledge of the properties of the solutes such as polarity, solubility, acidity/basicity, retention on reversed phase or normal phase silica-based medias are all useful when developing a method on a Hypercarb column. These properties of the solutes will determine the method development steps to take, as described below. Method performance indicators used in this method development guide are retention times and peak shape. Follow flow chart in Figure 5.

Table 1: Generic gradient method

Column:	Hypercarb, 5 μ m, 100 x 4.6 mm		
Part Number:	35005-104630		
Mobile Phase:	A: H ₂ O B: ACN/IPA (1:1) C: THF or DCM		
Gradient:	Time (min)	% B	% C
Stage 1	0	30	0
Stage 2	10	100	0
	25	25	75
	30	25	75
Flow Rate:	1 mL/min		
Detection:	UV at 215 nm; 275 nm at 7.5 min		
Temperature:	25 °C		

7.1. Generic conditions – A scouting gradient run is proposed if the sample contains solutes with a wide range of polarities or unknowns. The method, described in Table 1, uses a tertiary solvent system, with two gradient stages: Stage 1: An aqueous/organic gradient and, Stage 2: An organic/organic gradient. In the first stage of the run the percentage of the ACN/IPA mixture (intermediate strength solvent) is increased from 30 to 100%, in 10 minutes, for elution of the ionizable and neutral compounds of high and intermediate polarity. During the second stage, the gradient of DCM or THF (strongest solvent) develops from 0 to 75%, in 15 minutes, with the consequent elution of the less polar and apolar analytes.

Figure 4 illustrates the separation of 12 solutes of diverse polarity/hydrophobicity using this gradient method. On the first stage of the gradient the elution of the ionizable (water soluble vitamins), polar (phenol, acetophenone) and basic (anilines) analytes occurs. On the second stage of the gradient elution of the intermediate polarity (triazines) and apolar (fat soluble vitamins) analytes occurs. In this way

Hypercarb columns can be used to separate a range of analytes that would normally require two different analyses; one in reversed phase (RP) mode the other in normal phase (NP) mode. When the polarity and solubility of the solutes is known, then only one portion of the gradient needs to be run. Suggestions on further expansion of these generic conditions are outlined in the next section.

Figure 4: Chromatogram obtained with the generic gradient

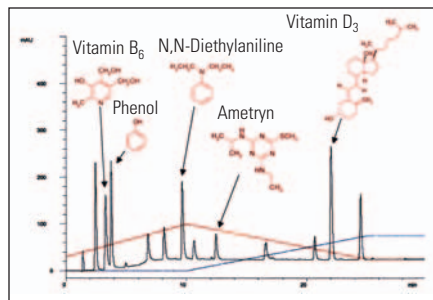

Figure 5: Method Development Quick Reference Flow Chart

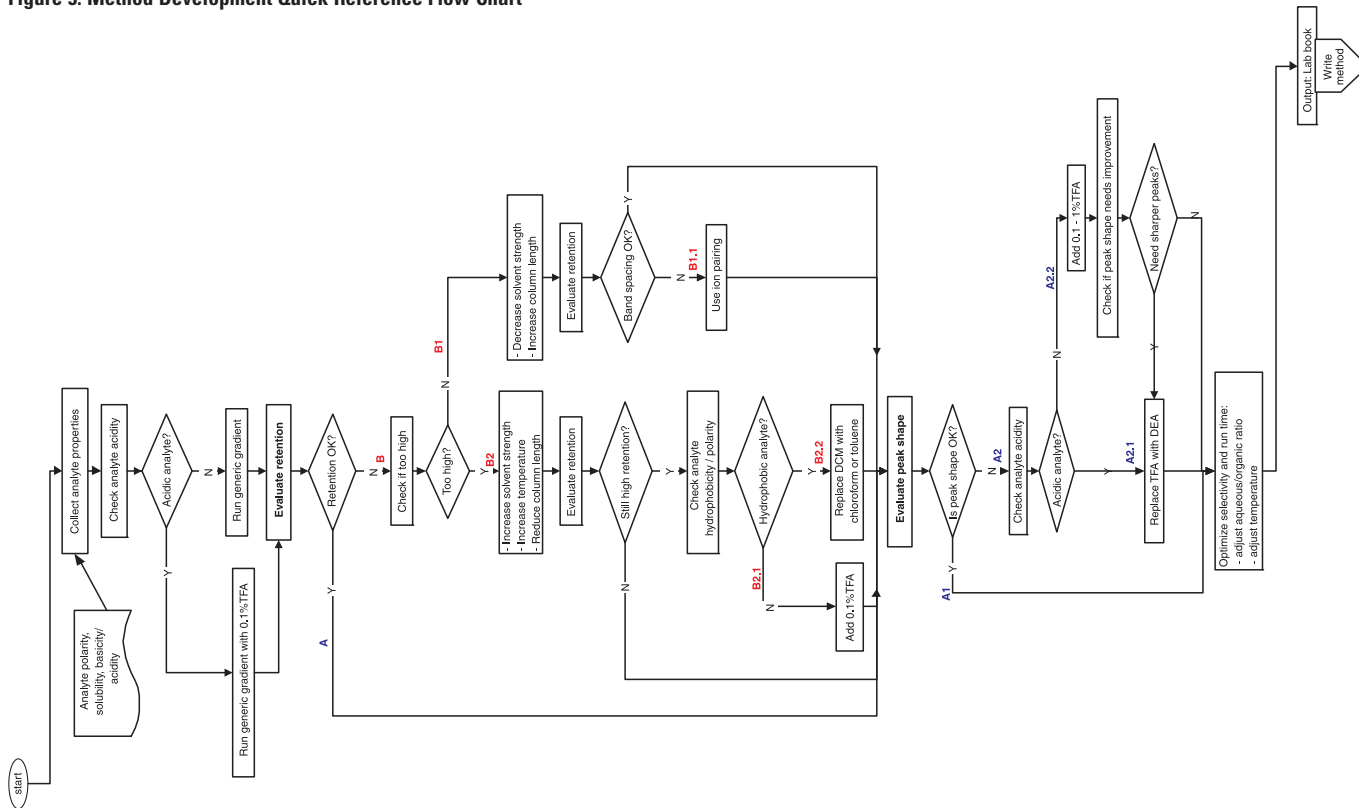

Table 2: Gradient for Very Polar Analytes

Column:	Hypercarb 5 μ m, 100 x 4.6 mm	
Part Number:	35005-104630	
Mobile Phase:	A: H ₂ O B: ACN	
Gradient:	Time (min)	% B
	0	30
	10	100
Flow Rate:	1 mL/min	
Detection:	As appropriate	
Temperature:	25 °C	

7.2. Very Polar Analytes – For the separation of very polar/hydrophilic analytes on a Hypercarb column, the first step is to run a gradient of water/ACN as described on Table 2.

When retention is suitable to obtain resolution of all analytes then optimization of the method can be done by adjusting the gradient steepness or mobile phase composition in isocratic conditions, and temperature, to obtain optimal selectivity and run time.

Nucleosides and nucleotides are polar compounds, which are normally separated by ion exchange chromatography or reversed phase chromatography with an ion pairing agent. The mobile phases used in these chromatographic modes are generally involatile and thus are avoided when mass spectrometric detection is

used. Nucleosides and nucleotides are well retained on Hypercarb columns with the mobile phases normally preferred in LC/MS. Figure 6 illustrates the separation of 4 nucleosides using a gradient of water and acetonitrile. Because these compounds get well retained on Hypercarb columns it is necessary to use a high percentage of acetonitrile to elute them which is beneficial for sensitivity in ESI.

Changes in resolution can often be obtained by the addition of a buffer to the mobile phase. Formic and acetic acids are very popular choices for mobile phase additives in LC/MS with positive ionization since they promote the protonation of basic compounds, and thus have a strong effect on the sensitivity improvement. Figure 7 illustrates the separation of the chemotherapeutic drug 5-fluorouracil and uracil, using a gradient of water/acetonitrile with 0.1% formic acid. The separation efficiency is very high, producing sharp, symmetrical peaks (asymmetry values are 1.05 and 1.07 for uracil and fluorouracil respectively) which makes this method ideal for quantitation. Higher percentages of formic or acetic acids can be used without any phase stability issues since Hypercarb is stable across the entire pH range. Figure 8 shows the analysis of three catecholamines by LC/ESI-MS using a mobile phase of water/acetonitrile and 0.5% of formic acid.

Ammonium formate, ammonium acetate and ammonia are generally used in LC/MS when buffering of the mobile phase is required. These provide good chromatographic performance on Hypercarb columns; Figure 9 illustrates the separation of three groups of nucleotides on a 30 x 3.0 mm Hypercarb column, using ammonium acetate, pH 6, and acetonitrile gradient with negative electrospray detection. These compounds are closely related in structure: the 5' monophosphates, 3' monophosphates and 2' monophosphates differ only by the position of attachment of the phosphate group to the riboside moiety; in the cyclic monophosphates the phosphate group is attached to either positions 3' and 5' or 2' and 3' of the riboside moiety.

The high peak capacity of Hypercarb columns for polar analytes allows, as demonstrated in this example, the separation of closely related compounds with a “MS friendly” mobile phase in a short column.

Figure 6: Nucleosides

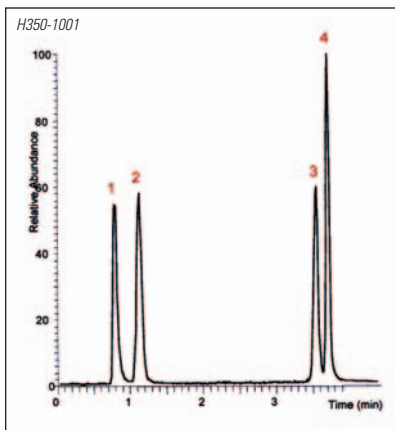

Column: Hypercarb 5 μ m, 50 x 2.1 mm

Part Number: 35005-052130

Mobile Phase: A: H₂O
B: ACN

Gradient: 50 to 100% B in 2 min

Flow Rate: 0.4 mL/min

Detection: - ESI-MS

Temperature: 25 °C

1. Cytidine
2. Uridine
3. Guanosine
4. Adenosine

Figure 7: 5-Fluorouracil

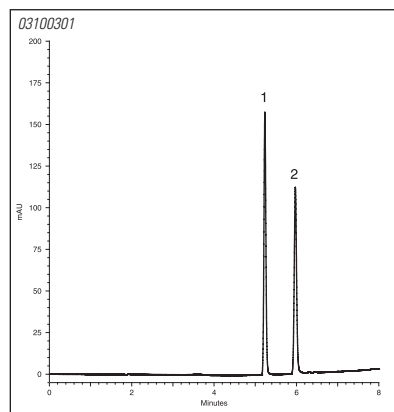

Column: Hypercarb, 5 μ m, 100 x 4.6 mm

Part Number: 35005-104630

Mobile Phase: A: H₂O + 0.1% Formic acid
B: ACN + 0.1% Formic acid

Gradient: 10 to 100% B in 10 min

Flow Rate: 0.8 mL/min

Detection: UV at 260 nm

Temperature: 30 °C

1. Uracil
2. 5-Fluorouracil

Figure 8: Catecholamines

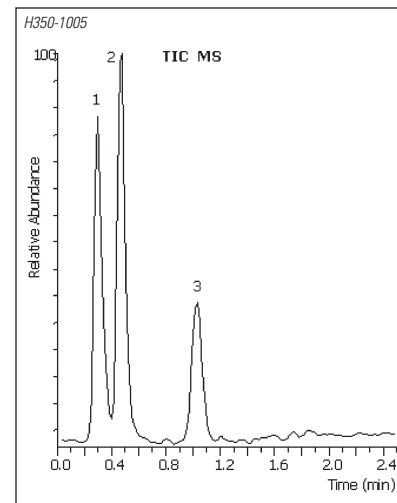

Column: Hypercarb, 5 μ m, 50 x 2.1 mm

Part Number: 35005-052130

Mobile Phase: A: H₂O + 0.5% Formic acid
B: ACN + 0.5% Formic acid

Gradient: 13 to 50% B in 2 min

Flow Rate: 0.4 mL/min

Detection: + ESI

Temperature: 25 °C

1. Adrenaline
2. Dopamine
3. L-Dopa

Figure 9: Ribonucleotides

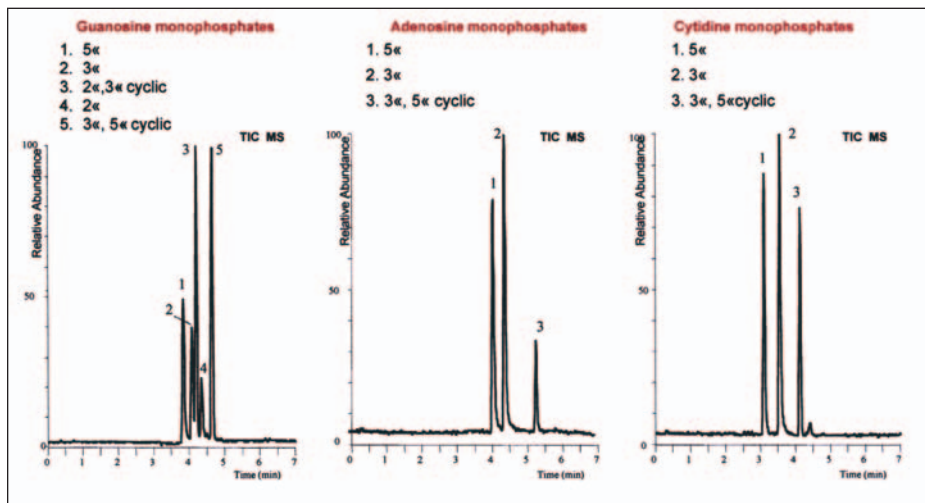

Column:	Hypercarb 5 μm, 30 x 3 mm
Part Number:	35005-033030
Mobile Phase:	A: Ammonium acetate 50 mM, pH6 B: ACN
Gradient:	5 to 70% B in 7 min
Flow Rate:	0.5 mL/min
Detection:	UV at 270 nm
Temperature:	-ESI

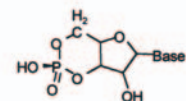

3',5cyclic nucleotide

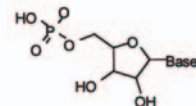

5'-monophosphate

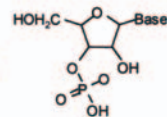

3'-monophosphate

Base:



Adenosine



Cytidine

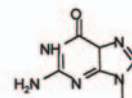

Guanosine

7.3. Acidic analytes – Generally, acidic solutes require the addition of TFA to the mobile phase in order to obtain elution in a reasonable run time. Thus, the suggested first step in developing a method on a Hypercarb column is to run the generic gradient, with 0.1% TFA on mobile phases A, B and C (Table 3). Once retention and peak shape are determined under these conditions, the next step can be selected from several options:

A1. – If retention is suitable to obtain resolution of all analytes and symmetrical peak shapes are obtained, then optimization of the method can be done by adjusting the mobile phase composition either in isocratic or gradient conditions, and temperature, to obtain optimal selectivity and run time. Figure 10 demonstrates the optimization of the separation of 4 hippuric acids. In Figure 10a a generic gradient of water containing 0.1% TFA to ACN/IPA (1:3) containing 0.1% TFA, 5% - 100% B in 10 minutes was used. Resolution and run time were improved (Figure10b) by changing to isocratic conditions and by reducing the organic strength of the mobile phase.

B – When the generic gradient does not provide acceptable retention of the analytes then it is necessary to take another approach; if retention is too high or too low but peak shape is symmetrical then the adjustment of solvent strength, temperature or column length is generally enough to bring a change in retention

B1 – For poorly retained analytes, decrease the organic modifier strength, i.e., use gradient of water and ACN with 0.1% TFA or increase column length;

B2 – For strongly retained analytes increase solvent strength (increase ratio of IPA/ACN to 3:1), increase the steepness of the gradient, increase the temperature of the column oven, reduce column length, or alternatively use a combination of these.

A2.1 – In extreme cases where not only the retention is unsuitable but the peak shape is asymmetrical or in the cases where there is no elution in a reasonable run time, then it will be necessary to replace the modifier, i.e., replace TFA with DEA. Figure 11 illustrates the separation of two isomers of retinoic acid, which is an example of extreme retention under the generic gradient. When elution strength was increased by running a gradient of ACN/IPA to THF, containing 0.1% TFA, retention times were reduced, however the peak for 9-*cis*-retinoic acid was very broad (Figure 11a). Elution of both isomers, with good peak shape, was obtained by running the generic gradient: stage 1, with 0.1% DEA.

Table 3. Generic gradient method with 0.1%TFA

Column:	Hypercarb, 5 µm, 100 x 4.6 mm		
Part Number:	35005-104630		
Mobile Phase:	A: H ₂ O+0.1 % TFA B: ACN/IPA (1:1)+ % TFA C: THF or DCM + % TFA		
Gradient:	Time (min)	% B	% C
	0	30	0
	10	100	0
	25	25	75
	30	25	75
Flow Rate:	1 mL/min		
Detection:	As appropriate		
Temperature:	25 °C		

Figure 10: Hippuric Acid Isomers

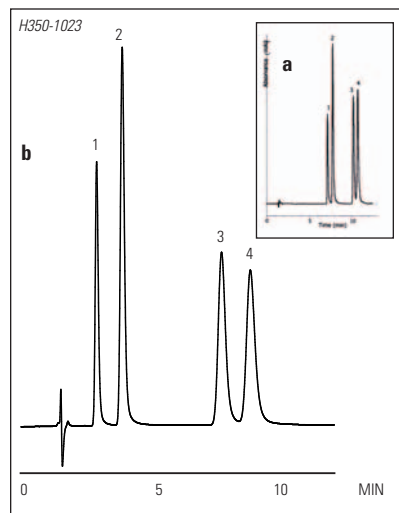

Column: Hypercarb, 5 μ m, 100 x 4.6 mm
 Part Number: 35005-104630
 Mobile Phase: H₂O + 0.1% TFA/ACN:IPA (1:3) + 0.1% TFA (40:60)
 Flow Rate: 1 mL/min
 Detection: UV at 225 nm
 Temperature: 25 °C

1. 2-Methylhippuric acid
2. Hippuric acid
3. 3-Methylhippuric acid
4. 4-Methylhippuric acid

Figure 11: Effect of the electronic modifier on the resolution and peak shape of two retinoic acid isomers

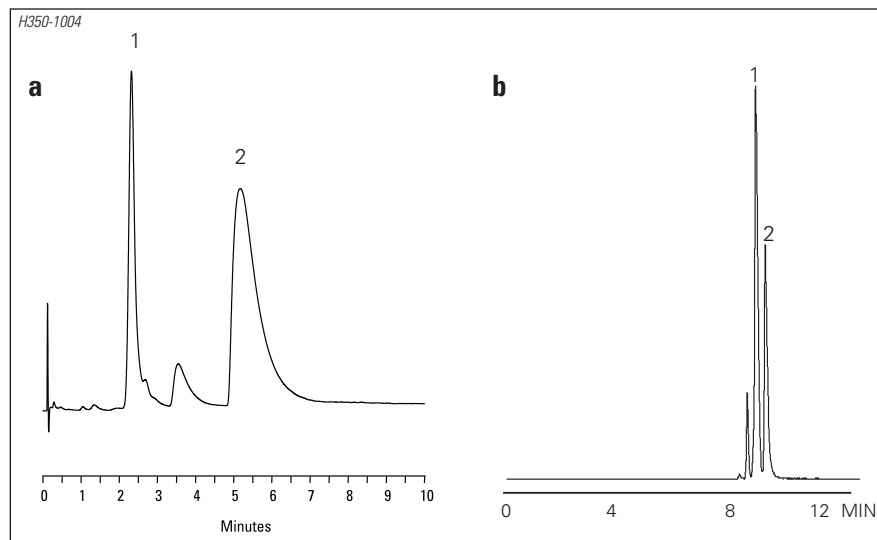

a Column: Hypercarb, 5 μ m, 30 x 2.1 mm
 Part Number: 35005-032130
 Mobile Phase: A: ACN/IPA + 0.1% TFA
 B: THF +0.1% TFA
 Gradient: 0 to 100% B in 10 min
 Flow Rate: 1 mL/min
 Detection: UV at 254 nm
 Temperature: 25 °C

1. 13-*cis*-Retinoic acid
2. 9-*cis*-Retinoic acid

b Column: Hypercarb, 5 μ m, 50 x 2.1 mm
 Part Number: 35005-052130
 Mobile Phase: A: H₂O + 0.1% DEA
 B: ACN:IPA (1:1) + 0.1% DEA
 Gradient: 3 to 100% B in 10 min
 Flow Rate: 0.4 mL/min
 Detection: - ESI
 Temperature: 25 °C

1. 13-*cis*-Retinoic acid
2. 9-*cis*-Retinoic acid

7.4. Non-acidic analytes – For the separation of analytes which are not acidic, the first step is to run the generic gradient described in Table 1 (see page 10). Once retention and peak shape are determined under these conditions, the next step can be selected from several options:

A – If retention is suitable to obtain resolution of all analytes and the peaks are symmetrical then optimization of the method can be done by adjusting the gradient or mobile phase composition in isocratic conditions, and temperature, to obtain optimal selectivity and run time.

B – If the generic gradient does not provide acceptable retention then it is necessary to take another approach; if retention is too high or too low but peak shape is symmetrical then either the adjustment of solvent strength, temperature or column length will generally be enough to bring a change in retention:

B1 – For poorly retained analytes increase the column length, where possible, or decrease the organic modifier strength, i.e., use gradient of water and ACN;

B1.1 – If this approach does not provide enough resolution of all analytes replace ACN with MeOH, or use an ion pairing reagent, such as a perfluorocarboxylic acid, to increase retention of basic analytes. Figure 12 illustrates the separation of 20 underivatized amino acids on a Hypercarb column using nonafluoropentanoic acid as the ion pairing reagent.

B2 – For strongly retained analytes, increase solvent strength (increase ratio of IPA/ACN to 3:1), increase the steepness of the gradient, increase the temperature of the column oven or reduce column length.

B2.1 – If none of these alternatives reduces retention then addition of TFA, as an electronic competitor, may be attempted to reduce the retention of very polar analytes.

B2.2 – If the analytes are hydrophobic, it may be necessary to increase solvent strength further with a mobile phase of ACN with toluene or ACN with chloroform.

A2.2 – If retention is adequate, but peaks are not symmetrical, then addition of 1-methylpiperidine will improve peak shape of basic analytes, as illustrated on Figure 13 for the separation of six anilines, where the addition of the modifier improves peak symmetry by >20%.

Quite often basic analytes can give rise to poor peak shapes. TFA and DEA can also be used to improve peak shape. Increasing the concentration of TFA above 0.1% can have a significant effect on the peak shape and resolution of the basic analytes as shown on Figures 14 and 15 for the separation of β -blockers, and procainamides and its metabolites, respectively. In Figure 14 the increase in the concentration of TFA from 0.1% to 0.5% allowed for improved peak symmetry and also improved resolution between the pairs of analytes 2,3 and 5,6. Procainamide and its metabolites are well known for producing poor peak shapes. Figure 15 illustrates the effect of increasing the %TFA (from 0.05% to 1.0%) on the resolution and peak shape of those basic analytes. Levels above 1% did not show further improvements for these analytes. The Hypercarb physical stability allows high concentration of aggressive buffers such as 1%TFA to be used with no detrimental effect on the column lifetime. In the extreme cases where TFA does not provide symmetrical peaks for basic analytes then replacement of TFA with 0.1%DEA is suggested (Figure 16). DEA is also the best modifier if analytes are strongly retained (for instance with hydrophobic analytes) or show tailing peaks.

Figure 12: Separation of 20 underivatized amino acids on a Hypercarb column

Column: Hypercarb, 5 μm , 100 x 2.1 mm
 Part Number: 35005-102130
 Mobile Phase: A: 20 mM Nonfluoropentanoic acid (NFPA) (aq)
 B: ACN

Gradient:	Time (min)	% B
	0	0
	10	15
	20	26
	30	50

Flow Rate: 0.2 mL/min
 Detection: ELSD (55 $^{\circ}\text{C}$, 2.2 bar)
 Temperature: 10 $^{\circ}\text{C}$

- | | | |
|------------------|-------------------|-------------------|
| 1. Glycine | 9. Glutamine | 17. Arginine |
| 2. Serine | 10. Glutamic acid | 18. Phenylalanine |
| 3. Alanine | 11. Valine | 19. Tyrosine |
| 4. Threonine | 12. Lysine | 20. Impurity |
| 5. Cysteine | 13. Leucine | 21. Impurity |
| 6. Asparagine | 14. Methionine | 22. Tryptophan |
| 7. Aspartic acid | 15. Isoleucine | |
| 8. Proline | 16. Histidine | |

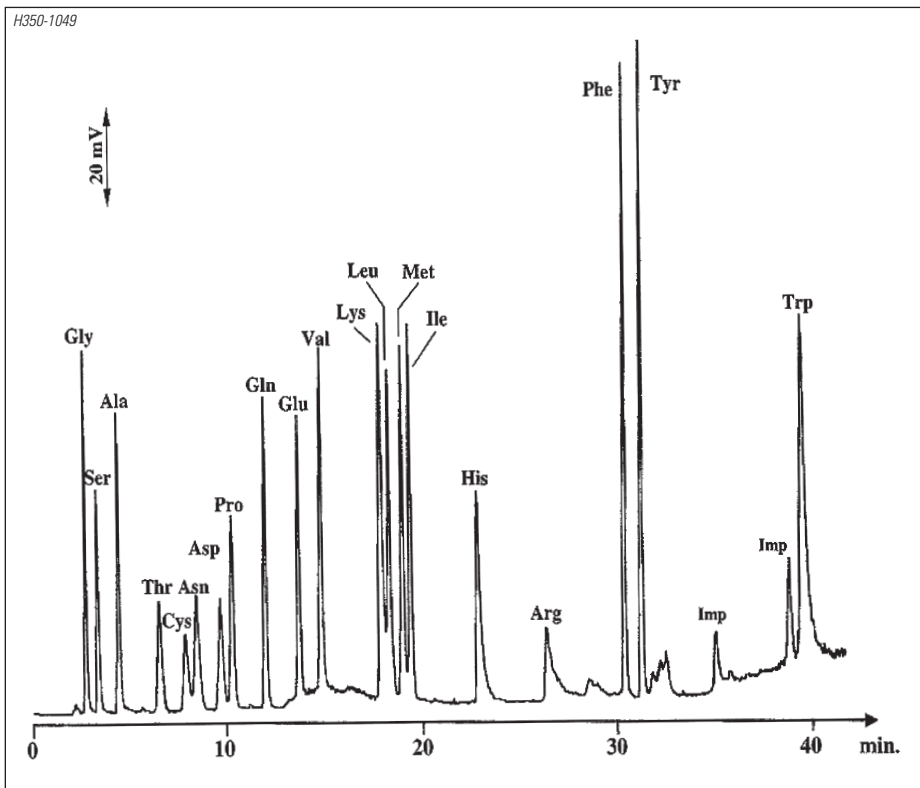

Figure 13: Effect of 1-methylpiperidine on peak symmetry of six anilines

Column:	Hypercarb 5 μ m, 100 x 4.6 mm
Part Number:	35005-104630
Mobile Phase:	a) A: H ₂ O B: ACN/IPA (1:1)
	b) A: 1-methylpiperidine 10 mM (aq.) pH 10.5 B: MeCN/IPA (1:1)
Gradient:	50 to 90% B in 10 min
Flow Rate:	1 mL/min
Detection:	UV at 270 nm
Temperature:	25 °C

1. Aniline
2. 3-Ethylaniline
3. 2-Ethylaniline
4. N-Ethylaniline
5. N,N-Dimethylaniline
6. N,N-Diethylaniline

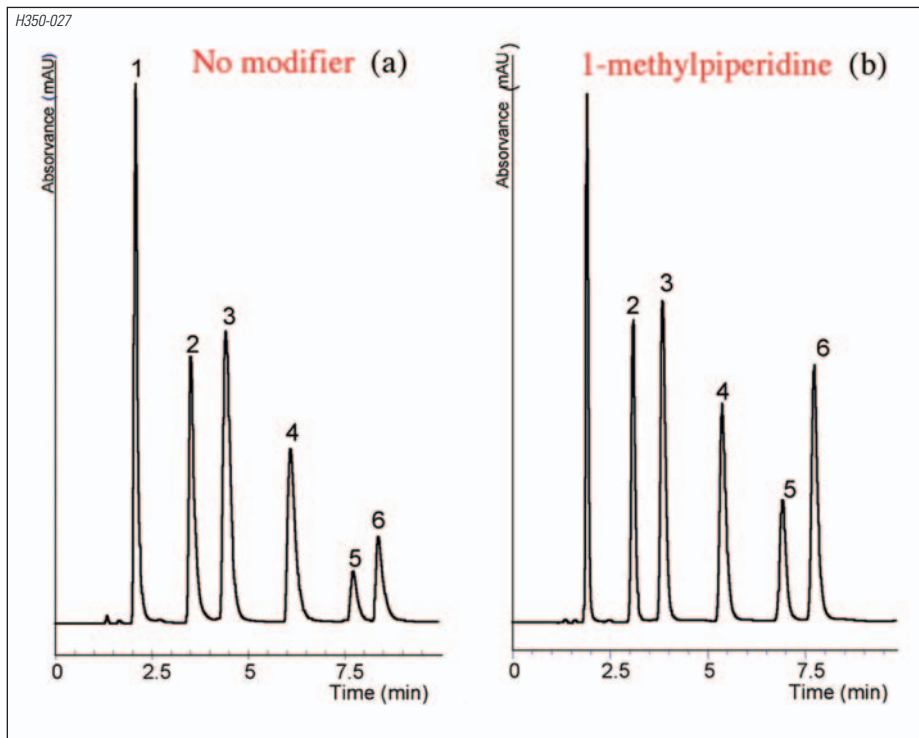

Figure 14: Effect of concentration of TFA on peak symmetry and resolution of six β -blockers

Column:	Hypercarb, 5 μ m, 100 x 4.6 mm
Part Number:	35005-104630
Mobile Phase:	a) A: H ₂ O + 0.1% TFA B: ACN:IPA (1:3) + 0.1% TFA b) A: H ₂ O + 0.5% TFA B: ACN:IPA (1:3) + 0.5% TFA
Gradient:	a) 5 to 100% B in 10 min b) 15 to 95% in 10 min
Flow Rate:	1 mL/min
Detection:	UV at 270 nm
Temperature:	a) 25 °C, b) 40 °C

- | | |
|---------------|---------------|
| 1. Atenolol | 4. Timolol |
| 2. Nadolol | 5. Alprenolol |
| 3. Metoprolol | 6. Pindolol |

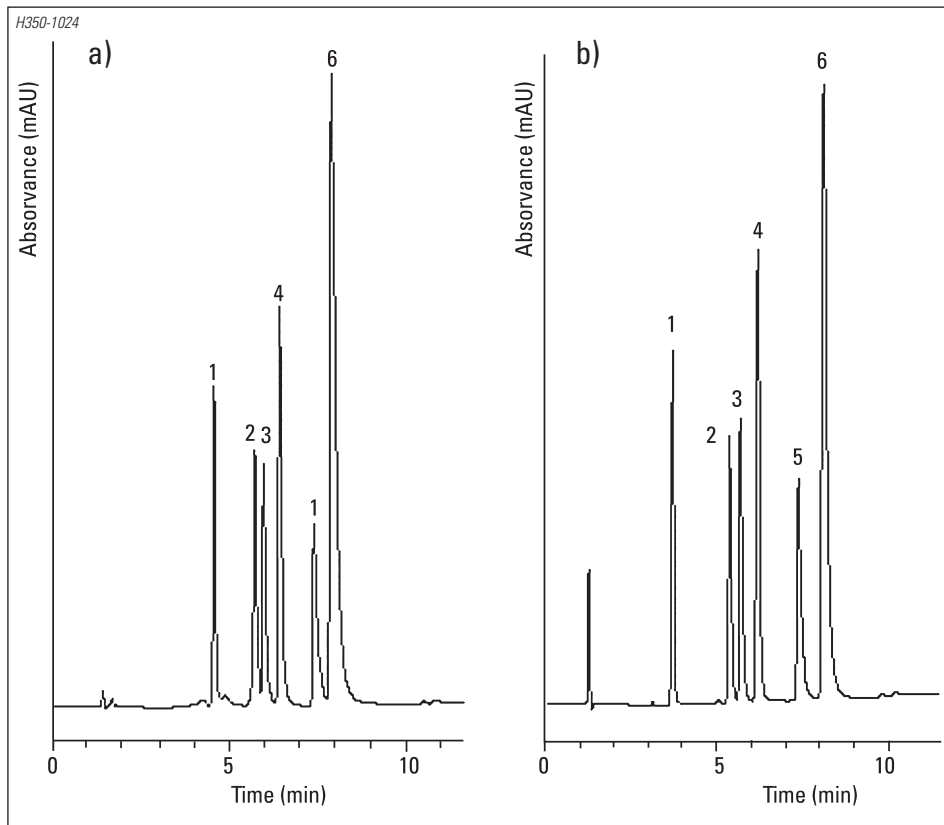

Figure 15: Effect of concentration of TFA on peak symmetry and resolution

Column:	Hypercarb 5 μ m, 100 x 4.6 mm
Part Number:	35005-104630
Mobile Phase:	A: H ₂ O with x % TFA B: ACN/IPA (1:3) + x % TFA
Gradient:	35 to 95%B in 10 min
Flow Rate:	1 mL/min
Detection:	UV at 270 nm
Temperature:	50 °C

1. Procainamide
2. N-acetyl-procainamide
3. N-propionyl procainamide

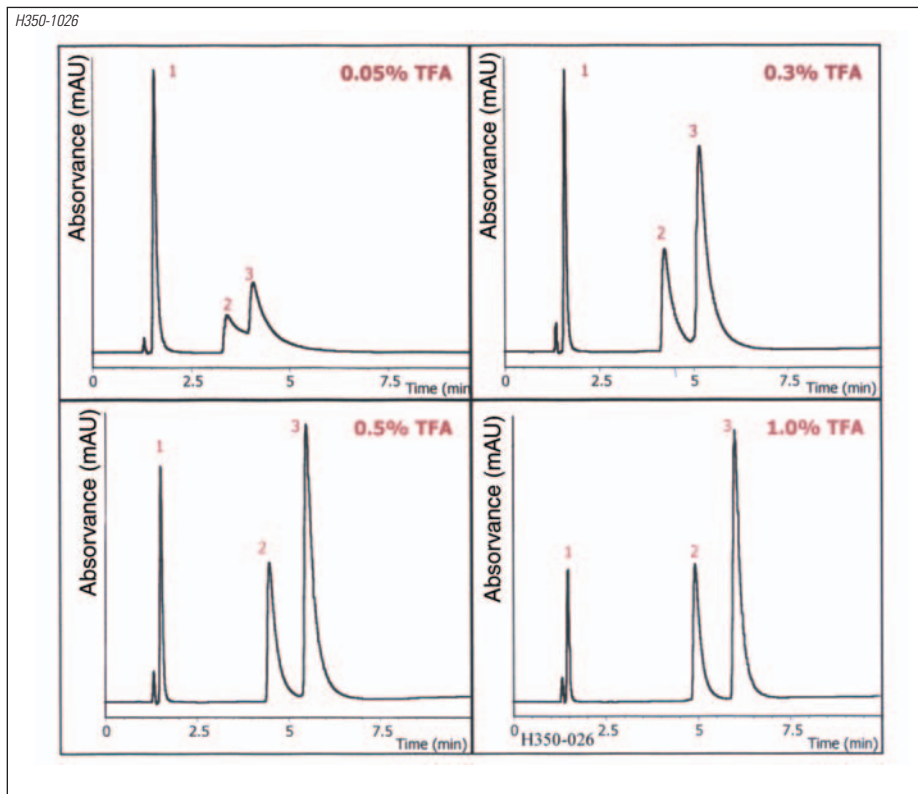
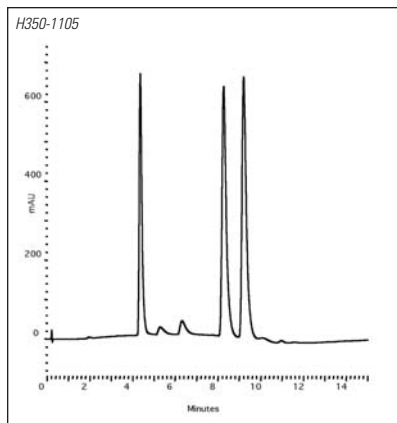

Figure 16: Separation of Procainamide, N-acetyl-procainamide and N-propionyl procainamide with DEA



Column:	Hypercarb, 5 μ m, 30 x 3.0 mm
Part Number:	35005-033030
Mobile Phase:	A: H ₂ O + 0.1% DEA B: ACN/IPA (1:1) + 0.1% DEA
Gradient:	20 to 100% B in 10 min
Flow Rate:	1 mL/min
Detection:	UV at 264 nm
Temperature:	55 $^{\circ}$ C

1. Procainamide,
2. N-acetyl-procainamide
3. N-propionyl procainamide

7.5. High temperature and temperature programming – Routine HPLC analyses use temperature control to avoid fluctuations and ensure reproducibility. Temperature can also be used to facilitate method development, as a tool in controlling retention, selectivity and peak efficiency. The use of wide temperature ranges from 25 to 200 $^{\circ}$ C provides a complementary tool to mobile phase composition and column chemistry.

The most common approach to method development is to first select the column and then the mobile phase composition for the sample to be separated. Elevated or high temperature can be used during the second stage of method development to optimize run time, selectivity and response, and temperature programming can be an alternative to mobile phase gradients.

7.5.1. High temperature to reduce run time

Generally in reversed-phase separations an increase in temperature will produce a reduction in retention times. In Figure 17, temperature is increased from 25 to 80 $^{\circ}$ C with a reduction in capacity factor for peak 4 of 59%; analysis time is halved. A more extreme reduction in analysis time is demonstrated in Figure 18a: the separation of 3 herbicides at 100 $^{\circ}$ C takes 27 minutes, at 200 $^{\circ}$ C takes 5 minutes, a reduction of over five fold with improved peak symmetry and peak height. Because the flow rate for optimum efficiency is shifted to a higher value at

higher temperatures and mobile phase viscosity is reduced as separation temperature increases run time can be further reduced by increasing the flow rate as shown in Figure 18b. The separation of the three herbicides now takes less than 2 minutes, with a pressure drop across the column of 177 bar.

7.5.2. Selectivity changes with temperature

Separation selectivity is determined by stationary phase chemistry, mobile phase composition and other parameters such as temperature. The ability of Hypercarb to separate positional isomers is combined in Figure 19 with elevated temperature LC to perform the analysis of xylene, hippuric acid and three methyl hippuric acid isomers in under 2 minutes (top chromatogram). The use of a separation temperature of 70 or 100 $^{\circ}$ C improves the resolution by changing the elution order of xylene. A second example of the change of selectivity with temperature is illustrated on Figure 20, for the separation of sulfonamides. Sulfonamides are basic compounds and as the temperature is increased, their pKa values decrease; mobile phase pH also changes with temperature; therefore the separation temperature affects the ionization state of the solute and its hydrophobic/polar retention on the porous graphitic carbon stationary phase.

Figure 17: Effect of elevated column temperature on run time

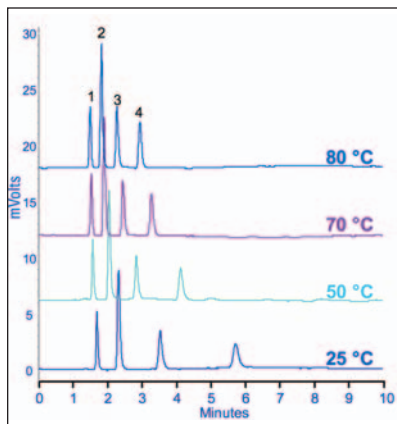

Column: Hypercarb High Temperature,
5 μ m, 100 x 4.6 mm

Part Number: 35005-104646

Mobile phase: MeOH / H₂O (95:5)

Flow rate: 0.8 mL/min

Detection: UV at 254 nm

Temperature: 25 °C

1. Acetone
2. Phenol
3. p-cresol
4. 3,5 - xylenol

Figure 18: Effect of temperature and flow rate on the separation of triazines

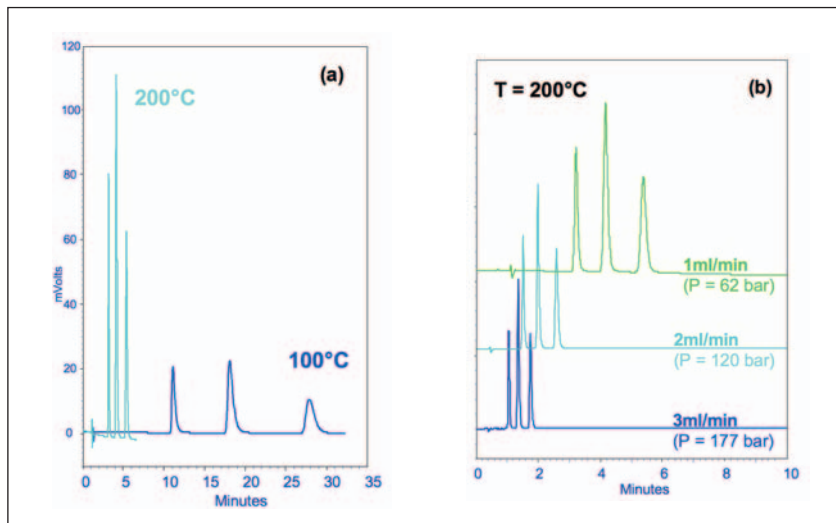

Column: Hypercarb High Temperature,
5 μ m, 100 x 4.6 mm

Part Number: 35005-104646

Mobile Phase: H₂O + 0.1% Formic acid
/ACN (60:40)

Flow Rate: 1 mL/min

Detection: UV at 240 nm

Temperature: 25 °C

1. Prometryn
2. Ametryn
3. Simetryn

Figure 19: Effect of temperature and flow rate on selectivity and analysis time

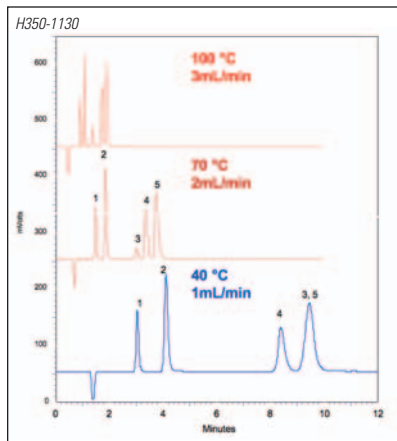

Column: Hypercarb High Temperature,
5 μ m, 100 x 4.6 mm

Part Number: 35005-104646

Mobile Phase: H₂O/ ACN (50:50)
+ 0.1% Formic acid

Flow Rate: 1.0, 2.0 or 3.0 mL/min

Detection: UV at 225 nm

Temperature: 40, 70 or 100 °C

1. 2-Methyl Hippuric acid
2. Hippuric acid
3. Xylene
4. 3-Methyl Hippuric acid
5. 4-Methyl Hippuric acid

Figure 20: Change of selectivity with high temperature

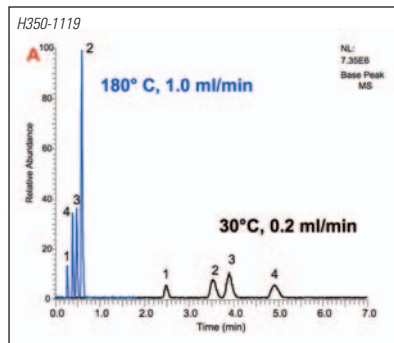

Column: Hypercarb High Temperature,
5 μ m, 100 x 2.1 mm

Part Number: 35005-102146

Mobile Phase: Ammonium acetate 10 mM pH9
MeCN (65:35)

Flow Rate: 0.2 mL/min or 1 mL/min

Detection: +APCI

Temperature: 30 °C or 180 °C

1. Sulfaguandine
2. Sulfamonomethoxine
3. Sulfamerazine
4. Sulfathiazole

7.5.3. Temperature programming –

When temperature programming is possible, a temperature gradient can replace a solvent gradient. One of the advantages of using temperature gradients is for analyses with detectors that are sensitive to differences in mobile phase composition such as evaporative light scattering, corona discharge detectors and mass spectrometry.

In Figure 21 seven herbicides and three metabolites of atrazine were separated with a solvent gradient of water and acetonitrile, at conventional temperature. These compounds have a wide range of hydrophobicity, $\log P = 0.32$ for atrazine-desethyl-1-desisopropyl and $\log P = 3.07$ for propanil. Porous graphitic carbon allows for good retention of the polar metabolites but also strongly retains hydrophobic solutes¹ such as propanil. Under these mobile phase and temperature conditions propanil does not elute in 45 minutes. The solvent gradient (5 to 100 % organic) was replaced with a temperature gradient from 140 to 200 °C at 20 °C / min and an isocratic mobile phase (50:50 v/v, water / acetonitrile); analysis time is reduced from 28 to 9 minutes, with elution of the 10 analytes and still exhibiting full baseline resolution. The observed resolution between any pair of solutes is > 1.5 in both of these runs (refer to Table 4).

A further practical advantage of using a temperature gradient in replacement of a solvent gradient is that column re-equilibration at the end of the gradient is faster, allowing for shorter cycle times. Typically ten column volumes are used for re-equilibration of a solvent gradient and therefore the 100 x 4.6 mm column running at 1 mL/min required approximately 10 minutes to re-equilibrate. In the example shown in Figure 21 the time required between temperature gradient runs to cool the oven down to the starting temperature (140 °C) was approximately 3 minutes.

7.5.4. “Green” LC – Increased separation temperature decreases the amount of organic modifier required in the mobile phase and in some cases it can even be eliminated completely, resulting in pure aqueous mobile phases.

The retention and separation of a mixture of purines and pyrimidines, obtained with a mobile phase of water, acetonitrile and formic acid, at 50 °C is shown in Figure 22a. By removing the organic component (acetonitrile) and the electronic modifier (formic acid) from the mobile phase, elution strength is greatly reduced, and at conventional temperatures this is too weak to elute the solutes from the PGC column. However, if the temperature of water is increased its elution strength increases due to a decreased

dielectric constant. In Figure 22b, the purines and pyrimidines are separated with a mobile phase of pure water at 190 °C. Although the elution order is maintained, the separation selectivity obtained with 100 % water at 190 °C is different and overall peak symmetry is improved at this high temperature. Asymmetry values for peaks 3 and 4 (at 10 % height) reduce from 1.37 and 1.56 under conventional conditions to 1.22 and 1.19 respectively at 190 °C. Parameters that can be changed, when running a pure water mobile phase to adjust run time and resolution, are temperature gradient slope, the gradient starting temperature and the flow rate (illustrated in Figure 23).

Table 4: Comparison of resolution (USP) for chromatograms in Figure 21

Peak Pair	Solvent Gradient (Figure 21a)	T Gradient (Figure 21b)
2, 1	18.68	4.24
3, 2	6.70	2.18
4, 3	3.45	2.72
5, 4	7.96	3.70
6, 5	2.55	1.87
7, 6	8.65	1.71
8, 7	2.44	3.11
9, 8	8.88	4.64
10, 9	–	6.08

Figure 21: Solvent gradient versus temperature gradient

Column:	Hypercarb High Temperature, 5 μ m, 100 x 4.6 mm
Part Number:	35005-104646
Mobile Phase:	H ₂ O/ACN
Gradient:	A) 5 to 100 % ACN in 15 min B) Isocratic (50:50)
Flow Rate:	1 mL/min
Detection:	UV at 215 nm
Temperature:	A) 40 °C B) 140 °C to 200 °C at 20 °C/min

1. Atrazine-desethyl-1-desisopropyl
2. Atrazine-desethyl
3. Atrazine-desisopropyl
4. Propazine
5. Prometryn
6. Atrazine
7. Ametryn
8. Simazine
9. Symetryn
10. Propanil

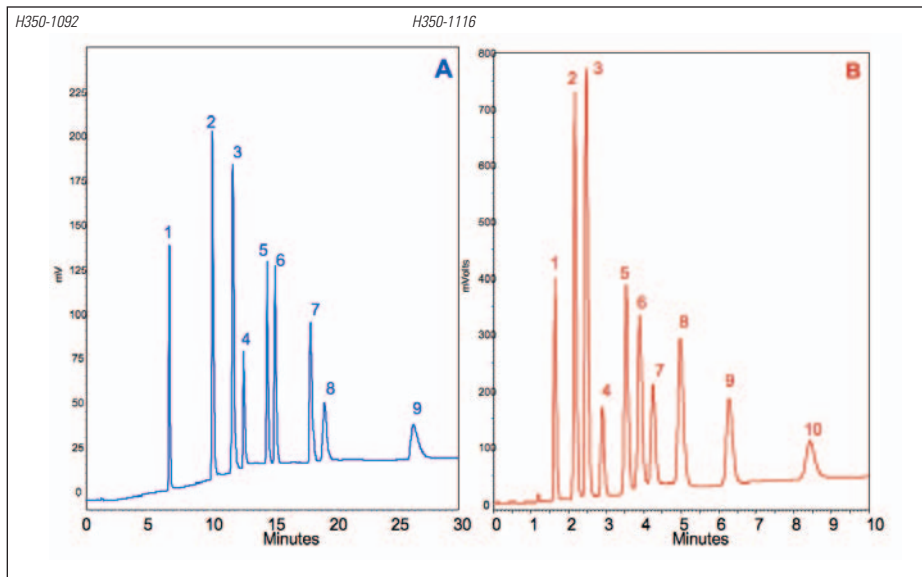

Figure 22: Comparison of the separation of purines and pyrimidines under conventional conditions (a) and with high-temperature water (b)

Column:	Hypercarb High Temperature, 5 μ m, 100 x 4.6 mm
Part Number:	35005-104646
Mobile Phase:	a) H ₂ O + 0.1 % Formic acid /ACN (85:15, v/v) b) H ₂ O
Flow Rate:	a) 0.8 mL/min; b) 2.0 mL/min
Detection:	UV at 254 nm
Temperature:	a) 50 °C; b) 190 °C

- | | |
|-------------|-----------------|
| 1. Cytosine | 4. Hypoxanthine |
| 2. Uracil | 5. Guanine |
| 3. Thymine | 6. Xanthine |

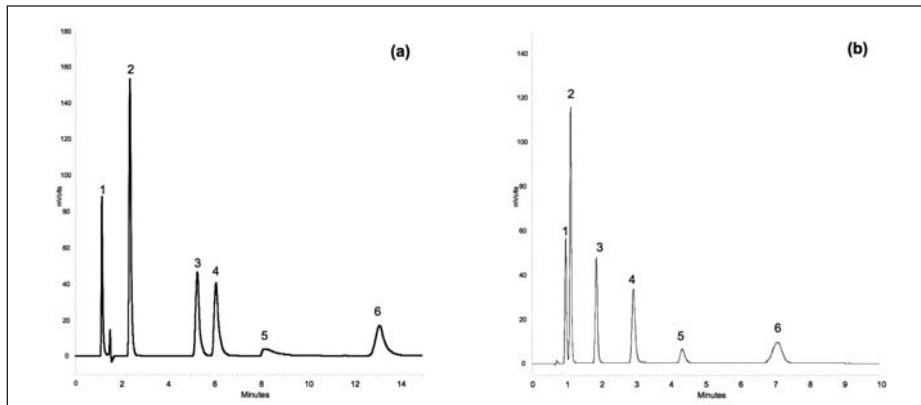
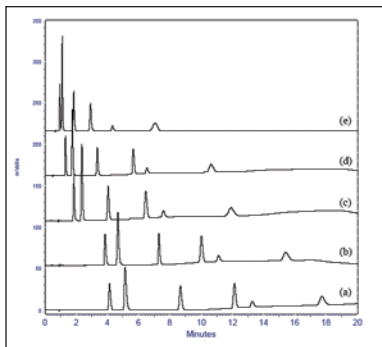

Figure 23: Method development with high temperature water

Column:	Hypercarb 5 μ m, 100 x 4.6 mm
Mobile phase:	H ₂ O
Detection:	UV at 254 nm

- a) T: 100 to 200 °C, at 10 °C/min, flow rate: 1.5 mL/min;
 b) T: 100 to 200 °C, at 15 °C/min, flow rate: 1.5 mL/min;
 c) T: 150 to 200 °C, at 15 °C/min, flow rate: 1.5 mL/min;
 d) T: 150 to 200 °C, at 15 °C/min, flow rate: 2 mL/min;
 e) T: 190 °C, flow rate: 2mL/min.

- | | |
|-------------|-----------------|
| 1. Cytosine | 4. Hypoxanthine |
| 2. Uracil | 5. Guanine |
| 3. Thymine | 6. Xanthine |



8. Wash procedures

8.1. Removal of TFA and DEA – TFA and DEA have the potential to adsorb to the surface of porous graphitic carbon; thus after using these additives in the mobile phase, regeneration of the column should be undertaken to ensure the original Hypercarb selectivity and that optimum performance will always be achieved. Testing of column performance can be undertaken using the experimental conditions in the test certificate provided with the column. The regeneration is as follows:

- Removal of TFA: Flush column with 70 column volumes of THF.
- Removal of DEA: Set column oven to 75 °C and flush column with 120 column volumes of MeCN.

8.2. Acid/base wash – The acid/base wash is suitable for ionized species being chromatographed in strongly aqueous eluents. The procedure based on a 100 x 4.6 mm column is outlined below:

1. Invert the column
2. Flush column at 1.0 mL/min. with 50 mL of THF:H₂O (1:1) containing 0.1% TFA (acid wash)

3. Flush column at 1.0 mL/min with 50 mL of THF:H₂O (1:1) containing 0.1% TEA or NaOH (base wash)
4. Flush column at 1.0 mL/min with 50 mL of THF:H₂O (1:1) containing 0.1% TFA (acid wash)
5. Re-equilibrate column with MeOH:H₂O (95:5)
6. Re-invert column and test performance.

8.3. Strong organic wash – The strong organic wash is suitable for applications involving polar and/or ionizable species chromatographed in an aqueous eluent using a 100 x 4.6 mm column:

1. Flush column at 1.0 mL/min with 50 mL of acetone
2. Flush column at 1.0 mL/min with 120 mL of dibutylether
3. Flush column at 1.0 mL/min with 50 mL of acetone
4. Re-equilibrate column with aqueous mobile phase.

8.4. Normal phase wash – The normal phase wash is suitable for applications running in predominately normal phase organic/nonpolar solvents. The procedure based on a 100 x 4.6 mm column is outlined below:

1. Flush column at 1.0 mL/min with 50 mL of dichloromethane.
2. Flush column at 1.0 mL/min with 50 mL of methanol.
3. Flush column at 1.0 mL/min with 50 mL of HPLC grade water.
4. Flush column at 1.0 mL/min with 100 mL of 0.1M hydrochloric acid.
5. Flush column at 1.0 mL/min with 50 mL of HPLC grade water.
6. Flush column at 1.0 mL/min with 50 mL of methanol.
7. Flush column at 1.0 mL/min with 50 mL of dichloromethane.
8. Re-equilibrate column with mobile phase.

9. Applications

Glyphosate and AMPA

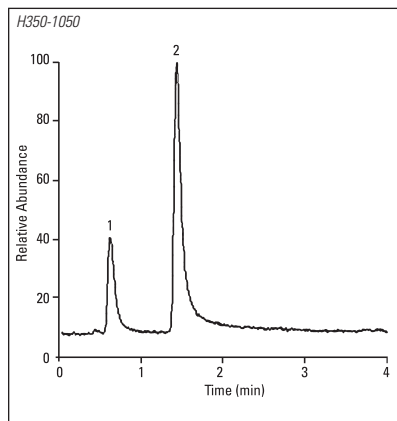

Column: Hypercarb, 5 μ m, 50 x 2.1 mm
Part Number: 35005-052130
Mobile Phase: A: H₂O + 0.1% Formic acid
B: ACN + 0.1% Formic acid
Gradient: 5 to 100% B in 10 min
Flow Rate: 0.3 mL/min
Detection: + ESI

1. Aminomethylphosphonic acid (AMPA)

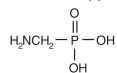

2. Glyphosate

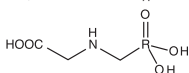

2'-Deoxynucleoside 5'-Monophosphates

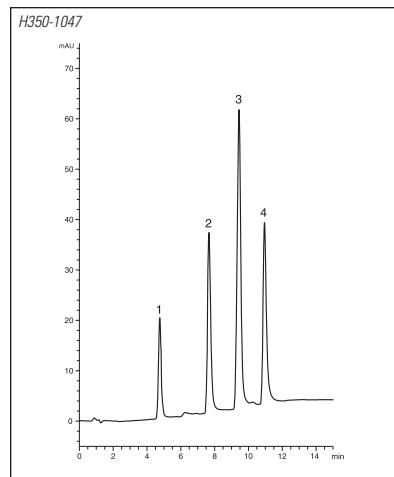

Column: Hypercarb, 5 μ m, 100 x 0.32 mm
Part Number: 35005-100365
Mobile Phase: A: H₂O + 0.1% Formic acid
B: ACN + 0.1% Formic acid
Gradient: 10 to 30% B in 10 min
Flow Rate: 6 μ L/min
Detection: UV at 254 nm
Temperature: 25 $^{\circ}$ C

1. dCMP
2. dUMP
3. dAMP
4. dGMP

Purines and Pyrimidines

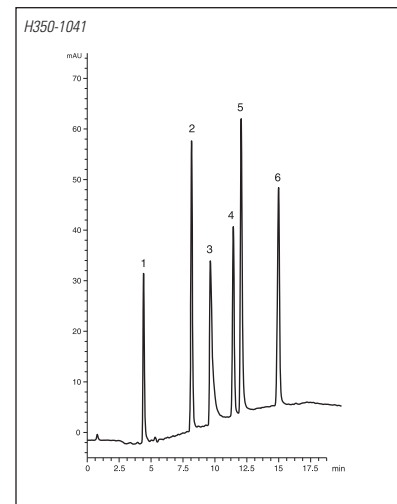

Column: Hypercarb, 5 μ m, 100 x 0.32mm
Part Number: 35005-100365
Mobile Phase: A: H₂O + 0.1% Formic acid
B: ACN + 0.1% Formic acid
Gradient: 0 to 25% B in 15 min
Flow Rate: 8 μ L/min
Detection: UV at 254 nm

1. Cytosine
2. Uracil
3. Guanine
4. Adenine
5. Xanthine
6. Thymine

Hydrophilic Peptides

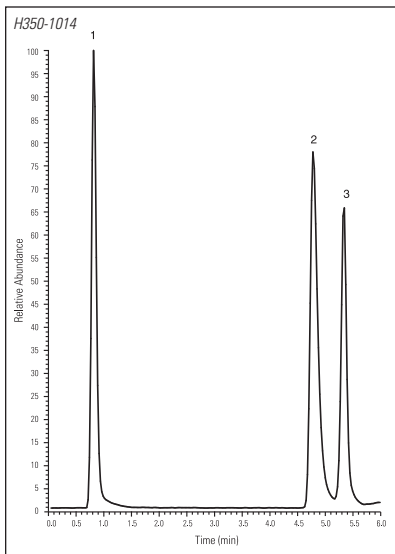

Column: Hypercarb, 5 μ m, 50 x 2.1 mm
 Part Number: 35005-052130
 Mobile Phase: A: 20 mM NH_4OAc at pH 6
 B: ACN
 Gradient: 5 to 100% B in 5 min
 Flow Rate: 0.3 mL/min
 Detection: + ESI
 Temperature: 35 $^\circ\text{C}$

1. Thr-Ser-Lys
2. Arg-Gly-Glu-Ser
3. Asp-Ser-Asp-Pro-Arg

RNB-Glycopeptides

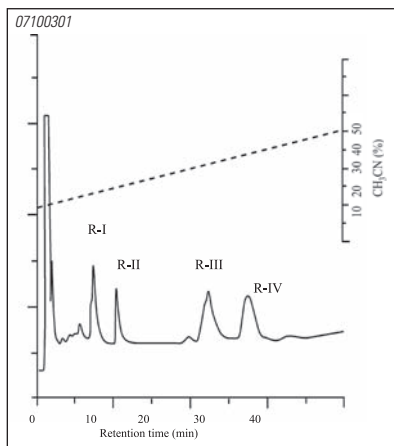

Column: Hypercarb, 5 μ m, 100 x 4.6 mm
 Part Number: 35005-104630
 Mobile Phase: A: H_2O
 B: ACN
 Gradient: 10 to 50% B in 50 min
 Flow Rate: 1 mL/min
 Detection: UV at 210 nm
 Temperature: 25 $^\circ\text{C}$
 Source: J. Fan and A. Kondo, Anal. Biochem. 219, 224 (1994).
 Reproduced with permission

1. R-I ($\text{Man}_6\text{GlcNAc}_2\text{Asn}$)
2. R-II ($\text{Man}_6\text{GlcNAc}_2\text{Asn}$)
3. R-III ($\text{Man}_6\text{GlcNAc}_2\text{AsnLeu}$)
4. R-IV ($\text{Man}_6\text{GlcNAc}_2\text{AsnLeu}$)

Acrylamide in Foodstuffs

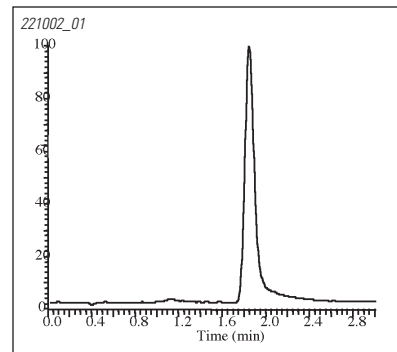

Column: Hypercarb, 5 μ m, 50 x 2.1 mm
 Part Number: 35005-052130
 Mobile Phase: H_2O
 Flow Rate: 0.4 mL/min
 Detection: +ESI
 Temperature: Ambient

1. Acrylamide

Oligosaccharides from a Glycoprotein

Column: Hypercarb, 5 μ m, 100 x 1.0 mm

Part Number: 35005-101030

Mobile Phase: A: 5 mM NH_4OAc at pH 9.6 +
2% ACN

B: 5 mM NH_4OAc at pH 9.6 +
80% ACN

Gradient: 5 to 40% B in 80 min

Flow Rate: 50 μ L/min

Detection: + ESI

Source: Nana Kawasaki, National
Institute of Health Science,
Tokyo, Japan

Reduced N-linked oligosaccharides from:

(A) RNase B

(B) Desialylated rhEPO

(C) Fetuin

(D) Sialylated rhEPO

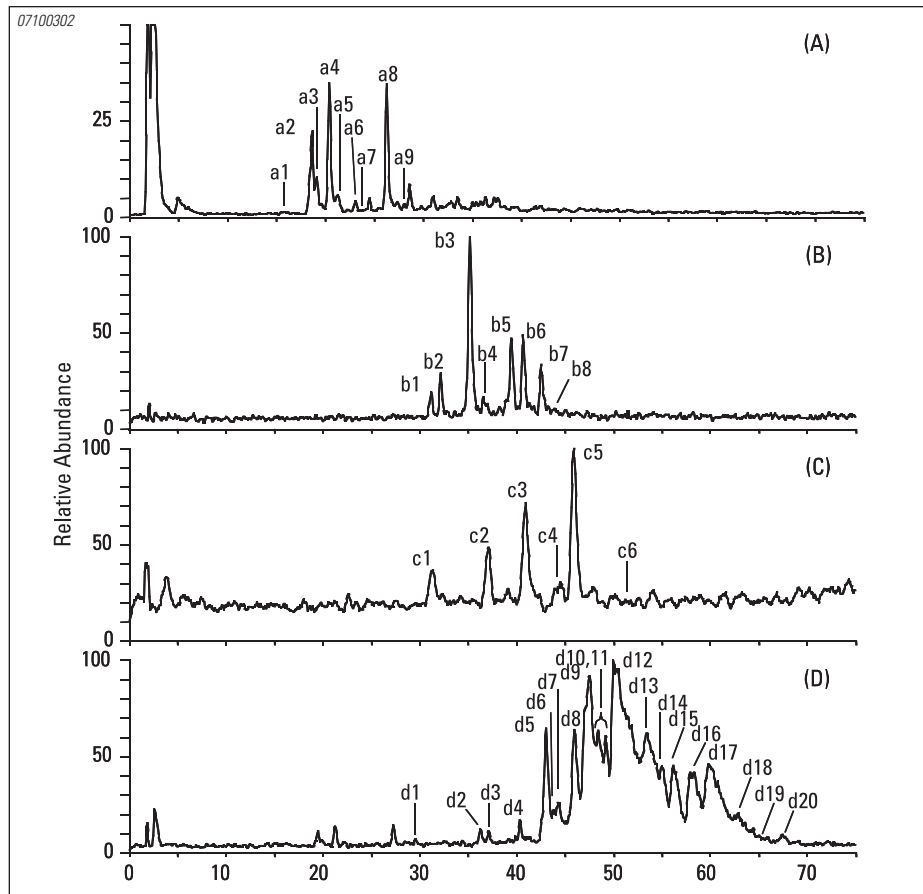

Anilines (UHT-LC)

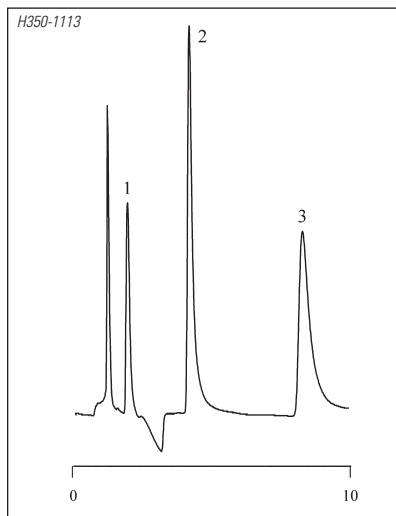

Column: Hypercarb, 7 μ m, 100 x 4.6 mm

Part Number: 35007-104646

Mobile Phase: H₂O

Flow Rate: 1 mL/min

Detection: UV at 254 nm

Temperature: 180 °C

Source: R. M.Smith and R. J. Burgess,
University Loughborough, UK

1. Aniline
2. N-Methylaniline
3. N-Ethylaniline

Water and Fat Soluble Vitamins

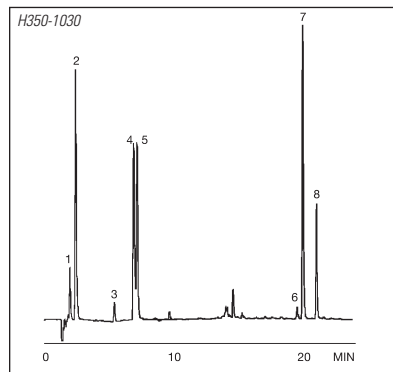

Column: Hypercarb, 5 μ m, 100 x 4.6 mm

Part Number: 35005-104630

Mobile Phase: A: 50 mM NH₄OAc at pH 6.0

B: ACN:IPA (1:1)

C: THF

Gradient:	Time (min)	% B	% C
	0	7	0
	10	60	0
	12	95	5
	25	0	100

Flow Rate: 1 mL/min

Detection: UV at 215 nm; 275 nm at 10 min

Temperature: 25 °C

- | | |
|----------------|---------------|
| 1. Vitamin B5 | 5. Vitamin B6 |
| 2. Vitamin B3 | 6. Vitamin A |
| 3. Vitamin H | 7. Vitamin D3 |
| 4. Vitamin B12 | 8. Vitamin D2 |

Triazines

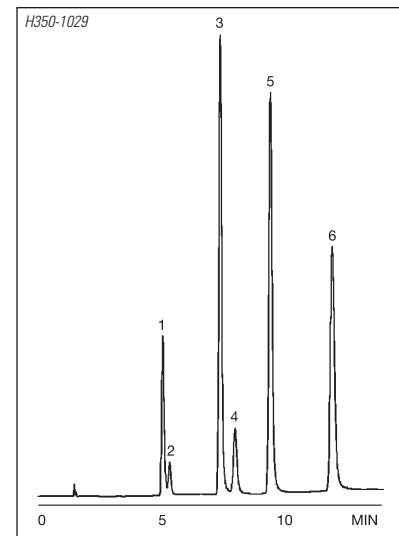

Column: Hypercarb, 5 μ m, 100 x 4.6 mm

Part Number: 35005-104630

Mobile Phase: A: H₂O

B: ACN:IPA (1:3)

Gradient: 35 to 95% B in 10 min

Flow Rate: 1 mL/min

Detection: UV at 240 nm

Temperature: 60 °C

- | | |
|--------------|-------------|
| 1. Prometon | 4. Simazine |
| 2. Propazine | 5. Ametryn |
| 3. Prometryn | 6. Simetryn |

Methylamines in Fish

Column: Hypercarb, 7 μm , 100 x 4.6 mm
Part Number: 35007-104630
Mobile Phase: 5 mM Heptanesulfonic acid +
5 mM KH_2PO_4 at pH 9
Flow Rate: 1 mL/min
Source: Lofti I. Monser, Analytica Chimica
Acta, 322 (1996) 63-68.

1. Trimethylamine (TMA)
2. Dimethylamine (DMA)
3. Methylamine (MA)

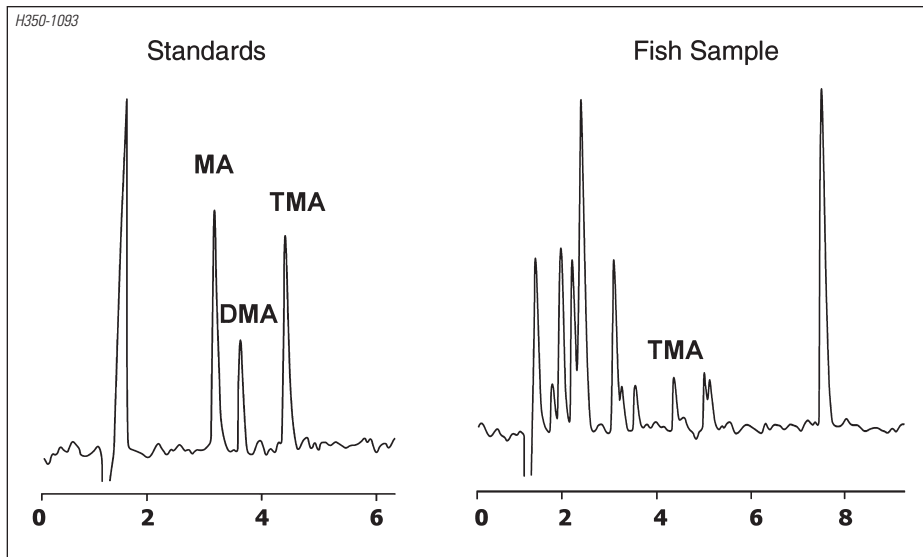

*Find more applications at the Chromatography
Resource Center at www.thermo.com/columns.*

10. References

1. P. Ross *LC-GC Europe*, 13, no.5, (2000)
2. P. Ross PhD Thesis, Edinburgh University (Edinburgh, UK, 1999)
3. J.H. Knox and P. Ross, "Quantification and Correlation of the Energies Associated with Retention of Polar analytes on Porous Graphitic Carbon" poster HPLC 99' Granada, Spain, 30 May- 4 June 1999
4. K. Gaudin, P. Chaminade, A. Baillet, *J. Chromatogr. A*, 973 (2002) 61-68
5. C. Elfakir, M. Dreux, *J. Chromatogr. A*, 727 (1996) 71-82
6. D. Guillarme, S. Heinisch, J.L. Rocca, *J. Chromatogr. A*, 1052 (2004) 39-51
7. I.D. Wilson, *Chromatographia Suppl.*, 52 (2000) S28–S34.
8. R. Tajuddin, R.M. Smith, *J. Chromatogr. A*, 1084 (2005) 194-200.
9. R. Tajuddin, R.M. Smith, *Analyst*, 127 (2002) 883–885
10. D. Guillarme, S. Heinisch, J.Y. Gauvrit, P. Lanteri, J.L. Rocca, *J. Chromatogr. A*, 1078 (2005) 22-27.
11. L. Pereira, S. Aspey, H. Ritchie, *J. Sep. Sci.*, 30 (2007) 1115-1124.
12. S. J. Marin, B.A. Jones, W.D. Felix, J. Clark, *J. Chromatogr. A*, 1030 (2004) 255-262.
13. B. Jones, S. Marin, D. Felix, J. Clark, *Proceedings of the Pittsburgh Conference abstracts*, Orlando, FL, 9-14 March 2003, 2020–2023.

Laboratory Solutions Backed by Worldwide Service and Support

Tap our expertise throughout the life of your instrument. Thermo Scientific Services extends its support throughout our worldwide network of highly trained and certified engineers who are experts in laboratory technologies and applications. Put our team of experts to work for you in a range of disciplines – from system installation, training and technical support, to complete asset management and regulatory compliance consulting. Improve your productivity and lower the cost of instrument ownership through our product support services. Maximize uptime while eliminating the uncontrollable cost of unplanned maintenance and repairs. When it's time to enhance your system, we also offer certified parts and a range of accessories and consumables suited to your application.

To learn more about our products and comprehensive service offerings, visit us at www.thermo.com.

Visit the Chromatography Resource Center at: www.thermo.com/columns

For Technical Support:

North America

T +1 800 437 2999

E techsupport.analyze.us@thermofisher.com

Africa, Asia, Europe, Latin America and Middle East

T +44 (0) 1928 581000

E techsupport.columns@thermofisher.com



ISO 9001:2000 FM 76231

Thermo Electron Corporation,
Bellefonte, PA is ISO Certified.



Thermo Hypersil Ltd.,
Runcom, UK is ISO Certified.

©2007 Thermo Fisher Scientific Inc. All rights reserved. All trademarks are the property of Thermo Fisher Scientific Inc. and its subsidiaries.

Specifications, terms and pricing are subject to change. Not all products are available in all countries. Please consult your local sales representative for details.

TG20394_E 12/07M

Thermo
SCIENTIFIC