



User manual



BAT.PAR 6 RGBWA
BAT.PAR 6 RGBUV

LED spotlight

Musikhaus Thomann
Thomann GmbH
Hans-Thomann-Straße 1
96138 Burgebrach
Germany
Telephone: +49 (0) 9546 9223-0
E-mail: info@thomann.de
Internet: www.thomann.de

17.03.2021, ID: 385435, 385475 (V3)

Table of contents

1	General information	6
	1.1 Further information.....	7
	1.2 Notational conventions.....	8
	1.3 Symbols and signal words.....	8
2	Safety instructions	11
3	Features	16
4	Installation	17
	4.1 Dealing with lithium batteries.....	20
5	Starting up	22
6	Connections and operating elements	24
7	Operating	30
	7.1 Starting the device.....	30
	7.2 Operating on the unit.....	30
	7.3 IR remote control.....	34
	7.4 Menu overview.....	35

7.5	Functions in 1-channel DMX mode.....	37
7.6	Functions in 4-channel DMX mode.....	37
7.7	Functions in 5-channel DMX mode.....	38
7.8	Functions in 6-channel DMX mode.....	40
7.9	Functions in 7-channel DMX mode.....	41
7.10	Functions in 8-channel DMX mode.....	44
8	Technical specifications.....	47
9	Plug and connection assignments.....	50
10	Troubleshooting.....	51
11	Cleaning.....	53
12	Protecting the environment.....	54



1 General information

This user manual contains important information on the safe operation of the device. Read and follow all safety notes and all instructions. Save this manual for future reference. Make sure that it is available to all persons using this device. If you sell the device to another user, be sure that they also receive this manual.

Our products and user manuals are subject to a process of continuous development. We therefore reserve the right to make changes without notice. Please refer to the latest version of the user manual which is ready for download under www.thomann.de.

1.1 Further information

On our website (www.thomann.de) you will find lots of further information and details on the following points:

Download	This manual is also available as PDF file for you to download.
Keyword search	Use the search function in the electronic version to find the topics of interest for you quickly.
Online guides	Our online guides provide detailed information on technical basics and terms.
Personal consultation	For personal consultation please contact our technical hotline.
Service	If you have any problems with the device the customer service will gladly assist you.

1.2 Notational conventions

This manual uses the following notational conventions:



Letterings



The letterings for connectors and controls are marked by square brackets and italics.

Examples: *[VOLUME]* control, *[Mono]* button.

1.3 Symbols and signal words

In this section you will find an overview of the meaning of symbols and signal words that are used in this manual.

Signal word	Meaning
DANGER!	This combination of symbol and signal word indicates an immediate dangerous situation that will result in death or serious injury if it is not avoided.
WARNING!	This combination of symbol and signal word indicates a possible dangerous situation that can result in death or serious injury if it is not avoided.
NOTICE!	This combination of symbol and signal word indicates a possible dangerous situation that can result in material and environmental damage if it is not avoided.
Warning signs	Type of danger
	Warning – high-voltage.
	Warning – dangerous optical radiation.

Warning signs	Type of danger
 A yellow triangular warning sign with a black border, depicting a crane hook lifting a rectangular load.	Warning – suspended load.
 A yellow triangular warning sign with a black border, featuring a large black exclamation mark.	Warning – danger zone.

2 Safety instructions

Intended use

This device is intended for use as an electronic lighting effect by means of LED technology. The device is designed for professional use only and is not suitable for use in households. Use the device only as described in this user manual. Any other use or use under other operating conditions is considered to be improper and may result in personal injury or property damage. No liability will be assumed for damages resulting from improper use.

This device may be used only by persons with sufficient physical, sensorial, and intellectual abilities and having corresponding knowledge and experience. Other persons may use this device only if they are supervised or instructed by a person who is responsible for their safety.



Extend the operating life of the device by regular breaks and by avoiding frequent switching on and off. The device is not suitable for continuous operation.

Safety



DANGER!

Danger for children

Ensure that plastic bags, packaging, etc. are disposed of properly and are not within reach of babies and young children. Choking hazard! Ensure that children do not detach any small parts (e.g. knobs or the like) from the unit. They could swallow the pieces and choke! Never let children unattended use electrical devices.



DANGER!

Electric shock caused by high voltages inside

Within the device there are areas where high voltages may be present. Never remove any covers. There are no user-serviceable parts inside. Do not use the device if covers, protectors or optical components are missing or damaged.



DANGER!

Electric shock caused by short-circuit

Always use proper ready-made insulated mains cabling (power cord) with a protective contact plug. Do not modify the mains cable or the plug. Failure to do so could result in electric shock/death or fire. If in doubt, seek advice from a registered electrician.



WARNING!

Eye damage caused by high light intensity

Never look directly into the light source.

**WARNING!****Risk of epileptic shock**

Strobe lighting can trigger seizures in photosensitive epilepsy. Sensitive persons should avoid looking at strobe lights.

**WARNING!****Incorrect handling of lithium batteries can result in injury**

In the event of a short circuit, overheating or mechanical damage, lithium batteries can cause severe injuries. Follow the advice on the correct handling of lithium batteries in the present section.

**NOTICE!****Risk of fire**

Do not block areas of ventilation. Do not install the device near any direct heat source. Keep the device away from naked flames.

**NOTICE!****Operating conditions**

This device has been designed for indoor use only. To prevent damage, never expose the device to any liquid or moisture. Avoid direct sunlight, heavy dirt, and strong vibrations. Only operate the device within the ambient conditions specified in the chapter 'Technical specifications' of this user manual. Avoid heavy temperature fluctuations and do not switch the device on immediately after it was exposed to temperature fluctuations (for example after transport at low outside temperatures). Dust and dirt inside can damage the unit. When operated in harmful ambient conditions (dust, smoke, nicotine, fog, etc.), the unit should be maintained by qualified service personnel at regular intervals to prevent overheating and other malfunction.



NOTICE!

Power supply



Before connecting the device, ensure that the input voltage (AC outlet) matches the voltage rating of the device and that the AC outlet is protected by a residual current circuit breaker. Failure to do so could result in damage to the device and possibly injure the user. Unplug the device before electrical storms occur and when it is unused for long periods of time to reduce the risk of electric shock or fire.



NOTICE!

Risk of fire due to incorrect polarity



Incorrectly inserted batteries may destroy the device or the batteries. Ensure that proper polarity is observed when inserting batteries.



NOTICE!

Possible damage by leaking batteries



Leaking batteries can cause permanent damage to the device. Take batteries out of the device if it is not going to be used for a longer period.



NOTICE!

Possible staining



The plasticiser contained in the rubber feet of this product may possibly react with the coating of your parquet, linoleum, laminate or PVC floor and after some time cause permanent dark stains. In case of doubt, do not put the rubber feet directly on the floor, but use felt-pad floor protectors or a carpet.



NOTICE!

Possible damage to lithium-ion batteries through incorrect storage



By deep discharge, lithium-ion batteries can be permanently damaged or lose some of their capacity. Before long breaks, charge the batteries to around 50 % of their capacity and then switch off the device. Store the device at room temperature or cooler in an environment as dry as possible. If the batteries are stored for a longer period, recharge them to 50 % every three months. Fully charge the batteries only shortly before use at room temperature.



NOTICE!

Possible damage due to installation of a wrong fuse



The use of different types of fuses can cause serious damage to the unit. Fire hazard! Only fuses of the same type may be used.

3 Features

Special features of the device:

- Model BAT.PAR 6 RGBWA: six RGBWA LEDs (red, green, blue, white, amber, 8 W each)
- Model BAT.PAR 6 RGBUV: six RGBUV LEDs (red, green, blue, UV, 8 W each)
- Stand-alone, master-slave or DMX mode operation
- Control via DMX, four different modes, with the supplied infrared remote control or the buttons and display on the unit
- Stand-alone operation with static colours
- Sound control
- Battery or mains powered
- Power adapter and infrared remote control included
- Suitable for use in clubs, bars, theatres, exhibitions, etc. or for mobile use

For technological reasons, the light output of LEDs decreases over their lifetime. This effect increases with higher operating temperature. You can extend the service life of the illuminants by providing adequate ventilation and operating the LEDs with the lowest possible brightness.

4 Installation

Unpack and check carefully there is no transportation damage before using the unit. Keep the equipment packaging. To fully protect the product against vibration, dust and moisture during transportation or storage use the original packaging or your own packaging material suitable for transport or storage, respectively.



WARNING!

Risk of injury caused by falling objects

Make sure that the installation complies with the standards and rules that apply in your country. Always secure the device with a secondary safety attachment, such as a safety cable or a safety chain.



NOTICE!

Risk of overheating

The distance between light output and the illuminated surface must be more than 1.5 m (19.7in).

Provide sufficient ventilation.

The ambient temperature must always be below 40 °C (104 °F).



NOTICE!

Use of stands

When mounting the device onto a stand, ensure that the stand is in a safe and stable position and that the weight of the device does not exceed the maximum permissible load capacity of the stand.

**NOTICE!****Possible data transmission errors**

For error-free operation make use of dedicated DMX cables and do not use ordinary microphone cables.

Never connect the DMX input or output to audio devices such as mixers or amplifiers.

Mounting options

You can install the unit in hanging or standing position. When in use, the device must always be attached to a solid surface or an approved truss. Use the openings provided on the two-piece bracket for attaching.

Always work from a stable platform whenever installing, moving or servicing the unit. In doing so, the area underneath the unit must be cordoned off.

The safety cable must be attached to the bracket.



Please note that this device must not be connected to a dimmer.

4.1 Dealing with lithium batteries



WARNING!

Incorrect handling of lithium batteries can result in injury

In the event of a short circuit, overheating or mechanical damage, lithium batteries can cause severe injuries.

Follow the advice on the correct handling of lithium batteries in the present section.

When handled correctly and appropriately lithium batteries pose no risk.

Store lithium batteries in a cool, dry place, ideally in the original packaging.

Store lithium batteries away from heat sources (e.g. radiators or sunlight). Lithium batteries are hermetically sealed. Never attempt to open a lithium battery.

If the battery housing is damaged small amounts of the electrolyte may leak out. If this should happen, seal the lithium battery in airtight packaging and wipe up the traces of electrolyte using absorbent paper towels. You must wear protective rubber gloves when doing so. Clean your hands and the affected surface thoroughly with cold water.

Never attempt to recharge non-rechargeable lithium batteries. When charging lithium batteries you must use a suitable charging device intended for the purpose.

Before disposing of the device remove the lithium batteries. Protect used lithium batteries against potential short circuits, e.g. by covering the poles with adhesive tape.

Only use powder extinguishers or other suitable extinguishing agents to extinguish a burning lithium battery.

5 Starting up

Create all connections while the device is off. Use the shortest possible high-quality cables for all connections. Take care when running the cables to prevent tripping hazards.

Connections in DMX mode

Connect the DMX input of the device to the DMX output of a DMX controller or another DMX device. Connect the output of the first DMX device to the input of the second one, and so on to form a daisy chain. Always ensure that the output of the last DMX device in the daisy chain is terminated with a resistor ($110\ \Omega$, $\frac{1}{4}\text{ W}$).

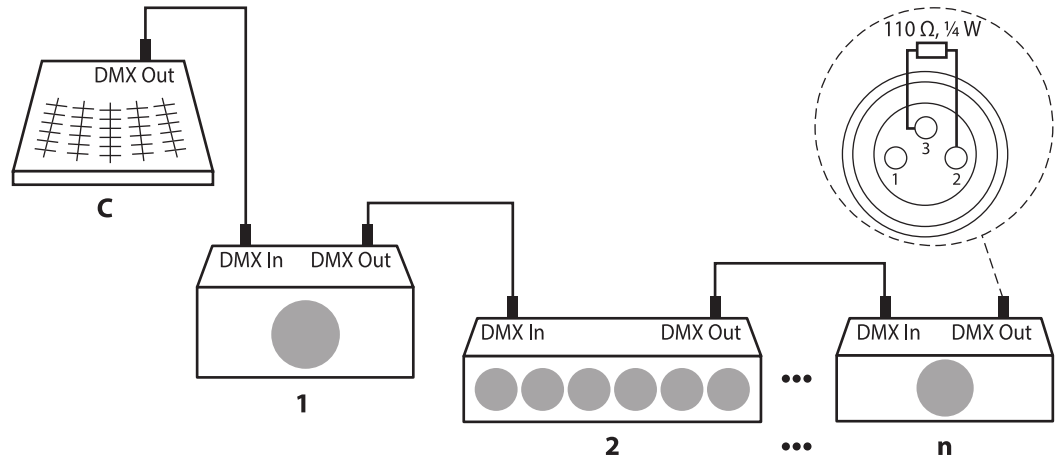

6 Connections and operating elements

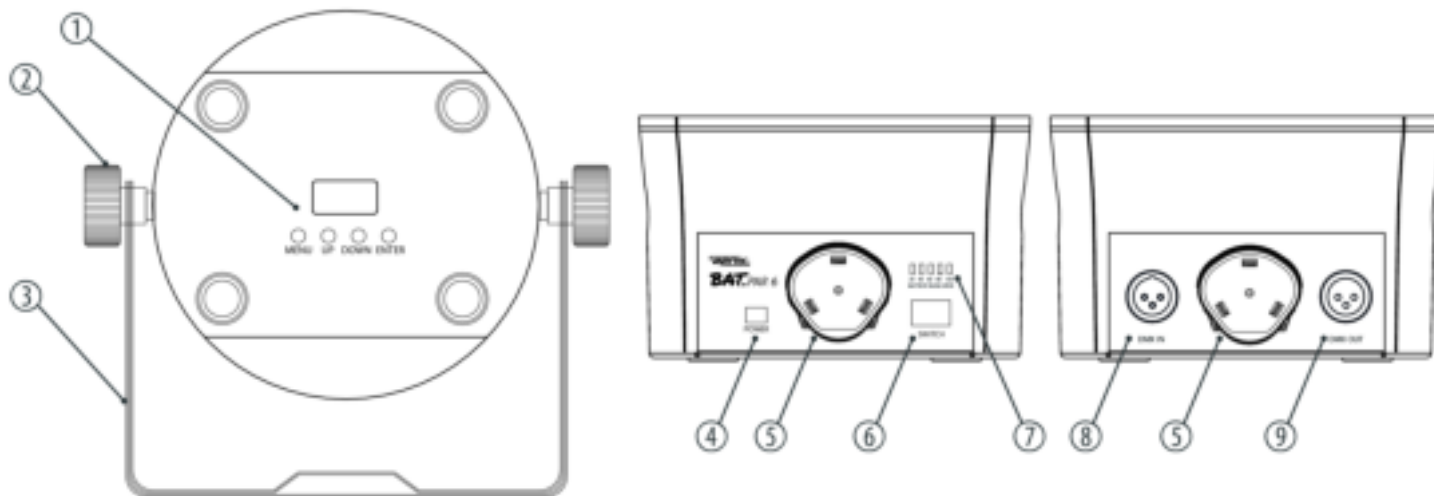

1	<p>Display and function buttons:</p> <p><i>[MENU]</i> Activates the main menu and toggles between menu items. Closes an opened submenu.</p> <p><i>[UP], [DOWN]</i> Toggles between the menu items of a menu level, increases or decreases the displayed value by one.</p> <p><i>[ENTER]</i> Selects an option of the respective operating mode, confirms the set value.</p>
2	Locking screws for the mounting bracket.
3	Bracket for floor placement or hanging.
4	<p><i>[POWER]</i> Connection socket for the 15 V power supply unit.</p>
5	Battery compartment
6	<p><i>[SWITCH]</i> Main switch. Turns the device on and off.</p>

7	<i>[BATTERY INDICATOR]</i> Remaining battery capacity display. When all the LEDs are on, the battery is fully charged. If only the red LED is on, the unit must be connected to the mains again to charge as soon as possible.
8	<i>[DMX IN]</i> DMX input.
9	<i>[DMX OUT]</i> DMX output.

Remote control

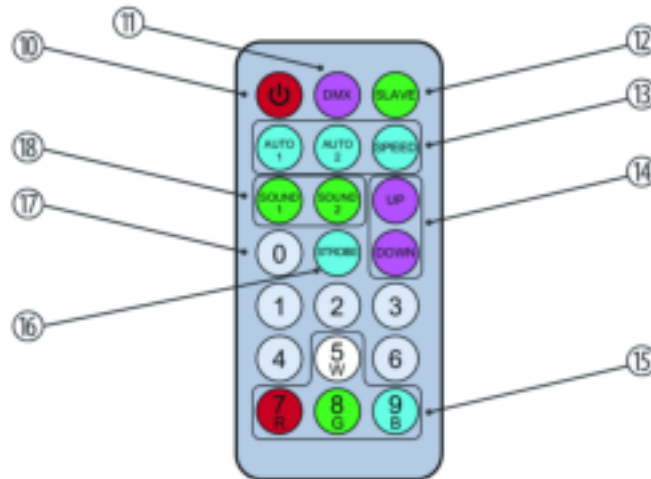

10	Button to turn the device on and off.
11	<i>[DMX]</i> Button to switch between DMX and stand-alone mode.
12	<i>[SLAVE]</i> Button to switch between Master and Slave mode.
13	<i>[AUTO 1], [AUTO 2], [SPEED]</i> Buttons to activate automatic mode 1 or 2 and to adjust the program's speed.
14	<i>[UP], [DOWN]</i> Buttons to switch between individual programs and to increase/decrease numeric values.
15	Buttons for colour selection. Use <ul style="list-style-type: none">■ <i>[W]</i> for white light.■ <i>[R], [G],</i> or <i>[B]</i> for primary colours red, green and blue.
16	<i>[STROBE]</i> Button to turn the strobe effect on/off.

17 Numerical buttons 0 ... 9 for direct number entry.

18 *[SOUND 1]*, *[SOUND 2]*

Buttons to activate automatic mode 1 or 2 of the sound control.

7 Operating

7.1 Starting the device

Turn on the power using the main switch. The display shows the current operation mode.

7.2 Operating on the unit

Wait for approx. 15 seconds after confirming the last modification of the setting until the display turns off. Now the settings are saved.

DMX address

Press *[MENU]*, *[UP]* or *[DOWN]* repeatedly until the display shows 'Addr'. Confirm with *[ENTER]*.

Now you can set the number of the first DMX channel to be used by the device (DMX address). Use *[UP]* and *[DOWN]* to select a value between 1 and 512 (display shows 'A001' ... 'A512'). Confirm with *[ENTER]*.

Make sure that this number matches the configuration of your DMX controller.

Sound control

Press *[MENU]*, *[UP]* or *[DOWN]* repeatedly until the display shows 'Soun'. Confirm with *[ENTER]*.

Use *[UP]* and *[DOWN]* to select the desired mode 'Sou1' or 'Sou2'. Confirm with *[ENTER]*.

Now you can adjust the sensitivity of the built-in microphone for sound control. Use *[Up]* and *[Down]* to select a value between 0 (low sensitivity) and 9 (high sensitivity), display shows 'Se0' ... 'Se9'.

Dimmer settings

Press *[MENU]*, *[UP]* or *[DOWN]* repeatedly until the display shows 'Stat'. Confirm with *[ENTER]*.

Use *[UP]* and *[DOWN]* to select the fixed colour for which the dimmer setting should be adjusted:

- **BAT.PAR 6 RGBWA (item no. 385435):** Red, green, blue, white, amber
- **BAT.PAR 6 RGBUV (item no. 385457):** Red, green, blue, UV, speed strobe effect

Adjust the setting as desired in a range from 0 ... 255 (0 % to 100 %) and confirm with *[ENTER]* to switch to the next colour in the menu.

Constant colour

Press *[MENU]*, *[UP]* or *[DOWN]* repeatedly until the display shows 'Colo'. Confirm with *[ENTER]*.

Use *[UP]* and *[DOWN]* to select a constant colour in a range from 'Col1' ... 'Col51'. Confirm with *[ENTER]*.

Operating mode Auto

Press *[MENU]*, *[UP]* or *[DOWN]* repeatedly until the display shows 'Auto'. Confirm with *[ENTER]*.

Use *[UP]* and *[DOWN]* to select the desired mode 'Aut1', 'Aut2' or 'Aut3'. Confirm with *[ENTER]*.
Now you can adjust the progress speed of the programme between 'SP 1' and 'SP 9'.

Device info

Press *[MENU]*, *[UP]* or *[DOWN]* repeatedly until the display shows 'Info'. Confirm with *[ENTER]*.
The display shows the version number of the currently installed software.

Use *[UP]* and *[DOWN]* to select the option 'tenP'. Confirm with *[ENTER]*. The display shows the current device temperature.

or

Use *[UP]* and *[DOWN]* to select the option 'uer'. Confirm with *[ENTER]*. The display shows the version number of the currently installed software.

Operating mode Slave

Press *[MENU]*, *[UP]* or *[DOWN]* repeatedly until the display shows 'SLav'. Confirm with *[ENTER]*.

The display shows 'Sla', the unit is now in Slave mode.

**DMX mode, BAT.PAR 6 RGBWA
(item no. 385435)**

Press *[MENU]*, *[UP]* or *[DOWN]* repeatedly until the display shows 'Chnd'. Confirm with *[ENTER]*.

Now use *[UP]* or *[DOWN]* to select one of the following DMX operating modes:

- '1Ch' (one channel)
- '5Ch' (five channels)
- '7Ch' (seven channels)
- '8Ch' (eight channels)

Confirm the selection with *[ENTER]*.

**DMX mode, BAT.PAR 6 RGBUV
(item no. 385457)**

Press *[MENU]*, *[UP]* or *[DOWN]* repeatedly until the display shows 'Chnd'. Confirm with *[ENTER]*.

Now use *[UP]* or *[DOWN]* to select one of the following DMX operating modes:

- '1Ch' (one channel)
- '4Ch' (four channels)
- '6Ch' (six channels)
- '7Ch' (seven channels)

Confirm the selection with *[ENTER]*.

7.3 IR remote control

Press *[MENU]*, *[UP]* or *[DOWN]* repeatedly until the display shows 'reno'. Confirm with *[ENTER]*.

Use *[UP]* and *[DOWN]* to select the option 'on' to operate the unit via the IR remote control. Confirm with *[ENTER]*.

7.4 Menu overview

BAT.PAR 6 RGBWA (item no. 385435)

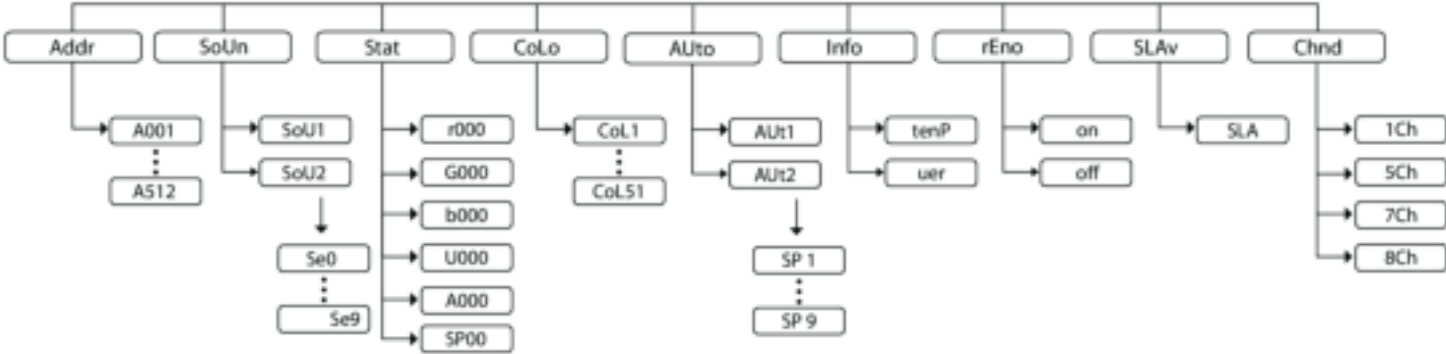

BAT.PAR 6 RGBUV (item no. 385457)



7.5 Functions in 1-channel DMX mode

Channel	Value	Function
1	0...255	Selecting colour macros 1 ... 51

7.6 Functions in 4-channel DMX mode

BAT.PAR 6 RGBUV (item no. 385457)

Channel	Value	Function
1	0...255	Intensity red (0 % to 100 %)
2	0...255	Intensity green (0 % to 100 %)

Channel	Value	Function
3	0...255	Intensity blue (0 % to 100 %)
4	0...255	Intensity UV light (0 % to 100 %)

7.7 Functions in 5-channel DMX mode

BAT.PAR 6 RGBWA (item no. 385435)

Channel	Value	Function
1	0...255	Intensity red (0 % to 100 %)
2	0...255	Intensity green (0 % to 100 %)
3	0...255	Intensity blue (0 % to 100 %)

Channel	Value	Function
4	0...255	Intensity white (0 % to 100 %)
5	0...255	Intensity amber (0 % to 100 %)

7.8 Functions in 6-channel DMX mode

BAT.PAR 6 RGBUV (item no. 385457)

Channel	Value	Function
1	0...255	Master dimmer (0 % to 100 %)
2	0...255	Intensity red (0 % to 100 %)
3	0...255	Intensity green (0 % to 100 %)
4	0...255	Intensity blue (0 % to 100 %)
5	0...255	Intensity UV light (0 % to 100 %)
6	0...255	Stroboscope effect (0 % to 100 %)

7.9 Functions in 7-channel DMX mode

BAT.PAR 6 RGBWA (item no. 385435)

Channel	Value	Function
1	0...255	Master dimmer (0 % to 100 %)
2	0...255	Intensity red (0 % to 100 %)
3	0...255	Intensity green (0 % to 100 %)
4	0...255	Intensity blue (0 % to 100 %)
5	0...255	Intensity white (0 % to 100 %)
6	0...255	Intensity amber (0 % to 100 %)
7	0...255	Stroboscope effect (0 % to 100 %)

BAT.PAR 6 RGBUV (item no. 385457)

Channel	Value	Function
1	0...255	Master dimmer (0 % to 100 %)
2	0...255	Intensity red (0 % to 100 %)
3	0...255	Intensity green (0 % to 100 %)
4	0...255	Intensity blue (0 % to 100 %)
5	0...255	Intensity UV light (0 % to 100 %)
6	0...15	No function
	16...31	Programme 1
	32...47	Programme 2
	48...63	Programme 3
	64...79	Programme 4
	80...95	Programme 5

Channel	Value	Function
	96...111	Programme 6
	112...127	Programme 7
	128...143	Programme 8
	144...159	Programme 9
	160...175	Programme 10
	176...191	Programme 11
	192...207	Programme 12
	208...223	Programme 13
	224...239	Sound mode 1
	240...255	Sound mode 2
7	0...255	Stroboscope effect (0 % to 100 %), if channel 6 = 0...15

Channel	Value	Function
		Programme speed, if channel 6 = 16...223
		Microphone sensitivity, if channel 6 = 224...255

7.10 Functions in 8-channel DMX mode

BAT.PAR 6 RGBWA (item no. 385435)

Channel	Value	Function
1	0...255	Master dimmer (0 % to 100 %)
2	0...255	Intensity red (0 % to 100 %)
3	0...255	Intensity green (0 % to 100 %)
4	0...255	Intensity blue (0 % to 100 %)

Channel	Value	Function
5	0...255	Intensity white (0 % to 100 %)
6	0...255	Intensity amber (0 % to 100 %)
7	0...15	No function
	16...31	Programme 1
	32...47	Programme 2
	48...63	Programme 3
	64...79	Programme 4
	80...95	Programme 5
	96...111	Programme 6
	112...127	Programme 7
	128...143	Programme 8
	144...159	Programme 9
160...175	Programme 10	

Channel	Value	Function
	176...191	Programme 11
	192...207	Programme 12
	208...223	Programme 13
	224...239	Sound mode 1
	240...255	Sound mode 2
8	0...255	Stroboscope effect (0 % to 100 %), if channel 6 = 0...15
		Programme speed, if channel 6 = 16...223
		Microphone sensitivity, if channel 6 = 224...255

8 Technical specifications

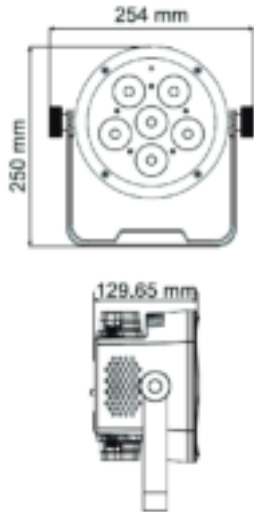

		BAT.PAR 6 RGBWA (Item no. 385435)	BAT.PAR 6 RGBUV (Item no. 385475)
Light source		6 × RGBWA, each 8 W	6 × RGBUV, each 8 W
Optical properties	Beam angle	25 °	
Control		DMX, infrared remote control, buttons and display	
Number of DMX channels		1, 5, 7 or 8	1, 4, 6 or 7
Input connections	Power supply	Plug-in power supply	
	DMX control	XLR chassis socket, 3-pin	
Output connections	DMX control	XLR chassis socket, 3-pin	
Power consumption		48 W	
Power supply		Power adapter, 100 - 240 V ~ 50/60 Hz	

		BAT.PAR 6 RGBWA (Item no. 385435)	BAT.PAR 6 RGBUV (Item no. 385475)
Operating voltage		15 V $\overline{\text{=}}$ / 5 A, centre positive	
Battery / rechargeable battery	Battery type	Interchangeable lithium-ion battery pack (item no. 385488)	
	Voltage	10.8 V	
	Capacity	1500 mAh	
	Operating time	max. 5 h	
Degree of protection		IP20	
Mounting options		Hanging, standing	
Dimensions (W × H × D)		250 mm × 254 mm × 130 mm	
Weight		2 kg	
Ambient conditions	Temperature range	0 °C...40 °C	
	Relative humidity	20 %...80 % (non-condensing)	

Further information

Construction	Flat PAR
LED type	x-in-1
Base housing	Yes
Fanless	No
Remote control	included
Wireless DMX	No
Housing colour	Black

9 Plug and connection assignments

Introduction

This chapter will help you select the right cables and plugs to connect your valuable equipment so that a perfect light experience is guaranteed.

Please take our tips, because especially in 'Sound & Light' caution is indicated: Even if a plug fits into a socket, the result of an incorrect connection may be a destroyed DMX controller, a short circuit or 'just' a not working light show!

DMX connections

The unit offers a 3-pin XLR socket for DMX output and a 3-pin XLR plug for DMX input. Please refer to the drawing and table below for the pin assignment of a suitable XLR plug.



Pin	Configuration
1	Ground, shielding
2	Signal inverted (DMX-, 'cold signal')
3	Signal (DMX+, 'hot signal')

10 Troubleshooting



NOTICE!

Possible data transmission errors

For error-free operation make use of dedicated DMX cables and do not use ordinary microphone cables.

Never connect the DMX input or output to audio devices such as mixers or amplifiers.

In the following we list a few common problems that may occur during operation. We give you some suggestions for easy troubleshooting:

Symptom	Remedy
Device not working, no light	Check the mains connection and the main fuse.
Not responding to DMX controller	1. Check the DMX connectors and cables to see if they are properly linked.
	2. Check the address settings and the DMX polarity.
	3. Try using another DMX controller.
	4. Check whether the DMX cables run near or parallel to high-voltage cables that may cause damage or interference to the DMX interface circuit.
The built-in battery can no longer be recharged	Do not attempt to replace the built-in battery yourself. Please contact our service centre.

If the procedures recommended above do not succeed, please contact our Service Center. You can find the contact information at www.thomann.de.

11 Cleaning

Optical lenses

Clean the optical lenses, that are accessible from the outside, regularly in order to optimize the light output. The frequency of cleaning depends on the operating environment: wet, smoky or particularly dirty surroundings can cause more accumulation of dirt on the optics of the device.

- Clean with a soft cloth using our lamp and lens cleaner (item no. 280122).
- Always dry the parts carefully.

Fan grids

The fan grids of the device must be cleaned of any contamination, such as dust, etc. on a regular basis. Before cleaning, switch off the device and disconnect mains-operated devices from the mains. Only use pH-neutral, solvent-free and non-abrasive cleaning agents. Clean the unit with a slightly damp lint-free cloth.

12 Protecting the environment

Disposal of the packaging material



For the packaging, environmentally friendly materials have been chosen that can be supplied to normal recycling.

Ensure that plastic bags, packaging, etc. are properly disposed of.

Do not just dispose of these materials with your normal household waste, but make sure that they are collected for recycling. Please follow the notes and markings on the packaging.

Disposal of batteries



Batteries do contain some hazardous chemicals so they should not be thrown away with the normal household waste. They should be returned to the manufacturer for disposal or recycled elsewhere in accordance with your local regulations.

Dispose lithium batteries only in discharged condition. Remove lithium batteries from the device before disposal. Protect used lithium batteries against potential short circuits, e.g. by covering the poles with adhesive tape. Dispose the built-in lithium batteries together with the device. Please check for an appropriate reception facility.

Disposal of your old device



This product is subject to the European Waste Electrical and Electronic Equipment Directive (WEEE) in its currently valid version. Do not dispose with your normal household waste.

Dispose of this device through an approved waste disposal firm or through your local waste facility. When discarding the device, comply with the rules and regulations that apply in your country. If in doubt, consult your local waste disposal facility.

