

Safety 1st[®]



4358-6979B
2.3.17

Guide 65

convertible car seat

rear-facing child restraint

5-40 lb (2.3-18 kg) and 19-40 in. (48-101.6 cm)

forward-facing child restraint

22-65 lb (10.1-29 kg) and 29-49 in. (73.6-125 cm)
and at least 1 year old

**KEEP INSTRUCTIONS FOR
FUTURE USE.**

Read all instructions
before using this
child restraint.



⚠ WARNING:

Failure to follow the warnings on the labels and in the instruction manual can result in serious injury or death to your child.

Safety 1st[®]

www.safety1st.com

©2016 Dorel Juvenile.

Choosing Rear or Forward Facing

Your child's height, weight, and age determine how your child restraint should be placed in the vehicle.

Please talk to your doctor about the best option for your child.

⚠️ WARNING: Verify your child's weight and height (do not guess) before choosing the child restraint's placement.

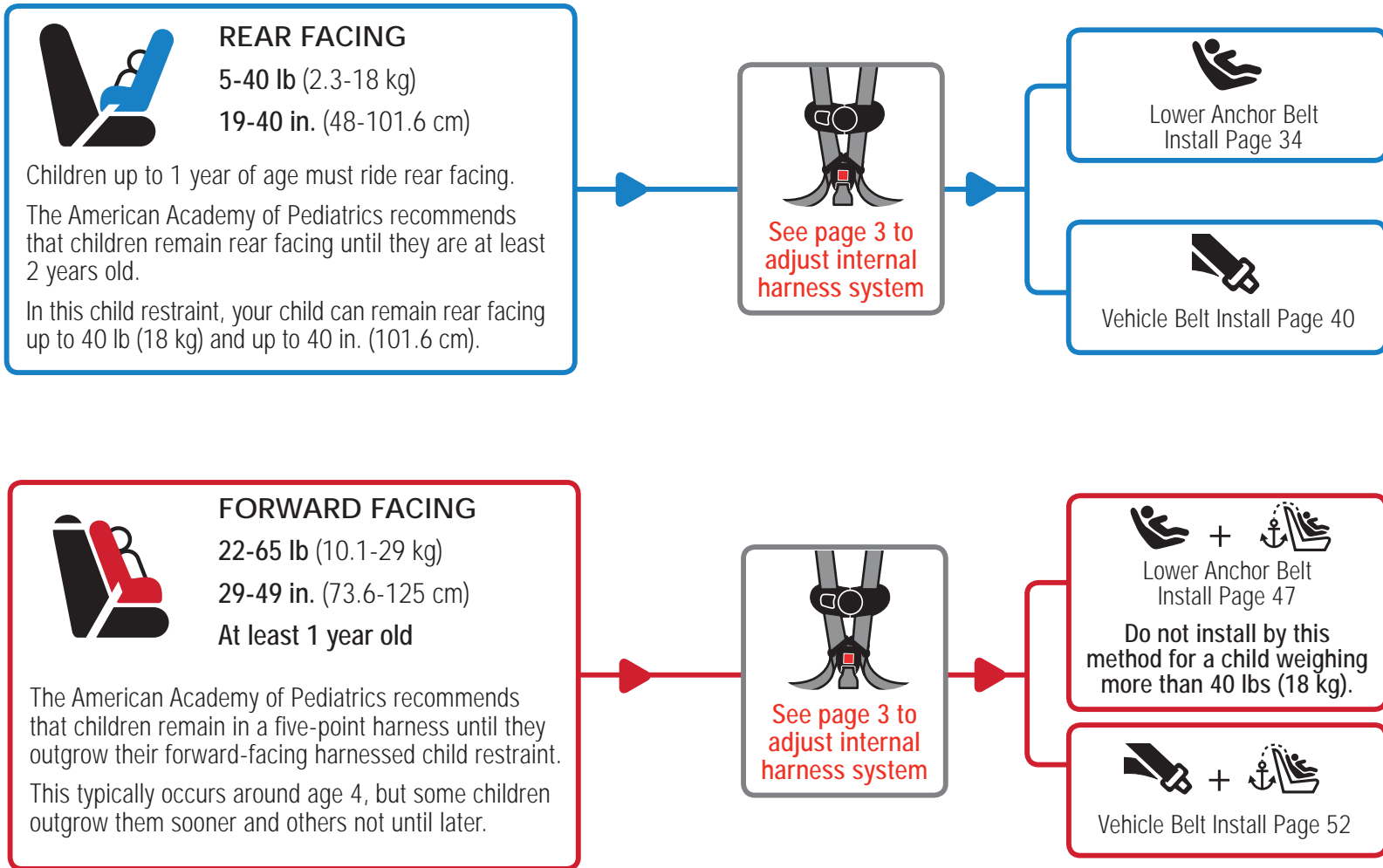











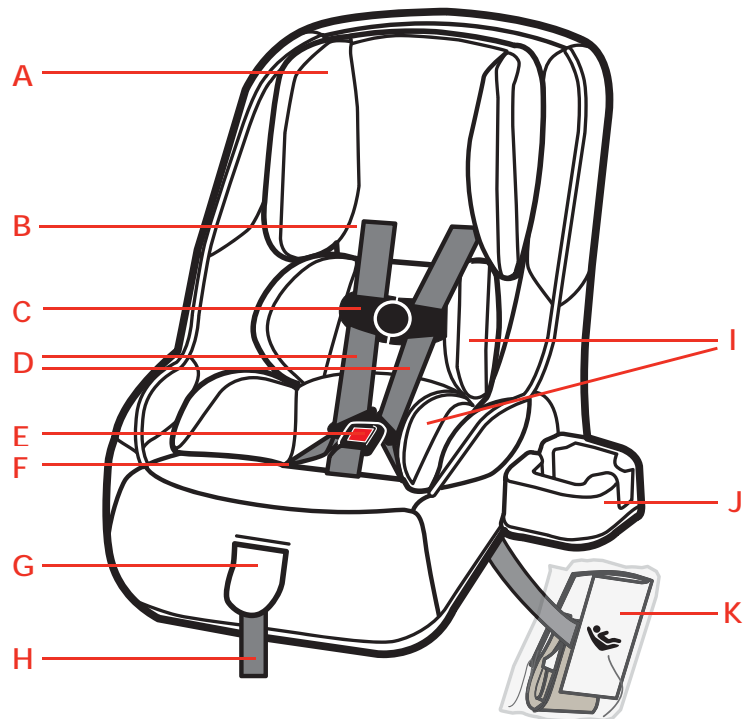

Table of Contents

 Getting Started	1
Parts of the Child Restraint.....	1
Prepare Child Restraint to Fit Your Child	3
How Does Your Child Fit?	5
Changing Position of Buckle.....	6
Adjusting Headrest/Harness Height	8
Securing Child in Child Restraint.....	11
 General Use	14
Reclining Child Restraint.....	14
Removing Harness System.....	15
Removing Seat Pad for Cleaning.....	18
Installing Harness System	20
Accessories on Select Models	23
 Safety Information	24
Child Restraint Use.....	24
Installation in Vehicle	24
Vehicle Seating Position	25
 Vehicle Information	27
Choosing Lower Anchor Belt or Vehicle Belts	27
Knowing Your Vehicle Belts.....	29
Aircraft Information	32
 Rear Facing	33
 Lower Anchor Belt Installation.....	34
 Vehicle Belt Installation	40
 Forward Facing	45
 Tether Use	46
 Lower Anchor Belt Installation.....	47
 Vehicle Belt Installation	52
 Important Information	55
Using a Locking Clip	55
Dorel Juvenile Group Information.....	57
Registration and Safety Notices	58
Troubleshooting.....	59
Replacement Parts Order Form.....	60
Warranty.....	62

Parts of the Child Restraint

Front View



- | | |
|----------------------------------|---|
| A. Adjustable Headrest | G. Harness Release Lever
(through opening in pad) |
| B. Shoulder Harness Slots | H. Harness Adjustment Strap |
| C. Chest Clip | I. Body Pillows |
| D. Harness Strap | J. Cup Holder
(see page 23) |
| E. Buckle | K. Lower Anchor Belt
(see page 27) |
| F. Hip Harness Slots | |

Side View

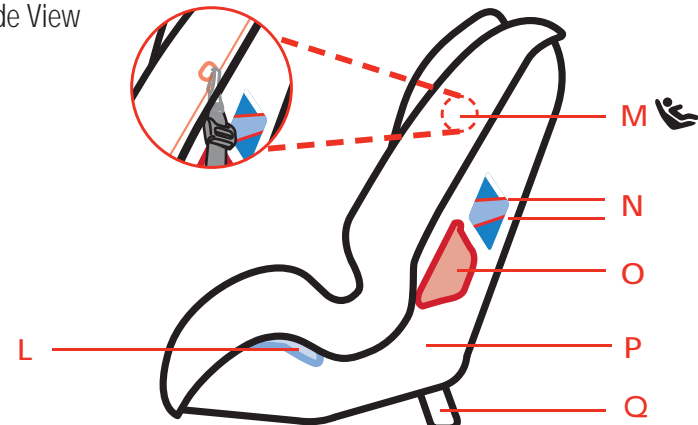

Back View

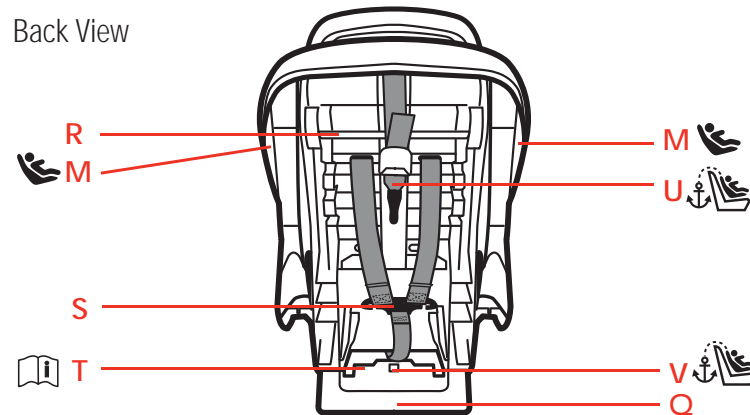

- | | |
|---|--|
| L. Rear-Facing Belt Path | R. Headrest Adjustment Bar |
| M. Lower Anchor Belt Attachment for Storage
(under side of shell) | S. Splitter Plate |
| N. Rear-Facing Level Lines | T. Instruction Manual Storage
(in recline stand) |
| O. Forward-Facing Belt Path | U. Tether (see page 46) |
| P. Shell (child restraint) | V. Tether Attachment for Storage |
| Q. Recline Stand | |

Prepare Child Restraint to Fit Your Child

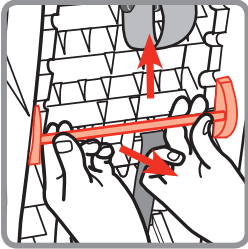

1. Adjust the Headrest to the Highest Position

Squeeze the headrest adjustment bar on the back of the seat towards you.

Slide the headrest all the way up to expose all of the shoulder harness slots.

Make sure it locks into place.

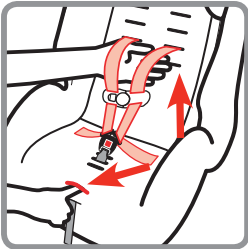
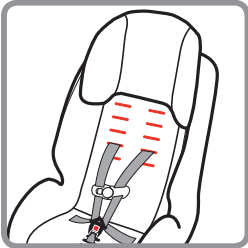

2. Fully Loosen Harness Straps

Push down on harness release lever (through opening in pad) while pulling out on harness straps as shown.



3. Unbuckle Harness

Press in on the red button.

Pull buckle tongues out.

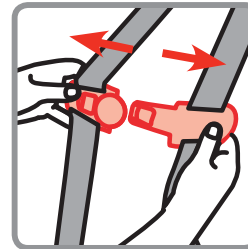

4. Release Chest Clip

Press on chest clip release button and pull apart.

Place harness straps out of the way.

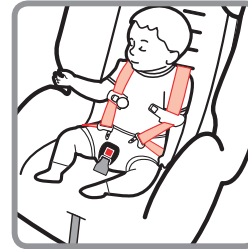

5. Place Child in Child Restraint to Determine Proper Harness Fit

The child's bottom and back should be flat against the child restraint.

See page 5 for fit guidelines.

How Does Your Child Fit?

Use the guidelines below to determine if the buckle and harness straps are in the right place for your child.

REAR FACING

Buckle Position



Start in the 1st slot and adjust outward as your child grows. Buckle should be used in slot closest to your child. The buckle should not be underneath or behind your child. 1st or 2nd slot **MUST** be used.

Harness Strap Position



Harness strap **MUST** be at or slightly below shoulders. Always choose the shoulder harness slots that are closest to your child's shoulder height.

If the lowest shoulder harness slots are above your child's shoulders, do not use this child restraint.

FORWARD FACING

Buckle Position



Start in the 1st slot and adjust outward as your child grows. Buckle should be used in slot closest to your child. The buckle should not be underneath or behind your child. Any slot can be used.

Harness Strap Position



Harness strap **MUST** be at or slightly above shoulders. Always choose the shoulder harness slots that are closest to your child's shoulder height.

If the highest shoulder harness slots are below your child's shoulders, do not use this child restraint.

To make changes to the buckle, see pages 6-7.

To adjust headrest/harness height, see pages 8-10.

Changing Position of Buckle

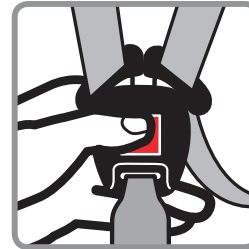

1. Unbuckle Harness

Press in on the red button.

Pull buckle tongues out.

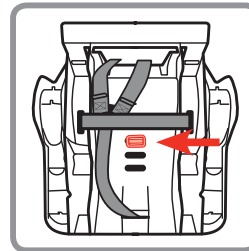

2. Turn Seat Over

Locate buckle's metal retainer on bottom of shell.

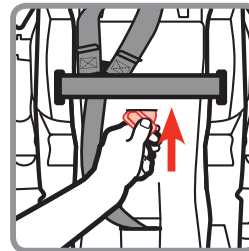

3. Rotate Metal Retainer and Push It Up Through Shell and Pad

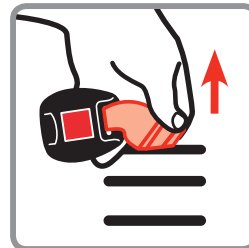

4. From Top of Seat, Pull Buckle Out of Shell and Pad

Adjusting Headrest/Harness Height

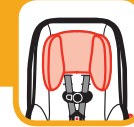

5. Insert Buckle's Metal Retainer into Slot Closest to Child

Buckle **MUST** face out.

You **MUST** use the 1st or 2nd buckle slots when child restraint is used rear facing.

Any slot can be used when forward facing.



6. Pull Metal Retainer Completely Through Pad and Shell

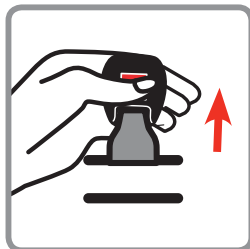

7. Check Buckle

Pull up on buckle to make sure it is secured.

The buckle **MUST** not pull out.

⚠ WARNING: Failure to place buckle's metal retainer completely through pad and shell can result in serious injury or death.

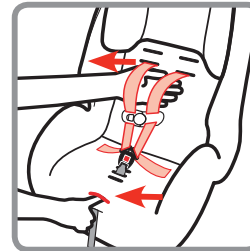

1. Fully Loosen Harness Straps

Push down on harness release lever (through opening in pad) while pulling out on harness straps as shown.

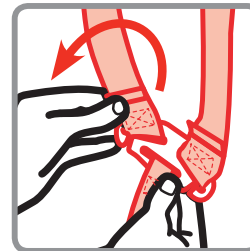

2. From Back, Remove Harness Strap Loops From Splitter Plate

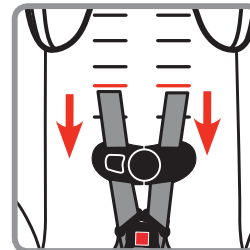

3. Pull Harness Strap Out of Shoulder Harness Slots

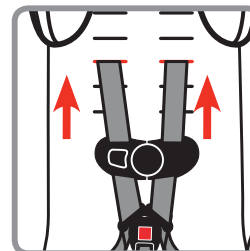

4. Rethread Harness Strap Into Correct Shoulder Harness Slots For Your Child

See page 5 for fit guidelines.

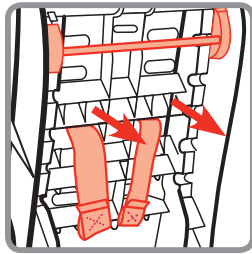

5. From the Back, Pull Harness Strap Through Pad and Shell

Harness strap **MUST** be under the headrest adjustment bar as shown. **DO NOT** twist harness strap.

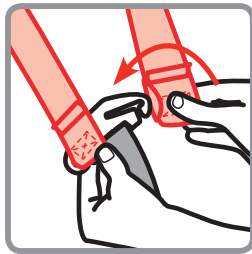

6. Attach Harness Strap Loops to Splitter Plate

Sewn ends of the harness strap loops **MUST** face towards you. **DO NOT** twist harness strap or harness adjustment strap.

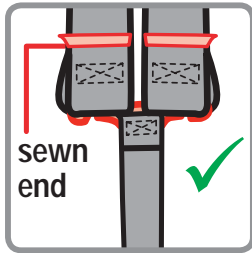

Make sure the harness strap loops are fitted **COMPLETELY ON** both sides of the splitter plate.



7. Place Child in Child Restraint to Determine Headrest Position

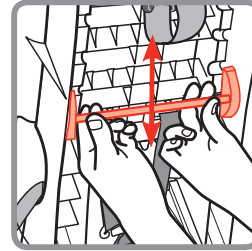

8. Adjust the Headrest

Squeeze the headrest adjustment bar on the back of the seat towards you.

Raise or lower the headrest to position it behind your child's head.

Make sure the metal bar is locked into position and above the harness strap.



⚠ WARNINGS: Make sure that the harness height is correct for your child's size.



Do not use this child restraint rear facing unless the top of your child's head is at least 1 in. (2.5 cm) below the top of the child restraint's headrest.

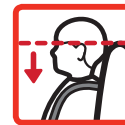

Do not use this child restraint forward facing if the tops of your child's ears are above the top of the child restraint's headrest.

Failure to follow these steps can result in serious injury or death.



Securing Child in Child Restraint



1. Place Child in Child Restraint

The child's bottom and back should be flat against the child restraint.

Position harness straps over child's shoulders and upper thighs.



2. Buckle Harness

Push buckle tongues into buckle until you hear a "click."

Pull up on harness straps to make sure buckle is locked.

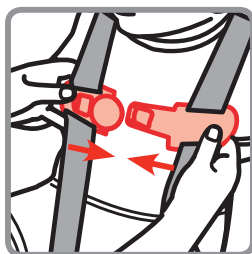

3. Close Chest Clip

Insert right half of chest clip into left half and snap together.

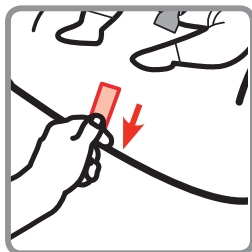

4. Tighten Harness

Pull on harness adjustment strap to tighten harness snugly.



5. Position Chest Clip

The chest clip must be placed at mid-chest (even with armpits) and away from the child's neck.

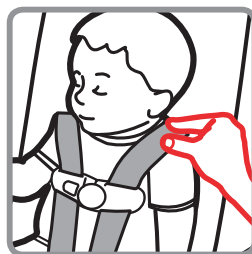

6. Check Harness Tightness

Try to pinch the harness at the shoulders vertically between index finger and thumb as shown.

If your fingers slip off, the harness is tight enough.

If you can pinch the harness strap, tighten more.

The harness strap should be snug throughout its length.

A snug strap should not allow any slack. It lies in a relatively straight line without sagging. It does not press on the child's flesh or push the child's body into an unnatural position.

Reclining Child Restraint



⚠ WARNINGS: Failure to fasten and tighten the harness system correctly may allow the child to be ejected from the child restraint in a crash or sudden stop causing serious injury or death.

Do not mistake comfort for safety. Harness system must be snugly adjusted.



DO NOT put snowsuits or bulky garments on your child when placing them in the child restraint.

Bulky clothing can prevent the harness straps from being tightened properly.

To Remove Child From Child Restraint:

1. Loosen Harness Strap
2. Unbuckle Harness
3. Release Chest Clip
4. Remove Child

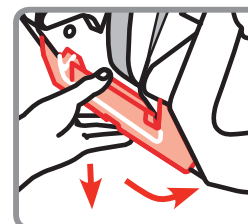
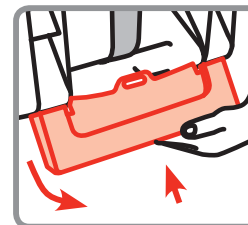
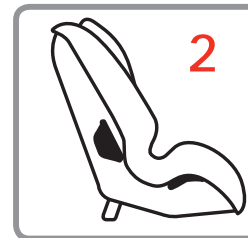
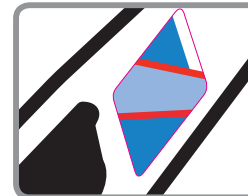
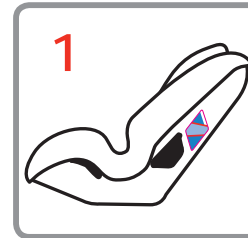

This child restraint has 2 positions:

Rear Facing - 1

For children between 5-22 lb (2.3-10 kg), the bottom level line on shell **MUST** be parallel with the ground.

For children 22-40 lb (10.1-18 kg) who can sit up unassisted, rotate the child restraint between the 2 level lines.

Forward Facing - 2 Upright

How to Change Positions

Upright

Rotate recline stand out and push upward to lock in position.

To Recline

Pull recline stand down and rotate under child restraint.



Removing Harness System

Only remove the harness system to clean the seat pad.

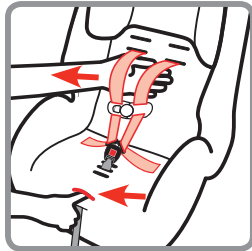

1. Fully Loosen Harness Straps

Push down on harness release lever (through opening in pad) while pulling out on harness straps as shown.



2. From Back, Remove Harness Strap Loops From Splitter Plate

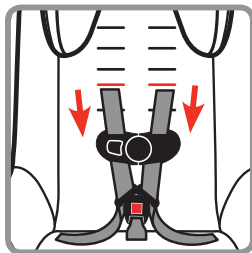

3. Pull Harness Strap Out of Shoulder Harness Slots

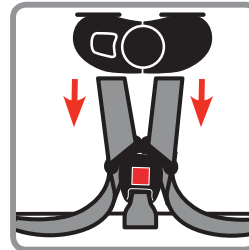

4. Unthread Chest Clip

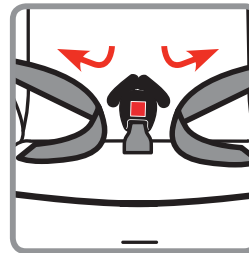

5. Unthread Buckle

Do not unbuckle.

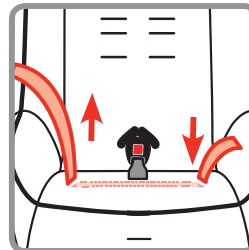

6. Pull Harness Strap Out of Seat

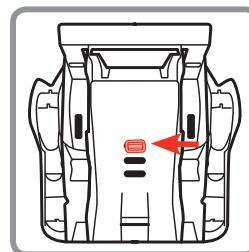

7. Turn Seat Over

Locate buckle's metal retainer on bottom of shell.

Removing Seat Pad for Cleaning

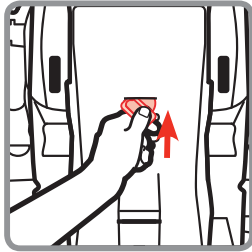

8. Rotate Metal Retainer and Push It Up Through Shell and Pad



9. From Top of Seat, Pull Buckle Out of Shell and Pad

You must remove the harness system to remove the pad from the shell. See pages 15-17.

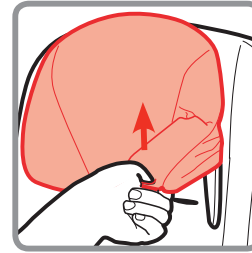

1. Pull Headrest Pad Off Bottom of Headrest As Shown

Remove headrest pad from shell.



2. Release Elastic Straps from Tabs on Back and Bottom of Shell As Shown

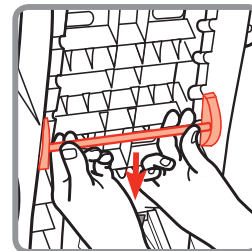
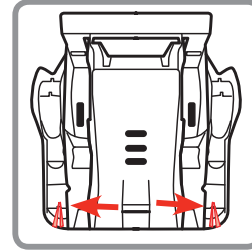

3. Adjust the Headrest to the Lowest Position

Squeeze the headrest adjustment bar on the back of the seat towards you.

Slide the headrest all the way down. Make sure it locks into place.

Installing Harness System

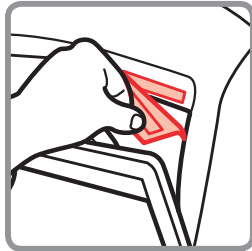

4. Undo Fastening Strip Behind Headrest

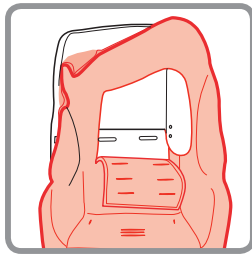

5. Remove Pad
Pull pad off the top of child restraint, around the headrest, and remove pad.

⚠ WARNINGS: Do not use child restraint without the seat pad. Failure to do this can result in serious injury or death.

Cleaning Pad and Accessories

Machine wash separately with cold water on a gentle cycle. Do not use bleach. Tumble dry separately for 10-12 minutes on low heat. Remove immediately.

Cleaning Harness Straps

Spot clean using warm sudsy water and damp cloth.

Replace Pad

Adjust the headrest to the highest position. Starting from the bottom, gently pull headrest pad onto headrest.

Starting from bottom of child restraint, slip pad on shell. Pull harness adjustment strap through pad. Wrap pad around the top of shell. Attach fastening strip. Attach elastic straps. Install harness system, see pages 20-22.

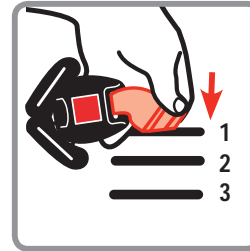

1. Insert Buckle's Metal Retainer into Slot Closest to Child

Buckle **MUST** face out.

You **MUST** use the 1st or 2nd buckle slot when child restraint is used rear facing.

Any slot can be used when forward facing.

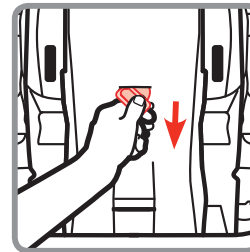

2. Pull Metal Retainer Completely Through Pad and Shell



3. Check Buckle

Pull up on buckle to make sure it is secured.

The buckle **MUST** not pull out.

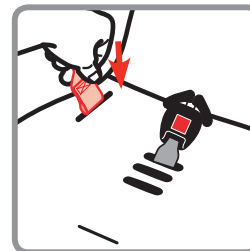

4. Thread Harness Strap

With sewn end of harness strap loop facing the buckle, thread harness strap down through hip harness slot.

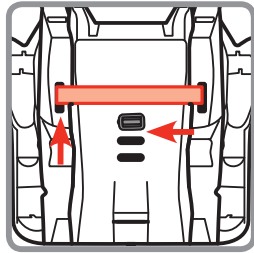

5. Pull Harness Strap Across Bottom of Shell

Push harness strap up through other hip harness slot.

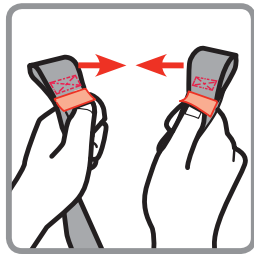

6. Make Harness Strap Even

Sewn ends of harness strap loops **MUST** face each other.

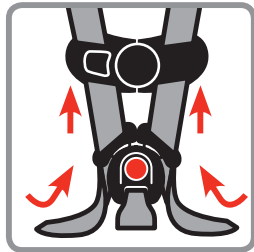

7. Thread Buckle and Chest Clip

Harness strap ends go through the back of buckle tongues and through the chest clip front to back as shown.

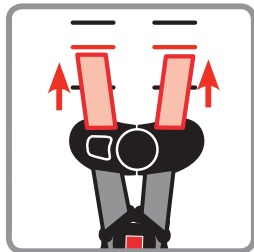

8. Thread Harness Straps into Correct Shoulder Harness Slots for Your Child

See page 5 for fit guidelines.

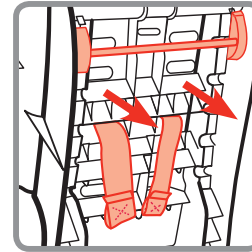

9. From the Back, Pull Harness Strap Through Pad and Shell

Harness strap **MUST** be under the headrest adjustment bar as shown.

DO NOT twist harness strap.

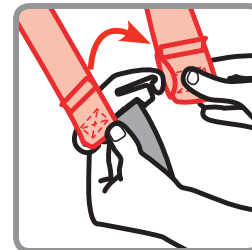

10. Attach Harness Strap Loops to Splitter Plate

Sewn ends of the harness strap loops **MUST** face towards you.

Harness adjustment strap and splitter plate **MUST** be behind the harness strap as shown.

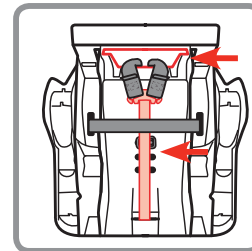

Harness strap loop ends **MUST** go through the recline stand as shown.

DO NOT twist harness straps or harness adjustment strap.

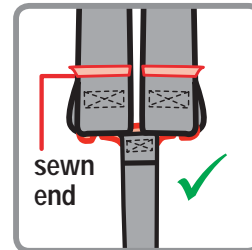

Correct

⚠ WARNINGS: Harness system must be installed correctly. Failure to follow these warnings can result in serious injury or death.



Accessories on Select Models

Child Restraint Use

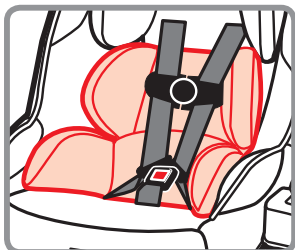

Body Pillows

To remove body pillows, slide out from behind the harness strap.

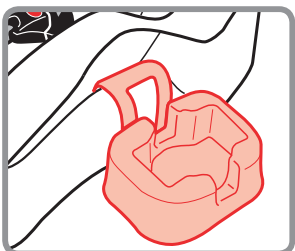

Cup Holder

Pull pad off corner. Hook bottom of cup holder to edge of shell.
Rotate cup holder up until it snaps into the hole on the shell.
Replace pad.

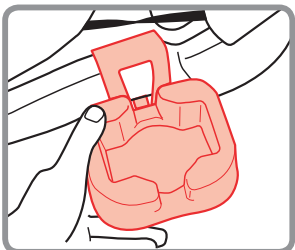

Cup holder can be on either side.

Never take your child out of the child restraint while the vehicle is moving.

Never leave child unattended.

Placing your child in a hot child restraint may result in burns.

Do not use a child restraint with damaged or missing parts.

Do not use cut, frayed or damaged harnesses.

Do not substitute parts or try to modify the child restraint in any way.

Do not lubricate buckles and fasteners.

Do not use any child restraint accessory except those approved by Dorel Juvenile Group.

Never allow any child to play with this child restraint; it is not a toy.

Do not remove or cover up any of the warning labels or other labels on the child restraint.

Read all instructions for additional warnings.

On the side of the child restraint there is a date of manufacture label. Do not use this child restraint more than 8 years after the date of manufacture.

Installation in Vehicle

Check the vehicle belt or lower anchor belt before each use. Use only if the belt is tightened properly and locked securely in place.

This child restraint should be securely belted in the vehicle even when not in use. In a crash or sudden stop, an unsecured child restraint could injure occupants.

Do not use a child restraint that has been in a crash. You must get a new child restraint.



Vehicle Seating Position



Never place a child rear facing in a seating position with an active frontal air bag.



Check the vehicle owner's manual for more information about air bag/child restraint use.



Use the child restraint only on vehicle seats that face forward.

Do not use on seats that face the sides or rear of the vehicle.

Use the center seating position if possible.

For vehicles without a back seat, refer to your vehicle owner's manual.

If you are not sure where to place the child restraint in your vehicle, consult your vehicle owner's manual, contact Dorel Juvenile Group Consumer Care Department, or visit your local Child Passenger Inspection Station. Go to <http://www.safercar.gov/cpsApp/cps/index.htm> to find your closest station.



Children are safer when properly restrained in rear seating positions than in the front seating positions.

According to National Highway Traffic Safety Administration information, children in rear seating positions are statistically safer, whether you have air bags, advanced air bags, or no air bags at all.

To avoid your child being seriously burned, take the following precautions:

1. Park in the shade or where sun does not directly hit the child restraint.
2. Cover the child restraint with a sheet or blanket when not in use.
3. Check for hot seat and buckles before placing child in child restraint.

To help protect your vehicle seat's upholstery from damage, use a single layer towel underneath and behind child restraint.



Choosing Lower Anchor or Vehicle Belts

Your vehicle's features may be considerably different than those pictured here.

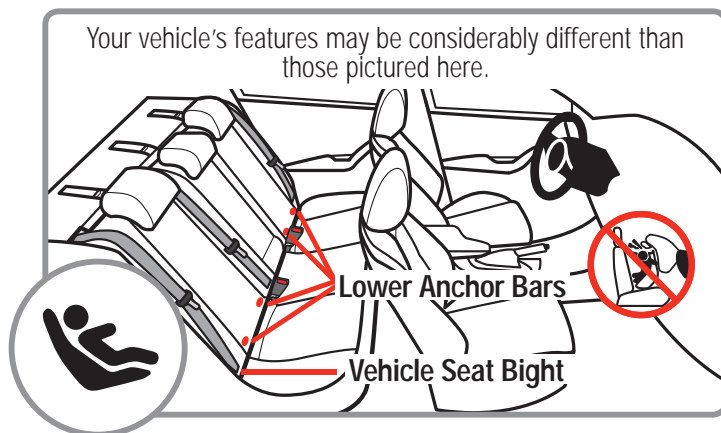

The LATCH System

The lower anchors of LATCH (Lower Anchors and Tethers for Children) is a universal system for installing child restraints without using vehicle seat belts.

The lower anchor system can **ONLY** be used in vehicles that have the lower anchor bars installed in designated LATCH seating positions. Most vehicles manufactured after September 2002 are equipped with lower anchor bars. Check your vehicle owner's manual to see which seating positions may be equipped with the LATCH system.

When installing with vehicle belts, the lower anchor hooks and belt MUST be properly stored.

To store the lower anchor belt on this child restraint: Thread lower anchor belt through forward-facing belt path. Then attach hooks to attachments behind pad as shown. Gently pull free end of belt to remove slack.

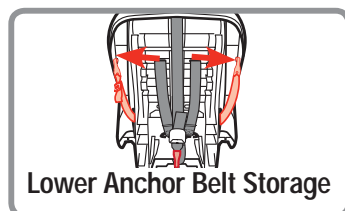
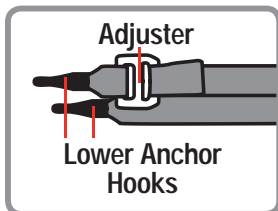

Your vehicle's features may be considerably different than those pictured here.

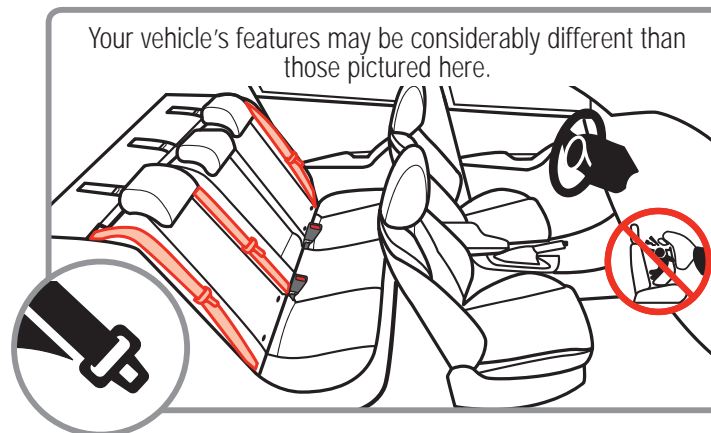

Vehicle Belts

If lower anchors are not an option or if your child weighs more than 40 lb (18 kg), you must use the vehicle seat belt system to install the child restraint.

There are some vehicle belts that will not work with a child restraint or will require special attention. Check your vehicle owner's manual for specific instructions.

⚠ WARNINGS: When used correctly the lower anchor belt or vehicle belts are equally safe. Do not use both the lower anchor belt and vehicle belt at the same time.



Knowing Your Vehicle Belts

Not all vehicle belts and seating positions will work with child restraints. Please follow the following steps to understand how to lock a child restraint with a vehicle belt.

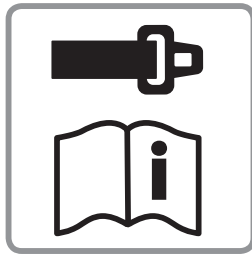

1. You **MUST** Review Your Vehicle Owner's Manual

Your vehicle owner's manual will let you know what vehicle belts and seating positions child restraints can be installed in.



2. Determine How the Child Restraint Will Be Locked Into Place

The vehicle belt **MUST NOT** loosen after tightening.

This means there needs to be a way to lock the vehicle belt.

The ways this can be done are:

- By using the seat belt's retractor;
- By using the seat belt's latch plate.

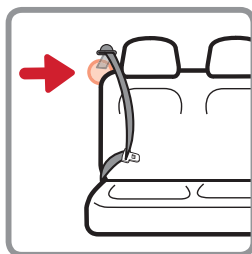

3. Check the Retractor

Retractors pull seat belts into stored positions and lock the belt to hold passengers in place.

A retractor is most likely how you will be locking a child restraint into place.

See the next page for some common types of vehicle belt retractors that will work with this child restraint.

Types of Retractors

Switchable Retractor (most vehicles have this type)



This retractor can be switched to a locking mode.

You **MUST** have the retractor in the locking mode to use the seat belt with this child restraint.

Switching to locking mode: Slowly pull the shoulder belt all the way out, then let it go back in an inch or two.

As it goes back in, you will most likely hear a ratcheting sound.

Gently pull the belt to see if it has locked. You will not be able to pull any more belt out if the lock has engaged.

Automatic Locking Retractor



This retractor always locks.

It will automatically lock after slowly pulling the seat belt out at least halfway and letting the belt go back into the retractor an inch or two.

Emergency Locking Retractor

See Step 4, "Check the Latch Plates," on next page.

If the retractor does not lock, it is most likely an Emergency Locking Retractor. These retractors only lock during a sudden stop or collision.

You will need to determine if your seat belt's latch plate can lock the belt. See Step 4, "Check the Latch Plates," on next page.



4. Check the Latch Plates

Latch plates are the part of the seat belt that goes into the buckle.

Hold the lap belt with one hand and with your other hand grasp the tongue of the latch plate (the part that goes inside the buckle). Pull the latch plate straight out in line with the lap belt.

If the latch plate does not slide up and down the vehicle belt, it is a **locking latch plate**.

If the latch plate slides up and down the vehicle belt, it is a **sliding latch plate**.

Sliding latch plates easily slip between the lap and shoulder portions of the belt.

If you have an Emergency Locking Retractor with a Sliding Latch Plate, you **MUST** use a locking clip to install the child restraint. See pages 55-56.

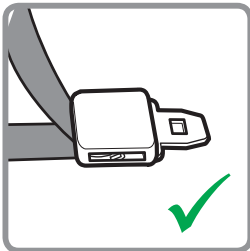

Locking Latch Plate

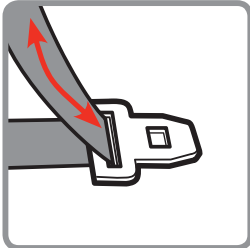

Emergency Locking Retractor with a Sliding Latch Plate

Never Use With This Child Restraint	
Emergency Locking Retractor Lap Only Belt	✘
Inflatable Seat Belts	✘

This restraint is certified for aircraft use.

Install the child restraint in a window seat to avoid blocking the aisle. If the aircraft lap belt is too short, ask the flight attendant for a belt extender.

Use only on forward facing aircraft seats.

Contact the airline for their specific policies.

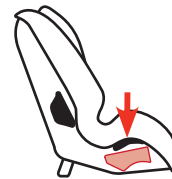

Some airlines may ask to see a label stating that this child restraint is certified for aircraft use.

There is an airplane certification label located on the side of this child restraint as shown.

⚠ WARNING: Store the lower anchor belt and tether strap when using the aircraft belts.



Rear Facing Aircraft Installation

For rear facing installation follow pages 40-44.



Forward Facing Aircraft Installation

For forward facing installation follow pages 52-54.



5-40 lb (2.3-18 kg)
19-40 in. (48-101.6 cm)

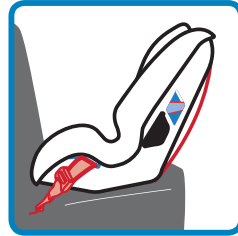

Lower Anchor Belt



Lap Belt



Lap/Shoulder Belt



⚠ WARNINGS: Never place a child rear facing in a seating position with an active frontal air bag. This can result in serious injury or death.

This child restraint **MUST** always face the rear of the vehicle when the child is less than 1 year old.

The American Academy of Pediatrics recommends that children remain rear facing until they are at least 2 years old.

Please talk to your doctor about the best option for your child.

⚠ WARNINGS: Do not use the lower anchor belt along with the vehicle lap or lap/shoulder belt.

Check the lower anchor belt before each use. Use only if the belt can be tightened properly and securely.

Do not fasten multiple lower anchor hooks on the same lower anchor bar in the vehicle.

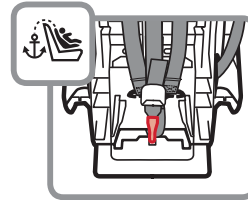

Store the tether hook when used rear facing. Attach the tether hook to storage attachment as shown.

Failure to follow these warnings can result in serious injury or death.

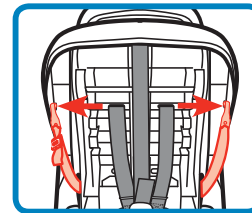

1. Remove Lower Anchor Belt from Storage Location

Pull the lower anchor belt out of the forward-facing belt path so both hooks are on the same side of the seat as shown.

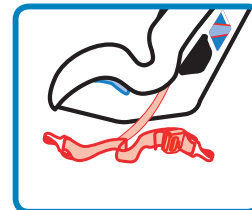

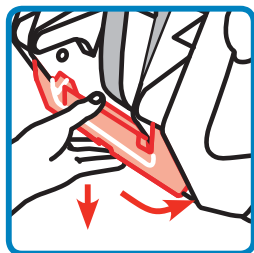

2. Pull Down Recline Stand to Unlock and Fold It Under Child Restraint

NOTE: Loosely attach the tether hook to the storage location before folding recline stand.

Fold recline stand and then gently tighten tether strap to remove slack.

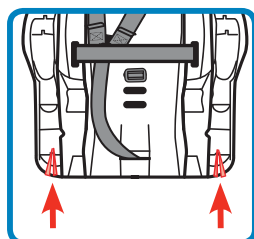

3. Release Elastic Straps From Tabs on Bottom of Shell and Pull Seat Pad Off the Front of the Shell

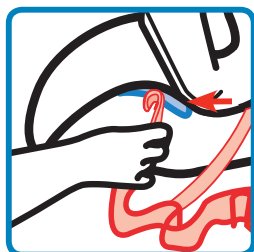
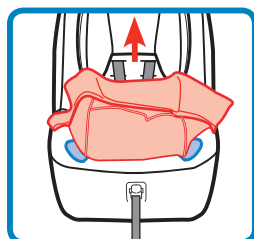

4. Route Lower Anchor Belt Through Rear-Facing Belt Path

The lower anchor belt adjuster can be on either side.

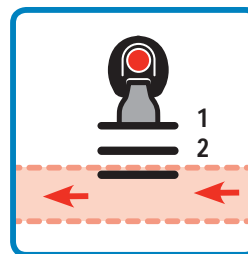

5. Pull Lower Anchor Belt Across to Opposite Side

Do not twist belt.

Belt **MUST** be in front of buckle strap and under seat pad.

You **MUST** use the 1st or 2nd buckle slot.

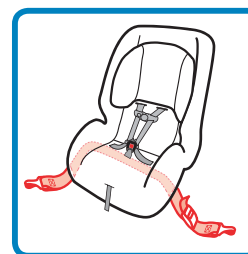

6. Finished Lower Anchor Belt Routing

Replace pad around front of shell and attach elastic straps to tabs on bottom of shell.

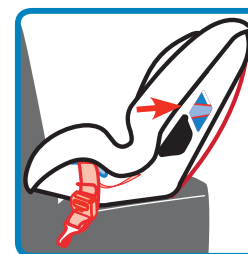

7. Place Child Restraint Rear Facing in Back Seat

For children between 5-22 lb (2.3-10 kg), the bottom level line on shell **MUST** be parallel with the ground.

For children 22-40 lb (10.1-18 kg) who can sit up unassisted, rotate the child restraint between the 2 level lines.

Start by making the bottom level line parallel with the ground, then rotate seat up. **Do not** rotate past the top level line.

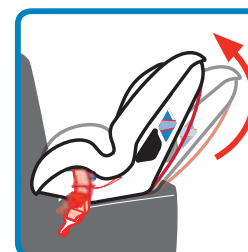



8. Attach Lower Anchor Hooks to Vehicle's Lower Anchors

Review your vehicle owner's manual for lower anchor locations and lower anchor belt use.

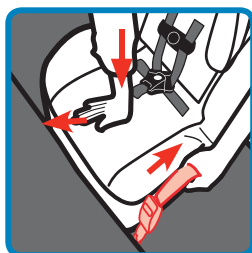

9. Tighten Belt

Place hand in child restraint. Firmly push the child restraint down and towards the vehicle seat back while pulling the free end of the belt to tighten.

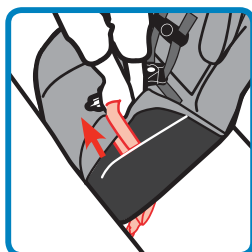

It may be easier to pull back the pad and pull the free end of the belt parallel with the belt path as shown.

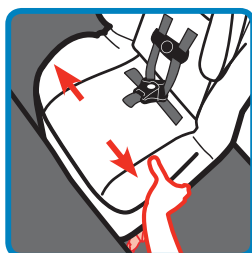

10. Check Belt Tightness

Hold child restraint at the belt path with your weakest hand. Push and pull from side to side. It should not move more than 1 in. (2.5 cm).

If it moves more than 1 in. (2.5 cm), you can try:

- A. Pulling the belt tighter.
- B. Reinstalling the child restraint.
- C. Changing to a different seating location.
- D. Switching to vehicle belt installation.



11. Secure Child in Child Restraint

See pages 11-13.

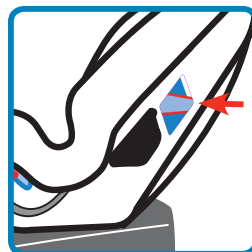

12. Recheck Level Lines

Make sure the child restraint is reclined according to your child's weight.

Repeat steps 7-12 if not reclined correctly.

You may need to place a large rolled towel(s) or foam pool noodle(s) under front of child restraint to help achieve the correct recline angle.

Check often to be sure padding is still in place and the belt is tight.

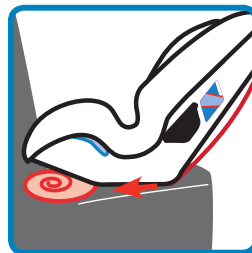

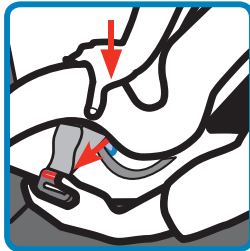

To Release Lower Anchor Belt

Remove child from child restraint.

Remove tension from the lower anchor belt by pushing down on side of child restraint with the lower anchor belt adjuster. Then press the adjuster button to loosen belt.



Unhook from anchor by squeezing spring lever on hook, pushing hook back into the seat bight, and twisting. Then pull it out of the vehicle seat.

Store lower anchor belt when not in use. See page 27.

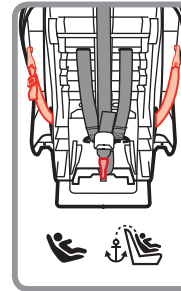

⚠ WARNINGS: Do not use the lower anchor belt along with the vehicle lap or lap/shoulder belt. Secure the lower anchor hooks to storage attachments as shown when installing with vehicle belts.

Store the tether hook when used rear facing. Attach the tether hook to storage attachment as shown.

Check the vehicle belt before each use. Use only if the belt can be tightened properly and locked securely in place.

Failure to follow these warnings can result in serious injury or death.

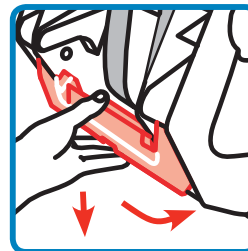

1. Pull Down Recline Stand to Unlock and Fold It Under Child Restraint

NOTE: Loosely attach the tether hook to storage location before folding recline stand. Fold recline stand and then gently tighten tether strap to remove slack.



2. Place Child Restraint Rear Facing in Back Seat

For children between 5-22 lb (2.3-10 kg), the bottom level line on shell **MUST** be parallel with the ground.

For children 22-40 lb (10.1-18 kg) who can sit up unassisted, rotate the child restraint between the 2 level lines.

Start by making the bottom level line parallel with the ground, then rotate seat up. **Do not** rotate past the top level line.



3. Check if Your Vehicle Belts Will Work With This Child Restraint

This is very important because **not all vehicle belts will work with child restraints.**

Review pages 29-31 and your vehicle owner's manual to determine what kind of vehicle belt you have and how to lock a child restraint in place.

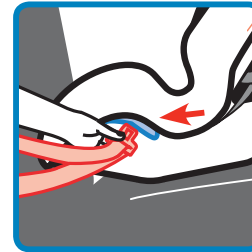

4. Route Vehicle Lap or Lap/Shoulder Belt Through Rear-Facing Belt Path

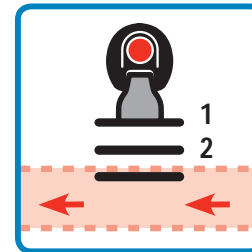

5. Pull Vehicle Belt Across to Opposite Side

Do not twist belt.

Belt **MUST** be in front of buckle strap and under seat pad.

You **MUST** use the 1st or 2nd buckle slot.

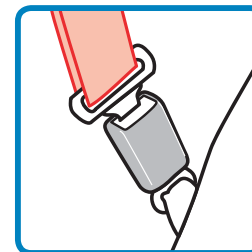

6. Buckle Vehicle Belt

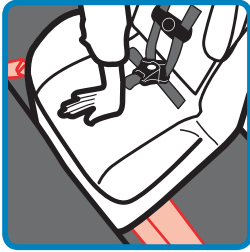

7. Tighten Belt

Place hand in child restraint.
Firmly push the child restraint down and towards the vehicle seat back while pulling the shoulder belt or the free end of lap belt down and towards you as shown.

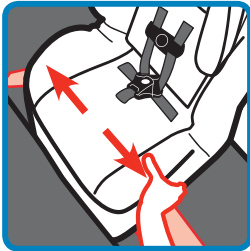
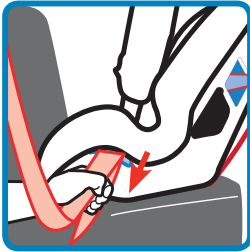

8. Check Belt Tightness

Hold child restraint at the belt path with your weakest hand.
Push and pull from side to side.
It should not move more than 1 in. (2.5 cm).

If it moves more than 1 in. (2.5 cm), you can try:

- A. Pulling the belt tighter.
- B. Reinstalling the child restraint.
- C. Changing to a different seating location.
- D. Switching to the lower anchor belt installation if lower anchors are available in your vehicle.



9. Secure Child in Child Restraint

See pages 11-13.

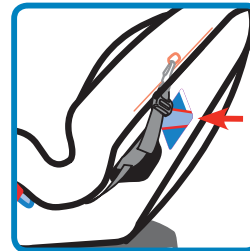

10. Recheck Level Lines

Make sure the child restraint is reclined according to your child's weight.

Repeat steps 2-10 if not reclined correctly.

You may need to place a large rolled towel(s) or foam pool noodle(s) under front of child restraint to help achieve the correct recline angle.

Check often to be sure padding is still in place and the belt is tight.

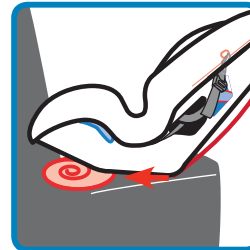



Forward Facing

Tether Use



22-65 lb (10.1-29 kg)
29-49 in. (73.6-125 cm)
At least 1 year old





Lower Anchor Belt with Tether
Do not install by this method for a child weighing more than 40 lbs (18 kg).



Lap Belt with Tether up to 65 lb (29 kg)



Lap/Shoulder Belt with Tether up to 65 lb (29 kg)

⚠️ WARNINGS: In this child restraint your child **MUST** be at least 1 year old before they sit forward facing.

The American Academy of Pediatrics recommends that children remain rear facing until they are at least 2 years old and remain in a five-point harness until they outgrow their forward-facing harnessed child restraint.

Please talk to your doctor about the best option for your child.

You **MUST** always attach, adjust, and secure the top anchorage (tether) strap when installing the child restraint forward facing with internal harness. Tethers improve the installation and stability of child restraints and reduce the risk of injury. Attach the tether hook to the tether anchor designated by your vehicle manufacturer for that seating position. Check your vehicle owner's manual for more information.

If the seating position does not have a tether anchor, use a different seating position or see your dealer or a qualified mechanic and have one installed.

⚠️ WARNING: Do not fasten multiple tether hooks on the same tether anchor in the vehicle.

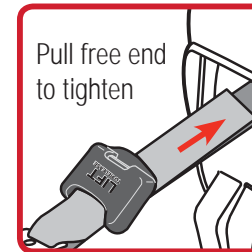

Adjusting Tether Strap

To tighten: After the child restraint is locked into place with lower anchor belt or vehicle belt, push down on child restraint and gently pull on free end of tether.

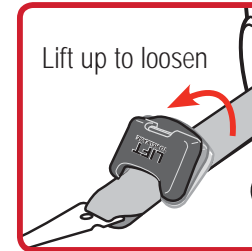

To loosen: Lift up on tether lock adjuster and push it towards tether hook.

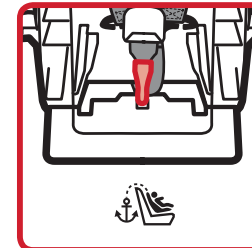

Storing Tether Strap

When installing rear facing or when not in use, attach the tether hook to its storage attachment on the recline stand as shown. Gently tighten to remove slack.



Lower Anchor Belt Installation

⚠ WARNINGS: Do not use the lower anchors of the child restraint anchorage system (LATCH system) to attach this child restraint when restraining a child weighing more than 40 lbs (18 kg).

The vehicle belt must be used for installation if your child weighs more than 40 lb (18 kg).

Do not use the lower anchor belt along with the vehicle lap or lap/shoulder belt.

Check the lower anchor belt before each use.

Use only if the belt can be tightened properly and securely.

Do not fasten multiple lower anchor hooks on the same lower anchor bar in the vehicle.

Failure to follow these warnings can result in serious injury or death.

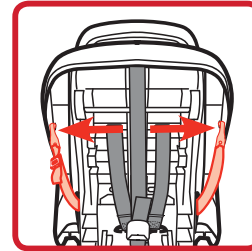

1. Remove Lower Anchor Belt from Storage Location

Or if the lower anchor belt was used rear facing, pull it out of the rear-facing belt path so both hooks are on the same side of the seat as shown.

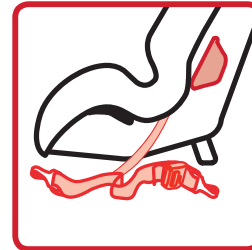

2. Route Lower Anchor Belt Through Forward-Facing Belt Path

Do not twist belt.

The lower anchor belt adjuster can be on either side.

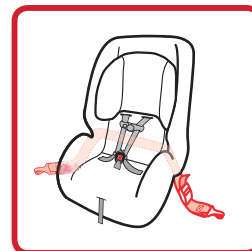
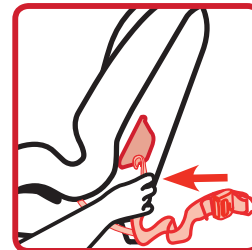

3. Finished Lower Anchor Belt Routing

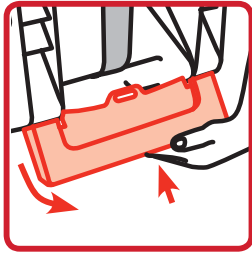

- 4. Rotate Recline Stand Out and Push Upward to Lock**



- 5. Place Child Restraint Forward Facing Flush Against Vehicle Seat Back**

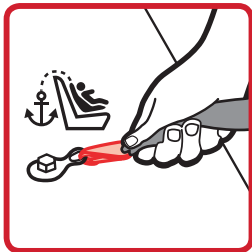

- 6. Loosely Attach Tether Hook to Vehicle's Tether Anchor**
Check vehicle owner's manual for specific location.



- 7. Attach Lower Anchor Hooks to Vehicle's Lower Anchors**

Review your vehicle owner's manual for lower anchor locations and lower anchor belt use.

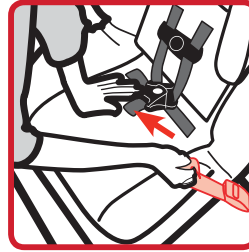

- 8. Tighten Belt**

Place hand in child restraint. Firmly push the child restraint down while pulling the free end of belt to tighten.



It may be easier to pull back the pad and pull the free end of the belt parallel with the belt path as shown.

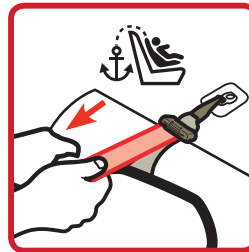

- 9. Tighten Tether**

Push firmly on the back of the seat and pull the tether strap to remove all slack and create tension on the strap.

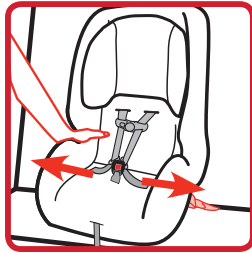

10. Check Belt Tightness

Hold child restraint at the belt path with your weakest hand. Push and pull from side to side. It should not move more than 1 in. (2.5 cm).

If it moves more than 1 in. (2.5 cm), you can try:

- A. Putting your knee in the seat and pulling the belt tighter.
- B. Reinstalling the child restraint.
- C. Changing to a different seating location.
- D. Switching to vehicle belt installation.



To Release Lower Anchor Belt

Remove child from child restraint.

Remove tension from the lower anchor belt by pushing down on side of child restraint with the lower anchor belt adjuster. Then press the adjuster button to loosen belt.

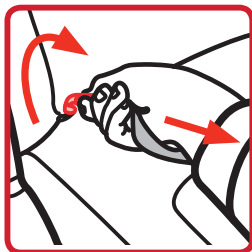

Unhook from anchor by squeezing spring lever on hook, pushing hook back into the seat bight, and twisting. Then pull it out of the vehicle seat.

Store lower anchor belt when not in use. See page 27.

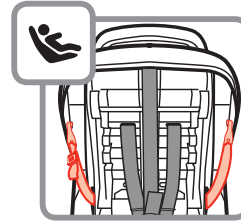

⚠ WARNINGS: Do not use the lower anchor belt along with the vehicle lap or lap/shoulder belt. Secure the lower anchor hooks to storage attachments as shown when installing with vehicle belts.

Check the vehicle belt before each use. Use only if the belt can be tightened properly and securely.

Failure to follow these warnings can result in serious injury or death.

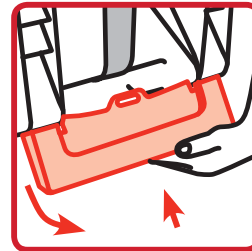

1. Rotate Recline Stand Out and Push Upward to Lock

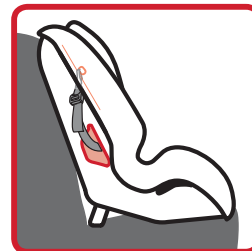

2. Place Child Restraint Forward Facing Flush Against Vehicle Seat Back



3. Loosely Attach Tether Hook to Vehicle's Tether Anchor

Check vehicle owner's manual for specific location.



4. Check if Your Vehicle Belts Will Work With This Child Restraint

This is very important because **not all vehicle belts will work with child restraints.**

Review pages 29-31 and your vehicle owner's manual to determine what kind of vehicle belt you have and how to lock a child restraint in place.

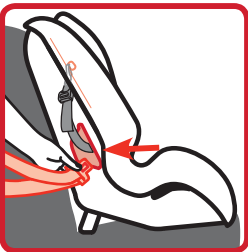

5. Route Vehicle Lap or Lap/Shoulder Belt Through Forward-Facing Belt Path

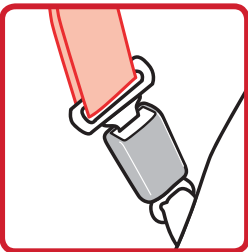

6. Buckle Vehicle Belt

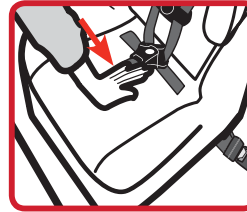

7. Tighten Belt

Place hand in child restraint.

Firmly push the child restraint down while pulling the shoulder belt or the free end of lap belt towards you as shown.

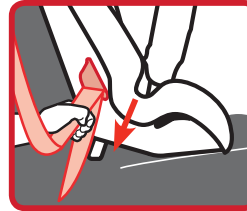

8. Tighten Tether

Push firmly on the back of the seat and pull the tether strap to remove all slack and create tension on the strap.



9. Check Belt Tightness

Hold child restraint at the belt path with your weakest hand.

Push and pull from side to side.

It should not move more than 1 in. (2.5 cm).

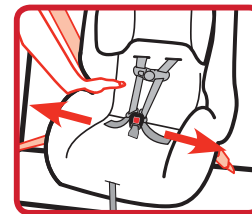

If it moves more than 1 in. (2.5 cm), you can try:

- A. Putting your knee in the seat and pulling the belt tighter.
- B. Reinstalling the child restraint.
- C. Changing to a different seating location.
- D. Switching to the lower anchor belt installation if lower anchors are available in your vehicle.



Using a Locking Clip

You will rarely need to use a locking clip except in some older vehicles. Built-in child restraint locking systems have been required in vehicles since 1996, and many vehicles had these features even earlier. Review pages 29-31 and your vehicle owner's manual to determine if your vehicle belts require a locking clip.

If you need a locking clip immediately, they are likely available at an auto dealership, an auto store, or where you purchased this child restraint. You can also call us at 1-800-544-1108 for one.

A locking clip will not fix all types of seat belt problems. You **MUST** have a lap and shoulder belt to use a locking clip.

For Rear Facing installation, follow Pages 40-43 Warnings and Steps 1-7 before starting locking clip installation.

For Forward Facing installation, follow Pages 52-54 Warnings and Steps 1-7 before starting locking clip installation.

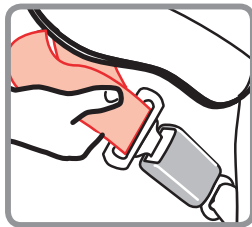

1. Determine Locking Clip Position

Grasp both vehicle belts together just behind the latch plate to mark the position for locking clip.

Unbuckle the belt.

NOTE: If the latch plate ends up just at the belt path opening so you cannot grasp the vehicle belt at the latch plate, grasp the vehicle belts on the opposite side of the child restraint, as close to the latch plate as possible.

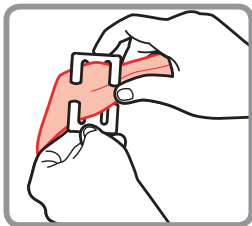

2. Attach Locking Clip

Thread both portions of the vehicle belt onto the locking clip, as close to the latch plate as possible.

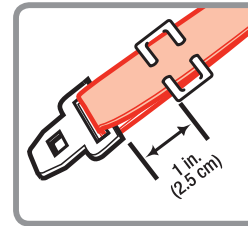

3. Position Locking Clip

It should be about 1 in. (2.5 cm) from vehicle belt's latch plate.

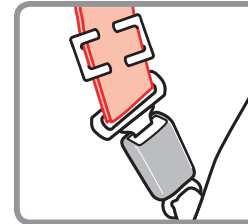

4. Rebuckle Vehicle Belt

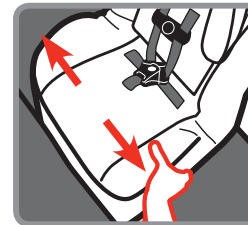

5. Check Belt Tightness

Hold child restraint at the belt path with your weakest hand.

Push and pull from side to side.

It should not move more than 1 in. (2.5 cm). **If it moves more than 1 in. (2.5 cm), you can try:**

- A. Reinstalling the child restraint.
- B. Changing to a different seating location.

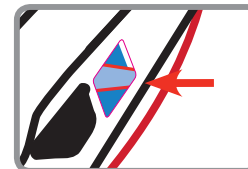

When installed rear facing, recheck the level lines to make sure it is reclined according to your child's weight.

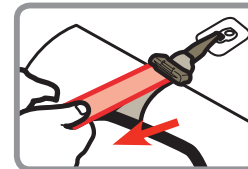

When installed forward facing, make sure to tighten the tether strap.

Remove the locking clip when the seat belt is not being used with a child restraint.

Dorel Juvenile Group Information

Thank you for choosing this child restraint. The DJG family is committed to creating child restraints with the most comfort and convenience available today.

Remember, parents are a child's first teachers and examples. If you always buckle your seat belt, your child will think it is the natural thing to do. Make it a firm rule that the vehicle does not go until everyone is buckled up. Make no exceptions.

No one can predict if use of a child restraint will prevent injury or death in a particular crash. However, when combined with careful driving, proper use of a child restraint can lower a child's risk of injury or death in most crashes.

Your child's safety is worth the time it will take to read and follow these instructions. After reading, if you still have questions or have any concerns with this child restraint, please contact our Consumer Care Department at:

Website: www.safety1st.com

Telephone: 1-800-544-1108
M-TH from 8 A.M. to 6 P.M. EST
FRI from 8 A.M. to 4:30 P.M. EST

Mailing Address:
Dorel Juvenile Group, Inc.
Consumer Care Department
P.O. Box 2609
Columbus, IN 47202-2609

Registration and Safety Notices

Please complete the postage-paid registration card that came with your child restraint, and send it to us. Child restraints could be recalled for safety reasons. You must register this restraint to be reached in a recall. Send your name, address, email address if available and the restraint's model number and manufacturing date to:

Dorel Juvenile Group, Inc.
Consumer Care Department
P.O. Box 2609, Columbus, IN 47202-2609

or call 1-800-544-1108 or register online at www.djgusa.com/registration/carseat/us.

For recall information, call the U.S. Government's Vehicle Safety Hotline at 1-888-327-4236 (TTY: 1-800-424-9153), or go to <http://www.NHTSA.gov>.

Consumer: Just fill in your name, address and email. Please print (use dark ink).

Your Name _____

Your Street Address _____

City _____ St _____

Em _____ (nal) _____

Model Number	Line Code	Manufacture Date
AB123CDE	COSCO CARSEAT	01/22/2015

L#11 B265035

Example of model number, manufacture date, and line code.

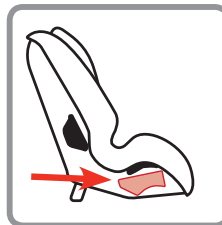

If you don't have the card or if your address changes, you will find the model number, manufacture date, and line code on the label located on side of shell.

Troubleshooting

1. Locate a Child Safety Seat Inspection Station for hands on training on how to use your child restraint:

Visit your local Child Passenger Inspection Station or go to <http://www.safercar.gov/cpsApp/cps/index.htm> to find your closest station.

2. If the child restraint buckle or harness release lever sticks or you cannot get the straps tight enough around child:

DO NOT LUBRICATE. Check around lever and retractor for dropped food, sticky spilled drinks, dirt, leaves, etc. Clean with warm water and/or remove object with tweezers. If you cannot get the harness to adjust and remain tight with the buckle securely locked, do not use the child restraint.

3. If your harness twists:

Straighten the harness each time you put your child in the child restraint to help prevent twisting. Lock the buckle and tighten harness and it will be ready for next use.

Replacement Parts Order Form

Complete the form. Your model number and manufacturer date code **MUST** be included on the form to ensure proper replacement parts. The codes can be found on a label on side of child restraint. Payment in U.S. dollars must accompany your order. Choose parts needed from the list on the next page. Return the form with payment to:

Dorel Juvenile Group, Inc.
Consumer Care Department
P.O. Box 2609
Columbus, IN 47202-2609

Please make money orders payable to Dorel Juvenile Group, Inc. Fill in the area on the next page to charge credit card. (Visa or MasterCard **only**). We do not accept cash, personal checks, or other credit cards. All outside of U.S. and Canada **MUST** use credit card.

Ship To: (Please Print)

Name: _____

Address: _____

City: _____

State/Province: _____ **Zip:** _____

Telephone: _____

Email Address: _____

We **MUST** have this information:

Model Number (8 to 9 characters): _____

Manufacture Date (mm/dd/yyyy): _____

Replacement Parts List

NOTE: If requested color is not available, similar color will be substituted. Prices are subject to change.

Part	Cost	Qty	Total Cost
Buckle Assembly	\$7.99	\$
Harness Strap.....	\$2.99	\$
Seat Pad Set.....	\$30.00	\$
Chest Clip.....	\$1.50	\$
Tether	\$6.00	\$
Lower Anchor Belt.....	\$17.99	\$
Instructions.....	\$0.00	\$
Locking Clip.....	\$2.50	\$

Merchandise Total: \$

Shipping and handling: \$

Up to \$25.00.....	\$5.95	\$100.01 to \$150.00	\$10.95
\$25.01 to \$50.00	\$6.95	\$150.01 to \$200.00	\$11.95
\$50.01 to \$75.00	\$8.95	\$200.01 and up.....	\$13.95
\$75.01 to \$100.00	\$9.95	Outside Continental USA	
		\$10.00

Sales Tax:..... \$

(Arizona, California, Georgia, Indiana, Missouri, South Carolina, and Texas residents add applicable sales tax.)

Grand Total \$

No shipping and handling on instructions for quantities under 6. Add \$.50 for each instruction over 6, then add applicable shipping and handling.

Fill Out For Credit Card
 Visa MasterCard

Card Exp. Date:

Cardholder's Name:

Card Number:

Signature:

Warranty

Dorel Juvenile Group, Inc. (DJG) warrants this product to the original retail purchaser as follows:

This product is warranted against defective materials or workmanship for one year from the date of original purchase. **An original receipt is required to validate your warranty.** DJG will, at its option, provide replacement parts or replace this product. DJG reserves the right to substitute if the part or model has been discontinued.

To make a claim under this warranty you may write to DJG, Consumer Care Department, P.O. Box 2609, Columbus, IN 47202-2609; or call 1-800-544-1108 from 8:00 a.m. to 6:00 p.m. EST Monday through Thursday and from 8:00 a.m. to 4:30 p.m. on Friday.

Proof of purchase is required and shipping charges are the responsibility of the consumer.

Warranty Limitations: This warranty does not include damages which arise from misuse or abuse of this product.

Limitation of Damages: The warranty and remedies as set forth are exclusive and in lieu of all others, oral or written, expressed or implied. In no event will DJG or the dealer selling this product be liable to you for any damages, including incidental or consequential damages, arising out of the use or inability to use this product.

Limitation of warranties and other warranty terms and state law rights:

Any implied warranties, including implied warranties of the merchantability and fitness for a particular purpose, shall be limited to the duration and terms of the express written warranty. Some states do not allow limitations as to how long an implied warranty lasts or the exclusion or limitation of incidental or consequential damages, so the above limitations may not apply to you.

This warranty gives you specific legal rights, and you may have other rights, which vary from state to state. Neither DJG nor the dealer selling this product authorized any person to create for it any other warranty, obligation, or liability in connection with this product.

CUT ON DOTTED LINE