



GAI-TRONICS®
A HUBBELL COMPANY

400-001 and 400-002NS RigCom Stations

TABLE OF CONTENTS

Confidentiality Notice 1

General Information 1

Important Safety Instructions..... 2

Installation 2

Speaker Horn Assembly (Model 400-001 Only)..... 3

Mounting..... 3

Hardware Configuration..... 4

 External 4

 Internal 5

Wiring 5

 Station Wiring 5

 System Line Balance..... 6

 System Wiring 7

Field Wiring Terminations..... 7

 TB1—Speaker Terminal Block 7

 TB2—AC Power Terminal Block..... 8

 TB3—DC Power Terminal Block..... 8

 TB4—Audio and Low Voltage Control Terminal Block 8

 P1—Front Cover Wire Harness Connections 9

 P3—Balanced/Unbalanced Jumper..... 9

 SW1—Master/Slave Switch 9

Cover Installation..... 9

Operation..... 9

Common Line System..... 10

Master/Slave System..... 10

Maintenance..... 11

F1/F2 Fuses 11

Cover Installation..... 11

Troubleshooting 12

Replacement Parts and Accessories 12

Specifications 12

AC Power..... 12

DC Power..... 12

Amplifier PCBA..... 13

Speaker (Model 400-001 Only)	13
Station	13
Environmental	13
<i>Approvals</i>	<i>13</i>
<i>Appendix A—Interfacing a Model 400-001 RigCom Station to a MS39xx RigCom Station System</i>	<i>14</i>
<i>Appendix B—Interfacing a Model 400-001 RigCom Station to EZ Page Stations</i>	<i>16</i>



GAI-TRONICS®
A HUBBELL COMPANY

400-001 and 400-002NS RigCom Stations

Confidentiality Notice

This manual is provided solely as an installation, operation, and maintenance guide and contains sensitive business and technical information that is confidential and proprietary to GAI-Tronics. GAI-Tronics retains all intellectual property and other rights in or to the information contained herein, and such information may only be used in connection with the operation of your GAI-Tronics product or system. This manual may not be disclosed in any form, in whole or in part, directly or indirectly, to any third party.

General Information

The GAI-Tronics Model 400-001 and 400-002NS RigCom Stations are designed for a common-talk or a master/slave communication system. The stations are approved for the following hazardous locations when installed in accordance with GAI-Tronics Pub. 42004-381, Control Drawing No. 73214:

- Model 400-001: Class I, Div. 1, Groups C and D
- Model 400-002NS: Class I, Div. 1, Groups B, C, and D

The system provides push-to-talk, release-to-listen operation, and has a local on/off volume control switch to activate and control the volume level for each station independently.

The Model 400-001 includes an attached speaker and driver unit. The Model 400-002NS does not include the speaker and driver unit but does have a 1/2-inch NPT hole to remotely mount and connect the speaker driver unit to the station.

The RigCom stations have connections for an auxiliary microphone and footswitch for remote operation from the station. The auxiliary microphone replaces the speaker as the microphone and the auxiliary footswitch provides the same functionality as the push-to-talk switch.

NOTE: The approved hazardous locations are reduced to Class I, Div. 1, Group D with the use of auxiliary items.

The Model 400-001 and 400-002NS RigCom Stations are designed to be field replacements for the previous MS39xx Series RigCom stations. The Model 400 Series must be configured as an unbalanced station when used as a field replacement for the MS39xx Series.

Along with operation with the MS39xx Series RigCom stations, the Model 400 Series are designed to operate with the EZ Page Series of GAI-Tronics equipment.

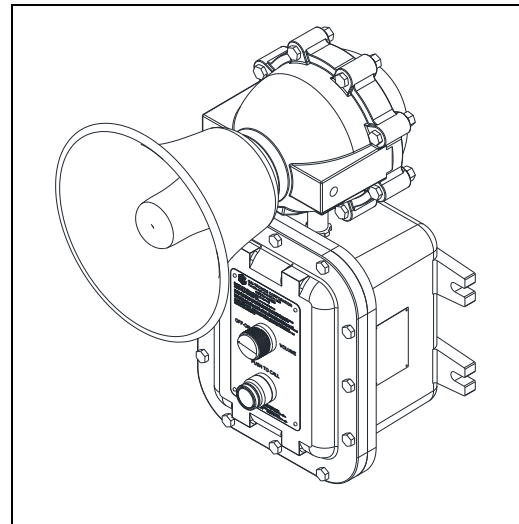







Figure 1. Model 400-001 RigCom Station



Safety Precautions

	CAUTION RISK OF ELECTRIC SHOCK. DO NOT OPEN!	
<p>CAUTION: TO REDUCE THE RISK OF ELECTRIC SHOCK, DO NOT REMOVE COVER (OR BACK). NO USER SERVICEABLE PARTS INSIDE. REFER SERVICING TO QUALIFIED SERVICE PERSONNEL.</p>		
	<p>This symbol indicates the presence of uninsulated “dangerous voltage” within the product’s enclosure. This may constitute a risk of electric shock.</p>	
	<p>The user should consult the operating and maintenance (servicing) instructions in the literature accompanying the appliance.</p>	
	<p>Attention: Installation should be performed by qualified service personnel only in accordance with the National Electrical Code or applicable local codes.</p>	

Important Safety Instructions

- **Read, follow, and retain instructions**—All safety and operating instructions should be read and followed before operating the unit. Retain instructions for future reference.
- **Heed warnings**—adhere to all warnings on the unit and in the operating instructions.
- **Attachments**—Attachments not recommended by the product manufacturer should not be used, as they may cause hazards.



This permanently connected apparatus must have an ALL-POLE MAINS switch with a contact separation of at least 3 mm in each pole incorporated in the electrical installation of the building.

 **WARNING**  —To reduce the risk of fire or electrical shock, do not expose this apparatus to rain or moisture.

Installation

These enclosures must be installed by trained, qualified, and competent personnel. Installation must comply with state and national regulations, as well as safety practices for this type of equipment.

The Models 400-001 and 400-002NS Rigcom stations must be installed in accordance with GAI-Tronics Pub. 42004-381, Control Drawing No. 73214.

 **CAUTION**  —Do not install this equipment in hazardous areas other than those indicated on the approval listing in the Approvals section of this manual. Such installation may cause a safety hazard and consequent injury or property damage.

The mounting location must be flat and provide proper clearance, rigidity, and strength to support the enclosure and all contained devices.

Securely fasten the enclosure to the mounting location using (customer-supplied) 7/16-inch diameter steel mounting bolts and washers, or washer head bolts.

 **WARNING**  —**Insure proper grounding to protective earthing.
Do not disconnect equipment while energized.**

Speaker Horn Assembly (Model 400-001 Only)

The Model 400-001 Speaker Horn Assembly must be assembled prior to installation:

1. Unpack the unit.
2. Locate the speaker horn and driver unit.
3. Place the speaker bell over the driver bushing.
4. Position two large diameter fiber washers with the large diameter steel washer sandwiched between them on the speaker bushing.
5. Place the small diameter rubber washer into the speaker horn tip, followed by the small diameter fiber washer.
6. Screw the speaker horn tip to the driver bushing until it is snug.

Mounting

NOTE: The mounting surface must be able to support the weight of the aluminum enclosure. See the Specifications section for the weights and dimensions of the unit.

Securely fasten the enclosure with 7/16-inch diameter steel mounting bolts located on all four mounting feet (see Figure 2 for mounting dimensions).

NOTE: Stainless steel hardware is recommended for applications in corrosive environments.

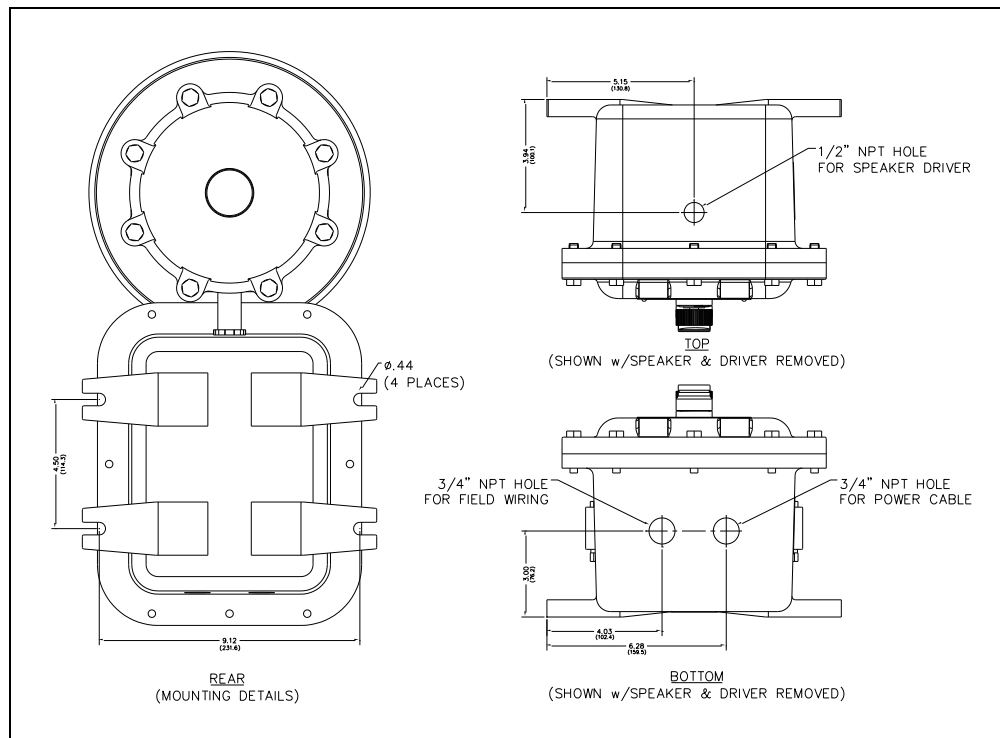

Figure 2. Model 400-001/400-002NS Mounting Details and Conduit Entries

Hardware Configuration

External

The enclosure contains a push-to-call button, an on-off/volume control switch, and applicable approval labeling. The enclosure has 12 cover mounting bolts located around the perimeter of the enclosure.

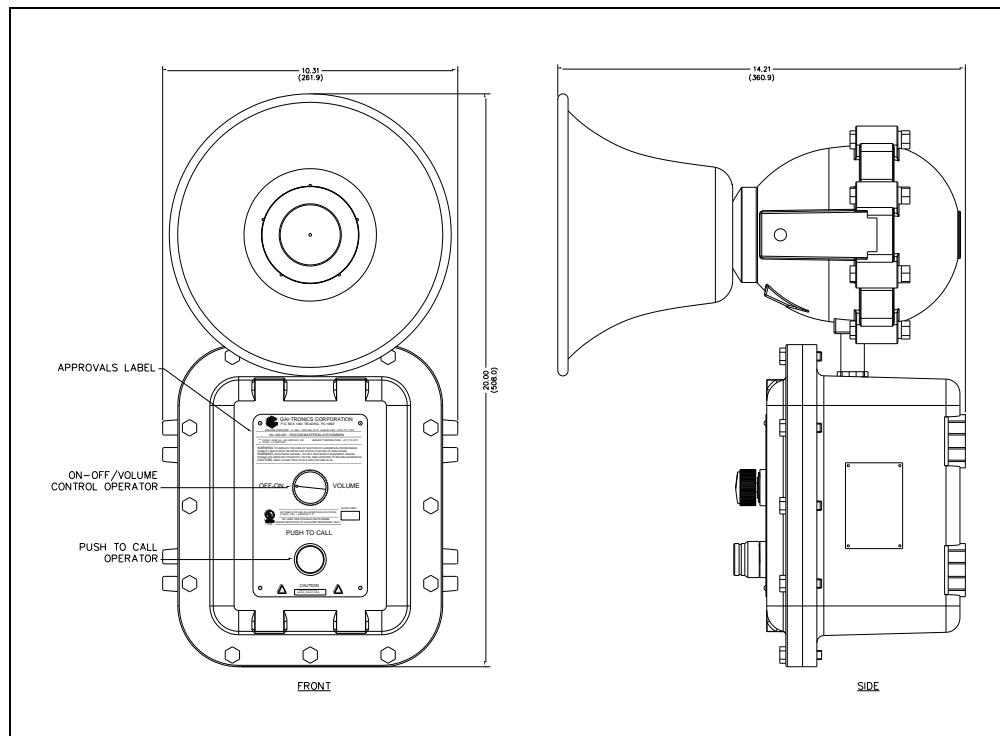

Figure 3. Model 400-001 RigCom Station Outline

Internal

The enclosure contains a single PCBA where all customer connections are made. All connections are made to the front cover by a single wiring harness with a plug.

Wiring

Station Wiring

1. Attach conduit or cable glands to the $\frac{3}{4}$ -inch NPT holes on the bottom of the enclosure.
2. Feed the low-voltage wiring through the conduit or cable gland and into the left-side hole, as viewed from the front of the station.
3. Feed the power wiring through the conduit or cable gland and into the right-side hole, as viewed from the front of the station.
4. Attach the wires to the terminal blocks located on the PCBA within the enclosure (see [Figure 4](#) and the [Field Wiring Terminations](#) section for connection points and descriptions).

5. *If using the 10438-002 Auxiliary Microphone Assembly:* Connect the assembly to the station at terminal block TB4-1 (+) and TB4-2 (-), and the shield to TB4-5, if used.

The maximum distance from the station is 50 feet using No. 18 AWG wire.

6. *If using the 51052-003 Auxiliary Footswitch Assembly:* Connect the assembly to the station at terminal block TB4-8 (+) and TB4-9 (-), and the shield to TB4-5, if used.

The maximum distance from the station is 50 feet using No. 18 AWG wire.

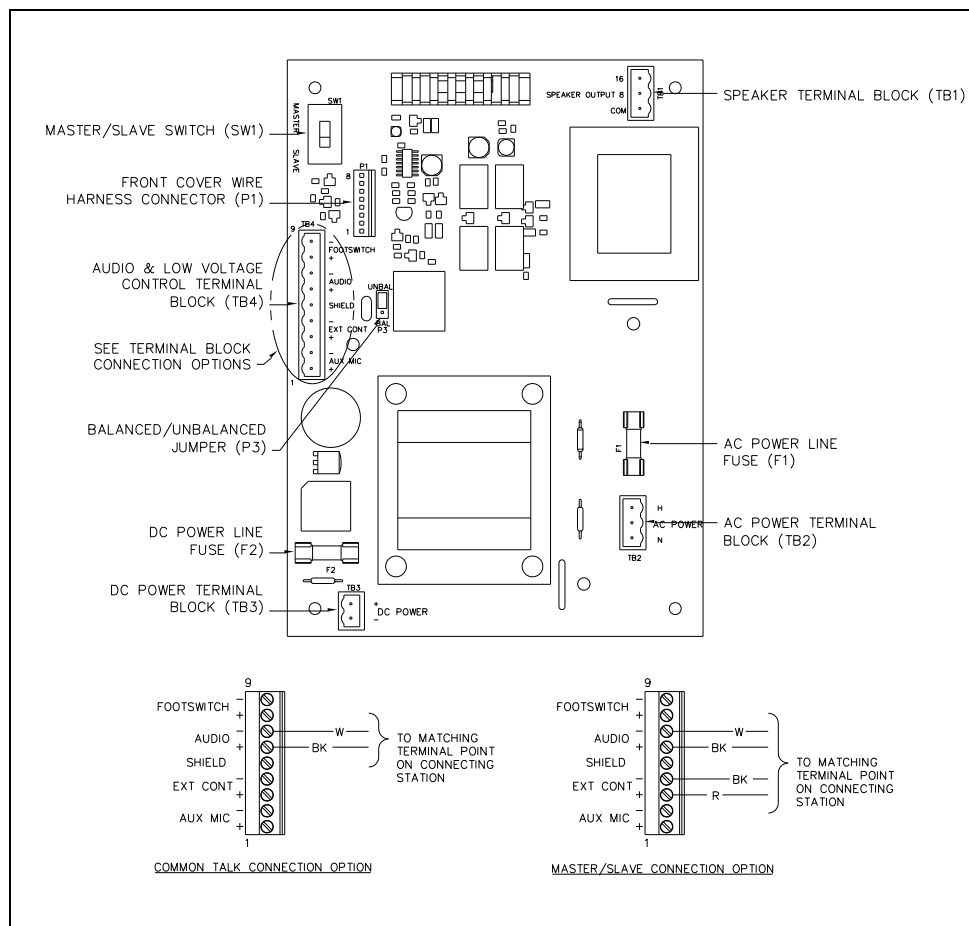

Figure 4. RigCom Station PCBA

System Line Balance

Each system requires termination of the audio pair wires with a 1-kilohm, 1-watt resistor assembly included with each unit. The line balance resistor assembly is made for easy installation into a customer-supplied junction box.

NOTE: Only one line-balance resistor assembly is needed per system.

Install the resistor assembly in a (customer supplied) junction box that is close to the center of the system when cable runs approximately 4000 feet (1219 m) or longer are used (see [Figure 5](#) and [Figure 6](#)).

NOTE: The junction box must be suitable for the applicable hazardous location where it is located.

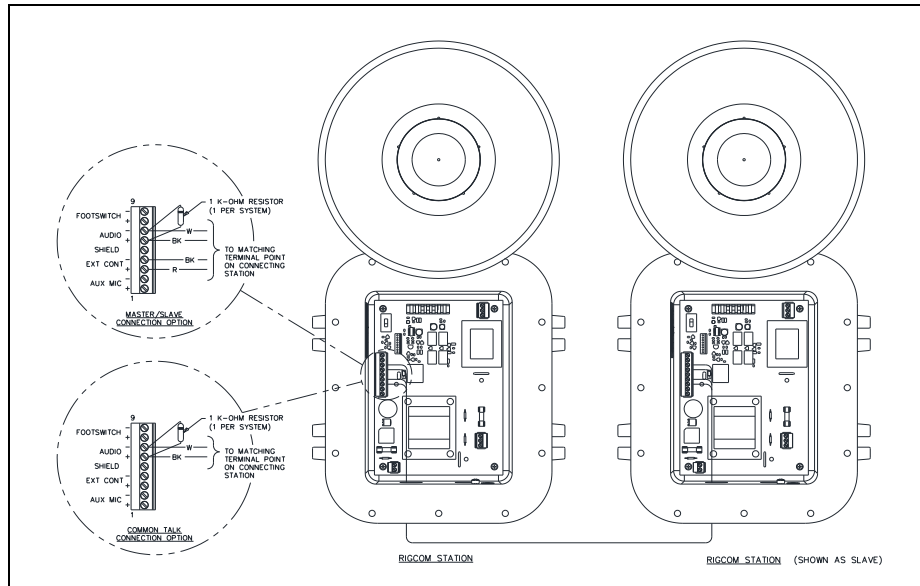

Figure 5. System cable wiring less than 4000 feet in length

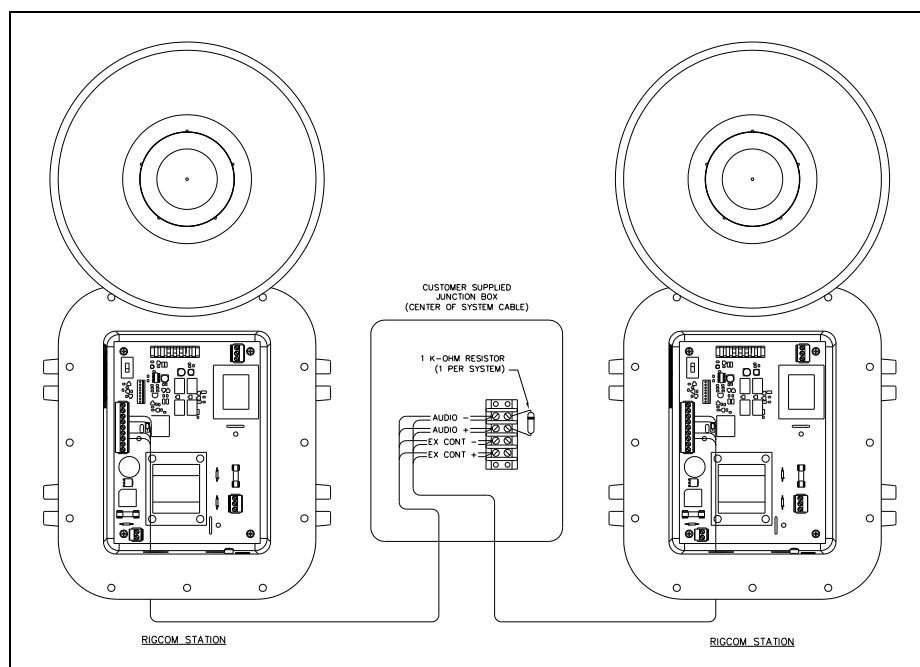

Figure 6. Master/Slave System cable wiring greater than 4000 feet in length

System Wiring

The maximum line length for the complete system, while still maintaining maximum output signal, is 15,000 feet for a system with less than ten stations. This is based on No. 18 AWG wire, the stations spaced equidistantly, and one station in talk mode at a time. For each station in talk mode, the signal level reduces by half (see [Figure 7](#) for systems with more than ten stations to determine the maximum line distance).

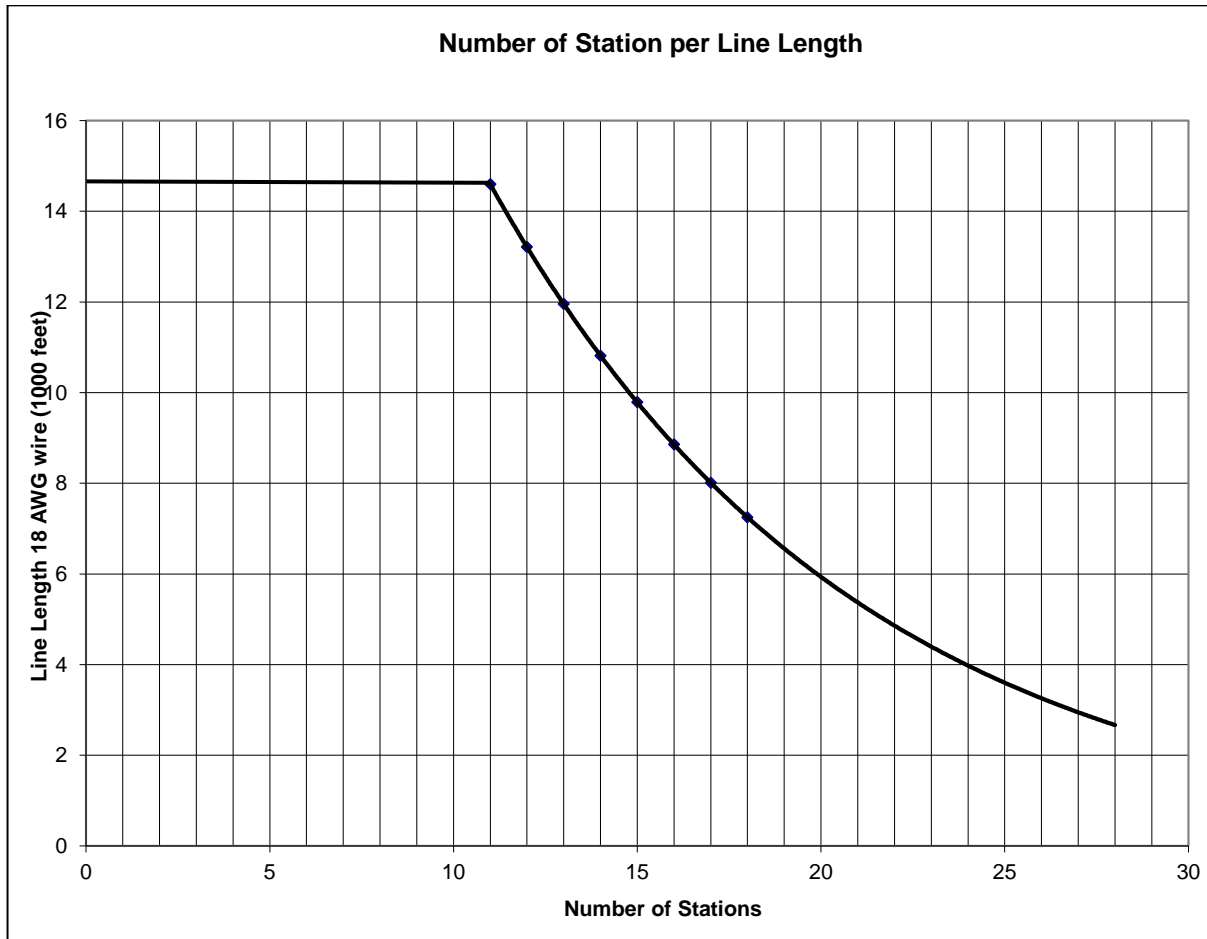

Figure 7. Number of Stations vs. Line Length

Field Wiring Terminations

TB1—Speaker Terminal Block

Table 1. Speaker Output Connection at Terminal Block TB1

Name	Pin No.	Description
16	1	16-ohm terminal for external speaker connection
8	2	8-ohm terminal for external speaker connection
COM	3	common terminal for external speaker connection

TB2—AC Power Terminal Block

Table 2. AC Power Connection at Terminal Block TB2

Name	Pin No.	Description
AC POWER H	1	external ac power supply positive terminal No connection when external ac power supply is not used.
AC POWER N	3	external ac power supply neutral terminal No connection when external ac power supply is not used.
AC POWER GND		ac power ground terminal must be electrically connected to the chassis

TB3—DC Power Terminal Block

Table 3. DC Power Connection at Terminal Block TB3

Name	Pin No.	Description
DC POWER INPUT+	2	external dc power supply positive terminal No connection when external dc power supply is not used.
DC POWER INPUT-	1	external dc power supply negative terminal No connection when external dc power supply is not used.

TB4—Audio and Low Voltage Control Terminal Block

Table 4. Audio Signal and Low Voltage Control Connections at Terminal Block TB4

Name	Pin No.	Description
AUX MIC+	1	Positive terminal for the auxiliary microphone.
AUX MIC-	2	Negative terminal for the auxiliary microphone.
EXT CONT+	3	Talk/listen control signal for Master/Slave operation. No connection in Common Line mode.
EXT CONT-	4	Ground reference for talk/listen control signal for Master/Slave operation. No connection in Common Line mode or UNBAL audio configuration.
SHIELD	5	Ground reference for shield terminations.
AUDIO+	6	Positive side of the audio port line during 600-ohm or 15-kilohm termination configuration.
AUDIO-	7	Negative side of the audio page port line during 600-ohm or 15-kilohm termination configuration.
FOOTSWITCH+	8	Positive side of auxiliary footswitch that operates as the local push-to-talk switch.
FOOTSWITCH-	9	Negative side of auxiliary footswitch that operates as the local push-to-talk switch.

P1—Front Cover Wire Harness Connections

Plug the front cover wire harness connector in at P1 (see [Figure 4](#)).

P3—Balanced/Unbalanced Jumper

Jumper P3 allows configuration of the unit for balanced or unbalanced audio connections. The assembly is configured for balanced audio input signals when the header is installed in the BAL position. The assembly is configured for unbalanced audio input signals when the header is installed in the UNBAL position.

NOTE: The system must be set up as an unbalanced system in systems where the external control signal is single-ended, such as previous GAI-Tronics Model MS39.xx RigCom Stations.

SW1—Master/Slave Switch

Switch SW1 allows configuration of the unit as a master or slave unit. The unit is configured as a master when the switch is in the MASTER position. The unit is configured as a slave when the switch is in the SLAVE position. The switch must be in the MASTER position for common line operation.

Cover Installation

1. Inspect and clean the machined flange flame joint surfaces of both the cover and box.
Surfaces must be smooth, free of nicks, scratches, dirt, or any foreign particle build-up that may prevent a proper seal. Surfaces must seat fully against each other to provide a proper explosion-proof joint.
2. Clean the surfaces by wiping them with a clean lint-free cloth.
3. Install all 12 cover bolts.
Use only the bolts supplied with the enclosure. Do not omit any bolts.
4. Torque the cover bolts to 17 ft·lb (23 N·m).

Operation

The station has an on-off/volume control switch and a push-to-talk switch.

1. Turn the unit on or off and adjust the volume level in the listen mode using the on-off/volume control switch.
2. Turn the unit off by turning the switch completely counterclockwise.
3. Adjust the switch completely clockwise for maximum volume.

The push-to-talk switch controls the audio communication between stations.

1. Press the push-to-talk switch to send a message to another station.
2. Release the push-to talk switch to put the station in listen mode so that the station receives messages from other stations.

The push-to-talk switch is not functional when the station is configured as a slave station.

Common Line System

All stations are on a common audio path and are normally in listen mode in the common line configuration. Activation of a station's push-to-talk toggle switch supplies its audio signal to the common audio path. All other units receive the audio signal and broadcast the announcement over their speakers. The push-to-talk switch must be held down while the operator talks. Releasing the switch deactivates the microphone and returns the unit to listen mode.

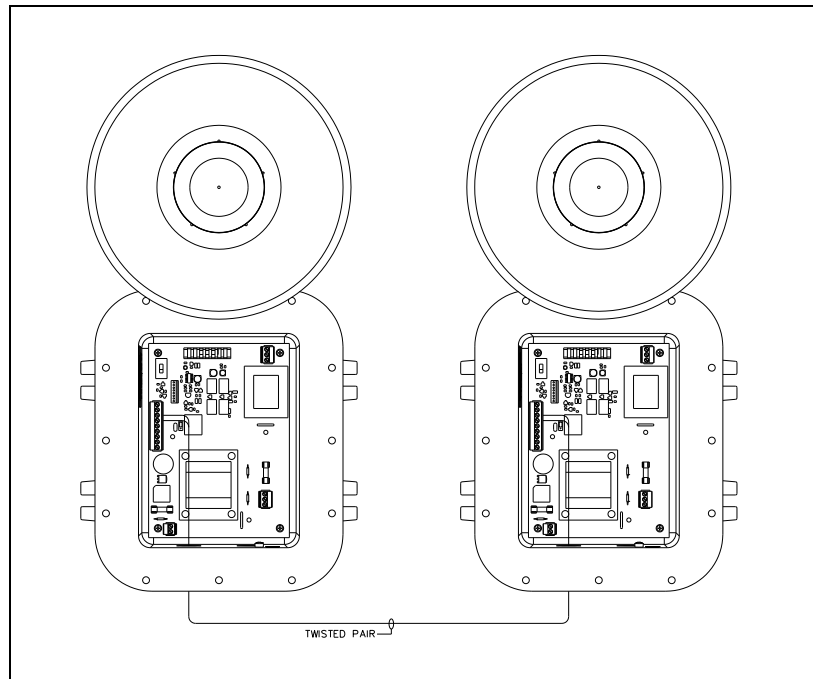

Figure 8. Common Talk Wiring Detail

Master/Slave System

A master station controls the talk-listen function of the slave units through external control wiring in the master/slave configuration. Slave stations are in talk mode allowing the master station to monitor the slave's audio when the master's push-to-talk is not activated. Activation of the master's push-to-talk toggle switch places the slaves in listen mode, allowing the master to transmit audio to the slave stations. The Slave's push-to-talk is not operable, and their operation is hands-free.

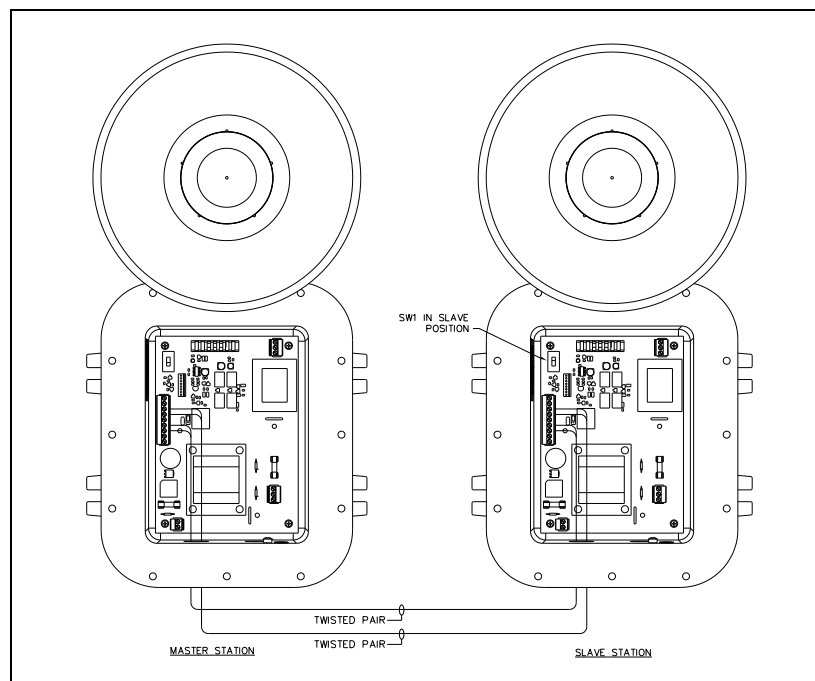



Figure 9. Master/Slave Wiring Detail



Maintenance



Contact a regional service center for a return authorization number (RA#) if the equipment requires service. Equipment must be shipped prepaid to GAI-Tronics with a return authorization number and a purchase order number. Repairs or a replacement will be made in accordance with GAI-Tronics' warranty policy if the equipment is under warranty. Please include a written explanation of all defects to assist our technicians in their troubleshooting efforts.

Call 800-492-1212 inside the USA or 610-777-1374 outside the USA for help identifying the Regional Service Center closest to you.



 **CAUTION**  —These servicing instructions are for use by qualified service personnel only. To reduce risk of electric shock, do not perform any servicing other than that contained in the Maintenance section unless you are qualified to do so.

Regular inspection and a good preventive maintenance program will increase the reliability of the GAI-Tronics station. The GAI-Tronics Field Service Department can formulate a service contract suited to specific needs for preventive maintenance.

 **WARNING**  —Before performing any of the following preventive maintenance steps, remove all power from the station.

 **CAUTION**  —To reduce the risk of ignition of hazardous atmospheres, disconnect the equipment from the supply circuit before making any adjustments to the PCBA's settings.

F1/F2 Fuses

 **WARNING**  —**Do not remove fuses when energized.**
Replace with the same type and size fuse for continued safe operation.

- Fuse F1—ac power line: 0.5 A, SLO-BLO, 250 V, 5×20 mm, UL.
- Fuse F2—dc power line: 2.0 A, SLO-BLO, 250 V, 5×20 mm, UL.

Cover Installation

1. Inspect and clean the machined flange flame joint surfaces of both the cover and box.
Surfaces must be smooth, free of nicks, scratches, dirt, or any foreign particle build-up that may prevent a proper seal. Surfaces must seat fully against each other to provide a proper explosion-proof joint.
2. Clean the surfaces by wiping them with a clean lint-free cloth.
3. Install all 12 cover bolts.
Use only the bolts supplied with the enclosure. Do not omit any bolts.
4. Torque the cover bolts to 17 ft·lb (23 N·m).

Troubleshooting

Problem	Solution
Any problem with station performance	Always review all steps of installation, ensuring that you correctly followed all steps. Check all terminations on the board.
Speaker volume needs adjustment	<ul style="list-style-type: none"> • Adjust volume control. • Replace speaker or driver.
Crosstalk	One or more system cable pairs may be improperly terminated. Visually inspect the system cable for accidental crossing of cable pairs or grounds.

Replacement Parts and Accessories

Contact GAI-Tronics for replacement part information.

Table 5. Available Accessories for RigCom Stations

Part No.	Description
12801-002	auxiliary microphone
51052-003	auxiliary footswitch
10438-002	microphone I.S. barrier kit (contains 12801-002 auxiliary mic assembly)
12807-001	connector kit
60075-001	audio cable, No. 18 AWG, (two-pair)

Specifications

AC Power

Voltage.....	120 V ac, 50/60 Hz
Power consumed (at nominal)	
Off (mute).....	6 VA, 1.8 W
Standby.....	7.2 VA, 3.6 W
Maximum speaker out.....	30 VA, 27 W

DC Power

Voltage.....	12 V dc
Power consumed (at nominal)	
Off (mute).....	0.3 W
Standby.....	3 W
Maximum speaker out.....	20 W

Amplifier PCBA

Frequency response.....	300 Hz–8 kHz, +/-3 dB
Audio output	8.0 W
Audio THD distortion	1% maximum, 8 W output
Hum/Noise	1% maximum, 8 W output
Gain—Listen mode	17 dB
Gain—Talk mode (speaker as the microphone)	42 dB
Gain—Talk mode (auxiliary microphone).....	48 dB

Speaker (Model 400-001 Only)

Rating.....	30 W maximum
Impedance	16 Ω
Frequency response.....	400 Hz–3.5 kHz, +/-6 dB
Sound pressure level, 1 W @ 1 m, swept sine wave.....	104 dB SPL

Station

Construction/finish.....	cast aluminum/tumblast finish
Mounting.....	wall or column, four 7/16-inch mounting feet with slots
Connections.....	plug-in style terminal blocks
Conduit entries	bottom: two, 3/4-inch NPT
.....	top: one, 1/2-inch NPT (Model 400-002NS only)
Dimensions	20.00 H × 10.31 W × 14.21 D in (508.0 × 261.9 × 360.9 mm)
Shipping weight	
Model 400-001	36.0 lb (16.4 kg)
Model 400-002NS	23.0 lb (10.5 kg)

Environmental

Temperature range (operating and storage)	-4 °F to +140 °F (-20 °C to +60 °C)
---	-------------------------------------

Approvals

The models below are approved for the following hazardous areas when installed in accordance with Pub. 42004-381, Control Drawing # 73214.

Model 400-001 RigCom Station:

NRTL listed (USA)..... Hazardous locations Class I, Div. 1, Groups C & D
when auxiliary microphone and/or footswitch is used:.....Hazardous locations Class I, Div. 1, Group D

Model 400-002NS RigCom Station:

NRTL listed (USA).....Hazardous locations Class I, Div. 1, Groups B, C & D
when auxiliary microphone and/or footswitch is used:.....Hazardous locations Class I, Div. 1, Group D

Appendix A—Interfacing a Model 400-001 RigCom Station to a MS39xx RigCom Station System

The Model 400-001 RigCom Station is designed to operate as a field replacement or system addition in systems containing MS39xx RigCom stations.

The MS39xx stations use an unbalanced system for communication and the negative of the audio pair is used for the ground reference of the control signal. The Model 400-001 can operate in an unbalanced or balanced system. In a balanced system, the audio pair is not ground referenced and the control signal requires a ground signal.

Configure the Model 400-001 for unbalanced operation by placing jumper P3 in the UNBAL position for interoperability between the Model 400-001 and the MS39xx Series stations. No changes are required to the MS39xx Series station(s). For Master/Slave operation:

1. Connect the AUDIO– to AUDIO (WH) terminal.
2. Connect the AUDIO+ to AUDIO (BLK) terminal.
3. Connect the EXT CONT+ to the KEY.

Only the audio wires require connection for common line operation.

The following wiring diagrams are for the different configurations of a RigCom system:

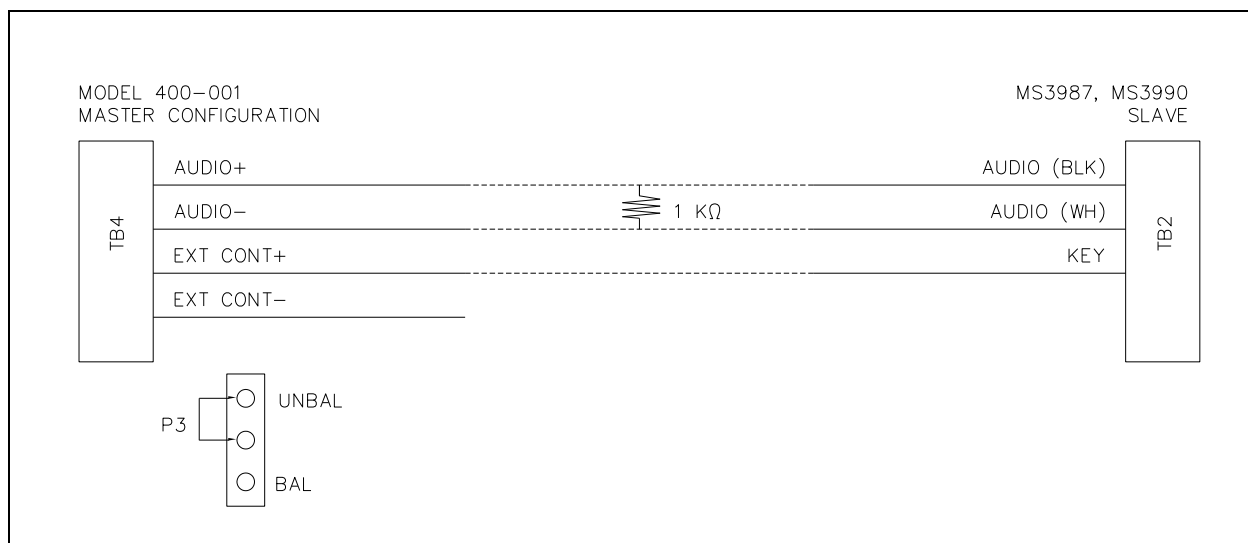

Figure 10. Master/Slave Configuration with the Model 400-001 as Master

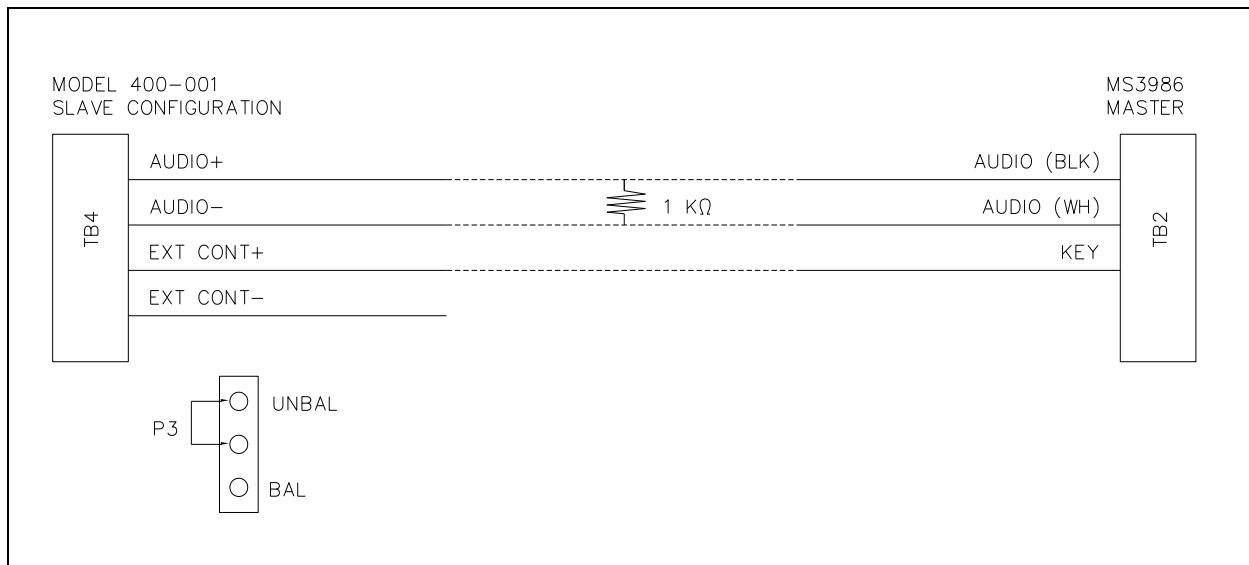

Figure 11. Master/Slave Configuration with the Model 400-001 as Slave

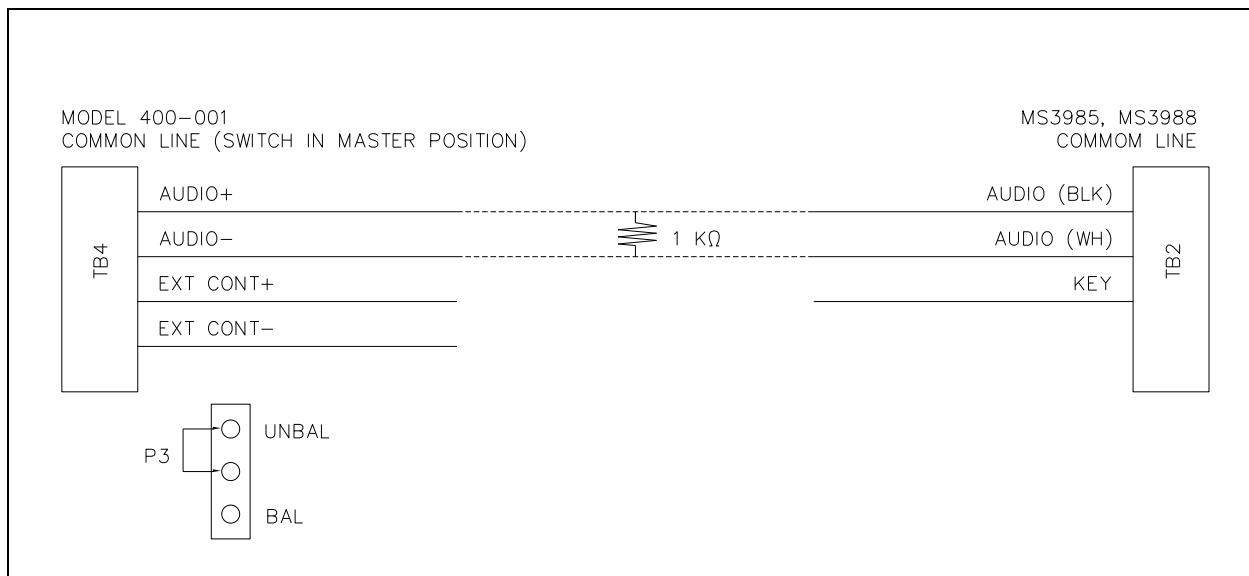

Figure 12. Common Line Configuration

Appendix B—Interfacing a Model 400-001 RigCom Station to EZ Page Stations

The Model 400-001 RigCom Station is designed to operate as an addition to a system of EZ Page stations.

The EZ Page Series and Model 400-001 Stations are designed to operate in either balanced or unbalanced systems. An unbalanced communication system uses the negative of the audio pair as the ground reference for the control signal. The audio pair is not ground referenced in a balanced system and the control signal requires a separate ground signal.

Configure the Model 400-001 RigCom stations and the EZ Page stations identically as balanced or unbalanced using jumper P3 on the Model 400-001 station(s) and jumper P5 on the EZ Page station(s) for interoperability between the Model 400-001 RigCom and the EZ Page Series stations.

The following are wiring diagrams are for the different configurations of a RigCom/EZ Page system:

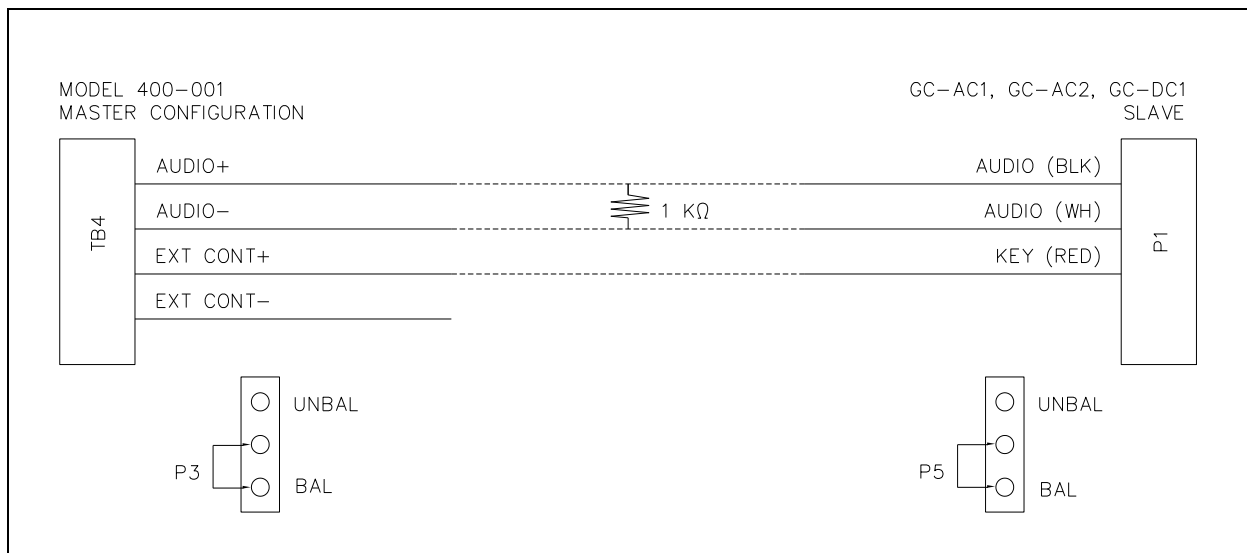

Figure 13. Master/Slave Unbalanced Configuration with the Model 400-001 as Master

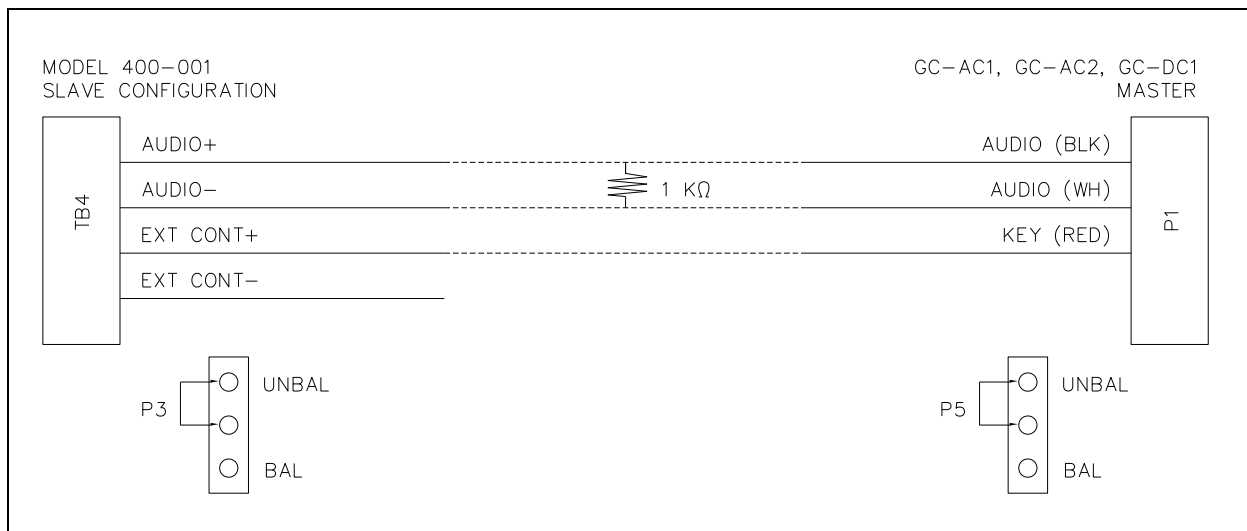

Figure 14. Master/Slave Unbalanced Configuration with the Model 400-001 as Slave

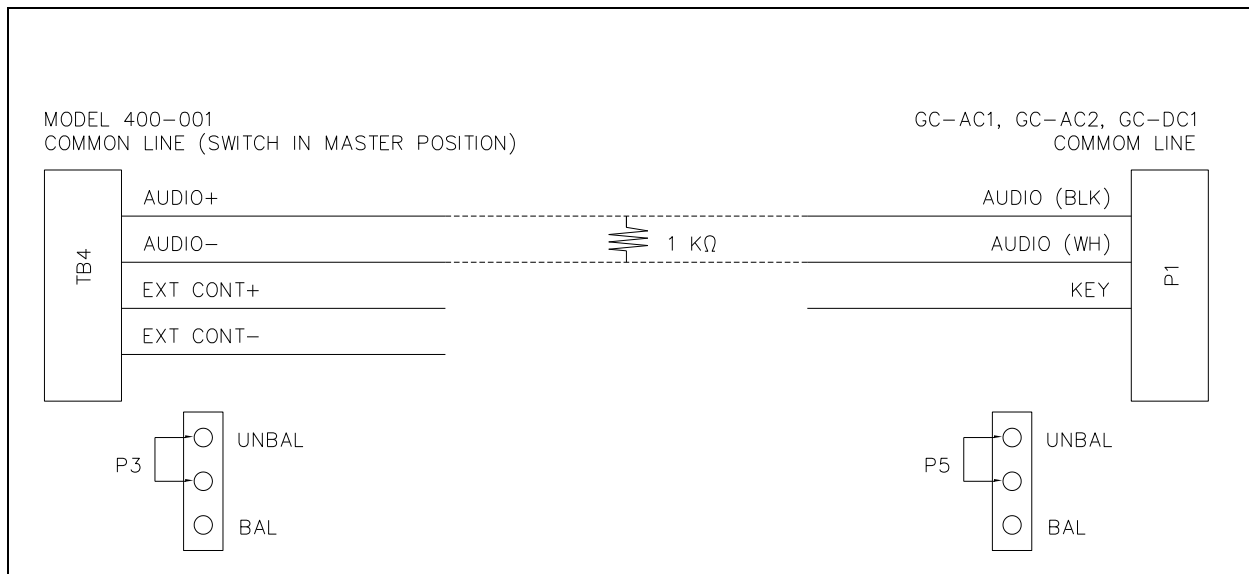

Figure 15. Unbalanced Common Line Configuration

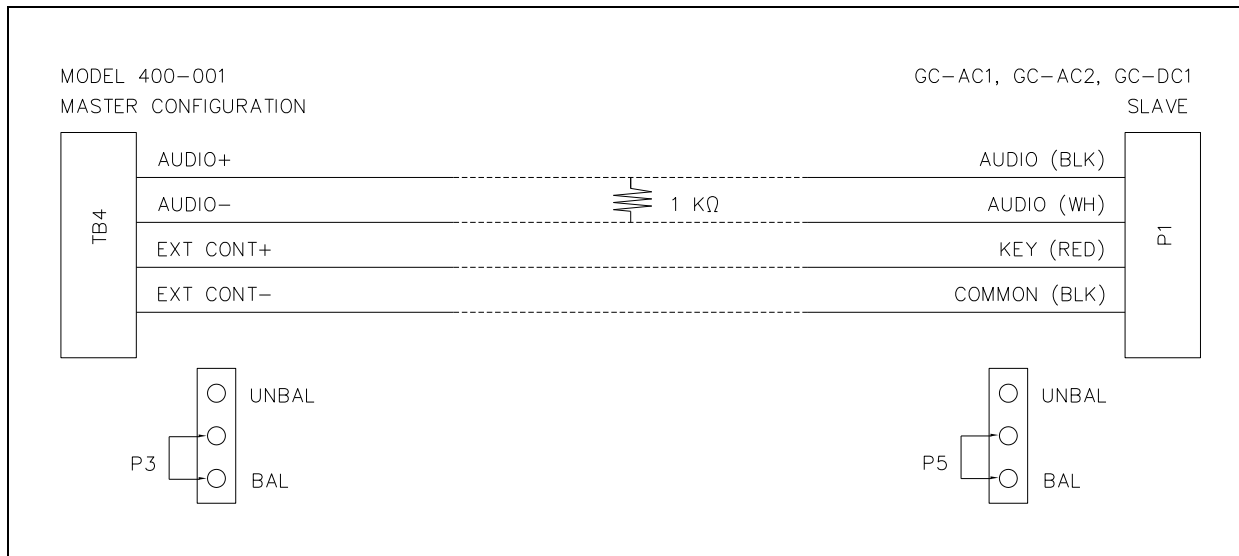

Figure 16. Master/Slave Balanced Configuration with Model 400-001 as Master

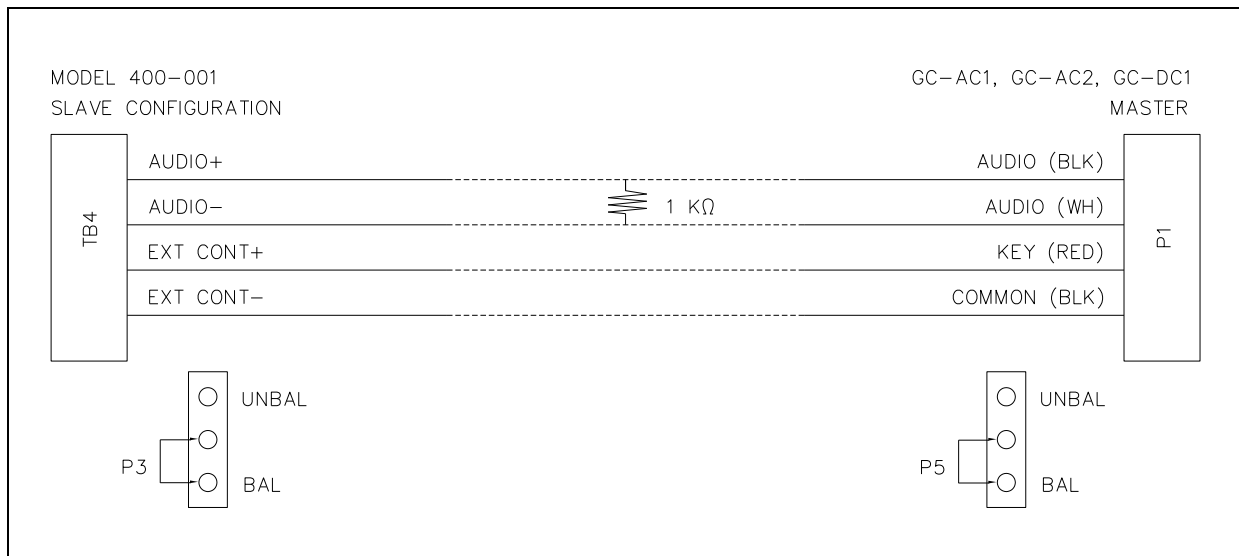

Figure 17. Master/Slave Balanced Configuration with Model 400-001 as Slave

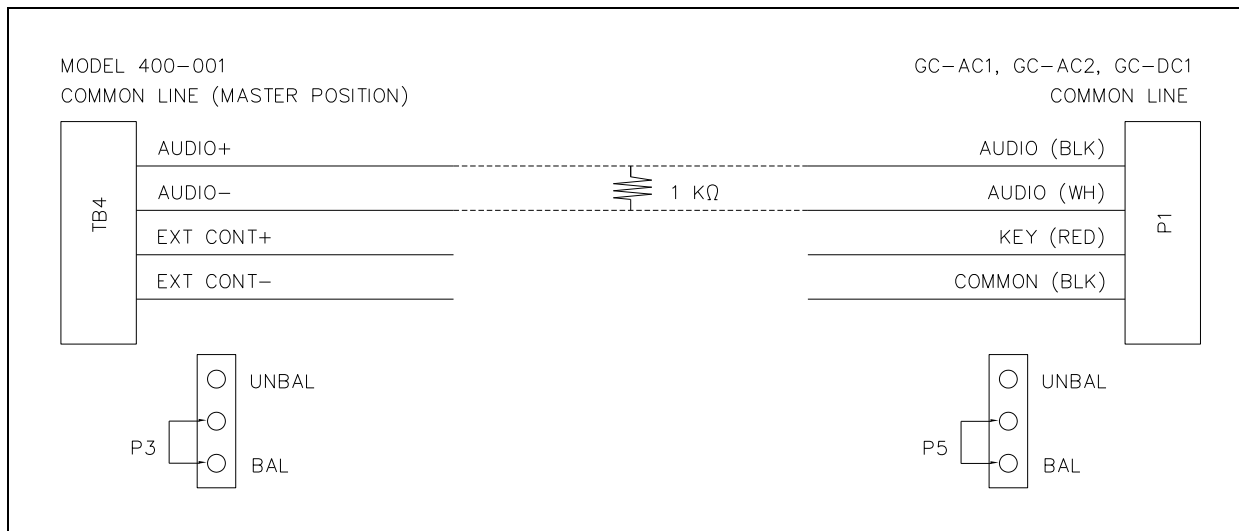

Figure 18. Balanced Common Line Configuration

Warranty

Equipment. GAI-Tronics warrants for a period of one (1) year from the date of shipment, that any GAI-Tronics equipment supplied hereunder shall be free of defects in material and workmanship, shall comply with the then-current product specifications and product literature, and if applicable, shall be fit for the purpose specified in the agreed upon quotation or proposal document. If (a) Seller's goods prove to be defective in workmanship and/or material under normal and proper usage, or unfit for the purpose specified and agreed upon, and (b) Buyer's claim is made within the warranty period set forth above, Buyer may return such goods to GAI-Tronics nearest depot repair facility, freight prepaid, at which time they will be repaired or replaced, at Seller's option, without charge to Buyer. Repair or replacement shall be Buyer's sole and exclusive remedy. The warranty period on any repaired or replacement equipment shall be the greater of the ninety (90) day repair warranty or one (1) year from the date the original equipment was shipped. In no event shall GAI-Tronics warranty obligations with respect to equipment exceed 100% of the total cost of the equipment supplied hereunder. Buyer may also be entitled to the manufacturer's warranty on any third-party goods supplied by GAI-Tronics hereunder. The applicability of any such third-party warranty will be determined by GAI-Tronics.

Services. Any services GAI-Tronics provides hereunder, whether directly or through subcontractors, shall be performed in accordance with the standard of care with which such services are normally provided in the industry. If the services fail to meet the applicable industry standard, GAI-Tronics will re-perform such services at no cost to buyer to correct said deficiency to Company's satisfaction provided any and all issues are identified prior to the demobilization of the Contractor's personnel from the work site. Re-performance of services shall be Buyer's sole and exclusive remedy, and in no event shall GAI-Tronics warranty obligations with respect to services exceed 100% of the total cost of the services provided hereunder.

Warranty Periods. Every claim by Buyer alleging a defect in the goods and/or services provided hereunder shall be deemed waived unless such claim is made in writing within the applicable warranty periods as set forth above. Provided, however, that if the defect complained of is latent and not discoverable within the above warranty periods, every claim arising on account of such latent defect shall be deemed waived unless it is made in writing within a reasonable time after such latent defect is or should have been discovered by Buyer.

Limitations / Exclusions. The warranties herein shall not apply to, and GAI-Tronics shall not be responsible for, any damage to the goods or failure of the services supplied hereunder, to the extent caused by Buyer's neglect, failure to follow operational and maintenance procedures provided with the equipment, or the use of technicians not specifically authorized by GAI-Tronics to maintain or service the equipment. **THE WARRANTIES AND REMEDIES CONTAINED HEREIN ARE IN LIEU OF AND EXCLUDE ALL OTHER WARRANTIES AND REMEDIES, WHETHER EXPRESS OR IMPLIED BY OPERATION OF LAW OR OTHERWISE, INCLUDING ANY WARRANTIES OF MERCHANTABILITY OR FITNESS FOR A PARTICULAR PURPOSE.**

Return Policy

If the equipment requires service, contact your Regional Service Center for a return authorization number (RA#). Equipment should be shipped prepaid to GAI-Tronics with a return authorization number and a purchase order number. If the equipment is under warranty, repairs or a replacement will be made in accordance with the warranty policy set forth above. Please include a written explanation of all defects to assist our technicians in their troubleshooting efforts.

Call 800-492-1212 (inside the USA) or 610-777-1374 (outside the USA) for help identifying the Regional Service Center closest to you.