

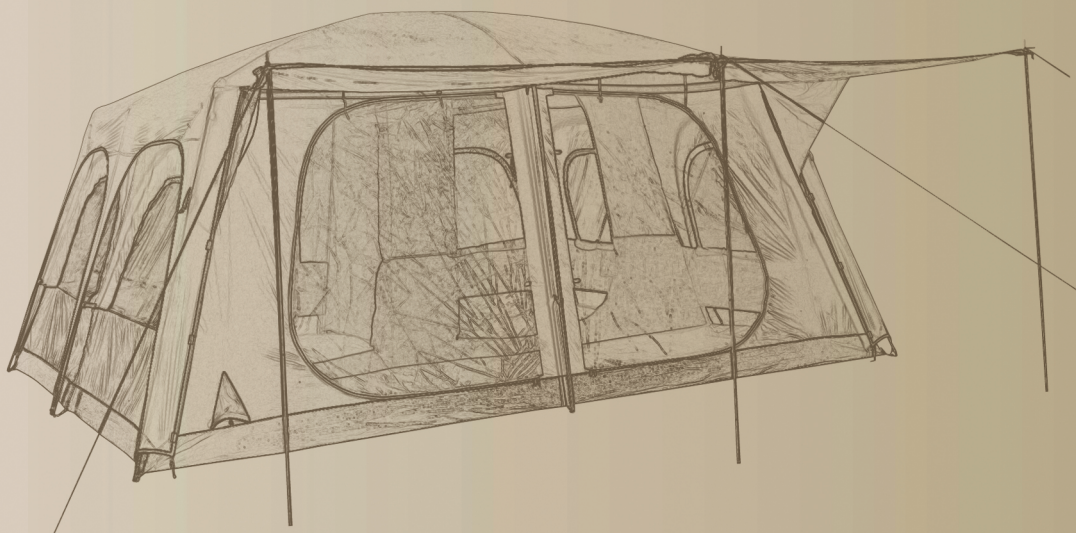

Owners Manual

Sportiva Lodge 9 Combo



DTS-LODC-B

www.oztrail.com.au

Contents

Products and Parts	3
Assembly Instructions	4
Disassembly Instructions and Folding Instructions	7
Warranty.....	8
Prolonging The Life Of Your Tent/Shelter	9
Important Safety and Care Information.....	10
Replacing the Shock-Cord in Tent Poles.....	12
Understanding Waterproofness.....	14
Zips.....	15

HELPFUL HINT

OZtrail advises to read your owner's manual fully and assemble your tent before going camping to ensure all parts are present and to become familiar with the assembly of your tent.

Sportiva Lodge 9 Combo

An extra wide tent with spacious headroom that is stable and easy to pitch. With great ventilation, large shade awnings and 3 large rooms this tent is ideal to fit a large family with all their gear.

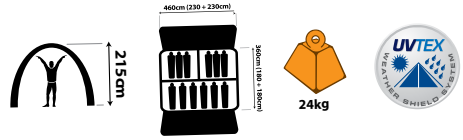

FEATURES

- UVtex®3000 UPF 50+ water proof polyester fly fabric provides long term sun protection
- Dryseam™ factory taped Fly seams for added water proofing
- Ultra fine No-See-Um insect proof mesh offers the ultimate in ventilation
- Sturdy powder coated steel poles and Duraplus® Fibreglass-Flex poles with stainless steel pole joiners allows corrosion resistant quick easy assembly
- A Portico Web™ frame offers cross brace strength, near vertical walls and spacious interior
- Front and rear oversize D doors for easy access to 3 separate rooms with internal access doors.
- The rear 2 rooms have a roll up dividing wall to allow for versatile floor plans.
- Large front and rear protective shade awning
- Generous size windows in all rooms with protective rain covers
- 2 year manufacturer's warranty

Product Code: DTS-LODC-B

Thank you for purchasing a quality OZtrail product. Please keep this Owner's Manual in a safe and dry place, it contains information and helpful information.

The following parts are included for Product Code: DTS-LODC-B

Part Description

<input checked="" type="checkbox"/>	2 x Grey fibreglass long roof poles, navy sticker	1
<input checked="" type="checkbox"/>	1 x Grey fibreglass roof pole, burgundy sticker	2
<input checked="" type="checkbox"/>	1 x Grey fibreglass short roof pole	3
<input checked="" type="checkbox"/>	4 x Black steel long corner wall poles, navy sticker	4
<input checked="" type="checkbox"/>	4 x Black steel side wall poles	5
<input checked="" type="checkbox"/>	3 x Silver steel awning poles	
<input checked="" type="checkbox"/>	1 x Pole bag	
<input checked="" type="checkbox"/>	2 x Cup holder	
<input checked="" type="checkbox"/>	10 x Guy ropes	
<input checked="" type="checkbox"/>	22 x Pegs	
<input checked="" type="checkbox"/>	1 x Peg bag	
<input checked="" type="checkbox"/>	1 x Inner tent	
<input checked="" type="checkbox"/>	1 x Fly sheet	
<input checked="" type="checkbox"/>	1 x Carry bag	

PLEASE NOTE

Due to our policy of continual product development, specifications, parts and features of the product may vary from details within this Owners Manual.

HELPFUL HINT

We recommend that you set up this product before you leave for your trip. Check that all parts are present and that you familiarise yourself with the assembly and disassembly of the product. If you have any questions, your OZtrail dealer will be happy to help you.

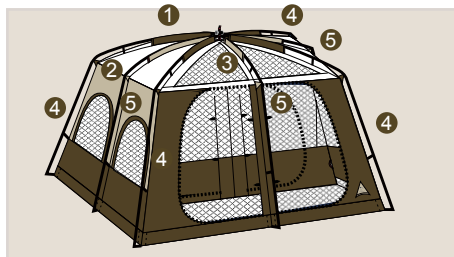

Assembly Instructions

Step 1 Choose the site

Select a sheltered camp site protected from the wind that will not allow water to pond under the tent floor. Clear a level area of all stones, twigs, etc.

Step 2 Lay out the tent

Unpack the contents of your tent. Lay out the inner tent facing the desired direction. Ensure that you have the doors facing the direction you desire.

HELPFUL HINT

1. After unpacking the tent or shelter, use the check list on page 3 to identify all parts and make sure all parts are present.

2. It is important to condition your tent or shelter before use. See page 9 for instructions

Step 3 Peg down the tent

Peg out the inner tent at the eight peg points. The peg point locations are indicated in Figure 1. Anchor the tent to the ground by inserting the pegs through the loops around the base of the tent at an angle of 45 degrees as indicated in Figure 2. Firm but not tight. As you work from one peg point to the other around the tent base pull the floor firmly, but not tight.

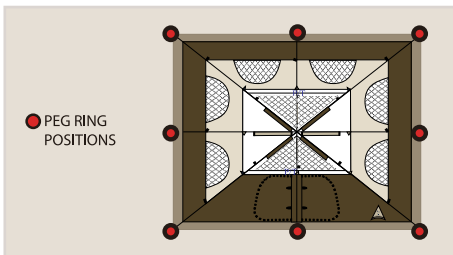

Figure 1

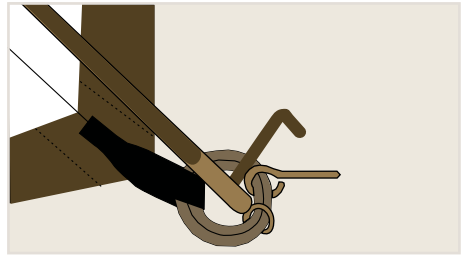

Figure 2

Step 4 Assemble the poles

Assemble all poles making sure each pole junction is securely connected. Place the assembled poles side by side for easy identification, see Figure 3.

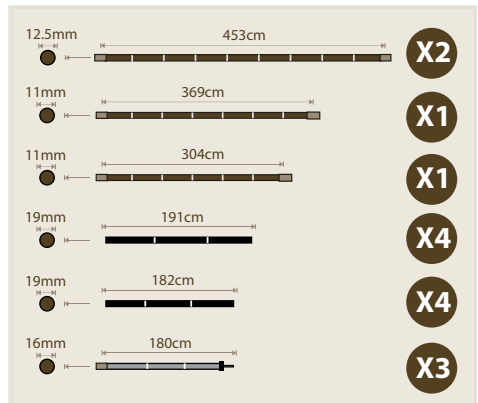

Figure 3

HELPFUL HINT

Do not force pole through the sleeves as this may damage the sleeve and could break the pole. Check to ensure the pole does not snag when sliding it through the sleeve.

Assembly Instructions cont.

Step 5 Fitting the Poles to the Portico Roof

With the help of at least one other person, select the two "grey fibreglass long roof poles with navy sticker". Insert the poles diagonally from corner to corner of the tent roof. Ensure the poles pass through the pole sleeves with the navy trim. Insert the pole ends into the corner portico hubs attached to the inner tent. The correct hub is marked with navy tape, see figure 4. Connect the corresponding pole clips on the inner tent to the poles.

Now select the "grey fibreglass roof pole with burgundy sticker". Insert the pole through the pole sleeves marked with the burgundy trim that run from side to side across the middle of the long side of the tent. Ensure that these poles cross under the two "grey fibreglass long roof poles with navy sticker". Place the ends of these poles into the portico hubs located across the middle of the long side of the tent. The correct hub is marked with burgundy tape. Connect the corresponding pole clips on the inner tent to the poles.

Finally select the "grey fibreglass short roof pole". Insert the pole through the pole sleeves that run from side to side across the middle of the short side of the tent. Ensure that these poles cross under the two "grey fibreglass long roof poles with navy sticker". Place the ends of these poles into the portico hubs located across the middle of the short side of the tent. Tie all poles together where they cross in the middle of the roof. Connect the corresponding pole clips on the inner tent to the poles.

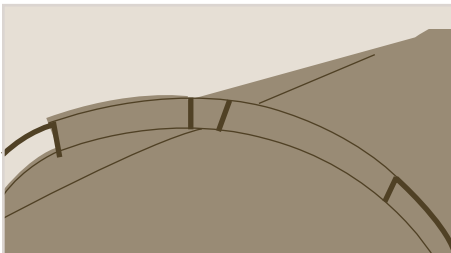

Figure 4

Step 6 Installing the Wall Poles of the tent

With the help of at least one other person, select one of the four "black steel long corner poles with navy sticker". Insert one end into the corner portico hub with navy tape and place the opposite end onto the ring and pin assembly at the base of the tent floor, see figure 2. The tent will stand up during this process, see Figure 5. Attach the pole clips located on the inner tent, see Figure 6. Repeat this process for the remaining three "black steel corner poles with navy sticker".

Select one of the four "black steel side wall poles". Insert one end into a portico hub in the middle of the side walls and place the opposite end onto the ring and pin assembly at the base of the tent floor directly below. Attach the pole clips located on the inner tent. Repeat this process for the remaining three "black steel wall poles".

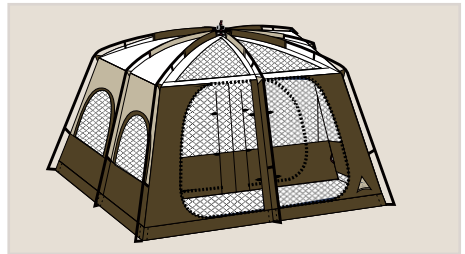

Figure 5

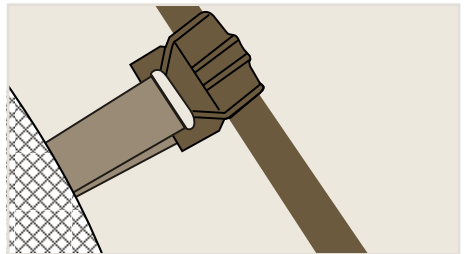

Figure 6

Assembly Instructions cont.

HELPFUL HINT

Before attempting this step it helps to open the doors of the tent. This allows for the air to enter into the tent as you raise it.

Step 7 Attaching the Fly Sheet

With the unfolded fly sheet on the ground, ensure that you have the front and the back of the fly aligned correctly with the tent. With the help of another person raise the fly sheet up and carefully draw it up and over the top of your tent. Do this slowly to avoid snagging the fly and causing any damage. Once the fly sheet is on top of your tent you can now securely attach all of the Posibrace™ Velcro™ reinforcing points on the underside of the fly sheet to the corresponding poles and hubs, see Figure 7.

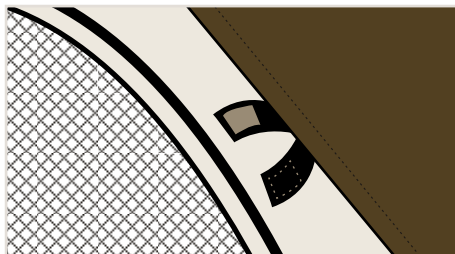

Figure 7

Step 8 Guy ropes and peg out

Ensure all guy ropes of the fly and tent are utilised. Make a loop (about 30 – 50cm long) with a slider on the end of the rope and peg out as far as possible from the tent, see Figure 8. Ensure all peg down points are utilised and all guy ropes are attached firmly and remain firm, see Figure 9

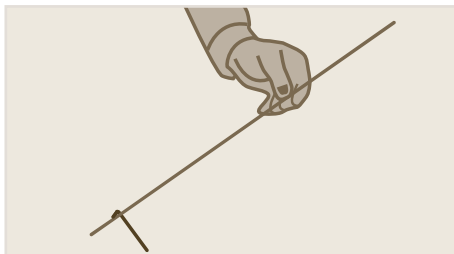

Figure 8



Figure 9

PLEASE NOTE

In severe conditions the tent should be dismantled

Disassembly Instructions

Step 1

Release guy ropes and Posibrace™ Velcro™ points that attach the fly to the poles and hubs. Remove fly from tent. Lay fly flat on ground and fold fly in half, third or quarters. The width of the folded fly should be the length of the pole bag. See Figure 10.

Step 2

Unzip doors and windows, collapse the tent by removing and disassembling the poles in the reverse order of the assembly instructions. Place the poles in the pole carry bag and tie shut.

Step 3

Remove pegs with a claw hammer or peg puller. Do not remove pegs from the ground by pulling on tent base as this may cause damage to the tent.

Step 4

Spread the tent out flat with all loose fabric folded within the edges of the tent base. Try to flatten the tent as much as possible.

Step 5

Fold the tent in half, third or quarters. The width of the folded tent should be the length of the pole bag. See Figure 10.

Step 6

Lay the folded fly over the folded inner tent. Beginning at the back portion of the Fly and inner tent bundle roll forward firmly allowing trapped air to escape. It may help to use the bag of tent poles as a rolling pin ensuring the tent edges are kept straight as you roll.

Step 7

Once the tent bundle is rolled up, tie straps around it and place into tent carry bag with peg bag, instruction booklet and other miscellaneous parts. If the tent won't fit into carry bag, unroll and reroll more tightly.

HELPFUL HINT

Never store your tent damp or dirty. If you have no choice to return home from your camping trip with a damp or dirty tent, make sure you lay it out to air in a cool, dry and shaded place as soon as possible and only pack it away when it is completely dry and clean.

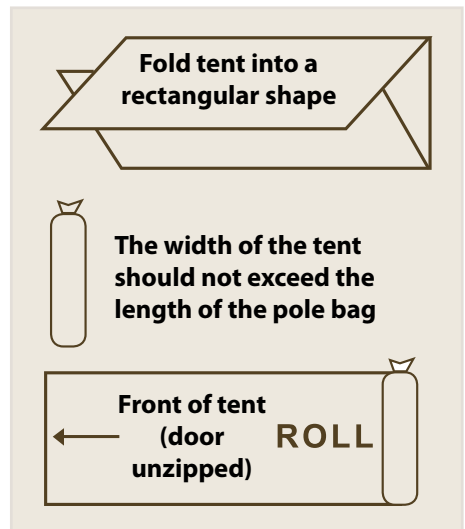

Figure 10

Warranty

This OZtrail product is warranted for two years from date of purchase. OZtrail agrees during the warranty period to repair any manufacturing defects in the product or, at its option, replace the product with another product or an equivalent product without cost to the owner for material or labour. Proof of purchase, including the purchase date will be required. **Exceptions** include fair wear and tear, damage caused by improper use, misuse or abuse. Commercial users are not covered by this warranty. Please note the shipping charges to and from the OZtrail warehouse or original place of purchase are not covered under warranty and are the responsibility of the purchaser.

PLEASE NOTE

Accessories shown may be for display purposes only and not included with the product. Due to our policy of continual product development, specifications and features of this product may vary from what is stated.

HELPFUL HINT:

AVOIDING MOULD AND MILDEW

You should always pack your products both clean and completely dry. In many climates there is a risk of Mould or Mildew damage to materials that are not packed away in a dry state, this condition is not covered by the warranty. After each camping trip, clean you products with warm soapy water and allow them to dry completely after rinsing them with fresh water.

CARING FOR YOUR SHOCK CORD

Shock cord is designed to help you keep your tent poles organised and to allow quick assembly of the poles. Over stretching the cord or dropping the poles will cause shock cord failure and this condition is not covered by the warranty.

INSURANCE, YOUR PROTECTION AGAINST THE UNEXPECTED

Most people have product problems from unexpected sources. Extreme weather is a good example of an unexpected problem. Make sure that you place you expensive Camping Products on your Home and Contents Insurance policy. Most good Insurers will cover the Storm damage to your tent or other products that falls outside of the warranty.

Prolonging The Life Of Your Tent/Shelter

- Temporary use only. Although our fabrics are treated for extra UV resistance, continuous exposure to sun light will reduce the life of the fabric. Fading of colour is an early warning sign. OZtrail products are not designed as permanent dwellings or structures.
- During rain always lower awnings to avoid water ponding.
- Never store a wet and/or soiled tent/shelter; as mildew and corrosion can form. Always allow the tent to dry completely before packing and stowing. If mildew occurs, use a soft bristle brush or sponge with mild detergent to clean it off. After beach use or wet weather treat all zips, poles and pegs with silicon spray.
- The elastic shock cord within the poles is provided for easy assembly of the poles. The shock cord is not required for any structural reason. The poles and tent perform perfectly well without the shock cord. Age, over stretching and mishandling may cause failure. Shock cord is not covered by warranty. It's easy to replace, see the instructions on page 12.
- Sometimes the zipper coil bursts open or does not close. This could be due to wear or metal fatigue. The problem can be easily fixed, see the instructions on page 15.
- Always carry a roll of heavy duty tape for simple repairs to small rips, cuts and ash burns. This not only blocks the hole, it will

prevent further tearing. Heavy Duty tape is also helpful for emergency pole repairs and many other uses around the camp site.

- When removing pegs, do not use the webbing or corner of the tent as your handle. Either use another peg, a peg remover or the claw of a hammer hooked under the peg to remove them.

HELPFUL HINT

CONDITIONING YOUR NEW TENT

Once you get your new tent home, it is important to condition the tent. Simply pitch your tent and wet it down with your garden hose until the fabric and all seams are saturated. Pay particular attention to the seams - the thread swells when wet and blocks the needle holes. The needle holes also shrink around the thread. The fabric also benefits from this because the fibre swells into the weave and the waterproof treatment settles within the fabric. Let the tent dry completely before repeating this wetting and drying process until there is no leakage during hosing. Always pack your tent away dry.

Important Safety and Care Information

Please read before setting up your tent/shelter

CAMP SAFE - SAFETY HABITS

Fabrics used in the construction of OZtrail tents/shelters are designed to meet fire retardant standards US CPIA-84. This fire retardant treatment reduces the rate at which the fabric will burn. Fabric treated to CPAI-84 standards will still burn if it comes into direct contact with a flame or extreme heat.

The application of any foreign substance to the fabric such as some water proofing treatments or insect sprays may render the fire retardant treatment process ineffective.

The following pages cover several safety tips that will help you avoid some of the common hazards encountered on a camping trip.

TO PREVENT INJURY CAUSED BY GAS POISONING OR SUFFOCATION

- Gas, fumes or lack of oxygen within the tent/shelter could result in unconsciousness, brain damage and even death.
- Always ensure your tent/shelter is well ventilated. Even on the coldest night do not close every vent, window and door. A well ventilated tent not only maintains healthy Oxygen levels but also reduces condensation build up inside the tent.
- Do not use fuel burning, oxygen consuming devices inside the tent. This includes candles, gas lanterns, kerosene lamps, stoves, cooking and heating appliances.
- Do not use gas appliances of any kind inside the tent/shelter.

TO PREVENT INJURY CAUSED BY FIRE

- Do not pitch the tent/shelter near a camp fire or any other flame source
- Do not use candles, matches or any other flame source in or near the tent (this includes stoves, cooking equipment, lighting and heating appliances)
- Only use recommended water repellent compounds on the tent/shelter fly
- Do not spray tent fabrics with insecticides



TO PREVENT INJURY CAUSED BY ELECTRICITY

- Always exercise care when using electricity and electric lighting in and near tents/shelters. Only use 12 volt lighting.



Important Safety and Care Information cont.

To prevent injury caused by your camping environment



- Do not pitch your tent/shelter on an area that could get flooded



- Do not pitch your tent/shelter near cliffs in case of collapse or rock fall



- Do not leave your tent/shelter erected in strong winds - collapse the tent onto the ground and seek refuge in your vehicle



- Do not pitch your tent/shelter under trees with dead branches or under trees known to drop branches

Tent Pole and Shock Cord Replacement

Fibreglass Tent Pole

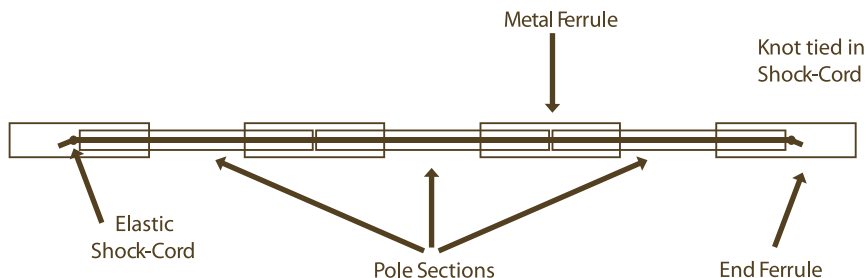

Figure 11

Tent Poles and Shock Cord are similar to the Tyres on your Car, they require both maintenance and replacement from time to time after unexpected damage. Over stretching, dropping and age are the most common causes of shock cord failure. Excessive curvature during tent assembly or during periods of high winds is the most common causes of pole failure. By maintaining both the Poles and Shock Cord you will be ensuring that you get the best performance and life out of your OZtrail Tent.

HELPFUL HINT

To maximise the life of your shock cord never drop the tents poles during transporting. When packing poles into their carry bag be careful not to settle them by tapping them vertically on a hard surface.

Replacing Shock-Cord

See Figure 11

Step One: Measure and Cut

Measure the length of the Tent Pole. You should use a length of Shock Cord roughly two-thirds the length of the Tent Pole. This will ensure that the Shock Cord has the appropriate amount of elasticity.

Step Two: Threading the Pole Sections

Tie a large knot in the end of the Shock Cord length. This knot needs to be large enough to stop it passing through the tubular hole in the pole sections whilst you are threading it. Thread the Shock Cord through the tubular hole in each pole section.

Tent Pole and Shock Cord Replacement cont.

HELPFUL HINT

Towards the end of the Pole Length it may get quite hard to thread the Pole Sections as the Shock Cord is stretching. To help avoid this, place all of the sections you have already threaded on the floor. Stretch the Shock Cord through them until you have much more than what you need for the rest of the sections to thread. Place your foot on the Shock Cord at the end of the last Pole Section you have threaded. This will maintain the stretch and give you plenty of Shock Cord to work with.

Once your new pole is cut to length you can follow the 'Replacing Shock-Cord' directions to get your Pole Length complete.

HELPFUL HINT

Helpful Hint Be prepared for unexpected breakages, always carry a few spare pole sections that match the diameter of your tent poles as well as some lengths of replacement shock cord. These items are available at all good Camping retailers.

Step Three: Tying Off

Once all of the Pole Sections have been threaded, you will need to tie a large knot in the Shock Cord, much the same as we did at the start. This Knot needs to be sufficiently large to stop it pulling through the hole. Once this is done, trim the excess Shock Cord at each end.

Replacing Tent Pole Sections

Much like Flat Tyre on your car, a broken Pole Section is an annoyance that can be easily rectified.

Cut the Shock Cord to enable you to remove the broken Pole Section. This is also a good time to replace the Shock Cord as well.

Measure both the diameter and overall length of the Pole Section. Once you have these measurements, you will be able to organise a Pole Replacement kit from your local Camping Goods retailer. You may have to cut the replacement pole to length. This can be done with a Hack Saw easily. Lightly sand the cut edge to remove any sharp edges.

Understanding Waterproofness

Know your tent

OZtrail tents are manufactured from waterproof and water repellent fabrics. However, with the addition of seams, zips and other desirable features a recreational tent will not be as waterproof as a car, house or other solid structures.

The following are common examples of how water can enter a tent: -

CONDENSATION

When warm moist air meets cooler air, condensation occurs. The tent/shelter fly forms an impermeable layer between the inside and outside conditions. The moisture inside the tent/shelter condenses on the fabric. Sometimes in cold conditions it appears that the fabric is leaking when in fact the cause is condensation. Condensation can be reduced if the tent/shelter is well ventilated.

ZIPS

All care is taken in the design to cover zips. At times wind driven rain could force water under the flaps and through the zips. To minimise this, make sure all doors and windows are closed with the flaps covering the zips.

FLOOR

If the ground is very wet or water pools under the floor, downward pressure of standing or kneeling on the floor could force water through

the floor fabric. To prevent this, do not pitch the tent over hollows and make sure water drains away from the tent.

STRUCTURAL INTEGRITY

A well pitched tent on level ground is structurally strong and most waterproof. During prolonged periods of rain and wind it may be necessary to tighten guy lines and reset the tent pegs and attend to drainage around the tent. Sagging and incorrect pitching weakens the tent structure and could allow water to pool on the fly placing undue forces on the tent causing leaking and breakages.

REDUCING THE RISK OF JAMMING FABRIC IN THE ZIP

- When using the zip, hold the pull-tab between your thumb and forefinger with your thumb facing you.
- As you are closing the zip clear the way in front and under the zip slider using the back of your hand, and cup the zip slider underneath with your remaining 3 fingers.

Use this action for opening or closing. Keep the fabric clear of the zip slider - zip and unzip slowly.

WHAT TO DO IF THE ZIPPER GETS CAUGHT

- Pull the fabric bit by bit out of the slider. Do not try and pull all the fabric in one go. Do not force the slider or the fabric.

IF THE SLIDER DOES NOT CLOSE THE ZIPPER PROPERLY

- With use, the jaws of the zip slider can open ever so slightly. When this occurs the slider does not compress the zip teeth or coil together tightly enough and the zip bursts open or does not close.
- Undo the zip and with the slider at the end of the zip lightly crimp the jaws of the slider together. Try top to bottom axis first and then side to side axis.

CRIMPING A ZIP-SLIDER

The most common reason why zips burst open is that the zip slider does not close the coil tightly enough. Wear and tear may cause the gap marked A to open up. See Figure 12.

By simply 'crimping' the slider together at points B & C with a pair of pliers, this solves the problem most of the time. Crimping in other planes is worth a try if B & C does not work. This is to be done when the zip slider is still attached to the zip in the open position. See Figure 12.

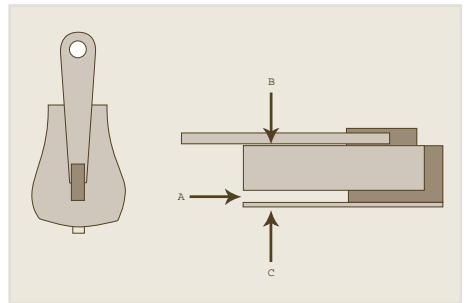

Figure 12

Check out **www.oztrail.com.au**
for other great products from OZtrail Leisure Products

